

Old Dominion University

ODU Digital Commons

Computational Modeling & Simulation
Engineering Theses & Dissertations

Computational Modeling & Simulation
Engineering

Summer 2016

Toward Simulation-Based Training Validation Protocols: Exploring 3d Stereo with Incremental Rehearsal and Partial Occlusion to Instigate and Modulate Smooth Pursuit and Saccade Responses in Baseball Batting

Ricardo A. Roca

Old Dominion University, ricroca@juno.com

Follow this and additional works at: https://digitalcommons.odu.edu/msve_etds



Part of the [Engineering Commons](#)

Recommended Citation

Roca, Ricardo A.. "Toward Simulation-Based Training Validation Protocols: Exploring 3d Stereo with Incremental Rehearsal and Partial Occlusion to Instigate and Modulate Smooth Pursuit and Saccade Responses in Baseball Batting" (2016). Doctor of Philosophy (PhD), Dissertation, Computational Modeling & Simulation Engineering, Old Dominion University, DOI: 10.25777/hvse-ts08
https://digitalcommons.odu.edu/msve_etds/3

This Dissertation is brought to you for free and open access by the Computational Modeling & Simulation Engineering at ODU Digital Commons. It has been accepted for inclusion in Computational Modeling & Simulation Engineering Theses & Dissertations by an authorized administrator of ODU Digital Commons. For more information, please contact digitalcommons@odu.edu.

**TOWARD SIMULATION-BASED TRAINING VALIDATION PROTOCOLS:
EXPLORING 3D STEREO WITH INCREMENTAL REHEARSAL
AND PARTIAL OCCLUSION TO INSTIGATE AND MODULATE
SMOOTH PURSUIT AND SACCADE RESPONSES IN BASEBALL BATTING**

by

Ricardo A. Roca
B.S.E. May 1986, Tulane University
M.S. January 2002, George Mason University

A Dissertation Submitted to the Faculty of
Old Dominion University in Partial Fulfillment of the
Requirements for the Degree of

DOCTOR OF PHILOSOPHY

MODELING & SIMULATION

OLD DOMINION UNIVERSITY
August 2016

Approved by:

Stacie I. Ringleb (Director)

Michel A. Audette (Member)

Lance M. Optican (Member)

Yiannis E. Pangelis (Member)

Daniel M. Russell (Member)

Ginger S. Watson (Member)

ABSTRACT

TOWARD SIMULATION-BASED TRAINING VALIDATION PROTOCOLS: EXPLORING 3D STEREO WITH INCREMENTAL REHEARSAL AND PARTIAL OCCLUSION TO INSTIGATE AND MODULATE SMOOTH PURSUIT AND SACCADE RESPONSES IN BASEBALL BATTING

Ricardo A. Roca
Old Dominion University, 2016
Director: Dr. Stacie I. Ringleb

“Keeping your eye on the ball” is a long-standing tenet in baseball batting. And yet, there are no protocols for objectively conditioning, measuring, and/or evaluating eye-on-ball coordination performance relative to baseball-pitch trajectories. Although video games and other virtual simulation technologies offer alternatives for training and obtaining objective measures, baseball batting instruction has relied on traditional eye-pitch coordination exercises with qualitative “face validation”, statistics of whole-task batting performance, and/or subjective batter-interrogation methods, rather than on direct, quantitative eye-movement performance evaluations. Further, protocols for validating transfer-of-training (ToT) for video games and other simulation-based training have not been established in general — or for eye-movement training, specifically. An exploratory research study was conducted to consider the ecological and ToT validity of a part-task, virtual-fastball simulator implemented in 3D stereo along with a rotary pitching machine standing as proxy for the live-pitch referent. The virtual-fastball and live-pitch simulation couple was designed to facilitate objective eye-movement response measures to live and virtual stimuli. The objective measures 1) served to assess the ecological validity of virtual fastballs, 2) informed the characterization and comparison of

eye-movement strategies employed by expert and novice batters, 3) enabled a treatment protocol relying on repurposed incremental-rehearsal and partial-occlusion methods intended to instigate and modulate strategic eye movements, and 4) revealed whether the simulation-based treatment resulted in positive (or negative) ToT in the real task. Results indicated that live fastballs consistently elicited different saccade onset time responses than virtual fastballs. Saccade onset times for live fastballs were consistent with catch-up saccades that follow the smooth-pursuit maximum velocity threshold of approximately 40-70°/sec while saccade onset times for virtual fastballs lagged in the order of 13%. More experienced batters employed more deliberate and timely combinations of smooth pursuit and catch-up saccades than less experienced batters, enabling them to position their eye to meet the ball near the front edge of home plate. Smooth pursuit and saccade modulation from treatment was inconclusive from virtual-pitch pre- and post-treatment comparisons, but comparisons of live-pitch pre- and post-treatment indicate ToT improvements. Lagging saccade onset times from virtual-pitch suggest possible accommodative-vergence impairment due to accommodation-vergence conflict inherent to 3D stereo displays.

Copyright, 2016, by Ricardo A. Roca, All Rights Reserved.

Dedicated to ...

My daughter Olivia ... for bugging me to play when I'm trying to work ...

My wife Dee ... for her unconditional love ... she is my sunshine ...

My mom and dad ... for pointing me in the right direction ...

My brothers and sister ... for caring and sharing of themselves for our mutual growth ...

My grandparents, aunts, uncles, and cousins ... for spoiling me ... in a good way ...

My nieces and nephews ... for always saving me a seat at the table ...

My wife's family and my friends ... for accepting me and my goofy ways ...

My teachers and colleagues ... for showing me how and allowing me to take part ...

My grandpa Eustorgio ... for showing me to use a lever to pull "that nail" ... teaching me along that "mankind is on this earth to rule over all things ... no the other way around."

"It is better to strike a match than to curse the darkness."

From an old Chinese proverb

ACKNOWLEDGMENTS

I am very fortunate and I am grateful for the opportunity to have made a contribution to the M&S discipline at ODU, as well as for the support and encouragement from ODU professors, family, friends, and colleagues. Among all of those who helped me through it all, I am eternally grateful to my dissertation advisor, Dr. Stacie Ringleb, for being the coxswain who coordinated my efforts and ensured that I stayed the course and didn't waver. I thank her for allowing me the creative flexibility I needed to put this project together and for her friendship and chats about our kids' flu shots and gymnastics practice following my weekly reports that helped me keep insanity at bay. I am so grateful to Dr. Lance Optican, not only for his wisdom and tutelage on oculomotor concepts, but also for welcoming me to his discipline and enthusiastically embracing my project. Likewise, I thank my dissertation committee members Dr. Michel Audette, Dr. Yiannis Papelis, Dr. Daniel Russell, and Dr. Ginger Watson for lending their expertise to this project and for their patience, understanding, and guidance. Many thanks to Dr. Roland Mielke, Dr. Rick Mckenzie, and Dr. Yuzhong Shen for their program guidance as well as to Mr. Trey Mayo for his academic advisory. I also need to mention and express my gratitude to baseball teammates and friends who have made it a real joy to continue to play ball even as our knees and backs scream for mercy. Sharing baseball anecdotes in the dugout contributed to selecting this project and to making it both fun and interesting.

“We don't stop playing [baseball] because we grow old;
we grow old because we stop playing [baseball].”

Adapted from George Bernard Shaw

NOMENCLATURE

A	Saccade Amplitude
ANOVA	Analysis of Variance
AOV	Angle of View
APIT	Alternative Pursuit Initiation Threshold
CLT	Cognitive Loat Theory
D	Saccade Duration
D	Display Diopter Distance
DCMSBL	District of Columbia Men's Senior Baseball League
EEG	Electroencephalography
EMG	Electromyography
EOG	Electrooculography
FoFix	Focus/Fixation
FOV	Field of View
fps	Feet per Second
ft	feet
Hz	Hertz
in	inches
IRB	Institutional Review Board
ISI	Inter-Stimulus Interval
ITS	Intelligent Tutoring Systems
LPS	Live-Pitch Server
MAE	Mean Absolute Error

M&S	Modeling & Simulation
mph	Miles per Hour
msec	milliseconds
ODU	Old Dominion University
OR	Orienting Reflex
P	Optical Power
PE	Positional Error
R^2	Coefficient of Determination
RS	Retinal Slip
rpm	Revolutions per Minute
sec	seconds
SDI	Systematic Design of Instruction
S-G	Savitsky-Golay (smoothing filter)
S1	Subject 001
S3	Subject 003
S4	Subject 004
S13	Subject 013
S15	Subject 015
ToT	Transfer of Training
T0	Saccade Onset Time
3D	Three Dimensional
2D	Two Dimensional
SS	Sum of Squares

SSE	Residual Sum of Squares
SUT	Saccade Usefulness Threshold
UDP	User Datagram protocol
USB	Universal Serial Bus
VPSS	Virtual-Pitch Simulation Server
XBT	Expertise-Based Training
\bar{x}	Sample Mean
\bar{x}^*	Empirical Bootstrap Sample
δ	Variation of sample mean
δ^*	Variation of bootstrap sample mean
μ	Population Mean
μ	Mean of Gaussian component
σ	variance of Gaussian component
λ	rate of exponential component

TABLE OF CONTENTS

	Page
LIST OF TABLES	xi
LIST OF FIGURES	xii
 Chapter	
1. INTRODUCTION	1
1.1. BACKGROUND AND CONTEXT OF THE STUDY	1
1.2. PROBLEM STATEMENT	4
1.3. PURPOSE OF THE STUDY	5
1.4. EXPERIMENTAL FRAMEWORK.....	8
1.5. AIMS OF THE STUDY AND RESEARCH QUESTIONS	9
1.6. SIGNIFICANCE OF THE STUDY.....	20
 2. LITERATURE RESEARCH	 22
2.1. VISUO-MOTOR REQUIREMENTS IN THE BATTING TASK.....	22
2.2. ANATOMY OF THE OCULOMOTOR PLANT	25
2.3. TYPES AND PARAMETERS OF EYE MOVEMENTS	26
2.4. CENTRAL-PERIPHERAL VISION AND ECCENTRICITY EFFECTS.....	34
2.5. PLASTICITY AND ADAPTIVE PROPERTIES OF EYE MOVEMENTS .	38
2.6. PREDICTIVE CONTROL OF EYE MOVEMENTS IN SPORT	41
2.7. VISUAL ORIENTING AND ATTENTION.....	42
2.8. COGNITIVE LOAD THEORY	43
2.9. EXPERTISE-BASED TRAINING.....	44
2.10. FIDELITY AND PART-TASK SIMULATION-BASED TRAINING	46
2.11. DISTRIBUTION OF PRACTICE AND INCREMENTAL REHEARSAL ..	49
2.12. VIEWER DISTANCE CONFIGURATION AND 3D STEREO DISPLAY .	53
2.13. EXPERT-NOVICE OCCLUSION METHOD IN BASEBALL/SPORT	59
2.14. TRAINING FOR EYE-ON-BALL COORDINATION IN BASEBALL	66
2.15. SINGLE-SUBJECT DESIGN AND BOOTSTRAP RESAMPLING	68

	Page
3. METHOD AND APPROACH	71
3.1. DEPENDENT AND INDEPENDENT VARIABLES	71
3.2. SELECTION OF PARTICIPANTS	72
3.3. EXPERIMENTAL SETUP.....	74
3.4. 3D STEREO DISPLAY CONFIGURATION.....	86
3.5. SELECTION OF 60 MPH FASTBALL TASK	87
3.6. EOG SERVER.....	87
3.7. CENTRAL MANAGEMENT CLIENT	89
3.8. TREATMENT	90
3.9. DATA ACQUISITION PROTOCOL.....	90
3.10. DATA PROCESSING	102
3.11. DATA ANALYSIS.....	105
4. RESULTS AND DISCUSSION	120
4.1. REFERENCE MEASURES	120
4.2. CONTEXTUAL MEASURES	135
4.3. DISCUSSION	155
BIBLIOGRAPHY	162
APPENDICES	178
A. Study Participant Recruitment Flyer.....	178
B. Study Participant Informed Consent Form	179
C. Subject Profile Questionnaire	183
D. Virtual Environment Assessment Questionnaire	185
E. 3D Stereo Screening Questions/Recommendations.....	190
F. Old Dominion University – IRB Approval Letter	191
VITA.....	193

LIST OF TABLES

Table	Page
1. Sample computations of 60-mph computational model	84
2. AOV MAE Results - Threshold Baselines Pre- and Post-Treatment 1 (degrees)	129
3. Mean Saccade Onset Time (msec) for 60-mph Fastballs	138
4. Mean Saccade Amplitude (degrees) for 60-mph Fastballs	138
5. Onset Times for Catch-up Saccades Live-Pitch Pre-Treatment (msec)	152
6. Onset Times for Catch-up Saccades Live-Pitch Post-Treatment (msec).....	152
7. Bootstrap p-values and Confidence Intervals	154

LIST OF FIGURES

Figure	Page
1. Distance of Pitched Ball Trajectory from the Pitcher’s Point of Release.....	23
2. Required AOV and AOV Rate of Change for Batter’s Eye in Smooth Pursuit [8,10].	24
3. Oculomotor Plant – Three Pairs of Muscles, Eyeball, and Optic Nerve [61].....	26
4. Characteristics of a 10 ⁰ Saccade [61].	29
5. Family of Temporal Saccades from 5 ⁰ to 40 ⁰ [101].....	30
6. Superimposed nasal (N) and temporal (T) saccades [101].	31
7. Preliminary Sample Response to 60-mph Fastball Pitch.	33
8. Relationship of Cone Density in Retina to Visual Resolution [115].	35
9. Notional Visual Angles of Foveal through Peripheral Vision [115].	36
10. Relationship of Viewer Distance and Display Diopter Distance [153].	57
11. Optimal Near and Far Limit for Viewing Objects in Depth in 3D Stereo [153].	58
12. Ranges of Acceptable Viewing Depth for 0.5 Diopter Mismatch [153].	59
13. Traditional Baseball Eye-on-Ball Coordination Training Aids.	67
14. Simulation Environment and EOG System Client-Server Architecture.....	75
15. Free Body Diagram of Rotational and Tangential Velocities.....	77
16. Floor Plan Configuration for Live-Pitch Simulations.....	79
17. Localized Configurations of Live-Pitch Server.	79
18. Instrumentation Configurations of Live-Pitch Simulation Server.	80
19. Scatter Plot of Live Fastball Terminal Location Test Trials.....	81
20. Texture Map Employed in Virtual-Pitch Simulation Server Baseball Model.	85
21. Screen Capture of Baseball Model Consisting of Texturized Sphere.....	85

Figure	Page
22. EOG Amplifier Circuit Configuration [168].	88
23. EOG Server: A – Amplifier, B – Amplifier Interfaced to Microcontroller, and C – Interfaced to Microcontroller and Participant.	89
24. Sample EOG Recording of Fixed-Target Calibration.	94
25. Sample EOG Recording of Pre-Treatment Baseline for Virtual-Pitch Tracking.	95
26. Sample EOG Recording of Pre-Treatment Baseline for Live-Pitch Tracking.	96
27. Sample EOG Recording of Smooth-Pursuit/Ramp Nominal Baseline.	97
28. Sample EOG Recording of Saccade/Step Nominal Baseline.	98
29. Sample EOG Recordings of Threshold Baseline Events.	99
30. Sample Raw EOG Signal Processed with Savitsky-Golay Digital Filter.	103
31. Sample Pre- and Post-Event Calibration Recordings Showing Baseline Drift.	105
32. Sample Mean Voltages of Pre- and Post-Event Calibration Baseline Drift.	105
33. Sample Data Set of 80-mph Live-Pitch Post-Treatment AOV Measures (S8).	107
34. Sample Data Set of 60-mph Live-Pitch Post-Treatment AOV Measures (S3).	108
35. Sample MAE of 60-mph Live-Pitch Pre- and Post-Treatment Data Sets (S3).	109
36. Required AOV and Angular Velocity for 60-mph Fastball.	111
37. Measured AOV and Derived Angular Velocity of 60-mph Live-Pitch (S1).	112
38. Derived Angular Velocity and Fitted Exponentially Modified Gaussian Model. ...	113
39. Notional Field-of-View Coverage by Central Vision (drawing not to scale).	116
40. Sample EOG to Voltage Conversion of Fixed-Target Calibration.	122
41. Sample Smooth-Pursuit/Ramp Baseline Calibration without Head Movement.	123
42. Sample Saccade/Step Baseline Calibration without Head Movement.	123

Figure	Page
43. Sample Smooth-Pursuit/Ramp Baseline Variations due to Head Movement.....	124
44. Sample Saccade/Step Baseline Using Multiple Saccades in Single Step.	125
45. Sample Saccade/Step Baseline Drift and Offset due to Head Movement.	125
46. Sample Threshold Baselines Pre-Treatment.	127
47. Sample Threshold Baselines Post-Treatment 1.	128
48. Sample of AOV Positional Responses to Live-Pitch Fastballs.	130
49. Sample of AOV Positional Responses to Virtual-Pitch Fastballs.	131
50. Notional Misleading MAE of Useful and Not-Useful Saccades.	133
51. Positional AOV Measures and MAE for 60-mph Protocol.	134
52. Positional AOV Measures and MAE for 80-mph Protocol.	134
53. Measures of Agreement Plots for Positional AOV.....	135
54. Corrective Saccades due to Target Moving with Constant Acceleration [112].....	137
55. Subject Responses to Live-Pitch Fastballs Pre-Treatment.	140
56. Subject Responses to Virtual-Pitch Fastballs Pre-Treatment.	141
57. Selected Responses of More-Capable and Less-Capable Batters.....	143
58. Subject Responses to Virtual-Pitch Fastballs Post-Treatment 1.....	145
59. Subject Responses to Virtual-Pitch Fastballs Post-Treatment 2.....	146
60. Sample Pursuit-Saccade Strategy of More-Capable Batter (S1) Pre-Treatment.	148
61. Sample Pursuit-Saccade Strategy of More-Capable Batter (S1) Post-Treatment....	149
62. Sample Pursuit-Saccade Strategy of Less-Capable Batter (S3) Pre-Treatment.....	150
63. Sample Pursuit-Saccade Strategy of Less-Capable Batter (S3) Post-Treatment.	151

CHAPTER 1

INTRODUCTION

It is generally agreed that baseball batting is one of the most difficult visuo-motor tasks in sport [1]. Ted Williams—one of the greatest and most celebrated hitters in baseball history—declared, “I think without question the hardest single thing to do in sport is to hit a baseball” [2]. Not surprisingly, “keeping your eye on the ball from the time it leaves the pitcher’s hand until the moment it hits your bat” has been a long-standing tenet in teaching (and learning) baseball batting [3]. But an equally long-standing and persistent question that has remained unresolved is, “how does one go about doing this?” How does one go about training the eyes to cope with this difficult task the way other parts of the body are trained? Numerous coaches, as well as baseball books and articles, promote the notion that a batter should “keep the eye on the ball until it hits the bat” but they do not elaborate on how to train for visual tracking of baseball trajectories in an objective, measurable, and repeatable way [4-6]¹.

1.1. BACKGROUND AND CONTEXT OF THE STUDY

The lack of established and objective eye-movement training paradigms for baseball batting is understandable given that even scientific researchers have been unable to explain the perceptual-motor intricacies of this task [7]. In fact, theoretical computations, validated at least partly by eye-movement research, suggest that humans are incapable of continuously tracking the entire trajectory of a pitched baseball from the

¹ IEEE Transactions and Journals style is used in this dissertation for formatting figures, tables, and references.

pitcher's hand at the mound to the back of home plate in the strike zone due to angular velocity limitations of the smooth pursuit system in the oculomotor plant [3, 8-13]. Is "keeping the eye on the ball", then, an exercise in futility?

Notwithstanding the findings of smooth pursuit limitations, the human oculomotor plant has evolved, and works in tandem with the central nervous system, not only to avail other types of eye movements that enable coping with targets exhibiting a variety of speeds, directions, and patterns, but also to program experiential eye-movement responses in memory that serve as a predictive mechanism that adjusts or guides sensory detection when tracking familiar target patterns [14-23]. Further, research on human adaptability alludes to the concept of "techno-adaptability", which is the ability of humans to compensate for their limited or declined physical abilities with technical support [24].

As such, it may be that professional (i.e., expert or more experienced/capable) baseball batters who are adept at tracking pitched baseballs employ a combination of continuous and discontinuous eye-movements [8, 10] and that their expertise may be due to superior adaptive alterations in physiological functions (i.e., functional potentialities) [24], substantially greater experiential perceptual models that inform and trigger eye-movement sequences and/or greater access to resources (e.g., facilities, training, technologies, etc.) that enable techno-adaptability, any and all of which may sub-serve swing/no-swing decisions and bat-swing-direction motor responses.

While baseball batters may not be able to continuously keep their eye on the ball every instant for the entire trajectory of a pitched ball, the accumulated research on eye-movement characteristics, predictive mechanisms, and even cognitive psychology

suggests not only that expert batters are capable of elaborating and employing strategies for following a pitched baseball trajectory proficiently (albeit in a piecemeal discontinuous way) but also that it is possible to train the eyes to do so [25-30]. So, why hasn't the baseball community taken advantage of these available research findings to develop corresponding eye-movement training paradigms for the batting task?

A notable emergent alternative to traditional baseball batting instruction —one attempting to leverage eye-movement research— has been the use of simulated environments. For instance, the visual-search research community has explored the use of still photographs, video clips, and animations, along with eye trackers for capturing eye movements [7, 31-38]. Video games have also been under consideration as an economical alternative for some types of visual training, albeit with limited and mixed results. In sport contexts, these “serious games” may be used in the same manner that video clips have been used to simulate situations in the field of play to train and measure the performance of athletes. For example, video games of the baseball batting task for the Wii (Nintendo, Kyoto, Japan) and Xbox/Kinect (Microsoft, Redmond, WA) consoles present animations of the pitcher wind-up followed by the pitched baseball which increases in size to simulate its approach. Users attempt to hit the ball through batting motions which are registered by hand-held controllers and/or motion-sensing input devices.

Why is it then that —given the proliferation of and access to high-end simulation technology, as well as the use of the knowledge base on eye movement, cognitive/education psychology, and baseball expertise, among other scientific research— more sophisticated and robust eye-movement training technology has yet to

emerge that can enable baseball players to train to “keep their eye on the ball” in a methodical way, so as to better cope with “... the hardest single thing to do in sport?”

1.2. PROBLEM STATEMENT

In spite of the advances in eye-movement research, eye-movement challenges that make the baseball batting task difficult make it also difficult to implement eye-movement know-how into paradigms for eye-movement training. Most notably among the difficulties of this task is controlling an event (i.e., the pitched baseball trajectory) which lasts in the order 450-700 milliseconds (ms) from youth to adult competitive baseball, and managing it into pedagogical building blocks that are conducive to measurable positive transfer-of-training (ToT). This explains, at least partly, why the baseball community at all levels continues to rely on traditional (available, convenient, and economical) methods, consisting of soft-toss labeled balls and batting tees (among others) for visuo-motor coordination, and on hitting statistics and measurements of full- or partial-body kinematics to infer eye-on-ball coordination proficiency [7, 9].

Although the aforementioned video games have been intended for entertainment, the proliferation of their platforms and development environments facilitates their use in instructional design experimentation with virtual environments. But so far, these simulated environments share a significant shortcoming in that they are not in keeping with the long standing tenet that a batter should “keep his eye on the ball from the time it leaves the pitcher's hand until the moment it hits his bat.” That is, when viewing these 2D formats, the ball never leaves the screen so there is no ball coming toward the batter that he or she may follow with the eyes into making contact with the bat. This format

causes batters to maintain their gaze on the screen, not only preventing them from developing the skill to track a ball into contact with the bat but also risking the development of bad habits (i.e., negative ToT) as it would reinforce looking straight ahead in the pitcher's direction throughout the trajectory of the ball.

Indeed, a significant shortcoming of serious games and of simulation-based training in general is the lack of established ToT validation paradigms [39]. Having employed these simulated formats, the visual-search research community has obtained inconsistent results, citing problems with the lack of realism and ecological validity in sport scenes—including those directed at training for anticipatory tasks that involve a ball traveling in depth (as in the baseball batting task, the tennis serve return, and the soccer penalty kick)—prompting more research that examines the effects of fidelity and dimensionality within applied sport contexts [40].

1.3. PURPOSE OF THE STUDY

The purpose of this exploratory modeling and simulation (M&S) research study was to examine the extent to which configurable 3D stereoscopic (3D stereo) virtual environments are conducive to more ecologically-valid synthetic sport scenes that enable objective and repeatable eye-movement motor-skill performance measures as well as innovative training paradigms afforded by artificial sport-scene manipulations not possible in live environments. Specifically, the study selected the baseball batting task subject to 60-mph fastballs to measure how well batters “keep the eye on the ball”, and a novel training paradigm that repurposes/adapts the occlusion method (from the expert-novice paradigm) and the incremental rehearsal flashcard method (from educational

psychology) to examine whether manipulating the sport scene in 3D stereo conduces to instigate and modulate eye movements. The descriptive research questions addressed in this study lend insight into the disciplinary and technological specifications that should be addressed in order to promote the advancement of simulation-based eye-movement training technologies and corresponding ToT validation protocols.

For example, although extensive research has been conducted on eye-movement in a variety of medical and other contexts, much of this has involved horizontal-plane target stimuli eliciting conjugate eye movements rather than convergent/divergent eye movements. That is, the study of eye-movements involving objects moving in depth has not been explored sufficiently. This deficiency is especially pronounced as it pertains to eye-movements subject to 3D stereo graphics stimuli in which eye-movement convergence/divergence takes place, but accommodation does not. Accommodation refers to the process by which the eye lens is adjusted to change optical power and maintain focus on an object as its depth distance varies. When viewing 3D stereo displays, accommodation is largely maintained on the viewing plane and the resulting accommodation-convergence disparity is believed to be responsible for adverse symptoms such as dizziness, vertigo, etc. The limited research in eye-movement, subject to 3D stereo stimuli, translates to limited knowledge and understanding, especially in terms of contextual applications (such as the baseball batting task), and to more pronounced limitations as one ponders the possible adverse effects on convergence eye-movement accuracy and reaction times in the absence of active accommodation feedback (and vice-versa) —especially in time-sensitive tasks, such as the baseball batting task.

In addition, the absence of ToT validation standards and protocols for simulation-based training applies across all domains that employ M&S technology, but is particularly inconspicuous in the social and cognitive sciences, in which behavioral phenomena dimensions are more difficult to specify, quantify, and validate. The configurable simulated 3D stereo virtual environment conceived and developed for this study was intended to facilitate the creation of ecologically-valid virtual environments that enable training strategies which emphasize part-tasks and perceptual cues conducive to the modulation of expertise programming. For example, the occlusion method used frequently in expert-novice paradigms to isolate the sources of expert advantage may be readily implemented in a virtual environment. But, in addition, the occlusion method may be repurposed in a virtual environment to accentuate identified sources of expert advantage in training protocols administered to experimental novice groups.

Manipulations of the experimental scene, such as the spatial-temporal kinematics of a pitched baseball trajectory, are not always possible in the real world and limit the possibilities of instructional design and expertise-based training. For instance, this study was interested in examining the smooth pursuit threshold of subjects when tracking a 60-mph fastball. That is, it was of interest not only to know how well a subject could track a 60-mph fastball, but also at what speed the subject fails to keep up with the ball. Such a measure is possible in the virtual world by preserving the geometry of a 60-mph fastball trajectory while reducing the speed (basically presenting the 60-mph fastball at various slow-motion speeds). Such spatial-temporal manipulation is not possible in the real world, since reducing the speed of the ball results in a different geometric trajectory—which is a different task. By manipulating the spatial-temporal kinematics of the

baseball trajectory, a researcher can measure the smooth pursuit threshold of a subject relative to a specific task in an incremental and deliberate way. Such information would be very valuable in learner analysis and corresponding training plans and training evaluation.

Data collected in this study provided contextual evidence and insights not only into eye-movement strategies employed by baseball batters of various skill levels but also into the demands of the baseball batting task itself. The insights prompt a variety of questions for future hypotheses and corresponding research—a desirable outcome for an exploratory research study.

1.4. EXPERIMENTAL FRAMEWORK

In response to the need for ecologically-valid, simulation-based training protocols for sport in general, and for the baseball batting task specifically, this exploratory research study designed a part-task, virtual-fastball simulator implemented in 3D stereo along with a rotary pitching machine standing as a proxy for the live-pitch referent. The virtual-fastball and live-pitch simulation couple was designed to facilitate objective eye-movement response measures to live and virtual stimuli. These objective measures 1) served as a basis for assessing the ecological validity of the virtual fastballs, 2) informed the characterization and comparison of eye-movement strategies employed by expert and novice baseball batters, 3) enabled a treatment protocol relying on repurposed incremental-rehearsal and partial-occlusion methods and intended to instigate and modulate strategic eye movements to 60-mph fastballs, and 4) provided evidence to

examine if the simulation-based treatment results in positive (or negative) ToT to the real task.

The simulation-based protocol design relied on selected findings and premises from baseball physics, simulation-based training, eye-movement, expert-novice, cognitive load theory, education psychology, and expert-performance research. The 3D stereo virtual environment was selected to explore and afford a more ecologically-valid presentation of the sport scene (as called for by the visual search researchers in sport [40, 41]) and to enable manipulation of the spatial-temporal kinematics of the sport scene in order to influence and/or take advantage of the adaptive properties of the human visual system. Manipulating the sport scene to instigate and modulate eye movements was motivated by findings in eye movement research which assert not only that eye movements are adaptable [20, 42], but also that some eye movements are driven by experiential prediction as much as by sensory perception [28]. Eye-movements driven by experiential predictions appear to be aligned with cognitive load theory (CLT) and expertise-based training (XBT), which postulate that acquisition of expertise is task-specific [43-48]. The format of the virtual-fastball and live-pitch simulation couple is a part-task trainer in that it is concerned with and addresses only the eye-movement training component (i.e., sub-task specific) of the overall batting task, which involves many degrees of freedom in musculoskeletal dynamics.

1.5. AIMS OF THE STUDY AND RESEARCH QUESTIONS

The following aims and descriptive research questions were addressed to determine measures of ecological validity for the virtual environment, measures of

comparison between novice and experienced baseball batters, and measures of comparison before and after simulation-based treatment for adaptability and ToT validation.

1.5.1. FIRST AIM AND RESEARCH QUESTION

The first aim of the study was to explore and obtain objective eye-movement measures that would serve as evidentiary basis for the validation of a 60-mph fastball virtual simulation presented in 3D stereo life-size theater format. Obtaining a measure of validity that establishes an acceptable similarity between the perceived trajectory kinematics of a computed/synthetic 60-mph fastball trajectory in 3D stereo and the perceived trajectory kinematics of the actual flight of a live 60-mph fastball is an essential criterion to the administration of ecologically-valid, simulation-based treatment conducive to positive ToT.

Although various 2D simulation formats have been attempted in training for the baseball batting and other sport tasks [1, 7, 31, 32, 34, 35, 37, 40, 41, 46, 49-58], and eye tracking of 2D gaze position in laboratory and sport settings is not uncommon, eye movement of 3D gaze in 3D stereo displays has not been studied sufficiently, and validation data of standard binocular trackers using active stereo displays is limited [33-35, 40, 41].

This aspect of the study concentrated on the types, durations, and sequences of eye movements employed by novice and experienced batters when tracking isolated fastball trajectories. The protocol of the virtual-fastball and live-pitch simulation couple employed in this exploratory study was intended to enable collection of batter spatial-

temporal eye-movement responses subject to both live and virtual stimuli, thereby providing a quantitative basis for comparing the two environments and deriving a measure of ecological validity of the virtual stimuli and its appropriateness for use in eye-movement training for the batting task (even as this evidence is limited or is applicable only to 60-mph fastball trajectories).

The protocol for this part of the study was guided by basic baseball-physics and eye-movement premises. In general, a 60-mph fastball takes approximately 685 msec to travel 55 feet (ft) —the approximate length of a pitched baseball trajectory from the pitcher's point-of-release to the back of home plate. The young human eye can accommodate (i.e., change focus) from 55 ft in less than 300 milliseconds [59] (relevant to the live pitch but not to the virtual pitch, since accommodation is always maintained on the viewing plane of a 3D stereo display). Large convergence eye movements (i.e., simultaneous inward movement of the eye balls toward each other) when tracking objects moving in depth from 55 ft (such as an incoming baseball pitch) require approximately less than one degree of convergence; therefore, in this study, ball tracking was expected to occur mostly with conjugate eye movements (i.e., parallel movement of the eyes when following a moving object) [10], but possibly resorting to some contributing response from the vergence system in the terminal phase of the trajectory (final 10-15 ft of trajectory).

Gaze depth has been found to respond to target depth under stereoscopic conditions [60], even though it has not been explicitly measured under the batting task conditions. Therefore, from the perspective of ascertaining ecological validation of the virtual environment, this study was concerned with obtaining evidence conducive to

establishing that the eye movements of batters interacting with live and virtual trajectories would be significantly similar and/or would uncover any evidence that would provide insights to the contrary.

Isolated fastball trajectories propelled by a rotary pitching machine and devoid of pitcher-movement visual cues (cues which potentially afford an advantage to expert batters) offer ecologically-valid trajectory kinematics (i.e., obey physical laws) in contrast to those that have been produced by mechanical or virtual simulations in previous studies [7-10, 12, 13, 31-38]. In those studies, the mechanical simulations amounted to a plastic ball attached to a fishing line and propelled by a falling counterweight or by an electric motor. The mechanical simulations were devoid of valid kinematics (e.g., projectile motion due to gravity, ball rotation) and neither mechanical nor virtual simulation incorporated the Magnus force due to ball rotation and its effect on projectile motion and the deceleration of the ball due to air drag.

This study postulated that the ecological validity of live 60-mph fastball trajectories launched from a pitching machine would necessarily elicit and establish a valid batter eye-movement referent which would be instrumental to the validation of trajectories generated in the virtual environment. Consequently, objective measures were sought to validate or invalidate the virtual environment.

The descriptive research question associated with this aim was: How do the eye-movement responses of baseball batters of various skill levels differ when tracking 60-mph fastballs in 3D stereo virtual environment compared to when tracking live machine-pitched 60-mph fastballs in the baseball batting task?

1.5.2. SECOND AIM AND RESEARCH QUESTION

The second aim of the study was to implement an expert-novice protocol to distinguish between the eye-movement strategies employed by experienced batters and those of novice batters. The specific objective was to obtain objective eye-movement type, duration, and sequence measures, with particular interest in smooth-pursuit thresholds and transitions from smooth pursuit to saccadic eye movements, as the angular velocity requirements on eye movements exceeded smooth pursuit thresholds in the critical terminal phase of the 60-mph fastball trajectory. Determining the eye movement strategies employed by experienced batters complements theoretical computations postulating optimal sequences and triggering of smooth pursuit and saccadic eye movements instrumental to the design of simulation-based treatment.

Strategies of eye-movement sequences employed by novice and experienced batters have only been studied and documented nominally, in laboratory settings with procedures affording only limited ecological validity [8, 10, 12]. Although theoretical computations of the angular velocity limits of smooth pursuit in the baseball batting task have been verified, at least partially, in controlled laboratory studies [8, 10, 12], the theoretical limitations of saccades —and especially the theoretical optimal sequences and transitions of smooth-pursuit and saccadic eye movements in the baseball batting task— have not been explored or verified. The theoretical computations of optimal eye-movement sequences considered in this exploratory study were based on the general smooth pursuit and saccadic eye-movement thresholds documented in the literature [61]. An expected outcome of this study included the validation of the theoretical computations based on measurements of eye-movement strategies employed by experienced batters.

Based on observations from previous studies involving the baseball batting task [8, 10, 11], anecdotal experience in baseball batting by the study proponent and his teammates, and evidence from eye-movement research [62], the study postulated that all batters would employ a sequence of smooth-pursuit and saccadic eye movements, but that the eye-movement thresholds and strategies (i.e., eye-movement types, sequences, transitions, durations) employed by experienced batters would be superior and more efficient than those of novices. The initial and early-middle phases of the trajectories would elicit smooth pursuit due to the slower angular velocity requirements, and the late-middle and terminal phases of the trajectories would elicit saccadic responses when angular velocity requirements exceed batters' smooth pursuit threshold [8, 10, 12]. The expert advantage would be attributed to perceptual models developed through extensive experience [36, 43-45, 47-49, 63-67].

Consequently, this study sought to obtain objective measures to confirm or refute that the advantage of experienced batters would be manifested in higher smooth-pursuit thresholds with spatial-temporal characteristics more closely aligned to the contour of the trajectories, followed generally by a catch-up saccade that would maintain the AOV on or slightly ahead of the ball in a coherent way. The objective would also confirm or refute the proposition that novice batters would have lower smooth-pursuit thresholds, followed by late and/or chaotic saccades that would reflect a non-coherent tracking of the fastball trajectory.

The descriptive research question associated with this aim was: What eye-movement strategies distinguish more-experienced from less-experienced baseball batters as they attempt to track 60-mph fastballs in the baseball batting task?

1.5.3. THIRD AIM AND RESEARCH QUESTION

The third aim of this study was to implement a treatment protocol in 3D stereo virtual environment using repurposed incremental-rehearsal and partial-occlusion methods to instigate and modulate a theoretically optimal and deliberate smooth pursuit and saccadic eye movement sequence to cope with the 60-mph fastball task. The theoretically optimal eye-movement strategy relied on general eye-movement threshold limits documented in the literature and tempered by empirical observations of eye-movement strategies employed by novice and experienced batters obtained as part of the second aim of this study.

In the laboratory, voluntary control of saccades and smooth pursuit was achieved using a few points of light moved in stereotypical fashion [25, 68]. Similarly, experiments using monkeys indicate that smooth pursuit training induces shortened latencies and increased initial eye velocities [69]. Goal selection modification of smooth pursuit or saccades for visual-search training in the tracking of isolated pitched baseball trajectories using stereoscopic 3D has not been studied, to my knowledge.

Expertise research asserts that expertise is task-specific, such that expert advantage is not innate but is, rather, a largely unconscious experiential cognitive sub-skill amenable to targeted systematic training, and that repurposing tasks used in expert-novice research (such as detection, categorization, and prediction) enhances sensory perception and decision-making skills [46]. This suggests that while traditional eye-on-ball coordination exercises, such as slow pitch, soft-toss, and t-ball exercises are useful to the development of general batting fitness, they may not be effective to the development

of specific tasks such as eye-movement competence and expertise in tracking fastballs and/or other specific types of baseball pitches. That is, in terms of eye-on-ball coordination, soft-toss drills are conducive to developing expertise in “keeping the eye” on soft-toss balls, but not necessarily to developing expertise in “keeping the eye” on fastballs.

Contingent upon validation of a fastball virtual pitch presented in 3D stereo, it was postulated that implementation of repurposed incremental-rehearsal and partial-occlusion methods would facilitate improvement in eye-movement skill directed at the specific task of tracking a 60-mph fastball. In contrast to live 60-mph fastballs, the kinematics of virtual 60-mph fastballs can be manipulated to emphasize features that would be conducive to increased task perception as well as to deemphasize features that would reduce the cognitive load in working memory. For instance, accentuating the red stitches of a baseball to make them appear larger resulted in improved batter performance at recognizing the type of pitch (i.e., fastballs vs. curve-balls) compared to occluding the the stitches with white paint to camouflage them against the leather coloring of the ball [37].

Following that line of reasoning, it was postulated that the validated virtual 60-mph fastball presented in 3D stereo format would be instrumental to ascertaining batters' smooth pursuit thresholds by decreasing the speed of the ball while maintaining the 60-mph spatial kinematics (i.e., motion geometry) of the trajectory until their eye-on-ball coordination mapped to an ideal tracking of the ball. The same approach in reverse would enable implementation of a treatment protocol such that the 60-mph fastball would be presented at increasing speeds to promote increased smooth pursuit thresholds.

Similarly, it was further postulated that occluding a segment of the virtual 60-mph fastball trajectory would instigate a strategic saccade at a theoretical optimal location. Adding such strategic occlusion to the incremental rehearsal protocol would also promote modulating strategic saccadic movements. In general, repurposed incremental rehearsal and occlusion methods in tandem with the 3D stereo virtual environment were considered as a viable approach to improve or facilitate clarity of perception [57, 70] during treatment.

Although it has been established that the terminal phase of a pitched baseball trajectory cannot be followed continuously with smooth pursuit eye movements [8, 10, 11], saccadic eye movements are characterized by high accuracy and high angular velocities [62] well above the 40-70°/sec angular velocity threshold of smooth pursuit. Given that gaze depth has been found to respond to target depth under stereoscopic conditions [60], and that parts of the brain can act as an adaptive control system that advantageously alters critical parameters within the saccadic system [20, 25, 42, 68, 69], it was of interest to explore if eye-movement goal selection would respond similarly to 3D stereo virtual environment stimuli. It was therefore postulated that smooth pursuit and saccadic eye movements may be conditioned to align with the contour of a 60-mph fastball trajectory by way of treatment that implements repurposed incremental-rehearsal and partial-occlusion methods in 3D stereo virtual environment. This study sought to obtain objective measures to confirm or refute the proposition that a treatment protocol based on repurposed incremental-rehearsal and partial-occlusion methods would improve smooth pursuit thresholds and make saccades timelier.

The descriptive research question associated with this aim was: Is modulation of smooth pursuit and saccadic thresholds achievable in novice batters, using 3D stereo 60-mph virtual fastball stimuli with an incremental-rehearsal and partial-occlusion treatment protocol, to moderate task difficulty and instigate strategic eye-movements in the baseball batting task?

1.5.4. FOURTH AIM AND RESEARCH QUESTION

The fourth aim of this study was to implement a rotary pitching machine server to stand as proxy for the live fastball referent and as stimuli for real-task responses. Real-task responses were necessary to determine whether modulation of smooth pursuit and saccadic eye movements obtained from simulation-based treatment (in the third aim of this study) transferred to tracking a live 60-mph fastball real task. Determining if eye movement conditioning acquired through the simulation-based training transferred to the real task would provide foundational evidence instrumental to the establishment of validation paradigms for 3D stereo and other virtual environments in sport training contexts.

Although video games and other simulation environments have been used in a variety of training domains, validation paradigms for objectively measuring ToT have remained an elusive challenge [39]. Eye-movement measures may be instrumental to this end, since eye-movements suggest at least some degree of overt visual attention such that eye-movement measurements arguably provide quantifiable evidence from which to draw reasonable inferences about training effectiveness.

According to information-processing theory, eye movements and interspersed fixations reflect the processing of information and are organized into visual-search patterns that fixate on important aspects of the environment and ignore unimportant ones [31]. According to Cognitive Load Theory (CLT), minimizing extraneous cognitive load while emphasizing germane cognitive load facilitates domain-specific cognitive schema construction in long-term memory, which is the essence of expertise and expert performance [71, 72]. This study postulated that a treatment protocol consisting of isolated 60-mph fastball trajectories presented in 3D stereo and moderated by repurposed incremental-rehearsal and partial-occlusion methods (as described in the third aim of this study) would be conducive to construction of cognitive schema in working memory. And it also postulated that, once this schema is committed to long-term memory, it would be manifested in other similar tasks, such as when viewing a live 60-mph fastball.

This study sought to obtain objective measures of positive or negative ToT from which it could be inferred whether or not the modulation of smooth pursuit and saccadic eye movements derived from the simulation-based treatment in the third aim of this study had occurred. The study did not explore other more-specific measures of working or long-term memory effects.

The descriptive research question associated with this aim was: Does positive (or negative) ToT occur following an incremental-rehearsal/partial-occlusion treatment protocol implemented in a 3D stereo virtual environment to moderate task difficulty and instigate/modulate strategic eye-movements in the baseball batting task?

1.6. SIGNIFICANCE OF THE STUDY

The study examined the effectiveness of a 3D stereo virtual environment used in conjunction with repurposed incremental-rehearsal and partial-occlusion methods for modulating the smooth pursuit and the saccadic eye-movements of novice and experienced baseball batters to expedite their proficiency in the baseball batting task. Improving smooth pursuit and saccadic eye-movement thresholds is important not only to “keep the eye on the ball” in and of itself, but it also to afford a more stable and coherent parabolic tracking of the fastball trajectory. This potentially reduces visual distortions and optical illusions caused by oscillating eye movements that transition between peripheral and central vision [73], and enables better use of the motion-detection sensitivity inherent to peripheral vision, thereby enhancing the batter’s ability to track the entire trajectory of the ball —especially the terminal phase of the trajectory when contact with the bat is desirable.

As such, this exploratory research study responds to calls from the visual-search research community expressing the need to explore the effects of fidelity and dimensionality on visual-search strategies, and to increase understanding of peripheral vision within sport contexts [31]. It also carries significant implications for the use and extension of 3D stereo graphics used for training in general, and for objective ToT validation of serious games and other simulation-based training paradigms [39].

The implications of eye-movement goal selection acquired through treatment in the 3D stereo virtual environment examined in this exploratory study extend to a variety of sport tasks beyond the baseball batting task, as well as to industrial and military tasks that involve attending to objects moving in depth, and to other visual search tasks. In

addition, the protocol employed in this study demonstrates an approach conducive to the implementation and evolution of interdisciplinary premises, referents, paradigms, and concepts and their roles in the validation of simulated environments. The results from this study may be particularly instrumental to motor-skill training communities that seek novel approaches to examine and employ practice planning/scheduling paradigms along with concepts from cognitive and education psychology (such as the spaced and interleaving effects associated with massed and distributed practice and contextual interference effect in random practice [47, 74-91]). The results of this study also inform the design, planning, validation, and implementation of simulation-based training paradigms and systems [39, 92].

CHAPTER 2

LITERATURE RESEARCH

This exploratory study examined the feasibility and validity of virtual fastballs presented in 3D stereo format to instigate, measure, and modulate smooth pursuit and saccadic eye movements of baseball batters. Such an examination required a review of interdisciplinary premises and principles in baseball and sport training practices, oculomotor and vision research, expertise-based training, expert-novice paradigms, single-subject analysis, and simulation-based training among other research areas. The following sections summarize both the non-exhaustive compilation of literature research conducted to inform the approach and the results derived from the examination.

2.1. VISUO-MOTOR REQUIREMENTS IN THE BATTING TASK

Baseball pitchers employ various types of pitches, including fastballs, curve balls, and sliders, among others. In general, fastballs are balls that travel with a back spin, whereas curve balls are balls that travel with a top spin, and sliders are balls that travel in a spiral spin. In competitive baseball, pitchers deliver fastballs in the range from the mid 60's mph at the high school level to the high 90's mph at the professional level. Elite high school pitchers may throw in the high 70's to low 80's mph range, and some professional pitchers can exceed 100 mph [93-95]. The ability to hit a 60-mph fastball may be arguably the low end mark of adult competitive baseball, at which one can begin to distinguish elite players from intermediate or novice players. As such, this exploratory study selected the 60-mph (88 feet-per-second (fps)) fastball, explained in more detail in Chapter 3, Methods and Approach.

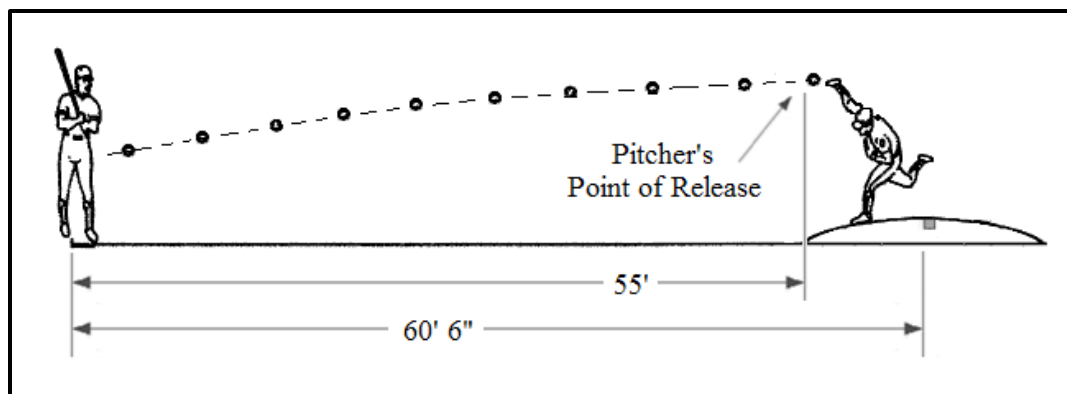

Fig. 1. Distance of Pitched Ball Trajectory from the Pitcher's Point of Release.

Fig. 1 shows that the regulation distance from the pitcher's plate to the back of the home plate is 60 ft, 6 inches (in). However, taking a pitcher's stride and point-of-release in consideration, the trajectory of a pitched baseball is approximately 55 ft. At a constant 60 mph speed with no opposing forces, it would take a baseball approximately 625 ms to travel a 55-ft linear distance. However, a pitched baseball travels in a parabolic path and decelerates due to the drag of air resistance. For example, it has been estimated that the last pitch of Tim Lincecum's no-hitter in July 13, 2013 dropped from 84 mph to 77 mph due to drag forces [96]. As such, a 60-mph fastball subject to drag forces may take approximately 685 ms to travel the 55-ft distance. This amounts to an increase in time in the vicinity of 10%, which is not insignificant given the nature of the task—and should be taken into account.

Fig. 2 illustrates the top-view of the nominal configuration of the batter, pitcher, and baseball trajectory involved in the batting task. The graph includes the required AOV and angular velocity for a ball traveling at a constant 60-mph velocity, as well as one with initial 60-mph velocity but decelerating due to air drag.

When tracking a pitched ball from the pitcher's point-of-release to the end of the trajectory at the back of the home plate, the batter's required AOV starts very small but increases dramatically at the terminal phase of the trajectory —precisely when contact with the bat is desired. As the graph in Fig. 2 indicates, in order for a batter to effectively track a 60-mph fastball, his eyes must rotate with an angular velocity of close to $850^0/\text{sec}$ as the ball crosses the leading edge of the home plate strike zone where contact with the bat is desired and recommended. The required angular velocity of the batter's eyes gets close to $1150^0/\text{sec}$ as the ball reaches the back of home plate at the end of the trajectory [8, 10]; however, this is rather inconsequential since it is impractical to track the ball at that location for the purpose of making contact with it.

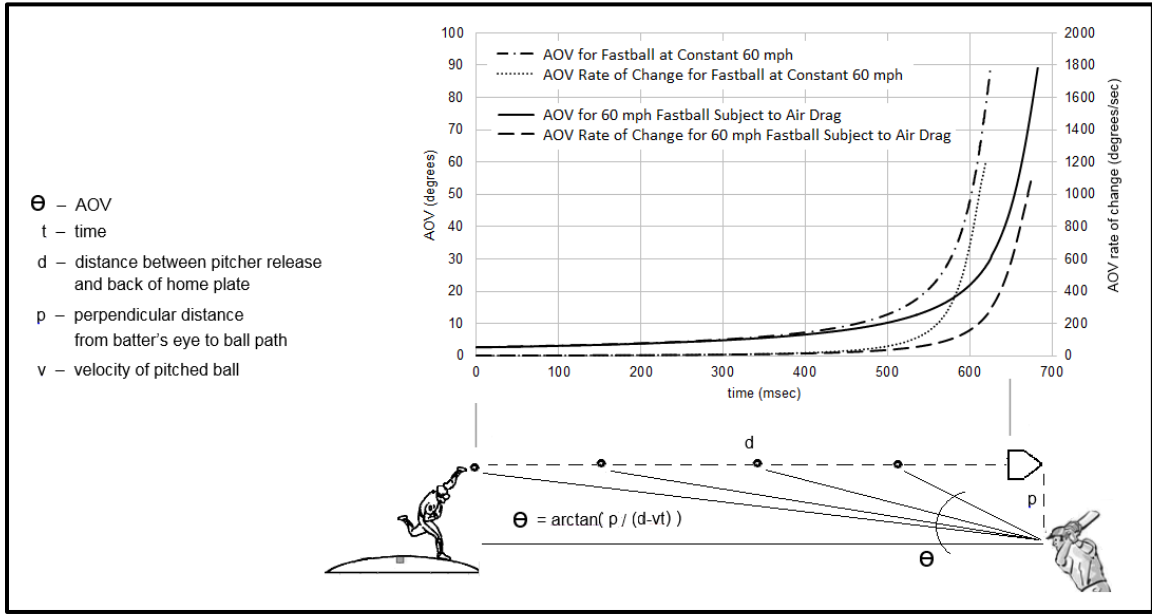

Fig. 2. Required AOV and AOV Rate of Change for Batter's Eye in Smooth Pursuit [8, 10].

To the extent that “keeping the eye on the ball” is an essential component of the baseball batting task, a method is needed for objective evaluations of the angular velocity of batter eye movements subject to the demands imposed by pitched baseballs, especially in the terminal phase of the pitched ball trajectory where the angular rotation of the batter’s eyes is greatest and most critical. Such objective evaluations would inform and establish reasonable thresholds not only for the assessment of player functional potentialities [24] but also for designing, planning, validating, and evaluating the effectiveness of eye-movement training protocols. The motivation of this study was to explore the use of 3D stereo virtual environment to facilitate such objective evaluations and to explore eye-movement training protocol parameters.

2.2. ANATOMY OF THE OCULOMOTOR PLANT

The human visual system involves the oculomotor plant and neural systems that control eye movements in order to see images clearly [61]. The oculomotor plant, illustrated in Fig. 3, consists of three agonist-antagonist extraocular muscle pairs and an eyeball, which can be rotated horizontally, vertically, and torsionally for a total of three degrees of freedom. The extraocular muscles are bundles of phasic and tonic fibers that either twitch in an all-or-none fashion in response to neural stimulation or contract with a force that varies with the frequency of the neural stimulus, respectively. The two fiber types work synergistically to fixate and rotate the eyes [97].

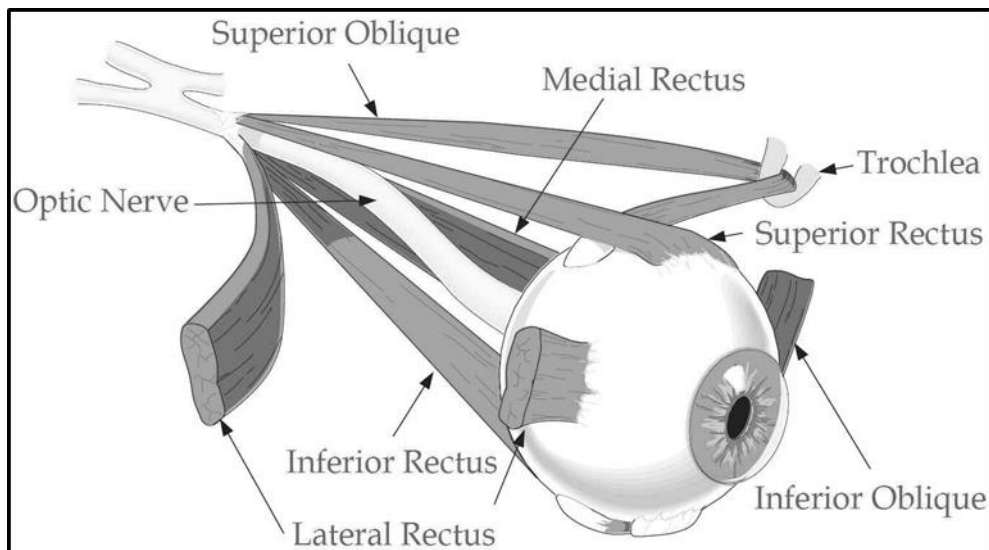

Fig. 3. Oculomotor Plant – Three Pairs of Muscles, Eyeball, and Optic Nerve [61].

2.3. TYPES AND PARAMETERS OF EYE MOVEMENTS

The oculomotor plant affords humans five types of rotational eye movements (i.e., saccades, smooth pursuit, optokinetic, vestibular, and vergence) each controlled by a different neural system that shares the same final common pathway to the extraocular eye muscles [61, 97]. Adaptation and accommodation refer to other non-positional eye movements involved in pupil dilation and lens focusing, respectively. Rotational eye movements orient the point-of-regard which refers to the point in the visual field that directly stimulates the fovea of the retina. Smooth pursuit and saccades, which move the eye, and fixations, during which the eye is still, in particular are central to the extraction of relevant information from the sport scene, in sport tasks in general and in the baseball batting task specifically. Awareness and understanding of these eye movements is necessary to the effective design and planning of an effective eye-movement training paradigm and the validation of visual content [98] used in simulation-based training systems.

Smooth pursuit refers to the slow eye movements that attempt to keep the image of a moving object centered on the fovea, saccades refer to the quick eye movements used to acquire targets and to scan a scene by jumping from one image to another, and optokinetic eye movements refer to the micro-saccades and slow drift movements that stabilize the retina on a stationary object of interest [61, 98]. The following sections expand on the characteristics of saccades and smooth pursuit eye movements, which are the principal eye movements used in the batting task and examined in this exploratory study.

2.3.1. CHARACTERISTICS OF SMOOTH PURSUIT

Smooth pursuit is a voluntary eye movement in response to position and velocity errors of a slow moving target, so as to maintain it centered on the fovea. At the onset of object movement, velocity seems to be more important than position. The maximum velocity of smooth pursuit is estimated to be in the order of 40-70⁰/sec and a time delay of approximately 100-200 msec occurs after acquiring a target to track [61].

The time delay and the angular velocity limitations of smooth pursuit in humans and other primates have been confirmed in various studies and limited experimental settings. Further, as has been presented in Section 2.1, the theoretical required angular velocity of the batter's eyes exceeds 850⁰/sec as the ball crosses the home plate, leading to the theoretical conclusion that humans are incapable of continuously tracking the entire trajectory of a pitched baseball from the mound to the plate purely and solely with smooth pursuit eye movements [8, 10].

In contrast to saccades, vision remains clear and uninterrupted during smooth pursuit but smooth pursuit requires a moving visual stimulus such that it cannot be elicited voluntarily. Smooth pursuit requires continuous visual feedback to keep eyes on target and optimal smooth pursuit results at angular velocities of approximately 40°/sec [62, 99]. Smooth pursuit is generally triggered in response to a moving target (or the recollection of a moving target), and often follows an initial catch-up saccade. Indeed, tracking targets in the real world often involves smooth pursuit assisted by catch-up saccades [61, 97, 99-101]. Studies have led to the observation that professional batters actually employ a combination of smooth pursuit, saccades, and peripheral vision to cope with the baseball batting task [8-12].

It has been postulated that a predictive mechanism controls the smooth pursuit system relying on an internal target velocity signal. Smooth pursuit performance depends on the quality of the stimulus and increases with predictable target movements to the extent that a subject may anticipate and track a moving target perfectly and without latency [17, 19, 61, 102, 103].

2.3.2. CHARACTERISTICS OF SACCADES

Saccades are quick and jerky movements used to direct gaze from one target to another, or for acquiring a moving target from one position to another. They are characterized by high accuracy and high angular velocity and are therefore frequently used in time-sensitive tasks —such as in the baseball batting task. They can be voluntarily elicited, such that a visual target is not necessary for a saccade to occur, but visual processing is turned off and the observer is effectively blind during a saccade (i.e.,

saccadic masking or saccadic suppression) [61]. Due to this saccadic suppression, it is assumed that visual-search strategies that employ fewer saccades tend to be more effective since fewer fixations of longer duration enable greater extraction and processing of relevant information [41].

Saccades range in amplitude from a few minutes of arc to approximately 100° with typical duration from 30 to 100 msec and latencies from 100 to 300 msec. Those triggered by the natural environment are generally in the order of 15° or less [61, 104]. Latency refers to the time it takes the central nervous system to process the retinal signal and deploy the oculomotor signal that moves the eyes to the appropriate location. The characteristics of a typical 10° saccade are illustrated in Fig. 4 including a latency, duration, and peak velocity of approximately 100 msec, 60 msec, and $400^{\circ}/\text{sec}$, respectively [61]. Saccades in the range of 5° - 40° magnitude have durations within 100 msec, as illustrated by the family of temporal saccades in Fig. 5 [101].

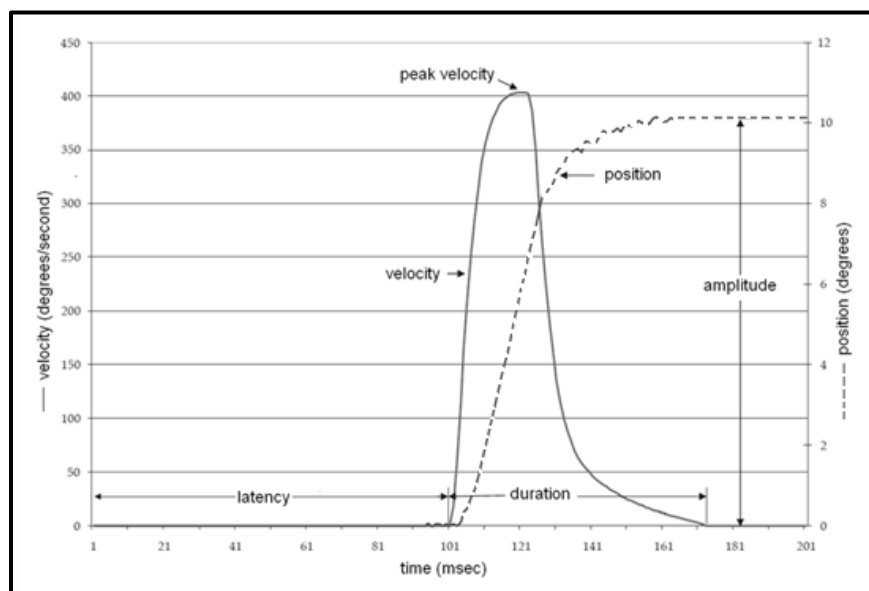

Fig. 4. Characteristics of a 10° Saccade [61].

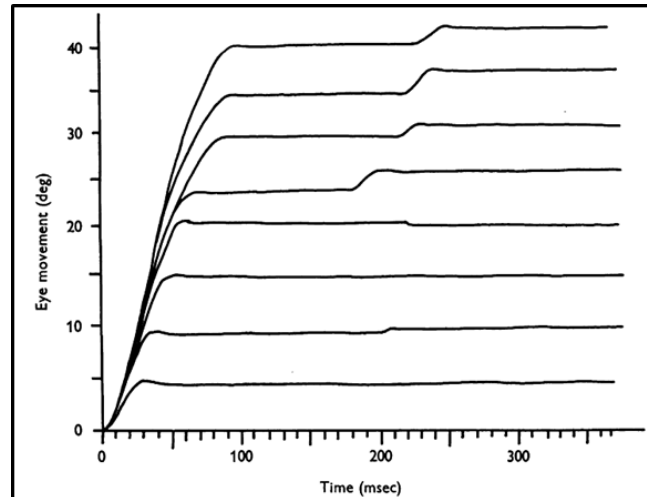

Fig. 5. Family of Temporal Saccades from 5° to 40° [101].

A re-fixation that exceeds 10° of arc is usually accomplished with a primary saccade followed by a corrective saccade. Undershooting large primary saccades (normal hypometria) seems to be preprogrammed; that is, a rapid adaptive system ensures that the primary saccade falls short because programming a corrective saccade in the same direction as a primary saccade takes less time than one in the opposite direction, as would be the case if the primary saccade overshoot the target [25]. Given the overhead of saccades (i.e., latency, duration, and vision suppression), and the limited duration of a 60-mph pitched baseball (i.e., approximately 685 msec), the use of saccades in the batting task should be deliberate and strategic so as to use as few as possible (e.g., perhaps only one) and to keep the gain not large (e.g., under 30°).

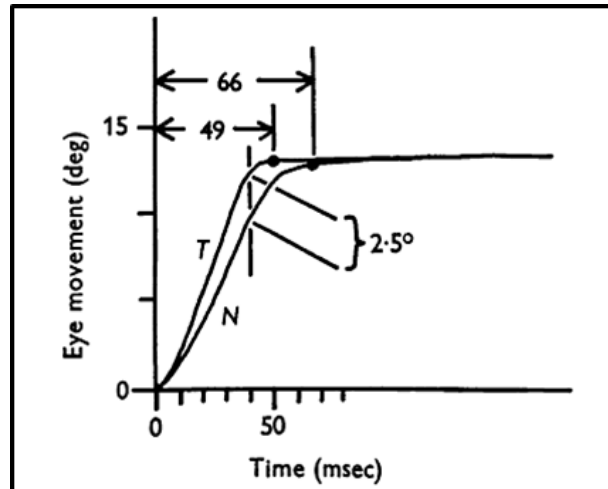

Fig. 6. Superimposed nasal (N) and temporal (T) saccades [101].

Horizontal saccades are temporal (directed towards the temple) or nasal (directed towards the nose). Temporal saccades are faster and have more overshoot than nasal saccades, as illustrated by the superimposed tracings of nasal (N) and temporal (T) saccades of 15° magnitude in Fig. 6 —and can result in image disparity of as much as 2.5° in a 15° conjugate saccade. Since both eyes are generally used in the batting task, such that both temporal and nasal saccades would be employed concurrently, eye dominance could play a role in visual-search performance in the batting task, although no statistically significant differences have been found in batting averages between batters with same and cross eye dominance [105].

Horizontal and vertical saccades are governed by separate anatomies that render horizontal saccades faster than vertical ones and downward saccades slower than upward ones [106, 107]. Pure horizontal or vertical saccades are actually rare, such that most saccades have horizontal and vertical components and are correspondingly oblique. Due to a lack of horizontal and vertical component synchronicity, and the inherent

component-speed differential, oblique saccades are almost always curved. Oblique saccades can be faster than purely horizontal or vertical saccades since they result from the summation of forces from the horizontal and vertical systems [108]. These characteristics may be advantageous to the visual tracking of pitched fastballs given their parabolic trajectories.

Although a batter is unable to maintain visual contact with a pitched fastball throughout its trajectory due to the angular velocity limitations of smooth pursuit and to the visual suppression of saccades, both systems are activated when tracking a fast moving object, like a pitched baseball, such that the saccadic system is triggered when the smooth pursuit system is unable to keep up with a moving object [26-28, 62, 109].

This study explored what combinations, magnitudes, and latencies of smooth pursuit and saccadic movement batters of different skill level employ to cope with the batting task. The results of this effort, along with the general characteristics documented in the literature, informed and provided a basis for the design of simulation-based treatment. The characteristics of the family of saccades illustrated in Fig. 5 provide a nominal reference frame for eye-movement limitations available to a batter. For example, preliminary observations exemplified in Fig. 7 indicate that in a typical response to a 60-mph fastball a novice batter naïve to the experimental protocol will begin to fall behind at approximately two-thirds of the trajectory (35 ft, 400 msec) and will not make a saccadic correction until after the ball has crossed the plate, or not at all. That is, at this location, it appears that the positional error (PE) and retinal slip (RS) become greater than what the smooth pursuit mechanism can handle, yet a catch-up saccade is not triggered in a timely manner in response to the PE and RS deficit [26-28].

The inability of the batter to trigger a catch-up saccade at that location provides insight instrumental to the design of possible corrective treatment protocols, such as to help improve the smooth pursuit threshold and/or to instigate a strategic and timely saccade to “keep the eye on the ball” at the critical terminal phase of the trajectory. Selection of the amplitude and duration of the saccade to be instigated is critical to the treatment protocol since the final one-third of the trajectory takes approximately 200 msec, which restricts the saccadic amplitude and the duration that can be used.

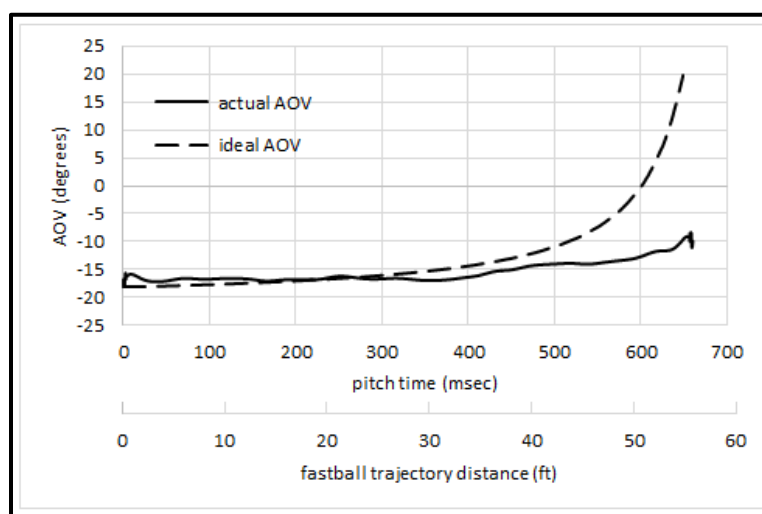

Fig. 7. Preliminary Sample Response to 60-mph Fastball Pitch.

2.3.3. MAIN SEQUENCE PARAMETER RELATIONSHIPS

Saccades are strongly stereotyped, such that there are strong relationships between amplitude, duration, and peak velocity. These relationships are known as “main sequence” parameter relationships [110, 111]. For most normal humans, the relationship between amplitude (A) and duration (D) is approximately linear, and data from studies on normal human subjects follows equation (1) [112]. The relationship between peak

velocity and amplitude can be fitted with an exponential curve, and various model coefficients have been offered [113].

$$D = 2.2A + 21 \quad (1)$$

2.4. CENTRAL-PERIPHERAL VISION AND ECCENTRICITY EFFECTS

“Keeping the eye on the ball” carries implications beyond simply keeping up with the ball. That is, the inability to coherently follow a pitched baseball without significant gaze fluctuations will result in optical illusions that will make the ball trajectory appear to make dramatic shifts in direction and position [73], such as making a pitched ball appear to travel a discontinuous path (e.g., a breaking ball), rather than the parabolic path that it can only take [114].

Once the eye is oriented at a target, its optics project an image onto the retina. The retina is a light-sensitive tissue lining the inner surface of the eye which consists of a large number of photo-receptor cells that trigger nerve impulses sent to the brain when struck by light. Rods and cones are two types of receptor cells found in the retina. Cones are found primarily in the macula (i.e., central retina) and are receptive to photopic (day/bright) light levels, whereas rods are found primarily in the peripheral retina and are receptive to scotopic (night/dim) light levels. Fig. 8 shows the relationship of cone density and visual acuity in the retina [115].

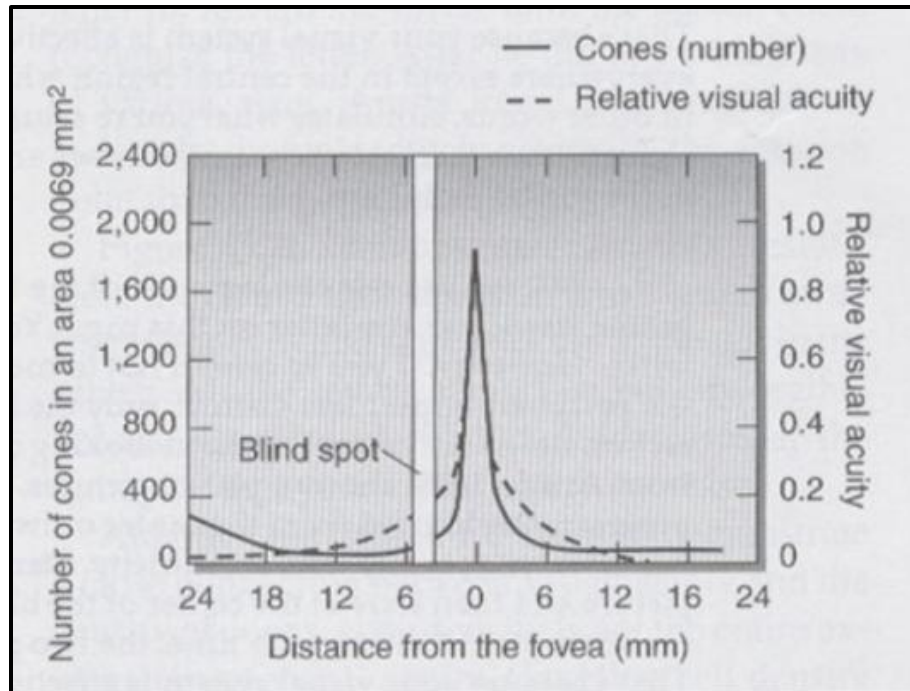

Fig. 8. Relationship of Cone Density in Retina to Visual Resolution [115].

The fovea is a pit located at the center of the macula and is responsible for high-acuity central vision, whereas the peripheral retina is responsible for motion-sensitive peripheral vision [116, 117]. Central and peripheral vision contribute differently to visual perception and should be considered appropriately and deliberately, relative to the study of visual search performance in sport as well as to the design of visual content in eye-movement training paradigms. Although all visual stimuli are processed simultaneously, peripheral-vision stimuli requires much greater time to process than central-vision stimuli [52]. Because visual processing capacity is limited, more capacity (and attention) is therefore allocated to central vision than to peripheral vision [118].

Many perceptual tasks depend on the deployment of attention, and time-sensitive tasks are particularly susceptible to visual eccentricity effects. Visual (or retinal) eccentricity refers to the visual angle (measured from the fixation point) required to view

an object, such that larger objects require larger visual angles and are said to be more eccentric. Central vision involves the fovea, which occupies approximately 1.5° to 2° of visual angle [119] (roughly the area covered by two thumbnails when viewed at arm's length) relative to the direction of gaze, whereas the periphery extends up to 160° vertically and 200° horizontally. The more eccentric an object is, the more difficult it is to see it sharply due to a greater reliance on peripheral vision [51]. Fig. 9 shows notional visual angles corresponding from foveal to peripheral vision [115].

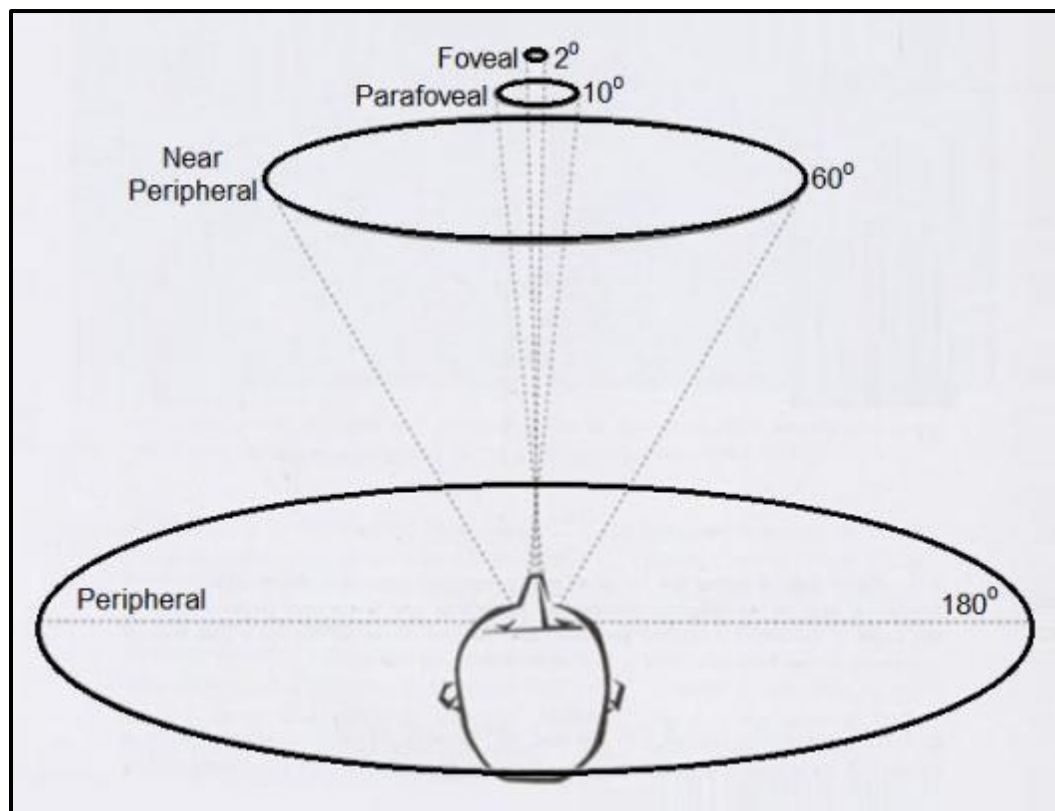

Fig. 9. Notional Visual Angles of Foveal through Peripheral Vision [115].

In addition to the differences in photoreceptors in the central and peripheral retina, there are anatomical and physiological differences between central and peripheral

vision implicating different cortical networks [120] such that foveal processing distinguishes the components of motion signals from a moving object (e.g., rotation vs. translation), whereas peripheral processing does not, and instead treats them as a composite motion signal [73]. The differences in foveal and peripheral processing have been examined [73]. When subjects viewed a vertically-descending disk spinning right-to-left in an interactive computer screen, the disk was perceived to descend vertically as long as the gaze was directed at the spinning disk. However, when the direction of gaze was offset to the right of the disk trajectory, such that the spinning disk was viewed peripherally, the disk appeared to descend in a curved path to the left. When the disk spun in the opposite direction, the perceived descent was a curved path to the right. More significantly, when gaze shifted to view the spinning disk alternatingly between central and peripheral vision, the perceived descent changed abruptly [73].

Other visual effects have been examined. Wind-tunnel analysis indicated that the two-seam and four-seam fastballs have similar parabolic trajectories even though anecdotal testimony from batters and pitchers assert different kinematic characteristics between the two [114]. A 90-mph fastball spins at approximately 1200 revolutions per minute (rpm) such that the perceived spin of two- and four-seam fastballs have been estimated to be below and above the human flicker threshold, respectively [121]. Given the perceptual illusion due to the inability of peripheral vision to separate motion signals, the visual perception of these and other types of pitches depends on the ability of the batter to mitigate perceptual illusions by tracking the ball in a way that eliminates (or at least minimizes) transitions between central and peripheral vision.

The differences in sensitivity and processing between central and peripheral vision have significant and obvious implications to visual-search performance and training for the batting task. Visual search is susceptible to perceptual illusions induced by the spinning and translation of a pitched baseball. These illusions are more pronounced if a pitched ball trajectory is followed with peripheral vision than with central vision, and dramatic if the image of the ball is allowed to transition between the fovea and the periphery. It is estimated that batters' shifts in gaze while attempting to track a ball may result in perceived (but non-occurring) breaks of up to 1.25 feet depending on the initial eccentricity and the occurrence of gaze shifts [73]. Ideally, a pitched baseball would be tracked exclusively with central vision to mitigate such perceptual illusions, further underscoring the need for eye-movement training protocols that improve not only the timing of smooth pursuit thresholds and saccadic movements, but also their spatial stability.

2.5. PLASTICITY AND ADAPTIVE PROPERTIES OF EYE MOVEMENTS

The brain changes constantly in response to a wide range of experiential factors. During motor-skill or perceptual learning, changes occur in the structure of the cells of the nervous system that underlie the motor skill and/or the improvement in perception. Brain plasticity (a.k.a., neuroplasticity or plasticity) refers to this inherent capacity of the nervous system to change its neural circuitry, reflecting a change in behavior or psychological function such as in the cases of injury recovery, addiction, or motor-skill learning [122].

Plasticity is manifested in the adaptive oculomotor mechanisms that detect abnormalities (e.g., ocular dysmetria) and recalibrate sensory-motor input-output relationships, whether these abnormalities emerge during normal development and aging or are the result of disease or injury. Within an eye-movement control subsystem, adaptive compensation will progressively mask the effects of a neurological lesion soon after its acquisition [68]. Researchers believe that the adaptive phenomenon is a fundamental property of the nervous system involved in active matching between aspects of the nervous system and the external physical world [123].

Plasticity is evident in the ability of the smooth pursuit and saccadic systems to adapt to ocular muscle weakness. Patients with partial unilateral abducens nerve palsies, who habitually viewed with the paretic eye, eventually (9 days) acquired accurate saccadic eye movements with the paretic eye while developing saccadic hypermetria with post-saccadic drift in the healthy eye, implying that the paretic eye experienced an increase in the size of saccadic pulse innervation whereas the healthy eye experienced a mismatch between the saccadic pulse and step of innervation. After covering the paretic eye for an extended time (3 days), a reversal occurred such that the healthy eye made accurate saccades without post-saccadic drift whereas the paretic eye made a hypometric saccade followed by a corrective saccade [68, 124]. Similarly, following habitual viewing with the paretic eye and before-and-after prolonged covering of the healthy eye, smooth pursuit of the healthy eye experienced inappropriate gains and oscillations, confirming that the neural drive is adjusted by the central nervous system in order to accommodate the habitually viewing eye [68].

The brain establishes neural pathways not only to compensate for neural injury, but also as a result of new learning and experience such that improved inter-neuron transmission occurs among the implicated neurons whenever knowledge or skill is acquired through repeated practice. But only learning that leads to changes in behavior results in plasticity, underscoring that highly personalized and relevant goals should be an essential part of instructional design in training. That is, new learning must be relevant, necessary, and rewarding in order for it to be integrated by the organism and adopted as behavior before the brain circuits are changed. Interactive play is a form of learning that has been found to be particularly conducive to brain plasticity [125].

The plasticity of perceptual learning is exemplified by the high degree of volitional control which characterizes saccades. When attempting to acquire elusive targets (i.e., points of light moved in stereotype fashion and programmed to jump ahead of monitored eye position before they are acquired), subjects eventually adapted their saccadic goal selection such that they would make a predictive saccade ahead to an anticipated location even when a target was not presented at that location [25]. Similarly, a response recovery phenomenon is supported by some data which indicate that omission of a regularly presented stimulus can lead to increased orienting, and that properties of the nervous system associated with this phenomenon explain the comparison that occurs between incoming stimulation and the expectancy derived from neuronal models [126].

In sport contexts, specifically in the baseball batting task and similar tasks, inferences have been drawn from smooth pursuit and saccade measurements about performances among experts and novices, males and females, young and old, and other various athlete profiles. However, the plasticity underlying the adaptive properties of the

smooth pursuit and saccadic systems has not been studied extensively in the context of perceptual learning of those sport tasks. That is, to my knowledge, visual search training paradigms for the baseball batting task and similar tasks have not attempted to deliberately stimulate the adaptive properties of the smooth pursuit and saccadic systems (especially not using simulation-based training) as a way to effect plastic changes in the oculomotor system.

2.6. PREDICTIVE CONTROL OF EYE MOVEMENTS IN SPORT

Successful performance in sport requires skill in sensory perception as well as in the execution of motor responses [40]. In the baseball batting task, the batter must recognize the trajectory of a pitched baseball while tracking it as it traverses the field of view, make a swing/no-swing decision based on the perceived trajectory, and then propel and direct the bat into contact with the ball [9]. Predicting the trajectory of the pitched baseball subserves the motor responses [9], and baseball batters rely heavily on eye movements to inform their predictions [48]. These predictions appear to be linked to cognitive schema incorporated into long-term memory; that is, the advantage of experts over novices in sport is not attributed (at least not entirely) to any superior physical characteristics and capabilities of their sensory and central nervous systems, but rather to specific processing strategies supported by perceptual models developed through experience specific to their sport which enable them to more-effectively and efficiently organize, interpret, and utilize the information that they extract from the play scene [48].

2.7. VISUAL ORIENTING AND ATTENTION

Visual search is a visual skill process [127] that scans a visual scene in order to extract information that is relevant to performing a task [128]. In contrast to a visual ability, which refers to the general traits of the visual system [129], a visual skill includes a cognitive element influenced by past experiences and involves the perception of visual information. Sport performance psychologists distinguish “hardware” visual abilities as non-task abilities (e.g., ocular health, visual acuity, accommodation) from “software” visual skills which refer to cognitive aspects of vision (e.g., visual perception, central-peripheral awareness, visual reaction time) [129]. Visual search is an overt visual attention task [130] which is the first step in processing stimulus information.

Visual attention is a cognitive mechanism that controls the flow of information from the environment to the various stages of neural processing [130], thus enabling, for example, differentiating an object of interest from among a number of distractors in the visual scene. It consists of intertwined covert and overt functions that account for the human ability to voluntarily dissociate visual attention from the direction of gaze [98]. Overt attention refers to volitional eye movements that are associated with specific kinds of neural processing [130] and that may be observed and measured using various eye-tracking techniques. In contrast, covert attention refers to a neural process that examines the signals from the object of interest but is not detectable by external observation. Although humans can allocate attention with central or peripheral vision, a tacit assumption in visual-search research is that overt attention is manifested in the orientation of foveal gaze (i.e., central vision) and that it reflects to a significant extent the make-up of perceptual models constructed or derived from covert attention [98].

Orienting is the first manifestation of information processing in response to a stimulus. That is, the orienting reflex (OR) is a “what is it?” response that conduces humans and animals to investigate changes in the world around them by orienting the appropriate receptor organ [126]. Orienting seems to be related to attentional processes, such that orienting can be used to study attention itself, attentional dysfunction [126, 131], and visual-search training.

2.8. COGNITIVE LOAD THEORY

Cognitive Load Theory (CLT) is based on the premise that there are three types of cognitive load that serve to manage instructional design and efficiency. Intrinsic cognitive load is associated with the intrinsic difficulty of the material to be learned. The difficulty of the material may not be altered by an instructor, but it can be decomposed into sub-schemas and taught in isolation, such as in part-tasks of whole tasks. Extraneous cognitive load is associated with the format of instruction, which can result in a split-attention effect that results from distracters in the instructional presentation which cause learners to split their attention and unnecessarily increase their cognitive load. Germane cognitive load is associated with processing, construction, and automation of schemas. Effective instructional design focuses on reducing unnecessary cognitive load and direct learners’ attention toward relevant information that is conducive to the construction of schemas [71, 72, 123, 132].

The importance of cognitive load management is indisputable when considering that experts do not perform notably better than novices in highly unusual situations, such that the expert advantage is in performing routine decision tasks involving minimal

cognitive load [44]. According to information-processing theory, eye movements and interspersed fixations reflect the processing of information and are organized into visual-search patterns that fixate on important aspects of the environment and ignore unimportant ones [31]. This is consistent with CLT and may be leveraged accordingly for instructional design.

CLT research has addressed the way memory resources are used in learning with animations. A significant concern with animation-based learning is that animations are likely to create high extraneous load if the underlying instructional design is arbitrary or is not planned deliberately. In order to ensure that an extraneous load is mitigated, an appropriate approach is to segment animations, allow learners to control the play of animations, and direct learner attention to important elements of the animation [92].

2.9. EXPERTISE-BASED TRAINING

Expertise-Based Training (XBT) research asserts that a deliberate selection of representative tasks is essential to effective cognitive load management and that sub-skill task selection can be methodically facilitated by the CLT central tenets.

XBT is an instructional design theory that leverages methods, findings, and theories from expert-novice studies of the past 40 years to elaborate instructional strategies that enable the acquisition of expertise by non-expert intermediate or advanced learners. Its central tenants are that 1) Expert-novice research can reveal key cognitive sub-skills that distinguish expert performance, 2) Expert-novice paradigms may be repurposed into instructional activities to systematically train key cognitive sub-skills,

and 3) Targeted instructional activities derived from expert-novice paradigms can hasten learner acquisition of sub-skill expertise [48].

The XBT research-to-practice approach reveals some of the most elusive aspects of expert performance [46]. It is a drill-and-practice approach aimed at enhancing the sensory perception and decision-making skills of learners by repurposing tasks used in expert-novice research, such as detection, categorization, and prediction. It attempts to exploit the notion derived from expert-novice research that decision-making employed by experts is not derived from innate intuition, but is instead a largely unconscious experiential cognitive sub-skill amenable to systematic training. It represents a compromise of cognitive fidelity in pursuit of instructional efficiency [48]. Although XBT is beginning to be applied to various domains, it has not become a routine part of training programs in sport [48].

In contrast to holistic instructional methods that emphasize whole-task learning activities and ecological validity, XBT focuses on part-task instructional activities targeted at sub-skills that have been identified by expert-novice research that distinguishes expert from intermediate performers. Whole-task practice of wide activity scope may not offer adequate repetition to develop the kind of sub-skill automaticity that characterizes expert performance [133]. Further, representative tasks used in laboratory settings do not lend themselves to whole-task learning activities because they are too difficult to isolate, control, and measure [48].

XBT research contends that sub-skill development through part-task training subserves and/or complements whole-task training. That is, schema automation obtained from part-task learning complements schema construction derived from whole-task

learning [133]. A key contribution to sports expertise research would be to demonstrate that de-coupled sub-skills developed by way of part-task training have positive transfer to the full task [45, 75]. In video simulation on lap-top, part-task pitch-recognition training activities complemented traditional part-task batting activities and were successfully integrated into live batting practice and game performance [38].

Other paradigms, such as intelligent tutoring systems (ITS) and systematic design of instruction (SDI), have focused on systematically analyzing expertise and efficiently training large numbers of learners to levels of consistently competent performance, but neither has focused on systematically representing and training the intuitive knowledge that underlies expert performance [48].

XBT focuses on the routine aspects of decision-making and borrows the notion from cognitive load theory (CLT) that minimizing extraneous and ineffective cognitive load while emphasizing that which is germane facilitates domain-specific knowledge acquisition [134]. The emergence and acceptance of XBT depends on continued research implementations that demonstrate its contribution to holistic instructional methods and its transfer to real tasks [48, 75]. The results from this exploratory study contributes to the XBT body of knowledge.

2.10. FIDELITY AND PART-TASK SIMULATION-BASED TRAINING

A primary concern and goal of simulation-based training research is to produce experimental simulated conditions that elicit behaviors that occur under similar circumstances in real-world situations [135]. To this end, establishing the proper level of simulation fidelity in a simulation trainer is not trivial, and failure to do so can adversely

affect cognitive work load, generate incorrect or incoherent user performance parameters, and potentially lead to negative ToT.

Simulation fidelity refers to the selection of and representational quality when codifying the referent (i.e., the body of knowledge about the thing being simulated) of a simuland (the thing being simulated) which includes accuracy, precision, resolution, sensitivity, granularity, fitness, tolerance, abstraction, detail, error, and potentially other qualifiers [136-138]. Although there is a natural tendency to assume that more fidelity is always better, factors such as cost, schedule, complexity, and effectiveness have led M&S researchers to conclude that the engineering process in simulation development includes understanding about the ‘reality’ that needs to be simulated, choosing the relevant aspects of a referent, and deciding how and how much of the referent to implement in the simulation [139].

Simulation-based experimental research generally falls into full- or part-task categories. Full-task studies take a holistic view and examine the full context of a problem space, whereas part-task studies focus on the behavior(s) (e.g., reaction time, accuracy) associated with specific tasks or functions [135]. The basic premise of a simulation-based part-task study is to isolate a single critical function and to measure the response to manipulations of that function. As such, the fidelity requirements for a part-task simulation study cannot be determined in general, but are, rather, selected deliberately on a case-by-case basis in direct response to the objectives of the study [135], such that the ultimate consideration is performance in, or positive ToT to, the real-world task under study [140].

A fundamental benefit of part-task simulation is in the evaluation of smaller and isolated task components, which are more amenable for experimental testing and objective data collection. Further, part-task simulation facilitates the exclusion of extraneous factors which may add unwanted variance to the sub-task of interest [140].

The fidelity requirements of a simulation-based trainer must distinguish physical from functional fidelity and their importance or relevance in the task under study. Physical fidelity refers to the look and feel of the simuland, in contrast to functional fidelity which refers to the behavior of the simuland. That is, physical fidelity is concerned with how realistically the simulated environment “looks like” the real-world simuland, whereas functional fidelity is concerned with how realistically the simulated environment “acts like” the real-world simuland [141]. ToT is assessed in terms of measures that depend on physical or functional attributes that have bearing on the task. Generally, cognitive tasks are more concerned with functional fidelity and motor-skill tasks are more concerned with physical fidelity.

The adaptive properties of the oculomotor system suggest that the eye-movement subtask of the baseball batting task may have both motor skill as well as cognitive components. For example, the difference in central and peripheral vision processing, which enables the decomposition of translational and rotational movement by central vision but not by peripheral vision, implicates the perception of the curvature of a pitched ball trajectory given the transitions that occur between central and peripheral vision while viewing a translating and rotating object (such as an incoming baseball pitch). Such perception can potentially adversely influence eye-movement modulation in working memory, and therefore requires that the translational as well as the rotational kinematics

of the pitched ball trajectory be properly accounted for, in order to avoid potential negative ToT. In this manner, the physical and functional fidelity requirements of a simulated virtual baseball pitch address the look-and-feel as well as the behavior of the ball trajectory, which is a fundamental provision toward achieving ecological validity in sport scenes.

Since the ultimate objective is to obtain positive ToT, the critical question in establishing simulation fidelity requirements is not how to maximize realism, but rather how to optimize training [142]. As such, simulation fidelity requirements are directly dependent not just on achieving positive ToT, but on the amount of transfer desired [75, 143].

2.11. DISTRIBUTION OF PRACTICE AND INCREMENTAL REHEARSAL

Although the effects of practice on motor-skill learning and performance have been studied extensively [74], results on the effects of distribution of practice have been mixed and in some cases conflicting [76-78, 80-82]. Distribution of practice refers to the planned periods of time spent performing motor-skill tasks coupled with interleaved periods of rest within a single practice session or between several practice sessions [76, 78, 83]. Much of the controversy may be attributed to a lack of standardization in the duration of inter-trial intervals and specifically as it pertains to rest intervals between the task intervals within a practice session [79]. Planning for inter-trial intervals may have significant implications to motor-skill practice, since rest periods are thought to be central to information processing and learning [84, 85]. In general, distributed practice refers to a practice protocol in which the sum of all inter-trial rest intervals is greater than the total

time practicing a motor-skill task. In contrast, massed practice refers to a practice protocol in which the sum of all inter-trial rest intervals is less than the total time practicing a motor-skill [85]. A Spacing Effect is recognized in the field of psychology as a phenomenon which suggests that it is easier and more effective to learn items when they are studied a few times spaced over a long period of time (i.e., spaced or distributed practice) than when they are repeatedly studied in a short period of time (i.e., massed practice) [86].

Varied practice is another perspective on practice and training protocols in which the practice schedule is concerned with presenting learners with different contexts of the information to be learned. It is grounded on a behavioral phenomenon known as the Contextual Interference Effect [90] and focuses not only on the distribution of practice time but also on the organization of activities and the interleaving of practice content to emphasize important aspects of tasks in order to facilitate learning. The Contextual Interference Effect refers to an observed learning benefit that occurs when the items to be learned are randomly intermixed across practice sessions rather than when grouped together [88]. This effect, originally demonstrated in verbal tasks, has been shown to apply to motor skill acquisition [90]. It has been suggested that the practical benefits of varied practice have not been explored systematically and may be largely untapped but that the available evidence on these benefits warrants further investigations [89]. The generalizability of the Contextual Interference Effect to a complex task has been examined and it was found that whole-task practice produced better retention than blocked part-task or interleaved part-task practice, suggesting that the Contextual Interference Effect either does not generalize to complex whole-task practice [91] (and is

better suited for part-task practice), or that whole-task practice is a special case of varied practice in that the complex task offers the contextual variety that leverages the Contextual Interference Effect to a greater extent than does part-task practice [90].

The effects of inter-trial distribution on timing tasks have been investigated [74]. Timing tasks refer to eye-hand coordination (or some other coordination between the eyes and other parts of the body) task execution in response to spatial-temporal stimuli associated with external events, such as in the baseball batting task. The effect of distributed practice in comparison to massed practice revealed no difference in terms of accuracy and variability on groups of young adults [74, 77, 78, 80, 82], although significant benefit was found among groups of older adults subject to distributed practice in contrast to massed practice, suggesting that aging may increase sensitivity to inter-trial intervals [74].

Traditional and interspersed flashcard procedures are practice paradigms that are relevant to simulation-based eye-movement motor-skill acquisition, not only because they are proven delivery mechanisms of massed and distributed practice [86], respectively, but also because of their possible kinship to frame-by-frame animation, which holds its own potential (even as more research is needed in this area) as an effective method to represent, experience, and assimilate a broad range of kinematics phenomena that enable learners to configure learning environments in a manner akin to physically distributed learning [92]. In contrast to traditional flashcard procedures, in which all of the items are unknown, interspersed flashcard procedures interleave unknown items with known items thereby introducing contextual variety. Incremental Rehearsal is a spaced-practice, interspersed-flashcard learning protocol developed and

evaluated by school psychologists which leverages not only the Spacing Effect but also the Interleaving Effect [86], as well as the more foundational Contextual Interference Effect. The simplicity of the incremental rehearsal protocol lends itself to computer graphical user interfaces and to computerized animation format extensions.

While the effect of distributed practice on isolated eye-movement tasks —and specifically on tracking pitched baseballs in the batting task— has not been examined, studies have examined the adaptation of eye-movement responses subject to predictable targets (such as light spots moving in horizontal sinusoid fashion) [17, 19, 20, 25, 42, 68, 69, 123, 124], as well as the contextual interference effect on the overall baseball batting task [87]. In examining eye-movement adaptation, subjects exhibited smooth-pursuit latencies and catch-up saccades at trial initiation, which are customary responses to unpredictable targets. But upon task continuation, subjects changed fixation in near synchrony to the change in stimulus, with the eyes actually preempting target position. This occurred even with as few as half a dozen of the oscillating and predictable target position changes [92]. In examining contextual interference, baseball players subject to additional interleaved batting practice performed better than those subject to additional blocked batting practice, who in turn performed better than a control group subject to no additional batting practice. The additional batting practice consisted of two sessions per week for six weeks, with each session administering 45 pitches (15 fastballs, 15 curveballs, and 15 change-ups). The interleaved practice involved a random ordering of the three types of pitches, whereas the blocked practice involved receiving 15 pitches of one type, followed by 15 pitches of another type, and finally 15 pitches of the remaining type [87]. The study asserted that interleaved practice is particularly appropriate for baseball

batting practice and suggested that chipping golf balls at various distances (e.g., 20, 40, 60, or 80 yards) is an example of how interleaved practice may be applicable and beneficial to other sport tasks [87].

In view of the applicability and benefits of the various practice paradigms available, findings in eye-movement adaptation research [92] suggest that smooth-pursuit and saccadic programming may be accomplished for a predictable 60-mph fastball trajectory by way of a single massed practice session, even if for modest improvement and/or temporary duration. On the other hand, findings in contextual interference research [87] suggests that a repurposed incremental rehearsal protocol consisting of presenting a persistent 60-mph fastball trajectory at various incremental slow motion speeds up to full speed (e.g., 10%, 20%, ... 80%, 90%, 100%) may leverage the Interleaving/Contextual Interference Effects to improve the smooth-pursuit threshold of batters. Further, extending this repurposed incremental rehearsal protocol to include occlusions in the trajectory so as to instigate saccades at the location of the trajectory where the smooth pursuit threshold is expected to be reached would introduce additional contextual variety to induce learning based on the Interleaving/Contextual Interference Effects and as measured by ToT tests [87].

2.12. VIEWER DISTANCE CONFIGURATION AND 3D STEREO DISPLAY

The separation of the two eyes in the human head creates two slightly different images of the scene (i.e., binocular vision or stereovision) and these differences (i.e., binocular disparity) are processed by the brain to provide depth perception. When viewing moving objects in depth, the vergence and accommodation mechanisms work in

tandem (i.e., accommodation-convergence reflex) to maintain single binocular vision and focus, respectively [144-146]. Binocular disparity, and therefore stereovision, can be induced artificially by projecting slightly different images to each eye by way of a stereoscope, 3D stereoscopic display, and other techniques [147].

Optical adjustment and binocular alignment are accomplished by the accommodation and vergence visual motor systems. Neural cross-links exist between the two systems such that accommodation is driven primarily by blur and vergence is driven primarily by disparity, but each receives some contribution from the other [148].

Accommodative-vergence is driven by the innervation to accommodation but not all of the accommodative effort contributes to accommodative-vergence. Likewise, vergence-accommodation is driven by the innervation to vergence but not all the vergence effort contributes to vergence-accommodation [149]. Accommodative vergence is relevant to viewing moving objects in depth in 3D stereo, since any accommodative impairment associated with 3D stereo images may adversely affect vergence. It is particularly worth noting then that latencies associated with accommodative vergence are 80-100 msec shorter than for accommodation, tonic vergence adapts to accommodative-vergence, accommodative-vergence plays a more dominant role during transient responses, and interactions between accommodation and vergence are velocity sensitive [149, 150].

Measurements and analysis of eye movements while viewing 2D displays have been conducted extensively. Eye movements subject to stereoscopic 3D stimuli have not been examined to a significant extent although some eye vergence movements have been measured with eye tracker while viewing the depth component of the 3D stereo gaze point [60]. The accommodation response of the eye has been measured while viewing

stereoscopic displays and changing perceived depth. The accommodation response to moving objects in depth in 3D stereoscopic display was both proportional to the perceived depth and consistent with the accommodation response while viewing real objects moving in depth [88].

3D stereoscopic displays are increasingly under consideration for uses other than entertainment, such as in scientific visualization and training. A significant shortcoming common to all stereoscopic displays is the conflict between accommodation and vergence that occurs when attempting to view a moving object. This focus/fixation (FoFix) conflict arises when the vergence mechanism responds to the moving object perceived to be in front or behind the display and to the accommodation mechanism which keeps focus on the display. The impact of this conflict to the oculomotor system is not well understood, but it has been attributed to visual discomfort when viewing 3D stereoscopic displays for extended times [151] and may adversely affect depth perception if a visual interface is not designed properly.

The vergence mechanism associated with binocular vision responds to retinal disparity and retinal blur, which are complementary cues of depth perception and are responsible for fusional and accommodative-vergence components, respectively. Fusional-vergence is driven by retinal disparity, which is the difference in visual-image perception from each eye due to the different angles in which each eye views the world, causing the eyes to move in opposite direction inward or outward to fuse the images together. Accommodative-vergence is driven by retinal blur, which is the result of inappropriate optical power for focusing by the crystalline lens, causing a change in the

shape of the lens in the eye, but also stimulating inward or outward rotation of the eyes [55, 152].

The eyes converge or diverge when objects move closer to or away from the viewer, respectively. When viewing a moving object at infinity the eyes make conjugate movements (i.e., they do not converge or diverge). The average distance between the axes of the eyes (i.e., interocular distance) for humans is 62-65 mm (approximately 2.5 inches) such that infinity is effectively at 60-90 feet for practical purposes and convergence greater than 0.5° does not occur until approximately 12 feet away from the observer. In the baseball batting task, the batter's AOV does not begin to change dramatically until approximately 10 feet from the strike zone, such that large convergence eye movements do not occur since viewing an incoming ball from 55 to 5 feet (the approximate length of a baseball trajectory) requires approximately less than one degree of convergence, and ball tracking should occur mostly with conjugate eye movements [10] aided by accommodation. Further, in the FoFix fight for control, the main culprit is retinal blur which tries to limit vergence movements that attempt to fixate objects in front of or behind the display such that the larger the screen and the farther the viewing distance, the less FoFix mismatch [153].

As such, the design configuration of a 3D stereo display depends significantly on the diopter distance of a display (display diopter distance, D) which is used to determine the viewer distance to the display. This is equivalent to the optical power (P) of a lens which determines the distance where rays of light are focused, or focal length. Both D and P are measured in inverse meters (meter^{-1} or m^{-1}), commonly called diopters, and are computed as the inverse of the viewer distance of the display and as the inverse of the

focal length, respectively. For example, the focal length of a lens with 3-diopter optical power focuses rays of light at 1/3 meter, and the equivalent 3-diopter 3D stereo display provides for an optimal viewer distance of 1/3 meter, as illustrated in Fig. 10.

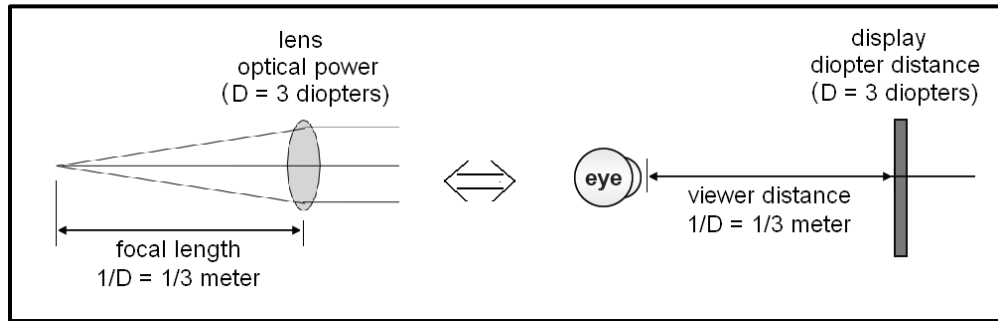

Fig. 10. Relationship of Viewer Distance and Display Diopter Distance [153].

When designing 3D stereoscopic visual interfaces, the heuristic for obtaining an optimal 3D depth range is to keep convergence distance within a 0.5 diopter mismatch, in order to minimize discomfort and potential adverse depth perception. This is accomplished by adding 0.5 diopters to the display diopter distance in order to determine the acceptable near limit for viewing objects in depth, and subtracting 0.5 diopters to the display diopter distance in order to determine the acceptable far limit for viewing objects in depth, as illustrated in Fig. 11 [153].

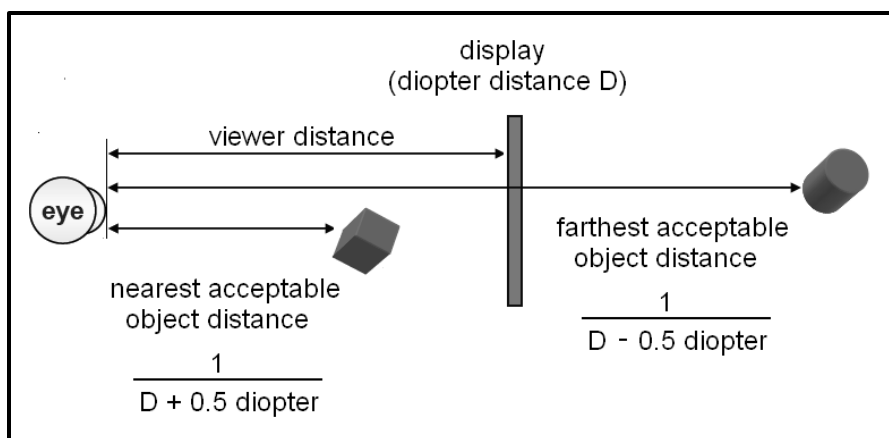

Fig. 11. Optimal Near and Far Limit for Viewing Objects in Depth in 3D Stereo [153].

Variations in viewer and fixation distances will result in different diopter mismatches. Fig. 12 shows the relationship between viewer distance and corresponding display diopter distance from which can be ascertained the acceptable ranges of depth and viewer distances, given a selected diopter mismatch. Note that the range of acceptable depth is greater, the larger the viewer distance [153]. The dashed boxes in Fig. 12 reflect the nearest and farthest acceptable object (depth) distances for a 0.5 diopter mismatch as per the equations in Fig. 11. For example, the middle box indicates that at a viewer distance of approximately 1 m, the display diopter distance is 1 diopter, the nearest acceptable distance of objects is 0.666 m ($1.0/(1.0 + 0.5)$), and the farthest acceptable distance of objects is 2.0 m ($1.0/(1.0 - 0.5)$). In contrast, the lower box indicates that at a viewer distance of 2.0 m and greater, the nearest acceptable distance of objects is 1.0 m, and there is no limit to how far the objects can be in depth. This exploratory study employed this guidance to select a viewer distance of 7 ft, which was appropriate for mitigating FoFix mismatch when viewing a fastball from 55 ft at the mound to 3 ft in from the back of the home plate.

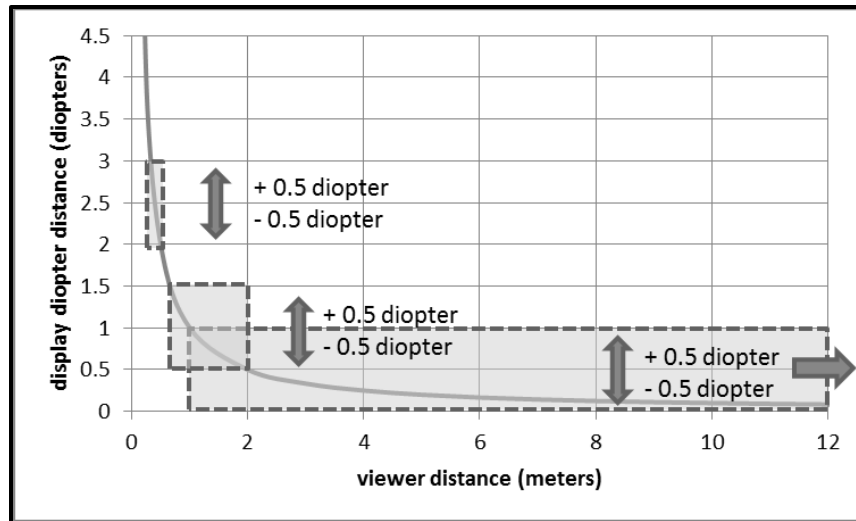

Fig. 12. Ranges of Acceptable Viewing Depth for 0.5 Diopter Mismatch [153].

2.13. EXPERT-NOVICE OCCLUSION METHOD IN BASEBALL/SPORT

The expert-novice paradigm is fundamental to expertise and to visual-search research. It involves the comparison of performance on representative tasks between experts and non-experts. Specifically, researchers are concerned with the decision-making and skill-execution aspects of representative tasks, and with the conditions under which expert performance diverges from that of non-experts. This is often done by way of the occlusion method, which consists of masking sources of spatial and/or temporal information which causes detriment to expert performance, thereby isolating specific sub-skills in which experts excel [48].

The expert-novice paradigm does not require true experts or novices. In practice, the designation of “expert” and “novice” can be arbitrary, as long as the comparison is reasonably made between performers that are more advanced and those that are less advanced [65].

The expert-novice paradigm was originally designed and implemented almost 40 years ago in a classic study of chess players aimed at ascertaining the characteristics of expert advantage [154]. It was in this study that researchers first discovered that experts were more adept than non-experts at recognizing and recalling contextual patterns of chess pieces on the board (i.e., chess piece arrangements taken from actual matches) but that no recognition advantage was manifested when the chess pieces were arbitrarily arranged. The conclusion of the researchers established that expert advantage does not come from innate traits, such as memory or intelligence, but from domain-specific schema systematically acquired through many years of practice and experience [154].

Expertise is highly specific, not only to a particular domain but also to particular tasks within a domain [48]. It takes approximately ten years to acquire the highest levels of human performance in different domains, given daily amounts of deliberate practice activities [43]. This creates an opportunity for training paradigms that can hasten the acquisition of expert skills.

In sport research, expert-novice studies have focused on identifying expert advantages related to anticipatory skills, related to body motions during task execution by opponents, such as in the baseball pitch delivery, tennis serve, and soccer penalty kick. In contrast, the study and search for visual cues related to recognition and prediction of ball-flight kinematics (e.g., ball speed, rotation, trajectory shape, direction, and initial and terminal locations) have been largely neglected in terms of the identification of sources of visual information that can be attributed to expert advantage.

When viewing 2D video of a pitcher delivering a series a pitches, novice batters moved their eyes faster and covered a wider distribution area of viewing points than

experts [31, 32]. Novices tended to move their eyes before the release of the ball and to fixate on the pitcher's head or trunk rather than on the elbow or release point [31, 32]. Experts fixated longer on the pitching arm than novices, set their visual pivot on the pitcher's elbow [32] or the ball release point [31], and used peripheral vision to follow the movements of the pitcher and trajectory of the ball. Experts performed better than novices at predicting (even guessing) types of pitches (i.e., fastball, curve-ball) [31] from pitcher movements rather than by observations of ball kinematics. Neither of the studies correlated the kinematic characteristics of pitch types to pitcher movements, measured predictions of terminal ball trajectory location in the strike zone, nor measured reaction times or other parameters of batting performance. The pitcher delivery was decomposed into four phases [32] for visual-search tagging and statistical analysis purposes, but the occlusion method was not employed to isolate the phases or any temporal or spatial information that would serve in the identification of expert advantage. It is unclear how these studies would connect the differential visual cue selection strategies of experts and novices to performance in any aspect of the batting task, especially in consideration that experienced pitchers will vary their delivery movements to attempt to mislead a hitter.

When employing the occlusion method to mask the proximal arm and racquet in video simulation, the advantage of expert tennis players over novices disappeared in the serve-recognition sub-skill [33, 35]. While experts and novices performed comparably at identifying the direction of the ball when any amount of the ball trajectory was shown, experts exhibited a clear advantage when the trajectory was occluded beyond the moment when the ball was struck by the racket [35]. Similarly, experts utilize advance cues to

inform their responses in tennis and volleyball [49, 58, 66]. But those results were not supported in a similar study of the baseball batting task [36].

The occlusion method has been used sporadically and with mixed results in examinations of the baseball batting task. The occlusion method has been examined when employed with video simulation to mask five stages of the pitching event, before and after the moment of ball release [36]. Experts and novices performed comparatively when predicting where the ball would cross the strike zone, from information gathered during the first three stages of occlusion that included pitcher delivery movements, moment of release, and initial 80 msec (approximately 3 meters) of the ball trajectory. Both groups showed increases in prediction accuracy through the fifth stage of occlusion. Ball trajectory prediction performance between experts and novices approached significance through the fourth and fifth stages of occlusion (160 msec – 240 msec), but not enough to support the hypothesis that expert advantage is derived from information received in the early stages of the pitching event. This study relied on the process of introspection, in which subjects verbally indicated their predictions with no direct measurements. Using video clips, expert batters recognized the type of pitch (i.e., fastballs and curve-balls) 74% of the time when the seams of the ball were occluded (i.e., ball painted white) and 81% when the seams were enhanced [37]. Live pitching and eye-tracking were employed to measure visual fixations on pitcher-delivery movements, and expert batters were more accurate and quicker than novices in making swing/no-swing decisions, but the information source of expert advantage was not identified [54]. Using cinematographic analysis of university batters in game situations, batters were able to sustain ball trajectory tracking using smooth pursuit eye movements only up to 8-to-10

feet from home plate [3, 9]. The study did not consider differential performance between experts and novices nor did it investigate visual cues extracted from ball trajectory kinematics that might be used by experts.

Studies involving tracking of the pitched baseball trajectory have focused mostly on characterizing the limitations of the oculomotor system but have neglected to implement the expert-novice paradigm and occlusion method to identify information sources of expert advantage. In studies of the baseball batting task, experts and novices tracked simulated pitched baseballs with smooth pursuit angular velocities of $70^{\circ}/\text{sec}$ and $120^{\circ}/\text{sec}$, respectively [8, 10-12]. From these results and theoretical computations, they concluded that batters cannot “keep the eye on the ball” with smooth pursuit until the ball comes into contact with the bat, since the angular velocity requirement on the eyes of a batter imposed by an incoming pitched ball can be in excess of $500^{\circ}/\text{sec}$. Eye movements were recorded using infrared emitters and photodetectors aimed at the iris-sclera border of expert and novice batters while viewing a physical simulation of a pitched ball. The simulation consisted of a white plastic ball threaded by a fishing line, supported at two ends 80 feet apart, and connected to a motor that pulled the ball at speeds between 60 and 100 mph. The occlusion method was not employed to identify the source of expert advantage, but it would have been of limited value, since the novel simulation did not represent the rotation of the ball, the corresponding parabolic trajectory of a pitched baseball, nor the deceleration of the ball due to wind resistance, which resulted in a difference between initial and terminal velocities of approximately 10-15%.

Varying the speed in a sequence of pitches led to an increase of temporal and spatial (height) errors in bat swings and incorporating ball rotation cues improved hitting performance for some batters [7]. That study used non-stereoscopic 3D simulation to investigate whether expert batters used the perceived speed of a pitched baseball to estimate pitch height when the ball crossed the strike zone. It also considered the perceptual effects of ball rotation, but it is unclear how this was connected to visual perception, since gravity was the only force represented in the simulated pitched ball trajectories; that is, the value of recognizing the ball rotation is in that it would enhance the prediction of the trajectory shape caused by the rotation-induced magnus force, which was not represented in the simulation. The occlusion method was not explicitly used, but the variations in pitch speed and incorporation of rotation cues provide strong evidence that pitched ball kinematics provide important visual cues.

Detection, categorization, and prediction tasks are typical in expert-novice research [64]. In the baseball batting task, these tasks are concerned with the orientation of gaze throughout the pitcher delivery and ball trajectory, the recognition of the type of pitch, and the orientation and terminal location of the ball trajectory, respectively. These tasks and the occlusion method itself may be repurposed for sub-skill training tasks.

Using the occlusion method in expert-novice studies of sport tasks similar to the baseball batting task, experts appear to have superior anticipatory visual-search skills than novices, which enables them to draw ball-trajectory expectations about an impending tennis serve, volleyball spike, cricket bowl, or soccer penalty kick from visual cues revealed through their opponent's movements during the preparatory phase of ball-delivery [31, 32, 34]. That is, the expert advantage disappears when the preparatory

phase occurring prior to the initiation of ball trajectory is occluded, such that experts and novices perform comparably when the source of information is limited to the ball trajectory phase immediately following the cricket bowler's point of ball release or right after the ball has been struck in the tennis serve, volleyball spike, or soccer penalty kick.

Studies specifically involving the batting task presented conflicting evidence. In one study, there was no significant differential performance between experts and novices, either in the preparatory phase or the trajectory phase [36], suggesting that visual cues in the preparatory phase may not be a significant contributor to expert advantage in the baseball batting task. In another study, batters showed improved performance at recognizing the type of pitch (i.e., fastballs vs. curve-balls) when the ball stitches were accentuated (i.e., colored to make them appear larger) compared to when the stitches were occluded (i.e., painted white to camouflage them against the leather coloring) [37]. Yet another study postulated that the perceived break (i.e., discontinuity) in the trajectory of a curve-ball is due to the optical illusion/distortion that results when viewing a rotating object that transitions from central to peripheral vision [73]. These studies suggest that information obtained directly from the kinematics of the trajectory itself is significant to batting performance.

The literature research suggests that studies directed at the baseball batting task have not sufficiently examined visual perception and corresponding eye-movement training involving the kinematics of the pitched baseball trajectory. Expert-novice studies of the batting task were mostly concerned with the anticipatory visual-search skill that baseball batters employ to scan the movements of pitchers during the wind-up preparatory phase up to the point when the ball is released. Other studies that have

examined the visual interaction of batters with the pitched-ball trajectory have fallen short of collecting sufficient eye-movement measurements. A significant aim of this study was to obtain eye-movement data on expert and novice batters subject to live and virtual fastballs to examine how batters of all skill levels cope with (i.e., execute and train for) what Ted Williams called “the hardest thing to do in sport” [2].

2.14. TRAINING FOR EYE-ON-BALL COORDINATION IN BASEBALL

Incorporating eye-movement practice and evaluation into a training paradigm is difficult, since measuring eye movements is a significantly more challenging proposition than measuring movements of limbs or other major parts of the body. The anatomy and displacement of the eyes are far more delicate and are not discernible without specialized instruments that are not portable or otherwise suitable for field measurements during the execution of sport tasks. Such measurements are particularly difficult in the baseball batting task, given that baseballs are small targets that travel very fast and batters must make motor-response decisions based on their visual perception during the first half of a pitched baseball trajectory which has a total flight time of approximately 450-685 ms [31].

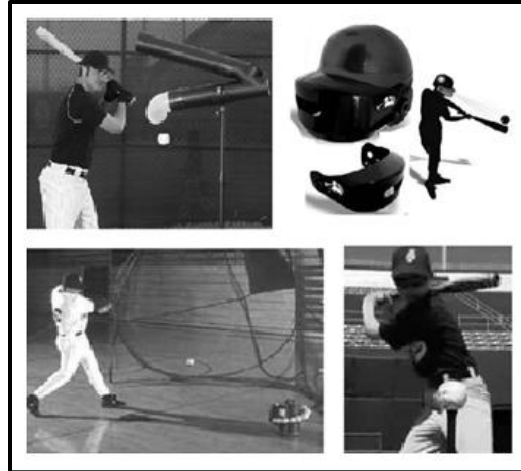

Fig. 13. Traditional Baseball Eye-on-Ball Coordination Training Aids [155].

Given the difficulties and limitations inherent to eye-movement measurement during sport tasks, research in sport training has tended to focus on observations of those body movements which are more easily measured. Visual performance analysis and training in the batting task based on eye-movement measurement has been largely neglected [9], as demonstrated by the persistent use of batting averages and other techniques as performance indicators [7, 9]. Such techniques attempt to manage the orientation of gaze toward ball locations using batting tees, soft-toss machines, hitting visors, and other devices, as depicted in Fig. 13. One popular method among baseball coaches, and reportedly employed by hitting-star Barry Bonds (holder of the Major League Baseball all-time and single-season home run records), includes writing numbers on tennis balls and then trying to swing only at odd-numbered balls during soft-toss drills [7]. By forgoing or neglecting visual-search measurements, these techniques simply infer visual-search training effectiveness from motor-response performance which may be attributable to any number of confounding factors.

2.15. SINGLE-SUBJECT DESIGN AND BOOTSTRAP RESAMPLING

It is generally inappropriate to consolidate the results of different subjects into group analysis when the effectiveness of interventions on individual cases needs to be examined [156]. In such cases, single-subject design is the appropriate approach. This refers to an evaluation method that seeks to explore the effects of interventions or treatments (i.e., independent variables) on the behavior of individual entities (e.g., single batter, baseball team, sport community) and to thereby provide evidence about the interventions' general effectiveness [157, 158]. Single-subject design generally relies on visual analysis to compare responses or behaviors pre- and post-treatment, and employs repeated measures of dependent variables to examine changes in the data over the course of experimental conditions [159].

In contrast to t-tests, analysis of variance (ANOVA), and other conventional (parametric) statistical procedures which evaluate differences in the means of data between experimental conditions, single-subject visual analysis is primarily concerned with data changes in variability, trend, and level, as well as with determining if the changes correspond with experimental manipulations [158]. For instance, in group analysis, variability is controlled by increasing sample size, whereas in single-subject analysis, it is controlled by identifying the sources of variability and removing them [158]. Further, group analysis is concerned with statistical significance that indicates whether or not detected differences occurred by chance, whereas single-subject analysis is concerned with practical significance (a.k.a., clinical significance or social validity), which is the determination of whether or not changes resulting from an intervention or treatment are important and/or useful [158].

Notwithstanding the differences between, and the motivations for, the use of group and single-subject analysis, it is not uncommon to employ visual analysis in combination with parametric and non-parametric statistical analysis [158], particularly as a way to interpret the data of an individual in the absence of between-subjects estimates of variability [156]. For example, the use of non-parametric bootstrap resampling to assess within-subject variability has been examined as an alternative approach to the use of between-subject variance [156].

The empirical bootstrap resampling method is a statistical technique that enables simple computations of point estimates and confidence intervals afforded especially by the availability of modern computing power. It relies on an empirical sampling distribution resulting from a large number of simple random samples with replacement drawn from the raw data, and therefore, it can be used to determine confidence intervals. The basic premise is to perform computations on the raw data to estimate the variation of statistics from the data itself (i.e., an empirical distribution), rather than from a generalized population distribution which may be unknown or unknowable. Because the bootstrap distribution is derived empirically from the raw data, it is appropriate for use when working with small samples (such as in single-subject analysis) in which assumptions of normality and equality of variances are not met [156, 160-163].

The bootstrap principle offers a practical and alternative approach to estimating confidence intervals from distributions which depend on knowing the variation of population point estimates. For example, instead of deriving a confidence interval from a distribution ($\delta = \bar{x} - \mu$) which depends on ascertaining how a sample mean (\bar{x}) varies around a population mean (μ), as is the case in conventional (parametric) statistical

procedures, bootstrapping approximates the distribution as $(\delta^* = \bar{x}^* - \bar{x})$ where \bar{x}^* is the mean of an empirical bootstrap sample. An empirical bootstrap sample is a simple random sample with replacement from the original sample. Since δ^* is computed by resampling the original data, a simple computer program can compute as many bootstrap samples as desired (10,000 samples is recommended), and thus by the law of large numbers, δ^* is estimated with high precision.

The $\delta^* = \bar{x}^* - \bar{x}$ is computed for each bootstrap sample and sorted from smallest to largest. The critical values for the confidence interval are approximated by the corresponding δ^* percentile. For instance, an 80% confidence interval using 10,000 bootstrap samples, is $[\bar{x} - \delta^*_{.1}, \bar{x} - \delta^*_{.9}]$, where $\delta^*_{.1}$ is the 90th percentile and corresponds to the 9,000th element and $\delta^*_{.9}$ is at the 10th percentile and corresponds to the 1,000th element [160-163].

The underlying assumption of bootstrapping is that the match between the true and empirical distributions is admittedly not perfect and there will be error in point estimates. However, because $\delta = \bar{x} - \mu$ describes the variation of \bar{x} about its center and $\delta^* = \bar{x}^* - \bar{x}$ describes the variation of \bar{x}^* about its center, even if the centers are different the variations about the centers will be approximately equal [160-163].

CHAPTER 3

METHOD AND APPROACH

The experimental design of this exploratory research study required the design, development, and testing of a part-task, virtual-fastball simulator implemented in 3D stereo along with a rotary pitching machine standing as a proxy for the live-pitch referent. The virtual-fastball and live-pitch simulation couple was designed to facilitate objective eye-movement response measures to live and virtual stimuli. It required the development of a low-cost electrooculography (EOG) amplifier and corresponding customized software for data processing and analysis. It required an appropriate treatment protocol to instigate and modulate eye movements. And it required an analytical approach that revealed insights about individual eye-movement strategies employed by both experienced and novice baseball batters.

3.1. DEPENDENT AND INDEPENDENT VARIABLES

The dependent measure for this exploratory study was the catch-up saccade onset time and amplitude (derived from positional AOV) subject to 60-mph live and virtual backspin fastballs with head restrained to isolate eye movements. Live pitches were launched by a rotary pitching machine, whereas virtual pitches were presented in a 3D stereo virtual environment and consisted of a 55 ft trajectory which corresponds to the approximate distance from a typical pitcher point-of-release to the back of the home plate. The positional AOV measures did not cover the entire 55 ft. trajectory, but instead focused on a 40° arc which spanned the initial point of the trajectory (point-of-release) to approximately 14 inches in front of the leading edge of the home plate where contact

with the bat is desired and recommended. The positional AOV measures provided a basis for observing smooth pursuit thresholds and saccade onset times employed by experienced and novice baseball players when tracking the fastball trajectories, which in turn provided a reference frame for AOV performance comparisons between live and virtual trajectories, pre- and post-treatment, and ToT.

3.2. SELECTION OF PARTICIPANTS

Novice and experienced baseball batters were recruited from the District of Columbia Men's Senior Baseball League (DCMSBL) [164] as well as from the community at-large. Of the 15 recruited participants, three did not register coherent EOG signals and were not included in the study. Of the 12 participants who registered coherent EOG signals, five completed an initial 80-mph fastball protocol, which was subsequently deemed too demanding for novice batters, as they showed little tracking response. It was, therefore, not useful for validation or other evaluation purposes. Of the remaining seven participants, one served to explore an alternative pitch velocity which resulted in recordings using live and virtual speed of approximately 65 mph, and one registered very erratic eye-movement behavior and the data set was discarded as unusable. The age of the remaining experimental participants ($n = 5$) was 42.4 ± 14.4 years and had competitive baseball experience of 17.4 ± 11.3 years. The participants did not have prior exposure to the protocol before data were collected for this study.

The participants were contacted by e-mail broadcast from the commissioner of the DCMSBL using the subject recruitment e-mail and flyer (Appendices A and B) approved by the Old Dominion University (ODU) Institutional Review Board (IRB). Participants

were asked to complete a screening questionnaire, to read the procedures concerning the study, and to read and sign the consent form approved by ODU IRB (Appendix C). The participants were screened based on the following inclusion/exclusion criteria:

INCLUSION CRITERIA

Subjects were required to meet the following eligibility criteria:

1. Male and female subjects between the 18 and 55 years of age².
2. Experience in competitive baseball at any level (preferably adult level).
2. Uncorrected or corrected (glasses or contacts) 20/40 vision or better.
3. Bat right-handed (or switch-hitter) without regard to eye dominance [105].
4. Pass stereo acuity test or otherwise demonstrate stereo 3D perception.

EXCLUSION CRITERIA

Subjects presenting any of the following limitations were not eligible:

1. Undergoing performance enhancement or depressant medication therapies.
2. History of eye injury, eye pathologies, or other innervation, muscular or orbital anomalies of the eye that would result in abnormal eye movements.
3. History of adverse symptoms while viewing 3D stereo displays.

The participants were asked to complete a Subject Profile Questionnaire (Appendix D) prior to data collection, and a Virtual Environment Evaluation Questionnaire (Appendix E) following data collection. A set of screening questions

² This age range corresponds to the age profile of the most popular 25-and-over age group at the DCMSBL

(Appendix F) were used to ensure that participants were not susceptible to adverse symptoms from exposure to 3D stereo stimuli (e.g., dizziness, nausea, vertigo, etc.)

3.3. EXPERIMENTAL SETUP

A part-task, virtual-fastball and live-pitch simulation couple was designed and implemented to specifically address the aims and research questions of this exploratory study. The simulation couple was a Live-Pitch Server (LPS) along with a custom Virtual-Pitch Simulation Server (VPSS) counterpart (Fig. 14), both configured to launch/present 60-mph top-spin fastballs at 1200 rpm to produce comparable and ecologically-valid 55-ft parabolic trajectories (the approximate distance from the pitcher's point-of-release to the back of home plate).

The LPS consisted of a rotary pitching machine, whereas the VPSS consisted of a custom 3D stereo virtual environment in a life-size theater format to promote conjugate eye movements (i.e., "keeping the eye on the ball") in-depth and in an immersive, ecologically-valid experience. The virtual-pitch fastball trajectory model implemented baseball physics principles that included mathematical representations of projectile motion, Magnus force, and air drag/resistance.

Eye movements were detected by EOG to account for temporal-spatial tracking of fastball trajectories. A low-cost EOG system was designed and developed using an integrated instrumentation amplifier and an Arduino Mega ADK (Arduino, Scarmagno, Italy) microcontroller.

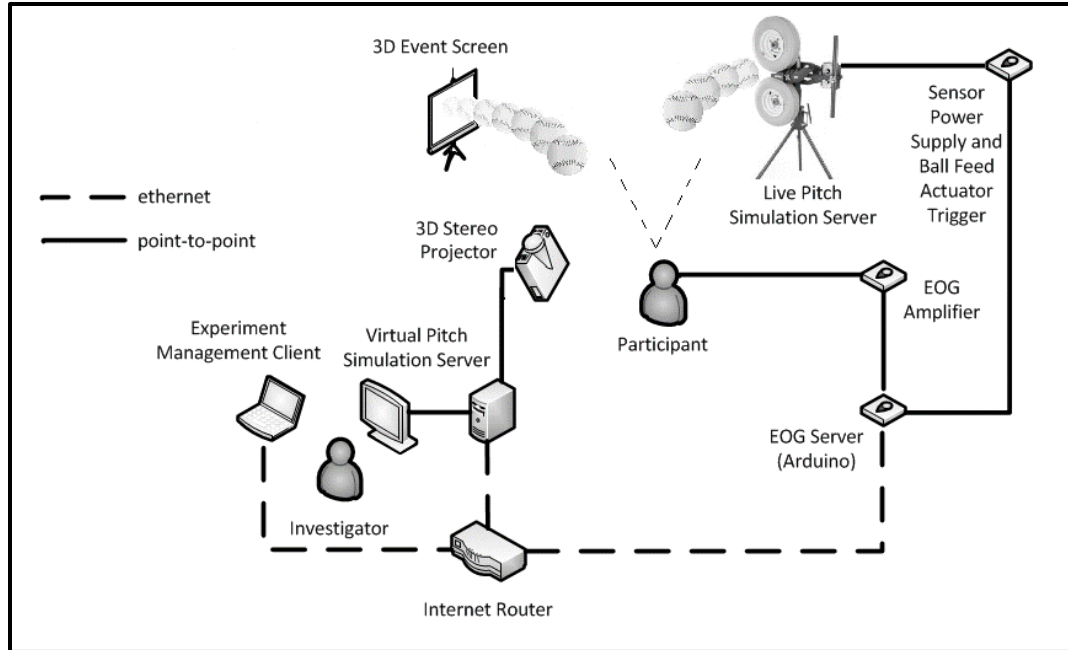

Fig. 14. Simulation Environment and EOG System Client-Server Architecture.

The simulation couple and the EOG system were configured as servers in a client-server architecture (Fig. 14). The client in this architecture was a custom-program central administrative application that synchronized the execution of the servers and managed the data acquisition and processing.

3.3.1. LIVE-PITCH SERVER

The LPS consisted of a dual wheel, electronically-adjustable JUGS (Tualatin, OR) professional pitching machine [165] instrumented with two Melexis (Melexis, Ieper, Belgium) MLX90217 Hall-Effect cam sensors, two Automation Direct (Automation direct, Cuming, GA) HE Series photoelectric sensors, and one Parallax (Parallax, Rocklin, CA) sound impact sensor (#29132), as well as a ball-feed actuator custom built from a surplus ink-jet printer. The Hall Effect sensors provided rotational speed

measures (in revolutions per minute (rpm)) of the pitching machine wheels. The photoelectric and sound impact sensors provided redundant recordings of the initial time of the fastball trajectory. An additional sound impact sensor located at the backstop behind the home plate provided a recording of the final time of the trajectory.

The sensors and actuator interfaced with an Arduino Leonardo and Motor Shield (Arduino, Scarmagno, Italy) microcontroller for power regulation and triggering. It also interfaced with the EOG Server to communicate the state of the sensors.

The rotational speeds of the pitching-machine wheels were used to estimate the initial tangential and rotational velocities of the pitched baseball. Fig. 15 illustrates the relationship of rotational and tangential velocities involved in dual-wheel baseball pitching and equations (2) thru (10) describe the required rotational velocity of the pitching machine wheels in order to launch a 60-mph fastball with 1200 rpm backspin. Equation (2) establishes the initial velocity and equations (3) thru (5) describe the correspondence of rotational velocity to tangential velocity at the edge of the baseball. The baseball is a rigid body, so the initial 60-mph velocity requirement applies throughout the ball. When the ball is fed in between the wheels, the tangential velocity of each of the wheels is transferred to the corresponding point of contact on the baseball and produces both translational as well as rotational velocities components on the baseball. Because of the required fastball backspin, the translational component and tangential equivalent of the rotational component are in the same direction for the bottom wheel but in the opposite direction for the top wheel, as captured in equations (6) and (7). Given the wheel radius (equation (8)), the corresponding rotational velocities of the required tangential velocities of the wheels are described in equations (9) and (10).

The computational model for the pitching machine wheels' rotation requirement did not consider coefficient of restitution for the pneumatic wheels (and associated variance due to temperature and other climate conditions), wheel air pressure, or other mechanical properties of the wheels. The idealized mathematical model indicated top and bottom wheel rotations of 1009 rpm and 1436 rpm, respectively, corresponding to a 60-mph fastball with 1200 rpm backspin.

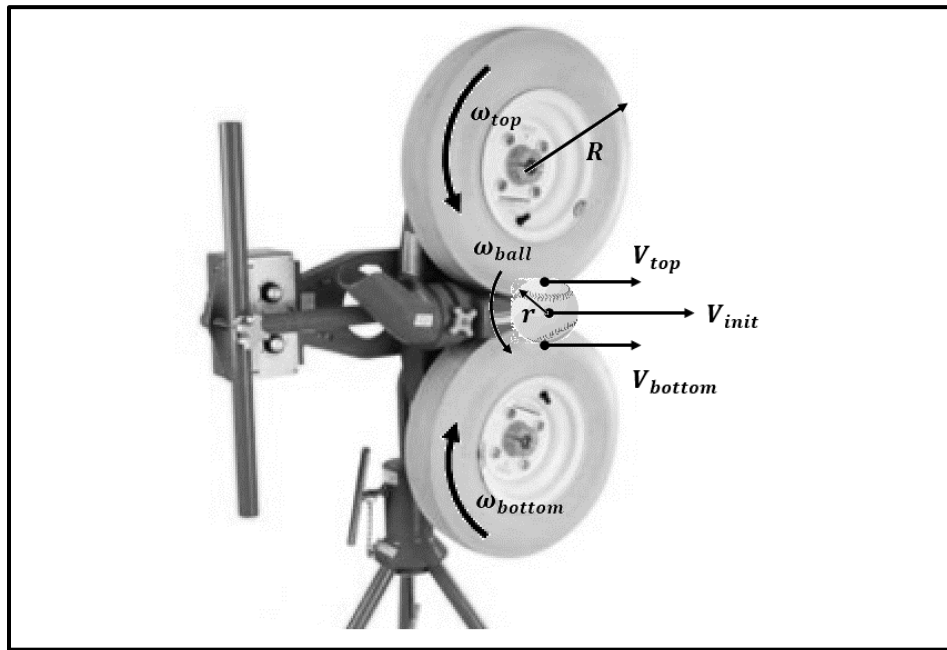

Fig. 15. Free Body Diagram of Rotational and Tangential Velocities.

$$V_{init} \stackrel{\text{def}}{=} \text{initial velocity of ball} = 60 \text{ mph} = 88 \text{ ft/sec} \quad (2)$$

$$\omega_{ball} \stackrel{\text{def}}{=} \text{angular velocity of ball} \stackrel{\text{def}}{=} 1200 \text{ rpm} = 20 \text{ rev/sec} \quad (3)$$

$$r \stackrel{\text{def}}{=} \text{radius of ball} \approx 1.47 \text{ in} \approx 0.1225 \text{ ft} \quad (4)$$

$$V_{ball} \stackrel{\text{def}}{=} \text{tangential velocity of ball} = \omega_{ball} \cdot 2\pi \cdot r = 15.39 \text{ ft/sec} \quad (5)$$

$$V_{bottom} \stackrel{\text{def}}{=} \text{tangential velocity of bottom wheel} = V_{init} + V_{ball} \quad (6)$$

$$V_{bottom} = 88 \text{ ft/sec} + 15.39 \text{ ft/sec} = 103.39 \text{ ft/sec}$$

$$V_{top} \stackrel{\text{def}}{=} \text{tangential velocity of top wheel} = V_{init} - V_{ball} \quad (7)$$

$$V_{top} = 88 \text{ ft/sec} - 15.39 \text{ ft/sec} = 72.61 \text{ ft/sec}$$

$$R \stackrel{\text{def}}{=} \text{radius of wheel} \approx 8.25 \text{ in} \approx 0.6875 \text{ ft} \quad (8)$$

$$\omega_{bottom} \stackrel{\text{def}}{=} \text{angular velocity of bottom wheel} = V_{bottom}/(2\pi \cdot R) \quad (9)$$

$$\omega_{bottom} = \frac{\left(103.39 \frac{\text{ft}}{\text{sec}}\right)}{2\pi \cdot 0.6875 \text{ ft}} = 23.93 \frac{\text{rev}}{\text{sec}} \approx \mathbf{1436 \text{ rpm}}$$

$$\omega_{top} \stackrel{\text{def}}{=} \text{angular velocity of top wheel} = V_{top}/(2\pi \cdot R) \quad (10)$$

$$\omega_{top} = \frac{\left(72.61 \frac{\text{ft}}{\text{sec}}\right)}{2\pi \cdot 0.6875 \text{ ft}} = 16.81 \frac{\text{rev}}{\text{sec}} \approx \mathbf{1009 \text{ rpm}}$$

The LPS was enclosed in a climate-controlled box (i.e., box with space heater) to maintain a consistent ambient temperature. It was located outdoors (the investigator's home patio) but the fastballs were launched into an indoor facility (i.e., the investigator's home basement) where the batter box, participant, and data collection equipment were located. A platform was built to ensure that the LPS and batter's box were on an even plane so that the initial height of the fastball trajectory was 5.0 ft (the approximate height of a pitched fastball at the pitcher's point-of-release). A supply of new Rawlings (St.

Louis, MO) R200 Official League baseballs were used in live-pitch measurements. Fig. 16 and Fig. 17 present the floor plan and localized configurations of the LPS. Fig. 18 presents instrumentation configurations of the LPS.

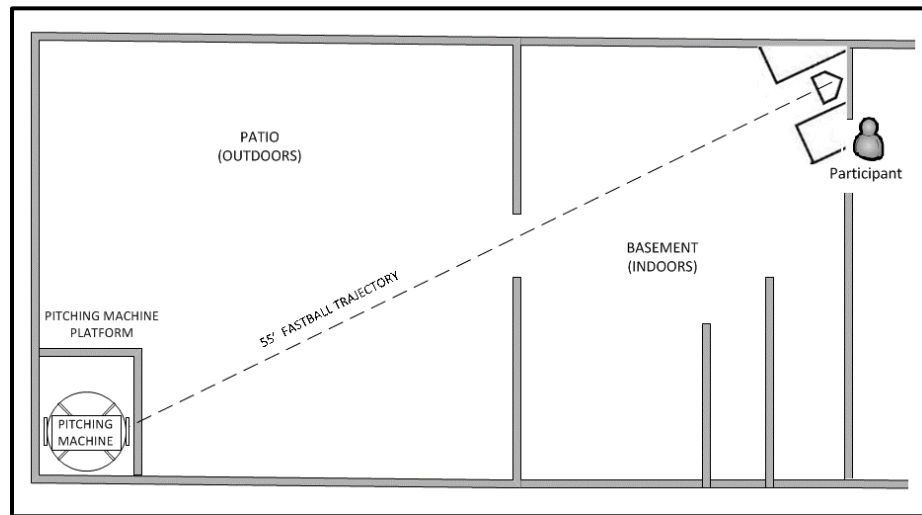

Fig. 16. Floor Plan Configuration for Live-Pitch Simulations.



Fig. 17. Localized Configurations of Live-Pitch Server.

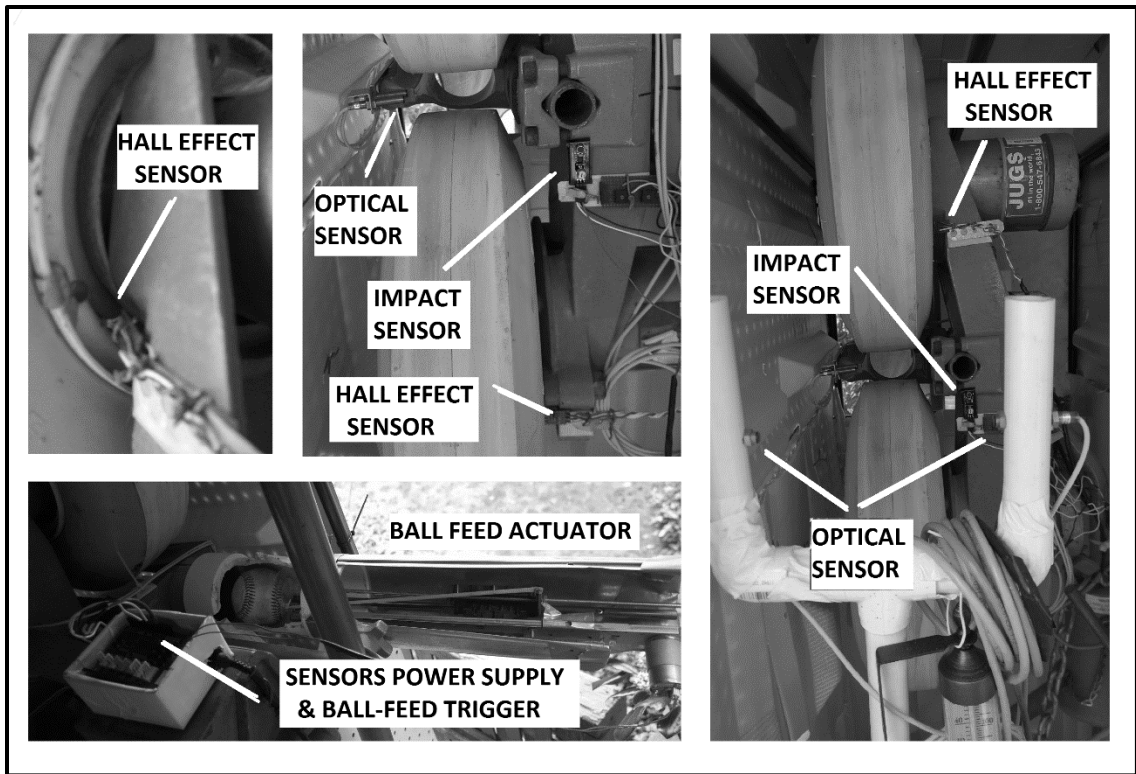

Fig. 18. Instrumentation Configurations of Live-Pitch Simulation Server.

Early empirical tests determined pitching top and bottom wheel settings at approximately 1140 rpm and 1390 rpm, respectively. The JUGS Sports Radar Gun (JUGS, Tualatin, OR) [166] was used to measure the speed of the pitched fastballs. The radar gun specifications indicated that the measurements corresponded to the fastest velocity detected, which in this case, corresponded to the initial velocity. Empirical measures of 172 pitches collected arbitrarily during the course of the engineering design produced an initial velocity of 60.23 ± 2.3 mph. Empirical measures of 135 pitches also collected arbitrarily during the course of the engineering design produced a mean total flight time of 685.55 ± 18.55 msec. An additional 20 pitch trials were measured to obtain a profile of the terminal location of the 60-mph live fastballs. The upper and lower

wheels were calibrated to 1005 and 1452 rpm, respectively, on a mild evening (8MAY2016, 64°F). The mean initial velocity was 58.55 ± 1.24 mph by radar gun and 58.02 ± 0.55 mph by photo sensors at the pitching machine shoot. The mean total flight time was 646.41 ± 6.09 msec. The average height and displacement from home plate center were 53.2 ± 4.96 inches and 3.73 ± 3.61 inches respectively, illustrated in the scatter plot in Fig. 19.

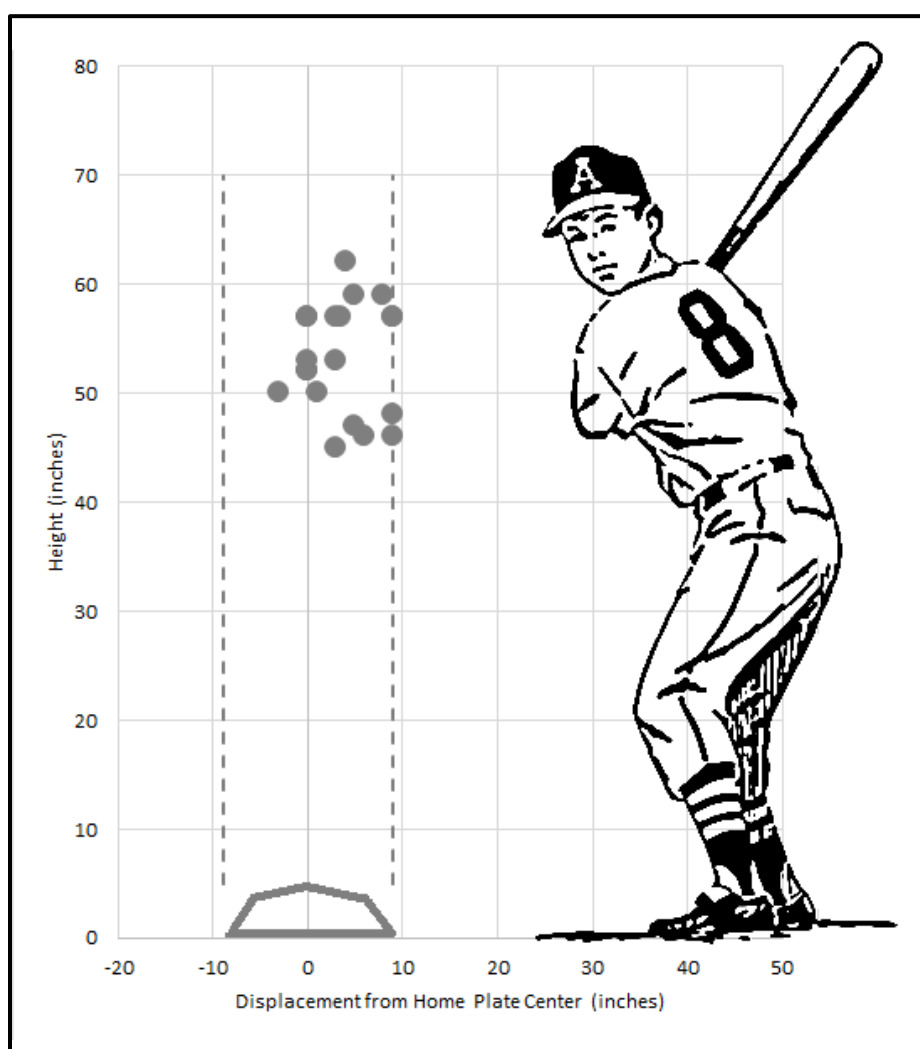

Fig. 19. Scatter Plot of Live Fastball Terminal Location Trials (illustration of batter obtained from public domain clip art [167]).

3.3.2. VIRTUAL-PITCH SIMULATION SERVER

The VPSS consisted of a simple monolithic application that rendered stereo pairs for a 60-mph fastball trajectory. The VPSS implemented the off-axis method (supported by OpenGL) which requires a non-symmetric camera frustum that affords independent focal points for each eye resulting in one common projection plane and introduces no vertical parallax [168]. The off-axis method is considered the correct way to render stereo pairs [168].

The computational model for the 60-mph trajectory involved simple projectile motion and included deceleration (i.e., drag) due to wind resistance based on the relationships represented in equations (11) thru (31) [96]. This computational model produced a decelerating fastball trajectory with a 60-mph initial velocity and a total flight time of 685 msec —consistent with the live-pitch empirical measures produced by the LPS. Table 1 includes sample computations of the 60-mph model. The graphical rendition of the baseball included 1200 rpm backspin, but the mathematical model did not include the Magnus effect (in which a spinning sphere curves away from its principal path due to its interaction with airflow).

$$\theta \stackrel{\text{def}}{=} \textit{initial altitude angle} = 6.5^\circ \quad (2)$$

$$g \stackrel{\text{def}}{=} \textit{acceleration due to gravity} = 32.174 \textit{ ft/sec}^2 \quad (3)$$

$$C_d \stackrel{\text{def}}{=} \textit{coefficient of drag} = 0.5 \quad (4)$$

$$\rho \stackrel{\text{def}}{=} \textit{air density} = 1.225 \textit{ kg/m}^3 \quad (5)$$

$$m_{ball} \stackrel{\text{def}}{=} \text{ball mass} = 0.14529 \text{ kg} \quad (6)$$

$$r_{ball} \stackrel{\text{def}}{=} \text{ball radius} \quad (7)$$

$$A_{ball} \stackrel{\text{def}}{=} \text{silouhette area of ball} = \pi \cdot r_{ball}^2 \quad (8)$$

$$D \stackrel{\text{def}}{=} \text{Drag of pitched ball} = \rho \cdot C_d \cdot A_{ball} / 2 \quad (9)$$

$$V_i \stackrel{\text{def}}{=} \text{initial velocity} = 60 \text{ mph} = 88 \text{ ft/sec} \quad (10)$$

$$V_{ix} \stackrel{\text{def}}{=} \text{x-component of initial velocity} = 0.0 \text{ mph} = 0.0 \text{ ft/sec} \quad (20)$$

$$V_{iy} \stackrel{\text{def}}{=} \text{y-component of initial velocity} = V_i \cdot \sin(\theta) \text{ ft/sec} \quad (11)$$

$$V_{iz} \stackrel{\text{def}}{=} \text{z-component of initial velocity} = V_i \cdot \cos(\theta) \text{ ft/sec} \quad (12)$$

$$a_x \stackrel{\text{def}}{=} \text{x-component of acceleration} = 0.0 \text{ m/sec}^2 = 0.0 \text{ ft/sec}^2 \quad (13)$$

$$a_y \stackrel{\text{def}}{=} \text{y-component of acceleration} = -g - \left(\frac{D}{m}\right) \cdot V_i \cdot V_{iy} \text{ ft/sec}^2 \quad (14)$$

$$a_z \stackrel{\text{def}}{=} \text{z-component of acceleration} = -\left(\frac{D}{m}\right) \cdot V_i \cdot V_{iz} \text{ ft/sec}^2 \quad (15)$$

$$V_x \stackrel{\text{def}}{=} \text{x-component of velocity} = V_{ix} + a_x \cdot \Delta t \text{ ft/sec} \quad (16)$$

$$V_y \stackrel{\text{def}}{=} y\text{-component of velocity} = V_{iy} + a_y \cdot \Delta t \text{ ft/sec} \quad (17)$$

$$V_{yz} \stackrel{\text{def}}{=} z\text{-component of velocity} = V_{iz} + a_z \cdot \Delta t \text{ ft/sec} \quad (18)$$

$$x \stackrel{\text{def}}{=} x \text{ location of ball} = V_{ix} \cdot \Delta t + a_x \cdot \Delta t^2 \text{ ft} \quad (19)$$

$$y \stackrel{\text{def}}{=} y \text{ location of ball} = V_{iy} \cdot \Delta t + a_y \cdot \Delta t^2 \text{ ft} \quad (30)$$

$$z \stackrel{\text{def}}{=} z \text{ location of ball} = V_{iz} \cdot \Delta t + a_z \cdot \Delta t^2 \text{ ft} \quad (20)$$

Table 1. Sample computations of 60-mph computational model

time (msec)	distance (ft)	time (msec)	distance (ft)	time (msec)	distance (ft)
0.00	0.00	250.37	21.30	550.32	45.00
50.01	4.36	300.55	25.40	600.73	48.79
100.05	8.67	350.76	29.45	650.34	52.47
150.12	12.93	450.47	37.33	684.83	54.99
200.23	17.14	500.79	41.22		

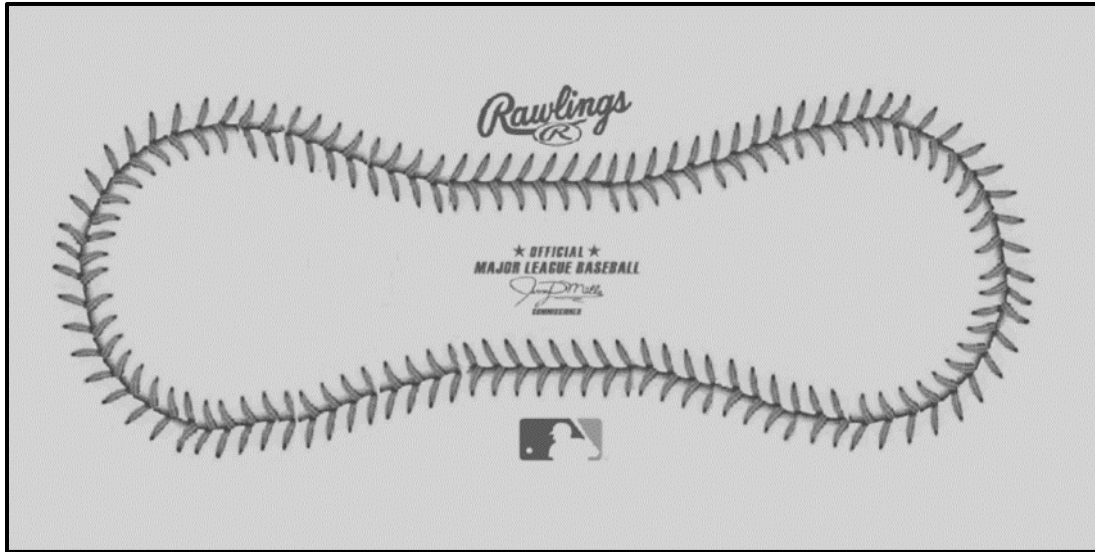

Fig. 20. Texture Map Used for Virtual-Pitch Baseball Model [169].

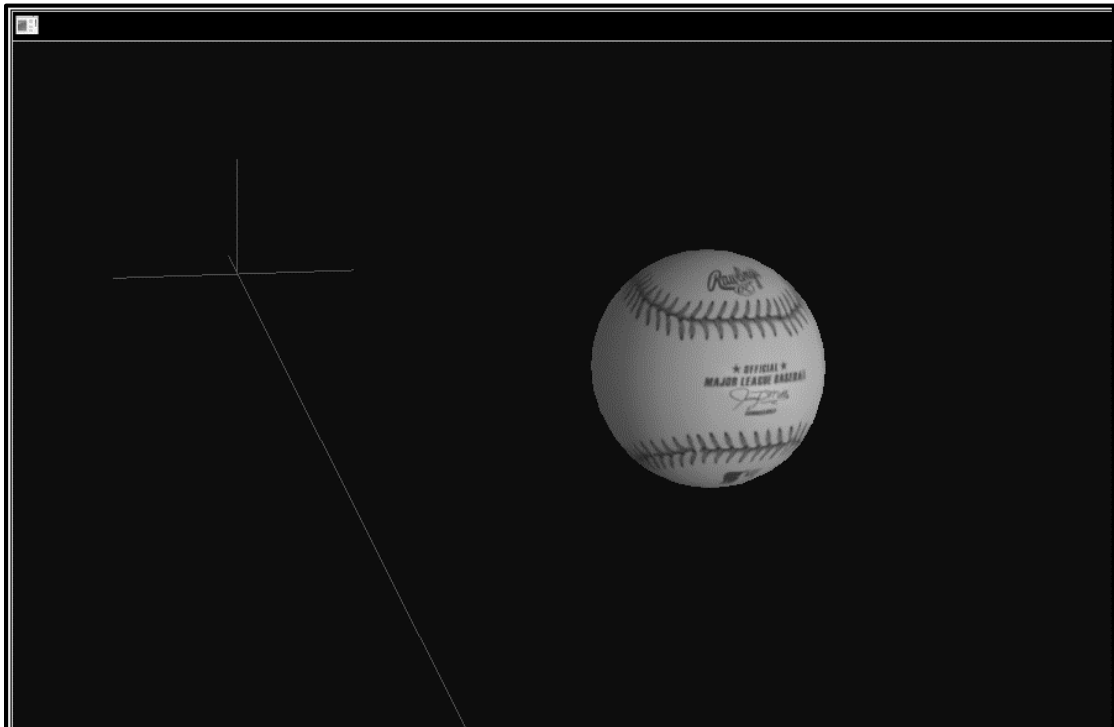

Fig. 21. Screen Capture of Baseball Model Consisting of Texturized Sphere [169].

The VPSS employed the OpenGL mipmapping function `loadMpMappedTexture()` to texturize a simple sphere. Fig. 20 illustrates the texture map used and Fig. 21 shows a screen capture of the texturized sphere.

The development environment of the VPSS consisted of Microsoft (Seattle, WA) Visual Studio 2010 Integrated Development Environment (IDE), Microsoft Windows 7 operating system, C and CUDA C languages, OpenGL (www.opengl.org standard specification API, NVIDIA (Santa Clara, CA) GeForce GTX 480/470/465 graphics processing unit (GPU), 24" ViewSonic (Walnut, CA) V3D245 3D Ready LED monitor, ViewSonic PJD5234 3D projector, and NVIDIA 3D Vision 2 Wireless Glasses Kit (shutter glasses).

3.4. 3D STEREO DISPLAY CONFIGURATION

The exploratory study observed a 0.5 diopter mismatch heuristic [153] (see Section 2.12) and designed the viewer distance at 7 ft, which is slightly over 2 m. At this viewer distance, the required width of the display was also 7 ft, in order to allow the batters' field of view (FOV) of interest to span 40° (i.e., $AOV = -20^{\circ}$ to $+20^{\circ}$) with 5° to 10° of buffer space at the left and right edges of the display. The near clipping plane of the 3D frustum was set at 1.0 ft from the viewer which exceeded the nearest acceptable distance for objects of approximately 1.0 m. This was a tradeoff without consequence (in order to accommodate the required 40° AOV for batters), since the two feet that exceeded the nearest acceptable distance also exceeded the measurable FOV of interest.

3.5. SELECTION OF 60-MPH FASTBALL TASK

The 80-mph fastball pitch was originally selected as the nominal target training objective, based on the low-end for fastballs in professional baseball [93, 170], Tier 3 collegiate baseball pitchers [95], as well as my personal anecdotal observations drawn from over 15 years of adult amateur baseball coaching and playing experience, which indicate a general inability of novice and intermediate players, in contrast to elite or expert players, to cope with baseball pitches at that speed. Pitches were aimed high (i.e., between chest and eye level) to emphasize the use of horizontal eye movements.

Data collection of five participants, including two former collegiate players who are top-tier hitters in the DCMSBL, revealed that 80-mph fastballs were too challenging for participants, rendering them (especially novice batters) unable to keep up with the ball.

Because the data-collection protocol included phases in which the spatial geometry of the 80-mph trajectory was preserved but the speed was manipulated from 10% to 100% of 80-mph in 10% increments, the data sets of the five participants suggested that responses at 80% of the 80-mph speed were more favorable in terms of keeping up with the ball. As such, the target velocity was modified to 60 mph (i.e., closest 10 percentile to $0.8 \times 80 \text{ mph} = 64 \text{ mph}$).

3.6. EOG SERVER

A low-cost EOG system was designed and developed to detect and record eye movements. The EOG system consisted of a Linear Technology LT1167 integrated instrumentation amplifier (Linear Technology, Milpitas, CA) and Arduino Mega ADK

(Arduino, Scarmagno, Italy) microcontroller and Ethernet shield. The circuit design followed the recommended configuration in the LT1167 data sheet (Fig. 22) [171]. Texas Instruments LM317 and LM337 3-terminal adjustable voltage regulators (Texas Instruments, Dallas, TX) were used to maintain steady voltage levels and mitigate power supply noise. Two 12-volt, 20-hr Universal UBI250 sealed lead-acid batteries (UPG, Coppell, TX) were used to maintain constant voltage levels at extended periods of time. The EOG amplifier was encased in a grounded Faraday box constructed from steel mosquito mesh. The EOG amplifier interfaced with the Arduino microcontroller with a 3-wire shielded cable (generic stock) and the microcontroller interfaced with the client PC with standard USB printer cable (Fig. 23). Silver-chloride electrodes #800-102 and resistive (carbon-granule) medical-grade pin lead wires #800-608 (Althea Medical Group, Atlanta, GA) were used to interface participants to the EOG amplifier (Fig. 23).

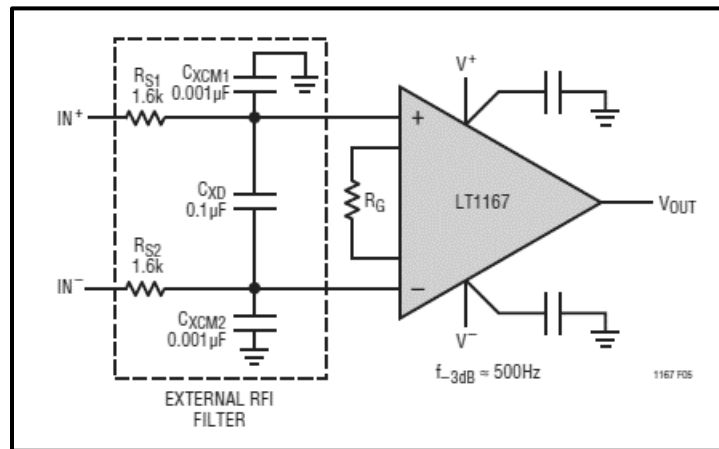

Fig. 22. EOG Amplifier Circuit Configuration [171].

The sampling rate of the Arduino Mega ADK was 3 KHz. Because of the Arduino's memory limitations, UDP data packets of 1472 characters were sent

continuously to the client. Each UDP data packet consisted of 10 time-stamped eye-movement digitized EOG voltage readings.

Self-adhesive silver-chloride electrodes were attached to the outer canthi of both eyes and to the forehead for ground, and were secured further with medical tape. Participants' skin was first cleaned with an alcohol pad. The bitemporal "cyclopean eye" electrode configuration is common and enables the collection of compound potential differences from both eyes. It has the advantage of increasing the signal-to-noise ratio as compared to monocular recordings [172].

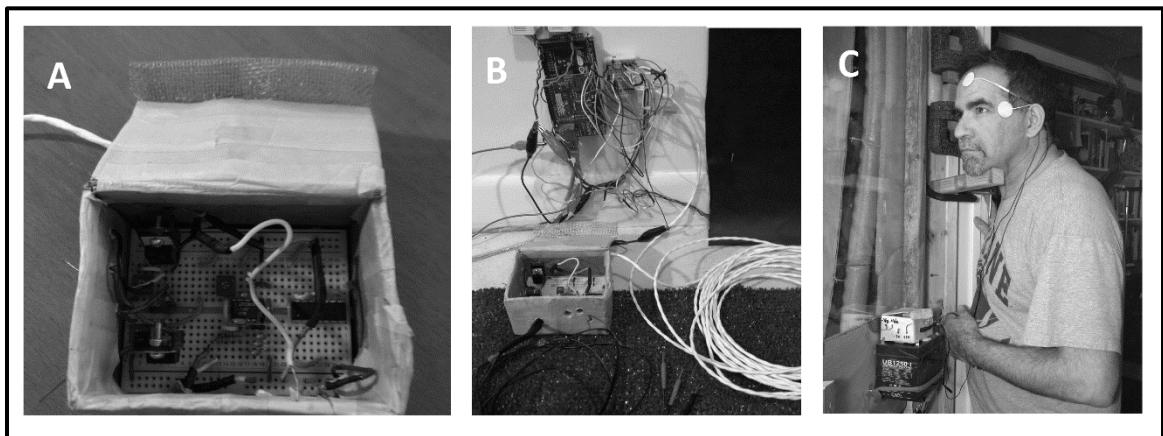

Fig. 23. EOG Server: A – Amplifier, B – Amplifier Interfaced to Microcontroller, and C – Interfaced to Microcontroller and Participant.

3.7. CENTRAL MANAGEMENT CLIENT

The Central Management Client (Client) was a custom-programmed administrative application written in the Microsoft Visual Studio 2015 (Microsoft, Seattle, WA) development environment, C language. It was designed to synchronize the execution of the servers and managed data acquisition and processing.

The Client employed user datagram protocol (UDP) sockets to communicate directly with the VPSS and EOG Server (communication with the LPS was done indirectly through the EOG Server).

The Client was principally used to synchronize the start of stimulus events and corresponding EOG data acquisition as well as to receive, process, and format data into Excel spreadsheets for analysis.

3.8. TREATMENT

The incremental-rehearsal part of the treatment protocol amounted to presenting 2 sets of 100 virtual fastball trajectories. Each set of 100 fastballs consisted of 10 groups of 10 trajectories that preserved the 60-mph spatial geometry but presented the trajectory in slow motion from 10% to 100% of the target speed (60 mph) in 10% (6 mph) increments.

The partial-occlusion part of the treatment protocol amounted to occluding the 450-550 msec portion of the trajectory in order to instigate an anticipatory saccade leading up to the 560 msec point in the trajectory where the approximate smooth pursuit angular velocity limit ($70^\circ/\text{sec}$) is reached. The partial-occlusion method was compounded onto the incremental-rehearsal configuration.

3.9. DATA ACQUISITION PROTOCOL

A partitioned data acquisition protocol was employed to minimize continuous exposure to the 3D stereo environment so as to mitigate fatigue and potential adverse symptoms (e.g., dizziness, vertigo, etc.). The partitioned approach was also intended to accommodate the data collection capacity limitations of the Arduino microcontroller

which was an integral part of the low-cost EOG system. The partitions of the protocol consisted of 38 sets of observable stimulus events, in which events amounted to live and virtual fastball pitches as well as static and moving targets used for calibration and baselining. The protocol included 20 sets of 10 treatment events in which no data was collected. The other 18 sets of five data acquisition events were organized into three general categories that included pre-treatment baseline events and interleaved treatment and post-treatment response events. In addition, each set of data acquisition events was preceded and followed by a set of calibration events that established the reference for EOG voltage-to-AOV conversions. The protocol is outlined below and described in the sub-sections that follow:

1. PRE-TREATMENT BASELINE EVENTS (8 sets of 5 events)
 - a. Pre-Treatment Live-Pitch Baseline (2 sets of 5 events)
 - b. Pre-Treatment Virtual-Pitch Baseline (2 sets of 5 events)
 - c. Pre-Treatment Smooth Pursuit/Ramp Nominal Baseline (1 set of 5 events)
 - d. Pre-Treatment Saccade/Step Nominal Baseline (1 set of 5 events)
 - e. Pre-Treatment Threshold Baseline Part 1 (1 set of 5 events)
 - f. Pre-Treatment Threshold Baseline Part 2 (1 set of 5 events)
2. SMOOTH-PURSUIT TREATMENT EVENTS (10 sets of 10 events)
3. SMOOTH-PURSUIT POST-TREATMENT EVENTS (4 sets of 5 events)
 - a. Smooth Pursuit Post-Treatment Response Part 1 (1 set of 5 events)
 - b. Smooth Pursuit Post-Treatment Response Part 2 (1 set of 5 events)
 - c. Smooth Pursuit Post-Treatment Response Part 3 (2 sets of 5 events)

4. SACCADE TREATMENT EVENTS (10 sets of 10 events)
5. SACCADE POST-TREATMENT EVENTS (4 sets of 5 events)
 - a. Saccade Threshold Post-Treatment Response Part 1 (1 set of 5 events)
 - b. Smooth Pursuit Threshold Post-Treatment Response Part 2 (1 set of 5 events)
 - c. Smooth Pursuit Threshold Post-Treatment Response Part 3 (2 sets of 5 events)
6. POST TREATMENT TRANSFER EVENTS (2 sets of 5 events)

3.9.1. CALIBRATION EVENTS

Each set of non-treatment data acquisition events consisted of five eye-movement-measurement events that were preceded and followed by a five-angle (-20°, -10°, 0°, +10°, +20°), fixed-target calibration sequence to provide a reliable EOG voltage-to-AOV conversion reference as well as to validate the EOG system measurements.

The redundant and repeated before-and-after dual-calibration approach was necessary (and has been recommended [172]) given the persistence of slow baseline drift caused primarily by the polarization of electrodes and changes in skin resistance [172], retinal potential changes due to ambient light changes (unavoidable in this study since the lab limitations involved exposure to outdoor light with live pitches and no exposure to outdoor light with virtual pitches) [173], contamination from electroencephalographic (EEG) and electromyographic (EMG) artifacts, and other potential sources (e.g., individual physiology, etc.) common in EOG data acquisition.

The low-cost EOG system relied on precision and filtering capabilities intrinsic to the Linear Technology LT1167 integrated precision instrumentation amplifier (Linear Technology, Milpitas, CA), and on passive low-pass filters ($f_c = 50$ Hz) between electrode leads and instrumentation amplifier inputs to mitigate 60 Hz power line and radio frequency ambient noise, but it did not incorporate circuitry or other capabilities to arrest baseline voltage drift.

In each of the two before-and-after calibration events, participants fixated on each of five fixed targets for 3 seconds. The targets were located directly in front of the participant (i.e., center = 0°) and at two locations to the left and right corresponding to $\pm 10^\circ$ and $\pm 20^\circ$. For live-pitch events, the targets were physically located on a perpendicular wall 20 ft away from the observer, whereas for virtual-pitch events the targets were displayed on a perpendicular screen 7 ft away from the observer. In both cases the targets were 6 ft from the ground (i.e., approximate eye-level of fastball trajectory at terminal phase). The physical targets were white disks 4 inches in diameter with 3-inch black numbers (1-5) identifying the targets (from left to right) and a half-inch dot in the middle to mitigate eye movement during target fixations. The 4-inch diameter (i.e., 1° eccentricity at 20 ft distance) was selected arbitrarily over the 2.865-inch baseball silhouette diameter to facilitate target location and mitigate eye-movement within central-vision eccentricity. The virtual targets were baseballs of 2.865-inch baseball silhouette diameter (i.e., 2° eccentricity at 7ft distance).

The calibration events produced EOG voltage recordings similar to Fig. 24. The mean of each of the five voltage levels was computed and interpolation

was employed (explained in Section 3.10.3 – EOG-VOLTAGE TO AOV-DEGREE CONVERSION) to estimate the eye-movement orientation during tracking a fastball trajectories.

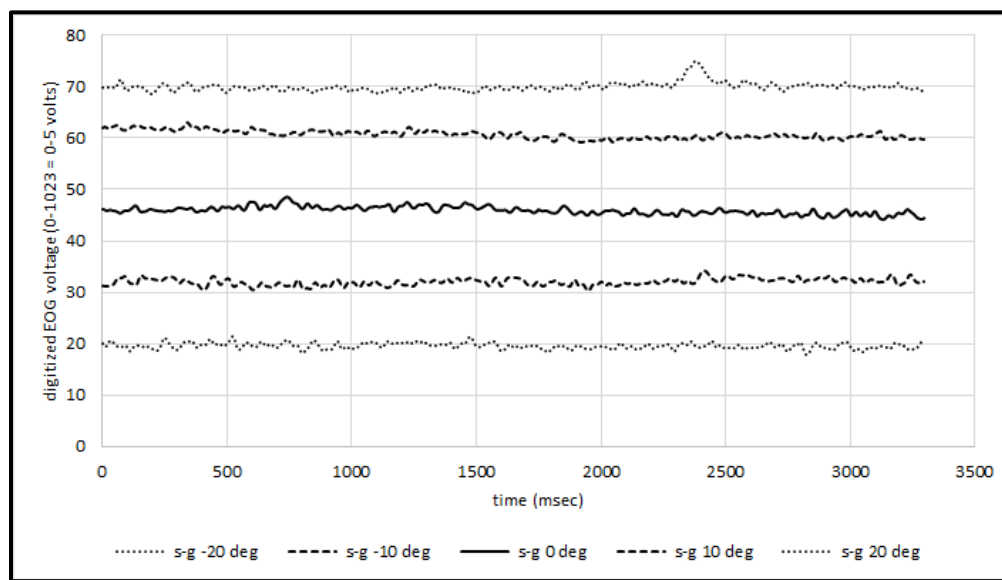

Fig. 24. Sample EOG Recording of Fixed-Target Calibration.

3.9.2. PRE-TREATMENT LIVE- AND VIRTUAL-PITCH BASELINE EVENTS

The data acquisition protocol included pre-treatment data-acquisition baseline events intended to establish the subjects' initial conditions —that is, their ability to keep their eye on a 60-mph fastball trajectory prior to receiving any treatment.

In the Pre-Treatment Live-Pitch Baseline events, participants viewed two sets of five live-pitch 60-mph fastballs, and in the Pre-Treatment Virtual-Pitch Baseline events, participants viewed two sets of five virtual-pitch 60-mph fastballs (Section 3.3 describes the configurations of the live- and virtual-pitch

stimuli). Each set of five-pitches was preceded and followed by calibration measurements (as explained previously in Section 3.9.1). These baseline measurements were counterbalanced such that subjects with odd-number identifiers observed live pitches followed by virtual pitches, whereas the order of live and virtual pitch sets was reversed for subjects with even-numbered identifiers. Fig. 25 and Fig. 26 present five-pitch sample baselines representative of pre-treatment virtual-pitch and pre-treatment live-pitch event recordings, respectively.

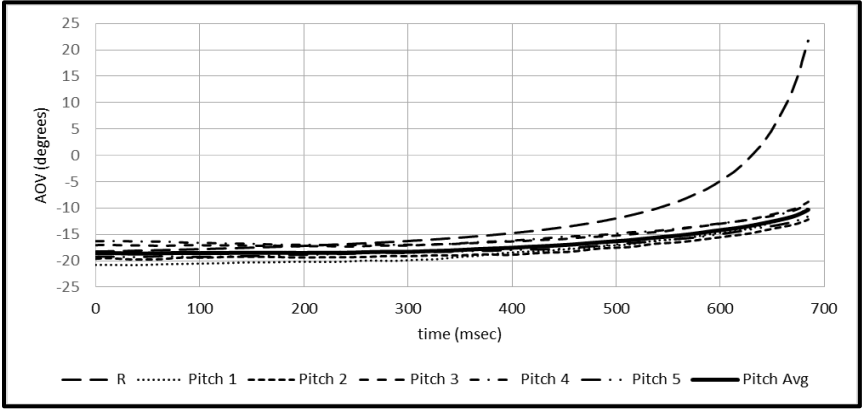

Fig. 25. Sample EOG Recording of Pre-Treatment Baseline for Virtual-Pitch Tracking.

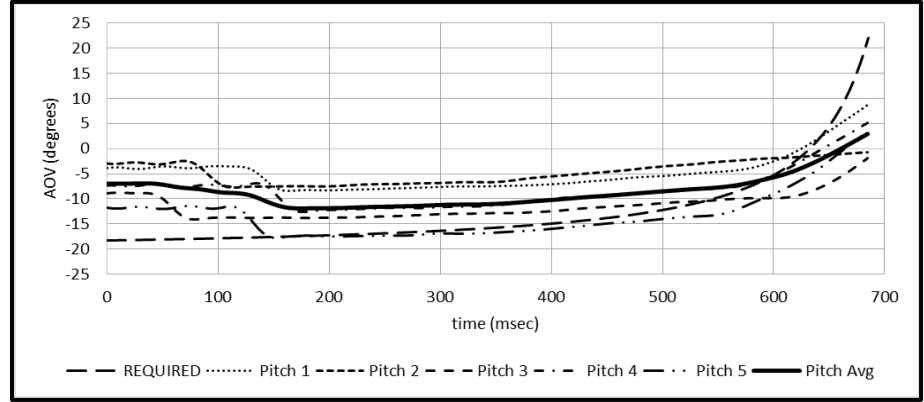

Fig. 26. Sample EOG Recording of Pre-Treatment Baseline for Live-Pitch Tracking.

3.9.3. PRE-TREATMENT THRESHOLD BASELINE EVENTS

The data acquisition protocol included pre-treatment data-acquisition events intended to provide nominal and threshold eye rotation baselines as well as redundant validation of EOG system measurements.

The Pre-Treatment Smooth Pursuit/Ramp Nominal Baseline events provided horizontal eye-rotation measurements to establish nominal smooth-pursuit ability. The stimuli consisted of one set of five individual target events each moving continuously left-to-right on a perpendicular plane 7 ft away from the observer. The target moved on a horizontal linear path at 12 mph requiring horizontal eye rotation of $12^\circ/\text{sec}$. The target speed and general configuration of the protocol were arbitrary (the entire event was equivalent to the duration of a 12 mph pitch), but were similar to previous studies which aimed to quantify smooth pursuit in normal subjects [19, 62]. Fig. 27 presents a sample baseline recording representative of smooth pursuit baseline events. The five smooth-pursuit threshold baseline events were preceded and followed by calibration measurements (as explained previously in Section 3.9.1).

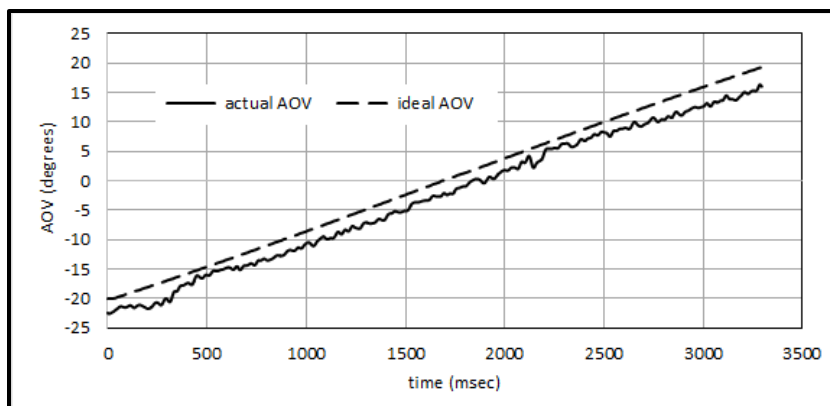

Fig. 27. Sample EOG Recording of Smooth-Pursuit/Ramp Nominal Baseline.

The Pre-Treatment Saccade/Step Nominal Baseline events provided horizontal eye rotation measurements to establish nominal saccadic ability. The stimuli consisted of one set of five individual targets each moving step-wise left-to-right on a perpendicular plane 7 ft away from the observer. The target moved instantaneously from -20° to $+20^{\circ}$ in 10° increments with inter-stimulus interval (ISI) of 1300 msec. The target amplitude, ISI, and general configuration of the protocol were arbitrary (the entire event sequence was equivalent to the duration of a 6-mph pitch) but were similar to previous studies which aimed to quantify saccades in normal subjects [174, 175]. Fig. 28 presents a sample baseline recording representative of saccade baseline events. The five saccade threshold baseline events were preceded and followed by calibration measurements (as explained previously in Section 3.9.1).

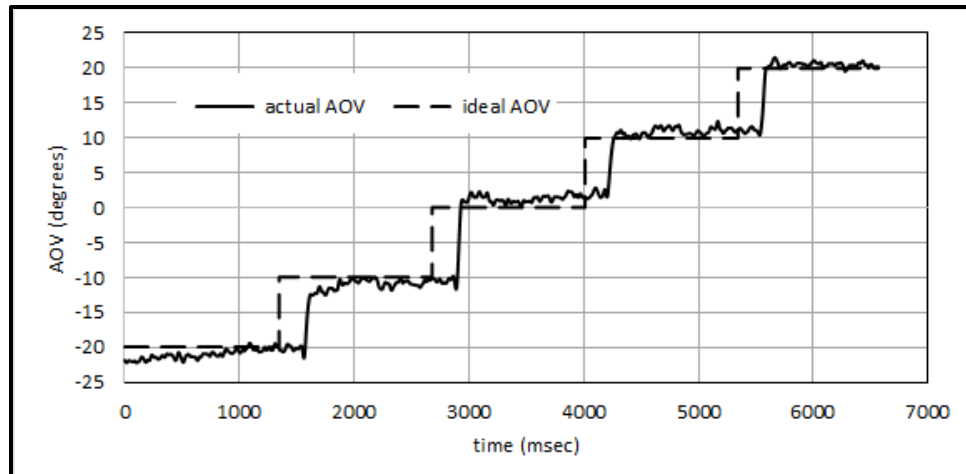

Fig. 28. Sample EOG Recording of Saccade/Step Nominal Baseline.

The Pre-Treatment Threshold Baseline Part 1 and Part 2 events were intended to provide horizontal eye-rotation measurements to establish a smooth-pursuit threshold reference during fastball tracking. Threshold measurements not only indicated the maximum speed at which participants were able to coherently “keep their eye on the ball” with smooth pursuit, but also informed the treatment strategy. The stimuli for each part consisted of one set of five virtual-pitch fastballs in slow motion from 100% to 60% (Part 1) and from 50% to 10% (Part 2) of target speed (60 mph) in 10% speed decrements. Fig. 29 presents selected sample eye-rotation recordings representative of threshold baseline events. Each set of five-pitches was preceded and followed by calibration measurements (as explained previously in Section 3.9.1).

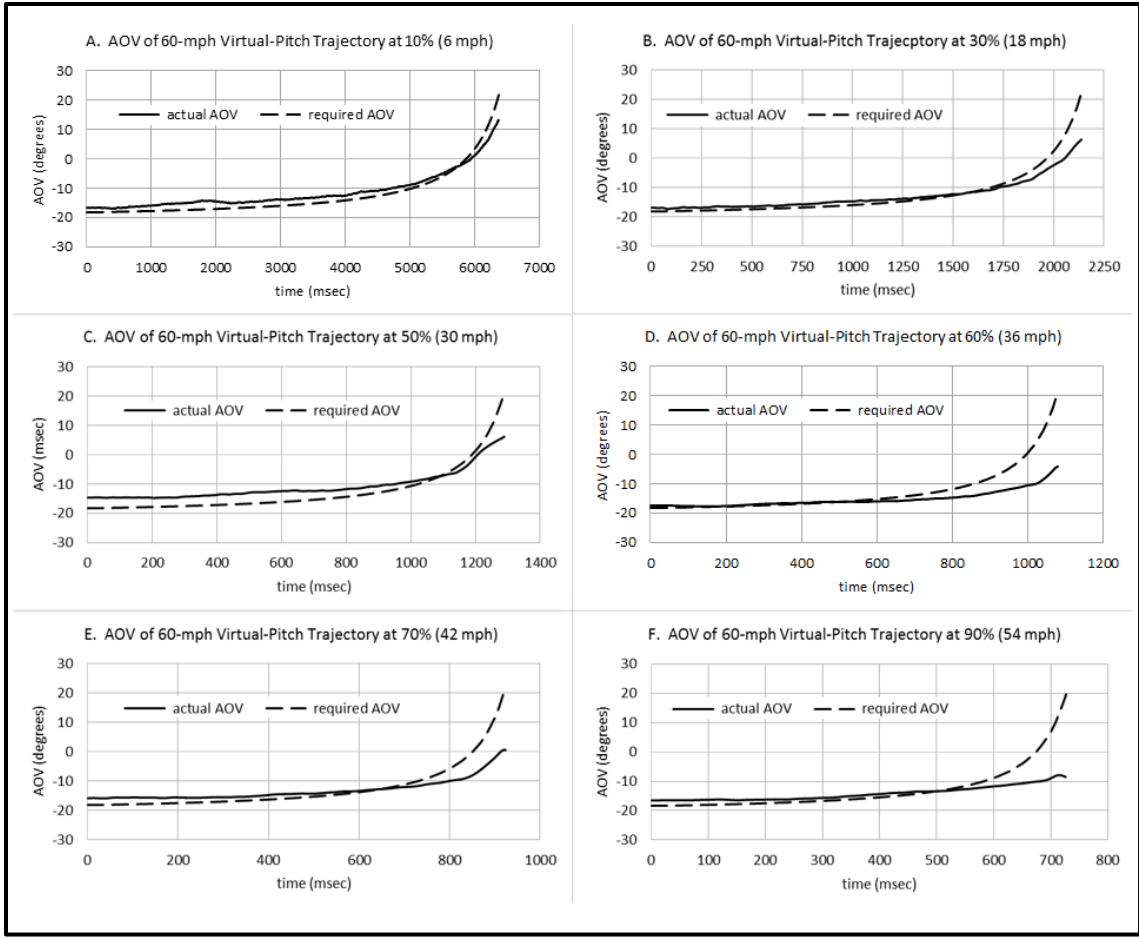

Fig. 29. Sample EOG Recordings of Threshold Baseline Events.

3.9.4. SMOOTH PURSUIT TREATMENT EVENTS

The training protocol employed an incremental-rehearsal paradigm to modulate and improve smooth-pursuit thresholds, as described previously in Section 3.8. No eye-rotation measurements were collected during these treatment events.

3.9.5. SMOOTH PURSUIT POST-TREATMENT EVENTS

The data acquisition protocol included post-smooth-pursuit-treatment data-acquisition events intended to provide objective measures of the smooth-pursuit treatment effect.

The Smooth Pursuit Post-Treatment Response Part 1 and Part 2 events provided horizontal eye-rotation measurements to analyze and determine any improvement in smooth-pursuit ability measured against the smooth-pursuit threshold baseline. The stimuli for each of these two parts was similar to, but in reverse order from, the Pre-Treatment Threshold Baseline Part 1 and Part 2 events. They consisted of one set of five virtual-pitch fastballs in slow motion from 10% to 50% (Part 1) and from 60% to 100% (Part 2) of target speed (60 mph) in 10% speed increments. The type of eye-rotation measurement outcomes for these events were similar to the samples presented in Fig. 29. Each set of five-pitches was preceded and followed by calibration measurements (as explained previously in Section 3.9.1).

The Smooth Pursuit Post-Treatment Response Part 3 events were intended to provide objective measures of subjects' ability to keep their eye on a 60-mph fastball trajectory after receiving the incremental-rehearsal treatment for smooth pursuit improvement measured against the pre-treatment virtual-pitch baseline. The protocol for these post-treatment events was identical to that of the Pre-Treatment Virtual-Pitch Baseline events. That is, participants viewed two sets of five virtual-pitch 60-mph fastballs. The type of eye-rotation measurement outcomes for these events were similar to the samples presented in Fig. 25. Each set of five-pitches was preceded and followed by calibration measurements (as explained previously in Section 3.9.1).

3.9.6. SACCADE TREATMENT EVENTS

The training protocol employed a partial-occlusion paradigm in tandem with incremental-rehearsal to instigate and modulate saccadic eye movements as described previously in Section 3.8. No eye-rotation measurements were collected during these treatment events.

3.9.7. SACCADE POST-TREATMENT EVENTS

The data acquisition protocol included post-saccade-treatment data-acquisition events intended to provide objective measures of the saccade treatment effect. The Saccade Post-Treatment Response Part 1 and Part 2 events provided horizontal eye-rotation measurements to analyze and determine any improvement in saccade ability measured against the smooth-pursuit threshold baseline. The stimuli for each of these two parts was similar to, but in reverse order from, the Pre-Treatment Threshold Baseline Part 1 and Part 2 events. They consisted of one set of five virtual-pitch fastballs in slow motion from 10% to 50% (Part 1) and from 60% to 100% (Part 2) of target speed (60 mph) in 10% speed increments. The type of eye-rotation measurement outcomes for these events were similar to the samples presented in Fig. 29. Each set of five-pitches was preceded and followed by calibration measurements (as explained previously in Section 3.9.1).

The Saccade Post-Treatment Response Part 3 events were intended to provide objective measures of subjects' ability to make strategic saccades after receiving the partial-occlusion treatment in tandem with incremental-rehearsal measured against the

pre-treatment virtual-pitch baseline. The protocol for these post-treatment events was identical to that of the Pre-Treatment Virtual-Pitch Baseline events. That is, participants viewed two sets of five virtual-pitch 60-mph fastballs. The type of eye-rotation measurement outcomes for these events were similar to the samples presented in Fig. 25. Each set of five-pitches was preceded and followed by calibration measurements (as explained previously in Section 3.9.1).

3.9.8. POST-TREATMENT TRANSFER EVENTS

The data acquisition protocol included post-treatment data-acquisition events intended to provide ToT objective measures. These events provided horizontal eye-rotation measurements to analyze and determine if the incremental-rehearsal and partial-occlusion treatment transferred to the real task measured against the pre-treatment live-pitch baseline.

The protocol for these post-treatment events was identical to that of the Pre-Treatment Live-Pitch Baseline events. That is, participants viewed two sets of five live-pitch 60-mph fastballs. The type of eye-rotation measurement outcomes for these events were similar to the samples presented in Fig. 26. Each set of five-pitches was preceded and followed by calibration measurements (as explained previously in Section 3.9.1).

3.10. DATA PROCESSING

Data processing consisted primarily of noise and artifact filtering, conversion from EOG voltages to AOV degrees, and formatting data into Microsoft Excel (Microsoft, Seattle, WA) spreadsheets for analysis. Normalization post-processing for the 60-mph live- and virtual-pitch fastball data acquisition events was not necessary,

since configuration of the live-pitch simulator produced consistent fastballs with initial 60-mph velocity and total flight time of approximately 685 msec, and the virtual-pitch simulator was programmed to match the live-pitch initial velocity and total flight time.

3.10.1. DATA FILTERING

A Savitzky–Golay (S-G) smoothing filter [176] was used to improve the signal-to-noise ratio of the EOG recordings without greatly distorting the signals. S-G filtering was a custom implementation written in the C language within the Client to expedite verification and usability of event data immediately after acquisition. The S-G filter implementation employed the convolution coefficients corresponding to a quadratic polynomial and a window size of 25 [176]. Fig. 30 illustrates a sample raw data set from this study processed by the custom S-G digital filter implementation.

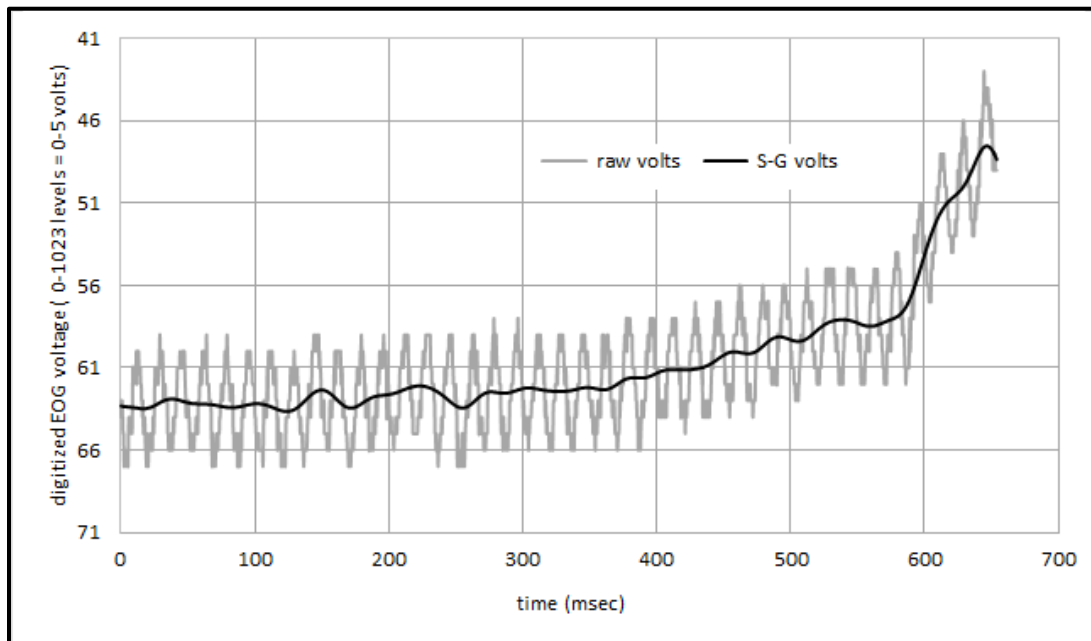

Fig. 30. Sample Raw EOG Signal Processed with Savitsky-Golay Digital Filter.

3.10.2. DATA INTERPOLATION

Data was sampled at approximately 3266 Hz such that it was not strictly equispaced. As such, the time stamp of corresponding data points between trials and relative to the theoretical required AOV varied slightly in the order of one or two hundredths of a msec. The comparison of multiple trials required that data be sampled at equispaced design points. Interpolation was used to resample irregularly spaced data at 3100 Hz as has been done elsewhere [177] resulting in consistent equispaced data sets amenable to statistical analysis.

3.10.3. EOG-VOLTAGE TO AOV-DEGREE CONVERSION

Conversion of measured retinal potentials (EOG voltages) to positional AOV degrees employed linear interpolation using the time-stamped pre- and post-event calibration references and initial time-stamps of each event within a set of events. Fig. 31 presents a sample set of pre- and post-event calibration recordings (after S-G filtering) showing typical baseline drift, and Fig. 32 presents a composite of the corresponding mean values of those calibration voltages. The linear correspondence among the five AOV voltage levels in that time frame (a little more than 3 minutes) suggests that the baseline drift is approximately linear across the working AOV range (-20° to $+20^{\circ}$) for at least the short periods of time used in the eye-rotation measurement events for this study. As such, it was determined that linear interpolation was suitable to estimate EOG voltages and AOV degrees from the pre- and post-event calibration references.

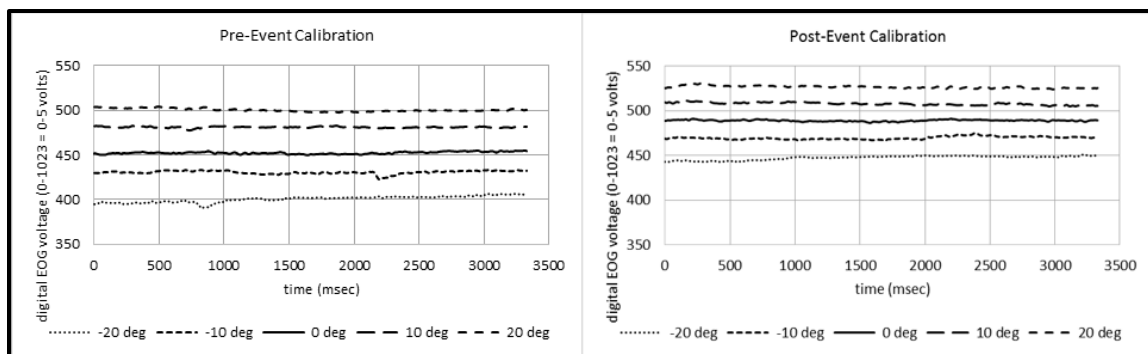

Fig. 31. Sample Pre- and Post-Event Calibration Recordings Showing Baseline Drift.

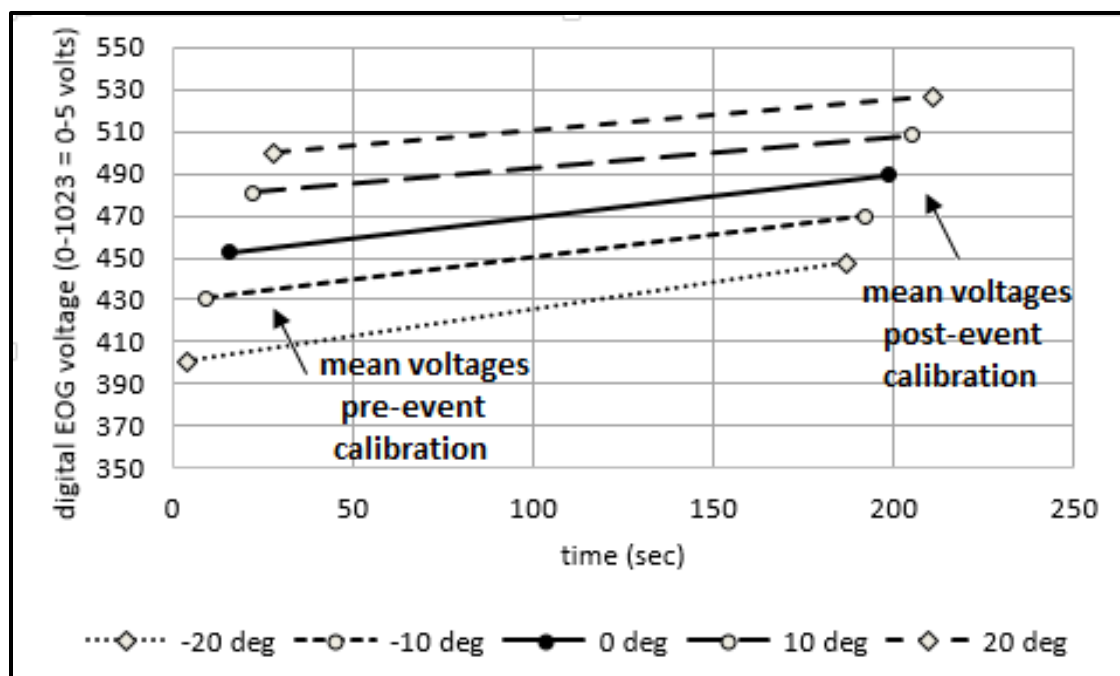

Fig. 32. Sample Mean Voltages of Pre- and Post-Event Calibration Baseline Drift.

3.11. DATA ANALYSIS

The exploratory study adopted an analytical approach resembling those used for interpreting results of single-subject research designs [156, 158-161, 178-181]. It involved preliminary visual/contextual analyses as well as descriptive and non-parametric statistical analysis. The approach considered the four measurement comparisons

(described in the next section) corresponding to each of the research questions.

Preliminary visual analysis provided quantitative reference frame and a “lay of the land” overview. It consisted of calibration and baseline measures, as well as of positional AOV measurement trends of total trajectory durations along with corresponding computations of mean absolute error (MAE). Contextual analysis relied on main sequence saccade parameter relationships described previously (Section 2.3.3), as well as on descriptive and non-parametric statistical analysis, to provide contextual insights and significance of catchup saccade onset time and amplitude measurements involving transitions between smooth pursuit and saccades.

3.11.1. MEASUREMENT COMPARISONS

The first research question concerned the validation of virtual fastballs, and thus compared combinations of eye-movement responses from batters of various skill levels to live and virtual pitches, pre-treatment. The second research question concerned insights about the difference in batter expertise and thus compared eye-movement responses/strategies between more-experienced and less-experienced batters subject to live and virtual pitches, pre-treatment. The third research question concerned eye-movement modulation resulting from virtual-pitch treatment, and thus compared eye-movement responses to virtual pitches only pre- and post-treatment. The fourth research question concerned transfer of the virtual treatment to the live-pitch task and thus compared eye-movement responses to live pitches only pre- and post-treatment.

3.11.2. PRELIMINARY ANALYSIS

The preliminary analysis resembled the visual analysis of graphed data approach used in interpreting results of single-subject research designs [158, 178]. It consisted of an initial review of data sets shortly after collection not only to ensure that the experimental design was appropriate and informative, but also to inform and guide the detailed analysis approach. For example, the experimental design initially selected 80 mph as the target velocity, but the preliminary review of initial subjects revealed that while more-experienced batters were able to follow the ball to some extent, less-experienced batters did not cope well, such that resulting eye-movement responses were largely flat (e.g., Fig. 33) and lacking in useful information for eye-movement assessment. The modified protocol reduced the target velocity to 60 mph, resulting in eye-movement responses from which saccadic activity profiles could be better discerned (e.g., Fig. 34).

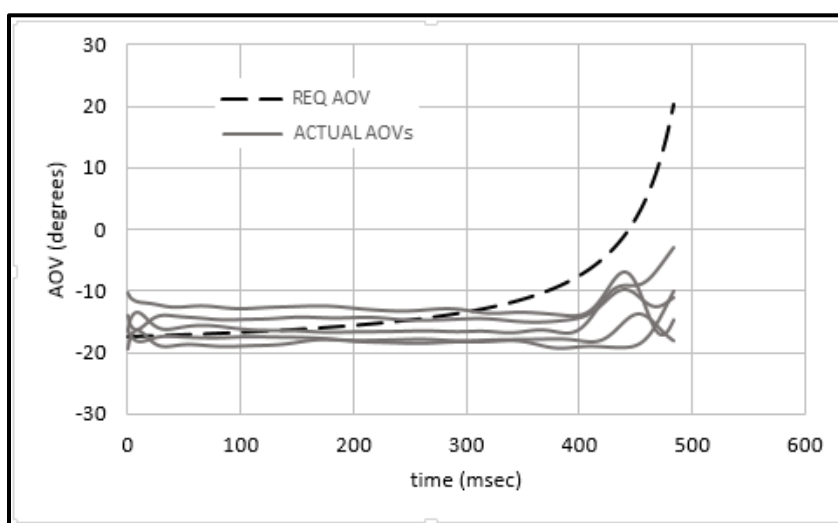

Fig. 33. Sample Data Set of 80-mph Live-Pitch Post-Treatment AOY Measures (S8).

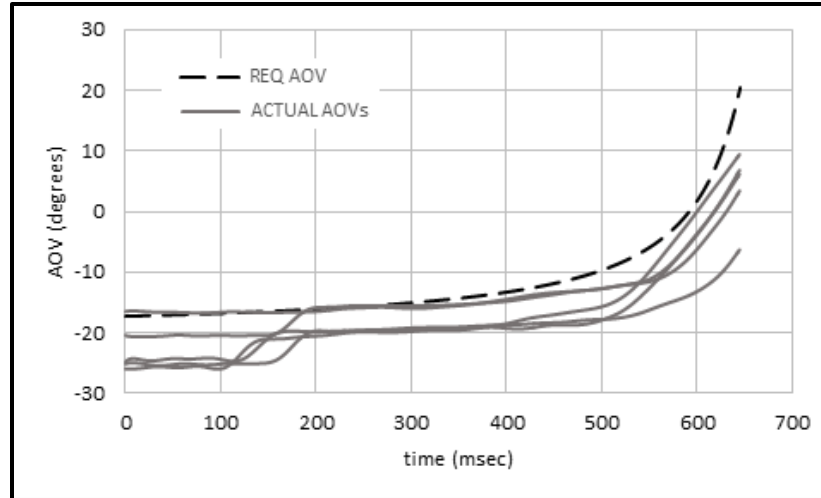

Fig. 34. Sample Data Set of 60-mph Live-Pitch Post-Treatment AOV Measures (S3).

The preliminary analysis computed the MAE at each time increment for the set of individual participant trials (e.g., Fig. 35) within each event category, as well for the aggregate of all participants also within each event category. The 60-mph and 80-mph data sets were analyzed separately but were compared informally, in order to derive insights on batter expertise differences. The horizontal axis of the MAE plots was normalized to the percentage of time covering the total flight of the fastball trajectory corresponding to the FOV of interest (i.e., $AOV = -20^{\circ}$ to $+20^{\circ}$).

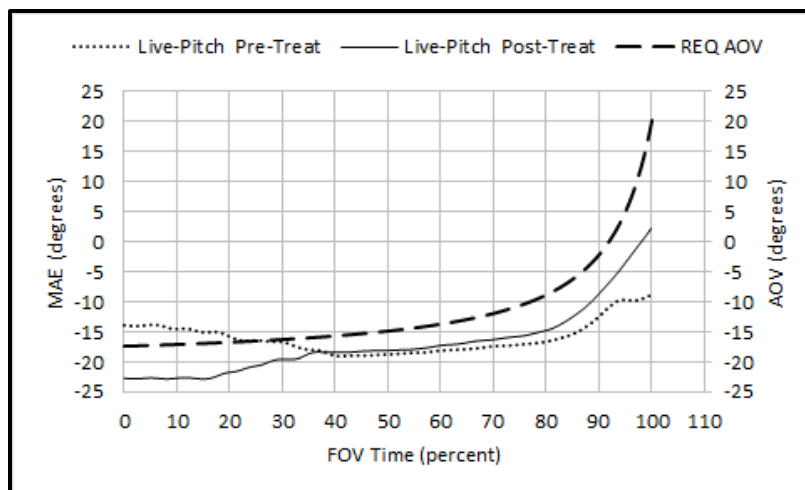

Fig. 35. Sample MAE of 60-mph Live-Pitch Pre- and Post-Treatment Data Sets (S3).

The MAE plots from the preliminary analytical approach provided quantitative objective measures of general eye orientation, but were insufficient, not only for characterizing saccades or for detecting transitions from smooth pursuit to saccades, but also for ascertaining the significance of eye-movement measurement comparisons. This limitation was addressed by the contextual analysis, which relied on main-sequence saccade onset time, peak velocity, and amplitude relationships.

3.11.3. CONTEXTUAL ANALYSIS

Saccades are extremely stereotyped, such that, for normal subjects, the relationship between amplitude and duration is fairly linear, and the relationship between amplitude and maximum velocity can be estimated by an exponential curve [110, 111, 113, 182-191]. Smooth pursuit parameters are not as stereotyped as saccades, making them more difficult to estimate, but the main-sequence saccade parameters were

sufficient to estimate the onset of saccades from which transitions from smooth pursuit to saccades could be inferred.

The main-sequence analysis focused on catchup saccade onset times and amplitudes derived from positional AOV involved in transitions from smooth pursuit to saccades. Contextually, measurement comparisons based on these two derived variables reveal the time when saccades are executed relative to the smooth pursuit maximum velocity threshold and the size of the saccade needed from its onset in order to orient the eye near the front edge of the home plate leading up to the location where the bat hits the ball. The analysis scrutinized the terminal phase of the fastball trajectory where these transitions are likely to take place. The maximum velocity of smooth pursuit has been estimated to be in the order of 50° - 70° /sec [61] and the onset of saccades has been identified by velocities of at least 30° - 40° /sec sustained for a minimum of 30 msec [113, 188]. From the required angular velocity profile for 60-mph fastballs illustrated in Fig. 36, it can be ascertained that angular velocities in the range of 30° - 70° /sec—corresponding to the smooth pursuit-saccade transition region— occur in the 400-500 msec range of the approximate 685 msec duration of a 60-mph fastball flight. This time period also corresponds approximately to a range of 60-80% of the total time the fastball trajectory is in the FOV of interest spanning an $AOV = -20^{\circ}$ to $+20^{\circ}$.

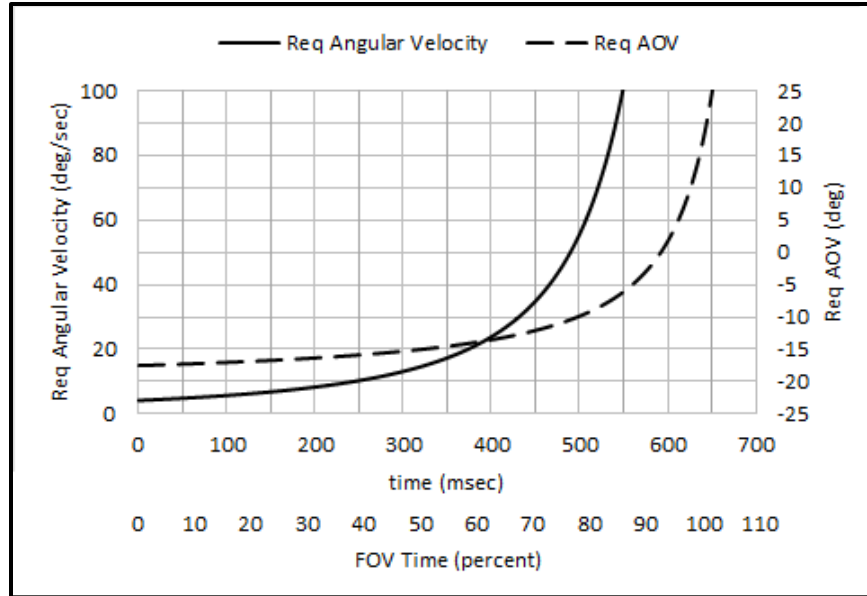

Fig. 36. Required AOV and Angular Velocity for 60-mph Fastball.

The main-sequence analysis extracted AOV position measurements beyond the 400 msec time period (i.e., terminal phase) for each participant in both 60-mph and 80-mph trials. These position measurements were differentiated to produce saccade velocity curves. A least-squares analysis was conducted to fit an Exponentially Modified Gaussian distribution [192, 193] (of the form of equation (32)) to the saccade velocity curves.

$$f(x; \mu, \sigma, \lambda) = \frac{\lambda}{2} + e^{\frac{\lambda}{2}(2\mu + \lambda\sigma^2 - 2x)} \operatorname{erfc}\left(\frac{\mu + \lambda\sigma^2 - x}{\sqrt{2}\sigma}\right) \quad (21)$$

This Exponentially Modified Gaussian model was selected based on its similarity of asymmetry and skewness against the saccade characteristics of study participants observed in the preliminary analysis phase. A custom C program was developed to compute the velocity curves from the actual positional AOV measurements as well as

their corresponding characteristic saccade velocity Exponentially Modified Gaussian models. The program performed iterative combinations of the mean of Gaussian component (μ), variance of Gaussian component (σ), and rate of exponential component (λ) to compute corresponding sum of squares (SS), residual sum of squares (SSE), and the coefficients of determination (R^2) to ascertain goodness of fit. The main sequence parameters (peak velocity, duration, and amplitude) for each saccade were derived from its corresponding Exponentially Modified Gaussian model. Sample AOV and velocity plots for a representative saccade collected in this study are presented in Fig. 37, and the same velocity plot, along with a corresponding fitted Exponentially Modified Gaussian model and differentiated acceleration curve from the fitted Exponentially Modified Gaussian model, is presented in Fig. 38.

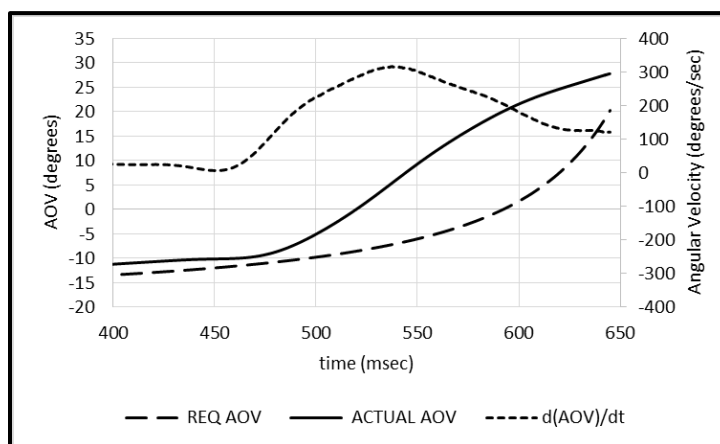

Fig. 37. Measured AOV and Derived Angular Velocity of 60-mph Live-Pitch (S1).

The onset of a saccade was assumed to be the first instance of an angular velocity exceeding $40^\circ/\text{sec}$ with duration of at least 30 msec [113] and occurring prior to the trial maximum velocity (which generally corresponded to the saccade maximum velocity).

The time corresponding to the saccade onset was derived from the Exponentially Modified Gaussian model by iterating the time variable (x in equation (32) and in Fig. 38) to meet the velocity threshold set at $40^\circ/\text{sec}$.

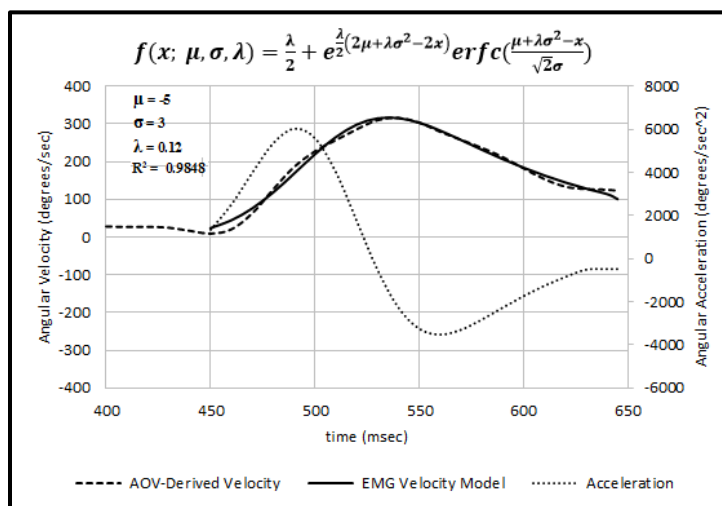

Fig. 38. Derived Angular Velocity and Fitted Exponentially Modified Gaussian Model.

Saccade amplitude was estimated as two times the difference between the AOV at peak velocity and the AOV at saccade onset. An assumption was made that catch-up saccades in the batting task would be in the order of 20° to 30° . This assumption is explained by Fig. 36, which shows that an angular velocity of $40^\circ/\text{sec}$ (approximate limit of smooth pursuit and saccade onset) and an AOV of -11° would be elicited at approximately the 466 msec mark of a 685-msec 60-mph fastball trajectory. From this position (i.e., AOV = -11°), an additional 20° to 30° is required to bring the AOV to approximately 1.5 ft in front of the home plate where contact with the bat is desired. This assumption was supported by preliminary main sequence parameter computations.

Saccade duration was estimated as two times the difference between the time at saccade onset and the time at saccade maximum velocity. This estimate was conservative, as it is commonly used in main sequence estimates for small-to-medium saccades (i.e., less than 20°), which are more symmetrical than large saccades which are skewed. Further, forward saccades (i.e., catch-up saccades that are in the same direction as preceding smooth pursuit movement) tend to be larger, since the smooth pursuit eye movement is added to the saccadic command during catch-up saccades [26]. However, the smooth pursuit component of catch-up saccades was not removed before analysis as has been recommended [26] (due to limited resources), and the assumption of symmetry was intended to compensate for the unremoved smooth pursuit component.

3.11.4. ALTERNATIVE PURSUIT INITIATION THRESHOLD

Eccentricity figures into the spatial-temporal characteristics of the fastball trajectory, relative to eye-movement requirements of the baseball batting task. This study defined the Alternative Pursuit Initiation Threshold (APIT) as the intersection of the inner edge of the central vision FOV with an ideal linear path of the fastball trajectory running from the point-of-release to the center of the back of the home plate (Fig. 39). The APIT will vary among batters, since it depends on their individual foveal eccentricity and on where they fixate at the initiation of the fastball trajectory. But, in general, smooth pursuit will not change much prior to the APIT (approximately less than 2° of change) due to the small AOV requirement in the initial phase of the fastball trajectory.

At the pitcher's point-of-release (approximately 55 ft from the batter's eye), the eccentricity of a baseball is approximately 0.25° while the entirety of foveal eccentricity

(2°) affords a central-vision viewing area equivalent to a 23-inch diameter disk. Having this much “available” central-vision viewing area at the beginning of the pitch is contextually significant, because it may not be necessarily advantageous to initially fixate on the pitchers’ elbow or point-of-release the way expert batters do, as has been reported [31, 32]. That is, a batter may direct the initial point-of-view as much as 23 inches away from the point-of-release and still maintain central vision on the ball. For example, a right-handed batter facing a right-handed pitcher may be able to direct his initial point-of-view to near the pitcher’s left shoulder and still maintain the point-of-release within his central vision (Fig. 39). This is significantly relevant to the elaboration of strategies for “keeping the eye on the ball”, since such a shift in initial fixation would afford a batter central vision on the initial 23 ft (~42%) of the fastball trajectory (compared to half as much benefit when the initial point-of-view is at the point-of-release) without his having to move his eyes at all! It is also relevant to note that the eccentricity required when viewing a baseball does not exceed the 2° central-vision foveal eccentricity until the ball is approximately 7 ft away from the batter (~82% point of the fastball trajectory). Once the ball gets closer than 7 ft, it becomes increasingly difficult to see the ball clearly, and it is more likely that optical illusions will be introduced due to the reliance on peripheral vision. Fig. 39 presents a notional representation of the viewing-area/eccentricity afforded by central-vision (as has been discussed).

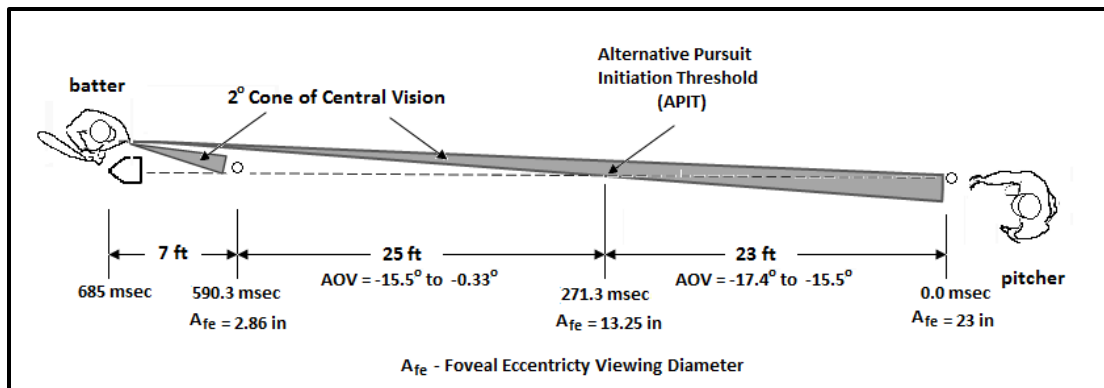

Fig. 39. Notional Field-of-View Coverage by Central Vision (drawing not to scale).

3.11.5. SACCADIC USEFULNESS THRESHOLD

Saccadic suppression, as well as visual cortex processing, also figures into the spatial-temporal characteristics of the fastball trajectory, relative to the eye-movement requirements of the baseball batting task. This study defined the Saccadic Usefulness Threshold (SUT) as the time boundary beyond which the processing time of any visual information obtained following a saccade exceeds the processing time of the visual cortex.

It takes approximately 85-100 ms for visual information to travel to the visual cortex [61]. The saccadic system needs approximately 90 msec to account for changes in target trajectory [26] and, under normal conditions, one saccade cannot follow another within 150 msec [112]. In addition, vision is impaired during the course of a saccade (i.e., saccadic suppression) such that the timing and duration of saccade execution are relevant —particularly as the traveling baseball enters the terminal phase of its trajectory.

Saccades are triggered in response to the accumulation of positional error due to retinal slip [194]. They are triggered when it is not likely that merely increasing smooth pursuit acceleration will catch up to the target [28]. For the 60-mph fastball batting task,

saccades are likely to be triggered at approximately 466 msec after pitch initiation where the angular velocity requirement is approximately $40^\circ/\text{sec}$ —the approximate maximum velocity threshold for smooth pursuit [28]. At this time, the required positional AOV is approximately -11° (in a -20° to $+20^\circ$ FOV) such that a saccade of approximately 29° in magnitude would be required to orient the eye at $+20^\circ$ or approximately 1.5 ft in front of the leading edge of home plate where contact with the bat is desired.

But the time requirement for visual processing (i.e., 85-100 msec) means that a batter may not be able to process information beyond 7 ft in front of the leading edge of the home plate, since it takes approximately 92 msec to travel the final 7 ft of the trajectory. This means that the offset (i.e., end) of a saccade must occur prior to this location in order for it to afford the batter useful information.

In addition, from the saccade duration-amplitude linear relationship [112] and the angular velocity requirement (Fig. 2 and/or Fig. 36), it can be ascertained that saccade amplitudes smaller than 23.5° are not feasible, since their relative duration exceeds the time it takes for a 60-mph fastball to travel the corresponding distance. Besides the duration limit, a 23.5° catch-up saccade corresponds to a required angular velocity at saccade onset of $\sim 140^\circ/\text{sec}$, which exceeds the smooth pursuit maximum velocity threshold. The 23.5° magnitude limit further restricts the SUT to no less than 8.5 ft from the leading edge of the home plate, corresponding to 570 msec of the 685 msec duration of a 60-mph fastball. That is, the onset of saccades must occur well below 570 msec (preferably between 465 and 520 msec) in order to afford useful information. As such, catch-up saccades occurring beyond 570 msec can be regarded as involuntary, even

desperate, attempts to keep up with the ball, indicating that a batter is not very experienced or capable at tracking 60-mph fastballs.

This 60-mph fastball SUT estimate was admittedly conservative, as it does not take into account other oculomotor or neurological processing, or the biomechanical time demands involved in swinging the bat. Nonetheless, it was instrumental in providing a nominal and contextual reference from which determination of batter experience, capability, and improvement could be evaluated. From a preliminary visual analysis of positional AOV measures, it can be ascertained how capable a batter is at “keeping the eye on the ball” based on the average onset time of catch-up saccades.

3.11.6. SINGLE-SUBJECT BOOTSTRAP ANALYSIS

Comparisons of main sequence saccade onset times were performed using single-subject analysis with statistical significance determined by non-parametric bootstrap resampling method. Single-subject designs are instrumental when examining the effectiveness of a treatment, since they do not obscure individual differences, as is the case with conventional group-averaged parametric statistical analysis [159, 179].

Bootstrapping is a robust and accepted non-parametric statistical method that relies on a distribution obtained empirically by iterative resampling the original data, making it a useful alternative when working with small sample sizes and when assumptions of normality and equality of variances cannot be established [156, 160, 161, 180]. The bootstrap method has been employed in single-subject studies and has compared favorably to conventional parametric statistical analysis [156, 181].

A custom C program was developed to compute the bootstrap p-values of saccade onset times for individual participants. The program drew $N = 10,000$ simple random samples of size 20 with replacement from an original data set consisting of 10 data points from each of two sets of saccade onset times. The same was done for each of two sets of saccade magnitudes being compared. The process was further repeated 10 times and the resulting p-values averaged.

CHAPTER 4

RESULTS AND DISCUSSION

The dependent variables for this exploratory study were the catchup saccade onset times and amplitudes (derived from positional AOV) in response to 60-mph live and virtual backspin fastballs. The independent variables were live vs. virtual fastballs for the first aim/research question, more-experienced vs. less-experienced batters for the second aim/research question, and pre- vs. post-treatment for the third and fourth aims/research questions. Analysis of results relied on single-subject research design methods using visual analysis of positional AOV measures as well as on non-parametric and descriptive parametric statistical analysis. Although this study focused on horizontal eye movements, and subjects were asked to refrain from moving their heads during eye-movement measurements, some movement and variations caused by reflex, anxiety, habit, and ball-tracking style were inevitable. As such, the single-subject analytical approach was selected, since it is deemed appropriate when the sample size is small (as was the case in this exploratory study (n=5)) and when the characteristics of the phenomenon under study may be obscured by conventional group-averaged parametric statistical analysis [159, 179].

4.1. REFERENCE MEASURES

Single-subject analysis relies on baseline measures to use as references against measures following the administration of an intervention or treatment. For this exploratory study, it was necessary to obtain calibration baselines to establish proper functioning of data acquisition instrumentation, nominal smooth-pursuit and saccade

baselines to establish subjects' eye-movement abilities and to further validate the experimental setup, and threshold baselines to gauge eye-movement abilities.

4.1.1. CALIBRATION BASELINES

Visual analysis was the primary approach used to evaluate calibration and baseline trials, and it was chiefly concerned with the integrity of the data collection method and set-up, and data usefulness. A head-rest frame was incorporated as a feature of the observation deck (see Fig. 23, panel C) to stabilize subjects' heads during testing. The frame provided a chin-rest and offered a beam on which the right side of the head could be rested. Subjects were instructed to assume a comfortable stance and to refrain from moving their heads—but heads were not restrained—making it possible that some head movement may have taken place (and thereby compromising the integrity and usefulness of the data), especially during live pitches about which some of the subjects may have felt uneasy, notwithstanding assurances made to them that the observation deck window was made of $\frac{3}{4}$ " shatter-proof polycarbonate.

During the calibration trials, subjects did not seem to move their heads. Fig. 40 presents representative samples of the calibration voltages and the corresponding conversions to positional AOV. Accuracy for each calibration angle was computed as the mean absolute error (MAE) divided by the 40° (i.e., -20° to $+20^\circ$) FOV range. Calibration accuracies were generally well within 5%, and similar to the accuracies computed for the calibration measurements in Fig. 40 (i.e., 2.34%, 0.91%, 0.92%, 0.77%, and 0.94% for the -20° , -10° , 0° , $+10^\circ$, and $+20^\circ$ AOVs, respectively).

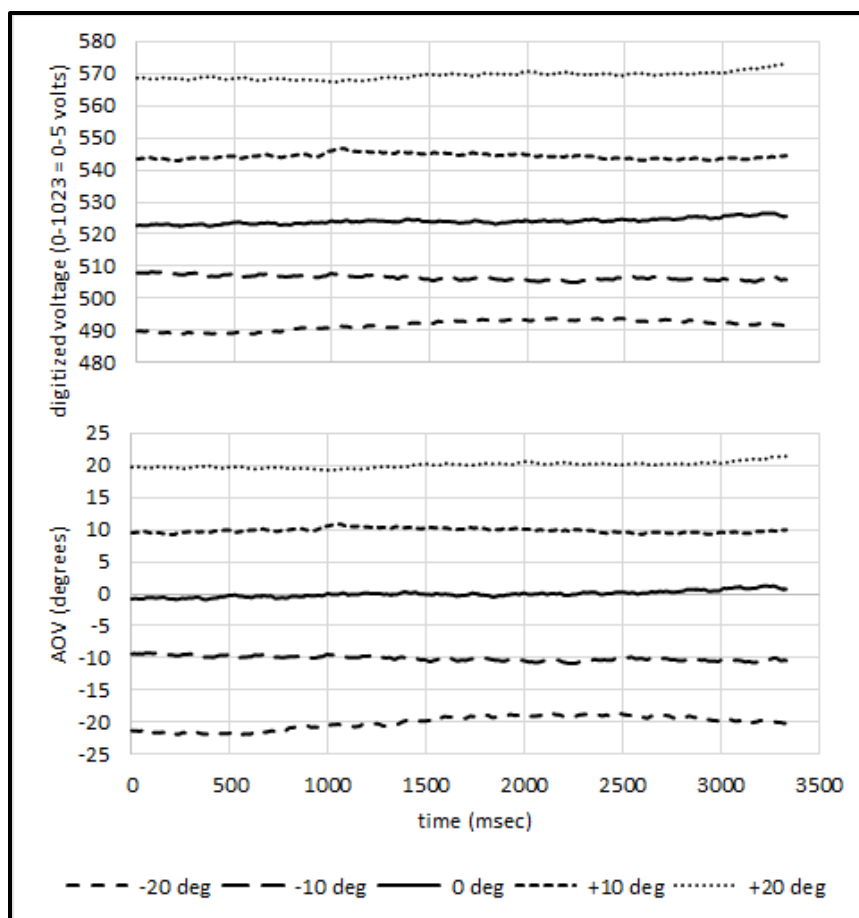

Fig. 40. Sample EOG to Voltage Conversion of Fixed-Target Calibration.

4.1.2. RAMP AND STEP BASELINES

Ramp and step baselines were obtained, in order to ascertain subjects' smooth pursuit and saccadic abilities. Representative baselines of smooth-pursuit/ramp and saccade/step are presented in Fig. 41 and Fig. 42, respectively. Eye position accuracy for the ramp and step baselines was computed as with the static-target calibration. Eye position accuracies for ramp baselines were within 5%, similar to Fig. 41 (i.e., 3.08%). Accuracies for step baselines were within 10%, similar to Fig. 42 (i.e., 6.93%). The difference in accuracies between ramp and step were largely due to latencies at saccade onset (200-280 msec in Fig. 42; typical is approximately 100 msec [61]). Velocity

accuracy for the ramp was between 10% and 12% (10.89% or 1.3°/sec for trial in Fig. 41) for a target moving on a horizontal linear path at 12 mph requiring horizontal eye rotation of 12°/sec.

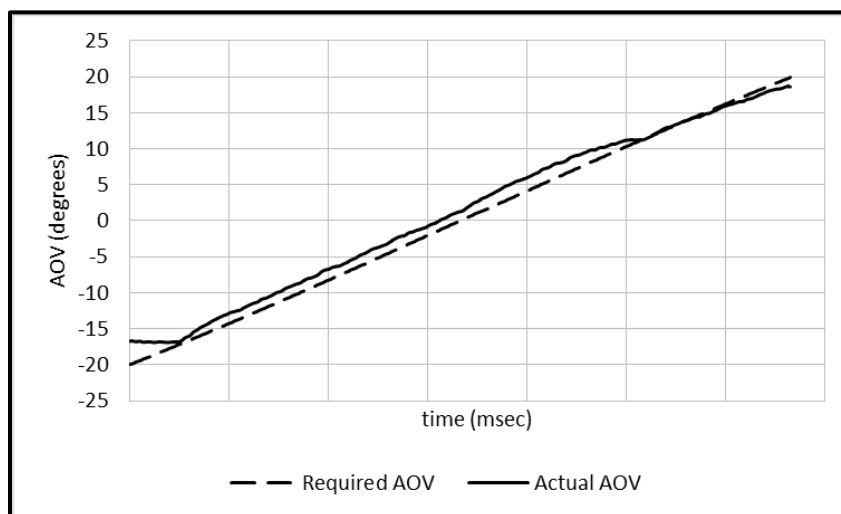

Fig. 41. Sample Smooth-Pursuit/Ramp Baseline Calibration without Head Movement.

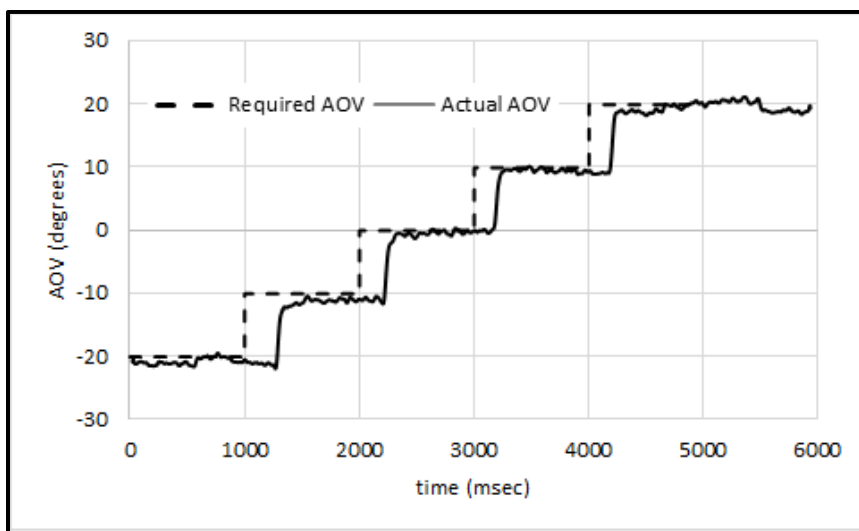

Fig. 42. Sample Saccade/Step Baseline Calibration without Head Movement.

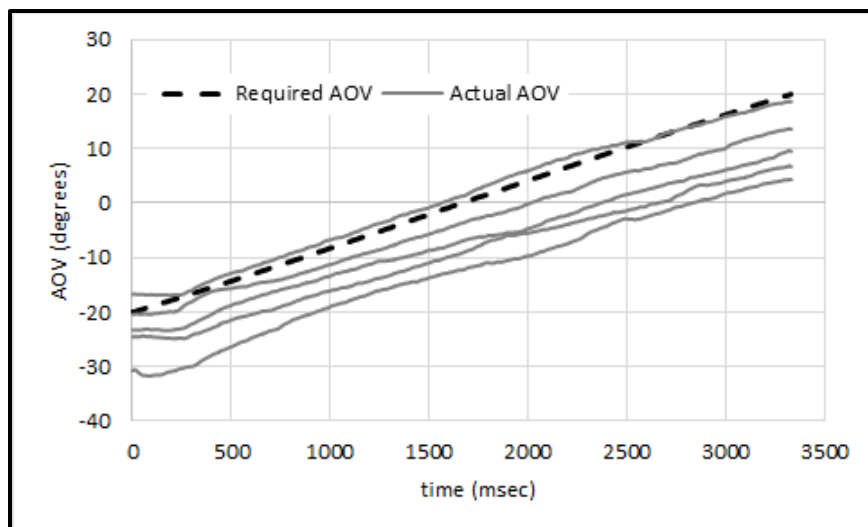

Fig. 43. Sample Smooth-Pursuit/Ramp Baseline Variations due to Head Movement.

Ramp and step baseline measurements were instrumental in detecting head movements and other pursuit and saccadic tendencies. Although subjects were instructed to keep their heads still and only to move their eyes to track the targets, they likely did not realize the sensitivity of head movements (e.g., one inch of head rotation arc corresponds approximately to 14° of AOY displacement). Head movements are manifested in Fig. 43 showing smooth-pursuit ramps with appropriate slope but displaced from the reference due to head repositioning prior to trial initiations. The normalization (interpolation) process ruled out baseline voltage drift, since the same process/algorithm was used in and validated with the static target calibrations, and since the displacements were not progressive but intermixed, providing strong evidence that the head was adjusted back and forth. Step baselines revealed the use of multiple small saccades during a step (Fig. 44) and head movement during fixations prior to and following saccades (Fig. 45), illustrating similar potential inaccuracies during fastball trials.

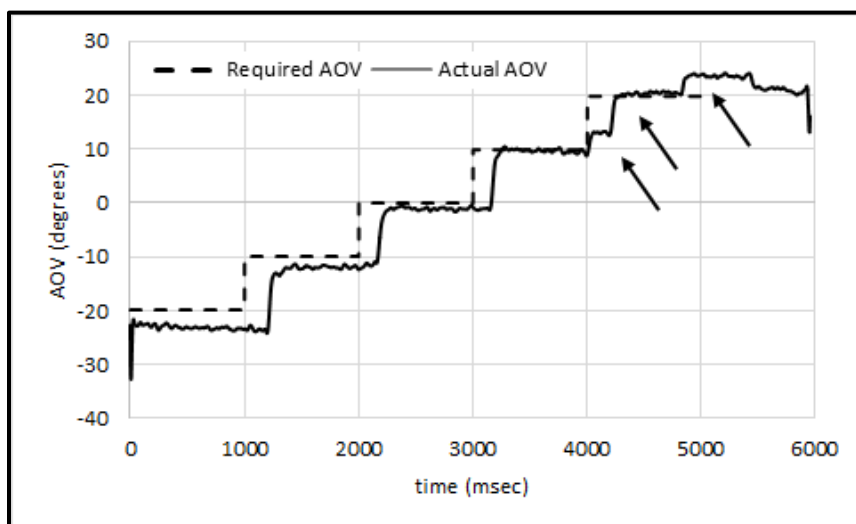

Fig. 44. Sample Saccade/Step Baseline Using Multiple Saccades in Single Step.

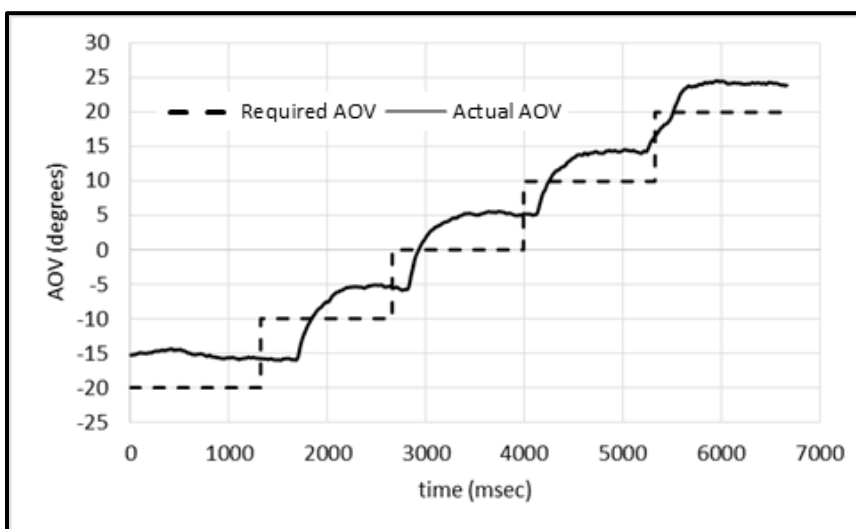

Fig. 45. Sample Saccade/Step Baseline Drift and Offset due to Head Movement.

4.1.3. THRESHOLD BASELINES

Threshold baseline measurements consisted of virtual 60-mph fastballs presented in slow motion speeds in 10% increments from 10% to 100% of the 60-mph target fastball speed. These measurements were intended to gain insight beyond whether or not a batter could keep up with a 60-mph fastball and to ascertain the batter's tracking capability limit (or threshold).

Threshold baselines provided not only insights into batter tracking abilities but also redundant validation to the calibration baselines. That is, small errors in slow-motion threshold baselines indicated that the data collection system was both properly calibrated and working as expected, such that measurement variations could be attributable to eye-movement performance, head movement error, and/or other sources but not to the data-collection instrumentation.

Threshold baselines were measured pre- and post-treatment for two compounded treatments. Treatment 1 consisted of incremental rehearsal and treatment 2 added partial occlusion to incremental rehearsal. The treatments were evaluated not only on the basis of their effectiveness on the 60-mph fastball challenge, but also on the basis of improving batters' smooth pursuit and saccade threshold baselines. Fig. 46 and Fig. 47 show selected representative pre- and post-treatment 1 threshold baselines for subject 003, respectively, that demonstrate the ability to track a 60-mph fastball at various slow-motion speeds.

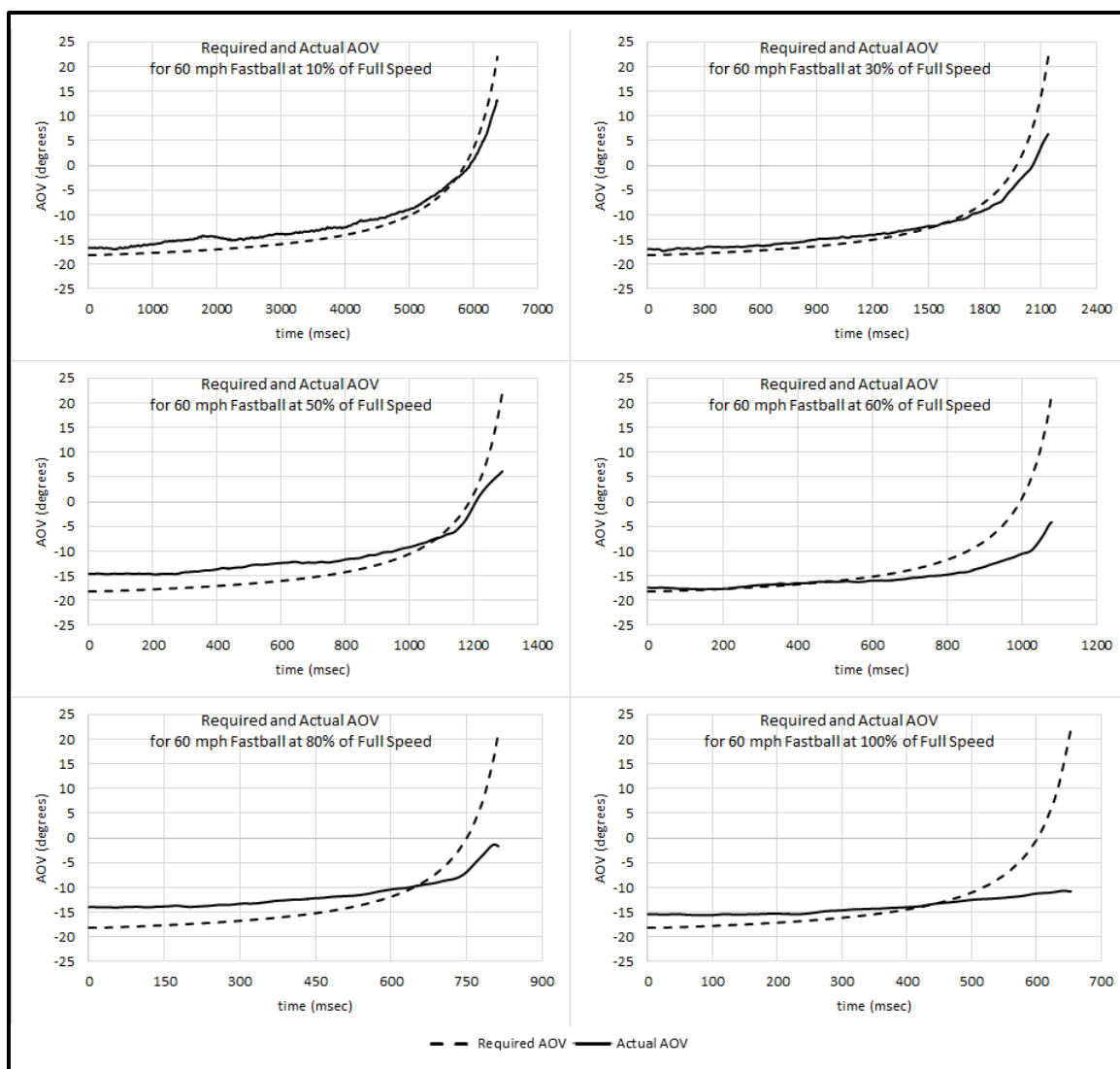

Fig. 46. Sample Threshold Baselines Pre-Treatment.

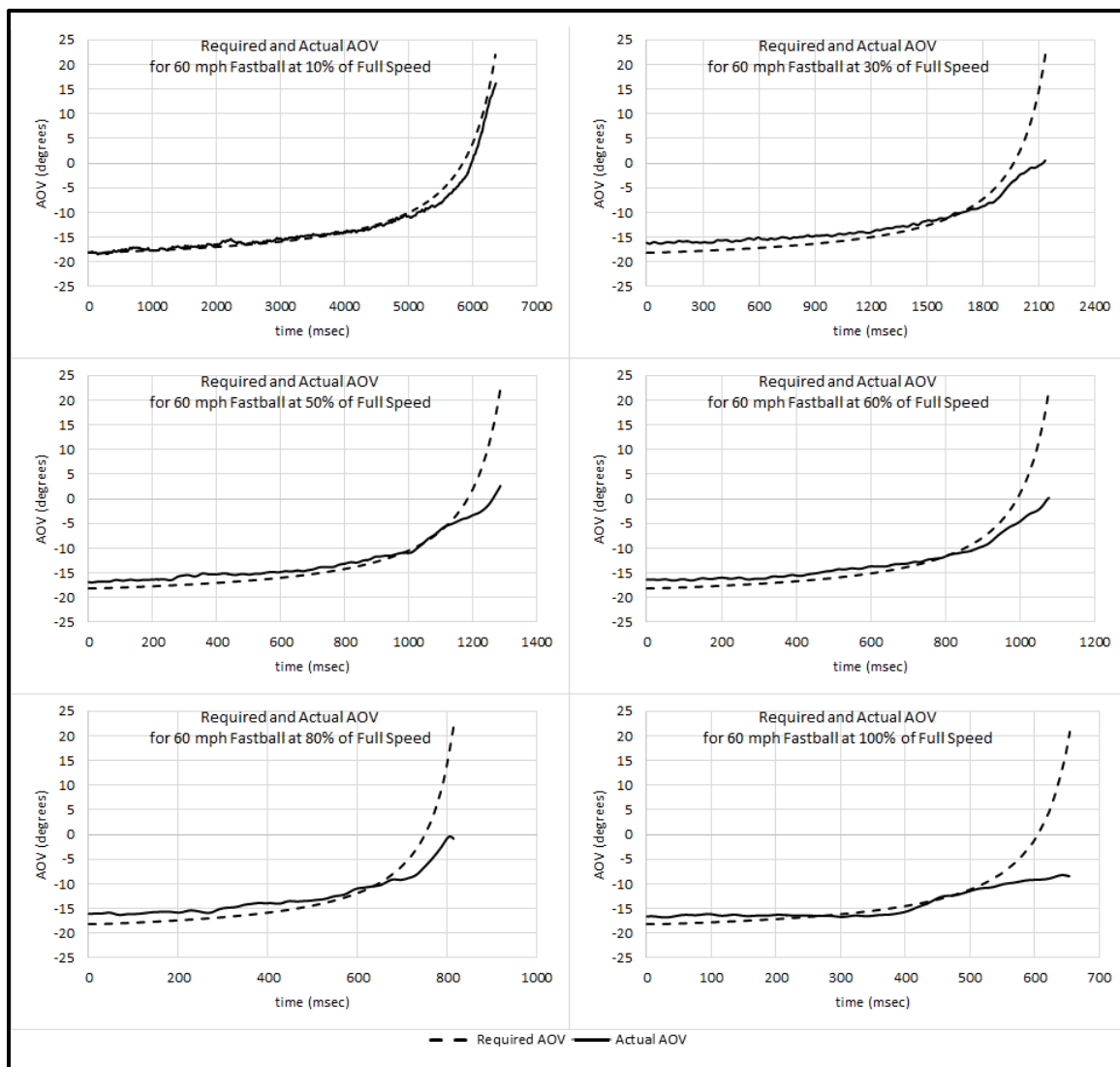

Fig. 47. Sample Threshold Baselines Post-Treatment 1.

Visual inspection and analysis reveal that in the pre-treatment threshold baselines, positional AOV error is small at 10% of full speed but increases even as early as 30% of full speed. Beyond the 30% slow-motion speed, all responses are flat with late saccadic responses —indicative of involuntary or desperate reactions to catch up to the ball as the ball reaches the home plate. In contrast, post-treatment 1 threshold baselines show AOV responses that are more aligned with the curvature of the required AOV —even at full

speed in which a deliberate attempt to keep up with the ball appears to take place in the 400-500 msec portion of the trajectory where the smooth pursuit maximum speed limit is reached (see Section 3.11.5 for explanation on smooth pursuit maximum speed threshold). Table 1 summarizes the MAE results comparing pre- and post-treatment 1 baseline thresholds with differences in parentheses and shaded cells indicating when post-treatment MAE is greater than pre-treatment MAE.

Table 2. AOV MAE Results - Threshold Baselines Pre- and Post-Treatment 1 (degrees)

	Subject 001	Subject 003	Subject 004	Subject 013	Subject 015
10% Pre-Treat	23.5	1.9	1.9	5.8	2.9
20% Pre-Treat	5.2	2.4	1.7	2.6	2.5
30% Pre-Treat	3.8	1.7	2.9	2.0	3.8
40% Pre-Treat	3.0	1.1	3.6	1.6	2.9
50% Pre-Treat	6.1	3.1	2.5	1.8	3.4
60% Pre-Treat	5.5	2.8	3.4	2.0	3.8
70% Pre-Treat	2.6	2.7	2.4	2.3	2.2
80% Pre-Treat	2.4	3.8	3.6	3.6	3.6
90% Pre-Treat	3.2	2.8	4.3	3.9	4.0
100% Pre-Treat	4.1	3.6	4.4	1.6	2.8
10% Post-Treat 1	2.2 (-21.3)	0.8 (-1.1)	2.0 (0.1)	4.5 (-1.3)	1.5 (-1.4)
20% Post-Treat 1	2.6 (-2.6)	1.7 (-0.7)	3.1 (1.4)	2.0 (-0.6)	2.9 (0.4)
30% Post-Treat 1	3.1 (-0.7)	2.2 (0.5)	1.4 (-1.5)	1.2 (-0.8)	3.1 (-0.7)
40% Post-Treat 1	2.2 (-0.8)	1.4 (0.3)	3.0 (-0.6)	1.7 (0.1)	2.9 (0.0)
50% Post-Treat 1	2.3 (-3.8)	1.9 (-1.2)	3.3 (0.8)	2.1 (0.3)	4.2 (0.8)
60% Post-Treat 1	1.8 (-3.7)	2.1 (-0.7)	2.2 (-1.2)	3.5 (1.5)	3.9 (0.1)
70% Post-Treat 1	3.2 (0.6)	3.0 (0.3)	2.7 (0.3)	2.7 (0.4)	4.3 (2.1)
80% Post-Treat 1	1.3 (-1.1)	2.6 (-1.2)	3.3 (-0.3)	2.3 (-1.3)	4.5 (0.9)
90% Post-Treat 1	6.0 (2.8)	2.5 (-0.3)	4.0 (-0.3)	4.3 (0.4)	3.6 (-0.4)
100% Post-Treat 1	13.7 (9.6)	2.5 (-1.1)	3.7 (-0.7)	3.5 (3.5)	4.1 (1.3)

4.1.4. POSITIONAL AOV

Positional AOV trial data sets (i.e. AOV plots) were the fundamental analytical building block. Representative samples of processed live-pitch and virtual-pitch responses are presented in Fig. 48 and Fig. 49, respectively. The plots reveal that responses within live-pitch trials and within virtual-pitch trials were consistent, but differed across live and virtual trials. Responses to virtual pitches appeared to be more precise (i.e., less variation), but were not very effective at eliciting catch-up saccades. In addition, the acquisition of live fastballs seemed to be a bit chaotic at the onset of the pitch.

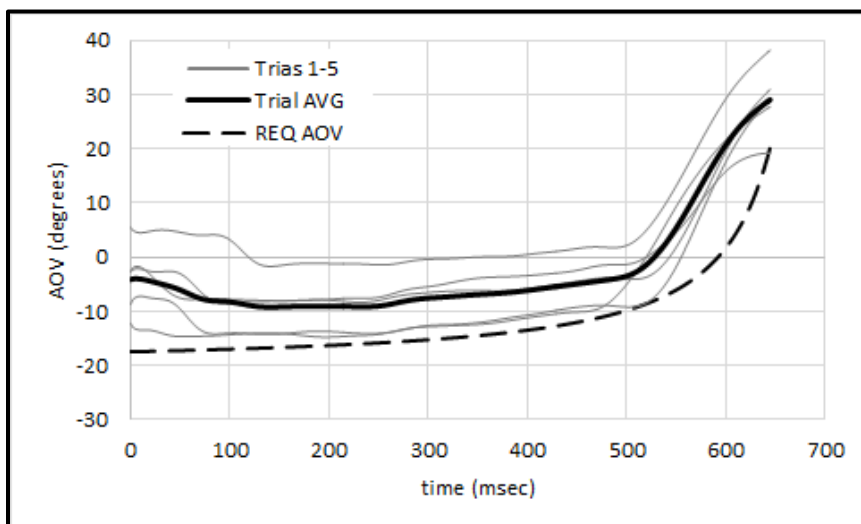

Fig. 48. Sample of AOV Positional Responses to Live-Pitch Fastballs.

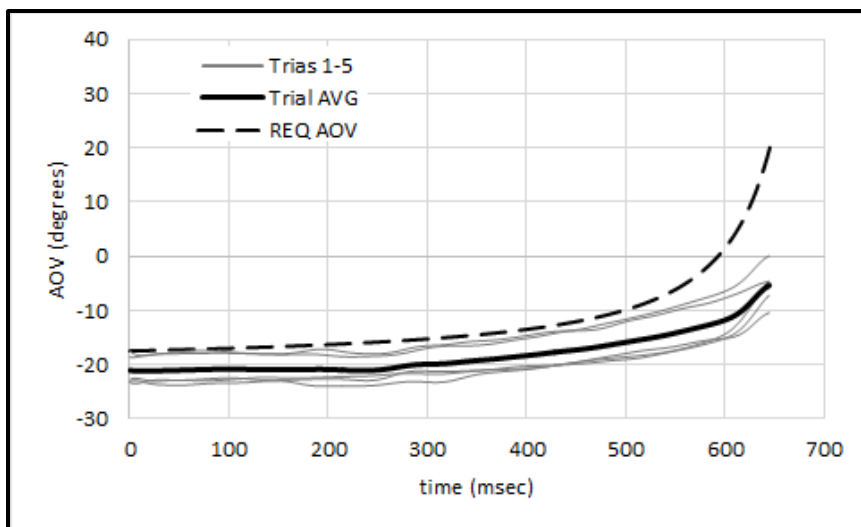

Fig. 49. Sample of AOV Positional Responses to Virtual-Pitch Fastballs.

The data sets were manipulated in a number of ways, in search of reactionary trends. One discovery was that eye-movement recordings were corrupted by head movements even as participants were instructed to refrain from moving during recordings. Even very small movements can cause large departures from the reference frame (approximately 14° of AOV displacement for an inch-arc of head rotation), such that even extreme head restraining (not practical for this study) would still likely introduce some error. These errors are evident in Fig. 48 and Fig. 49, with the live fastballs eliciting more head movement. Head-movement error was corrected by assuming that all participants were likely to reposition their heads even if slightly between trials but that they looked directly toward the ball at pitch initiation and that their heads remained fixed during the 685 msec duration of the fastball. The AOV during the initial 150 msec following the onset of the pitch was used as the initial AOV reference since the required movement during that period is less than 1.5° . The MAE was

computed between the AOV recording and the required AOV during the first 150 msec, and the actual AOV data set was adjusted accordingly.

Individual trial plots are informative, as they show the intricate movements exercised when attempting to track a fastball. But averages of these plots offer only limited value since the variability in eye-movement acceleration results in irregular oscillating patterns that obscure smooth pursuit and/or saccade characteristics. In addition, catch-up saccades have different onset times and amplitudes, such that the MAE does not distinguish between valid and useful saccades and, in fact, may assign false negatives and false positives in the form of high and low MAE scores to useful and not-useful saccades, respectively. Fig. 50 illustrates hypothetical useful saccades (A and B) and a not so useful saccade (C) in which the MAE (i.e., area between saccade line and required AOV curve) is smaller for the saccade that is not so useful, and also in which different MAEs result for two valid and useful saccades. Single-subject averages had less variability and were more useful. Still, aggregating across subjects provided valuable preliminary insights, especially in the region of the trajectory where trends of transitions from smooth pursuit to saccades could be detected.

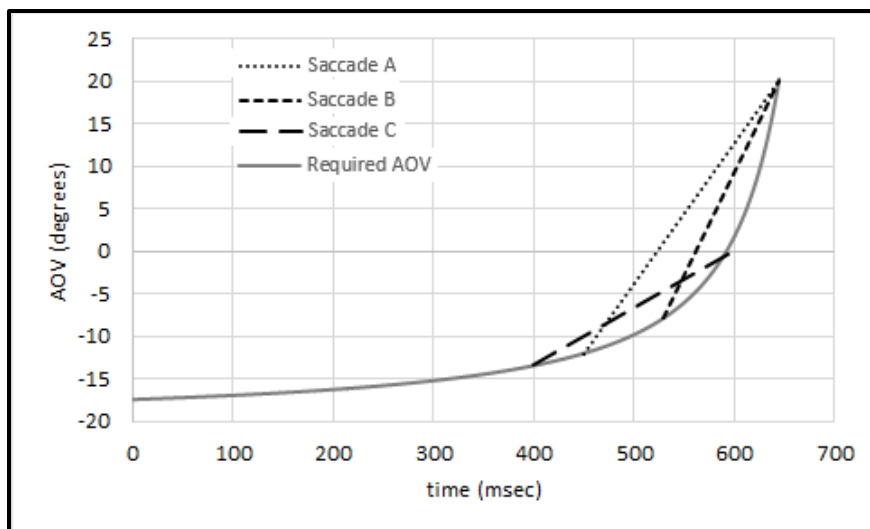

Fig. 50. Notional Misleading MAE of Useful and Not-Useful Saccades.

The MAE was computed at each time increment for the set of individual participant trials within each event category and for the aggregate of all participants also within each event category. Fig. 51 and Fig. 52 present composites of AOY measures from all participants for each event category. The MAE for the 400 msec to 500 msec portion of the 685 msec fastball trajectory (approximate location where transitions from smooth pursuit to saccades take place) was then isolated and Bland-Altman plots (Fig. 53) provided measures of agreement between event categories.

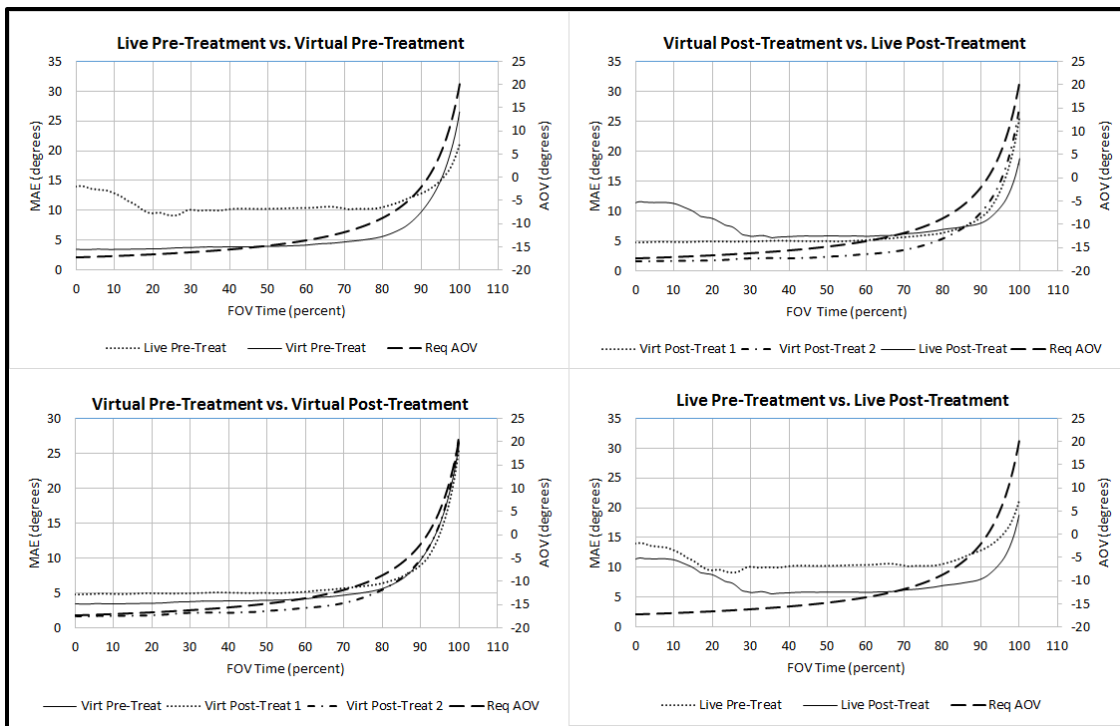

Fig. 51. Positional AOV Measures and MAE for 60-mph Protocol.

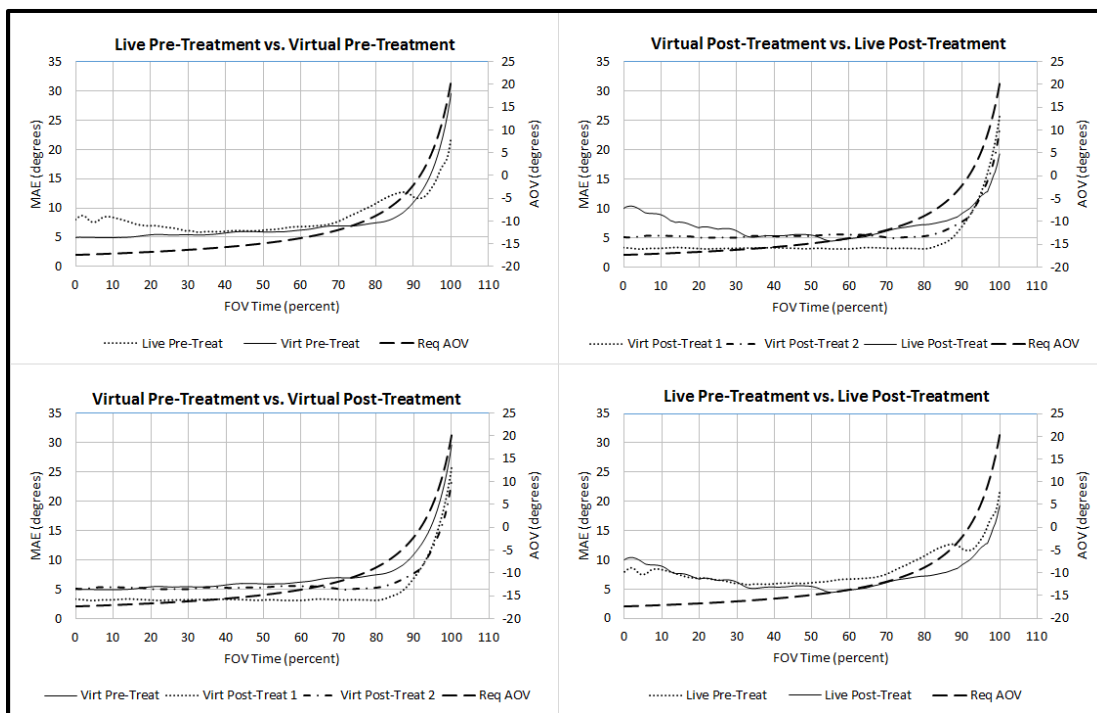

Fig. 52. Positional AOV Measures and MAE for 80-mph Protocol.

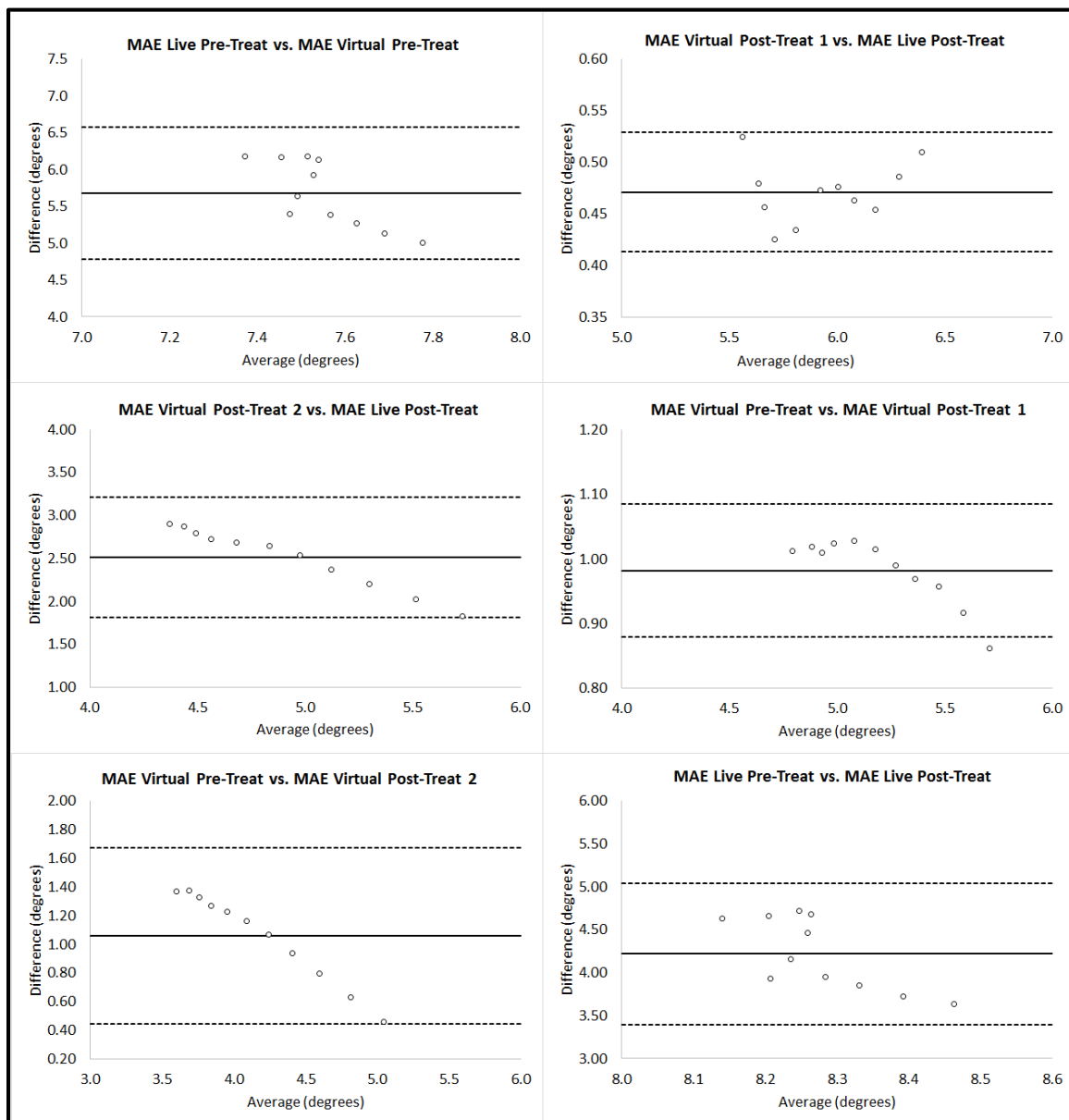

Fig. 53. Measures of Agreement Plots for Positional AOV.

4.2. CONTEXTUAL MEASURES

Ten trial data sets (i.e., individual trajectory eye-movement tracks) for each event type (i.e., live-pitch pre-treatment, live-pitch post-treatment, virtual-pitch pre-treatment, virtual-pitch post-treatment 1, and virtual-pitch post-treatment 2) were collected for each

of the five participants who underwent the 60-mph protocol, for a total of 250 individual data sets. The dependent variables were catchup saccade onset times and amplitudes (derived from positional AOV). Preliminary (non-statistical) visual analysis revealed consistent responses within individual subject trials and within event types but variability in responses across event types. The analysis also revealed differences in the combinations and timing of the smooth pursuit and saccades employed by more and less capable/experienced batters. This supported the use of single-subject analysis; therefore, visual and non-parametric bootstrap resampling was employed as appropriate to compare measures and trends between data sets in order to draw inferences about each of the research questions.

Saccade onset time was selected as the principal and obvious marker for determining the transition from smooth pursuit to saccade activity —and thus for comparisons used to address each of the research questions. Saccade amplitude was estimated conservatively from peak velocity (i.e., half amplitude was estimated from saccade onset to peak velocity), but could not be ascertained precisely because the task did not have a definitive target end state. That is, the end state of saccades was not defined because the pitched fastballs either continued until they hit the backstop (live pitch) or disappeared from the 3D display (virtual pitch) and, in both cases, eye-movement measurements stopped recording at approximately 685 msec in response to signals sent by the live- and virtual-pitch servers.

Whereas some participants appeared to employ a single saccade to meet the target near the front edge of the home plate, others appeared to employ a sequence of corrective saccades similar to human responses to targets moving with constant acceleration

reported elsewhere [112], as depicted in Fig. 54 and described in the following sections. The curve-fitting approach described in Section 3.11.3 worked well with single saccades but was not appropriate for corrective saccades. In trials where multiple corrective saccades were used, the onset time of the first saccade was used, but the peak velocities and amplitudes estimated were smaller than the composite amplitude of the saccade sequence. The saccade onset time was the primary marker of transitions from smooth pursuit to saccades, and amplitude was a secondary marker, so no remedy was sought for the amplitude estimation shortcoming. Saccade durations were limited in the same manner as amplitudes, and their added value was not apparent, so they were not used in the analyses.

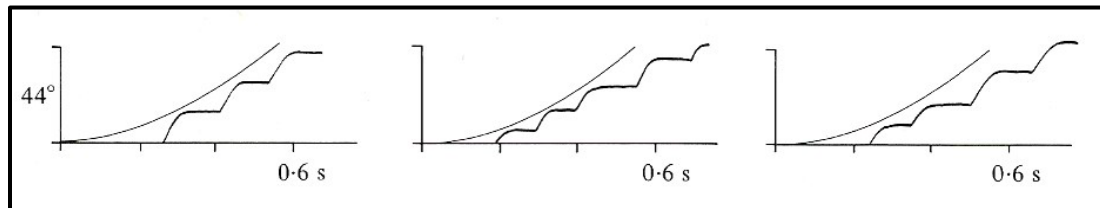

Fig. 54. Corrective Saccades due to Target Moving with Constant Acceleration [112].

Table 3. Mean Saccade Onset Time (msec) for 60-mph Fastballs

	Subject 001	Subject 003	Subject 004	Subject 013	Subject 015	Subject AVG
Live-Pitch Pre-Treatment	448.59 ± 41.39	536.52 ± 35.16	493.56 ± 49.41	447.82 ± 49.77	509.26 ± 32.48	487.15 ± 41.64
Virtual-Pitch Pre-Treatment	580.88 ± 18.64	529.29 ± 45.08	543.24 ± 45.31	551.88 ± 45.58	578.67 ± 9.18	556.79 ± 32.76
Virtual-Pitch Post-Treatment 1	588.17 ± 17.17	493.14 ± 58.94	561.31 ± 24.28	543.62 ± 60.18	561.92 ± 30.29	549.63 ± 38.17
Virtual-Pitch Post-Treatment 2	555.54 ± 25.42	493.78 ± 57.58	557.63 ± 25.47	553.20 ± 24.69	542.42 ± 39.04	540.51 ± 34.44
Live-Pitch Post-Treatment	508.09 ± 31.97	511.63 ± 35.61	524.36 ± 51.22	418.93 ± 9.76	453.29 ± 42.94	483.26 ± 34.30

Table 4. Mean Saccade Amplitude (degrees) for 60-mph Fastballs

	Subject 001	Subject 003	Subject 004	Subject 013	Subject 015	Subject AVG
Live-Pitch Pre-Treatment	32.29 ± 6.72	15.81 ± 15.33	15.43 ± 10.72	24.49 ± 23.23	25.50 ± 7.25	22.70 ± 12.65
Virtual-Pitch Pre-Treatment	12.55 ± 6.75	6.21 ± 3.66	6.01 ± 2.46	4.85 ± 2.50	5.71 ± 1.32	7.07 ± 3.34
Virtual-Pitch Post-Treatment 1	9.09 ± 4.59	6.39 ± 5.67	4.30 ± 2.61	8.19 ± 3.45	4.55 ± 1.19	6.50 ± 3.50
Virtual-Pitch Post-Treatment 2	12.93 ± 4.27	5.59 ± 3.49	6.78 ± 2.32	7.26 ± 2.23	5.25 ± 1.65	7.56 ± 2.79
Live-Pitch Post-Treatment	31.84 ± 11.57	32.34 ± 18.50	14.20 ± 8.04	24.83 ± 27.56	24.90 ± 6.90	25.62 ± 14.52

Table 3 and Table 4 summarize the saccade onset time and amplitude results. A pertinent observation is that subject averages in the right-most column show that group averages mask important characteristics and trends. For instance, there is a very small difference (~5 msec) difference between the averages of live-pitch pre-treatment and live-

pitch post-treatment onset times. If one were to use group analysis and conventional (parametric) statistical methods, this would lead to an inference that no differences were detected in live-pitch measurements pre- and post-treatment across subjects. However, upon closer inspection, it can be seen that individual subjects show significant differences in those instances. For instance, subject 1 (S1) shows a substantial difference (~60 msec) between the averages of live-pitch pre-treatment and live-pitch post-treatment onset times. The variability in saccade onset time responses across participants suggests that experience and habituation may influence responses differently and that responses to live and 3D stereo fastball pitches are processed differently. This observation further underscores the suitability of single-subject analysis for this exploratory study.

4.2.1. FIRST AIM AND RESEARCH QUESTION

The first research question concerned the validation of virtual fastballs and thus compared combinations of eye-movement responses from batters of various skill levels to live and virtual pitches, pre-treatment. The results for this research question relied on visual analysis and on the descriptive statistics summarized in Table 3 and Table 4.

Results indicate that live fastballs elicited saccade responses in the vicinity of the smooth-pursuit maximum velocity threshold (400-500 msec) across batters of different experience and ability (first set of five pitches presented in Fig. 55). The response to live fastballs also appears to have elicited some type of corrective eye movements at the beginning of the trajectory, up to approximately 100 msec. These initial corrective eye movements were likely an adjustment to the initial acquisition of the ball, since the ball was not visible prior to emerging from the pitching-machine shoot. The initial corrective

eye movements were considered not contextually significant, since the eye orientation seemed to stabilize after approximately 100 msec, up to the 400-500 msec pursuit-saccade transition period.

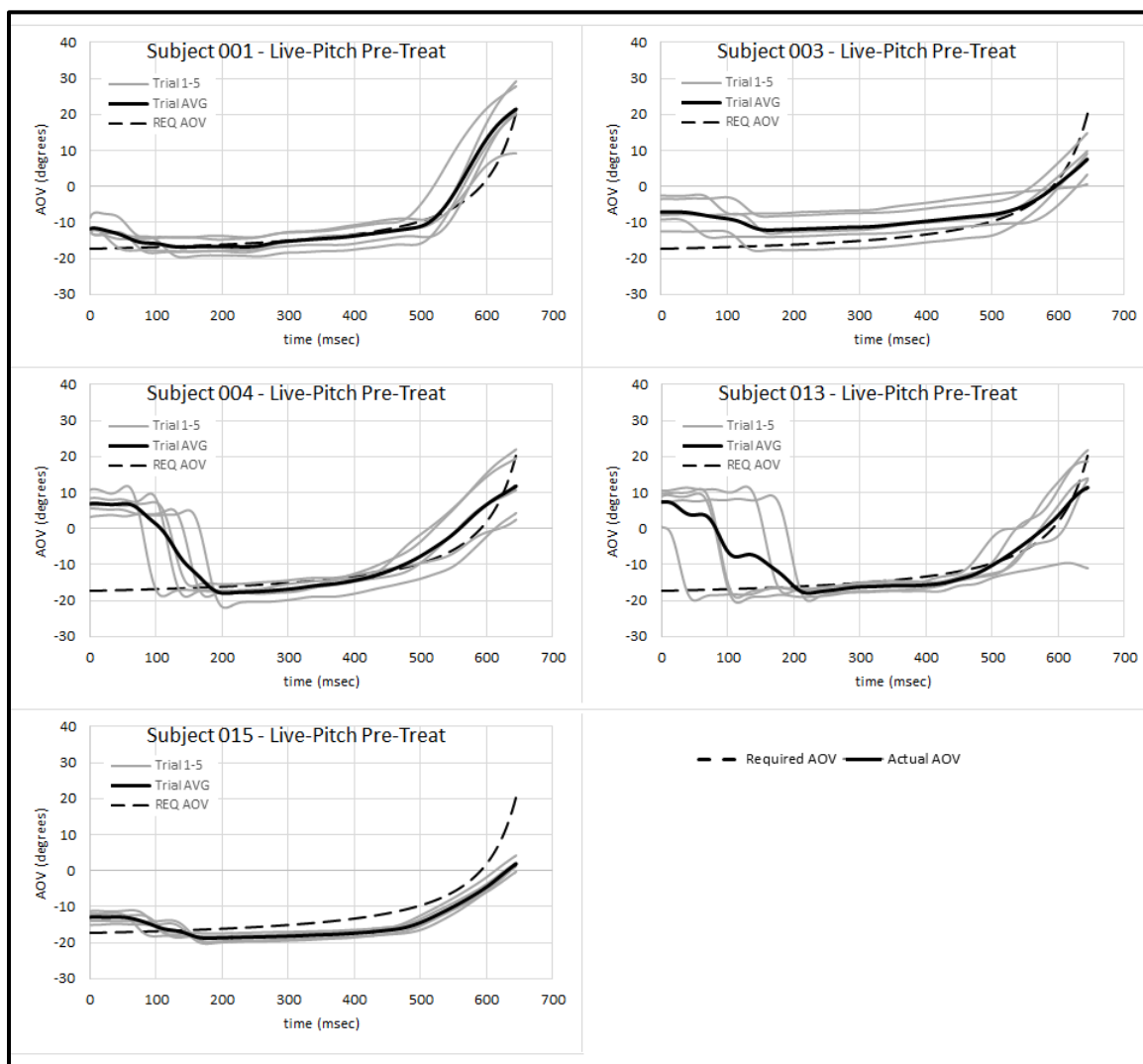

Fig. 55. Subject Responses to Live-Pitch Fastballs Pre-Treatment.

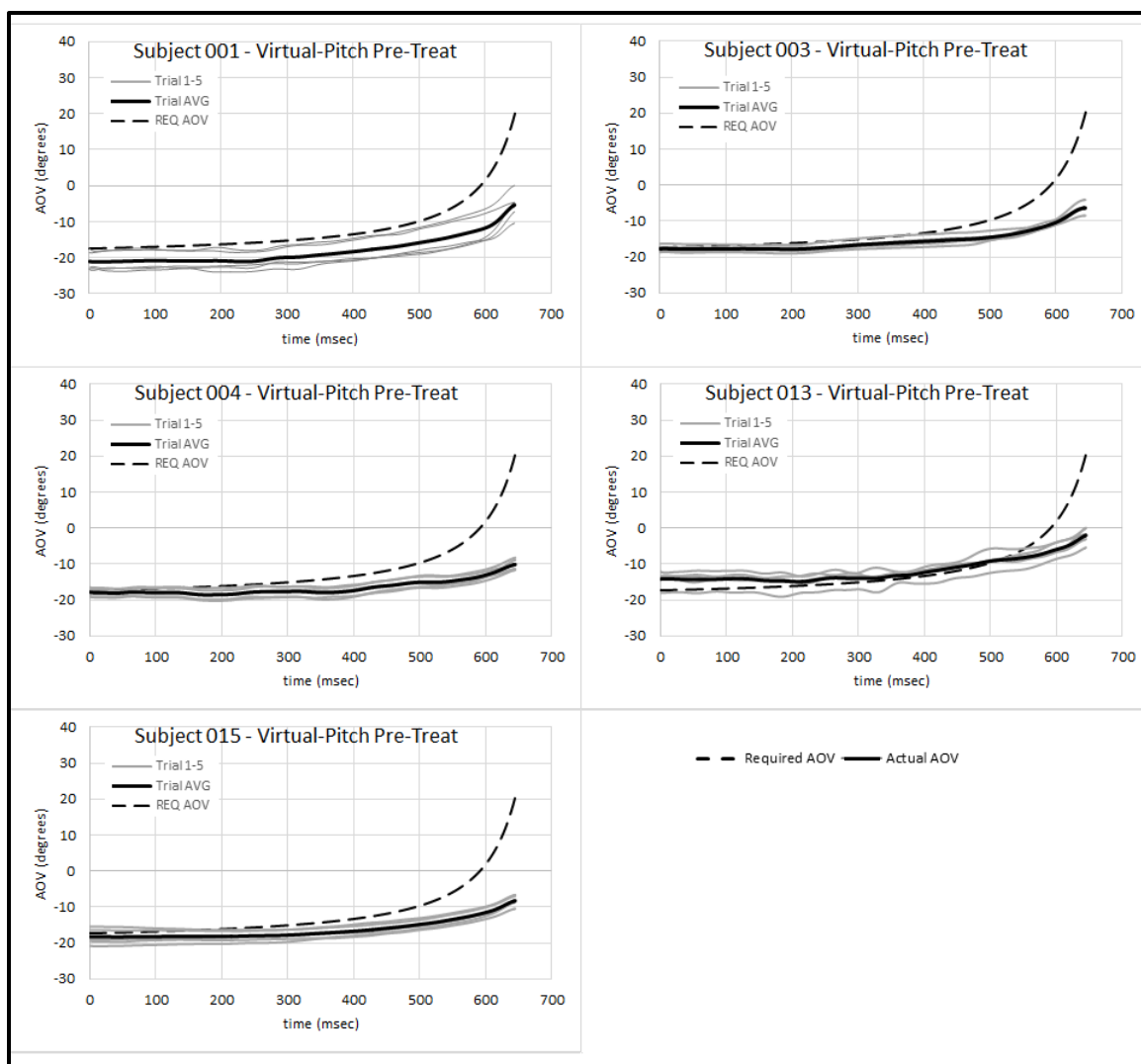

Fig. 56. Subject Responses to Virtual-Pitch Fastballs Pre-Treatment.

These results also indicate that responses to virtual fastballs were mostly flat, non-erratic, and steady throughout the trajectory, but with seemingly late saccade onsets. This is in contrast to responses to live fastballs. Saccade onset times for virtual fastballs were on average in the order of 70 msec later than those for live fastballs. In addition, saccade amplitudes for virtual fastballs were on average approximately 15° smaller than those for live fastballs (first set of five pitches presented in Fig. 56). However, estimates of

saccade amplitudes for virtual fastballs were limited by the end of eye-movement recording which occurred at approximately 645 msec (i.e., the time that coincided with the end of the FOV of interest when the EOG system was signaled to stop recording).

4.2.2. SECOND AIM AND RESEARCH QUESTION

The second research question concerned insights about the difference in batter expertise and thus compared eye-movement responses/strategies between more- and less-experienced batters subject to live pitches, pre-treatment. The results for this research question relied on visual analysis and on the descriptive statistics summarized in Table 3 and Table 4.

The results indicate that more-experienced/more-capable batters were more deliberate in selecting or implementing smooth pursuit and saccadic eye-movements to keep their eye on the ball. As presented in Fig. 57, the more-capable batters (S1, S4, and S13) employed smooth pursuit until approximately 450 msec and not exceeding 500 msec, which is consistent with the approximate smooth pursuit maximum velocity threshold. These batters then resorted to one catch-up saccade (S1) or a sequence of two corrective catch-up saccades (S4 and S13) totaling amplitudes greater than 30° —thereby orienting their eyes near the front edge of the home plate at the approximate time when the fastball reached that location. The onset of saccades was ascertained when the angular velocity exceeded approximately $50^\circ/\text{sec}$. In addition, the distinct upward and downward swings of the angular velocity curves reveal the deliberate nature of the saccades; that is, the eye movements not only accelerate and decelerate, but also the deceleration trends toward achieving zero angular velocity within the fastball's total trajectory time rather than moving aimlessly trying to keep up with the ball.

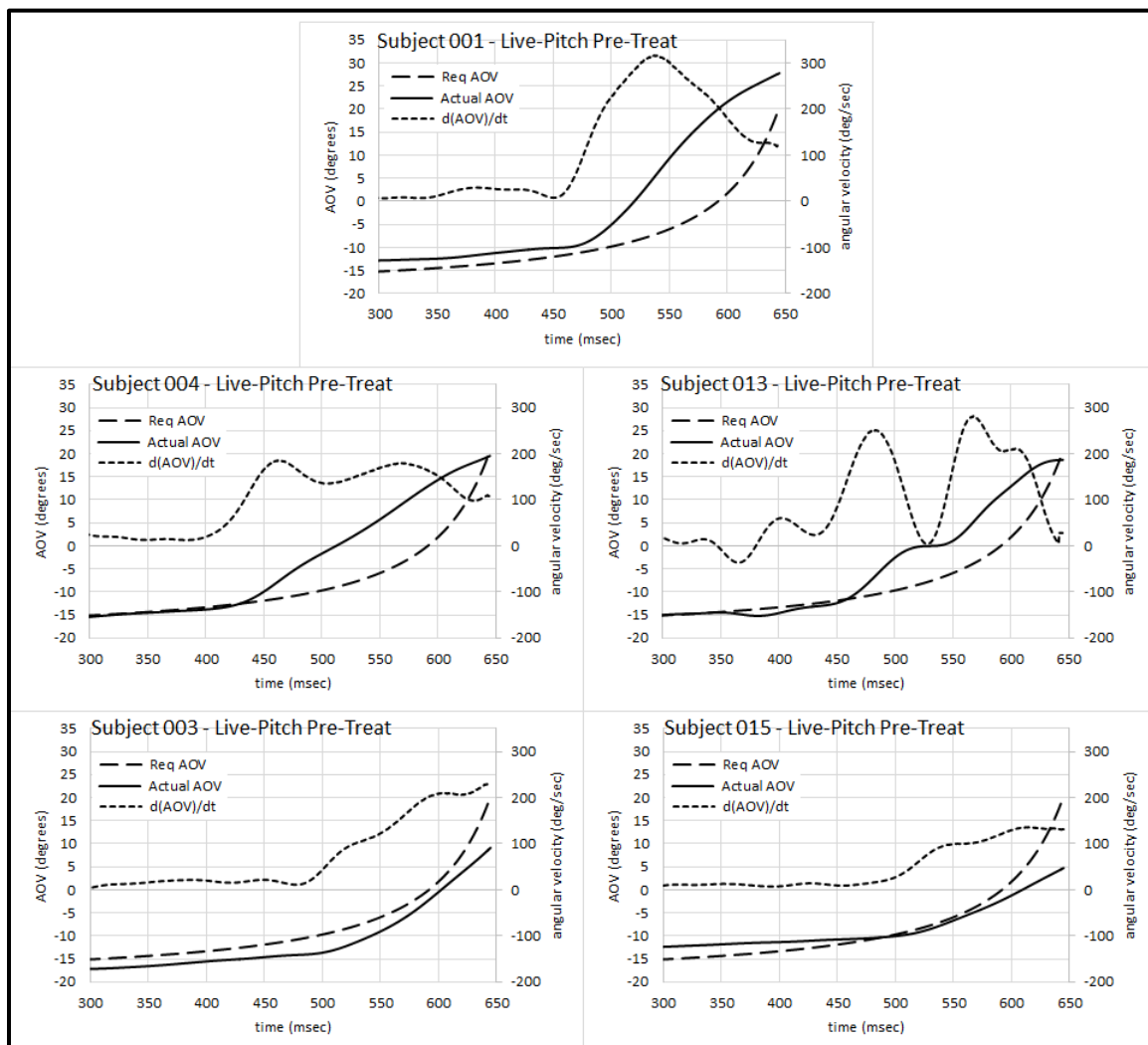

Fig. 57. Selected Responses of More-Capable (S1, S4, S13) and Less-Capable (S3, S15) Batters.

In contrast, the results also indicate that the less-experienced/less-capable batters (S3 and S15) had saccade onset times near or exceeding 500 msec, and their positional AOV did not exceed 10° , which would orient their eyes 4 or 5 feet in front of the leading edge of the home plate at the time when the ball was crossing the home plate. Although

these batters seemingly employed catch-up saccades to try to keep up with the ball, the angular velocity curves show accelerating trends but no deceleration, indicative of involuntary, incoherent, and untimely reactions.

4.2.3. THIRD AIM AND RESEARCH QUESTION

The third research question concerned eye-movement modulation resulting from virtual-pitch treatment, and thus compared eye-movement responses to virtual pitches only pre- and post-treatment. The results for this research question relied on visual analysis and on the descriptive statistics summarized in Table 3 and Table 4.

The results indicate small to negligible differences in responses between virtual fastballs pre-treatment (Fig. 56) and virtual fastballs post-treatment 1 (Fig. 58) or post-treatment 2 (Fig. 59). Some of the graphs seem to show the onset of late saccadic-like reactions in the vicinity of 600 msec. The flatness of these responses (pre- and post-treatment) is in contrast not only to responses to live fastballs, but also to the saccade/step baselines presented in Section 4.2.2 and the threshold baselines presented in Section 4.2.3—which employed slower stimuli speeds.

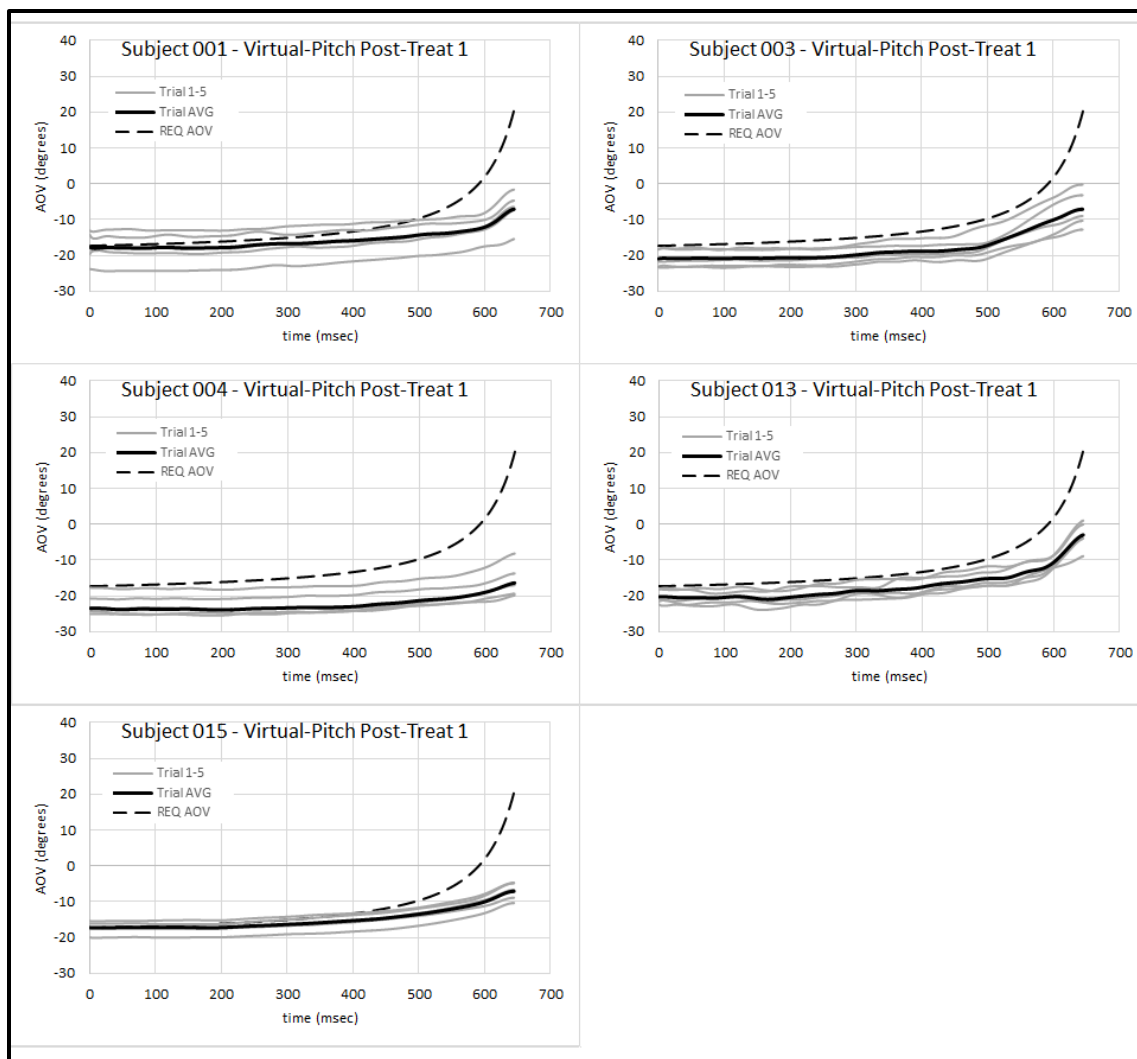

Fig. 58. Subject Responses to Virtual-Pitch Fastballs Post-Treatment 1.

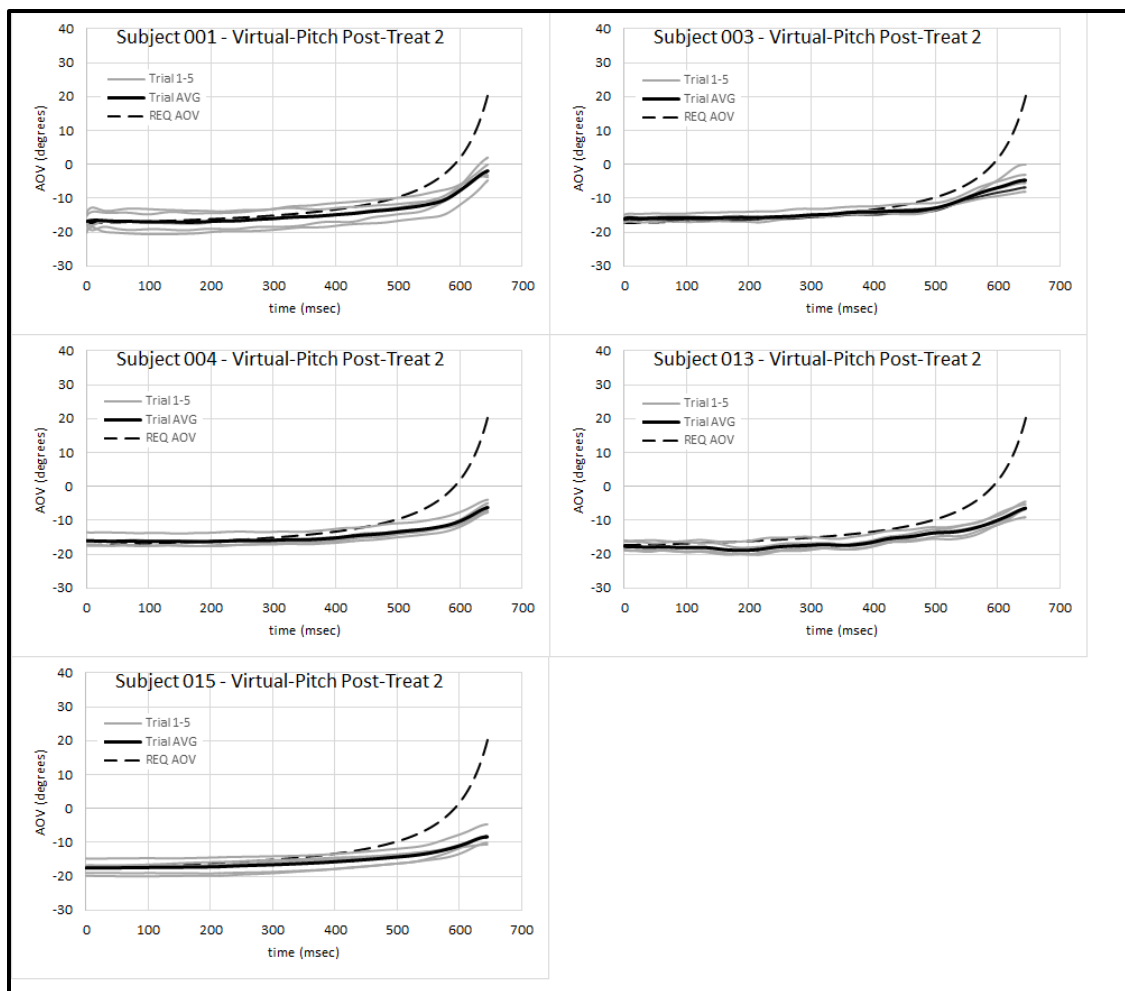

Fig. 59. Subject Responses to Virtual-Pitch Fastballs Post-Treatment 2.

It is relevant to note that the post-treatment 2 responses have no more saccadic activity than the post-treatment 1 responses, even though treatment 2 included partial occlusion intended to instigate saccades. Other than some head movement that accounts for the initial AOV above or below the required -18° point-of-release orientation, eye-movement responses for all virtual fastballs were very flat and steady—indicative not only of likely early ball acquisition (since the ball is displayed prior to trajectory initiation) but also of possible extended fixation in the pre-APIT region of the fastball trajectory (as in a comfort zone) followed by little pursuit or saccadic activity.

4.2.4. FOURTH AIM AND RESEARCH QUESTION

The fourth research question concerned transfer of the virtual treatment to the live-pitch task, and thus compared eye-movement responses to live pitches only, pre- and post-treatment. The results for this research question relied on visual analysis and on the descriptive statistics summarized in Table 3 and Table 4, as well as on non-parametric bootstrap resampling.

Results indicate contextual significance in saccade onset improvement from pre-treatment to post-treatment, in experienced as well as inexperienced batters, as exemplified by the selected trials of the more-capable subject 1 (S1) presented in Fig. 60 and Fig. 62, and the less-capable subject 3 (S3) presented in Fig. 62 and Fig. 63.

S1 improvement is characterized by extended saccade onset time, which also corresponds to extended smooth pursuit while adjusting (i.e., reducing) the saccade magnitude in order to satisfy the 20° AOV requirement that puts his eye on the ball at the front edge of the home plate. In contrast, S3 improvement is characterized by a reduced saccade onset time while also adjusting (i.e., increasing) saccade amplitude with the same objective of putting the eye on the ball at the front edge of the home plate.

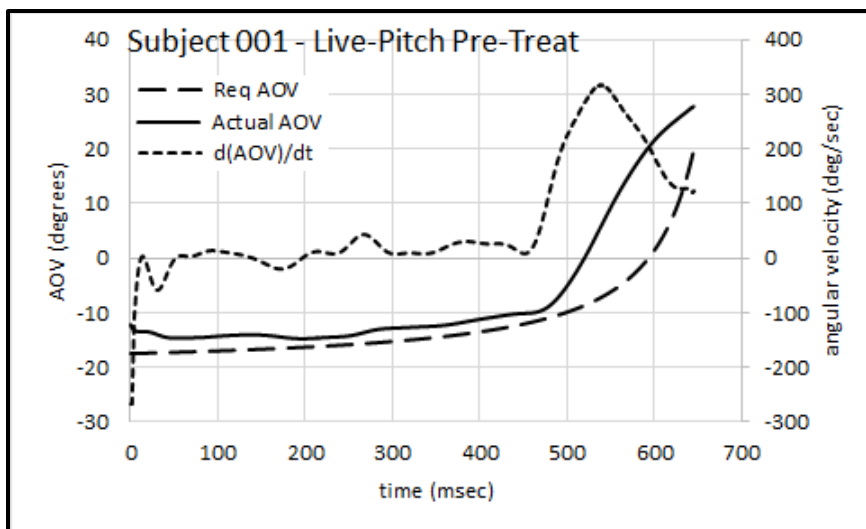

Fig. 60. Sample Pursuit-Saccade Strategy of More-Capable Batter (S1) Pre-Treatment.

Results indicate that the more-capable batter S1 started with a reasonable pre-treatment eye-movement strategy, as exemplified in the sample trial (Fig. 60). The strategy consisted of smooth pursuit with persistent AOI near the required AOI in the pre-APIT region, followed by a catch-up saccade of estimated 32.8° in amplitude with onset time of 446 msec (within the SUT region). The AOI at onset time was approximately -10° (i.e., 10° left of center), placing the AOI after catch-up saccade completion at 1.2 ft in front of the home plate leading edge at an estimated 546 msec. At the time of saccade completion, the ball was estimated to be at 8.8 ft from the leading edge of home plate. Thus, the pre-treatment strategy employed by S1 overshot the ball by approximately 7.6 ft —arguably enabling S1 to wait for the ball to come into view at the front edge of the home plate and affording S1 over 100 msec of visual processing and reaction time.

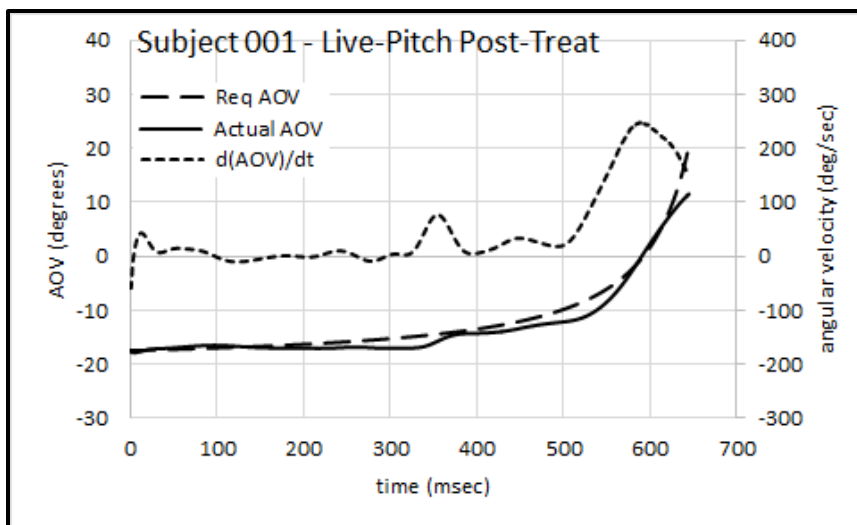

Fig. 61. Sample Pursuit-Saccade Strategy of More-Capable Batter (S1) Post-Treatment.

Following treatment, Fig. 62S1 modified his strategy which resulted in maintaining an AOV much closer to the required AOV, extending his smooth pursuit threshold, and adjusting the onset and amplitude of the catch-up saccade. In the sample trial (Fig. 61), S1 made a mini-saccade correction in the pre-APIT region prior to the onset of a catch-up saccade at 504 msec (within the SUT region). The amplitude of the catch-up saccade was estimated at 24.1° , placing the AOV after catch-up saccade completion at 6.2 ft in front of the home plate leading edge at an estimated 604 msec. At the time of saccade completion, the ball was approximately 6 ft from the leading edge of home plate —coinciding almost perfectly with the AOV, even as the limit of the required visual processing time was reached or exceeded.

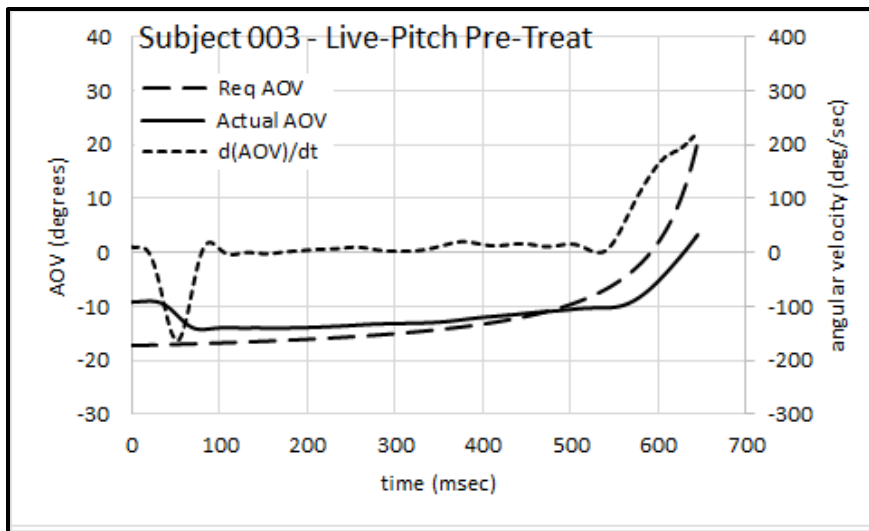

Fig. 62. Sample Pursuit-Saccade Strategy of Less-Capable Batter (S3) Pre-Treatment.

In contrast, the less-capable batter S3 employed a pre-treatment strategy indicative of not being able to keep up with the ball. This is exemplified by a best-case sample trial (Fig. 62) consisting of smooth pursuit in the pre-APIT region followed by a catch-up saccade of estimated 25° in amplitude with onset time of 541 msec (beyond the SUT region). The AOV at onset time was approximately -10° , placing the AOV after catch-up saccade completion at 2 ft in front of the home plate leading edge at an estimated 641 msec. At the time of saccade completion the ball was approximately 1.7 ft from the leading edge of home plate —leaving insufficient time for visual processing and reaction time (even as the AOV and ball position coincide near the leading edge of the home plate).

Following treatment, however, S3 conducted a more-deliberate smooth pursuit and saccade strategy. In the sample trial (Fig. 63), S3 maintained his AOV along the contour of the required AOV in the pre-APIT region and reduced the onset of a catch-up saccade to 502 msec (within the SUT region). The amplitude of the catch-up saccade

was estimated at 35° with an AOV at saccade onset of approximately 13° , placing the AOV after catch-up saccade completion at 1.3 ft in front of the home plate leading edge at an estimated 602 msec. At the time of saccade completion, the ball was approximately 4.6 ft from the leading edge of home plate —affording S3 sufficient visual processing and reaction time.

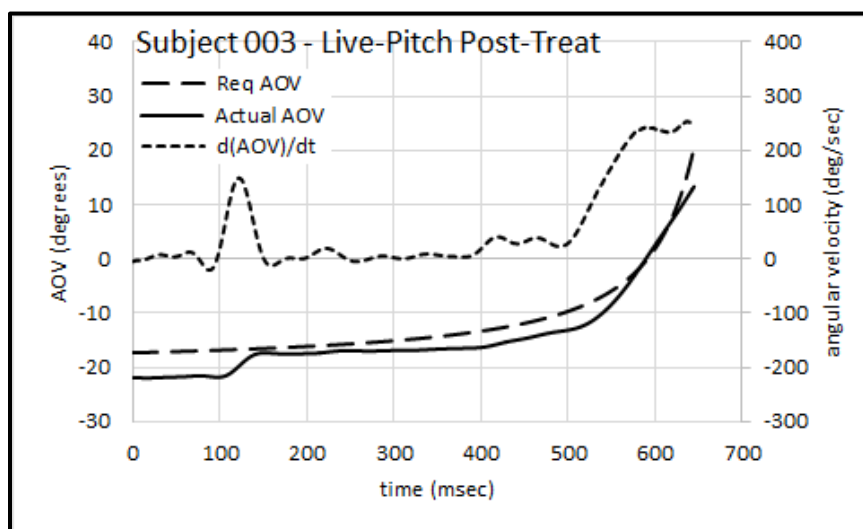

Fig. 63. Sample Pursuit-Saccade Strategy of Less-Capable Batter (S3) Post-Treatment.

In summary, improvement for the more-capable S1 batter consisted of extending the smooth-pursuit threshold resulting in a delayed catch-up saccade onset, maintaining the AOV in the pre-APIT region closer to the required AOV, and reducing the amplitude of the catch-up saccade to orient the AOV as close to the home plate as possible at the time when the ball is crossing the home plate. In addition, the improvement allowed enough time beyond the completion of the catch-up saccade for processing the visual information. For the less-capable S3 batter, improvement consisted of employing more-deliberate smooth pursuit in the pre-APIT region manifested in reduced catch-up saccade

onset times that occurred within the SUT region to allow for visual processing time. The catch-up saccade onset times for all subject trials, live-pitch, pre- and post-treatment, are summarized in Table 5 and Table 6.

Table 5. Onset Times for Catch-up Saccades Live-Pitch Pre-Treatment (msec)

Trial	Subject 001	Subject 003	Subject 004	Subject 013	Subject 015
Trial 1	446.00	505.20	383.75	545.00	541.40
Trial 2	469.00	613.80		483.50	534.20
Trial 3	469.00	541.40	518.60	514.25	523.30
Trial 4	419.00	505.20	445.25	405.70	496.15
Trial 5	469.00	496.15	514.60	415.20	460.00
Trial 6	469.00	568.00	536.80	423.75	540.00
Trial 7	348.75	523.30	511.40	450.90	534.20
Trial 8	486.00	550.45	502.35	408.55	523.30
Trial 9	428.45	523.30	493.30	423.75	480.00
Trial 10	481.70	538.40	536.00	407.60	460.00
Mean	448.59	536.52	493.56	447.82	509.26
Std. Dev.	41.39	35.16	49.41	49.77	32.48

Table 6. Onset Times for Catch-up Saccades Live-Pitch Post-Treatment (msec)

Trial	Subject 001	Subject 003	Subject 004	Subject 013	Subject 015
Trial 1	505.20	523.30	541.40	423.75	520.00
Trial 2	480.80	479.00	491.40	431.00	532.35
Trial 3	441.85	595.70	550.45	408.55	478.05
Trial 4	503.60	496.15	408.00	423.75	460.00
Trial 5	514.25	505.20	595.70	407.60	423.75
Trial 6	559.50	541.40	523.30	423.75	423.75
Trial 7	541.40	478.05	541.40	431.00	423.75
Trial 8	505.20	487.10	541.40	408.55	423.75
Trial 9	523.30	514.25	559.50	423.75	423.75
Trial 10	505.80	496.15	491.05	407.60	423.75
Mean	508.09	511.63	524.36	418.93	453.29
Std. Dev.	31.97	35.61	51.22	9.76	42.94

Bootstrap p-values and confidence intervals were computed using a custom resampling program written in the C language. The program drew $N = 10,000$ simple random samples of size 20 with replacement from the original data set consisting of 10 data points from each of the live-pitch pre-and post-treatment saccade onset times for each subject.

The p-values outlined in Table 7 represent the fraction of the time the difference between the pre- and post-treatment bootstrap sample means was greater than the difference between the pre- and post-treatment sample means [160-162]. In all cases, the difference was less than 10%, arguably supporting the inference that the difference in results from treatment was significant as it did not occur by chance.

The critical values for the confidence interval were approximated by computing the corresponding $\delta^* = \bar{x}^* - \bar{x}$ percentile, where \bar{x} is the sample mean and \bar{x}^* is the mean of an empirical bootstrap sample. The 90% confidence interval using 10,000 bootstrap samples was $[\bar{x} - \delta^*_{.05}, \bar{x} - \delta^*_{.95}]$, where $\delta^*_{.05}$ is the 95th percentile and corresponds to the 9,500th element and $\delta^*_{.95}$ is at the 5th percentile and corresponds to the 500th element [160-163]. The 90% confidence intervals summarized in Table 7 indicate where post-treatment catch-up saccade onset times can be expected. These confidence intervals indicate post-treatment contextual significance, in that catch-up saccade onset times can be expected to occur reasonably close to the smooth-pursuit maximum velocity threshold (which occurs in the 450-500 msec range for a 60-mph fastball), and also in the vicinity of the region between the APIT and the SUT.

Table 7. Bootstrap p-values and Confidence Intervals
for Live-Pitch Pre- and Post-Treatment

Subject	p-value	Confidence Interval [$\bar{x} - \delta^*_{.05}$, $\bar{x} - \delta^*_{.95}$]
Subject 001 (S1)	0.0021	[461.79, 495.92]
Subject 003 (S3)	0.0601	[510.46, 536.60]
Subject 004 (S4)	0.0790	[491.89, 527.84]
Subject 013 (S13)	0.0405	[418.74, 446.03]
Subject 015 (S15)	0.0027	[464.63, 498.30]

4.2.5. SYSTEM DELAYS

Delays associated with transmission of stimuli and responses across the client-server architecture and with 3D projector input lag were measured.

UDP socket transmission times of 30 isolated message trials (i.e., messages devoid of any processing overhead) between the client and the EOG system and Virtual-Pitch Simulation Server couple were measured. The mean time of a full-cycle message (i.e., a message initiated by the client, sent to and received by each of the two servers, response messages sent by the two servers back to the client, and messages received by the client) was 8 ± 3.3 msec.

Response times of 30 virtual-pitch triggers were measured. The mean response time (i.e., the mean time it took a virtual pitch to appear on the screen immediately following a client request) was 97.9 ± 3.3 msec. However, the response times were obtained by detecting the brightness of a white baseball on a dark screen using a generic RadioShack (Fort Worth, TX) 276-1657 photocell. The specification of this photocell indicates a response rise time of 50 msec, and specifications of comparable photocells

from Luna Optoelectronics (Thief River Falls, MN) indicate response rise times of 55-60 msec [195, 196].

A review of a Viewsonic PJD5 series projector indicates an input lag of 33 msec [197].

4.3. DISCUSSION

The following sections provide a review of how the research questions were addressed and how this exploratory study contributed to the body of knowledge. They also present limitations of the research and possible for future work.

4.3.1. FIRST AIM AND RESEARCH QUESTION

The first aim of the study was to explore and obtain objective eye-movement measures that would serve as the basis for the validation of a virtual environment that presents a 60-mph fastball trajectory in 3D stereo life-size theater format.

The descriptive research question associated with this aim was: Do virtual-pitch trajectories presented in 3D stereo elicit eye-movement responses similar to those elicited by live-pitch trajectories?

Results indicate that live and virtual fastballs elicited different kinds of responses in terms of delayed saccade onset times. Positional AOV responses to live and virtual fastballs were similar prior to reaching the smooth pursuit maximum velocity threshold and transitioning to saccades, which enforces the notion that eye-movement associated with ball tracking is not stimulated until positional error occurs at APIT.

Notwithstanding saccade onset variance times among participants, in all cases, the

saccade onset time responses to virtual fastballs was in the order of 13% (~70 msec) slower than responses to live fastballs.

Some of the difference in saccade onset times (i.e., slower onset time responses to virtual fastballs) may be attributable to system delays (see Section 4.2.5). That is, the system delays may account for 30-40 msec (i.e., projector lag time and client-server message transmission time) of the observed mean 70 msec slower response times. However, the system delays do not explain the consistent flatness or lack of gradual curvature in the virtual-pitch responses as is the case in live-pitch responses or the slower virtual-pitch threshold baseline responses. Some of the difference may be attributable to the vergence-accommodation conflict inherent to 3D stereo displays, in that 3D stereo impairment of the accommodation system mitigates the accommodative-vergence contribution to the vergence system (see Section 2.12), but this is speculative and is an open question that requires further investigation.

It is also possible that the 3D stereo display frame rate (120 Hz) adversely contributed to disparity. That is, this frame rate produced a smooth image for most of the trajectory, but the image became noticeably discontinuous as the required AOV angular velocity became more pronounced in the terminal phase of the trajectory. But the discontinuities occurred toward the end of the trajectory when the required angular velocity became larger than the smooth pursuit maximum velocity threshold—which is when saccades should have been triggered. It would be reasonable to speculate that such discontinuities would be an enabler, rather than a deterrent, to the onset of catch-up saccades.

These results do not necessarily invalidate the virtual fastball as an option for treatment (as the results associated with the fourth research aim suggest). But if accommodation is indeed impaired by 3D stereo displays, as has been suggested, then using human eye-movement responses (as has been done in this study) to validate 3D virtual environments involving fast objects moving in depth similar to the 60-mph fastball would be inappropriate.

Future work should consider research to better ascertain the influence and limits of accommodative-vergence on fast objects moving in depth in 3D stereo.

4.3.2. SECOND AIM AND RESEARCH QUESTION

The second aim of the study was to implement an expert-novice protocol to distinguish between the eye-movement strategies employed by more-experienced batters from those of less-experienced batters.

The descriptive research question associated with this aim was: What eye-movement characteristics distinguish expert baseball batters from novices?

This research study recruited two former collegiate baseball players, but they participated in an 80-mph protocol which did not produce usable measurements. The two players were not available to participate in the 60-mph protocol and no other player with collegiate or professional experience was recruited. Nevertheless, the limited number of participants who underwent the 60-mph protocol provided insights on the strategies that more experienced or more capable batters employ in contrast to those of less capable batters.

Results from live-pitch fastballs indicate that while all participants employed a combination of smooth pursuit followed by catch-up saccades, some (arguably more experienced batters) appeared more deliberate in their pursuit and their timing of catch-up saccades. In contrast, some (arguably less experienced batters) experienced early positional error and late saccade onsets. Results from virtual-pitch fastballs were less conclusive, and all subjects appeared to have systematic late saccadic onset times, which may have been caused by accommodative-vergence impairment (discussed in the previous section).

Results also appear to be consistent with previous estimates of smooth pursuit maximum velocity thresholds in the range of 40-70°/sec [61] and with computations involving the role of foveal eccentricity on the optimum range and threshold of saccade usefulness presented in Sections 3.11.4 and 3.11.5.

Future work should consider expanding on these exploratory findings using a larger sample size to obtain a profile of saccade onset times characterizing expert performance for different fastball speeds. Similar profiles should be obtained for different player categories (e.g., age, gender, experience, eye dominance, etc.). Other profiles may also be obtained for different types of pitches (e.g., curve balls, sliders, change-ups, etc.).

4.3.3. THIRD AIM AND RESEARCH QUESTION

The third aim of this study was to implement a treatment protocol in 3D stereo virtual environment using repurposed incremental-rehearsal and partial-occlusion

methods to instigate and modulate an optimal eye-movement strategy for coping with a 60-mph fastball.

The descriptive research question associated with this aim was: Is modulation of smooth pursuit and saccadic thresholds achievable in novice/intermediate batters, using 3D stereo 60-mph virtual fastball stimuli with an incremental-rehearsal/partial-occlusion protocol to moderate task difficulty and instigate strategic eye-movements?

It may be speculated from the results that smooth pursuit and/or saccadic eye movements may be modulated in response to incremental rehearsal and/or partial occlusion treatment incorporated in 3D stereo stimuli. This speculation comes from the apparent significant improvement experienced by some of the participants when comparing their responses —not to virtual-pitch stimuli but to live-pitch pre-treatment and live-pitch post-treatment. Live-pitch pre- and post-treatment response comparisons were intended and designed to evaluate ToT, whereas virtual-pitch pre- and post-treatment response comparisons were intended and designed to evaluate eye-movement modulation. But, as has been discussed in Section 4.3.1, the virtual-pitch comparisons show modest changes as compared to live-pitch comparisons which may be due to accommodative-vergence impairment inherent to 3D stereo displays. The significant changes in live-pitch pre- and post-treatment present something of a dichotomy or contradiction. That is, how can there be improvement in the live-pitch environment if the virtual-environment treatment was ineffective?

This contradiction, in fact, serves as a premise for the proposition that accommodative-vergence impairment (or something else) may explain the differences between live-pitch and virtual-pitch saccade onset time responses. It also serves as a

premise for the proposition that modulation of eye movements resulting from the 3D virtual environment treatment may have taken place, even as the modulation cannot be manifested by responses to the virtual environment stimuli.

Future work should examine more closely the role and influence of accommodative-vergence involving objects moving in depth in 3D stereo, as has been suggested in Section 4.3.1. It would also be informative to examine the perception of dynamic content in the absence of eye movement facilitated by 3D stereo accommodative-vergence impairment. Examining the perception of 3D in the absence of measurable stereo acuity [198], as well as other perception phenomena (e.g., subliminal messages) that may leverage accommodative-vergence and saccadic suppression, may be valuable in 3D stereo research.

An alternative experimental design that stops the virtual fastball within the FOV but beyond the smooth pursuit maximum velocity threshold (e.g., $100^\circ/\text{sec}$) would enable a more definitive measurement of catch-up saccade amplitude and onset time. Changing this fastball end state (possibly in tandem with the slow-motion approach taken in this study to measure threshold baselines) may be instrumental to computing catch-up saccade latencies associated with the virtual fastball to explore whether they are due to accommodative-vergence impairment or to something else.

The virtual-pitch and live-pitch simulation couple would be instrumental to examine other combinations of incremental rehearsal and partial occlusion, such as various configurations of practice/treatment involving Spacing Effect, Contextual Interference, interleaved/random and blocked practice schemes, and other paradigms. The effects of multiple-practice designs and retention could also be examined.

4.3.4. FOURTH AIM AND RESEARCH QUESTION

The fourth aim of the study sought to obtain objective measures of positive or negative ToT from which could be inferred whether or not modulation of smooth pursuit and saccadic eye movements derived from the simulation-based treatment in the third aim of this study had occurred.

The descriptive research question associated with this aim was: Does positive (or negative) ToT occur following an incremental-rehearsal/partial-occlusion treatment protocol implemented in 3D stereo virtual environment to moderate task difficulty and instigate strategic eye-movements in the baseball batting task?

Results of saccade onset times from live-pitch pre- and post-treatment indicate that some participants may have experienced positive ToT while some may have experienced negative ToT. Although the results varied across participants, the results of individual participants were relatively consistent. The effectiveness of either incremental-rehearsal or partial-occlusion cannot be determined conclusively in light of the open question discussed in the previous three sections involving the source of differing responses to live and virtual fastball stimuli. Notwithstanding the limitations and open questions, the results suggest that positive ToT may have taken place and should be investigated further.

Future work should consider not only a larger sample size but also other measures of batting performance that provide insights about the role and extent of eye-movement strategies on overall batting performance.

BIBLIOGRAPHY

- [1] W. A. Burroughs, "Visual Simulation Training of Baseball Batters," *International Journal of Sport Psychology*, vol. 15, pp. 117-126, 1984.
- [2] D. Peterson. (2011). *Hitting a Baseball - "The Hardest Thing to do in Sports"*. Available: <http://www.axonpotential.com/hitting-a-baseball-the-hardest-thing-to-do-in-sports/>
- [3] R. Smith, "You Can't Keep Your Eye on the Ball," *Sports Illustrated*, vol. 1, p. 73, 1954.
- [4] J. Groth and G. Kell, "Batting Styles," *Scholastic Coach*, vol. 19, 1950.
- [5] E. Boell, "Know the Rules," *Scholastic Coach*, vol. 17, pp. 28-34, 1948.
- [6] C. E. Bolin, "Batter Up," *Scholastic Coach*, vol. 19, pp. 10-11, 1948.
- [7] R. Gray, "Behavior of College Players in a Virtual Batting Task," *Journal of Experimental Psychology: Human Perception and Performance*, vol. 28, pp. 1131-1148, 2002.
- [8] A. T. Bahill and T. LaRitz, "Why Can't Batters Keep Their Eyes on the Ball?," *American Scientist*, vol. 72, pp. 248-253, 1984.
- [9] A. W. Hubbard and C. N. Seng, "Visual Movement of Batters," *The Research Quarterly of the American Association for Health, Physical Education, and Recreation*, vol. 25, pp. 42-57, 1954.
- [10] A. T. Bahill, "Does a Baseball Player 'Keep His Eye on the Ball?'," *Modeling and Simulation: Proceedings of the 12th Annual Pittsburgh Conference*, vol. 12, pp. 1201-1206, 1981.
- [11] T. LaRitz, D. J. Hall, and A. T. Bahill, "Modeling Head and Eye Coordination of Baseball Players," *Modeling and Simulation: Proceedings of the 14th Annual Pittsburgh Conference*, pp. 1059-1063, 1983.
- [12] A. T. Bahill and T. LaRitz, "Do Baseball and Cricket Players Keep Their Eyes on the Ball?," *Proceedings of the 1983 International Conference on Systems, Man and Cybernetics (India)*, pp. 79-83, 1983.
- [13] T. Bahill and D. G. Baldwin, "The Vertical Illusion of Batters," *The Baseball Research Journal*, vol. 32, pp. 26-30, 2003.
- [14] G. Diaz, J. Cooper, and M. Hayhoe, "Memory and Prediction in Natural Gaze Control," *Philosophical Transactions of The Royal Society Biological Sciences*, vol. 368, 2013.

- [15] G. Diaz, J. Cooper, C. Rothkopf, and M. Hayhoe, "Saccades to Future Ball Location Reveal Memory-Based Prediction in a Virtual-Reality Interception Task," *Journal of Vision*, vol. 13, pp. 1-14, 2013.
- [16] B. Bridgeman, "A Review of the Role of Efference Copy in Sensory and Oculomotor Control Systems," *Annals of Biomedical Engineering*, vol. 23, pp. 409-422, 1995.
- [17] A. T. Bahill and J. D. McDonald, "Adaptive Control Model for Saccadic and Smooth Pursuit Eye Movements," in *Progress in Oculomotor Research*, B. Fuchs, Ed., ed: Elsevier North Holland, Inc., 1981, pp. 551-558.
- [18] P. J. Dallos and R. W. Jones, "Learning Behavior of the Eye Fixation Control System," *IEEE Transactions on Automatic Control*, pp. 218-227, 1963.
- [19] W. Becker and A. F. Fuchs, "Prediction in the Oculomotor System: Smooth Pursuit During Transient Disappearance of Visual Target," *Experimental Brain Research*, vol. 57, pp. 562-575, 1985.
- [20] L. Stark, G. Vossius, and L. R. Young, "Predictive Control of Eye Tracking Movements," *IRE Transactions on Human Factors in Electronics*, pp. 52-57, 1962.
- [21] A. T. Bahill and J. D. McDonald, "Smooth Pursuit Eye Movements in Response to Predictable Target Motions," *Vision Research*, vol. 23, pp. 1573-1583, 1983.
- [22] T. Genewein, E. Hez, Z. Razzaghpahan, and D. A. Braun, "Structure Learning in Bayesian Sensorimotor Integration," *PLOS Computational Biology*, vol. 11, 2015.
- [23] J. J. Hopp and A. F. Fuchs, "The Characteristics and Neuronal Substrate of Saccadic Eye Movement Plasticity," *Progress in Neurobiology*, vol. 72, pp. 27-53, 2004.
- [24] K. Iwanaga, "Ch 8 - Human Adaptability to Emotional and Intellectual Mental Stresses," in *Human Variation - From the Laboratory to the Field*, C. G. N. Mascie-Taylor, A. Yasukouchi, and S. Ulijaszek, Eds., ed: CRC Press, 2010, pp. 111-115.
- [25] L. M. Optican, "Chapter 4 - Adaptive Properties of the Saccadic System, in Adaptive Mechanisms in Gaze Control – Facts and Theories," ed: Elsevier Science Publishers BV (Biomedical Division), 1985.
- [26] S. De Brouwer, M. Missal, G. Barnes, and P. Lefevre, "Quantitative Analysis of Catch-up Saccades During Sustained Pursuit," *Journal of Neurophysiology*, vol. 87, pp. 1772-1780, 2002.
- [27] S. De Brouwer, M. Missal, and P. Lefevre, "Role of Retinal Slip in the prediction of Target Motion During Smooth and Saccadic Pursuit," *The American Physiological society*, vol. 86, pp. 550-558, 2001.

- [28] S. DeBrouwer, D. Yuksel, G. Blohm, M. Missal, G. Barnes, and P. Lefevre, "What Triggers Catch-Up Saccades During Visual Tracking?," *Journal of Neurophysiology*, vol. 87, pp. 1646-1650, 2002.
- [29] A. C. Smit and J. A. M. Van Gisbergen, "An Analysis of Curvature in Fast and Slow Human Saccades," *Experimental Brain Research*, vol. 81, pp. 335-345, 1990.
- [30] S. P. Tipper, L. A. Howard, and M. A. Paul, "Reaching Affects Saccade Trajectories," *Experimental Brain Research*, vol. 136, pp. 241-249, 2001.
- [31] M. D. Shank and K. M. Haywood, "Eye Movements While Viewing a Baseball Pitch," *Perceptual and Motor Skills*, vol. 64, pp. 1191-1197, 1987.
- [32] T. Kato and T. Fukuda, "Visual Search Strategies of Baseball Batters: Eye Movements During the Preparatory Phase of Batting," *Perceptual and Motor Skills*, pp. 380-386, 2002.
- [33] R. N. Singer, et al., "Visual Search, Anticipation, and Reactive Comparisons Between Highly-Skilled and Beginning Tennis Players," *Journal of Applied Sport Psychology*, vol. 8, pp. 9-26, 1996.
- [34] D. Farrow and B. Abernethy, "Can Anticipatory Skills be Learned through Implicit Video-Based Perceptual Training?," *Journal of Sports Science*, vol. 20, pp. 471-485, 2002.
- [35] D. Farrow, et al., "The Effect of Video-Based Perceptual Training on the Tennis Return of Serve," *International Journal of Sport Psychology*, vol. 29, pp. 231-242, 1998.
- [36] G. Paul and S. Glencross, "Expert Perception and Decision-Making in Baseball," *Journal of Sport Psychology*, vol. 28, pp. 35-56, 1997.
- [37] R. Hyllegard, "The Role of Baseball Seam Pattern in Pitch Recognition. ," *Journal of Sport & Exercise Psychology*, vol. 13, pp. 80-84, 1991.
- [38] P. J. Fadde, "Video-Based Simulation Training of the Perceptual Decision-Making Skill of Pitch Recognition in the Sport of Softball," *Proceedings of the International Society of Sport Psychology, 11th World Congress on Sport Psychology*, 2005.
- [39] M. Peck, "Tools or Toys? Training Games are Popular, but No One Knows How Well They Work," *Training & Simulation Journal*, vol. 12, pp. 30-31, 2011.
- [40] A. M. Williams, et al., "Visual Search and Sport Performance," *Australian Journal of Science and Medicine in Sport*, vol. 25, pp. 55-65, 1993.

- [41] A. M. Williams, K. Davids, and J. G. Williams, *Visual Perception & Action in Sport*. New York, NY: Routledge, 1999.
- [42] G. Westheimer, "Eye Movement Responses to a Horizontal Moving Visual Stimulus," *American Medical Association Archives of Ophthalmology*, vol. 52, pp. 932-941, 1954.
- [43] K. A. Ericsson and A. C. Lehman, "Expert and Exceptional Performance: Evidence of Maximal Adaptation to Task Constraints," *Annual Review of Psychology*, vol. 47, pp. 273-305, 1996.
- [44] M. R. Endsley, "Expertise and Situation Awareness," in *The Cambridge Handbook of Expertise and Expert Performance*, K. Ericsson, et al., Ed., ed Cambridge: Cambridge University Press, 2006, pp. 633-651.
- [45] A. M. Williams and P. Ward, "Perceptual Expertise: Development in Sport," in *Expert Performance in Sports: Advances in Research in Sport Expertise*, J. Starkes, Ericsson, KA, Ed., ed Champaign, IL: Human Kinetics, 2003, pp. 219-247.
- [46] J. L. Starkes and S. Lindley, "Can We Hasten Expertise by Video Simulation?," *Quest*, vol. 46, pp. 211-222, 1994.
- [47] J. B. Shea and G. Paull, "Chapter 13 - Capturing Expertise in Sports," ed, pp. 321-335.
- [48] P. J. Fadde, "Expertise-Based Training: Getting More Learners Over the Bar in Less Time," *Technology, Instruction, Cognition, and Learning*, vol. 7, pp. 171-197, 2009.
- [49] B. Abernethy, "Visual Search in Sport and Ergonomics: Its Relationship to Selective Attention and Performer Expertise," *Human Performance*, vol. 1, pp. 205-235, 1988.
- [50] T. Balasaheb, P. Maman, and J. S. Sandhu, "The Impact of Visual Skills Training Program on Batting Performance in Cricketers," *Serbian Journal of Sports Sciences*, vol. 2, pp. 17-23, 2008.
- [51] M. Carrasco, et al., "The Eccentricity Effect: Target Eccentricity Affects Performance on Conjunction Searches," *Perception and Psychophysics*, vol. 57, pp. 1241-1261, 1995.
- [52] M. Carrasco and K. S. Frieder, "Cortical Magnification Neutralizes the Eccentricity Effect in Visual Search," *Vision Research*, vol. 37, pp. 63-82, 1997.
- [53] M. F. Land and P. McLeod, "From Eye Movements to Actions: How Batsmen Hit the Ball," *Nature Neuroscience*, vol. 3, pp. 1340-1345, 2000.
- [54] T. Takeuchi and K. Inomata, "Visual Search Strategies and Decision Making in Baseball Batting," *Perceptual and Motor Skills*, vol. 108, pp. 971-980, 2009.

- [55] R. I. Wang, et al., "Online Gaze Disparity via Binocular Eye Tracking on Stereoscopic Displays," *Proceedings of the Second Joint 3DIM/3DPVT Conference: 3D Imaging, Modeling, Processing, Visualization & Transmission (3DimPVT 2012)* 2012.
- [56] P. Ward, A. M. Williams, and P. A. Hancock, "Chapter 14 - Simulation for Performance and Training," in *The Cambridge Handbook of Expertise and Expert Performance*, K. Ericsson, charness, N, Feltovich, PJ, Hoffman, RR, Ed., ed New York: Cambridge University Press, 2006, pp. 243-262.
- [57] J. G. Williams, "Effects of Kinematically Enhanced Video-Modeling on Improvement of Form in a Gymnastic Skill," *Perceptual and Motor Skills*, vol. 69, pp. 473-474, 1989.
- [58] D. L. Wright, F. Pleasants, and M. Gomez-Mesa, "Use of Advanced Visual Cue Sources in Volleyball," *Journal of Sport & Exercise Psychology*, vol. 12, pp. 406-414, 1990.
- [59] R. A. Schachar, "The Mechanism of Accommodation and Presbyopia," *International Ophthalmology Clinics*, vol. 46, pp. 39-61, 2006.
- [60] A. T. Duchowski, et al., "Measuring Gaze Depth with an Eye Tracker During Stereoscopic Display," *Proceedings of Applied Perception in Graphics and Visualization (APGV)*, pp. 15-22, 2011.
- [61] J. D. Enderle, *Model of Horizontal Eye Movements - Part I: Early Models of Saccades and Smooth Pursuit*. University of Connecticut: Morgan & Claypool., 2010.
- [62] L. Schalen, "Quantification of Tracking Eye Movements in Normal Subjects," *Acta Otolaryngologica*, vol. 90, pp. 404-413, 1980.
- [63] B. Abernethy, R. J. Neal, and P. Koning, "Visual-Perceptual and Cognitive Differences Between Expert, Intermediate, and Novice Snooker Players," *Applied Cognitive Psychology*, vol. 8, pp. 185-211, 1994.
- [64] M. T. H. Chi, "Laboratory Methods for Assessing Experts' and Novices' Knowledge, ," in *The Cambridge Handbook of Expertise and Expert Performance*, K. Ericsson, et al., Ed., ed Cambridge: Cambridge University Press, 2006, pp. 167-184.
- [65] P. J. Fadde, "Instructional Design for Advanced Learners: Training Recognition Skills to Hasten Expertise," *Education Tech Research Dev*, 2007.
- [66] C. Goulet, C. Bard, and M. Fleury, "Expertise Difference in Preparing to Return a Tennis Serve: A Visual Information Processing Approach. ," *Journal of Sport & Exercise Psychology*, vol. 11, pp. 382-398, 1989.
- [67] S. Kalyuga, P. Ayres, P. Chandler, and J. Sweller, "The Expertise Reversal Effect," *Educational Psychologist*, vol. 38, pp. 23-31, 2003.

- [68] D. S. Zee and L. M. Optican, "Chapter 11 - Studies of Adaptation in Human Oculomotor Disorders, in *Adaptive Mechanisms in Gaze Control – Facts and Theories*," ed: Elsevier Science Publishers BV (Biomedical Division), 1985.
- [69] K. Fukushima, et al., "Adaptive Changes in Smooth Pursuit Eye Movements Induced by Cross-Axis Pursuit-Vestibular Interaction Training in Monkeys," *Experimental Brain Research*, vol. 139, pp. 473-481, 2001.
- [70] A. Bandura, *Social Foundations of Thought and Action: A Social Cognitive Theory*. Englewood Cliffs, NJ: Prentice-Hall, 1986.
- [71] J. Sweller, "Cognitive Load During Problem Solving: Effects on Learning," *Cognitive Science*, vol. 12, pp. 257-285, 1988.
- [72] J. Sweller, J. Van Merriënboer, and F. Paas, "Cognitive Architecture and Instructional Design," *Educational Psychology Review*, vol. 10, pp. 251-296, 1998.
- [73] A. Shapiro, "Transitions Between Central and Peripheral Vision Create Spatial/Temporal Distortions: A Hypothesis Concerning the Perceived Break of the Curveball," *PLoS ONE*, vol. 5, 2010.
- [74] C. M. F. Leite, H. Ugrinowitsch, M. F. S. P. Carvalho, and R. N. Benda, "Distribution of Practice Effects on Older and Younger Adults' Motor-Skill Learning Ability," *Human Movement*, vol. 14, pp. 20-26, 2013.
- [75] T. D. Lee, "Chapter 7 - Transfer-Appropriate Processing: A Framework for Conceptualizing Practice Effects in Motor Learning," in *Complex Management Behaviour: The Motor-Action Controversy*, O. G. Meijer and K. Roth, Eds., ed North-Holland: Elsevier Science Publishers B.V., 1988, pp. 201-215.
- [76] T. D. Lee and E. D. Genovese, "Distribution of Practice in Motor Skill Acquisition: Learning and Performance Effects Reconsidered," *Research Quarterly for Exercise and Sport*, vol. 59, pp. 227-287, 1988.
- [77] T. D. Lee and E. D. Genovese, "Distribution of Practice in Motor Skill Acquisition: Different Effects for Discrete and Continuous Tasks," *Research Quarterly for Exercise and Sport*, vol. 60, pp. 59-65, 1989.
- [78] A. V. Carron, "Performance and Learning in a Discrete Motor Task Under Massed vs. Distributed Practice," *Research Quarterly. American Association for Health, Physical Education and Recreation*, vol. 40, pp. 481-489, 1969.
- [79] O. Bock and S. Schneider, "Sensorimotor Adaptation in Young and Elderly Humans," *Neuroscience & Behavioral Review*, vol. 26, pp. 761-767, 2002.

- [80] O. Bock, M. Thomas, and V. Grigorova, "The Effects of Rest Breaks on Human Sensorimotor Adaptation," *Experimental Brain Research*, vol. 163, pp. 258–260, 2005.
- [81] J. A. García, F. J. Moreno, R. Reina, R. Menayo, and J. P. Fuentes, "Analysis of Effects of Distribution of Practice in Learning and Retention of a Continuous and a Discrete Skill Presented on a Computer," *Perceptual and Motor Skills*, vol. 107, pp. 261-272, 2008.
- [82] G. E. Stelmach, "Efficiency of Motor Learning as a Function of Inter-Trial Rest," *Research Quarterly for Exercise and Sport*, vol. 40, pp. 198–202, 1969.
- [83] T. K. Dail and R. W. Christina, "Distribution of Practice and Metacognition in Learning and Long-Term Retention of a Discrete Motor Task," *Research Quarterly for Exercise and Sport*, vol. 75, pp. 148-155, 2004.
- [84] A. W. Salmoni, R. A. Schmidt, and C. B. Walter, "Knowledge of Results and Motor Learning: A Review and Critical Reappraisal," *Psychological Bulletin*, vol. 95, pp. 355-386, 1984.
- [85] R. A. Schmidt and T. D. Lee, *Motor Control and Learning: A Behavioral Emphasis.*, Champaign 2011., Fifth ed. Champaign, ILL, 2011.
- [86] S. Varma and K. B. Schleisman, "The Cognitive Underpinnings of Incremental Rehearsal," *School Psychology Review*, vol. 43, pp. 222-228, 2014.
- [87] K. G. Hall, D. A. Domingues, and R. Cavazos, "Contextual Interference Effects with Skilled Baseball Players," *Perceptual and Motor Skills*, vol. 78, pp. 835-841, 1994.
- [88] R. A. Magill and K. G. Hall, "A Review of the Contextual Interference Effect in Motor Skill Acquisition," *Human Movement Science*, vol. 9, pp. 241-289, 1990.
- [89] F. N. Dempster and A. J. Corkill, "Interference and Inhibition in cognition and Behavior: Unifying Themes for Educational Psychology," *Educational Psychology Review*, vol. 11, pp. 1-88, 1999.
- [90] J. B. Shea and R. L. Morgan, "Contextual Interference Effects on the Acquisition, Retention, and Transfer of a Motor Skill," *Journal of Experimental Psychology: Human Learning and Memory*, vol. 5, pp. 179-187, 1979.
- [91] B. P. Goettl, "Contextual Interference Effects on Acquisition and Transfer of a Complex Motor Task," A. F. M. C. Human Resources Directorate Technical Training Research Division, Ed., ed. Brooks Air Force Base, Texas, 1995.
- [92] S. Ainsworth, "How Do Animations Influence Learning?," in *Current Perspectives on Cognition, Learning, and Instruction: Recent Innovations in Educational Technology that Facilitate Student Learning*, D. Robinson and G. Schraw, Eds., ed: Information Age Publishing, pp. 37-67.

- [93] NCSA_Athletic_Recruiting. *Baseball Pitcher*. Available: <http://www.ncsasports.org/recruiting-tools/college-baseball-recruiting/baseball-recruiting-guidelines/baseball-pitcher>
- [94] Maryland_Collegiate_Baseball_League. (2012). *MCBL 2012 Player Batting Stats*. Available: <http://www.htosports.com/teams/default.asp?u=BUCKEYE&t=c&s=baseball&p=stats>
- [95] eFastball.com. (2002). *Range of Speed (in MPH) for Various Baseball Pitches by Age Group*. Available: <http://www.efastball.com/baseball/pitching/grips/average-pitching-speed-by-age-group/>
- [96] D. Kagan and A. M. Nathan, "Simplified Models for the Drag Coefficient of a Pitched Baseball," *The Physics Teacher*, vol. 52, pp. 278-280, 2014.
- [97] D. A. Robinson, "The Oculomotor Control System: A Review," *Proceedings of the Institute for Electrical and Electronics Engineers*, vol. 56, pp. 1032-1049, 1968.
- [98] A. Duchowski, *Eye Tracking Methodology Theory and Practice*. Clemson, SC: Springer, 2007.
- [99] D. A. Robinson, "The Mechanics of Human Smooth Pursuit Eye Movement," *Journal of Physiology*, vol. 180, p. 569, 1965.
- [100] R. J. Leigh and D. S. Zee, *The Neurology of Eye Movements*. New York, NY: Oxford University Press, 1999.
- [101] D. A. Robinson, "The Mechanics of Human Saccadic Eye Movement," *Journal of Physiology*, vol. 174, pp. 245-264, 1964.
- [102] A. T. Bahill and J. D. McDonald, "Model Emulates Human Smooth Pursuit System Producing Zero-Latency Target Tracking," *Biological Cybernetics*, vol. 48, pp. 213-222, 1983.
- [103] A. T. Bahill and D. R. Harvey, "Open Loop Experiments for Modeling the Human Eye Movement System," *IEEE Transactions on Systems, Man and Cybernetics*, vol. 16, pp. 240-250, 1986.
- [104] A. T. Bahill, D. Adler, and L. Stark, "Most Naturally Occurring Human Saccades Have Magnitudes of 15 Degrees or Less," *Investigative Ophthalmology*, vol. 14, pp. 468-469, 1975.
- [105] D. M. Laby, et al., "The Effect of Ocular Dominance on the Performance of Professional Baseball Players," *Ophthalmology*, vol. 105, pp. 864-866, 1998.

- [106] A. T. Bahill and L. Stark, "Neurological Control of Horizontal and Vertical Components of Oblique Saccadic Eye Movements," *Mathematical Biosciences*, vol. 27, pp. 287-298, 1975.
- [107] J. G. Thomas, "The Dynamics of Small Saccadic Movement," *Journal of Physiology*, vol. 200, pp. 109-127, 1969.
- [108] J. G. Thomas and H. O'Beirne, "Curvature in the Saccadic Movement," *Archives of Ophthalmology*, vol. 77, pp. 105-109, 1967.
- [109] R. A. Williams and D. H. Fender, "Velocity Precision in Smooth Pursuit Eye Movements," *Vision Research*, vol. 19, p. 343, 1979.
- [110] A. T. Bahill, M. R. Clark, and L. Stark, "The Main Sequence, A Tool for Studying Human Eye Movements," *Mathematical Biosciences*, vol. 24, pp. 191-204, 1975.
- [111] U. o. Liverpool. *The Parameters of Eye Movement*. Available: <https://www.liverpool.ac.uk/~pcknox/teaching/Eymovs/params.htm>
- [112] R. H. S. Carpenter, *Movements of the Eyes*. London: Pion Limited, 1977.
- [113] R. W. Baloh, A. W. Sills, W. E. Kumley, and V. Honrubia, "Quantitative Measurement of Saccade Amplitude, Duration, and Velocity," *Neurology*, vol. 25, pp. 1065-1070, 1975.
- [114] R. G. Watts and T. Bahill, *Keep Your Eye on the Ball*. New York, NY: W.H. Freeman, 2000.
- [115] R. Blake and R. Sekuler, *Perception*, 5th ed.: McGraw-Hill Higher Education, 2005.
- [116] E. P. Widmaier, H. Raff, and K. T. Strang, *Vander's Human Physiology*, 11th ed. New York, NY: McGraw-Hill Higher Education, 2006.
- [117] B. M. Koeppen and B. A. Stanton, *Berne & Levy Physiology*, 6th ed.: Mosby Elsevier, 2008.
- [118] J. M. Wolfe, P. O'Neill, and S. C. Bennett, "Why are there Eccentricity Effects in Visual Search? Visual and Attentional Hypothesis," *Perception and Psychophysics*, vol. 60, pp. 140-156, 1998.
- [119] D. G. Green, "Regional Variations in the Visual Acuity for Interference Fringes on the Retina," *Journal of Physiology*, vol. 207, pp. 351-356, 1970.

- [120] M. A. Gariel, et al., "Cortical Networks are Massively Influenced by Eccentricity and Suggest Principles of Contextual Processing. ," *Society of Neurosciences*, vol. Annual Meeting:, p. Abstract, 2008.
- [121] T. Bahill and D. G. Baldwin, "The Rising Fastball and Other Perceptual Illusions of Batters," in *Biomedical Engineering Principles in Sports*, G. Hung, Pallis, J, Ed., ed: Kluwer Academic, 2004, pp. 257-287.
- [122] B. Kolb and I. Q. Whishaw, "Brain Plasticity and Behavior," *Annual Review of Psychology*, vol. 49, pp. 43-64, 1998.
- [123] A. Berthoz and G. M. Jones, "Adaptive Mechanisms in Gaze Control," in *Reviews of Oculomotor Research - Volume 1*, ed Amsterdam, The Netherlands: Elsevier Science Publishers B.V. (Biomedical Division), 1985.
- [124] G. Kommerell, D. Olivier, and H. Theopold, "Adaptive Programming of Phasic and Tonic Components in Saccadic Eye Movements. Investigations in Patients with Abducens Palsy. ," *Investigative Ophthalmology*, vol. 15, pp. 657-660, 1976.
- [125] Cognifit. (2012). *The Brain Plasticity and Cognition*. Available: <http://www.cognifit.com/brain-plasticity-and-cognition>
- [126] P. J. Lang, R. F. Simmons, and M. T. Balaban, *Attention and Orienting: Sensory and Motivational Processes*. Mahwah, New Jersey: Lawrence Erlbaum Associates Publishers, 1997.
- [127] G. Paterson, *Visual-Motor Response Times in Athletes and Non-Athletes*. Stellenbosch University: Stellenbosch, 2010.
- [128] R. A. Magill, *Motor Learning and Control: Concepts and Applications*, 5th ed ed. New York: McGraw-Hill, 2003.
- [129] A. Ludeke and J. T. Ferreira, "The Difference in Visual Skills Between Professional versus Non-Professional Rugby Players," *The South African Optometrist*, vol. 62, pp. 150-158, 2003.
- [130] W. S. Geisler and L. Cormack, "Chapter 24 - Models of Overt Attention, in Oxford Handbook of Eye Movements," ed New York, NY: Oxford University Press, 2011, pp. 439-454.
- [131] F. K. Graham and S. A. Hackley, "Passive and Active Attention to Input, in Handbook of Cognitive Psychophysiology," ed New York, NY: Wiley, 1991.
- [132] R. C. Clark, F. Nguyen, and J. Sweller, *Efficiency in Learning*. San Francisco, CA: Pfeiffer, 2006.

- [133] J. J. G. van Merriënboer and L. Kester, "Whole Task Models in Education," in *Handbook of Research on Educational Communications and Technology*, ed New York, NY: Routledge, 2008, pp. 441-456.
- [134] T. van Gog, et al., "Instructional Design for Advanced Learners: Establishing Connections Between the Theoretical Frameworks of Cognitive Load and Deliberate Practice," *Educational Technology Research and Development*, vol. 53, pp. 73-81, 2005.
- [135] A. J. Rehman, "A Handbook of flight Simulation Fidelity Requirements for Human Factors Research," U. D. o. T. F. A. A. T. Center, Ed., ed, 1995.
- [136] D. Gross, "Report from the Fidelity Implementation Study Group," *Proceedings of the 1999 Spring Simulation Interoperability Workshop*, 1999.
- [137] S. Youngblood and S. Harmon, "A Proposed Model for Simulation Validation Maturity," *Journal of Defense Modeling & Simulation*, vol. 2, pp. 179-190, 2005.
- [138] *M&S Glossary*. Available: <http://msco.mil/MSGlossary.html>
- [139] D. Gross, D. Pace, S. Harmon, and W. Tucker, "Why Fidelity?," *Spring 1999 Simulation Interoperability Workshop Paper - 99S-SIW-168*, pp. 1055-1061, 1999.
- [140] H. W. Orlady, R. T. Hennessy, R. Obermayer, D. Vreuls, and M. R. Murphy, "Using Full-Mission Simulation for Human Factors Research in Air Transport Operations ", A. R. Center, Ed., ed. Moffet Field, CA, 1988.
- [141] J. A. Allen, L. Buffardi, and R. Hays, "The Relationship of Simulator Fidelity to Task and Performance Variables," U. S. A. R. I. f. t. B. Sciences, Ed., ed, 1991.
- [142] W. M. Bunker, "Training Effectiveness Versus Simulation Realism," in *Eleventh NTEX/Industry Conference*, 1978.
- [143] R. G. Kinkade and G. R. Wheaton, "Training Device Design," in *Human Engineering Guide to Equipment Design*, H. P. VanCort and R. G. Kinkade, Eds., ed Washington, DC 20402: U.S. Government Printing Office, 1972.
- [144] S. C. Bhatnagar, *Neuroscience for the Study of Communicative Disorders*, 2nd ed. Baltimore, MD: Lippincott Williams & Wilins, 2002.
- [145] E. F. Finchman and J. Walton, "The Reciprocal Actions of Accommodation and Convergence," *Journal of Physiology*, vol. 137, pp. 488-508, 1957.
- [146] M. W. Morgan, "Accommodation and its Relationship to Convergence," *American Journal of Optometry & Archives of American Academy of Optometry*, vol. 21, pp. 183-195, 1944.

- [147] S. Yang and J. E. Sheedy, "Effects of Vergence and Accommodative Responses on Viewer's Comfort in Viewing 3D Stimuli, ," in *Stereoscopic Displays and Applications XXII*, ed San Francisco, CA, 2011.
- [148] J. Maxwell, J. Tong, and C. M. Schor, "Short-Term Adaptation of Accommodation, Accommodative Vergence, and Disparity Vergence Facility," *Vision Research*, vol. 62, pp. 93-101, 2012.
- [149] C. M. Schor and J. C. Kotulak, "Dynamic Interactions Between Accommodation and Convergence are Velocity Sensitive," *Vision Research*, vol. 26, pp. 927-942, 1986.
- [150] T. Inoue and H. Ohzu, "Accommodative Responses to Stereoscopic Three-Dimensional Display," *Applied Optics*, vol. 36, pp. 4509-4515, 1997.
- [151] P. Neveu, "Vergence Tracking: A Tool to Assess Oculomotor Performance in Stereoscopic Displays," *Journal of Eye Movement Research*, vol. 5, pp. 1-8, 2012.
- [152] M. L. Kung, T. L. Alvarez, and J. L. Semmlow, "Interaction of Disparity and Accommodative Vergence," *Proceedings of the IEEE 29th Annual Northeast Bioengineering Conference*, pp. 29-30, 2003.
- [153] J. O. Merritt, "Not Too Far, Not Too close, Just Right: 3D TV For The Home May Provide an Optimum Viewing Distance," ed. Stanford University Huang Engineering Center, 2011.
- [154] H. A. Simon and W. G. Chase, "Skill in Chess," *American Scientist*, vol. 61, pp. 394-403, 1973.
- [155] Unknown. *Baseball Training Aids*. Available: https://www.google.com/search?q=baseball+batter+clipart&espv=2&biw=1201&bih=659&tbm=isch&tbo=u&source=univ&sa=X&ved=0ahUKEwibwp3Bn7DOAhUDWxQKHacfCOUQsAQIGw#tbm=isch&tbs=ring%3ACWjJV0pS6apiIji1S5_1e6Zr8YoGzI7ImPodfniOAgKk4_1QQ04wcm8tJfQulHE-jnVDa-pbalv5n5GWVxWOKHYtkwpCoSCbVLn97pmvxiEdL1UJXcboq-KhIJgbMjuWY-h18R3MgRQxVce6gqEgmeI4CAqTj9BBGwqW25bzlpYioSCTTjByby019CEaMLS5I6oZ-9KhIJ6UcT6OdUNr4RCYU1sVgwes0qEgmltoi_1mfkZZRH4hmEnVDSzJioSCXFY4odi2TCkEScsE8Dpn7mW&q=baseball%20training%20aids&imgrc=Gt41SG0hFalWHM%3A
- [156] I. Oruc, O. Krigolson, K. Dalrymple, L. S. Nagamatsu, T. C. Handy, and J. J. S. Barton, "Bootstrap Analysis of the Single Subject with Event Related Potentials," *Neuropsychology*, vol. 28, pp. 322-337, 2011.
- [157] K. Ryan and J. Filene, "Design Options for Home Visiting Evaluation, Single Case Design Brief, Selecting Appropriate Single Case Designs for Evaluating MIECHV

Funded Home Visiting Programs," James Bell Associates, Projectg funded by the Administration for Children and Families in collaboration with the health Resources and Services Administration, Arlington, VA2012.

- [158] M. Wolery and S. R. Harris, "Interpreting Results of Single-Subject Research Design," *Physical Therapy*, vol. 62, pp. 445-452, 1982.
- [159] R. J. Engel and R. K. Schutt, "Single-Subject Design," in *The Practice of Research in social Work*, 3rd ed: SAGE Publications, 2012, pp. 206-246.
- [160] A. C. Tamhane and D. D. Dunlop, *Statistics and Data Analysis from Elementary to Intermediate*. New Jersey, NJ: Prentice Hall, 2000.
- [161] D. Shasha and M. Wilson, *Statistics is Easy!* St. Louis, MO: Morgan & Claypool, 2011.
- [162] B. Efron and R. J. Tibshirani, *An Introduction to the Bootstrap*: Chapman & Hall, 1993.
- [163] J. Orloff and J. Bloom. (2014). *Bootstrap Confidence Intervals - Class 24, 18.05, Spring 2014*. Available: <http://ocw.mit.edu>
- [164] L. Lombardi and R. Stanley. (2012). *District of Columbia Men's Senior Baseball League/Men's Adult Baseball League (DC MSBL/MABL)*. Available: http://www.dcmsbl.com/cgi-bin/foxweb.exe/show_league@leagues/Local_League?leagueID=DCMSBL
- [165] JUGS. (2009). *JUGS Combo Pitching Machine*. Available: <https://jugssports.com/pitching-machine-products/?id=641>
- [166] JUGS, "The JUGS Gun," ed, 2009.
- [167] Unknown. *Baseball Batter Clipart*. Available: <https://www.google.com/search?q=baseball+batter+clipart&espv=2&biw=1201&bih=659&tbm=isch&tbo=u&source=univ&sa=X&ved=0ahUKEwibwp3Bn7DOAhUDWxQKHacfCOUQsAQIGw>
- [168] P. Bourke. (1999). *Calculating Stereo Pairs*. Available: <http://paulbourke.net/stereographics/stereorender/>
- [169] Unknown. *Baseball Stitching Pattern Clipart*. Available: <https://www.google.com/search?q=baseball+batter+clipart&espv=2&biw=1201&bih=659&tbm=isch&tbo=u&source=univ&sa=X&ved=0ahUKEwibwp3Bn7DOAhUDWxQKHacfCOUQsAQIGw#tbn=isch&q=baseball+stitching+pattern&imgc=-pK9dXN44G7V8M%3A>

- [170] Sports_on_Earth. (2015). *Slowest Fastballs in the Majors*. Available: <http://www.sportsonearth.com/article/125659856/mlb-slowest-fastballs-masterson-vargas-lincecum-haren-weaver-buehrle>
- [171] Linear-Technology, "LT1167 - Single Resistor Gain Orprogrammable, precision Instrumentation Amplifier," L. Terchnology, Ed., ed. Milpitas, CA.
- [172] W. Heide, E. Koenig, P. Trillenber, D. Kompf, and D. S. Zee, "Recommendations for the Practice of Clinical Neurophysiology: Guidelines of the International Federation of Clinical Physiology (EEG Suppl. 52), Chapter 5 - Electrooculography: Technical Standards and Applications," *Clinical Neurophysiology*, pp. 223-240, 1999.
- [173] V. Henn, "Electronystagmography: The Answers One Might Get," in *Brain-Stem Localization and Function*, L. R. Caplan and H. c. Hopf, Eds., ed Berlin: Springer, 1993, pp. 93-99.
- [174] E. Isotalo, A. G. Lasker, and D. S. Zee, "Cognitive Influences on Predictive Saccadic Tracking," *Experimental Brain Research*, vol. 165, pp. 461-469, 2005.
- [175] B. L. Zuber, J. L. Semmlow, and L. Stark, "Frequency Characteristics of The Saccadic Eye Movement," *Biophysical Journal*, vol. 8, pp. 1288-1298, 1968.
- [176] A. Savitsky and M. J. E. Golay, "Smoothing and Differentiation of Data by Simplified Least Squares Procedures," *Analytical Chemistry*, vol. 36, pp. 1627-1639, 1964.
- [177] J. Fan and S.-K. Lin, "Test of Significance When Data are Curves," *Journal of the American Statistical Association*, vol. 93, pp. 1007-1021, 1998.
- [178] M. A. Harrington, "Comparing Visual and Statistical Analysis in Single-Subject Studies," PhD, Psychology, University of Rhode Island, Rhode Island, 2013.
- [179] M. V. Ellis, "Repeated Measures Design," *The Counseling Psychologist*, vol. 27, pp. 552-578, 1999.
- [180] R. R. Wilcox and H. J. Keselman, "Modern Robust Data Analysis Methods: Measures of Central Tendency," *Psychological Methods*, vol. 8, pp. 254-274, 2003.
- [181] L. Vizioli, K. Foreman, G. A. Rousselet, and R. Caldara, "Inverting Faces Elicits Sensitivity to Race on the N170 Component: A Cross-Cultural Study," *Journal of Vision*, vol. 10, pp. 1-23, 2010.
- [182] R. J. Leigh and C. Kennard, "Using Saccades as a Research Tool in the Clinical Neurosciences," *Brain*, vol. 127, pp. 460-477, 2004.

- [183] D. Boghen, B. T. Troost, R. B. Daroff, L. F. Dell'Osso, and J. e. Birkett, "Velocity Characteristics of Normal Human Saccades," *Investigative Ophthalmology*, vol. 13, pp. 619-623, 1974.
- [184] S. J. Fricker, "Dynamic measurement of Horizontal Eye Motion," *Investigative Ophthalmology*, vol. 10, pp. 724-732.
- [185] H. Cui, X.-h. Liu, K.-y. Wang, C.-y. Zhu, C. Wang, and X.-h. Xie, "Association of Saccade Duration and Saccade Acceleration/Deceleration Asymmetry During Visually Guided Saccade in Schizophrenia Patients," *PLoS ONE*, vol. 9, pp. 1-6, 2014.
- [186] S. Garbutt, M. R. Harwood, and C. M. Harris, "Comparison of the Main Sequence of Reflexive Saccades and the Quick Phase of Optokinetic Nystagmus," *British Journal of Ophthalmology*, vol. 85, pp. 1477-1483, 2001.
- [187] D. Pelisson and C. Prablanc, "Kinematics of Centrifugal and Centripetal Saccadic Eye Movements in Man," *Vision Research*, vol. 28, pp. 87-94, 1988.
- [188] H.-H. Lin, Y.-F. Chen, T. Chen, T.-T. Tsai, and K.-H. Huang, "Temporal Analysis of the Acceleration and Deceleration Phases for Visual Saccades," *Biomedical Engineering Applications, Basis & Communications*, vol. 16, pp. 355-362, 2004.
- [189] R. A. Abrams, "Speed and Accuracy of Saccadic Eye Movements: Characteristics of Impulse Variability in the Oculomotor System," *Journal of Experimental Psychology: Human Perception and Performance*, vol. 15, pp. 529-543, 1989.
- [190] A. J. Van Opstal and J. A. M. Van Gisbergen, "Skewness of Saccadic Velocity profiles: A unifying Parameter for Normal and Slow Saccades," *Vision Research*, vol. 27, pp. 731-745, 1987.
- [191] A. M. Bronstein and C. Kennard, "Predictive Eye Saccades are Different from Visually Triggered Saccades," *Vision Research*, vol. 27, pp. 517-520, 1987.
- [192] Wikipedia. *Exponentially Modified Gaussian Distribution*. Available: https://en.wikipedia.org/wiki/Exponentially_modified_Gaussian_distribution
- [193] E. Grushka, "Characterization of Exponentially Modified Gaussian Peaks in Chromatography," *Analytical Chemistry*, vol. 44, pp. 1733-1738, 1972.
- [194] J. J. Orban de Xivry and P. Lefevre, "Saccades and Pursuit: Two Outcomes of a Single Sensorimotor Process," *Journal of Physiology*, vol. 584, p. 11, 2007.
- [195] RadioShack. (1997). *Photocells Multi-Pack (276-1657) Specifications*. Available: http://support.radioshack.com/support_supplies/doc38/38703.htm

- [196] L. Optoelectronics. (2016). *CDS Photocells*. Available: <http://www.digikey.com/en/product-highlight/a/advanced-photonix/cds-photocells>
- [197] E. Powell. (2015). *Viewsonic LightStream PJD5555W Projector Review*. Available: <http://www.projectorcentral.com/viewsonic-pjd5555w-projector-review.htm?page=Performance>
- [198] L. P. Tidbury, R. H. Black, and A. R. O'Connor, "Perceiving 3D in the Absence of Measurable Stereo Acuity," *The British and Irish Orthoptic Journal*, vol. 11, pp. 34-38, 2014.

B. Appendix B – Study Participant Informed Consent Form

<p>INFORMED CONSENT DOCUMENT OLD DOMINION UNIVERSITY</p>	<p>Approved Institutional Review Board - ODU</p> <p>NOV 19 2015</p> <p>Expires 1 year from date Questions: (757) 683-3460</p>
<p>PROJECT TITLE: Repurposing the occlusion model in 3D stereoscopic virtual environment for manipulating the adaptive properties of the oculomotor system for visual skill development involving pitched baseball trajectories in the batting task.</p>	
<p>INTRODUCTION: The purposes of this form are to give you information that may affect your decision whether to say YES or NO to participation in this research, and to record the consent of those who say YES. The study "Repurposing the Occlusion Method in 3D Stereoscopic Virtual Environment for Manipulating the Adaptive Properties of the Oculomotor System for Visual-Search Skill Development Involving Pitched Baseball Trajectories in the Batting Task" will be conducted at 9298 Bailey Ln., Fairfax, VA 22031.</p>	
<p>RESEARCHERS: Responsible Project Investigator: Stacie Ringleb, Ph.D., Dept. of Mechanical and Aerospace Engineering</p> <p>Co-Investigator: Ric Roca, Dept. of Modeling, Simulation and Visualization Engineering</p>	
<p>DESCRIPTION OF RESEARCH STUDY: Several studies tried to determine where people look during the baseball batting task. If you decide to participate in this study, your eye movements will be measured while watching live-pitch baseballs launched by a rotary pitching machine as well as while watching virtual baseballs presented in a 3D stereoscopic virtual environment. You will be asked to participate in 1-3 sessions that last 1-2 hours each.</p> <p>If you decide to participate, you will be asked to complete a questionnaire to determine your baseball experience, baseball batting experience specifically, and other information conducive to inferring subjects' eye movement dexterity in the baseball batting task. Your vision will be tested. Additionally, your eye-movements will be measured while you view live 80 mile per hour (mph) fastballs launched by a rotary pitching machine as well as virtual fastballs of various speeds from a 3D stereo simulator. The eye-movement measurements will be obtained using three non-invasive electrodes (attached to the left and right temples for horizontal movements and to the forehead for reference) instrumented with adhesive conductive jell and further secured with medical tape to mitigate electrode detachment.</p> <p>If you are in the treatment group, you will undergo eye movement measurements while viewing 80 mph fastballs as well as calibration events in a 3D stereoscopic virtual environment for obtaining eye-movement threshold baselines. You will observe 100 to 200 80 mph fastball pitches in slow motion from 10% to 100% of full speed in 10% increments. The treatment may also include trajectories that are partially occluded to instigate fast catch-up eye movements. Following the treatment, you will undergo eye-movement measurements while viewing 80 mph fastballs in virtual environment as well as live fastballs launched from the rotary pitching machine for a second time.</p> <p>At the end of the session, you will be asked to complete a Virtual Environment Evaluation questionnaire.</p>	
<p>1</p>	

If you say YES, then your participation will consist of 1 to 2 sessions (1-2- hours per session) at 9298 Bailey Ln, Fairfax, VA 22031. Up to 60 batters may participate in this study.

EXCLUSIONARY CRITERIA:

If you do not have 20/40 corrected (or uncorrected) vision or better, or if your eyes do not have proper depth perception, you will not be allowed to participate. You should not have a history of eye injury or eye-related illnesses (nerve, orbital, or muscular) that would result in abnormal eye movements and keep you from participating in this study. In addition, you should be: a healthy male or female between the age of 18 and 55; 5.0 to 6.5 feet in height, actively participating or recently having participated in an organized collegiate or community baseball program; bat right-handed; not have a history of motion sickness or similar sickness induced by virtual environments; not be undergoing medication therapies that would have enhancement or depressant effects.

RISKS AND BENEFITS:

RISKS: If you decide to participate in this study, then you may face a risk of physical discomfort and even injury. You may get hit by a ball from the pitching machine, although the observation deck includes wooden, netting and acrylic protective shields to block potential stray balls making such a risk negligible.

There is a risk that you may experience dizziness, motion sickness, or some other symptom induced by the virtual reality scenario. It is expected that such symptoms will be minor or non-existent since the observation of a fastball pitch event presented in 3D stereo lasts approximately less than one half of one second and the total observation time of 100 to 200 pitches will last approximately 15 to 20 minutes non-continuous since there will be several seconds or minutes between pitching events. You will be allowed to take a break or stop participation if you experience these symptoms.

There is a risk that you may experience vertigo or other optical illusion effects after your participation in an experimental session thereby affecting your sense of balance or orientation and therefore your ability to walk or drive. These effects are also expected to be negligible because the duration of the 3D stereoscopic experience is very small. You will be allowed to rest after the session to determine if you are ok to drive and/or call someone if you need a ride home.

BENEFITS: There are no benefits for participating in this study.

COSTS AND PAYMENTS:

The researchers want your decision about participating in this study to be absolutely voluntary. Yet they recognize that your participation may pose time commitments and disruption to your personal schedule. Unfortunately, the researchers are unable to provide any payment for your participation in this study.

NEW INFORMATION:

If the researchers find new information during this study that would reasonably change your decision about participating, then they will give it to you.

CONFIDENTIALITY:

An additional risk to participation in this research is release of confidential test information acquired about the participant. However, the only personal information collected from you will include your name, age (no birth date), height, gender, race/ethnicity, and general information about your baseball



batting experience and performance. Notwithstanding the limited personal information, in order to avoid breach of confidentiality, participants will be assigned a random code number (e.g., Subject 0001) and no identifying information will be associated with the data. Research data will be stored in a locked file and any data stored online will be accessed through a secure server. All investigators will be current in their human subjects training. As with any research, there is a possibility of risks that we have not yet identified or anticipated.

The results of this study may be used in reports, presentations, and publications but any reference to your data will use your code (e.g., Subject 0001) and you will not be identified by name. Of course, your records may be subpoenaed by court order or inspected by government bodies with oversight authority.

WITHDRAWAL PRIVILEGE:

It is OK for you to say NO to participation in this study. Even if you say YES now, you are free to say NO later, and walk away or withdraw from the study at any time. Your decision will not affect your relationship with Old Dominion University or otherwise cause a loss of benefits to which you might otherwise be entitled. The researchers reserve the right to withdraw your participation in this study, at any time, if they observe potential problems with your continued participation.

COMPENSATION FOR ILLNESS AND INJURY:

If you say YES, then your consent in this document does not waive any of your legal rights. However, in the event of injury arising from this study, neither Old Dominion University nor the researchers are able to give you any money, insurance coverage, free medical care, or any other compensation for such injury. In the event that you suffer injury as a result of your participation in this research project, you may contact the investigator, Dr. Stacie Ringleb, at 757-683-5934, or Dr. George Maihafer, Chair of the Old Dominion University Institutional Review Board (757-683-4520), and they will be glad to review the matter with you.

VOLUNTARY CONSENT:

By signing this form, you are saying several things: You are saying that you have read the information in this form or have had it read to you, that you are satisfied that you understand the information in this form, the research study, and its risks and benefits. The researchers should have answered any questions you may have had about the research. If you have any questions later on, then the researchers should be able to answer them: Dr. Stacie Ringleb (757) 683-5934.

If at any time you feel pressured to participate, or if you have any questions about your rights or this form, then you should call Dr. George Maihafer, the current IRB chair, at 757-683-4520, or the Old Dominion University Office of Research, at 757-683-3460.

And importantly, by signing below, you are telling the researcher YES, that you agree to participate in this study. The researcher should give you a copy of this form for your records.

Subject's Printed Name & Signature



Date

INVESTIGATOR'S STATEMENT:

I certify that I have explained to this subject the nature and purpose of this research, including benefits, risks, costs, and any experimental procedures. I have described the rights and protections afforded to human subjects and have done nothing to pressure, coerce, or falsely entice this subject into participating. I am aware of my obligations under state and federal laws, and promise compliance. I have answered the subject's questions and have encouraged him/her to ask additional questions at any time during the course of this study. I have witnessed the above signature(s) on this consent form.

Investigator's Printed Name & Signature

Date

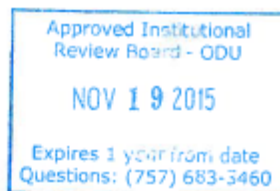

C. Appendix C – Subject Profile Questionnaire**SUBJECT PROFILE
QUESTIONNAIRE**

Please answer the following questions to the best of your availability:

1. How long have you played baseball (since what age, how many years)?
2. Did you play competitive baseball at the high school, collegiate, industrial, or professional levels? How long?
3. Have you played competitive baseball within the last year? Did you pitch? Did you catch?
4. How long has it been since you played competitive baseball?
5. Are you a right-handed hitter, left-handed hitter, or switch hitter? If switch, what percentage do you hit right handed?
6. If you are a right-handed hitter, do you throw right or left handed?
7. If you are a right-handed hitter, do you prefer hitting against a right-handed or left-handed pitcher?
8. Are you or have you been able to determine the type of pitch based on the rotation of the ball?
9. When facing a pitcher, what visual cues do you look for during the delivery of a pitch?
10. Where is your point of gaze during a pitch delivery?
11. Do you consider yourself a contact hitter or power hitter? Consistent or inconsistent?
12. Based on your experience, how often (%) did you make ball contact even if it resulted in an out?
13. Where would you put yourself in the batting order (1 thru 9; 1 = top, 9 = bottom)?
14. Rate your hitting (1 = novice, 2 = beginner, 3 = competent, 4 = proficient, 5 = expert)? What batting average would you designate to yourself?

15. What exercises or methods have you specifically employed to help you improve your hitting ability?
16. From 1 to 10 (1 = not proficient, 10 = very proficient), how well do you keep your eye on the ball?
17. Have you ever received any specialized training (other than traditional batting practice) designed to help you train your eyes to “keep your eye on the ball” in the batting task? Explain.
18. How tall are you? What is your age (do not provide birth date), race/ethnicity, and gender?
19. Is your vision acuity at least 20/40 uncorrected or corrected with eye-glasses or contacts lenses?
20. Have you ever experienced dizziness, vertigo, or other disorientation while viewing 3D stereo displays?

D. Appendix D – Virtual Environment Assessment Questionnaire

Virtual Environment Evaluation Questionnaire

Environment Factors

1. The shape of the virtual pitch trajectory resembled the shape of the live pitch trajectory.

① ————— ② ————— ③ ————— ④ ————— ⑤
 Strongly Agree Agree Neutral Disagree Strongly Disagree

2. The movement of the virtual pitch resembled the movement of the live pitch.

① ————— ② ————— ③ ————— ④ ————— ⑤
 Strongly Agree Agree Neutral Disagree Strongly Disagree

3. The speed of the virtual pitch resembled the speed of the live pitch.

① ————— ② ————— ③ ————— ④ ————— ⑤
 Strongly Agree Agree Neutral Disagree Strongly Disagree

4. The height of the virtual pitch resembled the height of the live pitch.

① ————— ② ————— ③ ————— ④ ————— ⑤
 Strongly Agree Agree Neutral Disagree Strongly Disagree

5. The initial and final locations of the virtual pitch resembled those of the live pitch.

① ————— ② ————— ③ ————— ④ ————— ⑤
 Strongly Agree Agree Neutral Disagree Strongly Disagree

6. The distance of the virtual pitch was comparable to the distance of the live pitch.

① ————— ② ————— ③ ————— ④ ————— ⑤
 Strongly Agree Agree Neutral Disagree Strongly Disagree

7. The rotation of the virtual pitch resembled the rotation of the live pitch.

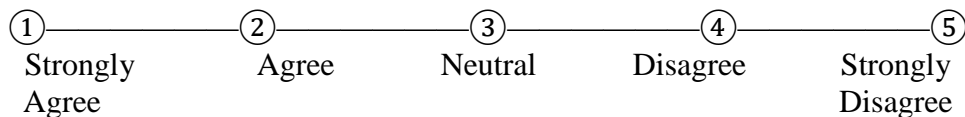

8. The size and look of the virtual baseball resembled the real baseball.

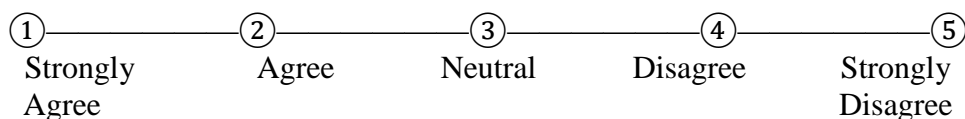

9. The sound of the traveling live pitch helped my visual ability to track the ball.

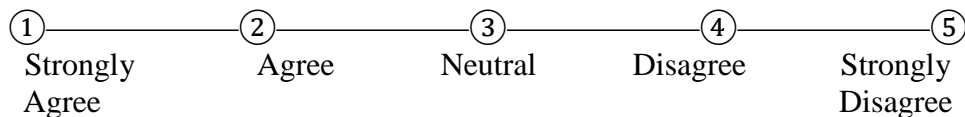

10. The lack of sound of the traveling virtual pitch helped my visual ability to track the ball.

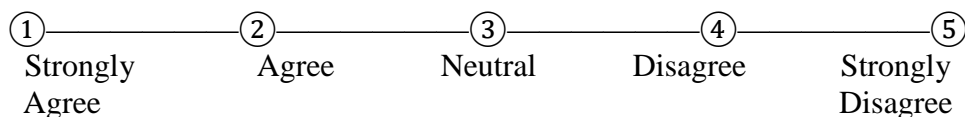

Equipment Factors

1. The protective shield at the viewing dock did not adversely affect my ability to track the ball.

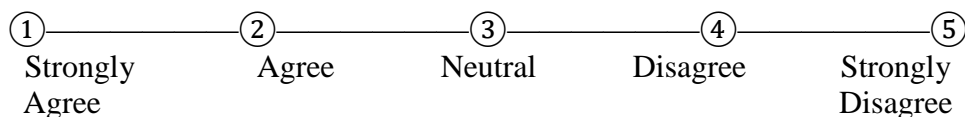

2. The 3D glasses were not cumbersome and did not adversely affect my view of the ball.

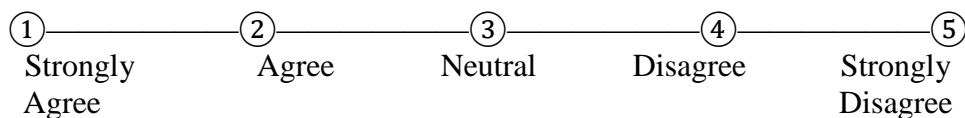

3. The 3D stereo display was adequate for viewing a fastball traveling in depth.

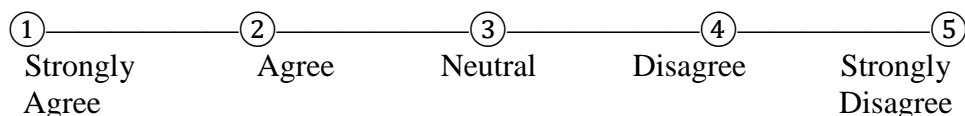

4. The live pitch environment was adequate for watching live fastball pitches.

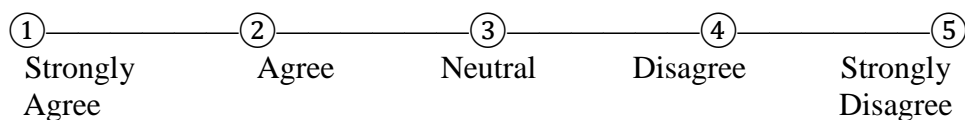

5. The virtual pitch background resembled the live pitch background.

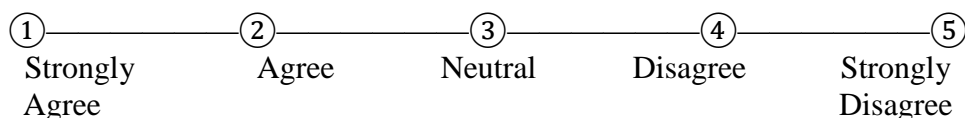

6. The live pitch lighting resembled the live pitch lighting.

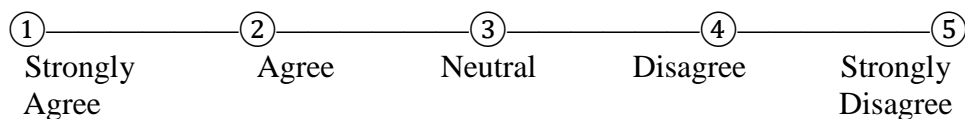

7. The live pitch environment had distractors that affected my viewing concentration.

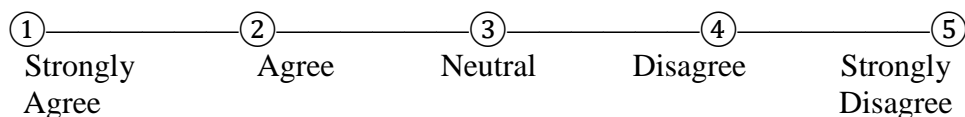

8. The virtual pitch environment had distractors that affected my viewing concentration.

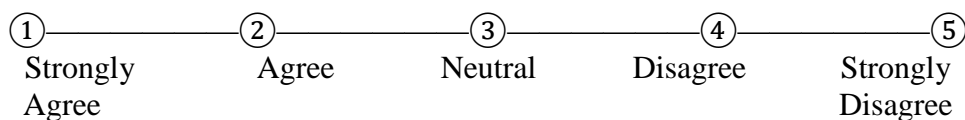

9. The three-tone pitch alerts helped me anticipate and track the live and virtual pitches.

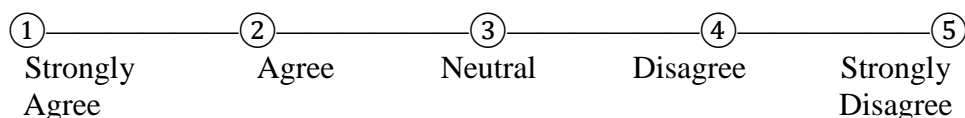

10. The timing of the three-tone pitch alerts of the virtual pitch and live pitch were comparable.

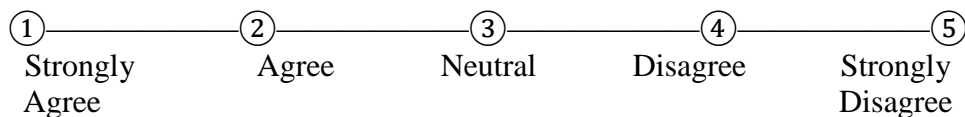

Visual Perception Factors

1. The virtual pitch in 3D stereo appeared to travel in depth towards me/beside me.

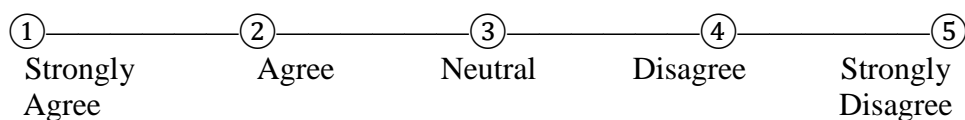

2. As the virtual pitch approached me it caused me to want to follow and/or grab the ball.

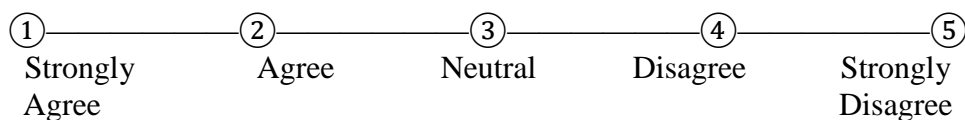

3. Viewing the virtual pitch evoked similar visual sensations as when viewing the live pitch.

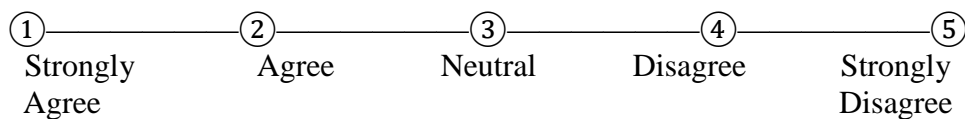

4. Tracking the virtual pitch felt similar to tracking the live pitch.

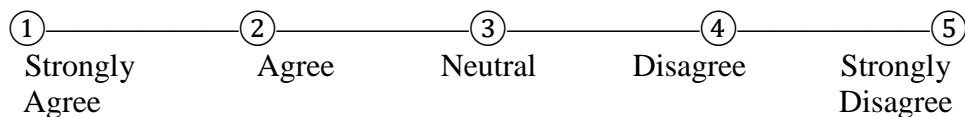

5. Progressing from slow-motion to full-speed virtual pitches seemed to improve my tracking.

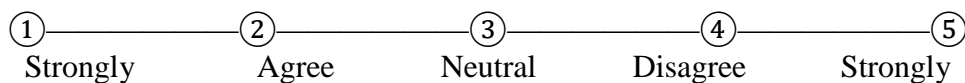

Agree

Disagree

6. The more I viewed virtual pitches the better I was able to track them.

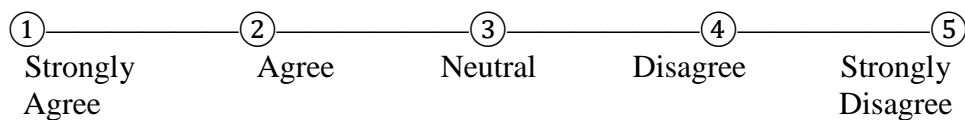

7. When the ball disappeared and reappeared, it made me track the ball better at the end.

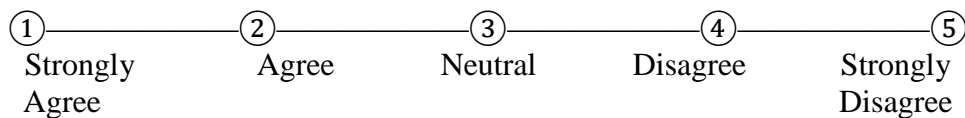

8. After tracking the virtual pitches I felt more comfortable tracking live pitches.

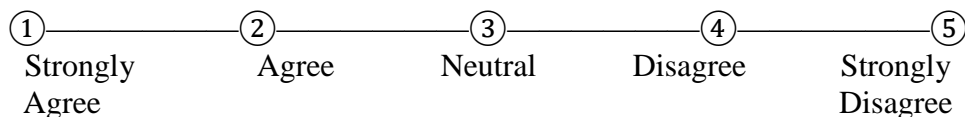

9. When I am batting I directly face the pitcher so my initial gaze is about zero degrees.

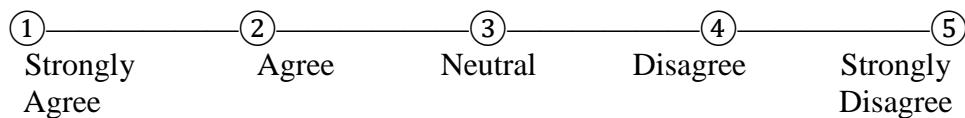

10. When I am batting I gaze at the pitcher looking to my left between zero and 20 degrees.

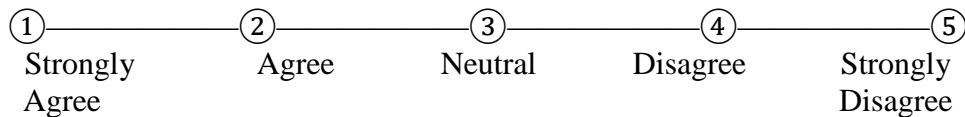

E. Appendix E – 3D Stereo Screening Questions/Recommendations

Phone Screening Questions

1. On a scale of 0 to 10, how frequently do you experience motion symptoms in common modes of transportation (car, plane, boat) where 0= never and 10=always?
2. On a scale of 0 to 10, when you do experience motion symptoms in common modes of transportation, how severe are the symptoms where 0=none and 10=incapacitating?

Test Session Monitoring Questions/Recommendations

1. Are you experiencing any discomfort or symptoms?
2. Take a break if you observe, increased swallowing, burping/belching, sighing or heavy breathing, change in skin pallor (becoming pale), touching stomach, heavy blinking, closing eyes, shaking head, or combination of these symptoms.

F. Appendix F – Old Dominion University – IRB Approval Letter



OFFICE OF THE VICE PRESIDENT FOR RESEARCH

Physical Address
4111 Monarch Way, Suite 203
Norfolk, Virginia 23508

Mailing Address
Office of Research
1 Old Dominion University
Norfolk, Virginia 23529
Phone(757) 683-3460
Fax(757) 683-5902

DATE: March 25, 2016

TO: Stacie Ringleb
FROM: Old Dominion University Institutional Review Board

PROJECT TITLE: [644252-6] Repurposing the occlusion model in 3D stereoscopic virtual environment for manipulating the adaptive properties of the oculomotor system for visual skill development involving pitched baseball trajectories in the batting task

REFERENCE #: 13-197; 14-210; 15-237
SUBMISSION TYPE: Amendment/Modification

ACTION: APPROVED
APPROVAL DATE: March 25, 2016
EXPIRATION DATE: November 19, 2016
REVIEW TYPE: Expedited Review

Thank you for your submission of Amendment/Modification materials for this project. The Old Dominion University Institutional Review Board has APPROVED the following amendments:

- addition of phone screen questions
- addition of Sim Sickness questionnaire
- update of consent form with expanded sim sickness information (NOTE: The IRB is no longer stamping consent forms. Please add a version number and version date to the header of the consent document. This will be used to identify the correct form and will be updated for subsequent amendments and/or renewals).

This approval is based on an appropriate risk/benefit ratio and a project design wherein the risks have been minimized. All research must be conducted in accordance with this approved submission.

This submission has received Expedited Review based on the applicable federal regulation.

Please remember that informed consent is a process beginning with a description of the project and insurance of participant understanding followed by a signed consent form. Informed consent must continue throughout the project via a dialogue between the researcher and research participant. Federal regulations require each participant receive a copy of the signed consent document.

Please note that any revision to previously approved materials must be approved by this office prior to initiation. Please use the appropriate revision forms for this procedure.

All UNANTICIPATED PROBLEMS involving risks to subjects or others (UPIRSOs) and SERIOUS and UNEXPECTED adverse events must be reported promptly to this committee. Please use the appropriate reporting forms for this procedure. All FDA and sponsor reporting requirements should also be followed.

All NON-COMPLIANCE issues or COMPLAINTS regarding this project must be reported promptly to this committee.

This project has been determined to be a Minimal Risk project. Based on the risks, this project requires continuing review by this committee on an annual basis. Please use the appropriate forms for this procedure. Your documentation for continuing review must be received with sufficient time for review and continued approval before the expiration date of November 19, 2016.

Please note that all research records must be retained for a minimum of three years after the completion of the project.

If you have any questions, please contact Adam Rubenstein at 757-683-3686 or arubens@odu.edu. Please include your project title and reference number in all correspondence with this committee.

This letter has been electronically signed in accordance with all applicable regulations, and a copy is retained within Old Dominion University Institutional Review Board's records.

VITA

Ricardo A. Roca

P.O. Box 5370, Arlington, VA 22205

EDUCATION

1986 BSE, Electrical Engineering, Tulane University, New Orleans, LA
 2001 MS, Systems Engineering, George Mason University, Fairfax, VA
 2016 PhD, Modeling & Simulation Engineering, Old Dominion University, VA

PROFESSIONAL EXPERIENCE

2008 – 2016

The Johns Hopkins University Applied Physics Laboratory (JHU-APL) - Laurel, MD

Sr. Systems Engineering Professional Staff, Modeling & Simulation

2012 – 2014

Office of the Undersecretary of Defense (Personnel and Readiness), Readiness and Force Management, Joint Assessment and Enabling Capability - Alexandria, VA

Deputy Director, Joint Assessment and Enabling Capability Office
 Chief of Modeling & Simulation Branch

2010

Marymount University - Arlington, VA

Adjunct Faculty – Mathematics Department

1986 – 2006

SAIC – Vienna, VA

L-3 Communications – Marine Systems – Leesburg, VA

General Dynamics – Fairfax, VA

Raytheon Technical Services – Falls Church, VA

Frontier Technology, Inc. – Arlington, VA

The MITRE Corp. – McLean, VA

Freddie Mac – McLean, VA; PRC – McLean, VA

Advanced Marine Enterprises/Nichols Research – Arlington, VA

General Physics, Corp. – Columbia, MD

Photon Research Associates – Arlington, VA

Systems Planning Corp. – Arlington, VA

Arlington County Public Schools – Arlington, VA

Institute for Defense Analyses – Alexandria, VA

ARINC Research Corp. – Annapolis, MD/Pensacola, FL

Systems Engineer in Modeling & Simulation and Other Engineering Capacities

CONTINUING STUDIES

- 2014 Defense Acquisition University – Continuous Learning – Alexandria, VA
 CLE068 – Intellectual Property and Data Rights
 CLM071 – Introduction to Data Management
 CLM072 – Data Management Strategy Development
 CLM073 – Data Management Planning
 CLM074 – Technical Data and Computer Software Rights
 CLM075 – Data Acquisition
 CLM076 – Data Markings
 CLM077 – Data Management Protection and Storage
- 2014 The Office of the Secretary of Defense – Alexandria, VA
 Introduction to Planning, Programming, Budgeting, and Execution (PPBE)
- 2013 Defense Acquisition University – Continuous Learning – Alexandria, VA
 COR222 – Contracting Officer Representative Course
- 01/11 Johns Hopkins University Applied Physics Lab – Laurel, MD
 Continuing Studies in DISTRIBUTED DEVELOPMENT ON THE WWW and in
 STATISTICAL METHODS AND DATA ANALYSIS
- 09/10 Johns Hopkins University Applied Physics Lab – Laurel, MD
 Continuing Studies in SOFTWARE DEVELOPMENT FOR REAL-TIME
 SYSTEMS
- 05/10 George Mason University – Fairfax, VA
 Continuing Studies in APPLIED PROBABILITY
- 12/09 Johns Hopkins University Applied Physics Lab – Laurel, MD
 Continuing Studies in APPLIED PHYSIOLOGY FOR BIOMEDICAL
 ENGINEERING
- 11/09 IBM Software Group/Rational University – Dahlgren, VA
 Introduction to IBM Rational Rhapsody Systems Development
- 09/09 IBM Software Group/Rational University – McLean, VA
 System Architect Fundamentals
- 04/09 The Armed Forces Communications & Electronics Association – Fairfax, VA
 DoD Architecture Framework Implementation Professional Development Course

- 08/08 Johns Hopkins University Applied Physics Lab – Laurel, MD
Continuing Studies in JAVA-6 PROGRAMMING
- 05/07 Fort Belvoir - Topographical Engineering Center – Alexandria, VA
Objective OneSAF (OOS) User Training Course
- 02/07 George Mason University – Fairfax, VA
Models, Simulations and DoD Acquisition Certificate Program
- 12/05 Alexandria Radio Club – Alexandria, VA
Amateur Radio License Course (Technician Level)
- 01/04 Linux Certified – Cupertino, CA
Certificate Program in LINUX DEVICE DRIVER DEVELOPMENT
- 05/03 Rational University – Falls Church, VA
Certificate program in UML AND FUNDAMENTALS OF RATIONAL ROSE
- 09/97 US Department of Agriculture Graduate School – Washington, DC
Continuing Studies in OBJECT-ORIENTED PROGRAMMING WITH C++
- 05/97 George Mason University – Fairfax, VA
Continuing Studies in INSTRUCTIONAL TECHNOLOGY
- 01/97 Carnegie Mellon University – Software Engineering Institute – Columbia, MD
Certificate program in CMM SOFTWARE PROCESS IMPROVEMENT
- 01/96 Silicon Graphics Technical Education – Columbia, MD
Certificate program in OPENGL AND X-WINDOWS/MOTIF
- 01/96 Learning Tree International – Reston, VA
Certificate program in X-WINDOWS/MOTIF
- 05/94 The George Washington University – Ashburn, VA
Certificate program in UNIX SYSTEM ADMINISTRATION AND TCP/IP
- 12/91 Johns Hopkins University – Baltimore, MD
Continuing studies in APPLIED MATH AND ELECTRONICS

AWARDS AND DISTINCTIONS

- 2014 Office of the Secretary of Defense Award for Outstanding Achievement
- 1998 White House Fellowship Program – NATIONAL FINALIST