

## Old Dominion University ODU Digital Commons

---

Engineering Technology Faculty Publications

Engineering Technology

---

2004

# Enhancing MET Curriculum with Applied Research Experience for Faculty Parametric Study of Water Jet Cutting Processes- A Case Study

Alok K. Verma

*Old Dominion University*, averma@odu.edu

Cheng Y. Lin

*Old Dominion University*

Carl J. Voglewede

Mike E. Tall

Follow this and additional works at: [https://digitalcommons.odu.edu/engtech\\_fac\\_pubs](https://digitalcommons.odu.edu/engtech_fac_pubs)

 Part of the [Engineering Education Commons](#)

---

### Repository Citation

Verma, Alok K.; Lin, Cheng Y.; Voglewede, Carl J.; and Tall, Mike E., "Enhancing MET Curriculum with Applied Research Experience for Faculty Parametric Study of Water Jet Cutting Processes- A Case Study" (2004). *Engineering Technology Faculty Publications*. 45.  
[https://digitalcommons.odu.edu/engtech\\_fac\\_pubs/45](https://digitalcommons.odu.edu/engtech_fac_pubs/45)

### Original Publication Citation

Verma, A. K., Lin, C. Y., Voglewede, C. J., & Tall, M. E. (2004). *Enhancing MET curriculum with applied research experience for faculty parametric study of water jet cutting (WJC) processes - A case study*. Paper presented at the 2004 ASEE Annual Conference, Salt Lake City, Utah.

This Conference Paper is brought to you for free and open access by the Engineering Technology at ODU Digital Commons. It has been accepted for inclusion in Engineering Technology Faculty Publications by an authorized administrator of ODU Digital Commons. For more information, please contact [digitalcommons@odu.edu](mailto:digitalcommons@odu.edu).

## **Enhancing MET Curriculum with Applied Research Experience for Faculty - Parametric Study of Water Jet Cutting (WJC) Processes – A Case Study**

Alok K. Verma, Cheng Y. Lin  
Department of Engineering Technology  
Old Dominion University

Carl J. Voglewede, Mike E. Tall  
Technology Development and Integration Branch  
NASA Langley Research Center

### **Abstract**

In today's global competitive environment, the engineering technology curriculum must adopt and reflect the changing needs of industry. This can happen only if the faculty are aware of the current trends in industry and are actively involved with industry and research projects. ASEE/NASA Faculty Fellowship program offers opportunities for professional development for Engineering Technology faculty. A parametric study of water jet cutting (WJC) process was done under the ASEE / NASA faculty fellowship program at NASA Langley Research Center. This research experience has been used to enhance undergraduate curriculum in Mechanical Engineering Technology at Old Dominion University (ODU).

### **I Introduction**

Success of engineering technology programs depends upon the effectiveness with which the curriculum addresses needs of industry, the primary customer. It can be argued that faculty development and curriculum development are inter-related<sup>1</sup>. Curriculum development is often a by-product of faculty development effort while curriculum development is part of the job requirement for most faculty. A number of articles have been written on issues involved with curriculum development<sup>2,3,4</sup>. Most of these publications discuss the common approaches to faculty development like participation in conferences, continuing education programs and internships in industry. This article discusses a faculty fellowship program, which faculty members in an undergraduate engineering technology program can use for professional growth.

The ten-week summer faculty fellowship program offered by ASEE and NASA provides an ideal setting for curriculum enhancement through research experience. Programs like these also enrich the undergraduate learning experience for ET students.

## **II Research Environment in ET Programs**

Traditionally, ET programs have placed a larger emphasis on teaching compared to research. This is especially true for programs that offer only undergraduate education in Engineering Technology. Consequently a number of faculty were hired primarily for teaching. At these institutions, a Master's degree is the terminal degree required for the faculty. One can argue that research environment in these programs is not conducive to generation of research and publication. Among the reasons cited are the lack of graduate students and lack of faculty with terminal degree. During the last decade, we have seen a shift in this paradigm. Increasing number of institutions now require externally funded research and journal publication by the faculty. This changing research environment has created pressure on faculty to explore new opportunities for faculty development.

## **III Faculty Development in ET Programs**

The need to be current in one's field is critical for faculty in Engineering Technology programs since these faculty are often involved in industrial projects as well as applied research<sup>5,6,7</sup>. The professional development needs are generally met by participation in conferences and continuing education programs. In addition to participation at conferences, some opportunities for faculty internships are also available at selected companies. Any opportunity for faculty development often results in development of curriculum and enhancement of the learning experience of the students.

## **IV ASEE/NASA Faculty Fellowship Program**

ASEE and NASA jointly offer a Faculty Fellowship Program, which provides ten weeks of experience at one of the NASA's facilities. This opportunity for professional development is available to all engineering technology faculty. The selection is based upon recommendations from the place of employment and area of interest in research. This program is jointly managed by ASEE and the Universities Space Research Association (USRA). The NFFP combines aspects of two successful former and long running NASA programs, the NASA/ASEE Summer Faculty Fellowship Program and the NASA/USRA Joint Venture (JOVE) program.

The NFFP is designed to give college and university faculty members a rewarding personal as well as enriching professional experience. The program varies slightly at each center to accommodate the needs of the NASA Center, however, the common features of the program at each center include:

- Short courses and workshops
- Tours of the center
- Seminars and retreats
- Program Evaluation
- Social activities for participants and families

The NASA Faculty Fellowship Program (NFFP) offers hands-on exposure to NASA's research challenges through 10-week summer research residencies at participating NASA research centers for full-time science and engineering faculty at U.S. colleges and universities. Participants work closely with NASA colleagues on research that is important to NASA's five strategic enterprises.

## **V. Example of Faculty Participation**

During summer 2003, I participated in the ASEE/NASA Faculty Fellowship program at NASA Langley Research Center in Hampton, Virginia. I am a faculty member in the engineering technology department at Old Dominion University in Norfolk, Virginia. NASA Langley Research Center is located only 20 miles from the university and thus was the obvious choice. However, the program offers travel and relocation allowances for faculty who may have to move during the ten-week period. My research interests lie primarily in the manufacturing area and therefore I contacted the fabrication branch in the system's competency. The fabrication branch had recently acquired a dual laser cutting system and a water jet cutting system. My research experience in process optimization and interest in laser cutting and water jet cutting process resulted in a match of the research areas. During the ten-week period, I collaborated with several NASA employees in the fabrication branch and conducted parametric study of the laser and water jet cutting process. The results related to water jet cutting process is presented in this paper.

## **VI. Case Study – Water Jet Cutting Process (WJC)**

Non-traditional manufacturing processes offer today's design engineers flexibility of choosing among a variety of manufacturing processes for fabricating a part. Water jet cutting (WJC) has become a popular choice among these non-traditional processes. A parametric study of WJC was done under the ASEE / NASA faculty fellowship program at NASA Langley Research Center. The research experiences from the study have been used to enhance an undergraduate course in MET curriculum.

The research experience focused on the parametric study of kerf quality in water jet cutting. During the machining process, the quality of kerf depends upon several controllable and uncontrollable variables. The controllable variables include: orifice size, cutting speed, nozzle-tip-distance and cutting pressure. Operational regions for this process have been explored while changing one variable at a time. Specimens were prepared from aluminum 6061-T6 plates of six different thickness. Material properties and composition of specimen were confirmed with spectrometer tests. Surface roughness of kerf for water-jet-cut samples was measured by a stylus-based perthometer in the research hardware validation and verification branch. Mean surface roughness  $R_a$  was calculated. Digital photographs of kerf roughness and scanning electron micrographs of specimen were prepared.

A typical set up for this cutting process is shown in Figure-1 below.

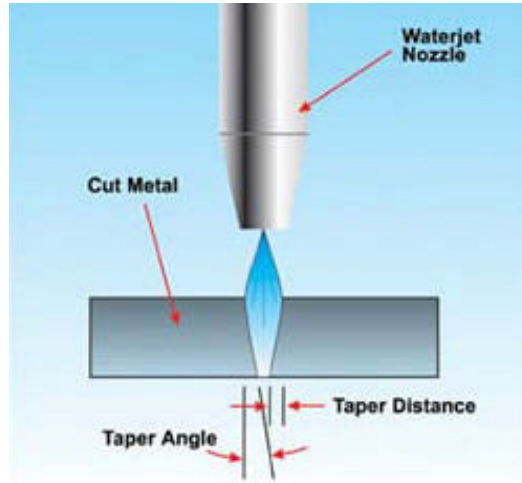

Figure 1. Setup for Water Jet Cutting

**a. Water Jet Cutting System by Flow International Inc.**

Water jet cutting was done on an abrasive jet system by Flow International. The equipment used water at 50,000 PSI and garnets as abrasives for enhanced cutting. The equipment had a table size of 40x20 inches and a resolution of +/- 0.005 in X & Y direction. Maximum cutting speed is at 300 in/min. Figure-2 shows the head of the abrasive jet cutting system and Figure-3 shows the cutting unit with the computer.

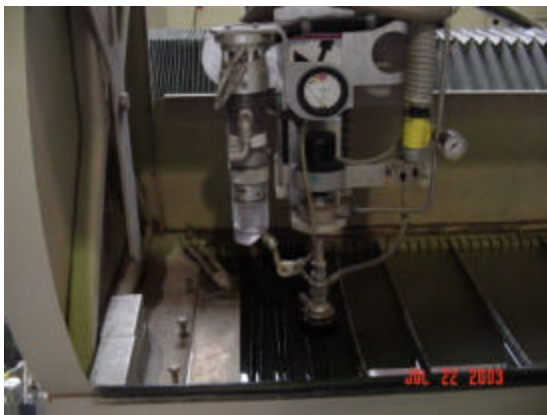

Figure 2. Cutting Head in WJC Equip.



Figure 3. Water Jet Cutting System

**b. Cutting Parameters**

Kerf quality is an important quality characteristic from customer's viewpoint. Water jet cutting has become extremely popular during the last decade for cutting various types of materials. The

reduction in cost of equipment along with improved kerf quality have made this process more desirable in comparison to traditional methods like mechanical shearing. In water jet cutting, kerf quality depends on a number of parameters. Important among these are pressure, garnet size, Nozzle tip distance (NTD), Feedrate and thickness of material. Table-1 lists some of these parameters and the levels at which experiments were conducted to measure kerf roughness.

Parameters	Type	Level	Level	Level	Level	Level	Level
Roughness	Response	Mean Roughness - Ra					
Kerf Width	Response	Mean Kerf Width - W					
Taper	Response	Mean Taper					
NTD	Variable	.0625	0.125	0.18	0.255	0.3	0.4
Feed Rate	Variable	30%	40%	50%	60%	70%	80%
Thickness	Variable	0.063	0.09	0.125	0.25	0.375	0.5
Pressure	Constant	50.000 PSI					
Orifice/Mixing Tube	Constant	Orifice 0.013, Mixing Tube 0.04					

Table 1. Cutting Parameters

**c. Kerf Quality Measurement**

Kerf quality can be expressed by kerf roughness. The roughness of the cut edge can be measured and expressed either as maximum peak to valley roughness or mean roughness as shown in figure-4. Mean surface roughness can be measured with stylus-based profilometer, if the thickness of material is large enough to allow for stylus movement. Sample materials for this study were cut from copper foil, 0.001 inch thick. Maximum peak to valley measurement at four locations were taken and averaged to calculate the kerf roughness.

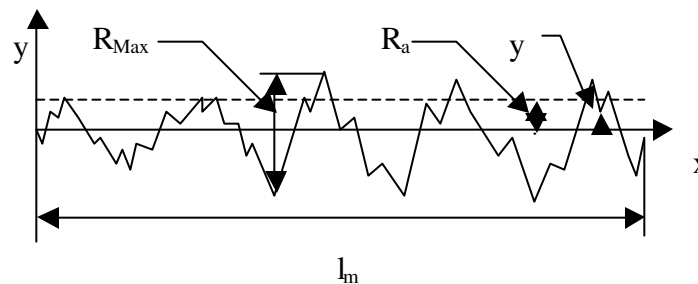
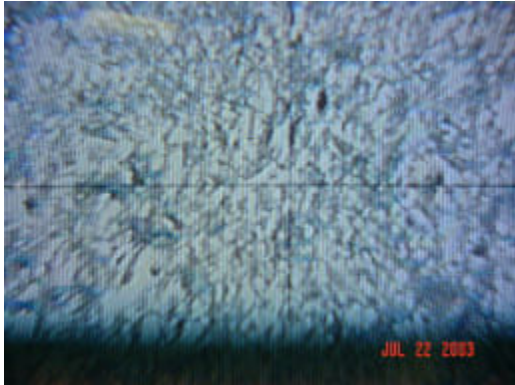

Figure 4. Kerf Roughness Measurement.

The copper foil samples were cut using the laser at parameter settings indicated in Table-1 and observed with an optical microscope to obtain peak to valley roughness. A typical kerf profile photograph and the expression for mean surface roughness is shown in Figure-5.



Max. Peak to Valley Roughness =  $R_{Max}$

$$\text{Mean Roughness} = R_a = \frac{1}{l_m} \int_0^{l_m} |y| dx$$

Figure 5. Photomicrograph at T= 0.375 in, Al 6061-T-6, Mag. 4X

**d. Kerf Width and Taper vs. Nozzle Tip Distance (NTD)**

Figure-6 shows the plot of kerf width vs. NTD. As NTD increases, kerf width increases and this increase is more prominent at higher values of NTD. The difference between the top width and bottom width gives the value of taper, which is plotted as the bottom curve. Thus, as NTD increases, taper increases.

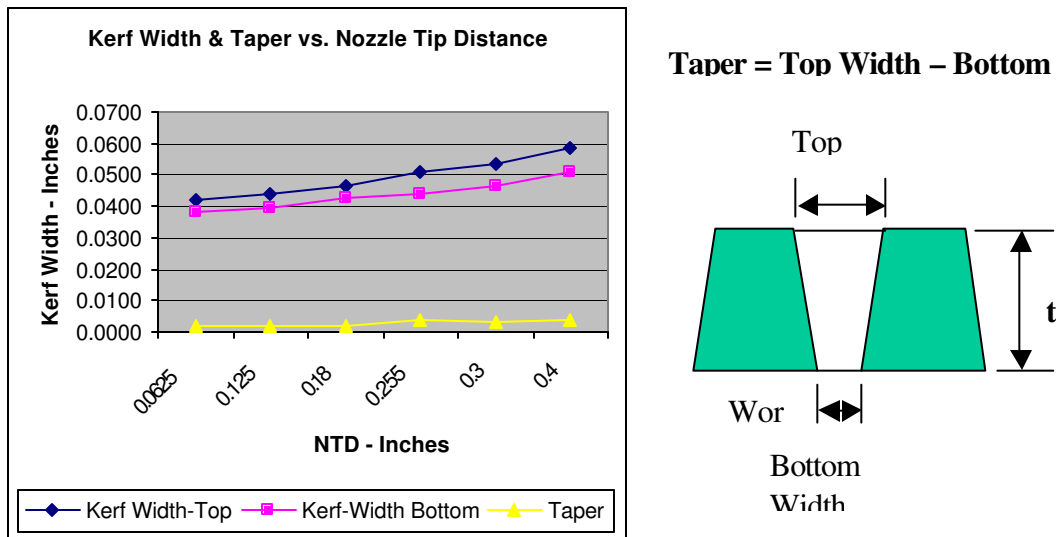

Figure 6. Kerf Width & Taper vs. NTD

**e. Kerf Roughness vs. Nozzle Tip Distance**

Figure-7 shows the plot of kerf roughness vs. NTD for the two opposite faces. As NTD increases kerf roughness increases and this increase is almost linear. A small difference in the roughness of opposite faces exists. This could be due to small misalignment in the nozzle axis.

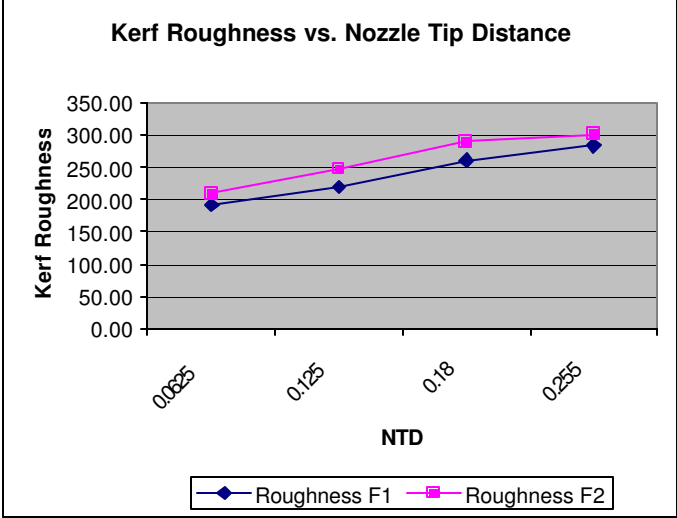

Figure 7. Kerf Roughness vs. NTD

**f. Average Surface Roughness vs. Feed Rate**

In general, average roughness increases as feed rate increases. Feed rate on the equipment could only be changed as a percentage of the maximum. Increase in roughness is not as marked at lower values of feed rate as at higher values as shown in Figure-8.

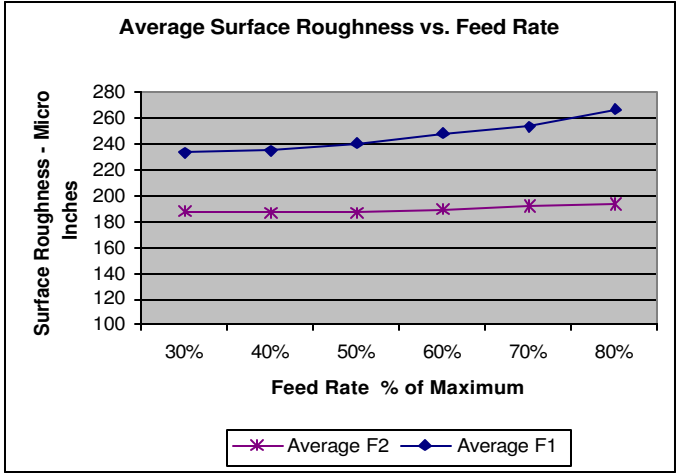

Figure 8. Average Surface Roughness vs. Feed Rate



## VII. Impact on Curriculum Development

The summer experience resulted in a proposal submitted to the fabrication branch for the optimization of laser beam cutting and water jet cutting processes. In addition the results obtained during the summer have been presented at two conferences. The impact on curriculum development was also notable. The Advanced Manufacturing Processes course (MET-410) in the mechanical Engineering Technology curriculum was modified to include results obtained during the internship program. In addition, the seminars organized by the program on various topics expanded my research interests. Collaboration with other NASA employees proved invaluable. The contacts and network made possible due to this program have opened a number research collaboration opportunities for me.

## VIII. Advanced Manufacturing Processes Course

Advanced manufacturing processes (MET-410) is a senior elective in the mechanical engineering technology program at Old Dominion University. The course description reads:

*“ Lecture3 hours: 3 Credits. Prerequisites: MET 200. A course in non-traditional manufacturing processes including ultrasonic machining, abrasive jet machining, water jet cutting, electro mechanical machining, electric discharge machining, plasma arc machining and chemical milling. Semester project is required.”*

The content of this course has changed as a result of this fellowship program with more emphasis on water jet cutting and laser beam machining. First hand experience with the water jet equipment has helped author gain a better understanding of the issues related to use of such equipment and take these experiences to class room.

## IX. Summary

Faculty members in undergraduate Engineering Technology Programs have several opportunities for research and professional development. In face of the increasing emphasis on research and publication, lack of graduate programs and graduate students is no longer a valid argument. The ten-week faculty fellowship program offered by ASEE and NASA offers a unique opportunity for professional development. Faculty in ET programs can use it as a stepping-stone for exploring research opportunities in various areas. The fellowship also provides opportunities for meeting faculty members from other institutions and exploring collaborative research with them. These experiences also result in curriculum development and enhancement of undergraduate learning experience.

## Bibliography

1. Dark, Melissa J.; Depew, Dennis R.; Herrick, Robert J. @ Creating a competitive edge with faculty and curricular development. @, *Proceedings of the ASEE annual conference* at University of Illinois at Urbana-Champaign, June 20-

23,1993.

2. Shea, John E.; West, Thomas M. , Methodology for curriculum development using multi objective programming. @, *Proceedings of the 19<sup>th</sup> International conference on computers and industrial engineering*, Miami, March 4-6, 1996.
3. Sekhar, Sashi; Sil Chandra Sekhar, Shamir, Technology curriculum for the year 2000 and beyond minor in management programs for technology. @, *Proceedings of the ASEE annual conference, Seattle*, June 28- July 1, 1998.
4. Savitz, C. M.; Schultz, K. C.; King W. J.; Turpin, R. H., Assessment measures to enhance teaching and curriculum effectiveness. @, *Proceedings- Frontiers in Education conference, Reno*, October 10-13, 2001.
5. Verma, A. K., Crossman, G. R. & Lin, C.,@Bringing industry and Academia together with Applied Research Projects@, *Proceedings of the ASEE annual conference*, June 1994.
6. Crossman, G. R. & Marchello, J. M., March, 1989. "The Engineering Technology Clinic at Old Dominion University- Meeting Professional Needs." *Industry and Higher Education*.
7. Verma, A. K. & Hackworth, J.,@Design and Construction of an Automated Battery Testing Machine@. *International Mechanical Engineering Congress and Exposition*, 1999.
8. Homkes, R. A Writing and Publishing Your Way to tenure@, *Proceedings of the ASEE annual conference*, June 1996.
9. Verma, A. K. AEffect of Various Parameters on the Efficacy of Cutting Process in Abrasive Jet Machining,@, *International Mechanical Engineering Congress and Exposition*, 2000.

## Biography

### ALOK K. VERMA

Alok K. Verma is Associate Professor and, Director of the Automated Manufacturing Laboratory at Old Dominion University. He joined the Engineering Technology Department at Old Dominion University in 1981. Since then, he has served as department chairman and interim associate dean of the college. Alok is a licensed professional engineer in the state of Virginia, a certified manufacturing engineer and has certification in Lean Manufacturing and Six Sigma. His publications are in the areas of Lean Manufacturing, Process Automation and improvement, Advanced Manufacturing Processes, CAD/CAM, and Robotics. His current research interests are in the area of process optimization and Lean implementation models for job shop and designed to build environments. Alok Verma has co-edited the proceedings of the International Conference on CAD/CAM & Robotics for which he was the general chairman. He is serving as the associate editor for the International Journal of Agile Manufacturing. Alok has developed the training program in Lean Enterprise for Northrop Grumman Newport News Apprentice School and continues his participation through a joint National Shipbuilding Research Program (NSRP) project to develop and design new simulation tools for Lean enterprise training. He is active in ASME, ASEE and SME.

### CHENG Y. LIN

Cheng Y Lin is an Associate Professor of Engineering Technology at Old Dominion University. Dr. Lin is a registered Professional Engineer of Virginia. He teaches Machine Design, CAD, CNC, and Robotics and is active in local industrial research and consultation. He earned his B.S. and M.S. degrees of Mechanical Engineering from National Cheng-Kung University in 1975 and 1977 and a Ph.D. of Mechanical Engineering from Texas A&M University in 1989.