

2016

An application of a simulation technique on rail container transport between Laem Chabang Port and Inland Container Depot Ladkrabang, Thailand

Ud Tuntivejakul
World Maritime University

Follow this and additional works at: http://commons.wmu.se/all_dissertations

Recommended Citation

Tuntivejakul, Ud, "An application of a simulation technique on rail container transport between Laem Chabang Port and Inland Container Depot Ladkrabang, Thailand" (2016). *World Maritime University Dissertations*. 529.
http://commons.wmu.se/all_dissertations/529

This Dissertation is brought to you courtesy of Maritime Commons. Open Access items may be downloaded for non-commercial, fair use academic purposes. No items may be hosted on another server or web site without express written permission from the World Maritime University. For more information, please contact library@wmu.se.

WORLD MARITIME UNIVERSITY

Malmö, Sweden

**AN APPLICATION OF A SIMULATION
TECHNIQUE ON RAIL CONTAINER TRANSPORT
BETWEEN LAEM CHABANG PORT AND INLAND
CONTAINER DEPOT LADKRABANG, THAILAND**

By

Ud Tuntivejakul

Kingdom of Thailand

A dissertation submitted to the World Maritime University in partial
Fulfilment of the requirements for the award of the degree of

MASTER OF SCIENCE

In

MARITIME AFFAIRS

(PORT MANAGEMENT)

2016

DECLARATION

I certify that all the material in this dissertation that is not my own work has been identified, and that no material is included for which a degree has previously been conferred on me.

The contents of this dissertation reflect my own personal views, and are not necessary endorsed by the University.

(Signature): 

(Date): ~~- 19th September 2016 -~~

Supervised by: Devinder Grewal

World Maritime University

Assessor: Ilias Visvikis

Institution/organization: World Maritime University

Co-Assessor: Gerhardt Müller

Institution/organization: USMMA Kings Point

ACKNOWLEDGEMENTS

First of all, I would like to express my gratitude to the Port Authority of Thailand and Laem Chabang Port for providing me an opportunity to expand knowledge of maritime affairs, especially, Dr. Yohei Sasakawa, the chairman of the Nippon Foundation who provided a full scholarship for me to study at World Maritime University.

My appreciation also goes to my distinguish professor, Professor Dr. Devinder Grewal, who monitored my dissertation work, provided advice and suggestions which led me to completion.

Special thanks to the director of Port Operation Division, Mr. Veerachart Phuttaraksa, and all members of the division who provide valuable information. Thanks to Mr. Siripong Koomprapan, Chief,Marketing and Development Freight Division of the State Railway of Thailand and Mr. Khomkit Puttarat of Hutchison Ports (Thailand) Limited who gave the vital information for this dissertation.

I would like to thank my senior students from my country Surasak Changjul and Sirirath Thepanual, who helped me settled down during the first period of study at World Maritime University. Thanks to my classmates Pitinoot Kotcharat, Aditya Srivastava, Thet Wai Lynn Htut, Alexandros Tsalavoutas, and Avinash Kumar, who always supported me during my dissertation progress.

Lastly, I would like to express my sincere gratitude to my parents, Arporn Tuntivejakul, Kasidis Tuntivejakul, my sister Kanokchon Tuntivejakul and my girlfriend, Ramita Musikapong, who always encouraged and supported me since my first day of study to the completion.

ABSTRACT

Title of Dissertation: **An Application of a Simulation Technique on Rail Container Transport between Laem Chabang Port and Inland Container Depot Ladkrabang, Thailand**

Degree: **Master of Science**

Since the increasing demand of container transport through Laem Chabang Port, Thailand, the port faces landside congestion due to the large share of road transport. The Inland Container Depot Ladkrabang is the dry port facility to support and increase the efficiency, and ease the congestion at the port by linking the dry port and the seaport by rail; however, the share of transport between the two facilities is largely by road.

There are three modes of transport at Laem Chabang Port i.e. road, rail, and barge. The large share of a modal split by road creates severe landside congestion. Moreover, the Inland Container Depot Ladkrabang, which serves the direct rail link to Laem Chabang Port has a larger share of road transport. This causes traffic congestion from the increasing container throughput and other problems, i.e. air emissions, pollution in port and local community, excess cost of transport, and road accidents.

This dissertation aims to study the reason why the modal share by rail has not increased, which hinders the growth of the rail transport between the two facilities by rail container transport data analysis. Furthermore, the research studies the effectiveness of government policies and investment into the rail transport system between Laem Chabang Port and Inland Container Depot Ladkrabang. Finally, the simulation technique is utilized using Rockwell Software Arena 14 to generate the virtual model, which is based on the real world system parameters and characteristics.

The virtual simulation model allows free configurations and adjustments based on the real world applicability. Three scenarios are assumed, constructed, and quantified by the software. The results show that there are possibilities to create more efficient systems in the virtual models. The presentation of the real world application shows how the virtual model could be implemented and which measures are required to maintain the system efficiency. This also illustrates the impact of the system application to the current situation.

KEY WORDS: Simulation, Port Competition, Port Congestion, Modal Split, Dry Port, Rail Container Transport.

TABLE OF CONTENTS

Declaration.....	ii
Acknowledgements.....	iii
Abstract.....	iv
Table of Contents.....	v
List of Tables.....	ix
List of Figures.....	x
List of Abbreviations.....	xii
CHAPTER 1: INTRODUCTION.....	1
1.1 Background	1
1.2 Objectives.....	2
1.3 Methodology	3
1.4 Contribution of this research.....	4
1.5 Layout of dissertation.....	4
CHAPTER 2: RAIL FREIGHT TRANSPORT IN THAILAND	6
2.1 Rail freight transport	6
2.2 Multimodal transport.....	6
2.3 Overview of rail freight transport	7
2.5 Laem Chabang Port.....	9
2.6 Inland Container Depot Ladkrabang.....	13
2.7 Statistics of the container handled in ICD and LCP	16

2.8 Import and Export processes	19
2.8.1 Import process	19
2.8.2 Export process	20
2.9 Operation details and layouts	21
2.9.1 ICD's Layout of the operational areas.....	23
2.9.2 LCP's Layout of the operational areas	24
2.10 Limitation of rail freight transport	25
2.11 Policies, strategies, plans and projects to improve the capacity and efficiency of the rail freight services.....	26
2.12 Examination of the effects of the government policies and investments on rail freight transport.....	30
2.12.1 Tariffs reduction strategy	31
2.12.2 Double track construction.....	38
2.12.3 Purchasing of new locomotives.....	38
2.13 Chapter summary	38
CHAPTER 3: LITURATURE REVIEW	40
3.1 Logistics concept.....	40
3.2 Port performance and competition	41
3.3 Comparative analysis of road and rail transport	42
3.4 Dry port concept.....	44
3.5 Rail freight transport challenges and solutions in other literature	45
3.5.1 Hinterland connectivity of Malaysian container seaports: Challenges and solutions.....	45

3.5.2 An exploratory analysis of the effects of modal split obligations in terminal concession contracts	46
3.5.3 Hinterland access regimes in seaports	47
3.5.4 Analysis of optimal resource level in rail transportation for Lat Krabang Inland Container Depot (LICD) to Laem Chabang Port (LCB) Route	48
3.6 Chapter summary	48
CHAPTER 4: RAIL CONTAINER TRANSPORT OPERATION ANALYSIS USING SIMULATION TECHNIQUE	50
4.1 Analysis of the current system	50
4.2 Simulation technique.....	58
4.3 Development of simulation model	60
4.3.1 System description.....	60
4.3.2 Components of the model.....	60
4.3.3 Input parameter.....	61
4.3.4 Current State simulation	67
4.4 Scenario assumptions	69
4.4.1 Scenario 1	70
4.4.2 Scenario 2	70
4.4.3 Scenario 3	71
4.5 Chapter Summary.....	75
CHAPTER 5: RESULTS, CONCLUSIONS, AND RECOMMENDATIONS	77
5.1 Results of scenario simulation	77
5.2 Application to the real world system	80

5.3 Theoretic impact from the system implementation.....	82
5.5 Conclusion.....	84
References.....	86
Appendices.....	88
Appendix 1.....	88
Appendix 2.....	91

LIST OF TABLES

Table 1. Rail transfer charges of LCP.....	28
Table 2. Financial analysis scenario 1	35
Table 3. Financial analysis scenario 2	36
Table 4. Financial analysis scenario 3	37
Table 5. Container throughput of ICD from 2012-2015.....	38
Table 6. Simulation results of the current state	69
Table 7. Scenario 2 train schedule	71
Table 8. Scenario 3 train schedule.....	74
Table 9. Simulation results of Scenario 1	77
Table 10. Simulation results of Scenario 2.....	78
Table 11. Simulation results of Scenario 3.....	79

LIST OF FIGURES

Figure 1 Import and export process.	7
Figure 2 Share of commodity cargo by rail freight transport (millions tons), 2014.	8
Figure 3 SRT rail network.	9
Figure 4 The location of Laem Chabang Port.	10
Figure 5 Layout of Laem Chabang Port.	11
Figure 6 The location of ICD Ladkrabang.	14
Figure 7 Container throughput of ICD and LCP.	16
Figure 8 Containers transported by rail at ICD.	17
Figure 9 Percentage of the modal split between rail and road at ICD.	18
Figure 10 Percentage of the modal split between rail and road at LCP.	19
Figure 11 Overview of the container handling operation between ICD and LCP.	22
Figure 12 Layout of ICD.	23
Figure 13 Layout of Laem Chabang Port rail yard areas.	24
Figure 14 Breakdown of domestic freight transportation, 2014.	27
Figure 15 The modal split of LCP, 2015.	29
Figure 16 Policy implementation and investments by government on rail transport.	30
Figure 17 Annual operating cost of container handling equipment.	32
Figure 18 Break down of annual operating cost of reach stacker.	33
Figure 19 Unimodal alternatives (road and rail).	43
Figure 20 Multimodal transport (road and rail).	44
Figure 21 Comparison of a conventional transport and an implemented dry port concept.	45
Figure 22 Histogram of number of wagons each trip from ICD to LCP.	51
Figure 23 Histogram of number of wagons each trip from LCP to ICD.	52
Figure 24 Histogram of the amount of time that locomotives spend at LCP.	52
Figure 25 Histogram of the amount of time that locomotives spend at ICD.	53

Figure 26 Histogram of delay time from ICD to LCP.....	54
Figure 27 Histogram of delay time from LCP to ICD.....	55
Figure 28 Proportion of rail freight transport by day.....	56
Figure 29 Container share of gate operators at ICD.....	56
Figure 30 Container share of terminal operators at LCP.....	57
Figure 31 Simulation process.....	59
Figure 32 Diagram of the system.....	60
Figure 33 Components of the model.....	61
Figure 34 Analysis procedure.....	62
Figure 35 Distribution of inter-arrival time ICD to LCP.....	63
Figure 36 Distribution of inter-arrival time LCP to ICD.....	64
Figure 37 Addition of calculation formulas to the model.....	66
Figure 38 Rail container transport between ICD and LCP simulation in Arena 14.....	68
Figure 39 Details of transit time.....	72
Figure 40 Layout of Laem Chabang station.....	73
Figure 41 Comparison of the current system and the Scenario 3 system.....	75
Figure 42 Comparison of simulations results.....	80
Figure 43 Comparison of the actual modal spilt and theoretical modal spilt of ICD (2015).....	83
Figure 44 Comparison of the actual modal spilt and theoretical modal spilt of LCP (2015).....	84

LIST OF ABBREVIATIONS

The following abbreviations are used in this dissertation:

ICD	Inland Container Depot Ladkrabang
LCP	Laem Chabang Port
PAT	Port Authority of Thailand
SRT	State Railway of Thailand

CHAPTER 1: INTRODUCTION

1.1 Background

International trade of Thailand has been growing continuously. The Lehman Brothers crisis in 2009 and floods in 2011 slowed down the international trade and had an impact on Thailand's economy. Even though, the growth of international trade is still steadily increasing afterward.

Since the introduction of containerized cargo transport, the volume of containerized cargo has risen steadily (UNESCAP, 1999). Credit should be given to the standardization of container boxes, which allows fast, easy, and secure handling. The boxes are compatible to mount on vehicles, trailers, and rail wagons, which make multimodal transport operation run smoothly and efficiently. The benefits of the standardization of containers increase the popularity of containerized cargo transport across the globe, thus increasing the containerized cargo volume (Ham & Rijsenbrij, 2012).

In order to accommodate the growing international trade, the main infrastructure is the port. The port is an important infrastructure of the nation and a central focus of transport nodes where cargo is stored and handled. The port is also the place where sea and land transport interface (Notteboom & Rodrigue, 2005). The port provides safety and security of cargo handling in order to ensure the effectiveness and efficiency of the transport chain; however, the port can bring both positive and negative effects to the region and community. Positive effects are stimulating and facilitating the national and regional economies, employment creation, and creation of maritime related business. On the other

hand, the negative effects are congestion on both landside and the seaside due to increasing traffic, throughput and overcapacity (Jaržemskis & Vasiliauskas, 2007). Laem Chabang Port (LCP) is a major seaport in Thailand. Starting the operation in 1991 with the continuously growing cargo volume, the port became the gateway of Thailand's international trade. Inland Container Depot Ladkrabang (ICD) is the supporting facility of LCP. ICD acts as a dry port in order to ease the congestion at LCP by providing a railway link to transport containers to and from both facilities. However, there is growing landside congestion due to a large amount of container traffic transported by road at LCP and ICD. Despite having the rail container handling facilities and daily operation of rail container transport, the share of road transport is still very large. The large share of the road transport causes an impact on the surrounding community around the port, environmental problems, excessive budget for road maintenance, and congestion.

1.2 Objectives

There is a growing congestion at LCP since the port has a continuously growing throughput. Most of the day, there are several long truck queues outside the terminal gates. In the peak day, each truck could wait up to many hours due to the large share of a modal split by road. Meanwhile, at ICD, due to the low share of a modal split by rail transport, the traffic congestion at ICD is also severe.

As aforementioned, the objective of ICD is to promote an environmentally friendly and fuel efficiency mode of transport. This also helps reducing the landside congestion by transporting containers by rail instead of transporting by road; however, the objective of the ICD has not been met due to the modal split by rail is a lot lower than an modal split by road. Therefore, there is a growing congestion situation in both ICD and LCP.

The objective of this study is to find out how to improve and promote rail transport by attracting more exporters, importers, forwarders, and shipping lines to use rail transport. In other words, the volume of rail transport should be increased and the road congestion problem should be mitigated. These can be defined as the following items.

- Identify the system constraints or bottlenecks of the rail container transport between ICD and LCP, which hinder the system efficiency.
- Quantify the potential capacity of the system.
- Present the alternatives and possible changes in the system to improve system efficiency.
- Present the measures to apply the virtual experiment to the real world system.

1.3 Methodology

The author has used methods to conduct this research according to the following steps.

Step 1: By acquiring knowledge and collecting information in order to identify useful knowledge for the topic. Relevant articles have provided a basic overview of rail freight transport in Thailand in general.

Step 2: By doing a literature review – there are many best practices or multimodal transport problem cases. The author has used some of these methods as a tool to find a suitable way to solve this problem.

Step 3: By identification of the operation process in order to find the constraints or bottlenecks, which might hinder the system efficiency.

Step 4: Applying simulation techniques by using discrete event simulation software (Arena 14) to mimic the rail container transport system between ICD and LCP.

Step 5: Apply configurations and adjustments to the model in order to see the potential capacity and efficiency of the system.

Step 6: Linking the virtual simulation to the real world application by giving possible recommendations and suggestions.

1.4 Contribution of this research

Obviously, the rail transport between ICD and LCP is inefficient. This research will observe a bottleneck in the system and present the practical means of operation to improve the system efficiency. Without any empirical experiment, the study will be conducted by using simulation software. The concept of this study is to observe the effects of the system modification in order to quantify and assess the results of the modification. It should be noted that each modification will be examined by scenario.

The idea in each scenario will contribute to the further empirical testing on the real system, thus, improve the system efficiency. Other benefits from efficient rail transport are road congestion reduction, which is an environmentally friendly promotion by using more energy efficient mode of transport, accident reduction from a less congested road, and increasing the port competitiveness by improving the hinterland connection efficiency.

The simulation model can contribute to future research on the rail freight transport between ICD and LCP or can be utilized in other rail transport systems since the model can be modified and adjusted according to the different system parameters.

1.5 Layout of dissertation

This dissertation is divided into five chapters. First, the contents of chapter 1 introduce the topic, background, objectives, methodology, and research contribution. Chapter 2 presents the general ideas of rail freight transport in Thailand. This chapter involves a lot in background study of rail freight transport, multimodal transport, LCP, ICD, statistical information, a process of rail container transport, layouts of the facilities, limitations, and policies implemented on rail container transport. The third chapter illustrates a literature review of the relevant articles and research. Chapter 4 discusses the current system efficiency and application of the simulation techniques on the rail container transport between ICD and LCP in order to examine the current situation and present the potential scenarios to improve the system efficiency. Finally, chapter 5 presents the results of the

findings, suggestions and recommendations in the real world application, the impacts from the changes, and conclusions.

CHAPTER 2: RAIL FREIGHT TRANSPORT IN THAILAND

2.1 Rail freight transport

Rail freight transport is an economical mode of transport on land, which can carry a large volume of cargo in the concept of economy of scale. This creates a competitiveness, energy saving, and causes low pollution (Armstrong, 1978). Rail freight transport, which involves two or more modes of transport or so-called multimodal transport, will be explained further.

2.2 Multimodal transport

Multimodal transport is the transport of goods, which involves at least two different modes of transport (UNCTAD, 2001). In the case of rail freight transport between LCP and ICD, it involves sea, rail, and road transport as the following explanation. In the case of import cargo, containers are discharged at LCP, then transfer to the rail yard within the port area to be handled onto the rail wagon. The train carries the containers to ICD where the container is either unstuffed or delivered by the road transport to the final destination. Conversely, in the case of export cargo, either the containers are transferred by road transport to ICD or cargo are transported by road and consolidated at ICD. Then the containers are loaded to the rail wagon and transported to LCP, where the containers are unloaded and transferred to the terminal for sea transport. The system is shown in Figure 1.

Import and export process

Import Process

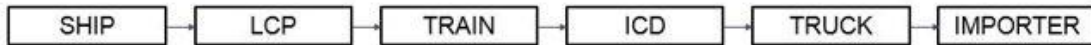

Export Process

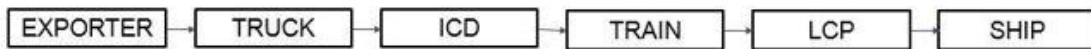

Figure 1.

Source: The author

2.3 Overview of rail freight transport

This section explains the overview of the rail freight transport in Thailand. In 2014, 12.8 millions tons of freight was carried by rail. The break down number is as follows. There are 7.7 millions tons of containerized cargo, 2.2 millions tons of petroleum and fuel, and 0.7 millions tons of cement, sand, and stone. This percentage share of rail freight transport is more or less unchanged until present.

Share of commodity cargo by rail freight transport (millions tons), 2014

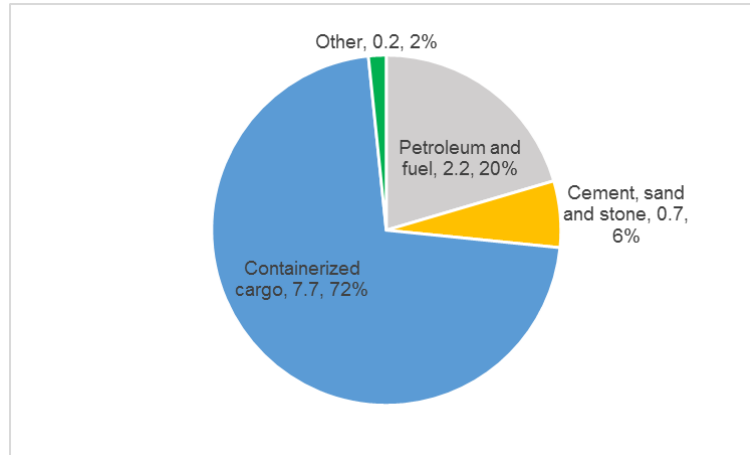

Figure 2.

Source: Adapted from State Railway of Thailand

As seen in Figure 2, the containerized cargo contributes mostly in the total rail freight transport of Thailand and most of the traffic happens between ICD and LCP.

As the supplier of rail transport, SRT is a responsible agency for constructing, operating and maintaining Thailand's railway infrastructure, as well as providing freight carriage services. The total length of railroads is about 4,100 km, serving 47 provinces. The main links between rail and road transport are Bangkok Port, LCP, and ICD. The railway network can link with neighboring countries, which are Lao People's Democratic Republic, Cambodia, and Malaysia.

SRT rail network



Figure 3.

Source: www.railway.co.th

2.5 Laem Chabang Port

Laem Chabang Port is situated in the eastern part of Thailand in the area of Thung Sukla sub-district, Sriracha district, Chonburi province, covering a total area of 2,572 acres. The distance is approximately 130 km. southeast of Bangkok. The first phase construction of the port started in 1987 and finished in 1991, when the actual operation began. The development consisted of dredging and reclamation to structure the shape of finger piers, which are protected by a 1,300 meters long offshore breakwater. The channel was dredged to the depth of 16 meters and the basin was dredged to the depth of 14 meters.

Due to the increasing volume of cargo handled by the port, the phase two development began in 1997 and was completed in 2000. Two of the so called basins were dredged to the depth of 16 meters along with deepening the entrance channel and breakwater extension to 1,900 meters.

The location of Laem Chabang Port



Figure 4.

Source: Adapted from Google maps

Layout of Laem Chabang Port



Figure 5.

Source: Adapted from Google maps

LCP operates under the Port Authority of Thailand (PAT), which is under the supervision of the Ministry of Transport of Thailand. It is the major deep sea port of Thailand, which can accommodate up to post panamax ships and provides various kinds of maritime transport services. The port uses the landlord model, so PAT supervises the overall infrastructure including approaching channel maintenance dredging, water supply, electricity supply, access to the port (roads and lighting), port entrance gates, navigational aids, tug boats, and mooring line handling. On the other hand, the port has given concession agreements to private operators to handle the operation, for instance, construction of the superstructure, purchasing of the handling equipment, cargo operation, maintenance of the terminal area, and personnel recruitment. The maritime transport services are provided by the terminal operators as follows:

- Container terminals (8 terminals)
- Multipurpose terminals (2 terminals)

- Roro terminals (1 terminals)
- Passenger terminals (1 terminal)
- General cargo terminals (1 terminal)
- Shipyard (1 yard)

The port gave concessions to major shipping lines and terminal operators, which are AP Moller, Evergreen, PSA, MOL, NYK, DP World, and HPH who are responsible for the terminals' operation and also some other areas for rent to other private or governmental agents, which are private companies, Industrial Estate of Thailand, Customs Bureau, Animal and Plant Quarantine Agency, Dangerous Cargo Warehouse, which have supporting or connecting operations to the port. The port is associated with 14 terminals categorized by letter A, B, and C according to the series of terminals and the harbor basins.

The list of terminal operators are as follows:

- LCMT Co, Ltd. (A0 Terminal)
- NYK Auto Logistics Co., Ltd. (A1 Terminal)
- Thai Laem Chabang Terminal Co., Ltd. (A2 Terminal)
- Hutchison Laem Chabang Terminal Co., Ltd. (A3 and C1-2 Terminal)
- Aawthai Warehouse Co., Ltd. (A4 Terminal)
- Namyong Terminal Public Company Limited (A5 Terminal)
- LCB Container Terminal 1 Co., Ltd. (B1 Terminal)
- Evergreen Container Terminal (Thailand) Co., Ltd. (B2 Terminal)
- Eastern Sea Laem Chabang Terminal Co., Ltd. (B3 Terminal)
- TIPS Co., Ltd. (B4 Terminal)
- Laem Chabang International Terminal Co., Ltd. (B5 and C3 Terminal)
- Laem Chabang International Ro-Ro Co., Ltd. (C0 Terminal)

2.6 Inland Container Depot Ladkrabang

Supporting the port operations, the Inland Container Depot Ladkrabang (ICD) was built in 1996. The inland container depot or so-called dry port is a concept of easing the congestion in the seaports to inland facilities. The cargo volume is transferred to the dry port allowing ports to better utilize the area. The dry port also acts as a hub for intermodal transport by linking through the ports by rail or road (Roso et al., 2009)

In 1989, Japan International Cooperation Agency (JICA) cooperated with the Thai government to make a feasibility study regarding to the construction of the inland container depot to support the operation of LCP. Hence, the ICD was constructed.

ICD situated in the Ladkrabang district covering a total area of 256 acres. The distance is approximately 44 km. east of Bangkok. The first operation started in 1996. The area is designed for handling containers by rail connecting mainly to LCP and also other parts of Thailand. The annual capacity of the ICD is 600,000 TEU. There are import/export processing activities and customs clearance as a one-stop service basis.

The location of ICD Ladkrabang

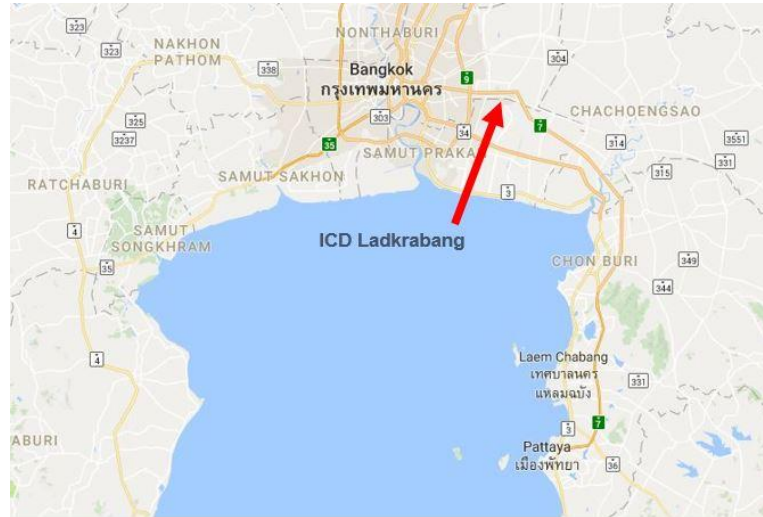

Figure 6.

Source: Adapted from Google maps

Objectives of the construction and operation of ICD are as follows:

- Facilitate the import/export activities.
- Promote the usability of LCP by reducing the tariff between ICD and LCP.
- Support the planning policy of the Bangkok port congestion reduction.
- Environmentally friendly and fuel efficiency promotion.

ICD operates under the State Railway of Thailand (SRT), which is under the supervision of the Ministry of Transport. Similar to the landlord model in LCP, ICD gave concession agreements to six private module operators who are taking care of the cargo operations and handling the containers to and from the rail wagon and also taking care of stuffing/unstuffing the containers, purchasing and maintenance of the handling equipment, and personal recruitment. SRT is responsible for rolling stocks management, rail scheduling, railway maintenance, sleepers, mounting rail, signaling, locomotives, and wagons. The list of the module operators are as follows:

- Siam Shoreside Services Ltd. (Gate 1) (SSS)
- Eastern Sea Laem Chabang Terminal Co., Ltd. (Gate 2) (ECCO)
- Evergreen Container Terminal (Thailand) Co., Ltd. (Gate 3) (ECTT)
- TIFFA ICD Co., Ltd. (Gate 4) (TIFFA)
- Thai Hanjin Logistics Co., Ltd. (Gate 5) (THL)
- NYK Distribution Service (Thailand) Co., Ltd. (Gate 6) (NYK)

The distance of rail connection from ICD to LCP is 118 kilometers; the track is meter gauge type, the average speed of the rolling stock is around 40 kilometers/hour, and the transit time is nearly three hours. There are on average 24 trips of trains/day. Each trip carries 37 wagons and each wagon carries two TEU of containers; the rail operation between ICD and LCD involves containerized cargo only. From 1996 to 2012, the railway from Ladkrabang to Laem Chabang station was single track and from 2012 to present after the transport and logistics promotion policy of Thailand by the Ministry of Transport, SRT constructed double track railway to enhance the track capacity; however, the connection from the Laem Chabang station to the rail yards inside LCP area is around 4 kilometers and is still single track.

There are rail yards in LCP to accommodate the container throughput from ICD. In the export operation, once the wagons are all fully loaded from ICD, the rolling stock spends nearly three hours from ICD to LCP then stops at the rail yard. The container handling is performed by the terminal operators in LCP. For the import, the containers are unloaded from the ship and transferred to the rail yard. The containers will be loaded by the terminal operators onto the rail wagons, and once the train has been unloaded, it will travel back to ICD.

The ICD functions to support the LCP operation, and as a dry port. The ICD helps reducing congestion for LCP. Moreover, ICD acts as a hub for stuffing and unstuffing containers. Mostly break bulk cargo is transported to ICD for stuffing to the container before being transferred to LCP for export. In addition, import containers are also

unstuffed at ICD for final delivery; LCP also imports empty containers to supply ICD for export cargo.

2.7 Statistics of the container handled in ICD and LCP

The following section shows the statistics of the container handled at ICD and LCP in order to show some analysis which leads to the objective of the study.

Container throughput of ICD and LCP

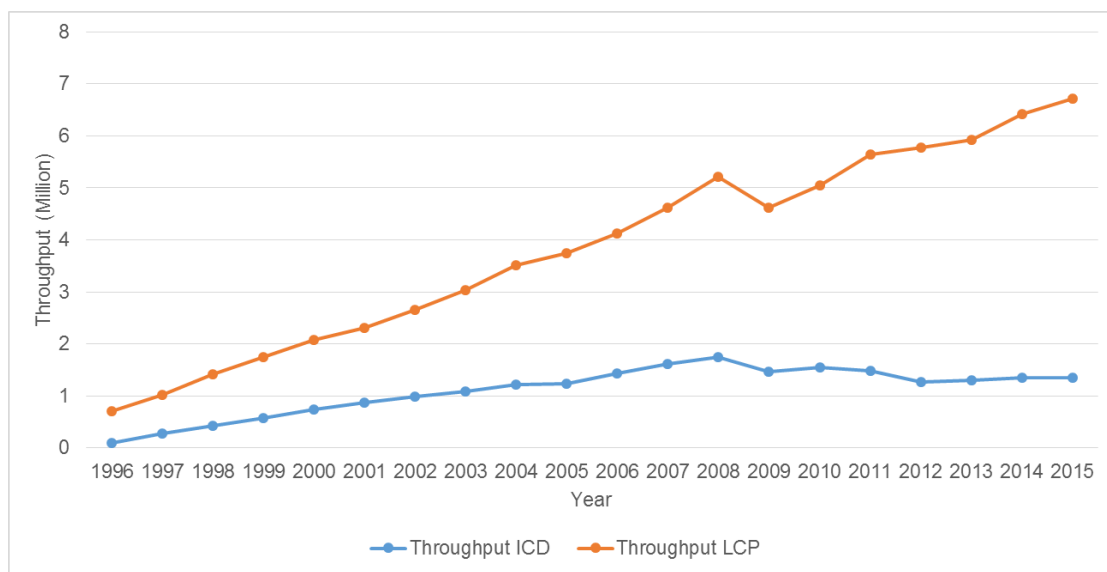

Figure 7.

Source: Adapted from State Railway of Thailand

Figure 7 shows that the container throughput at LCP is growing every year except in 2009 due to the financial crisis, and in 2005 the port reached 6.7 millions TEU. On the other hand, ICD has been continuously growing since the opening in 1996 until 2008, when it reached its peak at 1.7 millions TEU, then dropped to remain continuously steady at around 1.2 to 1.5 millions TEU until present. The reason that ICD has not grown since 2008 is due to the fact that there has been overcapacity since 2000. The capacity of ICD, as above mentioned, is 600,000 TEU/annum.

Containers transported by rail at ICD

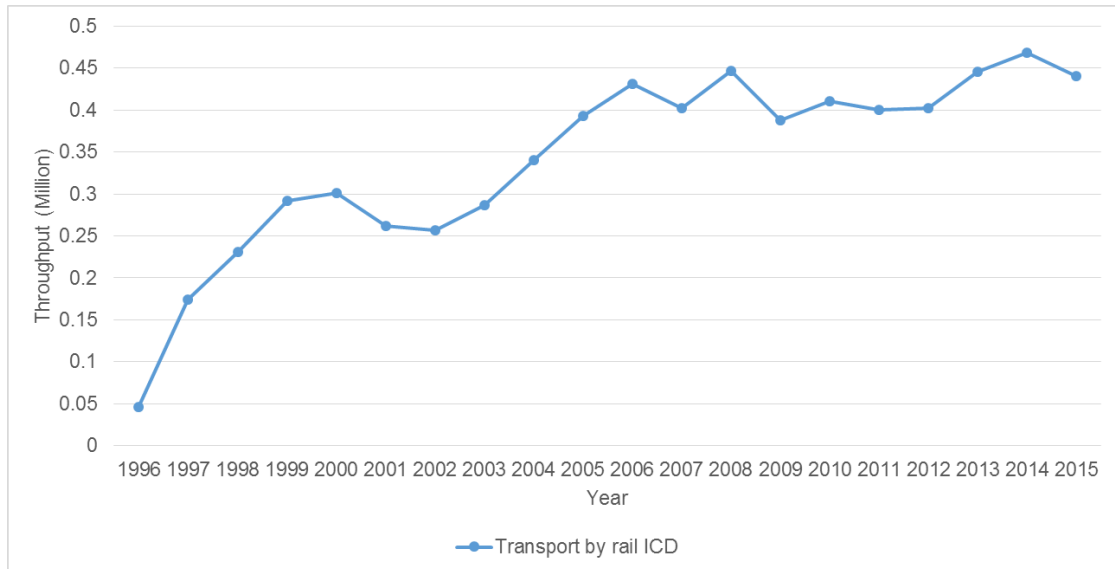

Figure 8.

Source: Adapted from State Railway of Thailand

According to Figure 8, the volume of containers is the total volume regardless of the mode of transport. Figure 9 gives an annual modal split information of ICD. The rail container volume has fluctuated since the beginning of the operations and there is a sharp increase in the very first year, but dropping in 2000 and dropping again in 2008-2009 due to the financial crisis but have remained steady until present.

Percentage of the modal split between rail and road at ICD

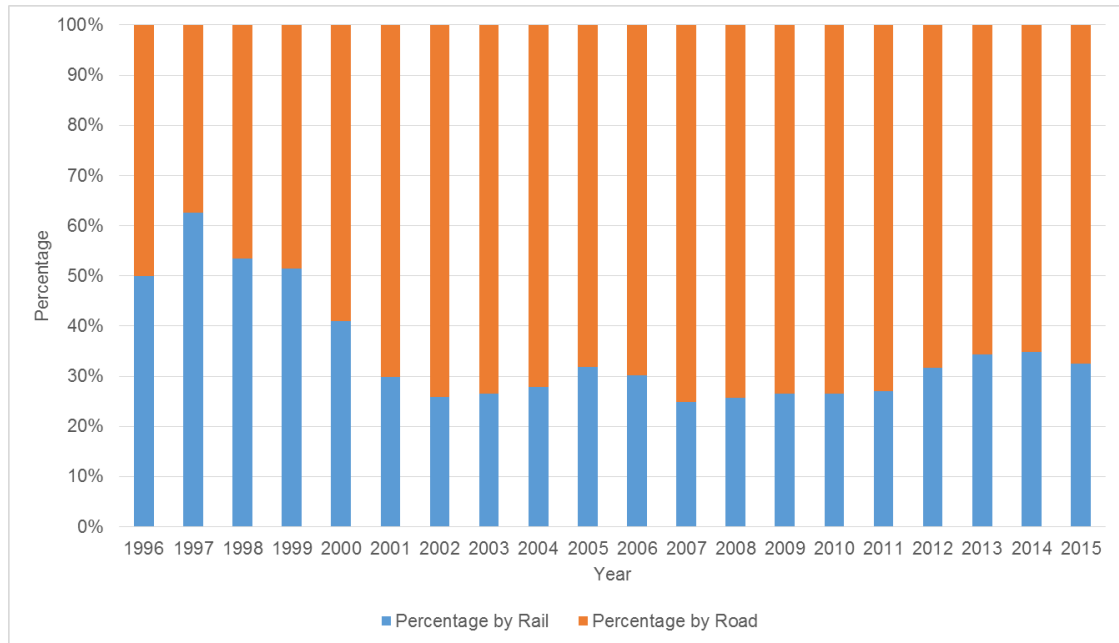

Figure 9.

Source: Adapted from State Railway of Thailand

As Figure 9 shows, the percentage of a modal split by rail at ICD, which reached its peak in 1997 of which more than 60% and dropped slowly to the year 2001. Since the 30% share of rail transport in 2001, the rail transport volume remains steady at around 25%-35%.

Percentage of the modal split between rail and road at LCP

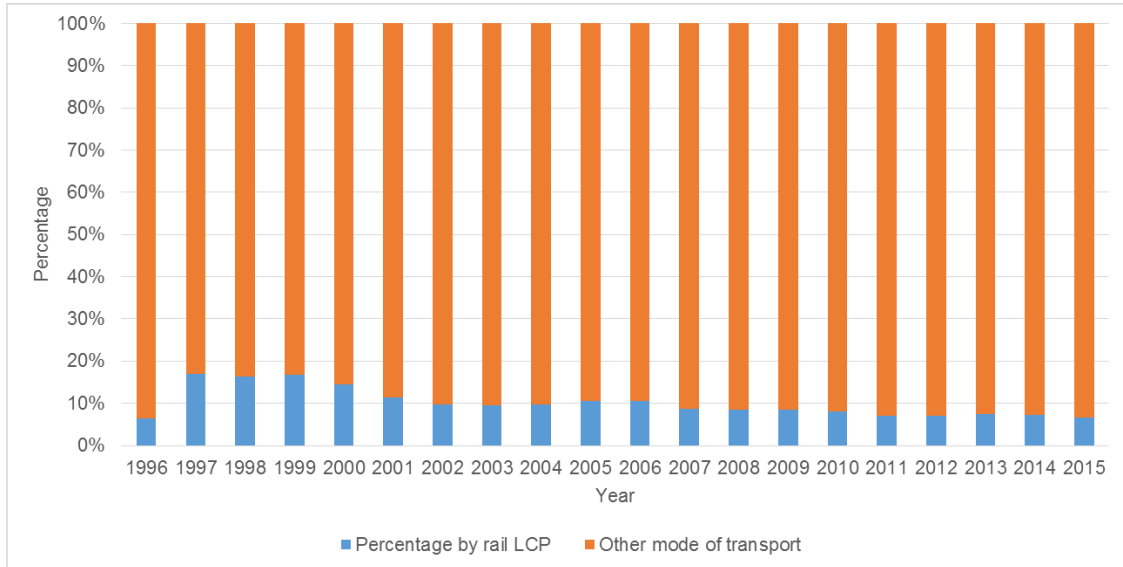

Figure 10.

Source: Adapted from State Railway of Thailand

Figure 10 shows the percentage of the modal split by rail at LCP. The percentage of rail containers has been declining since 1999 due to the growing volume of containers at LCP whereas, the capacity of ICD has been fully utilized since 2000.

2.8 Import and Export processes

This section explains the detail of rail freight operation, which links between ICD and LCP. There are details of import and export processes, layouts of the operational area and limitations of freight transport.

2.8.1 Import process

The process involves many parties concerned with the arrangement of the operation and sending information. First of all, the consignee sends the confirmation to transport the containers by rail to the shipping line, which is done via the internet (e.g. e-mail, company's website). Once the shipping line acknowledges the confirmation, the terminal

operator at LCP is informed, requesting the containers to be handled at the rail yard for further transport. The shipping line also informs the module operator in ICD to arrange the wagon booking for the containers. The wagon booking should be done by the module operator by informing SRT in the daily meeting, which is conducted to share the wagons among operators. Since there are six module operators, conflict of interest happens due to limited resources of SRT (there are 24 trips of trains per day and each train carries 37 wagons, with a capacity of 74 TEU). Once the daily meeting is done, the wagon proportion of that meeting should be the share of wagons for the following day; hence, the request from the consignee should be done in advance.

Once the ship has arrived at the port, the unloading operation is performed by the terminal operators at LCP, and then the terminal operators will transfer the containers to the rail yard. The duty of the consignee or the shipping line is to make a declaration form to the customs office called “customs permission of transport cargo by other modes of transport”. The concept behind this document is that the customs office has set up a control area called customs limit in order to prevent smuggling of cargo or transport of containers out of the customs limit without customs release order. However, the customs permission of transport cargo by other modes of transport enables the transporter to make a customs release order at the point of discharge, in this case, at ICD. The terminal operators have to ensure that the documentation is done before loading the containers to the rail wagon. Once the containers are loaded into the wagon, SRT will transport the wagon by a locomotive to the ICD, where the containers will be unloaded by the module operators for further delivery.

2.8.2 Export process

First of all, the shipping line makes a decision to transport containers by rail because generally transporting containers by rail is cheaper than road transport. Therefore, the shipping line prefers to use rail rather than the road. The shipping line will inform the module operators to transport the containers by rail, and then the module operators will

plan to make a wagon booking in the daily meeting with SRT. Once the wagon request is confirmed, the module operators will send the confirmation to the shipping line and contact the terminal operators in LCP with a notice about container arrival. After that, the container will be transported to the container yard at LCP and transferred to the terminal by the terminal operators and wait to be loaded onto the ship.

2.9 Operation details and layouts

SRT is responsible for the rail freight operation between ICD and LCP by making concession agreements to module operators to conduct the cargo handling operation. The locomotives and wagons are also managed by SRT. Within the ICD premises, there are government agents who regulate to the import and export procedures, namely Customs Bureau, Quarantine Office, and Food and Drugs Agency.

The distance between ICD and LCP is 118 kilometers, and there are 24 trips/day, 12 of which are from ICD to LCP for export containers and another 12 trips are from LCP to ICD for import containers. The track is meter gauge, and the distance 114 kilometers to the Laem Chabang station is 114 kilometers with double tracks and the remaining 4 kilometers within LCP area is single track.

Cargo handling time on both ICD and LCP sides are approximately 60 minutes. Once finishing cargo handling operations, SRT takes 30 minutes as a preparation time (disconnecting/connecting the locomotives to the wagons and general safety check) before moving the rolling stock. The transit time between ICD and LCP is around 175 minutes. There are 8 locomotives in service, each locomotive carries 37 freight wagons and each freight wagon carries the maximum two TEUs of container; in other words, two 20' containers or one 40' container. There is weight limitation of the wagons, carrying capacity of the wagons ranging from 24-38 tons; therefore, sometimes the heavy 20' containers are carried on only one wagon due to loading of another 20' container with a significant weight difference which can cause an accident due to instability. The following Figure 11 elaborates the overview of the operations.

Overview of the container handling operation between ICD and LCP

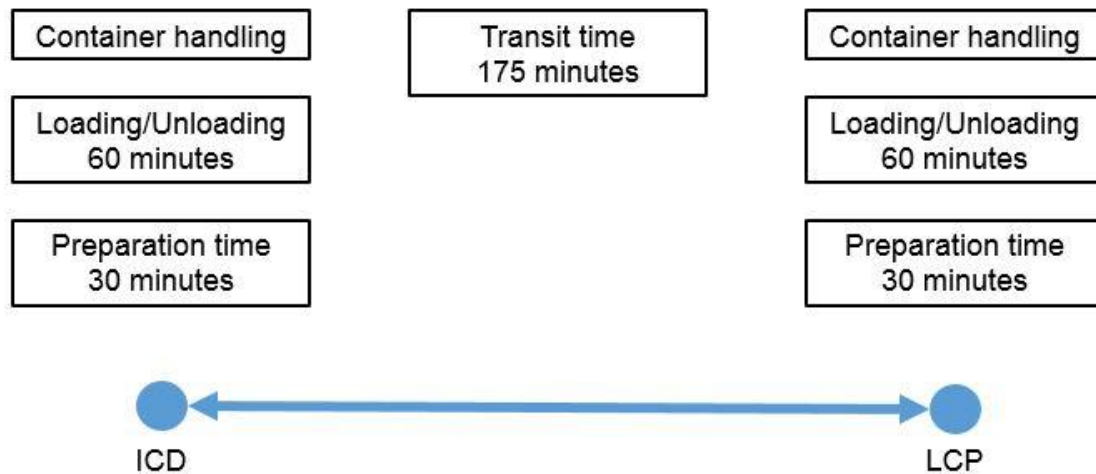

Figure 11.

Source: Adapted from State Railway of Thailand

Figure 11 gives the big picture of the operation overview. In more details of the loading/unloading operations, there are tally and inspection and cargo handling together within 60 minutes, and within 30 minutes, there are disconnecting and connecting of locomotive and wagons including general safety checking.

The export process is the process whereby containers are transported from the container yards by reach stackers and loaded onto the truck chassis at ICD. The truck will deliver the containers to the apron beside the track and the container will be lifted and loaded onto the rail wagon. Once the containers are transported to LCP, unloading is performed by reach stackers and then the containers will be loaded to the truck chassis at the rail yard before moving to the terminal area by terminal trucks. The containers are then stacked in the container yard by Rubber Tired Gantry Cranes (RTG).

In the import process, the containers are unloaded from the ship and then transported to the stacking area in the terminal before transferred to the rail yards at LCP. Reach stackers, which are stationed at the rail yards, will load the containers onto the rail wagons. The

containers are transported by the rolling stock to the rail yards at ICD for further direct delivery or being unstuffed before delivery.

The layout of the operational areas of both ICD and LCP in order to provide the general understanding of the movement of containers, locomotives, and freight wagons is shown as follows:

2.9.1 ICD's Layout of the operational areas

Layout of ICD

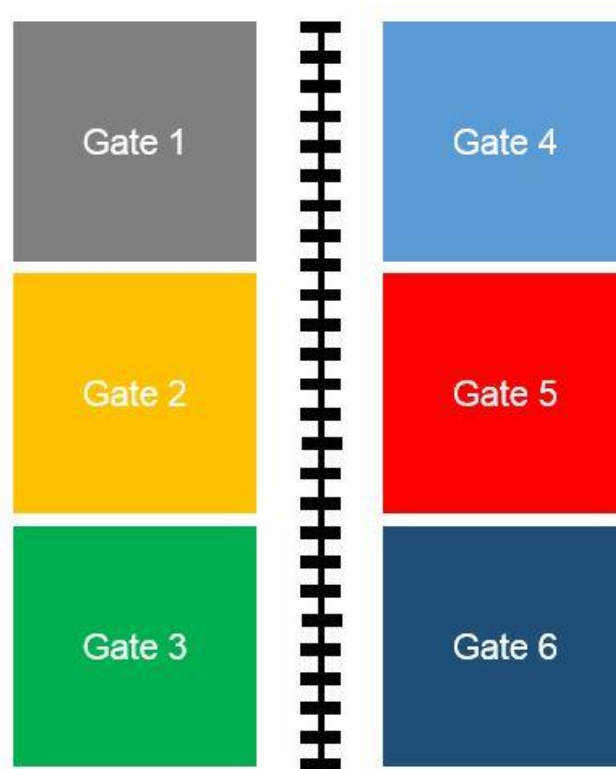

Figure 12.

Source: The author

ICD has been separated into six sub-terminals (Gates), in different gates, where there are different terminal operators who are concessioned by SRT to perform container and cargo handling activities. Each gate comprises warehouses, container yards, container handling

equipment (mainly reach stackers, empty handlers, and terminal truck), and cargo handling equipment (mainly forklifts).

Rolling stocks travel through the middle of all gates, and gate operators bring reach stackers to operate loading and unloading operations at the apron in front of the track. Delivering or receiving cargo and containers is performed at the terminal gates on the opposite side of the apron.

2.9.2 LCP's Layout of the operational areas

Layout of Laem Chabang Port rail yard areas

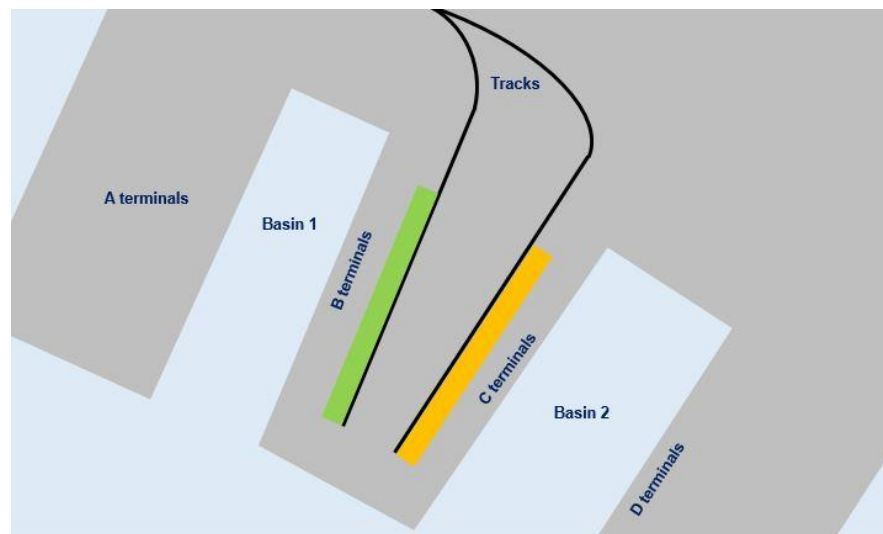

Figure 13.

Source: The author

The main container terminals at LCP are in the B series terminals and C series terminals. The rail yard of B terminals is represented in green color and the rail yard of C terminals is represented in yellow color. Rolling stocks travel from ICD have to choose either B or C according to the container destinations. For the ease of operation and cost saving methods, most containers which have the same terminal of destination will be loaded on the same trip of the train.

In the export process, once the train has arrived, terminal operators dispatch reach stackers to load and unload containers and temporarily store them at the rail yards before moving to the terminal. In the import process, terminal operators transfer the containers to the rail yards by truck for temporary storage before loading them onto the rail wagons by reach stacker.

2.10 Limitation of rail freight transport

There are limitations which constrain or disallow importers, exporters, and forwarders to transport containers by rail as follows.

- Refrigerated container limitation – Currently, there is no refrigerated container reception equipment installed in the wagon. For that reason, importers, exporters, and forwarders have to transport refrigerated containers by truck. There are some refrigerated containers handled at ICD, and these containers are all transported by truck.
- Dangerous cargo container limitation – Currently, there are no limitations in the transport of dangerous goods by rail. However, according to LCP regulations, for safety reasons, all dangerous goods have to be handled, stored and managed by the designated company, which is the expert in handling dangerous goods. Therefore, once the containers have arrived at LCP, the containers have to be directly transferred to a Dangerous Cargo Warehouse within the port area. This causes additional charges involving the transfer of containers. Consequently, the total cost of transporting dangerous cargo is no longer less expensive than direct transport by truck from the point of origin.
- Container Security Initiative¹ (CSI) by U.S. Customs and Border Protection – In case a container has been randomly picked for scanning according to CSI, the

¹ CSI addresses the threat to border security and global trade posed by the potential for terrorist use of a maritime container to deliver a weapon. CSI proposes a security regime to ensure all containers that pose a potential risk for terrorism are identified and inspected at foreign ports before they are placed on vessels destined for the United States. CBP has stationed teams of U.S. CBP Officers in foreign locations to work together with our host foreign government

container has to be transferred to the scanning facilities within the port area prior to being loaded on to the ship. This causes additional charges involving the transfer of containers. Consequently, the total cost of the scanned container is more expensive than direct transport by truck from the point of origin. However, the CSI performs the task on a random basis; therefore, there is around a 5% chance subject to the probability and exporter profiles.

- There is weight limitation of the wagons, carrying capacity of the wagons ranging from 24-38 tons; therefore, sometimes the heavy 20” containers are carried on only one wagon due to loading of another 20” container with a significant weight difference which can cause an accident due to instability. There is 25% of rail wagons transported between ICD and LCP carrying only one TEU.

2.11 Policies, strategies, plans and projects to improve the capacity and efficiency of the rail freight services

A major strategy proposed by the government to reduce the cost of transport is to reduce the share of road transport and shift to rail and barge transport. In the perspective of the Ministry of Transport, rail transport is an efficient means of transport as it is environmentally friendly, and helps reducing road congestion, road accident, and logistics cost. Thailand has a very high percentage share of road transport; however, very low rail transport as shown in Figure 14.

counterparts. Their mission is to target and prescreen containers and to develop additional investigative leads related to the terrorist threat to cargo destined to the United States. (Source: www.cbp.gov)

Breakdown of domestic freight transportation, 2014

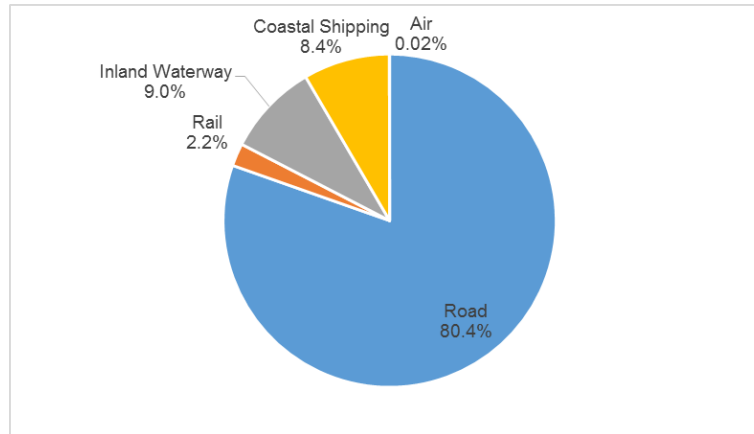

Figure 14.

Source: Adapted from Ministry of Transport

The Ministry of Transport imposed strategies to attract importers and exporters to utilize freight transport by rail. This strategy was derived to SRT and PAT to find ways to promote more rail traffic. The effort to promote alternative modes of transport and rail transport promotion through the policy of the Ministry of Transport, PAT made an announcement to temporarily decrease the rail transfer charges of LCP from the original tariffs, which is shown in Table 1.

Table 1. Rail transfer charges of LCP

Items	20"	40"	More than 40"
<i>Import Container</i>			
FCL / LCL	690 (US\$20)	1,040 (US\$30)	1,110 (US\$32)
Empty	250 (US\$7)	370 (US\$11)	400 (US\$12)
<i>Export Container</i>			
FCL / LCL	520 (US\$15)	780 (US\$22)	830 (US\$24)
Empty	250 (US\$7)	370 (US\$11)	400 (US\$12)

Note: The charges cover the transfer of FCL², LCL³ or empty containers from the container yard to the rail yard and also the loading of containers on the rail wagons in the case of import container or vice versa, the currency is in Thai Baht (THB).

Source: Laem Chabang Port

The charges were reduced to 470 Baht (US\$14) and finally to 315 Baht (US\$10) for all container status in 2004. This strategy attracted shipping lines, importers, exporters, and forwarders to utilize rail transport as the main mode of container transport between ICD and LCP due to the cost being lower than road transport after the reduction of tariffs.

Moreover, there is a privilege for the containers which use other modes of transport (coastal vessel or barge and rail) rather than road announced by LCP. This policy stated that containers which utilize coastal vessels or barges and rail transport should have only one hour closing time⁴. This gives a high flexibility for the exporters and forwarders, who are responsible for delivering the containers to the terminal compared to road transport whose closing time is 24 hours.

² FCL is a container shipment which loaded and sealed at origin by single supplier or manufacturer, then shipped by a combination of ocean, road or/and rail to final destination (<https://cargofromchina.com/fcl-lcl/>).

³ LCL is container shipment which loaded by multiple suppliers or manufacturers, this allows exporters to ship smaller amounts of cargo that is not of a large enough volume to make FCL a viable option. This means the container is combined with many shipping consignments headed for the same destination (<https://cargofromchina.com/fcl-lcl/>).

⁴ Closing time is the limit of a time window for a container to be delivered to terminal prior to the berthing of the ship which intends to carry the container, in the case of exporters, forwarders, and trucking companies fail to deliver the container within the time window, consequently, the container shall not be accepted to the terminal. The closing time is only applied for the export container (Laem Chabang Port).

Apart from the container handling charges' reduction, infrastructure improvement projects are also introduced. There are five categories: double tracking, track rehabilitation, new network expansion, upgrading of signaling, and telecommunication systems. The major improvement between ICD and LCP was double tracking which was completed and has been fully in operation since 2012. This provides unlimited track capacity and eliminates waiting time from shunting.

Moreover, SRT also purchased new locomotives for replacing aging ones to improve the operations in 2015; therefore, the carrying capacity has been increased from 30 wagons to 37 wagons per locomotive.

Despite having many major improvements and investments in the operations, rail freight transport has not improved considerably because the major mode of container transport of LCP is still dominantly carried out by road according to Figure 15.

The modal split of LCP, 2015

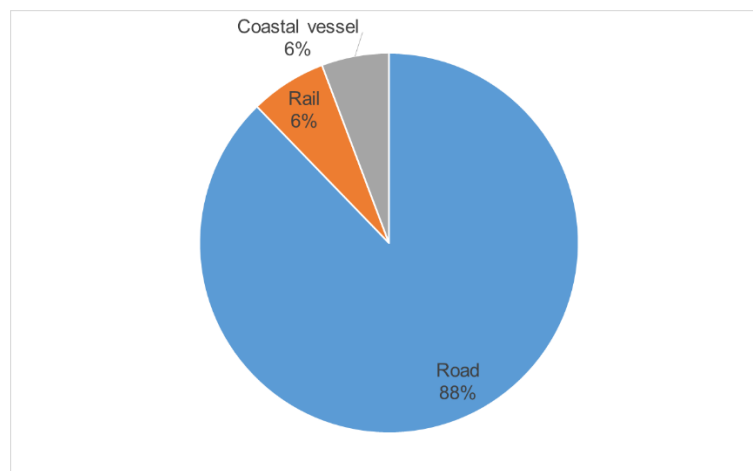

Figure 15.

Source: Adapted from Laem Chabang Port

The large share of road causes severe traffic congestion, accidents and pollution problems, which lead to high road maintenance costs and several complaints from local communities, trucking companies, and port users.

2.12 Examination of the effects of the government policies and investments on rail freight transport

This section shows the effectiveness of the government’s policies, strategies, and plans/projects intended to improve the capacity and efficiency of the rail freight services. As aforementioned, the Ministry of Transport has been supporting the modal shift from road to other modes of transport in order to reduce the logistics cost, environmental impacts, and congestions. A series of policy implementations and investments have been done as follows:

Policy implementation and investments by government on rail transport

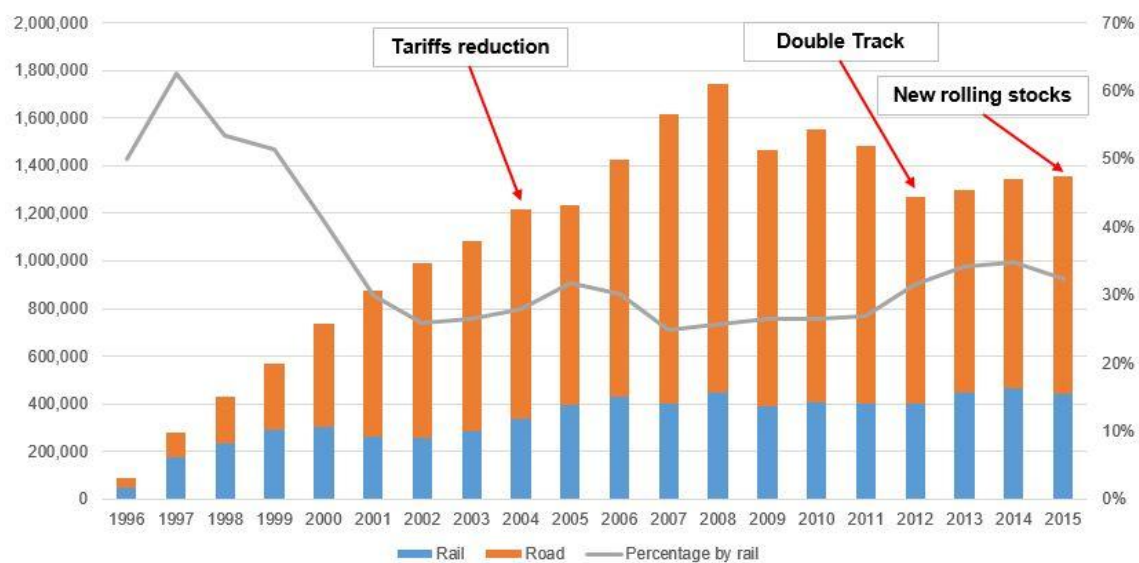

Figure 16.

Source: Adapted from State Railway of Thailand

Figure 16 shows the proportion of modal split on the total throughput at ICD; the left vertical axis indicates the container throughput and the horizontal axis indicates years. The blue color of the bar chart represents the rail transport proportion, the orange color represents the road transport proportion and the gray line illustrates the percentage of rail transport at ICD. The percentage level is indicated on the right vertical axis.

Word boxes and red arrows point out the implementation of policy and investments on the certain points of time. As seen in 2004, in order to attract importers, exporters, forwarders, and shipping lines to use rail freight transport, tariff reduction policies were announced. In 2012 and 2015, double track construction and purchasing of new locomotives were performed respectively.

In 2004, after the reduction of prices, the ICD throughput went up dramatically to its peak in 2008 (nearly 1.8 millions TEU). However, the upward trend was seen as a large share of road transport rather than rail.

The drop in 2009 was the consequence of the global financial crisis. Since then the throughput remains steady until the present. The construction of double tracks and purchasing of the new locomotives did not generate a significant increase in container throughput.

2.12.1 Tariffs reduction strategy

Implemented in 2004, the tariffs have reduced to 315 Baht (US\$10) for all containers and status transported by rail to LCP. This section is to investigate how effective the strategy implementation is.

The main equipment in the rail yard operations in both LCP and ICD are reach stackers for loading and unloading containers. Transport to and from terminals is done by truck and chassis. The next stage is a rough discussion about the costs and revenues of the rail container operations by terminal operators.

Annual operating cost of container handling equipment

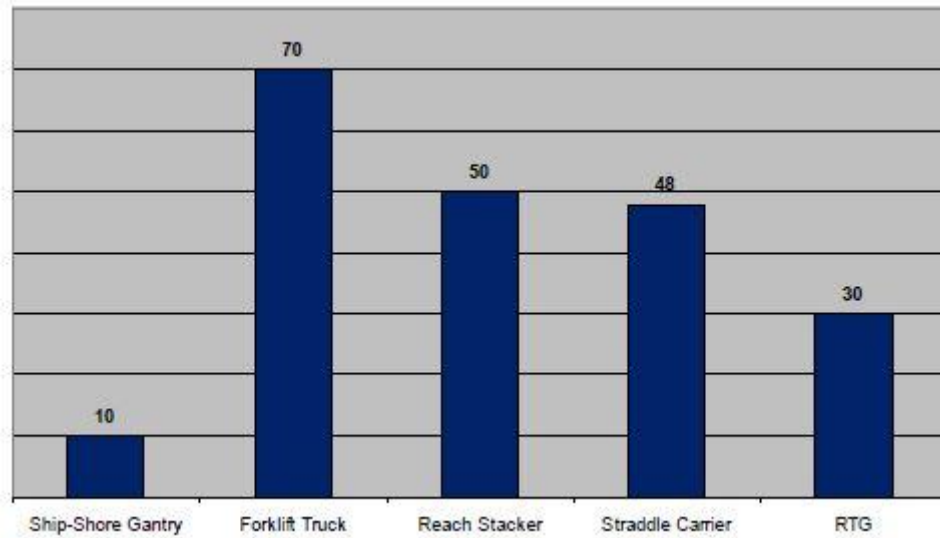

Figure 17.

Source: World Bank

The data from the World Bank shows that the annual operating cost of reach stackers is approximately 50% of the purchasing price.

Within the annual operating costs, the break down in more detail is illustrated as follow:

Break down of annual operating cost of reach stacker

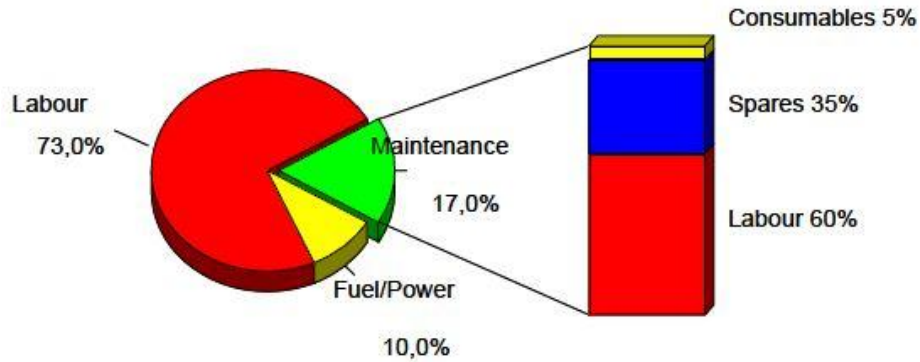

Figure 18.

Source: World Bank

Assumptions of the financial analysis of the rail container operation:

- Fixed cost

Reach stacker costs analysis: Purchasing prices of reach stackers is approximately 600,000 USD or around 18,000,000 Baht. For the efficient operations, there are two reach stackers; therefore, the cost of a reach stacker is 36,000,000 Baht.

Depreciation of the reach stacker should be estimated by the straight line method through the economic life cycle of 10 years: 2,880,000 Baht.

Operating cost

According to the World Bank estimation, it is around 50% of the purchasing price; however, according to lower operating cost in Thailand (lower labor cost and maintenance cost), the estimation should be around 35%: 12,600,000 Baht. Escalation is estimated at 2% annually.

- Variable cost

Fuel: According to the World Bank, the annual fuel price is around 10% of the purchasing price i.e. 1,260,000 Baht. There are three scenarios in the assumption that the fuel cost should vary, plus or minus 20% according to the number of containers handled.

- Revenue

The assumption of the revenue is based on the number of containers handled. According to statistics, the author will make 3 assumptions (handling of containers of 20,000, 30,000, and 40,000 boxes), the tariff per box is 315 Baht (US\$10); however, due to the fact that the rail yards are the property of LCP; therefore, it is LCP's policy to deduct 15 Baht (US\$0.5) for each box for the common use of the rail yards as the budget for maintenance and operational lightings. Then, the net revenue of the terminal operator is 300 Bath (US\$9.5) /box.

- Indicator of the analysis is the annual profit and loss of the operations.

The financial analysis parts into three scenarios, the first of which is the event of handling 20,000 boxes of containers annually and the fuel consumption is reduced to 20% less than the World Bank estimation. The second scenario is the event of handling 30,000 boxes of containers annually and the fuel consumption is based on the World Bank estimation. Lastly, the third scenario is the event of handling 40,000 boxes of containers annually and the fuel consumption is added to 20% more than the World Bank estimation.

Table 2. Financial analysis scenario 1

	0	1	2	3	4	5	6	7	8	9	10	
Initial Cost	36,000,000											
Fixed Cost												
<i>Depreciation</i>		2,880,000	2,880,000	2,880,000	2,880,000	2,880,000	2,880,000	2,880,000	2,880,000	2,880,000	2,880,000	
<i>Operating cost</i>		12,600,000	12,852,000	13,109,040	13,371,221	13,638,645	13,911,418	14,189,646	14,473,439	14,762,908	15,058,166	
Total Fixed cost		15,480,000	15,732,000	15,989,040	16,251,221	16,518,645	16,791,418	17,069,646	17,353,439	17,642,908	17,938,166	
Variable Cost												
<i>Fuel</i>		1,008,000	1,008,000	1,008,000	1,008,000	1,008,000	1,008,000	1,008,000	1,008,000	1,008,000	1,008,000	
Total Variable cost		1,008,000	1,008,000	1,008,000	1,008,000	1,008,000	1,008,000	1,008,000	1,008,000	1,008,000	1,008,000	
Total Cost		16,488,000	16,740,000	16,997,040	17,259,221	17,526,645	17,799,418	18,077,646	18,361,439	18,650,908	18,946,166	
Revenue		6,000,000	6,000,000	6,000,000	6,000,000	6,000,000	6,000,000	6,000,000	6,000,000	6,000,000	6,000,000	
Profit/Loss		(36,000,000)	(10,488,000)	(10,740,000)	(10,997,040)	(11,259,221)	(11,526,645)	(11,799,418)	(12,077,646)	(12,361,439)	(12,650,908)	(5,746,166)

Scenario 1 analysis: Handling 20,000 boxes of containers annually, fuel consumption of 1,008,000 Baht/year. The result shows a loss every year.

Table 3. Financial analysis scenario 2

	0	1	2	3	4	5	6	7	8	9	10	
Initial Cost	36,000,000											
Fixed Cost												
<i>Depreciation</i>		2,880,000	2,880,000	2,880,000	2,880,000	2,880,000	2,880,000	2,880,000	2,880,000	2,880,000	2,880,000	
<i>Operating cost</i>		12,600,000	12,852,000	13,109,040	13,371,221	13,638,645	13,911,418	14,189,646	14,473,439	14,762,908	15,058,166	
Total Fixed cost		15,480,000	15,732,000	15,989,040	16,251,221	16,518,645	16,791,418	17,069,646	17,353,439	17,642,908	17,938,166	
Variable Cost												
<i>Fuel</i>		1,260,000	1,260,000	1,260,000	1,260,000	1,260,000	1,260,000	1,260,000	1,260,000	1,260,000	1,260,000	
Total Variable cost		1,260,000	1,260,000	1,260,000	1,260,000	1,260,000	1,260,000	1,260,000	1,260,000	1,260,000	1,260,000	
Total Cost		16,740,000	16,992,000	17,249,040	17,511,221	17,778,645	18,051,418	18,329,646	18,613,439	18,902,908	19,198,166	
Revenue		9,000,000	9,000,000	9,000,000	9,000,000	9,000,000	9,000,000	9,000,000	9,000,000	9,000,000	9,000,000	
Profit/Loss		(36,000,000)	(7,740,000)	(7,992,000)	(8,249,040)	(8,511,221)	(8,778,645)	(9,051,418)	(9,329,646)	(9,613,439)	(9,902,908)	(2,998,166)

Scenario 2 analysis: Handling 30,000 boxes of containers annually, fuel consumption of 1,260,000 Baht/year. The result shows a loss every year.

Table 4. Financial analysis scenario 3

	0	1	2	3	4	5	6	7	8	9	10	
Initial Cost	36,000,000											
Fixed Cost												
<i>Depreciation</i>		2,880,000	2,880,000	2,880,000	2,880,000	2,880,000	2,880,000	2,880,000	2,880,000	2,880,000	2,880,000	
<i>Operating cost</i>		12,600,000	12,852,000	13,109,040	13,371,221	13,638,645	13,911,418	14,189,646	14,473,439	14,762,908	15,058,166	
Total Fixed cost		15,480,000	15,732,000	15,989,040	16,251,221	16,518,645	16,791,418	17,069,646	17,353,439	17,642,908	17,938,166	
Variable Cost												
<i>Fuel</i>		1,512,000	1,512,000	1,512,000	1,512,000	1,512,000	1,512,000	1,512,000	1,512,000	1,512,000	1,512,000	
Total Variable cost		1,512,000	1,512,000	1,512,000	1,512,000	1,512,000	1,512,000	1,512,000	1,512,000	1,512,000	1,512,000	
Total Cost		16,992,000	17,244,000	17,501,040	17,763,221	18,030,645	18,303,418	18,581,646	18,865,439	19,154,908	19,450,166	
Revenue		12,000,000	12,000,000	12,000,000	12,000,000	12,000,000	12,000,000	12,000,000	12,000,000	12,000,000	12,000,000	
Profit/Loss		(36,000,000)	(4,992,000)	(5,244,000)	(5,501,040)	(5,763,221)	(6,030,645)	(6,303,418)	(6,581,646)	(6,865,439)	(7,154,908)	(250,166)

Scenario 3 analysis: Handling 40,000 boxes of containers annually, with a fuel consumption of 1,512,000 Baht/year. The result shows a loss every year.

2.12.2 Double track construction

Table 5. Container throughput of ICD from 2012-2015

Year	Throughput	Rail throughput	Road throughput	Percentage by rail
2012	1.271	0.402	0.869	32%
2013	1.301	0.446	0.855	34%
2014	1.344	0.468	0.876	35%
2015	1.355	0.44	0.915	32%

Note: Throughput shown in millions TEU.

Double track construction was fully functional in 2012. Table 5 shows statistics of container throughput of ICD between 2012 and 2015. There are very marginal increases in throughput from year to year and also minor changes in the percentage of rail throughput.

2.12.3 Purchasing of new locomotives

New locomotives were purchased in 2015 to replace all of the old models; consequently, the efficiency of the operations improved from the transport of 30 wagons to 37 wagons each trip. It is expected to be up to a 25% increase in container throughput.

2.13 Chapter summary

The freight transport of Thailand mostly concentrates on road transport rather than rail, and 72% of the rail freight transport is containerized cargo which is transported to and from LCP and ICD because the LCP is a gateway port of containerized cargo. Even if most of the cargo is transported by rail between these two facilities, the rail freight transport share is still low compared to road transport. The government has generated policies and strategies to improve the service quality, which aims to attract importers, exporters, forwarders, and shipping lines to use more rail transport services due to the fact that, rail transport is a more energy efficient mode of transport, more environmentally

friendly, and has a less impact on the local community from congestion compared to road transport. However, the effectiveness of these policies is lower than the expectations. Moreover, the reduction of tariffs is damaging the terminal operators business by generating a loss in the operation.

CHAPTER 3: LITURATURE REVIEW

3.1 Logistics concept

The word logistics has been widely used and defined and there are a lot of definitions such as “A business planning framework for the management of material, service, information and capital flows. It includes the increasingly complex information, communication and control systems required in today's business environment.” (Logistix Partners Oy, Helsinki, FI, 1996) in a business definition, “The process of strategically managing the procurement, movement and storage of materials, parts and finished inventory (and the related information flows) through the organization and its marketing channels in such a way that current and future profit ability are maximized through the cost-effective fulfillment of orders” (Christopher, 2005). In a military definition “The science of planning and carrying out the movement and maintenance of forces those aspects of military operations that deal with the design and development, acquisition, storage, movement, distribution, maintenance, evacuation and disposition of material; movement, evacuation, and hospitalization of personnel; acquisition of construction, maintenance, operation and disposition of facilities; and acquisition of furnishing of services” (JCS Pub 1-02 excerpt). The Webster dictionary has given the definition as “The procurement, maintenance, distribution, and replacement of personnel and materiel”, “The process of planning, implementing, and controlling the efficient, effective flow and storage of goods, services, and related information from point of origin to point of consumption for the purpose of conforming to customer requirements Note that this definition includes

inbound, outbound, internal, and external movements, and return of materials for environmental purposes” (Reference: Council of Logistics Management, <http://www.clm1.org/mission.html>, 12 Feb 98). “The process of planning, implementing, and controlling the efficient, cost-effective flow and storage of raw materials, in-process inventory, finished goods and related information from point of origin to point of consumption for the purpose of meeting customer requirements” (Reference: Canadian Association of Logistics Management, <http://www.calm.org/calm/AboutCALM/AboutCALM.html>, 12 Feb, 1998). There are many other definitions, which provide similar or near similar meanings, and as mentioned, it can be summarized that logistics is the cargo and information movement management in such an efficient and cost-effective manners. The main focus of the logistics is time and cost which can be derived as 3R’s consists of Right thing, at the Right place, at the Right time; on top of the 3R’s can be Right price, Right customer, Right condition, and Right quantity. (Class notes, Port logistics and planning, World Maritime University, 2016).

3.2 Port performance and competition

By comparing the actual and optimal throughput in tonnage or amount of containers handled is the common means of ports performance appraisal. In case the gap between actual throughput and optimal throughput narrows, the performance has enhanced, and if the gap is widen, the performance has declined. The concept of port competition has two types, inter-port competition, which means between ports and intra-port competition, which means within the port. The main factors that force the port to behave competitively is the presence of competitors (Talley, 2009). In the competitive environment and port customers (carriers and shippers), the main focus is how well and effectively the port manages and utilizes resources in providing throughput services. The port efficiency is the concerned target in the perspective of financial efficiency, operational efficiency, land use efficiency, and environmental efficiency.

There are factors regarding the port competition as explored by Yuan et al. in 2011. There are three groups of port users, who are shipping lines, forwarders, and shippers. By using the Analytic Hierarchy Process (AHP) to the industry experts, it found that, the factors considered in this study are port location, costs at port, variety of rates, port facility, storage space, shipping services, terminal operators, port information system, electronic information, hinterland connection, customs, and government regulations. The results showed that the most important factor for the shipping lines is costs at port (terminal handling fees and other expenses), followed by customs and government regulations and hinterland connections. In the perspective of forwarders, the most important factor is port location, followed by hinterland connection. In the viewpoint of shippers, port location is the most important factor. From the empirical results, it is illustrated that hinterland connection is not the most important factor for all the port users; however, among the top ranking factors, it is the significant factor to consider and could be one of the influential elements for the port competitiveness.

3.3 Comparative analysis of road and rail transport

In order to understand the characteristics of the modes of transport, a review of some of the cost and utility comparisons between different types of transport is important.

Unimodal alternatives (road and rail)

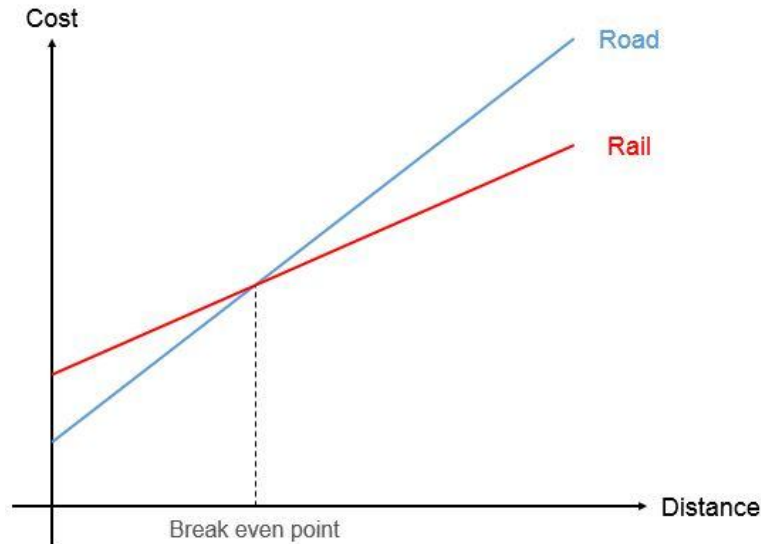

Figure 19.

Source: Adapted from Jonkeren et al. (2011)

Figure 19 shows the comparison of the costs of road and rail transport. The beginning points on the cost axis represent fixed costs of each transport mode. Road transport has the lowest fixed as it requires only marginal investment in capital i.e. mainly trucks, and chassis. The fixed cost of rail transport is higher because of the initial investment in locomotives, terminals, and wagons. In this case, it is assumed that investments in infrastructure, such as highways and rail tracks are done publicly. However, on a long distance, road transport tends to generate higher cost than that of rail transport; however, it has a cost advantage on a shorter distance. On the other hand, rail transport gains cost advantage over a longer distance (Inmuang, 2010). The break-even point shown in the horizontal axis is the point where the cost of two transport modes are equal.

Multimodal transport (road and rail)

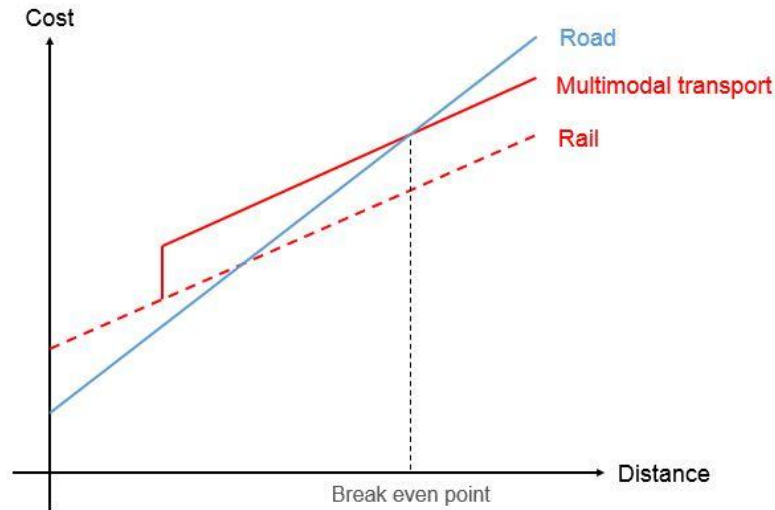

Figure 20.

Source: Adapted from Banomyong and Beresford (2001)

With the cost at the multimodal transfer point, the rail transport cost curve shifts upward and becomes a multimodal transport cost curve. Examples of the transfer costs are handling costs, terminal fees, and surcharges (Banomyong & Beresford, 2001). This makes the break-even point move to longer distance.

3.4 Dry port concept

“A dry port is an inland intermodal terminal directly connected to a seaport by rail, where customers can leave and/or collect their standardized units as if directly to the seaport” (Roso, 2009). The link between ICD and LCP follows the same concept of a dry port which links between two transport facilities by rail. The facilities act as an intermodal terminal, where the dry port is situated inland which offering related services, such as customs clearance, forwarding, storage, and container maintenance (Roso, 2009).

Comparison of a conventional transport and an implemented dry port concept

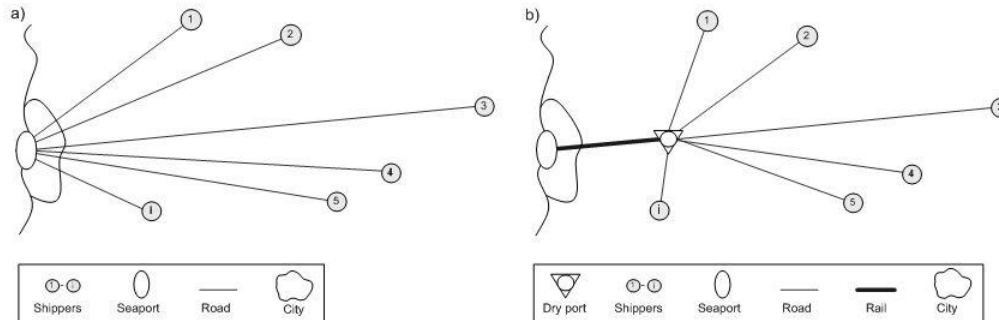

Figure 21.

Source: Roso (2009)

As seen in Figure 21, instead of transport by point to point from the cargo origins to the seaport as (a), all the points of transport are concentrate at the dry port, which directly links to the seaport as (b), resulting in shorter transport route, more energy efficient mode of transport, and less congestion for roads and city (Roso, 2009). However, this generates higher cargo handling cost than the additional cargo handling has at the dry port.

3.5 Rail freight transport challenges and solutions in other literature

This section is a review of relevant literature and articles. Books or articles are shown in the sub-topics and the brief description, methodology, and summary is explained in the following.

3.5.1 Hinterland connectivity of Malaysian container seaports: Challenges and solutions

Chen et al., (2015) discussed a hinterland transport network in Malaysia regarding the infrastructure and services for container hinterland transfer. There are discussions about the lack of efficiency of cargo flow from foreland to the hinterland and an unequal modal split, low utilization of intermodal terminals, and road congestion which lead to low competitiveness of the port within the region.

There are problems of imbalance of a modal split (98% transported by road and 2% transported by rail), road congestion, space constraint in dry port, emission and environmental problems from road transport, service reluctance of trucking companies over the short distance, and limitation in rail transport due to track capacity (single track). Interviews were used to find the problems, solutions, and recommendations.

Chen et al., (2015) has summarized that in order to improve the efficiency of Malaysian transport infrastructure, responsible agencies need to develop the following guidelines:

- Improve rail infrastructure to electrified double tracks.
- Improve the quality of wagons.
- Improving the trade corridor by improving rail facilities and cargo services.
- Reduce haulage cargo formalities.
- Moving non-maritime activities away from the seaport.
- Deploy traffic polices to check overload trucks.
- Road expansion.
- Dry ports provide haulage services to deliver the container to the destination.
- Joint collaboration among dry ports for efficient utilization of land space.

3.5.2 An exploratory analysis of the effects of modal split obligations in terminal concession contracts

Due to the fact that competitiveness of the hinterland connection mainly relies on a multimodal transport network (Notteboom & Rodrigue, 2005) and also the increasing focuses on the impact of the GHG (Green House Gas) emission, put pressures on the port and terminal operators to make a better measure of the environmental performance. Intermodal transport has positive effects on the environment due to efficiently transporting large amounts of cargo in a single haul of transport e.g. rail and barge. However, due to the large modal split in road transport, it led to the landside congestion problem (Berg & De Langen, 2014). The Port of Rotterdam needs to find solutions to promote other modes

of transport and ensure the sustainability. This shows how the Port Authority of Rotterdam annexes the modal split obligations in the concession agreements in order to ensure sustainable hinterland connectivity.

Berg and De Langen, (2014) used interviews, questionnaires, and inserting a concession obligation clause to force terminal operators to have a volume of modal split according to the Port Authority's desired proportion.

The results of this study are shown as follows.

- Shippers and forwarders have realized that more proportion in a modal split in rail or barge can improve port competitiveness; however, more proportion in modal split may cause effects on terminal layout, design, and operations.
- More investment in intermodal services should be applied to accommodate more intermodal cargo.
- The business model of terminal operating companies to have a certain proportion of different modes of transport.
- Intermodal transport pricing should be defined.
- The modal split obligation has a significant impact on some of the terminal operating companies who need to re-engineer the business decisions and terminal layout.
- Modal split obligation can accelerate the development of intermodal transport.

3.5.3 Hinterland access regimes in seaports

Hinterland access becomes more important than the port. In order to ensure the competitiveness of the port the governmental body must guarantee the quality of hinterland access (De Langen & Chouly, 2004). Moreover, ensuring the improvement of the hinterland access is beyond the single entity responsibility and task; however, it is inter-organizational challenges because many players, such as terminal operators, freight

forwarders, transport operators, and port authorities participate. Nevertheless, all the parties should gain benefits from doing so (De Langen & Chouly, 2004).

There are problems defined in literature, namely hinterland accessibility problem, the problem of quality of the hinterland services, and inter-firm alliances feasibility.

De Langen and Chouly, (2004) used open interview and the result shows that hinterland access is a collective action problem, so inter-organizational collaboration is needed to improve hinterland accessibility.

3.5.4 Analysis of optimal resource level in rail transportation for Lat Krabang Inland Container Depot (LICD) to Laem Chabang Port (LCB) Route

Sajasophon and Wasusri, (2008) conducted an analysis of the resource level of rail transport between ICD and LCP by using historical data as baseline information. By using Exponential Smoothing Methods with Holt Winters Trend and Seasonal together with simulation modeling by using Arena 10.0 software led to obtaining the optimal resources level.

Sajasophon and Wasusri, (2008) found that by utilizing the double track railway with the 11 locomotives is the optimal resource level, which best responds to future demands; however, to make the project be successful, suitable organization management and information technology systems should be in place.

3.6 Chapter summary

The chapter concluded that the logistics concept is to minimize time and cost of transport when delivering the right cargo at the right time to the right place. The literature review elaborated the port performance and competition, which focus on how effective and efficient the ports manage their resources to serve customers. Hinterland connection is one of the top factors that influences customers to use the port services. Having a good hinterland connection can increase customer satisfaction.

A comparative analysis of road and rail transport was made despite having the higher initial cost of transport in rail than that of road transport; however, rail transport can achieve lower transport cost than that of the road over a certain distance. Multimodal transport shifts the transport cost due to the handling of cargo at the intermodal point, which increases the break even distance between two modes of transport.

A dry port functions as a seaport but is situated inland. It offers all cargo services i.e. customs clearance, forwarding, storage, and container maintenance. With the direct link to the seaport by rail or road, the dry port can reduce the seaport congestion by regulating the flow of cargo; thus, increasing the seaport capacity and competitiveness.

Challenges and solutions in other literature point out that improvement of hinterland infrastructure, upgrading the locomotives and wagons, and upgrading the cargo handling equipment can help increasing the volume of container transport by rail. The more the proportion of the modal split is by rail or barge can help increasing the port competitiveness since the cost of transport is lower and the port landside congestion can be reduced. The most important issue is the integration and collaboration between organizations, which need to be achieved in order to meet the desired proportion of a modal split since the intermodal transport and hinterland connectivity problems are inter-organizational issues.

CHAPTER 4: RAIL CONTAINER TRANSPORT OPERATION ANALYSIS USING SIMULATION TECHNIQUE

This chapter focuses on the development of a simulation model using Rockwell Software Arena 14. The simulation parameters in this study were determined by using historical data of rail freight transport between ICD and LCP. The objectives are to assess the situation and utilize the model for further adjustments in a scenario analysis.

The essential points of the simulation study are the understanding of the system, having clear goals, the logic of the model, translating the model to the software, input data, verification of the model, design of the scenario, running the experiments, results analysis, insight from the analysis, and findings documentation (Kelton et al., 2007). The development of the model is presented as follows.

4.1 Analysis of the current system

From the data of the rail freight transport between ICD and LCP, the analysis briefly shows the current situation in the systems.

The figures shows that the average wagons carried from ICD to LCP are 37 wagons per locomotive, which is considered full capacity on each train; on the other hand, the average number of wagons carried from LCP to ICD is 20 wagons/locomotive which means that there are on average 14 empty wagons each trip. Twenty-four (24) % of the locomotives carry empty wagons. The reason is there is an imbalance of the international trade in LCP. The export containers, which include rail freight transport from ICD to LCP, are mostly

full containers. Conversely, the import containers, which include rail freight transport from LCP to ICD, are mostly empty containers since the road transportation of empty containers is cheaper than the full container. Additionally, the empty containers are mostly transported to empty container depots, which are located nearby LCP and industrial areas. Therefore, transporting the empty containers by using trucks is favored by the shipping lines or freight forwarders. Those empty containers should be cleaned or maintained before reusing them for the export cargo. For this reason, SRT struggles to attract customers to fill the empty wagons. Despite the cheaper transport cost of empty containers by road rather than rail, there are also empty containers transported from LCP to ICD. These containers are mostly used for stuffing non-containerized general cargo at ICD for export.

Histogram of number of wagons each trip from ICD to LCP

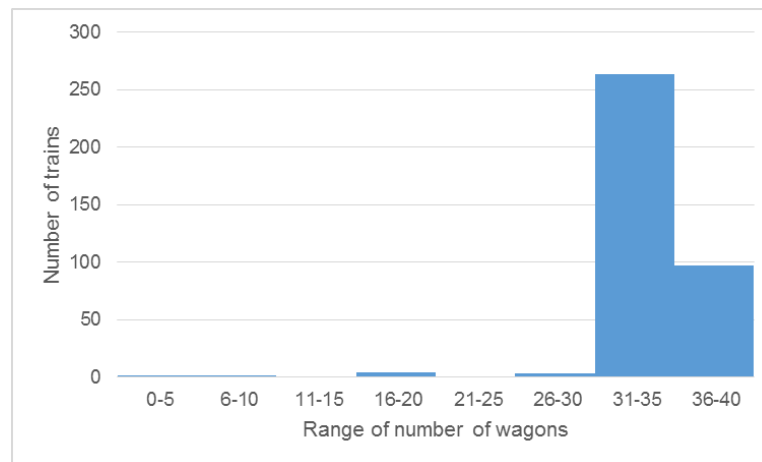

Figure 22.

Source: The author

In Figure 22, the histogram illustrates the distribution of the number of full wagons carried by each locomotive. The vertical axis represents the number of trains and the horizontal axis represents the interval of full wagons (five wagons interval). This histogram shows that most of the time, the locomotives travel from ICD to LCP carrying full capacity.

Histogram of number of wagons each trip from LCP to ICD

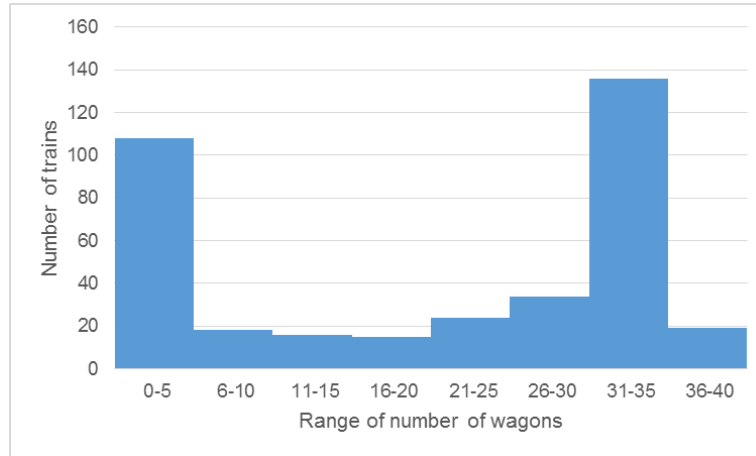

Figure 23.

Source: The author

In Figure 23, the histogram shows that most of the time, rolling stocks from LCP to ICD are transported with almost full capacity at around 31 to 35 full wagons. Furthermore, there are quite a few rolling stocks transported empty or almost empty (0-5 wagons). Moreover, most of the containers transported from LCP to ICD are empty.

Histogram of the amount of time that locomotives spend at LCP

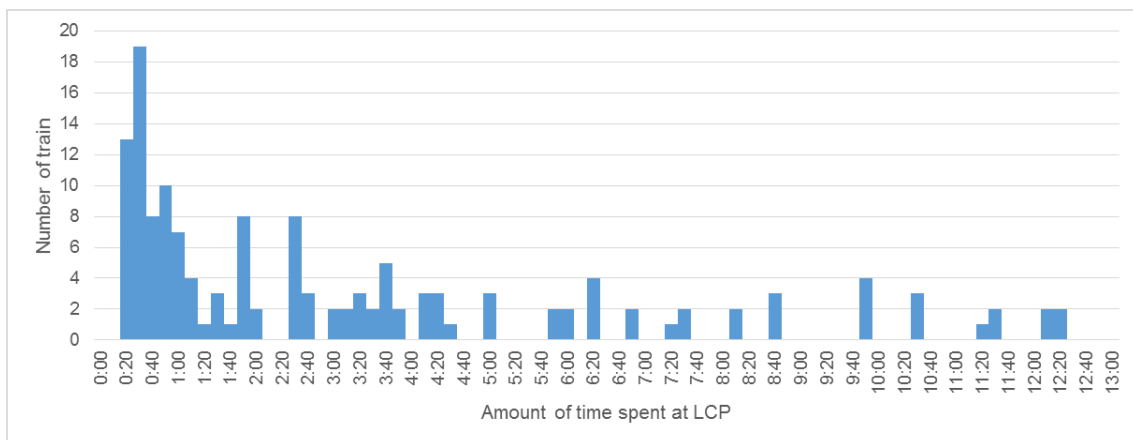

Figure 24.

Source: The author

In Figure 24, the histogram illustrates the distribution of the amount of time that locomotives spend at LCP. The vertical axis represents the number of trains and the horizontal axis represents the amount of time spent at LCP (20 minutes interval). This histogram illustrates how many locomotives spend time in certain intervals. As shown, most of the time, locomotives spend around 20-40 minutes at LCP. The operation involves connection of the wagons to the locomotive, checking the brake system, and general safety check before the journey, which on average, the whole operation takes around 30 minutes. However, there are many locomotives that spend excessive time which could be up to more than 12 hours. The reason is the slow cargo handling operation at LCP, which makes the locomotives wait for containers. Moreover, this excessive time makes the average time spent at LCP equal to three hours and 12 minutes.

Histogram of the amount of time that locomotives spend at ICD

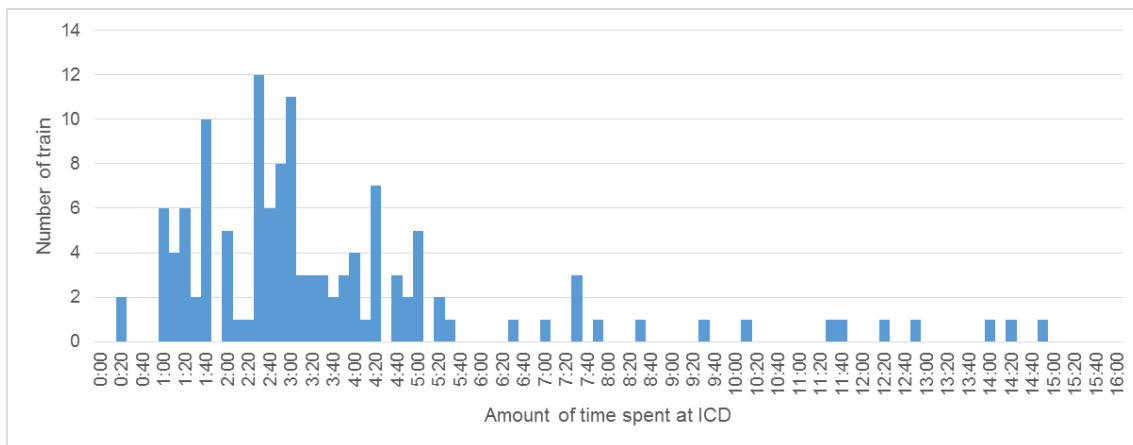

Figure 25.

Source: The author

In Figure 25, the histogram illustrates the distribution of the amount of time which locomotives spend at ICD. The vertical axis represents the number of trains and the horizontal axis represents the amount of time spent at ICD (20 minutes interval). As shown, most of the time, locomotives spend around one to four hours at ICD. The

excessive time could be up to more than 14 hours. The reason is the locomotives and wagon inspection and maintenance, so the locomotives need to stop operation during the day for fixing the schedule. The average time spent at ICD is 3 hours and 39 minutes.

Histogram of delay time from ICD to LCP

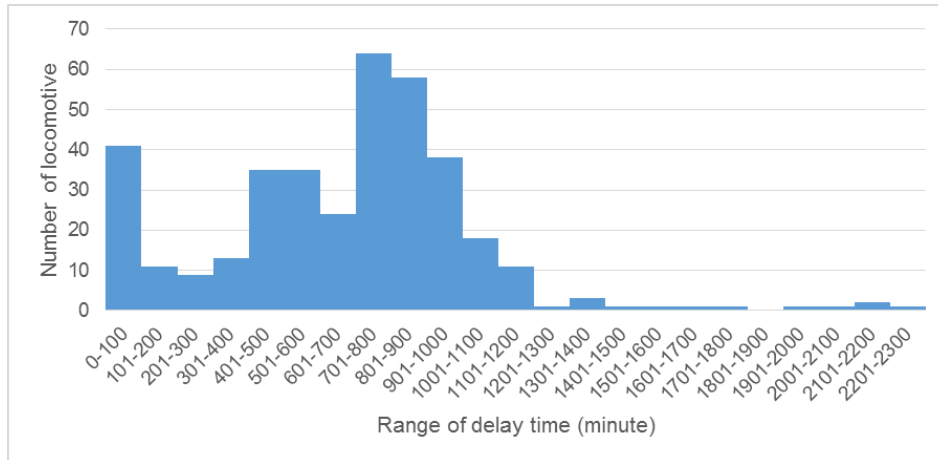

Figure 26.

Source: The author

The data show the inefficiency in the system of freight transport. The trains mostly depart behind the schedule, so the average delay of the ICD to LCP leg is 671 minutes; the maximum delay is 2,210 minutes. The range of delay time mostly falls to the range of 701 to 800 minutes.

Histogram of delay time from LCP to ICD

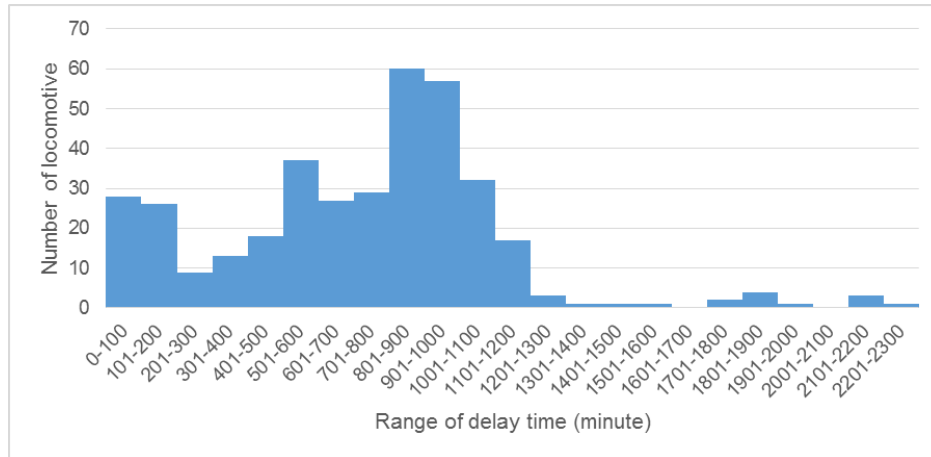

Figure 27.

Source: The author

The rail container transport from the LCP to ICD is also inefficient as the average delay time is 727 minutes; the maximum delay is 2,205 minutes. Most of the time the delay is around 801 to 900 minutes. This inefficient and unreliable service is the reason that mostly containers from ICD to LCP are transported by truck. The reason that trains usually miss the schedule is due to the delay in the container handling operation at LCP. The cumulative amount of delay time makes most of the trains miss schedules.

Proportion of rail freight transport by day

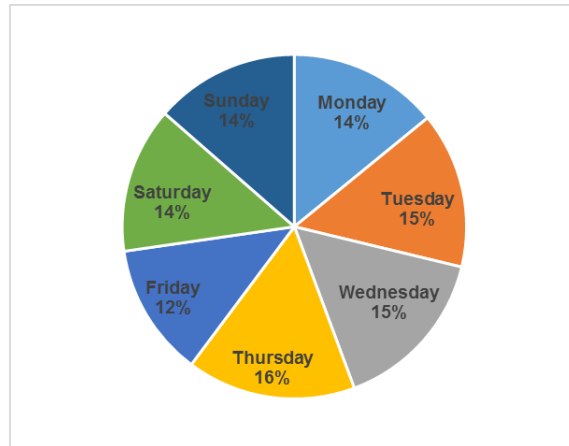

Figure 28.

Source: The author

The data show that on average Friday has the least traffic of rail freight transport in terms of train trips. In addition, the most shares falls to Thursday; however, there is no significant difference between these days.

Container share of gate operators at ICD

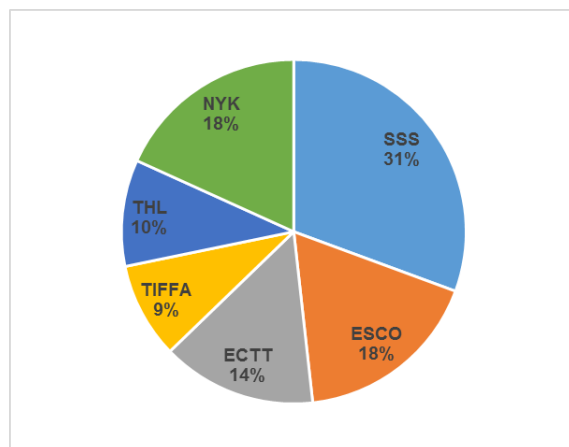

Figure 29.

Source: The author

The data show that the largest share of container transport at ICD is 31% conducted by Siam Shoreside Services Ltd. (Gate 1) (SSS); the share of the remaining operators is shown in Figure 29.

Container share of terminal operators at LCP

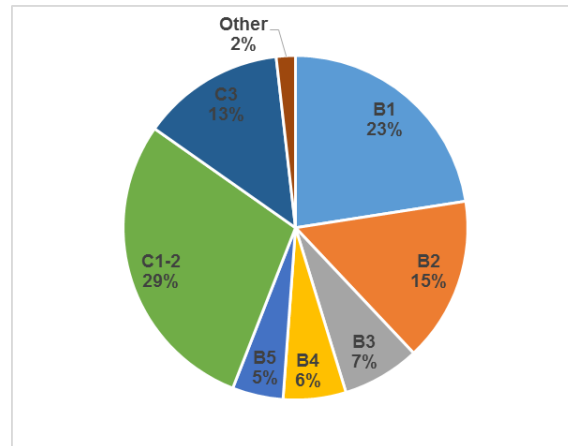

Figure 30.

Source: The author

The data shows that the largest share of container transport at LCP is 29% conducted by C1-2 terminal following by 23% by B1 terminal, the share of the rest operators shown in figure 30.

To sum up, in the analysis of the current system, the export containers transported by rail from ICD to LCP are mostly run with full locomotive capacity. The import ones are mostly empty containers and many empty wagons from LCP to ICD. Locomotives spend excessive time at LCP due to slow container handling at the rail yard, which causes accumulated delay in the system. Container traffic throughout the week has no sign of peak during the period. The service quality is very low due to the system unreliability; therefore, exporters, importer, forwarders, and shipping lines choose road transport if the containers are time sensitive.

4.2 Simulation technique

Simulation techniques using discrete simulation software called Arena 14 in order to mimic the real world system of the operation in LCP have been used (Kelton et al., 2007). The software has been widely used as a tool to analyze the business process in many business sections, namely manufacturing system, port and terminal operation, logistics, and supply chain. This makes it possible to understand certain situations. The potential changes in the process or the system can be trialed and observed without any physical constructions or actual experiments. The simulation modeling technique is widely used as a method of port and terminal operations analysis. This is an important tool for decision making in planning. In the operation efficiency analysis, this technique helps a lot in making an adjustment to the system without empirical modification (Kelton et al., 2007). Figure 31 shows the common process of simulation.

Simulation process

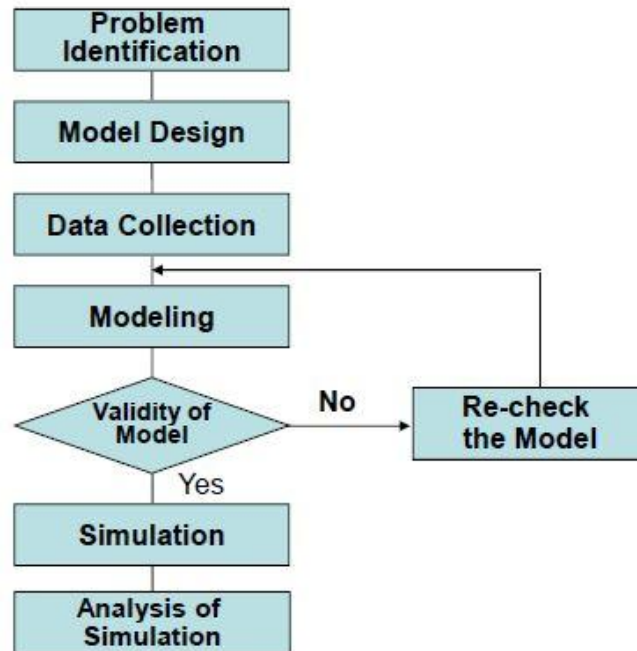

Figure 31.

Source: Class notes, Port Logistics and Planning, Port Management, World Maritime University, 2016

First of all, the process of problem identification has defined the problem about the rail transport and to study the potential capacity of the existing infrastructure.

The next step is the model design, where the model should be constructed on the software; the model should reflect the real world system.

The following task is the data collection. This step is considered as one of the most important steps in the simulation. The real world system can be modeled to make a computer understand and be ready to process and calculate the result; however, without data, the model can become meaningless.

Modeling is the process of providing data into the model parameters.

Model validity is the important step which researchers have to carefully examine. The logic in the model, which is constructed in the computer, should provide the results which are similar or near similar to the real world system. If the results are away from the reality, the model should be checked, corrected, rerun and revalidated accordingly.

4.3 Development of simulation model

The model consists of the dispatch of rolling stock, travel time, loading and unloading of containers, and departure of rolling stock.

4.3.1 System description

When the rolling stocks are dispatched from either ICD or LCP, there is travel time between the two facilities. Once the rolling stocks arrive, loading and unloading of containers will be performed, and finally, when the loading and unloading of containers is finished the rolling stocks will leave the system. The diagram of the system is illustrated in Figure 32.

Diagram of the system

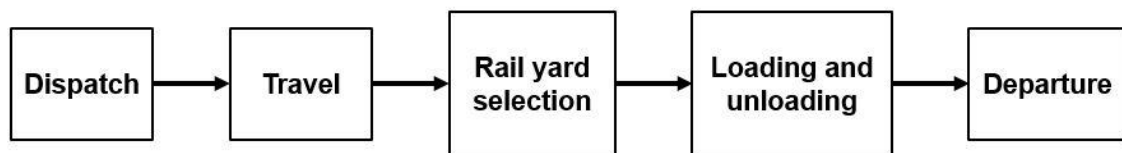

Figure 32.

Source: The author

4.3.2 Components of the model

Once the logic of the system is identified, the process, as shown in Figure 32, will be broken down into components and constructed in the software. The simulation model components are developed as in Figure 33.

Components of the model

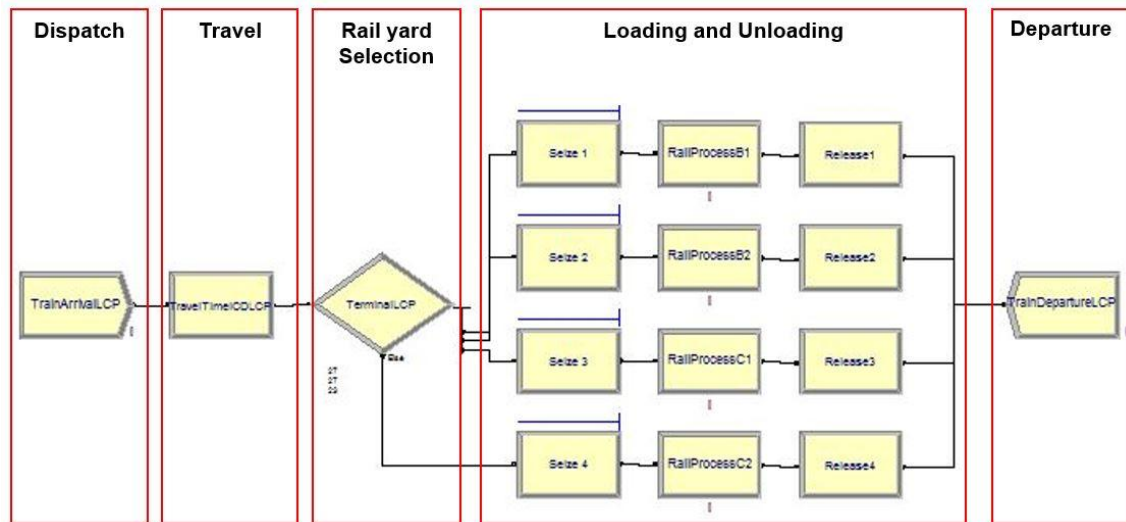

Figure 33.

Source: The author

The first module from the left represents the dispatch of the rolling stocks from the facilities (ICD or LCP). The second module represents the travel time of the rolling stocks. As there are four container handling stations at ICD and two rail yards with two container handling stations per each rail yard at LCP, the third module represents the selection of the rail yard, where rolling stocks will travel to. The fourth box is the set of modules which represents the occupation of a rail yard by the rolling stocks and the delay for container handling. Lastly, the fifth module represents the departure of the rolling stocks where they leave the system.

4.3.3 Input parameter

There are four types of parameters in the model. The first input parameter is a probability distribution. The second input parameter is a constant value. The third input is a percentage by chance. Lastly, the fourth input parameter is a calculation formula.

4.3.3.1 Probability distribution

Arena 14 comes with several tools, one of which is called input analyzer which is designed specifically to fit the distribution, parameters estimation, and measure the goodness of distribution fitting to the data (Kelton et al., 2007). The Input analyzer needs text files as an input in the software to fit the probability distributions. The Input analyzer will process and evaluate the best fit distribution to the data. The first step is to acquire the data. The second step is to process the data by using the Input Analyzer tool and make a distribution fitting. The fourth is to take the distribution expression as an input parameter to the simulation model. The process of data analysis can be explained as follows.

Analysis procedure

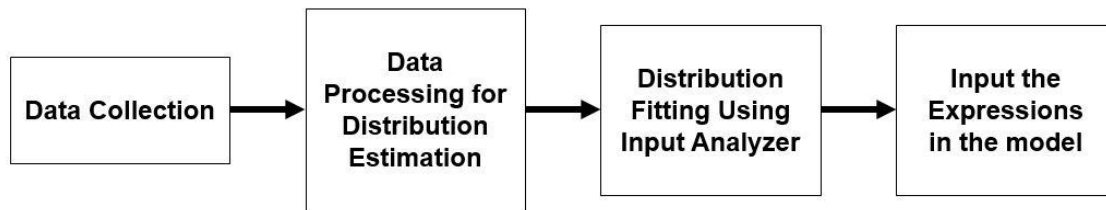

Figure 34.

Source: The author

The probability distribution value regulates the flow of rolling stocks at the dispatch module. The value of the probability distribution can be expressed as follows.

Distribution of inter-arrival time ICD to LCP

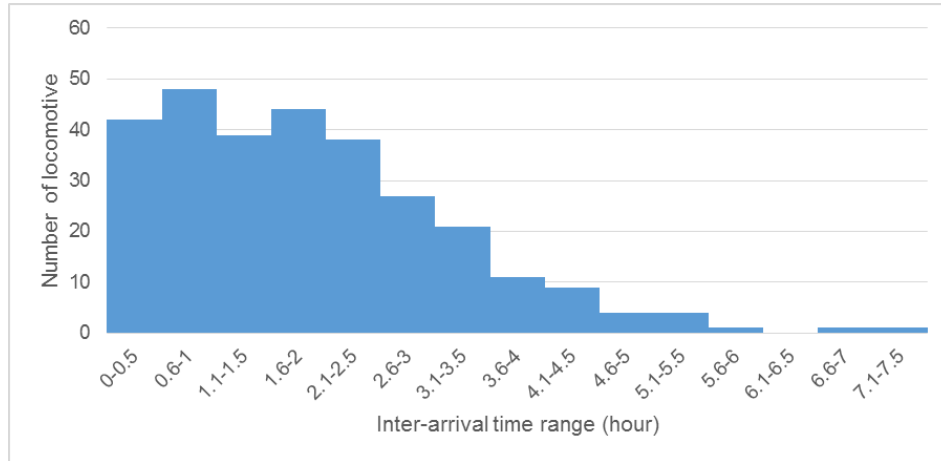

Figure 35.

Source: The author

From Figure 35, most of the inter-arrival time distribution from ICD to LCP concentrates in the range from 0-3.5 hour, the average value is 1.95 hours and the maximum value is 7.16 hours. By using the Input Analyzer tool the distribution summary is fit to Erlang Distribution (Expression: $-0.001 + \text{ERLA}(0.975, 2)$) with 0.003558 square error, which means very marginal errors in the distribution fitting.

Distribution of inter-arrival time LCP to ICD

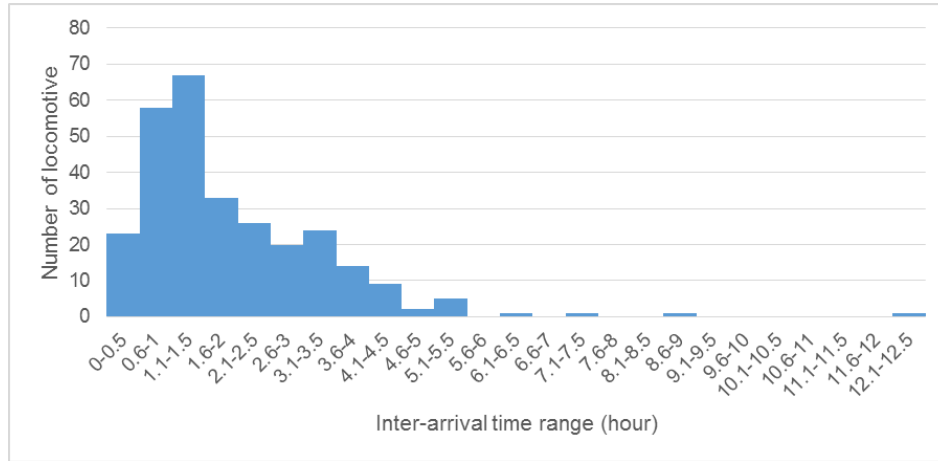

Figure 36.

Source: The author

From Figure 36, most of the inter-arrival time distribution from LCP to ICD concentrates in the range from 0-4.5 hours; the average value is 1.95 hours and the maximum value is 12.5 hours. By using the Input Analyzer tool, the distribution summary is fit to Lognormal Distribution (Expression: $-0.001 + \text{LOGN}(2.1, 2)$) with 0.005199 square error, which means very marginal errors in the distribution fitting. The expressions of both distribution of inter-arrival time ICD to LCP and LCP to ICD will be an input to the dispatch module (see Figure 33).

4.3.3.2 Constant value

The constant values are provided in the travel and loading and unloading modules. The value provided to travel is 175 minutes, which is the travel time between ICD and LCP. For the loading and unloading modules, the value of one hour is provided, which is the average container handling time at the rail yards.

4.3.3.3 Percentage by chance

The percentage by chance is the values provided to the rail yard selection modules. According to historical data, at LCP, there is a 54% chance that the rolling stocks to handle the containers at B rail yard and a 46% chance to handle the container at C rail yard. There are two container handling stations each at B and C rail yards; therefore, the 54% and 46% have to be divided by two. Then the values provided to the rail yard selection modules for the system of rail container transport from ICD to LCP are 27%, 27%, 23%, and 23%.

At ICD, there are four container handling stations. The values provided to the rail yard selection modules for the system of rail container transport from LCP to ICD are 25% for all chances of selection due to the fact that there are equal chances of rolling stocks to handle containers at all stations.

4.3.3.4 Calculation formulas

The calculation formulas need to be stored in the additional module called assign module; the calculation formulas are utilized to quantify the results of simulations.

Addition of calculation formulas to the model

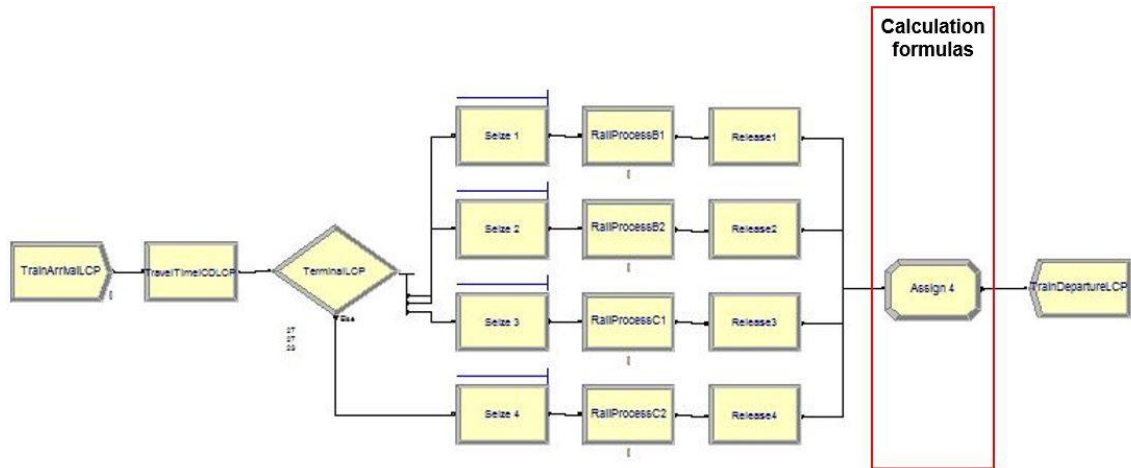

Figure 37.

Source: The author

Formulas aim to measure the outputs of the system, which are the number of trains, the number of wagons, and the number of containers.

The number of trains can be calculated by the “EntitiesOut” variable; the function of this variable is to record tally of the trains departing from the system.

The number of wagons carried from ICD to LCP can be calculated by multiplying “EntitiesOut” by 37 because the average number of wagons carried from ICD to LCP is 37 wagons per locomotive.

The number of wagons carried from LCP to ICD can be calculated by using the following formula:

$$\begin{aligned}
 & (\text{EntitiesOut} * 0.24 * 0) + (\text{EntitiesOut} * 0.11 * 5) + (\text{EntitiesOut} * 0.08 * 16) + \\
 & (\text{EntitiesOut} * 0.16 * 25) + (\text{EntitiesOut} * 0.05 * 30) + (\text{EntitiesOut} * 0.36 * 37)
 \end{aligned}$$

Formula explanation: From the statistics, there are 24% of the locomotives that carry empty wagons, 11% carry five wagons, 8% carry 16 wagons, 16% carry 25 wagons and 5% carry 30 wagons, and 36% carry 37 wagons.

The reason for the empty wagons is due to an imbalance of the international trade in LCP. The number of containers carried from ICD to LCP can be calculated by the following formula:

$$(\text{Number of wagons} * 0.75 * 2) + (\text{Number of wagons} * 0.25)$$

Formula explanation: There are 75% of wagons carrying two TEUs, and there is 25% carrying one TEU. The reason for many wagons carrying only one TEU is the imbalance of 20” container weight when loaded on the same wagon, which can cause instability; therefore, loading only one 20” container on the wagon is unavoidable.

The number of containers carried from LCP to ICD can be calculated by multiplying the number of wagons by two due to the fact that most of the time, containers transported from LCP to ICD are empty due to the trade imbalance. Therefore, the wagons are fully utilized by two TEUs.

4.3.4 Current State simulation

In order to validate the model, the Current State Simulation has to be developed. The assumption is the simulation results of the current state model should be the same or close to the real world results. The model will be utilized as a baseline for further study.

Rail container transport between ICD and LCP simulation in Arena 14

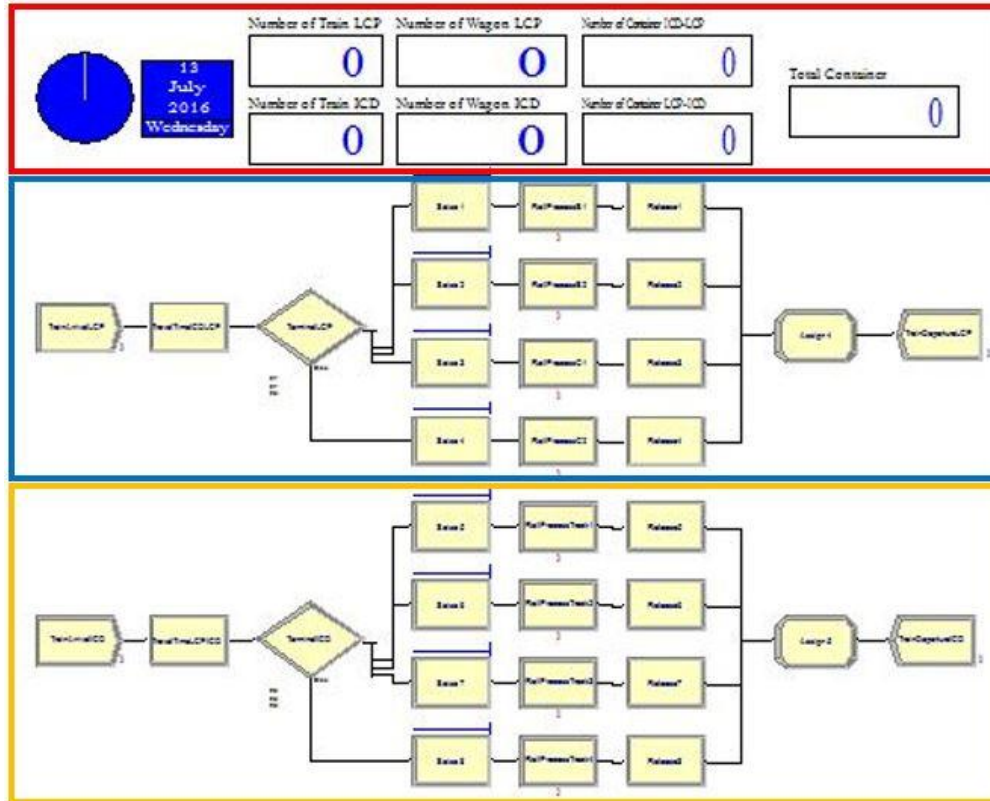

Figure 38.

Source: The author

From the figure 38, the red box on the top consists of the clock and calendar on the left side, and the rest are displays which are outputs of the simulation. The blue box in the middle is the rail process from ICD to LCP and the yellow box is the rail process from LCP to ICD.

The outputs of the simulation model will be compared with the annual throughput of rail container transport between ICD and LCP. By setting the replication length of 365 days and run 10 times replication. The reason for making 10 times replication is because the simulation model uses probability to calculate and generate the results; therefore, the

simulation results of each replication are different. In order to obtain the accurate results, the average results of numbers of replication should be calculated correctly. Average results of 10 replications are applied in the methodology. Thus, the simulation model is ready to generate the outputs which are shown in Table 6.

Table 6. Simulation results of the current state

Replication	Number of trains	Number of wagons	Total Container (TEU)
1	8,650	250,890	460,894
2	8,595	251,291	460,827
3	8,706	253,239	464,919
4	8,485	247,024	453,423
5	8,678	253,086	464,372
6	8,707	253,097	464,725
7	8,572	249,786	458,400
8	8,755	254,464	467,247
9	8,794	254,632	467,943
10	8,708	253,363	465,119
Average	8,665	252,087	462,787

After 10 times replication, the average result is: Number of trains is 8,665 trips, Number of wagons is 252,087 and the number of total containers is 462,787 TEU. By comparing the results to the actual average throughput of the past 3 years, the study found that there is 2.5% error, which is acceptable; therefore, the model is capable of further experiments.

4.4 Scenario assumptions

After having the model, the next process is to present the method to improve the system efficiency since the software allows free configuration of parameters; however, the adjustments have to be applicable in the real world. There will be three scenarios presented in this study.

4.4.1 Scenario 1

Scenario 1 is the assumption that all the trains make on time departure in both ICD and LCP. The aim of this scenario is to examine the system efficiency if all the trains are on schedule. The parameters are unchanged.

The methodology is to correct the data in the spreadsheet to make delays to be on time on the schedule, using the input analyzer to fit the probability distribution, changing the expressions of both distribution of inter-arrival time ICD to LCP and LCP to ICD, and running to obtain the results.

4.4.2 Scenario 2

Scenario 2 aims to study the maximum potential capacity by rescheduling the train operation, which is subject to available resources, i.e. locomotives and wagons. Currently, there are 8 locomotives and 407 wagons in operation. Considering the time spent in each point of operation: at ICD and LCP, locomotives take 30 minutes to disconnect/connect to the wagons and prepare for the journey. The transit time between ICD and LCP or vice versa is 175 minutes. Therefore, the total time of the loop is 6:50 hours. Regarding the refuel time and engine idling time, each train can run 3 times a day. Only 7 out of 8 locomotives can be utilized as one of the locomotive always needs to be out of service for a scheduled maintenance. The maintenance cycle will run through all of the locomotives. According to the given resources by having similar parameters as the Current State simulation, the ideal situation is having a train in every one and half hour. The train schedule can be created as shown in Table 7.

Table 7. Scenario 2 train schedule

Rolling stock number	Arrival at ICD	Departure to LCP	Arrival at LCP	Departure to ICD
5101	00:00	00:30	03:25	03:55
5102	01:30	02:00	04:55	05:25
5103	03:00	03:30	06:25	06:55
5104	04:30	05:00	07:55	08:25
5105	06:00	06:30	09:25	09:55
5101	06:50	07:20	10:15	10:45
5106	07:30	08:00	10:55	11:25
5102	08:20	08:50	11:45	12:15
5107	09:00	09:30	12:25	12:55
5103	09:50	10:20	13:15	13:45
5104	11:20	11:50	14:45	15:15
5105	12:50	13:20	16:15	16:45
5101	13:40	14:10	17:05	17:35
5106	14:20	14:50	17:45	18:15
5102	15:10	15:40	18:35	19:05
5107	15:50	16:20	19:15	19:45
5103	16:40	17:10	20:05	20:35
5104	18:10	18:40	21:35	22:05
5105	19:40	20:10	23:05	23:35
5106	21:10	21:40	00:35	01:05
5107	22:40	23:10	02:05	02:35
5101	00:00	00:30	03:25	03:55

After creating the train schedule, the inter-arrival time has to be calculated and fit the probability distribution using the input analyzer, changing the expressions of both distributions of inter-arrival time ICD to LCP and LCP to ICD, and running to obtain the results.

4.4.3 Scenario 3

Scenario 3 aims to further increase the efficiency of the system by shortening the travel time between ICD and LCP. The physical infrastructures of the system consist of railway tracks and stations. Further details are explained as follows:

Details of transit time

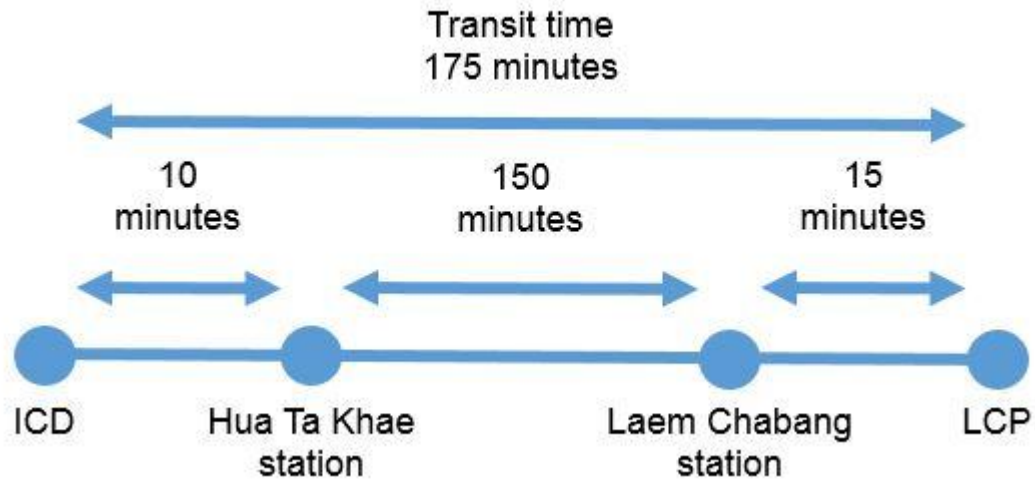

Figure 39.

Source: Adapted from State Railway of Thailand

Figure 39 elaborates the details of transit time. Trains spend 10 minutes traveling from ICD to the Hua Ta Khae station, and then spend 150 minutes to travel to the Laem Chabang station before entering LCP, where it will spend 15 minutes, so the transit time is 175 minutes. At the Laem Chabang station, there is potential to store freight wagons because there are four tracks available. By having additional locomotives running between the Laem Chabang station and LCP, the transit time should be reduced by 15 minutes each trip.

Layout of Laem Chabang station

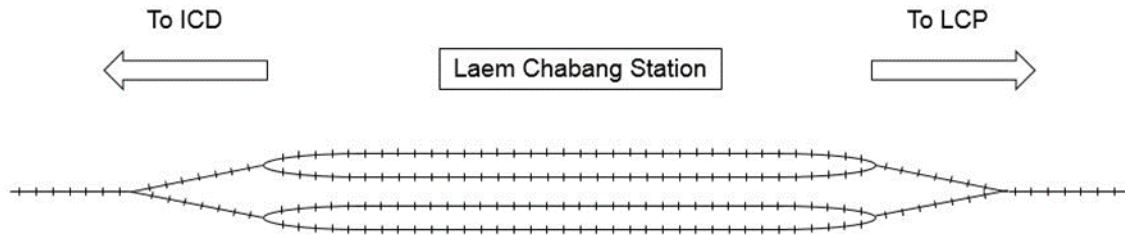

Figure 40

Source: The author

According to Figure 40, there are 4 tracks with shunting necks on both sides of the station. At this point, the rail freight system is divided into two separate systems. The first system is the rail freight running between ICD and the Laem Chabang station. The second system is the rail freight running between the Laem Chabang station and rail yards within LCP. Tracks in between can be utilized as an intermediate wagons reception between the two systems. This method can reduce the transit time between ICD and LCP from 175 to 150 minutes.

The next step is to create a train schedule. The schedule is based on the same resources and parameters as scenario 2, and the different parameters are only travel time which is reduced to 150 minutes and different probability distributions.

Table 8. Scenario 3 train schedule

Rolling stock number	Arrival at ICD	Departure to LCP	Arrival at LCP	Departure to ICD
5101	00:00	00:30	03:10	03:40
5102	01:30	02:00	04:40	05:10
5103	03:00	03:30	06:10	06:40
5104	04:30	05:00	07:40	08:10
5105	06:00	06:30	09:10	09:40
5101	06:20	06:50	09:30	10:00
5106	07:30	08:00	10:40	11:10
5102	07:50	08:20	11:00	11:30
5107	09:00	09:30	12:10	12:40
5103	09:20	09:50	12:30	13:00
5104	10:50	11:20	14:00	14:30
5105	12:20	12:50	15:30	16:00
5101	12:40	13:10	15:50	16:20
5106	13:50	14:20	17:00	17:30
5102	14:10	14:40	17:20	17:50
5107	15:20	15:50	18:30	19:00
5103	15:40	16:10	18:50	19:20
5104	17:10	17:40	20:20	20:50
5105	18:40	19:10	21:50	22:20
5106	20:10	20:40	23:20	23:50
5107	21:40	22:10	00:50	01:20
5101	22:30	23:00	01:40	02:10
5102	00:00	00:30	03:10	03:40

Likewise, after creating the train schedule, the inter-arrival time has to be calculated and fit the probability distribution using the input analyzer, changing the expressions of both distributions of inter-arrival time ICD to LCP and LCP to ICD, and running to obtain the results. Comparison of the system diagrams is shown in Figure 41.

Comparison of the current system and the Scenario 3 system

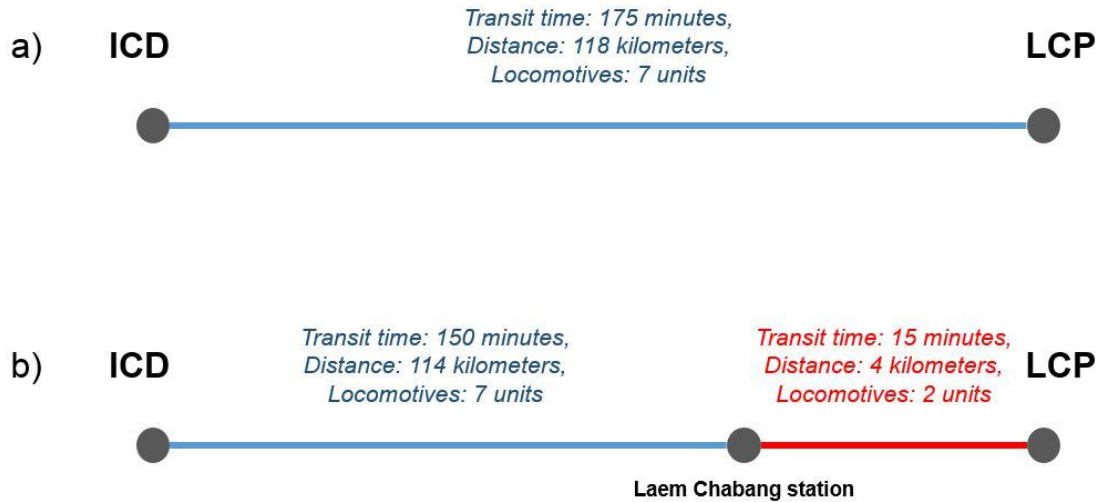

Figure 41.

Source: The author

Figure 41 shows the comparison of the current system (a) and the Scenario 3 system (b). The current system of transport has 175 minutes of transit time, which runs with seven units of locomotives. The Scenario 3 system has a separated system on the existing route which reduces the transit time to 150 minutes; however, it has two additional locomotives in operation for the separated system.

4.5 Chapter Summary

This chapter has analyzed the current system of transport between ICD and LCP. It found that the system is inefficient and unreliable and needs a lot of improvement in order to increase the transport volume.

The illustration of the simulation model development defines the input parameters from the historical data. The model validation is a very important stage for further discussion, system improvement, and results analysis.

There are three assumption scenarios conducted in the model. The first scenario generated was based on the assumption that all the trains are dispatched on schedule. The second scenario generated was based on the potential capacity of the system available resources. Lastly, the third scenario is the presentation of the idea to improve the system efficiency by shortening the transit time between ICD and LCP, based on the existing infrastructures. All the system parameters are the same as the Current State simulation except the probability distribution and transit time, which are varied according to different scenario assumptions.

CHAPTER 5: RESULTS, CONCLUSIONS, AND RECOMMENDATIONS

This chapter presents the results of the simulation scenarios. Scenario 1 is the simulation on the assumption that all the trains run on schedule without any delay. Scenario 2 is the simulation on the assumption that all the trains run every one hour and 30 minutes from each facility based on the resources of 8 locomotives. Lastly, Scenario 3 is the assumption of making a separate system running between the Laem Chabang station and LCP, which shortens the transit time 15 minutes for each train. All of the experiments are based on the same parameters as the Current State simulation.

5.1 Results of scenario simulation

Table 9. Simulation results of Scenario 1

Replication	Number of trains	Number of wagons	Total Container (TEU)
1	9,027	262,942	482,585
2	9,220	268,644	493,018
3	9,084	263,841	484,540
4	9,119	265,136	486,806
5	9,011	261,614	480,493
6	9,133	266,079	488,322
7	9,099	265,263	486,754
8	9,103	264,054	485,067
9	8,950	259,929	477,364
10	8,999	260,876	479,294
Average	9,075	263,838	484,424

The average result of Scenario 1 is 451,871 TEU, which is 4.7% more than the Current State simulation.

Table 10. Simulation results of Scenario 2

Replication	Number of trains	Number of wagons	Total Container (TEU)
1	15,479	445,749	820,153
2	15,413	444,288	817,286
3	15,445	445,145	818,889
4	15,508	446,838	822,054
5	15,441	444,768	818,302
6	15,428	445,170	818,726
7	15,456	444,685	818,358
8	15,436	444,828	818,330
9	15,459	445,401	819,420
10	15,433	444,636	818,018
Average	15,450	445,151	818,954

The average result of Scenario 2 is 818,954 TEU, which is 77% more than the Current State simulation.

Table 11. Simulation results of Scenario 3

Replication	Number of trains	Number of wagons	Total Container (TEU)
1	16,951	488,425	898,557
2	16,957	489,072	899,555
3	16,993	489,374	900,409
4	16,933	488,069	897,837
5	17,001	489,899	901,255
6	16,977	489,615	900,569
7	16,965	488,844	899,323
8	16,943	488,276	898,250
9	16,942	488,320	898,303
10	16,965	488,501	898,830
Average	16,963	488,840	899,289

The average result of Scenario 3 is 899,289 TEU, which is 90.1% more than the Current State simulation.

Comparison of simulations results

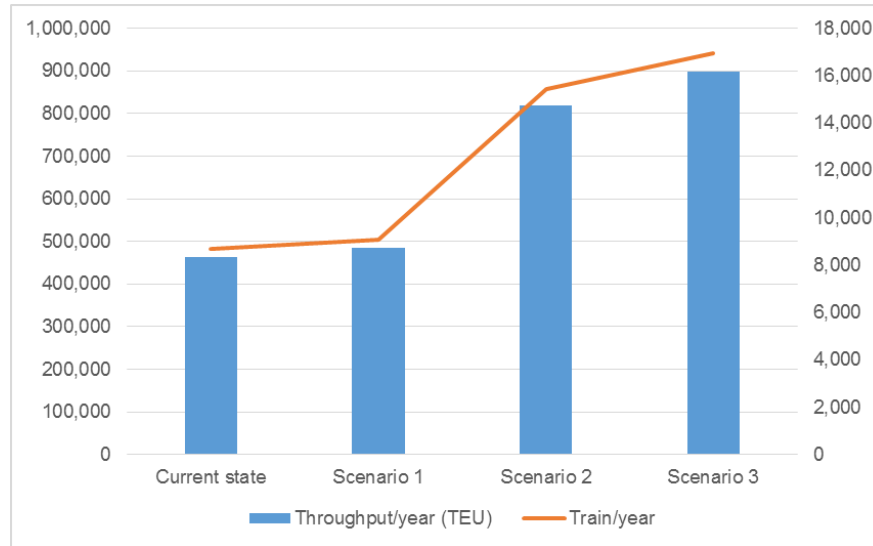

Figure 42.

Source: The author

According to Figure 42, Scenario 1 slightly generates more throughput than the current state; on the other hand, Scenarios 2 and 3 significantly generate high throughput and Scenario 3 generates the best result. The study suggests that having a separate system at the Laem Chabang station by running the separate trains is considered as an internal system within LCP, and the main system runs between ICD and the Laem Chabang station by using the Laem Chabang station as an intermediate terminal. It should be noted that, all the scenarios have the same parameters as the Current State simulation regarding to the container volume on each rolling stock. However, the scenario which creates a more efficient system that could attract more customers to use the rail container transport. Therefore, the container throughput could be higher than the virtual results.

5.2 Application to the real world system

The simulation technique is a virtual experiment, which allows free configuration of parameters in order to foresee and examine the potential capacity and efficiency of the

system; however, in a real world application, there are several factors and approaches that need to be considered and implemented.

First of all, trains need to run on time, and this is the basic approach in order to achieve such throughput as in Scenario 3. Because the containers are, most of the time, ready to be transported from ICD to LCP, and as trains from ICD to LCP are always fully loaded, however, the unreliability of the schedule makes the trains depart from ICD on average more than 11 hours later than scheduled. This forces exporters, forwarders, and shipping lines to shift the mode of transport to trucks, which are considered having no benefits to gain from closing time, and being more expensive although faster and more reliable.

The next issue is the improvement of the cargo handling operation in ICD and LCP. Trains are supposed to spend 30 minutes at ICD and LCP to disconnect and connect to and from the wagons including safety checking. However, on average, trains spend more than three hours at both ICD and LCP. The reason is the delay of cargo handling at ICD and LCP; consequently, this caused a delay to the whole system. PAT and SRT need to ensure that no delay will occur at both facilities. The terminal operators should be regulated by using KPI's or incentives to maintain the right performance. Investment or joint investment between or among PAT, SRT, and terminal operators should be made to improve the system efficiency by purchasing more container handling equipment or re-engineering the rail container handling system that should be applied.

Scheduled maintenance should be fixed and well managed, in the Scenario 3 simulation, simulation run 7 from 8 locomotives which means, at all time, one locomotive and wagons will stop for maintenance and check-ups for a period of time. If the system runs smoothly without any accidents or breakdown, the expected throughput could be achieved. In order to minimize the impacts from unexpected events, which could disrupt the system, risk assessment and contingency plans should be applied to tackle the unexpected events.

The separate system at LCP should be run by at least three locomotives due to disconnection/connection operations of wagons in both the Laem Chabang station and at the B terminals. The C terminal rail yards take a total time of at least one hour, so the locomotive has to serve between B terminal and C terminal rail yards and it takes 15 minutes to travel to the Laem Chabang station. Only one locomotive could not match the mere hourly train from ICD, therefore, having three locomotives for the LCP internal system is recommended. It should be noted that two locomotives need to be in operation at all times, and one locomotive should be out of the operation according to the schedule maintenance. The maintenance schedule should apply to all locomotives. There are old locomotives, from SRT from the replacement in 2015, which could be deployed for the operation.

Apart from physical applications, policy implementation should be set. The modal split obligation can be implemented by SRT and PAT who are regulated bodies of ICD and LCP, respectively. This policy can be defined in the concession agreement. Clauses regarding the environmental issue could be included in the port and transport system. However, once such policy is implemented SRT and PAT should facilitate and support private operators to achieve mutual targets.

5.3 Theoretic impact from the system implementation

This section illustrates the theoretic impact to the overall rail freight transport system between ICD and LCP from the implementation of the system (Scenario 3) and recommendations. The theoretic impact will make a comparison between the latest statistical data (2015).

Comparison of the actual modal split and theoretical modal split of ICD (2015)

Actual Modal Split of ICD (2015)

Theoretical Modal Split of ICD (2015)

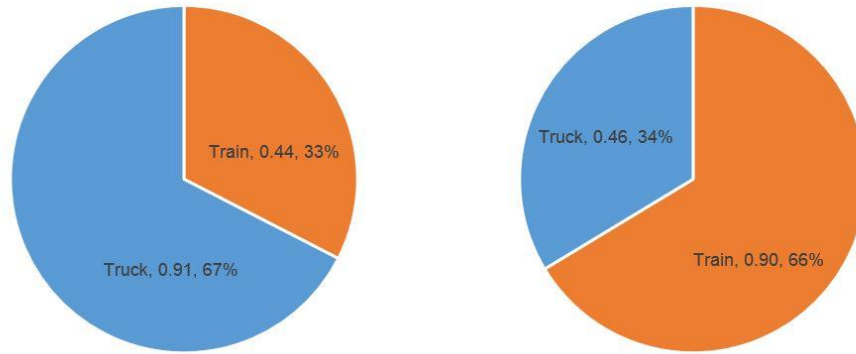

Figure 43.

Note: Throughput is shown in millions.

Source: The author

According to Figure 43, at ICD the modal share of train transport could increase from 33% to 66% and reduce the share of truck transport from 67% to 34%, so this could reduce the share of road transport at ICD by 33%.

Comparison of the actual modal split and theoretical modal split of LCP (2015)

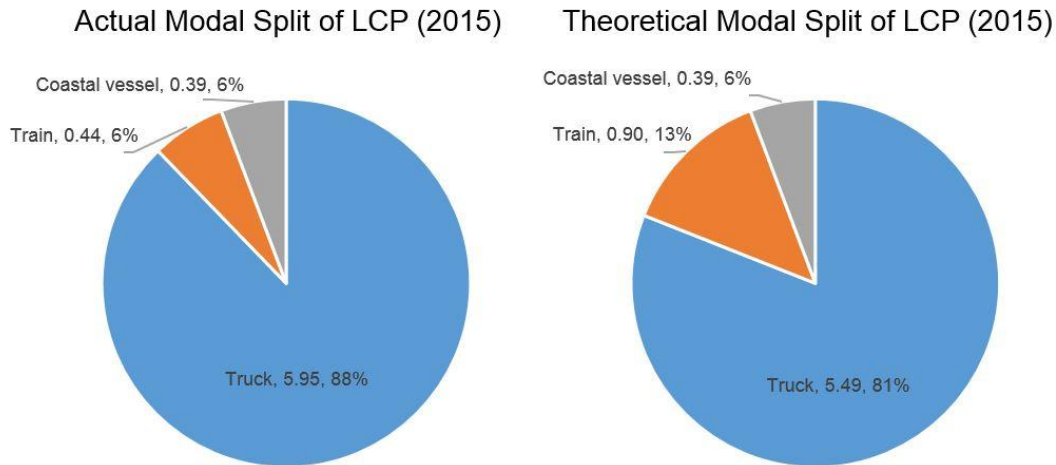

Figure 44.

Note: Throughput shown in millions.

Source: The author

According to Figure 44, at LCP the modal share of train transport could increase from 6% to 13% and reduce the share of truck transport from 88% to 81%, so this could reduce the share of road transport at LCP by 7%.

5.5 Conclusion

The rail container transport system between ICD and LCP needs to be improved in accommodating the increasing amount of containers in the future. Having ICD as a dry port to increase the efficiency and competitiveness of LCP is a good model; however, service unreliability and container handling constraints hinder the system to perform efficiently. These result in heavy road congestion and increasing waiting time of trucks due to the large share of road transport. The only way to minimize the impact from road congestion is to reduce the share of road transport and promote the share of rail or barge transport.

Although the rail transport promotion has been conducted by the government, i.e. rail freight tariffs reduction and double track construction, the share of the mode of transport still largely depends on the road.

The simulation technique was applied to examine the potential capacity and efficiency of the system. The technique allows free configurations and adjustment of the simulation parameters whether to see the change in transport volume by interpretation of the new methodology into the system. The simulation model was developed to study the potential capacity of the system by constructing the virtual model to mimic the real world system. Three scenario assumptions have been established to test and quantify the changes to the system. The results showed that by introducing a separate system at LCP can help reducing the transit time between ICD and LCP, which resulted in a huge increase in the transport volume. Consequently, the modal share has changed, which might reduce road congestion. However, the suitable equipment, system, policy and contingency plan have to be in place together with controlling and monitoring of a regulated body to ensure that the system runs smoothly and efficiently to achieve the targets.

References

- Armstrong, J. H., & Green, M. (1978). *The railroad, what it is, what it does: The introduction to railroading*. Omaha, NE: Simmons-Boardman Pub.
- Banomyong, R., & Beresford, A. K. (2001). Multimodal transport: The case of Laotian garment exporters. *International Journal of Physical Distribution & Logistics Management Int Jnl Phys Dist & Log Manage*, 31(9), 663-685.
- Berg, R. V., & De Langen, P. W. (2014). An exploratory analysis of the effects of modal split obligations in terminal concession contracts. *IJSTL International Journal of Shipping and Transport Logistics*, 6(6), 571.
- Chen, S., Jeevan, J., & Cahoon, S. (2015). Hinterland Connectivity of Malaysian Container Seaports: Challenges and Solutions. *Conference: Asian Logistics Round Table Conference, At Soochow University, Taipei, Taiwan*.
- Container Security Initiative. (2002, January). Retrieved September 5, 2016, from <https://www.cbp.gov/border-security/ports-entry/cargo-security/csi/csi-brief>
- De Langen, P. W., & Chouly, A. (2004). Hinterland Access Regimes in Seaports. 361-380.
- Google Maps. (n.d.). Retrieved from <https://www.google.com/maps>
- Ham, H. V., & Rijsenbrij, J. (2012). Chapter 4 Standardization A must for global spreading. In *Development of Containerization: Success Through Vision, Drive and Technology* (pp. 37-52). IOS Press.
- Inmuang, C. (2010). *Modeling Transport Costs and Modal Shifts in Freight Transport: A Case of Thailand* (Unpublished master's thesis). Erasmus University. Retrieved August 3, 2016, from <https://thesis.eur.nl>
- Jarżemskis, A., Vasiliauskas, A. V. (2007). Research on dry port concept as intermodal node. *Transport*, 22:3, 207-213
- Jonkeren, O., Jourquin, B., & Rietveld, P. (2011). Modal-split effects of climate change: The effect of low water levels on the competitive position of inland waterway transport in the river Rhine area. *Transportation Research Part A: Policy and Practice*, 45(10), 1007-1019.
- Kelton, W. D., Sadowski, R. P., & Sturrock, D. T. (2007). *Simulation with Arena*. Boston: McGraw-Hill Higher Education.
- Laem Chabang Port. (n.d.). Retrieved August 11, 2016, from <http://laemchabangport.com/index.php>

- Notteboom, T. E., & Rodrigue, J. (2005). Port regionalization: Towards a new phase in port development. *Maritime Policy & Management*, 32(3), 297-313.
- Ocean Freight Shipping from China: FCL or LCL? (n.d.). Retrieved September 11, 2016, from <https://cargofromchina.com/fcl-lcl/>
- Report of The Sub-regional Seminar and Country-level Workshops on Development of Freight Forwarding and Multimodal Transport, 1999. (1999, December 30). Retrieved August 1, 2016, from <http://www.unescap.org/resources/report-sub-regional-seminar-and-country-level-workshops-development-freight-forwarding-and>
- Roso, V., Woxenius, J., & Lumsden, K. (2009). The dry port concept: Connecting container seaports with the hinterland. *Journal of Transport Geography*, 17(5), 338-345.
- Sajasophon, P., & Wasusri, T. (2008). The Analysis of Optimal Resource Level in Rail Transportation for Lat Krabang Inland Container Depot (LICD) to Laem Chabang Port (LCB) Route. *Operation Research Network in Thailand*, 148-159.
- State railway of Thailand. (n.d.). Retrieved from <http://www.railway.co.th/>
- Talley, W. K. (2009). 10 Port performance and competition. In *Port economics* (pp. 140-142). London: Routledge.
- UNCTAD secretariat. (2001). Chapter 1 MULTIMODAL TRANSPORT - GENERAL OVERVIEW. In *Implementation of multimodal transport rules* (p. 5). Genève: UNCTAD.
- What is logistics? -- A collection of Logistics Definitions from LogisticsWorld. (n.d.). Retrieved from <http://www.logisticsworld.com/logistics.htm>
- Yuen, C. A., Zhang, A., & Cheung, W. (2012). Port competitiveness from the users' perspective: An analysis of major container ports in China and its neighboring countries. *Research in Transportation Economics*, 35(1), 34-40.

Appendices

Appendix 1

Probability distribution fitting using Input Analyzer

A.1 Current State simulation: Distribution of inter-arrival time ICD to LCP

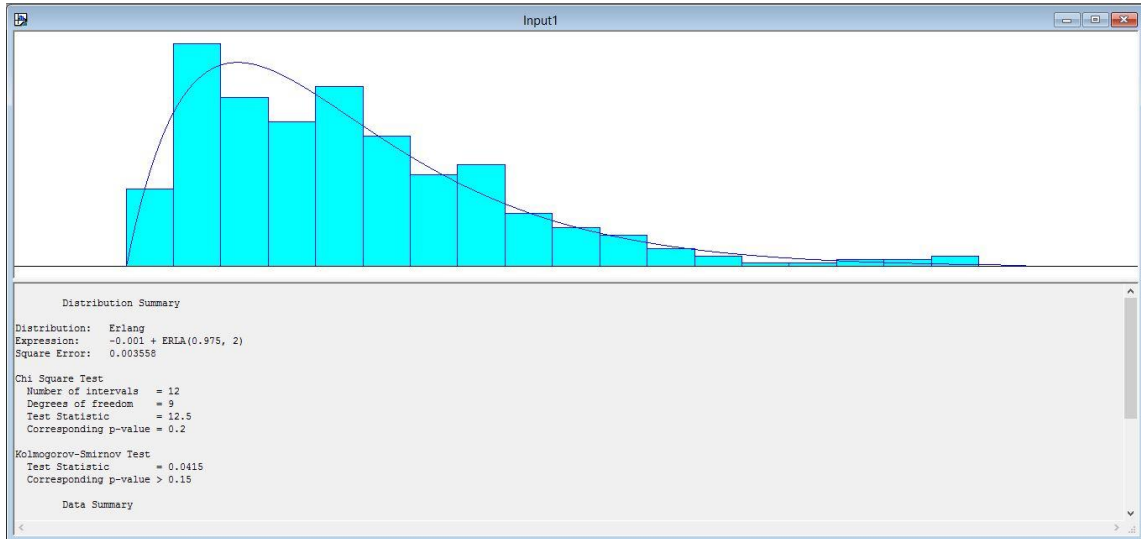

A.2 Current State simulation: Distribution of inter-arrival time LCP to ICD

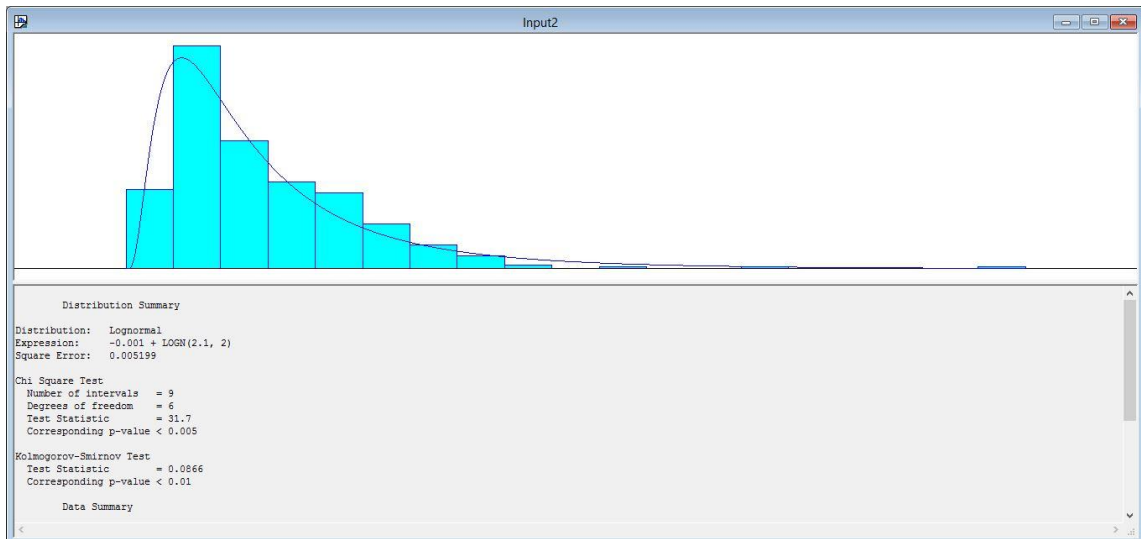

A.3 Scenario 1: Distribution of inter-arrival time ICD to LCP

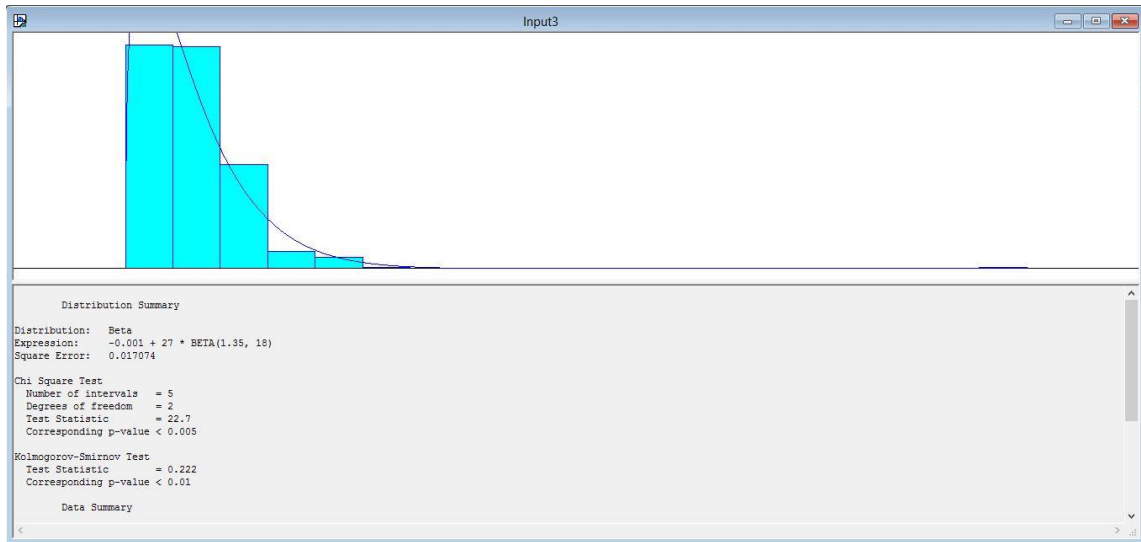

A.4 Scenario 1: Distribution of inter-arrival time LCP to ICD

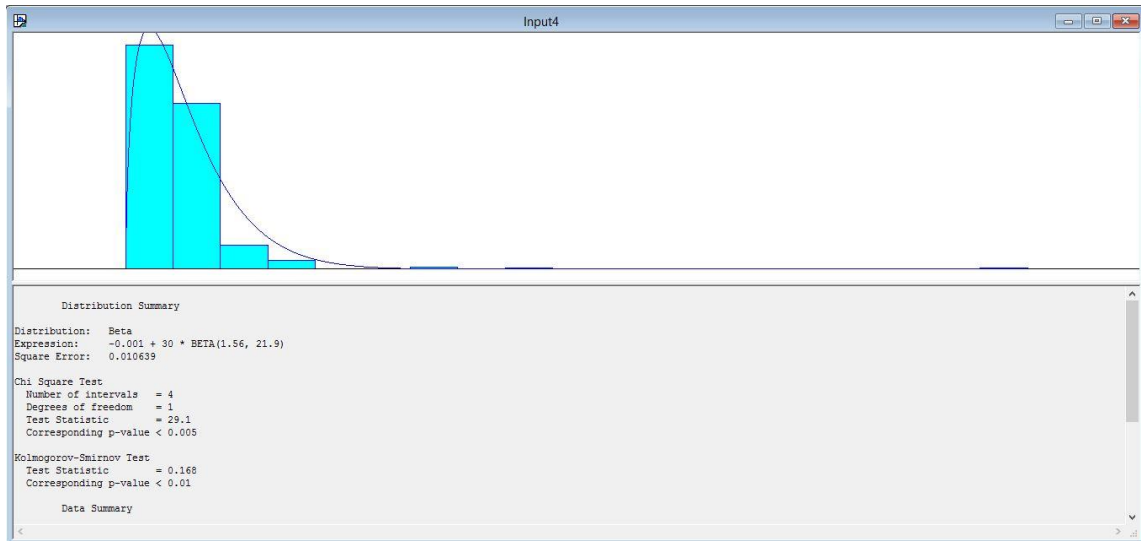

A.5 Scenario 2: Distribution of inter-arrival time LCP to ICD and ICD to LCP

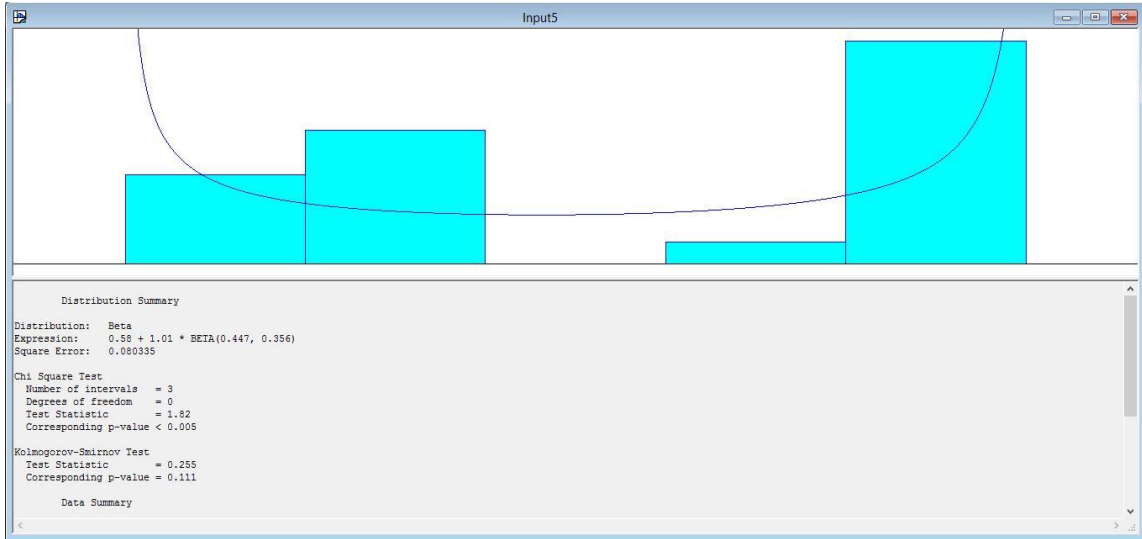

A.6 Scenario 3: Distribution of inter-arrival time LCP to ICD and ICD to LCP

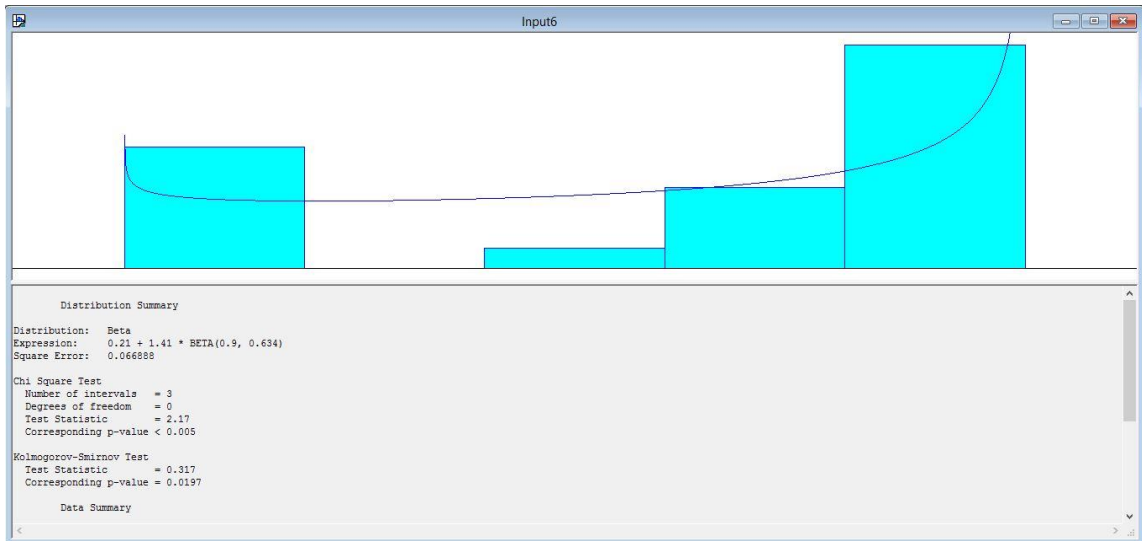

Appendix 2 Simulation results

B.1 Simulation results of the Current State replication 1

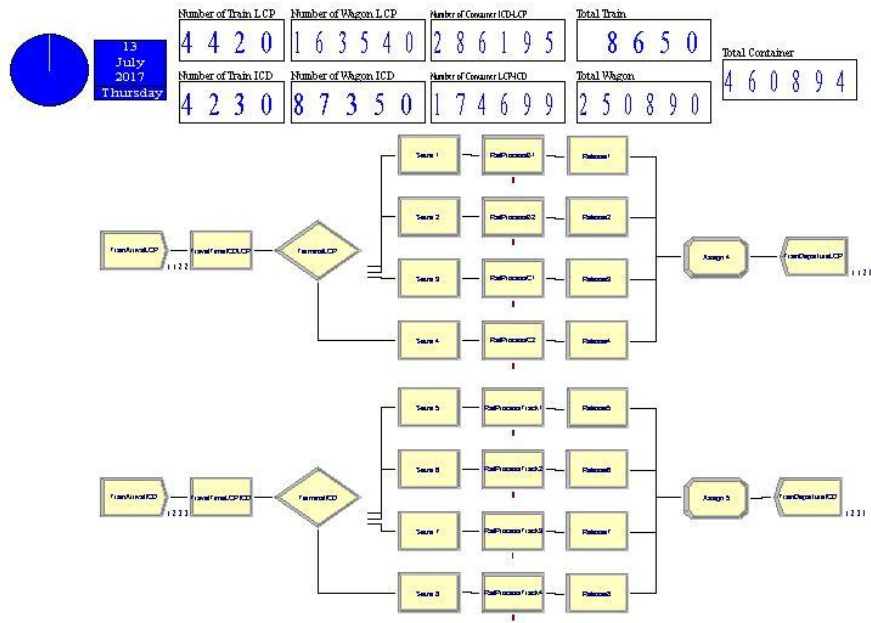

B.2 Simulation results of the Current State replication 2

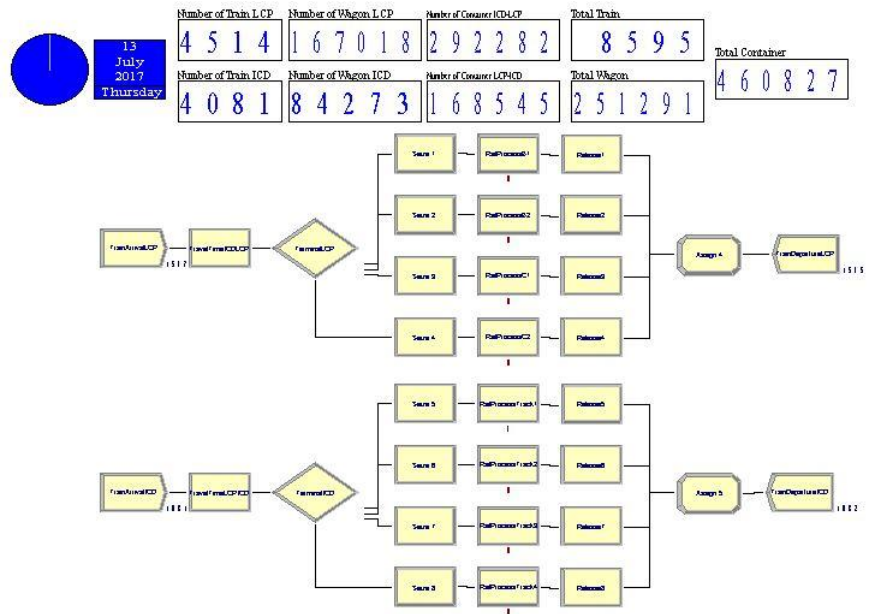

B.3 Simulation results of the Current State replication 3

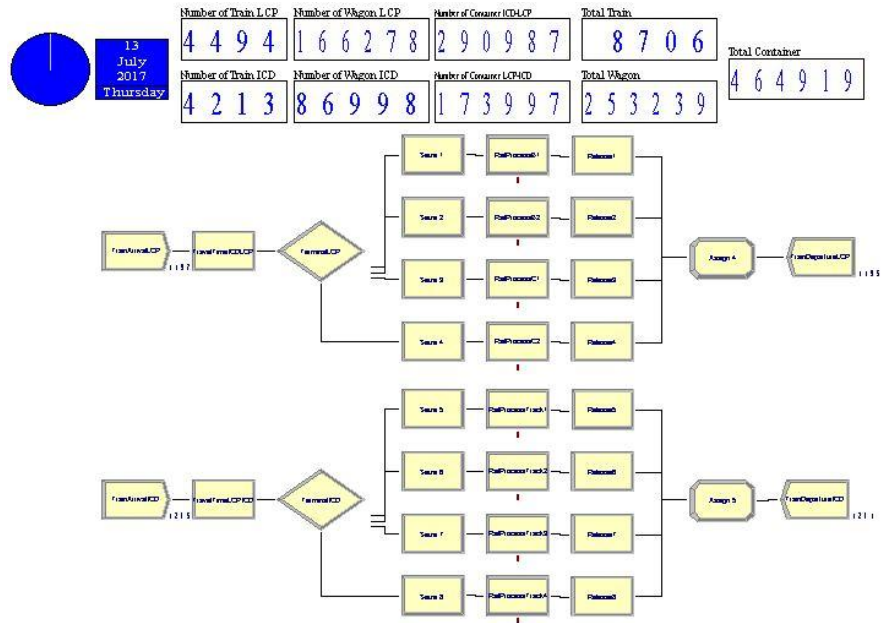

B.4 Simulation results of the Current State replication 4

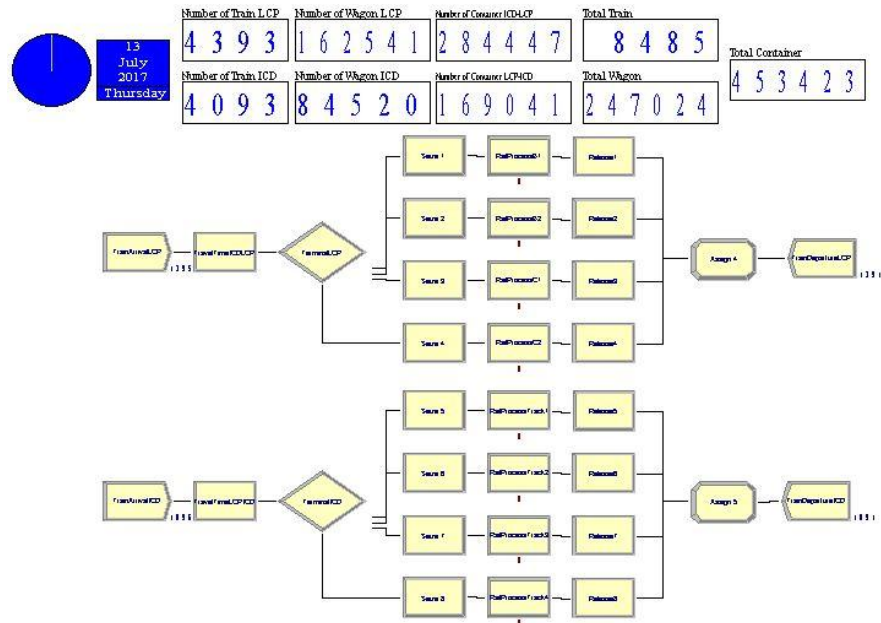

B.5 Simulation results of the Current State replication 5

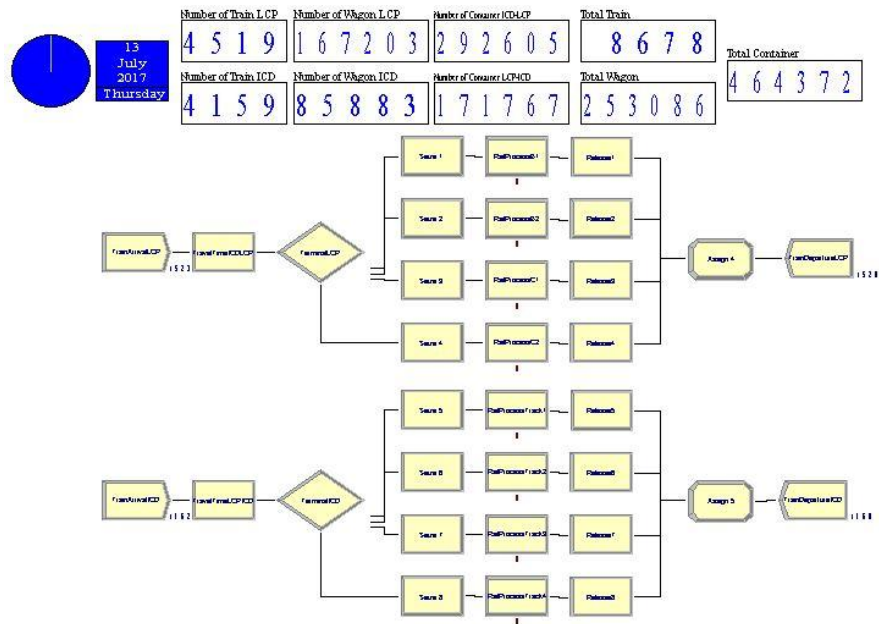

B.6 Simulation results of the Current State replication 6

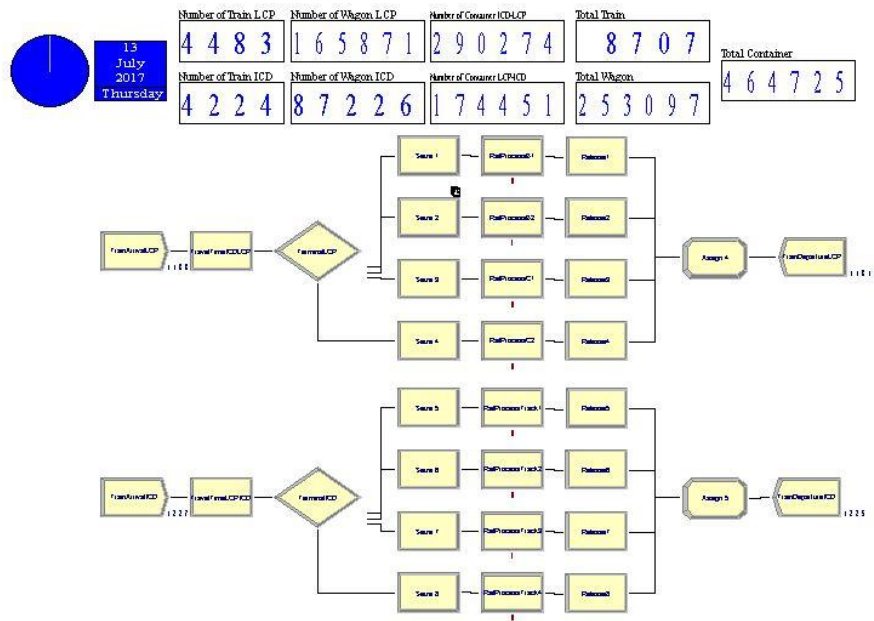

B.7 Simulation results of the Current State replication 7

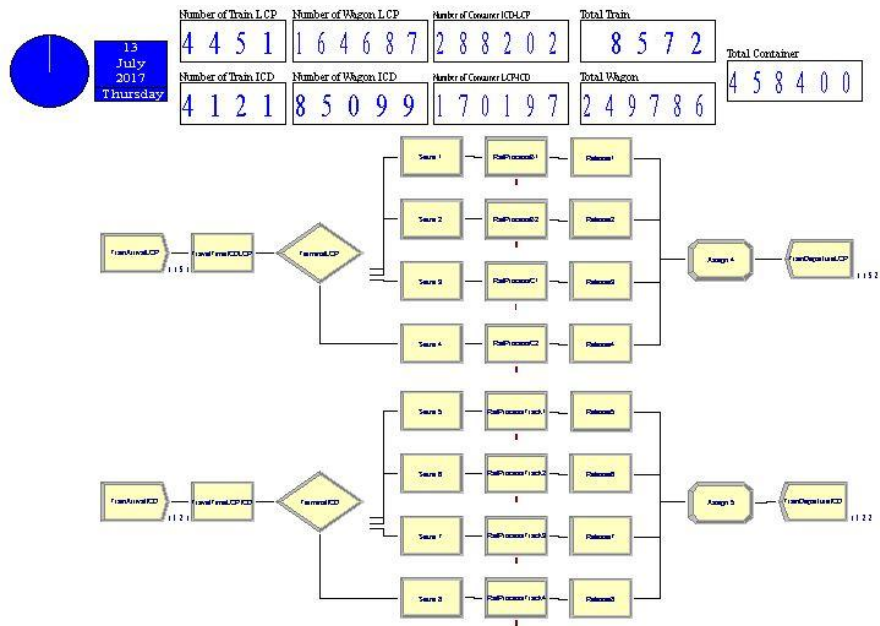

B.8 Simulation results of the Current State replication 8

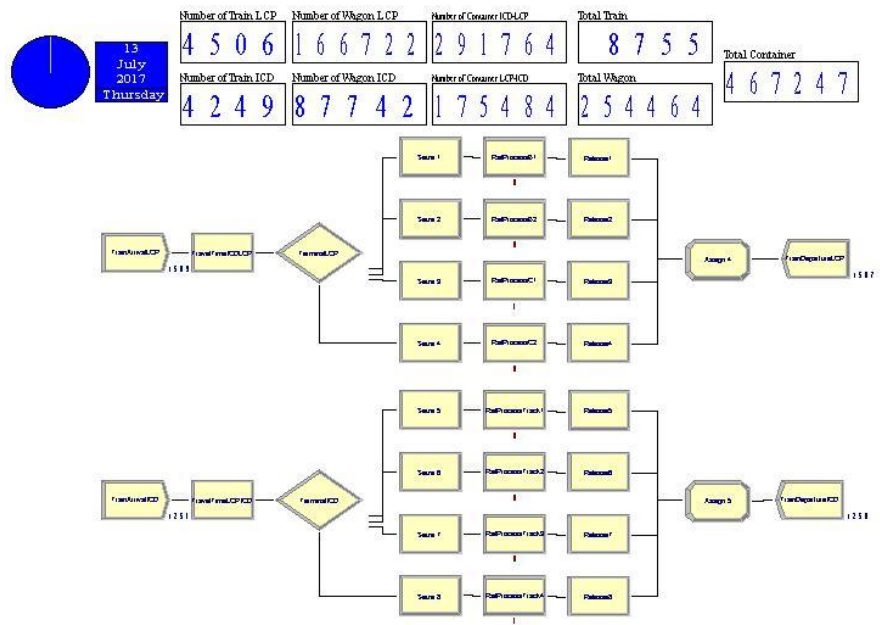

B.9 Simulation results of the Current State replication 9

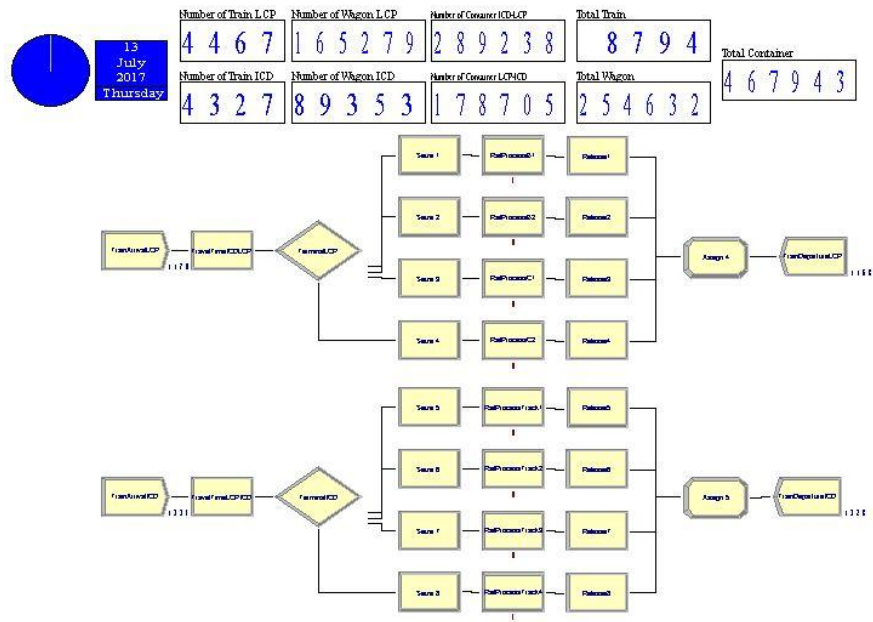

B.10 Simulation results of the Current State replication 10

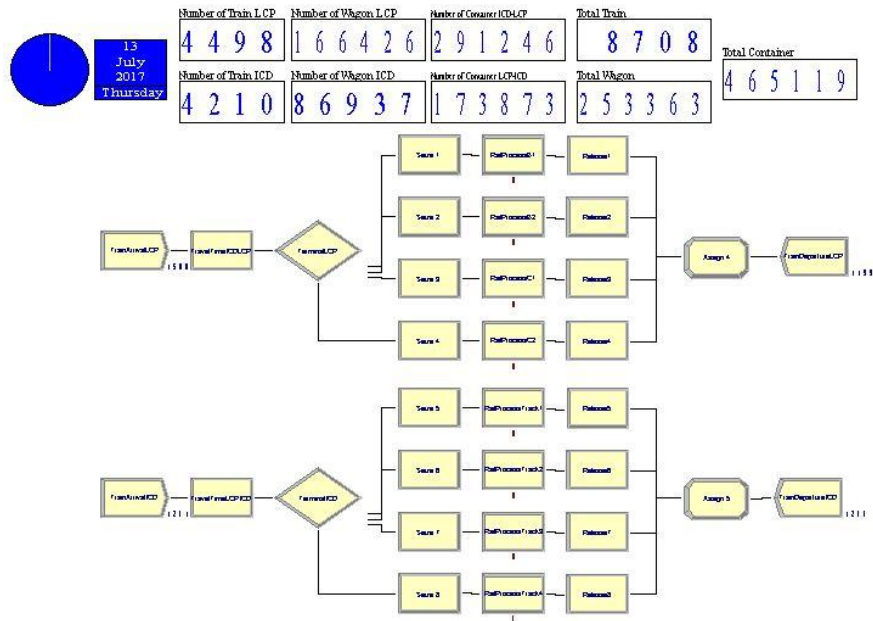

B.11 Simulation results of Scenario 1 replication 1

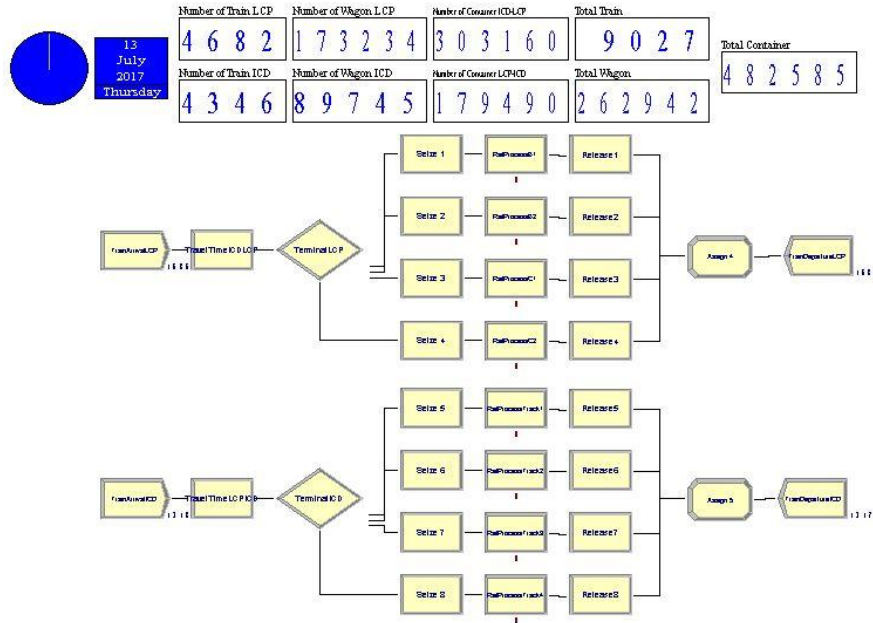

B.12 Simulation results of Scenario 1 replication 2

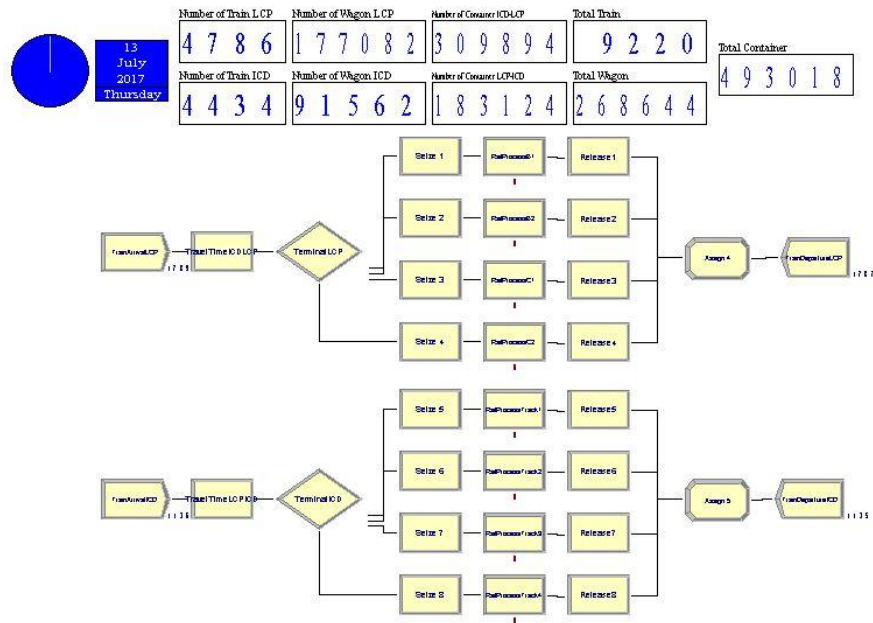

B.13 Simulation results of Scenario 1 replication 3

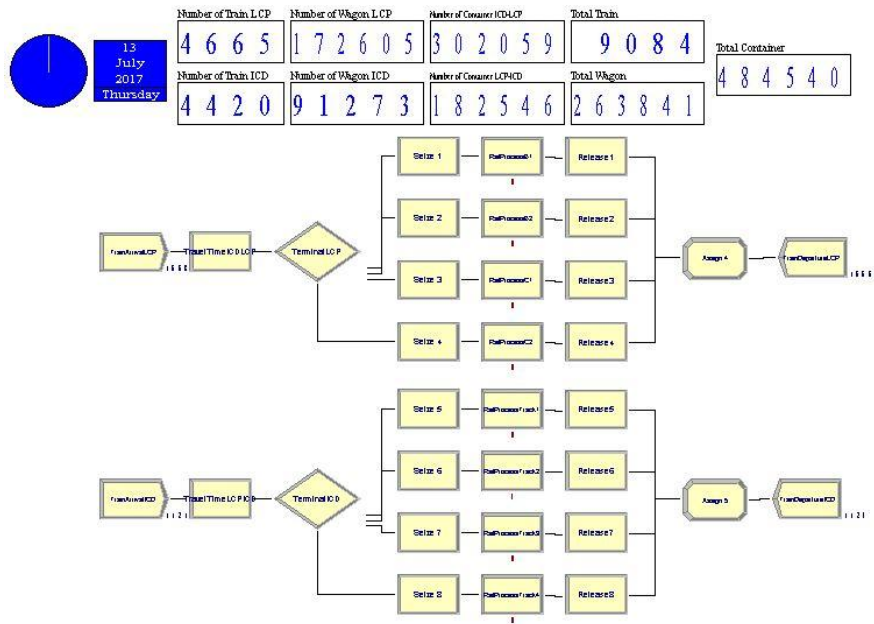

B.14 Simulation results of Scenario 1 replication 4

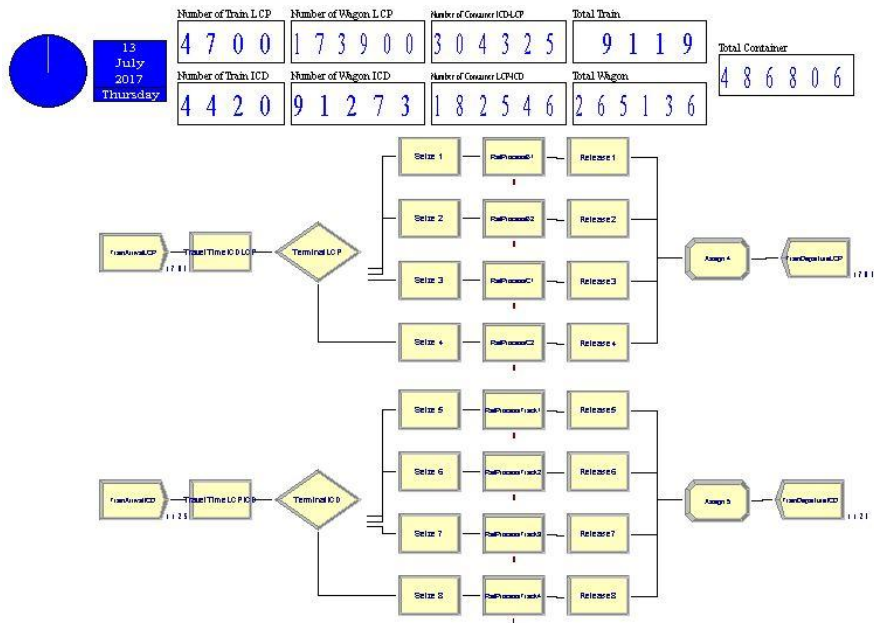

B.15 Simulation results of Scenario 1 replication 5

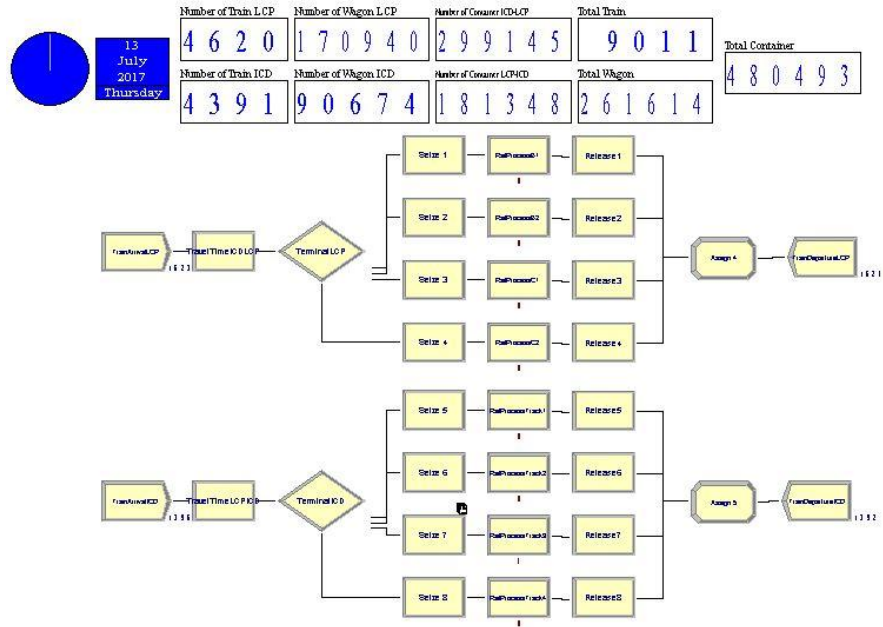

B.16 Simulation results of Scenario 1 replication 6

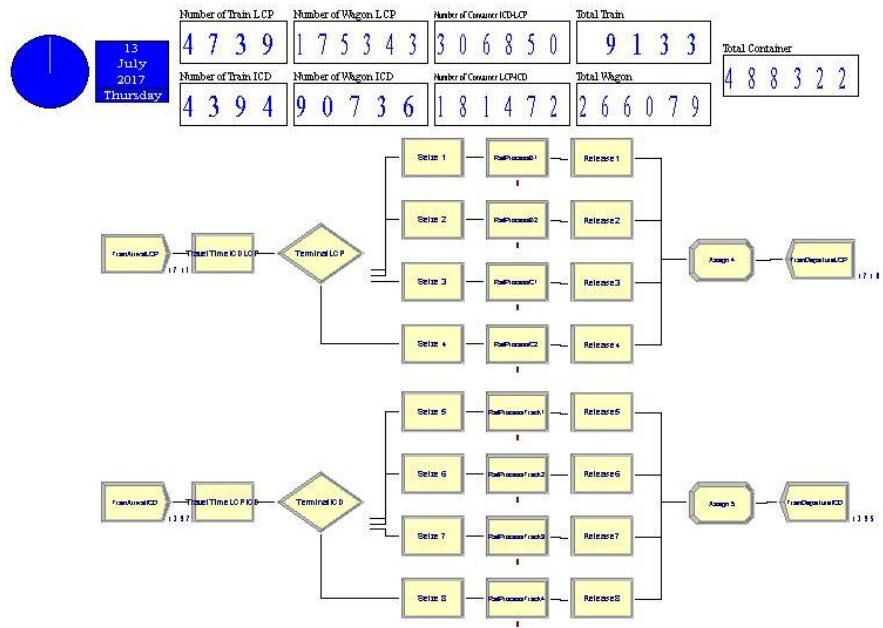

B.17 Simulation results of Scenario 1 replication 7

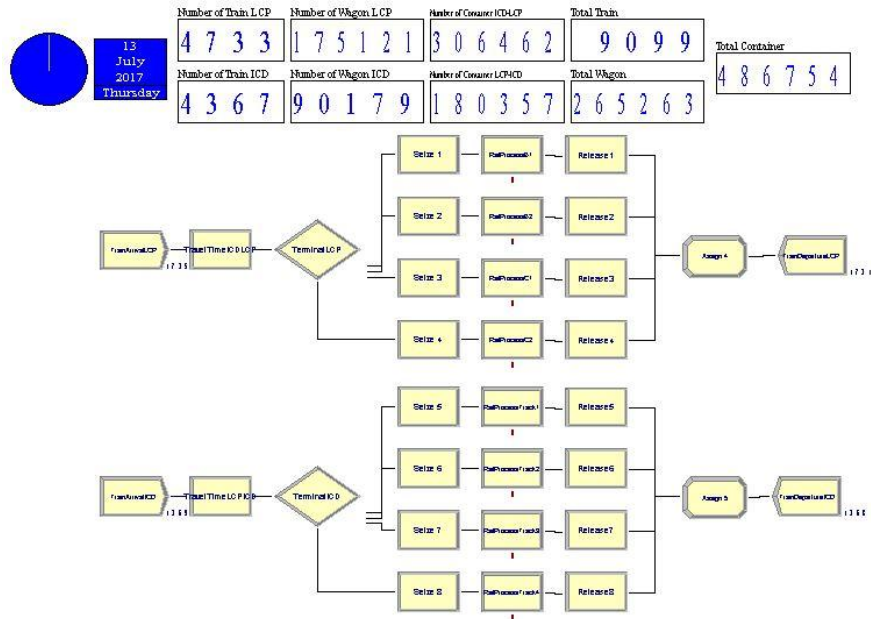

B.18 Simulation results of Scenario 1 replication 8

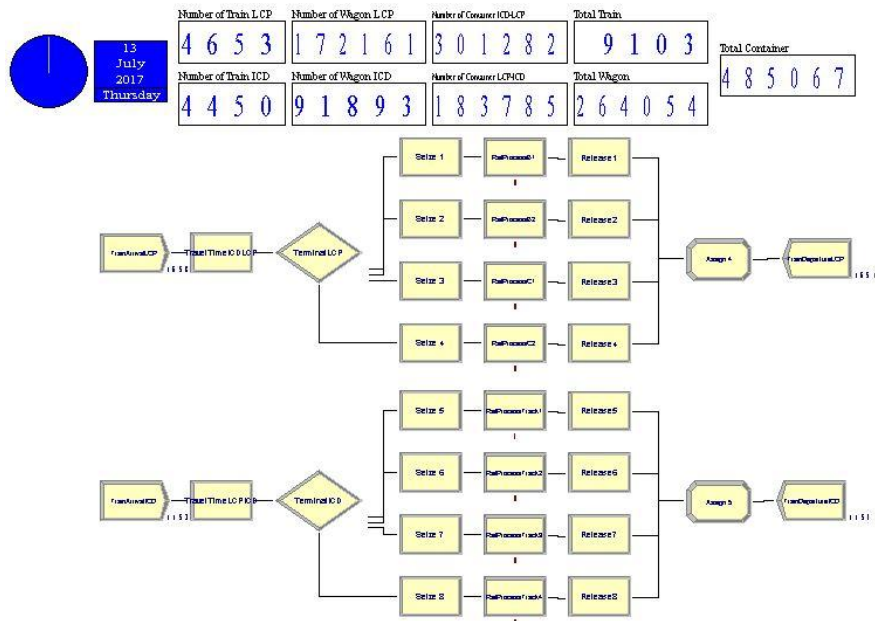

B.19 Simulation results of Scenario 1 replication 9

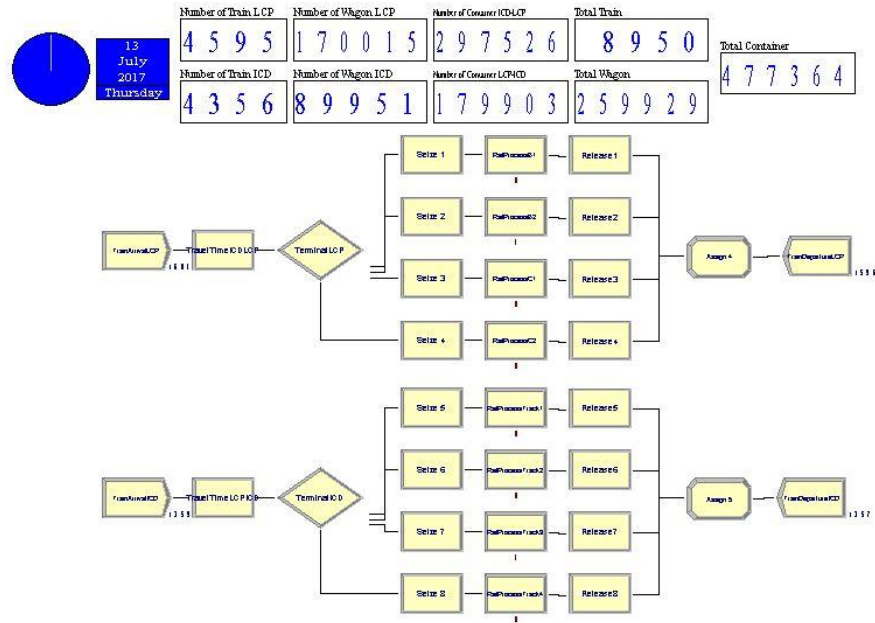

B.20 Simulation results of Scenario 1 replication 10

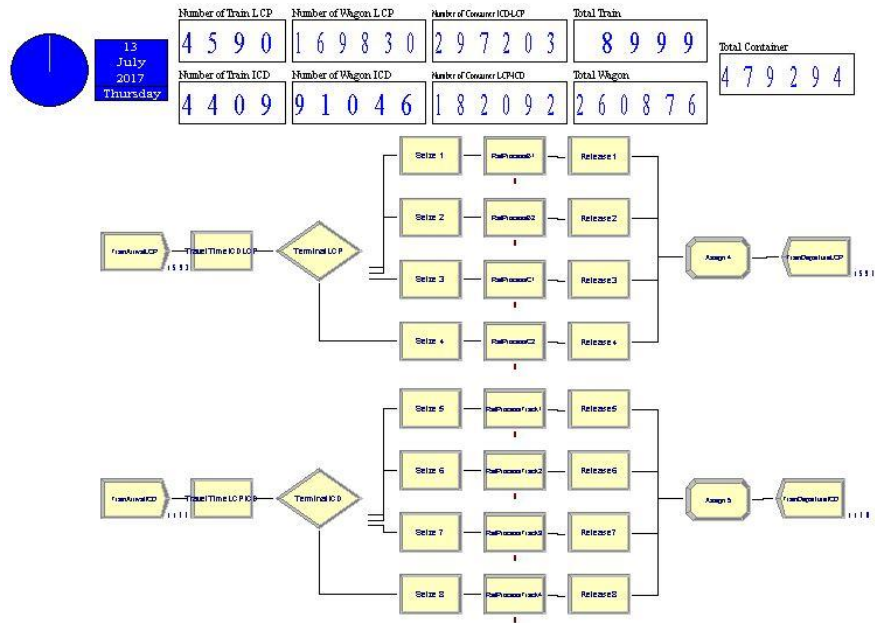

B.21 Simulation results of Scenario 2 replication 1

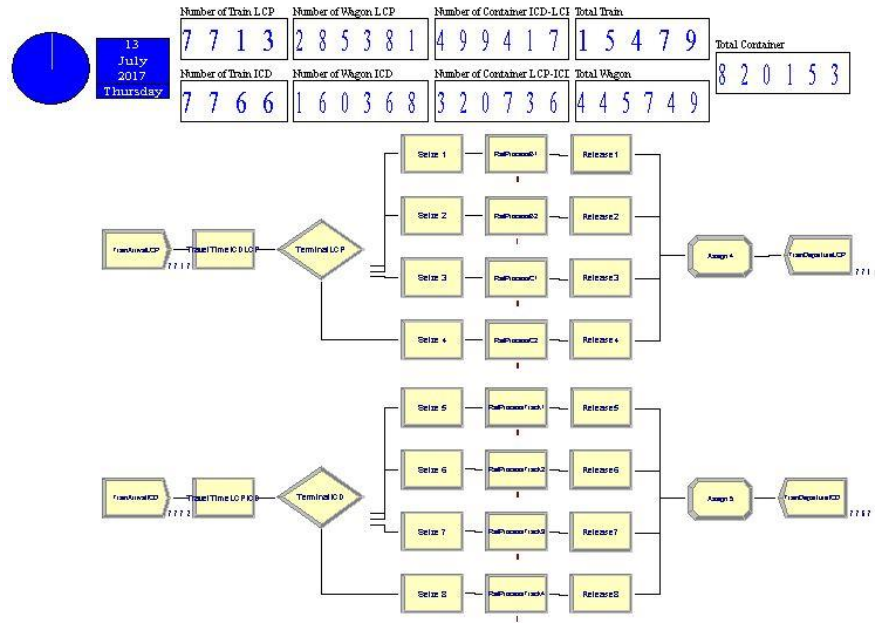

B.22 Simulation results of Scenario 2 replication 2

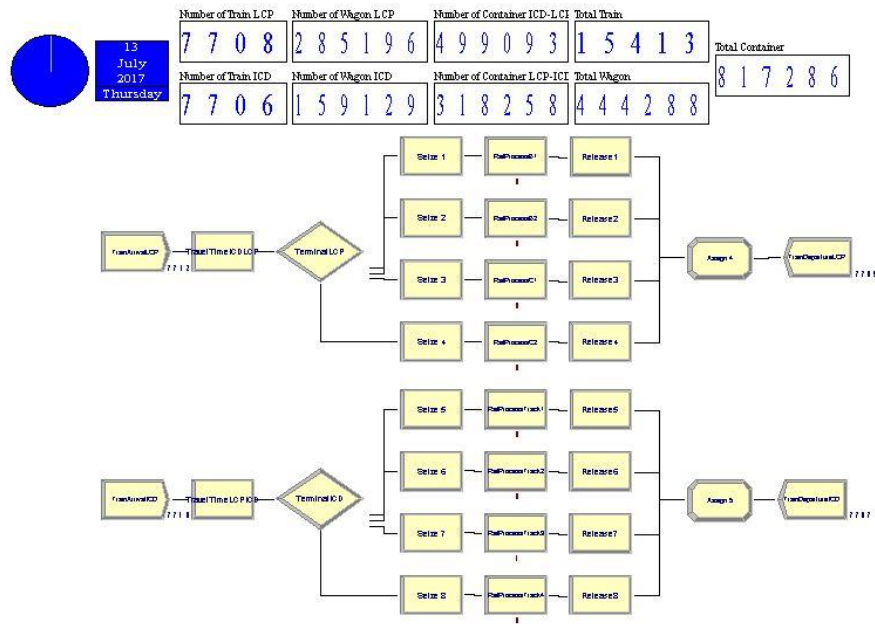

B.23 Simulation results of Scenario 2 replication 3

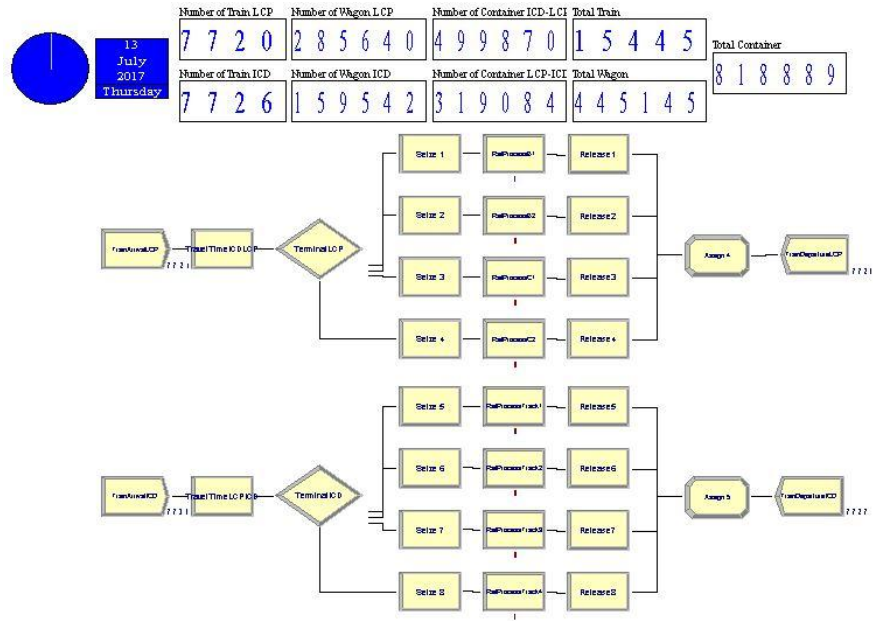

B.24 Simulation results of Scenario 2 replication 4

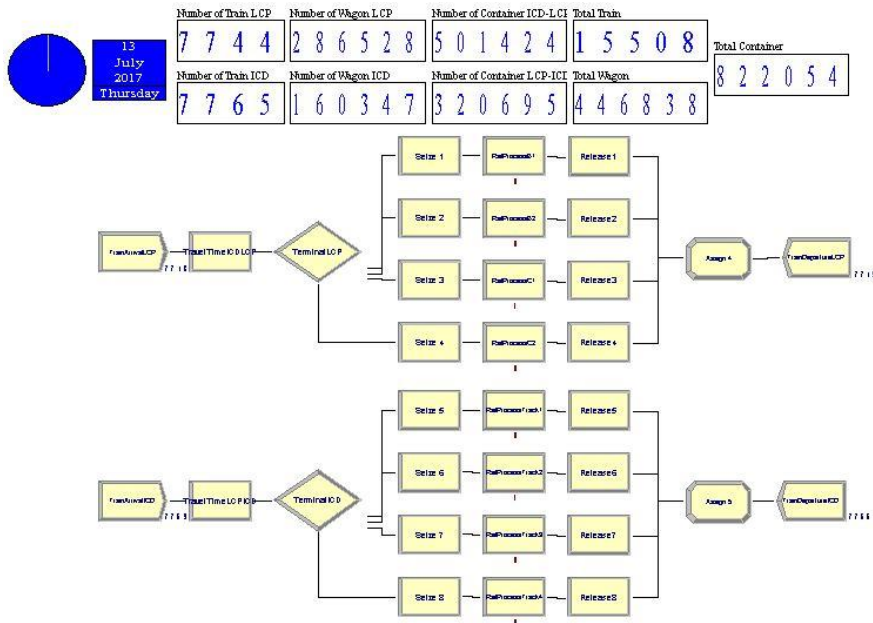

B.25 Simulation results of Scenario 2 replication 5

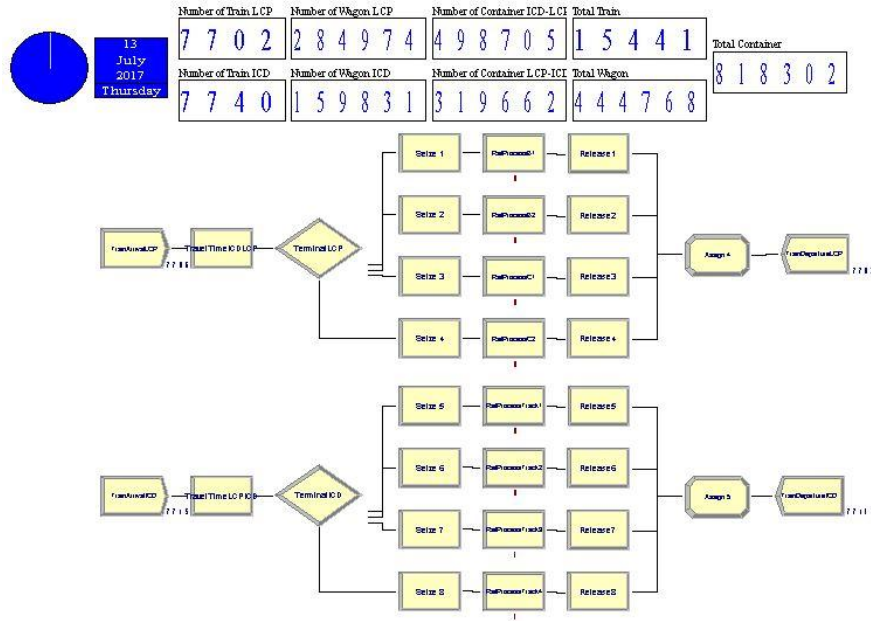

B.26 Simulation results of Scenario 2 replication 6

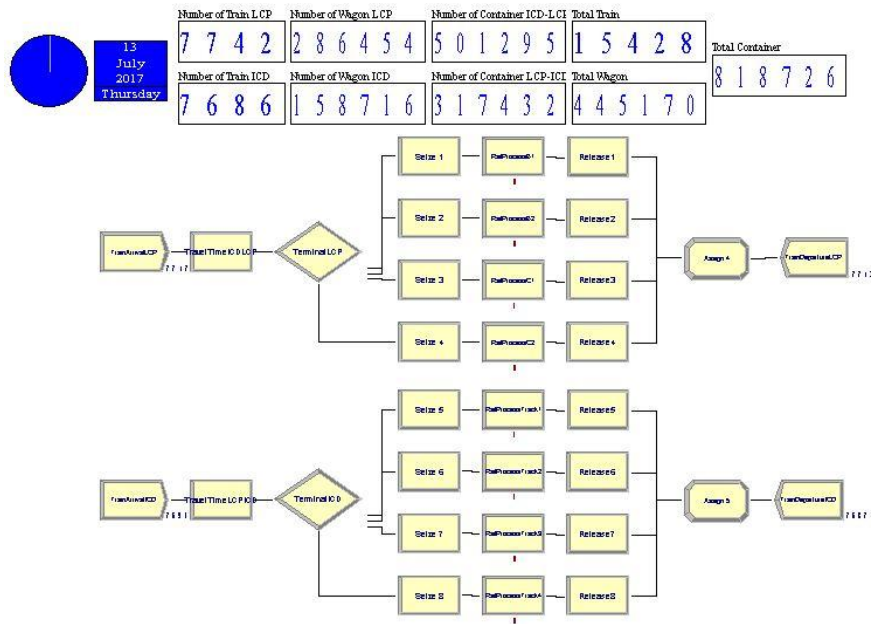

B.27 Simulation results of Scenario 2 replication 7

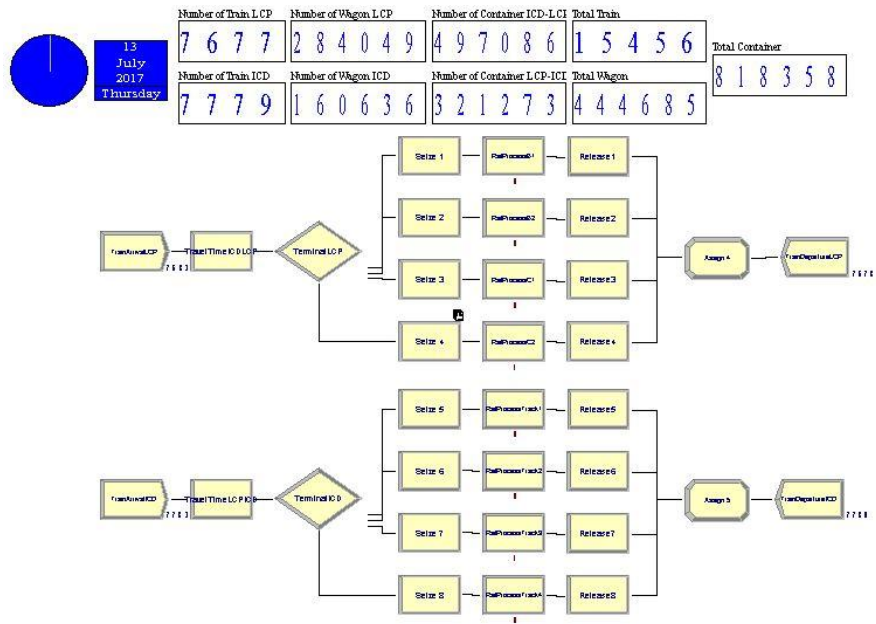

B.28 Simulation results of Scenario 2 replication 8

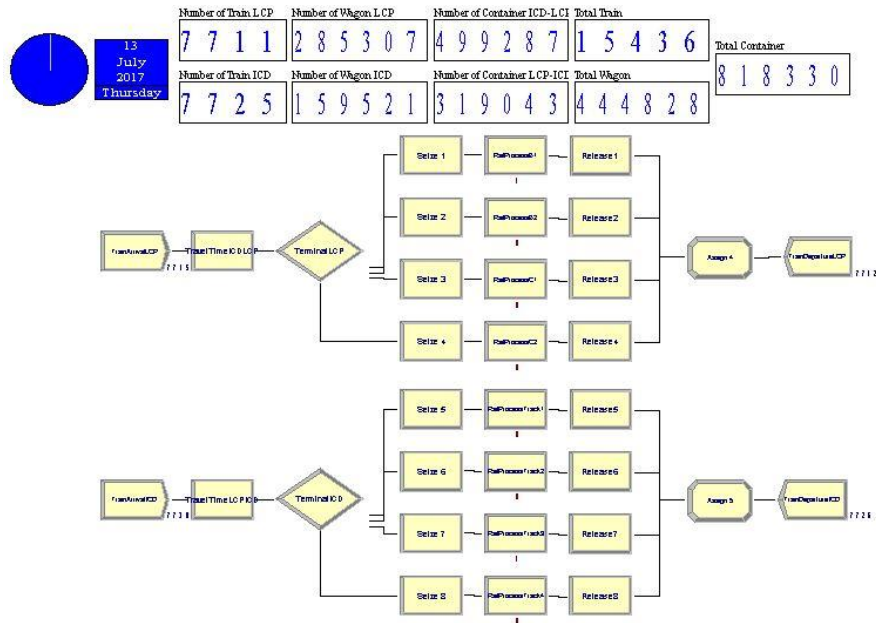

B.29 Simulation results of Scenario 2 replication 9

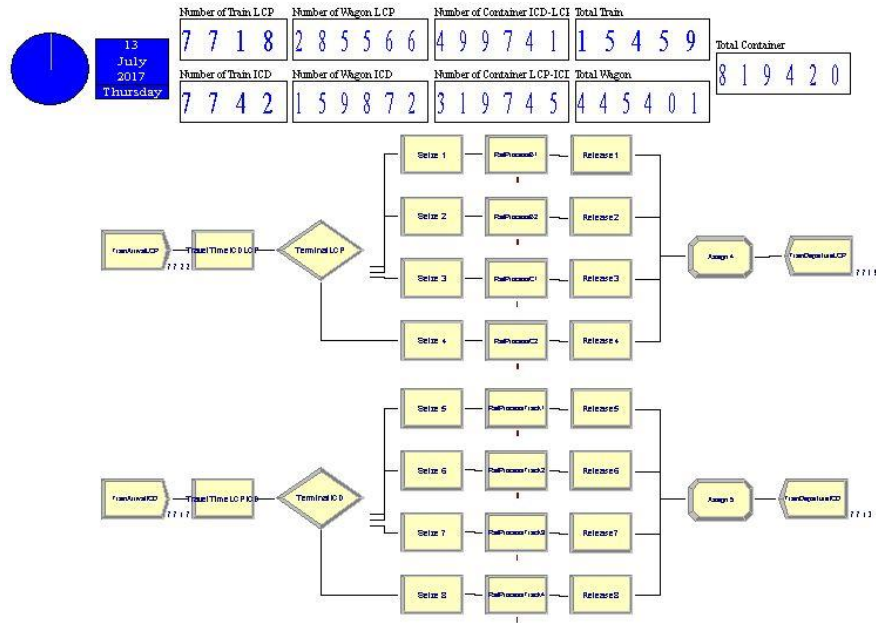

B.30 Simulation results of Scenario 2 replication 10

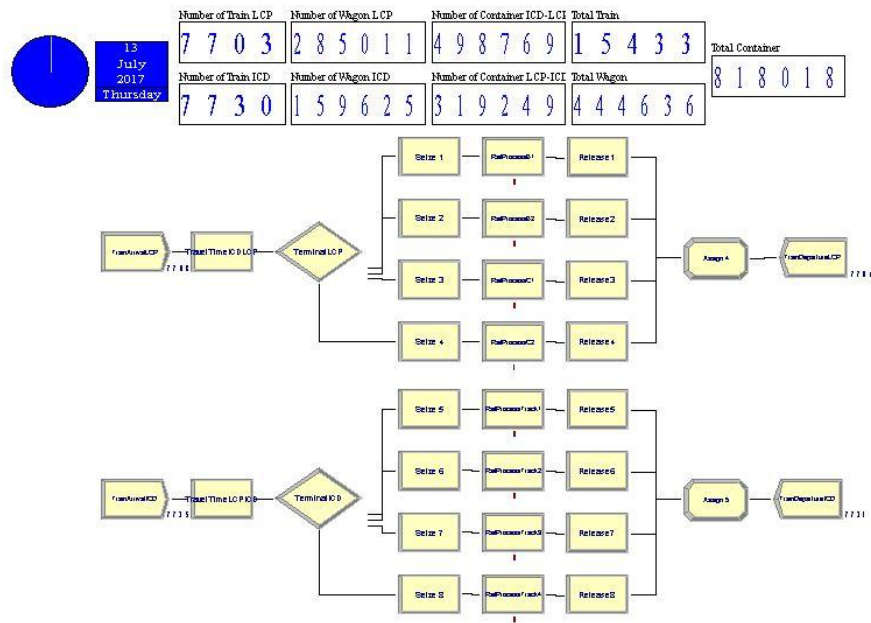

B.31 Simulation results of Scenario 3 replication 1

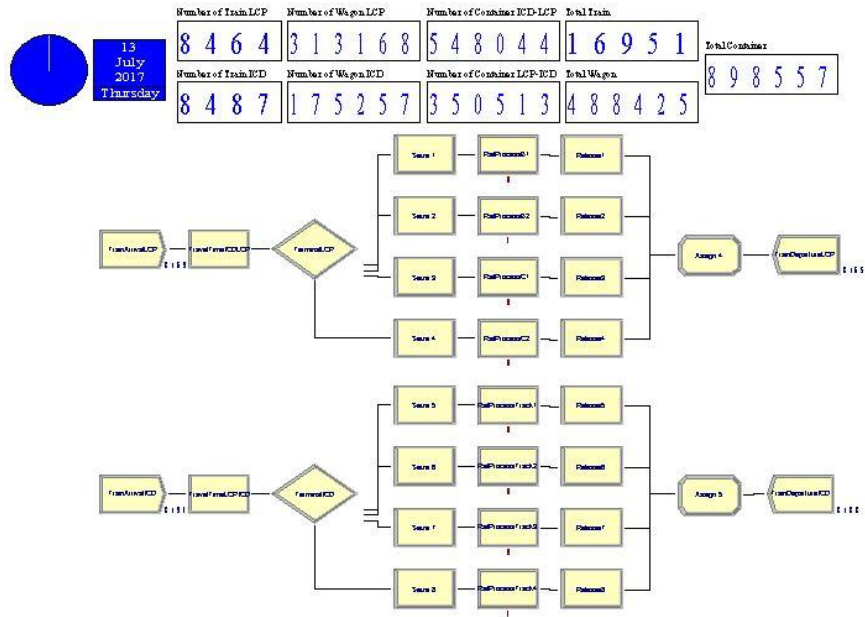

B.32 Simulation results of Scenario 3 replication 2

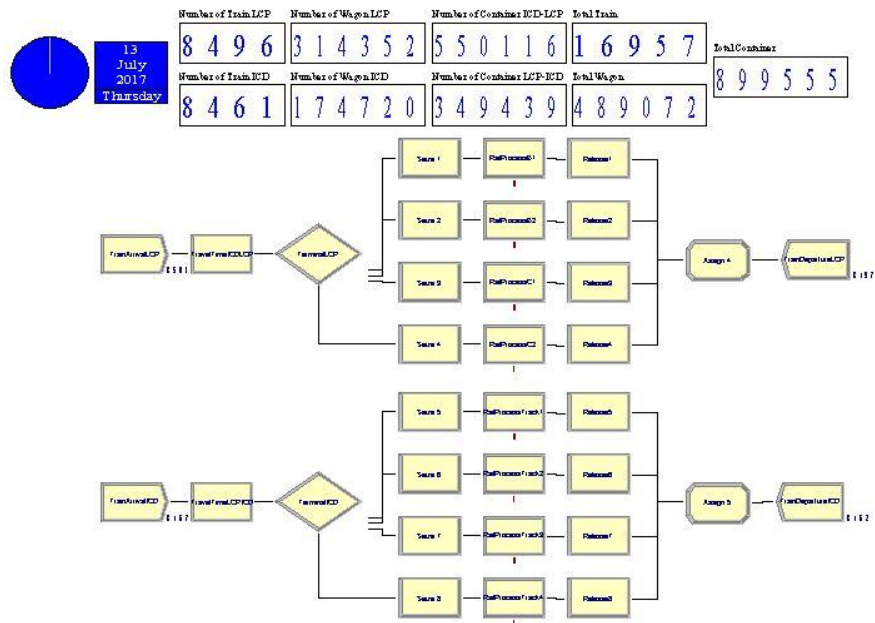

B.33 Simulation results of Scenario 3 replication 3

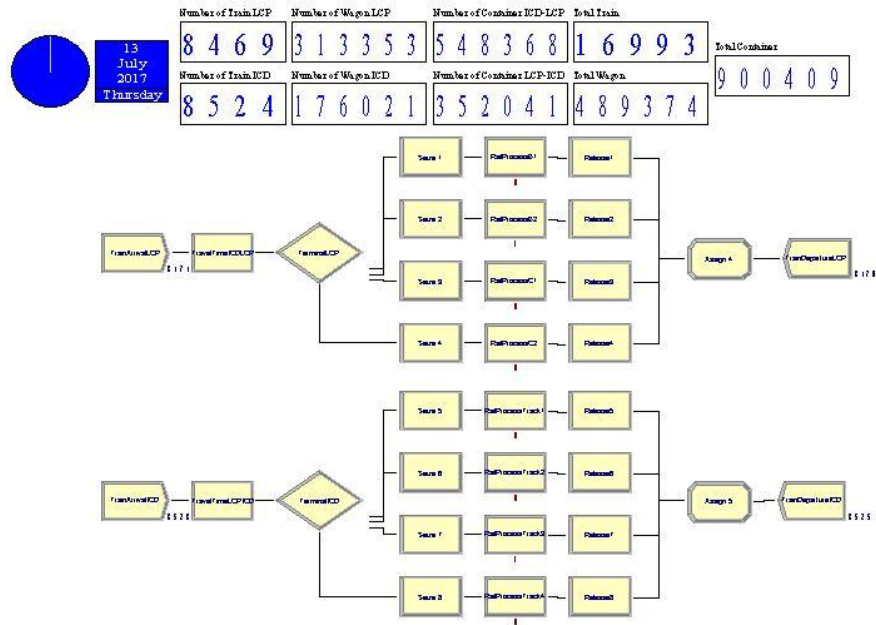

B.34 Simulation results of Scenario 3 replication 4

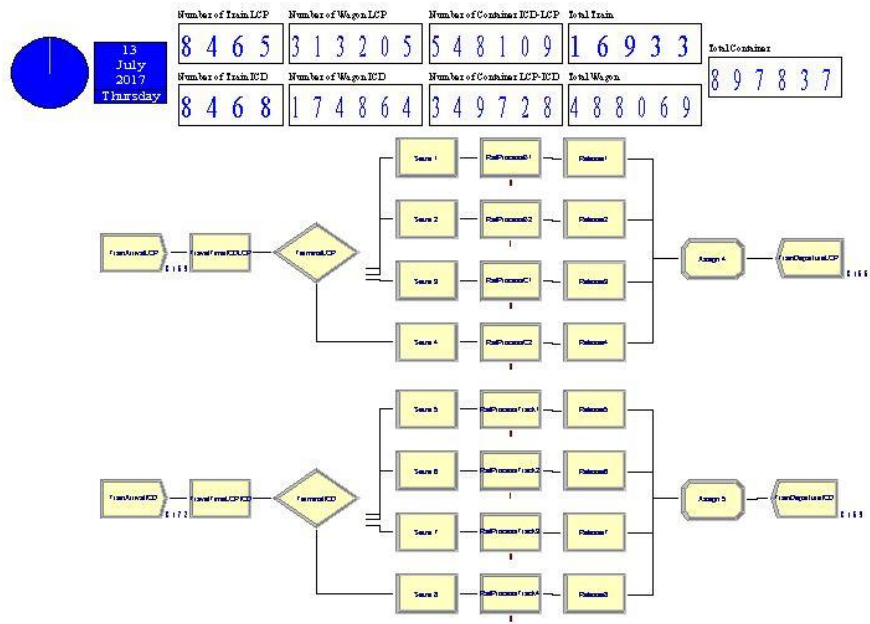

B.35 Simulation results of Scenario 3 replication 5

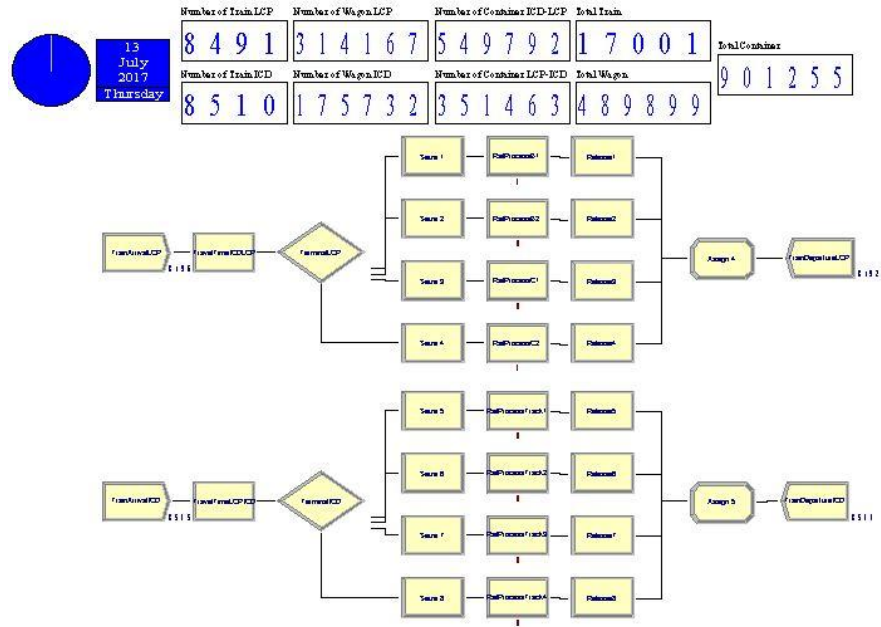

B.36 Simulation results of Scenario 3 replication 6

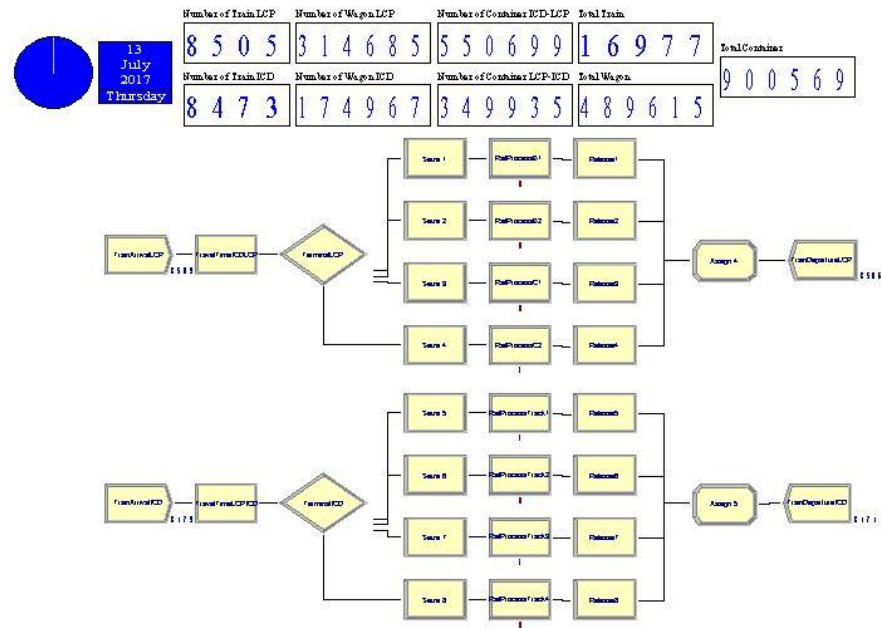

B.37 Simulation results of Scenario 3 replication 7

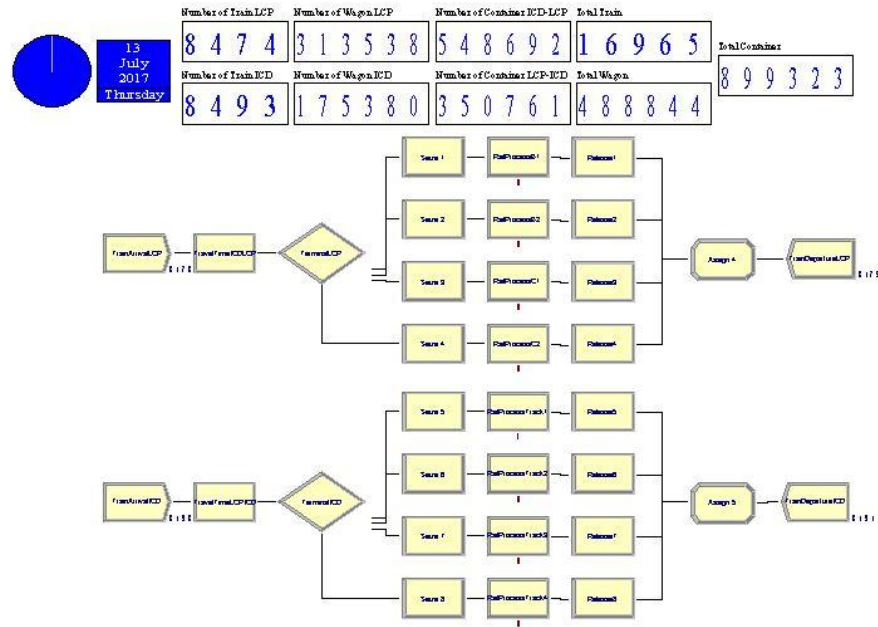

B.38 Simulation results of Scenario 3 replication 8

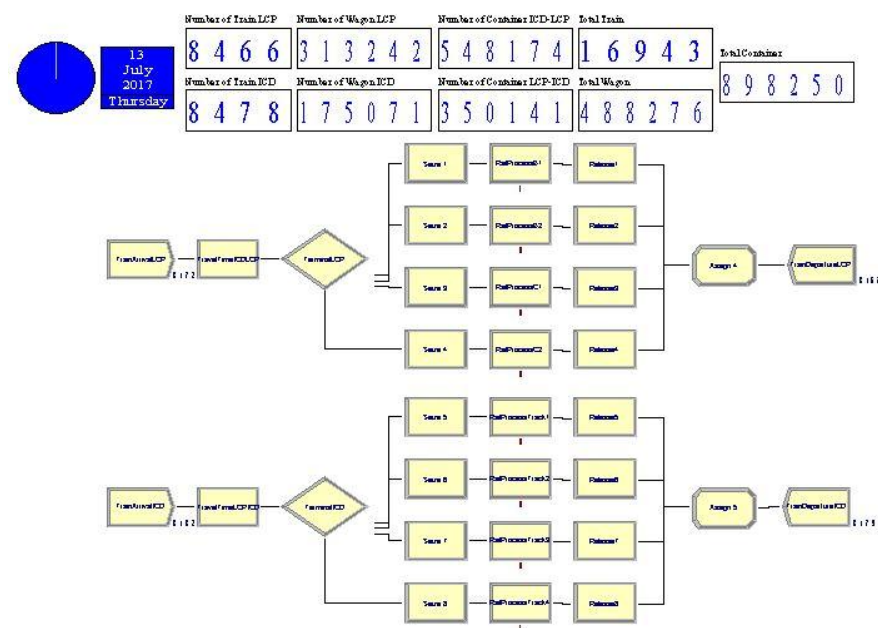

B.39 Simulation results of Scenario 3 replication 9

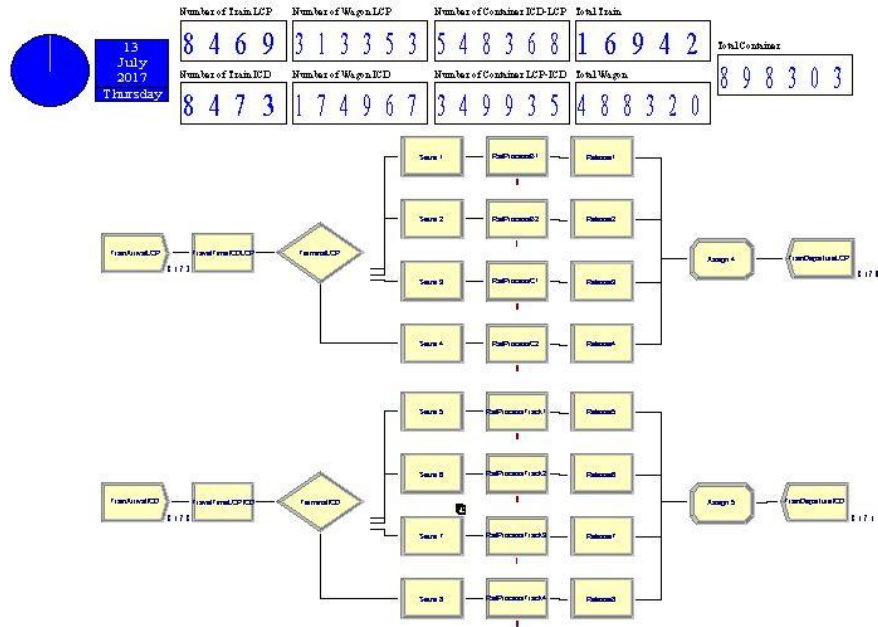

B.40 Simulation results of Scenario 3 replication 10

