

World Maritime University  
**The Maritime Commons: Digital Repository of the World  
Maritime University**

---

World Maritime University Dissertations

Dissertations

---

2004

# Impacts of automatic identification system on collision avoidance and the need for training

Junzhong Bao

*World Maritime University*

Follow this and additional works at: [http://commons.wmu.se/all\\_dissertations](http://commons.wmu.se/all_dissertations)

 Part of the [Engineering Commons](#)

---

## Recommended Citation

Bao, Junzhong, "Impacts of automatic identification system on collision avoidance and the need for training" (2004). *World Maritime University Dissertations*. 183.

[http://commons.wmu.se/all\\_dissertations/183](http://commons.wmu.se/all_dissertations/183)

This Dissertation is brought to you courtesy of Maritime Commons. Open Access items may be downloaded for non-commercial, fair use academic purposes. No items may be hosted on another server or web site without express written permission from the World Maritime University. For more information, please contact [library@wmu.se](mailto:library@wmu.se).

**WORLD MARITIME UNIVERSITY**  
Malmö, Sweden

**Impacts of Automatic Identification System on  
Collision Avoidance and The Need for Training**

By  
**BAO JUNZHONG**  
China

A dissertation submitted to the World Maritime University in partial  
fulfilment of the requirements for the award of the degree of

**MASTER OF SCIENCE  
IN  
MARITIME AFFAIRS**  
**(MARITIME EDUCATION AND TRAINING)**

**2004**

**Dedicated to:**  
**My dear wife, Xiaojie Tan**  
**and**  
**My Son, Zhenren Bao**

## **DECLARATION**

I certify that all the material in this dissertation that is not my own work has been identified, and that no material is included for which a degree has previously been conferred on me.

The contents of this dissertation reflect my own personal views, and are not necessarily endorsed by the University.

Bao Junzhong

Date: 30th August 2004

### **Supervised by:**

Jan Horck

Captain, Port and Shipping Management

World Maritime University

### **Internal Assessor:**

Jan-Åke Jönsson

Associate professor, Maritime Administration and Environmental Protection

World Maritime University

### **External Assessor:**

Dr. Bernhard Berking

Professor,

Institute of Ship Operation, Sea Transport and Simulation

Hamburg, Germany

## **ACKNOWLEDGEMENTS**

This dissertation was developed as part of my studies at WMU. These studies would not have been possible without the kind support of a number of people and organizations to which I am most grateful.

First of all, I am grateful to the senior staff in Dalian Maritime University for giving me the opportunity and encouraging me to apply to WMU, and also for the support and guidance given throughout the application and acceptance processes and during my studies. My special thanks to the Director of the Department of International Affairs, Minister of Communication China, Mr Chengzhi Ju, who encouraged and approved my application to the World Maritime University.

I wish to express my profound gratitude and sincere thanks to Nippon Foundation Japan for the invaluable sponsorship provided to facilitate my studies. My sincere thanks must also be extended to my dissertation supervisor, Captain Jan Horck, lecturer at the Maritime Education and Training Faculty; Dr Peter Muirhead, former MET Course Professor and Dr Malek Pourzanjani, MET Course professor of WMU; Library Staff, Ms Cecilia Denne and Ms Susan Eklöw; the English instructor Mr Clive Cole and Dr Bernhard Berking, visiting Professor of WMU. Their guidance and advice were instrumental in overcoming many of the difficulties encountered not only in the preparation of this dissertation but also throughout my course of study. Thank you all very much.

My deepest appreciation and greatest respect are extended to my dear wife, Xiaojie Tan, who braved it alone for the whole part of my studies, looking after our son, Zheren Bao. Throughout all of this she continually gave me the encouragement and strength to persevere.

Title: **Impacts of Automatic Identification System  
on Collision Avoidance and the Need for Training**

Degree: **MSc**

### **Abstract**

Due to the introduction of new technology on the bridge, the navigator's working environment and navigational tools have changed. In this dissertation, several safety issues related to the application of hi-tech equipment have been discussed. In order to provide an alternative in the event of failure of hi-tech equipment the importance of traditional navigational skills has been restated.

All SOLAS ships are supposed to have been fitted with AIS by 1 July 2004 in an accelerated schedule due to the events of "9/11". With little knowledge of AIS's capabilities and limitations on collision avoidance and situation awareness, navigators have to use AISs to improve safety. This has brought deep safety concerns related to watch keeping and collision avoidance. Several potential risks of using AIS have been discussed in the paper.

Currently there are no relevant IMO conventions, regulations, resolutions, and guidelines that directly stress AIS training. However there are certain provisions in some instruments that indirectly refer to AIS training. The importance of faithful interpretation of these provisions has been stated to develop an effective AIS training syllabus and to organize efficient AIS training both on board and on shore.

The limitation of current AIS training, which is current carried out on board mainly by self-study with a manufacturer-provided CD, has been examined. Also, on shore training has been discussed and its limitations are defined. At the end of this paper, recommendations and an AIS training syllabus are proposed.

Key Words: AIS IBS ECDIS MKD GPS OOW Collision

## TABLE OF CONTENTS

Declaration.....	II
Acknowledgements.....	III
Abstract.....	IV
Table of Contents.....	V
List of Figures and Tables.....	X
Abbreviations .....	X
<b>Chapter I Introduction</b>	
1.1 Importance of the Study.....	1
1.2 Objectives of the Study.....	3
1.3 Order of Presentation.....	3
1.4 Scope and Methodology.....	5
<b>Chapter II Recent Technological Challenges on a Ship’s Bridge</b>	
2.1 Introduction.....	6
2.2 Changes in Technology on the Bridge.....	6
2.3 Disadvantages of IBS.....	9
2.3.1. Risks of Over-reliance on IBS.....	9
2.3.2. Loss of Traditional Navigational Skills.....	10
2.3.3. Lost “Feel” for Situations.....	11
2.4 The Introduction of AIS into the Ship’s Bridge.....	12
<b>Chapter III AIS Triggered Safety Issues</b>	
3.1 Introduction.....	14
3.2 Carriage Requirements of AIS.....	15
3.2.1 AIS Carriage Requirements of SOLAS Chapter V Regulation 19..	15
3.2.2 U.S. Carriage Requirements of AIS.....	16
3.2.3 AIS Standards and Guidelines.....	16

3.2.4	Types of Automatic Identifications Systems.....	17
3.3	AIS Information.....	17
3.3.1	The Information Provided by the AIS.....	18
3.3.2	AIS Information Update Rates.....	19
3.4	Display of AIS Information.....	20
3.4.1	Minimum Display.....	20
3.4.2	Graphical Display.....	20
3.4.3	Radar Display.....	21
3.5	Non-AIS Ships.....	23
3.6	Connecting Problems with Pre-1995 Versions of GPS.....	24
3.7	AIS Impacts on Detecting Risks of Collision.....	25
3.7.1	AIS does not Replace Radar.....	25
3.7.2	AIS Impacts on COLREGs.....	27
3.7.3	Over-reliance on AIS.....	28
3.8	The Issues of AIS Training.....	29
3.9	The Issues of the integration of AIS with Radar/ARPA or ECDIS.....	29

## Chapter IV Advantages and Limitations of AIS

4.1	Introduction.....	31
4.2	Advantages of AIS.....	31
4.2.1	Ship Identification Using AIS.....	32
4.2.2	Real-time Dynamic Display of AIS Information.....	32
4.2.3	Enlarged Coverage of AIS.....	33
4.2.4	Effects on VHF Traffic Volume.....	34
4.2.4.1	Reducing Traffic Volume between Ships and VTS Operators.....	34
4.2.4.2	Improved Traffic Image Accuracy.....	34
4.2.5	Instant Detections of ship's Manoeuvring Intention.....	35
4.2.6	AIS Provides More Accurate Information Than Radar.....	36
4.3	Limitations of AIS.....	36



4.3.1	Passing arrangement against COLREGs.....	37
4.3.2	Negative effects of Poorly Located AIS Display Units on Safety.....	36
4.3.3	Wrong and Uncoordinated Messages Transmitting via AIS.....	40
4.3.4	Potential Risks to Small Boats.....	41
4.3.4.1	Risks to Non-SOLAS Ships.....	41
4.3.4.2	Risks by Overload of AIS Information.....	42
4.3.5	Switching off AIS.....	43
4.3.6	The accuracy of AIS Information is Dependent on Other Equipment....	43
4.3.7	Non-integration Between AIS and ECDIS & Radar/ARPA.....	46
4.3.8	Negative Effects of AIS Pilot Laptop Display.....	48

## Chapter V Current Status and Limitations of AIS Training

5.1	Introduction.....	49
5.2	Requirements Related to AIS Training in Conventions and Regulations....	50
5.2.1	AIS Training Requirements in Chapter V, SOLAS.....	50
5.2.2	Rules Relating to AIS Training in COLREGs.....	51
5.2.2.1	Rule 5 Look-out.....	51
5.2.2.2	Rule 7 Risk of Collision.....	51
5.2.2.3	Rules 8, 16 and 17 AIS-an Important Monitoring Role....	52
5.2.3	AIS Training-related Requirements in STCW Code.....	52
5.2.3.1	Interpretation of Regulation I/14.....	53
5.2.3.2	Technical References in Table A-II.....	54
5.2.4	IMO Resolution for Operational Use of AIS.....	54
5.3	Current Situations of AIS Installation.....	53
5.4	Overview of Current Situations of AIS training.....	57
5.4.1	An AIS training Program of MTC.....	57
5.4.2	Limitations of Current Available AIS Training on board.....	58
5.4.3	Lack of Awareness of AIS training.....	58

## Chapter VI Suggestions to Improve AIS Training

6.1	Introduction.....	61
6.2	On-shore Training.....	63
6.2.1	Key Elements of Training Syllabus.....	63
6.2.2	Exercises and Scenarios of Simulation Training.....	64
6.3	On-board AIS training.....	65
6.3.1	A Lesson from GMDSS Training.....	66
6.3.2	Keeping Competency by Doing.....	67
6.3.3	Organization of on-board Training.....	67

## Chapter VII Conclusions and Recommendations

7.1	Conclusions.....	69
7.1.1	Reservation of Traditional Skills.....	69
7.1.2	Awareness of the Roles of AIS.....	70
7.1.3	Awareness of Negative Effects of AIS on Safety .....	70
7.1.4	The Need for AIS Training.....	71
7.2	Recommendations .....	73
7.2.1	Using AIS properly and Attending Shore-based AIS Training...73	
7.2.2	Amendments of STCW 95.....	74
7.2.3	AIS Training Syllabus.....	74

<b>Bibliography</b> .....	78
---------------------------	----

### Appendices

Appendix I	An Overview of AIS .....	84
Appendix II	Technical Description of AIS.....	85
Appendix III	AIS Display Options and Its Elements.....	86
Appendix IV	Comparison of AIS- and Radar-based Information.....	88
Appendix V	Relationship Between IBS and INS.....	89
Appendix VI	Lessons to Learn from the Royal Majesty's Grounding.....	90
Appendix VII	The Principle of UAIS STDMA.....	92

Appendix VIII	AIS Information Display on PC Screen .....	95
Appendix IX	AIS-Minimum Keyboard Display.....	96
Appendix X	AIS and Radar Data Association.....	97

## List of Figures and Tables

Figure 4-1	Potential ARPA “tracking error” or “interpretation error”.....	35
Figure 4-2	Example of A Poorly Located AIS Display Unit (1).....	36
Figure 4-3	Example of A Poorly Located AIS Display Unit (2).....	37
Figure 5-1	AIS Connections on Board.....	56
Table 3-1	Report Rate of Dynamic AIS Information.....	19
Table 7-1	Syllabus of AIS Training.....	75

## Abbreviations

AIS	Automatic Identification System
ARPA	Automatic Radar Plotting Aid
AtoN	Aid to Navigation (e.g. buoys...)
BIIT	Built-in Integrity Test
CPA	Closest Point of Approach
CPU	Central Processing Unit
COG	Course Over Ground
COLREGs	International Regulations for Preventing Collisions at Sea, 1972
DGNSS	Differential Global Navigation Satellite System
ECDIS	Electronic Chart Display and Information Service
ECS	Electronic Chart System
ENC	Electronic Nautical Chart
EPFS	Electronic Position Fixing System
GMDSS	Global Maritime Distress and Safety System
GNSS	Global Navigation Satellite System
GPS	Global Positioning System
GT	Gross Tonnage
IALA	International Association of Marine Aids to Navigation and Lighthouse Authorities

IBS	Integrated Bridge System
ICS	Integrated Control System
IEC	International Electrotechnical Commission
IFC	Information Flow Chart
IFSMA	International Federation of Shipmasters' Associations
IMO	International Maritime Organisation
INMARSAT	International Maritime Satellite Organisation
INS	Integrated Navigation System
ITU	International Telecommunication Union
Loran C	Long-Range (Hyperbolic) Navigation System
MMSI	Maritime Mobile Service Identification
MAIB	The UK Marine Accident Investigation Branch
MTSA	Maritime Transportation Security Act of 2002
NTSB	National Transportation Safety Board
NAV	IMO Sub-Committee on Safety of Navigation
STW	IMO Sub-Committee on Standards of Training and Watching
NM	Nautical Mile
OOW	Officer of the Watch
RAIM	Receiver Autonomous Integrity Monitoring
ROT	Rate of Turn
ROTI	Rate of Turn Indicator
RX	Receiver
SAR	Search and Rescue
SGS-85	Soviet Geodetic System 1985
SOG	Speed Over Ground
SOLAS	International Convention for the Safety of Life at Sea
STCW	Standards of Training, Certification and Watchkeeping for Seafarers
STDMA	Self-organised Time Division Multiple Access
TCPA	Time to Closest Point of Approach
TNS	Traditional navigational skills

TX	Transmitter
U-AIS	Universal Automatic Identification System
UTC	Universal Time Co-ordinated
VHF	Very High Frequency (30 – 300 MHz)
VTS	Vessel Traffic Service
WMC	Western Marine Community
WGS 84	World Geodetic System 1984 (chart datum)

## **Chapter I**

### **Introduction**

In the Foreword to Third Edition of *Training and Assessment on Board*, the former Secretary-General of the International Maritime Organization, W.A. O'Neil (2002) emphasised that:

“At the present time the technology of shipping is changing very rapidly and it is important that education and training keep pace with the changes. Traditional skills and experience of today's seafarers shall pass on to the next generation, while at the same time they shall be properly trained to use new technology as it is introduced. This will need to take place not only through lectures in classrooms and training centers ashore but also on board ship.”

In light of O'Neil comments, the principle purpose of this dissertation is to examine how traditional navigational skills should be looked at when new technology is being introduced on ship bridge, how Automatic Identification System (AIS) training should be organized and what should be included in AIS training syllabus.

#### **1.1 Importance of the Study**

Integrated Bridge System (IBS) on modern ship bridge has gradually replaced previously isolated installed electronic equipment on traditional ship bridge. Consequently, working environment and navigational tools have changed. It is necessary to examine certain impacts of application of high-tech equipment on ship safety, especially on collision avoidance and situation awareness.

Recently AIS has been frequently targeted for safety concerns. AIS has been developed as an information providing system to help identify ships and assist in tracking targets, as well as enhance situation awareness. The events of “9/11” has made the original IMO AIS carriage-fitting timetable considerably short. On 1st July 2004, all SOLAS ships have been equipped with AISs. The accelerated AIS installation schedule has left AIS training far behind. Without properly understanding the limitations and capabilities, the navigators are expected to use the AIS for safety of navigation & ship identification. From shore training point of view, not only does competent training mean that trainees should be trained for the basic operation of AIS, but they also need to fully understand AIS’s pros and cons. Therefore, it is necessary to examine AIS’s capabilities and limitations for collision avoidance and situation awareness. Meanwhile, technical contents itself is not enough to develop an effective AIS training syllabus. Without proper guidance of relevant regulations, the AIS training syllabuses can be substantially different from one training center to another. Therefore it is difficult to assess the competency of trainees. This might be also true for on board training of AIS.

On the other hand, technology is changing faster than the development of relevant regulations. There is not a single legal instrument that directly stress AIS training. However there are some legal instruments that indirectly reflect AIS training. The fact is that using AIS to assist in collision avoidance and situation awareness will affect the implementation of certain provisions in COLREGs, especially when AIS has been integrated with Radar/ARPA, ECDIS. Certain technical provisions in STCW code have been involved too. AIS application also interacts with VTS traffic control and information exchange, coastal management, as well as even further for anti-terrorism measures. Therefore, it is essential to examine which fundamental requirements of AIS application are implicated in relevant conventions as well as other legal instruments. Those requirements will guide how AIS should be operated, and furthermore, to instruct how AIS training should be organized and what contents should be included in an AIS training syllabus.



Finally, the study will be used as a reference to develop an AIS training program in the author's organization, Dalian Maritime University. The trainees will be existing deck officers and seafaring students in that University.

## **1.2 Objectives of the Study**

The objectives of this dissertation are as follows:

- (1) To examine challenges of new technology on a ship's bridge;
- (2) To define current safety issues triggered by AIS;
- (3) To discuss advantages and limitations of using AIS on board ships;
- (4) To define limitations of current AIS training;
- (5) To identify how AIS training should be organized;
- (6) To develop an effective AIS training syllabus.

## **1.3 Order of Presentation**

The order of presentation is arranged in a logical sequence to focus and attain the desired objectives of this dissertation. In Chapter II, challenges resulting from new technology on bridge will be discussed. IBS can provide a navigator for quick and accurate information, however it induces the navigator to be over-reliant on IBS. In addition, working with IBS may result in the navigator losing the traditional navigational skill and the "feel" of situations around the ship. Furthermore, information flow chart may be changed unconsciously. As a member of IBS, not only has AIS all the above features but it also has its unique challenges to the navigator.

By 1 July 2004, all SOLAS ships have to be fitted with AIS. The safety issues are of much concern. Chapter III will examine several AIS triggered safety issues. This chapter will focus on carriage requirements of AIS by relevant regulations; types of AIS; non-AIS ships; connecting problems of AIS; AIS impacts on detection of collision Risks; AIS training issues; integrations of AIS with IBS.

To know well about the advantages and limitations of using AIS on board is key to developing an effective AIS training syllabus. In Chapter IV, the advantages and limitations of AIS will be discussed. This chapter mainly deals with AIS merits in managing collision avoidance and deficiencies related to safety. Several risks related to using AIS in collision avoidance will be examined and evaluated, such as issue of COLREGs violation by vessels during collision avoidance manoeuvres; risk to small boats; Inaccuracy of AIS information; risk by poorly located AIS display units; switching off AIS.

Analysis of Limitations of current AIS training, both on-board and on-shore, will provide a basis to improve the competency of AIS training. Chapter V focuses on the drawbacks of AIS training. Existing legal instruments will be examined to find implicated requirements of AIS training. Certain provisions of SOLAS, COLREGs, STCW and IMO resolutions are carefully studied. Meanwhile, current situation of AIS installation on bridge is discussed as guidance for training objectives. Current situations of AIS training both on board and on shore are examined to find their limitations. The study provides a road map to improve effectiveness of existing AIS training.

The issues of how an effective AIS training could be organized is discussed in Chapter VI. Experience of GMDSS training is used as a reference to propose a well-organized AIS training. Training for using both MKD AIS and integrated AIS is proposed. Key elements of what should comprise the in an effective syllabus are listed. Certain issues of on board ASI training are also discussed.

In the final chapter, based on the study of this dissertation, several safety issues related to new technology, especially to AIS, have been included. These conclusions can be referred to develop a company safety policy, on board AIS training procedures and activities, safety culture establishment. Meanwhile, several recommendations have been given with regard to how both on shore and on board

AIS training should be organized. An AIS training syllabus has been proposed for training centers to refer to develop individual training programs.

#### **1.4 Scope and methodology**

Contact was made with a few AIS technical experts who have provided important technical materials to contribute the study. A literature search was extensively undertaken to examine what findings have been got by current AIS trails and other research. Some visiting and resident experts in the field at the World Maritime University were interviewed to seek their opinion and advice. IMO relevant resolutions, AIS trail reports and AIS related papers, as well as some AIS-related proposals submitted by IMO Party States during IMO Subcommittees' meetings were collected and examined to support the study. The author also used his personal experience as a deck officer and as a GMDSS training officer. This experience helped to identify main issues relevant to the objectives of the research.

During the field trip to Germany, the author has been on board two Ro-Ro ferries and interviewed duty officers for seeking their opinion and perspectives on AIS application. The author also has got an opportunity to view how AIS works on board. This experience has greatly benefited this study.

In order to achieve the goals of this paper, the author has examined 4 high-tech assisted marine accidents and air clash disasters. Meanwhile potential risks caused by the introduction of new technologies on bridge have been discussed. Therefore the study will contribute to find out why traditional navigational skills are important to be used as back-up measures to ensure the safety in event of failure of positioning equipment in IBS, such as GPS, AIS etc.

## **Chapter II**

### **Recent Technological Challenges on a Ship's Bridge**

#### **2.1 Introduction**

On the bridge of modern ships technological change can be found everywhere. Two decades ago, isolated installed electronic equipment was the featured layout of the traditional bridge. Today, post-isolated installed electronic equipment has been integrated into an E-Shaped IBS. With IBS, navigators are more inclined to interpret the information shown on a screen for decision making and less by visual observation themselves; navigators having got benefited from this. However, there are some potential risks with IBS; the latest technology-AIS has been introduced on the bridge and the carriage of an AIS for all SOLAS ships has become mandatory. Using AIS effectively is another challenge.

#### **2.2 Changes of Technology on Bridge**

An IBS consists of an integrated navigation system (INS), integrated control system (ICS), individual steering and propulsion controls, machinery monitoring, fire detection, cargo control etc. Engineers intend to separate IBS into two parts, i.e. INS, which is used by a navigator for navigating and conning the vessel, and a technical management system, which can be considered as a totally separate system.

According to the IEC, IBS is:

Any combination of systems that are interconnected in order to allow centralized access to sensor information or command /control from workstations to perform two or more of the following operations: passage execution; communications; machinery control; loading, discharging and cargo control; safety and security. Management operation may also be performed within the IBS. (Fairplay Solutions, 1999, p.25)

In contrast, Mr. Alastair Messer, a surveyor in LR's control engineering department, defines INS as a combination of systems that are interconnected to increase safe and efficient operation navigation by suitably qualified personnel and would typically include GPS, radar, chart, etc. He further summarizes that INS is specific, whereas IBS is generic (Fairplay Solutions, 1999, p.25). STN ATLAS (2004) includes a diagram to show the relationship between INS and IBS. See Appendix V.

New technology applied in IBS has vastly improved situational awareness for bridge decision-makers simply because of accelerated information processing and superior displays (Luniewski, 1999, p.41). Over the past several decades, a navigator has been busy in fixing ship's positions mainly by GPS and Radar observations, especially during sailing in narrow waters, heavy-density traffic zones and shallow water areas etc. Today, ships have become bigger and faster. The faster the ship the more nervous a navigator may become, simply because it sails further than a slower one in the same period of time. For example, a traditional ship, which has a speed of 15 knots, can only make 1.25 nautical miles in 5 minutes, while a container ship with a speed of 25 knots can sail 2 nautical miles in 5 minutes. Some captains require navigators to present a ship's position in shorter intervals than 5 minutes. One can imagine how heavy the workload is for the navigator. Fortunately, the situation is different on today's bridge, on which IBS releases a heavy workload in certain aspects. With IBS, a junior officer can only stand in front of a screen on which information from different sources can be shown in one.

Luniewski (1999, p.42) explains that this is a revolutionary shift from the days of manoeuvring on board, grease pencil CPAs and three-minute fixes. Information presentation on the modern bridge allows navigators to execute, at a glance, the data collection and collation functions.

The Electronic Nautical Chart (ENC) can provide a navigator an accurate visual position. He/she can “see” where ships are and where ships are going as well as where ships will sail in 3 or 5 minutes. The track on ENC presents a navigator with visual routes that the ships have followed at an earlier stage. Therefore there is a dynamic presentation of a ship's track and a navigator can easily find out if the ship is sailing according to the passage plan. Hence, a navigator is released from the heavy task of paper chart working, not only position fixing but also passage preparation.

The fixes shown on the ENC can be accurate within a few meters and is updated every 15 seconds. Real-time position presentation on ENC with frequent position updates allows a navigator to be well aware of his/her surroundings. In addition, the ENC can show an electronic "voyage plan" which provides navigators with turn recommendations, compensating course recommendations to correct for set and drift and other elements. One can conclude that these features will greatly ease the burden of a navigator and minimize human error.

Luniwwski (1999, p.44) adds:

Compared with paper charts, which are considered the most labour-intensive task, ECDIS automated chart management capabilities will achieve large savings in man power and increased safety. On-line correction or CD correction will greatly ease heavy burden of officers to correct paper charts from printed and broadcast Notices to Mariners.

## 2.3 Disadvantages of IBS

“It is on men that safety at sea depends and they cannot make a greater mistake than to suppose that machines can do all their work for them”

*(Justice Cairns, in the English Admiralty Court, 1967)*

### 2.3.1 Risks of Over-reliance on IBS

IBS processes data much quicker and provides information more accurately than the old systems. Therefore a navigator may become over-reliant on the system and gradually lose the capability to detect any false information when the system goes wrong. The system can provide navigators with what they want to support decision making in a much quicker and more accurate way. Therefore, they are going to trust the system and become more and more dependent on it. In other words, they just simply trust what the system provides. However, when suddenly something goes wrong, it is very difficult for navigators to quickly recognize what has gone wrong, or if they know what has gone wrong, they do not exactly know why it has gone wrong, because what they see day-by-day is the result of computer processed data, and they are not involved in the process to work out the result. Therefore they lack the ability to track the problem from the result back to the process and, in turn to the origin of problem.

The report of the investigation of the TRANSIT Flight 238 accident shows that the parameters shown in the meters on the information board indicate something wrong in the fuel tanks, but the parameters can not lead pilot to recognize there was a leak of oil. In other words, a pilot could not imagine there was a leak of fuel oil by interpreting the parameters in the meters of the fuel oil tanks (Discovery Channel, 25<sup>th</sup> April 2004).

Although there is more time for a navigator on board ship to interpret problem-related parameters than on board an airplane, less practice makes the navigator lose the ability to anticipate problems and interpret problem-related parameters.

The US National Transportation Safety Board (NTSB) has released a report of the investigation into the ROYAL MAJESTY's grounding, which occurred in 1995. The report shows that a navigator was of over-reliance on the automated features of the IBS, and had insufficient training in the technical capabilities and limitations of the system. He also had poor practice in watch keeping with new technologies. Some specific factors that contributed to the accident are: the echo sounder alarm had been set to zero depth; the navigator had inefficient monitoring of the status of the GPS and had no cross-checking of the GPS derived positions (NTSB, 2004).

Cross-checking of the GPS derived positions with other positioning instruments needs to be emphasized. A navigator should be aware that over-reliance on the new technology is a risk.

Additional training is needed to make navigators adapt to the use of new technology and to know new technology's capabilities and limitations. To interpret information and use this to increase safety is important.

### **2.3.2 Loss of Traditional Navigational Skills**

Traditional navigational skills (TNS) have been developed over centuries. These skills are condensed professional skills that have been passed down from predecessors and they are definitely important in sailing a ship safely at that time. The young generation today faces both traditional navigational skills and modern technology-based computerization. There is a choice that either people use only new technology or both. Currently it is easy to say that seafarers need both because they still have the opportunity to work on traditional ships. In the future, will people still need traditional navigational skills? There should be more research into this issue. Young cadets will argue that what they learn in school is not useful on board because the skills are out of date and not adapted to IBS. Furthermore, computers can manage many of those tasks. Therefore cadets may think it is a



waste of their time to learn such old skills that will never be used and the training syllabus should be changed to reflect the needs of the new technology.

However, most important is to be aware that the system is not designed to manage everything. What the system does is to calculate, monitor, control, such as ETA, passage plan, cargo operation etc. It is designed to help a navigator but not to replace him/her. In other words, the system is a tool, an aid, but not a new brain. Being aware of this is important for safety. A Captain should be aware that navigators, rather than systems, must carry out necessary functions.

Navigators have known that just before the year 2000, the Y2K problem was a hot issue. Scientists had anticipated it might cause a lot of problems to computer systems on board ships. Navigators were taking celestial fixes to prepare for the sudden failure of GPS. Since then, navigators have become to realize that traditional navigational skills are still useful. Today, these skills should be used to do crosschecking. Therefore, in the case of a GPS failure, navigators should still be able to make a celestial fix. In addition, the Loran-C system, which is a backup system of GPS, can be used to fix a ship positions in the event of a GPS failure. Therefore, traditional navigational skills (TNS) should be passed on to the younger generation. The more TNS they have, the stronger ability they will have to handle technical problems and anticipate system failures.

### **2.3.3 Lost “Feel” for Situations**

A navigator can easily lose the “feel” of a situation when working with IBS. The traditional duties of a navigator make him or her know the ship's positions well. Every 30-minute GPS or Radar fix on the chart makes the navigator aware of the surroundings. Therefore the navigator will instinctively check if the ship is keeping to the plan. No doubt, this procedure will benefit safety. Furthermore, during this

well accepted process, a navigator's capability of controlling, monitoring, and observing has been maintained and even more built up step-by-step. However, computers can do what the navigator was supposed to do before. An accurate GPS position is shown on an electronic chart every 6 minutes, including various vectors or data related to a ships' maneuvering. Even better, overhead presentations with large figures show all the information necessary for decision making. Meanwhile, a Captain does not have to ask a junior officer for information. The Captain simply glances at the screen and knows what information they want to get. Then, they do what is needed with a little push or pull. Finally the ship drives itself according to the Captain's orders.

gardnews (1999, p.11) identified that bridge automation takes the responsibility away from the individual and this can lead to boredom, daydreaming, monotony and a lack of stimulation. There is no need for celestial fixing and no need for 30-minute GPS positioning on charts. This feature contributes less busy times, especially when vessels are in the deep sea. Not being able to converse with a fellow human being for a long time might make officers less sensitive to certain surroundings and it is easy for the mind to wander.

#### **2.4 The Introduction of AIS into the Ship's Bridge**

IALA has presented the first proposal of AIS to IMO. The initiative of IALA to develop AIS is to identify Radar targets within the VTS coverage, since VTS operators have problems in identifying Radar targets. However, the potential of AIS to benefit ship maneuvering has been quickly recognized and AIS has begun to be introduced on ships.

AIS is a ship and shore based broadcast system, operating in the VHF maritime band. It will provide a series of other ship's information for navigators, i.e. ship's name, call sign, bearing and distance, size and draft of ships, port of destination, the change

in a ship's heading, course/speed over ground, rate of turn, etc. Some of this information is important to ship safety.

According to IMO Resolution A.917(22), AIS has been introduced to help identify ships; assist in target tracking; simplify information exchange; and provide additional information to assist situation awareness (IMO, 2002b). Appendix I shows an overview of the AIS system and its components.

The original IMO timetable requires all SOLAS ships to be fitted with AIS no later than 2008. However, the events of "9/11" have forced the timetable to shrink. In fact, all SOLAS ships have to be fitted with AIS by 1 July 2004. Whether being accepted or not, AIS has been a member of IBS (Refer to Appendix V). Some AISs are stand-alone units, while others are integrated with Radar/ARPA or ECDIS etc. However not many are so. gardnews (2002, p.11) argues that ship operators installed AISs on their ships with the minimum cost to meet the minimum carriage requirements without understanding their benefits and limitations and without paying much attention to navigator training in using AIS properly. With a little or no training, navigators have to use AIS to serve safety as well as security. AIS experts have recognized its potential for safety. However, they are still working hard to discover AIS's limitations. Poorly trained OOWs would make AIS potential compromised and might contribute to AIS-assisted accidents. Thus, some safety-related issues resulting from AIS have been debated recently.

Summary: Navigators have benefited from IBS, however its risks to safety have come out simultaneously without being well known. The newcomer, AIS, is supposed to contribute more to safety, but without being well understood by the navigators, AIS could make IBS's risks much higher to safety than before. Therefore, it is essential to study AIS's capabilities and limitations, especially on collision avoidance and situation awareness. Officers who have to use AIS should be well trained in its use.

## Chapter III

### AIS Triggered Safety Issues

“...Until now we have been very busy in getting technology under control.”

*(Patrick O’Ferrall, Chairman of Lloyd’s Register, 1996)*

#### 3.1 Introduction

Due to the accelerated process of AIS installation on all SOLAS ships, manufactures have not been left much time to develop their AIS products. They have been pushed hard to meet the minimum requirements to catch the surge in AIS installation within the shipping industry. A series of trials with objectives to evaluate AIS’s value as a navigation aid have been carried out over the past few years and experts are still working on further trials and the evaluation of the results. Navigators have appreciated the benefits of AIS to safety but at the same time, the AIS experts and users find that there are several inherent deficiencies and technical problems that have been left unsolved.

Several problems are highlighted, such as the non-integration between AIS and other electric equipment of IBS; risks to non-AIS small ships; the poor location of the AIS display unit on the bridge; wrong and uncoordinated message transfer; interference among Radar, AIS, GPS etc.

### **3.2 Carriage Requirements of AIS**

To be aware of what ships have been fitted with AIS is a pre-condition in examining the limitations of AIS and its effect on safety. In addition, some ships have been fitted with Class A AIS, while others are about to be fitted with Class B AIS. Both Classes of AIS have effects on safety. According to SOLAS Chapter V Regulation 19, the carriage requirements of AIS are mandatory for certain types of ships. Meanwhile, the U.S. carriage requirements of AIS laid down in the Maritime Transportation Security Act of 2002 (MTSA) extend to the effects on self-propelled vessels of 20 meters or more in length. Furthermore, some standards and guidelines of AIS adopted by IMO describe how AIS should perform, how it should be operated and where it should be fitted.

#### **3.2.1 AIS carriage requirements of SOLAS Chapter V Regulation 19**

According to Regulation 19, all ships of 300 GRT or upwards would have been fitted with AIS by 1 July 2004. The details in Regulation 19 are as follows:

2.4.2.4 in the case of ships, other than passenger ships and tankers, of 300 gross tonnage and upwards but less than 50,000 gross tonnage, not later than the first safety equipment survey after 1 July 2004 or by 31 December 2004, whichever occurs earlier. (IMO, 2002a)

Warships, naval auxiliaries and other ships owned or operated by governments are not required to be fitted with AIS (IMO, 2002a). The majority of leisure craft and fishing vessels are unlikely to be fitted with AIS for many years to come, if ever. Also, objects, such as containers lost overboard, other flotsam and ice obviously will not be fitted with AIS (Stitt, 2004). Off-shore platforms and navigation aids are also not required to be fitted with AIS according to SOLAS.

### 3.2.2 U.S. Carriage Requirements of AIS

The MTSA (2002) delineates the U.S. AIS carriage requirements. The requirements are nearly identical to SOLAS. The special requirements are as follows:

§ 164.46 Automatic Identification System (AIS)

(a.1) Self-propelled vessels of 65 feet or more in length, other than passenger and fishing vessels, in commercial service and on an international voyage, not later than December 31, 2004. (USCG, 2004)

### 3.2.3 AIS Standards and Guidelines

Currently, there are several standards and guidelines to affect the performance of AIS.

- (1) IMO Resolution MSC.74 (69), Annex 3, i.e. *Recommendation on Performance Standards for a Universal Ship borne Automatic Identification Systems (AIS)*.
- (2) ITU-R Recommendation M.1371-1, i.e. *Technical Characteristics for a Universal Ship borne Automatic Identification System Using Time Division Multiple Access in the Maritime Mobile Band*.
- (3) IEC 61993-2 Ed.1, *Maritime navigation and radio communication requirements - Automatic identification systems (AIS) - Part 2: Class A ship borne equipment of the universal automatic identification system (AIS) - Operational and performance requirements, methods of test and required test results*
- (4) IMO Resolution A.917 (22), i.e. *Guidelines for the onboard operational use of shipborne automatic identification system (AIS)*.
- (5) IMO SN/Circ. 227, *Guidelines for the installation of a shipborne automatic identification system (AIS)*.
- (6) IALA *Recommendation on AIS Shore Stations and Networking Aspects Relating to the AIS Service, Edition 1.0, September 5, 2002*.

(USCG, 2004)

### 3.2.4 Types of Automatic Identification Systems

There are two types of AIS, i.e. Class A and Class B.

- (1) Class A is the ship-borne mobile equipment intended for vessels meeting IMO AIS carriage requirements.
- (2) Class B is the ship borne mobile equipment, which provides facilities not necessarily in accordance with IMO AIS carriage requirements. IEC has begun work on a Class B certification standard, which should be completed by 2004 - 2005. The Class B is nearly identical to the Class A, but with the following exceptions:

- Has a reporting rate less than a Class A (e.g. every 30 sec. when under 14 knots, as opposed to every 10 sec. for Class A);
- Does not transmit the vessel's IMO number or call sign;
- Does not transmit ETA or destination;
- Does not transmit navigational status;
- Is only required to receive, not transmit, text safety messages;
- Is only required to receive, not transmit, application identifiers;
- Does not transmit rate of turn information
- Does not transmit maximum present static draught

(USCG, 2004)

### 3.3 AIS Information

The IMO Resolution A.917 (22) states that the purpose of AIS is to help identify vessels; assist in target tracking; simplify information exchange (e.g. reduce verbal mandatory ship reporting); and provide additional information to assist situation awareness. The on-board AIS broadcasts a series of standardised information to achieve the purpose.

### 3.3.1 The Information Provided by AIS

According to IMO Resolution MSC 74(69), the information provided by AIS should include the following.

- (1) I.D.: MMSI number (Maritime Mobile Service Identify)
- (2) Static:
  - IMO number (where available)
  - Call sign & name
  - Length and beam
  - Type of ship
  - Location of position-fixing antenna on the ship (aft of bow and port or starboard of centerline)
- (3) Dynamic:
  - Ship's position with accuracy indication and integrity status
  - Time in UTC
  - Course over ground
  - Speed over ground
  - Heading
  - Navigational status (e.g. NUC, at anchor, etc. - manual input)
  - Rate of turn (where available)
  - Optional - Angle of heel (where available)
  - Optional - Pitch and roll (where available)
- (3) Voyage related:
  - Ship's draught
  - Hazardous cargo (type)
  - Destination and ETA (at Master's discretion)
  - Optional - Route plan (waypoints)
- (4) Short safety-related message

(IMO MSC 74 (69), May 1998)



In addition, according to IMO Resolution A.917 (22), navigational statuses that are recommended to use are listed as follows<sup>1</sup>:

- (1) Underway by engines
- (2) At anchor
- (3) Not under command (NUC)
- (4) Restricted in ability to maneuver (RIATM)
- (5) Moored
- (6) Constrained by draught
- (7) Aground
- (8) Engaged in fishing
- (9) Underway by sail

(IMO A.917 (22), 25th January 2002)

### 3.3.2 AIS Information Update Rates

According to the IMO performance standards (IMO A.917 (22)), the data is autonomously sent at different update rates:

- (1) Dynamic information dependent on speed and course alteration (see Table 3-1),
- (2) Static and voyage related data every 6 minutes or on request (responds automatically without user action).

Type of ship	Reporting interval
Ship at anchor	3 min
Ship 0-14 knots	12 sec
Ship 0-14 knots and changing course	4 sec
Ship 14-23 knots	6 sec
Ship 14-23 knots and changing course	2 sec
Ship >23 knots	3 sec
Ship >23 knots and changing course	2 sec

Table 3- 1: Report Rate of Dynamic AIS Information

<sup>1</sup> Navigational status information has to be manually entered by an OOW and changed as necessary. In practice, since all these relate to the COLREGs, any change that is needed could be undertaken at the same time that the lights or shapes were changed.

### 3.4 Display of AIS Information

The AIS provides data that can be presented on the minimum display or on any suitable display. In the 50<sup>th</sup> session of IMO NAV 50, a Performance Standards for Radar Equipment are proposed by Norway. The presentation of AIS on radar is also included in the standards.

#### 3.4.1 Minimum Display

The minimum Keyboard display, so called MKD, provides not less than three lines of data consisting of bearing, range and the name of a selected ship. Other data of the ship can be displayed by horizontal scrolling of data, but scrolling of bearing and range is not possible. Vertical scrolling will show all the other ships known to the AIS<sup>1</sup>. In Appendix IX of this paper, there is a Figure “AIS-Minimum Keyboard Display” to show an AIS Display unit with Minimum Keyboard Display (MKD). Only a ship’s MMSI, names, range and bearing are shown on the screen. If the OOW wants to identify a Radar target, he/she needs to associate the Radar target with an AIS target by AIS target’s range and bearing. Sometimes, it is difficult for OOWs to associate an AIS target with a Radar target. Professor Berking (August 2004) argued in an AIS-related lecture at World Maritime University in Malmö Sweden that the MKD of AIS information is worth less to improve the safety of navigation

#### 3.4.2 Graphical Display

AIS information can be shown on a stand-alone graphical display. Where AIS information is used with a graphical display, the following target types are recommended for display<sup>2</sup>:

- (1) Sleeping target-A sleeping target indicates only the presence of a vessel equipped with AIS in a certain location. No additional information is presented until activated, thus avoiding information overload.

---

<sup>1</sup> IMO A.917 (22), 25th January 2002.

<sup>2</sup> IMO A.917 (22), 25th January 2002.

- (2) Activated target-If the user wants to know more about a vessel's motion, he has simply to activate the target (sleeping), so that the display shows immediately:
  - A vector (speed and course over ground),
  - The heading, and
  - ROT indication (if available) to display actually initiated course changes.
- (3) Selected target-If the user wants detailed information on a target (activated or sleeping), he may select it. Then the data received, as well as the calculated CPA and TCPA values, will be shown in an alphanumeric window. The special navigation status will also be indicated in the alphanumeric data field and not together with the target directly.
- (4) Dangerous target-If an AIS target (activated or not) is calculated to pass pre-set CPA and TCPA limits, it will be classified and displayed as a dangerous target and an alarm will be given.
- (5) Lost target-If a signal of any AIS target at a distance of less than a preset value is not received, a lost target symbol will appear at the latest position and an alarm will be given.

The stand-alone graphical display of AIS information can present more information than the MKD, such as a ship's heading, ROT, COG, SOG etc. Although AIS targets are presented as symbols and are categorized, one major drawback of the stand-alone graphical display is that AIS targets are not automatically associated with Radar targets.

### **3.4.3 Radar Display**

AIS and Radar data association was highlighted in the 50<sup>th</sup> session of IMO NAV 50. The proposal of the Performance Standards for Radar Equipment submitted by Norway states that the most logical display for indication graphically AIS

information from other ships is the radar display. Radar tracking information can also be significantly enhanced by incorporating information available from AIS (IMO NAV 50, April 2004).

In the Performance Standards, AIS target capacity, filtering of AIS sleeping targets, activation of AIS targets, AIS presentation status, AIS graphical presentation, AIS target data, operational alarms as well as AIS and radar target association are mentioned. As long as the proposal is adopted and enters into force, the new radar equipment should be capable of presenting AIS information and meet the requirements. In order to avoid the presentation of two target symbols for the same physical target, the principles of AIS and Radar target association are qualified as follows:

- (1) If the target data from AIS and radar tracking are both available and if the association criteria<sup>1</sup> (e.g. position, motion) are fulfilled such that the AIS and radar information are considered as one physical target, then as a default condition, the activated AIS target symbol and the alphanumeric AIS target data should be automatically selected and displayed.
- (2) The user should have the option to change the default condition to the display of tracked radar targets and should be permitted to select either radar tracking or AIS alphanumeric data.
- (3) For an associated target, if the AIS and radar information become sufficiently different, the AIS and radar information should be considered as two distinct targets and one activated AIS target and one radar-tracked target should be displayed. No alarm should be raised. (IMO NAV 50, April 2004).

In the Appendix X, there is a Figure “AIS and Radar Data Association” to show how AIS and Radar data are associated. In this Figure, AIS targets are presented with

---

<sup>1</sup>Simplified Static Association Criteria: Range < 5%; Bearing < 5°; Speed < +/-5 kts; Course < +/-20°. (Berking, 2004)

small triangles. Each triangle is associated with a single radar target. The OOW can easily identify which radar target is associated with which AIS target. By selecting of any AIS target, the OOW will know the particulars of the radar target.

### 3.5 Non-AIS Ships

There are some ships that are not required to carry an AIS, such as non-SOLAS ships, SOLAS ships of less than 300GRT and ships engaged in national voyages, which are less than 500GRT. Therefore, an AIS cannot detect them. In order to remind OOWs of being aware of non-AIS ships, cautions are given in IMO Resolution A.917 (22). They are as follows:

#### CAUTION

- (1) Not all ships carry AIS.
- (2) The officer of the watch (OOW) should always be aware that other ships, in particular leisure craft, fishing boats and warships, and some coastal shore stations including Vessel Traffic Service (VTS) centres, might not be fitted with AIS.
- (3) The OOW should always be aware that AIS fitted on other ships as a mandatory carriage requirement might, under certain circumstances, be switched off on the master's professional judgment.

(IMO, 2002b)

Experts, who attended the trial of the 2002 Test of AIS<sup>1</sup>, suggest that regulators and coastal authorities should require boats that are longer than 20 m to carry AIS, and

---

<sup>1</sup> The AIS Test in British Columbia Summer 2002 is a project where the Bridge Teams of 3 modern cruise ships evaluated the current implementation of AIS during the summer of 2002 while cruising British Columbian and S. E. Alaskan waters. Their evaluation resulted in findings and recommendations aimed at improving its value as a navigation aid. For information, refer to <http://www.uais.org/CruiseShipIIFinalReportV1.2.htm>

the regulators should simplify the technical requirements for class “B” transponders, so that their component and production costs can be reduced. Furthermore, coastal authorities should broadcast ARPA targets of ships and boats that are not fitted with AIS and are longer than 20 m in LOA (UAIS, 2004).

### **3.6 Connecting Problems with Pre-1995 Versions of GPS**

According to IMO Resolution SIN/Cir 227, sensors installed to meet the carriage requirements of SOLAS Chapter V should be connected to AIS. The sensor information transmitted by AIS should be the same information being used for navigation of the ship (IMO, 2003a). Therefore, existing GPSs, as well as other sensors that have been used for navigation of ships, are recommended to be connected to AIS. However, because of different versions of communication protocols, problems with connecting AIS with existing sensors exist.

Pot (2002a) points out that proper installation of AIS on older ships is complicated by the requirements that AIS broadcasts positions, SOG and COG from the same GPS being used for navigation, because Pre-1995 versions of GPS use old communication protocol that AIS does not understand. The same problems exist when connecting AIS with other sensors. The United Kingdom has submitted a proposal to review resolution A.917 (22) where it has mentioned similar problems as follows:

To meet the Performance Standards in Resolution MSC. 74(69), AIS equipment must be interfaced to an external Electronic Position Fixing System (EPFS - most commonly GPS). However, some older EPFS that do not meet the latest IMO performance standards in Resolution MSC. 112(73) are interfaced to AIS. In addition, older EPFS equipment may not include any significant check on the integrity of the data being sent to the AIS transmitter. This is also true for other sensors connected, such as compass, Rate Of Turn (ROT) (where installed) and speed log. (IMO NAV 50/4/2, April 2004)

The response to the UK's proposal is that NAV 50 has decided not to change A.917 yet, but to keep an Eye on AIS problems in practical onboard use. According to Resolution of A.917 (22), an AIS consists of, among others things, a built in GPS for timing purposes and position redundancy (IMO, 2002b). See Appendix I. Even though GPS with new communication protocol can provide ship positions for AIS, the ship's positions transmitted by AIS should be the same ones that are derived for the GPS used for the navigation of the ship.

### **3.7 AIS Impacts on Detecting of Risks of Collision**

Berking & Pettersson (2002) note that there are some concerns on AIS, i.e. AIS might replace radar; mariners might over-rely on AIS; and COLREGs might be unduly changed or disobeyed.

#### **3.7.1 AIS does not Replace Radar**

The potentials and objectives of AIS both in ship-ship and ship-shore communication are to:

- (1) Identify vessels;
- (2) Assist in and improve target tracking (near real-time, ground-stabilized, small risk of target loss);
- (3) Immediately present course alterations of targets;
- (4) Provide additional information to determine risks of collision;
- (5) Provide an overview and improve traffic flow;
- (6) Reduce and simplify (verbal) information exchange.

(Berking & Pettersson, 2002)

The limitations of Radar can be summarised as follows:

- (1) Radar does not allow identification of other targets;
- (2) The display of radar target echoes may be obscured by clutter;
- (3) Radar coverage (range performance) may be limited by rain and snow;

- (4) Target detection is limited by masking (bends, bridges, other objects);
- (5) The shape of the echo display may appear different from the shape of the target. Thus, the centre of reflection is different from the centre of the target;
- (6) The discrimination of targets close to each other is limited;
- (7) For tracking, radar echo based positions and velocities must be smoothed. Consequently,
  - All ARPA data are delayed; in particular;
  - Manoeuvre detection is significantly delayed.
- (8) Automatically tracked targets may be lost due to clutter, fast manoeuvres and target swap.

(Berking & Pettersson, 2002)

It seems that AIS can compensate Radar's deficiencies, especially in the identification of targets and instant manoeuvre detection etc. Therefore, it is reasonable for people to remain in some doubt that AIS would replace Radar in the near future and become an important tool for safety and a powerful source of supplementary information available to OOWs for collision avoidance.

However, since not all ships are equipped with AIS, or the AIS might be switched off at the Master's discretion, it could not provide an accurate picture of traffic flow around ones own ship. Berking & Pettersson (2002) emphasise that it is essential to keep the radar on-board and use it as usual as the most important tool for collision avoidance. Also, Pettersson (2001) emphasises that navigators should be aware of the differences between Radar and AIS and of the importance of turning Radar on to detect non-AIS small ships. Furthermore, people are further worried that with an AIS display on a Radar/ARPA or ECDIS screen, an OOW might ignore "fine tuning" the Radar to detect small ships. Finally, IMO Resolution A.917 (22) suggests that:



AIS is an additional source of navigational information. It does not replace, but supports, navigational systems such as radar target-tracking and VTS; and the user should not rely on AIS as the sole information system, but should make use of all safety-relevant information available. (IMO, 2002b)

### **3.7.2 AIS Impacts on the COLREGs**

In an article dealing with how AIS interacts with COLREGs, Still (2004) has examined several Rules and discussed what kind of effects AIS would have on COLREGs. He concludes that AIS is nothing more than one of several tools that should enable navigators to execute their existing obligations under the COLREGs and AIS does not change directly the requirements of the Rules, although it does provide an important source of additional information to enhance OOWs' "situation awareness". However, he argues that Rules 6 and 7 may have to be amended to provide specific guidance on the use of AIS and to recognise the effect of AIS. In addition, Rule 19 will need to be amended, because AIS will provide another tool to assist in determining if a risk of collision exists. In particular, Rule 19(d) should reflect AIS's potential.

Furthermore, IMO Resolution A.917 (22) suggests that:

The use of AIS does not negate the responsibility of the OOW to comply at all times with COLREGs. The use of AIS on board ship is not intended to have any special impact on the composition of the navigational watch, which should continue to be determined in accordance with the STCW Convention. (IMO, 2002b)

Berking & Pettersson (2002) emphasise that there may be agreed action contradictory to COLREGs between ships. Their answer regarding the question whether COLREGs need to be amended because of the introduction of AIS is no.

### 3.7.3 Over-reliance on AIS

Being recognized that AIS can provide more information than needed, and also being aware that AIS has limitations of its sources of data input, experts worry that OOWs would tend to be over-reliant on AIS. This issue was highlighted during the IMO NAV 50<sup>th</sup> session. Besides the mentioned problems in Section 3.4 of this Chapter, the proposal further emphasises that:

It is recognized that Problems have been experienced with regard to setting up AIS installations on board ship to Ensure that the correct static, dynamic and voyage related information will be transmitted. There is therefore a concern that over-reliance on AIS information for navigational safety Should be avoided until steps can be taken to ensure that all transmitting ships provide the Necessary degree of data accuracy and integrity for all connected sensors and that the existing Guidance in Resolution A.917 (22) does not adequately cover these concerns. (IMO NAV 50/4/2, April 2004)

IMO Resolution A.917 (22) suggests that:

The information given by the AIS may not be a complete picture of the situation around the ship. The accuracy of AIS information received is only as good as the accuracy of the AIS information transmitted. Poorly configured or calibrated ship sensors (position, speed and heading sensors) might lead to incorrect information being transmitted. Incorrect information about one ship displayed on the bridge of another could be dangerously confusing. The user should not rely on AIS as the sole information system, but should make use of all safety-relevant information available. (IMO, 2002b)

### **3.8 The Issues of AIS Training**

Concerns on AIS training will focus on what AIS training should cover and how it should be taught, what a syllabus should contain, what training standards and assessment standards for competency should be, and if AIS training should be mandatory, as well as if the STCW code should be amended to introduce provisions of AIS training. A Model Course covering AIS training should be developed.

Currently there are no legal instruments to be directly referred to creating an AIS training syllabus. Winbow (2003) advises that basic AIS training operations at the level of the minimum installation allowed on board should be addressed. In particular, fundamental skills, such as setting up the AIS, entry and changing of voyage data, changing screens and selecting relevant information etc. must be taught. He further points out besides training for AIS operation, the AIS's use in conjunction with Radar and ECDIS should be addressed during the training. However, the extent to which it should be addressed remains in question. He finally stresses that the use of AIS information and how to correlate AIS data with that from other sources-visual, radar, ECDIS, VHF etc, has to be focused on any training; OOWs should have the knowledge and skills to be able to select the correct source or sources of information before making navigation and other decisions.

### **3.9 The Issues of the Integration of AIS with Radar/ARPA or ECDIS**

According to IMO Resolution MSC.74 (69), AIS should be provided with an interface through which AIS information could be presented on a separate system. Also, referring to Resolution A. 917(22), AIS consists of, among others, interfaces to Radar/ARPA, ECDIS/ECS and INS. If the integration of AIS with this equipment had been achievable, the effectiveness of AIS would be significantly increased. Furthermore, it can be concluded that a MKD with three lines of data is the minimum display requirement. The integration of AIS with other equipment is recommended.

Currently, a three-line MKD of AIS information meets the minimum mandatory carriage requirements. However, it is not accepted to assist OOWs in decision making for collision avoidance. In addition a stand-alone MKD AIS has a screen separated from the Radar/ARPA or ECDIS screen. In the Summary of the 2002 Test of AIS, team members on one cruise ship commented that it is almost impossible for OOWs to monitor 2 or 3 separate screens and, worse than that, OOWs need to associate AIS targets with Radar/ARPA targets. This makes AIS information distracting rather than a supplementary information source for collision avoidance and surveillance awareness. The experts suggest that the regulators and competent authorities are to require SOLAS ships to integrate AIS information on existing navigation screens (UAIS, 2004).

## Chapter IV

### Advantages and Limitations of AIS

It is imperative that shipowners ensure that the gap in the human-technology interface is bridged by providing competent comprehensive training in operation and understanding the limitations of high technology equipment and an awareness of the “distraction” factors. (*gardnews*, 166, May/July 2002)

#### 4.1 Introduction

To know well the advantages and limitations of AIS is important to develop a good training syllabus. From the competency point of view, not only should navigators know how to operate AIS, but they also should know its advantages and limitations. Without the proper knowledge of AIS's limitations, the operation of the system might lead to AIS-assisted accidents.

#### 4.2 Advantages of AIS

Several advantages of AIS have been identified. Most of them are widely recognized, such as ship identification using AIS; real-time dynamic display of AIS information; enlarged coverage of AIS; positive effects on VHF traffic volume; instant detection of ship's data and providing more accurate information etc.

#### **4.2.1 Ship Identification Using AIS**

One of the purposes of AIS on board a ship is to help identify vessels. The AIS information transmitted by a ship is of three different types, e.g. static information, dynamic information and voyage-related information. First, static information can show a ship's particulars. An OOW can anticipate a ship's maneuvering ability based on the ship's length and beam, the type of the ship and the ship's draught. However, it is difficult to achieve this by Radar observation. Secondly, the OOW can call other ships by their names and call signs. It is easy for OOWs to establish communication between ships. In contrast, it is difficult for OOWs to establish voice contact between ships by a radar bearing and distance. Thirdly, AIS can provide an OOW with a ship's real-time positions and its COG and SOG. However, Radar cannot do these. Finally, AIS can provide an OOW with a ship's navigational status; this is another element that is not available with Radar. The ship heading, the Rate of turn, COG and SOG can help an OOW predict the ship path in minutes or in an even long period of time. Radar itself cannot provide a ship's COG and SOG, the Rate of turn. Radar can indicate a ship's heading, but sometimes there is a delay because Radar determination is based on relative motion. This will be proved later in Chapter IV Section 4.2.5. In Appendix VIII of this paper, an example of AIS information display on PC Screen is presented by a Figure. In this Figure, another ship's particulars are shown on the right bottom. Thus the OOW on own ship can know another ship's name, ID, positions etc. that are important for the safety of navigation. On the left side of the Figure, a ship path is plotted which is also important for collision avoidance.

#### **4.2.2 Real-time Dynamic Display of AIS Information**

In a new version of AIS, many impressive symbols of AIS targets can be presented on a Radar or ECDIS screen, such as the relative true scale outline of an AIS target. It is quite easy for navigators to recognize any maneuvers taken by other ships. With some brands of AIS, real time tracking of a ship's movements can be shown on the Radar or ECDIS screen. Therefore, AIS makes navigators quickly recognize the intention of other ships in the vicinity. Most important is that the vectors of a ship's

movements are shown properly, hence navigators can be aware of the intention of the targets at a quick glance. This will definitely ease a navigator's mental stress and workload while passing those critical areas. This feature reduces the possibility of human error introduced in interpreting radar target data or visual observation.

In an AIS Conference in 2003, Eddle Hadnett, a former P&O deck officer, said that no less than 26 different large cruise ships in the summer of 2003 were operating within Alaska's inside passage. The navigational conditions there are complicated due to the confined waters with numerous navigational hazards and large tidal ranges. Under these conditions, AIS is an invaluable tool in assisting the bridge team to effectively manage collision avoidance, reducing the number of close-quarters situations to a minimum (Fairplay, November 2003).

#### **4.2.3 Enlarged Coverage of AIS**

In AIS, VHF frequencies are used to broadcast messages. Therefore, the coverage of AIS should be 20-30 nautical miles. Actually, the coverage would be larger than it is expected. During the author's survey trip<sup>1</sup> on board the ROBIN HOOD, the author noticed that a few far stations had been identified. For example, the three furthest ships on 107 nm, 81nm and 69 nm were examined. Of course, those ships are not relevant to collision avoidance decision-making. Atmospheric ducting results in a great extension of the VHF reception range. It can be concluded that coverage of AIS is larger than that of Radar and Visual lookout.

The frequencies broadcast by AIS can propagate far away, further than the human eye can see visually and the Radar can track. In addition, they can travel over some geographical obstacles, such as hills or buildings. This feature allows AIS to show more targets than Radar can track and navigators can see visually. Furthermore, AIS

---

<sup>1</sup> During the field trip to Germany, the author has been on board Ro-Ro ferries, ROBIN HOOD and NILS HOLGERSSON. This has been the only chance for the author to observe how AIS works on ships and to interview deck officers about their opinions and perspectives on AIS.

was found to be especially useful in presenting targets in Radar blind spots or around bends in rivers etc.

In areas such as dense fog or heavy rain, and narrow waters with complicated geographical situations, AIS makes “hidden” targets visible when “hidden” targets are equipped with AIS units. Phil (2004) says that AIS works independently of Radar and can thus display information about ships around bends in rivers and is not susceptible to target swap. This capability of AIS will help navigators to detect a closing vessel early. The navigator can then set a course to avoid interaction.

#### **4.2.4 Effects on VHF Traffic Volume**

It is believed that Using AIS properly will reduce the traffic volume between ships and VTS operators and improve vessel traffic image accuracy.

##### **4.2.4.1 Reducing Traffic Volume Between Ships and VTS Operators**

Most VTS organizations in the world present their own regulations to cover certain types of ships when approaching or entering the VTS areas. They require vessels to report certain information to VTS centers. For example, when sailing in Singapore Strait VTS areas, navigators need frequent voice exchange with VTS operators. This is time-consuming, especially for navigators with bad spoken English. AIS is found to reduce VHF voice messages and improve safety. The use of AIS would minimise language problems and reduce the chances of vessels misunderstanding messages from a VTS centre and vice versa (IALA, 2002),

The Maritime and Port Authority (MPA) of Singapore completed a pilot project in 1999 to evaluate the performance of such a system and the results from the pilot test indicated that AIS ship transponders could reduce a VTS operator’s time spent on verbal communications by as much as half (UAIS, 2004).

##### **4.2.4.2 Improved Traffic Image Accuracy**

ARPA vessel tracking is sensitive to interference. For example, it is easy to lose targets, due to the interference of rough seas, heavy rain or snow etc. Sometimes



track swap takes place, especially when two vessels are close to each other. This is an inherent deficiency of ARPA track. The proximity of the two close targets makes ARPA confused, and swapping may occur. The result of swapping is that the identification of one track is transferred to the other (IALA, 2002). Although AIS cannot provide a complete picture of the situation around the ship or within VTS areas, it can definitely improve the quality of traffic image and AIS can effectively avoid target swapping.

#### 4.2.5 Instant Detections of Ship's Manoeuvring Intention

The AIS provides other ship's manoeuvring data in nearly real time, while ARPA calculates that based on historic Radar data. With the high rate of data updating, AIS can provide ship's manoeuvring data much quicker than that of ARPA. Consequently, the accuracy of target data can be improved and the effectiveness of action taken can be increased. Berking & Pettersson (2002) indicates the different presentation between AIS data and ARPA ones' using an example as follows:

A long tanker starts to turn to starboard. The ship's heading will then change to starboard, but initially the stern with its antenna will swing slightly to port, as the ship is turning around its pivot point (Fig. 4-1). For some time, the ARPA vector will (at least might) show port. The ARPA radar tracks the part of the ship which gives the best radar return, normally on a loaded

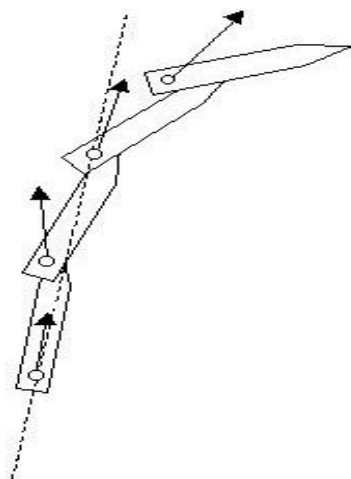

tanker the superstructure at the stern. A big tanker, turning and tracked by ARPA radar, could have turned 40-60°, before this is detected by the ARPA radar on another ship or at the VTS, and 3 –5 minutes could have passed since the turn started. With the AIS sending the heading from the gyro (maximum +/- 2° error) at intervals down to 2 seconds, this misinformation from the radar can be eliminated with a significant improvement in the situational awareness.

Figure 4-1: Potential ARPA “tracking error” or “interpretation error”

(Berking & Pettersson, 2002)

#### **4.2.6 AIS Provides More Accurate Information Than Radar**

In the 50<sup>th</sup> session of IMO NAV, Norway submitted the Draft Radar Performance Standards for Ship-borne Radar Equipment in 2004. In this Performance Standards, the radar system range and bearing accuracy requirements are defined as follows:

- (1) Range: within 30m or 1% of the screen range scale in use, whichever is greater;
- (2) Bearing: within 1°.

Meanwhile, Tracked Target Accuracy is defined as such that measured target range and bearing should be within 50m (or +/- 1% of target range) and two degrees.

In contrast, IMO MSC adopted the Resolution MSC.112 (73)-The Revised Performance Standards for Ship-borne GPS Receiver Equipment in December 2000. In this Performance Standards, Paragraph 3.15 states that when a GPS receiver is equipped with a differential receiver, performance standards for static and dynamic accuracies should be 10 m (95%).

In addition, Berking & Pettersson (2002) claims that firstly the ship's Radar/ARPA can provide a ship's position with the accuracy less than 30m. But the accuracy of AIS ship's positions is between 1 and 5m. Secondly, the CPA and TCPA determined by Radar/ARPA are based on the radar distance and bearing. And the accuracy of CPA determined by ARPA is within 0.5 to 0.7 nm. However, the CPA and TCPA provided by AIS are based on D/GNSS. See Appendix IV. Therefore, it can be concluded that the AIS information is more accurate than Radar's.

#### **4.3 Limitations of AIS**

Apart from considerable direct benefits to navigators and shore-based authorities, there are several safety issues concerned, such as the passing arrangement against COLREGs; risks to small boats; switching off AIS; the potential for its misuse by pirates, armed robbers or terrorists etc.

### **4.3.1 Passing Arrangement Against COLREGs**

The capability of AIS to identify nearby vessel traffic is likely to induce navigators to make passing arrangements individually. It is much easier to do this than before the introduction of AIS. Nowadays, both ships that are in a close quarters situation are identified by name, motion vectors etc. Navigators will tend to contact each other to make passing arrangements against COLREGs. Before the introduction of AIS, navigators used to make a call on VHF to attempt to identify each other and find out if they are the ones at risk of collision. In some cases, a navigator was calling the other, but the other did not respond, even though he/she knew they had been called. In fact, most Chinese navigators tend to do this. Sometimes, it is difficult to get positive identification, even though the conversation is being established. Therefore, there was always a possibility that the ships that have contacted each other are not actually the ones talking. Navigators have learnt lessons from collisions that resulted from this kind of conversation and are aware of that. Naturally they tend just to comply with COLREGs even if the conversation is established between ships and kept alert until the risk is over.

With AIS, the barrier of misidentification is minimized. Navigators know well the ships they want to talk with and they are confident in making private arrangements. There are no more fears left to make private agreements that may be against COLREGs. When they do that, it definitely confuses nearby ships, because the nearby ships will observe unusual behaviour done by the two ships at that moment. The final report of the 2002 Test of AIS suggests that making private passing arrangements would be dangerous because other nearby ships, even if they were equipped with AIS, would not be aware of the specific arrangements (WMC, 2002). Therefore, navigators should be aware of this and avoid making such arrangements, especially when they are anti-COLREGs. For the young generation of seafarers, effective training will make them aware.

### 4.3.2 Negative Effects of Poorly Located AIS Display Units on Safety

On board old ships, Radars are installed away from the chart room, in which GPSs have been fitted and, more often than not, AIS have also sometimes been installed, near to the GPSs. In these cases, if a navigator wants to get a dangerous target's particulars, he/she needs to shift eyes from the Radar to the AIS. It might take a few minutes to go back to the Radar to keep an eye on the target. This naturally, is not secure watch keeping and might also discourage the navigator from looking at the AIS screen. Therefore, AIS will be less beneficial to safety. Figures 4-2 and 4-3 present two examples of poorly located AIS units.

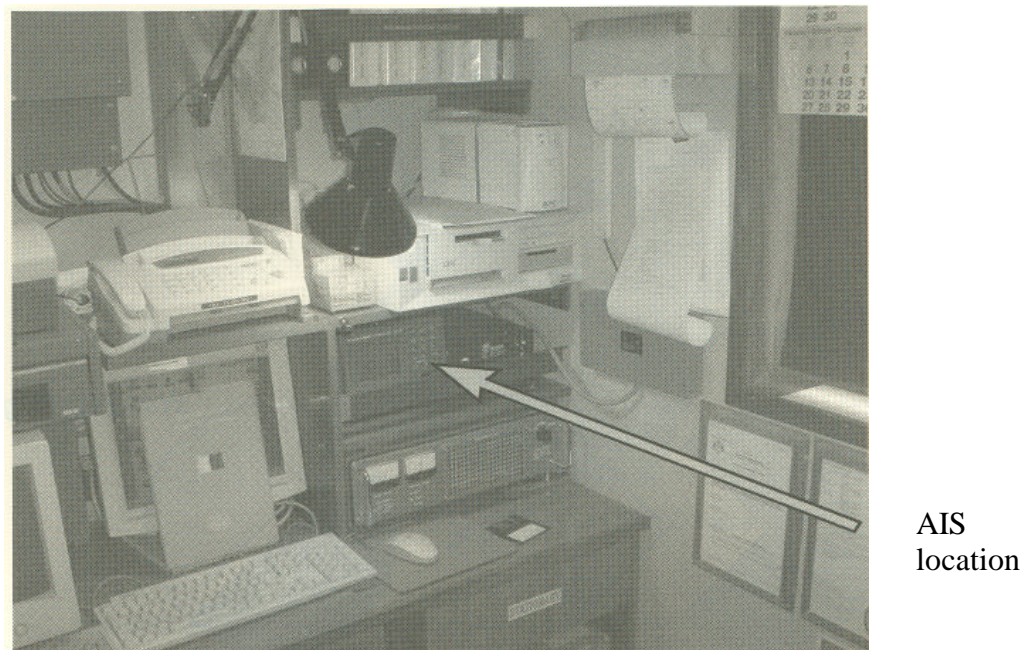

Figure 4-2 Example of A Poorly located AIS Display Unit (1)  
(Source: Pratt, 2004)

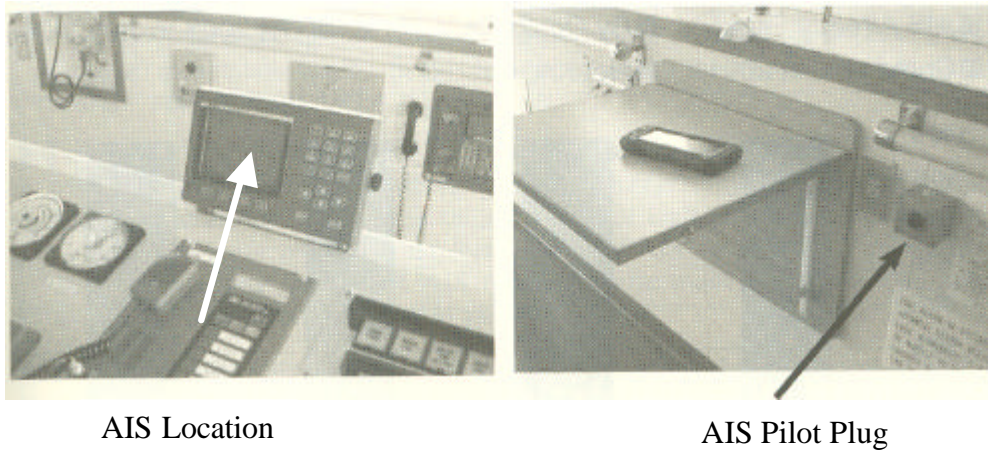

Figure 4-3 Example of A Poorly Located AIS Display Unit (2)  
(Source: Pratt, 2004)

In addition, some old-versions of AIS may only display certain types of text, such as a list in small black font size to show certain items of ship particulars. In these cases, how long navigators will spend catching what they want depends on how capable they are of interpreting the text. That is a limitation of AIS that needs senior officers to become aware of. During the 2002 Test of AIS, Bridge Teams felt that AIS information should be shown on Radar and ECDIS screens, since it is unsafe if navigators are required to shift watch from Radar or ECDIS screens to a separate AIS screen from time to time. The Teams also felt that it takes too much time to interpret AIS target information on a separate AIS screen and then associate it with visually observed target information on RADAR/ARPA or ECDIS screens. The Teams added that it is too distracting, and in that sense, AIS could be a deterrent rather than an aid to navigation (WMC, 2002).

Normally, navigators are used to keeping their eyes on the Radar/ARPA screens, therefore the above-mentioned problems give good excuses for them to give up watching the separate screen of the AIS. One may argue that ignoring AIS means cutting a source of watch keeping distraction. This problem will hamper the execution of potential AIS's functionality. A solution to this problem could be by using a modem to transfer the existing AIS message format to be consistent with the

Radar/ARPA display or ECDIS display. Since both AIS and other electronic sets are technically different, the barrier is difficult to break and thus the alternative could be shifting AIS next to one of the other screens. Although this is not a very sound solution, for the existing AIS on board ships, it could be a cost-effective way to help AIS to be used correctly.

The final report of the 2002 Test of AIS suggests that manufacturers of ISB should allow a ship operator to upgrade the software of an existing Bridge System at a reasonable cost so that it will display AIS information on Radar and ECDIS screens (WMC, 2002).

#### **4.3.3 Wrong and Uncoordinated Messages Transmitting via AIS**

A recent study shows that in many cases wrong messages have been put in AIS and then sent out. Such wrong messages may be related to the draught of a vessel, a ship's callsign, cargo names, as well as destinations etc. Phil (2004) says that many VTS operators have already reported that between 60 and 80 percent of all AIS messages contain errors. Some errors come from not updating messages in AIS, and some others result from incorrect message input. A lack of coordinated and unified message codes makes certain messages ambiguous.

At the 50<sup>th</sup> session of IMO sub-committee on safety of navigation, four northwest European countries, including Denmark, Norway, Finland and Sweden highlighted the problem that mariners are using different names for the same destination, when entering destination data in their AIS units. They identified that numerous variations in the spelling of the same port makes it difficult for other vessels and shore authorities to identify the port uniquely. A suggestion to coordinate the message format of the destination was submitted at this session (IMO NAV 50, April 2004). A solution to this problem could be the efficient training for using AIS. Training makes navigators aware of the potential risk to a ship's safety. Furthermore, training will make them more responsible for that.

A Collision Avoidance Policy, which was proposed by USCG in 2003, suggests that under certain conditions, ships transmitting improper or wrong messages will be imposed fines detailed here:

AIS enforcement under the proposed policy will allow two warnings before fines are imposed. An AIS Violation is committed if a ship, that is required to carry an AIS Device, is either not transmitting the proper messages or if the content of the messages is erroneous. A VTS operator who notices an AIS Violation will issue a formal warning. (UAIS, 2003)

#### **4.3.4 Potential Risks to Small Boats**

Nowadays, the enclosed bridge is becoming popular on new built ships. The navigators will have a good working place on those ships and enjoy the watch-keeping. As a result, navigators will at least lose the opportunity to listen for the fog signals of other ships as they did on older vessels. Moreover, they will lose the touch of the ambience by feeling, instead acquiring the situations around their ships by monitoring IBS, especially by Radar/ARPA, ECDIS, AIS etc.

##### **4.3.4.1 Risks to Non-SOLAS Ships**

AIS provides far more than navigators want. If lucky, AIS information will be presented on Radar and ECDIS screens, and then navigators will sit on a comfortable chair in front of impressive pictures and tend to concentrate on the pictures instead of looking out of the window. This tendency will impose a great risk on small boats. Most navigators have the experience that small boats, especially wooden fishing boats, are difficult to be detected by radar. They are aware and remain alert to that. While the information of AIS will partially solve this problem if some small boats are equipped with AIS, there is still a big percentage of small boats that have no AIS is on board at all. This means AIS cannot help the big ships to detect non-AIS small boats.

The most dangerous point here is that some of the small boats have AIS and some others do not. Navigators perhaps spend too much time monitoring screens and in

turn they do less to keep a visual look-out. Therefore, the possibility to find out non-AIS small boats by visual look-out will decrease. This will certainly increase the collision risk for small boats. Navigators shall be aware that there are a huge number of non-SOLAS ships sailing around the world, including small boats. The AIS is the non-mandatory carriage requirement for them. For example, many yachts in northwest European countries are not fitted with AIS. Meanwhile, some owners of fishing boats in developing countries cannot afford to fit AIS. Even though some small boats are fitted with AIS on a voluntary basis, without proper competent training, crews cannot use it correctly or sometimes the AIS itself does not work properly.

#### **4.3.4.2 Risks by Overload of AIS Information**

On ECDIS screens, only AIS-boats are shown, if the AIS is working properly, whereas non-AIS boats are not be shown. Therefore if navigators concentrate on an ECDIS screen, it is easy to ignore non-AIS small boats in the vicinity. While on Radar screens, apart from the non-AIS boats not being shown, there is another potential problem, i.e. it is possible for too many symbols of AIS-ships to be shown around the center of the screens. In turn, the overload of AIS-ships' symbols will saturate non-AIS radar targets nearby the own ship, especially in bad weather conditions. No doubt, there are some non-SOLAS small boats fitted with individual AIS. Those AIS symbols will be concentrated on the radar screens of big ships. This would contribute to the saturation of non-AIS radar targets. Without effective training, it is easy for navigators to ignore the non-AIS boats ahead of them. At the same time, the crew on board small boats may think that the big ships will give way to them as usual. However, with AIS, the situation might be different. Navigators will tend to either ignore non-AIS small boats or discover them too late to take action. Fortunately, some navigators have already noticed this problem and keep alert when surrounded by small boats. During the author's survey trip on board the MV NILS HOSGERSSON and MV ROBIN HOOD, the OOWs were aware that most of the yachts sailing in the Baltic Sea are not fitted with AIS.



#### 4.3.5 Switching off AIS

AIS might, under certain circumstances, be switched off, based on the master's professional judgement. According to Regulation 19, Chapter V, SOLAS, all ships fitted with AIS shall maintain AIS in operation at all times except where international agreements, rules or standards provide for the protection of navigational information (IMO, 2002). In certain circumstances, AIS should be switched off for safety or business purposes. However, the effects on safety should be identified and proper training should be taken for navigators to be aware of this.

Sometimes Captains should switch off the AIS at their discretion. For example, when sailing in some areas where pirates prevail, such as the Malacca Straits, The Captain will not want everyone in the vicinity to know what the ship is carrying. At that moment, it is the Captain's responsibility to switch off the AIS in order to secure the ship. Furthermore, navigators shall be aware that some AIS equipped ships do not turn AIS on for competitive reasons when operating in certain areas. For instance, fishing boats do not want to make their locations public when fishing.

#### 4.3.6 The Accuracy of AIS Information is Dependent on Other Equipment

In the 50<sup>th</sup> session of IMO NAV, the United Kingdom submitted a proposal - Requirements for the Display and Use of AIS Information on Ship-borne Navigational Displays in 2004. In this proposal, Paragraph 7 states that:

According to IMO Resolution MSC.74(69)<sup>1</sup> and SN/Sirc.217<sup>2</sup>, all ships are required to transmit, if available, position, COG and SOG(supplied by a GPS to the AIS equipment itself) via AIS. However, the integrity, reliability and accuracy of the source data cannot necessarily be relied upon. For example, Resolution A.819(19)<sup>3</sup>

---

<sup>1</sup> IMO Resolution MSC.74(69) Performance Standards for AIS.

<sup>2</sup> IMO SN/Circ.217 on the Interim Guidelines for the Presentation and Display of AIS Target Information.

<sup>3</sup> IMO Resolution A.819(19) on the Performance Standards Applicable for GPS Receivers Installed before 1 July 2003.

and associated Test Standard IEC.61108-1 Ed 1 contain no requirements for:

- The use of Receiver Autonomous Integrity Monitoring (RAIM);
- Generation of COG and SOG and output to the digital interface;
- Marking of the validity of any such COG and SOG output; and
- Accuracy of any such COG and SOG output.

Furthermore, there were no requirements and therefore no controls for the way in which, COG and SOG information may or may not be, smoothed, filtered or averaged, before being output to the interface.

In addition, Paragraph 8 in this proposal states that:

The accuracy of all received AIS information, including that of position, COG and SOG, transmitted via AIS should be relied upon until the integrity of the information is proven.

The accuracy of AIS information depends on the other ship's equipment. For example, the GPS provides the AIS with a ship's position, course and speed over ground. This means the limitations of GPS will definitely affect the accuracy of the system's information. Therefore, cross-checking with other data is necessary before using the AIS information. Furthermore, the OOW is involved in putting voyage related and short safety related messages in the AIS, thus human errors might be experienced. Hence, the reliability of these kinds of AIS information is likely decrease.

Stitt (2004) argues that:

AIS is linked to GPS as its basis for positioning and for computing course and speed over the ground. Thus, any GPS errors will be reflected in the outputs. Information on heading and rates of turn may be derived from other sensors. None of those sensors can be monitored by the receiving vessel.

Whereas Ramsvik (2004) notes in his article:

For the pre 2003 GPSs, course and speed from GPS are not defined at all; the filters are of great different and the accuracy is unknown. For the post 2003 GPS, the accuracy is known but the filters are undefined. Therefore ARPA information and AIS information will not be the same.

AIS is independent from Radar, therefore the AIS may keep away from the effect of Radar limitations. However, if AIS information is shown on Radar screens, conflicting and confusing information may occur that will cause navigational distraction. On the other hand, if AIS information is presented on a Radar/ARPA screen, navigators can make a choice, either AIS target symbol or Radar echo/ARPA track symbol. Navigators should be aware that the two kinds of data might be different. Stitt (2004) argues that:

Radar/ARPA may be operated in a variety of modes, such as true motion sets in water-stabilised or ground-stabilised, relative motion. He mentions none of these will correspond directly with AIS information. Watchkeeper will need to be able to appreciate the effects of the differences. Also, AIS information is of ground-stabilised, while Radar/ARPA information is of sea stabilised. Therefore the display and the effect on true vectors may be different.

The course and speed over ground is very different from the course and speed through the water. Therefore for the same target, the information from AIS is different from that of the Radar, i.e. navigators will get different data for the same target from the two information sources.

Germany proposes that if the AIS and Radar information are considered as one target, then as a default condition, the activated AIS target symbol and the alphanumeric AIS

target should be automatically selected and displayed (IMO, 2004). Berking (2004) notes that the data have to be “optimised” and the automatic association function has to check if a set of radar data and a set of AIS data match and belong to the same physical target. He adds that the “target” association criteria have not yet been finally developed.

#### **4.3.7 Non-integration Between AIS and ECDIS & Radar/ARPA**

Non-integration between AIS & ECDIS, Radar/ARPA is being recognized gradually. On board MV NILE HOLGERSSON, AIS, Radar/ARPA and ECDIS were produced by the same manufacturer, i.e. ATLAS. The AIS is integrated with Radar/ARPA, ECDIS pretty well. Radar/ARPA and ECDIS were installed in a user-friendly way. It is very convenient for OOW to swift his/her eyes from one to another. Also, AIS information can be displayed on demand on the Radar/ARPA and ECDIS screens. While MV ROBIN HOOD was built in 1995 and delivered to serve in 1996, on this ship, AIS cannot be integrated with Radar/ARPA as they are produced by different manufacturers, i.e. ALTAS for Radar, NAUTICAST for AIS. The AIS is a stand-alone unit with its own screen in text display.

So far, many ships have been fitted with old versions of AIS and might only meet the minimum requirements of AIS information display, i.e. the 3-line MKD. In addition, earlier AIS products have been designed to stand-alone and integration with other electronic equipment such as Radar/ARPA, ECDIS etc has not been looked at. Furthermore, there were technical barriers to achieve the consistency among electronic units produced by different manufacturers.

IMO has recognised that many AIS have already been fitted without integration with other electronic equipment. Therefore, certain performance standards that highlight AIS’s integration were adopted on the basis of guidelines. However, they are non-mandatory. In turn, non-integration will exist for a long time. Many AIS will serve only to meet the mandatory SOLAS requirements. Whether it can benefit a ship’s

safety depends on the OOW's capability to use it properly. For ship owners, they will be interested in the minimum carriage requirements of AIS, rather than how much AIS will benefit safety and how efficient their employees can use it.

Human eyes are more sensitive in observing moving or flashing symbols than fixed black text. No doubt, if AIS information cannot be displayed on Radar/ARPA or ECDIS, its functionality will be compromised greatly.

In 2002, WMC organized a test of AIS. One of the participating vessels, IAANDAM had integrated problem between the AIS and the NAVISAILOR ECDIS. The bridge team suggested that AIS information should be displayed both on radar and ECDIS with an option to select which information to show. STN-ATLAS has this option but not all others. On board another ship, VOLENDAM, the bridge team felt that a listing of AIS targets was not useful in assessing the traffic situation mostly because it was not integrated with Radar. That means AIS targets do not relate with Radar targets (WMC, 2002).

The final report of the 2002 Test of AIS also indicated that on ships, integration of AIS was not achieved (WMC, 2002). Many manufacturers had achieved the harmonized AIS display on their own products, such as ATLAS, TRANSACT MARINE, etc. but, so far, integration of the AIS display in different Brands of electronic equipment has not been realised. Owners of new built ships can buy a package of products, and then the problem can be solved in the first place. However, in existing ships, the problems may exist for a long time. Since this problem cannot be solved in the near future during training programs, such characteristics should be identified and an approach to improve AIS benefits should be discussed.

In a Collision Avoidance Policy, USCG (2003) proposed that if AIS information was not displayed on a ship's Radar or ECDIS screen, it was to be seen as an AIS

violation and huge fines will be charged if the conditions are not met as detailed here:

An AIS Violation is committed if an Inspector finds that AIS information is not displayed on the ships ECS, ECDIS or Radar. Port State Competent Authorities will log such Violations in the EQUASIS database for follow-up. The amount of AIS Violation fines will be set at 0.1 % of a ship's estimated market value for the 3rd violation and double with each additional violation. (UAIS, 2003)

Different manufacturers apply different information protocol to produce their products. Therefore technical barriers exist in integrating them. Hence from a technical point of view, it is not feasible to require all existing ships to meet USCG's specific requirements on AIS. The SOLAS convention does not require that. IMO guidelines related to AIS performance are a sort of soft law and hence there is no legal support to require all existing ships to meet this requirement.

#### **4.3.8 Negative Effects of Pilot Laptop Display of AIS Data**

More and more AIS pilot plugs have been fitted as a package to AIS units (see Fig. 4-3). AIS information will be displayed on the ENC on the pilot laptop, even if there is a MKD AIS. If OOWs have been working on a MKD AIS ship, they might not be comfortable with colourful and flashing AIS symbols presented on ENC. Therefore, this will discourage team members from intervening a pilot's decision-making. This is a potential risk to safety, especially when sailing in heavy traffic areas. The Captain should be aware of this and take action to increase the information exchange in the bridge team.

## Chapter V

### Current Status and Limitations of AIS Training

Some owners may be lured by manufactures into buying sophisticated shipboard equipment by highlighting the additional safety as well as long-term saving costs without sufficient attention being given to the training of those who are going to have use the equipment.

*(gardnews, 166 May/July 2002)*

#### 5.1 Introduction

The implementation of mandatory AIS carriage on board ships has been accelerated due to the events of “9/11”. There are not enough trials to disclose its potentials and limitations. In addition, regulations and training standards are not keeping pace with these hurried steps and the current AIS training proceeds without approved standards. There are no criteria to evaluate the competency of trainees. Meanwhile, on board training is not receiving enough attention and, as a result, there is no well-organized training. Although there are conventions, regulations, a Resolution, Model courses, and training programs to be referred to develop AIS training programs, none of them directly stress AIS training. These documents, if faithfully interpreted, can be considered as a framework for developing AIS training programs.

To develop an effective training program, there are several important issues to be addressed, such as the faithful interpretation of relevant conventions and regulations;

understanding the current situation of AIS installation and training and development of very defined and complete training syllabus etc.

## **5.2 Requirements related to AIS Training in Conventions and Regulations**

Chapter V SOLAS requires mandatory carriage of AIS. Although it does not directly stress AIS training, it does give fundamental requirements for it. It is well known that a faithful interpretation will contribute to developing a practical standard and valid training syllabus. They will all become bases to amend relevant conventions, especially when introducing AIS training provisions.

Currently, both COLREGS and STCW 95 are not involved in the use of AIS information and AIS related training. However, certain provisions in these Conventions do give some references for administrators to develop standards to cover AIS training, and for training officers to produce an AIS training syllabus. To meet the training needs, administrators and training centre officers will have to make their own interpretations to develop standards for AIS training and training syllabi respectively.

### **5.2.1 AIS Training Requirements in SOLAS Chapter V,**

Subparagraph 2.4, Regulation 19 provides guidance on the use of AIS information. It requires that OOWs should be capable of:

- (1) Providing and updating dynamic messages, such as navigational status, and other safety-related information, as well as monitoring static messages;
- (2) Monitoring traffic situations and tracking ships;
- (3) Exchanging data with shore-based facilities, if on demand.

It further stresses that OOWs should also know special international agreements, rules, or standards for the protection of navigational information, such as security-related or fishery information. Further, AIS operation should comply with IMO Resolution A.917 (22).



### **5.2.2 Rules Relating to AIS Training in COLREGs**

Both AIS static and dynamic messages are important for situational awareness and collision avoidance. COLREGs provides regulations to cover both aspects. Training is an efficient tool to make OOWs capable of using AIS information properly to assist collision avoidance and to keep surveillance. Therefore as COLREGs is a legal reference for AIS training, when developing AIS training syllabus, the Rules hereinafter mentioned should be taken into account.

#### **5.2.2.1 Rule 5 Look-out**

The phrase “by all available means appropriate...” laid out in this rule, can be understood to mean that AIS is included as a navigational aid. Carriage of AIS is mandatory for SOLAS ships. Hence “proper look-out” should include the use of AIS for collision avoidance. Meanwhile, AIS information is crucial for OOWs to make a decision. Therefore, this rule could also be interpreted as to require OOWs to be capable of using AIS information properly to make collision avoidance decisions. Stitt (2004) emphasises that it is widely recognised that Rule 5 involves maintaining good “situational awareness” and reacting properly to the relevant facts and circumstances. AIS will make OOWs well aware of situations if the information is interpreted properly and used correctly.

#### **5.2.2.2 Rule 7 Risk of Collision**

Rule 7 (b) requires proper use of radar to obtain an early warning of risks of collision. If AIS is integrated with Radar/ARPA, AIS information shown on Radar/ARPA screens can definitely provide an early warning of the risks of collision. AIS can overcome Radar limitations in early warnings as defined in Chapter III. It therefore follows that OOWs should properly observe AIS information on a Radar Screen to acquire early warning. Stitt (2004) argues that Rule 7(b) could include intelligent correlation of radar and AIS information. Details, such as course and speed as obtained by ARPA or other methods of plotting, should be compared with AIS information and the causes of any substantial differences should be determined.

### **5.2.2.3 Rules 8, 16 and 17 AIS-an Important Monitoring Role**

AIS's principle and its capabilities make it play an important monitoring role. This role can meet the requirements that certain Rules, such as Rule 8, Rule 16 and 17 provide. Stitt (2004) emphasises that:

Not only can AIS assist OOWs to make an early assessment of if a risk of collision exists, but also subsequently enable them to monitor action taken by other ships. The dynamic messages show much earlier and more accurate information than radar of if the other ship alters the course and speed. In addition, the static messages present a broad picture of the other ship's size and type, and hence the OOW can anticipate her likely manoeuvring features.

According to Rules 5, 7, 8, 16,17 and so on, during training, navigators should acquire the capabilities of properly interpreting and using AIS information for collision avoidance, as well as maintaining good situational awareness. In addition, the ability for correlation of Radar and AIS information, as well as recognition of material differences between AIS and Radar/ARPA information, should also be acquired. Furthermore, the effective use of AIS information to monitor a ship's safety of passage should be an integral part of any syllabus.

### **5.2.3 AIS Training-related Requirements in STCW Code**

STCW95 is a framework for seafarer training today. It was designed in such a way that regulations in the Convention and provisions in the Code correspond to each other. The detailed technical requirements and their supporting Resolution are also provided in the Code. All technical provisions in STCW 95 were specified in less ambiguous language. Moreover, provisions of the Code define the minimum requirements of MET and IMO has developed a series of Model Courses to guide seafarer training in light of the technical provisions.

Although the STCW 95 Code does not make specific references to AIS training directly, Regulation I/14 and Table A-II are associated with it.

### **5.2.3.1 Interpretation of Regulation I/14**

Subparagraph 1.4 of Regulation I/14 states that companies are responsible for ensuring that seafarers are familiar with all equipment relevant to their routine or emergency duties. Thus, it can be interpreted that companies are responsible for navigators to be familiar with AIS, especially in respect of operation, limitations and capabilities. Even though, in the near future, AIS-related training can be carried out widely, the familiarization with ship-specific AIS operation is still needed. Stitt (2004) argues that because different manufacturers will have different “bells and whistles” on their equipment (AIS), a significant part of any training appears likely to have to be devoted to how to use a particular set.

One can imagine that because of limited financial resources, a training center is likely fitted with a specific brand of AIS; the demonstration during AIS training will be based on the AIS operation procedure of that brand. However, on board ship OOWs will probably face another brand of AIS. Hence efficient ship-specific AIS familiarization is needed. Section A-I/14 states that companies and masters have the responsibility for ensuring that newly employed seafarers are familiar with the specific equipment and the associated operation procedures relating to their duties. Subparagraph 2.2 in this section indicates that familiarization should not be a self-study by running an hour-long CD or by reading the manufacturers’ handbooks. A knowledgeable officer should be assigned to provide enough instructions and demonstrations to newcomers until they can operate ship-specific AIS properly.

### 5.2.3.2 Technical References in Table A-II

Column 2 implicates that trainees should acquire:

- Knowledge of AIS operating principles, limitations, sources of error, detection of misrepresentation of information and methods of corrections;
- The ability to determine ships position by using electronic navigational aids which should include AIS;
- The ability to operate and to interpret and analyse AIS information shown on Radar/ARPA screens;
- The ability to obtain an accurate position by using AIS;
- The ability to evaluate navigational information from all sources, including AIS, Radar/ARPA, and in turn to make decisions for collision avoidance.

Column 3 can be interpreted in such a way that AIS training can be carried out on approved PCs or multi-media, and approved simulators, as well as approved in-service experience.

Column 4, implicates that Navigators should be capable of:

- Performance checks and tests to navigation systems, including AIS, complying with a manufacturer's recommendations and good practices;
- Correcting interpretation and analysing of information from Radar/ARPA, including AIS information being shown on screens, while considering the limitations of AIS;
- Taking action to avoid a close encounter or collision.

### 5.2.4 IMO Resolution for Operational Use of AIS

Resolution A. 917 (22) was adopted in November 2001. In the Resolution the purpose of AIS is stressed, i.e. to help identify vessels; assist in target tracking; simplify information exchange; and provide additional information to assist situational awareness. The Resolution states the minimum requirements that the user should meet before using AIS. Furthermore, the Resolution focuses on detailed

description of the system regarding operational and technical aspects as well as shore-based application. Finally, the Resolution is a practical instrument that training officers can refer to for developing an effective AIS training syllabus and can be considered as a blue book for such. A well-developed syllabus should at least meet the minimum requirements as set out.

### **5.3 Current Situations of AIS Installation**

Compared with training for other electronic equipment, AIS training is much further behind than the installation process itself. In addition, technical standards to develop AIS and to integrate it with other electronic equipment are still being developed. Therefore, when on board, OOWs might have to operate differential AIS in terms of the technical aspects. Hence it is necessary to analyse the situations of AIS installation, in order to develop valid training programs.

Larry Bischoff of Holland American Line explains that for fleet standardization and budget considerations he has postponed making a connection between ECDIS and AIS for the whole fleet until it has become "plug-N-play". He added that connecting ECDIS and AIS on the IAANDAM AND VOLENDAM showed that it prolongs installation and is not foolproof. Dave Smith of Alaska Tanker Company plans to use the minimum keyboard display at least until the dust settles (Pot, 2002).

Like the initial radar sets, some AIS equipment is not particularly user friendly. The abridged timetable means that the first generation equipment, usually in the form of MKD, will be around for years to come. Many ship owners are unlikely to be willing to upgrade their equipment until forced to do so (Stitt, 2004).

Because MKD AIS will exist for a long time, during AIS training, MKD AIS operation, its capabilities and limitations, information interpretation, especially in association with radar targets shall take a part of the syllabus. Some AIS may have connections with few other sources, whereas others may have more sources. The potential sources should be re-stressed during the training (See Figure 5-1). Some data can be

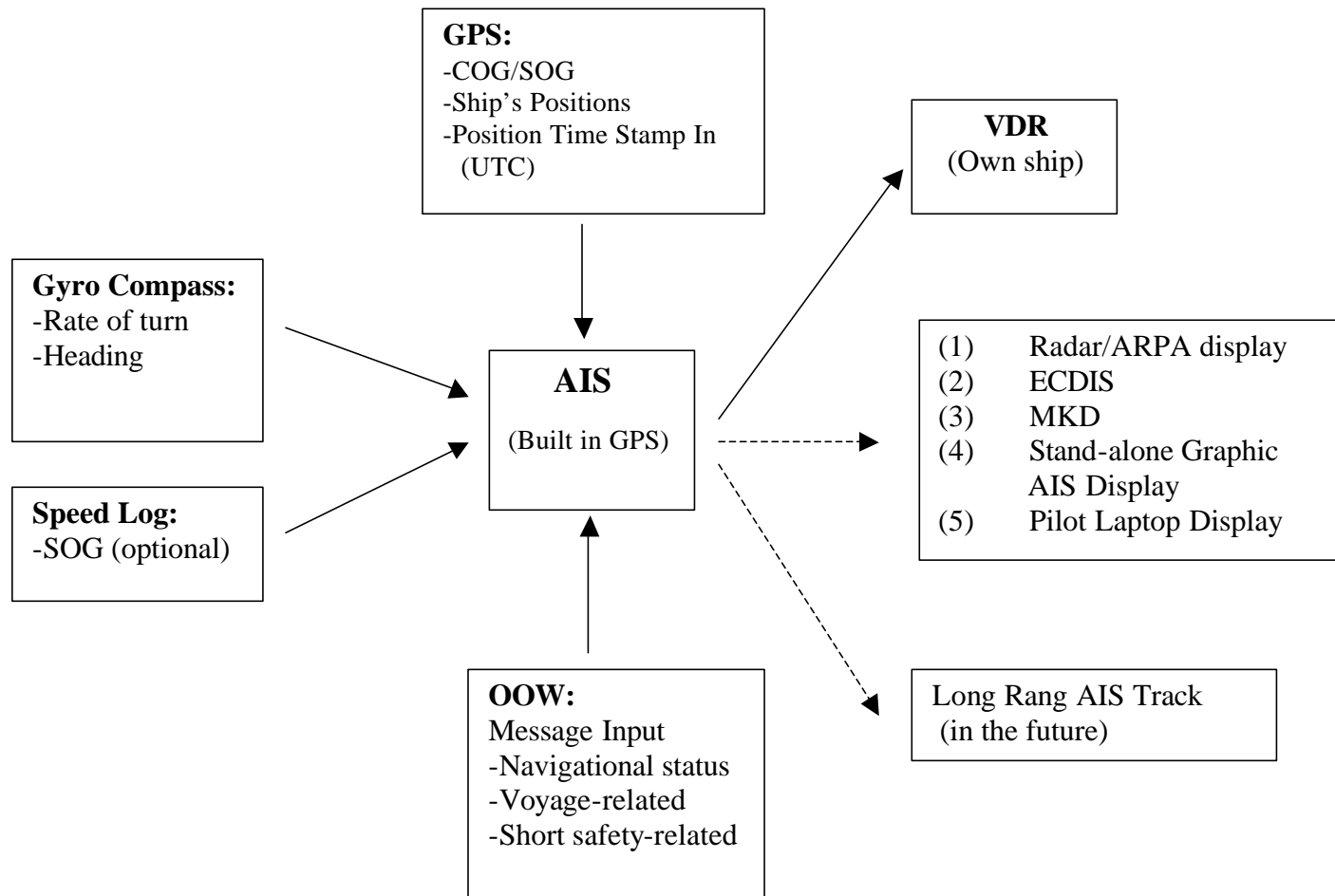

(Source: Berking, 2004)

Figure 5-1 AIS Connections on Board a Ship

fed to AIS automatically but certain other data should be entered manually, especially dynamic messages, such as, cargo names, destinations, ports of call, draught of ship, as well as safety-related messages. Trainees should acquire the capabilities to decide what data should be entered and upgraded. Furthermore, as long as there are many AISs integrated with Radar/ARPA, ECDIS, AIS training should not ignore the links among them. The limitations and proper use of AIS information on ECDIS, Radar/ARPA should be identified in a training program.

#### **5.4 Overview of Current Situations of AIS Training**

Due to the hurried process to equip vessels with AIS to meet the anti-terrorism requirements, manufacturers have failed to give enough time to the development of AIS concerning performance, operation procedures, integration and communication protocol etc. Unlike GMDSS, the AIS training mechanism is very incomplete. Therefore Party States find it difficult to produce effective standards to cover AIS training. In addition, training centers have not developed effective programs to carry out AIS training. Until now, AIS training is not mandatory and training programs vary from one training center to another. In fact, most navigators have not received efficient training before AIS is presented to them.

##### **5.4.1 An AIS Training Program of MTC**

The Makarov Training Centre (MTC), St Petersburg, Russia, has developed AIS training programs for OOW engaged in AIS use and maintenance for safety of navigation. The programs are as follows:

- International and Russian national legal documents regulating AIS installation, operation and servicing;
- AIS Network structure;
- Specific features of installation and operation;
- AIS use for collision prevention;
- Basic principles of formation and functioning.

(MTC, 2004)

This training program seems very brief and many important items have not been included. There are some other training programs, being carried out in other training centers which are similar to this, only meeting the requirements to a certain extent that some regulations and provisions in COLREG and STCW 95 can be understood. Thus, a complete and efficient training program should be developed to meet these requirements so that trainees can use AIS properly.

#### **5.4.2 Limitations of Current Available AIS Training on Board**

In most cases, after installing an AIS, the manufacturer provides a CD for the OOW's self-study. Some CDs cover the operation for only 3-line display in a stand-alone MKD AIS and others may cover more about the operation of AIS on Radar/ARPA or ECDIS screen, if the integration of AIS with this equipment has been achieved.

Such CDs definitely show the operation procedures of the specific brand of AIS. This is enough for OOWs to know how to operate the AIS but probably there is nothing related to the limitations of AIS, as well as its deficiencies. There is no reason to criticise manufacturers for not describing some of them because there are no resolutions or Resolution to cover this. Furthermore, some trials to examine the limitations or deficiencies of AIS have been carried out recently and the results need to be assessed further. There are several AIS conferences that have been held recently or are about to be carried out in the near future. More evidence needs to be collected to support the research results. This is a reason why the current CD self-study training is not efficient for OOWs to be competent to use AIS properly.

#### **5.4.3 Lack of Awareness of AIS Training**

It seems that OOWs ignore the importance of AIS training on board. They use Radar/ARPA daily, and they push a button, then an information window pops up or pops out. They can get what they want by touching a button. It appears that when AIS is fitted, using the manufacturers' handbooks or CD guides, they can also



operate it and AIS works as the handbooks or CDs say. Therefore it is a good excuse to say that no more AIS training is needed. OOWs who have operated GPSs may have the experience that it is easy to operate and properly conclude that AIS operation is not any more difficult than that of GPS. However, navigators have already learnt a lesson from the ROYAL MAJESTY's grounding, a GPS-assisted accident. Meanwhile there is a persistent belief that if AIS is integrated with a Radar/ARPA and someone can operate Radar/ARPA, then he/she can operate AIS too. If such is the case, then it would be difficult for OOWs to recognise the importance of AIS training. In an AIS 03 seminar, Pratt & Taylor (2004) introduced the results of pilots' survey for an AIS process of installation on board ships calling at Southampton and the Tees Bay. They released that:

A number of ships officers on the inquired ships knew little of or indeed had heard nothing about. There appeared to be little evidence of any formalized training, and navigators are given a few words by the installation technician or refer to the information in the manufacturers' handbooks about the use of AIS. They add that unfortunately many OOWs don't recognize the necessity of AIS training.

In view of the current status of training related to AIS, there is not enough that involves the capabilities and limitations of AIS. To solve these problems, there is a need for better cooperation among the manufacturers, shipowners, navigators, training centers and administrators. Firstly, manufacturers should contribute to the capabilities and certain limitations of AIS in terms of technical aspects. Secondly, navigators who have the experience of using AIS in reality should provide feedback about AIS deficiencies and/or limitations in operation aspects. Thirdly, shipowners should take the responsibility for collecting this feedback and present it to other interested parties. Shipowners should also be in charge of on board AIS familiarization training. Finally, the administrators should become the coordinators in order to accelerate the development of AIS training programs.

Stitt (2004) says that currently most OOWs are not trained properly for the use of AIS, as well as its potential benefits and shortcomings, because AIS capabilities and limitations have not yet been properly recognized. He adds that the increased emphasis is now being set on anti-terrorist and ship-to-shore applications. Thus it can be concluded that training for these aspects tends to be the major part of the syllabus. As a result, much less training time is allocated to the training of the effective use of AIS for collision avoidance and situational awareness. With these limitations, AIS training effectiveness is compromised.

## Chapter VI

### Suggestions to Improve AIS Training

“Man is the single greatest asset the shipowner has. He is worth looking after, and money spent training him to understand and operate technology will pay handsome dividends”.

*(John Lang, Chief Inspector Admiral of MAIB, 2002)*

#### 6.1 Introduction

The technology is changing faster than the development of training-related rules. Administrators and training centers are scrambling to keep up. Without guidance by training standards, training syllabi at an early stage may always be different from one training center to another and, in turn, it is difficult to assess the competency of trainees against a widely accepted standard.

Training is an effective tool to keep OOWs updated with technical change. Consequently they can use high-tech equipment to serve safety rather than to make accidents. IMO has been aware of the importance of training for technical change, and W.A. O’Neil has emphasised this point in a few articles, summarising that:

The equipment used on ships is becoming more and more sophisticated. It is not correct to say the technology will provide a solution to certain problems, because unless properly used technology could make the problem worse. This means that the seafarers who have to use it need to

be very highly trained. We have to make sure that training keeps pace with technical change. (O'Neil, 1999)

The United Kingdom has further raised the training requirements for the operation of AIS at STW 34 through documents STW 34/9/4. However, since STW 34 no further development of AIS training appears to have materialized, mainly due to the fact that the performance standards have not been finalised. During IMO STW 35<sup>th</sup> Session, the International Federation of Shipmasters' Associations (IFSMA) submitted a proposal to highlight the requirements for shipboard AIS training once again. The proposal suggests that:

Whilst AIS is being implemented to meet security demands, there is no doubt that with proper training the use of AIS will enhance safe navigation. There is an operational requirement for AIS to be operational in 2004 and the operational training will not be available at this time. This will mean that many of operational benefits derived from AIS will not be understood by the users. Therefore the requirements to have proper standardised training requirements for operators of AIS is needing urgent consideration.

(IMO STW 35, November 2003)

IFSMA also recommends that it would not be necessary to amend the STCW Convention as the reference to AIS equipment already exists within the Convention. The training module relating to AIS could be introduced by developing a Model Course in a similar manner to ECDIS (IMO STW 35, November 2003).

Not only shall AIS training focus on the operation of the system itself, but also stress any inherent limitations as well as an awareness of risk when using the system. John Long (2002) <sup>1</sup>emphasized that when carrying out training related to hi-tech, three

---

<sup>1</sup> John Long's opinion was quoted in *Computerisation of bridges and engine rooms: Progress or regression* (2002, May/July). *gardnews*, 166,10-12.

issues must be considered: an ability to operate the system or equipment correctly; an understanding of any limitations and an awareness of the distraction factor.

The fact is that not only do OOWs need to use the information from AIS properly, but they should also be capable of filtering appropriate data from several sources and make decisions based on that. If AIS training is well organized, then it could ensure that OOWs are competent to do this. In order to ensure that OOWs are competent in using AIS information properly and in operating AIS correctly, besides effective on-shore training, on-board training is also important.

## **6.2 On-shore Training**

Until now, AIS training is not mandatory, apart from the mandatory carriage requirements of AIS. However, on-shore training has already been carried out in many training centers even though the syllabus is very different among training centers. To achieve the competency for OOWs to use AIS, consideration should be given to the way of carrying on-shore training. Stitt (2004) suggests that, for on-shore training, time could be better spent on the techniques and procedures for using the information that AIS can provide to avoid collisions. In respect of cost benefit and short shore-leave for OOWs, AIS training can be incorporated into ECDIS or Radar/ARPA training.

### **6.2.1 Key Elements of Training Syllabus**

A syllabus is a crucial part of any training program and it could be developed in such a way that it could take into account both the current situation and the future. Party States may develop guidelines to affect current AIS training based on current provisions in STCW 95 and AIS related regulations given by other party states.

Besides the statement of the aims, objectives and learning outcomes, a training syllabus should at least cover the following key elements:

- (1) AIS legislation, regulations, guidelines and requirements;
- (2) Basic AIS operating principles;
- (3) AIS capabilities and limitations defined in Chapter IV;
- (4) Criteria of presentation of AIS information;
- (5) Scenarios and exercises developed for navigators to be familiar with the use of AIS;
- (6) Major differences of AIS and Radar/ARPA information;
- (7) Shore-base AIS application.

### **6.2.2 Exercises and Scenarios of Simulation Training**

With respect to the current situation, if AIS training is completely incorporated into ECDIS, and/or Radar/ARPA training, it might be insufficient for competency purposes because stand-alone MKD AIS training is still needed. The training should take into account both aspects, i.e. MKD AIS training and integrated AIS. However, integration of AIS with Radar/ARPA and/or ECDIS is the future philosophy of AIS development. While training can be carried out on a PC, or simulator, training on real AIS equipment will definitely be the most efficient.

AIS manufacturers normally provide CDs for the end users' self-study. Training centers should be fitted with more than one brand of real AIS equipment. Therefore, training officers will have some CDs to demonstrate the basic operations of MKD AIS. The CDs can be run on computers. For the purpose of demonstration, this might be useful. However, such CDs might not be designed to run on simulators. Meanwhile, manufacturers have not done enough to develop effective exercises and scenarios for training purposes. The fact is that such CDs are produced by AIS manufacturers rather than simulator producers or training program developers with a pedagogical background, thus might not meet the demands of training. Hence training officers need to develop AIS training exercises and scenarios or to get the professional companies to do this for their own needs.

When designing exercises, consideration should be given to the following concerns:

- (1) The exercises should focus on developing trainees' capabilities to interpret, analyse and apply AIS information to ensure safety;
- (2) The exercises should include both normal situations and abnormal phenomena, such as:
  - Failure of AIS connected sensors;
  - Failure of AIS components.
- (3) Besides some exercises that are designed for MKD AIS, others should be integrated with Radar/ARPA, and/or ECDIS training.

AIS training scenarios might be difficult to develop. However, many VTS centers are equipped with sophisticated systems and traffic images with AIS information display around VTS areas can be filmed. Information technology makes it possible to run these films on computers and simulators, thus allowing training officers to access films for training purposes. Many training objectives can be achieved by presenting scenario-recorded films, such as AIS information interpretation, recognition of AIS symbols on Radar/ARPA, ECDIS as well as path predication etc. In addition, in order to improve training effectiveness, trainees' involvement is necessary during simulator training. Appropriate training software needs to be developed, something that is the duty of specialized training program developers. However, training officers need to define what exercises and scenarios should be created for effective AIS training.

### **6.3 On-board AIS Training**

After on-shore AIS training, on-board training and hands on practices are still important to keep OOWs fully competent. Besides familiarization, Captains should aim to encourage OOWs to use AIS daily, while also paying attention to increasing the OOWs' capabilities of interpreting AIS information not only displayed on MKD, but also on Radar/ARPA and ECDIS screens.

### **6.3.1 A Lesson from GMDSS Training**

The Author has been a GMDSS training officer for years in China. During the training, the Author has carried out some surveys on how efficient OOWs use GMDSS equipment. The surveys give some suggestions about how on-board AIS training should be carried out besides on-shore training. GMDSS training has been carried out for years. It is expected that after training, OOWs are competent in using GMDSS equipment properly for both routine and emergency duties.

However, due to the reduction of the manning level and the reallocation of communication and emergency duties, it seems that only Captains can access GMDSS equipment. In some cases, 3<sup>rd</sup> officers can be allowed to operate the equipment, as they are supposed to execute communication tasks in an emergency. Other OOWs will not be allowed to access GMDSS, because of the sensitive information coming in or out via it. No doubt the capabilities of OOWs to operate GMDSS equipment will be reduced due to not operating them over a long period.

On-shore training does not work well without the support of on-board training. Previously seafaring has been a sort of hands on career whereas, nowadays, it appears to be high technology oriented. However some basic knowledge and hands-on experience is still important. Besides ship-specific AIS formularization, repetition of operating AIS is also necessary. During this process, the ability to handle AIS will be improved and safety awareness and responsibilities can be acquired. On-board training is particularly efficient in these aspects because seafarers are loyal to their employers; they love the ships and are easy to motivate and are committed. During the first several years of GMDSS equipment on-board, a lot of false alarms caused by false operations were received and the SAR organizations issued circulars to emphasize the problems. Party States have asked training centers to address these problems during on-shore training while ship owners have given their masters instructions to solve the problem. It is becoming better now, because of the awareness concerning the effects on safety together with the impact of training.



Thus, a lesson should be learnt from GMDSS application, when carrying out on-board AIS training.

### **6.3.2 Keeping Competency by Doing**

During a presentation in 2003 at WMU, Mr Olsen, the Sale Representative of Poseidon Simulation AS, showed some statistics reporting that a majority of marine accident alarms in Norwegian coastal waters had been sent from mobile phones (Olsen, 2003). This means that people use mobile phones on a daily basis, and in turn they are familiar with the operation procedures. Naturally they will pick mobile phones up and send alerts out in cases of emergency. Therefore, It follows that if OOWs operate AIS often, they will be familiar with it and willing to touch it. Furthermore, if OOWs handle AIS information regularly, they will be much more sensitive to the information it gives, especially those related to collision avoidance. Therefore, as soon as certain strange information occurs, it will be quickly recognised and lead OOWs to analyse what is going wrong.

### **6.3.3 Organization of On-board Training**

The responsibilities laid down in the STCW Code require companies to be in charge of on-board training and Captains to carry out on-board AIS training. On-board training needs to be well organized to achieve its objectives. To do that, consideration should be given to the following issues:

- (1) Effective use of on-board training materials, resources, aids;
- (2) Taking care of generation differences between the younger and the older one;
- (3) Focusing on ship-specific AIS operation and its limitations;
- (4) Familiarization of ship-specific AIS connected sensors and their limitations;
- (5) Awareness of integration situations of AIS into IBS;
- (6) Special requirements of AIS application for anti-terrorist application
- (7) Well designed training activities, such as follows:
  - Captain's inquiry of OOWs about AIS basic operational knowledge to discover how an OOW is competent;

- A discussion among OOWs to consider confusions and clarify them.
- (8) Including the following AIS-related activities in the departure and/or daily duty shift schedules:
    - Updating of AIS dynamic data;
    - Checking of the integration of AIS.
  - (9) Using AIS information as an integral part of on-boarding training for cadets;
  - (10) Exercises on the correct interpretation of AIS data for both MKD display and integrated ones;
  - (11) Predicting path by a target's ROT.

Although it is claimed that hi-tech equipment greatly releases navigator's regional workload, it has also been observed that their overall workload is increasing considerably. Ship turnover is much quicker than before. It is difficult to organize effective on-board training, especially on coastal or short voyage ships. On-board training might be more effective and easy to organize on deep-sea ships. Companies might make a policy to assign cadets to on-board ocean voyage ships so that they can receive well-organized on-board training. In addition, because AIS, as a member of IBS, will interact with other equipment on the bridge, AIS training could also be part of the integral training of IBS. In particular, Radar/ARPA, ECDIS and AIS could be considered as a whole; hence on-board AIS training of this equipment should be incorporated. In this way, cadets would understand that this equipment works together with and affects the other items.

Existing approved references are enough to be referred to in developing an effective syllabus. There is a need for faithful interpretation of relevant provisions in these instruments; therefore, amendments to STCW 95 may not need to be hurried. Both on-shore training and on-board training should be emphasised to ensure OOWs competence for using AIS properly. Besides training for the capacities of AIS, the inherent limitations and risk of over-reliance on the system should be stressed. Learning by doing should thus become the philosophy of AIS training.

## **Chapter VII**

### **Conclusions and Recommendations**

#### **7.1 Conclusions**

From the discussions in this paper, the findings of this researcher may be summarised briefly as follows: reservation of traditional skills is necessary in the event of failure of AIS and other high-tech equipment in IBS; the roles of AIS and its negative effects on collision avoidance need to be well known; proper training is necessary for the OOWs to be competent in using AIS properly.

##### **7.1.1 Reservation of Traditional Skills**

When examining contents laid down in Table II, STCW Code, besides requirements of capabilities of using modern technology, traditional skills, such as celestial, terrestrial and coastal navigation, are also required to meet requirements of competency. High-tech equipment in IBS makes ships much easier to be commanded than before, without much input of the OOW. However, it can be two-side edge for safety. When it goes wrong, the OOW will be less dependent on it. In this sense, traditional navigational skills will be the back-up in the event of failure of such equipment in IBS.

Training should focus on not only modern electronic technology, but also on traditional navigational skills. The young generation should be aware of the importance of traditional navigational skill and should understand that AIS, is not designed to replace navigators, but to support them to keep surveillance awareness and make decision of collision avoidance.

### **7.1.2 Awareness of the Roles of AIS**

Although AIS can greatly enhance situation awareness and provide valuable information for collision avoidance if properly used, the roles of AIS in IBS should be re-examined and reconsidered. AIS should be recognised as:

- An information providing system;
- One of the important navigational tools;
- A dependent system from external sensors;
- It does not replace Radar/ARPA but AIS and Radar can complement each other;
- Human elements are involved in updating certain AIS information;
- The use of AIS does not negate OOWs' responsibility in COLREGs and does not affect the composition of watch keeping;
- AIS may not provide a complete picture of the traffic flow around a ship;
- OOW should not place over-reliance on AIS;
- Crosschecking with other data is essential before using AIS information.

### **7.1.3 Awareness of Negative Effects of AIS on Safety**

Firstly, the OOW should know that some types of ships might not be equipped with AIS and that AIS fitted on other ships might be switched off at Captains' discretion. AIS cannot detect non-AIS small boats and the ships that their AIS are switched off. Early warning alarm on collision targets has been incorporated as a result of the introduction of AIS. This will alert the OOW to a collision risk at an early stage even before it can be detected by Radar or visually. However, this can lead to the OOW being over-reliant on AIS. This is specially a risk in case of the non-AIS targets which cannot be detected at an earlier stage. The AIS is not a substitute for officer lookout but can only provide supplementary information for collision avoidance and situation awareness. It should not be used as a sole source of navigation information but only as a tool to enhance the safety of navigation

Secondly, the integration between AIS and ECDIS & Radar/ARPA has not yet been achieved currently. Since AIS information cannot be overlaid on Radar or ECDIS, its

benefits will be compromised considerably. Most ships have been fitted with MKD AIS and the MKD AIS itself has less contribution to safety. The OOW has to associate AIS targets with Radar targets by the target bearing and range shown on the MKD AIS in order to identify other ships. Whether this can benefit a ship's safety depends on the OOW's capability to correlate the two targets properly.

Thirdly, the integrity, reliability and accuracy of AIS source data cannot necessarily be relied upon since the use of Receiver Autonomous Integrity Monitoring (RAIM) and the accuracy and validity of COG/SOG output are not required by approved standards currently. The OOW should be aware that the accuracy of dynamic AIS information depends on the other ship's equipment and that the reliability of static, voyage related and short safety related messages might decrease since Humans are involved in putting these data in the system. Hence, the accuracy of all received AIS information including that of position, COG and SOG, should not be relied upon until the integrity of the information is proved. The OOW should do cross-checking with other data before using the AIS information.

Finally, the AIS should be installed at a position from which the ship is normally operated. It is much preferred to place the AIS as close as possible to Radar/ARPA, or ECDIS. However, there are some ships on which the AIS are at improper places. On those ships, the AIS can be a watchkeeping distraction if it is not used properly. The OOW should be aware of its negative effects on safety.

#### **7.1.4 The Need for AIS Training**

Firstly, the urgent need for proper standardised training requirements for operators of AIS has been highlighted in the 35<sup>th</sup> session of IMO STW in 2004. ALSO, Paragraph 2 of IMO Resolution A.917 (22) states that the user should become familiar with the operation of the equipment, including the correct interpretation of the displayed data. Without the proper operational training, many of the operational benefits derived from AIS will not be understood by the users. Thus, the users should receive the

approved AIS training in order to be competent in using the system properly and interpreting its information displayed on the Radar Screen or ECDIS. Such training is the key to empower the users to be aware of the limitations and capabilities of the AIS as well as the consequences of transmission of outdated data.

Secondly, the AIS has become a number of IBS currently. Although the MKD AIS meets the minimum carriage requirement of SOLAS ships, the presentation of AIS on Radar is included in the Draft Radar Performance Standards for ship-borne Radar Equipment submitted by Norway in the 50<sup>th</sup> session of IMO NAV in 2004. Thus, the new ship-borne radar equipment will be able to display AIS information. Furthermore, AIS information can also be presented on ECDIS. Therefore, on the same screen, the OOWs will face different sources of information and this information will be complicatedly associated, which will bring some inherent deficiencies. Hence, the OOWs should know the criteria of the association of the information as well as its deficiencies so that they can use the displayed AIS information correctly to handle the ships in a safe manner.

Thirdly, the necessity of AIS training has not yet been properly recognized presently and most navigators have not received proper training before using the AIS on board. Although, the manufacturers may provide the operational manuals and CDs for on board self-study training, which are focused on the particular brands of the AIS. These materials are not enough to keep the users to be competent in using the AIS and interpreting the displayed AIS information correctly. Therefore, both on-shore AIS training in accordance with approved standards and well-organized on-board training are important for the OOWs to be competent to use AIS properly.

Finally, Training can be an effective tool in training navigators to be competent in handling AIS generated information and its interpretation, failure of external data input, crosschecking of information and enabling AIS to contribute to the safety rather than to cause accidents. Companies will always gain when spending money on

seafaring training. The rewards of that for safety can be huge. Both on-board training and on-shore training should consist of company policy for safety culture and the companies should organize for the AIS training.

## **7.2 Recommendations**

Based on the study in this paper, an AIS training syllabus is proposed; suggestions to amendments of ATCW 95 are given; how to use AIS properly on board a ship and how to choose a proper AIS training program are recommended.

### **7.2.1 Using AIS properly and Attending Shore-based AIS Training**

With regard to current situations of installation of stand-alone MKD AIS, OOWs may have a little benefit from potentials of AIS in collision avoidance. In addition, without proper training in using AIS, it can be a factor of watch keeping distraction.

In view of these limitations, a company perhaps whose whole fleet is equipped with MKD AIS, can make a policy to guide the OOWs on MKD AIS for broadcasting information to other ships or shore-based authorities. The OOWs should be informed of the potential risks of using a MKD AIS as a tool for assisting in collision avoidance.

On-board training may also focus on basic operation of MKD AIS, choices of data input etc. It is believed that in the future, with software development, AIS can be integrated with Radar/ARPA, or ECDIS by “plug N play”. Therefore, when taking shore-based AIS training programs, those that cover both a MKD AIS and integrated one would be appreciated. If part of training can be run on simulation, it is believed that training effectiveness will be greatly improved. On the other hand, the OOWs might have a little chance to operate integrated AIS on board. Therefore they may quickly lose their capabilities to handle integrated AIS. Therefore, on board training can be effective in updating the capabilities by Distance Learning. By this way, the OOWs could be updated for integrated AIS operation. This will contribute to safety greatly.

### **7.2.2 Amendments of STCW 95**

STCW 95 should also be amended so that mandatory AIS training can be introduced and AIS training provisions can be inserted. However, if whether it is the correct time to amend STCW 95 is questionable. Probably not now, because many ships have been equipped with MKD type AIS and Integration of AIS with other ship borne electronic equipment is still being developed. Moreover, capabilities and limitations are being discovered through a series of trials. It can be a long process to develop effective provisions to be added into the STCW Code to guide effective AIS training at the moment. The AIS training provisions should come out when the dust settles.

Existing Conventions, Guidelines, Regulations do provide a legal framework for developing AIS training programs. The key point is how interested parties interpret them faithfully so that these instruments can guide a well-developed training syllabus. Amendments to STCW 95 on the AIS training should not be done in a similar way to that of the AIS installation. More time should be given to develop realistic and practical provisions to cover the AIS training. In addition, when amending STCW 95, the training for ECDIS, VDR and Radar/ARPA should be synchronized with the AIS training for ergonomic principles and user-friendly purposes.

### **7.2.3 AIS Training Syllabus**

A well-developed AIS training syllabus is the key to achieve the objectives of the training. Based on the study of this paper, an AIS training syllabus is proposed. The syllabus meets basic requirements of current legal instruments on the basis of faithful interpretation and covers both basic operations of AIS and capabilities and limitations of using AIS on collision avoidance. When developing the syllabus, some proposals submitted by IMO Party States during sessions of Sub. Committee on safety of navigation have been referred. This syllabus can be used to develop an AIS training program. It is the author's belief that the syllabus can contribute to the validity of AIS training. The details of the syllabus are shown on Table 7-1.



## Syllabus of AIS Training<sup>1</sup>

<b>Knowledge, understanding and proficiency</b>	
<b>1. Legal aspects and requirements</b>	
Area objectives: Describe the essential legal aspects and responsibilities in the use of AIS	
1.1 Explain:	<ul style="list-style-type: none"> <li>.1 SOLAS Chapter V, carriage requirements</li> <li>.2 STCW 95 training requirements related to AIS</li> <li>.3 COLREGs Rules related to AIS operation</li> <li>.4 IMO performance standards for AIS, A.74 (69)</li> <li>.5 IMO Resolution A.917 (22)</li> <li>.6 USCG MTSA AIS operation requirements</li> </ul>
<b>2. AIS principles and Basic operations</b>	
Area objectives: Explain AIS principles and describe AIS basic operations.	
1.2 Explain:	<ul style="list-style-type: none"> <li>.1 The fundamental principles of AIS</li> <li>.2 Coverage of AIS</li> <li>.3 AIS system (overview)</li> <li>.4 Technical description of AIS</li> <li>.5 Activation of AIS units</li> <li>.6 AIS components, functionalities, connections</li> <li>.7 Different types of AIS information sent by ships</li> <li>.8 Different update rates of AIS data</li> <li>.9 Difference between AIS stabilised mode and Radar/ARPA stabilised mode</li> <li>.10 "Pseudo" AIS information</li> <li>.11 Unified and coordinated messages for AIS information</li> <li>.12 Master discretion of switching off AIS and recording the action</li> <li>.13 An automatic built-in integrity test (BIIT)</li> </ul>
1.3 Describe:	<ul style="list-style-type: none"> <li>.1 Setting up and maintaining an AIS display</li> <li>.2 Basic AIS operation at MKD level</li> <li>.3 Advanced operation integration of AIS with Radar/ARPA, ECDIS etc</li> <li>.4 Manual input of data</li> <li>.5 Checks of AIS input information, including the following items:               <ul style="list-style-type: none"> <li>• Failure of heading information and ROT</li> <li>• Failure of COG/SOG</li> <li>• Position input information</li> <li>• Outdated voyage data</li> </ul> </li> </ul>

<sup>1</sup> IMO Reference, Textbooks/Publication are referred to the Bibliography in this dissertation.

### 3. AIS capabilities and limitations

Area objectives: Describe AIS capabilities and limitations as well as their impacts on safety.

#### 3.1 Describe:

- .1 AIS capabilities on collision avoidance
  - Automatic Identification and dynamic data indication
  - Path prediction provided by AIS
  - Course change erroneously observed on an ARPA and a significant improvement provided by AIS
  - Compensation of respective deficiencies between AIS and Radar
- .2 AIS limitations on collision avoidance
- .3 Non-SOLAS ships and SOLAS ships switching off AIS
- .4 Incomplete picture of the situation around the ships
- .5 Non-integration between AIS and ECDIS & Radar/ARPA
- .6 Limitations of using MKD AIS
- .7 Impacts of a poorly located AIS display unit on safety

#### 3.2 Explain:

- .1 Awareness of AIS triggered safety issues on bridge

### 4. Presentation of AIS

Area objectives: Knowledge AIS presentation status and symbols of AIS; Describe characteristics of presentation of AIS data, and how to analyse and interpret AIS information.

#### 4.1 Knowledge:

- .1 AIS presentation status
  - AIS ON/OFF
  - Filtering of AIS sleeping targets
  - Automatic activation of AIS targets
  - CPA/TCPA alarm
  - Lost Target alarm
  - Target association
- .2 Symbols of AIS targets data and of Radar/ARPA targets data
- .3 Operational alarms and indications of AIS information

#### 4.2 Describe:

- .1 AIS display characteristics
- .2 AIS data presenting on a MKD AIS
- .3 The correct interpretation of the displayed data
- .4 Recognizing dangerous targets and assessing safety situations
- .5 Distinguishing target data from AIS or Radar/ARPA or from a combination of these two.
- .6 Distinguishing incomplete received AIS information
- .7 monitoring own ships AIS data on request
- .8 AIS and Radar automatic target association function and criteria of target association
- .9 Correlation of AIS and Radar/ARPA information
- .10 Determination of any substantial differences of information from both AIS and Radar

<p><b>5. Sensors</b></p> <p>Area objectives: Describe the performance limits of sensors and assess their impact on the safe use of AIS</p> <p>5.1 Explain:</p> <ol style="list-style-type: none"> <li>.1 The performance limits concerning availability, accuracy and integrity of all navigational sensors connected to AIS (as defined in Figure 5-1)</li> <li>.2 Awareness of a deterioration in sensor performance</li> <li>.3 Analysis and interpretation of failure indication of sensors</li> </ol>
<p><b>6. Roles of AIS</b></p> <p>Area objectives: Describe the roles that AIS acts in IBS and their impacts on safety; Explain the potential risks of using AIS to ships</p> <p>6.1 Describe:</p> <ol style="list-style-type: none"> <li>.1 AIS-an additional source for navigational information</li> <li>.2 AIS not replacing but supporting navigational systems</li> <li>.3 No negative impact on responsibility in COLREGS when using AIS</li> </ol> <p>6.2 Explain:</p> <ol style="list-style-type: none"> <li>.1 A potential risk of data inaccuracy is inherent in AIS</li> <li>.2 Errors/inaccuracies of sensors' data</li> <li>.3 Risks of over-reliance on AIS</li> <li>.4 The necessity of crosschecking of information in a navigational watch</li> <li>.5 Assessment of integrity of the system and all data at all times</li> </ol>
<p><b>7. Shore-based AIS application</b></p> <p>Area objectives: Describe further AIS application on shore and its impact on ship safety.</p> <p>7.1 Describe:</p> <ol style="list-style-type: none"> <li>.1 Text message sent by VTS centers</li> <li>.2 (D)GNSS corrections</li> <li>.3 Functionality of AIS in SAR operation and a long range applications</li> <li>.4 AIDs to navigation</li> <li>.5 Use of AIS in ship reporting and routeing</li> <li>.6 A land-based AIS system and Common Baltic Sea Monitoring System</li> <li>.7 AIS information for anti-terrorist purpose</li> </ol>

Table 7-1 A syllabus of AIS training

## Bibliography

- Abdullah, M.S. (2000). *VTS the Singapore strait: An investigation into mandatory traffic control*. Unpublished master's thesis, World Maritime University, Malmö, Sweden.
- Baker, J.C. (2000, July). AIS – Right problem wrong solution? *Seaways*, 23-24.
- Belcher, P. (2004). If it works properly, the benefits of AIS could be huge. *The Sea*, (169), pp.4-5.
- Berking, B. (2004). *Composite Radar with Radar, AIS, GNSS and ENC Data Correlation*. *European Journal of Navigation*, 2(2), 22-28.
- Berking, B. & Pettersson, B. (2002). *How can AIS assist in collision avoidance?* Unpublished lecture handout, World Maritime University, Malmö, Sweden.
- Buckens, K. (2002). *AIS & non-SOLAS ships*. Retrieved 28<sup>th</sup> June 2004 from <http://www.uais.org/DisplayIssues.htm>.
- Cockcroft, A.N. & Lameijer, J.N.F. (1996). *A guide to the collision avoidance Rules: International Regulations for Preventing Collisions at Sea (5<sup>th</sup> Ed.)*. Oxford: Butterworth Heinemann.
- Creech, J.A.& Ryan, J.F. (2003). AIS: the cornerstone of national security? *The Journal of Navigation*, 56(1), 31-44.
- Donderi, D.C. (2004). Simulated navigation performance with marine electronic chart and information display systems (ECDIS). *The Journal of Navigation*, 57(2), 189-202.
- Foxwell, D. (2003, November, 6). AIS: The next big thing in navigation *Fairplay*, 349(6250), 38-39.
- Computerisation of bridges and engine rooms: Progress or regression (2002, May/July). *gardnews*, 166, 10-12.
- OMBO-One man bridge operation or one more banned operation? (1999, June/August). *gardnews*, 154, 9-14.
- Hadnett, E. (2003, November, 6). Value-added application. *Fairplay*, 349 (6250), 44.

- Hecht, H., Berking B. & Buttgenbach G. (2002). *The electronic chart: Functions, potential and limitations of a new marine navigation system*. Lemmer, The Netherlands: GTB, Meppel, The Netherlands
- Holder, L.A. (2002). *Training and Assessment on Board*. London: Witherby
- International Association of Lighthouse Authorities [IALA]. (2003). *Guidelines on the aspects of the training of VTS personal*. IALA: Author.
- International Maritime Organization [IMO]. (1992). *International Convention on Training, Certification and Watchkeeping for Seafarers, 1978 : 1991 amendments*. London: Author.
- IMO. (1996). *STCW 95: International Convention on Standards of Training, Certification and Watchkeeping for Seafarers, 1978, as amended in 1995*. London: Author
- IMO (1998a). *Adoption of new and amended performance standards: Annex 3: Performance Standards for an Universal Shipborne Automatic Identification System (AIS) Resolution MSC.74(69)*. IMO, London.
- IMO. (1998b). *Resolution MSC.86(70): Adoption of new and amended performance standards for navigational equipment to permit operation of ECDIS in RCDS (Raster chart) mode (MSC.86(70))*, Author, London
- IMO. (1999a). *Differences between RCDS and ECDIS (SN/Circ.207)*. Paper submitted at the Maritime Safety Committee, 70th session, January 7, 1999, Author, London.
- IMO. (1999b). *Model course 1.07: Radar navigation-operational level*. London: Author.
- IMO. (1999c). *Model course 1.08: Radar navigation management*. London: Author.
- IMO. (2000a). *Model course 1.27: Operational use of ECDIS*. London: Author.
- IMO. (2000b). *Resolution MSC.112 (73): Revised recommendation on performance standards for shipborne Global Positioning System (GPS) receiver equipment (MSC 73/21/Add.3)*. Author, IMO
- IMO. (2001a). *Model course 6.09: Training course for instructors (2001 Ed.)*. London: Author.
- IMO. (2001b). *STCW white list expanded*. Paper submitted at the Maritime Safety Committee, 74th session. Retrieved March 8 2004 from: [http://www.imo.org/Newsroom/contents.asp?topic\\_id=67 & doc\\_id=1026](http://www.imo.org/Newsroom/contents.asp?topic_id=67 & doc_id=1026)

- IMO. (2002a). *Amendments to the International Convention for the Safety of Life at Sea, 1974, as amended: Draft*. London: Author.
- IMO. (2002b). *Guidelines for the onboard operational use of shipborne Automatic Identification Systems (AIS)*. (Resolution A 22/Res.917), Author, London.
- IMO. (2002c). *International Safety Management Code and revised guidelines on implementation of the ISM Code by administrations*. London: Author
- IMO (2002d). *Requirements for the display and use of AIS information on Shipborne Navigational Displays (NAV48/16)*. Paper submitted at the Sub-committee on Safety of Navigation, 48<sup>th</sup> Session, 28 January 2002 by the United Kingdom. Author, London
- IMO. (2002e). *SOLAS: International Convention for Safety of Life at Sea, 1974, and 1988 Protocol relating thereto: 2000 amendments effective January and July 2002*. London: Author.
- IMO. (2003a). *Guidelines for the installation of a shipborne Automatic Identification System (AIS) (SN/Circ.227)*. Author, London.
- IMO (2003b). *Measures to enhance maritime security: Shipboard AIS training (STW 35/9)*. Paper submitted at the STW Sub-committee, 11 November 2003, by the International Federation of Shipmasters' Associations (IFSMA). Author, London
- IMO (2004a). *Requirements for the Display and Use of AIS Information on Shipborne Navigation Displays*. Paper submitted at the Sub-committee on Safety of Navigation, 50<sup>th</sup> Session, 28 March 2004, by Germany. Author, London
- IMO (2004b). *Requirements for the display and use of AIS Information on shipborne navigation displays : Recommendation to review Resolution A.917(22) (NAV50/4/2)*. Paper submitted at the Navigation Sub-Committee, 50<sup>th</sup> session, 26<sup>th</sup> April 2004, by the United Kingdom.
- IMO (2004c). *Review of performance standards for radar equipment*. Paper submitted at the Sub-committee on Safety of Navigation, 50<sup>th</sup> Session, 1 April 2004, by Norway. Author, London
- IMO (2004d). *Use of the destination-field in AIS message (NAV50/18/1)*. Paper submitted at the Navigation Sub-Committee, 50<sup>th</sup> session, 29<sup>th</sup> April 2004 by Denmark, Finland, Norway and Sweden.
- International Shipping Federation. (1995). *The revised STCW convention: A guide for the shipping industry*. London: Author

- Luniweski, R.H. (1999, March). Impact of the 'Modern Bridge'. *Sea Technology* 40(3), 41-46.
- Lutzhof, M. & Dekker, S.W.A. (2003, November). On your watch: Automation on the bridge. *Seaways*, 8-12.
- Makarov Training Center [MTC]. (2004). *AIS training program has been developed*. Retrieved May 22 2004 from: <http://www.makarov.spb.ru/eng/hotnews/news5#3>
- Mikosch, K. (2000). *Development of guidelines and operational proposals for the use of shipborne AIS*. Unpublished master's thesis, Hamburg University of Applied Sciences, Hamburg, Germany.
- Morrison, W.S.G. (1997). *Competent crews = Safer ships : An aid to understanding STCW 95*. Malmö, Sweden: WMU Publications.
- National Transportation Safety Board [NTSB]. (1997). *Marine Accident Report: grounding of the Panamanian passenger ship "Royal Majesty on Rose and Crown Shoal near Nantucket, Massachusetts* (NTSB 97/01). Retrieved May 22 2004 from: <http://www.nts.gov/publictn/1997/MAR9701.pdf>.
- AIS as a tool for Safety of Navigation and Security-Improvement or Not? (2004). *Navigare*, (1), 34-35
- Technology demands enhanced training. (2003, April-June). *Ocean Voice*, 32-33.
- O'Neil, W.A. (1999). Is IMO still relevant? *BIMCO Review 1999*. London: Stroudgate Plc. for BIMCO.
- Muirhead, P. (1992). *One man bridge-operational aspects and future training needs*. Unpublished lecture notes, World Maritime University, Malmö, Sweden.
- Muirhead, P. (2003), *The revised STCW*. Unpublished lecture notes, World Maritime University Malmö, Malmö, Sweden.
- Pettersson, B. (2001). This is AIS. *The Swedish Club Letter*, (1), 8-13.
- Pettersson, B. (2003). The implication of AIS-automatic identification system. *European Journal of Navigation*, 1(2), 49-53.

- Pratt, C. R. & Taylor G. (2004). *AIS- A pilot's perspective*. *The Journal of Navigation*, 57(2), 181-188.
- Pot, F.W. (2002a). *What AIS does to radar?* Retrieved 25<sup>th</sup> June 2004 from <http://www.uais.org/DisplayIssues.htm>
- Pot, F.W. (2002b). *From analog to digital: What AIS does to radar?* Retrieved 25<sup>th</sup> June 2004 from: <http://www.uais.org/DisplayIssues.htm>.
- Pot, F.W. (2004). *I need to equip my ships with AIS...* Retrieved June 7, 2004, from: [http://www.uais.org/AIS\\_Conference\\_Report\\_JA-FP\[2\].htm](http://www.uais.org/AIS_Conference_Report_JA-FP[2].htm)
- Pyke, D. (2004, January). AIS could be bad news for small boat. *All At Sea*, p.5.
- Ramsvik, H. (2004). AIS as a tool for safety of navigation and security: Improvement or not?. *European Journal of Navigation*, 2(2), 20-22.
- Ross, R. G. (2004). *VTS Lower Mississippi River and AIS implementation* Unpublished lecture notes, World Maritime University, Malmö, Sweden.
- Stitt, I.P.A. (2003). The use of VHF in collision avoidance at sea. *The Journal of Navigation*, 56(1), 67-78.
- Stitt, I.P.A. (2004). AIS and collision avoidance- A sense of *déjà vu*. *The Journal of Navigation*, 57(2), 167-180.
- United States Coast Guard [USCG]. (2004). *Automatic Identification System (AIS)*. Retrieved May 22 2004 from: <http://www.navcen.uscg.gov/enav/ais/default.htm>
- Western Marine Community [WMC]. (1999). *British Columbia AIS test summer 1999*. Retrieved 25<sup>th</sup> June 2004 from <http://www.uais.org/1999AISTestTOC.htm>
- Where does INS end and IBS begin? (1999,September). *Fairplay Solutions*, 36, 25.
- WMC. (2000). *British Columbia AIS test summer 2000*. Retrieved 25<sup>th</sup> June 2004 from the World Wide Web: <http://www.uais.org/BCAISTest2000.htm>
- WMC. (2002). *2002 test of AIS*. Retrieved May 27th 2004 from the World Wide Web: <http://www.uais.org/CruiseShipIIFinalReportV1.21.htm>
- Winbow, A. (2003). *Training mariners to use AIS*. AIS Workshop, HQS Wellington January 2003



Case Study List

Collision between Panamanian Container Ship Ever Grade and U.S. Coast Guard Buoy Tender Cowslip, Columbia River near Astoria, Oregon, May 14, 1997. **NTSB Report Number:** MAB-99-01, adopted on 12/30/1999. Retrieved 26<sup>th</sup> June 2004 from the World Wide Web: <http://www.nts.gov/publicctn/1999/MAB9901.htm>

Marine Accident Report Grounding of the Panamanian Passenger Ship ROYAL MAJESTY on Rose and Crown Shoal near Nantucket, Massachusetts June 10, 1995. **NTSB Report Number:** MAR-97-01, adopted on 4/2/1997. Retrieved 26<sup>th</sup> June 2004 from the World Wide Web: <http://www.nts.gov/publicctn/1999/MAB9901.htm>

Report on the investigation of the collision between the container ship **P&O Nedlloyd Vespucci** and the yacht **Wahkuna** English Channel 28 May 2003. **MAIB Report No 28/2003**, adopted on December 2003. Retrieved 26<sup>th</sup> June 2004 from: [http://www.dft.gov.uk/stellent/groups/dft\\_maritimesafety/documents/page/dft\\_masafety\\_026317.pdf](http://www.dft.gov.uk/stellent/groups/dft_maritimesafety/documents/page/dft_masafety_026317.pdf)

An Overview of AIS

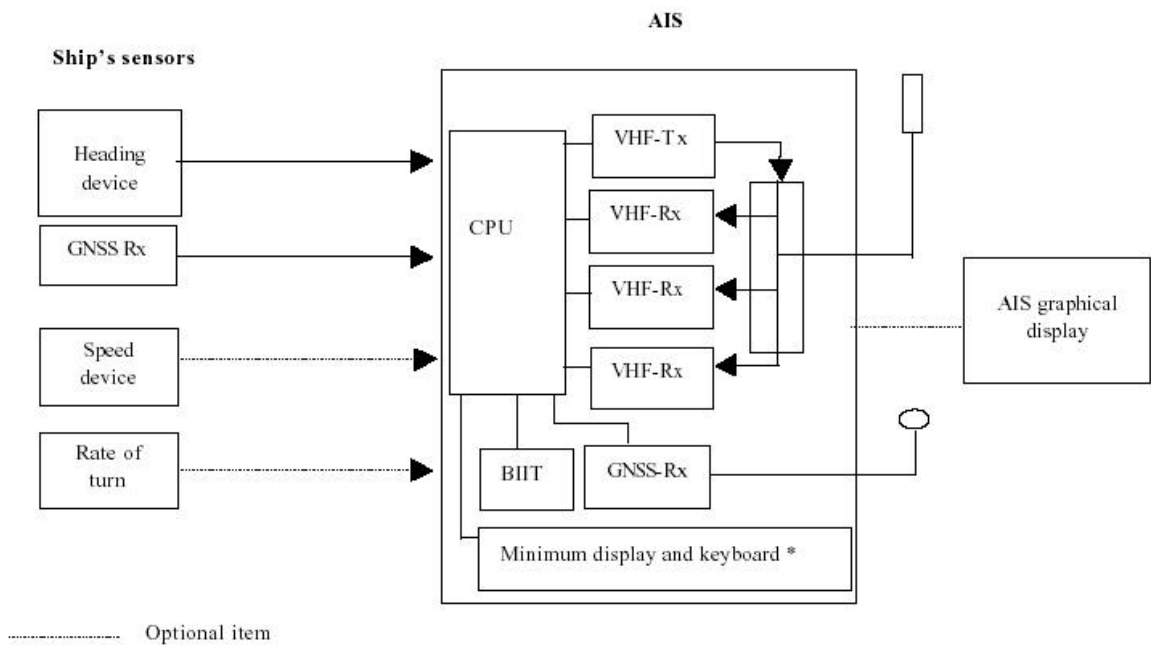
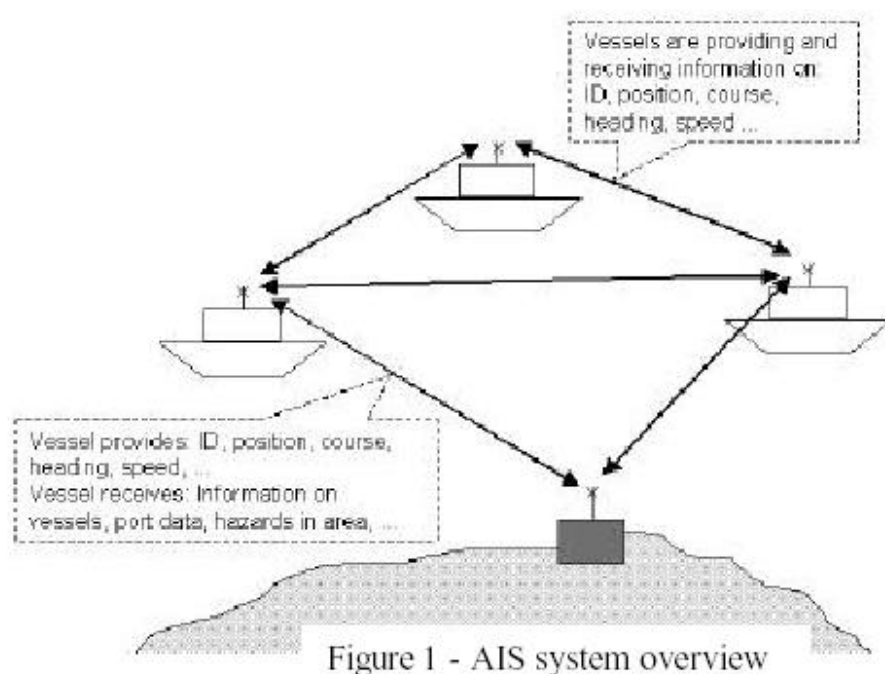

Figure 2 - AIS Components

(Source: IMO, 2002)

### Technical Description of AIS<sup>1</sup>

1, AIS operates primarily on two dedicated VHF channels (AIS1 - 161,975 MHz and AIS2 - 162,025 MHz). Where these channels are not available regionally, the AIS is capable of automatically switching to alternate designated channels.

2, The required ship reporting capacity according to the IMO performance standard amounts to a minimum of 2000 time slots per minute (see figure 1). The ITU Technical Standard for the Universal AIS provides 4500 time slots per minute. The broadcast mode is based on a principle called (S)TDMA (Self-organized Time Division Multiple Access) that allows the system to be overloaded by 400 to 500% and still provide nearly 100% throughput for ships closer than 8 to 10 NM to each other in a ship-to-ship mode. In the event of system overload, only targets far away will be subject to drop-out in order to give preference to targets close by that are a primary concern for ship-to-ship operation of AIS. In practice, the capacity of the system is unlimited, allowing for a great number of ships to be accommodated at the same time.

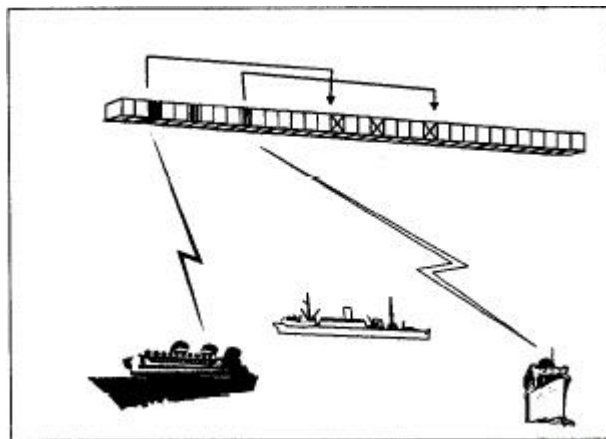
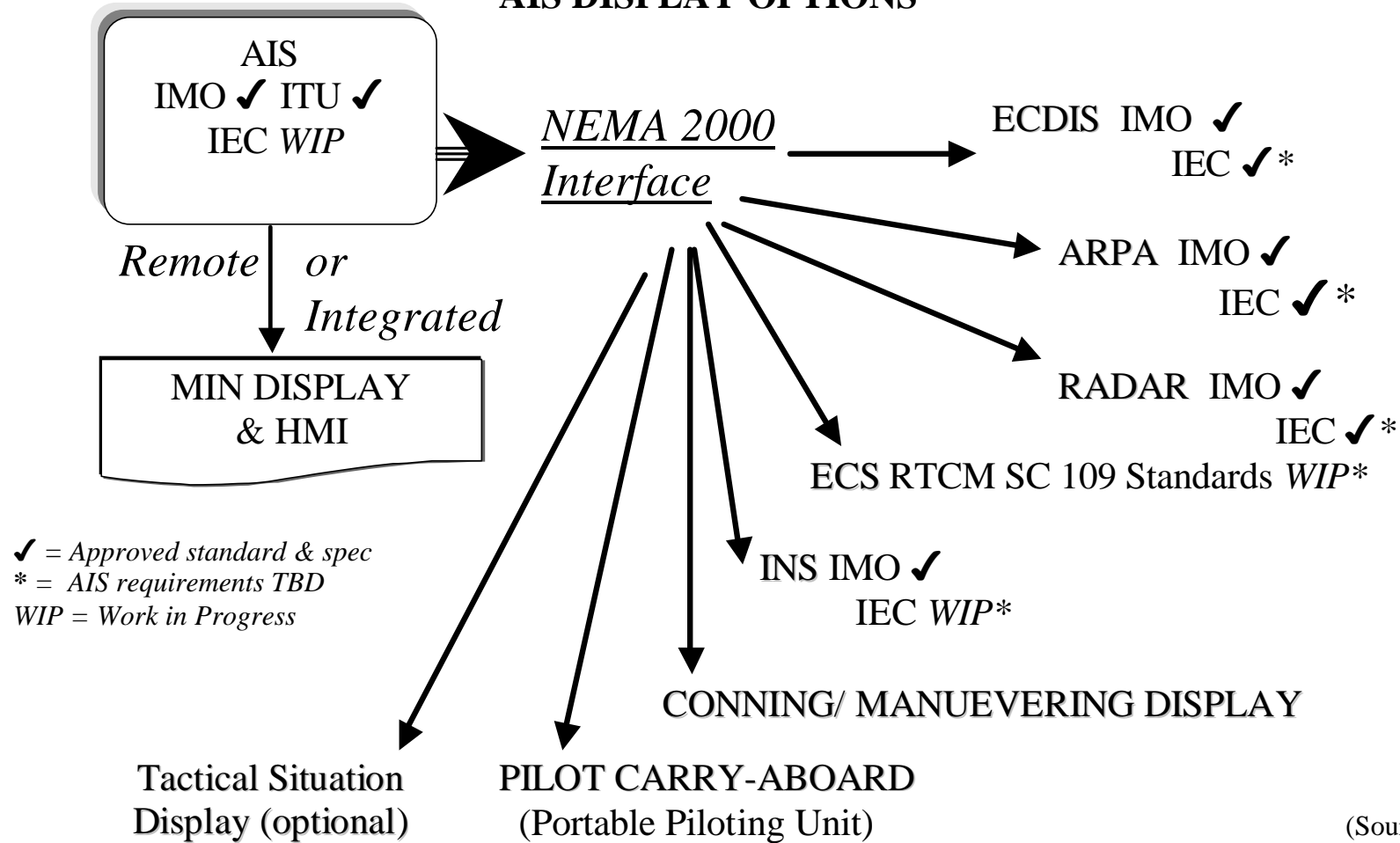

Figure 1 - Principles of TDMA

---

<sup>1</sup> Derived from IMO Resolution A.917 (22)

**AIS DISPLAY OPTIONS**



(Source: Ross, 2004)

### AIS ELEMENTS

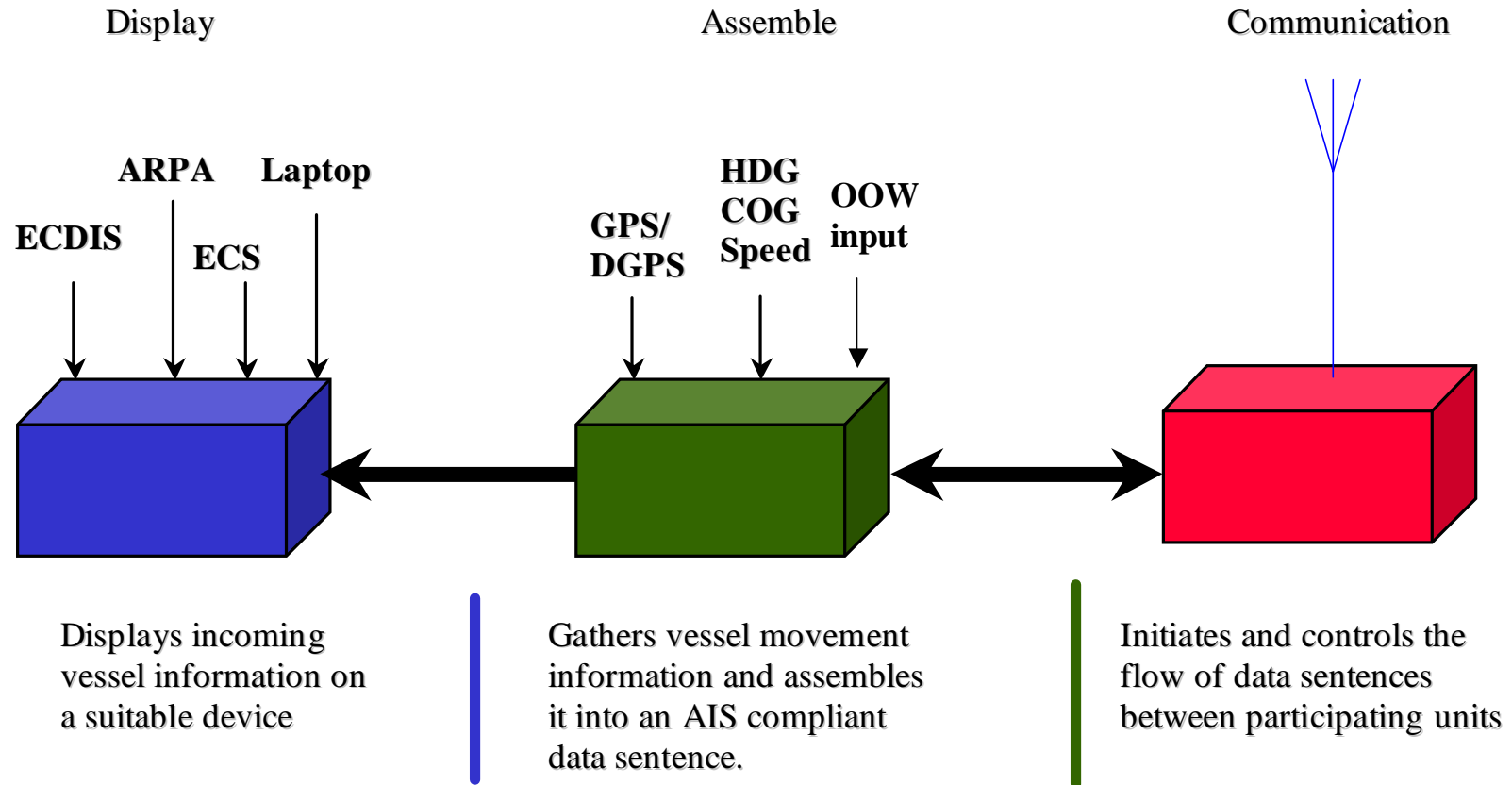

(Source: Ross, 2004)

### Comparison of AIS- and Radar-based information

Functions	Radar / ARPA	AIS	AIS Exemple / Comment
<b>ID and static data</b>			
	- - - - -	<ul style="list-style-type: none"> <li>• MMSI</li> <li>• Call sign and name</li> <li>• IMO number</li> <li>• Length and beam</li> <li>• Type of ship</li> <li>• GNSS antenna location</li> </ul>	
<b>Dynamic data</b>			
Position			With
- Absolute	-	X	• Time stamp
- Relative	X	-	• Accuracy indication
- Accuracy	Ship: < 30 m VTS: < 20 m	1-5 m 1-5 m	• Integrity status
Speed			
- SOG / COG	X, if SOG input	X	
- STW / CTW	X (ambiguous value), if STW input	-	Heading replaces CTW
Heading	-	X	From target's gyro
ROT	-	X 10°/min flag	Transmitted if available; or heading-based
Nav. status	-	X	"Underway by engine"; "at anchor"; "moored"
CPA /TCPA	X Distance/bearing-based	X D/GNSS-based	
Rudder	-	-	Intendedly not!
<b>Voyage related data</b>			
Draught	-	X	
Cargo	-	X	
Destination; ETA	-	X	
Route plan	-	(x)	Master's discretion
<b>Targets and symbols</b>			
Basic information	Raw radar	Sleeping target	
More information	Acquired target (vector)	Activated target (Vector, heading, ROT flag)	
Detailed information	Selected target data display	Selected target	
Risk	Dangerous target	Dangerous target	
	Lost target	Lost target	
<b>Essentials</b>			
Aspect	(CTW values only)	X	Via headings
Ship autonomous	X	-	GNSS dependent
Target display	Radar-conspicuous target	AIS-equipped target	
Manoeuvre detection	30 – 90 sec	5- 10 sec	AIS misses very unlikely
Display	Radar	Radar; ECDIS; AIS only	
Data fusion	With AIS	With radar	
Wind, weather	-	X	Via binary messages

(Source: Berking & Pettersson, 2004)

### Relationship Between IBS and INS

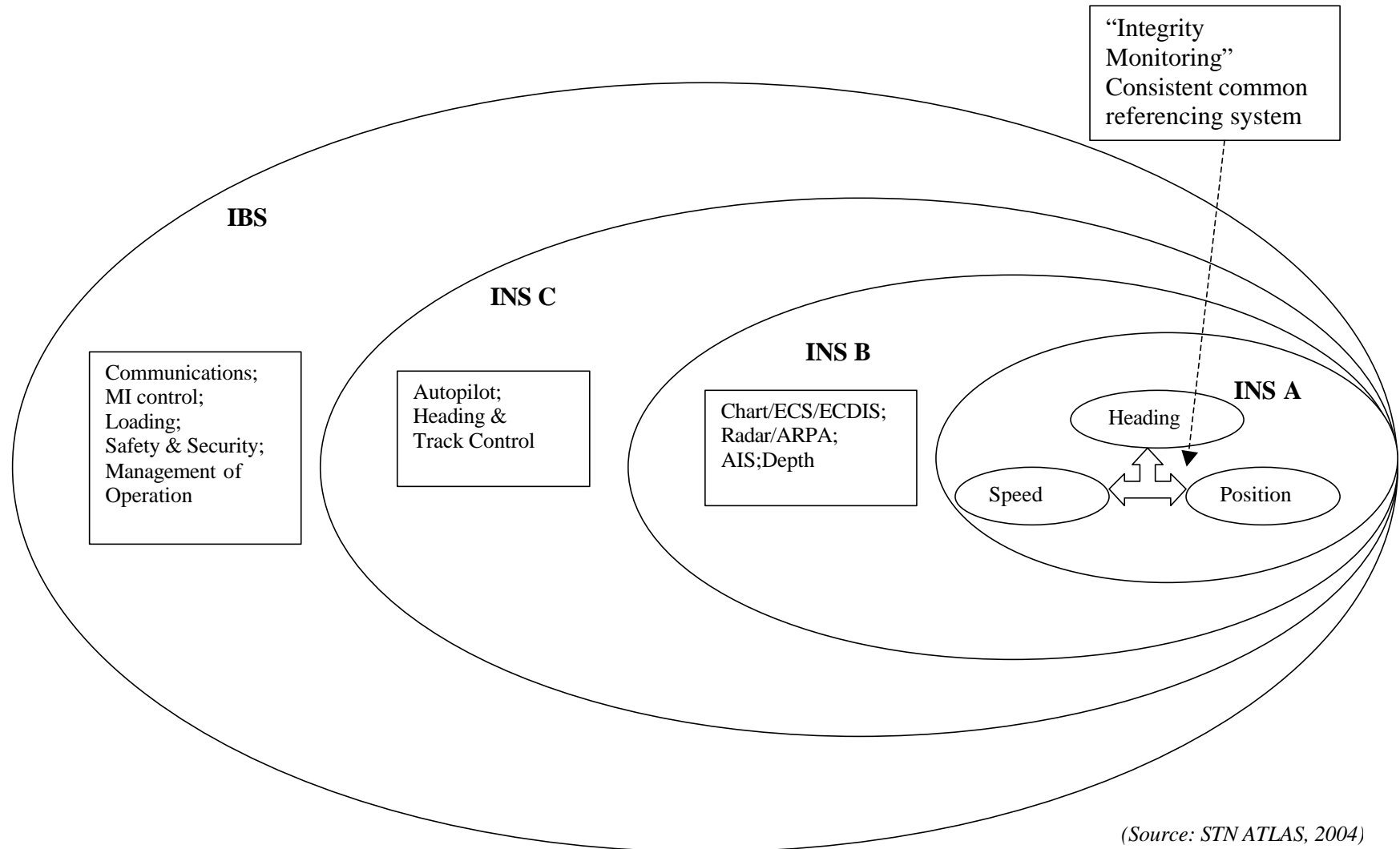

## Appendix VI

### Lessons to Learn from the Royal Majesty's Grounding

#### 1. Over-reliance on integrated navigation system led to grounding of cruise vessel

This summary is based on a report issued earlier in the year by the US National Transportation Safety Board. It is included here with their kind permission.

On the evening of 10 June 1995, the Panamanian registered passenger vessel ROYAL MAJESTY grounded on Rose and Crown Shoal about 10 miles east of Nantucket Island, Massachusetts. The vessel, with 1,509 persons on board, was en route from St Georges, Bermuda, to Boston, Massachusetts.

About an hour after leaving St Georges the Global Positioning System (GPS) antenna cable became partly disconnected causing the GPS to switch to dead reckoning mode. Nobody noticed. The autopilot continued to react to the information derived from the GPS. Thus the set of the vessel, caused by wind, current and sea conditions, was not detected and allowed for by the system. The fault with the GPS, and the fact that the vessel was not in the position indicated by the integrated bridge navigational system, remained unnoticed by the watch officers during the 34 hours prior to the grounding.

Initial attempts to re-float the vessel were unsuccessful while deteriorating weather and sea conditions prevented the evacuation of passengers and crew.

On 11 June, ROYAL MAJESTY was re-floated with the aid of five tugs. Initial damage surveys revealed deformation of the vessel's double bottom. However, no penetration or cracking of the hull was detected, and no fuel oil had been spilled. The US Coast Guard gave the vessel permission to proceed to Boston to disembark the passengers. She arrived there safely on 12 June.

Although there were no injuries as a result of this accident, the costs of repairs to the vessel and lost revenue were estimated at about US \$7 million.

#### 2 The Lessons

This was a well-found vessel with fully qualified and experienced bridge watch keepers. Like most, if not all, passenger liners the ROYAL MAJESTY was equipped with modern navigational aids including GPS, which is capable of determining a vessel's position with great accuracy.

- (1) Despite their experience and qualifications the watch keepers remained unaware of the increasing deviation from the planned track in the 34-hour period after leaving Bermuda.



## **The principle of UAIS STDMA<sup>1</sup>**

### **1. The Equipment of AIS**

The shipboard and shore station equipment consists of a box containing two (one as a reserve back up) fully synthesized VHF transmitter and receiver units capable of operating on any frequency within the marine band (136 -174 MHz). Two VHF channels within this band have been allocated for intership transponder use by the International Telecommunications Union (ITU) namely AIS1 (161.975Mhz) and AIS2 (162.025Mhz). If these become overloaded or are allocated to alternative usage within any area then the system will be switchable to another available channel within the marine band. The unit also contains a GPS receiver and a computer.

### **2. Basic Principle of Operation**

Each station transmits data in pulses on the VHF frequency and any station within VHF range will be able to receive the information and display it either on the radar, ECDIS or a dedicated display. The system can therefore be used for ship to ship and ship to shore (4S) identification and transfer of data. Using the two channels the system is designed to provide about 4500<sup>2</sup> slots per minute for transmission of information "blocks". Depending on the information required a ship will require more than one slot to transmit the relevant information. There are four types of information "block".

---

<sup>1</sup> This article is derived from *AIS-More Discussion Required?* By Baker, J.C. that was published in *Seaways*, July 2000.

<sup>2</sup> The author mentioned that 4,500 slots per minute appears more than adequate for even the busiest waterway but the industry's ambitious plans for it to relay chunks of data about each vessel will eat into that capacity.

## Appendix

- (1) **Static:** this will probably consist of Name, Callsign, IMO & MMSI numbers, Length & Draft. The information will be repeated about every 6 minutes.
- (2) **Dynamic<sup>3</sup>:** GPS Position, Course and Speed made well, Gyro heading and Rate of Turn. Information is updated every time slot or on request.
- (3) **Voyage related:** Ship type, Cargo, Destination, ETA etc. Repeated every 6 minutes or updated as required.
- (4) **Short Messages:** Safety related transmitted as required.

The system will operate in 3 different modes:

### (1) Autonomous and Continuous

When a vessel is at sea it will be operating in this mode and will transmit basic static and dynamic data, which can be displayed and read by other stations within VHF range. The transponder monitors other transmissions and transmits when there is a clear slot between other transmissions.

### (2) Assigned mode

Upon entering a VTS area the transmissions will be automatically controlled by the shore base station and assigned a slot to link in with other traffic. Ship to shore transmissions will normally take place on a dedicated port frequency different from the AIS 1 & 2 intership frequencies. When a ship enters a port area it will be requested to switch AIS operation to that channel by the polling mode.

### (3) Polled or Controlled mode

The shore station automatically interrogates the other station and requests specific information and advises the port working frequency to be worked. Operation in this

---

<sup>3</sup> There is currently no requirement for vessels to carry GPS or DGPS. As the Author understands it the GPS receiver to be incorporated into the AIS unit will be of low grade with the primary function of controlling the timer of the unit.

mode may possibly take place on Channel 70 in the form of a DSC short message in order not to conflict with the other modes.

### **3. Practical Operation**

#### **(1) Ship to Ship**

The system displays the static and dynamic information of other shipping within VHF range and the advantage of the system is that it will work in heavy clutter and radar shadow sectors such as behind a headland. Interestingly, opinions of the serving officers present at the seminar differed as to the merits of positive identification of shipping. The short sea traders could see distinct advantages in being able to identify the "Port Hand Charlie" whereas a deep-sea officer was of the opinion that what was required was not more excuses for VHF conversations but for shipping to obey the COLREGS. The point was also raised that the existing COLREGS made no provision for VHF conversations! There was however a general consensus of opinion that with their identity being beamed out continuously watch-keepers would tend to be more vigilant!

#### **(2) Ship to Shore**

The advantages here are more obvious since AIS will remove the need for vessels to report to shore stations with their details or to update their position passing reporting points. VHF conversations will thus be minimized. The promoters of the system claim that it will be able to handle around 400 ships. The dynamic information received is expected to provide sufficient information for a more positive interaction between a VTS centre and shipping and thus reduce the requirement for compulsory pilotage. The system could also be used to re-transmit VTS radar positions of vessels not fitted with AIS to shipping to enable these to be displayed on a vessel's ECDIS or pilot laptop display<sup>4</sup>.

---

<sup>4</sup> Currently it is not possible for this VTS information to be received and displayed as vectors, i.e. a moving vessel will appear as a spot that will jump each time the signal is transmitted.

**General causal factors in the grounding include:**

- Over-reliance by watch keeping officers on the automated features of the integrated bridge system;
- Inadequate training in the technical capabilities and limitations of the integrated bridge system;
- Poor navigational watch keeping practices in general.

**Specific factors include:**

- The routing of the GPS antenna cable, which made it vulnerable to damage;
- The fact that the echo sounder alarm had been set to zero depth;
- Deficient monitoring of the status of the GPS;
- No cross-checking of the GPS derived positions by watch keepers;
- Sole reliance on the position-fix alarm for warning of deviation from the vessel's intended track;
- The configuration of the integrated bridge system, which neither recognised nor allowed for the fact that the GPS had switched to dead reckoning mode. Its design did not adequately incorporate human factors engineering;
- The remoteness of the GPS receiver, and the short duration of the aural alarm which sounds when switched to the dead reckoning mode, contributed to the failure of the watch keepers to notice the change.

- (2) MAIB Comment. Modern navigation aids can fail; sometimes without being noticed by the operator. A fundamental rule of safe navigation is to always check the primary method of navigation by an independent source. Radio aids, astro-navigation, visual fixing and use of the echo sounder are all available to the conscientious navigator. Special care is needed when making a landfall.

*(MAIB, 1997)*

**AIS Information Display on PC Screen  
Ship Is Following The Constant-Radius Turning**

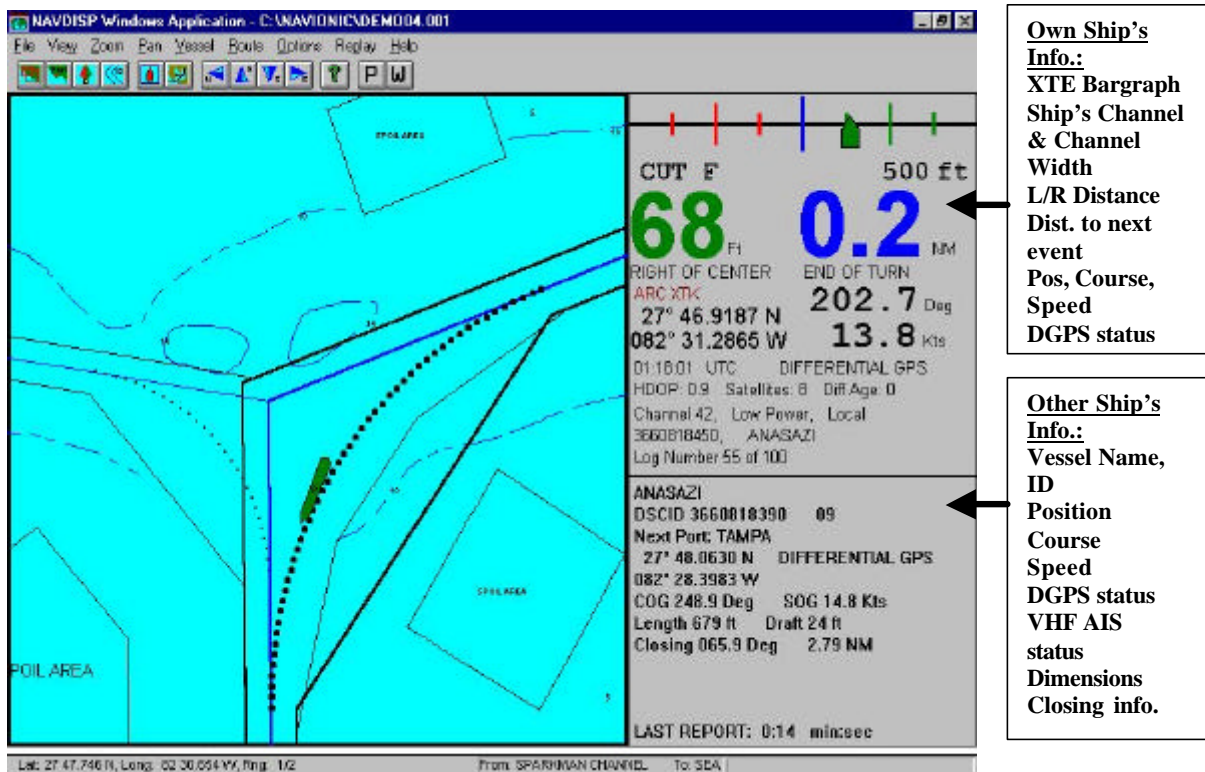

(Source: Ross, 2004)

**AIS – Minimum Keyboard Display**



(Source: Berking, 2004)

## AIS and Radar Data Association

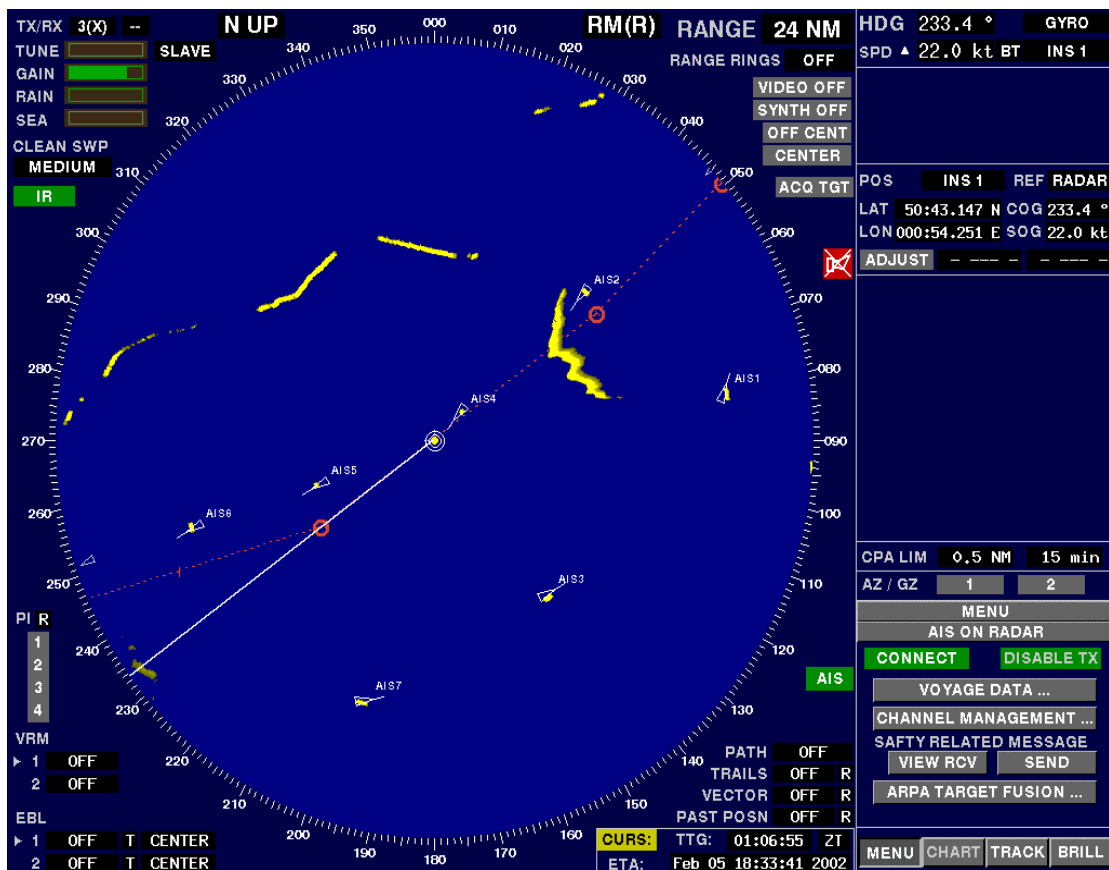

(Source: SAM 1000, 2004)

## Notes:

- An AIS targets will be displayed by switching the AIS button to “ON”.
- As default the Sleeping Target symbol will be displayed. For more information, the target has to be activated.
- Sub menus can be selected for additional information.
- Switching AIS button to “OFF”, only activated targets will be displayed to avoid clutter on the PPI and information overload.