

University of Wisconsin Milwaukee UWM Digital Commons

Theses and Dissertations

May 2018

Role of the Two Adaptor Proteins in the Chp Chemosensory System of *Pseudomonas Aeruginosa*

Swati Sharma

University of Wisconsin-Milwaukee

Follow this and additional works at: <https://dc.uwm.edu/etd>

 Part of the [Microbiology Commons](#), and the [Molecular Biology Commons](#)

Recommended Citation

Sharma, Swati, "Role of the Two Adaptor Proteins in the Chp Chemosensory System of *Pseudomonas Aeruginosa*" (2018). *Theses and Dissertations*. 1916.

<https://dc.uwm.edu/etd/1916>

This Thesis is brought to you for free and open access by UWM Digital Commons. It has been accepted for inclusion in Theses and Dissertations by an authorized administrator of UWM Digital Commons. For more information, please contact open-access@uwm.edu.

ROLE OF THE TWO ADAPTOR PROTEINS IN THE CHP CHEMOSENSORY
SYSTEM OF *PSEUDOMONAS AERUGINOSA*

by

Swati Sharma

A Thesis Submitted in
Partial Fulfillment of the
Requirements for the Degree of

Master of Science
in Biological Sciences

at

The University of Wisconsin-Milwaukee

May 2018

ABSTRACT

ROLE OF THE TWO ADAPTOR PROTEINS IN THE CHP CHEMOSENSORY SYSTEM OF *PSEUDOMONAS AERUGINOSA*

by

Swati Sharma

The University of Wisconsin-Milwaukee, 2018
Under the Supervision of Professor Sonia L. Bardy

The Chp chemosensory system in *Pseudomonas aeruginosa* controls two outputs: twitching motility (surface-mediated movement via Type IV pili) and intracellular adenosine 3', 5'-cyclic monophosphate (cAMP) levels (by modulating the activity of major adenylate cyclase CyaB). This study was done to investigate the roles of the two adaptor proteins, PilI and ChpC in connecting one methyl-accepting protein (MCP) to one histidine kinase. We assayed β -galactosidase activity as an indicator of the relative levels of intracellular cAMP and measured twitching motility. We also studied the interaction of the adaptor proteins within the Chp chemosensory system. Our bacterial adenylate cyclase two-hybrid analysis showed that PilI and ChpC interacted with each other, but did not show interaction with themselves or with the MCP. Both adaptor proteins were required for the proper functioning of the system. However, PilI played a much bigger role than ChpC in regulating both twitching motility and cAMP levels.

To
my parents,
and my brothers

TABLE OF CONTENTS

Abstract.....	ii
List of figures.....	vi
List of tables.....	vii
Acknowledgements.....	viii
Introduction.....	1
Materials and methods.....	4
Growth conditions.....	4
Mutant generation.....	5
Complementation of deleted gene.....	5
Ligations.....	5
Transformation.....	6
Heat shock.....	6
Electroporation.....	6
Twitching motility assay.....	6
β -galactosidase assay.....	7
Immunoblotting.....	7
Bacterial adenylate cyclase two-hybrid (BACTH) strains generation.....	7
BACTH assay.....	8
Results.....	8
PilI plays a larger role on intracellular cAMP levels than ChpC.....	8
PilI has a larger role in regulating twitching motility than ChpC.....	10

The adaptor proteins PilI and ChpC interact with each other.....	11
Discussion.....	12
References.....	34

LIST OF FIGURES

Figure 1. Genetic organization of the cluster IV chemosensory genes in <i>P. aeruginosa</i>	18
Figure 2. Model for outputs of the Chp chemosensory system.....	19
Figure 3. Schematic of the Chp chemosensory system.....	20
Figure 4. Different potential signaling array combinations in the Chp chemosensory system.....	21
Figure 5. PilI plays a larger role than ChpC in regulating intracellular cAMP levels.....	22
Figure 6. Expression of his-tagged PilI and ChpC proteins in the complemented strains.....	23
Figure 7. Measure of twitching motility indicating PilI playing a larger role than ChpC.....	24
Figure 8. BACTH analysis showing interaction of PilI-T18 and ChpC-T25.....	25
Figure 9. BACTH analysis showing interaction of ChpC-T18 and PilI-T25.....	26
Figure 10. BACTH analysis showing interaction of PilI-T18 and PilI-T25.....	27
Figure 11. BACTH analysis showing interaction of ChpC-T18 and ChpC-T25.....	28
Figure 12. BACTH analysis showing interaction of PilJ-T18 and PilI-T25.....	29
Figure 13. BACTH analysis showing interaction of PilJ-T18 and ChpC-T25.....	30

LIST OF TABLES

Table 1. List of the strains used in the study.....	31
Table 2. List of the plasmids used in the study.....	32
Table 3. List of the primers used in the study.....	33

ACKNOWLEDGEMENTS

I want to express my sincere gratitude to my advisor Dr. Sonia L. Bardy for giving me the opportunity to be a part of her lab, for her helpful insights and guidance throughout. This thesis was not possible without her constant help and expert advice. I appreciate her for being so caring and understanding. I want to thank her for constantly motivating me to do my best. I had a wonderful experience working with her and I will always cherish my time here. I want to thank my committee members Dr. Mark McBride and Dr. Ching-Hong Yang for their helpful suggestions and remarks that improvised this project.

I appreciate the amazing office staff of the biological sciences department for their help right from the beginning, from the application process until the very end. I want to thank my colleagues Kayla Simanek, Dr. Vibhuti Jansari, Michelle Torijjos and Dr. Jesse Reinhardt for their help and support that kept me going and for making the lab environment enjoyable. I am very thankful to Caitlin Sanfelippo and all my other friends in Milwaukee for all the happy memories and joyful times that made my journey a little easier when I was away from my family.

Lastly and most importantly, I want to thank my parents, my brothers Tarun Sharma and Varun Sharma for making this possible. I cannot imagine having accomplished this if it was not for their love, constant encouragement, trust and support. I am grateful to my relatives and the family friends for their guidance and well wishes.

Introduction

Pseudomonas aeruginosa is a Gram-negative, rod shaped bacterium. It is commonly found in the environment and is an opportunistic pathogen that can infect compromised patients including those with Cystic Fibrosis, AIDS, burn injuries, those undergoing chemotherapy and more. It is the primary cause of mortality in patients with Cystic Fibrosis, an inherited disease (Fulcher, Holliday, Klem, Cann, & Wolfgang, 2010). Additionally, it infects numerous other eukaryotes such as nematodes, insects, plants etc (Bertrand, West, & Engel, 2010). It is a leading cause of nosocomial infections, and can cause both acute and chronic biofilm infections in humans (Hickman, Tifrea, & Harwood, 2005).

Type IV pili (TFP) are filamentous appendages located at the poles of *P. aeruginosa* that play a role in surface attachment, virulence, DNA uptake and biofilm formation (Bertrand et al., 2010; Buensuceso et al., 2017). PilA is the major pilin subunit in *P. aeruginosa* (Burrows, 2012). TFP function to extend or retract via assembly or disassembly of pilin monomers at the base of the pilus structure to bring about locomotion over surfaces, known as twitching motility (Inclan et al., 2016). Pilus fibers extend, explore the surface before adhering to it and then the attached pili become shorter so that the cell can move forward. Twitching occurs on moderately viscous moist surfaces such as 0.1% agar (Burrows, 2012).

There are a total of five clusters of chemotaxis-like genes in *P. aeruginosa* and 26 genes that are homologous to the *Escherichia coli* methyl-accepting chemotaxis protein (MCP) genes (Ferrandez, Hawkins, Summerfield, & Harwood, 2002). The Chp chemosensory system (cluster IV) (Fig. 1) regulates twitching motility and intracellular levels of second messenger signaling molecule adenosine 3', 5'-cyclic monophosphate (cAMP) by modulating the activity of the major adenylate cyclase CyaB (Fulcher et al., 2010; Jansari, Potharla, Riddell, & Bardy, 2016)

(Fig. 2). cAMP binds and activates the Vfr protein (Virulence factor regulator; homolog of CAP/CRP in *E. coli*) which modulates expression of more than 200 genes including virulence genes, genes for the TFP motor ATPases PilB/T/U, and TFP assembly genes (Buensuceso et al., 2017; Francis, Stevenson, & Porter, 2017). While TFP production is controlled through modulation of cAMP, the function of TFP (extension and retraction of T4P; twitching motility) is cAMP independent, yet also controlled through the Chp system (Fulcher et al., 2010).

The Chp chemosensory system is a two-component signal transduction system and is similar to the chemotaxis system in *E. coli*. PilJ is the transmembrane MCP in the Chp chemosensory system. This chemoreceptor, PilJ, senses the external signal(s) and transduces it to the histidine kinase, ChpA (Inclan et al., 2016; Whitchurch et al., 2004). PilK is the methyltransferase (homolog of CheR in *E. coli*) and ChpB is the methylesterase (homologous to CheB in *E. coli*), that is activated when phosphorylated by ChpA (Ferrandez et al., 2002) (Fig. 3).

When the MCP senses the environmental signal, it undergoes a conformational change and the signal is transmitted to the histidine kinase (Inclan et al., 2016). There is trans-autophosphorylation of a histidine residue on one of the monomers of the histidine protein kinase dimer by the γ -phosphoryl group of an ATP molecule which is bound on the other monomer (Wadhams & Armitage, 2004). ChpA is known to have eight potential phosphorylation sites, out of which six are histidine domains, one threonine and one serine domain. ChpA also has a receiver domain which has a role in auto-dephosphorylation (Silversmith, Wang, Fulcher, Wolfgang, & Bourret, 2016). Three out of the six histidine phosphotransfer (Hpt4-6) domains can be phosphorylated by ATP. These three domains plus two others (Hpt2-6) can be reversibly phosphorylated by the ChpA receiver domains. One Hpt domain (Hpt1) and the two

serine/threonine domains cannot be phosphorylated at all. The phosphoryl group from the histidine is then transferred to the aspartate residue of the response regulators PilG or PilH (both are homologous to CheY in *E. coli*), or transferred to the receiver domain of ChpA (Inclan et al., 2016) (Fig. 3). Hpt2 and Hpt3 phosphorylate PilG and PilH, respectively (Bertrand et al., 2010; Silversmith et al., 2016). When PilG is phosphorylated, it modulates the activity of ATPase PilB to activate pilus extension and modulates CyaB to increase intracellular cAMP levels. When PilH is phosphorylated it acts as a phosphate sink to limit signaling through PilG and modulates the activity of the ATPase PilT to drive pilus retraction and reduce the intracellular cAMP levels by inhibiting CyaB (Bertrand et al., 2010; Buensuceso et al., 2017). The phosphorylation of PilH is preferred over PilG (Buensuceso et al., 2017).

In chemotaxis-like systems, the interaction between the MCP and the histidine kinase is mediated by the adaptor protein(s). The Chp chemosensory system differs from the well-studied *E. coli* chemotaxis system in that there is only one MCP, ChpA is significantly more complex than CheA, and there are two CheW-like adaptor proteins in the Chp system: PilI and ChpC (Fulcher et al., 2010; Park et al., 2006; Wadhams & Armitage, 2004) (Fig. 3).

A chemotactic signaling array is made up of a trimer of MCP homodimers, two adaptor proteins, and a histidine kinase dimer. *E. coli* is able to form functional signaling arrays from five different MCPs, one adaptor protein and one histidine kinase. Other bacteria, such as *Helicobacter pylori* use multiple versions of adaptor proteins (CheW and CheVs) when forming signaling arrays. CheVs have a CheW-like domain and a receiver domain, which acts as a phosphate sink leading to signal termination. In *H. pylori* there are four transducer proteins (MCP-like), four adaptor proteins (two perform the majority of the function: CheW and CheV1)

and one histidine kinase that form the signaling arrays (Abedrabbo, Castellon, Collins, Johnson, & Ottemann, 2017).

This study was done to investigate why there are two CheW-like adaptor proteins to connect one MCP to one histidine kinase in the *P. aeruginosa* Chp chemosensory system. This chemosensory system is more complicated than the chemosensory system in *E. coli* and other organisms as it has two outputs: twitching motility and cAMP, so we considered the possibility that each adaptor protein was functionally distinct – one adaptor forming signaling arrays to regulate cAMP, while the other adaptor forming signaling arrays to regulate twitching motility (Fig. 4). In contrast to our hypothesis, our results show that both adaptor proteins are important in both outputs, with Pili having a larger impact on signal transduction. We also studied the interaction of the two adaptor proteins with each other and with PilJ.

Materials and methods:

Growth conditions

P. aeruginosa PAO1 and derived mutants were grown at 37°C in Luria Bertani (LB) (10 g/L tryptone, 5 g/L yeast extract, 2.5 g/L NaCl). *E. coli* S17-1 was grown at 30°C in LB unless otherwise specified. Tetracycline at 10 µg/ml was used to grow *E. coli* strains with pEX18Tc plasmid. Gentamicin was used at 10 µg/ml (*E. coli*), 50 µg/ml and 100 µg/ml (*P. aeruginosa*) for pSB109 plasmids. In *P. aeruginosa*, transformants were selected using 100 µg/ml gentamicin, and plasmids were maintained with 50 µg/ml gentamicin. Strains for bacterial adenylate cyclase two-hybrid assay (BACTH) were grown at 37°C in LB with ampicillin (100 µg/ml) selection for pUT18 based plasmids and kanamycin (50 µg/ml) for pKNT25 based plasmids. *E. coli* DHM1 was used as the host for the BACTH.

Mutant Generation

In-frame deletion of *chpC* was made using splicing by overlap extension (SOE) PCR. 1kb sections of the PAO1 genome immediately upstream and downstream of *chpC* were amplified and fused together during a subsequent round of PCR using the primers listed in table 3. Colony PCR was used for the initial amplification. The Δ *chpC* fusion was ligated into pEX18Tc, and was transformed into NEB5 α competent *E. coli* cells. The construct was sequenced to ensure that there were no mutations. This construct was then transformed into *E. coli* S17-1 by electroporation and then introduced into *P. aeruginosa* PAO1 via conjugation. Merodiploids were selected on 75 μ g/ml tetracycline and 5 μ g/ml chloramphenicol. Resolution of the merodiploids was achieved through 10% sucrose counter selection, and screened on tetracycline and sucrose plates. The deletion was confirmed by PCR and gel electrophoresis.

Complementation of deleted gene

PCR amplified *pilI* and *chpC* were each ligated in pSB109 and transformed into NEB5 α competent *E. coli* cells. The constructs were confirmed with sequencing to make sure that there were no mutations. *pilI* and *chpC* were then transformed into the corresponding PAO1 (Δ *pilI*/ Δ *chpC*) strains and the Δ *pilI*/ Δ *chpC* reporter strains by electroporation. pSB109 is derived from pJN105 and has an arabinose inducible promoter (araC-P_{BAD}) that allows for induction (Newman & Fuqua, 1999).

Ligations

Ligations of insert and plasmid DNA were set up with 1X NEB T4 DNA ligase buffer and 400 units (for 20 μ l reaction) or 200 units (for 10 μ l reaction) of T4 DNA ligase enzyme.

The reactions were incubated at 16°C overnight before proceeding with the transformations in NEB5 α competent *E. coli* cells.

Transformations

Heat Shock

NEB5 α competent *E. coli* cells were incubated with ligation products on ice for 30 minutes. The cells were heat shocked at 42°C for 30 seconds. Following a 5 minutes incubation on ice, Super Optimal broth with Catabolite repression (SOC) media was added and the cells were grown at 37°C for 1 hour for recovery. Then the cells were spread on plates with the appropriate antibiotic.

Electroporation

Overnight cultures of *P. aeruginosa*, *E. coli* S17-1, or *E. coli* reporter strain DHM1 were centrifuged (8000 rpm, 2.5 min). The resulting cell pellet was washed two times in 10% ice cold glycerol. The final cell pellet was re-suspended in ice cold glycerol, and 50 μ l aliquots were used for each transformation. Approximately 100 ng of plasmid DNA was added to the competent cells and electroporated at 1600 V. SOC was added and the cells were incubated at 37°C for 2 hours, prior to plating on LB agar containing the appropriate antibiotic.

Twitching motility assay

Nine bacterial colonies were stab inoculated into 1% LB or 1% LB gentamicin (50 μ g/ml) agar plates. The plates were incubated at 37°C for 40 hours. After 40 hours of incubation, the agar was scraped off and diameters of the twitching zones on the plates were measured.

β -galactosidase assay

To estimate the relative levels of intracellular cAMP in *P. aeruginosa*, the indicated strains containing the *lacP1-lacZ* reporter construct were grown on LB plates for lawn growth (37°C, overnight)(Fulcher et al., 2010). The cells were scraped off the plate and re-suspended in LB broth. Optical density (OD₆₀₀) was measured and the cultures were diluted to OD₆₀₀ 0.28-0.7. 100 μ l of cells were added to 400 μ l Z-buffer. The cells were lysed with chloroform and 0.1% SDS and incubated at 30°C for 5 minutes. Addition of ONPG started the reaction and 1M Na₂CO₃ was added to stop the reaction when the sample turned yellow. Then the samples were centrifuged at 14,000 rpm for 3 minutes and the OD₄₂₀ of the supernatant was measured.

Immunoblotting

Surface grown cells from LB or LB+0.01% arabinose plates were suspended in liquid LB or LB+0.01% arabinose respectively. 1:10 dilutions of the samples were separated on a 15% SDS-PAGE and transferred to polyvinylidene difluoride (PVDF) membrane by semi-dry transfer. After blocking in 5% skim milk powder, the membrane was then exposed to mouse anti-His primary antibody (1:3000 dilution) and then to sheep anti-mouse secondary antibody (1:10,000 dilution). Immunoblots were developed with chemiluminescent reagent from SuperSignal West Femto maximum sensitivity substrate kit and a Fotodyne Luminary system.

Bacterial adenylate cyclase two-hybrid (BACTH) strains generation

The gene of interest was PCR amplified and then ligated into pUT18 or pKNT25. The resulting plasmids were transformed into NEB5 α competent *E. coli* cells using heat-shock method. Then the respective pUT18 plasmids containing the C-terminus T18 complementary

fragment of the adenylate cyclase and the pKNT25 plasmids containing the C-terminus T25 complementary fragment of the adenylate cyclase were co-transformed into *E. coli* DHM1 by electroporation method.

BACTH assay

To study the protein-protein interactions, *E. coli* DHM1 containing the indicated plasmids were grown in LB liquid media with ampicillin and kanamycin to obtain an optical density OD₆₀₀ between 0.4-0.9. 100 µl of cells were added to 400 µl Z-buffer. The cells were lysed with chloroform and 0.1% SDS and incubated at 30°C for 5 minutes. Addition of ONPG started the reaction and 1M Na₂CO₃ was added to stop the reaction when the sample turned yellow. Then the samples were centrifuged at 14,000 rpm for 3 minutes and the OD₄₂₀ of the supernatant was measured.

The DHM1 strains were streaked for isolation on LB X-gal (5-bromo-4-chloro-3-indoyl-β-D-galactopyranoside 40 µg/ml), IPTG (Isopropylthio-β-D-thiogalactopyranoside 0.5 mM), ampicillin and kanamycin plates to screen for blue-white colonies to study the interaction between two proteins. Blue colonies indicate positive interaction while white (or pale blue) colonies indicate no interaction between the two test proteins.

Results

PilI plays a larger role on intracellular cAMP levels than ChpC

One output of the Chp chemosensory system is the regulation of CyaB activity to increase the levels of intracellular cAMP when the response regulator PilG is phosphorylated and to decrease the levels of intracellular cAMP when the other response regulator PilH is

phosphorylated (Fulcher et al., 2010). In *P. aeruginosa*, Vfr is the master virulence regulator; a protein homologous to CAP (catabolite activator protein) in *E. coli*. To measure the levels of cAMP, a reporter construct containing the *lacP1* promoter fused to *lacZ* was inserted into the genome of PAO1 at the ϕ CTX phage site (Fulcher et al., 2010). All mutants for the β -galactosidase assays were derived from this original reporter strain. cAMP binds to Vfr to turn on the promoter for *lacZ* gene transcription. So, the output (β -galactosidase activity, measured in Miller Units) indirectly indicates the relative level of cAMP bound to Vfr. CyaB is the major adenylate cyclase and produces approximately 90% of the intracellular cAMP. Correspondingly, Δ *cyaB* was used as the negative control for these β -galactosidase assays.

With the *pilI* deletion, there was about 94% reduction in cAMP levels and with the *chpC* deletion there was about 47% reduction in cAMP levels as compared to the wild type levels (Fig. 5A). cAMP levels were not restored to wild type levels in either the *chpC* or *pilI* complementation, with or without arabinose induction. In ChpC complementation, the cAMP levels were 65% of the wild type (without arabinose) and 54% of the wild type (0.01% arabinose induction) (Fig. 5A and 5B). Protein levels were slightly increased with 0.01% arabinose induction in ChpC complement strain than without arabinose as seen on a Western Blot (Fig. 6B). In PilI complementation, cAMP levels were only 19% of wild type (without arabinose) and 15% of wild type (0.01% arabinose induction) (Fig. 5A and 5B). Arabinose induction increased expression of PilI protein in the Δ *pilI::lacP1-lacZ* complementation strain, compared to the uninduced sample, as seen in Fig 6B. Expression of ChpC-His and PilI-His was not detected in Δ *chpC::lacP1-lacZ* and Δ *pilI::lacP1-lacZ* containing empty vector (pSB109), similar to wild type (WT containing pSB109). The PilI complementation experiment was repeated three times but there was discrepancy with this data. In one experiment the PilI protein levels were the same

regardless of arabinose induction, however there were differences in the amount of protein loading as seen on the SDS gel (data not shown). The other two times the PilI levels were increased with 0.01% arabinose than without arabinose. One representative image is shown in Fig. 6B. The increased expression of ChpC and PilI proteins with arabinose induction did not correlate with an increase in the cAMP levels upon complementation (Fig. 5 and 6), emphasizing the importance of stoichiometry in the function of chemotaxis-like systems (Sourjik & Armitage, 2010).

PilI has a larger role in regulating twitching motility than ChpC

The second output of the Chp chemosensory system is the regulation of twitching motility. Phosphorylation of the response regulators PilG or PilH results in extension and retraction of the TFP, respectively. Twitching motility assays were done to understand the role of the two adaptor proteins in the Chp chemosensory system of *P. aeruginosa* PAO1 in regulating twitching motility.

With the *pilI* deletion, there was about 89% reduction in twitching motility as compared to 36% reduction with the *chpC* deletion with respect to the wild type strain. It was also seen that twitching motility was restored completely to the wild type levels with *chpC* complementation. Interestingly, the partial complementation of cAMP levels and full complementation of twitching motility occurred with similar levels of the ChpC protein in both the non-reporter strain (Δ *chpC*+*chpC*-His; used in twitching motility assay) and reporter strain (Δ *chpC*::*lacPI-lacZ* +*chpC*-His; used in β -galactosidase assays for estimating cAMP levels) as seen in Fig. 6A. Δ *chpC* (V) had no ChpC-His protein expression, as expected.

Similar to the cAMP complementation studies, *pilI* complementation only partially

restored twitching motility (43% of the wild type, Fig 7A). Following inclusion of 0.01% arabinose, Pili expression was increased (Fig 6B) resulting in maximum complementation at 65% of the wild type (Fig. 7B). Further increases in arabinose decreased twitching motility below the levels seen in Fig 7B (data not shown). $\Delta pilA$ (major pilin subunit; non-piliated strain) was the negative control for the twitching motility assay.

The adaptor proteins Pili and ChpC interact with each other

The BACTH system was used to study the protein-protein interactions. This experiment used the two complementary fragments (T25 and T18) of the catalytic domain of adenylate cyclase CyaA from *Bordetella pertussis*. When these fragments are separated, there is no cAMP production. In this assay, the two fragments are fused with the two test proteins, and if the two test proteins interact, only then there is functional complementation of the T25 and T18 fragments which results in the synthesis of cAMP. The cAMP binds to the CAP site in *E. coli* to turn on expression of genes for *lac* and *mal* operons (Euromedex). The stronger the interaction between the test proteins, the more cAMP is produced which allows more cAMP to bind to CAP resulting in higher β -galactosidase activity (which is measured in Miller Units). As a result, higher β -galactosidase activity correlates with a stronger interaction between the proteins. The interaction was also studied on the X-gal/IPTG plates for blue-white screening. Blue color results from the cleavage of the chromogenic substrate X-gal by β -galactosidase. IPTG is the inducer of the *lac* promoter and induces full expression of the hybrid proteins and the β -galactosidase reporter enzyme (Euromedex).

To study the interaction between the two adaptor proteins, Pili-T18 (*pili*-pUT18) and Pili-T25 (*pili*-pKNT25) fusion proteins were generated, along with ChpC-T18 (*chpC*-pUT18)

and ChpC-T25 (*chpC*-pKNT25). There is an interaction between PilI and ChpC, as shown in Fig. 8 and 9. As controls, it was also tested that the adaptor protein-fusions did not interact with the empty vector, pUT18 or pKNT25. Surprisingly, in this assay PilI and ChpC did not interact with themselves, as shown in Fig. 10 and 11. The two adaptor proteins also did not show interaction with the MCP, PilJ (Fig. 12 and 13). T18-zip (pUT18C-zip) and T25-zip (pKT25-zip) was the positive control and (-) indicates the empty vectors present in the cell used as negative controls. Based on statistical analysis by ANOVA, followed by Tukey HSD, our values for PilI (T18/T25)-ChpC (T25/T18), PilI-PilI, ChpC-ChpC and PilJ (T18)-PilI (T25)/ChpC (T25) were not significantly different from the negative control (T18-T25).

Discussion

Across a variety of bacterial species there are various combinations of proteins that make up a chemosensory system. The most well-studied system is found in *E. coli*, which has five MCPs, one adaptor protein (CheW) and one histidine kinase, CheA (Wadhams & Armitage, 2004). Examples of these different protein combinations found in other bacteria can include a wide range in the number of MCPs that feed into a system, or the presence or absence of phosphate sinks (such as CheZ in *E. coli*) (Wadhams & Armitage, 2004). Adaptor proteins are important in linking the MCPs to the histidine kinase and are essential for signal transduction (Park et al., 2006; Wadhams & Armitage, 2004). Some bacteria have more than one adaptor protein for a single chemosensory system. *H. pylori*, for example, has four transducer (MCP-like) proteins (Wadhams & Armitage, 2004), four adaptor proteins (out of which two are major functional ones), and one histidine kinase. The four adaptor proteins in *H. pylori* are CheW, CheV1, CheV2 and CheV3. The CheV proteins have a CheW domain plus a response regulator-

like domain (Rec). The rec domain acts as a phosphate sink and leads to signal termination as the response regulator, CheY, does not get phosphorylated by CheA. CheW and CheV1 are the two major adaptor proteins as both are absolutely necessary for wild type chemotaxis (Abedrabbo et al., 2017). In a recent study the histidine kinase CheA was not activated in the absence of CheW or CheV1 (Abedrabbo et al., 2017). However, the influence of CheW was stronger than CheV1 and had a greater ability to activate CheA. The *cheW* deletion resulted in non-polarly localized, non-functional chemotaxis whereas the *cheV1* deletion resulted in non-polarly localized, functionally impaired chemotaxis. The other two CheV proteins, CheV2 and CheV3 play a minor role in the chemotaxis system in *H. pylori* (Abedrabbo et al., 2017). *cheV2*, *cheV3* single mutants and *cheV2V3* double mutant were fully chemotactic. CheV1 was seen to substitute for the loss of CheV2 and CheV3 (Pittman, Goodwin, & Kelly, 2001).

The *P. aeruginosa* Chp chemosensory system has one MCP, PilJ, two adaptor proteins, ChpC and PilI, and one histidine kinase, ChpA (Whitchurch et al., 2004) (Fig. 3). We did this study to investigate why the Chp chemosensory system needs two adaptor proteins when there is only one MCP and one histidine kinase in this signal transduction system. The system has two outputs: twitching motility and regulation of intracellular cAMP levels by modulating the activity of CyaB. cAMP is required for TFP biogenesis, yet the function of TFP (twitching motility) is independent of cAMP (Fulcher et al., 2010). Experiments were performed to check the importance of both adaptor proteins on twitching motility and cAMP levels. We deleted the *chpC* and *pilI* genes and then complemented them and performed the twitching motility assay and β -galactosidase assay to estimate the cAMP levels.

Of the two adaptors encoded in the *pil-chp* gene cluster, PilI seems to play a greater role in signal transduction than ChpC, as both relative cAMP levels and twitching motility show

greater decreases in $\Delta pill$ than $\Delta chpC$. This is consistent with a previous study done by Fulcher *et al.* where similar studies were done on strain PAK (Fulcher et al., 2010). In our study, deletion of *pill* resulted in ~6% β -galactosidase activity (relative to wild type), which is comparable to the negative control ($\Delta cyaB$, 6% of wild type) (Fig. 5A) suggesting that PilI is required to activate CyaB. In the PAK strain, $\Delta pill$ had ~20% β -galactosidase activity relative to the parent strain, comparable to the negative control $\Delta cyaAB$ (~14% of the parent strain) (Fulcher et al., 2010). However, in contrast to previous studies (Fulcher et al., 2010), we were not able to restore cAMP to wild type levels in $\Delta pill$ through complementation even with arabinose induction (Fig. 5A and 5B). This incomplete complementation could be because of downstream effects from the *pill* deletion on *pilJ* expression. The MCP PilJ is absolutely necessary in the functioning of the Chp chemosensory system in *P. aeruginosa* as without PilJ, there is loss of twitching motility and significant reduction in cAMP levels (Jansari et al., 2016). In support of our hypothesis for the *pill* deletion resulting in downstream effects on PilJ expression, previous studies revealed the levels of *pilJ-mCherry* expressed from the native site in the chromosome were slightly less in the *pill* deletion strain than in wild type, as seen by western blot (Jansari, 2017).

Given that T4P biogenesis is dependent on cAMP, it was not unexpected that the *pill* deletion strain also showed reductions in twitching motility (11% relative to wild type), comparable to the negative control for twitching ($\Delta pilA$, 10% of wild type) (Fig 7A). Previous studies have shown that the *pill* deletion strain also has a significant reduction in twitching motility (17% relative to the parent strain) in the PAK strain (Fulcher et al., 2010). Again, unlike Fulcher *et al.*, we could not fully restore twitching motility in the PilI complement. This partial complementation of twitching motility likely correlates with the partial complementation of cAMP levels (and expected partial complementation of pilus biogenesis).

The *chpC* mutant resulted in ~54% β -galactosidase activity (relative to wild type) (Fig. 5A), comparable to ~70% β -galactosidase activity, relative to the parent PAK strain in the study by Fulcher *et al.* (Fulcher et al., 2010). Fulcher *et al.* also studied the intracellular cAMP levels as measured by an enzyme immunoassay and found that the levels in Δ *chpC* were not statistically different relative to the parent strain (Fulcher et al., 2010). It is important to note however, that the reporter construct indicates levels of cAMP bound to Vfr, while the enzyme immunoassay quantifies levels of free cAMP. We did not use the immunoassay to measure the intracellular cAMP levels.

Similar to PiliI complementation, we were not able to restore cAMP to wild type levels in Δ *chpC* upon complementation (Fig. 5A and 5B). It is under question why we were not able to restore cAMP levels in Δ *chpC* upon complementation. One possibility is that the addition of the His-tag interferes with the function of ChpC. Alternatively, the use of a multi-copy plasmid may result in expression of ChpC at levels higher than seen in wild type. In protein complexes that are sensitive to stoichiometry, including chemotaxis systems, too much protein can be as detrimental as insufficient amounts of protein (S. Parkinson, personal communication).

With the *chpC* deletion, twitching motility was ~65% relative to the wild type in our PAO1 strain (Fig. 7A), comparable to ~80% in the PAK strain in the study by Fulcher *et al.* (Fulcher et al., 2010). We were able to restore twitching motility to wild type levels with *chpC* complementation (Fig. 7A). The restoration of twitching motility through *chpC* complementation may indicate that these levels of intracellular cAMP support TFP formation at levels sufficient to mediate wild type levels of twitching motility. This hypothesis will need to be tested by examining the levels of surface piliation in the Δ *chpC* and complemented strain, relative to wild type.

With both PilI and ChpC, there was an increase in protein expression with arabinose induction as compared to without arabinose in the *lacP1-lacZ* reporter construct, but this increase did not result in increased cAMP production (Fig. 5 and 6B). We hypothesize that too much protein expression is hindering the cAMP production. Further experimentation will include quantitation of the PilI protein levels in the complemented $\Delta pilI + pilI$ -His strain (used in twitching motility assay) to check if there is a difference in expression levels with and without arabinose induction. Additionally, we need to remake the *pilI* mutant to see if we can eliminate any downstream effects on PilJ expression and repeat these assays.

We also studied the interaction of the adaptor proteins in the Chp chemosensory system with themselves and with the MCP, PilJ. We wanted to check whether signaling complexes (trimer of MCP dimers, two adaptor proteins and a histidine kinase dimer) could be made with PilI-PilI or PilI-ChpC or ChpC-ChpC interaction (Fig. 4). The BACTH study was done in *E. coli* and we expect these results will hold true in *P. aeruginosa* as well. Our results indicate that PilI and ChpC can interact (Fig. 8 and 9), but we found no evidence for PilI-PilI or ChpC-ChpC interactions (Fig. 10 and 11).

Given the functional difference between the two adaptor proteins, we tested if this could be explained through preferential interaction between PilJ (the MCP) and PilI compared to ChpC. However, our results do not show interaction between the two adaptor proteins and PilJ (Fig 12. and 13). These results are surprising, as previous studies done in *E. coli*, *H. pylori* and *Thermotoga maritima* show that the adaptor proteins interact with the MCP. CheW was shown to interact with the MCP Tar in *E. coli* using direct pull down assay (Boukhvalova, Dahlquist, & Stewart, 2002). In *H. pylori*, both the major adaptor proteins CheW and CheV1 interacted with the transducer TlpA, while only CheV1 interacted with transducers TlpB and TlpD, as seen by

BACTH analysis. Both the adaptor proteins were seen to interact with each other and with themselves (Abedrabbo et al., 2017). In *T. maritima*, a 3.2 Å resolution crystal structure of the MCP shows its interaction with the adaptor protein CheW (Li et al., 2013). We expected that in the *P. aeruginosa* Chp chemosensory system, where there is only one MCP, at least one of the adaptor proteins would interact with PilJ. One possible reason why we did not see interaction might be because the adenylate cyclase T18 fragment-tag is at the C-terminus of PilJ, so the tag could be affecting the protein folding and interfering with its interaction with the adaptor proteins.

In summary, our work shows that PilI plays a larger role than the second adaptor protein, ChpC, in controlling both twitching motility and cAMP levels in the Chp chemosensory system of *P. aeruginosa*. As seen with the BACTH analysis, both the adaptor proteins surprisingly did not interact with themselves, they interacted with each other, but neither of them showed interaction with PilJ, which is unlikely. This is the first time the interaction study has been done in *P. aeruginosa*, but based on similar chemosensory system in other bacteria the MCP is known to interact with the adaptor protein(s). Future work will include cloning *pilJ* in the pUT18C or pKT25 plasmids thereby placing the tag at the N-terminus of the PilJ and then testing for interaction with the adaptor proteins. Further experimentation would also include BACTH analysis to study interaction between the adaptor proteins and the histidine kinase, ChpA.

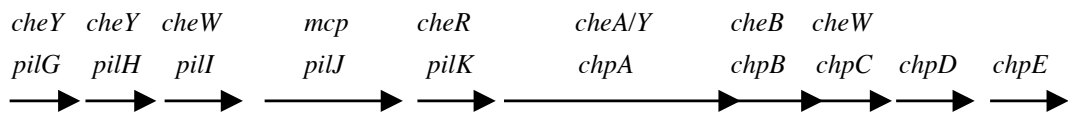

Fig. 1. Genetic organization of the cluster IV chemosensory genes in *P. aeruginosa*. The *P. aeruginosa* gene names are indicated above the black arrows and the respective *E. coli* homologous gene names are indicated above the *P. aeruginosa* gene names.

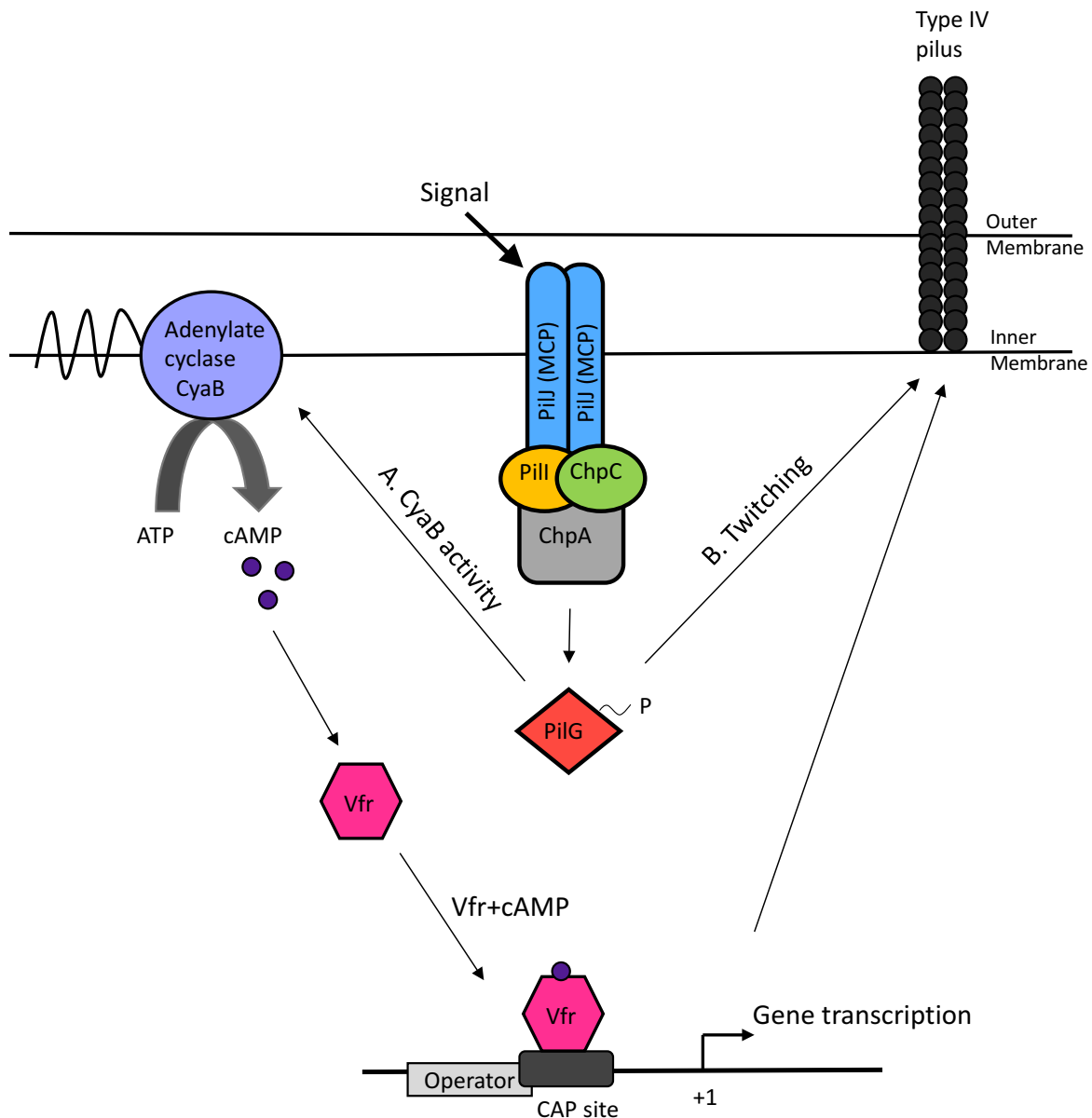

Fig. 2. Model for outputs of the Chp chemosensory system in *P. aeruginosa*. A) When the response regulator PilG gets phosphorylated, it modulates the activity of the major intracellular adenylate cyclase CyaB to synthesize cAMP. cAMP then binds to the Virulence factor regulator (Vfr; homologous to CAP protein in *E. coli*) protein and they both bind to the CAP site to modulate the gene transcription for a number of genes including the pilus biogenesis. The assembly of TFP is therefore cAMP-dependent. B) Independent of cAMP, PilG~P also controls the extension of TFP. Retraction of the TFP is mediated by phosphorylated PilH (other response regulator; not illustrated here). As long as sufficient TFP are present, twitching motility (mediated by extension and retraction of TFP) can occur without dependence on the production of cAMP (Modified from Fulcher et al., 2010).

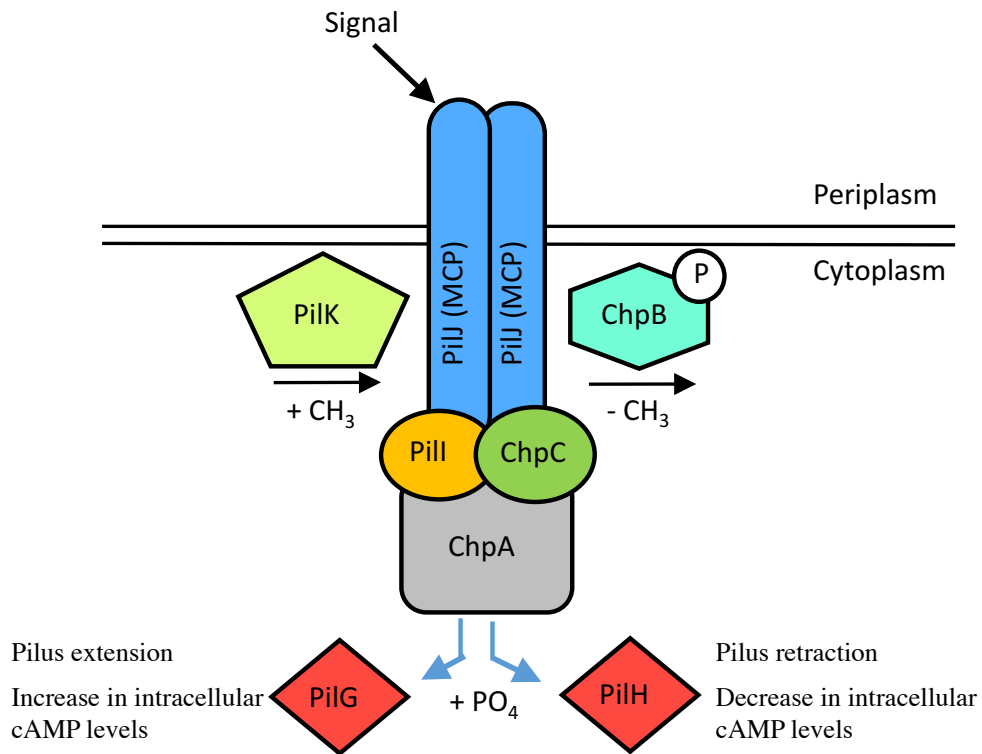

Fig. 3. Schematic of the Chp chemosensory system in *P. aeruginosa*. PilJ is the MCP; PilI and ChpC are the two adaptor proteins; ChpA is the histidine kinase; PilG and PilH are the two response regulators; PilK is the methyltransferase; and ChpB is the methyl-erasure.

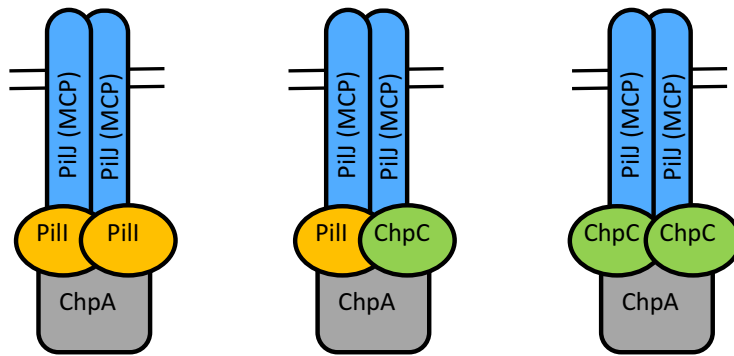

Fig. 4. Different potential signaling array combinations in Chp chemosensory system of *P. aeruginosa*. We tested whether there is a PiII-PiII, PiII-ChpC or a ChpC-ChpC interaction that forms the signaling complex.

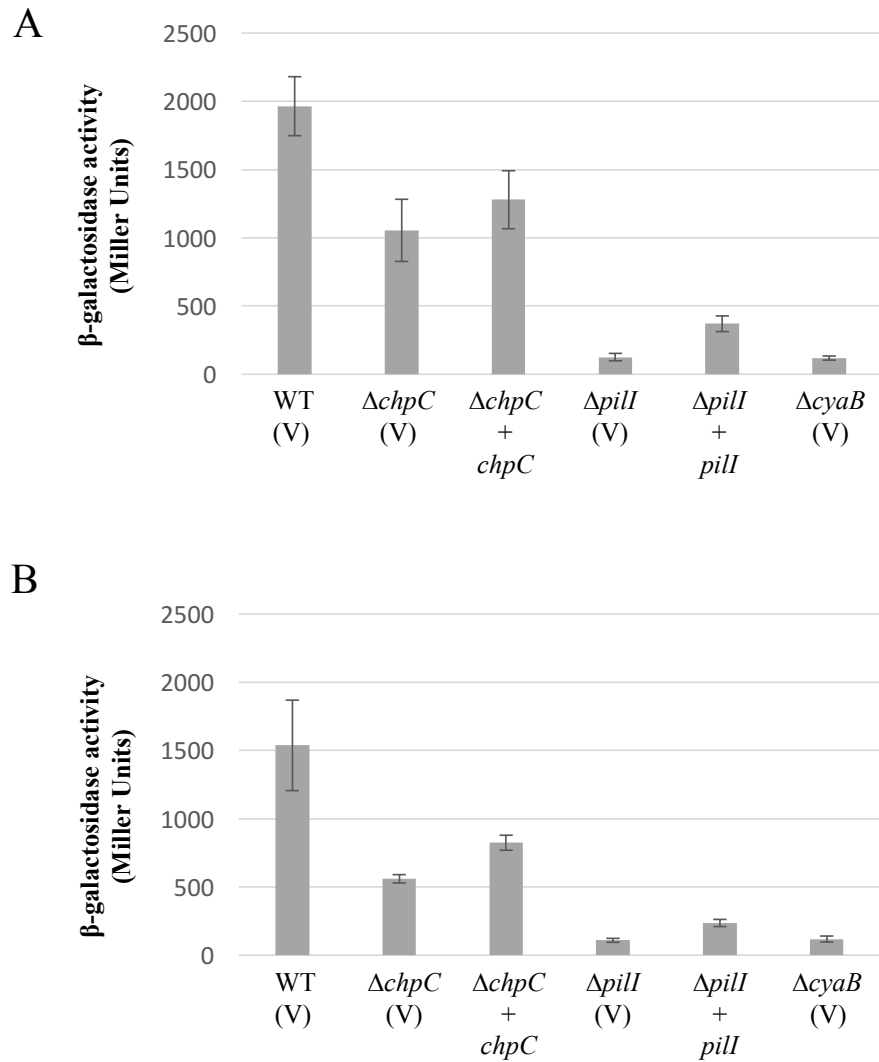

Fig. 5. *PilI* plays a larger role in regulating intracellular cAMP levels as compared to the other adaptor protein, *ChpC*. Relative levels of intracellular cAMP bound to Vfr were measured using β -galactosidase assay. All the strains contained the *lacP1-lacZ* reporter construct (see materials and methods). Three biological replicates of surface grown cells of each strain were assayed in triplicate to calculate the average Miller Units and standard error of the mean. A) β -galactosidase activity of each strain grown on LB plates with Gentamicin 50 μ g/ml and no arabinose. B) β -galactosidase activity of each strain grown on LB plates with Gentamicin 50 μ g/ml and 0.01% arabinose.

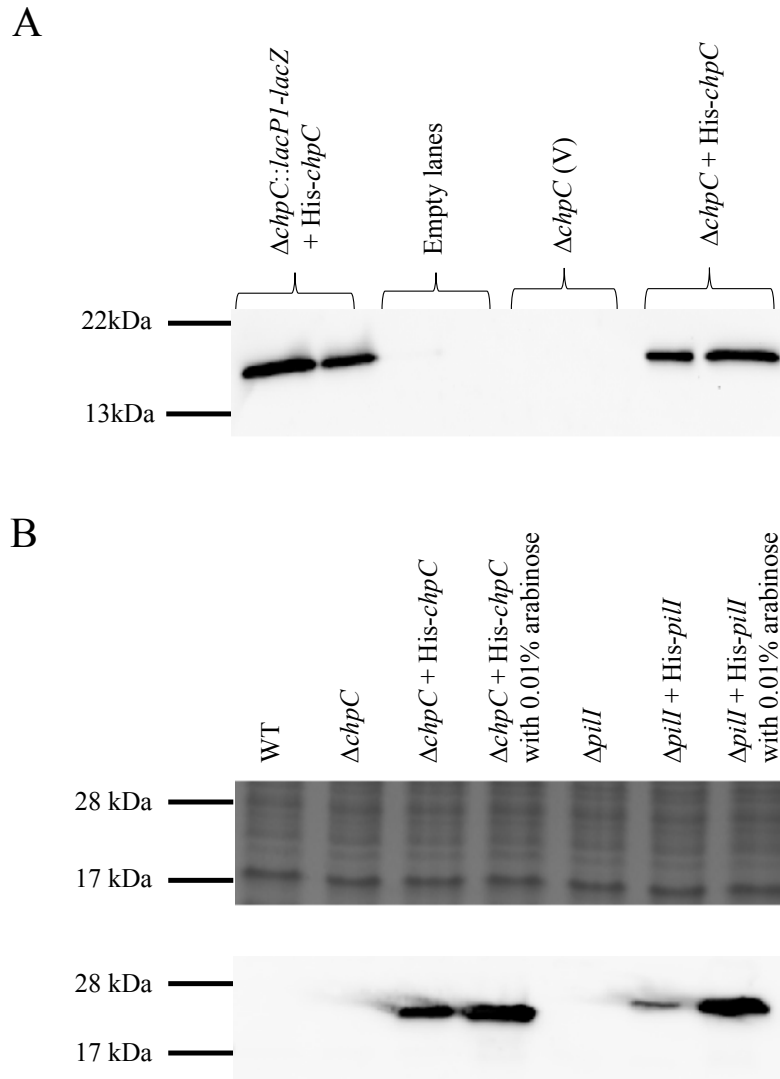

Fig. 6. Expression levels of His tagged adaptor proteins during complementation studies. Whole cell levels of His-ChpC and His-PilI were tested. A) Expression of ChpC was similar in both the reporter (*lacP1-lacZ*) and non-reporter strains. Two different colonies were tested for each strain. B) Induction with 0.01% arabinose increased levels of His-ChpC and His-PilI in respective deletion mutants of the reporter strains (*lacP1-lacZ*). This experiment was repeated three times and a representative image is shown above.

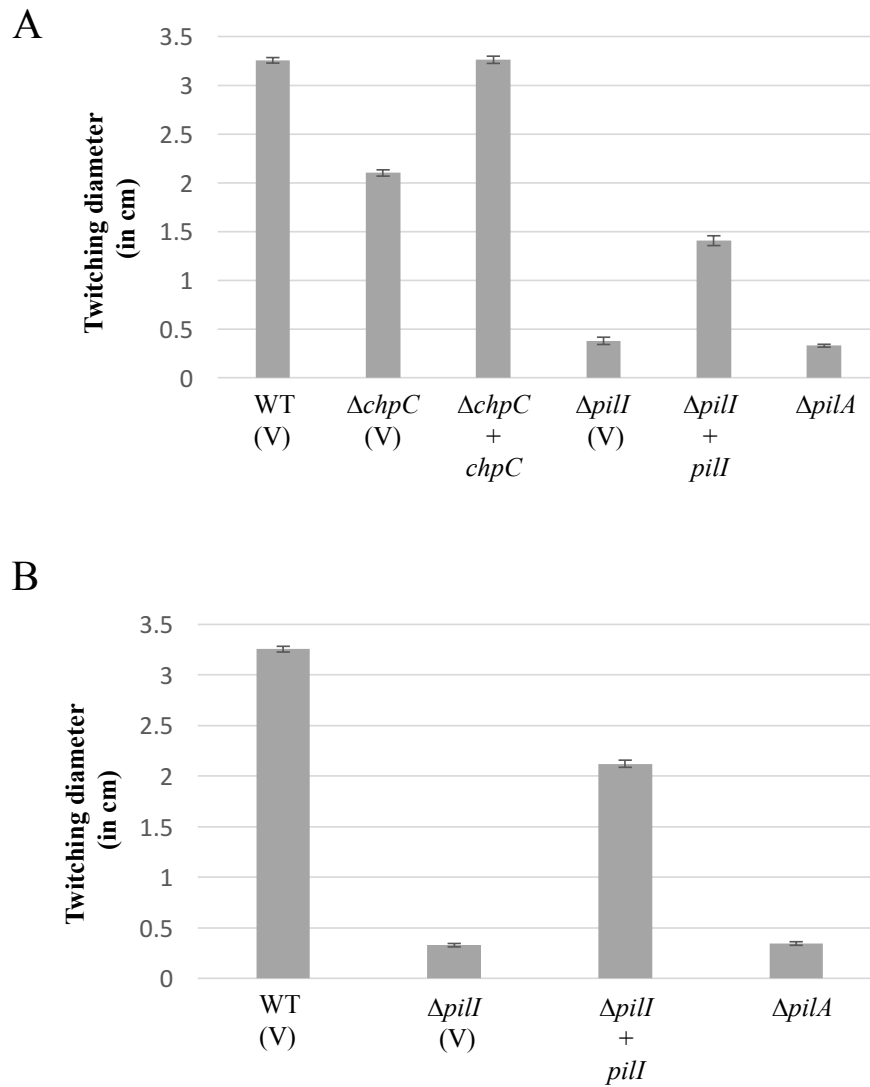

Fig. 7. PilI plays a larger role in twitching motility as compared to the other adaptor protein, ChpC. The diameter (in cm) of the zone of twitching motility was measured. Nine individual colonies of the strains were tested to determine the average diameter and the standard error of mean. (V) indicates the cells contained empty vector pSB109. A) Twitching motility measured on LB Gentamicin 50 $\mu\text{g/ml}$ plate B) Twitching motility measured on LB Gentamicin 50 $\mu\text{g/ml}$ plate containing 0.01% arabinose.

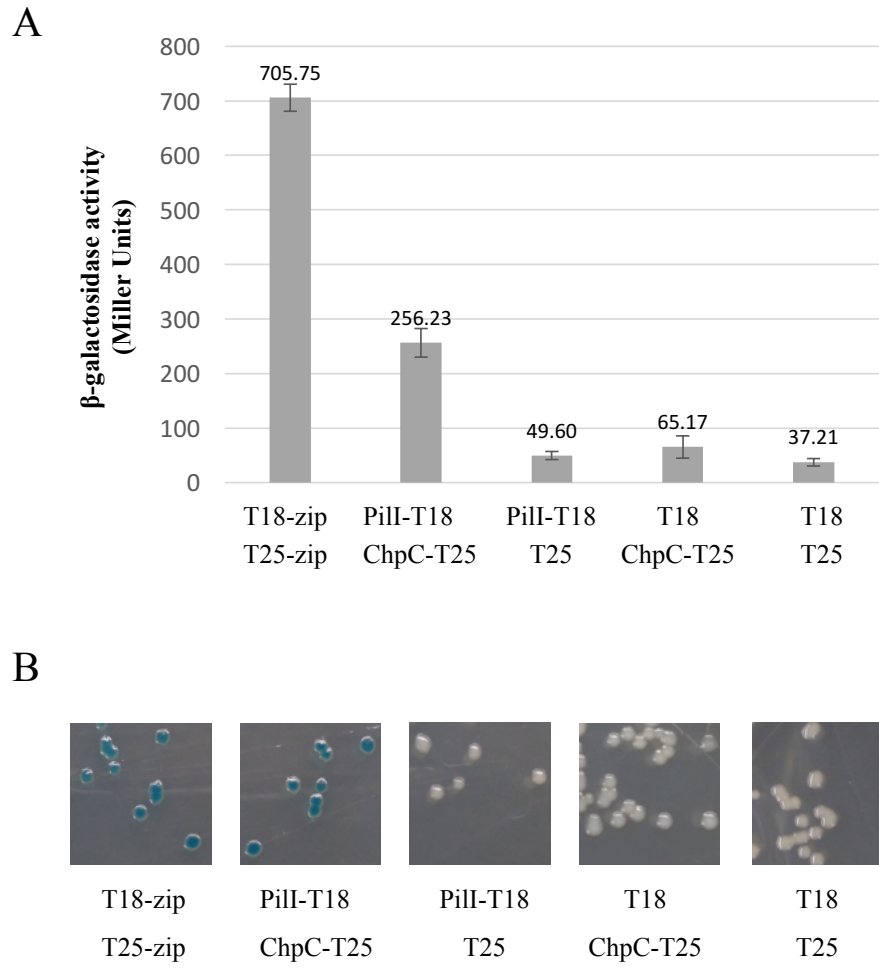

Fig. 8. The two adaptor proteins, PiiI and ChpC, interact with each other as shown by the BACTH analysis. The indicated plasmids were co-expressed in DHM1. A) The assay was done in triplicates from the liquid cultures and it was repeated with three independent colonies to calculate the average β -galactosidase activity resulting from the protein-protein interaction and the standard error of the mean. B) Colonies from each interaction grown on LB X-gal+IPTG plates. Interacting proteins show blue color and non-interacting proteins show white color. The positive control was cells with leucine zippers fused to T18 and T25. Empty vectors are indicated by T18 and T25 alone.

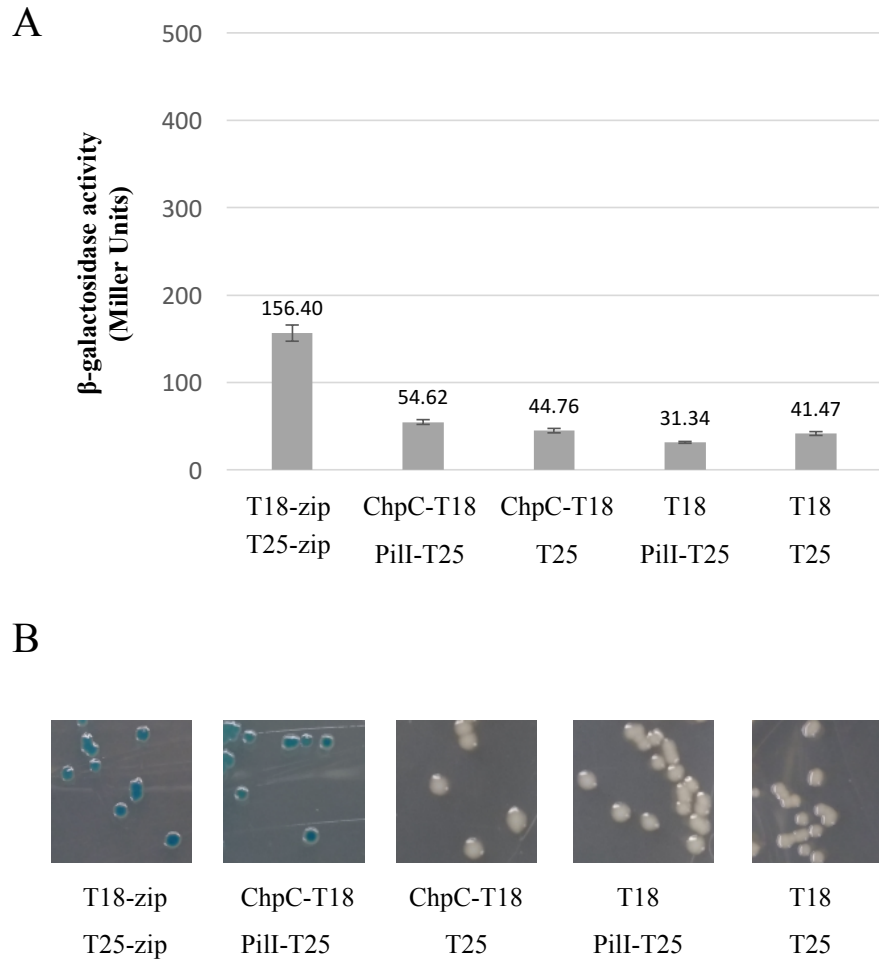

Fig. 9. The two adaptor proteins, PilI and ChpC, interact slightly with each other as shown by the BACTH analysis. The indicated plasmids were co-expressed in DHM1. A) The assay was done in triplicates from the liquid cultures and it was repeated with three independent colonies to calculate the average β -galactosidase activity resulting from the protein-protein interaction and the standard error of the mean. B) Colonies from each interaction grown on LB X-gal+IPTG plates. Interacting proteins show blue color and non-interacting proteins show white color. The positive control was cells with leucine zippers fused to T18 and T25. Empty vectors are indicated by T18 and T25 alone.

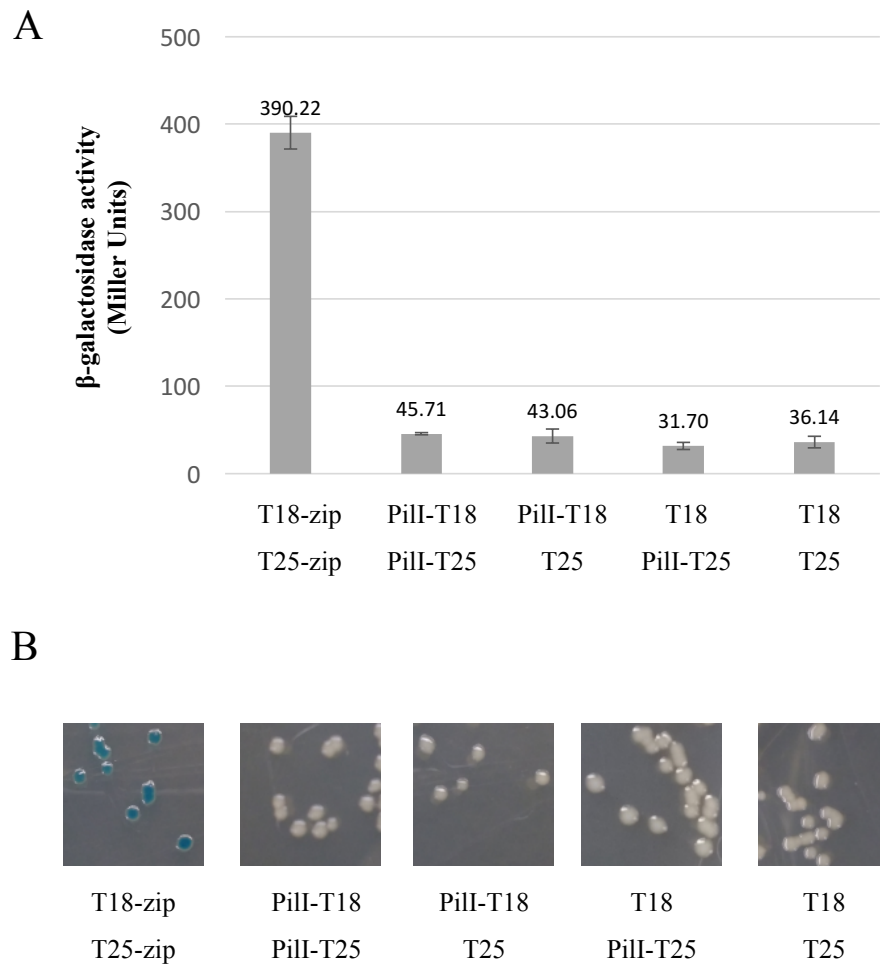

Fig. 10. The adaptor protein, PiII shows no interaction with itself as shown by the BACTH analysis. The indicated plasmids were co-expressed in DHM1. A) The assay was done in triplicates from the liquid cultures and it was repeated with three independent colonies to calculate the average β -galactosidase activity resulting from the protein-protein interaction and the standard error of the mean. B) Colonies from each interaction grown on LB X-gal+IPTG plates. Interacting proteins show blue color and non-interacting proteins show white color. The positive control was cells with leucine zippers fused to T18 and T25. Empty vectors are indicated by T18 and T25 alone.

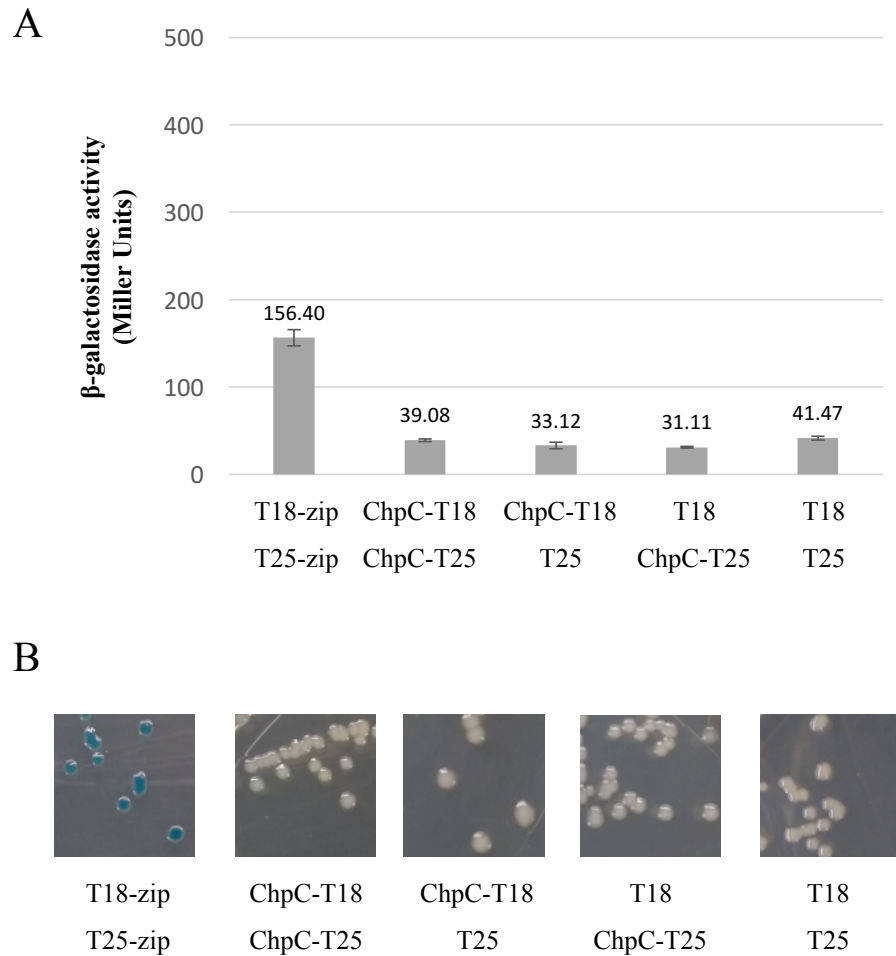

Fig. 11. The adaptor protein, ChpC does not interact with itself as shown by the BACTH analysis. The indicated plasmids were co-expressed in DHM1. A) The assay was done in triplicates from the liquid cultures and it was repeated with three independent colonies to calculate the average β -galactosidase activity resulting from the protein-protein interaction and the standard error of the mean. B) Colonies from each interaction grown on LB X-gal+IPTG plates. Interacting proteins show blue color and non-interacting proteins show white color. The positive control was cells with leucine zippers fused to T18 and T25. Empty vectors are indicated by T18 and T25 alone.

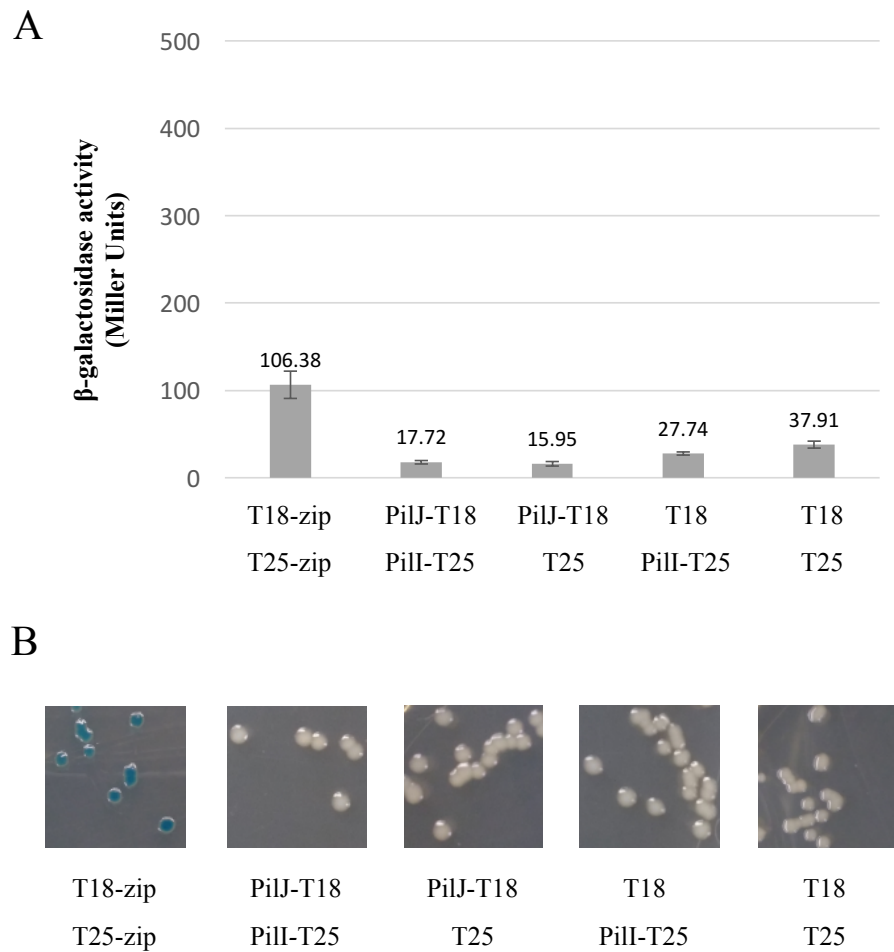

Fig. 12. BACTH analysis does not reveal interaction between the adaptor protein, PilI with the methyl accepting chemotaxis protein, PilJ. The indicated plasmids were co-expressed in DHM1. A) The assay was done in triplicates from the liquid cultures and it was repeated with three independent colonies to calculate the average β -galactosidase activity resulting from the protein-protein interaction and the standard error of the mean. B) Colonies from each interaction grown on LB X-gal+IPTG plates. Interacting proteins show blue color and non-interacting proteins show white color. The positive control was cells with leucine zippers fused to T18 and T25. Empty vectors are indicated by T18 and T25 alone.

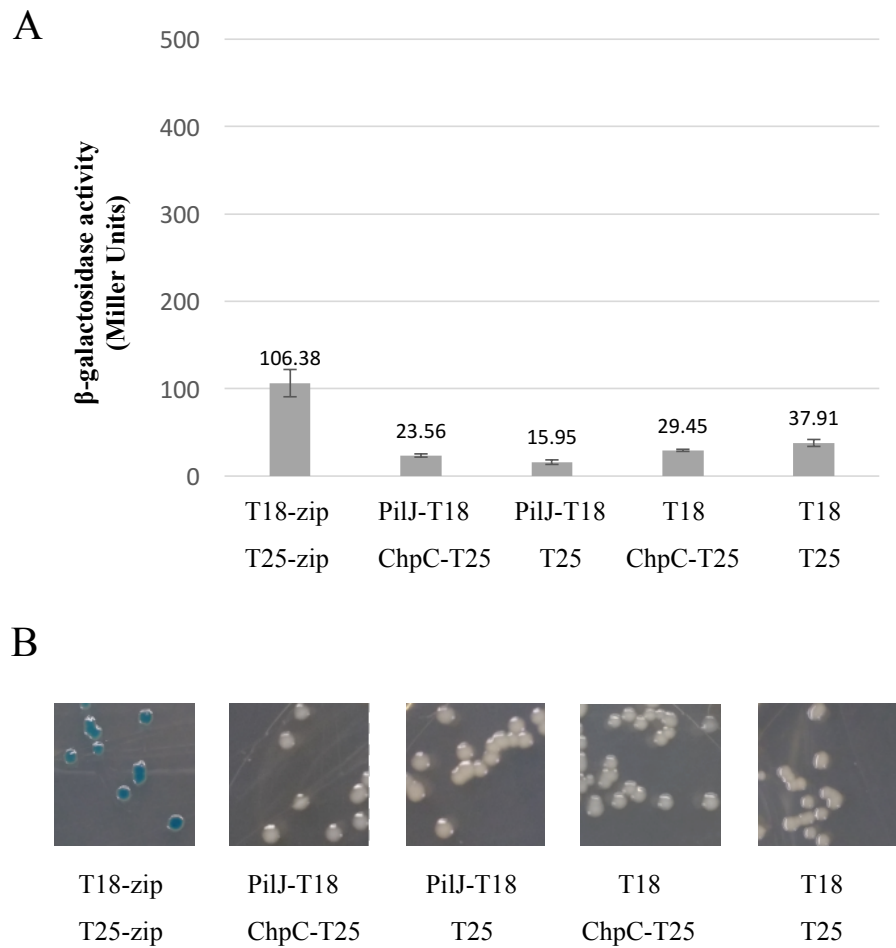

Fig. 13. BACTH analysis does not reveal interaction between the adaptor protein, ChpC with the methyl accepting chemotaxis protein, PilJ. The indicated plasmids were co-expressed in DHM1. A) The assay was done in triplicates from the liquid cultures and it was repeated with three independent colonies to calculate the average β -galactosidase activity resulting from the protein-protein interaction and the standard error of the mean. B) Colonies from each interaction grown on LB X-gal+IPTG plates. Interacting proteins show blue color and non-interacting proteins show white color. The positive control was cells with leucine zippers fused to T18 and T25. Empty vectors are indicated by T18 and T25 alone.

Table 1: Strains used in this study.

Strain	Description	Reference or Source
<i>Pseudomonas aeruginosa</i>		
PAO1	Wild type Iglewski strain	C. Harwood
PAO1:: <i>lacP1-lacZ</i>	Chromosomal <i>lacP1</i> promoter reporter in PAO1	(Jansari, 2017)
Δ <i>chpC</i>	Deletion of <i>chpC</i> (PA0415), made by leaving sequence for 9 amino acids in the middle	This study
Δ <i>chpC</i> :: <i>lacP1-lacZ</i>	<i>chpC</i> deletion introduced into PAO1:: <i>lacP1-lacZ</i> reporter strain	This study
Δ <i>pill</i>	In frame deletion of <i>pill</i> (PA0410)	(Jansari, 2017)
Δ <i>pill</i> :: <i>lacP1-lacZ</i>	<i>pill</i> deletion introduced into PAO1:: <i>lacP1-lacZ</i> reporter strain	(Jansari, 2017)
<i>Escherichia coli</i>		
NEB5 α competent cells	<i>fhuA2</i> Δ (<i>argF-lacZ</i>) <i>U169 phoA glnV44</i> Φ 80 Δ (<i>lacZ</i>) <i>M15 gyrA96 recA1 relA1 endA1 thi-1 hsdR17</i>	New England BioLabs
DHM1	Reporter strain for Bacterial two-hybrid assay. F-, <i>cya-854</i> , <i>recA1</i> , <i>endA1</i> , <i>gyrA96</i> (Nal r), <i>thi1</i> , <i>hsdR17</i> , <i>spoT1</i> , <i>rfbD1</i> , <i>glnV44</i> (AS)	D. Frank
DHM1(pKT25zip-pUT18Czip)	Positive control for bacterial adenylate cyclase two-hybrid assay	D. Frank
S17-1	<i>Thi pro hsdR recA RP4-2</i> (Tc::Mu) (Km::Tn7)	D. Saffarini

Table 2: Plasmids used in this study

Plasmid name	Description	Reference or Source
pEX18Tc	Gene replacement vector, Tet ^R	This study
pEX18Tc- Δ <i>chpC</i>	pEX18Tc based plasmid for deletion of <i>chpC</i>	This study
pSB109	Arabinose inducible expression vector, Gm ^R	(Ketelboeter & Bardy, 2017)
pSB109- <i>chpC</i>	<i>chpC</i> cloned into pSB109 at EcoRI and SmaI sites	This study
pSB109- <i>pill</i>	<i>pill</i> cloned into pSB109 at EcoRI and HindIII sites	This study
pUT18	Bacterial adenylate cyclase two hybrid vector, Amp ^R	D. Frank
pUT18- <i>chpC</i>	<i>chpC</i> fused in frame at the N-terminus of T18 fragment of the pUT18 plasmid at EcoRI and PstI sites	This study
pUT18- <i>pill</i>	<i>pill</i> fused in frame at the N-terminus of T18 fragment of the pUT18 plasmid at EcoRI and PstI sites	This study
pUT18- <i>pilJ</i>	<i>pilJ</i> fused in frame at the N-terminus of T18 fragment of the pUT18 plasmid at EcoRI and BamHI sites	This study
pKNT25	Bacterial adenylate cyclase two hybrid vector, Kan ^R	D. Frank
pKNT25- <i>chpC</i>	<i>chpC</i> fused in frame at the N-terminus of T25 fragment of the pKNT25 plasmid at EcoRI and PstI sites	This study
pKNT25- <i>pill</i>	<i>pill</i> fused in frame at the N-terminus of T25 fragment of the pKNT25 plasmid at EcoRI and PstI sites	This study

Table 3: Primers used in this study

Primer name	Oligonucleotide sequence (5' -3')
chpC_Del_UpF	TGCCGGAATTCGCAGCGCCACGTGTTGCA
chpC_Del_UpRev	GTCAGATCAGGCCGGCGTCGGCCTGGTTCATGTTTCG
chpC_Del_DnF	CGAAACATGAACCAGGCCGACGCCGGCCTGATCTGAGC
chpC_Del_DnRevNew	ACAAAGCTTGGAAGCCGCCGGTCAAACCG
DelChpC_PAO1outA	CTCTTTGTGGCGCTCGCG
DelChpC_PAO1outB	GGCGTCGCGCAAGCCTTG
UP_ChpC_Insert	CATGCGAATTCATGAACCAGGCCGTGATC
DN_ChpC_Insert	CTGCGGCCGGACTAGACTGGGCCCTATG
ChpCInsert_Rev	GTATCCCGGGTCAGATCAGGCCGGCGTC
pilI_Insert_REV	CGCGCAAGCTTTTATACGGCGACGTCGAG
ForwardpilI_inser	GTACAGAATTCATGTCGGACGTTTCAGACC
Primers for BACTH assays	
pilIFR-KNT-UT-C	GTTCTGCAGGATGTCGGACGTTTCAGACCCCCTTC
chpCFR-KNT-UT-C	GAAGCCTGCAGGATGAACCAGGCCGTGATCGAGC
pilIrev-KNT-UT	CAGGGATCCTCTACGGCGACGTCGAGGAAGCC
chpCrev-KNT-UT	CAGGGATCCTCGATCAGGCCGGCGTCGGCGAG
pilJ-all-For	GTCGGATCCCATGAAGAAAATCAACGCAG
PilJ-KNT-UT/CRev	GTTAGAATTCGAGGCCTGCTCCACGCCCTC

References

- Abedrabbo, S., Castellon, J., Collins, K. D., Johnson, K. S., & Ottemann, K. M. (2017). Cooperation of two distinct coupling proteins creates chemosensory network connections. *Proc Natl Acad Sci U S A*, *114*(11), 2970-2975. doi:10.1073/pnas.1618227114
- Bertrand, J. J., West, J. T., & Engel, J. N. (2010). Genetic analysis of the regulation of type IV pilus function by the Chp chemosensory system of *Pseudomonas aeruginosa*. *J Bacteriol*, *192*(4), 994-1010. doi:10.1128/jb.01390-09
- Boukhvalova, M. S., Dahlquist, F. W., & Stewart, R. C. (2002). CheW binding interactions with CheA and Tar. Importance for chemotaxis signaling in *Escherichia coli*. *J Biol Chem*, *277*(25), 22251-22259. doi:10.1074/jbc.M110908200
- Buensuceso, R. N. C., Daniel-Ivad, M., Kilmury, S. L. N., Leighton, T. L., Harvey, H., Howell, P. L., & Burrows, L. L. (2017). Cyclic AMP-independent control of twitching motility in *Pseudomonas aeruginosa*. *J Bacteriol*, *199*(16). doi:10.1128/jb.00188-17
- Burrows, L. L. (2012). *Pseudomonas aeruginosa* twitching motility: type IV pili in action. *Annu Rev Microbiol*, *66*, 493-520. doi:10.1146/annurev-micro-092611-150055
- Euromedex. BACTH System Kit Bacterial Adenylate Cyclase Two-Hybrid System Kit.
Retrieved from
http://static.bioport.cn/data/upload/product/specification/396/1342594983673_396560.pdf
- Ferrandez, A., Hawkins, A. C., Summerfield, D. T., & Harwood, C. S. (2002). Cluster II che genes from *Pseudomonas aeruginosa* are required for an optimal chemotactic response. *J Bacteriol*, *184*(16), 4374-4383.
- Francis, V. I., Stevenson, E. C., & Porter, S. L. (2017). Two-component systems required for virulence in *Pseudomonas aeruginosa*. *FEMS Microbiol Lett*, *364*(11). doi:10.1093/femsle/fnx104
- Fulcher, N. B., Holliday, P. M., Klem, E., Cann, M. J., & Wolfgang, M. C. (2010). The *Pseudomonas aeruginosa* Chp chemosensory system regulates intracellular cAMP levels by modulating adenylate cyclase activity. *Mol Microbiol*, *76*(4), 889-904. doi:10.1111/j.1365-2958.2010.07135.x
- Hickman, J. W., Tifrea, D. F., & Harwood, C. S. (2005). A chemosensory system that regulates biofilm formation through modulation of cyclic diguanylate levels. *Proc Natl Acad Sci U S A*, *102*(40), 14422-14427. doi:10.1073/pnas.0507170102

- Inclan, Y. F., Persat, A., Greninger, A., Von Dollen, J., Johnson, J., Krogan, N., Gitai, Z., & Engel, J. N. (2016). A scaffold protein connects type IV pili with the Chp chemosensory system to mediate activation of virulence signaling in *Pseudomonas aeruginosa*. *Mol Microbiol*, *101*(4), 590-605. doi:10.1111/mmi.13410
- Jansari, V. H. (2017). The role of PilJ and its structural domains in the localization and function of the Chp chemosensory system in *Pseudomonas aeruginosa*. (Doctor of Philosophy), University of Wisconsin-Milwaukee.
- Jansari, V. H., Potharla, V. Y., Riddell, G. T., & Bardy, S. L. (2016). Twitching motility and cAMP levels: signal transduction through a single methyl-accepting chemotaxis protein. *FEMS Microbiol Lett*, *363*(12). doi:10.1093/femsle/fnw119
- Ketelboeter, L. M., & Bardy, S. L. (2017). Characterization of 2-(2-nitro-4-trifluoromethylbenzoyl)-1,3-cyclohexanedione resistance in pyomelanogenic *Pseudomonas aeruginosa* DKN343. *PLoS One*, *12*(6), e0178084. doi:10.1371/journal.pone.0178084
- Li, X., Fleetwood, A. D., Bayas, C., Bilwes, A. M., Ortega, D. R., Falke, J. J., Zhulin, I. B., & Crane, B. R. (2013). The 3.2 Å resolution structure of a receptor: CheA:CheW signaling complex defines overlapping binding sites and key residue interactions within bacterial chemosensory arrays. *Biochemistry*, *52*(22), 3852-3865. doi:10.1021/bi400383e
- Newman, J. R., & Fuqua, C. (1999). Broad-host-range expression vectors that carry the L-arabinose-inducible *Escherichia coli* *araBAD* promoter and the *araC* regulator. *Gene*, *227*(2), 197-203.
- Park, S. Y., Borbat, P. P., Gonzalez-Bonet, G., Bhatnagar, J., Pollard, A. M., Freed, J. H., Bilwes, A. M., & Crane, B. R. (2006). Reconstruction of the chemotaxis receptor-kinase assembly. *Nat Struct Mol Biol*, *13*(5), 400-407. doi:10.1038/nsmb1085
- Pittman, M. S., Goodwin, M., & Kelly, D. J. (2001). Chemotaxis in the human gastric pathogen *Helicobacter pylori*: different roles for CheW and the three CheV paralogues, and evidence for CheV2 phosphorylation. *Microbiology*, *147*(Pt 9), 2493-2504. doi:10.1099/00221287-147-9-2493
- Silversmith, R. E., Wang, B., Fulcher, N. B., Wolfgang, M. C., & Bourret, R. B. (2016). Phosphoryl Group Flow within the *Pseudomonas aeruginosa* Pil-Chp Chemosensory System: differential function of the eight phosphotransferase and three receiver domains. *J Biol Chem*, *291*(34), 17677-17691. doi:10.1074/jbc.M116.737528

- Sourjik, V., & Armitage, J. P. (2010). Spatial organization in bacterial chemotaxis. *EMBO J*, 29(16), 2724-2733. doi:10.1038/emboj.2010.178
- Wadhams, G. H., & Armitage, J. P. (2004). Making sense of it all: bacterial chemotaxis. *Nat Rev Mol Cell Biol*, 5(12), 1024-1037. doi:10.1038/nrm1524
- Whitchurch, C. B., Leech, A. J., Young, M. D., Kennedy, D., Sargent, J. L., Bertrand, J. J., Semmler, A. B., Mellick, A. S., Martin, P. R., Alm, R. A., Hobbs, M., Beatson, S. A., Huang, B., Nguyen, L., Commolli, J. C., Engel, J. N., Darzins, A., & Mattick, J. S. (2004). Characterization of a complex chemosensory signal transduction system which controls twitching motility in *Pseudomonas aeruginosa*. *Mol Microbiol*, 52(3), 873-893. doi:10.1111/j.1365-2958.2004.04026.x