

December 2014

# Novel Protein Secretion and Chitin Utilization Machinery of *Flavobacterium Johnsoniae*

Sampada Suresh Kharade  
*University of Wisconsin-Milwaukee*

Follow this and additional works at: <https://dc.uwm.edu/etd>

 Part of the [Genetics Commons](#), [Microbiology Commons](#), and the [Molecular Biology Commons](#)

---

## Recommended Citation

Kharade, Sampada Suresh, "Novel Protein Secretion and Chitin Utilization Machinery of *Flavobacterium Johnsoniae*" (2014). *Theses and Dissertations*. 703.  
<https://dc.uwm.edu/etd/703>

This Dissertation is brought to you for free and open access by UWM Digital Commons. It has been accepted for inclusion in Theses and Dissertations by an authorized administrator of UWM Digital Commons. For more information, please contact [open-access@uwm.edu](mailto:open-access@uwm.edu).

NOVEL PROTEIN SECRETION AND CHITIN UTILIZATION MACHINERY OF

*FLAVOBACTERIUM JOHNSONIAE*

by

SAMPADA S. KHARADE

A Dissertation submitted in

partial fulfillment of the

Requirements for the Degree of

Doctor of Philosophy

in Biological Sciences

at

The University of Wisconsin-Milwaukee

December 2014

## ABSTRACT

### NOVEL PROTEIN SECRETION AND CHITIN UTILIZATION MACHINERY OF

#### *FLAVOBACTERIUM JOHNSONIAE*

by

Sampada S. Kharade

The University of Wisconsin-Milwaukee, 2014  
Under the Supervision of Dr. Mark J. McBride

*Flavobacterium johnsoniae*, a member of phylum *Bacteroidetes*, is a gliding bacterium that digests insoluble chitin. A novel protein secretion system, the Type IX secretion system (T9SS), secretes the motility adhesins SprB and RemA and is also required for chitin utilization. In order to understand *F. johnsoniae* chitin utilization and the role of the T9SS, Fjoh\_4555 (*chiA*) was targeted for analysis. Disruption of *chiA* resulted in cells that failed to digest chitin and complementation restored this ability. Antisera raised against ChiA were used to characterize its secretion. ChiA was secreted in soluble form by wild-type cells but remained cell-associated in T9SS mutant strains. Proteins secreted by T9SSs typically have conserved carboxy-terminal domains (CTDs) belonging to the TIGRFAM families, TIGR04131 and TIGR04183. ChiA did not exhibit strong similarity to these sequences but instead had a novel CTD. Deletion of this CTD resulted in accumulation of ChiA inside of cells. Fusion of the ChiA CTD to mCherry resulted in secretion of mCherry into the medium. These results indicate that ChiA is a

soluble extracellular chitinase required for chitin utilization and that it relies on a novel CTD for its secretion by the *F. johnsoniae* T9SS.

Proteins involved in secretion by the T9SS include GldK, GldL, GldM, GldN, SprA, SprE, and SprT. *Porphyromonas gingivalis* has orthologs for each of these T9SS proteins and they are required for secretion of gingipain proteases. *P. gingivalis* *porU* and *porV* have also been linked to T9SS-mediated secretion and *F. johnsoniae* has orthologs of these. Cells of an *F. johnsoniae* *porV* deletion mutant failed to secrete ChiA and RemA, but retained the ability to secrete SprB. The *porV* mutant was partially deficient in attachment to glass, apparently because of the absence of RemA and other adhesins on the cell surface. The *porV* mutant also appeared to be deficient in secretion of numerous other proteins that have CTDs associated with targeting to the T9SS. PorU was not required for secretion of ChiA, RemA, or SprB, indicating that it does not play an essential role in the *F. johnsoniae* T9SS.

*chiA* is located downstream of a cluster of genes likely to be involved in chitin utilization. Deletion of Fjoh\_4558 (*cusD<sub>I</sub>*) resulted in a partial defect in chitin utilization, and deletion of the region spanning Fjoh\_4558 through Fjoh\_4562 which includes *cusD<sub>I</sub>*, *cusD<sub>II</sub>*, *cusC<sub>I</sub>* and *cusC<sub>II</sub>* resulted in almost complete loss of ability to utilize chitin. The CusC and CusD proteins are similar in sequence to the *Bacteroides thetaiotaomicron* starch utilization system outer membrane proteins SusC and SusD respectively. SusC and SusD are involved in active uptake of starch oligomers across the outer membrane. The *F. johnsoniae* CusC and CusD proteins may perform similar functions, and cooperate with ChiA to allow efficient utilization of insoluble chitin.

©Copyrights by Sampada Kharade, 2014

All Rights Reserved

## TABLE OF CONTENTS

<b>List of Figures</b>	ix
<b>List of Tables</b>	xi
<b>Acknowledgements</b>	xii
<b>Chapter 1. Introduction</b>	1
Type IX secretion system	2
Chitin and chitinases	12
<i>F. johnsoniae</i> chitin utilization loci	16
References	20
<b>Chapter 2. The <i>Flavobacterium johnsoniae</i> chitinase ChiA is required for chitin utilization and is secreted by the type IX secretion system.</b>	25
Abstract	25
Introduction	26
Material and Methods	28
Bacterial and bacteriophage strains, plasmids, and growth conditions.	28
Disruption and complementation of <i>chiA</i>	28
Deletion of the <i>chiA</i> CTD-encoding region	29
Deletion of Fjoh_4175	30
Generation of mCherry fusion constructs.	30
Determination of chitinase activity	31
Protein expression and antibody production	31
Western blot analyses	32
Liquid chromatography-tandem mass spectrometry (LC-MS/MS) analysis.	33

Results: <i>chiA</i> mutant cells are defective in chitin utilization	40
ChiA is a soluble extracellular protein	44
The T9SS is required for secretion of ChiA	50
The C-terminal region of ChiA is necessary and sufficient for secretion.	52
Cells of the <i>chiA</i> mutant exhibit wild-type gliding motility	58
Discussion	60
References	66
<b>Chapter 3. <i>Flavobacterium johnsoniae</i> PorV is required for secretion of a subset of proteins targeted to the type IX secretion system.</b>	72
Abstract	72
Introduction	73
Materials and Methods	76
Bacterial and bacteriophage strains, plasmids, and growth conditions	76
Construction and complementation of <i>porV</i> and <i>porU</i> mutant	77
Determination of chitinase activity	78
Western blot analyses	79
Analysis for secretion of cell-surface SprB and Myc-tagged RemA	80
Cell aggregation studies	80
Measurement of bacteriophage sensitivity	80
Microscopic observations of cell attachment	81
Liquid chromatography-tandem mass spectrometry (LC-MS/MS) analysis	81
Analysis of starch utilization	83

Sequence analyses	83
Results: <i>F. johnsoniae</i> <i>porU</i> and <i>porV</i>	88
<i>porV</i> mutant cells are defective for chitin utilization and for secretion of the chitinase ChiA	89
<i>porV</i> mutant cells fail to secrete RemA	95
PorU and PorV are not required for secretion of the major motility adhesin SprB, or for gliding motility	98
<i>porV</i> mutant cells are resistant to some <i>F. johnsoniae</i> phages	100
Cells of $\Delta$ <i>porV</i> mutant are defective in attachment to glass	10
<i>porV</i> mutant cells appear to be defective for secretion of at least thirty-two additional proteins	105
The T9SS and PorV are required for efficient starch utilization	111
Fjoh_0288, which exhibits limited sequence similarity to PorV, does not appear to be required for T9SS function	112
Discussion	112
References	116
<b>Chapter 4. Role of <i>F. johnsoniae</i> Chitin Utilization Locus in Chitin uptake and utilization.</b>	120
Abstract	120
Introduction	121
Material and Methods	123
Bacterial and bacteriophage strains, plasmids, and growth conditions	123
Construction of deletion mutants and complementation	123
Qualitative determination of growth on chitin	125
Results: <i>F. johnsoniae</i> has a PUL that appears to be involved in uptake and utilization of chitin	130



The SusC-like and SusD-like proteins appear to function in chitin utilization	131
Discussion	134
References	139
<b>Chapter 5. Summary</b>	140
<b>Appendix 1. Analyzing the carboxy terminal domain (CTD) of ChiA required for secretion by the T9SS</b>	142
References	147
<b>Appendix 2. Protocol for preparing colloidal chitin slurry</b>	148
<b>Curriculum vitae</b>	149

## LIST OF FIGURES

### Chapter 1

1.	Distribution of T9SS genes among members of the phylum <i>Bacteroidetes</i>	4
2.	<i>F. johnsoniae</i> motility and secretion proteins	5
3.	Photomicrographs of <i>F. johnsoniae</i> colonies	6
4.	<i>sprE</i> is required for chitin utilization	6
5.	Model of T9SS in <i>P. gingivalis</i>	8
6.	Bacterial type I – type IX protein secretion systems.	10
7.	Bacterial strategies for polysaccharide utilization	18

### Chapter 2

8.	The <i>chiA</i> gene and predicted features of the ChiA protein	41
9.	<i>chiA</i> is required for chitin utilization	42
10.	Chitinase activities of wild-type and mutant cells	43
11.	ChiA is a soluble extracellular protein	45
12.	Analysis of secreted ChiA protein by SDS-PAGE	47
13.	LCMSMS data analysis of 92 kDa band	48
14.	LCMSMS data analysis of 65 kDa band	49
15.	Mutations in T9SS genes disrupt secretion of ChiA	51
16.	The C-terminal region of ChiA is required for chitin utilization	53
17.	ChiA CTD is sufficient for secretion of the heterologous protein mCherry	54
18.	Alignment of the C-terminal domain (CTD) of ChiA with the CTDs of <i>F. johnsoniae</i> TIGR04131 family members using MUSCLE.	55

19.	Alignment of the C-terminal domain (CTD) of ChiA with the CTDs of <i>F. johnsoniae</i> TIGR04183 family members using MUSCLE	56
20.	Disruption of <i>chiA</i> does not affect gliding motility	59
<b>Chapter 3</b>		
21.	Map of the region spanning <i>porU</i> and <i>porV</i>	88
22.	<i>porV</i> is required for chitin utilization	91
23.	PorV is required for secretion of the soluble extracellular chitinase ChiA	93
24.	PorV is required for secretion of the heterologous fusion protein mCherry-CTD <sub>ChiA</sub>	94
25.	Deletion of <i>porV</i> disrupts secretion of RemA	96
26.	Effect of <i>porV</i> on RemA-mediated cell aggregation	97
27.	Photomicrographs of <i>F. johnsoniae</i> colonies	100
28.	Susceptibility of wild-type and mutant cells to bacteriophages	102
29.	Soluble extracellular proteins of wild-type and mutant cells	107
30.	LCMSMS data analysis	108
31.	Starch digestion by wild-type and mutant cells	111
<b>Chapter 4</b>		
32.	Map of chitin PUL	131
33.	SusC-like and SusD-like proteins appear to function in chitin utilization	133
34.	Model for <i>F. johnsoniae</i> chitin utilization	137
35.	Model for <i>F. johnsoniae</i> secretion and chitin utilization machinery	141
36.	80 amino acid of ChiA CTD is sufficient for secretion of the heterologous protein mCherry	144

## LIST OF TABLES

### Chapter 1

1. Bacterial secretion systems 11

### Chapter 2

2. Strains and plasmids used in this study 36
3. Primers used in this study 38

### Chapter 3

4. Strains and plasmids used in this study 84
5. Primers used in this study 86
6. Deletion of *porV* disrupts secretion of Myc-tagged RemA. 97
7. PorV and PorU are not required for localization of SprB to the cell surface 99
8. Bacteriophage sensitivity of *F. johnsoniae* wild-type and mutant strains 103
9. Deletion of *porV* results in decreased attachment of cells to glass 105
10. Candidate proteins secreted by the T9SS identified by LC-MS/MS analysis of cell-free culture fluid 109

### Chapter 4

11. Strains and plasmids used in this study 126
12. Primers used in this study 128

### Appendix 1

13. Strains and plasmids used in this study 145
14. Primers used in this study 146

## ACKNOWLEDGMENTS

My sincere gratitude and appreciation goes first towards my advisor Dr. Mark J. McBride for his guidance, camaraderie, and mentorship that has led me to successfully complete my doctoral research dissertation. Looking back at my email correspondence with him while applying for doctoral program, his emails were always very enthusiastic about his research work and I am glad that I got the opportunity to share that enthusiasm for research with him in his lab. I could not have asked for a better advisor for my doctoral dissertation. Not only has he advised me during my research but also given me enough independence to grow as a research scientist. The other qualities I admire in him are his patience and humor that not only made some of my horrific and miserably failed experiment days bearable, but also allowed me to be persistent and most importantly enjoy research. Mark, I really cannot thank you enough!

The other person that has played a very important role in my graduate life is Dr. Daad Saffarani. I would like to thank her for the advice and guidance during graduate application process, lab and committee meetings and also for letting me use her lab instruments. I thank my committee members Dr. Charles Wimpee, Dr. Sonia Bardy and Dr. Sergei Kuchin for their inputs and expertise towards my research.

I acknowledge Dr. Ryan Rhodes (who calls himself my adopted American dad) for his mentorship and guidance that has been invaluable in my research. I acknowledge my previous and current lab members. Dr. Yongtao Zhu, Surashree Kulkarni and Joseph

Johnston, I will remember all the crazy and not so crazy scientific discussion. Most of all I will remember the ‘arts and crafts’ done in lab.

I would also like to thank National Science Foundation (NSF MCB-1021721), Research Growth Initiative (RGI), Ruth Walker Grant and University of Wisconsin Milwaukee in acknowledging my hard work and providing financial aid and supporting my research. I would like to acknowledge Ryan and Yongtao for editorial suggestions for the published manuscripts. I also thank Greg Sabat and Greg Barrett-Wilt at the University of Wisconsin Madison Mass Spectroscopy Facility for the LC-MS/MS analyses.

Most importantly, I would like to thank my family and friends for my research accomplishments. Thank you dad: Dr. Suresh D. Kharade, for babysitting me in your clinic where, I initially developed an interest for science. Thank you mom: Sanjivani S. Kharade, you have always inspired me, and taught me to be strong yet humble. I would like to thank both of you for your selflessness and love that has allowed me to attain my doctoral degree. I would also like to thank my loving sisters: Smruti S. Kharade and Samruddhi S. Kharade and my husband: Nishant N. Trivedi and his parents for their unconditional love and support, thus letting me successfully persevere and complete this doctoral dissertation. ‘To transmute dreams into reality one has to have a consistent purpose.’ is something my parents have taught me and this has been my self-motivating adage throughout my life. I would like to thank all of you for allowing me to attain my purpose of achieving and successfully completing my doctoral degree.

## Chapter 1. Introduction

*Flavobacterium johnsoniae*, belonging to the phylum *Bacteroidetes*, is a Gram-negative rod shaped bacterium that digests the insoluble polymer chitin (65). Cells of *F. johnsoniae* crawl over a wide range of surfaces by a process called gliding motility (41). Gliding motility has been loosely defined as cell movement over surfaces without the help of flagella or pili (40). *gld* and *spr* genes are required for gliding motility because cells with mutations in these genes are defective in gliding. *gld* mutant cells are completely non-motile, whereas *spr* mutant cells exhibit reduced but detectable movement (1, 7, 28, 37, 39, 40, 42). *F. johnsoniae* gliding motility relies on cell surface motility adhesins, such as SprB and RemA (46, 62). These adhesins are propelled rapidly along the cell surface. Attachment of the adhesins to a substratum results in cell movement. Mutations in gliding motility genes often result in inability to digest chitin, but the reason for this was not known.

A novel protein secretion system, the type IX secretion system (T9SS), initially known as the Por Secretion System, was recently discovered in *F. johnsoniae* and in the oral pathogen, *Porphyromonas gingivalis* (44, 54, 55). The *F. johnsoniae* T9SS is required for secretion of the motility adhesins SprB and RemA, and thus T9SS mutants are nonmotile. T9SSs are common among members of the *Bacteroidetes* phylum and are important for secretion of extracellular enzymes and virulence factors in addition to secretion of cell surface motility adhesins (35, 44). This thesis explores *F. johnsoniae* chitin utilization and the role of the T9SS in this process.

## The type IX secretion system

The T9SS was first identified in *F. johnsoniae* and *P. gingivalis* and later found to be common throughout the phylum *Bacteroidetes* (44, 54, 55) (Figure 1). The *F. johnsoniae* T9SS is required for secretion of the cell surface motility adhesins SprB and RemA (Figure 2). The *F. johnsoniae* T9SS is composed of some of the Gld and Spr proteins. Mutations in *gldK*, *gldL*, *gldM*, *gldN*, *sprA*, *sprE*, and *sprT* result in defects in secretion of SprB and RemA (61). This results in inability to glide and the formation of non-spreading colonies (Figure 3). These mutants are also deficient in chitin utilization (Figure 4), suggesting the possibility that a secreted chitinase may rely on the T9SS to exit the cell. Since mutations in the *F. johnsoniae* T9SS genes result in loss of motility and inability to utilize chitin (53), this suggested that *F. johnsoniae* gliding motility and chitin utilization were dependent on each other. Although much progress has recently been made in our understanding of gliding motility, the mechanism of *F. johnsoniae* chitin utilization has not been explored in detail.

Proteins secreted by T9SSs have N-terminal signal peptides, allowing transit across the cytoplasmic membrane via the Sec system, and conserved carboxy-terminal domains (CTDs) that are thought to target the proteins to the T9SS (22, 44, 55, 57, 60, 63). These CTDs typically belong to TIGRFAM families TIGR04131 or TIGR04183. *F. johnsoniae* has fifty-three proteins with these CTD's, including SprB and RemA (35, 54). The exact role of the CTD and its involvement in targeting proteins to the T9SS is not well understood. Identification of the major chitinase responsible for chitin utilization in *F. johnsoniae*, determination of the role of the T9SS in its secretion and the possible



involvement of the major chitinase CTD in this process, are some of the topics addressed in chapter 2.

		T9SS genes						
Class	Organism	<i>gldK</i>	<i>gldL</i>	<i>gldM</i>	<i>gldN</i>	<i>sprA</i>	<i>sprE</i>	<i>sprT</i>
Flavobacteriia	<i>Capnocytophaga canimorsus</i> Cc5							
	<i>Capnocytophaga ochracea</i> DSM7271 <sup>T</sup>							
	<i>Cellulophaga algicola</i> DSM 14237 <sup>T</sup>							
	<i>Cellulophaga lytica</i> DSM 7489 <sup>T</sup>							
	<i>Croceibacter atlanticus</i> HTCC2559 <sup>T</sup>							
	<i>Flavobacteriaceae bacterium</i> 3519-10							
	<i>Flavobacterium johnsoniae</i> ATCC 17061 <sup>T</sup>							
	<i>Flavobacterium psychrophilum</i> JIP02/86							
	<i>Gramella forsetii</i> KT0803							
	<i>Maribacter</i> sp. HTCC2170							
	<i>Riemerella anatipestifer</i> DSM 15868 <sup>T</sup>							
	<i>Robiginitalea biformata</i> HTCC2501 <sup>T</sup>							
	<i>Weeksella virosa</i> DSM 16922 <sup>T</sup>							
	<i>Zunongwangia profunda</i> SM-A87 <sup>T</sup>							
Cytophagia	<i>Cytophaga hutchinsonii</i> ATCC 33406 <sup>T</sup>							
	<i>Dyadobacter fermentans</i> DSM 18053 <sup>T</sup>							
	<i>Leadbetterella byssophila</i> DSM 17132 <sup>T</sup>							
	<i>Marivirga tractuosa</i> DSM 4126 <sup>T</sup>							
Sphingobacteriia	<i>Spirosoma linguale</i> DSM 74 <sup>T</sup>							
	<i>Chitinophaga pinensis</i> DSM2588B <sup>T</sup>							
	<i>Pedobacter heparinus</i> DSM 2366 <sup>T</sup>							
	<i>Pedobacter saltans</i> DSM 12145 <sup>T</sup>							
Bacteroidia	<i>Alistipes shahii</i> WAL 8301 <sup>T</sup>							
	<i>Bacteroides fragilis</i> NCTC 9343 <sup>T</sup>							
	<i>Bacteroides helcogenes</i> P 36-108 <sup>T</sup>							
	<i>Bacteroides salanitronis</i> DSM 18170 <sup>T</sup>							
	<i>Bacteroides thetaiotaomicron</i> VPI-5482 <sup>T</sup>							
	<i>Bacteroides vulgatus</i> ATCC 8482 <sup>T</sup>							
	<i>Bacteroides xylanisolvens</i> XB1A <sup>T</sup>							
	<i>Odoribacter splanchnicus</i> DSM 20712 <sup>T</sup>							
	<i>Paludibacter propionigenes</i> WB4 <sup>T</sup>							
	<i>Parabacteroides distasonis</i> ATCC 8503 <sup>T</sup>							
Incertae sedis	<i>Porphyromonas gingivalis</i> ATCC 33277 <sup>T</sup>							
	<i>Prevotella melaninogenica</i> ATCC25845 <sup>T</sup>							
	<i>Prevotella ruminicola</i> 23							
	<i>Rhodothermus marinus</i> DSM 4252 <sup>T</sup>							
	<i>Salinibacter ruber</i> DSM 13855 <sup>T</sup>							

Figure 1. Distribution of T9SS genes among members of the phylum *Bacteroidetes* (44). White squares indicate the absence of an ortholog, whereas a grey square indicates the presence of an ortholog. Modified from (44).

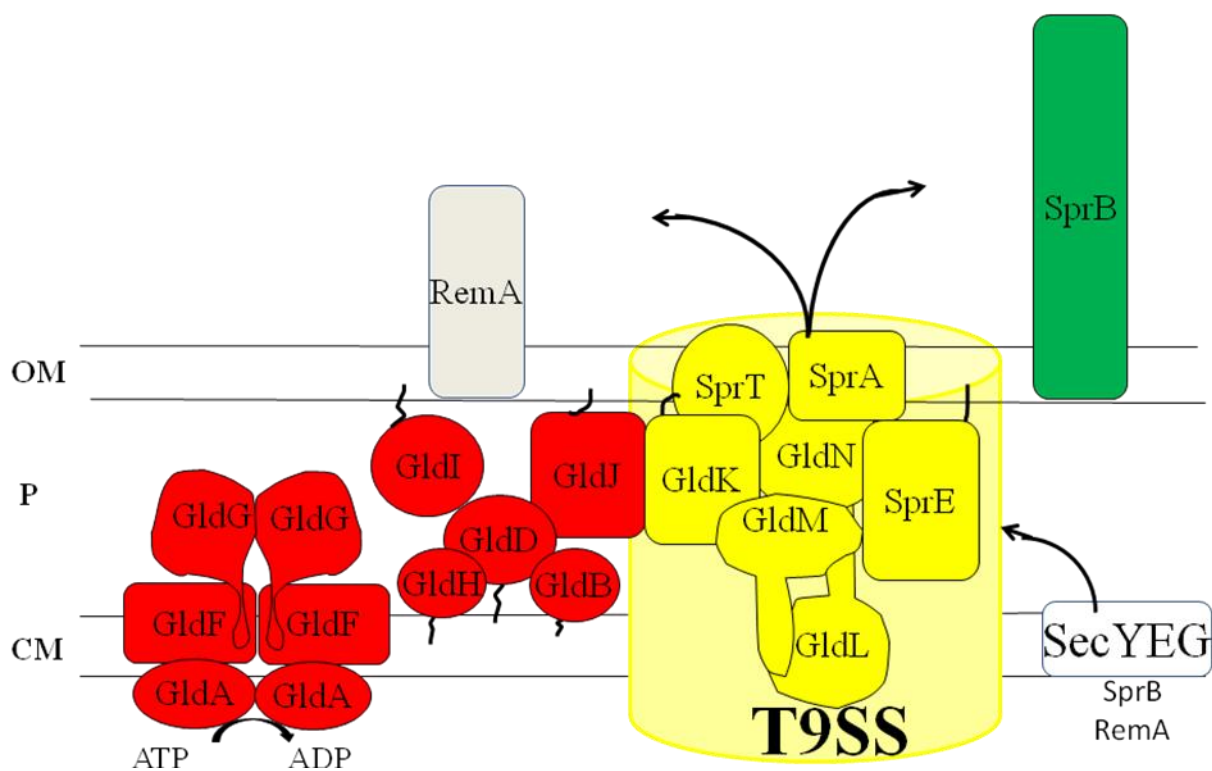

Figure 2. *F. johnsoniae* motility and secretion proteins. T9SS proteins are in yellow. Other proteins related to gliding motility are in red. The T9SS is required for secretion of the motility adhesins SprB and RemA. OM-outermembrane, P-periplasm and CM-cytoplasmic membrane.

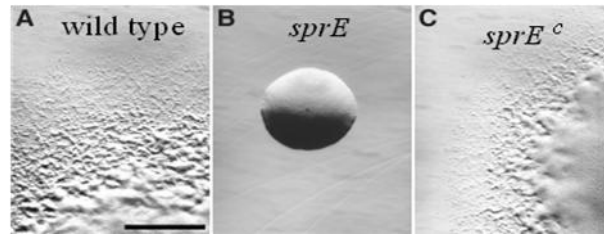

Figure 3. Photomicrographs of *F. johnsoniae* colonies. (A) wild type *F. johnsoniae* FJ1 (B) *sprE* mutant FJ149 (C) *sprE* mutant FJ149 complemented with pNap2 carrying *sprE*. Bar in panel A = 0.5 mm applies to all panels. Modified from (53)

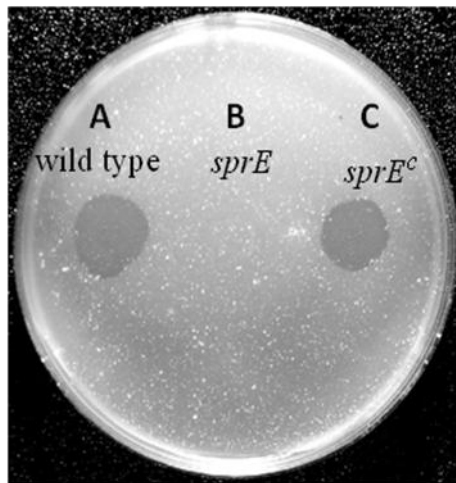

Figure 4. *sprE* is required for chitin utilization. Approximately  $10^6$  cells of (A) wild type *F. johnsoniae* UW101, (B) *sprE* mutant FJ149 and (C) *sprE* mutant FJ149 complemented with pNap2 carrying *sprE* were spotted on MYA- chitin medium and incubated at 25°C for 2 days. Modified from (53).

*P. gingivalis* is a human periodontal pathogen that secretes gingipain proteases resulting in tissue damage (Figure 5). The *P. gingivalis* T9SS, composed of homologs of the *F. johnsoniae* Spr and Gld proteins, is involved in secretion of gingipain proteases which are its major virulence factors (54). *P. gingivalis* strains with mutations in *porK*, *porL*, *porM*, *porN*, *sov*, *porW*, and *porT* (homologs to *F. johnsoniae* *gldK*, *gldL*, *gldM*, *gldN*, *sprA*, *sprE* and *sprT* respectively) are defective for gingipain secretion (29, 54).

In *P. gingivalis*, two additional proteins, PorU and PorV, are linked to T9SS mediated secretion (12, 22, 54). *P. gingivalis* PorU is thought to function as the peptidase that removes the CTDs from proteins that are secreted via the T9SS (Figure 5) (22). *P. gingivalis* PorV is required for secretion of proteins targeted to the T9SS, including the gingipains RgpA, RgpB and Kgp (Figure 5) (29, 30). PorV has also been suggested to play a role in LPS modification. *P. gingivalis* produces two distinct forms of LPS, one of which carries O-antigen (O-LPS) whereas the other carries an anionic polysaccharide (A-LPS). PorV has also been called LptO, and has been shown to affect O-deacylation of lipopolysaccharide (12). PorV directly or indirectly affects the partial deacylation of A-LPS prior to attachment of this lipopolysaccharide to cell-surface proteins secreted by the T9SS. PorV may function as a deacylase, or it may be involved in secretion of a deacylase. *F. johnsoniae* has homologs of *P. gingivalis* *porU* and *porV* but these were not previously studied. Chapter 3 explores the roles of *F. johnsoniae* PorU and PorV in secretion.

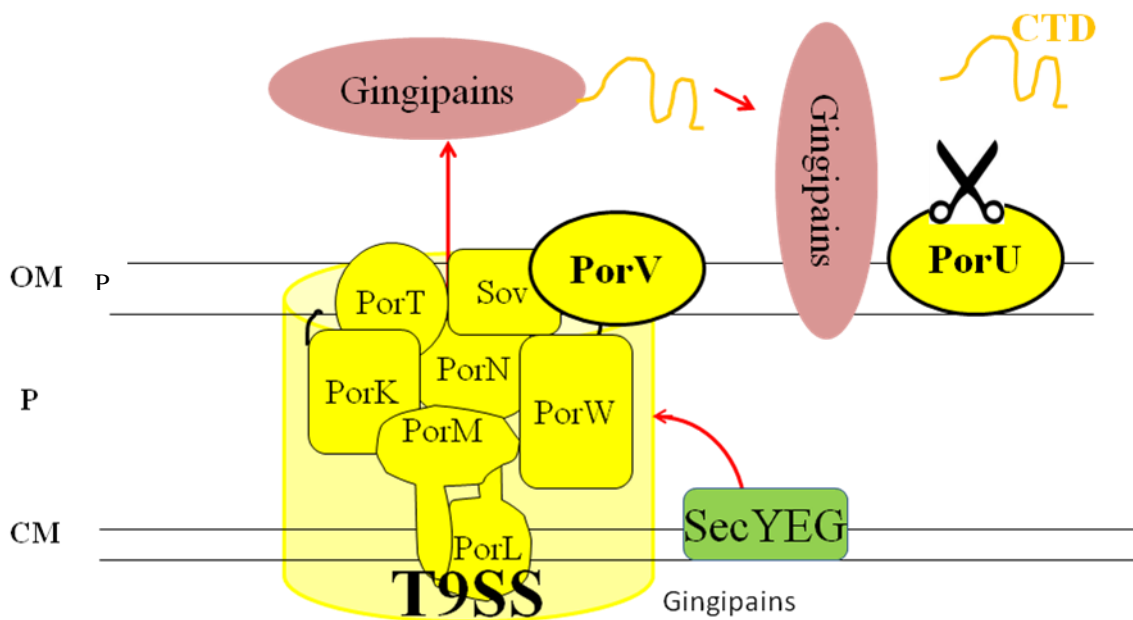

Figure 5. Model of T9SS in *P. gingivalis*. PorK, PorL, PorM, PorN, PorT, PorU, PorV, PorW and Sov form the T9SS required for secretion of its virulence factors, gingipains. Based on the information from (12, 22, 54). PorU appears to cleave CTD of proteins secreted via the T9SS.

OM-outer membrane, P-periplasm and CM-cytoplasmic membrane. ✂ indicates cleavage.

T9SSs is not closely related to the well studied type I through type VIII protein secretion systems (T1SS-T8SS) of Gram-negative bacteria (Figure 6) (Table 1) and appears to be confined to the phylum *Bacteroidetes* (11, 54, 69). Type I, type III, type IV and type VI secretion systems are used for transport of proteins across the cytoplasmic and outer membranes in a single step (Figure 6 right side) (11, 18, 26, 37, 44). In contrast, the type II, type V, type VII and type VIII secretion systems function in conjunction with the Sec or Tat protein export pathways (Figure 6 left side). The Sec or Tat protein export pathways transport proteins across the cytoplasmic membrane into the periplasm (48). These proteins are then transported across the outer membrane via the secretion systems. The components of the T9SS are not similar to T1SS-T8SSs of Gram-negative bacteria (4, 9, 10, 16).

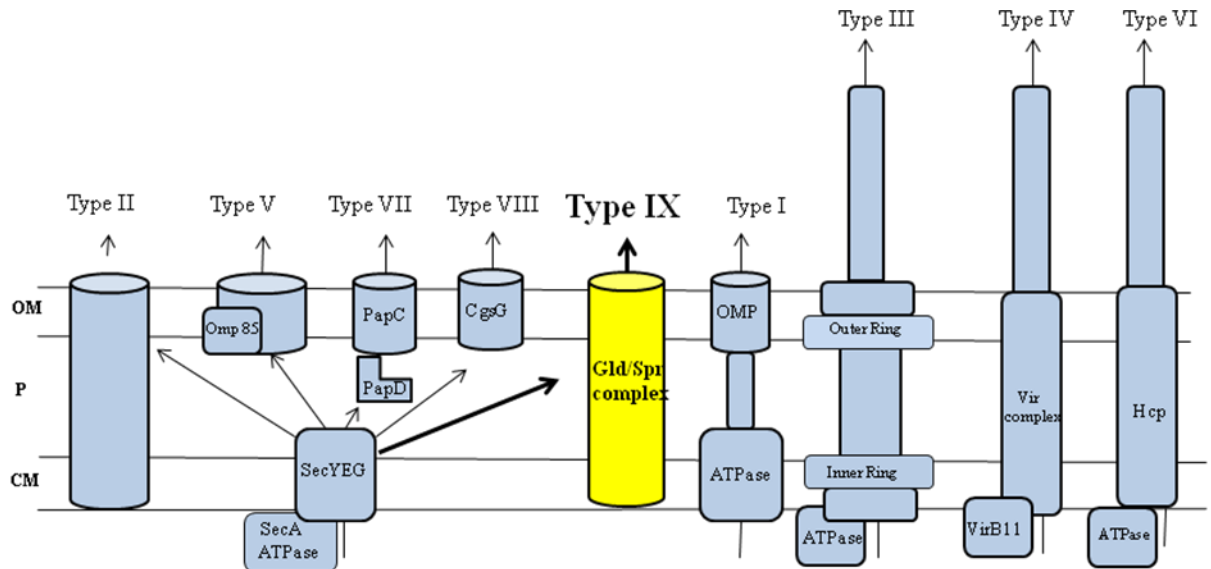

Figure 6. Bacterial protein secretion systems. The T1SS, T3SS, T4SS and T6SS transport proteins from the cytoplasm directly to the cell exterior. For the T3SS, T4SS, and T6SS this involves a needle-like structure at the cell surface. The T2SS, T5SS, T7SS, T8SS and T9SSs function in conjunction with the Sec system or the Tat system (not shown). OM-outer membrane, P-periplasm, CM-cytoplasmic membrane. Modified from (69)



Table 1. Bacterial secretion systems

Secretion system	Example	References
Type I	<i>E. coli</i> HlyA secretion by HlyB, HlyD, TolC	(10, 20, 27)
Type II	<i>Klebsiella oxytoca</i> pullulanase secretion by <i>GspC</i> , <i>GspD</i> , <i>GspE</i> , <i>GspF</i> , <i>GspG</i> , <i>GspL</i> , <i>GspM</i>	(48, 49)
Type III	Secretion of flagellin by bacterial flagella Secretion of virulence factors by <i>Yersinia pestis</i> Ysc proteins	(2) (14)
Type IV	<i>Agrobacterium tumefaciens</i> protein secretion and conjugative transfer of DNA by Vir proteins	(13, 38)
Type V	<i>E. coli</i> EspP autotransporter <i>Bordetella pertussis</i> two-partner secretion system for filamentous hemagglutinin (FHA, TpsA)	(8) (32, 33)
Type VI	<i>Vibrio cholerae</i> VgrG effector protein secretion	(50)
Type VII	<i>E. coli</i> chaperone usher pathway	(9, 10, 16)
Type VIII	<i>E. coli</i> extracellular nucleation-precipitation (ENP) pathway involved in assembly of cell-surface curli fibers	(4, 10, 16)
Type IX	<i>Bacteroidetes</i> specific secretion system found in <i>F. johnsoniae</i> , <i>P. gingivalis</i> , and many related bacteria	(44, 54)

## **Chitin and chitinases**

Insoluble polysaccharides such as cellulose and chitin are thought to be the most abundant biopolymers on our planet (15). These polymers play important structural roles in plants and insects. Although these polymers are resistant to digestion, many soil and aquatic microorganisms have strategies to attack them. Some of these organisms are being used to convert polysaccharides into bio-fuels such as ethanol (23). Studies of the mechanisms employed by bacteria to digest insoluble polysaccharides therefore have environmental and biotechnological significance (17).

Chitin is a linear insoluble polymer of  $\beta$ -1,4-linked *N*-acetylglucosamine (GlcNAc) (19). Chitin and its modified forms are employed in wastewater treatment, drug delivery, wound healing and as dietary fiber (15). Enzymatic conversion of chitin has received attention because of prospects in transforming an abundant insoluble component of biomass into useful products such as soluble chito-oligomers. These chito-oligomers have medical, agricultural and industrial applications as antibacterial, antifungal, hypocholesterolemic and food quality enhancing agents (5). Chitin is a major constituent of the shells of crustaceans such as crab and shrimp, the exoskeletons of insects, and the cell walls of yeasts and other fungi (5).

Digestion of polysaccharides is performed by a multitude of bacterial and fungal enzymes termed glycoside hydrolases (GHs) (72). GHs are classified into families based on amino acid sequence similarities, structures, activities, and evolutionary relationships

(72). The most recent and up to date sequence-based classifications are found in the Carbohydrate Active Enzymes (CAZy) database (<http://www.cazy.org>).

Chitin can be digested primarily in two ways. The first approach is chitinolytic that involves hydrolysis of the  $\beta$ -glycosidic bond in the chitin chain by chitinases (GH18 and GH19 families) to form chito-oligosaccharides (often chitobiose) (19). These chito-oligosaccharides are further hydrolyzed to GlcNAc monomers by  $\beta$ -*N*-acetylglucosaminidases (typically belong to family GH20) (19). The second approach towards chitin digestion involves deacetylation of chitin by chitin deacetylases (usually belong to the carbohydrate esterase family 4) to form chitosan (a deacylated form of chitin), that is further converted to glucosamine by chitosanases (often belong to the families GH8, GH46, GH75 and GH80).

Chitinases typically belong to the GH18 and GH19 families (25). Family GH19 (originally identified in plants) exclusively contains chitinases. Chitinases belonging to the family of GH18 are the most widespread and well studied chitinolytic enzymes. The GH18 family in addition to chitinases contains endo- $\beta$ -*N*-acetylglucosaminidases, and also a subclass of non-hydrolytic proteins including lectins and xylanase inhibitors (19). GH18 chitinases share conserved residues DXXDXDXE at their catalytic region (19, 24). Additionally, some family 18 chitinases may digest chitosan (64) and some chitinases in this family also break down peptidoglycans (6).

Biochemically chitinases can be classified by their mode of action on chitin chains. Endo-chitinases cleave chitin randomly at internal sites to form long oligomers of

GlcNAc. Exo-chitinases, on the other hand, cleave chitin from either the reducing or non-reducing end. Exo-chitinases are typically chitobiosidases that catalyze release of chitobiose from the non-reducing end of chitin. (15). Typically exo-chitinases are processive, repeatedly releasing sugars from the end of the oligomer. A deep substrate binding cleft or tunnel is often observed in exo-acting enzymes allowing this processive mode of action. In contrast, most non-processive endo-acting enzymes have shallow substrate binding clefts (19). Endo-acting and exo-acting enzymes appear to work synergistically to hydrolyse chitin (19, 15).

Many chitinolytic organisms synthesize multiple chitinases (15). Some of these undergo post-translational modifications such as glycosylation and proteolysis (15). Chitinases are isolated and purified from many sources including plants, animals, fungi, bacteria, and viruses (15). Multiple chitinases have been reported in several microorganisms such as *Alteromonas* sp Strain O-7 (47), *Serratia marcescens* (71), *Bacillus circulans* WL-12 (45), *Streptomyces griseus* (31) and *Pyrococcus kodakaraensis* KOD1(67). Orikoishi et. al. reported the synergistic action of four chitinases, *AO7ChiA*, *AO7ChiB*, *AO7ChiC* and *AO7ChiD*, in chitin degradation in the marine bacterium *Alteromonas* sp. Strain O-7. Although the *Alteromonas* chitinases have similar catalytic domains some were more active against powdered insoluble chitin, whereas others were more active against more soluble forms of chitin (47). Synergistic action of the *S. marcescens* chitinases *SmChiA*, *SmChiB* and *SmChiC1* was demonstrated (66). *SmChiA* and *SmChiB* are thought to digest chitin chains from opposite ends, whereas *SmChiA* acts on the reducing end and, *SmChiB* degrades chitin from the non-reducing end (66).

Chitinases are often modular enzymes that consist of catalytic modules and carbohydrate binding modules (CBMs) that bind specifically to chitin (19, 24). Many common bacterial chitin binding domains belong to CBM families 5 and 12 (19). CBMs are thought to bind the substrate and position the enzyme to facilitate digestion (72). In addition they may modulate the activity of the enzyme, attach the enzyme to the bacterial cell surface, and potentially disrupt crystalline portions of the substrate thus improving accessibility to the catalytic domain (72). Recently some CBMs have also been shown to sense the target substrate and regulate transcription of genes associated with polysaccharide digestion (34).

Carbohydrate binding module family 33 (CBM33) until recently was considered to comprise of enzymes that were thought to be chitin binding proteins (19). Due to the observed oxidative activity of the enzymes in the family of 'CBM33', it has been renamed 'auxiliary activity family 10' (AA10). AA10 enzymes are lytic polysaccharide monooxygenases (LPMOs) (70). Some AA10 enzymes oxidize chitin whereas others oxidize cellulose. These enzymes introduce chain breaks in the polysaccharides, generating oxidized chain ends (70). They are thought to convert the crystalline insoluble polysaccharides into forms that can be readily attacked by glycoside hydrolases. The *F. johnsoniae* genome does not encode any AA10 family proteins so it apparently does not rely on this mechanism to attack chitin.

The *F. johnsoniae* major chitinase discussed in chapter 2, Fjoh\_4555 (ChiA), has 2 GH18 domains that appear to be involved in chitin degradation. No CBM has been

recognized in *F. johnsoniae* ChiA, although it may have novel chitin binding domains or may interact with other proteins that bind chitin.

### ***F. johnsoniae* chitin utilization locus**

Bacteria including *F. johnsoniae* employ various strategies to digest polysaccharides (Figure 7). Some bacteria including *Saccharophagus degradans*, secrete enzymes that digest the polysaccharides into small monomers or dimers that are taken up by the cell (Figure 7) (68). In contrast, other bacteria including the cellulolytic clostridia, *Clostridium thermocellum* and *Clostridium cellulovorans*, produce multi-protein complexes of enzymes and polysaccharide binding proteins called cellulosomes that are exposed on the cell surface (21). These interact with the polysaccharides and release soluble monomers and dimers for utilization by the cell (21). Both of the above-discussed strategies result in the polysaccharide being digested primarily outside of the cell. Members of the phylum *Bacteroidetes* have evolved a different strategy for polysaccharide utilization. *Bacteroides thetaiotaomicron*, an anaerobic inhabitant of the human large intestine, is well studied for employing the Starch Utilization System (Sus) pathway (51). In *B. thetaiotaomicron*, the *sus* locus consists of eight genes *susR*, *susA*, *susB*, *susC*, *susD*, *susE*, *susF* and *susG* (58). Starch binding is achieved by the concerted function of the cell surface proteins SusD, SusE and SusF (52, 58). SusD binds starch and facilitates limited digestion by nearby glycoside hydrolases such as the outer membrane  $\alpha$ -amylase SusG resulting in long oligomers (52, 59). These oligomers are actively transported across the outer membrane through a channel-like protein, SusC. SusC is a member of the TonB-dependent receptor family that transports macromolecules through

an energy dependent mechanism. Transport is thought to require a proton motive force and the TonB-ExbBD complex (56). Further digestion of starch oligomers in the periplasm by SusA and SusB results in release of monosaccharides and disaccharides. Transcriptional regulation of the *sus* locus genes is accomplished by the sensor/ regulator SusR (72). *B. thetaiotaomicron* has numerous genes encoding SusC-like and SusD-like proteins allowing it to utilize many polysaccharides. *susC*-like and *susD*-like genes are paired with each other and are usually adjacent to genes encoding the glycoside hydrolases that digest the polysaccharide. Such a gene cluster is called a **Polysaccharide Utilization Locus (PUL)**.

The *Bacteroidetes* SusCD strategy has been demonstrated only for utilization of relatively soluble substrates such as starch. Genome analysis of *F. johnsoniae* suggests that the SusCD paradigm may extend to the digestion of highly insoluble polysaccharides as well, since many genes encoding proteins similar to *B. thetaiotaomicron* SusC and SusD were adjacent to genes predicted to encode glycoside hydrolases that attack insoluble polysaccharides (43). *F. johnsoniae* digests chitin, plant cell wall hemicelluloses such as xylans and mannans and many other polysaccharides. It has 44 *susC*-like genes and 42 *susD*-like genes within its many PULs (3). One of its PULs is predicted to be involved in chitin utilization (Fjoh\_4564-Fjoh\_4555). Fjoh\_4555 encodes ChiA, the major extracellular chitinase discussed in chapter 2. The other genes in this PUL including *cusC<sub>I</sub>* and *cusC<sub>II</sub>* (*susC*-like genes of the **chitin utilization system**) and *cusD<sub>I</sub>* and *cusD<sub>II</sub>* (*susD*-like genes) appear to play roles in chitin utilization and are discussed in chapter 4.

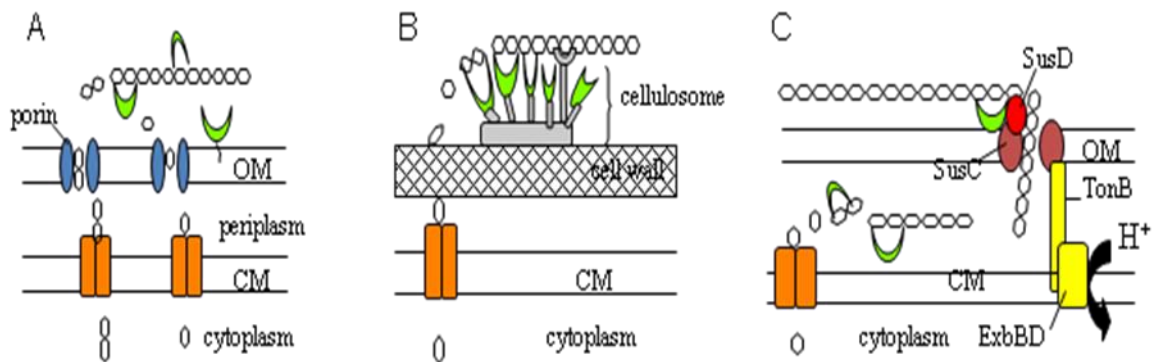

Figure 7. Bacterial strategies for polysaccharide utilization. (A) Extracellular enzyme strategy used by *Saccharophagus degradans*. Extracellular enzymes digest the polymer releasing monomers or dimers that passively diffuse through outer membrane porins and are actively transported across the cytoplasmic membrane. (B) Enzyme complex (cellulosome) strategy used by *Clostridium thermocellum*. Multiple polysaccharide lytic enzymes are displayed on the cell surface as a complex. The enzymes work together to digest polysaccharides to monomers and dimers that are actively transported across the cytoplasmic membrane. (C) *Bacteroidetes* SusCD strategy. Polysaccharides attach to SusD-like protein (red) on cell surface. Nearby cell associated enzymes (green) cut the polysaccharide into long oligomers that are actively transported across the outer membrane through the SusC channel (purple), with the help of TonB-ExbBD (yellow). Further digestion occurs in the periplasm and cytoplasm. OM- outer membrane and CM- cytoplasmic membrane. (Courtesy Mark McBride)



This thesis is focused on the *F. johnsoniae* major extracellular chitinase ChiA, the T9SS protein PorV, and the chitin utilization proteins CusC<sub>I</sub>, CusC<sub>II</sub>, CusD<sub>I</sub> and CusD<sub>II</sub>. Chapter 2 covers the extracellular chitinase ChiA and its secretion by the T9SS. A slightly modified form of this chapter was published in the Journal of Bacteriology (35). Chapter 3 covers the T9SS protein PorV and its involvement as an accessory protein of the T9SS. A modified form of this chapter was also published in the Journal of Bacteriology (36). The only difference between the papers published in Journal of Bacteriology and the chapters in this thesis are that some of the online supplemental materials associated with the published papers are integrated into the thesis chapters. Chapter 4 is focused on *F. johnsoniae* chitin utilization system proteins CusC<sub>I</sub>, CusD<sub>I</sub>, CusC<sub>II</sub> and CusD<sub>II</sub>. Results that relate to chapter 2 but that were not included in the associated publication are presented in appendix 1 following chapter 4

## References

1. **Agarwal, S., D. W. Hunnicutt, and M. J. McBride.** 1997. Cloning and characterization of the *Flavobacterium johnsoniae* (*Cytophaga johnsonae*) gliding motility gene, *gldA*. Proc Natl Acad Sci U S A **94**:12139-44.
2. **Aizawa, S. I.** 2001. Bacterial flagella and type III secretion systems. FEMS Microbiol Lett **202**:157-64.
3. **Anderson, K. L., and A. A. Salyers.** 1989. Genetic evidence that outer membrane binding of starch is required for starch utilization by *Bacteroides thetaiotaomicron*. J Bacteriol **171**:3199-204.
4. **Barnhart, M. M., and M. R. Chapman.** 2006. Curli biogenesis and function. Annu Rev Microbiol **60**:131-47.
5. **Bhattacharya, D., A. Nagpure, and R. K. Gupta.** 2007. Bacterial chitinases: properties and potential. Crit Rev Biotechnol **27**:21-8.
6. **Bokma, E., G. A. van Koningsveld, M. Jeronimus-Stratingh, and J. J. Beintema.** 1997. Hevamine, a chitinase from the rubber tree *Hevea brasiliensis*, cleaves peptidoglycan between the C-1 of N-acetylglucosamine and C-4 of N-acetylmuramic acid and therefore is not a lysozyme. FEBS Lett **411**:161-3.
7. **Braun, T. F., M. K. Khubbar, D. A. Saffarini, and M. J. McBride.** 2005. *Flavobacterium johnsoniae* gliding motility genes identified by mariner mutagenesis. J Bacteriol **187**:6943-52.
8. **Brunder, W., H. Schmidt, and H. Karch.** 1997. EspP, a novel extracellular serine protease of enterohaemorrhagic *Escherichia coli* O157:H7 cleaves human coagulation factor V. Mol Microbiol **24**:767-78.
9. **Busch, A., and G. Waksman.** 2012. Chaperone-usher pathways: diversity and pilus assembly mechanism. Philos Trans R Soc Lond B Biol Sci **367**:1112-22.
10. **Chagnot, C., M. A. Zorgani, T. Astruc, and M. Desvaux.** Proteinaceous determinants of surface colonization in bacteria: bacterial adhesion and biofilm formation from a protein secretion perspective. Front Microbiol **4**:303.
11. **Chagnot, C., M. A. Zorgani, T. Astruc, and M. Desvaux.** 2013. Proteinaceous determinants of surface colonization in bacteria: bacterial adhesion and biofilm formation from a protein secretion perspective. Front Microbiol **4**:303.
12. **Chen, Y. Y., B. Peng, Q. Yang, M. D. Glew, P. D. Veith, K. J. Cross, K. N. Goldie, D. Chen, N. O'Brien-Simpson, S. G. Dashper, and E. C. Reynolds.** 2011. The outer membrane protein LptO is essential for the O-deacylation of LPS and the co-ordinated secretion and attachment of A-LPS and CTD proteins in *Porphyromonas gingivalis*. Mol Microbiol **79**:1380-401.
13. **Christie, P. J., and E. Cascales.** 2005. Structural and dynamic properties of bacterial type IV secretion systems (review). Mol Membr Biol **22**:51-61.
14. **Cornelis, G. R., and H. Wolf-Watz.** 1997. The *Yersinia* Yop virulon: a bacterial system for subverting eukaryotic cells. Mol Microbiol **23**:861-7.
15. **Dahiya, N., R. Tewari, and G. S. Hoondal.** 2006. Biotechnological aspects of chitinolytic enzymes: a review. Appl Microbiol Biotechnol **71**:773-82.

16. **Desvaux, M., M. Hebraud, R. Talon, and I. R. Henderson.** 2009. Secretion and subcellular localizations of bacterial proteins: a semantic awareness issue. *Trends Microbiol* **17**:139-45.
17. **Downing, K. J., and J. A. Thomson.** 2000. Introduction of the *Serratia marcescens* chiA gene into an endophytic *Pseudomonas fluorescens* for the biocontrol of phytopathogenic fungi. *Can J Microbiol* **46**:363-9.
18. **Economou, A., P. J. Christie, R. C. Fernandez, T. Palmer, G. V. Plano, and A. P. Pugsley.** 2006. Secretion by numbers: Protein traffic in prokaryotes. *Mol Microbiol* **62**:308-19.
19. **Eijsink, V., I. Hoell, and G. Vaaje-Kolstada.** 2010. Structure and function of enzymes acting on chitin and chitosan. *Biotechnol Genet Eng Rev* **27**:331-66.
20. **Fath, M. J., and R. Kolter.** 1993. ABC transporters: bacterial exporters. *Microbiol Rev* **57**:995-1017.
21. **Felix, C. R., and L. G. Ljungdahl.** 1993. The cellulosome: the exocellular organelle of *Clostridium*. *Annu Rev Microbiol* **47**:791-819.
22. **Glew, M. D., P. D. Veith, B. Peng, Y. Y. Chen, D. G. Gorasia, Q. Yang, N. Slakeski, D. Chen, C. Moore, S. Crawford, and E. C. Reynolds.** 2012. PG0026 is the C-terminal signal peptidase of a novel secretion system of *Porphyromonas gingivalis*. *J Biol Chem* **287**:24605-17.
23. **Gray, K. A., L. Zhao, and M. Emptage.** 2006. Bioethanol. *Curr Opin Chem Biol* **10**:141-6.
24. **Hamid, R., M. A. Khan, M. Ahmad, M. M. Ahmad, M. Z. Abdin, J. Musarrat, and S. Javed.** 2013. Chitinases: An update. *J Pharm Bioallied Sci* **5**:21-9.
25. **Henrissat, B., and A. Bairoch.** 1993. New families in the classification of glycosyl hydrolases based on amino acid sequence similarities. *Biochem J* **293** (Pt 3):781-8.
26. **Holland, I. B.** 2010. The extraordinary diversity of bacterial protein secretion mechanisms. *Methods Mol Biol* **619**:1-20.
27. **Holland, I. B., B. Kenny, and M. Blight.** 1990. Haemolysin secretion from *E coli*. *Biochimie* **72**:131-41.
28. **Hunnicut, D. W., and M. J. McBride.** 2001. Cloning and characterization of the *Flavobacterium johnsoniae* gliding motility genes *gldD* and *gldE*. *J Bacteriol* **183**:4167-75.
29. **Ishiguro, I., K. Saiki, and K. Konishi.** 2011. Analysis of *Porphyromonas gingivalis* PG27 by deletion and intragenic suppressor mutation analyses. *Mol Oral Microbiol* **26**:321-35.
30. **Ishiguro, I., K. Saiki, and K. Konishi.** 2009. PG27 is a novel membrane protein essential for a *Porphyromonas gingivalis* protease secretion system. *FEMS Microbiol Lett* **292**:261-7.
31. **Itoh, Y., T. Kawase, N. Nikaidou, H. Fukada, M. Mitsutomi, and T. Watanabe.** 2002. Functional analysis of the chitin-binding domain of a family 19 chitinase from *Streptomyces griseus* HUT6037: substrate-binding affinity and cis-dominant increase of antifungal function. *Biosci Biotechnol Biochem* **66**:1084-92.

32. **Jacob-Dubuisson, F., C. Buisine, E. Willery, G. Renauld-Mongenie, and C. Locht.** 1997. Lack of functional complementation between *Bordetella pertussis* filamentous hemagglutinin and *Proteus mirabilis* HpmA hemolysin secretion machineries. *J Bacteriol* **179**:775-83.
33. **Jacob-Dubuisson, F., C. Locht, and R. Antoine.** 2001. Two-partner secretion in Gram-negative bacteria: a thrifty, specific pathway for large virulence proteins. *Mol Microbiol* **40**:306-13.
34. **Kahel-Raifer, H., S. Jindou, L. Bahari, Y. Nataf, Y. Shoham, E. A. Bayer, I. Borovok, and R. Lamed.** 2010. The unique set of putative membrane-associated anti-sigma factors in *Clostridium thermocellum* suggests a novel extracellular carbohydrate-sensing mechanism involved in gene regulation. *FEMS Microbiol Lett* **308**:84-93.
35. **Kharade, S. S., and M. J. McBride.** 2014. The *Flavobacterium johnsoniae* chitinase ChiA is required for chitin utilization and is secreted by the type IX secretion system. *J Bacteriol.***196**:961-970
36. **Kharade, S. S., and M. J. McBride.** 2014. *Flavobacterium johnsoniae* PorV is required for secretion of a subset of proteins targeted to the type IX secretion system. *J Bacteriol.*
37. **Kostakioti, M., C. L. Newman, D. G. Thanassi, and C. Stathopoulos.** 2005. Mechanisms of protein export across the bacterial outer membrane. *J Bacteriol* **187**:4306-14.
38. **Lessl, M., and E. Lanka.** 1994. Common mechanisms in bacterial conjugation and Ti-mediated T-DNA transfer to plant cells. *Cell* **77**:321-4.
39. **Liu, J., M. J. McBride, and S. Subramaniam.** 2007. Cell surface filaments of the gliding bacterium *Flavobacterium johnsoniae* revealed by cryo-electron tomography. *J Bacteriol* **189**:7503-6.
40. **McBride, M. J.** 2001. Bacterial gliding motility: multiple mechanisms for cell movement over surfaces. *Annu Rev Microbiol* **55**:49-75.
41. **McBride, M. J.** 2004. Cytophaga-flavobacterium gliding motility. *J Mol Microbiol Biotechnol* **7**:63-71.
42. **McBride, M. J., and T. F. Braun.** 2004. GldI is a lipoprotein that is required for *Flavobacterium johnsoniae* gliding motility and chitin utilization. *J Bacteriol* **186**:2295-302.
43. **McBride, M. J., G. Xie, E. C. Martens, A. Lapidus, B. Henrissat, R. G. Rhodes, E. Goltsman, W. Wang, J. Xu, D. W. Hunnicutt, A. M. Staroscik, T. R. Hoover, Y. Q. Cheng, and J. L. Stein.** 2009. Novel features of the polysaccharide-digesting gliding bacterium *Flavobacterium johnsoniae* as revealed by genome sequence analysis. *Appl Environ Microbiol* **75**:6864-75.
44. **McBride, M. J., and Y. Zhu.** 2013. Gliding motility and Por secretion system genes are widespread among members of the phylum *Bacteroidetes*. *J Bacteriol* **195**:270-8.
45. **Mitsutomi, M., M. Isono, A. Uchiyama, N. Nikaidou, T. Ikegami, and T. Watanabe.** 1998. Chitosanase activity of the enzyme previously reported as beta-

- 1,3-1,4-glucanase from *Bacillus circulans* WL-12. *Biosci Biotechnol Biochem* **62**:2107-14.
46. **Nelson, S. S., S. Bollampalli, and M. J. McBride.** 2008. SprB is a cell surface component of the *Flavobacterium johnsoniae* gliding motility machinery. *J Bacteriol* **190**:2851-7.
47. **Orikoshi, H., S. Nakayama, C. Hanato, K. Miyamoto, and H. Tsujibo.** 2005. Role of the N-terminal polycystic kidney disease domain in chitin degradation by chitinase A from a marine bacterium, *Alteromonas* sp. strain O-7. *J Appl Microbiol* **99**:551-7.
48. **Pugsley, A. P.** 1993. The complete general secretory pathway in gram-negative bacteria. *Microbiol Rev* **57**:50-108.
49. **Pugsley, A. P., and O. Possot.** 1993. The general secretory pathway of *Klebsiella oxytoca*: no evidence for relocalization or assembly of pilin-like PulG protein into a multiprotein complex. *Mol Microbiol* **10**:665-74.
50. **Pukatzki, S., A. T. Ma, D. Sturtevant, B. Krastins, D. Sarracino, W. C. Nelson, J. F. Heidelberg, and J. J. Mekalanos.** 2006. Identification of a conserved bacterial protein secretion system in *Vibrio cholerae* using the Dictyostelium host model system. *Proc Natl Acad Sci U S A* **103**:1528-33.
51. **Reeves, A. R., J. N. D'Elia, J. Frias, and A. A. Salyers.** 1996. A *Bacteroides thetaiotaomicron* outer membrane protein that is essential for utilization of maltooligosaccharides and starch. *J Bacteriol* **178**:823-30.
52. **Reeves, A. R., G. R. Wang, and A. A. Salyers.** 1997. Characterization of four outer membrane proteins that play a role in utilization of starch by *Bacteroides thetaiotaomicron*. *J Bacteriol* **179**:643-9.
53. **Rhodes, R. G., M. N. Samarasam, E. J. Van Groll, and M. J. McBride.** 2011. Mutations in *Flavobacterium johnsoniae* *sprE* result in defects in gliding motility and protein secretion. *J Bacteriol* **193**:5322-7.
54. **Sato, K., M. Naito, H. Yukitake, H. Hirakawa, M. Shoji, M. J. McBride, R. G. Rhodes, and K. Nakayama.** 2010. A protein secretion system linked to bacteroidete gliding motility and pathogenesis. *Proc Natl Acad Sci U S A* **107**:276-81.
55. **Sato, K., H. Yukitake, Y. Narita, M. Shoji, M. Naito, and K. Nakayama.** 2012. Identification of *Porphyromonas gingivalis* proteins secreted by the Por secretion system. *FEMS Microbiol Lett* **338**:68-76.
56. **Schauer, K., D. A. Rodionov, and H. de Reuse.** 2008. New substrates for TonB-dependent transport: do we only see the 'tip of the iceberg'? *Trends Biochem Sci* **33**:330-8.
57. **Seers, C. A., N. Slakeski, P. D. Veith, T. Nikolof, Y. Y. Chen, S. G. Dashper, and E. C. Reynolds.** 2006. The RgpB C-terminal domain has a role in attachment of RgpB to the outer membrane and belongs to a novel C-terminal-domain family found in *Porphyromonas gingivalis*. *J Bacteriol* **188**:6376-86.
58. **Shipman, J. A., J. E. Berleman, and A. A. Salyers.** 2000. Characterization of four outer membrane proteins involved in binding starch to the cell surface of *Bacteroides thetaiotaomicron*. *J Bacteriol* **182**:5365-72.

59. **Shipman, J. A., K. H. Cho, H. A. Siegel, and A. A. Salyers.** 1999. Physiological characterization of SusG, an outer membrane protein essential for starch utilization by *Bacteroides thetaiotaomicron*. *J Bacteriol* **181**:7206-11.
60. **Shoji, M., K. Sato, H. Yukitake, Y. Kondo, Y. Narita, T. Kadowaki, M. Naito, and K. Nakayama.** 2011. Por secretion system-dependent secretion and glycosylation of *Porphyromonas gingivalis* hemin-binding protein 35. *PLoS One* **6**:e21372.
61. **Shrivastava, A., J. J. Johnston, J. M. van Baaren, and M. J. McBride.** 2013. *Flavobacterium johnsoniae* GldK, GldL, GldM, and SprA are required for secretion of the cell surface gliding motility adhesins SprB and RemA. *J Bacteriol* **195**:3201-12.
62. **Shrivastava, A., R. G. Rhodes, S. Pochiraju, D. Nakane, and M. J. McBride.** 2012. *Flavobacterium johnsoniae* RemA is a mobile cell surface lectin involved in gliding. *J Bacteriol* **194**:3678-88.
63. **Slakeski, N., C. A. Seers, K. Ng, C. Moore, S. M. Cleal, P. D. Veith, A. W. Lo, and E. C. Reynolds.** 2010. C-terminal domain residues important for secretion and attachment of RgpB in *Porphyromonas gingivalis*. *J Bacteriol* **193**:132-42.
64. **Sorbotten, A., S. J. Horn, V. G. Eijsink, and K. M. Varum.** 2005. Degradation of chitosans with chitinase B from *Serratia marcescens*. Production of chito-oligosaccharides and insight into enzyme processivity. *FEBS J* **272**:538-49.
65. **Stanier, R. Y.** 1947. Studies on nonfruiting myxobacteria; *Cytophaga johnsonae*, n. sp., a chitin decomposing myxobacterium. *J Bacteriol* **53**:297-315.
66. **Suzuki, K., N. Sugawara, M. Suzuki, T. Uchiyama, F. Katouno, N. Nikaidou, and T. Watanabe.** 2002. Chitinases A, B, and C1 of *Serratia marcescens* 2170 produced by recombinant *Escherichia coli*: enzymatic properties and synergism on chitin degradation. *Biosci Biotechnol Biochem* **66**:1075-83.
67. **Tanaka, T., T. Fukui, and T. Imanaka.** 2001. Different cleavage specificities of the dual catalytic domains in chitinase from the hyperthermophilic archaeon *Thermococcus kodakaraensis* KOD1. *J Biol Chem* **276**:35629-35.
68. **Taylor, L. E., 2nd, B. Henrissat, P. M. Coutinho, N. A. Ekborg, S. W. Hutcheson, and R. M. Weiner.** 2006. Complete cellulase system in the marine bacterium *Saccharophagus degradans* strain 2-40T. *J Bacteriol* **188**:3849-61.
69. **Tseng, T. T., B. M. Tyler, and J. C. Setubal.** 2009. Protein secretion systems in bacterial-host associations, and their description in the Gene Ontology. *BMC Microbiol* **9 Suppl 1**:S2.
70. **Vaaje-Kolstad, G., B. Westereng, S. J. Horn, Z. Liu, H. Zhai, M. Sorlie, and V. G. Eijsink.** An oxidative enzyme boosting the enzymatic conversion of recalcitrant polysaccharides. *Science* **330**:219-22.
71. **Watanabe, T., K. Kimura, T. Sumiya, N. Nikaidou, K. Suzuki, M. Suzuki, M. Taiyoji, S. Ferrer, and M. Regue.** 1997. Genetic analysis of the chitinase system of *Serratia marcescens* 2170. *J Bacteriol* **179**:7111-7.
72. **White, B. A., R. Lamed, E. A. Bayer, and H. J. Flint.** Biomass utilization by gut microbiomes. *Annu Rev Microbiol* **68**:279-96.

**Chapter 2. The *Flavobacterium johnsoniae* chitinase ChiA is required for chitin utilization and is secreted by the type IX secretion system.**

This chapter is a modified version of a paper published in Journal of Bacteriology (68) that includes some of the online supplemental materials of the published paper integrated into it.

**Abstract**

*Flavobacterium johnsoniae*, a member of phylum *Bacteroidetes*, is a gliding bacterium that digests insoluble chitin and many other polysaccharides. A novel protein secretion system, the type IX secretion system (T9SS), is required for gliding motility and for chitin utilization. Five potential chitinases were identified by genome analysis. Fjoh\_4555 (ChiA), a 168.9 kDa protein with two glycoside hydrolase family 18 (GH18) domains, was targeted for analysis. Disruption of *chiA* by insertional mutagenesis resulted in cells that failed to digest chitin, and complementation with wild-type *chiA* on a plasmid restored chitin utilization. Antiserum raised against recombinant ChiA was used to detect the protein and to characterize its secretion by *F. johnsoniae*. ChiA was secreted in soluble form by wild-type cells but remained cell-associated in strains carrying mutations in any of the T9SS genes, *gldK*, *gldL*, *gldM*, *gldNO*, *sprA*, *sprE* and *sprT*. Western blot and liquid chromatography-tandem mass spectrometry (LC-MS/MS) analyses suggested that ChiA was proteolytically processed into two GH18 domain-containing proteins. Proteins secreted by T9SSs typically have conserved carboxy-terminal domains (CTDs) belonging to the TIGRFAM protein domain families,

TIGR04131 and TIGR04183. ChiA does not exhibit strong similarity to these sequences and instead has a novel CTD. Deletion of this CTD resulted in accumulation of ChiA inside of cells. Fusion of the ChiA CTD to recombinant mCherry resulted in secretion of mCherry into the medium. The results indicate that ChiA is a soluble extracellular chitinase required for chitin utilization, and that it relies on a novel CTD for secretion by the *F. johnsoniae* T9SS.

## **Introduction**

The gliding bacterium *Flavobacterium johnsoniae* efficiently digests many polysaccharides including insoluble chitin, a homopolymer of  $\beta$ -1,4-linked *N*-acetyl-D-glucosamine (GlcNAc) (62). Chitin is one of the most abundant biomolecules on earth, and determination of the mechanisms of its digestion has biotechnological and environmental implications (39). Analysis of the *F. johnsoniae* genome revealed ten genes predicted to encode glycohydrolases involved in chitin utilization (37). These included five predicted chitinases to cut the long chitin polymers, and five predicted  $\beta$ -N-acetylglucosaminidases to release N-acetylglucosamine from the soluble chitooligosaccharides. The exact functions of each of these enzymes in chitin utilization are not known.

It has been known for many years that mutations that disrupt gliding motility often result in inability to digest chitin (12). More recently it was recognized that *F. johnsoniae* has a protein secretion system, originally called the Por secretion system and now referred to as the type IX secretion system (T9SS), that is required for both motility



and chitin utilization (38, 53, 55, 59). The components of T9SSs are not closely related to those of the well-studied type I-type VI secretion systems of Gram-negative bacteria (17, 20, 38). They are also unrelated to the components of the chaperone-usher pathway that has recently been called the type VII secretion system (9, 11, 16), the components of the extracellular nucleation-precipitation pathway involved in secretion and assembly of curli amyloid fibers, which has been referred to as the type VIII secretion system (3, 16), and to the mycobacterial ESX (ESAT-6) system (1, 11). The T9SS is required for secretion of the cell surface motility proteins SprB and RemA, and is thus needed for motility. SprB and RemA are adhesins that move rapidly on the cell surface, apparently propelled by the still poorly defined gliding motor (40, 41, 60). Cells with mutations in T9SS genes fail to utilize chitin and lack extracellular chitinase activity (49, 50, 53, 59). One predicted chitinase (Fjoh\_4555, which we refer to as ChiA) was identified in the spent culture medium of wild-type cells but not of a T9SS mutant (53). ChiA was thus predicted to be secreted by the T9SS and to have a role in chitin utilization.

T9SSs are common in members of the phylum *Bacteroidetes*, of which *F. johnsoniae* is a member (38). They have been studied not only in *F. johnsoniae*, but also in the nonmotile oral pathogen *Porphyromonas gingivalis*, which uses its T9SS to secrete gingipain protease virulence factors and other proteins (53-55). Proteins secreted by T9SSs have N-terminal signal peptides, allowing transit across the cytoplasmic membrane via the Sec system, and conserved C-terminal domains (CTDs) that are thought to target the proteins to the T9SS (18, 38, 55, 57, 58, 60, 61). These CTDs typically belong to TIGRFAM families TIGR04131 or TIGR04183. *F. johnsoniae* has

fifty-three proteins with these CTD's, including SprB and RemA (59). One predicted chitinase, Fjoh\_4175, has a CTD that belongs to TIGR04183 and thus may be secreted by the T9SS. Surprisingly, the secreted chitinase ChiA does not have a recognizable T9SS CTD, so its relationship to the T9SS or to another secretion system required further study.

Here we demonstrate that *chiA* encodes the major extracellular chitinase required for chitin utilization and that ChiA is a soluble enzyme that requires the T9SS for secretion. We also show that the C-terminal 105 amino acids of ChiA are necessary for secretion, and are sufficient to target a foreign protein for secretion by the T9SS.

## Materials and Methods

**Bacterial and bacteriophage strains, plasmids, and growth conditions.** *F. johnsoniae* ATCC 17061 strain UW101 was the wild-type strain used in this study (34, 37). *F. johnsoniae* strains were grown in Casitone-yeast extract (CYE) medium at 30°C (36), or in motility medium (MM) at 25°C (32), as previously described. *E. coli* strains were grown in Luria-Bertani medium (LB) at 37°C. Strains and plasmids used in this study are listed in Table 2 and primers are listed in Table 3. Antibiotics were used at the following concentrations when needed: ampicillin, 100 µg/ml; chloramphenicol, 30 µg/ml; erythromycin, 100 µg/ml; streptomycin, 100 µg/ml; and tetracycline, 20 µg/ml.

**Disruption and complementation of *chiA*.** For disruption of *chiA*, a 1299-bp region internal to *F. johnsoniae chiA* was amplified by PCR using primer 937 with engineered BamHI site and primer 938 with engineered SalI site. The fragment was inserted into pLYL03 that had been digested with BamHI and SalI to generate pSAM1.

pSAM1 was introduced into *F. johnsoniae* by conjugation (21, 36) and recombined into the chromosome to yield the *chiA* mutant, CJ1808. The insertion was confirmed by PCR using primer 737 and primer 941.

For complementation of *chiA*, a 4974 bp fragment was amplified using primer 974 (engineered XbaI site) and 975 (engineered BamHI site). This fragment was introduced into complementation vector pCP23, which had been digested with BamHI and XbaI, to generate pSSK05.

**Deletion of the *chiA* CTD-encoding region.** The previously described strategy to generate unmarked deletions was employed (48) to generate a truncated gene encoding ChiA lacking the C-terminal 106 amino acids. A 2121 bp fragment upstream of the *chiA* CTD-encoding region was amplified using Phusion DNA polymerase (New England Biolabs, Ipswich, MA) and primers 1378 and 1379. The amplified fragment was digested with BamHI and SalI and cloned into pRR51 that had been digested with the same enzymes, generating pSSK26. A 2033 bp fragment downstream of *chiA* was amplified by PCR using primers 1380 (engineered SalI site) and 1381(engineered SphI site). This fragment was ligated into pSSK26 that had been digested with SalI and SphI, to generate pSSK27. pSSK27 was introduced into the streptomycin-resistant wild type *F. johnsoniae* strain CJ1827 by conjugation. The *chiA* CTD deletion mutant was isolated essentially as previously described (48). The *chiA* CTD deletion mutant, CJ2325, was confirmed by PCR amplification using primers 1391 and 1392 and by sequencing the product.

**Deletion of Fjoh\_4175.** A 2118 bp fragment upstream of Fjoh\_4175 was amplified using primers 1229 (engineered SalI site) and 1230 (engineered SphI site). The amplified fragment was digested with SalI and SphI and cloned into pRR51 that had been digested with the same enzymes, generating pSSK32. A 1948 bp fragment downstream of Fjoh\_4175 was amplified using primers 1227 (engineered XbaI site) and 1228 (engineered SalI site). This fragment was introduced into pSSK32 that had been digested with XbaI and SphI, to generate pSSK34. pSSK34 was introduced into *F. johnsoniae* CJ1827 by conjugation and the Fjoh\_4175 deletion mutant CJ2355 was isolated essentially as previously described (48) and confirmed by PCR amplification and sequencing using primers 1463 and 1464.

**Generation of mCherry fusion constructs.** A plasmid expressing the N-terminal region of ChiA (encoding the signal peptide) fused to mCherry and to the C-terminal 105 amino acids of ChiA (CTD<sub>ChiA</sub>) was constructed. A 708 bp region of mCherry was amplified from pME-mCherry using primer 862 (engineered BamHI site) and primer 1266 (engineered XbaI site). This fragment was cloned into the BamHI and XbaI sites of pCP23, generating pSSK30. A 484 bp fragment spanning the *chiA* promoter, start codon, and N-terminal signal peptide encoding region was amplified using primer 1593 (engineered KpnI site) and primer 1516 (engineered BamHI site). The fragment was inserted into KpnI and BamHI digested pSSK30 to generate pSSK51. To introduce the CTD-encoding region, 566-bp was amplified using primer 1600 (engineered XbaI site) and primer 1404 (engineered SphI site). The product was cloned into pSSK51, to generate pSSK52. A plasmid expressing ChiA N-terminal signal peptide fused to

mCherry without CTD<sub>ChiA</sub> was also constructed as a control. mCherry was amplified using primers 862 and 1443 (engineered XbaI site) and introduced into BamHI and XbaI digested pCP23 generating pSSK45. The ChiA N-terminal signal peptide-encoding region was amplified using primers 1593 and 1516 and was cloned into pSSK45 to generate pSSK54.

**Determination of chitinase activity.** Chitin utilization on agar was observed as previously described using colloidal chitin prepared from crab shells (34, 47, 49). Chitinase activities in cell-free culture supernatants (spent media), whole cells, and cell extracts were measured as previously described (49) using the synthetic substrates 4-methylumbelliferyl  $\beta$ -D-N,N'-diacetyl-chitobioside [4-MU-(GlcNAc)<sub>2</sub>] and 4-methylumbelliferyl  $\beta$ -D-N, N', N''-diacetyl-chitotrioside [4-MU-(GlcNAc)<sub>3</sub>] (Sigma-Aldrich, St. Louis, MO) except that activities were measured for 30 min. Activities in the spent media (secreted chitinase), whole cells, and cell extracts were indicated as pmol 4-methylumbelliferone released during the 30 min per  $\mu$ g total protein in the original cell suspension. Protein concentrations were determined by the bicinchoninic acid (BCA) assay (Thermo Fisher Scientific, Waltham, MA).

**Protein expression and antibody production.** An 1833-bp fragment of *chiA* encoding a region spanning the N-terminal glycoside hydrolase domain was amplified by PCR using primers 1066 (engineered BamHI site) and 1067 (engineered SalI site). This fragment was digested with BamHI and SalI and ligated into pET30a that had been digested with the same enzymes, generating pSSK07. pSSK07 was introduced into *E. coli* Rosetta 2(DE3) (Novagen, Madison, WI), which expresses seven rare tRNAs

required for efficient ChiA expression. Cells were grown to mid-log phase at 37°C in LB and expression of recombinant ChiA was induced by addition of 0.5 mM isopropyl- $\beta$ -D-thiogalactopyranoside (IPTG) and incubation for an additional 4 h. Cells were collected by centrifugation, disrupted using a French press, and inclusion bodies containing recombinant ChiA were isolated by centrifugation at  $6,415 \times g$  for 30 min. Inclusion bodies were suspended in 20 mM Tris-HCl (pH 7.4) containing 200 mM NaCl, 1 mM EDTA, and 200  $\mu$ g/ml lysozyme and incubated for 15 min at 25°C. Inclusion bodies were collected by centrifugation at  $20,000 \times g$  for 15 min and washed twice by suspension in 20 mM Tris-HCl (pH 7.4) containing 200 mM NaCl, 1mM EDTA and 1% Triton X-100 with sonication followed by centrifugation. The inclusion bodies were solubilized in 8 M urea for 1 h at room temperature. Insoluble material was removed by centrifugation at  $20,000 \times g$  for 30 min, and the soluble material containing ChiA was boiled in SDS-PAGE loading buffer and separated on 7.5% acrylamide gels by SDS-PAGE. Recombinant ChiA was visualized by  $\text{CuCl}_2$  staining (30), the band was cut from the gel and destained in 0.25 M Tris (pH 9.0), 0.25 M EDTA, and the protein was electroeluted at 60 mA for 5 h into 25 mM Tris, 192 mM glycine, 0.1% SDS (pH 8.8) using a model 422 Electro-Eluter (Bio-Rad). Polyclonal antibodies against recombinant ChiA were produced and affinity purified using the recombinant protein by Proteintech Group, Inc. (Chicago, IL).

**Western blot analyses.** *F. johnsoniae* cells were grown to mid-log phase in MM at 25°C with shaking. Cells were pelleted by centrifugation at  $22,000 \times g$  for 15 min, and the culture supernatant (spent medium) was filtered using 0.22  $\mu$ m pore-size

polyvinylidene difluoride filters (Thermo Fisher Scientific). For whole-cell samples, the cells were suspended in the original culture volume of phosphate buffered saline consisting of 137 mM NaCl, 2.7 mM KCl, 10 mM Na<sub>2</sub>PO<sub>4</sub>, and 2 mM KH<sub>2</sub>PO<sub>4</sub> (pH 7.4). Equal amounts of spent media and whole cells were boiled in SDS-PAGE loading buffer for 9 min. Proteins were separated by SDS-PAGE, and western blot analyses were performed as previously described (49) using affinity purified antibody against ChiA (1:5,000 dilution). Equal amounts of each sample based on the starting material were loaded in each lane. For cell extracts this corresponded to 15 µg protein whereas for spent medium this corresponded to the equivalent volume of spent medium that contained 15 µg cell protein before the cells were removed. To determine whether ChiA was associated with membrane vesicles that had been released into the spent medium, the sample was fractionated into soluble and insoluble (membrane) fractions by centrifugation at 352,900 x g for 30 min. For detection of mCherry by Western blot, commercially available antibodies against mCherry (0.5 mg per ml; BioVision Incorporated, Milpitas, CA) were used at dilution of 1:5,000.

**Liquid chromatography-tandem mass spectroscopy (LC-MS/MS analysis).** *F. johnsoniae* cells were grown to mid-log phase in MM at 25°C with shaking. Cells were pelleted by centrifugation at 22,000 x g for 15 min, and the spent culture medium was filtered (0.22 µm polyvinylidene difluoride filters) to remove residual cells. The spent medium was concentrated 1000 fold using Pierce concentrators (Thermo Fisher Scientific) and proteins were separated by SDS-PAGE and detected using the BioRad (Hercules, CA) Silver Stain kit.

Enzymatic in-gel digestion and mass spectrometric analysis of the peptides were performed at the University of WI-Madison Mass Spectrometry Facility essentially as previously described (14, 56). Enzymatic digestion and peptide recovery was performed as outlined on the website:

<http://www.biotech.wisc.edu/facilities/massspec/protocols/ingelprotocol>. Peptides were analyzed by nanoLC-MS/MS using the Agilent 1100 nanoflow system (Agilent Technologies, Palo Alto, CA) connected to a hybrid linear ion trap-orbitrap mass spectrometer (LTQ-Orbitrap XL, Thermo Fisher Scientific) equipped with a nanoelectrospray ion source. Chromatography of peptides prior to mass spectral analysis was accomplished using a C18 reverse phase HPLC trap column (Zorbax 300SB-C18, 5  $\mu$ M, 5 x 0.3 mm, Agilent Technologies) and a capillary emitter column (in-house packed with MAGIC C18, 3  $\mu$ M, 150 x 0.075 mm, Michrom Bioresources, Inc.) onto which 8  $\mu$ l of extracted peptides were loaded. NanoHPLC system-delivered solvents were as follows: A) 0.1% (v/v) formic acid in water, and B) 95% (v/v) acetonitrile, 0.1% (v/v) formic acid. Sample loading was performed at 10  $\mu$ L/min and peptide elution was performed at 0.20  $\mu$ L/min using a gradient from 1% (v/v) B to 60% (v/v) B over 60 minutes followed by a gradient from 60% (v/v) B to 100% (v/v) B over 10 minutes. As peptides eluted survey MS scans were acquired in the Orbitrap with a resolving power of 100,000 over the mass range 300 to 2000 m/z. The 5 most intense peptides detected per scan were fragmented and detected in the ion trap. Raw MS/MS data were converted to mgf file format using the Trans Proteomic Pipeline (Seattle Proteome Center, Seattle, WA). The resulting files were used to search against the *F. johnsoniae* protein database



concatenated with a list of common lab contaminants (5,057 protein entries) with cysteine carbamidomethylation as fixed modification and methionine oxidation and asparagine/glutamine deamidation as variable modifications. Peptide mass tolerance was set at 20 ppm and fragment mass tolerance at 0.8 Da. Matrix Science Mascot version 2.2.07 was used as search engine and protein identifications with at least two matched peptides with ion scores of 25 or above were reported.

Table 2. Strains and plasmids used in this study

Strain or plasmid	Genotype and/or description <sup>a</sup>	Source or reference
<i>F. johnsoniae</i> strains		
ATCC 17061 strain UW101	Wild type	(34, 37)
UW102-3	Spontaneous <i>sprA</i> mutant	(49, 66)
UW102-57	Spontaneous <i>gldK</i> mutant	(6, 12)
UW102-176	Nitrosoguanidine-induced <i>gldM</i> mutant	(12, 49)
UW102-344	Spontaneous <i>gldL</i> mutant	(49, 66)
CJ1631A	$\Delta(gldN\ gldO)$	(49)
CJ1808	<i>chiA</i> disruption mutant; (Em <sup>r</sup> )	This study
CJ1827	Strain used for construction of deletion mutants; <i>rpsL2</i> ; (Sm <sup>r</sup> )	(48)
CJ2325	Mutant lacking CTD encoding region of <i>chiA</i> ; <i>rpsL2</i> ; (Sm <sup>r</sup> )	This study
CJ2355	Fjoh_4175 deletion mutant; <i>rpsL2</i> ; (Sm <sup>r</sup> )	This study
FJ149	<i>sprE</i> disruption mutant; (Em <sup>r</sup> )	(50)
KDF001	<i>sprT</i> disruption mutant; (Em <sup>r</sup> )	(53)
Plasmids		
pCP23	<i>E. coli-F. johnsoniae</i> shuttle plasmid; Ap <sup>r</sup> (Tc <sup>r</sup> )	(2)
pET30a	Protein expression vector; (Km <sup>r</sup> )	Novagen
pKF002	pCP23 carrying <i>sprT</i> ; Ap <sup>r</sup> (Tc <sup>r</sup> )	(53)
pLYL03	Suicide vector used for insertional mutagenesis; Ap <sup>r</sup> (Em <sup>r</sup> )	(31)
pME-mCherry	Plasmid expressing fluorescent protein mCherry; Km <sup>r</sup>	(29)
pNap2	pCP23 carrying <i>sprE</i> ; Ap <sup>r</sup> (Tc <sup>r</sup> )	(50)
pRR51	<i>rpsL</i> -containing suicide vector for construction of deletions; Ap <sup>r</sup> (Em <sup>r</sup> )	(48)
pSAM1	1,299 bp fragment of <i>chiA</i> in pLYL03 for constructing <i>chiA</i> disruption mutant CJ1808; Ap <sup>r</sup> (Em <sup>r</sup> )	This study
pSN48	pCP23 carrying <i>sprA</i> ; Ap <sup>r</sup> (Tc <sup>r</sup> )	(42)
pSSK05	pCP23 carrying <i>chiA</i> ; Ap <sup>r</sup> (Tc <sup>r</sup> )	This study
pSSK07	1,833 bp fragment of <i>chiA</i> inserted into pET30a; (Km <sup>r</sup> )	This study
pSSK26	2,121 bp fragment upstream of <i>chiA</i> CTD-encoding region in pRR51; Ap <sup>r</sup> (Em <sup>r</sup> )	This study
pSSK27	Construct used to delete CTD-encoding region of <i>chiA</i> ; 2,033 bp region downstream of <i>chiA</i> inserted into pSSK26; Ap <sup>r</sup> (Em <sup>r</sup> )	This study

pSSK30	pCP23 carrying <i>mcherry</i> ; Ap <sup>r</sup> (Tc <sup>r</sup> )	This study
pSSK32	2,118 bp region downstream of Fjoh_4175 inserted into pRR51; Ap <sup>r</sup> (Em <sup>r</sup> )	This study
pSSK34	Construct used to delete Fjoh_4175; 1,948 bp region upstream of Fjoh_4175 inserted into pSSK32; Ap <sup>r</sup> (Em <sup>r</sup> )	This study
pSSK45	<i>mcherry</i> with stop codon amplified with primers 862 and 1443 and cloned into pCP23; Ap <sup>r</sup> (Tc <sup>r</sup> )	This study
pSSK51	484 bp fragment spanning the <i>chiA</i> promoter, start codon, and N-terminal signal peptide encoding region inserted into pSSK30; Ap <sup>r</sup> (Tc <sup>r</sup> )	This study
pSSK52	566 bp region encoding 105 amino acid CTD <sub>ChiA</sub> inserted into pSSK51; Ap <sup>r</sup> (Tc <sup>r</sup> )	This study
pSSK54	484 bp fragment spanning the <i>chiA</i> promoter, start codon, and N-terminal signal peptide encoding region inserted into pSSK45; Ap <sup>r</sup> (Tc <sup>r</sup> )	This study
pTB79	pCP23 carrying <i>gldN</i> ; Ap <sup>r</sup> (Tc <sup>r</sup> )	(6)
pTB81a	pCP23 carrying <i>gldL</i> ; Ap <sup>r</sup> (Tc <sup>r</sup> )	(6)
pTB94a	pCP23 carrying <i>gldM</i> ; Ap <sup>r</sup> (Tc <sup>r</sup> )	(6)
pTB99	pCP23 carrying <i>gldK</i> ; Ap <sup>r</sup> (Tc <sup>r</sup> )	(6)

<sup>a</sup>Antibiotic resistance phenotypes are as follows: ampicillin, Ap<sup>r</sup>; cefoxitin, Cf<sup>r</sup>; erythromycin, Em<sup>r</sup>; streptomycin, Sm<sup>r</sup>; tetracycline, Tc<sup>r</sup>. The antibiotic resistance phenotypes given in parentheses are those expressed in *F. johnsoniae* but not in *E. coli*. The antibiotic resistance phenotypes without parentheses are those expressed in *E. coli* but not in *F. johnsoniae*.

Table 3. Primers used in this study

Primers	Sequence and Description
737	5'-AGGCACCCCAGGCTTTACT-3'; Reverse primer binding downstream of multiple cloning site of pLYL03.
862	5'-GCTAGGGATCCATGGTGAGCAAGGGCGAGG-3'; mCherry forward primer used in construction of pSSK30 and pSSK45; BamHI site underlined.
937	5'-GCTAGGGATCCTGATCCGTCAAGAACTGTTCCGC-3'; Reverse primer used in construction of pSAM1; BamHI site underlined.
938	5'-GCTAGGTCGACAGTCCGGTAGCAAGAGCTGCATTA-3'; Forward primer used in construction of pSAM1; SalI site underlined.
941	5'-TTGCACCTGCAACCGGATTTGTTC-3'; Reverse primer used for confirming and sequencing <i>chiA</i> disruption mutant CJ1808; Binds 532 bp upstream of primer 937.
974	5'-GCTAGTCTAGAGGTTTCATAATGCGCATCCTTAGGCA-3'; Reverse primer used to amplify <i>chiA</i> for construction of complementation plasmid pSSK05; XbaI site underlined.
975	5'-GCTAGGGATCCCTTCCAACCTGCAGTTGAGCGAAA-3'; Forward primer used to amplify <i>chiA</i> for construction of complementation plasmid pSSK05; BamHI site underlined.
1066	5'-GCTAGGGATCCAGTCCGGTAGCAAGAGCTGCATTA-3'; Forward primer used to amplify <i>chiA</i> for constructing pSSK07; BamHI site underlined.
1067	5'-GCTAGGTCGACTTTTGCACCTGCAACCGGATTTGTTC-3'; Reverse primer used to amplify <i>chiA</i> for constructing pSSK07; SalI site underlined.
1227	5'-GCTAGTCTAGATGCAGATCAGTCACCATCGCTTCA-3'; Forward primer used to amplify upstream region of Fjoh_4175 for constructing pSSK34; XbaI site underlined.
1228	5'-GCTAGGTCGACAGAAACAGAACCTCCTCCAAGCGA – 3'; Reverse primer used to amplify upstream region of Fjoh_4175 for constructing pSSK34; SalI site underlined.
1229	5'-GCTAGGTCGACTTCTTCTCGGCAGAAGTTTTCGGGA- 3'; Forward primer used to amplify downstream region of Fjoh_4175 for constructing pSSK32; SalI site underlined.
1230	5'-GCTAGGCATGCTCCTAAAGTTGTTGTTCCGTTTGC-3; Reverse primer used to amplify downstream region of Fjoh_4175 for constructing pSSK32; SphI site underlined.
1266	5'-GCTAGTCTAGACTTGTACAGCTCGTCCATGCCG– 3'; Reverse primer to amplify mCherry for constructing pSSK30; XbaI site underlined.
1378	5'- GCTAGGGATCCGCAGTTCCTGCAAATCCAACAGTT- 3'; Forward primer to amplify the upstream region of <i>chiA</i> CTD for constructing pSSK26; BamHI site underlined.
1379	5'- GCTAGGTCGACAGATAATTCAGATGAATTACCGCAAGA-3'; Reverse primer to amplify the upstream region of <i>chiA</i> CTD for constructing pSSK26; SalI site

	underlined.
1380	5'-GCTAGGTCGACA <u>ACTAATAAATGATTGAAAATTTAGAA</u> -3'; Forward primer to amplify the region downstream of <i>chiA</i> for constructing pSSK27; SalI site underlined.
1381	5'-GCTAGGCATGCTGAAATTTCCATTAGCCAGC -3'; Reverse primer to amplify the region downstream of <i>chiA</i> for constructing pSSK27; SphI site underlined.
1391	5'-TCTGGAAGAACATATACTATGCAGCCA- 3'; Forward primer used to confirm and sequence <i>chiA</i> CTD deletion.
1392	5'-TCACCTAATACAATAACTAACCTC-3'; Reverse primer used to confirm and sequence <i>chiA</i> CTD deletion.
1404	5'-GCTAGGCATGCTCACCTAATACAATAACTAACCTC-3'; Reverse primer to amplify <i>chiA</i> CTD for making construct pSSK52; SphI site underlined.
1443	5'-GCTAGTCTAGATTACTTGTACAGCTCGTCCATGCCG- 3'; Reverse primer to amplify mCherry for constructing pSSK45; XbaI site underlined.
1463	5'-AACAGTATCGATGTTTCGCATTTAG-3'; Used for confirming and sequencing Fjoh_4175 deletion.
1464	5'-GCAAAGAGCGCCAAGTTTAC-3'; Used for confirming and sequencing Fjoh_4175 deletion.
1516	5'-GCTAGGGATCCC <u>ACTACTTTTTTCCCGTGGGCTGGCTG</u> -3'; Reverse primer to amplify short N-terminal region of <i>chiA</i> to construct pSSK52 and pSSK54; BamHI site underlined.
1593	5'- GCTAGGGTACCTTCCCCGGTAGAGATAGTTATGGCTAT -3' Forward primer to amplify N-terminal region of <i>chiA</i> to make constructs pSSK52,,and pSSK54; Binds 400 bp upstream of <i>chiA</i> start codon; KpnI site underlined.
1600	5'GCTAGTCTAGAGCTTATGCAGCTTATTTTCGCATCACAA -3' forward primer to amplify <i>chiA</i> CTD region for making construct pSSK52; XbaI site underlined

## Results

***chiA* mutant cells are defective in chitin utilization.** Chitinases have catalytic glycoside hydrolase domains belonging to families 18 (GH18) and 19 (GH19) (19). The *F. johnsoniae* genome encodes five predicted chitinases with such domains (37). One of these, Fjoh\_4555 which we refer to as ChiA (Figure 8), has previously been implicated in chitin utilization. Cells with a mutation in the T9SS gene *sprT* failed to accumulate ChiA in the extracellular fluid and failed to utilize chitin (53). ChiA has two GH18 domains, each predicted to have chitinolytic activity (Figure 8). We disrupted *chiA* to determine its role in chitin utilization. Cells of the *chiA* mutant CJ1808 failed to utilize chitin (Figure 9A) and the mutant cells were deficient in extracellular chitinase activity (Figure 10). Complementation with pSSK05, which carries *chiA*, restored extracellular chitinase activity and the ability to utilize chitin (Figure 9A, 10). Chitinase activities associated with intact cells and with cell extracts were less affected by disruption of *chiA*, suggesting that the other predicted chitinases may contribute to these cell-associated activities (Figure 10). Extracts prepared from cells carrying pSSK05 exhibited elevated levels of activity against 4-MU-(GlcNAc)<sub>3</sub>, perhaps indicating that ChiA expressed from the plasmid was not efficiently secreted. Deletion of the T9SS genes *gldN* and *gldO* also resulted in decreased extracellular chitinase as previously reported (49), presumably because of a failure to secrete ChiA. Another predicted chitinase, Fjoh\_4175, exhibits sequence similarity to the GH18 chitinase domain near the amino terminus of ChiA (GH18N). The CTD of Fjoh\_4175 is similar in sequence to the CTDs of members of TIGRFAM family TIGR04183. These CTDs are thought to target the proteins for

secretion by the T9SS. Given the importance of the T9SS in chitin utilization we examined the role of Fjoh\_4175 in this process. The Fjoh\_4175 deletion mutant CJ2355 digested and grew on chitin (Figure 9B). Cells of the mutant also had as much extracellular and cell-associated chitinase activities as did wild type cells (Figure 10) indicating that Fjoh\_4175 does not play a major role in chitin utilization under the conditions examined.

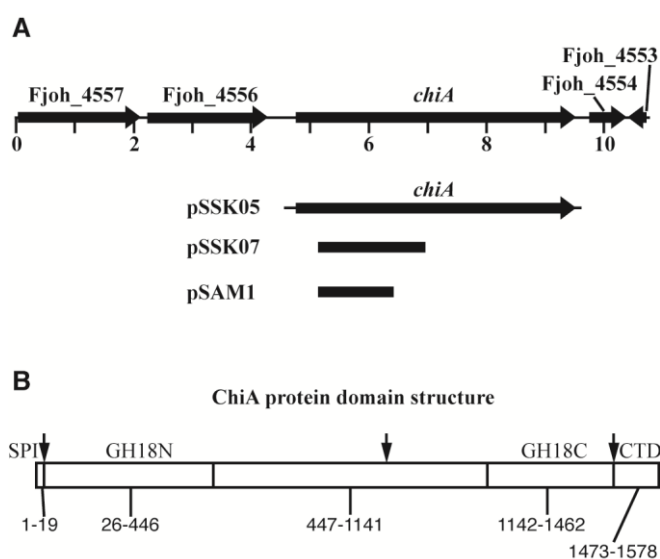

Figure 8. The *chiA* gene and predicted features of the ChiA protein. A) Map of the *chiA* region. Numbers below the map refer to kilobase pairs of sequence. The regions of DNA carried by the plasmids pSSK05 (used for complementation), pSSK07 (used for expression of recombinant ChiA in *E. coli*) and pSAM1 (used for insertional mutagenesis of *chiA*) are indicated beneath the map. B) Predicted features of the ChiA protein. SPI: Type I signal peptide. GH18N and GH18C: glycohydrolase 18 family domains located near the amino and carboxy termini respectively. CTD: C-terminal domain involved in secretion by the type IX secretion system. Arrows denote approximate sites of apparent proteolytic processing, and numbers indicate approximate amino acid ranges for each predicted domain.

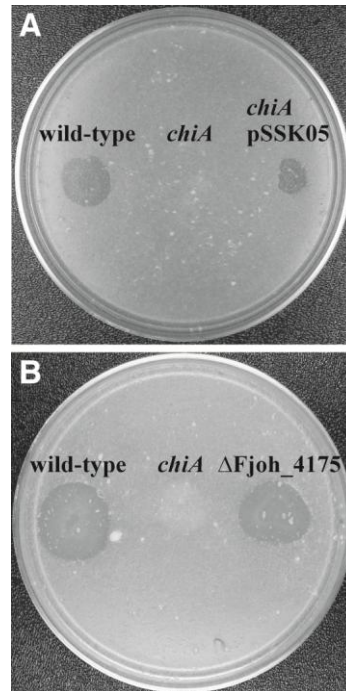

Figure 9. *chiA* is required for chitin utilization. A) Approximately  $10^6$  cells of wild-type *F. johnsoniae* UW101, *chiA* mutant CJ1808, and CJ1808 with pSSK05 which carries *chiA*, were spotted on MYA-chitin media and incubated at 25°C for 2.5 d. B) Wild type *F. johnsoniae* CJ1827, *chiA* mutant CJ1808, and Fjoh\_4175 deletion mutant CJ2355 were spotted on MYA-chitin media and incubated at 25°C for 2.5 d.



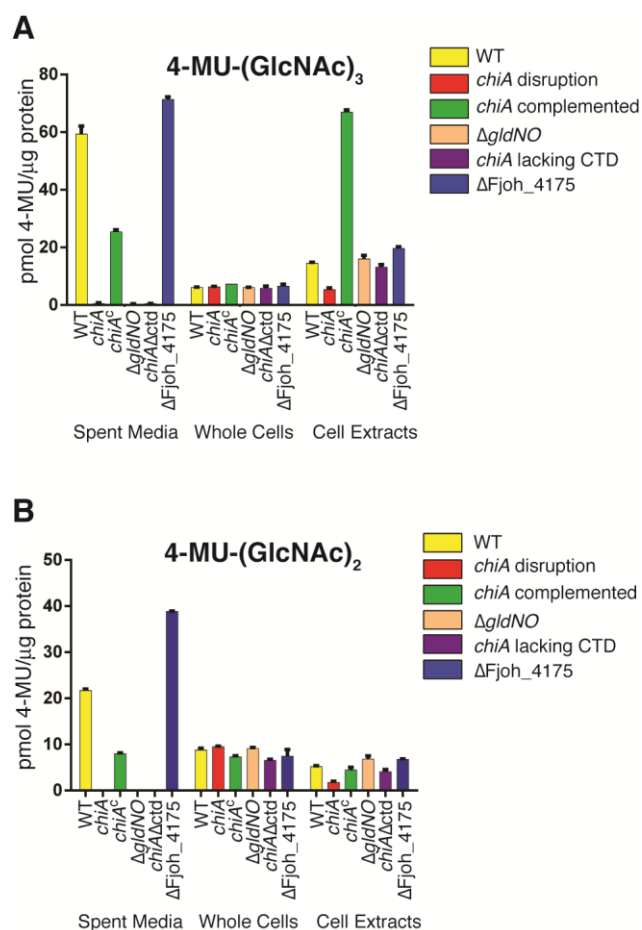

Figure 10. Chitinase activities of wild-type and mutant cells. Chitinase activities of spent media, intact cells, and cell extracts were determined using the synthetic substrates 4-MU-(GlcNAc)<sub>2</sub>, and 4-MU-(GlcNAc)<sub>3</sub>. Equal amounts of each sample, based on the protein content of the cell suspension, were incubated with 10 nmol of synthetic substrate for 30 min at 37°C, and the amount of 4-MU released was determined by measuring fluorescence emission at 460 nm following excitation at 360 nm. Yellow, wild type *F. johnsoniae* UW101. Red, *chiA* mutant CJ1808. Green, CJ1808 with pSSK05 which carries *chiA*. Tan, *gldNO* deletion mutant CJ1631A. Purple, CJ2325, which produces ChiA lacking the C-terminal 106 amino acids. Blue, Fjoh\_4175 deletion mutant CJ2355.

**ChiA is a soluble extracellular protein.** A portion of ChiA spanning the N-terminal GH18 domain (GH18N) was overexpressed in *E. coli* and polyclonal antiserum was raised against this fragment. The antiserum was used to detect ChiA in cultures of wild-type *F. johnsoniae*. ChiA was present primarily in the cell-free spent medium, with little if any cell-associated ChiA (Figure 11A). ChiA was detected in spent media from wild-type cells but was absent from spent media of the *chiA* mutant (Figure 11B). Introduction of *chiA* into the mutant on pSSK05 restored production of ChiA. Expression from pSSK05 resulted in large amounts of ChiA, and fragments of ChiA, in the spent medium and in intact cells (Figure 11B). The extra bands observed for the complemented strain may be the result of failure to efficiently secrete the overexpressed protein, perhaps resulting in degradation. To determine whether ChiA in the spent medium from wild type cells was present in soluble form or was associated with membrane vesicles or cell debris, particulate material was pelleted by ultracentrifugation twice at 352,900 x g for 30 min. ChiA was found in the soluble fraction (Figure 11C), indicating that ChiA is a soluble secreted protein.

ChiA is predicted to be 166 kDa in size after removal of its N-terminal signal peptide. We refer to the cell-associated 166 kDa protein as proChiA (Figure 11B). In contrast, the secreted ChiA detected with our antiserum migrated with an apparent molecular mass of approximately 92 kDa (Figure 11) suggesting that the protein was proteolytically processed. The antiserum used to detect ChiA was raised against the region spanning the N-terminal GH18 domain, and thus did not efficiently detect other regions of ChiA released during processing.

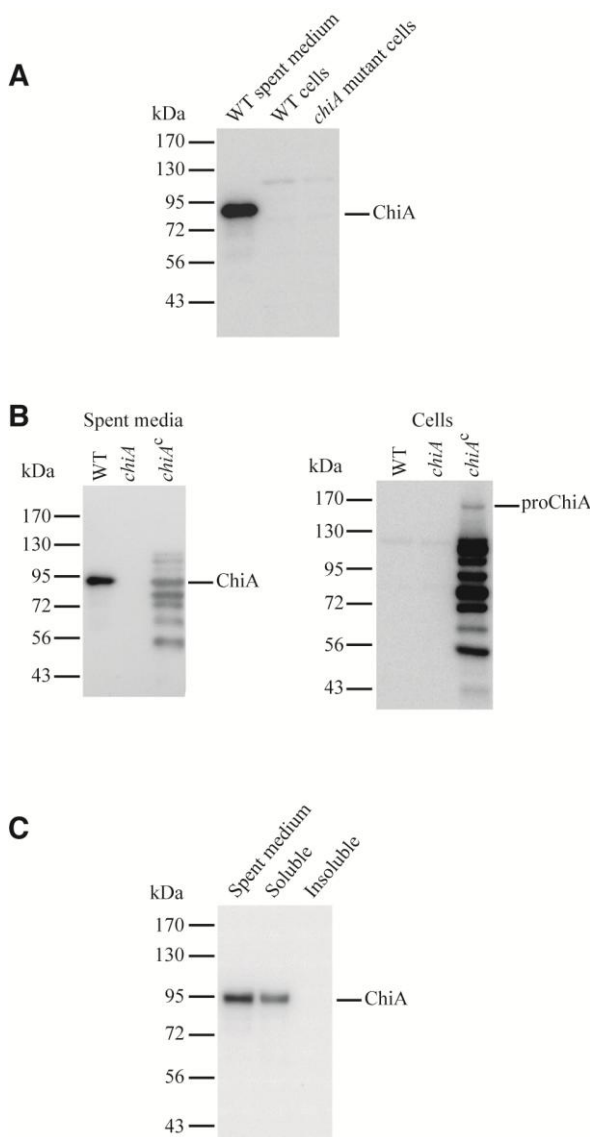

Figure 11. ChiA is a soluble extracellular protein. Panels A and B: Spent medium and whole cells of wild-type (WT), *chiA* mutant (*chiA*), and *chiA* mutant complemented with pSSK05 (*chiA<sup>c</sup>*) were examined for ChiA by SDS-PAGE followed by Western blot analysis. Panel C: Spent medium from a culture of wild-type *F. johnsoniae* UW101 was examined for ChiA before (Spent medium) and after fractionation into Soluble and Insoluble (membrane) fractions by centrifugation at 352,900 x g for 30 min. For each panel, equal amounts of each sample based on the starting material were loaded in each lane. For cells this corresponded to 15  $\mu$ g protein, whereas for spent medium this corresponded to the equivalent volume of spent medium that contained 15  $\mu$ g cell protein before the cells were removed.

Cell-free spent media from wild-type, *chiA* mutant, and complemented cells were also examined by SDS-PAGE followed by silver staining to identify the prominent bands. Proteins of approximately 92 kDa and 65 kDa were observed in spent media from wild type and complemented cells, but not in spent medium of the *chiA* mutant (Figure 5). The 92 kDa and 65 kDa proteins secreted by cells of the *chiA* mutant CJ1808 complemented with pSSK05 which expresses ChiA were identified by LC-MS/MS (Figure 13 and 14). The two bands corresponded to the two GH18 domains of ChiA with flanking sequences, suggesting that proteolytic processing released these in soluble form. The 92 kDa band (ChiA<sub>GH18N</sub>) corresponded to a fragment containing the amino-proximal GH18 fragment and adjacent regions, and the 65 kDa band (ChiA<sub>GH18C</sub>) corresponded to a fragment containing primarily the carboxy-proximal GH18 and adjacent regions. LC-MS/MS analysis of the 65 kDa band also revealed two peptides corresponding to regions of the protein closer to the amino terminus. These were apparently low abundance proteins in the band (Figure 14) and may have corresponded to breakdown products of the 92 kDa protein. Such breakdown products of approximately 65 kDa were expected, because they were also observed by Western blot using antiserum against the amino terminal portion of ChiA (Figure 11B). LC-MS/MS analysis of the 65 kDa and 92 kDa proteins failed to detect the amino terminal signal peptide and the C-terminal 91 amino acid region.

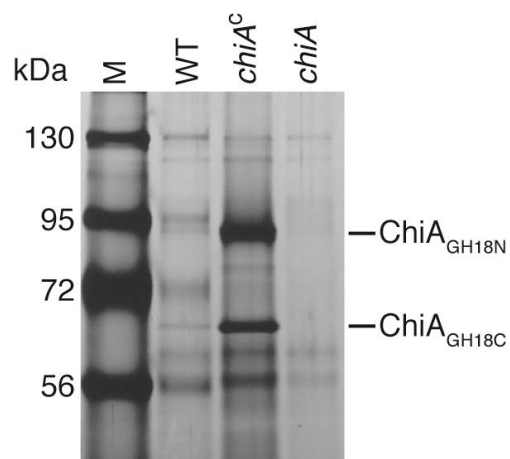

Figure 12. Analysis of secreted ChiA protein by SDS-PAGE. Equal amounts of cell-free spent media from cultures of wild-type (WT), *chiA* mutant CJ1808 (*chia*), and CJ1808 complemented with pSSK05 which carries *chiA* (*chia<sup>c</sup>*) were separated by SDS-PAGE. Proteins were detected by silver staining. ChiA<sub>GH18N</sub> and ChiA<sub>GH18C</sub> refer to amino proximal and carboxy proximal GH18-containing fragments respectively of ChiA as determined by LC-MS/MS analysis of material from the 92 kDa and 65 kDa bands (Figure 13 and 14). M= molecular weight markers.

```

1 MKHYRLLFLLLPLLASAQPAHGKKVVGYYAQWSIYARDFNVPKIDGSK
51 LTHLNYSFYGTTYDPAHPENTKLNKCLDITYADFEHMEGGIPWDAPVKGNFY
101 DLMKMKQKYPHLKILISVGGWTKGQDLSPAAASPVARAALAADMANFIVT
151 YPFIDGFDIDWEYPLSGGTGTEIVNGMPVPPQKYSPDDNKNLVLLKAM
201 RQAMPNKLVTIAAGNNVRNVSKQYLGPNRAQYGMTEDISTYCDYITYFG
251 YDFGGNWDKTCYNAPLYASGNPNDPLYGATQSESLDELNTQYLVNIGFP
301 ANKLIMGLPFYGGKFDNVAANSTNGLFVAAPRYIVPGCTNPQNPTGTWDG
351 SGACEKSGSIEICDLVGNPVTNSHAYLDPNTMMVTPSAASAGWVRYFDNT
401 TKVPYLYNSTLKQFISYEDKQSMDLKVQYIKSRNLAGGMIWELSQDTRGS
451 IPNSLLNQVDTSFGSVVPGTVSISGSVKNGSALVTDVTVELRNASNAVIQ
501 TVVSANGNFAPNNLTSGQNYSLTALKATYTFTPVTLVNVTVNQTAVVING
551 TQPTYTVSGTVLDGSTPVSGVTVTAVSGSTTLTAVSNASGVYSIAGLTAG
601 LNFTVTAAKSGFSYAPASTVYNAIDSNKTLNFTQGAPVVNYTVSGTVLNS
651 TTPVSGVTVTASFTGGSYAAVTNASGTYSLSLSPSGGNYTVTAALTGQFTF
701 PASTVYSNLNANKTLNFTQDVVVSTSKISGTVKNGTNPVAGAKVELVLPW
751 TDNTHNWKSVIATTAQGKYSFDNSVVDGYTQVLSLKLNSWQNGEVAYYP
801 NNLANFAVPANPTVYNFNTSSSTAKSALAAAANLISGTVKNGTTPVAGAKV
851 EIVLPWTDNTHNWKSVLATTDASGNYSFDNSVVAGYTQILSLKLNGWENG
901 DVTYYPNLANFAVPTTPTIYNFNRQAVVATKPVVTITAPTASAIAINLG
951 SAINFVASVGLSAVDATTISSVVFSLDGQSLSTANSSGTYTAAWTPAANQ
1001 FLSHTLTVTATASNGTTDSKYSFTLTCSGANCPNALPVITWNSPSNTT
1051 VYQNTFQVVPISVTAVSDGTVSGVTITINGTFNMTAGTNNTYTYNFTP
1101 SAYQDYPVVIKATDNKSGVTTLNNTIKIATVSTNRFIPLPSKIILGYAHS
1151 WENAGAPPLYFSQMVGSKFNVVDYSFVETVNRDGYTPILTTNDTRYLTNG
1201 VFNKQLLKNDIKSLRDSGVPVIVSIGGQNGHVLDNVTQKNIFVNLKAI
1251 IDEYQFDGVDIDFEGGSMNFNAGGLRDISYAGISAYPRLKNVVDAPKELK
1301 AYYGPGFLLTAAPETQYVQGGYTYTDTFGSFLPIIQNLRNELDLAVQL
1351 YNTGGENGLDQYYGTAKKSNMVTALDMVIKGYNIASTGMRFDGLPASK
1401 VLIALPACPSAAGSGYLTPTEGINAMHYLRTGTTFSGRTYTMQPGGPYP
1451 LRGLMTWSVNWDASSCGNSSELSKAYAAFASQTAAKTLVLDDISAKSNA
1501 TIAYFKNNALSVTNENEDIAQVDVFNVLGQNLVSHRNVQNNKEVLLHNQS
1551 FSSKQLFLVVVTDKAGNKSKFKVMNFLN

```

Figure 13. The approximately 92 kDa secreted form of ChiA corresponds to the amino-proximal portion of the full length ChiA. Cell-free spent medium from the *chiA* mutant CJ1808 complemented with pSSK05 which carries *chiA* was separated by SDS-PAGE and proteins were detected by silver staining. The approximately 92 kDa band was cut from the gel shown in Figure 12 and subjected to LC-MS/MS analysis. The primary amino acid sequence of ChiA is shown, with the regions detected by LC-MS/MS highlighted in red. 131 spectral matches were detected to ChiA. All of these fell between amino acids 27 and 864, which corresponds to the amino-proximal region of the protein after removal of the signal peptide.

```

1 MKHYRLLFLLLPPLLASAQAHPGKVKVGYAQS IYARDFNVPKIDGSK
51 LTHLNYSFYGTTYDPAHPENTKCLKLDTYADFEHMEGGI PWDAPVKGNFY
101 DLMKLGKQKYPHLKILISVGGWTKGQDLSP IAASPVARAALAADMANFIVT
151 YPFIDGFDIDWEYPLSGGTDGTEI VNGMPVPPQKYS PDDNKNLVLGKAM
201 RQAMPNKLVTIAAGNNVRNVSKQYLGPNNRAQYGMTE D I STYCDYITYFG
251 YDFGGNWDKTCYNAPLYASGNPNDFLYGATQSESLDEL TNQYLNVI GFP
301 ANKLIMGLPFYGGKFDNVAANSTNGLFVAAPRYI I VPGCTNPQNPTGTWDG
351 SGACEKSGSIEICDLVGNPVTNSHAYLDPNTMMVTPSAASAGWVRYFDNT
401 TKVPYLYNSTLTKQFISYEDKQSMDLKVQYI KSRNLAGGMIWELSQDTRGS
451 IPNSLLNQVDTSFSGSVVPGTVSISGSVKNGSALVTDVTVELRNASNAVIQ
501 TVVSANGNPAFNNLTSGQNYSLTALKATYTFTPVTLVNVTVNQTA VVING
551 TQPTYTVSGTVLDGSTPVSQVTVTAVSGSTLTAVSNASGVYSIAGLTAG
601 LNFTVTAAKSGFSYAPASTVYNAIDSNKTLNFTQGAPVVNYTVSGTVLNS
651 TTPVSGVTVTASFTGGSYAAVTNASGTYSLSLPSGGNYTVTAAL TGQFTFT
701 PASTVYSNLNANKTLNFTQDVVSTSKI SGTVKNGTNPVAGAKVELVLPW
751 TDNTHNWKSVIATTTDAQGKYSFDNSVVDGYTQVLSLKLNSWQNGEVAYYP
801 NNLANFAVPANPTVYNFNTSSTAKSALAAAANLISGTVKNGTTPVAGAKV
851 EIVLPWTDNTHNWKSVLATTDASGNYSFDNSVVAAGY TQILSLKLNWENG
901 DVTYYPNNLANFAVPTTPTIYNFNRQAVVATKPVVTITAPTASAIAINLG
951 SAINFVASVGLSAVDATTISSVVFSLDQSLSTANSSGTYTAAWT PAANQ
1001 FLSHSLTLVTATASNGTTDSKTYSPFTLTCSGANCPNALPVITWNSPSNTT
1051 VYQNTFQVVPISVTAVSDGTVSGVTITINGGTFNM TAGTNNTYTYNFTF
1101 SAYQDYPVVIKATDNKSGVTTLNNTIKIATVSTNRFIPLPSKI ILGYAHS
1151 WENAGAPFLYFSQMVGSKFNVDYSFVETVNRDGYTP ILLTNDTRYLTNG
1201 VFNKQLLKNDIKSLRDSGVPIVSI GGQNGHVVDNVTQKNIFVNGLKAI
1251 IDEYQFDGVDIDFEGGSMNFNAGGLRDISYAGISAYPRLKNVVD AFKELK
1301 AYYGPGFLLTAAPETQYVQGGYTTYTDTFGSFLPI IQNLRNELDLLAVQL
1351 YNTGGENLDGQYYGTAKKSNMVTALDMVIKGYNIAS TGMRFDGLPASK
1401 VLIALPACPSAAGSGYLTPTEGINAMHYLR TGTFPSGRTYTMQPGGYPYS
1451 LRGLMTWSVNWDASSCGNSELSKAYAAYFASQTAAK TLVLDDISAKSNA
1501 TIAYFKNNALSVTNNENEDIAQVDVFNVLGQNLVSHRNVQNNKEVLLHNQS
1551 FSSKQLFLVVVTDKAGNKKSFKVMNPLN

```

Figure 14. The approximately 65 kDa secreted form of ChiA appears to correspond to the carboxy-proximal portion of full length ChiA. Cell-free spent medium from the *chiA* mutant CJ1808 complemented with pSSK05 which carries *chiA* was separated by SDS-PAGE and proteins were detected by silver staining. The approximately 65 kDa band was cut from the gel shown in figure 12 and subjected to LC-MS/MS analysis. The primary amino acid sequence of ChiA is shown, with the regions detected by LC-MS/MS highlighted. Regions in red correspond to sequences for which multiple (2 to 7) spectral matches were obtained, and regions in orange correspond to sequences for which single spectral matches were obtained, and which were thus apparently less abundant. In total, 79 spectral matches were detected to ChiA. 77 of these fell between amino acids 850 and 1487, which corresponds to the carboxy-proximal region of the protein immediately upstream of the C-terminal region involved in targeting to the type IX secretion system. The 2 spectral matches to sequences at positions 315 to 332 and 449 to 478 probably correspond to breakdown products of the 92 kDa amino-proximal portion of ChiA. No spectral matches were detected to the carboxy-terminal 91 amino acids suggesting that this region may have been removed by proteolysis during secretion.

**The T9SS is required for secretion of ChiA.** Mutations in the *F. johnsoniae* T9SS genes *gldK*, *gldL*, *gldM*, *gldN*, *sprA*, *sprE*, and *sprT* result in defects in chitin utilization (49, 50, 53, 59). The effect of such mutations on secretion of ChiA was examined. ChiA accumulated in the spent culture medium of wild type cells, but not of cells of the T9SS mutants (Figure 15A). Complementation of the T9SS mutants with plasmids carrying the appropriate T9SS genes restored secretion of ChiA into the culture medium. Cells were also examined for ChiA. Wild type cells accumulated little if any ChiA protein, whereas cells of the T9SS mutants accumulated some proChiA (Figure 15B). The amount of proChiA that accumulated in cells of the T9SS mutants was less than the amount of processed ChiA found in the culture fluid of wild-type cells. We do not know the reason for this, but likely explanations could include decreased expression of ChiA or degradation of the improperly localized ChiA in the T9SS mutants.



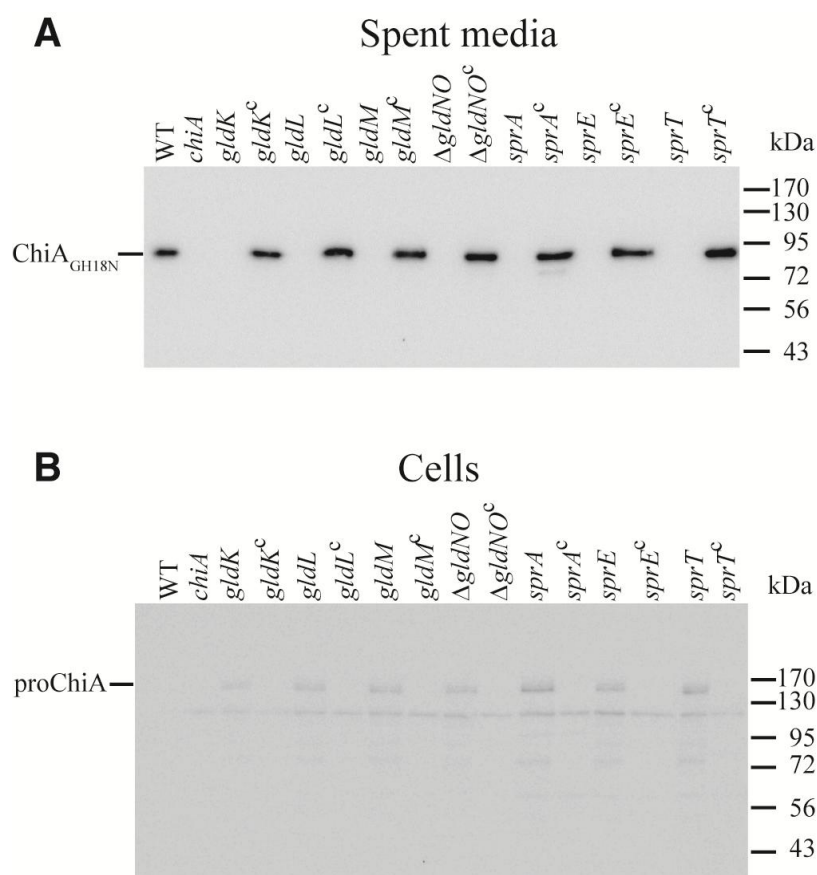

Figure 15. Mutations in T9SS genes disrupt secretion of ChiA. Cell-free spent media (Panel A) and cells (Panel B) were examined for ChiA by SDS-PAGE followed by Western blot analysis using antiserum against recombinant ChiA. WT: wild-type *F. johnsoniae* UW101. *chiA*: *chiA* mutant CJ1808. *gldK*: *gldK* mutant UW102-57. *gldK<sup>c</sup>*: UW102-57 complemented with pTB99 which carries *gldK*. *gldL*: *gldL* mutant UW102-344. *gldL<sup>c</sup>*: UW102-344 complemented with pTB81a which carries *gldL*. *gldM*: *gldM* mutant UW102-176. *gldM<sup>c</sup>*: UW102-176 complemented with pTB94a which carries *gldM*.  $\Delta$ *gldNO*: *gldNO* deletion mutant CJ1631A.  $\Delta$ *gldNO<sup>c</sup>*: CJ1631A complemented with pTB79 which carries *gldN*. *sprA*: *sprA* mutant UW102-3. *sprA<sup>c</sup>*: UW102-3 complemented with pSN48 which carries *sprA*. *sprE*: *sprE* mutant FJ149. *sprE<sup>c</sup>*: FJ149 complemented with pNap2 which carries *sprE*. *sprT*: *sprT* mutant KDF001. *sprT<sup>c</sup>*: KDF001 complemented with pKF002 which carries *sprT*. Samples loaded in panel B corresponded to 15  $\mu$ g protein per lane, and samples loaded in panel A corresponded to the volume of spent medium that contained 15  $\mu$ g cell protein before the cells were removed.

**The C-terminal region of ChiA is necessary and sufficient for secretion.** *F. johnsoniae* proteins known to be secreted by the T9SS have conserved CTDs that belong to TIGRFAM families TIGR04131 (such as SprB) and TIGR04183 (such as RemA). ChiA does not exhibit strong similarity to members of these TIGRFAM families (Figure 18 and 19). However, ChiA has a C-terminal region of unknown function that might perform a similar role, and this region does exhibit limited similarity to the CTDs of TIGR04183 members (Figure 19). A mutant, CJ2325, which expresses ChiA lacking the C-terminal 106 amino acids was constructed. Cells of CJ2325 failed to utilize chitin and failed to accumulate ChiA extracellularly (Figure 10 and 16). Instead, the mutant cells accumulated cell-associated proChiA, suggesting a role for the C-terminal region in secretion.

To determine if the ChiA CTD is sufficient for secretion we constructed a plasmid that expressed the foreign protein mCherry sandwiched between the ChiA signal peptide (at the amino terminus) and a 105 amino acid region encompassing the ChiA CTD (at the carboxy terminus). Expression of mCherry with the 105 amino acid C-terminal region of ChiA resulted in accumulation of mCherry in the spent medium, whereas expression of mCherry without the ChiA C-terminal region did not (Figure 17). Cells of a strain lacking the T9SS genes *gldN* and *gldO* failed to secrete mCherry-CTD<sub>ChiA</sub>. Together these results suggest that the CTD of ChiA targets proteins for secretion by the T9SS.

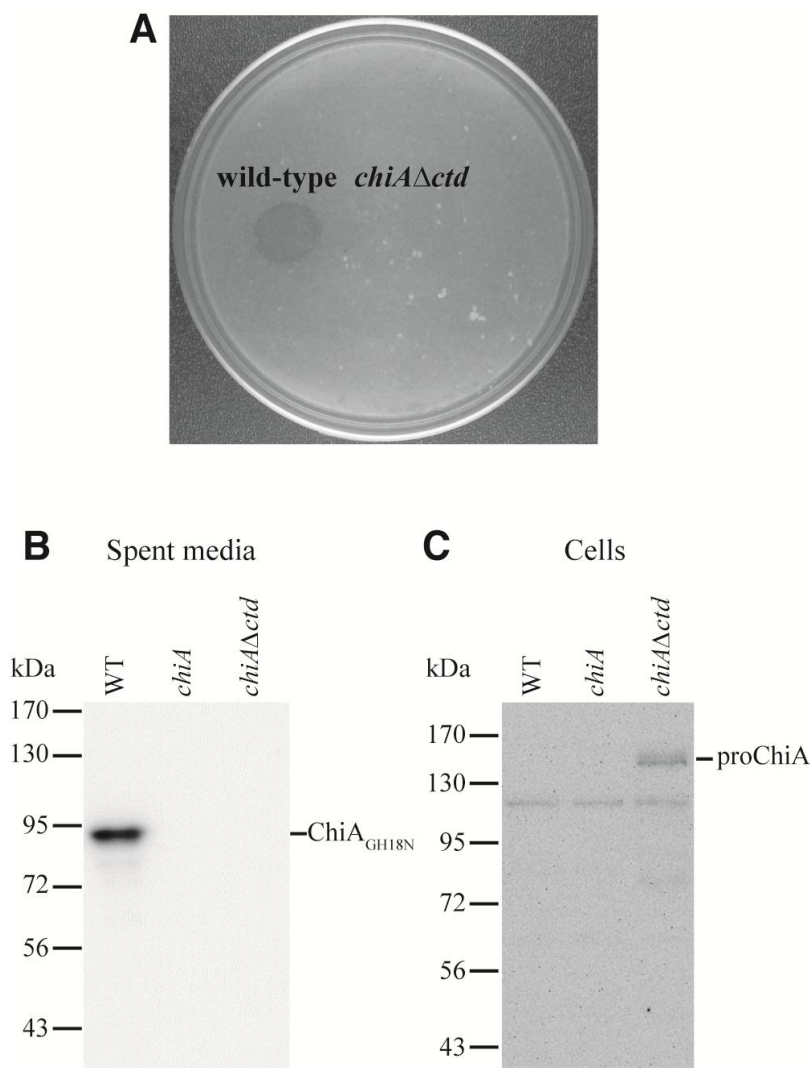

Figure 16. The C-terminal region of ChiA is required for chitin utilization. Panel A) Deletion of the region of *chiA* encoding the CTD results in defects in chitin utilization. Approximately  $10^6$  cells of wild-type *F. johnsoniae* CJ1827 and of the *chiAΔctd* mutant CJ2325 were spotted on MYA-chitin medium and incubated at 25°C for 2.5 d. Panels B and C) The C-terminal region of ChiA is required for secretion. Cell-free spent media (B) and cells (C) were examined for ChiA by SDS-PAGE followed by Western blot analysis using antiserum against recombinant ChiA. WT: wild-type *F. johnsoniae*. *chiA*: *chiA* disruption mutant CJ1808. *chiAΔctd*: *chiA* mutant CJ2325 which encodes ChiA lacking its CTD. Samples loaded in Panel C corresponded to 15 μg protein per lane, and samples loaded in Panel B corresponded to the volume of spent medium that contained 15 μg cell protein before the cells were removed.

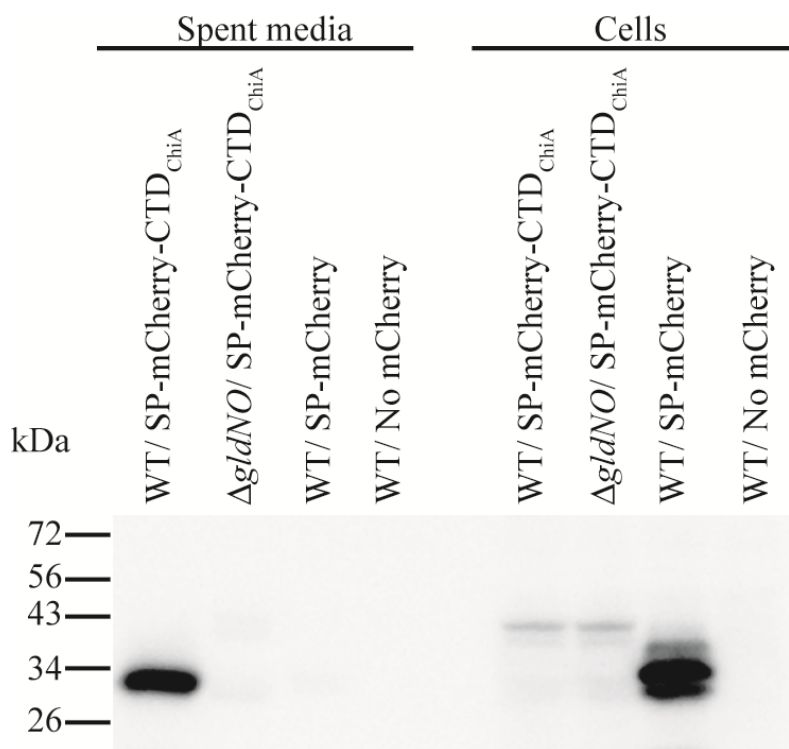

Figure 17. ChiA CTD is sufficient for secretion of the heterologous protein mCherry. Cell-free spent media and whole cells were analyzed for cultures of wild-type (WT) cells carrying pSSK54 that expresses mCherry with the N-terminal signal peptide from ChiA (SP-mCherry), or carrying pSSK52 that expresses mCherry with the N-terminal signal peptide from ChiA and the 105 amino acid C-terminal region of ChiA (SP-mCherry-CTD<sub>ChiA</sub>). Cells and spent media from cultures of the T9SS mutant CJ1631A ( $\Delta$ *gldNO*) carrying pSSK52 were also analyzed. 'No mCherry' indicates spent media or cells from *F. johnsoniae* carrying the control vector pCP23. Cell samples corresponded to 15  $\mu$ g protein per lane and samples from spent media corresponded to the volume of spent media that contained 15  $\mu$ g cell protein before the cells were removed. Samples were separated by SDS-PAGE and mCherry was detected using antiserum against mCherry.

```

SprB      - - I T V R R D K N G C T D T K D Y Y I E Y V - - - - D V C L L D N Y P T P N G D G V N D F W G P G C - - - T N - I Y N H L K F S I 6443
Fjoh_1123 - - V Y L R D K E G C G Q D S K E V T - - - - V I D Y P K F F T P N N D G Y N D F W H I K N - - - T S - K F P N S K I S I 1045
Fjoh_1645 - - V V V E D N S D Y E N I D G D K P T V L D L N G C K I K V L N A F S P N G D Q K N E R P Y I Q G - - - L E - C Y P E N T V V I 2421
Fjoh_1720 - - A Y V V K E K N G C G G I G L D F V - - - - V L V F P A F F T P N N D S Y N D L W E V T G - - - M E - N Y P Q A Q V T I 673
Fjoh_1985 - - V V F T N K E G C Q A E D S V T I T V I P L E - - K D E T K Y G P S P N G D G I N D F W E I D K - - - I T - D Y P E N E V L I 2000
Fjoh_2273 - - - - A L T D G D N V P N D F F - - - - - I P D G P S P N G D G I N D S P V I K D - - - I E F L Y P N Y T L E I 811
Fjoh_3478 - - - - P L D V D A A N N S A S A S V E P I - - - - C L T V Y N E P T P N N D G A N D L P R I D C - - - I E - S Y P N N E L K V 3678
Fjoh_3952 - - I K V E D K S D A A N E N G D A P T E I D V N G C K I K I F N A I S L N G D N M N E R P Y I R G - - - I E - C Y P D N T V Q I 3125
Fjoh_3971 - - - - Q I D T N S S N N Q D S A A V - - - - S P N - - - C L K I Y N E P S P N D D G Q N D T P Y I D C - - - I T - Q Y P D N Q L E I 3548
Fjoh_4538 I L L T M E V N D D C K V L A C E - - - - N I L V H N A P S P N G D G K N D V P L I D G I G D L T - C Y P E N T V E I 2518
Fjoh_4750 I K Q T V T Y P F G C Q Y S Y S A T I K V E K - - G Y S L I M P N A F T P N N D G Y N D T P A P - - - V F L G L S D I T L D V 1406
Fjoh_4934 - - A I A K D K N G C G L S N S F L L Y - - - - V L D Y P R F F T P N N D G Y N D L W V I E D - - - S N - V L P N Y T I H I 722
ChiA     - - - A S S C G N S S E L S K A Y A A Y F A S Q T A A K T L V L D D I S A K S N A T I A Y P K N N A L S V T N E N E D I A Q V D V 1524

```

```

SprB      P D R Y G R V I A K - Y T Y G Q K - - - W D G R Y - - - - N G E E L P S G D Y W Y V L K L N D E N D G - - - - R E F - V G 6491
Fjoh_1123 P D R Y G K L I K E L F A N D H G - - - W D G F Y - - - - N G S Q M P A D D Y W F K A N F N E N - - - - I N F - S G 1091
Fjoh_1645 Y N R W G V L V F D V D H Y N N V D R V F K G Y S F G R T T M K Q S E G L P V G T Y F Y I L K Y K D S D S N - - - - P H E T - S G 2481
Fjoh_1720 P D R Y G K L I A Q L N A S K M S - - - W D G T F - - - - E K T P M P A S D Y W Y A L K I I D D S - - - - - K P I L R G 720
Fjoh_1985 Y S R W G D L V Y Q T K G Y D N S T N V F S G I A N K S R N L - G A S Q L P E G T Y F F E I R V N Q P H H P - - - - K K L - K G 2058
Fjoh_2273 P N R Y G N G M Y K G D K N K P A - - - W D G M N Y E K S G I - A G V A P N G V Y F Y V L H F N K D N K P - - - - P K - Q G 865
Fjoh_3478 P N R Y G A L V Y S K Q H Y E N D - - - W D G T A N V S G V V N R G D M L P T G T Y F Y V I T I G D G T V K - - - - - K G 3731
Fjoh_3952 P N R W G V L V F E R D H Y N N N D I Y F K G F S E G R T T V K E S N G L P E G T Y F Y I V R Y K D N N S N - - - - P K Q E - A G 3185
Fjoh_3971 P N R W G N L V Y Y K K G Y D N T - - - W D G K A D G - - - - S A K T L P E G T Y F Y V L D L - - - G N G S - - - - A K K - S G 3597
Fjoh_4538 Y N R W G I L Y F E T H N Y N N T N A F D G T S R G R T T I R Q S E G L P T G T Y F Y I V T Y K S V D G N N V I Q N N K K - E G 2582
Fjoh_4750 P D T W G G V I Y T E K G T N I R G - - - W N G K V - - - - K D I D A E N G N Y Y K I I L K T F Y N H - - - - T I V E K G 1457
Fjoh_4934 P D R Y G K F L K E M N Q N S P G - - - W N G L F - - - - - N G Q L P S D D Y W F T L T F A D G - - - - - R N V - K G 768
ChiA     P N V L G Q N L V S H R N V Q N N - - - K E V L L - - - - - H N Q S F S S K Q L F L V V V T D K A G N K - - - - K S F - - K 1572

```

```

SprB      H F T L Y R 6497
Fjoh_1123 H F S L K R 1097
Fjoh_1645 Y L Y I N K 2487
Fjoh_1720 H F S L K R 726
Fjoh_1985 Y L V L K R 2064
Fjoh_2273 R L Y L N R 871
Fjoh_3478 W L S T M R 3737
Fjoh_3952 Y L Y L I K 3191
Fjoh_3971 W L Y L K - 3602
Fjoh_4538 Y L Y L S K 2588
Fjoh_4750 A F T L I K 1463
Fjoh_4934 H F S L K R 774
ChiA     V M N F L N 1578

```

Figure 18. Alignment of the C-terminal domain (CTD) of ChiA with the CTDs of *F. johnsoniae* TIGR04131 family members using MUSCLE. Dark shading indicates identical amino acids and light shading indicates similar amino acids. TIGR04131 is described as ‘gliding motility-associated C-terminal domain’ on the TIGRFAM website (<http://www.jcvi.org/cgi-bin/tigrfams/HmmReportPage.cgi?acc=TIGR04131>). TIGR04131 family members were identified by searching the *F. johnsoniae* genome using the IMG v 4.0 Function Profile Tool. As shown, the ChiA CTD has little if any similarity to the CTDs of TIGR04131 family members.

Alignment of the CTD of ChiA with the CTDs of *F. johnsoniae* TIGR04183 family members

Fjoh_0074	V	K	A	Y	P	N	P	T	-	S	D	V	I	N	F	T	V	K	T	-	-	N	E	S	-	K	N	L	R	-	-	L	Y	D	L	-	N	G	R	A	L	G	N	P	I	D	I	Q	S	S	E	E	V	N	T	T	V	M	S	L	-	-	-	1106		
Fjoh_0547	L	S	L	Y	P	N	P	V	V	N	G	K	V	Y	I	S	S	K	N	-	-	-	D	L	E	K	E	I	I	-	-	V	F	D	I	-	L	G	K	K	Y	L	Q	A	-	H	L	T	T	K	E	-	-	-	L	N	V	-	-	-	86					
Fjoh_0549	I	T	V	I	P	V	T	F	V	N	P	F	-	A	K	T	V	Q	S	N	V	N	V	-	E	D	S	I	Q	P	Y	S	I	N	-	-	V	Y	N	F	-	E	G	Q	K	V	L	T	K	-	-	E	V	K	S	I	E	E	N	K	S	L	D	526		
Fjoh_0707	V	Y	Y	P	N	P	V	-	R	P	T	Y	S	G	T	V	K	V	-	-	A	G	L	I	D	K	A	N	I	K	-	-	J	T	D	I	-	E	G	N	L	V	Y	E	T	-	-	T	S	D	G	G	T	I	E	W	D	T	T	A	F	-	-	-	729	
Fjoh_0798	F	V	L	Y	P	N	P	N	-	K	G	S	F	T	V	Q	F	K	S	-	-	-	E	S	T	S	V	K	V	F	-	-	V	N	D	I	-	L	G	K	T	I	Y	A	K	-	T	F	E	T	D	G	D	-	-	F	N	O	N	I	-	-	-	858		
Fjoh_0808	G	L	L	I	S	-	-	V	K	D	K	T	I	R	V	T	S	A	K	-	-	-	E	N	I	K	E	V	N	-	-	I	F	D	I	-	T	G	K	L	I	Y	N	K	-	-	K	K	V	G	N	-	-	T	E	L	S	I	-	-	-	1407				
Fjoh_0848	F	Y	V	F	P	N	P	A	-	Q	T	T	I	T	V	E	N	L	N	-	-	-	S	K	N	F	D	F	E	-	-	F	F	N	F	-	E	S	K	S	V	L	K	G	-	-	-	K	T	S	D	-	-	G	T	I	N	I	-	-	-	443				
Fjoh_0886	F	A	L	Y	P	N	P	V	-	E	S	E	L	N	V	T	V	S	E	-	-	-	E	N	A	Y	S	Y	K	-	-	J	I	N	A	-	L	G	Q	Q	L	G	S	G	-	-	Q	V	S	G	A	-	-	-	I	D	V	-	-	-	898					
Fjoh_1022	V	T	L	Y	P	N	P	S	-	P	D	R	I	T	V	N	A	P	Q	-	-	-	-	Q	S	T	I	S	-	-	V	I	S	P	-	S	G	S	V	I	Y	Q	K	-	K	T	T	S	E	N	-	-	T	E	I	N	L	-	-	-	438					
Fjoh_1188	V	V	I	H	P	N	P	T	-	K	G	E	L	N	I	K	N	V	N	-	-	-	-	L	E	K	A	N	-	-	V	Y	N	V	-	L	G	Q	L	V	K	S	F	T	L	N	S	N	N	T	D	-	-	N	T	I	N	L	-	-	-	1363				
Fjoh_1189	V	V	I	H	P	N	P	T	-	K	G	E	L	H	I	Q	N	V	N	-	-	-	-	L	E	K	A	N	-	-	V	Y	N	V	-	L	G	Q	L	V	K	S	F	T	L	N	S	N	N	T	D	-	-	N	T	I	N	L	-	-	-	1653				
Fjoh_1208	I	S	I	Y	P	N	P	S	V	N	N	E	F	N	V	V	L	P	E	-	-	-	L	E	S	G	D	M	A	S	I	S	-	-	V	S	D	I	-	N	G	R	T	V	L	T	E	-	-	R	L	S	S	-	-	G	K	I	D	H	-	-	-	1023		
Fjoh_1231	P	F	L	Y	P	N	P	V	-	S	G	T	L	Y	L	S	D	Q	N	-	-	-	-	Q	K	V	E	K	V	Q	-	-	J	Y	N	V	-	L	G	V	L	V	K	T	S	-	-	Q	E	G	N	-	-	E	S	I	D	Z	-	-	-	893				
Fjoh_1269	F	R	Y	Y	P	N	P	V	-	Q	H	V	L	N	I	S	N	A	S	-	-	-	-	N	I	D	E	V	E	-	-	V	I	S	V	-	S	G	K	S	I	L	V	K	-	-	Q	I	N	N	T	H	-	-	S	E	I	D	L	-	-	-	848			
Fjoh_1408	V	N	L	Y	P	N	P	V	-	S	N	H	F	T	L	S	T	A	V	-	-	-	-	-	S	E	V	Q	-	-	J	Y	S	V	-	S	G	Q	F	V	K	S	F	-	-	A	S	N	G	N	-	-	V	D	F	Q	F	-	-	-	928					
Fjoh_1905	M	A	V	Y	T	D	E	V	-	S	D	H	L	R	I	E	T	N	H	-	-	-	E	G	T	A	D	V	E	-	-	I	F	N	I	-	N	G	Q	E	V	L	K	R	N	V	N	F	V	E	G	N	-	-	L	S	E	I	E	V	-	-	-	669		
Fjoh_2150	L	A	V	Y	P	N	P	V	-	K	N	T	L	N	L	S	Y	Q	D	-	-	-	-	K	I	D	N	I	K	-	-	I	F	N	V	-	L	G	Q	E	V	L	N	K	-	-	N	I	S	A	S	N	-	-	D	T	V	D	M	-	-	-	330			
Fjoh_2389	F	L	V	Y	P	N	P	T	-	K	S	N	I	S	F	L	F	D	N	-	-	-	-	E	T	A	S	V	S	-	-	J	Y	S	L	-	L	G	Q	K	L	I	E	K	-	-	Q	I	T	N	Q	N	-	-	P	V	L	S	V	-	-	-	507			
Fjoh_2456	F	K	V	W	P	Y	P	T	-	N	G	N	F	S	V	L	L	D	N	-	-	-	E	I	E	K	A	D	L	K	-	-	J	Y	D	V	-	L	G	K	E	V	Q	K	R	N	I	N	G	E	T	T	E	-	-	N	I	H	L	-	-	-	897			
Fjoh_2666	I	E	A	I	P	N	P	A	-	V	T	Y	T	N	V	I	I	G	Y	-	-	-	D	P	T	E	G	T	A	S	-	-	V	I	D	I	-	L	G	R	I	L	Q	Q	F	-	-	S	I	N	S	R	T	-	-	V	P	V	D	L	-	-	-	531		
Fjoh_3203	V	S	I	Y	P	N	P	S	V	N	N	E	F	N	I	A	L	P	E	-	-	-	L	S	P	D	D	T	A	I	I	T	-	-	V	T	D	I	-	N	G	R	K	V	L	V	K	-	-	K	L	N	S	S	-	-	A	K	I	N	H	-	-	-	956	
Fjoh_3246	F	F	I	S	P	V	P	N	-	D	G	N	F	T	L	H	L	N	G	-	-	-	-	D	E	G	T	F	D	L	V	-	-	J	F	D	A	-	N	G	K	A	V	Y	K	Q	P	E	L	E	I	N	S	N	-	-	F	S	K	E	Z	-	-	-	2732	
Fjoh_3296	F	F	I	A	Q	D	N	Y	-	N	Q	L	L	R	A	S	N	P	D	-	-	-	-	T	R	N	F	K	S	F	S	-	-	L	Y	D	I	-	S	G	K	K	V	L	F	F	N	N	L	G	T	E	Q	N	-	-	Y	S	F	S	T	-	-	-	568	
Fjoh_3324	I	I	V	Y	P	N	P	S	-	K	G	L	F	H	L	S	K	E	L	-	-	-	-	E	W	T	-	-	-	-	V	F	S	V	-	S	G	S	K	I	K	E	G	-	-	-	R	G	N	-	-	E	I	S	T	-	-	-	948							
Fjoh_3421	M	T	A	Y	P	N	P	V	-	I	D	E	L	S	L	V	V	N	D	-	-	-	D	I	L	D	D	L	S	Y	G	-	-	V	F	D	I	-	N	G	K	T	V	S	Q	N	-	-	L	K	V	T	T	S	E	-	-	T	R	V	S	M	-	-	-	136
Fjoh_3731	I	E	A	I	P	N	P	A	-	V	T	Y	T	N	V	I	I	G	Y	-	-	-	D	P	T	E	G	T	A	S	-	-	V	I	D	I	-	L	G	R	I	L	Q	Q	F	-	-	S	I	N	S	R	T	-	-	V	P	V	D	L	-	-	-	525		
Fjoh_3777	Y	K	I	Y	P	N	P	S	-	S	N	I	I	N	I	N	L	A	D	E	N	Y	R	P	V	S	S	L	I	R	A	E	-	-	L	Y	N	I	-	S	G	D	L	E	S	A	V	-	-	T	I	E	N	H	T	-	-	A	Q	L	D	V	-	-	-	1137
Fjoh_3855	C	Y	L	K	Q	N	P	V	-	Q	D	N	L	V	L	E	I	A	E	-	-	-	E	Y	K	N	E	E	T	L	L	K	-	-	J	Y	N	T	-	S	G	V	L	Z	K	E	S	-	-	-	S	Y	R	P	-	-	E	G	L	S	V	-	-	-	258	
Fjoh_4051	A	K	L	Y	P	N	P	I	Q	T	G	K	A	I	T	V	E	A	D	F	P	Q	E	E	L	N	N	M	Q	I	S	-	-	L	Y	S	V	-	S	G	Q	L	I	K	T	V	-	-	Q	S	S	A	L	-	-	T	E	I	Q	L	P	-	-	-	2236	
Fjoh_4174	L	N	I	Y	P	N	P	V	-	S	D	V	L	S	F	T	T	D	V	-	-	-	-	T	G	G	K	I	N	-	-	I	I	D	S	-	Q	G	A	V	I	G	S	Q	-	-	-	N	A	A	E	-	-	N	S	L	N	V	-	-	-	931				
Fjoh_4175	L	T	V	Y	P	N	P	S	-	E	D	T	L	F	F	S	A	E	V	-	-	-	-	S	G	A	N	V	S	-	-	I	I	N	S	-	E	G	G	A	T	V	S	T	-	-	Q	K	A	N	D	N	-	-	S	I	N	V	-	-	-	515				
Fjoh_4176	L	N	V	Y	P	N	P	V	-	E	N	T	L	F	T	T	D	L	-	-	-	-	-	S	G	G	D	V	K	-	-	J	V	N	A	Q	S	G	N	T	V	L	S	K	-	-	K	S	N	G	N	-	-	S	I	D	V	-	-	-	858					
Fjoh_4177	F	A	V	Y	P	N	P	A	-	G	N	Y	I	Q	V	S	L	P	E	-	-	-	N	L	N	N	K	I	J	I	T	-	-	J	Y	D	N	-	S	G	T	L	M	L	Q	N	K	P	E	A	N	A	S	E	-	-	S	V	I	D	L	-	-	-	1306	
Fjoh_4242	F	F	I	H	P	T	L	I	-	G	K	N	E	E	L	F	I	E	A	-	-	-	P	K	E	Q	N	A	V	F	Y	-	-	L	Y	T	I	-	S	G	Q	N	T	I	T	S	P	L	I	S	L	T	N	S	-	-	I	T	L	N	T	-	-	-	879	
Fjoh_4436	I	V	V	Y	P	N	P	T	-	S	G	L	F	S	I	Q	I	K	R	-	-	-	P	K	S	A	K	A	T	V	C	-	-	J	Y	N	L	-	N	G	R	V	Z	Q	K	R	N	I	I	F	S	E	E	R	-	-	Q	S	F	E	F	-	-	-	1144	
Fjoh_4721	F	S	I	Y	P	N	P	S	-	N	G	H	F	T	I	Q	L	K	D	-	-	-	-	S	N	E	T	S	N	I	E	-	-	I	I	S	I	-	L																											

Fjoh_0074	R	-	N	L	N	A	G	L	Y	I	Y	T	L	S	E	N	N	K	V	V	-	Y	E	N	K	I	L	K	N	-	-	-	-	1133		
Fjoh_0547	S	-	D	L	V	P	G	V	Y	I	I	R	I	S	E	Q	N	A	T	-	-	A	T	R	K	L	L	I	R	-	-	-	-	112		
Fjoh_0549	-	-	S	L	K	S	G	I	Y	I	I	K	S	K	N	-	-	-	-	-	-	-	E	T	R	K	V	L	K	-	-	-	-	546		
Fjoh_0707	G	R	Y	K	V	S	S	G	V	Y	M	I	F	I	S	A	Q	D	G	S	E	T	K	V	K	E	Y	M	I	I	R	-	-	-	760	
Fjoh_0798	F	L	P	N	A	A	S	G	L	Y	L	V	T	V	I	D	G	D	K	R	-	-	T	V	K	K	I	I	I	N	-	-	-	886		
Fjoh_0808	S	N	L	Q	S	A	D	Q	V	L	L	V	K	V	N	L	E	N	N	A	Q	-	-	I	T	R	K	V	I	F	K	-	-	-	1436	
Fjoh_0848	L	-	-	G	L	D	S	G	F	Y	I	L	K	T	T	I	G	E	T	V	-	-	E	T	F	K	V	I	K	E	-	-	-	469		
Fjoh_0886	S	-	-	R	L	S	T	G	I	Y	L	I	E	L	N	N	G	E	K	E	-	-	I	V	K	F	A	K	K	-	-	-	-	924		
Fjoh_1022	G	-	-	S	Q	S	S	G	I	Y	F	V	K	I	S	N	D	D	F	K	S	-	-	I	T	K	V	I	L	K	-	-	-	465		
Fjoh_1188	S	-	-	G	L	P	K	G	V	Y	V	Y	L	I	N	Q	D	T	A	-	-	S	A	K	K	V	I	V	E	-	-	-	-	1389		
Fjoh_1189	S	-	-	G	L	P	K	G	V	Y	V	Y	L	I	N	Q	D	A	A	-	-	S	A	K	K	V	I	V	E	-	-	-	-	1679		
Fjoh_1208	-	-	-	R	L	A	S	G	I	Y	I	V	N	I	V	S	K	E	Y	K	-	-	T	T	F	K	L	I	V	K	-	-	-	1048		
Fjoh_1231	G	-	-	S	L	A	S	G	T	Y	L	A	K	I	F	T	T	D	G	S	-	-	I	S	Q	T	I	V	K	E	-	-	-	919		
Fjoh_1269	S	-	-	S	V	S	S	G	L	Y	F	L	K	V	K	S	E	G	Q	S	-	-	K	T	I	K	I	V	K	E	-	-	-	874		
Fjoh_1408	G	V	S	E	L	Q	T	G	L	Y	I	V	K	A	S	D	E	N	G	K	I	-	-	Q	V	M	K	F	K	E	-	-	-	957		
Fjoh_1905	S	-	-	R	L	P	K	G	V	Y	I	V	R	N	D	G	A	G	S	-	-	Y	S	K	V	L	K	Q	-	-	-	-	695			
Fjoh_2150	S	-	-	Q	M	L	P	G	T	Y	I	A	K	I	S	A	N	N	I	V	-	-	Q	T	F	K	I	V	K	I	-	-	-	356		
Fjoh_2389	E	-	-	G	L	T	N	G	L	Y	F	Y	T	F	D	A	G	S	L	H	-	-	K	T	G	K	I	I	K	Q	-	-	-	533		
Fjoh_2456	-	-	-	R	E	K	G	V	Y	I	L	K	V	S	N	P	N	N	K	V	L	H	V	K	K	I	I	V	Q	-	-	-	-	924		
Fjoh_2666	S	-	-	H	Y	A	E	G	I	Y	I	K	I	K	T	D	V	K	T	-	-	E	S	V	K	V	I	K	T	V	R	-	-	559		
Fjoh_3203	-	-	-	D	L	A	S	G	I	Y	V	V	T	I	H	S	N	A	L	N	-	-	I	S	K	L	I	V	K	-	-	-	-	981		
Fjoh_3246	K	T	H	L	R	A	S	G	V	Y	F	L	I	L	Q	N	A	D	K	S	-	-	Y	E	A	F	L	I	K	-	-	-	-	2760		
Fjoh_3296	S	-	-	G	L	S	H	G	V	Y	I	A	V	F	L	T	D	D	N	E	K	-	-	I	S	Q	K	V	T	I	S	N	S	R	N	599
Fjoh_3324	S	-	-	E	Q	A	S	G	I	Y	F	L	K	T	N	A	S	A	-	-	-	-	K	A	I	I	I	S	K	Q	-	-	-	972		
Fjoh_3421	Q	-	-	G	L	N	Q	G	V	Y	F	L	V	I	N	K	N	S	K	N	I	-	-	K	T	F	K	I	I	K	E	-	-	-	163	
Fjoh_3731	S	-	-	H	Y	A	E	G	I	Y	I	I	K	I	K	T	D	V	K	T	-	-	E	S	V	K	V	I	K	T	V	R	-	-	553	
Fjoh_3777	S	-	-	A	L	P	L	G	V	Y	V	L	R	I	N	V	D	G	K	T	-	-	E	S	H	Q	V	L	V	K	-	-	-	1163		
Fjoh_3855	S	-	-	D	L	S	Q	G	I	Y	F	L	S	V	N	N	N	G	A	S	-	-	K	K	I	K	F	I	K	K	-	-	-	284		
Fjoh_4051	Q	-	-	T	I	E	S	N	I	L	M	V	V	L	E	T	P	N	V	K	-	-	K	S	F	K	V	I	V	K	-	-	-	2262		
Fjoh_4174	S	-	-	N	L	K	Q	G	I	Y	F	I	V	L	E	K	D	G	Q	K	-	-	T	I	E	R	F	I	K	E	-	-	-	957		
Fjoh_4175	S	-	-	G	L	K	S	G	I	Y	L	I	L	V	E	K	D	G	I	K	-	-	T	V	R	R	F	I	K	E	-	-	-	541		
Fjoh_4176	S	-	-	H	L	A	K	G	I	Y	L	I	V	F	E	K	D	G	K	Q	-	-	T	I	E	R	F	I	K	E	-	-	-	884		
Fjoh_4177	S	-	-	R	L	T	K	G	I	Y	I	L	N	F	K	S	D	Q	K	S	-	-	W	T	K	L	I	K	Q	-	-	-	1332			
Fjoh_4242	A	-	-	-	S	G	I	Y	I	Y	K	I	I	T	G	S	G	K	V	-	-	Q	T	G	K	I	A	I	F	-	-	-	-	903		
Fjoh_4436	N	I	T	G	A	T	F	G	I	Y	L	I	R	V	D	C	L	E	G	M	-	-	T	Q	N	L	I	L	E	N	-	-	-	1172		
Fjoh_4721	N	-	-	N	I	Q	K	G	I	Y	I	V	R	I	T	Q	G	S	K	T	-	-	S	S	E	K	I	I	I	N	-	-	-	617		
Fjoh_4723	S	-	-	Y	L	P	S	G	I	Y	I	V	K	I	E	K	D	S	K	T	-	-	T	I	E	K	I	I	I	N	-	-	-	614		
Fjoh_4948	-	I	P	S	L	T	T	G	V	Y	I	F	Q	I	T	Y	A	N	G	T	V	-	-	K	T	E	N	L	A	V	N	-	-	-	320	
ChiA	S	-	-	-	S	K	Q	L	F	L	V	V	V	T	D	K	A	G	N	K	-	-	K	S	F	K	V	M	N	F	L	N	-	-	1578	

Figure 19. Alignment of the C-terminal domain (CTD) of ChiA with the CTDs of *F. johnsoniae* TIGR04183 family members using MUSCLE. Dark shading indicates identical amino acids and light shading indicates similar amino acids. TIGR04183 is described as ‘Por secretion system C-terminal sorting domain’ on the TIGRFAM website (<http://www.jcvi.org/cgi-bin/tigrfams/HmmReportPage.cgi?acc=TIGR04183>). TIGR04183 family members were identified by searching the *F. johnsoniae* genome using the IMG v 4.0 Function Profile Tool. Fjoh\_2336, Fjoh\_2338, Fjoh\_2339, and Fjoh\_3296 were eliminated because of poor matches to the consensus. As shown, the ChiA CTD has limited similarity to the CTDs of TIGR04183 family members.

**Cells of the *chiA* mutant exhibit wild-type gliding motility.** Many mutants of *F. johnsoniae* that have defects in chitin utilization have been studied, and each of these also had defects in gliding motility (7, 34, 35, 49, 50, 53, 59). The connection between chitin utilization and gliding motility was unclear until it was recognized that assembly of the gliding motility apparatus and secretion of ChiA relied on the same T9SS. Unlike the T9SS mutants, cells of the *chiA* mutant CJ1808 formed spreading colonies on agar (Figure 20), and cells moved rapidly over surfaces similar to wild-type cells, demonstrating that the ability to utilize chitin was not required for gliding motility.



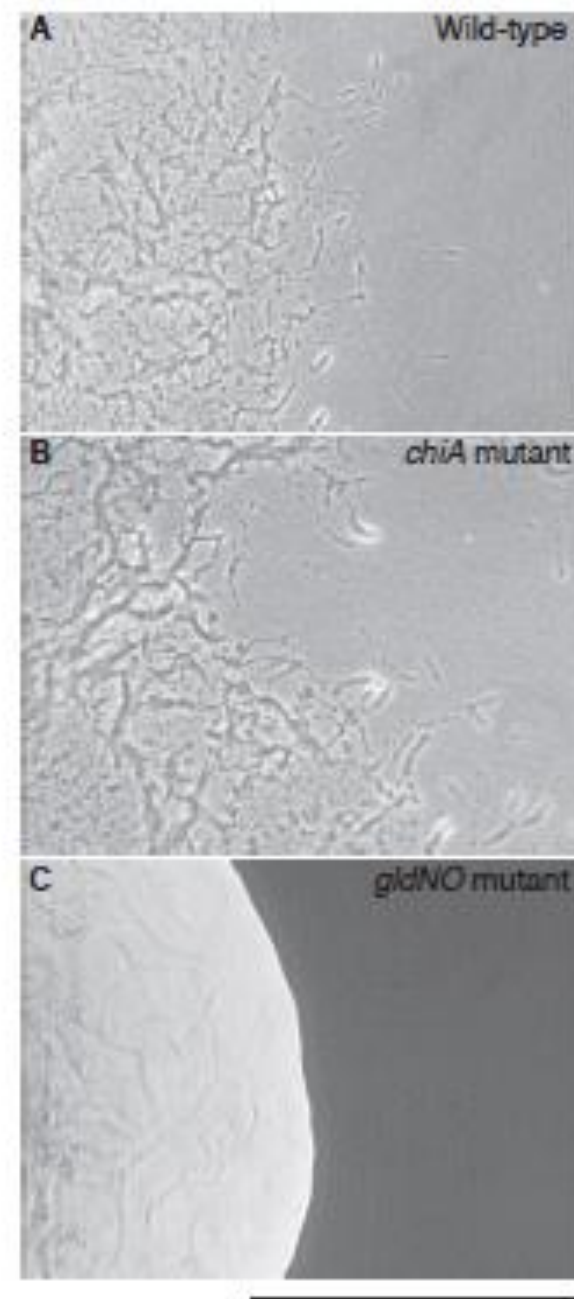

Figure 20. Disruption of *chiA* does not affect gliding motility. Colonies were grown for 42 h at 25°C on PY2 agar medium. Photomicrographs were taken with a Photometrics CoolSNAP<sub>cf</sub><sup>2</sup> camera mounted on an Olympus IMT-2 phase-contrast microscope. (A) Wild-type *F. johnsoniae* UW101. (B) *chiA* mutant CJ1808. (C) *gldNO* deletion mutant CJ1631A. Bar indicates 0.5 mm and applies to all panels.

## Discussion

*F. johnsoniae* rapidly digests insoluble chitin, and its genome encodes five predicted chitinases that may have roles in this process (37). Here we demonstrate that one of these, ChiA, is essential for chitin utilization. ChiA is a soluble extracellular enzyme. Disruption of *chiA* eliminates soluble extracellular chitinase activity and results in inability of cells to digest insoluble chitin. Cell associated chitinase activities were still present, presumably contributed by some of the remaining four predicted chitinases. Some of these may reside on the cell surface whereas others may be periplasmic, allowing the digestion of oligomers of chitin that have been imported across the outer membrane. At least one of the predicted chitinases, Fjoh\_4175, was not essential for chitin digestion under the conditions employed. Deletion of Fjoh\_4175 failed to decrease the levels of secreted or cell-associated chitinase activities. Fjoh\_4175 may be a minor chitinase, may not be expressed under the conditions of our experiments, or may not assist in digestion of the form of chitin (insoluble colloidal chitin prepared from crab shells) used in this study.

ChiA appears to be secreted by the T9SS. Mutations in any of the T9SS genes resulted in failure to secrete soluble ChiA, and accumulation of unprocessed proChiA inside of cells. Sequence analysis did not predict that ChiA would be secreted by the T9SS. Most other proteins known to be secreted by T9SSs have CTDs that belong to TIGRFAM families TIGR04131 (which includes SprB) and TIGR04183 (which includes RemA), but ChiA was not recognized by algorithms used to detect members of these families. ChiA does however have a region C-terminal to the predicted catalytic domains

that appears to perform a similar function. Deletion of this region resulted in failure to secrete ChiA, and attachment of this region to a foreign protein, mCherry, resulted in secretion in soluble form. BlastP analysis of the C-terminal 106 amino acid sequence against the non-redundant protein sequences in Genbank identified only three proteins that exhibit significant similarity to the *F. johnsoniae* ChiA CTD. Each of these are predicted chitinases from *Flavobacterium* species, and each are similar to ChiA not only over the CTD, but also over the entire protein. The ChiA CTD thus does not seem to represent a large family of previously unrecognized T9SS CTDs. The results reported here, and those previously published (18, 44, 54, 57, 58, 61, 63, 67), indicate that CTDs are involved in secretion by the T9SS but that there is considerable variation in the CTD sequences. Some features are apparently common to all, including the presence of multiple positively charged residues near the carboxy terminus. The sequence variations suggest that the structures of the CTDs may be more important than the exact sequences in targeting proteins to the T9SS.

The T9SS probably secretes many proteins besides those involved in motility and chitin utilization. *F. johnsoniae* is predicted to encode 53 proteins that have CTDs that belong to TIGRFAM families TIGR04131 and TIGR04183, which are thought to target proteins for secretion by the T9SS (59). This list includes nine predicted glycoside hydrolases, one polysaccharide lyase, and four peptidases in addition to proteins such as SprB and RemA that were previously known to be secreted by this system. Mutations that disrupt the T9SS are thus likely to have pleiotropic effects in addition to the known defects in motility and chitin utilization.

Proteins secreted by T9SSs often localize to the outer surface of the outer membrane. The *F. johnsoniae* motility proteins SprB and RemA, and the *P. gingivalis* gingipains and adhesins are examples of such proteins (13, 57-60, 63, 67). Some of these surface associated proteins have been shown to be modified by attachment of a glycolipid that may anchor them to the cell surface (13). This modification has been proposed as a general property of proteins secreted by T9SSs (63). Our results with ChiA indicate that it is secreted in soluble form by the T9SS, suggesting that this type of modification is not a requirement for secretion by the system. Many members of the phylum *Bacteroidetes* have dozens or even hundreds of genes predicted to encode CTD-containing proteins secreted by T9SSs (38, 63). It is perhaps not surprising that among this large number of proteins some are cell-surface associated and others are soluble extracellular proteins.

ChiA may undergo multiple processing events during or after secretion from the cell. ChiA has a predicted cleavable N-terminal signal peptide that is thought to target it to the Sec system for transit across the cytoplasmic membrane. Mutations in *secDF* result in decreased digestion of chitin (43), which is consistent with the involvement of the Sec system in export of ChiA. T9SS mediated secretion across the outer membrane may involve cleavage of the CTD from ChiA. This C-terminal region was not detected by LC-MS/MS analysis of secreted ChiA, suggesting that it may have been removed from the major secreted products. Evidence of removal of T9SS CTDs by proteolytic processing during secretion was recently reported for proteins of *P. gingivalis*, *Tannerella forsythia*, *Parabacteroides distasonis*, *Prevotella intermedia*, and *Cytophaga hutchinsonii* (18, 55, 58, 63, 67). PG0026, also referred to as PorU, was required for removal of the CTDs

from secreted proteins of *P. gingivalis* (18). *F. johnsoniae* has an ortholog of PorU that may perform a similar function. In addition to removal of the amino- and carboxy-terminal regions, *F. johnsoniae* ChiA may have had another processing event involving proteolysis between the two GH18 domains, resulting in two major soluble products each predicted to have chitinase activity. We do not know whether this processing event is important for the functioning of ChiA or whether it is the result of nonspecific digestion by one of the many proteases produced by *F. johnsoniae* (37). ChiA<sub>GH18N</sub> is similar in sequence to *Bacillus circulans* ChiA1 (65), and ChiA<sub>GH18C</sub> is similar in sequence to *B. circulans* ChiD (64) (see Fig. S6 and Fig. S7 in the supplemental material of (68) ). The two GH18 domains of *F. johnsoniae* ChiA exhibit little similarity to each other, but each has the signature active site sequence (DXXDXDXE) that is characteristic of GH18 chitinases (19). *B. circulans* *chiA1* and *chiD* are adjacent on the genome, and the protein products presumably work together to digest chitin (64). Additional experiments are needed to determine the exact functions of *F. johnsoniae* ChiA<sub>GH18N</sub> and ChiA<sub>GH18C</sub> and the synergy, if any, that they exhibit.

In addition to their catalytic domains, many bacterial chitinases have carbohydrate-binding modules (CBMs) belonging to families 5 or 12 (19). Examination of proteins encoded by the *F. johnsoniae* genome revealed the complete absence of such domains, as presented in the Carbohydrate Active enZYmes (CAZY) database (<http://www.cazy.org/>) (5, 10). ChiA itself does not harbor a recognizable CBM of any family. ChiA may have novel CBMs or may rely on its catalytic domains to interact with chitin.

ChiA is required for *F. johnsoniae* chitin digestion, but further experiments are needed to determine if the four other predicted chitinases (37) have roles in this process. Synergistic interactions between multiple chitinases may be needed to efficiently digest crystalline chitin in nature. Such synergy has been demonstrated for the chitinases of other bacteria (8). Variations in organization of the polymer strands in the  $\alpha$ -,  $\beta$ -, and  $\gamma$ -forms of crystalline chitin, variation in the degree of acetylation, and variations regarding the components complexed with chitin (proteins, polysaccharides, inorganic materials) (4, 19) may mean that no single enzyme or set of enzymes is ideally suited to efficiently digest all forms of chitin. Additional experiments will be needed to determine the entire complement of chitinolytic enzymes that allows optimal digestion and utilization of different forms of chitin by *F. johnsoniae* cells.

Chitin is one of the most abundant biopolymers produced on earth and is a common component of organisms in soil, freshwater and marine environments (22, 26, 39, 46). Bacteria of the phylum *Bacteroidetes* are important and sometimes dominant members of the chitinolytic communities in these environments (25). Members of the phylum *Bacteroidetes* are known to use novel strategies to utilize polysaccharides (51), and an improved understanding of the mechanisms used by *F. johnsoniae* and related bacteria to digest chitin may enhance our understanding of the turnover of this important biopolymer in nature. Such studies may also have more targeted practical value. For example, *F. johnsoniae* and closely related bacteria are common in the rhizosphere (23, 24, 27, 28, 33, 45), and have been linked to enhanced disease resistance of plants (28, 52). Chitinases released by these bacteria may contribute to this resistance because of

their activities against fungal or insect pests. The chitin modifying enzymes may also be useful for the production of chitooligosaccharides and other pharmaceutical products (15).

The results presented in this paper identify the major extracellular chitinase, ChiA, of *F. johnsoniae* and characterize its secretion by the T9SS. The motility adhesins SprB and RemA are also known to be secreted by the *F. johnsoniae* T9SS. Unlike SprB and RemA, ChiA is not attached to the cell surface after secretion, but instead is released in soluble form. Further study is needed to determine what features of the proteins result in anchoring on the cell surface or release in soluble form. The results of such studies could have broad implications. Analysis of the *F. johnsoniae* genome suggests that many proteins are secreted by the T9SS, and these are likely to undergo similar CTD recognition and processing events. Moreover, T9SSs appear to be common in the large and diverse phylum *Bacteroidetes* (38, 63), and an understanding of the events occurring during secretion of cell-surface and extracellular proteins of these bacteria will likely be of both practical and fundamental significance.

## References

1. **Abdallah, A. M., N. C. Gey van Pittius, P. A. Champion, J. Cox, J. Luirink, C. M. Vandenbroucke-Grauls, B. J. Appelmelk, and W. Bitter.** 2001. Type VII secretion--mycobacteria show the way. *Nat. Rev. Microbiol.* **5**:883-891.
2. **Agarwal, S., D. W. Hunnicutt, and M. J. McBride.** 1997. Cloning and characterization of the *Flavobacterium johnsoniae* (*Cytophaga johnsonae*) gliding motility gene, *gldA*. *Proc. Natl. Acad. Sci. USA* **94**:12139-12144.
3. **Barnhart, M. M., and M. R. Chapman.** 2006. Curli biogenesis and function. *Annu. Rev. Microbiol.* **60**:131-147.
4. **Beier, S., and S. Bertilsson.** 2013. Bacterial chitin degradation-mechanisms and ecophysiological strategies. *Frontiers in Microbiology* **4**:Article 149.
5. **Boraston, A. B., D. N. Bolam, H. J. Gilbert, and G. J. Davies.** 2004. Carbohydrate-binding modules: fine-tuning polysaccharide recognition. *The Biochemical journal* **382**:769-81.
6. **Braun, T. F., M. K. Khubbar, D. A. Saffarini, and M. J. McBride.** 2005. *Flavobacterium johnsoniae* gliding motility genes identified by *mariner* mutagenesis. *J. Bacteriol.* **187**:6943-6952.
7. **Braun, T. F., and M. J. McBride.** 2005. *Flavobacterium johnsoniae* GldJ is a lipoprotein that is required for gliding motility. *J. Bacteriol.* **187**:2628-2637.
8. **Brurberg, M. B., I. F. Nes, and V. G. Eijsink.** 1996. Comparative studies of chitinases A and B from *Serratia marcescens*. *Microbiology* **142**:1581-9.
9. **Busch, A., and G. Waksman.** 2012. Chaperone-usher pathways: diversity and pilus assembly mechanism. *Philosophical transactions of the Royal Society of London. Series B, Biological sciences* **367**:1112-22.
10. **Cantarel, B. L., P. M. Coutinho, C. Rancurel, T. Bernard, V. Lombard, and B. Henrissat.** 2009. The Carbohydrate-Active EnZymes database (CAZy): an expert resource for Glycogenomics. *Nucleic acids research* **37**:D233-8.
11. **Chagnot, C., M. A. Zorgani, T. Astruc, and M. Desvaux.** 2013. Proteinaceous determinants of surface colonization in bacteria: bacterial adhesion and biofilm formation from a protein secretion perspective. *Frontiers in microbiology* **4**:303.
12. **Chang, L. Y. E., J. L. Pate, and R. J. Betzig.** 1984. Isolation and characterization of nonspreading mutants of the gliding bacterium *Cytophaga johnsonae*. *J. Bacteriol.* **159**:26-35.
13. **Chen, Y. Y., B. Peng, Q. Yang, M. D. Glew, P. D. Veith, K. J. Cross, K. N. Goldie, D. Chen, N. O'Brien-Simpson, S. G. Dashper, and E. C. Reynolds.** 2011. The outer membrane protein LptO is essential for the O-deacylation of LPS



- and the co-ordinated secretion and attachment of A-LPS and CTD proteins in *Porphyromonas gingivalis*. *Molecular microbiology* **79**:1380-401.
14. **Crosby, H. A., E. K. Heiniger, C. S. Harwood, and J. C. Escalante-Semerena.** 2010. Reversible N epsilon-lysine acetylation regulates the activity of acyl-CoA synthetases involved in anaerobic benzoate catabolism in *Rhodopseudomonas palustris*. *Molecular microbiology* **76**:874-88.
  15. **Dahiya, N., R. Tewari, and G. S. Hoondal.** 2006. Biotechnological aspects of chitinolytic enzymes: a review. *Applied microbiology and biotechnology* **71**:773-82.
  16. **Desvaux, M., M. Hebraud, R. Talon, and I. R. Henderson.** 2009. Secretion and subcellular localizations of bacterial proteins: a semantic awareness issue. *Trends in microbiology* **17**:139-45.
  17. **Economou, A., P. J. Christie, R. C. Fernandez, T. Palmer, G. V. Plano, and A. P. Pugsley.** 2006. Secretion by numbers: protein traffic in prokaryotes *Mol. Microbiol.* **62**:308-319.
  18. **Glew, M. D., P. D. Veith, B. Peng, Y. Y. Chen, D. G. Gorasia, Q. Yang, N. Slakeski, D. Chen, C. Moore, S. Crawford, and E. Reynolds.** 2012. PG0026 is the C-terminal signal peptidase of a novel secretion system of *Porphyromonas gingivalis*. *J. Biol. Chem.* **287**:24605-24617.
  19. **Hoell, I. A., G. Vaaje-Kolstad, and V. G. H. Eijsink.** 2010. Structure and function of enzymes acting on chitin and chitosan. *Biotechnology and Genetic Engineering Reviews, Vol 27* **27**:331-366.
  20. **Holland, I. B.** 2010. The extraordinary diversity of bacterial protein secretion mechanisms. *Methods Mol. Biol.* **619**:1-20.
  21. **Hunnicutt, D. W., and M. J. McBride.** 2000. Cloning and characterization of the *Flavobacterium johnsoniae* gliding motility genes, *gldB* and *gldC*. *J. Bacteriol.* **182**:911-918.
  22. **Jeuniaux, C., and M. F. Vossfoucart.** 1991. Chitin Biomass and Production in the Marine-Environment. *Biochemical Systematics and Ecology* **19**:347-356.
  23. **Johansen, J. E., and S. J. Binnerup.** 2002. Contribution of Cytophaga-like bacteria to the potential of turnover of carbon, nitrogen, and phosphorus by bacteria in the rhizosphere of barley (*Hordeum vulgare* L.). *Microbial Ecology* **43**:298-306.
  24. **Johansen, J. E., P. Nielsen, and S. J. Binnerup.** 2009. Identification and potential enzyme capacity of flavobacteria isolated from the rhizosphere of barley (*Hordeum vulgare* L.). *Canadian Journal of Microbiology* **55**:234-241.
  25. **Kirchman, D. L.** 2002. The ecology of *Cytophaga-Flavobacteria* in aquatic environments. *FEMS Microbiol. Ecol.* **39**:91-100.

26. **Kirchner, M.** 1995. Microbial colonization of copepod body surfaces and chitin degradation in the sea. *Helgolander Meeresuntersuchungen* **49**:201-212.
27. **Kolton, M., S. J. Green, Y. M. Harel, N. Sela, Y. Elad, and E. Cytryn.** 2012. Draft genome sequence of *Flavobacterium* sp strain F52, isolated from the rhizosphere of bell pepper (*Capsicum annuum* L. cv. Maccabi). *Journal of bacteriology* **194**:5462-5463.
28. **Kolton, M., Y. M. Harel, Z. Pasternak, E. R. Graber, Y. Elad, and E. Cytryn.** 2011. Impact of biochar application to soil on the root-associated bacterial community structure of fully developed greenhouse pepper plants. *Applied and environmental microbiology* **77**:4924-4930.
29. **Kwan, K. M., E. Fujimoto, C. Grabher, B. D. Mangum, M. E. Hardy, D. S. Campbell, J. M. Parant, H. J. Yost, J. P. Kanki, and C. B. Chien.** 2007. The Tol2kit: A multisite Gateway-based construction kit for Tol2 transposon transgenesis constructs. *Developmental Dynamics* **236**:3088-3099.
30. **Lee, C., A. Levin, and D. Branton.** 1987. Copper staining: a five minute protein stain for sodium dodecyl sulfate-polyacrylamide gels. *Analyt. Biochem.* **166**:308-312.
31. **Li, L.-Y., N. B. Shoemaker, and A. A. Salyers.** 1995. Location and characterization of the transfer region of a *Bacteroides* conjugative transposon and regulation of the transfer genes. *J. Bacteriol.* **177**:4992-4999.
32. **Liu, J., M. J. McBride, and S. Subramaniam.** 2007. Cell-surface filaments of the gliding bacterium *Flavobacterium johnsoniae* revealed by cryo-electron tomography. *J. Bacteriol.* **189**:7503-7506.
33. **Manter, D. K., J. A. Delgado, D. G. Holm, and R. A. Stong.** 2010. Pyrosequencing reveals a highly diverse and cultivar-specific bacterial endophyte community in potato roots. *Microbial Ecology* **60**:157-166.
34. **McBride, M. J., and T. F. Braun.** 2004. GldI is a lipoprotein that is required for *Flavobacterium johnsoniae* gliding motility and chitin utilization. *J. Bacteriol.* **186**:2295-2302.
35. **McBride, M. J., T. F. Braun, and J. L. Brust.** 2003. *Flavobacterium johnsoniae* GldH is a lipoprotein that is required for gliding motility and chitin utilization. *J. Bacteriol.* **185**:6648-6657.
36. **McBride, M. J., and M. J. Kempf.** 1996. Development of techniques for the genetic manipulation of the gliding bacterium *Cytophaga johnsonae*. *J. Bacteriol* **178**:583-590.
37. **McBride, M. J., G. Xie, E. C. Martens, A. Lapidus, B. Henrissat, R. G. Rhodes, E. Goltsman, W. Wang, J. Xu, D. W. Hunnicutt, A. M. Staroscik, T. R. Hoover, Y. Q. Cheng, and J. L. Stein.** 2009. Novel features of the

- polysaccharide-digesting gliding bacterium *Flavobacterium johnsoniae* as revealed by genome sequence analysis. *Appl. Environ. Microbiol.* **75**:6864-6875.
38. **McBride, M. J., and Y. Zhu.** 2013. Gliding motility and Por secretion system genes are widespread among members of the phylum *Bacteroidetes*. *J. Bacteriol.* **195**:270-278.
  39. **Muzzarelli, R. A. A.** 1999. Native, industrial and fossil chitins, p. 1-6. *In* P. Jolles and R. A. A. Muzzarelli (ed.), *Chitin and Chitinases*. Birkhauser Verlag, Basel, Switzerland.
  40. **Nakane, D., K. Sato, H. Wada, M. J. McBride, and K. Nakayama.** 2013. Helical flow of surface protein required for bacterial gliding motility. *Proc. Natl. Acad. Sci. USA* **110**:11145-11150.
  41. **Nelson, S. S., S. Bollampalli, and M. J. McBride.** 2008. SprB is a cell surface component of the *Flavobacterium johnsoniae* gliding motility machinery. *J. Bacteriol.* **190**:2851-2857.
  42. **Nelson, S. S., P. P. Glocka, S. Agarwal, D. P. Grimm, and M. J. McBride.** 2007. *Flavobacterium johnsoniae* SprA is a cell-surface protein involved in gliding motility. *J. Bacteriol.* **189**:7145-7150.
  43. **Nelson, S. S., and M. J. McBride.** 2006. Mutations in *Flavobacterium johnsoniae* *secDF* result in defects in gliding motility and chitin utilization. *J. Bacteriol.* **188**:348-351.
  44. **Nguyen, K. A., J. Travis, and J. Potempa.** 2007. Does the importance of the C-terminal residues in the maturation of RgpB from *Porphyromonas gingivalis* reveal a novel mechanism for protein export in a subgroup of Gram-Negative bacteria? *J. Bacteriol.* **189**:833-843.
  45. **Peterson, S. B., A. K. Dunn, A. K. Klimowicz, and J. Handelsman.** 2006. Peptidoglycan from *Bacillus cereus* mediates commensalism with rhizosphere bacteria from the *Cytophaga-Flavobacterium* group. *Applied and environmental microbiology* **72**:5421-7.
  46. **Poulicek, M., and C. Jeuniaux.** 1991. Chitin biodegradation in marine environments - an experimental approach. *Biochemical Systematics and Ecology* **19**:385-394.
  47. **Reichenbach, H.** 1992. The genus *Lysobacter*, p. 3256-3275. *In* A. Balows, H. Truper, M. Dworkin, W. Harder, and K. Schleifer (ed.), *The Prokaryotes*, 2 ed. Springer-Verlag.
  48. **Rhodes, R. G., H. G. Pucker, and M. J. McBride.** 2011. Development and use of a gene deletion strategy for *Flavobacterium johnsoniae* to identify the redundant motility genes *remF*, *remG*, *remH*, and *remI*. *J. Bacteriol.* **193**:2418-2428.

49. **Rhodes, R. G., M. N. Samarasam, A. Shrivastava, J. M. van Baaren, S. Pochiraju, S. Bollampalli, and M. J. McBride.** 2010. *Flavobacterium johnsoniae* *gldN* and *gldO* are partially redundant genes required for gliding motility and surface localization of SprB. *J. Bacteriol.* **192**:1201-1211.
50. **Rhodes, R. G., M. N. Samarasam, E. J. Van Groll, and M. J. McBride.** 2011. Mutations in *Flavobacterium johnsoniae* *sprE* result in defects in gliding motility and protein secretion. *Journal of Bacteriology* **193**:5322-7.
51. **Salyers, A. A., A. Reeves, and J. D'Elia.** 1996. Solving the problem of how to eat something as big as yourself: diverse bacterial strategies for degrading polysaccharides. *J. Indust. Microbiol.* **17**:470-476.
52. **Sang, M. K., and K. D. Kim.** 2012. The volatile-producing *Flavobacterium johnsoniae* strain GSE09 shows biocontrol activity against *Phytophthora capsici* in pepper. *Journal of Applied Microbiology* **113**:383-398.
53. **Sato, K., M. Naito, H. Yukitake, H. Hirakawa, M. Shoji, M. J. McBride, R. G. Rhodes, and K. Nakayama.** 2010. A protein secretion system linked to bacteroidete gliding motility and pathogenesis. *Proc. Natl. Acad. Sci. USA* **107**:276-281.
54. **Sato, K., E. Sakai, P. D. Veith, M. Shoji, Y. Kikuchi, H. Yukitake, N. Ohara, M. Naito, K. Okamoto, E. C. Reynolds, and K. Nakayama.** 2005. Identification of a new membrane-associated protein that influences transport/maturation of gingipains and adhesins of *Porphyromonas gingivalis*. *J. Biol. Chem.* **280**:8668-8677.
55. **Sato, K., H. Yukitake, Y. Narita, M. Shoji, M. Naito, and K. Nakayama.** 2013. Identification of *Porphyromonas gingivalis* proteins secreted by the Por secretion system. *FEMS microbiology letters* **338**:68-76.
56. **Saveliev, S. V., C. C. Woodroffe, G. Sabat, C. M. Adams, D. Klaubert, K. Wood, and M. Uhr.** 2013. Mass spectrometry compatible surfactant for optimized in-gel protein digestion. *Analytical chemistry* **85**:907-14.
57. **Seers, C. A., N. Slakeski, P. D. Veith, T. Nikolof, Y. Y. Chen, S. G. Dashper, and E. C. Reynolds.** 2006. The RgpB C-terminal domain has a role in attachment of RgpB to the outer membrane and belongs to a novel C-terminal-domain family found in *Porphyromonas gingivalis*. *J. Bacteriol.* **188**:6376-6386.
58. **Shoji, M., K. Sato, H. Yukitake, Y. Kondo, Y. Narita, T. Kadowaki, M. Naito, and K. Nakayama.** 2011. Por secretion system-dependent secretion and glycosylation of *Porphyromonas gingivalis* hemin-binding protein 35. *PLOS One* **6**:e21372.
59. **Shrivastava, A., J. J. Johnston, J. M. van Baaren, and M. J. McBride.** 2013. *Flavobacterium johnsoniae* GldK, GldL, GldM, and SprA are required for

- secretion of the cell-surface gliding motility adhesins SprB and RemA. *Journal of Bacteriology* **195**:3201-3212.
60. **Shrivastava, A., R. G. Rhodes, S. Pochiraju, D. Nakane, and M. J. McBride.** 2012. *Flavobacterium johnsoniae* RemA is a mobile cell-surface lectin involved in gliding. *J. Bacteriol.* **194**:3678-3688.
  61. **Slakeski, N., C. A. Seers, K. Ng, C. Moore, S. M. Cleal, P. D. Veith, A. W. Lo, and E. C. Reynolds.** 2011. C-terminal domain residues important for secretion and attachment of RgpB in *Porphyromonas gingivalis*. *J. Bacteriol.* **193**:132-142.
  62. **Stanier, R. Y.** 1947. Studies on non-fruiting myxobacteria. I. *Cytophaga johnsonae*, N. Sp., A chitin-decomposing myxobacterium. *J. Bacteriol.* **53**:297-315.
  63. **Veith, P. D., N. A. Nor Muhammad, S. G. Dashper, V. A. Likic, D. G. Gorasia, D. Chen, S. J. Byrne, D. V. Catmull, and E. C. Reynolds.** 2013. Protein substrates of a novel secretion system are numerous in the *Bacteroidetes* phylum and have in common a cleavable C-terminal secretion signal, extensive post-translational modification and cell surface attachment. *J. Proteome Res.* **12**:4449-4461.
  64. **Watanabe, T., W. Oyanagi, K. Suzuki, K. Ohnishi, and H. Tanaka.** 1992. Structure of the gene encoding chitinase D of *Bacillus circulans* WL-12 and possible homology of the enzyme to other prokaryotic chitinases and class III plant chitinases. *Journal of bacteriology* **174**:408-14.
  65. **Watanabe, T., K. Suzuki, W. Oyanagi, K. Ohnishi, and H. Tanaka.** 1990. Gene cloning of chitinase A1 from *Bacillus circulans* WL-12 revealed its evolutionary relationship to *Serratia* chitinase and to the type III homology units of fibronectin. *The Journal of biological chemistry* **265**:15659-65.
  66. **Wolkin, R. H., and J. L. Pate.** 1985. Selection for nonadherent or nonhydrophobic mutants co-selects for nonspreading mutants of *Cytophaga johnsonae* and other gliding bacteria. *J. Gen. Microbiol.* **131**:737-750.
  67. **Zhou, X. Y., J. L. Gao, N. Hunter, J. Potempa, and K. A. Nguyen.** 2013. Sequence-independent processing site of the C-terminal domain (CTD) influences maturation of the RgpB protease from *Porphyromonas gingivalis*. *Molecular microbiology* **89**:903-17.
  68. **Kharade, S. S., and M. J. McBride.** 2014. The *Flavobacterium johnsoniae* chitinase ChiA is required for chitin utilization and is secreted by the type IX secretion system. *J. Bacteriol.* **196**:961-970

### **Chapter 3. *Flavobacterium johnsoniae* PorV is required for secretion of a subset of proteins targeted to the type IX secretion system.**

This chapter is a modified version of a paper published in Journal of Bacteriology (47) that includes some of the online supplemental materials of the published paper integrated into it.

#### **Abstract**

*Flavobacterium johnsoniae* exhibits gliding motility and digests many polysaccharides, including chitin. A novel protein secretion system, the type IX secretion system (T9SS), is required for gliding and chitin utilization. The T9SS secretes the cell-surface motility adhesins SprB and RemA, and the chitinase ChiA. Proteins involved in secretion by the T9SS include GldK, GldL, GldM, GldN, SprA, SprE, and SprT. *Porphyromonas gingivalis* has orthologs for each of these that are required for secretion of gingipain protease virulence factors by its T9SS. *P. gingivalis* *porU* and *porV* have also been linked to T9SS-mediated secretion and *F. johnsoniae* has orthologs of these. Mutations in *F. johnsoniae* *porU* and *porV* were constructed to determine if they function in secretion. Cells of a *porV* deletion mutant were deficient in chitin utilization and failed to secrete ChiA. They were also deficient in secretion of the motility adhesin RemA, but retained the ability to secrete SprB. SprB is involved in gliding motility and is needed for formation of spreading colonies on agar, and the *porV* mutant exhibited gliding motility and formed spreading colonies. However the *porV* mutant was partially deficient in attachment to glass, apparently because of the absence of RemA and other adhesins on the cell surface. The *porV* mutant also appeared to be deficient in secretion of numerous

other proteins that have carboxy-terminal domains associated with targeting to the T9SS. PorU was not required for secretion of ChiA, RemA, or SprB, indicating that it does not play an essential role in the *F. johnsoniae* T9SS.

## **Introduction**

Cells of *Flavobacterium johnsoniae*, and of many members of the phylum *Bacteroidetes*, crawl rapidly over surfaces by a process known as gliding motility (18). *F. johnsoniae* gliding involves the rapid movement of the adhesins SprB and RemA along the cell surface (23, 24, 41). These proteins are secreted across the outer membrane by a novel protein secretion system originally called the Por secretion system, and more recently referred to as the type IX secretion system (T9SS) (35, 40). Motility proteins are not the only cargo for the *F. johnsoniae* T9SS. It is also required for secretion of the soluble extracellular chitinase ChiA (15), and 51 other *F. johnsoniae* proteins are predicted to use this secretion system (40). Many proteins secreted by T9SSs are very large. ChiA, RemA, and SprB, for example, are 166, 152, and 669 kDa respectively (15, 24, 41). The mechanism that allows efficient secretion of such large proteins by the T9SS is not known. T9SSs are found in many members of the phylum *Bacteroidetes*, and they are apparently limited to this phylum (22, 42). The proteins required for T9SS-mediated secretion are not similar in sequence to proteins of other bacterial secretion systems (4, 22, 35). Although the T9SS was only recently discovered, it has already been associated with motility (31), virulence (35), chitin and cellulose digestion (15, 46), and colonization of and protection of plants from pathogens (16).

T9SSs were originally identified in *F. johnsoniae* and in the oral pathogen *Porphyromonas gingivalis* (31, 35). *P. gingivalis* secretes virulence factors such as gingipain proteases and adhesins using its T9SS. Proteins secreted by T9SSs have cleavable N-terminal signal peptides and are apparently exported across the cytoplasmic membrane via the Sec system (37, 42). They also have conserved carboxy-terminal domains (CTDs) of approximately 60 to 100 amino acids that target them for secretion across the outer membrane by the T9SS (15, 26, 37, 40, 42). The CTDs appear to be proteolytically cleaved during or after secretion across the outer membrane (8, 42). The CTDs are necessary and sufficient for secretion by the T9SS. *P. gingivalis* HBP35 and *F. johnsoniae* ChiA lacking their CTDs are not secreted, and heterologous fusion proteins carrying the HBP35 and ChiA CTDs are efficiently secreted (15, 38). Many T9SS CTDs of *F. johnsoniae* and *P. gingivalis* belong to TIGRFAM protein domain family TIGR04183 (22, 37, 40). There appears to be considerable diversity in T9SS CTDs, and not all fall within the boundaries of TIGR04183. *F. johnsoniae* SprB, for example, requires the T9SS for secretion but its carboxy-terminal region exhibits no similarity to TIGR04183 family members, but rather belongs to the unrelated domain family TIGR04131. Eleven other *F. johnsoniae* proteins have TIGR04131-type CTDs, as do numerous proteins from other species belonging to the phylum *Bacteroidetes* that have T9SSs. We have speculated that these TIGR04131-type CTDs target proteins for secretion by the T9SS (15, 22), but with the exception of SprB, T9SS-mediated secretion of these proteins has not been experimentally demonstrated in any organism.



Proteins required for secretion by the *F. johnsoniae* T9SS include GldK, GldL, GldM, and GldN or its paralog GldO (31, 40). SprA, SprE, and SprT also have important roles in T9SS-mediated secretion and cells with mutations in the genes encoding these proteins are severely but incompletely deficient in secretion (32, 35, 40). The *P. gingivalis* T9SS has orthologs for GldK, GldL, GldM, GldN, SprA, SprE, and SprT, and these are required for secretion (33, 35, 36). *P. gingivalis* PorP is also required for secretion. Unlike *P. gingivalis*, *F. johnsoniae* has multiple genes that exhibit similarity to *porP*. One of these, *sprF*, is required for secretion of SprB but is not needed for secretion of other proteins by its T9SS (29). The *F. johnsoniae* genome is predicted to encode ten PorP-like proteins in addition to SprF, and each of these may facilitate secretion of specific cargo proteins.

Five additional *P. gingivalis* proteins PorQ, PorU, PorV, PorX, and PorY are linked to T9SS function (7, 8, 12, 35). Mutations in *P. gingivalis porQ*, *porX* and *porY* result in partial defects in T9SS-mediated secretion. The function of PorQ is not known, but PorX and PorY are thought to form a two-component regulatory system that controls expression of the T9SS genes (35). The related *F. johnsoniae* proteins do not appear to play similar roles since deletion of the *F. johnsoniae* orthologs of *porQ*, *porX*, and *porY* has no effect on secretion of SprB, RemA or ChiA (39). The functions of *F. johnsoniae* PorU and PorV in secretion have not previously been studied. *P. gingivalis* PorU is thought to function as the peptidase that removes the CTDs of secreted proteins (8). *P. gingivalis* PorV is required for secretion of proteins targeted to the T9SS, including the gingipain proteases RgpA, RgpB and Kgp (11, 12). PorV, which has also been called

LptO, is required for the partial *O*-deacylation of lipopolysaccharide (7). PorV may have deacylation activity or it may be required for secretion of a deacylase. *F. johnsoniae* has orthologs of *porU* and *porV* but their functions have not been determined. In this study we constructed and examined *F. johnsoniae* mutants to determine the roles of PorU and PorV in secretion. Deletion of *porU* had little effect on secretion indicating that it was not essential for *F. johnsoniae* T9SS function. In contrast, PorV was required for the secretion of many but not all proteins targeted to the T9SS. Deletion of *porV* eliminated secretion of RemA and ChiA but had no effect on secretion of SprB.

## Materials and Methods

**Bacterial and bacteriophage strains, plasmids, and growth conditions.** *F. johnsoniae* ATCC 17061<sup>T</sup> strain UW101 was the wild-type strain used in this study (5, 19, 21). The streptomycin resistant *rpsL* mutant of UW101 (CJ1827) was used to construct deletion mutants (30). *F. johnsoniae* strains were grown in Casitone-yeast extract (CYE) medium at 30°C (20). To observe colony spreading cells were grown on PY2 agar at 25°C (1), and to observe motility of individual cells they were grown in motility medium (MM) at 25°C (17). *E. coli* strains were grown in Luria-Bertani medium (LB) at 37°C (34). Strains and plasmids used in this study are listed in Table 4 and primers are listed in Table 5. Antibiotics were used at the following concentrations when needed: ampicillin, 100 µg/ml; cefoxitin, 100 µg/ml; erythromycin, 100 µg/ml; streptomycin, 100 µg/ml; and tetracycline, 20 µg/ml.

**Construction and complementation of *porV* and *porU* mutants.** Unmarked deletions were generated as previously described (30). To delete *porV*, a 2,442 bp fragment upstream of *porV* was amplified using Phusion DNA polymerase (New England Biolabs, Ipswich, MA), and primers 1203 (engineered BamHI site) and 1204 (engineered SalI site). The amplified fragment was digested with BamHI and SalI and cloned into pRR51 that had been digested by the same enzymes, generating pSSK20. A 2,271 bp fragment downstream of *porV* was amplified using primers 1201 (engineered SalI site) and 1202 (engineered SphI site). This fragment was introduced into pSSK20 that was digested with SalI and SphI, to generate pSSK22. pSSK22 was introduced into the *F. johnsoniae* strain CJ1827 by triparental conjugation. Colonies containing the plasmid integrated into the chromosome were obtained by selecting for erythromycin resistance, and *porV* deletion mutants that had lost the integrated plasmid were obtained by selecting for streptomycin resistance and confirmed by PCR essentially as previously described (30).

*porU* deletion mutants were constructed in a similar manner. A 2,282 bp fragment upstream of *porU* was amplified using primers 1207 (engineered BamHI site) and 1208 (engineered SalI site). The amplified fragment was digested with BamHI and SalI and cloned into pRR51 that had been digested with the same enzymes, generating pSSK21. A 2,305 bp fragment downstream of *porU* was amplified using primers 1205 (engineered SalI site) and 1206 (engineered SphI site). This fragment was ligated with pSSK21 that had been digested with SalI and SphI, generating pSSK23. pSSK23 was used to construct the *porU* deletion strain as described above. A strain with a polar insertion mutation in

*porU* (CJ1818) was also constructed. For this purpose a 1050-bp fragment internal to *porU* was amplified using primers 948 (engineered BamHI site) and 949 (engineered Sall site). This fragment was cloned into pLYL03 which had been cut with BamHI and Sall to generate pSSK01. pSSK01 was introduced into wild-type *F. johnsoniae* UW101 by conjugation, and selection for erythromycin resistance resulted in integration of the plasmid into the genome and disruption of *porU*. The insertion was confirmed by PCR using primers 737 and 948.

For complementation of the *porV* mutant, a 1,516 bp region spanning *porV* was amplified using primers 972 (engineered SphI site) and 973 (engineered KpnI site) and introduced into pCP29, to generate pSSK03. Similarly, for complementation of *porU* mutants, a 4,309 bp region spanning *porU* was amplified using primers 988 (engineered XbaI site) and 989 (engineered BamHI site) and introduced into pCP23, to generate pSSK04.

**Determination of chitinase activity.** Chitin utilization on agar was observed as previously described using colloidal chitin prepared from crab shells (19, 28, 31). Chitinase activities in cell-free culture fluid (spent media), intact cells, and cell extracts were measured as previously described (31) using the synthetic substrates 4-methylumbelliferyl  $\beta$ -D-N,N'-diacetyl-chitobioside [4-MU-(GlcNAc)<sub>2</sub>] and 4-methylumbelliferyl  $\beta$ -D-N, N', N''-diacetyl-chitotrioside [4-MU-(GlcNAc)<sub>3</sub>] (Sigma-Aldrich, St. Louis, MO) except that activities were measured for 30 min. Activities in the spent media (secreted chitinase), intact cells, and cell extracts were indicated as pmol 4-methylumbelliferone released during the 30 min per  $\mu$ g total protein in the original cell

suspension. Protein concentrations were determined by the bicinchoninic acid (BCA) assay (Thermo Fisher Scientific, Waltham, MA).

**Western blot analyses.** *F. johnsoniae* cells were grown to late-exponential phase in MM at 25°C with shaking. Cells were pelleted by centrifugation at 22,000 x g for 15 min, and the spent culture fluid was filtered using 0.22 µm pore-size polyvinylidene difluoride filters (Thermo Fisher Scientific). For whole-cell samples, the cells were suspended in the original culture volume of phosphate buffered saline (PBS) consisting of 137 mM NaCl, 2.7 mM KCl, 10 mM Na<sub>2</sub>PO<sub>4</sub>, and 2 mM KH<sub>2</sub>PO<sub>4</sub> (pH 7.4). Equal amounts of spent media and whole cells were boiled in SDS-PAGE loading buffer for 9 min. Proteins were separated by SDS-PAGE, and Western blot analyses were performed as previously described (31) using affinity purified antibody against ChiA (1:5,000 dilution). Equal amounts of each sample based on the starting material were loaded in each lane. For cell extracts this corresponded to 15 µg protein whereas for spent medium this corresponded to the equivalent volume of spent medium that contained 15 µg cell protein before the cells were removed. For detection of mCherry by Western blot, commercially available antibodies against mCherry (0.5 mg per ml; BioVision Incorporated, Milpitas, CA) were used at dilution of 1:5,000.

Myc-tagged RemA was detected as previously described (41). *F. johnsoniae* cells were grown to late-exponential phase in CYE at 25°C with shaking. Whole cells and spent culture fluid were prepared for SDS-PAGE and Western blots were performed as described above for ChiA, except that antisera against the *c-myc* epitope (1:10,000 dilution; AbCam, Cambridge, MA) were used.

**Analysis for secretion of cell-surface SprB and Myc-tagged RemA.** Secretion of SprB was examined essentially as previously described (32, 40). Briefly, cells were grown overnight in MM without shaking at 25°C. Purified anti-SprB (1 µl of a 1:10 dilution of a 300-mg/liter stock), 0.5- µm-diameter protein G-coated polystyrene spheres (1 µl of a 0.1% stock preparation; Spherotech, Inc., Libertyville, IL), and bovine serum albumin (1 µl of a 1% solution) were added to 7 µl of cells (approximately 5 x 10<sup>8</sup> cells per ml) in MM. The cells were introduced into a tunnel slide (41) and examined by phase contrast microscopy at 25°C. Samples were examined 2 min after spotting, and images were recorded for 30 s to determine the percentage of cells that had anti-SprB-coated spheres attached to them. Surface-localized Myc-tagged RemA was detected similarly, except that antisera against the Myc tag (EQKLISEEDL; AbCam) was used.

**Cell aggregation studies.** The effect of RemA on aggregation was determined as previously described (41). Cultures (10 ml) were grown overnight in test tubes at 25°C in EC medium (5) with appropriate antibiotics on a platform shaker set at 120 rpm. Cultures were examined for turbidity and for accumulation of cell aggregates at the bottom of the tubes.

**Measurement of bacteriophage sensitivity.** *F. johnsoniae* bacteriophages used in this study were φCj1, φCj13, φCj23, φCj28, φCj29, φCj42, φCj48 and φCj54 (5, 27, 43). Sensitivity to phages was determined as previously described (31). Briefly, 3 µl of phage lysate (approximately 10<sup>9</sup> PFU/ml) was spotted onto lawns of cells in CYE overlay agar. The plates were incubated for 24 h at 25°C. A quantitative assay was also used to measure sensitivity to bacteriophages. This involved serial dilution of phage lysates in 10

mM Tris-8 mM MgSO<sub>4</sub> (TM buffer, pH 7.5) and determination of the number of plaque forming units. Wild-type *F. johnsoniae* cells were cultured overnight in CYE at 30°C. 100 µl of phage dilutions were added to 200 µl of cells to allow adsorption. Four ml of overlay agar at 42°C was added and the samples were briefly mixed and poured onto CYE agar plates. After solidification of the overlay agar the plates were incubated for 24 h at 25°C and plaques were counted.

**Microscopic observations of cell attachment.** Wild-type and mutant cells of *F. johnsoniae* were examined for attachment to glass as previously described (40). Cells were grown overnight in MM without shaking at 25°C and harvested at an OD<sub>600</sub> of 0.18. Cells (2.5 µl) were added to a Petroff-Hausser counting chamber, covered with a glass coverslip, and allowed to incubate for 2 min at 25°C. The number of cells attached to 9 randomly selected 0.03 mm<sup>2</sup> regions of the glass coverslip was determined.

**Liquid chromatography-tandem mass spectrometry (LC-MS/MS) analysis.** Cells of *F. johnsoniae* wild type (CJ1827),  $\Delta porU$  mutant CJ2116,  $\Delta porV$  mutant CJ2130 and  $\Delta(gldN gldO)$  mutant CJ2090 (referred to hereafter as  $\Delta gldNO$ ) and cells of complemented mutants were grown in MM at 25°C with shaking until cells reached an OD<sub>600</sub> of 0.7 (late exponential phase of growth). Cells were pelleted by centrifugation at 22,000 x g for 15 min and the spent culture medium was filtered (0.22 µm polyvinylidene difluoride filters) to remove residual cells. Membrane vesicles and insoluble cell debris were removed from the cell-free spent medium by centrifugation at 100,000 x g for 1 h. This process was repeated once to ensure complete removal of insoluble material, the cell-free spent medium was concentrated 1000 fold using Amicon concentrators

(Millipore, Darmstadt, Germany), and proteins were separated by SDS-PAGE and detected using the BioRad (Hercules, CA) silver stain kit. Enzymatic in-gel digestion was performed at the University of WI-Madison Mass Spectrometry Facility as outlined on the website (<https://www.biotech.wisc.edu/services/massspec>).

Peptides were analyzed by nano LC-MS/MS using the Agilent 1100 nanoflow system (Agilent, Palo Alto, CA) connected to a hybrid linear ion trap-orbitrap mass spectrometer (LTQ-Orbitrap, Thermo Fisher Scientific, Bremen, Germany) equipped with an EASY-Spray™ electrospray source. Chromatography of peptides prior to mass spectral analysis was accomplished using a capillary emitter column (PepMap C18, 3 μM, 100Å, 150 x 0.075 mm, Thermo Fisher Scientific) onto which extracted peptides were automatically loaded. NanoHPLC system delivered solvents were as follows: (A) 0.1% (v/v) formic acid in water, and (B) 99.9% (v/v) acetonitrile, 0.1% (v/v) formic acid. Sample loading was performed at 0.60 μL/min and peptide elution directly into the nano-electrospray was performed at 0.3 μL/min using a gradient from 0% (v/v) B to 40% (v/v) B over 20 min followed by a gradient from 40% (v/v) B to 100% (v/v) B over 5 min. As peptides eluted from the HPLC-column/electrospray source survey MS scans were acquired in the Orbitrap with a resolution of 100,000. The 5 most intense peptides per scan were fragmented and detected in the ion trap over the mass range 300 to 2000 m/z. Redundancy was limited by dynamic exclusion. Raw MS/MS data were converted to mgf file format and used to search against a *F. johnsoniae* protein database (5,507 protein entries) concatenated with a list of common lab contaminants. Peptide mass tolerance was set at 20 ppm and fragment mass at 0.8 Da. Scaffold version 4.3.2 (Proteome



Software Inc., Portland, OR) was used to validate MS/MS based peptide and protein identifications. Peptide identifications were accepted if they could be established at greater than 90.0% probability by the Peptide Prophet algorithm (13) with Scaffold delta-mass correction. Protein identifications were accepted if they could be established at greater than 95.0% probability and contained at least 2 identified peptides. Protein probabilities were assigned by the Protein Prophet algorithm (25).

**Analysis of starch utilization.** Wild-type and mutant cells of *F. johnsoniae* were examined for starch hydrolysis using a plate assay. Cells were streaked on CYE agar supplemented with 0.25% starch and incubated overnight at 25°C. Starch was detected by flooding the agar with a solution of 1% KI and 1% iodine.

**Sequence analyses.** Sequences were analyzed with MacVector software (Cary, NC) and comparisons to database sequences were made using the BLAST algorithm (2). Predictions regarding cellular localization were made using PSORTb (45) TMpredict (9), and CELLO (44).

Table 4. Strains and plasmids used in this study.

Strain or plasmid	Genotype and/ or description	Source or reference
<i>F. johnsoniae</i> strains		
UW101 (ATCC 17061)	Wild type	(19, 21)
CJ1631A	$\Delta(gldN\ gldO)$ in <i>F. johnsoniae</i> UW101	(31)
CJ1808	<i>chiA</i> disruption mutant; (Em <sup>r</sup> )	(15)
CJ1818	<i>porU</i> disruption mutant; (Em <sup>r</sup> )	This study
CJ1827	<i>rpsL2</i> ; (Sm <sup>r</sup> ) “wild-type” strain for construction of all deletion mutants except CJ1631A	(30)
CJ1922	<i>rpsL2</i> $\Delta$ <i>sprB</i> ; (Sm <sup>r</sup> )	(30)
CJ1984	<i>rpsL2</i> $\Delta$ <i>remA</i> ; (Sm <sup>r</sup> )	(41)
CJ1985	<i>rpsL2</i> $\Delta$ <i>sprB</i> $\Delta$ <i>remA</i> ; (Sm <sup>r</sup> )	(41)
CJ2082	<i>rpsL2</i> $\Delta$ <i>Fjoh_0288</i> ; (Sm <sup>r</sup> )	This study
CJ2083	<i>rpsL2</i> <i>remA::myc-tag-1</i> ; (Sm <sup>r</sup> )	(41)
CJ2089	<i>rpsL2</i> $\Delta$ ( <i>gldN gldO</i> ) <i>remA::myc-tag-1</i> ; (Sm <sup>r</sup> )	(41)
CJ2090	<i>rpsL2</i> $\Delta$ ( <i>gldN gldO</i> ); (Sm <sup>r</sup> )	(41)
CJ2116	<i>rpsL2</i> $\Delta$ <i>porU</i> ; (Sm <sup>r</sup> )	This study
CJ2130	<i>rpsL2</i> $\Delta$ <i>porV</i> ; (Sm <sup>r</sup> )	This study
CJ2323	<i>rpsL2</i> $\Delta$ <i>porV remA::myc-tag-1</i> ; (Sm <sup>r</sup> )	This study
CJ2445	<i>rpsL2</i> $\Delta$ <i>porV</i> $\Delta$ <i>sprB</i> ; (Sm <sup>r</sup> )	This study
CJ2446	<i>rpsL2</i> $\Delta$ <i>porV</i> $\Delta$ <i>Fjoh_0288</i> ; (Sm <sup>r</sup> )	This study
Plasmids		
pCP23	<i>E. coli-F. johnsoniae</i> shuttle plasmid; Ap <sup>r</sup> (Tc <sup>r</sup> )	(1)
pCP29	<i>E. coli-F. johnsoniae</i> shuttle plasmid; Ap <sup>r</sup> (Cf <sup>r</sup> Em <sup>r</sup> )	(14)
pRR51	<i>rpsL</i> containing suicide vector; Ap <sup>r</sup> (Em <sup>r</sup> )	(30)
pRR39	pCP23 carrying <i>remA</i> ; Ap <sup>r</sup> (Tc <sup>r</sup> )	(41)
pSSK01	1050-bp fragment of <i>porU</i> in pLYL03 for constructing <i>porU</i> disruption mutant CJ1818; Ap <sup>r</sup> (Em <sup>r</sup> )	This study
pSSK03	1,516-bp SphI-KpnI fragment spanning <i>porV</i> amplified with primer 972 and 973 and inserted into pCP29; Ap <sup>r</sup> (Cf <sup>r</sup> Em <sup>r</sup> )	This study
pSSK04	4,309-bp XbaI-BamHI fragment spanning <i>porU</i> amplified with primer 988 and 989 and inserted into pCP23; Ap <sup>r</sup> (Tc <sup>r</sup> )	This study
pSSK14	2332-bp XbaI-SalI fragment downstream of	This study

	<i>Fjoh_0288</i> amplified with primers 1104 and 1105 and inserted into pSSK16; Ap <sup>r</sup> (Em <sup>r</sup> )	
pSSK16	2,301-bp BamHI-XbaI fragment upstream of <i>Fjoh_0288</i> amplified with primers 1102 and 1103 and inserted into pRR51; Ap <sup>r</sup> (Em <sup>r</sup> )	This study
pSSK20	2,442-bp BamHI-SalI region upstream of <i>porV</i> amplified with primers 1203 and 1204 and inserted into pRR51; Ap <sup>r</sup> (Em <sup>r</sup> )	This study
pSSK21	2,282-bp BamHI-SalI region upstream of <i>porU</i> amplified with primers 1207 and 1208 and inserted into pRR51; Ap <sup>r</sup> (Em <sup>r</sup> )	This study
pSSK22	2,271-bp SalI-SphI region downstream of <i>porV</i> amplified with primers 1201 and 1202 and inserted into pSSK20; Ap <sup>r</sup> (Em <sup>r</sup> )	This study
pSSK23	2,305-bp SalI-SphI region downstream of <i>porU</i> amplified with primers 1205 and 1206 and inserted into pSSK21; Ap <sup>r</sup> (Em <sup>r</sup> )	This study
pTB79	pCP23 carrying <i>gldN</i> ; Ap <sup>r</sup> (Tc <sup>r</sup> )	(3)

<sup>a</sup>Antibiotic resistance phenotypes are as follows: ampicillin, Ap<sup>r</sup>; cefoxitin, Cf<sup>r</sup>; erythromycin, Em<sup>r</sup>; streptomycin, Sm<sup>r</sup>; tetracycline, Tc<sup>r</sup>. The antibiotic resistance phenotypes given in parentheses are those expressed in *F. johnsoniae* but not in *E. coli*. The antibiotic resistance phenotypes without parentheses are those expressed in *E. coli* but not in *F. johnsoniae*.

Table 5. Primers used in this study

Primers	Sequence and Description
737	5'-AGGCACCCAGGCTTTACT-3'; Reverse primer binding downstream of multiple cloning site of pLYL03.
948	5' - GCTAGGGATCCTCTTGCAGGCTCAACTACCGGAAT - 3'; Forward primer to construct pSSK01; BamHI site underlined
949	5' - GCTAGGTCGACCTTTTCGCTTGCCAAACCGTCTTCA - 3'; Reverse primer to construct pSSK01; SalI site underlined
972	5' - GCTAGGCATGC TACGTGGGACGGAAGGGATGATTT - 3'; Forward primer used for constructing pSSK03; SphI site underlined
973	5' - GCTAGGGTACCCCTGAGAAAGCTCATTGATGGTGTCG - 3'; Reverse primer to construct pSSK03; KpnI site underlined
988	5' - GCTAGTCTAGAGCCGTGCCAACATCAATACCATT - 3'; Forward primer used for constructing pSSK04; XbaI site underlined
989	5' - GCTAGGGATCCAGTTGCAACACCCTGGTCTCCTAA - 3'; Reverse primer to construct pSSK04; BamHI site underlined
1102	5' - GCTAGGGATCCGGCAAACCTTCGAACTTCGTA - 3'; Forward primer to amplify upstream region of <i>Fjoh_0288</i> to construct pSSK16; BamHI site underlined
1103	5' - GCTAGTCTAGAGGCATCGACACCAATATTCAT - 3'; Reverse primer to amplify upstream region of <i>Fjoh_0288</i> to construct pSSK16; XbaI site underlined
1104	5' - GCTAGTCTAGAGCTTTGTA CTCAAATATTTTTTCGATA - 3'; Forward primer to amplify downstream region of <i>Fjoh_0288</i> to construct pSSK14; XbaI site underlined
1105	5' - GCTAGGTCGACCAGTTTTATCGCCTGAGCTTC - 3'; Reverse primer to amplify downstream region of <i>Fjoh_0288</i> to construct pSSK14; SalI site underlined
1201	5' - GCTAGGTCGACTACCACGAAAGCCCTATGAAAGGA - 3'; Forward primer to amplify downstream region of <i>porV</i> to construct pSSK22; SalI site underlined
1202	5' - GCTAGGCATGCCTCCTTCAGCTACTGTATCACAAC-3'; Reverse primer to amplify downstream region of <i>porV</i> to construct pSSK22; SphI site underlined
1203	5' - GCTAGGGATCCTGCCATTGATGCGTCTGACTAC - 3'; Forward primer to amplify upstream region of <i>porV</i> to construct pSSK20; BamHI site underlined
1204	5' - GCTAGGTCGACAGGGCGCTCAATATCTTGGGCTTT - 3'; Reverse primer to amplify upstream region of <i>porV</i> to construct pSSK20; SalI site underlined
1205	5' - GCTAGGTCGACGATTTTGGCGACCGGATTGGAAAAGGA - 3'; Forward primer to amplify downstream region of <i>porU</i> to construct pSSK23;

	SaI site underlined
1206	5' - GCTAGGCATGCCCATACCAATTGGCTGAACGTGGT - 3'; Reverse primer to amplify downstream region of <i>porU</i> to construct pSSK23; SphI site underlined
1207	5' - GCTAGGGATCCCGACAGTTCCTGCAGTGTTTCTAAGC-3'; Forward primer to amplify upstream region of <i>porU</i> to construct pSSK21; BamHI site underlined
1208	5' - GCTAGGTCGACAAAGTATGCGATCAGGGCTTGTTTCAT - 3'; Reverse primer to amplify upstream region of <i>porU</i> to construct pSSK21; SaI site underlined

## Results

***F. johnsoniae* porU and porV.** Analysis of the *F. johnsoniae* genome revealed orthologs of the *P. gingivalis* T9SS genes *porU* and *porV*. *F. johnsoniae* PorU exhibits 26% identity to *P. gingivalis* PorU over 1170 amino acids, and *F. johnsoniae* PorV exhibits 44% identity to *P. gingivalis* PorV over 385 amino acids. *F. johnsoniae* PorU and PorV have predicted N-terminal signal peptides, and both proteins are predicted by PSORTb and CELLO analyses to reside in the outer membrane. *F. johnsoniae* *porU* and *porV* are located adjacent to each other on the genome (Figure 21) as are *P. gingivalis* *porU* and *porV* (8, 12, 35). A putative promoter (TTG-N18-TANNTTTG) which matches the *Bacteroidetes* housekeeping promoter consensus (6), lies between *porU* and *porV*, and several possible promoter sequences lie upstream of *porU*, suggesting that these genes may be transcribed separately. A predicted terminator begins 25 bp downstream of the *porV* stop codon (AATCCAAATTTCTGCATTTTAGAAATTTGGATTTTTTTT).

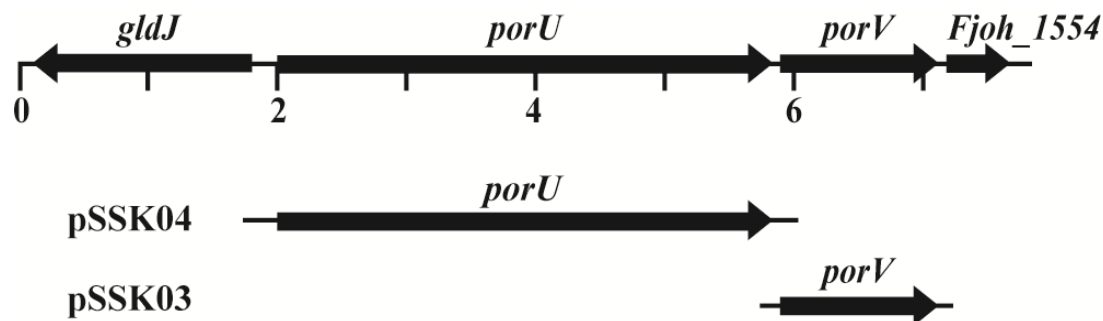

Figure 21. Map of the region spanning *porU* and *porV*. Numbers below the map refer to kilobase pairs of sequence. The regions of DNA carried by complementation plasmids used in this study are indicated beneath the map.

***porV* mutant cells are defective for chitin utilization and for secretion of the chitinase ChiA.** Cells of *F. johnsoniae* T9SS mutants fail to secrete the soluble extracellular chitinase ChiA and are thus defective in chitin utilization (15, 31, 32, 35, 40). The *F. johnsoniae porU* and *porV* genes were deleted to determine whether they have roles in T9SS function. Deletion of *porV* resulted in loss of ability of cells to digest chitin (Figure 22A). Complementation with pSSK03, which carries *porV*, restored this ability. In contrast deletion of *porU* had little effect on chitin digestion. Similarly, insertional disruption of *porU* using the suicide vector pLYL03 also had little effect on chitin utilization. pLYL03 insertions result in polar mutations that prevent expression of downstream genes of an operon (10). The ability of the *porU* disruption mutant to digest chitin (Figure 22A) supports the suggestion made above that *porU* and *porV* are transcribed separately. Chitinase activity was also examined in cell-free spent culture fluid, intact cells, and cell extracts, using a quantitative assay. Chitinase activity was detected in the cell-free spent culture fluid from wild-type cells and from cells of the  $\Delta porU$  mutant, but was not detected in spent culture fluid from cells of the  $\Delta porV$  mutant (Figure 22B), suggesting that PorV was required for secretion of the major soluble extracellular chitinase ChiA. Cell-associated chitinase levels (intact cells and cell extracts) were similar for wild-type and mutant cells. Genome analysis predicted the existence of four chitinases in addition to ChiA that may contribute these activities (21).

Western blot analyses were used to examine the presence of ChiA protein in cells and in the spent culture fluid of wild-type and mutant strains. Wild-type cells secreted ChiA into the culture fluid with little if any ChiA detected in cell extracts (Figure 23). In

contrast cells of the *porV* mutant failed to secrete ChiA and instead accumulated small amounts of the larger proChiA inside of cells. Complementation of the *porV* mutant with pSSK03 resulted in secretion of ChiA into the culture medium and failure to accumulate proChiA inside of cells, similar to wild-type cells. The effect of deletion of *porV* on ChiA secretion was nearly identical to that observed for deletion of the region spanning the T9SS genes *gldN* and *gldO* (Figure. 23). Deletion of other T9SS genes also resulted in failure to secrete ChiA (15). In contrast to the results with the *porV* mutant, cells of the *porU* deletion mutant behaved similar to wild-type cells. The *porU* mutant strain secreted ChiA and failed to accumulate it inside of cells. Secreted ChiA from wild-type and *porU* mutant cells migrated at the same size, suggesting that in *F. johnsoniae* PorU is not required for secretion or processing of ChiA.

Proteins secreted by T9SSs typically have conserved CTDs involved in this process (26, 40, 42). The C-terminal 105 amino acids of ChiA are necessary and sufficient for secretion by the T9SS since mCherry fused to the CTD of ChiA is efficiently secreted by wild-type cells but not by cells of T9SS mutants (15). Secretion of mCherry-CTD<sub>ChiA</sub> by wild-type cells and by *porU* and *porV* mutant cells was examined. Wild-type cells and cells of the *porU* deletion mutant secreted mCherry-CTD<sub>ChiA</sub> (Figure 24). The secreted protein corresponded to the size of mCherry, suggesting that the protein was processed, perhaps removing the CTD, during or after secretion. In contrast, cells of the  $\Delta$ *porV* mutant and of the  $\Delta$ *gldNO* mutant failed to secrete mCherry-CTD<sub>ChiA</sub> and instead accumulated a small amount of a protein corresponding in size to mCherry-



CTD<sub>ChiA</sub> in the cells. The results indicate that PorV is required for secretion of proteins carrying CTD<sub>ChiA</sub>.

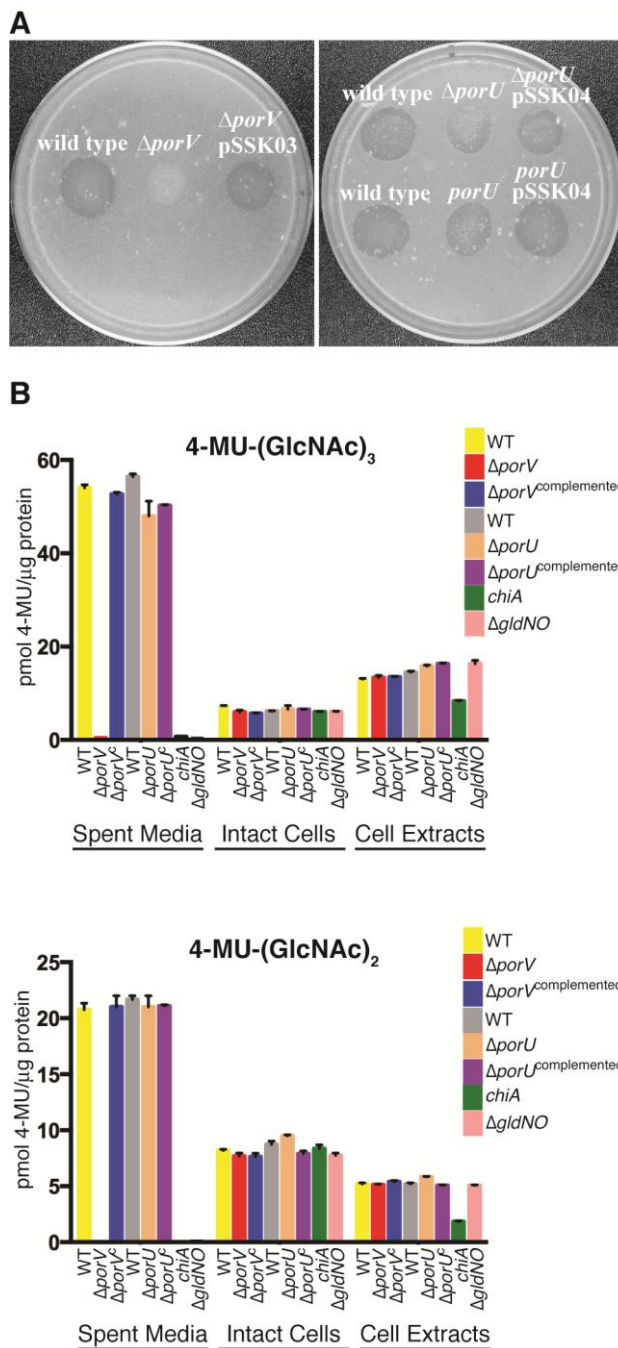

Figure 22. *porV* is required for chitin utilization. A) Chitin digestion on agar media. Approximately  $10^6$  cells of wild-type and mutant strains of *F. johnsoniae* were spotted on MYA-

chitin media (19) and incubated at 25°C for 2.5 d. Left panel, left to right: wild-type *F. johnsoniae* CJ1827; *porV* deletion mutant CJ2130; CJ2130 complemented with pSSK03 which carries *porV*. Right panel, top row left to right: wild-type *F. johnsoniae* CJ1827; *porU* deletion mutant CJ2116; CJ2116 with pSSK04 which carries *porU*. Right panel, bottom row left to right: wild-type *F. johnsoniae* UW101; *porU* disruption mutant CJ1818; CJ1818 with pSSK04 which carries *porU*. B) Chitinase activities of wild-type and mutant cells. Chitinase activities of spent media, intact cells, and cell extracts were determined using the synthetic substrates 4-MU-(GlcNAc)<sub>3</sub>, and 4-MU-(GlcNAc)<sub>2</sub>. Equal amounts of each sample, based on the protein content of the cell suspension, were incubated with 10 nmol of synthetic substrate for 30 min at 37°C, and the amount of 4-MU released was determined by measuring fluorescence emission at 460 nm following excitation at 360 nm. Yellow, wild-type *F. johnsoniae* UW101 carrying control vector pCP29. Red, *porV* deletion mutant CJ2130 carrying pCP29. Blue, CJ2130 complemented with pSSK03 which carries wild-type *porV*. Grey, wild-type *F. johnsoniae* UW101 carrying control vector pCP23. Tan, *porU* deletion mutant CJ2116 carrying pCP23. Purple, CJ2116 complemented with pSSK04 which carries wild-type *porU*. Green, *chiA* mutant CJ1808. Pink, *gldNO* deletion mutant CJ1631A.

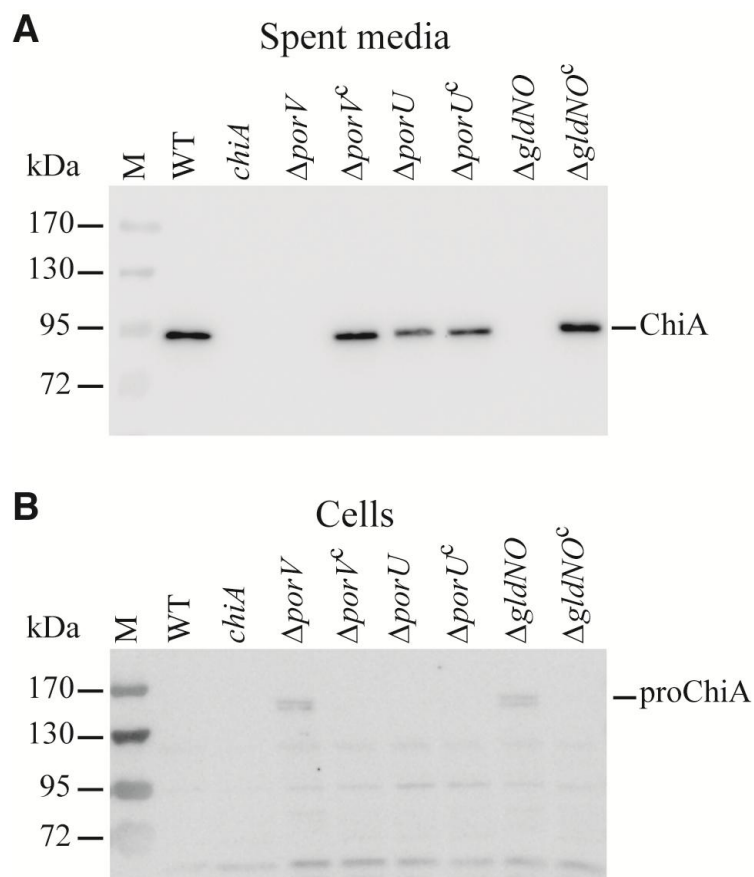

Figure 23. PorV is required for secretion of the soluble extracellular chitinase ChiA. Cell-free spent media (A) and cells (B) were examined for ChiA by SDS-PAGE followed by Western blot analysis using antiserum against recombinant ChiA. M, molecular weight markers. WT, wild-type *F. johnsoniae* CJ1827. *chiA*, *chiA* mutant CJ1808.  $\Delta porV$ , *porV* deletion mutant CJ2130.  $\Delta porV^c$ , CJ2130 complemented with pSSK03 which carries *porV*.  $\Delta porU$ , *porU* deletion mutant CJ2116.  $\Delta porU^c$ , CJ2116 complemented with pSSK04 which carries *porU*.  $\Delta gldNO$ , *gldNO* deletion mutant CJ1631A.  $\Delta gldNO^c$ , CJ1631A complemented with pTB79, which carries *gldN*. Samples loaded in panel B corresponded to 15  $\mu$ g protein per lane, and samples loaded in panel A corresponded to the volume of spent medium that contained 15  $\mu$ g cell protein before the cells were removed.

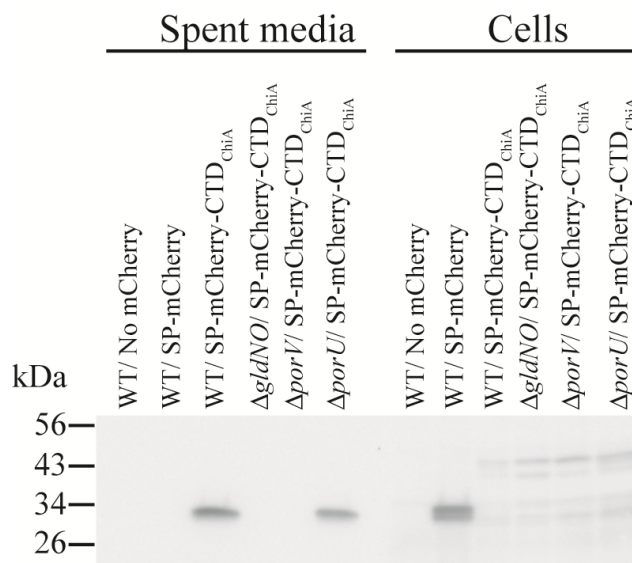

Figure 24. PorV is required for secretion of the heterologous fusion protein mCherry-CTD<sub>ChiA</sub>. Cell-free spent media and whole cells were analyzed for cultures of wild-type (WT) cells carrying pSSK54 that expresses mCherry with the N-terminal signal peptide from ChiA (SP-mCherry), or carrying pSSK52 that expresses mCherry with the N-terminal signal peptide from ChiA and the 105 amino acid C-terminal region of ChiA (SP-mCherry-CTD<sub>ChiA</sub>). Cells and spent media from cultures of the T9SS mutant CJ1631A ( $\Delta gldNO$ ), the *porV* deletion mutant CJ2130 ( $\Delta porV$ ), and the *porU* deletion mutant CJ2116 ( $\Delta porU$ ) each carrying pSSK52 were also analyzed. "No mCherry" indicates spent media or cells from *F. johnsoniae* carrying the control vector pCP23. Cell samples corresponded to 15  $\mu$ g protein per lane and samples from spent media corresponded to the volume of spent media that contained 15  $\mu$ g cell protein before the cells were removed. Samples were separated by SDS-PAGE and mCherry was detected using antiserum against mCherry.

***porV* mutant cells fail to secrete RemA.** The cell-surface motility adhesin RemA is secreted by the T9SS (41). The ability of cells of the *porV* deletion mutant to secrete a Myc-tagged version of RemA was examined using antisera against the *c-myc* peptide. Wild-type and  $\Delta$ *porV* mutant cells produced Myc-tagged RemA (Figure 25, right hand side), but whereas wild-type cells localized RemA on the cell surface, cells of the  $\Delta$ *porV* mutant failed to do this (Table 6). Wild-type cells also secreted substantial amounts of RemA into the culture fluid (Figure. 25, left hand side) whereas cells of the *porV* mutant did not. Soluble secreted RemA from wild-type cells was present as fragments of 100 and 130 kDa, significantly smaller than cell-associated RemA. We do not know if these soluble fragments of RemA are functional, but they serve as additional evidence that PorV is required for secretion of RemA.

RemA is a cell surface galactose/rhamnose-binding lectin, and cells expressing this protein aggregate to form multi-cell clumps (41). This phenomenon is most easily observed when RemA is moderately overexpressed (approximately 10 fold) from plasmid. Wild-type and *porV* mutant cells expressing RemA were examined for the formation of large cell aggregates. Wild-type cells aggregated extensively, rapidly falling to the bottom of the culture fluid, whereas cells of the *porV* mutant remained dispersed (Figure 26), further indicating that *porV* mutant cells fail to secrete RemA to the cell surface.

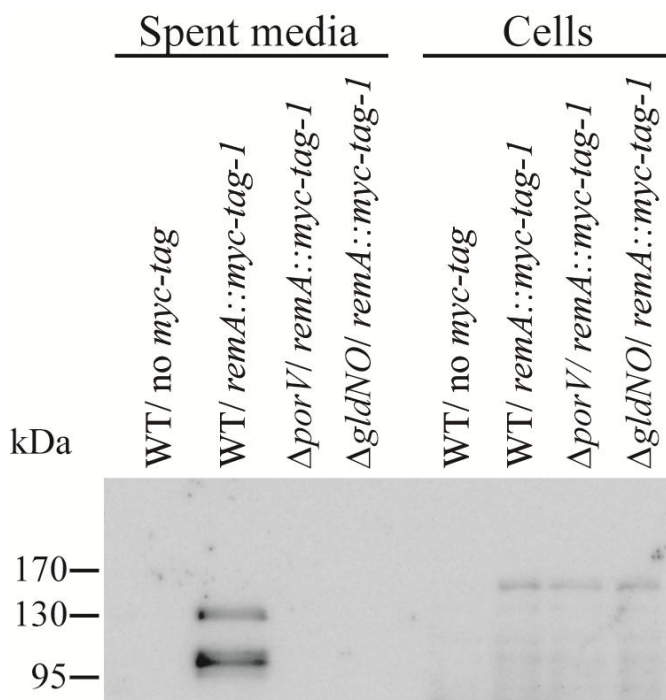

Figure 25. Deletion of *porV* disrupts secretion of RemA. Immunodetection of Myc-tagged RemA in spent media or in cells of wild-type or mutant *F. johnsoniae* strains. Cell-free spent media and whole cells were analyzed for cultures of wild type *F. johnsoniae* CJ1827 (WT, no *myc-tag*), CJ2083 (WT, *remA::myc-tag-1*), CJ2323 ( $\Delta$ *porV remA::myc-tag-1*), and CJ2089 ( $\Delta$ *gldNO, remA::myc-tag-1*). Cell samples corresponded to 20  $\mu$ g protein per lane and samples from spent media corresponded to the volume of spent media that contained 20  $\mu$ g cell protein before the cells were removed. Samples were separated by SDS-PAGE and Myc-tagged RemA was detected using antiserum against the Myc-tag peptide.

Table 6. Deletion of *porV* disrupts secretion of Myc-tagged RemA.

Strain	Description	Antibody added	Avg (SD) % of cells with spheres attached <sup>a</sup>
CJ1827	Wild type, no <i>myc</i> -tag	Anti-Myc	0.0 (0.0)
CJ2083	Wild type, <i>remA::myc</i> -tag-1	No antibody	0.0 (0.0)
CJ2083	Wild type, <i>remA::myc</i> -tag-1	Anti-Myc	44.6 (3.3)
CJ2323	$\Delta$ <i>porV</i> , <i>remA::myc</i> -tag-1	Anti-Myc	0.0 (0.0)
CJ2323/pSSK03	$\Delta$ <i>porV</i> , <i>remA::myc</i> -tag-1, complemented with pSSK03 carrying <i>porV</i>	Anti-Myc	40.6 (3.0)

<sup>a</sup> Purified anti-Myc-tag antiserum and 0.5- $\mu$ m-diameter protein G-coated polystyrene spheres were added to cells as described in Materials and Methods. Samples were introduced into a tunnel slide, incubated for 2 min at 25°C, and examined using a phase-contrast microscope. Images were recorded for 30 s, and 100 randomly selected cells were examined for the presence of spheres that remained attached to the cells during this time. The numbers in parentheses are standard deviations calculated from three measurements.

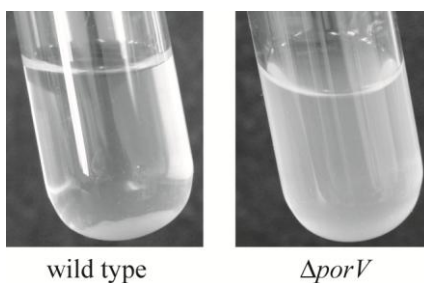

Figure 26. Effect of *porV* on RemA-mediated cell aggregation. Cells of CJ1827 (wild type) and CJ2130 ( $\Delta$ *porV*) were incubated in EC medium for 16 h at 25°C. Both strains carried *remA*-expressing plasmid pRR39.

**PorU and PorV are not required for secretion of the major motility adhesin SprB, or for gliding motility.** The T9SS is required for secretion of the motility adhesin SprB to the cell-surface (31, 32, 35, 40). Antibodies against SprB were used to determine if SprB was present on the surface of  $\Delta porU$  and  $\Delta porV$  mutant cells. Latex spheres coated with antibodies against SprB readily attached to wild-type,  $\Delta porU$ , and  $\Delta porV$  mutant cells (Table 7). In contrast, they failed to attach to cells of the T9SS mutant CJ2090 ( $\Delta glfNO$ ), or to cells of the *sprB* deletion mutant CJ1922. These results indicate that although PorV is required for secretion of RemA and ChiA it is not required for secretion of SprB.

The presence of SprB on the cell surface is required for efficient cell movement over agar resulting in the formation of spreading colonies. Cells of *sprB* mutants, and cells of T9SS mutants that disrupt secretion of SprB, form nonspreading colonies (24, 31, 32, 35, 40). In contrast, cells of *porU* and *porV* mutants formed spreading colonies (Figure 27), consistent with the ability of these mutants to express and secrete SprB. As shown above *porV* mutant cells were deficient in secretion of the motility adhesin RemA. However, as previously reported (41), and as confirmed in this study (Figure 27), deletion of *remA* had no effect on movement of cells over agar. Although not required for movement over agar, RemA is thought to facilitate attachment to and movement over other types of surfaces (such as glass) that are coated with rhamnose- or galactose-containing polysaccharides produced by the cells (41).



Table 7. PorV and PorU are not required for localization of SprB to the cell surface.

Strain	Description	Antibody added	Avg (SD) % of cells with spheres attached <sup>a</sup>
CJ1827	Wild type	No antibody	0.0 (0.0)
CJ1827	Wild type	Anti-SprB	44.5 (3.54)
CJ1827/pCP29	Wild type with empty vector pCP29	Anti-SprB	43.5 (3.05)
CJ1827/pCP23	Wild type with empty vector pCP23	Anti-SprB	39.5 (3.48)
CJ1922	$\Delta sprB$	Anti-SprB	0.0 (0.0)
CJ2090	$\Delta(gldN gldO)$	Anti-SprB	0.0 (0.0)
CJ2130/pCP29	$\Delta porV$ with empty vector pCP29	Anti-SprB	30.4 (2.9)
CJ2130/pSSK03	$\Delta porV$ complemented with pSSK03 carrying <i>porV</i>	Anti-SprB	37.5 (1.88)
CJ2116/pCP23	$\Delta porU$ with empty vector pCP23	Anti-SprB	37.0 (2.17)
CJ2116/pSSK04	$\Delta porU$ complemented with pSSK04 carrying <i>porU</i>	Anti-SprB	35.8 (2.51)

<sup>a</sup> Purified anti-SprB antiserum and 0.5- $\mu$ m-diameter protein G-coated polystyrene spheres were added to cells as described in Materials and Methods. Samples were introduced into a tunnel slide, incubated for 2 min at 25°C, and examined using a phase-contrast microscope. Images were recorded for 30 s, and 100 randomly selected cells were examined for the presence of spheres that remained attached to the cells during this time. The numbers in parentheses are standard deviations calculated from three measurements.

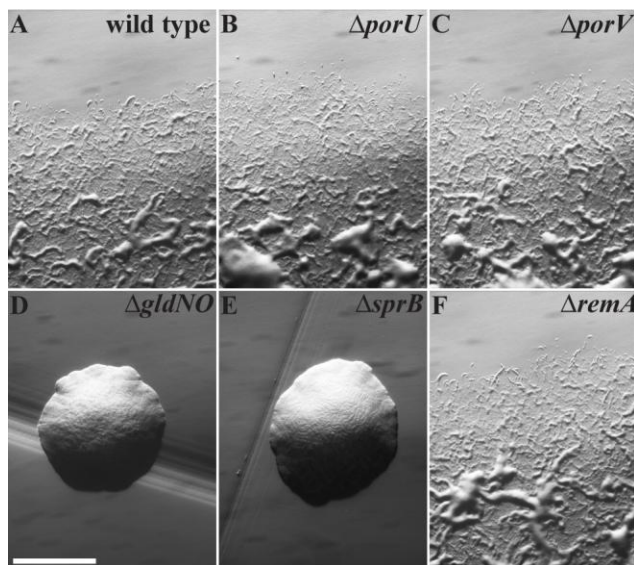

Figure 27. Photomicrographs of *F. johnsoniae* colonies. Colonies grown from single cells were incubated at 25°C on PY2 agar for 44 h. Photomicrographs were taken with a Photometrics CoolSNAP<sub>cf</sub><sup>2</sup> camera mounted on an Olympus IMT-2 phase-contrast microscope. (A) Wild type *F. johnsoniae* CJ1827. (B) *porU* deletion mutant CJ2116. (C) *porV* deletion mutant CJ2130. (D) *gldNO* deletion mutant CJ2090. (E) *sprB* deletion mutant CJ1922. (F) *remA* deletion mutant CJ1984. Bar in panel D indicates 1 mm and applies to all panels.

***porV* mutant cells are resistant to some *F. johnsoniae* phages.** Cells with mutations in genes essential for T9SS function exhibit resistance to all known bacteriophages that infect *F. johnsoniae* (31, 32, 40). For example, cells of the  $\Delta gldNO$  mutant CJ2090 were resistant to all bacteriophages tested (Figure 28I). This is thought to be the result of inability to secrete cell surface proteins that function as phage receptors, such as SprB, RemA, and other motility adhesins (24, 40, 41). *porU* mutants remained sensitive to all phages (Figure 28B), consistent with the findings presented above that

PorU is not required for secretion by the *F. johnsoniae* T9SS. In contrast, the *porV* deletion mutant CJ2130 was resistant to at least two of the eight phages tested,  $\phi$ Cj48 and  $\phi$ Cj54 (Figure 28C and see Table 8). Complementation with pSSK03, which carries *porV*, restored sensitivity to these phages. Previous results indicated that SprB is a likely receptor for phages  $\phi$ Cj1,  $\phi$ Cj13, and  $\phi$ Cj23, and one of several receptors for  $\phi$ Cj29 (24, 40) (and see Figure 28F). Sensitivity of the *porV* mutant to phages  $\phi$ Cj1,  $\phi$ Cj13,  $\phi$ Cj23, and  $\phi$ Cj29 supports the suggestion made above that PorV is not required for secretion of SprB. PorV is required for the secretion of RemA, as shown above, and it is also likely to be involved in the secretion of other cell surface proteins. This is illustrated by the sensitivity of the  $\Delta$ *remA* mutant to phages  $\phi$ Cj48 and  $\phi$ Cj54 compared to the complete resistance of the  $\Delta$ *porV* mutant to these phages (see table 8). Comparison of the phage resistances of the  $\Delta$ *sprB* and  $\Delta$ *porV* mutants with the  $\Delta$ *sprB*  $\Delta$ *porV* double mutant suggests that some phages may use multiple cell-surface receptors. Cells of the  $\Delta$ *sprB* or  $\Delta$ *porV* mutants were susceptible to  $\phi$ Cj29 and  $\phi$ Cj42 whereas cells of the double mutant ( $\Delta$ *sprB*  $\Delta$ *porV*) were completely resistant to both phages (Figure 28 compare panels C, F and H, and see Table 8). Phages  $\phi$ Cj29 and  $\phi$ Cj42 may use either SprB, or cell surface proteins secreted by PorV, as receptors.

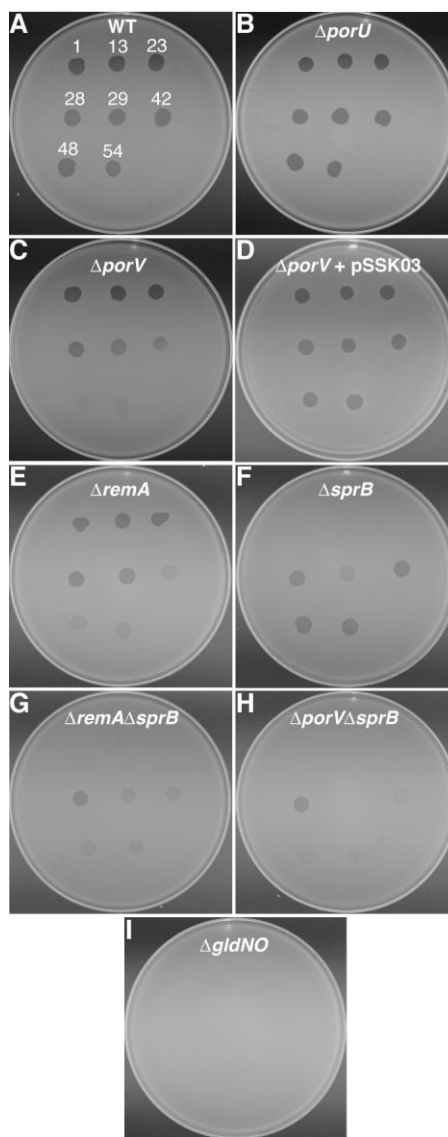

Figure 28. Susceptibility of wild-type and mutant cells to bacteriophages. Bacteriophages (3  $\mu$ l of lysates containing approximately  $10^9$  PFU/ml) were spotted onto lawns of cells in CYE overlay agar. The plates were incubated at 25°C for 24 h to observe lysis. Bacteriophages were spotted in the following order from left to right, as also indicated by the numbers in panel A: top row,  $\phi$ Cj1,  $\phi$ Cj13, and  $\phi$ Cj23; middle row  $\phi$ Cj28,  $\phi$ Cj29, and  $\phi$ Cj42; bottom row,  $\phi$ Cj48 and  $\phi$ Cj54. (A) Wild-type *F. johnsoniae* CJ1827. (B) CJ2116 ( $\Delta porU$ ). (C) CJ2130 ( $\Delta porV$ ). (D) CJ2130 complemented with pSSK03 which carries *porV*. (E) CJ1984 ( $\Delta remA$ ). (F) CJ1922 ( $\Delta sprB$ ). (G) CJ1985 ( $\Delta remA \Delta sprB$ ). (H) CJ2445 ( $\Delta porV \Delta sprB$ ). (I) CJ2090 ( $\Delta gldNO$ ).

Table 8. Bacteriophage sensitivity of *F. johnsoniae* wild-type and mutant strains<sup>a</sup>.

Phage Host Strain	φ1 pfu/ml	φ13 pfu/ml	φ23 pfu/ml	φ28 pfu/ml	φ29 pfu/ml	φ42 pfu/ml	φ48 pfu/ml	φ54 pfu/ml
WT (CJ1827)	1.5 x 10 <sup>8</sup>	1.6 x 10 <sup>8</sup>	1.5 x 10 <sup>8</sup>	1.7 x 10 <sup>9</sup>	1.5 x 10 <sup>9</sup>	1.7 x 10 <sup>9</sup>	1.7 x 10 <sup>9</sup>	1.7 x 10 <sup>9</sup>
Δ <i>porU</i>	1.5 x 10 <sup>8</sup>	1.5 x 10 <sup>8</sup>	1.5 x 10 <sup>8</sup>	1.7 x 10 <sup>9</sup>	1.4 x 10 <sup>9</sup>	1.6 x 10 <sup>9</sup>	1.6 x 10 <sup>9</sup>	1.7 x 10 <sup>9</sup>
Δ <i>porV</i>	1.4 x 10 <sup>8</sup>	1.4 x 10 <sup>8</sup>	1.5 x 10 <sup>8</sup>	1.7 x 10 <sup>9</sup>	1.1 x 10 <sup>9</sup>	1.3 x 10 <sup>9</sup>	< 10	< 10
Δ <i>porV</i> + pSSK03	1.5 x 10 <sup>8</sup>	1.5 x 10 <sup>8</sup>	1.5 x 10 <sup>8</sup>	1.7 x 10 <sup>9</sup>	1.4 x 10 <sup>9</sup>	1.6 x 10 <sup>9</sup>	1.6 x 10 <sup>9</sup>	1.7 x 10 <sup>9</sup>
Δ <i>remA</i>	1.5 x 10 <sup>8</sup>	1.5 x 10 <sup>8</sup>	1.5 x 10 <sup>8</sup>	1.7 x 10 <sup>9</sup>	1.5 x 10 <sup>9</sup>	1.5 x 10 <sup>9</sup>	1.5 x 10 <sup>9</sup>	1.6 x 10 <sup>9</sup>
Δ <i>sprB</i>	< 10	1.2 x 10 <sup>3</sup>	< 10	1.7 x 10 <sup>9</sup>	1.0 x 10 <sup>9</sup>	1.7 x 10 <sup>9</sup>	1.6 x 10 <sup>9</sup>	1.7 x 10 <sup>9</sup>
Δ <i>remA</i> Δ <i>sprB</i>	< 10	1.1 x 10 <sup>3</sup>	< 10	1.7 x 10 <sup>9</sup>	1.0 x 10 <sup>9</sup>	1.4 x 10 <sup>9</sup>	1.5 x 10 <sup>9</sup>	1.6 x 10 <sup>9</sup>
Δ <i>porV</i> Δ <i>sprB</i>	< 10	< 10	< 10	1.7 x 10 <sup>9</sup>	< 10	< 10	< 10	< 10
Δ <i>gldNO</i>	< 10	< 10	< 10	< 10	< 10	< 10	< 10	< 10

<sup>a</sup> Each phage stock was serially diluted, mixed with cells of *F. johnsoniae*, plated on CYE agar in CYE overlay agar, incubated 24 h at 25°C, and the number of plaque forming units (pfu) per ml of original phage stock was determined on each bacterial strain. '<10' indicates that no plaques were observed even when 0.1 ml of undiluted phage stock was tested. 'WT' indicates the streptomycin resistant *rpsL2* strain CJ1827, which is wild-type for secretion and motility and was used to construct deletion mutants. Δ*porU*, CJ2116. Δ*porV*, CJ2130. Δ*remA*, CJ1984. Δ*sprB*, CJ1922. Δ*remA* Δ*sprB*, CJ1985. Δ*porV* Δ*sprB*, CJ2445. Δ*gldNO*, CJ2090. pSSK03 carries *porV* and was used to complement the Δ*porV* mutant.

**Cells of  $\Delta porV$  mutant are defective in attachment to glass.** Wild-type cells attached efficiently to glass whereas cells of  $\Delta gldNO$  mutant CJ2090 were completely deficient in attachment (Table 9). This supports the previous suggestion that the T9SS secretes cell-surface adhesins (40). The motility adhesins SprB and RemA are secreted by the T9SS and their absence on the surface of T9SS mutants accounts for some of the defect in attachment. Cells of the *sprB* deletion mutant CJ1922 attached well to glass and cells of the *remA* deletion mutant CJ1984 appear to have had a slight deficiency in attachment, but cells of the double mutant CJ1985 ( $\Delta remA \Delta sprB$ ) exhibited a substantial defect in attachment (Table 9). An even greater defect in attachment was observed for cells of the  $\Delta porV$  mutant CJ2130, suggesting that PorV is required for secretion of other adhesins in addition to RemA. The few  $\Delta porV$  mutant cells that attached to glass exhibited gliding motility, consistent with the results described above that indicated that PorV was not required for gliding motility. CJ2445 ( $\Delta porV \Delta sprB$ ) was almost entirely deficient in attachment to glass, suggesting that PorV is required for secretion of most of the glass-binding adhesins other than SprB. The results suggest that RemA, SprB, and other adhesins secreted by the T9SS are responsible for attachment to glass. Some of these adhesins may function as phage receptors, helping to explain the phage resistance of *porV* mutant cells (Figure 28). Cells of the *porU* mutant CJ2116 attached to glass almost as well as wild-type cells, indicating that PorU is not required for secretion of the *F. johnsoniae* adhesins.

Table 9. Deletion of *porV* results in decreased attachment of cells to glass.

Strain	Description	Avg (SD) no. of cells attached to 0.03-mm <sup>2</sup> region of glass coverslip <sup>a</sup>
CJ1827	Wild type	40.5 (2.2)
CJ1827/pCP29	Wild type with empty vector pCP29	38.7 (6.7)
CJ1827/pCP23	Wild type with empty vector pCP23	32.4 (6.7)
CJ2090	$\Delta(gldN\ gldO)$	0.0 (0.0)
CJ1984/pCP29	$\Delta remA$ with empty vector pCP29	32.3 (6.5)
CJ1922/pCP29	$\Delta sprB$ with empty vector pCP29	41.4 (9.0)
CJ1985/pCP29	$\Delta remA\ \Delta sprB$ with empty vector pCP29	17.8 (5.5)
CJ2130/pCP29	$\Delta porV$ with empty vector pCP29	7.0 (1.6)
CJ2130/pSSK03	$\Delta porV$ complemented with pSSK03 carrying <i>porV</i>	31.3 (2.7)
CJ2445/pCP29	$\Delta porV\ \Delta sprB$ with empty vector pCP29	0.1 (0.3)
CJ2116/pCP23	$\Delta porU$ with empty vector pCP23	31.5 (2.7)
CJ2116/pSSK04	$\Delta porU$ complemented with pSSK04 carrying <i>porU</i>	30.3 (2.7)

<sup>a</sup> Approximately 10<sup>6</sup> cells in 2.5  $\mu$ l of MM medium were introduced into a Petroff-Hausser counting chamber and incubated for 2 min at 25°C. Samples were observed using an Olympus BH-2 phase-contrast microscope, and cells attached to a 0.03-mm<sup>2</sup> region of the cover glass were counted. Numbers in parentheses are standard deviations calculated from 9 measurements.

***porV* mutant cells appear to be defective for secretion of at least thirty-two additional proteins.** Spent culture fluid of wild-type,  $\Delta gldNO$ ,  $\Delta porV$ , and  $\Delta porU$  mutant cells, and of complemented cells, were examined for the presence of secreted proteins by SDS-PAGE. Several prominent bands between 60 and 240 kDa that were present in the cell-free spent culture fluids from wild-type and  $\Delta porU$  mutant cells were absent or decreased in intensity in culture fluid of  $\Delta gldNO$ , and  $\Delta porV$  mutant cells, and

were restored to near wild-type levels in the complemented mutants (Figure 29). LC-MS/MS analysis of one of these bands, at approximately 90 kDa, demonstrated that it corresponded to ChiA (Figure 30), which as mentioned above is secreted by the T9SS.

The regions of the gels in Figure 30 between 60 and 240 kDa were excised and analyzed by LC-MS/MS (Table 10), and see TableS3 in the supplemental material of (47)). Proteins present in the culture fluid from wild-type cells, but absent or greatly reduced in culture fluid from the  $\Delta$ *gldNO* mutant, included eighteen proteins with TIGR04183 CTDs (including RemA), six proteins with TIGR04131 CTDs, and nine proteins that lacked obvious conserved CTDs. Twenty-six of the proteins mentioned above were also absent or greatly reduced in the cell-free culture fluid of the  $\Delta$ *porV* mutant. The other seven proteins (Fjoh\_0601, Fjoh\_0602, Fjoh\_0604, Fjoh\_0606, Fjoh\_1123, Fjoh\_3952, Fjoh\_4934) apparently do not require PorV for secretion by the T9SS. All of the proteins listed in Table 10 that have TIGR04183-type CTDs required PorV for efficient secretion. Proteins in cell-free culture fluid of  $\Delta$ *porU* mutant cells were similar to those in culture fluid of wild-type cells (Figure 29), although a few proteins were apparently reduced in intensity or absent in the culture fluid from the  $\Delta$ *porU* mutant (Table 10). These results indicate that PorU is not required for *F. johnsoniae* T9SS-mediated secretion, but it may enhance the secretion of some proteins.

In addition to the proteins that appeared to be secreted by the T9SS mentioned above many other proteins were also identified in the cell-free culture fluid (see Table S3 in the supplemental material of (47)). Analysis of the *F. johnsoniae* genome suggested the presence of a type II secretion system (22) which may account for the secretion of



some of these proteins. Some proteins were present in much higher amounts in the culture fluid of T9SS mutants than in the culture fluid of wild-type cells (see Table S3 in the supplemental material (47)). These may be cellular (non-secreted) proteins that were released because of cell surface defects of the T9SS mutants. Consistent with this, many of these proteins were predicted to localize to the cytoplasm, periplasm, or outer membrane, where they presumably reside in wild-type cells.

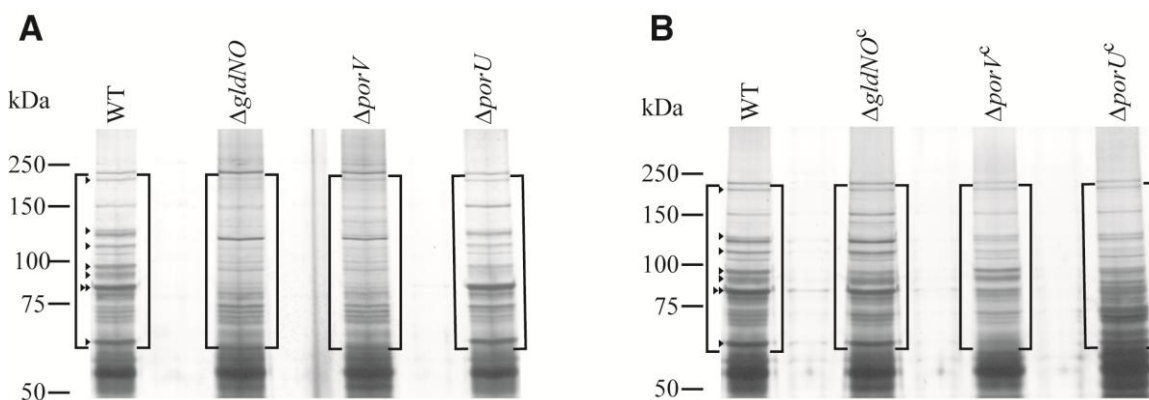

Figure 29. Soluble extracellular proteins of wild-type and mutant cells. Cells of *F. johnsoniae* wild type (CJ1827),  $\Delta gldNO$  mutant (CJ2090),  $\Delta porV$  mutant (CJ2130),  $\Delta porU$  mutant (CJ2116), CJ2090 complemented with pTB79 which carries *gldN*, CJ2130 complemented with pSSK03 which carries *porV*, and CJ2116 complemented with pSSK04 which carries *porU*, were grown in MM at 25°C with shaking until cells reached an  $OD_{600}$  of 0.7. Equal amounts of cell-free spent media of wild-type and mutant cells were separated by SDS-PAGE and proteins were detected by silver staining. Arrowheads indicate bands present in the culture fluid of wild-type cells that were absent or reduced in intensity in the culture fluid of the  $\Delta gldNO$  mutant cells. The double arrowhead corresponds to the N-terminal fragment of ChiA (Figure 30). The boxed regions were subjected to LC-MS/MS analysis (Table 10) and see Table S3 in the supplemental material (47)).

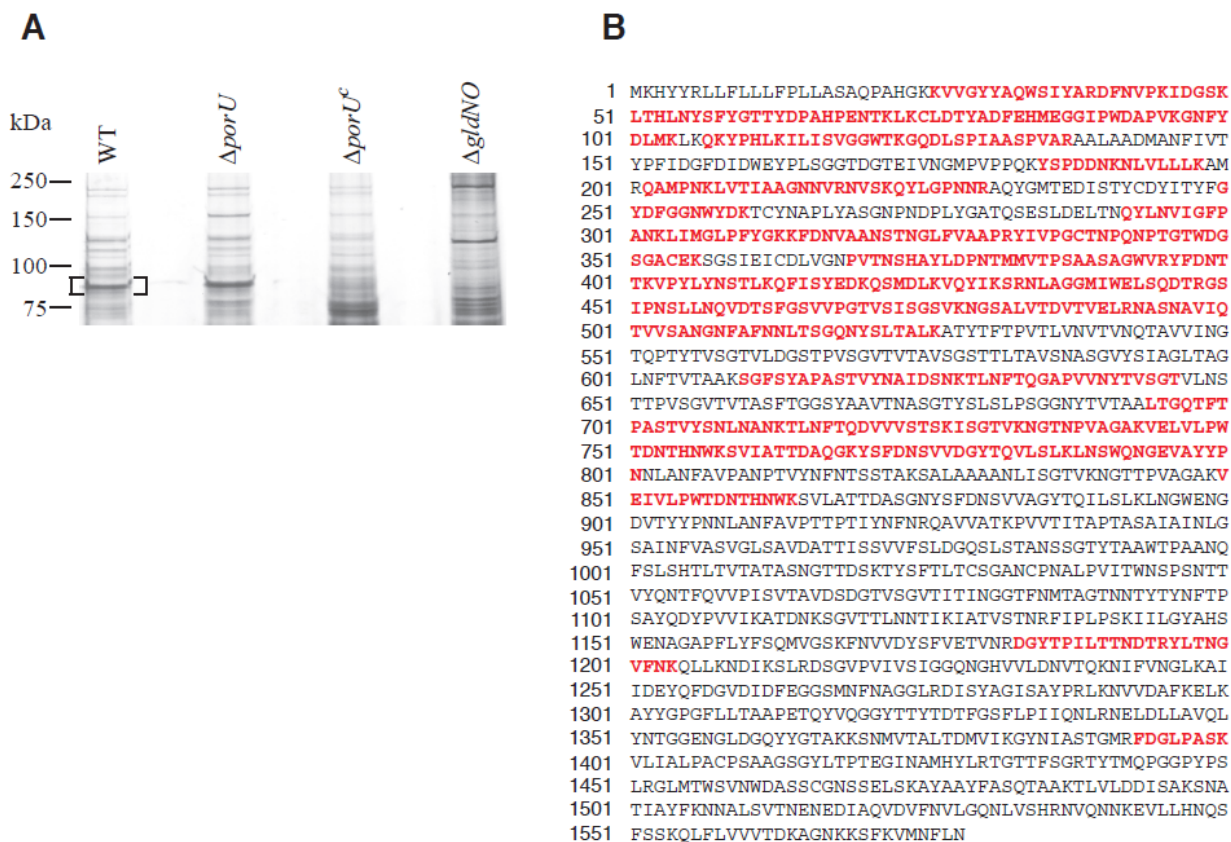

Figure 30. The approximately 90 kDa protein present in culture fluid of wild-type cells but not in culture fluid of the  $\Delta gldNO$  mutant corresponds to the N-terminal portion of ChiA. A) Cell-free spent medium from wild-type cells (WT) and from cells of the  $\Delta porU$  mutant,  $\Delta porU$  mutant complemented with pSSK04, and  $\Delta gldNO$  mutant were separated by SDS-PAGE and proteins were detected by silver staining. The approximately 90 kDa band that was present in the cell-free culture fluid of wild-type cells (bracketed) but was not present in culture fluid of the  $\Delta gldNO$  mutant was cut from the gel and subjected to LC-MS/MS analysis. B) The primary amino acid sequence of ChiA is shown, with the regions detected by LC-MS/MS highlighted in red. 469 spectral matches were detected to ChiA. All of these except for 3 fell between amino acids 26 and 864, which corresponds to the amino-proximal region of the protein after removal of the signal peptide. ChiA has previously been shown to be processed into N-terminal and C-terminal fragments, each of which has a chitinase catalytic domain (15).

Table 10. Candidate proteins secreted by the T9SS identified by LC-MS/MS analysis of cell-free culture fluid<sup>a</sup>.

Locus tag/Protein name	Mol mass <sup>b</sup> (kDa)	Predicted localization <sup>c</sup>	CTD <sup>d</sup>	Predicted protein function <sup>e</sup>	Wild type	$\Delta gldNO$	$\Delta gldNO$ + pTB79	$\Delta porV$	$\Delta porV$ + pSSK03	$\Delta porU$	$\Delta porU$ + pSSK04
Fjoh_0074	123.1	OM, E	TIGR04183	Nuclease/phosphatase	42	3	108	7	84	95	129
Fjoh_0601	208.2	OM			115	0	84	71	78	118	148
Fjoh_0602	279.3	OM			68	0	38	57	59	65	86
Fjoh_0604	144.2	E			47	0	39	42	44	40	45
Fjoh_0606	409.5	OM			163	0	172	77	169	176	198
Fjoh_0808/ RemA	154.0	E	TIGR04183	Motility adhesin	38	0	47	0	56	37	67
Fjoh_0886	99.1	E	TIGR04183	Peptidase	12	0	19	0	21	14	18
Fjoh_1022	51.1	E	TIGR04183	Licheninase	6	0	6	0	6	1	8
Fjoh_1123	121.9	E, OM	TIGR04131		34	0	10	27	3	37	32
Fjoh_1188	152.7	E, OM	TIGR04183		49	0	104	0	42	52	75
Fjoh_1189	181.4	E	TIGR04183	Lectin	74	0	112	1	69	112	79
Fjoh_1208	112.5	E	TIGR04183	$\alpha$ amylase	45	0	66	6	91	58	126
Fjoh_1231	97.8	E	TIGR04183	Pectate lyase	9	0	13	0	6	35	31
Fjoh_1269	94.3	E, OM	TIGR04183		27	4	43	3	40	34	56
Fjoh_1408 <sup>f</sup>	106.0	E	TIGR04183	$\alpha$ amylase	2	0	4	0	2	0	6
Fjoh_1645 <sup>f</sup>	258.1	E	TIGR04131		2	0	6	0	1	2	3
Fjoh_2150	39.0	E, OM	TIGR04183		6	0	6	0	7	3	3
Fjoh_2273	93.3	E	TIGR04131		4	0	5	1	5	5	1
Fjoh_2389 <sup>f</sup>	57.7	E, OM	TIGR04183	Peptidase	2	0	7	0	12	0	6
Fjoh_2667	129.7	OM			28	0	7	0	3	5	33
Fjoh_2687	155.8	E			26	1	26	7	35	26	43

Fjoh_3108	30.9	OM, E, P			7	0	10	0	8	0	10
Fjoh_3246	299.4	OM, E	TIGR04183		12	0	77	0	6	23	41
Fjoh_3324	105.3	E	TIGR04183	Carbohydrate-binding	16	1	40	5	20	49	59
Fjoh_3729	195.1	OM			46	0	32	0	52	23	79
Fjoh_3777	128.1	OM, E	TIGR04183	Deacylase	10	0	25	0	9	10	34
Fjoh_3952	330.6	E	TIGR04131		22	0	11	12	16	11	17
Fjoh_4174	102.5	E	TIGR04183	Carbohydrate-binding	40	5	40	6	62	55	36
Fjoh_4176	95.4	E	TIGR04183	Carbohydrate-binding	48	3	65	7	63	108	76
Fjoh_4177	144.9	E	TIGR04183	Glycoside hydrolase	22	0	35	0	34	67	60
Fjoh_4750	158.1	E	TIGR04131		13	0	3	3	3	3	10
Fjoh_4819	112.5	C, OM, P		Glycoside hydrolase	34	0	5	0	1	12	9
Fjoh_4934	84.8	E	TIGR04131		11	1	7	19	4	17	17

<sup>a</sup> Proteins in cell-free culture fluid from wild type *F. johnsoniae* CJ1827,  $\Delta$ *gldNO* mutant CJ2090,  $\Delta$ *porV* mutant CJ2130,  $\Delta$ *porU* mutant CJ2116,  $\Delta$ *gldNO* complemented with pTB79,  $\Delta$ *porV* complemented with pSSK03, and  $\Delta$ *porU* complemented with pSSK04 were separated by SDS-PAGE, silver stained, and the regions shown in Figure 29 spanning approximately 60 to 240 kDa were cut from the gel and analyzed by LC-MS/MS. Total/unweighted spectrum counts corresponding to total number of spectra associated to a single protein and indicative of relative abundance of that protein are indicated for each of the seven strains analyzed. For the complete data set including proteins that were apparently secreted by other secretion systems or were released by cell lysis see Table S3 in the supplemental material of (47).

<sup>b</sup> Mol mass, molecular mass as calculated for full-length protein before removal of signal peptide. <sup>c</sup> Protein localization as predicted by CELLO v 2.5 subcellular localization predictor (44). OM-outer membrane, E-extracellular, P-periplasmic and C-cytoplasmic.

<sup>d</sup> CTD-type identified by BLASTP analysis.

<sup>e</sup> Predicted protein functions as listed on the Integrated Microbial Genomes website (<https://img.jgi.doe.gov>), except for RemA (41).

<sup>f</sup> The small number of spectra identified from wild type cells for these proteins made the prediction of secretion by the T9SS less certain. These proteins were included because no spectra were observed from  $\Delta$ *gldNO* or  $\Delta$ *porV* mutant cells and because complementation of the  $\Delta$ *gldNO* mutant resulted in 4 to 7 spectral hits for each protein.

**The T9SS and PorV are required for efficient starch utilization.** The predicted  $\alpha$ -amylases Fjoh\_1208 and Fjoh\_1408 were detected in cell-free culture fluid of wild-type cells but not in culture fluid of  $\Delta gldNO$  mutant cells (Table 10). Examination of wild-type and mutant cells confirmed that the T9SS has a role in starch utilization (Figure 31). The  $\Delta gldNO$  and  $\Delta porV$  mutant cells were partially deficient in digestion of starch. The small amount of residual starch digestion detected with these mutants may be the result of additional amylases released by other secretion systems, or may indicate that a small amount of Fjoh\_1208 or Fjoh\_1408 was released from the mutant cells.

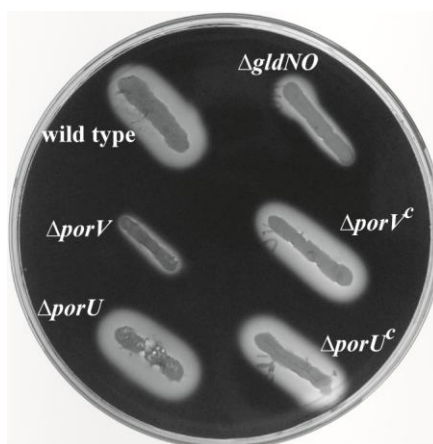

Figure 31. Starch digestion by wild-type and mutant cells. Cells were streaked on CYE agar containing 0.25% starch and incubated overnight at 25°C. The agar was flooded with a solution of 1% KI and 1% iodine to detect starch. Clearing zones around the cells indicate starch digestion. Wild type: *F. johnsoniae* CJ1827.  $\Delta gldNO$ : *gldNO* deletion mutant CJ2090.  $\Delta porV$ : *porV* deletion mutant CJ2130.  $\Delta porV^c$ : CJ2130 complemented with pSSK03 which carries *porV*.  $\Delta porU$ : *porU* deletion mutant CJ2116.  $\Delta porU^c$ : CJ2116 complemented with pSSK04 which carries *porU*.

**Fjoh\_0288, which exhibits limited sequence similarity to PorV, does not appear to be required for T9SS function.** Examination of the *F. johnsoniae* genome revealed one gene, *Fjoh\_0288*, encoding a protein that exhibits 30% amino acid identity with PorV over a 135 amino acid region. *Fjoh\_0288* was deleted in wild-type cells and in cells of the  $\Delta porV$  mutant. Cells of CJ2082 ( $\Delta Fjoh_0288$ ) and of CJ2446 ( $\Delta Fjoh_0288 \Delta porV$ ) spread on agar as well as wild-type cells (data not shown) suggesting that SprB was secreted to the cell surface. Deletion of *Fjoh\_0288* also had no effect on secretion of ChiA, and no effect on sensitivity to the eight phages used in this study (data not shown). These results suggest that Fjoh\_0288 is not involved in T9SS-mediated secretion.

## Discussion

T9SSs, discovered in *P. gingivalis* and *F. johnsoniae*, are common among members of the phylum *Bacteroidetes* (22, 35, 42). Seven proteins (GldK, GldL, GldM, GldN, SprA, SprE, SprT) are important for T9SS function in *F. johnsoniae*, and orthologs of these are required for secretion in *P. gingivalis* (31-33, 35, 36, 40). *P. gingivalis* PorP is also required for secretion (35), whereas in *F. johnsoniae* the function of PorP appears to be split between multiple PorP-like proteins, such as SprF which is required specifically for secretion of SprB (29). Two additional *P. gingivalis* proteins (PorU and PorV) are involved in gingipain secretion (7, 8, 12, 35). In this study we examined the potential roles of *F. johnsoniae* PorU and PorV in secretion.

*F. johnsoniae* PorU was not required for secretion of proteins by the T9SS. Three proteins, RemA, ChiA, and SprB, known to be secreted by the T9SS (15, 31, 40, 41) were each secreted in functional form by cells of a *porU* deletion mutant. SDS-PAGE

followed by LC-MS/MS analysis of proteins secreted by wild-type and mutant cells revealed that whereas cells of the *gldNO* deletion mutant appeared to be defective for the secretion of at least 33 proteins, proteins secreted by cells of the *porU* deletion mutant were similar to those secreted by wild-type cells. PorU is thought to function as the peptidase that removes the CTDs of *P. gingivalis* proteins during or after secretion (8). Our results suggest that *F. johnsoniae* either does not require CTD processing for secretion or it has other proteases that render PorU unnecessary. No paralogs of *porU* were detected in the genome, but *F. johnsoniae* produces many peptidases (21).

*F. johnsoniae* PorV was required for secretion of many but not all proteins that are targeted to the T9SS. Secretion of RemA and ChiA required PorV, whereas secretion of SprB did not. Defects in phage sensitivity and in attachment of cells to glass were also associated with deletion of *porV*, and suggested that PorV is required for the secretion of additional cell-surface adhesins besides RemA. Analysis of spent culture fluid of wild-type and mutant cells revealed 26 proteins that appear to require *porV* for efficient secretion. These proteins were also absent in culture fluid of the  $\Delta$ *gldNO* mutant, suggesting that they are secreted from wild-type cells by the T9SS. Eighteen of these proteins had CTDs that belong to protein domain family TIGR04183, suggesting that proteins with TIGR04183-type CTDs might require PorV for secretion. Some proteins with TIGR04131-type CTDs, and some proteins that lacked recognizable T9SS CTDs also appeared to require PorV for secretion, whereas others did not since they were found in the cell-free culture fluid of both wild-type and *porV* mutant cells.

T9SS-mediated secretion of proteins with TIGR04183-type CTDs has been documented for many proteins of diverse members of the phylum *Bacteroidetes* (22, 37,

40-42). In contrast, the role of TIGR04131-type CTDs in targeting proteins for secretion is less well established. *F. johnsoniae* SprB is the only example of a TIGR04131 family member that has been demonstrated to be secreted by the T9SS (29, 31, 35, 40). The observation of six additional *F. johnsoniae* proteins with TIGR04131-type CTDs that appear to be secreted by the T9SS supports the suggestion that TIGR04131 CTDs target proteins to the T9SS. The *F. johnsoniae* genome is predicted to encode 12 proteins with TIGR04131-type CTDs, and we hypothesize that each of these are secreted by the T9SS. Proteins that have TIGR04131-type CTDs are also common among the many members of the phylum *Bacteroidetes* that have T9SSs. Proteins in addition to those with TIGR04183-type CTDs and TIGR04131-type CTDs are also secreted by T9SSs. For example *F. johnsoniae* ChiA is secreted by the T9SS but its CTD, which is necessary and sufficient for secretion, does not closely resemble members of either TIGR04183 or TIGR04131 (15). Here we identified nine additional proteins (Fjoh\_0601, Fjoh\_0602, Fjoh\_0604, Fjoh\_0606, Fjoh\_2667, Fjoh\_2687, Fjoh\_3108, Fjoh\_3729, and Fjoh\_4819) that were apparently secreted by the T9SS but that did not exhibit similarity to members of either TIGR04183 or TIGR04131. There is considerable sequence diversity among T9SS CTDs (37, 42) and these nine proteins may have novel T9SS-targeting domains that have thus far escaped detection.

The results reported here identify thirty-five proteins (including ChiA, SprB and RemA) that appear to be secreted by the *F. johnsoniae* T9SS. This is probably only a partial list of proteins secreted by this system. Fifty-four *F. johnsoniae* proteins were previously predicted to be secreted by the T9SS based on the presence of CTDs belonging to TIGR04183 and TIGR04131 (40). In addition, the identification of proteins



that lack obvious T9SS-targeting CTDs but that are apparently secreted by the T9SS suggests that additional proteins may be secreted by this system. Further study is needed to determine the diversity of T9SS-targeting sequences and to reveal the mechanism of T9SS-mediated protein secretion in *F. johnsoniae* and in other members of the phylum *Bacteroidetes*.

## References

1. **Agarwal, S., D. W. Hunnicutt, and M. J. McBride.** 1997. Cloning and characterization of the *Flavobacterium johnsoniae* (*Cytophaga johnsonae*) gliding motility gene, *gldA*. Proc. Natl. Acad. Sci. USA **94**:12139-12144.
2. **Altschul, S. F., W. Gish, W. Miller, E. W. Myers, and D. J. Lipman.** 1990. Basic local alignment search tool. J. Mol. Biol. **215**:403-10.
3. **Braun, T. F., M. K. Khubbar, D. A. Saffarini, and M. J. McBride.** 2005. *Flavobacterium johnsoniae* gliding motility genes identified by *mariner* mutagenesis. J. Bacteriol. **187**:6943-6952.
4. **Chagnot, C., M. A. Zorgani, T. Astruc, and M. Desvaux.** 2013. Proteinaceous determinants of surface colonization in bacteria: bacterial adhesion and biofilm formation from a protein secretion perspective. Front. in Microbiol. **4**:303.
5. **Chang, L. Y. E., J. L. Pate, and R. J. Betzig.** 1984. Isolation and characterization of nonspreading mutants of the gliding bacterium *Cytophaga johnsonae*. J. Bacteriol. **159**:26-35.
6. **Chen, S., M. Bagdasarian, M. G. Kaufman, A. K. Bates, and E. D. Walker.** 2007. Mutational analysis of the *ompA* promoter from *Flavobacterium johnsoniae*. J. Bacteriol. **189**:5108-5118.
7. **Chen, Y. Y., B. Peng, Q. Yang, M. D. Glew, P. D. Veith, K. J. Cross, K. N. Goldie, D. Chen, N. O'Brien-Simpson, S. G. Dashper, and E. C. Reynolds.** 2011. The outer membrane protein LptO is essential for the O-deacylation of LPS and the co-ordinated secretion and attachment of A-LPS and CTD proteins in *Porphyromonas gingivalis*. Mol. Microbiol. **79**:1380-401.
8. **Glew, M. D., P. D. Veith, B. Peng, Y. Y. Chen, D. G. Gorasia, Q. Yang, N. Slakeski, D. Chen, C. Moore, S. Crawford, and E. Reynolds.** 2012. PG0026 is the C-terminal signal peptidase of a novel secretion system of *Porphyromonas gingivalis*. J. Biol. Chem. **287**:24605-24617.
9. **Hofmann, K., and W. Stoffel.** 1993. TMbase - A database of membrane spanning proteins segments. Biol. Chem. Hoppe-Seyler **374**:166.
10. **Hunnicutt, D. W., and M. J. McBride.** 2000. Cloning and characterization of the *Flavobacterium johnsoniae* gliding motility genes, *gldB* and *gldC*. J. Bacteriol. **182**:911-918.
11. **Ishiguro, I., K. Saiki, and K. Konishi.** 2011. Analysis of *Porphyromonas gingivalis* PG27 by deletion and intragenic suppressor mutation analyses. Mol. oral Microbiol. **26**:321-35.
12. **Ishiguro, I., K. Saiki, and K. Konishi.** 2009. PG27 is a novel membrane protein essential for a *Porphyromonas gingivalis* protease secretion system. FEMS Microbiol. Lett. **292**:261-267.
13. **Keller, A., A. I. Nesvizhskii, E. Kolker, and R. Aebersold.** 2002. Empirical statistical model to estimate the accuracy of peptide identifications made by MS/MS and database search. Anal. Chem. **74**:5383-5392.
14. **Kempf, M. J., and M. J. McBride.** 2000. Transposon insertions in the *Flavobacterium johnsoniae* *ftsX* gene disrupt gliding motility and cell division. J. Bacteriol. **182**:1671-1679.

15. **Kharade, S. S., and M. J. McBride.** 2014. The *Flavobacterium johnsoniae* chitinase ChiA is required for chitin utilization and is secreted by the type IX secretion system. *J. Bacteriol.* **196**:961-970.
16. **Kolton, M., O. Frenkel, Y. Elad, and E. Cytryn.** 2014. Potential role of flavobacterial gliding-motility and type IX secretion system complex in root colonization and plant defense. *Mol. Plant-Microbe Interact.* **27**:1005-1013.
17. **Liu, J., M. J. McBride, and S. Subramaniam.** 2007. Cell-surface filaments of the gliding bacterium *Flavobacterium johnsoniae* revealed by cryo-electron tomography. *J. Bacteriol.* **189**:7503-7506.
18. **McBride, M. J.** 2001. Bacterial Gliding Motility: Multiple mechanisms for cell movement over surfaces. *Annu. Rev. Microbiol.* **55**:49-75.
19. **McBride, M. J., and T. F. Braun.** 2004. GldI is a lipoprotein that is required for *Flavobacterium johnsoniae* gliding motility and chitin utilization. *J. Bacteriol.* **186**:2295-2302.
20. **McBride, M. J., and M. J. Kempf.** 1996. Development of techniques for the genetic manipulation of the gliding bacterium *Cytophaga johnsonae*. *J. Bacteriol.* **178**:583-590.
21. **McBride, M. J., G. Xie, E. C. Martens, A. Lapidus, B. Henrissat, R. G. Rhodes, E. Goltsman, W. Wang, J. Xu, D. W. Hunnicutt, A. M. Staroscik, T. R. Hoover, Y. Q. Cheng, and J. L. Stein.** 2009. Novel features of the polysaccharide-digesting gliding bacterium *Flavobacterium johnsoniae* as revealed by genome sequence analysis. *Appl. Environ. Microbiol.* **75**:6864-6875.
22. **McBride, M. J., and Y. Zhu.** 2013. Gliding motility and Por secretion system genes are widespread among members of the phylum *Bacteroidetes*. *J. Bacteriol.* **195**:270-278.
23. **Nakane, D., K. Sato, H. Wada, M. J. McBride, and K. Nakayama.** 2013. Helical flow of surface protein required for bacterial gliding motility. *Proc. Natl. Acad. Sci. USA* **110**:11145-11150.
24. **Nelson, S. S., S. Bollampalli, and M. J. McBride.** 2008. SprB is a cell surface component of the *Flavobacterium johnsoniae* gliding motility machinery. *J. Bacteriol.* **190**:2851-2857.
25. **Nesvizhskii, A. I., A. Keller, E. Kolker, and R. Aebersold.** 2003. A statistical model for identifying proteins by tandem mass spectrometry. *Anal. Chem.* **75**:4646-4658.
26. **Nguyen, K. A., J. Travis, and J. Potempa.** 2007. Does the importance of the C-terminal residues in the maturation of RgpB from *Porphyromonas gingivalis* reveal a novel mechanism for protein export in a subgroup of Gram-Negative bacteria? *J. Bacteriol.* **189**:833-843.
27. **Pate, J. L., S. J. Petzold, and L.-Y. E. Chang.** 1979. Phages for the gliding bacterium *Cytophaga johnsonae* that infect only motile cells. *Curr. Microbiol.* **2**:257-262.
28. **Reichenbach, H.** 1992. The genus *Lysobacter*, p. 3256-3275. In A. Balows, H. Truper, M. Dworkin, W. Harder, and K. Schleifer (ed.), *The Prokaryotes*, 2 ed. Springer-Verlag, Berlin, Germany.

29. **Rhodes, R. G., S. S. Nelson, S. Pochiraju, and M. J. McBride.** 2011. *Flavobacterium johnsoniae sprB* is part of an operon spanning the additional gliding motility genes *sprC*, *sprD*, and *sprF*. *J. Bacteriol.* **193**:599-610.
30. **Rhodes, R. G., H. G. Pucker, and M. J. McBride.** 2011. Development and use of a gene deletion strategy for *Flavobacterium johnsoniae* to identify the redundant motility genes *remF*, *remG*, *remH*, and *remI*. *J. Bacteriol.* **193**:2418-2428.
31. **Rhodes, R. G., M. N. Samarasam, A. Shrivastava, J. M. van Baaren, S. Pochiraju, S. Bollampalli, and M. J. McBride.** 2010. *Flavobacterium johnsoniae gldN* and *gldO* are partially redundant genes required for gliding motility and surface localization of SprB. *J. Bacteriol.* **192**:1201-1211.
32. **Rhodes, R. G., M. N. Samarasam, E. J. Van Groll, and M. J. McBride.** 2011. Mutations in *Flavobacterium johnsoniae sprE* result in defects in gliding motility and protein secretion. *J. Bacteriol.* **193**:5322-7.
33. **Saiki, K., and K. Konishi.** 2007. Identification of a *Porphyromonas gingivalis* novel protein Sov required for the secretion of gingipains. *Microbiol. Immunol.* **51**:483-491.
34. **Sambrook, J., E. F. Fritsch, and T. Maniatis.** 1989. Molecular cloning: a laboratory manual. Cold Spring Harbor Laboratory, Cold Spring Harbor, N. Y.
35. **Sato, K., M. Naito, H. Yukitake, H. Hirakawa, M. Shoji, M. J. McBride, R. G. Rhodes, and K. Nakayama.** 2010. A protein secretion system linked to bacteroidete gliding motility and pathogenesis. *Proc. Natl. Acad. Sci. USA* **107**:276-281.
36. **Sato, K., E. Sakai, P. D. Veith, M. Shoji, Y. Kikuchi, H. Yukitake, N. Ohara, M. Naito, K. Okamoto, E. C. Reynolds, and K. Nakayama.** 2005. Identification of a new membrane-associated protein that influences transport/maturation of gingipains and adhesins of *Porphyromonas gingivalis* *J. Biol. Chem.* **280**:8668-8677.
37. **Sato, K., H. Yukitake, Y. Narita, M. Shoji, M. Naito, and K. Nakayama.** 2013. Identification of *Porphyromonas gingivalis* proteins secreted by the Por secretion system. *FEMS Lett* **338**:68-76.
38. **Shoji, M., K. Sato, H. Yukitake, Y. Kondo, Y. Narita, T. Kadowaki, M. Naito, and K. Nakayama.** 2011. Por secretion system-dependent secretion and glycosylation of *Porphyromonas gingivalis* hemin-binding protein 35. *PLOS One* **6**:e21372.
39. **Shrivastava, A.** 2013. Cell surface adhesins, exopolysaccharides and the Por (type IX) secretion system of *Flavobacterium johnsoniae*. University of WI-Milwaukee, Milwaukee.
40. **Shrivastava, A., J. J. Johnston, J. M. van Baaren, and M. J. McBride.** 2013. *Flavobacterium johnsoniae* GldK, GldL, GldM, and SprA are required for secretion of the cell-surface gliding motility adhesins SprB and RemA. *J Bacteriol* **195**:3201-3212.
41. **Shrivastava, A., R. G. Rhodes, S. Pochiraju, D. Nakane, and M. J. McBride.** 2012. *Flavobacterium johnsoniae* RemA is a mobile cell-surface lectin involved in gliding. *J. Bacteriol.* **194**:3678-3688.

42. **Veith, P. D., N. A. Nor Muhammad, S. G. Dashper, V. A. Likic, D. G. Gorasia, D. Chen, S. J. Byrne, D. V. Catmull, and E. C. Reynolds.** 2013. Protein substrates of a novel secretion system are numerous in the *Bacteroidetes* phylum and have in common a cleavable C-terminal secretion signal, extensive post-translational modification and cell surface attachment. *J. Proteome Res.* **12**:4449-4461.
43. **Wolkin, R. H., and J. L. Pate.** 1985. Selection for nonadherent or nonhydrophobic mutants co-selects for nonspreading mutants of *Cytophaga johnsonae* and other gliding bacteria. *J. Gen. Microbiol.* **131**:737-750.
44. **Yu, C. S., Y. C. Chen, C. H. Lu, and J. K. Hwang.** 2006. Prediction of protein subcellular localization. *Proteins* **64**:643-651.
45. **Yu, N. Y., J. R. Wagner, M. R. Laird, G. Melli, S. Rey, R. Lo, P. Dao, S. C. Sahinalp, M. Ester, L. J. Foster, and F. S. Brinkman.** 2010. PSORTb 3.0: Improved protein subcellular localization prediction with refined localization subcategories and predictive capabilities for all prokaryotes. *Bioinformatics* **26**:1608-1615.
46. **Zhu, Y., and M. J. McBride.** 2014. Deletion of the *Cytophaga hutchinsonii* type IX secretion system gene *sprP* results in defects in gliding motility and cellulose utilization. *Appl. Microbiol. Biotechnol.* **98**:763-775.
47. **Kharade, S. S., and M. J. McBride.** 2014. The *Flavobacterium johnsoniae* PorV is required for secretion of subset of proteins targeted to the type IX secretion system. *J. Bacteriol.*

## Chapter 4. Characterization of the *F. johnsoniae* chitin utilization locus.

### Abstract

Chitin and cellulose are thought to be the most abundant polysaccharides on earth and therefore have the potential to be used as sources of energy. Bacteria employ various strategies to digest polysaccharides. Some bacteria secrete extracellular enzymes that hydrolyze the polymers to monomers and dimers, while others rely on their cell-surface enzyme complexes to perform the same task. A member of the phylum *Bacteroidetes*, *Bacteroides thetaiotaomicron*, uses a different strategy. Its cell surface starch utilization system proteins, SusC and SusD bind long starch oligomers and transport them across the outer membrane where they are digested further. The related bacterium *Flavobacterium johnsoniae* digests many polysaccharides including chitin. *F. johnsoniae* has 44 *susC*-like genes and 42 *susD*-like genes within its many polysaccharide utilization loci (PULs). One PUL predicted to be involved in chitin utilization was investigated. Single and multiple deletion mutants were constructed to determine the roles of the two *susC*-like genes (*cusC<sub>I</sub>* and *cusC<sub>II</sub>*) and the two *susD*-like genes (*cusD<sub>I</sub>*, and *cusD<sub>II</sub>*) in chitin utilization. Cells of a *cusD<sub>I</sub>* deletion mutant and of a double mutant lacking both *cusD<sub>I</sub>*, and *cusD<sub>II</sub>* exhibited reduced growth on chitin. Individual deletions of *cusC<sub>I</sub>*, *cusC<sub>II</sub>* and *cusD<sub>II</sub>* did not result in obvious defects in chitin utilization. *chiA*, which encodes the extracellular chitinase required for chitin utilization, is also part of the chitin PUL, as is another predicted chitinase, Fjoh\_4560. Cells deleted for Fjoh\_4560 grew on chitin as well as the wild-type. Deletion of the region spanning *cusD<sub>I</sub>* (Fjoh\_4558) through *cusC<sub>II</sub>* (Fjoh\_4562) resulted in complete loss of ability to grow on chitin. These results suggest that *F. johnsoniae* employs SusC-like and SusD-like proteins to utilize the insoluble

polymer chitin. ChiA may act synergistically with these proteins to efficiently utilize chitin.

## **Introduction**

Cellulose, hemicelluloses and chitin are thought to be the most abundant insoluble polysaccharides in the environment and are rich sources of energy that can be converted into liquid biofuels (3, 11, 12). Chitin is a major constituent of shells of crustaceans such as crabs and shrimps, the exoskeletons of insects, and the cell walls of yeasts and other fungi (4). Chitin is a linear insoluble polymer of  $\beta$ -1,4-linked *N*-acetylglucosamine (GlcNAc) and is resistant to digestion (6). Chitin and its modified forms have applications in wastewater treatment and drug delivery systems. Moreover modified forms of chitin are also employed as food quality enhancing agents, antibacterial agents, antifungal agents and as dietary fiber supplements (3, 4). Dietary polysaccharides affect human health, since gut microbes that digest them supply energy to the human body, impact the host immune system, and affect the ability of pathogens to colonize the intestinal tract. The human distal gut is inhabited by trillions of microbes. Bacteria in the gut digest and ferment resistant glycans to fatty acids that are easily absorbed (9, 16). This microbial process contributes up to 10% of daily caloric intake (9). Several bacterial phyla including *Bacteroidetes* and *Firmicutes*, are capable of metabolizing a variety of polysaccharides (24). Members of the phylum *Bacteroidetes* often dominate the large intestine. Several *Bacteroidetes* have become model organisms to study the molecular mechanisms underlying polysaccharide digestion, in part because of the genetic tools available for their manipulation (16, 23).

Bacteria employ various strategies to digest polysaccharides some include secretion of extracellular enzymes that hydrolyze the polymers to monosaccharides and disaccharides, while other strategies rely on their cell-surface enzyme complexes to perform the same task. Members of the phylum *Bacteroidetes* employ a different strategy to utilize these polymers (2). This involves cell surface enzymes that partially hydrolyze the polysaccharides into long oligomers. These oligomers apparently bind to a cell surface glycan binding protein SusD, and are taken up actively by a TonB dependent porin, SusC. The oligomers are further digested in the periplasm. *Bacteroides thetaiotaomicron* a starch utilizing anaerobic bacterium belonging to the phylum *Bacteroidetes*, employs this Sus strategy for polymer digestion (20). *B. thetaiotaomicron* enzymes involved in starch utilization are cell associated (25). Some of these are located on the cell surface and others are internal (periplasmic and cytoplasmic) (26). *B. thetaiotaomicron* has numerous genes encoding SusC-like and SusD-like proteins allowing it to utilize many soluble polysaccharides. *susC*-like and *susD*-like genes are paired with each other and are usually adjacent to genes encoding glycohydrolases involved in digesting polysaccharides. These gene clusters are called **Polysaccharide Utilization Loci (PULs)** (19).

*Flavobacterium johnsoniae* belongs to the phylum *Bacteroidetes* and digests chitin and many other polysaccharides (19). Genome analysis of *F. johnsoniae* suggests that SusC-like and SusD-like proteins may be involved not only in the utilization of relatively soluble polysaccharides such as starch, but also in the utilization of highly insoluble crystalline polysaccharides such as chitin (5). Many genes encoding proteins similar to *B. thetaiotaomicron* SusC and SusD were revealed in the *F. johnsoniae*



genome (19). It has 44 *susC*-like genes and 42 *susD*-like genes within its many PULs (2). One of its PULs is predicted to be involved in chitin utilization (Fjoh\_4564-Fjoh\_4555) (Figure 32). Fjoh\_4555 encodes ChiA, the major extracellular chitinase. The other genes in this PUL including *cusC<sub>I</sub>* and *cusC<sub>II</sub>* (*susC*-like genes) and *cusD<sub>I</sub>* and *cusD<sub>II</sub>* (*susD*-like genes) were predicted to play roles in chitin utilization.

## Materials and Methods

**Bacterial and bacteriophage strains, plasmids, and growth conditions.** *F. johnsoniae* ATCC 17061 strains UW101 was the wild-type strains used in this study. The streptomycin resistant *rpsL* mutant of UW101 (CJ1827) was used to construct deletion mutants (21). *F. johnsoniae* strains were grown in Casitone-yeast extract (CYE) medium at 30°C (18) or Stanier media supplemented with chitin for analyzing growth on chitin. *E. coli* strains were grown in Luria-Bertani medium (LB) at 37°C. Strains and plasmids used in this study are listed in Table 11 and primers are listed in Table 12. Antibiotics were used at the following concentrations when needed: ampicillin, 100 µg/ml; chloramphenicol, 30 µg/ml; erythromycin, 100 µg/ml; kanamycin, 30 µg/ml; and tetracycline, 20 µg/ml.

### Construction of deletion mutants and complementation.

The previously described strategy was employed (21) to generate single gene deletions in the predicted chitin PUL. A 1718 bp fragment upstream of *cusD<sub>I</sub>* was amplified by PCR using Phusion DNA polymerase (New England Biolabs, Ipswich, MA) and primers 1166 and 1167. The amplified product was digested with XbaI and SalI and

cloned into pRR51 that had been digested with the same enzymes, generating pSSK13. A 1725 bp fragment downstream of *cusD<sub>I</sub>* was amplified by PCR using primers 1168 (engineered SalI site) and 1169 (engineered SphI site). This product was ligated into pSSK13 that had been digested with SalI and SphI, to generate pSSK18. pSSK18 was introduced into *F. johnsoniae* strain CJ1827 by conjugation and integration into the genome by recombination was selected using erythromycin. Subsequent selection with streptomycin allowed isolation of the  $\Delta cusD_I$  mutant (CJ2121) that had lost the integrated plasmid (21). The  $\Delta cusD_I$  mutant was confirmed by PCR amplification using primers primer 1444 and 1445 and by sequencing the product.

Strains with deletions in *cusD<sub>II</sub>* (CJ2018), *cusC<sub>I</sub>* (CJ2086), *cusC<sub>II</sub>* (CJ2340), and Fjoh\_4560 (CJ2350), were constructed in the same way using the primers and plasmids listed in Table 11 and Table 12. The  $\Delta cusD_I \Delta cusD_{II}$  double mutant, CJ2156, was generated by starting with the  $\Delta cusD_I$  mutant CJ2121 and deleting *cusD<sub>II</sub>* as described above.

To delete a region spanning *cusD<sub>I</sub>* to *cusC<sub>II</sub>* a 1766 bp region downstream of *cusC<sub>II</sub>* was amplified by PCR using primers 1252 (engineered SalI site) and 1253 (engineered SphI site). This product was digested with SalI and SphI and ligated into pSSK13 that had been digested with the same enzymes to generate pSSK39. pSSK39 was introduced into *F. johnsoniae* strain CJ1827 by conjugation and streptomycin selection was used to obtain the  $\Delta(cusD_I-cusC_{II})$  mutant CJ2349. The deletion was confirmed by PCR amplification using primers 1465 and 1466 and sequencing.

To complement the *cusD<sub>I</sub>* mutant, a 1937 bp region spanning *cusD<sub>I</sub>* was amplified with primers 1514 (engineered SalI site) and 1515 (engineered SphI site). This product was digested with SalI and SphI and ligated into pCP23 that had been digested with the same enzymes to generate pSSK47.

To express recombinant CusD<sub>I</sub> in *E.coli* for biochemical characterization, a 1518 bp region of *cusD<sub>I</sub>* was amplified with primers 1561 (engineered NheI site) and 1562 (engineered XhoI site). This fragment was digested with NheI and XhoI and ligated into pET28a that had been digested with the same enzymes to generate pSSK49. Similarly a 1461 bp region of *cusD<sub>II</sub>* was amplified using primers 1563 (engineered NheI site) and 1564 (engineered XhoI site). This product was digested with NheI and XhoI and ligated into pET28a that had been digested with the same enzyme to generate pSSK50. pSSK49 and pSSK50 were introduced into *E.coli* Rosetta to allow production of recombinant CusD<sub>I</sub> and CusD<sub>II</sub>.

**Qualitative determination of growth on chitin.** Cells of the wild type and mutant strains were inoculated in minimal Stanier broth supplemented with colloidal chitin prepared from crab shells (13, 17, 22). The cells were incubated at 25°C for 48h, and examined for growth of cells and solubilization of chitin.

Table 11. Strains and plasmids used in this study

Strain or plasmid	Genotype and/or description <sup>a</sup>	Source or reference
Strains		
UW 101 (ATCC 17061)	Wild type	(17)
CJ1808	<i>chiA</i> disruption mutant; (Em <sup>r</sup> )	(13)
CJ1827	<i>rpsL2</i> ; (Sm <sup>r</sup> ) “wild type” strain for construction of deletion mutants	(21)
CJ2018	<i>rpsL2</i> $\Delta$ <i>cusD<sub>II</sub></i> ; (Sm <sup>r</sup> )	This study
CJ2086	<i>rpsL2</i> $\Delta$ <i>cusC<sub>I</sub></i> ; (Sm <sup>r</sup> )	This study
CJ2121	<i>rpsL2</i> $\Delta$ <i>cusD<sub>I</sub></i> ; (Sm <sup>r</sup> )	This study
CJ2156	<i>rpsL2</i> $\Delta$ <i>cusD<sub>I</sub> cusD<sub>II</sub></i> ; (Sm <sup>r</sup> )	
CJ2340	<i>rpsL2</i> $\Delta$ <i>cusC<sub>II</sub></i> ; (Sm <sup>r</sup> )	This study
CJ2349	<i>rpsL2</i> $\Delta$ <i>cusD<sub>I</sub>-cusC<sub>II</sub></i> ; (Sm <sup>r</sup> )	This study
CJ2350	<i>rpsL2</i> $\Delta$ <i>Fjoh_4560</i> ; (Sm <sup>r</sup> )	This study
Plasmids		
pCP23	<i>E. coli-F. johnsoniae</i> shuttle plasmid; Ap <sup>r</sup> (Tc <sup>r</sup> )	(1)
pRR51	<i>rpsL</i> containing suicide vector; Ap <sup>r</sup> (Em <sup>r</sup> )	(21)
pET28a	pET28a [replaced thrombin site to rTEV (cleavable N-terminal His tag) site in Rosetta2(DE3) (Km <sup>r</sup> Cm <sup>r</sup> )	Nicole Koropatkin
pSSK08	1,827-bp BamHI-SalI region downstream of <i>cusD<sub>II</sub></i> amplified with primers 1055 and 1056 and inserted into pRR51; Ap <sup>r</sup> (Em <sup>r</sup> )	This study
pSSK09	Construct used for deletion <i>cusD<sub>II</sub></i> : 1,328-bp SalI-SphI region upstream of <i>cusD<sub>II</sub></i> amplified with primers 1057 and 1058 and inserted into pSSK08; Ap <sup>r</sup> (Em <sup>r</sup> )	This study
pSSK13	1,718-bp XbaI-SalI region downstream of <i>cusD<sub>I</sub></i> amplified with primers 1166 and 1167 and inserted into pRR51; Ap <sup>r</sup> (Em <sup>r</sup> )	This study
pSSK15	1,504-bp XbaI-SalI region downstream of <i>cusC<sub>I</sub></i> amplified with primers 1170 and 1052 and inserted into pRR51; Ap <sup>r</sup> (Em <sup>r</sup> )	This study
pSSK17	Construct used for deletion <i>cusC<sub>I</sub></i> : 1,827-bp SalI-SphI region upstream of <i>cusC<sub>I</sub></i> amplified with primers 1053 and 1054 and inserted into pSSK15; Ap <sup>r</sup> (Em <sup>r</sup> )	This study
pSSK18	Construct used for deletion <i>cusD<sub>I</sub></i> : 1,725-bp SalI-SphI region upstream of <i>cusD<sub>I</sub></i> amplified with primers 1168 and 1169 and inserted into pSSK13; Ap <sup>r</sup> (Em <sup>r</sup> )	This study
pSSK29	1,899-bp XbaI-SalI region downstream of <i>cusC<sub>II</sub></i> amplified with primers 1250 and 1251 and inserted into pRR51; Ap <sup>r</sup> (Em <sup>r</sup> )	This study
pSSK33	Construct used for deletion <i>cusC<sub>II</sub></i> : 1766-bp SalI-SphI region	This study

	upstream of <i>cusC<sub>II</sub></i> amplified with primers 1252 and 1253 and inserted into pSSK29; Ap <sup>r</sup> (Em <sup>r</sup> )	
pSSK38	1,510-bp BamHI-SalI region upstream of <i>Fjoh_4560</i> amplified with primers 1423 and 1424 and inserted into pRR51; Ap <sup>r</sup> (Em <sup>r</sup> )	This study
pSSK39	Construct used for deletion ( <i>cusD<sub>I</sub></i> to <i>cusC<sub>II</sub></i> ) 1,766-bp SalI-SphI region upstream of <i>cusC<sub>II</sub></i> amplified with primers 1252 and 1253 and inserted into pSSK13; Ap <sup>r</sup> (Em <sup>r</sup> )	This study
pSSK40	Construct used for deletion <i>Fjoh_4560</i> : 1,560-bp SalI-SphI region downstream of <i>Fjoh_4560</i> amplified with primers 1425 and 1426 and inserted into pSSK39; Ap <sup>r</sup> (Em <sup>r</sup> )	This study
pSSK47	1,937-bp SalI-SphI fragment spanning <i>cusD<sub>I</sub></i> amplified with primer 1514 and 1515 and inserted into pCP23; Ap <sup>r</sup> (Tc <sup>r</sup> )	This study
pSSK49	1,518-bp NheI-XhoI fragment spanning <i>cusD<sub>I</sub></i> amplified with primer 1561 and 1562 and inserted into pET28a; Ap <sup>r</sup> (Tc <sup>r</sup> )	This study
pSSK50	1,461-bp NheI-XhoI fragment spanning <i>cusD<sub>II</sub></i> amplified with primer 1563 and 1564 and inserted into pET28a; Ap <sup>r</sup> (Tc <sup>r</sup> )	This study

<sup>a</sup>Antibiotic resistance phenotypes are as follows: ampicillin, Ap<sup>r</sup>; erythromycin, Em<sup>r</sup>; streptomycin, Sm<sup>r</sup>; tetracycline, Tc<sup>r</sup>. The antibiotic resistance phenotypes given in parentheses are those expressed in *F. johnsoniae* but not in *E. coli*. The antibiotic resistance phenotypes without parentheses are those expressed in *E. coli* but not in *F. johnsoniae*.

Table 12. Primers used in this study

Primers	Sequence and Description
1052	5' - GCTAGGTCGACACAGGTGATGCAAGAAATGCAGGC – 3', reverse primer to amplify downstream region of Fjoh_4559 used for constructing pSSK15; SalI site underlined
1053	5' - GCTAGGTCGACTTTTACCTGTGCAAGCGAAACCTG – 3', forward primer to amplify upstream region of Fjoh_4559 used for constructing pSSK17; SalI site underlined
1054	5' - GCTAGGCATGCGCTCCTGCAAGTCAGGCAAGTATT – 3', reverse primer to amplify upstream region of Fjoh_4559 used to construct pSSK17, SphI site underlined
1055	5' - GCTAGGGATCCTTTTACCTGTGCAAGCGAAACCTG – 3', forward primer to amplify downstream region of Fjoh_4561 to construct pSSK08, BamHI site underlined
1056	5' - GCTAGGTCGACGCTCCTGCAAGTCAGGCAAGTATT – 3', reverse primer to amplify downstream region of Fjoh_4561 to construct pSSK08, SalI site underlined
1057	5' - GCTAGGTCGACTGTAAGCTGACCTGCAGGATTTGG – 3', forward primer to amplify upstream region of Fjoh_4561 to construct pSSK09, SalI site underlined
1058	5' - GCTAGGCATGCAATGCACCGGGAGCTTACAAGAAC – 3', reverse primer to amplify upstream region of Fjoh_4561 to construct pSSK09, SphI site underlined
1166	5' GCTAGTCTAGATAACAATTCGATATCCTCCTGCCC 3', forward primer to amplify downstream region of Fjoh_4558 to construct pSSK13, XbaI site underlined
1167	5 GCTAGGTCGACGGAGTTTCTAAATTGGGCGGACCA ' 3', reverse primer to amplify downstream region of Fjoh_4558 to construct pSSK13, SalI site underlined
1168	5'- GCTAGGTCGACGGCGAGTAACAAAGTACAAATAGTTGCTTT - 3', forward primer to amplify upstream region of Fjoh_4558 to construct pSSK18, SalI site underlined
1169	5'- GCTAGGCATGCTGGTTGTCGATTGCTTCTAGATACAGTTAT -3', reverse primer to amplify upstream region of Fjoh_4558 to construct pSSK18, SphI site underlined
1170	5' - GCTAGTCTAGACTGAGCAGTACCGCCCATATTCCA – 3', forward primer to amplify downstream region of Fjoh_4559 to construct pSSK15, XbaI site underlined
1250	5'- GCTAGGTCGACGTAGCAAATGGAGTTGTTAATACAGGA - 3', reverse primer to amplify downstream region of Fjoh_4562 to construct pSSK29, SalI site underlined
1251	5'- GCTAGTCTAGAAGTTTACATCCCACCAAACCTTACCAG- 3', forward primer to amplify downstream region of Fjoh_4562 to construct pSSK29, XbaI site underlined
1252	5'- GCTAGGCATGCCTGCTGCAAATTCCTCTAAAAGC – 3, reverse primer to amplify upstream region of Fjoh_4562 to construct pSSK33, SphI site underlined
1253	5' - GCTAGGTCGACAGCAGATGCCTGAATCGTATAACATACC -3', forward primer to amplify upstream region of Fjoh_4562 to construct pSSK33, SalI site underlined
1423	5'- GCTAGGGATCCTTTACTCAATTATGTATGTCTGGAGAC - 3', forward primer to amplify upstream region of Fjoh_4560 to construct pSSK38, BamHI site underlined
1424	5'- GCTAGGTCGACAAGGATGCCTAATAAGGCTTTATTTTT - 3', reverse primer to amplify upstream region of Fjoh_4560 to construct pSSK38, SalI site

	underlined
1425	5'- GCTAGGTCGACTACAAGACTTCAGGCATGTGCGGT - 3', forward primer to amplify downstream region of <i>Fjoh_4560</i> to construct pSSK40, SalI site underlined
1426	5'- GCTAGGTCGACAAGGATGCCTAATAAGGCTTTATTTTT - 3', reverse primer to amplify downstream region of <i>Fjoh_4560</i> to construct pSSK40, SphI site underlined
1444	5'- TTG ATA TTT ATG GTT TAC CTT CTA CCA-3' used for sequencing <i>Fjoh_4558</i>
1445	5'- ATT CGG AGC ATT TAC ATC CCA CCA AAC -3' used for sequencing <i>Fjoh_4558</i>
1465	5'- ATCCTAACGATGAGATGCAGAAA-3' used for sequencing <i>Fjoh_4560</i> and checking deletion of <i>Fjoh_4558</i> to <i>Fjoh_4562</i>
1466	5'- CAATCAATAATCTGCTGCTCGAAA- 3' used for sequencing <i>Fjoh_4560</i> and checking deletion of <i>Fjoh_4558</i> to <i>Fjoh_4562</i>
1467	5'- ACCAGTTGGAGTTGCCATATAA-3' used for sequencing <i>Fjoh_4559</i>
1468	5'- GGATAACGATTTTCGTGCAACATAA-3' used for sequencing <i>Fjoh_4562</i>
1469	5'- CTGATAATATCCGTCTCCAGACATAC-3' used for sequencing <i>Fjoh_4562</i>
1470	5'- GCGCGAAATCTATTGACATTCAG-3' used for sequencing <i>Fjoh_4561</i>
1471	5'- CAAAGCTGTCGGCAGATAAGTA-3' used for sequencing <i>Fjoh_4561</i>
1512	5' – GCTAGGGTACCGGAAGTGGCTCAGGATTCTT – 3', Forward primer to amplify <i>Fjoh_4559</i> . KpnI site underlined.
1513	5' – GCTAGGTCGACCGGCGAGTAACAAAGTACAAATAG – 3', Reverse primer to amplify <i>Fjoh_4559</i> . SalI site underlined.
1514	5'-GCTAGGTCGACCTACACAAGTGGAGGAAGA-3', Forward primer to amplify <i>Fjoh_4558</i> . SalI site underlined.
1516	5'-GCTAGGCATGCCTGTGTACCATTTGCTAACC-3', Reverse primer to amplify <i>Fjoh_4558</i> . SphI site underlined.
1561	5'- GCTAGGCTAGCACAGATAATTTTGAAGACATTAATACT-3', forward primer to amplify <i>Fjoh_4558</i> . NheI site underlined
1562	5'- GCTAGCTCGAGTTAGAAATTCGGAGCATTACATCCCA-3', reverse primer to amplify <i>Fjoh_4558</i> . XhoI site underlined
1563	5'- GCTAGGCTAGCACAGAAAATTTTGACGAACTGATAAAG-3', forward primer to amplify <i>Fjoh_4561</i> . NheI site underlined
1564	5'- GCTAGCTCGAGTTAGTTTACATCCCACCAAACCTTACC-3', forward primer to amplify <i>Fjoh_4561</i> . XhoI site underlined

## Results

***F. johnsoniae* has a PUL that appears to be involved in chitin utilization.** The *F. johnsoniae* genome was analyzed for PULs containing *susC*-like and *susD*-like genes (19). One PUL (Fjoh\_4564 to Fjoh\_4555) was predicted to be involved in chitin utilization (Figure 32). It includes Fjoh\_4555 that encodes the major extracellular chitinase ChiA required for chitin utilization as discussed in chapter 2. It also includes genes encoding other hydrolytic enzymes, SusC-like proteins, SusD-like proteins and regulatory proteins. As typical in other organisms in the phylum *Bacteroidetes*, the *susC*-like genes are located upstream of *susD*-like genes, and are situated near genes encoding hydrolytic enzymes. In addition to *chiA* (Fjoh\_4555) the PUL includes Fjoh\_4560 that is predicted to encode another chitinase. The predicted chitin PUL also includes genes predicted to encode a  $\beta$ -*N*-acetylglucosaminidase (Fjoh\_4556) and a glucosamine-6-phosphate deaminase (Fjoh\_4557). These two enzymes are predicted to be involved in later steps of chitin utilization.

Fjoh\_4558 and Fjoh\_4561 are predicted to encode SusD-like proteins. They exhibit similarity to members of the SusD-like family pfam12741 (7, 8). Fjoh\_4559 and Fjoh\_4562 are predicted to encode SusC-like proteins and these proteins exhibit similarity to members of the SusC-like TIGRFAM families TIGR04056 and TIGR04057. These SusC-like and SusD-like proteins were predicted by PSORTb and CELLO to localize to the outer membrane. The *F. johnsoniae*, SusD-like proteins CusD<sub>I</sub> and CusD<sub>II</sub> exhibit 27% sequence identity over 561 amino acids with each other, whereas the SusC-



like proteins CusC<sub>I</sub> and CusC<sub>II</sub> exhibit 33% sequence identity over 1096 amino acids with each other.

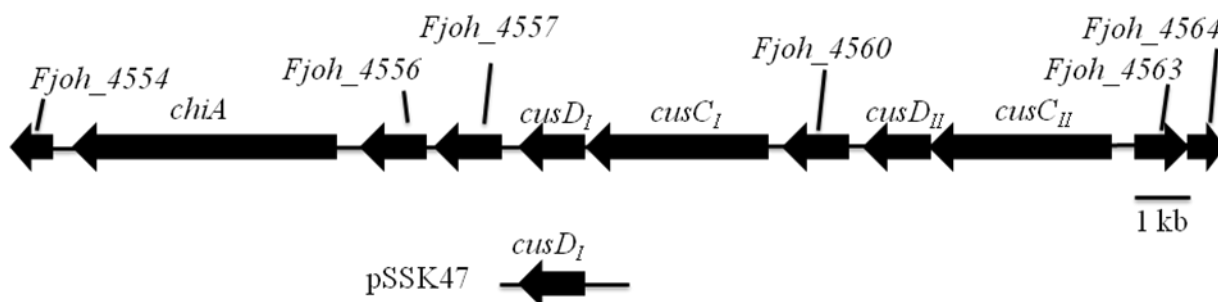

Figure 32. Map of region spanning *susC*-like genes (*cusC<sub>I</sub>*, *cusC<sub>II</sub>*) and *susD*-like genes (*cusD<sub>I</sub>*, *cusD<sub>II</sub>*). Bar indicates one kilobase pair sequences.

#### The SusC-like and SusD-like proteins appear to function in chitin utilization.

Single and multiple deletion mutants were constructed to determine the roles of *F. johnsoniae* *susC*-like and *susD*-like genes in the putative chitin PUL. The ability to utilize chitin was tested in Stanier broth supplemented with colloidal chitin. Cells of CJ2121 ( $\Delta cusD_I$ ) and CJ2156 ( $\Delta cusD_I \Delta cusD_{II}$ ) were partially defective in chitin utilization (Figure 33). In contrast cells with single deletions in CJ2086 (*cusC<sub>I</sub>*), CJ2340 (*cusC<sub>II</sub>*) and CJ2018 (*cusD<sub>II</sub>*) appeared to utilize chitin as well as the wild type cells. Cells of the *chiA* mutant were completely defective in chitin utilization as reported in chapter 2. In contrast, cells of CJ2350 ( $\Delta Fjoh\_4560$ ) predicted to encode another chitinase appeared to grow on chitin as well as the wild-type (Figure 33). A strain lacking all of the *susC*-like and *susD*-like genes of the chitin PUL was also generated. Cells of this  $\Delta(cusD_I$  to *cusC<sub>II</sub>*) mutant CJ2349, appeared to be completely deficient in growth on chitin (Figure 33). This strain also lacked *Fjoh\_4560* which as shown above appears not to be essential for chitin

utilization. The cells of  $\Delta(cusD_I \text{ to } cusC_{II})$  mutant appeared not to grow at all in Stanier broth supplemented with chitin, as compared to the small amount of growth exhibited by the  $(\Delta cusD_I \Delta cusD_{II})$  mutant cells. This suggests that the SusD-like and SusC-like proteins may both have roles in chitin utilization.

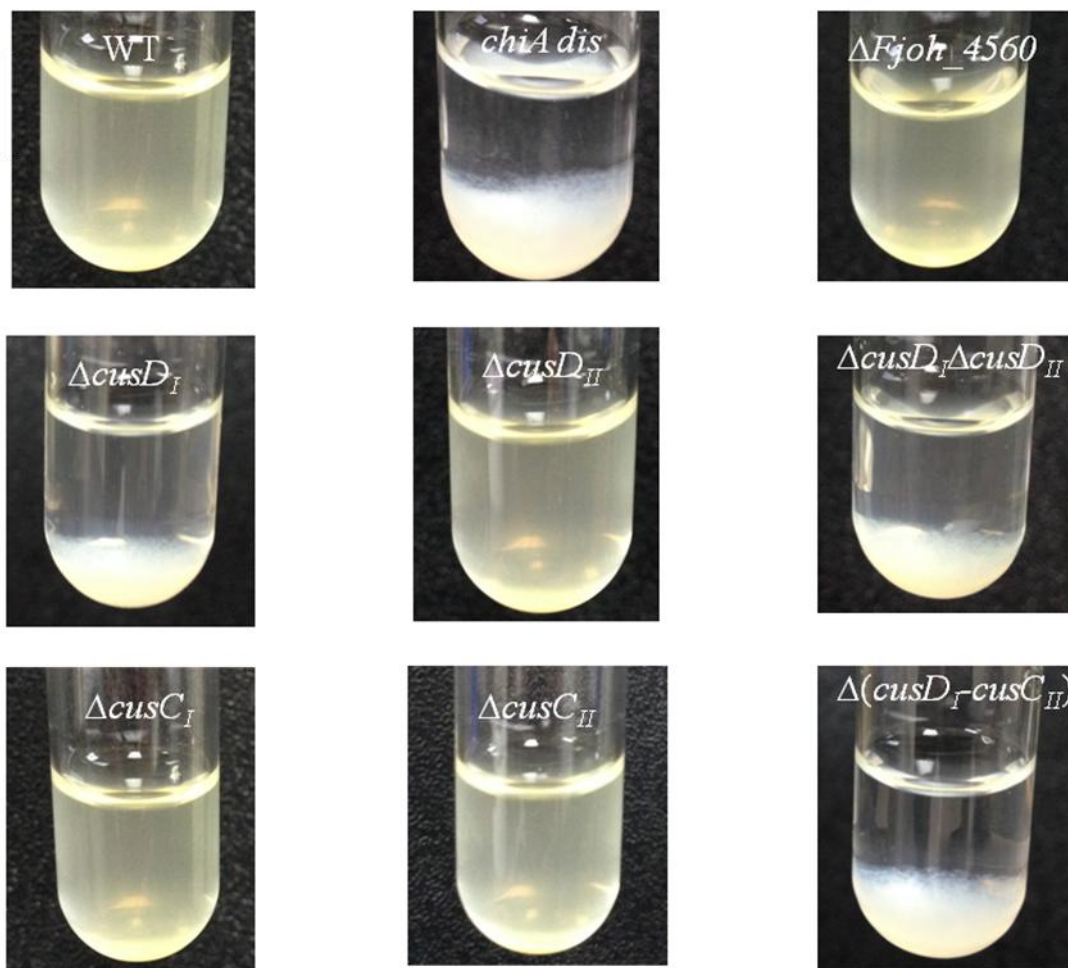

Figure 33. SusC-like and SusD-like proteins appear to function in chitin utilization. Cells of wild type, *chiA* mutant CJ1808,  $\Delta Fjoh\_4560$  mutant CJ2350,  $\Delta cusD_I$  mutant CJ2121,  $\Delta cusD_{II}$  mutant CJ2018,  $\Delta cusD_I \Delta cusD_{II}$  mutant CJ2156,  $\Delta cusC_I$  mutant CJ2086,  $\Delta cusC_{II}$  mutant CJ2340 and  $\Delta (cusD_I \text{ to } cusC_{II})$  mutant CJ2349 were inoculated into Stanier media supplemented with chitin (white) and incubated at 25°C for 48h. Tubes with the  $\Delta cusD_I$  mutant and  $\Delta cusD_I \Delta cusD_{II}$  mutant appear to exhibit minimal turbidity in the broth (indicating bacterial cells) and chitin (white) settled at the bottom. In the tubes of *chiA* mutant,  $\Delta cusD_I$  mutant,  $\Delta cusD_I \Delta cusD_{II}$  mutant, and  $\Delta (cusD_I \text{ to } cusC_{II})$  mutant chitin (white) can be seen at the bottom of the tubes.

## Discussion

*F. johnsoniae*, a member of the phylum *Bacteroidetes*, digests the insoluble polymer chitin (13, 19). Other members of the phylum *Bacteroidetes* are thought to employ outer membrane SusC-like and SusD-like proteins in polymer utilization (14, 15, 19, 26). Analysis of *B. thetaiotaomicron*, starch utilization resulted in the Sus paradigm for polysaccharide utilization by members of the phylum *Bacteroidetes* (16). SusD has been shown to bind starch and its oligomers on the cell surface and SusC is thought to actively transport the starch oligomers across the outer membrane. The oligomers are further digested in the periplasm (16, 26). The results presented in this chapter elucidate the roles of *F. johnsoniae* SusC-like and SusD-like proteins in chitin utilization. Cells of  $\Delta cusD_I$  and  $\Delta cusD_I \Delta cusD_{II}$  mutants were defective in chitin utilization. Cells with individual mutations in *cusC\_I*, *cusC\_{II}* and *cusD\_{II}* appear to utilize chitin as well as the wild-type cells. However, when the region spanning *cusD\_I* to *cusC\_{II}* was deleted the ability to utilize chitin appeared to be completely lost. This suggests redundancy between some of the genes in this region. Quantitative analysis to compare the growth observed in the cells of  $\Delta cusD_I$  and  $\Delta cusD_I \Delta cusD_{II}$  mutants may further elucidate redundant roles in chitin utilization between CusD<sub>I</sub> and CusD<sub>II</sub>. Additionally, construction of a double deletion mutant lacking both *cusC\_I* and *cusC\_{II}* is needed to specifically determine whether CusC<sub>I</sub> and CusC<sub>II</sub> have redundant roles in chitin utilization. Complementation of the  $\Delta(cusD_I-cusC_{II})$  mutant with individual genes or combinations of these genes could also help to determine the roles of individual proteins in chitin utilization.

In *B. thetaiotaomicron* a regulatory gene that controls expression of the *sus* genes is included in the PUL (26). Genes (Fjoh\_4563, Fjoh\_4564) predicted to encode the components of a two-component signal transduction system are located immediately upstream of the *F. johnsoniae* chitin PUL. Further study will be needed to determine whether the proteins encoded by these genes regulate expression of the chitin PUL. Moreover the genes *susA* and *susB* the *B. thetaiotaomicron* in starch PUL encode hydrolytic enzymes that are thought to further hydrolyse starch oligomers internally (periplasmic). Fjoh\_4556 and Fjoh\_4560 are predicted to encode hydrolytic enzymes that might perform the function of further hydrolyzing the internalized chito-oligomers.

The Sus paradigm apparently plays a role in *F. johnsoniae* chitin utilization. Based on the observed results a model for chitin utilization in *F. johnsoniae* is presented (Figure 34). In this model the extracellular chitinase ChiA (discussed in chapter 2) partially digests chitin to produce chito-oligomers that bind to CusD<sub>I</sub> and CusD<sub>II</sub>. The bound oligomers may be actively internalized by the CusC<sub>I</sub> and CusC<sub>II</sub> porins. The oligomers could be hydrolyzed further in the periplasm by hydrolytic enzymes predicted to be encoded by Fjoh\_4556 and Fjoh\_4557. A key feature of Sus-like systems is the coordinated action of several gene products involved in substrate binding, uptake and degradation (16). *F. johnsoniae* CusC<sub>I</sub>, CusC<sub>II</sub>, CusD<sub>I</sub>, and CusD<sub>II</sub> may work synergistically with ChiA to allow efficient utilization of the insoluble polymer chitin.

Insoluble polymers such as chitin and cellulose are thought to be the most abundant polymers on earth (3, 11, 12). These polymers play structural roles in plants, invertebrates and fungi, and they are resistant to digestion. Flavobacteria and related

bacteria are abundant in many environments and presumably contribute to turnover of these polysaccharides. Knowledge of the mechanisms used to utilize insoluble polysaccharides will improve our understanding of carbon turnover in nature. Polysaccharide digesting intestinal bacteria are also beneficial to human health. Understanding the molecular mechanisms underlying insoluble polymer digestion may enable the manipulation of intestinal polysaccharide digesting bacteria to maintain human health. Improved understanding of mechanisms for digestion of insoluble polysaccharides may also allow development of strategies to efficiently convert biomass to biofuels (10). In summary, an improved understanding of the mechanisms involved in the utilization of chitin and other insoluble polysaccharides could have positive biotechnological, economical and human health implications.

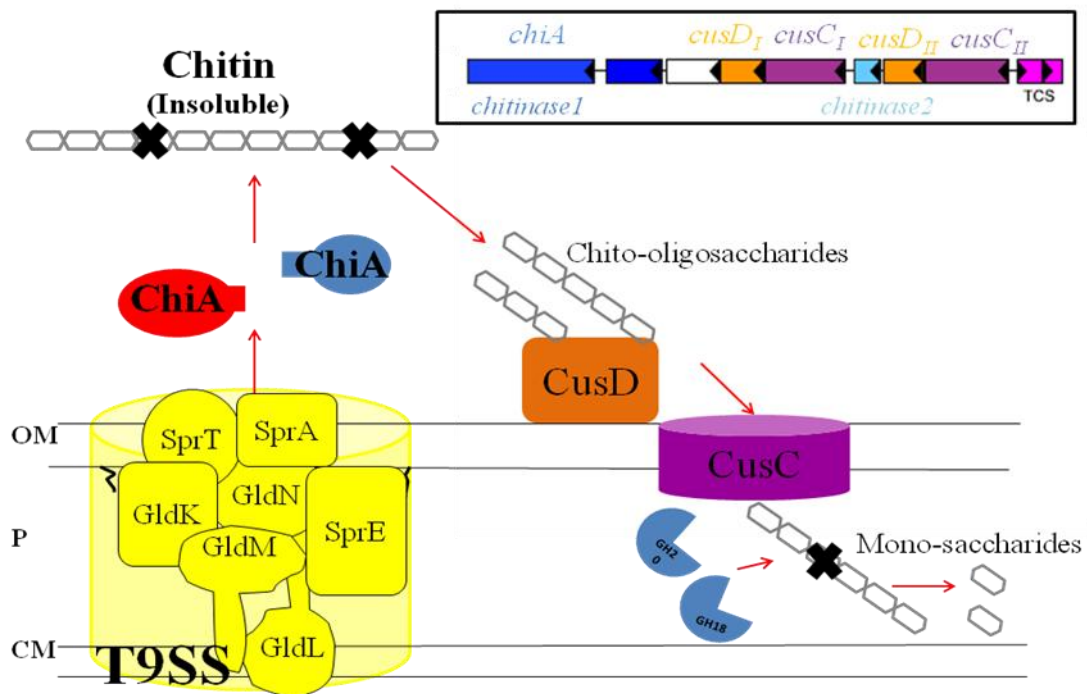

Figure 34. Model for *F. johnsoniae* chitin utilization. Extracellular ChiA (Red and blue) cut chitin into long oligomers. Chitin oligomers bind to SusD-like proteins CusD<sub>I</sub> and CusD<sub>II</sub> (orange) on cell surface and are actively transported (TonB dependent proton pump not shown) across the outer membrane through the SusC like porins CusC<sub>I</sub> and CusC<sub>II</sub> (purple). Other enzymes (light blue) digest the oligomers in the periplasm or cytoplasm. OM-outer membrane, P-periplasm and CM-cytoplasmic membrane. X- hydrolysis. The inset shows the chitin utilization locus. TCS-genes encoding the components of the the two component signal transduction system. Modified from (19).

## References

1. **Agarwal, S., D. W. Hunnicutt, and M. J. McBride.** 1997. Cloning and characterization of the *Flavobacterium johnsoniae* (*Cytophaga johnsonae*) gliding motility gene, *gldA*. Proc. Natl. Acad. Sci. USA **94**:12139-12144.
2. **Anderson, K. L., and A. A. Salyers.** 1989. Genetic evidence that outer membrane binding of starch is required for starch utilization by *Bacteroides thetaiotaomicron*. J Bacteriol **171**:3199-204.
3. **Bayer, E. A., and R. Lamed.** 1992. The cellulose paradox: pollutant par excellence and/or a reclaimable natural resource? Biodegradation **3**:171-88.
4. **Bhattacharya, D., A. Nagpure, and R. K. Gupta.** 2007. Bacterial chitinases: properties and potential. Crit Rev Biotechnol **27**:21-8.
5. **Cameron, E. A., M. A. Maynard, C. J. Smith, T. J. Smith, N. M. Koropatkin, and E. C. Martens.** 2012. Multidomain Carbohydrate-binding Proteins Involved in *Bacteroides thetaiotaomicron* Starch Metabolism. J Biol Chem **287**:34614-25.
6. **Eijsink, V., I. Hoell, and G. Vaaje-Kolstada.** 2010. Structure and function of enzymes acting on chitin and chitosan. Biotechnol Genet Eng Rev **27**:331-66.
7. **Finn, R. D., A. Bateman, J. Clements, P. Coggill, R. Y. Eberhardt, S. R. Eddy, A. Heger, K. Hetherington, L. Holm, J. Mistry, E. L. Sonnhammer, J. Tate, and M. Punta.** 2013. Pfam: the protein families database. Nucleic Acids Res **42**:D222-30.
8. **Finn, R. D., B. L. Miller, J. Clements, and A. Bateman.** 2013. iPfam: a database of protein family and domain interactions found in the Protein Data Bank. Nucleic Acids Res **42**:D364-73.
9. **Flint, H. J., E. A. Bayer, M. T. Rincon, R. Lamed, and B. A. White.** 2008. Polysaccharide utilization by gut bacteria: potential for new insights from genomic analysis. Nat Rev Microbiol **6**:121-31.
10. **Gray, K. A., L. Zhao, and M. Emptage.** 2006. Bioethanol. Curr Opin Chem Biol **10**:141-6.
11. **Keyhani, N. O., and S. Roseman.** 1996. The chitin catabolic cascade in the marine bacterium *Vibrio furnissii*. Molecular cloning, isolation, and characterization of a periplasmic beta-N-acetylglucosaminidase. J Biol Chem **271**:33425-32.
12. **Keyhani, N. O., and S. Roseman.** 1999. Physiological aspects of chitin catabolism in marine bacteria. Biochim Biophys Acta **1473**:108-22.
13. **Kharade, S. S., and M. J. McBride.** 2014. The *Flavobacterium johnsoniae* chitinase ChiA is required for chitin utilization and is secreted by the type IX secretion system. J Bacteriol. **196**:961-970
14. **Larsbrink, J., T. E. Rogers, G. R. Hemsworth, L. S. McKee, A. S. Tauzin, O. Spadiut, S. Klintner, N. A. Pudlo, K. Urs, N. M. Koropatkin, A. L. Creagh, C. A. Haynes, A. G. Kelly, S. N. Cederholm, G. J. Davies, E. C. Martens, and H. Brumer.** 2014. A discrete genetic locus confers xyloglucan metabolism in select human gut *Bacteroidetes*. Nature **506**:498-502.



15. **Larsbrink, J., A. J. Thompson, M. Lundqvist, J. G. Gardner, G. J. Davies, and H. Brumer.** 2014. A complex gene locus enables xyloglucan utilization in the model saprophyte *Cellvibrio japonicus*. *Mol Microbiol* **94**:418-33.
16. **Martens, E. C., N. M. Koropatkin, T. J. Smith, and J. I. Gordon.** 2009. Complex glycan catabolism by the human gut microbiota: the *Bacteroidetes* Sus-like paradigm. *J Biol Chem* **284**:24673-7.
17. **McBride, M. J., and T. F. Braun.** 2004. GldI is a lipoprotein that is required for *Flavobacterium johnsoniae* gliding motility and chitin utilization. *J. Bacteriol.* **186**:2295-302.
18. **McBride, M. J., and M. J. Kempf.** 1996. Development of techniques for the genetic manipulation of the gliding bacterium *Cytophaga johnsonae*. *J. Bacteriol.* **178**:583-590.
19. **McBride, M. J., G. Xie, E. C. Martens, A. Lapidus, B. Henrissat, R. G. Rhodes, E. Goltsman, W. Wang, J. Xu, D. W. Hunnicutt, A. M. Staroscik, T. R. Hoover, Y. Q. Cheng, and J. L. Stein.** 2009. Novel features of the polysaccharide-digesting gliding bacterium *Flavobacterium johnsoniae* as revealed by genome sequence analysis. *Appl Environ Microbiol* **75**:6864-75.
20. **Reeves, A. R., J. N. D'Elia, J. Frias, and A. A. Salyers.** 1996. A *Bacteroides thetaiotaomicron* outer membrane protein that is essential for utilization of maltooligosaccharides and starch. *J Bacteriol* **178**:823-30.
21. **Rhodes, R. G., H. G. Pucker, and M. J. McBride.** 2011. Development and use of a gene deletion strategy for *Flavobacterium johnsoniae* to identify the redundant motility genes *remF*, *remG*, *remH*, and *remI*. *J. Bacteriol.* **193**:2418-2428.
22. **Rhodes, R. G., M. N. Samarasam, A. Shrivastava, J. M. van Baaren, S. Pochiraju, S. Bollampalli, and M. J. McBride.** 2009. *Flavobacterium johnsoniae* *gldN* and *gldO* are partially redundant genes required for gliding motility and surface localization of SprB. *J Bacteriol* **192**:1201-11.
23. **Salyers, A. A., G. Bonheyo, and N. B. Shoemaker.** 2000. Starting a new genetic system: lessons from bacteroides. *Methods* **20**:35-46.
24. **Salyers, A. A., S. E. West, J. R. Vercellotti, and T. D. Wilkins.** 1977. Fermentation of mucins and plant polysaccharides by anaerobic bacteria from the human colon. *Appl Environ Microbiol* **34**:529-33.
25. **Shipman, J. A., K. H. Cho, H. A. Siegel, and A. A. Salyers.** 1999. Physiological characterization of SusG, an outer membrane protein essential for starch utilization by *Bacteroides thetaiotaomicron*. *J Bacteriol* **181**:7206-11.
26. **White, B. A., R. Lamed, E. A. Bayer, and H. J. Flint.** 2014. Biomass utilization by gut microbiomes. *Annu Rev Microbiol* **68**:279-96.

## Chapter 5. Summary

*Flavobacterium johnsoniae*, a member of phylum *Bacteroidetes*, is a gliding bacterium that digests chitin. A novel protein secretion system Type IX secretion system (T9SS) secretes motility adhesins, SprB and RemA. Based on the results presented in this thesis, a model for protein secretion and chitin utilization machinery in *F. johnsoniae* is hypothesized (Figure 35). ChiA, discussed in chapter 2, is a major extracellular soluble chitinase required for chitin utilization. The novel carboxy terminal domain (CTD) of ChiA appears to target ChiA and foreign proteins to the T9SS. Chapter 3 focuses on PorV, an accessory protein of the T9SS required for the secretion of RemA, ChiA and some other proteins secreted via the T9SS. PorV appears to be required for the secretion of proteins with conserved (TIGRFAM 04183) and novel CTDs. In chapter 4, a polysaccharide utilization locus likely to be involved in chitin utilization is presented. SusC-like (TonB dependent porin) proteins and SusD-like (glycan binding) proteins appear to function in chitin utilization. A model has been hypothesized, ChiA secreted via the T9SS cuts the chitin into long oligomers or chito-oligosaccharides. These oligomers appear to bind SusD-like protein CusD. The oligomers are internalized via the SusC-like protein CusC. Chitooligomers are further hydrolysed by hydrolytic enzymes internally. ChiA appears to work with CusC and CusD synergistically to efficiently utilize chitin.

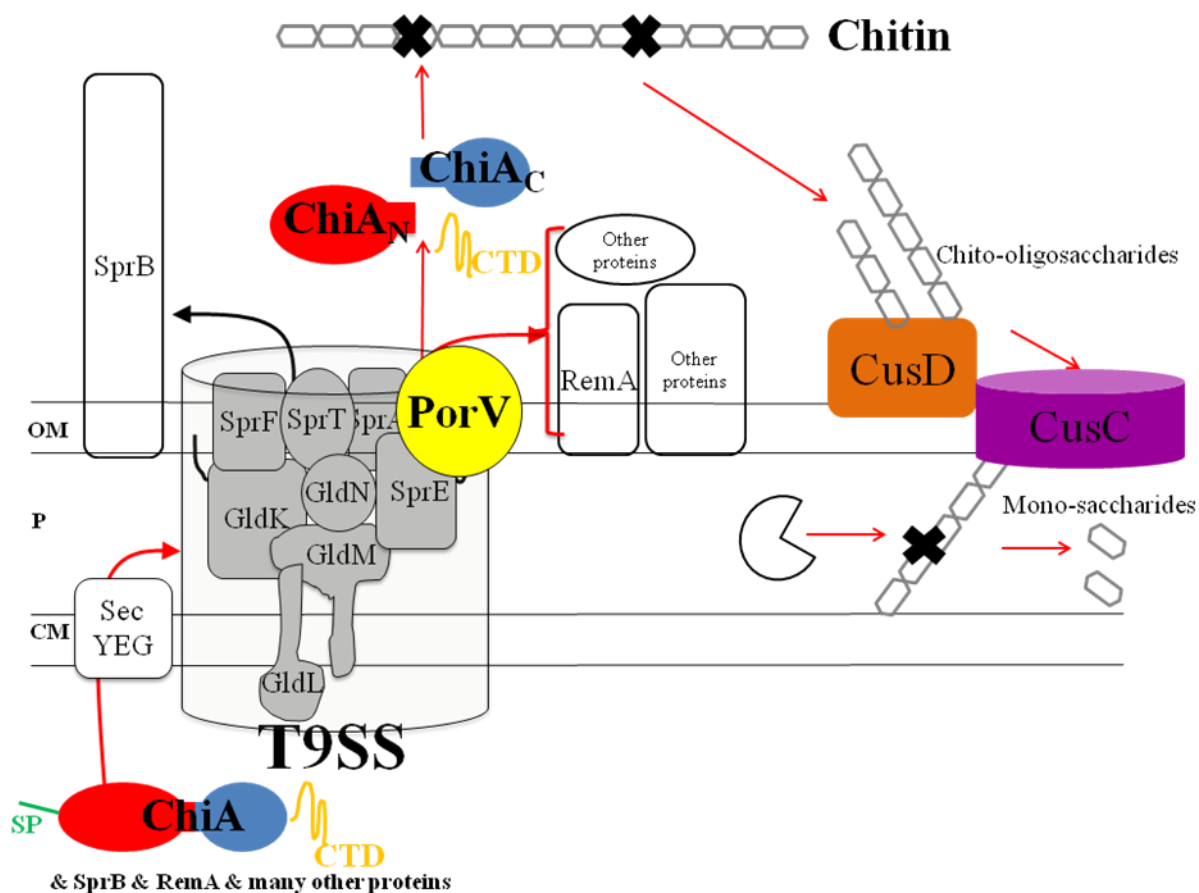

Figure 35. Model of *F. johnsoniae* secretion and chitin utilization machinery based on the results presented in this thesis. In addition to the secretion of motility adhesin SprB and RemA, the major extracellular chitinase ChiA (Red and blue) is secreted by the T9SS. PorV (yellow) is an accessory protein of the T9SS required for the secretion of RemA, ChiA and some other proteins that are secreted via the T9SS. ChiA appears to perform limited hydrolysis of chitin into chito-oligosaccharides, that bind to SusD-like proteins CusD (orange). The oligosaccharides are internalized via the SusC like porins CusC (purple). Chito-oligomers are further hydrolyzed internally by hydrolytic enzymes. ChiA appears to work with CusC and CusD protein to allow efficient utilization of chitin. OM-outer membrane, P-periplasm and CM-cytoplasmic membrane. X- hydrolysis.

## **Appendix 1. Analysis of the carboxy terminal domain (CTD) of ChiA required for secretion by the T9SS.**

As discussed in chapter 2 the novel carboxy-terminal domain (CTD) of ChiA is necessary and sufficient for secretion by the T9SS (2). Proteins secreted by T9SSs typically have conserved CTDs belonging to the TIGRFAM families, TIGR04131 or TIGR04183 (2). The ChiA CTD does not belong to either of these families but instead is novel. Removal of the C-terminal 106 amino acids of ChiA resulted in accumulation of ChiA inside of cells. Fusion of the C-terminal 105 amino acids of ChiA to recombinant mCherry resulted in secretion of mCherry into the media. To further ascertain the minimal size required for secretion of proteins by the T9SS, the C-terminal 80 amino acids of ChiA was fused to recombinant mCherry and analyzed.

A plasmid expressing the N-terminal region of ChiA (encoding the signal peptide) fused to mCherry and to the C-terminal 80 amino acids of ChiA (CTD<sub>ChiA80aa</sub>) was constructed (Table 13 and 14). A 708 bp region of mCherry was amplified from pME-mCherry using primer 862 (engineered BamHI site) and primer 1266 (engineered XbaI site). This product was digested with BamHI and XbaI and cloned into pCP23 that had been digested with the same enzymes, generating pSSK30. A 484 bp fragment spanning the *chiA* promoter, start codon, and N-terminal signal peptide encoding region was amplified using primer 1593 (engineered KpnI site) and primer 1516 (engineered BamHI site). The product was inserted into KpnI and BamHI digested pSSK30 to generate pSSK51. To introduce the CTD-encoding region, a 491 bp region was amplified using primer 1599 (engineered XbaI site) and primer 1404 (engineered SphI site). The product

was cloned into pSSK51, to generate pSSK53. pSSK53 was conjugated into wild type and  $\Delta gldNO$  mutant cells to generate CJ2434 and CJ2435 respectively.

Secretion of mCherry was examined in wild type and  $\Delta gldNO$  mutant cells expressing mCherry fused to C-terminal 105 and 80 amino acid regions of ChiA. mCherry fused to the C-terminal 105 amino acids of ChiA was efficiently secreted from wild type cells, but was not secreted from cells of the T9SS ( $\Delta gldNO$ ) mutant. When the C-terminal 80 amino acids of ChiA were fused to mCherry the protein was also seen in the cell free culture fluid of cells of the wild-type, but at a much lower level. This secretion required the T9SS because no mCherry was seen in the culture fluid of cells of the  $\Delta gldNO$  mutant expressing this protein. When mCherry was expressed without the ChiA CTD it did not accumulate in the spent medium; rather, mCherry accumulated in the cells (Figure 36). The results suggest that the 80 C-terminal amino acids region is sufficient to allow some secretion by the T9SS but the inclusion of the an additional 25 amino acids appear to result in more efficient secretion. Additional studies are needed to define the minimal ChiA CTD region and further identify the features that result in optimal secretion by the T9SS. Since the ChiA CTD is novel, similar studies will also be needed to be performed with other CTDs belonging to TIGRFAM families, TIGR04183 (such as RemA) and TIGR04131 (such as SprB) to gain insights into general features required for secretion.

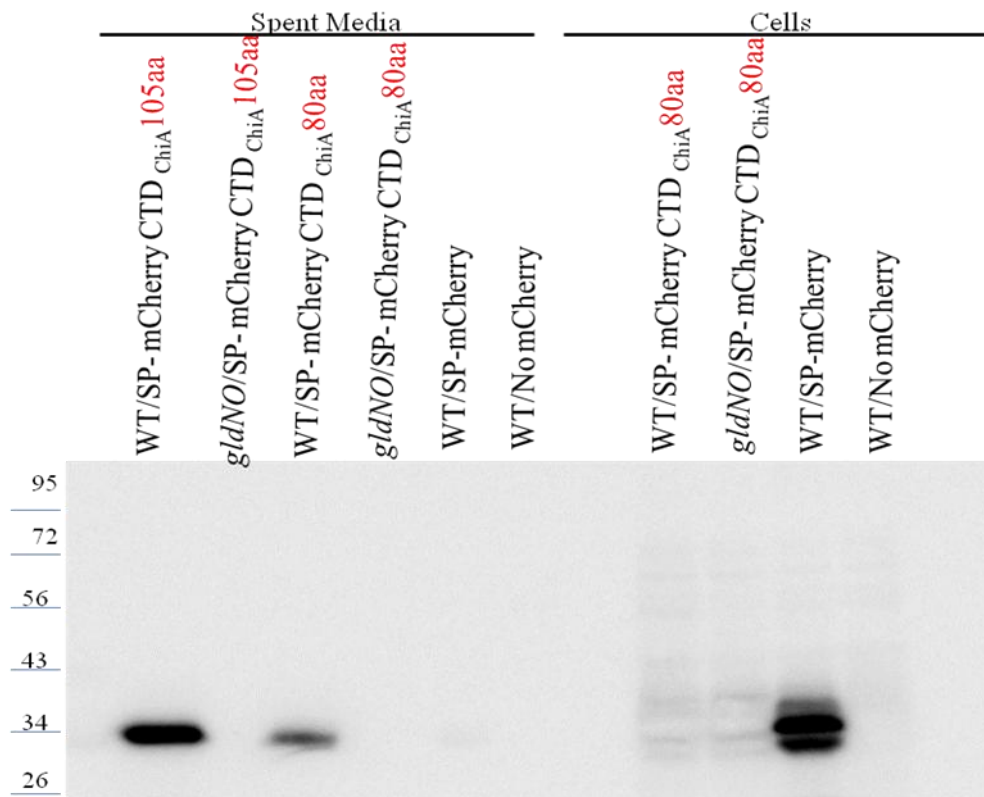

Figure 36. 80 amino acid of ChiA CTD is sufficient for secretion of the heterologous protein mCherry. Cell-free spent media and whole cells were analyzed for cultures of wild-type (WT) cells carrying pSSK54 that expresses mCherry with the N-terminal signal peptide from ChiA (SP-mCherry), or carrying pSSK52 that expresses mCherry with the N-terminal signal peptide from ChiA and the 105 amino acid C-terminal region of ChiA (SP-mCherry-CTD<sub>ChiA</sub>) or carrying pSSK53 that expresses mCherry with N-terminal signal peptide from ChiA and the 80 amino acid C-terminal region of ChiA. Cells and spent media from cultures of the T9SS mutant CJ1631A ( $\Delta$ *gldNO*) carrying pSSK52 and pSSK53 were also analyzed. 'No mCherry' indicates spent media or cells from *F. johnsoniae* carrying the control vector pCP23. Cell samples corresponded to 15  $\mu$ g protein per lane and samples from spent media corresponded to the volume of spent media that contained 15  $\mu$ g cell protein before the cells were removed. Samples were separated by SDS-PAGE and mCherry was detected using antiserum against mCherry.

Table 13. Strains and plasmids used in this study

Strain or plasmid	Genotype and/or description	Source or reference
<i>F. johnsoniae</i> strains		
ATCC 17061 strain UW101	Wild type	(4, 5)
CJ1631A	$\Delta(gldN gldO)$	(7)
CJ1827	Strain used for construction of deletion mutants; <i>rpsL2</i> ; (Sm <sup>r</sup> )	(6)
Plasmids		
pCP23	<i>E. coli-F. johnsoniae</i> shuttle plasmid; Ap <sup>r</sup> (Tc <sup>r</sup> )	(1)
pME-mCherry	Plasmid expressing fluorescent protein mCherry; Km <sup>r</sup>	(3)
pSSK45	<i>mcherry</i> with stop codon amplified with primers 862 and 1443 and cloned into pCP23; Ap <sup>r</sup> (Tc <sup>r</sup> )	(2)
pSSK51	484 bp fragment spanning the <i>chiA</i> promoter, start codon, and N-terminal signal peptide encoding region inserted into pSSK30; Ap <sup>r</sup> (Tc <sup>r</sup> )	(2)
pSSK52	566 bp region encoding 105 amino acid CTD <sub>ChiA</sub> inserted into pSSK51; Ap <sup>r</sup> (Tc <sup>r</sup> )	(2)
pSSK53	491 bp region encoding 80 amino acid CTD <sub>ChiA</sub> inserted into pSSK51; Ap <sup>r</sup> (Tc <sup>r</sup> )	This study
pSSK54	484 bp fragment spanning the <i>chiA</i> promoter, start codon, and N-terminal signal peptide encoding region inserted into pSSK45; Ap <sup>r</sup> (Tc <sup>r</sup> )	(2)

Table 14. Primers used in this study

Primers	Sequence and Description
1404	5'-GCTAGGCATGCTCACCTAATACAATAACTAACCTC-3'; Reverse primer to amplify <i>chiA</i> CTD for making construct pSSK52; SphI site underlined.
1516	5'-GCTAGGGATCCCACTACTTTTTTCCCGTGGGCTGGCTG -3'; Reverse primer to amplify short N-terminal region of <i>chiA</i> to construct pSSK52 and pSSK54; BamHI site underlined.
1593	5'- GCTAGGGTACCTTCCCCGGTAGAGATAGTTATGGCTAT -3' Forward primer to amplify N-terminal region of <i>chiA</i> to make constructs pSSK52,,and pSSK54; Binds 400 bp upstream of <i>chiA</i> start codon; KpnI site underlined.
1599	5' GCTAG TCTAGA GCAACGATAGCTTATTTTAAAAACAAT -3' forward primer to amplify <i>chiA</i> CTD (80 aa) region for making construct pSSK53; XbaI site underlined
1600	5'GCTAGTCTAGAGCTTATGCAGCTTATTTTCGCATCACAA -3' forward primer to amplify <i>chiA</i> CTD (105 aa) region for making construct pSSK52; XbaI site underlined



## References

1. **Agarwal, S., D. W. Hunnicutt, and M. J. McBride.** 1997. Cloning and characterization of the *Flavobacterium johnsoniae* (*Cytophaga johnsonae*) gliding motility gene, *gldA*. Proc. Natl. Acad. Sci. USA **94**:12139-12144.
2. **Kharade, S. S., and M. J. McBride.** 2014. The *Flavobacterium johnsoniae* chitinase ChiA is required for chitin utilization and is secreted by the type IX secretion system. J Bacteriol. **196**:961-970
3. **Kwan, K. M., E. Fujimoto, C. Grabher, B. D. Mangum, M. E. Hardy, D. S. Campbell, J. M. Parant, H. J. Yost, J. P. Kanki, and C. B. Chien.** 2007. The Tol2kit: A multisite Gateway-based construction kit for Tol2 transposon transgenesis constructs. Developmental Dynamics **236**:3088-3099.
4. **McBride, M. J., and T. F. Braun.** 2004. GldI is a lipoprotein that is required for *Flavobacterium johnsoniae* gliding motility and chitin utilization. J. Bacteriol. **186**:2295-2302.
5. **McBride, M. J., G. Xie, E. C. Martens, A. Lapidus, B. Henrissat, R. G. Rhodes, E. Goltsman, W. Wang, J. Xu, D. W. Hunnicutt, A. M. Staroscik, T. R. Hoover, Y. Q. Cheng, and J. L. Stein.** 2009. Novel features of the polysaccharide-digesting gliding bacterium *Flavobacterium johnsoniae* as revealed by genome sequence analysis. Appl. Environ. Microbiol. **75**:6864-6875.
6. **Rhodes, R. G., H. G. Pucker, and M. J. McBride.** 2011. Development and use of a gene deletion strategy for *Flavobacterium johnsoniae* to identify the redundant motility genes *remF*, *remG*, *remH*, and *remI*. J. Bacteriol. **193**:2418-2428.
7. **Rhodes, R. G., M. N. Samarasam, A. Shrivastava, J. M. van Baaren, S. Pochiraju, S. Bollampalli, and M. J. McBride.** 2010. *Flavobacterium johnsoniae* *gldN* and *gldO* are partially redundant genes required for gliding motility and surface localization of SprB. J. Bacteriol. **192**:1201-1211.

**Appendix 2. Protocol for making 2% w/v colloidal chitin slurry**

1. Suspend 20 g Chitin in 400 ml HCl (~32%).
2. Stir the mixture for 20-30 min until black colloidal solution appears.
3. Pour into 5 L of ice-cold deionized water. The solution will turn white.
4. Continue stirring for 10 min.
5. Centrifuge at 8,000 rpm for 5 min and remove supernatant.
6. Resuspend the pellet in deionized water.
7. Repeat steps 5-6 for 5 times. A pH value of about 4 will be attained.
8. Adjust the pH to 7 with NaOH.
9. Dilute the volume 1 L (final concentration 2% (w/v))

## CURRICULUM VITAE

### Personal:

Name: Sampada S. Kharade  
Address: Department of Biological Sciences,  
UW Milwaukee, 3209 N. Maryland Avenue  
Milwaukee WI-53211

### Education:

PhD: Molecular Biology: 2009-2014  
Department of Biological Sciences, University of Wisconsin-Milwaukee

Masters in Microbiology: 2005-2007  
Department of Microbiology, Bhavan's College, University of Mumbai, India

Bachelors in Microbiology 2001-2004  
Major: Microbiology  
Minor: Chemistry and Zoology  
Bhavan's College, University of Mumbai, India

### Publication:

1. **Kharade S. S.**, McBride M.J. '*F. johnsoniae* PorV is required for secretion of a subset of proteins targeted to the type IX secretion system' – *J. Bacteriol.* 2014 (In press)
2. **Kharade S. S.**, McBride M.J. 'The *F. johnsoniae* chitinase ChiA is required for chitin utilization & is secreted by a type IX secretion system.' *J. Bacteriol.* 2014.196(5):961-70
3. **Kharade S. S.**, Bhathena Z. B. 'Use of Myxobacterial pigment as a Bio-textile dye agent.' *Poll. Res.* 2008.27(3):471-479
4. **Kharade S. S.**, *et al.* 'The *F. johnsoniae* chitin utilization system proteins CusC and CusD.' 2014 (In preparation)
5. Zhu Y.T., **Kharade S. S.** *et al* 'Outer membrane proteins related to *Bacteroides thetaiotaomicron* SusC and SusD are not required for *Cytophaga hutchinsonii* cellulose utilization' 2014 (In preparation)

**Poster Presentation:**

**Kharade S. S.**, McBride M.J. The *Flavobacterium johnsoniae* chitinase ChiA is required for chitin utilization and is secreted by a type IX secretion system. American Society of Microbiology (ASM), Denver Colorado & UW Milwaukee Symposium, 2013

Zhu Y. T., **Kharade S.S.**, McBride. Polysaccharide utilization locus in *Cytophaga hutchinsonii* Gordon Research Conference (GRC), New Haven, 2013

Shrivastava A, **Kharade S.S.**, Rhodes R.G., Van Baaren J.M. McBride M.J. Novel Protein Secretion and gliding motility machineries of *F. johnsoniae*. (GRC), Vermont 2012

Shrivastava.A., **Kharade S. S.**, Rhodes R.G. & McBride M.J. Genetic & genomic analysis of *Flavobacterium johnsoniae* adhesin, motility & protein secretion. Proceedings of *Flavobacterium* 2012 Meeting, Finland, 2012

**Kharade S.S.**, *et al.* A Novel Protein secretion Machine of *Flavobacterium johnsoniae* University of Wisconsin Milwaukee Symposium, 2010

**Kharade S.S.**, Aging Remedies - Natural and Synthetic. University of Mumbai, 2006

**Invited Lectures:**

‘Novel motility, protein secretion and chitin utilization machinery of *F. johnsoniae*.’ 2013 Milwaukee Microbiology Society, Great Lakes Water Institute, Milwaukee

‘Novel protein secretion and chitin utilization machinery of *F. johnsoniae*.’, 2014 Department of Biological Sciences Colloquium Series, UWM

**Awards/honors:**

Ruth Walker Graduate Award for Outstanding Achievement, UWM, 2014

Ruth Walker Graduate Scholarship Award, UWM, 2013-14

Student Travel Award, UWM, 2013

Chancellor’s Award, UWM, 2009-12

Ruth Walker Graduate Award for Outstanding Student, UWM, 2011

Best Poster Presentation Award, Biological Science Symposium, UWM, 2010

Funding for Master's Project, Bhavan's College, University of Mumbai, 2007

Bhavan's Association of Microbiologist Award, University of Mumbai, 2006

Honor's Award, Bhavan's College, University of Mumbai, 2004

### **Employments:**

Teaching Assistant for General Microbiology, 2012-2014 & 2009-2011  
Department of Biological Sciences, University of Wisconsin Milwaukee.

Research Assistant, 2011-2012  
Department of Biological Sciences, University of Wisconsin Milwaukee.

Lecturer for Microbiology, Microbial Physiology and Biotechnology, 2008  
Department of Microbiology, University of Mumbai.

Research Assistant, 2007  
Project: 'Characterization of bio-solids from UASB using TEM and ESEM'  
Indian Institute of Technology, Mumbai.

Teaching Assistant and Lecturer for Microbiology, 2006  
Department of Microbiology, Bhavan's College, University of Mumbai.

Teaching Assistant for Workshop, 2005  
Department of Microbiology, Bhavan's College, University of Mumbai.

Internships,  
Project: 'Microbiological Analysis of cat litter soil', 2003  
Department of Microbiology, University of Mumbai

Project: 'Identification & maintenance of microorganisms from activated sludge', 2002  
German Remedies, Department of Microbiology, University of Mumbai.

**Memberships:**

American Society of Microbiologist (ASM), 2009-present

Bhavan's Association of Microbiologist (BAM), Bhavan's College 2001-present

Fund Raiser & Social Events Officer, Graduate Association of Microbiologist (GOBS), UWM, 2010-12

Fund raiser event officer for 'Dhala Felication Fund', Bhavan's College, 2003  
Bhavan's Association of Microbiologist (BAM), Department of Microbiology.