

2014

# Development of Test Methodology for Evaluation of Fuel Economy in Motorcycle Engines

Alexander Michlberger  
*Cleveland State University*

Follow this and additional works at: <https://engagedscholarship.csuohio.edu/etdarchive>

 Part of the [Mechanical Engineering Commons](#)

**How does access to this work benefit you? Let us know!**

---

## Recommended Citation

Michlberger, Alexander, "Development of Test Methodology for Evaluation of Fuel Economy in Motorcycle Engines" (2014). *ETD Archive*. 855.

<https://engagedscholarship.csuohio.edu/etdarchive/855>

This Thesis is brought to you for free and open access by EngagedScholarship@CSU. It has been accepted for inclusion in ETD Archive by an authorized administrator of EngagedScholarship@CSU. For more information, please contact [library.es@csuohio.edu](mailto:library.es@csuohio.edu).

**DEVELOPMENT OF TEST METHODOLOGY FOR EVALUATION OF FUEL  
ECONOMY IN MOTORCYCLE ENGINES**

**ALEXANDER MICHLBERGER**

Bachelor of Science in Mechanical Engineering

University of Akron

May, 2010

Submitted in partial fulfillment of requirements for the degree

**MASTER OF SCIENCE IN MECHANICAL ENGINEERING**

at the

**CLEVELAND STATE UNIVERSITY**

Spring 2014

We hereby approve this thesis

For

**ALEXANDER MICHLBERGER**

Candidate for the Master of Science in Mechanical Engineering Degree

for the Department of

Mechanical Engineering

And

CLEVELAND STATE UNIVERSITY'S

College of Graduate Studies by

---

**Dr. Jerzy T. Sawicki, Thesis Committee Chairperson**  
Department of Mechanical Engineering

---

Date

---

**Dr. Stephen F. Duffy, Thesis Committee Member**  
Department of Civil Engineering

---

Date

---

**Dr. Ana V. Stankovic, Thesis Committee Member**  
Department of Electrical and Computer Engineering

---

Date

Student's Date of Defense: 4/11/2014

## **ACKNOWLEDGEMENTS**

I would like to sincerely thank Dr. Jerzy Sawicki for his guidance during my Master's work at Cleveland State University. Dr. Sawicki has always been very interested in my scholastic and personal development. In almost a decade of collegiate studies, Dr. Sawicki stands out as one of the best educators I've ever had the opportunity to study under.

I would also like to thank the members of the Thesis Review Committee, Dr. Stephen F. Duffy, Dr. Ana V. Stankovic, and Dr. Alexander H. Pesch for their review of this thesis.

I would also like to thank the Mechanical Engineering and Testing (MET) department at The Lubrizol Corporation for allowing me to document the development of this engine test for use as my thesis and support my goal of obtaining a graduate degree. Particularly I would like to thank Peter Kampe, Joseph Vujica, and Michael Conrad from the MET department for their support of this venture.

I would also like to thank Michael Sater, one of the best and most creative mechanical fabricators at The Lubrizol Corporation I've ever had the pleasure of working with. Although it was my responsibility for the design, installation, and operation of the engine test rig, Michael was the talent responsible for the cutting, grinding, welding, and fitting of all mechanical parts and really made my design and vision successful.

I would also like to thank Daniel Geisman, Senior Instrumentation Engineer, at The Lubrizol Corporation for his expert help in the design and construction of the electrical and instrumentation systems necessary to install this engine test rig.

I would also like to thank Dr. Brent Dohner and Michael Marcella, who are both engine oil formulators at The Lubrizol Corporation. Both Brent and Michael have years

of experience within the oil and petroleum industries and have patiently and repeatedly taken the time to explain the complicated chemistry of engine oils to me.

I would also like to thank David Duncan, Global Technology Director of Engine Oils at The Lubrizol Corporation, for his guidance, support, and genuine interest in my development as an engineer.

Finally, I would like to thank my wife Catlin and my parents, George and Brenda, for their unwavering support and instruction which has been instrumental in helping me reach goals throughout my life.

**DEVELOPMENT OF TEST METHODOLOGY FOR EVALUATION OF FUEL  
ECONOMY IN MOTORCYCLE ENGINES**

**ALEXANDER MICHLBERGER**

**ABSTRACT**

Rising fuel costs and concerns over fossil fuel emissions have resulted in more stringent fuel economy and emissions standards globally. As a result, motor vehicle manufacturers are constantly pushed to develop more efficient engine and drivetrain systems. Along with advances in hardware, the development of highly fuel efficient engine oils and driveline lubricants can have a significant impact on total system efficiency.

Recently motorcycle fuel economy and emissions have come under increased scrutiny. While the passenger vehicle and heavy duty vehicle industries employ a variety of American Society for Testing and Materials (ASTM) standardized tests to measure fuel economy and exhaust emissions, the motorcycle industry has very little standardization and no industry standard fuel economy engine tests. The objective of this work is to fill this void with the development of a motorcycle fuel economy test methodology. The developed testing methodology is demonstrated experimentally using a Honda PCX150 motorcycle engine, which is commercially available and of a size and architecture which is representative of a wide range of motorcycles throughout the world. The fuel economy test is developed to incorporate four unique, steady-state stages in

which engine load and speed are controlled while fuel consumption is measured. Each stage is tailored to produce lubrication in different operating regimes. After suitable test conditions are determined, three oils are prepared and tested. Each test oil was prepared and selected to investigate differences in both oil viscosity and chemical additives. The developed test is shown to have the ability to quantitatively evaluate test oils based on each oil's effect on fuel consumption.

# TABLE OF CONTENTS

ABSTRACT.....	iviii
LIST OF TABLES.....	x
LIST OF FIGURES.....	xi
NOMENCLATURE.....	xiii
CHAPTER	
I. INTRODUCTION.....	1
1.1 Background.....	1
1.1.1 Small Engine Industry.....	2
1.1.2 Brief Description of Engine Oil Additives.....	2
1.1.3 Motorcycle Engine Characteristics.....	5
1.1.4 Motorcycle Engine Comparison to Passenger Vehicle Engines.....	7
1.1.5 Objectives and Goals of the Thesis.....	9
1.2 Literature Review.....	10
1.2.1 Lubrication Regimes.....	10
1.2.2 Standardized Engine Oil Testing.....	11
1.2.3 Passenger Vehicle Engine Oil Tests.....	12
1.2.4 Divergence of Motorcycle Technology.....	14
1.2.5 Need for Motorcycle Specific Tests.....	14
1.2.6 Existing Small Engine Tests.....	16
1.2.7 Initial Investigations.....	18
II. THEORY OF LUBRICATION TESTING FOR FUEL ECONOMY.....	27
2.1 Introduction.....	27
2.2 Concept of Break Specific Fuel Consumption.....	27
2.3 The Stribeck Curve.....	29
2.4 Operating Condition Development.....	31



2.4.1	Speed.....	32
2.4.2	Load .....	33
2.4.3	Viscosity and Temperature .....	35
2.5	Frictional Impact on Fuel Economy .....	37
2.6	Predicted Results .....	38
2.6.1	Piston Ring/Cylinder Bore Friction .....	38
2.6.2	Bearings .....	39
2.6.3	Valvetrain.....	40
2.6.4	Lubrication System .....	40
2.6.5	Summary .....	41
III.	EXPERIMENTAL APPARATUS.....	42
3.1	Introduction .....	42
3.2	Engine Mounting Considerations .....	45
3.2.1	CVT Operation.....	46
3.3	Engine Test Rig Configuration.....	47
3.3.1	Dynamometer.....	50
3.4	Control Systems .....	52
3.4.1	Engine and Dynamometer Control .....	52
3.4.2	Speed Control.....	53
3.4.3	Load Control .....	54
3.4.4	Cooling System.....	55
3.4.5	Combustion Air System.....	60
3.4.6	Exhaust System.....	60
3.4.7	Fuel System.....	62
3.4.8	Test Control Computer .....	63
3.4.9	Control System Summary .....	64
3.5	Vehicle Electrical Systems .....	65
3.5.1	Wiring Harness .....	65
3.5.2	Vehicle Sensors.....	65
3.6	Measurement Systems and Sensors.....	66
3.6.1	Fuel Flow Meter.....	66
3.6.2	Temperature .....	68
3.6.3	Speed.....	69
3.6.4	Load .....	70

3.6.5 Pressure Transducers .....	70
3.7 Safety Systems .....	71
3.7.1 Fuel .....	71
3.7.2 Rotating Components.....	73
3.7.3 Extreme Temperatures .....	73
3.7.4 Dynamometer Cooling.....	73
3.7.5 Programmable Safety Stops.....	74
IV. EXPERIMENTAL RESULTS .....	75
4.1 Introduction .....	75
4.2 Operating Condition Optimization.....	76
4.2.1 Load Estimation.....	76
4.2.2 Thermal Management .....	82
4.2.3 Test Condition Optimization.....	88
4.2.4 Further Test Control Optimization.....	89
4.3 Test Operation .....	92
4.4 Data Acquisition and Analysis .....	94
4.5 Experimental Test Plan .....	94
4.6 Testing Sequence.....	95
4.7 Test Results .....	97
4.8 Discussion .....	100
4.8.1 Main Observations.....	100
4.8.2 Additional Observations .....	102
V. CONCLUSIONS.....	107
5.1 Introduction .....	107
5.2 Industrial Application.....	107
5.3 Possible Directions of Future Research.....	109
5.4 Final Thoughts.....	110
BIBLIOGRAPHY.....	112
APPENDICES .....	118
A. Experimental Fuel System .....	118
B. Experimental Data Acquisition System (Temperature) .....	119

C. Experimental Data Acquisition System (Pressure) .....	120
D. Experimental Control Computer .....	121

## LIST OF TABLES

Table

I.	JASO T 904:2006 MB vs. MA Friction Classification .....	17
II.	JASO T 904:2006 MA1 vs. MA2 Friction Classification.....	17
III.	Commercial Oil with Molybdenum .....	19
IV.	Experimental Oil with Organic FM .....	20
V.	Initial Test Stages .....	75
VI.	Throttle Opening Calculations.....	79
VII.	Second Iteration Test Stages .....	89
VIII.	Third Iteration Condition Sets.....	91
IX.	Test Oils.....	94
X.	Oil Test Matrix.....	96
XI.	BSFC Test Data .....	98
XII.	Average BSFC Test Data .....	98
XIII.	Average Fuel Economy Improvement .....	100
XIV.	FEI and Standard Deviation Test Oil #2 (5W-30 No FM) .....	105
XV.	FEI and Standard Deviation Test Oil #3 (5W-30 With FM) .....	105

## LIST OF FIGURES

Figure

1. VID Test results, Fuel Economy Improvement .....	21
2. Friction Torque Test (FTT) Installation.....	22
3. FTT Data at 120 °C Oil Sump Temperature .....	23
4. FTT data at 140 °C Oil Sump Temperature.....	24
5. Example Stribeck Curve .....	30
6. 2013 Honda PCX 150.....	44
7. Engine/CVT Unit.....	45
8. Engine Crankshaft Adapter Drawing.....	48
9. Engine to dynamometer coupling system .....	49
10. Midwest Model 46 dynamometer .....	51
11. Engine Coolant Heat Exchanger.....	56
12. Stock Thermostat and Housing.....	57
13. Thermostat Replacement Plate Drawing .....	58
14. Thermostat Deletion Plate.....	59
15. Thermostat Deletion Plate Installed on Engine .....	59
16. Exhaust Damper.....	61
17. Flow Meter Error .....	67
18. Fuel Flow Meter.....	67
19. ATI SmartTach .....	69
20. Dynamometer Load Cell.....	70
21. Pressure Transducers .....	71
22. Throttle Body Schematic .....	78

23. Throttle Opening, Actual vs. Linear .....	79
24. Pressure differential across Throttle Body.....	80
25. BSFC vs. Engine Speed .....	99
26. Average FEI.....	100
27. Average FEI with suspect outlier removed.....	106

## NOMENCLATURE

$A_{Bore}$	Area of throttle body, $in^2$
$A_{Projected}$	Projected area of throttle plate, $in^2$
$A$ and $B$	Viscosity coefficients for Walther equation, dimensionless
$BSFC$	Break Specific Fuel Economy, $g/kW^*h$
DFI	Dynamic Friction Characteristic Index, dimensionless
FEI	Fuel Economy Improvement, %
FTT	Friction Torque Test
$N$	Rotating Velocity, revolutions/second
$P$	Contact Pressure, Pa
$P_1$	Intake Air Temperature before Throttle Plate, kPa
$P_2$	Intake Air Temperature after Throttle Plate, kPa
$S$	Stribeck Number, dimensionless
SFI	Static Friction Index, dimensionless
STI	Stop Time Index, dimensionless
$\mu$	Dynamic Viscosity, $m^2/s$

# **CHAPTER I**

## **INTRODUCTION**

### **1.1 Background**

Rising fuel costs and concerns over emissions caused by the combustion of fossil fuels have resulted in more stringent fuel economy and emissions standards globally. As a result, motor vehicle manufacturers are constantly pushed to develop more efficient engine and drivetrain systems. Along with advances in hardware, the development of highly fuel efficient engine oils and driveline lubricants can have a significant impact on total system efficiency.

While market trends have emphasized fuel economy in the passenger car and heavy duty vehicle industries for some time, motorcycle and non-road engines have been largely exempt. However, recently motorcycle fuel economy and emissions have come under increased scrutiny [1-3].

The passenger vehicle and heavy duty vehicle industries employ a variety of ASTM (American Society for Testing and Materials) standardized tests to measure fuel economy and exhaust emissions. In contrast, the motorcycle industry has very little standardization and no industry standard fuel economy tests. The objective for this work will be to



develop a test methodology for fuel economy measurement in motorcycle engines with an emphasis on engine oil testing.

### **1.1.1 Small Engine Industry**

The small engine industry, which includes motorcycle engines, is a very unique industry. It is very broad in scope, incorporating such varied technologies as two-stroke air-cooled power tool engines to four-stroke liquid-cooled engines for outboard and recreational use. Even within the sub-category of motorcycle engines, engine configurations are quite diverse. For example, some motorcycle engines, particularly those for use in off-road and scooter applications use two-stroke engines, while the vast majority of on-road engines are of a four-stroke design. All these differences in configuration and end use create a landscape that is very difficult to define, much less to regulate. Because of these many niche markets and products, manufacturers tend to develop their own, proprietary methods of evaluations.

### **1.1.2 Brief Description of Engine Oil Additives**

Although the purpose of this work is to develop a fired engine fuel economy test, it will ultimately be used in the evaluation of engine oils, and thus a brief discussion on engine oils is appropriate.

Engine oils have many important physical and chemical properties including density, viscosity, color, cloud point, flash point, and Total Base Number (TBN). Arguably, the single most important characteristic is viscosity. Viscosity is the most important oil property because it impacts oil film thickness, oil pumpability, and a number of other important factors within an engine. Viscosity is simply the measure of a fluid's resistance to flow. Viscosity is measured as kinematic viscosity, and has units of  $L^2/T$ ,

where L is length and T is time. In the SI system, the unit becomes the centistoke and is abbreviated as cSt and is defined as one mm<sup>2</sup>/s. Another way to describe viscosity is in terms of absolute viscosity, which is the product of kinematic viscosity and density. Units for absolute viscosity in the SI system are centipoise or cP [4].

Engine oils consist of three major groups of materials; base oil, viscosity modifier, and additive package. The base oil, or base stock, makes up the largest percentage of the finished engine oil, typically 80-90%. As the title implies, the base oil is the base of every fully formulated engine oil and is responsible for the oil's bulk fluid properties. There are four major groups of base stocks ranging from conventional (Group I) to full synthetic (Group IV). Mineral oils, oils which use hydrocarbon base stocks, consist of molecules formed by long hydrocarbon chains. The length of these chains is the biggest contributor in determining the viscosity of the base stock. Crude oils that are highly refined produce higher grade base stocks. These higher grade base stocks have hydrocarbon chains which are very similarly sized. Base stocks having similarly sized molecular chains in turn have consistent properties.

Crude oil also contains impurities, or other compounds and elements that lead to undesired characteristics in the base stock. For example, most crude oil contains a high amount of wax. High wax content significantly hampers low temperature oil performance. Wax content is perhaps the largest difference between a Group I and Group II base stocks. The higher extent to which a crude oil is refined generates a base stock with more consistent properties.

Viscosity modifiers typically occupy approximately 10% by volume of the finished engine oils. The job of the viscosity modifier is to alter the viscosity of an engine oil.

Without viscosity modifiers, all oil would be very thick at low temperatures and very thin at high temperatures. The job of the viscosity modifier is to make the viscosity of the oil more thermally stable. Viscosity modifiers are very long molecules that coil in ball-like structures when cold and unravel when hot. Since longer hydrocarbon chain molecules increase viscosity, viscosity modifiers are able to prevent the thinning of oil at high temperatures while allowing base oil properties to dominate at cooler temperatures [4].

The additive package is the final group in the fully formulated oil. It contains a variety of specially developed molecules that enhance oil performance and tailor it to a final application such as transmission fluid, gear oil, or engine oil. Typical additive packages include dispersants, detergents, friction modifiers, anti-wear additives and antioxidants, though they are not limited to these. The dispersant performs the important role of suspending sludge and dirt molecules in the oil so they do not settle in the engine and can be removed by the oil filter. If particles are allowed to settle, they can form sludge deposits within the engine. Detergents are molecules that prevent deposits from forming on critical engine parts. Friction modifiers are polar molecules that attach themselves to engine components and allow metal parts to slide past each other with low friction. Friction modifiers are essential for the development of highly fuel efficient engine oils. Friction modifiers can be organic, containing no metals or inorganic metal containing. Most commonly, the element molybdenum is used in inorganic friction modifiers. Organic and inorganic friction modifiers use different mechanisms to operate, which will be discussed later [4-6].

Like friction modifiers, anti-wear additives are polar molecules that attach themselves to metal components. These anti-wear additives generate a 'sacrificial layer' on moving

metal components which prevents metal to metal contact, thus reducing wear. Anti-wear additives are particularly useful in the boundary lubrication regime, where operating speeds are low, film thicknesses are thin, and loads are high. Boundary lubrication will be discussed more in successive chapters, as it is central to the topic of fuel economy. Finally, the anti-oxidants within an oil's additive package perform the important role of inhibiting the harmful chemical process of oxidation. Oil is always susceptible to oxidation, but this susceptibility increases exponentially with temperature. Since engine oils operate at very high temperatures, especially in high pressure applications like the piston rings and cylinder, oxidation is quite possibly oil's biggest enemy. Oxidation, if allowed to occur, will thicken an oil to the point where it loses its ability to be pumped to critical engine parts.

The additive package performs many critical roles within a fully formulated engine oil, and its importance cannot be overstated. Even if the highest quality base stocks and viscosity modifiers are used in the development of an engine oil, if the additive package is not optimized for the application, the end result will be a poorly performing lubricant.

### **1.1.3 Motorcycle Engine Characteristics**

As mentioned previously, within the already diverse category of small engines, motorcycle engines can come in a variety of configurations, shapes and sizes. Since the vast majority of motorcycles currently produced for road use are four-stroke designs, this discussion will focus on four-stroke engines only. Four-stroke motorcycle engines can be broken up into several different categories, air-cooled versus liquid cooled, and single-cylinder versus multi-cylinder. Generally speaking, smaller engines utilize air-cooling while larger engines are typically liquid-cooled. Although there are no hard rules in the

design of these engines, in many cases, air-cooled engines tend to be single cylinder configurations and liquid cooled engines tend to have multiple cylinders. A noted exception to this 'rule' would be Harley Davidson V-twin engines, nearly all of which are twin cylinder motorcycles that use air cooling.

Cooling method is a very significant consideration because it impacts the design and operation of the engine. Air-cooled engines typically run much hotter than their liquid-cooled counterparts. As a result, tolerances within an air cooled engine tend to be larger to accommodate for increased thermal expansion of engine components. Oiling systems within air-cooled engines are also more rudimentary when compared to those in liquid-cooled engines, having relatively low pressure and flow rates, and typical only a small oil screen instead of an oil filter. Air-cooled engines also typically incorporate rolling element bearings for the crankshaft and camshafts.

Liquid-cooled engines, on the other hand, are not exposed to such drastic temperature swings. A more controlled, tighter operating temperature range, means critical engine components can be more optimized and built to tighter tolerances. These tighter tolerances lend themselves to the use of hydrodynamic bearings for crankshafts and camshafts. The architecture of the multi-cylinder motorcycle engine is therefore more similar to high-output passenger vehicle engines.

Multi-cylinder engines may come in a variety of arrangements, including in-line, V-configuration, and opposed cylinder designs. All designs are currently available and in production today. In-line cylinder configurations lend themselves to high revving, high power output designs. This is evidenced by the many modern sport and racing motorcycles that use this configuration. V-type arrangements often have a lower

maximum engine speed, but offer a flatter torque curve. This flatter torque curve often results in a motorcycle that is easier to ride, since transmission gear selection is not as critical. Finally, opposed-cylinder engine designs are also in production, but are only used in a few production models due to limited space of a narrow motorcycle frame.

#### **1.1.4 Motorcycle Engine Comparison to Passenger Vehicle Engines**

Even though most motorcycles utilize the same four-stroke cycle employed in passenger vehicle engines, there are still many differences between them. One of the largest differences is that the majority of motorcycle engines incorporate the clutch and transmission into the engine case itself. This design produces a very compact powertrain, but also causes unique issues. Lubricating oils are optimized for the components in which they are used. For example a passenger vehicle gear oil or manual transmission fluid is formulated with special anti-wear and extreme pressure additives. These additives are essential to protect against wear and pitting caused by the high pressures and asperity contact experienced in gear mesh. Additionally, gear oils are typically blended to be higher viscosity than engine oils. This thicker viscosity oil forms a thicker film on the gear surfaces which also aids in wear protection.

Conversely, engine oils are formulated with much lower levels of anti-wear and extreme pressure additives and are often blended to achieve much thinner viscosities to enhance pumpability and fuel economy. Additionally, engine oils must be formulated with additives that neutralize acidic combustion products, are resistant to the extremely high temperatures experienced in combustion, and suspend sludge particles for easy extraction in the oil filter. The engine and transmission environments are very different and the requirements they place on lubricating oils are often at odds with each other.

Adding to the complexity, most motorcycle engines use a multi-disc, wet clutch. This wet clutch consists of several steel and fiber plates that operate in a bath of oil. A motorcycle lubricant must therefore strike a delicate balance between reducing friction in the engine, but still providing enough friction for proper clutch operation. Formulating optimized motorcycle oil is a very difficult task.

Yet another constraint that motorcycle engines place on a lubricant is the low capacity of engine oil they contain. Motorcycle oil sumps themselves are much smaller than passenger vehicle oil sumps. This is especially true in the case of the small, single-cylinder, air-cooled engines typically found in scooters and small motorcycles. Any given engine has a minimum lubrication requirement. The oil pump's task is to deliver an oil flow rate that meets or exceeds this lubrication requirement at all speeds, temperatures, and loads. In an engine using a wet sump which includes nearly all passenger vehicle engines and most motorcycle engines, oil is either circulating within the engine, lubricating and removing heat from components, or waiting to do so in the oil sump. The smaller the oil sump becomes, the more time oil spends circulating and the less time it spends in the sump. This means that each oil molecule is thermally cycled more frequently as sump size decreases. This increased rate of thermal cycling together with high temperatures inherent in small engines creates the potential for accelerated oxidation.

Engine components themselves are optimized for the type of riding the motorcycle is designed for. For example, sport and racing motorcycle engines are highly optimized for high speed operation. Reducing component mass is very important at high engine speeds, and as a result, manufacturers have specially designed components to be as light

as possible. Pistons are designed to be very short and wide. Typically, an engine optimized for high speed operation will have a short stroke and large bore. This configuration of wide bore and short stroke is referred to as 'over square'. The longer the stroke, the faster piston speeds must be for any particular rotational speed. Conversely, large displacement, slow speed engines such as those found in heavy duty vehicles use a much smaller bore but a much longer stroke. Since these engines operate at slow speeds, maximum piston speeds are lower and components can therefore be heavier. Engines with a shorter bore than stroke length are called 'under square'.

Other components that are optimized for high speed operation are the valvetrain components. Most passenger vehicles use hydraulic valve lash adjustment components (lifters or camshaft followers). While these provide valve actuation with no need for adjustment, they can become unreliable at very high operation speeds. Additionally, most modern passenger vehicle engines feature rolling contacts in the valvetrain, this reduces wear but makes valve followers heavier. Motorcycle engines commonly use 'bucket and shim' type valve actuation methods. Bucket and shim components are very lightweight, and allow for very high speed operation, but they produce sliding contact with the camshaft lobes. A consequence of sliding contacts is the potential for accelerated wear. The presence of sliding contacts therefore places additional requirements on the engine oil to prevent this wear.

### **1.1.5 Objectives and Goals of the Thesis**

The objective of this work is to develop a fuel economy test using a commercially available motorcycle engine. The test must be accurate enough to repeatedly differentiate



between engine oils based on bulk fluid properties, such as viscosity and additive package differences like the presence of friction modifiers.

To do this, it is first necessary to select and obtain a suitable engine, then develop a test rig capable of supporting the test engine, and finally develop a testing strategy and condition set to evaluate fuel economy in various operating regimes.

## **1.2 Literature Review**

Any venture that is planned to investigate the unknown must be based in a thorough understanding of the past. Before a new test can be developed, it is essential to study earlier works which have made contributions to the current subject matter. In this case, a brief discussion of lubrication theory and several SAE papers are presented for the reader to build this basic understanding.

### **1.2.1 Lubrication Regimes**

There are four different regimes of lubrication which are; hydrodynamic, elastohydrodynamic, mixed, and boundary.

Hydrodynamic lubrication is also referred to as full film lubrication. In this regime, both metal surfaces are separated by a thick film of oil. In bearings, the relative motion causes a high pressure wedge of fluid to form, which suspends the journal in the bearing and prevents surface contact. This is the regime that journal bearings are designed to operate in. Since there is an oil film between metal parts, properties are based almost entirely on the oil's bulk fluid properties [4, 5].

Elastohydrodynamic lubrication is characterized by high loads and high speeds in non-conforming contacts (typically rolling element bearings) where surfaces deform elastically under high pressure. This high pressure is generated due to the

incompressibility of the lubricating oil. Since this regime occurs in rolling contacts such as rolling bearings, it is typically not analyzed in journal bearings [4, 5].

Mixed lubrication can be thought of as a transitional regime between the boundary and hydrodynamic regimes. In mixed lubrication, the load is sufficiently high and speeds are sufficiently low that a full oil film cannot develop between the bearing surfaces, leaving the tallest asperities unprotected. In operation, these asperities can generate localized metal to metal contact [4, 5].

Boundary lubrication is the regime in which a full fluid film has not developed. High pressures, thin oil films, and slow operating speeds characterize boundary lubrication. Because there is no fluid film separating components, asperity contact is prevalent. The result of this asperity contact is relatively high friction and wear [4, 5].

A working knowledge of these lubrication regimes is necessary to understand friction within an engine, and the best methods to mitigate it. Since normal vehicle operation includes the entire spectrum of engine loads, operating speeds, and temperatures, a robust fuel economy test must also consist of multiple stages that target each lubrication regime.

### **1.2.2 Standardized Engine Oil Testing**

The American Petroleum Institute (API) and International Lubrication and Standards Council (ILSAC) have, in conjunction with the American Standards for Testing and Materials (ASTM) created a series of tests that must be run and standards that must be met for an engine oil to receive certification. These tests are very broad in scope and cover a number of performance criteria including oxidation resistance, deposit control, sludge mitigation, valvetrain wear, fuel economy and fuel economy durability. These

tests were developed to evaluate passenger vehicle engine oils and therefore do not pertain to motorcycle engine oils.

### **1.2.3 Passenger Vehicle Engine Oil Tests**

These standards are particularly well defined in the passenger vehicle engine oil segment. The ASTM Sequence III test evaluates oxidative stability and deposit control [7]. The Sequence IV evaluates valvetrain wear [8], the Sequence V evaluates sludge deposit control [9], the Sequence VI evaluates fuel economy and fuel economy durability [10], and finally Sequence VIII evaluates bearing corrosion [11]. Since this project focuses on fuel economy, only the Sequence VI will be discussed.

The Sequence VI has been the ASTM standard for passenger vehicle engine oil fuel economy testing for many years now. Current API standards specify testing protocol and standards for the third iteration of this test, the VID, or Sequence Six D. This test evaluates not only the initial fuel economy improvement (FEI 1) of a candidate oil but also the fuel economy improvement durability (FEI 2). Since fuel economy is by nature difficult to measure, each candidate oil is compared to an industry standard reference oil. All fuel economy improvement results are relative to this reference oil [10].

The Sequence VID test consists of six unique engine condition sets. Each set is intended to induce one of the three main regimes of lubrication, boundary, mixed, and hydrodynamic. Here regimes are referred to in a general sense because each component will experience each lubrication regime at different conditions. For example, the piston ring/cylinder wall interface will experience all their regimes of lubrication in one crankshaft revolution. When the piston is at top dead center (TDC) during a power stroke, cylinder pressures are very high due to combustion. During the combustion event

the hot expanding gasses push the piston ring outward onto the cylinder wall. While this is necessary for optimal combustion chamber sealing, it creates a boundary lubrication condition between the cylinder wall and piston ring due to the high pressures, thin oil film and slow speeds. As combustion continues, the piston accelerates and cylinder pressure decreases. As this occurs the piston ring/cylinder wall interface enters the mixed lubrication regime. As the piston accelerates even more toward the mid-point of its stroke, it enters hydrodynamic lubrication where speed is sufficiently high and contact pressure is sufficiently low to allow the formation of an oil film which separates the components from contact entirely [12]. Likewise, since camshaft rotation speed is half of crankshaft rotation speed, it is a common occurrence that lubrication regimes are different at any particular engine speed.

Each of the six stages is run first with the baseline oil, then with the candidate or test oil, and again with the baseline oil. Fuel consumption for the first and second baseline tests are then averaged and compared to that of the candidate oil test. The results are reported as the fuel economy improvement one (FEI 1). Between the candidate test and second baseline test, a high detergent oil is used to flush the engine. This high detergent flush is necessary to clean all the friction modifiers from the engine. This step is critical to the development of a repeatable test, because the friction modifiers used to reduce friction adhere to metal surfaces and can remain in the engine even after the oil is drained. If they are not removed, their presence will skew results of the next oil [10].

After the FEI 1 evaluation, the candidate oil is reintroduced to the test engine and aged for the equivalent of 6500 miles. After the candidate oil is aged, the same six-stage evaluation is repeated with the baseline and candidate oils to determine FEI 2. This

second evaluation is referred to as fuel economy durability. It is very important because it explains how an oil will perform at the end of its drain interval [10].

#### **1.2.4 Divergence of Motorcycle Technology**

For decades, consumers used passenger car motor oils in their motorcycles. With the advent of ILSAC GF-2, in 1996, passenger vehicle motor oils were required to pass a fuel economy test to be licensed. The best improvements in fuel economy were obtained by the introduction of friction modifiers to the oil. The friction modifiers bond to the metal parts inside the engine and form a sacrificial layer, preventing metal to metal contact and allowing parts to slide past each other with low coefficients of friction. While these friction modifiers had a positive impact on passenger car engine oils by reducing friction, this reduction in friction proved to be detrimental to wet-clutch operation in motorcycles. This event coupled with the acknowledged difference in hardware between motorcycle and passenger vehicle engines and technology signaled a need for motorcycle specific engine oils [13].

#### **1.2.5 Need for Motorcycle Specific Tests**

Throughout the industry, there are no standardized tests for four-stroke motorcycle engine oil, rather original equipment manufacturers (OEMs) are left to develop their own standards for oil performance. This leads to a market that is flooded not only with service fill oils, but also factory branded oils – all of which can be very confusing to the consumer. Further, performance in ASTM standard tests for passenger vehicle engine oils does not necessarily correlate to performance in motorcycle engines. Clearly, there is need for standardization in the world of motorcycle engine oil testing.

For many years, fuel economy in motorcycles was not a concern; as fuel consumption was already much lower than passenger vehicles due to their small size and weight. Additionally, in markets such as North America, motorcycling is seen as a hobby, not as primary transportation. Recently however, the motorcycle industry has also been pushed to improve efficiency and reduce emissions.

In July 2013, during the research for this project, Japan's motorcycle manufacturers voluntarily began displaying the fuel economy values for their motorcycles [14]. The test used to evaluate fuel economy is the World Motorcycle Test Cycle (WMTC). This cycle consists of three 10 minute cycles (Parts 1 – 3). All three parts use transient cycles and each part has a different maximum speed, with Part 3 having the highest speed followed by Part 2 and Part 1 being the slowest. Motorcycles are placed into three classes depending on engine displacement. Class 1 motorcycles are the smallest and Class 3 are the largest. Each class has a unique combination of parts that are run, how the results are weighted, and whether they are run hot or cold. Each drive cycle is performed with the complete motorcycle operated on a chassis dynamometer.

While this new WMTC test sets a benchmark for vehicle performance, typically results generated from chassis dynamometers do not have the precision necessary to differentiate fuel economy testing for engine oils. Items such as tire pressure, drive chain adjustment, air and fuel temperature, and even how the motorcycle is strapped down to the dynamometer all have large impacts on measured fuel economy. This is exactly why the Sequence VID test is not conducted on a chassis dynamometer, but rather on an engine test dynamometer. When the engine is removed and installed in this way, it is

possible to monitor and control nearly every parameter to ensure consistent engine operation and consistent testing.

### **1.2.6 Existing Small Engine Tests**

The Japanese Automotive Standards Organization (JASO) realized the divergence in engine requirements and developed a friction test evaluate an engine oil's characteristics in three key parameters when used in a wet-clutch. From this test, two categories were determined based on the oil's characteristics. The designation for passenger vehicle engine oils, or 'low friction' oils was MB, and the designation for motorcycle engine oils, or 'high friction' oils became MA. The category of MA was further classified into MA1 oils and MA2 oils, with MA 2 providing the highest friction [15].

The test used for this evaluation is procedure JASO T 903:2011 [16]. It is important to note that when initial work was conducted, the previous specification (JASO T 904:2006) was in effect [17]. Because of this, specifics of the previous version will be discussed in the following sections.

Both JASO T 903:2011 and T 904:2006 tests utilize a clutch pack consisting of several steel disks and fiber plates enclosed in a test head. The clutch pack operates in a temperature controlled oil bath. An electric motor is then used to rotate the fiber plates to 3,600 RPM while the steel disks are held static in the test head. During this motoring phase, there is no pressure applied to the clutch pack. Once speed and temperature set points are met, pressure is then applied to the clutch pack to cause lock up. This event is referred to as a dynamic engagement. A metal disc connected to the electric motor simulates vehicle inertia. During this dynamic engagement, parameters such as speed and torque are measured and are used to calculate the Dynamic Friction Characteristic

Index (DFI) and Stop Time Index (STI). These are the first two parameters which are used to classify an engine oil's frictional performance. The third parameter is called the Static Friction Characteristic Index (SFI). For this evaluation, the same set-up is used, but now the evaluation begins with the pressure applied to the clutch to facilitate lock up. A low speed (300 RPM), high torque motor is used to 'break' the clutch pack loose and cause slippage. Once again, torque, speed, and other parameters are measured and used to calculate SFI. The following chart shows the required performance characteristics for each index JASO category [15, 17].

**Table I JASO T 904:2006**

**MB vs. MA Friction Classification [15]**

JASO MB	JASO MA
$0.5 \leq \text{DFI} < 1.45$	$1.45 \leq \text{DFI} < 2.5$
$0.5 \leq \text{SFI} < 1.45$	$1.15 \leq \text{SFI} < 2.5$
$0.5 \leq \text{STI} < 1.55$	$1.55 \leq \text{STI} < 2.5$

**Table II JASO T 904:2006**

**MA1 vs. MA2 Friction Classification [17]**

JASO MA1	JASO MA2
$1.45 \leq \text{DFI} < 1.8$	$1.8 \leq \text{DFI} < 2.5$
$1.15 \leq \text{SFI} < 1.7$	$1.7 \leq \text{SFI} < 2.5$
$1.55 \leq \text{STI} < 1.9$	$1.9 \leq \text{STI} < 2.5$



While this test provided a solution for the immediate problem of slipping motorcycle clutches by developing a standard for motorcycle engine oil friction, it did not touch on any of the other motorcycle specific lubricant needs such as transmission gear durability, oxidative resistance or valvetrain wear.

### **1.2.7 Initial Investigations**

Fuel economy, especially in the context of small engines, is a topic that the author has previously studied [18, 19]. One of the first was an experiment in which engine oils were aged with a motorcycle engine and then evaluated in bench tests. In another experiment, an electric motor driven motorcycle engine was used to evaluate oil's ability to reduce internal engine friction. Both of these experiments have resulted in technical papers, and more importantly, knowledge that is used for the next generation of fuel economy tests. In this way, a more complete picture of engine friction and fuel economy has emerged.

#### **1.2.7.1 Motorcycle Oil Aging**

In 2011, the author was part of a group of researchers who conducted a series of experiments on motorcycle engine oils that resulted in an SAE paper [18]. The objective of this work was to investigate the process of oil aging within a typical, air-cooled motorcycle engine, with particular attention given to the friction modifiers within the lubricant.

The experiment involved the testing of two engine oils. The first was a high quality, commercially available engine oil, the second was an experimental engine oil formulated by chemists at The Lubrizol Corporation. The commercially available engine oil was

formulated with a molybdenum-based friction modifier. Molybdenum is a metal that has very well-known friction reduction properties. The experimental oil contained a proprietary, non-metallic, organic friction modifier. Both oils met JASO MB specifications [18].

A two stage drive cycle was developed which simulated low and moderate speed and load driving at 20 MPH and 45 MPH. 75% of the test was conducted at the 20 MPH condition set and the remaining 25% of the test was conducted at the 45 MPH stage. This condition set was chosen to be very mild, and is believed to be equal or possibly less severe than the typical commuting rider’s drive cycle. The test engine was a Honda XR250, single cylinder, air cooled motorcycle engine. The engine was removed from the frame of the motorcycle and installed into an engine dynamometer test rig [18].

Both the commercially available oil and the experimental oil were aged in a motorcycle engine for an equivalent of 625, 1250, 2500, and 5000 miles. At the end of each mileage accumulation period the oil was drained, chemically analyzed, and evaluated in the JASO T 904:2006 test. The hypothesis being tested was that the oil formulated with the molybdenum-based friction modifier would lose its effectiveness more quickly than the oil formulated with an organic friction modifier. The results of this experiment can be seen in the following tables [18].

**Table III Commercial Oil with Molybdenum [18]**

Miles of Oil Aging	0	625	1250	2500	5000
DFI	1.29	1.38	1.65	1.97	1.97
SFI	1.06	1.29	1.51	1.76	1.79
STI	1.35	1.51	1.72	1.95	1.98
Oil Classification	MB	MA1	MA1	MA2	MA2

**Table IV Experimental Oil with Organic FM [18]**

Miles of Oil Aging	0	625	1250	2500	5000
DFI	1.52	1.66	1.66	1.71	1.68
SFI	0.55	0.94	1.14	1.35	1.39
STI	1.50	1.72	1.73	1.82	1.76
Oil Classification	MB	MB	MB	MA1	MA1

The hypothesis was therefore found to be valid. The commercial oil formulated with a molybdenum-based friction modifier degraded to MA1 within the first 625 miles, whereas the experimental oil's performance did not decrease to this level until the 2500 mile drain interval. Additionally, the commercial oil further degraded into an MA2 oil by 2500 miles, while the experimental oil never degraded to MA2 [18].

To further validate the experimental test and results, these two oils were also tested in the ASTM VID passenger vehicle fuel economy test. Although there are a number of very important differences between this VID passenger vehicle engine and motorcycle engines, the results are in agreement directionally. Both oils initially provide about 1.0% fuel economy improvement over a baseline, however after the standard aging cycle, the commercially available oil only maintains about 20% of its initial fuel economy improvement, whereas the experimental oil offers about 60%. The results can be seen in the following figure. It is hypothesized that the molybdenum friction modifiers break down, especially in the presence of high temperatures. When these additives break down, they lose a large amount of their friction reducing capabilities [18].

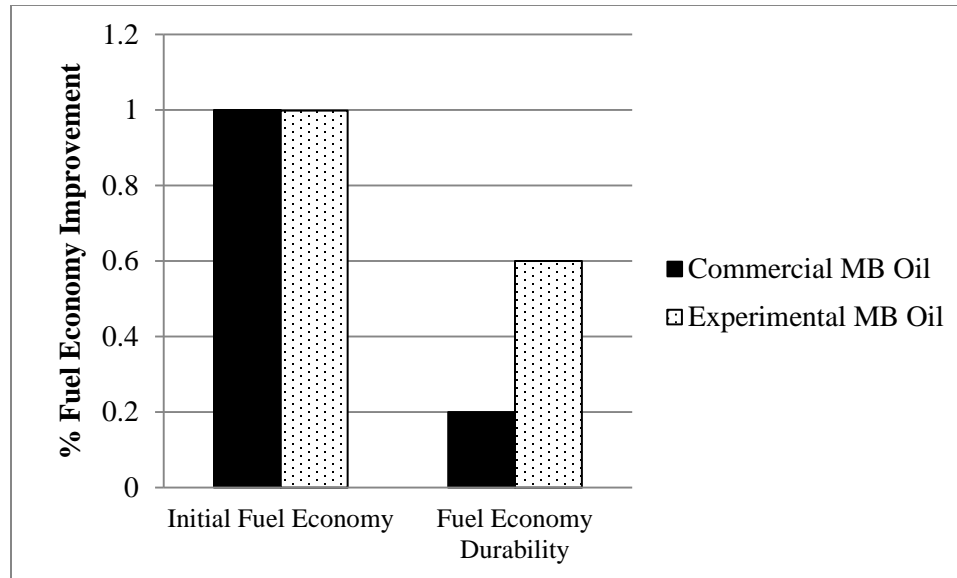

**Figure 1 VID Test results, Fuel Economy Improvement [18]**

Although the results of these tests were very promising, none of the actual fuel economy data was generated in a motorcycle engine. In the experimental test, the motorcycle engine was used only to age engine oils. The actual performance metric, the friction evaluation, took place in the JASO T 904:2006 friction test. In the follow-up testing, the ASTM VID test was used to evaluate the same two oils. While results do directionally match those of the oil aging experiment, it is important to remember that this test uses a passenger vehicle engine and not a motorcycle engine [18].

### **1.2.7.2 Friction Torque Test**

In 2012, the author began experimentation to develop a new test to evaluate frictional losses within a motorcycle engine [19]. This work represented a joint venture between Honda R & D Corporation and The Lubrizol Corporation. For this test, an electric motor was used to drive a motorcycle engine at various speeds. Torque measurements were taken via a high-precision torque meter located between the electric motor and

motorcycle engine. The engine chosen for this evaluation was the Honda CRF 110cc, single cylinder, air-cooled engine with a 4 speed transmission [19].

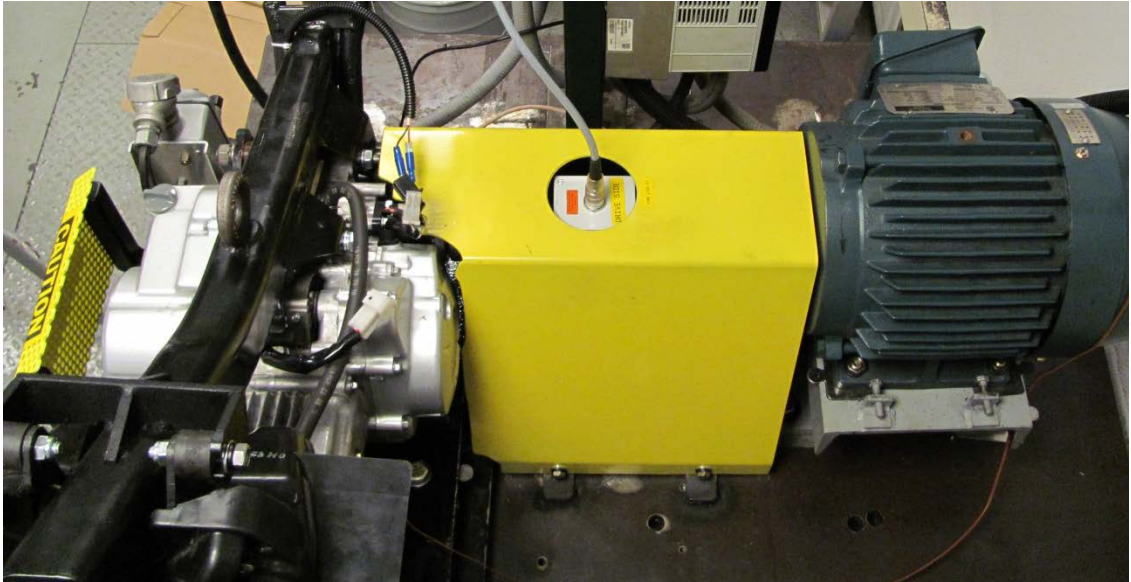

**Figure 2 Friction Torque Test (FTT) Installation: Engine left, motor right, torque meter center [19]**

Each test consists of data gathered from eight (8) engine speeds (2,000 RPM to 9,000 RPM) evaluated at five (5) different oil sump temperatures (60 °C to 140 °C), for a total of forty (40) individual data points. Each oil is compared to a baseline oil to determine performance. Results can be plotted and interpreted in a number of ways. For example, the following plot displays data from an experiment that compared three oils. All oils were identical in viscosity and additive package with the exception of the friction modifier. The first oil is the baseline oil, and has no friction modifier. The second uses molybdenum as the friction modifier and the third uses a proprietary organic friction modifier containing only Nitrogen, Oxygen, Carbon, and Hydrogen (NOCH). Results were normalized to determine performance relative to the baseline oil which contained no

friction modifier. On following plot, Friction Torque Reduction refers to the % reduction in friction compared to the baseline [19].

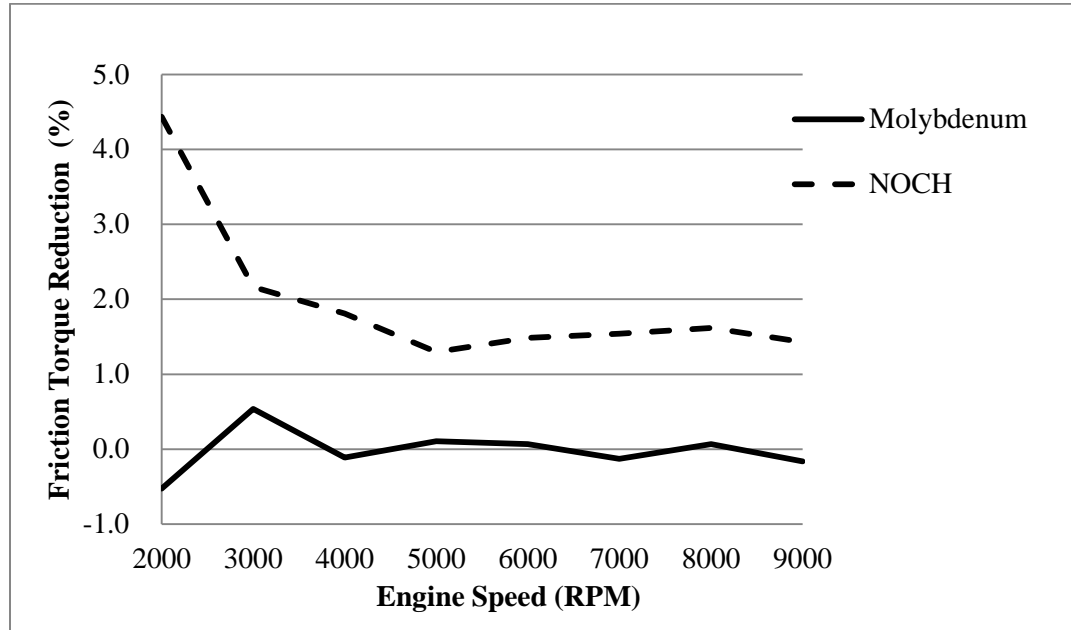

**Figure 3 FTT Data at 120 °C Oil Sump Temperature [19]**

Since both oils have been normalized with respect to the oil which contains no FM, a reduction in friction torque appears as a positive number while an increase in friction torque appears as a negative number. In this dataset, at 120 °C oil sump temperature, oil films are relatively thin. At low speeds, particularly 2,000 - 4,000 RPM, the advantage of the organic friction modifier is very apparent. This result follows logic. Thin oil films (high temperature) and low engine speeds induce boundary lubrication; during boundary lubrication asperity contact occurs. Friction modifiers form a sacrificial layer on metal surfaces and lower coefficients of friction when they come into contact [19].

It is also apparent that the oil formulated with the molybdenum-based friction modifier offers virtually no reduction in friction when compared to the reference. The

fact that the molybdenum friction modifier offers such poor performance in this case is very interesting because molybdenum is known to reduce friction. Some friction modifiers that contain molybdenum are known to be thermally activated – or heated up to the point where the FM forms the sacrificial layer on the metal surfaces. This can be a disadvantage for such inorganic friction modifiers, because they will only reach optimal performance under certain high temperature conditions. Organic friction modifiers like the NOCH chemistry use a different mechanism to reduce friction and do not depend on high activation temperatures. This mechanism will be discussed later in this section [19].

However, as the component and oil temperature increases the molybdenum based friction modifier becomes activated, and begins reducing component friction. In this test, the activation point occurred around 140 °C oil sump temperature. At this point, the molybdenum-containing friction modifier approaches the performance of the organic friction modifier. This result can be seen in the next figure [19].

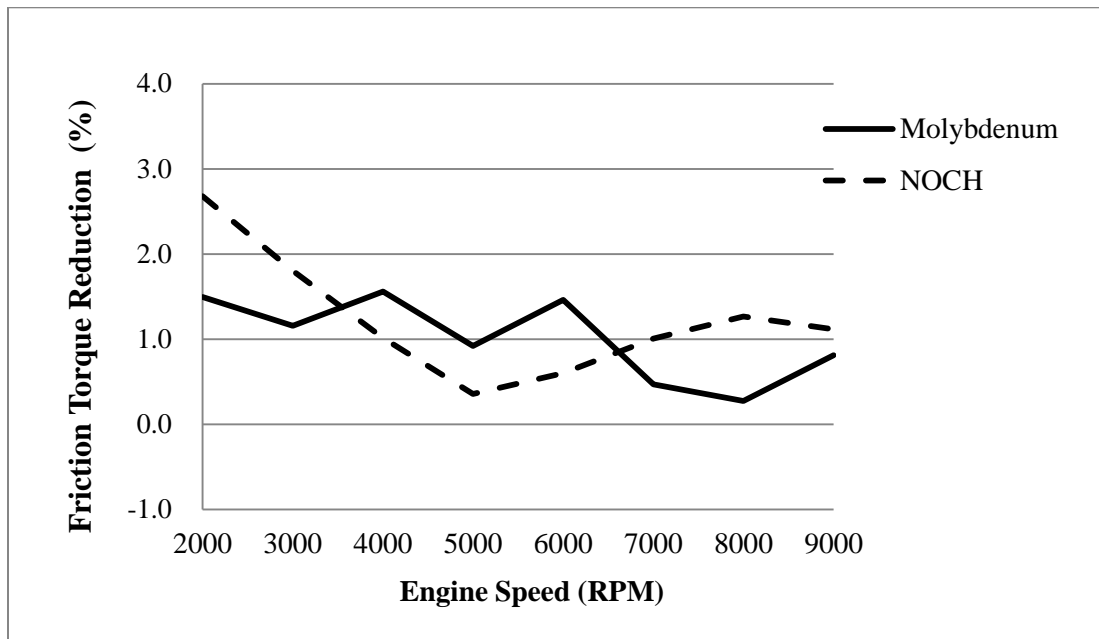

**Figure 4 FTT data at 140 °C Oil Sump Temperature [19]**

### 1.2.7.3 Friction Modifier Mechanisms

Organic friction modifiers and inorganic friction modifiers both reduce component friction, or the type of friction that occurs in boundary lubrication. Organic friction modifiers have the added benefit of reducing viscous friction that occurs in mixed and hydrodynamic lubrication. This is due to the different chemical interactions that each group employs at the oil/component interface.

Inorganic friction modifiers, commonly those which contain molybdenum, develop a layered lattice structure when they come into contact with hot engine parts. This thermal activation is actually the decomposition of the soluble ends of the FM molecule. When the soluble ends decompose, the core of the FM plates out on the metal surface and causes layers of MoS or MoO to form [4]. These layers stack upon each other with each layer being held together by strong covalent bonds. However, *between* the layers only weak Van der Waals force interactions exist. These Van der Waals forces can be easily overcome once a tangential force is applied, causing relative motion between the plates. It is the sliding of these additive layers that lowers the coefficient of friction between two sliding components which operate in boundary lubrication. Due to the thickness of this additive layer, inorganic friction modifiers typically offer lower friction compared to organic friction modifiers within boundary lubrication.

Organic friction modifiers, such as NOCH chemistry, consist of a polar 'head' molecule attached to a long, oil soluble 'tail' molecule. The polar head absorbs into the surface of the metal engine components and leaves the tail in the bulk oil pointing away from the surface. When two components within the engine experience sliding contact in boundary lubrication, the tails of these FM molecules easily slide past each other, as only



very weak forces exist between them. This action prevents asperity contact and lowers coefficients of friction. No thermal activation or plating-out is necessary as in the case of molybdenum based friction modifiers. An interesting consequence of this mechanism is that it also reduces friction within the bulk oil in mixed and even hydrodynamic lubrication. Head groups are attracted by dipole interactions, which are relatively strong and occur in the bulk engine oil. Tail groups are also attracted to each other, but only by Van der Waals forces that are very weak. In mixed and hydrodynamic lubrication, several layers of these head-to-head and tail-to-tail molecules can form in the bulk oil. This creates multiple shear planes *within* the bulk engine oil that will allow tangential motion at low coefficients of friction. In this manner, organic friction modifiers reduce both component and viscous friction.

Once again, a new method of evaluating motorcycle engine oils has been developed. This Friction Torque Test rig allowed for evaluation an engine oil's frictional characteristics, and as a result, insight into friction generation at various operating conditions has been gained. This test in particular is important because it has the accuracy and repeatability of a small scale bench test, but is conducted in an actual motorcycle engine.

## **CHAPTER II**

### **THEORY OF LUBRICATION TESTING FOR FUEL ECONOMY**

#### **2.1 Introduction**

There are several different ways to measure fuel efficiency. One can express fuel efficiency in terms of fuel economy in miles per gallon (MPG), or express fuel consumption in terms of the number of gallons to drive a given amount of miles. In this manner, fuel economy is inversely proportional to fuel consumption. Drivers desire high fuel economy and low fuel consumption. Before a test can be developed, it is important to have an understanding of fuel consumption measurements.

#### **2.2 Concept of Break Specific Fuel Consumption**

While fuel economy is a simple way to express how far a vehicle can travel on a gallon of fuel, it is not a true measure of efficiency. For example, a heavy duty, commercial diesel truck may have an average fuel economy of 6 MPG while a small passenger vehicle may have a fuel economy of 40 MPG. This difference in fuel economy would cause most to say that the small car is more efficient. While the car indeed does have a higher fuel economy, it very well may have a lower efficiency. Speaking about fuel economy in this manner does not take into account power that the engine produces – which is a critical element. If the truck is carrying its maximum payload, it may weigh

up to 80,000 lbs., the small car may only weigh 3,000 lbs. Clearly, more power would be necessary to move the vehicle with the higher mass.

A method is therefore necessary to ‘normalize’ fuel consumption per unit power. The industry accepted method of doing this is by comparing the rate of fuel consumption to the amount of power generated. This method is called Break Specific Fuel Consumption or BSFC, and has SI units of grams of fuel consumed per hour, per kW of power produced. BSFC allows the comparison of not only vehicle types, but also engine types ranging from two-stroke engines to gasoline or diesel four-stroke engines to jet turbine engines because it compares the fuel’s energy to the amount of power produced, regardless of what cycle the engine uses to produce that power. The equation for BSFC is formulated as follows.

$$BSFC = \frac{\text{Fuel Consumption Rate}}{\text{Power Output}} \quad (2.1)$$

Where fuel consumption rate has SI units of grams of fuel per hour and power output has SI units of kW.

To compare the relative performance of two engine oils, the Fuel Economy Improvement (FEI) can be determined as follows:

$$FEI(\%) = \frac{BSFC_1 - BSFC_2}{BSFC_1} \times 100 \quad (2.2)$$

Here,  $BSFC_1$  refers to the BSFC at a specific engine speed and load condition set of a baseline engine oils.  $BSFC_2$  refers to the BSFC at the same condition sets for a second

oil. This method of comparison is very useful when working with engine oils because the absolute value of the BSFC delta is often very small.

From the BSFC, actual overall engine efficiency can be determined as follows:

$$\text{Overall Engine Efficiency} = \frac{1}{\text{BSFC} \times \text{LHV}} \quad (2.3)$$

Where *LHV* is any particular fuel's lower heating value, with SI units of kW\*h/g, and represents the amount of energy stored in a fuel per unit mass. It is also important to note that an engine's fuel consumption and efficiency depend on operating conditions. Typically, reciprocating piston engines will be most efficient while operating at full throttle near peak torque. Peak torque is usually achieved at wide open throttle (WOT) and near the lower end of an engine's operating range. As engine speed increases air has less time to enter the combustion chamber. This reduced time to fill the combustion chamber results in incomplete combustion chamber filling, in the case of a stoichiometric engine, this translates to less fuel, and ultimately produces lower torque.

### **2.3 The Stribeck Curve**

The ideal fuel economy test would incorporate a variety of stages with each stage operating the engine at a single lubrication regime. Indeed, test stages *aim* to isolate lubrication regimes, but cannot completely do so. As explained earlier in the Background section, different components operate at different speeds at any time within an engine; this is the nature of a reciprocating four-stroke engine. The pistons are continually accelerating and decelerating, camshafts spin at half the speed of the crankshaft, while speed and load influences pressure on the bearings. All these things cause constant local

transitions between boundary, mixed, and hydrodynamic lubrication. It is therefore impossible to force all components to operate in the same regime at the same time.

The strategy for test development then is to determine a condition set where one particular lubrication regime can dominate. Without changing engine design or geometry, the three characteristics that can be used to achieve these lubrication regimes are speed, load, and viscosity. The fundamental relationships that ties these parameters together and governs lubrication regime can be seen in the Stribeck curve [5]. The Stribeck curve relates these three parameters, speed, load, and viscosity to coefficient of friction. A sample Stribeck can be seen in the Figure 6.

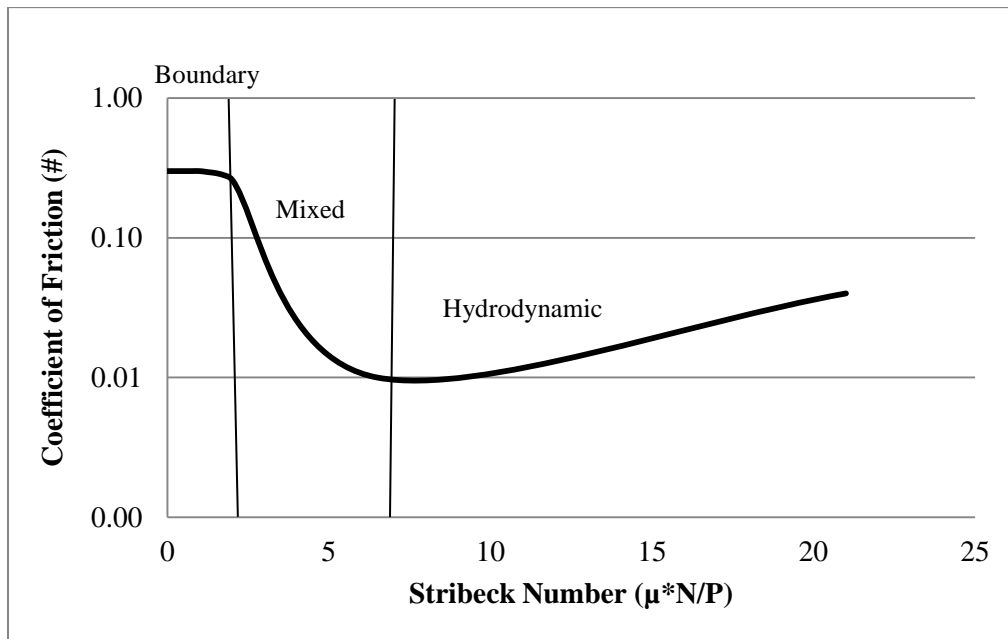

**Figure 5 Example Stribeck Curve**

Stribeck number, or the dimensionless parameter that represents the product of rotational speed ( $N$ ) and dynamic viscosity ( $\mu$ ) divided by pressure ( $P$ ), is plotted against

the coefficient of friction. The Stribeck Number can be calculated for any two components in contact as in the following equation.

$$\text{Stribeck Number} = \frac{N \times \mu}{P} \quad (2.4)$$

In this dimensionless form,  $N$  has the SI units of  $\frac{\text{rad}}{\text{s}}$ ,  $\mu$  has the SI units of  $\frac{\text{N} \times \text{s}}{\text{m}^2}$ , and  $P$  has the SI units of  $\frac{\text{N}}{\text{m}^2}$ .

The graph is separated into three distinct regions that represent the three lubrication regimes. Minimization of the Stribeck number results in boundary lubrication (far left of graph), while maximizing the Stribeck number results in hydrodynamic lubrication (far right of graph). The transitional regime separates these two regions. Engine bearings are typically designed to operate in the hydrodynamic regime, which minimizes friction and wear.

It is important to note that there are various forms of the Stribeck number in use, i.e. dynamic viscosity vs. kinematic viscosity or rotational speed vs. linear velocity. In this case, the terminology ‘Stribeck relationship’ may be more accurate than Stribeck number. In any form, the importance of the Stribeck’s contribution is the relationship between observed lubrication phenomena and the interaction of relative speed, fluid viscosity, and pressure.

## **2.4 Operating Condition Development**

For the development of a robust fuel economy test, it is essential that operating conditions be developed that force as many components to operate in each lubrication

regime as possible. From careful examination of the Stribeck curve, some important conclusions can be made that help with this condition set development.

### **2.4.1 Speed**

Perhaps the simplest of the parameters in the calculation of the Stribeck number, speed has possibly the greatest influence on lubrication regime. Speed is also very easily controlled in the case of engine test development. Since engine speed is in the numerator, as speed increases, the Stribeck number increases and the system trends to the hydrodynamic regime. Conversely, when the speed of a component or system is reduced, the Stribeck number decreases and the system trends toward boundary lubrication. In both case, speed is defined as a relative speed between two components. For use in the dimensionless Stribeck number, speed is taken to be in units of radians per second. Either Customary or SI units may be used, so long as they agree with other two terms to produce a dimensionless parameter.

Some components, such as those typically found in the valvetrain characteristically run at one half the rotational speed of the crankshaft speed. This is true for all four-stroke engines. Due to this fact, many valvetrain components tend to operate in the boundary lubrication regime. Subsequently, these valvetrain components often wear more than other faster-moving engine components. Additionally, many motorcycle valvetrain designs incorporate components with sliding contacts as opposed to rolling contacts – which also tends to increase wear.

Other engine bearings, such as crankshaft main bearings are designed to operate completely in the hydrodynamic regime. Under normal operation, these bearings will theoretically never operate in boundary lubrication, however, in practice do enter

boundary lubrication every time the engine is started and stopped. This is the reason for relatively high amounts of wear that can occur upon engine start-up and shut-down. Speed also has another, less intuitive contribution to the bearing dynamics which will be discussed in the load section.

### **2.4.2 Load**

Here, load is defined as the amount of pressure (normal force divided by contact area) which exerted on a lubricated contact. Like speed, load is a simple concept to understand as it pertains to the Stribeck number, but can be considerably more difficult to calculate and measure in practice. This is because an actual engine's journal bearing is a very dynamic environment, with loads changing instantaneously. Load can come from a variety of sources, with some being more obvious than others, but all having a significant impact on bearing load. Possibly the most typical loading experienced in engine bearings comes from cylinder pressure resulting from combustion, spring pressure, and inertia.

Take for example a camshaft which is simply supported by journal bearings. Further simplify the example with the camshaft only having one lobe to operate either an intake or exhaust valve. It is easy to imagine that when the valve is closed, there is minimal or no pressure between the camshaft and valve actuator (lifter, rocker, or bucket depending on engine architecture), and only the minimal weight of the crankshaft needs to be supported by the bearings. When the camshaft rotates to the point where maximum valve lift is obtained, maximum bearing loading will occur (if rotation is slow enough to be considered quasi-static). If the valve spring rate is known along with bearing geometry, it is relatively easy to calculate the pressure on the camshaft bearings. There is also a torsional load which develops in the camshaft as the cam lobe rotates to open the valve.



In the preceding example, inertia effects were ignored. This was done for simplicity and at slow speeds can be a reasonable simplification because the mass of valvetrain components are typically small when compared to other components such as the engine's reciprocating assembly (piston, wrist pin, and connecting rod). It is important to note that in actual operation, even the low mass of the valvetrain components can contribute enough inertia at high speeds to cause a condition called 'valve float'. Valve float occurs when the valve spring rate is insufficient to facilitate contact between the lifter and camshaft lobe during the closing of the valve. The result is a valve that remains open after the camshaft rotates back to its base circle.

A more subtle, but certainly significant contribution to bearing load, especially at high speeds is this inertia effect. As engine speed increases, maximum piston velocities increase. To facilitate these increasing engine speeds, the piston and connecting rod must be accelerated more quickly. Regardless of maximum piston speed, the piston must always stop at the top and bottom of its stroke and reverse its direction. Since the piston, connecting rod, and wrist pin have non-zero masses, large forces are generated which tend to stretch and compress the connecting rod. Add to this the combustion event which is powering engine operation and it is apparent that the load experienced by a crankshaft journal bearing is a combination of several high magnitude forces which are constantly changing.

The calculation of actual bearing loads has been a subject of much study, with many papers being published. The calculation of actual bearing loads is beyond the scope of this work and will not be pursued. For the development of this engine test, calculation of lubricated contact loading is less important than understanding how engine load and

rotational speed impact lubrication regime. Since the load term appears in the denominator of the Stribeck number, when loading between two components in a lubricated contact is high, the Stribeck number decreases, and the system tends to boundary lubrication. When the loading is low, the Stribeck number increases and the system tends toward hydrodynamic lubrication.

### **2.4.3 Viscosity and Temperature**

Fluid viscosity plays a major role in the determination of the characteristics of a lubricated contact. Since the viscosity term is in the numerator of the Stribeck number, as the viscosity increases, the Stribeck number also increases. Increasing viscosity tends to push a lubricated contact into mixed and hydrodynamic lubrication. The mechanism behind this is phenomena can be explained by the increased film thickness and resistance to shear associated with higher viscosity fluids. As the film thickness between lubricated parts increases, components are pushed farther apart, thus producing a key element for hydrodynamic lubrication.

While temperature does not appear in the calculation of the Stribeck number, it is very important to note that temperature has a very large impact on engine oil's viscosity. The dependence on temperature to a liquid's viscosity is very common, but more apparent in some fluids than others. For example, both the viscosity of water and maple syrup change with temperature, but from experience we know that the change in viscosity is much larger with maple syrup than water if both are heated equally. Engine oils exhibit this same characteristic. Indeed, this viscosity change with temperature is both a blessing and a problem for engine designers and is the reason for the creation of 'Multi-grade' engine oils.

There are several methods for calculating oil viscosity at various temperatures, with some methods having advantages over others. One of the most well-known and most used is the Walther model. The ASTM D 341 viscosity-temperature charts are based on this model [20, 21]. The fundamental equation for the Walther model is as follows:

$$\log \log(v + C) = A + B \times \log(T) \quad (2.5)$$

Here  $v$  represents the oil's kinematic viscosity in centistokes at any temperature  $T$  (in absolute units).  $A$  and  $B$  are constants determined from empirical data and must be calculated for each oil.  $C$  represents a constant scaling factor which the industry normally takes to be 0.7 and applies to most engine oils using mineral oil base stocks.

Using the fundamental Walther viscosity-temperature relationship, kinematic viscosity can be solved for explicitly using the laws of logarithms to give the following equation:

$$v = 10^{10^{A+B \times \log(T)} - 0.7} \quad (2.6)$$

For the determination of constants  $A$  and  $B$ , viscosity at two temperatures must be known; most commonly the viscosity at 40 °C and 100 °C are used. The following equations can be used to determine these constants, and are unique for each individual oil:

$$A = \log(\log(v_1 + C)) + B \times \log(T_1) \quad (2.7)$$

and,

$$B = \frac{\log\left(\frac{\log(v_1 + C)}{\log(v_2 + C)}\right)}{\log\left(\frac{T_2}{T_1}\right)} \quad (2.8)$$

Where  $v_1$  and  $v_2$  represents kinematic viscosity measured at  $T_1$  and  $T_2$ . For this work, these points will be the kinematic viscosity measured at 40 °C and 100 °C.

Both reduction of lubricant viscosity and introduction of friction modifiers into the lubricant can reduce engine friction. Typically, both methods are used in the formulation of low friction engine oils. The Walther equation can then be used to separate out the contributions to friction reduction that viscosity differences make.

## 2.5 Frictional Impact on Fuel Economy

To develop useable shaft power, a reciprocating engine must first overcome all internal friction. Friction comes from a variety of sources within an engine, but all friction has the same impact in terms of increasing mechanical losses, and thus reducing engine efficiency. This friction can be thought of as an additional load placed on the engine.

Total friction can come from two sources, component friction and viscous friction. Simplifying further, these sources can be thought of as being analogous to the boundary and hydrodynamic lubrication, respectively. Component friction will occur when a lubricated contact experiences asperity interaction. Viscous friction occurs in the absence of asperity contact and is the result of shearing the lubricating oil. In either case, these frictional losses conspire to reduce the mechanical efficiency of the engine. A robust

attempt to reduce total friction should address both component and viscous sources of friction. In terms of friction reduction via engine oils, past experimentation has shown that component friction can be reduced by the addition of friction modifying additives to the engine oil while reducing engine oil viscosity reduces viscous friction [19, 22, 23].

## **2.6 Predicted Results**

It is clear then, that a reduction in frictional losses within the engine will improve fuel economy, but empirical data suggests that this is not a one to one correlation [24]. For example, a 10% reduction in engine friction will result in a reduction in fuel consumption less than 10%. To understand why this is, it is necessary to examine friction generation more thoroughly within specific engine components.

### **2.6.1 Piston Ring/Cylinder Bore Friction**

The friction developed here represents the single largest contribution to total engine friction. This is due to the nature of the contacting surfaces. Piston rings seal the combustion chamber when expanding gasses from combustion force the piston ring out radially and into the cylinder bore. This results in very high pressure between the cylinder wall and piston ring. The oscillatory motion of the piston also contributes to the large friction experienced in this interface. At the top and bottom of each stroke the piston makes, the piston must decelerate rapidly, come to a complete stop, and then accelerate in the opposite direction. When the piston is stationary, especially at the top of the power stroke, the high cylinder pressure and low/zero velocity cause boundary lubrication. As the piston accelerates, cylinder pressure decreases and the piston ring/cylinder contact enters mixed and eventually hydrodynamic lubrication [25-27].

As oil viscosity decreases, the oil becomes easier to shear which reduces friction. However, as the viscosity is reduced, the oil's film thickness also decreases which increases the chances of asperity contact and boundary lubrication. Since the piston's motion starts from boundary lubrication at the top and bottom of its stroke, a thinner film thickness can cause this boundary lubrication to extend farther towards the center of the stroke. Since the system is spending more time in boundary lubrication, average friction increases. In this boundary lubrication regime, wear control is achieved by the sacrificial additive layer, which is supplied by performance additive package within the engine oil. The piston ring/cylinder wall interface thus represents an area that experiences both component and viscous friction.

### **2.6.2 Bearings**

Bearings are another source of friction within an engine. During normal engine operation, journal bearings are designed to operate in the hydrodynamic lubrication regime. As oil viscosity decreases, the oil shears more easily and the bearing consumes less energy. This translates to higher fuel efficiency within a reciprocating engine. Much like the piston ring and cylinder interface though, if oil viscosity becomes too low, the oil film can deplete, resulting in boundary lubrication. In boundary lubrication, the friction increases and engine efficiency decreases. Bearing geometry and loading considerations dictate which oil viscosity ranges are appropriate to prevent such a scenario. In the hydrodynamic regime, the oil's additive package is less critical since the bearings should not typically operate in boundary lubrication.

In the case of rolling element bearings, such as ball bearings and needle bearings, a lubricant with a higher viscosity also increases friction because the rolling elements must push the lubricant out of the contact path as they rotate.

### **2.6.3 Valvetrain**

Since a four-stroke's camshaft operates at half the speed of the crankshaft, valvetrain components typically operate more closely to the boundary lubrication regime than the crankshaft rotating assembly. In this region, a lubricant's friction modifiers, anti-wear, and extreme pressure additives are critical to prevent valvetrain component wear. As oil viscosity is reduced, thin oil films between high pressure components can be almost completely squeezed out. The lower the oil viscosity, the easier it is for this to occur. Many of the lubricated contacts within the valvetrain therefore represent component friction.

### **2.6.4 Lubrication System**

A typical pressure-fed lubrication system consists of a sump where oil is held, a pump to produce a pressurized flow of oil, a filter to remove large contaminants, and a network of passages through which the oil travels to all critical engine components. The restrictions in this oil system are largely a function of the oil passageway's geometry and as such remain constant. The pump is usually a positive displacement pump of the gear type. The pump's flow rate is therefore a function of speed only. Therefore at any given oil flow rate, as oil viscosity decreases, the amount of energy required to pump the oil through the engine reduces. The energy required to drive the oil pump comes directly from the shaft power that the engine produces. Therefore, any reduction in the amount

of energy required to drive the oil pump can be used as additional shaft power. This is an example of reduction of viscous friction.

### **2.6.5 Summary**

Since relative motion between components in a lubricated contact necessitates the shearing of the lubricant between them, reducing viscosity will by definition, reduce friction. However, this only holds true to a certain point. If the lubricant becomes so thin that it cannot maintain a consistent film between components, asperities can break through this film and cause boundary lubrication and result in high friction and wear. In other areas of the engine where boundary lubrication is expected and routinely occurs, lubricant viscosity has less impact in terms of friction. In these areas, the performance additive package within the lubricating oil is largely responsible for friction reduction and wear prevention. Further, engine architecture, bearing geometry and type, and the presence of sliding or rolling valvetrain components all are optimized for a specific oil viscosity range. Straying too far from an engine manufacturer's viscosity recommendation can cause damage to engine components.

For the specific engine and test oils being used for this experimental research, the author predicts that a large reduction in Brake Specific Fuel Consumption will be obtained with the use of low viscosity oils. The author also predicts that a small but measureable reduction in Brake Specific Fuel Consumption will be obtained by the introduction of a friction modifier when compared to an engine oil of the same viscosity without a friction modifier.



## **CHAPTER III**

### **EXPERIMENTAL APPARATUS**

#### **3.1 Introduction**

While both the engine oil aging experiment and the Friction Torque Test are very good indicators of lubricant performance, neither measure fuel economy directly. To really optimize various engine oil formulations and verify performance, oil must be tested in an actual fired-engine fuel economy test.

Before a test could be developed, a suitable engine must be found. Any engine could be used, but some engines lend themselves to testing better than others. Most importantly, the engine must be commercially available. This is important not only in simplifying the acquisition of test engines and replacement parts, but also because using a commercially available engine gives credibility to a test result. It is also desirable that the test engine is fuel injected. A closed-loop fuel injection system, one that uses an oxygen sensor located in the exhaust as feedback to the engine's electronic control unit (ECU), will continually adjust or 'trim' the amount of fuel delivered to the combustion chamber. This continual adjustment will optimize combustion with much more

repeatability than a carburetor could. For any type of engine testing consistency is critical and a well-tuned fuel injection system helps provide this consistency.

Another technical consideration was the motorcycle's final drive system. Most motorcycles utilize a multi-disk wet clutch to couple the engine to the transmission. As previously mentioned, these applications limit the amount of optimization that can be done for fuel economy because of a lower allowable limit on friction mandated for proper clutch operation. Many scooters on the other hand, use constantly variable transmissions (CVTs). A scooter equipped with a CVT does not use a wet clutch and therefore is compatible with low friction oils. Due to their small size, low price and fuel consumption, scooters are also very popular in the Asian market.

Additionally, the engine's size and type should be in alignment with strategic commercial markets. For example, most motorcyclists in North America typically ride motorcycles as a hobby, not for daily transportation. Because of this, fuel economy is not as critical to them as it would be to the average rider in Southeast Asia where motorcycles and scooters are a form of primary transportation. Therefore, the development of a fuel economy test using a large American V-Twin motorcycle engine may be technically valid, but will not be as commercially beneficial as developing the test with a small scooter engine common to Asia. Due to this, only motorcycles produced in Asia are considered.

A motorcycle that meets all the aforementioned criteria is the Honda PCX 150 scooter. It is powered by a 153cc single cylinder, fuel injected engine, and is equipped with a CVT. Additionally, it is liquid-cooled, which aids in the control of operating

temperatures. The following picture shows one of two scooters purchased for this testing.

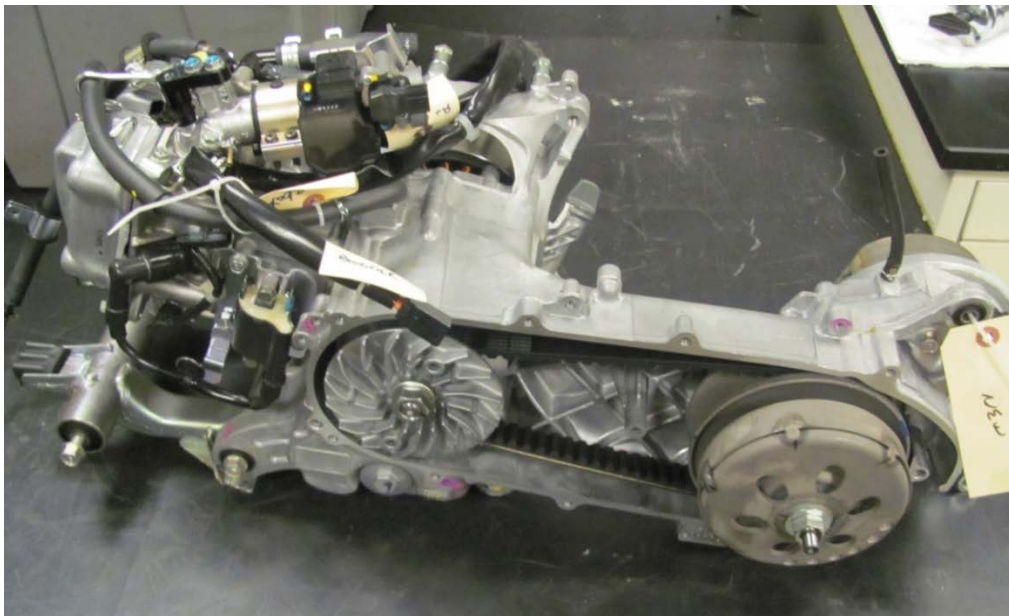

**Figure 6 2013 Honda PCX 150 [28]**

Once the test vehicles had been purchased, they were carefully disassembled. This disassembly was necessary because the engine would be installed into an engine test rig, not tested on a chassis dynamometer. Fuel economy is very difficult to measure, if testing was conducted on a chassis dynamometer with the complete vehicle, parameters such as tire air pressure and temperature can drastically reduce test repeatability. Installing the engine directly on an engine dynamometer allows for much more precise control and eliminates many variables associated with vehicle testing.

### 3.2 Engine Mounting Considerations

Most motorcycles incorporate an engine mounting system in which the engine is rigidly attached to the motorcycle frame. A chain then connects the drive sprocket on engine/transmission unit to the sprocket on the rear wheel. The motorcycle's suspension system allows the rear wheel to move up and down with respect to the motorcycle's frame. The chain drive system allows for relative motion between the wheel and drive sprocket without binding. However, constant variable transmissions require a rigid body between the drive and driven pulleys to operate correctly. In the Honda PCX 150 scooter, this is achieved by the utilization of a single casting that houses both the engine and final drive assembly. This one piece assembly provides a rigid member between and facilitates the transfer of power from the crankshaft to the rear axle. To facilitate suspension motion, this entire engine/CVT unit pivots as the rear suspension articulates. A photograph of this engine/CVT unit can be seen in the following figure.



**Figure 7 Engine/CVT Unit**

### **3.2.1 CVT Operation**

CVTs can increase overall vehicle efficiency, but the transmissions themselves are actually much less efficient than a traditional gear drive system [29]. However, CVTs can increase overall vehicle efficiency by allowing the engine to operate at its most efficient operating range during acceleration. This is an important concept due to the nature of engine optimization. Typically, the optimizations made to a spark ignited internal combustion engine to improve low speed operation are a detriment to high speed operation and vice versa. This means that without sophisticated controls such as variable valve timing, engine design is a compromise between optimization for all engine speeds and loads.

If a vehicle is equipped with a CVT, the engine can be optimized for a particular range of operating conditions. During acceleration, instead of the engine accelerating and successively shifting up through gears as with conventional transmissions, the engine can be held at its most efficient operating point and the transmission ratio varied to achieve the desired speed.

CVTs themselves however, are very inefficient when compared to traditional gear drive systems. The belt used to transmit power from the drive pulley to the variator (driven pulley) can slip. In the case of the Honda PCX150 scooter, a rubber belt is used. These rubber belts are sensitive to temperature changes and can affect driveline efficiency. All these attributes stand to hamper the development of a test which must be precise enough to measure small variations in BSFC as a result of friction reduction from engine oils.

The design of the PCX 150's drive therefore causes a challenge for installation into an engine test stand. The CVT could not be installed with the engine due to its inherent variability, but it could not be easily removed since it shared a common housing with the engine. Additionally, if the CVT was removed, a special adapter would be necessary to couple the dynamometer directly to the engine's crankshaft. This would necessitate the use of a special low-inertia, high speed dynamometer. The dynamometers and dynamometer controllers which are readily available at the testing facility are optimized for low speed (2,000-4,000 RPM) operation. The only other method to reduce dynamometer speed and allow for high speed engine operation would be to use a speed reducing gearbox between the engine and dynamometer. If a gearbox would be used, it would represent yet another source of variability in the final test. A method for controlling gearbox oil temperature would need to be employed to mitigate variability.

After weighing all these considerations, the best solution was determined to be separating the CVT from the engine and coupling the engine directly to the dynamometer. A band saw was used to cut through the aluminum engine casting to free it from the CVT. This reduced the size of the overall engine, and allowed access to the crankshaft for coupling. A special low-inertia, high speed dynamometer would be purchased, and a special adapter would be designed and machined to join the engine to the dynamometer.

### **3.3 Engine Test Rig Configuration**

The anatomy of almost any engine test rig, regardless of size, is the same. The three major hardware components are the engine, the load absorption device or dynamometer, and the driveshaft system to couple the two. For this application, the engine crankshaft

would be directly coupled to the dynamometer. To facilitate this connection, a special adapter was necessary. The portion of the engine's crankshaft which protruded from the engine case was very small, and optimized to only support the small CVT pulley. The crankshaft was connected to the CVT pulley via splines.

An adapter was developed using a two piece design. The first piece would be machined with internal splines and mate to the engine's crankshaft. A locking nut would then be used to secure this part to the crankshaft. The second part would bolt to the first and accept a standard 1.00 inch keyed shaft. Concentricity of these components was vital and achieved by a circular recess machined into the crankshaft side part which mates with a circular boss on the driveshaft side. A three dimensional rendering of this hub adapter can be seen in the following figure.

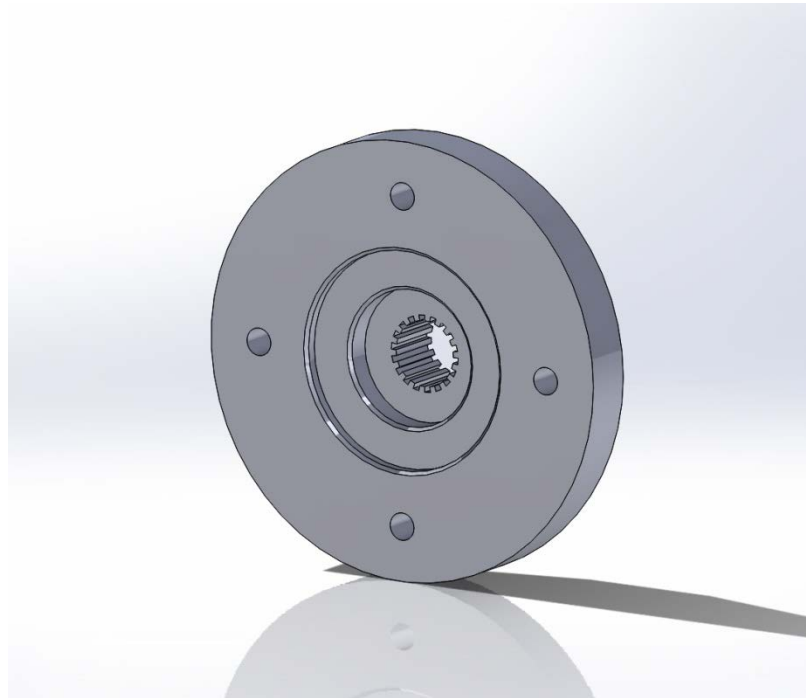

**Figure 8 Engine Crankshaft Adapter Drawing**

The dynamometer also required the design and manufacture of a special adapter, and a similar design was used. The first piece was machined to fit the tapered and keyed

dynamometer shaft, with a nut securing this piece to the dynamometer shaft. A second part was then machined to bolt to the first, and accepted a special, high-speed rubber damper to reduce vibration and allow for a small degree of misalignment between the engine and dynamometer. This damper included a hub to accept the 1.00 inch keyed shaft and make the final connection between the engine and dynamometer. A photograph of the completed driveshaft system can be seen in the following figure.

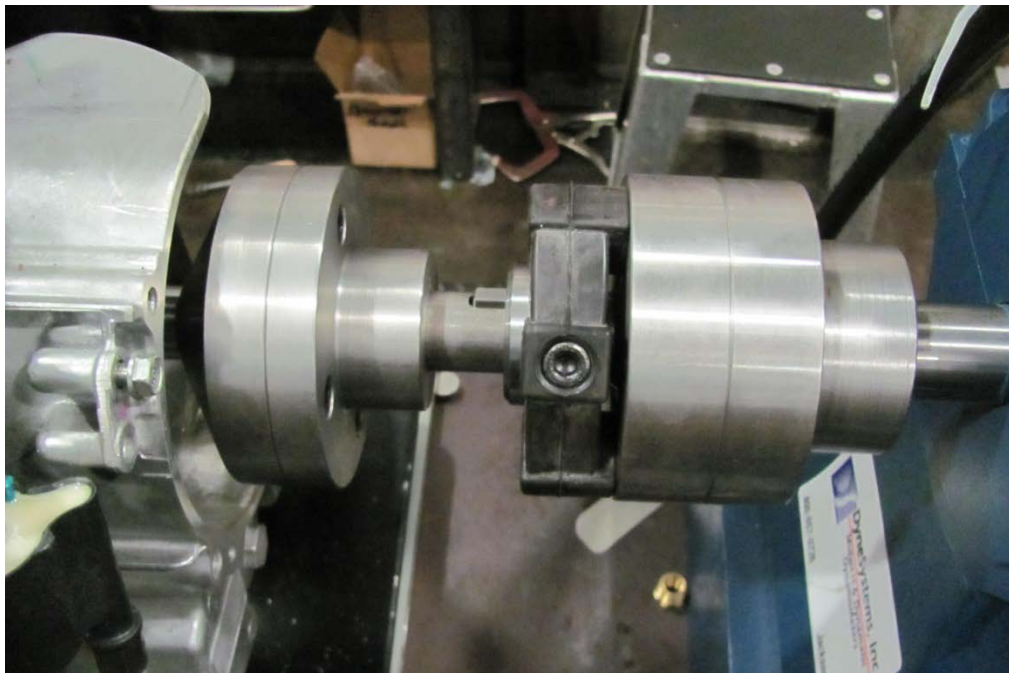

**Figure 9 Engine to dynamometer coupling system**

The design and manufacture of each adapter was done in house at The Lubrizol Corporation, with the exception of cutting the very intricate splines in the crankshaft adapter piece. The spline cutting was completed at a specialty machine shop. The damper selected for this application was a High Temperature Rubber (HTR) torsional damper, part number LF4, and was manufactured by the LoveJoy Corporation. To ensure



shaft concentricity would be maintained, a spherical pilot bearing was used pressed into a machined pocket on the dynamometer side hub, located just behind the rubber damper.

### **3.3.1 Dynamometer**

Dynamometer sizing for this application was particularly challenging. A balance needed to be struck between absorption ability and inertia. Due to the small size of the PCX150 test engine, along with the fact that the crankshaft drives the dynamometer directly, it was critical to keep dynamometer inertia as low as possible. Conversely, most dynamometers that met the low inertia criteria were not capable of absorbing the approximately 13 HP that the engine could produce. To further complicate dynamometer selection, the dynamometer needed to have a relatively high operating speed because the engine would be driving the dynamometer directly.

The dynamometer selected for this installation was the Midwest Model 46 AC eddy current dynamometer. It is a low-inertia dynamometer, can be used up to 7,000 RPM, but can only absorb 10 HP. These dynamometer capabilities placed limitations on the test conditions that could be achieved, but were deemed satisfactory because the fuel economy test would not include be operated at WOT and maximum engine speed.

The dynamometer uses eddy currents developed in stationary windings to induce a magnetic field around the spinning rotor to exert a braking force on the rotor, thus loading the test engine. In this method, energy from the engine is turned into heat. This heat is removed by the dynamometer's liquid cooling system. Water is pumped through a cooling jacket around the stationary windings and through a jacket around the bearing pedestals which support the dynamometer. A photograph of the dynamometer can be seen in the following figure.

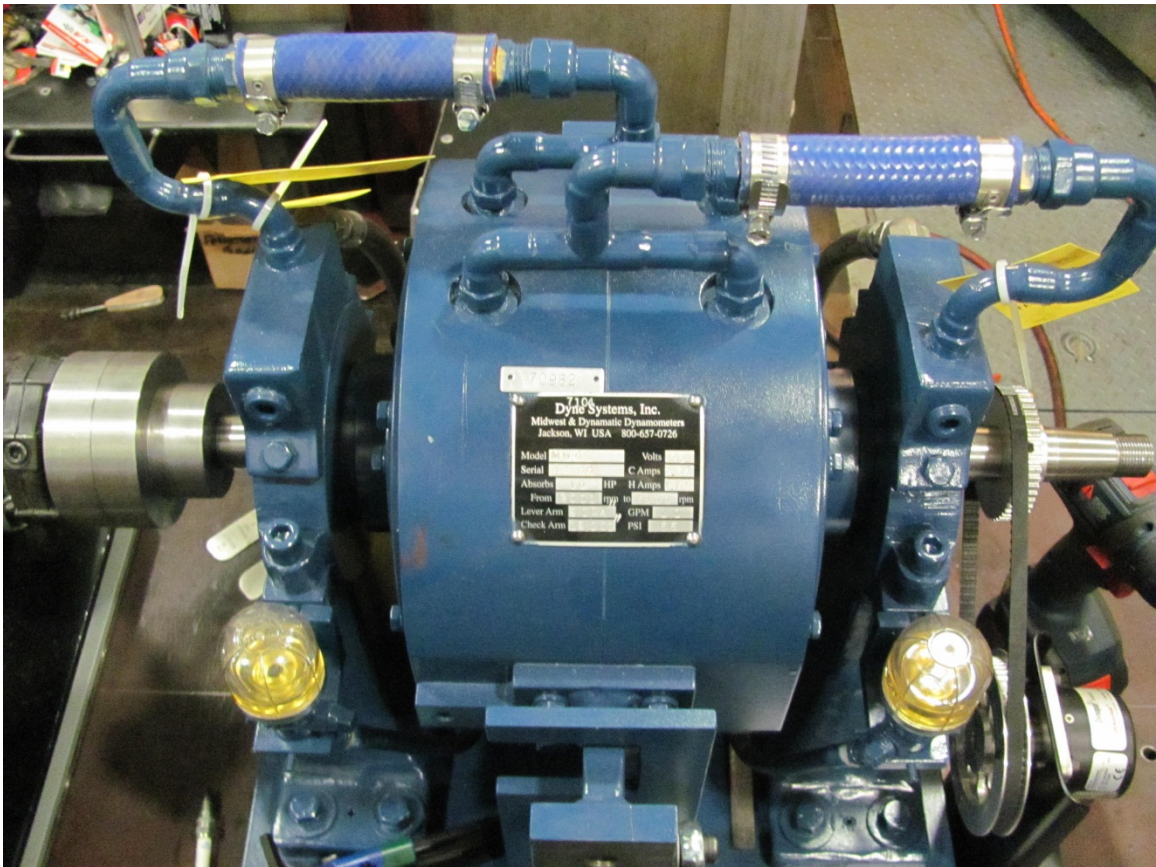

**Figure 10 Midwest Model 46 dynamometer**

Eddy current dynamometers are ideal for this type of engine testing because they can be operated for extended periods of time at both steady-state or cyclic conditions. Torque produced by the test engine and absorbed by the dynamometer is measured via a load cell. This load cell is connected to a torque arm which is mounted to the side of the dynamometer and braced against the dynamometer mount. This load cell provides the only resistive force which prevents dynamometer rotation. Since the distance from the centerline of the dynamometer shaft to the torque arm is known, torque can be calculated by the product of this distance and force measured by the load cell. Rotational speed, measured at the dynamometer shaft by a high resolution encoder can then be used with

this torque value to calculate power. This encoder is driven by a high speed synchronous belt and can be seen on the right side of the dynamometer in the previous picture.

An alternative to this dynamometer would have been an AC motoring dynamometer. Motoring dynamometers have several advantages over eddy current dynamometers such as being able to start an engine and the ability to supply torque to the rotor, which in effect, reduces rotor inertia. This gives the ability for a larger dynamometer to be used for a low inertia application. Additionally, many AC motoring dynamometers are 'regenerative' which means they can be used to generate electricity that can then be used throughout the facility to offset energy consumption. Even though the AC motoring dynamometer would be the best technical solution and offer the most versatility, they are more expensive than eddy current dynamometers and require more expensive control software and hardware.

The AC eddy current dynamometer is therefore a compromise that best meets the most important criteria of cost, sizing/inertia, and performance. However, one consequence of using this dynamometer are the limitations imposed by the maximum power absorption rating. Since the engine produces ~13 HP and the dynamometer will only absorb 10HP, it would be impossible to conduct WOT testing and fuel consumption mapping at every speed. The test conditions would then be developed to avoid the operational conditions which produced loading in excess of the hardware limitations.

### **3.4 Control Systems**

#### **3.4.1 Engine and Dynamometer Control**

The process of operating a test engine and dynamometer in unison to achieve a desired condition set is quite challenging. When an engine powers a vehicle on a road,

the vehicle inertia, in effect, dampens engine response. At speed, if a single gear is maintained, the throttle can be completely released or completely opened abruptly with very little immediate increase or reduction in speed. This is due to the large amount of inertia provided by the vehicle's mass. However, when the same engine is installed in a test rig, dynamometer inertia is a mere fraction of vehicle inertial and will not appreciably dampen engine acceleration. This means that if the throttle is abruptly opened or closed, a change in engine speed will take effect almost immediately. Test engine control must then be broken down into two separate but related systems and controlled independently. Each system is then continuously monitored and adjusted by the test control computer using proportional, integral, and derivative (PID) control strategies. The two systems are speed and load.

### **3.4.2 Speed Control**

Engine speed is controlled by varying dynamometer load, or the amount of rotational resistance the dynamometer exerts on the test engine. Dynamometer load is controlled by supplying the dynamometer with a very precise amount of current and voltage. It is the job of the dynamometer controller to provide this control current and voltage. The dynamometer controller is a separate computer from the test control computer. The speed control circuit begins with the test control computer requesting a certain rotational speed. This request is fed into the dynamometer controller as a 0-5V input. The dynamometer controller then determines the appropriate current and voltage changes to meet the condition set requested by the test control computer. The feedback for this speed control loop is the speed measured at the dynamometer. Because this test rig connects the engine directly to the dynamometer, engine speed should always be the

same as dynamometer speed. For applications with transmissions, gear ratios are programmed into the test control computer. The test control computer then calculates the quotient of the engine speed and dynamometer speed to display the gear number.

### **3.4.3 Load Control**

Engine load, or the amount of torque which the engine is producing, is controlled by varying the engine's throttle position. Throttle position is controlled by a high resolution stepper motor attached to the throttle cable. In the load control loop, the test computer requests a certain load. The test computer then sends a 0-5V signal to the stepper motor to open or close the throttle to meet this load request. The feedback for this control loop is engine torque output. There are multiple ways to describe engine load, many of which will be described in the following Chapter 4.

Achieving and maintaining both speed and load control loops is accomplished through PID control. These control loops are very challenging to tune and optimize. Even though these loops are separate, they are not independent. For example, if the engine is operating at steady state conditions when a step change is requested in engine load, the throttle will either open or close to meet the new set point. If the change in throttle position is abrupt, the engine speed will change. As the engine speed changes, the dynamometer speed will also change. Once the speed feedback drifts from its set point, the speed loop will become active trying to control speed by applying load to or releasing load from the dynamometer. Controls must act fast enough to bring both speed and load into agreement with their respective set points, but if controllers are tuned to be too fast or sensitive, they can create oscillations that build off of each other. If this occurs, the whole system may become very unstable and normally results in the

triggering of an over speed safety limit that shuts the stand down. Optimizing these control loops was therefore very challenging and included the application of control system theory.

#### **3.4.4 Cooling System**

Once the engine speed and load loops have been successfully tuned and optimized, the other engine support systems can be adjusted. One of the most important considerations to ensure engine longevity is engine temperature. Engine temperature can be measured in a number of different places and controlled in a variety of different ways. The Honda PCX 150 is liquid cooled. Liquid cooling significantly simplifies the temperature control strategy when compared to an air-cooled engine.

To cool the PCX 150 test engine, a shell and tube heat exchanger is used to replace the stock radiator. A mixture of 50% ethylene glycol and 50% water is used to circulate through the engine and heat exchanger. Heat is removed from the engine coolant by process water available at the testing facility. The facility maintains process water temperature at approximately 20°C. A pneumatically actuated metering valve, or research valve, is installed on the outlet side of the heat exchanger. This research valve controls the flow of cool process water through the heat exchanger and removes heat from the engine's coolant. It is important that this research valve meters flow out of the heat exchanger and not into the heat exchanger. This is because it is important that both sides of the heat exchanger are always full. If the research valve would be used to meter flow into the heat exchanger, the water side could become dry. If the cooling water side became dry, the system could be thermally shocked or even produce steam once the cooling water would enter the heat exchanger. Once again, the test control computer with

a PID control loop is used to maintain engine coolant temperature. Feedback for this system is the temperature of the coolant coming out of the engine. Both coolant temperature out of the engine and into the engine are monitored and recorded by the test control computer. A photograph of the heat exchanger can be seen in the following figure.



**Figure 11 Engine Coolant Heat Exchanger**

The PCX 150 engine incorporates a thermostat for the purpose of changing the coolant flow path to allow the engine to reach operating temperature more quickly. The thermostat prevents coolant from leaving the engine until it reaches a certain temperature.

While this feature is beneficial when the engine is in the vehicle, it reduces the ability of the external coolant system to control temperature. Unlike most automotive thermostats which can be removed from the housing, this engine uses one-piece, sealed unit. A photo of the thermostat can be seen in the following figure.



**Figure 12 Stock Thermostat and Housing**

To facilitate unrestricted coolant flow into and out of the engine, the thermostat was completely removed and a new plate was designed to take the thermostat's place. A rendering of this part can be seen in the following figure.



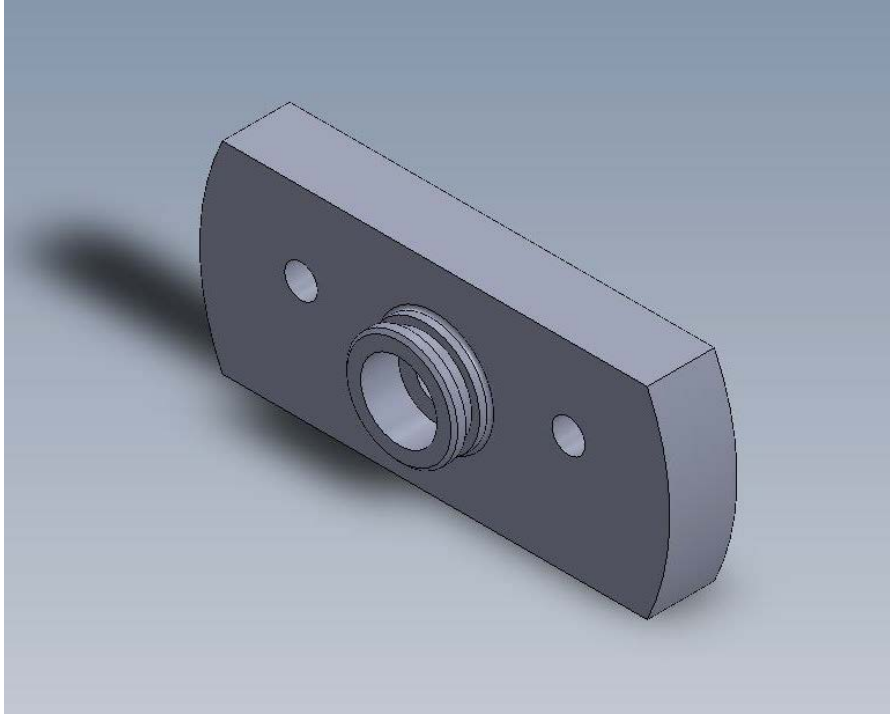

**Figure 13 Thermostat Replacement Plate Drawing**

Once again, The Lubrizol Corporation's in-house machine shop was used for the production of this part. The front side was made to the same dimensions as the stock part, including a groove for the rubber O-ring. The rear side of the part was drilled and tapped for ¼" NPT to accept a pipe fitting that would eventually connect to the coolant hose. The part was also trimmed for ample clearance around other engine parts. This was done after all the primary machining on the part had been finished. This trimming was not incorporated in the solid model.



**Figure 14 Thermostat Deletion Plate**

This modification allows uninhibited coolant flow into and out of the engine which is necessary for precise coolant temperature control. A photograph of the finished assembly installed on the test engine can be seen in the following figure.



**Figure 15 Thermostat Deletion Plate Installed on Engine**

To further quantify engine temperature, a washer thermocouple is installed underneath the spark plug. Before installation, the spark plug gasket was removed to ensure the heat value of the spark plug does not change. A spark plug's heat value refers to the depth that the electrode protrudes into the combustion chamber. Since this engine is liquid cooled, no additional cooling for the cylinder head is necessary. If this engine was air-cooled, it would be necessary to duct cooling air to the cylinder and cylinder head to maintain and control normal operational temperatures.

#### **3.4.5 Combustion Air System**

Humidity and temperature controlled air is used for the engine's combustion air supply. This combustion air supply is ducted directly into the engine's airbox to ensure the engine always has a sufficient supply of clean, cool, and consistent combustion air. The combustion air system supplies enough air to maintain a very slight, but positive pressure within the airbox. This ensures that the engine will never consume ambient test cell air, which is not controlled.

#### **3.4.6 Exhaust System**

Through trial and error test development and experience with other test rigs, exhaust back pressure was determined to have a small but significant impact on fuel consumption measurement. Engine pumping losses are the result of the work the engine does to draw air into and expel exhaust gasses from the combustion chamber. Minor but significant changes in fuel economy have been observed between tests performed on sunny, high pressure days versus stormy low pressure days. The barometric pressure differential

between high and low pressure days is believed to have caused enough difference in exhaust back pressure to change pumping losses, and thus BSFC.

To eliminate this source of variability, a high temperature damper with a pneumatic control was installed into the exhaust system. Suction from a roof mounted exhaust gas removal system is plumbed into the test cell which terminates at the top of the exhaust damper. The bottom of the exhaust gas damper is plumbed directly to the engine's exhaust port. A high precision absolute pressure transducer measures exhaust back pressure between the engine and the damper. The damper interfaces with the test control computer to maintain a back pressure that is slightly above atmospheric pressure. In this way, the same back pressure can be obtained regardless of ambient conditions. The following figure shows the pneumatically actuated damper in the exhaust system.

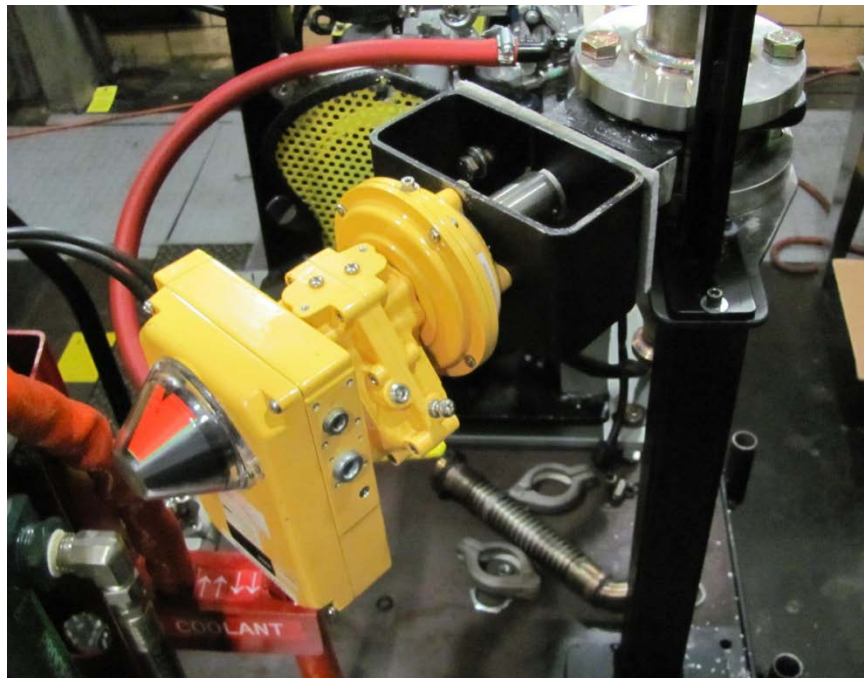

**Figure 16 Exhaust Damper**

In addition to exhaust back pressure, exhaust gas temperature, and air fuel ratio (AFR) via a lambda sensor are measured and recorded. These are important parameters to monitor because they give essential information about the combustion process.

### **3.4.7 Fuel System**

The Honda PCX 150 engine utilizes port fuel injection. For proper operation, the test rig's fuel system must supply the injector with a constant source of fuel pressurized to approximately 240 kPa (35 psi). It is also desirable to include a provision for fuel pressure adjustment as this adjustment can provide fine tuning of the engine's air/fuel ratio (AFR). A large (20,000 gallon) fuel tank supplies this installation and other adjacent test cells with fuel. This fuel enters the test cell at approximately 138 kPa (20 psi). Since this pressure would be insufficient for proper engine operation, an electric in-line pump is added to increase pressure. The output of the pump is connected to a bypass pressure regulator. Fuel that is bled off to maintain the desired pressure is returned to the low pressure side of the pump. This relief system is necessary to prevent dead-heading the pump. Since the fuel consumption of the engine is much lower than the volume that the pump supplies, the majority of the fuel returns to the low pressure side of the pump in this manner. Due to inefficiencies of the electric pump and friction, the fuel absorbs heat each time it passes through the pump. If nothing is done to mitigate this heat transfer, fuel will gain heat until it vaporizes in the fuel lines. Obviously, this scenario would be a problem for a number of reasons. To eliminate this potential hazard, a heat exchanger was installed on the recirculation loop. This shell and tube heat exchanger uses chilled glycol at -10 °C to cool the fuel and prevents any fuel vaporization. An added benefit of

this system is that fuel temperature can also be precisely controlled, adding further consistency to engine operation.

The fuel that is not re-circulated by the bypass regulator travels to the engine for combustion, but before it enters the engine, the fuel passes through a high precision Coriolis flow meter. This flow meter measures the mass of fuel passing through it, which is the amount of fuel the engine is consuming. Data from this flow meter is collected by the test control computer. Since the computer also monitors power, BSFC can be calculated.

### **3.4.8 Test Control Computer**

The test control computer is responsible for controlling every aspect of engine operation and all support systems. The test computer is located outside of the test cell which allows the operator to remotely control every aspect of engine operation in a safe, reduced noise environment. The test computer is a standard PC that runs the proprietary test control software EZ Test. EZ Test was developed in-house at The Lubrizol Corporation. It uses custom made circuit boards that function as input and output hubs in addition to filtering and converting signals from analog, digital, and frequency based sensors.

Within EZ Test, programs are written to control test routines. These programs are called 'Sequencer Macros'. Sequencer Macros consist of a collection of various condition sets, or a list of simultaneous operating parameters. These condition sets contain set points for parameters such as engine speed, engine load, oil temperature, coolant temperature, fuel temperature, intake air charge pressure, etc. The test control computer then uses the PID control loops to control each parameter to meet these set

points. EZ Test also monitors and records un-controlled parameters such as exhaust gas temperature and AFR.

EZ Test is also very configurable, and can be programmed to conduct tests that are steady state, multi-stage or transient. For the purpose this fuel economy evaluation, EZ Test is used to conduct a multi-stage test. With each stage consisting of steady state conditions designed to reach and maintain equilibrium in critical engine temperatures, speed, and load. Each stage attempts to accentuate conditions for the boundary, mixed, and hydrodynamic lubrication regimes.

### **3.4.9 Control System Summary**

For all testing, especially in the case of fuel economy testing, the most critical element is consistency. The fuel efficiency improvements produced by the use of highly fuel efficient engine oils are measurable and significant, but are generally small in magnitude when compared to the engine's total fuel consumption. This means that all engine parameters must be controlled very tightly, in fact, more tightly than would be necessary for a deposit test or durability test.

The test computer, along with EZ Test control software, allows for this precise control. Both controlled and non-controlled parameters are continuously recorded. The test control computer interfaces with various sensors and controllers through electronic and pneumatic solenoids, signal conditioners and filters, and dedicated microprocessors responsible for dynamometer control and engine speed signal filtering. After the completion of the test, data is uploaded from the test control computer to The Lubrizol Corporation's network where it can be analyzed and reported.

## **3.5 Vehicle Electrical Systems**

### **3.5.1 Wiring Harness**

Modern vehicles, even a seemingly simple scooter, can be very complicated. This is apparent when an engine is removed from a vehicle. For ease of operation and test rig construction, as much of the vehicle's wiring harness is maintained and utilized on the test rig as possible. The more a vehicle's wiring harness is modified and sensors removed, the more difficult it becomes to troubleshoot issues when they arise. Sometimes, efforts to 'simplify' the wiring harness by removing components result in an even more complex system.

The test control computer supplies the engine's wiring harness with 12V DC energy, as the battery would if the engine was in the motorcycle frame. The test control computer also uses a solenoid to switch power on and off to the ignition circuit, replacing the ignition switch. The ignition then becomes an accessory that can be turned on or off by the operator or by the test computer itself via the test program. Other components necessary to engine operation such as the fuel pump are also programmable accessories.

### **3.5.2 Vehicle Sensors**

The PCX150 scooter in its stock form uses many sensors to optimize operation and rider safety. Sensors that deal with engine operation include a mass airflow sensor, throttle position sensor, oxygen sensor, and coolant temperature sensor. These sensors must be maintained for proper engine operation. The scooter also uses sensors that are aimed at improving safety for the rider. An example of one such safety feature is the kickstand switch that prevents the motorcycle from starting if the kickstand is down. Another is the brake switch, which prevents the motorcycle from starting unless the brake



is applied. Yet another is an inertial switch that stops the engine in the event that the motorcycle is crashed or falls over. These sensors must be removed or defeated to allow for operation on a test rig.

### **3.6 Measurement Systems and Sensors**

All the control systems previously mentioned and any data generated can only be as accurate as the measurement systems employed. Significant effort has therefore gone into each system to provide the best accuracy and resolution possible.

#### **3.6.1 Fuel Flow Meter**

The flow meter chosen for this application was the Proline Promass 83 produced by Endress+Hauser. This model is a Coriolis flow meter and was chosen because Coriolis flow meters are the most accurate type of flow meter available. The Coriolis flow meter uses two U-shaped tubes that vibrate at their resonant frequency. As a liquid or gas passes through the flow meter, the frequency of the vibrating tubes changes. This change in frequency is observed by built-in transducers. From this vibration speed and amplitude mass flow rate can be calculated. In addition to mass, density of the fluid can also be calculated.

The Endress+Hauser Promass 83 was specifically chosen not only for its accuracy, but also for its capability in measuring very low flow rates. For proper measurements it is critical that the flow meter be sized correctly. Coriolis flow meters are extremely accurate when used within their calibrated range. The following figure is an example of a typical flow meter error curve. Within about 25% of total rated flow up to 100%, accuracy is very good. Below 25% however, flow meter error grows rapidly.

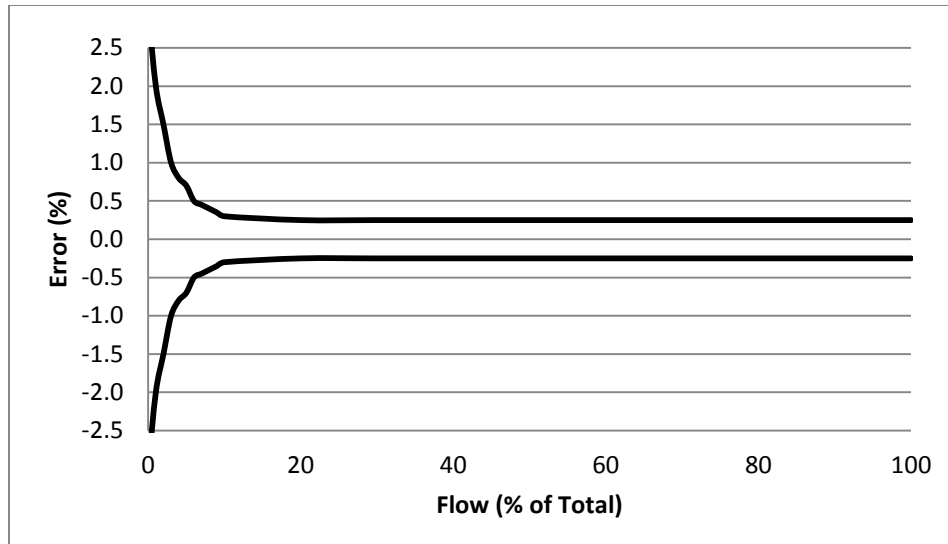

**Figure 17 Flow Meter Error**

Care was therefore taken to ensure the flow meter was sized properly. From experience with other engines this size, the fuel flow rate was assumed to be approximately 1-4 kg/hr, and therefore a flow meter with a maximum flow rate of 4 kg/hr was selected.



**Figure 18 Fuel Flow Meter**

### 3.6.2 Temperature

Temperature is one of the most critical parameters in the engine oil testing, because temperature directly affects oil viscosity. Viscosity in turn, directly affects oil film thickness, and oil film thickness is a key driver for determining lubrication regime. Oil temperature is measured by a thermocouple located in the oil sump. The oil drain plug is modified to accept a threaded fitting that secures the thermocouple. To provide long life, a stainless steel shielded, and ungrounded thermocouple is installed in the drain plug. To provide maximum resolution of this critical parameter, a J-type thermocouple is used. J-type thermocouples offer a smaller temperature range, but more resolution when compared to the K-type thermocouples.

While engine oil temperature is critical, it is also necessary to quantify engine temperature. To do this, a washer style thermocouple is installed underneath the sparkplug. This washer thermocouple directly contacts the cylinder head in one of its thinnest locations, and provides a good reference for general engine temperature. Engine coolant temperatures are also measured in and out of the engine. As previously discussed in the control section, these thermocouples are used as feedback to the PID engine coolant control loop.

Additional thermocouples are located in the airbox to measure combustion air temperature, in the fuel system, and in the exhaust pipe. The signal from all thermocouples are filtered, amplified and sent to the data acquisition board located in the test control computer.

### 3.6.3 Speed

Engine speed is monitored via an inductive clamp over the spark plug wire. ATI's SmartTach is then used to filter this signal and generate a voltage output and connects to the data acquisition board. The ATI SmartTach was chosen because it is simple yet highly configurable. Filters allow the same system to be used on a low voltage, total-loss power tool engine ignition system up to a multi-cylinder, a high voltage motorcycle or automotive ignition system.



**Figure 19** ATI SmartTach

Dynamometer speed is also a critical parameter since it provides the feedback for the dynamometer control loop. The rate at which the dynamometer controller updates and adjusts is very fast, optimal control requires a very high resolution and fast updating speed sensor. To meet this requirement, a high-speed, high-resolution encoder is used.

### 3.6.4 Load

A linear load cell is used to determine engine load (torque output). This load value is then used for feedback in the engine load control loop. Since this load value is used as a feedback value, its precision is critical. For this installation, a 50 lb load cell was chosen because it will provide sufficient resolution yet will be large enough to provide a buffer for any spikes that may occur during a fast transient or an emergency stop.

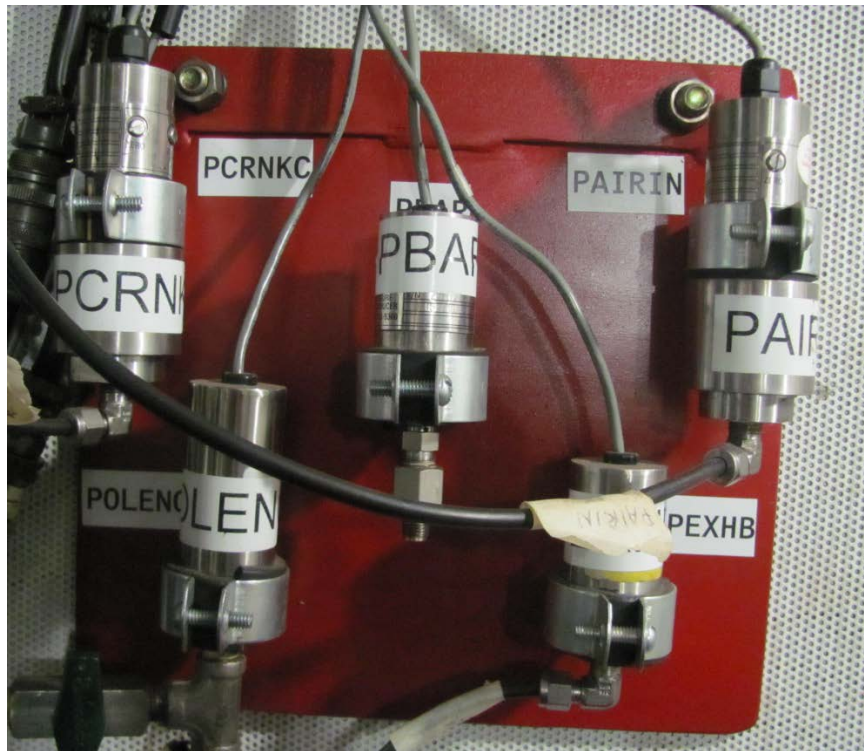

**Figure 20 Dynamometer Load Cell**

### 3.6.5 Pressure Transducers

In addition to temperature, speed, and load, certain pressures are very important to engine operation. Fuel pressure can have a big impact on air fuel ratio. Oil pressure can make the difference between boundary and hydrodynamic lubrication regimes. All

critical pressures are measured by pressure transducers that have been specifically sized for that particular application. Here again, for optimal resolution, a sensor should be selected that will read approximately in the center of its range under normal operation. Care must also be taken, however to ensure that any spikes in the system or cold start-ups will not cause any damaging pressure spikes to the transducer.



**Figure 21 Pressure Transducers**

### **3.7 Safety Systems**

#### **3.7.1 Fuel**

As with any industrial type environment, safety concerns are always paramount. In the case of this engine test, the primary defense is an enclosed test cell around the test

engine. This test cell is made specifically to eliminate noise and contain the spread of any dangerous scenario such as catastrophic engine failure or fire. The test cell measures 8 feet wide by 10 feet long, and has a ceiling height of 8 feet.

Fuel is perhaps the most hazardous compound used in this test. The fuel source for this engine and adjacent test stands is a 20,000 gallon fuel tank. Fuel is supplied by underground lines from the tank to the test cell. Since the fuel source is nearly unlimited, controlling fuel flow becomes the most effective way at preventing any un-controlled energy releases. The primary method employed to control fuel flow is the installation of two normally closed, electric solenoids. The first is installed on the fuel supply line just as it enters the test cell. The second is installed as close to the engine as possible. These fuel solenoids work in conjunction with fuel vapor detection sensors located within the trenches in the test cell. In the event of an un-controlled release of fuel into the test cell, these vapor sensors will trigger a safety stop of the test stand and close both fuel solenoids.

Two fuel solenoids are installed, not only for redundancy, but also to eliminate specific hazards. The solenoid controlling fuel flow into the test cell would be most effective at stopping a fuel leak within the systems many components, fittings, and sensors, but would be ineffective at quickly stopping fuel flow to the engine. The fuel system contains a large volume of fuel and would allow the engine to run for an extended period of time before it would stall due to lack of fuel. This could create a problem if the engine was in a run-away type scenario, or caught fire. The second fuel solenoid is located very close to the engine, this solenoid prevents fuel flow to the engine in the event of a catastrophic failure, and will ensure the engine would stall out quickly due to

the small amount of fuel between the solenoid and line when closed. Since both solenoids are normally closed, in the event of a power failure, solenoids will automatically shut. In this way, valves fail 'safe'.

### **3.7.2 Rotating Components**

Fuel is by far the biggest concern, but certainly not the only safety concern. Rotating components such as the driveshaft, dynamometer flywheel and encoder are shielded with heavy gauge steel to ensure a failure that results in fragmentation will not escape the enclosure. As an additional safety, the driveshaft guard incorporates a safety switch that trips in the event of a driveshaft failure. This safety is tied into the test computer's emergency stop, or E-stop circuit. If the driveshaft breaks, power and fuel are immediately cut to the engine.

### **3.7.3 Extreme Temperatures**

Hot components, such as exhaust components and components for the engine's cooling system are labeled and guarded to prevent accidental contact. This is very important due to the test cell's tight quarters. If these guards were not in place it would be very easy for an operator to become accidentally exposed and possibly burned by a hot surface. An exhaust gas removal system is connected directly to the engine's exhaust and continually draws exhaust gasses out of the engine so hazardous gasses cannot escape into the test cell.

### **3.7.4 Dynamometer Cooling**

The dynamometer uses process water for cooling. The pumps that supply the facility with process water can fail, even though there are redundant systems in place to prevent



this. In addition to a pump failure, something as simple as a clogged line or a clogged chiller could restrict or prevent flow. At full load, a dynamometer can overheat very quickly if this vital cooling water is removed. To reduce the potential for this failure, a flow switch is installed on the process water line which exits the dynamometer. If for any reason water flow stops or slows, a safety top will be triggered.

### **3.7.5 Programmable Safety Stops**

In addition to these hardware related safety stops, the test computer also has programmable safety stops. These are useful in preventing a component failure. Any parameter can be monitored and used for a safety stop, but the most common are maximum temperatures and speeds. For example, a cylinder head temperature approaching 300°C can result in catastrophic engine failure. To prevent this, a safety stop can be set at a lower temperature, say 250°C, such that the engine will automatically enter a cool down phase or stop if the high limit temperature is reached.

## CHAPTER IV

### EXPERIMENTAL RESULTS

#### 4.1 Introduction

From the discussion of the Stribeck number in the Chapter II, we see that boundary lubrication occurs when oil viscosity is low (high temperatures), rotational speed is low, and contact pressures are high. These conditions can often be found in the valvetrain where slow speeds and sliding contacts are present. For the development of a test stage that favors these conditions, the engine is run hot to reduce oil viscosity, operated at slow speeds, and at high loads. Initial condition sets were developed using this logic and are displayed in the following table.

**Table V Initial Test Stages**

Stage	Target Lubrication Regime	Engine Speed	Load	Oil Temperature
		(RPM)	(%)	(°C)
1	Boundary	2500	75	120
2	Boundary	3500	50	110
3	Mixed	4500	25	100
4	Hydrodynamic	5500	25	80
5	Hydrodynamic	6500	15	60

This table was used as a starting point for the iterative process of determining optimized test conditions.

## **4.2 Operating Condition Optimization**

### **4.2.1 Load Estimation**

While engine speed and oil temperature are directly quantitative measurements, percent load is somewhat more subjective and can have more than one meaning. Because of this, it is worthwhile to discuss percent load more thoroughly.

All stoichiometric engines or engines that meter both airflow and fuel flow to maintain a fixed air/fuel ratio, use some device to throttle airflow into the engine. This is required because fuel and air must be precisely mixed to ensure optimal combustion at any variety of engine speeds and loads. For a gasoline fueled, spark ignited engine, this stoichiometric ratio is approximately 14.7-15 units of air to one unit of fuel, by mass. This ratio is a consequence of the balanced oxidation reaction for complete combustion.

On most gasoline engines, including the Honda PCX150, a butterfly valve is used to meter airflow into the engine. At idle, the valve is almost completely closed and the engine receives only a minimal amount of air. When the throttle plate rotates 90 degrees, the engine is said to be at wide open throttle (WOT) and receives the maximum air flow. Since the test engine is a stoichiometric engine, torque output is proportional to fuel flow, which is also proportional to air flow. (This differs from a diesel engine where air is relatively constant since there is no throttle plate, and power is proportional to fuel only.)

Therefore, it stands to reason that engine load should correlate to throttle position. While this is mostly correct, there is a caveat in that the intake airflow does not linearly correlate to throttle position. This is due to the geometry of the throttle plate, pivoting in

the throttle body. Consider the most common throttle body shape, the circular disc in the cylindrical throttle body bore. The area of this circular bore can be shown as:

$$A_{Bore} = \frac{\pi \times d^2}{4} \quad (4.1)$$

Where  $d$  is the diameter of the throttle body bore. This represents the total area that is available for airflow at WOT. Note, that the axis that the throttle plate rotates on is considered sufficiently small when compared to the area of the throttle plate and is therefore omitted from the calculation.

However, when the throttle plate begins to open, airflow occurs around both top and bottom surfaces of the throttle plate and the cross-section of the throttle plate is no longer round when viewed from the flow path. The area that can then be used to flow air is the difference between throttle body bore area and the projected area of the throttle plate in the flow direction.

$$A_{Flow} = A_{Bore} - A_{Projected} \quad (4.2)$$

The projected area of the throttle plate is then:

$$A_{Projected} = \int_{A_{Bore}} \cos(\theta) dA_{Bore} \quad (4.3)$$

When the throttle plate is modeled as a circular disc, this differential equation simplifies to the following:

$$A_{\text{Projected}} = \frac{\pi \times d^2}{4} \times \cos(\theta) \quad (4.4)$$

The concept is illustrated in the following schematic:

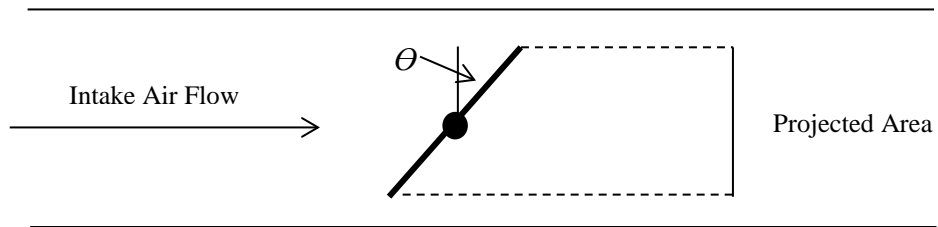

**Figure 22 Throttle Body Schematic**

Using the developed formulas, a relationship between throttle opening percentage, throttle plate angle in degrees, and percentage open area can be calculated. To simplify calculation, a throttle body diameter of 1.00 inch was used. This dimension is completely arbitrary as results are displayed as a dimensionless percentage, but useful in simplifying computations. The results can be seen in the following table:

**Table VI Throttle Opening Calculations**

Throttle Rotation	Throttle Angle	Projected Area	Actual Open Area	Actual Open Area
(%)	(deg.)	(in <sup>2</sup> )	(in <sup>2</sup> )	(%)
0	0	0.785	0	0
10	9	0.776	0.01	1.2
20	18	0.747	0.038	4.9
30	27	0.7	0.086	10.9
40	36	0.635	0.15	19.1
50	45	0.555	0.23	29.3
60	54	0.462	0.324	41.2
70	63	0.357	0.429	54.6
80	72	0.243	0.543	69.1
90	81	0.123	0.663	84.4
100	90	0	0.785	100

For a more visual interpretation of this data, the actual opening % was plotted versus throttle plate rotation %. A linear response was also plotted on the same graph to show the deviation from a linearly operating throttle.

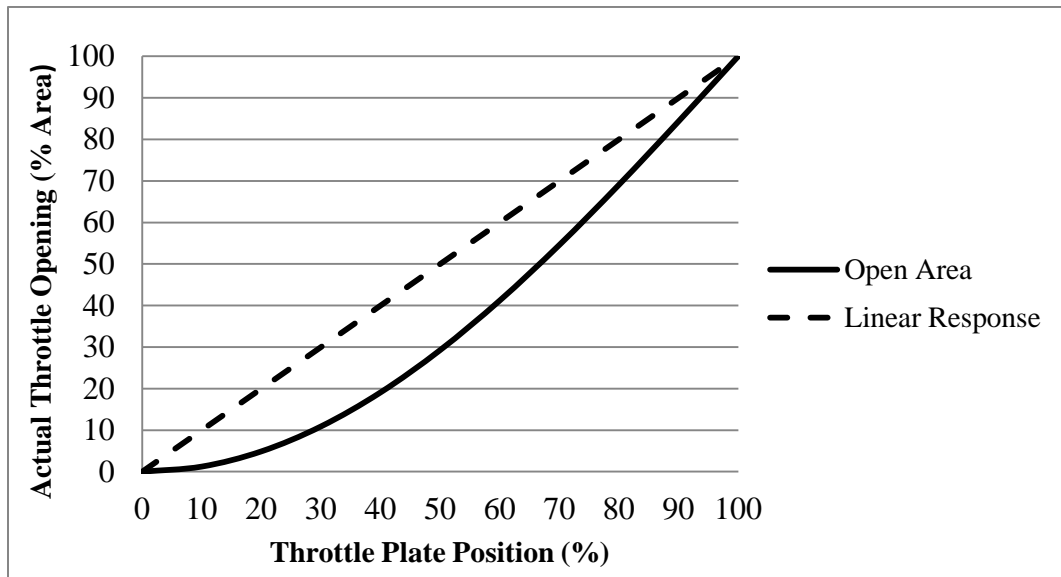
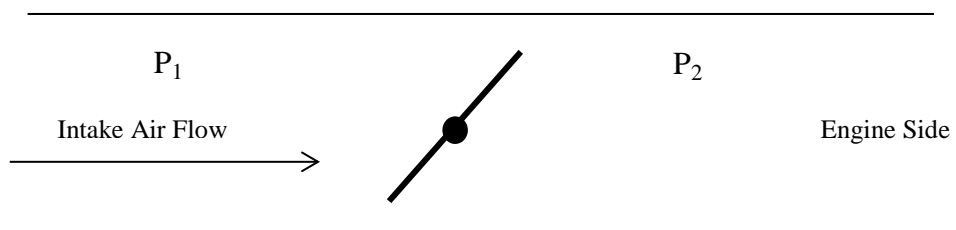

**Figure 23 Throttle Opening, Actual vs. Linear**

This deviation from linearity illustrates that if a throttle plate 50% open, that condition does not necessarily correspond to a 50% restriction or a 50% of the maximum intake air flow rate. Additionally, in actual engine operation, the throttle restriction depends on engine speed and intake runner and cylinder head geometry. Because of these discrepancies, other methods of determining engine load must be investigated.

If a complete WOT power curve is available, the partial load (power or torque) at any particular engine speed can be compared to the WOT load (power or torque) at the same speed. For example, if the engine is operating at 3,000 RPM and 3.0 kW, and the WOT power at this speed is known to be 6 kW, the engine is operating a 50% of maximum load at that speed – regardless of throttle plate position. This is a simple and very accurate way to evaluate engine load. However, due to the mechanical limitations of the test dynamometer, a full WOT power curve could not be completed.

Yet another method at determining engine load can be achieved through comparison of intake air pressure before the throttle plate and after the throttle plate. Consider the following diagram:



**Figure 24 Pressure differential across Throttle Body**

Since the test engine is a stoichiometric engine, the mass flow rate of air into the engine is proportional to engine torque. The caveat to this rule is that for drivability and

engine responsiveness, the engine is normally tuned to operate at AFRs richer than stoichiometric under certain conditions, which does impact power output. For example, if intake air mass flow rate is held constant and AFR is changed from 14.5 to 13.5, power output will change. The fuel injection system holds AFR very constant and any minor fluctuation can be ignored. With this assumption then, we can calculate load in the following manner.

$$Load (\%) = \frac{P_2}{P_1} \times 100 \quad (\text{Eq. 4.5})$$

When the engine is operating at partial throttle,  $P_2$  will be below atmospheric pressure. For a naturally aspirated engine,  $P_1$  will be at equal to (or very near) atmospheric pressure. At wide open throttle, the pressures at  $P_1$  and  $P_2$  will be nearly equal. To make these measurements on the test engine, air pressure within the airbox provides the  $P_1$  measurement and a vacuum line connected to the port between the throttle body and cylinder head provides the  $P_2$  measurement.

The engine has a fixed displacement determined by the engine's bore diameter, stroke length, and number of cylinders. Since the displacement is constant, the engine's demand for intake air (volumetric flow rate per unit time) changes with engine speed. The throttle components are designed and sized for maximum conditions, WOT and maximum speed operation – this has an important consequence. At low engine speeds, not much air is being demanded and as a result, mass air flow rate is relatively low. At high engine speeds, more air is being demanded. Since the throttle functions as a restriction, at any



particular opening other than WOT, it is more effective at restricting high flow rates. For example a throttle opening of 30% at 3,000 RPM will produce a higher engine load than the same 30% opening at 6,000 RPM. The same throttle opening at lower engine speeds (air flow rates) acts as less of a restriction than the same throttle opening at higher speeds (air flow rates).

For the remainder of this work, engine load will be referred to as a percent of full load and calculated with the pressure method discussed in this section.

#### **4.2.2 Thermal Management**

Engine oil temperature is perhaps the most critical parameter to control during testing. Oil temperature is vital because the oil's viscosity changes significantly with temperature and viscosity is arguably the most important characteristic of any lubricating oil. The initial conditions for engine oil temperature were chosen based on experience testing motorcycle engines, and represent a wide viscosity range for any particular grade of oil.

Additionally, this initial list of condition sets does not include a coolant temperature. This is because coolant temperature will be maintained at whatever temperature will help maintain the desired engine oil temperature. In this manner, coolant temperature becomes an uncontrolled parameter and serves as the process variable for the oil temperature control loop. Further, although the coolant and oil systems are separate, they are fundamentally linked in that they are both circulating in the same engine. It would therefore be difficult or impossible to maintain very low coolant temperature and very high oil temperature or vice versa. Through observation of similar small engines, it has been noted that the oil temperature is approximately 10 degrees Celsius higher than the

coolant temperature, however this typically only holds true at moderate speeds and loads. At high loads, oil temperature has been observed to be 30 or 40 degrees Celsius higher than coolant temperature. Cooling is provided via the water to coolant heat exchanger controlled by the test computer to control temperatures.

Whether an engine uses a liquid-cooling system or an air-cooling system, its purpose is to reject waste heat to the atmosphere. Cooling is the result of all three forms of heat transfer including convection, conduction, and radiation, with convection providing by far the largest effect. There is however, a discontinuity between the cooling an engine experiences in a vehicle traveling down the road compared to the cooling the same engine receives in an engine test stand. When a motorcycle is in operation, airflow over the engine's fins or radiator provides the convective heat transfer to facilitate cooling. In this example, the heat transfer that is available is a function of the airflow over the engine or radiator and engine/coolant temperature. This airflow is influenced almost completely by vehicle speed. In this manner, heat transfer can be thought of as fixed – as it will only appreciably change with vehicle speed (assuming ambient temperatures, engine temperatures and conditions are constant).

This stands in stark contrast to cooling when the engine is operated in a test cell. In a test cell, all components are rigidly secured, so there is no relative motion. Cooling is provided either by ducting air to an air-cooled engine or metering water to a coolant/water heat exchanger in the case of a liquid cooled engine. Both methods are controlled independent of engine speed and vehicle speed is not applicable because the engine is stationary.

To better illustrate this concept, consider the following example: Two engine oils are to be evaluated, the first having a relatively high thermal conductivity, and the second having a relatively low thermal conductivity. (The majority of an engine oil's thermal characteristics are determined by the base oil.) Two identical motorcycle engines are filled, one with each oil, and both motorcycles are then ridden under the same duty cycle while temperature data is logged. From experimental observations of transient cycles, the motorcycle containing the first oil with the higher conductivity will tend to have lower oil temperatures compared to the engine with the lower conductivity engine oil. Why is this? Both motorcycles have the same amount of airflow during operation. It is hypothesized that this is a result of the oil with the higher conductivity is absorbing heat from the engine and releasing that heat to the surroundings more efficiently than the lower conductivity oil. Obviously, the heating through viscous and component friction also has a big impact on oil temperature, but these sources are small compared to the larger heat flux entering the system from combustion.

If the same two oils are tested in the same engine installed in the laboratory this important difference may go unnoticed because oil temperature is typically a controlled parameter. The result would be that the engine oil whose conductivity was lower would receive higher coolant flow from the external water source. This higher coolant flow would then provide the higher heat transfer required to maintain temperature. To summarize this experiment, in an actual vehicle application, heat transfer can be thought of as constant. If the heat transfer is constant and the oil's thermal conductivity changes, engine oil temperature must change. In the laboratory, engine oil temperature is maintained at a constant value, so if the oil's thermal conductivity changes, heat transfer

must change. To ensure these intricacies are not missed, control loop voltage is also monitored and recorded.

For steady-state operation with a control volume drawn around the engine, the system can be described by the following heat transfer rate balance.

$$\dot{Q}_{out} = \dot{Q}_{in} + \dot{Q}_{gen}. \quad (4.6)$$

Where  $\dot{Q}_{out}$  represents the net heat flow rate out of the system,  $\dot{Q}_{in}$  represents the net heat flow rate into the system, and  $\dot{Q}_{gen}$  represents the net heat generation rate within the system. If we assume that no heat is entering the system, heat from combustion is considered to be generated in the system, the relation simplifies to the following:

$$\dot{Q}_{out} = \dot{Q}_{gen}. \quad (4.7)$$

Again, heat that is rejected from the engine occurs via convection, conduction, and radiation, with convection providing the largest contribution.  $\dot{Q}_{out}$  is best described by forced convection on external engine surfaces for an air-cooled engine and internal coolant passages on a liquid-cooled engine. It will be a function of vehicle speed (air flow rate over the engine/radiator), surface temperature, ambient air temperature, and the geometry of the surfaces. It is important that the reader understand where this term comes from and how it fits into the system, but a detailed thermal analysis is beyond the scope of this work due to the geometric complexities of a complete engine.  $\dot{Q}_{gen}$ .

represents the rate of heat transfer that is the sum of all heat produced within the system which includes heat from combustion, compression and expansion (negative contribution), heat from viscous friction and component friction. This can be seen in the heat transfer rate balance below.

$$\dot{Q}_{gen.} = \dot{Q}_{combustion} + \dot{Q}_{compression - expansion} + \dot{Q}_{visc.} + \dot{Q}_{component} + \dot{Q}_{misc.} \quad (4.8)$$

Here,  $\dot{Q}_{combustion}$  represents the rate of heat transfer from combustion,  $\dot{Q}_{compression - expansion}$  represents the rate of heat transfer from compression and expansion of gasses within the cylinder,  $\dot{Q}_{visc.}$  represents the rate of heat transfer from viscous friction, and  $\dot{Q}_{component.}$  represents the rate of heat transfer due to component friction. Note that  $\dot{Q}_{misc.}$  term has been included to compensate for any other unaccounted forms of heat generation/rejection within an engine. For example, the vaporization of fuel droplets within the combustion chamber imparts a cooling effect due to the liquid-vapor phase change. Since these sources should not appreciably interact with engine oil and a detailed thermal analysis of this system is beyond the scope of this paper, these effects will not be discussed but were included for completeness.

Engine oils can reduce operating temperatures by increasing heat transfer via convection (carrying heat away from hot components) and by reducing the heat generated inside the engine. Oils with high thermal conductivity will increase heat transfer from high temperature components to the bulk oil and ultimately to engine cases which are

exposed to the atmosphere. This increased heat transfer will result in increased engine case surface temperature. Increased surface temperatures will increase convective heat transfer to the atmosphere, which will in turn result in reduced engine temperatures under steady-state operation. As mentioned previously, thermal properties of an engine oil are largely controlled by the base oil because base oil makes up such a large percentage of the finished engine oil.

Another way that engine oils can reduce engine temperatures is by reducing the rate at which heat is generated through friction reduction. Friction can be generated through viscous friction (shearing oil in bearings, orifices, pumps and passages) or through component friction (asperity contact of engine surfaces). As viscosity decreases, viscous friction also decreases. This is exactly why the transportation industries and OEMs have been developing engines that operate on lower and lower viscosity engine oils over the past 30 years. If durability can be maintained, an engine oil with a lower viscosity will by definition produce less viscous friction and viscous heating compared to a higher viscosity oil. Again, viscosity is almost entirely dictated by the base oil and viscosity modifiers within the oil, not the additive package.

Component friction is generated at the interface of two contacting surfaces that experience relative motion. Even though lubricated contacts offer much lower friction coefficients than unlubricated ones, friction is still present and heat is still generated. In this case however, both oil viscosity (base oil properties) and additive package properties play a critical role in reducing friction. When an engine oil comes in contact with a metal component, it forms a thin film. The film thickness is directly related to the oil's viscosity. This thin film ideally prevents contact between the surfaces, but under some

conditions such as boundary lubrication, contact does occur. If the engine oil has been formulated with the correct friction modifiers and anti-wear additives, these molecules will create a sacrificial additive layer on the metal surfaces. When contact does occur, the additive layer substantially reduces friction which in turn, reduces the amount of heat generated within the contacting region.

It is therefore very important not only to monitor and control engine hardware and oil temperatures, but also to understand how oil properties can be altered to optimize thermal performance, and how this thermal performance can impact total system operation and fuel economy.

#### **4.2.3 Test Condition Optimization**

The discussed theories of load, speed, and temperature management were very helpful to develop the initial condition sets, but after the first test-fire of the engine on the dynamometer several things became apparent:

1. The PCX 150 engine is very thermally stable – this made it difficult to achieve extremes in oil temperatures.
2. Engine speed has a bigger impact on oil temperature than load – this made it difficult to achieve high oil temperatures at low speeds.

These important determinations led to a significant alteration of the condition sets. Engine oil temperature could not be reliably maintained over 80 C at engine speeds below 4500 RPM. This means that oil temperature during the boundary lubrication regime targeted stages must be somewhat lower than desired. To compensate for this lower temperature, load was increased in both stages. This second iteration of condition sets can be seen in the following table.

**Table VII Second Iteration Test Stages**

Stage	Target Lubrication Regime	Engine Speed	Load	Oil Temperature
		(RPM)	(%)	(°C)
1	Boundary	2500	80	80
2	Boundary	3500	70	80
3	Mixed	4500	25	75
4	Hydrodynamic	5500	20	70
5	Hydrodynamic	6500	15	60

#### **4.2.4 Further Test Control Optimization**

After the several experimental tests were conducted using the second iteration of condition sets, it was discovered that the coolant temperature had little impact on the engine oil temperature. It became apparent that the original method of using coolant temperature to control engine oil temperature would not be an effective method. This change represented a fundamental shift in temperature control – which would later be verified by experimental data. The engine coolant system and oil cooling systems were split. The cooling system now used the temperature of the coolant coming out of the engine as feedback for the PID loop. In this loop, the research valve that allowed process water into the heat exchanger would remain the process variable, and the setpoint would be the desired temperature of the coolant coming out of the engine. As the engine heats from operation, coolant temperature is continuously monitored. Once the temperature of the engine coolant out of the engine nears or passes the prescribed temperature, the PID control loop responds and allows more cool process water through the liquid-to-liquid heat exchanger. This increased cooling water flow reduces the temperature of the engine coolant entering the engine, thus reducing the temperature of the engine coolant exiting



the engine. This strategy proved to work very effectively and maintained engine coolant temperature to about  $\pm 2$  °C for the duration of the test.

While this solved the issues of coolant temperature control, a method for oil temperature control needed to be devised. Oil circulates throughout the engine and can be difficult to cool. Since all the oil returns to the engine sump, cooling this area was the easiest way to access the largest volume of oil. To facilitate engine oil cooling, two air ducts were added to the test rig and positioned under the engine and directed at the engine oil sump. Computer controlled stepper motors control the supply of cooling air through these ducts. Oil sump temperature becomes the feedback for this PID loop, and damper position becomes the process variable, metering the flow of cooling air to the engine oil sump. Although this system was installed, the option of keeping the system off was also maintained to further simulate on-road type conditions as the engine does not receive this type of air flow when installed in the vehicle.

All of these considerations led to the third iteration of condition sets. This time, the author approached the determination of condition sets in a fundamentally different manner. Instead of determining theoretical conditions and forcing the engine to operate at them, the engine was operated at each desired speed, and load was added or removed until the engine and test rig was operating at a 'sweet spot'. Once this operating condition set was attained, the engine oil and coolant temperatures were allowed to reach an equilibrium point – where the PID controller could easily control temperatures up or down without much trouble. Finding this middle point would ensure the capability for controlling temperatures when there are fluctuations in ambient conditions. The final iteration of condition sets can be seen in the table below.

**Table VIII Final Condition Sets**

Stage	Target Lubrication Regime	Engine Speed	Load	Oil Temperature	Coolant Temperature
		(RPM)	(%)	(°C)	(°C)
1	Boundary	2500	-	55	-
2	Mixed	3500	-	60	-
3	Mixed	4500	-	65	-
4	Hydrodynamic	5500	-	85	-

This third iteration of condition sets represents a compromise between targeted conditions and achievable conditions. Initially, temperatures were intended to be higher at lower speeds to induce boundary lubrication and lower at higher speeds to encourage hydrodynamic lubrication. In operation however, this was not possible. Additionally, engine load was intended to be higher at lower speeds and lower at higher speeds. Again, operationally, the large inertia of the dynamometer and couples proved that higher loads were necessary to maintain steady operation at high engine speeds. The fifth stage was also omitted to promote hardware longevity. While these changes reflect a step away from the ideal condition sets, they still proved quite capable of investigating fuel economy in various lubrication regimes.

Determination of the optimal condition sets has been the result of hours of dynamometer testing and data analysis. This development represents a significant investment of The Lubrizol Corporation and is seen as a competitive advantage. Because of this, the final values for engine load and coolant temperature have been omitted from this publication.

### 4.3 Test Operation

Once the final condition sets were determined, a method to operate the engine at each set was obtained. To do this, the test computer is programmed with all essential condition sets for each test stage along with condition sets for warm-up, cool-down, soft-stop, and emergency stops. To promote hardware longevity, condition sets are ‘ramped’ from one value to the next. For example, if the engine is transitioned from a 10% load condition to a WOT condition with no ramp, the throttle will be opened abruptly. This abrupt throttle opening will reduce the life of couples, mounts and other components on the test rig. Additionally, PID loop tuning is often a compromise between transient response and steady-state stability. This means if a control loop is optimized for transient cycle, control may be reduced for steady state operation and vice versa.

The test computer uses a sequencer macro, or a program that calls various condition sets. Criteria for advancing to the next condition set are achieved when any parameter reaches a pre-determined value or trigger. These triggers can be set on time, temperature, speed, or any other measured parameter. Triggers can also be set for rates of change for any parameter. Most commonly, triggers based on time and/or temperature are used.

The fuel economy test procedure begins with a warm-up stage where the engine is run at low load for 5 minutes. In addition to providing time for the engine to warm-up, and begin closed-loop operation, this time gives the operator an opportunity to check the engine test rig for any leaks or incorrect instrumentation. At the end of this initial warm-up, the control computer automatically loads the first test condition set. The engine is then operated at this condition set for 5 minutes and allowed to stabilize. After this stabilization period, the same condition set is reloaded and maintained for an additional

15 minutes while data is collected. The stabilization period is vital to ensuring the engine has reached thermal equilibrium before data is collected. After the 15 minute data logging cycle is complete, the conditions for the next test stage are loaded, and the cycle repeats until the test has finished. The exception to this cycle is the first stage which is run for a 15 minute warm-up period before data capture to ensure the engine has reached operating temperature, especially from a cold start. To promote quick warm-up, the second stage (3500 RPM) is run first followed by the 2500 RPM stage. This also increases the oil temperature above the natural stabilization temperature for the 2500 RPM stage.

Special condition sets were also developed to be automatically loaded in the event of an unscheduled stop or emergency. For example, if during the warm-up or any test stage an operator notices an oil leak, he may 'interrupt' the test by selecting an interrupt button from the test operation menu on the test control computer. This action loads the interrupt macro which saves the current location in the test macro, brings the engine down to a low-load cool-down state, and stops the test clock. The operator can then fix the leak, restart the engine, and resume the test from where it was interrupted. Additionally, there are several strategically located E-Stop buttons inside and outside the test cell. In an emergency situation the operator can press one of these buttons which loads a fast-stop macro into the test computer. This fast-stop macro will immediately stop fuel flow, de-energize the ignition, cut power to electric accessories, and apply load to the dynamometer to stop the engine as quickly as possible. Because such a stop is conducted so quickly it can damage hardware and is reserved for emergency situations only.

#### 4.4 Data Acquisition and Analysis

The test control computer also records all engine operational data. Thirty (30) individual parameters are monitored and recorded during each test stage. Each parameter is recorded at a rate of ten (10) Hz for each fifteen (15) minute test stage, for a total of 9000 samples. Therefore, each test stage generates a spreadsheet with 270,000 individual data points (30 parameters x 9000 samples). Since each evaluation consists of 4 stages, one data set consists of over one million individual data points! Due to this large amount of data, analysis cannot be done by hand and therefore, Microsoft Excel was used to analyze data.

#### 4.5 Experimental Test Plan

The over-riding goal of this work is to develop a fired fuel economy test using a common, commercially available scooter engine with the ability to differentiate engine oils by their ability to reduce break specific fuel consumption (BSFC). The test must be sensitive enough to differentiate engine oils based on viscosity and presence of a friction modifier within the additive package. To determine if the newly developed test would meet these criteria, three engine oils were developed which represent various viscosities and additives. Each oil's characteristics can be seen in the following table:

**Table IX Test Oils**

<b>Test Oil</b>	<b>SAE Viscosity Grade</b>	<b>Friction Modifier</b>
Test Oil #1	20W-50	No
Test Oil #2	5W-30	No
Test Oil #3	5W-30	Yes

All three engine oils were specifically developed for evaluating the performance of this test. The first two oils (Test Oil #1 and Test Oil #2) differ only in the base oils and viscosity modifiers used to achieve the specific SAE viscosity grades. The additive package for each of these oils is identical, with neither oil containing a friction modifier. The second and third oil samples (Test Oil #2 and Test Oil #3) share the same oil base stocks, viscosity modifier, additive package, and differ only in that the third (Test Oil #3) contains an organic friction modifier, at 0.25% concentration by mass.

The first evaluation was conducted between Test Oil #1 and Test Oil #2. Since neither oil sample contains a friction modifier, the only difference between them is the viscosity. Since viscous differences can have a major influence on engine friction and thus fuel consumption, a large difference between these oil samples is expected.

The second evaluation was conducted between Test Oil #2 and Test Oil #3. Here, the only difference is the presence of a friction modifier in the third sample. This difference is small when compared to the large difference in viscosity of the first two samples, and as a result, a smaller difference in fuel consumption is expected.

#### **4.6 Testing Sequence**

A bracketed test strategy is employed for this testing. In a bracketed test strategy, each test oil evaluation is preceded and followed by a baseline oil test. This is a test procedure that is used by the current ASTM Sequence VID passenger vehicle fuel economy test [4], and very effective at minimizing variability while allowing normalized comparison over the life of the test engine.

Over time, a test engine will vary subtly, but significantly change as a result of wear and deposit formation. Since fuel consumption measurement involves very small magnitude changes, it is usually described in comparison to a baseline. The baseline for this testing will be Test Oil #1. As testing progresses and the engine subtly changes, the performance of this baseline (Test Oil #1) will also change. The bracketed test method, in essence, allows for comparison of engine response to the baseline oil both before and after the candidate test (Test Oils #2 and #3) are conducted. Since the baseline oil will be constant throughout test engine life, it also allows for tracking of long-term severity shifts, since baseline tests are conducted continuously.

The test matrix using this bracketed testing strategy was then developed and can be seen in the following table:

**Table X Oil Test Matrix**

<b>Test Number</b>	<b>SAE Viscosity Grade</b>	<b>Description</b>	<b>Friction Modifier</b>
1	20W-50	Test Oil #1 Run 1	No
2	5W-30	Test Oil #2 Run 1	No
3	5W-30	Test Oil #2 Run 2	No
4	20W-50	Test Oil #1 Run 2	No
5	5W-30	Test Oil #3 Run 1	Yes
6	5W-30	Test Oil #3 Run 2	Yes
7	20W-50	Test Oil #1 Run 3	No

When the bracketed test method is used, the baseline (Test Oil #1) tests before and after the candidate (Test Oils #2 and #3) tests are averaged, as seen in the following equation.

$$BSFC_{BL\ Avg.} = \frac{BSFC_{BL\ Run\ 1} + BSFC_{BL\ Run\ 2}}{2} \quad (4.8)$$

Where  $BSFC_{BL\ Avg.}$  refers to the average baseline (Test Oil #1) BSFC values for each stage while  $BSFC_{BL\ Run1}$  and  $BSFC_{BL\ Run2}$  refer to each data point from the baseline oil evaluations before and after the candidate oil (Test Oils #2 and #3) evaluations.

This average baseline is then compared to the candidate (Test Oils #2 and #3). If repeat testing is conducted between baseline (Test Oil #1) evaluations, data can also be averaged in the same manner. This can improve data quality by reducing test variability.

Following this method insures that:

1. Performance of test oils are always compared to a baseline oil – in this case, Test Oil #1 is the baseline oil. This relative comparison allows for normalized testing of multiple engine oils.
2. As engine response changes due to engine age, continuous baseline testing ensures that each relative comparison is relevant.

#### **4.7 Test Results**

All seven (7) tests were conducted in the order described in the preceding test matrix. Again, Test Oil #1 was treated as the baseline test oil, and was evaluated three (3) times total. Both Test Oil #2 and Test Oil #3 were evaluated twice, providing repeat test data. The individual BSFC values for each test stage and each oil evaluation can be seen in the following table.



**Table XI BSFC Test Data**

	BSFC (g/kW-h)			
	Stage 1	Stage 2	Stage 3	Stage 4
Test Oil #1 Run1	346.9	269.0	268.8	273.1
Test Oil #2 Run 1	337.6	259.8	261.4	264.5
Test Oil #2 Run2	344.7	261.9	262.0	265.5
Test Oil #1 Run 2	346.6	274.2	270.6	275.6
Test Oil #3 Run 1	342.4	262.8	265.0	265.8
Test Oil #3 Run 2	345.9	262.8	262.4	266.8
Test Oil #1 Run 3	350.5	275.0	274.5	278.8

For simplification, average values for BSFC of each test oil at each test stage were calculated. These values can be seen in the following table.

**Table XII Average BSFC Test Data**

	Average BSFC (g/kW-h)			
	Stage 1	Stage 2	Stage 3	Stage 4
Average Test Oil #1	348.0	272.7	271.3	275.8
Average Test Oil #2	341.2	260.9	261.7	265.0
Average Test Oil #3	344.2	262.8	263.7	266.3

To improve data visualization, these calculated averages are plotted and can be seen in the Figure 25.

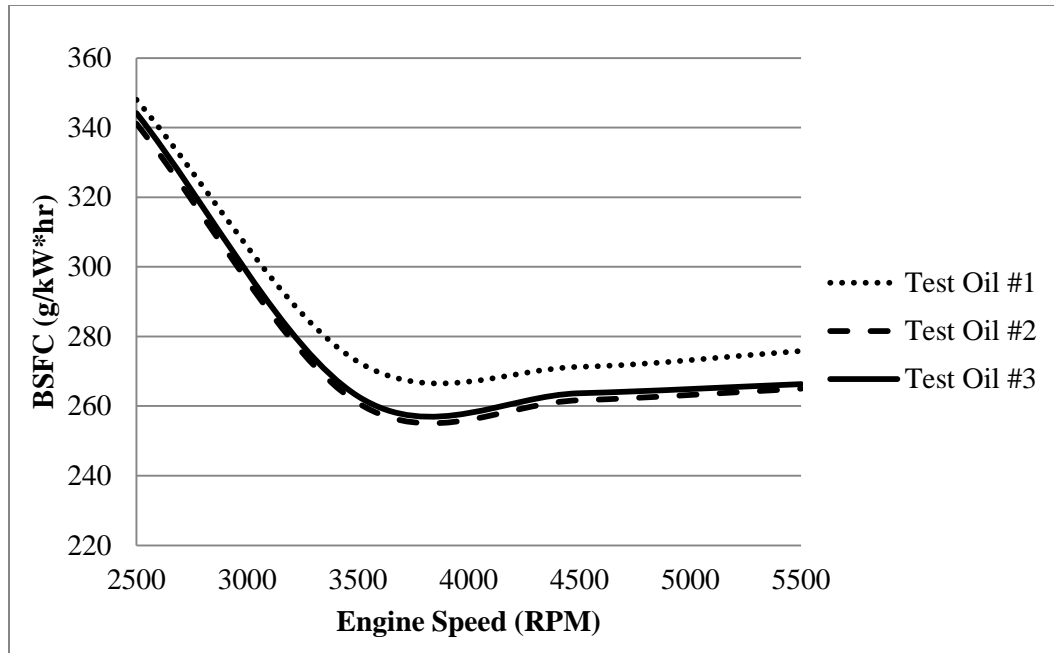

**Figure 25 BSFC vs. Engine Speed**

There is a clear difference in BSFC between the high viscosity oil, Test Oil #1, and both lower viscosity oils, Test Oils #2 and #3. Each curve bears a striking resemblance to the Stribeck curve.

To determine the relative performance of Test Oil #2 and Test Oil #3 compared to Test Oil #1, Fuel Economy Improvement (FEI) is calculated. For the calculation of FEI, the averaged BSFC values for each test stage of Test Oil #2 and Test Oil #3 are used, respectively.

For example, in the calculation of FEI for Test Oil #2, the average BSFC of Test Oil #1, (Runs 1 and 2) are compared (via FEI equation 2.2) to the average BSFC of Test Oil #2 (Runs 1 and 2). In this manner, average FEI for both Test Oil #2 and Test Oil #3 at each stage is calculated and can be seen in the following table.

**Table XIII Average Fuel Economy Improvement**

	Average FEI (%)				
	Stage 1	Stage 2	Stage 3	Stage 4	Average
Test Oil #2	1.63	3.94	2.97	3.41	2.99
Test Oil #3	1.27	4.30	3.24	3.93	3.18

The same data can also be displayed graphically as in the following plot.

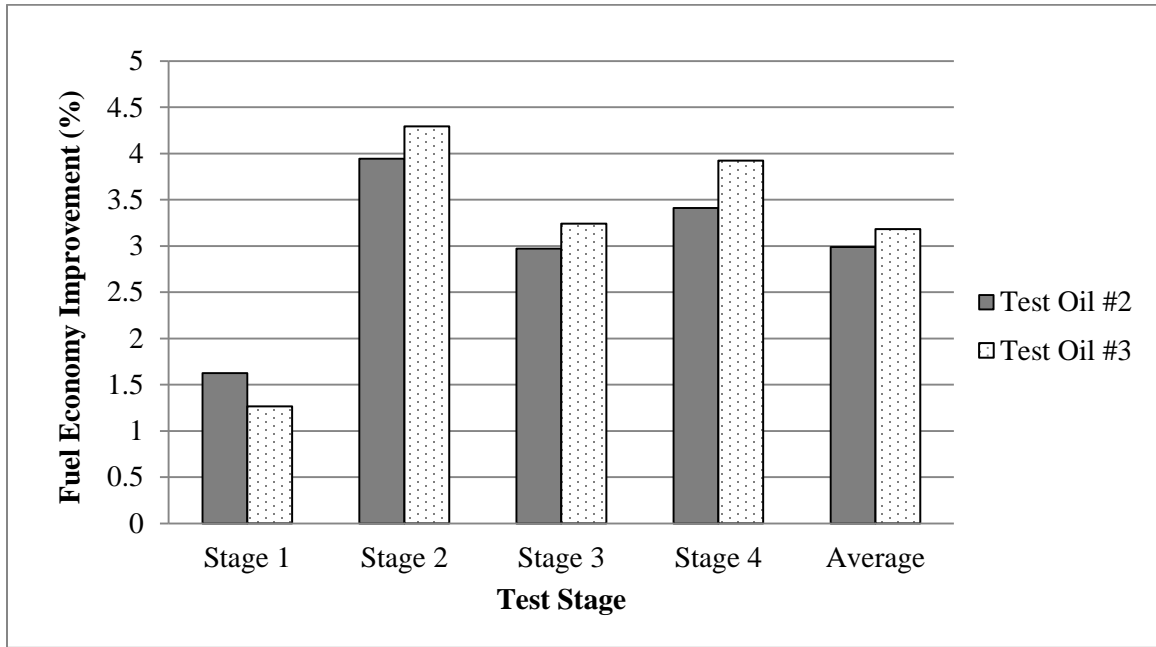

**Figure 26 Average FEI**

## 4.8 Discussion

### 4.8.1 Main Observations

The new engine test is able to differentiate engine oils based on their ability to reduce Brake Specific Fuel Consumption. The test consistently shows large reductions in BSFC when lower viscosity oils (Test Oil #2 and #3) are compared to the higher viscosity oil (Test Oil #1). The test also shows a smaller but significant difference between oils with

and without friction modifying additives (Test Oils #2 and #3). This is true for all test stages except for test Stage 1, where Test Oil #3 appears to have slightly increased friction when compared to Test Oil #2. Theories for this unexpected result will be discussed in Section 4.8.2.3.

Since the largest gains in friction reduction occur with the use of low viscosity oils, this is the expected result. The reduction of oil viscosity can be thought of as viscosity having a ‘global’ impact on friction, while the friction modifying additives work more ‘locally’. A fully formulated engine oil is optimized to take full advantage of both low viscosity base oils and a performance additive package which includes one or several types of friction modifier.

In the case of the three test oils used for this study, the difference in Fuel Economy Improvement between Test Oils #2 and #3 was small, but it is important to reiterate that the only difference between these oils is the presence of 0.25% organic friction modifier in Test Oil #3. When this test is used in industry in the development of engine oils, each candidate oil will be more optimized for fuel economy, which will result in larger magnitude differences in FEI.

Further, the use of a baseline or reference oil (Test Oil #1) provides the ability to directly compare the benefits of multiple oils based on their Fuel Economy Improvement (FEI) relative to the same baseline. The implementation of the bracketed test method accommodates slight changes in the engine’s fuel economy response over time. This is very important because, the engine can become ‘mild’ or ‘severe’ in the way it responds to engine oil chemistry over its life. Indeed even in this testing, the engine became more severe, with the absolute value of BSFC trending numerically higher as testing

progressed. This caused the absolute value of BSFC for some stages of the Test Oil #3 evaluation to be *higher* than the corresponding stages of Test Oil #2! It was only through the normalization of the bracketed test method that this trend was determined. Again, the bracketed testing method is a recognized and accepted test procedure.

#### **4.8.2 Additional Observations**

Many important findings were made in the development of this engine test – some directly relating to fuel economy measurement, others not. This section will give a brief discussion of many of these findings.

##### **4.8.2.1 Relationship between Friction Reduction and Fuel Economy**

To produce useable shaft power, a reciprocating internal combustion engine converts heat energy (generated via combustion) into mechanical energy through the motion of the piston, connecting rod, and crankshaft. Engine bearings allow for reduced friction; however a significant amount of energy is needed to overcome the frictional losses of the cylinder liner and piston ring interface, bearings, gears, etc. The theory behind increasing fuel economy through engine oil development is the reduction of this friction.

For steady-state operation in propulsion of a vehicle, an engine must produce enough power to overcome rolling resistance, air resistance, frictional losses in the driveline, and frictional losses in the engine. Any reduction in these parasitic and frictional losses will improve overall vehicle efficiency. Reductions in engine friction will improve engine efficiency, however there is a caveat that prevents a reduction in engine friction from having a similar magnitude impact on engine efficiency. That caveat is a consequence of how a stoichiometric engine responds to a change in friction, and is more easily illustrated by an example.

Consider a vehicle driving down a straight, level road at a constant speed. Assume that driveline losses, rolling resistance, air resistance, engine frictional losses, and any other parasitic losses sum to 20 HP. Now, let's imagine 2 HP represents engine frictional losses. If engine friction is halved, as a result of low friction components and engine oils, the engine's frictional losses reduce to 1 HP. As a result, now only 19 HP is required to maintain speed under the same conditions. To adjust to this lower power demand, the engine will respond with a throttle position which will be slightly more closed when compared to the original 20 HP condition. Less air will be ingested which means less fuel will be burned per unit of distance travelled, producing a higher fuel economy. While this is true, it is important to realize that as the throttle plate closes, higher pumping losses are generated. The increased throttle restriction forces the engine to do more work than before to fill each cylinder. In effect, when engine friction is reduced, pumping losses force the engine to operate in a *less* efficient operating zone!

#### **4.8.2.2 Fired Engine vs. Bench Test**

Bench tests refer to a category of tests that isolate one particular phenomenon from a more complex system in attempts to accurately study it. Bench tests are typically small in scale and often times can physically fit on a bench – hence the name. Friction is a phenomenon that is often studied via bench testing, and test apparatus can range in complexity from a simple steel ball pressed against a rotating disk to a full-scale FTT rig as described in the Chapter 1.

While these bench tests are perfectly valid and very useful for research, they do not account for the exact conditions seen in an actual fired engine. Even in the case of the FTT rig, a relatively complex bench test which uses a complete engine, conditions can be

much different than they would be in a fired engine. In the case of the FTT rig, combustion events are not accounted for. Combustion creates very high cylinder pressures and temperatures. The FTT rig ignores the consequences of these conditions.

Both high pressure and high temperature tend to drive a lubricated contact toward boundary lubrication. It is therefore quite possible that the corresponding lubricated contacts such as the piston ring/cylinder interface within a fired engine experiences boundary lubrication much more than the same contact in an FTT rig. Other factors such as fuel dilution within the oil can also reduce the bench test's ability to correctly replicate the fired engine phenomena.

For all of these reasons, the resulting friction reduction generated via bench tests are typically more optimistic than those obtained in actual fired engine tests. This is why fired engine testing must be conducted during engine oil development and as a final proof of performance.

#### **4.8.2.3 Variability of Boundary Lubrication Regime**

Of all the experimental data which was generated, the only data point that does not match expectations is the higher FEI of Test Oil #2 observed at the 2500 RPM test stage (Stage 1). Since only two test repeats were conducted, the amount of statistical analysis that could be performed is limited. Nevertheless, in attempts to understand the phenomena driving this observation, the variation between test runs was evaluated, and can be seen in the following tables.

**Table XIV FEI and Standard Deviation Test Oil #2 (5W-30 No FM)**

	Fuel Economy Improvement (%)			
	Stage 1	Stage 2	Stage 3	Stage 4
Test Oil #2 Run 1	2.648	4.329	3.075	3.604
Test Oil #2 Run 2	0.602	3.558	2.866	3.221
Standard Deviation	1.447	0.545	0.147	0.271

**Table XV FEI and Standard Deviation Test Oil #3 (5W-30 With FM)**

	Fuel Economy Improvement (%)			
	Stage 1	Stage 2	Stage 3	Stage 4
Test Oil #3 Run 1	1.757	4.304	2.78	4.103
Test Oil #3 Run 2	0.777	4.286	3.707	3.748
Standard Deviation	0.693	0.013	0.656	0.251

While variation between each oil in each stage is present, the standard deviation of the FEI for the Test Oil #2 (5W-30 with no FM) is twice as high as the next highest standard deviation. This suggests that one of the two data points for the first stage may be an outlier. Since only 2 repeats were run, there is not sufficient evidence to determine if either point is a statistical outlier. However there is strong anecdotal evidence that the first data point is an outlier. Indeed, the variation between these two data points of Stage 1 with Test Oil #2 has a larger variation than the variation *between* Test Oils #2 and #3. If this single data point (Stage 1, Run 1, Test Oil #2) is removed, then the data more closely matches expectations and bench test results. This can be seen in the Figure 27.



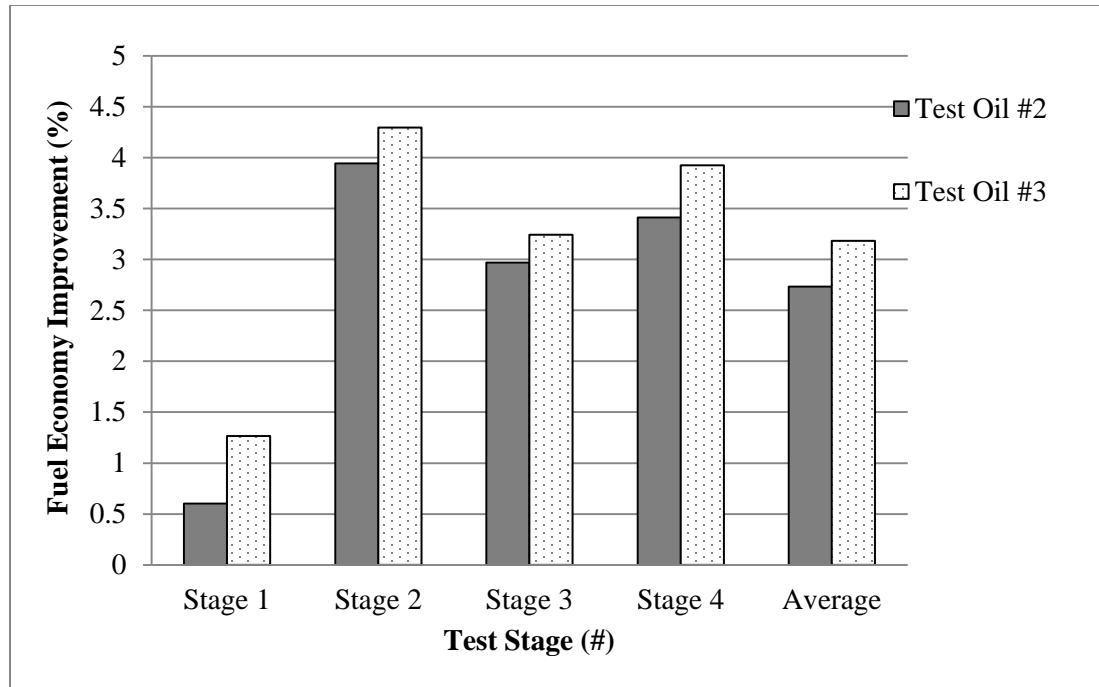

**Figure 27 Average FEI with suspect outlier removed**

Through the development of this fired engine test and the earlier motor-driven FTT test, it has been observed that test stages aimed at generation of boundary lubrication have the highest variability. The author theorizes that this may be attributable to several phenomena. First, boundary lubrication is defined by asperity contact, by definition then, boundary lubrication is *never the same twice*. Asperities are constantly being flattened, raised and moved. This dynamic environment means measurement is by nature variable. Another hypothesis is that the low speeds and high loads that are required to induce boundary lubrication tend create low frequency, high amplitude vibrations. These vibrations can affect sensors and lead to higher variability.

## **CHAPTER V**

### **CONCLUSIONS**

#### **5.1 Introduction**

Environmental concerns along with increasing fuel costs have pushed manufacturers to develop more fuel efficient vehicles. In attempts to improve fuel efficiency, nearly every system on modern vehicles are being redesigned and optimized. The lubrication system, specifically the oil chosen to lubricate the engine can have a significant impact on total system efficiency through the mitigation of friction. A prerequisite for the development of low friction, high fuel efficiency engine oils is a methodology to rigorously test them. The newly developed motorcycle fuel economy test provides this method, and has shown the ability to successfully and repeatedly differentiate engine oils based on their ability to reduce engine friction and thus improve overall engine efficiency.

#### **5.2 Industrial Application**

The industrial application for this new test is narrow in scope, but extremely valuable within that scope. In the world of passenger vehicles, standardized tests exist for the determination of fuel economy both macroscopically (complete vehicle tests) and microscopically (engine tests). The Environmental Protection Agency (EPA) uses a

series of standardized drive cycles that evaluate fuel economy and emissions of a passenger vehicle as a whole. These tests are conducted on a chassis dynamometer and determine average fuel economy used for Corporate Average Fuel Economy (CAFE) standards. Microscopically, the ASTM Sequence VID test is used to determine the ability of an engine lubricant to increase fuel economy. By necessity, this test must be much more precise and is carried out in a laboratory with the engine directly connected to a dynamometer [30].

Conversely, the small engine and motorcycle industries suffer from a general lack of standardized testing, with the major Japanese motorcycle manufacturers only adopting the first motorcycle fuel economy test during the writing of this thesis [14]. While the adoption of this test offers a step forward toward standardization, it can be thought of as analogous to the EPA's vehicle fuel economy test, and offers little if any benefit to the development of fuel efficient engine oils. This leaves a void within the industry where there is no industry standard fuel economy test to evaluate an engine lubricant's impact on fuel economy in a motorcycle engine.

The engine test described in this work has been developed to specifically fill this void and directly investigate a lubricant's impact on fuel economy in motorcycle hardware. Therefore, the test developed here provides an essential tool for the formulation of engine oils to enhance fuel economy.

There are many, often competing, aspects of performance to be considered when developing an engine oil. Engine oil formulators are continuously working to develop products which enhance fuel economy. The largest gains in fuel economy can be obtained by reduction of viscosity. This reduction in viscosity reduces the energy

required to shear the lubricant and thus reduces friction, however, it also creates a thinner oil film on components [31]. This thinner film reduces the protection to critical engine parts. The additive package must then be fortified to gain back the durability that the thicker base oil provided. Balancing these competing criteria is very difficult and will benefit greatly from the developed testing methodology.

### **5.3 Possible Directions of Future Research**

While the development of this test has represented one great stride in the investigation of motorcycle fuel economy, it is by no means all conclusive, and leaves much room for future research.

Due to the complexity and quantity of the many sliding and rolling contacts, bearings, piston rings, valvetrain components, chains, etc. in the test engine, a detailed computational analysis of friction generation across all engine systems was beyond the scope of the test methodology development. Additionally, in an industrial or commercial setting, actual experimental data is usually more convincing than computational results. Although experimental data is seen as a proof of performance, computational analysis is very valuable because it gives insight into the mechanisms that drive the observed phenomena. When the mechanisms which drive friction are thoroughly understood, more optimized systems can be developed. Striving to model friction in each major engine component type (piston rings/cylinder, bearings, valvetrain, etc.) would be an excellent direction for future research.

Another area for future research could be the evaluation of a larger test oil matrix. The matrix could be expanded to include various types of friction modifiers, viscosity modifiers, and other common engine oil additives such as dispersants and detergents in

various amounts to understand how these additives improve or reduce fuel economy. The test matrix could also include a sufficient number of repeat tests to allow for a detailed and robust statistical analysis.

Another area for future research would be tracking the response of the test engine over many hours of testing. This test was developed to be a ‘flush-and-run’ test type, with no scheduled engine rebuilds between tests. However, it is well-known within the industry, and shown in this test development that as an engine ages, it can exhibit long-term trends [10]. With the collection of data from many tests, these long-term trends can be observed and algorithms can be developed to compensate for the trends. Indeed, the ASTM Sequence VID test utilizes a correction factor to account for engine age. The development of such a correction factor requires the analysis of hundreds of hours of test data.

In addition to all of these areas, this test can be used to study various types of friction modifiers. For the test development, only an organic friction modifier was used. An engine oil developed for fuel economy typically has a combination of both organic and inorganic friction modifiers.

#### **5.4 Final Thoughts**

As fuel economy becomes an increasing concern in every transportation sector, new and innovative ways are being investigated and developed to reduce fuel consumption. Large gains in fuel economy can be realized by radical solutions such as electrifying vehicles, developing advanced combustion strategies, and reducing vehicle weight through the use of composite materials. Unfortunately, the solutions that offer the

biggest gains in fuel economy also are typically the most expensive and hardest to implement [32-35].

Since there are millions of internal combustion engine powered vehicles in operation today, even a small, incremental improvement in fuel economy and reduction in emissions like those obtained from the use of fuel efficient engine oil, can have a big impact. The developed fuel economy engine test methodology provides an accurate method with which to measure fuel economy and is an essential tool for the development of highly fuel efficient motorcycle engine oils.

## BIBLIOGRAPHY

- [1] United States Environmental Protection Agency, 2002, "Exhaust Emission Factors for Nonroad Engine Modeling – Spark Ignition" NR-010c pp.1-9.
- [2] Nelson, D., Rivera, M. Babb, T., Callender, C. et al., 2000, "Reduction in Emissions and Noise from a 500cc Snowmobile," 2000-01-2575, SAE International, Warrendale, PA, DOI 10.4271/2000-01-2575.
- [3] Salazar, V. and Ghandhi, J., 2008, "Discussion of the Role of Fuel-Oil Diffusion in the Hydrocarbon Emissions from a Small Engine," 2008-32-0014, SAE International, Warrendale, PA, DOI: 10.4271/2008-32-0014.
- [4] Mang, T., Bobzin, K., Bartels, T., 2011, "Industrial Tribology: Tribosystems, Friction, Wear and Surface Engineering, Lubrication," Wiley-vch, Weinheim, Germany, Chap. 7
- [5] Pawlak, Z., 2003, "Tribiochemistry of Lubricating Oils," **45**, Elsevier B.V., Amsterdam, The Netherlands, ISBN: 0-444-51296-9.
- [6] Vettor, A., Tripaldi, G., Fattori, S., Le Mogne, T., et al., 2003, "Mo-Compounds Efficiency and Interactions with Engine Oil Additives," 2003-01-1955, SAE International, Warrendale, PA, DOI: 10.4271/2003-01-1995.
- [7] ASTM International Standard, 2003, "Standard Test Method for Evaluation of Automotive Engine Oils in the Sequence IIIG, Spark-Ignition Engine," D7320-13, DOI: 10.1520/D7320.
- [8] ASTM International Standard, 2003, "Standard Test Method for Evaluation of Automotive Engine Oils in the Sequence IVA, Spark-Ignition Engine, " D6891-13a, DOI: 10.1520/D6891A.

- [9] ASTM International Standard, 2003, “Standard Test Method for Evaluation of Automotive Engine Oils for Inhibition of Deposit Formation in a Spark-Ignition Engine Internal Combustion Engine Fueled with Gasoline and Operated Under Low-Temperature, Light-Duty Conditions,” D6593-13b, DOI: 10.1520/D6593B.
- [10] ASTM International Standard, 2003, “Standard Test Method for Measurement of Effects of Automotive Engine Oils on Fuel Economy of Passenger Cars and Light-Duty Trucks in Sequence VID Spark Ignition Engine,” D7589-13, DOI: 10.1520/D7589.
- [11] ASTM International Standard, 2003, “Standard Test Method for Evaluation of Automotive Engine Oils in the Sequence VIII Spark-Ignition Engine (CLR Oil Test Engine),” D6709-13, DOI: 10.1520/D6709.
- [12] Dearlove, J. and Cheng, W., 1995, “Simultaneous Piston Ring Friction and Oil Film Thickness Measurements in a Recipricating Test Rig,” 1995-10-01, SAE International, Warrendale, PA, DOI: 10.4271/952470.
- [13] Kasai, M., Ishiwawa, M., and Miyaji, T., 2003, “Effect of Engine Oil Additives on Motorcycle Clutch System,” 2003-01-1956, SAE International, Warrendale, PA, DOI: 10.4271/2003-01-1956.
- [14] Japan Automobile Manufacturers Association, Inc., 2013, “Japan’s Motorcycle Manufacturers Opt for Voluntary Display of WMTC-Based Motorcycle Fuel Consumption Values,” JAMA Press Releases, June 27<sup>th</sup> 2013.
- [15] Japanese Automobile Standard, 2006 “JASO T 903-2006 Motorcycles – Four Stroke Cycle Gasoline Engine Oil Specification,” T 903-2006.
- [16] Japanese Automobile Standard, 2011, “JASO T 903-2011 Motorcycles – Four Stroke Cycle Gasoline Engine Oils”, T 903-2011.



- [17] Japanese Automobile Standard, 2006, “JASO T 904-2006 Motorcycles – Four Stroke Cycle Gasoline Engine Oil – Test Procedure for Friction Property of Clutch System,” T 904-2006.
- [18] Dohner, B., Michlberger, A., Szappanos, G., and Gajanayake, A., 2011, “Fuel Economy Durability – A Concept to be Considered for Motorcycle Oils,” 2011-32-0545, SAE International, Warrendale, PA, DOI: 10.4271/2011-32-0545.
- [19] Dohner, B., Michlberger, A., Castanien, C., Gajanayake, A. et al., 2013, “Improving Fuel Efficiency of Motorcycle Oils,” 2013-32-9063, SAE International, Warrendale, PA, DOI: 10.4271/2013-32-9063.
- [20] ASTM International Standard, 2009, “Standard Practice for Viscosity-Temperature Charts for Liquid Petroleum Products,” D341-09, DOI: 10.1520/D0341-09.
- [21] Sanchez-Rubio, M., Chinas-Castillo, F., Ruiz-Aquino, F., and Lara-Romero, J., 2006, “A new focus on the Walther equation for lubricant viscosity determination”, *Lubrication Science*, **18**, pp. 95-107, Wiley InterScience, DOI: 10.1002/lis.9.
- [22] Singh, D., Fieldhouse, J., Jain, A., Tyagi, M, et al., 2011, “Investigating the Effect of Operating Variables and Engine Lubricant Viscosity on Engine Friction – A DOE Approach,” 2011-10-06, SAE International, Warrendale, PA, DOI: 10.4271/2011-28-0052.
- [23] Supp, J., Wilk, M., and Dohner, B., 1997, “An investigation into the Effect of Viscosity Modifiers and Base Oils on ASTM Sequence VIA Fuel Economy,” 1997-10-01, SAE International, Warrendale, PA, DOI: 10.4271/972925.

- [24] Park, S., et al., 2009, “The Effect of Viscosity and Friction Modifier on Fuel Economy and the Relationship Between Fuel Economy and Friction,” 2009-01-2662, SAE International, Warrendale, PA, DOI:10.4271/2009-01-2662.
- [25] Fujii, I., Yagi, S., Sono, H., and Kamiya, H., 1988, “Total Engine Friction in Four Stroke S.I. Motorcycle Engine,” 1988-02-01, SAE International, Warrendale, PA, DOI: 10.4271/880268
- [26] Thring, R., 1992, “Engine Friction Modeling,” 1992-02-01, SAE International, Warrendale, PA, DOI: 10.4271/920482.
- [27] Tung, S. and Gao, H., 2003, “Tribological characteristics and Surface interaction between piston ring coatings and a blend of energy-conserving oils and ethanol fuels,” Elsevier Science B.V., Philadelphia, PA, DOI: 10.1016/S0043-1648(03)00240-0.
- [28] The Lubrizol Corporation, 2013, *Photograph of Honda PCX150*, Copyright The Lubrizol Corporation, Wickliffe, Ohio.
- [29] Burke, M., Briffet, G., Fuller, J., Heumann, H., and Newall, J., 2003, “Powertrain Efficiency Optimization of the Torotrak Infinitely Variable Transmission,” 2003-01-0971, SAE International, Warrendale, PA, DOI: 10.4271/2003-01-0971.
- [30] United States Environmental Protection Agency, 2012, “Regulations and Standards,” Office of Transportation and Air Quality, December 18<sup>th</sup> 2012, from <http://www.epa.gov/fueleconomy/regulations.htm>
- [31] Ushioda, N., Miller, T., Sims, C., Parsons, G., et al., 2013, “Effect of Low Viscosity Passenger Car Motor Oils on Fuel Economy Engine Tests,” 2013-10-14, SAE International, Warrendale, PA, DOI: 10.427/2013-01-2606.

- [32] Francfort, J. and Slezak, L., 2002, "Electric and Hybrid Vehicle Testing," 2002-01-1916, SAE International, Warrendale, PA, DOI 10.4271/2002-01-1916.
- [33] Ogburn, M., Nelson, D., Wipke, K., and Markel, T., 2000, "Model and Validation of a Fuel Cell Hybrid Vehicle," 2000-01-1566, SAE International, Warrendale, PA, DOI: 10.4271/2000-01-1566.
- [34] Wohlecker, R., Johannaber, M., and Espig, M., 2008, "Determination of Weight Elasticity of Fuel Economy for ICE, Hybrid and Fuel Cell Vehicles," 2007-01-0343, SAE International, Warrendale, PA, DOI: 10.4271/2007-01-0343.
- [35] Wagner, J., Mencher, B., and Keller, S., 2008, "Bosch System Solutions for Reduction of CO<sub>2</sub> and Emissions," 2008-01-09, SAE International, Warrendale, PA, DOI: 10.4271/2008-01-09.

## **APPENDIX**

## APPENDIX A

### Experimental Fuel System Schematic

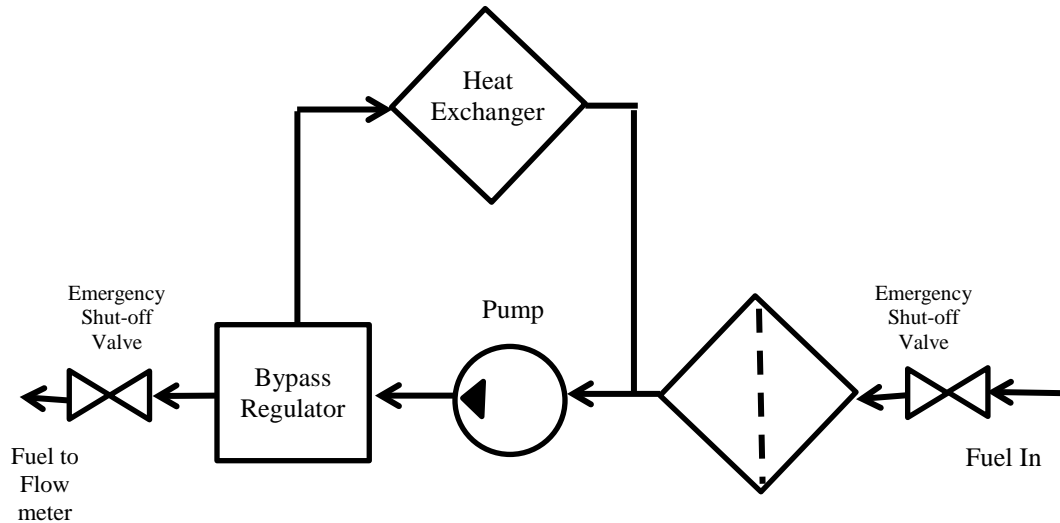

The fuel pump used for this system is an electric, high volume, 12V, automotive-style pump. Since the fuel demand of the test engine is comparatively low, a large amount of fuel is recirculated and returned to the low pressure side of the fuel pump. The bypass regulator provides hydraulic relief and eliminates the possibility of dead-heading the pump. Since most fuel is bypassed before it is consumed it travels through the pump several times, warming on each pass. The heat exchanger uses chilled glycol to remove heat from the fuel that the pump imparts. Under normal operation, this loop is cooled to approximately 10 degrees C.

## APPENDIX B

### Experimental Data Acquisition System (Temperature)

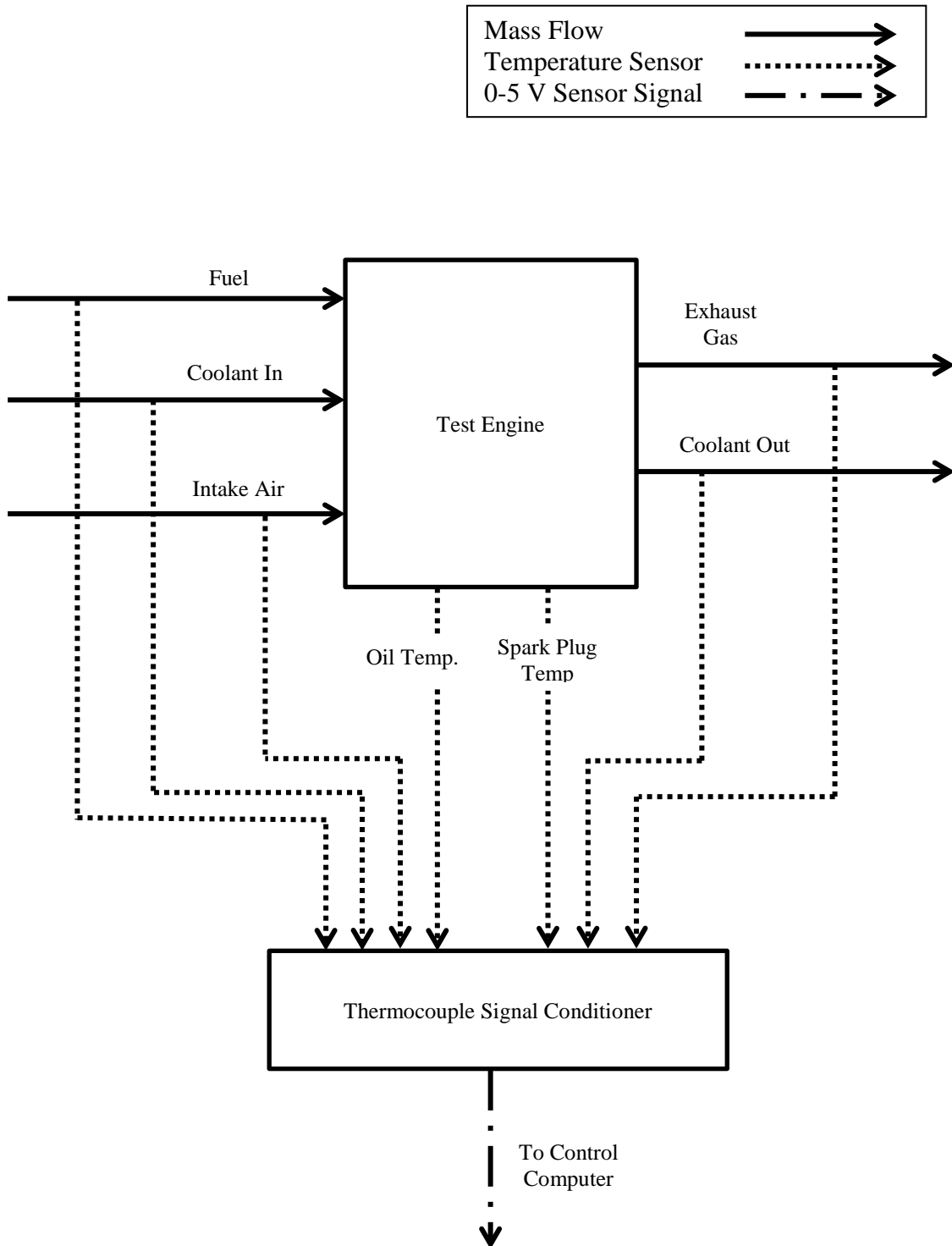

# APPENDIX C

## Experimental Data Acquisition System (Pressure)

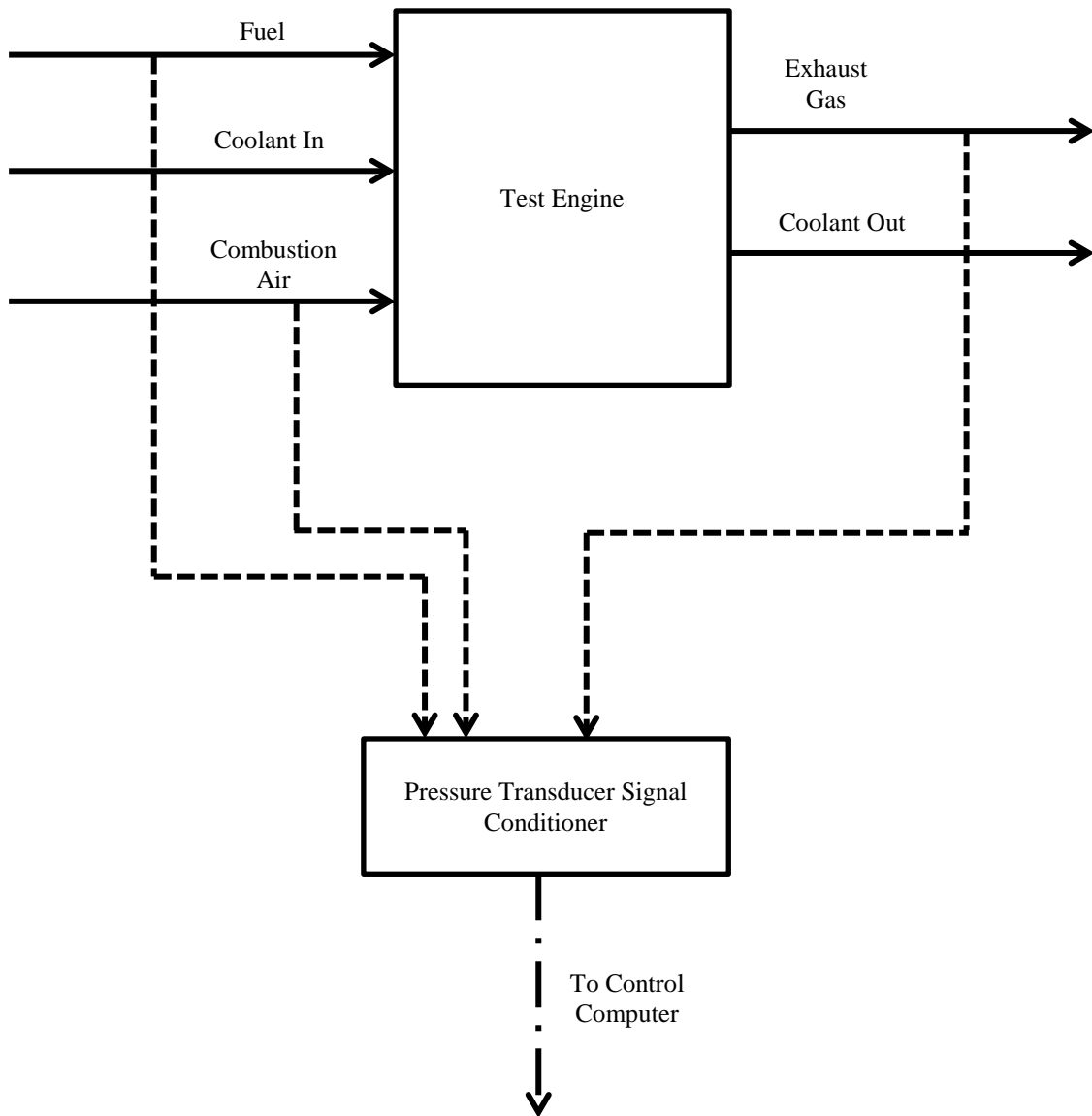
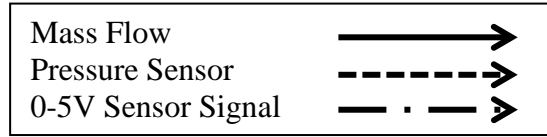

## APPENDIX D

### Experimental Data Acquisition System (Control Computer)

