

University of New Orleans  
**ScholarWorks@UNO**

---

Electrical Engineering Faculty Publications

Department of Electrical Engineering

---

12-2014

## Finding the Minimum Input Impedance of a Second-Order Twofold-Gain Sallen-Key Low-Pass Filter Without Calculus

Kenneth V. Cartwright  
*The College of the Bahamas*

Edit J. Kaminsky  
*University of New Orleans, [ejbourne@uno.edu](mailto:ejbourne@uno.edu)*

Follow this and additional works at: [https://scholarworks.uno.edu/ee\\_facpubs](https://scholarworks.uno.edu/ee_facpubs)



Part of the [Electrical and Electronics Commons](#)

---

### Recommended Citation

Cartwright, K.V. and E. J. Kaminsky, "Finding the minimum input impedance of a second-order twofold-gain Sallen- Key low-pass filter without calculus," *Lat. Am. J. Phys. Educ.*, Dec. 2014, pp. 4316-1–4316-8.

This Article is brought to you for free and open access by the Department of Electrical Engineering at ScholarWorks@UNO. It has been accepted for inclusion in Electrical Engineering Faculty Publications by an authorized administrator of ScholarWorks@UNO. For more information, please contact [scholarworks@uno.edu](mailto:scholarworks@uno.edu).



# Finding the minimum input impedance of a second-order twofold-gain Sallen-Key low-pass filter without calculus

**Kenneth V. Cartwright<sup>1</sup>, Edit J. Kaminsky<sup>2</sup>**

<sup>1</sup>*School of Mathematics, Physics and Technology, College of The Bahamas, P.O. Box N4912, Nassau, Bahamas.*

<sup>2</sup>*Department of Electrical Engineering, EN 846 Lakefront Campus, University of New Orleans, New Orleans, LA 70148, USA.*

**E-mail:** kvcartwright@yahoo.com

(Received 28 June 2014, accepted 30 November 2014)

## Abstract

We derive an expression for the input complex impedance of a Sallen-Key second-order low-pass filter of twofold gain as a function of the natural frequency  $\omega_0$  and the quality factor  $Q$ . From this expression, it is shown that the filter behaves like a Frequency Dependent Negative Resistance (FDNR) element for low frequencies and as a single resistor at high frequencies. Furthermore, the minimum input impedance magnitude is found without using calculus. We discovered that the minimum input impedance magnitude is inversely proportional to  $Q$  and can be substantially less than its high-frequency value. Approximations to the minimum input impedance and the frequency at which it occurs are also provided. Additionally, PSpice simulations are presented which verify the theoretical derivations.

**Keywords:** Sallen-Key low-pass filter, Minimum without calculus, Input impedance.

## Resumen

Derivamos una expresión para la impedancia de entrada compleja de un filtro Sallen-Key de paso bajo de segundo orden y ganancia 2 en función de la frecuencia natural  $\omega_0$  y el factor de calidad  $Q$ . Comenzando con esta expresión, mostramos que el filtro se comporta como una resistencia negativa dependiente de la frecuencia (FDNR) para frecuencias bajas y como un sólo resistor para altas frecuencias. Es más, encontramos la magnitud de la impedancia mínima sin usar cálculo. Descubrimos que la magnitud de la impedancia mínima es inversamente proporcional a  $Q$  y que puede ser significativamente menor que a frecuencias altas. Proveemos aproximaciones para la impedancia de entrada mínima y para la frecuencia a la que ocurre. Presentamos también simulaciones en PSpice que verifican las derivaciones teóricas.

**Palabras Clave:** Filtro Sallen-Key de paso bajo, mínimo sin cálculo, impedancia de entrada.

**PACS:** 84.30.Vn, 01.40.-d, 00.02, 07.50.Ek.

**ISSN 1870-9095**

## I. INTRODUCTION

Figure 1 shows the circuit diagram of an active second-order Sallen-Key low-pass filter, which is widely used in electronics. One important parameter of such a filter is its transfer function, which has been widely studied and which relates its output voltage to its input voltage. Another important parameter is its input impedance. Unfortunately, as pointed out in [1], very little has been written about this input impedance, even though designers need to know its minimum value to ensure that the filter does not load down the source or a previous stage. Inspection of Figure 1 would suggest to the naive designer that the minimum input impedance is  $R_1$ , as it is in series with the rest of the circuit.

Unfortunately, as recently shown by Cartwright and Kaminsky [1] for the unity-gain filter, this is not the case: the input impedance can be very much lower than  $R_1$ , depending upon the value of  $Q$ , the quality factor of the filter. However, it is not known how the input impedance for the second-order Sallen-Key low-pass filter behaves for other gains. The purpose of this paper is to study this input impedance when the gain of the filter is two, and the capacitors have equal value. According to [2], such second-order filters can be made to have any  $Q$  value: in fact, as we show below,  $Q = 1/\sqrt{r}$ , where  $r = R_2/R_1$ . On the other hand, unity-gain filters must satisfy  $Q = \frac{\sqrt{r}}{1+r} \sqrt{\frac{C_1}{C_2}}$ .

In this paper, we find the minimum value of the input impedance for the case where  $C_1 = C_2$  and  $R_3 = R_4$  without using calculus, which should be of benefit to the student who has not yet had the opportunity to study math at this level.

Not only do we report our theoretical findings, but we also verify these with PSpice simulations. (PSpice is a popular electrical and electronic circuits simulation software package that is widely used by electrical engineers and some physicists. The latest demo version can be freely obtained from reference [3]).

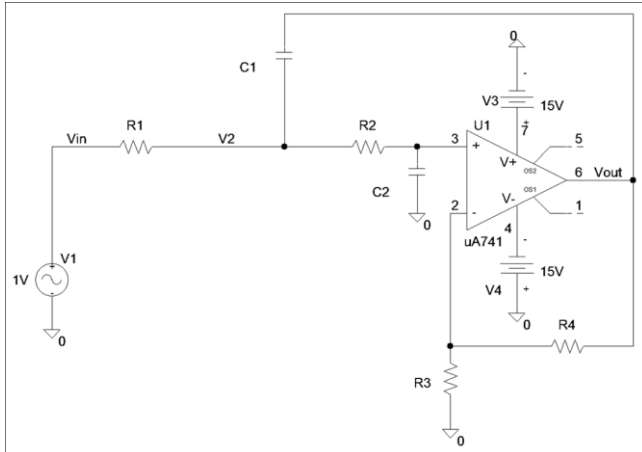

**FIGURE 1.** Circuit diagram of second-order twofold-gain Sallen-Key low-pass filter. Note that in this paper  $C_1 = C_2 = C$  and  $R_3 = R_4 = R$ .

## II. TRANSFER FUNCTION FOR THE SALLEN-KEY LPF OF FIGURE 1

In this section, the transfer function for the circuit of Figure 1 will be given, so that the key parameters such as natural frequency  $\omega_o$  and quality factor  $Q$  can be defined. Indeed, it is straightforward to show, as demonstrated in the Appendix, that if  $C_1 = C_2 = C$  and  $R_3 = R_4$ , the transfer function is given by:

$$T(s) = \frac{V_{out}(s)}{V_{in}(s)} = \frac{2}{s^2 C^2 R_1 R_2 + s C R_2 + 1}, \quad (1)$$

where  $s = i\omega$ , with  $i = \sqrt{-1}$  and  $\omega$  (rad/sec) is the angular frequency of the applied sine-wave. Clearly, the gain is 2 for  $s=0$ .

The denominator of Equation 1 can be written as:

$$\begin{aligned} s^2 R_1 R_2 C^2 + \left[ \frac{R_2 C}{\sqrt{R_1 R_2 C}} \right] s \sqrt{R_1 R_2 C} + 1 \\ = \left( \frac{s}{\omega_o} \right)^2 + \frac{1}{Q} \frac{s}{\omega_o} + 1, \end{aligned} \quad (2)$$

where the natural frequency is  $\omega_o = 1/\sqrt{R_1 R_2 C}$  and  $Q$ , the quality factor of the filter, is  $\sqrt{\frac{R_1}{R_2}}$ .

## III. INPUT IMPEDANCE FOR THE SALLEN-KEY LPF OF FIGURE 1

As we show in the Appendix, the normalized complex input impedance  $Z(s)/R_1$  for the circuit of Figure 1 is given by:

$$\begin{aligned} \frac{Z(s)}{R_1} &= \frac{s^2 C^2 R_1 R_2 + s C R_2 + 1}{s^2 R_1 R_2 C^2} \\ &= \frac{\left( \frac{s}{\omega_o} \right)^2 + \frac{1}{Q} \frac{s}{\omega_o} + 1}{\left( \frac{s}{\omega_o} \right)^2}. \end{aligned} \quad (3)$$

Interestingly, Equation 3 becomes unity for large frequencies ( $\omega \rightarrow \infty$ ), *i.e.*, the input impedance looks simply as  $R_1$ , and the phase is  $0^\circ$ . On the other hand, for low frequencies (as  $\omega$  approaches zero), Equation 3 becomes, approximately,  $\omega_o^2/s^2$ , *i.e.*, the input impedance looks like a Frequency Dependent Negative Resistance (FDNR) element [4] whose impedance is  $Z = ((j\omega)^2 D)^{-1}$ , with  $D = 1/R_1 \omega_o^2$ . Hence, for low frequencies, the magnitude of the input impedance is  $\frac{1}{\omega^2 D} = \frac{R_1 \omega_o^2}{\omega^2}$ , and the phase approaches  $-180^\circ$ .

### A. Magnitude of the input impedance

From Equation 3, the magnitude of the normalized impedance becomes:

$$\left| \frac{Z(s)}{R_1} \right| = \frac{|-p^2 + ip/Q + 1|}{|-p^2|}, \quad (4)$$

where  $p = \omega/\omega_o$  is the normalized frequency.

Actually, it will be more convenient to work with the magnitude squared for the normalized impedance. Hence, Equation 4 becomes:

$$\begin{aligned} \left| \frac{Z(s)}{R_1} \right|^2 &= \frac{(-p^2 + 1)^2 + p^2/Q^2}{p^4} \\ &= \frac{p^4 - (2 - 1/Q^2)p^2 + 1}{p^4}. \end{aligned} \quad (5)$$

Furthermore, Equation 5 can be rewritten as:

$$\left| \frac{Z(s)}{R_1} \right|^2 = \frac{x^2 - Ax + 1}{x^2}, \quad (6)$$

where  $x = p^2$  and  $A = 2 - 1/Q^2$ .

Taking the square root of Equation 6 allows us to make a plot of the normalized impedance in dB (i.e.,  $20\log(|Z(s)/R_1|)$ ) as a function of the normalized frequency, as shown in Figure 2, for various  $Q$  values. Also shown is a straight-line plot of the magnitude of the normalized resistance of the equivalent FDNR element, confirming our earlier statement that the magnitude of the input impedance for low frequencies is simply that of a FDNR element.

Clearly, Figure 2 also verifies the high-frequency value of the input impedance noted earlier.

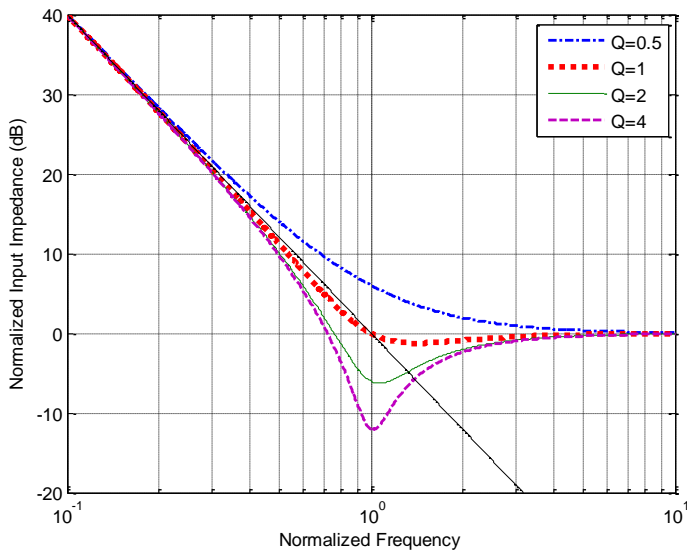

**FIGURE 2.** Magnitude of the normalized input impedance (in dB) as a function of the normalized frequency. The straight-line is the plot of the magnitude of the normalized resistance (in dB) of the equivalent FDNR element, i.e.,  $20\log(\omega_o^2/\omega^2)$ .

### B. Phase of the Input Impedance

The phase of the input impedance is easily found from Equation (3) to be

$$\phi = \tan^{-1} \left( \frac{p}{Q(1-p^2)} \right) - 180^\circ. \quad (7)$$

For  $p = 1$ , the phase becomes  $\phi = -90^\circ$  and for  $p > 1$ , Equation (7) can be written as

$$\phi = -\tan^{-1} \left( \frac{p}{Q(p^2-1)} \right). \quad (8)$$

Note from Equation (7) that for  $\omega \rightarrow 0$ ,  $\phi \rightarrow -180^\circ$ , and from Equation (8) that as  $\omega \rightarrow \infty$ ,  $\phi \rightarrow 0$ . These facts are also confirmed by a plot of Equation (7) and Equation (8) shown in Figure 3.

Clearly, Figure 3 verifies the low-frequency and high-frequency values of the phase of the complex input impedance noted earlier.

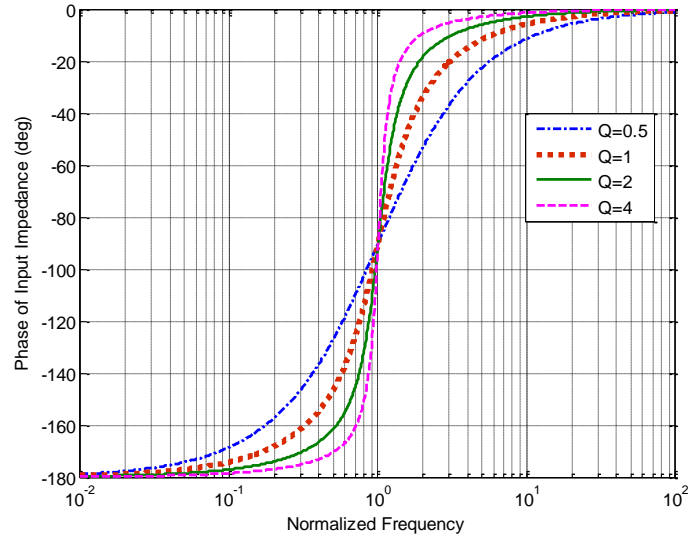

**FIGURE 3.** Phase of input impedance (deg) as a function of the normalized frequency.

## IV. FINDING THE MINIMUM INPUT IMPEDANCE MAGNITUDE WITHOUT CALCULUS

Now that the normalized input impedance has been found, it can be shown how its minimum value can be obtained without calculus.

Using long division, Equation 6 can be written as:

$$\left| \frac{Z(s)}{R_1} \right|^2 = 1 - \frac{A}{x} + \frac{1}{x^2} = \left( \frac{1}{x} - \frac{A}{2} \right)^2 + 1 - \frac{A^2}{4}. \quad (9)$$

Clearly, for Equation 9 to be a minimum,  $x = 2/A$  or

$$\begin{aligned} \omega_{\min} &= \omega_o \sqrt{\frac{2}{2-1/Q^2}} = \omega_o \sqrt{\frac{2Q^2}{2Q^2-1}} \\ &= \omega_o \sqrt{\left( 1 - \frac{1}{2Q^2} \right)^{-1}} = \omega_o \left( 1 - \frac{1}{2Q^2} \right)^{-1/2}. \end{aligned} \quad (10)$$

Using  $(1+z)^r \approx 1+rz$  for small  $z = -1/2Q^2$  [6], Equation (10) becomes:

$$\omega_{\min} \approx \omega_o \left( 1 + \frac{1}{4Q^2} \right). \quad (11)$$

To illustrate how the normalized minimum frequency depends upon the quality factor of the filter, Equation (10) is plotted in Figure 4.

In order for Equation 10 to be valid,  $2Q^2 - 1 > 0$ . Hence,  $Q > \sqrt{\frac{1}{2}}$  in order for there to be a minimum in the input impedance magnitude. For  $Q \leq \sqrt{\frac{1}{2}}$ , the input impedance decreases monotonically from infinity to  $R_1$  as the frequency increases from zero to infinity. This is illustrated in Figure 5.

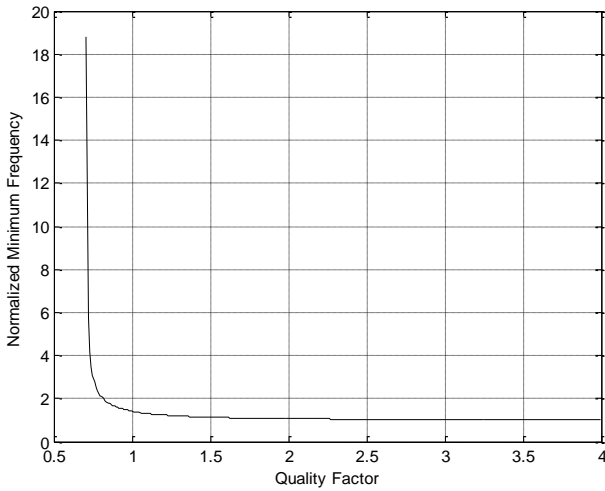

**FIGURE 4.** Normalized minimum frequency as a function of the quality factor of the filter.

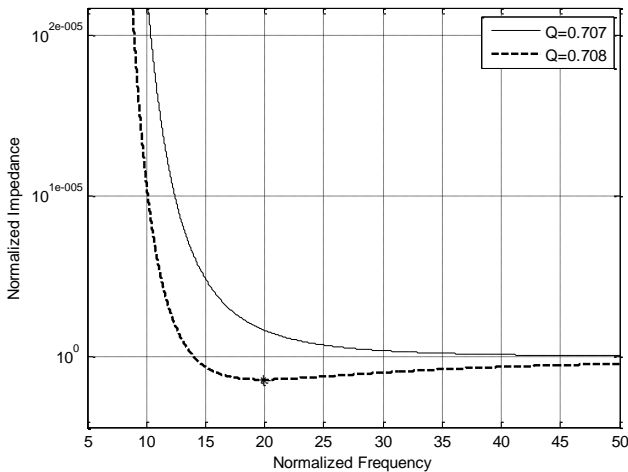

**FIGURE 5.** Normalized impedance as a function of the normalized frequency, for  $Q$  values on either side of  $Q_{\min} = \sqrt{1/2} = 0.7071$ . In order for a minimum impedance to exist,  $Q > Q_{\min}$ .

Notice from Figure 5 that if there is a minimum, then there is also a frequency at which the normalized impedance is unity. From Equation 6, this frequency is determined to be:

$$\frac{\omega_{\text{unity}}}{\omega_o} = \sqrt{\frac{Q^2}{2Q^2 - 1}} = \frac{1}{\sqrt{2}} \sqrt{\left( 1 - \frac{1}{2Q^2} \right)^{-1}}. \quad (12)$$

Hence, for large  $Q$ , Equation 12 becomes:

$$\frac{\omega_{\text{unity}}}{\omega_o} \approx \frac{1}{\sqrt{2}} \left( 1 + \frac{1}{4Q^2} \right). \quad (13)$$

A plot of the percentage error,  $100 (1 - \text{approximate value}/\text{true value})$ , of Equation 13 is shown in Figure 6, where it is clearly seen that the percentage error is quite good even for small values of  $Q$ , in spite of the fact that Equation 13 was derived for large  $Q$ .

Note also that  $\omega_{\text{unity}}$  behaves as a lower bound on  $\omega_{\min}$

In fact, comparing Equation 13 with Equation 11 reveals that:

$$\omega_{\min} \approx \sqrt{2} \omega_{\text{unity}}. \quad (14)$$

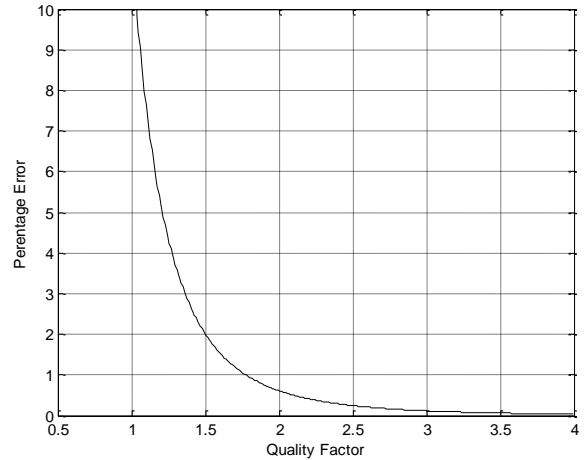

**FIGURE 6.** Percentage error of Equation (13) approximation to the minimum frequency.

Also, from Equation 9, the minimum value of the input impedance is:

$$\begin{aligned} |Z(s)|_{\min} &= R_1 \sqrt{1 - \frac{A^2}{4}} = R_1 \sqrt{1 - \left( 1 - \frac{1}{2Q^2} \right)^2} \\ &= R_1 \sqrt{1 - \left( 1 - \frac{1}{Q^2} + \frac{1}{4Q^4} \right)} \\ &= \frac{R_1}{Q} \sqrt{1 - \frac{1}{4Q^2}}. \end{aligned} \quad (15)$$

For large  $Q$ , Equation 15 becomes:

$$|Z(s)|_{\min} \approx \frac{R_1}{Q}, \quad (16)$$

or more accurately:

$$|Z(s)|_{\min} \approx \frac{R_1}{Q} \left( 1 - \frac{1}{8Q^2} \right). \quad (17)$$

Plotting the percentage error of Equation 17 in Figure 7 shows that it provides a more accurate estimation for the minimum input impedance than Equation 16 does, as expected.

## V. PSPICE SIMULATIONS

In order to verify the theoretical derivations, we performed PSpice simulations of the filter in Figure 1. For all the simulations, we set  $\omega_o = 1000$  rad/s or  $f_o = 159.15$  Hz,  $Q = 1$ ,  $R_1 = R_2 = R_3 = R_4 = 1000\Omega$ . Hence,  $C_1 = C_2 = 10^{-6}$  F.

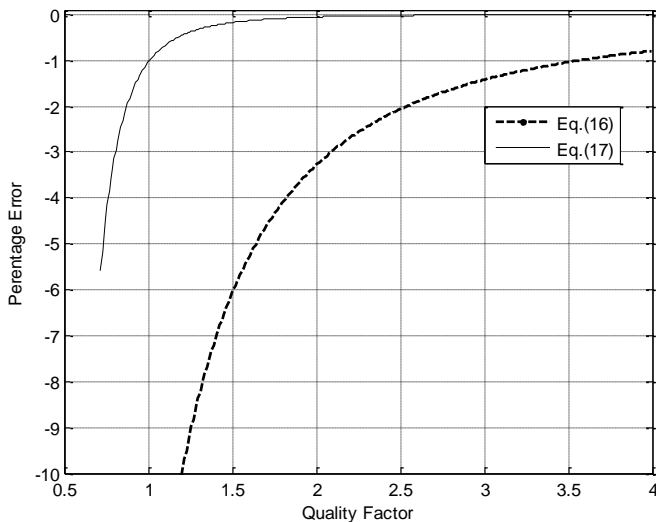

FIGURE 7. Percentage error of Equation (16) and Equation (17) approximations to the minimum magnitude of the impedance.

### A. Verification of the design of the filter

The first thing we want to do with our simulations is to verify that our design has met our specifications for  $\omega_o$  and  $Q$ . To do this, we find the maximum gain of the filter,  $|T(\omega)|_{\max}$ , by plotting the magnitude response of the simulated filter, as shown in Figure 8. From this graph, it is clear that the maximum gain is 7.2711 dB or 2.3097.

However, from Equation 12 of [5],

$$|T(\omega)|_{\max} = 2Q / \sqrt{1 - 1/(4Q^2)} = 2.3097; \quad \text{hence, the}$$

$$\text{simulated } Q = \sqrt{\frac{1.1548^2 + \sqrt{1.1548^4 - 1.1548^2}}{2}} = 1.0000.$$

Also, from Figure 8, the frequency at which the maximum gain occurs is found to be  $\omega_{\max} = 2\pi 112.695 = 708.08$  rad/s. Hence, the simulated natural frequency is  $\omega_o = \omega_{\max} / \sqrt{1 - (2Q^2)^{-1}} = \sqrt{2}\omega_{\max} = 1001.4$  rad/s. (See Equation 11 of [5]).

Clearly, the parameters of the simulation match the theoretical design quite well.

### B. Verification of the Magnitude of the Input Impedance

PSpice measures the magnitude of the input impedance by dividing  $V_{in}$  by  $I(R_1)$ , the current through  $R_1$ . Furthermore, the PSpice command  $dB(V_{in}/I(R_1))$  measures  $20\log(|Z|)$ , i.e. the magnitude of the input impedance in dB, a plot of which is shown in Figure 9. Also shown in this figure is the straight-line plot of the magnitude of the resistance of the equivalent FDNR element for low-frequencies, which is:

$$20\log\left(\frac{1}{\omega^2 D}\right) = 20\log\left(\frac{10^9}{4\pi^2 f^2}\right).$$

Clearly, the simulated plot coincides with the magnitude of the Frequency Dependent Negative Resistance (FDNR) straight-line plot at low frequencies, as expected.

Furthermore, the simulated plot shows that the magnitude of the input impedance approaches 60 dB or 1000  $\Omega$ , as expected for high-frequencies.

Additionally, from Equation 12, the theoretical value of  $\omega_{unity} = \omega_o = 1000$  rad/s or 159.15 Hz. From Figure 9, PSpice simulates this as 158.74 Hz or 997.39 rad/s.

Also, from Figure 9,  $f_{\min} = 224.497$  Hz or  $\omega_{\min} = 1410.56$  rad/s. The theoretical value for this is given by Equation 10, i.e.,  $\sqrt{2} * 1000 = 1414.21$  rad/s or given approximately by Equation 11, i.e.,  $5/4 * 1000 = 1250$  rad/s.

Furthermore, from Figure 9, the minimum magnitude of the input impedance is 58.7490 dB or 865.865  $\Omega$ . On the other hand, Equation 15 gives the theoretical value for this as  $1000\sqrt{3}/2 = 866.025\Omega$ . Alternatively, Equation 17 gives the approximate value of 875  $\Omega$ .

### C. Verification of the Phase of the Input Impedance

The PSpice command  $P(V_{in}/I(R_1))$  measures the phase of the input impedance in degrees, a plot of which is shown in

Figure 10. As can be seen, the phase becomes  $-180^\circ$  at low-frequencies and  $0^\circ$  at high frequencies, as expected.

Furthermore, recall (from Equation 7 with  $\rho = 1$ ) that the theoretical phase at the natural frequency ( $1000/(2\pi) = 159.155$  Hz) is  $-90^\circ$ , which is verified by the PSpice simulation.

**D. Summary of theoretical-PSpice comparison**

For convenience, the theoretical and PSpice results given above are summarized in Table I. As can be seen, there is excellent agreement between the two.

**TABLE I.** Summary of Theoretical-PSpice comparison.

Item	Theoretical Value	PSpice Value	Percentage Difference
$\omega_o$	1000 rad/s	1001.4 rad/s	0.14
Q	1	1.000	0.00
$\omega_{unity}$	1000 rad/s	997.39 rad/s	0.26
$\omega_{min}$	1414.21 rad/s	1410.56 rad/s	0.26
Phase at $\omega_o$	$-90^\circ$	$-90.000^\circ$	0.00
Min. Input Impedance	866.025 $\Omega$	865.865 $\Omega$	0.02

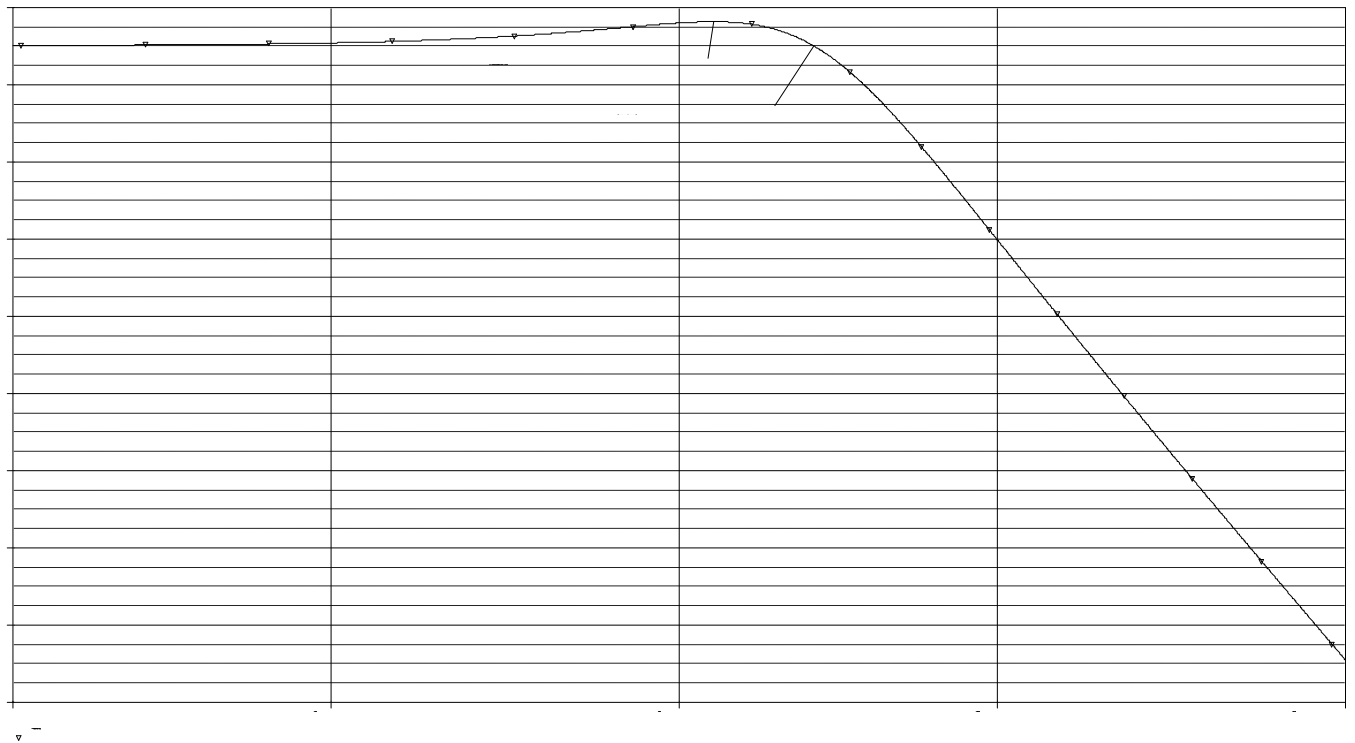

**FIGURE 8.** Simulated magnitude response (dB) of the filter.

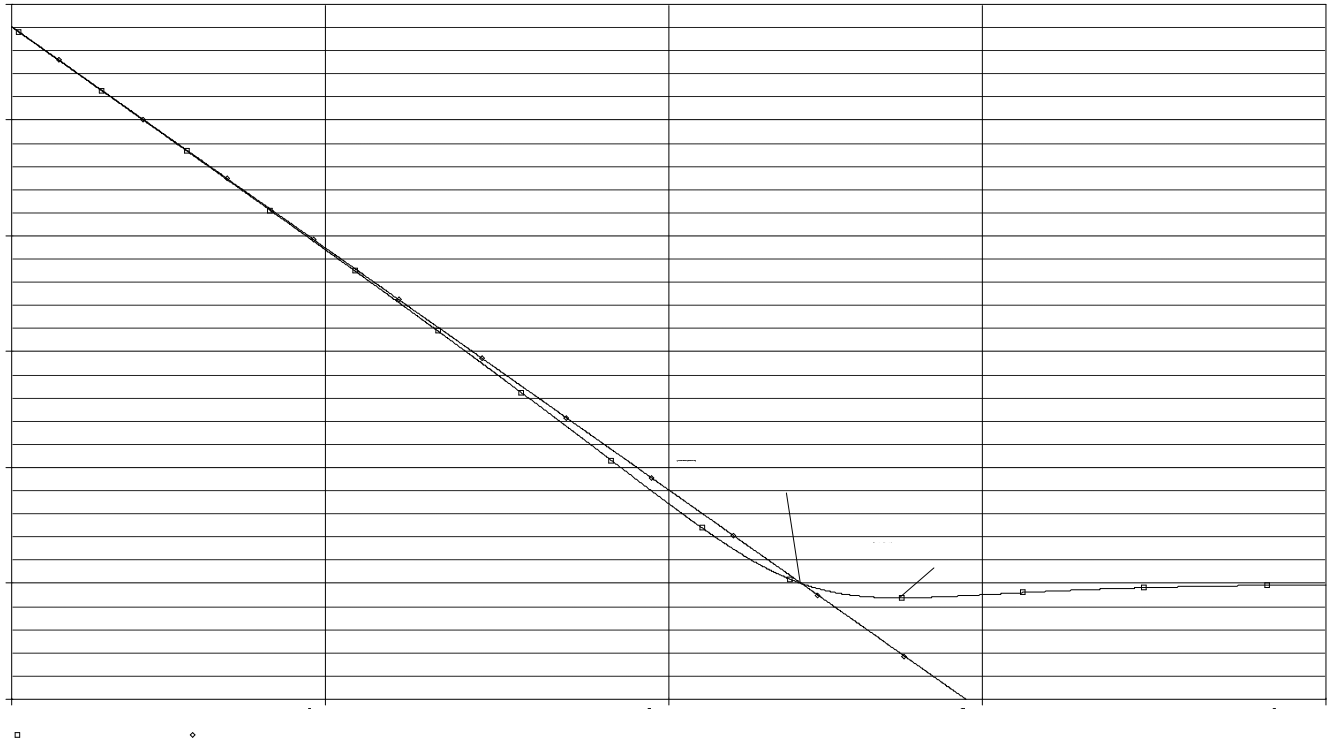

**FIGURE 9.** Simulated magnitude (dB) of the input impedance of the filter. The straight-line is the magnitude of the resistance (dB) of the equivalent FDNR element at low-frequencies, *i.e.*,  $20\log\left[10^9/(2\pi f)^2\right]$ .

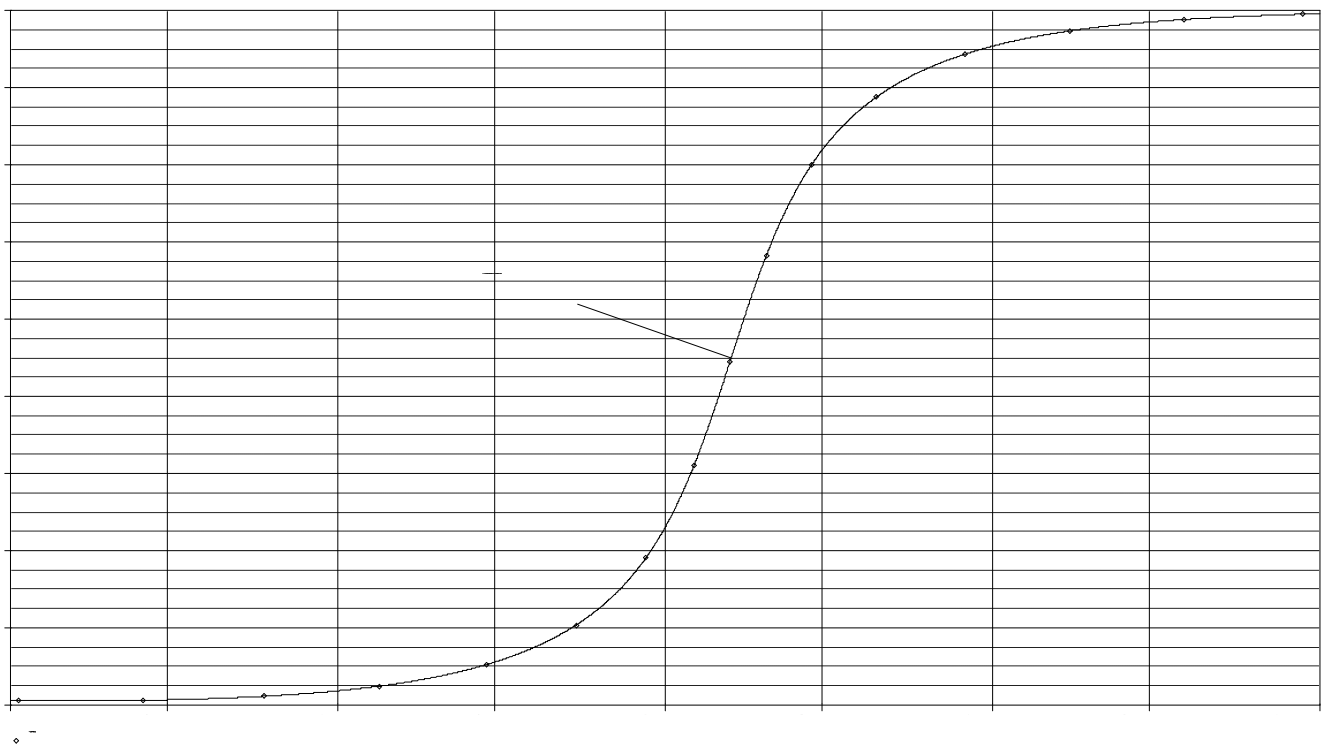

**FIGURE 10.** Simulated phase response (deg) of the input impedance of the filter.



## VI. CONCLUSIONS

We have derived an expression for the input complex impedance for the second-order twofold-gain Sallen-Key low-pass filter, which is given in Equation (3). From this expression, we have shown that the input complex impedance is  $R_1$  for high-frequencies, whereas for low-frequencies it behaves like a Frequency Dependent Negative Resistance (FDNR) element. Furthermore, we have found the minimum of the magnitude of the input impedance without calculus, as given in Equation 15 and its approximations in Equation 16 and Equation 17. We have also discovered an expression for  $\omega_{\min}$ , as given in Equation 10 and its approximation in Equation 11. Finally, we provided PSpice simulations which verified the theoretical results.

In future work, we intend to study the input impedance for arbitrary gain Sallen-Key low-pass and high-pass filters.

## REFERENCES

- [1] Cartwright, K. V. and Kaminsky, E. J., *Finding the minimum input impedance of a second-order unity-gain Sallen-Key low-pass filter without calculus*, Lat. Am. J. Phys. Educ. **7**, 525-535 (2013).
- [2] Paul, C., *Design second- and third-order Sallen-Key filters with one op amp*, EDN Network, (2011). <http://www.edn.com/design/analog/4363970/Design-second-and-third-order-Sallen-Key-filters-with-one-op-amp>. Accessed in: 12 June 2014.
- [3] Orcad PSpice demo download: <http://www.cadence.com/products/orcad/pages/downloads.aspx#demo> Accessed in 15 May 2014.
- [4] Susan, D. and Jayalalitha, S., *Frequency dependent negative resistance-a review*, Research Journal of Applied Sciences, Engineering and Technology **4**, 2988-2994 (2012). Available from <http://www.maxwellsci.com/jp/abstract.php?jid=RJASET&no=211&abs=22>.
- [5] Cartwright, K. V., Russell, P. and Kaminsky, E. J., *Finding the maximum magnitude response (gain) of second-order filters without calculus*, Lat. Am. J. Phys. Educ. **6**, 559-565 (2012).
- [6] Mungan, C. E., *Three important Taylor series for introductory physics*, Lat. Am. J. Phys. Educ. **3**, 535-538 (2009).

## APPENDIX

In this appendix, we derive Eqs. 1 and 3.

Let  $I_{in}(s)$  be the current through the source  $V_1$ ,  $I_1(s)$  be the current through  $C_1$  from bottom to top, and  $I_2(s)$  be the current through  $R_2$  from left to right. Looking at the node marked with voltage  $V_2(s)$  we obtain:

$$I_2(s) = \frac{V_2(s)}{R_2 + \frac{1}{sC_2}} = \frac{sC_2 V_2(s)}{sC_2 R_2 + 1}, \quad (A1)$$

and

$$I_1(s) = \frac{V_2(s) - V_{out}(s)}{\frac{1}{sC_1}} = (V_2(s) - V_{out}(s))sC_1. \quad (A2)$$

Noticing that the voltage across  $C_2$  is  $V_{out}(s)/2$  (because  $R_3 = R_4$ ) and using voltage division, we obtain:

$$V_{out}(s) = \frac{\frac{1}{sC_2}}{R_2 + \frac{1}{sC_2}} 2V_2(s). \quad (A3)$$

Or

$$V_2(s) = (sC_2 R_2 + 1)V_{out}(s)/2. \quad (A4)$$

Using (A4) in (A1) and (A2) gives, respectively:

$$I_2(s) = sC_2 V_{out}(s)/2, \quad (A5)$$

and

$$I_1(s) = \frac{(sC_2 R_2 + 1)V_{out}(s) - 2V_{out}(s)}{\frac{2}{sC_1}}, \quad (A6)$$

$$= sC_1 (sC_2 R_2 - 1)V_{out}(s)/2.$$

Using KCL and  $C_1 = C_2 = C$  gives:

$$I_{in}(s) = I_1(s) + I_2(s), \quad (A7)$$

$$= s^2 R_2 C^2 V_{out}(s)/2.$$

Writing the loop equation for the leftmost loop using KVL, we obtain:

$$V_{in}(s) = I_{in}(s)R_1 + I_2(s) \left( R_2 + \frac{1}{sC_2} \right). \quad (A8)$$

Finally, using (A7) and (A5) in (A8) and  $C_2 = C$ , we get the expression relating the output voltage to the input voltage:

$$V_{in}(s) = s^2 C^2 R_2 R_1 V_{out}(s)/2 + sC \left( R_2 + \frac{1}{sC} \right) V_{out}(s)/2 \quad (A9)$$

$$= \frac{V_{out}(s)}{2} \left[ s^2 C^2 R_1 R_2 + sCR_2 + 1 \right].$$

Equation A9 can clearly be written as the transfer function shown in Equation 1.

In order to find the input complex impedance, we simply divide the input voltage by the input current, using A9 and A7 to get:

Finally, dividing by  $R_1$  we obtain the normalized complex impedance of Equation (3).

$$\begin{aligned} Z(s) &= \frac{V_{in}(s)}{I_{in}(s)} \\ &= \frac{V_{out}(s) [s^2 C^2 R_1 R_2 + s C R_2 + 1] / 2}{s^2 R_2 C^2 V_{out}(s) / 2} \quad (\text{A10}) \\ &= \frac{s^2 C^2 R_1 R_2 + s C R_2 + 1}{s^2 R_2 C^2}. \end{aligned}$$