

University of New Orleans

ScholarWorks@UNO

University of New Orleans Theses and
Dissertations

Dissertations and Theses

12-17-2010

Comparative Analysis of Wind, Solar and Landfill Gases as Alternative Sources of Energy for Electricity Generation

Suruchi Verma

University of New Orleans

Follow this and additional works at: <https://scholarworks.uno.edu/td>

Recommended Citation

Verma, Suruchi, "Comparative Analysis of Wind, Solar and Landfill Gases as Alternative Sources of Energy for Electricity Generation" (2010). *University of New Orleans Theses and Dissertations*. 1262.

<https://scholarworks.uno.edu/td/1262>

This Thesis is protected by copyright and/or related rights. It has been brought to you by ScholarWorks@UNO with permission from the rights-holder(s). You are free to use this Thesis in any way that is permitted by the copyright and related rights legislation that applies to your use. For other uses you need to obtain permission from the rights-holder(s) directly, unless additional rights are indicated by a Creative Commons license in the record and/or on the work itself.

This Thesis has been accepted for inclusion in University of New Orleans Theses and Dissertations by an authorized administrator of ScholarWorks@UNO. For more information, please contact scholarworks@uno.edu.

Comparative Analysis of Wind, Solar and Landfill Gases as Alternative Sources
of Energy for Electricity Generation

A Thesis

Submitted to the Graduate Faculty of the
University of New Orleans
in partial fulfillment
of the requirements for the degree of

Master of Science
in
Engineering
Electrical

By

Suruchi Verma

B.Tech., Punjab Technical University, India, 2007

December, 2010

Acknowledgement

It gives me pleasure to thank the many people who made this thesis possible.

First and foremost, I would like to thank my advisors, Dr. Bhaskar Kura and Dr. Parviz Rastgoufard. I appreciate all their contributions of time, ideas, and funding to make my graduate experience productive and stimulating. I would also like to thank Dr. Ittiphong Leevongwat who was a source of good advice and collaboration.

I am indebted to Dr. Vic Culpeper, River Birch landfill and Ms. Cathy Dunn, Port of New Orleans, for providing financial support towards my graduate assistantship.

I am grateful to the faculty and staff of both Electrical and Environmental Engineering Departments for helping me in many ways.

Most importantly, I am honored to express my gratitude to my beloved father, Late Mr. Suresh K. Verma, who was the one to introduce me to the world of engineering right at home. Without his constant support, love and affection, I could never dream of coming so far away from home to pursue a Masters degree. It is him that I want to dedicate this thesis to.

I am also grateful to my mother, Mrs. Anjali Verma, who has always been my best friend and supported me in every possible way. Her love, encouragement and faith have always been a pillar of strength and a guiding light for me.

I wish to thank my sister, Abha Verma and her husband, Navneet Goyal, for providing a loving environment for my stay here at New Orleans.

Lastly, I would like to thank all my friends in New Orleans and back in India, for their constant morale support during the tough times and for their emotional support.

Table of Contents

List of Figures	v
List of Tables	vii
Abstract	viii
1. Introduction.....	1
a. Worldwide Energy demand	1
b. Objectives	3
2. Current and Future Electricity Demand and Impact of Conventional Sources	4
a. Worldwide electricity Demand.....	4
b. Electricity consumption for a typical household	7
c. Conventional sources of electricity generation.....	9
d. Electricity Generation in North America.....	13
e. GHG emissions from power plants using Conventional sources	16
f. Need for Alternative Sources for electricity generation	19
3. Alternative Sources of Energy	21
a. Introduction to Alternative Sources for electricity generation	21
b. Solar Energy	23
3.2.1 Introduction.....	23
3.2.2 Technologies used.....	24
3.2.3 Feasibility – Economical and Technical	28
c. Wind Energy	30
3.3.1 Introduction.....	30
3.3.2 Technologies used	30
3.3.3 Feasibility – Economical and Technical.....	32
d. Landfill gas Energy.....	33

3.4.1 Introduction.....	33
3.4.2 Technologies used	34
3.4.3 Feasibility – Economical and Technical.....	36
4. Mathematical models for Solar and Wind Energy.....	38
a. Mathematics for Solar Energy	38
4.1.1 Introduction	38
4.1.2 Generation of Electricity by Photovoltaic Effect.....	38
4.1.3 Model of a PV Panel Consisting of n Cells in Series	42
4.1.4 Model of a PV Panel Consisting of n Cells in Parallel.....	44
b. Mathematics for Wind Energy.....	45
4.2.1 Introduction.....	45
4.2.2 Evaluation of Wind Intensity.....	45
4.2.3 Wind Power and Torque.....	48
5. Mathematical models to quantify emissions from landfills.....	51
a. EPA based LandGEM.....	51
b. Inverse Gaussian Method	52
c. Comparison of the two models.....	57
6. Electricity generated	58
a. Amount of electricity generated by a test case landfill.....	58
b. Amount of electricity generated by a test case Wind Energy Plant	60
c. Amount of electricity generated by a test case Solar Energy Plant.....	62
d. Comparison of three test cases	64
7. Conclusions	68
8. References.....	71
9. Vita.....	75

List of Figures

Figure 1.1: World Marketed Energy Use by Fuel Type, 1980-2030.....	2
Figure 2.1: Growth in World Electric Power Generation and Total Energy Consumption, 1990-2030.....	4
Figure 2.2: Annual Increase of electricity; 1970 – 2030	5
Figure 2.3: World Net Electric Power generation; 1980 – 2030	6
Figure 2.4: Non – OECD Net Electricity generation by region; 1980 – 2030	7
Figure 2.5: Percentage of Total Electricity Consumption in an average U.S household, 2001	7
Figure 2.6: World Electricity Generation by Fuel Type; 2006-2030	11
Figure 2.7: Use of Petroleum Liquids as a Source of Electricity; 1996-2009	12
Figure 2.8: Renewables as a Source of Electricity; 1996-2009	13
Figure 2.9: Electricity Generation in North America; 1980-2030.....	14
Figure 2.10: Electricity Generation in North America by Fuel Type; 2006 and 2030	14
Figure 2.11: Electricity generation in the United States by source, 2009	14
Figure 2.12: Non hydropower renewable sources meet 41% of total electricity generation growth from 2008 to 2035.....	15
Figure 2.13: Emissions from electricity generation, 1973 and 2007	18
Figure 2.14: Contribution towards Global Warming by various countries	20
Figure 3.1: World Renewable Electricity Generation by Energy Source, 2006, 2015, and 2030	22
Figure 3.2: World Renewable Electricity Generation by Source, 2006-2030.....	22
Figure 3.3: Non Hydroelectric Renewable Sources of Electricity generation in U.S, 2003-2025.....	23

Figure 3.4: Working of a Photovoltaic cell.....	24
Figure 3.5: Combination of Solar cells to form Modules and Arrays to supply electricity for heavier loads.....	25
Figure 3.6: Different types of Concentrating Solar Power Units	27
Figure 3.7: Different Types of Wind turbines	32
Figure 4.1: Equivalent Electrical Circuit of a single PV cell.....	38
Figure 4.2: Output Power and Current Vs. Cell Voltage at various solar intensities	41
Figure 4.3: Series Arrangement of n similar Photovoltaic cells in a Panel	42
Figure 4.4: Series Arrangement of n similar Photovoltaic cells in a Panel	44
Figure 5.1: Gaussian Dispersion Model	54
Figure 6.1: The process of Landfill gas being collected for both Electrical and Heating utilization at ALZA Pharmaceuticals, San Francisco	59
Figure 6.2: the Energy Payback Ratio of Coal and Nuclear powered plants in comparison with DePere Wind Farm.....	62
Figure 6.3: A View of Nellis Solar Power Plant, Nevada.....	64

List of Tables

Table 2.1: U.S. Residential Electricity Consumption by End Use, 2008	8
Table 2.2: OECD and Non – OECD Net Electricity generation by Energy Source; 2006 – 2030	10
Table 2.3: Carbon dioxide Equivalents of other Greenhouse Gases in terms of 100 year warming potential.....	17
Table 2.4: Emissions from Energy Consumption at Conventional Power Plants and Combined- Heat-and-Power Plants, 1997 through 2008.....	18
Table 3.1: Internal Combustion Engine Sizes.....	35
Table 6.1: Comparison of Wind, Solar and Landfill Gas as Alternative Sources of Electricity Generation	65

Abstract

The document reviews the current and projected electricity demand until the year 2030 along with the fuel mix. Several projections based on different agencies were studied in order to understand the trend of fuel mix projected to be used. Clearly, the fuel mix being used or projected is unsustainable. Depletion of fossil fuels, increasing demand and environmental impacts are some of the factors that emphasize the use of Alternative Sources of Electricity. Three of the upcoming Alternative Sources - Solar, Wind and Landfill Gases - are discussed and compared in the document. Based on the comparison, Landfill Gas projects seem to be very favorable, despite the higher costs related with such projects, several advantages over the other two Alternative Sources are discussed in the document. The several advantages of Landfill Gas projects, such as emissions reduction, better power quality, reduction in transmission losses, and several others are discussed in the document.

Keywords: Alternative Sources, electricity generation, GHG emissions from Power plants, LFG to electricity, wind energy, solar energy

Chapter 1 – Introduction

1.1) World Energy Demand

The world population is currently 6.9 billion (as in 2010) and is expected to increase to 8.1 billion by 2030. Worldwide economy¹ is growing yearly at the rate of 2.2 percent for the OECD (Organization for Economic Co-operation and Development) countries and at 4.9 percent for non OECD countries. Energy demand around the globe is increasing day by day proportional to population and economic expansion. During the last few years, the global energy demand almost doubled and is projected to show a similar increase by the year 2030. Currently the OECD countries have a well established energy infrastructures as compared to the Non OECD countries.

Economic growth and a region's population are important factors to growing energy demands of a region. For Non OECD countries, the growth of energy demand is projected to increase more rapidly than in the OECD countries. The energy consumption in Non OECD countries increases approximately by 73 percent as compared to an increase of 15 percent increase in OECD countries [Ref 36]. China and India are the fastest growing Non OECD economies that are the biggest contributors towards this rapid increase in energy consumption of the Non OECD countries.

Marketed energy is the trading of energy source such as petroleum, coal, etc by transmission or transportation and distribution network to an end use consumer. Fossil fuels are projected to remain the major source of energy worldwide. Figure 1.1 shows the trend of increasing marketed energy by fuel type.

¹Measured in GDP of purchasing power

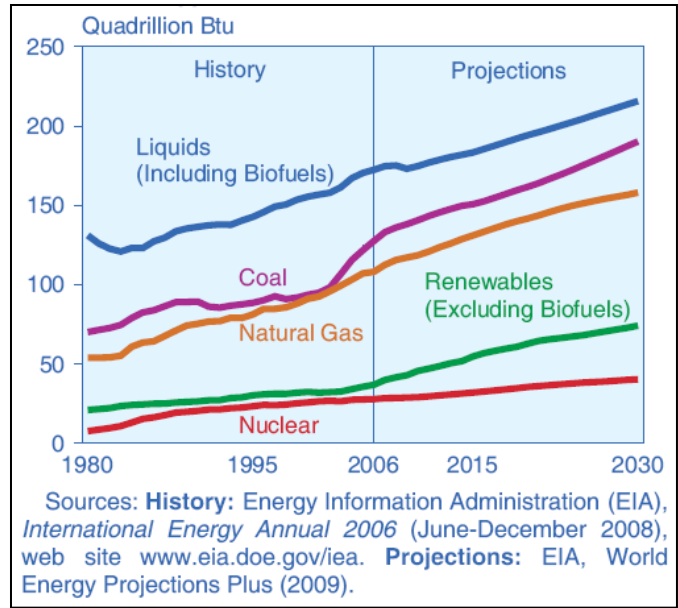

Figure 1.1: World Marketed Energy Use by Fuel Type, 1980-2030 [Ref 36]

Electricity is one of the major components of energy consumption in today's world. Most of the electricity demand is met by the conventional sources like coal, petroleum, and natural gas. Recent interest in sustainability issues relating to electricity demand and generation require additional research. Per-capita electricity demand can be minimized through efficiency improvement in housing, transportation, and industrial production. Even with efficiency increase, the electricity demand will continue to rise due to population increase and the growth of the economy. Because of the obvious rise in electricity demand, there is a strong need for Alternative Sources of Electricity to minimize environmental impacts. Conventional Sources of Electricity are known emit air pollutants such as Greenhouse Gases (e.g., Carbon Dioxide) and criteria air pollutants (e.g., Sulfur Dioxide, Oxides of Nitrogen, Particulates) that cause environmental damage (e.g., acid rain, global warming, and poor air quality) and human health impacts.

1.2) Objectives

The main objective of this research is to document the sustainability issues of electricity demand and generation as well as the need for promoting Alternative Sources of Electricity such as LFG-to-Electricity.

The more specific objectives of this study include:

1. Review worldwide current and future electricity demand and generation
2. Review sustainability issues related to electricity demand and generation
3. Identify selective Alternative Sources of Energy and their technical, environmental, and economical feasibility
4. Identify a model to predict the amount of landfill gases
5. Determine the amount of electricity generated by landfill gases and perform a comparative analysis for its viability when compared with electricity produced by solar and wind energy
6. Evaluate GHG emissions from power plants using conventional and Alternative Sources of Energy

This research is expected to provide important insight needed to promote the alternative sources of electricity, especially, the electricity generated by Landfill gases in the vicinity of urban areas for reduced transmission and power losses.

Chapter 2 – Electricity Demand and the Impact of Conventional Sources

2.1) Worldwide Electricity Demand

Electricity is one of the major components of energy consumption in today's world. The rate of increase in net electricity generation outpaces the rate of increase in total energy consumption as shown in Figure 2.1. According to the Energy Information Administration's (EIA) International Energy Outlook for 2009, World electricity generation is projected to follow an increase of 2.4 percent per year from 2006 (18.0 trillion kilowatt-hours) to 2030 (31.8 trillion kilowatt-hours) which is a 77 percent increase, as depicted by Figure 2.2.

According to the report, the ongoing recession is expected to decrease the current demand of electricity, especially in the Industrial sector. But, the trend is predicted to follow its original predicted path after 2010.

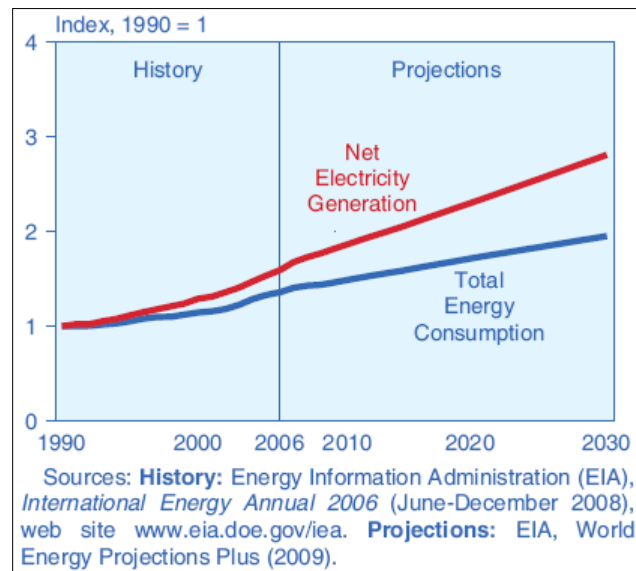

Figure 2.1: Growth in World Electric Power Generation and Total Energy Consumption, 1990-2030

[Source: Ref 36]

The Net Electric Power generation can be seen to increase in a different pattern for OECD (Organization for Economic Cooperation and Development) and Non-OECD countries as depicted by Figure 2.2.

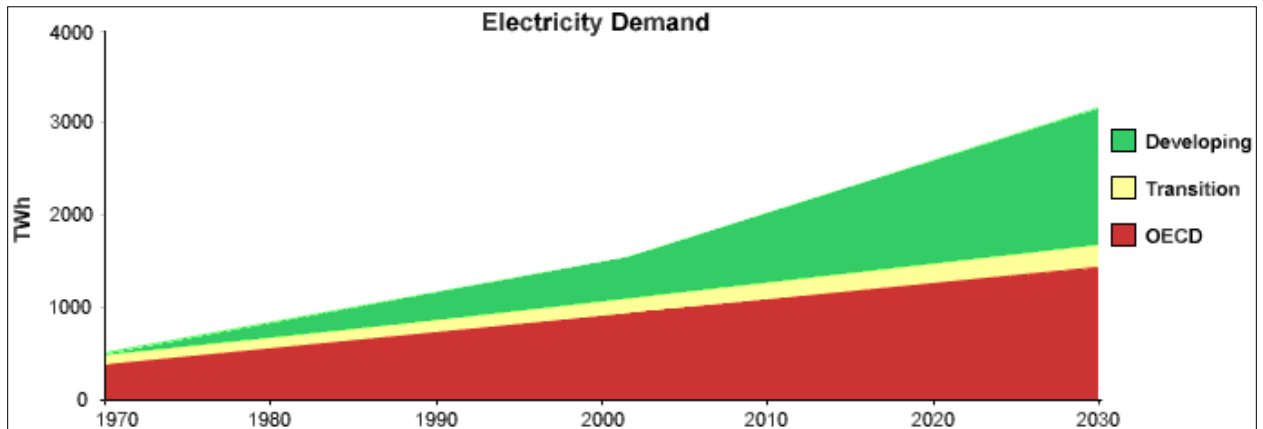

Figure 2.2 Annual Increase of electricity demand; 1970 – 2030

Clearly, the rate of increase in Non-OECD countries is much higher than for OECD countries as seen in Figure 2.3. This is mainly because electricity market is well established in the OECD countries while the market is still developing in the others. The electricity market is well established in OECD group of countries, while there are large parts of Non-OECD countries where, the demand is unmet in the present. Such areas play the key role in the sharp increase seen in the electricity demand for the Non-OECD countries.

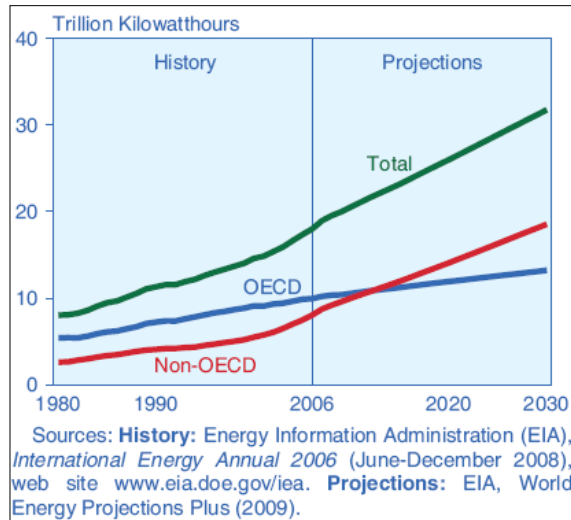

Figure 2.3: World Net Electric Power generation; 1980 – 2030 [Source: Ref 1]

Figure 2.3 also depicts the worldwide growth of electricity by 10 Trillion Kilowatt-hour over every 25 years starting from 1980. The gradual increase in OECD countries is because the countries are already developed and hence there is not much increase in demand. On the other hand, the Non OECD countries are currently developing and hence, the improving lifestyle causes a rapid increase in demand of electricity. Another reason for this rapid increase in electricity demand among the Non OECD part is that there is a huge part of non OECD countries including countries in Middle East and Central and South America that are still deprived from a reliable electricity supply. These parts are also at a rise for demand and hence generation of electricity. However, the Non – OECD countries in Asia exhibit a faster growth of electricity generation as depicted in Figure 2.4 [Ref 1].

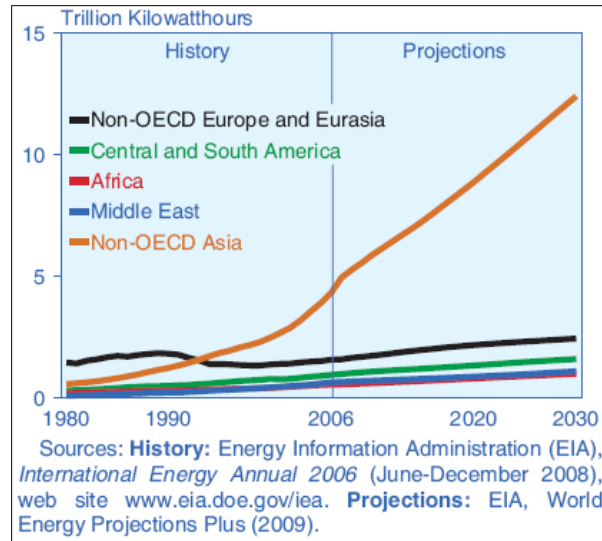

Figure 2.4: Non – OECD Net Electricity generation by region; 1980 – 2030 [Source: Ref 1]

2.2) Electricity Consumption for a Typical Household

In the year 2001, Energy Information Administration (EIA) did a Residential Energy Consumption Survey in U.S, where they collected the data from households all over the country to compute the average electricity usage in an average house in the United States. Figure 2.5 depicts the electricity usage by different types of appliances in a household. According to the survey, an average U.S household consumes 10,656 KWh of electricity annually.

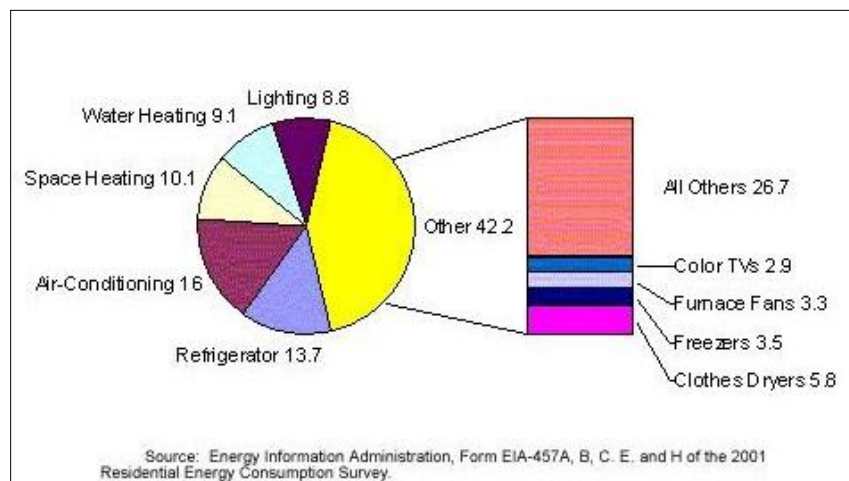

Figure 2.5: Percentage of Total Electricity Consumption in an average U.S household, 2001 [Source: Ref 20]

According to Figure 2.5, Air conditioning alone consumes 16% of the total electricity consumption of the household. Also, two-third of the electricity is used for appliances such as refrigerator and lighting. Except for refrigerators, no single appliance dominates the percentage distribution of electricity usage.

Given in Table 2.1 is “U.S. Residential Electricity Consumption by End Use” in an average household. This table shows a list of household appliances that are used in an average household with their electricity usage.

Table 2.1: Annual U.S. Residential Electricity Consumption by End Use, 2008 [Source: Ref 20]

	Annual Consumption		
	(in kWh)		
		Dishwasher	313
		Electric Range Top	536
Total Households	6,505	Electric Oven	440
		Microwave Oven	209
Refrigerators	1,239	Electric Toaster Oven	50
		Coffee Makers	116
Air-Conditioning		Color TV	137
Central Air-Conditioners	1,707	VCR/DVD	70
Room Air-Conditioners	580	Cable Boxes	120
Total		Satellite Dish	130
Space Heating		Personal Computer	262
Main Space-Heating Systems	2,151	(Desk Top)	
Secondary Space-Heating Equipment	307	Personal Computer	77
Total		(Lap Top)	
		Printer with Fax/copier	216
Water Heating	1,558	Printer without Fax/copier	45
		Pool Filter/pump	1,500
Lighting (indoor and outdoor)	574	Pool/Hot Tub/Spa Heater	2,300
		Ceiling Fan	50
Other Appliances (total of list below)	2,744	Clothes Washer	120
Clothes Dryer	658	Waterbed Heater	900
Freezer	1,039	Well Water Pump	400
Furnace Fan	500	Dehumidifier	400
		Evaporator Cooler	1,183

Compact Stereo System	81	Cordless Telephone	26
Component Stereo System	55	Rechargeable Tools	43
Portable Stereo (Boom Box)	19	Humidifier	100
Other Stereo System	55	Automobile	200
Large, Heated Aquarium	548	Block/Engine/Battery Heater	
Answering Machine	35		

Once we know the power ratings for each appliance and the time duration, for which it was working, we can compute the amount of total power consumed by that appliance using the following equation [Ref 9]. Computing the **Daily Kilowatt-hour (kWh) Consumption** for each appliance we can then compute the Total Daily Kilowatt-hour (kWh) for the household.

$$\text{Daily Consumption (Daily Kilowatt-hour (kWh))} = (\text{Wattage} \times \text{Hours Used Per Day})/1000$$

2.3) Conventional Sources of Electricity Generation

Conventional Sources of electricity mainly consist of fossil fuels such as coal, petroleum, natural gas and also nuclear power. Although these sources are inexpensive and readily available for now, their supply is limited and generation of fossil fuels takes years altogether. Also, burning of fossil fuels emits air pollutants (such as Carbon Dioxide, Sulfur Dioxide, etc) that are harmful to the environment. The sources of electricity generation vary from region to region. Table 1.2 [Ref 1] shows the variation of the electricity generation by sources in different regions – OECD (Organization for Economic Co-operation and Development) and Non OECD. There have been various sources of electricity generation, but coal has always been the most widely used source all over the world. The main reason for this is that coal is economically and abundantly available. Also, it is easier to transport coal than it is to transport other sources of electricity generation. Recent awareness and concerns about the Greenhouse gas emissions from burning coal and other fossil fuel sources like oil has increased interest for development of Alternative Sources of electricity generation. This recent concern has caused the OECD countries to dwell into

researching other options like Solar energy, Wind energy and many others for electricity generation.

Coal continues to be the main source of production of electricity for Non-OECD countries and its utilization is increasing annually by an average of 3.9 percent as depicted by Table 2.2. The Table also suggests that worldwide, the average annual utilization of coal is projected to increase by 2.5% annually from the year 2006 to 2030.

Table 2.2: OECD and Non – OECD Net Electricity Generation by Energy Source; 2006 – 2030
(Trillion Kilowatt-hours)

Region	2006	2010	2015	2020	2025	2030	Average Annual Percent Change, 2006-2030
OECD							
Liquids	0.3	0.3	0.3	0.3	0.3	0.3	-0.4
NaturalGas	2.0	2.2	2.4	2.7	3.0	3.1	1.8
Coal	3.7	3.9	4.0	4.0	4.0	4.3	0.6
Nuclear	2.2	2.3	2.4	2.4	2.5	2.6	0.6
Renewables	1.6	1.9	2.2	2.5	2.8	2.9	2.5
Total OECD	9.9	10.6	11.3	11.9	12.6	13.2	1.2
Non-OECD							
Liquids	0.6	0.6	0.6	0.6	0.6	0.6	0.1
Natural Gas	1.6	2.0	2.5	3.0	3.4	3.7	3.6
Coal	3.7	4.8	5.5	6.4	7.8	9.2	3.9
Nuclear	0.4	0.5	0.7	0.9	1.2	1.3	4.8
Renewables	1.8	2.2	2.7	3.2	3.4	3.8	3.2
Total Non-OECD	8.0	10.0	12.0	14.1	16.3	18.6	3.5
World							
Liquids	0.9	0.9	0.9	0.9	0.9	0.9	-0.1
NaturalGas	3.6	4.2	4.9	5.7	6.4	6.8	2.7
Coal	7.4	8.7	9.5	10.4	11.8	13.6	2.5
Nuclear	2.7	2.8	3.0	3.4	3.6	3.8	1.5
Renewables	3.4	4.1	4.9	5.7	6.1	6.7	2.9
Total World	18.0	20.6	23.2	26.0	28.9	31.8	2.4

*Note: Totals may not equal sum of components due to independent rounding.

Liquid sources are the only energy source for power generation that does not grow on a worldwide basis. This is because the availability of oil and other liquid sources is limited to a few regions. In recent times, the huge increase in the price of these liquids caused electricity producers to shift to other economical sources than Oil and Petroleum. Most of the nations either eliminate liquids as a source; a few others that produce oil in abundance are also trying to limit its use as a source of electricity production. Hence, on an average, the use of oil and other petroleum is projected to decrease by 0.9% as depicted in Table 2.2.

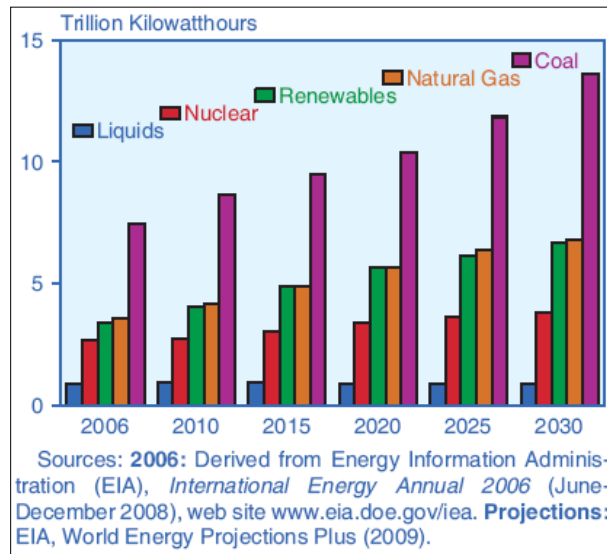

Figure 2.6: World Electricity Generation by Fuel Type; 2006-2030 [Source: Ref 1]

Figure 2.6 shows world electricity generation by the type of fuel used all over the world in both OECD and Non OECD nations. From the figure, it is evident that the use of coal is following an increasing trend while the use of liquids is almost constant and varies very little. The use of Renewables, Natural Gas and Nuclear sources is on the rise. Figure 2.7 gives a closer look at the variation of usage of liquids as the source of electricity in the United States. Clearly, use of liquid sources has fallen to a minimum level in 2009 when compared to the usage in 1996.

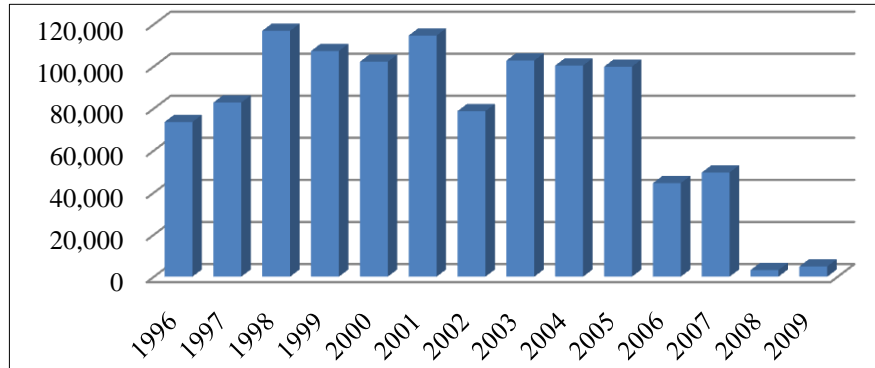

Figure 2.7: Use of Petroleum Liquids as a Source of Electricity; 1996-2009 [Source: Table2.2]

Renewable Energy sources are one of the fastest growing sources used for electricity generation, with a 2.9% annual increase from the year 1996 to 2009. Figure 2.8 shows the use of Renewable energy in the U.S. from 1996 to 2009. Renewable energy sources are rapidly increasing their share in world electricity generation from 19% in 2006 to 21% in 2010. Although these have a positive impact on the environment, most of the Renewable Sources are not economically feasible when compared to fossil fuels. Many new technologies to improve the efficiency and economic feasibility of these sources are coming up these days. The Renewable Sources include Hydroelectricity, Wind, Solar, Geothermal and several others. Wind and Solar will be discussed in detail along with Landfill Gases in this document.

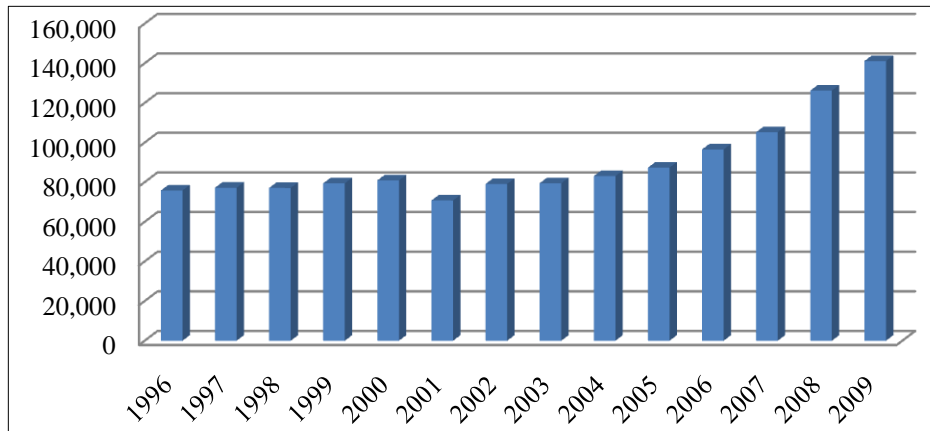

Figure 2.8: Renewables as a Source of Electricity; 1996-2009 [Source: Table 2.2]

2.4) Electricity Generation in North America

When compared to coal, natural gas plays a larger role in U.S. generation projections in recent times. More than 90 percent of the power plants to be built in the next 20 years will likely be fueled by natural gas [Ref 2]. Figure 2.9 shows electricity generation in OECD North America which consists of Canada, U.S and Mexico. United States accounts for a major part of the electricity generation followed by Canada and Mexico respectively. Figure 2.10 gives us a better insight as to what sources are used in these countries. Clearly, where Canada depends on Renewable Sources, United States still depends on the conventional sources like coal and natural gas. Although an increase in usage of Renewable Sources is there when compared to the prediction of the EIA Energy Outlook, a lot needs to be done to further increase the growth of using these sources instead of the conventional sources.

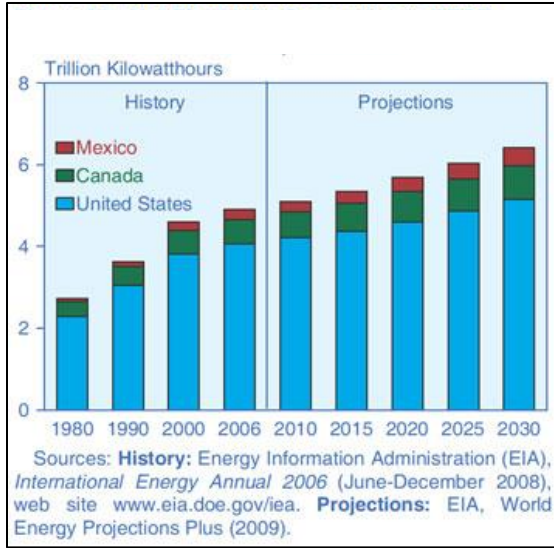

Figure 2.9: Electricity Generation in North America; 1980-2030 [Source: Ref 1]

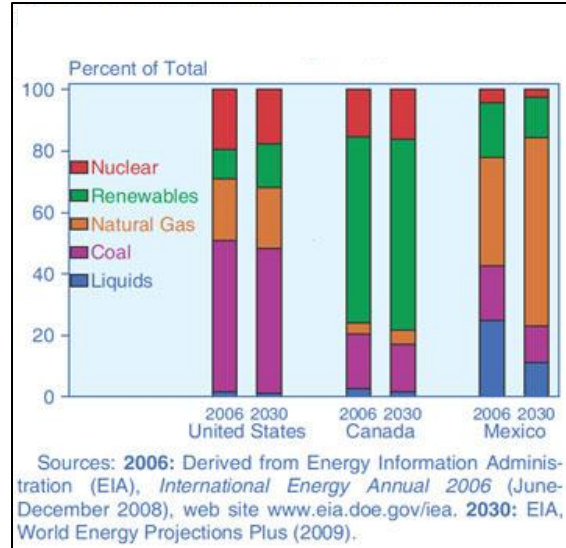

Figure 2.10: Electricity Generation in North America by Fuel Type; 2006 and 2030 [Source: Ref 1]

The various sources used for Electricity generation in the United States (2009) are coal, natural gas, nuclear power, hydroelectric and various others. The percentage of different sources being used for electricity generation in the United States is also shown in Figure 2.11.

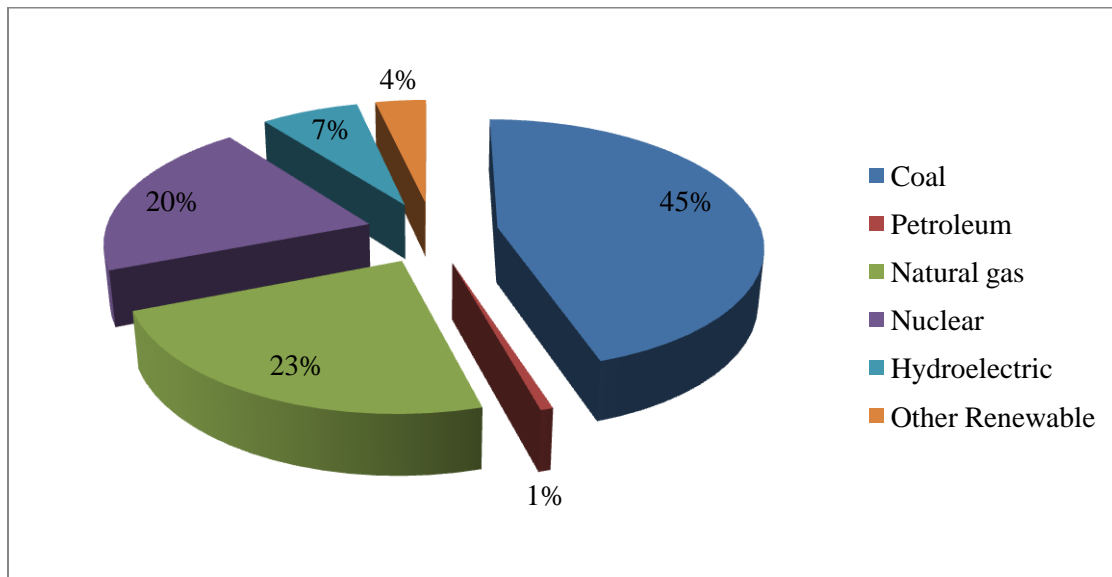

Figure 2.11: Electricity generation in the United States by source, 2009

[Source: Tables from Ref 1 and Ref 36]

- 44.9% of electricity in the US is generated by burning coal
- 20.3% from nuclear power,
- 23.4% from natural gas
- 6.9% from hydroelectric,
- 1% from burning petroleum
- 3.6% from other renewable energy sources such as wind power and solar energy geothermal power, and biomass.
- Renewable energy accounts for about 10% of all electricity generated.

Where coal continues to be the major fuel type used for electricity generation, Renewables are also on the rise. Figure 2.12 shows us that a sudden increase in use of Renewable Sources is seen in the coming few years. This increase can be justified due to all the Federal and State incentives being offered to electricity producers for using Renewable Sources instead of using the Conventional Sources like coal.

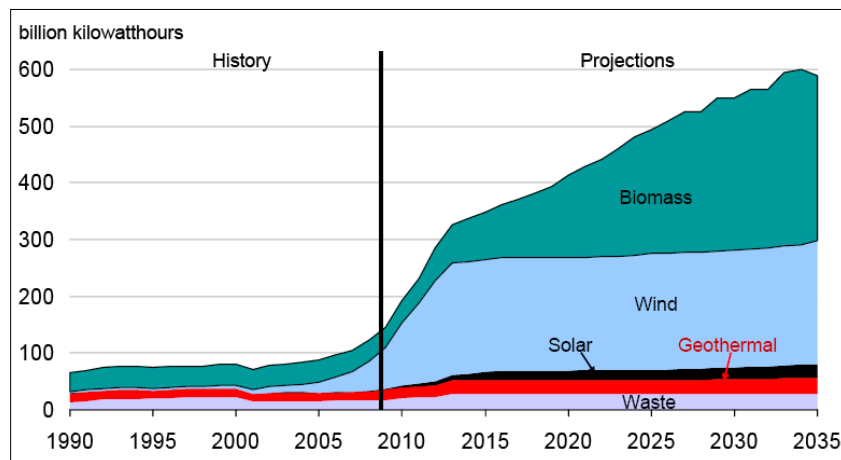

Figure 2.12: Non hydropower renewable sources meet 41% of total electricity generation growth from 2008 to 2035

Source: Annual Energy Outlook 2010, EIA [Ref 3]

Renewable Sources consists of Hydropower, Wind, Solar, Biomass and many others. Figure 2.12 shows a comparison between the various Renewable Sources of electricity other than Hydropower – Biomass, Wind, Solar, Geothermal and Waste and their projections of further use in the coming years. Wind energy seems to dominate the other sources because of many economic and technical feasibility issues discussed later. Although Solar Energy and that from Waste is not a very huge percentage, both these are relatively new, technologies are being researched into, to further increase their contribution as sources of electricity.

2.5) GHG Emissions from Power Plants using Conventional Sources

As discussed in previous sections, burning of fossil fuels generates many harmful gases that are dangerous to the environment and the living organisms. Greenhouse Gases (GHG) are the gases that absorb the Sun's radiation and retain within the Earth's atmosphere. These gases are useful for survival of mankind but are harmful when present in large amounts. This is due to the fact that their abundance absorbs more radiation and thus, causing Global Warming. Greenhouse Gases consist of Carbon Dioxide (CO₂), Methane (CH₄), Nitrous Oxide (N₂O) and Ozone (O₃).

The total Greenhouse Gas emissions for the year 2005 were estimated to be 44,153MtCO₂ equivalent (Million Metric Tons of CO₂ equivalent). These include all the GHGs in terms of their CO₂ equivalent. Table 2.3 gives us an idea of how these equivalents are calculated in terms of their 100 year potential. The table also tells us about the major sources of all the GHGs. Clearly, small amounts of Methane (21 times) and Nitrogen oxide (310 times) are much more harmful when compared to equal amount of Carbon Dioxide.

Since power generation involves mainly CO₂ emissions within the GHG group and also as other GHGs are calculated based on their CO₂ equivalents, only CO₂ emissions are discussed in this section. These CO₂ emissions will include all GHG emissions from the power plants.

Table 2.3: Carbon Dioxide Equivalents of other GHGs in terms of 100 Year Warming Potential [Source: Ref 4]

Greenhouse Gas	100-Year Warming Potential	Sources
CO ₂	1	Combustion
CH ₄	21	Landfills, coal mines, oil and gas production, agriculture
N ₂ O	310	Combustion, fertilizers, nitric/adipic acid plants
Hydrofluorocarbons (HFCs)	140 - 11,700	Semiconductor, refrigeration, fire protection
Perfluorocarbons	6,500 - 9,200	Semiconductor, refrigeration, fire protection
Sulfur Hexafluoride	23,900	Electric power - circuit breakers, gas-insulated substations, and switchgear

Whenever a Fossil Fuel burns, it releases energy due to the carbon content present in it. On burning, this carbon present in the fuel is almost completely converted into the form of CO₂.

Figure 2.13 [Ref 22] shows a comparison of Carbon Dioxide (CO₂) emissions from electricity generation around the world, irrespective of the source between the year 1973 and 2007. The OECD countries show a considerable decrease in emissions from 65.8% to 44.9%. Developing nations like China have drastic increases in emissions due to the fact that they are developing very quickly and hence the demand is also increase at a proportional rate. Asian countries excluding China are also on the track of fast development and show an increase of 7% in emissions related to electricity generation from 1973 to 2007.

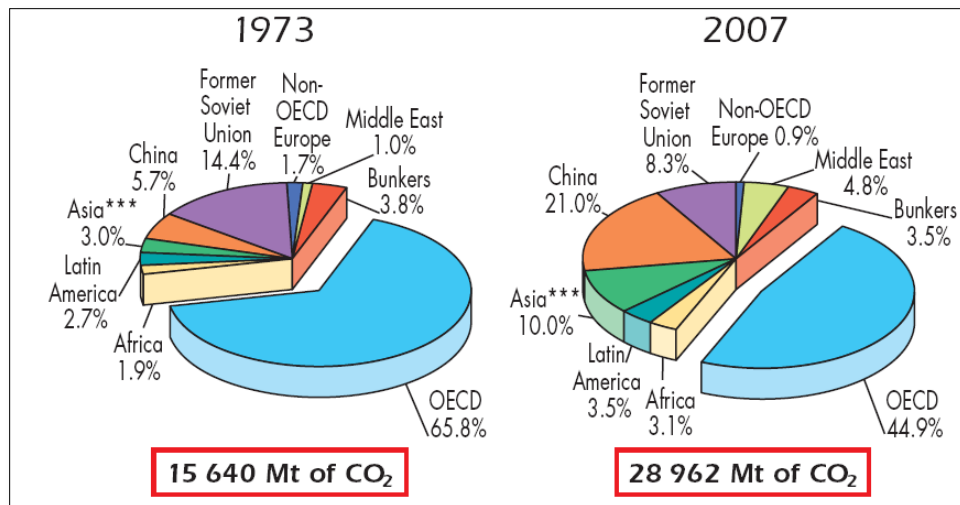

*** Asia excludes China

Figure 2.13: Emissions from electricity generation, 1973 and 2007 [Source: Ref 22]

Table 2.4 shows us the emissions from a Conventional Power Plant from the year 1997 to 2008 in United States. A Conventional Power Plant is the one that uses Conventional Sources of electricity generation as discussed earlier.

Table 2.4: Emissions from Energy Consumption at Conventional Power Plants and Combined-Heat-and-Power Plants, 1997 through 2008 (Thousand Metric Tons) [Source: Ref 21]

Emission	2008	2004	2000	1999	1998	1997
Carbon Dioxide (CO₂)	2,477,213	2,479,971	2,464,550	2,360,424	2,345,951	2,253,783
Sulfur Dioxide (SO₂)	7,830	10,309	11,963	12,843	13,464	13,480
Nitrogen Oxides (NO_x)	3,330	4,143	5,638	5,955	6,459	6,500

It is evident from the table that on the whole, there is a need for prevention measures. There is a huge need of Alternative Sources of electricity generation to replace the existing major sources like coal and other fossil fuels which will reduce emissions of CO₂, SO₂, and NO_x. As can be seen from the following table, air pollutant emission factors (or emission potential) of alternative sources of energy are lower compared to that of conventional sources.

2.6) Need of Alternative Sources of Energy

As discussed in previous sections, coal and other fossil fuels act as the major source of electricity generation in today's world. Fossil fuels that were once present in abundance seem to be exhausting sooner than thought. The generation of these fossil fuels takes up several years and hence it is not easy to retrieve them. If the current trend continues, the energy prices will raise sky high and it will be very difficult for many undeveloped nations to be able to meet with their energy demands.

As mentioned before, combustion of these fossil fuels generate large amounts of CO₂ and other GHGs. These GHGs when emitted into the atmosphere have the ability to absorb and retain the radiation from the Sun for a very long time. In the early years, it was considered as a blessing because this retention of radiation in the atmosphere acted as a blanket in harsh winters.

Recently, since the emissions have increased to such a large extent, this retention of radiations is causing the planet to heat up. The annual average temperature of the planet is rising every year and the climates are changing. Another adverse effect of releasing GHGs into the atmosphere is that the Ozone layer is thinning and hence causing more Global Warming.

Figure 2.14 shows us the contribution of various countries towards Global Warming. Clearly, China and United States are the top two contributors, followed by Russia, India, Japan and other countries [Ref 37].

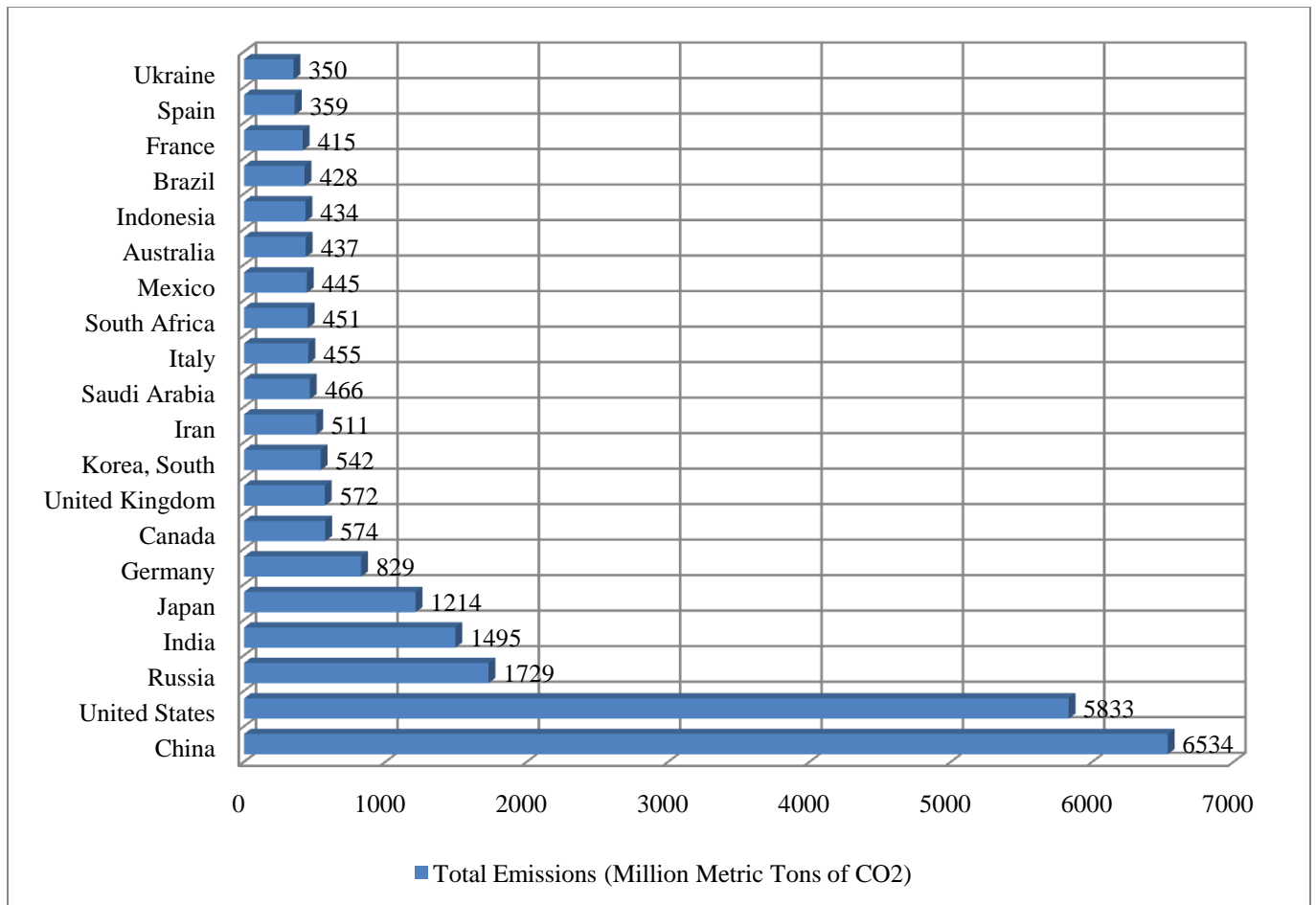

Figure 2.14: Contribution towards Global Warming by various countries for 2008

Alternative Sources of energy are those that do not have any undesirable effects as those seen with the Conventional Sources. Hence, we see that there is a strong need for Alternative Sources of energy. These Alternative Sources consist of Solar energy, Wind energy, Biomass energy, Hydropower energy and many others. Electricity generation being the one sector that contributes most to the emissions of Greenhouse Gases our main concern revolves around the same for the purpose of this document. The following sections will explore three of the Alternative Sources of Electricity – Solar, Wind and Landfill Gases.

Chapter 3 – Alternative Sources of Electricity Generation

3.1) Introduction to Alternative Sources for Electricity Generation

The tax credits and other financial benefits being offered by Federal and State agencies are one of the major reasons for the current increase in interest among electricity producers to use Renewable Sources of electricity generation. The projected growth in Renewable Sources accounts for 45 percent of increase in growth of total electricity generation. These projections are based on the fact that the incentives keep on increasing while the output efficiency may not be very high. The growth will not be so high if the output efficiency is required to meet similar output efficiency of fossil fuel fired power plants.

Figure 3.1 shows the trend being followed by OECD and Non-OECD nations using Renewable Sources of electricity generation. Among many renewable sources, most popular sources consist of Solar, Wind and Hydropower Sources. The comparison in Figure 3.1 shows that Non-OECD countries largely depend on Hydropower as their major source of electricity generation than on Fossil fuels. Hydropower plants have a lot lower emissions than that of fossil fuel powered power plants.

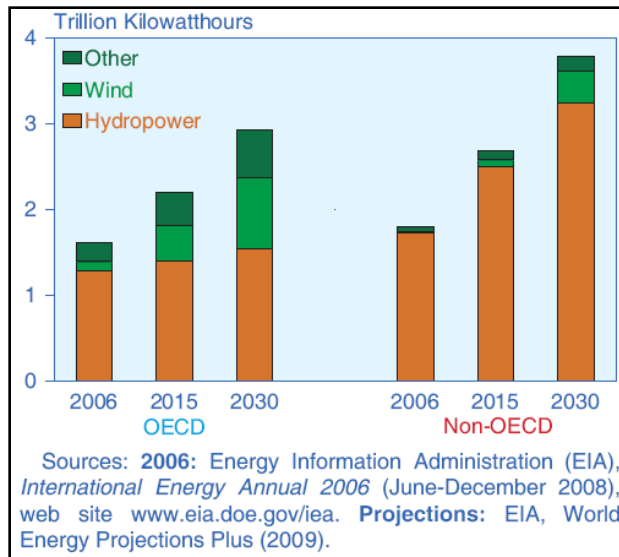

Figure 3.1: World Renewable Electricity Generation by Energy Source, 2006, 2015, and 2030 [Source: Ref 1]

Several other Renewable Sources, such as Geothermal, Tidal, Biomass, etc, have also coming up in recent years. These other sources may not be large contributors to electricity generation, as seen in Figure 3.2. Hydroelectricity is one the most successful Renewable Sources of electricity. It has low emissions and a good output is generated when compared with Fossil fuels and other Renewable Sources respectively.

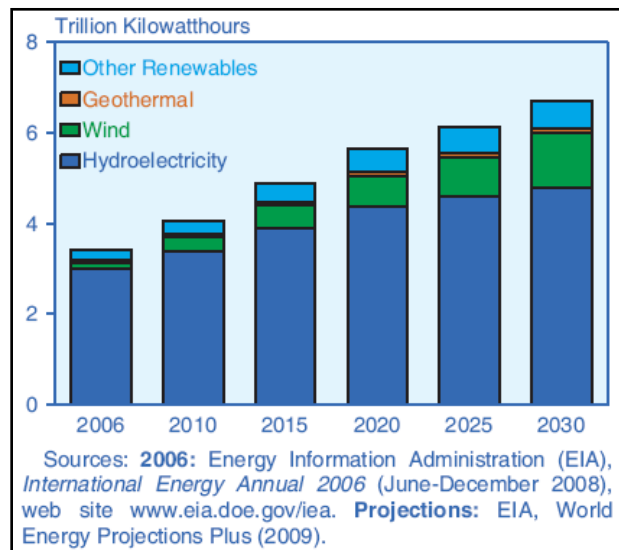

Figure 3.2: World Renewable Electricity Generation by Source, 2006-2030 [Source: Ref 1]

In the United State, use of Renewable Sources increases sharply as seen in Figure 3.3. It is evident from the figure that non hydroelectric renewable sources witness an increase of about 45% from the year 2003 to 2025.

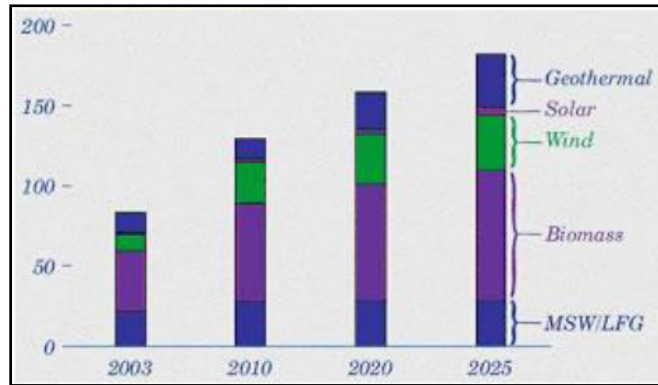

Figure 3.3: Non Hydroelectric Renewable Sources of Electricity generation in U.S, 2003-2025 [Source: Ref 10]

[in billion Kilowatthours]

This increase is the result of the recently introduced State and Federal incentives for using Renewable Sources to generate electricity. It is also expected that more of such incentives will be offered in future so as to further increase the usage of these Alternative Sources instead of the Conventional Sources of electricity generation. Also, many new technologies are being researched to make the use of these Alternative Sources more efficient and economical. Here, we discuss three of the most upcoming Alternative Sources of electricity generation – Solar, Wind and Landfill Gases.

3.2) Solar Energy

3.2.1) Introduction

Solar power is the most interesting source of electricity generation. Although solar power is less economical than other forms of energy, it is certainly more feasible.

Environmentally speaking, the problems relating to solar power are centered on manufacturing of mirrors, chemicals involved (like polysilicon, phosphorus, boron, aluminum, etc) with manufacturing of photovoltaic cells and the land impacts that these projects have [7]. The solar energy plants are also very unpredictable as they largely depend on the presence of sunlight and the amount of sunrays being received on a particular time and day.

3.2.2) Technologies Used in Solar Powered Electricity Generating Units

Solar Energy is by far the most feasible type of energy source present on Earth. If harnessed properly, it can supply enough electric power to meet the present and predicted demand of electricity. The basic kind of technology used to convert sunlight into electricity is by the use of Photovoltaic cells (PV cells). Smaller Solar plants can supply electricity to homes, small industries and remote locations, while bigger plants can be used as an added supply to the current electric grid system.

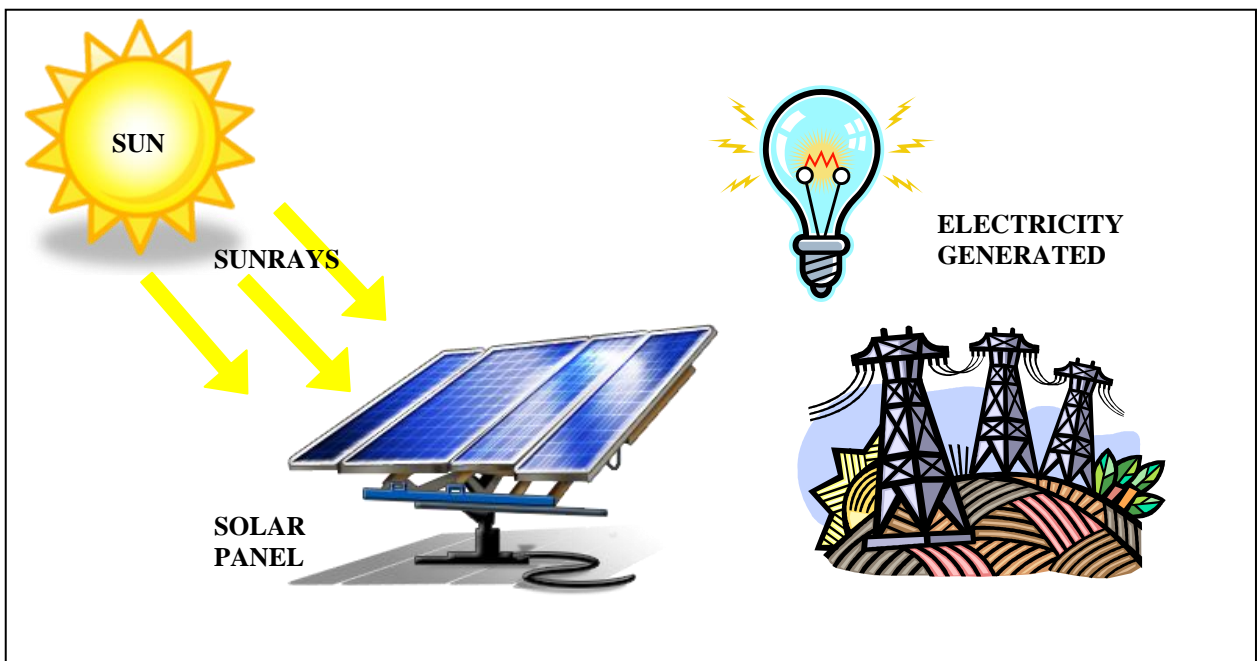

Figure 3.4: Working of a Photovoltaic cell

A Photovoltaic cell consists of a semiconducting material such as Silicon and Germanium. These materials have the ability to transmit electricity when in contact with a photon of light. These conduct electricity at atomic level as soon as a sufficient amount of photon energy strikes the material.

A basic Photovoltaic cell, also known as Solar cells is shown in Figure 3.4. When sunlight strikes the front contact of the Solar Cell, electrons in the atoms of the semiconducting material start conducting electricity due to motion of electrons. To conduct electricity we need to apply conductors to generate an electric field consisting of a positive and a negative side. This completes the circuit and hence, the solar cell can conduct electricity if an external load (like the electric bulb shown in Figure 3.4).

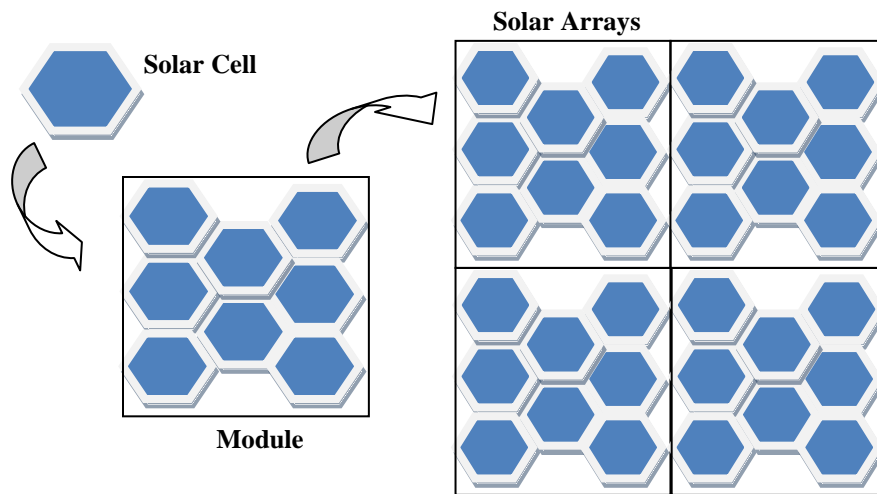

Figure 3.5: Combination of Solar cells to form Modules and Arrays to supply electricity for heavier loads

Source: NASA Science, 2002 [11]

A PV cell is not very powerful, and hence, is not sufficient for our purpose of electricity generation on a large scale. Hence, a series or parallel combination of such cells is used together to generate large amount of electricity as shown in Figure 3.5. Modules are formed to supply a certain amount of electricity. Several such modules are

connected to form an Array of solar cells to provide larger amounts of electricity for heavy loads.

The problem with using this type of Solar cells is that their efficiency is around 10 – 15% [Ref 12] only. Many new technologies are being researched to make them more efficient and economical.

The following are a few of the technologies being used all over the world to harness sunlight and generate electricity [Ref 7].

1. **Concentrating Solar Power:** Concentrating solar power (CSP) units utilize heat from sun to generate electricity. Hence, these are also known as Solar Thermal Plants. CSP unit consists of several mirrors arranged in such a way so as to obtain a large amount of sun's heat. These mirrors are further connected to a heat conducting fluid (such as oil or water) which get heated to very high temperatures (depends on the conducting material used). This heat conducting material is used to generate steam which in turn is used to rotate a steam turbine to generate electricity.

CSP units vary by the type of mirror system used such as:

- a. **Linear Concentrator:** these CSP units use long rectangular mirrors or U-shaped mirrors.
- b. **Dish/Engine:** These CSP units are supplied with mirrors that resemble huge satellite dish. This type of CSP unit is sometimes used to move pistons of mechanical generators or alternators to generate electricity.
- c. **Tower Systems:** Tower systems use large sun tracking mirrors known as heliostats that track and concentrate the sunlight to a receiver place on top of the tower.

A study conducted by Greenpeace International with International Energy association concluded that if CSP units continue to grow in potential at the current rate, they are capable of providing for 25% of the world's electricity demands by 2050. Figure 3.6 shows the three types of CSP units just described.

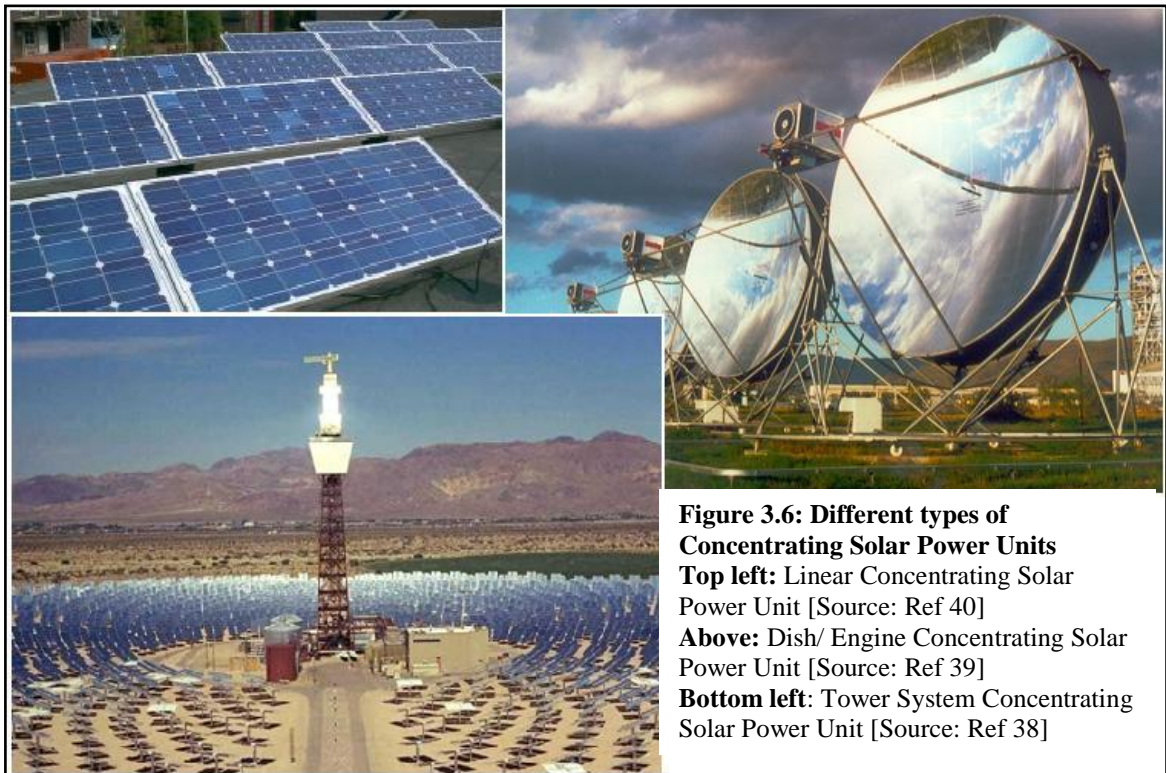

- 2. Passive Solar Technology:** This technology is mainly used to heat residential and industrial buildings during harsh winters. Materials that have the ability to absorb and retain sun's energy are used to make rooftops, walls, etc, depending upon the design of the building. They are incorporated in such a way that they receive a large amount of sunlight during the day, so they can slowly release it during the night also. Although this type of building design may be a blessing during winters, it can act as a problem during hot summer days. In the recent past, new designs have been

made that allow the Passive Solar Technology to keep the building cool in summer and hot in winters.

3. **Solar Photovoltaic Technology:** Solar Photovoltaic cells directly use sunlight to generate DC electricity. This technology has already been discussed in detail in previous section of this chapter. PV cells are costly because of the expensive semiconducting material used in them. But since a very little amount is required for every solar cell, they are actually beginning to become more cost effective. In recent years, many new materials are being used instead of the expensive Silicone, which is making a PV cell economically more feasible.

3.2.3) Feasibility – Economical and Technical

Solar Energy and all the Alternative Sources of electricity generation depend entirely on the availability of the source. Solar cells can only be put to use if they receive a large amount of sunlight. Hence, not all the regions in the world are capable of generating electricity that is large enough to be considered as an additional supply to the already existing power grid. Also, Solar energy cannot be harnessed during night when there is no sun.

It is also very difficult to incorporate Solar Powered electricity generating plants into the already existing electricity grid. Solar Power plants require large areas to generate useful amount of electricity and such areas are not generally available in or around a city or town. Also, if an individual wants to incorporate a Solar panel for his residence or commercial use, electricity generation might get affected due to the presence of surrounding buildings or landscapes. The location of Solar Panels is very crucial to the

performance of the system because it requires a large amount of electricity. Also, pollution in the surrounding air can further decrease the efficiency of a PV cell. Economically speaking, due to the low efficiency of a PV cell, a large number of cells have to be used in order to generate an amount of electricity that can be used. The semiconducting material used to manufacture these PV cells is very expensive and hence, the initial investment required for setting up a solar system is very high. As the price of Solar panels is seen to be decreasing in recent years, it is possible that this initial investment may decrease by a huge amount.

Environmentally, Solar electricity generation plants are silent and clean. When compared to any Fossil fuel powered power plant, these can be a great help in avoiding any kind of Greenhouse gas emissions involved in Conventional Power plants. Also, Solar Power Plants are silent as they do not have any such noise generating parts involved. However, if we have a look at the life cycle of such a plant, there are environmental problems related to manufacturing of the PV cells. On the other hand, if we look at the overall environmental problems faced in the life cycle of a Solar Power plant and that of a fossil fuel powered power plant, it is very evident, that a Solar Power plant is still much safer option than the other.

Although there are a few disadvantages of using Solar energy as a source of electricity generation, there are more advantages to using this Alternative Source of electricity generation.

3.3) Wind Energy

3.3.1) Introduction

Wind is considered to be the one source that has the potential to provide the whole United States with electricity [6]. Despite the various subsidies and tax credits provided by the government, electricity generation from wind still is a very costly process. Also, the wind electricity generation plants cause a lot of noise pollution, requires a lot of land and material to set up the plant. Also, it is a hazard for birds. Peak electricity demand may not be met if the wind is not at its peak. It is a highly unpredictable source of energy. The prices for buying the wind turbines and installing the complete project are rising constantly since the past few years [8]. In 2008 Department of Energy, United States submitted a report [13] in which they claimed that by the year 2030, 20% of the demand of electricity in the U.S will be met by Wind Energy alone.

3.3.2) Technologies Used in Wind Powered Electricity Generating Units

Most of the technologies associated with a Wind farm, are either used in stand alone, or in combination with another power plant (Solar plant or a Conventional power plant or both). The present technology enables the wind energy to generate some electricity, but more research is being done to enable more efficient wind farms so as to generate a large amount of electricity. The major areas where research is being done are capital cost, capacity of the wind farm and enhanced system reliability.

The current wind farms around the world, consists of three bladed rotors with diameter of 70 to 80 m [Ref 13] mounted on a tower (60 – 80m). A single wind turbine is not sufficient for electricity generation. Hence, a typical wind farm consists of 30 – 150

such turbines. The average electricity generated by a Wind turbine in U.S is about 1.6MW, but it is dependent on the speed of the motion of blades around the rotor. The minimum speed of wind that can generate electricity is 5.36m/s [13]. Similarly, the maximum output is achieved at the speed of 12.52m/s – 13.41m/s.

We also know that wind speeds increase with increase in altitude. Hence, the currently designed Wind Farms have been known to have increased the height of the tower and length of the blades while bearing a minimum increase in cost of material involved.

Due to varying wind conditions around the globe, there are different types of Wind Farms depending on the way the Wind energy needs to be harnessed. The various types of Wind Farms are as briefly discussed below.

1. **Large Wind Technologies:** This technology works towards attaining a higher capacity factor for a turbine with little or no increase in cost. The main component that was changed was the blade of the turbine. It is known as the Sweep Twist Adaptive Rotor (STAR) blade, which is slightly curved at the tip. This kind of blade is designed so that it can take maximum advantage of all varieties of wind speed (including slower speeds also). There are several other small modifications done in conjunction with the blade. The result is an increase of 7% in the capacity of the turbine. In 1990, the capacity of an average wind turbine used to be 22%. While it went up to 35% in during 2005 – 2007. Also, the cost of wind energy has seen a decrease from 80 cents per kWh in 1980s to 8 cents per kWh today.
2. **Offshore Wind Technologies:** Offshore Wind Farms have the ability to generate very huge amounts of electricity to meet a huge share of the present and future demand. These farms can be much bigger and rugged than those on land because

the winds are generally much stronger offshore than on land. Also, transportation is not an obstacle for such plants.

- 3. Distributed (Small) Wind Technologies:** These consist of Wind Farms for small or mid size generation of electricity (less than 1MW).

A typical wind turbine is shown in Figure 3.7



Figure 3.7: Different Types of Wind turbines.

Top left: Large Wind Turbines; **Right:** Offshore Wind Turbines [Source: Ref 41]; **Bottom left:** Small Wind Turbines [Source: Ref 42]

3.3.3) Feasibility – Economical and Technical

Unlike sun, wind does not flow constantly for a particular time period. Hence, Wind as an Alternative Source is highly unreliable.

Environmentally speaking, although Wind Farms are a clean source of electricity generation, they are not very silent. The wind farms generate a lot of noise due to motion of several blades together. This causes inconvenience to any localities living

close to such farms. Also, offshore Wind Farms cause much more noise being bigger in size. This noise causes acoustic impact on marine life both on the shore and inside water. On land, Wind Farms can become a threat to wildlife and plants. The blades of these turbines are a life threat to bats and other birds.

Economically, the initial capital cost of manufacturing a wind turbine is very high. Technology wise, a lot of effort is being put into making Wind Farms the future of electricity supply. Much research has helped attain higher efficiency at the same or lesser capital cost. Also, electricity being generated is being sold at a lesser value than before. Hence, many utility generators are willing to buy this electricity.

A Wind powered electricity generation may be noisy but has no emissions as those in Fossil Fuel powered plants. A single 1.5MW wind turbine has the ability to displace 2,600 metric tons of CO₂ per year. Hence, using wind as an Alternative Source may have high capital cost, but helps avoiding any new GHG emissions from a Conventional power plant.

3.4) Landfill Gas Energy

3.4.1) Introduction

In the United States alone, the Municipal Solid Waste (MSW) landfills accumulate about 135 million tons of solid waste in 2008 [Ref 14]. Municipal Solid Waste (MSW) consists of things we use in our daily life, such as, food scrapings, garden waste, old furniture, etc. These do not contain hazardous, industrial or construction waste. Such landfills emit gases like methane (CH₄), carbon dioxide (CO₂), hydrogen sulfide (H₂S), and some non-methane volatile organic compounds (VOCs) such as benzene, toluene,

xylene etc., due to decomposition of organic materials present in them. All these gases are collectively known as Landfill Gases (LFG) which mainly consists of Methane and Carbon Dioxide. Due to presence of approximately 50% of Methane, LFG has half the potential of Natural Gas.

Generation of electricity from Landfill gas (LFG) is another upcoming and a popular Alternative Source of electricity generation. The electricity generation basically depends on the amount of LFG generated from the landfill in a unit time. Hence, the power plant greatly depends on the size and age of the landfill. This is due to the fact that emission of LFG varies with age and environmental conditions of a landfill. Also, larger landfills will have more LFG emission due to more waste being decomposed. Landfills are usually sited away from the main city, so, we need to find a good end user for the usage of electricity generated. It is one of the most stable, continuous and reliable source with limited emissions and has a variety of viable technologies. Relatively high capital, operating and maintenance costs make it difficult to harness.

3.4.2) Technologies Used in LFG Powered Electricity Generating Units

Landfill gas can be burned directly to generate electricity or it can be processed into a higher-energy gas for power generation. It can also be burned as a heat source for various industrial processes. Landfill gas can be used in three different ways [Ref 15]. It can either be used directly, replacing a pre-existing fuel (like coal, natural gas, etc) in boilers, dryers, and many other components of a plant for powering or heating. Secondly, LFG can be used in co-generation to generate both power and heat for

industries or residential buildings. Lastly, LFG is known to have been supplied to the natural gas pipeline system as high and/or medium – Btu fuel.

The diversity of project types related to electricity generation is discussed below.

1. Internal Combustion Engine (Range: 800kW to 3 MW)

Internal Combustion (IC) Engines are the most widely used technology for electricity generation from LFG. Presently, 70% of the existing LFG to electricity conversion plants use IC Engines due to their lower costs and higher efficiency (25%-35%) [Ref 16]. These engines also form a good match with the LFG required as an input in the conversion process and the output from the collection system installed in the landfills. These engines have the capacity to generate 800kW to 3MW of electricity. In other words, IC Engines can be used for landfills generating 0.4 to 1.6 million cubic feet of LFG (50% methane) is produced per day [Ref 16]. If a project is larger than 3MW, it can still use IC Engines in combination with each other.

Engine Size	Gas Flow (in cfm at 50% Methane)
540 kW	204
633 kW	234
800 kW	350
1.2 MW	500

Cfm: Cubic Feet per minute

Table 3.1 is a compilation of the available sizes of IC Engines that are most widely used currently.

2. Gas Turbine (Range: 800kW to 10.5MW)

Gas Turbines are generally used for larger electricity generation plants that generate more than 5MW of electricity [Ref 16]. The major reason for Gas

Turbines not being used for smaller projects is that they are not as economic for smaller projects (generating less than 3MW). As the generating capacity increases, the cost of generating per kW decreases and the efficiency of the turbine increases.

3. Microturbine (Range: 30kW to 250kW)

Microturbines are used for projects even smaller than IC Engines. Although they prove to be more expensive than IC Engines, they are preferred for electricity generation for small landfills, where LFG flow is less than 300cfm, which is the minimum flow required for installment of an IC Engine. Another reason that Microturbines are being used instead of IC Engines is that they can even generate electricity with same efficiency as IC Engines for LFG containing methane as low as 35% [Ref 16]. They are much easy to install, thus, more units can be added whenever more gas starts to flow from the landfill to the generation unit.

Microturbines come in sizes of 30kW, 70kW and 250kW and can be used in different combinations.

3.4.3) Feasibility – Economical and Technical

According to EPA, a landfill containing 1million ton of MSW can generate electricity with an initial cost of \$600,000 to \$750,000 and can face operating costs of \$40,000 to \$50,000 a year [Ref 17]. Capital costs vary from project to project depending on process used to clean methane and convert it to usable energy. These may vary from \$600 per kW to \$6,000 per kW.

From the above statement, incorporating a LFG to electricity generation plant looks like an expensive deal. However, there are several incentives and tax credits for landfill

owner, contractors working on projects generating such electricity, and the end users who buy electricity generated from a LFG plant. End user may be a utility provider or a Community partner. All these incentives from local, state and federal government allow LFG projects to be a not so expensive project. Once, such a project starts, all the initial investment is generally returned in 4-5years [Ref 18].

The technologies to generate electricity that are currently being used are very similar to those used in the Conventional Power plants. Thus, it is not difficult to research into these technologies to modify them so as to use them with LFG as a source to generate electricity.

MSW landfills are the second largest man made source of methane emissions in the United States releasing an estimated 30 million metric ton of carbon equivalent in 2008 alone [Ref 15]. If these projects are not initiated, the LFG gas would either be released into the atmosphere, or, they will be flared. As discussed previously, LFG consists of 50% Methane and 50% Carbon Dioxide and traces of other Volatile organic Compounds. Methane and carbon dioxide, both are among the harmful GHGs that cause Global warming. Methane is 21 times more potent than Carbon Dioxide and has an atmospheric life span of 10 years. According to EPA one LFG to electricity project has the ability to use up to 60 to 90% of methane from the landfill.

An LFG project generating 3MW of electricity is environmentally equivalent to [Ref 19]

- removing 25,000 cars from the road;
- planting 35,000 acres of trees; or
- preventing the use of 304,000 barrels of oil

Chapter 4 – Mathematical Models for Solar and Wind Energy

4.1) Mathematics for Solar Energy

4.1.1) Introduction

The sun is one of the free, silent and clean sources of energy. Its energy can either be used indirectly to heat water or other fluids used for various domestic, industrial or commercial uses. The solar energy can directly be used to generate electricity using photovoltaic panels or modules made up of solar cells as discussed in previous sections. A solar cell can be considered as a battery of low voltage [Ref 34] generating around 0.6V and being recharged at the same time. Modules consist of several solar cells arranged in series or parallel combination. Various arrangements allow a variety of current and voltage outputs depending on the design of the system. The design of the system can vary the output electricity generated from a few watts to megawatts depending on the arrangement of the solar cells in the module.

4.1.2) Generation of Electricity by Photovoltaic Effect

In order to understand how electricity is generated by photovoltaic effect, we consider the circuit shown in Figure 4.1.

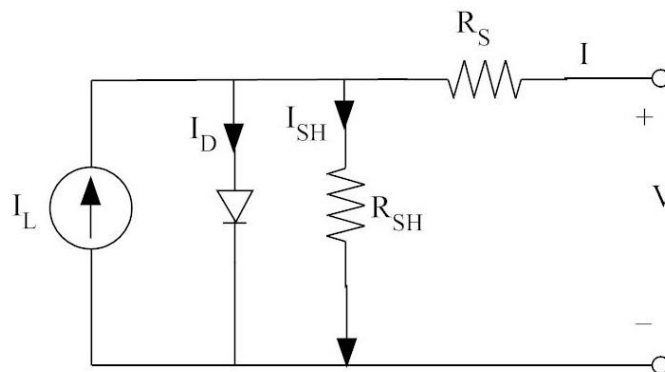

Figure 4.1: Equivalent Electrical Circuit of a single PV cell [Source: Ref 34]

Figure 4.1 shows an equivalent circuit that can be used to represent a single solar cell. From the figure, equation 4-1 can be derived to calculate output current,

$$I = I_L - I_D - I_{SH} \quad (4-1)$$

Where,

I_L is the Photon Current;

I_D is the temperature dependent diode current; the diode used is Shockley diode

I_{SH} is the PV cell leakage current;

The photon current I_L is dependent on illumination intensity and also on the wavelength of the light falling on the PV cell. Let standard illumination intensity be $L_s = 1.0$ Sun at which the prescribed value of Photon current is I_{LS} . Then, for all other intensities of illumination (L), the photon current can be represented as

$$I_L = \frac{L}{L_S} I_{LS} \quad (4-2)$$

Also, the Shockley diode current is known to be

$$I_D = I_S \left(e^{qV_d/\eta kT} - 1 \right) \quad (4-3)$$

Where,

I_S is the Reverse Saturated current of the diode (100pA for a silicon cell);

k is the Boltzman constant ($=1.38 \times 10^{-23}$ J/K);

q is the electron charge ($=1.602 \times 10^{-19} \text{C}$);

V_d is the diode voltage in Volts;

η is the Empirical Constant;

T is the absolute temperature given as a function of temp ($^{\circ}\text{C}$), t_c , generally $T=298\text{K}$ for 25°C ;

$q/kT = 38.945\text{C/J}$ for $t_c = 25^{\circ}\text{C}$;

Also, for any temperature $T^{\circ}\text{C}$, $q/K = 1160.47\text{C}$;

The internal losses or the leakage current across Shockley diode are represented by the shunt/parallel resistance R_{SH} . These leakages or losses lie between 200 to 300 Ω . The series resistance, R_S , between the photon current source and the load lies between 0.05 to 0.10 Ω depending on the manufacturing quality of the PV cell.

Hence, substituting equation (4-3) into equation (4-1) we get

$$I = I_L - I_S \left(e^{qV_d/kT} - 1 \right) - \frac{V_d}{R_{SH}} \quad (4-4)$$

The diode voltage being a function of load resistance (R_L) and output power can be written as

$$V_d = I(R_S + R_L) \quad (4-5)$$

Hence, we can re-write equation (4-4) using (4-5) as

$$I = \frac{R_{SH}}{R_{SH} + R_S + R_L} \left[I_L - I_S \left(e^{qV_d/kT} - 1 \right) \right] \quad (4-6)$$

It is important to use an Empirical factor, η , in the exponential term in the equation (4-4) and (4-6) so as to adjust the various variable according to manufacturer's specifications. Hence, (4-5) can be modified as

$$I = \frac{R_{SH}}{R_{SH}+R_S+R_L} [I_L - I_S(e^{qV_a/\eta kT} - 1)] \quad (4-7)$$

The output power (P) is the product of output voltage and current. Therefore, output power can be written as

$$P = V I$$

Or,
$$P = \frac{V R_{SH}}{R_{SH}+R_S+R_L} [I_L - I_S(e^{qV(1+R_S/R_L)/\eta kT} - 1)] \quad (4-8)$$

Figure 4.2 shows output characteristics of solar cell for a typical control design of a system connected to PV arrays. The figure depicts output power Vs the cell voltage and the output current Vs cell voltage at various illumination intensities [Ref 35].

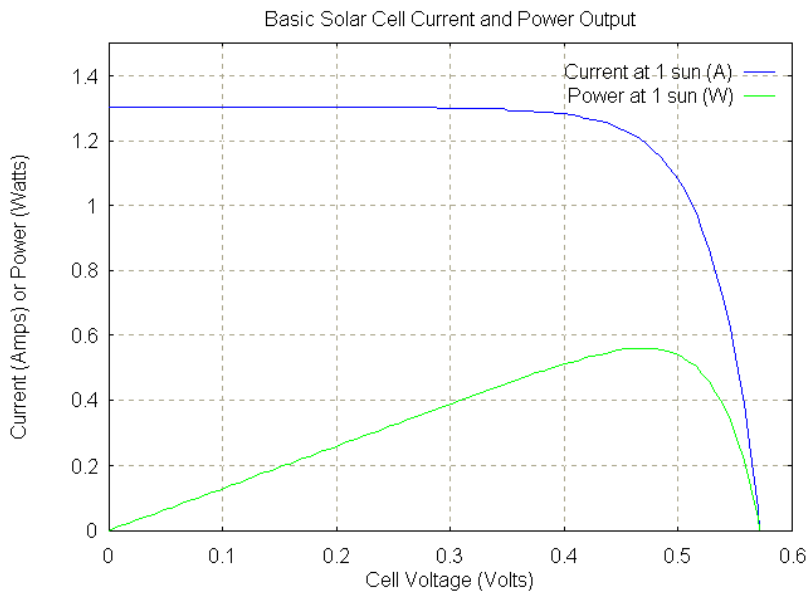

Figure 4.2: Output Power and Current Vs. Cell Voltage at various solar intensities [Source: Ref 35]

4.1.3) Model of a PV Panel Consisting of n Cells in Series

When several PV cells are combined in series arrangement, it is assumed that the cells have identical structure and output characteristics. This helps in avoiding circulation of various internal currents among the cells with different characteristics. Figure 4.3 shows one of such series arrangements, where 2 of similar PV cells are arranged in series.

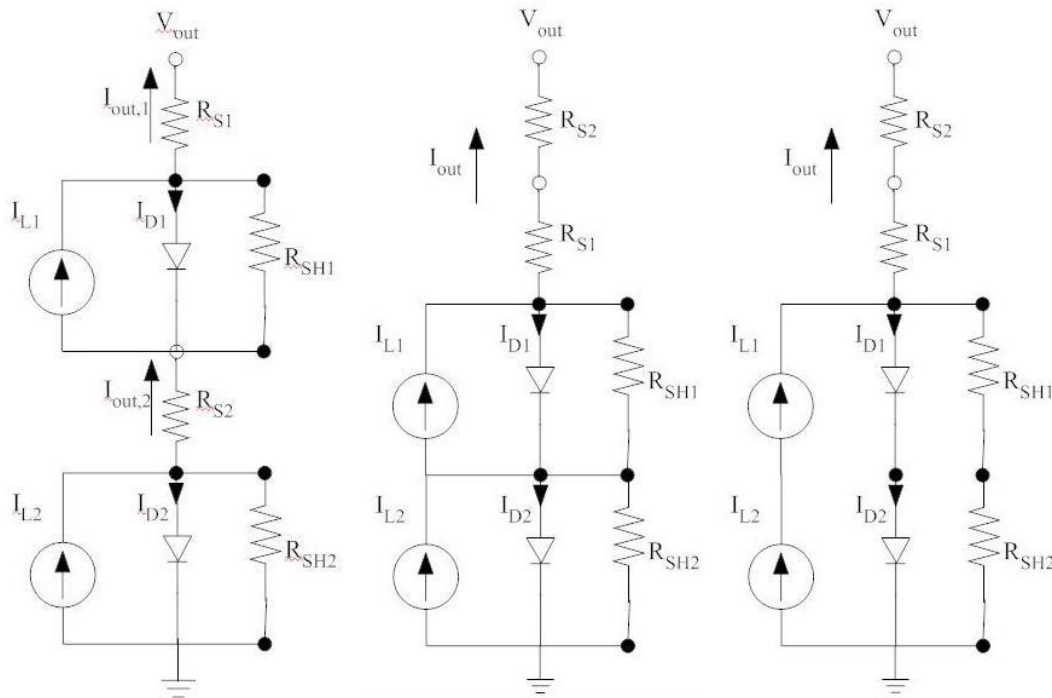

Figure 4.3: Series Arrangement of 2 similar Photovoltaic cells in a Panel [Source: Ref 34]

Due to similarity in characteristics of the various PV cells, the following can be assumed.

$$I_{L1} = I_{L2} = \dots = I_{Ln} \quad (4-9a)$$

$$I_{d1} = I_{d2} = \dots = I_{dn} \quad (4-9b)$$

$$V_{d1} = V_{d2} = \dots = V_{dn} \quad (4-9c)$$

$$R_{S1} = R_{S2} = \dots = R_{Sn} \quad (4-9d)$$

$$R_{SH1} = R_{SH2} = \dots = R_{SHn} \quad (4-9e)$$

Hence, the output Voltage (add up in series combination) and current (remains same as of individuals) of the complete set up shown in Figure 4.3 can be written as

$$V_{out} = 2 V_{out,i} \quad \text{and} \quad I_{out} = I_{out,i} \quad (4-9f)$$

Where,

$V_{out,i}$ and $I_{out,i}$ are average voltage and current in an individual cell 'i'.

If we were to extend this arrangement of series combination up to 'n' PV cells in series, the output Voltage and current can be written as

$$V_{out} = n V_{out,i} \quad \text{and} \quad I_{out} = I_{out,i} \quad (4-10)$$

For maximum power generated, the efficiency of a solar panel (which consists of a combination of PV cells) can be depicted as

$$\eta = \frac{P_{electrical}}{P_{illumination}} \times 100\%$$

Also, the power output of such an arrangement would be the product of output voltage and current.

$$P_{out} = V_{out} I_{out}$$

$$P_{out} = n V_{out,i} I_{out,i} \quad (4-11)$$

4.1.4) Model of a PV Panel Consisting of n Cells in Parallel

Figure 4.4 shows two PV cells combined in parallel across two common terminals ‘a’ and ‘b’ as shown. When connected in parallel, there is no direct interaction between any of the cells with each other. For our convenience, we assume that the cells used for the connection have similar characteristics in terms of diode voltage, leakages and current source.

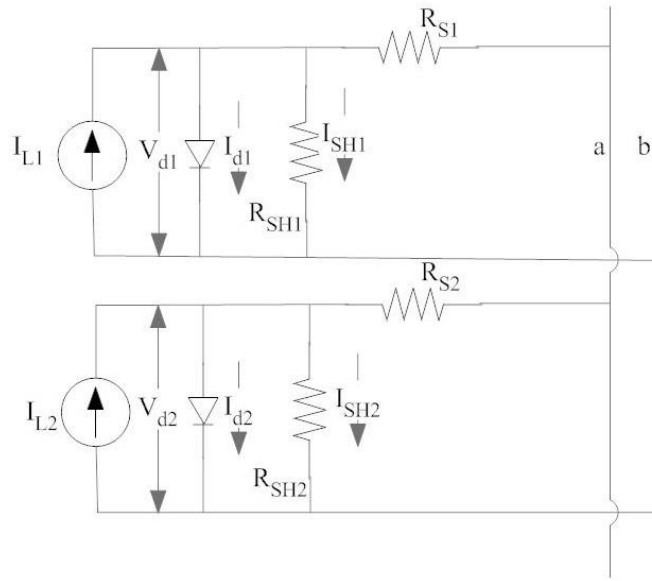

Figure 4.4: Series Arrangement of 2 similar Photovoltaic cells in a Panel [Source: Ref 34]

Hence, the output Voltage and current of the set up shown in Figure 4.4 can be written as

$$V_{out} = V_{out,i} \quad \text{and} \quad I_{out} = 2 I_{out,i}$$

Where,

$V_{out,i}$ and $I_{out,i}$ are average voltage (remain constant as that of individual cells) and current (currents of all individual cells add up to give the total current) in an individual cell ‘i’.

In a similar manner, we can deduce that if we use ‘n’ cells in parallel, the output Voltage and current can be written as

$$V_{out} = V_{out,i} \quad \text{and} \quad I_{out} = n I_{out,i} \quad (4-12)$$

Also, the power output of the parallel arrangement would be the product of output voltage and current.

$$P_{out} = V_{out} I_{out}$$

$$P_{out} = n V_{out,i} I_{out,i} \quad (4-13)$$

Comparing (4-11) and (4-13), we see that no matter what combination of cells is used (series or parallel), the total output power remains the same provided the cell characteristics remain the same.

4.2) Mathematics for Wind Energy

4.2.1) Introduction

The movement of air mass is the source of mechanical energy that drives wind turbines and hence generates electricity. The electricity generation depends on the speed of wind, hence, it is very important to study and observe an appropriate location where there are strong and steady winds.

4.2.2) Evaluation of Wind Intensity

The energy generated by a wind turbine is related directly to the cube of wind speed. To estimate the mechanical power, P , from a wind turbine, we use Bernoulli’s equation,

$$\frac{v^2}{2g} + h + \frac{p}{\rho g} = \frac{P}{\rho g Q} \quad (4-14)$$

Where,

v = flow speed (m/s)

g = gravity constant (= 9.81m/s²)

h = height (of tower here) (m)

p = pressure of air (N/m²)

P = Mechanical Power (kg.m/s)

Q = Flow rate (m³/s)

ρ = density of air (kg/ m³)

Here, the Bernoulli's equation is used with respect to flow derivative of its Kinetic energy, K_e

$$P = \frac{dK_e}{dt} = \frac{1}{2} v^2 \frac{dm}{dt} \quad (4-15)$$

$\frac{dm}{dt}$ = mass flow rate of air moving per second

v = Velocity of air

A = Circular area swept by rotor blades

We know that for any fluid (liquid or gaseous), the average flow rate can be written as

$$\bar{Q} = A\bar{v}$$

Thus,

$$\frac{dm}{dt} = \rho \frac{dv}{dt} = \rho A\bar{v} \quad (4-16)$$

ρ = Density of air = 1.2929 kg/m³ at 0°C at sea level

Let us assume two different velocities of air, v_1 and v_2 , just before reaching the turbine and just after air leaves the turbine respectively.

Hence, the average speed of air passing through an area A, becomes

$$v_{avg} = \frac{v_1 + v_2}{2}$$

Using this v_{avg} , we can re-write equation (4-16) as

$$\frac{dm}{dt} = \rho \frac{A(v_1+v_2)}{2} \quad (4-17)$$

Due to the difference in velocities, there is also a difference in Kinetic Energy just reaching and leaving the turbine. (Kinetic Energy for air = 9.8W = 9.8 kg.m/s)

Thus, the Mechanical Energy associated with this net difference in KE can be estimated from equation (4-15) and written as

$$P_m = \frac{dK_e}{dt} = \frac{1}{2} (v_1^2 - v_2^2) \frac{dm}{dt} \text{ W/m}^2 \quad (4-18)$$

Combining (4-17) and (4-18), we get the total power

$$P_m = \frac{1}{4} \rho A (v_1^2 - v_2^2) (v_1 + v_2)$$

$$P_m = \frac{1}{4} \rho A v_1^3 \left(1 - \frac{v_2^2}{v_1^2}\right) \left(1 + \frac{v_2}{v_1}\right)$$

$$P_m = \frac{1}{2} \rho C_p A v_1^3 \quad (4-19)$$

Where, C_p is the Power coefficient or rotor efficiency = $\frac{1}{2} \left(1 - \frac{v_2^2}{v_1^2}\right) \left(1 + \frac{v_2}{v_1}\right)$

The maximum value the C_p can attain is for $\frac{v_2}{v_1} = \frac{1}{3}$

This is the maximum value for C_p above which the turbine would no longer work as soon as the air passes through the blades. This limit is known as Betz Limit [Ref 35]. Betz limit is achieved only when the turbine blades are working at 100% efficiency. In practice, the collection efficiency is not even 50% (is barely between 35-45%).

4.2.3) Wind Power and Torque

As discussed in previous section, only a part of the full wind energy available can be used for electricity generation. This small part is quantified by the power coefficient, C_p . This power coefficient is the relation of the generation of power possible to the total amount of power contained in the wind.

Equation (4-19) shows turbine mechanical power is directly dependent to distribution of wind speed. The air density ρ in equation (4-19) can be corrected using the well known gas law ($\rho = P/RT$). For every pressure and temperature, the following equation can be represented

$$\rho = 1.2929 \frac{273}{T} \frac{P}{760} \quad (4-20)$$

Where,

P is the Atmospheric Pressure (mm hg);

R is the Reynold's constant,

T is the Kelvin absolute temperature (K);

Under normal conditions, P = 760mm Hg and T = 296K = 25°C, the value of $\rho = 1.192 \text{ kg/m}^3$

Also, P = 760mm Hg and T = 288K = 15°C, the value of $\rho = 1.225 \text{ kg/m}^3$

Assuming the temperature decrease of approximately 1°C for every 150m, the air density for any altitude (h, in meters; 10,000ft = 3048m) can be calculated using series expansion method. Using the first two terms as calculated previously, the series sum can be calculated as below

$$\rho = \rho_0 e^{-[0.297/3048 h]} \approx 1.225 - 1.194 \times 10^{-4} h \quad (4-21)$$

Also, from the equation (4-15), the Turbine Torque (T_t) can be written as

$$T_t = \frac{P_t}{\omega} = \frac{1}{2} \rho A R V^2 C_T$$

Where, $C_T = C_p \lambda$ is the Torque Coefficient.

Wind Potential is the wind power per swept area = P/A (W/m^2). Ignoring the Aerodynamic losses in the rotor, the wind speed variations at several locations in blade sweeping area, the rotor type, etc, the maximum wind potential can be obtained using equation (4-19).

$$\frac{P}{A} = \frac{1}{2} \rho V^3 C_P = \frac{1}{2} (0.5926)(1.2929)V^3 = 0.3831V^3 \quad (4-22)$$

Instead of ignoring the above mentioned variables, which cause a very small losses, equation (4-22) can be re-written as

$$\frac{P}{A} = 0.25V^3$$

This gives us the true Wind Potential of a particular region taking into account all kinds of aerodynamic losses due to the presence of manmade and natural barriers.

Chapter 5 – Mathematical Models to Quantify Emissions from Landfills

5.1) EPA's LandGEM

The National Risk Management Research Laboratory (NRMRL) at the United States Environmental Protection Agency (U.S. EPA) developed LandGEM [Ref 23] (Landfill Gas Emissions Model), a software application which is based on Microsoft Excel to estimate the emission of gaseous pollutants (landfill gases) from Municipal Solid Waste (MSW) Landfills. LandGEM is based on a first-order decomposition rate equation for quantifying emissions from the decomposition of biodegradable waste. LandGEM is used to estimate uncontrolled emission rates for total landfill gas, methane, carbon dioxide, non-methane organic compounds, and individual air pollutants from landfills.

The model contains two sets of default parameters,

- i.) **CAA Defaults (Clean Air Act):** The CAA defaults are based on requirements for MSW landfills laid out by CAA, including New Source Performance Standards (NSPS) or federal Emission Guidelines (EG) and National Emission Standards for Hazardous Air Pollutants (NESHAP). This set of default parameters yields conservative emissions estimates and can be used for determining whether a landfill is subject to the control requirements of the NSPS/EG or NESHAP.
- ii.) **Inventory Defaults:** The inventory defaults are based on emission factors in EPA's Compilation of Air Pollutant Emission Factors (AP-42) and can be used to generate emission estimates for use in emission inventories and air permits in the absence of

site-specific test data [Ref 23]. This is the most widely used landfill gas emission model in USA and other parts of the world.

LandGEM along with other biogas production models, involve many assumptions and mathematical limitations. A few problems with biogas production models are that they are only theoretical, a good record of waste deposits is needed, and the models can not estimate the percentage of landfill gas captured versus that gas that is lost when emitted to the atmosphere.

LandGEM is mostly considered as a screening tool to estimate the probable amount of emissions of landfill gases from a landfill. It largely depends on the data that is available to us about the landfill. More the input data more accurate is the model prediction. Changes that occur in the working of the landfill or the changes in the operating conditions of the landfill cause a large change in the amount of emissions from the landfill over time. These changes cannot be predicted by such a model. Hence, it does not give precise results over a large interval of time.

5.2) Inverse Gaussian Method

The new mathematical model for landfill gas quantification is fundamentally similar to method developed by the University of Central Florida using an inverse dispersion calculation algorithm [Ref 24]. Gaussian dispersion model is based on the fact that pollutants being emitted from a single source point disperse vertically and horizontally along the wind direction following normal distribution. This is widely used as a basis of air dispersion models like AERMOD of USEPA, AUSPLUME of Australian EPA. The basic equation of Gaussian dispersion model and a graphical presentation of dispersion for a point source are given below.

$$C = \frac{Q}{2\pi u \sigma_y \sigma_z} \left(-\frac{y^2}{2\sigma_y^2} \right) \left\{ \exp \left(-\frac{(z-He)^2}{2\sigma_z^2} \right) + \exp \left(-\frac{(z+He)^2}{2\sigma_z^2} \right) \right\} \quad (5-1)$$

Where,

C= steady-state concentration at a receptor point (located at x, y, z), $\mu\text{g}/\text{m}^3$

Q= emission rate, $\mu\text{g}/\text{s}$

σ_y, σ_z = horizontal and vertical dispersion coefficients (in m) which are function of distance x and atmospheric stability

u= average wind speed at the physical stack height, m/s

y= horizontal distance from plume centerline, m

z= vertical distance from ground level, m

H_e = effective stack height [physical stack height (H_s) + plume rise (Δh)], m

H_s = actual height of the stack itself (physical stack height), m

Δh = rise of the plume above tip of the stack, m

Since the sources (the crack and opening) in a landfill are very close the ground level, ' H_e ' is assumed as zero and as measurement of pollutants like Carbon Dioxide and methane are taken near to the ground surface, 'z' is also zero; so the Equation (5-1) is converts into Equation (5-2).

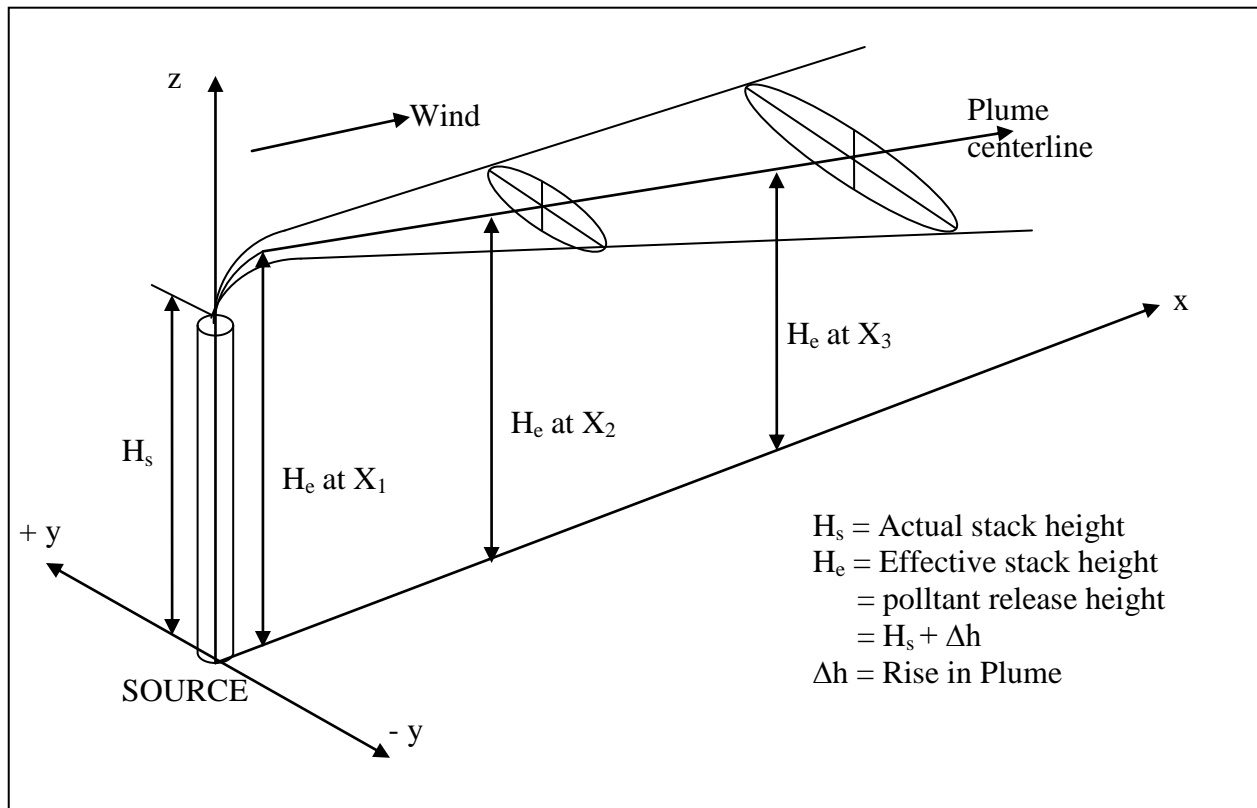

Figure 5.1: Gaussian Dispersion Model [Source: Ref 24]

The Inverse Gaussian Dispersion methodology involves measuring near-surface concentrations of pollutants at a number of locations [known latitude and longitude], known as receptors [say “n” receptors]. This data in combination with selective number of sources [less than number of receptors] and site-specific meteorological data are used to calculate emissions at each of the identified source by using the inverse of Gaussian dispersion equation (equations 5-2 through 5-5). Sum of emissions from all sources gives the total emissions from the landfill [Ref 24].

$$C = \frac{Q}{\pi u \sigma_y \sigma_z} e^{\left[-\frac{1y^2}{2\sigma_y^2}\right]} \quad (5-2)$$

$$C_{i,j} = f(x,y)_{i,j} \times Q_j \quad (5-3)$$

$C_{i,j}$ represents the modeled concentration at receptor i due to source j in ($\mu\text{g}/\text{m}^3$)

Q_j is the source j emission rate in ($\mu\text{g}/\text{sec}$)

$f(x,y)_{i,j}$ is the rest of equation (5-1) = F

$$\sigma_y = ax^b \quad (5-4)$$

$$\sigma_z = cx^d + f \quad (5-5)$$

The parameters a , b , c , d , and f are constants that are functions of downwind distance, x (in km), and atmospheric stability. Assuming the total modeled concentration ($\mu\text{g}/\text{m}^3$), $C_{i,modeled}$, at each receptor is the sum of all the modeled concentrations at receptor i from each of the n sources as shown in equation (5-6).

$$C_{i,modeled} = \sum_{j=1}^n C_{i,j} \quad (5-6)$$

To estimate accurate methane emission rate, Q_j , within a landfill involves a big set of trial and error to find the optimal set of Q_j to minimize R^2 error. A more efficient method for determining the optimal set involves using equivalent matrix notation shown in equation (5-7). Equation (5-8), represented in matrix notation, shows how to minimize the 2-norm of the residual; where F is the m by n matrix of (real) values of the function $f(x,y)_{i,j}$, Q is a vector of n - sources and $C_{measured}$ is a vector of m ($m \geq n$) - measured receptor concentrations.

$$\text{Minimize: } R^2 = \sum_{i=1}^m (C_{i,measured} - C_{i,modeled})^2 \quad (5-7)$$

$$\frac{Min}{0 \leq Q_j} \|F \cdot Q - C_{measured}\|_2^2 \quad (5-8)$$

Equation (5-8) can be solved using linear least-squares regression theory when subject to the following constraints:

- 1) The number of sources(n) must be less than or equal to the number of receptors(m),
- 2) Each Q_j must be greater than or equal to zero, and
- 3) If any downwind distance is negative F must be forced zero because the receptor is upwind from the source.

The vector Q that minimizes equation (5-8) is unique if and only if F has full rank. If F has full rank, Q can be determined using the normal equations as equation (5-9), where the pseudo-inverse F^+ is shown in equation (5-10).

$$Q = F^+ C_{measured} \quad (5-9)$$

$$F^+ = (F^T F)^{-1} F^T \quad (5-10)$$

However, this formulation does not guarantee that each Q_j is non-negative. Therefore, a more general approach, equation (5-10), is necessary that requires the solution of the non-negative constrained least squares problem; where 'I' is the identity matrix. The non-negative least squares (NNLS) problem can be solved numerically using a variety of available transformation, active-set, or iterative algorithms. While developing the code for this algorithm in MATLAB, the equation (5-11) has been used to get non-negative values of emission rate (q) at different sources.

$$Q = \|F \cdot Q - C_{measured} | I \cdot q \geq 0\|_2 \quad (5-11)$$

5.3) Comparison of the Two Methods

LandGEM is a predictive model developed based on the theoretical understanding of the waste deposited in the landfill, waste decomposition rate (which further depends on moisture content, temperature, rainfall etc.) and other influencing parameters. The inverse-dispersion method helps in quantifying methane emissions from an existing landfill for the current conditions. If a landfill has a LFG collection system the methane emissions measured by inverse-dispersion methodology will only compute methane emissions that are released into the environment. In order to compute total methane emissions, one has to combine (a) the methane collected by the LFG collection system and (b) the methane emissions computed by the inverse-dispersion methodology. While the actual methane collected by the LFG collection system is available for power generation, inverse-dispersion methodology helps the landfill owner in understanding the amount of methane escaping the LFG collection system. While a direct comparison of LandGEM and inverse-dispersion methodologies may not be feasible and outside the scope of this work, inverse-dispersion method could be useful in calibrating the LandGEM model through further research.

Chapter 6 – Electricity Generation from Alternative Sources

6.1) Electricity Generated by a Test Case Landfill [Ref 33]

ALZA Pharmaceuticals (ALZA), a division of Johnson & Johnson (J&J) had to reduce their GHG emissions by 21.5 million pounds per year to meet the target set by J&J of reducing GHG emissions to 7% of their 1990 emissions. ALZA's research and development center in San Francisco was near the Shoreline Landfill, which is a 150-acre facility [Ref 25] already closed in 1993. The landfill came into existence in 1960 and has 11.82 million tons of MSW in place. Decaying of waste at the landfill was producing LFG, which was captured and flared as per the requirements of the EPA. Although the LFG emissions were reduced due to proper collection and flaring of the gas, this option was wasting very precious source of renewable energy. The energy manager at ALZA contacted the landfill owners and proposed a project to utilize this LFG at the facilities in close proximity to the Shoreline Landfill. The proposal was accepted in 2004, and a 15-year contract was signed between the city of Mountain view and ALZA. According to the contract, ALZA would be using LFG to provide power and hot water to three of their research and development facilities near the landfill. The contract also had a scope of extension up to five more years.

ALZA used three 970-KW generators at each facility to supply power to the building. Also, the heat from the exhaust was used to heat water to provide hot water for the complete facility. ALZA installed their pipeline network right before the gas was being flared. The gas was supplied to a cleaning process on site that had a basic moisture elimination system with three blowers running to maintain the gas flow at 6 psi so it can pass through the chiller.

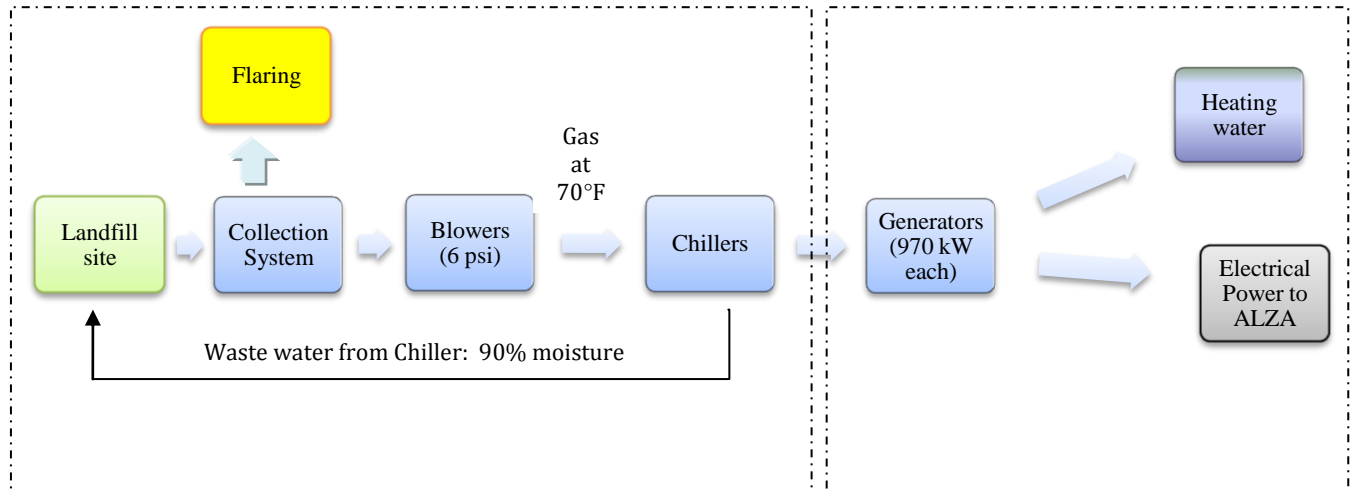

Figure 6.1: The process of Landfill gas being collected for both Electrical and Heating utilization at ALZA Pharmaceuticals, San Francisco

The temperature of the gas coming from the blower is somewhere around 70°F. When such a hot gas is passed through a cooling system, the water present in the gas cools down and separates out in the form of moisture droplets. The main reason that ALZA wanted this cleaning system at the landfill site was that this wastewater could be disposed off at the landfill itself. The gas leaving the condensate removal system is considered 90% free of moisture. The LFG flowing in to the project is 1.44 MM standard cubic feet per day (scfd) [Ref 26].

LFG, which is free of moisture, is then transported to the three research and development facilities at ALZA through pipelines. Each facility has three GE – Jenbacher generators installed with a capacity of 970 kilo watt (KW) for burning LFG, with a total capacity being 2.91 mega watt (MW) [Ref 27]. These generators are configured for both heat and electric use. Also, a few parts of the generator were altered by GE to prevent large emissions of NO_x and CO₂ from the generator itself. While the electrical output supplies power to the complete facility, the waste heat from the exhaust is used to provide hot water to the facility.

A flare system at the landfill is still up and working in case there is a sudden decrease in the utilization of the LFG at ALZA. At times, especially in winters, there is less demand for electricity at the facility; hence, the generators are made to run in parallel with the electric grid of the city. However, the local utility does not offer any kind of net metering for this electricity generated from LFG, which implies that ALZA cannot sell this excess power generated to the grid and will have to find an individual client for the same.

The system generated 24,000 MW-hours of electricity per year and will consequently displace 1,500 MM Btu of natural gas consumption per hour. The project is estimated to prevent 7,256 tons of CO₂-equivalent emissions per year just by avoiding use of an external source of electricity and reducing natural gas consumption. The actual capital cost for the project was \$11 million which was partially paid to ALZA by three financial grants totaling \$2.5 million [Ref 27].

6.2) Electricity Generated by a Test Case Wind Energy Plant

The next test case that we are going to consider is located in Town of Glenmore near City of DePere, Wisconsin. This site generates a total of 1.2MW of electricity using two Tacke 600e Turbines. These turbines are operated by the Wisconsin Public Service Corporation (WPSC) and are co-owned by the Madison Gas and Electricity, Alliant Energy (Wisconsin Power and Light as known previously), Wisconsin Electric Power Co., EPRI (Electric Power Research Institute) and DOE/EPRI TVP (Turbine Verification Program).

Due to the involvement of DOE/EPRI, the time for which the plant would be working was limited to 5 years. This was because of the fact that under the DOE/EPRI TVP programs, the turbines used are in experimental phase and hence, are used only as test cases and not for long

term usage. Even though it was predicted, that each wind turbine had a life of 20 years minimum, a five year lease was signed with WPSC and the township. The predicted capacity factor for the turbines was 31% [Ref 28]. Therefore, a yearly electricity generation of 3.3GWh (1.2MW x 8760hours/year = 10.51GWh at full capacity) of electricity was projected to be generated by the site [Ref 29]. A Projected Lifetime Electricity Production limit was computed to be 65GWh based on the capacity factor of turbine and the assumption that the wind turbine has a 20 year lifetime.

Being a wind powered electricity generation unit, most of the energy required for the unit is related to material production. This is because of the fact that no resource of any kind is required once the project is installed. Operating and maintenance of the wind farm is limited to the maintenance of the movable parts of the turbine and the tower. These need to be monitored and services on regular basis and require a significant amount of lubrication.

The DePere Wind project generated 17 times more energy (as electricity) than it was required to make it throughout the lifetime of the plant. Energy Payback Ratio is the ratio of useful energy generated (electricity in this case) with the energy that was consumed to generate that electricity throughout the lifetime of the project (transportation, manufacture of materials used, etc).

Figure 6.2 compares the Wind farm under test with a conventional coal fired plant and a nuclear plant. It is very evident that coal powered plants have a low EPR. In the figure, if we compare the EPR of a wind farm that generates more electricity than the test case, the EPR may become higher than any of the other fueled power plants.

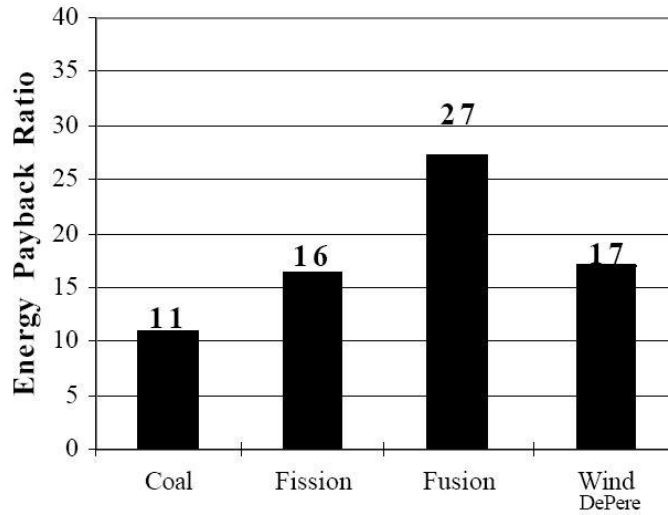

Figure 6.2: the Energy Payback Ratio of Coal and Nuclear powered plants in comparison with DePere Wind Farm [Source: Ref 28]

Also, the CO₂ generated during the lifecycle of a Wind Farm is 50-100 times lower than a coal fired power plant [Ref 28]. The CO₂ emissions from any Wind Farm are mainly due to the wind turbine production and repair.

At this point of time, we do not have many wind farms to generate electricity. No matter how beneficial these farms may be, they cannot compensate for the conventional fueled power plants due to the absence of technologies to store electricity for the time when these Alternative Sources are not present. Presently, the need for such storage of electricity is not required because of such small amount being generated. Whatever is generated is supplied to the pre existing grid such that it is consumed instantaneously.

6.3) Electricity Generated by a Test Case Solar Energy Plant

Located within Nellis Air Force Base in Clark County, Nevada, on the north of Las Vegas, the Nellis Solar Power Plant is spread over 140 acres of land on lease from the Air Force Base. The

plant not only supplies for 25% of the electricity demand of the Air Force Base, but also caters to the demand of civilians at the Air Force Base [Ref 30].

The system consists of around 72,000 solar panels consisting of 5 million solar cells in total. Each Solar Panel generates 300KW of electricity. The plant uses 18 transformers and 54 invertors supplied by Xantrex Technology Inc. The construction of this plant shows a unique partnership between the public and the private sector. The Nellis Solar Power Plant uses technology from SolarPower Corporation and received financial help from MMA Renewable Ventures. Although it is an Air Force project, it received minimal financial support from the Air Force itself.

Nellis Solar Power plant is one of the largest solar plants in United States and uses a solar tracker technology which incorporated by the SolarPower T20 Tracker. The SolarPower T20 trackers are single axis trackers, which maximize the time interval for which the solar panels receive solar energy, hence, maximizing the electricity generation. The trackers can be seen in the Figure 6.3 below.

With maximum generating capacity being 14 Megawatts (MW), the Solar Plant supplies the Nellis Air Force Base with over 30 million kilowatt hours of clean and usable electricity annually [Ref 31]. The MMA Renewable Ventures, which are the owners and operators of the unit, claim to have a generating capacity of 20% [Ref 32].

The amount of electricity generated by the plant is sufficient to supply electric power to 13,000 homes during day. Not much is said about the initial economics of the project or about the

operation and maintenance cost in resources available. The project annually helps to save \$1 million for the Air Force Base just by supplying 25% of the electricity demand.



Figure 6.3: A View of Nellis Solar Power Plant, Nevada. [Source: Ref 31]
(The single axle trackers can be seen attached to the solar panels)

The plant is said to reduce 24,000 tons of CO₂ emissions annually which is similar to removal of 185,000 cars from the road or planting 260,000 trees. The plant not only supplies clean electricity but also utilizes an old landfill area which was closed and capped. Many of the panels are built on top of the landfill area. Thus, the project utilized an area which was otherwise difficult to be used for some other purpose.

6.4) Comparison of Three Test Cases

A comparison between the three Alternative Sources of Electricity generation can be based on various factors such as land requirements, capital cost, operation and maintenance costs, technology advancements, transmission requirements, etc. The land requirements for all the three sources are large. Wind and Solar energy on one hand need new land to begin with, Landfill Gas

to electricity projects do not have such a requirement. Most of the cities that are highly developed or settled have no land availability for Solar or Wind Electricity plants. If at all they do have the land availability, the prices may be so high that the capital costs suffer a huge blow.

Reliability of the source is another major issue. Wind does not blow equally in all parts of the world. It may be strong in an area and very weak in another. Similarly, solar intensity is not the same worldwide. It varies largely as we increase distance from the equator. Landfill gas to electricity plants has no such reliability issues. Once the LFG starts flowing through the collection system, it continues to flow with a constant flow rate for 20-25 years.

A comparison table is shown below in table 6.1 based on a few of these parameters. The table consists of various parameters involved with generation of 1MW of electricity.

Table 6.1: Comparison of Wind, Solar and Landfill Gas as source of Electricity Generation

Parameter	Wind Power	Solar Power	Landfill Gas
Land Required	New/on lease	New/ on lease	Not required
Typical units required	1 wind turbine	45,000 panels	1-2 generators
Efficiency of main generating unit	25% - 40%	10% - 20%	70% and above
Efficiency of subsequent equipment	20%-30% (Transformer)	20%-30% (Invertor)	N.A
CO2 Emissions, lb/MWh	0	0	Negative (eliminates CH4)
Capital cost	\$1 million/MWh	\$3.5 million/MWh	\$2.3million - \$5.5 million/MWh
O&M cost	\$7000/MWh	\$2000/MWh	\$30,000 - \$40,000/MWh
Output Power Quality	Better than Solar	Not so good	Good quality for several years
Payback time	1-2 years	1 - 2.5 years	3-4 years
Availability of Source	Unreliable	Unreliable	Reliable for many years

Transmission of output generated	Mostly long lines	Mostly long	Not so long
---	-------------------	-------------	-------------

Capital Costs include cost of installation and initial costs associated with the various units used in plants to generate electricity using the three Alternative Sources. From the table, it can be said that Capital Costs for LFG to electricity projects are on the higher side when compared with Wind or Solar (to some extent). A few years back, this was the major drawback of such projects. However, in the recent years, the various State and Federal incentives and other Tax credits offered act as a boost for initiating such plants. These incentives cause an overall decrease in the Capital costs of LFG to electricity plants.

Although the O&M costs are also more for LFG projects as compared to Solar and Wind power plants, the output power quality is a major advantage that LFG projects have over the other Alternative Sources. Solar PV cells generate dc current, which needs to be converted to ac current using an Inverter circuit. This inversion causes introduction of a lot of switching in the output power generated. Hence, this output needs more refining to obtain usable electricity. In case of a Wind plant, although the output power quality is better, there is a lot of variation in output generated due to regular changes in the wind velocities. As discussed in previous sections, power generated by a Wind turbine depends on cube of wind velocity, the output power changes by a huge number even for a small change in wind velocity.

Another advantage that LFG projects have over Solar and Wind projects are less Transmission loses. Usually, when a solar or wind plant is built, it is built far from the main city due to big land requirements of the two. This causes long transmission lines to supply the electricity generated into the already existing power grid. On the other hand, landfills are relatively closer

to the city limits. Hence, very small transmission lines are required to carry electricity generated by LFG plant to the power grid. This causes decrease in the following two losses:

- I^2R losses: Conductors never have zero resistance. Whenever current flows through a conducting wire, some of the energy is lost in order to overcome this resistance in the form of heat. Hence, I^2R losses are also known as heat losses. I^2R losses are a major source of loss when long transmission lines are present. Reducing these would cause reduced generation of electricity and hence, reduced usage of fuel.
- I^2X losses: Reduction in Reactive Power losses will increase life span of generators. Increase in reactive power causes decrease in life of the generator. Hence, cost saving in long term.

Technologically speaking, LFG projects are most advanced when compared to Solar and Wind power plants. This is due to the fact that LFG plants use the technology used to generate electricity from Conventional power plants. Hence, achieve more than 70% efficiencies (sometimes as high as 98%). Wind and Solar power plants are relatively new in this respect. Research is still being done in various areas in order to achieve maximum efficiencies.

Conclusions

The main objective of this research is to document the sustainability issues of electricity demand and generation as well as the need for promoting Alternative Sources of Electricity such as LFG-to-Electricity.

This research analyzed the current and future electricity demand within the United States and worldwide along with the current and projected sources of electricity. Worldwide electricity demand in 2006 was 18.2 Trillion KWh and is projected to be 31.8 Trillion KWh by 2030. In the United States, about 49% of the electricity was produced using coal, about 17% was produced by natural gas, and about 3% was produced by petroleum with a meager 2.3% produced by Alternative Sources of electricity in the year 2009.

As discussed in this document, burning these fossil fuels releases Carbon Dioxide which is an important Greenhouse Gas contributing to the global warming. In 2007, the worldwide electricity generation related emissions (in CO₂ equivalents) summed up to 28.96 Trillion metric tons. In 2008, United States alone accounted for 2.48 Trillion metric tons of CO₂ released due to electricity generation. Additionally, burning of fossil fuels also emits Sulfur Dioxide and Oxides of Nitrogen which are responsible for acid rain and air quality deterioration in the immediate region. Even if we acquire new technologies that decrease the emissions related to burning the fossil fuels, we cannot ignore the fact that the fossil fuels are limited and are depleting at a faster rate than they are generated. Hence the strong need for electricity generation from sources other than fossil fuels is being recognized worldwide.

This document reviewed sustainability issues related to electricity demand and generation. Important Alternative Sources for Electricity generation were identified as the solution to meet the increasing demand of electricity and reducing the emissions from the use of Conventional Sources like coal and petroleum. The Alternative Sources discussed in the document are Wind energy, Solar energy and Landfill Gases. The technologies for electricity generation using these Alternative Sources currently are vast in nature and many new technologies are being researched to increase the efficiency.

Capital investments needed in case of Alternative Sources of Electricity generation are higher compared to that of Conventional Sources. However, the state & federal incentives being offered, and lower operational & maintenance costs help reduce the burden of high capital costs. Also, the payback period is reasonable short.

Although Wind and Solar Energy are the center of attention of electricity producers, we cannot ignore Landfill gases as a source of electricity generation. If not used, the LFG is already being released into the atmosphere or being flared off. In either case, precious fuel capable of generating electricity is being wasted. Also, if LFG is not used, it adds to the Global Warming by emitting Methane (21 times more potent compared to CO₂ in causing global warming) and Carbon Dioxide.

In order to use the LFG, we need to know exactly how much of it is being released into the air. There are various models that help us to quantify LFG which is essential to properly plan LFG-to-Energy projects. There are many factors such as solid waste quantity, solid waste characteristics, landfill design, landfill working mechanism, and meteorological conditions that affect the accuracy of these LFG predictive models. However, Inverse Dispersion Model discussed in the document is one model that quantifies LFG based on actual data measured from the landfill. Hence, there are no assumptions involved and the results could be used to calibrate the other LFG predictive models such as the LandGEM model.

Electricity generation from Alternative Sources not only help to meet the ever increasing demand of continuous supply of electricity but also decrease the GHG emissions from the Conventional power plants and hence are also environmentally friendly.

From the research done, the following important conclusions can be drawn:

- World population and economy is growing causing increased demand for electricity.
- It is apparent from the literature and the analysis, that the conventional sources of electricity will not meet the complete demand expected in the future. Additionally, use of conventional sources of electricity will deteriorate the environmental quality at a rapid rate making it unsustainable. Even if we find a way to reduce the emissions, we need to

use the alternative sources because the conventional sources are limited and are depleting.

- Among many alternative sources of electricity, three sources, viz. solar, wind, and landfill gas appear to be promising based on the recent emphasis/innovation by the governmental agencies, research organizations, and commercial organizations. These sources do have several advantages in terms of reduced environmental impacts/burden (e.g., reduced GHG emissions, criteria pollutants and waste discharges) compared to the conventional sources such as coal and petroleum.
- Using Landfill gases as a source of electricity generation will not only reduce the usage of conventional sources to some extent, but also save the environment from the harmful effects of Methane and Carbon Dioxide that otherwise will be released into the air.

References

- [1] International Energy Outlook 2009 with projections to 2030; Chapter 5 – Electricity, prepared by Energy Information Administration (EIA), Washington DC.
- [2] US Department of Energy (DOE) – Sources of Electricity generation
<http://www.energy.gov/energysources/electricpower.htm>
- [3] Annual International Energy Outlook 2010 Early release, Energy Information Administration (EIA), Washington DC, April 2010.
- [4] The United States Environmental Protection Agency (EPA) on Greenhouse Gas (GHG) emissions inventory, 2010 - Electricity Chapter, April 2010.
- [5] “Key World Energy Statistics”, by International Energy Agency (IEA) for 2009-
http://www.iea.org/textbase/nppdf/free/2009/key_stats_2009.pdf
- [6] Renewable Energy: Not Cheap, Not "Green" by **Robert L. Bradley Jr** -
<http://www.cato.org/pubs/pas/pa-280.html>
- [7] NREL Technology and Program Market Data for Solar Energy as Source of electricity generation - <http://www.nrel.gov/solar/>
- [8] NREL Technology and Program Market Data for Wind Energy as Source of electricity generation- http://www.nrel.gov/analysis/re_market_data_wind.html
- [9] “Estimating Appliance and Home Electronic Energy Use”, by Department of Energy, Energy Efficiency and Renewable Energy -
http://www.energysavers.gov/your_home/appliances/index.cfm/mytopic=10040
- [10] Electricity Chapter in “Annual Energy Outlook 2010” with Projections to 2035, released on May 1, 2010, by Energy Information Administration's National Energy Modeling System -
<http://www.eia.doe.gov/oiaf/aeo/electricity.html>
- [11] “How do Photovoltaics work?” by Gil Knier in NASA Story “Edge of Sunshine”.
<http://science.nasa.gov/science-news/science-at-nasa/2002/solarcells/>

- [12] “Disadvantage of Alternative Energy” on Benefits on Recycling - <http://www.benefits-of-recycling.com/disadvantagesofalternativeenergy.html>
- [13] “20% Wind Energy by 2030: Increasing Wind Energy's Contribution to U.S. Electricity Supply” published by Department of Energy in 2008
- [14] “Municipal Solid Waste Generation, Recycling, and Disposal in the United States: Facts and Figures for 2008”, a report submitted by Environmental Protection Agency (EPA) in the United States.
- [15] Basic Information provided for Landfill Methane Outreach Program (LMOP) initiated by Environmental Protection Agency (EPA) of United States. - <http://www.epa.gov/lmop/basic-info/index.htm> ; (last visited on 1 October, 2010)
- [16] “Chapter 3: Project Technology Options” from “Project Development Handbook” published by Environmental Protection Agency (EPA) of United States for their Landfill Methane Outreach Program (LMOP), revised edition for September, 2010.
- [17] U.S. Environmental Protection Agency, Landfill Methane Outreach Program, “Potential Benefits Gained by Landfill Owners/Operators from Landfill Gas Energy”.
- [18] “Chapter 4: Project Economics and Financing” from “Project Development Handbook” published by Environmental Protection Agency (EPA) of United States for their Landfill Methane Outreach Program (LMOP), revised edition for September, 2010.
- [19] U.S. Environmental Protection Agency, “2006 Update: The State of U.S. Landfill Gas Utilization Projects” by Rachel Goldstein (Washington, D.C., 2006), - <http://www.energyvortex.com/files/landfillgasupdate11-06.pdf> ; (last visited on 1 October, 2010)
- [20] Residential Energy Consumption Survey (RECS) in 2001, - <http://www.eia.doe.gov/emeu/recs/recs2001/enduse2001/enduse2001.html> (page visited on 10/1/10)
- [21] Electric Power Annual 2009 - http://www.eia.doe.gov/cneaf/electricity/epa/epa_sum.html

- [22] World Energy Stats 2009 by Energy Information Administration (EIA) – Pg 47 –
http://www.iea.org/textbase/nppdf/free/2009/key_stats_2009.pdf
- [23] “Landfill Gas Emissions Model (LandGEM), Version 3.02, User’s Guide”, US Environmental Protection Agency, Washington DC.
- [24] Figueroa V.K., Cooper C.D., and Mackie K. R. (2008). “Estimating Landfill Greenhouse Gas Emissions from Measured Ambient Methane Concentrations and Dispersion Modeling”, Annual Conference and Exhibition, 2008, Air and Waste Management Association. Paper # 327.
- [25] California Government on Shoreline Landfill project:
<http://www.calrecycle.ca.gov/SWFacilities/Landfills/Gas/CaseStudies/Shoreline/default.htm> (accessed in February 2010).
- [26] EPA Landfill Methane Outreach Program data for operational landfill to energy projects –
<http://www.epa.gov/lmop/projects-candidates/index.html> (accessed in March 2010).
- [27] Case Study – Shoreline Landfill done by EPA: <http://www.epa.gov/lmop/projects-candidates/profiles/johnsonjohnsonalzaandmoun.html> (accessed in February 2010).
- [28] S.W. White and G.L. Kulcinski (1998), “Net Energy Payback and CO2 Emissions from Wind-generated Electricity in the Midwest”, Fusion Technology Institute, Wisconsin.
- [29] “Low wind speed turbine projects”, prepared on Wisconsin Wind Projects, 1998.
- [30] “Nellis Air Force Base Solar Power System”, by Nellis Air Force Base in their Media releases.
- [31] “Nellis activates Nations largest PV Array”, by Airman 1st Class Ryan Whitney, Nellis AFB Public Affairs on 12/18/2007. <http://www.nellis.af.mil/news/story.asp?id=123079933> (last visit on 10/19/10)
- [32] Wikipedia Article, “Nellis Solar Power Plant”.
http://en.wikipedia.org/wiki/Nellis_Solar_Power_Plant (last visit on 10/19/10)
- [33] Verma, S., Kalbar, P. P., Kura, B., and Asolekar, R. S. (2010). "Waste to Energy: Comparison of Technologies and Environmental Regulatory Framework in the US and

India," 103rd Annual Conference & Exhibition of the Air & Waste Management Association, Calgary, Alberta, Canada, June 22-25, 2010.

- [34] "Integration of Alternative Sources of Energy", Felix A. Farret and M. Godoy Simões, published in IEEE Press and Wiley Interscience, 2006.
- [35] "The Solar Sprint PV Panel", by Chuck Wright - <http://chuck-wright.com/SolarSprintPV/SolarSprintPV.html>
- [36] International Energy Outlook 2009 with projections to 2030; Chapter 1 – Overview, prepared by Energy Information Administration (EIA), Washington DC.
- [37] "Each Country's Contribution of CO2 Emissions", by Union of Concerned Scientist in their section on Global Warming –
http://www.ucsusa.org/global_warming/science_and_impacts/science/each-countrys-share-of-co2.html.
- [38] "Concentrating Solar Power (CSP) Units", published by Energy Solar -
http://energysolar.org.uk/csp_systems.html
- [39] ICI Argent Main Image database - <http://iciargent.com/main/images/stories/slide/>
- [40] Blackburn with Darwen Borough Council Information Gateway on Solar Panels -
<http://www.blackburn.gov.uk/server.php?show=conMediaFile.16759>
- [41] "Concentrating Solar Power (CSP)", published by Energy Star, U.K -
http://energysolar.org.uk/csp_systems.html
- [42] "Wind Power gets gust of Help from Ontario Government", Jake Gosselin, January 2009. -
<http://www.windpowerninja.com/wind-power-government-industry-news/wind-power-gets-gust-of-help-from-ontario-government-68844/>

Vita

Suruchi Verma was born in Chandigarh, Punjab, India and received her B.Tech. degree in Electronics and Instrumentation Engineering from Institute of Engineering and Technology, Bhaddal, affiliated to Punjab Technical University in 2007. In July 2007, she joined a 6 months Post Graduate Diploma in VLSI at VEDANT, an institute managed by ISRO, Government of India. In 2008, she joined Gilard Electronics Pvt. Ltd. as a Trainee Engineer in New Product Development. Later in the year, she joined University of New Orleans as a Masters student in the Department of Electrical Engineering. During her academic program at UNO, she participated in Transmission and Distribution Conference and Exposition hosted by IEEE PES at New Orleans, Louisiana and presented a poster on “Electricity Generation from Landfill Gases in Louisiana”. Her work on environment management has also been published as a conference paper in 103rd Annual Conference and Exhibition of Air and Waste Management Association in June 2010.