

Conf-920362--31

MAY 18 1992

GA-A20870

ALPHA PARTICLE DIAGNOSTICS USING IMPURITY PELLET INJECTION

by

R.K. FISHER, J.M. McCHESNEY, A.W. HOWALD,
P.B. PARKS, J.A. SNIPES, J.L. TERRY,
E.S. MARMAR, S.J. ZWEBEN, and S.S. MEDLEY

MAY 1992

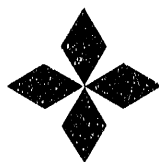

GENERAL ATOMICS

DISTRIBUTION OF THIS DOCUMENT IS UNLIMITED

DISCLAIMER

This report was prepared as an account of work sponsored by an agency of the United States Government. Neither the United States Government nor any agency thereof, nor any of their employees, makes any warranty, express or implied, or assumes any legal liability or responsibility for the accuracy, completeness, or usefulness of any information, apparatus, product, or process disclosed, or represents that its use would not infringe privately owned rights. Reference herein to any specific commercial product, process, or service by trade name, trademark, manufacturer, or otherwise, does not necessarily constitute or imply its endorsement, recommendation, or favoring by the United States Government or any agency thereof. The views and opinions of authors expressed herein do not necessarily state or reflect those of the United States Government or any agency thereof.

ALPHA PARTICLE DIAGNOSTICS USING IMPURITY PELLET INJECTION

by

R.K. FISHER, J.M. McCHESNEY, A.W. HOWALD,
P.B. PARKS, J.A. SNIPES,* J.L. TERRY,*
E.S. MARMAR,* S.J. ZWEBEN,** and S.S. MEDLEY**

This is a preprint of an invited paper presented at the
Ninth Topical Conference on High-Temperature Plasma
Diagnostics, March 16-20, 1992, Santa Fe, New Mexico,
and to be printed in *Review of Scientific Instruments*.

Work supported by
U.S. Department of Energy Contracts
DE-AC03-89ER53277, DE-FG02-90ER54084,
and DE-AC02-76-CHO-3073

*Massachusetts Institute of Technology, Cambridge, Massachusetts
**Princeton Plasma Physics Laboratory, Princeton, New Jersey

GENERAL ATOMICS PROJECT 3468
MAY 1992

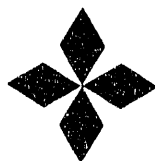

GENERAL ATOMICS

MASTER

ef

Alpha particle diagnostics using impurity pellet injection

R.K. FISHER, J.M. MCCHESENEY, A.W. HOWALD, and P.B. PARKS
 General Atomics,
 P.O. Box 85608, San Diego, California 92186-9784

J.A. SNIPES, J.L. TERRY, and E.S. MARMAR
 Massachusetts Institute of Technology,
 77 Massachusetts Ave., Cambridge, Massachusetts 02139

S.J. ZWEBEN and S.S. MEDLEY
 Princeton Plasma Physics Laboratory,
 P.O. Box 451, Princeton, New Jersey 08543

ABSTRACT

We have proposed using impurity injection to measure the energy distribution of the fast confined alpha particles in a reacting plasma [R.K. Fisher *et al.*, *Fusion Technol.* **13**, 536 (1988)]. The ablation cloud surrounding the injected pellet is thick enough that an equilibrium fraction $F_0^\infty(E)$ of the incident alphas should be neutralized as they pass through the cloud. By observing neutrals created in the large spatial region of the cloud which is expected to be dominated by the helium-like ionization state, e.g., Li^+ ions, we can determine the incident alpha distribution $dn_{\text{He}^{2+}}/dE$ from the measured energy distribution of neutral helium atoms dn_{He^0}/dE using $dn_{\text{He}^0}/dE = dn_{\text{He}^{2+}}/dE \cdot F_0^\infty(E, \text{Li}^+)$.

Initial experiments were performed on TEXT in which we compared pellet penetration with our impurity pellet ablation model [P.B. Parks *et al.*, *Nucl. Fusion* **28**, 477 (1988)], and measured the spatial distribution of various ionization states in carbon pellet clouds [R.K. Fisher *et al.*, *Rev. Sci. Instrum.* **61**, 3196 (1990)]. Experiments have recently begun on TFTR with the goal of measuring the alpha particle energy distribution during D-T operation in 1993-94. A series of preliminary experiments are planned to test the diagnostic concept. The first experiments will observe neutrals from beam-injected deuterium ions and the high energy ^3He tail produced during ICH

minority heating on TFTR interacting with the cloud. We will also monitor by line radiation the charge state distributions in lithium, boron, and carbon clouds. Later experiments are planned to measure the energy distribution of the 3.7 MeV alphas created by $^3\text{He-D}$ reactions during ICH minority heating. Observations of 3.7 MeV alphas should allow single-particle alpha physics to be studied now and result in a fully tested diagnostic prior to D-T operation of TFTR.

CONTENTS

Abstract	iii
I. Introduction	1
II. Choice of Pellet Material	3
III. Charge Exchange Neutral Technique	5
IV. Cloud Ionization State Distribution Measurements and Modeling	7
V. Observation of Fast Neutrals from TFTR	9
VI. Planned Measurements with Energy-Resolved Neutral Analyzer	13
VII. Measurement of D-T Alphas on TFTR	17
VIII. Conclusions	19
IX. Acknowledgment	21
X. References	23

Figures

1. Calculated equilibrium fractions for He incident on Li^+ and C^{4+} pellet ablation clouds	6
2. Light intensity contours of Li^+ line radiation	8
3. Schematic of simple neutral particle analyzer	10
4. Scintillation light patterns observed using simple analyzer	11
5. Calculated ^3He counting rate for the Ioffe neutral particle energy analyzer	14
6. Calculated ^4He counting rates for the same analyzer and geometry of Fig. 5	15

I. INTRODUCTION

Fusion ignition requires that the alpha particles created by deuterium-tritium (D-T) reactions deposit a large fraction of their energy in the reacting plasma before they are lost. Upcoming D-T experiments on TFTR and JET will give us the first opportunity to study alpha particle confinement and slowing-down in a fusion plasma. Measurements of the spatial profile of the fast confined alpha particle energy distribution in a reacting plasma will be very difficult and is a high priority diagnostic goal.

Several reviews and workshops have addressed alpha particle measurements.¹⁻⁴ Thomson scattering from the electron cloud surrounding the alphas has been proposed using microwave^{5,6} and laser⁷ radiation. Based on the original proposal of Post *et al.*,⁸ charge exchange recombination spectroscopy^{9,10} and charge exchange neutral measurements¹¹ have been proposed using injected neutral particle beams. Another proposed approach uses the ion cyclotron emission near the cyclotron harmonics of the alphas.¹² All of these techniques have limitations and concerns associated with them.

We have proposed using impurity pellet injection to provide a target for double and sequential single charge exchange interactions of fast alpha particles with the ablation cloud surrounding the pellet.^{13,14} By measuring the resultant helium neutrals escaping from the plasma, this technique offers a direct measurement of the energy distribution of the incident high-energy alphas. Since 1988, we have been developing an alpha diagnostic based on this approach.

II. CHOICE OF PELLET MATERIAL

Only low- Z materials such as lithium, beryllium, boron, and carbon are of interest in order to avoid causing too large an increase in the plasma radiation losses. The lower the atomic charge Z , the larger the pellet that the plasma can accommodate. The higher the heat of the ablation, the farther a given size pellet can penetrate into a tokamak plasma. Because pellet penetration is an important issue, our initial studies had emphasized carbon as the pellet material of choice due to its very high heat of ablation (7.5 eV/atom).

Recent TFTR experiments with lithium pellet injection have demonstrated beneficial tokamak wall conditioning effects.¹⁵ TFTR's results with lithium pellets have led us to study lithium as a pellet material for alpha diagnostics. As discussed in Section III, we have found lithium will produce the largest alpha diagnostic signal levels. The smaller heat of ablation for lithium (1.6 eV/atom) makes pellet penetration more difficult, however, and millimeter diameter lithium pellets injected at 400 to 700 m/sec penetrate only to $r/a \sim 0.5$ in TFTR supershots. The best choice may turn out to be boron with its 5.3 eV/atom heat of ablation for better penetration combined with prospects for beneficial wall conditioning effects similar to those observed for lithium. Experiments with gaseous boronization done on other tokamaks have been very successful.^{16,17} A very small number (~ 10) of boron pellets has been injected into TFTR with wall conditioning results similar to those observed with lithium pellets. More boron pellet experiments are planned.

In this paper, we will discuss primarily the results of lithium and carbon pellet injection experiments and their relevance to alpha particle diagnostics.

III. CHARGE EXCHANGE NEUTRAL TECHNIQUE

A small fraction of the alpha particles incident on the pellet ablation cloud will be converted to helium neutrals as they pass through the cloud. In the case of lithium pellets, both double charge exchange interactions

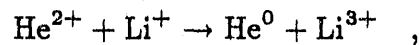

and sequential single charge exchange

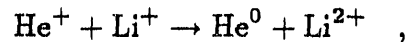

will result in helium neutrals whose energy is essentially unchanged by the charge transfer interactions. Interactions with Li^+ are of interest because a large spatial region of the cloud is expected to be dominated by this helium-like ionization state of lithium as discussed in Section IV.

The density in the Li^+ region of the cloud should be high enough to produce an equilibrium fraction F_0^∞ of helium neutrals. Hence, the energy distribution of the helium neutrals dn_{He^0}/dE measured by a neutral particle analyzer viewing the Li^+ portion of the cloud is related to the incident alpha distribution $dn_{\text{He}^{2+}}/dE$ by

$$\frac{dn_{\text{He}^0}}{dE} = \frac{dn_{\text{He}^{2+}}}{dE} F_0^\infty(E, \text{Li}^+) \quad . \quad (1)$$

The equilibrium fractions of helium neutrals for helium-like ionization state targets of Li^+ and C^{4+} can be calculated¹⁸ from the appropriate atomic cross-sections and are shown in Fig. 1. Although the equilibrium fraction for B^{3+} has not yet been calculated, it is expected to lie somewhere between the results for lithium and carbon. Again, the helium-like ionization states are of interest because they are expected to dominate a large spatial region of their respective pellet ablation clouds. Hence, measurement of the energy spectrum of helium neutrals escaping the plasma and use of Eq. (1) should allow determination of the incident fast confined alpha energy spectrum $dn_{\text{He}^{2+}}/dE$.

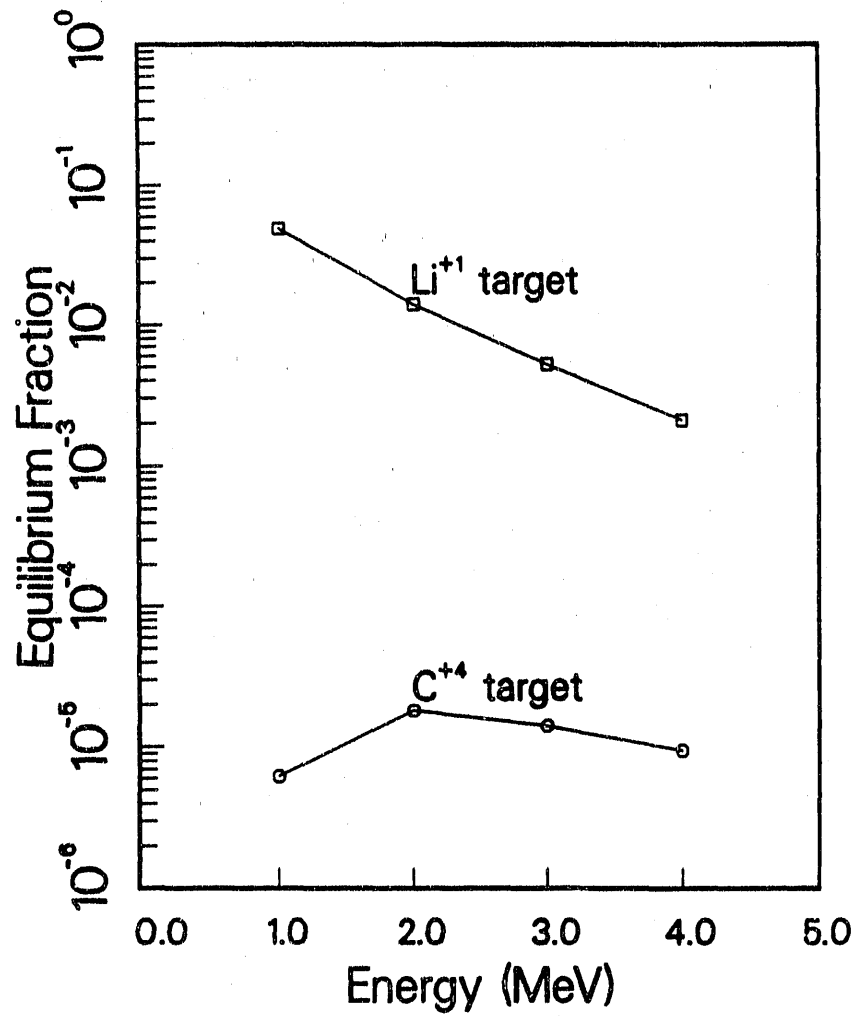

FIG. 1. Calculated equilibrium fractions for He incident on Li⁺ and C⁴⁺ pellet ablation clouds.

IV. CLOUD IONIZATION STATE DISTRIBUTION MEASUREMENTS AND MODELING

Our prediction that a large spatial region of the cloud will be dominated by the helium-like ionization state is based on simple atomic physics arguments. Neutral atoms ablated from the pellet surface by the tokamak plasma electron heat loading will become ionized within a few millimeters of the pellet surface. The resulting ions will continue to expand essentially spherically until the pellet cloud pressure drops below the magnetic field pressure and the ions are then constrained to follow the total magnetic field lines. Hence, the pellet ablation cloud will be elongated in the direction of the tokamak magnetic field. This elongation of the cloud in magnetic field direction has been observed experimentally.¹⁴ As the cloud temperature increases monotonically from the pellet surface temperature to the tokamak plasma temperature far from the pellet, the ionization state of the cloud will gradually increase. Because the ions like to keep their last two electrons, there is a jump in the ionization potential at the helium-like ionization state. This should result in a large region in cloud temperature space, and hence in distance from the pellet, which is dominated by the helium-like ionization state. This simple model ignores, however, the effect of ionization by the portion of the tokamak plasma electrons that are able to penetrate into this part of the cloud. Hence, the problem is really quite complicated, requiring calculation of ionization by both the cloud and tokamak plasma electrons and recombination. This, of course, requires knowledge of the cloud density and temperature as a function of distance from the pellet. The existing model, which includes all the above effects, also predicts a large region of the cloud dominated by the helium-like ionization state.¹⁹

For these reasons, we have tried to measure the ionization state distributions in pellet clouds on TEXT and TFTR. By photographing the line radiation from ionization states of interest, we hope to determine their spatial profiles in the ablation cloud. All measurements on TEXT were done on carbon pellets.¹⁴ We found that C^{3+} peaked about 2 cm to each side of the pellet at $n_{e0} = 2.6 \cdot 10^{13} \text{ cm}^{-3}$ and that C^{2+} light appeared to peak closer to the pellet as expected. The toroidal length of the C^{3+} and C^{2+} clouds decreased rapidly as the plasma electron density increased on TEXT. We were unable to observe a measurable C^{4+} line radiation signal on TEXT. C^{4+} has been observed on TFTR and extends as far as 45 cm toroidally from the pellet. Although the toroidal length of the cloud decreases as the plasma density

is increased in TFTR, it does not exhibit the strong density dependence observed in TEXT for C^{3+} and C^{2+} .

In the case of lithium pellets, Li^+ line radiation at 5485 \AA extends approximately 25 to 30 cm to each side of the pellet as shown in Fig. 2. We have not yet been able to measure the Li^0 or Li^{2+} cloud sizes on TFTR, but measurements of Li^0 clouds at 6708 \AA on Alcator C showed clouds smaller than Li^+ clouds as expected. Lithium cloud state distribution measurements will be an important part of the next stage experiments on TFTR.

TFTR 52197
 Li^+ light at 5485 \AA
 Pellet viewed from behind.
 $N_e = 6.8 \times 10^{13} \text{ cm}^{-3}$ $T_e = 2.3 \text{ keV}$

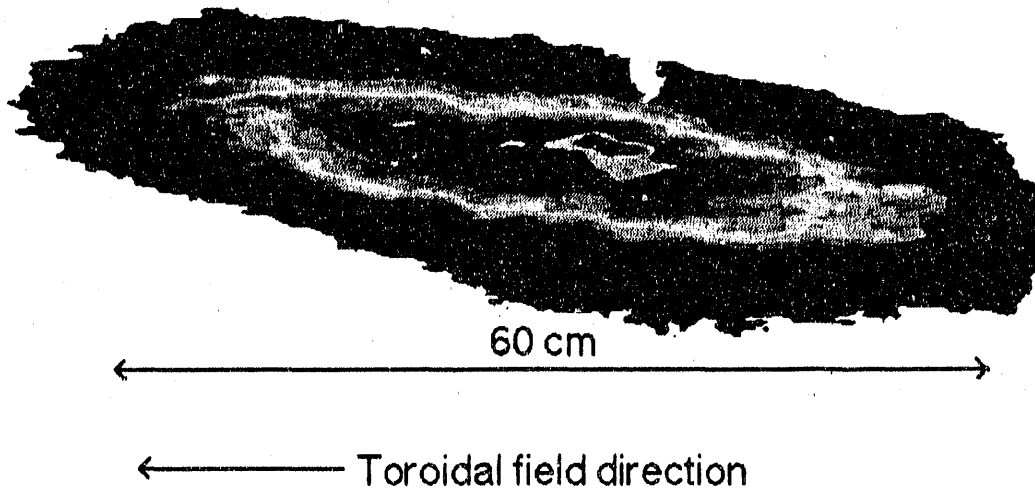

FIG. 2. Light intensity contours of Li^+ line radiation at 5485 \AA from ablation cloud surrounding a lithium pellet injected into TFTR. The toroidal cloud length is about 60 cm.

V. OBSERVATION OF FAST NEUTRALS FROM TFTR

As a first step test of this diagnostic, we recently installed a simple neutral particle analyzer viewing the path of pellets injected into on TFTR. The goal of this experiment was to observe neutrals from the interaction of fast ions in TFTR interacting with the pellet ablation cloud. This simple analyzer, shown in Fig. 3, used a 250 Å-thick carbon foil to strip the escaping neutrals. We utilized the residual tokamak toroidal field (which varies from 6 to 7 kG over the ion orbit region in the analyzer) to bend the resultant fast ions down onto a thin ZnS(Cu) scintillator. The scintillator thickness of approximately 40 mg/cm² is only slightly larger than the range of the incident ions to minimize the neutron- and gamma ray-induced background. The scintillation efficiency is approximately 12%. The light pattern on the 5 cm long by 2.5 cm wide scintillator was imaged by a lens onto the input of a coherent fiber optic bundle. The output end of this fiber bundle was viewed by a Xybion ISG-03 gated intensified CID camera located in the basement of TFTR where the neutron- and gamma ray-background is small.

Figure 4(a) shows the scintillation light pattern observed during lithium pellet injection into the beam-heated phase of TFTR shot 61311. The light is due to deuterium neutrals resulting from the interaction of neutral beam-injected and thermal deuterium ions interacting with the pellet ablation cloud. The low energy end of the scintillator, the end closest to the stripping foil, is to the left in Fig. 4. The original analyzer design included a horizontal slit near the carbon foil to provide energy resolution, but this slit was removed when no signal was observed during the initial data runs. The data in Fig. 4, taken with a wide open entrance aperture equal to the 1.3 cm carbon foil diameter, has extremely poor energy resolution. For example, 50 keV D⁺ ions can strike all the way from the low energy end of the scintillator to approximately three-quarters of the way toward the high energy end, depending on where the neutrals enter the stripping foil. Because of the poor energy resolution, it is difficult to draw any quantitative conclusions on the energy spectrum of the incident neutrals.

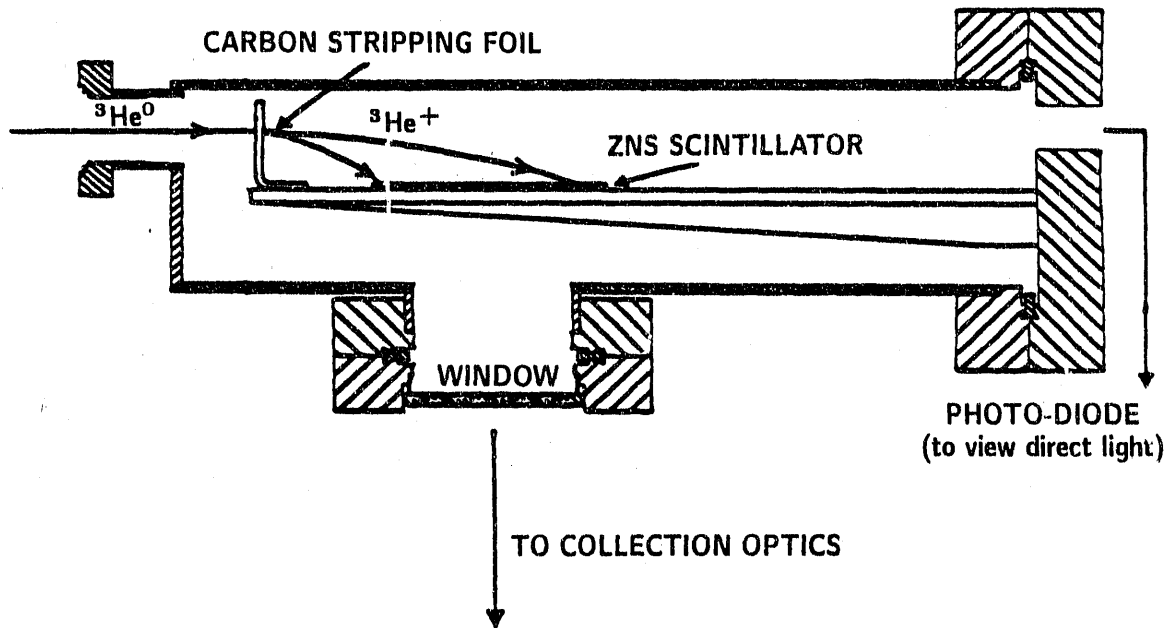

FIG. 3. Schematic of simple neutral particle analyzer used to observe neutrals from deuterium ions in TFTR interacting with a lithium pellet ablation cloud. Neutrals from the cloud are stripped in the 250 Å carbon foil and bent down by the tokamak toroidal field to strike the scintillator.

The observed scintillation light signal is only present during pellet injection. The camera was gated on for the 1 msec lifetime of the lithium pellet in Fig. 4. No signal was observed when the camera gate was delayed until 10 msec after the pellet event.

We also obtained data with TFTR operating at a toroidal field of about one-third of the usual value. The scintillation light signal during neutral beam injection then appeared brightest on the high energy end of the scintillator as shown in Fig. 4 (b), consistent with the lower toroidal field at the analyzer not bending the ions down to the scintillator as fast. This observed change in the light pattern with toroidal field gives us confidence we're not observing x-rays from the pellet cloud striking the scintillator or direct visible light from the pellet cloud.

The observed signals were only observed with lithium pellets. No signal was observed for the only carbon pellet shot and only one of ten boron pellet shots

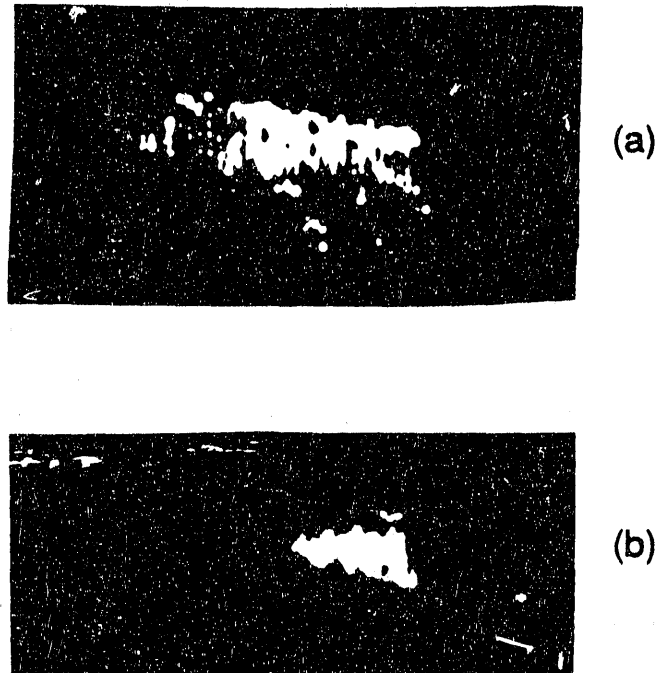

FIG. 4. Scintillation light patterns observed using simple analyzer during lithium pellet injection into beam-heated phase of TFTR. The light is due to deuterium neutrals resulting from the interaction of neutral-beam injected deuterium ions interacting with the lithium pellet ablation clouds. The low energy end of the scintillator is to the left. Signal is shown at (a) normal toroidal field, and (b) one-third the usual toroidal field on TFTR.

exhibited even a very weak signal with our present light collection optics. This is in agreement with our calculations that $F_0^\infty(E)$ is largest for lithium, smaller for boron, and smaller still for carbon pellet clouds.

The overall signal size is consistent with our calculations of the expected signal giving us confidence we are observing neutrals from the pellet cloud interactions.

VI. PLANNED MEASUREMENTS WITH ENERGY-RESOLVED NEUTRAL ANALYZER

Determination of the incident alpha energy spectrum requires confidence in our ability to determine the equilibrium fraction $F_0^\infty(E)$. A good way to check our calculations of $F_0^\infty(E)$ is to perform measurements of the energy spectrum of neutrals from fast ions in TFTR interacting with pellet clouds. Plans are underway to install a high energy (1 to 3.5 MeV ^4He) neutral particle analyzer built by the Ioffe Institute and previously used on the JET tokamak.¹¹ This analyzer will allow us to measure the energy spectrum of the energetic ^3He ion tail during ICH minority heating experiments on TFTR. The results will be compared to the expected TFTR ^3He ion distributions based on calculations and other diagnostic information. Figure 5 shows the calculated ^3He counting rate for the Ioffe analyzer radially viewing a 10 cm^2 area of Li^+ cloud with a 10 mm^2 entrance aperture. Signals for three different values of the ^3He ion tail temperature are shown with $n_{\text{tail}} = 4 \cdot 10^{11}\text{ cm}^{-3}$. The signal counting rate is large enough that radially resolved measurements should be possible using $100\ \mu\text{sec}$ time slices of the pellet path.

Measurements will also be made as a function of toroidal distance in the ablation cloud away from the pellet, to determine if the variation in the measured neutral energy spectrum is consistent with the expected variation in $F_0^\infty(E)$. The charge state distribution in the portion of the cloud viewed by the analyzer will be monitored by viewing the cloud with a spectrometer through the straight-through port on the back of the analyzer.

We also hope to measure the energy spectrum of the 3.7 MeV alpha particles created by fusion reactions of the ^3He energetic tail ions with thermal D ions in TFTR. The calculated signal level shown as curve (b) in Fig. 6 should be more than sufficient. This would result in a fully tested alpha particle diagnostic as well as providing information on single particle alpha physics prior to D-T operation of TFTR.

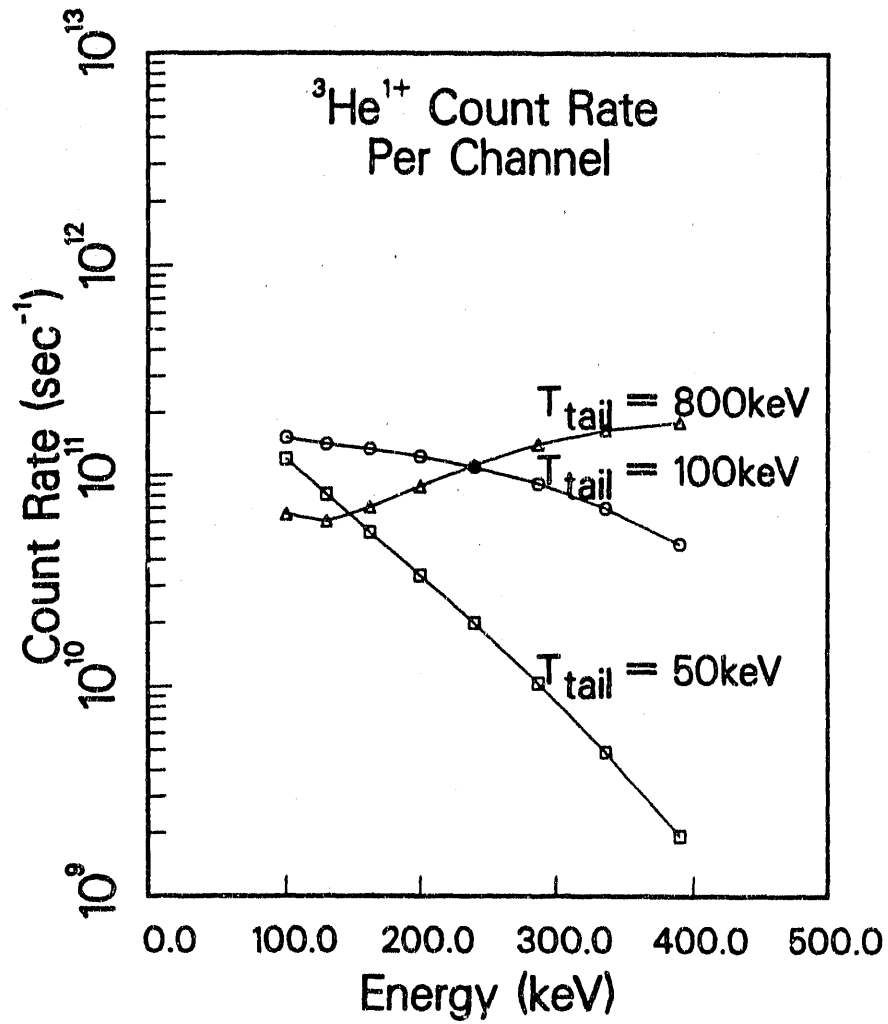

FIG. 5. Calculated ³He counting rate for the Ioffe neutral particle energy analyzer radially viewing a 10 cm² area of Li⁺ ablation cloud with a 10 mm² entrance aperture.

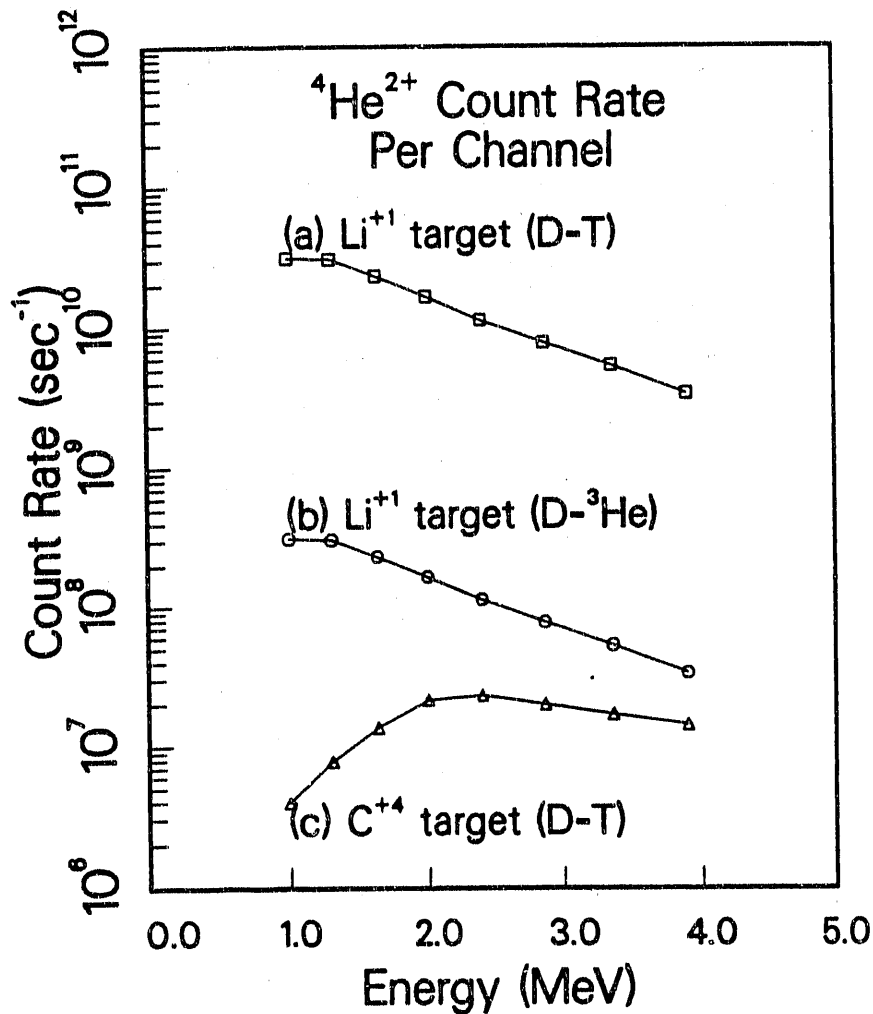

FIG. 6. Calculated ${}^4\text{He}$ counting rates for the same analyzer and geometry of Fig. 5. (a) and (c) show the D-T alpha signals for Li^{+} and C^{4+} cloud targets, respectively. (b) shows the calculated D- ${}^3\text{He}$ alpha signal for a Li^{+} cloud target during ICH minority heating experiments in TFTR.

VII. MEASUREMENT OF D-T ALPHAS ON TFTR

The final goal of the TFTR experiments is to measure the energy distribution of the 3.5 MeV D-T alpha particles. This will require shielding the scintillator with neutron and gamma-ray shielding and fiberoptically coupling the scintillation light to detectors outside the TFTR test cell. The calculated signal levels for Li^+ and C^{4+} cloud targets are shown in curves (a) and (c) of Fig. 6. The expected signal size will easily allow radially-resolved alpha particle measurements.

VIII. CONCLUSIONS

Results from preliminary experiments on TEXT and TFTR are very encouraging. The existing data on ionization state distributions, although not conclusive, supports the idea of a large spatial region of the cloud being predominantly helium-like, e.g., Li^+ . The observations of neutrals from fast ions in TFTR interacting with the pellet cloud give us confidence to proceed to the planned measurements of the energy spectrum of the ^3He ion tail produced during ICH minority heating experiments on TFTR. We also hope to measure the energy distribution of 3.7 MeV ^4He from ^3He -D reactions in TFTR. This will result in a fully-tested alpha particle diagnostic as well as providing information on single particle alpha physics prior to D-T operation of TFTR.

IX. ACKNOWLEDGMENT

This is a report of work supported by U.S. DOE Contracts No. DE-AC03-89ER53277, DE-FG02-90ER54084 and DE-AC02-76-CHO-3073.

X. REFERENCES

- ¹K. M. Young, Princeton Plasma Physics Laboratory, AA-870710-PPPL-06, June 1987.
- ²O. N. Jarvis and A. E. Costley, JET Joint Undertaking, JET-P(87)05, December 1986.
- ³D. Post, S. Zweben, and L. Grisham, Alpha particle diagnostics, 1986 Varenna Diagnostics School.
- ⁴S. J. Zweben, Rev. Sci. Instrum. **57**, 1723 (1986).
- ⁵P. P. Woskov et al., Rev. Sci. Instrum. **59**, 1565 (1988); D. Y. Rhee et al., this conference.
- ⁶A. E. Costley et al., JET Joint Undertaking, JET-R(88)08, 1988.
- ⁷D. P. Hutchinson et al., Rev. Sci. Instrum. **61**, 3233 (1990).
- ⁸D. E. Post et al., J. Fusion Energy **1**, 129 (1981).
- ⁹B. C. Stratton et al., this conference.
- ¹⁰M. Von Hellerman, Plasma Phys. and Contr. Fusion **33**, 1805 (1991).
- ¹¹A. B. Izvozchikov et al., JET Joint Undertaking, JET-R(91)12, 1991.
- ¹²J. C. Dooling et al., Rev. Sci. Instrum. **61**, 3205 (1990).
- ¹³R. K. Fisher et al., Fusion Technol. **13**, 536 (1988).
- ¹⁴R. K. Fisher et al., Rev. Sci. Instrum. **61**, 3196 (1990).
- ¹⁵J. A. Snipes et al., Bull. Am. Phys. Soc. **36**, 2377 (1991).
- ¹⁶J. Winter et al., J. Nucl. Mater. **162-164**, 713 (1989).
- ¹⁷G. L. Jackson et al., Phys. Rev. Lett. **67**, 3098 (1991).
- ¹⁸S. K. Allison, Rev. Mod. Phys. **30**, 1140 (1958).
- ¹⁹Abdel-Ghafar Mahmood El-Cashlan, Ph.D. Thesis, Old Dominion University, Norfolk, Virginia, 1990.

END

**DATE
FILMED**

7 / 13 / 92

