

FINAL REPORT

EVALUATION OF DEPLETED URANIUM  
IN THE ENVIRONMENT AT  
ABERDEEN PROVING GROUNDS, MARYLAND  
AND  
YUMA PROVING GROUNDS, ARIZONA

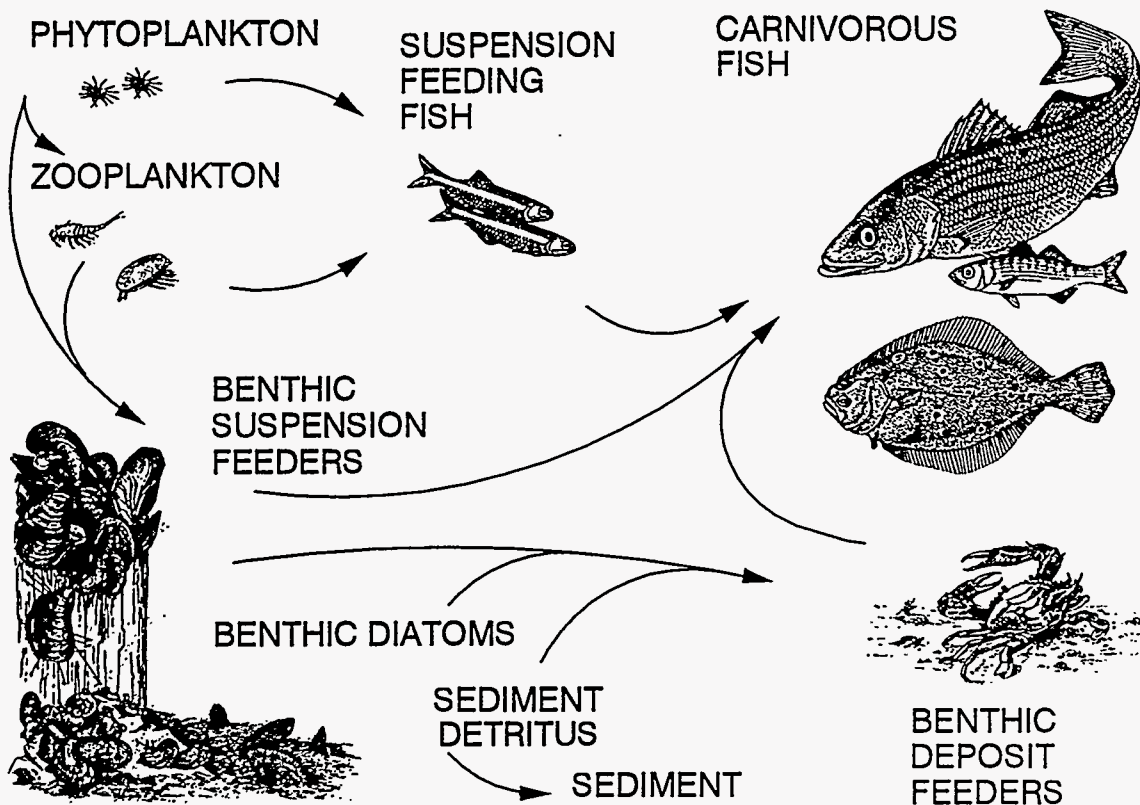

Patricia L. Kennedy    William H. Clements  
Orrin B. Myers  
Heidi T. Bestgen  
David G. Jenkins  
*Department of Fishery and Wildlife Biology  
Colorado State University  
Fort Collins, CO 80523*

Contract 9-XQ2-Z7115-1

MASTER

DISTRIBUTION OF THIS DOCUMENT IS UNLIMITED

DH/oz

## **DISCLAIMER**

**This report was prepared as an account of work sponsored by an agency of the United States Government. Neither the United States Government nor any agency thereof, nor any of their employees, make any warranty, express or implied, or assumes any legal liability or responsibility for the accuracy, completeness, or usefulness of any information, apparatus, product, or process disclosed, or represents that its use would not infringe privately owned rights. Reference herein to any specific commercial product, process, or service by trade name, trademark, manufacturer, or otherwise does not necessarily constitute or imply its endorsement, recommendation, or favoring by the United States Government or any agency thereof. The views and opinions of authors expressed herein do not necessarily state or reflect those of the United States Government or any agency thereof.**

## **DISCLAIMER**

**Portions of this document may be illegible in electronic image products. Images are produced from the best available original document.**

## TABLE OF CONTENTS

Table of Contents	i-ii
List of Figures	iii-iv
List of Tables	v-vi
Acknowledgements	vii
Contributors	viii
Foreword	ix-xi
Section A: Evaluation of Depleted Uranium at Aberdeen Proving Grounds, Maryland	
Chapter 1. APG Overview	1-10
Chapter 2. Using Sensitivity/Uncertainty Analyses to Guide the Development of Ecological Exposure Models	11-40
Chapter 3. APG Field Collections	41-53
Chapter 4. APG Laboratory Experiments: Foreword	54-56
Chapter 5. APG Field Exposures	57-63
Chapter 6. Bioconcentration of Uranium by Phytoplankton	64-70
Chapter 7. Toxicity of Uranium to Zooplankton	71-85
Chapter 8. Physical Desorption of Uranium From Laboratory Sediments	86-94
Chapter 9. Bioaccumulation of Uranium by Benthic Invertebrates	95-112
Chapter 10. Bioconcentration of Uranium by Benthic Invertebrates	113-120
Chapter 11. Bioconcentration of Uranium by Fish	121-128
Chapter 12. Transfer of Uranium to Fish in a Simple Food Chain	129-138

Section B: Evaluation of Depleted Uranium at Yuma Proving Grounds, Arizona

Chapter 13. YPG Overview	139-148
Chapter 14. Terrestrial YPG Exposure Model: Sensitivity/Uncertainty Analyses	149-159
Chapter 15. YPG Field Studies	160-167
Chapter 16. Uptake and Elimination of Uranium by Kangaroo Rats	168-179
Chapter 17. Effects of Uranium on Kangaroo Rat Kidneys	180-186
References	187-200
Appendix A: Future Studies	201-202
Appendix B: YPG Model	203-211

## LIST OF FIGURES

FIGURE 1.1	Schematic representation of work completed.	7
FIGURE 1.2	Comparison of ion chromatography data with inductively coupled plasma emission spectrophotometry-mass spectrophotometry data.	9
FIGURE 2.1	Conceptual model for transport of depleted uranium through the aquatic food web at APG.	14
FIGURE 2.2	Relative uncertainty of exposure model compartments.	29
FIGURE 2.3	DU concentrations calculated for aquatic exposure model compartments when input variables assumed beta probability distribution.	32
FIGURE 2.4	Example of relationships between rate parameters in ecological exposure model and the ecological parameters that control these rates.	35
FIGURE 3.5	DU transport pathways identified from uncertainty and sensitivity analyses as having major and intermediate to minor influence on DU concentrations in the APG exposure model.	37
FIGURE 3.1	APG field sampling locations.	43
FIGURE 4.1	Abiotic and biotic processes governing the environmental fate and transport of depleted uranium from contaminated sediment.	56
FIGURE 7.1	Comparison of concentrations expected at APG and sublethal toxic effects on <i>Ceriodaphnia dubia</i> .	83
FIGURE 8.1	Concentrations of uranium in spiked sediments used in the desorption experiment.	93
FIGURE 9.1	Concentration of uranium in spiked sediments used in the chironomid bioaccumulation experiment.	106
FIGURE 9.2	Concentration of uranium in spiked sediments significantly affected bioturbation by benthic invertebrates.	107

FIGURE 9.3	Comparison of bioturbation by three species of benthic invertebrates in experimental microcosms containing uranium-spiked sediment.	109
FIGURE 13.1	Spatial distribution of total uranium in soil at Kofa Firing Range, Yuma Proving Ground (compiled from Price 1991). Dimensions of firing lines are approximately 1 x 4 km at GP-20 and 1 x 4.5 km at GP-17A.	141
FIGURE 13.2	Spatial distribution of uranium isotopic ratios of soil at Kofa Firing Range, Yuma Proving Ground (compiled from Price 1991). Dimensions of firing lines are approximately 1 x 4 km at GP-20 and 1 x 4.5 km at GP-17A.	142
FIGURE 13.3	Annual variation in precipitation at Yuma Proving Ground, Yuma, AZ.	144
FIGURE 13.4	Monthly variation in precipitation at Yuma Proving Ground, Yuma, AZ.	144
FIGURE 14.1	Conceptual model for DU transport through the terrestrial environment at the Kofa Firing Range at YPG.	151
FIGURE 14.2	Nominal and maximum concentrations predicted for biological compartments by the YPG transport model.	157
FIGURE 15.1	Layout of pitfall traps used to sample invertebrates, reptiles and amphibians. Pitfall diameters were approximately 14 cm and 9 cm.	162
FIGURE 15.2	Biotic and abiotic samples collected from 5 locations each along GP-20 and GP-17A firing lines at YPG, August 1992.	163
FIGURE 16.1	Accumulation of uranium by Ord's kangaroo rats fed three levels of dietary uranium. Livers and kidneys were analyzed separately, but carcasses include complete gastrointestinal tracts containing variable amounts of experimental diets.	178

## LIST OF TABLES

TABLE 2.1	Ecological compartments of a carbon flow model in the mesohaline region of Chesapeake Bay used to structure the DU exposure model.	17
TABLE 2.2	Relative sensitivities of calculated DU concentrations ( $C_i$ in mg/kg) and inventories ( $Q_i$ in mg/m <sup>2</sup> ) to exposure model input variables when values are drawn from uniform and beta distributions.	27
TABLE 3.1	Water quality data (July 1992) from APG sites.	50
TABLE 3.2	Water quality data (October 1992) from APG sites.	51
TABLE 3.3	Environmental samples collected at APG which contained measurable amounts of <sup>235</sup> U and <sup>238</sup> U.	51
TABLE 3.4	Total uranium content in environmental samples collected at APG in October 1992.	52
TABLE 5.1	Revised schedule for the field exposure experiment.	60
TABLE 6.1	Water quality data from APG.	66
TABLE 7.1	Percent mortality of <i>Ceriodaphnia dubia</i> exposed to uranyl acetate for 24 and 48 hours.	79
TABLE 7.2	Reproduction of <i>Ceriodaphnia dubia</i> exposed to uranyl acetate for 7 days.	80
TABLE 12.1	Summary of experimental samples which were pooled in the transfer of uranium in a simple food chain experiment.	135
TABLE 13.1	Status of research activities to estimate ecological exposure of DU to life at Yuma Proving Ground.	148
TABLE 15.1	Numbers and types of samples collected at YPG GP-20 and GP-17A firing lines to estimate relationships between DU contamination of soils and redistribution to biotic components of the environment.	165
TABLE 15.2	Total uranium concentrations (mg/kg wet) from samples collected at YPG GP-20 and GP-17A firing lines to estimate	



	relationships between DU soil contamination and redistribution to biotic components of the environment.	166
TABLE 17.1	Uranium dose levels and sampling schedule used to estimate kangaroo rat kidney concentrations and histopathological effects. Animals received a single 1-ml gavage of an aqueous uranyl nitrate solution.	183
TABLE 17.2	Uranium dose levels and sampling schedule used to estimate kangaroo rat kidney concentrations and histopathological effects. Animals received 1-ml gavages of aqueous uranyl nitrate solution over three consecutive days.	184
TABLE B-1.	Rate equations used in YPG terrestrial model to estimate environmental fate of DU.	203
TABLE B-2.	Parameter values and ranges used in YPG terrestrial model uncertainty analysis.	205

## ACKNOWLEDGEMENTS

Support for this work was provided by the U.S. Army Test and Evaluation Command. Raymond G. Pollard, III, and Tanya Palmateer Oxenberg provided logistical support and technical guidance. Larry Davis and John Beckman provided valuable assistance with field sampling at Aberdeen Proving Grounds. Frank Dunfrund and Valerie Morrill assisted us at Yuma Proving Grounds. Victoria J. Drietz, Tylan F. Dean, Charlotte A. Buckingham, Linda K. Bourgeois, and Nichole Hoem provided assistance and support during field work and laboratory experiments. Boris C. Kondratieff identified invertebrate samples. David M. Getzy assessed kangaroo rat kidneys for injury, and Larry E. Travis and Sue Vandewoude provided valuable assistance and guidance with animal care. Animal care and use practices were performed under Colorado State University Animal Care and Use Committee Animal Research/Teaching Protocol Approval Number 92-051A-01.

## CONTRIBUTORS

Michael H. Ebinger, Ph.D.

Environmental Sciences Group, EES-15 MS J495  
Los Alamos National Laboratory  
Los Alamos, NM 87545

Richard J. Beckman, Ph.D.

Statistical Analyses, A-1 F600  
Los Alamos National Laboratory  
Los Alamos, NM 87545

Patricia L. Kennedy, Ph.D.

Department of Fishery and Wildlife Biology  
Colorado State University  
Fort Collins, CO 80523

William H. Clements, Ph.D.

Department of Fishery and Wildlife Biology  
Colorado State University  
Fort Collins, CO 80523

Orrin B. Myers, Ph.D.

Department of Fishery and Wildlife Biology  
Colorado State University  
Fort Collins, CO 80523

Heidi T. Bestgen, M.S.

Department of Fishery and Wildlife Biology  
Colorado State University  
Fort Collins, CO 80523

Dave G. Jenkins, Ph.D.

Biology Department  
Sangamon State University  
Springfield, IL 62794

## FOREWORD

This report represents an evaluation of depleted uranium (DU) introduced into the environment at the Aberdeen Proving Grounds (APG), Maryland and Yuma Proving Grounds (YPG), Arizona and was prepared in fulfillment of contract #9-XQ2-Z7115-1 with the Department of Defense. This was a cooperative project between the Environmental Sciences (EES-15) and Statistical Analyses (A-1) Groups at Los Alamos National Laboratory (LANL) and with the Department of Fishery and Wildlife Biology at Colorado State University (CSU). Each group was responsible for different portions of the project. LANL served as the project coordinator. LANL technical responsibilities included determining the quantity and spatial distribution of DU at APG and YPG, and a description of the physical processes governing the transport of uranium in the environment. LANL was also responsible for determining uranium concentrations in field and experimental samples and conducting a human-health risk assessment. CSU was responsible for conducting field sampling at the APG and YPG sites and laboratory experiments to study the fate and transport of DU in biota of aquatic and terrestrial ecosystems.

This project represents a unique approach to assessing the environmental impact of depleted uranium in two dissimilar ecosystems. Ecological exposure models were created for each ecosystem and sensitivity/uncertainty analyses were conducted to identify exposure pathways which were most influential in the fate and transport of depleted uranium in the environment. Results from these analyses were used to guide research efforts. Research included field sampling, field exposure experiments, and laboratory experiments. As results

become available, data will be used to validate and refine model parameters which will allow us to better understand potential risks of depleted uranium in the APG and YPG ecosystems.

The first section of the final report addresses DU at the APG site. Chapter 1 is an overview and provides background and provides justification for the fieldwork and laboratory studies which were conducted. Chapter 2 is the bioenergetics-based food web model which was created for the APG site. This manuscript was submitted to *Environmental Toxicology and Chemistry* on 5 October 1993. Results from the July and October 1992 APG field collections are summarized in Chapter 3. Chapter 4 provides a brief overview of the laboratory and field experiments conducted. Chapter 5 is a summary of a field exposure experiment conducted on-site at APG. Laboratory experiments are presented in detail in chapters 6 to 12. The experiment described in chapter 6 evaluated the bioconcentration by phytoplankton, primary producers in the Chesapeake Bay. The toxicity of uranium to zooplankton, a primary food item in the Chesapeake Bay ecosystem, is examined in Chapter 7. In chapter 8, the physical processes governing the desorption of uranium from sediment into the overlying water column is evaluated. The experiment in chapter 9 examined the transfer of uranium from sediment to benthic invertebrates. Additionally, this experiment also measured bioturbation (disturbance of sediments by benthic organisms) and resulting effects on overlying water concentrations. Chapter 10 describes an experiment which determined how quickly uranium was adsorbed by benthic invertebrates from surrounding water. This information was used in subsequent experiments where spiked food (invertebrates exposed to contaminated water) were fed to carnivorous fish. Experiments described in chapters 11 and 12 measured the uptake of uranium by fish. Chapter 11

examined bioconcentration rates while chapter 12 evaluated the uptake of uranium from a contaminated food source.

The final section of the report addresses DU at the YPG site. An overview of conditions at YPG is given in Chapter 13. Chapter 14 describes and analyzes our model representation of DU transport processes and pathways for the YPG ecosystem. Our approach in the model parallels that taken for the APG ecosystem. In Chapter 15 we review the results of field studies we conducted at YPG to evaluate the performance of the exposure model. In Chapter 16 we estimate uptake and elimination rates for kangaroo rats, which are ecologically important keystone species in the YPG ecosystem. Finally, in Chapter 17 we report our experiment to estimate the threshold for chemical toxicity in kangaroo rat kidneys.

# **SECTION A**

## **EVALUATION OF DEPLETED URANIUM AT ABERDEEN PROVING GROUNDS, MARYLAND**

# **\*\* CHAPTER 1 \*\***

## **APG OVERVIEW**

### **BACKGROUND**

Aberdeen Proving Grounds (APG) is approximately 50 km northeast of Baltimore, Maryland and is a designated Major Range Test Facility operated by the U.S. Department of Defense. APG is located on approximately 7,000 ha of coastal plain bordering the upper Chesapeake Bay. Since development and testing of weapons and weapon systems is a primary function of APG, about 80 to 85% of the land at APG is dedicated to ballistic test ranges, impact areas, vehicle test tracks, and other test facilities. Armor-piercing penetrators composed of a DU alloy (99.25% DU and 0.75% titanium) have been field-tested at APG for in-flight accuracy since the 1950s. DU has been used in armor-piercing penetrators because of its high density, good mechanical properties, pyrophoric qualities, and relatively low cost. Approximately 70,000 kg of DU has been fired into APG impact areas. Routine recovery of penetrators is both difficult and hazardous because of heavy vegetation and unexploded ordnance at APG. Additionally, penetrators often fragment upon impact while others become buried in marshes. Approximately 20% of the DU fired at APG has been recovered. As a consequence, catch boxes have recently been erected to minimize dispersal of penetrators in the impact areas. Continued testing of DU penetrators will likely result in further accumulation of DU at APG. Because of APG's proximity to the Chesapeake Bay, the Department of Defense is concerned about potential migration of DU off-site. Although no environmental impact has been observed or predicted, the Department of Defense has



attempted to be proactive in its attempts to evaluate possible environmental impacts from DU (CSTA 1990, Price 1990). This manuscript represents a summary of current efforts by LANL and CSU to determine the environmental fate and transport of DU at APG and potential direct and indirect effects on the Chesapeake Bay ecosystem and surrounding human population.

Isotopic composition of natural uranium is 99.2746%  $^{238}\text{U}$ , 0.7200%  $^{235}\text{U}$ , and 0.0054%  $^{234}\text{U}$ . Uranium enrichment procedures condense and remove the majority of the  $^{235}\text{U}$  isotope, creating DU as a by-product. DU consists of 99.7956%  $^{238}\text{U}$ , 0.2002%  $^{235}\text{U}$ , 0.0007%  $^{234}\text{U}$ , and 0.0029%  $^{236}\text{U}$ . The amount of radiation from DU, 0.36 uCi/g DU, is much less than from natural uranium, 0.68 uCi/g natural-U. Consequently, while DU may act as a radiological hazard, chemical toxicity is more likely to pose the greatest risk (NCRP65 1980, Kocher 1989, Legget 1989). Background uranium concentrations surrounding the APG area have been reported to be 0.3 ug/L in freshwater, 1.7 ug/L in brackish, estuarine water (Erikson et al. 1990), and approximately 1.8 ug/g, dry weight in sediment (NCRP77 1987, Price 1990). Introduction of DU into the environment represents a chemical burden in addition to background natural-uranium concentrations.

DU corrosion products, primarily hydrated uranium (VI) oxides, can be fairly mobile in the environment (Grandstaff 1976, Giblin et al. 1981, Erikson et al. 1990). Penetrators begin to oxidize as soon as they enter the environment and oxidation products can be solubilized by ground or surface water. While inorganic ligands, primarily carbonates and phosphates, increase solubility in water, other complexing agents, such as organic carbon and particulates, serve to mitigate the transport of DU (Panson and Charles 1977, Li et al. 1980,

Giblin et al. 1981, Shanbhag and Choppin 1981, Erikson et al. 1990b, Nagao and Nakashima 1992). Consequently, chemical mobility of uranium at APG is a product of two antagonistic forces, solubility in water and sorption by sediment. Given the soil and water types at APG, maximum solubility of uranium is likely to be < 200 ug/L in estuarine water with slightly lower values in freshwater (Erikson et al. 1990b). At these levels, aqueous concentrations of uranium are below acutely toxic levels for most organisms (Tarzwell and Henderson 1960, Davies 1980, Poston et al. 1984, Ahsanullah and Williams 1986, Bywater et al. 1991) but may approach chronic toxicity values for sensitive organisms (Poston et al. 1984, Hyne et al. 1992).

## **JUSTIFICATION**

Sediments at APG represent the largest source of DU for aquatic ecosystems.

Bioaccumulation of uranium occurs primarily through direct contact with sediment or through food chain exposure (Emery et al. 1981, Poston 1982, Swanson 1985). However, detailed information regarding the fate and transport of uranium in the aquatic environment is sparse. Furthermore, there is no single method which adequately evaluates chemical contamination and sole reliance on any single technique is fallacious. The most useful, conservative, and defensible approach for assessing environmental contamination should utilize a myriad of techniques. Our approach for evaluating DU in the environment employed field collections in concert with laboratory experiments to achieve a broad, multi-faceted risk assessment.

The initial step of our ecological risk assessment was to create a bioenergetics-based food-web exposure model (Chapter 2). This exposure model provided a theoretical

framework to help define and guide research efforts towards areas with the largest informational gaps, thereby maximizing our effectiveness. As suggested in the EPA guidelines for risk assessment (Norton et al. 1992, USEPA 1992), this model incorporated ecological and toxicological principles. Sensitivity analysis was used to identify environmental compartments and rate processes which contributed the greatest amount of predictive capability while uncertainty analysis identified model components which were poorly defined and/or highly variable. Based on these analyses, field collections and laboratory experiments were conducted to validate and refine estimates of rate processes and compartmental concentrations.

Field sampling represents one method used to evaluate the fate and mobility of DU in the environment. Because the isotopic ratio of DU differs from that of natural uranium, corrosion products of DU penetrators may be traced in the environment. If organisms contained DU, this would unequivocally reflect contamination from APG activities. Information of this type is not attainable by other means. Consequently, field sampling is an invaluable tool in determining if DU is entering the biosphere.

Field collections, however, are extremely sensitive to sampling methods, seasonality, weather, and localized conditions. In general, organisms exhibiting toxic responses to high levels of contaminants often "disappear" by crawling under rocks and vegetation where they cannot be sampled. Field collections lacking these organisms may skew data and results may not be representative of actual conditions in the field. Additionally, living organisms tend to integrate exposure over time and space and attempts to correlate tissue residue concentrations with abiotic samples which often display extreme variability in spatial and temporal

concentrations can lead to erroneous conclusions regarding the bioavailability of a contaminant. As a result, field collections should be viewed as conditions which exist during a specific time at a single location but not representative of the overall temporal or spatial conditions of an area.

The laboratory experiments used in this project were designed to assess uptake and depuration rates of uranium by aquatic organisms. Unlike field samples, information from these experiments allows a direct comparison between abiotic (water and sediment) uranium concentrations and concentrations in biota (living organisms). By quantifying the rates of uranium uptake by organisms under controlled laboratory conditions, we can interpolate exposure conditions which field-collected organisms must have experienced on average in the environment. Similarly, this information could be used to predict tissue concentrations which would result if abiotic concentrations were to change. When used in conjunction with each other, field samples, laboratory experiments, and computer modeling become powerful tools in evaluating environmental contamination.

## STUDY LIMITATIONS

DU is a difficult metal to detect in small quantities using standard analytical techniques used for other heavy metals. Furthermore, the use of isotopic ratios is required to differentiate between naturally occurring uranium and DU in field-collected samples while the decreased radioactivity DU precludes the use of many radiological methods. Techniques capable of isotopic differentiation and with relatively low detection limits include ion

chromatography, delayed neutron activation, and inductively coupled plasma emission spectrophotometry/mass spectrophotometry (ICP-MS).

Initially, ion chromatography was to be used on field and experimental samples because of low reported detection limits (0.001 mg/L U in water), cost effectiveness, and isotopic differentiation capabilities (Mike Ebinger, LANL, personal communication). Ion chromatography was initially intended to be used to measure total-U concentrations and delayed neutron activation analysis for determining isotopic ratios. Preliminary discussions of experimental design and analytical detection capabilities between CSU and LANL personnel occurred 12 June 1992. LANL projected turn around time on sample analysis to be one to three weeks and detection capabilities with ion chromatography to be in the low parts per billion (ppb = ug/kg = ug/L), regardless of sample biomass. All experiments were designed to fully utilize ion chromatography detection limits and each experiment built on results from previous experiments. Unfortunately, method development with the ion chromatography took longer than anticipated and LANL was unable to meet their projected analytical turn around time (Figure 1.1). As a result, CSU was forced to continue experiments without analytical information in order to complete work as scheduled and within budget. Some experiments examining food chain transfer of uranium were not initiated since CSU had no information regarding uranium concentrations in prey items which precluded proper study design.

Using ion chromatography, analysis of a limited number of sediment samples from the desorption experiment were analyzed. Sediment containing nominal concentrations of 100 and 1000 mg/kg U were found to contain average uranium concentrations (and standard

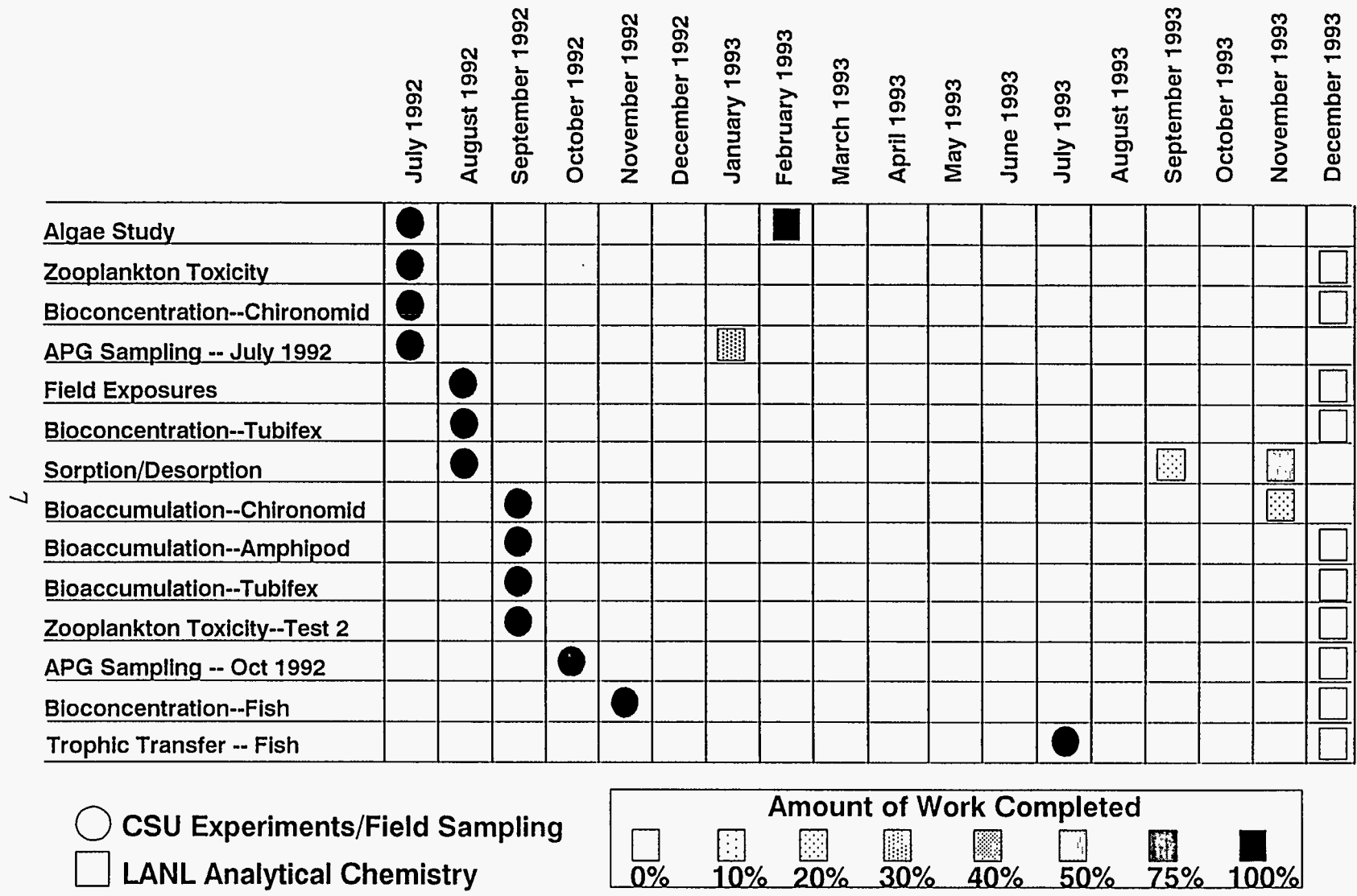

FIGURE 1.1. Schematic representation of work completed by Colorado State University (CSU) and Los Alamos National Laboratory (LANL).

deviations) of 166 (125) and 719 (267) mg/kg U, respectively. Comparison of ion chromatography data to data obtained by neutron activation revealed the detection capability of ion chromatography was  $> 10$  mg/kg U in sediment and detection of uranium was severely attenuated as uranium concentration increased (Figure 1.2). This inability to detect uranium was approximately four orders of magnitude greater than predicted detection limits.

Preliminary analysis of uranium concentrations from experimental samples suggested that ion chromatography could not detect uranium at environmentally realistic concentrations (i.e.  $\leq 10$  mg/kg U). Background uranium concentrations for the APG area have been reported as  $< 2$   $\mu\text{g/L}$  U in water and 0.13 mg/kg U (mg/kg = parts per million = ppm) in sediment (Price 1989, Erikson et al. 1990b). Analytical detection of DU at environmentally realistic concentrations is important since toxic effects to aquatic organisms often occur in the parts per billion range (Poston et al. 1983, Ahsanullah and Williams 1986, Bywater et al. 1991).

Additionally, uranium concentrations detected by ion chromatography were much more variable than those obtained by delayed neutron activation. Within a single sediment sample (LANL replicates and CSU split samples), measured concentrations had a coefficient of variation that ranged from 3.1 to 173.2%. Average analytical error was 34.6%, 115.5%, 23.3%, and 31.2% for sediment nominally spiked to concentrations of 0, 10, 100, and 1000 mg/kg U (dry weight), respectively. Such analytical variability would be multiplied through models, resulting in increased uncertainty, and, ultimately, severely limit our ability to make any definitive statements regarding uranium transport at APG or YPG.

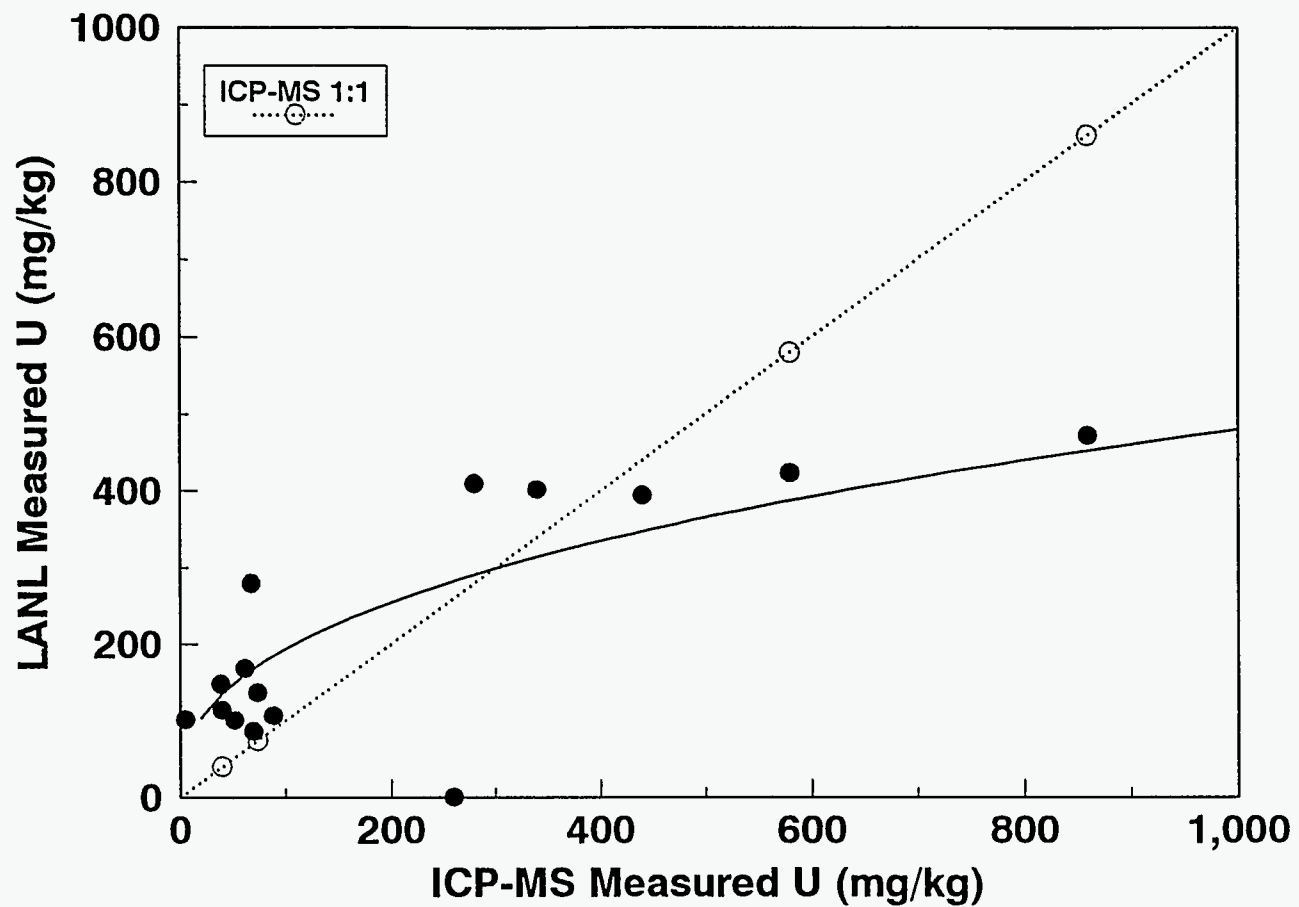

Figure 1.2. Comparison of ion chromatography (LANL) data with inductively coupled plasma emission spectrophotometry (ICP-MS). Uranium concentrations detected by LANL attenuate with increasing concentration in sediment. Ion chromatography values are also more variable than values obtained by ICP-MS (variability not shown).



Delayed neutron activation was initially selected as the most appropriate method for analyzing the isotopic ratios of field samples. However, only a limited number of samples were analyzed before the nuclear reactor was shut down. As a result of IC variability and high detection limits in combination with the reactor shut down, all remaining samples were shipped to Core Laboratories [CL] (Anaheim, CA) for total-U and isotopic ratio determination by ICP-MS.

Detection capabilities of ICP-MS were reported to be  $\geq 0.1$  mg/kg U (M. Ebinger, LANL, personal communication), two orders of magnitude greater than detection limits originally predicted for ion chromatography. Because experiments were designed based on the predicted ion chromatography detection limits and these experiments were completed before the decision was made to change analytical techniques, some experimental data may be lost because of the lack of a sensitive analytical technique. As of 10 December 1993, these analyses have not been received (Figure 1.1). This report summarizes the results of CSU's studies based on analytical results received by 10 December 1993.

## **\*\* CHAPTER 2 \*\***

### **USING SENSITIVITY/UNCERTAINTY ANALYSES TO GUIDE THE DEVELOPMENT OF ECOLOGICAL EXPOSURE MODELS**

#### **INTRODUCTION**

Aberdeen Proving Ground (APG) is a U. S. Department of Defense designated Major Range Test Facility Base on the western shore of Chesapeake Bay. APG has served as a major military testing and training facility since 1919, with 80 - 85% of the area being composed of ballistic test ranges, impact areas, vehicle test tracks, and other test facilities. As a result of depleted uranium (DU) penetrator munitions testing programs begun in the 1950s, DU has been deposited across about 650 - 700 ha at APG. Most penetrator impacts occurred within about 500 m perpendicular to the firing axis after the DU munitions passed through soft targets used to check accuracy and performance. Penetrators strike the ground, trees, and wetlands after hitting soft targets and eventually come to rest in the impact zone. About 25% of all DU fired has been removed from the firing range for disposal. The balance remains on the impact zone. The site is a restricted area and very likely will remain a dedicated testing facility for the foreseeable future. It is possible, however, that continued addition of DU to this site over many years and any subsequent redistribution of DU in the environment could cause risks to human and nonhuman populations to increase.

DU in the environment has potential for causing adverse ecological and human health effects due to its toxicological and radiological properties (Kocher 1989, Leggett 1989).

Natural uranium has a relative isotopic abundance of 99.2746%  $^{238}\text{U}$  (physical half-life =  $4.5 \times 10^9$  y), 0.7200%  $^{235}\text{U}$  ( $7.0 \times 10^8$  y), and 0.0054%  $^{234}\text{U}$  ( $2.4 \times 10^5$  y) (Walker et al. 1977) and specific activity of about 25.5 kBq/g. Depleted uranium, in comparison, is 99.7956%  $^{238}\text{U}$ , 0.2002%  $^{235}\text{U}$ , 0.0007%  $^{234}\text{U}$ , and 0.0029%  $^{236}\text{U}$  ( $2.3 \times 10^7$  y) and has specific activity of about 14.3 kBq/g due to lower activity of  $^{234}\text{U}$  and  $^{235}\text{U}$  in DU. Although radiation from uranium can cause lethal cancers when ingested or inhaled (Kocher 1989), chemical toxicity is a more likely hazard with regard to DU and has been argued to be the basis for standards set to protect humans (Legget 1989). The threshold for toxic effects to the mammalian kidney may occur at concentrations of 1 - 3  $\mu\text{g}$  uranium/g of kidney, but could be an order of magnitude lower if toxicity is indicated by increased urinary excretion of proteins and amino acids (Legget 1989, SuLu and Zhao 1990). Although the toxicity threshold for other organisms is much less well understood, compared to other animals, humans appear to be more tolerant to renal injury (Legget 1989).

APG and adjacent areas provide habitat for a variety of terrestrial and aquatic life, some of which are exploited for commercial and recreational use and others that are protected by Federal statutes. These habitats have already be degraded as Chesapeake Bay has suffered from a variety of anthropogenic disturbances not associated with APG (Mackiernan 1990). Aquatic and terrestrial life at APG do not show negative effects due to the DU penetrator testing (U.S. Army Combat Systems Test Activity 1990), although the uncertainty in this assessment is undetermined. Given the long-lasting nature of potential DU hazards (Cothorn et al. 1983, Kocher 1989, Legget 1989), the likely additions of DU to the environment, and uncertainty about ecological risks of DU, further assessment is warranted if

negative ecological effects are to be avoided. Risk managers need estimates of likely DU exposures to aquatic life in Chesapeake Bay along with their inherent uncertainty to understand and manage ecological risks of APG operations.

Models to calculate ecological exposure and risk are hypotheses about the distribution and effects of environmental disturbances. Uncertainty about processes and parameters in these models can cause risk estimates to span several orders of magnitude (Lipton and Gillett 1991). However, it is only recently that point estimates of risk have been replaced with more realistic exposure assessments where projected risk estimates include their uncertainty (Lipton and Gillett 1991, Bartell et al. 1992). Our problem was to evaluate ecological risk to Chesapeake Bay aquatic life due to the deposition and persistence of DU to the environment at APG. Here we focus on exposure assessment. The objective of this paper is not to present an ecological exposure ready for risk estimation. Our objective is to present an approach whereby a reliable exposure model may be produced. We use a bioenergetics-based food web model to provide the foundation of an ecological exposure assessment for DU. In this paper we 1) present a food web model as our hypothesis of how DU is transported through the aquatic food web at APG, 2) describe uncertainty and sensitivity analyses we performed to identify model parameters and processes most influential in causing uncertainty about hypothesized DU concentrations in aquatic organisms at APG, and 3) show how these analyses can provide guidance for planning field and laboratory experiments that will reduce uncertainty about predicted DU concentrations in aquatic organisms. Our work

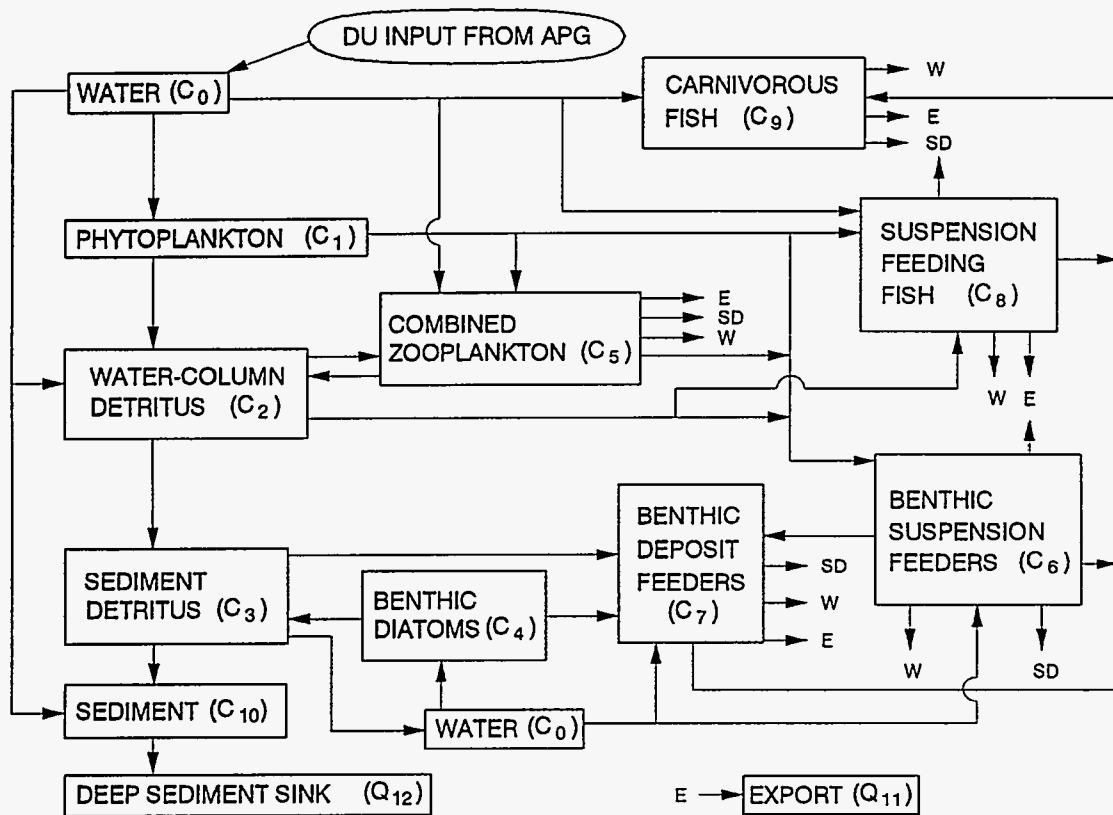

FIGURE 2.1. Conceptual model for transport of depleted uranium (DU) through the aquatic food web at Aberdeen Proving Ground, Maryland, based on a Chesapeake Bay ecosystem model (Baird and Ulanowicz 1989, their Figure 13]. Representative organisms for compartments are listed in Table 2.1. Arrows to W, SD, and E represent losses from compartments to water, sediment detritus, and export.

illustrates the value of using uncertainty and sensitivity analyses in an iterative approach to exposure/risk modeling and assessment (Norton et al. 1992).

## **MODEL STRUCTURE**

We developed a food web model (Myers et al. 1993) to describe our hypothesis about DU transport in the aquatic ecosystem adjacent to APG by adapting a carbon-flow model for the mesohaline (6 - 18 g/kg) region of Chesapeake Bay, USA (Baird and Ulanowicz 1989). APG is situated 20 km north of Baltimore, Maryland, near the northern boundary of the mesohaline region of Chesapeake Bay. Although APG is not mesohaline, we used the model as our working hypothesis about biotic DU transport, because a published, site-specific transport model does not exist. In developing the carbon model, Baird and Ulanowicz (1989) calculated mean seasonal biomass for 36 compartments and the exchanges of carbon among them. In their model gross primary production of autotrophic organisms (phytoplankton and benthic algae) was assumed to equal combined net primary production and algal respiration. Net primary production was partitioned among consumers according to herbivore diets and their energy requirements. Intake rates of heterotrophs were balanced relative to their summed rates of secondary production, respiration and egestion, where egestion was material ingested but not assimilated and released back to the environment as feces. Catches of commercially exploited fish populations were used to estimate standing crop biomass and export. Their model is deterministic and aggregates several species into compartments that correspond to dominant feeding strategies (Baird and Ulanowicz 1989, their Figure 13]. We represent our adaptation of this model (Myers et al. 1992) schematically in Figure 2.1, where

compartments (boxes) correspond to species aggregates and flows between compartments (arrows) are pathways for DU transport. We calculated mg-DU/kg of dry matter (DM) for all compartments ( $C_i$ ) except for the deep sediment sink and for export ( $Q_i$ ), which were mg-DU/m<sup>2</sup> removed from the system. Human harvest and emigration were included in export (Baird and Ulanowics 1989, Myers et al. 1993). The DU source in model simulations was ambient water concentrations of DU ( $C_0$ , mg-DU/L) in tidal creeks flowing from APG into Chesapeake Bay.

Our food web model has the form of a first order rate equation model (Landrum et al. 1992). We calculated changes in the DU concentration in any compartment,  $C_i$ , with each time step as the sum of all inputs from other compartments,  $C_j$ , to  $C_i$  minus all losses from  $C_i$ :

$$\frac{dC_i}{dt} = \sum_{ij} (C_j \lambda_{ij} - C_i \lambda_{ji}), \quad (1)$$

where  $\lambda_{ij}$  is the rate of uptake (1/d) to  $C_i$  from  $C_j$  and  $\lambda_{ji}$  is the rate of loss (1/d) from  $C_i$  to  $C_j$  (Myers et al. 1993). Compartment inventories ( $Q_{11}$ , export;  $Q_{12}$ , deep sediment sink) were calculated in the same fashion. Most of the rate coefficients could not be obtained directly, because these rates have not been estimated empirically. We derived them from the structural and functional characteristics of the aquatic food web and physiological properties of the compartment organisms. The structural characteristics are the relative abundances of species in different compartments. Functional characteristics are the rates of material flow between compartments. We assumed that three compartments,  $C_1$ ,  $C_2$ , and  $C_4$  (Table 2.1), had DU transfer rates that were much more rapid than one day, primarily due to adsorptive

processes. The model does not use different-sized time steps, so concentrations in these compartments were calculated using bioconcentration factors ( $BCF_i$ ), which were multiplied times  $C_0$ .

*Derivation and estimation of  $\lambda_{ij}$*

DU transfer between compartments is represented conceptually by arrows in the box model (Figure 2.1), and mathematically by  $\lambda_{ij}$ . Any compartment  $j$  contained  $C_j$  mg DU/kg so the rate of increase in  $C_i$  from any food source,  $C_j$ , was  $C_j\lambda_{ij}$ . The  $\lambda_{ij}$  used to describe rates of DU transport between model compartments were functions of physiological and ecological parameters such as compartment biomass ( $\beta_i$ , kg dry matter/m<sup>2</sup>), consumption rates ( $k_{ij}$ , 1/d), and DU assimilation rates ( $\alpha_{ij}$ , dimensionless). Of the 86 total input variables used in the model, 49% were obtained from the Chesapeake Bay model (Baird and Ulanowicz 1989) to describe food web structure and function, and another 26% specifically describe DU transport processes or equilibrium concentrations (Mahon 1982, Trabalka and Garten 1983, Wrenn et al. 1985, Anderson et al. 1989a,b). The remaining  $\lambda_{ij}$  and their ranges were taken from published values from similar systems or species (Myers et

TABLE 2.1. Ecological compartments of a carbon flow model in the mesohaline region of Chesapeake Bay (Baird and Ulanowicz 1989, their Figure 13) used to structure the DU exposure model (Myers et al. 1993).

Carbon model compartment	Exposure model compartment ID
Phytoplankton	$C_1$
Suspended organic matter	$C_2$
Sediment organic matter	$C_3$
Benthic algae	$C_4$
Combined zooplankton	$C_5$
Benthic suspension feeders	$C_6$
Benthic deposit feeders	$C_7$
Suspension-feeding fish	$C_8$
Carnivorous fish	$C_9$



(1989) found that the structure and function of the mesohaline region of Chesapeake Bay did not change substantially among seasons, so we felt justified in using static structural and functional characteristics within each simulation. We scaled annual rates of carbon flow between model compartments (mg-C/m<sup>2</sup>/yr) (Baird and Ulanowicz 1989) so that daily rates integrated over a year were equal to annual flows in the carbon model and expressed this rate,  $k_{ij}$ , as the daily fraction of prey biomass,  $\beta_j$ , (kg dry matter/m<sup>2</sup>) consumed each day (Myers et al. 1993). Thus,  $\beta_j k_{ij}$  represents the daily amount of biomass ingested (kg dry matter/m<sup>2</sup>/d) by organisms in the compartment described by  $C_i$ . We used published mean, median, or modal values to set nominal values for input variables. Upper and lower values were estimated from published ranges, variances, or assumed to be a constant proportion of nominal values (Myers et al. 1993). We used these values to analyze uncertainty in estimated DU concentrations caused by uncertainty in input variables.

We allowed model compartments to accumulate DU from food and water only. A fraction of total DU ingested with food was assimilated ( $\alpha_{ij}$ ) (Wrenn et al. 1985), so that the DU transfer rate ( $\lambda_{ij}$ , 1/d) to compartment  $i$  from compartment  $j$  was

$$\lambda_{ij} = \frac{\beta_j k_{ij} \alpha_{ij}}{\beta_i}, \quad (2)$$

where  $\beta_i$  (kg dry matter/m<sup>2</sup>) is standing crop biomass of the consumer (Baird and Ulanowicz 1989).

The rate parameters for uptake from water,  $\lambda_{i0}$  (L/kg/d), for  $C_5 - C_9$  were calculated as:

$$\lambda_{i0} = \frac{k_{i0} \alpha_{i0}}{\beta_i}, \quad (3)$$

where  $k_{i0}$  is L/m<sup>2</sup>/d and other parameters are as already defined. We derived  $k_{i0}$  for  $C_7 - C_9$  using the relationship

$$k_{i0} = \frac{\nu_i \beta_i \gamma_i}{\delta_i}, \quad (4)$$

where  $\nu_i$  = volume of water passing over the gill (L/d/kg fresh mass) (Langille et al. 1983),

$\gamma_i$  = parameter to scale ventilation volume to compartment-specific metabolic rate,

and

$\delta_i$  = converts  $\beta_i$  to fresh mass (Jørgenson 1979).

For any  $C_i$ , loss rate of DU from  $C_i$  to  $C_j$  due to feeding were calculated as  $-\lambda_{ji} C_i$ .

We used the steady state average annual biomass values from the Baird and Ulanowicz model (Baird and Ulanowicz 1989) for our nominal  $\beta_i$  (Myers et al. 1993). A constant biomass structure causes DU concentrations to be diluted as growth and recruitment of new biomass replace that lost through mortality processes. Many physiological processes are related to body size and metabolic rates of organisms (Calder 1984), including contaminant elimination rates (Newman and Heagler 1991). For example, we calculated DU elimination ( $\lambda_{0,i}$ ) from

compartments  $C_5 - C_9$  to water at rates that were a multiple ( $\tau_i$ ) of respiration rate,  $\rho_i$ , (1/d).

These rates were calculated as

$$\lambda_{0i} = \frac{\rho_i}{\tau_i}. \quad (5)$$

For details about derivation and estimation of  $\lambda_{ij}$  refer to Myers et al. (1993).

## MODEL UNCERTAINTY AND SENSITIVITY ANALYSES

Investigations of relationships between input variables and output from exposure and risk assessment models can be divided into two areas, uncertainty and sensitivity. The goal of uncertainty analysis is to estimate the uncertainty in the output variables, or computed DU concentrations in this case, given the uncertainty in the input variables. Input variables in these model equations represent abiotic or biotic parameters, that are known with varying degrees of certainty. When the input values are uncertain, then calculated model outputs also are uncertain. One way to characterize uncertainty about input variables is with a lower bound, an upper bound, and a nominal value. The nominal value may in some sense represent the most likely value for the input variable, whereas the range represents the possible values of input variables. The uncertainty in model output reflects the variability in these variables as the input variables take on values within their range.

There are two basic philosophies of uncertainty analysis. One may assume that there is a true value for each input variable, and that the ranges and nominal values for each do not represent any notion of probability. In this case, the uncertainty in the output variable is viewed as the maximum and minimum value the output variable can attain over the ranges of

input variables. From a practical standpoint, the maximum and minimum values of the output variables are impossible to compute for all but the smallest number of input variables. For example if there are 84 input variables and if it is known that the output variable is a monotonic function of the inputs (the direction unknown), then it would take more than  $10^{25}$  computer runs to determine the maximum and minimum values of the output variables. Given the impossibility of this task even with an efficient search algorithm, we used the second method of uncertainty analysis, which is to assume that a probability distribution characterizes the uncertainty in the input parameters.

Assuming that the input parameters are characterized by a probability distribution is not unusual. Probability distributions are subjective assessments of the state of knowledge about the parameters (Savage 1954, Lindley 1965). Without this probabilistic paradigm, the nominal value of an input variable has no clear meaning. With it, however, the nominal value is considered the "most likely" value of the parameter (*e.g.*, the mean or median value).

In contrast to uncertainty analysis, sensitivity analysis involves the study of the uncertainty bounds of model output to determine those parameters that contribute most to these bounds. There are numerous methods for doing these analyses (Inman and Helton 1988). We used a derivative method similar to that of Ronen (1988) where the variance of a function of  $n$  variables,  $f(v_1, v_2, \dots, v_n)$  is approximated by

$$Var(f) \approx \sum_i^n \left[ \frac{\partial f}{\partial v_i} \right]^2 \sigma_i^2 \quad (6)$$

and where  $\sigma_i^2$  is the variance of the variable,  $v_i$ . The range (upper bound minus the lower bound) of each individual input variable is an approximation of its variance. Therefore, the individual components of  $|\partial f/\partial v_i| R_i$  are sensitivity measures, where  $R_i$  is the range of the  $i^{\text{th}}$  input variable  $v_i$ . The values of  $|\partial f/\partial v_i|$  are computed by numerical derivatives for each of the input variables.

We used two distributions in our uncertainty and sensitivity analyses. First, a uniform distribution across the range of the input variable was assumed. In this case the nominal value is discarded, and any value in the range of input values is equally likely. Our second approach was to use the nominal value and assume that the uncertainty in an input variable can be represented by a probability distribution that has the nominal value as its mean value and is unimodal like a normal or Gaussian distribution. The probability density functions used here are from the family of beta distributions represented by

$$f(x) \propto (x - L)^{(p-1)} (U - x)^{(q-1)} \quad (7)$$

where  $L$  is the lower limit of the range and  $U$  is the upper limit. The constants  $p$  and  $q$  fix the mean of the distribution at the nominal value, make the distribution unimodal, and given the other two requirements, to have a large variance. The variance of the distribution is made large to reflect the fact that the range of the input parameter along with its nominal value determines the uncertainty in the parameter.

For the distribution to be unimodal, both  $p$  and  $q$  must be larger than 1. The expected or mean value, of the beta distribution is

$$E(x) = \left[ \frac{p}{(p+q)} \right] (U - L) + L . \quad (8)$$

The variance of the distribution is maximized if either  $p$  or  $q$  is close to 1. Therefore, we set one of these parameters equal to 1.1. The beta distributions are skewed toward the lower bound,  $L$ , if  $p > q$  and toward the upper bound,  $U$ , if  $p < q$ . The distribution is symmetric for  $p = q$ . We skewed the distribution toward the lower bound if the nominal value was closer to the lower bound than to the upper bound. We skewed it toward the upper bound if the opposite was true.

For the nominal,  $N$ , closer to  $L$  than to  $U$

$$p = 1.1 \left[ \frac{N - L}{U - N} \right] \quad (9)$$

and

$$q = 1.1$$

otherwise,

$$p = 1.1$$

and

$$q = 1.1 \left[ \frac{U - N}{N - L} \right] . \quad (10)$$

Regardless of the distribution used (uniform or beta distribution), the variance (i.e., the uncertainty) in the output,  $Y_i$ , can be approximated using a Taylor series by

$$\text{Var}(Y_i) = \text{Var}(h(\mathbf{X})) \approx \sum_{j=1}^n \left( \frac{\partial h}{\partial x_j} \right)^2 \sigma_{x_j}^2 \quad (11)$$

where  $\mathbf{X}$  is a vector of input variables,  $x_j$  is the  $j^{\text{th}}$  input variable and  $\sigma_{x_j}^2$  is the variance of  $x_j$  (Ronen 1988). Each input variable therefore contributes

$$\left( \frac{\partial h}{\partial x_j} \right)^2 \sigma_{x_j}^2 \quad (12)$$

to the uncertainty in the output variable. So,

$$\left| \left( \frac{\partial h}{\partial x_j} \right) \right| \sigma_{x_j} \quad (13)$$

is used as a sensitivity measure for the  $j^{\text{th}}$  input variable.

The variance  $\sigma_{x_j}^2$  for the uniform distributions was

$$\sigma_{x_j}^2 = \frac{(U - L)^2}{12} \quad (14)$$

and

$$\sigma_{x_j}^2 = \frac{(U - L)^2 pq}{(p + q)^2 (p + q + 1)} \quad (15)$$

for the beta distributions.

For uncertainty analyses a total of 1,000, 5,000-day simulations of the exposure model was performed. For each simulation, values of the input variables were chosen by latin hypercube sampling from the uniform or beta probability distributions (McKay et al.

1979). Latin-hypercube sampling forces input variables to be drawn from the full range of possible values by dividing the range into  $n$  subranges of equal probability from which random values are drawn. For each output variable, summary statistics, such as mean, standard deviation, and the percentiles, were compiled.

For sensitivity analyses, numeric derivatives were computed by perturbing each parameter at its nominal value. We constructed plots of sensitivity measures for each combination of input and output variables and graphically assessed the importance of each input variable on DU concentrations. We collected input variable sensitivity measures (Eq. 13) from an arbitrary time step (day 3,000), squared these values, and used the square root of the sum of these measures to evaluate the relative contributions by food web compartment and parameter categories to output uncertainty. Model input parameters were partitioned into those that described the uranium source, physiological processes, structural and functional characteristics of the aquatic food web, and abiotic properties and processes. Physiological parameters described interactions of individual organisms with DU, such as DU assimilation and elimination rates. Structural parameters described the state of the system, *e.g.*, standing crop biomass of each compartment. Functional parameters described rates of change of the system on an ecological scale, *e.g.*, feeding rates (Bartell et al. 1992). We used 3 bioconcentration factors in the model, 4 input variables classified into the abiotic transport category, 10 structural variables, 28 functional variables, and 39 physiological variables.



## RESULTS

### *Model uncertainty and sensitivity analyses*

*Uniform input distributions.* DU concentrations calculated for model compartments were highly sensitive to water concentrations used to drive the model (Table 2.2). Input water concentrations had a lower bound of  $3 \times 10^{-4}$  mg/L and an upper bound of 3 mg/L, and uncertainty in this input variable dominated all others. If water concentration was exactly known, then no more than 2 parameters per compartment accounted for nearly 95% of the uncertainty in DU concentrations of zooplankton, fish, and benthic organisms ( $C_5 - C_9$ ). The single most influential food web parameter was the assimilation coefficient for uptake from water ( $\alpha_{i,0}$ , Table 2.2), which averaged 78% (range: 62 - 86%) of total uncertainty in consumer compartments when source effects were excluded. The parameter,  $\tau_i$ , scaled DU elimination rates relative to compartment metabolic rates. It averaged about 16% (8 - 32%) of the uncertainty when the influence of water concentration was eliminated.

Total uncertainty as estimated by the sum of squared sensitivity measures (Eq. 13) relative to each compartment was greatest for carnivorous fish. The order of relative uncertainty of other compartments was suspension-feeding fish > zooplankton > benthic diatom = phytoplankton > benthic deposit feeders > benthic suspension feeders (Figure 2.2A). We calculated phytoplankton and benthic diatom concentrations using equilibrium bioconcentration factors, and these parameters were large contributors to overall uncertainty in the exposure model (Figure 2.2B). Physiological model parameters used to predict DU uptake and elimination contributed the most to uncertainty of DU concentrations, largely due to uncertainty in assimilation rates from water (Table 2.2). DU elimination rates

TABLE 2.2. Relative sensitivities of calculated DU concentrations ( $C_i$  in mg/kg) and inventories ( $Q_i$  in mg/m<sup>2</sup>) to exposure model input variables when input values were drawn from uniform and beta probability distributions.

Compartment ID <sup>b</sup>	Relative sensitivity of input variables <sup>a</sup>		
	Major	Intermediate	Minor
Uniform distributions			
$C_1$	$C_0$	$BCF_1$	
$C_2$	$C_0$	$BCF_2$	
$C_3$	$C_0$	$\alpha_{7,0}, BCF_2$	$k_{10,3}, \tau_7$
$C_4$	$C_0$	$BCF_4$	
$C_5$	$C_0$	$\alpha_{5,0}$	$\tau_5, k_{5,0}$
$C_6$	$C_0$	$\alpha_{6,0}$	$\tau_6$
$C_7$	$C_0$	$\alpha_{7,0}$	$\tau_7$
$C_8$	$C_0$	$\alpha_{8,0}$	$\tau_8$
$C_9$	$C_0$	$\alpha_{9,0}$	$\tau_9$
$C_{10}$	$C_0$	$\beta_{10}, k_{10,0}$	
$Q_{11}$	$C_0$	$\alpha_{5,0}, \tau_{5,0}$	$k_{5,0}$
$Q_{12}$	$C_0$	$k_{12,10}, k_{10,0}$	
Beta distributions			
$C_1$	$C_0$	$BCF_1$	
$C_2$	$C_0$	$BCF_2$	
$C_3$	$k_{10,3}$	$\alpha_{7,0}, \beta_7, k_{7,3}, k_{3,2}$	$C_0, \beta_9, \delta_7, \rho_7, \beta_8, \beta_3, \beta_2$
$C_4$	$C_0$	$BCF_4$	
$C_5$	$\beta_5$	$\alpha_{5,0}$	$C_0, \rho_5$
$C_6$	$\beta_6, \alpha_{6,0}$	$\rho_6, k_{3,6}, k_{11,6}$	$C_0, k_{6,1}, k_{6,0}, \alpha_{6,1}, k_{7,6}, \beta_1$
$C_7$	$\alpha_{7,0}$		$k_{3,7}, C_0, \delta_7, \rho_7, \gamma_7$

$C_8$	$\alpha_{8,0}$	$k_{3,8}$	$\rho_8, C_0, \delta_8, k_{9,8}, k_{11,8}, \beta_8$
$C_9$	$\alpha_{9,0}$	$k_{3,9}$	$\rho_9, k_{11,9}, C_0, \delta_9, \gamma_9$
$C_{10}$	$k_{12,10}$	$C_0$	$k_{10,0}$
$Q_{11}$	$\alpha_{5,0}$	$k_{11,5}$	$C_0, \beta_9, k_{11,7}$
$Q_{12}$	$k_{12,10}$		$C_0$

<sup>a</sup>Inputs are listed in order of descending sensitivity values within each compartment and category.

<sup>b</sup>Compartment IDs are explained in Table 1, except for  $C_{10}$  (surface sediments),  $Q_{11}$  (quantity exported from system), and  $Q_{12}$  (quantity in deep sediment sink).

and ventilation rates also contributed to this source of uncertainty. Structural and functional aspects of the aquatic food web and abiotic transport parameters had comparably small effects on overall model uncertainty (Figure 2B).

*Beta input distributions.* When input water concentrations were drawn from a beta distribution having a nominal value of 0.003 mg/L and variance scaled to the range used above, large values were much less likely and the sensitivity of this input variable on DU concentrations was reduced accordingly (Table 2.2). Whereas it dominated model uncertainty when uniform input distributions were used, it was a major contributor to uncertainty in DU concentrations in only three compartments ( $C_1, C_2, C_4$ ) that were based solely on water concentrations and bioconcentration factors. Water concentrations accounted for an average of 2% (0.6 - 2.7%) of the uncertainty in DU concentrations for the other 5

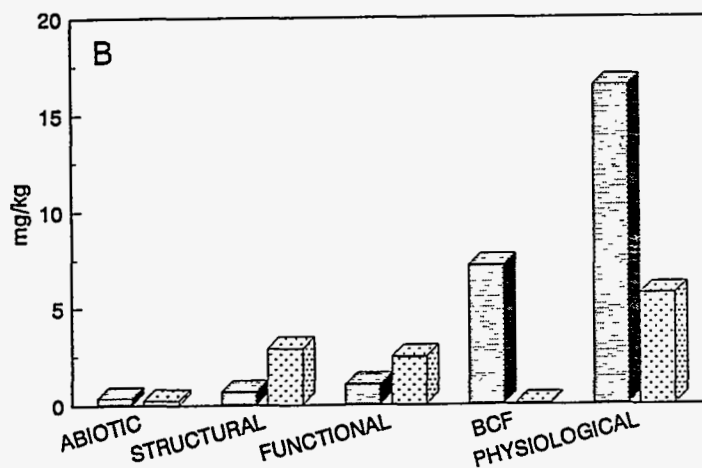
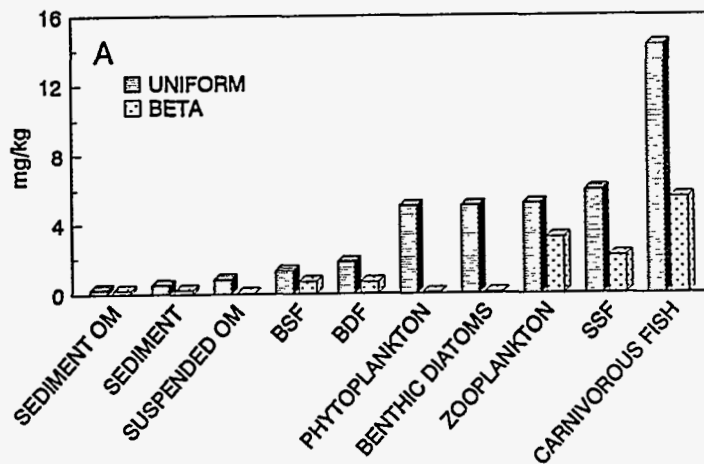

FIGURE 2.2. Relative uncertainty of exposure model compartments (OM = organic matter, BSF = benthic suspension feeders, BDF = benthic deposit feeders, and SSF = suspension feeding fish) measured by the square root of the sum of squared input variable sensitivity values generated from uniform and beta probability distributions (Figure 2.2A), and when input sensitivity values were aggregated into categories based on their roles in the exposure model (Figure 2.2B). Abiotic parameters described transport between abiotic compartments, and structural and functional parameters, respectively, described the standing crop biomass structure of the food web and the rates of material exchange between its compartments. BCF were bioconcentration factors that calculated compartment concentrations at equilibrium, and physiological parameters included compartment ventilation rates, elimination rates, and DU assimilation rates. Uncertainty due to water concentrations was not included.

biotic compartments ( $C_5 - C_9$ ) and 2% of uncertainty in sediment detritus concentrations ( $C_3$ ). Forty-four percent of the variation in sediment concentrations was attributed to variation in the concentration of DU in water. Fractional assimilation of DU from water by organisms ( $\alpha_{i,0}$ ) was also influential when beta probability distributions were used to propagate uncertainty (Table 2.2). An average of 61% of output uncertainty for zooplankton, fish, and benthic organism compartments ( $C_5 - C_9$ ) was due to  $\alpha_{i,0}$ . Compartment biomass ( $\beta_i$ ) was more influential than  $\alpha_{i,0}$  for zooplankton (78% of uncertainty) and shellfish (44% of uncertainty) compartments. Compartment biomass determined the dilution of DU in each compartment and helped set consumption, ventilation, and elimination rates. Decomposition rate ( $k_{10,3}$ ) for sediment detritus exerted the strongest control over DU concentrations in this compartment.

Overall, the added information of a "most likely" nominal value imposed on each range of input values caused model uncertainty to be much less than when uncertainty was propagated from uniform distributions. Uncertainty measures based on uniform distributions and aggregated over food web compartments ( $C_1 - C_9$ ) was  $>3 \times 10^5$  times the same measure based on beta distributions. Most of the uncertainty was due to water concentrations, however, and when this effect was removed, uncertainty in food web compartments was about 7 times higher when inputs had uniform distributions than when we used beta input distributions. Exposure model compartments did not have the same rank order of uncertainty as when uniform input distributions were used (Figure 2.2A). Physiological parameters also were a dominant source of uncertainty when beta input distributions were used, but the importance of bioconcentration factors was reduced. Structural characteristics of the food

web contributed 18% of food web uncertainty and functional characteristics accounted for 13% (Figure 2.2B).

### *Predicted DU concentrations*

DU in phytoplankton and benthic diatom compartments were calculated based on bioconcentration factors and had the largest estimated nominal concentrations of 2.6 mg/kg. Carnivorous fish had an estimated nominal concentration of 1.7 mg/kg. Nominal DU levels estimated for zooplankton, suspension feeding fish, and sediments were 0.5 - 1.0 mg/kg; were 0.5 - 0.1 mg/kg in suspended detritus, benthic deposit feeders, and benthic suspension feeders; and were 0.05 mg/kg in sediment detritus. The nominal water concentration was 0.003 mg/L, although concentrations as low as  $3 \times 10^{-4}$  mg/L and as high as 3 mg/L were allowed as model inputs. Using a uniform probability distribution of water concentrations, the expected value for the mean is the midpoint of the range (1.5 mg/L). When we sampled input water concentrations from a beta distribution based on these values, the mean input value was 0.0045 mg/L, although extreme values were possible (Figure 2.3). The large range of input water concentrations plus uncertainty associated with other model parameter values caused equilibrium output concentrations calculated for compartments to cover several orders of magnitude (Figure 2.3). Values between the 25<sup>th</sup> and 75<sup>th</sup> percentiles give approximations of likely values given this exposure model and beta distributions assigned to model inputs. At the 75<sup>th</sup> percentile, phytoplankton and benthic diatoms concentrations were about 3.5 mg/kg, carnivorous fish concentrations were about 2 mg/kg, and all other

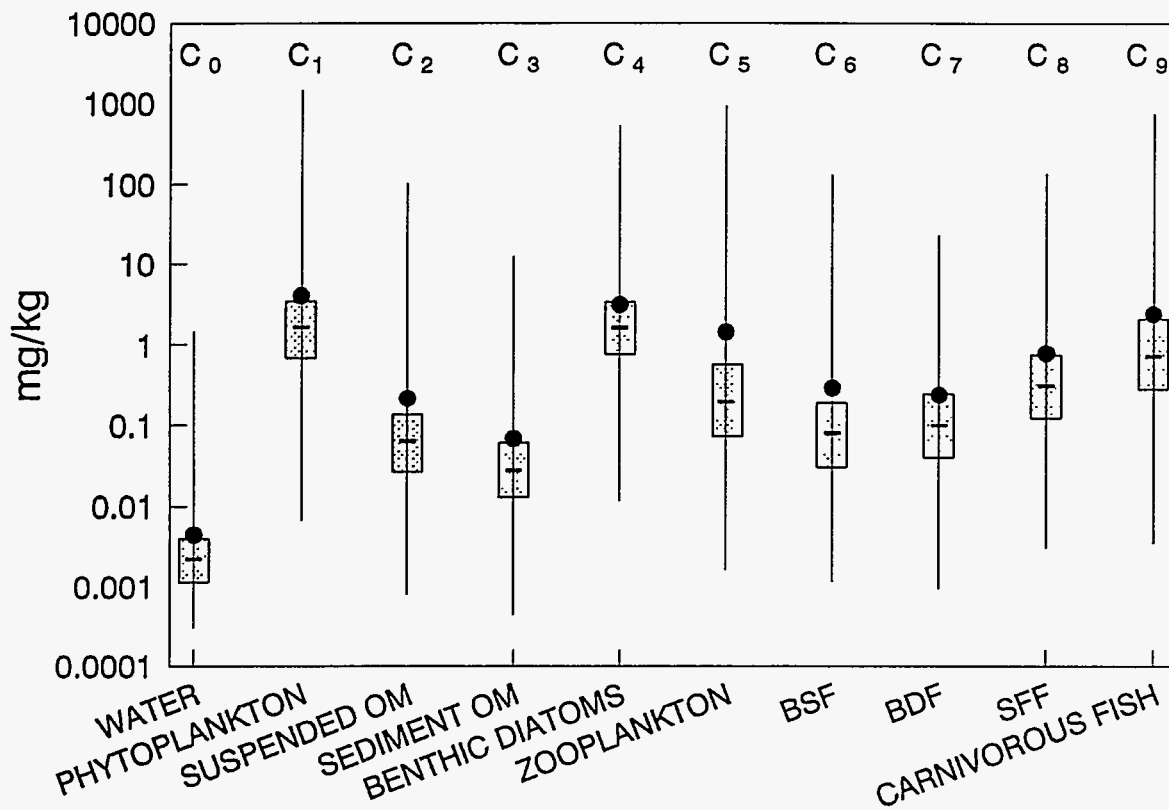

FIGURE 2.3. DU concentrations calculated for aquatic exposure model compartments when input variables assumed beta probability distributions. Water concentrations (mg/L) were the source of DU exposure and are provided for reference. Vertical lines are ranges, dots are means, horizontal lines are medians, and boxes contain the 25<sup>th</sup> to the 75<sup>th</sup> percentiles. (BSF = benthic suspension feeders, BDF = benthic deposit feeders, and SFF = suspension feeding fish)

concentrations were  $< 1$  mg/kg. Median values for biotic compartments were all greater than the median water concentration. No compartments were predicted to concentrate DU to more than 2 - 3 orders of magnitude that of water.

## DISCUSSION

### *Model uncertainty and sensitivity analyses*

*Uncertainty and sensitivity analysis methodology.* The sensitivity analysis we used is one of many possible techniques to investigate the behavior of response variables (predicted DU concentrations) as they relate to the input parameters of a model. Computing the derivatives is the simplest of all sensitivity methods; the number of computer runs required is at most only twice the number of parameters, and they allow for combining the sensitivities of various parameters by adding together some of the individual terms of Eq. 6. However, these sensitivity measures give information about the derivatives only at one point (here the nominal value of the parameters) in a multidimensional space. Other methodologies compute the standard deviation and the variance of the derivatives at randomly selected positions in the multidimensional parameter space (Morris 1991), compute regressions or partial correlation coefficients (Inman et al. 1981a,b), calculate variance decompositions (McKay 1992), or find directions of reduced dimensionality in the parameter space (Li 1991, 1992). The number of computer runs required for each of these methodologies is about 10 times the number of parameters. Since the code used here ran in a short amount of time, each of these alternative methodologies was implemented and computed. The alternative methodologies



identified the same most-sensitive parameters for this model as our analysis using uniform input distributions (R.J. Beckman, unpublished data).

*Input distributions, sensitivities and output uncertainty.* The range of water concentrations dominated all other sources of uncertainty propagated using uniform input distributions. Uncertainty projections using uniform input distributions were unacceptably high because this approach ignored information about biotic and abiotic processes. When uncertainty due to the source term was eliminated, overall model uncertainty was still greater when uniform distributions were used due to inefficient use of available information. When information on likely nominal values and probability distributions were included, predicted uncertainty about DU concentrations declined. Although we could have used normal, lognormal, or other probability distributions to generate input variable distributions, we used beta distributions because of their flexibility and because we often lacked information to specify other distributions. We used input variable ranges and estimates of central tendency to scale beta input distributions so that values taken by input variables were more likely to be near the nominal value than the upper and lower bounds of their ranges. These distributions also had large variances to reflect our uncertainty about the exact parameter distributions. Better descriptions of ecological exposure model rate equations are likely to further reduce uncertainty by reducing variance in predicted exposures, as well as reducing bias in predicted concentrations.

Physiological, structural and functional parameters caused the most uncertainty in predictions of the exposure model based on beta distributions, because DU transport through

the aquatic food web was mainly a function of these three parameter categories (Figure 2.4, *e.g.*, Eq. 2). Physiological parameters determined rates of DU assimilation and elimination by organisms.

PARAMETER CATEGORIES  
STRUCTURAL x FUNCTIONAL x PHYSIOLOGICAL

$$\lambda_{ij} = \frac{B_j}{B_i} \times k_{ij} \times \alpha_{ij}$$

In the case of trophic interactions, structural parameters governed what organisms interacted in the model ecosystem, and functional parameters controlled the rates of these interactions. The nature of how these parameters interact to control and limit organisms has long been a topic of disagreement (see Mattson and Hunter 1992, Hunter and Price 1992, Power 1992, Strong 1992, Menge 1992 and Mattson and Berryman 1992, Berryman 1992, Ginzburg and Akçakaya 1992, Arditi and Saïah 1992, Gutierrez 1992, Slobodkin 1992 for recent reviews). Therefore, the same factors that are important in setting food web dynamics are important determinants of DU transport in food webs.

FIGURE 2.4. Example of relationships between rate parameters in ecological exposure model ( $\lambda_{ij}$ , Eq. 2) and the ecological parameters that control these rates. Structural parameters describe the state of the model system (biomass of interacting compartments), functional parameters describe rates of material flow between compartments (*e.g.*, feeding rates), and physiological parameters describe DU interactions with individual organisms (*e.g.*, assimilation rates).

### *Predicted DU concentrations*

Equilibrium compartment concentrations we calculated using nominal input values were within an order of magnitude of reported uranium concentrations in the respective

trophic levels. The model predicted that zooplankton ( $C_5$ ) would accumulate DU an average of 175 - 350 times ambient water concentrations, compared to bioconcentration factors of about 350 for marine amphipods (Ahsanullah and Williams 1986). Predicted DU concentrations in shellfish ( $C_6$ ) and other benthic organisms ( $C_7$ ) were 50 - 75 times water concentrations (Myers et al. 1993) compared to uranium bioconcentration factors of between 4 and 18 for benthic organisms (Ahsanullah and Williams 1989). At environmental uranium concentrations similar to our nominal water value, wild trout had bioconcentration factors as high as 140 - 260 (Nichols and Scholz 1989), and experimentally exposed trout accumulated between 2 and 40 times water uranium concentrations (Poston 1982). Fish compartments in the model accumulated 230 - 554 times nominal water concentrations.

#### *A strategy for reducing uncertainty of predicted exposures*

Modeling approaches are necessary for producing probabilistic estimates of ecological exposure and risk (Barnthouse 1992), and ecological exposure models based on literature values from surrogate ecosystems can provide a valuable starting point. However, knowledge about transport processes in these models will be imperfect and will cause uncertainty about predictions. Uncertainty and sensitivity analyses of exposure models have provided insights into sources of uncertainty in model predictions. For example, Breshears et al. (Breshears et al. 1992) conducted variance-based sensitivity analysis of the PATHWAY (Whicker and Kirchner 1987) terrestrial food chain model to identify input parameters that were most influential in determining human ingestion of  $^{131}\text{I}$  and  $^{137}\text{Cs}$ . Parameters such as foliar deposition rates and radionuclide resuspension factors had large influences on model

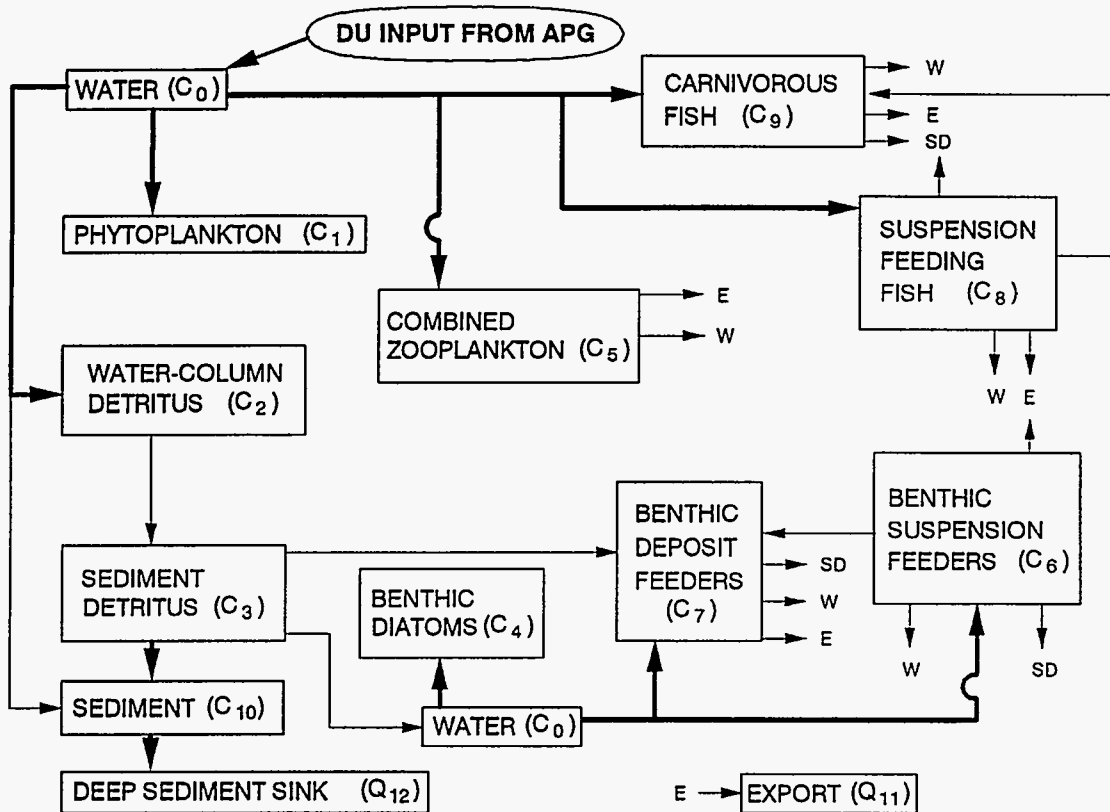

FIGURE 2.5. Depleted uranium (DU) transport pathways identified from uncertainty and sensitivity analyses as having major (bold arrows) and intermediate to minor (solid arrows) influence on DU concentrations in the APG exposure model. Important pathways should be targeted for experiments and sampling to efficiently reduce model uncertainty.

outputs, and they (Breshears et al. 1992) encouraged further study of these processes to reduce uncertainty in model predictions. Instead of performing uncertainty/sensitivity analyses when a final exposure model was assembled, we constructed and analyzed a preliminary model or set of working hypotheses about DU transport at APG. We used uncertainty and sensitivity analyses to identify potentially important pathways in the model so that relevant experiments and field sampling programs could be designed to test these hypotheses.

We identified the obvious result that the source of DU exposure in our model was the single most important piece of information needed to estimate concentrations in biota. When a likely probability distribution was assumed for water concentrations, other uptake processes from water to organisms became highly influential in determining DU concentrations in the food web. DU concentrations also were sensitive to flows of DU between compartments due to elimination, export from the system, and return to the sediment detritus pool. With this information, research aimed at reducing uncertainty about these pathways and other transport processes can be planned and implemented. Any reduction in uncertainty about DU transport processes and parameters will reduce uncertainty about predicted DU concentrations in aquatic life at APG (Figure 2.5). Important transport pathways will have  $\lambda_{ij}$  values that are significantly greater than zero when estimated from laboratory or field experiments. For example, laboratory studies could be conducted to estimate time-dependent concentrations of DU in phytoplankton, zooplankton, benthic deposit feeders, and carnivorous fish by the water pathway and to estimate sediment-water sorption-desorption parameters (Figure 2.5). In addition, measurements of site-specific uptake kinetics of benthic suspension feeders and

benthic deposit feeders from field exposures or on site collections could be used to adjust food web structure from that in the Chesapeake Bay model (Baird and Ulanowicz 1989) to that at APG. Bartell et al. (Bartell et al. 1992) compared measured effects of phenols in an aquatic food web and effects predicted by several exposure models. The most important factor controlling the quality of their site-specific predictions was knowledge of site-specific food web structure, followed by the quality of exposure concentration estimates. Our analyses did not evaluate uncertainty due to inadequate model structure, but the model does provide a framework for studies to evaluate the appropriateness of this structure. Our site is north of the mesohaline region of Chesapeake Bay, upon which the model is based, and has a different suite of interacting species. Thorough field surveys can provide information on food web structural components. During model development we recognized that our adaptation of the Chesapeake Bay model (Baird and Ulanowicz 1989) does not adequately account for DU uptake from sediments and sediment pore water or by transdermal absorption (Yuile 1973). Therefore, relevant laboratory experiments to explore these processes and to estimate their parameters would be needed to reduce uncertainty about these DU transport pathways.

Laboratory and field experiments can generate input parameter values and probability distributions for refining preliminary exposure models. Comparison of a revised model with DU concentrations in aquatic organisms from APG can give an assessment of the quality of model predictions. The relative fit of predictions from each model version also documents the reduction in uncertainty produced by each set of experiments (Bartell et al. 1992).

Additional iterations of sensitivity/uncertainty analyses, experimentation and model revision

can be performed until sufficient information is assembled to predict exposures within acceptable levels of uncertainty.

Complex ecosystem exposure models may not be the most efficient models for making long-term predictions about ecological impacts, however, data to select a best model among competing models often are inadequate (Barnthouse et al. 1984). The primary function of the model we presented was not to accurately predict DU concentrations in aquatic organisms, but rather to provide a framework for collecting data capable of rejecting this model in favor of an alternative. An alternative model having site-specific structural and functional characteristics and parameterized with site-specific data would better predict DU concentrations in aquatic life at APG. Our uncertainty and sensitivity analyses helped to identify data needed to construct such a model. Thus, by focusing attention and resources on parameters and processes most influential in causing uncertainty under modeling scenarios, efficient reduction of uncertainty about ecological exposures may be achieved.

## **\*\* CHAPTER 3 \*\***

### **APG FIELD COLLECTIONS**

#### **INTRODUCTION**

Concentrations of DU in the environment are likely to reflect the total amount of uranium introduced into the environment as well as the degree to which penetrators fragment and/or bury themselves in soils and sediment. Unstable environmental conditions may transport contaminated sediments away from their point of origin thereby spreading contamination over a large area. Due to the nature of APG activities, spatial and temporal concentrations in sediment are expected to be highly variable.

While sediment and water may be expected to contain measurable amounts of DU, it is unclear how much uranium would be taken up by living organisms. Uranium has been shown to accumulate in living tissue with concentrations decreasing with each step in the food chain (Kovalsky et al. 1967, Thompson et al. 1972, Blaylock and Witherspoon 1976, Mahon 1982). Consequently, we would expect to find highest concentrations in phytoplankton and lowest levels in carnivorous fish (e.g., sunfish [Centrarchidae] and white perch [*Morone americanus*]).

The total amount of uranium accumulated in aquatic ecosystems appears to be site-specific (Mahon 1982). Uranium uptake in the environment is dependent upon the amount of uranium present, its spatial distribution, the type of biota present in the area and their individual physiological capabilities to bioaccumulate uranium, as well as abiotic factors such as the physicochemical characteristics of water and the binding capacity of local soils and



sediment (Osburn 1974 [in Mahon 1982], Brenchley et al. 1977, Mahon 1982).

Consequently, field samples were collected from many different trophic compartments to obtain a general impression of uranium concentrations and their spatial distribution at APG. Biota containing DU would indicate corrosion products from penetrators are bioavailable and may represent a toxicological hazard.

## **MATERIALS AND METHODS**

Field sampling locations were non-randomly selected in order to maximize the chance of detecting DU in the environment. Using penetrator-recovery information, site selection was based on best estimates of where the highest DU concentrations might be and where tidal flows could transport corrosion products off-site (Figure 3.1). Penetrators were typically not visible due to heavy vegetation and turbid water.

Field collections were made in APG impact areas during the summer (25 and 26 July 1992) and fall (10 and 11 October 1992). Due to APG firing schedules and availability of ordinance personnel, sampling time at APG was limited. However, a total of 11 sites were sampled and 394 samples were collected during two sampling trips. Biotic and abiotic samples were collected from as many different environmental compartments as possible at each sampling location. Because of the diversity of taxa, number of samples, and nonrandom sampling locations, samples collected were expected to have a high probability of detecting DU, if present, in biota.

Field sampling techniques employed during the July and October trips were identical. A portion of the July field samples were analyzed prior to the October trip to identify

APG SAMPLING LOCATIONS

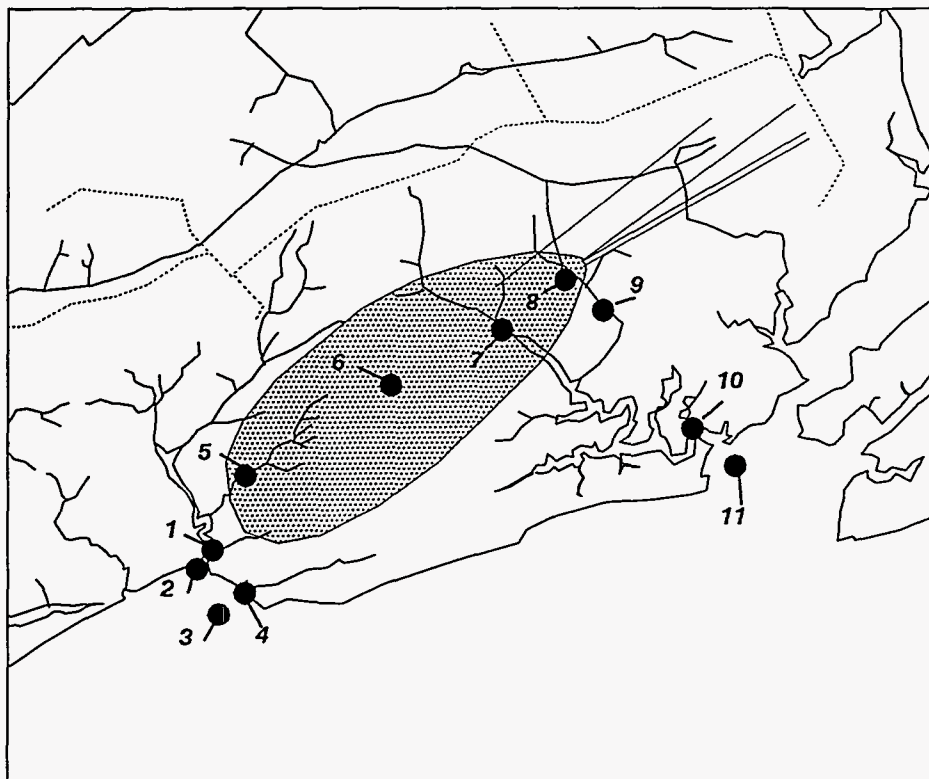

MAP ID	SITE
1	<i>Delph Creek 1</i>
2	<i>Delph Creek 2</i>
3	<i>Old Woman's Gut 2</i>
4	<i>Old Woman's Gut 1</i>
5	<i>Upper Delph Creek</i>
6	<i>DU Road</i>
7	<i>Upper Mosquito Creek</i>
8	<i>B3 Catchbox</i>
9	<i>B3 Creek</i>
10	<i>Mosquito Creek 1</i>
11	<i>Mosquito Creek 2</i>

FIGURE 3.1. Samples were collected from twelve locations during the July and October 1992 field sampling trips.

environmental compartments, such as sediment, which contained DU. Based on those findings, those compartments containing DU were preferentially collected during the October trip.

### *Water Chemistry*

Water samples were collected at sampling locations during both trips. Visibility and water depth were measured to the nearest 0.1 m using a Secchi disk. Dissolved oxygen and temperature were measured with a Yellow Springs Instrument Co. (Yellow Springs, OH 43587) model 57 oxygen meter. Salinity and conductivity were measured with a Yellow Springs Instrument Co. (Yellow Springs, OH 43587) model 33 conductivity meter and pH was measured with a Jenco (San Diego, CA 92126) model 60009 pH meter. All meters were calibrated according to manufacturers directions prior to use and were rinsed with 10% nitric acid and ultrapure water between sites to prevent cross-contamination. Approximately 3 L of unfiltered water was collected at all sites and stored in Cubitainers. Water was acidified with analytical-grade nitric acid (Mallinckroft Specialty Chemical Co., Paris, KY 40361) to a pH of 3 and frozen for shipment to LANL. Freezing and acidification are preservation techniques which minimize surface adsorption of uranium to container surfaces.

### *Sampling procedures*

In shallow areas, hand-held seines and kick nets were used to collect fish and benthic macroinvertebrates. Taxa from several different aquatic feeding guilds were collected, including suspension feeders (creek chub [*Semotilus atromaculatus*], clams), benthic

detritivores (blue crabs [*Callinectes sapidus*], tadpoles [*Rana* sp.], grass shrimp [*Paleomonetes* sp.]), and carnivores (mummichog [*Fundulus heteroclitus*], dragonfly naiads [*Gomphus* sp.], giant water bugs [*Belastoma* sp.], American eel [*Anguilla rostrata*], sunfish [Centrarchidae], and pickerel [*Esox americanus*]). Sediment was also collected from each sampling location.

In deeper waters, samples were collected using an otter trawl at the mouths of Mosquito Creek and Delph Creek. A plankton tow net (mesh size = 80  $\mu\text{m}$ ; Wildlife Supply Co., Saginaw, MI 48602) was used to collect phytoplankton, zooplankton, and suspended particulate matter. Sediment and benthic invertebrates were collected with a Ponar sampler. Benthic invertebrates were retrieved from sediment by washing sediment through a 1.0 mm sieve and removing organisms from remaining litter. Sorted invertebrates were rinsed, sealed in plastic bags, and frozen. Aquatic macrophytes were collected by hand, rinsed, and frozen in plastic bags.

All samples were sorted to lowest possible taxa in the field and frozen for shipment to LANL for total uranium and isotopic ratio analyses. Since uranium tends to preferentially accumulate in certain tissues, especially bone and kidney, these tissues were dissected from larger organisms. Individual organisms and individual organs were used for uranium analysis whenever practical, but sample number restrictions and small biomass forced some samples to be pooled. All dissection equipment was rinsed with a 10% nitric acid solution followed by an ultrapure water rinse between samples to prevent cross-contamination.

Field sampling was often serendipitous and the July 1992 collection included a moribund great blue heron (*Ardea herodias*). Since herons predominately feed upon fish

and, as a consequence, may accumulate DU from the environment, tissue samples from the heron were analyzed for uranium content. Tissue samples included vertebral bone, pectoral muscle, kidney, liver, and gastrointestinal tract.

### *Sample Preparation*

**\*\*\* MIKE, INSERT INFO ON SAMPLE PREP FOR NEUTRON ACTIVATION OF JULY 1992 FIELD SAMPLES \*\*\***

Sediment and tissue samples were prepared for ICP-MS at Los Alamos. Initial ("wet") weights of all samples were recorded, then samples were dried at 120°C. Dry weights were recorded after samples had cooled, and sediment samples were packaged in storage containers. Biological samples were then ashed in a muffle furnace programmed to hold at 250°C for 3 hours, 350°C for 3 hours, and finally at 450°C for four hours. Ash weights were recorded after samples had cooled, then each sample was packaged for later analysis and storage.

Sample preparation procedures for water included ... **\*\*\* MIKE, INSERT INFORMATION CONCERNING RESIN AND ELUTION COLUMNS (IF USED) \*\*\***

### *Chemical Analysis*

**\*\*\* MIKE, WHO AND WHERE WERE SAMPLES SHIPPED TO FOR NEUTRON ACTIVATION (JULY 1992 FIELD SAMPLES) \*\*\***

Delayed neutron activation analysis allows differentiation of natural and DU through the use of isotopic ratios. Delayed neutron activation (Amiel 1962, Coleman and Pierce

1967) irradiates samples in a flux of neutrons, and, after a 25 to 35-sec delay, samples are counted in a boron trifluoride neutron detector.

Like ion chromatography, delayed neutron activation allows differentiation of natural and DU through the use of isotopic ratios. The ratio of  $U^{235}$  to  $U^{238}$  in natural uranium is 0.7 : 99.3; a ratio richer in  $U^{238}$  indicates the presence of DU. Field-collected specimens were expected to contain background concentrations of natural uranium while any DU found in environmental samples collected at APG would necessarily be derived from DU penetrators. Detection limits of neutron activation were reported to be **XXX mg/kg U**.

**\*\*\* MIKE, WE STILL HAVE NO INFO ON NEUTRON ACTIVATION DETECTION LIMITS, INSTRUMENTATION OR QUALITY CONTROLS PROCEDURES USED FOR DELAYED NEUTRON ACTIVATION \*\*\***

Samples which were to be analyzed by ICP-MS were shipped to CL (Anaheim, CA) for analysis via overnight courier. The samples were checked in to CL and a Receipt of Acknowledgement form was returned to LANL. Uranium or DU in each sample was extracted using EPA Method 3050 (**\*\*\* MIKE, PLEASE INSERT APPROPRIATE CITATION HERE**). Briefly, the method involves extraction of metals with hot concentrated nitric and hydrochloric acids, then oxidation of organics with hydrogen peroxide. The extracts were separated from the remaining solids, filtered, and diluted for ICP-MS analysis. ICP-MS analyses were conducted using EPA Method 6020 (**\*\*\* MIKE, PLEASE INSERT APPROPRIATE CITATION HERE \*\*\***).

Quality assurance and quality control (QA/QC) measures were followed as prescribed in EPA Method 6020. A series of QA/QC blanks, standards, duplicates, and spikes were analyzed with each set of samples. Instrumental and Method blanks demonstrated that there was no uranium in the samples as a result of sample handling, and sample blank demonstrated that uranium analyses below detection were true (\*\* MIKE, PLEASE CLARIFY THE LAST PART OF THIS STATEMENT \*\*). <sup>238</sup>U samples were run after calibration with certified laboratory standards of 0.5 to 200 µg/L. Each batch of samples and standards showed the expected and actual values of the standards for comparison and to demonstrate that the instrument was in proper working order. <sup>238</sup>U samples were analyzed at a lower concentration, ranging from 0.5 to 50 µg/L to ensure accurate values in the lower concentration range. <sup>235</sup>U samples were run in the same manner as the <sup>238</sup>U samples, except that the laboratory standard was derived from weathered DU collected from YPG. The DU had an isotopic ratio (<sup>235</sup>U/<sup>238</sup>U) of 0.0021 ± 0.0004. The calibration range for <sup>235</sup>U was 1 to 200 µg/L.

Matrix spikes were samples of known value to which spikes of 50 µg/L U were added. Samples of 1.2, 1.5, and 46 mg/L were used and provided a check on the percent recovery during the analyses. Duplicates of the 1.2, 1.5, and 46 µg/L samples were run and compared to show that the instrument was working in correct order.

ICP-MS concentrations (µg/L) were converted to µg-U/kg by adjusting the reported ICP-MS concentration for the dilution factors and the weight of the sample. The resulting concentration on an ashed or oven-dry basis was reported from CL to LANL. Results presented in this report are results provided to CSU from LANL.

## RESULTS

Water quality parameters at APG sampling sites are summarized below (Tables 3.1 and 3.2). Only a partial data set of isotopic ratios and uranium concentrations in field samples (46 of 394 samples) was available by the deadline for the final report. Of the July 1992 field samples, 46 of the 157 samples had been analyzed for DU. Unfortunately, detection limits were insufficient to determine isotopic ratios in the majority of the 46 samples. Without isotopic ratio data it is impossible to determine whether or not samples contained DU or not. Only 8 of 46 samples were above detection limits for both  $U^{235}$  and  $U^{238}$ . However, 50% of these data (4 of 8 samples) contained DU (Table 3.3).

Total uranium concentrations are available for 173 of 225 samples collected in the October 1992 trip (Table 3.4), none of these samples have been analyzed for isotopic ratios. As a consequence, no information is available regarding the concentrations of DU in the October 1992 field samples.



TABLE 3.1. Water quality data collected July 1992 from sites at Aberdeen Proving Ground, MD.

SITE	Temperature (°C)	pH	Dissolved Oxygen (mg/L)	Salinity (%)	Conductivity (µmhos)	Depth (m)	Visibility (m)
Delph Creek #1	22.0	7.04	5.5	0.5	975	1.2	0.4
Delph Creek #2	22.5	6.96	6.0	0.75	1100	0.8	0.4
Upper Delph Creek	nd	5.07	nd	0	440	nd	nd
Upper Mosquito Creek	20.0	5.99	5.2	0	70	nd	nd
Mosquito Creek #1	23.2	7.07	6.5	0.5	925	0.4	0.3
Mosquito Creek #2	23.5	7.40	7.0	0.5	1025	1.4	0.4
Old Woman's Gut #1	22.5	7.18	6.9	0.5	910	0.6	0.4
Old Woman's Gut #2	23.2	7.53	7.5	0.5	850	1.5	0.4
B3 Creek	23.0	6	6.5	0	62	nd	nd
DU Road	23.0	5.77	4.0	0	40	nd	nd
B3 Catchbox	nd	nd	nd	nd	nd	nd	nd

nd = no data collected

TABLE 3.2. Water quality data collected October 1992 from sites at Aberdeen Proving Ground, MD.

SITE	Temperature (°C)	pH	Dissolved Oxygen (mg/L)	Salinity (%)	Conductivity (µmhos)	Depth (m)	Visibility (m)
Delph Creek #1	17.0	nd	10.0	2.2	2950	1.7	0.9
Delph Creek #2	17.0	nd	10.8	2.1	3600	1.1	1.0
Upper Delph Creek	16.0	5.0	8.4	nd	1900	nd	nd
Mosquito Creek #1	18.0	4.9	10.0	0.05	1000	0.7	0.4
Mosquito Creek #2	18.5	nd	11.4	0.8	1100	1.2	0.4
Old Woman's Gut #1	17.0	nd	9.6	2.0	3300	0.65	0.65
Old Woman's Gut #2	nd	nd	nd	nd	nd	nd	nd
B3 Creek	nd	nd	nd	nd	nd	nd	nd

nd = no data collected

TABLE 3.3. Environmental samples collected at Aberdeen Proving Grounds, MD which contained measurable amounts of <sup>235</sup>U and <sup>239</sup>U are summarized. A <sup>235</sup>U/<sup>239</sup>U ratio < 0.8 indicates the presence of DU while values > 1.0 indicate natural uranium.

SITE	SAMPLE	<sup>235</sup> U Conc (mg/kg)	<sup>239</sup> U Conc (mg/kg)	<sup>235</sup> U/ <sup>239</sup> U ratio
Delph Creek #2	Sediment	4.215	3.408	1.237
Delph Creek #1	Sediment	6.094	5.469	1.114
Mosquito Creek #2	Sediment	4.176	3.810	1.096
Mosquito Creek #1	Sediment	4.870	6.043	0.806
DU Road	Amphibians: 12 tadpoles ( <i>Rana</i> sp.)	5.933	8.667	0.685
DU Road	Sediment	2.856	4.640	0.616
Upper Delph Creek	Sediment	4.624	7.527	0.614
Upper Delph Creek	Sediment	7.232	22.147	0.327

TABLE 3.4. Total uranium content in environmental samples collected at Aberdeen Proving Grounds, MD in October 1992. Samples were analyzed using inductively coupled plasma emission spectrophotometry-mass spectrophotometry (ICP-MS) and represent 173 of 225 samples collected.

Species	Scientific Name	N	Mean	Std. Dev.
American Eel	<i>Anguilla rostrata</i>	1	120.0	*
Bay Anchovy	<i>Anchoa mitchilli</i>	6	214.7	304.3
Black Bullhead	<i>Ameiurus nebulosus</i>	3	360	165.2
Blue Crab	<i>Callinectes sapidus</i>	2	87.5	2.1
Clams	Pelecypoda	1	30.0	*
Crawfish	Decapoda	1	310.0	*
Creek Chub	<i>Semotilus atromaculatus</i>	2	72.0	31.1
Darter	Percidae	1	31.0	*
Deer Pellets	---	2	915.0	544.5
Detritus	---	1	9700	*
Dragonfly naiads	Odonata	1	1200.0	*
Giant Water Bugs	<i>Belostoma</i> sp.	1	280.0	*
Grass Shrimp	<i>Palaemonetes</i> sp.	3	390	240.6
Hogchoker	<i>Trinectes maculatus</i>	4	94.2	66.7
Striped Killifish	<i>Fundulus majalis</i>	2	543.0	646.3
Madtom	<i>Noturus</i> sp.	2	113.5	79.9
Mosquitofish	<i>Gambusia holbrooki</i>	1	25.0	*
Seston	---	4	2950.0	1502.2
Shiner	<i>Notropis</i> sp.	2	200.0	28.3
Stonefly larvae	Plecoptera	2	1200	1272.8
Stoneroller	<i>Camptostoma anomalum</i>	5	201.4	136.7
Striped Bass	<i>Morone saxatilis</i>	1	94	*
Sunfish	Centrarchidae	38	144.3	143.1
Tadpoles	<i>Rana</i> sp.	2	490.0	169.7
Water Beetle	Hydrophilidae	2	1180.0	1301.1
White Perch	<i>Morone americanus</i>	80	121.3	110.3
Yellow Perch	<i>Perca flavescens</i>	3	87.7	4.5

## DISCUSSION

Preliminary results indicate detectable amounts of DU were found in some field collected samples, including tadpoles (*Rana* sp.) and sediment. In fact, 50% of the samples for which isotopic ratio data were available contained DU. However, no conclusions should be drawn concerning the overall presence of DU in the aquatic environment at APG due to the small sample size (N=8). When complete data sets are received, we should have a better understanding of the presence or absence of DU in the aquatic environment at APG.

## **\*\* CHAPTER 4 \*\***

### **APG EXPERIMENTS**

#### **OVERVIEW**

The majority of DU released into the environment from APG activities is expected to partition into soils and sediment due to its high sorptive and binding efficiency relative to water. Because benthic invertebrates are in direct contact with sediments, DU associated with the sediment may be ingested or adsorbed by these organisms and, thereby, introduced into aquatic food chains (Swanson 1985). Benthic invertebrates are a primary food source for many carnivorous fish in the Chesapeake Bay ecosystem and transfer of uranium from sediment to benthic invertebrates to fish may represent a critical exposure pathway which should be evaluated when assessing the fate and transport of uranium in the aquatic environment. Since APG sediments act as a repository, the purpose of the majority of experiments conducted was to determine the bioavailability of DU from APG sediments to living organisms.

An on-site field exposure was conducted to observe site-specific bioavailability of DU to aquatic biota. Often bioavailability of metals in the field is significantly different from predicted values due to site-specific physicochemical characteristics and inherent complexity of natural systems. For example, theoretical solubility limits suggest aqueous concentrations of DU at APG are not likely to exceed 0.200 mg/L U (Erikson et al. 1990b). However,

field-collected water samples were found to contain 0.222 mg/L U (Ebinger et al. 1991). Consequently, the use of field exposures, in conjunction with field sampling and laboratory experiments, provides a more realistic accounting of the processes which dictate the fate and transport of DU in the environment.

In general, laboratory experiments were conducted to evaluate the transport of uranium from sediments to aquatic biota (Figure 4.1) and to provide specific information regarding uranium kinetics for ecological risk assessment models. Rates of bioconcentration, bioaccumulation, bioturbation, and transfer of DU through trophic levels were determined through the use of laboratory microcosms. Benthic invertebrates and fish were exposed to DU in these laboratory microcosms which were filled with water and sediment. Because solubility and bioavailability are significantly affected by physical and chemical conditions, water and sediment used in laboratory microcosms were similar in quality to those found at APG during field collections and reported from other nearby locations (USGS 1992; M. Ebinger, LANL, personal communication).

## Physical Processes

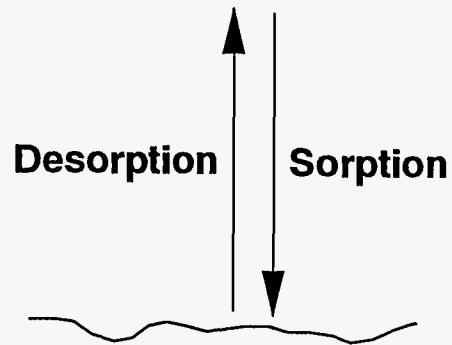

56

## Bioturbation

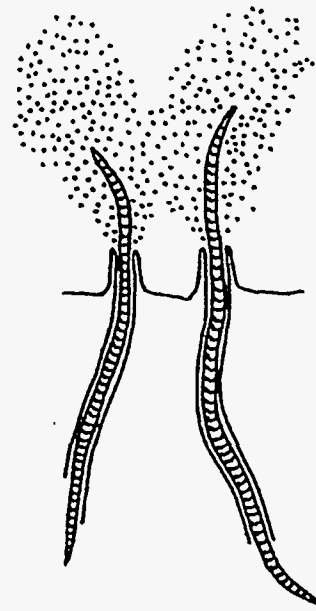

## Food-Chain Transfer

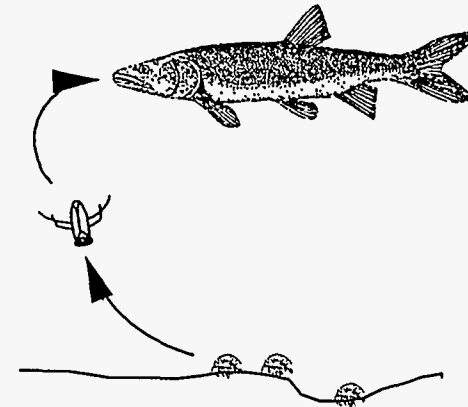

**FIGURE 4.1.** Abiotic and biotic processes governing the fate and transport of contaminants from sediment into overlying water and aquatic food chains. These three general processes were studied in laboratory experiments conducted by Colorado State University to evaluate depleted uranium in the environment at Aberdeen Proving Grounds, Maryland.

## **\*\* CHAPTER 5 \*\***

### **APG FIELD EXPOSURE EXPOSURES**

#### **INTRODUCTION**

An *in situ* experiment was conducted at APG to evaluate potential uptake and internal distribution of DU in aquatic organisms. Aquatic organisms were enclosed for up to four weeks with penetrator fragments that had been previously recovered from the firing range. Enclosures were placed in Mosquito Creek, upstream from High Velocity Road at APG. Mosquito Creek flows through the firing range and drains range land: the experiment site was within the firing range. This experiment was an attempt to represent "worst case" conditions for *in situ* exposure by restricting aquatic organisms to close association with DU fragments.

Two experiments were attempted prior to the one described below. Both experiments used blue crabs (*Callinectes sapidus*) and wedge clams (*Rangia cuneata*) but were aborted due to poor survival of organisms. Mortality was apparently due to heavy silt loads (and presumably low oxygen) in the creek. Difficulties encountered in these two experiments affected the selection of organisms and design of the final experiment. Upon consultation with APG (Larry Davis, John Beckman) and LANL (Mike Ebinger) personnel, channel catfish (*Ictalurus punctatus*) and wedge clams (*Rangia cuneata*) were selected for the third experiment.



## **MATERIALS AND METHODS**

### *Test Organisms*

Channel catfish were obtained from Maryland Pride Farms, Aberdeen, MD on 29 August. Catfish were transported to APG in coolers of pond water, weighed (nearest 0.1 g), and identified by caudal fin clips. Catfish were then transported to Mosquito Creek in coolers with ice and were promptly placed in cages in the creek. Following placement of clam enclosures and DU fragments, cages were closed and placed in the creek. Catfish food (from Maryland Pride Farms) was added to cages weekly in an effort to enhance survival of the pond-raised fish in Mosquito Creek.

Clams were collected from Nanjemoy Creek in the morning of 28 August and transported (in Nanjemoy Creek water) to APG that day. Nanjemoy Creek is a tributary of the Potomac River in southern Maryland. Salinity at time of collection was 4 ppt. Clams were individually numbered with fingernail polish, weighed to the nearest 0.1 g (blotted dry), and placed in small cages. Clams were then immersed at the mouth of Mosquito Creek overnight.

### *Field Enclosures*

Enclosures (cages) were constructed of polyethylene mesh (0.5 in. openings: ADPI Enterprises, Philadelphia, PA). Cages were rectangular (40 x 20 x 20 in.) and were placed in the creek (long axis horizontal) with two upright steel stakes per cage. Cages were lined on the bottom with solid plastic sheeting. DU fragments were strapped to the bottom of each

cage, on top of the plastic sheet. Catfish were able to move throughout the cage. A smaller, cylindrical enclosure (20 in. long, 20 in. circumference, same mesh) was suspended inside each rectangular cage and contained only clams. This small cage served two purposes: clams were isolated from catfish to minimize potentially harmful interactions and suspended above sediments in an attempt to avoid siltation/low oxygen mortality. Clams were suspended approximately 6 in. above the DU fragments.

### *Experimental Design*

Experimental design was based on the availability of 16 DU fragments (approximately equal to 4 whole penetrators). In order to maximize potential exposure and collection of survivors through the experiment, 8 cages were used, each initially containing 3 catfish, 6 clams, and 2 DU fragments. Two cages were randomly selected for collection each week (4 weeks total). In addition, 6 catfish and 8 clams were set aside as pre-exposure samples. The experiment was conducted from 29 August 1992 through 25 September 1992.

At week 1, a number of catfish had already died, although all clams in all cages were surviving. In an attempt to maximize chances of surviving catfish for the experiment, cages were rescheduled for sampling (Table 5.1). Cages were randomly assigned to weeks 1 and 2 for sampling, but cages with 2 surviving catfish were purposely designated for sampling at week 3. This sampling schedule was followed for the remainder of the experiment and no mortality of catfish or clams was observed after week 1.

TABLE 5.1. Revised schedule for field exposure experiment.

No. Catfish Alive at Week 1	Rescheduled Sampling Week	Cage #
1	1	4
1	1	7
1	2	1
1	2	6
2	3	3
2	3	8
0	4	2
0	4	5

*Sample Preparation*

All collected organisms (including pre-exposure organisms) were processed similarly according to the following procedure. Upon collection, organisms were placed in coolers on ice and returned to the APG lab, where they were weighed as before. Organisms were then stored on ice until dissections could be performed ( $\leq 48$  hours after collection). Organisms were rinsed thoroughly in flowing tap water before dissection, and dissection equipment was similarly rinsed between samples. Catfish samples were processed separately from clam samples. Individual specimens were pooled per enclosure (e.g., catfish kidneys were pooled from cage #8) to form one sample type per cage. Pre-exposure organisms were randomly split into subsamples: 3 catfish each and 4 clams each. Catfish were dissected for kidneys,

liver, and muscle tissue. Clams were dissected for whole soft tissue (viscera, gills, mantle combined). All dissected tissue samples were sealed in Whirlpak bags and frozen immediately after dissection.

All samples from the final experiment were shipped in a cooler with dry ice to LANL by overnight express service on 14 October 1992 and received by LANL on 15 October 1992.

Tissue samples were prepared for ICP-MS at Los Alamos. Initial ("wet") weights of all samples were recorded, then samples were dried at 120°C. Dry weights were recorded after samples had cooled. Biological samples were then ashed in a muffle furnace programmed to hold at 250°C for 3 hours, 350°C for 3 hours, and finally at 450°C for four hours. Ash weights were recorded after samples had cooled, then each sample was packaged for later analysis and storage.

### *Chemical Analysis*

Samples were shipped via overnight courier to CL for ICP-MS analysis. The samples were checked in to CL and a Receipt of Acknowledgement form was returned to LANL. Uranium or DU in each sample was extracted using **EPA Method 3050 (\*\* MIKE, PLEASE INSERT APPROPRIATE CITATION HERE \*\*)**. Briefly, the method involves extraction of metals with hot concentrated nitric and hydrochloric acids, then oxidation of organics with hydrogen peroxide. The extracts were separated from the remaining solids, filtered, and diluted for ICP-MS analysis. ICP-MS analyses were

conducted using EPA Method 6020 (**\*\*\* MIKE, PLEASE INSERT APPROPRIATE CITATION HERE \*\*\*** ).

Quality assurance and quality control (QA/QC) measures were followed as prescribed in EPA Method 6020. A series of QA/QC blanks, standards, duplicates, and spikes were analyzed with each set of samples. Instrumental and Method blanks demonstrated that there was no uranium in the samples as a result of sample handling, and sample blank demonstrated that uranium analyses below detection were true (**\*\*\*MIKE, PLEASE CLARIFY THE LAST PART OF THIS STATEMENT \*\*\***).  $^{238}\text{U}$  samples were run after calibration with certified laboratory standards of 0.5 to 200  $\mu\text{g/L}$ . Each batch of samples and standards showed the expected and actual values of the standards for comparison and to demonstrate that the instrument was in proper working order.  $^{238}\text{U}$  samples were analyzed at a lower concentration, ranging from 0.5 to 50  $\mu\text{g/L}$  to ensure accurate values in the lower concentration range.  $^{235}\text{U}$  samples were run in the same manner as the  $^{238}\text{U}$  samples, except that the laboratory standard was derived from weathered DU collected from YPG. The DU had an isotopic ratio ( $^{235}\text{U}/^{238}\text{U}$ ) of  $0.0021 \pm 0.0004$ . The calibration range for  $^{235}\text{U}$  was 1 to 200  $\mu\text{g/L}$ .

Matrix spikes were samples of known value to which spikes of 50  $\mu\text{g/L}$  U were added. Samples of 1.2, 1.5, and 46  $\text{mg/L}$  were used and provided a check on the percent recovery during the analyses. Duplicates of the 1.2, 1.5, and 46  $\mu\text{g/L}$  samples were run and compared to show that the instrument was working in correct order.

ICP-MS concentrations ( $\mu\text{g/L}$ ) were converted to  $\mu\text{g-U/kg}$  by adjusting the reported ICP-MS concentration for the dilution factors and the weight of the sample. The resulting

concentration on an ashed or oven-dry basis was reported from CL to LANL. Results presented in this report are results provided to CSU from LANL.

## **RESULTS**

No analytical results have been received and, without data, no conclusions can be drawn.

## **\*\* CHAPTER 6 \*\***

### **Bioconcentration of Uranium by Phytoplankton**

#### **INTRODUCTION**

Because sediments at APG have a high binding affinity, the majority of DU introduced into the environment at APG will partition into sediment and a small, but measurable, fraction of uranium will solubilize in surface waters. Given the geophysicochemistry of APG, surface water concentrations may approach 0.200 mg/L U (Erikson et al. 1990b, Ebinger et al. 1991). While these concentrations may not result in acute toxicity to many organisms (Tarzwell and Henderson 1960, Davies 1980, Poston et al. 1984, Ahsanullah and Williams 1986, Bywater et al. 1991), aqueous uranium may be bioconcentrated by phytoplankton and introduced into food webs. Toxic effects to first-order consumers could potentially result from the ingestion of highly contaminated phytoplankton.

The ability of microorganisms to bioconcentrate uranium is well documented in the literature (Sakaguchi et al. 1978, Nakajima et al. 1979, Horikoshi et al. 1979a and 1979b, Horikoshi et al. 1981, Nakajima et al. 1981, Strandberg et al. 1981, Tsezos and Volesky 1981, DiSpirito et al. 1983, Mann and Fyfe 1985). Even though aqueous concentrations can be extremely low, algae are capable of concentrating uranium 1000's to 10,000's of times greater than in surrounding water (Sakaguchi et al. 1978, Horikoshi et al. 1979a, Nakajima et al. 1981, Mann and Fyfe 1985). Consequently, bioconcentration of aqueous uranium by phytoplankton at APG could result in algae concentrations easily in excess of 100  $\mu\text{g/g}$  U

(parts per million). Because bioconcentration by algae tends to be primarily a surface-adsorption phenomenon (Horikoshi et al. 1979a, Nakajima et al. 1981), toxic effects to algae are unlikely to occur. However, organisms which feed upon algae, such as filter-feeding clams or planktivorous fish, would ingest a highly contaminated food source. The effects of food-web exposure to these organisms is unknown.

The purpose of this study was to determine the bioconcentration of uranium by the green algae, *Selenastrum capricornutum*. Based on the results from this experiment, planktivorous organisms would be fed uranium-contaminated algae to determine if toxic effects resulted from food-chain exposure.

## MATERIALS AND METHODS

### *Phytoplankton*

*Selenastrum capricornutum* (UTEX 1648), a green algae, was cultured in 8 L of Deep Rock<sup>R</sup> artesian water inoculated with the contents of 8 tubes of Alga-Gro<sup>R</sup> algae growth medium (Carolina Biological Supply Company). Cultures were grown in Erlenmeyer flasks placed in an environmental chamber with continual florescent lighting (30-33 ft-candles). Temperature was maintained at 25°C  $\pm$  0.5°C and cultures were continuously mixed using a stirplate to maintain algal cells in suspension. After 10 days, algal cultures were harvested by allowing algae to settle, followed by centrifugation at 2000 rpm for 1 min, and removal of the supernatant. Algae was resuspended in reservoir water and calibrated to 3.0-3.5 x 10<sup>7</sup> cells/ml using a Spec 20 spectrophotometer (wavelength = 550 nm; Bausch & Lomb). In



anticipation of subsequent experiments using uranium-contaminated algae as food for zooplankton, this density of algal cells was selected because it represents the concentration of algae commonly used to feed *Ceriodaphnia dubia* (USEPA 1989).

### *Water Quality*

Water was soft, unfiltered reservoir water (Horsetooth Reservoir, Larimer Co., CO) which closely resembled water quality characteristics of freshwater at APG (Table 6.1). Initial physicochemical parameters of the reservoir water were: hardness = 26 mg/L as CaCO<sub>3</sub>; alkalinity = 29 mg/L as CaCO<sub>3</sub>; and pH was 5.7. After the 24 hr exposure period, pH had risen to 9.2. Temperature was maintained in an experimental chamber at 25° ± 0.5°C during the experiment.

TABLE 6.1. Water quality data from Aberdeen Proving Grounds, MD (M. Ebinger, LANL, personal communication).

	Mosquito Creek		Delph Creek	Swamp
	Site A	Site B	(mouth)	(on-site)
Hardness	18	21	56	8
Alkalinity	25	14	34	<0.6
pH	6.37	6.17	7.04	5.12

### *Experimental Design*

Uranium spiking solutions were prepared by combining depleted uranyl acetate (UO<sub>2</sub>(C<sub>2</sub>H<sub>3</sub>O<sub>2</sub>)<sub>2</sub>\*H<sub>2</sub>O; Mallinckrodt Specialty Chemical Company, Paris, KY 40361) with

ultrapure water. Aliquots (0.1 ml) of this spiking solution were dispensed into test tube cultures to obtain nominal test concentrations. The volume of the spiking solution represented <1% of the test solution volume and would not be expected to change the physicochemical conditions.

Algae solutions were spiked to achieve five nominal concentrations (0, 0.01, 0.1, 1, and 10 mg-U/L) and 14.6 ml aliquots were placed into polypropylene test tubes. Six replicates were used for each concentration. Since uranium bioconcentration by algae is largely a surface-adsorption phenomenon which reaches equilibrium within a few hours (Horikoshi et al. 1979a, Nakajima et al. 1981), only a single exposure time (24 hr) was used.

After 24 hr, 30 algae samples were centrifuged (2000 rpm, 4 min) and supernatant was removed. Samples were resuspended with ultrapure water to rise away any remaining spiking solution and immediately centrifuged again. Rinse water was removed and centrifuge tubes containing algae samples were frozen for analysis.

To concentrate aqueous uranium for chemical analysis, spiking solutions were passed through elution columns containing AGOW-X8 cation-exchange resin (Bio-Rad Laboratories, Richmond, CA 94804). Five elution columns representing each spiking concentration were used. These columns were frozen and shipped to LANL for analysis.

### *Chemical Analysis*

**\*\*\* MIKE, WHO WERE SAMPLES SHIPPED TO FOR NEUTRON ACTIVATION.  
ALSO, PLEASE INCLUDE SAMPLE PREP INFO FOR NEUTRON ACTIVATION.**

Delayed neutron activation analysis allows differentiation of natural and DU through the use of isotopic ratios. Delayed neutron activation (Amiel 1962, Coleman and Pierce 1967) irradiates samples in a flux of neutrons, and, after a 25 to 35-sec delay, samples are counted in a boron trifluoride neutron detector.

Like ion chromatography, delayed neutron activation allows differentiation of natural and DU through the use of isotopic ratios. The ratio of  $U^{235}$  to  $U^{238}$  in natural uranium is 0.7 : 99.3; a ratio richer in  $U^{238}$  indicates the presence of DU. Field-collected specimens were expected to contain background concentrations of natural uranium while any DU found in environmental samples collected at APG would necessarily be derived from DU penetrators. Detection limits of neutron activation were reported to be **XXX mg/kg U**.

**\*\*\* MIKE, WE STILL HAVE NO INFO ON NEUTRON ACTIVATION DETECTION LIMITS, INSTRUMENTATION OR QUALITY CONTROLS PROCEDURES USED FOR DELAYED NEUTRON ACTIVATION \*\*\***

## **RESULTS**

This experiment was completed on 12 July 1992 and 30 algae samples and five elution columns were shipped to LANL. LANL pooled two algae samples in order to have enough biomass to analyze with neutron activation. Despite sample pooling, algae samples were below detection limits of delayed neutron activation. This result was unexpected since algae should have contained 0.007 to 56 mg U per sample based on bioconcentration factors

from numerous studies (Sakaguchi et al. 1978, Horikoshi et al. 1979a, Nakajima et al. 1981, Mann and Fyfe 1985).

## DISCUSSION

The ability of phytoplankton to bioconcentrate uranium from aqueous solution has been well documented in the literature. Inability to detect uranium in algae from this experiment is likely due to the small biomass of experimental samples, regardless of uranium content. It is unlikely that results were indicative of a lack of bioconcentration by algae. Alternatively, rinsing may have removed some uranium which was sorbed to exterior cell surfaces. However, rinsing procedures were used successfully by other researchers (Sakaguchi et al. 1978, Horikoshi et al. 1979a and b, Nakajima et al. 1979, Horikoshi et al. 1981, Nakajima et al. 1981).

Phytoplankton are critically important to the Chesapeake Bay since they convert sunlight into biomass which can be consumed by other organisms. As a result, algae's ability to bioconcentrate uranium from surrounding water represents a potential source of uranium exposure for higher trophic levels. Organisms which feed directly upon algae would be expected to receive the highest doses of uranium and toxic effects could potentially occur to these organisms. Future studies could address this concern (Appendix A). Similarly, filter-feeding clams would be expected to ingest large amounts of uranium-contaminated algae and, consequently, tissue burdens could be transferred to human consumers. Future experimental work is also suggested to explore this avenue. However, any future study

initiated should utilize analytical techniques capable of detecting uranium at environmentally realistic concentrations.

## **\*\* CHAPTER 7 \*\***

### **Toxicity of Uranium to Zooplankton**

#### **INTRODUCTION**

The vast majority of DU introduced into the environment is expected to become associated with soils and sediment. Aqueous concentrations are predicted to be  $\leq 200$  ug/L U (Erikson et al. 1990b) and would be below acute toxicity levels for most organisms (Bywater et al. 1991, Ahsanullah and Williams 1986, Poston et al. 1984, Parkhurst et al. 1984, Davies 1980, Tarzwell and Henderson 1960). However, some sensitive species could be affected and sublethal effects may occur at much lower concentrations for these organisms (Gross and Koczy 1946, Tannenbaum and Silverstone 1951).

Zooplankton, specifically cladocerans, are often sensitive indicators of environmental contamination and toxic effects might be expected to first appear in this group. Zooplankton are fundamentally important to the Chesapeake Bay ecosystem because they represent a critical link between primary producers and fish communities. Toxic effects could significantly reduce zooplankton densities leading to a cascade of indirect effects on other aquatic life in the Chesapeake Bay. Disruption of zooplankton populations could ultimately harm commercial fisheries.

Unfortunately, the toxicity of uranium to zooplankton is not well documented in the literature. Two studies found acute toxicity (measured as mortality) of cladocerans ranged from 0.41 to 1.29 mg/L U (24-hr  $LC_{50}$ ) in soft, slightly acidic water to 6 mg/L U (48-hr

LC<sub>50</sub>) in moderately hard, slightly alkaline water (Bywater et al. 1991, Poston et al. 1984). LC<sub>50</sub> values are defined as the concentration of a chemical which causes 50% lethality within a specified length of time (Rand and Petrocelli 1985). Based on the physicochemical water parameters at APG, we would predict acute toxicity at concentrations similar to the study with soft, slightly acidic water. Chronic toxicity (measured as a reduction in reproduction) for other cladocerans ranged from 0.5 mg/L to 3.5 mg/L U in moderately hard, alkaline water (Poston et al. 1984). Chronic values for soft, acidic water were not available. We would predict chronic toxicity at APG would be lower than the reported range because of the soft and slightly acidic water found at APG. This study was designed to evaluate acute and chronic effects of DU on zooplankton in water of similar physicochemical characteristics as the water found at APG.

## MATERIALS AND METHODS

### *Test Organisms*

*C. dubia* were obtained from U.S. Environmental Protection Agency-Duluth (U.S. EPA) stocks in 1983. Mass cultures were continuously maintained in 1-L glass beakers filled with moderately-hard reconstituted water until organisms were prepared for use in toxicity tests. Mass cultures were acclimated to water hardness similar to that used in tests at least 7 d prior to the isolation of brood stock. Individual *C. dubia* were isolated prior to testing and reproduction was monitored. Neonates (<12-hr old) used in toxicity tests were produced from isolated brood stock were from the third brood which contained  $\geq 9$  individuals.

### *Experimental Design*

Water was soft, unfiltered reservoir water (Horsetooth Reservoir, Larimer Co., CO) which closely resembled water quality characteristics of freshwater at APG (Table 6.1). In the first experiment, initial physicochemical parameters of the reservoir water were: hardness = 26 mg/L as CaCO<sub>3</sub>; alkalinity = 29 mg/L as CaCO<sub>3</sub>; and conductivity = 76 umhos/cm. Dissolved oxygen averaged 7.44 (standard deviation = 0.37) and mean pH was 7.3 (0.56) throughout the entire test. Initial physicochemical parameters of the reservoir water in the second experiment were: hardness = 28 mg/L as CaCO<sub>3</sub>; alkalinity = 32 mg/L as CaCO<sub>3</sub>; and conductivity = 74 umhos/cm. Dissolved oxygen averaged 7.44 (0.37) and mean pH was 7.8 (0.15) throughout the entire second experiment. Temperature was maintained at 25° ± 0.5°C for both experiments.

Uranium spiking solutions were prepared by combining depleted uranyl acetate (UO<sub>2</sub>(C<sub>2</sub>H<sub>3</sub>O<sub>2</sub>)<sub>2</sub>\*H<sub>2</sub>O; Mallinckrodt Specialty Chemical Company, Paris, KY 40361) with ultrapure water. This spiking solution was diluted with reservoir water to obtain the highest test concentration. Spiking solution represented <1% of the test solution volume. Serial dilutions, using reservoir water as diluent, were prepared from this highest test concentration solution.

Test procedures generally followed established EPA guidelines for acute and chronic tests with *C. dubia* (USEPA 1989). Neonates were pooled and randomly assigned to 30 ml polystyrene test vessels containing 15 ml water. Individual *C. dubia* were fed 200 ul of an algae (*Selenastrum capricornutum*)-yeast-trout chow-Cerophyl diet per test vessel per day. Test vessels were randomly assigned positions within an environmental chamber. Organisms



were placed into new test vessels three times during the exposure period. Uranium concentrations were maintained by static renewal procedures with uranium stock solutions. Temperature was maintained at  $20^{\circ} \pm 0.5^{\circ}\text{C}$ . Photoperiod was 16:8 light:dark regime under cool, white fluorescent lights (30-33 ft-candles). Water in test vessels was not aerated and vessels were covered to minimize evaporative loss. Dissolved oxygen, conductivity, and pH were measured daily while water hardness and alkalinity were measured prior to test initiation. Dissolved oxygen and conductivity were measured with a Yellow Springs Instrument Co. (Yellow Springs, OH 43587) model 57 oxygen meter and a Yellow Springs Instrument Co. model 33 conductivity meter, respectively. A Jenco (San Diego, CA 92126) model 60009 meter was used to determine pH. All meters were calibrated according to manufacturers directions prior to use and were rinsed with 10% nitric acid (Analytical-grade, Mallinckroft Specialty Chemical Co., Paris, KY 40361) and ultrapure water between solutions to prevent cross-contamination. Hardness and alkalinity were determined by titration (APHA 1985).

Acute and chronic toxicity was assessed with two separate experiments. Based on the results of these initial tests, toxicity tests were repeated to validate and to more narrowly define uranium concentrations which caused toxic effects. For each acute exposure concentration, twenty neonates were tested, five organism per test vessel. Serial dilution was used to prepare six uranium solutions for use in 48-hr acute toxicity tests. Nominal concentrations for the initial acute experiment were 0, 1, 3, 5, 7.5, and 11 mg/L U. For the second trial, nominal concentrations were 0, 0.4, 0.75, 1.5, 3, and 6 mg/L U. Survival of neonates was observed every 24-h. Mortality was defined as the lack of movement by an

organism and was confirmed by gentle prodding by a blunt glass rod. Survival of control animals was  $\geq 90\%$  in each test.

For chronic tests, another six solutions were tested over a period of 7 d. For each chronic exposure concentration, ten neonates were tested, each organism in its own individual test vessel. Endpoints for chronic tests included lethality and reproduction, measured as the number of living neonates produced per female during the exposure period. The duration of the test was dictated by the reproduction of control organisms. When 60% or more of living control organisms had three broods the test was concluded. Offspring produced by test organisms were enumerated daily and removed from the test vessel. Nominal concentrations were 0, 0.1, 0.25, 0.5, 1, and 3 mg/L for the initial chronic test and 0, 0.012, 0.025, 0.05, 0.1, and 0.2 mg/L U for the second trial. Since water used in experiments was extremely soft, an additional control using moderately hard reconstituted water (Peltier and Weber 1985) was instituted to verify the health status of *C. dubia*. Initial water quality parameters for moderately hard reconstituted water were: hardness = 86 mg/L as CaCO<sub>3</sub>; alkalinity = 63 mg/L as CaCO<sub>3</sub>; pH = 7.8; dissolved oxygen = 7.5 mg/L; and conductivity = 338 umhos/cm.

Survival and reproduction of control organisms in both experiments exceeded minimal acceptability criteria for these tests (USEPA 1989). For the first experiment, survival in both control groups was  $\geq 90\%$  and reproduction averaged 24.2 and 25.5 neonates in three broods for soft water control and moderately hard reconstituted water control, respectively. For the second experiment, survival in both control groups was 100% and reproduction

averaged 27.2 and 23.0 neonates in three broods for soft water control and moderately hard reconstituted water control organisms, respectively.

### *Sample Preparation*

Water samples from each concentration of stock solution were acidified to a pH of 3 with analytical-grade nitric acid (Mallinckroft Specialty Chemical Co., Paris, KY 40361), frozen, and shipped to LANL for sample preparation. A known volume of water was eluted through columns filled with Chelex-100 resin (Bio-Rad Laboratories, Richmond, CA 94804) and resin was analyzed for uranium content and original aqueous concentrations were calculated.

**\*\*\* MIKE, WE HAVE NO FURTHER INFO ON WATER SAMPLE PREP. PLEASE EXPAND AS APPROPRIATE \*\*\***

Quality assurance samples sent by CSU included spiked water samples and sample blanks. Background uranium concentrations in water were measured in control samples.

### *Chemical Analysis*

**\*\*\* MIKE, PLEASE INSERT INFORMATION REGARDING INSTRUMENTATION AND QUALITY CONTROLS PROCEDURES USED BY LANL \*\*\***

### *Statistical Analysis*

When partial mortality of *C. dubia* occurred in at least one test concentration, acute test data were analyzed using the trimmed Spearman-Kärber method (Hamilton et al. 1977) and results were reported as LC<sub>50</sub> values. The Spearman-Kärber method is a non-parametric test which is statistically conservative, yet calculated LC<sub>50</sub> values are generally similar to those determined by using parametric tests (Rand and Petrocelli 1985). Probit analysis of acute data was not possible since this test requires partial kills in at least two concentrations which did not always occur in our toxicity tests. Since significant mortality (>20%) occurred in chronic test concentrations in the first experiment, 24- and 48-hr lethality data were combined from acute and chronic tests to provide a better estimate of LC<sub>50</sub> values. When partial mortality did not occur, the LC<sub>50</sub> value was calculated to be the geometric mean of the highest test concentration with no mortality and the lowest test concentration with 100% mortality. Chronic test data were analyzed using one-way analysis of variance (ANOVA) followed by Dunnett's procedure (USEPA 1989). Dunnett's analysis is a comparison of means procedure which identified test concentrations where reproduction was significantly different than in control solutions. Significance level for all statistical tests was  $p < 0.05$ .

## RESULTS

### *Acute Tests*

The first experiment was completed 13 July 1992 and was revised and repeated on 23 September 1992. Mortality data for both acute and chronic tests are presented in Table 7.1. The 24-hr LC<sub>50</sub> value in the first experiment was calculated to be 2.52 mg/L U (95% confidence interval = 2.18 to 2.92) and the 48-hr LC<sub>50</sub> was 0.99 mg/L (95% confidence interval = 0.78 to 1.26). In the second test, the 24-hr LC<sub>50</sub> was 3.82 mg/L U (95% confidence interval = 3.63 to 4.02) and the 48-hr LC<sub>50</sub> value was 1.12 mg/L U. Average LC<sub>50</sub> values for both tests were 3.17 mg/L and 1.06 mg/L for the 24- and 48-hr LC<sub>50</sub> values, respectively. These calculated values are based on nominal uranium concentrations. Actual uranium concentrations are not available at this time.

### *Chronic Tests*

Chronic toxicity values were lower than initially anticipated. Significant mortality occurred within the first 24 and 48 hours in the higher test concentrations and no organisms exposed to  $\geq 0.50$  mg/L U survived the exposure period. Consequently, data from these concentrations were not used to evaluate chronic toxicity. *C. dubia* reproduction did occur in the remaining test concentrations, 0.25 and 0.1 mg/L U, but was significantly reduced compared to reproduction by control organisms (Table 7.2). There was no significant difference in reproduction between control groups.

TABLE 7.1. Percent mortality in *Ceriodaphnia dubia* exposed to depleted uranyl acetate for 24- and 48-hours. An additional control, moderately hard reconstituted water (MH Control), was used in addition to the diluent control (0 mg/L).

Nominal U Concentration (mg/L)	Test 1		Nominal U Concentration (mg/L)	Test 2	
	24-hr	48-hr		24-hr	48-hr
Acute Test			Acute Test		
MH Control	0	0	MH Control	0	0
0	0	10	0	0	0
1	0	85	0.4	0	0
3	30	100	0.75	0	0
5	100	100	1.5	0	100
7.5	100	100	3	15	100
11	100	100	6	100	100
Chronic Test			Chronic Test		
MH Control	0	0	MH Control	0	0
0	0	0	0	0	0
0.1	0	0	0.012	0	0
0.25	10	20	0.025	0	0
0.5	20	30	0.05	0	0
1	70	100	0.1	0	0
3	100	100	0.2	0	0

TABLE 7.2. Reproduction in *Ceriodaphnia dubia* exposed to depleted uranyl acetate for 7-days. Reproduction reported as average number of living neonates produced during test. An additional control, moderately hard reconstituted water (MH Control), was used in addition to the diluent control (0 mg/L). Asterisks (\*) identify average reproduction values which were significantly different than in diluent control.

Nominal U Concentration (mg/L)	Test 1		Nominal U Concentration (mg/L)	Test 2	
	N	Ave.		N	Ave.
MH Control	10	25.5	MH Control	10	23.0*
0	9	24.2	0	10	27.2
0.1	10	12.7*	0.012	10	25.9
0.25	8	4.5*	0.025	9 <sup>b</sup>	25.0
0.5	0 <sup>a</sup>	0	0.05	10	24.5*
1	0 <sup>a</sup>	0	0.1	10	21.1*
3	0 <sup>a</sup>	0	0.2	10	6.3*

<sup>a</sup> Significant mortality experienced in these concentrations and, consequently, were not used in analysis of reproductive data.

<sup>b</sup> One male; not included in analysis.

Based on the results from the first experiment, chronic test concentrations were diluted further for the second test. *C. dubia* survival in all test concentrations in the second chronic test was  $\geq 80\%$ . Reproduction was significantly different between control groups but, most importantly, was highest in diluent controls. Reduced reproduction of *C. dubia* control organisms in moderately hard reconstituted water may be indicative of acclimation stress. Since *C. dubia* stock cultures had previously been maintained in soft, reconstituted water similar to diluent water quality, introduction of organisms into moderately hard reconstituted water may have caused sublethal, osmotic shock. Since reproduction was greatest in the diluent control (0 mg/L U), test results were not compromised by the difference in reproduction among control groups.

In the second test, reproduction in concentrations  $\geq 0.05$  mg/L U was significantly reduced compared to the diluent control group (Table 7.2). The maximum acceptable toxicant concentration (MATC) by definition occurs in the region between the lowest observed effect concentration (LOEC) of 0.05 mg/L U and the no observed effect concentration (NOEC) of 0.025 mg/L U. If the MATC is assumed to be the geometric mean of the LOEC and the NOEC then the MATC value was 0.0375 mg/L U. All calculated values are based on nominal concentrations.

## DISCUSSION

Analysis of data suggests acute uranium toxicity to *C. dubia* occurred at concentrations within the range of values previously reported for other cladocerans (Bywater et al. 1991, Poston et al. 1984). Average 24- and 48-hr LC<sub>50</sub> values were 3.17 and 1.06



mg/L U, respectively. Because these calculated values are based on nominal concentrations, LC<sub>50</sub> values are expected to change slightly when actual concentrations are received.

Chronic toxicity, however, occurred at concentrations much lower than anticipated. Reproduction was significantly reduced in concentrations  $\geq 0.05$  mg/L U, an order of magnitude lower than previously reported for other cladocerans (Poston et al. 1984). The probable cause of this enhanced toxicity was likely due to the softer, more acidic water used in these experiments. As with most heavy metals, uranium toxicity is inversely related to hardness and alkalinity (Parkhurst et al. 1984, Poston et al. 1984, Sprague 1985, Spry and Wiener 1991). Alkalinity is a measure of anions in solutions, primarily carbonates, while cations, primarily Ca<sup>+2</sup> and Mg<sup>+2</sup>, are measured by hardness. In solution, uranium tends to form inorganic complexes with hydroxyl and carbonate ions (Grandstaff 1976, Panson and Charles 1977). While uranium-carbonate complexes increase solubility, these complexes reduce bioavailability of the toxic uranyl ion (UO<sub>2</sub><sup>+2</sup>) to aquatic organisms (Horikoshi et al. 1979a, Parkhurst et al. 1984, Ahsanullah and Williams 1989). Cationic species are thought to compete with free uranyl ions (UO<sub>2</sub><sup>+2</sup>) for active uptake sites on gill lamellae surfaces, hence reducing the bioavailability of uranium to aquatic organisms. Conversely, the lack of carbonate ions in the soft water used for this experiment allows free uranyl ions to exist in greater concentrations than in alkaline solutions. Since the free uranyl ions are thought to be the toxic form of uranium in aquatic systems, bioavailability and toxicity of uranium in soft water is increased. Since water quality at APG is similar to the characteristics of the water used in this experiment, particularly in terms of alkalinity, hardness, and pH, toxicity of uranium would be expected to be comparable to values reported in these experiments.

Because DU concentrations at APG are capable of reaching 0.2 mg/L (Erikson et al. 1990b, Ebinger et al. 1991), reproduction by zooplankton at APG may be adversely effected by APG activities (Figure 7.1). Similarly, concentrations of 0.1 mg/L has been shown to reduce diatom survival (Gross and Koczy 1949). Aqueous concentrations previously reported from APG sites have been as high as an average of 13 mg/L U (CSTA 1990). Given the theoretical solubility of uranium reported by Erikson et al. 1990b), we believe this concentration may have been incorrectly reported and should be 13  $\mu$ g/L U or 0.013 mg/L. If this value (0.013 mg/L U) is correct, average uranium concentrations on-site at APG are within a factor of 3 of the calculated MATC value. Safety factors typically applied to protect against interspecific differences, unknown or other adverse effects, and Type II statistical errors in aquatic toxicology should not be less than 10 and may range to 1000 for extremely toxic substances (Holdway 1992). Consequently, given the theoretical solubility limits of uranium at APG, aqueous concentrations of DU could result in toxic effects to aquatic biota.

If the concentration was correctly reported as 13 mg/L, which has been documented at other localities using DU munitions (Hanson 1980), then toxic effects would occur. Analysis of field-collected water samples (Chapter 3) will help assess actual aqueous concentrations at APG. When this information is coupled with the spatial distribution of DU at APG, we would allow us to determine if toxic effects are likely to be localized or more widespread. If DU were transported off-site through storm events or tidal flows, the brackish water of the Chesapeake Bay may mitigate toxic effects of aqueous uranium via elevated pH and increased presence of carbonates.

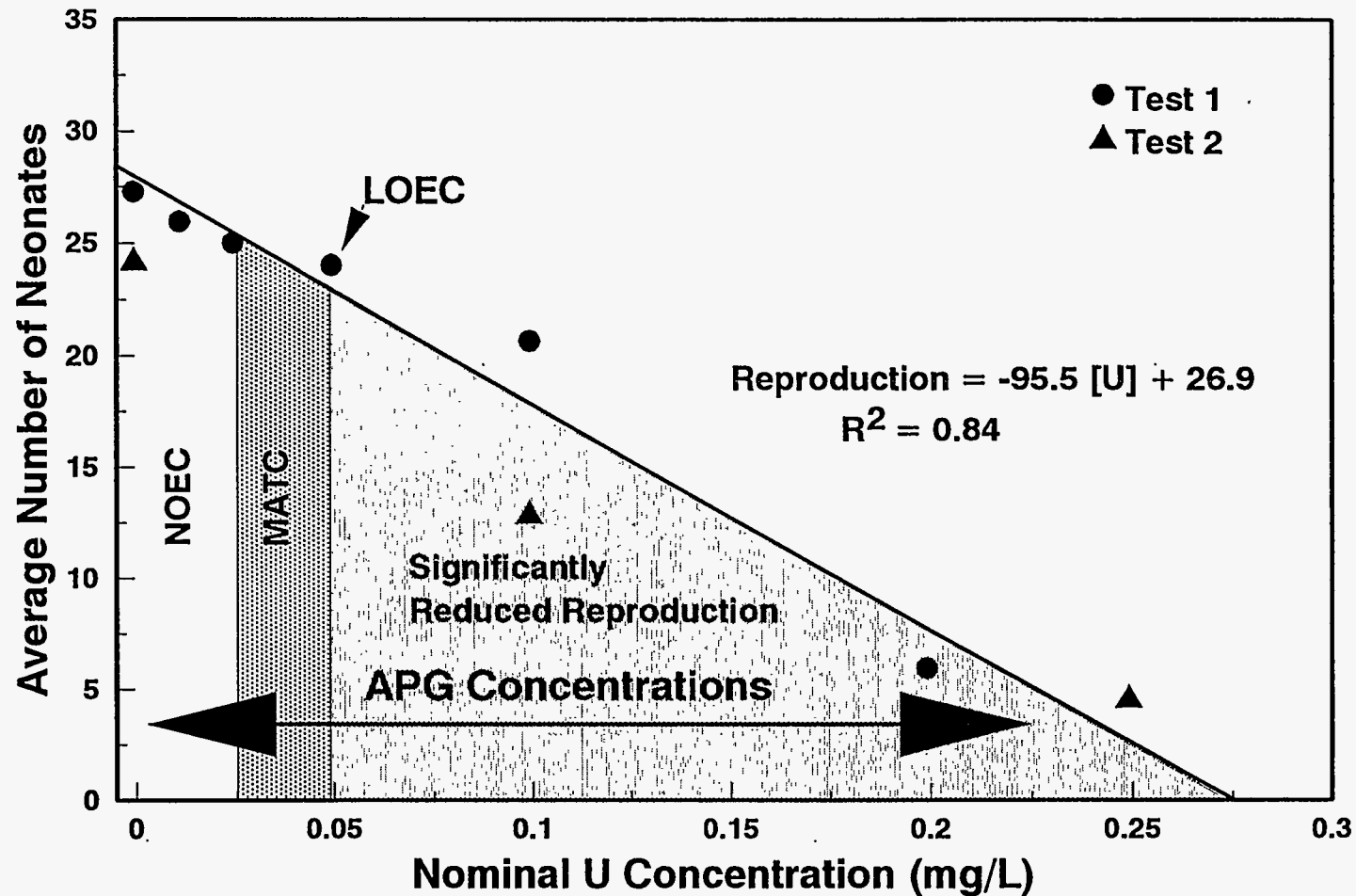

Figure 7.1. Reproduction of *Ceriodaphnia dubia* (N=87) exposed to uranyl acetate solutions during a 7-d exposure period. Relationship between reproduction and uranium concentration was determined by linear regression. No observed effect concentrations (NOEC) ranged from 0 to 0.025 mg/L U. Maximum acceptable toxicant concentration (MATC) lies within the range between 0.025 and 0.050. Lowest observed effect concentration (LOEC) was at 0.05 mg/L U. Concentrations of 0.050 or greater resulted in significantly reduced reproduction. Uranium concentrations at APG have been reported as high as 0.222 mg/L U (Ebinger et al. 1991).

DU adds to background concentrations of naturally occurring uranium and, consequently, total uranium concentrations are of concern when evaluating toxic effects. The finding of toxic effects at aqueous concentrations close to those previously reported is a concern. Because zooplankton are an essential link in aquatic food chains, linking primary production of algae to higher trophic levels, including fish. Without this link, food chains are fundamentally disrupted. As a cornerstone in the Chesapeake Bay ecosystem (Baird and Ulanowiz 1989), reduction in zooplankton densities could have many indirect repercussions which may be experienced by other forms of aquatic life. In a worst-case scenario, the reduction in a zooplankton could result in decreased production of commercial fisheries.

## **\*\* CHAPTER 8 \*\***

### **PHYSICAL DESORPTION OF URANIUM FROM LABORATORY SEDIMENTS**

#### **INTRODUCTION**

Once DU penetrators are introduced into the environment, the mobility of uranium is controlled primarily by physical and chemical characteristics of the surrounding water and sediment (Erikson et al. 1990b, Lovley et al. 1991, Giblin et al. 1981). The primary purpose of this experiment was to determine the rate and magnitude of uranium released from contaminated sediments into the overlying water column in experimental microcosms during a 14-day period. The amount of uranium which diffused from sediments due to physical processes would later be compared to results from other experiments where bioturbation by benthic invertebrates and fish occurred. Bioturbation is the release of contaminants and particulates from sediments into the overlying water column due to the burrowing actions of aquatic biota.

#### **MATERIALS & METHODS**

##### *Laboratory Microcosms*

An artificial sediment containing 3% total organic carbon was used in the aquatic microcosms. Sediment was composed of 83.1% sand ("Mystic White" No. 18, New England Silica, Inc., South Windsor, CT), 14.7% clay and silt (ASP 400, Engelhard Corp.,

Edison, NJ), 2.2% *Sphagnum* moss (milled to an average particle size of 840  $\mu\text{m}$ ; D. L. Browning Co., Mather, WI), 0.01% soluble humic acids (Aldrich Chem. Co., Milwaukee, WI), and 0.05% dolomitic limestone (Southern Agri-Minerals Corp., Hartford, AL). A detailed description of the physical and chemical characteristics of the artificial sediment is described in Walsh et al. (1992).

Sediment was spiked with depleted uranyl nitrate ( $\text{UO}_2(\text{NO}_3)_2 \cdot 6\text{H}_2\text{O}$ ; J.T. Baker Chemical Company, Phillipsburg, NJ 08865) and mixed on a rolling mill for one hour. Spiked sediment was placed in a fume hood and excess water was allowed to evaporate for 48 hr. Moist spiked sediment was then placed into 1-L polystyrene beakers and lightly packed to remove large air pockets. Sediment volume was 200 ml, approximately equivalent to 260 g sediment, dry weight.

Overlying water was soft, unfiltered reservoir water (Horsetooth Reservoir, Larimer Co., CO) which closely resembled water quality of freshwater at APG (Table 6.1). Water quality parameters of the reservoir water were: hardness = 26 mg/L, alkalinity = 27 mg/L, pH = 7.5, and conductivity = 73  $\mu\text{mhos/cm}$ . After the sediment was packed into beakers, overlying water was slowly added to the beakers in order to minimize sediment disturbance. Approximately 700 ml of overlying water was added to beakers to obtain a final volume of 900 ml per microcosm.

### *Experimental Design*

Microcosms were randomly assigned positions within an environmental chamber. Temperature was maintained at  $20^\circ \pm 0.5^\circ\text{C}$ . Photoperiod was a 16:8 light:dark regime

under cool, white fluorescent lights (30-33 ft-candles). Water in microcosms was not aerated and beakers were covered to minimize evaporative loss. Dissolved oxygen and pH were measured during each sampling period. Dissolved oxygen was measured in mid-water column and at the sediment-water interface. Water hardness, alkalinity, and conductivity were measured upon test initiation and completion. Dissolved oxygen and temperature were measured with a Yellow Springs Instrument Co. (Yellow Springs, OH 43587) model 57 oxygen meter. Conductivity was measured with a Yellow Springs Instrument Co. (Yellow Springs, OH 43587) model 33 conductivity meter and pH was measured with a Jenco (San Diego, CA 92126) model 60009 pH meter. All meters were calibrated according to manufacturers directions prior to use and were rinsed with 10% nitric acid and ultrapure water between microcosms to prevent cross-contamination. Hardness and alkalinity were determined by titration.

Four exposure groups each consisting of 21 microcosms were used per test concentration. Nominal concentrations of spiked sediments were 0, 10, 100, and 1000 mg/kg U, dry weight. Since field-collected sediment samples were not analyzed prior to test initiation, sediment concentrations were based on sediment concentrations found in the literature (Mahon 1982, Neame et al. 1982, Van Netten and Morley 1982, Mahon and Mathewes 1983, Swanson 1985, Nicholson and Stuart 1986, Waite et al. 1988, Veska and Eaton 1991) and were intended to be of the same magnitude of potential DU concentrations at APG. Within each exposure group, microcosms were randomly assigned to one of seven sampling times (0, 0.5, 1, 2, 4, 7, or 14 d). Three replicate microcosms were used for each sampling time and concentration.

During a given sampling period and prior to the destructive sampling of individual microcosms, a 125 ml sample of overlying water was siphoned from the center of the water column for chemical analysis. Water samples were combined with 5 g of Chelex-100 resin (Bio-Rad Laboratories, Richmond, CA 94804) to bind aqueous uranium, acidified with analytical-grade nitric acid (Mallinckrodt Specialty Chemical Co., Paris, KY 40361) to a pH of 3, and frozen for shipment to LANL. Remaining water was siphoned off and discarded. Sediment was collected and split into two samples. All samples were immediately frozen in Whirl-Paks and shipped to LANL for sample preparation.

#### *Sample Preparation*

Sediment samples were prepared for ICP-MS at LANL. Initial ("wet") weights of all samples were recorded, then samples were dried at 120°C. Dry weights were recorded after samples had cooled, and sediment samples were packaged in storage containers.

Sample preparation procedures for water included ...

**\*\*\* MIKE, INSERT INFORMATION CONCERNING RESIN AND ELUTION  
COLUMNS (IF USED) \*\*\***

#### *Chemical Analysis*

Isotopic determination of laboratory samples was unnecessary since experiments used DU to spike sediments and background concentrations (natural-U) were measured in unspiked, control microcosms containing sediment and water. Quality assurance samples included split and spiked water and sediment samples. Spiked samples sent by CSU to



LANL were created by mixing a known volume of spiking solution to a given amount of sediment or water which were immediately shipped to LANL. Uranium concentrations in sediment are expressed on a dry weight basis.

Samples were shipped from LANL via overnight courier to CL for ICP-MS analysis. The samples were checked in to CL and a Receipt of Acknowledgement form was returned to LANL. Uranium or DU in each sample was extracted using EPA Method 3050 (\*\***MIKE, PLEASE INSERT APPROPRIATE CITATION HERE** \*\*\*). Briefly, the method involves extraction of metals with hot concentrated nitric and hydrochloric acids, then oxidation of organics with hydrogen peroxide. The extracts were separated from the remaining solids, filtered, and diluted for ICP-MS analysis. ICP-MS analyses were conducted using EPA Method 6020 (\*\***MIKE, PLEASE INSERT APPROPRIATE CITATION HERE** \*\*\*).

Quality assurance and quality control (QA/QC) measures were followed as prescribed in EPA Method 6020. A series of QA/QC blanks, standards, duplicates, and spikes were analyzed with each set of samples. Instrumental and Method blanks demonstrated that there was no uranium in the samples as a result of sample handling, and sample blank demonstrated that uranium analyses below detection were true (\*\***MIKE, PLEASE CLARIFY THE LAST PART OF THIS STATEMENT** \*\*\*).  $^{238}\text{U}$  samples were run after calibration with certified laboratory standards of 0.5 to 200  $\mu\text{g/L}$ . Each batch of samples and standards showed the expected and actual values of the standards for comparison and to demonstrate that the instrument was in proper working order.  $^{238}\text{U}$  samples were analyzed at a lower concentration, ranging from 0.5 to 50  $\mu\text{g/L}$  to ensure accurate values in the lower

concentration range.  $^{235}\text{U}$  samples were run in the same manner as the  $^{238}\text{U}$  samples, except that the laboratory standard was derived from weathered DU collected from YPG. The DU had an isotopic ratio ( $^{235}\text{U}/^{238}\text{U}$ ) of  $0.0021 \pm 0.0004$ . The calibration range for  $^{235}\text{U}$  was 1 to 200  $\mu\text{g}/\text{L}$ .

Matrix spikes were samples of known value to which spikes of 50  $\mu\text{g}/\text{L}$  U were added. Samples of 1.2, 1.5, and 46  $\text{mg}/\text{L}$  were used and provided a check on the percent recovery during the analyses. Duplicates of the 1.2, 1.5, and 46  $\mu\text{g}/\text{L}$  samples were run and compared to show that the instrument was working in correct order.

ICP-MS concentrations ( $\mu\text{g}/\text{L}$ ) were converted to  $\mu\text{g}-\text{U}/\text{kg}$  by adjusting the reported ICP-MS concentration for the dilution factors and the weight of the sample. The resulting concentration on an ashed or oven-dry basis was reported from CL to LANL. Results presented in this report are results provided to CSU from LANL.

### *Statistical Analysis*

Because only 37% of the total number of samples from this experiment have been analyzed for uranium content, no rigorous statistical analyses were initiated. One-way analysis of variance (ANOVA) was used to determine if uranium concentrations in sediment or water quality parameters of the overlying water column changed during the experiment (SAS Institute 1988).

## **RESULTS**

The experiment was completed on 13 August 1992. A partial data set was received

from LANL on 24 September 1993 and again on 19 November 1993. A total of 105 spiked sediment samples were analyzed, representing 37% (105 of 284) of the total number of water and sediment samples generated by CSU and sent to LANL. Because these data represent a small percentage of the total samples from this experiment, the following summary should be regarded as preliminary and results may change as more information becomes available.

Uranium was detected in all sediment samples. Background concentration (and standard deviation) of uranium in uncontaminated (control) sediment was 0.202 (0.178) mg/kg U. Since experimental sediment was spiked at concentrations  $\geq 10$  mg/kg U, background uranium will not confound results.

Sediment was spiked at three nominal concentrations, 10, 100, and 1000 mg/kg U. Average reported values (and standard deviations) were 6.50 (2.04), 63.9 (21.6), and 588 (245) mg/kg U, respectively (Figure 8.1). Sediment concentrations did not significantly change during the experimental timecourse ( $p=0.778$ ).

Dissolved oxygen concentrations initially declined and then rose, possibly due to algal growth within microcosms. Mean dissolved oxygen concentration (and standard deviation) in mid-water column was 5.0 (0.5) mg/L O<sub>2</sub> and 4.5 (0.5) mg/L O<sub>2</sub> at the sediment/water interface.

## DISCUSSION

Uranium concentrations of spiked sediment in this experiment did not significantly change during the 14-day experimental period. Given the high uranium concentrations in the spiked sediment and uranium's low solubility in water, only a relatively small fraction of the

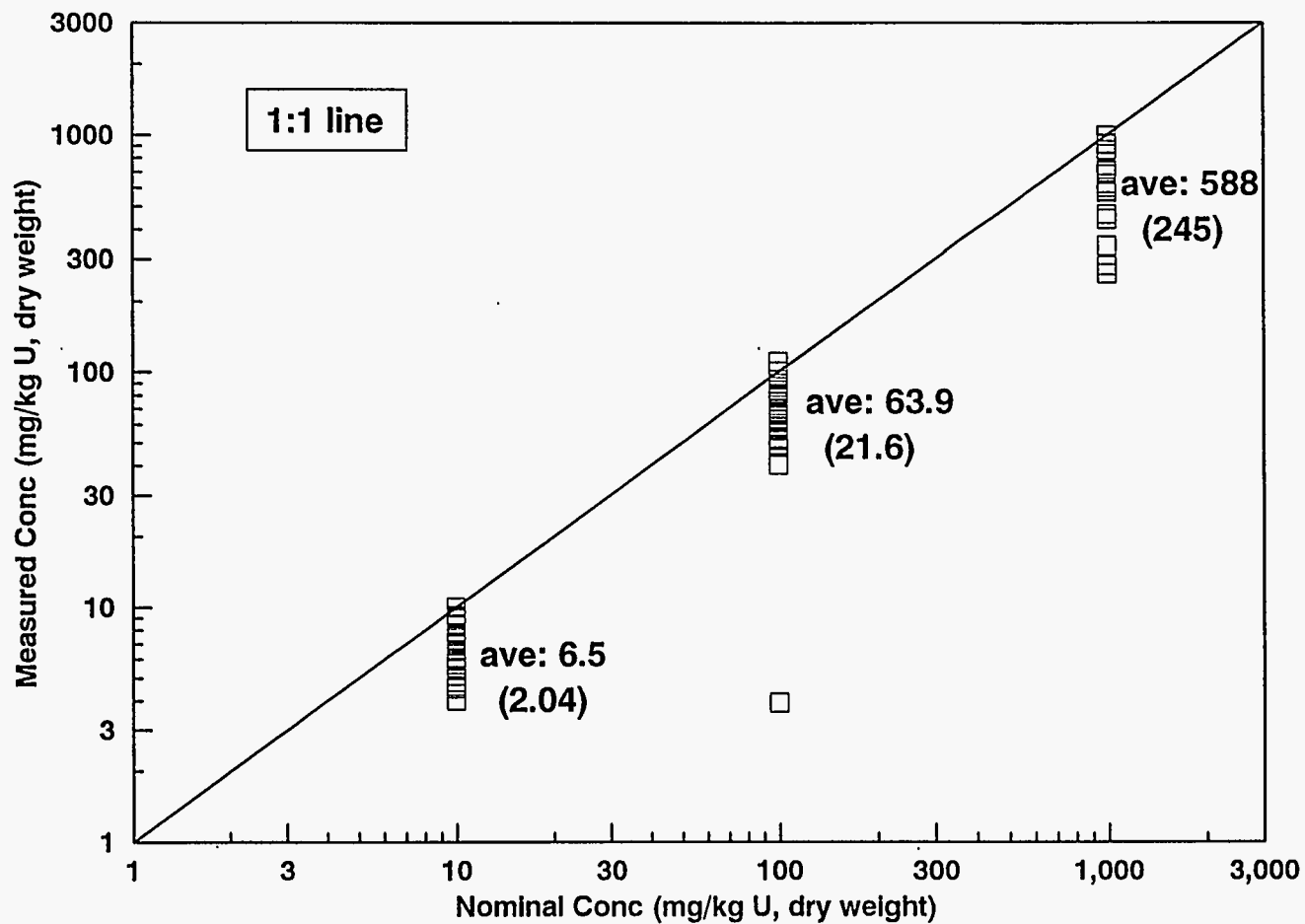

FIGURE 8.1. Concentrations of uranium in spiked sediment from the desorption experiment. Background concentrations determined from unspiked (control) sediment were 0.202 mg/kg U, dry weight. Values represent 105 of 192 sediment samples submitted to LANL and, consequently, may change as more data is received. Average measured values (and standard deviations) are reported.

uranium in the sediment was expected to be released into the water column. At this time it is unknown how much uranium, if any, was liberated into the water column since chemical analysis of the water samples are not available. However, the concentration of uranium in the overlying water column and the rate at which equilibrium is achieved is of interest since this information will be compared to results from other similar experiments where benthic invertebrates and fish are allowed to interact with the sediments. Increased uranium concentrations in the overlying water of microcosms which contained living organisms relative to those containing no organisms would indicate bioturbation and could increase bioavailability of DU in the environment.

## **\*\* CHAPTER 9 \*\***

### **Bioaccumulation of Uranium by Benthic Invertebrates**

#### **INTRODUCTION**

Because benthic invertebrates live in direct contact with sediments, contaminants associated with sediment may be ingested and absorbed through the gastrointestinal tract or absorbed to the invertebrates exterior surfaces. When the organisms are consumed by other animals, such as fish, contaminants can become introduced into aquatic food webs (Swanson 1985, Nebeker et al. 1984). Since benthic invertebrates serve as a primary food source for many carnivorous fish, the rate that uranium is transferred from sediment to benthic invertebrates is important in assessing uranium fate and transport in the aquatic ecosystems.

Furthermore, benthic invertebrates may liberate interstitial water and contaminated particulates into overlying water through their normal feeding and burrowing activities (Graneli 1979, Karickhoff and Morris 1985, Matisoff et al. 1985). Contaminants which normally have a high binding affinity to sediment, such as DU, can be continually liberated into the water column through this process, thereby increasing bioavailability of contaminants to other organisms through the ingestion of suspended particulates and absorption of dissolved ions across gill membranes.

The purpose of this experiment was to assess the transfer of uranium from contaminated sediments to several benthic invertebrates (chironomids [*Chironomus tentans*], oligochaetes [*Tubifex tubifex*], and amphipods [*Hyalella azteca*]). Secondly, we wished to

determine if these benthic organisms were capable of releasing uranium from spiked sediments. These species were selected because they have a cosmopolitan distribution, exist in high densities, and are preferred food items for many species of fish (Pennak 1978). Because each species used in this experiment has different modes of burrowing into sediment, their ability to liberate uranium into the water column through bioturbation and the release of interstitial water would be expected to be quite different (Graneli 1979, Robbins et al. 1979, Karickhoff and Morris 1985, Matisoff et al. 1985). Additionally, physiological differences among the different taxa may effect uptake and depuration rates (Rainbow 1993). These benthic organisms are also easily maintained in laboratory cultures and have been successfully used in other sediment studies. Information obtained from this experiment will be used to evaluate kinetic parameter ranges used in the food-web exposure model.

## **MATERIALS AND METHODS**

### *Laboratory Microcosms*

An artificial sediment containing 3% total organic carbon was used in the aquatic microcosms. Sediment was composed of 83.1% sand ("Mystic White" No. 18, New England Silica, Inc., South Windsor, CT), 14.7% clay and silt (ASP 400, Engelhard Corp., Edison, NJ), 2.2% *Sphagnum* moss (milled to an average particle size of 840 um; D. L. Browning Co., Mather, WI), 0.01% soluble humic acids (Aldrich Chem. Co., Milwaukee, WI), and 0.05% dolomitic limestone (Southern Agri-Minerals Corp., Hartford, AL). A

detailed description of the physical and chemical characteristics of the artificial sediment is described in Walsh et al. (1992).

Sediment was spiked with depleted uranyl nitrate ( $\text{UO}_2(\text{NO}_3)_2 \cdot 6\text{H}_2\text{O}$ ; J.T. Baker Chemical Company, Phillipsburg, NJ 08865) and mixed on a rolling mill for one hour. Spiked sediment was placed in a fume hood and excess water was allowed to evaporate for 48 hr. Moist spiked sediment was then placed into 1-L polystyrene beakers and lightly packed to remove large air pockets. Sediment volume was 200 ml, approximately equivalent to 260 g sediment, dry weight.

Overlying water was soft, unfiltered reservoir water (Horsetooth Reservoir, Larimer Co., CO) which closely resembled water quality of freshwater reported at APG. Initial physicochemical parameters of the reservoir water were: hardness = 29 mg/L, alkalinity = 28 mg/L, pH = 7.7, and conductivity = 76  $\mu\text{mhos/cm}$ . After the sediment was packed into 1-L polystyrene beakers, overlying water was slowly added to the beakers in order to minimize sediment disturbance. Approximately 700 ml of overlying water was added to beakers to obtain a final volume of 900 ml per microcosm.

### *Test Organisms*

Chironomid larvae used in this experiment were cultured from egg sacs derived from the National Fisheries Contaminant Research Center (Columbia, MO). Cultures were maintained in 35-L glass aquaria equipped with flight cages and culturing procedures generally followed methods described by Nebeker et al. (1984). Aerated cultures were maintained on a shredded paper towel substrate and fed 2.0 ml of a food slurry *ad libitum*.



This food mixture consisted of 600 mg Cerophyl (1.5 ml dry volume) and 100 mg (0.3 ml) finely crushed Tetra-Min fish flakes mixed in ultrapure water and frozen till used. Water used for culturing was from the same source used in experiments.

Amphipods were locally collected and cultured in 35-L glass aquaria following the procedures of Ingersoll and Nelson (1990). Amphipods were maintained on a cottonwood (*Populus* sp.) leaf substrate. Ground rabbit chow pellets were added every other week *ad libitum*. Cultures were continually aerated and water was replaced every week. Water used for culturing was from the same source used in experiments.

Oligiochaetes were obtained from a local pet store in Ft. Collins, CO. These organisms were maintained in 35-L aquaria with a sand substrate. Aquaria were continuously aerated and water was replaced weekly. Water used for culturing was from the same source used in other experiments. Oligiochaetes were fed the same food slurry as used in chironomid cultures.

After the microcosms were allowed to settle for 24 hrs, benthic organisms were introduced. For microcosms containing chironomids, 20 fourth-instar larvae were used. Experimental trials showed chironomids were capable of surviving for 14 days in laboratory microcosms without apparent detrimental effects: Survival was  $\geq 80\%$ , sediment was visible in the digestive tracts of larvae, and emergence into the adult life stage appeared normal. Consequently, it was assumed that chironomids are capable of obtaining suitable nutrition from the ingestion of artificial sediment so supplemental food was deemed unnecessary.

Microcosms containing oligiochaetes or amphipods each contained 50 organisms. More individuals were necessary in these microcosms to increase biomass for chemical

analysis. Although crowded (approx. 6500/m<sup>2</sup>), densities of this magnitude are not uncommon in the environment (Pennak 1978). Both of these species were cultured in laboratory facilities at Colorado State University for a minimum of two months prior to use in experiments.

### *Experimental Design*

Microcosms were randomly assigned positions within an environmental chamber. Temperature was maintained at 20° ± 0.5°C. Photoperiod was a 16:8 light:dark regime under cool, white fluorescent lights (30-33 ft-candles). Water in microcosms was not aerated and beakers were covered to minimize evaporative loss. Dissolved oxygen and pH were measured during each sampling period. Dissolved oxygen was measured in mid-water column and at the sediment-water interface. Water hardness, alkalinity, and conductivity were measured upon test initiation and completion. Dissolved oxygen and temperature were measured with a Yellow Springs Instrument Co. (Yellow Springs, OH 43587) model 57 oxygen meter. Salinity and conductivity were measured with a Yellow Springs Instrument Co. (Yellow Springs, OH 43587) model 33 conductivity meter and pH was measured with a Jenco (San Diego, CA 92126) model 60009 pH meter. All meters were calibrated according to manufacturers directions prior to use and were rinsed with 10% nitric acid and ultrapure water between microcosms to prevent cross-contamination. Alkalinity and hardness were determined by titration (APHA 1985).

Three exposure groups consisting of 21 microcosms were used per test concentration. Nominal concentrations of spiked sediments were 10, 100, and 1000 mg/kg U, dry weight.

Since field-collected sediment samples were not analyzed prior to test initiation, sediment concentrations were based on sediment concentrations found in the literature (Mahon 1982, Neame et al. 1982, Van Netten and Morley 1982, Mahon and Mathewes 1983, Swanson 1985, Nicholson and Stuart 1986, Waite et al. 1988, Veska and Eaton 1991) and were intended to be of the same magnitude of potential DU concentrations at APG. Additionally, concentrations used were identical to those used in the previous experiment (Chapter 8) and, therefore, would allow measurement of bioturbation effects (i.e., liberation of uranium from sediment due to the physical action of invertebrates in sediment). Within each exposure group, microcosms were randomly assigned to one of seven sampling times (0, 0.5, 1, 2, 4, 7, or 14 d). Due to the lack of adult amphipods, the 7- and 14-day sampling periods were eliminated. Three replicate microcosms were used for each sampling time and concentration for chironomids. Only two replicates were used for all microcosms containing oligochaetes or amphipods because of limited availability of adult organisms.

During each sampling period and prior to the destructive sampling of a microcosm, a 100 ml sample of overlying water was siphoned from the center of the water column for chemical analysis. Another 100 ml of overlying water was occasionally collected and filtered through a 0.45  $\mu\text{m}$  membrane filter (Supor Acrodisc 25, Gelman Sciences, 600 South Wagner Rd., Ann Arbor, MI 48106) to determine the proportion of dissolved uranium relative to total aqueous uranium concentrations. Interstitial water samples were collected by taking three samples from microcosm sediment. These sediment samples were examined for the presence of any invertebrates which were removed, if present. Sediment samples were pooled, centrifuged, and supernatant was collected. Because interstitial uranium

concentrations were expected to be extremely high, a 2.5 ml aliquot was collected and brought up to volume in 100 ml of ultrapure water. All water samples, unfiltered overlying, filtered overlying and interstitial, were acidified to a pH of 3 with nitric acid (Analytical-grade, Mallinckroft Specialty Chemical Co., Paris, KY 40361), and frozen for shipment to LANL. Invertebrates were picked from remaining microcosm sediment, rinsed three times in ultrapure water, and frozen for analysis. Microcosm sediment was immediately frozen in Whirl-Paks until analyzed. Tissue and sediment samples were stored at 0°C then shipped to LANL for sample preparation prior to chemical analysis.

By the fourth day of the experiment, bioturbation by benthic invertebrates was evident as a visible suspension of particulates in the overlying water column. This turbidity was immediately quantified after overlying water was collected from microcosms for chemical analysis during 4-, 7-, and 14-d sampling times, by retaining a portion of the remaining water and measuring percent transmission (wavelength = 550 nm) using a Spec 20 spectrophotometer (Bausch & Lomb). Ultrapure water served as a blank for calibrating the instrument.

### *Sample Preparation*

Sample preparation procedures used by LANL included elution of overlying water samples through columns filled with Chelex-100 resin (Bio-Rad Laboratories, Richmond, CA 94804). Resin was analyzed for uranium content by ICP-MS and aqueous concentrations were back-calculated.

**\*\*\* MIKE INSERT INFORMATION CONCERNING RESIN AND ELUTION  
COLUMNS (IF USED) HERE \*\*\***

Sediment and tissue samples were prepared for ICP-MS at Los Alamos. Initial ("wet") weights of all samples were recorded, then samples were dried at 120°C. Dry weights were recorded after samples had cooled, and sediment samples were packaged in storage containers. Biological samples were then ashed in a muffle furnace programmed to hold at 250°C for 3 hours, 350°C for 3 hours, and finally at 450°C for four hours. Ash weights were recorded after samples had cooled, then each sample was packaged for later analysis and storage.

*Chemical Analysis*

Isotopic determination of laboratory samples was unnecessary since experiments used DU to spike sediments and background concentrations (natural-U) were measured in unspiked, control microcosms containing sediment and water. Quality assurance samples included split and spiked water and sediment samples. Spiked samples prepared by CSU were created by mixing a known volume of spiking solution to a given amount of sediment or water and were immediately prepared for shipment to LANL. Uranium concentrations in sediment are expressed on a dry weight basis.

Samples were shipped via overnight courier to CL for ICP-MS analysis. The samples were checked in to CL and a Receipt of Acknowledgement form was returned to LANL.

Uranium or DU in each sample was extracted using EPA Method 3050 (\*\* MIKE, PLEASE INSERT APPROPRIATE CITATION HERE \*\*). Briefly, the method involves extraction of metals with hot concentrated nitric and hydrochloric acids, then oxidation of organics with hydrogen peroxide. The extracts were separated from the remaining solids, filtered, and diluted for ICP-MS analysis. ICP-MS analyses were conducted using EPA Method 6020.

Quality assurance and quality control (QA/QC) measures were followed as prescribed in EPA Method 6020 (\*\* MIKE, PLEASE INSERT APPROPRIATE CITATION HERE \*\*). A series of QA/QC blanks, standards, duplicates, and spikes were analyzed with each set of samples. Instrumental and Method blanks demonstrated that there was no uranium in the samples as a result of sample handling, and sample blank demonstrated that uranium analyses below detection were true (\*\*MIKE, PLEASE CLARIFY THE LAST PART OF THIS STATEMENT \*\*). <sup>238</sup>U samples were run after calibration with certified laboratory standards of 0.5 to 200  $\mu\text{g/L}$ . Each batch of samples and standards showed the expected and actual values of the standards for comparison and to demonstrate that the instrument was in proper working order. <sup>238</sup>U samples were analyzed at a lower concentration, ranging from 0.5 to 50  $\mu\text{g/L}$  to ensure accurate values in the lower concentration range. <sup>235</sup>U samples were run in the same manner as the <sup>238</sup>U samples, except that the laboratory standard was derived from weathered DU collected from YPG. The DU had an isotopic ratio (<sup>235</sup>U/<sup>238</sup>U) of  $0.0021 \pm 0.0004$ . The calibration range for <sup>235</sup>U was 1 to 200  $\mu\text{g/L}$ .

Matrix spikes were samples of known value to which spikes of 50  $\mu\text{g/L}$  U were added. Samples of 1.2, 1.5, and 46  $\text{mg/L}$  were used and provided a check on the percent recovery during the analyses. Duplicates of the 1.2, 1.5, and 46  $\mu\text{g/L}$  samples were run and compared to show that the instrument was working in correct order.

ICP-MS concentrations ( $\mu\text{g/L}$ ) were converted to  $\mu\text{g-U/kg}$  by adjusting the reported ICP-MS concentration for the dilution factors and the weight of the sample. The resulting concentration on an ashed or oven-dry basis was reported from CL to LANL. Results presented in this report are results provided to CSU from LANL. All uranium concentrations in this experiment are reported on an oven-dry weight basis.

### *Statistical Analysis*

Turbidity was measured as percent transmission by spectrophotometry. Because some sediment disturbance was inevitable when overlying water was added to experimental microcosms, all measurements were normalized by setting mean percent transmission values from microcosms containing no organisms equal to 100%. Accordingly, water from microcosms containing organisms were reported as relative percent transmission. Analysis of variance (ANOVA) was used to test for differences in mean transmission between type of organism, sampling time, and concentration of sediment (SAS Institute 1988).

Water quality measurements measured at each sampling time included dissolved oxygen concentrations and pH. ANOVA was initially used to determine if any values were significantly different between sampling times. This was followed by a test for significance

of slope using a linear regression model to determine whether a significant trend in dissolved oxygen concentrations or pH occurred during the experiment.

Mortality data were recorded for each microcosm and a cursory analysis of survival data was performed. One-way ANOVA was calculated for each species to determine if time or exposure concentration significantly reduced survival in experimental microcosms. Significance level for all statistical tests was  $p < 0.05$ .

## RESULTS

All experiments were completed by 30 September 1992. Uranium concentrations in 39 of 250 total samples were received from LANL on 22 November 1993. All samples analyzed were sediment samples; no data on uranium concentrations in overlying water or tissues of organisms has been received. Average uranium concentrations (and standard deviations) measured in spiked sediments were 7.59 (2.38), 79.1 (22.5), and 561 (202) mg-U/kg, dry weight (Figure 9.1). Concentration of uranium did not change during the duration of the experiment ( $p = 0.437$ ).

Water quality parameters measured at each sampling period remained constant over the duration of the experiment. The average dissolved oxygen concentrations (and standard deviation) was 5.17 (0.72) mg/L while the mean pH value was 7.16 (0.05).

Turbidity of the overlying water column was used as indicator of bioturbation in experimental microcosms. When uranium data is received, bioturbation will also be measured as a function of uranium content in the overlying water. Concentration of uranium



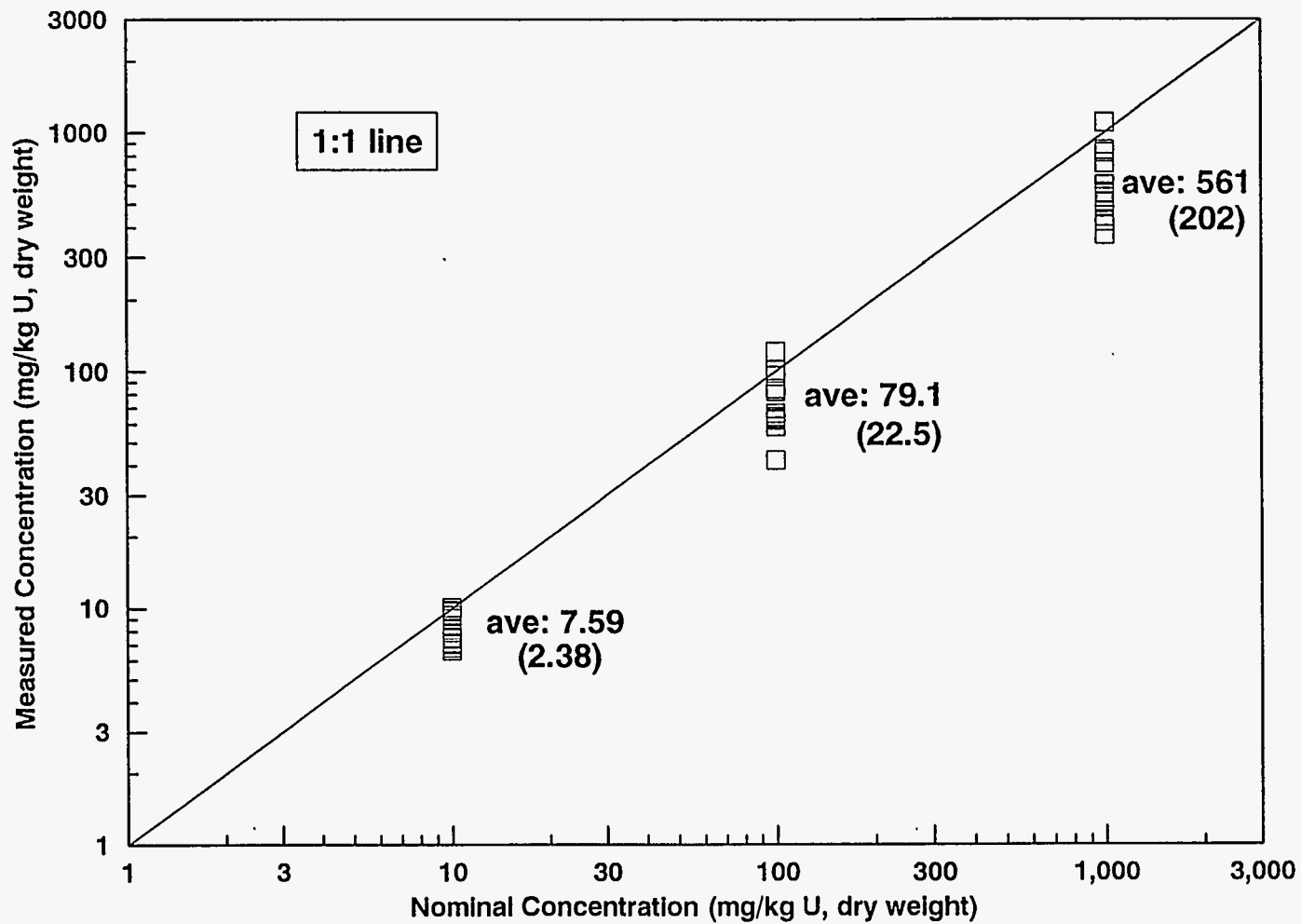

FIGURE 9.1. Comparison of measured and nominal uranium concentrations in spiked sediments used in laboratory microcosms. Mean concentrations (and standard deviations) for 39 sediment samples are reported and values are likely to change as more data are received from LANL. This experiment was designed to assess bioaccumulation in the benthic invertebrate, Chironomus tentans.

in the sediment significantly effected the amount of turbidity (Figure 9.2) in experimental microcosms ( $p = 0.002$ ). This response did not produce the typical dose-response curve one might expect.

Turbidity (Figure 9.3) was also influenced by the type of organism in the microcosm ( $p = 0.001$ ). Chironomids and oligochaetes visibly avoided burrowing in highly contaminated sediment (1000 mg/kg U). At lower concentrations, chironomids and oligochaetes burrowed into sediment, though chironomids still remained closer to the surface at 100 mg/kg U than when sediment contained 10 mg/kg U. No behavioral avoidance of sediments was noted in amphipods. Turbidity in amphipod microcosms more closely resembled a typical dose-response curve. The activity of chironomids and amphipods disturbed the sediment which resulted in significant turbidity of the overlying water. Conversely, the activity of tubifex oligochaetes did not result in increased turbidity. Exposure time from 4- to 14-days did not significantly alter turbidity ( $p = 0.909$ ). Turbidity visibly increased from 0- to 4-days, but turbidity was not measured during this time period.

Because this experiment was intended to assess bioaccumulation, experimental design did not facilitate a rigorous examination of toxic effects. Survival was significantly related to time (chironomids:  $p < 0.0005$ ; oligochaetes:  $p = 0.001$ ; amphipods:  $p < 0.0005$ ). Amphipods in control beakers did not survive the 14-day exposure period. Consequently, no further analysis was performed on those data. No control beakers were used for chironomid exposures during this experiment.

If one accepts that chironomid survival in control beakers after 14-days would have been  $\geq 80\%$  based on other results from other previous and subsequent exposures (H.T.

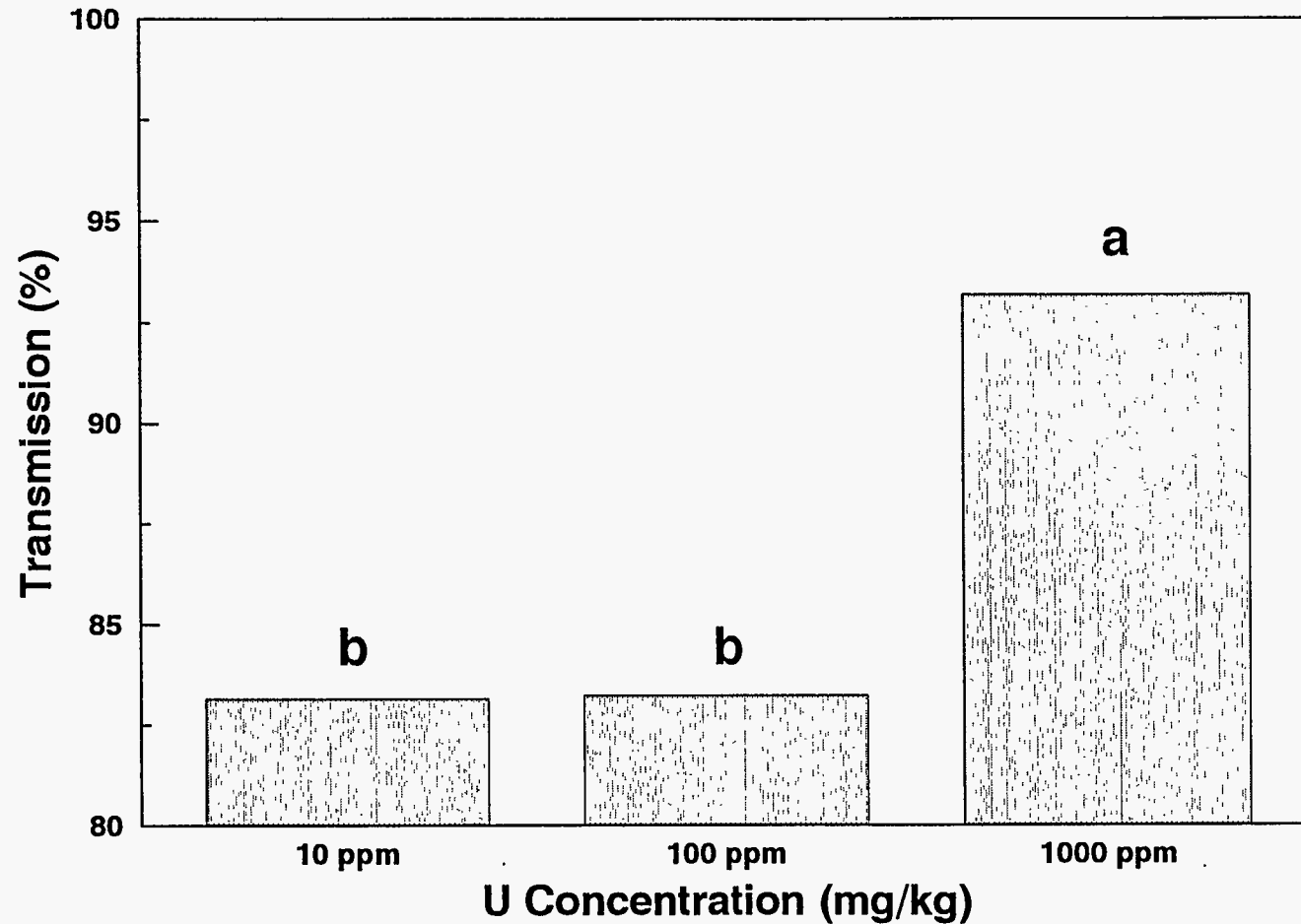

**FIGURE 9.2.** Concentration of uranium in sediment significantly affected the turbidity of the overlying water ( $p = 0.002$ ). Increased relative transmission is indicative of decreased bioturbation by benthic invertebrates. Letters designate mean transmission measurements which were significantly different from each other ( $p < 0.05$ ).

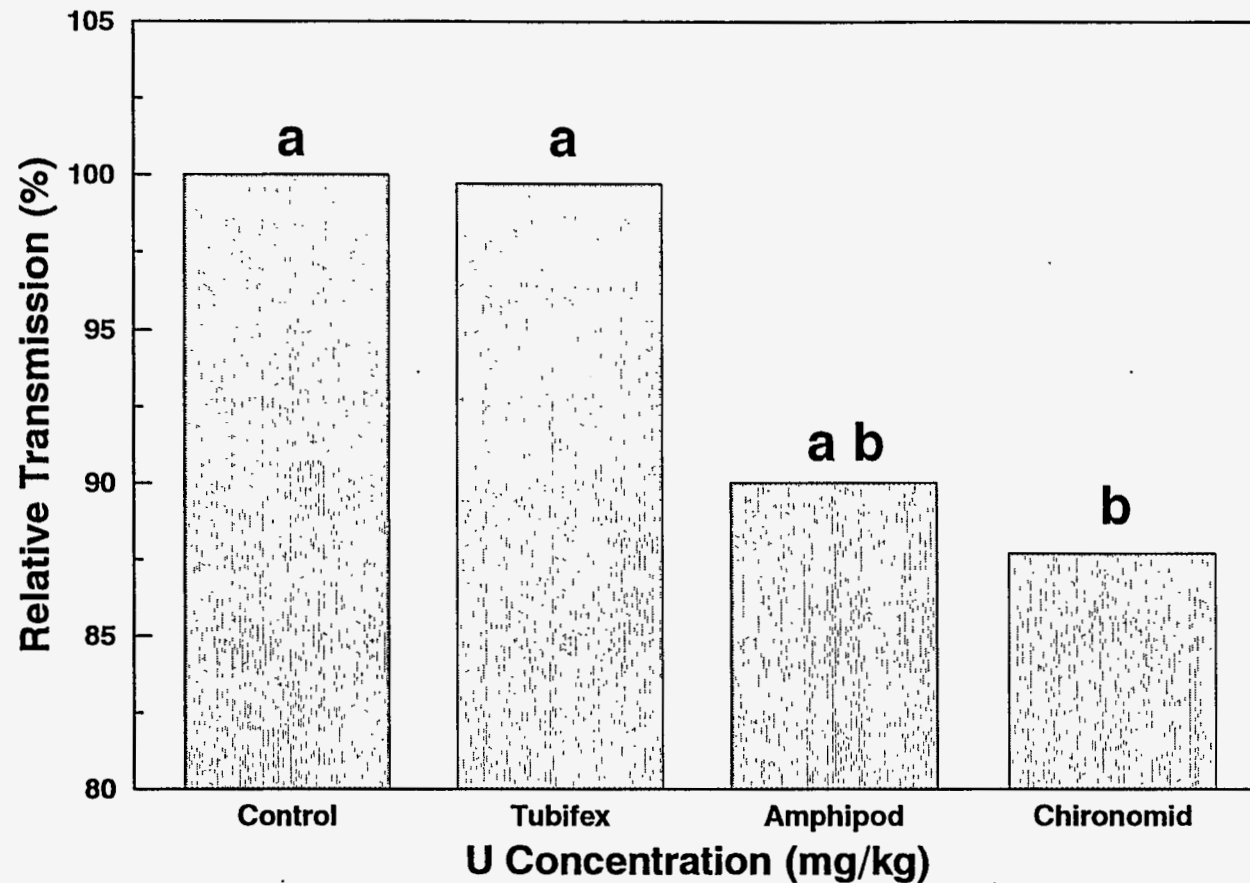

FIGURE 9.3. Turbidity (measured as relative transmission) was significantly affected by the type of benthic invertebrate in laboratory microcosms ( $p=0.001$ ). Chironomids (Chironomus tentans) and amphipods (Hyalella azteca) caused considerable turbidity, while aquatic oligochaetes (Tubifex tubifex) did not. Control microcosms contained no organisms. Means with the same letter are not significantly different.

Bestgen and E. Harrahy, Colorado State University, personal communication), significant mortality would have occurred. Average survival in microcosms containing 10, 100, and 1000 mg/kg U spiked sediment was 45%, 78%, and 42%, respectively. We hypothesize that there was a complex interaction between uranium concentrations in sediment and chironomid behavior which affected mortality rates. If all sediment concentrations were toxic, chironomids in the lowest concentrations which actively burrowed into sediments would have been exposed to toxic levels of uranium from sediment and interstitial water. Conversely, reduced burrowing activity by chironomids in the two higher concentrations may have minimized exposure to interstitial water and ingested sediment resulting in reduced mortality at intermediate uranium concentrations. Sediment containing the highest concentration, however, may have been toxic regardless of chironomid avoidance behaviors. When uranium concentrations in overlying water are analyzed, data may help clarify these results.

Oligochaete survival data are more definitive than for other species. Survival in control microcosms was  $\geq 90\%$  over the 14-d exposure period. The 14-d survival percentages of the exposure groups were not statistically significant ( $p = 0.052$ ), probably due to the lack of statistical power due to small sample size. Interestingly, survival was again lowest in the 10 mg/kg U microcosm and rose with increasing uranium concentration. Differences in survival may be a statistical anomaly but, alternatively, may be due to behavioral avoidance of sediment similar to that observed in chironomids.

## DISCUSSION

Feeding, burrowing, respiratory and excremental activities of benthic invertebrates can release of contaminants from sediment via the release of interstitial water and sorbed particles into the overlying water column. Amphipods tend to be superficial deposit feeders whose swimming and shallow burrowing activity is generally restricted to the upper 1 to 3 cm of sediment. In contrast to the relatively mobile amphipods, oligochaetes and chironomids form semi-permanent feeding and dwelling burrows. Tubificid oligochaetes occupy the upper 10 cm of sediment and movement of contaminants sorbed to particulates is highly directional towards the surface (Rhoads 1974, Karickhoff and Morris 1985). Chironomids occupy sediments to depths reaching 20 cm or more and their behavior has been shown to cause movement of sediment and interstitial water (Matisoff et al. 1985).

Bioturbation in this experiment was measured as turbidity of the overlying water and aqueous uranium concentrations. Turbidity was significantly different among different types of organisms. We believe complex, species-specific behavioral patterns dictated bioturbation. Movement of chironomids and amphipods significantly disturbed the sediment, liberating particulates into the overlying water. DU sorbed to sediment fines may become suspended in the water column and, thereby, increase contaminant availability. Because suspended particulates increase the total surface area of sediment, an equilibrium between two opposing reactions will tend to arise. Because of the relatively high binding capacity of sediments, suspended particulates will strip aqueous uranium from the water column. Opposing this reaction is the dissolution of uranium from contaminated sediment particles. If sediments are highly contaminated, aqueous concentrations of uranium may be allowed to

reach solubility maxima defined by physicochemical conditions of ambient water, such as pH and alkalinity. When uranium concentrations are received, we will have a better idea of how this complex chemical scenario might reach equilibrium in the APG environment.

Not only can bioturbation increase the relative availability of uranium in the water column via suspended particulates, but these solids could potentially be transported off-site. Considering the numerical abundance of these organisms in estuarine ecosystems, the displacement of DU off of APG land through the movement of suspended particulates could be considerable. However, without analytical data to support or refute such suppositions, it is impossible to assess the degree to which uranium is being transported off-site.

Benthic invertebrates exhibited a behavioral avoidance to contaminated sediments. This behavior has been documented for other heavy metals (Wentzel et al. 1977). Benthic invertebrates disturb sediment through normal activity and measurement of turbidity is a measurement of this activity. In general, the activity of benthic invertebrates diminished as uranium content in sediments increased. Chironomids, in particular, avoided highly contaminated sediment by remaining on the sediment surface while chironomids in lower concentrations burrowed into sediment.

Because this experiment was designed to evaluate bioaccumulation by benthic invertebrates and not toxic effects, mortality data was inconclusive. Survival of benthic invertebrates in uranium contaminated sediment may be reduced but appears to be confounded by behavioral avoidance of contaminated sediment at high concentrations. Toxic effects of sediment to benthic invertebrates should be more rigorously explored with further research.

## **\*\* CHAPTER 10 \*\***

### **Bioconcentration of Uranium by Benthic Invertebrates**

#### **INTRODUCTION**

In addition to the ingestion of contaminated sediment, invertebrates also may accumulate uranium through waterborne exposure. For example, interstitial water often contains extremely high concentrations of contaminants relative to overlying water. Organisms exposed to interstitial water may experience toxic effects or may bioconcentrate contaminants in their tissues. This experiment examined the uptake of uranium directly from water by two benthic invertebrates, *C. tentans* and *T. tubifex*.

The purpose of examining bioconcentration in benthic invertebrates was two-fold. Measuring bioconcentration will allow us to determine the relative importance of aqueous versus sediment exposure. It is generally accepted that aqueous exposure is the primary exposure route for heavy metals when water concentrations are extremely elevated. However, when aqueous concentrations are relatively low, contaminated sediment may become an important source of exposure in aquatic systems. Since aqueous concentrations are expected to be relatively low at APG due to solubility limitations (Erikson et al. 1990b), the latter scenario is most probable. APG soils and sediment are likely to contain the greatest concentration of DU in the environment and these concentrations are likely to increase with continued test firing of DU penetrators at APG. Determining the relative



impacts of aqueous versus sediment exposure can refine predictive capabilities of ecological risk assessment models.

In benthic invertebrates, bioconcentration (sorption of uranium from water) occurs concurrently with bioaccumulation (sorption of uranium from food and water) as organisms feed and burrow through sediment material. These two processes are difficult to isolate in field samples, but laboratory experiments can differentiate between these two routes of exposure. If uptake from interstitial water is subtracted from the uptake of invertebrates in contaminated sediments, one can estimate the amount of uranium accumulated from ingestion of contaminated sediment.

This experiment was conducted to determine the uranium concentrations and exposure times to spike invertebrates for use in subsequent experiments. Chironomids exposed to aqueous uranium were expected to bioconcentrate uranium. These contaminated invertebrates would then be fed to carnivorous fish to study the transfer of uranium in food chains (Chapter 12). Due to the large numbers of spiked organisms needed and the time-consuming process of retrieving invertebrates from sediment, aqueous exposure, rather than exposure to contaminated sediment, was obligatory. Furthermore, logistical constraints in the food chain transfer experiment necessitated short-term exposures ( $\leq 48$  hr) at relatively high aqueous concentrations. Results from this experiment were intended to guide the spiking regime used in the subsequent trophic transfer experiment.

## MATERIALS AND METHODS

### *Exposure Beakers*

Water was soft, unfiltered reservoir water (Horsetooth Reservoir, Larimer Co., CO) which closely resembled water quality characteristics of freshwater at APG (Table 6.1). Water quality parameters were: hardness = 26 mg/L, alkalinity = 28 mg/L, pH = 7.6, and conductivity = 73  $\mu\text{mhos/cm}$ . One-liter polystyrene beakers were filled with 900 ml uranium-spiked water. Water was spiked with reagent-grade depleted uranyl nitrate ( $\text{UO}_2(\text{NO}_3)_2 \cdot 6\text{H}_2\text{O}$ ) supplied by J.T. Baker Chemical Co. (Phillipsburg, NJ 08865).

### *Test Organisms*

Two different benthic invertebrates, chironomids (*Chironomus tentans*) and aquatic oligochaetes (*Tubifex tubifex*), were used as prey items. Chironomid larvae used in this experiment were cultured from egg sacs derived from the National Fisheries Contaminant Research Center (Columbia, MO) and were raised in 35-L glass aquaria as described by Nebeker et al. (1984). Aerated cultures were maintained on a shredded paper towel substrate and fed a mixture of 600 mg Cerophyl (1.5 ml dry volume) and 100 mg (0.3 ml) finely crushed Tetra-Min fish flakes. Water used for culturing all organisms and in experiments was from the source mentioned above.

Oligochaetes were obtained from a local pet store. These organisms were maintained in 35-L aquaria with a sand substrate. Aquaria were continuously aerated and water was replaced weekly. Water used for culturing was from the same source used in experiments.

Oligochaetes were fed the same food slurry as used in chironomid cultures. Both of these species were cultured in laboratory facilities at Colorado State University for a minimum of two months prior to use in experiments.

### *Exposure Conditions*

Exposure beakers were randomly assigned positions within an environmental chamber. Temperature was maintained at  $20^{\circ} \pm 0.5^{\circ}\text{C}$ . Photoperiod was a 16:8 light:dark regime under cool, white fluorescent lights (30-33 ft-candles). Water in microcosms was not aerated and beakers were covered to minimize evaporative loss. Dissolved oxygen and pH were measured during each sampling period. Dissolved oxygen was measured in mid-water column. Water hardness, alkalinity, and conductivity were measured upon test initiation and completion. Dissolved oxygen and conductivity were measured with a Yellow Springs Instrument Co. (Yellow Springs, OH 43587) model 57 oxygen meter and a Yellow Springs Instrument Co. model 33 conductivity meter, respectively. A Jenco (San Diego, CA 92126) model 60009 meter was used to determine pH. All meters were calibrated according to manufacturers directions prior to use and were rinsed with 10% nitric acid (Analytical-grade, Mallinckroft Specialty Chemical Co., Paris, KY 40361) and ultrapure water between solutions to prevent cross-contamination. Hardness and alkalinity were determined by titration (APHA 1985).

### *Experimental Design*

Three exposure groups consisting of twelve exposure beakers were used per test concentration. Nominal concentrations of spiked water were 0, 0.5, and 1.0 mg/L U. Choice of aqueous concentrations was based on concentrations reported to cause acute toxic effects to chironomids and other organisms (Bywater et al. 1991, Ahsanullah and Williams 1986, Poston et al. 1984, Davies 1980, Tarzwell and Henderson 1960). No information is available concerning the toxicity of uranium to oligochaetes. Although the 1 mg/L U concentration was not anticipated to cause direct mortality, this concentration was expected to cause high tissue residue levels. A second concentration containing half the amount of uranium (0.5 mg/L U) was used in case acute mortality did occur when organisms were exposed to 1 mg/L U. Control water (0 mg/L U) was used to assess background uranium concentrations in unspiked water and unexposed organisms.

Within each exposure group, beakers were randomly assigned to one of four sampling times (0, 12, 24, and 48 hr). Three replicate beakers were used for each sampling time and concentration. Fifty organisms, either fourth-instar chironomid larvae or adult tubifex (>2 cm length), were placed in microcosms. During a given sampling period and prior to the destructive sampling of individual microcosms, a 100 ml sample of overlying water was siphoned from the center of the water column for chemical analysis. Invertebrates were collected from beakers, rinsed three times in ultrapure water, and frozen for shipment to LANL for uranium analysis.

### *Sample Preparation*

Sample preparation procedures used by LANL included elution of overlying water samples through columns filled with Chelex-100 resin (Bio-Rad Laboratories, Richmond, CA 94804). Resin was analyzed for uranium content by ICP-MS and aqueous concentrations were back-calculated.

**\*\*\* MIKE INSERT INFORMATION CONCERNING RESIN AND ELUTION COLUMNS (IF USED) HERE \*\*\***

Sediment and tissue samples were prepared for ICP-MS at Los Alamos. Initial ("wet") weights of all samples were recorded, then samples were dried at 120°C. Dry weights were recorded after samples had cooled, and sediment samples were packaged in storage containers. Biological samples were then ashed in a muffle furnace programmed to hold at 250°C for 3 hours, 350°C for 3 hours, and finally at 450°C for four hours.

**\*\*\* MIKE, ARE YOUR STILL ASHING ALL BIOLOGICAL SAMPLES? I THOUGHT WE HAD DECIDED TO USE OVEN-DRIED WEIGHTS FOR BIOLOGICAL SAMPLES IN EXPERIMENTS \*\*\***

Ash weights were recorded after samples had cooled, then each sample was packaged for later analysis and storage.

### *Chemical Analysis*

Isotopic determination of laboratory samples was unnecessary since experiments used DU to spike water and background concentrations (natural-U) were measured in unspiked

water. Samples were shipped via overnight courier to CL for ICP-MS analysis. The samples were checked in to CL and a Receipt of Acknowledgement form was returned to LANL. Uranium or DU in each sample was extracted using EPA Method 3050 (\*\* MIKE, PLEASE INSERT APPROPRIATE CITATION HERE \*\*). Briefly, the method involves extraction of metals with hot concentrated nitric and hydrochloric acids, then oxidation of organics with hydrogen peroxide. The extracts were separated from the remaining solids, filtered, and diluted for ICP-MS analysis. ICP-MS analyses were conducted using EPA Method 6020 (\*\* MIKE, PLEASE INSERT APPROPRIATE CITATION HERE \*\*).

Quality assurance and quality control (QA/QC) measures were followed as prescribed in EPA Method 6020. A series of QA/QC blanks, standards, duplicates, and spikes were analyzed with each set of samples. Instrumental and Method blanks demonstrated that there was no uranium in the samples as a result of sample handling, and sample blank demonstrated that uranium analyses below detection were true (\*\* MIKE, PLEASE CLARIFY THE LAST PART OF THIS STATEMENT \*\*).  $^{238}\text{U}$  samples were run after calibration with certified laboratory standards of 0.5 to 200  $\mu\text{g/L}$ . Each batch of samples and standards showed the expected and actual values of the standards for comparison and to demonstrate that the instrument was in proper working order.  $^{238}\text{U}$  samples were analyzed at a lower concentration, ranging from 0.5 to 50  $\mu\text{g/L}$  to ensure accurate values in the lower concentration range.  $^{235}\text{U}$  samples were run in the same manner as the  $^{238}\text{U}$  samples, except that the laboratory standard was derived from weathered DU collected from YPG. The DU

had an isotopic ratio ( $^{235}\text{U}/^{238}\text{U}$ ) of  $0.0021 \pm 0.0004$ . The calibration range for  $^{235}\text{U}$  was 1 to 200  $\mu\text{g}/\text{L}$ .

Matrix spikes were samples of known value to which spikes of 50  $\mu\text{g}/\text{L}$  U were added. Samples of 1.2, 1.5, and 46  $\text{mg}/\text{L}$  were used and provided a check on the percent recovery during the analyses. Duplicates of the 1.2, 1.5, and 46  $\mu\text{g}/\text{L}$  samples were run and compared to show that the instrument was working in correct order.

ICP-MS concentrations ( $\mu\text{g}/\text{L}$ ) were converted to  $\mu\text{g-U}/\text{kg}$  by adjusting the reported ICP-MS concentration for the dilution factors and the weight of the sample. The resulting concentration on an ashed or oven-dry basis was reported from CL to LANL. Results presented in this report are results provided to CSU from LANL. Sediment uranium concentrations in this experiment are reported on an oven-dry weight basis.

### *Statistical Analysis*

No statistical analysis was initiated since no analytical data have been received.

## **RESULTS & DISCUSSION**

Experiment was completed by 5 August 1992. No uranium concentration data have been received at this time. Without data, no conclusions can be drawn.

## **\*\* CHAPTER 11 \*\***

### **Bioconcentration of Uranium by Fish**

#### **INTRODUCTION**

Ingestion of fish and other aquatic organisms by humans represents a primary route of human exposure to DU from APG. As a consequence, uptake and transport of DU in the environment is of critical importance in estimating human exposure. Additionally, the economic and biological importance of fish communities necessitates evaluation of potential impacts DU may have on fish populations. Ecological impacts of uranium must be addressed as well as the human health hazards.

Uptake of uranium by fish occurs two ways. Uranyl ions ( $UO^{+2}$ ) cross the gill lamellae entering the bloodstream and is distributed throughout the body. This route is important when aqueous uranium concentrations are elevated. The second route is uptake across the gastrointestinal tract after ingestion of food and accompanying sediment. This route is thought to be most important when water concentrations are low and sediment concentrations are high. This experiment evaluates the uptake of uranium directly from water. Results will be compared to uptake rates in Chapter 12 where gastrointestinal absorption occurs. Results from these two studies will allow the ecological risk assessment model to estimate uptake of uranium by fish as a function of water and/or sediment concentrations.



Elimination of uranium from fish tissues will also be examined in this study.

Knowledge of uptake and elimination rates enables us to model tissue concentrations at non-equilibrium states. Uptake and elimination kinetics are important parameters for the ecological risk assessment model (See Chapter 2).

## **MATERIALS AND METHODS**

### *Test Organisms*

Sheepshead minnow (*Cyprinodon variegatus*) were used to assess bioconcentration of uranium by fish. Sheepshead minnow were selected as test organisms because they are common estuarine fish found in the Chesapeake Bay (Hildebrand and Schroeder 1928). In culture sheepshead feed primarily upon invertebrates. Additionally, these euryhaline fish are extremely hardy and local laboratory reared stock of known health status were readily available.

Fish were acclimated by the supplier (Aquatic Biosystems, Inc., Ft. Collins, CO 80524) to freshwater conditions (salinity < 1%; temperature 25°C; pH = 7.88; alkalinity 165 mg/L as CaCO<sub>3</sub>). Fish were approximately 3 1/2 months old and ranged from 2 to 3 cm total length. Upon arrival to CSU, sheepshead minnow were acclimated to ambient exposure conditions for 30 days. Fish were fed Tetra-Min flake food *ad libitum* twice a day throughout the entire holding period and experiment.

### *Exposure Conditions*

Water was soft, unfiltered reservoir water (Horsetooth Reservoir, Larimer Co., CO) which closely resembled water quality of freshwater at APG (Table 6.1). Although sheepshead minnow can tolerate a wide range of salinities, including freshwater (0% salinity), a small amount of sea salts (Instant Ocean synthetic seawater) were added to aquaria to minimize any physiological stress. Average physicochemical parameters (and standard deviations) of the reservoir water were hardness = 38 (12) mg/L as CaCO<sub>3</sub>; alkalinity = 35 (11) mg/L as CaCO<sub>3</sub>; pH = 7.77 (0.22); conductivity = 352 (66) umhos/cm, salinity = 0.1% (0); and dissolved oxygen = 7.4 (0.4). Water was spiked with reagent-grade depleted uranyl nitrate (UO<sub>2</sub>(NO<sub>3</sub>)<sub>2</sub>\*6H<sub>2</sub>O; J.T. Baker Chemical Company, Phillipsburg, NJ 08865).

Uranium exposure of sheepshead minnow occurred in six 10-gallon (37.8-L) glass aquaria. A 75% water change occurred three times per week to prevent build-up of waste products and to ensure that aqueous uranium concentrations were maintained during the exposure period. Feces and excess food were siphoned out of the aquaria daily to minimize ingestion of contaminated organic matter by fish. No substrate was used in aquaria. Temperature was maintained at 20° ± 1.0°C. Photoperiod was a 16:8 light:dark regime under ambient laboratory lighting using cool, white florescent lights. Water in aquaria was aerated to maintain dissolved oxygen concentrations at acceptable levels. Temperature, dissolved oxygen and pH were measured at daily, while hardness, alkalinity, conductivity, and salinity were measured during each water change. Dissolved oxygen and temperature were measured with a Yellow Springs Instrument Co. (Yellow Springs, OH 43587) model

57 oxygen meter. Salinity and conductivity were measured with a Yellow Springs Instrument Co. (Yellow Springs, OH 43587) model 33 conductivity meter and pH was measured with a Jenco (San Diego, CA 92126) model 60009 pH meter. All meters were calibrated according to manufacturers directions prior to use and were rinsed with 10% nitric acid (Analytical-grade, Mallinckroft Specialty Chemical Co., Paris, KY 40361) and ultrapure water between microcosms to prevent cross-contamination. Hardness and alkalinity were determined by titration (APHA 1985).

### *Experimental Design*

Sheepshead minnow were exposed to aqueous uranium in a static-renewal exposure experiment. Fish were exposed to aqueous uranium for a maximum of 14 d and then allowed to depurate for up to 14 d. Three nominal concentrations of 10, 100, and 1000  $\mu\text{g/L}$  U were used, with two replicates per concentration. Twenty-eight sheepshead minnow were randomly assigned to each exposure aquaria. Three fish from each group were immediately sacrificed to determine background uranium concentrations. During each sampling time (1, 2, 4, 7, 14, 21, and 28 d), three sheepshead minnow were collected from each aquaria. Fish were caught by dip net, euthanized by immersion in an overdose solution of tricane methanesulfonate (MS-222), and were frozen in Whirl-Paks for shipment to LANL. The three fish from each aquaria were pooled into a single sample to increase biomass for uranium analysis. Aquaria were observed at least twice a day and mortality or unusual behavior was recorded. Mortality was defined as the lack of opercular movement and lack of movement when gently prodded. Dead individuals were immediately removed from

aquaria, rinsed in ultrapure water, and frozen for uranium analysis.

Although aqueous uranium concentrations at APG likely to be approximately 200  $\mu\text{g/L}$  U or less (Erikson et al. 1990b, Ebinger et al. 1991), exposure concentrations in this experiment were relatively high to ensure that uptake and elimination rates could be measured in a relatively short timeframe. A 14-d exposure was preferred over a longer exposure (e.g., 30-d) for two reasons. A 14-d exposure period facilitates direct comparison with results from other experiments. Secondly, long laboratory exposures are stressful for fish and may provide unrealistic measurements of uptake and depuration rates. A 28-d test (14 days of uranium exposure followed by a 14-d depuration period) was the longest period we felt comfortable in maintaining fish without any unreasonable stress.

To determine the average aqueous uranium concentrations in exposure aquaria, water was collected from aquaria before and after water changes. Unfiltered water samples were collected, acidified to a  $\text{pH} \leq 3$  with analytical-grade nitric acid (Mallinckroft Specialty Chemical Co., Paris, KY 40361), and frozen for shipment to LANL. Additionally, a series of water samples were filtered with a  $0.45 \mu\text{m}$  membrane filter (Supor Acrodisc 25, Gelman Sciences, 600 South Wagner Rd., Ann Arbor, MI 48106) and prepared as described above. Water and fish samples were stored at  $0^\circ\text{C}$  then shipped to LANL for sample preparation prior to chemical analysis.

### *Sample Preparation*

Sample preparation procedures used by LANL included elution of overlying water

samples through columns filled with Chelex-100 resin (Bio-Rad Laboratories, Richmond, CA 94804). Resin was analyzed for uranium content by ICP-MS and aqueous concentrations were back-calculated.

**\*\*\* MIKE INSERT INFORMATION CONCERNING RESIN AND ELUTION COLUMNS (IF USED) HERE \*\*\***

Tissue samples were prepared for ICP-MS at Los Alamos. Initial ("wet") weights of all samples were recorded, then samples were dried at 120°C. Dry weights were recorded after samples had cooled, and samples were packaged in storage containers. Biological samples were then ashed in a muffle furnace programmed to hold at 250°C for 3 hours, 350°C for 3 hours, and finally at 450°C for four hours.

**\*\*\* MIKE, ARE YOUR STILL ASHING ALL BIOLOGICAL SAMPLES? I THOUGHT WE HAD DECIDED TO USE OVEN-DRIED WEIGHTS FOR BIOLOGICAL SAMPLES IN EXPERIMENTS \*\*\***

Ash weights were recorded after samples had cooled, then each sample was packaged for later analysis and storage.

*Chemical Analysis*

Isotopic determination of laboratory samples was unnecessary since DU was used and background concentrations in fish and water were measured in fish collected at time 0, just prior to spiking aquaria water with uranium. Samples were shipped via overnight courier to CL for ICP-MS analysis. The samples were checked in to CL and a Receipt of

Acknowledgement form was returned to LANL. Uranium or DU in each sample was extracted using EPA Method 3050 (**\*\*\* MIKE, PLEASE INSERT APPROPRIATE CITATION \*\*\***). Briefly, the method involves extraction of metals with hot concentrated nitric and hydrochloric acids, then oxidation of organics with hydrogen peroxide. The extracts were separated from the remaining solids, filtered, and diluted for ICP-MS analysis. ICP-MS analyses were conducted using EPA Method 6020 (**\*\*\* MIKE, PLEASE INSERT APPROPRIATE CITATION \*\*\***).

Quality assurance and quality control (QA/QC) measures were followed as prescribed in EPA Method 6020. A series of QA/QC blanks, standards, duplicates, and spikes were analyzed with each set of samples. Instrumental and Method blanks demonstrated that there was no uranium in the samples as a result of sample handling, and sample blank demonstrated that uranium analyses below detection were true (**\*\*\*MIKE, PLEASE CLARIFY THE LAST PART OF THIS STATEMENT \*\*\***).  $^{238}\text{U}$  samples were run after calibration with certified laboratory standards of 0.5 to 200  $\mu\text{g/L}$ . Each batch of samples and standards showed the expected and actual values of the standards for comparison and to demonstrate that the instrument was in proper working order.  $^{238}\text{U}$  samples were analyzed at a lower concentration, ranging from 0.5 to 50  $\mu\text{g/L}$  to ensure accurate values in the lower concentration range.  $^{235}\text{U}$  samples were run in the same manner as the  $^{238}\text{U}$  samples, except that the laboratory standard was derived from weathered DU collected from YPG. The DU had an isotopic ratio ( $^{235}\text{U}/^{238}\text{U}$ ) of  $0.0021 \pm 0.0004$ . The calibration range for  $^{235}\text{U}$  was 1 to 200  $\mu\text{g/L}$ .

Matrix spikes were samples of known value to which spikes of 50  $\mu\text{g/L}$  U were

added. Samples of 1.2, 1.5, and 46 mg/L were used and provided a check on the percent recovery during the analyses. Duplicates of the 1.2, 1.5, and 46  $\mu\text{g/L}$  samples were run and compared to show that the instrument was working in correct order.

ICP-MS concentrations ( $\mu\text{g/L}$ ) were converted to  $\mu\text{g-U/kg}$  by adjusting the reported ICP-MS concentration for the dilution factors and the weight of the sample. The resulting concentration on an ashed or oven-dry basis was reported from CL to LANL. Results presented in this report are results provided to CSU from LANL. Uranium concentrations in fish tissue were reported here on a dry weight basis.

#### *Statistical Analysis*

No statistical analysis was initiated since no analytical results were received from LANL prior to this final report.

## **RESULTS & DISCUSSION**

Experiment completed by 30 November 1992. To date, no analytical data have been received. No conclusions can be drawn about the rate uranium was bioconcentrated by fish in the absence of data.

## **\*\* CHAPTER 12 \*\***

### **Transfer of Uranium to Fish in a Simple Food Chain**

#### **INTRODUCTION**

DU introduced into the environment partitions into two phases, water and sediment. Physicochemical conditions within each of these two phases dictate the bioavailability of DU to fish and other aquatic organisms. Bioconcentration of DU from water is thought to be most important when aqueous concentrations are high and this process was studied in several of the previous experiments (Chapters 6, 10, and 11). Conversely, when aqueous concentrations are low, contaminated sediments become the primary source of exposure via food chain exposure or direct contact (Emery et al. 1981, Swanson 1983, Dallinger and Kautzky 1985, Swanson 1985, Biddinger and Gloss 1984). Because of the binding capacity of sediments, most of the uranium introduced into the environment at APG is expected to partition into sediment while aqueous concentrations remain relatively low (Erikson et al. 1990b). Organisms in direct contact with sediment, such as bottom-feeding fish or benthic invertebrates, may ingest uranium-contaminated sediment resulting in bioaccumulation of uranium (Emery et al. 1981, Swanson 1983, Swanson 1985). Consumption of these organisms results in food-chain transfer of uranium (Swanson 1983, Swanson 1985).

The transfer of uranium in aquatic food chains is not well understood but appears to be governed by site-specific water and sediment characteristics (Mahon 1982, Parkhurst et al.



1984, Nichols and Scholz 1989). As with many heavy metals, bioavailability of uranium is heavily dependent upon water quality parameters, especially pH, alkalinity, and hardness (Nakajima et al. 1979, Ahsanullah and Williams 1989, Parkhurst et al. 1984, Poston et al. 1984, Spry and Wiener 1991). In general, transfer of uranium through food webs is not efficient and tissue concentrations tend to decrease with increased trophic status (Parkhurst et al. 1984, Swanson 1985, Nichols and Scholz 1989). However, the water quality in these studies was moderately hard to hard with neutral to basic pH values. Consequence, uranyl ions would be expected to form carbonate and hydroxyl complexes, leading to reduced bioavailability of uranium to aquatic organisms. Accurate assessment of bioavailability, bioconcentration, and bioaccumulation requires site-specific physicochemical conditions to be simulated (Parkhurst et al. 1984). Food-chain accumulation of uranium in a soft, slightly acidic aquatic environment, such as the APG site, may be markedly different than results reported for other studies. Consequently, the purpose of this experiment was to evaluate the uptake of uranium in a simple food chain, from sediment --> benthic invertebrate --> carnivorous fish. Information gathered from this experiment will be used to refine parameter estimates in the food-web exposure model (Chapter 2). These experiments will minimize uncertainty in our model and result in more accurate predictions.

## MATERIALS AND METHODS

### *Test Organisms*

Chironomid larvae were used as prey items for carnivorous fish and were cultured from egg sacs derived from the National Fisheries Contaminant Research Center (Columbia, MO). Chironomids were raised in 35-L glass aquaria generally following the procedures outlined by Nebeker et al. (1984). Aerated cultures were maintained on a shredded paper towel substrate and fed a mixture of 600 mg Cerophyl (1.5 ml dry volume) and 100 mg (0.3 ml) finely crushed Tetra-Min fish flakes *ad libitum*. Water used for culturing all organisms and in experiments was from the source mentioned above. Only fourth-instar larvae were used as food items for sheepshead minnow.

Sheepshead minnow (*Cyprinodon variegatus*) were used to assess bioaccumulation of uranium by fish. Sheepshead minnow were selected as test organisms because they are common estuarine fish found in the Chesapeake Bay (Hildebrand and Schroeder 1928). In culture, sheepshead voraciously feed upon invertebrates. Additionally, these euryhaline fish are extremely hardy and local laboratory reared stock of known health status were readily available.

Fish were acclimated by the supplier (Aquatic Biosystems, Inc., Ft. Collins, CO 80524) to freshwater conditions (salinity 0‰; temperature 25°C; pH = 8.03; alkalinity 140 mg/L as CaCO<sub>3</sub> and hardness = 60 mg/L as Ca CO<sub>3</sub>) similar to experimental conditions. Fish were approximately 3 1/2 months old and ranged from 2.5 to 3 cm total length. Fish were fed Tetra-Min flake food *ad libitum* twice a day throughout the entire holding period.

### *Laboratory Microcosms*

An artificial sediment containing 3% total organic carbon was used in the aquatic microcosms. Sediment was composed of 83.1% sand ("Mystic White" No. 18, New England Silica, Inc., South Windsor, CT), 14.7% clay and silt (ASP 400, Engelhard Corp., Edison, NJ), 2.2% *Sphagnum* moss (milled to an average particle size of 840  $\mu\text{m}$ ; D. L. Browning Co., Mather, WI), 0.01% soluble humic acids (Aldrich Chem. Co., Milwaukee, WI); and 0.05% dolomitic limestone (Southern Agri-Minerals Corp., Hartford, AL). A detailed description of the physical and chemical characteristics of the artificial sediment is described in Walsh et al. (1992).

Sediment was spiked with depleted uranyl nitrate ( $\text{UO}_2(\text{NO}_3)_2 \cdot 6\text{H}_2\text{O}$ ; J.T. Baker Chemical Company, Phillipsburg, NJ 08865) and mixed on a rolling mill for one hour. Spiked sediment was placed in a fume hood and excess water was allowed to evaporate for 48 hr. Moist spiked sediment was then placed into 1-L polystyrene beakers and lightly packed to remove large air pockets. Sediment volume was 150 ml, approximately equivalent to 200 g sediment, dry weight.

Overlying water was soft, unfiltered reservoir water (Horsetooth Reservoir, Larimer Co., CO) which closely resembled water quality of freshwater at APG (Table 6.1). Initial physicochemical parameters of the reservoir water were: hardness = 22 mg/L, alkalinity = 27 mg/L, pH = 7.2, and conductivity = 127  $\mu\text{mhos/cm}$ . After the sediment was packed into beakers, overlying water was slowly added to the beakers in order to minimize sediment disturbance. Approximately 700 ml of overlying water was added to beakers to obtain a

final volume of 900 ml per microcosm. Organisms were introduced to microcosms after 24 hr.

### *Experimental Design*

Microcosms were randomly assigned positions within an environmental chamber. Temperature was maintained at  $20^{\circ} \pm 0.5^{\circ}\text{C}$ . Photoperiod was a 16:8 light:dark regime under cool, white fluorescent lights (30-33 ft-candles). Water in microcosms was aerated to maintain high dissolved oxygen concentrations and beakers were covered to minimize evaporative loss. Dissolved oxygen and pH were measured during each sampling period. Water hardness, alkalinity, and conductivity were measured upon test initiation and completion. Dissolved oxygen and temperature were measured with a Yellow Springs Instrument Co. (Yellow Springs, OH 43587) model 57 oxygen meter. Salinity and conductivity were measured with a Yellow Springs Instrument Co. (Yellow Springs, OH 43587) model 33 conductivity meter and pH was measured with a Jenco (San Diego, CA 92126) model 60009 pH meter. All meters were calibrated according to manufacturers directions prior to use and were rinsed with 10% nitric acid (Analytical-grade, Mallinckroft Specialty Chemical Co., Paris, KY 40361) and ultrapure water between microcosms to prevent cross-contamination. Hardness and alkalinity were determined by titration (APHA 1985).

A 2x2 factorial experimental design was used for this study. Exposure groups containing either spiked food, sediment, both, or neither. Each exposure group consisted of 18 microcosms except for the control group which consisted of six microcosms. Control

microcosms contained unspiked sediment and were fed chironomids from the laboratory cultures. Three replicate exposure microcosms and one control microcosm were destructively sampled during each sampling period (0, 2, 4, 7, 14 and 21 d). Each microcosm contained one sheepshead minnow. Fish were fed approximately 10, fourth-instar chironomids three times per week.

Since no analytical results were available from previous experiments prior to the initiation of this experiment, uranium concentrations used to spike sediment and chironomids were selected based on our best scientific judgment. Nominal concentrations of spiked sediment was 10 mg/kg U, dry weight. Spiked chironomids used as prey items were exposed for 24 h to aqueous uranium at a nominal concentration of 1000 mg/L.

Due to restrictions on the number of analytical samples which we could submit for uranium analysis, some experimental samples were pooled (Table 12.1) and the number of control microcosms were limited. During sampling periods, a sample of overlying water was siphoned from the center of the microcosm for chemical analysis. A series of filtered water samples were also collected by filtering 100 ml of overlying water through a 0.45  $\mu\text{m}$  membrane filter (Supor Acrodisc 25, Gelman Sciences, 600 South Wagner Rd., Ann Arbor, MI 48106). Water samples were acidified with analytical-grade nitric acid (Mallinckroft Specialty Chemical Co., Paris, KY 40361) to a pH of  $\leq 3$ , and frozen for shipment to LANL. Sediment samples were immediately frozen in Whirl-Paks for shipment. Fish were collected from microcosms and euthanized by immersion in an overdose solution of tricane methanesulfonate (MS-222). Fish were individually frozen for analysis. All tissue and sediment samples were stored at 0°C then shipped to LANL prior to chemical analysis.

TABLE 12.1. Summary of experimental samples which were pooled during each sampling period.

EXPOSURE MICROCOSM	SAMPLE TYPE		
	Fish	Water	Sediment
Control food/Control sediment (N=6)	not pooled (N = 6)	not pooled (N = 6)	not pooled (N = 6)
Spiked food/Control sediment (N=18)	not pooled (N = 18)	pooled (N = 6)	pooled (N = 6)
Control food/Spiked sediment (N=18)	not pooled (N = 18)	not pooled (N = 18)	pooled (N = 6)
Spiked food/Spiked sediment (N=18)	not pooled (N = 18)	not pooled (N = 18)	pooled (N = 6)

*Sample Preparation*

Sample preparation procedures used by LANL included elution of overlying water samples through columns filled with Chelex-100 resin (Bio-Rad Laboratories, Richmond, CA 94804). Resin was analyzed for uranium content by ICP-MS and original aqueous concentrations were calculated.

**\*\*\* MIKE INSERT INFORMATION CONCERNING RESIN AND ELUTION COLUMNS (IF USED) HERE \*\*\***

Sediment and tissue samples were prepared for ICP-MS at Los Alamos. Initial ("wet") weights of all samples were recorded, then samples were dried at 120°C. Dry weights were recorded after samples had cooled, and sediment samples were packaged in

storage containers. Biological samples were then ashed in a muffle furnace programmed to hold at 250°C for 3 hours, 350°C for 3 hours, and finally at 450°C for four hours.

**\*\*\* MIKE, ARE YOUR STILL ASHING ALL BIOLOGICAL SAMPLES? I THOUGHT WE HAD DECIDED TO USE OVEN-DRIED WEIGHTS FOR BIOLOGICAL SAMPLES IN EXPERIMENTS \*\*\***

Ash weights were recorded after samples had cooled, then each sample was packaged for later analysis and storage.

### *Chemical Analysis*

Isotopic determination of laboratory samples was unnecessary since experiments used DU to spike food and sediment. Background concentrations (natural-U) were measured in control microcosms. Samples were shipped via overnight courier to CL for ICP-MS analysis. The samples were checked in to CL and a Receipt of Acknowledgement form was returned to LANL. Uranium or DU in each sample was extracted using EPA Method 3050 (**\*\*\* MIKE, PLEASE INSERT APPROPRIATE CITATION HERE \*\*\***). Briefly, the method involves extraction of metals with hot concentrated nitric and hydrochloric acids, then oxidation of organics with hydrogen peroxide. The extracts were separated from the remaining solids, filtered, and diluted for ICP-MS analysis. ICP-MS analyses were conducted using EPA Method 6020 (**\*\*\* MIKE, PLEASE INSERT APPROPRIATE CITATION HERE \*\*\***).

Quality assurance and quality control (QA/QC) measures were followed as prescribed in EPA Method 6020. A series of QA/QC blanks, standards, duplicates, and spikes were

analyzed with each set of samples. Instrumental and Method blanks demonstrated that there was no uranium in the samples as a result of sample handling, and sample blank demonstrated that uranium analyses below detection were true (**\*\*\*MIKE, PLEASE CLARIFY THE LAST PART OF THIS STATEMENT \*\*\***).  $^{238}\text{U}$  samples were run after calibration with certified laboratory standards of 0.5 to 200  $\mu\text{g/L}$ . Each batch of samples and standards showed the expected and actual values of the standards for comparison and to demonstrate that the instrument was in proper working order.  $^{238}\text{U}$  samples were analyzed at a lower concentration, ranging from 0.5 to 50  $\mu\text{g/L}$  to ensure accurate values in the lower concentration range.  $^{235}\text{U}$  samples were run in the same manner as the  $^{238}\text{U}$  samples, except that the laboratory standard was derived from weathered DU collected from YPG. The DU had an isotopic ratio ( $^{235}\text{U}/^{238}\text{U}$ ) of  $0.0021 \pm 0.0004$ . The calibration range for  $^{235}\text{U}$  was 1 to 200  $\mu\text{g/L}$ .

Matrix spikes were samples of known value to which spikes of 50  $\mu\text{g/L}$  U were added. Samples of 1.2, 1.5, and 46  $\text{mg/L}$  were used and provided a check on the percent recovery during the analyses. Duplicates of the 1.2, 1.5, and 46  $\mu\text{g/L}$  samples were run and compared to show that the instrument was working in correct order.

ICP-MS concentrations ( $\mu\text{g/L}$ ) were converted to  $\mu\text{g-U/kg}$  by adjusting the reported ICP-MS concentration for the dilution factors and the weight of the sample. The resulting concentration on an ashed or oven-dry basis was reported from CL to LANL. Results presented in this report are results provided to CSU from LANL. Uranium concentrations in fish and sediment from this experiment are reported on an oven-dry weight basis.



### *Statistical Analysis*

No statistical analysis was initiated since no analytical results were received from LANL prior to this final report.

### **RESULTS & DISCUSSION**

Experiment was completed by 3 May 1993. As of 10 December 1993, no analytical data was received. No conclusions can be made at this time in the absence of data.

## **SECTION B**

### **EVALUATION OF DEPLETED URANIUM AT YUMA PROVING GROUNDS, ARIZONA**

## **\*\* CHAPTER 13 \*\***

### **YPG OVERVIEW**

#### **BACKGROUND**

The magnitude and sources of ecological risk to the YPG environment are important parts of a comprehensive evaluation of the continued use of DU at YPG. This portion of our study of DU in the environment was initiated to examine the potential risk from DU to the terrestrial ecosystem at YPG where DU and DU alloy munitions are test-fired on the Kofa Firing Range. Although the emphasis of our overall evaluation of DU in the environment was somewhat greater for APG than for YPG, more than 500 samples were collected from YPG firing lines and approximately 300 samples collected in the course of experiments on YPG indicator organisms. Our integration of modeling, field and laboratory approaches represent a unique approach to ecological exposure and risk assessment that, when complete, will greatly enhanced understanding of ecological risk to the YPG environment.

Depleted uranium is deposited at YPG in much the same way as at APG: penetrators pass through target areas, impact the earth, and may ricochet downrange. Penetrators ultimately come to rest either at the initial impact site or at dispersed locations downrange. At each impact soils are contaminated as penetrators are abraded, fragmented, and aerosolized. Contaminated soil and DU particles remain in the impact crater and are ejected for varying distances depending on particle size and velocity, wind, and topography. Initial impacts are clustered behind targets, so that contamination zones from individual impacts

may overlap. Thus after multiple impacts, areas of hundreds to thousands of m<sup>2</sup> are contaminated with up to hundreds of mg DU/kg (Price 1991). When penetrators ricochet downrange, more impact craters and soil ejection zones are produced. Soil contamination may be lower at these sites, because multiple impacts are much less likely to occur nearby. Some DU also is dispersed as penetrators ultimately come to rest and as penetrators slowly degrade in the environment. The *in situ* degradation process can produce high levels of soil contamination but occurs at the scale of only a few cm<sup>2</sup>. For example, Ebinger et al. (1990) detected approximately 0.5% U by mass in surface soil horizons beneath DU penetrators. Price (1991) described the spatial distribution of uranium along two firing lines in the Kofa Firing Range, which are designated GP-20 and GP-17A (Figure 13.1). Soil concentrations were higher at GP-17A than at GP-20, were highest along the east-west axes of the firing lines, and greatest behind target areas where DU munitions first impact the earth. Downrange uranium concentrations were near background levels except in the vicinity of DU penetrators or fragments. The source of the elevated uranium concentrations as DU was confirmed by the observed isotopic ratios (Figure 13.2). Thus, several spatial patterns of DU contamination have resulted at YPG. Deterioration of penetrators causes significant soil contamination at small spatial scales (cm<sup>2</sup>). Soil ejection during munitions impacts causes soils to be contaminated at lower levels in and around individual impact craters (tens to hundreds of m<sup>2</sup>). In addition, clustering of impact craters along firing lines causes thousands of m<sup>2</sup> to be covered with contaminated soils (Figure 13.1). Finally, DU penetrators and impact craters are widely dispersed so that several km<sup>2</sup> are contaminated to some degree by DU (Figure 13.2).

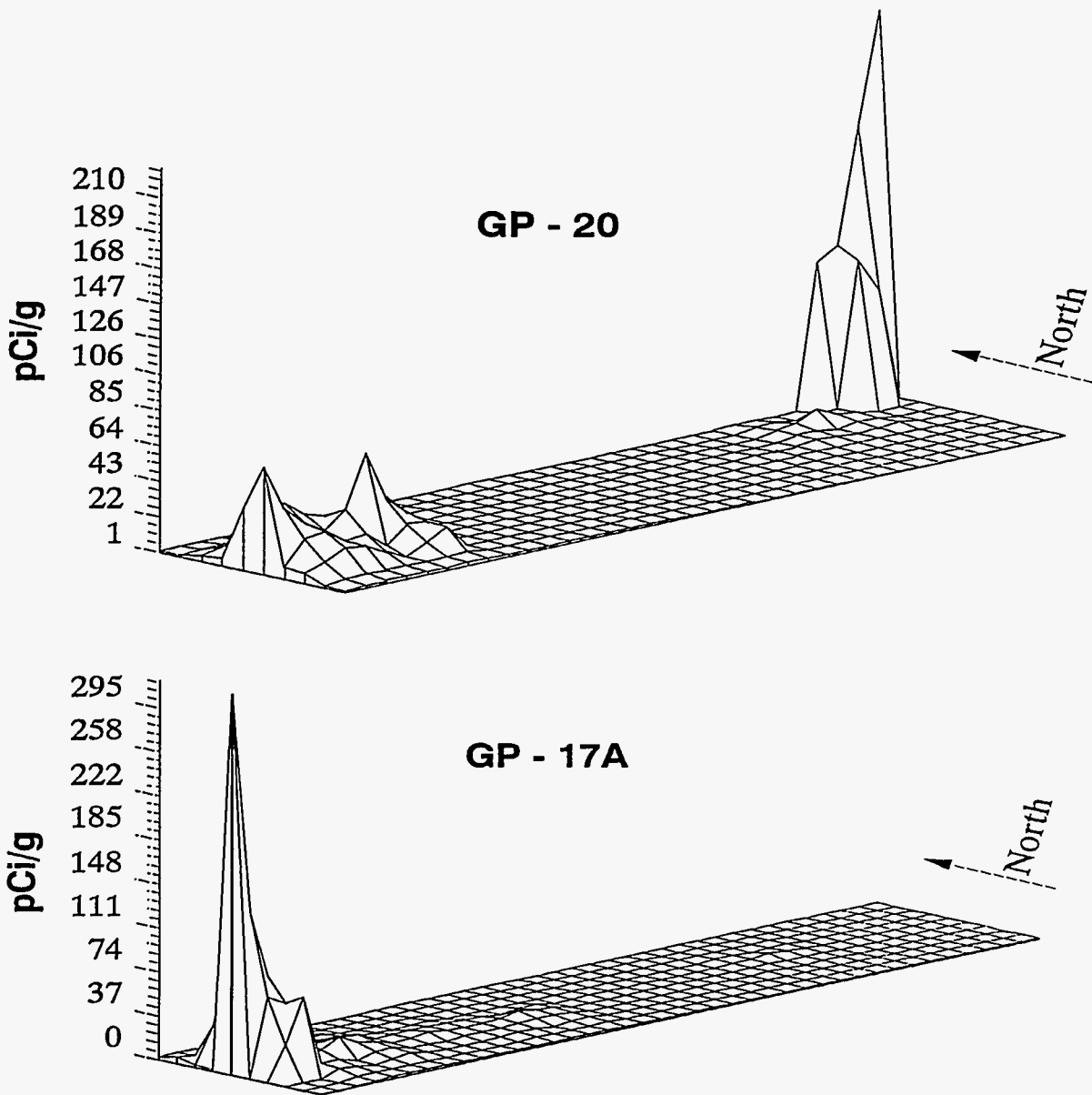

FIGURE 13.1. Spatial distribution of total uranium in soil at Kofa Firing Range, Yuma Proving Ground (compiled from Price 1991). Dimensions of firing lines are approximately 1 x 4 km at GP-20 and 1 x 4.5 km at GP-17A.

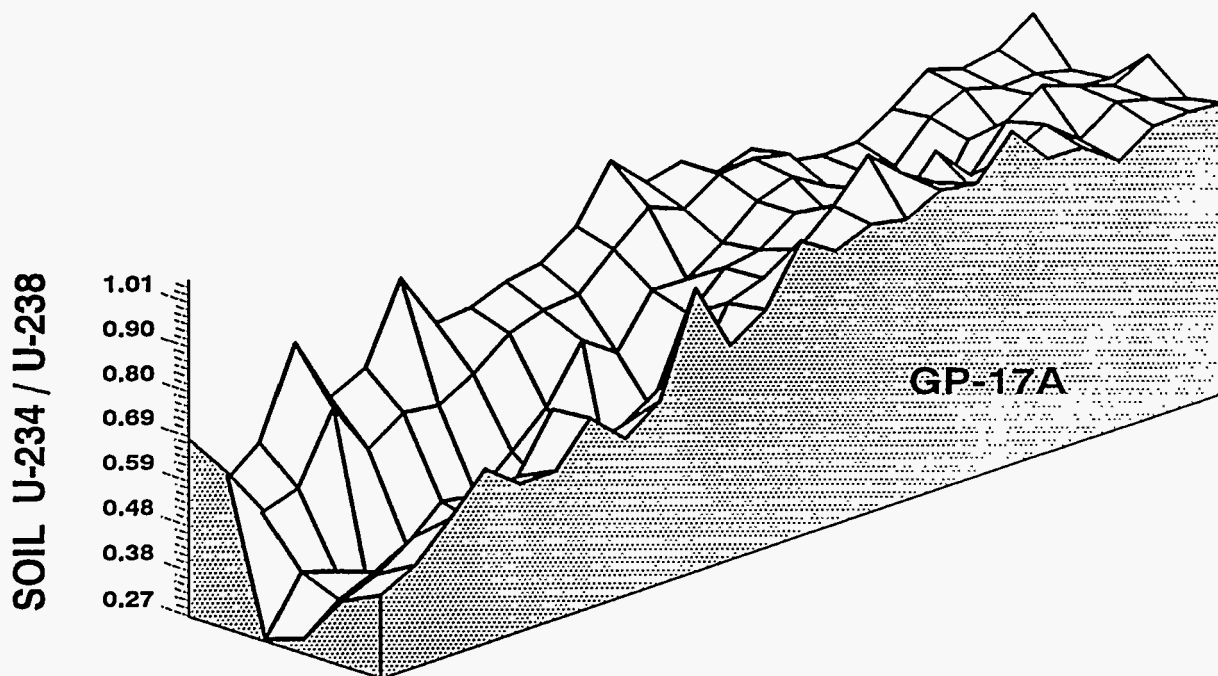
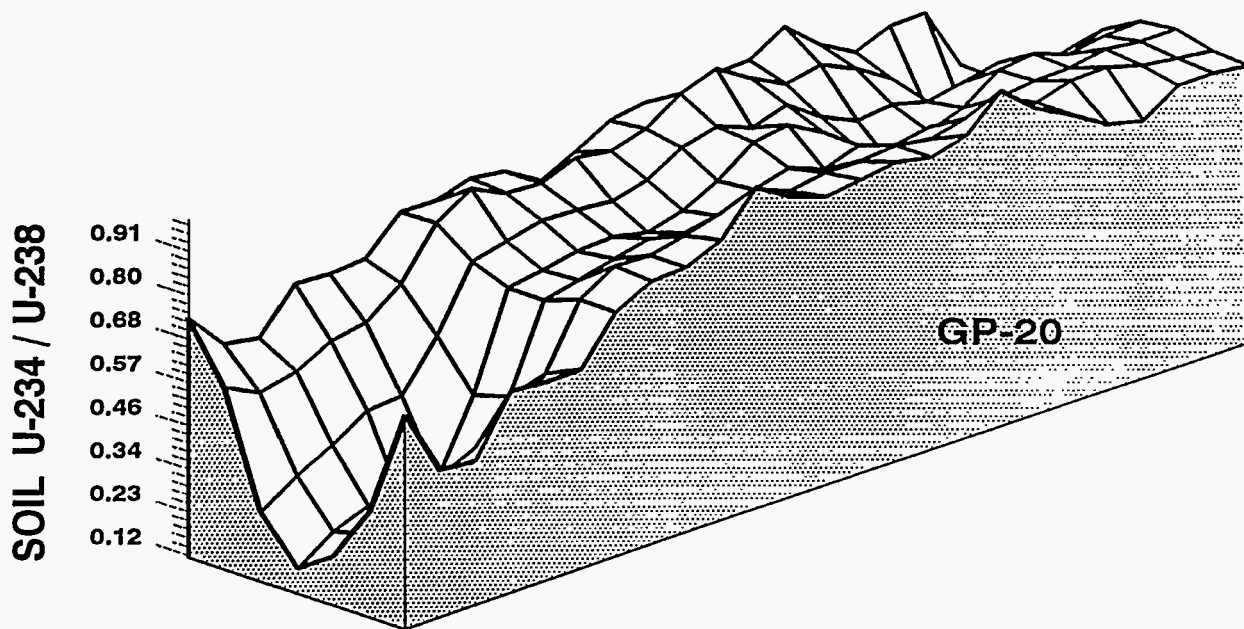

FIGURE 13.2. Spatial distribution of uranium isotopic ratios of soil at Kofa Firing Range, Yuma Proving Ground (compiled from Price 1991). Dimensions of firing lines are approximately 1 x 4 km at GP-20 and 1 x 4.5 km at GP-17A.

The widespread deposition of DU across the Kofa Firing Range presents the potential for uptake of DU by plants and animals in the terrestrial environment at YPG. The firing lines are situated in the Lower Colorado River Valley near the transition between the Lower Sonoran Desert and the Mohave Desert to the east. Moisture availability is low; average annual precipitation is about 90 mm per year and sporadic (CV = 42%, Figure 13.3). Within years, precipitation is patterned into summer monsoons and winter rains (Figure 13.4). These patterns of moisture stress cause primary productivity to be low relative to other environments. The sparse vegetation is dominated by creosote (*Larrea tridentata*) and white bursage (*Ambrosia dumosa*) with palo verde (*Cercidium floridum* and *C. mircophyllum*) being found in washes where moisture availability is greater. Portions of the area are covered by desert pavement, which is almost completely lacking in vegetative cover (Brown 1982). The combination of aridity and sparse vegetation cause other forms of biodiversity to be less abundant than in other communities (Polis 1991). Nevertheless, unique and complex food webs have involved under these conditions. Considering only terrestrial vertebrates, there are some 137 families, 422 genera, and 735 species associated with the Sonoran Desert (Crosswhite and Crosswhite 1982). The biological diversity of the invertebrate fauna is even more rich (Polis 1991). This richness of ecological communities is made possible by specialized behaviors and physiologies that allow life in the stressful, arid environment.

Water conservation strategies are critical factors in the success of terrestrial life at YPG. One aspect of water conservation is minimizing water loss. Animals may accomplish this using behavioral approaches, which minimizes the time spent in the driest, hottest

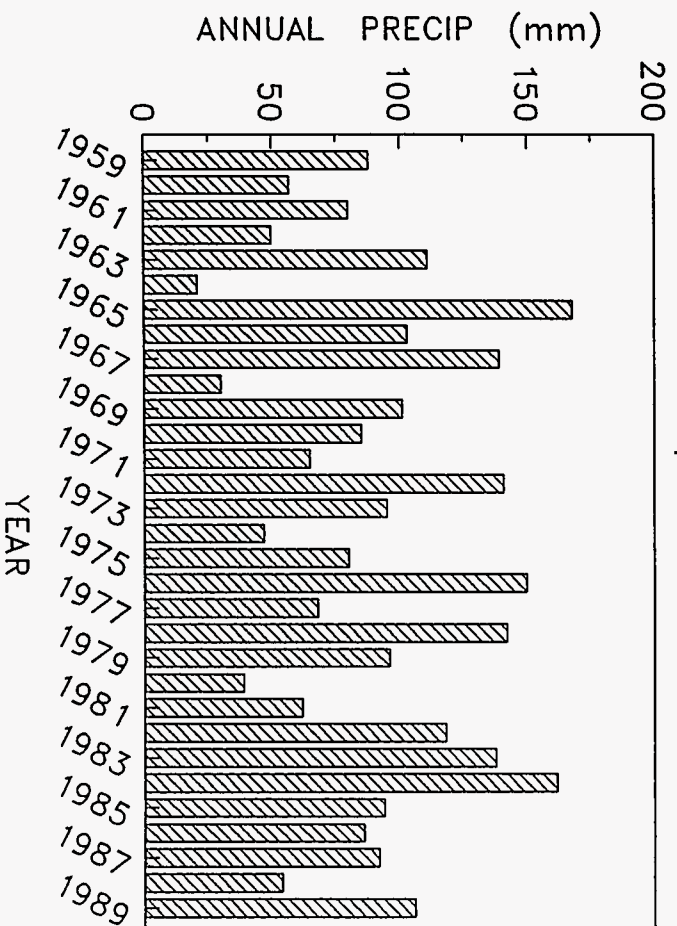

FIGURE 13.3. Annual variation in precipitation at Yuma Proving Ground, Yuma, AZ.

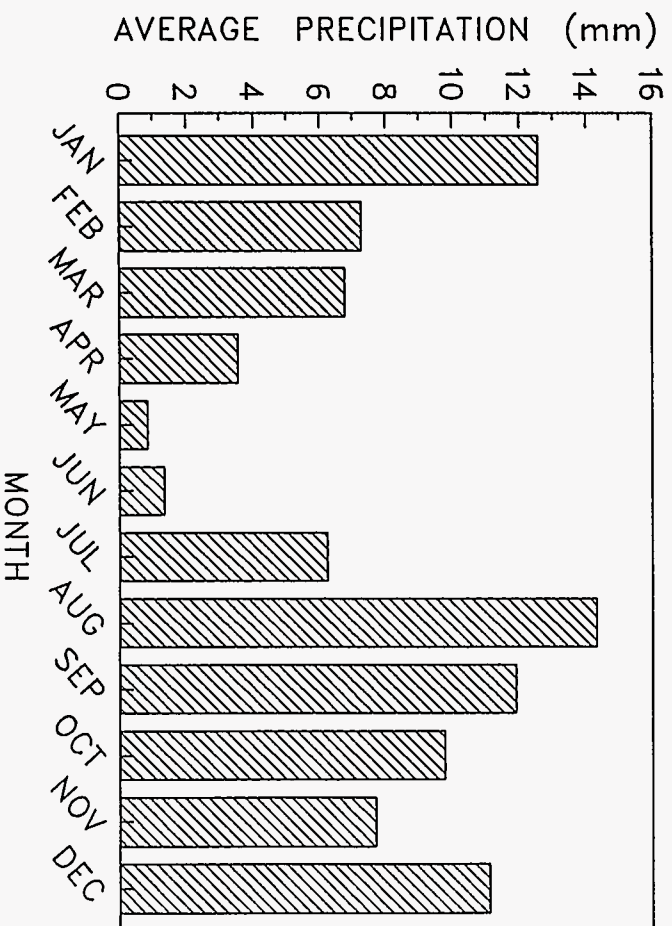

FIGURE 13.4. Monthly variation in precipitation at Yuma Proving Ground, Yuma, AZ.



microclimates. Water losses can be reduced further by physiological specialization. Kangaroo rats, for example, have specialized kidneys, elongated renal papillae, and long nasal passages for countercurrent heat exchange to reduce water loss (Mares 1983). Some of these physiological processes that enhance water conservation may be at risk for animals exposed to DU at YPG.

An early, sublethal effect of uranium in mammals is interference with renal function (Hodge 1973). Although many of these effects are not acutely toxic to laboratory animals in controlled, benevolent environments (Yuile 1973), minor inhibition of water conservation mechanisms could have significant effects on survival of desert organisms. Any change in survival also affects population size and the ecological structure of the environment, the numbers and types of organisms in the environment. Also, any change in ecological structure affects the direction and magnitude of the flow of energy and materials in the environment, its ecological function. Any change in the ecological structure or function of the YPG environment could pose long-term risks to its sustainability. It also is possible that any in ecosystem structure or function could impact overall DU redistribution patterns, such as by changing erosional transport rates.

## **JUSTIFICATION**

Our evaluation of DU exposure to the environment at YPG was performed in parallel with the APG phase of the project. Our goal is to ultimately produce a defensible, science-based assessment of exposure and risk to terrestrial life at YPG. The distribution of DU among organisms and risk to organisms at YPG is also important supporting information for

assessments of risks to human health and to the values that humans place on biological diversity. The common approach for the two sites was to summarize and integrate information about the ecosystem structures, the ecological functions of ecosystem components, and the physiological and toxicological properties of DU into simple ecosystem models. Next we used uncertainty/sensitivity analyses to identify model parameters and processes that most influenced the uncertainty in the DU exposures predicted by these models. The processes and parameters identified in these analyses then could be especially targeted in subsequent field and laboratory studies with the purpose of providing data for efficient evaluation of the performance of these models and of competing models. In August 1992 we conducted field studies at YPG to estimate the amount of DU plants and animals at YPG. We sampled each trophic level represented in the YPG exposure model across a range of soil contamination levels so that empirical relationships between biotic and abiotic DU might be developed.

Field samples alone are limited in their ability to produce the information needed to estimate parameters for ecological exposure and risk models. Animals integrate many exposure levels as they move between sites with variable levels on contamination, and exposure processes may exhibit significant variation over time. Also if any negative effects occur, the organisms may not survive to be captured or may move to other habitats as the impacted habitat becomes unsuitable. These new habitats may be inferior to the ones from which they were displaced.

We used laboratory experiments to overcome these shortcomings of field approaches. For example, we estimated the uptake and elimination rates of DU by kangaroo rats

(Chapter 16). With this information it is possible to predict the DU concentrations for varying exposure levels. We also estimated the histological effects that DU has on kangaroo rat kidneys (Chapter 17), because small effects on kidney function may have large effects on desert organisms. An estimate of a toxicity threshold also is necessary for estimating ecological risk.

## **STUDY LIMITATIONS**

The YPG phase of the project experienced many of the same difficulties described for APG in Chapter 1. We made significant progress toward developing defensible estimates ecological exposure to DU upon which estimates of risk can be based. Delays between the collection of experimental samples and field monitoring samples and the receipt of chemical analysis results (Table 13.1), however, preclude us from making any meaningful statements about DU and ecological exposure and risk at YPG. Sample turn-around times did not permit planning and scheduling a second sampling trip to YPG. This problem also hampered the planning and execution of experiments, because results from pilot studies were not available. We still lack uranium isotopic ratio data from all YPG field samples, and only a few, scattered results are available from experiments to estimate uranium uptake, depuration and toxicity to YPG indicator organisms (Table 13.1). When these data are received, summarized, analyzed and synthesized in an ecological context, significant improvements in understanding of DU exposure and risk processes at YPG can be achieved.

TABLE 13.1. Status of research activities to estimate ecological exposure of DU to life at Yuma Proving Ground.

Activity	Completion of sample collection phase	Analytical results received by December 1993
YPG field sampling - 1992	August 1992	0% <sup>1</sup>
YPG field sampling - 1993	NA <sup>2</sup>	NA <sup>2</sup>
Kangaroo rat uptake/depuration studies	November 1992	10%
Kangaroo rat renal toxicity threshold studies	October 1993	0%

<sup>1</sup>Total uranium results received from less than 5% of submitted samples. Uranium isotopic ratios are necessary to evaluate the source of uranium in these samples.

<sup>2</sup>Follow-up sampling trip for 1993 was not scheduled, because results from initial trip or laboratory studies were not available for planning purposes.

## **\*\* CHAPTER 14 \*\***

### **TERRESTRIAL YPG EXPOSURE MODEL:**

### **SENSITIVITY/UNCERTAINTY ANALYSES**

#### **INTRODUCTION**

In this Chapter we present a food web model for the transport and fate of DU in the YPG environment. Models for estimating ecological exposures to contaminants such as DU are hypotheses about dynamic, ecological processes. The ecological processes in the DU model and the parameter values used to describe these processes are necessarily uncertain. Part of this uncertainty is a natural part of the YPG ecosystem, but part of this uncertainty is caused by incomplete knowledge about the site-specific processes and parameters that describe DU transport and fate. Our goal was to reduce this latter source of uncertainty to the greatest extent possible by

1. specifying a model for DU transport and fate in the YPG food web,
2. analyzing the model to identify the ecological processes and parameters most influential in causing uncertainty in the predicted concentrations of DU in YPG plants and animals,
3. collecting field samples from the YPG environment to estimate environmental variation in DU concentrations in the food web and to evaluate the model structure and performance,

4. experimentally estimating parameters used to describe important ecological, physiological and toxicological processes in the model, and by
5. formulating a revised model with reduced uncertainty based on information gained from the field and laboratory studies.

This Chapter addresses goals 1 and 2 so that the remaining goals may be accomplished (Chapters 15 - 17).

## MODEL STRUCTURE

We estimated environmental fate of DU at YPG in much the same way as at APG. DU is deposited to soil, and abiotic and biotic processes cause it to be redistributed among several compartments. We modeled these processes with coupled differential equations as before (Chapter 2). We calculated changes in the DU concentration of any compartment,  $C_i$ , with each time step as the sum of all inputs from other compartments,  $C_j$ , to  $C_i$  minus all losses from  $C_i$ :

$$\frac{dC_i}{dt} = \sum_{ij}^n (C_j \lambda_{ij} - C_i \lambda_{ji}), \quad (1)$$

where  $n$  is the number of interacting compartments,  $\lambda_{ij}$  is the rate of uptake (1/d) to  $C_i$  from  $C_j$  and  $\lambda_{ji}$  is the rate of loss (1/d) from  $C_i$  to  $C_j$ . Rate parameters ( $\lambda_{ij}$  and  $\lambda_{ji}$ ) represent abiotic, ecological, or physiological processes, or functions of several processes, and control flows into and out of each compartment (Chapter 2).

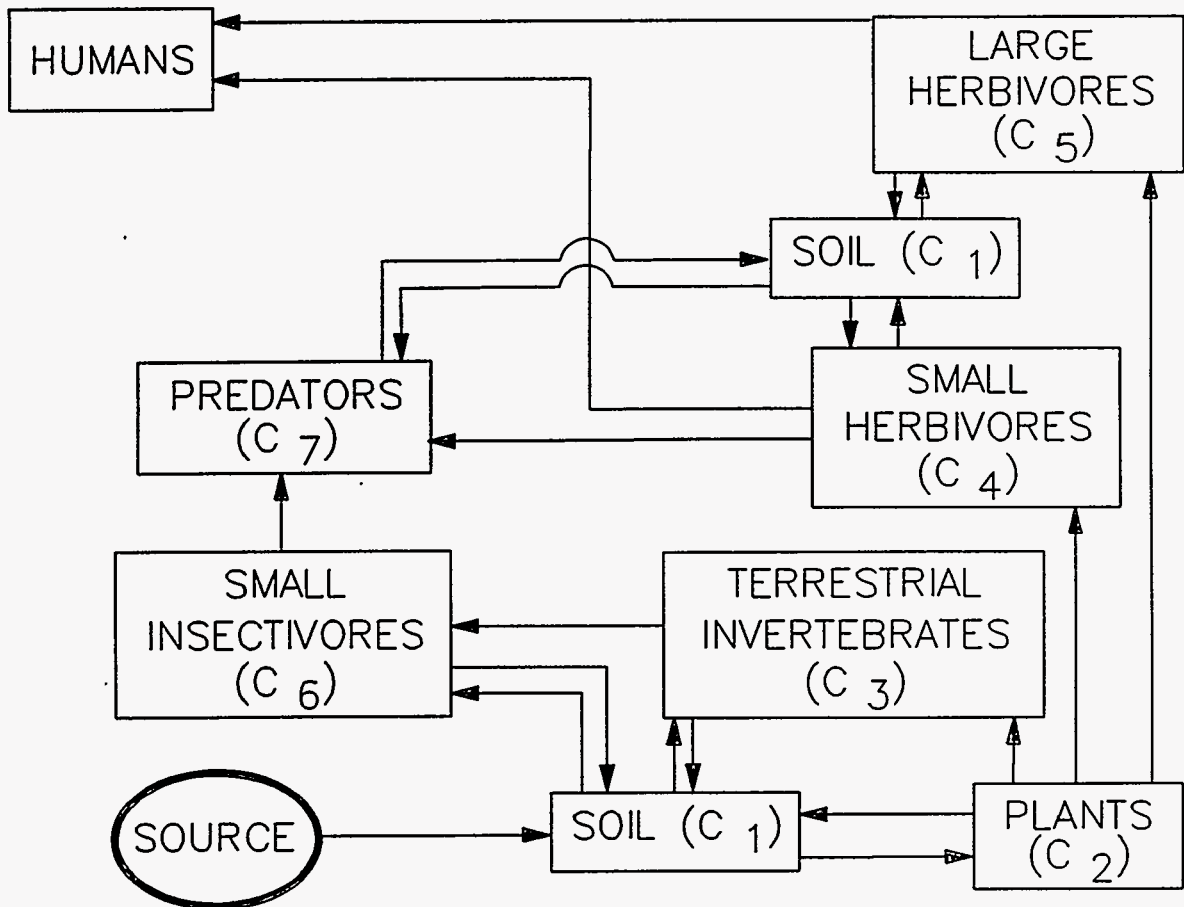

FIGURE 14.1. Conceptual model for DU transport through the terrestrial environment at the Kofa Firing Range at YPG.

Our model of DU in plants and animals at YPG assumed that DU was uniformly distributed to soil ( $C_1$ ) by the munitions testing program. Thus, all subsequent calculations depend on this state variable. Our preliminary conceptual model for DU transport and fate in the above-ground segment of the terrestrial environment at YPG contains state variables for estimating DU concentrations in plants, terrestrial invertebrates, small insectivores, small herbivores, larger herbivores, and predators (Figure 14.1). In addition, the concentration of DU in litter ( $C_8 = \text{detritus}$ ) is calculated. The litter compartment receives input from the

death of plants and animals and from DU in excreta. Litter was removed by consumption by invertebrates and decomposition. Rate equations used to represent DU transport in the YPG environment may be found in Table B-1 of Appendix B. Nominal values for model parameters and their ranges may be found in Table B-2.

The kinds of species present and their abundance are important ecological factors necessary for estimating environmental fate of DU. Ecosystem structure was determined by relationships between above-ground biomass (kg-DM/m<sup>2</sup>) and biomass conversion efficiencies of consumer trophic levels or from literature values. We estimated above-ground plant biomass ( $B_2$ ) from literature values for the Sonoran Desert (Begon et al. 1990:652). We calculated biomass of invertebrates ( $B_3$ ) and large herbivores ( $B_5$ ) as fractions of above-ground plant biomass. One parameter,  $BE_{HV}$ , estimated the fraction of plant biomass contained in all herbivore compartments. A fraction of this mass was allocated to invertebrates according to the value of  $FHV_3$ , and another fraction of herbivore biomass was allocated to large herbivores by  $FHV_5$ . Large herbivore biomass was calculated as

$$B_5 \text{ (kg/m}^2\text{)} = B_2 BE_{HV} FHV_5 ,$$

for example. Amounts of small herbivore biomass ( $B_4$ ) were estimated from Chew and Chew (1970). We assumed that insectivore biomass ( $B_6$ ) was equal to invertebrate biomass times the biomass conversion efficiency ( $BE_{IV}$ ) for this group and that the biomass conversion efficiency of carnivores ( $BE_{CV}$ ) would adequately estimate carnivore biomass as a function of total prey biomass ( $B_4 + B_6$ ). The amount of dead plant material standing and on the soil surface was also estimated as a fraction of above-ground plant biomass ( $B_2 \times fp$ ).

Plant uptake from soil to internal vegetation parts was calculated by



$$C_{2i} = C_1 \frac{\lambda_{2,1}}{Kd} ,$$

where  $\lambda_{2,1}$  was daily plant uptake and  $Kd$  was used to partition soil uranium into available and unavailable fractions.

Surface soils are available for deposition onto plant surfaces. The quantity of DU on the labile soil surface ( $QSS$ , mg-DU/m<sup>2</sup>) and available for suspension and rainsplash was calculated based on a labile soil depth of 0.001 m ( $z_s$ ), a soil concentration ( $C_1$ ), and soil bulk density ( $PS$ , kg/m<sup>3</sup>) (Whicker and Kirchner 1987). The quantity of DU in soil surfaces was estimated by

$$QSS = C_1 PS z_s .$$

We estimated deposition to plant surfaces by suspension and rainsplash in the manner used by Whicker and Kirchner (1987):

$$\text{Suspension rate} = QSS \times RF \times V$$

$$\text{Rainsplash rate} = QSS k_r .$$

Removal of DU from plant surfaces was calculated by

$$\text{Weathering rate} = C_{2s} k_w .$$

Uptake rates from feeding depended on daily dry matter intake and the fraction of ingested DU that was absorbed. The amount of dry matter ingested (DMI, g/d) each day by animals is related to body mass by  $DMI = aW^b$ . We estimated daily dry matter intake as a fraction of body mass ( $FB_i$ ) as

$$FB_i \text{ (1/d)} = a_i W_i^{(b_i-1)} .$$

The coefficients,  $a_i$  and  $b_i$  (Nagy 1987), were chosen based on feeding mode of the compartments.  $DMI$  could come from one of  $n$  compartments, so we partitioned  $DMI$  intake for any compartment  $i$  from other compartments  $j$  with the coefficient  $FD_{i,j}$  such that

$$\sum_{j=1}^n FD_{ij} = 1. \text{ Only a fraction of ingested DU is absorbed to blood. We assumed that the}$$

assimilation coefficient ( $E_{i,j}$ ) was independent of level of intake. The amount of DU ingested with food and absorbed to blood by large herbivores, for example, was calculated as

$$\begin{aligned} \text{mg DU} \cdot \text{kg}^{-1} \cdot \text{d}^{-1} &= C_2 FB_5 FD_{5,2} E_{5,2} \\ &= C_2 \lambda_{5,2} \end{aligned}$$

Animals ingest soil deliberately or incidentally during feeding and grooming. We assumed that a fraction of daily intake was soil and that a fraction of soil DU as assimilated. Rate of daily uptake of DU from was estimated as

$$\lambda_{i,1} = fs_i FB_i E_{i,1} ,$$

where  $fs_i$  was the fraction of daily dry matter intake that was soil.

Plants and animals lose biomass to the dead organic matter pool ( $C_8$ ) through excretion, death, and senescence. Daily mortality rates not associated with feeding by other organisms ( $\lambda_{8,j}$ , 1/d) were derived from (1 - annual survival), where survival rate was predicted by  $as_j W_j^{bs_j}$  (Calder 1984). Loss from compartments (1/d) due to feeding by other organisms was handled as

$$\lambda_{j,i} = \frac{B_j}{B_i} FB_j FD_{j,i} .$$

Animals added DU to the dead organic matter pool ( $C_8$ ) through elimination of unabsorbed, dietary uranium at the rate  $\lambda_{i,j}$ ,

$$\lambda_{i,j} = \frac{B_{i'}}{B_8} FB_{i'} FD_{i,j} (1 - E_{i,j})$$

Urinary excretion back to soil was calculated as a multiple ( $FU_i$ ) of metabolic rate estimated from body mass (Calder 1984),  $\lambda_{1,j} = FU_j am_j W_j^{bm_j}$ , except for elimination by invertebrates ( $\lambda_{1,3}$ ). This rate was approximated from the four-day lead budget for *Orchella cincta* (van Straalen et al. 1987). The daily rate was estimated from the amount of ingested lead ( $f_{3i}$ ) that was retained in the body ( $f_{3b}$ ) according to  $f_{2b} = f_{2i} e^{-rt}$ , for  $t = 4$  d so that  $\lambda_{1,3} = r$ .

## MODEL UNCERTAINTY AND SENSITIVITY ANALYSES

No model existed for the YPG food web or of site-specific DU transport or fate, so our model was assembled from descriptions of other sites gleaned from the scientific literature. Uncertainty in exposure models based on literature values can easily span several orders of magnitude (*e.g.*, Chapter 2, Lipton and Gillett 1991), but not all model parameters and processes contribute equally. Identification of model parameters and processes most influential in creating uncertainty in estimated DU concentrations is important for understanding and managing ecological exposure and risk. Relevant field and laboratory studies directed at these factors can then determine whether the uncertainty is due to inherent variability in nature or merely due to our lack of understanding of natural processes. Uncertainty may therefore be reduced by directing research in these areas.

The methods used to evaluate model uncertainty and parameter sensitivity for the APG aquatic transport model (Chapter 2) were applied to the terrestrial model for YPG. Basically, nominal parameter values that were best estimates of the true values were selected for the model. Ranges for each value were also selected that reflected our degree of uncertainty about the nominal values. No scientifically-credible model existed for the biodiversity at YPG or of uranium effects specific to these species. Therefore, confidence in nominal values and in the model structure necessarily were low, and parameters had broad ranges. The variation in model inputs was then analyzed to ascertain the impact each parameter had on estimated DU concentrations.

## RESULTS AND DISCUSSION

Depleted uranium concentrations predicted by the model were highly variable (Figure 14.2). Plant tissues had a nominal estimate of about 3 mg/kg (maximum of about 30), whereas plant surfaces contaminated by suspended DU contributed another 11 mg/kg (maximum of about 80). Except for small herbivores, other consumers were predicted to contain less than or equal to about 1 mg U/kg.

The uncertainty in these estimates could be reduced by replacing the parameter values taken from the literature with site-specific values or by revising the model structure. An efficient approach to evaluating model structure and for refining model parameter values is to target research and sampling on ecological parameters and processes that were most influential in producing uncertainty in the model.

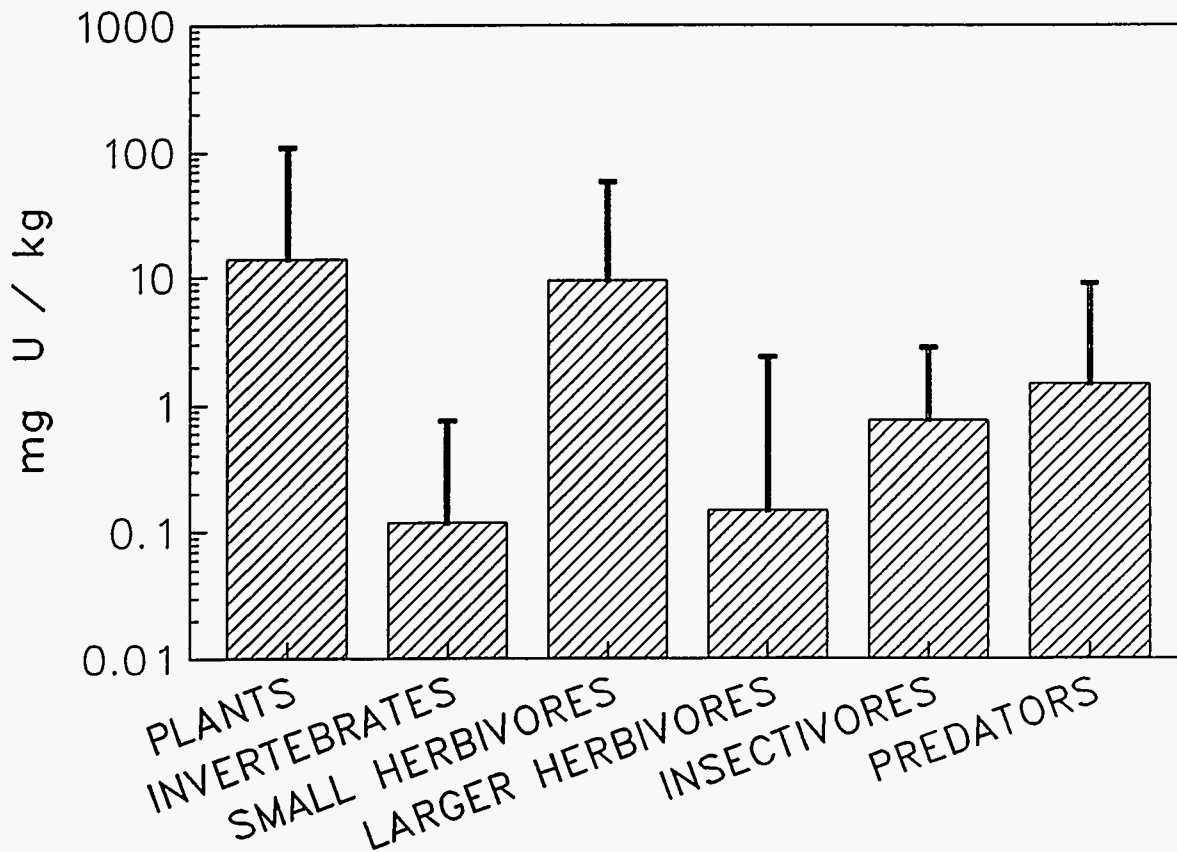

FIGURE 14.2 Nominal and maximum concentrations predicted for biological compartments by the YPG transport model.

Uranium concentrations in soil are the source of DU to biological diversity at YPG and were highly influential in causing variation in the estimated DU content of all model compartments. Four parameters relating to the DU found in or on plants also were important in producing uncertainty in other compartments. Suspension of DU and subsequent deposition on plants was a function of  $RF$  and  $V$ , and  $Kd$  controlled the amount of soil uranium that was available to be taken up by plant roots. The amount of plant biomass ( $B_2$ ) also had a large influence on model uncertainty for several reasons. First, the amount of biomass in other compartments was calculated based on the amount of plant biomass, so

uncertainty in this value directly adds to the uncertainty of other compartments. This parameter also controls the pool of biomass that receives the suspended fraction of soil uranium, and the level of contamination of plant biomass has large direct and indirect effects on DU redistribution to heterotrophs. Plant concentrations were also affected by parameters describing litter fall, plant consumption rates by invertebrates, and the biomass of vertebrate herbivores.

In addition to the parameters  $B_2$ ,  $RF$ , and  $V$ , predicted concentrations in invertebrates were sensitive to the amount of DU uptake directly from soil, to invertebrate dry matter intake rates, and to their ability to assimilate ingested DU from the litter compartment ( $C_8$ ). Parameters describing the DU elimination rates of large herbivores were important contributors to the uncertainty in the estimated DU content of large herbivores, and the amount of soil consumed by insectivores made a modest contribution to the uncertainty observed for predicted insectivore concentrations. The uncertainty about predicted predator concentrations was sensitive to DU elimination rate parameters and to the DU assimilation efficiency of predators from their small herbivore prey.

These results provide guidance for field sampling and experimental laboratory studies to evaluate model performance. The extent of soil contamination obviously was the most important factor controlling the amount of DU available for redistribution to plants and animals. In the model, soil was deposited on plant surfaces, was absorbed by plants, and was ingested by animals. Collection of plants and animals from areas of different soil concentrations would produce data for generating empirical relationships between soil and biotic contamination levels that are specific to YPG. Uncertainty in some animal

compartments were sensitive to DU assimilation and elimination rates, so experimental estimates of these rates should help to reduce overall model uncertainty. Small mammals ( $C_4$ ) were estimated to contain the greatest amounts of DU in animals, and additional research on this compartment should reduce uncertainty about ecological exposure to DU at YPG. Finally, the small mammal communities of deserts contain important keystone species that are capable of having ecosystem-level effects not always suggested by their absolute abundance (Brown and Heske 1990). A better understanding of DU dynamics in the small mammal community will help describe the likelihood of significant ecological effects caused by the munitions testing program at YPG.

## **\*\* CHAPTER 15 \*\***

### **YPG FIELD STUDIES**

#### **INTRODUCTION**

Munitions testing at YPG disperses DU across the Kofa Firing Range. The distribution of this DU is not uniform, however, and several areas contain concentrations that are many times background levels (Price 1991). Environmental contaminants, such as DU, are ecological disturbances that may affect ecosystem structure by altering the amount of biomass and the distribution of biomass among interacting species. The magnitude of the flows of energy and materials between these species also may be impacted by contaminants. Any effects that contaminants have on the ecological structure or functioning of ecosystems will therefore alter those ecosystems in ways that may or may not be acceptable. The effect that contaminants have on ecosystems is dependent upon the level of exposure of plants and animals to the contaminant and on species-specific responses to contamination.

We developed a terrestrial transport model for DU in the environment at YPG (Chapter 14) to estimate potential DU levels in several components of the YPG ecosystem. The dominant function of the model, however, was aid in identifying important ecological parameters and process that limit our certainty about the extent of redistribution of DU from soils to the rest of the YPG ecosystem. The model was developed in the absence of detailed site-specific information on YPG ecosystem structure or function and without species-specific dose-response functions for DU. Any predictions from the model therefore have high levels



of uncertainty associated with them. Our analysis of this uncertainty identified several of its key sources (Chapter 14).

In this chapter we report work conducted to evaluate the performance of the transport model, to estimate site-specific parameters for the model, to produce alternative formulations of the model, and to seek alternative models for describing DU distribution in the environment at YPG. Field data are essential to evaluate performance of the YPG model and to generate relationships between DU in the abiotic environment and its redistribution to plants and animals. Thus, we collected biological samples at YPG to estimate levels of likely exposure to DU, assuming that exposure was positively correlated with soil contamination.

## **MATERIALS AND METHODS**

We established sample plots on two Kofa firing lines at YPG, GP17A and GP20. Plots were distributed nonrandomly along the firing line in areas where first penetrator impacts were closely clustered and had been identified as having high levels of DU contamination (Price 1991, Figure 13.1). These areas were situated along the axis of the firing line and could be identified by impact craters, recently displaced soils, and by observation of DU fragments. Within these areas we established 5 sample plots on each firing line where high levels of biodiversity overlapped zones of apparent DU contamination. High biodiversity was indicated by the distribution of vegetation, animal sign, and observations of animals. These criteria caused plot locations to be in draws and washes that transected the firing lines and in a trench along the firing line. Locations for sample plots

were at different distances from the firing line and distances from observable impact craters and thus were assumed to cover a range of contamination levels for each firing line.

At each plot we sampled biotic and abiotic components of the YPG ecosystem. We first collected surface (2 - 3 cm depth) soil samples to estimate local soil contamination on the plot and then established a drift fence and pitfall trap array at that point.

Individual sections of drift fences were approximately 0.15 x 1.5 m (Figure 15.1).

We operated pitfall traps for 72 hours and collected trap contents in the 2 - 3 hours after dawn and before dark. Using the

pitfall array as the center point for the plot, we selected the nearest *Larrea tridentata* plant and collected samples of the surface

soil and litter beneath the canopy and collected foliage samples from the canopy (Figure 15.2). Foliage samples were clipped from multiple locations in the canopy. We also identified the non-*Larrea* shrub or tree species nearest the plot center and collected foliage and litter samples from it by the same procedure. We sampled the grass/forb component of vegetation by collecting the above ground biomass of the representative nearest the plot center. We clustered Sherman live traps (size) around each plot center in rough proportion to the abundance of burrows and other small mammal sign, such as tracks and droppings. We operated live traps over three nights. Traps were checked in the morning, closed during



FIGURE 15.1. Layout of pitfall traps used to sample invertebrates, reptiles and amphibians. Pitfall diameters were approximately 14 cm and 9 cm.

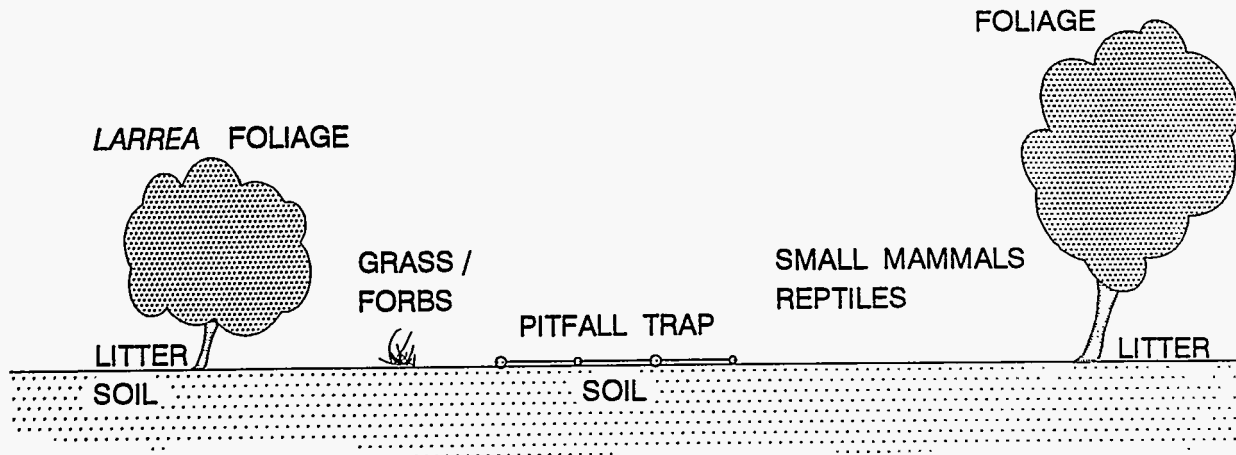

FIGURE 15.2. Biotic and abiotic samples collected from 5 locations each along GP-20 and GP-17A firing lines at YPG, August 1992.

the day, and opened in the evenings. In addition, we used opportunistic sampling in the vicinity of plot centers to collect snakes, lizards, rabbits, and invertebrates. We captured lizards by striking them with large rubber bands. We used a spotlight and shotgun to collect rabbits in the hour before dawn and after sunset.

Biotic samples were placed in coolers with dry ice for storage while in the field. We dissected small mammals to extract kidney and liver tissues for separate analysis. Rabbits were dissected to extract kidney, liver and muscle samples for determination of DU. Tissue

samples, rabbit and small mammal carcasses, and whole bodies of other vertebrates and invertebrates were frozen in plastic bags until they could be prepared for analyses.

#### *Sample Preparation*

**\*\* MIKE: insert the sample preparation procedures you used.**

#### *Chemical Analysis*

**\*\* MIKE: insert the chemical analysis procedures used.**

### **RESULTS**

We collected more than 225 plant, animal, soil, and detritus (litter) samples from YPG firing lines (Table 15.1). Invertebrates rarely contained enough mass for individual analysis so were pooled by pitfall trap site and taxonomic status. In addition, we dissected 134 liver and kidney tissues from small mammalian herbivores and 30 liver, kidney and muscle tissue samples from larger herbivores. Soft tissue samples were collected to estimate levels of physiological risk to these species and to provide estimates of amounts of DU that could be transferred to human consumers. Each compartment in the YPG exposure model (Chapter 14) was represented (Table 15.1).

Only very limited numbers of chemical analysis results are available (Table 15.2). We have no soil results to indicate the range of DU contamination that was spanned by our 10 sampling sites on the Kofa Firing Range. Ash weight of samples analyzed have yet to be received, so we assumed that fresh weight were 5% of ash. Uranium was detected in all

TABLE 15.1. Numbers and types of samples collected at YPG GP-20 and GP-17A firing lines to estimate relationships between DU contamination of soils and redistribution to biotic components of the environment.

Model compartment	Samples	<i>n</i>
Soil (C <sub>1</sub> )	Pitfall trap sites	10
	sites beneath <i>Larrea tridentata</i> plants	10
Vegetation (C <sub>2</sub> )	<i>Larrea tridentata</i> foliage	10
	Other shrub/tree foliage ( <i>Cercidium floridum</i> , <i>Encelia farinosa</i> , <i>Olneya tesota</i> , <i>Ambrosia dumosa</i> , <i>Cercidium microphyllum</i> )	10
	Forb/grass ( <i>Erioneuron pulchellum</i> , <i>Beloperonia californica</i> , <i>Ditaxis sp.</i> , <i>Euphorbia sp.</i> , <i>Erigonum sp.</i> )	10
Invertebrates (C <sub>3</sub> ) <sup>1</sup>	Tenebrionid beetles ( <i>Orizabus clunalis</i> , <i>Asbolus verracousus</i> , <i>Asidina confluens</i> , <i>Cerenopus concolor</i> , <i>Cryptoglossa muricata</i> , <i>Edrotes ventricosus</i> , <i>Eleodes longicollis</i> ), Scarabaeid beetle ( <i>Orizabus clunalis</i> ), grasshoppers (Acridae), crickets (Orthoptera), spiders (Araneida), ants (Formicidae), scorpions ( <i>Hadrurus spadix</i> and other Scorpionidae) and mantises (Mantidae)	45
Small herbivores (C <sub>4</sub> )	Pocket mice ( <i>Perognathus spp.</i> )	40
	Merriam's kangaroo rat ( <i>Dipodomys merriamii</i> )	8
	Whitethroat woodrat ( <i>Neotoma albigula</i> )	14
	Desert woodrat ( <i>Neotoma lepida</i> )	5
	Desert iguana ( <i>Dipsosaurus dorsalis</i> )	4
Large herbivores (C <sub>5</sub> )	Desert cottontail ( <i>Sylvilagus audubonii</i> )	5
	Blacktail jackrabbit ( <i>Lepus californicus</i> )	5
Insectivores (C <sub>6</sub> )	Couch's spadefoot ( <i>Scaphiopus couchii</i> )	2
	Desert horned lizard ( <i>Phrynosoma platyrhinos</i> )	3
	Long-nosed leopard lizard ( <i>Gambelia wislizenii</i> )	1
	Side-blotched lizard ( <i>Uta stansburiana</i> )	4
	Western whiptail ( <i>Cnemidophorus tigris</i> )	7
	Zebra-tailed lizard ( <i>Callisaurus draconoides</i> )	12
	small lizard <i>Urosaurus sp.</i>	1
Predators (C <sub>7</sub> )	Sidewinder ( <i>Crotalus cerastes</i> )	2
	Coyote ( <i>Canis latrans</i> ) scat	1
Litter (C <sub>8</sub> )	<i>Larrea tridentata</i> litter	10
	Other shrub/tree litter	10

<sup>1</sup>Each sample is composed of several individuals to obtain adequate mass for chemical analysis.

TABLE 15.2. Total uranium concentrations (mg/kg wet) from samples collected at YPG GP-20 and GP-17A firing lines to estimate relationships between DU soil contamination and redistribution to biotic components of the environment. Uranium concentrations were assumed to be 5% of reported ash concentrations.

Sample	<i>n</i>	Mean	CV (%)
Forb ( <i>Euphorbia</i> sp.)	1	8500	
Creosotebush ( <i>Larrea tridentata</i> )	1	1150	
Couch's spadefoot ( <i>Scaphiopus couchii</i> )	1	800	
Desert iguana ( <i>Dipsosaurus dorsalis</i> )	1	145	
Zebra-tailed lizard ( <i>Callisaurus draconoides</i> )	1	140	
Sidewinder ( <i>Crotalus cerastes</i> )	1	105	
Pocket mouse ( <i>Perognathus</i> sp.) <sup>1</sup>	1	800	
Merriam's kangaroo rat ( <i>Dipodomys merriamii</i> ) <sup>1</sup>	6	454	146
Whitethroat woodrat ( <i>Neotoma albigula</i> ) <sup>1</sup>	8	916	156
Desert woodrat ( <i>Neotoma lepida</i> ) <sup>1</sup>	1	14	
Coyote scat ( <i>Canis latrans</i> )	1	1850	

<sup>1</sup>Sample is carcass minus liver and kidney.

samples and represents total uranium in plants and animals or on their surfaces or pelage. Isotopic ratio data were not available to evaluate the source of the uranium measured in biological samples, however, these samples were collected from areas previously identified as contaminated with DU. Several Merriam's kangaroo rats and whitethroat woodrats had total uranium concentrations that were well above background.

## DISCUSSION

Some of the samples analyzed so far probably contain significant amounts of DU. Portions of the DU may be in pelage or on plant and animal surfaces and not likely to cause negative physiological effects to organisms. DU on plant and animal surfaces is highly relevant to DU transport, as consumers rarely sort exterior and interior biomass.

DU in the body may be unevenly distributed among the gastrointestinal tract, bone, kidney, liver, muscle and other tissues and fluids (ICRP 1975) in proportions that will change as whole body content changes. The distribution of this uranium among tissues is critical to assessment of any impact on individual animals, populations and ecosystems. Without distribution data, exposure cannot be reliably assessed. The samples we collected, however, will permit estimation of uranium distribution among several ecological functional groups (trophic levels), among several species within each group, among individuals within a species, and among tissues within an individual. For example, for small mammalian herbivores, we collected samples from four species over a range of DU contamination levels. From each of these species we are awaiting data on the distribution of DU among liver, kidney and whole body. The two species of larger herbivores will provide these data and, in addition, will provide data on distribution to muscle tissue.

When all data from field sampling are received, analysis of whole body concentrations will permit comparisons between firing lines, species, and trophic-level status. Correlations between abiotic uranium and uranium in biological samples also will produce alternative empirical models for estimating ecological exposure across the Kofa Firing Range.

## **\*\* CHAPTER 16 \*\***

### **UPTAKE AND ELIMINATION OF URANIUM**

#### **BY KANGAROO RATS**

##### **INTRODUCTION**

Accurate prediction of DU in the tissues of YPG organisms is critical for estimating the potential for these organisms to experience negative effects resulting from consumption of DU. Uranium intake rates in the field will be variable as animals move about areas with different levels of contamination, so a dynamic model of intake and elimination is required to represent this variation. Several models of differing complexity exist for predicting uranium biokinetics in mammals. For example, Fisher et al. (1991) described elimination of uranium hexafluoride following an acute exposure with a five-compartment model, and Wrenn et al. (1985) reviewed several two-compartment models specific to bone and kidney tissues. In the YPG exposure model (Chapter 14) each compartment is handled as a one-compartment model for whole body uranium dynamics although more complex elimination processes may actually be involved. This study was conducted to evaluate the amount of error and uncertainty in exposure estimates that is produced by using this simplified approach and to construct a dynamic model appropriate for kangaroo rats (*Dipodomys spp.*).

We chose kangaroo rats as subjects for this study for two reasons. First, toxicological effects of uranium have not been conducted on animals with specialized



physiologies for water conservation. Thus, animals like kangaroo rats may be at higher risk to kidney damage from uranium ingestion than mammals with non-specialized kidneys. Second, kangaroo rats function as keystone species in desert communities via their influence on seed dispersal and soil disturbance rates (Brown and Heske 1990). Keystone species, such as kangaroo rats, have impacts that affect the survival and subsequent population densities of other species, which may have effects on the ecological structure and functioning of the YPG ecosystem.

The work was done in two phases to estimate uptake and elimination processes. For the uptake portion of the study, we exposed Ord's kangaroo rats (*Dipodomys ordii*) to a range of dietary uranium levels to:

1. Evaluate experimental procedures to quantitatively dose kangaroo rats,
2. Obtain information regarding dosage levels that could be detected in animal tissues,
3. Estimate the relationship between dietary intake levels and time-dependent uranium whole body burdens, and
4. Estimate the time-dependent uranium concentrations of selected tissues given these dietary exposures and body burdens.

For the elimination portion of the study, our objectives were to:

1. Evaluate experimental procedures for measuring uranium elimination,
2. Estimate maximum whole body, liver and kidney burdens of uranium following dietary uranium exposure, and

3. Estimate whole body, liver and kidney elimination rates from time-dependent whole body and tissue burdens.

These data were collected primarily to provide critical information for planning and executing additional experiments aimed at estimating uranium biokinetics, tissue burdens, and ecological risk endpoints for the YPG environment. The whole body burden data will be useful for evaluating adequacy of existing models for uranium biokinetics in kangaroo rats and for the YPG terrestrial transport model. In addition, these data can be used to reformulate and reparameterize such models. Tissue burden data may be used for these same purposes, but more importantly, they will aid our identification of the levels of risk to these organisms over the range of the experimental intakes.

## **MATERIALS AND METHODS**

We collected kangaroo rats from wild populations east of Ft. Collins, Colorado, (40°39'30" north, 104°24'00" west) during July - September 1992 using Sherman live traps (23 x 8 x 9 cm) baited with rolled oats. Traps were set near burrows, foraging areas and other high use areas in the evenings and checked the next morning shortly after dawn. Each trap contained bedding material for protection against unseasonably cold temperatures. Animals were transported to Fort Collins, dusted with a 5% carbaryl powder, and housed at the Colorado State University Laboratory Animal Care and Use Facility. Animals were kept in plastic laboratory rat cages (45 x 22 x 21 cm) containing 2 - 3 cm of heat-treated hardwood laboratory bedding (Northeastern Products Corp., Warrensburg, NY) and were maintained on commercial laboratory animal rations (Agway Prolab RMH 3200 meal;

Syracuse, N.Y.), rolled oats, and millet for up to 30 days. Animals were housed from two to three weeks before experiments were conducted. Supplemental water was provided, although kangaroo rats can exist for extended periods without access to free water. Rectangular pieces of aluminum (10 x 20 cm) were fashioned into dome-roofed shelters and placed into each cage to provide refuges for animals when humans were present. Lab animal suites were kept on a 12 hours light and 12 hours dark schedule and maintained at between 22 - 24° C. Animal care and use practices were performed under Colorado State University Animal Care and Use Committee Animal Research/Teaching Protocol Approval Number 92-051A-01.

#### *Uranium uptake*

Kangaroo rat diets were prepared by spraying aqueous solutions of uranyl nitrate (reagent grade depleted  $\text{UO}_2(\text{NO}_3)_2 \cdot 6\text{H}_2\text{O}$  supplied by J.T. Baker Chemical Co., Phillipsburg, NJ 08865) into feed while the feed was blended in a food processor. Experimental diets then were placed in acid-washed glass cake pans, oven-dried overnight, and placed in clean plastic containers until needed. Nominal uranium concentrations in diets were 0, 10, and 50 mg U/kg. We assumed that uptake kinetics over the range of our exposures were linear (Wrenn 1985).

We fed experimental diets to 19 animals for five days (27 - 31 August 1992) *ad libitum*. We sacrificed animals by immersion in  $\text{CO}_2$  on the morning of the sixth day. Animals were then dissected to remove liver and kidney tissues. All tissues and the

remaining carcasses were frozen separately in Whirlpaks until analyzed for total uranium content.

During feeding trials cage bedding was removed and animals were raised above the cage bottom by a 0.4-cm wire mesh and an 18 x 43 cm sheet of cardboard. We estimated feed consumed each day to the nearest 0.01 g by subtracting the amount spilled or remaining in feeder from the amount provided the previous day. We recorded the body mass of all animals to the nearest 0.1 g at the beginning and the completion of the dietary exposure.

### *Uranium elimination*

We exposed 15 Ord's kangaroo rats to dietary uranium for 20 d (7 October - 6 November 1992) followed by a 10-d period where animals were maintained on feed without added uranium to estimate uranium elimination rates. Because this was a pilot study, we use only one dietary exposure level, 50 mg U/kg, for the experiments prepared as in the uptake study. We measured the *ad libitum* consumption of uranium for 20 d before switching animals back to the control diet. At this time (day 0 of elimination phase), 3 animals were selected at random and sacrificed by immersion in CO<sub>2</sub> to estimate liver, kidney and carcass uranium content. We also sacrificed two other animals at the start of the uptake portion of this study to estimate baseline uranium content. Three animals were sacrificed on days 1, 2, 4 and 10 of the elimination phase to estimate time-dependent tissue and carcass uranium content. In addition, we collected feces at day 0, 0.3, 1 and 2 to estimate gut clearance rate and its effect on whole body uranium content.

After sacrifice, animals were treated as in the uptake study. Feces samples were placed in Whirlpaks and frozen.

### *Sample Preparation*

**\*\*\* MIKE: you will have to correct me on the sample preparation. I don't have a record from you on which samples were dried and which were taken all the way to ash.**

Kangaroo rat carcasses, livers, kidneys, and diet samples were prepared for ICP-MS at Los Alamos National Laboratory. Initial (fresh) wets of all samples were recorded before oven drying at 120° C. Dry weights were recorded after samples cooled. Next, samples were ashed in a muffle furnace (3 hr @ 250° C, followed by 3 hr @ 350° C, and finally 4 hr @ 450° C). After cooling and ash weights were recorded, samples were packaged for storage and later analysis.

### *Chemical Analysis*

Isotopic determination of laboratory samples was unnecessary since experiments used DU to spike diets and background concentrations (natural-U) were measured in unspiked, control diets.

Samples were shipped from LANL via overnight courier to CL for ICP-MS analysis. The samples were checked in to CL and a Receipt of Acknowledgement form was returned to LANL. Uranium or DU in each sample was extracted using EPA Method 3050 (**\*\*\* MIKE, PLEASE INSERT APPROPRIATE CITATION HERE \*\*\***). Briefly, the method involves extraction of metals with hot concentrated nitric and hydrochloric acids, then

oxidation of organics with hydrogen peroxide. The extracts were separated from the remaining solids, filtered, and diluted for ICP-MS analysis. ICP-MS analyses were conducted using EPA Method 6020 (\*\* MIKE, PLEASE INSERT APPROPRIATE CITATION HERE \*\*).

Quality assurance and quality control (QA/QC) measures were followed as prescribed in EPA Method 6020. A series of QA/QC blanks, standards, duplicates, and spikes were analyzed with each set of samples. Instrumental and Method blanks demonstrated that there was no uranium in the samples as a result of sample handling, and sample blanks demonstrated that uranium analyses below detection were true (\*\*MIKE, PLEASE CLARIFY THE LAST PART OF THIS STATEMENT \*\*).  $^{238}\text{U}$  samples were run after calibration with certified laboratory standards of 0.5 to 200  $\mu\text{g/L}$ . Each batch of samples and standards showed the expected and actual values of the standards for comparison and to demonstrate that the instrument was in proper working order.  $^{238}\text{U}$  samples were analyzed at a lower concentration, ranging from 0.5 to 50  $\mu\text{g/L}$  to ensure accurate values in the lower concentration range.  $^{235}\text{U}$  samples were run in the same manner as the  $^{238}\text{U}$  samples, except that the laboratory standard was derived from weathered DU collected from YPG. The DU had an isotopic ratio ( $^{235}\text{U}/^{238}\text{U}$ ) of  $0.0021 \pm 0.0004$ . The calibration range for  $^{235}\text{U}$  was 1 to 200  $\mu\text{g/L}$ .

Matrix spikes were samples of known value to which spikes of 50  $\mu\text{g/L}$  U were added. Samples of 1.2, 1.5, and 46  $\mu\text{g/L}$  were used and provided a check on the percent recovery during the analyses. Duplicates of the 1.2, 1.5, and 46  $\mu\text{g/L}$  samples were run and compared to show that the instrument was working in correct order.

ICP-MS concentrations ( $\mu\text{g/L}$ ) were converted to  $\mu\text{g-U/kg}$  by adjusting the reported ICP-MS concentration for the dilution factors and the weight of the sample. The resulting concentration on an ashed or oven-dry basis was reported from CL to LANL. Results presented in this report are results provided to CSU from LANL.

### *Uptake/Elimination Models*

Precise estimates of the temporal dynamics of tissue concentrations are essential for assessing risk to individual organisms, therefore one goal of this study was to identify the appropriate model structure for predicting kangaroo rat tissue uranium concentrations and dynamics. DU elimination has been described by one and two-compartment models (Wrenn et al. 1985, Chapter 14), so two models were evaluated. First, kidney uptake and loss were described in Model I as:

$$\frac{dC_k}{dt} = \frac{If_1f_k}{m_k} - C_k\lambda_k$$

and

$$C_{k,\infty} = \frac{If_1f_k}{m_k\lambda_k},$$

where  $C_k$  = kidney concentration (mg-U/kg),  
 $I$  = mg-U/d ingested,  
 $f_1$  = fraction of  $I$  absorbed to blood,  
 $f_k$  = fraction of absorbed U deposited in kidney,  
 $m_k$  = kidney fresh mass (kg),

$\lambda_k$  = kidney U elimination rate (1/d), and

$C_{k,\infty}$  = equilibrium kidney concentration (mg-U/kg).

We will use time-dependent measurements of  $C_k$ ,  $I$ , and  $m_k$  to estimate the uptake parameters  $f_i$  and  $f_k$  and the elimination rate parameter  $\lambda_k$ . The parameters  $f_i$  and  $f_k$  cannot be estimated separately with this experimental design, however the value of their product can be estimated. Therefore, the parameter  $\eta = f_i f_k$  will be substituted into analysis models.  $C_{k,\infty}$  for any constant uranium intake level can be estimated once parameters are estimated.

The second uptake and loss model, Model II, to be evaluated was:

$$\frac{dC_k}{dt} = \frac{If_1f_k}{m_k} - C_k(\rho_1\lambda_{k1} + \rho_2\lambda_{k2})$$

and

$$C_{k,\infty} = \frac{If_1f_k}{m_k(\rho_1\lambda_{k1} + \rho_2\lambda_{k2})},$$

where  $C_k$  = kidney concentration (mg-U/kg),

$I$  = mg-U/d ingested,

$f_i$  = fraction of  $I$  absorbed to blood,

$f_k$  = fraction of absorbed U deposited in kidney,

$m_k$  = kidney fresh mass (kg),

$\lambda_{k1}$  and  $\lambda_{k2}$  = kidney U elimination rates (1/d),

$\rho_1$  and  $\rho_2$  = fractions of kidney U eliminated at rates  $\lambda_{k1}$  and  $\lambda_{k2}$ , and

$C_{k,\infty}$  = equilibrium kidney concentration (mg-U/kg).



Each of these models can also be used to describe the dynamics of liver or of whole body uranium kinetics. Comparison of the two models with data will permit a test of whether one or two-compartment elimination processes are required to describe DU concentrations for ecological compartments in the YPG model (Chapter 14) and to describe the uranium dynamics of specific tissues.

### *Statistical Analysis*

Few uranium concentration data were available at this time to explore relationships between dietary uranium and uptake and elimination by kangaroo rats. Thus, all analyses are preliminary. We analyzed response variables and their log-transforms using linear model procedures with and without dummy variables (PROC REG and PROC GLM, SAS Institute 1988). We will use nonlinear, least-squares regression (PROC NLIN, SAS Institute 1988) to fit uptake and elimination parameters when data sets are complete.

## **RESULTS**

No data were received for the DU elimination study and incomplete data were received for the uptake portion of the study. To date, we have received uranium data for incomplete kangaroo rat carcasses (body minus liver and kidney tissues). The uranium concentrations of incomplete kangaroo rat carcasses were approximately 1% of nominal dietary concentrations. The relationship between nominal dosage and incomplete carcass uranium concentration was approximately linear (Figure 16.1), although the best fit to the data was given by a power function,  $Y = aX^b$ . For these data,  $Y =$  incomplete carcass

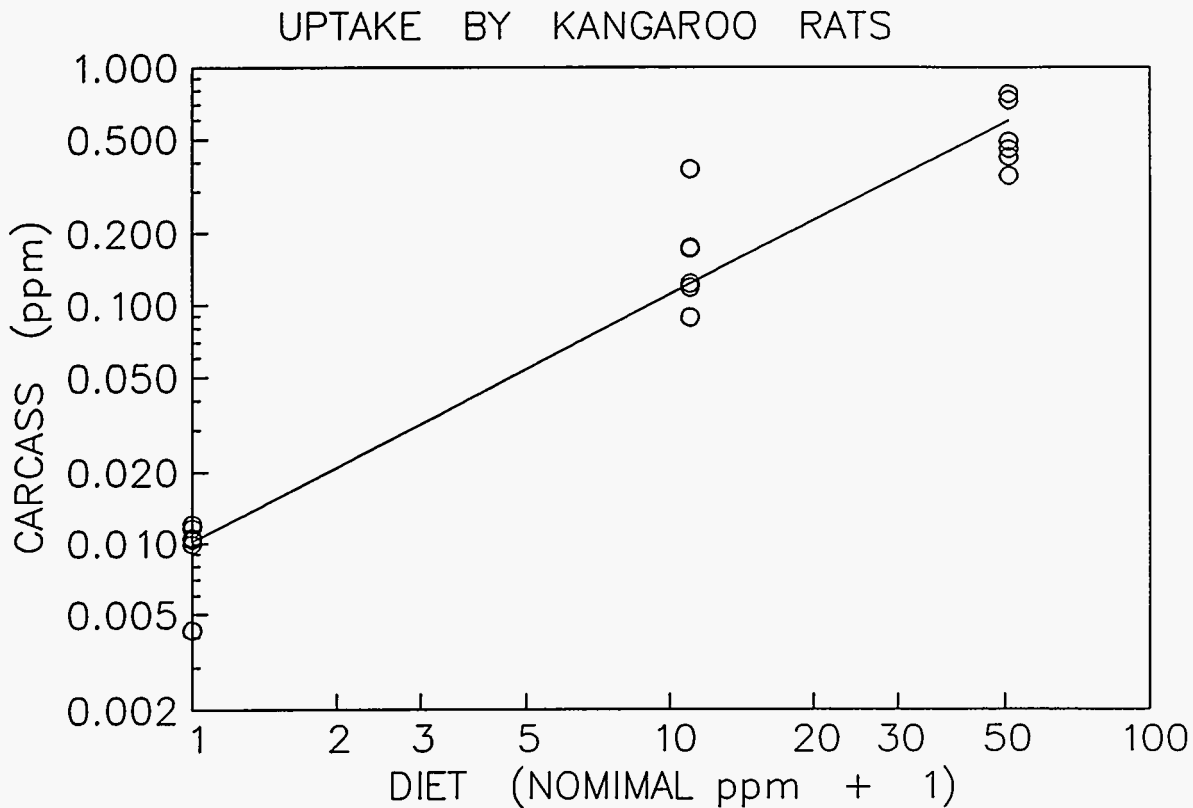

FIGURE 16.1. Accumulation of uranium by Ord's kangaroo rats fed three levels of dietary uranium. Livers and kidneys were analyzed separately, but carcasses include complete gastrointestinal tracts containing variable amounts of experimental diets.

uranium concentration (mg U/kg fresh mass),  $X$  = nominal diet plus one (to allow log transformation),  $a = 0.0102$  (95% CI = 0.0077 - 0.0138), and  $b = 1.0347$  (95% CI = 0.9171 - 1.1523). The power function fit better ( $R^2 = 0.95$ ) than a linear one  $R^2 = 0.80$  primarily due to lack of fit at the control intake level.

## DISCUSSION

Without liver and kidney concentrations whole body burdens cannot be reconstructed to evaluate fit to Model I or Model II or to evaluate the structure of the YPG food web

model (Chapter 14). Uranium was detectable in all carcass samples, but it is unknown if analytical techniques will permit detection of uranium in liver and kidney tissues at experimental levels. Until quantitative measurements of time-dependent tissue uranium across the range of experimental dosages are available, exposure and risk to individual organisms or their populations and ecosystems cannot be addressed.

## **\*\* CHAPTER 17 \*\***

### **EFFECTS OF URANIUM ON KANGAROO RAT KIDNEYS**

#### **INTRODUCTION**

The threshold for toxic effects of uranium on mammalian kidneys has been estimated as being between 3 and about 1  $\mu\text{g-U/g}$  kidney (Wrenn et al. 1985, Legget 1989, SuLu and Zhao 1990). Desert animals, such as Merriam's kangaroo rats (*Dipodomys merriamii*), are highly dependent upon proper renal functioning in order to survive in the arid environment at YPG, and any loss in renal function may significantly impact their population dynamics. The Kofa Firing Range at YPG has soil uranium levels that range from background to several hundred mg U/kg, with elevated concentrations being a result of munitions testing (Price 1991). The effects that these concentrations will have on the terrestrial ecosystem are dependent upon the extent that uranium is redistributed from soil to animal tissues and on species-specific responses to uranium exposure. In Chapters 15 and 16 we collected field and experimental samples, respectively, to assess likely levels of exposure to plants and animals at YPG. To begin to assess the effects of uranium exposure to the YPG environment, here we estimate the effects of dietary uranium on the renal histology of kangaroo rats.

#### **MATERIALS AND METHODS**

We collected kangaroo rats (*Dipodomys ordii*) from wild populations east of Ft.

Collins, Colorado, (40°39'30" north, 104°24'00" west) during July - August 1993 using Sherman live traps (23 x 8 x 9 cm) baited with rolled oats. Traps were set near burrows, foraging areas and other high use areas in the evenings and checked the next morning shortly after dawn. Each trap contained bedding material for protection against unseasonably cold temperatures. Animals were transported to Fort Collins, dusted with a 5% carbaryl powder, and housed at the Colorado State University Laboratory Animal Care and Use Facility. Animals were kept in plastic laboratory rat cages (45 x 22 x 21 cm) containing 2 - 3 cm of heat-treated hardwood laboratory bedding (Northeastern Products Corp., Warrensburg, NY) and were maintained on rolled oats, millet, sunflower seeds and carrots for up to two weeks before experiments were initiated. During experiments, animals were maintained on a mix of millet and sunflower seeds (Pretty Boy Bird Food, Audubon Park Co., Akron, CO 80720) and a one-cm slice of fresh carrot each day. Supplemental water was not provided. Rectangular pieces of aluminum (10 x 20 cm) were fashioned into dome-roofed shelters and placed into each cage to provide refuges for animals when humans were present. Lab animal suites were kept on a 12 hours light and 12 hours dark schedule and maintained at between 22 - 24° C.

We dosed kangaroo rats with aqueous uranyl nitrate solutions. Test solutions were prepared by dissolving uranyl nitrate (reagent grade depleted  $\text{UO}_2(\text{NO}_3)_2 \cdot 6\text{H}_2\text{O}$  supplied by J.T. Baker Chemical Co., Phillipsburg, NJ 08865) in ultrapure water and were administered to animals by one-ml gavage (18 gauge needle). Animals were placed under light methoxyflurane anesthesia (Metofane supplied by Pitman Moore, Inc., Mundelein, IL 60060) to reduce stress to animals during the dosing procedure. Animals were returned to

cages after dosing and allowed access to food. At predetermined times after experimental exposures, animals were sacrificed by immersion in CO<sub>2</sub> and dissected to remove liver and kidney tissues. Kidneys were placed in either 5% neutral buffered formalin or frozen until analyzed for total uranium content. Livers and the remaining carcasses were frozen separately in Whirlpaks until analyzed for total uranium content. Animal care and use practices were performed under Colorado State University Animal Care and Use Committee Animal Research/Teaching Protocol Approval Number 92-051A-01.

### *Experimental Design*

We evaluated the effects of four dosage levels on kangaroo rat kidneys. Dosages were selected to represent uranium intake produced by ingestion of contaminated soil, uranium intake predicted to cause renal injury ("threshold" level to produce a concentration of 1 mg U/kg kidney), two times the threshold intake, and no added uranium. The threshold dosage level was estimated using Model I from Chapter 16 assuming:

Dosage causing damage (mg/kg)	= 0.1 mg U in blood/kg body mass (Yuile 1973),
Gastrointestinal uptake ( $f_1$ )	= 0.01,
Fraction to kidney ( $f_2$ )	= 0.11,
Kidney fresh mass (kg)	= $0.68 \times 10^{-3}$ , and
Body mass (kg)	= 0.065.

The soil exposure dosage level was estimated assuming:

Daily dry matter intake (kg)	= 0.006,
Soil intake rate	= 5% of DMI, and

Soil concentration (mg U/kg) = 850.

Animals received a single gavage and then were sacrificed at 4 hr or 5 d to harvest tissues (Table 17.1). Four-hour samples were used to estimate kidney concentrations, and 5-d samples were used to estimate kidney concentrations and to assess histopathology.

TABLE 17.1. Uranium dose levels and sampling schedule used to estimate kangaroo rat kidney concentrations and histopathological effects. Animals received a single 1-ml gavage of an aqueous uranyl nitrate solution.

Level	Dose (mg)	Solution concentration (mg/L)	Number sampled at 4 hours <sup>1</sup>	Number sampled at 5 days <sup>2</sup>
0	0	0	3	6
Soil exposure levels	0.255	255	3	6
Threshold	0.65	650	3	6
2 x Threshold	1.3	1,300	3	6

<sup>1</sup> For chemistry only.

<sup>2</sup> For chemistry and histopathology. Right kidneys to histopathology. Left kidneys pooled into pairs based on body size.

A second experiment was conducted to evaluate histopathological effects at higher kidney uranium concentrations (Table 17.2). In this study the 2 x threshold concentration was administered over three consecutive days and tissues were harvested 5 days after the last gavage.

TABLE 17.2. Uranium dose levels and sampling schedule used to estimate kangaroo rat kidney concentrations and histopathological effects. Animals received 1-ml gavages of aqueous uranyl nitrate solution over three consecutive days.

Level	Dose (mg)	Solution concentration (mg/L)	Number sampled at 5 days <sup>a</sup>
0	0	0	5
2 x Threshold	1.3	1,300	10

<sup>a</sup> Five full days after dose for chemistry and histopathology. Right kidneys to histopathology. Left kidneys pooled into pairs based on body size.

#### *Sample Preparation*

**\*\* MIKE:** add section on how samples were prepared for chemistry

#### *Chemical Analyses*

**\*\* MIKE:** add section on how samples were analyzed

#### *Histopathology*

Kidney samples were prepared for histopathology by the College of Veterinary Medicine and Biomedical Sciences Diagnostic Laboratory, Colorado State University (Fort Collins, CO 80523). After fixation with 10% neutral buffered formalin, sections of the kidney were placed in a tissue cassette and processed by routine histological procedures. Tissues were sequentially dehydrated in increasing concentrations of ethanol, cleared in xylene, and embedded in paraffin. Tissues sections were cut at 4-6  $\mu\text{m}$  using a rotary



microtome, stained with hematoxylin and eosin according to the Armed Forces Institute of Pathology Staining Manual (Luna 1968), flooded with mounting media, and coverslipped. Dr. David M. Getzy, Head of Pathology Services, examined kidney tissue sections for evidence of injury and renal dysfunction.

## RESULTS

Histopathology results from the two dosing regimes were received 15 December 1993. In the first study, tubular degeneration was seen in 4 of 10 animals used for controls. Lesions were minimal to mild in severity, multifocal in distribution, and were non-specific with respect to etiology. These lesions likely are incidental "background" changes, as they were not severe enough to result in clinical disease or renal dysfunction. One treatment animal (0.65 mg dose) showed tubular epithelial degeneration and necrosis at a severity that was indistinguishable from controls. Significant karyomegaly in proximal tubular epithelial cells was found in three out of six high-dose animals (1.3 mg dose).

In the second study, mild lymphoplasmacytic interstitial inflammation was noted in two of the five control kidneys. These lesions were not severe enough to result in clinical disease or renal dysfunction and may be "background" changes. Two treatment animals showed tubular epithelial degeneration that was of moderate severity. The granular and hyaline degeneration of the tubules also was different from control animals in either study. Finally, significant karyomegaly in proximal tubular epithelial cells was found in 7 out of 10 animals given 1.3 mg U each day for three days.

No results from chemical analyses are available at this time.

## DISCUSSION

Several of the kidney lesions were as prevalent in control kidneys as in the kidneys of animals treated with uranyl nitrate. However, in the second study tubular degeneration was qualitatively different in the treatment animals from that observed in controls. In that study, kidneys of treatment animals also were more likely to exhibit significant karyomegaly of the proximal tubular epithelia. Although this is a non-specific change, it was not as striking or as severe in the control group. This change may be associated with increased ploidy of the nucleus as a result of synthesis for cell division or as a result of inhibited cytokinesis.

When tissue uranium concentrations are available it will be possible to relate concentration to probability of effects.

## REFERENCES

- Ahsanullah, M. and A.R. Williams. 1989. Kinetics of uranium uptake by the crab *Pachygrapsus laevimanus* and the zebra winkle *Austracochlea constricta*. *Marine Biology* 101:323-327.
- Ahsanullah, M. and A.R. Williams. 1986. Effect of uranium on growth and reproduction of the marine amphipod *Allorchestes compressa*. *Marine Biology* 93:459-464.
- Amiel, S. 1962. Analytical applications of delayed neutron emission in fissionable elements. *Analytical Chemistry* 34:1683-1692.
- Anderson, R.F., M.Q. Fleisher, and A.P. LeHuray. 1989a. Concentration, oxidation state, and particulate flux of uranium in the Black Sea. *Geochimica et Cosmochimica Acta* 53:2215-2224.
- Anderson, R.F., A.P. LeHuray, M.Q. Fleisher, and J.W. Murray. 1989b. Uranium deposition in Saanich Inlet sediments, Vancouver Island. *Geochimica et Cosmochimica Acta* 53:2205-2213.
- Anspaugh L. R., J.H. Shinn, P.L. Phelps, and N.C. Kennedy. 1975. Resuspension and redistribution of plutonium in soils. *Health Physics* 29:571-582.
- APHA (American Public Health Association, American Water Works Association, and Water Pollution Control Federation). 1985. *Standard Methods for Examination of Water and Wastewater, 16<sup>th</sup> Edition*. American Public Health Association, Washington, D.C.
- Arditi, R. and H. Saïah. 1992. Empirical evidence of the role of heterogeneity in ratio-dependent consumption. *Ecology* 73:1544-1551.
- Baird, D. and R.E. Ulanowicz. 1989. The seasonal dynamics of the Chesapeake Bay ecosystem. *Ecological Monographs* 59(4):329-364.
- Barnthouse, L.W. 1992. The role of models in ecological risk assessment: a 1990's perspective. *Environmental Toxicology and Chemistry* 11:1751-1760.
- Barnthouse, L.W., J. Boreman, S.W. Christensen, C.P. Goodyear, W. Van Winkle, and D.S. Vaughan. 1984. Population biology in the courtroom: the Hudson River controversy. *BioScience* 34:14-19.
- Bartell, S.M., R.H. Gardner, and R.V. O'Neill. 1992. *Ecological risk estimation*. Lewis Publishers, Chelsea, MI.

- Begon, M., J.L. Harper, and C.R. Townsend.** 1990. *Ecology: individuals, populations and communities*. Blackwell Scientific Publications, Boston, MA. 945pp.
- Berryman, A.A.** 1992. The origins and evolution of predatory-prey theory. *Ecology* 73:1530-11535.
- Biddinger, G.R. and S.P. Gloss.** 1984. The importance of trophic transfer in the bioaccumulation of chemical contaminants in aquatic ecosystems. *Residue Reviews* 91:103-145.
- Blaylock, B.G. and J.P. Witherspoon.** 1976. Evaluation of radionuclides released from the light water reactor nuclear fuel cycle to the aquatic environment. Environmental Chemistry and the Cycling Process. Symposium in Augusta, Georgia. CONF-760429 NTIS.
- Brenchley, D.L., J.K. Soldat, J.A. McNeese, and E.C. Watson.** 1977. Environmental assessment methodology of the nuclear fuel cycle. Battelle Pacific Northwest Laboratories. BNWL-2219.
- Breshears, D.D., T.B. Kirchner, and F.W. Ward.** 1992. Contaminant transport through agroecosystems: assessing relative importance of environmental, physiological, and management factors. *Ecological Applications* 2:285-297.
- Brown, D.E., editor.** 1982. Biotic communities of the American Southwest—United States and Mexico. *Desert Plants* 4:1-342.
- Brown, J.H., and E.J. Heske.** 1990. Control of a desert-grassland transition by a keystone rodent guild. *Science* 250:1705-1707.
- Bywater, J.F., R. Banaczowski, and M. Bailey.** 1991. Sensitivity to uranium of six species of tropical freshwater fishes and four species of cladocerans from northern Australia. *Environmental Toxicology and Chemistry* 10:1449-1458.
- Calder, W.A.** 1984. *Size, function, and life history*. Harvard University Press, Cambridge, MA.
- Chew R. M. and A.W. Chew.** 1970. Energy relationships of the mammals of a desert shrub *Larrea tridentata* community. *Ecological Monographs* 40:1-21.
- Coleman, R.F. and T.B. Pierce.** 1967. Activation analysis: A review. *Analyst* 92(1090): 1-19.
- Cothorn, C.R., W.L. Lappenbusch, and Cotruvo, J.A.** 1983. Health effects guidance for uranium in drinking water. *Health Physics* 44(Supplement 1):377-384.

- Crosswhite, F.S., and C.D. Crosswhite.** 1982. The Sonoran Desert. In G.L. Bender, editor, *Reference handbook on the deserts of North America*. Greenwood Press, Westport, CT. pp. 163-319.
- CSTA (U.S. Army Combat Systems Test Activity).** 1990. Environmental assessment for testing of depleted uranium penetrator munitions. U.S. Army Combat Systems Test Activity, Aberdeen Proving Ground, Aberdeen, MD.
- Dallinger, R., and H. Kautzky.** 1985. The importance of contaminated food for the uptake of heavy metals by rainbow trout (*Salmo gairdneri*): a field study. *Oecologia* (Berlin) **67**:82-89
- Davies, P.** 1980. Acute toxicity of uranium to brook trout (*Salvelinus fontinalis*) and rainbow trout (*Salmo gairdneri*) in soft water. Colorado Division of Wildlife. Unpublished report.
- DiSpirito, A.A., J.W. Talnagi, Jr., and O.H. Tuovinen.** 1983. Accumulation and cellular distribution of uranium in *Thiobacillus ferrooxidans*. *Archives of Microbiology* **135**:250-253.
- Dreicer M., T.E. Hakonson, G.C. White, and F.W. Whicker.** 1984. Rainsplash as a mechanism for soil contamination of plant surfaces. *Health Physics* **46**:177-187.
- Ebinger, M.H., E.H. Essington, E.S. Gladney, B.D. Newman, and C.L. Reynolds.** 1990. Long-term fate of depleted uranium at Aberdeen and Yuma Proving Grounds Final Report, Phase I: Geochemical transport and modeling. Los Alamos National Laboratory Report LA-11790-MS, Los Alamos, NM.
- Ebinger, M.H., D. Brooks, E.L. Kelly, P.L. Kennedy, and W.H. Clements.** 1991. Potential risk to humans and the environment due to DU testing at APG and YPG. Quarterly Report (January 1 - March 31, 1991) prepared by Los Alamos National Laboratory. Submitted to U.S. Army Combat Systems Test Activity, Aberdeen Proving Ground, Aberdeen, MD.
- Ellis, W.R., and M. Ahsanullah.** 1984. The use of nuclear techniques to investigate the levels of uranium in marine waters and its uptake and distribution by marine biota. *Nuclear Tracks and Radiation Measurements* **8**(1-4):437-441.
- Emery, R.M., D.C. Klopper, D.A. Baker, and J.K. Soldat.** 1981. Potential radiation dose from eating fish exposed to actinide contamination. *Health Physics* **40**:493-510.
- Erikson, R.L., C.J. Hostetler, J.R. Divine, and K.R. Price.** 1990a. A review of the environmental behavior of uranium derived from depleted uranium alloy penetrators. PNL-7213, Pacific Northwest Laboratory, Richland, WA.

- Erikson, R.L., R.J. Serve, J.R. Divine, and K.R. Price.** 1990b. Measured and theoretical behavior of depleted uranium corrosion products in soil systems. Prepared by the Pacific Northwest Laboratory for the U.S. Army Combat Systems Test Activity, Aberdeen Proving Ground, MD.
- Fisher, D.R., R.L. Kathren, and M.J. Swint.** 1991. Modified biokinetic model for uranium from analysis of acute exposure to UF-6. *Health Physics* 60:335-342.
- Garten, C. T.** 1980. Ingestion of soil by hispid cotton rats, white-footed mice, and eastern chipmunks. *Journal of Mammalogy* 61:136-137.
- Giblin, A.M., B.D. Batts, and D.J. Swaine.** 1981. Laboratory simulation of uranium mobility in natural waters. *Geochimica et Cosmochimica Acta* 45:699-709.
- Giesy, J.P., C.J. Rosiu, R.L. Graney, and M.G. Henry.** 1990. Benthic invertebrate bioassays with toxic sediment and pore water. *Environmental Toxicology and Chemistry* 9:233-248.
- Ginzburg, L.R., and H.R. Akçakaya.** 1992. Consequences of ratio-dependent predation for steady-state properties of ecosystems. *Ecology* 73:1536-1543.
- Grandstaff, D.E.** 1976. A kinetic study of the dissolution of uraninite. *Economic Geology* 71:1493-1506.
- Graneli, W.** 1979. The influence of *Chironomus plumosus* larvae on the exchange of dissolved substances between sediment and water. *Hydrobiologia* 66:149-159.
- Gross, F. and F.F. Koczy.** 1946. Photometric measurements of the growth of phytoplankton cultures. *Mediterranean Oceanography Institute*, No. 10.
- Gutierrez, A.P.** 1992. Physiological basis of ratio-dependent predator-prey theory: the metabolic pool model as a paradigm. *Ecology* 73:1552-1563.
- Hamilton, M.A., R.C. Russo, and R.V. Thurston.** 1977. Trimmed Spearman-Kärber method for estimating median lethal concentrations in toxicity bioassays. *Environmental Science and Technology* 11:714-719. Correction. 1978. 12:417.
- Hanson, W.C.** 1980. Ecological considerations of natural and depleted uranium. Pages 1682-1697 in Gesell, T.F. and W. Lowder, eds. *Natural Radiation Environment III*. Symposium proceedings, Vol.II. Technical Information Center, U.S. Department of Energy.
- Hildebrand, S.F. and W.C. Schroeder.** 1928. *Fishes of the Chesapeake Bay*. Smithsonian Institution Press, Washington, D.C. 388 pp.

- Hodge, H.C.** 1973. A history of uranium poisoning (1824-1942). *Handbook of Experimental Pharmacology* 36:5-68.
- Holdway, D.A.** 1992. Uranium mining in relation to toxicological impacts on inland waters. *Ecotoxicology* 1:75-88.
- Horikoshi, T., A. Nakajima, T. Sakaguchi.** 1979a. Uptake of uranium by *Chlorella regularis*. *Agricultural and Biological Chemistry* 43(3):617-623.
- Horikoshi, T., A. Nakajima, T. Sakaguchi.** 1979b. Uptake of uranium from sea water by *Synechococcus elongatus*. *Journal of Fermentation Technology, Osaka* 57(3):191-194.
- Horikoshi, T., A. Nakajima, T. Sakaguchi.** 1981. Studies on the accumulation of heavy elements in biological systems. XIX. Accumulation of uranium by microorganisms. *European Journal of Applied Microbiology and Biotechnology* 12:90-96.
- Hunter, M.D. and P.W. Price.** 1992. Playing chutes and ladders: heterogeneity and the relative roles of bottom-up and top-down forces in natural communities. *Ecology* 73:724-732.
- Hyne, R.V., G.D. Rippon, and G. Ellender.** 1992. pH dependent uranium toxicity to freshwater hydra. *The Science of the Total Environment* 125:159-164.
- ICRP.** 1975. *Report of the task group on referenc man.* ICRP Publication 26. Pergamon Press, New York, NY.
- Inman, R.L., and J.C. Helton.** 1988. An investigation of uncertainty and sensitivity analysis techniques for computer models. *Risk Analysis* 8:71-90.
- Inman, R.L., J.C. Helton, and J.E. Campbell.** 1981a. An approach to sensitivity analysis of computer models: part I introduction, input variable selection and preliminary variable assessment. *Journal of Quality Technology* 13:174-183.
- Inman, R.L., J.C. Helton, and J.E. Campbell.** 1981b. An approach to sensitivity analysis of computer models: part II ranking of input variables, response surface validation, distribution effect and technique synopsis. *Journal of Quality Technology* 13:232-240.
- Ingersoll, C.G. and M.K. Nelson.** 1990. Testing sediment toxicity with *Hyaella azteca* (Amphipoda) and *Chironomus riparius* (Diptera). Pages 93-103 in W.G. Landis and W.H. van der Schalie, eds. *Aquatic Toxicology and Risk Assessment: Thirteenth Volume*, ASTM STP 1096, American Society for Testing and Materials.

- Jørgenson, S.E.** 1979. *Handbook of environmental data and ecological parameters*. Pergamon Press, Oxford, U.K.
- Karickhoff, S.W. and K.R. Morris.** 1985. Impact of tubificid oligochaetes on pollutant transport in bottom sediments. *Environmental Science and Technology* 19:51-56.
- Klemmedson, J. O., and R. C. Barth.** 1974. *Distribution and balance of biomass and nutrients in desert shrub ecosystems*. US/IBP Desert Biome Research Memorandum 75-5. Utah State University, Logan 18pp.
- Kocher, D.C.** 1989. Relationship between kidney burden and radiation dose from the chronic ingestion of U: Implications for radiation standards for the public. *Health Physics* 57:9-15.
- Kovalsky, V.V., I.E. Voronitskaya and V.S. Lakarev.** 1967. Biogeochemical food chains of uranium in aquatic and terranean organisms. In Aberg, P. and F.P. Hungate, eds. *International Symposium on Radiological Concentration Processes*. Stockholm. Pergamon Press.
- Landrum, P.F., H. Lee, II, and M.J. Lydy.** 1992. Toxicokinetics in aquatic systems: model comparisons and use in hazard assessment. *Environmental Toxicology and Chemistry* 11:1709-1725.
- Langille, B.L., E.D. Stevens, and A. Anantaraman.** 1983. Cardiovascular and respiratory flow dynamics. In P.W. Webb and D. Weihs, eds. *Fish biomechanics*. Prager Publ. New York, N.Y. pp. 92-139.
- Legget, R.W.** 1989. The behavior and chemical toxicity of U in the kidney: a reassessment. *Health Physics* 57:365-383.
- Li, K.C.** 1991. Sliced inverse regression for dimension reduction (with discussion). *Journal of the American Statistical Association* 86:316-342.
- Li, K.C.** 1992. On principal Hessian directions for data visualization and dimension reduction: another application of Stein's lemma. *Journal of the American Statistical Association* 87:1025-1039.
- Li, W.C., D.M. Victor, and C.L. Chakrabarti.** 1980. Effect of pH and uranium concentration on interaction of uranium(VI) and uranium (IV) with organic ligands in aqueous solutions. *Analytical Chemistry* 52:520-523.
- Lindley, D.V.** 1965. *Introduction to probability and statistics from a Bayesian viewpoint, part 1, probability, and part 2, inference*. University Press, Cambridge, MA.



- Lipton, J. and J.W. Gillett.** 1991. Uncertainty in ocean-dumping health risks: influence of bioconcentration, commercial fish landings and seafood consumption. *Environmental Toxicology and Chemistry* 10:967-976.
- Lovley, D.R., E.J.P. Phillips, Y.A. Gorby, and E.R. Landa.** 1991. Microbial reduction of uranium. *Nature* 350:413-416.
- Luna, L. G., editor.** 1968. *Manual of histologic staining methods of the Armed Forces Institute of Pathology*. 3rd edition. McGraw-Hill, New York, NY.
- Luoma, S.N.** 1983. Bioavailability of trace metals to aquatic organisms: A review. *The Science of the Total Environment* 28:1-22.
- Mackiernan, G.B.** 1990. State of the Chesapeake Bay. *Water Environment & Technology* 2:60-67.
- Mahon, D.C.** 1982. Uptake and translocation of naturally-occurring radionuclides of the uranium series. *Bulletin of Environmental Contamination and Toxicology* 29:697-703.
- Mahon, D.C. and R.W. Mathewes.** 1983. Seasonal variation in the accumulation of radionuclides of the uranium series by yellow pond-lily (*Nuphar lutea*). *Bulletin of Environmental Contamination and Toxicology* 30:575-581.
- Mann, H. and W.S. Fyfe.** 1985. Algal uptake of U and some other metals: Implications for global geochemical cycling. *Precambrian Research* 30:337-349.
- Mares, M.A.** 1983. Desert rodent adaptation and community structure. *Great Basin Naturalist Memoirs* 7:30-43.
- Matisoff, G., J.B. Fisher, and S. Matis.** 1985. Effects of benthic macroinvertebrates on the exchange of solutes between sediments and freshwater. *Hydrobiologia* 122:19-33.
- Matson, P. and A. Berryman.** 1992. Ratio-dependent predator-prey theory. *Ecology* 73:1529.
- Matson, P.A., M.D. Hunter.** 1992. The relative contributions of top-down and bottom-up forces in population and community ecology. *Ecology* 73:723.
- McKay, M.D.** 1992. Interim report on the status of research on uncertainty analysis of computer models. Los Alamos National Laboratory Unclassified Report LA-UR 92-4299, Los Alamos, NM.

- McKay, M.D., W.J. Conover, and R.J. Beckman. 1979. A comparison of three methods for selecting values of input variables in the analysis of output from a computer code. *Technometrics* 21:239-245.
- Menge, B.A. 1992. Community regulation: under what conditions are bottom-up factors important on rocky shores? *Ecology* 73:755-765.
- Morris, M.D. 1991. Factorial sampling plans for preliminary computational experiments. *Technometrics* 33:161-174.
- Mount, D.I. and T.J. Norberg. 1984. A seven-day life-cycle cladoceran toxicity test. *Environmental Toxicology and Chemistry* 3:425-434.
- Myers, O.B., P.L. Kennedy, D.J. Beckman, W.H. Clements, and M.H. Ebinger. 1992. Improving aquatic exposure assessments: uncertainty analysis of a food web exposure model. Los Alamos National Laboratory Unclassified Report LA-UR 93-2004, Los Alamos, NM.
- Nagao, S. and S. Nakashima. 1992. Possible complexation of uranium with dissolved humic substances in pore water of marine sediments. *The Science of the Total Environment* 117/118:439-447.
- Nagy K. A. 1987. Field metabolic rate and food requirement scaling in mammals and birds. *Ecological Monographs* 57:111-128.
- Nakajima, A., T. Horikoshi, and T. Sakaguchi. 1979. Ion effects on the uptake of uranium by *Chlorella regularis*. *Agricultural Biology and Chemistry* 43(3):625-629.
- Nakajima, A., T. Horikoshi, and T. Sakaguchi. 1981. Studies on the accumulation of heavy metal elements in biological systems. XVII. Selective accumulation of heavy metal ions by *Chlorella regularis*. *European Journal of Fermentation Biotechnology* 12:76-83.
- Neame, P.A., J.R. Dean, and B.G. Zytaruk. 1982. Distribution and concentrations of naturally-occurring radionuclides in sediments in a uranium mining area of northern Saskatchewan, Canada. *Hydrobiologia* 91:355-361.
- Nebeker, A.V., M.A. Cairns, J.H. Gakstatter, K.W. Malueg, G.S. Schuytema, and D.F. Krawczyk. 1984. Biological methods for determining toxicity of contaminated freshwater sediments to invertebrates. *Environmental Contamination and Chemistry* 3:617-630.

- Nelson, M.K., C.G. Ingersoll, and F.J. Dwyer.** 1989. New standard guide for conducting solid-phase toxicity tests with freshwater invertebrates. American Society for Testing and Materials, ASTM Committee E-47, pp. 1-58.
- Newman, M.C., and M.G. Heagler.** 1991. Allometry of metal bioaccumulation and toxicity. In M.C. Newman and A.W. McIntosh, eds. *Metal toxicology: concepts and applications*. Lewis Publishers, Chelsea, MI. pp. 91-130.
- Nichols, D.G., and A.T. Scholz.** 1989. Concentrations of Cd, Sr, and U in fish and water samples collected from a small stream receiving uranium mine drainage. *Journal of Freshwater Ecology* 5:13-25.
- Nicholson, R.A. and M.E. Stuart.** 1986. Uranium in superficial sediments of the North Sea. *Marine Environmental Research* 19:177-183.
- Norton, S.B., D.J. Rodier, J.H. Gentile, W.H. van der Schalie, W.P. Wood, and M.W. Slimak.** 1992. A framework for ecological risk assessment at the EPA. *Environmental Toxicology and Chemistry* 11:1663-1672.
- NRCP65.** 1980. Management of persons accidentally contaminated with radionuclides. Pages 108-112 for the National Council on Radiation Protection Measurements, Washington, D.C.
- NRCP77.** 1987. Exposure from the uranium series with emphasis on radon and its daughters. Pages 57-59 in Report 65 for the National Council on Radiation Protection and Measurements, Bethesda, MD.
- Oakden, J.M., J.S. Oliver, and A.R. Flegal.** 1984. Behavioral responses of a phoxocephalid amphipod to organic enrichment and trace metals in sediment. *Marine Ecology Progress Series* 14:253-257.
- Pagenkopf, G.K.** 1983. Gill surface interaction model for trace metal toxicity to fishes: Role of complexation, pH, and water hardness. *Environmental Science and Technology* 17:342-347.
- Panson, A.J. and R.G. Charles.** 1977. Carbonate Chemistry of Uranium. Pages 728-739 in *Energy and Mineral Resource Recovery*, American Nuclear Society and Department of Energy Topical Meeting CONF-770440.
- Parkhurst, B.R., R.G. Elder, J.S. Meyer, D.A. Sanchez, R.W. Pennak, and W.T. Waller.** 1984. An environmental hazard evaluation of uranium in a Rocky Mountain stream. *Environmental Toxicology and Chemistry* 3:113-124.

- Peltier, W.H. and C.I. Weber.** 1985. *Methods for measuring the acute toxicity of effluents to freshwater and marine organisms*. EPA/600/4-85/013. Technical Report. U.S. Environmental Protection Agency, Cincinnati, OH.
- Pennak, R.W.** 1978. *Fresh-water invertebrates of the United States, 2nd Edition*. John Wiley & Sons, New York. 803 pp.
- Polis, G.A., editor.** 1991. *The ecology of desert communities*. The University of Arizona Press, Tucson, AZ.
- Poston, T.M.** 1982. Observations on the bioaccumulation potential of thorium and uranium in rainbow trout (*Salmo gairdneri*). *Bulletin of Environmental Contamination and Toxicology* 28:682-690.
- Poston, T.M.** 1983. Observations on the bioaccumulation potential of thorium and uranium in rainbow trout (*Salmo gairdneri*). *Bulletin of Environmental Contamination and Toxicology* 28:682-690.
- Poston, T.M., R.W. Hanf, Jr., and M.A. Simmons.** 1984. Toxicity of uranium to *Daphnia magna*. *Water, Air, and Soil Pollution* 22:289-298.
- Power, M.E.** 1992. Top-down and bottom-up forces in food webs: do plants have primacy? *Ecology* 73:733-746.
- Price, K.R.** 1990. *Revised environmental radiation monitoring plan for the depleted uranium penetrator testing program*. Prepared by the Pacific Northwest Laboratory for the U.S. Army Combat Systems Tests Activity, Aberdeen Proving Ground, Aberdeen, MD.
- Price, K.R., I.C. Nelson, and J.R. Raymond.** 1989. *A review of environmental data for the depleted uranium testing areas operated by the Combat Systems Test Activity, Aberdeen Proving Ground, Maryland*. Report prepared by Pacific Northwest Laboratory for U.S. Army Combat Systems Test Activity.
- Price, K.R.** 1991. *The analysis of soil and vegetation samples collected from the Yuma Proving Ground*. Pacific Northwest Laboratory Report TD 2761, Richland, WA.
- Rainbow, P.S.** 1993. The significance of trace metals in marine invertebrates. Pages 4-23 in R. Dallinger and P.S. Rainbow, eds. *Ecotoxicology of Metals in Invertebrates*. SETAC Special Publication Series, Lewis Publishers, Ann Arbor, MI.
- Rand, G.M. and S.R. Petrocelli.** 1985. *Fundamentals of aquatic toxicology*. Hemisphere Publishing Corporation, New York. 666 pp.

- Remmert H.** 1981. Body size of terrestrial arthropods and biomass of their populations in relation to the abiotic parameters of their milieu. *Oecologia* 50:12.
- Rhoads, D.C.** 1974. Organism-sediment relations on the muddy sea floor. *Oceanography and Marine Biology Annual Review* 12:263-300.
- Robbins, J.A., P.L. McCall, J.B. Fisher, and J.R. Krezoski.** 1979. Effects of deposit feeders on migration of <sup>137</sup>cesium in lake sediments. *Earth and Planetary Science Letters* 42:277-287.
- Ronen, Y.** 1988. *Uncertainty analysis*. CRC Press, Boca Raton, FL.
- Sakaguchi, T., T. Horikoshi, A. Nakajima.** 1978. Uptake of uranium from sea water by microalgae. *Journal of Fermentation Biology* 56(6):561-565.
- Santos P. F., N.Z. Elkins, Y. Steinberge, and W.G. Whitford.** 1984. A comparison of surface and buried *Larrea tridentata* leaf litter decomposition in North American hot deserts. *Ecology* 65:278-284.
- SAS Institute.** 1988. *SAS/STAT<sup>®</sup> User's Guide*. Release 6.03 Edition. Cary, NC.
- Savage, L.J.** 1954. *The foundations of statistics*. Wiley and Sons, New York, N.Y.
- Shanbhag, P.M. and G.R. Choppin.** 1981. Binding of uranyl by humic acid. *Journal of Inorganic Nuclear Chemistry* 43(12):3369-3372.
- Sheppard, S. C., and W. G. Evenden.** 1988. Critical compilation and review of plant/soil concentrations ratios for uranium, thorium and lead. *Journal of Environmental Radioactivity* 8:255-285.
- Simon, S. L.** 1985. *Uptake and kinetics of Ra, Pb and Po in big sagebrush*. Ph.D. Dissertation, Colorado State University, Fort Collins. 169pp.
- Slobodkin, L.B.** 1992. A summary of the special feature and comments on its theoretical context and importance. *Ecology* 73:1564-1566.
- Sprague, J.B.** 1985. Factors that influence toxicity. Pages 124-163 in G.M. Rand and S.R. Petrocelli, eds. *Fundamentals of Aquatic Toxicology: Methods and Applications*. Hemisphere Publishing Corp., New York.
- Spry, D.J. and J.G. Weiner.** 1991. Metal bioavailability and toxicity to fish in low-alkalinity lakes: A critical review. *Environmental Pollution* 71:243-304.

- Strandberg, G.W., S.E. Shumate, II., and J.R. Parrott, Jr.** 1981. Microbial cells as biosorbants for heavy metals: Accumulation of uranium by *Saccharomyces cerevisiae* and *Pseudomonas aeruginosa*. *Applied and Environmental Microbiology* 41(1):237-245.
- Strojan C. L., F.B. Turner, and Castetter R.** 1979. Litter fall from shrubs in the northern Mojave desert. *Ecology* 60:891-900.
- Strong, D.R.** 1992. Are trophic cascades all wet? Differentiation and donor-control in speciose ecosystems. *Ecology* 73:747-754.
- SuLu, S. and F. Zhao.** 1990. Nephrotoxic limit and annual limit on intake for natural U. *Health Physics* 58:619-623.
- Swanson, S.M.** 1983. Levels of  $^{226}\text{Ra}$ ,  $^{210}\text{Pb}$  and  $^{\text{Total}}\text{U}$  in fish near a northern Saskatchewan aquatic system. *Health Physics* 45(1):67-90.
- Swanson, S.M.** 1985. Food-chain transfer of U-series radionuclides in a northern Saskatchewan aquatic system. *Health Physics* 49(5):747-770.
- Tannenbaum, A. and H. Silverstone.** 1951. Factors affecting uranium poisoning. Pages 11-15 in Tannenbaum, A., ed. *Toxicology of Uranium*. McGraw-Hill Book Co., New York.
- Tarzwell, C.M. and C. Henderson.** 1960. Toxicity of less common metals to fishes. *Industrial Wastes* 5:12.
- Thompson, C.E., C.A. Burton, D.J. Quinn, and Y.C. Ng.** 1972. Concentration factors of chemical elements in edible aquatic organisms. N.C.R.L. 50564 Rev. 1.
- Trabalka, J.R., and J.T. Garten, Jr.** 1983. Behavior of the long-lived synthetic elements and their natural analogs in food chains. *Advances in Radiation Biology* 10:39-104.
- Tsezos, M. and B. Volesky.** 1981. Biosorption of uranium and thorium. *Biotechnology and Bioengineering* 23:583-604.
- U.S. Army Combat Systems Test Activity.** 1990. Environmental assessment for testing of depleted uranium penetrator munitions. U.S. Army Combat Systems Test Activity, Aberdeen Proving Ground, Aberdeen, MD.
- USEPA.** 1989. *Short-term methods for estimating the chronic toxicity of effluents and receiving waters to freshwater organisms, Second Edition*. EPA/600/4-89/001. Technical Report. U.S. Environmental Protection Agency, Cincinnati, OH.

- USEPA.** 1992. *Framework for ecological risk assessment*. EPA/630/R-92/001. Technical Report. U.S. Environmental Protection Agency, Washington, D.C.
- USGS (U.S. Geological Service) database.** 1992. Hydrodata: Quality of water, Vol. 1. Computer laser optical disks, EarthInfo, Boulder, CO.
- Van Netten, C. and D.R. Morley.** 1982. Uptake of uranium and molybdenum from uranium rich soils by barley. *International Journal of Environmental Studies* 19:43-45.
- Van Straalen, N.M., T.B.A. Burghouts, M.J. Doornhof, G.M. Groot, M.P.M. Janssen, E.N.G. Joosse, J.H. van Meerendonk, J.P.J.J. Theeuwen, H.A. Verhoef, and H.R. Zoomer.** 1987. Efficiency of lead and cadmium excretions in populations of *Orchesella cincta* (Collembola) from various contaminated forest soils. *Journal of Applied Ecology* 24:953-968.
- Veska, E. and R.S. Eaton.** 1991. Abandoned rayrock uranium mill tailings in the Northwest Territories: Environmental conditions and radiological impact. *Health Physics* 60(3):399-409.
- Waite, D.T., S.R. Joshi, and H. Sommerstad.** 1988. The effect of uranium mine tailings on radionuclide concentrations in Langley Bay, Saskatchewan, Canada. *Archives of Environmental Contamination and Toxicology* 17:373-380.
- Walker, F.W., G.J. Kirouac, and F.M. Rourke.** 1977. *Chart of the nuclides*, 12th ed. General Electric Company, San Jose, CA.
- Walsh, G.E., D.E. Weber, L.K. Esry, M.T. Nguyen, J. Noles, and B. Albright.** 1992. Synthetic substrata for propagation and testing of soil and sediment organisms. *Pedobiologia* 36:1-10.
- Wentzel, R., A. McIntosh, W.P. McCafferty, G. Atchison, and V. Anderson.** 1977. Avoidance response of midge larvae (*Chironomus tentans*) to sediment containing heavy metals. *Hydrobiologia* 55(2):171-175.
- Whicker, F.W., and T.B. Kirchner.** 1987. PATHWAY: a dynamic food-chain model to predict radionuclide ingestion after fallout deposition. *Health Physics* 52:717-737.
- Wrenn, M.E., P.W. Durbin, B. Howard, J. Lipsztein, J. Rundo, E.T. Still, and D.L. Willis.** 1985. Metabolism of ingested U and Ra. *Health Physics* 48:601-633.
- Yuile, C.L.** 1973. Animal experiments. *Handbook of Experimental Pharmacology* 36:165-196.

Zach, R., and K. R. Mayoh. 1984. Soil ingestion by cattle: a neglected pathway. *Health Physics* 46:426-431.



**APPENDIX A**

**PROPOSED FUTURE STUDIES**

## Evaluation of the Transfer of Uranium to Zooplankton from Phytoplankton

### **Objective:**

- 1) Determine the amount of uranium transferred from phytoplankton (green algae, *Selenastrum capricornutum*) to zooplankton (cladoceran, *Ceriodaphnia dubia*)
- 2) Determine the acute and chronic toxicity of uranium-contaminated phytoplankton to zooplankton

### **Rationale:**

- 1) Food chain transfer of uranium from phytoplankton to zooplankton represents an important ecological route of uranium exposure since zooplankton are major food sources of many fish. Ultimately, this route of exposure directly impacts human consumption of uranium through trophic transfer -- from phytoplankton to plankton to fish to humans.
- 2) This route of exposure in the ecological risk assessment model has a moderately high level of uncertainty associated with it. Consequently, our ability to quantify exposure to higher trophic levels, including striped bass and humans, is limited without this study.

## Experimental Design:

### Range-finding Tests\*

6 uranium concentrations for algae cultures (100, 10, 1, 0.1, 0.01, and 0 ppm depleted uranium)

7-d exposure period for zooplankton fed uranium-contaminated algae evaluating survival and reproduction (follow EPA guidelines for 7-d toxicity tests with *Ceriodaphnia dubia*)

10 zooplankton per concentration

### Definitive Tests\*

Algae concentrations adjusted to more narrowly define range of toxic effects (follow EPA guidelines for 7-d toxicity tests with *Ceriodaphnia dubia*)

### Bioaccumulation Tests\*

Algae concentration is the highest concentration which did not result in toxic effects (determined from toxicity tests).

Evaluate bioaccumulation over a 7-d period. *Ceriodaphnia* grown in mass cultures and fed uranium-spiked algae. Sampling times at 0, 0.125, 0.25, 0.5, 1, 2, 4, and 7 d.

\* Algae is an exceptional biosorbant, consequently, little uranium is likely to be released into the water column to cause aqueous toxicity to zooplankton. However, filtered water samples should be taken to ensure this fact.

**APPENDIX B**

**YPG MODEL**

TABLE B-1. Rate equations used in YPG terrestrial model to estimate environmental fate of DU.

---



---

Vegetation Interior

$$\frac{dC_{2i}}{dt} = C_1 \frac{\lambda_{2i,1}}{K_d} - C_{2i} (\lambda_{3,2i} + \lambda_{4,2i} + \lambda_{5,2i} + \lambda_{8,2i})$$

Vegetation Surface

$$\frac{dC_{2s}}{dt} = C_1 \lambda_{2s,1} - C_{2s} (\lambda_{3,2s} + \lambda_{4,2s} + \lambda_{5,2s} + \lambda_{1,2s} + \lambda_{8,2s})$$

Arthropods

$$\frac{dC_3}{dt} = C_1 \lambda_{3,1} + (C_{2i} + C_{2s}) \lambda_{3,2} + C_8 \lambda_{3,8} - C_3 (\lambda_{1,4} + \lambda_{4,3} + \lambda_{6,3} + \lambda_{8,3})$$

Small Herbivores

$$\frac{dC_4}{dt} = C_1 \lambda_{1,4} + (C_{2i} + C_{2s}) \lambda_{4,2} + C_3 \lambda_{4,3} - C_4 (\lambda_{1,4} + \lambda_{7,4} + \lambda_{8,4})$$

Large Herbivores

$$\frac{dC_5}{dt} = C_1 \lambda_{5,1} + (C_{2i} + C_{2s}) \lambda_{5,2} - C_5 (\lambda_{1,8} + \lambda_{8,5})$$

Table B-1. Continued.

---



---

Insectivores

$$\frac{dC_6}{dt} = C_1 \lambda_{6,1} + C_3 \lambda_{6,3} - C_6 (\lambda_{1,6} + \lambda_{7,6} + \lambda_{8,6})$$

Predators

$$\frac{dC_7}{dt} = C_1 \lambda_{7,1} + C_4 \lambda_{7,4} + C_6 \lambda_{7,6} - C_7 (\lambda_{1,7} + \lambda_{8,7})$$

Litter

$$\begin{aligned} \frac{dC_8}{dt} = & \frac{(C_{2i} + C_{2s})B_2 \lambda_{8,2} + C_3 B_3 \lambda_{8,3} + C_4 B_4 \lambda_{8,4} + C_5 B_5 \lambda_{8,5} + C_6 B_6 \lambda_{2,6} + C_7 B_7 \lambda_{2,7}}{B_8} \\ & + (C_{2i} + C_{2s}) (\lambda_{3',2} + \lambda_{4',2} + \lambda_{5,2}) + C_3 (\lambda_{4',3} + \lambda_{6',3}) + C_4 \lambda_{7,4} + C_6 \lambda_{7,6} + C_8 \lambda_{3',8} \\ & - C_8 (\lambda_{1,8} + \lambda_{3,8}) \end{aligned}$$

---

TABLE B-2. Parameter values and ranges used in YPG terrestrial model uncertainty analysis.

Parameter	Nominal value	Range	Units	Explanation	Source
$a_4$	0.15	0.09 - 0.24	g/d	variable in equation predicting $FB_i$	Nagy (1987)
$a_5$	0.15	0.09 - 0.24	g/d	variable in equation predicting $FB_i$	Nagy (1987)
$a_6$	0.65	0.49 - 0.86	g/d	variable in equation predicting $FB_i$	Nagy (1987)
$a_7$	0.15	0.09 - 0.24	g/d	variable in equation predicting $FB_i$	Nagy (1987)
$am_4$	8.57	$\pm 50\%$	kJ/d	variable in equation predicting metabolic rate rate and used to estimate $\lambda_{i,j}$	Calder (1984)
$am_5$	8.4	$\pm 50\%$	kJ/d	variable in equation predicting metabolic rate rate and used to estimate $\lambda_{i,j}$	Calder (1984)
$am_6$	14.3	$\pm 50\%$	kJ/d	variable in equation predicting metabolic rate rate and used to estimate $\lambda_{i,j}$	Calder (1984)
$am_7$	8.4	$\pm 50\%$	kJ/d	variable in equation predicting metabolic rate rate and used to estimate $\lambda_{i,j}$	Calder (1984)
$as_4$	0.59	$\pm 50\%$	1/yr	variable in equation predicting annual survival rate and used to estimate $\lambda_{8,j}$	Calder (1984)
$as_5$	0.59	$\pm 50\%$	1/yr	variable in equation predicting annual survival rate and used to estimate $\lambda_{8,j}$	Calder (1984)
$as_6$	1.38	$\pm 50\%$	1/yr	variable in equation predicting annual survival rate and used to estimate $\lambda_{8,j}$	Calder (1984)

TABLE B-2. Continued.

Parameter	Nominal value	Range	Units	Explanation	Source
$as_7$	0.59	$\pm 50\%$	1/yr	variable in equation predicting annual survival rate and used to estimate $\lambda_{8j}$	Calder (1984)
$B_2$	0.7	0.1 - 2	kg/m <sup>2</sup>	dry mass in compartment 2: vegetation	Begon et al. (1990:652)
$b_4$	0.79	0.73 - 0.84	1/d	variable in equation predicting $FB_i$	Nagy (1987)
$B_4$	1.13E-04	8.82E-05 - 1.38E-04	kg/m <sup>2</sup>	dry mass in compartment 4: small herbivores	Chew and Chew (1970)
$b_5$	0.79	0.73 - 0.84	1/d	variable in equation predicting $FB_i$	Nagy (1987)
$b_6$	0.65	0.60 - 0.70	1/d	variable in equation predicting $FB_i$	Nagy (1987)
$b_7$	0.79	0.73 - 0.84	1/d	variable in equation predicting $FB_i$	Nagy (1987)
$BE_{CV}$	0.02	0.01 - 0.1	unitless	efficiency of biomass conversion by predators	
$BE_{HV}$	0.02	0.01 - 0.1	unitless	efficiency of biomass conversion by herbivores	
$BE_{IV}$	0.02	0.01 - 0.1	unitless	efficiency of biomass conversion by insectivores	
$bm_4$	0.54	$\pm 30\%$	unitless	variable in equation predicting metabolic rate rate and used to estimate $\lambda_{1j}$	Calder (1984)
$bm_5$	0.66	$\pm 30\%$	unitless	variable in equation predicting metabolic rate rate and used to estimate $\lambda_{1j}$	Calder (1984)
$bm_6$	0.43	$\pm 30\%$	unitless	variable in equation predicting metabolic rate rate and used to estimate $\lambda_{1j}$	Calder (1984)



TABLE B-2. Continued.

Parameter	Nominal value	Range	Units	Explanation	Source
$bm_7$	0.66	$\pm 30\%$	unitless	variable in equation predicting metabolic rate and used to estimate $\lambda_{1j}$	Calder (1984)
$bs_4$	0.56	$\pm 30\%$	unitless	variable in equation predicting annual survival rate and used to estimate $\lambda_{8j}$	Calder (1984)
$bs_5$	0.56	$\pm 30\%$	unitless	variable in equation predicting annual survival rate and used to estimate $\lambda_{8j}$	Calder (1984)
$bs_6$	0.36	$\pm 30\%$	unitless	variable in equation predicting annual survival rate and used to estimate $\lambda_{8j}$	Calder (1984)
$bs_7$	0.56	$\pm 30\%$	unitless	variable in equation predicting annual survival rate and used to estimate $\lambda_{8j}$	Calder (1984)
$C_1$	1	—	mg DU/kg	assumed initial soil concentration	—
$C_2$	0	—	mg DU/kg	DU plant concentration ( $C_{21} + C_{2S}$ )	—
$C_{21}$	0	—	mg DU/kg	DU in vegetation	—
$C_{2S}$	0	—	mg DU/kg	DU on vegetation	—
$C_3$	0	—	mg DU/kg	DU in invertebrates	—
$C_4$	0	—	mg DU/kg	DU in small herbivores	—
$C_5$	0	—	mg DU/kg	DU in large herbivores	—
$C_6$	0	—	mg DU/kg	DU in insectivores	—
$C_7$	0	—	mg DU/kg	DU in predators	—
$C_8$	0	—	mg DU/kg	DU in litter	—

TABLE B-2. Continued.

Parameter	Nominal value	Range	Units	Explanation	Source
$DM_4$	0.3	0.2 - 0.6	unitless	dry matter content	
$DM_5$	0.3	0.2 - 0.6	unitless	dry matter content	
$DM_6$	0.3	0.2 - 0.6	unitless	dry matter content	
$DM_7$	0.3	0.2 - 0.6	unitless	dry matter content	
$E_{3,1}$	0.01	0.0035 - 0.02	unitless	DU assimilation coefficient	Wrenn et al. (1985)
$E_{3,2}$	0.01	0.0035 - 0.02	unitless	DU assimilation coefficient	Wrenn et al. (1985)
$E_{3,8}$	0.01	0.0035 - 0.02	unitless	DU assimilation coefficient	Wrenn et al. (1985)
$E_{4,1}$	0.01	0.0035 - 0.02	unitless	DU assimilation coefficient	Wrenn et al. (1985)
$E_{4,2}$	0.01	0.0035 - 0.02	unitless	DU assimilation coefficient	Wrenn et al. (1985)
$E_{4,3}$	0.01	0.0035 - 0.02	unitless	DU assimilation coefficient	Wrenn et al. (1985)
$E_{5,1}$	0.01	0.0035 - 0.02	unitless	DU assimilation coefficient	Wrenn et al. (1985)
$E_{5,2}$	0.01	0.0035 - 0.02	unitless	DU assimilation coefficient	Wrenn et al. (1985)
$E_{6,1}$	0.01	0.0035 - 0.02	unitless	DU assimilation coefficient	Wrenn et al. (1985)
$E_{6,3}$	0.01	0.0035 - 0.02	unitless	DU assimilation coefficient	Wrenn et al. (1985)
$E_{7,1}$	0.01	0.0035 - 0.02	unitless	DU assimilation coefficient	Wrenn et al. (1985)
$E_{7,3}$	0.01	0.0035 - 0.02	unitless	DU assimilation coefficient	Wrenn et al. (1985)
$E_{7,4}$	0.01	0.0035 - 0.02	unitless	DU assimilation coefficient	Wrenn et al. (1985)
$E_{7,4}$	0.01	0.0035 - 0.02	unitless	DU assimilation coefficient	Wrenn et al. (1985)
$E_{7,6}$	0.01	0.0035 - 0.02	unitless	DU assimilation coefficient	Wrenn et al. (1985)
$ER$	0.5	0.2 - 0.8	unitless	erosion loss	
$f_{3b}$	0.76	$\pm 0.06$	ng	variable in equation for predicting $\lambda_{1,3}$	van Straalen et al. (1987)

TABLE B-2. Continued.

Parameter	Nominal value	Range	Units	Explanation	Source
$f_{31}$	2.3	$\pm 0.04$	ng	variable in equation for predicting $\lambda_{1,3}$	van Straalen et al. (1987)
$fb_3$	0.07	0.02 - 0.3	unitless	dry matter intake as a fraction of $B_3$	
$FD_{3,8}$	0.73	0.37 - 0.93	unitless	fraction of diet for compartment 3 coming from compartment 8. $FD_{3,2} = 1 - FD_{3,8}$ so that $\Sigma FD_{3,j} = 1$	
$FD_{4,2}$	0.9	0.8 - 0.95	unitless	fraction of diet for compartment 4 coming from compartment 2. $FD_{4,3} = 1 - FD_{4,2}$ so that $\Sigma FD_{4,j} = 1$	
$FD_{7,3}$	0.5	0 - 1	unitless	fraction of diet for compartment 7 coming from compartment 3. $FD_{7,4} = (1 - FD_{7,3}) * pshv$ and $FD_{7,6} = (1 - FD_{7,3}) * (1 - pshv)$ so that $\Sigma FD_{7,j} = 1$	
$FHV_3$	0.55	0.3 - 0.8	unitless	fraction of herbivore biomass as 3	
$FHV_5$	0.05	0.01 - 0.1	unitless	fraction of herbivore biomass as 5	
$fp$	0.08	0.06 - 0.10	unitless	estimates mass of litter from $B_2$	Klemmedson and Barth (1974)
$fs_3$	0.04	0 - 0.2	unitless	soil intake as fraction of daily intake	Garten (1980), Zach and Mayo (1984)
$fs_4$	0.04	0 - 0.2	unitless	soil intake as fraction of daily intake	Garten (1980), Zach and Mayo (1984)
$fs_5$	0.04	0 - 0.2	unitless	soil intake as fraction of daily intake	Garten (1980), Zach and Mayo (1984)

TABLE B-2. Continued.

Parameter	Nominal value	Range	Units	Explanation	Source
$fs_6$	0.04	0 - 0.2	unitless	soil intake as fraction of daily intake	Garten (1980), Zach and Mayo (1984)
$fs_7$	0.04	0 - 0.2	unitless	soil intake as fraction of daily intake	Garten (1980), Zach and Mayo (1984)
$FU_4$	2.0	0.3 - 3.0	1/kJ	scales metabolic rate (kJ/d) to elimination rate (1/d)	
$FU_5$	2.0	0.3 - 3.0	1/kJ	scales metabolic rate (kJ/d) to elimination rate (1/d)	
$FU_6$	2.0	0.3 - 3.0	1/kJ	scales metabolic rate (kJ/d) to elimination rate (1/d)	
$FU_7$	2.0	0.3 - 3.0	1/kJ	scales metabolic rate (kJ/d) to elimination rate (1/d)	
$kd$	1080	180 - 3E05	unitless	partitions bound DU/available DU in soil	Simon (1985) and Sheppard and Evender (1988)
$k_r$	0.00086	$\pm 50\%$	1/d	rainsplash rate	Whicker and Kirchner (1987) see Dreicer et al. 1984
$k_w$	0.0495	$\pm 50\%$	1/d	weathering rate	Whicker and Kirchner (1987) see Ho79
$\lambda_{1,8}$	0.0015	0.00099 - 0.0023	1/d	litter to soil transfer	Santos et al. (1984)
$\lambda_{2,1}$	0.36	$\pm 50\%$	1/d	plant uptake from soil	Simon (1985)
$\lambda_{8,2}$	0.0012	0.00019 - 0.0023	1/d	litter fall	Strojan et al. (1979)
$PS$	1460	$\pm 50\%$	kg/m <sup>3</sup>	soil bulk density	Whicker and Kirchner (1987)
$pshv$	0.5	0.25 - 0.75	unitless	partitions intake by predators	

TABLE B-2. Continued.

Parameter	Nominal value	Range	Units	Explanation	Source
$RF$	0.0001	$10^{-10}$ - $10^{-2}$	1/m	resuspension factor	Whicker and Kirchner (1987) see Anspugh et al. 1975
$V$	173	2.6 - 4900	m/d	deposition velocity	Whicker and Kirchner (1987) see Whicker & Schultz 1982, mi83
$W_3$	0.05	$\pm 50\%$	g/individual	live body mass	Remmert (1981)
$W_4$	65	58 - 73	g/individual	live body mass	Chew and Chew (1970)
$W_5$	40,000	10,000 - 60,000	g/individual	live body mass	Nagy (1987)
$W_6$	50	25 - 300	g/individual	live body mass	Nagy (1987)
$W_7$	5,000	1,000 - 10,000	g/individual	live body mass	Nagy (1987)
$z_s$	0.001	0.0005 - 0.0015	m	labile soil depth	Whicker and Kirchner 1987