

SERI/TP-622-1139

CONF-800973 --3

**MASTER**

BIOMASS THERMAL CONVERSION  
RESEARCH AT SERI

THOMAS A. MILNE  
RAYMOND E. DESROSIERS  
THOMAS B. REED

SEPTEMBER 1980

PRESENTED AT THE 11TH BIOMASS  
THERMOCHEMICAL CONVERSION  
CONTRACTORS MEETING  
RICHLAND, WASHINGTON  
23-24 SEPTEMBER 1980

PREPARED UNDER TASK NOS.  
1031.00 AND 3356.01

**Solar Energy Research Institute**

A Division of Midwest Research Institute

1617 Cole Boulevard  
Golden, Colorado 80401

Prepared for the  
U.S. Department of Energy  
Contract No. EG-77-C-01-4042

AC02-77CH00178

DISTRIBUTION OF THIS DOCUMENT IS UNLIMITED

## **DISCLAIMER**

**This report was prepared as an account of work sponsored by an agency of the United States Government. Neither the United States Government nor any agency Thereof, nor any of their employees, makes any warranty, express or implied, or assumes any legal liability or responsibility for the accuracy, completeness, or usefulness of any information, apparatus, product, or process disclosed, or represents that its use would not infringe privately owned rights. Reference herein to any specific commercial product, process, or service by trade name, trademark, manufacturer, or otherwise does not necessarily constitute or imply its endorsement, recommendation, or favoring by the United States Government or any agency thereof. The views and opinions of authors expressed herein do not necessarily state or reflect those of the United States Government or any agency thereof.**

## **DISCLAIMER**

**Portions of this document may be illegible in electronic image products. Images are produced from the best available original document.**

11TH BIOMASS THERMOCHEMICAL CONVERSION CONTRACTORS MEETING  
Richland, WA Sept. 23-24, 1980

Biomass Thermal Conversion Research at SERI

Thomas A. Milne, Raymond E. Desrosiers  
and Thomas B. Reed  
Biomass Thermal Conversion and Exploratory Branch  
Chemical and Biological Division  
Solar Energy Research Institute

ABSTRACT

SERI's involvement in the thermochemical conversion of biomass to fuels and chemicals is reviewed. In-house work is being sponsored by Biomass Energy Systems, by the Office of Alcohol Fuels and by the Solar Thermal Program. The University Program, the Solar Thermal Test Facility and the Biomass Program Office support relevant sub-contract work. The scope and activities of the Biomass Thermal Conversion and Exploratory Branch are reviewed. The current status and future plans for three tasks are presented: (1) Pyrolysis Mechanisms; (2) High Pressure O<sub>2</sub> Gasifier; and (3) Gasification Test Facility. (The Fast Pyrolysis studies are described in detail in a separate paper.)

DISCLAIMER

This book was prepared as an account of work sponsored by an agency of the United States Government. Neither the United States Government nor any agency thereof, nor any of their employees, makes any warranty, expressed or implied, or assumes any legal liability or responsibility for the accuracy, completeness, or usefulness of any information, apparatus, product, or process disclosed, or represents that its use would not infringe privately owned rights. Reference herein to any specific commercial product, process, or service by trade name, trademark, manufacturer, or otherwise, does not necessarily constitute or imply its endorsement, recommendation, or favoring by the United States Government or any agency thereof. The views and opinions of authors expressed herein do not necessarily state or reflect those of the United States Government or any agency thereof.

DISTRIBUTION OF THIS DOCUMENT IS UNLIMITED

MGW

## I. INTRODUCTION

The Solar Energy Research Institute, in existence for three years, and in laboratory facilities for just over a year, has embarked on a diversified and ambitious program in biomass thermochemical conversion. Of particular relevance to this group are the activities in gasification and combustion, both in-house and subcontracted, which are summarized in Table 1.

Table 1

---

### SERI RESEARCH INVOLVEMENT IN GASIFICATION & COMBUSTION

---

#### I. Fundamental and Exploratory Studies

##### A. SERI Universities Program

1. Howard - MIT - Basic Pyrolysis Processes.
2. Antal - Princeton - Secondary Cracking of Model Cpds.
3. Krieger - U. of Wash. - Pyrolysis Behavior of Large Particles.
4. Malte - U. of Wash. - Destruction of Tars and Oils in Wood Stoves.
5. Graboski - CSM - Gasif. Kinetics of Pelletized Char.
6. Hoenig - Arizona - ESP Cleaning of Gasifier Effluent

##### B. SERI Biomass Program Office (Subcontracted)

1. Antal - Princeton - Effect of Pressure on Pyrolysis.

##### C. STTF and Solar Thermal Supported Biomass Work

1. Antal - Princeton - Flash Pyrolysis by Direct Irradiation.
2. Benham - SERI - Entrained Flow Fast Pyrolysis.

##### D. SERI In-House Biomass Supported Work

1. Milne - SERI - Kinetics and Mechanism of Fast Pyrolysis.
2. Chum - SERI - Electrochemical Conversion of Biomass Derived Chemicals.

#### II. Engineering Studies

##### A. SERI In-House Solar Thermal Supported Work (Fuels & Chemicals Program)

1. Benham - SERI - Solar Receiver Fast Pyrolysis Reactor Development.

##### B. SERI In-House Biomass Supported Work

1. Desrosiers - SERI - Modeling of Air Gasifiers
2. Diebold - SERI - Fast Pyrolysis of Large Particles
3. Reed - SERI - High Pressure O<sub>2</sub> Gasifier (Alcohol Fuels Office)

##### C. SERI Director's Discretionary Funds Supported Work.

1. Desrosiers & Staff - SERI - Low BTU Gasification Boiler Retrofit.
-

## II. SUBCONTRACTED AND SOLAR THERMAL WORK

### A. SERI Biomass Program Office

SERI is funding Prof. Mike Antal, at Princeton, through partial support of Visiting Fellow from Brazil, Dr. Jose Moreira and for a basic study "Biomass Gasification Rates and Products in a Pressurized Environment". Moreira has recently completed his stay at Princeton, returning to the Institute of Physics at the Univ. of Sao Paulo where he and Dr. Jose Goldemberg will initiate a program on thermochemical conversion of wood to liquid fuels. He assisted Antal in the design and operation of a focused light source study of flash pyrolysis of powdered biomass.

Antal, in work starting this summer, is carrying out high-pressure TGA and DSC using the Setaram instrument, coupled with pressurized tubular reactor experiments on the primary pyrolysis reaction kinetics and the products and reaction rates of secondary gas-phase reactions.

### B. SERI Solar Thermal Test Facility Users Association

This group is funding Antal in a second phase of solar-assisted gasification studies entitled: "Flash Pyrolysis of Biomass Using Concentrated Solar Radiation. Phase 2: Reactor Development". Experiments with laboratory light sources, and at the Georgia Tech test facility, are involved.

### C. SERI - University Program

SERI's Academic and University Programs Branch is in the second year of an extensive grant program supporting basic and exploratory research in solar conversion, with a strong emphasis on biomass thermal conversion.

Professor Jack Howard, MIT, is in the second year of a two year study entitled: "Fundamental Studies of the Production of Premium Fuels by Controlled Pyrolysis of Biomass". His group is using the programmed heating of electrical grids to pyrolyze biomass at rates up to 1000°C/sec and temperatures to 1100°C. The system can accommodate 100 mg samples and permits weight loss measurement, and gas and liquid collection and analysis. Mass balances of 95% are being achieved with cellulose. Samples of isolated cellulose, hemicellulose and lignin, from the same wood, will be studied and compared with whole wood.

Five new grants were initiated this summer. Professor Barbara Krieger (U. of Washington) is studying "Product Formation Kinetics in the Single, Large Pellet Pyrolysis of Biomass". She will experimentally study the detailed product distribution from the high heat flux pyrolysis of a single, large pellet of biomass, quantitatively relating the product formation rates to the parameters that govern heat and mass transfer. Such studies will be relevant to combustion as well as pyrolysis.

Professor Stuart Hoenig (Univ. of Arizona) will investigate the "Development of New Technology for Clean Up of Producer and Synthesis Gas". The approach is to adapt prior work on the control of diesel smoke and aerosol suspension to the cleaning of gasifier effluents, using unique electrostatic precipitator techniques to agglomerate, and then precipitate, particulate matter. The apparatus developed will be tested on real gasifier effluents, perhaps at SERI's Air Gasification Test Facility (See below).

Prof. Philip Malte (Univ. of Washington) will explore "The Oxidation of Volatiles in Residential Wood Burning Equipment". He will measure and characterize the rate of oxidation of volatile matter released from wood, especially the condensible hydrocarbons. Two laboratory systems will be used, a jet-stirred combustion reactor doped with model compounds and a special laboratory wood combustor. The goal is to indicate the time and temperature conditions needed for clean wood burning in small stoves.

Professor Antal (Princeton) will carry out "Mechanistic and Kinetic Studies of the Gas Phase Pyrolysis Chemistry of Biomass Using Model Compounds". The objective is to better define the mechanisms and kinetics of the gas-phase pyrolysis of biomass through use of carefully selected model compounds. A laminar, tubular plug flow reactor will be employed to study the effects of residence time, temperature and reactant concentrations on final products, with an emphasis on olefins and the high-value chemical products of fast pyrolysis.

Prof. Mike Graboski (Colorado School of Mines) will study the "Pyrolysis and Gasification Kinetics of Densified Biomass". Three tasks will address the effect of densification and particle dimension on char formation; on the intrinsic rate of char gasification; and on the global rate of gasification. Results will be used to develop a comprehensive kinetic design model which may be used to predict gasifier performance

#### D. Solar Thermal Supported In-House Biomass Gasification Research

Dr. Chuck Benham and his colleagues in the Solar Thermal Research Branch are carrying out two related studies. In the first, an improved version of the China Lake (1979) entrained flow fast pyrolysis apparatus is being used to map the behavior of a variety of powdered feedstocks as a function of temperature, residence time and other variables, with an emphasis on olefin yields for subsequent conversion to liquid fuels. Some work is underway in feedstock preparation and fast pyrolysis catalytic conversion to liquids. In the second study, focused solar cavity reactors are being designed to transfer solar heat across a wall to an entrained flow of powdered biomass.

### III. SERI BIOMASS THERMAL CONVERSION AND EXPLORATORY BRANCH IN-HOUSE RESEARCH IN GASIFICATION

#### A. Introduction

The Biomass Thermal Conversion and Exploratory Branch is concerned with the whole range of non-biological biomass conversion processes. The initial emphasis is on gasification and electrochemical conversion with future projects likely to involve combustion, direct liquefaction, low-temperature thermal treatment (thermolysis), fuels production from the products of gasification and fuels properties.

A group of ten scientists and engineers is pursuing five tasks: two fundamental and three with an engineering orientation (Table 2). Under the Fundamental and Exploratory Group, basic studies of pyrolysis mechanisms are underway, seeking a better understanding of chemical pathways to aid optimization and design of new processes. Electrochemical conversion research aims to upgrade the value of biomass derived materials by electrochemical processing (e.g., fermentation acids to gasoline-like hydrocarbons).

## FY81 PROGRAM STRUCTURE

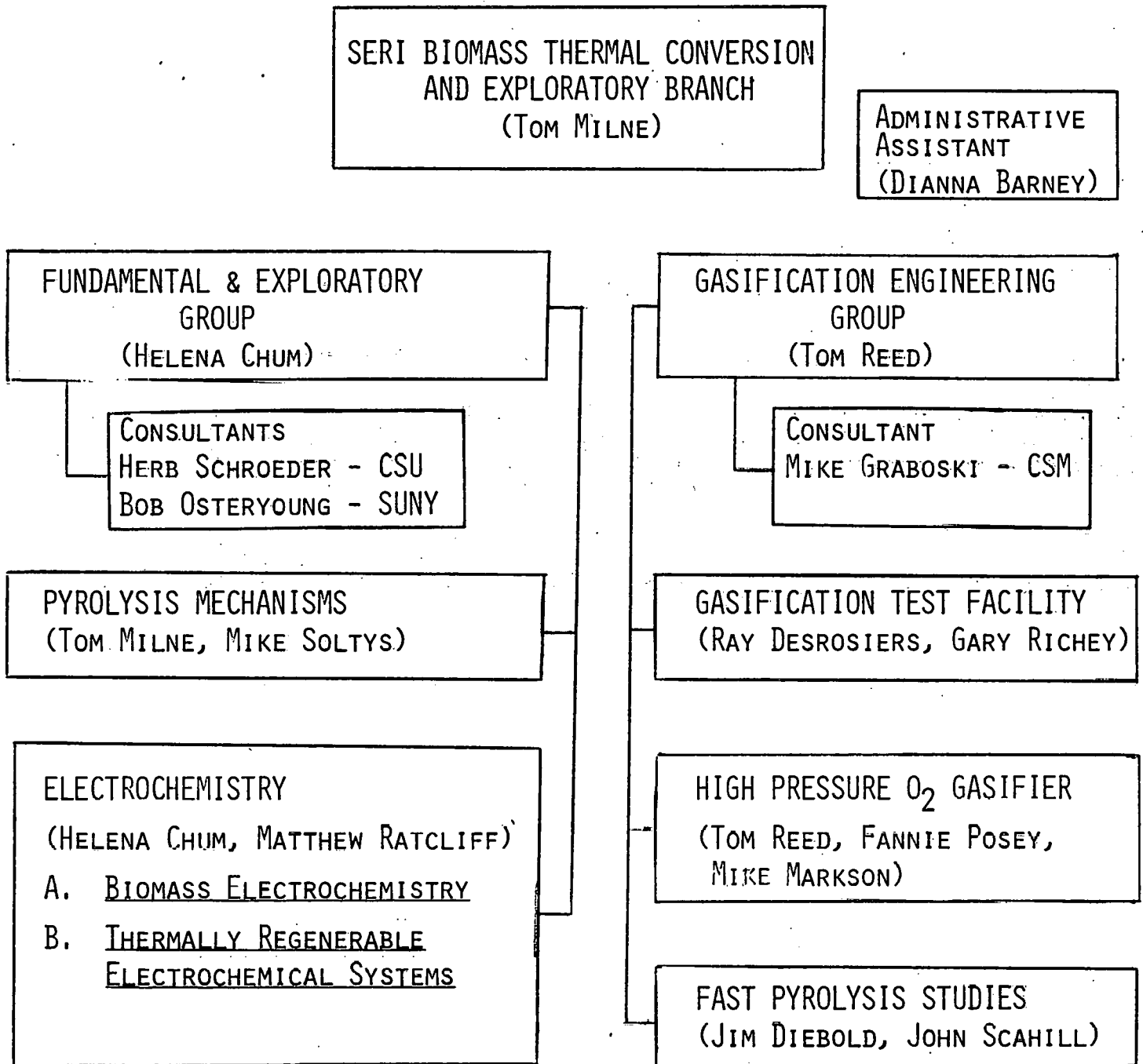

Table 2.



Under the Gasification Engineering Group, two process development units are under construction, each employing novel design configurations. At one extreme, a high-pressure,  $O_2$ , downdraft gasifier is being developed to convert biomass cleanly to  $CO$  and  $H_2$  for subsequent synthesis of methanol and ammonia at the farm-coop scale. At the other extreme, a fast pyrolysis reactor has been designed to create high-value intermediate products such as ethylene and benzene, for subsequent conversion to liquid fuels or for petrochemical feedstock replacements. Both of these programs are supported by a third task aimed at mathematical modeling of a variety of gasifier configurations based on data obtained from carefully instrumented test reactors.

The electrochemical program, though in many cases involving "gasification" (e.g., formation of volatile products from condensed-phase compounds) will not be described in detail. It involves the conversion of biomass-derived products into high energy content chemicals and petrochemical substitutes. The initial studies will involve hydrocarbon and hydrogen production. Special emphasis will be given to the investigation (by electrochemical means) of the carboxylic acids obtained in the liquefaction of wood. Oxidations and reductions will be attempted. The liquefaction procedures include mild autooxidation pretreatment of wood. The long term research will involve indirect electrochemical processes involving unusual valence states and electroorganic synthesis with conventional or modified electrodes applied to the reduction of polyalcohols aiming at the production of hydrocarbons or monoalcohols. These syntheses aim to yield more specific products for easier separation from the aqueous solutions, and thus avoid steps in the biomass refining. Fundamental electrochemical investigations include the study of emerging lignins, e.g., from steam explosion procedures, lignin model compounds, and oils resulting from the pyrolytic treatment of wood.

Branch personnel are involved in a supporting role in a boiler retrofit demonstration at a neighboring correctional institute. The objectives are to test the feasibility of:

- a. Retro-fitting a boiler to run on producer gas.
- b. Separating the paper fraction of municipal solid waste.
- c. Cubing and densifying the cellulosic fractions for use as a feed for the gasifier.

Also to:

- d. Gain hands on experience at operating the above kinds of equipment on a routine basis.
- e. Evaluate the entire system for future scale up.

The classification equipment and the cuber are being provided by the SPM Group (Service Precision Machinery). The gasifier is a Forest Fuels, sloping grate, close coupled, air-blown gasifier. The boiler being retro-fitted is located at Camp George West in Golden. This is a minimum security prison operated by the Department of Corrections of the State of Colorado and inmate labor is being used for some of the construction and will be used for much of the operating labor.

The gasifier will be run first on wood chips. The classification equipment will be tested with waste from the Federal Center in Lakewood, Co. Each portion of the system will be tested independently at first. The ultimate goal of the test will be to have all components operating for a sufficient length of time to evaluate performance. SERI involvement with the test is through technical coordination and 50% funding.

Three of the principal, long-term gasification tasks are discussed in the following sections. The fast pyrolysis studies are described in a companion paper at this meeting.

## B. The Kinetics and Mechanisms of Fast Pyrolysis (T.A. Milne)

### 1. Introduction

At the 9th Thermochemical Conversion Contractors Meeting (1979) the general goals and approach in our fast pyrolysis studies were reviewed, with a discussion of the principals of high-pressure, molecular-beam, mass spectrometric sampling. We have now completed construction and preliminary testing of the sampling system and are preparing for the introduction of powdered biomass into a hot steam environment for observation, in real time, of some of the pyrolysis steps leading to olefins and related products. The following sections review the general approach, the design and performance of the sampling system and the plans for biomass pyrolysis experiments.

### 2. Background

Underlying all biomass thermal conversion processes, including combustion, gasification or liquifaction, is a pyrolysis step or steps. An understanding of the fundamental processes of pyrolysis, under the variety of heating conditions encountered in real or proposed conversion schemes, is important both in optimizing existing systems for desired products and in conceiving of entirely new conversion routes to novel products.

The objective of the present task is to determine the fundamental chemical and physical processes by which biomass pyrolyzes, using realistic but controlled laboratory conditions. The emphasis of initial studies is on the fast pyrolysis of both finely divided and massive pieces of biomass.

A thorough review of past research in gasification and pyrolysis of biomass reveals that voluminous laboratory studies of thermal behavior of wood, cellulose, lignin, MSW, etc. have been performed. (Milne, 1979). However, few workers achieved the desired combination of: (1) simulating conditions, at the laboratory scale, of relevance to "real" gasifiers and (b) applying sampling devices and analytical techniques of sufficient versatility to record the entire process of pyrolysis with both high spatial and time resolution. This has been especially true for the case of fast pyrolysis of finely divided biomass to achieve highly non-equilibrium products. Our review has indicated that such fast pyrolysis/gasification, which yields a high-value and versatile olefin product, is a promising candidate for additional fundamental as well as applied research.

A number of studies partially characterize pyrolysis gasification under conditions of rapid heatup, high temperature, or short residence time. These studies can be grouped under four categories:

- (a) slow-solid pyrolysis followed by short residence time for re-forming or secondary pyrolysis (Anlal et al. 1979; Antal, 1980.)
- (b) fast-solid pyrolysis followed by almost instantaneous quenching of primary products in cold gas or vacuum (Lincoln 1965, 1974; Lincoln and Covington 1975; Martin 1965; Lewellen et al. 1976; Hileman et al. 1976; Broido and Martin 1961, Howard et al., 1980.)
- (c) fast-solid pyrolysis followed by relatively short residence times for re-forming or secondary pyrolysis (Brink and Massoudi 1978; Allan and Mattila 1971; Prahacs et al. 1971; Rensfelt et al. 1978; Berkowitz, Mattuck and Noguchi 1963; Diebold and Smith 1979; Kuester 1978; Brink et al. 1973; Mallon 1974).

- (d) fast pyrolysis followed by relatively long residence times for re-forming or secondary pyrolysis (Brink 1976; Stern et al. 1965; Barber-Coleman 1975); or very high effective temperatures (Brown 1979; Krieger et al. 1979; Allan and Mattilla 1971).

These studies are summarized and results compared in Milne (1979) with the emphasis on production of olefins, since these high value products are observed only in fast pyrolysis.

From all the evidence cited it appears that the products of primary pyrolysis are a sensitive function of physical size and state of the material, inorganic impurities, heating rate, and final temperature. Gaseous environment seems to be relatively unimportant. Secondary reactions are a function of contact with char, temperature, pressure, dilution, and residence time, with gaseous environment again perhaps secondary (air excluded). The "ideal" fast pyrolysis/gasification study should permit time resolved measurement of both the residue and gaseous species during the entire course of the reaction, with millisecond time resolution, in a realistic gaseous process environment at pressure and with particle sizes and loadings of practical interest.

### 3. Experimental Approach:

Under this task, we have constructed specialized apparatus to permit detailed mechanistic studies of fast pyrolysis under controlled, but realistic laboratory conditions. The approach is to combine a pulverized biomass, fast flow, rapid heat-up, short-residence time reactor/pyrolyzer/gasifier with a direct, high-pressure, molecular-beam, mass-spectrometric sampling system.

#### a. High-Pressure, Molecular Beam Mass-Spectrometry.

A versatile method of sampling reactive systems at atmospheric pressure and above, is to extract gas through small, conical, sonic orifice into high vacuum. If proper combinations of differentially pumped regions are used, the extracted gas is expanded to collisionless flow in microseconds, and the resulting molecular flow can be collimated so that a portion directly enters the ion source of the mass spectrometer without wall collisions. In this manner even highly reactive free radicals and condensable species can be sampled, with the mass spectrometer constituting one of the most versatile analytical detectors available.

The molecular beam sampling system constructed for this work, follows a design used successfully in previous work at Midwest Research Institute for the study of the early pyrolysis/combustion stages of pulverized coal flames, among other applications. A schematic of the system is shown in Fig. 1. (Milne & Beachey, 1977, a,b; Milne & Greene, 1969).

#### b. Fast Pyrolysis/Gasifier Reactor.

In the design of a fast pyrolysis reactor it is desirable to incorporate the following features:

- (1) Fast Pyrolysis of small particles:
  - (a) Dilute solid phase, entrained flow reactor capable of interfacing with the sampling system from the earliest stages of reaction.
  - (b) Heating rates up to  $10^{50}\text{C/sec}$ .

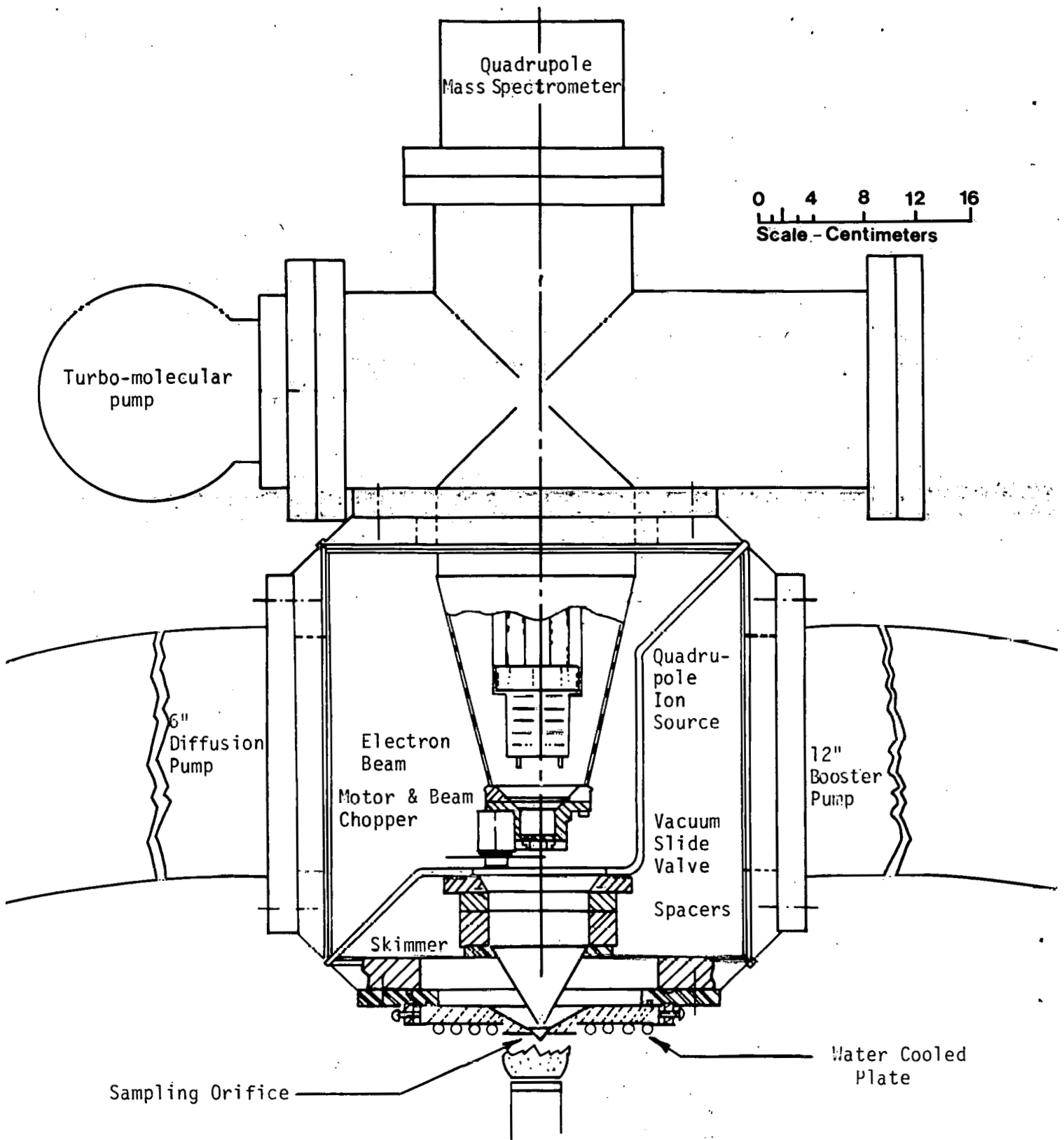

Fig. 1. Schematic of the Direct, Molecular-Beam, Mass-Spectrometric, Sampling System

- (c) Sampling time resolution of milliseconds.
  - (d) One-dimensional, characterizable flow.
  - (e) Usable with inert gases, steam, H<sub>2</sub>, other gases
  - (f) Capable of handling a variety of finely divided feedstocks.
- (2) Fast pyrolysis of large particles:
- (a) High heat deposition rates from a uniform, controllable source.
  - (b) Ability to interface the pyrolysis plume with the molecular beam sampling system under a variety of atmospheres and range of pressures from vacuum to several atmospheres.

The laboratory pyrolysis reactor being tested consists of a combustion system, burning slightly rich, which will produce a hot steam/CO<sub>2</sub> environment. Particles of biomass will be injected into the burnt gas and their behavior studied as pyrolysis proceeds. The flame has several advantages. Quite extreme cracking conditions can be achieved and the atmospheres can be varied from nearly pure CO<sub>2</sub> (in a CO-O<sub>2</sub> flame) to nearly pure H<sub>2</sub>O (in a H<sub>2</sub>-O<sub>2</sub> flame). One can easily probe through the system to observe the very earliest stages of pyrolysis as the particles mix and heat up in the flame gases. In addition, this system models quite realistically one of the possible reactor configurations that may be adapted from commercial petroleum practice to biomass application. (Gomi & Araki, 1971 and Kniel et al., 1980).

#### 4. Performance of the SERI High-Pressure, Molecular-Beam, Mass Spectrometric Sampling System.

We have carried out a few generic tests of the new SERI system to relate the performance to previous systems used at Midwest Research Institute (Milne & Beachey, 1977).

To test the pumping capability of the various stages of the system, and the variation of beam intensity with the crucial variable orifice-skimmer distance ( $z$ ), a series of measurements were made with thin, circular orifices attached to a moveable inlet tube. The system pressures are shown in Table 3 and the behavior of molecular beam intensity with orifice size and orifice-skimmer distance is shown in Fig. 2.

The system seems to work well with one-atmosphere air and orifices as large as 0.030" diameter. In sampling heterogeneous systems, orifices of this diameter may be necessary to minimize physical plugging during an experiment. Actually, with hot gases the mass flow across the sonic orifice is a function of  $T^{-1/2}$  so that even larger orifices may be feasible. Also shown on Fig. 2 is a single point for a 0.020" orifice at the apex of a spun-copper cone (as shown in Fig. 1). Good beam intensity is shown at the  $z$ -value chosen. In fact, with hot flame gases ( $\approx 2000$  K), beam intensities increase about a factor of five.

PRESSURE, TORR

ORIFICE	STAGE I		STAGE II		STAGE III	ORIFICE-TO- SKIMMER DISTANCE
	CHAMBER	FOREPRESSURE	CHAMBER	FOREPRESSURE	CHAMBER	Z
0.010", Flat	$1.8 \times 10^{-2}$	$2 \times 10^{-1}$	$1.0 \times 10^{-4}$	$2 \times 10^{-2}$	$5.3 \times 10^{-7}$	0.77"
0.020", Flat	$3.3 \times 10^{-2}$	$5 \times 10^{-1}$	$1.1 \times 10^{-4}$	$4 \times 10^{-2}$	$5.0 \times 10^{-7}$	1.18"
0.030", Flat	$2.5 \times 10^{-1}$	1.0	$5.0 \times 10^{-4}$	$1 \times 10^{-1}$	$1.0 \times 10^{-6}$	0.85"
0.020", Cone	$3.0 \times 10^{-2}$	$5 \times 10^{-1}$	$1.6 \times 10^{-4}$	$5 \times 10^{-2}$	$4.8 \times 10^{-7}$	0.92"

Table 3. Typical Sampling System Pressures at Optimized Orifice-to-Skimmer Distances. (Except for conical orifice, which was fixed at 0.92")

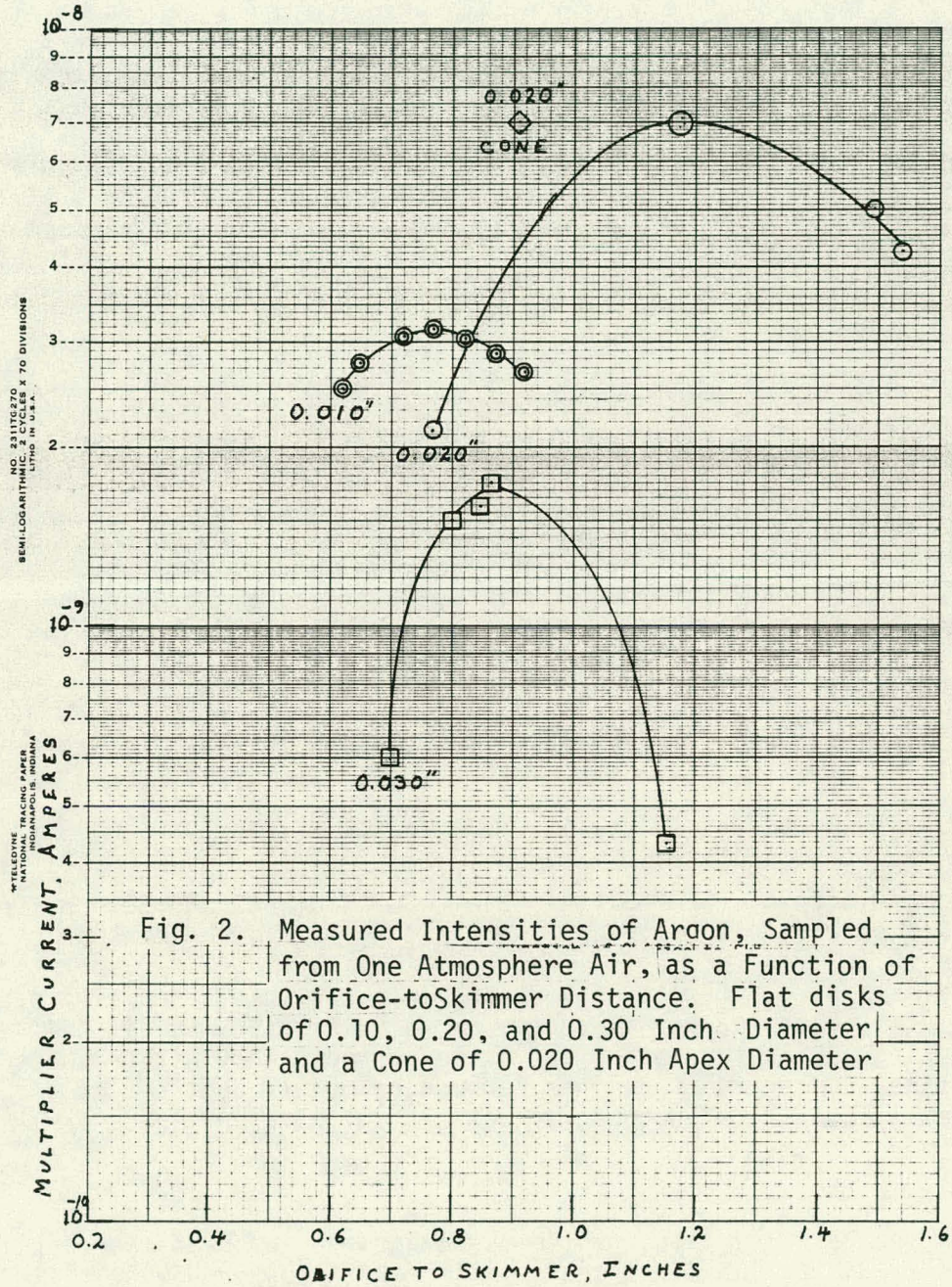

The differential pumping achieved in the various stages of the system resulted in an excellent signal-to-noise ratio for the chopped beam that finally reached the mass spectrometer ion source. Fig. 3 shows an oscilloscope trace of the modulated signal (nominal 100 Hz chopping frequency) from the  $O_2$  component of air. The signal-to-noise ratio is about 14/1, a very satisfactory value.

Another test of sampling system behavior consists of observations of the ratios of argon clusters in the expansion of pure Argon. Fig. 4 shows the  $Ar_n^+$  cluster ions observed when one atmosphere of argon, at room temperature, is expanded through a flat, 0.010" dia. orifice. The behavior is consistent with extensive past work (Milne and Greene, 1969) indicating a shock-free, adiabatic expansion of the sampled gas to collisionless molecular flow.

As a further test of system capability, mass spectral scans were made while sampling room air and the gases from the reaction zone of a stoichiometric  $CH_4$ /air flame. Figures 5-7 show typical scans over a limited mass range by which daily performance is monitored. Figure 5 is a scan of total multiplier output, with no modulated beam present (DC), and represents the background contamination in the mass spectrometer. The major peaks at  $H_2O$ ,  $N_2 + CO$ ,  $O_2$ , Ar and  $CO_2$  are not unexpected. Figure 6 shows the peaks obtained from a one-atmosphere air beam using phase-sensitive detection of the chopped beam (AC). The dominant peaks,  $N_2$  and  $O_2$  are off scale. The 1% argon and about 0.03%  $CO_2$  are clearly visible as is the  $H_2O$  peak. Water cluster peaks are seen at mass 19 ( $H_3O^+$ ) and  $37^+$  ( $H_3O^+ \cdot H_2O$ ). Other peaks are fragment ions or common isotopes. Fig. 7 shows a similar AC scan of the gases from the reaction zone of a stoichiometric methane-air flame.  $CO_2$  and  $H_2O$  are now quite large, the water clusters are gone and hydrocarbon-originating peaks at  $15^+$  (probably  $CH_3^+$  from  $CH_4$ ) and  $26^+$  are now present. Note also the  $30^+$  peak, probably due to NO. In  $H_2$ - $O_2$ -Ar flames, hydrocarbons will be easier to detect. (Note: all these spectra were taken at 50 eV ionizing electron energy. At lower electron energies, fragmentation will be reduced and free radicals like OH can be observed.)

In relatively slower scans ( $\sim 5$  amu/minute) over bigger mass ranges, higher sensitivity results are shown for species from air (Table 4) and species from the methane-air flame (Table 5). As an indication of sensitivity, note that the natural Kr isotopes in air can be seen at the 130 to 650 parts per billion level. Fig. 8 shows a portion of a scan from the flame over the Kr region. (The abundance in air is:  $82^+$ ,  $83^+$ ,  $84^+$ ,  $86^+$  at 130, 130, 650 and 200 ppb. respectively.) Even higher sensitivity can be achieved with slower scans or signal averaging.

As a final example of very preliminary tests, species profiles through the one-atmosphere  $CH_4$ -air flame are shown in Fig. 9. We did not yet have a good positioning device for moving the flame reproducibly with respect to the sampling orifice, but the dotted lines connecting points upstream of the reaction zone and those in the reaction zone, are consistent with previous work.

## 5. Future Work.

The basic sampling system is now tested and ready for application to pyrolysis studies. The first tests will be with powdered wood fed into burnt gas columns (steam) of a stoichiometric  $H_2$ - $O_2$ -Ar flame. Measurements are also planned for pyrolysis of massive particles under high heat flux. These studies will provide information directly relevant to some of the new concepts being studied in our task on fast pyrolysis engineering. The heat flux will be provided by either



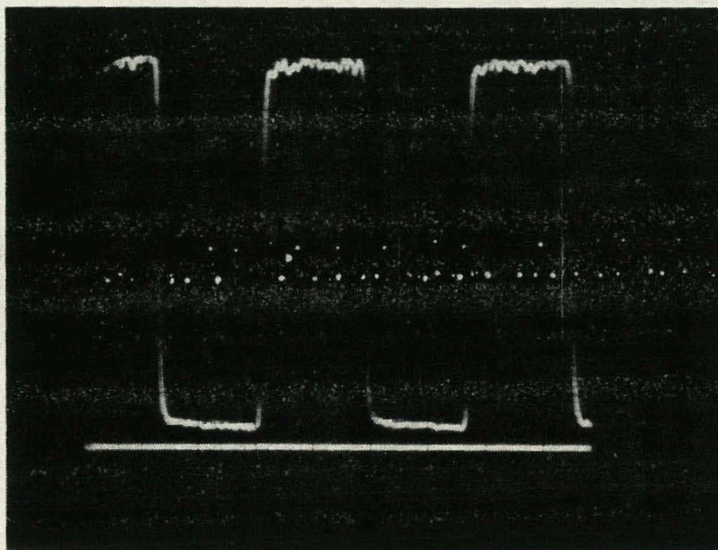

Fig. 3. Oscilloscope Photo of  $O_2$  Beam Intensity at a Chopping Frequency of about 100 Hz

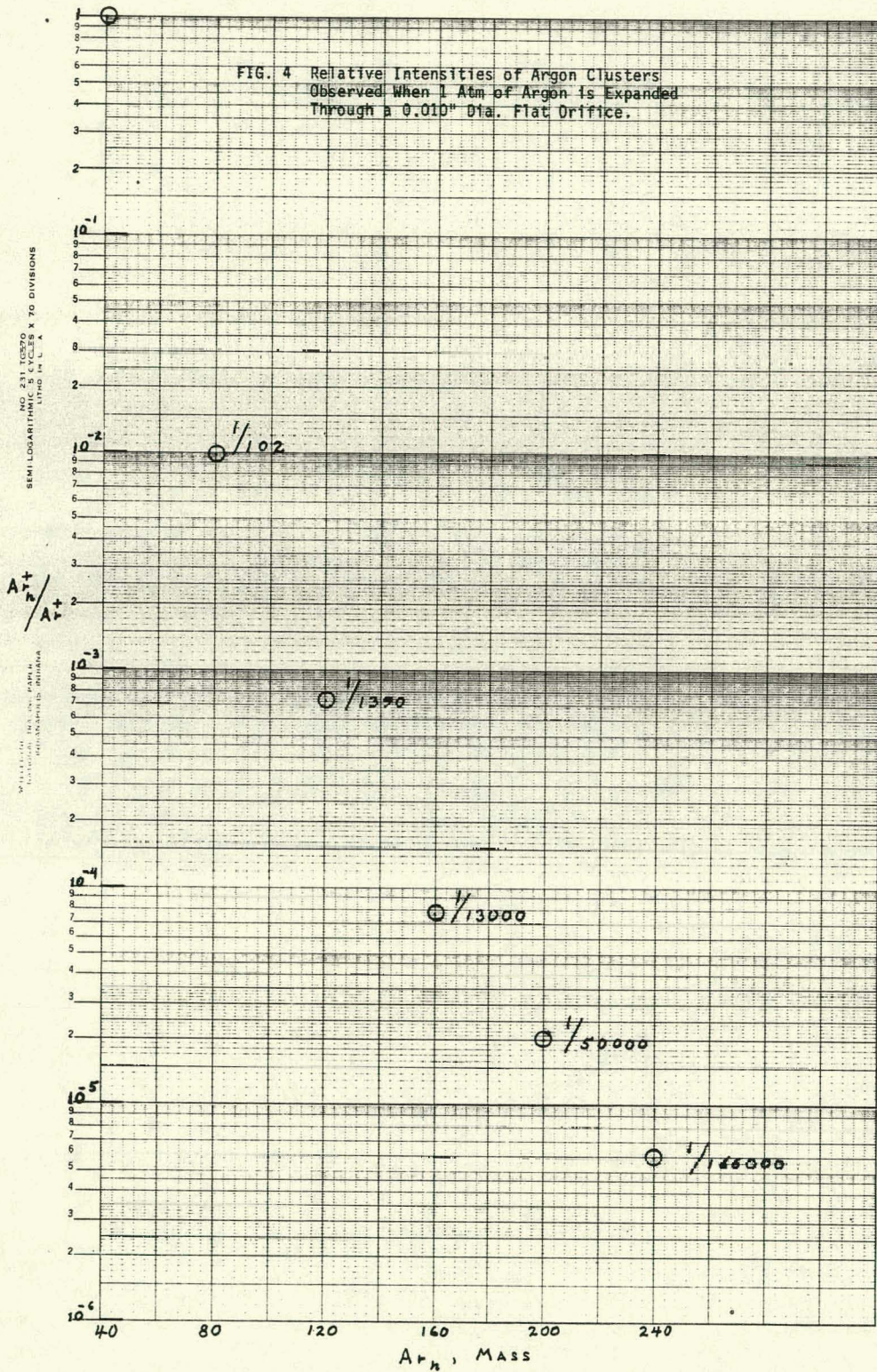

Fig. 4. Relative Intensities of Argon Clusters Observed When 1 Atm. of Argon Is Expanded Through a 0.010 Inch Diameter Flat Orifice

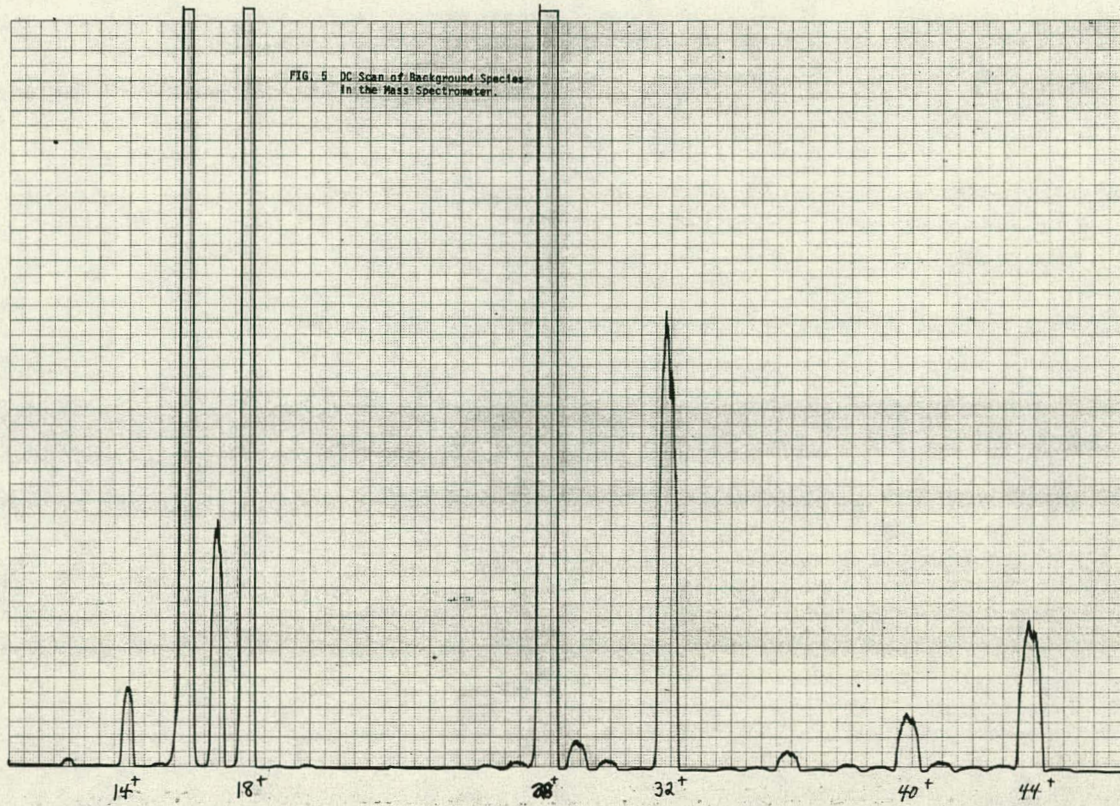

Fig. 5. DC Scan of Background Species in the Mass Spectrometer

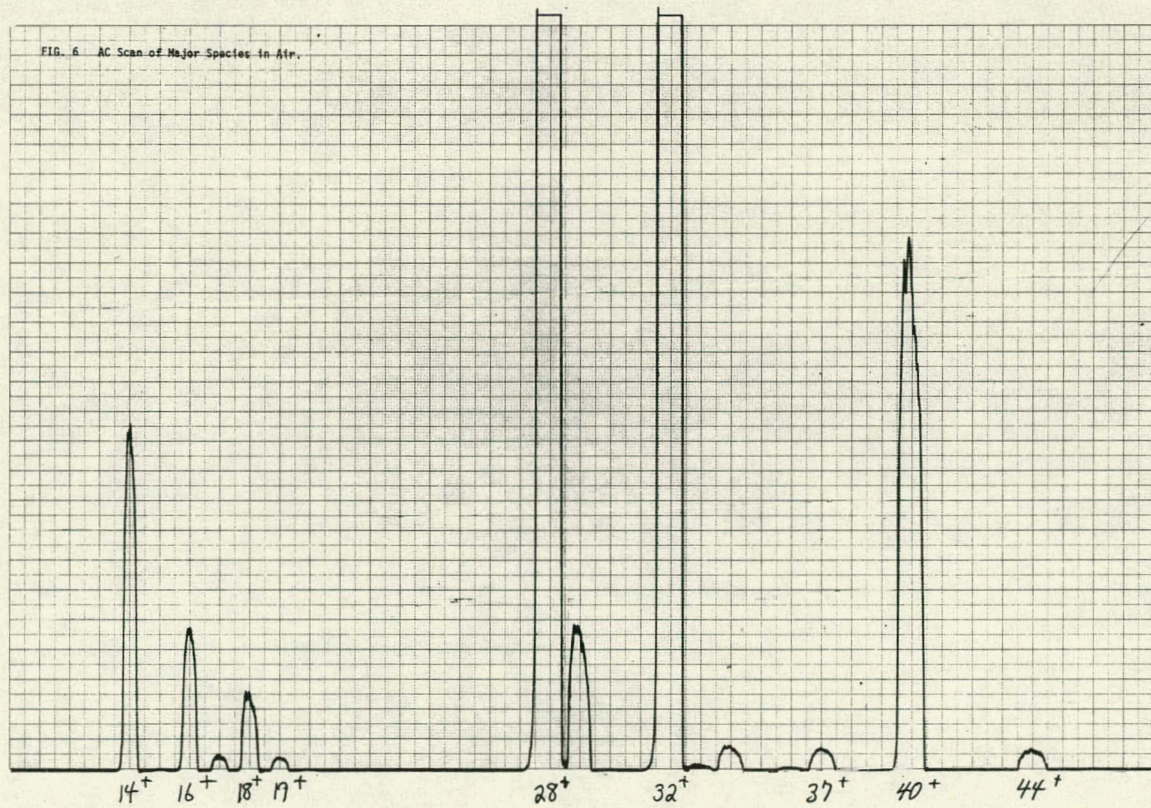

Fig. 6. AC Scan of Major Species in Air

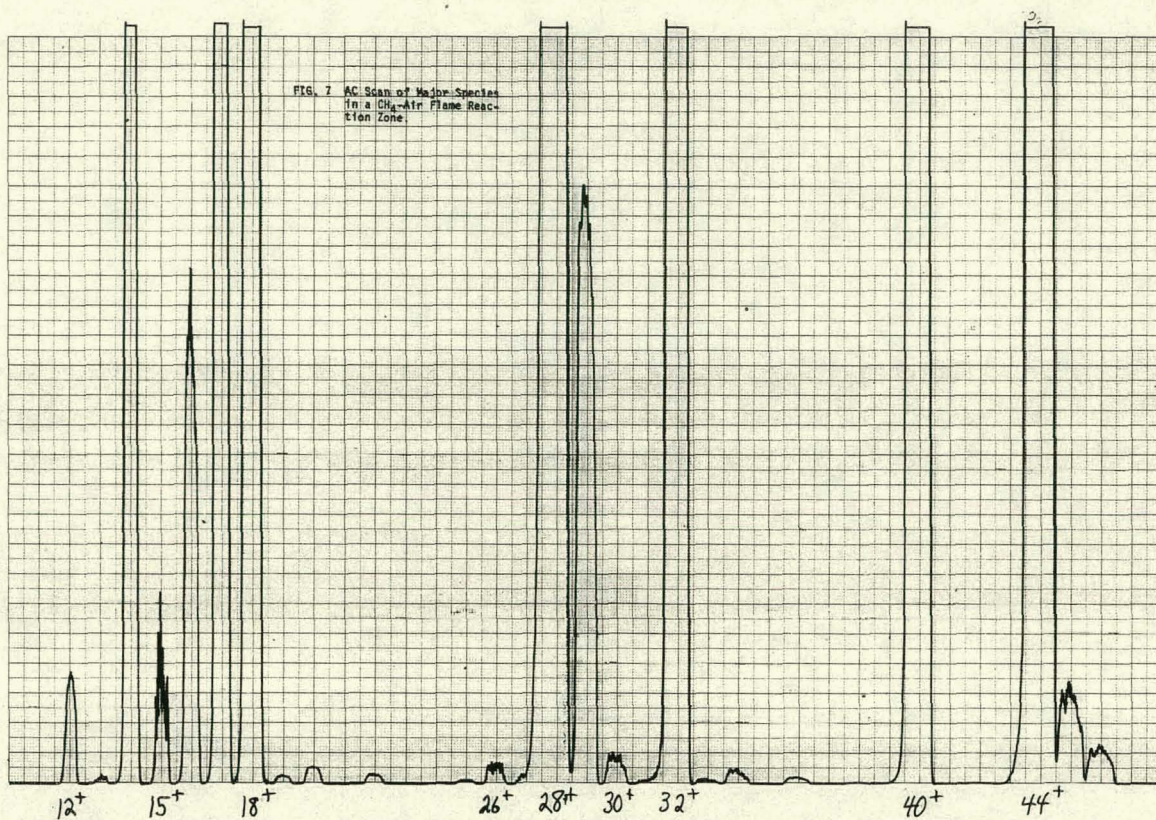

Fig. 7. AS Scan of Major Species in a CH<sub>4</sub>-Air Flame Reaction Zone

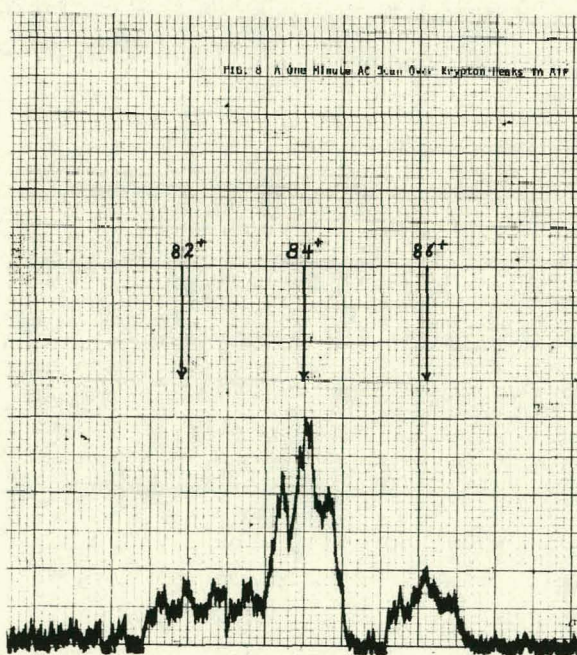

Fig. 8. A One Minute AC Scan Over Krypton Peaks in Air

Table 4

ORDER OF MAGNITUDE CONCENTRATION OF SPECIES IN A  
ROOM TEMPERATURE AIR BEAM

<u>MASS</u>	<u>"CONCENTRATION"</u> <u>PPM**</u>	<u>MASS</u>	<u>CONCENTRATION</u> <u>PPM</u>
13*	<0.3 ppm	60	2.8
14	7,200.	64	7.6
15	--	68	1.0
16	2,800.	69	0.3
17	270.	72	1.7
18	1,300.	73	133.
19	270.	75	0.9
20	--	84	0.7
21	0.6	91	-
22	0.6	93	0.4
28	>13,300.		
29	3,100.		
30	11.		
32	>13,300.		
33	--		
34	479.		
36	--		
37	330.		
38	6.9		
40	(9,300.)		
42	2.0		
43	0.4		
44	330.		
45	4.4		
46	12.2		
47	0.4		
48	3.5		
54	0.9		
55	200.		
56	--		
57	1.6		

\*Mass numbers of less than 0.3 ppm are not listed.

\*\*"Concentrations" are estimated by comparing ion ratios to 40<sup>+</sup>, which was assumed to be at 9,300 ppm in air.

18  
Table 5

ORDER OF MAGNITUDE CONCENTRATION OF SPECIES IN A  
STOICHIOMETRIC CH<sub>4</sub>-AIR FLAME NEAR THE REACTION ZONE

<u>MASS</u>	<u>"CONCENTRATION"</u> <u>PPM**</u>
11	<0.1
12	630.
13	6.3
14	>3,680.
15	>3,680.
16	2,300.
17	>3,680.
18	>3,680.
19	48.
20	110.
22	66.
26	0.3
28	>3,680.
29	3,200.
30	70.
32	>3,680.
33	5.1
34	26.
36	29.
38	5.9
40	(9,300.)
41	0.55
42	1.3
44	>3,680.
45	700.
46	260.
47	2.6
48	0.3
82	0.2
83	0.2
84	0.7
86	0.3

\*Mass numbers less than 0.1 ppm are not unlisted.

\*\*"Concentrations" are estimated by comparing ion rations to 40<sup>+</sup>, which was assumed to be at 9,300 ppm in the flame.

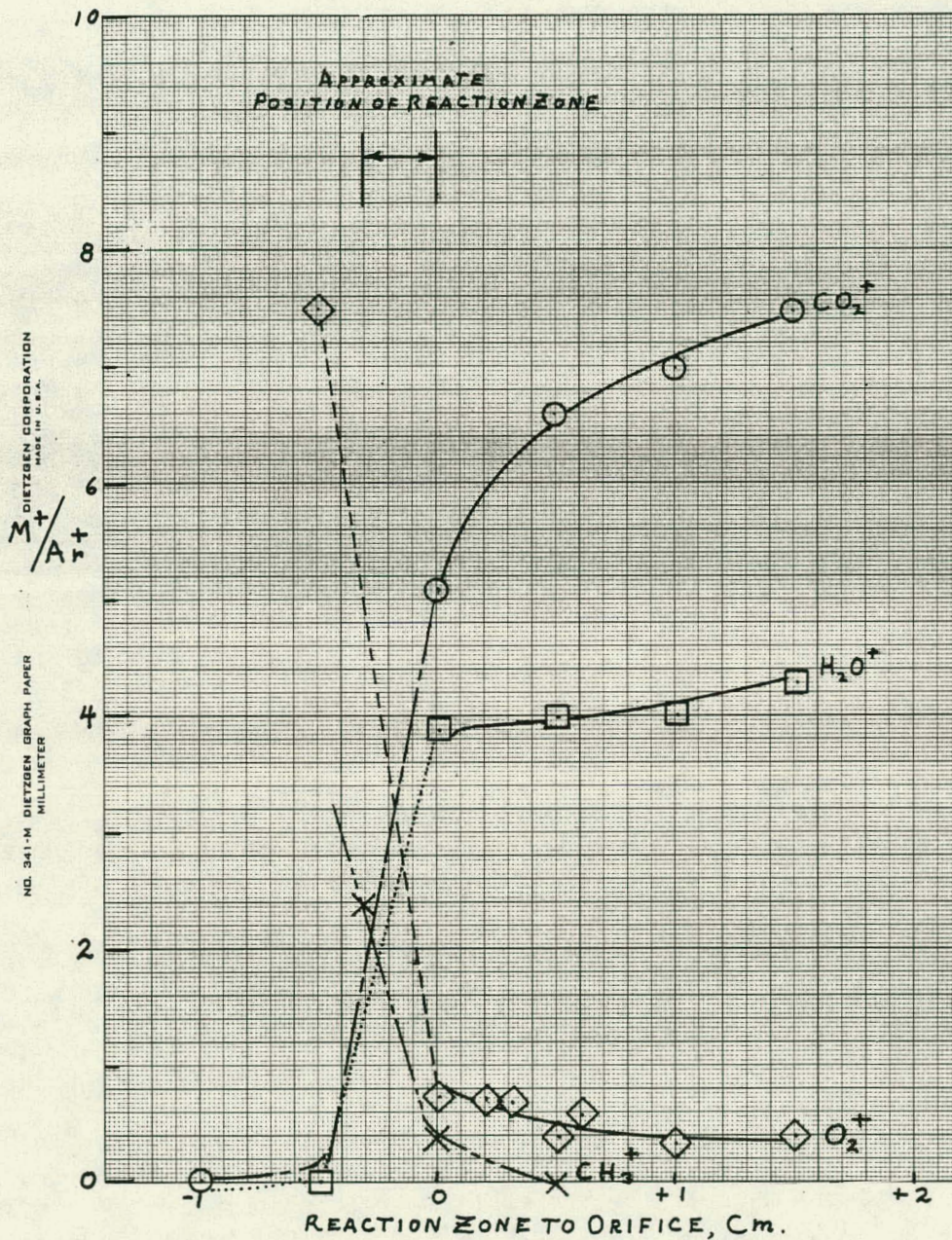

Fig. 9. Flame Profiles Through a Stoichiometric  $CH_4$ -Air Conical Flame

a CO<sub>2</sub> or Nd-YAG CW laser. The laser produced pyrolysis products will be sampled by techniques developed by Greene (1977).

### C. The SERI High Pressure Oxygen Gasifier (T.B. Reed and M. Graboski).

#### 1. Introduction.

Gasification is a well tested method for converting solid fuels such as coal or biomass to a gas that can be used for heat, power production or pipeline gas. The gas produced consists primarily of CO, H<sub>2</sub> and CH<sub>4</sub> and can also be used to synthesize liquid fuels such as methanol or gasoline.

Although both coal and biomass gasifiers have been widely used in the past, there are no biomass gasifiers presently available to make a medium energy gas suitable for chemical synthesis. [See SERI's Survey of Biomass Gasification, 3 Volumes, SERI/TR-33-239 (1979, 1980)]

#### 2. Design Considerations for an Oxygen Gasifier.

The simplest method for generating a suitable medium energy gas is oxygen gasification. The Union Carbide Purox gasifier produced primarily CO and H<sub>2</sub> which could have been used for chemical synthesis. The Purox gasifier was an updraft gasifier which produced large quantities of a heavy oil which was scrubbed from the gas near room temperature and returned to the gasifier. This proved to be more difficult than operation of the gasifier itself and imposed severe water cleanup problems on the 250 ton/day plant operated in South Charleston, W. Va. between 1974 and 1978. Also the gas had a high methane content and was produced at atmospheric pressure and so would have required compression to 50-100 atmospheres for catalytic conversion, an energy intensive process. No commercial Purox plants are being built in the U.S. today, though the process is being developed further in Japan. An engineering analysis of the use of biomass in the Purox process was carried out by Desrosiers (1979). (SERI/TR-33-151)

In an updraft gasifier, air or oxygen enters under a grate, gasifies the char on the grate to form hot CO and H<sub>2</sub>, and then passes up through the entering biomass, pyrolysing it and drying it to add pyrolysis oils and water to the gas stream. These oils can contain as much as 30% of the original biomass energy.

In a downdraft gasifier, air or oxygen and biomass enter the reaction zone together causing an initial pyrolysis and drying. The oils, CO<sub>2</sub> and H<sub>2</sub>O produced then pass down through a bed of hot charcoal, cracking these oils and reducing the CO<sub>2</sub> and H<sub>2</sub>O to CO and H<sub>2</sub>. Thus the order of events in a downdraft gasifier is reversed from the updraft and as a result very little oil is produced due to the cracking action of the char bed. A million or so of these gasifiers were used in Europe during World War II to power cars and trucks.

In 1978, SERI and Environmental Energy Engineering at Morgantown West, Virginia operated a small World War II (Hesselman, 50 kW) gasifier on wood pellets and on "air" gradually enriched by oxygen up to pure oxygen. To the surprise of the operators, the temperature in the gasifier only increased about 100°C as the air was gradually replaced by oxygen at a fixed biomass feed rate. We believe the explanation of this effect lies in what we have termed "reaction temperature stabilization" that occurs in a downdraft gasifier. If the operating temperature of about 1000°C increases, the endothermic reactions involving reduction of CO<sub>2</sub> and H<sub>2</sub>O and cracking of pyrolysis oils speed up, thus minimizing the temperature increase. If for any reason the temperature tends to decline, the endothermic reactions become sluggish and the exothermic combustion reactions dominate, thus minimizing the temperature decrease. We believe this to be a very important principle and have incorporated it in the design of the SERI oxygen gasifier.

Although downdraft gasifiers produce much less tars than updraft, there is still enough tar to that the gas must be filtered before it is used in engines. The hot char zone in downdraft gasifiers is typically only about 10 cm long, so that even though the oils are not thermodynamically stable at high temperatures, it is not surprising that not all of the tars crack in this zone. However, it should be possible to crack all the tars, provided a long, hot char zone can be maintained.



### 3. Gasifier Design and Construction.

Initial sketches of a small "proof of concept" gasifier incorporating these principles were taken to Hazen Research Inc., an R & D Company located in Golden, Colorado in December 1979. In conference with several of their engineers, the final gasifier vessel, shown in Figure 10 was designed early in 1980. The piping and instrumentation diagram of Figure 11 was designed also in consultation with their engineers and an estimate of \$140,000 for the design and construction phase was made by Hazen. Actual construction under a SERI purchase order began in March 1980 and was finished August 15, 1980.

The gasifier in Figure 10 is a downdraft, non-slugging, high pressure, oxygen gasifier. Biomass (initially sawdust pellets) are introduced in the ball valve lock hopper at the top. A burner operating on propane and oxygen supplies pre-heat to the pellets for pyrolysis, since the pyrolysis stage is endothermic. (In a production unit, this heat would be supplied by a small amount of product gas.) The gasifier maintains a bed of char approximately 1 meter long to crack the tars from this pyrolysis and reduce the CO<sub>2</sub> and H<sub>2</sub>O from pyrolysis.

It is planned to operate the char bed at 1000°C. Higher temperatures would risk melting of the ash while lower temperatures would slow down the reactions. In order to maintain this temperature, oxygen is injected at three stages through four lances at each stage. A central thermocouple tube containing 9 type k thermocouples is mounted axially in the bed to monitor temperature on a 24 point L&N recorder. Oxygen flows will be controlled at each level to maintain 1000°C.

In updraft gasifiers the grate has two functions. It supports the weight of the fuel and it allows air or oxygen to contact the hot char. Because this reaction is very exothermic, grate temperatures tend to limit throughput for up-draft gasifiers. The grate in Figure 10 is only a "physical grate" for support of the bed. The actual reaction at a "chemical grate" occurs at the top of the bed and at the sides, a total area of 0.42 m<sup>2</sup> (4.5 ft<sup>2</sup>), so that we expect to have rapid char reduction with relatively low "chemical grate" temperatures.

### 4. Operation of the Gasifier.

The first run was on September 15 using charcoal only and lasted 5 hours. Some difficulty with the lock hopper was encountered, but all instrumentation and temperature control systems were operating well, and a gas containing 20% CO was produced in a bed of charcoal 5-10 cm (2-4 inches) deep. The ball valve feed is being improved and we plan to operate in rapid succession on atmospheric pressure air, then oxygen, then 10 atmospheres air and finally 10 atmospheres oxygen.

### 5. Future Plans.

At present the gas produced is being flared. However plans are underway to construct a catalytic conversion line to produce small amounts of methanol and alcohol fuels. Commercial catalysts will be tested initially, but we will seek unusual new fuel catalysts to test as well.

FIG. 10.

SERI Oxygen Biomass Gasifier

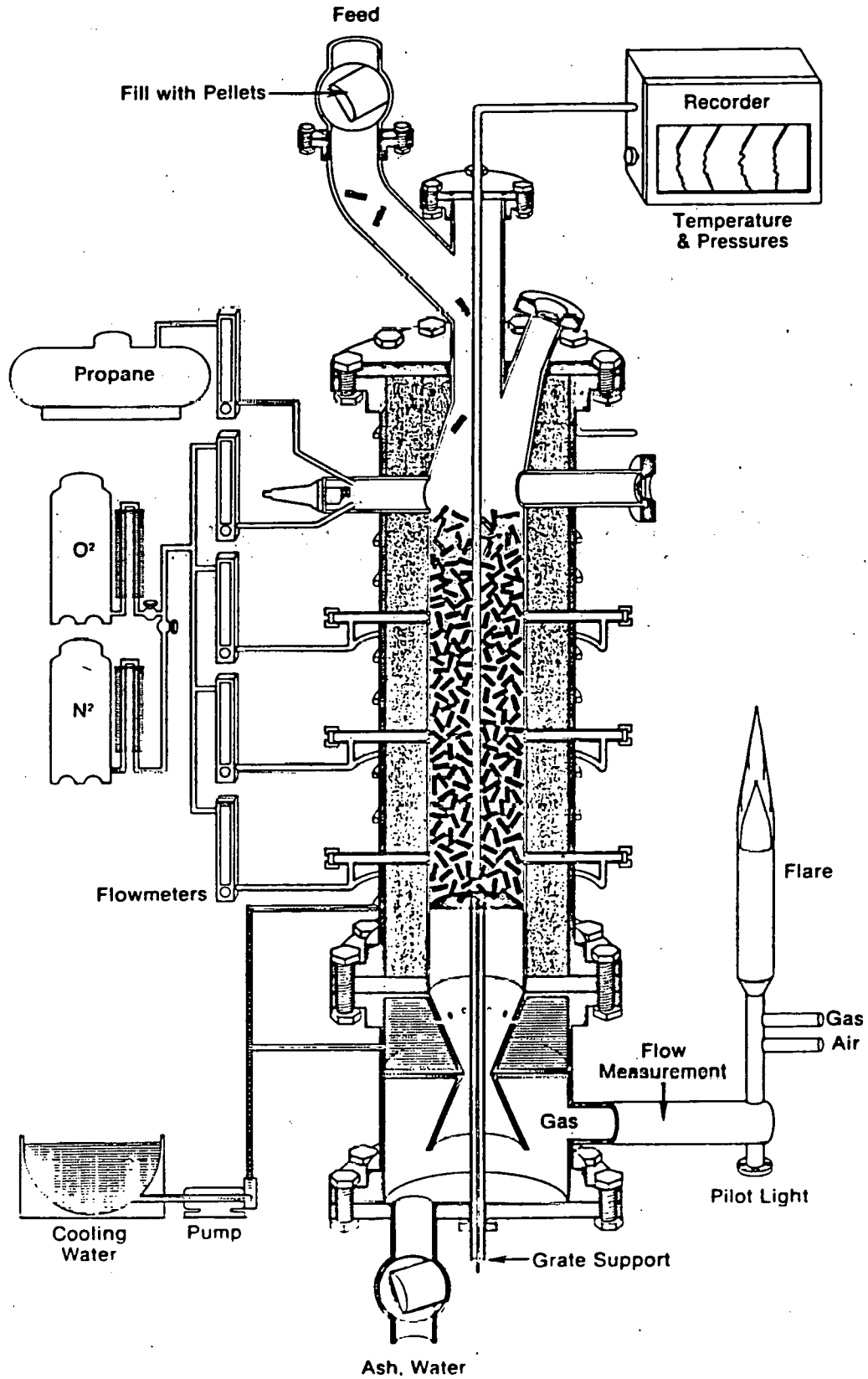

Fig. 10. SERI Oxygen Biomass Gasifier

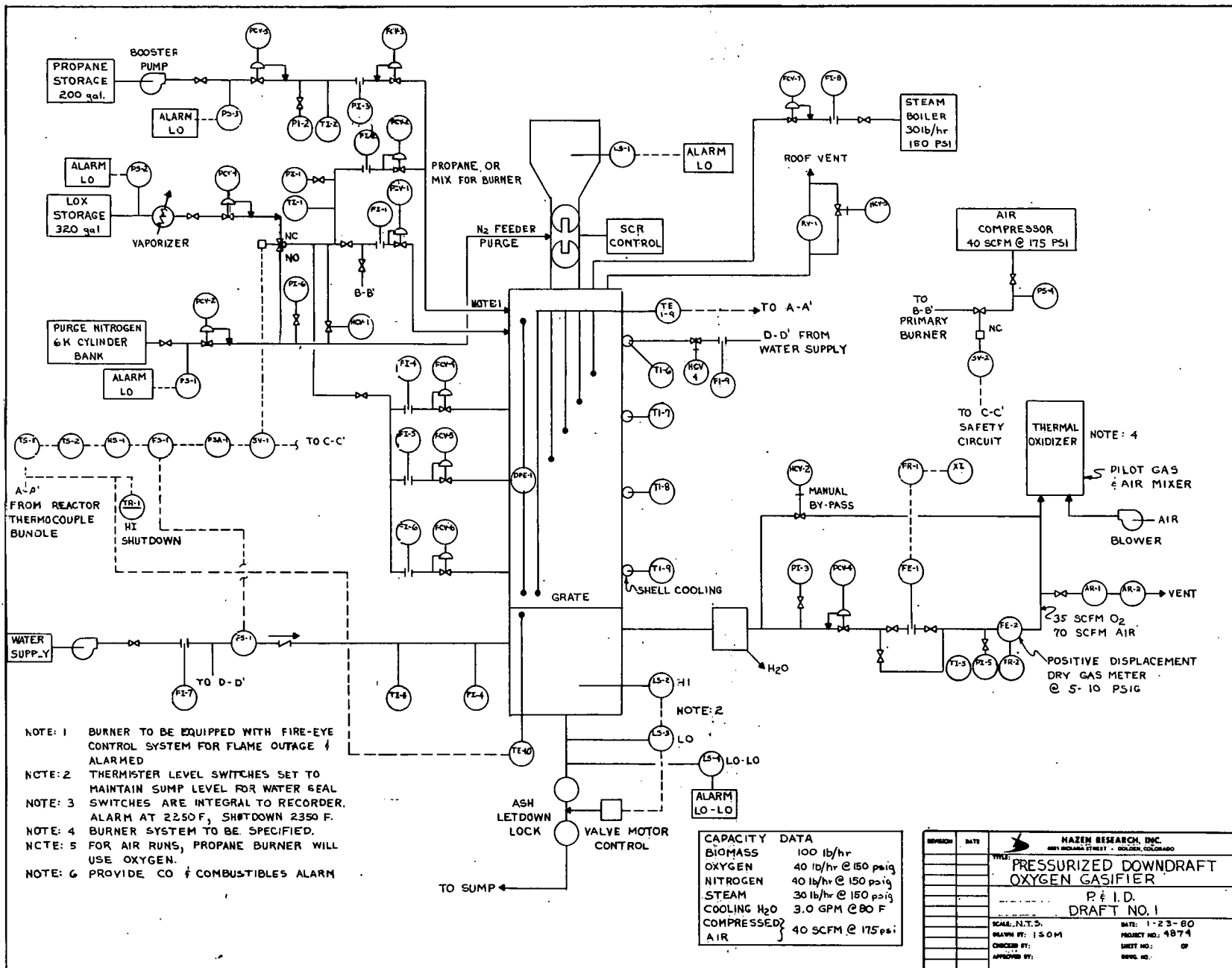

Fig. 11. Piping Diagrams for SERI Pressurized Oxygen Gasifier

## D. Gasification Engineering (R. Desrosiers)

### 1. Introduction

#### 1.1 Thermal Conversion by Gasification

Gasification is a means of converting a solid fuel such as coal or wood to a gaseous fuel. One method of accomplishing gasification is termed partial oxidation pyrolysis. In this process, the heat required for the conversion steps is generated in situ by burning a portion of the feed.

The method of contacting the fluid and solid streams determines the type of equipment used to carry out the gasification step. The simplest type is the moving bed reactor in which the solid feed moves downward, countercurrently to the gas stream. The bed is supported by a grate through which an air stream is passed. The material immediately above the grate is burned to carbon dioxide. The hot carbon dioxide and any steam in the air blast then react with charred feed to yield carbon monoxide and hydrogen. The rising hot gases then encounter fresh feed and the latter undergoes pyrolysis: a splitting into char, oil, and gas. The final product is hot, oil-laden, combustible gas. The raw gas is suitable for combustion in a gas fired boiler. Other methods of contacting such as fluidized or cocurrent moving beds yield a cleaner product because the oils evolved from the pyrolysis of fresh feed have a greater residence time in the bed and are cracked before exiting the reactor. However, the same basic processes described above for the updraft reactor occur in all gasification schemes.

The quality of the product gas can be tailored to match the end use. Gasifiers are currently being used to supply boiler fuel and gas for stationary and transportation engines. The clean gas consists of carbon monoxide, hydrogen, methane (the combustible components), carbon dioxide, and nitrogen (dilutents of zero fuel value). If oxygen is used for gasification in place of air then the product gas is relatively free of nitrogen and with some further processing could be made suitable for chemical synthesis, e.g., the production of methanol.

#### 1.2 The Need for Fundamental Data

Since gasification can utilize a renewable fuel (wood) and satisfy a variety of end uses, several economic studies have been made which attempt to predict capital investment and product costs for wood gasification systems. The studies usually indicate that over half the product cost is attributable to feedstock cost, thus making the overall economics very sensitive to conversion efficiency. Mass balances for biomass thermal conversion schemes have not been closed to better than 10%, thus conversion efficiencies can be in error by at least this amount. Nothing is more fundamental to a chemical reaction than its stoichiometry.

The distribution of biomass sources leads to the conclusion that these fuels may best be used near the sites where they are produced in small capacity units. If gasification is to make a significant contribution to the supply of fuel gas then the technology must be available to adapt the common reactor types to convenient size ranges and to tailor gas quality to the needs of each particular user. This is the realm of reactor design and the major input required is kinetic data on processes occurring in gasification reactors. This data is simply not currently available. Reported rates for gasification of chars can vary by a factor of ten for similar materials. In addition, most of the data has been obtained with fine particles, not the

bulk material used in moving bed reactors. What is needed is fundamental rate data which can be incorporated into a reactor model and used to predict behavior under any process condition and to scale reactors to desired capacities.

## 2. Objectives

The overall objective is a reliable design capability for moving bed biomass gasifiers. It is intended that the goal be achieved by gathering fundamental process data on prototype reactors and developing predictive reactor design models.

Specific objectives include closure of mass balances, and obtaining temperature and composition profiles through a moving bed under steady state conditions.

Specific objectives of the model are to extract intrinsic kinetics of char gasification reactions and to predict the effect of throughput on the air/fuel ratio. From thermodynamic considerations one would expect that there exists an optimum value of this ratio. Under pyrolysis conditions (no air), some char is inevitably produced. As the air/fuel ratio is progressively increased from zero to approximately one fourth of the stoichiometric value (that required for complete combustion) char production is reduced to zero. It is at this point that one achieves maximum conversion: the greatest storage of feedstock energy in the gas phase. However, it appears that the air/fuel ratio is not an independent variable for a wide range of mass fluxes in moving bed gasifiers. That is, suppose one is operating at a steady state at some fixed air rate: if the air blast is then increased then the output will be boosted but the air/fuel ratio may change very little. For some fixed bed depth however, there is a maximum air rate that can be achieved before oxygen breakthrough occurs and the air/fuel ratio greatly exceeds the optimum value. It would be desirable to predict how great a mass flux could be achieved for a particular reactor without departing excessively from the optimum air/fuel ratio.

## 3. Experimental Methods

We have chosen to study an atmospheric pressure updraft gasifier initially. In this type of reactor the solid and gas streams move countercurrently and the processes of combustion, char gasification, and pyrolysis occur in distinct zones which can be individually probed. We have constructed a prototype reactor which is 10 inches in diameter and 30 inches high. (Descriptions of the equipment and flow schematics are included in the appendix).

Initial experiments are being performed with a feed of densified wood pellets. The pellets are produced with constant diameter and the moisture content varies very little in storage. In addition, they are converted to a very dense char which is not easily fractured. This mechanical strength results in lower losses of combustible material to the ash pit.

The primary object is careful measurement of input and output streams. The solid pellets are fed continuously using a feeder which incorporates a lock hopper, a bank of three speed-controlled metering screws, and an injection screw operated at a constant speed of 100 rpm. The separation of the metering and feeding functions in this way results in a reproducible correlation of feed rate and screw speed. We have calibrated the feeder with  $\frac{1}{4}$  inch and  $\frac{3}{8}$  inch pellets and obtained feed rates reproducible to within two

percent. The air input is monitored with an orifice meter/pressure transmitter and is controlled with a Westinghouse Veritrak flow controller. The orifice meter is calibrated against a dry gas meter.

The measurement of the product gas stream is more difficult because of the heavy oil loading. The entire gas stream is quenched and scrubbed and the total flow of cold gas passed through a gas meter. In addition, a tracer injection method is being developed. The entire scrubber water inventory is collected and analyzed for its oil content. The oil loading is also obtained by passing small, measured quantities of gas through in-line, glass fiber filters. Thus both the oil and gas streams are measured by two independent methods.

Gas samples are drawn from various portions of the bed through a specially designed eight-port valve. Ceramic tubes of various lengths are connected to these ports. The valve allows for purging seven tubes with nitrogen while a sample is withdrawn from the eighth. The offgas levels of CO, CO<sub>2</sub>, H<sub>2</sub>O and CH<sub>4</sub> are monitored continuously with Anarad IR analyzers. The most critical measurement is that of water since this cannot be measured on the gas chromatograph.

Samples are withdrawn intermittently from the offgas and analyzed by a Carle Model 111-H gas chromatograph. This is a five-column, three-valve instrument which can reproducibly detect H<sub>2</sub>, CO, CO<sub>2</sub>, N<sub>2</sub>, O<sub>2</sub>, CH<sub>4</sub>, and C<sub>2</sub> thru C<sub>6</sub> hydrocarbons to better than 1% accuracy when properly calibrated. The accuracy of our standard calibration gases is the operating limit of error.

Bed samples are withdrawn through the eight port valve and stored in sample bottles equipped with septa. A syringe is used to withdraw samples from the bottle but the gas sampling valves on the Carle GC are actually used for sample injection. (Syringe injection methods for gas samples are inherently limited in accuracy).

#### 4. Results

Procurement began in August of 1979 and is now complete. All equipment and instrumentation has been installed and checked out. We had our first run on June 4, 1980. At this date we have run eight times, solving equipment problems and gaining operating experience. We are now developing efficient methods of sample collection and analysis.

##### Operational Results:

1. A safe and rapid start-up procedure has been developed.
2. The feeder can charge wood pellets to the reactor continuously and against pressure over the range 0 to 40 kg/hr. The calibration of feed rate with motor speed is linear over this range.
3. The reactor can be brought to steady state in 2.5 hours from a cold start.
4. The scrubber/demistor combination removes 99+% of the oil mist from the offgas.

\*We are still waiting to receive a pressure transmitter and low density pulser. These are the only items not yet installed.

### Analytical Results:

1. With some additional insulation on the reactor we reduced the radial temperature gradient to zero. Axial temperature profiles indicate that with a ten inch bed at steady state, the reactor is nearly isothermal. The range of input air rates investigated so far is only 1.6-7 Nm<sup>3</sup>/h. (1-4 SCFM).
2. We have not been able to get a complete mass balance as yet because we still do not have an analytical procedure for determining concentrations of oil in water. Such a procedure is being developed under subcontract at Hauser Labs in Boulder, CO. However, we are able to collect all effluent.
3. The gas sampling valve works well and we are able to obtain composition profiles through the bed. Preliminary results indicate that we are getting two peaks in CO<sub>2</sub> concentration in the bed. A maximum in CO concentration coincides with the minimum in CO<sub>2</sub> concentration. It appears that the CO<sub>2</sub> formed in the combustion zone is reduced nearly completely to CO in the char gasification zone and that the final CO<sub>2</sub> contribution in the offgas is due to the gas evolution in the pyrolysis zone.

### 5. Modeling

A zero order model has been developed and software is now being written for execution on a Hewlett Packard 9845 desktop computer. As a first cut the model assumes no radial gradients and ignores axial dispersion (plug flow) and gas phase oxidation of H<sub>2</sub> and CO. The following reactions are considered:

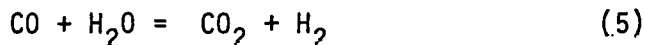

Reactions (1) through (4) are treated as heterogeneous and irreversible and we use a global rate expression incorporating bulk and pore diffusion resistances. Reaction (5) is considered at equilibrium throughout the bed. Drying and devolatilization are considered instantaneous.

The plan is to calculate temperature and composition profiles for this model and then to individually relax the restrictive assumptions made to see which are most in error. The model becomes more cumbersome with each increase in sophistication. Therefore, the degree of complexity will be determined by the level of agreement with the data obtained from experiment. When the differences in model predictions become smaller than the scatter in the data obtained the model development will be concluded.

## References

- Allan, G.G.; Matilla, T. 1971. "High Energy Degradation." Chapter 14 in Lignins. Sarkanen, K. and Ludwig, E.H., ed. Wiley-Interscience.
- Antal, M.J.; Edwards, W.E.; Friedman, H.C.; Rogers, F.E. 1979. "A Study of the Steam Gasification of Organic Wastes." Final Report; EPA University Grant No. R 804836010.
- Antal, M.J. 1980. "Mechanistic and Kinetic Studies of the Gas Phase Pyrolysis Chemistry of Biomass Using Model Compounds." SERI University Program Grant.
- Barber-Coleman. 1975. Molten Lead-Bath Pyrolysis. Houston, TX: NASA LBJ Space Center; March; Final Report on Contract NAS 9-14305.
- Berkowitz-Mattuck, J.B.; Noguchi, T. 1963. "Pyrolysis of Untreated and APO-TIIPC Treated Cotton Cellulose During 1 sec Exposure to Radiant Flux Levels of 5-25 cal/cm<sup>2</sup>-sec." J. Applied Polymer Science. Vol. 7: p. 709.
- Brink, D.L. 1976. "Pyrolysis-Gasification-Combustion: A Process for Utilization of Plant Material." Applied Polymer Symposium. No. 28: p. 1377.
- Brink, D.L.; Massoudi, M.S. 1978. "A Flow of Reactor Technique for the Study of Wood Pyrolysis. I. Experimental." J. Fire and Flammability. Vol. 9: p. 176.
- Brink, D.L.; Massoudi, M.S.; Sawyer, R.F. 1973. "A Flow Reactor Technique for the Study of Wood Pyrolysis." Presented at Fall 1973 meeting of the Western States Section, Combustion Institute.
- Broido, A.; Martin, S.B. 1961. "Effect of Potassium Bicarbonate on the Ignition of Cellulose by Radiation." Fire Research Abstracts and Reviews. Vol. 3: p. 29.
- Brown, D.S. 1979. "Plasma Arc Reduction of Biomass for the Production of Synthetic Fuel Gas." Hawaii ACS Meeting Abstracts, April.
- Diebold, J.P.; Smith, G.D. 1979. "Noncatalytic Conversion of Biomass to Gasoline." ASME Paper No. 79-Sol-29.
- Gomi, S.; Araki, S. 1971. "Pyrolysis of Hydrocarbons using Superheated Steam (2000°C) as Heat Carrier." World Petroleum Congress, 8th Moscow, Sept. 1971. Volume 4, p. 371.
- Greene, F.T. 1977. Private communication, Midwest Research Institute.
- Hileman, F.D.; Wojcik, L.H.; Futrell, J.H.; Einhorn, I.N. 1976 "Comparison of the Thermal Degradation Products of  $\alpha$ -Cellulose and Douglas Fir Under Inert and Oxidative Environments." Thermal Uses and Properties of Carbohydrates and Lignins Symposium. Shafizadeh, Sarkanen, and Tillman, eds. Academic Press; P. 49-71.
- Howard, J.B.; Longwell, J.P.; Peters, W.A. 1980. "Fundamental Studies of the Production of Premium Fuels by Controlled Pyrolysis of Biomass." SERI University Programs Grant.
- Kniel, L.; Winter, O.; Stork, K. 1980. "Ethylene, Keystone to the Petrochemical Industry." Marcel Dekker, N.Y.



- Krieger, B.B.; Graef, M.; Allan, G.G. 1979. "Rapid Pyrolysis of Biomass/Lignin for Production of Acetylene." Hawaii ACS Meeting abstracts. April.
- Kuester, J.L. 1978. "Urban Wastes as an Energy Source." Energy Systems: An Analysis for Engineers and Policy Makers. Marcel Dekker; Jan.
- Lewellen, P.C.; Peters, W.A.; Howard, J.B. 1976. "Cellulose Pyrolysis Kinetics and Char Formation Mechanism." Sixteenth Symposium (International) on Combustion. The Combustion Institute. p. 1471.
- Lincoln, K.A. 1965. "Flash Vaporization of Solid Materials for Mass Spectrometry by Intense Thermal Radiation." Analytical Chemistry. Vol. 37: p. 541.
- Lincoln, K.A. 1974. "A New Mass Spectrometer System for Investigating Laser-Induced Vaporization Phenomena." International J. Mass Spectrometry and Ion Physics. Vol. 13: p. 45.
- Lincoln, K.A.; Covington, M.A. 1975. "Dynamic Sampling of Laser-Induced Vapor Plumes by Mass Spectrometry." International J. Mass Spectrometry and Ion Physics. Vol. 16: P. 191.
- Mallon, G. 1974. U.S. Patent 3,846,096. "Gasification of Carbonaceous Solid." Nov. 5.
- Martin, S. 1965. "Diffusion-Controlled Ignition of Cellulosic Materials by Intense Radiant Energy." Tenth Symposium (International) on Combustion. The Combustion Institute. p. 877.
- Milne, T.A. 1979. "Pyrolysis-The Thermal Behavior of Biomass Below 600°C." Chapter 5 in "A Survey of Biomass Gasification Vol. II. Principles of Gasifications." SERI/TR-33-239. July, 1979.
- Milne, T.A.; Beachey, J.E. 1977<sup>a</sup>. "The Microstructure of Pulverized Coal - Air Flames. Part I. Stabilization on Small Burners and Direct Sampling Techniques. Part II. Gaseous Species, Particulate and Temperature Profiles." Combustion Sci. and Techn. 16, 123-152. 1977.
- Milne, T.A.; Greene, F.T. 1969. "Molecular Beams in High Temperature Chemistry." In Eyring, L., ed., Advances in High Temperature Chemistry. Vol. 2, Academic Press, N.Y.
- Milne, T.A.; Beachey, J.E. 1977<sup>b</sup>. "Direct Sampling and Characterization of Gaseous Species Responsible for Fireside Corrosion in Fossil Fuel-Fired Systems." ERDA Contract No. E949-18)-2288. Annual Report - Phase I. August 22, 1977.
- Prahacs, S.; Barclay, H.G.; Bhaba, S.P. 1971. "A Study of the Possibilities of Producing Synthetic Tonnage Chemicals from Lignocellulosic Residues." Pulp and Paper Magazine of Canada. Vol. 72: p. 69.
- Rensfelt, E.; Blomkvist, G.; Ekstrom, C.; Engstrom, S.; Espenas, B.G.; Liinanki, L. 1978. "Basic Gasification Studies for Development of Biomass Medium - BTU Gasification Processes." IGT Biomass Symposium.
- Stern, E.W.; Logindice, A.S.; Heinemann, H. 1965. "Approach to Direct Gasification of Cellulosics." Industrial Engineering Chemistry Process Design and Development. Vol. 4: p. 171.

## APPENDIX

## 1. Description of Installed Equipment.

The system can be broken down into four process areas. These are pictured schematically in Figure 33-G-FSCH. The first requirement is an air supply (area 100) for the gasifier and combustion chamber. The gasifier, feeder, and flow measurement functions comprise process area 200. In order to carefully measure flow rates of product, the gas must be cooled and cleaned. The scrubber system and gas meter are the main components of process area 300. The flare system (process area 400) consists of a burner mounted on a heavily insulated combustion chamber, a pilot gas supply, and a chimney.

## 2. Process Area 100 (See Drawing 33-G-PID-1).

The blower is a Gardner Denver 3CDL8 rotary blower rated for 200 SCFM at a discharge pressure of 14 psig. The drive is a 30 hp motor with variable speed belt converter. The blower is equipped with an air filter, intake silencer, and discharge check (CV-102) and relief (RC-101) valves. Beyond the discharge silencer, the air is cooled to ambient temperature in a water cooled, finned-tube heat exchanger and then split into three streams. A recycle stream is metered through an armored tube flowmeter (FI-111), and valve (V-111). Combustion air is delivered to process area 400 through a pressure reducing valve (PCV-141). The air blast for the gasifier is delivered through a shut-off valve (V-122) and a pressure reducing valve (PCV-121). Building chilled water is used to cool the heat exchanger and is monitored through a rotameter (FI-121). Condensate is drained through a shut-off valve (V-121). Blower discharge pressure is indicated on PG1. Air temperature is indicated at the blower discharge (TG1), and upstream (TG2) and downstream (TG3) of the heat exchanger. An automatic high temperature shut-off is installed (TC-101). Early warning of excessive temperature rise is provided through thermocouple TC1. This temperature is recorded on a Leeds and Northrup recorder. This circuit is alarmed with a warning light (L1) and horn (H1). The delivered air temperature is remotely sensed through thermocouple TC-J6 and is displayed on a rack-mounted pyrometer.

## 3. Process Area 200 (See Drawing 33-G-PID-2).

## Reactor:

The gasifier is constructed of 316 SS and is 10 inches in diameter, 30 inches high, and sealed with .25 inch flanges. The grate is SS mesh and rests on a shelf 5 inches above the bottom flange. The shelf is a portion of the inlet air plenum. Sixteen 0.375 inch holes are drilled on the circumference of the plenum and provide an evenly distributed air blast below the grate. Welded couplings on the lid provide access for movable thermocouples, a gas sampling valve, and a bed level indicator. Explosion relief is provided through a rupture disc (V-271) installed in a 2-inch NPT line which is vented overhead. A Dwyer DP cell is used to monitor the pressure drop across the reactor.

## Solid Feed:

Wood feed (pellets or chips) is charged through a lock hopper to a bin on the feeder which has hi and lo level indicators. The lo level indicator is alarmed with a horn and warning light. Pressure is maintained during charging through two air-actuated slide valves. Three SCR-controlled screws provide

metered feed to an injection screw operated at constant speed. The feed rate is calibrated with a tachometer on the metering screw drive.

#### Air Blast:

Air at 3-6 psig is metered through an orifice plate. Upstream temperature (TG6) and pressure (PG2) are monitored and the pressure drop across the plate is converted to a 4-20 ma signal in a Gould pressure transmitter (PT1). A Westinghouse Veritrak controller uses this signal to actuate a current-to-pneumatic converter on a flow control valve (FCV-201). The flow rate is recorded on a Veritrak 2-pen recorder. The inlet air temperature to the gasifier is also recorded on the second pen.

#### Purge System:

A three way valve (V-202) in the air supply is normally in the straight run position. If the pilot flame on the burner (see process area 400) is extinguished, a UV flame detector trips a relay which shuts off the air and opens V-202 in the branch-run position, allowing a nitrogen flow into the reactor. The nitrogen stops the production of combustible gas and initiates cooling of the fuel bed. The nitrogen purge can also be introduced manually through shut-off valve V-212. Thermocouple TC-A1 is wired to a temperature switch (TA1). This switch activates a warning light (L5) on the control panel should the bed temperature rise beyond a preset limit.

#### Start-up System:

Normally the product gas exits the gasifier through a 2-inch NPT line (termination E on drawing 33-G-PID-2). However, on start-up the gasifier is run in a suction mode and gas is drawn through valve V-241 on a 1-inch NPT line. Suction is provided by an air ejector (see area 400). Air for start-up is drawn through a 2-inch coupling on the bottom lid of the gasifier. The ignition source is a Meeker burner. Normally ignition is achieved in thirty seconds and the combustion in the bed becomes self-sustaining in two or three minutes.

#### Sampling System:

Bed samples are withdrawn through an eight-port sampling valve. Ceramic tubes (3/32 inch OD) are connected to the valve and extend to various depths in the bed. Purge gas is introduced through a rotameter (FI-212) to keep the tubes clean.

Off-gas samples are withdrawn through a heat traced line which is plumbed directly to IR analyzers and to a gas chromatograph. Samples of cooled, cleaned gas are obtained downstream of the demistor.

#### 4. Process Area 300 (See Drawing 33-G-PID-3)

The raw gas stream issuing from the reactor (20 to 50 SCFM, 600 to 800°F) is connected to the scrubber with a short run of heavily insulated pipe. The gas is kept hot to insure that oils condense in the scrubber and not in the transfer line. The scrubber consists of two 10 inch pipe spools 30 inches long, with flanged entrance and exit sections. The lower spool is packed with 304 SS pall rings (nominal 1 inch), the upper spool with 3/4 inch Stoneware Berl saddles,

and the disengaging section with Kimre B-Gon mist elimination media (to trap water mist). Chilled water (2 GPM) is introduced at the top of the column. The water is chilled in order to reduce the moisture content of the exiting gas. Scrubber water exits the column and is discharged to a closed tank fitted with a liquid level gauge. Approximately 4 GPM of liquid is pumped to a heat exchanger, half of which is returned to the tank through valve V-308 for agitation. The remainder is passed through to the top of the column. The heat load of the exchanger is taken up by a chiller. The heat load on the chiller is vented outside.

The cold gas may still contain a minor amount of oil mist and this is removed by a fume coalescer (demistro) which is essentially a protective device for the gas meter. Gas samples are withdrawn periodically through an infrared analyzer to monitor the composition ( $\text{CO}$ ,  $\text{CO}_2$ ,  $\text{CH}_4$ ,  $\text{H}_2\text{O}$ ) of the stream.

The pressure drops across the scrubber (PT2) and orifice plate (PT3) are recorded continuously. The pressure drop across the demistor is indicated on a DP cell (DP5). The gas meter is equipped with a low density pulser to totalize the gas flow. The pulser in conjunction with a timer is used to calibrate the orifice plates.

#### 5. Process Area 400 (See Drawing 33-G-PID-4).

The flare system consists of a burner, combustion chamber, flue stack, air supply, and pilot and ignition systems.

Building air and natural gas are used for the pilot system. The pilot mixing tube and burner are threaded into a 3/4 inch opening in the main burner housing and is spark ignited by 6000 volt transformer and spark plug.

A UV flame detector is also screwed into the burner housing. A flameout condition trips a relay which cuts off the air supply to the gasifier and floods the reactor with nitrogen. Flameout also activates a horn (H3) and a warning light (L3).

Combustion air is admitted through a pressure reducing valve (PCV-401). The low pressure air stream supplies primary air through flow meter FI-401 and secondary air through FI-402. On start-up, high pressure air is metered through flowmeter FI-403 to an aspirator which puts the gasifier under suction.

The stack is a 10 inch ID, triple walled conduit running from lab 268 to six feet above roof level. On start-up, the stack is heated by a gas flame to induce a flow by natural draft. The combustion chamber exhaust temperature is sensed by thermocouple TC2. This temperature is recorded continuously and the circuit is alarmed. An exhaust temperature in excess of  $1100^\circ\text{F}$  sounds a horn (H2) and a warning light (L2). The flue gas can be tempered easily by increasing the flow rate of combustion air.

Title: AIR GASIFICATION TEST FACILITY	Project No: 33E6.20	Tolerances:		 <b>Solar Energy Research Institute</b> Golden, Colorado 80401 A Division of Midwest Research Institute Operated for the U.S. Department of Energy
	Draftsperson: Ray Desrosiers			
Date: 12/16/79	Drawing No.: 33-G-FSCH	Approval:	Scale:	Sheet

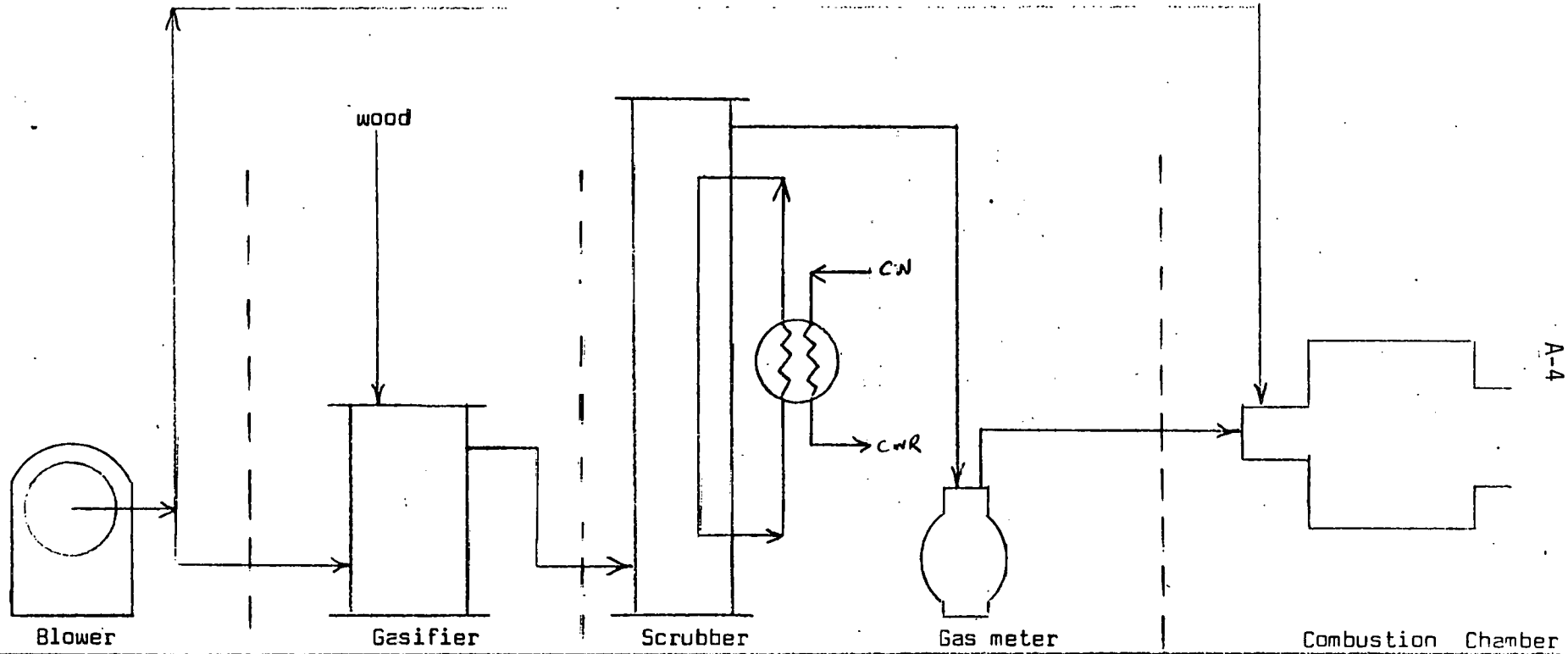

<u>PROCESS AREA 100</u> Air supply	<u>PROCESS AREA 200</u> Gasification of precisely measured air and fuel streams	<u>PROCESS AREA 300</u> Gas cleanup and volumetric measurement	<u>PROCESS AREA 400</u> Flare system
---------------------------------------	------------------------------------------------------------------------------------	-------------------------------------------------------------------	-----------------------------------------

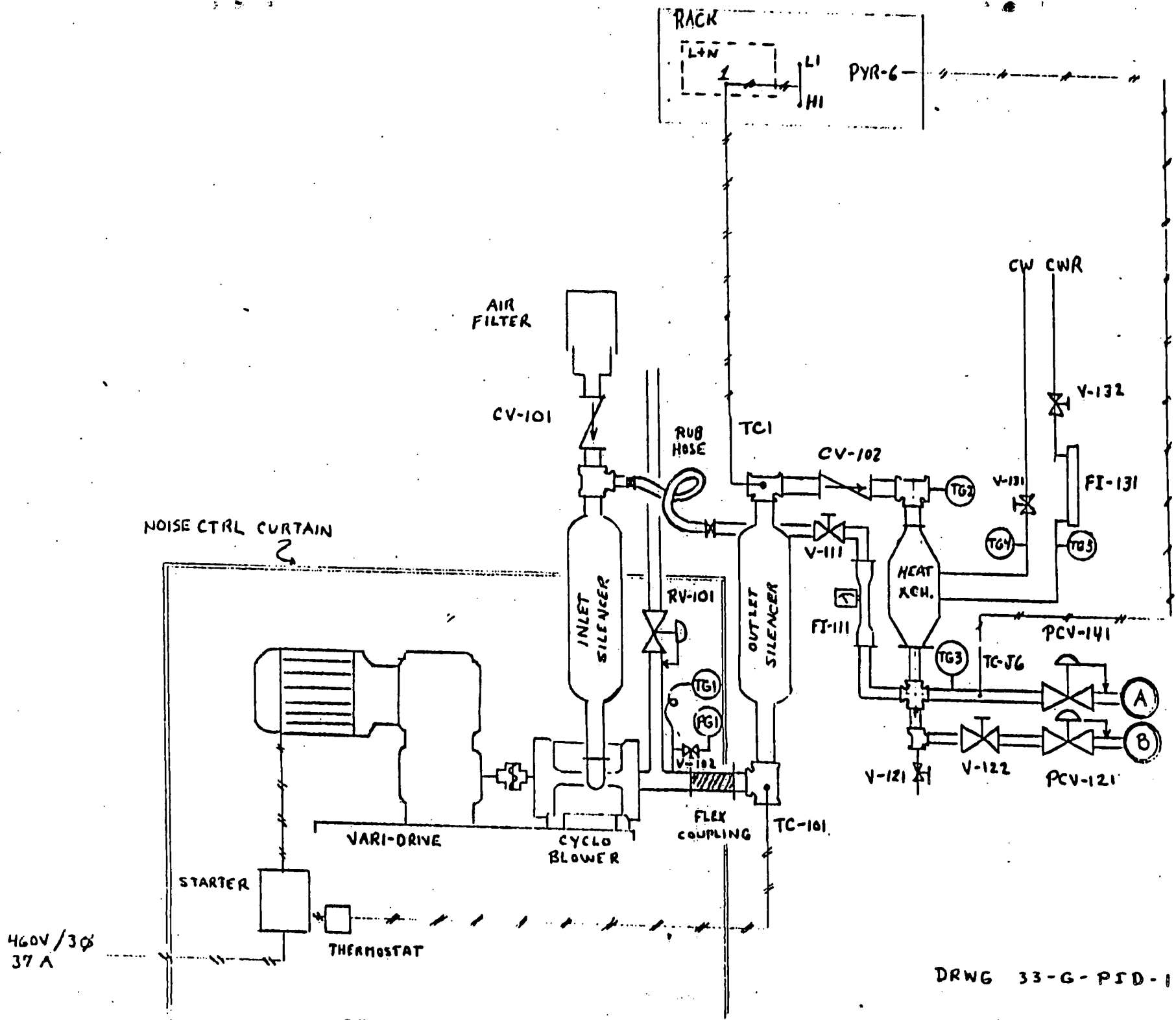

A-5

DRWG 33-G-PID-1

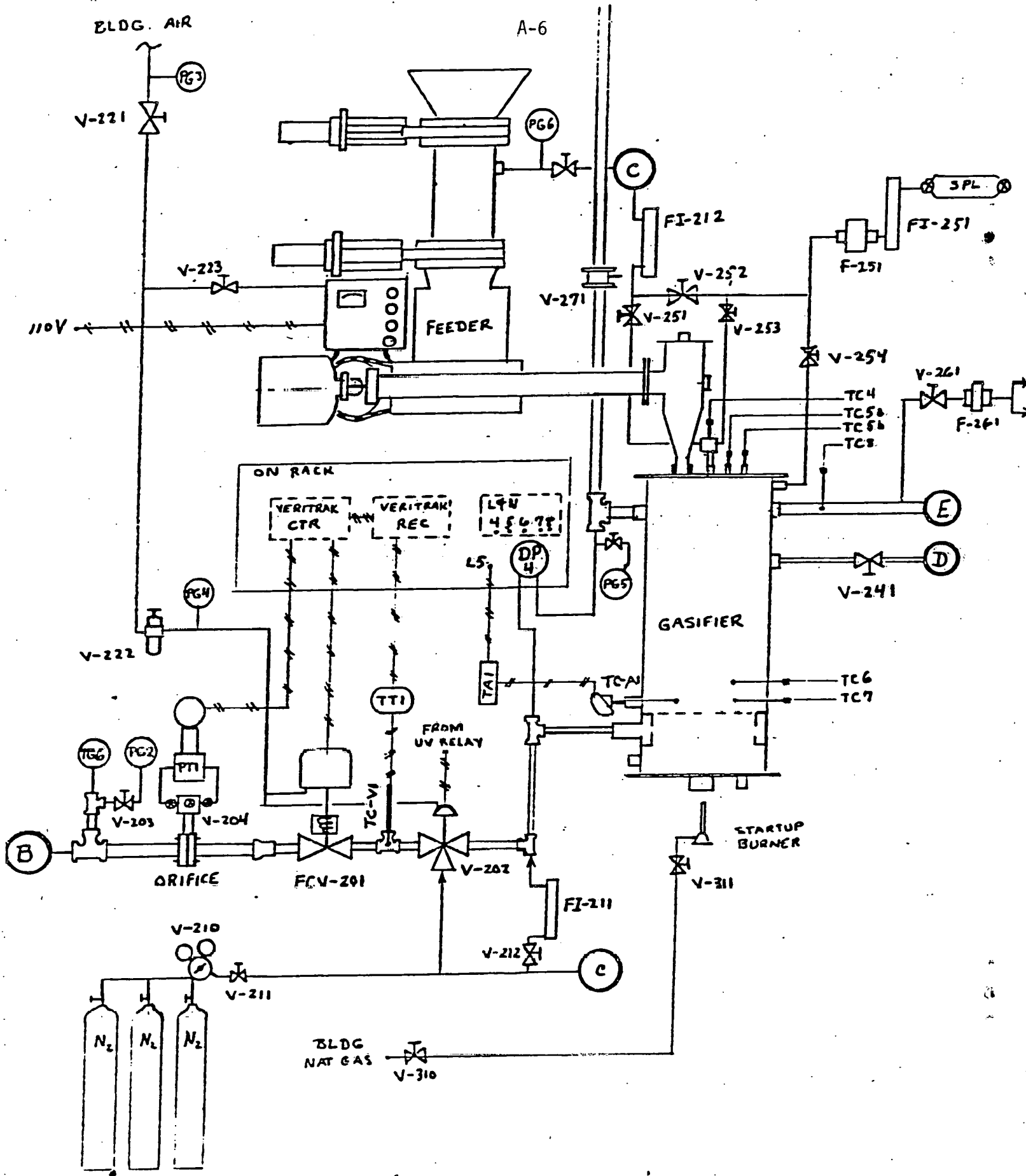

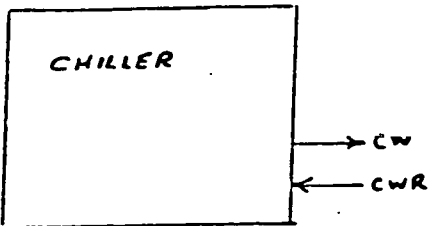
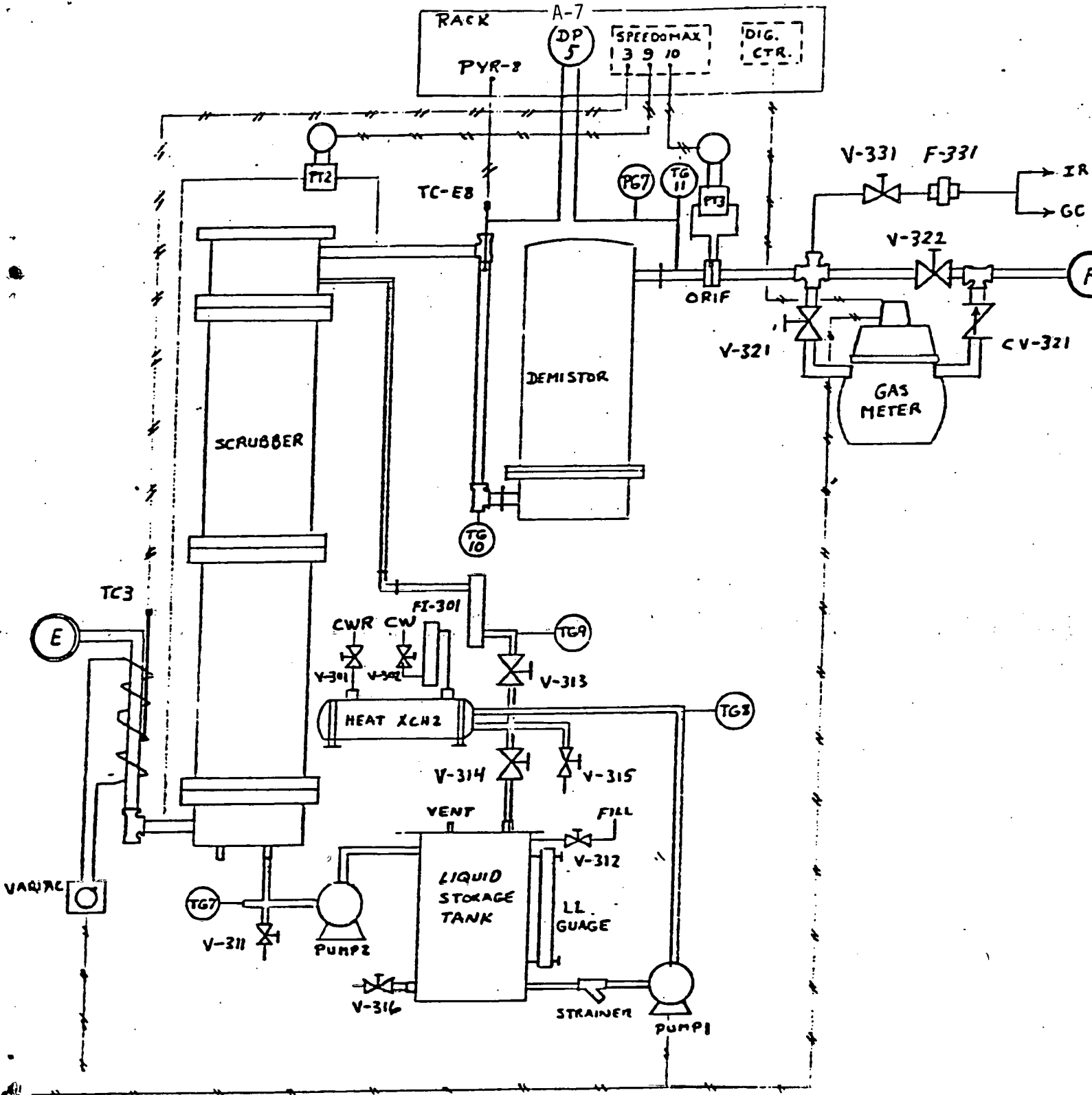

DRWG 33-G-PID-3



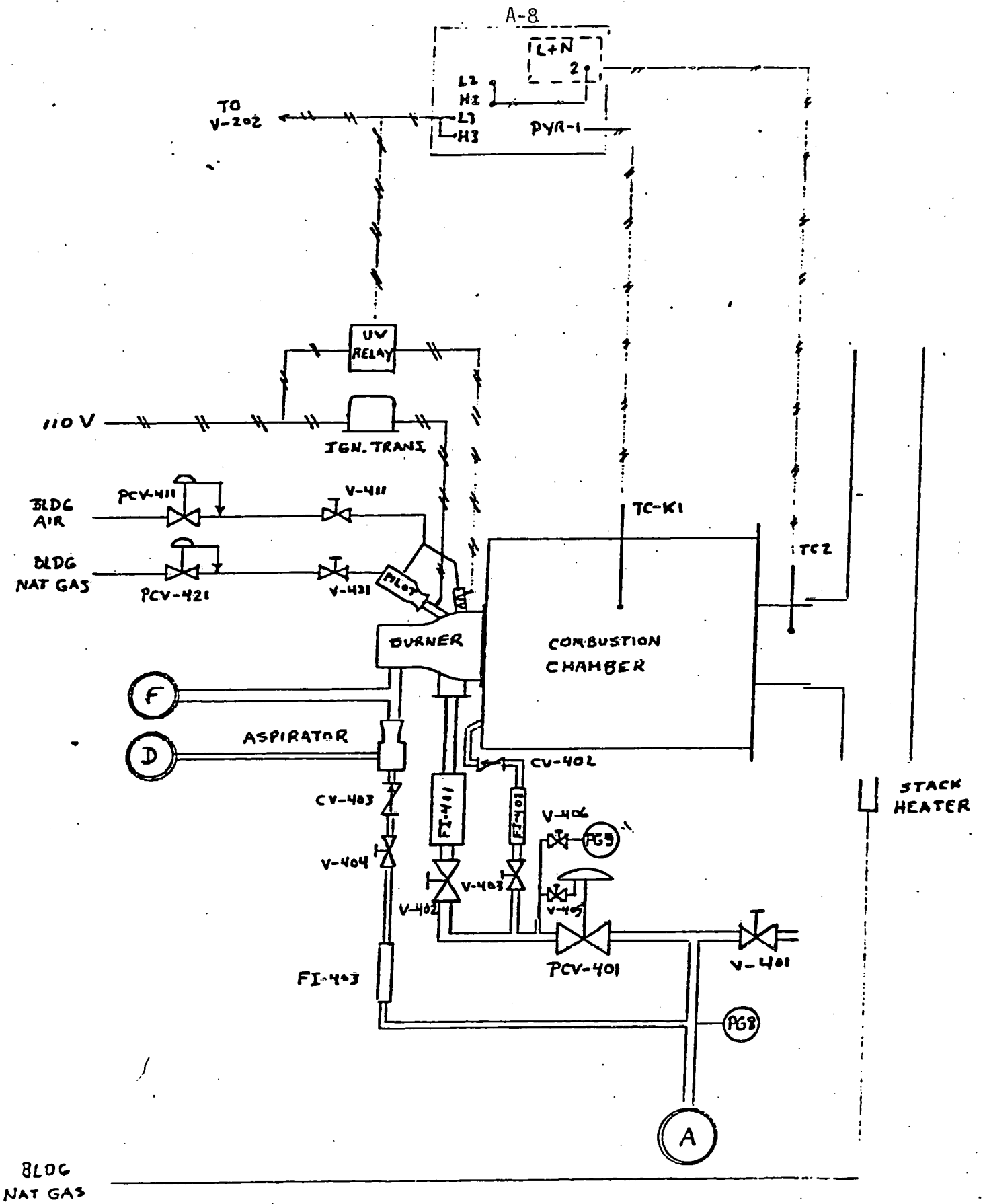

8LDC  
NAT GAS