



Quantum Communication, Sensing and Measurement in Space

Study start date: June 25, 2012
Study end date: December 14, 2012
Final Report submission date: December 14, 2012

Team Leads:

Baris I. Erkmen
Jet Propulsion Laboratory, California Institute of Technology
baris.i.erkmen@jpl.nasa.gov

Jeffrey H. Shapiro
Massachusetts Institute of Technology
jhs@mit.edu

Keith Schwab
California Institute of Technology
schwab@caltech.edu

© 2012. All rights reserved.

Core Participants of Study Program and Co-authors

	Name	Affiliation	E-mail
1	Adhikari, Rana	California Institute of Technology	rana@caltech.edu
2	Aspelmeyer, Markus	University of Vienna	markus.aspelmeyer@univie.ac.at
3	Baumgartel, Lukas	University of Southern California	lbaumgar@jpl.nasa.gov
4	Birnbaum, Kevin	Jet Propulsion Laboratory	kevin.m.birnbaum@jpl.nasa.gov
5	Boroson, Don	MIT Lincoln Laboratory	boroson@ll.mit.edu
6	Caves, Carlton	University of New Mexico	caves@info.phys.unm.edu
7	Chen, Yanbei	California Institute of Technology	yanbei@caltech.edu
8	Combes, Joshua	University of New Mexico	joshua.combes@gmail.com
9	Dixon, Ben	Massachusetts Institute of Technology	bendixon@mit.edu
10	Dolinar, Sam	Jet Propulsion Laboratory	sam.dolinar@jpl.nasa.gov
11	Durkin, Gabriel	NASA Ames Research Center	gabrieladurkin@gmail.com
12	Erkmen, Baris	Jet Propulsion Laboratory	baris.i.erkmen@jpl.nasa.gov
13	Giovannetti, Vittorio	Scuola Normale Superiore	v.giovannetti@sns.it
14	Guha, Saikat	Raytheon BBN Technologies	sguha@bbn.com
15	Hindi, Munther	NASA SCan/ASRC	mhindi2@comcast.net
16	Hughes, Richard	Los Alamos National Laboratory	rxh@lanl.gov
17	Kaltenbaek, Rainer	University of Vienna	rainer.kaltenbaek@univie.ac.at
18	Kumar, Prem	Northwestern University	kumarp@northwestern.edu
19	Kwiat, Paul	University of Illinois at Urbana-Champaign	kwiat@illinois.edu
20	Nordholt, Jane	Los Alamos National Laboratory	jnordholt@lanl.gov

continues on next page...

...continued from previous page

21	Rambo, Timothy	Northwestern University	timothyrambo2017@u.northwestern.edu
22	Schwab, Keith	California Institute of Technology	schwab@caltech.edu
23	Shapiro, Jeffrey	Massachusetts Institute of Technology	jhs@mit.edu
24	Spero, Robert	Jet Propulsion Laboratory	spero@jpl.nasa.gov
25	Tsang, Mankei	National University of Singapore	eletmk@nus.edu.sg
26	Turyshev, Slava	Jet Propulsion Laboratory	turyshev@jpl.nasa.gov
27	Vallisneri, Michelé	Jet Propulsion Laboratory	michele.vallisneri@jpl.nasa.gov
28	Wong, Franco	Massachusetts Institute of Technology	ncw@mit.edu
29	Yu, Nan	Jet Propulsion Laboratory	nan.yu@jpl.nasa.gov

Table of Contents

I. Executive Summary	8
II. Introduction	14
II.1. A clarifying note on ‘quantum’ versus ‘classical’	14
II.2. The promise of quantum-enhanced technologies.....	15
II.3. The timing of our study program.....	17
II.4. Objectives of the workshop and study program.....	19
III. Scope and Organization of the Study Program.....	20
III.1. Scope of the workshop and study program	20
III.2. Organization of the workshop and study program.....	21
IV. Results Emerging from the Study.....	24
IV.1. Fundamental science in space.....	24
IV.1.1. Opportunities for fundamental physics measurements in space.....	25
IV.1.2. Low-frequency gravitational-wave interferometer in space	27
IV.1.3. A space-based ultra-stable laser frequency reference derived from gravitational wave technology	29
IV.1.4. Atomic clocks and quantum sensors for science applications.....	32
IV.1.4.1. Atomic quantum inertial sensors	33
IV.1.4.2. High accuracy optical clocks	35
IV.1.5. Science motivations and technology priorities	36
Atomic quantum sensor enabled science.....	38
Clock enabled science	39
Meeting technology challenges.....	40
IV.2. Sensing and Measurement in Space.....	42
IV.2.1. Opportunities for quantum enhancements.....	42
IV.2.1.1. No-go theorems for remote target detection with Type I and Type III sensors	44
IV.2.2. Recent advances in quantum-enhanced sensing systems.....	45
IV.2.2.1. Type II sensing systems: nonclassical receivers for classical (coherent-state) illumination.....	45
IV.2.2.2. Quantum filtering and smoothing in Type II systems	48
Quantum filtering	48
Quantum smoothing.....	49
IV.2.2.3. Quantum illumination: a Type III sensor for high noise and loss.....	50

IV.2.2.4. Active ghost imaging: classical (Type 0) and quantum (Type III).....	51
Computational ghost imaging	55
Comparison of Computational Ghost imaging with floodlight LADAR	56
IV.2.2.5. Interferometry	57
Active interferometry with classical and nonclassical light	57
Passive stellar interferometry	58
Quantum information-theoretic perspective.....	59
Entangled interferometry	59
Passive ghost imaging (intensity interferometry) using stellar light	60
IV.2.2.6. Weak measurements for space applications	60
Weak-value based signal amplification	61
Illustrative weak-values example.....	63
Rover-based detection and observation.....	64
Communication and control signaling between a planet and a satellite.....	65
Detection and observation of astronomical objects.....	66
Weak-value based simultaneous measurements of non-commuting observables	67
Additional possibilities for weak-value based measurements in space	68
IV.2.2.7. Quantum parameter estimation bounds for sensing	68
Quantum Cramér-Rao bounds	69
Beyond quantum Cramér-Rao bounds.....	69
Quantum-optimal imaging systems.....	70
IV.2.3. A cross-cutting enabling technology: multifunction and reconfigurable entangled-photon source	70
IV.2.3.1. Applications enabled by multifunction nonclassical sources.....	71
Scientific exploration using nonclassical sources of light in space.....	71
Quantum measurements in space	73
IV.2.3.2. Nonclassical sources.....	74
Sources based on three-wave mixing in nonlinear crystals.....	74
Sources based on four-wave mixing in optical fibers	76
Sources based on semiconductors	77
Future source improvements.....	78
IV.2.4. Conclusions and recommendations for future work	79

IV.3. Communication and Measurement in Space.....	82
IV.3.1. Quantum-limited classical communication with photons.....	82
IV.3.1.1. Opportunities for quantum-enhanced classical communication using light in space	83
IV.3.1.2. Classical versus quantum limits to photon versus spectral efficiency, and promises of approaching those limits	87
Evaluating the ultimate limit to capacity	87
Joint-detection receivers and codes to close the gap to the Holevo limit... ..	88
Novel receivers for lower latency decoding in high spectral efficiency	89
Turbulent atmospheric propagation: ergodic Holevo capacity.....	89
Approaching the classical capacity limit of direct-detection receivers	90
IV.3.1.3. Potential for improvements relative to state-of-the-art.....	91
IV.3.2. Secure communications to, in, and from space	92
IV.3.2.1. Background on free-space QKD and the state of the art.....	93
State of the art.....	93
Satellite QC system architecture	95
IV.3.2.2. Satellite-to-ground QKD experiment: objectives and requirements	97
Experimental plan	97
Space resource requirements	98
Operations plan	98
What can only be learned with a space experiment as opposed to an air-to- ground experiment?	99
IV.3.2.3. Technology benefits to the nation and society	100
IV.3.3. Conclusions and recommendations for future work	101
V. Main Conclusions of the Study Program	103
VI. List of Abbreviations	106
VII. References.....	109
VIII. Workshop agenda	131
IX. Acknowledgement.....	136

I. Executive Summary

As part of the Keck Institute for Space Studies (KISS) 2012 Study Programs we conducted a study titled “Quantum Communication, Sensing, and Measurement in Space,” bringing together 29 leading researchers from academia, national laboratories and industry, including 5 members who are junior researchers (PhD candidates or postdoctoral scholars). We report here on the organization of the study program, the main discussion topics, key conclusions, and recommendations for future work.

The study program was organized with the objectives of: (1) identifying fundamental physics opportunities in space, as well as application areas in communications and sensing that could benefit from novel quantum-enhanced techniques under realistic environmental conditions; (2) identifying key performance requirements to realize the promised gains; and (3) capturing the state-of-the-art relative to these requirements in order to determine the research and development avenues that could deliver quantum-enhanced capabilities. Our study program has identified both near-term opportunities that could be ready for space-based experiments within a few years span, and more ambitious longer-term science, communication, and sensing opportunities where new research and development efforts are likely to result in high payoffs.

The study program was kicked-off with a 5-day workshop June 25th to 29th at the KISS facility in Pasadena, CA, bringing together the 29 core participants of the study. Due to the diverse backgrounds of the participants, a short course was held the first day with the purpose of establishing a common scientific and technological foundation on which the study could build. During the workshop four main topic areas were addressed and discussed extensively, with lead-in talks by experts in each category, followed by moderated discussion sessions:

1. Fundamental science opportunities in space enabled by quantum mechanics.
2. Classical communication to, from, and in space at ultimate quantum-mechanical limits.
3. Quantum communication to, from, and in space.
4. Quantum enhancements to remote-sensing and *in situ* instruments in space.

Eight subtopic areas emerged from the workshop as warranting further investigation and refinement in the following four months of the study. Each subtopic was assigned a lead investigator, and a set of experts were recommended from the core participants list, which assured that each topic would receive its due attention. All participants were encouraged to engage in studies in all subtopics within their realms of interest and expertise. Several near-term, and some longer-term opportunities were identified during this period, as will be detailed below.

The study program concluded with the subtopic leads re-assembling at the KISS

facility November 8th and 9th, to discuss the findings in their subtopics (provided as a report to the core participants of the study), and to agree on the organization of the final report. The final report was distributed to all core participants before the final submission, and all inputs were incorporated into the final report.

The subtopic areas of study after the workshop were as follows:

A. Fundamental science

- a. Frequency standards, timing, atom interferometers: The benign space environment—free from atmospheric interferences and low-frequency vibrations—and quantum-enhanced precision measurement tools provide a unique combination for exploring new physics in space. This subtask investigates the science enabled by employing quantum sensors such as atomic clocks and atom interferometers in space, reports on the state-of-the-art in their development, and recommends future research and development efforts towards enabling these technologies in space.
- b. Gravity science in space and the intersection of gravity and quantum mechanics: The relativistic accelerations of massive bodies produce gravitational waves, which—if detected—promise to give us detailed information about the bulk motions of astrophysical objects, as well as testing some of Einstein’s fundamental theories. This task investigates new science that may be enabled by quantum mechanical technologies in space, including squeezed light for enhanced gravitational-wave sensing, and foundational tests on opto-mechanically coupled quantum multipartite systems to understand the role of gravitational fields.
- c. A space-based ultra-stable laser frequency reference via interferometry: Although not part of the initial charter of our workshop, discussions during the workshop resulted in the idea that a stable laser frequency source could be derived from a space-based interferometer similar to that considered for the LISA mission. Space-based gravitational wave detectors depend on extraordinarily low noise in the separation between spacecraft, which results in a very stable frequency reference. This subtask investigated the feasibility of utilizing two techniques developed for the LISA mission—high-gain arm-locking and time-delay interferometry—to transfer the ultra-stable frequency reference from a space-based interferometer to Earth, where it can be used in ultra-high-precision experiments.

B. Communication and measurement:

- a. Achieving high photon and spectral efficiency classical communication with photons: Optical communication is indispensable to the future communication links supporting space missions. Nearly all work on the communication theory of optical channels, such as that done for systems with laser transmitters and either coherent-detection (homodyne and heterodyne) or direct-detection (photon-counting) receivers, uses

semiclassical (shot-noise) models. Fundamentally, however, light waves are quantum mechanical, i.e., they are boson fields, which necessitates an explicitly quantum analysis to determine the ultimate capacity limits on optical communication. This subtopic of the report summarizes the state of the art in our understanding of the ultimate quantum limit to the rate of reliable optical communication (the Holevo limit), and quantifies the gaps between that limit and what can be achieved by the best-known conventional methods.

- b. Secure communications to, in, and from space: Quantum key distribution (QKD) is an emerging technology for transferring cryptographic keys using single-photon quantum communications (QC), with the security assurances provided by incontrovertible principles of quantum physics. It has achieved a state of development from which the practicality of re-keying satellites on-orbit can be confidently predicted. This subtask investigated the current state-of-knowledge in space-based QKD systems and the feasibility of a space-based demonstration.
- C. Sensing and measurement
- a. Classical and quantum sensing instruments: This subtask focuses on detection, parameter estimation, and imaging problems, wherein inferences are derived from measurements on electromagnetic waves. Quantum mechanical enhancements can be attained by novel measurement techniques that take into account the quantum nature of electromagnetic radiation, and in the case of active sensing systems, by utilizing quantum-mechanically optimized probe states for the sensing problem at hand. This subtask reports various quantum-enhanced sensing methodologies that perform substantially better than their classical counterparts, and defines operational conditions under which these enhancements prevail.
 - b. Weak measurements for *in situ* sensing: Weak values are a novel metrology technique. They allow one to achieve the optimum classical measurement in non-standard ways, enabling the matching of measurement technique to system constraints (e.g. noisy environments or detector weight limits). An emerging application of weak values is the ability to perform new types of quantum measurements that may benefit space-based quantum communication or quantum foundational research.
 - c. Multifunction and reconfigurable entangled-photon source in space: Spontaneous parametric downconversion (SPDC) sources are reconfigurable devices capable of providing different quantum states of electromagnetic fields, such as entangled photons in multiple degrees of freedom, squeezed states, and broadband correlated light pulses. These quantum states can, in turn, be used for various science and technology measurements in sensing and communication applications in space. This

task investigates the state-of-the-art in entangled-photon technologies including SPDC, identifies space science and technology advances that would be enabled by such a source in space, and provides recommendations for future research avenues to realize an entangled-photon source in space.

This study program covered a broad spectrum of topics that would benefit from our ability to observe, control and exploit quantum mechanical phenomena in the space environment, with specific emphasis on science, communication, and sensing capabilities. As perhaps could have been anticipated from the diverse topic agenda, our findings also spread over a broad spectrum of new capabilities, which can be generally grouped into three categories: (1) those that have the clear potential to positively impact the NASA mission and have reached a level of technical maturity that would warrant consideration for significant investments for near-term space demonstrations; (2) those that have well-defined space applications and significant potential for enabling new science and technology, but would require further focused seedling-level efforts to affirm that the potential advantages would endure the practical conditions of the space environment; and (3) those that have emerged as interesting and promising concepts offering performance enhancements, but do not have immediate space-based applications associated with them.

An important conclusion from our study program is that QKD technology has reached a level of maturity such that the operational re-keying of satellites on-orbit can be confidently predicted. With an on-orbit QKD capability, cryptographic keys could be distributed to users located anywhere within the satellite's coverage. Several cross-linked QKD satellites could provide worldwide key distribution to networks of land, sea, air, and space-based users. In our opinion, however, the next major milestone towards operational QKD links ought to be a low-Earth orbit (LEO)-satellite to fixed ground location QKD demonstration to prove the technology, and obtain critical data for refining future technology iterations towards efficient and secure operation.

Another prominent outcome from our study program is that developing a space-qualified multifunction and reconfigurable entangled-photon source based on SPDC could enable numerous science experiments that improve our understanding of fundamental physics, as well as play a crucial role in several technology demonstrations that improve communication and sensing systems of the future. Specifically, reconfigurable SPDC sources could be employed to generate entangled photons in multiple degrees of freedom, to generate squeezed states, and to generate broadband correlated light pulses. Several promising SPDC source technologies are readily available and widely used in laboratory environments. In order to enable such a multifunction technology for future space applications, further research on and development of sources are warranted. These efforts should concentrate on evaluating flight qualification for different types of SPDC sources and developing more advanced types of entangled light tailored for the needs of specific missions.

The main theme of the conclusions drawn for classical communication systems operating at optical or higher frequencies is that there is a well-understood performance gain in photon efficiency (bits/photon) and spectral efficiency (bits/s/Hz) by pursuing coherent-state transmitters (classical ideal laser light) coupled with novel quantum receiver systems operating near the Holevo limit (e.g., joint detection receivers). However, recent research indicates that these receivers will require nonlinear and nonclassical optical processes and components at the receiver. Consequently, the implementation complexity of Holevo-capacity-approaching receivers is not yet fully ascertained. Nonetheless, because the potential gain is significant (e.g., the projected photon efficiency and data rate of MIT Lincoln Laboratory's Lunar Lasercom Demonstration (LLCD) could be achieved with a factor-of-20 reduction in the modulation bandwidth requirement), focused research activities on ground-receiver architectures that approach the Holevo limit in space-communication links would be beneficial.

The potential gains resulting from quantum-enhanced sensing systems in space applications have not been laid out as concretely as some of the other areas addressed in our study. In particular, while the study period has produced several interesting high-risk and high-payoff avenues of research, more detailed seedling-level investigations are required to fully delineate the potential return relative to the state-of-the-art. Two prominent examples are (1) improvements to pointing, acquisition and tracking systems (e.g., for optical communication systems) by way of quantum measurements, and (2) possible weak-valued measurement techniques to attain high-accuracy sensing systems for *in situ* or remote-sensing instruments. While these concepts are technically sound and have very promising bench-top demonstrations in a lab environment, they are not mature enough to realistically evaluate their performance in a space-based application. Therefore, it is recommended that future work follow small focused efforts towards incorporating practical constraints imposed by a space environment.

The space platform has been well recognized as a nearly ideal environment for some of the most precise tests of fundamental physics, and the ensuing potential of scientific advances enabled by quantum technologies is evident in our report. For example, an exciting concept that has emerged for gravity-wave detection is that the intermediate frequency band spanning 0.01 to 10 Hz—which is inaccessible from the ground—could be accessed at unprecedented sensitivity with a space-based interferometer that uses shorter arms relative to state-of-the-art to keep the diffraction losses low, and employs frequency-dependent squeezed light to surpass the standard quantum limit sensitivity. This offers the potential to open up a new window into the universe, revealing the behavior of compact astrophysical objects and pulsars. As another set of examples, research accomplishments in the atomic and optics fields in recent years have ushered in a number of novel clocks and sensors that can achieve unprecedented measurement precisions. These emerging technologies promise new possibilities in fundamental physics, examples of which are tests of relativistic gravity theory, universality of free fall, frame-dragging precession, the gravitational inverse-square law at micron scale, and new ways of

gravitational wave detection with atomic inertial sensors. While the relevant technologies and their discovery potentials have been well demonstrated on the ground, there exists a large gap to space-based systems. To bridge this gap and to advance fundamental-physics exploration in space, focused investments that further mature promising technologies, such as space-based atomic clocks and quantum sensors based on atom-wave interferometers, are recommended.

Bringing a group of experts from diverse technical backgrounds together in a productive interactive environment spurred some unanticipated innovative concepts. One promising concept is the possibility of utilizing a space-based interferometer as a frequency reference for terrestrial precision measurements. Space-based gravitational wave detectors depend on extraordinarily low noise in the separation between spacecraft, resulting in an ultra-stable frequency reference that is several orders of magnitude better than the state of the art of frequency references using terrestrial technology. The next steps in developing this promising new concept are simulations and measurement of atmospheric effects that may limit performance due to non-reciprocal phase fluctuations.

In summary, this report covers a broad spectrum of possible new opportunities in space science, as well as enhancements in the performance of communication and sensing technologies, based on observing, manipulating and exploiting the quantum-mechanical nature of our universe. In our study we identified a range of exciting new opportunities to capture the revolutionary capabilities resulting from quantum enhancements. We believe that pursuing these opportunities has the potential to positively impact the NASA mission in both the near term and in the long term. In this report we lay out the research and development paths that we believe are necessary to realize these opportunities and capitalize on the gains quantum technologies can offer.

II. Introduction

This report documents the objectives, scope, key findings, and recommendations for future actions from the study titled “Quantum Communication, Sensing, and Measurement in Space,” which was conducted as part of the 2012 Keck Institute for Space Studies (KISS) Study Program. It represents the study team’s consensus on promising paths towards bringing quantum technologies to fruition in space that can enable the investigation of new scientific frontiers, as well as the development of sensing and communication systems that attain unsurpassed performance.

In this section, we begin with a brief discussion of important nomenclature used throughout this report, namely the distinction between ‘classical’ and ‘quantum.’ Then in Section II.2 we provide an introduction to the potential of quantum enhancements in sensing and communication systems. Section II.3 motivates the timing of this study program, and Section II.4 concludes this section by defining the objectives of our study program.

II.1. A clarifying note on ‘quantum’ versus ‘classical’

It has long been accepted that electromagnetic radiation is fundamentally quantized: the energy of a monochromatic plane-wave electromagnetic field is discrete in integer multiples of a fundamental quantum referred to as a *photon* whose energy is $\hbar\omega_0$, where ω_0 is the frequency of the radiation. This quantum nature has been observed at optical frequencies through high-sensitivity photodetection [Mandel1995]. It is therefore true that *all* electromagnetic phenomena, including the observations resulting from measurements on them, are quantum mechanical in nature. Nonetheless, it has also long been known that the photodetection statistics of a light beam in a coherent state, or a statistical mixture of coherent states, can be calculated by using the semiclassical (shot noise) theory of photodetection. In this theory electromagnetic fields are (possibly stochastic) functions of space and time that obey Maxwell’s equations. The fundamental noise in photodetection arises from the discrete nature of the electron charge. Despite the significantly disparate interpretations resulting from these two theories regarding the physical origin of the noise seen in photodetection, the quantitative outcome of either calculation is *identical* when the illuminating quantum field is in a coherent state or a random mixture of coherent states. Therefore, it has been widely accepted that optical phenomena that can be explained with the semiclassical theory do not demonstrate the quantum nature of incident radiation. Consequently, throughout this report, we adopt the following convention:

- 1) A ‘classical’ result refers to an observation that can be quantitatively explained by the semiclassical theory of detection. For example, photon-counting statistics from a laser beam or a thermal source are classical phenomena.

-
- 2) A ‘quantum’ result refers to those effects that *cannot* be quantitatively described using the semiclassical theory, and requires a quantum description of radiation and detection. For example, the sub shot-noise variance resulting from homodyne detection of squeezed light is a quantum phenomenon.

Accordingly, our references to quantum-enhanced performance in this report imply that the enhancements cannot be explained using semiclassical theory. However, we also recognize that pursuit of quantum-enhancements often leads to new insights into and inventions of communication and sensing systems that are classical, but nonetheless inspired by quantum systems. Neither our study, nor our report excludes such novel outcomes purely on the basis of taxonomy. However, we will be diligent in calling out these cases as classical to provide an accurate and consistent description throughout our report.

II.2. The promise of quantum-enhanced technologies

Much of NASA’s sensing instrumentation and all of its space communication rely on exploiting electromagnetic (EM) radiation. At optical and higher frequencies, the ambient noise floor of the environment becomes sufficiently low that we are able to observe, manipulate, and ultimately exploit the quantum nature of EM radiation to fulfill macroscopic engineering tasks, such as detection, parameter estimation, imaging, and communication. Quantum mechanics has shown that these tasks can be carried out at performance levels that significantly exceed what would have been possible in a purely ‘classical’ world. Some examples of quantum-enhanced performance are as follows (this list is not exhaustive, but rather a broad-brush set of examples in the relevant categories of communication, sensing, and fundamental science):

- 1) The standard quantum limit (SQL) for sensing (e.g., imaging, metrology), achievable with classical states of light and conventional receiver architectures, admits a sensitivity scaling that is $1/\sqrt{N}$, where N refers to the mean detected photon number. The SQL can be surpassed by using nonclassical states of light and nonstandard measurements to achieve Heisenberg-limited sensitivity, which has a scaling law of $1/N$, provided that losses can be kept sufficiently low [Abouraddy2002, Giovannetti2004a, Goldstein2011, Kira2011, Tsang2011a].
- 2) Communicating classical information between two distant points by harnessing the full quantum nature of light can achieve a reliable communication rate strictly greater than the reliable rate achievable using known semiclassical techniques (e.g., intensity modulation and photon counting, or complex-field modulation and homodyne detection) [Shapiro2009a, Dolinar2011, Guha2011a]. The potential for improvement in the energy efficiency of the communication system (i.e., bits of information transferred per detected photon) can be up to a factor of 4, and the improvement in the bandwidth efficiency of the system (i.e., bits of information transferred per modulation bandwidth utilized) can be a factor of 10 or higher, in current operating regimes for deep-space optical links.

-
- 3) Remote-sensing instruments operating in environments subject to high loss and high background noise can also benefit from quantum-enhanced performance, despite the fact that the loss and noise removes any nonclassical signature at the time of measurement. For example, the probability of error in detecting a weakly-reflecting object engulfed in high noise can be improved by a factor of 4 in error exponent via a technique referred to as quantum illumination [Tan2008, Guha2009, Shapiro2009b]. In quantum illumination a pair of beams consisting of entangled photon pairs are generated via spontaneous parametric downconversion (SPDC), and one beam is kept local whereas the other interrogates the target. A joint measurement on the returned and retained beams — which have an entirely classical description — provides the aforementioned improvement.
 - 4) Scientific experiments in space may help improve our understanding of quantum mechanics itself: for example, understanding how gravity plays a role in quantum mechanics (e.g., is gravity quantized?) is a foundational question that pervades quantum mechanics [Marshall2003, Arndt2009, Romero-Isart2011, Kaltenbaek2012]. Using opto-mechanically coupled quantum systems in the gravity-free environment of space would enable one to observe the coupling between gravity and macroscopic particles ($\sim 10^{10}$ atoms) acting as quantum systems. Experiments in space also allow one to test the physics of entanglement and decoherence over long baselines in an almost dissipation-free environment. For example, although no major surprises are expected, the Bell's inequality violations that invalidate any local hidden-variable theories as an alternative to the statistical nature of quantum mechanics have not been tested with all loopholes closed simultaneously [Rideout2012]. Space would be a near-ideal medium to perform an experiment in which all such loopholes are indeed closed simultaneously.

We believe that approaching the ultimate quantum-mechanics-limited sensitivities offers the potential to significantly improve future space missions, both by enabling new scientific exploration and investigation possibilities, and also by enabling new technologies that are utilized in support of current research interests of the scientific community. For example, improvements to remote-sensing instrument sensitivity and resolution would enhance our capabilities of monitoring changes on planet Earth, providing new possibilities for Earth science. Higher accuracy measurements at the Heisenberg limit could enable better telescopes for imaging, or improved scientific instruments (e.g., spectroscopy, microscopy) that operate on rovers sent to extraterrestrial planets.

Quantum-enhanced instrumentation can also result in many indirect benefits to NASA's scientific exploration charter. Information processing is crucial, both on our space assets and on the ground. Improvements to information storage (e.g., quantum memory), reliable information transmission (e.g., quantum-limited optical communication, X-ray communication), and information acquisition (e.g., quantum-limited data compression) improve our access to scientific data, and enable stronger command and control of our spaceborne instrumentation. In addition, the principle

that measurements on quantum systems perturb their state in detectable ways can offer a physical notion of security in many of the aforementioned information processing and storage tasks.

II.3. The timing of our study program

If we may summarize the scientific progress in the past century as that of establishing and understanding quantum mechanics, then we predict that this century will be one of utilizing quantum mechanical principles to enhance our technological capabilities, further expanding our scientific understanding, and deriving societal benefits.

Ongoing and completed advanced research programs in the last decade, funded primarily by defense agencies and also some by NASA, have fostered the development and demonstration of novel quantum techniques that surpass the standard limits of ‘classical’ communication and sensing in controlled laboratory environments. These programs have resulted in a theoretical and experimental foundation that convincingly demonstrates enhancements to the state-of-the-art, motivated by the desire to surpass the ‘classical’ limits of communication and sensing, and approach the ultimate quantum-mechanical limits.

While the advances have reached a maturity that opens the possibility of reaping the advantages of systems operating close to the quantum limits, two significant areas of investigation in relation to space applications remain scarcely populated.

- 1) There have been limited comprehensive studies to identify the high-payoff space application areas in which to pursue quantum enhancements.
- 2) There remain significant unanswered questions pertaining to the key requirements for realizing these performance improvements.

With this motivation, we have assembled a technical forum with the leading experts from academia, national laboratories, and industry—subject to the maximum number of allowed participants in the workshop—and have held a workshop and study program with the objective to identify the driving needs for enhanced capabilities in deep-space exploration and near-Earth science, and pair these needs with the solutions offered by quantum-optimal systems. This report is an outcome of these aforementioned activities.

Some relevant examples of the advanced research programs we have referred to above are as follows. In the DARPA Quantum Sensors Program (QSP), 200× resolution enhancements to a 3D homodyne laser ranging and imaging system have been shown, theoretically, to be available by using quantum image-enhancing operations (specifically, squeezed-vacuum injection and phase-sensitive amplification) prior to photodetection. During this program, a taxonomy for

quantum-enhanced sensors has also been developed and the potential for performance enhancements have been identified for each quantum-sensor classification. Information in a Photon (InPho) is an ongoing DARPA program that investigates the ultimate quantum-mechanical limits to information extractable from photons in both terrestrial communications and imaging systems. The program aims to use novel quantum states and measurement schemes to demonstrate several orders of improvement in photon efficiency. A 2005-2009 DoD-funded Quantum Imaging MURI (Multidisciplinary University Research Initiative) studied combinations of nonclassical states of light and novel measurement techniques to improve resolution and signal-to-noise ratio (SNR) of longitudinal (e.g., ranging, optical coherence tomography) and transverse (e.g., ghost imaging, lithography) imaging systems. In a series of recent publications Tsang *et al.* have derived the quantum-mechanical limits for continuous-time phase and instantaneous-frequency estimation (see [Tsang2011a] and references therein), and applied the results to optimal opto-mechanical force sensing, which may be utilized in space-based interferometry experiments (e.g., LISA), or in testing the fundamental principles of quantum mechanics. In addition, enhancing the sensitivity of interferometers (e.g., LIGO) by use of squeezed-vacuum injection has been demonstrated in a laboratory environment, which may be applied to suitable space-based gravity interferometers as well. In other programs DARPA (QUASAR, ORCHID) pursues advanced quantum-enhanced sensors that can very efficiently couple disparate-frequency photons, e.g., a hybrid transducer that mechanically couples optical and microwave cavities.

In recent years there has been a surge of interest in pursuing quantum experiments in space. The current European Space Agency's QUEST program aims to perform quantum physics and quantum key distribution experiments from the International Space Station (ISS) [Ursin2009]. A Canadian collaboration QEYSSAT is investigating space-based quantum physics experiments, aiming to quantify the near- and longer-term science opportunities [Higgins2012, Rideout2012]. A project underway in Singapore aims to fly a compact entangled-photon source in a CubeSat and demonstrate entanglement on orbit [Ling2012]. Most recently China has announced its plans for a science satellite that aims to perform a variety of quantum experiments in space ranging from entanglement distribution to quantum key distribution [Xin2011].

NASA, too, has had a recent surge in activity investigating quantum-enhanced communication and sensing technologies for space applications. The NASA Technology Roadmap identifies quantum communication and quantum key distribution, as well as high-energy photonic communications (specifically, X-ray) as revolutionary technological capabilities in communication and navigation. Quantum optical interferometry and a quantum-entangled optical comb clock are stated as revolutionary technologies for future science instruments, observatories, and sensor systems. The ongoing 2011 NASA Innovative Advanced Concepts program includes an award to investigate the utility of entanglement for information transfer in space, as well as an award for using quantum-imaging-inspired passive

interferometry techniques (ghost imaging) for feature extraction of astrophysical objects. In addition, NASA's first Quantum Future Technologies conference has been held at NASA Ames in January 2012, which has initiated discussion on how future NASA missions may benefit from the recent advances in quantum measurement, computing, and cryptography.

II.4. Objectives of the workshop and study program

The technical objectives of our the study program were to: (1) identify the set of application areas in space communications and sensing that could benefit from novel quantum-enhanced techniques under realistic environmental conditions; (2) identify key performance requirements to realize the promised gains; and (3) capture the state-of-the-art relative to these requirements in order to determine the research and development avenues that could deliver quantum-enhanced capabilities. The overarching goal was to have formulated several promising concepts by the end of this study, which can then be matured into viable space-technology concepts during the possible follow-on program. The rest of this report will describe the study's accomplishments with respect to the preceding three objectives and the overarching goal.

III. Scope and Organization of the Study Program

Our aim in this study program was to highlight the potential science opportunities and technology enhancements that are accessible by the utilization of the fundamentally-quantum principles of EM radiation and microscopic particles. Consequently, the study program and this report span a broad set of topics. In this Section III.1 we define the scope of our study program, and in Section III.2 we discuss its organization during the workshop and post-workshop periods.

III.1. Scope of the workshop and study program

Figure III-1 summarizes both the logical organization and the scope of the study program. Our study program was built around two primary application areas: (1) sensing instruments; and (2) communication systems. Within each application area we addressed two categories that are strongly coupled in terms of the underlying enabling technologies, but have distinct objectives and performance criteria:

- 1) Sensing and measurement:
 - a. Fundamental science experiments in space: This category encompasses the scientific experiments that can be conducted in a space environment that would fundamentally rely on the manipulation and observation of quantum systems, and would improve our understanding of the universe or quantum mechanics itself. Atom interferometry, gravitational-wave detection and testing the coupling between gravity and quantum mechanics constitute a subset of topics that were discussed at the workshop.
 - b. Quantum-enhanced remote-sensing and *in situ* instruments: This category addresses the development of remote sensing or *in situ* precision measurement instrumentation that can achieve or approach quantum-limited sensitivities. Some topics that were discussed at the workshop include quantum-limited active spectroscopy and metrology using nonclassical states, quantum illumination, and weak measurements.
- 2) Communication and measurement:
 - a. Classical communication at the quantum limit: This category refers to the reliable transfer of *classical* information from one point to another, using a quantum-mechanical carrier of information, i.e., photons. Some topics of discussion include optimal modulation states for deep-space and near-Earth communication, and optimal measurement strategies that approach quantum limits.
 - b. Quantum communication: This category refers to the reliable transfer of the *quantum state* of a system (e.g., a photon, an atom) from one point to another. Topics of discussion for the workshop included quantum key distribution, and the distribution of entanglement over long distances.

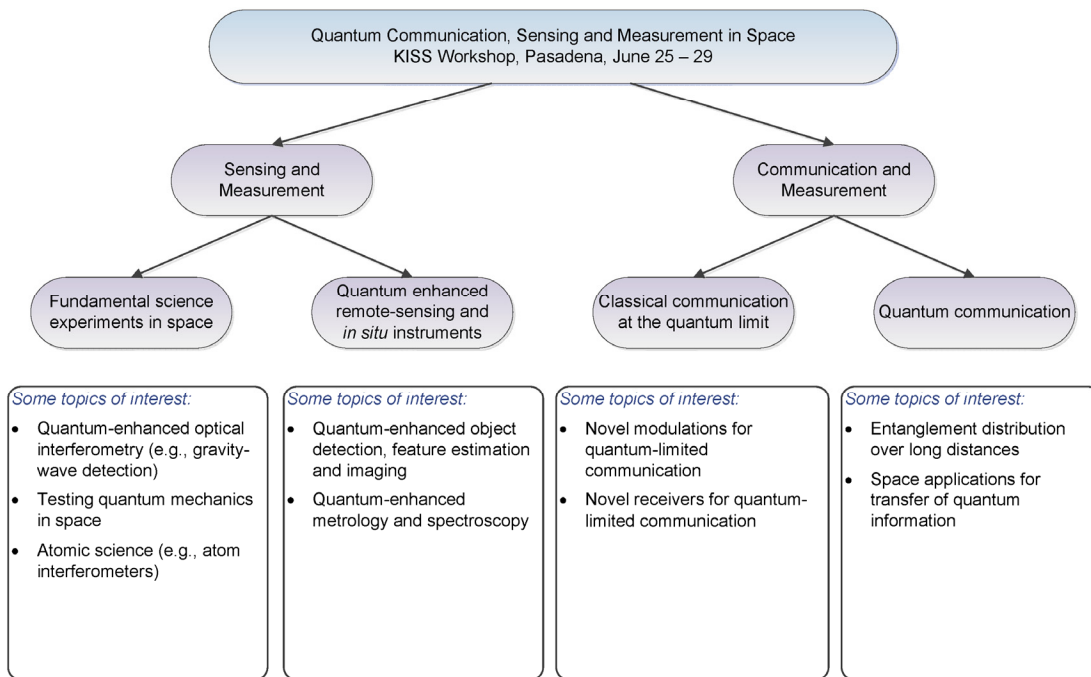

Figure III-1 Scope of study program and organization of topics.

III.2. Organization of the workshop and study program

To kick-off the study program a single focused workshop was held June 25th- 29th. The workshop addressed the four categories detailed in the previous subsection and shown in Figure III-1. The general structure of the workshop consisted of the following:

Short Course: The workshop opened with a day-long short course, consisting of four lectures on the primary categories of the workshop, given by experts amongst our core participants. The lectures were intended to be introductory and to provide relevant background to all participants, whose individual expertise collectively represented a very diverse background. The lectures — which were open to the entire JPL and Caltech communities — were as follows.

1. Solar System Tests of Relativistic Gravity in Space: History, Recent Progress and Possible Future Directions, by Slava Turyshev (JPL).
2. Fundamentals of Optical Interferometry for Gravitational Wave Detection, by Yanbei Chen (Caltech).
3. Quantum measurements, by Vittorio Giovannetti (Scuola Normale Superiore).
4. Fundamentals of Free-Space Optical Communication, by Sam Dolinar (JPL).

Discussion Sessions: The general structure of the workshop consisted of a series of discussion sessions, each dedicated to a topic area within each category. Every session started with a “lead-in talk” that was given by an expert in the field summarizing the state-of-the-art and the grand challenges, and concluding with thought provoking ideas or questions for the participants. Each lead-in talk was followed by a moderated discussion session that used the lead-in as a springboard. Although each discussion was moderated and therefore had a particular focus, they were structured so as to allow free evolution into whatever productive direction might arise.

Several sessions towards the end of the workshop were purposefully kept unassigned, to be dedicated to emerging topics of interest. These sessions became devoted to extended discussions of quantum imaging and classical communication.

A critical component of our discussion sessions were volunteer note-takers. Postdoctoral associates who had background in the pertinent topic area volunteered for this activity. After the session their notes were ported onto the workshop’s Wiki page for further use by all core participants.

Open Technical Lecture: As part of the workshop event, Prof. Markus Aspelmeyer, one of the core participants of our workshop, delivered a technical lecture at Caltech. The title of his talk was “Quantum Experiments in Space.” The lecture was well attended (over 100 attendees) from Caltech, JPL, and nearby universities.

Informal Presentations by Junior Researchers: Junior researchers (graduate students and postdoctoral associates) actively participated in our workshop, and were an indispensable component to lively discussions, the utilization of our online resources (e.g., the Wiki), and for continued progress during the study period that followed the workshop. To provide an opportunity for these junior researchers to discuss their own research, share their progress, and receive friendly feedback from other core participants, we invited each of them to give a 10-minute presentation during one session of the workshop. The discussions that ensued during this session, as well as the insights that were developed, not only accomplished the original intention of providing feedback, but also led to new ideas that will be discussed in Section IV of this report.

Post-Workshop Study Period: At the conclusion of the workshop, a roadmap for the study period and a plan for drafting the final report were developed. Eight subtopics of interest were identified (listed below). Core participants were designated to lead preparation of a report on each subtopic, with a list of suggested contributors for each subtopic named to assist. (The motivation for this organization was expressly not to compartmentalize, but ensure that each topic received due attention.) Cross-fertilization and contribution to multiple subtopics were encouraged. After the initial drafts were prepared, they were reviewed by other members of the study program. The full draft of the report was reviewed at a follow-on meeting held on November 8-9 at the KISS facility with the workshop Co-Leads and subtopic leads.

The eight subtopic areas emerging from the workshop are shown in Table III-1. The results of the investigations in these subtopics will be discussed in Section IV.

	Subtopics
Fundamental science	<ul style="list-style-type: none"> • Gravity science in space, and the intersection of gravity and quantum mechanics. • Frequency standards, timing, and atom interferometers. • A space-based ultra-stable laser frequency reference via interferometry.
Sensing	<ul style="list-style-type: none"> • Achieving high photon and spectral efficiency classical communication with photons. • Secure communications to, in, and from space.
Communication	<ul style="list-style-type: none"> • Classical and quantum sensing instruments. • Weak measurements for <i>in situ</i> sensing. • Multifunction and reconfigurable entangled-photon source in space.

Table III-1 Subtopics investigated during the post-workshop study period.

IV. Results Emerging from the Study

The evolution of the organization and focus of our Study Program is illustrated in Figure IV-1. Following the workshop, eight subtopics of interest were identified for further study, as listed in Section III.2. At the end of the study period, the subtopic leads and the study program co-leads evaluated the emerging results and re-integrated the subject matter consistent with the theme and objectives of our study program. This report strives to present a coherent summary of the emerging significant results from our study program, grouped into three main categories: (1) Fundamental Science in Space; (2) Sensing and Measurement in Space; and (3) Communication and Measurement in Space. The mapping between the workshop organization, the study period organization, and that final report organization is shown in Figure IV-1.

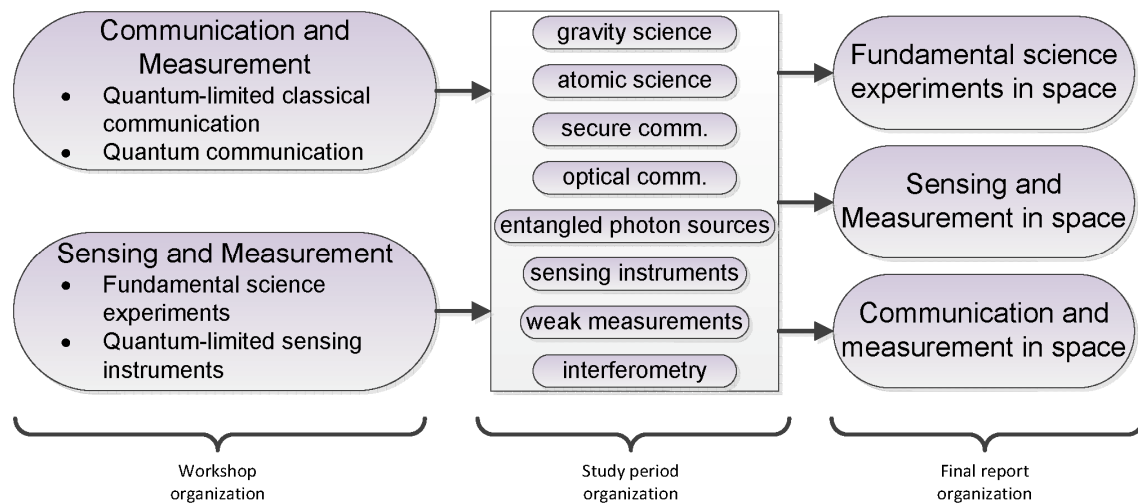

Figure IV-1 A timeline of the organizational evolution of our study program.

IV.1. Fundamental science in space

Space offers a significant potential for performing experiments that improve our understanding of the fundamental scientific theories and principles that govern our universe. Examples include — but are not limited to — tests of the effect of gravity on macroscopic objects in free-fall to determine the fundamental role of gravity as well as its quantization in the general framework of quantum mechanics, gravitational wave detection in low frequency bands in which terrestrial interferometers cannot achieve the required sensitivities, and high precision measurements of the universe’s fundamental constants or their variation in space and time. In Section IV.1.1 we first summarize the potential opportunities for fundamental physics experiments in space. Section IV.1.2 discusses gravity-wave detection opportunities that benefit from quantum technologies. Section IV.1.3

addresses potential utilization of space-based gravity wave interferometers as stable frequency resources. Section IV.1.4 treats the use of atomic clocks and quantum sensors for science applications. Finally, Section IV.1.5 summarizes the technology development priorities based on scientific motivations.

IV.1.1. Opportunities for fundamental physics measurements in space

Quantum phenomena are often regarded as mysterious and non-intuitive effects that only happen in the spooky atomic world. The science of light and atomic systems often confronts quantum-mechanical phenomena by necessity, because phenomena such as entanglement and particle waves have no counterparts in the classical world. On the other hand, these unique phenomena of quantum mechanics enable new measurement techniques and devices that are difficult or impossible to achieve in the classical world.

Some of the quantum-enabled measurement capabilities are exemplified by recent advances in atomic, molecular, and optical physics: laser-cooling techniques have been invented, quantum gases have been generated, precision atomic clocks have been developed, and atom-wave interferometer sensors have been demonstrated. This new generation of clocks and quantum sensors provides ideal tools for exact tests of fundamental physical laws in which there is high potential for new physics to be discovered. In addition, the ability to cool and control micro-mechanical systems continues to push the quantum boundary to larger microscopic mechanical systems. Quantum phenomena no longer are limited to atomic particles. Interesting quantum decoherence and gravitational interaction can now be explored in these microscopic mechanical systems.

It may be appropriate to consider that the current state of the understanding of fundamental physics is in a similar situation to the beginning of 20th century when our understanding of the natural laws of physics were completely transformed by the new theories of quantum mechanics, relativity, and the standard model [Turyshev2007]. Today, while these theories describe our observations nearly perfectly by themselves, there exist irreconcilable inconsistencies among them that imply new physical laws are necessary and waiting to be discovered. Finding a better understanding of the relation between gravity and quantum physics is one of the biggest challenges in physics today. Unified theories of quantum gravity, in general, predict deviations from general relativity, e.g., deviations from the universality of free fall. Several planned space missions intend to test the universality of free fall with unprecedented accuracy (e.g., MICROSCOPE), or to test the universality of free fall with novel methods, such as atom interferometry (e.g., STE-QUEST). Deviations from standard physics are, however, also expected in the regime of quantum physics as we perform matter-wave experiments with increasingly massive particles. In particular, several models have been proposed

that suggest novel decoherence mechanisms in addition to standard quantum decoherence. Some of these “macrorealistic” decoherence models are directly based on the assumption of deviations from quantum theory due to the quantization of space time (e.g., [Ellis1992]) or due to effects of quantum gravity that become apparent for quantum superpositions with sufficiently large masses (e.g., [Karolyhazy1966]). Other models of this type are based on the assumption that there should be a continuous transition between quantum behavior and classical behavior as the size, mass and complexity of quantum systems increases (e.g., [Diósi2007, Ghirardi1986, Ghirardi1990, Penrose1986]).

Recently, it was proposed to perform a double-slit-type experiment in space to test quantum physics in a regime where deviations according to the models mentioned above should become apparent [Kaltenbaek2012]. That proposal is based on using novel techniques from quantum opto-mechanics to prepare an optically trapped nanosphere (~ 100 nm radius or $\sim 10^{10}$ atoms) in a macroscopic superposition. The characteristics of the resulting interference pattern are then compared both to the predictions of quantum theory, and to the predictions of models that deviate from quantum theory. While this particular experiment requires further development to improve its technology readiness level (TRL), it is a promising example demonstrating that experimental techniques are evolving towards a breakthrough that will enable us to perform experiments in space, in a completely new and hitherto inaccessible parameter regime. These efforts should be seen as complementary to proposed tests of the universality of free fall. Using these different approaches, we will eventually progress — from several angles — into a new parameter regime where deviations from standard physics due to quantum gravity may become apparent.

The space platform and quantum-enabled precision measurement tools provide a unique combination for exploring the aforementioned new physics possibilities through measurements of the utmost precision. On the one hand, the benign nature of the space environment — with its microgravity, freedom from atmospheric interferences, and low vibration — enhances the performance of many quantum sensors, making them more sensitive than their counterparts on the ground. On the other hand, most experiments testing the fundamentals of physics require large spatial separation, high velocity, and high gravity extent and variations that only a space platform can offer, which enables significantly higher-sensitivity physics tests than one can achieve on the ground. Therefore, employing quantum sensors or systems such as atomic clocks, atom interferometers, and macroscopic quantum systems in space will significantly improve our measurements in gravity and fundamental physics investigations in space, laying the foundation for new discoveries. The interconnections between quantum-enabled sensors, the space environment, and the benefits to fundamental physics are illustrated in Figure IV-2.

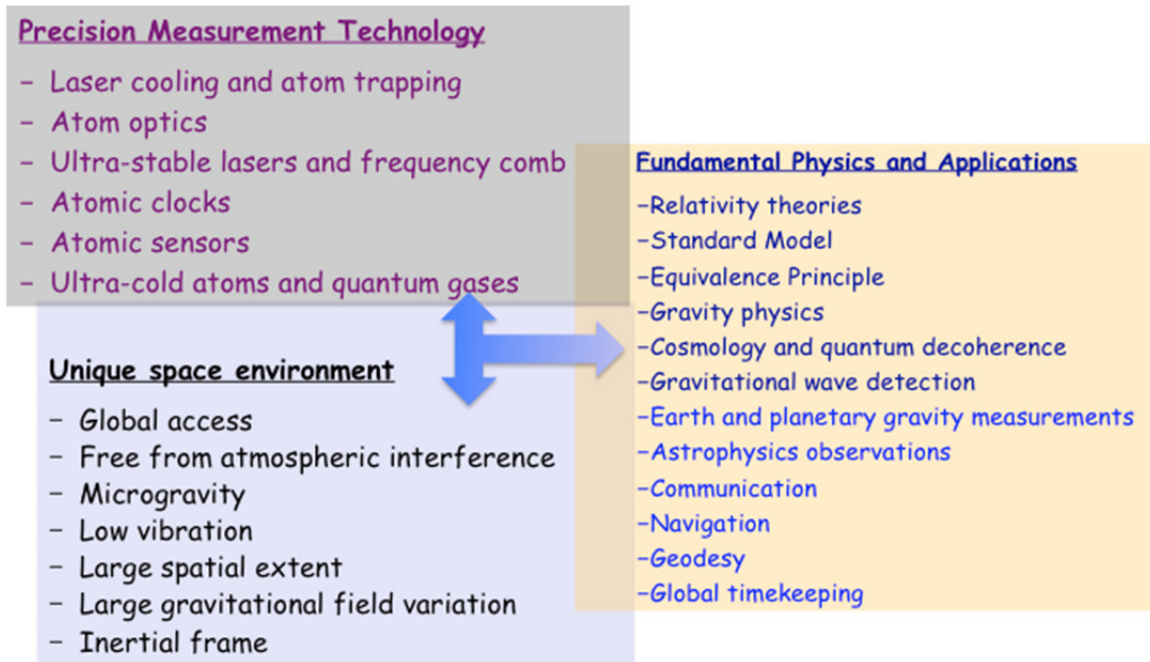

Figure IV-2 Challenging space measurements can benefit from capabilities enabled by quantum technologies, which can also be enhanced by space environments. The combination will provide unique opportunities for tests of fundamental physics and new discoveries.

IV.1.2. Low-frequency gravitational-wave interferometer in space

The relativistic accelerations of massive bodies produce distortions in space-time according to general relativity theory. These distortions are known as gravitational waves and promise to give us detailed information about the bulk motions of astrophysical objects and to perhaps also test Einstein's theory.

For a decade, terrestrial detectors (laser interferometers) of gravitational waves have been searching (unsuccessfully) for waves with frequencies of ~ 100 - 10000 Hz. The planned space missions for gravitational-wave detection (NGO from ESA, and the Japanese DECIGO project) are targeting the mHz band, where there should be strong signals from the mergers of supermassive black holes.

In the intermediate band (0.01 - 10 Hz), there exists an opportunity to combine recent advances in technology to make an early discovery. This frequency band is inaccessible from the ground: perturbations of the interferometer mirrors from local seismicity and fluctuating Newtonian gravity place a lower limit on terrestrial detectors of ~ 10 Hz [Driggers2012]. These obstacles are removed by going to space. In this frequency band, the strongest signals will come from the inspiralling orbits of quantum-degenerate compact objects: white dwarfs and neutron stars [Creighton2008]. As the orbital energy is lost to gravitational radiation, the objects spiral closer and closer, eventually colliding and producing a massive

electromagnetic burst [Phinney2009]. At these low frequencies the rate of energy loss is so low that the sources evolve only very slowly, lasting from minutes to years. Combining the electromagnetic and gravitational observations would permit us to construct a much clearer picture of our violent universe.

The measurement of gravitational-wave induced space-time strain is made by using laser interferometry to probe the relative separation of mirrors spaced many kilometers apart. At high frequencies, the sensitivity is limited by photon-counting statistics, and at low frequencies the limit is set by quantum radiation-pressure noise [Caves1980]. As probe-laser power is increased, the radiation pressure noise is also increased, while shot-noise-limited sensitivity improves. The tradeoff and fundamental limits due to the quantum nature of light are described by Braginsky's standard quantum limit (SQL) [Braginsky1992].

In the past decade, several groups have demonstrated interferometer sensitivity improvements by using squeezed states of light. Custom tailoring of these squeezed states allows for measuring the interferometer strain below the level of the SQL (uncertainty in the quadrature being measured is minimized while simultaneously maximized in the orthogonal—unmeasured—quadrature). This squeezing technique can already reduce the effective phase noise by 10 dB, and can conceivably exceed 15 dB within the next decade, leading to an increase of nearly a factor of 100 in the gravitational-wave event rate.

The enemy of high-amplitude quantum noise squeezing is loss along the optical paths. Each transverse plane along the propagation path with an optical loss contaminates the squeezed state by partial introduction of the vacuum state. The configuration of the LISA and NGO [www2012a] interferometers are such that nearly all of the light is lost between satellites; the laser beam size at each remote satellite is many orders-of-magnitude larger than the receiving optics. The DECIGO [www2012b] mission design calls for Fabry-Perot cavities formed between the satellites, but there are significant losses due to diffraction effects; too much loss to gain any benefit from the introduction of squeezed light.

There is a piece of the parameter space in interferometer design that has not yet been exploited. By shrinking the interferometer length by an order of magnitude (from the DECIGO length of 1000 km to 100 km), the diffraction loss can be made quite small using mirrors of reasonable size. This is a threshold effect: if the clipping losses are below 10 ppm, the squeezed state can survive within the interferometer and allow operation with low-power lasers.

In the past decade, a number of groups have demonstrated high levels of phase squeezing down to ~ 1 Hz. Their use of high quality optics and control of stray light have reduced dramatically the technical limits that constrained squeezing to be applicable only above the audio band.

In addition to the technique of squeezed light injection, which itself would allow us to surpass the SQL in space, the choice of a low-loss optical system allows for

possibility of using other quantum non-demolition (QND) techniques for the readout. Speed meters [Purdue2002] and low-loss squeezed light rotation cavities can be used to achieve the phase-noise reduction at higher frequencies while minimizing radiation pressure-noise fluctuations at lower frequencies. Recent work has also described how one might use nano-scale optical cavities with optical dilution to produce such QND effects for low frequencies in the cryogenic environment of space.

The use of such quantum measurement techniques can open up a new window into the universe, revealing the behavior of compact astrophysical objects, pulsars, and, possibly the unknown.

IV.1.3. A space-based ultra-stable laser frequency reference derived from gravitational wave technology

Study programs with participants from diverse technical backgrounds have the potential to generate new ideas and insights. The results reported in this section fall squarely within that category. Although not part of the initial charter of our workshop, discussions during the workshop resulted in an emergent idea that a stable laser frequency source could be derived from a space-based interferometer commensurate with the technology offered by LISA.

Space-based interferometric gravitational-wave detectors, such as LISA [Bender1998] necessarily exhibit extremely low noise in the measured distance between fiducial points, ∂L , over a large separation L : typically $\partial L = 5 \text{ pm}/\sqrt{\text{Hz}}$ at Fourier frequencies near 10 mHz, and $L = 5 \times 10^6 \text{ km}$, giving $\partial L/L \sim 10^{-21} / \sqrt{\text{Hz}}$. Within the LISA constellation, this stability can be transferred to the laser light that traverses the distance L between a pair of spacecraft. Laser stabilization by “arm locking” [McKenzie2009] is routinely implemented in ground-based detectors such as LIGO, and is planned for LISA-like space-based detectors as well. The frequency stability can be as good as

$$\partial \nu = \nu \frac{\partial L}{L} = 3 \times 10^{-7} \text{ Hz}/\sqrt{\text{Hz}}$$

for laser wavelength of $1 \mu\text{m}$. We refer to this as “stable-21 light,” after the fractional frequency stability $\partial \nu/\nu = 10^{-21} / \sqrt{\text{Hz}}$.

In planning to date, this ultra-stable reference has not been accessible outside of the constellation of LISA spacecraft. Often the question is asked, “Are there any applications of LISA other than gravitational-wave detection?” The emerging answer is that there is one application: transferring the LISA frequency reference to Earth, to improve the best frequency standards by several orders of magnitude.

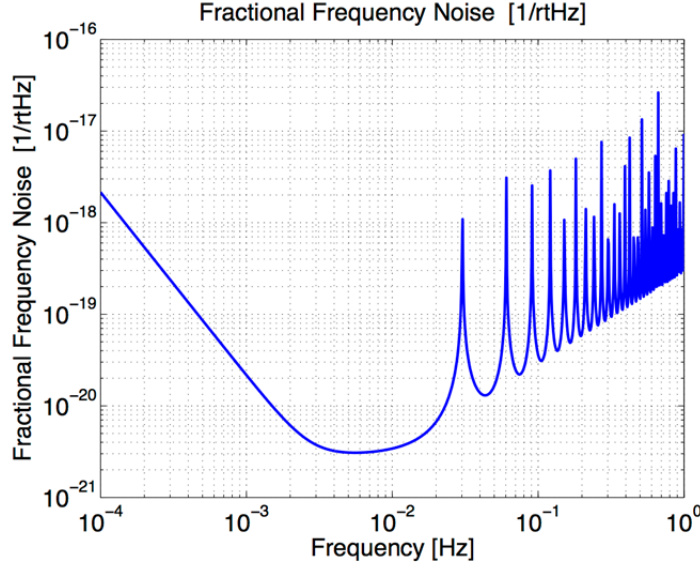

Figure IV-3 Fractional frequency stability of the separation between two LISA-like spacecraft.

There are two issues that determine the practicability of the concept: How would the reference be transferred to Earth without incurring noise, and once transferred, how it would be used. We address here the first question, and conclude that there are promising techniques to transfer stable-21 light through the Earth's atmosphere. The question of utility arises because, unlike atomic or molecular frequency standards, the laser light would not be a good absolute frequency reference. Rather, it would improve on existing standards over a specific range of frequencies, covering at most the span between 10^{-4} and 10^{-1} Hz. We believe that this limitation is not lethal to the concept: indeed, all existing frequency standards have limited ranges of applicable Fourier frequencies. Consequently, in this report we do not explore applications for stable-21 light. We do expect that once made available, it would find applicability in a wide range of experiments.

The features of the fractional frequency noise spectrum shown in Figure IV-3 derive from the design parameters of the LISA detector. The low-frequency tail has a f^{-2} shape, corresponding to a white spectrum of acceleration noise acting on the proof masses that serve as fiducials for the LISA measurement,

$$a(f) = 3 \times 10^{-15} \text{ m s}^{-2} \text{ Hz}^{-1/2}.$$

The corresponding displacement noise is $x_a(f) = a(f)(2\pi f)^{-2}$. At $f = 10^{-2}$ Hz and above, the noise is dominated by photon-counting statistics in the ~ 100 pW levels of laser light received by the spacecraft telescopes, resulting in noise of

$$x_s(f) = 1 \times 10^{-11} \text{ mHz}^{-1/2}.$$

The high-frequency spectrum also has a series of peaks that correspond to nulls in the sensitivity to laser frequency variations. Accounting for the travel time between

the arms, the fractional frequency sensitivity is

$$\partial\nu/\nu = (\partial L/L)/H(f),$$

where $H(f) = 1 - e^{-i\omega\tau}$ accounts for the round-trip delay between spacecraft, with $\tau = 33$ seconds and $\omega = 2\pi f$.

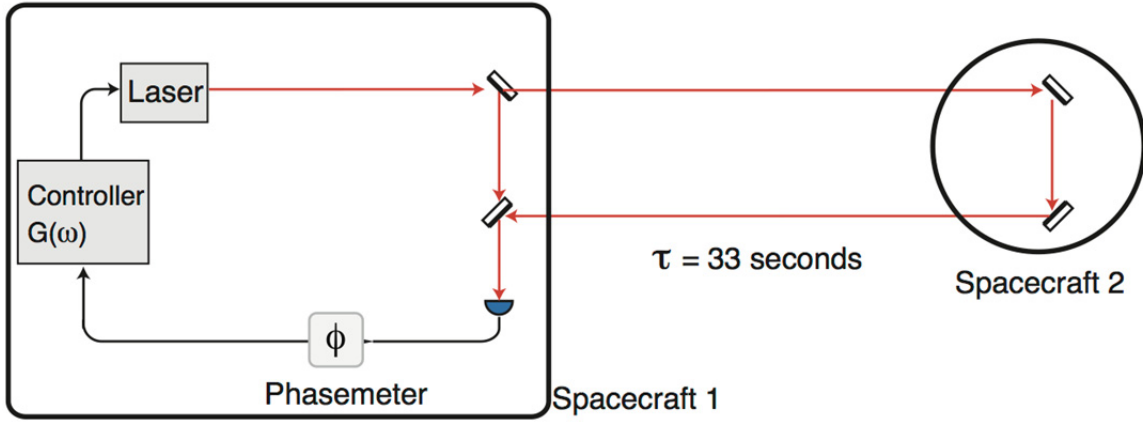

Figure IV-4 Schematic of locking the laser frequency to the arm length.

The “arm-locking” concept of ultra-stable measurement of the laser frequency between the satellites is shown in Figure IV-4. Consider the laser on spacecraft 1 to be the master oscillator, with free-running phase noise $\varphi_L(f)$. The laser on spacecraft 2 can be phase locked to the incoming light, thus spacecraft 2 appears to act like an amplifying mirror. The light that returns from spacecraft 2 is interfered with the local oscillator beam and the phase difference is recorded on the phasemeter,

$$\varphi_M(f) = \varphi_L(f)H(f) + \varphi_x(f),$$

where $\varphi_x(f)$ is displacement noise divided by laser wavelength, $\varphi_x(f) = x(f)/\lambda$. This very high precision measurement of the laser phase noise contains all the required information to enable high fidelity measurements with this light. There are practical advantages to stabilizing the laser to the spacecraft separation using the arm-locking technique, so that in addition to very precise knowledge of the laser frequency, the laser frequency will be made very stable.

The arm-locking control system feeds back to the master laser resulting in stabilized phase noise of $\varphi_s(f)$,

$$\varphi_s(f) = \frac{\varphi_L(f) + \varphi_x(f)G(f)H(f)}{1 + G(f)H(f)}.$$

Here $G(f)$ is the open loop gain of the controller. Practical limits, such as achievable control-loop gain, imply that the light itself will not reach the stability of the spacecraft separation. Nonetheless, the full frequency stability of the spacecraft separation can be recovered by recording the phase measurement signal and sending this to the ground.

Stabilized laser light can be transferred optically through a noisy path via a two-way measurement. For example, in a recent experiment [Mullavey2010] light was transmitted through 4.6 km of optical fiber, with fractional frequency noise added by the fiber less than $2 \times 10^{-18} \text{ Hz}^{-1/2}$. This is much less noise than the inherent one-way noise of the fiber; noise cancellation was achieved by measuring a local laser's phase against the incoming light at both ends.

Analogous to the fiber transfer experiments, the stable-21 light — plus transponded phase measurements provided that the control system gain is inadequate — would be directed to Earth via a telescope that is similar to the telescopes that direct laser light between spacecraft. A ground-based telescope of the order of 1 m diameter would receive the light, where it would be phase-locked to a local laser and transponded back to the satellite, allowing phase measurements at both ends. The laser brightness on Earth will have stellar magnitude ~ 3 , providing an ideal guide star for an adaptive optics system.

Unlike the noise-cancellation achieved with fiber-optic delays, the round-trip time from the satellites to Earth is on the order of the measurement times, namely $\tau \sim 100 \text{ s}$. This requires extra processing to cancel the atmospheric noise, using the phase-delayed combinations of the time delay interferometry (TDI) formalism [Armstrong1999, Shaddock2004]. To the extent that the atmospheric noise is the same for the uplink and downlink laser beams, it can be canceled by TDI combinations of phase measurements on the ground and at the satellite. Non-reciprocal noise is not cancelled, but can be mitigated by transponding multi-wavelength beams, such as a frequency-doubled version of the original wavelength. The next step in pursuing the transfer of stable-21 light to the Earth is to conduct a study of nonreciprocal atmospheric phase noise.

IV.1.4. Atomic clocks and quantum sensors for science applications

The field of the research related to atomic clocks and quantum sensors has had an incredibly productive decade marked by Nobel Prizes awarded for discoveries in laser cooling (1997), Bose-Einstein condensation and atom lasers (2001), and laser-based precision spectroscopy and the optical frequency-comb technique (2005). The field is now mature both from the point of view of the understanding of the basic physics underlying laser cooling and laser manipulation of atoms and for the development of a solid technology for the experimental implementation of new quantum devices. Below we present details for atom-wave interferometer-based

quantum sensors and clocks based on trapped and laser-cooled atomic systems.

IV.1.4.1. Atomic quantum inertial sensors

Atomic quantum inertial sensors exploit the particle-wave duality of atoms for ultra-sensitive interferometric measurements similar to laser interferometers. According to quantum mechanics, atoms also exhibit wave properties, called matter waves. While the wave properties of atoms are intrinsic, they have been difficult to harness until the advent of laser cooling of atoms. Laser-cooling techniques can reduce the motional temperature of atoms to micro-Kelvin and below, where their matter wavelengths become long enough that atom optics can be implemented. Among all possible implementations of atom optics, atom optics based on interactions between atoms and laser light — and the resulting atom interferometers — have been the most successful in realizing practical sensor devices.

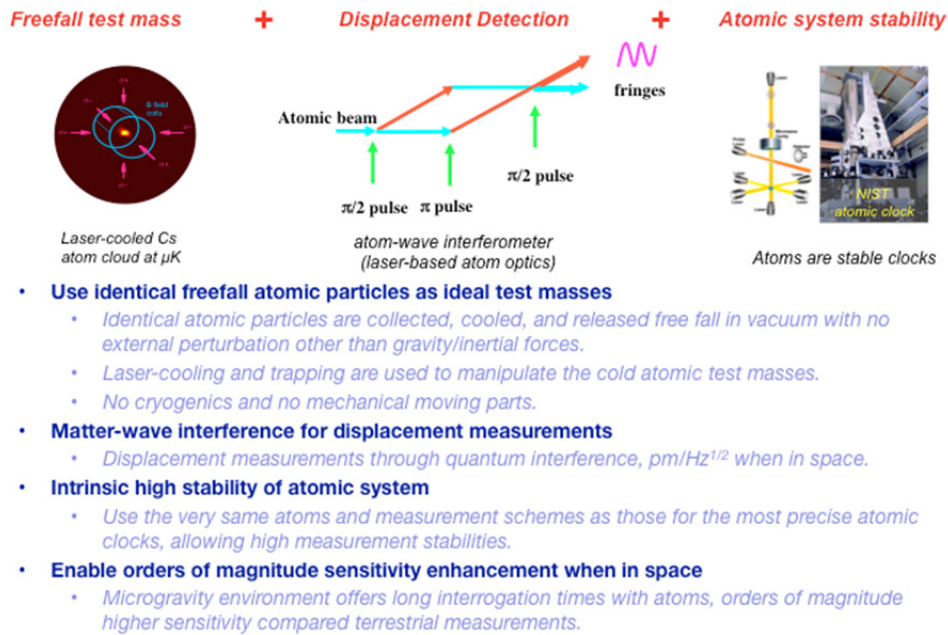

Figure IV-5 Unique aspects of atom interferometer based inertial sensors and their characteristics.

It should be emphasized that atom-interferometer sensor technology is potentially powerful not simply because of its novelty, but also owing to a number of unique characteristics, which have been detailed in Figure IV-5. First, laser cooling of atoms makes it possible to have totally drag-free free-fall atoms that are nearly perfect inertial test masses. Second, the quantum nature of matter-wave interference makes it possible to measure the extremely small motional changes due to inertial forces. Finally, because of the use of atomic systems, quite similar to an atomic clock, the system can be very stable over long time periods. These advantages — ideal free-fall test masses, matter-wave interferometry displacement measurement, and atomic

clock-like stability — will lead to a new generation of space inertial force-sensors for gravity and fundamental physics measurements in space.

Presently, laboratory atom interferometers have achieved $\Delta a \sim 10^{-8} \text{ m/s}^2/\text{Hz}^{1/2}$ [Peters1999] as accelerometers and $\Delta\Omega \sim 6 \times 10^{-10} \text{ rad/s/Hz}^{1/2}$ [Gustavson2000] as gyroscopes, already surpassing the state of the art in traditional sensors. Significant advances have been made more recently in sensor performance and technology maturity. Various transportable systems are being developed around the world, including gravimeters, gradiometers, and gyroscopes.

Major advances are still being made today in research laboratories. For example, a large momentum transfer for atom-wave splitting has been demonstrated with high fringe-contrast [Müller2008]. A larger momentum transfer results in a larger effective interferometer area and therefore higher sensitivity for a rotation-sensing interferometer. In addition, the use of coherent quantum matter waves offers potential for further improvement to overcome standard atom projection noise by exploiting quantum entanglement and nonclassical states.

A flight experiment in microgravity will greatly enhance the performance of atomic sensors because of the long interaction times achievable in a free-fall environment. This enhancement of longer interrogation time is especially strong for atom-interferometer sensors because the gain is proportional to the square of the coherence time. Better vibration isolation available on certain space platforms is also a benefit; the stability of the gratings or light fields that do the beam-splitting affects the phase stability of the atom interferometer, so less vibration is very important. Thus, if used as accelerometers, atom interferometers could potentially reach the level of $\Delta a \sim 10^{-12} \text{ m/s}^2/\text{Hz}^{1/2}$ or better [Yu2006, Dimopoulos2008], and if used as gyroscopes $\Delta\Omega \sim 10^{-11} \text{ rad/s/Hz}^{1/2}$ [www2003].

Light-pulse atom-interferometer inertial sensors rely on direct laser manipulation of atoms, and require lasers similar to those used in laser-cooled atomic clocks. In addition to small and reliable space-qualified lasers, light-control photonics with long lifetimes and precise frequency, phase, and intensity control are required. These requirements pose significant challenges because the types of lasers and optics needed are much more demanding than those already used in space, such as in LIDAR. Performance testing and relevant technology validation in the microgravity environment will be challenging. Microgravity validations may be performed in a drop tower, 0-g plane, the International Space Station (ISS), or as part of technology-demonstration satellite missions.

While most of the atomic sensor system developments to date are for terrestrial use, several efforts for developing space-based atomic sensors (e.g., QuITE, QWEP, STE-QUEST, and HYPER) have been undertaken. NASA's Earth Science Technology Office (ESTO) has funded atom-interferometer gravity gradiometer development to be used for global gravity mapping in space [Yu2002].

Maturation of these types of measurement systems for space requires further development of laser and optics systems, optically accessible vacuum systems¹, high-flux atom sources, and low-noise atom detection techniques. The potential systematics of atomic quantum sensor based measurement systems will also need careful study. In addition, investment should be made to continue basic atom-interferometer research to better understand these inertial sensors and their error sources, and to generate new capabilities.

IV.1.4.2. High accuracy optical clocks

For many years microwave transitions have served as the basis for highly-accurate and ultra-stable atomic clock systems. Laser cooling and trapping of ions or neutral atoms achieve extremely low temperatures in which systems of confined atoms can be well controlled. New ultra-stable optical reference cavities achieve laser stabilization to one part in 10^{15} in 1 second. A new type of clock based on optical atomic transitions promises dramatic improvements. In an optical atomic clock, a laser in the visible region of the electromagnetic spectrum is used to induce a forbidden atomic transition. By using optical frequencies ($\nu_0 \sim 10^{15}$ Hz) rather than microwave frequencies ($\nu_0 \sim 10^{10}$ Hz), an optical clock operates with a much smaller unit of time. This leads to an enormous improvement in stability and also to higher accuracy, since several key frequency shifts are fractionally much smaller in the optical domain.

The measurement of optical frequencies has recently been made practical by the advent of self-referencing (octave-spanning) optical frequency combs (OFC) of femtosecond lasers [Diddams2010]. With an OFC it is possible to phase-coherently link optical frequencies to microwave frequencies, so that lasers can be used to count seconds, and so that they can be compared to traditional microwave clocks. Combined with narrow-linewidth lasers, this has made possible the first generation of optical atomic frequency standards and clocks based on cold trapped neutral atoms and ions.

The short-term performance of microwave clocks is mostly limited by the available ultra-stable quartz oscillators to the 10^{-13} level, although more complicated cryogenically-cooled sapphire oscillators can achieve stabilities at the 10^{-15} level. Highly stabilized lasers have already routinely achieved the $10^{-15} \tau^{-1/2}$ level, limited by the thermal noise of the reference cavity [Ludlow2007]. A $10^{-16} \tau^{-1/2}$ level has now been demonstrated at lower temperature. When referenced to suitable optical transitions of atoms in ion traps or optical lattices, clock accuracies of approximately one part in 10^{17} have been demonstrated in recent years [Rosenband2008, Swallows2012]. While most of the preceding achievements have

¹ The thermal-shield concept proposed for MAQRO as part of ESA's Cosmic Vision program may prove valuable in developing optically-accessible vacuum systems for atom-interferometers in space.

been made in leading metrology research laboratories, substantial activities aimed at developing more practical devices are beginning. DARPA currently has a program to develop rack-sized optical clocks. The ESA ELIPS program is actively developing the Space Optical Clock (SOC) with neutral atoms, which is the next generation clock experiment for the ISS.

In space, where weightlessness and the extremely quiet environment ensure the ideal conditions for laboratory experiments, clock performance can be improved even further. Clocks in space represent unique tools to test fundamental laws of physics at an unprecedented level of accuracy and to develop applications in time and frequency metrology, universal time scales, global positioning and navigation, and geodesy. The absence of a strong gravity bias also benefits operation of an atom trap. A much weaker trap — and therefore lower atom cloud temperatures — can be achieved in microgravity. Thus, a released-atom or slow-beam clock could benefit from colder temperatures. In addition, reduced vibration in space will also be very beneficial for optical clocks.

Both laser-cooled cold-atom microwave clocks and optical clocks are viable for space operations. Currently demonstrated optical clocks are either based on trapped ions or neutral atoms. Cold-atom-based microwave clocks are a more mature technology and have synergistic technology areas in laser cooling and trapping. Large performance gains are expected by increasing the clock frequency from the microwave regime to the optical regime. Although small space-qualifiable optical clocks have not been studied in detail, several groups in the United States operate optical clocks at TRL 3 (lab demonstration). A program can be established to further develop these advanced atomic clocks for space applications. The program can support an initial development of several advanced clock technologies and common component technologies. It will then focus on one approach for a specific science experiment concept. For optical clocks, TRL 6 could be achievable within five years with sufficient investment.

IV.1.5. Science motivations and technology priorities

Today physics stands at the threshold of major discoveries as growing observational evidence points to the need for new physics. Efforts to discover new fundamental symmetries, investigations of the limits of established symmetries, tests of the general theory of relativity, the search for gravitational waves, and attempts to understand the nature of dark matter were among the topics at the focus of scientific research at the end of the last century. These efforts were intensified with the unexpected discovery of the accelerated expansion of the universe (i.e., “dark energy”) made in the late 1990s and triggered many new activities aimed at answering important questions related to the most fundamental laws of nature [Turyshev2009].

The fundamental physical laws of nature are currently described by the standard model and Einstein's general theory of relativity. Despite the beauty and simplicity of general relativity and the success of the standard model, however, our present understanding of the fundamental laws of physics is incomplete. In particular, a grand unification theory would quantize the gravitational field, which must lead to modification of general relativity and quantum theory. The search for a realistic theory of quantum gravity remains a challenge. This continued inability to merge gravity with quantum mechanics, together with the challenges posed by the discovery of dark energy, indicates that the pure tensor gravity of general relativity needs modification or augmentation. It is believed that new physics is needed to resolve this issue.

Theoretical physics models that can solve the preceding problems typically induce new physical interactions, some of which could manifest themselves as violations of the Equivalence Principle, variation of fundamental constants, modification of the inverse-square law of gravity at various distances, Lorentz-symmetry breaking, and large-scale gravitational phenomena. Each of these manifestations offers an opportunity for precision measurement experiments and could lead to a major discovery. Space is one of the most likely places where these manifestations may be investigated: while providing access to greater variation of gravitational potentials, greater velocities, and full orientation coverage, space also mimics the well-understood and controlled laboratory environment.

With recent advances in high-performance atomic clocks and atomic inertial sensors, a new suite of high-precision fundamental physics experimental concepts have been proposed and are being implemented. These concepts take advantage of new capabilities for ultra-high-accuracy metrology of distance, acceleration, rotation, and time. Already, ESA is readying the 2015 launch of a new generation of space clocks based on laser-cooled atoms in microgravity on the ISS. The clocks are expected to be the best atomic microwave clocks. Together with similar clocks on the ground, the ISS experiment will set new limits on Einstein's gravitational redshift and fundamental Lorentz symmetry. It will also demonstrate unprecedented precision in global frequency and time transfer as well as new relativistic geodesy. Furthermore, atom-interferometer quantum sensors are being studied for tests of Einstein's Equivalence Principle in ESA's ISS and Cosmic Vision programs. NASA is starting a Cold Atom Laboratory (CAL) facility on the ISS, providing a unique opportunity to explore ultra-cold atom physics and quantum gases in micro-gravity. In addition, NASA has plans for an atomic-clock flight experiment in 2015, and there are serious proposals on using atomic quantum sensors for gravitational-wave detection.

Many advances in atom-based quantum sensors have been made in ground-based laboratories. The time is now ripe to develop the corresponding technologies for space and mission concept designs for science measurements. They can help address fundamental science questions such as the following: "Does gravity behave as Einstein predicted?"; "What will be the nature of a theory of quantum gravity?";

“Where and how will the standard model fail?”; “Are the fundamental constants of nature truly constant?”; “What is the nature of dark matter and dark energy?” The space technologies resulting from the developments made to address such questions will also undoubtedly benefit the nation and society as a whole.

Atomic quantum sensor enabled science

Atomic quantum inertia sensors can become a key technology for ultra-precise measurements of accelerations and rotations. Their space deployment can be used to support new classes of experiments, such as tests of the gravitational inverse-square law at distances of a few microns, the universality of free fall, and new tests of the Equivalence Principle (EP) using atoms, as well as measurements of the relativistic frame-dragging precession [Tino2007]. These sensors also afford new experiment possibilities for gravitational wave detection [Dimopoulos2009]. In addition, a new generation of instruments using these novel technologies, such as precision gyroscopes, can support precision spacecraft attitude control for future space telescopes and x-ray observatories.

When used as sensitive accelerometers, cold atoms in space, as truly drag-free proof-masses, provide excellent candidates for tests of the universality of free fall. By measuring the differential acceleration of two co-located matter-wave interferometers with different atomic species, atom interferometers in space can be used to perform highly accurate searches for a violation of the EP, potentially reaching ultimate accuracies in these experiments. The EP is at the foundation of the general theory of relativity and other metric theories of gravity. Such a fundamental principle should be tested to utmost precision. Many modern theories of physics beyond the standard model predict a violation of the EP at different levels. The current limits of 1×10^{-13} on EP violations are set by ground-based torsion balance experiments. Atom interferometers in space could be used to reach accuracies beyond these current limits. Thus, the original goal of the Quantum Interferometry Test of Equivalence (QuITE) experiment was to achieve 1×10^{-16} . More recent advances in the field of matter-wave interferometry suggest that even better measurement precisions should be achievable. It should also be emphasized that new science can result from these test masses being quantum-mechanical atomic particles. QWEP, an ESA ISS experiment, is currently under study with a science objective similar to that of QuITE.

As sensitive rotation sensors, cold-atom interferometers can provide opportunities for mapping the Lense-Thirring precession. A feasibility study of hyper-precision cold-atom interferometry in space (HYPER), which relies on an atom gyroscope orbiting the Earth, was performed not too long ago by ESA [Bagnasco2002, www2003]. HYPER-like missions would be able to investigate two of the fundamental forces of nature: gravity and electromagnetism. For its gravitational investigation, HYPER would precisely map the fabric of the space-time around the

Earth. For its investigation of the electromagnetic force, HYPER would precisely measure the value of the fine-structure constant α .

More recently, a more exciting possibility has arisen with the application of atom interferometers to gravitational-wave detection, both on the ground and in space. Direct detection of gravitational waves is one of the most important modern physics experiments. It also offers an invaluable observational tool to probe our universe in astrophysics and cosmology. The detection of gravitational waves requires extremely sensitive detectors. Atom interferometers offer some distinct advantages in comparison with the LIGO and LISA experiments. Their key features can be summarized as the naturally drag-free free-fall test masses of laser-cooled atoms, the improvement in sensitivity in the spectral gap between LIGO and LISA, and the potential for simplification in the mission concepts (resulting in lower cost). A preliminary study indicates that a cold-atom-based gravitational-wave detector can complement LISA and LIGO detectors in providing the coverage for the entire spectrum of gravitational waves. Atomic sensors can also be combined with LISA-like classical detectors to be used as more convenient test masses.

Similar to the benefits that the microgravity of space affords to cold atomic clocks and atomic interferometers (which we discussed earlier), it can be argued that other cold atom-based experiments will be much more sensitive in the microgravity environment of space than on the ground, provided that the ground-based experiment has reached the precision limit set by the finite interaction time obtainable on the ground. As an example, cold atom-based permanent electron electric dipole moment measurements can benefit tremendously from space-based experiments and investigations of this concept have indicated that the ground-based sensitivity could be improved by several orders of magnitude. Permanent electron electric dipole moment measurements are a sensitive test for non-standard model sources of charge-conjugation symmetry and parity-symmetry (CP) violation. Direct measurement of any standard-model extension effects would herald a new era, fundamentally changing the perspective on the fabric of modern physics.

Clock enabled science

Clock comparison is one major category of experiments for probing the special theory of relativity and Lorentz invariance. The basic idea is to operate two or more high-precision clocks simultaneously and to compare their rates correlated with orbit parameters such as velocity relative to the fixed stars and position in a gravitational environment. A modified version of the standard model known as the standard-model extension (SME) allows for the possibility that comparisons of the signals from different clocks will yield very small differences. Several such space experiments have been proposed for free-flyer spacecraft and for onboard the ISS. They include the Superconducting Microwave Oscillator (SUMO), the Primary Atomic Reference Clock in Space (PARCS), the Rubidium Atomic Clock Experiment

(RACE) in the United States, and the European Atomic Clock Ensemble in Space (ACES). ACES is the only remaining space experiment of its kind, and is scheduled for launch in 2016. More recently, optical clocks have shown the potential for even greater precision than their microwave counterparts. Several mission proposals using optical clocks have already been proposed in the ESA Cosmic Vision program. In Europe, there is currently a great deal of work underway for potential future ESA projects on optical clocks and atom interferometry.

Clock experiments in space can also help to answer one of the most intriguing questions related to non-Einsteinian physics, i.e., whether the fundamental constants have time variations. Several models attempting to unify the forces of nature based on the symmetry properties of quantum dimensions allow variation of the fundamental constants. Any variation of the fundamental constants will entail a violation of the universality of free fall. This allows one to compare the ability of two classes of experiments — clock and proof-mass based EP tests — to search for a violation in a model-independent way. The proposed SpaceTime mission is an atomic-clock mission designed to search for a variation of the fine-structure constant and will be carried out on a spacecraft that flies to within six solar radii of the Sun under the influence of a highly-varying gravitational potential [Maleki2001]. This type of clock comparison is also one of the most straightforward but powerful tests of the EP.

Meeting technology challenges

While there exist many experiments and mission concepts for the use of atom-based quantum sensors in space, their development will benefit from appropriate maturation of the corresponding technologies. This maturity can be reached via important development of the following crucial elements:

- Suitable laser systems: currently, the lack of efficient space-qualified stable lasers is a major limitation.
- High-flux sources of cold atoms and degenerate quantum gases for atom-interferometer based instruments.
- Optical benches and high-quality optical interfaces with vacuum systems.
- Component- and system-level volume and mass reduction.
- Continued improvement of ground experiments: today, all quantum technologies and experiments are at the frontiers of knowledge. Ground experiments will always be a necessary prerequisite to prepare for and support space missions, as well as for the advancement of our scientific knowledge.

To meet the challenges in fundamental physics in the next decade, technology investments are required at the present time. The most important focus areas are: (1) tunable lasers (to cool and manipulate atoms); (2) stabilized clock lasers and

frequency combs (for laser interferometry and optical clocks); (3) atom interferometry (to measure accelerations, rotations); and (4) atomic clocks (to measure time and distance). Challenges of space deployment impose additional requirements on the reliability of the instruments and put pressure to minimize their mass, volume, and power requirements. This brings about the need for miniaturization and space qualification efforts.

IV.2. Sensing and Measurement in Space

In broad terms, sensing encompasses detection, estimation, and reconstruction of a set of parameters related to an object (target) of interest (e.g., range, shape, size, transverse real or complex reflectivity, spectral composition) based on active or passive probing of the region of interest and measurements collected by an instrument pertinent to the sensing problem at hand (e.g., camera, laser range finder, star tracker, pointing and tracking system, spectroscope etc.). The quantum enhanced instruments and concepts discussed in this section aim to achieve performance that exceeds that implied by the classical systems limited by the shot-noise floor of conventional photodetection, either by employing novel probe states in active systems, or by utilizing novel measurements on the received EM fields yielding smaller measurement uncertainty than conventional photodetection.

Sensing instruments are built and utilized in space applications in almost all wavelength ranges of EM radiation. However, because the low ambient noise floor at near-infrared and shorter wavelengths simplifies observation of the quantum nature of light at these wavelengths, the primary focus of the technical discussion in this section will be in this regime. We begin our exposition in Section IV.2.1 with a brief introduction to quantum and classical sensing systems, as well as a review of their taxonomy. In doing so, we identify opportunities for quantum-enhanced sensing instruments. Then, in Section IV.2.2, we discuss promising emerging quantum-enhanced sensing technologies. Section IV.2.3 focuses on a key technology, namely an entangled-photon source in space, which would enable several sensing concepts discussed in the previous section. We conclude, in Section IV.2.4, with recommendations for future work in this area.

IV.2.1. Opportunities for quantum enhancements

We considered sensing systems in two distinct environments: (1) endo-atmospheric systems, which need to cope with the deleterious effects of EM propagation through turbulence (extinction loss, beam spread, angle-of-arrival spread, multipath spread, time-dependent fading, and loss of spatial and temporal coherence), and (2) exo-atmospheric systems, which essentially have field propagation in vacuum, but may have to cope with various other deleterious effects such as cosmic rays, higher rates of dark counts due to radiation effects, etc. Sensing instrumentation can also be classified according to their nominal range of operation (short- versus long-range sensors). Table IV-1 summarizes key aspects of sensing systems in different categories based on the aforementioned classification.

	Short range	Long range
Endo-atmospheric	(e.g., short-range imaging sensors, entry, descent and landing systems) <ul style="list-style-type: none"> • Losses are moderate due to diffraction and atmospheric extinction. • Scintillation is often the dominant turbulence effect. • Sky-scattered sunlight generates background radiance uniformly across sensor field-of-view. • Integration times are limited, often due to motion in targets of interest. 	(e.g., Earth-observing sensors, Earth-bound telescopes) <ul style="list-style-type: none"> • Losses are high due to diffraction, turbulence-induced beam spread and angular spread, and atmospheric extinction. • Turbulence present, often dominant. • Sky-scattered sunlight generates background radiance that is essentially uniform across sensor field-of-view. Downlooking sensors versus uplooking sensors see different radiance values.
Exo-atmospheric	(e.g., an instrument on a rover, auto-docking systems) <ul style="list-style-type: none"> • Losses can be low in a controlled environment. • Turbulence is not present or not dominant. • Background is not dominant. • Power levels can be low, but integration times can be long. 	(e.g., on-orbit telescopes, deep-space imaging sensors, navigation sensors) <ul style="list-style-type: none"> • Losses are high due to diffraction, but no turbulence effects. • Background limited to cosmic radiation and sources in the sensing instrument's field of view. • Integration times often are necessarily long due to very low photon fluxes.

Table IV-1 Classification table for imaging sensors based on the environment in which they operate.

We can further classify sensors according to the EM radiation source: *active* systems generate their own illumination to probe a region of interest, and perform a measurement on the returned field. *passive* systems, on the other hand, rely on illumination sources that are naturally present (i.e., not controlled by the sensing system). Therefore, active imaging has a richer combination of possibilities for quantum enhancements to imaging sensor systems. Table IV-2 summarizes an active-sensor taxonomy that was developed for quantum sensors in a prior defense-agency-sponsored research program [Burdge2009]. We adopt this taxonomy in this report as well. Type 0 sensors are conventional classical sensing systems. The transmitted illumination is a coherent state (ideal laser light) and a conventional measurement is performed on the target-return illumination (i.e., homodyne, heterodyne or direct detection). Type I sensors generate nonclassical states to probe the region of interest. These states may or may not be multipartite, and therefore they may or may not utilize entanglement. However, the key requirement for this class of sensors is that the state transmitted from the instrument has no entanglement with any local states that may be stored for use by the receiver. Type II sensors transmit classical light, i.e., coherent states or mixtures thereof, and they too have no entanglement with resources local to the receiver. However, the receiver utilized to make a measurement on the target-return field is not a

conventional receiver, thus allowing for the possibility of approaching the ultimate measurement sensitivities predicted by quantum mechanics. The third category corresponds to having a multipartite nonclassical state generated at the transmitter. But unlike Type I sensors, the transmitted field *is* entangled to a local state that is stored for use by the receiver together with the target-return field.

Type	Definition	Example
0	A coherent state (ideal laser light) is transmitted and a conventional measurement (heterodyne, homodyne, direct detection) is performed at the receiver.	Conventional imaging LADAR, and LIDAR systems.
I	A nonclassical state is transmitted, but any local states stored at the receiver have no entanglement with the transmitted state.	N00N-state interferometry [Kok2002,Cable2007].
II	A classical state that is <i>not</i> entangled with any local resource at the receiver is transmitted, but a nonconventional measurement is performed at the receiver on the target-return field.	Quantum-enhanced coherent LADAR with squeezed-vacuum injection and phase-sensitive amplification [Dutton2010a, Dutton2010b].
III	A classical or nonclassical state is transmitted, and there is a local state stored at the receiver that is entangled at the time of transmission (the entanglement does not have to be present between the received state and the local state).	Quantum illumination (see IV.2.2.3) [Tan2008].

Table IV-2 Different sensor types, as used in our report.

Although the focus of this report is on the positive impact potential of quantum-enhanced sensing, it is important to recognize that there are certain operating regimes in which quantum enhancements are *not* significant. Thus, we conclude this overview of quantum-enhancement opportunities with a review of known *no-go theorems* that quantify operating conditions under which quantum-enhancements are at best incremental.

IV.2.1.1. No-go theorems for remote target detection with Type I and Type III sensors

The huge disparity at high average photon number ($N \gg 1$) between the $\Delta\phi \sim 1/\sqrt{N}$ standard quantum limit for phase measurements, and its $\Delta\phi \sim 1/N$ Heisenberg limit, has prompted much work aimed at quantum-enhanced interferometry. For optics-based remote sensing, in very lossy but noiseless environments, the situation is rather different. Here Nair [Nair2011a] has provided no-go theorems that limit

what benefits might accrue from the use of Type I or Type III sensors for target detection. In particular, he compared the error probability achievable with laser illumination and optimal quantum detection (a Dolinar receiver) for deciding between the equally likely hypotheses of specular point-target absence or presence in a known azimuth-range-Doppler bin with upper and lower bounds on what could be achieved with optimum Type I or Type III sensing at the same average transmitted photon number. When the round-trip return of the transmitted state is very weak and little to no background noise is present, the conventional laser-light (coherent-state) system's error probability is asymptotically equivalent to the error probability attainable with optimum Type I sensing and optimum Type III sensing, revealing that there is very little to be gained from replacing a coherent-state sensor with a Type I or Type III system in noise-free target detection. Note, however, that Nair's no-go theorems do not apply to Type II quantum enhancement, such as the squeezed-vacuum injection (SVI) and phase-sensitive amplification (PSA) system that will be described later. Nor do they pertain to the lossy and noisy environment, for which quantum illumination — a Type-III sensor — offers significant performance improvements over classical-state operation. Finally, the results do not preclude quantum enhancements in low-to-moderate loss scenarios, such as *in situ* sensing or short-range remote sensing. These cases will be exemplified in the upcoming sections.

IV.2.2. Recent advances in quantum-enhanced sensing systems

In subsections that follow we will highlight the important advances that have been made in understanding the operating regimes in which quantum-enhanced performance is promising, and the technology concepts that have been developed and demonstrated towards sensors that can attain quantum-enhanced performance. We will consider both active and passive sensors. Some of the sensing systems are in effect *classical* systems, but they have been inspired through the study of quantum-enhancements to conventional sensing systems. Consequently, we include them in our report.

IV.2.2.1. Type II sensing systems: nonclassical receivers for classical (coherent-state) illumination

Laser radars can achieve angular resolution $\sim\lambda/D$, range resolution $\sim c/B$, and velocity resolution $\sim \lambda/T$, where λ , D , B , and T are, respectively, the radar's operating wavelength, objective-optics diameter, modulation bandwidth, and measurement dwell time. Here, resolution refers to the ability to readily distinguish the presence of two targets of roughly similar radar cross-section — as opposed to one with the same total cross-section — by their separation in angle, range, or Doppler shift. For localization in any of these modalities, it is *accuracy*, rather than resolution, that is important. In a conventional, direct-detection or heterodyne-

detection laser radar whose signal-to-noise ratio (SNR) is sufficient to approach Cramér-Rao-bound performance, the root-mean-squared angle, range, and velocity accuracies split their respective resolutions by factors of $1/\sqrt{\text{SNR}}$. At the signal shot-noise limit, $\text{SNR} \approx N$ prevails, where N is the average number of detected signal photons, yielding accuracies at the standard quantum limit (SQL). The SQL is substantially inferior to the Heisenberg limit, in which root-mean-squared accuracy equals resolution divided by N . Heisenberg-limited accuracy, however, requires nonclassical light sources whose favorable characteristics are destroyed by the exceedingly-high roundtrip propagation loss encountered in most laser radar applications, e.g., a 1-m-diameter receiver standing off 100 km from an extended quasi-Lambertian reflector suffers 100 dB propagation loss just in vacuum-propagation from the target to the radar receiver.

The challenge of exceeding the SQL in laser-radar angle, range, or velocity measurement accuracy has been addressed — at least in part — through the Table IV-2 taxonomy for active imagers. In particular, Type I active imagers, which transmit nonclassical light that is not entangled with any state left behind at the radar receiver and use conventional (direct, heterodyne, or homodyne) detection, are not expected to be of any value for high-loss active imaging such as will be of interest in many space scenarios. Type III imagers, in which the transmitted light — classical or nonclassical — is entangled with a state at the radar receiver, have received some attention under the rubric of quantum illumination. As discussed later in this section, quantum illumination can significantly outperform classical-state systems of the same transmitted power in target detection, but that advantage accrues for very lossy channels that also have high-brightness background noise, and the latter condition will not apply at operating wavelengths from the infrared into the ultraviolet. That leaves Type II imagers, which transmit laser light but use nonconventional receivers, as possible candidates for quantum-enhanced imaging. The concept here is roughly analogous to what will be seen in Section IV.3 for quantum-enhanced classical communication over the pure-loss channel: laser transmitters employed together with novel receivers provide quantum enhancement. Understanding of how much performance might be gained from Type II imaging is, however, far less mature than what is known about the Holevo limit for classical communication as discussed in Section IV.3.

An initial suggestion for advantageous Type II imaging was made by Kumar *et al.* [Kumar2007], and a more detailed evaluation of its performance was later reported by Dutton *et al.* [Dutton2010a, Dutton2010b]. They considered a soft-aperture radar receiver, see Figure IV-6, whose Gaussian-transmission entrance pupil was chosen to apodize the receiver's point-spread function at the cost of losing some high spatial-frequency information. The combination of squeezed-vacuum injection (SVI), phase-sensitive amplification (PSA), and homodyne detection could recover the lost high spatial-frequency content by reducing the quantum noise at these aperture-attenuated spatial frequencies (with SVI) and then noiselessly amplifying these spatial frequencies (with PSA) so that downstream inefficiencies did not

preclude reaping the quantum enhancement. With 15 dB SVI, 15 dB PSA, and 6 dB of downstream losses, simulations in [Dutton2010a, Dutton2010b] showed an 11 dB reduction in the average received photon number needed to angle-resolve a pair of closely-spaced point targets with 0.03 error probability.

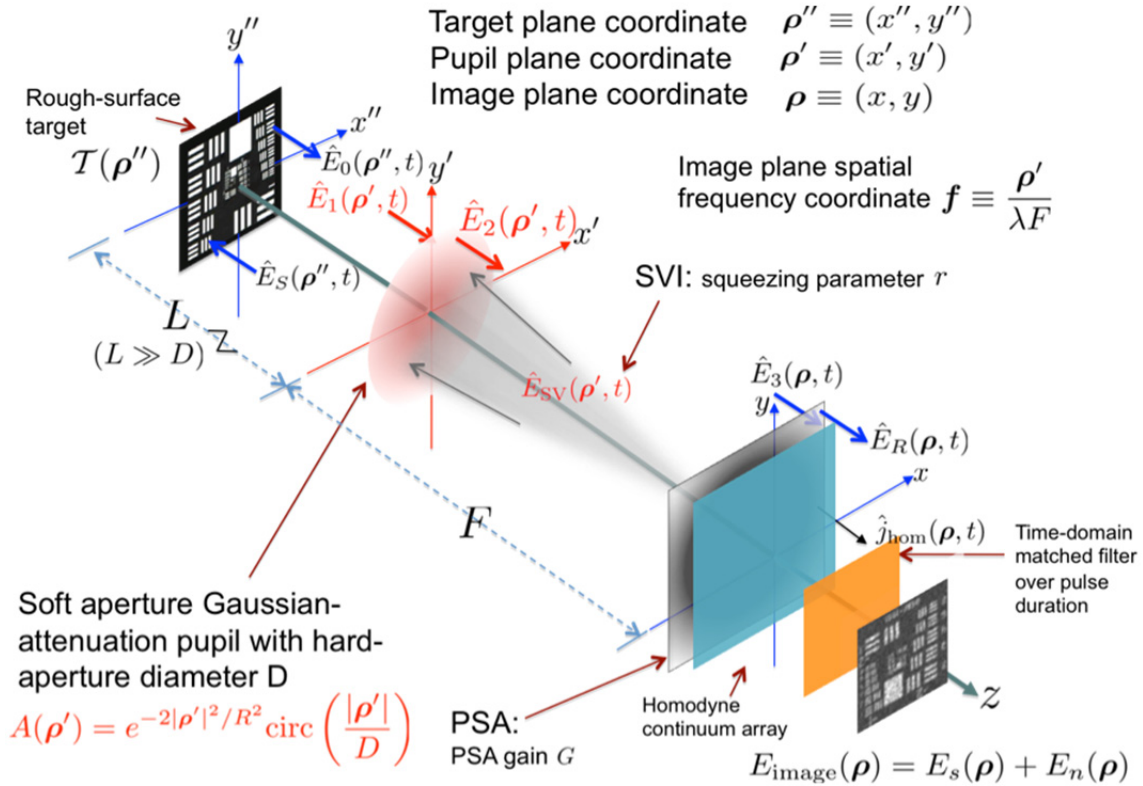

Figure IV-6 Notional configuration for Type-II laser radar receiver using squeezed-vacuum injection (SVI), phase-sensitive amplification (PSA), and homodyne detection to achieve improved angle resolution in a coherent-state, soft-aperture laser radar.

The technical challenges required to translate this initial assessment into an experimental demonstration — not to mention what would be needed to realize fieldable or space-qualified systems — are quite considerable but not inconceivable to overcome. First steps in that direction were taken in experiments performed at Northwestern University [Lim2011] and the Harris Corporation [Wasilousky2011], and additional theory extended previous results to address the angle and range resolution achievable with the Harris implementation [Santivanez2011, Nair2011b]. The Harris experiments employed heterodyne detection, rather than homodyne detection, despite its long being thought that phase-sensitive amplification should be followed by homodyne detection for best performance, with phase-insensitive amplification (PIA) being the appropriate preamplifier for heterodyne reception [Yuen1987]. It turned out, however, that Harris' novel technique for phase-locking the PSA's gain quadrature to the heterodyne detector's local-oscillator field then permits downstream losses to be overcome in the heterodyne configuration.

Moreover, when the amplifiers and detectors are treated in full, broadband analysis — unlike the simpler single-mode treatment from [Yuen1987] — PSA operation with heterodyne detection affords 3 dB higher signal-to-noise ratio than does PIA operation with heterodyne detection when it is impossible to adequately suppress the image-band amplified spontaneous emission by a post-amplification (pre-detection) optical filter. Although such filtering will easily be possible in many optical communication applications, this may not be the case in laser radar systems used for vibration sensing.

IV.2.2.2. Quantum filtering and smoothing in Type II systems

Feedback control is indispensable to a variety of space optics applications, such as LIDAR target tracking and adaptive optics for ground-based telescopes. Measurements in space applications are necessarily noisy, so statistical techniques are needed to extract real-time information from the measurements, such as target position and optical phase fluctuations, for the purpose of optimal feedback control. Real-time estimation is commonly called filtering, and when the system at hand is quantum-mechanical, quantum filtering is needed for optimal estimation and control.

Quantum filtering

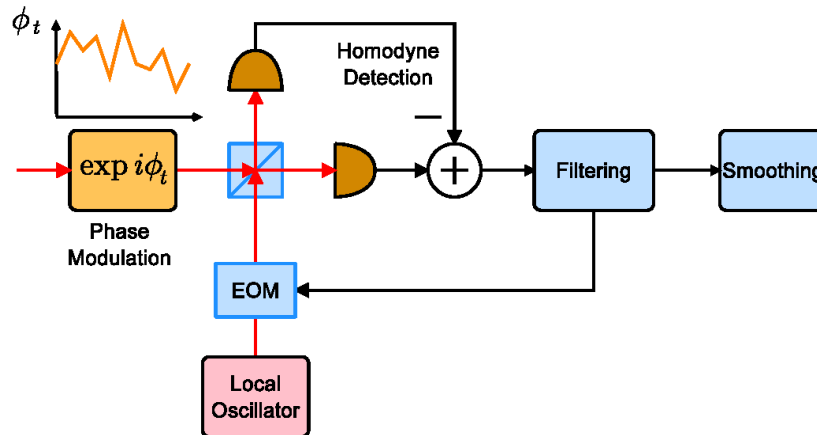

Figure IV-7 Schematic of a homodyne optical phase-locked loop for phase tracking and estimation.

Quantum filtering in this context refers to real-time data processing techniques that takes into account the quantum nature of the system of interest but can still be implemented by a classical processor. For example, optical phase tracking is fundamentally limited by the inherent quantum noise in laser light, and a quantum-optimal measurement can be implemented by an optical homodyne phase-locked loop with an in-loop quantum filter [Tsang2008, Tsang2009a, Wheatley2010, Yonezawa2012]. The quantum filter takes the homodyne signal and modulates the

local-oscillator phase as a function of it, such that the signal-to-noise ratio of the homodyne detection is optimized.

The synthesis of quantum filters is greatly simplified when the system of interest obeys linear equations of motion with additive Gaussian noise. In that case, the optimal quantum filters have the same form as the optimal linear filters, namely the Kalman and Wiener filters [Wiseman2010]. The theory for and the experimental realization of quantum-optical phase-locked loops, as depicted in Figure IV-7, take advantage of this correspondence [Tsang2008, Tsang2009a, Wheatley2010, Yonezawa2012], as the quantum Kalman filter maximizes the homodyne signal-to-noise ratio and also locks the measurements in the linear regime to ensure its own optimality. The in-loop filter estimates the optical phase in real time and modulates the local-oscillator phase through an electro-optic modulator (EOM), such that the homodyne detector is locked onto the phase quadrature of the incoming optical beam. Offline processing via smoothing can be performed to further enhance phase estimation accuracy [Tsang2008, Tsang2009a, Wheatley2010, Yonezawa2012].

It is important to note that the use of quantum filters is not limited to the processing of noisy quantum optical measurements, or of classical input states. It applies equally well to estimation, prediction and filtering tasks for nonclassical states, i.e., Type I systems. Furthermore, advanced experiments in space using quantum technologies such as opto-mechanics, atomic ensembles, and superconducting microwave circuits will likely require quantum mechanics to fully model their dynamics, and thus quantum filters to predict their behavior for optimal feedback control. Thus, we anticipate that quantum filtering's playing a prominent role in high-sensitivity sensing applications, such as gravitational-wave detection, magnetometry, and gyroscopy. The use of quantum filters and feedback control is crucial to ensure that the quantum sensors work in an optimum configuration.

Quantum smoothing

While the real-time nature of filtering is useful for the purpose of feedback control, it is well known in estimation theory that it is not the optimal waveform estimation technique if delay is permitted. Delayed waveform estimation is commonly called smoothing, which can be significantly more accurate than filtering depending on the situation. Although smoothing is not as useful for feedback control, it can improve the filtering results by offline processing and therefore become useful for "after-the-fact" analyses in sensing and imaging applications. A theory of quantum smoothing has been developed recently [Tsang2009b, Tsang2009c, Tsang2010] and is envisioned to be useful for future quantum sensing applications.

IV.2.2.3. Quantum illumination: a Type III sensor for high noise and loss

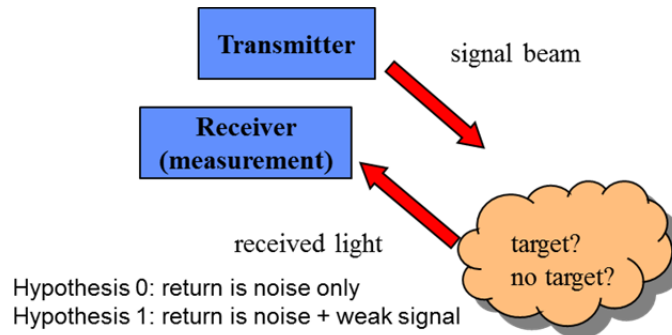

Figure IV-8 Quantum illumination concept for target detection in the presence of a weak signal return and high background.

In brief summary, quantum illumination (QI) is a Type III quantum sensor whose task is to determine the absence or presence of a weakly-reflecting target in a region flooded with high background radiation (noise), given a constraint on the mean photon number in the probe beam [Tan2008, Lloyd2008, Shapiro2009b]. It has been shown that it can significantly outperform Type 0 (classical-state) remote-sensing instruments using the same transmitted power in target detection when operating in noisy and lossy operating environments.

As shown in the Figure IV-8 illustration, light received from a region of interest — after being illuminated by the probe — is used to decide whether the object is present or absent. The QI transmitter uses entangled signal and idler beams generated via spontaneous parametric downconversion (SPDC), and transmits the signal beam to interrogate the region of interest while storing the idler locally. The classical (Type 0) system, on the other hand, uses a coherent-state transmitter with the same average number of photons as the QI transmitter’s signal beam. The error exponent achieved by the QI system, when it is paired with the optimal measurement on the target-return field and the locally-stored idler field, is 3 dB to 6 dB greater than the error-probability exponent achieved by the optimal classical coherent-state system, with the gap asymptotically approaching the 6 dB value as the product of measurement time and SPDC bandwidth increases. This advantage accrues despite there being no entanglement left between the light collected from the target region and the retained beam.

The optimal quantum receiver that can realize the predicted gain remains unknown (i.e., a block diagram describing how the desired abstract quantum measurement can be realized with available apparatus does not exist). Nonetheless, two structured optical receivers that achieve up to 3 dB improvement in the error exponent have been proposed [Guha2009]. These receivers provide readily implementable measurement architectures that can outperform the best classical sensor in the high loss and noise regime in which QI is advantageous.

The advantage of QI accrues when the region of interest is very lossy and has high-brightness background noise. The ambient background encountered in typical terrestrial and space scenarios at infrared frequencies and higher does not yield high-brightness background. Thus the applications of interest at these wavelengths would be targeted to specific *in situ* sensing scenarios in which the background radiation emitted from the region of interest has high-brightness and the signature of interest is weak. Perhaps more promising is an application to microwave frequencies, at which the ambient background radiation is bright. Here ground-penetrating radar or entry, descent and landing radars may benefit from QI. Further feasibility studies are necessary prior to establishing the value of pursuing QI in these application domains.

It is also worthwhile to point out that QI has also been extended to a secure communication protocol, resulting in an eavesdropper having orders-of-magnitude higher error probability than the intended receiver [Shapiro2009c]. Therefore, it is possible to fathom that QI could find application areas outside of the realm of sensing.

IV.2.2.4. Active ghost imaging: classical (Type 0) and quantum (Type III)

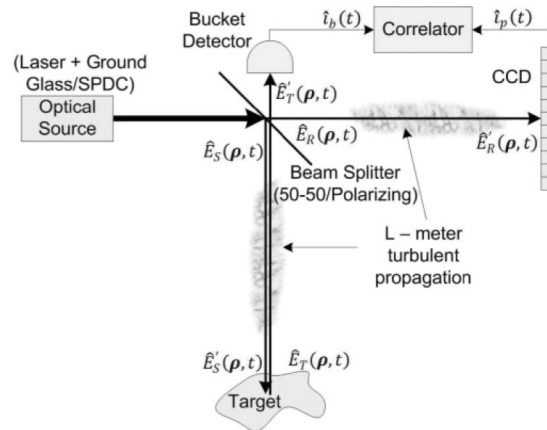

Figure IV-9 Block diagram for active ghost imaging for standoff sensing with either a quantum source or a classical source.

Ghost imaging is a transverse imaging modality whose roots go back to early investigations of utilizing the entanglement between pairs of photons (biphotons) obtained from spontaneous parametric downconversion to perform imaging. After its first realization with entangled photons, it was demonstrated that ghost imaging can be performed both with classical or quantum sources. To date, quantum ghost imaging has used entangled photons from SPDC [Pittman1995], and classical ghost imaging has focused on thermal light [Valencia2005, Ferri2005, Cai2005] and classical phase-sensitive light [Erkmen2010, Venkatraman2011]. Aside from minor implementation variations, virtually all ghost imaging demonstrations have thus far

utilized the cross correlation between the photocurrents obtained from illumination of two spatially-separated photodetectors by a pair of highly-correlated optical beams (see Figure IV-9 for a generic block diagram). One beam interrogates a target (or sample) and then illuminates a single-pixel (bucket) detector that provides no spatial resolution. The other beam does not interact with the target, but it impinges on a scanning pinhole detector or a high-resolution camera, hence affording a multi-pixel output. The term “ghost imaging” was coined soon after the initial experiments were reported, its rationale being that neither photocurrent alone is sufficient to obtain the target image: the light hitting the bucket detector has interacted with the target but that detector has no spatial resolution, whereas the light hitting the multi-pixel detector has not interrogated the target. It is only by jointly processing (specifically, by cross correlating) the two photocurrents that an image is obtained.

We can group ghost imaging systems into two categories: (1) quantum ghost imaging, which refers to ghost imaging that uses entangled photons obtained from spontaneous parametric downconversion; and (2) classical ghost imaging, which refers to ghost imaging using a thermal field or a classical field exhibiting phase-sensitive coherence. Within category (2), it is worth separating out a sub-branch, ‘computational (classical) ghost imaging’ wherein structured illumination replaces the aforementioned classical sources, and consequently the reference arm can be eliminated from the imaging setup [Shapiro2008, Bromberg2009]. This category has a strong overlap with active computational imaging, and therefore encompasses the application of advanced and novel reconstruction techniques, such as compressed sensing or basis-pursuit reconstruction [Katz2009]. We first address the comparative merits of categories (1) and (2), and then focus on the benefits and applications of computational ghost imaging. Table IV-3 summarizes the key advantages and challenges associated with quantum and classical ghost imaging.

Quantum ghost imaging primarily enjoys a native contrast advantage over classical ghost-imaging systems, unless the classical ghost imagers utilize DC-blocks or background subtraction prior to reconstructing the image. Its primary disadvantages are the paucity of its photon-pair generation (state-of-the-art is $\sim 10^8$ photon pairs/s) relative to the photon flux of classical sources, which results in the quantum imager’s needing much longer integration times than its classical counterpart. The contrast advantage of quantum ghost imaging also vanishes for remote-imaging scenarios in which the mean number of background photons per spatiotemporal mode exceeds the mean photon-number per spatiotemporal mode in the ghost-imager’s reference arm, which is always $\ll 1$. The contrast advantage would prevail, however, in short-range imaging systems with controlled environments, such as *in situ* imaging instruments on rovers.

Classical ghost imaging has the primary advantage of easy access to bright sources, which can significantly reduce image acquisition time over nonclassical sources. For example, a nanowatt of laser power at $1 \mu\text{m}$ wavelength, which is a weak laser pulse, contains approximately 5×10^9 photons/s. Thus, it is easy to generate many orders of magnitude higher photon fluxes using classical light than what is achievable with

SPDC for entangled photon pairs. This flux advantage is why, in recent years, active ghost imaging with classical sources has been of greater interest than its quantum counterpart for application of ghost imaging to remote sensing.

	Advantages	Challenges
Quantum ghost imaging	<ul style="list-style-type: none"> • Native contrast advantage over classical ghost imaging without DC blocking. Could be used in <i>in situ</i> imaging with low loss (e.g., microscopy, spectroscopy on a rover-type device.) • Very broadband source. 	<ul style="list-style-type: none"> • Contrast advantage is sensitive to background radiance. • Photon flux is nominally low (SOA $\sim 10^8$ photons/s), resulting in long integration times. • SNR is proportional to coincidence rate, which suffers significantly from loss in either arm.
Classical ghost imaging	<ul style="list-style-type: none"> • Easy to obtain high photon flux. • Background radiance does not pose a significant limitation to contrast. • Computational ghost imaging could be used <i>in situ</i> imaging (e.g., life detection via microscopy or spectroscopy) as well as remote imaging applications. • Computational ghost imaging can achieve 3D imagery with no modification to optical or imaging hardware. 	<ul style="list-style-type: none"> • Native contrast is low (requires DC filtering). • SNR is inversely proportional to resolution.

Table IV-3 Highlights for strengths, application areas, and implementation challenges for classical and quantum ghost imaging.

Long-distance standoff sensing with ghost imaging requires us to address two primary effects [Hardy2011,Erkmen2012a]: (1) the roughness of the target surface results in diffuse surface scattering of quasi-Lambertian nature manifesting itself as a loss in total received power and a speckled return; and (2) propagation through a long turbulent path resulting in beam spread, angle-of-arrival spread, and scintillation, with aperture sizes, propagation distances, and distribution of turbulence along propagation path impacting the relative significance of these effects.

Rough-surfaced targets (with roughness on the order of the wavelength of the

illumination) scatter their impinging illumination in a random manner, casting random speckle patterns in their far fields that, on average, correspond to a quasi-Lambertian distribution. This implies that the reflected field will scatter into 2π steradians, and will exhibit angular coherence at the scale of the objects' spatial bandwidth. Consequently, the ghost imager's bucket detector will, on average, collect only the solid angle subtended with respect to the object, approximately the fraction A/L^2 of the target-scattered light, where A is the bucket detector's area and L is the distance between the target and the object. The effective image resolution is equal to the nominal size of the speckles cast on the target, i.e., $\lambda^2 L^2 / D^2$, where D is the source's spatial extent (diameter) and λ is the center wavelength of the illumination. The time-independent speckle cast by the target reflection results in the SNR saturating at a maximum value (when the speckle is fully developed) as the power increases. Thus improving the SNR beyond this maximum requires averaging the image over independent speckle realizations, which requires slightly different look angles, or multiple wavelength illumination, etc. For example, multiple realizations of the speckle can be averaged to suppress fully-developed speckle by taking several images separated further than the coherence angle of the return. Other degrees of freedom, such as wavelength or polarization, can also be used to combat fully-developed speckle. As we have alluded to earlier, the size of the transmitted illumination beam provides a tradeoff between SNR and resolution. Larger-area transmitter beams result in higher-resolution images; the number of on-target resolution cells is proportional to transmitter-beam area. However the SNR is inversely proportional to the number of on-target resolution cells, resulting in a trade-off between resolution and SNR.

The impact of turbulence on ghost-imaging remote sensing is perhaps one of the more interesting aspects of this imaging scheme. We find that the impact varies with the cause. Atmospheric turbulence on the target-return path has little to no effect on image resolution, which makes ghost imaging desirable when the path from the object to the bucket detector lies within a highly-turbulent region. The impact of atmospheric turbulence in the target-illumination path depends on where the turbulence is concentrated. In particular, turbulence near the transmitter aperture is most devastating, as any aperture larger than the atmospheric coherence length provides no additional resolution, unless adaptive optics are employed. On the other hand, turbulence near the target has negligible impact on image resolution. Turbulence on the signal and reference paths has the same degrading impact. In particular, the resolution becomes turbulence-limited when the atmospheric coherence length at the source plane becomes smaller than the source size. Therefore it is advantageous to keep the reference field in a controlled (turbulence-free) environment. Turbulence also degrades ghost-image SNR by decreasing the saturation SNR from its target-induced speckle value.

Computational ghost imaging

A significant breakthrough in the applicability of ghost imaging as a viable imaging technique was invention of a computational version of this imager [Shapiro2008]. Figure IV-10 illustrates a generic block diagram of computational ghost imaging. Note that the light-beam behavior necessary for conventional two-arm ghost imaging is achievable by transmitting a spatially coherent laser beam through a spatial light modulator (SLM) whose pixels are driven by statistically independent noise processes. In fact, it is sufficient — and desirable — to drive the pixels with orthogonal or pseudorandom time functions, rather than truly random functions. Once deterministic modulation is employed, there is no need for the reference arm used in conventional ghost imaging, because its illumination is subject only to free-space diffraction and hence can be precomputed from the known drives applied to the SLM. What results is *computational ghost imaging*: the photocurrent generated by the single-pixel (bucket) detector, as a result of the SLM output light interacting with the target and impinging on the detector, is correlated with the precomputed far-field pattern corresponding to the structured field constructed by the SLM. This connects ghost imaging with the field of active computational imaging via structured illumination, which has applications *both* for *in situ* imaging (e.g., microscopy), and for remote sensing (e.g., far-field imaging).

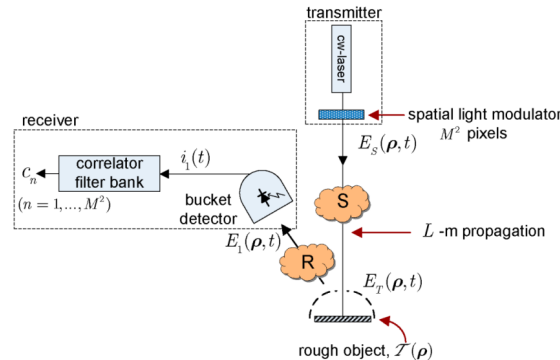

Figure IV-10 Computational ghost imaging block diagram for standoff sensing.

One important advantage of computational ghost imaging over the conventional two-arm ghost imaging architecture is that the reference intensity patterns can be computed at a variety of target ranges so that ghost images can be formed for these target ranges from the same bucket-detector data. This range sectioning in conventional two-arm classical or quantum ghost imaging would necessitate separate measurements for each possible target range.

The SNR comparison between classical and quantum ghost imaging does *not* lead to a scenario in which one scheme universally dominates over the other [Erkmen2009, Hardy2011]. Specifically, source and detector parameters, such as bandwidth and brightness, determine whether classical or quantum sources have superior SNR. Some general conclusions are that the SNR of bright classical ghost imaging

(wherein target-induced speckle is fully developed) is proportional to the image contrast. For quantum ghost imaging with low-brightness (i.e., when the source output is a stream of biphotons), the SNR is proportional to the mean coincidence rate.

Comparison of Computational Ghost imaging with floodlight LADAR

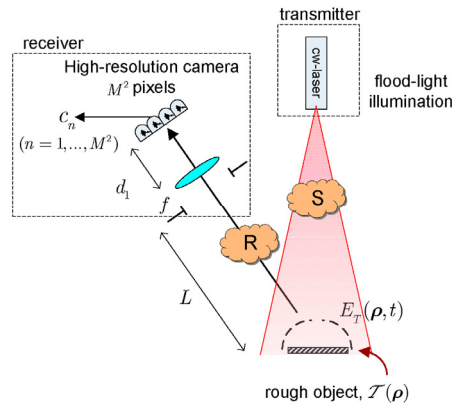

Figure IV-11 Block diagram of conventional floodlight LADAR. Cloud icons indicate atmospheric turbulence.

Conventional active remote imagers rely on flooding the region of interest with laser illumination, and imaging the backscatter onto a camera (floodlight LADAR). A block diagram for floodlight LADAR is shown in Figure IV-11. It is important to address scenarios in which a computational ghost imager may offer performance or complexity advantages over floodlight LADAR. Table IV-4 below summarizes the distinctions and similarities between the two imaging schemes. Perhaps most obviously, utilizing computational ghost imaging instead of flood illuminating a target with laser light eliminates the need for a spatially-resolving detector at the receiver. Furthermore, several single-pixel detectors could be utilized to suppress target-induced speckle. Computational ghost imaging is also desirable for distributed imaging applications. For example, because co-location of the transmitter and receiver is not required, computational ghost imaging is conducive to having a single high-complexity transmitter, and multiple low-cost receivers scattered throughout a region of interest. Such multi-static imaging configurations, though not too common, have been proposed in prior literature. For example, the aerosol profile of the atmosphere has been imaged using bistatic imagers. Finally, ghost imaging may permit imaging at electromagnetic frequencies for which single-pixel detectors or small arrays are feasible, but large arrays have yet to be developed, such as the terahertz spectral range. Even in the infrared regime, for which large arrays of photon-counting photodetectors are not yet cost effective, a small array can be paired with a multi-megapixel SLM transmitter to achieve resolutions beyond what is achievable with available photon-counting arrays alone.

Ghost Imaging	Active imaging camera (LADAR)
<ol style="list-style-type: none"> 1. Calculates speckle-pattern correlation strength with transmitted patterns 2. Receiver-path turbulence <i>does not</i> impact image resolution 3. Turbulence limits resolution when transmit pupil is <i>greater</i> than coherence length at the transmitter 4. Resolution same as LADAR for horizontal-path turbulence 5. Desirable for <i>bistatic</i> imaging with <i>minimal</i> turbulence at transmitter aperture (e.g., transmitter looking down from space, detector on the ground) 6. With short-exposure images turbulence effects may be mitigated 7. Extends to 3D sectioning with additional signal processing, specifically, by correlation of measurements with illumination patterns at varying ranges. 	<ol style="list-style-type: none"> 1. Images target-scattered laser light onto detector plane 2. Signal-path turbulence <i>does not</i> impact image resolution 3. Turbulence limits resolution when receive pupil is <i>greater</i> than coherence length at the receiver 4. Resolution same as ghost imaging for horizontal-path turbulence 5. Desirable for <i>bistatic</i> imaging with <i>minimal</i> turbulence at receiver aperture (e.g., camera looking down from space, source on ground). 6. With short-exposure images turbulence effects may be mitigated 7. Extends to 3D sectioning with high-bandwidth photodetection to resolve multiple reflections.

Table IV-4 Table highlighting relative merits of computational ghost imaging versus floodlight LADAR imager.

IV.2.2.5. Interferometry

Interferometry plays a central role in many sensing applications that seek phase or frequency information from the received fields. Its applications range from gravitational-wave detection and astrophysics to biomedical imaging. Quantum enhancements to interferometry are stated below for both active and passive systems.

Active interferometry with classical and nonclassical light

Optical coherence tomography (OCT), which uses broadband classical light and transverse scanning to provide high-resolution 3D imaging from Michelson interferometry [Huang1991], has found its way into clinical medicine [Zysk2007, Drexler2008]. Quantum optical-coherence tomography (Q-OCT) uses the entangled

signal and idler from a spontaneous parametric downconversion (SPDC) source together with photon-coincidence counting to obtain a factor of 2 improvement in axial resolution and immunity to group-velocity dispersion in comparison with a conventional OCT setup of the same optical bandwidth [Abouraddy2002, Nasr2003]. Analysis by Erkmen and Shapiro [Erkmen2006] showed that it was the phase-sensitive cross correlation between the SPDC's signal and idler that was responsible for these advantages, and that the same advantages would accrue to a classical-state transmitter that used phase-sensitive cross correlation in a two-pass interrogation of the object being imaged with phase-conjugation employed after the first pass and Michelson interferometry of the light received after the second pass. This system, which was dubbed phase-conjugate optical coherence tomography (PC-OCT) and was later demonstrated by Le Gouët *et al.* [LeGouët2009], is a quantum-mimetic imager because it uses classical-state light to derive the principal advantages afforded by a quantum imager. In other quantum-mimetic work, the Resch group used chirped-pulse interferometry to reproduce the dispersion cancellation of Q-OCT along with a factor of $\sqrt{2}$ improvement in axial resolution [Kaltenbaek2009, Lavoie2009]. Here, sum-frequency generation provides the mixing needed to derive these benefits. A recent review article summarizes these and other achievements in quantum and quantum-mimetic OCT [Teich2012].

Passive stellar interferometry

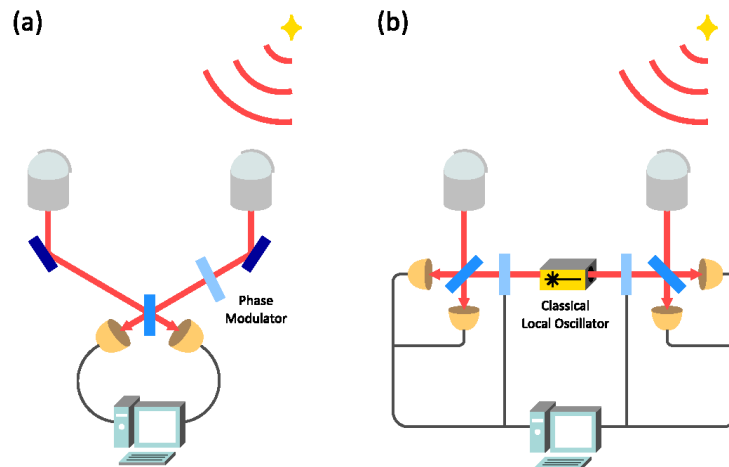

Figure IV-12 Schematics of (a) the direct detection scheme, an example of nonlocal quantum measurement, and (b) a local measurement scheme, which performs spatially separate measurements and permits only classical communication and control between the two sites. Examples of the latter include heterodyne and homodyne detection. Quantum theory shows that the nonlocal measurements are fundamentally much more accurate than any local measurement technique in stellar interferometry when the collected photon flux is low [Tsang2011b].

The basic goal of stellar interferometry is to retrieve astronomical information from the mutual coherence between optical modes collected by telescopes [Mandel1995,

Monnier2003]. Imaging resolution improves with the distance between the collected optical modes, called the baseline, motivating the development of long-baseline stellar interferometry using light collected from a telescope array [Monnier2003]. The standard method of stellar interferometry in the optical regime is direct detection, which coherently combines the optical paths in the form of the classic Young's double-slit experiment. Its efficiency suffers from decoherence in the form of accumulating optical loss along the paths as the baseline is increased. To avoid optical loss, an alternative method is to perform separate heterodyne detection at the two telescopes, before combining the measurement results via classical communication and data processing [Monnier2003].

Quantum information-theoretic perspective

In quantum information theory, direct detection can be classified as a nonlocal measurement scheme, which requires joint quantum operations on the two optical modes, while heterodyne detection is a local measurement scheme, which does not require quantum coherence between the separate detectors [Holevo2001]; see Figure IV-12. Townes has previously analyzed the quantum noises in direct and heterodyne detection and concluded that direct detection is superior at high optical frequencies and heterodyne detection is superior at low frequencies [Townes2000]. Heterodyne detection is, however, only one example of local measurements, and it remains a fundamental and important question whether any other local measurement can perform as well as nonlocal measurements while not suffering from decoherence. It was recently discovered that, when the average photon flux is low, nonlocal measurements, such as direct detection, have a much smaller error in estimating the mutual coherence of bipartite thermal light than any local measurement can achieve [Tsang2011b]. This implies that a fundamental advantage may be present for nonlocal optical measurements in stellar interferometry.

Entangled interferometry

Although the concept has not yet fully matured, an interesting proposal by Gottesman *et al.* [Gottesman2012] to overcome decoherence in very-long-baseline optical interferometry is worthy of mention. In this work, quantum repeaters and quantum memory are used to share entangled photons between two distant ground telescopes for stellar interferometry. One-half of the entangled-photon pair at one telescope is used as a local resource to teleport the incoming stellar photons to the second telescope site without destroying their coherence, such that they can then be interfered with stellar photons collected by the second telescope. The quantum repeaters are necessary to create long-distance entanglement from shorter-distance entanglement via entanglement swapping to mitigate loss in the communication channels [Sangouard2011].

For this entangled interferometry protocol to become competitive with conventional interferometry, the entangled photons must be generated and shared at a rate comparable to the bandwidth of photodetectors, on the order of 5 GHz in

current technology [Monnier2003]. Current state-of-the-art entangled photon pair generation rates are only around 10 MHz [Sangouard2011], and practical quantum repeaters have yet to be demonstrated experimentally, making entangled interferometry an unlikely possibility in the near future. Nonetheless, the quantum-information-theoretic perspective is able to reveal the inherent advantage of measurement nonlocality in stellar interferometry, and we expect that this will motivate further developments in more practical coherent optical measurements.

Passive ghost imaging (intensity interferometry) using stellar light

The realization that ghost imaging can be performed with thermal light, has created some interest in considering whether sunlight can be utilized for ghost-imaging applications. The crux of ghost imaging with natural illumination is to obtain correlated speckle patterns on the two detectors. Unfortunately, because sunlight has very low spatial coherence, a beam splitter is necessary along the path between the source and the object, which can be cost prohibitive. In particular, the diameter of the Sun is $D = 1.38 \times 10^9$ m, so the separation of the two detectors in ghost imaging without a beam splitter between the sun and the two detectors must be significantly less than $2 L \lambda / (\pi D) \approx 69 \lambda$. At $1 \mu\text{m}$ center wavelength this corresponds to $69 \mu\text{m}$, which is an impractical separation for ghost-image formation. Conversely, starlight can have quite significant spatial coherence, which could obviate the beam splitter problem, but the enormous size of starlight speckles implies that the detectors often serve as pinhole detectors, which makes ghost imaging closer to Hanbury-Brown and Twiss intensity interferometry. Nonetheless, this connection is noteworthy, and deserves further exploration. Intensity interferometry can be utilized for imaging an object between the source and the detectors if: (1) the star's coherence properties are known; and (2) an object along the propagation path (e.g., a planet, or a weak gravitational lens) modifies these coherence properties by a detectable amount. Whether measurements of the correlation function by the two pinhole detectors in the two arms of conventional ghost imaging has sufficient SNR is one thrust of an ongoing NASA Innovative Advanced Concepts project. In this project, ghost-imaging-like interferometry techniques are being investigated for detection of small exoplanets around bright parent stars, exploration of Kuiper belt asteroids, and the study of the space influenced by massive galaxies or dark energy.

IV.2.2.6. Weak measurements for space applications

The concepts of weak values and weak measurements result from a careful analysis of measurement theory from a quantum mechanical perspective [Aharonov1988, Aharonov2007]. Although this perspective results in new and possibly counter-intuitive insights, in many cases the ultimate formulation does not require quantum mechanics and can be described classically [Aiello2008, Howell2010]. The benefits afforded to space-based applications from weak values fall into two categories:

benefits resulting from a novel type of signal amplification, and benefits resulting from the ability to simultaneously measure non-commuting observables (albeit only over an ensemble).

Space applications present a range of distances over which weak-value based amplification can be used: short distances for applications such as rovers and explorers; medium distances such as communication between planet and satellite; and long distances such as detection of astronomical objects. It should be noted that not all situations in which weak-value-based measurement techniques are advantageous for space applications are understood. However, by using the paradigm of weak-value measurement, possibilities for their use can be found. A summary of types of applications that may benefit from weak values and their characteristics are shown in Table IV-5.

Weak-value based signal amplification

Weak-value based signal amplification [Aharonov1988] relies upon a probe (such as an optical beam) with known characteristics interacting with a system of interest that links two of these known characteristics. The probe is then filtered on one characteristic leaving the remaining characteristic to be measured.

The benefit of this technique is not that it has a better theoretical signal-to-noise ratio (SNR) than the more conventional strong measurement [Starling2009], but rather that the optimum SNR can be reached in different and possibly easier ways. Because the beam is filtered in post-selection, lower power detectors can be used. Additionally, because the perturbations are amplified, lower resolution detectors can be used. Additional practical benefits include an increased robustness to probe imperfections and system misalignments [Kedem2012, Brunner2010], a decrease in the size of the required measurement apparatus [Starling2009], and the ability to use the filtered light for other purposes (this light is filtered coherently, and is not necessarily lost).

This amplification technique has broad applicability in optical sensing. It can amplify transverse beam deflections and displacements, as well longitudinal beam displacements, which allow for many types of systems to be probed. For example, systems exhibiting optical birefringence, index gradients, spin Hall effects, spectral shifts, or polarization shifts can be probed with appropriate weak-value based metrology setups [Hosten2008, Dixon2009, Brunner2010, Starling2010a, Starling2010b]. The main drawback associated with this technique is that it only works for a limited class of signals: the requirements of pre-selection, post-selection, and the linking interaction restrict the signals that can be used in a weak-value based apparatus. An additional difficulty is in identifying scenarios in which standard system limitations match the benefits provided by weak values.

Application example	Weak value aspect	Distance scale	Advantages	Challenges	Maturity of technique
rover based sensors	amplification	short	decreased limitation in detector system. increased robustness to noise or system misalignment.	limited types of measurements	well understood
planet-to-satellite communication	amplification	medium	decreased limitation in detector system. increased robustness to noise or system misalignment.	limited types of measurements	well understood
detection of astronomical objects	amplification	long	decreased limitation in detector system. increased robustness to noise or system misalignment.	limited types of measurements	well understood
quantum foundations	simultaneous measurement	short & medium	enables new experiments	unknown	not well understood
gravitational science	amplification & simultaneous measurement	unknown	enables new sensors	unknown	not well understood
quantum receiver design	amplification & simultaneous measurement	short & medium	unknown	unknown	not well understood

Table IV-5 A summary of applications that may benefit from weak value techniques and their characteristics.

Illustrative weak-values example

Small deflection measurements of optical beams is a useful example that demonstrates the concept of weak-value signal amplification, highlights the differences between weak-value techniques and standard techniques, and illustrates the benefits of using weak values. Consider a beam of light passing through a birefringent prism that sends horizontally-polarized beams through undeflected² and deflects vertically-polarized beams down slightly. Our interest is in determining the deflection angle imparted by this prism.

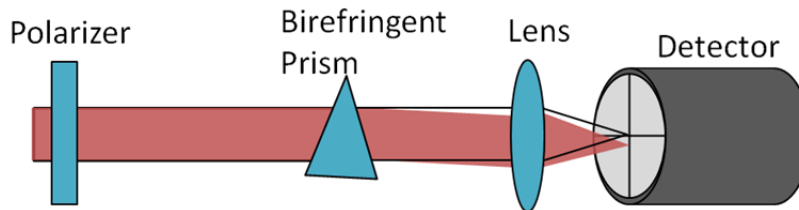

Figure IV-13 A standard technique to measure beam deflection is shown. A prism deflects the incident beam. The beam is focused onto a position sensitive detector, such as a quad-cell detector.

The standard method of measuring the deflection imparted by the prism is shown in Figure IV-13. Here the prism is probed with a beam whose propagation direction and polarization (vertical) are known. After this beam passes through the prism and is deflected, it is focused onto a beam shift detector, such as a quad-cell detector. This focusing reduces the size of the pattern on the detector but increases the fractional spatial shift caused by the deflection, thus increasing its sensitivity to small deflections.

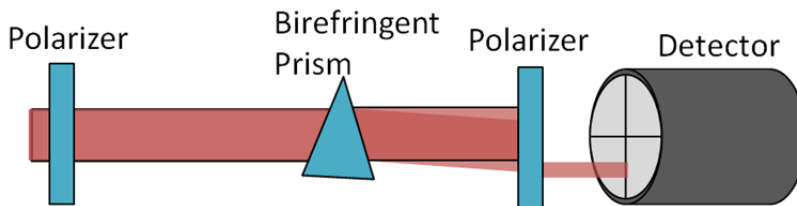

Figure IV-14 A weak value technique to measure beam deflection is shown. A beam with a pre-selected polarization is deflected by a prism. The beam is then post-selected on a nearly orthogonal polarization and sent to a position sensitive detector, such as a quad-cell detector.

The weak value method of determining the deflection effect of the prism is shown in Figure IV-14. Here, we again use a probe beam with a known propagation direction and polarization (now set to be a superposition of horizontal and vertical). However, now the final steps are to send the deflected beam through a second nearly-crossed polarizer, followed by a beam-shift detector, such as a quad-cell

² A birefringent prism would deflect both polarizations, but here we are concerned with the deflection of the vertically-polarized component relative to the horizontally-polarized component.

detector. In the language of weak values, the beam is initially pre-selected with known characteristics of polarization and direction. By selecting a polarization that does not align with one of the principal polarization axes of the birefringence, the beam acquires two polarization-dependent deflections. The birefringent prism is said to link deflection direction with polarization. The deflected beam has three spatial regions; the main central region that for the most part has the initial polarization, the bottom deflected region that has vertical polarization, and the top region that has horizontal polarization. The second polarizer is aligned to be nearly orthogonal to the initial polarization, meaning the central beam region is blocked. The offset from perfectly crossed polarizers is tuned to preferentially pass the vertically-polarized bottom beam section. This second polarizer post-selects the polarization, leaving the beam shift to be measured by the detector.

Several differences between the standard measurement technique and the weak-value measurement technique now become apparent. By using weak values the beam shift is amplified: the post-selection selects the outer edges of the beam. Although the post-selection results in a reduction of intensity on the detector, the beam-shift amplification makes up for the inherent loss of signal due to the post-selection, resulting in the same ultimate measurement limits [Starling 2009]. In other words, the limit is determined by the optical power incident on the birefringent prism, and not on the post-selected photon flux incident on the detector. In addition, the weak-value technique does not focus the beam onto the detector, resulting in a pattern with a much lower radiant flux density (W/m^2).

The preceding differences become the strengths of weak-value measurement techniques; they allow one to overcome possible physical system limitations that standard methods do not. The post-selected beam is weaker and not focused, implying that the pattern incident on the photodetectors has lower total photon flux and lower radiant flux density than the corresponding pattern using standard techniques. This advantage can be used towards either relaxing the requirements on the detectors, or towards increasing the photon-flux of the probe beam to achieve a higher-sensitivity measurement. In addition, because the lens system is replaced by a polarizer, the system alignment may become easier. Finally, the post-selected beam has an amplified displacement. This amplification can bring small signals above the detector noise floor, allowing for smaller perturbations to be measured or for noisier detector systems to be employed (e.g., detectors with higher electrical noise or physical jitter).

Rover-based detection and observation

A rover-based weak-value measurement apparatus is the most direct extension of current weak-value measurement research to space applications. It consists of simply implementing well-understood laboratory weak-value schemes on a rover platform, giving rover sensors the benefits and flexibility of weak-value based measurements, such as the ability to use more robust, lower power, lower

resolution detectors [Kedem2012, Brunner2010].

An example of a rover-based sensor that could make use of weak values is one that measures the index of refraction — either of the local region of the rover, or of the region around a heated sample — giving information about the chemical make-up of the region or of the sample. A weak-value apparatus for measuring longitudinal phase shifts [Brunner2010] would allow for this measurement to be made and could detect small changes in index. This type of sensor could be used to determine relative abundance of certain chemicals, or it could even be used for detection of water or organic compounds, thus giving information about the existence of life or of the life-sustaining capabilities of planets.

Communication and control signaling between a planet and a satellite

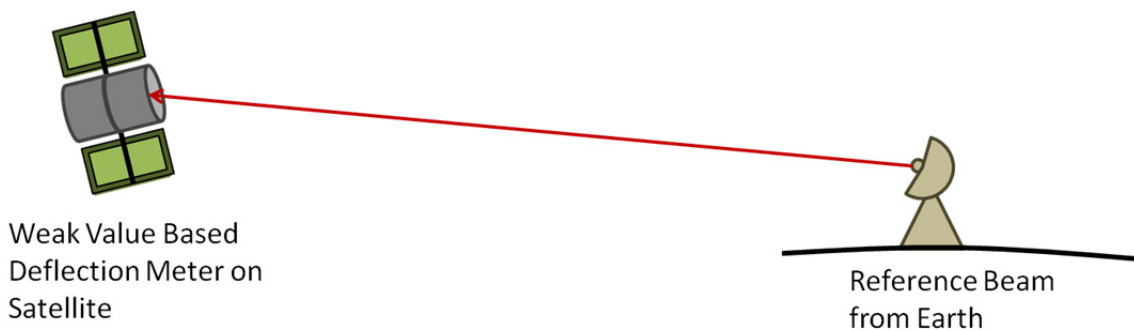

Figure IV-15 A reference beam from Earth acts as an orientation beacon for a satellite. The satellite uses a weak value based deflection meter [Hosten2008, Dixon2009] to align itself to the beacon.

Applications requiring communication between a satellite and a planet — e.g., a satellite controlling a planetary rover, or a planet-based beacon controlling a satellite's orientation — are particularly well suited to weak-value based metrology techniques. Access to both the source characteristics and the receiver characteristics allow for optimum system design to maximize weak-value based amplification effects. Additionally, the size, cost, and robustness constraints of space-based systems match well with the benefits afforded by weak-value based technologies. By using weak-value sensors, one can use lower power and lower resolution detectors, with a decreased sensitivity to imperfections and system misalignments [Kedem2012, Brunner2010]. In addition, by encoding information in an unused degree of freedom (e.g., in optical frequency) the filtered light can be used for other communication purposes.

One example in this category that may have significant practical implications is a reference optical beam from Earth that a satellite uses to stabilize its orientation, as illustrated in Figure IV-15. If a weak-value based deflection meter is implemented on the satellite [Dixon2009], the satellite tracking system could benefit from the significant gains detailed above (e.g., relaxed detector requirements).

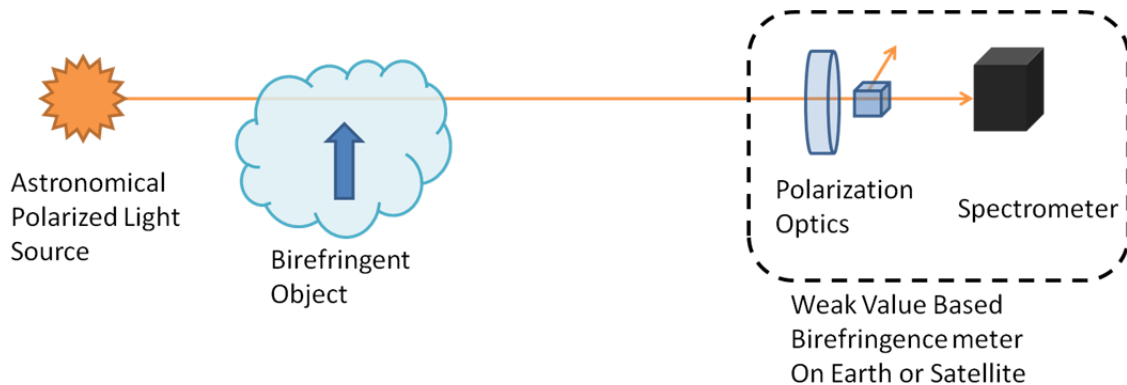

Figure IV-16 Polarized light from an astronomical source is used to probe a birefringent astronomical object. When the birefringent object passes in front of the light source, a weak value based birefringence meter measures the object [Brunner2010].

Using weak-value techniques to detect and observe astronomical objects such as exo-planets or interstellar dust clouds presents an added difficulty: since we generally cannot control characteristics of the illumination source, they may not allow for the required post-selection filtering step to be carried out. The commonly used polarization-based filtering requires a well-polarized source, however there are fairly common astronomical sources of polarized light, including astronomical masers, light passing through long distances of interstellar dust, and even certain kinds of stars [Iniesta2007, Fujiwara2012]. Using these polarized light sources allows one to have a complete weak-value based metrology apparatus for observing astronomical objects.

Again, a weak-value based detector on a satellite offers the advantages of lower incident-power requirements, lower resolution requirements on detector arrays, and performance that is less sensitive to imperfections and system misalignments [Kedem2012, Brunner2010]. The filtered light in these examples can be used to make other measurements on unused degrees of freedom, giving more information about the system of interest.

Following the proposal of Brunner and Simon [Brunner2010] — modified for space applications — one could measure the birefringence of an astronomical object moving through space as it passes in front of a source of polarized light, as illustrated in Figure IV-16. Knowledge of this birefringence may then be used to determine other properties such as density and chemical composition.



Figure IV-17 Light from a planetary system is used as an exo-planet detection probe. An exo-planet causes the light from the star to have a small periodic Doppler shift. A weak value based spectrometer [Starling2010b] can detect the presence of the exo-planet by observing the Doppler shift.

A weak-value based spectrometer could be implemented for space applications such as exo-planet detection, see Figure IV-17. In this example, light from a planetary system experiences a small periodic Doppler shift caused by the gravitational pull of the exo-planet. Thus, the presence of an exo-planet and its size can be inferred from detecting and measuring the magnitude this Doppler shift. This application is especially interesting because the usual requirements of pre-selection and linking interaction take a slightly different form, as shown in [Starling2010b]. The pre-selection and post-selection happen in the weak-value spectrometer apparatus, and the linking interaction is a frequency-dependent deflection (such as a prism) in the apparatus, combined with the small Doppler modulation on the beam caused by the exo-planet. By splitting the linking interaction into two parts, we ease the requirement that this interaction happen between the pre-selection and post-selection, i.e., only part of it (the prism) must happen between pre-selection and post-selection.

Weak-value based simultaneous measurements of non-commuting observables

Using weak values to simultaneously measure non-commuting observables is a more exotic application than signal amplification discussed above. It is the reverse of the amplification technique in that now the photons in the probe beam are the system of interest and their characteristics are unknown, whereas the interaction that links the characteristics is known [Kocsis2011, Lundeen2011]. In the problem formulation, each photon is assumed to have unknown non-commuting characteristics of interest, e.g., position and momentum. One of these characteristics, say momentum, is weakly linked to a polarization shift. Then, by splitting the beam at a polarizing beam splitter and measuring the position of the photons in the two resulting beams, we gain information about both the position and the momentum of the photons.

Using weak values to simultaneously measure non-commuting observables enables

careful probing of the foundations of quantum mechanics. For example, weak-value techniques have been used to directly measure the quantum wave-function [Lundeen2011], and allowed one formulation of Heisenberg's uncertainty principle to be experimentally falsified [Rozema2012]. This suggests that weak-value metrology techniques can be implemented in fundamental physics experiments involving a space-based nonclassical source (see Section IV.2.3). Gravitational effects and separation distance effects on Heisenberg's uncertainty principle, as well as on wave-function dynamics can be probed.

Additional possibilities for weak-value based measurements in space

Additional possibilities may exist for both weak-value amplification and weak-value based simultaneous measurements of non-commuting observables. Both concepts, however, are currently being developed, and it is unclear what possibilities are best suited for space applications. These possibilities are related to other topics in this report, such as gravitational science, foundational experiments, and receiver design.

Currently, weak-value based amplification techniques are being investigated for laboratory gravitational measurements [Turner2011] and may have utility for space-based gravitational sensing applications. Weak values have been used to probe foundational issues such as Leggett-Garg inequalities [Dressel2011], quantum contextuality [Dressel2010], quantum paradoxes such as Hardy's paradox [Lundeen2009], which suggests that weak values may be used for additional tests of quantum foundations in space. Weak-value measurement schemes for use in quantum-receiver designs are another possibility. In general, the receivers discussed in Section IV.3 are inherently quantum and may benefit from the simultaneous measurement of non-commuting observables allowed by weak measurements. However, these receivers may also benefit from the classical aspects of weak measurements, where they would act as a type of quantum-limited nondestructive measurement, implemented as part of the quantum receiver. Indeed the connections between weak values and quantum receiver designs are presently being investigated, and it may be that some well-understood receivers, such as a conditional-nulling receiver, may be cast as weak-value measurements.

IV.2.2.7. Quantum parameter estimation bounds for sensing

In classical estimation and detection problems significant insight can be garnered by studying performance bounds for a broad class of measurement instruments and processing algorithms. In particular, these bounds can: (1) assist in determining system parameters that most significantly impact the overall performance; or (2) quantify the gap between the performance of known architectures and the ultimate achievable performance; or (3) serve as good approximations to the performance of well-performing systems, whose explicit performance may be too difficult to

determine without resorting to extensive simulations. The same motivations apply to quantum estimation and detection problems, which has resulted in a number of important bounds being reported in the technical literature [Helstrom1976]. However, evaluating quantum bounds to obtain explicit performance expressions has occasionally proven more challenging than their classical counterparts. Here we report on some important performance bounds known for quantum sensing systems.

Quantum Cramér-Rao bounds

When the collected light intensity is low in a space-imaging application, shot noise due to the particle nature of light can severely hamper the performance of an imaging system. To extract as much information as possible from the photons, one should take into account the full quantum nature of light in the modeling and design of the space-imaging device. In quantum optics, the properties of light are characterized by its quantum state. For example, laser light used in a LIDAR system may be modeled by a coherent state, while a natural light source from Earth or other astronomical objects is more appropriately described by a thermal state [Mandel1995]. Given that the functional relationship between a set of parameters—e.g., the position and brightness of a star—and their influence on the state of a quantum system is known, it is possible to calculate the quantum Cramér-Rao lower bounds (QCRBs) to the mean-squared parameter estimation errors resulting from inferences made by measurements on the quantum system [Helstrom1976]. The QCRBs are valid for any kind of measurement of the collected light, so they provide fundamental limits to the accuracy of parameter estimation for a given quantum state. Most research on the QCRBs so far has focused on single-parameter estimation [Giovannetti2011], but any realistic imaging application requires multiple parameters to be estimated. One way of modeling multiple parameters in an image is to define a multidimensional waveform as the unknown signal of interest [Goodman2004]. The waveform can be modeled as a random process, such as one with stationary Gaussian statistics, to simplify the analytics. A QCRB for waveform estimation has been developed in [Tsang2011a], and its application and generalization to the spatial domain should reveal insights into the fundamental quantum limits to imaging.

Beyond quantum Cramér-Rao bounds

Although the QCRBs impose rigorous limits on the minimum possible mean-squared estimation error, it was realized only recently that, similar to their classical counterparts, the QCRBs may not be tight and can be much lower than any achievable estimation error. Alternative quantum bounds much tighter than the QCRBs in certain situations have since been developed [Tsang2012, Giovannetti2012a, Hall2012, Nair2012a]. Among the various alternatives, the most

general one is called the quantum Ziv-Zakai bound (QZZB) [Tsang2012], which relates the quantum parameter estimation error to the error probability of a related quantum binary hypothesis testing problem, analogous to the classical version [VanTrees2007]. Generalization of the QZZB to multiparameter estimation problems would also potentially reveal a tighter lower bound to the performance of space imagers than that obtained from evaluating the QCRBs.

Quantum-optimal imaging systems

Once quantum bounds for imaging have been developed, the natural next question to ask is how such fundamental limits may be approached in a practical imaging system. A quantum-information-theoretic perspective can yield fresh insights into the design of imaging devices for space applications. For example, it is now known [Tsang2008, Tsang2009a] and experimentally demonstrated [Wheatley2010, Yonezawa2012] that the optimal estimation of the time-varying phase of a coherent state requires homodyne detection together with adaptive control of the local-oscillator phase in a phase-locked loop setup. Generalization of such time-domain techniques to the spatial domain can result in novel adaptive optics for imaging technology. For example, homodyne detection in two spatial dimensions can be implemented by on-axis digital holography, and a spatiotemporal phase-locked loop with an adaptively-modulated local oscillator could be implemented, in principle, to optimize multidimensional information acquisition. Such coherent adaptive optical information processors can have fundamental advantages over more simplistic imaging systems that rely on digital data post-processing, such as higher signal-to-noise ratios, less unwanted data due to signal pre-processing at the physical layer, and enhanced robustness through the use of feedback control.

IV.2.3. A cross-cutting enabling technology: multifunction and reconfigurable entangled-photon source in space

Spontaneous parametric downconversion (SPDC) sources are reconfigurable devices capable of providing different types of electromagnetic fields, such as entangled or correlated photons in multiple degrees of freedom, squeezed states, and broadband correlated light pulses, that can be used for multiple science and technology measurements in space-based sensing and communication applications. Future research and development would qualify these SPDC devices for space flights and enable advanced types of entangled light for use in more demanding missions.

Quantum communications, sensing, and measurements in space involve a number of enabling technologies including sources of nonclassical light. These sources can be designed to generate entangled photons, correlated photons, or squeezed states of light tailored for specific classical or quantum applications. Typically the same source can be used in different measurement setups with only minor or no

modifications, which is particularly relevant in space applications where flight requirements on payload weight and power consumption play an important role in technology choices. A multifunction nonclassical source that can be utilized in multiple tasks is therefore highly desirable for space deployment.

Different types of nonclassical light sources have been developed with varying degrees of performance and maturity. One way to classify them is by the nonlinear medium that is used for the generation of nonclassical light. Common nonclassical light sources rely on nonlinear optical crystals, standard optical fibers and photonic crystal fibers, and, more recently, semiconductor materials. The type of entanglement and hence the sources are often chosen for specific applications of interest. In Section IV.2.3.1 we briefly describe the application areas in which a multifunction nonclassical source is necessary or can make an impact. Section IV.2.3.2 focuses on the characteristics of different types of nonclassical sources, and gives an educated projection of their future performance and utility in quantum measurements. It is intended that within these sections we see two different source-application groupings emerge. One group represents current nonclassical sources that can be used for some quantum measurements in space for which we expect to see good results. The second group focuses on improvements or innovations in sources that are needed for carrying out measurement schemes that are more demanding, or that yield new capabilities.

IV.2.3.1. Applications enabled by multifunction nonclassical sources

A nonclassical source of entangled photons or squeezed light is a technology enabler for fundamental scientific inquiry, advanced quantum communication, and enhanced quantum measurements in practical applications. Some of these applications can utilize existing sources and some require future improvements to achieve their promising measurement potentials. In this section we summarize briefly some of these areas that may appear in more detail elsewhere in this report.

Scientific exploration using nonclassical sources of light in space

The characteristics of nonclassical sources of light, such as those generating entangled photons or squeezed light, have been extensively studied over the last three decades during which the scientific community has built a significant knowledge base. While there are still fundamental questions about nonclassical light and many applications based on these sources to be explored, they can be done on Earth without the complexity of performing the experiments in a space environment. There are, however, certain scientific inquiries that are best answered in space. For example, investigating a biphoton state extending over a very large distance in space, and studying how gravity affects the wave function and its collapse in quantum measurements can only be answered by performing the

experiments in space. In addition, the concept of entanglement distribution over a vast expanse in space and time can be intriguing.

The ability to study distributed entanglement in space brings with it otherwise unrealizable experimental regimes. In particular, it is interesting to perform fundamental science experiments on entanglement at large separations and in reference frames in relative motion. In this case, one can study the additional constraints on the effective classical “speed” of quantum influences (i.e., assuming that there really was communication from one side to the other, how fast would it need to be in order to explain the measured correlations). Preliminary terrestrial experiments have been limited to only tens-of-kilometers separation [Zbinden2001a, Zbinden2001b]. Some additional interesting work has been done in investigating the role of accelerating frames of reference on entanglement survival [Downes2011, Fuentes-Schuller2005]. Although it is not clear whether it would be feasible to achieve the required accelerations in order to perform precision measurements of this kind, it is more likely to be feasible in the vast expanse of space than terrestrially. Finally, in some alternative theories to quantum mechanics, it is interaction with the gravitational field which effectively causes a collapse of the quantum mechanical wavefunction [Penrose2000]. Although such experiments are extremely difficult to perform [Simon2003], there may be regimes in which performing them on opposite sides of a gravitational gradient — e.g., as could be realized in a distributed space experiment — could be interesting and valuable.

In these scientific and fundamental studies we need a source of nonclassical light with properties that are as ideal as possible, so that small changes due to gravity effects can be extracted. For biphoton sources the desired near-perfect entanglement has been achieved in sources based on SPDC in nonlinear crystals. It is also necessary to have high efficiency and high flux to reduce measurement times, especially over long distances where propagation loss due to diffraction and finite receiver apertures can be significant. Finally, future improvements in source technology can provide a boost too. On-demand production of single photons or entangled photons [Migdall2002, Jeffrey2004, Shapiro2007, Mower2011] would mitigate the flux limitation of SPDC due to the probabilistic nature of generating photon pairs in nonlinear crystals or optical fibers. Another potential game-changer is the generation of multi-photon entangled states [Mikami2004, McCusker2009, Megidish2012] at high flux that would allow multi-photon interferometric measurements to be carried out quickly. Other quantum measurements may become feasible with better source technology, such as a comparison of gravity effects in multiple space-time regions.

Quantum measurements in space

In a space environment, a number of measurements can be significantly enhanced using quantum resources. Section IV.1.4 discussed the importance of clock synchronization and timing distribution in space and the possibility of quantum enhancement in time measurements. Hong-Ou-Mandel (HOM) two-photon interferometry [Hong1987, Steinberg1992] measures the relative arrival times of two identical photons at a beam splitter with sub-picosecond accuracy and without the need for high-speed detectors. HOM interferometry is potentially useful for clock synchronization and relative timing measurements in space including pathways to and from the ground because HOM measurements are not sensitive to atmospheric dispersion (except for a time delay). Depending on the protocols, one or more pulsed sources of identical photons are needed to perform HOM interferometry with high visibility. For sources at remote locations it is necessary to synchronize the local clocks and the timing of their output photons to perform HOM measurements [Kaltenbaek2006]. One way to ensure that the SPDC outputs are synchronized is to use pure-state single photons, which are single photons that are transform-limited in time and frequency [Mosley2008, Kuzucu2008]. Distance measurements with enhanced accuracies by a factor of square root of N are possible using a source of coincident-frequency N -entangled photons [Giovannetti2001, Giovannetti2002], a technique which has been demonstrated so far only for $N = 2$ [Kuzucu2005].

The sensing and imaging applications of Section IV.2.2.3 through IV.2.2.5 utilize a variety of light sources, including correlated photons, entangled photons, and broadband cross-correlated light that can be provided by SPDC sources. Periodic calibration of on-board instrumentation is an important function in space-based measurements. In this respect, a high-quality SPDC source can be utilized for calibrating single-photon counters or multi-pixel single-photon cameras using heralded single photons. High-quality SPDC sources are ideal quantum random-number generators that are essential for many quantum measurements, including active basis-choice selection in quantum key distribution (see Section IV.3.2). The same source with entangled photons can also be used to verify the integrity of a quantum channel or to check the fidelity of a quantum measurement apparatus using quantum process tomography. SPDC sources can be operated to generate twin beams that are entangled over a very large number of temporal (and spectral) modes which can be utilized in continuous-variable quantum measurements such as quantum illumination discussed in Section IV.2.2.3.

In general, most quantum-enhanced measurement applications utilize, in some form, sources for nonclassical light. It is therefore important to evaluate the space requirements for such sources, in terms of weight, power consumption, size, long-term stability and susceptibility to radiation. High flux, high efficiency, and excellent entanglement quality are essential criteria in choosing suitable sources. In addition, it is desirable that the sources can be used with or without simple configuration

changes in multiple measurement applications. For example, one such multifunction source is SPDC in nonlinear crystals, which can also be configured, under strong pulsed pumping, as classical sources of broadband photons with frequency anti-correlation. These anti-chirped sources can be utilized to yield measurement results that are typically associated with entangled photons, such as HOM dip [Kaltenbaek2008] and quantum optical coherence tomography [Lavoie2009, LeGouët2010]. The key advantage of these quantum-mimetic measurements [Teich2012] is that the salient measurement advantages obtained with entangled-photon sources can be replicated at much higher acquisition rates due to the availability of bright classical sources and standard (linear-mode) photodetectors.

IV.2.3.2. Nonclassical sources

Sources based on three-wave mixing in nonlinear crystals

Traditionally, entanglement sources use nonlinear optical crystals for generating entangled photons using a three-wave mixing process called spontaneous parametric downconversion in which a pump photon is split into two lower-energy photons, signal and idler. This nonresonant process in crystals such as beta barium borate (BBO) [Altepeter2005], periodically-poled potassium titanyl phosphate (PPKTP) [Wong2006], and periodically-poled lithium niobate (PPLN) [Martin2010] has weak nonlinearity and typical conversion efficiency is about 10^{-7} to 10^{-11} , depending on the type of crystals and whether a waveguide is used. SPDC has been enormously successful in generating entanglement in different degrees of freedom with very high entanglement quality, as measured by two-photon quantum interference or by violation of Bell's inequality.

The most common form of entanglement is in polarization, but high quality entanglement in time-energy, frequency, momentum, and orbital angular momentum have also been demonstrated. Different types of entanglement are used for different applications. For example, it is common to use polarization-entangled photons for free-space quantum communication tasks [Ursin2007] because neither the atmosphere (under clear-weather conditions) nor vacuum affects the polarization state. On the other hand, quantum communications through optical fibers are often conducted using time-bin or time-energy entanglement [Tittel2000], in which only the arrival times of the photons matter. Standard single-mode fibers can be used to transport polarization-entangled photons for short distances [Zhong2010], or moderate distances if care is taken to mitigate depolarization — by means of a servo or pilot pulse — caused by temperature and mechanical perturbation of the fibers. Hyperentanglement has also been shown to be feasible, in which a photon pair is entangled simultaneously and independently in multiple degrees of freedom allowing multi-qubit quantum measurements [Barreiro2005].

The spatial, spectral, and temporal characteristics of entangled photon pairs are essential features that can be tailored to create optimal measurement results.

Typical pulse widths are in picoseconds, although there are techniques such as embedding the nonlinear medium in an optical cavity to create long pulses or mode-locked pulses [Kuklewicz2006, Wolfgramm2008]. There are different techniques to manipulate the phase-matching function of the nonlinear materials to yield desirable features, including the use of external spatial and spectral filtering. The current trend in entanglement sources is to couple the photons into single-mode optical fibers to allow easy transport from the source to wherever they are needed. Single-mode fibers and waveguides do, however, prohibit the use of spatial-mode entanglement, and some applications may be optimized with few-mode sources. To this end, theory predicts [Bennink2010] and recent measurements have confirmed that a loosely focused pump beam in a bulk nonlinear crystal yields very high fiber-coupling efficiency for both photons. However, the loose focusing technique does not take advantage of all the multi-spatial-mode output pairs, thus obtaining high flux at a modest pump power can be a problem. Nonlinear crystal waveguides offer both spatial-mode selection and high-flux simultaneously. Due to spatial-spectral correlations of SPDC in nonlinear waveguides, the fundamental spatial mode can be extracted by using a nearly lossless spectral filter to remove all higher-order modes [Mosley2009]. Also, the transverse phase-matching conditions of waveguides give rise to significantly higher conversion efficiency than bulk crystals by as much as two orders of magnitude [Zhong2009], though extracting the modes efficiently (e.g., into a single-mode fiber) is still an area of active research [Zhong2012].

Most quantum applications require measurements in which the generation rate is much less than one pair per measurement window, to avoid multi-pair events that degrade entanglement quality. The measurement times range from as little as 50 ps for superconducting nanowire single-photon detectors (SNSPDs) to ~ 1 ns for Si or InGaAs avalanche photodiodes (APDs), to 10's of ns for transition-edge superconducting detectors. However, there are quantum-mimetic measurement techniques that use classical sources to mimic quantum measurement techniques and yield results that are similar, but with the advantages of using classical sources, standard detectors, and hence achieving much faster acquisition times [Kaltenbaek2008, Lavoie2009, LeGouët2010, Teich2012]. Often the quantum-mimetic measurements require phase-sensitive cross correlations between the signal and idler beams (just like weakly-pumped SPDC), which can be obtained using SPDC sources driven at high pump power such as a pulsed laser [LeGouët2009]. In this case, the pulsed SPDC source can yield many photons per pulse, an output which behaves in many respects like a classical light beam with a broad bandwidth. Therefore, nonlinear crystals can serve as multifunction sources of quantum entangled beams, correlated photon pairs, or classically many-photon broadband pulses. Different types of outputs can be obtained using the same pump source with one or more nonlinear crystals. Likewise, many of the optical components can be reused.

The generation of discrete qubits via SPDC is not the only use of nonlinear crystals in quantum information and measurement science. Squeezed states of light may also be generated by the same three-wave mixing process in nonlinear crystals.

However, it is necessary to operate at a much higher pumping level which usually requires the use of either a pulsed pump with a high peak power [Kim1994], or an optical cavity to enhance the weak nonlinearity [Takeno2007]. Quadrature squeezing, as it is called in the literature because of the squeezing of one of two field quadratures of the electromagnetic wave, from a below-threshold optical parametric oscillator (OPO) degrades easily due to its sensitivity to losses in its generation, propagation, and detection. Squeezing is, however, the only method to bring measurement sensitivity substantially below the standard quantum limit (shot noise) in gravitational-wave detectors such as those in the LIGO project [Goda2008]. In the remainder of this section we focus on entanglement between photons instead of the optical field quadratures because of squeezed states' high sensitivity to losses that are often present in most practical applications. Nonetheless, as discussed in Section IV.1.2, there are scenarios for which quadrature squeezing could yield promising gains.

Sources based on four-wave mixing in optical fibers

Spontaneous four-wave mixing (SFWM) in standard optical fibers and in photonic crystal fibers can also efficiently generate entangled photon pairs as well as squeezed states of light. In this case, two pump photons are converted into signal and idler photons, with the frequencies of the pump photons in the same spectral range as the output photons, which may simplify their spectral manipulation, such as the use of dense wavelength division multiplexing (DWDM) filters in the 1550-nm telecom band. Phase matching is also used to tailor the spectral properties of the SFWM process by changing the pump wavelengths or by modifying the fabrication process of the microstructure fiber.

Many characteristics of SFWM in fibers are similar to those of SPDC in nonlinear crystals, but there are also differences that can favor one or the other depending on the application and operating environment. Optical fibers guarantee that the outputs are in a single spatial mode and therefore eliminate the problem of single-mode extraction in bulk nonlinear crystals [Fiorentino2002, Li2005, Lee2006, Hall2009, Medic2010]. In the telecom band, the availability of high-quality commercial components such as DWDM filters and optical switches reduces cost and development effort but at the same time these components tend to be too lossy for quantum-measurement applications. It is sometimes more advantageous to have the light coupled out of the fiber pass through low-loss bulk optical components, such as polarizers and dichroic mirrors, and then re-couple into a fiber for transmission or measurement. Lossy coupling into and out of photonic crystal fibers is particularly problematic because there are few low-loss fiber components that interface well with the microstructure of these photonic crystal fibers [Fan2007]. Improvements in lowering the insertion loss of fiber-optic components and more innovative designs are therefore highly desirable. One example is the recently demonstrated high-speed, low-loss switching topology [Hall2011], which is superior to traditional high-speed switches, provided that better-performing components are

available to realize its outstanding performance promise. Background noise, accompanying SFWM in fibers due to spontaneous Raman scattering, is a major problem that reduces the purity of the source outputs, especially when the pump power is high [Voss2004, Voss2006]. Fortunately, the problem is mitigated by either operating the fibers in liquid nitrogen [Medic2010] or by judiciously choosing the operating wavelengths to avoid the strong Stokes band of the Raman-scattered photons [Fan2007].

Sources based on semiconductors

Recently, new platforms for nonclassical light generation have emerged using silicon or silicon-nitride nano-waveguides and micro-resonators as nonlinear media [Sharping2006, Takesue2008, Harada2008, Clemmen2009, Levy2010, Azzini2012]. In such devices, SFWM is similarly employed to create photon pairs, squeezed light, and optical frequency combs. Compared to the aforementioned nonlinear-crystal and optical-fiber systems, they are readily integrated with on-chip optical components for generating, routing, switching, and processing of photonic signals, as well as for creating micro-scale lasers. This unique capability offers the potential of low-cost, fully-monolithic, and entirely-sealed sources of nonclassical light, whose advantages include insensitivity to the surrounding environment even without any isolation. Devices of this kind are particularly suitable for use in applications under extreme, non-laboratory conditions, such as those in space or underwater. Moreover, compared to optical fibers, semiconductor sources yield relatively low background level of spontaneous Raman scattering, due to a much narrower Raman-gain spectral window.

In practice, silicon waveguides and micro-resonators benefit from mature fabrication technology. However, they suffer from two-photon absorption and associated free-carrier absorption at telecom-band wavelengths. As a result, the production efficiency and the quantum-state purity of photon pairs are low in results reported to date. In addition, because of significant material absorption in the visible range, silicon-based devices are in general unsuitable for visible-band applications. Silicon nitride, on the other hand, yields a much larger band gap than single-crystal silicon and thus is not prone to two-photon absorption in the telecom band. Being a dielectric, it is also free of free-carrier absorption, an effect that has been a major limiting factor for fabrication of high- Q silicon resonators. These favorable features, together with very low material loss throughout a wide optical range (spanning from 300 nm to several microns) and a relatively high refractive index (around 2), make silicon-nitride based devices promising for nonclassical light sources over a wide spectral range. Recently, high-performance silicon-nitride micro-resonators have been fabricated with radii on the order of 10 microns and Q -factors in excess of 10^5 [Gondarenko2009, Levy2010].

Thus far, photon pairs that are entangled in time bin [Takesue2007] and in polarization [Takesue2008] have been created in silicon nano-waveguides, with

two-photon interference visibility greater than 70%. Very recently, highly-efficient generation of correlated photon pairs has been demonstrated using a silicon ring resonator with CW pump power of only 200 microwatts, yielding a production rate for the signal and idler photon pairs of around 0.2 MHz and coincidences-to-accidentals ratio of about 250 [Azzini2012]. In addition to the above devices for telecom-band applications, high-performance silicon-nitride micro-resonators have also been fabricated for applications in the visible band. For example, fabricated on a silicon-nitride layer and isolated from silicon substrate by an oxide layer, a microring cavity with $Q > 10^6$ has been demonstrated for 660-nm light, with mode volume as small as hundreds of cubic microns [Hosseini2009]. These advances open a door to high-performance, low-cost, on-chip CMOS-compatible devices for nonclassical light generation that are potentially robust for use in space. However, the quality of the quantum states produced will need to be improved considerably before they would yield a quantum advantage.

Future source improvements

The SPDC process in nonlinear crystals is well understood and the technology is generally mature. However, there are still a few areas for improvements that can contribute substantially to certain space-based applications. One is the aforementioned high-efficiency extraction of an entangled pair of photons from a high-flux source such as a nonlinear waveguide, which is hindered by internal waveguide losses and in-/out-coupling efficiencies. For applications that depend on multiple pairs of photons, nearly lossless generation and extraction of photon pairs would be very useful because the required measurement time scales as the overall efficiency of generating, extracting, and detecting each photon pair. For example, multiplexing a large number of SPDC sources temporally or spatially can in principle allow efficient generation of single photons on demand that is not constrained by the usual Poisson statistics of a single SPDC source [Migdall2002, Jeffrey2004, Shapiro2007]. Other likely applications that utilize multiple pairs include heralding a single pair of entangled photons using three initial pairs [Barz2010]. Ultimately, these more sophisticated and engineered sources of photons would be used as part of an essential quantum photonic toolbox for fundamental tests and discovery, as well as practical applications, in quantum measurements and quantum information science.

Triggered single and entangled photons from the radiative decay of electrically-driven biexcitons in single quantum dots [Stevenson2006, Mohan2010] have the potential to create on-demand sources of single and entangled photons without the multiplexing used with SPDC sources. Photon blockade for a single quantum dot that is embedded in an optical microcavity allows a semiconductor source to generate single photons one at a time [Englund2012]. This feature of quantum-dot semiconductor sources suggests they may be ideal for generating single photons and entangled photons on demand, although significant improvements in that

technology are needed to realize its full potential. For example, control of re-excitation of the quantum dot is needed to eliminate multiple-photon generation in a single cycle of excitation, and reduction of coupling losses together with higher-efficiency extraction is required to improve the generation rates. One can envision that these sources can be integrated with on-chip detectors, switches, and routers to form quantum subsystems for implementing a variety of quantum measurements. We should note that integration of multiple quantum devices is not restricted to semiconductor devices, and that similar ideas in integrating fiber-optic devices and nonlinear crystals would also significantly improve the quantum toolbox for quantum measurements in both space and terrestrial applications.

IV.2.4. Conclusions and recommendations for future work

Quantum-enhanced sensing refers to detection, parameter estimation, and imaging problems, wherein inferences are derived from measurements of electromagnetic waves. Quantum mechanical enhancements can be attained by novel measurement techniques that take into account the quantum nature on EM radiation, and in the case of active-sensing systems, by utilizing quantum-mechanically optimized probe states for the sensing problem at hand.

Some of the key quantum-sensing conclusions from the study period are as follows:

- 1) Type II sensors emerge as having the broadest applicability in remote-sensing scenarios of interest to space because classical-state probes yield graceful degradation in performance when the interaction medium is lossy. Whereas some applications of Type II sensors have been seen in recent years (e.g., the SVI-PSA system studied in Section IV.2.2.1, as well as the quantum filtering and smoothing presented in Section IV.2.2.2), further study of promising application areas are advisable. Pointing, acquisition and tracking (PAT) systems may be an important area in which Type II sensors could offer advantages for quantum-limited communication systems.
- 2) Type I and III systems also have regimes in which their performance significantly exceeds that of classical sensors, albeit narrower in scope than Type II sensors. Quantum illumination emerges as the most prominent example for quantum enhancement, which applies only when the interaction medium is highly lossy and subject to high-brightness background. Note, however, that this combination is more typical for microwave frequencies wherein entangled photon generation may prove more challenging. Therefore further study of these systems is recommended. Type I sensors using nonclassical probe states can also have notable performance advantages, but only in imaging scenarios in which the loss and noise are both low. *In situ* measurements are more likely to admit to such a combination. For example, microscopy or optical coherence tomography

have potential applications for Type I sensors.

- 3) Passive imaging systems can attain quantum-enhanced performance only by optimization of measurement techniques, as the illumination is not controlled by the sensing instrument. This does not, however, eliminate the possibility of enhancements. Quantum filtering and smoothing techniques, as well as the recently proposed entanglement-based very-long-baseline optical interferometry are examples of possible improvements over classical passive-sensing systems.
- 4) Weak measurements have recently emerged as a formalism that often does not require a fully quantum-mechanical interpretation, but offers unique and new insights into measurement techniques that achieve high sensitivity with potentially low-complexity implementations. One of the more concrete application possibilities identified in this study is the sensing of small deflections by space-based astrophysics instruments or *in situ* sensors present on planetary rovers. Lab demonstrations of very high sensitivity measurements offers promise, but quantitative studies are recommended before the benefits of weak measurements for space applications can be assessed.
- 5) An efficient and robust entangled-photon source in space would be a significant and cross-cutting technological advancement for quantum-enhanced instruments in space. In particular, entangled photon pairs are the most commonly required resource in the active-sensing instruments studied in this section. It is also needed in some of the communication architectures studied in Section IV.3, and in some of the science experiments discussed in Section IV.1. It is natural to conclude, therefore, that a space-qualified entangled photon source would become a highly-utilized resource. The broad nature of its potential application areas implies that a reconfigurable architecture suitable for a variety of tasks would be a desirable property for (at least) initial demonstrations of this technology in space.

This report identifies several avenues of research and development that could lead to instruments surpassing the performance of classical sensors, but further focused research efforts are required to chart out the potential improvements expected from such technology. On the other hand, a space-qualified, multifunction, and reconfigurable entangled-photon source is an important enabling technology that has significant science, communication and sensing benefits both in the short-term and in the long-term. With these conclusions at hand, *future efforts* may focus on the following:

- a) Development of a space-qualified multifunction entangled-photon source: Multi-wave mixing sources using nonlinear crystals, fibers, and semiconductor materials are reconfigurable multifunction devices of entangled or correlated photons in various degrees of freedom that are

essential for many quantum measurements in science and technology missions in space. Some of these devices also provide ultrabroadband laser-like pulses for classical sensing measurements discussed in this report. While multi-wave mixing sources based on nonlinear crystals and optical fibers are mature for laboratory use, additional research and development is recommended for advancing the state of the art to achieve more sophisticated capabilities, and for space qualification that maximizes their use for multiple measurements with a minimum of configuration variations. Longer-term research is also needed for improving sources based on semiconductor devices that may yield highly-integrated quantum devices for space applications.

- b) Investigation of quantum-enhanced pointing, acquisition and tracking: Precision pointing a spacecraft-mounted instrument (e.g., an optical communication terminal) is crucial in many space missions. The application of weak-measurements-based insights into improving the sensing performance or reducing the detection complexity, as well as utilization of adaptive measurement strategies that saturate the quantum Cramér-Rao bounds are high payoff avenues for future research and development.
- c) Weak-valued measurements for high-sensitivity sensing: Weak-valued measurements offer unique and new insights into high-accuracy and high-sensitivity *in situ* measurements in a resource-constrained scenario, such as on a planetary rover or a remote satellite. Although often the resultant measurement techniques admit to fully semiclassical interpretations, the formulation of weak-measurement theory yields simple measurement architectures suitable to measure small variations in the parameter of interest (small translations, rotations and deflections). Weak-measurement techniques have been demonstrated in bench-top experiments, and are ripe for focused and detailed studies in mapping these techniques to sensing and communication systems in space.
- d) Extensions of quantum illumination to feature identification and secure communication: Quantum illumination is a target-detection technique that offers significant potential for improvement in an operating regime of high loss and high-brightness background noise. It also has an extension as a secure communication protocol, resulting in an eavesdropper having orders-of-magnitude higher error probability than the intended receiver. Although an immediate and apparent application area in space has not emerged from our study program, it would still be beneficial to investigate extensions of quantum illumination beyond target detection towards feature identification, as well as its applicability to secure communication protocols.

IV.3. Communication and Measurement in Space

Virtually all space communication systems rely on EM radiation as the physical carrier of information, i.e., photons. In this section we investigate the quantum limits to laser communication systems in two primary contexts: (1) the reliable transfer of classical information at the data rates and photon efficiencies predicted by the communication theories taking into account the quantum nature of photons; and (2) the transfer of quantum states and quantum information. Specifically, Section IV.3.1 addresses modulation and measurement strategies that achieve the highest photon and spectral efficiencies afforded by the quantum theory of light, and investigates methods by which one may approach them. In Section IV.3.2, we turn our attention to one of the most promising and concrete applications in the field of quantum communications, namely enabling secure communication between two parties via a provably-secure key exchange.

IV.3.1. Quantum-limited classical communication with photons

Optical communication is indispensable to space applications — be it beaming sensor information back to Earth from interplanetary satellites, communicating between satellites and from satellite to ground for telecom applications, or supporting a fast-pace low-Earth-orbit CubeSat sensor network in the future. Nearly all work on the communication theory of optical channels, such as that done for systems with laser transmitters and either coherent-detection (homodyne and heterodyne) or direct-detection receivers, uses semiclassical (shot-noise) models. Fundamentally, however, light waves are boson fields, which necessitates an explicit quantum analysis to determine the ultimate capacity limits on optical communication. This section of the report summarizes the state of the art in our understanding of the ultimate quantum limit — the Holevo capacity — to the rate of reliable optical communication, and quantifies the gaps between that limit and what can be achieved by the best-known conventional methods. In particular, we observe that even though a conventional laser-based transmitter is sufficient to achieve the Holevo capacity, much more complicated receiver constructs (as compared to the conventional optical receivers) will be required. As an example performance improvement, we argue that attaining the Holevo capacity will enable retaining the projected photon efficiency and data rate performance of MIT Lincoln Laboratory's Lunar Lasercom Demonstration (LLCD) program, while reducing the bandwidth requirement on the transmitter and receiver by roughly a factor of 20. On the other hand, for a given transceiver bandwidth, a quantum-optimal receiver could enable boosting the data rates on a deep-space link by a factor of 2 to 4. Furthermore, we observe that being able to implement quantum-limited sensing may improve the performance of the current pointing, acquisition and tracking systems, which are essential ingredients for long haul free-space optical communication links, due to the extremely narrow beam-widths employed at

optical frequencies. This enhanced pointing and tracking capability may boost link distances without sacrificing capacity. Finally, the pursuit of codes and joint-detection optical receivers to attain the Holevo limit on optical channel capacity will not only benefit key space applications, but will also advance our understanding of the fundamental limits that quantum physics imposes on our ability to manipulate light.

We begin this section with an overview of classical communication improvement opportunities by exploiting the quantum nature of photons. Then we discuss classical and quantum limits to photon and spectral efficiency, as well as some promises to approaching those limits. We then address the potential for improvements from state-of-the-art in applications, and conclude with recommendations for future avenues of work in realizing quantum-enhancements to space communications.

IV.3.1.1. Opportunities for quantum-enhanced classical communication using light in space

NASA has had a longstanding interest in developing long-haul free-space laser-based communication systems, for use on deep-space exploration missions, as well as for transmitting data between satellites, and between satellites and ground-based stations. Lasercom technology promises significant advantages over radio-frequency (RF) communications in terms of increased spectral efficiency and data rates (due to higher bandwidth), lower probabilities of detection and interception (due to orders of magnitude narrower beam-widths), spacecraft mass and power savings, and the flexibility associated with the currently unregulated spectra of optical frequencies. Furthermore, laser-based terminals are easy to install on a wide variety of platforms, including satellites, space vehicles, aircraft, ships, and ground-based terminals, which could enable an ultra-high-speed network in the future without the need for the large antennas of RF systems. However, these advantages of lasercom come with a burden of very stringent requirements on pointing, acquisition and tracking (PAT) as compared to RF, which is a challenge at typical space-scale distances.

The upper limit to the rate at which information can be reliably transmitted over a line-of-sight vacuum-propagation optical communication link is known as the *Holevo limit* [Holevo1998], a channel capacity limit that derives from treating laser light as a quantum electromagnetic field and invoking quantum Shannon theory — a relatively recent extension of Shannon’s information theory to account for the quantum properties of a communication channel and that of the information carrier. The diffraction-limited noiseless optical channel is a *pure-loss bosonic* channel.

Lasercom systems have been analyzed in great detail, primarily using the semi-classical theory of photodetection. However, the Holevo capacity of the pure-loss

bosonic channel was found relatively recently by some members of our KISS study team [Giovannetti2004b]. Besides evaluating the Holevo capacity, that work's two key findings were: (1) modulating coherent states (ideal laser light pulses) is sufficient to attain the Holevo limit, *but*, (2) attaining the Holevo limit would require an optimal code and an optical receiver that makes joint-detection measurements on long codewords (i.e., on long blocks of modulation symbols). Several members of our study team have made great progress in recent years in finding Holevo-capacity-achieving codes [Wilde2012a, Guha2012], and several strategies to build an optimal joint-detection receiver (JDR) [Guha2011b, Erkmen2012b, Wilde2012b]. However, an explicit blueprint for such an optimal JDR, which can be constructed using known optical components, still remains to be found.

Figure IV-18 shows the fundamental tradeoff between *photon information efficiency* (PIE) — the number of bits that can be transmitted per photon captured by the receiver, and *spectral efficiency* — the number of bits that can be transmitted per second, per Hz of the transmitter's modulation bandwidth. For a single-mode channel with multiple temporal modes (pulse slots), with one modulation symbol occupying a time slot, spectral efficiency is the number of bits transmitted per time slot. The colored plots show the capacity tradeoff that can be achieved using conventional (viz., homodyne, heterodyne, and single-photon detection) optical receivers, whereas the shaded area is the gap to the Holevo capacity limit. Since the Holevo capacity can be achieved by laser-light modulation, all the required additional complexity to bridge the gap to the Holevo limit lies in the receiver. Based on recent advances in this field it seems quite likely that the Holevo-capacity-achieving receiver will need quantum-optical processing of the received optical signal, which will involve optical nonlinearities in the receiver's design. If realized, however, this quantum-driven performance enhancement holds significant promise to be a practical gain, because all of the required quantum-driven processes would be local to the receiver, which can be in a well-controlled environment.

The upcoming NASA Lunar Laser Communication Demonstration (LLCD), being designed and built by MIT Lincoln Laboratory, will attempt to be the first system to achieve a high-rate lasercom system between the Earth and Lunar orbit [Boroson2012]. It makes use of high-speed photon-counting technology to achieve the highest photon efficiency performance of any fielded lasercom system to date. The system uses a pulse-position modulation (PPM) and superconducting nanowire single-photon multi-spatial-mode detector architecture, and operates at 2 bits/photon, and 0.125 bits/sec-Hz. Compared with this already record-setting operating point, however, there is still further potential for almost 16-fold increase in spectral efficiency as Figure IV-18 shows, if it were possible to build a Holevo-capacity-achieving code and JDR and to operate with the multi-mode received beam. This would mean retaining the currently projected data rate performance of the LLCD system, while alleviating the bandwidth requirement on the transmitter and the receiver by a factor of 16. Similarly, at a spectral efficiency between 1 to 3 bits/sec-Hz, an optimal JDR could potentially achieve a factor of 2 to 3 times higher PIE. This will translate to a 2 to 3 times higher data rate as compared to what is

achievable using direct detection, for a given transceiver bandwidth. These capacity enhancements could translate to either a longer possible transmission range for a fixed transmitter-receiver aperture area product, or being able to sustain the same rate with smaller apertures, or potentially, to achieving a higher data rate on a given channel geometry under given modulation and detection-bandwidth constraints.

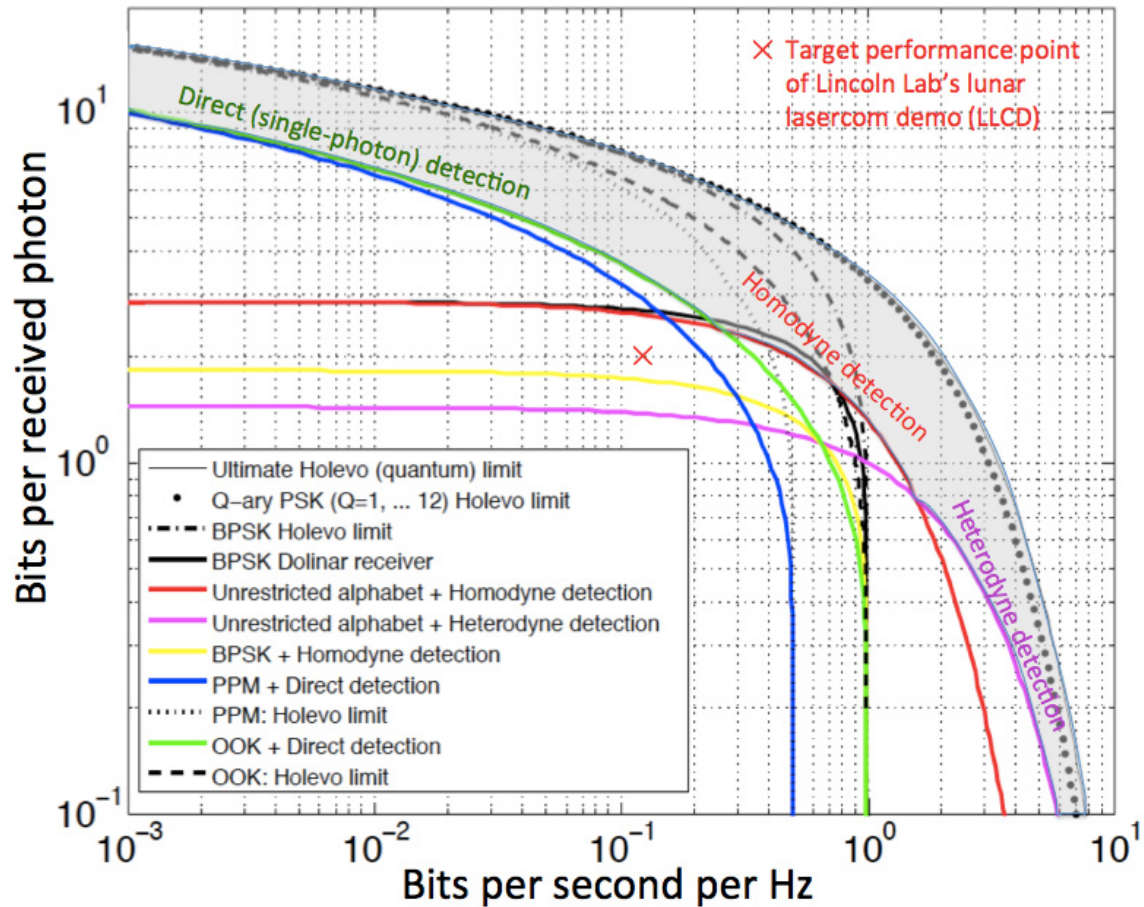

Figure IV-18 Photon versus spectral efficiency of a far-field optical channel. The colored (non-black) lines show the best performance achievable with standard techniques. The shaded area is the gap between achievable rate and the Holevo capacity.

Finally, we believe that the current PAT systems could benefit from using quantum-enhanced techniques, i.e., ones that approach or attain the quantum Cramér-Rao bound on estimating the position of the beam spot for a given number of photons impinging the quad-cell surface. The feedback alignment system of Lincoln Laboratory's quad-cell based PAT system uses fast-steering mirrors (FSMs) that steer the input beam to maximally couple it into the receiver optics. On the other hand, JPL has developed a multi-element photon-counting array that simultaneously derives the uplink data and provides PAT information. Neither one of these architectures, however, represents the ultimate limit on PAT performance.

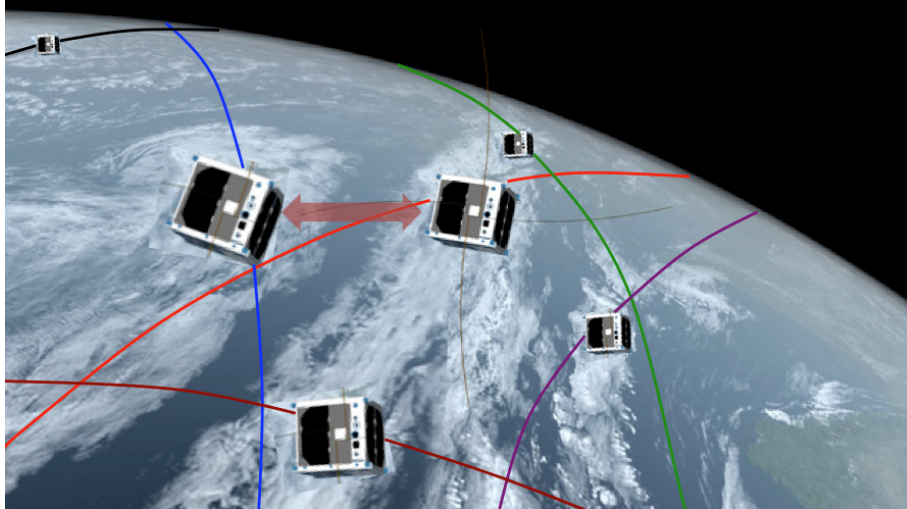

Figure IV-19 Shown is a conception of a quantum-secure LEO cube-satellite network. Satellite pairs periodically replenish shared secret keys using quantum key distribution at closest points of approach of their orbits. Figure is not drawn to scale.

The aforementioned advances to optical communication links can create synergistic opportunities with quantum communication techniques that ensure the security of information, as described in Section IV.3.2. For example, Holevo-capacity-approaching optical communications performance and a lightweight space-based short-range QKD system could be brought together to build an agile quantum-secure optical communication network between a swarm of low-Earth-orbit (LEO) cube and nano-satellites (see Figure IV-19). Satellite pairs would periodically replenish shared secret keys when their respective LEO orbits are at closest points of approach. Alternatively, satellite pairs could establish a small amount of shared entanglement during their brief close contact, and store them in quantum memories. These pairwise entangled states could later be used to generate more complex multiparty entanglement, which could in turn be used to execute complex quantum-limited multiparty privacy-preserving communication and authentication protocols. This satellite network could be used as a secure Earth-sensing network, or as a space-based secure-communications backbone.

IV.3.1.2. Classical versus quantum limits to photon versus spectral efficiency, and promises of approaching those limits

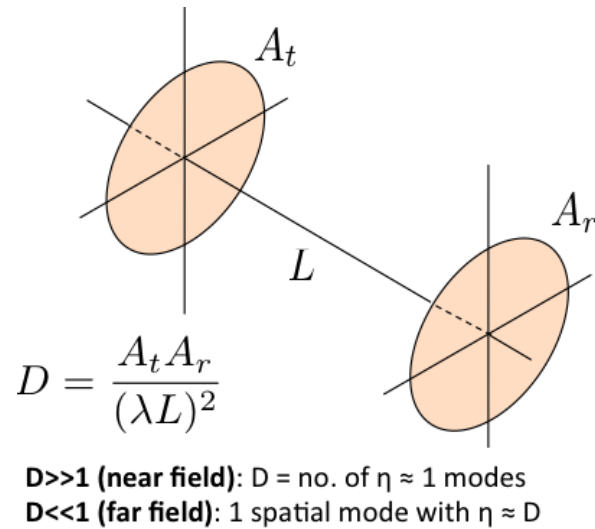

Figure IV-20 A line-of-sight free-space optical channel.

Consider the line-of-sight L -m free-space optical channel shown in Figure IV-20. Propagation of a λ -center-wavelength quasimonochromatic field through this channel can be broken up into an infinite set of pairwise input-output spatial mode functions, which form mutually-orthogonal mode sets over the transmit and receive aperture areas A_t and A_r , respectively. If the Fresnel number product $D \equiv A_t A_r / (\lambda L)^2 \gg 1$, the channel is said to be in the *near field*, in which regime there are roughly D input-output mode pairs with near-unity power transmissivity, $\eta \approx 1$. Most free-space links relevant to space communications are however deep in the *far field* regime, i.e., $D \equiv A_t A_r / (\lambda L)^2 \ll 1$, wherein there is just one spatial mode with A_t -to- A_r power transmissivity $\eta \approx D$. Therefore, we will focus on this single-spatial-mode pure-loss bosonic channel, with multiple temporal modes (or pulse slots).

Evaluating the ultimate limit to capacity

With the constraint of a mean photon number \bar{n} received per pulse slot at the receiver, the Holevo capacity of the pure-loss bosonic channel is given by $g(\bar{n})$ bits per pulse slot [Giovannetti2004b] where $g(\bar{n}) \equiv (1 + \bar{n}) \log(1 + \bar{n}) - \bar{n} \log \bar{n}$. A coherent-state modulation can achieve the Holevo limit, albeit with an optimal joint-detection receiver. In the lossless setting (achievable only in the near-field regime), photon number states can also attain the Holevo capacity, with a (simpler) direct-detection receiver. However, almost all optical communications relevant to the NASA mission would operate deep in the diffraction-limited far field, in which using coherent state (ideal laser-light) modulation is the only way to achieve the Holevo limit to capacity. The Holevo bound predicts that, with a coherent-state transmitter,

we can build better receivers towards closing about a 4 dB gap in photon efficiency gain *or* yield about 10 dB in spectral efficiency gain (see Figure IV-18).

In the presence of thermal noise, say N_B received thermal photons per mode, coherent-state modulation, along with an optimal JDR can achieve a capacity $g(\bar{n} + N_B) - g(N_B)$ bits per mode. This achievable lower bound to channel capacity was conjectured to be the Holevo capacity of the thermal noise channel [Giovannetti2004b]. Shapiro, Guha and Erkmen, later showed that in a turbulent-free propagation in bright sunlight, $N_B \approx 10^{-6}$ at $\lambda = 1.55 \mu\text{m}$, which leads to the lossless channel capacity $g(\bar{n})$ being an exceedingly tight upper bound to the true capacity, such that from a practical point it can be treated as the capacity [Shapiro2005]. More recently, Giovannetti *et al.* have found a suite of very tight lower and upper bounds to the Holevo capacity of the general thermal-noise lossy bosonic channel [Giovannetti2012b].

Joint-detection receivers and codes to close the gap to the Holevo limit

Efficiently decodable codes and fully explicit optical designs of joint detection receivers that achieve the Holevo limit remain unknown. However, several members of our KISS team have made appreciable progress in recent years toward code and receiver designs capable of attaining the Holevo limit:

Polar codes: Wilde and Guha developed the first explicit (linear) code and quantum measurement combination that can provably achieve communication at any rate R up to the Holevo limit [Wilde2012a, Guha2012]. They achieved this by generalizing the classical polar codes invented by Arikan, which can provably achieve the Shannon capacity of a (classical) discrete memoryless channel [Arikan2008]. Arikan's polar code uses a *successive-cancellation* decoder that recursively computes nR log-likelihood ratios from the n -symbol output of the channel to decode the transmitted message. The Wilde-Guha result, on the other hand, uses a *quantum successive-cancellation* receiver, which performs a sequence of nR nondestructive binary-projective collective measurements on the entire n -symbol (optical) codeword. An efficient optical realization of this receiver has yet to be found.

Vacuum-or-not receiver: Another technique that can provably attain the Holevo rate, however with a random (hence, potentially complex) code, uses a sequence of 2^{nR} non-destructive binary-projective *vacuum-or-not* measurements on the received n -symbol codeword, interspersed with mixing the codeword on a bank of n beam splitters with strong laser local oscillators [Wilde2012b]. Optical implementation of the non-demolition n -mode vacuum-or-not may involve optical nonlinearities, and remains unknown.

Single-photon-shutoff: Erkmen, Dolinar and collaborators have recently found a technique [Erkmen2012b] where, in each pulse interval, the receiver sends instantaneous feedback to the transmitter at the first click arrival, asking the transmitter to stop transmitting the remainder of the pulse (thereby saving

photons). Assuming the availability of that feedback channel, this technique achieves the Holevo limit in the high PIE regime. Of course, instantaneous feedback is impossible over the link distances contemplated for deep-space applications, but it might be approximated in the LEO CubeSat network shown in Figure IV-19.

The slicing receiver: da Silva, Guha and Dutton recently found a technique that can achieve minimum error discrimination of an arbitrary set of multimode coherent states [daSilva2012], and hence achieve the Holevo capacity (by optimally discriminating codeword waveforms of an optimal code). It slices the coherent states into small chunks, such that each *slice* is close to a qubit in the span of the vacuum and one-photon states for that time slice. The receiver then coherently couples each slice into a small ancilla register via a circuit of single- and two-qubit photonic quantum gates, and detects the ancilla.

Novel receivers for lower latency decoding in high spectral efficiency

In the high spectral efficiency regime (the magenta segment in Figure IV-18, in which heterodyne detection outperforms all conventional receivers), high-order modulation sets (such as QAM or QPSK) are required to reach capacity. Heterodyne detection, with an optimally-chosen modulation constellation, is known to asymptotically achieve the Holevo capacity in the high spectral efficiency regime. However, in this regime, Nair, Guha and Tan recently found that a *sequential waveform-nulling* receiver, which uses coherent processing of the received field on a beam splitter with a local oscillator laser, single-photon detection and feedback, can achieve the quantum-limited error-rate of discriminating between the symbols of the modulation alphabet yielding an error exponent that is a factor of four higher than that of heterodyne detection [Nair2012b]. This translates to a much lower coding latency, and could significantly reduce the coding overhead to achieve capacity in the high spectral-efficiency regime.

Turbulent atmospheric propagation: ergodic Holevo capacity

In optical communication through the Earth's atmosphere — such as in a satellite to ground, or deep-space to Earth direct link — atmospheric turbulence can become a significant impairment to the maximum possible rate of reliable optical communications. In recent years, Shapiro and collaborators have extensively studied the turbulent near-field (multiple-spatial-mode) free-space channel, and have found the ultimate limits to reliable communication with atmospheric turbulence — the *ergodic Holevo capacity* of the multimode near-field channel — for a variety of spatial mode sets: the Laguerre-Gaussian, the Hermite-Gaussian, and focused-beam modes sets [Chandrasekaran2012]. They have analyzed both mild and strong turbulence regimes, and considered receivers that employ perfect adaptive optics, and those that detect a pre-determined fixed set of spatial modes (non-adaptive receivers). Figure IV-21 shows channel-transmissivity results, and

the associated ergodic Holevo-capacity from their work.

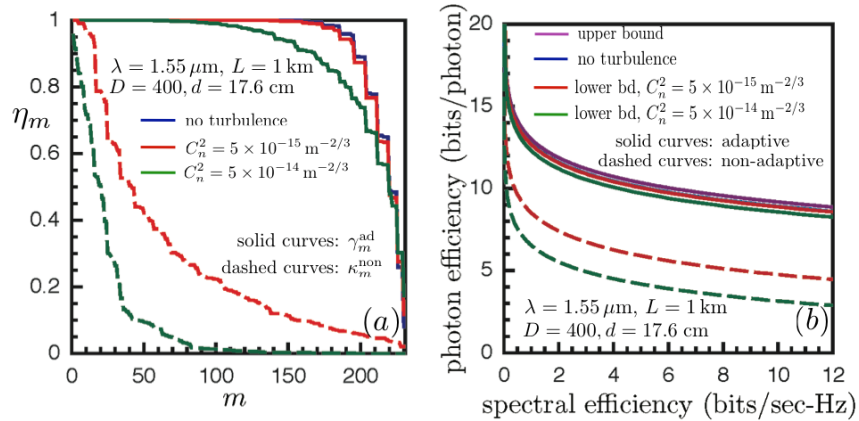

Figure IV-21 (a) LG/HG mode transmissivity results for a near-field link, (b) Ergodic Holevo capacity bounds: PIE vs. spectral efficiency.

Approaching the classical capacity limit of direct-detection receivers

The thick green line segment in Figure IV-18 denotes the Shannon capacity limit of an *on-off-keyed (OOK)* modulation with a single-photon detection receiver. With OOK modulation, a photon-number resolving (PNR) detector is unnecessary. Some of our team members have recently evaluated the capacity of the OOK direct-detection channel with various detector non-idealities, such as detector dark clicks, dead time, sub-unity quantum efficiency, and detector-timing jitter. In high-PIE operation, the optimal on-off duty cycle is very skewed, with the *on* probability scaling as $p \approx -\bar{n} \ln(\bar{n})/3$, which is very small when $\bar{n} \ll 1$. The conventional wisdom for the low-photon-number direct-detection channel is to use pulse-position modulation (PPM) with a Reed-Solomon outer code. However, little is known about codes with skewed 0-1 duty cycles that also approach the Shannon capacity of the OOK direct-detection channel with typical detector non-idealities.

Note that in Figure IV-18 no capacity plot is shown in for an *unconstrained modulation* with a PNR direct-detection receiver. The reason is that this capacity — which is attained by an M -ary pulse amplitude modulation (PAM) constellation and PNR detection — is as yet unknown. In the high-PIE, low-spectral-efficiency regime, binary OOK modulation is known to be asymptotically optimal for direct detection. However, in the intermediate regime, PAM modulation could do significantly better than OOK. Transition-edge sensor (TES) sensor PNR detectors now routinely achieve $\sim 98\%$ detection efficiency, and ns-scale timing jitter has recently been demonstrated [Lamas-Linares2012]. Thus they could provide the detector technology needed to reach the PAM capacity of direct detection.

Guha and Shapiro have recently found a two-pulse PPM modulation technique that ensures detector dead-time immunity — without loss of capacity in comparison

with conventional PPM — by leveraging the low duty-cycle requirement to enforce a minimum spacing between successive pulses. As an example, at the 10 bits/photon operating point, the 2-pulse-PPM technique is resilient to dead time that is 2000 times the pulse width. For a 1 GHz modulation bandwidth, this translates to 1 μ s dead-time tolerance, a value that is well within the realm of TES detectors. However, finding efficient bit-to-symbol mappings and efficient outer codes for this run-length-constrained two-pulse-PPM modulation code remains an open problem.

IV.3.1.3. Potential for improvements relative to state-of-the-art

Research enabling classical optical communication at photon and spectral efficiencies approaching the Holevo limit could lead to several improvements to future optical communication systems, relative to the state-of-the-art. The potential advances listed below could be of considerable value in future NASA missions.

Optimal codes and joint-detection receivers: These developments could increase the spectral efficiency (therefore, data rates) of long-haul optical channels (both deep-space, as well as satellite-to-ground links) by roughly a factor of 10.

Better direct-detection modulation and coding techniques: These techniques could close the performance gap between conventional PPM with single-photon-detection, and the highest capacity achievable using photon-number-resolving detection, resulting in a factor-of-two gain in spectral efficiency for a long-range link.

Quantum-limited pointing, acquisition and tracking systems: These systems could enable tracking to the same accuracy with fewer photons, which would enable sustaining a desired data rate at longer distance.

Quantum-limited secret-key generation: Development of quantum-optimal receivers could also lead to means for reaching the quantum limit on the rate at which two distant parties could generate a shared secret key that is information-theoretically secure. This capability could significantly improve upon the rates of conventional QKD systems.

Kilo-pixel photon-counting arrays: Kilo-pixel photon counting arrays are being constructed by JPL, both for in-flight and ground deployment. The flight-qualified array will have a detection efficiency (DE) of \sim 20%-50% at \sim 900-1600 nm, dark-count rates $<$ 1 kHz, and 200 ps single-photon timing resolution. However dark-count rates will not be the dominant source of noise in a space-based receiver, because the Earth is quite bright at \sim 1 μ m. On the other hand, the ground-based detection will operate at \sim 40% DE in a broadband mode over 400-2000 nm, or over 85% DE for a \sim 100 nm bandwidth. The detector pixels will have dark-count rates $<$ 100 Hz, and \sim 50 ps single-photon timing resolution. Thus these ground-based detectors will be of value for imaging as well as communication applications.

IV.3.2. Secure communications to, in, and from space

Quantum key distribution (QKD) is an emerging technology for transferring cryptographic keys³ using single- and entangled-photon quantum communications (QC), with the security assurances provided by incontrovertible principles of quantum physics [Nordholt2002a]. It has achieved a state of development from which the practicality of re-keying satellites on-orbit can be confidently predicted. (See Figure IV-22.)

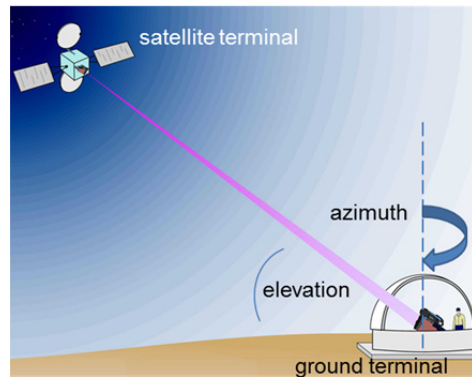

Figure IV-22 In a satellite QKD experiment, polarized single-photons would be transmitted from a space terminal, referred to as “Alice”, to a ground terminal, known as “Bob”, generating shared, secret random bits that constitute cryptographic keys.

With the attractive feature of forward security⁴ [Hughes2011], QKD is particularly compelling for enhanced security for satellite tracking, telemetry and control (TT&C) and secure data dissemination. This is because, as both on-orbit lifetimes and downlink data volumes increase, cryptographic key replacement requirements exceed what is possible with keys pre-placed at launch, which is in any event susceptible to an insider attack. There is therefore a need for an on-orbit key-update capability with stronger future security assurances than is possible with today’s public key cryptography. With an on-orbit QKD capability comes a new possibility: cryptographic keys could be distributed to users located anywhere that the satellite can contact [Nordholt2002b, Hughes2012a, Hughes2012b]. Several cross-linked QKD satellites could provide worldwide key-distribution to networks of land, sea, air, and space-based users. This capability would enhance electronic key management, making it more powerful, adding flexibility, and providing strong security assurances beyond the advent of quantum computers, while reducing the

³ Cryptographic keys are random bit sequences that are used as parameters in cryptographic algorithms to provide confidentiality, authenticity, integrity and non-repudiation functions. The secrecy of cryptographic keys and methods for their distribution are fundamentally important in achieving secure communications.

⁴ Forward security means that the security functions (confidentiality, authenticity, etc.) provided by past uses of a cryptographic key will not be compromised by exposure of information about the key in the future.

insider threat. Thus, satellite QKD can become an important tool for solving secure communications needs that are anticipated over the next decade and beyond. To realize the secure communications advantages offered by a space-based QKD capability, and to have this new tool available to meet future operational needs, it is necessary to move forward with an on-orbit experimental test and demonstration. The essential next step is to perform a low-Earth orbit (LEO) satellite to a fixed ground location QKD experiment that provides sufficient quantities of data to characterize and validate the fundamental physics, engineering, modeling, cryptographic and information assurance aspects, while providing crucial proof-of-principle systems-level demonstrations and concept of operations (CONOPS) experience that only an orbital test-bed can provide. The technical capabilities necessary for achieving this experimental advance, with acceptable risk, were represented at our KISS workshop, including: space-based optical communications payload engineering; satellite-to-ground optical pointing, acquisition, and tracking (PAT); free-space QKD; suitable light sources, e.g., spontaneous parametric downconversion (SPDC) photon-pair sources; and optical communications ground facilities (e.g., JPL's OCTL Table Mountain Facility [Wilson2003] in Wrightwood, CA).

IV.3.2.1. Background on free-space QKD and the state of the art

Quantum cryptography was invented by Charles Bennett and Gilles Brassard in 1984 [Bennett1984], who went on to perform a proof-of-principle QKD experiment in 1991, over a 32-cm transmission distance in air [Bennett1992] using what is now known as the BB84 protocol. This led many research groups to investigate QKD over optical fibers. The essential methodology (a contact architecture, wavelength plan, and background-rejection mechanisms) that allows free-space QKD to be performed reliably with high-availability over multi-kilometer atmospheric paths, even under full daylight conditions, was invented in the mid-1990s, and a CONOPS and expected performance for using QKD to re-key satellites on-orbit was described. These concepts were set out in two US Patents [Hughes1999a, Hughes2004] and a series of papers [Hughes2000a, Nordholt2002b, Buttler1998, Hughes1999b, Hughes2010], and validated in a series of free-space QKD experiments [Hughes1999c, Hughes2000b, Buttler2000], including in 2001 a point-to-point 10-km atmospheric path in daylight, with extinction, background and turbulence at least as challenging as would be faced on a satellite-to-ground path [Hughes2002]. Free-space QKD research has since built on this experimental methodology.

State of the art

Results of satellite quantum communication (QC) optical link modeling have since been published by research groups in Europe [Rarity2002, Aspelmeyer2003, Bonato2009], Japan [Toyoshima2008], China [Er-Long2005] and Canada [Meyer-Scott2011]. Free-space QKD experiments have since been performed at night over

campus-scale ranges in: the UK [Rarity2001]; the US [Bienfang2004]; Singapore [Marcikic2006]; Germany [Weier2006]; and Canada [Erven2008]; over multi-kilometer ranges at night: by European collaborations in Germany [Kurtsiefer2002], and between two of the Canary Islands [Schmidt-Manderbach2007]; in China [Peng2005]; and over an air-to-ground path by a German collaboration [Nauerth2012]. ([Hughes2002] remains the only multi-km experimental demonstration in full daylight.) Together, these results provide strong evidence for the ultimate feasibility of satellite-to-ground QC. China has announced plans [Xin2011] to launch a quantum science satellite in 2016, one aspect of whose mission will be a space-based QKD experiment. Japan's SOCRATES micro-satellite laser communications demonstrator mission, scheduled for launch in early 2014, will include a secondary experiment to test basic principles of on-orbit QKD [Takenaka2011]. The European Space-QUEST collaboration has proposed an ambitious suite of QC experiments that could be performed on the International Space Station (ISS), including a space-to-ground QKD demonstration [Ursin2009, Ursin2008]. The Canadian QEYSSAT collaboration is proposing a quantum science mission on a small-sat, which would include a space-to-ground QKD experiment [Higgins2012]. A team at National University of Singapore (NUS) has embarked on a program to space-qualify an SPDC source of polarization-entangled photon pairs, targeting a CubeSat flight opportunity [Morong2012].

For satellite QKD, a system architecture must be devised that can accommodate multiple additional challenges beyond those present in a static ground-to-ground, or an air-to-ground link. These include: link pointing, acquisition, and tracking; synchronization and timing; a QC space-terminal design that can be space-qualified and accommodated within satellite size, weight and power (SWaP) budgets; and a QKD protocol design that is consistent with the constrained computational and conventional communications resources of a space platform [Nordholt2002b, Hughes2010]. The ability to execute a complete QKD session within a single, few-minute duration, LEO-to-ground optical contact, with specified security parameters, and link availability (in daylight as well as night) are overarching requirements. Integration of QC with free-space optical communications (FSOC) is natural, and highly desirable for both satellite QKD and satellite laser communications (to demonstrate high-bandwidth secure satellite communications). Analyses show that, drawing on the heritage from satellite laser communications and satellite laser-ranging techniques, only modest size optical apertures on the space terminal (5 – 20-cm diameter) and on the ground (~50 – 100-cm diameter) are required.

Satellite QC system architecture

Space-to-ground QKD can be accomplished using single-photon polarization qubits, because they experience negligible decoherence or polarization-dependent loss⁵. One way in which the required BB84 states can be produced in the QC transmitter (“Alice”) is using short (< 1ns), highly attenuated pulses of linearly-polarized laser light (mean photon number < 1), and polarization-analyzed into BB84 states using passive polarization optics in the QC receiver (“Bob”) [Hughes2002]. An architecture in which Alice is located in space and Bob is located on the ground has multiple advantages. There is considerable heritage for lasers in space, the optically disruptive influence of atmospheric turbulence is located in the far-field, a large receiver aperture is simpler and cheaper to implement on the ground, and the computationally-intensive portions of the QKD protocol can be performed on the ground where greater resources are more readily available [Nordholt2002b]. An alternative method of producing polarization qubits is to use a source of photon pairs, e.g., SPDC. This would be located on the space platform, with one member of each photon pair detected locally, and the other directed to the optical ground terminal as in the attenuated-laser approach⁶. In this way a satellite QKD experiment could be performed in conjunction with other space-based quantum communications experiments that require an entangled-photon-pair source (e.g., SPDC). Advances in the photon flux per unit bandwidth of these sources in recent years make them competitive with attenuated laser sources for free-space QKD [Wong2006]. However, there is little heritage for SPDC sources in space, and so risk-mitigation experiments and space qualification of sources would be additional tasks that would need to be undertaken in this alternative approach.

Analysis of secret-bit yield as a function of wavelength [Nordholt2002b], taking into account single-photon detection efficiencies, atmospheric transmission, and background shows that a photon wavelength of ~780 nm will be optimal, permitting the use of commercially available silicon avalanche photo-diode detectors in Bob⁷.

⁵ QKD can also be implemented in a state space with dimension greater than two, e.g., using time-bin encoding. This approach has been used very successfully in optical fiber but has received very little attention in free-space QC, and is therefore much less advanced for a satellite experiment than the polarization qubits.

⁶ If the SPDC source is configured to produce polarization-entangled pairs, it could also provide the random-number generation function required for QC protocols. In contrast, for the attenuated-laser approach, the necessary space-qualified true random number generators are already commercially available.

⁷ An alternative wavelength plan would locate the quantum channel in the 1550-nm telecom band. In principle, superconducting nanowire single-photon detectors could be used in the ground receiver, provided that adequate free-space coupling efficiency could be achieved. Although some research has been performed with these detectors for free-space optical communications in the photon-starved regime, and they have been used successfully in optical fiber QC experiments, there have been no free-space QC experiments using them. The 780-nm free-space QC wavelength plan is therefore much more amenable to a near-term satellite experiment, and the alternative 1550-nm free-space QC approach remains to be evaluated.

With these detectors and typical receiver apertures of 50-cm to 1-m diameter, spectral filtering of ~ 0.1 nm, and detector field of view (FOV) of $< 200 \mu\text{rad}$ ($1/e^2$ diameter, set by a spatial filter), there is a clear difference between night and day regimes [Hughes2002]. At night, polarization errors in the QC optics dominate over background, and so the signal-to-noise ratio (SNR) can be improved by increasing the size of the receive aperture. In contrast, sky radiance is as much as a factor of 10^9 higher in daylight than at night, and background becomes the dominant error source: increasing the receive aperture will not improve the SNR in this case [Hughes2002].

Achieving a sufficiently high SNR for QKD in daylight as well as at night, which is desirable for high availability, is possible with a narrow quantum beam width, such as the $25\text{-}\mu\text{rad}$ ($1/e^2$ diameter) achievable with a diffraction-limited 10-cm diameter aperture at 780 nm. Alice must point the quantum beam accurately at Bob, but typical satellite position and attitude knowledge uncertainties are such that open-loop pointing errors are comparable to the beam width. Similarly, the uncertainty in the ephemeris typically available to Bob will be larger than the detector's field-of-view (FOV). The problems of link acquisition and tracking can be overcome using uplink and downlink optical beacons at wavelengths outside the sensitive range of the single-photon detectors. Given sufficient divergence, Bob's uplink beacon can be acquired by a position-sensitive detector within the space terminal, providing a pointing reference for the downlink quantum beam. Using a fast-steering mirror in the transmitter optical path and closed-loop tracking of the reference direction, angular jitter of the quantum beam can be reduced to a fraction of its width. Similarly, a downlink beacon with sufficient divergence, co-boresighted with the quantum beam, can be detected by a position-sensitive detector in the ground terminal, allowing Bob to acquire and track Alice's quantum beam with a residual jitter much smaller than the FOV of Bob's photon detectors [Nordholt2002b]. The optical power required for the beacons is comfortably below eye-safety thresholds.

To achieve the SNR required for QKD the QC receiver's polarization reference direction must be continuously aligned with the transmitter's to compensate for the field rotation introduced by two-axis telescope gimbals [Nordholt2002b]. By imparting a linear polarization to the downlink optical beacon, Bob can determine and apply the necessary compensation for field rotation rates of up to several degrees per second [Nordholt2012]. To compensate for range variations of up to tens of ns per ms, Alice can apply a known pseudo-random temporal modulation sequence to the downlink beacon, enabling Bob to reliably synchronize his detected photon sequence with Alice's transmissions, despite the typical range-knowledge uncertainties. The optical beacons can also provide the conventional communications required for the QKD public channel, using only a small portion of the available FSOC bandwidth.

Using the architecture that we have outlined, a LEO satellite-to-ground QKD experiment will be feasible with yields of several hundred secret cryptographic keys (each of 256 bits) per contact. (Air-to-ground QC would also be possible.) Analyses

of cloud-cover data at several optical ground terminal sites for Bob in the US Southwest show a single-site cloud-free line-of-sight (CFLOS) probability, and therefore an overly pessimistic availability lower bound, of 30%. As with satellite-to-ground laser communications, with several ground sites separated by ~100 km mitigation of cloudiness over any single ground site would be possible, greatly increasing availability [Piazolla2002, Link2004] and potentially allowing multiple contact opportunities each day.

IV.3.2.2. Satellite-to-ground QKD experiment: objectives and requirements

A definitive satellite-to-ground QKD experiment would:

- provide the large data sets necessary to validate the quantum physics, single-photon-level atmospheric optics, information assurance, information-theoretic and cryptographic aspects of QKD in space;
- form the basis from which future operational satellite QKD systems could be reliably designed and their information assurance aspects predicted; and
- include on-orbit demonstrations of the use of QKD from which the CONOPS for possible future operational space-based QKD concepts and applications can be developed.

These requirements are to be contrasted with a “hero” experiment in which the mere feasibility of the quantum transmissions of QKD from a satellite would be demonstrated in a ~one-time transmission, but without generating adequate data or even necessarily achieving sufficient transmission quality to allow complete protocol execution. Such an experiment would have little or no value for either the quantum information or the information assurance communities, and could actually cripple the future of QKD for operational space missions — another flight experiment would be unlikely, yet there would be insufficient data to prove out QKD’s cryptographic capabilities. The above data gathering requirements for the experiment would be drivers in terms of project philosophy and the balance between risk and cost.

Experimental plan

A spacecraft’s orbital parameters determine the number of contacts per day and the rate at which a key can be generated with a particular ground location on each contact. A large number of key bits, generated under widely varying conditions, are needed so that they can be examined for cryptographic quality and usability. The experimental procedure on each overhead pass would be as follows: acquire the optical link between the satellite and the ground location as the satellite rises above the horizon; perform multi-minute quantum communication while the satellite is

above the local horizon; perform the classical post-processing and communications as the satellite approaches the opposite horizon (or store data on-board for a more favorable subsequent contact). This classical communications could be performed optically if the QKD experiment was integrated with optical communications utilizing the PAT beacons. Otherwise, RF communications could be used.

Space resource requirements

A QKD system could be accommodated on many three-axis stabilized platforms, including several agile small-sat buses. Orbital parameters determine the overall secret bit yield given the space-based transmitter-telescope and ground station receiver-telescope apertures. Nominal platform requirements for a QKD experiment are provided in Table IV-6.

Nominal Platform	3-axis stabilized, capable of tracking specified fixed ground position to $< 1^\circ$ (1 st choice), or nadir-pointing (2 nd choice)
Nominal Orbit	Circular, 400-800 km, 40° inclination
On-orbit Operation	9 months - 1 year
Payload resources:	Nominal values
QKD subsystem	<i>Weight: 2 kg, power: <10 W; volume: (0.3 x 0.05 x 0.6) m³</i>
PAT subsystem	<i>Weight: 10 kg, power: 20 W; volume: (0.5 x 0.5 x 0.5) m³</i> 1- μ rad level residual pointing bias/jitter
Optical Ground Station(s)	For example: OCTL Table Mountain 1-m telescope 5- μ rad level residual tracking jitter
Mission Ground Station	Provided by mission
Telemetry	Downlink: Data: 20 Mb/s; payload status (housekeeping) Uplink: Tasking prior to pass, data: 100 Mb/pass

Table IV-6 Nominal platform requirements for a QKD experiment.

Operations plan

An on-orbit test of QKD must be designed to fully test and demonstrate the physical, orbital, and cryptographic elements of a QKD design. To this end we believe several phases are required:

-
- An ~2-month “Experiment Phase” during which quantum bits and the associated diagnostic data would be generated between the satellite and the QKD ground terminal. The focus would be on providing the detailed data necessary to perform a full diagnostic of its operation, so that the physics of the transmitter and receiver operation (synchronization, polarization tracking) and the free-space/atmospheric coupling can be fully characterized. Transmitter diagnostics and quantum communicated data would be downlinked by conventional communications to the ground.
 - A several-month “Demonstration Phase” to show the following.
 - QKD-supported on-orbit re-key: shared secret keys would be produced between the satellite and the ground unit, and used for on-orbit re-key of cryptographic hardware or software; and
 - key transfer via satellite between ground-based users in different locations would be demonstrated, potentially including intercontinental key agreement. Potential secondary optical ground sites include: NICT’s facility in Koganei, Japan, the ESA’s OGS facility on the Canary Islands, or Germany’s DLR facility.
 - Depending on spacecraft availability, a third, “Residual Phase”, after minimum operational tests are performed, would allow testing of other modes of operation or experiments to examine any questions that arise from data already in hand.
 - Finally, experience from ground-based experiments shows that a ~1 year post-operation phase is required for the analysis of data from which system performance and modeling can be validated.

What can only be learned with a space experiment as opposed to an air-to-ground experiment?

An air-to-ground QKD experiment would be very interesting in its own right and open up other potential new applications for key distribution. Several experimental airborne platforms are suitable, including the low-cost JPL Optical Communications demonstrator [Biswas2010]. A preliminary analysis shows that a QKD experiment could be integrated with a JPL FSOC system, and demonstrated between their airborne platform and a ground terminal at the Table Mountain OCTL facility. Such an experiment could be performed relatively quickly, within ~1 year, and would provide valuable risk-mitigation experience for a space-based QKD experiment. However, in accordance with NASA doctrine, such an experiment cannot be a substitute for a space experiment. This is because the envisioned ultimate use of satellite QKD requires it to be an integral element of a spacecraft’s communications system. Whenever such mission-critical technologies are being developed it is essential that they be fully tested in the space environment. An on-orbit QKD experiment will provide invaluable information about trending of the system

parameters, especially the security parameters. It will also provide opportunities to develop CONOPS experience that can guide future operational concepts.

IV.3.2.3. Technology benefits to the nation and society

Satellites and their communications constitute essential elements of our critical national and global infrastructure. But satellites are not immune to cyber threats, as demonstrated by the infamous “Captain Midnight” hack of an HBO satellite in 1986. GAO reports have highlighted the cyber threats to our satellite systems, whether for commerce, science, homeland security, or defense, and news media have carried reports of attempts to hack NASA Earth-observing systems. It is essential for the proper functioning of our society that we have technologies that provide assured control of our space assets, and availability of the data they produce. Cryptographic systems capable of providing the necessary long-term security assurances peculiar to the space environment, where direct human access is essentially impossible, must be developed. Today’s public key cryptosystems cannot provide these assurances, but QKD can. A satellite QKD experiment will therefore be a major step in advancing satellite cyber security.

When integrated with QKD, satellite optical communications would provide new, lower-cost, more flexible capabilities for securely controlling future spacecraft science instrumentation. QKD-secured satellite-to-ground FSOC would enable flight Principal Investigators to securely control their spacecraft instruments directly from convenient ground locations, instead of the present-day more burdensome requirement to use the dedicated ground station only. Further, QKD-secured satellite laser communications would enable secure partitioning of data in multi-national space platform environments.

While QC in general, and satellite QKD in particular, were pioneered by researchers based in North America, in recent years other nations have surged into the lead. The US must retake its place at the forefront of this rapidly growing area of modern science by embarking on a satellite QKD experiment. This experiment will also prevent technological surprise, and contribute to our National Economic Security by advancing the Technology Readiness Level of satellite QKD sufficiently far that it can subsequently be transferred to, and ultimately be manufactured by, US industry.

IV.3.3. Conclusions and recommendations for future work

Below we summarize our principal conclusions both for quantum-limited classical communications (Section IV.3.1) and for secure communications (Section IV.3.2).

Structured designs of Holevo-capacity-achieving receivers:

- a. The ultimate capacity of optical communication can be achieved by modulating laser light, but the receiver needs to make joint measurements over long symbol blocks, which may require the use of optical nonlinearities and other novel optical processing blocks prior to the final measurement of the fields. Understanding the requirements on the efficiency and precision of these optical processing blocks is critical to progress towards bench-top (and later prototype) systems.
- b. Finding binary and non-binary error-correcting codes that approach the Holevo limit with a strong error exponent and with efficient decoders remains an open problem of significance. Quantum polar codes show promise in this direction (they are provably Holevo-capacity achieving), but the receiver requires further study to arrive at an implementable architecture. Binary multimode quantum non-demolition measurements may be a key enabling technology in implementing this and some other recently-found JDR techniques.
- c. It is important to recognize that the JDR techniques that have been emerging in recent years show strong correlation with qubit gate operations used in the field of quantum computing. For example, optical implementations of deterministic single- and two-qubit gates on single-rail-encoded photonic qubits is sufficient for the slicing receiver (discussed in Section IV.3.1.2) to attain the Holevo limit. Therefore, as quantum computing implementations mature it should be expected that JDR receiver implementations will mature along with them. Significant insights, and revolutionary technology advances may emerge from this synergy with the quantum computing community.

Quantum-enhanced pointing, acquisition and tracking (PAT):

- a. The narrow beam-widths achievable with light bring along the requirement that the communication terminals have high-accuracy pointing and tracking capability, in order to keep the beams on target. This task is performed with active tracking systems that either tap off part of the communication beam (which eats into the photon budget for communication), or that track a dedicated pilot beacon (which increases complexity and power consumption). Therefore, it is important to consider improvements to the pointing and tracking systems via quantum-enhanced receivers. Quad-cell-based PAT architectures in which the photodetector outputs are optimally

processed and fed into an alignment system (utilizing fast steering mirrors) have been shown to saturate the quantum Cramér-Rao bound for an input in a single focused-beam mode and with perfect direct detection available at each quadrant. Immediate generalizations should consider pixel arrays, more complex beam patterns, and practical limitations to photon counting. In the longer term, the relative gains from adaptive receiver architectures for multi-shot PAT systems on dynamic platforms, and their gap to the optimal quantum measurement are important avenues of research. PAT systems are fundamentally sensing instruments, and therefore the conclusions and recommendations in Section IV.2.4 apply here as well.

Quantum-limited secure-key generation and direct secure communication:

- a. Secure space-based communications are of critical importance, and both the technologies and concepts are sufficiently mature to support a significant demonstration of the pertinent core capabilities in the near future. Using the architecture outlined in Section IV.3.2, a LEO satellite-to-ground QKD experiment will be feasible with yields of several hundred secret 256-bit cryptographic keys per contact. (Air-to-ground QC would also be possible.) The essential next step is an experimental QC-sat. A number of LEO-platforms would be suitable, ranging from a dedicated three-axis stabilized small satellite, to a secondary experiment on an imaging or optical communications satellite, to the ISS. With one or more QC satellites, low-latency quantum-secured communications could then be provided to ground-based users on a global scale. A QKD satellite experiment could be performed in conjunction with other quantum information experiments in space, using a source of entangled photons (e.g., SPDC), or in conjunction and integrated with a space-based optical communications demonstration. The full promise of QKD to allow on-orbit satellite re-key and provide secure keys anywhere on the planet awaits only an orbital demonstration for it to be realizable.
- b. There is significant room for improving security proofs for dynamically-varying channels (such as free-space links impaired by pointing-induced fluctuations and atmospheric turbulence). The technology demonstrations that might be pursued in the near future can both inform, and be informed by a parallel theoretical effort to better delineate the security of dynamically-varying channels, and any requirements it may place on system architectures.
- c. Improving existing protocols and codes towards the information-theoretic limit on key-generation rates is an open problem that should continue to receive attention.

V. Main Conclusions of the Study Program

This study has focused on new fundamental science opportunities, as well as technology enhancement opportunities, in sensing and communication that would stem from our ability to observe, control, and exploit quantum-mechanical phenomena in the space environment. In Section IV we provided detailed discussions in the three primary thrusts of our study program: (1) fundamental science, (2) sensing and measurement, and (3) communication and measurement. In this section, we summarize the general conclusions from our study program under these three topic areas.

Fundamental science in space:

Sections IV.1.2 through IV.1.5 highlight several promising future research avenues, both for capitalizing on new fundamental science opportunities, and for the associated technology development needs. Space offers a platform that has been well-recognized as ideal for some of the most precise tests of fundamental physics, thanks largely to its providing significant variations of the gravitational field, and virtually unlimited spatial extent traversable at arbitrary velocities. Precision measurements typically involve optical and atomic systems as frequency standards and sensors, many of which are in the domain of semiclassical and quantum physics. Research accomplishments in the atomic and optics fields in recent years have ushered in novel clock and sensor technologies that are enabling unprecedented measurement precisions, to the point at which new physics could be discovered. While the relevant technologies and their discovery potentials have been well demonstrated on the ground, there exists a large gap to be bridged in making them into space-based systems. To bridge this gap and advance fundamental-physics space exploration, focused investments should be made to develop and mature the technologies in the areas of space-based atomic clocks, and quantum sensors based on atom-wave interferometers. As a parallel effort it is important to engage the science community to help identify and prioritize a set of fundamental-physics measurement mission concepts that not only have the most significant science return, but also a realistic chance of realization in the near future.

Our study has identified two exciting new concepts in the fundamental science category that would benefit from small focused efforts to further refine them, and develop them into proposals that can be moved further up the maturation ladder with larger-scale investments. The first is a gravity-wave detection interferometer that spans the intermediate band (0.01 – 10 Hz), which is inaccessible from the ground due to terrestrial noise sources. By using an interferometer geometry that yields moderate losses in its arms, squeezed-light injection can be employed to beat the semiclassical noise floor, making gravity-wave measurements with previously-unattainable sensitivity feasible. The second concept emerging from our study program arose from the collaborative environment within our multidisciplinary team of researchers. In particular, recognizing that the fractional length stability of

space-based gravity-wave interferometers are unmatched by any terrestrial frequency reference, and that techniques developed for the LISA mission could enable the transfer of this stabilized light to Earth, led to a promising concept of developing this frequency reference for high-precision ground-based experiments (within its applicable frequency range). Some open questions regarding atmospheric phase fluctuations are tasks that need to be addressed in future work.

Sensing and measurement in space:

The conclusions and recommendations in Section IV.2.4 highlight several avenues of research and development that could lead to instruments surpassing the standard quantum limit. Of these, the most promising conclusion is probably a multifunction entangled-photon source, whose development has significant potential across the science, sensing, and communication frontiers we explored in this study program. Spontaneous parametric downconversion (SPDC) sources are reconfigurable multifunction devices of entangled photons in different degrees of freedom that are essential for many quantum measurements in science and technology missions in space. The same SPDC devices also provide ultrabroadband laser-like pulses for classical-sensing measurements. While SPDC sources based on nonlinear crystals — or spontaneous four-wave mixing (SFWM) sources based on optical fibers — are mature for laboratory use, additional research is recommended for advancing the state of the art to achieve more sophisticated capabilities and for space qualification. Longer-term research on sources based on semiconductor devices may yield highly-integrated quantum devices for space applications.

Our conclusions in this category identified several high-risk and high-payoff avenues of research, but in all cases small-scale focused investigations are the ultimate recommendation. Two prominent examples are: (1) using quantum measurements to improve the accuracy of PAT systems, which would have an immediate measurable impact on (classical and quantum) communication demonstrations; and (2) weak-values measurement techniques that may attain high-accuracy position sensing for *in situ* instruments on a rover-like planetary explorer.

Weak-values measurement is a novel metrology technique that allows one to achieve optimum quantum-measurement performance in nonstandard ways by matching the measurement technique to the system constraints (e.g. noisy environments or detector weight limits). An emerging application of weak values is the ability to perform new types of quantum measurements that may benefit space-based quantum communication or quantum foundational research. However, the understanding of weak values as a quantum measurement technique is not yet developed enough to conclusively assert whether it affords benefits for space applications. Several weak-value techniques have been demonstrated in the laboratory and future work includes matching appropriate weak-value techniques to space-based sensing and communication systems by further investigating both the present limitations of these systems, as well as characteristics of external signals

of interest (e.g., exo-planets). It would be beneficial that future work follow focused efforts towards incorporating practical constraints imposed by the space environment.

Communication and measurement in space:

Our conclusions and recommendations for quantum-enhanced communication systems are detailed in Section IV.3.3. Perhaps the most mature of all opportunities discussed in this study resides in this area: demonstrating the core technology necessary for a quantum-mechanically secure key-distribution protocol, namely quantum key distribution (QKD), has emerged as having a level of maturity sufficient for a significant investment towards a space-based demonstration. QKD can be summarized as an emerging technology for transferring cryptographic keys using single-photon quantum communications (QC), with the security assurances provided by incontrovertible principles of quantum physics. It has achieved a state of development from which the practicality of re-keying satellites on-orbit can be confidently predicted. With an on-orbit QKD capability, cryptographic keys could be distributed to users located anywhere that the satellite can contact. Several cross-linked QKD satellites could provide worldwide key distribution to networks of land, sea, air, and space-based users. The essential next step is to perform a low-Earth orbit (LEO)-satellite to fixed ground location QKD demonstration.

The ultimate quantum limit to the rate of reliable *classical* optical communication is referred to as the Holevo capacity, which subsumes the Shannon capacities attainable with any structured modulation and receiver combination. It has been observed in recent years that attaining the Holevo capacity likely requires joint measurements over multiple optical symbols, namely joint-detection receivers (JDRs). All receiver architectures that have been proposed to date as Holevo-capacity-attaining have been highly conceptual, and have indicated the need for highly-complex and nonclassical optical processing blocks prior to any destructive measurement. However, if realized, the returns are significant: as an example, attaining the Holevo capacity would enable retaining the projected photon efficiency and data rate of MIT Lincoln Laboratory's Lunar Lasercom Demonstration (LLCD) program, while reducing the bandwidth requirement by about a factor of 20. For this reason, focused efforts that continue to refine the receiver building-blocks and their operational requirements could yield significant progress towards realizing the potential efficiency gains in future optical communication systems.

VI. List of Abbreviations

ACES	Atomic Clock Ensemble in Space
APD	Avalanche photodiode
ASRC	Arctic Slope Regional Corporation
BBO	Beta barium borate
CAL	Cold Atom Laboratory
CFLOS	Cloud-free line of sight
CMOS	Complementary metal-oxide semiconductor
CONOPS	Concept of operations
CP	charge-conjugation symmetry and parity symmetry
CW	Continuous wave
DARPA	Defense Advanced Research Projects Agency
DE	Detection efficiency
DECIGO	Deci-Hertz Interferometer Gravitational Wave Observatory
DoD	Department of Defense
DWDM	Dense wavelength-division multiplexing
ELIPS	European Programme for Life and Physical Sciences
EM	Electromagnetic
EP	Equivalence Principle
ESA	European Space Agency
ESTO	Earth Science Technology Office
FOV	Field of view
FSM	Fast-steering mirror
FSOC	Free-space optical communications
GAO	Government Accountability Office
HOM	Hong, Ou, and Mandel
HYPER	Hyper-precision cold atom interferometry in space
InGaAs	Indium gallium arsenide
InPho	Information in a Photon
ISS	International Space Station
JDR	Joint-detection receiver
JPL	Jet Propulsion Laboratory
KISS	Keck Institute for Space Studies

LADAR	Laser radar (radio detection and ranging)
LEO	Low-Earth orbit
LIDAR	Light detection and ranging
LIGO	Laser Interferometer Gravitational Wave Observatory
LISA	Laser Interferometer Space Antenna
LLCD	Lunar Laser Communication Demonstration
MAQRO	Macroscopic Quantum Resonators
MICROSCOPE	Micro-Satellite à traînée Compensée pour l'Observation du Principe d'Equivalence (French acronym for Micro-Satellite with drag Control for the Observation of the Equivalence Principle)
MURI	Multidisciplinary University Research Initiative
NASA	National Aeronautics and Space Administration
NCDC	National Climatic Data Center
NGO	New Gravitational Wave Observatory
NICT	National Institute of Information and Communications Technology
NUS	National University of Singapore
OCT	Optical coherence tomography
OCTL	Optical Communications Telescope Laboratory
OFC	Optical frequency comb
OOK	On-off keying
OPO	Optical parametric oscillator
PAM	Pulse amplitude modulation
PARCS	Primary Atomic Reference Clock in Space
PAT	Pointing, acquisition, and tracking
PC-OCT	Phase-conjugate optical coherence tomography
PIA	Phase-insensitive amplification
PIE	Photon information efficiency
PNR	Photon-number resolving
PPKTP	Periodically poled potassium titanyl phosphate
PPLN	Periodically poled lithium niobate
PPM	Pulse position modulation
PSA	Phase-sensitive amplification
QAM	Quadrature amplitude modulation
QC	Quantum communication
QCRB	Quantum Cramér-Rao bound
QEYSSAT	Quantum Encryption and Science Satellite
QI	Quantum illumination
QKD	Quantum key distribution
QND	Quantum non-demolition
Q-OCT	Quantum-optical coherence tomography
QPSK	Quadrature phase-shift keying

QSP	Quantum Sensors Program
QUEST	Quantum Entanglement in Space Experiments
QuITE	Quantum Interferometry Test of Equivalence
QWEP	Quantum Weak Equivalence Principle project
QZZB	Quantum Ziv-Zakai bound
RACE	Rubidium Atomic Clock Experiment
RF	Radio frequency
SCaN	Space Communications and Navigation
SFWM	Spontaneous four-wave mixing
Si	Silicon
SLM	Spatial light modulator
SME	Standard-model extension
SNR	Signal-to-noise ratio
SNSPD	Superconducting nanowire single-photon detector
SOC	Space optical clock
SOCRATES	Space Optical Communications Research Advanced Technology Satellite
SPDC	Spontaneous parametric downconversion
SQL	Standard quantum limit
STE-QUEST	Space-Time Explorer and Quantum Equivalence Principle Space Test
SUMO	Superconducting Microwave Oscillator
SVI	Squeezed-vacuum injection
SWaP	Size, weight, and power
TDI	Time-delay interferometry
TES	Transition-edge sensor
TRL	Technology Readiness Level
TT&C	Tracking, telemetry, and control

VII. References

-A-

- [Abouraddy2002] A. F. Abouraddy, M. B. Nasr, B. E. A. Saleh, A. V. Sergienko, and M. C. Teich “Quantum-optical coherence tomography with dispersion cancellation,” *Phys. Rev. A* **65**, 053817 (2002).
- [Aharonov1988] Y. Aharonov, D. Z. Albert, and L. Vaidman, “How the result of a measurement of a component of the spin of a spin-1/2 particle can turn out to be 100,” *Phys. Rev. Lett.* **60**, 1351 (1988).
- [Aharonov2007] Y. Aharonov and L. Vaidman, “The Two-State Vector Formalism of Quantum Mechanics: an Updated Review,” arXiv:quant-ph/0105101v2 (2007).
- [Aiello2008] A. Aiello and J. P. Woerdman, “Role of beam propagation in Goos-Haenchen and Imbert-Fedorov shifts,” *Opt. Lett.* **33**, 1437 (2008).
- [Altepeter2005] J. Altepeter, E. Jeffrey, and P. Kwiat, “Phase-compensated ultra-bright source of entangled photons,” *Opt. Express*, **13**, 8951 (2005).
- [Arikan2008] E. Arikan, “Channel polarization: a method for constructing capacity-achieving codes,” in *Proceedings of the 2008 IEEE International Symposium on Information Theory (ISIT)*, 1173 (2008); e-print arXiv:0807.3917v5 [cs.IT].
- [Armstrong1999] J. W. Armstrong, F. B. Estabrook, and M. Tinto, “Time delay interferometry for space-based gravitational wave searches,” *Astrophys. J.* **527**, 814 (1999).
- [Arndt2009] M. Arndt, M. Aspelmeyer, and A. Zeilinger, “How to extend quantum experiments,” *Fortschr. Phys.* **57**, 1153 (2009).
- [Aspelmeyer2003] M. Aspelmeyer, T. Jennewein, M. Pfennigbauer, W. R. Leeb, and A. Zeilinger, “Long-distance quantum communications with entangled photons using satellites,” *IEEE J. Sel. Top. Quant. Elect.* **9**, 1541 (2003).
- [Azzini2012] S. Azzini, D. Grassani, M. J. Strain, M. Sorel, L. G. Helt, J. E. Sipe, M. Liscidini, M. Galli, and D. Bajoni, “Ultra-low power generation of twin photons in a compact silicon ring resonator,” *Opt. Express* **20**, 23100 (2012).

-B-

- [Bagnasco2002] G. Bagnasco and S. Airey, “HYPER: a potential ESA flexi-mission in the fundamental physics domain [online],” in First HYPER Symposium, <http://sci2.esa.int/hyper/HyperSymposium1/HYPERCD/Bagnasco.pdf> (2002).

-
- [Barreiro2005] J. T. Barreiro, N. K. Langford, N. A. Peters, and P. G. Kwiat, "Generation of hyperentangled photon pairs," *Phys. Rev. Lett.* **95**, 260501 (2005).
- [Barz2010] S. Barz, G. Cronenberg, A. Zeilinger, and P. Walther, "Heralded generation of entangled photon pairs," *Nature Photon.* **4**, 553 (2010).
- [Bender1998] P. Bender, A. Brillet, I. Ciufolini, A. M. Cruise, C. Cutler, K. Danzmann, F. Fidecaro, W. M. Folkner, J. Hough, P. McNamara, M. Peterseim, D. Robertson, M. Rodrigues, A. Rüdiger, M. Sandford, G. Schäfer, R. Schilling, B. Schutz, C. Speake, R. T. Stebbins, T. Sumner, P. Touboul, J.-Y. Vinet, S. Vitale, H. Ward, and W. Winkler, "LISA: Laser Interferometer Space Antenna for the detection and observation of gravitational waves," *LISA Pre-Phase A Report*, 2nd ed., MPQ 233 (1998); e-print <http://lisa.gsfc.nasa.gov/Documentation/ppa2.08.pdf>.
- [Bennett1984] C. H. Bennett and G. Brassard, "Quantum Cryptography, Public Key Distribution and Coin Tossing," in *Proceedings of the International Conference on Computers, Systems and Signal Processing*, 175 (1984).
- [Bennett1992] C. Bennett, F. Bessette, G. Brassard, L. Salvail, and J. Smolin, "Experimental quantum cryptography," *J. Crypto.* **5**, 3 (1992).
- [Bennink2010] R. S. Bennink, "Optimal collinear Gaussian beams for spontaneous parametric down-conversion," *Phys. Rev. A* **81**, 053805 (2010).
- [Bienfang2004] J. Bienfang, A. Gross, A. Mink, B. Hershman, A. Nakassis, X. Tang, R. Lu, D. Su, C. Clark, C. Williams, E. Hagley, and J. Wen, "Quantum key distribution with 1.25 Gbps clock synchronization," *Opt. Express* **12**, 2011 (2004).
- [Biswas2010] A. Biswas, J. Kovalik, M. W. Regehr, and M. Wright, "Emulating an optical planetary access link with an aircraft," in *Proceedings of the SPIE* **7587**, 75870B (2010).
- [Bonato2009] C. Bonato, A. Tomaello, V. Da Deppo, G. Naletto, and P. Villoresi, "Feasibility of satellite quantum key distribution," *New J. Phys.* **11**, 045017 (2009).
- [Boroson2012] D. M. Boroson, B. S. Robinson, D. A. Burianek, D. V. Murphy, and A. Biswas, "Overview and status of the Lunar Laser Communication Demonstration," in *Proceedings of the SPIE* **8246**, 82460C (2012).
- [Braginsky1992] V. B. Braginsky, F. Ya Khalili, *Quantum Measurement*, K. S. Thorne ed., Cambridge Univ. Press, Cambridge (1992).
- [Buttler1998] W. T. Buttler, R. J. Hughes, P. G. Kwiat, S. K. Lamoreaux, G. G. Luther, G. L. Morgan, J. E. Nordholt, C. G. Peterson, and C. M. Simmons, "Practical free-space quantum key distribution over 1 km," *Phys. Rev. Lett.* **81**, 3283 (1998).
- [Bromberg2009] Y. Bromberg, O. Katz, and Y. Silberberg, "Ghost imaging with a single detector," *Phys. Rev. A* **79**, 053840 (2009).
-

-
- [Brunner2010] N. Brunner and C. Simon, "Measuring small longitudinal phase shifts: weak measurements or standard interferometry?," *Phys. Rev. Lett.* **105**, 010405 (2010).
- [Burdge2009] G. Burdge, G. Deibner, J. Shapiro, F. Wong, P. Kumar, H. Yuen, M. Vasilyev, N. Stelmakh, Z. Dutton, S. Guha, and J. Habif, "Quantum Sensors Program final technical report," *Defense Technical Information Center (DTIC)*, AFRL-RI-RS-TR-2009-208 (2009); e-print <http://www.dtic.mil/cgi-bin/GetTRDoc?AD=ADA506209>.
- [Buttler2000] W. T. Buttler, R. J. Hughes, S. K. Lamoreaux, G. L. Morgan, J. E. Nordholt, and C. G. Peterson, "Daylight quantum key distribution over 1.6 km," *Phys. Rev. Lett.* **84**, 5652 (2000).

-C-

- [Cable2007] H. Cable and J. P. Dowling, "Efficient generation of large number-path entanglement using only linear optics and feed-forward," *Phys. Rev. Lett.* **99**, 163604 (2007).
- [Cai2005] Y. Cai and S.-Y. Zhu, "Ghost imaging with incoherent and partially coherent light radiation," *Phys. Rev. E* **71**, 056607 (2005).
- [Caves1980] C. M. Caves, "Quantum mechanical radiation pressure fluctuations in an interferometer," *Phys. Rev. Lett.* **45**, 75 (1980).
- [Chandrasekaran2012] N. Chandrasekaran, J. H. Shapiro, L. Wang, "Photon information efficient communication through atmospheric turbulence," in *Proceedings of the SPIE* **8518**, 851808 (2012).
- [Clemmen2009] S. Clemmen, K. Phan Huy, W. Bogaerts, R. G. Baets, Ph. Emplit, and S. Massar, "Continuous wave photon pair generation in silicon-on-insulator waveguides and ring resonators," *Opt. Express* **17**, 16558 (2009).
- [Creighton2008] T. Creighton and R. H. Price, "Black holes," http://www.scholarpedia.org/article/Black_holes, (2008).

-D-

- [daSilva2012] M. P. da Silva, S. Guha, and Z. Dutton, "Achieving minimum-error discrimination of an arbitrary set of laser-light pulses," *submitted to Phys. Rev. Lett.*; e-print arXiv:1208.5758v2 [quant-ph] (2012).
- [Diddams2010] S. A. Diddams, "The evolving optical frequency comb [Invited]," *J. Opt. Soc. Am. B* **27**, B51 (2010).

-
- [Dimopoulos2008] S. Dimopoulos, P. W. Graham, J. M. Hogan, and M. A. Kasevich, "General relativistic effects in atom interferometry," *Phys. Rev. D* **78**, 042003 (2008).
- [Dimopoulos2009] S. Dimopoulos, P. W. Graham, J. M. Hogan, M. A. Kasevich, and S. Rajendran, "Gravitational wave detection with atom interferometry," *Phys. Lett. B* **678**, 37 (2009); e-print arXiv:0712.1250v2 [gr-qc].
- [Diósi2007] L. Diósi, "Notes on certain Newton gravity mechanisms of wavefunction localization and decoherence," *J. Phys. A* **40**, 2989 (2007).
- [Dixon2009] P. B. Dixon, D. J. Starling, A. N. Jordan, and J. C. Howell, "Ultrasensitive beam deflection measurement via interferometric weak value amplification," *Phys. Rev. Lett.* **102**, 173601 (2009).
- [Dolinar2011] S. Dolinar, K. M. Birnbaum, B. I. Erkmen, and B. Moision, "On approaching the ultimate limits of photon-efficient and bandwidth-efficient optical communication," in *IEEE International Conference on Space Optical Systems and Applications (ICSOS)*, 269 (2011).
- [Downes2011] T. G. Downes, I. Fuentes, and T. C. Ralph, "Entangling moving cavities in noninertial frames," *Phys. Rev. Lett.* **106**, 210502 (2011).
- [Dressel2010] J. Dressel, S. Agarwal, and A. N. Jordan, "Contextual Values of Observables in Quantum Measurements," *Phys. Rev. Lett.* **104**, 240401 (2010).
- [Dressel2011] J. Dressel, C. J. Broadbent, J. C. Howell, and A. N. Jordan, "Experimental violation of two-party Leggett-Garg inequalities with semi-weak measurements," *Phys. Rev. Lett.* **106**, 040402 (2011).
- [Drexler2008] W. Drexler and J. G. Fujimoto eds., *Optical Coherence Tomography: Technology and Applications*, Springer, Berlin (2008).
- [Driggers2012] J. C. Driggers, J. Harms, and R. X. Adhikari, "Subtraction of Newtonian noise using optimized sensor arrays," *Phys. Rev. D* **86**, 102001 (2012).
- [Dutton2010a] Z. Dutton, J. H. Shapiro, and S. Guha, "LADAR resolution improvement using receivers with squeezed-vacuum injection and phase-sensitive amplification," *J. Opt. Soc. Am. B* **27**, A63 (2010).
- [Dutton2010b] Z. Dutton, J. H. Shapiro, and S. Guha, "LADAR resolution improvement using receivers with squeezed-vacuum injection and phase-sensitive amplification: erratum," *J. Opt. Soc. Am. B* **27**, 2007 (2010).

-E-

- [Ellis1992] J. Ellis and N. E. Mavromatos, and D. V. Nanopoulos, "String theory modifies quantum mechanics," *Phys. Lett. B* **193**, 37 (1992).

-
- [Englund2012] D. Englund, A. Majumdar, M. Bajcsy, A. Faraon, P. Petroff, and J. Vučković, "Ultrafast photon-photon interaction in a strongly coupled quantum dot-cavity system," *Phys. Rev. Lett.* **108**, 093604 (2012).
- [Erkmen2006] B. I. Erkmen and J. H. Shapiro, "Phase-conjugate optical coherence tomography," *Phys. Rev. A* **74**, 041601(R) (2006).
- [Erkmen2009] B. I. Erkmen and J. H. Shapiro, "Signal-to-noise ratio of Gaussian-state ghost imaging," *Phys. Rev. A* **79**, 023833 (2009).
- [Erkmen2010] B. I. Erkmen and J. H. Shapiro, "Ghost imaging: from quantum to classical to computational," *Adv. Opt. Photon.* **2**, 405 (2010).
- [Erkmen2012a] B. I. Erkmen, "Computational Ghost Imaging for Remote Sensing," *J. Opt. Soc. Am. A* **29**, 782 (2012).
- [Erkmen2012b] B. I. Erkmen, B. E. Moision, S. J. Dolinar, K. M. Birnbaum, and D. Divsalar, "On approaching the ultimate limits of communication using a photon-counting detector," in *Proceedings of the SPIE* **8246**, 824605 (2012).
- [Er-Long2005] M. Er-long, H. Zheng-fu, G. Shun-sheng, Z. Tao, D. Da-sheng, and G. Guang-can, "Background noise of satellite-to-ground quantum key distribution," *New J. Phys.* **7**, 215 (2005).
- [Erven2008] C. Erven, C. Couteau, R. Laflamme, and G. Weihs, "Entangled quantum key distribution over two free-space optical links," *Opt. Express* **16**, 16840 (2008); e-print arXiv:0807.2289v2 [quant-ph].

-F-

- [Fan2007] J. Fan, M. D Eisaman, and A. Migdall, "Quantum state tomography of a fiber-based source of polarization-entangled photon pairs," *Opt. Express* **15**, 18339 (2007).
- [Ferri2005] F. Ferri, D. Magatti, A. Gatti, M. Bache, E. Brambilla, and L. A. Lugiato, "High-resolution ghost image and ghost diffraction experiments with thermal light," *Phys. Rev. Lett.* **94**, 183602 (2005).
- [Fiorentino2002] M. Fiorentino, P. L. Voss, J. E. Sharping, and P. Kumar, "All-fiber photon-pair source for quantum communications," *IEEE Photon. Technol. Lett.* **14**, 983 (2002).
- [Fuentes-Schuller2005] I. Fuentes-Schuller and R. B. Mann, "Alice falls into a black hole: entanglement in noninertial frames," *Phys. Rev. Lett.* **95**, 120404 (2005).
- [Fujiwara2012] M. Fujiwara, Y. Matsuoka, and N. Ienaka, "Polarization and variation of near-infrared light from Fermi/Lat Gamma-ray sources," *Astronomical J.* **144**, 112 (2012).

- [Ghirardi1986] G. C. Ghirardi, A. Rimini, and T. Weber, "Unified dynamics for microscopic and macroscopic systems," *Phys. Rev. D* **34**, 470 (1986).
- [Ghirardi1990] G. C. Ghirardi, P. Pearle, and A. Rimini, "Markov processes in Hilbert space and continuous spontaneous localization of systems of identical particles," *Phys. Rev. A* **42**, 78 (1990).
- [Giovannetti2001] V. Giovannetti, L. Maccone, and S. Lloyd, "Quantum-enhanced positioning and clock synchronization," *Nature* **412**, 417 (2001).
- [Giovannetti2002] V. Giovannetti, L. Maccone, J. H. Shapiro, and F. N. C. Wong, "Generating entangled two-photon states with coincident frequencies," *Phys. Rev. Lett.* **88**, 183602 (2002).
- [Giovannetti2004a] V. Giovannetti, S. Lloyd, and L. Maccone, "Quantum-enhanced measurements: beating the standard quantum limit," *Science* **306**, 1330–1336 (2004).
- [Giovannetti2004b] V. Giovannetti, S. Guha, S. Lloyd, L. Maccone, J. H. Shapiro, and H. P. Yuen, "Classical capacity of the lossy bosonic channel: the exact solution," *Phys. Rev. Lett.* **92**, 027902 (2004).
- [Giovannetti2011] V. Giovannetti, S. Lloyd, and L. Maccone, "Advances in quantum metrology," *Nature Photon.* **5**, 222 (2011).
- [Giovannetti2012a] V. Giovannetti, S. Lloyd, and L. Maccone, "Quantum measurement bounds beyond the uncertainty relations," *Phys. Rev. Lett.* **108**, 260405 (2012).
- [Giovannetti2012b] V. Giovannetti, S. Lloyd, L. Maccone, and J. H. Shapiro, "Electromagnetic channel capacity for practical purposes," e-print arXiv:1210.3300 [quant-ph] (2012).
- [Goldstein2011] G. Goldstein, P. Cappellaro, J. R. Maze, J. S. Hodges, L. Jiang, A. S. Sørensen, and M. D. Lukin, "Environment-assisted precision measurement," *Phys. Rev. Lett.* **106**, 140502 (2011).
- [Goda2008] K. Goda, O. Miyakawa, E. E. Mikhailov, S. Saraf, R. Adhikari, K. McKenzie, R. Ward, S. Vass, A. J. Weinstein, and N. Mavalvala, "A quantum-enhanced prototype gravitational-wave detector," *Nature Phys.* **4**, 472 (2008).
- [Gondarenko2009] A. Gondarenko, J. S. Levy, and M. Lipson, "High confinement micron-scale silicon nitride high Q ring resonator," *Opt. Express* **17**, 11366 (2009).
- [Goodman2004] J. W. Goodman, *Introduction to Fourier Optics*, McGraw-Hill, New York (2004).
- [Gottesman2012] D. Gottesman, T. Jennewein, and S. Croke, "Longer-baseline telescopes using quantum repeaters," *Phys. Rev. Lett.* **109**, 070503 (2012).

-
- [Guha2009] S. Guha and B. I. Erkmen, "Gaussian-state quantum-illumination receivers for target detection," *Phys. Rev. A* **80**, 052310 (2009).
- [Guha2011a] S. Guha, Z. Dutton, and J. H. Shapiro, "On quantum limit of optical communications: concatenated codes and joint-detection receivers," in *IEEE International Symposium on Information Theory (ISIT)*, 274 (2011).
- [Guha2011b] S. Guha, "Structured optical receivers to attain superadditive capacity and the Holevo limit," *Phys. Rev. Lett.* **106**, 240502 (2011).
- [Guha2012] S. Guha and M. Wilde, "Polar coding to achieve the Holevo capacity of a pure-loss optical channel," in *Proceedings of the 2012 IEEE International Symposium on Information Theory (ISIT)*, 546 (2012); e-print arXiv:1202.0533v2 [cs.IT].
- [Gustavson2000] T. L. Gustavson, A. Landragin, and M. A. Kasevich, "Rotation sensing with a dual atom-interferometer Sagnac gyroscope," *Class. Quant. Grav.* **17**, 2385 (2000).

-H-

- [Hall2009] M. A. Hall, J. B. Altepeter, and P. Kumar, "Drop-in compatible entanglement for optical-fiber networks," *Opt. Express* **17**, 14558 (2009).
- [Hall2011] M. A. Hall, J. B. Altepeter, and P. Kumar, "Ultrafast switching of photonic entanglement," *Phys. Rev. Lett.* **106**, 053901 (2011).
- [Hall2012] M. J. W. Hall, D. W. Berry, M. Zwiernik, and H. M. Wiseman, "Universality of the Heisenberg limit for estimates of random phase shift," *Phys. Rev. A* **85**, 041802 (2012).
- [Harada2008] K.-I. Harada, H. Takesue, H. Fukuda, T. Tsuchizawa, T. Watanabe, K. Yamada, Y. Tokura, and S.-I. Itabashi, "Generation of high-purity entangled photon pairs using silicon wire waveguide," *Opt. Express* **16**, 20368 (2008).
- [Hardy2011] N. D. Hardy and J. H. Shapiro, "Reflective ghost imaging through turbulence," *Phys. Rev. A* **84**, 063824 (2011).
- [Helstrom1976] C. W. Helstrom, *Quantum Detection and Estimation Theory*, Academic Press, New York (1976).
- [Higgins2012] B. Higgins, J. Bourgoin, N. Gigov, E. Meyer-Scott, Z. Yan, and T. Jennewein, "Detailed performance analysis of the proposed QEYSSAT quantum receiver satellite," in *CLEO: QELS-Fundamental Science OSA Technical Digest*, JW4A.118 (2012).
- [Holevo1998] A. S. Holevo, "The capacity of the quantum channel with general signal states," *IEEE Trans. Inf. Theory* **44**, 269 (1998).

-
- [Holevo2001] A. S. Holevo, *Statistical Structure of Quantum Theory*, Springer-Verlag, Berlin (2001).
- [Hosseini2009] E. S. Hosseini, S. Yegnanarayanan, A. H. Atabaki, M. Soltani, and A. Adibi, "High quality planar silicon nitride microdisk resonators for integrated photonics in the visible wavelength range," *Opt. Express* **17**, 14543 (2009).
- [Hosten2008] O. Hosten and P. Kwiat, "Observation of the spin Hall effect of light via weak measurements," *Science* **319**, 787 (2008).
- [Hong1987] C. K. Hong, Z. Y. Ou, and L. Mandel, "Measurement of subpicosecond time intervals between two photons by interference," *Phys. Rev. Lett.* **59**, 2044 (1987).
- [Howell2010] J. C. Howell, D. J. Starling, P. B. Dixon, P. K. Vudyasetu, and A. N. Jordan, "Interferometric weak value deflections: quantum and classical treatments," *Phys. Rev. A* **81**, 033813 (2010).
- [Huang1991] H. Huang, E. A. Swanson, C. P. Lin, J. S. Schuman, W. G. Stinson, W. Chang, M. R. Hee, T. Flotte, K. Gregory, C. A. Puliafito, and J. G. Fujimoto, "Optical coherence tomography," *Science* **254**, 1178 (1991).
- [Hughes1999a] R. J. Hughes, W. T. Buttler, P. G. Kwiat, G. G. Luther, G. L. Morgan, J. E. Nordholt, C. G. Peterson, and C. M. Simmons, "Secure Communications with Low-Orbit Spacecraft Using Quantum Cryptography," *US Patent* 5,966,224 (1999).
- [Hughes1999b] R. J. Hughes and J. E. Nordholt, "Quantum cryptography takes to the air," *Physics World (May issue)*, 31 (1999).
- [Hughes1999c] R. J. Hughes, W. T. Buttler, P. G. Kwiat, S. K. Lamoreaux, G. G. Luther, G. L. Morgan, J. E. Nordholt, C. G. Peterson, and C. M. Simmons, "Practical free-space quantum key distribution," *Lecture notes in Computer Science* **1509**, 200 (1999).
- [Hughes2000a] R. J. Hughes, W. T. Buttler, P. G. Kwiat, S. K. Lamoreaux, G. L. Morgan, J. E. Nordholt, and C. G. Peterson, "Quantum cryptography for secure satellite communications," in *Proceedings of the 2000 IEEE Aerospace Conference*, 191 (2000).
- [Hughes2000b] R. J. Hughes, W. T. Buttler, P. G. Kwiat, S. K. Lamoreaux, G. L. Morgan, J. E. Nordholt, and C. G. Peterson, "Free-space quantum key distribution in daylight," *J. Mod. Opt.* **47**, 549 (2000).
- [Hughes2002] R. J. Hughes, J. E. Nordholt, D. Derkacs, and C. G. Peterson, "Practical free-space quantum key distribution over 10 km in daylight and at night," *New J. Phys.* **4**, 43 (2002).
- [Hughes2004] R. J. Hughes, W. T. Buttler, S. K. Lamoreaux, G. L. Morgan, J. E. Nordholt, C. G. Peterson, and P. G. Kwiat, "Method and apparatus for free-space quantum key distribution in daylight," *US patent* 6,748,083 (2004).
-

[Hughes2010] R. J. Hughes, "Satellite-based quantum communications," in *Proceedings of the Updating Quantum Cryptography and Communications Conference*, LA-UR-10-06352 (2010).

[Hughes2011] R. J. Hughes and J. E. Nordholt, "Refining quantum cryptography," *Science* **333**, 1584 (2011).

[Hughes2012a] R. J. Hughes, J. E. Nordholt, and C. G. Peterson, "Secure multi-party communication with quantum key distribution managed by trusted authority," *US Patent Application* 12/895,367; *World Intellectual Property Organization (PCT) application* WO 2012/044855 A2, (2012).

[Hughes2012b] R. J. Hughes, J. T. Thrasher, and J. E. Nordholt, "Quantum key management," *US patent application* 13/600,898, (2012).

-I-

[Iniesta2007] J. C. d. T. Iniesta, *Introduction to Spectropolarimetry*, Cambridge Univ. Press, Cambridge (2007).

-J-

[Jeffrey2004] E. Jeffrey, N. A. Peters, and P. G. Kwiat, "Towards a periodic deterministic source of arbitrary single-photon states," *New J. Phys.* **6**, 100 (2004).

-K-

[Kaltenbaek2006] R. Kaltenbaek, B. Blauensteiner, M. Żukowski, M. Aspelmeyer, and A. Zeilinger, "Experimental interference of independent sources," *Phys. Rev. Lett.* **96**, 240502 (2006).

[Kaltenbaek2008] R. Kaltenbaek, J. Lavoie, D. N. Biggerstaff, and K. J. Resch, "Quantum-inspired interferometry with chirped laser pulses," *Nature Phys.* **4**, 864 (2008).

[Kaltenbaek2009] R. Kaltenbaek, J. Lavoie, and K. J. Resch, "Classical analogues of two-photon quantum interference," *Phys. Rev. Lett.* **102**, 243601 (2009).

[Kaltenbaek2012] R. Kaltenbaek, G. Hechenblaikner, N. Kiesel, O. Romero-Isart, K. C. Schwab, U. Johann, and M. Aspelmeyer, "Macroscopic Quantum Resonators (MAQRO)," *Exp. Astron.* **34**, 123 (2012).

-
- [Karolyhazy1966] F. Karolyhazy, "Gravitation and quantum mechanics of macroscopic objects," *Nuovo Cim. A* **42**, 390 (1966).
- [Katz2009] O. Katz, Y. Bromberg, and Y. Silberberg, "Compressive ghost imaging," *Appl. Phys. Lett.* **95**, 113110 (2009).
- [Kedem2012] Y. Kedem, "Using technical noise to increase the signal-to-noise ratio of measurements via imaginary weak values," *Phys. Rev. A* **85**, 060102(R) (2012).
- [Kim1994] C. Kim and P. Kumar, "Quadrature-squeezed light detection using a self-generated matched local oscillator," *Phys. Rev. Lett.* **73**, 1605 (1994).
- [Kira2011] M. Kira, S. W. Koch, R. P. Smith, A. E. Hunter, and S. T. Cundiff, "Quantum spectroscopy with Schrödinger-cat states," *Nature Phys.* **7**, 799 (2011).
- [Kocsis2011] S. Kocsis, B. Braverman, S. Ravets, M. J. Stevens, R. P. Mirin, L. K. Shalm, and, A. M. Steinberg, "Observing the average trajectories of single photons in a two-slit interferometer," *Science* **332**, 1170 (2011).
- [Kok2002] P. Kok, H. Lee, and J. P. Dowling, "The creation of large photon-number path entanglement conditioned on photodetection," *Phys. Rev. A* **65**, 052104 (2002).
- [Kuklewicz2006] C. E. Kuklewicz, F. N. C. Wong, and J. H. Shapiro, "Time-bin-modulated biphotons from cavity-enhanced down-conversion," *Phys. Rev. Lett.* **97**, 223601 (2006).
- [Kumar2007] P. Kumar, V. Grigoryan, and M. Vasilyev, "Noise-free amplification: towards quantum laser radar," presented at the *14th Coherent Laser Radar Conference*, Snowmass, Colorado (2007).
- [Kurtsiefer2002] C. Kurtsiefer, P. Zarda, M. Halder, H. Weinfurter, P. M. Gorman, P. R. Tapster, and J. G. Rarity, "Quantum cryptography: A step towards global key distribution", *Nature* **419**, 450 (2002).
- [Kuzucu2005] O. Kuzucu, M. Fiorentino, M. A. Albota, F. N. C. Wong, and F. X. Kärtner, "Two-photon coincident-frequency entanglement via extended phase matching," *Phys. Rev. Lett.* **94**, 083601 (2005).
- [Kuzucu2008] O. Kuzucu, F. N. C. Wong, S. Kurimura, and S. Tovstonog, "Joint temporal density measurements for two-photon state characterization," *Phys. Rev. Lett.* **101**, 153602 (2008).

-L-

- [Lamas-Linares2012] A. Lamas-Linares, B. Calkins, N. A. Tomlin, T. Gerrits, A. E. Lita, J. Beyer, R. P. Mirin, and S. W. Nam, "Nanosecond-scale timing jitter in transition edge sensors at telecom and visible wavelengths," e-print arXiv:1209.5721v1 [quant-ph] (2012).

-
- [Lavoie2009] J. Lavoie, R. Kaltenbaek, and K. J. Resch, "Quantum-optical coherence tomography with classical light," *Opt. Express* **17**, 3818 (2009).
- [Lee2006] K. F. Lee, J. Chen, C. Liang, X. Li, P. L. Voss, and P. Kumar, "Generation of high-purity telecom-band entangled photon pairs in dispersion-shifted fiber," *Opt. Lett.* **31**, 1905 (2006).
- [LeGouët2009] J. Le Gouët, D. Venkatraman, F. N. C. Wong, and J. H. Shapiro, "Classical low-coherence interferometry based on broadband parametric fluorescence and amplification," *Opt. Express* **17**, 17874 (2009).
- [LeGouët2010] J. Le Gouët, D. Venkatraman, F. N. C. Wong, and J. H. Shapiro, "Experimental realization of phase-conjugate optical coherence tomography," *Opt. Lett.* **35**, 1001 (2010).
- [Levy2010] J. S. Levy, A. Gondarenko, M. A. Foster, A. C. Turner-Foster, A. L. Gaeta, and M. Lipson, "CMOS-compatible multiple-wavelength oscillator for on-chip optical interconnects," *Nature Photon.* **4**, 37 (2010).
- [Li2005] X. Li, P. L. Voss, J. E. Sharping, and P. Kumar, "Optical-fiber source of polarization-entangled photons in the 1550 nm telecom band," *Phys. Rev. Lett.* **94**, 053601 (2005).
- [Ling2012] A. Ling, "Entangled photon systems for small satellites," presented at *First NASA Quantum Future Technologies Conference (QFT)*, Moffett Field, California (2012); e-print <http://quantum.nasa.gov/materials/2012-01-21-A3-Ling.pdf>.
- [Lim2011] O.-K. Lim, Z. Dutton, G. Alon, C.-H. Chen, M. Vasilyev, and P. Kumar, "Enhanced optical resolution in target detection with phase-sensitive versus phase-insensitive pre-amplification," in *Proceedings of the SPIE* **8163**, 816306 (2011).
- [Link2004] R. P. Link, R. J. Alliss, and M. E. Craddock, "Mitigating the impact of clouds on optical communications," in *Proceedings of the SPIE* **5338**, 223 (2004).
- [Lloyd2008] S. Lloyd, "Enhanced sensitivity of photodetection via quantum illumination," *Science* **321**, 1463 (2008).
- [Ludlow2007] A. D. Ludlow, X. Huang, M. Notcutt, T. Zanon-Willette, S. M. Foreman, M. M. Boyd, S. Blatt, and J. Ye, "Compact, thermal-noise-limited optical cavity for diode laser stabilization at 1×10^{-15} ," *Opt. Lett.* **32**, 641 (2007).
- [Lundeen2009] J. S. Lundeen and A. M. Steinberg, "Experimental joint weak measurement on a photon pair as a probe of Hardy's paradox," *Phys. Rev. Lett.* **102**, 020404 (2009).
- [Lundeen2011] J. S. Lundeen, B. Sutherland, A. Patel, C. Stewart, and C. Bamber, "Direct measurement of the quantum wavefunction," *Nature* **474**, 188 (2011).

-M-

- [Maleki2001] L. Maleki and J. Prestage, "SpaceTime mission: clock test of relativity at four solar radii," *Gyros, Clocks, Interferometers: Testing Relativistic Gravity in Space* **562**, 369 (2001).
- [Mandel1995] L. Mandel and E. Wolf, *Optical Coherence and Quantum Optics*, Cambridge Univ. Press, Cambridge (1995).
- [Marcikic2006] I. Marcikic, A. Lamas-Linares, and C. Kurtsiefer, "Free-space quantum distribution with entangled photons," *Appl. Phys. Lett.* **89**, 101122 (2006); e-print arXiv:quant-ph/0606072v2 [quant-ph].
- [Marshall2003] W. Marshall, C. Simon, R. Penrose, and D. Bouwmeester, "Towards quantum superpositions of a mirror," *Phys. Rev. Lett.* **91**, 130401 (2003).
- [Martin2010] A. Martin, A. Issautier, H. Herrmann, W. Sohler, D. B. Ostrowsky, O. Alibart, and S. Tanzilli, "A polarization entangled photon-pair source based on a type-II PPLN waveguide emitting at a telecom wavelength," *New J. Phys.* **12**, 103005 (2010).
- [McCusker2009] K. T. McCusker and P. G. Kwiat, "Efficient optical quantum state engineering," *Phys. Rev. Lett.* **103**, 163602 (2009).
- [McKenzie2009] K. McKenzie, R. E. Spero, and D. A. Shaddock, "Performance of arm locking in LISA," *Phys. Rev. D* **80**, 102003 (2009).
- [Medic2010] M. Medic, J. B. Altepeter, M. A. Hall, M. Patel, and P. Kumar, "Fiber-based, telecom-band source of degenerate entangled photons," *Opt. Lett.* **35**, 802 (2010).
- [Megidish2012] E. Megidish, T. Shacham, A. Halevy, L. Dovrat, and H. S. Eisenberg, "Resource efficient source of multiphoton polarization entanglement," *Phys. Rev. Lett.* **109**, 080504 (2012).
- [Meyer-Scott2011] E. Meyer-Scott, Z. Yan, A. MacDonald, J.-P. Bourgoin, H. Hübel, and T. Jennewein, "How to implement decoy-state quantum key distribution for a satellite uplink with 50-dB channel loss," *Phys. Rev. A* **84**, 062326 (2011).
- [Migdall2002] A. L. Migdall, D. Branning, and S. Castelletto, "Tailoring single-photon and multiphoton probabilities of a single-photon on-demand source," *Phys. Rev. A* **66**, 053805 (2002).
- [Mikami2004] H. Mikami, Y. Li, and T. Kobayashi, "Generation of the four-photon W state and other multiphoton entangled states using parametric down-conversion," *Phys. Rev. A* **70**, 052308 (2004).
- [Mohan2010] A. Mohan, M. Felici, P. Gallo, B. Dwir, A. Rudra, J. Faist, and E. Kapon, "Polarization-entangled photons produced with high-symmetry site-controlled quantum dots," *Nature Photon.* **4**, 302 (2010).

-
- [Monnier2003] J. D. Monnier, "Optical interferometry in astronomy," *Rep. Prog. Phys.* **66**, 789 (2003).
- [Morong2012] W. Morong, A. Ling, and D. Oi, "Quantum optics for space platforms," *Optics and Photonics News* **23** (10), 42 (2012).
- [Mosley2008] P. J. Mosley, J. S. Lundeen, B. J. Smith, P. Wasylczyk, A. B. U'Ren, C. Silberhorn, and I. A. Walmsley, "Heralded generation of ultrafast single photons in pure quantum states," *Phys. Rev. Lett.* **100**, 133601 (2008).
- [Mosley2009] P. J. Mosley, A. Christ, A. Eckstein, and C. Silberhorn, "Direct measurement of spatial-spectral structure of waveguided parametric down-conversion," *Phys. Rev. Lett.* **103**, 233901 (2009).
- [Mower2011] J. Mower and D. Englund, "Efficient generation of single and entangled photons on a silicon photonic integrated chip," *Phys. Rev. A* **84**, 052326 (2011).
- [Mullavey2010] A. J. Mullavey, B. J. J. Slagmolen, D. A. Shaddock, and D. E. McClelland, "Stable transfer of an optical frequency standard via a 4.6 km optical fiber," *Opt. Express* **18**, 5213 (2010).
- [Müller2008] H. Müller, S.-W. Chiow, Q. Long, S. Herrmann, and S. Chu, "Atom interferometry with up to 24-photon-momentum-transfer beam splitters," *Phys. Rev. Lett.* **100**, 180405 (2008).

-N-

- [Nair2011a] R. Nair, "Discriminating quantum-optical beam-splitter channels with number-diagonal signal states: Applications to quantum reading and target detection," *Phys. Rev. A* **84**, 032312 (2011).
- [Nair2011b] R. Nair, B. J. Yen, J. H. Shapiro, J. Chen, Z. Dutton, S. Guha, and M. P. da Silva, "Quantum-enhanced LADAR ranging with squeezed-vacuum injection, phase-sensitive amplification, and slow photodetectors," in *Proceedings of the SPIE* **8163**, 816310 (2011).
- [Nair2012a] R. Nair, "Fundamental limits on the accuracy of optical phase estimation from rate-distortion theory," e-print arXiv:1204.3761v1 [quant-ph] (2012).
- [Nair2012b] R. Nair, S. Guha, and S.-H. Tan, "A realizable exponentially-optimal receiver for discriminating any M coherent states," poster presentation at the *2012 IEEE International Symposium on Information Theory (ISIT)*, (2012); e-print arXiv:1212.2048v1 [quant-ph].
- [Nasr2003] M. B. Nasr, B. E. A. Saleh, A. V. Sergienko, and M. C. Teich, "Demonstration of dispersion-cancelled quantum-optical coherence tomography," *Phys. Rev. Lett.* **91**, 083601 (2003).

-
- [Nauerth2012] S. Nauerth, F. Moll, M. Rau, C. Fuchs, J. Horwath, and H. Weinfurter, "Air to ground quantum key distribution," extended abstract in *Proceedings of the Annual Conf. on Quantum Cryptography (QCRYPT)*, (2012); e-print http://2012.qcrypt.net/docs/extended-abstracts/qcrypt2012_submission_12.pdf.
- [Nordholt2002a] J. E. Nordholt and R. J. Hughes, "A new face for cryptography", *Los Alamos Science* **27**, 68 (2002); e-print <http://lib-www.lanl.gov/cgi-bin/getfile?00783355.pdf>.
- [Nordholt2002b] J. E. Nordholt, R. J. Hughes, G. L. Morgan, C. G. Peterson, and C. C. Wipf, "Present and future free-space quantum key distribution," in *Proceedings of the SPIE* **4635**, 116 (2002).
- [Nordholt2012] J. E. Nordholt, R. T. Newell, C. G. Peterson, and R. J. Hughes, "Polarization tracking system for free-space optical communication, including quantum communication," *US Patent application* 13/600,918 (2012).

-P-

- [Peng2005] C.-Z. Peng, T. Yang, X.-H. Bao, J. Zhang, X.-M. Jin, F.-Y. Feng, B. Yang, J. Yang, J. Yin, Q. Zhang, N. Li, B.-L. Tian, and J.-W. Pan, "Experimental free-space distribution of entangled photon pairs over 13km: towards satellite-based global quantum communication," *Phys. Rev. Lett.* **94**, 150501 (2005).
- [Penrose1996] R. Penrose, "On Gravity's role in Quantum State Reduction", *Gen. Rel. Grav.* **28**, 581 (1996).
- [Penrose2000] R. Penrose, "Wavefunction collapse as a real gravitational effect," in *Mathematical Physics 2000*, eds. A. Fokas A. Grigoryan, T. Kibble, and B. Zegarlinski, Imperial College, London (2000).
- [Peters1999] A. Peters, K. Y. Chung, and S. Chu, "Measurement of gravitational acceleration by dropping atoms," *Nature* **400**, 849 (1999).
- [Phinney2009] E. S. Phinney, "Finding and Using Electromagnetic Counterparts to Gravitational Wave Sources: a white paper for Astro2010 decadal review," *white paper submitted to the Astro2010 Decadal Survey* (2009); arXiv:0903.0098v1 [astro-ph.CO].
- [Piazolla2002] S. Piazolla and S. Slobin, "Statistics of link blockage due to cloud cover for free-space optical communications using NCDC surface weather observations," in *Proceedings of the SPIE* **4635**, 138 (2002).
- [Pittman1995] T. B. Pittman, Y. H. Shih, D. V. Strekalov, and A. V. Sergienko, "Optical imaging by means of two-photon quantum entanglement," *Phys. Rev. A* **52**, R3429 (1995).

[Purdue2002] P. Purdue and Y. Chen, "Practical speed meter designs for quantum nondemolition gravitational-wave interferometers," *Phys. Rev. D* **66**, 122004 (2002).

-R-

[Rarity2001] J. G. Rarity, P. R. Tapster, and P. M. Gorman, "Secure free-space key exchange to 1.9km and beyond," *J. Mod. Opt.* **48**, 1887 (2001).

[Rarity2002] J. G. Rarity, P. R. Tapster, P. M. Gorman, and P. Knight, "Ground to satellite secure key exchange using quantum cryptography," *New J. Phys.* **4**, 82 (2002).

[Rideout2012] D. Rideout, T. Jennewein, G. Amelino-Camelia, T. F. Demarie, B. L. Higgins, A. Kempf, A. Kent, R. Laflamme, X. Ma, R. B. Mann, E. Martín-Martínez, N. C. Menicucci, J. Moffat, C. Simon, R. Sorkin, L. Smolin, and D. R. Terno, "Fundamental quantum optics experiments conceivable with satellites—reaching relativistic distances and velocities," *Class. Quantum Grav.* **29**, 224011 (2012).

[Romero-Isart2011] O. Romero-Isart, "Quantum superposition of massive objects and collapse models," *Phys. Rev. A* **84**, 052121 (2011).

[Rosenband2008] T. Rosenband, D. B. Hume, P. O. Schmidt, C. W. Chou, A. Brusch, L. Lorini, W. H. Oskay, R. E. Drullinger, T. M. Fortier, J. E. Stalnaker, S. A. Diddams, W. C. Swann, N. R. Newbury, W. M. Itano, D. J. Wineland, and J. C. Bergquist, "Frequency Ratio of Al⁺ and Hg⁺ Single-Ion Optical Clocks; Metrology at the 17th Decimal Place," *Science* **319**, 1808 (2008).

[Rozema2012] L. A. Rozema, A. Darabi, D. H. Mahler, A. Hayat, Y. Soudagar, and A. M. Steinberg, "Violation of Heisenberg's measurement-disturbance relationship by weak measurements," *Phys. Rev. Lett.* **109**, 100404 (2012).

-S-

[Sangouard2011] N. Sangouard, C. Simon, H. de Riedmatten, and N. Gisin, "Quantum repeaters based on atomic ensembles and linear optics," *Rev. Mod. Phys.* **83**, 33 (2011).

[Santivanez2011] C. A. Santivanez, S. Guha, Z. Dutton, M. Annamalai, M. Vasilyev, B. J. Yen, R. Nair, and J. H. Shapiro, "Quantum enhanced LIDAR with multi-spatial-mode phase sensitive amplification," in *Proceedings of the SPIE* **8163**, 81630Z (2011).

-
- [Schmidt-Manderbach2007] T. Schmitt-Manderbach, H. Weier, M. Fürst, R. Ursin, F. Tiefenbacher, T. Scheidl, J. Perdigues, Z. Sodnik, C. Kurtsiefer, J. G. Rarity, A. Zeilinger, and H. Weinfurter, "Experimental demonstration of free-space decoy-state quantum key distribution over 144km," *Phys. Rev. Lett.* **98**, 010504 (2007).
- [Shaddock2004] D. A. Shaddock, B. Ware, R. E. Spero, and M. Vallisneri, "Post-processed time delay interferometry for LISA," *Phys. Rev. D* **70**, 081101(R) (2004).
- [Shapiro2005] J. H. Shapiro, S. Guha, and B. I. Erkmen, "Ultimate channel capacity of free-space optical communications [Invited]," *J. Opt. Netw.* **4**, 501 (2005).
- [Shapiro2007] J. H. Shapiro and F. N. C. Wong, "On-demand single-photon generation using a modular array of parametric downconverters with electro-optic polarization controls," *Opt. Lett.* **32**, 2698 (2007).
- [Shapiro2008] J. H. Shapiro, "Computational ghost imaging," *Phys. Rev. A* **78**, 061802(R) (2008).
- [Shapiro2009a] J. H. Shapiro, "The quantum theory of optical communications," *IEEE J. Sel. Top. Quantum Electron.* **15**, 1547 (2009).
- [Shapiro2009b] J. H. Shapiro and S. Lloyd, "Quantum illumination versus coherent-state target detection," *New J. Phys.* **11**, 063045 (2009).
- [Shapiro2009c] J. H. Shapiro, "Defeating Passive Eavesdropping with Quantum Illumination," *Phys. Rev. A* **80**, 022320 (2009).
- [Sharping2006] J. E. Sharping, K. F. Lee, M. A. Foster, A. C. Turner, B. S. Schmidt, M. Lipson, A. L. Gaeta, and P. Kumar, "Generation of correlated photons in nanoscale silicon waveguides," *Opt. Express* **14**, 12388 (2006).
- [Simon2003] C. Simon, R. Penrose, and D. Bouwmeester, "Towards quantum superpositions of a mirror," *Phys. Rev. Lett.* **91**, 130401 (2003).
- [Starling2009] D. J. Starling, P. B. Dixon, A. N. Jordan, and J. C. Howell, "Optimizing the signal-to-noise ratio of a beam-deflection measurements with interferometric weak values," *Phys. Rev. A* **80**, 041803(R) (2009).
- [Starling2010a] D. J. Starling, P. B. Dixon, N. S. Williams, A. N. Jordan, and J. C. Howell, "Continuous phase amplification with a Sagnac interferometer," *Phys. Rev. A* **82**, 011802 (2010).
- [Starling2010b] D. J. Starling, P. B. Dixon, A. N. Jordan, and J. C. Howell, "Precision frequency measurements with interferometric weak values," *Phys. Rev. A* **82**, 063822 (2010).
- [Steinberg1992] A. M. Steinberg, P. G. Kwiat, and R. Y. Chiao, "Dispersion cancellation and high-resolution time measurements in a fourth-order optical interferometer," *Phys. Rev. A* **45**, 6659 (1992).

-
- [Stevenson2006] R. M. Stevenson, R. J. Young, P. Atkinson, K. Cooper, D. A. Ritchie, and A. J. Shields, "A semiconductor source of triggered entangled photon pairs," *Nature* **439**, 179 (2006).
- [Swallows2012] M. D. Swallows, M. J. Martin, M. Bishof, C. Benko, Y. Lin, S. Blatt, A. M. Rey, and J. Ye, "Operating a ^{87}Sr optical lattice clock with high precision and at high density," *IEEE Trans. Ultrason., Ferroelectr., and Freq. Control* **59**, 416 (2012).

-T-

- [Takenaka2011] H. Takenaka, M. Toyoshima, Y. Takayama, Y. Koyama, and M. Akioka, "Experimental plan for a small optical transponder onboard a 50 kg-class small satellite," in *IEEE International Conference on Space Optical Systems and Applications (ICSOS)*, 113 (2011).
- [Takeno2007] Y. Takeno, M. Yukawa, H. Yonezawa, and A. Furusawa, "Observation of -9 dB quadrature squeezing with improvement of phase stability in homodyne measurement," *Opt. Express* **15**, 4321 (2007).
- [Takesue2007] H. Takesue, Y. Tokura, H. Fukuda, T. Tsuchizawa, T. Watanabe, K. Yamada, and S. Itabashi, "Entanglement generation using silicon wire waveguide," *Appl. Phys. Lett.* **91**, 201108 (2007).
- [Takesue2008] H. Takesue, H. Fukuda, T. Tsuchizawa, T. Watanabe, K. Yamada, Y. Tokura, and S. Itabashi, "Generation of polarization entangled photon pairs using silicon wire waveguide," *Opt. Express* **16**, 5721 (2008).
- [Tan2008] S.-H. Tan, B. I. Erkmen, V. Giovannetti, S. Guha, S. Lloyd, L. Maccone, S. Pirandola, and J. H. Shapiro, "Quantum illumination with Gaussian states," *Phys. Rev. Lett.* **101**, 253601 (2008).
- [Teich2012] M. C. Teich, B. E. A. Saleh, F. N. C. Wong, and J. H. Shapiro, "Variations on the theme of quantum optical coherence tomography: a review," *Quantum Inf. Process.* **11**, 903 (2012).
- [Tino2007] G. M. Tino, L. Cacciapuoti, K. Bongs, Ch. J. Bordé, P. Bouyer, H. Dittus, W. Ertmer, A. Görlitz, M. Inguscio, A. Landragin, P. Lemonde, C. Lammerzahl, A. Peters, E. Rasel, J. Reichel, C. Salomon, S. Schiller, W. Schleich, K. Sengstock, U. Sterr, and M. Wilkens, "Atom interferometers and optical atomic clocks: new quantum sensors for fundamental physics experiments in space," *Nuclear Physics B (Proc. Suppl.)* **166**, 159 (2007).
- [Tittel2000] W. Tittel, J. Brendel, H. Zbinden, and N. Gisin, "Quantum cryptography using entangled photons in energy-time Bell states," *Phys. Rev. Lett.* **84**, 4737 (2000).

-
- [Townes2000] C. H. Townes, "Noise and sensitivity in interferometry," in *Principles of Long Baseline Stellar Interferometry*, ed. P. R. Lawson, Ch. 4 (2000); e-print <http://olbin.jpl.nasa.gov/iss1999/coursenotes.html>.
- [Toyoshima2008] M. Toyoshima, Y. Takayama, W. Klaus, H. Kunimori, M. Fujiwara, and M. Sasaki, "Free-space quantum cryptography with quantum and telecom communication channels," *Acta Astronautica* **63**, 179 (2008).
- [Tsang2008] M. Tsang, J. H. Shapiro, and S. Lloyd, "Quantum theory of optical temporal phase and instantaneous frequency," *Phys. Rev. A* **78**, 053820 (2008).
- [Tsang2009a] M. Tsang, J. H. Shapiro, and S. Lloyd, "Quantum theory of optical temporal phase and instantaneous frequency. II. Continuous-time limit and state-variable approach to phase-locked loop design," *Phys. Rev. A* **79**, 053843 (2009).
- [Tsang2009b] M. Tsang, "Time-symmetric quantum theory of smoothing," *Phys. Rev. Lett.* **102**, 250403 (2009).
- [Tsang2009c] M. Tsang, "Optimal waveform estimation for classical and quantum systems via time-symmetric smoothing," *Phys. Rev. A* **80**, 033840 (2009).
- [Tsang2010] M. Tsang, "Optimal waveform estimation for classical and quantum systems via time-symmetric smoothing. II. Applications to atomic magnetometry and Hardy's paradox," *Phys. Rev. A* **81**, 013824 (2010).
- [Tsang2011a] M. Tsang, H. M. Wiseman, and C. M. Caves, "Fundamental quantum limit to waveform estimation," *Phys. Rev. Lett.* **106**, 090401 (2011).
- [Tsang2011b] M. Tsang, "Quantum nonlocality in weak-thermal-light interferometry," *Phys. Rev. Lett.* **107**, 270402 (2011).
- [Tsang2012] M. Tsang, "Ziv-Zakai error bounds for quantum parameter estimation," *Phys. Rev. Lett.* **108**, 230401 (2012).
- [Turner2011] M. D. Turner, C. A. Hagedorn, S. Schlamming, and J. H. Gundlach, "Picoradian deflection measurement with an interferometric quasi-autocollimator using weak value amplification," *Opt. Lett.* **36**, 1479 (2011).
- [Turyshev2007] S. G. Turyshev, U. E. Israelsson, M. Shao, N. Yu, A. Kusenko, E. L. Wright, C. W. F. Everitt, M. A. Kasevich, J. A. Lipa, J. C. Mester, R. D. Reasenberg, R. L. Walsworth, N. Ashby, H. Gould, and H.-J. Paik, "Space-based research in fundamental physics and quantum technologies," *Inter. J. Mod Phys. D* **16**, 1879 (2007); e-print arXiv:0711.0150 [gr-qc].

[Turyshev2009] S. G. Turyshev, T. W. Murphy Jr., E. G. Adelberger, J. Battat, D. Currie, W. M. Folkner, J. Gundlach, S. M. Merkowitz, K. L. Nordtvedt, R. D. Reasenberg, I. I. Shapiro, M. Shao, C. W. Stubbs, M. Tinto, J. G. Williams, and N. Yu, "Opportunities for probing fundamental gravity with Solar system experiments," *white paper submitted to the Cosmology and Fundamental Physics Science Frontier Panel of the Astro2010 Decadal Survey*, (2009); e-print arXiv:0902.3004 [gr-qc].

-U-

[Ursin2007] R. Ursin, F. Tiefenbacher, T. Schmitt-Manderbach, H. Weier, T. Scheidl, M. Lindenthal, B. Blauensteiner, T. Jennewein, J. Perdigues, P. Trojek, B. Ömer, M. Fürst, M. Meyenburg, J. Rarity, Z. Sodnik, C. Barbieri, H. Weinfurter, and A. Zeilinger, "Entanglement-based quantum communication over 144 km," *Nature* **3**, 481 (2007).

[Ursin2008] R. Ursin, T. Jennewein, J. Kofler, J. M. Perdigues, L. Cacciapuoti, C. J. de Matos, M. Aspelmeyer, A. Valencia, T. Scheidl, A. Fedrizzi, A. Acin, C. Barbieri, G. Bianco, C. Brukner, J. Capmany, S. Cova, D. Giggenbach, W. Leeb, R. H. Hadfield, R. Laflamme, N. Lutkenhaus, G. Milburn, M. Peev, T. Ralph, J. Rarity, R. Renner, E. Samain, N. Solomos, W. Tittel, J. P. Torres, M. Toyoshima, A. Ortigosa-Blanch, V. Pruneri, P. Villoresi, I. Walmsley, G. Weihs, H. Weinfurter, M. Zukowski, and A. Zeilinger, "Space-QUEST: experiments with quantum entanglement in space," e-print arXiv:0806.0945v1 [quant-ph] (2008).

[Ursin2009] R. Ursin, T. Jennewein, J. Kofler, J.M. Perdigues, L. Cacciapuoti, C.J. de Matos, M. Aspelmeyer, A. Valencia, T. Scheidl, A. Acin, C. Barbieri, G. Bianco, C. Brukner, J. Capmany, S. Cova, D. Giggenbach, W. Leeb, R.H. Hadfield, R. Laflamme, N. Lütkenhaus, G. Milburn, M. Peev, T. Ralph, J. Rarity, R. Renner, E. Samain, N. Solomos, W. Tittel, J.P. Torres, M. Toyoshima, A. Ortigosa-Blanch, V. Pruneri, P. Villoresi, I. Walmsley, G. Weihs, H. Weinfurter, M. Zukowski, and A. Zeilinger, "Space-quest, experiments with quantum entanglement in space," *Europhysics News* **40**, 26 (2009).

-V-

[Valencia2005] A. Valencia, G. Scarcelli, M. D'Angelo, and Y. Shih, "Two-photon imaging with thermal light," *Phys. Rev. Lett.* **94**, 063601 (2005).

[VanTrees2007] H. L. Van Trees and K. L. Bell eds., *Bayesian Bounds for Parameter Estimation and Nonlinear Filtering/Tracking*, Wiley-IEEE, Piscataway (2007).

[Venkatraman2011] D. Venkatraman, N. D. Hardy, F. N. C. Wong, and J. H. Shapiro, "Classical far-field phase-sensitive ghost imaging," *Opt. Lett.* **36**, 3684 (2011).

[Voss2004] P. L. Voss and P. Kumar, "Raman-noise induced noise-figure limit for $\chi^{(3)}$ parametric amplifiers," *Opt. Lett.* **29**, 445 (2004).

[Voss2006] P. L. Voss, K. G. Köprülü, and P. Kumar, "Raman-noise induced quantum limits for $\chi^{(3)}$ nondegenerate phase-sensitive amplification and quadrature squeezing," *J. Opt. Soc. Am. B* **23**, 598 (2006).

-W-

[Wasilousky2011] P. A. Wasilousky, K. H. Smith, R. Glasser, G. L. Burdge, L. Burberry, B. Deibner, M. Silver, R. C. Peach, C. Visone, P. Kumar, O.-K. Lim, G. Alon, C.-H. Chen, A. R. Bhagwat, P. Manurkar, M. Vasilyev, M. Annamalia, N. Stelmakh, Z. Dutton, S. Guha, C. Santivañez, J. Chen, M. Silva, W. Kelly, J. H. Shapiro, R. Nair, B. J. Yen, and F. N. C. Wong, "Quantum enhancement of a coherent LADAR receiver using phase-sensitive amplification," in *Proceedings of the SPIE* **8163**, 816305 (2011).

[Weier2006] H. Weier, T. Schmitt-Manderbach, N. Regner, C. Kurtsiefer, and H. Weinfurter, "Free-space quantum key distribution: towards a real life application," *Fortschr. Phys.* **54**, 840 (2006).

[Wheatley2010] T. A. Wheatley, D. W. Berry, H. Yonezawa, D. Nakane, H. Arao, D. T. Pope, T. C. Ralph, H. M. Wiseman, A. Furusawa, and E. H. Huntington, "Adaptive optical phase estimation using time-symmetric quantum smoothing," *Phys. Rev. Lett.* **104**, 093601 (2010).

[Wilde2012a] M. Wilde and S. Guha, "Polar codes for classical-quantum channels," to appear in *IEEE Transactions on Information Theory*; e-print arXiv:1109.2591v3 [quant-ph] (2012).

[Wilde2012b] M. Wilde, S. Guha, S. H. Tan, S. Lloyd, "Explicit capacity-achieving receivers for optical communication and quantum reading," in *2012 IEEE International Symposium on Information Theory (ISIT)*, 551 (2012); e-print arXiv:1202.0518v2 [quant-ph].

[Wilson2003] K. E. Wilson, N. Page, J. Wu, and M. Srinivasan, "The JPL Optical Communications Telescope Laboratory test bed for the future optical Deep Space Network," *Interplanetary Network Progress Report* **42-153**, 1 (2003); e-print http://ipnpr/progress_report/42-153/title.htm.

[Wiseman2010] H. M. Wiseman and G. J. Milburn, *Quantum Measurement and Control*, Cambridge Univ. Press, Cambridge (2010).

[Wolfgramm2008] F. Wolfgramm, X. Xing, A. Cerè, A. Predojević, A. M. Steinberg, and M. W. Mitchell, "Bright filter-free source of indistinguishable photon pairs," *Opt. Express* **16**, 18145 (2008).

[Wong2006] F. N. C. Wong, J. H. Shapiro, and T. Kim, "Efficient generation of polarization-entangled photons in a nonlinear crystal," *Laser Phys.* **16**, 1517 (2006).

[www2003] European Space Agency Space Science, "Hyper overview," http://www.esa.int/esaSC/SEM056WO4HD_index_0_m.html, (2003).

[www2012a] European Space Agency Space Science, "LISA Mission Summary," <http://sci.esa.int/lisa>, (2012).

[www2012b] DECIGO Space Gravitational Wave Antenna webpage, "What is DECIGO?," http://tamago.mtk.nao.ac.jp/decigo/wdecigo_e.html, (2012).

-X-

[Xin2011] H. Xin, "Chinese Academy takes space under its wing," *Science* **332**, 904 (2011).

-Y-

[Yonezawa2012] H. Yonezawa, D. Nakane, T. A. Wheatley, K. Iwasawa, S. Takeda, H. Arao, K. Ohki, K. Tsumura, D. W. Berry, T. C. Ralph, H. M. Wiseman, E. H. Huntington, and A. Furusawa, "Quantum-Enhanced Optical-Phase Tracking," *Science* **337**, 1514 (2012).

[Yu2002] N. Yu, J. M. Kohel, L. Romans, and L. Maleki, "Quantum gravity gradiometer sensor for Earth science applications," *Earth Science Technology Conference*, Pasadena, California (2002).

[Yu2006] Yu, N., J.M. Kohel, J.R. Kellogg, and L. Maleki, "Development of an atom-interferometer gravity gradiometer for gravity measurement from space," *Appl. Phys. B.* **84**, 647 (2006).

[Yuen1987] H. P. Yuen, "Design of transparent optical networks by using novel quantum amplifiers and sources," *Opt. Lett.* **12**, 789 (1987).

-Z-

[Zbinden2001a] H. Zbinden, J. Brendel, W. Tittel, and N. Gisin, "Causality, relativity and quantum correlation experiments with moving reference frames," *Pramana J. of Physics* **56**, 349 (2001).

-
- [Zbinden2001b] H. Zbinden, J. Brendel, N. Gisin, and W. Tittel, "Experimental test of nonlocal quantum correlation in relativistic configurations," *Phys. Rev. A* **63**, 022111 (2001).
- [Zhong2009] T. Zhong, F. N. C. Wong, T. D. Roberts, and P. Battle, "High performance photon-pair source based on a fiber-coupled periodically poled KTiOPO₄ waveguide," *Opt. Express* **17**, 12019 (2009).
- [Zhong2010] T. Zhong, X. Hu, F. N. C. Wong, K. K. Berggren, T. D. Roberts, and P. Battle, "High-quality fiber-optic polarization entanglement distribution at 1.3 μm telecom wavelength," *Opt. Lett.* **35**, 1392 (2010).
- [Zhong2012] T. Zhong, F. N. C. Wong, A. Restelli, and J. C. Bienfang, "Efficient single-spatial-mode periodically-poled KTiOPO₄ waveguide source for high-dimensional entanglement-based quantum key distribution," *Opt. Express* **20**, 26868 (2012).
- [Zysk2007] A. M. Zysk, F. T. Nguyen, A. L. Oldenburg, D. L. Marks, and S. A. Boppart, "Optical coherence tomography: A review of clinical development from bench to bedside," *J. Biomed. Opt.* **12**, 051403 (2007).

VIII. Workshop agenda

Figure VIII-1 through Figure VIII-5 provide a day-by-day agenda of the workshop held at the KISS facility in Pasadena, CA from June 25, 2012 to June 29, 2012.

 Quantum Communication, Sensing and Measurement in Space Workshop June 25-29, 2012 Overview Schedule		
Monday, June 25, 2012 - Hameetman Auditorium - Cahill Building		
Time	Short Course	Speaker
7:30 - 8:00	Coffee and refreshments	
8:00 - 8:05	Introduction	Team Leads
8:05 - 9:20	<i>Tests of Relativistic Gravity in Space: History, Recent Progress and Future Directions</i> (includes 15 minutes for Q+A)	Slava Turyshev
9:20-9:30	Mini-break for stretching between lectures	
9:30 - 10:45	<i>Fundamentals of optical interferometry for gravitational wave detection</i> (includes 15 minute for Q+A)	Nergis Mavalvala
10:45 - 11:15	Break	
11:15 - 12:30	<i>Quantum Measurements</i> (includes 15 minutes for Q+A)	Vittorio Giovannetti
12:30 - 1:30	On site, informal lunch provided by KISS for all short course attendees	
1:30 - 2:45	<i>Fundamentals of free-space optical communication</i> (includes 15 minutes for Q+A)	Sam Dolinar
2:45	SHORT COURSE CONCLUDES	
Monday, June 25, 2012 - Third Floor - Keith Spalding Building		
Time	Workshop	Speaker
2:45 - 3:30	Invitation-only workshop participants walk to Keck Institute and check in at Keith Spalding Bldg. 3rd Floor Rm 367 and enjoy refreshments	
3:30 - 4:00	Introduction to the Institute and to KISS	Michele Judd
4:00 - 5:00	Participant Introductions and Goal Setting	All
5:00 - 5:45	<i>Provocative Questions</i> for group to start thinking about	Team Leads
5:45 - 6:00	Walk to Athenaeum	
6:00 - 9:00	KISS Dinner on the Athenaeum Lawn	

Figure VIII-1 First-day agenda of workshop. The short course (open to the community) is followed by a welcoming session (open to the core participants) in which the objectives of the workshop are discussed.



Quantum Communication, Sensing and Measurement in Space Workshop
June 25-29, 2012
Overview Schedule

Tuesday, June 26, 2012 - Keith Spalding Building - Third Floor		
Theme: Measurement in Space		
Time	Workshop	Speaker
8:30 - 9:00	Coffee and refreshments	
9:00 - 9:30	<i>Interferometry in Space</i> Lead in Talk (includes 10 minutes for Q+A)	Robert Spero
9:30 - 10:30	GROUP DISCUSSION: possible topics include a) scientific phenomena and signatures of interest; b) approaching quantum-limited sensitivity; c) squeezed-light in space	Moderated by: Rani Adhikari
10:30 - 11:00	Break	
11:00 - 12:00	Group discussion (breakout sessions can be formed if needed)	Moderated by: Rana Adhikari
12:00 - 12:30	Review session highlights and conclusions	All
12:30 - 2:00	KISS Lunch at the Athenaeum	
2:00 - 2:30	<i>Fundamental Science in Space</i> Lead in Talk (includes 10 minutes for Q+A)	Nan Yu
2:30 - 3:30	GROUP DISCUSSION: possible topics include a) observing quantum mechanical principles in space; b) fundamental physics tests in space; c) quantum precision measurements in the space environment (metrology, spectroscopy etc.)	Moderated by: Keith Schwab
3:30 - 4:00	Break	
4:00 - 5:00	Group discussion (breakout sessions can be formed if needed)	Moderated by: Keith Schwab
5:00 - 5:30	Review session highlights and conclusions	All
6:00 - 8:00	No-Host Dinner in Pasadena (KISS to pay for all postdocs and graduate students)	

Figure VIII-2 Second-day agenda of workshop, devoted to science opportunities in space. Morning and afternoon discussion sessions are on interferometry and fundamental science, respectively.



Wednesday, June 27, 2012 - Keith Spalding Building - Third Floor		
Theme: Communication in Space		
Time	Workshop	Speaker
8:30 - 9:00	Coffee and refreshments	
9:00 - 9:30	<i>Classical Communication To and From Space</i> Lead in Talk (includes 10 minutes for Q+A)	Don Boroson
9:30 - 10:15	GROUP DISCUSSION: possible topics include a) classical and quantum communication applications in space; b) approaching quantum-limits for classical information communication; c) high-energy photons in communication (e.g., X-ray)	Moderated by: Jeffrey Shapiro
10:15 - 10:45	Break	
10:45 - 11:30	Group discussion (breakout sessions can be formed if needed)	Moderated by: Jeffrey Shapiro
11:30 - Noon	Review session highlights and conclusions	All
Noon - 1:30	KISS Lunch at the Athenaeum	
1:30 - 2:00	<i>Entanglement Distribution Through Space</i> Lead in Talk (includes 10 minutes for Q+A)	Richard Hughes
2:00 - 2:45	GROUP DISCUSSION: possible topics include a) applications for entanglement distribution in space; b) entanglement-assisted communication; c) quantum communication in space (e.g., teleportation, superdense-coding)	Moderated by: Jane Nordholt
2:45 - 3:15	Break	
3:15 - 4:00	Group discussion (breakout sessions can be formed if needed)	Moderated by: Jane Nordholt
4:00 - 4:20	Review session highlights and conclusions	All
4:20 - 4:30	Workshop participants walk from Keck Institute to open technical lecture in Lees-Kubota Auditorium, Guggenheim Building	
4:30 - 5:00	Refreshments prior to lecture	
5:00 - 6:00	KISS Lecture (open to the public, targeted at Caltech, JPL and local university interested parties)	Markus Aspelmeyer
6:00 - 8:00	KISS Dinner at the Athenaeum	

Figure VIII-3 Third-day agenda of workshop, devoted to communication in space. Morning and afternoon discussion sessions are on classical and quantum communication, respectively. The Open Technical Lecture is delivered in the afternoon.



Quantum Communication, Sensing and Measurement in Space Workshop
June 25-29, 2012
Overview Schedule

Thursday, June 28, 2012 - Keith Spalding Building - Third Floor Theme: Quantum-Limited Imaging and Sensing in Space		
Time	Workshop	Speaker
8:30 - 9:00	Coffee and refreshments	
9:00 - 9:30	<i>Quantum-limited imaging and sensing in space</i> Lead in Talk (includes 10 minutes for Q+A)	Mankei Tsang
9:30 - 10:15	GROUP DISCUSSION: possible topics include a) scientific objects and phenomena of interest; b) possibilities for resolution & sensitivity improvements with quantum imaging; c) quantum-limited ranging (e.g., phase and frequency estimation)	Moderated by: Franco Wong
10:15 - 10:45	Break	
10:45 - 11:30	Group discussion (breakout sessions can be formed if needed)	Moderated by: Franco Wong
11:30 - Noon	Review session highlights and conclusions	All
12:00 - 2:00	KISS sponsored pizza lunch and student/postdoc presentations (10 minutes + 5 minutes Q+A). Will be held in the Institute.	All
2:00 - 4:00	OPEN/HOT TOPICS: revisiting/continuing discussions, lightning talks, refinement of ideas (breakout sessions can be formed if needed)	All
4:00 - 4:30	Break	
4:30 - 5:45	Informal study time to gather in small like-minded groups, or individual think time / preparation time for tomorrow's planning session	All
6:00 - 8:00	Dinner at The Athenaeum (spouses/guest invited)	

Figure VIII-4 Fourth-day agenda of workshop, devoted to imaging in space. Morning discussion session is on quantum-limited imaging. The afternoon includes a session for the junior researchers in our group to present their work, followed by an open slot for discussions on ‘hot topics’ emerging from the workshop.

			Quantum Communication, Sensing and Measurement in Space Workshop June 25-29, 2012 Overview Schedule		
Friday, June 29, 2012 - Keith Spalding Building - Third Floor					
Time	Workshop			Speaker	
8:30 - 9:00	Coffee and refreshments				
9:00 - 10:30	Identify promising avenues that have come out of the workshop			Team Leads to moderate	
10:30 - 11:00	Break				
11:00 - 11:45	Final action plan for path forward and final report			Team Leads to moderate	
11:45 - Noon	Logistics of checking out, and workshop slideshow			Michele Judd	
12:00	Workshop concludes				

Figure VIII-5 Fifth and last day of the workshop is devoted to summarizing the discussions that took place during the workshop, and charting a road-map for the study period.

IX. Acknowledgement

The contributions of JPL authors to this report have been carried out at the Jet Propulsion Laboratory, California Institute of Technology, under a contract with the National Aeronautics and Space Administration.