

Syracuse University

SURFACE

Electrical Engineering and Computer Science

College of Engineering and Computer Science

10-2009

A Broadcast Approach for Fading Wiretap Channels

Yingbin Liang

Syracuse University, yliang06@syr.edu

Lifeng Lai

University of Arkansas - Little Rock

H. Vincent Poor

Princeton University

Shlomo Shamai (Shitz)

Technion-Israel Institute of Technology

Follow this and additional works at: <https://surface.syr.edu/eecs>



Part of the [Electrical and Computer Engineering Commons](#)

Recommended Citation

Y. Liang, L. Lai, H. V. Poor, and S. Shamai, "Broadcasting over fading wiretap channels," in 2012 IEEE International Symposium on Information Theory, ISIT 2012, 2012, pp. 234-238.

This Article is brought to you for free and open access by the College of Engineering and Computer Science at SURFACE. It has been accepted for inclusion in Electrical Engineering and Computer Science by an authorized administrator of SURFACE. For more information, please contact surface@syr.edu.

A Broadcast Approach for Fading Wiretap Channels ^{1 2}

Yingbin Liang, Lifeng Lai, H. Vincent Poor and Shlomo Shamai (Shitz) ³

Abstract

A (layered) broadcast approach is studied for the fading wiretap channel without the channel state information (CSI) at the transmitter. Two broadcast schemes, based on superposition coding and embedded coding respectively, are developed to encode information into a number of layers and use stochastic encoding to keep the corresponding information secret from an eavesdropper. The layers that can be successfully and securely transmitted are determined by the channel states to the legitimate receiver and the eavesdropper. The advantage of these broadcast approaches is that the transmitter does not need to know the CSI to the legitimate receiver and the eavesdropper, but the scheme still adapts to the channel states of the legitimate receiver and the eavesdropper. Three scenarios of block fading wiretap channels with a stringent delay constraint are studied, in which either the legitimate receiver's channel, the eavesdropper's channel, or both channels are fading. For each scenario, the secrecy rate that can be achieved via the broadcast approach developed in this paper is derived, and the optimal power allocation over the layers (or the conditions on the optimal power allocation) is also characterized. A notion of probabilistic secrecy is also introduced and studied for scenarios when the eavesdropper's channel is fading, which characterizes the probability that a certain secrecy rate of decoded messages is achieved during one block. Numerical examples are provided to demonstrate the impact of the channel state information at the transmitter and the channel fluctuation of the eavesdropper on the average secrecy rate. These examples also demonstrate the advantage of the proposed broadcast approach over the compound channel approach.

¹The material in this paper was presented in part at the IEEE Information Theory Workshop (ITW), Taormina, Sicily, Italy, October 2009 [1].

²The work of Y. Liang was supported by a National Science Foundation CAREER Award under Grant CCF-10-26565 and by the National Science Foundation under Grants CCF-10-26566 and CNS-11-16932. The work of L. Lai was supported by a National Science Foundation CAREER Award under Grant CCF-10-54338 and the National Science Foundation under Grant CNS-11-16534. The work of H. V. Poor was supported by the National Science Foundation under Grants CNS-09-05398. The work of S. Shamai (Shitz) was supported by the Israel Science Foundation (ISF), and the preliminary version of this study has also been supported by the European Commission in the framework of the FP7 Network of Excellence in Wireless COMMunications NEWCOM++.

³Yingbin Liang is with the Department of Electrical Engineering and Computer Science, Syracuse University, Syracuse, NY 13244 USA (email: yliang06@syr.edu). Lifeng Lai is with the Department of Systems Engineering, University of Arkansas, Little Rock, AR 72204 USA (email: lxlai@ualr.edu). H. Vincent Poor is with the Department of Electrical Engineering, Princeton University, Princeton, NJ 08544 USA (e-mail: poor@princeton.edu). Shlomo Shamai (Shitz) is with the Department of Electrical Engineering, Technion-Israel Institute of Technology, Technion City, Haifa 32000 Israel (email: sshlomo@ee.technion.ac.il).

1 Introduction

Physical layer security is a promising technique for providing security protection against eavesdropping for wireless networks. As a complement to cryptographic techniques, physical layer security does not use secret keys, but exploits physical channel randomness for secure transmissions. Such an approach was first introduced and proven to be successful by Wyner in [2] via the wiretap channel model, and was further extended to a more general broadcast scenario by Csiszár and Körner in [3]. More recently, there has been surge in interest in applying this approach to wireless networks (see the recent monographs [4, 5] for overview of recent work).

As physical layer security exploits physical channel statistics to achieve secure communication, successful implementation of this approach depends crucially on the transmitter's knowledge about the channel state information (CSI), which determines channel statistics to the legitimate receiver and to the eavesdropper. Previous studies on physical layer security have been mostly focused on scenarios in which the CSI is available to the transmitter although with some exceptions, e.g., [6–9] and the references mentioned below. However, in wireless networks, such CSI may not be available to the transmitter possibly due to limited feedback resources. (The receivers, however, may be able to estimate the channel states, especially for block fading channels as in this paper.) More specifically to security concerns, eavesdroppers do not generally have incentive to feed their channel states back to transmitters. Thus, the design of physical layer security under channel uncertainty is essential for effectively implementing this technique. To design and analyze physical layer security under channel uncertainty, a reasonable approach is to model a system as the compound wiretap channel with multiple states and guarantee the transmitted message to be decoded and kept secure under any channel state, in particular under the worst channel state, as studied in, e.g., [10–14]. An approach similar to the above is to model the system as an arbitrary varying channel which has been studied in [15, 16]. However, in order to guarantee the performance for the worst case which may occur only rarely, the channel resources are not used in an efficient manner if the actual channel state is better than the worst case. The focus of this paper is on the design of schemes that achieve as a high secrecy rate as the legitimate receiver's channel supports, and as the eavesdropper's channel permits. Since the channel state is unknown to the transmitter, the problem we address here is to design communication schemes that do not exploit channel state realizations but still adapt to the actual channel state that occurs in order to achieve as good of secrecy performance as possible.

Towards this end, a novel (layered) broadcast approach is especially appealing; this approach has been introduced for wireless systems without secrecy constraints in [17] to improve efficiency of transmission to a mobile receiver, whose channel state is not known at the transmitter. This methodology is based on superposition coding first introduced in [18] for broadcast channels. In this strategy, the transmitter splits the entire message into a number of components with each component being transmitted via one layer of input. These layers of

inputs are then combined into one channel input using superposition encoding. The receiver decodes the layers one after another via successive interference cancelation. The realization of the channel state of the receiver determines up to which layer the receiver can decode. More layers of messages can be decoded if the receiver's channel state is better. Hence, with a fixed coding scheme that does not require the transmitter to know the receiver's channel state, such an approach still offers the receiver to obtain as many layers of messages as its instantaneous channel state supports. We also note that the notion of the broadcast approach addressed in [17] has been conceptually extended and streamlined by introducing the variable-to-fixed channel coding in [19].

In this paper, we generalize the broadcast approach in [17] to the fading wiretap channel, in which both legitimate receiver and eavesdropper's channels are time-varying block fading channels. The channel states are constant over one block and change independently across blocks. In particular, the CSI, i.e., the instantaneous channel realization, is not known at the transmitter, and is known only at the corresponding receiver. A delay constraint is assumed so that messages must be transmitted within one block, i.e., coding across blocks as in [6] is not allowed. Our goal is to design transmission schemes such that the legitimate receiver decodes more information as its channel gets better, and out of information decoded at the legitimate receiver, more information is kept secure from the eavesdropper, as the eavesdropper's channel gets worse. We wish to characterize the rate of information that is decodable at the legitimate receiver and is secure from the eavesdropper. In particular, the performance measure of interest here is the delay-limited secrecy rate averaged over a long time range. This is different from the outage performance studied in [20–22], which focused on the delay-limited rate only over a short time range (say one coherence block).

We first develop two types of broadcast approaches respectively for two simpler fading channel scenarios in which only one of the channel is fading. These two approaches are then combined to study the general scenario in which both channels are fading. In the first scenario, only the legitimate receiver's channel is fading and the eavesdropper's channel is constant. For this scenario, the entire message is split into a number of layers with each layer employing stochastic encoding [2,3] (also see [4, Section 2.3]) to achieve secrecy. These layers are then combined using superposition coding. Depending on its channel state, the legitimate receiver can decode messages up to a certain layer. Since the eavesdropper's channel is constant, all layers of messages are guaranteed to be kept secure from the eavesdropper via the stochastic encoding. We show the secrecy guarantee by computing the equivocation rate of the messages given the output at the eavesdropper. Based on this approach, we derive the average secrecy rate over a large number of blocks for a given power allocation across the layers of messages. We then employ the Euler equation derived in the calculus of variations to characterize the optimal power allocation to achieve optimal average secrecy rate.

In the second scenario, only the eavesdropper's channel is fading and the legitimate receiver's channel is constant. In contrast to the first scenario, in which layers of messages are encoded into codewords in different subcodes, here all layers of messages are encoded

into one codeword in an embedded fashion as in [23]. Each layer of message corresponds to one index that identifies the codeword. In particular, lower layers of messages serve as randomization for protecting higher layer of messages from the eavesdropper. Depending on the eavesdropper's channel state, down to certain layers of messages are kept secure from the eavesdropper. We show the secrecy guarantee by computing the equivocation rate of these layers of messages given the output at the eavesdropper. Since the legitimate receiver's channel is fixed, the entire codeword is decodable by the legitimate receiver, and hence all layers of messages are decodable. Based on this approach, we derive the average secrecy rate over a large number of blocks. We further show that the secrecy rate achieved this broadcast approach is the best secrecy rate that the instantaneous channel allows although the transmitter does not know the eavesdropper's CSI. The only sacrifice due to no CSI at the transmitter is that some lower layer messages may not be kept secure from the eavesdropper. This is in contrast to the first type broadcast approach developed for the case when the legitimate receiver has a fading channel, for which all messages transmitted over the channel are guaranteed to be kept secure from the eavesdropper, but the secrecy rate achieved may not be optimal.

For the third scenario with both channels to the legitimate receiver and the eavesdropper undergo fading, we combine the two types of broadcast approaches developed before. In particular, the entire message is split into layers identified by two-dimensional index pairs (say along horizontal and vertical index directions). For a given state of legitimate receiver (i.e., a fixed horizontal index), all layers of messages are encoded via the vertical indices into one codeword in an embedded fashion via the broadcast approach developed for the second scenario, and codewords with different horizontal indices are then encoded together via the broadcast approach developed for the first scenario. Depending on its channel state, the legitimate receiver can decode messages up to a certain layer indexed by a horizontal index. Also depending on the eavesdropper's channel state, messages down to a certain layer indexed by a vertical index can be kept secure from the eavesdropper. We show the secrecy guarantee by computing the equivocation rate of the messages given the output at the eavesdropper for any eavesdropper's channel state. Thus, the layers of messages that are both decodable by the legitimate receiver and are kept secure from the eavesdropper contribute to the secrecy rate. Based on this scheme, we derive the average secrecy rate over a large number of blocks for a given power allocation across the layers of messages. We also employ the Euler equation developed in the calculus of variations to characterize necessary conditions for an optimal power allocation to achieve the optimal average secrecy rate. We also illustrate the structure of the optimal power allocation via a numerical example.

We note that from the three scenarios mentioned above, it is clear that the broadcast approach does not guarantee that all transmitted messages are kept secure from the eavesdropper for all eavesdropper's states for the scenarios when the eavesdropper experiences a fading channel. The actual eavesdropper's channel state realization determines which layers of messages are secure, and the probability that such a state occurs determines the probability of achieving the corresponding secrecy rate. We hence introduce and study a notion

of probabilistic secrecy, which characterizes the probability that certain layers of decoded messages are kept secure, i.e., the probability that the corresponding secrecy rate is achievable. Furthermore, probabilistic secrecy also suggests that our broadcast approach protects different layers of messages unequally with higher layers of messages being more likely to be secure. Hence, for scenarios in which multiple messages with heterogeneous security demands need to be simultaneous transmitted over the channel, the messages with higher levels of security demands should be encoded into layers with larger indices so that these messages are less likely to be learned by the eavesdropper. We also note that probabilistic secrecy is different from deterministic secrecy required for the classical wiretap channel [2], the fading wiretap channels (see, e.g., [6,24,25]), and the compound wiretap channel (see, e.g., [10–14]), in which all decoded messages by the legitimate receiver are guaranteed to be secure (with probability one).

We finally provide numerical examples to demonstrate the impact of the CSI at the transmitter and the channel fluctuation of the eavesdropper on the average secrecy rate. These numerical results suggest that the legitimate receiver’s CSI affects the secrecy rates much more than the eavesdropper’s CSI. Without the legitimate receiver’s CSI, the transmitter has to spread its power to accommodate a number of possible state realizations, and such power spreading reduces the secrecy rate. However, the eavesdropper’s CSI affects mostly the legitimate receiver’s knowledge about which layers of messages are secure, but does not affect much the amount of information that is kept secure from the eavesdropper. Another important factor that affects the secrecy rate is the channel fluctuation (i.e., fading) of the eavesdropper, which creates opportunities for achieving better secrecy rates.

We finally note that this study is different from the recent study in [26]. This study applies the conceptual idea of the original broadcast approach in [17] of transmitting layers of messages, but the actual coding scheme is different from that in [17] by incorporating stochastic coding either for each layer of messages or in an embedded fashion to guarantee secrecy for messages. Hence, secrecy is achieved solely via the broadcast approach, and no further feedback from the legitimate receiver is allowed to assist secrecy achievement. However, the study in [26,27] uses the original coding scheme in [17] for signal transmission, which does not guarantee secrecy, and secrecy of messages is achieved by allowing feedback from the legitimate user.

The organization of the paper is as follows. In Section 2, we introduce our system model. In Sections 3, 4, and 5, we study three scenarios in more detail. In Section 6, we provide numerical examples. Finally, in Section 7, we conclude the paper with some comments on future directions. We note that although the first two scenarios are special cases of the third scenario, they are presented separately for developing two types of broadcast approaches that are useful for the general scenario. Including these two scenarios also helps to understand the combined approach for the third scenario.

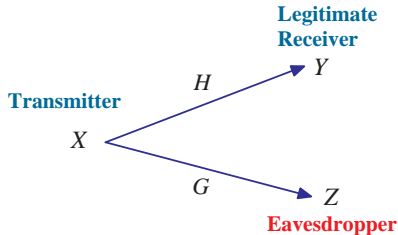

Figure 1: An illustration of the fading wiretap channel.

2 System Model

In this paper, we study the fading wiretap channel (see Fig. 1), in which a transmitter sends a message to a legitimate receiver and wishes to keep this message secret from an eavesdropper. Both the legitimate receiver's and the eavesdropper's channels are corrupted not only by additive complex Gaussian noise, but also by multiplicative fading gain coefficients. The channel input-output relationship for one channel use is given by

$$Y = HX + W \quad \text{and} \quad Z = GX + V \quad (1)$$

where X is the input from the transmitter, Y and Z are outputs at the legitimate receiver and the eavesdropper respectively, H and G are fading channel gain coefficients, and the noise variables W and V are proper complex Gaussian random variables with zero means and unit variances. The noise variables are independent and identically distributed (i.i.d.) over channel uses. The fading gain H and G are assumed to experience block fading, i.e., they are constant within a block and change independently across blocks. The block length are assumed to be sufficiently long such that one codeword can be successfully transmitted if properly constructed. The channel input is subject to an average power constraint P over each block, i.e.,

$$\frac{1}{n} \sum_{i=1}^n \mathbb{E} [|X_i|^2] \leq P \quad (2)$$

where i denotes the symbol time (i.e., channel use) index, and where n is the blocklength.

It is assumed that the transmitter does not know the instantaneous channel state information, and each receiver knows its own channel state. Each message is required to be transmitted within one block, i.e., the message is transmitted under a delay constraint. The legitimate receiver is required to decode the transmitted message with a small probability of error at the end of each block, and the message needs to be kept as secure as possible from the eavesdropper. The measure of security is based on the equivocation rate given by

$$\frac{1}{n} H(W|Z^n) \quad (3)$$

where Z^n is the received outputs at the eavesdropper over one block, and hence depends on the channel state realization of the eavesdropper during this block. The message W is kept

secure from the eavesdropper during one block if there exists a positive ϵ_n that approaches zero as n goes to infinity such that

$$\frac{1}{n}H(W|Z^n) \geq \frac{1}{n}H(W) - \epsilon_n.$$

In this paper, it is not required that all messages transmitted over the channel be perfectly secure. However, our performance measure is the secrecy rate, which is the rate of the messages that are kept secure from the eavesdropper. If all messages transmitted over one block are viewed as a single message, then our performance measure can be interpreted as the level of secrecy achieved for this message. Furthermore, we are interested in characterizing the secrecy rate under the delay constraint, but averaged over a large number of blocks, i.e., the average secrecy rate over blocks.

We also introduce the notion of probabilistic secrecy, which characterizes the probability that a certain secrecy rate of decoded messages can be achieved during a block, i.e., decoded messages at a certain rate can be kept secure from the eavesdropper. Such a probabilistic manner arises because the eavesdropper's channel is random and unknown to the transmitter, and hence encoding at the transmitter may not guarantee all messages decoded by the legitimate receiver to be secure from the eavesdropper at any eavesdropper's state. The state of the eavesdropper determines which messages are kept secure, and the probability that such a state occurs determines the probability of achieving the corresponding secrecy rate.

3 Fading Channel to Legitimate Receiver

In this section, we study the case in which only the legitimate receiver experiences a block fading channel, i.e., H is a constant over one block and changes independently to another realization from one block to another. The channel to the eavesdropper is assumed to be a constant, i.e., G is fixed and is hence known to every node. The transmitter does not know the instantaneous channel state to the legitimate user, but the legitimate receiver is assumed to know the channel state. In the sequel, we first develop a layered broadcast approach for the case with a discrete fading state and then generalize the approach to the case with a continuous fading state.

3.1 Discrete Legitimate Channel States

We first consider the case in which the legitimate receiver has a finite number of channel states, i.e., H may take L values, say H_1, \dots, H_L with $|H_1| \leq |H_2| \leq \dots \leq |H_L|$. For this channel, we propose a (layered) broadcast approach, which generalizes the approach introduced in [17] for the broadcast channel without secrecy constraints. More specifically,

the entire message is split into L parts, i.e., L layers of messages denoted by W_l for $l = 1, \dots, L$.

Definition 1. A secrecy rate tuple (R_1, \dots, R_L) is achievable if there exists a coding scheme that encodes the messages W_1, \dots, W_L at the rate tuple (R_1, \dots, R_L) such that for $l = 1, \dots, L$, the legitimate receiver decodes W_l with a small probability error if its channel realization is H_l , and all messages W_1, \dots, W_L are kept secure from the eavesdropper.

The following theorem characterizes secrecy rate tuples that can be achieved by a broadcast approach.

Theorem 1. For the fading wiretap channel with the legitimate receiver having one of the L fading states H_1, \dots, H_L , where $|G| < |H_1| \leq |H_2| \leq \dots \leq |H_L|$, and with the eavesdropper having a fixed channel state G , the following secrecy rate tuples (R_1, \dots, R_L) are achievable:

$$R_l = \log \left(1 + \frac{|H_l|^2 P_l}{1 + |H_l|^2 \sum_{k=l+1}^L P_k} \right) - \log \left(1 + \frac{|G|^2 P_l}{1 + |G|^2 \sum_{k=l+1}^L P_k} \right), \quad l = 1, \dots, L \quad (4)$$

where P_l denotes the transmission power assigned for transmitting W_l and satisfies the power constraint $\sum_{l=1}^L P_l \leq P$.

Remark 1. For the case when the legitimate receiver also has a fixed fading state (i.e., the channel now is the Gaussian wiretap channel), the total secrecy rate of all messages following from Theorem 1 is optimal. Hence, the broadcast approach that we develop (see the proof of Theorem 1) is optimal for the Gaussian wiretap channel.

We note that in this degraded setting, since messages decoded by a receiver with a worse channel state should also be decoded by the receiver with a better channel state, the legitimate receiver at the channel state H_l can decode W_1, \dots, W_l if (R_1, \dots, R_L) is achievable. Hence, the total rate of the messages that the legitimate receiver at the state H_l can decode is given by

$$\begin{aligned} \sum_{j=1}^l R_j &= \sum_{j=1}^l \left[\log \left(1 + \frac{|H_j|^2 P_j}{1 + |H_j|^2 \sum_{k=j+1}^L P_k} \right) - \log \left(1 + \frac{|G|^2 P_j}{1 + |G|^2 \sum_{k=j+1}^L P_k} \right) \right] \\ &= \sum_{j=1}^l \left[\log \left(1 + \frac{|H_j|^2 P_j}{1 + |H_j|^2 \sum_{k=j+1}^L P_k} \right) \right] - \log \left(1 + \frac{|G|^2 \sum_{k=1}^l P_k}{1 + |G|^2 \sum_{k=l+1}^L P_k} \right). \end{aligned} \quad (5)$$

We also note that the second term in (4) seems to suggest that the eavesdropper may also decode the current layer by removing interference caused by the layers that it has decoded. However, this interpretation is misleading. We will show below that the eavesdropper does not obtain any information about the messages W_1, \dots, W_L , i.e., perfect secrecy is achieved for all layers of messages.

We next provide the proof of the above theorem, which describes the layered broadcast approach in more detail.

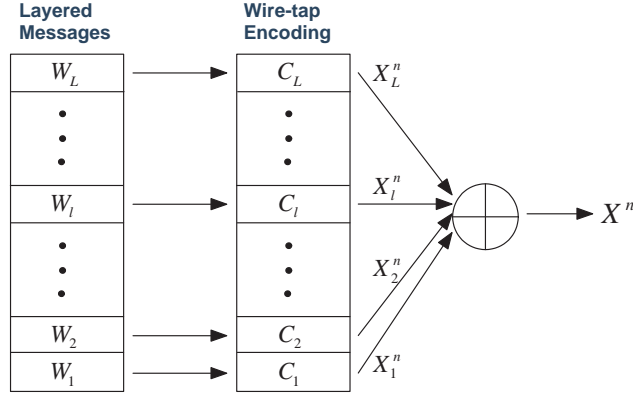

Figure 2: A codebook for the broadcast approach.

Proof of Theorem 1. We consider a codebook that contains L subcodebooks corresponding to L layers (see Fig. 2). For each layer l , the subcodebook \mathcal{C}_l contains $2^{n\tilde{R}_l}$ codewords $x_l^n(w_l)$ indexed by $w_l = 1, \dots, 2^{n\tilde{R}_l}$, where

$$\tilde{R}_l = \log \left(1 + \frac{|H_l|^2 P_l}{1 + |H_l|^2 \sum_{k=l+1}^L P_k} \right), \quad (6)$$

$\frac{1}{n} \sum_{i=1}^n x_{li}^2(w_l) \leq P_l$ for $w_l = 1, \dots, 2^{n\tilde{R}_l}$, and $\sum_{l=1}^L P_l \leq P$. These codewords are divided into 2^{nR_l} bins, where

$$R_l = \log \left(1 + \frac{|H_l|^2 P_l}{1 + |H_l|^2 \sum_{k=l+1}^L P_k} \right) - \log \left(1 + \frac{|G|^2 P_l}{1 + |G|^2 \sum_{k=l+1}^L P_k} \right). \quad (7)$$

The encoding scheme is described as follows. In order to transmit a message tuple (w_1, \dots, w_L) , for each l , the message w_l is mapped into the w_l th bin in the subcodebook \mathcal{C}_l , and one codeword x_l^n in the bin is randomly chosen with a uniform distribution over the entire bin. The final input transmitted over the channel is given by

$$x^n = \sum_{l=1}^L x_l^n.$$

Following steps similar to those in [4, Section 2.3], it can be shown that there exists a codebook as described above such that if this codebook and the encoding scheme as described above are applied to the Gaussian wiretap channel with the channels to the legitimate receiver and the eavesdropper respectively being at the state H_l and G , the legitimate receiver can successfully decode W_1, \dots, W_l with a small probability of error. Furthermore, the eavesdropper can successfully decode X_l^n with a small probability of error if it knows W_1, \dots, W_l for all $l = 1, \dots, L$. In particular, this property implies that there exists a positive δ_n which

approaches zero as n goes to infinity such that

$$H(X_1^n | Z^n, W_1) \leq n\delta_n \quad (8)$$

$$H(X_2^n | Z^n, W_1, W_2) \leq n\delta_n \quad (9)$$

⋮

$$H(X_L^n | Z^n, W_1, \dots, W_L) \leq n\delta_n. \quad (10)$$

We next show that all layers of the messages are kept secure from the eavesdropper. Towards this end, we compute the following equivocation rate:

$$\begin{aligned} & H(W_1, \dots, W_L | Z^n) \\ &= H(W_1, \dots, W_L, Z^n) - H(Z^n) \\ &= H(W_1, \dots, W_L, Z^n, X_1^n, \dots, X_L^n) - H(X_1^n, \dots, X_L^n | W_1, \dots, W_L, Z^n) - H(Z^n) \\ &= H(W_1, \dots, W_L, X_1^n, \dots, X_L^n) + H(Z^n | W_1, \dots, W_L, X_1^n, \dots, X_L^n) \\ &\quad - H(X_1^n, \dots, X_L^n | W_1, \dots, W_L, Z^n) - H(Z^n) \\ &\geq H(X_1^n, \dots, X_L^n) + H(Z^n | X_1^n, \dots, X_L^n) - H(X_1^n, \dots, X_L^n | W_1, \dots, W_L, Z^n) - H(Z^n). \end{aligned} \quad (11)$$

It is clear from the codebook structure and the encoding scheme that X_1^n, \dots, X_L^n are independent and each X_l^n is uniformly distributed over the codewords in the subcodebook \mathcal{C}_l for $l = 1, \dots, L$. We note that throughout the paper, all messages are assumed to be uniformly distributed over its alphabet space. Hence,

$$H(X_1^n, \dots, X_L^n) = n \sum_{j=1}^L \tilde{R}_j. \quad (12)$$

Using (8)-(10), we obtain

$$H(X_1^n, \dots, X_L^n | W_1, \dots, W_L, Z^n) < n\epsilon_n \quad (13)$$

where ϵ_n approaches zero as n goes to infinity. We also compute

$$H(Z^n | X_1^n, \dots, X_L^n) - H(Z^n) \quad (14)$$

$$\begin{aligned} &\geq n \log 2\pi e - \sum_{i=1}^n \log \text{Var}(Z_i) \\ &= n \log 2\pi e - \sum_{i=1}^n \log 2\pi e \left(|G|^2 \sum_{l=1}^L \text{Var}(X_{li}) + 1 \right) \end{aligned} \quad (15)$$

$$\begin{aligned} &\geq n \log 2\pi e - \sum_{i=1}^n \log 2\pi e \left(|G|^2 \sum_{l=1}^L \mathbb{E}[|X_{li}|^2] + 1 \right) \\ &\geq n \log 2\pi e - n \log 2\pi e \left(\frac{|G|^2}{n} \sum_{i=1}^n \sum_{l=1}^L \mathbb{E}[|X_{li}|^2] + 1 \right) \end{aligned} \quad (16)$$

$$\begin{aligned} &\geq n \log 2\pi e - n \log 2\pi e \left(|G|^2 \sum_{l=1}^L P_l + 1 \right) \\ &\geq -n \log \left(1 + |G|^2 \sum_{l=1}^L P_l \right) \end{aligned} \quad (17)$$

where (15) follows because X_1^n, \dots, X_L^n are independent, and (16) follows from Jensen's inequality. Combining (12), (13) and (17), we obtain

$$\begin{aligned} \frac{1}{n} H(W_1, \dots, W_L | Z^n) &\geq \sum_{j=1}^L \tilde{R}_j - \log \left(1 + |G|^2 \sum_{l=1}^L P_l \right) - \epsilon_n \\ &= \sum_{j=1}^L R_j - \epsilon_n \\ &= \frac{1}{n} H(W_1, \dots, W_L) - \epsilon_n \end{aligned} \quad (18)$$

which implies that perfect secrecy is achieved asymptotically as n approaches infinity. \square

3.2 Continuous Legitimate Channel State

In this subsection, we generalize our result for the discrete fading channel to the continuous fading channel. We still assume that only the legitimate receiver's channel is block fading and the eavesdropper's channel is fixed. Hence, the legitimate receiver's channel gain H can take continuous values. For each channel state $H = h$, we let $s = |h|^2$, and use s as an index for the layer of the message that is intended for the legitimate receiver at the state h to decode. For each layer s , we assume that the transmitter allocates power $\rho(s)ds$. We

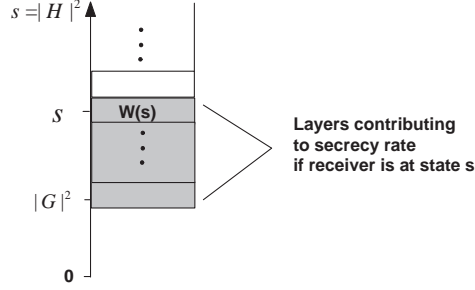

Figure 3: An illustration of layers of messages.

use $\Sigma(s)$ to denote the total power allocated to the layers corresponding to better channel states, i.e., the states \hat{s} such that $\hat{s} > s$. Hence,

$$\Sigma(s) = \int_s^\infty \rho(x) dx, \quad (19)$$

and

$$\rho(s) = -\Sigma'(s). \quad (20)$$

The following result on the average secrecy rate follows directly by applying Theorem 1.

Corollary 1. *For the fading wiretap channel with the legitimate receiver having a block fading channel with continuous states and the eavesdropper having a fixed channel state at G , the average secrecy rate under the delay constraint achieved via a broadcast approach is given by*

$$R = \max_{\Sigma(x)} \log e \int_{|G|^2}^\infty (1 - F(x)) \left[\frac{-x\Sigma'(x)}{1 + x\Sigma(x)} + \frac{|G|^2\Sigma'(x)}{1 + |G|^2\Sigma(x)} \right] dx \quad (21)$$

where $f(\cdot)$ is the probability density function of the fading state s , and $F(\cdot)$ is the cumulative distribution function of s .

Proof of Corollary 1. Following from (4), we obtain the following secrecy rate corresponding to layer $s = |h|^2$. If $s > |G|^2$, then the secrecy rate is given by

$$\begin{aligned} dR &= \log \left(1 + \frac{s\rho(s)ds}{1 + s\Sigma(s)} \right) - \log \left(1 + \frac{|G|^2\rho(s)ds}{1 + |G|^2\Sigma(s)} \right) \\ &\approx \log e \left[\frac{s\rho(s)ds}{1 + s\Sigma(s)} - \frac{|G|^2\rho(s)ds}{1 + |G|^2\Sigma(s)} \right] \end{aligned} \quad (22)$$

where the second approximate equation follows because ds approaches zero. If $s \leq |G|^2$, then $dR = 0$.

It can be seen that if the legitimate receiver's channel is at state s , then it can decode messages corresponding to all layers x if $x \leq s$ (see Fig. 3). Hence, the total secrecy rate achievable if the legitimate receiver's channel is at state s is given by

$$R(s) = \log e \int_{|G|^2}^s \frac{x\rho(x)dx}{1+x\Sigma(x)} - \frac{|G|^2\rho(x)dx}{1+|G|^2\Sigma(x)}. \quad (23)$$

Averaging the above rate over all fading state realizations of the legitimate receiver's channel, we obtain

$$\begin{aligned} R &= \int_{|G|^2}^{\infty} f(s)R(s)ds \\ &= \log e \int_{|G|^2}^{\infty} (1-F(x)) \left[\frac{x\rho(x)}{1+x\Sigma(x)} - \frac{|G|^2\rho(x)}{1+|G|^2\Sigma(x)} \right] dx \end{aligned} \quad (24)$$

where $f(\cdot)$ is the probability density function of the fading state s , and $F(\cdot)$ is the cumulative distribution function of s . The above average rate can be further improved by optimizing over power allocations $\rho(\cdot)$, or equivalently $\Sigma(\cdot)$. We can also use (20) to replace $\rho(x)$ in the final equation for the average rate, which completes the proof. \square

To obtain the optimal average rate R given in (21) and the corresponding optimal power allocation function $\Sigma(\cdot)$, we study the following optimization problem. In particular, we focus on continuous power allocation functions, i.e., $\Sigma(\cdot)$ is a continuous function defined over $[0, \infty)$.

$$\begin{aligned} &\max_{\Sigma(x)} \int_{|G|^2}^{\infty} S(x, \Sigma(x), \Sigma'(x))dx \\ &\text{subject to } 0 \leq \Sigma(x) \leq P, \Sigma'(x) \leq 0, \quad \text{for } x \geq 0 \end{aligned} \quad (25)$$

where

$$S(x, \Sigma(x), \Sigma'(x)) = (1-F(x)) \left[\frac{-x\Sigma'(x)}{1+x\Sigma(x)} + \frac{|G|^2\Sigma'(x)}{1+|G|^2\Sigma(x)} \right]. \quad (26)$$

The following theorem characterizes the structure of the optimal power allocation function.

Theorem 2. *Let*

$$\eta(x) = \frac{1-F(x) - (x-|G|^2)f(x)}{xf(x)(x-|G|^2) - (1-F(x))|G|^2}. \quad (27)$$

An optimal solution to (25), if one exists, has the following structure. There exist $0 \leq x_1 < y_1 < x_2 < y_2 < \dots < x_n < y_n = x_0$, such that $\eta(x)$ is strictly decreasing over $[x_i, y_i]$ for $i = 1, \dots, n$, $\eta(x_1) = P$, $\eta(y_n) = \eta(x_0) = 0$, $\eta(y_i) = \eta(x_{i+1})$ for $i = 1, \dots, n-1$, and

$$\Sigma^*(x) = \begin{cases} P & 0 \leq x \leq x_1; \\ \eta(x) & x_i \leq x \leq y_i, \quad \text{for } i = 1, \dots, n; \\ \eta(y_i) = \eta(x_{i+1}), & y_i < x < x_{i+1}, \quad \text{for } i = 1, \dots, n-1; \\ 0 & y_n = x_0 \leq x. \end{cases} \quad (28)$$

Remark 2. The functions $\Sigma(x)$ that satisfy the conditions given in Theorem 2 may not be unique.

Remark 3. In Theorem 2, $y_n = x_0$ may be infinity.

Proof of Theorem 2. It is clear that any optimal $\Sigma^*(x)$ if one exists must have the following form:

$$\Sigma^*(x) = \begin{cases} P & 0 \leq x \leq x_1; \\ \text{a strictly decreasing function} & x_i \leq x \leq y_i, \quad \text{for } i = 1, \dots, n; \\ \text{a constant,} & y_i < x < x_{i+1}, \quad \text{for } i = 1, \dots, n-1; \\ 0 & y_n = x_0 \leq x. \end{cases} \quad (29)$$

where $0 \leq x_1 < y_1 < x_2 < y_2 < \dots < x_n < y_n = x_0$.

The optimization problem (25) is a problem of the constrained calculus of variation. We thus apply the technique in [28] to provide a necessary condition that $\Sigma^*(x)$ satisfies. Over the intervals $(x_1, y_1]$, $[x_i, y_i]$ for $i = 2, \dots, n-1$, and $[x_n, y_n)$, since $\Sigma^*(x)$ is strictly decreasing, it does not satisfy the inequality constraints in (25) with equality, i.e., it is not on the boundary of the constraint set. Due to the complementary slackness conditions [28], the following Euler equation must be satisfied:

$$S_\Sigma - \frac{d}{dx} S_{\Sigma'} = 0, \quad (30)$$

where

$$S_\Sigma = \frac{\partial S(x, \Sigma(x), \Sigma'(x))}{\partial \Sigma}, \quad \text{and} \quad S_{\Sigma'} = \frac{\partial S(x, \Sigma(x), \Sigma'(x))}{\partial \Sigma'}.$$

For the function $S(x, \Sigma(x), \Sigma'(x))$ given in (26), we obtain

$$\begin{aligned} S_\Sigma &= (1 - F(x)) \left[\frac{x^2 \Sigma'(x)}{(1 + x \Sigma(x))^2} - \frac{|G|^4 \Sigma'(x)}{(1 + |G|^2 \Sigma(x))^2} \right] \\ S_{\Sigma'} &= (1 - F(x)) \left[\frac{-x}{1 + x \Sigma(x)} + \frac{|G|^2}{1 + |G|^2 \Sigma(x)} \right] \\ \frac{d}{dx} S_{\Sigma'} &= \frac{x f(x)}{1 + x \Sigma(x)} - \frac{f(x) |G|^2}{1 + |G|^2 \Sigma(x)} \\ &\quad + (1 - F(x)) \left[\frac{x^2 \Sigma'(x) - 1}{(1 + x \Sigma(x))^2} - \frac{|G|^4 \Sigma'(x)}{(1 + |G|^2 \Sigma(x))^2} \right]. \end{aligned}$$

We substitute the above equations into the Euler equation and obtain

$$\Sigma^*(x) = \eta(x) = \frac{1 - F(x) - (x - |G|^2) f(x)}{x f(x) (x - |G|^2) - (1 - F(x)) |G|^2}, \quad (31)$$

over the intervals $(x_1, y_1]$, $[x_i, y_i]$ for $i = 2, \dots, n-1$, and $[x_n, y_n)$. This also implies that $\eta(x)$ must be strictly decreasing over these intervals. Due to the continuity of $\Sigma^*(x)$, the values

of $\Sigma^*(x)$ over (y_i, x_{i+1}) are given by $\eta(y_i) = \eta(x_{i+1})$ for $i = 1, \dots, n-1$, which also implies that $\eta(x)$ must satisfy $\eta(y_i) = \eta(x_{i+1})$ for $i = 1, \dots, n-1$. Also due to the continuity of $\Sigma^*(x)$, $\eta(x_1) = P$, and $\eta(y_n) = \eta(x_0) = 0$. \square

Example 1. *In this example, we consider the case when the channel to the legitimate receiver experiences Rayleigh fading. Hence, $s = |H|^2$ is exponentially distributed, and*

$$f(x) = \frac{1}{\sigma_1} e^{-\frac{x}{\sigma_1}} \quad \text{and} \quad F(x) = 1 - e^{-\frac{x}{\sigma_1}}, \quad x \geq 0 \quad (32)$$

where σ_1 is the parameter of the exponential distribution.

Substituting (32) into (27), we obtain

$$\eta(x) = \frac{\sigma_1 - x + |G|^2}{x(x - |G|^2) - \sigma_1 |G|^2}. \quad (33)$$

By solving $\eta(x_1) = P$ and $\eta(x_0) = 0$, we obtain

$$\begin{aligned} x_0 &= \sigma_1 + |G|^2, \quad \text{and} \\ x_1 &= \frac{(P|G|^2 - 1) + \sqrt{(P|G|^2 - 1)^2 + 4P(P\sigma_1|G|^2 + |G|^2 + \sigma_1)}}{2P}. \end{aligned} \quad (34)$$

It is easy to check that $|G|^2 < x_1 < x_0$. We also note that $\eta(x)$ is strictly decreasing over the range $[x_1, x_0]$, because the numerator of $\eta(x)$ is decreasing, and the denominator of $\eta(x)$ is increasing over the interval $[x_1, x_0]$. Since x_1 and x_0 are both unique solutions to $\eta(x_1) = P$ and $\eta(x_0) = 0$, respectively, and $\eta(x)$ is strictly decreasing over $[x_1, x_0]$, the optimal $\Sigma^*(x)$ is thus given by

$$\Sigma^*(x) = \begin{cases} P & 0 \leq x \leq x_1; \\ \eta(x) & x_1 \leq x \leq x_0; \\ 0 & x_0 \leq x. \end{cases} \quad (35)$$

Since the above $\Sigma^*(x)$ is the unique function that satisfies the conditions given in Theorem 2, it is the only possible optimal solution for the power allocation function.

By taking the derivative of $\Sigma^*(x)$, we obtain

$$\rho^*(x) = -\Sigma^{*'}(x) = \frac{-x^2 + 2\sigma_1 x - 2\sigma_1 |G|^2 + 2|G|^2 x - |G|^4}{(x(x - |G|^2) - \sigma_1 |G|^2)^2}. \quad (36)$$

By substituting $\Sigma^*(x)$ and $\Sigma^{*'}(x)$ to (21), we can obtain the optimal average secrecy rate via a broadcast approach for the Rayleigh fading channel. Numerical results are provided in Section 6.

4 Fading Channel to Eavesdropper

In this section, we study the case in which only the eavesdropper experiences a block fading channel, i.e., G is a constant over each block, and changes independently from one block to another. The legitimate receiver's channel gain H is assumed to be a constant, and is thus known to all nodes. As for the case in which only the legitimate receiver's channel is fading, it is assumed that the transmitter does not know the instantaneous channel state to the eavesdropper, but the eavesdropper knows its own channel state. In the rest of this section, we first study the case with a discrete fading state, and then generalize our result to the case with a continuous fading state.

4.1 Discrete Eavesdropping Channel States

We first consider the case in which the eavesdropper has a finite number of channel states, i.e., G may take L values, say G_1, \dots, G_L with $|G_1|^2 < |G_2|^2 < \dots < |G_L|^2 < |H|^2$. For this case, we develop a second type of broadcast approach that is different from the one developed in Section 3. To proceed, we start by splitting the entire message into L layers of messages W_1, W_2, \dots, W_L .

Definition 2. *A secrecy rate tuple (R_1, \dots, R_L) is achievable if there exists a coding scheme that encodes W_1, \dots, W_L at the rate tuple (R_1, \dots, R_L) such that the legitimate receiver can decode all messages with a small probability of error, and message W_l is kept secure from the eavesdropper if the eavesdropper's channel state is G_l for $l = 1, \dots, L$.*

The following theorem characterizes achievable secrecy rate tuples via a broadcast approach.

Theorem 3. *Consider the fading wiretap channel with the legitimate receiver having a fixed channel state H and the eavesdropper possibly having one of L fading states G_1, \dots, G_L with $|G_1|^2 < |G_2|^2 < \dots < |G_L|^2 < |H|^2$. The following secrecy rate tuples (R_1, \dots, R_L) are achievable:*

$$\begin{aligned} R_l &= \log(1 + |G_{l+1}|^2 P) - \log(1 + |G_l|^2 P), \quad \text{for } l = 1, \dots, L-1, \quad \text{and} \\ R_L &= \log(1 + |H|^2 P) - \log(1 + |G_L|^2 P). \end{aligned} \quad (37)$$

Since the messages that are secure from the eavesdropper with the state G_j are also secure from the eavesdropper with the state G_l if $|G_j| > |G_l|$, all W_1, \dots, W_L are secure from the eavesdropper at the state G_l if (R_1, \dots, R_L) is achievable. Hence, the total rate of the messages that are secure from the eavesdropper at the channel state G_l is given by

$$R_l + R_{l+1} + \dots + R_L = \log(1 + |H|^2 P) - \log(1 + |G_l|^2 P). \quad (38)$$

It is also clear that the secrecy rate given in (38) achieved by the second type broadcast approach (described in the proof for Theorem 3) is the best secrecy rate (i.e., the secrecy

capacity) that the instantaneous channel allows although the transmitter does not know the eavesdropper's CSI. The only sacrifice due to no CSI at the transmitter is that some lower layer messages may not be kept secure from the eavesdropper. This is in contrast to the first type broadcast approach developed for the case when the legitimate receiver has a fading channel, for which all messages transmitted over the channel are guaranteed to be kept secure from the eavesdropper, but the secrecy rate achieved may not be optimal.

We note that although the legitimate receiver does not know the eavesdropper's channel state, the broadcast approach still prevents the eavesdropper from knowing certain layers of information with these layers determined by the eavesdropper's channel state. However, without knowing the eavesdropper's channel state, the legitimate receiver understands only the probability that certain layers of messages are kept secure, which is referred to as probabilistic secrecy and is studied in the following subsection.

We next provide the details of the proof for Theorem 3, in which the second type broadcast approach is developed in detail.

Proof of Theorem 3. In contrast to the broadcast approach developed for proving Theorem 1 that employs a subcodebook for each layer of messages, the broadcast approach here generalizes the embedding code structure proposed in [23] that uses only one codebook. Each codeword is indexed by a random index and all layers of messages. Depending on the channel state of the eavesdropper, up to certain layers of messages jointly with the random index serve as randomness to protect the remaining higher-layer messages. In this way, these higher-layer messages can be viewed as a vector bin number, and the lower-layer messages and the random index can be viewed as the index (vector) of the codeword within each bin. In particular, the entire code can be viewed in an embedded fashion in that each layer of messages serve as bin numbers with the corresponding bins being embedded into larger bins indexed by messages one layer higher. We describe this codebook in more detail as follows.

We construct a codebook that contains $2^{n \log(1+|H|^2P)}$ codewords x^n , which are indexed by $(q, w_1, \dots, w_{L-1}, w_L)$ with

$$\begin{aligned}
 q &= 1, 2, \dots, 2^{n \log(1+|G_1|^2P)}, \\
 w_1 &= 1, 2, \dots, 2^{n[\log(1+|G_2|^2P) - \log(1+|G_1|^2P)]}, \\
 w_2 &= 1, 2, \dots, 2^{n[\log(1+|G_3|^2P) - \log(1+|G_2|^2P)]}, \\
 &\vdots \\
 w_{L-1} &= 1, 2, \dots, 2^{n[\log(1+|G_L|^2P) - \log(1+|G_{L-1}|^2P)]}, \\
 w_L &= 1, 2, \dots, 2^{n[\log(1+|H|^2P) - \log(1+|G_L|^2P)]}.
 \end{aligned} \tag{39}$$

Using this codebook, to transmit a message tuple (w_1, w_2, \dots, w_L) , the encoder randomly selects an index q with the uniform distribution and transmits $x^n(q, w_1, w_2, \dots, w_L)$. To connect this approach to the wiretap binning scheme, here, for an eavesdropper's channel

state G_l , the codewords in the codebook can be viewed as being assigned to the bins indexed by (w_1, \dots, w_L) .

Due to the codebook structure specified in (39) and following steps similar to those in [4, Section 2.3], it can be shown that there exists a codebook with the above structure such that if this codebook and the above encoding scheme are applied, then the legitimate receiver can decode X^n , and hence W_1, \dots, W_L , with a small probability of error. Furthermore, for $l = 1, \dots, L$, if the eavesdropper's channel state is G_l , then the eavesdropper can decode the channel input X^n with a small probability of error if it knows W_1, \dots, W_L . We note that this property implies that there exists a positive δ_n which approaches zero as n goes to infinity such that

$$\begin{aligned} H(X^n|Z_1^n, W_1, \dots, W_L) &\leq n\delta_n, \\ H(X^n|Z_2^n, W_2, \dots, W_L) &\leq n\delta_n, \\ &\vdots \\ H(X^n|Z_L^n, W_L) &\leq n\delta_n, \end{aligned} \tag{40}$$

where Z_l is the channel output at the eavesdropper if its channel state is G_l for $l = 1, \dots, L$.

From the codebook construction and the above property, it is clear that the legitimate receiver can decode all layers of messages. It is then sufficient to show that for each channel state realization G_l , the eavesdropper is kept ignorant of the messages W_1, \dots, W_L for $l = 1, \dots, L$. Towards this end, we compute the following equivocation rate:

$$\begin{aligned} &H(W_1, \dots, W_L|Z_l^n) \\ &= H(W_1, \dots, W_L, Z_l^n) - H(Z_l^n) \\ &= H(W_1, \dots, W_L, Z_l^n, X^n) - H(X^n|W_1, \dots, W_L, Z_l^n) - H(Z_l^n) \\ &= H(W_1, \dots, W_L, X^n) + H(Z_l^n|W_1, \dots, W_L, X^n) \\ &\quad - H(X^n|W_1, \dots, W_L, Z_l^n) - H(Z_l^n) \\ &\geq H(X^n) + H(Z_l^n|X^n) - H(X^n|W_1, \dots, W_L, Z_l^n) - H(Z_l^n). \end{aligned} \tag{41}$$

By the codebook construction and encoding scheme, and the fact that the messages are uniformly distributed, we obtain

$$H(X^n) = n \log(1 + |H|^2 P). \tag{42}$$

Using (40), we obtain

$$H(X^n|W_1, \dots, W_L, Z_l^n) \leq n\delta_n. \tag{43}$$

We also compute

$$\begin{aligned}
& H(Z_l^n | X^n) - H(Z_l^n) \\
& \geq n \log 2\pi e - \sum_{i=1}^n \log \text{Var}(Z_{li}) \\
& = n \log 2\pi e - \sum_{i=1}^n \log 2\pi e (|G_l|^2 \text{Var}(X_i) + 1) \\
& \geq n \log 2\pi e - \sum_{i=1}^n \log 2\pi e (|G_l|^2 \mathbb{E}[|X_i|^2] + 1) \\
& \geq n \log 2\pi e - n \log 2\pi e \left(\frac{|G_l|^2}{n} \sum_{i=1}^n \mathbb{E}[|X_i|^2] + 1 \right) \\
& \geq n \log 2\pi e - n \log 2\pi e (|G_l|^2 P + 1) \\
& \geq -n \log(1 + |G_l|^2 P). \tag{44}
\end{aligned}$$

Substituting (42), (43), (44) into (41), we obtain

$$\begin{aligned}
\frac{1}{n} H(W_l, \dots, W_L | Z_l^n) & \geq \log(1 + |H|^2 P) - \log(1 + |G_l|^2 P) - \delta_n \\
& = \sum_{j=l}^L R_j - \delta_n = \frac{1}{n} H(W_l, \dots, W_L) - \delta_n \tag{45}
\end{aligned}$$

which implies that perfect secrecy is achieved asymptotically as n approaches infinity. \square

We note that the broadcast approach developed above is different from the original broadcast approach [17] and the one developed in Section 3 in that the power is not spread over layers of messages because one codebook that contain information about all layers of messages is employed. Furthermore, our scheme generalizes the embedding scheme in [23] (that treats the scenario with two eavesdropper's channel states) to the broadcast approach with multiple-layer embedding to accommodate multiple eavesdropper's channel states. This scheme is further extended for the case with infinite number of layers in the following subsection. More importantly, our scheme with multiple-layer embedding does not result in reduction in the secrecy rate due to the single codebook design and no power spreading over layers.

4.2 Continuous Eavesdropping Channel State

We now generalize the result in the preceding subsection to the case in which the eavesdropper has a continuous channel state, i.e., the channel gain G takes continuous values. In this case, the message should be encoded correspondingly to a continuum of layers. For each state $G = g$, we let $u = |g|^2$, and use u as an index for the layer of the message that needs to be

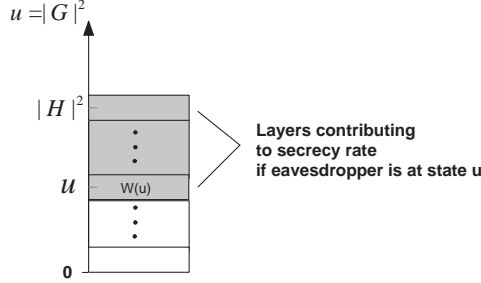

Figure 4: An illustration of the layers of messages that are secure from the eavesdropper.

kept secure from the eavesdropper in the state g . The following result follows directly from Theorem 3.

Corollary 2. *For the fading wiretap channel with the legitimate receiver having a fixed channel state H and the eavesdropper having a block fading channel, the average secrecy rate under the delay constraint achieved via a broadcast approach is given by*

$$R = Q(|H|^2) \log(1 + |H|^2 P) - \int_0^{|H|^2} q(u) \log(1 + uP) du \quad (46)$$

where $q(\cdot)$ and $Q(\cdot)$ are the probability density function and cumulative distribution function of $|G|^2$, respectively.

We note that the above rate R can be easily computed numerically.

Proof of Corollary 2. Following from (38), the total secrecy rate when the eavesdropper's channel state is $u = |G|^2$ is given as follows (see Fig. 4):

$$R(u) = \begin{cases} \log(1 + |H|^2 P) - \log(1 + uP), & \text{if } u < |H|^2 \\ 0, & \text{otherwise.} \end{cases} \quad (47)$$

Averaging the above rate over all eavesdropper's channel state realizations, we obtain

$$\begin{aligned} R &= \int_0^{|H|^2} q(u) R(u) du \\ &= \int_0^{|H|^2} q(u) [\log(1 + |H|^2 P) - \log(1 + uP)] du \end{aligned} \quad (48)$$

$$= Q(|H|^2) \log(1 + |H|^2 P) - \int_0^{|H|^2} q(u) \log(1 + uP) du, \quad (49)$$

which concludes the proof. \square

Based on the above proof, we now characterize probabilistic secrecy for this scenario, i.e., the probability that a given secrecy rate R is achievable, denoted by $Pr(R)$. It is clear from (47) that if R is greater than the maximum rate $\log(1 + |H|^2P)$ decodable at the legitimate receiver, $Pr(R) = 0$. Otherwise, in (47), we set $R(u_R) = R$ to obtain

$$u_R = \frac{2^{\log(1+|H|^2P)-R} - 1}{P}$$

which is the best eavesdropper's state such that messages with the rate R are still secure. Since these messages are also secure for any eavesdropper's state $u \leq u_R$, $Pr(R)$ should be equal to $Pr\{u \leq u_R\}$, which is $Q(u_R)$, i.e., the cumulative probability distribution of u evaluated at u_R . In summary, $Pr(R)$ is given by

$$Pr(R) = \begin{cases} Q(u_R) & \text{for } R \leq \log(1 + |H|^2P); \\ 0 & \text{otherwise.} \end{cases}$$

5 Fading Channels to Both Legitimate Receiver and Eavesdropper

In this section, we study the general case, in which both the legitimate receiver and the eavesdropper experience block fading channels, i.e., H and G are constant over each block, and change independently to other realizations from one block to another. It is assumed that the transmitter knows neither the instantaneous channel state to the legitimate receiver nor the channel state to the eavesdropper, but the legitimate receiver and the eavesdropper know their corresponding channel states. As in the previous sections, we start with the case when the channel gains have finite numbers of states. We then study the case with continuous channel states.

5.1 Discrete Legitimate and Eavesdropping Channel States

We first consider the case in which both the legitimate receiver and the eavesdropper have finite numbers of channel states, i.e., H and G take one of H_1, \dots, H_L values and one of G_1, \dots, G_K values, respectively, where $|H_1| < \dots < |H_L|$ and $|G_1| < \dots < |G_K|$. For each $1 \leq l \leq L$, we use K_l to denote the largest index of the state level of G that is below H_l , i.e., $K_l = \max_{|G_k| \leq |H_l|} k$. We develop a broadcast approach that combines the two broadcast approaches developed in Sections 3 and 4. We first split the entire message into a number of components $W_{l[1, K_l]}$ for $1 \leq l \leq L$, where $W_{l[1, K_l]}$ denotes W_{l1}, \dots, W_{lK_l} .

Definition 3. A secrecy rate tuple $\{R_{l[1, K_l]}\}_{l=1, \dots, L}$ is achievable if there exists a coding scheme that encodes the messages $W_{l[1, K_l]}$ at the rates $R_{l[1, K_l]}$ for $1 \leq l \leq L$ such that if the legitimate receiver's channel is at H_l and the eavesdropper's channel is at G_k for $1 \leq l \leq L$

and $1 \leq k \leq K_l$, then the legitimate receiver decodes the message W_{lk} and the eavesdropper is kept ignorant of the message W_{lk} .

The following theorem characterizes achievable secrecy rate tuples via a broadcast approach.

Theorem 4. *For the fading wiretap channel with the legitimate receiver having one of L fading states H_1, \dots, H_L with $|H_1| < \dots < |H_L|$ and the eavesdropper having one of K fading states G_1, \dots, G_K with $|G_1| < \dots < |G_K|$, the following secrecy rate tuples $(R_{1,[1,K_1]}, \dots, R_{L,[1,K_L]})$ are achievable:*

$$R_{lk} = \begin{cases} \log \left(1 + \frac{|G_{k+1}|^2 P_l}{1 + |G_{k+1}|^2 \sum_{j=l+1}^L P_j} \right) - \log \left(1 + \frac{|G_k|^2 P_l}{1 + |G_k|^2 \sum_{j=l+1}^L P_j} \right), & \text{for } 1 \leq l \leq L, \\ & 1 \leq k \leq K_l - 1 \\ \log \left(1 + \frac{|H_l|^2 P_l}{1 + |H_l|^2 \sum_{j=l+1}^L P_j} \right) - \log \left(1 + \frac{|G_{K_l}|^2 P_l}{1 + |G_{K_l}|^2 \sum_{j=l+1}^L P_j} \right), & \text{for } 1 \leq l \leq L, k = K_l \end{cases} \quad (50)$$

where P_l denotes the transmission power assigned to state l and satisfies the power constraint $\sum_{l=1}^L P_l \leq P$.

We note that since the messages that are decodable by the legitimate receiver at any state H_j can also be decoded by the legitimate receiver at the state H_l if $|H_j| < |H_l|$, the legitimate receiver at the state H_l can decode all messages $W_{1,[1,K_1]}, \dots, W_{l,[1,K_l]}$ for $l = 1, \dots, L$. And since the messages that are secure from the eavesdropper with any state G_j are also secure from the eavesdropper with the state G_k if $|G_j| > |G_k|$, all $W_{1,[k,K_1]}, \dots, W_{L,[k,K_L]}$ are secure from the eavesdropper at the state G_k .

We also note that similarly to the case in which only the channel to the eavesdropper is fading, employment of the broadcast approach does not require that the legitimate receiver know the channel state to the eavesdropper. However, without knowing the eavesdropper's channel state, the legitimate receiver understands only the probability that certain layers of messages are kept secure, which is studied in the following subsection as probabilistic secrecy.

Proof of Theorem 4. The basic idea combines the two types of broadcast approaches developed in Sections 3 and 4. The details are as follows.

We consider a codebook that contains L subcodebooks corresponding to L layers of the legitimate receiver's channel. For each layer l , the subcodebook \mathcal{C}_l contains $2^{n \log \left(1 + \frac{|H_l|^2 P_l}{1 + |H_l|^2 \sum_{j=l+1}^L P_j} \right)}$

codewords x_l^n indexed by $(q_l, w_{l1}, w_{l2}, \dots, w_{lK_l})$, where

$$\begin{aligned}
q_l &= 1, 2, \dots, 2^{n \log \left(1 + \frac{|G_1|^2 P_l}{1 + |G_1|^2 \sum_{j=l+1}^L P_j} \right)}, \\
w_{l1} &= 1, 2, \dots, 2^{\left[\log \left(1 + \frac{|G_2|^2 P_l}{1 + |G_2|^2 \sum_{j=l+1}^L P_j} \right) - \log \left(1 + \frac{|G_1|^2 P_l}{1 + |G_1|^2 \sum_{j=l+1}^L P_j} \right) \right]}, \\
w_{l2} &= 1, 2, \dots, 2^{\left[\log \left(1 + \frac{|G_3|^2 P_l}{1 + |G_3|^2 \sum_{j=l+1}^L P_j} \right) - \log \left(1 + \frac{|G_2|^2 P_l}{1 + |G_2|^2 \sum_{j=l+1}^L P_j} \right) \right]}, \\
&\vdots \\
w_{l(K_l-1)} &= 1, 2, \dots, 2^{\left[\log \left(1 + \frac{|G_{K_l}|^2 P_l}{1 + |G_{K_l}|^2 \sum_{j=l+1}^L P_j} \right) - \log \left(1 + \frac{|G_{K_l-1}|^2 P_l}{1 + |G_{K_l-1}|^2 \sum_{j=l+1}^L P_j} \right) \right]}, \\
w_{lK_l} &= 1, 2, \dots, 2^{\left[\log \left(1 + \frac{|H_l|^2 P_l}{1 + |H_l|^2 \sum_{j=l+1}^L P_j} \right) - \log \left(1 + \frac{|G_{K_l}|^2 P_l}{1 + |G_{K_l}|^2 \sum_{j=l+1}^L P_j} \right) \right]}. \tag{51}
\end{aligned}$$

The encoding scheme is given as follows. To transmit a set of messages $w_{1[1, K_1]}, \dots, w_{L[L, K_L]}$, for each $l = 1, \dots, L$, the transmitter randomly and uniformly selects q_l , and q_l together with $w_{l[1, k_l]}$ determines a codeword $x_l^n(q_l, w_{l1}, \dots, w_{lK_l})$. The input transmitted over the channel is then given by

$$x^n = \sum_{l=1}^L x_l^n(q_l, w_{l1}, \dots, w_{lK_l}).$$

Following steps similar to those in [4, Section 2.3], it can be shown that there exists a codebook as described above such that if the legitimate receiver has the channel state H_l , then it can decode X_1^n, \dots, X_l^n , and hence the messages $W_{1[1, K_1]}, \dots, W_{l[1, K_l]}$, with a small probability of error, and if the eavesdropper's channel is at G_k , then the eavesdropper can successfully decode X_l^n with a small probability of error if it knows $W_{l[k, K_l]}$ and X_1^n, \dots, X_{l-1}^n , for $l = 1, \dots, L$. More formally, this property implies that there exists a positive δ_n which approaches zero as n goes to infinity such that for $k = 1, \dots, K$,

$$\begin{aligned}
H(X_1^n | Z_k^n, W_{1[k, K_1]}) &\leq n\delta_n \\
H(X_2^n | Z_k^n, W_{2[k, K_2]}, X_1^n) &\leq n\delta_n \\
&\vdots \\
H(X_L^n | Z_k^n, W_{L[k, K_L]}, X_1^n, \dots, X_{L-1}^n) &\leq n\delta_n \tag{52}
\end{aligned}$$

where Z_k^n denotes the channel output received by the eavesdropper if its channel state is G_k .

From the codebook construction, it is clear that if the legitimate receiver has a channel realization H_l , it can decode X_1^n, \dots, X_l^n , and hence the messages $W_{1[1, K_1]}, \dots, W_{l[1, K_l]}$. It is then sufficient to show that if the eavesdropper is in the state G_k , the messages $W_{1[k, K_1]}, \dots, W_{L[k, K_L]}$ are kept secure from the eavesdropper. Towards this end, we com-

pute the following equivocation rate:

$$\begin{aligned}
& H(W_{1[k,K_1]}, \dots, W_{L[k,K_L]} | Z_k^n) \\
&= H(W_{1[k,K_1]}, \dots, W_{L[k,K_L]}, Z_k^n) - H(Z_k^n) \\
&= H(W_{1[k,K_1]}, \dots, W_{L[k,K_L]}, Z_k^n, X_1^n, \dots, X_L^n) \\
&\quad - H(X_1^n, \dots, X_L^n | W_{1[k,K_1]}, \dots, W_{L[k,K_L]}, Z_k^n) - H(Z_k^n) \\
&= H(W_{1[k,K_1]}, \dots, W_{L[k,K_L]}, X_1^n, \dots, X_L^n) + H(Z_k^n | W_{1[k,K_1]}, \dots, W_{L[k,K_L]}, X_1^n, \dots, X_L^n) \\
&\quad - H(X_1^n, \dots, X_L^n | W_{1[k,K_1]}, \dots, W_{L[k,K_L]}, Z_k^n) - H(Z_k^n) \\
&\geq H(X_1^n, \dots, X_L^n) + H(Z_k^n | X_1^n, \dots, X_L^n) \\
&\quad - H(X_1^n, \dots, X_L^n | W_{1[k,K_1]}, \dots, W_{L[k,K_L]}, Z_k^n) - H(Z_k^n). \tag{53}
\end{aligned}$$

Following from the codebook construction and the encoding scheme, it is clear that X_1^n, \dots, X_L^n are independently and uniformly distributed over their corresponding subcodebooks. Hence, we obtain

$$H(X_1^n, \dots, X_L^n) = n \sum_{l=1}^L \log \left(1 + \frac{|H_l|^2 P_l}{1 + |H_l|^2 \sum_{j=l+1}^L P_j} \right). \tag{54}$$

Using (52), we obtain

$$H(X_1^n, \dots, X_L^n | W_{1[k,K_1]}, \dots, W_{L[k,K_L]}, Z_k^n) < n\epsilon_n \tag{55}$$

where ϵ_n approaches zero if n goes to infinity. Following the steps in (14)-(17), we obtain

$$H(Z_k^n | X_1^n, \dots, X_L^n) - H(Z_k^n) \geq -n \log \left(1 + |G_k|^2 \sum_{j=1}^L P_j \right). \tag{56}$$

Hence,

$$\begin{aligned}
& \frac{1}{n} H(W_{1[k,K_1]}, \dots, W_{L[k,K_L]} | Z_k^n) \\
&\geq \sum_{l=1}^L \log \left(1 + \frac{|H_l|^2 P_l}{1 + |H_l|^2 \sum_{j=l+1}^L P_j} \right) - \log \left(1 + |G_k|^2 \sum_{j=1}^L P_j \right) - \epsilon \\
&= \sum_{l=1}^L \left[\log \left(1 + \frac{|H_l|^2 P_l}{1 + |H_l|^2 \sum_{j=l+1}^L P_j} \right) - \log \left(1 + \frac{|G_k|^2 P_l}{1 + |G_k|^2 \sum_{j=l+1}^L P_j} \right) \right] - \epsilon \tag{57}
\end{aligned}$$

where the last step applies

$$\log \left(1 + |G_k|^2 \sum_{j=1}^L P_j \right) = \sum_{l=1}^L \log \left(1 + \frac{|G_k|^2 P_l}{1 + |G_k|^2 \sum_{j=l+1}^L P_j} \right)$$

Comparing equation (57) with the rates of the messages given in (51), we conclude that perfect secrecy is achieved asymptotically as n approaches infinity. \square

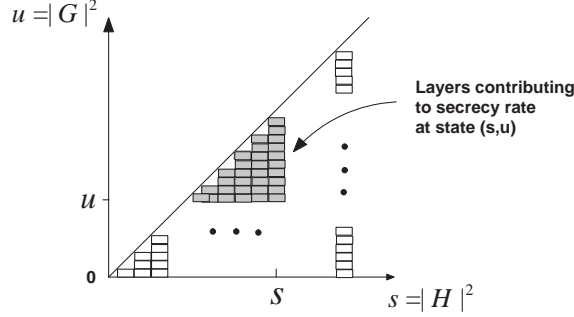

Figure 5: An illustration of the layers of messages that are decodable at the legitimate receiver and secure from the eavesdropper.

5.2 Continuous Channel States

We now generalize our result in the preceding subsection to the case in which the channel states take continuous values. For each channel state pair $(H, G) = (h, g)$, we let $(s, u) = (|h|^2, |g|^2)$, and use (s, u) to index layers of messages. For each layer s , we assume that the transmitter allocates power $\rho(s)ds$, and we use $\Sigma(s)$ to denote the total power allocated to the layers with better channel states, i.e., the states \hat{s} such that $\hat{s} > s$. Hence,

$$\Sigma(s) = \int_s^\infty \rho(x)dx \quad (58)$$

and

$$\rho(s) = -\Sigma'(s). \quad (59)$$

Following from Theorem 4, we obtain the following result on the average secrecy rate.

Corollary 3. *For the fading wiretap channel with both the legitimate receiver and the eavesdropper having block fading channels with continuous channel states, the average secrecy rate under the delay constraint achieved via a broadcast approach is given by*

$$R = \max_{\Sigma(x)} \log e \int_0^\infty dx (1 - F(x)) \Sigma'(x) \left[\frac{-xQ(x)}{1 + x\Sigma(x)} + \int_0^x du \frac{uq(u)}{1 + u\Sigma(x)} \right] \quad (60)$$

where $F(\cdot)$ and $Q(\cdot)$ are cumulative distribution functions for s and u , respectively.

Proof of Corollary 3. Consider the case when the legitimate receiver and the eavesdropper have the channel states $(s, u) = (|h|^2, |g|^2)$. Following from (50), if $s > u$, then the rate of the messages that can be decoded by the legitimate receiver at the state s while being kept secure from the eavesdropper at the state u is given by

$$\begin{aligned} dR &= \log \left(1 + \frac{s\rho(s)ds}{1 + s\Sigma(s)} \right) - \log \left(1 + \frac{u\rho(s)ds}{1 + u\Sigma(s)} \right) \\ &\approx \log e \left[\frac{s\rho(s)ds}{1 + s\Sigma(s)} - \frac{u\rho(s)ds}{1 + u\Sigma(s)} \right] \end{aligned} \quad (61)$$

where the second equation follows because ds approaches zero. If $s \leq u$, then $dR = 0$. Since all messages corresponding to the legitimate receiver's state x such that $x < s$ can be decoded by the legitimate receiver at state s , the total rate of the messages that can be decoded by the legitimate receiver at the state s and also be kept secure from the eavesdropper at the state u is given by

$$R(s, u) = \log e \int_u^s \left[\frac{x\rho(x)}{1+x\Sigma(x)} - \frac{u\rho(x)}{1+u\Sigma(x)} \right] dx \quad (62)$$

if $s > u$, and $R(s, u) = 0$ if $s \leq u$. An illustration of the layers of messages that contribute to the secrecy rate $R(s, u)$ is depicted in Fig. 5.

Averaging the above rate over all fading state realizations of the legitimate receiver's channel and the eavesdropper's channel, we obtain

$$\begin{aligned} R &= \int_0^\infty ds \int_0^s du f(s)q(u)R(s, u) \\ &= \log e \int_0^\infty du \int_u^\infty ds f(s)q(u) \int_u^s dx \left[\frac{x\rho(x)}{1+x\Sigma(x)} - \frac{u\rho(x)}{1+u\Sigma(x)} \right] \\ &= \log e \int_0^\infty du q(u) \int_u^\infty dx \rho(x) \left[\frac{x}{1+x\Sigma(x)} - \frac{u}{1+u\Sigma(x)} \right] \int_x^\infty ds f(s) \\ &= \log e \int_0^\infty du q(u) \int_u^\infty dx (1 - F(x))\rho(x) \left[\frac{x}{1+x\Sigma(x)} - \frac{u}{1+u\Sigma(x)} \right] \\ &= \log e \int_0^\infty dx (1 - F(x))\rho(x) \left[\frac{x}{1+x\Sigma(x)} \int_0^x du q(u) - \int_0^x du \frac{uq(u)}{1+u\Sigma(x)} \right] \\ &= \log e \int_0^\infty dx (1 - F(x))\rho(x) \left[\frac{xQ(x)}{1+x\Sigma(x)} - \int_0^x du \frac{uq(u)}{1+u\Sigma(x)} \right], \end{aligned} \quad (63)$$

where $F(\cdot)$ and $Q(\cdot)$ are cumulative distributions for s and u , respectively. The average rate R given above can be further improved by optimizing over all possible power allocation functions $\rho(\cdot)$, or equivalently, over all possible cumulative power allocation functions $\Sigma(\cdot)$. We can also use (59) to replace $\rho(x)$ with $-\Sigma'(x)$, which concludes the proof. \square

As in Section 4, we can also characterize the probability that a given secrecy rate R is achievable, denoted by $Pr(R)$. By setting $u = 0$ in (62), we obtain the following total rate of the messages that the legitimate receiver at the state s can decode:

$$R(s) = \log e \int_0^s \frac{x\rho(x)}{1+x\Sigma(x)} dx.$$

We set $R(s_T) = R$, and can numerically obtain s_T , which represents the lowest state of the legitimate receiver that can decode the messages at the rate R . If $s < s_T$, the probability of achieving the secrecy rate R when the legitimate receiver's state is in s is zero, i.e., $Pr(R|s) = 0$. Otherwise, for any state $s \geq s_T$, we characterize the probability that the given secrecy rate R is achievable. Towards this end, we set $R(s, u_R) = R$ in (62), and then fix s

and solve the equation to obtain $u_R(s)$, which is a function of s . Such $u_R(s)$ exists because $R(s, u)$ in (62) is monotonic as a function of u , and can be found numerically. It is clear that $u_R(s)$ is the best eavesdropper's state such that messages with the rate R are secure. Since these messages are also secure in any eavesdropper's state $\hat{u} \leq u_R(s)$, $Pr(R|s) = Q(u_R(s))$. Thus, the total probability $Pr(R)$, which is the probability that the messages with the given rate R are secure from the eavesdropper, can be obtained by averaging $P(R|s)$ over all states $s \geq s_T$, and is given by

$$Pr(R) = \int_{s_T}^{\infty} f(s)Q(u_R(s))ds.$$

From the legitimate receiver's point of view, since it knows its own channel state, the conditional probability $P(R|s) = Q(u_R(s))$ characterizes the probability to achieve a certain secrecy rate R at the current block with the state $s = |H|^2$.

In order to obtain the optimal average secrecy rate R given in (60), we need to solve the following optimization problem:

$$\begin{aligned} & \max_{\Sigma(x)} \int_0^{\infty} S(x, \Sigma(x), \Sigma'(x))dx \\ & \text{subject to } 0 \leq \Sigma(x) \leq P, \quad \Sigma'(x) \leq 0, \quad \text{for } x \geq 0; \end{aligned} \quad (64)$$

where

$$\begin{aligned} & S(x, \Sigma(x), \Sigma'(x)) \\ & = (1 - F(x))Q(x) \frac{-x\Sigma'(x)}{1 + x\Sigma(x)} + (1 - F(x))\Sigma'(x) \int_0^x \frac{uq(u)}{1 + u\Sigma(x)} du. \end{aligned} \quad (65)$$

Theorem 5. *An optimal solution to (64), if one exists, has the following structure. There exist $0 \leq x_1 < y_1 < x_2 < y_2 < \dots < x_n < y_n = x_0$, and a function $\eta(x)$, such that $\eta(x)$ satisfies*

$$\frac{(1 - F(x))Q(x)}{(1 + x\eta(x))^2} = \frac{xf(x)Q(x)}{1 + x\eta(x)} - f(x) \int_0^x \frac{uq(u)}{1 + u\eta(x)} du \quad (66)$$

and is strictly decreasing over $[x_i, y_i]$ for $i = 1, \dots, n$, $\eta(x_1) = P$, $\eta(y_n) = \eta(x_0) = 0$, $\eta(y_i) = \eta(x_{i+1})$ for $i = 1, \dots, n - 1$, and an optimal $\Sigma^*(x)$ is given by

$$\Sigma^*(x) = \begin{cases} P & 0 \leq x \leq x_1; \\ \eta(x) & x_i \leq x \leq y_i, \quad \text{for } i = 1, \dots, n; \\ \eta(y_i) = \eta(x_{i+1}), & y_i < x < x_{i+1}, \quad \text{for } i = 1, \dots, n - 1; \\ 0 & y_n = x_0 \leq x. \end{cases} \quad (67)$$

Proof. The argument is similar to that for proving Theorem 2. Hence, we here provide only details for obtaining the Euler condition (66). Due to the complementary slackness conditions, over the intervals $(x_1, y_1]$, $[x_i, y_i]$ for $i = 2, \dots, n - 1$, and $[x_n, y_n)$, since $\Sigma^*(x)$

does not satisfy the inequality constraints with equality, i.e., it is not on the boundary of the constraint set, then the following Euler equation must be satisfied:

$$S_{\Sigma} - \frac{d}{dx}S_{\Sigma'} = 0. \quad (68)$$

For the function $S(x, \Sigma(x), \Sigma'(x))$ given in (65), we obtain

$$\begin{aligned} S_{\Sigma} &= (1 - F(x))Q(x) \frac{x^2 \Sigma'(x)}{(1 + x \Sigma(x))^2} + (1 - F(x)) \Sigma'(x) \int_0^x \frac{-u^2 q(u)}{(1 + u \Sigma(x))^2} du \\ S_{\Sigma'} &= (1 - F(x))Q(x) \frac{-x}{1 + x \Sigma(x)} + (1 - F(x)) \int_0^x \frac{uq(u)}{1 + u \Sigma(x)} du \\ \frac{d}{dx} S_{\Sigma'} &= [-f(x)Q(x) + (1 - F(x))q(x)] \frac{-x}{1 + x \Sigma(x)} + (1 - F(x))Q(x) \frac{-1 + x^2 \Sigma'(x)}{(1 + x \Sigma(x))^2} \\ &\quad - f(x) \int_0^x \frac{uq(u)}{1 + u \Sigma(x)} du + (1 - F(x)) \frac{xq(x)}{1 + x \Sigma(x)} \\ &\quad - (1 - F(x)) \int_0^x \frac{u^2 q(u) \Sigma'(x)}{(1 + u \Sigma(x))^2} du. \end{aligned} \quad (69)$$

We substitute the above equations into the Euler equation and obtain the condition given in (66). \square

Example 2. Consider the case when the channels to the legitimate receiver and the eavesdropper experience independent Rayleigh fading, i.e., s and u are exponentially distributed as characterized by:

$$f(x) = \frac{1}{\sigma_1} e^{-\frac{x}{\sigma_1}} \quad \text{and} \quad F(x) = 1 - e^{-\frac{x}{\sigma_1}}, \quad x \geq 0, \quad (70)$$

$$q(x) = \frac{1}{\sigma_2} e^{-\frac{x}{\sigma_2}} \quad \text{and} \quad Q(x) = 1 - e^{-\frac{x}{\sigma_2}}, \quad x \geq 0. \quad (71)$$

where σ_1 and σ_2 are parameters for the exponential distributions of s and u , respectively.

The Euler condition (66) now becomes

$$\frac{1 - e^{-\frac{x}{\sigma_2}}}{(1 + x \Sigma(x))^2} - \frac{x(1 - e^{-\frac{x}{\sigma_2}})}{\sigma_1(1 + x \Sigma(x))} + \frac{1}{\sigma_1 \sigma_2} \int_0^x \frac{u e^{-\frac{u}{\sigma_2}}}{1 + u \Sigma(x)} du = 0. \quad (72)$$

Consider the case with $\sigma_1 = \sigma_2 = 1$. Following from the above condition, if $\Sigma(x_0) = 0$, then x_0 satisfies

$$2 - 2e^{-x_0} - x_0 = 0$$

whose root can be computed numerically and is equal to

$$x_0 = 1.5936.$$

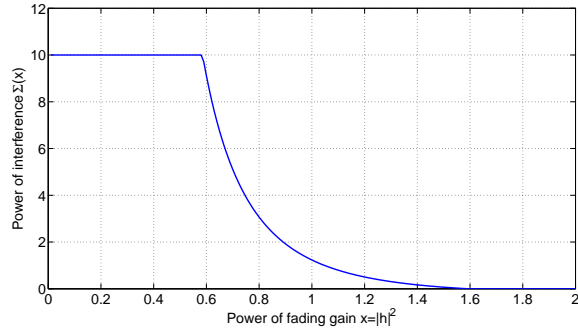

Figure 6: An optimal function $\Sigma(x)$ for the Rayleigh fading channel with $P = 10dB$ and $\sigma_1 = \sigma_2 = 1$.

Using the condition (72), it is easy to find a $\Sigma^*(x)$ function that satisfies the necessary condition given in Theorem 5. We plot the function $\Sigma^*(x)$ in Fig. 6 for the case with the power $P = 10dB$ and $\sigma_1 = \sigma_2 = 1$. We note that this function $\Sigma^*(x)$ is strictly decreasing over the interval $[x_1, x_0]$, which suggests that the optimal solution is unique if it exists.

This example also demonstrates the impact of probabilistic secrecy, under which we achieve a positive secrecy rate under delay constraints for certain channel state realizations as demonstrated in Section 6. However, under a deterministic secrecy constraint that requires all transmitted messages be secure from the eavesdropper, zero secrecy rate can be achieved for any block. Even over a large number of blocks, the secrecy rate is zero under a deterministic secrecy constraint if the legitimate receiver and the eavesdropper have the same channel statistics whereas the secrecy rate is positive under probabilistic secrecy for the same scenario as for the above example.

6 Numerical Results

In this section, we provide numerical examples to demonstrate the impact of the CSI at the transmitter on the average secrecy rate. We also compare the average secrecy rates for the three scenarios studied in the paper.

We first study scenario 1 as studied in Example 1, in which only the legitimate receiver's channel is fading with the Rayleigh distribution and the eavesdropper's channel is constant. The distribution of $s = |H|^2$ is exponential with the parameter $\sigma_1 = 2$, i.e., $p(s) = \frac{1}{\sigma_1} e^{-s/\sigma_1}$. The eavesdropper's channel state is at $|G|^2 = 0.5$. In Fig. 7, we plot the average secrecy rates achieved via the broadcast approach and compare them with the rates achievable when the legitimate receiver's CSI is known at the transmitter and the eavesdropper. With the legitimate receiver's CSI at the transmitter, the average secrecy rate (which is also the capacity) can be obtained by averaging the secrecy rate for each channel state over the state

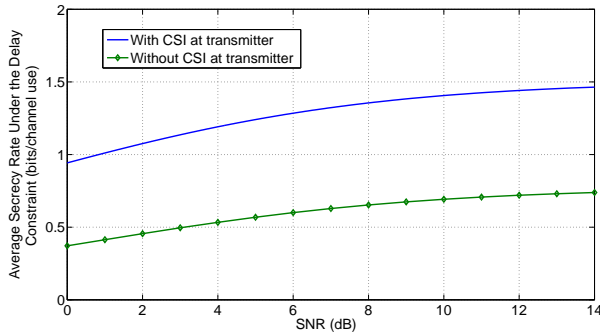

Figure 7: Comparison of rates for scenario 1: only the channel to the legitimate receiver is fading

distribution and optimizing over all possible power allocation over the channel states as given below

$$\bar{R} = \max_{P(s): E_s[P(s)] \leq P} \int_{|G|^2}^{\infty} [\log(1 + sP(s)) - \log(1 + |G|^2 P(s))] \rho(s) ds \quad (73)$$

where the optimizing power allocation can be obtained by using the Lagrangian multiplier method as in [22, 24].

It is clear from Fig. 7 that the knowledge of the legitimate receiver's CSI provides a great advantage to achieve better secrecy rates. Due to the lack of the CSI, the transmitter's power is spread over many layers of messages in order to accommodate possibly occurring channel states. However, when the CSI is available, the transmitter spends all its power for the particular state realization at each coherence block. In this way, the CSI helps to use the transmitter's power more efficiently. We also note that if one adopts the compound channel approach [13] that requires secrecy no matter which legitimate receiver's state occurs, then the secrecy rate for this example is zero. Hence, the broadcast approach greatly improves the achievable secrecy rate although the transmitter does not have the CSI. We also note that for this scenario, if there is no delay constraint, even if the transmitter does not know the CSI, it can exploit the statistics of the legitimate receiver's channel to achieve a better secrecy rate. Here, the channel statistics help to avoid power spreading whereas the broadcast approach inherently degrades the rates due to power spreading over layers.

We then study scenario 2, in which only the eavesdropper's channel is fading with the Rayleigh distribution and the legitimate receiver's channel is constant. The distribution of $u = |G|^2$ is exponential with the parameter $\sigma_2 = 0.5$, i.e., $p(u) = \frac{1}{\sigma_2} e^{-u/\sigma_2}$. The legitimate receiver's channel state is at $|H|^2 = 2$. In Fig. 8, we plot the average secrecy rates achieved via the broadcast approach and compare them with the rates achievable when the eavesdropper's CSI is known at the transmitter. With the eavesdropper's CSI at the transmitter, the average

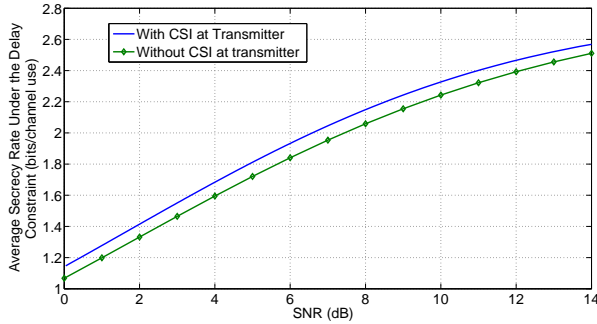

Figure 8: Comparison of rates for scenario 2: only the channel to the eavesdropper is fading

secrecy rate (which is also the capacity) under the delay constraint is given by

$$\bar{R} = \max_{P(u): E_u[P(u)] \leq P} \int_0^{|H|^2} [\log(1 + |H|^2 P(u)) - \log(1 + uP(u))] q(u) du \quad (74)$$

where the optimizing power allocation can be obtained by using the Lagrangian multiplier method as in [22, 24].

It is clear from Fig. 8 that the rates corresponding to the two cases are very close, suggesting that the knowledge of the eavesdropper's CSI does not provide much advantage to achieve better secrecy rates. This is not surprising, as we have seen in Section 4 that the broadcast approach already achieves the maximum possible secrecy rate for each block. The small gap between the two rates is because with the CSI, the transmitter can adapt its power allocation over the channel states to achieve a better rate. Another role that the CSI plays is that with the CSI the transmitter guarantees secrecy for all transmitted messages, whereas without the CSI the transmitter does not guarantee secrecy for all transmitted messages, and the legitimate receiver knows only the probability that a certain secrecy rate is achievable without the eavesdropper's CSI. We further note that the secrecy rate that can be achieved using the compound channel approach is zero for this example due to the assumption that all transmitted messages must be secure no matter which eavesdropper's state occurs. Therefore the broadcast approach adopted here again significantly improves the secrecy rate. However, unlike the first scenario and the compound channel approach, the broadcast approach developed here does not guarantee the secrecy of the entire message and achieves only probabilistic secrecy.

We now study scenario 3 as studied in Example 2, in which both the channel to the legitimate receiver and the channel to the eavesdropper are fading. The distributions of $s = |H|^2$ and $u = |G|^2$ are independent and are both exponential with the parameters $\sigma_1 = 2$ and $\sigma_2 = 0.5$, i.e., $p(s) = \frac{1}{\sigma_1} e^{-s/\sigma_1}$ and $p(u) = \frac{1}{\sigma_2} e^{-u/\sigma_2}$, respectively. In Fig. 8, we plot the average secrecy rates achieved via the broadcast approach and compare them with the rates achievable when both channels' CSI is known at the transmitter and the eavesdropper. With the CSI at the transmitter, the average secrecy rate (which is also the capacity) under the

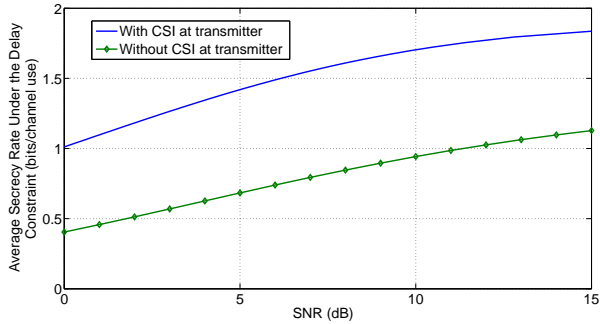

Figure 9: Comparison of rates for scenario 3: the channels to both the legitimate receiver and the eavesdropper are fading

delay constraint is given by

$$\bar{R} = \max_{P(u,s): E_{s,u}[P(s,u)] \leq P} \int_0^\infty ds \int_0^s du \rho(s) q(u) [\log(1 + sP(s,u)) - \log(1 + uP(s,u))] \quad (75)$$

where the optimizing power allocation can be obtained by using the Lagrangian multiplier method as in [22, 24]. From our understanding of scenarios 1 and 2, the gap between the rates corresponding to the two cases is mainly due to the lack of the legitimate receiver's CSI which results in the transmitter's power being spread over states. Similar to scenario 2, the secrecy rate that can be achieved using the compound channel approach is zero for this example. Therefore the broadcast approach adopted here again improves the secrecy rate although the entire message may not be fully kept secure.

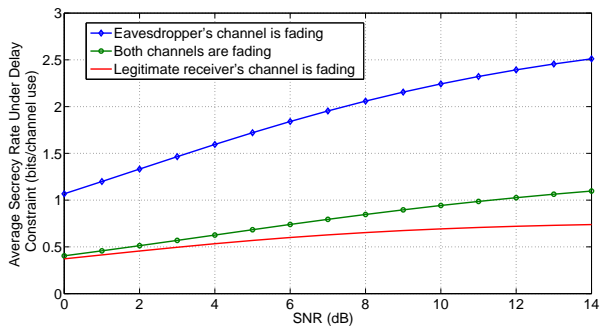

Figure 10: Comparison of rates for the three scenarios

We finally compare the average secrecy rates for the three scenarios in Fig. 10, all of which do not have the CSI at the transmitter. It is clear from the figure that scenario 2 has the best rate, and scenario 3 has a better rate than scenario 1. It is easy to understand that scenario 3 has worse rates than scenario 2 because the transmitter's power is spread over the states due to no knowledge of the legitimate receiver's CSI. However, it may seem counter-intuitive

that scenario 3 has better rates than scenario 1. This is due to the fact that when the eavesdropper's channel is fading, there is a good chance that its state is below the channel average, and such channel fluctuation facilitates achievement of a better secrecy rate and overcomes the effect of no eavesdropper's CSI at the transmitter. Therefore, the two major factors that affect the secrecy rate are the knowledge of the legitimate receiver's CSI and the channel fluctuation of the eavesdropper. The knowledge of the eavesdropper's CSI only weakly affects the secrecy rate.

7 Conclusion

In this paper, we have studied a (layered) broadcast approach for fading wiretap channels. We have developed two broadcast approaches for the cases when either the legitimate receiver's or the eavesdropper's channel is fading, respectively, and have combined these two approaches for the general cases when both nodes' channels are fading. For each case, we have obtained the average secrecy rate achieved under the delay constraint by using the broadcast approach and have derived the optimal power allocation across layers. We have also introduced a notion of probabilistic secrecy, and characterized the probability that a given secrecy rate is achievable for the valid scenarios when the eavesdropper's channel is fading. Moreover, we have provided numerical examples to demonstrate how the CSI at the transmitter and the channel fluctuation of the eavesdropper affect the average secrecy rate. Several directions are interesting to explore in the future. For the case with a delay constraint, it is of interest to explore the broadcast approach jointly with a key-based technique recently proposed in [29]. It is also of interest to study the broadcast approach for the case with a relaxed delay constraint, in which coding over a few blocks is allowed. Some ideas in [30] may be further explored for the case with a secrecy constraint. Moreover, it is of great importance to evaluate the penalty incurred by delay constraints, in particular, a stringent one-block constraint, by comparing the secrecy rate under a delay constraint and the ergodic secrecy rate.

References

- [1] Y. Liang, L. Lai, H. V. Poor, and S. Shamai (Shitz). The broadcast approach over fading Gaussian wiretap channels. In *Proc. of IEEE Information Theory Workshop (ITW)*, Taormina, Sicily, Italy, October 2009.
- [2] A. D. Wyner. The wire-tap channel. *Bell Syst. Tech. J.*, 54(8):1355–1387, October 1975.
- [3] I. Csiszár and J. Körner. Broadcast channels with confidential messages. *IEEE Trans. Inform. Theory*, 24(3):339–348, May 1978.

- [4] Y. Liang, H. V. Poor, and S. Shamai (Shitz). Information theoretic security. *Foundations and Trends in Communications and Information Theory*, 5(4-5):355–580, Now Publishers, Hanover, MA, USA, 2008.
- [5] M. Bloch and J. Barros. *Physical-Layer Security: From Information Theory to Security Engineering*. Cambridge University Press, New York, 2011.
- [6] P. Gopala, L. Lai, and H. El Gamal. On the secrecy capacity of fading channels. *IEEE Trans. Inform. Theory*, 54(10):4687–4698, October 2008.
- [7] Z. Li, R. D. Yates, and W. Trappe. Secret communication with a fading eavesdropper channel. In *Proc. IEEE Int. Symp. Information Theory (ISIT)*, pages 1296–1300, Nice, France, June 2007.
- [8] A. Khisti, A. Tchamkerten, and G. Wornell. Secure broadcasting over fading channels. *IEEE Transactions on Information Theory, Special Issue on Information Theoretic Security*, 54(6):2453–2469, June 2008.
- [9] X. He and A. Yener. The role of channel states in secret key generation. In *Proc. IEEE International Symposium on Personal, Indoor and Mobile Radio Communications (PIMRC)*, Istanbul, Turkey, September 2010.
- [10] E. Ekrem and S. Ulukus. Degraded compound multi-receiver wiretap channels. submitted to *IEEE Transactions Inform. Theory*, 2009.
- [11] A. Khisti. On the MISO compound wiretap channel. In *Proc. Information Theory and Applications Workshop (ITA)*, La Jolla, CA, USA, January 2010.
- [12] T. Liu, V. Prabhakaran, and S. Vishwanath. The secrecy capacity of a class of parallel Gaussian compound wiretap channels. In *Proc. IEEE Int. Symp. Information Theory (ISIT)*, Toronto, Ontario, Canada, July 2008.
- [13] Y. Liang, G. Kramer, H. V. Poor, and S. Shamai (Shitz). Compound wire-tap channels. *EURASIP Journal on Wireless Communications and Networking, Special Issue on Wireless Physical Layer Security*, 2009.
- [14] M. Kobayashi, Y. Liang, S. Shamai (Shitz), and M. Debbah. On the compound MIMO broadcast channels with confidential messages. In *Proc. of IEEE International Symposium on Information Theory (ISIT)*, Seoul, Korea, June-July 2009.
- [15] X. He and A. Yener. Providing secrecy when the eavesdropper channel is arbitrarily varying: A case for multiple antennas. In *Proc. 48th Annu. Allerton Conf. Communication, Control and Computing*, Monticello, IL, USA, September-October 2010.
- [16] X. He and A. Yener. MIMO wiretap channels with arbitrarily varying eavesdropper channel states. submitted to *IEEE Transactions Inform. Theory*, July 2010, also available online at <http://arxiv.org/abs/1007.4801>.
- [17] S. Shamai (Shitz) and A. Steiner. A broadcast approach for a single-user slowly fading MIMO channel. *IEEE Trans. Inform. Theory*, 49(10):2617–2635, October 2003.
- [18] T. M. Cover. Broadcast channels. *IEEE Trans. Inform. Theory*, 18(1):2–14, January 1972.

- [19] S. Verdú and S. Shamai (Shitz). Variable-rate channel capacity. *IEEE Trans. Inform. Theory*, 56(6):2651–2667, June 2010.
- [20] P. Parada and R. Blahut. Secrecy capacity of SIMO and slow fading channels. In *Proc. IEEE Int. Symp. Information Theory (ISIT)*, pages 2152–2155, Adelaide, Australia, September 2005.
- [21] M. Bloch, J. Barros, M. R. D. Rodrigues, and S. W. McLaughlin. Wireless information-theoretic security. *IEEE Trans. Inform. Theory*, 54(6):2515–2534, June 2008.
- [22] Y. Liang, H. V. Poor, and S. Shamai (Shitz). Secure communication over fading channels. *IEEE Transactions on Information Theory, Special Issue on Information Theoretic Security*, 54(6):2470–2492, June 2008.
- [23] H. D. Ly, T. Liu, and Y. Blankenship. Security embedding codes. to appear in *IEEE Transactions on Information Forensics and Security*, also appear in *Proc. IEEE Int. Symp. Information Theory (ISIT)*, pages 2533–2537, Austin, Texas, June 2010.
- [24] Y. Liang and H. V. Poor. Secure communication over fading channels. In *Proc. 44th Annu. Allerton Conf. Communication, Control and Computing*, Monticello, IL, USA, September 2006.
- [25] Z. Li, R. Yates, and W. Trappe. Secrecy capacity of independent parallel channels. In *Proc. Annu. Allerton Conf. Communication, Control and Computing*, Monticello, IL, USA, September 2006.
- [26] X. Tang, R. Liu, P. Spasojevic, and H. V. Poor. Secret-key sharing based on layered broadcast coding over fading channels. In *Proc. IEEE Int. Symp. Information Theory (ISIT)*, pages 2762–2766, Seoul, Korea, June-July 2009.
- [27] X. Tang, R. Liu, P. Spasojevic, and H. V. Poor. A broadcast approach to secret key generation over slow fading channels. submitted to *IEEE Transactions on Information Theory*, also available at http://arxiv.org/PS_cache/arxiv/pdf/1103/1103.3113v1.pdf.
- [28] J. Gregory and K. Pericak-Spector. New methods of solving general constrained calculus of variations problems involving pdes. *Utilitas Mathematica*, 58:215–224, November 2000.
- [29] K. Khalil, M. Youssef, O. O. Koyluoglu, and H. El Gamal. On the delay limited secrecy capacity of fading channels. In *Proc. IEEE Int. Symp. Information Theory (ISIT)*, Seoul, Korea, June-July 2009.
- [30] P. A. Whiting and E. M. Yeh. Broadcasting over uncertain channels with decoding delay constraints. *IEEE Trans. Inform. Theory*, 52(3):904–921, March 2006.