

University of Windsor

Scholarship at UWindor

Electronic Theses and Dissertations

Theses, Dissertations, and Major Papers

11-27-2018

Optimal RWA for SDM Optical Network under Dynamic Traffic

Dhruvi Patel

University of Windsor

Follow this and additional works at: <https://scholar.uwindsor.ca/etd>

Recommended Citation

Patel, Dhruvi, "Optimal RWA for SDM Optical Network under Dynamic Traffic" (2018). *Electronic Theses and Dissertations*. 7619.

<https://scholar.uwindsor.ca/etd/7619>

This online database contains the full-text of PhD dissertations and Masters' theses of University of Windsor students from 1954 forward. These documents are made available for personal study and research purposes only, in accordance with the Canadian Copyright Act and the Creative Commons license—CC BY-NC-ND (Attribution, Non-Commercial, No Derivative Works). Under this license, works must always be attributed to the copyright holder (original author), cannot be used for any commercial purposes, and may not be altered. Any other use would require the permission of the copyright holder. Students may inquire about withdrawing their dissertation and/or thesis from this database. For additional inquiries, please contact the repository administrator via email (scholarship@uwindsor.ca) or by telephone at 519-253-3000ext. 3208.

Optimal RWA for SDM Optical Network under dynamic traffic

By

Dhruvi Patel

A Thesis

Submitted to the Faculty of Graduate Studies
through the School of Computer Science
in Partial Fulfillment of the Requirements for the
Degree of Master of Science
at the University of Windsor

Windsor, Ontario, Canada

2018

© 2018 Dhruvi Patel

Optimal RWA for SDM Optical Network under dynamic traffic

By

Dhruvi Patel

APPROVED BY:

Z. Hu

Department of Mathematics and Statistics

A. Ouda

School of Computer Science

Y. Aneja, Co-Advisor

Odette School of Business

A. Jaekel, Advisor

School of Computer Science

November 27, 2018

DECLARATION OF ORIGINALITY

I hereby certify that I am the sole author of this thesis and that no part of this thesis has been published or submitted for publication.

I certify that, to the best of my knowledge, my thesis does not infringe upon anyone's copyright nor violate any proprietary rights and that any ideas, techniques, quotations, or any other material from the work of other people included in my thesis, published or otherwise, are fully acknowledged in accordance with the standard referencing practices. Furthermore, to the extent that I have included copyrighted material that surpasses the bounds of fair dealing within the meaning of the Canada Copyright Act, I certify that I have obtained a written permission from the copyright owner(s) to include such material(s) in my thesis and have included copies of such copyright clearances to my appendix.

I declare that this is a true copy of my thesis, including any final revisions, as approved by my thesis committee and the Graduate Studies office, and that this thesis has not been submitted for a higher degree to any other University or Institution.

ABSTRACT

With the rapid increase in demand for data transmission in our generation where Internet and cloud concepts play an essential role, it has become mandatory that we handle data most efficiently. A promising solution to overcome the capacity crunch problem which is so evident in future is applications of Space Division Multiplexing, where we explore the remaining unused domain that is the spectral and spatial domain. Space Division Multiplexing using multi-core fibers (MCF), and few-mode fibers (FMF) has been studied in our work to enhance the data-carrying capacity of optical fibers while minimizing the transmission cost per bit. The objective is to develop a path protection scheme to handle communication requests in the data center (DC) networks using elastic optical networking and space division multiplexing (SDM). Our approach to this problem is to 1) determining the initial allocation of light path on the topology, 2) possible spectrum allocation using the flex-grid flexible-SDM model, 3) choose the best possible route to minimize the number of subcarriers needed for data transfer. We propose to evaluate the developed Integer Linear Programming (ILP) formulation based on this scheme.

DEDICATION

*Dedicated to my grandmother **Late Shri Shardaben Patel**, my
parents **Manubhai and Komalben Patel**, and my brother
Harsh Patel.*

ACKNOWLEDGMENT

I would like to express my sincere gratitude to my advisor **Dr. Arunita Jaekel** and **Dr. Yash Aneja** for their continuous support in my research, for their patience, motivation, and immense knowledge. Their guidance helped me throughout my time of research and writing of this thesis. I could not have imagined having better mentors for my study.

I would also like to thank my thesis committee members **Dr. Abdelnasser Ouda** and **Dr. Zhiguo Hu** for their valuable comments and suggestions for the completion of this thesis. I would like to sincerely thank **Dr. Saja Al Mamoori**, who has been the fundamental support throughout my work.

Also, I would like to thank **Parth Patel** and **Meet Patel**, who has been encouraging elements during the development of this work. Last but not the least, my deepest gratitude to my family for their unconditional love, support, and belief.

TABLE OF CONTENTS

DECLARATION OF ORIGINALITY	iii
ABSTRACT	iv
DEDICATION	v
ACKNOWLEDGMENT	vi
LIST OF FIGURES	ix
LIST OF TABLES	x
LIST OF SYMBOLS	xi
1 INTRODUCTION	1
1.1 Overview of the Networks	1
1.2 Motivation of our work	3
1.3 Problem Statement & Solution Outline	4
1.4 Structure of the thesis	5
2 REVIEW OF RELATED TOPICS	7
2.1 Fundamentals of Optical Networks	7
2.1.1 Components of Optical fiber	8
2.1.2 Total Internal Reflection	9
2.2 Optical Networks in Cloud Computing	10
2.3 Data Centers in Cloud Computing	11
2.4 Wavelength Division Multiplexing	12
2.4.1 Process of Wavelength Division Multiplexing	12
2.4.2 Types of multiplexers for Wavelength Division Multiplexing	14
2.4.3 Lightpaths Establishment in Wavelength Division Multiplexing	14
2.5 Routing and Wavelength Assignment	15
2.5.1 Static Routing and Wavelength Assignment	16
2.5.2 Dynamic Routing and Wavelength Assignment	16
2.6 Optical Orthogonal Frequency Division Multiplexing	17
2.7 Routing and Spectrum Allocation	19
2.8 Space Division Multiplexing	19
2.8.1 Types of Fibers used in SDM	21
2.8.2 Ways of realizing SDM Transmission	23
2.9 Optical Reach	25
2.10 Modulation Format	26
2.11 Literature Review	27
3 OPTIMAL RSA FOR SDM OPTICAL NETWORK UNDER DYNAMIC TRAFFIC	33
3.1 Introduction to the problem	33
3.2 Assumptions	34
3.3 The Objective of our Approach	34
3.4 Virtual Node	35
3.5 Concept of Gaps	37
3.6 Notations used in the ILP	40
3.7 Formulation of ILP for optimal solution	42

3.8	Justification of ILP	43
3.9	Example of our Approach	45
4	SIMULATION AND RESULTS	51
4.1	Simulation	51
4.1.1	Simulation Setup	52
4.1.2	Topology Used for Simulation	55
4.2	Performance Study	57
4.2.1	Blocking Probability and Resource Utilization vs Traffic Load	58
4.2.2	Blocking Probability vs Number of Cores	59
4.2.3	Blocking Probability vs Number of Requests	60
5	CONCLUSIONS AND FUTURE WORK	62
5.1	Conclusions	62
5.2	Future Work	62
	BIBLIOGRAPHY	64
	VITA AUCTORIS	70

LIST OF FIGURES

2.1	Optical Cable	8
2.2	Total Internal Reflection	10
2.3	Wavelength Division Multiplexing	13
2.4	Physical and Logical topology	15
2.5	Static and dynamic Traffic	16
2.6	Spectrum in WDM	17
2.7	Spectrum in OFDM	18
2.8	Orthogonality in OFDM	18
2.9	Six node network topology for SDM	20
2.10	Multiple core division in SDM	21
2.11	Single mode fiber	21
2.12	Multi core fiber	22
2.13	Fewer-mode and Multi-mode fiber	22
2.14	SDM Model: Fixed-grid- Single	23
2.15	SDM Model: Flex-grid- Single	24
2.16	SDM Model: Flex-grid/Fixed	24
2.17	SDM Model: Flex-grid/Semi-Flexible	24
2.18	SDM Model: Flex-grid/Flexible	25
2.19	Optical Reach	26
3.1	Six node network topology with a virtual node at 0	36
3.2	A six node network topology with data centers	37
3.3	Available spectrum	38
3.4	Bandwidth allocation on available spectrum	39
3.5	Concept of Gaps	39
3.6	Bandwidth allocation in gaps	40
3.7	Six-node topology with Distance	45
3.8	Before allocation of the new request	46
3.9	Calculating gaps	47
3.10	Possible allocation	48
3.11	Allocation of the new request	49
3.12	Resource allocation using Modulation Format	50
4.1	Flow diagram for simulation setup	53
4.2	8-Node Network	56
4.3	COST239 Network	56
4.4	NSFnet Network	57
4.5	Blocking Probability in Flexgrid/Flexible and Flexgrid/Fixed for multiple data rate of traffic	58
4.6	Resource Utilization in Flexgrid/Flexible and Flexgrid/Fixed for multiple data rate of traffic	59
4.7	Blocking Probability vs Number of Cores	60
4.8	Blocking Probability vs Number of Requests	61

LIST OF TABLES

2.1 Modulation Format 27

LIST OF SYMBOLS

Symbol	Definition
bps/Hz	bytes per second per Hertz
BPSK	Binary Phase Shift Keying
DWDM	Dense Wavelength Division Multiplexing
EON	Elastic Optical Network
FMF	Few-mode Fiber
Gbps	Gigabytes per second
GHz	Giga Hertz
ICT	Information and Communication Technology
ILP	Integer Linear Program
LtoSR	Light path-to-Spatial-Resource
Mbps	Megabytes per second
MCF	Multi Core Fiber
MCM	Multi-Carrier Modulation
MMF	Multi Mode Fiber
OC	Optical Carrier
OFDM	Orthogonal Frequency Division Multiplexing
PDM	Polarization Division Multiplexing
QAM	Quadrature Amplitude Modulation
QPSK	Quadrature Phase Shift Keying
RSA	Routing and Spectrum Allocation
RSCA	Routing, Spectrum and Core Allocation
RWA	Routing and Spectrum Assignment
SCF	Single Core Fiber

SDM	Space Division Multiplexing
SMF	Single Mode Fiber
SpRcs	Spectral and Spatial Resources
TDM	Time Division Multiplexing
Tbps	Terabytes per second
WAN	Wide Area Network
WDM	Wavelength Division Multiplexing
XT	Cross Talk

Chapter 1

INTRODUCTION

1.1 Overview of the Networks

Initially, the computer communication started over the copper wire as a medium of carrying electrical signals encoding the data to communicated from one computer to the another [1]. To overcome the limitation of copper wires with increasing Internet traffic, progress has been made in using alternative media of communication such as optical networks. Optical fibers are essentially very thin glass cylinder or filaments which carry signals in the form of the light (i.e., optical signals). The network in which the dominant physical layer of technology for transport in optical fiber is known as optical network [1]. The optical network provides a means of communication in which electrical signals are converted into modulated optical signals for communicating data from specified source nodes to specified destination nodes in the network [2]. Optical networks are dominant in the Information and Communication Technology (ICT) sector because of their all-optical approach for a wide-area network, where the required information can be transmitted in the optical domain between nodes, which may be hundreds or even thousands of kilometers apart, without any conversion to the electrical domain.

Optical fibers provide a higher rate of data communication, compared to copper wires [1]. It is cheap and more resilient towards electromagnetic interference, carries a tremendous amount of information and capable of covering long distance without signal degradation. Optical fibers have a high bandwidth capacity of Gigabytes per second (Gbps) [3]. In other words, the capability to send 40Gbps to 100Gbps on a single strand is now commercially available in backbone networks using Wavelength Division Multiplexing (WDM) [1].

Optical fiber carries some optical signals with different carrier wavelengths simultaneously on the same fiber with WDM. WDM is an optical technique which can combine optical signals of different wavelengths onto a single strand of optical fiber. It is achieved by adding multiplexer at the transmitters end and the demultiplexer at the receivers end [4]. The advent of WDM technology has helped in increasing the capacity of the network without the installation of more fibers.

The inflexible nature of WDM networks create limitations on efficient network utilization. In the WDM network, there is a mismatch of granularities between the client layer, which possess a board range of capacity demands with granularities of several gigabits per second to 100 Gbps or more, and the physical wavelength layer, which has a rigid and large granularity of a wavelength [5]. For instance, when the end-to-end client traffic is not sufficient to fill the capacity of the wavelength, the residual bandwidth of wavelength is wasted. It is known as *stranded bandwidth issue*. Although, when the requested end-to-end capacity is higher than the wavelength, several wavelengths are grouped and allocated according to the request. The adjacent wavelengths in such groups have to be separated by a buffer in the spectral domain for wavelength demultiplexing, which leads to spectral efficiency [5]. Orthogonal Frequency-Division Multiplexing (OFDM) technology is recently introduced as a promising solution for high-speed optical transmission. The modulation technique in OFDM achieves better spectral efficiency, flexibility, and tolerance to impairment [5]. OFDM delivers the required capacity of bandwidth depending on the demand size. Thus, higher bandwidth capacity can be achieved with an order of Terabits per second (Tbps) using OFDM.

The IP traffic is growing with the Compound Annual Growth Rate (CAGR) of 22% from 2015 to 2020 [6]. Progress has been made in finding the innovative idea to increase the capacity of carrying data on a single optical fiber, hence minimizing the number of fibers required [7]. One recent approach is to consider the unused dimension i.e., space

dimension. Thus, Space Division Multiplexing (SDM) in optical networks seems to be an upcoming significant solution to overcome the *capacity crunch* problem in the backbone networks [8]. In SDM, a single fiber is replaced with multiple cores and used in parallel transmissions. It enables higher data transmission by using the same resources simultaneously, hence saves both time and resources and leads to a potential reduction in cost and required energy [8].

1.2 Motivation of our work

Optical networks are the backbone of modern communication networks, carrying data rate anywhere from a few kilometers to miles on a transcontinental scale. Earlier in the 1980s, when optical fibers started to substitute copper wire, the first-generation systems operated at bit rates of 50 Megabytes per second (Mbps) and required support from repeaters every 10 km. However, the current updated long-haul networks offer 100 Gbps per wavelength [4]. With the advancement of smart devices, video-based application, and development in communication between devices the data traffic is increasing rapidly with no sign of slowing down. According to the present scenario, 100 Gbps technology will be able to serve for a few years but will not be enough for future demands [3]. Therefore, researchers are investigating alternative solutions for the required data rates of 400 Gbps and 1Tbps over 1000km [4]. For that, the first step would be exploring various modulation formats to obtain higher spectral efficiency (i.e., how much data rate can be supported for a limited spectral bandwidth). The next step is the use of super-channels that include multiple subcarriers beyond the 50 GHz grid [8]. Even after such advancement, the data transfer capacity will remain limited, so that 400 Gbps and 1 Tbps running on legacy systems will be unable to bridge distances greater than 2000 km in the long links with high spectral efficiency [4]. These issues lead to maximum available spectral efficiency for 2000

km for single-mode fiber (fibers allowing a single light signal to propagate) of less than 7 bps/Hz [8] (Spectral efficiency is measured in b/s/Hz, by dividing maximum throughput with bandwidth in Hertz). There are various approaches to increase optical transmission system capacity over a fixed bandwidth, one of them is using an available space dimension [8]. Space Division Multiplexing has been proposed as a solution to enhance the capacity minimizing the cost per bit of fiber optic transmission [9] [1].

1.3 Problem Statement & Solution Outline

Over a few decades, researchers are accomplishing modeling and optimization of the communication networks. However, the networks have undergone important changes driven by the emergence and rapid expansion of new services. The concepts of cloud computing are the most significant technologies that have gained wide interest [10]. Cloud computing revolutionized various ways to deliver end-users, network services through Internet irrespective to their physical locations. The key issue is to model and optimize the network with the dynamic traffic patterns to allow the cost-effective implementation of recent networking services with Quality of Service (QoS) and high scalability [10]. In general, the cloud is a virtual data repository which refers to accessing computer, software application, and information technology through a network connection. It is often accessed by data centers using Wide Area Networking (WAN) or Internet connectivity [11]. The idea of a data center is known as a centralized repository which can be physical or virtual for maintenance of data [12]. Methodologies had to be modified from WDM when it began including DCs as it considers data storage in various location. Subsequently, it has drifted to Elastic Optical systems enable every communication to dynamically adjust its resources, depending on the transmission characteristic and bandwidth requirements for the communication [13]. A large portion of current work on DCs focuses on static lightpath allocation where lightpaths are setup before the system starts working. Although, the present sce-

nario expects that the paths should be allocated on user demand and resources should be restored after a significant period, such that the freed resources can be reused for a different communication.

In this thesis, we address this approach with optimal utilization of the spatial and spectral resources for Space Division Multiplexing Optical Network. Considering dynamic allocation of the user requests such that the demands are tear-down after a significant amount of time. SDM enables parallel transmission of optical signals propagating through spatial channels in fiber optic media. Here, spatial expansion reflects either multiple fibers, cores, or modes or a group of cores with few modes, which are capable of multi-carrier transmission (i.e., super-channel transmission) [14]. Current, WDM networks possess single-carrier transmission, within a fixed frequency grid where only one optical channel is used, and cannot be split in the spatial domain. Such a network is inflexible in both spectral and spatial domains. For achieving flexibility in the spectral domain, the flexible grid was introduced in an elastic optical network (EON) architecture [13]. Furthermore, for the spatial domain, the parallel channels are added. Thus, transmission of high-capacity super-channel over a network may consist of some optical carriers (OCs) which are generated/ terminated using the transceiver devices, each of them using certain modulation format and carrying a multiple of aggregated traffic [14].

1.4 Structure of the thesis

The remaining chapters are organized as follows. In Chapter 2, we discuss basic concepts of the optical networks based on SDM. We present our proposed approach in Chapter 3 with a detailed explanation of ILP formulation which is a primary contribution of our thesis. In chapter 4 we describe the implementation details of our proposed approach, and the simulation results to support the thesis. We compare our results with the ILP formulation of Flex-grid/Fixed model proposed in the thesis of Ms. Biswas [2]. Chapter 5 provides a

general summary conclusion of the thesis with the directions for possible future work.

Chapter 2

REVIEW OF RELATED TOPICS

2.1 Fundamentals of Optical Networks

Over a past decade of years, networks are evolving rapidly from being relatively static, having uniform traffic to being more configurable and providing a complex number of services. Computer communication had started with copper wires as the medium of communication that carries electrical signals, encoding the data to transmit from one device to another. However, the important limitation of copper as a medium of communication is its relatively high attenuation, provides limited bandwidth, susceptibility to malicious attacks, and electromagnetic interference. Therefore, in the past two decades, enormous progress has been made in using alternative media for communication. The enormous growth in the usage of Internet services has made high-bandwidth computer communication an important and strategic infrastructure. Deregulation of the telephone industry and the dramatic increase of data, as opposed to voice, traffic over communication networks have also spurred the deployment of high-speed networks.

The rapid growth of optical networks is primarily due to inherent high speed and the reliability of optical communication. Initially, the optical networks simply replaced copper wire with optical cables, to take advantage of the higher bandwidth of optical communication, while handle switching and other network operations before. The speed of electronic processing lead to bottleneck for such networks. Hence, the switching, the routing, and many other network operations perform at the optical level. The optical networks are being increasingly deployed to meet the increasing demand for high-speed backbone networks and cost-effective compared to copper-wired networks.

The optical network can define as a technological arrangement of signals that connects more than a single computer or any devices which can generate or store data in electronic format using optical fibers. It consists of some nodes which are interconnected using optical fibers and possesses the ability to carry out communication across the network using optical signals. Both local area networks, as well as wide area networks, use it. It can carry large amounts of data at high speed and over long distances. Not only does it provide a higher capacity but is also cost-effective, hence can be efficiently used for new applications on the Internet, Cloud Computing or other Multimedia interaction.

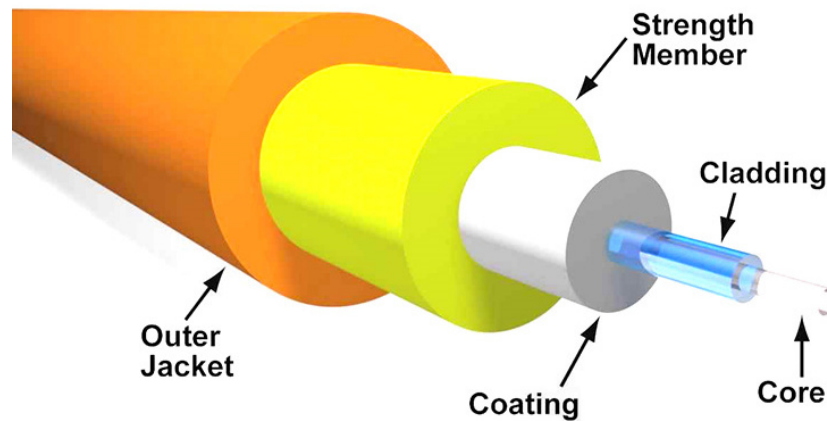

Figure 2.1: Optical Cable

2.1.1 Components of Optical fiber

The internal construction of an Optical Fiber consists of five layers as shown in Figure 2.1:

- Core - The physical layer that is a continuous glass strand, that transports the optical data signals. The cores diameter in microns [1].
- Cladding - The second layer that covers the core as a protective sheath and causes the reflection to allow light to transmit through the inner fiber-core segment [15].

- Plastic Coating - The thick plastic layer surrounds the cladding and helps protect the fiber core [15].
- Strengthening fibers - The strengthening fibers that help protect the core against damage during installation or from being crushed [15].
- Cable jacket - Lastly, the outer layer of fiber is wrapped in a cable jacket to protect against elements [15].

The light transmission in an optical fiber is the total internal reflection when the angle of incidence exceeds a critical value, and light cannot get out of the glass; instead, it bounces back in. Hence, the light can quickly move down the fiber-optic line. It is possible to transmit information down fiber optic cables in the form of light pulses. Therefore, plastic and glass are the primary materials for optical fibers.

In comparison to the core, cladding has a relatively lower refractive index to keep the light signals inside the core. Optical signals travel down a fiber-optic cable by repeatedly bouncing off the boundary between core and cladding. When an optical signal hits the glass at an angle less than the critical angle, it reflects in again due to total internal reflection. A very minimal loss during transmission allows Optical Fibers to transmit light or data quickly over long distance.

2.1.2 Total Internal Reflection

The Total internal reflection occurs when a propagating light waves strike a surface or a medium at a point (i.e., which makes an angle) which is greater than a critical angle concerning the normal to the surface. The refraction index of glass or an optical material is a measure of the speed of the light in the material, and any change in this index of refraction causes light to bend. Refraction causes light to be reflected from the surface after a certain

angle; hence this reflection is used by the optical fiber to trap light in the core of the fiber, which has a proper index of refraction.

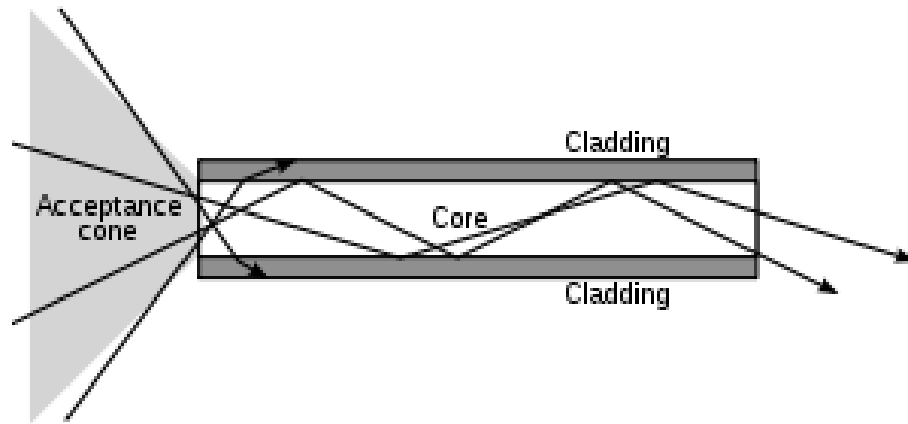

Figure 2.2: Total Internal Reflection

2.2 Optical Networks in Cloud Computing

With the recent and significant advances in Information and Communication Technology (ICT), cloud computing appears to be a commodity model for our generation after water, electricity, gas and telephony [16]. In the Cloud Computing model, the user accesses the data services by the requirement irrespective of location, time or device, if they are connected to the Internet. It is the high capacity Internet-based computing which requires large data centers to store the data. For convenience and prompt access to distributed and powerful computing (data centers) and networking resources is critical for provisioning high-quality services for intensive data applications. Therefore, to facilitate efficient interworking of the computing, storage resources, and networking in the new generation networks for cloud services; Optical networking technology plays an essential role in realizing cost-effective interconnection of a wide variety of resources over a highly distributed computing environment [17]. In other words, Cloud Computing is a techno-scientifically distributed computing model; it differs from the traditional one as [2]:

- It is largely scalable,
- It can be encapsulated as an abstract entity that delivers various levels of the services outside the cloud,
- It is driven by markets of scale, and
- The services can be dynamically configured (via virtualization or other approaches) and delivered on demand.

Generally, research institutes, industry leaders, Government are adopting Cloud solution to solve massive data exchange and processing arising in this Internet Era [17].

2.3 Data Centers in Cloud Computing

Cloud Computing relies on the compute and storage infrastructure provided by the data centers [18]. The data center centralizes the IT operations and equipment of an organization, where it stores, manages and disseminates its data. Nowadays, reaching content across the Internet autonomously without reference to the underlying hosting infrastructure of the Internet is standard practice. This structure consists of data centers that are observed, controlled and maintained around the clock by the service providers [19]. The service providers such as IBM, Amazon, Microsoft, Google, Salesforce, have established the new data centers for hosting Cloud Computing applications in several locations across the world to provide redundancy and secure reliability in case of disasters or site failure. Since the user requirements for the cloud services varies, the content providers must ensure that they can be flexible in the service delivery while keeping the user isolated from the underlying infrastructure [2]. To achieve ultra high-speed communication, Space Division Multiplexing appears to be the up-and-coming solution for the Data Center Network to overcome the bandwidth limitations [20].

2.4 Wavelength Division Multiplexing

Before the advancement of the Internet, the telephones were the most common means of communicating information. When the analog signals in human voice are converted to digital signals, the resulting signals are of 64,000 bits over each one-second duration. Hence, the bit rate of the optical bit stream is 64 kbit/s. As fiber-optic communication systems have the capacity of transmitting 40 Gbit/s, it would be a huge loss of bandwidth if a single telephone call was sent over a fiber. For utilizing the capacity of fiber, it is necessary to carry multiple channels together through multiplexing. This can be resolved through Wavelength-Division Multiplexing, which is suitable for both digital and analog signals and used in the broadcasting of radio and television channels [21].

A fiber transmits multiple optical signals in a wavelength band; those optical signals must be at different carrier wavelengths. It is possible to visualize the available bandwidth as a set of channels. Each optical signal is allotted a distinct channel so that each channel has enough bandwidth to accommodate the modulated signal. For getting rid of interference between the optical signals, each of them is separated from the other optical channels with minimum bandwidth known as channel spacing. For instance, a channel bandwidth of 10GHz and a channel spacing of 100GHz in the networks can accommodate up to 80 channels each of them having a bandwidth of 10 GHz. Hence, the shorter channel spacing (25 GHz) will lead to as many as 200 channels. The techniques of using a combination of optical signals on the same fiber strand known as Wavelength Division Multiplexing (WDM) [1].

2.4.1 Process of Wavelength Division Multiplexing

Wavelength Division Multiplexing is based on the phenomenon of light waves. A wide

range of colors of light can be seen in the meantime, and the colors are carried simultaneously through the air. The colors may mix, but they are effectively isolated with a device, for example, a prism. Light waves can transmit through an optical fiber. Through a fiber many wavelengths can be sent with the utilization of filters and couplers; the waves are sorted to the intended detectors [22].

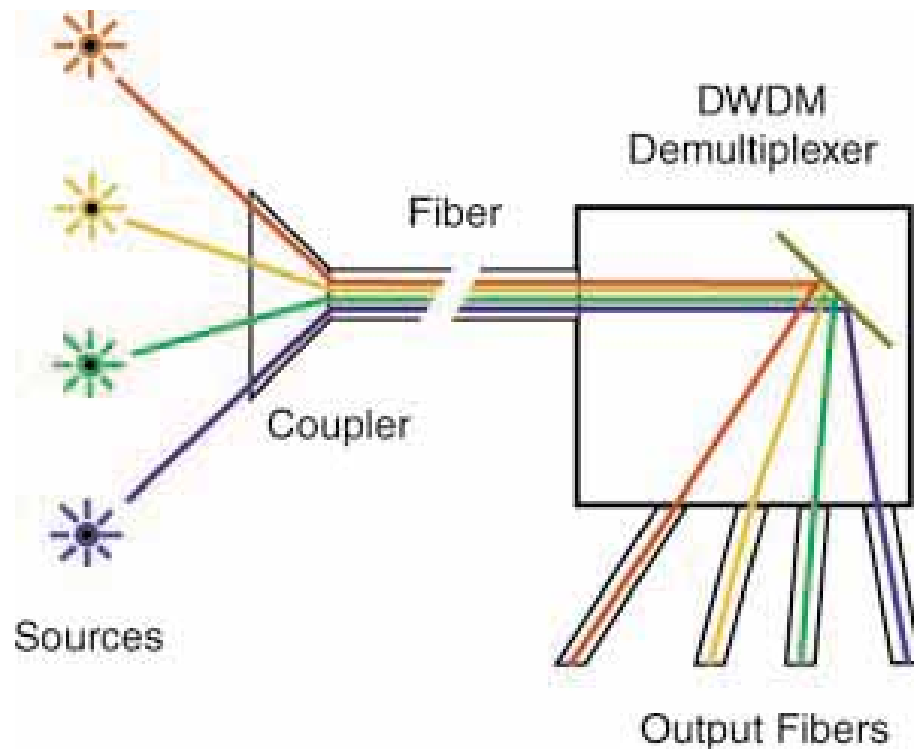

Figure 2.3: Wavelength Division Multiplexing [22]

In the process as shown in Figure 2.3, from the input end of the WDM couples the inputs into an output fiber. Generally, WDM has numerous data sources. Demultiplexing includes taking the input fiber, and collimating the light into a narrow, travel in a parallel beam of light. When the light shines on a grating such as a prism, it separates the light into the various wavelengths by transmitting at separate angles. The optics focus on each of the light in the fiber to creates a different output signal for each wavelength of the light. This technique is possible in the regular link. Therefore, it can be easily used in the current system, whereas the WDM demultiplexers must be chosen efficiently so that each channel

is correctly decoded at the receiving end [22].

2.4.2 Types of multiplexers for Wavelength Division Multiplexing

For increasing the capacity of information carried on a fiber network they used Dense Wavelength Division Multiplexers (DWDM), which can transmit the multiple streams of information on a single fiber with minimal interference. Moreover, to increase the channel spacing Course Wavelength Division Multiplexing is used which are less sophisticated and comparatively cheaper transceiver designs. This technology enhanced the capacity of fiber-optic communication systems dramatically that data transmission at 1 Tbps was realized in 1996 [21].

Increasing demands of bandwidth lead to exhaustion of available spectral resources. Over the next decade, or so, Single-Mode Fibers (SMFs) in real networks will reach their capacity limits due to the nonlinear Shannon limit [14]. Therefore, for more data transmission over the same fiber upgrading the fibers at the ends appears to be a solution and the cost of transmitting is also manageable.

2.4.3 Lightpaths Establishment in Wavelength Division Multiplexing

In WDM networks, the physical topology consists of physical links and nodes in the network whereas the logical topology consists of lightpaths between end nodes. Figure 2.4 shows the physical topology of a small network topology of four end-nodes and four router nodes. Router nodes receive the data either from a source node or other router nodes and forward them to the destination node or next router node in a route. Here, the undirected lines represent fiber links, and the directed lines represent lightpaths established over the physical topology. For example, lightpath L1 can be set up to send data from end-node A to C. It starts from source node A, passes through router nodes R1, R2, R3 and finally reaches

the destination node C. The set of lightpaths established creates the logical topology. Figure the logical topology corresponding to the lightpaths shown in Fig 2.4a. For instance, logical edge $A \rightarrow C$ represent lightpath L3 [23].

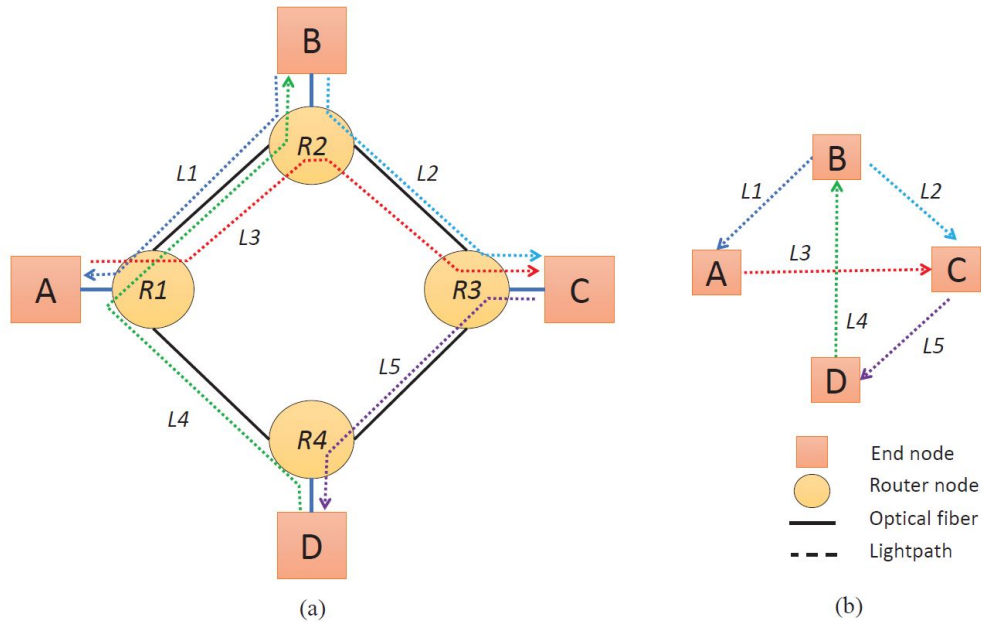

Figure 2.4: (a) Lightpaths established on physical topology, (b) logical topology corresponding to physical topology [23]

2.5 Routing and Wavelength Assignment

Wavelength-Division Multiplexing is an efficient solution for the optical networks to fulfill the growth of the data traffic volume. For efficient and scalable optical technology for telecommunication, many issues related to Routing and Wavelength Assignment (RWA), resource utilization, fault management, and quality of service provisioning must be addressed with the utmost importance [21].

The RWA problem involves the establishment of lightpaths by finding a route and assigning a wavelength (i.e., a channel) to each lightpath. RWA is known to be an NP-hard problem for Ad-hoc networks [23]. Therefore, several heuristic techniques have been proposed

to solve this problem sub-optimally [23]. In optical networks, lightpaths or connection requests may be categorized into static and dynamic.

2.5.1 Static Routing and Wavelength Assignment

With Static RWA, all connection requests known in advance. The traffic demands are specified regarding source-destination pairs [23]. This pair is chosen for the relatively long-term requirement and does not change significantly over time. The purpose is to optimally find the end-to-end routes and assign the wavelength for the traffic demand while the number of wavelengths is minimized [21].

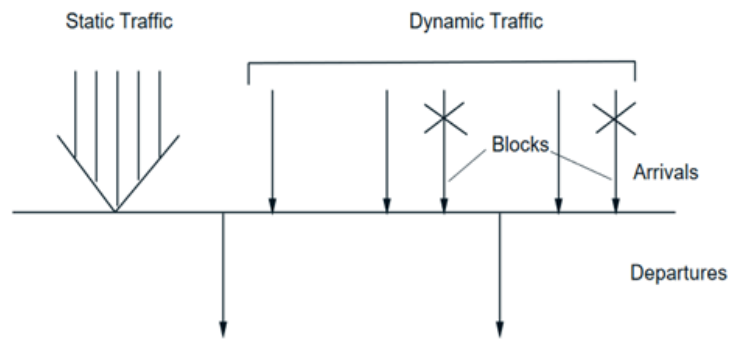

Figure 2.5: Scenario of Static and Dynamic Traffic in SDM

2.5.2 Dynamic Routing and Wavelength Assignment

For the dynamic RWA, the requests are not known in advance. When a connection request arrives, a lightpath from the source node to the destination node specified in the request set up, if possible. This lightpath is torn down after a finite amount of time so that the resources used by the lightpath are available for future requests for communication. The objective in dynamic RWA is to set up lightpaths and assign wavelengths in a manner that minimizes the blocking probability- the ratio of the number of requests for communication that could not be handled successfully to the total number of requests for communication

[21].

2.6 Optical Orthogonal Frequency Division Multiplexing

The researchers witnessed a dramatic increase in data traffic which requires more efficient and robust data transmission methodology for bandwidth more than 100Gbps. WDM networks follow fixed bandwidth allocation of each request for communication as shown in Figure 2.6, thus to address the limitation they introduced Orthogonal Frequency Division Multiplexing (OFDM) as a modulation technique for optical network [24].

OFDM is a Multi-Carrier Modulation (MCM) scheme that communicates a data stream dividing it into a number of subcarriers, each carries a comparatively low data rate signal [24]. The number of subcarriers gets allocated according to the request. More than one contiguous subcarriers get allocated when a connection demands a capacity more significant than a single OFDM subcarrier as shown in Figure 2.7 [24]. The minimum allowed gap separating two bandwidths using the same fiber in the optical network defines *guard band* [24] as shown in Figure 2.6 and 2.7. In this way, only part of available bandwidth on each fiber is used, as opposed to the WDM technique. OFDM is suitable for communication which requires more bandwidth due to its nature of elasticity in bandwidth allocation property which possesses better spectral efficiency and impairment tolerance [24].

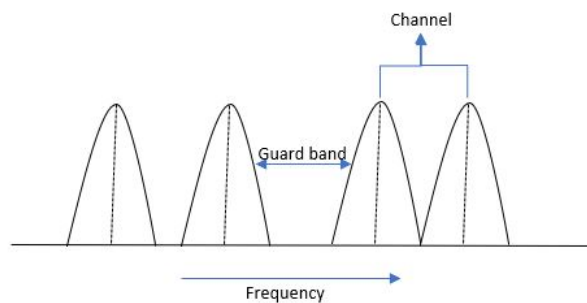

Figure 2.6: Spectrum in WDM

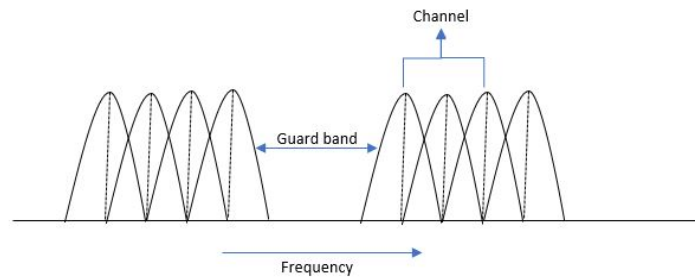

Figure 2.7: Spectrum in OFDM

Orthogonality in OFDM: In OFDM technology, subcarriers overlap with each other. However, the information of one subcarrier does not get overlap with the subcarrier such that when a subcarrier is at its peak, other subcarriers have zero crossing at that particular point. Hence, the information is only being read when the subcarrier is at its peak level as shown in Figure 2.8. It certainly avoids the interference of two signals. Ultimately, the use of orthogonal subcarriers allows usage of more subcarriers per bandwidth which in turn increases the spectral efficiency.

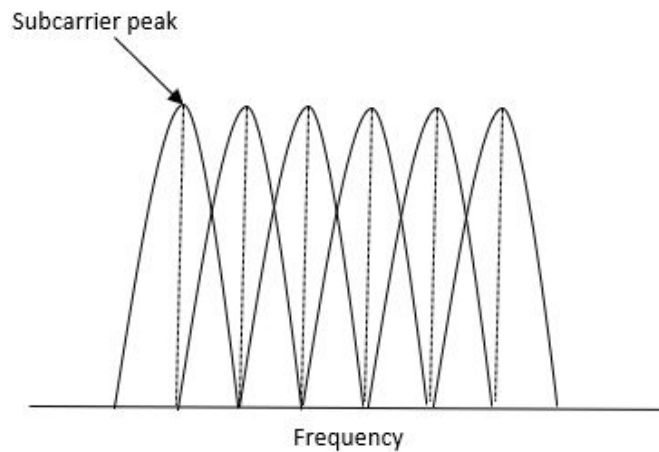

Figure 2.8: Orthogonality in OFDM

2.7 Routing and Spectrum Allocation

In a network, a route and a spectrum have to be allocated to each communication request which consists of a source for the communication, the destination for the communication and, on each fiber in the path to accommodate the required number of subcarriers (i.e., equal to or more than required bandwidth) for the communication. This process of determining the route and spectrum for the communication request is known as Routing and Spectrum Allocation (RSA) [2]. The objective of RSA is to efficiently find an appropriate path and assign a spectrum for the communication request, such that no two requests are allotted the same bandwidth where one or more edges are being shared. Also, each communication request should maintain the same bandwidth [25]. The main goal of RSA is to minimize the number of connections on the network by minimizing the usage of the frequency spectrum. RSA mainly consists of two constraints:

- **Spectrum Continuity Constraint:** According to this constraint, the spectrum assigned to each lightpath must be the same throughout the route. Thus the starting frequency/bandwidth should be the same for each request from the source to the destination on all the fibers to be used in the lightpath [26].
- **Spectrum Contiguity Constraint:** This constraint assures that the subcarriers allocated are contiguous in the spectrum [26].

2.8 Space Division Multiplexing

The techniques used in optical technology in the telecommunication are Wavelength Division Multiplexing (WDM), Time Division Multiplexing (TDM), Orthogonal Frequency Division Multiplexing (OFDM) and Polarization Division Multiplexing (PDM). For overcoming the exponential growth of data traffic, the optical network has promising solution

approaches with the strategy of exploring the unused dimension, that is space [8].

A rapid increase in popularity and variety of bandwidth-demanding applications resulted in incremental exhaustion of available spectral resources according to Shannon capacity in the current networks. Space Division Multiplexing (SDM) approach appears as a promising solution approach for overcoming the bandwidth limitations. This technology has dragged attention of researchers due to its superior advantages for optical communication [14]. One of them being its greater data transmission capacity as it can transfer larger quantity of information through a single optical fiber making it both cost and time effective.

Space Division Multiplexing uses multi-core fibers or Few-Mode Fibers which increases capacity and reduces the cost per bit of fiber-optic transmission [27]. The difference from the other multiplexing schemes and in SDM is, a single fiber is replaced with the multiple strands and used parallel transmission concept. For instance, consider the following Figure 2.9 where data to be flowing from node 1 to 2, earlier we considered bidirectional edges for the data flow, whereas for SDM multiple cores (for example, four cores between two nodes as shown in Figure 2.10) are used to carry data from the source (node 1) to the destination (node 2). It enables more substantial data transmission using the same resource simultaneously.

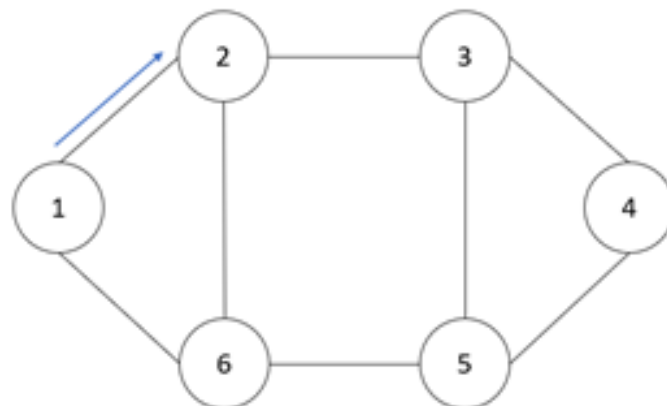

Figure 2.9: Six-node Network topology

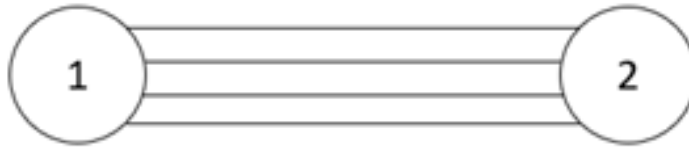

Figure 2.10: One super-channel divided into multiple cores in SDM

2.8.1 Types of Fibers used in SDM

Space Division Multiplexing supports parallel communication of optical channels transmitting through spatial channels in fiber optics medium. Various fiber optic media proposed for SDM are as follows:

- **Single Mode Fiber (SMF):** Single fiber optic cable possess a small diametrical core which allows the only single mode of the optical signal to propagate. Hence, the number of reflections generated as the light passes through the core decreases, creating the ability and lowering attenuation for the signal to travel further. Therefore, this cable is appropriate for the long distance and higher bandwidth [28]. For SDM, a bundle of fibers is achieved with the aggregation of SMFs. However, it has high deployment cost [14].

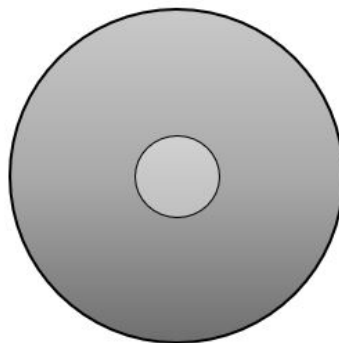

Figure 2.11: Cross section of a Single mode fiber

- **Multi Core Fiber (MCF):** The multi-core fiber involves multiple single mode cores collectively embedded in the same fiber cladding. This core placement

comprises of the various structure such as one-ring, dual-ring, linear-array, two-pitched and hexagonal close-packed structure. This MCF cables, due to crosstalk between the adjacent cores when the optical signals or lights are transmitted in an overlapping spectrum segment leads to signal impairments [14].

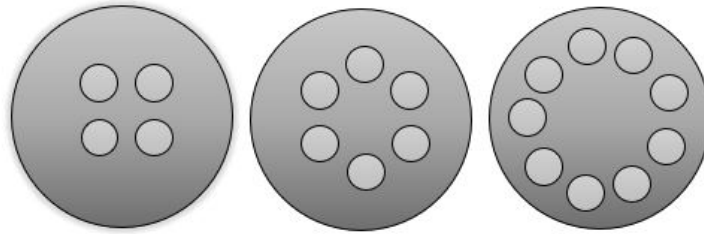

Figure 2.12: Multi core fiber

- **Multi mode Fiber or Few-Mode Fiber (MMF/FMF):** Multimode fiber optic cable possess large diametrical core which allows multiple modes of the optical signal to propagate. Because the number of light reflections created as the light passes through the core increases, this creates the ability for more data to pass through at a given time. Due to the high attenuation rate and dispersion with the fiber, the quality of signal reduces over increasing distance. This fiber cable is suitable for the short distance, data and audio/video applications in LANs [28].

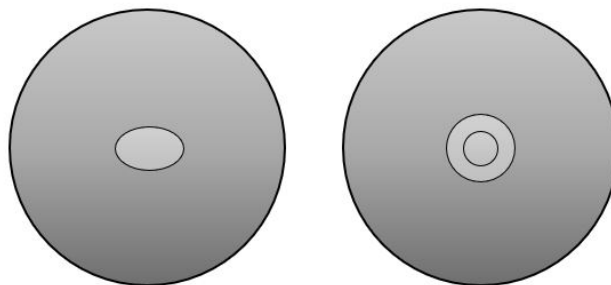

Figure 2.13: Fewer-mode and Multi-mode fiber

2.8.2 Ways of realizing SDM Transmission

Space Division Multiplexing allows multi-carrier transmission (i.e., super-channel transmission). The Optical Carriers (OCs) generated or terminated using transceiver devices as transmitted as a high-capacity super-channel over the network. Each super-channel uses a modulation format and carries a fraction of aggregated traffic. In SDM, the super channels are transmitted using Spectral and Spatial Resources (SpRcs). The optical carriers use both the frequency and spatial domain. There are various models which differ in the grade of spectral and spatial flexibility used in different scenarios of data transmission. They are as follows: [14].

- Fixed-grid/Single - This scenario corresponds to the simplest case of a WDM network with the expansion in the spatial domain as shown in Figure 2.14. The model has a fixed frequency grid and possesses a single-carrier transmission where the optical channel cannot be split in the spatial domain.

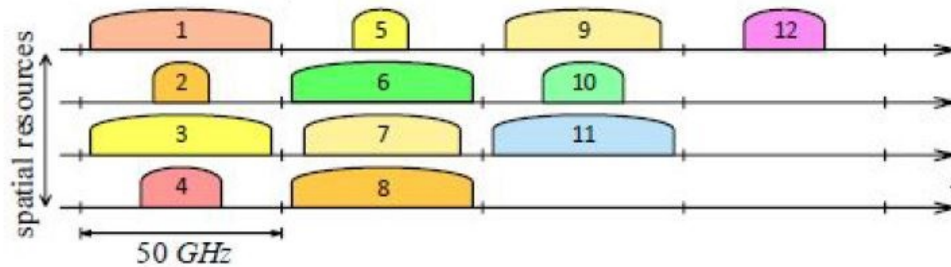

Figure 2.14: SDM Model: Fixed-grid- Single [14]

- Flex-grid/Single Here in Figure 2.15, the flexibility is introduced in the spectral domain in the Elastic Optical Network (EON) architecture. However, the super-channels occupy flexibly allocated segment of spectrum, thus only spectral domain is used for data transmission [14].

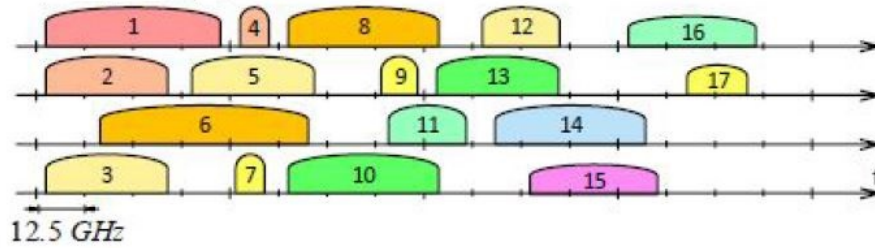

Figure 2.15: SDM Model: Flex-grid/Single [14]

- Flex-grid/Fixed - In the Figure 2.16, the super-channel uses the spectral and spatial domain. The optical carriers (OCs) belonging to a super-channel can be transmitted using the different spatial resources but use the same spectrum segment. Moreover, the super-channels cannot overlap the spectrum domain. The model is suitable for MMF/FMF systems. [14].

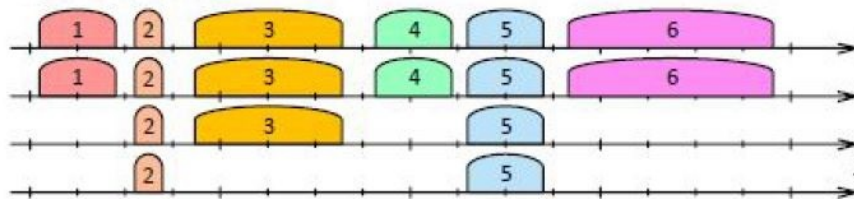

Figure 2.16: SDM Model: Flex-grid/Fixed [14]

- Flex-grid/Semi-flexible - In this Figure 2.17, the super-channels are further extended in the spatial domain by the introduction of spatial groups. Here, SpRcs are divided into some groups and only one super-channel can be carried through each group within given spectrum window [14].



Figure 2.17: SDM Model: Flex-grid/Semi-Flexible [14]

- Flex-grid/Flexible - In this Figure 2.18, full spectral and spatial flexibility in forming super-channels is considered. [14]. Although this scenario enables best resource utilization theoretically, it may lead to fragmentation of spectrum that is residual of remaining gaps instead of fixed spacing which is generally not considered for allocation of new requests. Therefore, implementation of this model is possible but also is challenging from the perspective of efficient demand allocation.

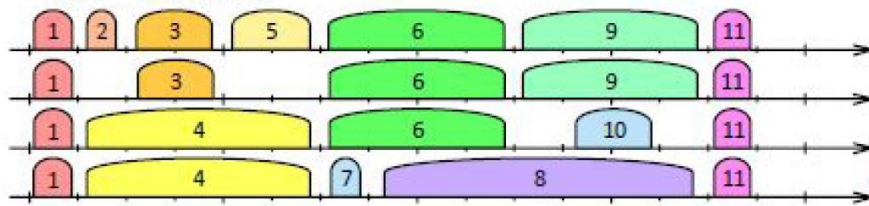

Figure 2.18: SDM Model: Flex-grid/Flexible [14]

2.9 Optical Reach

When the optical signal travels a long distance through the optical fiber, the quality of the optical signal starts degrading at a certain distance in the optical fiber. Here, the *Optical Reach* is defined as the distance an optical signal can traverse before the signal quality degenerates to a level that necessitates regeneration [29]. A smaller number of regeneration required for the longer optical reach of optical signals, and hence less equipment required thus lower operating costs. To achieve longer optical reach, more expensive equipment such as amplifiers and transponders are needed. As the optical reach continues to increase, the cost-benefit provided by reduced regeneration is eventually offset by the more expensive system equipment [29]. The factors affect the optical reach are the launched power of the signal, the type of amplification, the modulation format and likewise [29].

Consider a topology shown in Figure 2.19 the lightpath from node 1 to node 5, the optical reach of the lightpath is 1400 km.

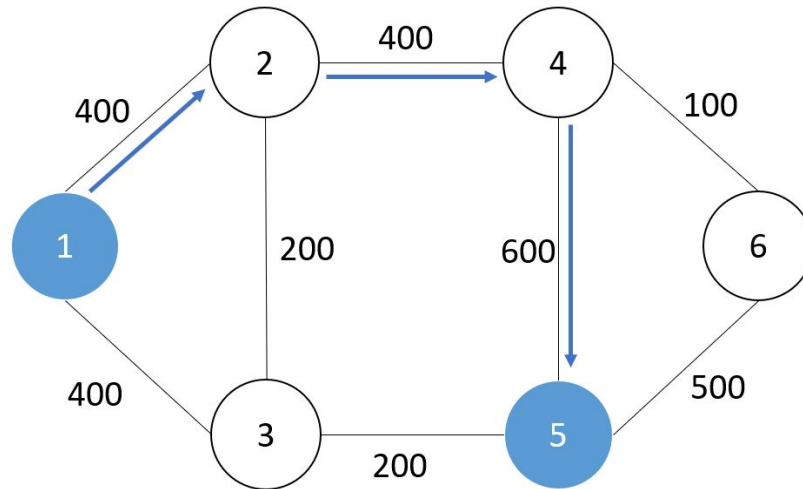

Figure 2.19: Optical Reach

2.10 Modulation Format

The optical fiber system gives network services at high speed as they have high capacity transport infrastructure. This system drive for low costs per transmitted bit with high spectral efficiency. The fiber-optic system has the capability to transmitting Tb/s bits over 1000 kilometers. The system can have an attenuation coefficient 0.2db/km for several THz of bandwidth, exceeding the transmission distance than 10,000 km and having a capacity of more than 10Tbps. The channel utilization and capacity can be improved using advanced modulation format. A better performance of Optical fiber can be achieved by using different modulation formats. In flex-grid networks, the modulation format for every communication can be chosen independently during the process of the allocation. Distance-adaptive concepts add new trade-off between optical reach and spectral efficiency [25]. For instance, modulation such as Binary Phase-shift Keying (BPSK) has a long optical reach, at the cost

of low spectral efficiency. Quadrature Phase Shift Keying (QPSK) provides better spectral efficiency than BPSK [25]. Moreover, modulation format like 16-Quadrature Amplitude Modulation (QAM) transmits the same bit rate possessing approximately one-fourth of the bandwidth of BPSK, however with a significantly shorter optical reach.

For the topology in Figure 2.19 where the length of optical reach is 1400 km, therefore 8-QAM is best suitable modulation format which can be applied to the considered network topology.

Modulation Format	Optical Reach (km)	Spectral efficiency (bps/Hz) (M_p)
BPSK	9600	1
QPSK	4800	2
8-QAM	2400	3
16-QAM	1200	4

Table 2.1: Modulation Format

2.11 Literature Review

In [2], the author outlines the Integer Linear Programming (ILP) considering the possibility of disasters in the Data Center (DC) Network. Their work focuses on developing a path protection scheme to handle communication requests in Data Center (DC) networks using Elastic Optical Networking (EON) and Space Division Multiplexing (SDM). They determine a dedicated primary path and backup path for communication as they concentrate on fault tolerance, possible allocation of the spectrum using Flex-grid/Fixed SDM model and measure the cost of the resources required to handle the new request. The research chooses the possible modulation format for data transfer to minimize the number of subcarriers needed [2]. Their study presents that the blocking probability of the network reduces with increasing the number of Data Centers (DC) in the network, the number of

subcarriers per core and the number of cores [2].

Krzysztof Walkowiak et al. in [14] presents the Integer Linear Programming (ILP) streamlining models for SDM flex grid optical systems. The proposed models exhibit the diverse ways for information transmission through SDM, each described with different flexibility in the utilization of Spectral and Spatial Resources (SpRcs). They have analyzed the details of the ILP models depicting the technological aspects of SDM. Their work focuses on generic ILP formulations that can be utilized to model various versions of SDM which can lead to the discovery of various methods for using the spatial domain available in SDM optical network. The paper depicts the types of fiber strands which can be utilized for SDM optical networks for parallel transmission of optical light signals and briefly talks about the idea of super-channels. When a high-limit super-channel is transmitted over the network, it may comprise of some Optical Carriers (OCs), which get generated or terminated using devices called transceiver, using a modulation format and transmitting a fraction of the flowing traffic. The OCs in SDM can be transmitted using both frequency and space domains. Authors have concentrated on channel-based modeling in this paper and describe a few models through which SDM transmission can be acknowledged, specifically Fixed-grid/single, Flex-grid/single, Flex-grid/fixed, Flex-grid/semi-flexible, Flex-grid/flexible. They additionally formulate three ILP models and apply it to three SDM situations, the primary being Flex-grid/Flexible. The main aim was to minimize the overall spectrum usage of the network to provision the demands, considering all the links and SpRcs. The considered model uses a Flex-grid/Single scenario when each demand is assigned to at most one SpRc on each connection. Although the arrangement assessed by explaining this model fulfilled every one of the requirements, it failed to address one major issue presented by SDM, i.e., Light path-to-Spatial-Resource (LtoSR) assignment. Their last model examines Flex-grid/Fixed situation when all the SpRcs (fibers, cores, modes) are considered as one single entity while having the oppor-

tunity of exchanging spectral slices freely. They analyzed the optimal solution given by the three ILP models and inferred that the initial two did not appear to be scalable when explained specifically utilizing exact methods so that they might come up with a heuristic arrangement of it in future.

The paper [25] focuses on a distance-adaptive scenario when a similar connection demand can be transmitted with various modulation formats and is related to multiple spectral efficiencies and optical reach. As spectrum fragmentation degrades the performance (i.e., blocking probability). In flex-grid networks, the modulation format can be chosen autonomously for every connection amid the resource allocation process. For instance, modulations like BPSK, have longer optical reach, however, have low spectral proficiency, though 16-QAM transmits same information using one-fourth of the bandwidth. The paper describes on the allocation of dynamic connection demands when they are received, deciding its route, modulation, and the band to be designated through Routing and Spectrum Assignment (RSA). Zaragoza et al. review the existing RSA approach in the paper which apply to heterogeneous flex-grid optical networks, assessing their blocking probability averaged among services, their decency in adjusting the blocking probabilities seen by different functions. The simulation study has been performed to analyze the performance of two different RSA algorithms namely blocking model and incremental model. In the paper, the authors compare the network capacity and fairness performances for a set of previously proposed algorithms, revealing their merits in both dimensions.

In the paper [30] Muhammad et al. examines that for including the capacity limitation of the networks dependent on Single-Core Fiber (SCF) and for accomplishing far higher transmission throughput and spectral efficiency. The authors have thought of exploiting the only available measurement, i.e., space. For allocating of spectrum slices by the traffic requests in flex-grid networks, the Routing and Wavelength Assignment (RWA) problem is modified to the Routing and Spectrum Allocation (RSA) problem. The flex-grid networks

utilize multi-core fibers for spectrum and core allocation during traffic demands. Because of the spectrum, non-overlapping constraint in flex-grid different traffic demands with current spectrum slices cannot traverse through the same network link. Even though requests can be routed through a similar connection but different cores if they share some common spectrum slices [30]. The paper also investigates the Routing, Spectrum and Core Allocation (RSCA) problem for flex-grid optical networks formulates RSCA network planning problem using ILP. For an RSCA problem, all the traffic requests in the system are known before, i.e., the requests are static. They give an optimal solution for provisioning the requests through the appropriate allocation of spectrum and core, while effectively using all the spectrum resources. The optimal solution evaluates the number of spectrum slices required to serve given traffic demand, and furthermore fulfill all the other constraints, for example, inter-core crosstalk (XT) and spectrum overlapping simultaneously [30]. The paper gives a summary of the crosstalk issue for systems with MCF. For incorporating the inter-core crosstalk (XT) in the ILP formulation, two different methodologies were proposed. In the first place, slices with the same spectrum cannot be assigned to different demands that transmit through neighboring cores unless the crosstalk level at the receiver end is beneath a given threshold. The other methodology is to pre-process the crosstalk values for every path and choose a route with the amount of crosstalk below a given threshold [30]. An adaptable and viable heuristic is proposed for a similar issue. After analysis of the solutions, they inferred that their proposed ILP demonstrate adaptable for small networks and low traffic, however, more significant topologies with high traffic requests effective solutions within the ideal time can be obtained if heuristic approaches are utilized. The connected heuristic strategy conveys the traffic requests as per the required spectrum and path. To establish a new request, the spectrum resources are gradually increased after every iteration until the demands are met in the network. The results conclude that the proposed heuristic can generate a solution which might be close to the optimal solution in polynomial

time [30].

The paper [13] gives an overview of the most recent advancements and methodologies concerning flexible optical networking and the observed advantages that spatially flexible networking approaches can contribute to optical networks. It alludes to the limit of a network to dynamically modify its resources, such as the modulation format, or optical bandwidth according to the required bandwidth and transmission characteristics of each requested connection. Klouidis et al. talks regarding the different channel allocation options over the available fiber dimensions which are its wavelength, bandwidth or space approved by the latest relevant technology advances and research efforts. Next, the possible flexible networking approaches considering both spectral and spatial network flexibility are commented on and discussed, identifying their benefits, limitations, and synergies [13]. The author says that the classic SDM approach of placing a spatial demultiplexer is before a spectral demultiplexer to process and extract the spatially multiplexed data can also be applied to the spectrally flexible networking systems. The last part focuses on network design, planning, operation, and control issues, addressing the latest advancements in flexible optical networking, while also highlighting the primary research directions and required modifications for the introduction of flexibility in the space dimension [13].

Wang et al. in [31] talk about the Orthogonal Frequency Division Multiplexing (OFDM) technology empowers the elastic and flexible bandwidth allocation in the SLICE network [32]. When a user request requires multiple sub-carriers, consecutive sub-carriers in the spectrum domain are allocated and overlapped without using the spectral gap or the guard-band frequencies [31]. Similar to RWA in WDM networks, the SLICE network deploys the routing and spectrum allocation (RSA) process to serve the traffic demands [31]. The aim of the paper [31] is to consider an optimal solution and propose new methodologies for the analysis of the number of subcarriers used in a general mesh network. The authors present Integer Linear Programming (ILP) formulations for optimal RSA with two

optimizations goals. One, minimizing the maximum subcarrier index among all the fibers, and the second being the minimization of the total allocated sub-carriers over all the fibers, keeping five constraints in mind, namely, the traffic demand constraint and Sub-carrier capacity constraint, Spectrum Continuity Constraint, Guard-Carrier Constraint, Sub-carrier Consecutiveness Constraint [31]. They also analyze the upper and lower bounds for the maximum subcarrier index in a SLICE network. These methods improve the limits for the case with predetermined routing knowledge. Also, the simulations presented in [32] review two other efficient heuristic algorithms, namely the BLSA or the balanced load spectrum allocation and SPSR or the shortest path with maximum spectrum reuse under different optimization goals [31].

The problem of optimization and modeling of RSSA has been a subject of several papers. In [30], [33], [34], ILP formulations of RSSA for SDM network with MCFs are proposed. Besides, in [30] and [35] some heuristics for XT-aware SDM network planning are developed. The authors of [36] use a simple k-shortest path and first fit allocation algorithm to analyze different SDM switching strategies in an off-line network planning scenario. Similarly, a comparison of SCh allocation schemes in a dynamic SDM network is a subject of [37]. Moreover, some heuristic algorithms for dynamic lightpath setup are studied in [37], [38], [39], [40].

Chapter 3

OPTIMAL RSA FOR SDM OPTICAL NETWORK UNDER DYNAMIC TRAFFIC

3.1 Introduction to the problem

In recent years, growing demands for the cloud services all over the network, requirement of the bandwidth is increasing exponentially. To increase the ultra speed for satisfying user requirements, models of Space Division Multiplexing are in discussion. In a data center network, a network consists of nodes which comprise of typically computers or data center representing either source of data or destination for the data, and edges which represent fiber links connected to the nodes in the network. A cloud service network contains various data centers which handle the customer requests regardless of the location of the customer. Generally, the data centers process a request of a file determined from a user and communicate the requesting file to the user node. In a robust data communication network, the data center ensures that the requested file is communicated to the user even if a disaster occurs. For maintaining the robust DC network, it must ensure that the multiple replicated data must store in the various data center of the network.

In our problem, we are considering the dynamic traffic scenario where a specific communication scheme is defined in response to each request for communication. For our problem, we are not considering the scenario of the disaster of the nodes or links in the network. Considering a network topology with n nodes in a network, E bidirectional edges (fiber links) in a network, C number of cores per fiber, set of data centers in a network S and set of existing communications Q . The set of data centers $\{S_1, S_2, \dots, S_n\}$ are prede-

terminated according to requirements of data centers in a topology described in [20]. We determine a primary communication path using Routing and Wavelength Assignment for the dynamic traffic. This path is torn down within a finite amount of time. The primary path allocated is the optimal path amongst the available path for the demanded request. If the required resources are not available to satisfy the requested bandwidth, then that connection request is blocked.

3.2 Assumptions

The assumptions made for the resource allocation in a Data Center Network are as follows:

- The network uses Routing and Wavelength Assignment (RWA) for data communication.
- The network uses flex-grid flexible model for SDM networks.
- The network supports the number of on-going communications on the network when a new request arrived for transmission. The details of each existing communication Q are known, we have all the information about the available and used resources to handle the arriving demand.

3.3 The Objective of our Approach

For our algorithm, we consider the set $\{q_1, q_2, \dots, q_p\}$ as the set of requests and the set $\{S_1, S_2, \dots, S_n\}$ as a set of Data centers in a network. Our objective is to determine the optimal path from the data center node to the destination node; the allocation handles the new request using Flex-grid Flexible model.

- The primary communication will be from some node S_i , $1 \leq i \leq n$, to node S_j , $1 \leq j \leq n$.
- The length of the path used by the primary communication will determine the optimum path using Routing and Wavelength Assignment, and the path is recorded for the further arriving requests.
- The detail information regarding path set up during allocation of the communication is used while tearing down the path in a finite amount of time.
- Allocating the optimal path amongst the available paths which minimize the number of subcarriers needed to carry out the new communication.
- Measure the cost of the resources used to handle the new request by the sum of the spectrum bandwidths needed for the new communication.
- Calculating the blocking probability on the basis of the blocked demands in the network.

3.4 Virtual Node

Considering a data center network, when the data is requested for the communication the source node is not specified. In other words, only the data is to be retrieved for the node is specified. Our approach needs to determine which node will act the source node of the path. This node corresponds to one of the data center nodes S_i from the set of the data center nodes $\{S_1, S_2, \dots, S_n\}$ which stores all the information regarding the requested data. To determine which data center will act as a source node, for the primary path, let's consider a virtual node s with new virtual edges from the virtual node as shown in the

Figure 3.1. The virtual edges are the unidirectional edges between the virtual node s and the data center nodes S_i , $1 \leq i \leq n$.

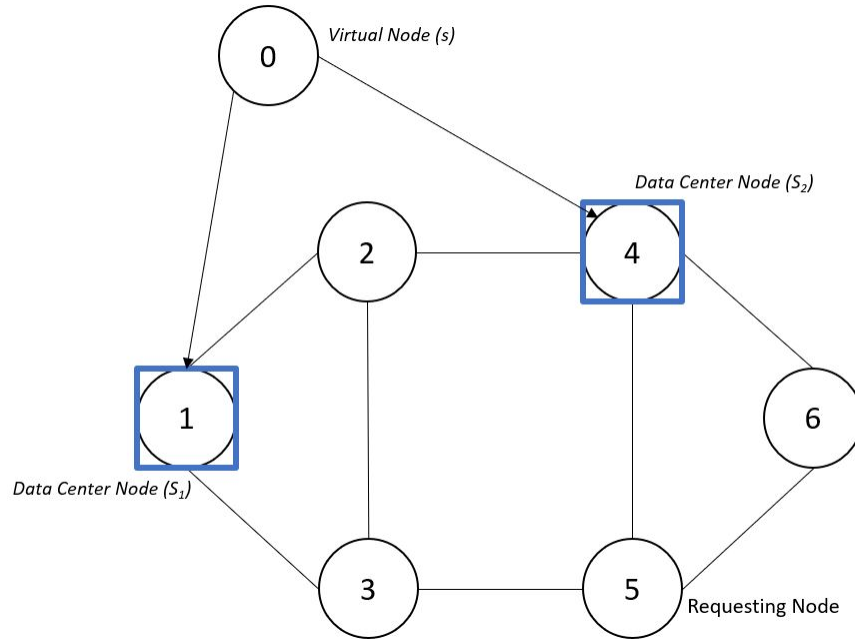

Figure 3.1: Six node network topology with a virtual node at 0

This virtual node s does not exist as a node in the network. Since all the virtual edges from this virtual node have length 0, it does not affect the minimum utilization of the resource (i.e., the subcarrier) constraints. Our approach picks the nearest data center from the destination and follows the standard network flow algorithm to find a primary path for the new request from the virtual node s to the destination node n . Generally, ignoring the virtual edges, we get the primary path from the data center node S_i to the destination node n .

For instance, in Figure 3.1 the topology represents the 6-physical nodes with numbered 1 - 6 and a virtual node assigned number 0. Here, the virtual node is not the part of the topology but the concept of use of a simple single commodity network flow algorithm. If the node 1 and 4 are the data center nodes which contain the information regarding all the requested data to be communicated, the virtual node 0 is connected to the data center node 1 and 4 in the network which are the potential sources of the communication as shown in

the Figure 3.1 The ILP choose one source node among node 1 or node 4, to obtain the optimal path from source node to destination node (i.e., the one which is nearest).

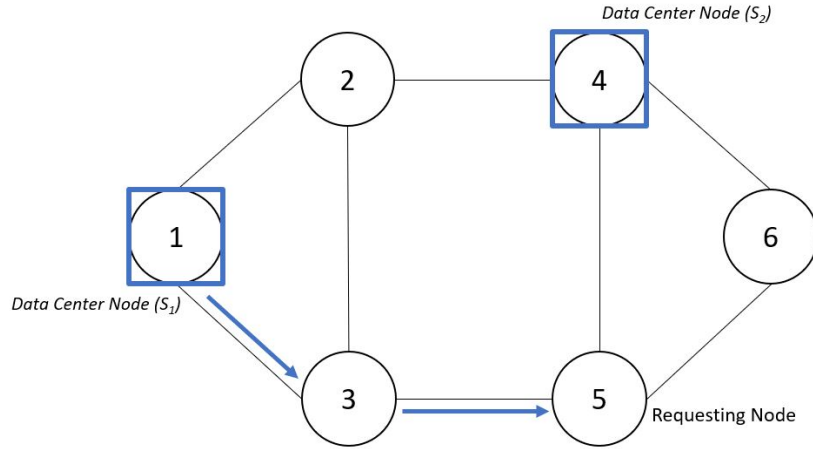

Figure 3.2: Actual path of the communication

Our approach determines the optimal path from the virtual node to the requested node based on the various factors such as the available spatial and spectrum resources on a fiber in the path and the distance from the destination node. We get the actual path for communication by ignoring the virtual edges in the path. For example, the requesting node is 5 assuming that it picks the path $0 \rightarrow 1 \rightarrow 3 \rightarrow 5$, the actual path for the communication obtained by ignoring the virtual edges (i.e., $0 \rightarrow 1$) for the communication is $1 \rightarrow 3 \rightarrow 5$ in the Figure 3.2.

3.5 Concept of Gaps

Figure 3.2 shows a six-node network with data centers at node 1 and node 4 storing the requested data, and node 5 is requesting node for the data. The edges $1 \rightarrow 3$ and $3 \rightarrow 5$ indicates that the path for primary communication is $1 \rightarrow 3 \rightarrow 5$. We are using Flex-grid/Flexible model for SDM networks for allocating bandwidth to the newly requested

communication. In SDM networks with multiple core fiber where a single link from the source node to destination node represents multiple cores. Figure 3.3 shows that the edge $1 \rightarrow 3$ has divided into multiple cores (4 here) and is now responsible for carrying out the communication. Similarly, edge $3 \rightarrow 5$ gets subdivided into four cores for the new request.

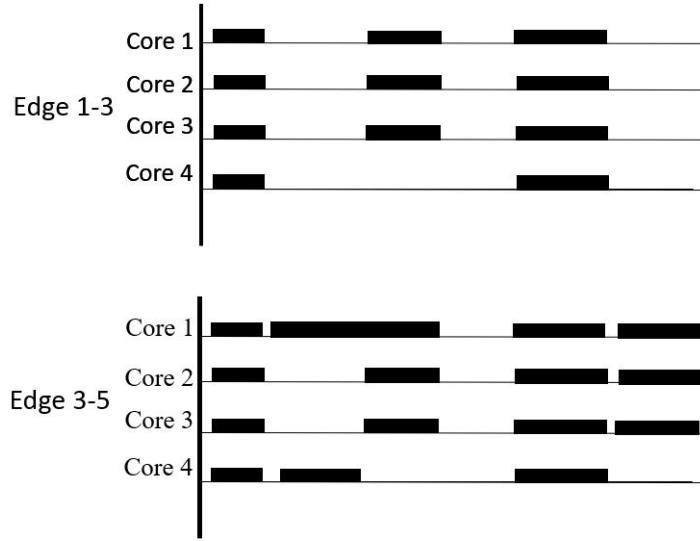

Figure 3.3: Available spectrum on cores of Edge $1 \rightarrow 3$ and Edge $3 \rightarrow 5$

Figure 3.3 shows the available spectrum on cores of the edge $1 \rightarrow 3$ and edge $3 \rightarrow 5$ where the resource allocation should take place for setting up the new communication request and where on each core must have an equal number of subcarriers allocation over the spectrum.

The grey rectangular boxes in Figure 3.4 depicts the bandwidth allocation on available spectrum on edge $1 \rightarrow 3$ and edge $3 \rightarrow 5$. The equal bandwidth allocation of spectrum takes place in all the cores because of the Flex-grid/Flexible model. During resource allocation process, the Flex-grid/Flexible model chooses the same range of spectrum on both edges as shown in Figure 3.4. For that, we need to calculate the number of subcarriers available in each gap of a core on each edge by calculating the difference of ending subcarrier and starting subcarrier of the gap as shown in the Figure 3.5. For instance in Figure 3.5, the gap 0 on core 0 have starting subcarrier denoted by $a_{13}^{00} = 6$ and ending subcarrier denoted by

$b_{13}^{00} = 12$ hence the difference will be $12 - 6 + 1 = 7$.

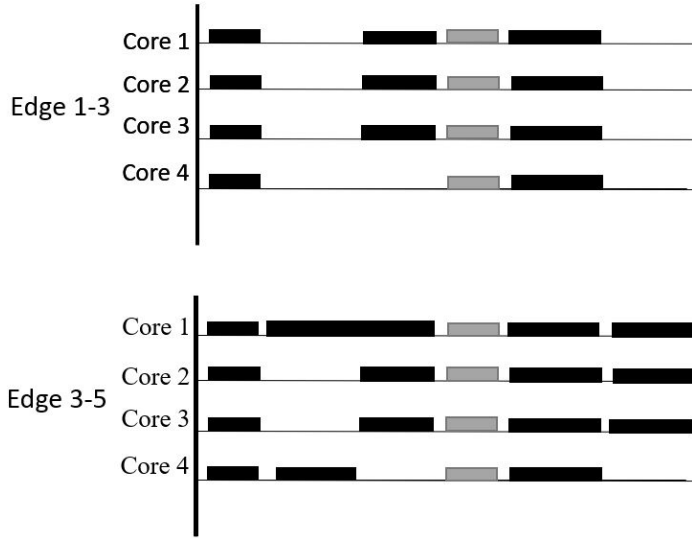

Figure 3.4: Bandwidth allocation on available spectrum

Figure 3.5 shows a bundle of fibers, representing an edge $i \rightarrow j$ (consider edge $1 \rightarrow 3$ in Figure 3.5). The portions with the black boxes of each fiber in this Figure 3.5 are already assigned to existing ongoing communication. Therefore we cannot use the portions with the black subcarriers for the new request. Hence we will use unused spectrum (i.e., gaps) available on edge $1 \rightarrow 3$ for the new request. Figure 3.5 shows gaps available for allocation of the spectrum using the Flex-grid/Flexible SDM model.

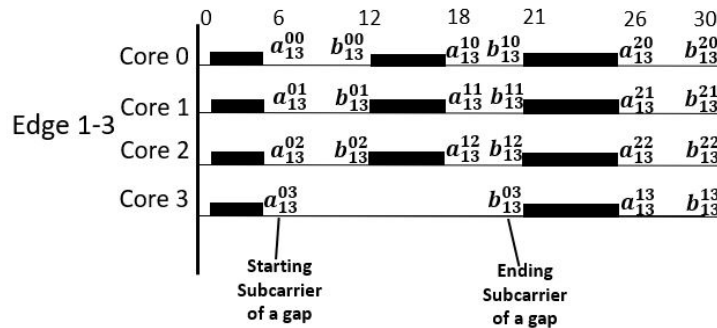

Figure 3.5: Concept of Gaps

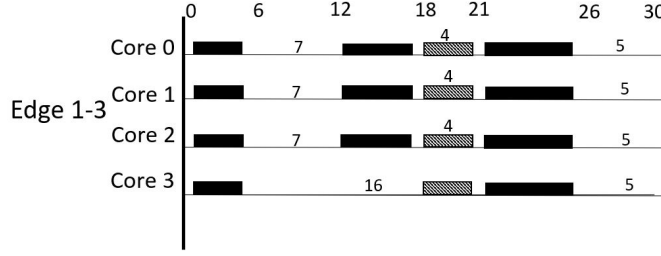

Figure 3.6: Bandwidth allocation in gaps

If a new communication uses edge $i \rightarrow j$, the spectrum allotted to the new communication must be within the bandwidths shown in Figure 3.6. We call these permissible bandwidths the gaps on edge $(i \rightarrow j)$. The situation described in Figure 3.5, there are 3 gaps available on core 0, where gap 0 has a starting subcarrier $a_{13}^{00} = 6$, ending subcarrier $b_{13}^{00} = 12$ and the available spectrum is $12 - 6 + 1 = 7$. Similarly gap 1 has a starting subcarrier as $a_{13}^{10} = 18$, ending subcarrier $b_{13}^{10} = 21$ and available spectrum is 4, and gap 2 has a starting subcarrier as $a_{13}^{20} = 26$, ending subcarrier $b_{13}^{20} = 30$ and available spectrum is 5. Similarly, the gaps are calculated on all the cores. On the basis of bandwidth required, gaps/spectrum are been allocated. For example, considering required bandwidth is 15, the most appropriate spectrum is presented with grey portion in Figure 3.6 because the gaps used in the spectrum are $(4 + 4 + 4 + 4 = 16)$. For the other spectrum, the gaps are comparatively bigger which will decrease the continuous unused subcarriers on cores, may result in blocking the future communication.

3.6 Notations used in the ILP

In this section we outline the notations used to formulate our proposed algorithm.

N : set of end nodes in the physical network topology.

E : set of bidirectional edges (links) in the network.

C : number of cores per fiber.

S : the set of data center location (data source) if considering data center networks.

Q : set of existing communications (since we consider the dynamic traffic case).

g : a gap of core $c \in C$ on edge $(i, j) \in E$.

G : set of Gaps of all the cores $\forall c \in C$ on all the edges $\forall (i, j) \in E$.

$s(d)$: source(destination) of the new request for the communication.

B : required bandwidth by the new request (number of subcarrier needed).

ε : a small positive number, $0 < \varepsilon < 1$.

M : a large number.

a_{ij}^{gc} : a constant for all gap $g \in G$, core $c \in C$ and edge $(i, j) \in E$ that represent the starting subcarrier of the g^{th} gap of core c on edge (i, j) .

b_{ij}^{gc} : a constant for all gap $g \in G$, core $c \in C$ and edge $(i, j) \in E$ that represent the ending subcarrier of the g^{th} gap of core c on edge (i, j) .

x_{ij} : a binary variable for all edge $(i, j) \in E$ where $x_{ij} = 1$ the new request uses edges (i, j) ; 0 otherwise.

z_{ij}^{gc} a binary variable for all gap $g \in G$, core $c \in C$ and edge $(i, j) \in E$ where $x_{ij}^{gc} = 1$ if gap g of core c on edge (i, j) is used by the new request; 0 otherwise.

f_{ij}^{gc} a continuous variable for all gap $g \in G$, core $c \in C$ and edge $(i \rightarrow j) \in E$

θ : an continuous variable representing the starting subcarrier number of the new request.

ϕ : an continuous variable representing the ending subcarrier number of the new request.

3.7 Formulation of ILP for optimal solution

The model Flex-grid/Flexible is proposed in [14] presents the full spectral and spatial flexibility in forming super-channels. We demonstrate the model with ILP which determines the path for the primary communication scheme, such that the total spectrum needed is as low as possible. In the description below with objective function and set of constraints, with the constraint number for setting up the primary path for the new request arrived.

Objective Function:

$$\text{minimize } \phi - \theta + 1 + \varepsilon \sum_{e:i \rightarrow j \in E} x_{ij} \text{ where } 0 < \varepsilon < 1 \quad (3.1)$$

Subject to:

1. Flow balance equation:

$$\sum_{e:i \rightarrow j \in E} x_{ij} - \sum_{e:j \leftarrow i \in E} x_{ji} = \begin{cases} 1, & \text{if } i = s, \\ -1, & \text{if } i = d, \\ 0, & \text{otherwise.} \end{cases} \quad \forall i \in N \quad (3.2)$$

2. At most one gap of one core must be used for the new request

$$\sum_{g \in G} z_{ij}^{gc} \leq x_{ij}, \quad \forall i, j \in E, c \in C \quad (3.3)$$

3. At least one gap on edge must be used for the new request

$$\sum_{g \in G} \sum_{c \in C} z_{ij}^{gc} \geq x_{ij}, \quad \forall i, j \in E \quad (3.4)$$

4. The starting subcarrier of the new request must be greater than or equal to the starting subcarrier of the g^{th} gap of the core c on edge (i, j)

$$\theta \geq a_{ij}^{gc} \cdot z_{ij}^{gc} \quad \forall (i, j) \in E, c \in C, g \in G \quad (3.5)$$

5. The ending subcarrier of the new request must be less than or equal to the ending subcarrier of the g^{th} gap of the core c on edge (i, j)

$$\phi \leq b_{ij}^{gc} + M \cdot (1 - z_{ij}^{gc}) \quad \forall (i, j) \in E, c \in C, g \in G \quad (3.6)$$

6. The total number of subcarriers on all gaps and cores used must be greater than or equal to the required bandwidth

$$\sum_{g \in G} \sum_{c \in C} (\phi - \theta + 1) z_{ij}^{gc} \geq B \cdot x_{ij} \quad \forall i, j \in E \quad (3.7)$$

To linearize the constraint, assume $f_{ij}^{gc} = (\phi - \theta + 1) z_{ij}^{gc}$; where $f_{ij}^{gc} \geq 0$:

$$\sum_{g \in G} \sum_{c \in C} f_{ij}^{gc} \geq B \cdot x_{ij} \quad \forall i, j \in E \quad (3.8)$$

$$f_{ij}^{gc} \leq \phi - \theta + 1 \quad \forall i, j \in E, c \in C, g \in G \quad (3.9)$$

$$f_{ij}^{gc} \leq M \cdot z_{ij}^{gc} \quad \forall i, j \in E, c \in C, g \in G \quad (3.10)$$

$$f_{ij}^{gc} \geq (\phi - \theta + 1) - M \cdot (1 - z_{ij}^{gc}) \quad \forall i, j \in E, c \in C, g \in G \quad (3.11)$$

3.8 Justification of ILP

While establishing the primary communication for the request, the objective is to minimize the total number of resources used for the allocation of the connection by reducing the sum of the frequency subcarriers used for the primary communication and find the optimal path among the possible path for the communication. Thus, the minimal number of

frequency subcarriers are used. It is calculated by $\phi - \theta + 1$ for the communication and shortest path 1% probability is given to the primary edges used. Constraint 3.1 represents the objective function of the formulation.

Constraint 3.2 corresponds to the Flow Conservation equation for the new primary communication request to be established where x_{ij} is a binary value (0/1). It becomes 1 if the link $(i \rightarrow j) \in E$ is used by the new primary communication request; otherwise the $x_{ij} = 0$.

Constraint 3.3 represents that at most one gap of one core must be used by the new request where $x_{ij} = 1$. The z_{ij}^{gc} is 1 if the gap of the particular core on edge is used for the new request; otherwise, the z_{ij}^{gc} is 0.

Constraint 3.4 depicts that if the $x_{ij} = 1$ then at least one gap should be used on edge, whereas Constraint 3.3 presents that its not mandatory that each gap on each of the core should be used; anyone gap $g \in G$ should be used on the used edge $(i \rightarrow j)$, $\forall (i \rightarrow j) \in E$ for the new request.

To determine the starting subcarrier for the used gap on the core of the edge for the new request, the Constraint 3.5 states that the starting subcarrier frequency θ of the new primary communication must be greater than or equal to the starting subcarrier of the $g \in G$ of the $c \in C$ on $(i \rightarrow j)$, $\forall (i \rightarrow j) \in E$. When the $z_{ij}^{gc} = 1$ then the starting subcarrier a_{ij}^{gc} for the particular gap of the core on edge is used; otherwise, the RHS of the Constraint is 0.

Similarly, for the ending subcarrier for the used gap on the core of the edge for the new request, the Constraint 3.6 presents that the ending subcarrier frequency ϕ of the new primary communication must be less than or equal to the ending subcarrier of the $g \in G$ of the $c \in C$ on the $(i \rightarrow j)$, $\forall (i \rightarrow j) \in E$. When the $z_{ij}^{gc} = 1$ then the ending subcarrier b_{ij}^{gc} for the particular gap of the core on edge is used where the RHS of the Constraint is b_{ij}^{gc} ; otherwise, the RHS is a large number M .

The last Constraint 3.7 determines to the total number of subcarriers on all the gaps used $\forall g \in G$ on the cores $\forall c \in C$ of the edges $\forall (i \rightarrow j) \in E$ must be greater than or equal to the

required bandwidth B . When z_{ij}^{gc} and x_{ij}^{gc} becomes 1, then the total number of subcarriers on each used gap of the cores on the edges is calculated.

As the Constraint 3.7 is non-linear, to linearize the Constraint 3.8, 3.9, 3.10 and 3.11 are used. Constraint 3.8 replaces the non-linear part with a integer variable f_{ij}^{gc} .

3.9 Example of our Approach

Consider a six-node topology with 8 bidirectional edges with distance posses 4 cores and 30 frequency subcarriers on each core, and a virtual node 0 as shown in Figure 3.1 where node 1 and 4 are the data center nodes. For this problem, let's consider node 5 as the requesting node with the required bandwidth 11.

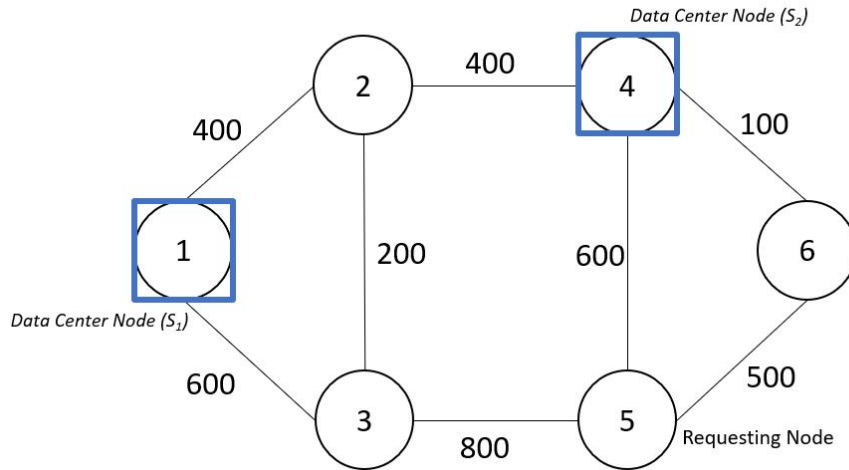

Figure 3.7: Six-node topology with Distance

Our approach will find an optimal path from the data center node $\{1, 4\}$ to the requesting node 5. In our case, from both the data center nodes it has to use two edges (i.e., $1 \rightarrow 3 \rightarrow 5$ or $4 \rightarrow 6 \rightarrow 5$ or $4 \rightarrow 5$) to reach the destination node. The ILP chooses the optimal path depending upon the total number of resource available spectrally or spatially. For instance, ILP picks the route $1 \rightarrow 3 \rightarrow 5$ assuming other two possible paths are occupied by other

existing communication.

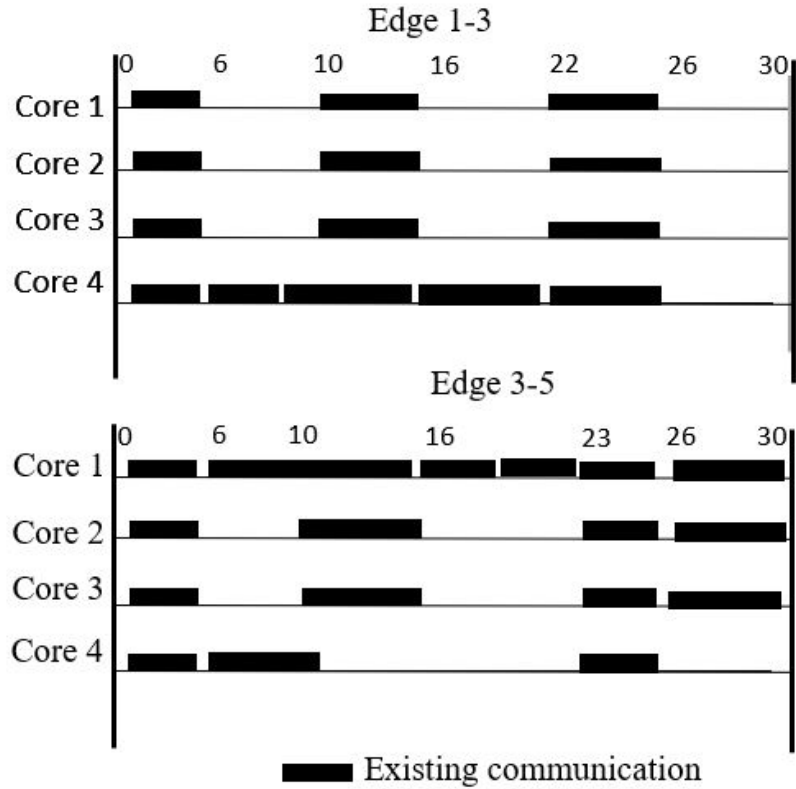

Figure 3.8: Before allocation of the new request

Figure 3.8 shows the on-going communication on edge $1 \rightarrow 3$ and $3 \rightarrow 5$. The next step is to calculate the unused frequency subcarriers (i.e., gaps) available on each core of the edge. Figure 3.9 calculates the unused resources on each core of edge by taking the difference of the ending subcarrier of the gap and the starting subcarrier of the gap as calculated before in Figure 3.5. As shown in Figure 3.9 on core 1 of the edge $1 \rightarrow 3$, $9 - 6 + 1 = 4$ frequency subcarriers are available on Gap 0, 6 subcarriers on Gap 2 and 5 subcarriers on Gap 3. Similarly, it is calculated on all the core of the edge $1 \rightarrow 3$ and cores of edge $3 \rightarrow 5$.

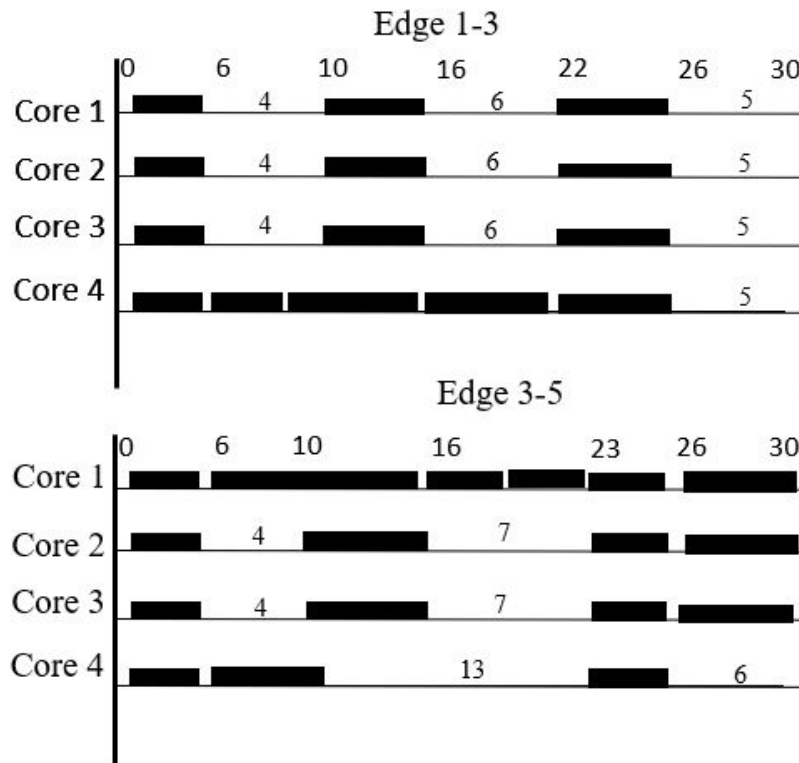

Figure 3.9: Calculating gaps

After calculation of gaps, the possible allocation of the bandwidth on the edges is shown in Figure 3.10. For the allocation of the new request, it's mandatory that all the frequency blocks used should be on the same spectrum. In the Figure 3.10, the black blocks depicts the ongoing communication, the dotted blocks shows the feasible solution for the allocation as they make greater than or equal to 11 slots in the same spectrum which is our required bandwidth, and the shaded lined blocks shows infeasible option as in the same spectrum the available frequency subcarriers are less than 11 or the same spectrum slots is not available on the other edge (As shown in Figure 3.10, we have 12 subcarriers on edge $1 \rightarrow 3$ from subcarrier 6 to subcarrier 9 but we do not have enough subcarrier on edge $3 \rightarrow 5$). If their are multiple feasible options, then ILP will choose the optimal option out of them.

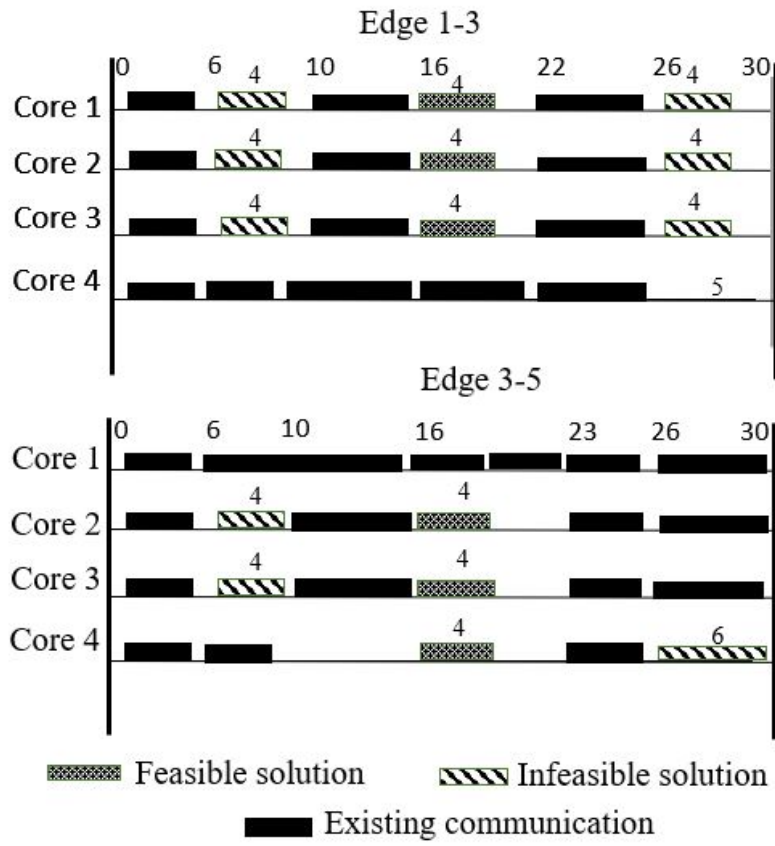

Figure 3.10: Possible allocation

As shown in the Figure 3.10 the possible allocation on edge $1 \rightarrow 3$ are 3 whereas on edge $3 \rightarrow 5$ only 1. When the new request uses two or more edges for the allocation, the value of starting subcarrier and the ending subcarrier remains the same (i.e., same spectrum); it minimizes the number of subcarriers on core. Therefore, in our example, it will use the blocks with 4 frequency slots on core 1, core 2 and core 3 on edge $1 \rightarrow 3$ and on core 2, core 3 and core 4 on edge, $3 \rightarrow 5$ as shown in Figure 3.11.

In Flex-grid/Flexible model, the different cores are used when the new request uses two or more edges for the allocation. The number of subcarriers used for the allocation of the new request is $(4 + 4 + 4) = 12$. Therefore, there is 1 unused slot for this communication.

While the allocation of the request, the ILP choose either the right-most gaps or the

left-most gaps, to achieve maximum continuous gaps for future new requests.

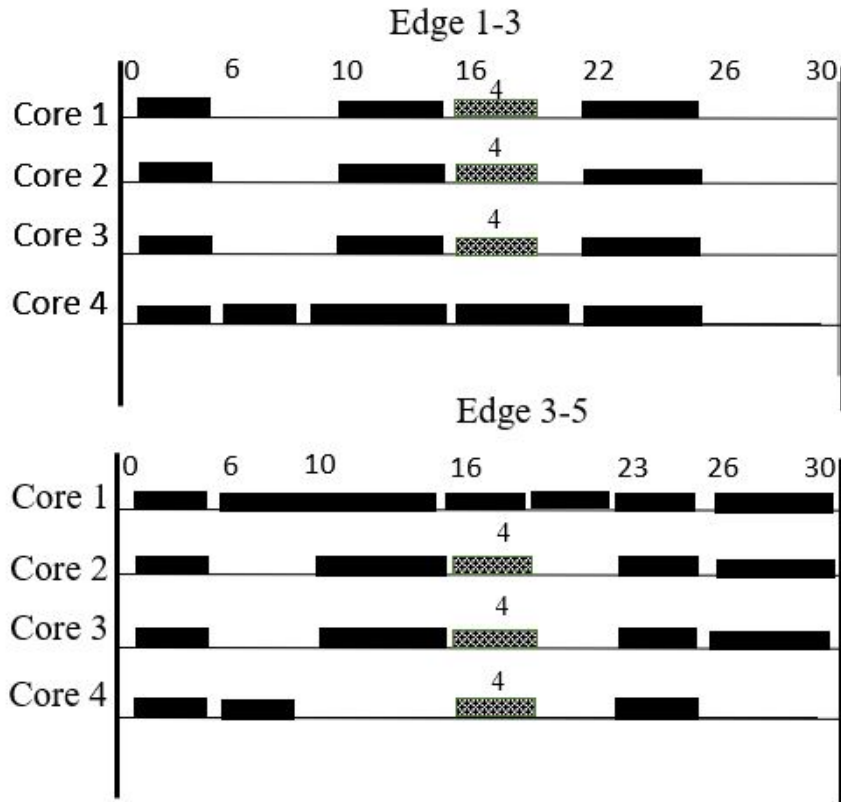

Figure 3.11: Allocation of the new request

While connection establishment of the path, our approach keeps the record of the used resources for the allocation of the path. As the teardown request emerges at different times, the used resources are freed up.

Total distance between edge $1 \rightarrow 3$ and edge $3 \rightarrow 5$ is $600km + 800km = 1400km$. Therefore, 8-QAM modulation format is suitable for this optical reach which has a spectral efficiency of 3 bps/Hz. Here, the number of subcarriers used on each core of the edge is 4. Hence, after modulation format, the subcarrier used on each core will be $(4/3) = 1.34$, so it will use 2 subcarriers on each core of the edge. The allocation of the new request is shown in Figure 3.12 using modulation format.

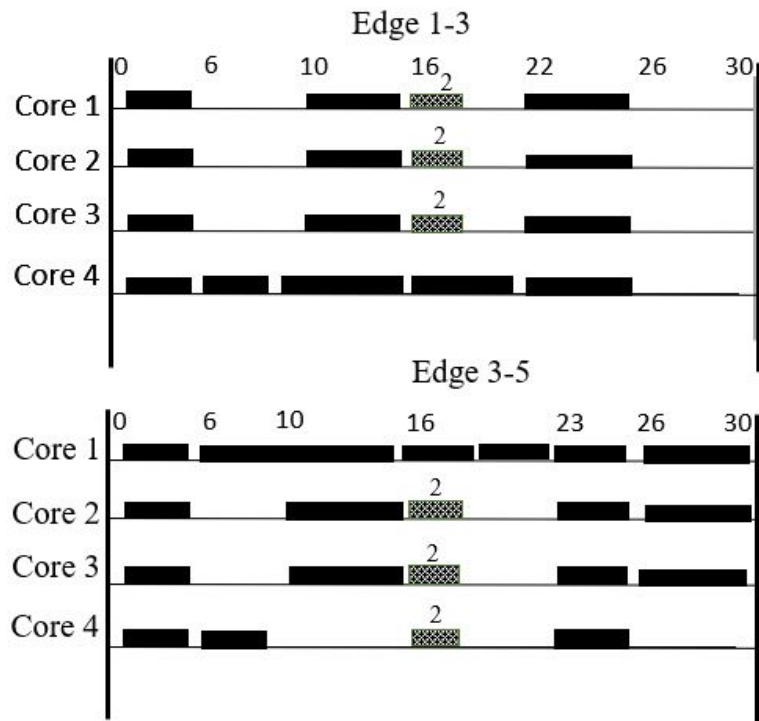

Figure 3.12: Resource allocation using Modulation Format

Chapter 4

SIMULATION AND RESULTS

4.1 Simulation

To study and analyze the performance of an algorithm, the efficient technique in computer networking for a problem is the simulation. With a network simulator, it is not necessary to deploy a network physically. The ILP formulation presented in Chapter 3 generates an optimal solution for the Flexgrid/Flexible model which can be a benchmark for the other heuristic approaches. The primary objective of studying the simulation is to evaluate the proposed ILP formulation.

We have performed several simulations to study the ILP formulation with use of three network topologies - an 8-Node network [2], an 11-Node network (the COST239 network) [41], and a 14-Node network (the NSFnet) [42]. A bi-directional optical fiber with multiple cores, connecting two nodes x and y , is denoted by an edge, $x \rightarrow y$ in the physical topology. For each such network link containing multiple cores, available spectral on each core are divided into fixed slices or slots, where each slice may be used by a subcarrier having the corresponding carrier wavelength. We carried out simulations with multiple rates of data traffic, and compared the resource utilization and blocking probability with the Flexgrid/Fixed model proposed in [2]. Each communication request, is specified by a requesting node (i.e., destination node) and the required bandwidth to serve the communication request.

The important metrics for our thesis are as follows:

- Resource utilization, defined as the number of subcarriers used for allocating the set of communication requests, and,

- Blocking probability, known as the percentage of the number of communication requests which could not be handled by the network (due to lack of spectral and spatial resources) to the total number of requests for communication.

4.1.1 Simulation Setup

The objective of the ILP described in Chapter 3 is to find an optimal solution for handling the requests for communication. Hence, for a new request, the ILP determines

- an optimal primary path used for communication in the network,
- a scheme to determine the cores and the range of subcarrier wavelengths that will be used for communication.

such that by minimizing the total number of spectrum used for a communication request.

For our simulations, we use a simulator, written in C, that uses the IBM ILOG CPLEX [43] to determine the route and spectrum allocated to each request, under various scenarios. A simplified flow diagram for the simulator is shown in Figure 4.1.

As shown in the Figure 4.1 the inputs to the simulator are as the following:

- a file containing a definition of the network topology, consisting of the list of nodes in the network, the list of edges in the network. Each edge represents a bidirectional fiber link and is characterized by the length of the link.
- a file defining the data centers. It identifies which nodes are being used as data centers and assumes that each data center contains a replica of all the information required.
- a file containing the spectrum and other information giving the number of sub-carriers per fiber and the number of cores in each fiber.

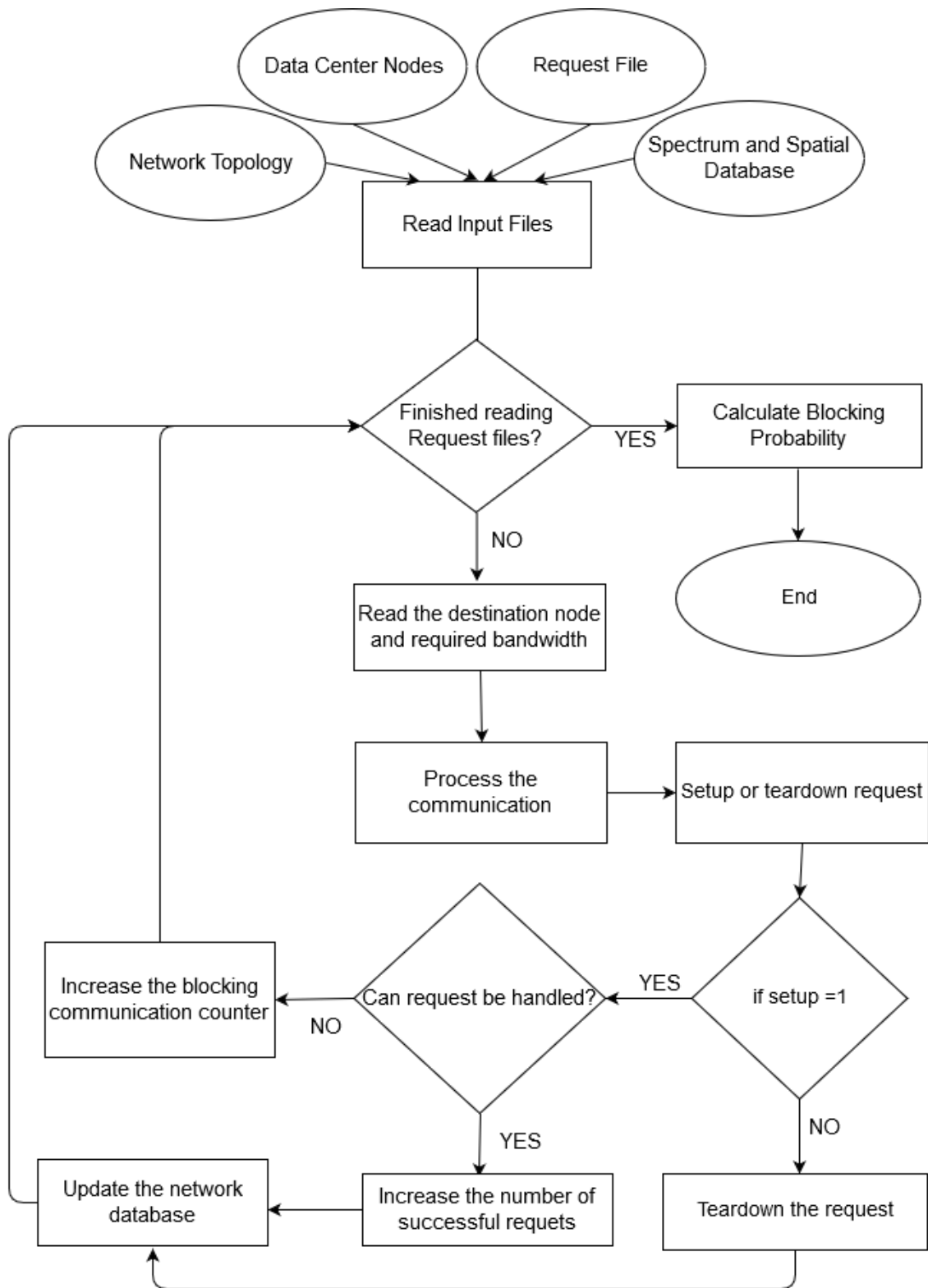

Figure 4.1: Flow diagram for simulation setup

- A file containing a set of requests, each request consists of the destination node and the required data rate for communication, specified by the number of sub-carriers needed.

The simulator maintains an internal database that includes the information in the files mentioned above. The internal database also contains the current network state – defined by the spectrum used on each core of each fiber in the network. When the simulator starts, the network is empty in the sense that no spectrum is initially allotted to any communication. When a new request for communication is processed, and resources are available to handle the request, the network state is updated to include the spectrum resources allotted to set up the spectrums that must be reserved to handle the new request.

The first step (shown in the first block) of our simulator reads the first four input files. Then the simulator enters into a loop that iterates until all the requests in the demands file have been considered (condition for continuing the loop is shown in the second block). In each iteration of this loop, the simulator

1. reads the next request for the demands file.
2. generates constraints for our ILP to solve to handle the request currently being considered. These constraints consider the network state, and the current request and are saved in a file of type lp.
3. invokes the CPLEX ILP solver. The solver reads the .lp file and attempts to find, if possible, an optimal solution for the problem.
4. The solver will check whether the lightpath is to be generated or torn down.
 - (a) If the lightpath is to be generated, then the solver can find a solution for the lightpath, and the output generated by the solver is a file that gives

- a primary path that is used for communication in the network,
- a scheme to determine the subcarrier wavelengths and the cores that will be used for communication. The assignment of subcarriers is determined by the spectral efficiency of the modulation formats (16-QAM, 8-QAM, QPSK, BPSK) and the optical reach for each of these formats.

The simulator reads the file generated by the CPLEX solver, updates the network state and increments the number of successful requests and increments the total number of resources utilized by request.

- (b) If the lightpath is to be torn down the solver finds the resources used by the lightpath and releases (i.e., frees) those resources.

5. If the solver is unable to find a solution, the simulator increments the number of blocked requests.

When all the requests have been processed, the simulator exits the iterative process described above. The simulator calculates the blocking probability by computing the ratio between the number of blocked requests to the total number of requests provided for the simulation.

4.1.2 Topology Used for Simulation

The topologies we used for the performing simulations to study the behavior of Flexgrid/Flexible and Flexgrid/Fixed models are:

1. a 8-Node network,

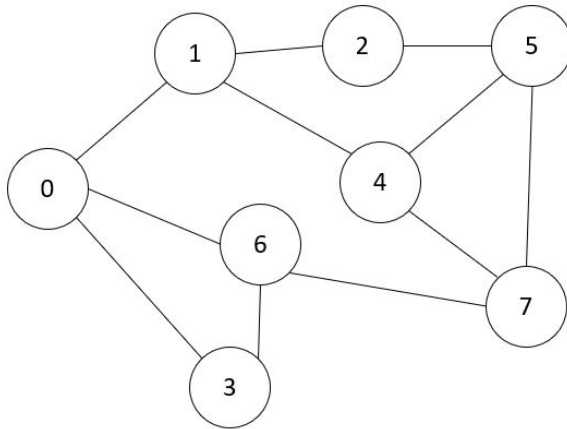

Figure 4.2: 8-Node network [2]

2. the COST239 network,

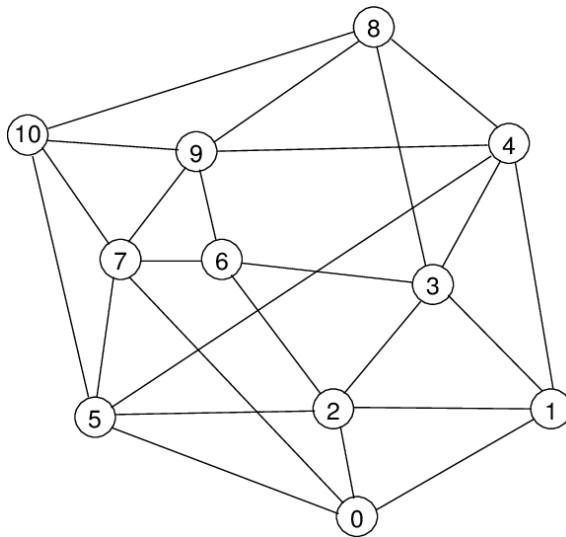

Figure 4.3: COST239 Network [41]

3. the NSFnet network.

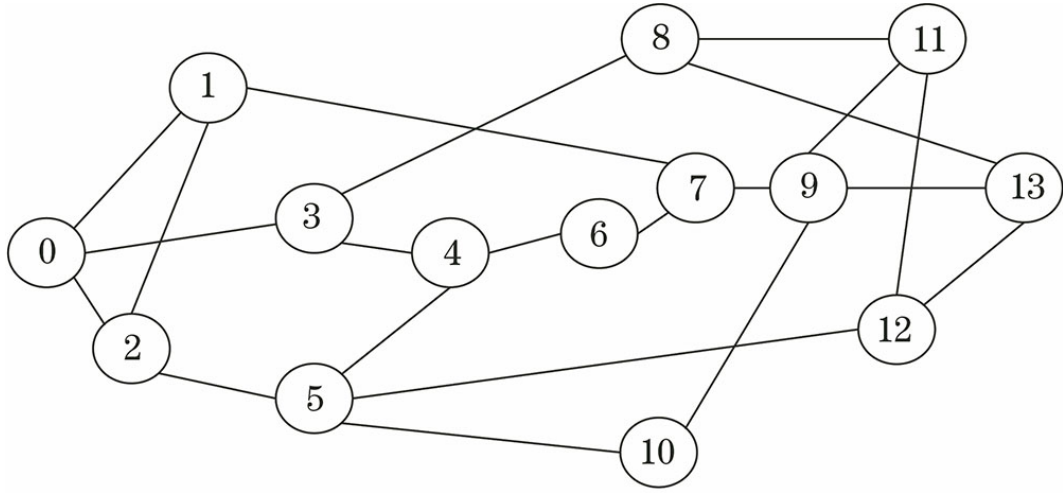

Figure 4.4: NSFnet Network [42]

4.2 Performance Study

We present the simulation results in this section. We studied how the performance of the algorithm varies with multiple rates of traffic, the increase in the number of requests and the increase in the number of cores. The simulation was carried out on an 8-node network, the COST239 network (a European network with 11 nodes), NSFnet (a 14-node network in the US). The simulation is done for 50 requests, 70 requests and 90 requests for each specified network topology. Each value in the graphs shown below is based on the average values which we got after running a particular size of request file five times, each time with different request files. We analyzed the blocking probability and resource utilization as the network size increased, the number of cores per fiber link increased and the number of requests increased.

4.2.1 Blocking Probability and Resource Utilization vs Traffic Load

These simulations were performed for different levels of traffic load, with bandwidth requirements per request ranging from 10 to 50 subcarriers (for low traffic), 10 to 100 subcarriers (for medium traffic) and 50 to 100 subcarriers (for high traffic) with 4-Cores per fiber link each of them having 60 subcarriers and 50 demands.

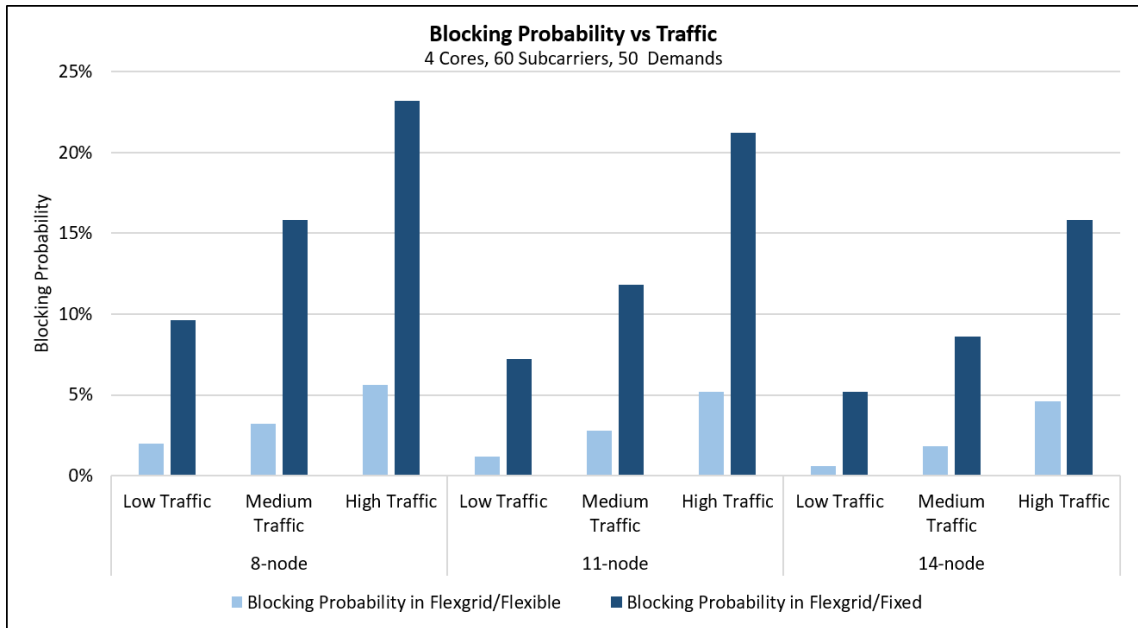

Figure 4.5: Blocking Probability in Flexgrid/Flexible and Flexgrid/Fixed for multiple data rate of traffic

- Figure 4.5 shows that the blocking probability for both approaches increases with the increase in data rate traffic. But, the blocking probability for the proposed Flexgrid/Flexible model is consistently lower than the Flexgrid/Fixed model.
- Figure 4.6 shows that, as expected, the resources used in the network increases with traffic load for both models. We note that the resources utilized in our approach are comparatively more than the Flexgrid/Fixed model. This is because

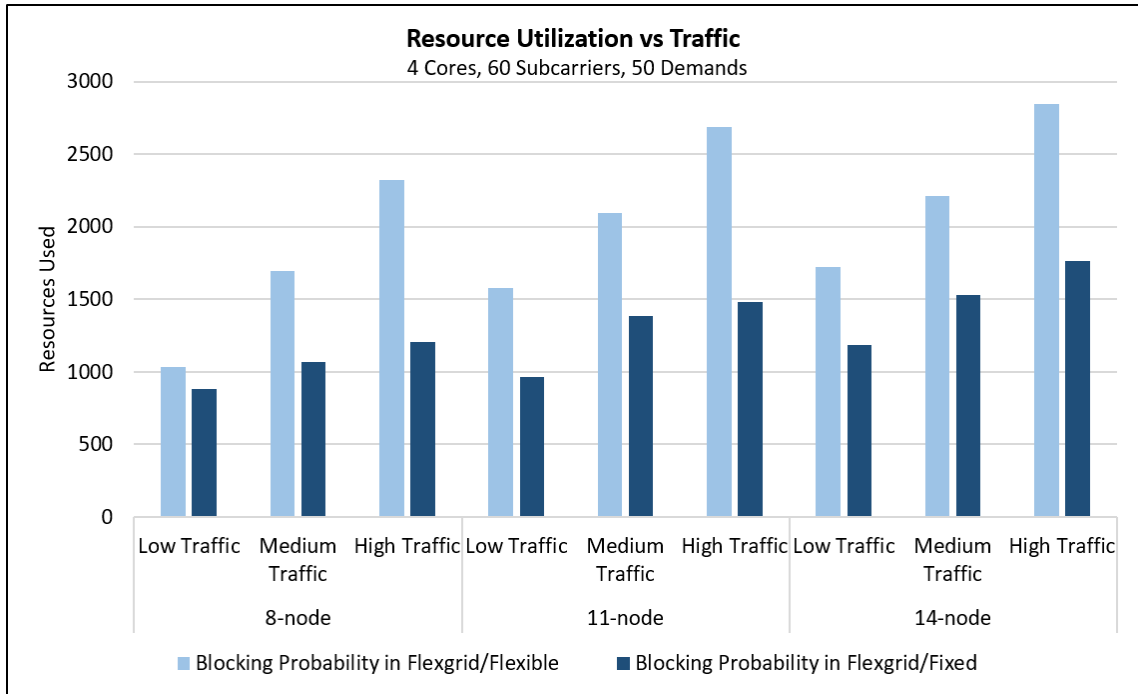

Figure 4.6: Resource Utilization in Flexgrid/Flexible and Flexgrid/Fixed for multiple data rate of traffic

the proposed approach is able to handle more requests, with the same amount of total available resources, so the actual resource utilization is higher.

4.2.2 Blocking Probability vs Number of Cores

In this section, we report the blocking probability when the number of available cores per fiber link is changed. We assume each core can accommodate 60 subcarriers, and the traffic load is set to 70 requests, each requiring from 10 to 100 subcarriers (i.e., medium traffic).

- The blocking probability decreases with the increase in the number of cores, thus enabling the availability of more resources to accommodate more requests as observed in Figure 4.7. In many cases, all requests could be handled in Flexgrid/Flexible model with 14-node topology having 9-Cores per fiber link. The non-zero values of blocking probability in Figure 4.7 arises because some

of the simulation runs used in calculating the average resulted in a few blocked requests.

- The blocking probability of the Flexgrid/Fixed model is higher than our approach as shown in Figure 4.7.

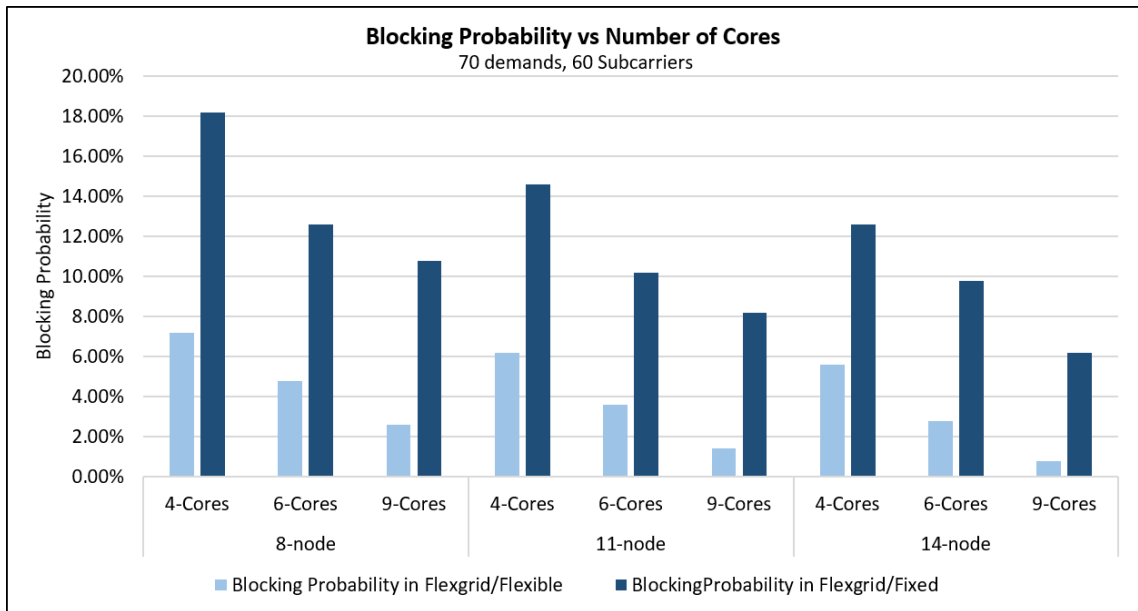

Figure 4.7: Blocking Probability vs Number of Cores

4.2.3 Blocking Probability vs Number of Requests

In this simulation we varied the number of requests in each demand set and considered demand sets with 50, 70 and 90 requests. Each fiber link consisted of 4-Cores, with each of them having 60 subcarriers.

- The blocking probability increases as the number of demands increases as observed in Figure 4.8 the blocking probability for the Flexgrid/Flexible model is lower than the Flexgrid/Fixed model.

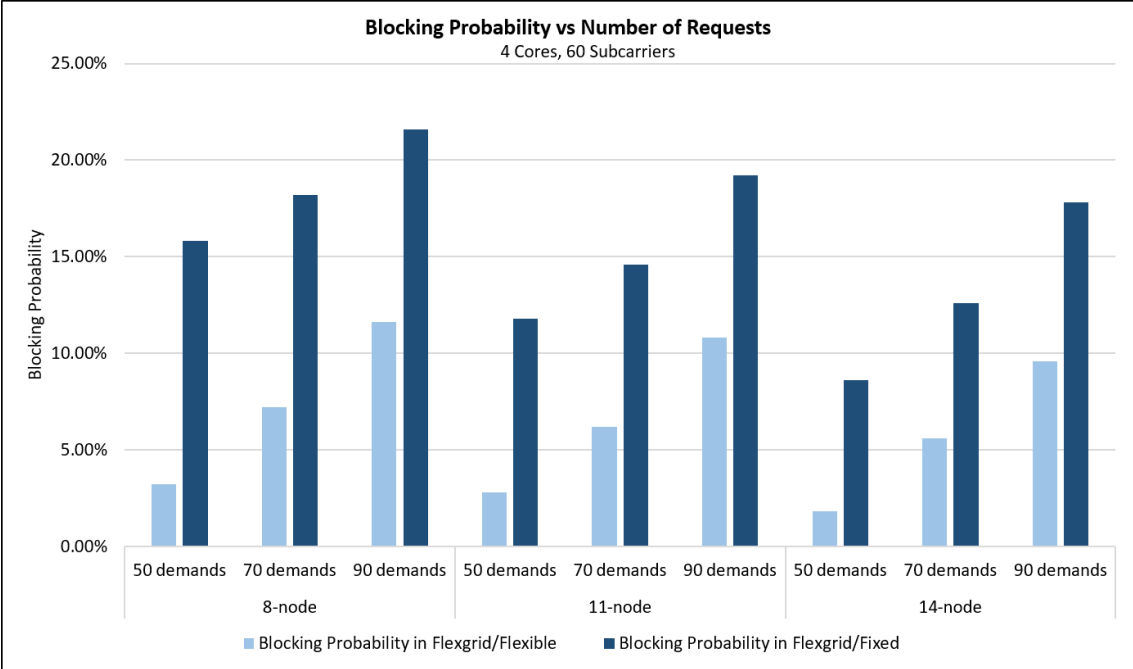

Figure 4.8: Blocking Probability vs Number of Requests

Chapter 5

CONCLUSIONS AND FUTURE WORK

5.1 Conclusions

In our work, we studied an optimal routing and spectrum assignment algorithm for allocating resources in a data center network using Space Division Multiplexing. Our approach presents the utilization of the resources by forming full spectral and spatial flexible superchannels. We find the optimal path between the data center node and the requesting node. As we applied SDM technology enabling us to use multiple cores for data transmission, the approach finds the range of subcarriers used on cores by required bandwidth. Our main objective is to minimize resource usage and improve the spectral efficiency (i.e., the number of subcarriers used for communication). The modulation format facilitates improvement in efficiency in determining the subcarriers required to carry out a requested communication. We compare our work with the Flexgrid/Fixed model presented in [2] and [14] with varying ranges of traffic, number of cores and number of requests. We conclude that our model can lead to lower blocking probability and more efficient use of resources compared to the Flexgrid/Fixed model.

5.2 Future Work

The possible future work for the thesis are as follows:

- We can develop techniques to handle defragmentation of spectrum in the Flexgrid/Flexible model, to improve spectrum utilization with the goal of reducing

the unusable spectrum gaps. As signals occupying the different number of slots are established and released over time, it generates spectrum gaps, making it difficult to allocate a certain number of contiguous slots to new signals. With defragmentation, we can achieve the optimum results for the model by rerouting and reallocating spectrum resources as needed.

- In the data center network, the frequent occurrences of human-made or natural disasters can be considered to make the network more robust. Under any circumstances of disaster or network failure, backup communication for the model can be determined to successfully re-route traffic around the failed nodes/links.

BIBLIOGRAPHY

- [1] S. Bandyopadhyay, *Dissemination of information in optical networks : from technology to algorithms*, ser. Texts in theoretical computer science. Berlin: Springer, 2008.
- [2] A. Biswas, *Robust Data Center Network Design using Space Division Multiplexing*. Scholarship at UWindsor, 2018.
- [3] K. Christodoulopoulos, I. Tomkos, and E. A. Varvarigos, “Elastic bandwidth allocation in flexible ofdm-based optical networks,” *Journal of Lightwave Technology*, vol. 29, no. 9, pp. 1354–1366, 2011.
- [4] A. Kodakanchi, “Energy aware routing in optical grid networks,” *Electronic Theses and Dissertations*, Jul. 2015. [Online]. Available: <https://scholar.uwindsor.ca/etd/5313>
- [5] M. Jinno, B. Kozicki, H. Takara, A. Watanabe, Y. Sone, T. Tanaka, and A. Hirano, “Distance-adaptive spectrum resource allocation in spectrum-sliced elastic optical path network [topics in optical communications],” *IEEE Communications Magazine*, vol. 48, no. 8, 2010.
- [6] M. Klinkowski, P. Lechowicz, and K. Walkowiak, “Survey of resource allocation schemes and algorithms in spectrally-spatially flexible optical networking,” *Optical Switching and Networking*, vol. 27, pp. 58–78, Jan. 2018. [Online]. Available: <http://www.sciencedirect.com/science/article/pii/S157342771730053X>
- [7] D. Richardson, J. Fini, and L. Nelson, “Space-division multiplexing in optical fibres,” *Nature Photonics*, vol. 7, no. 5, pp. 354–362, 2013.

- [8] Coriant, “Space division multiplexing: A new milestone in the evolution of fiber optic communication.” [Online]. Available: http://modegap.eu/wp-content/uploads/2013/12/coriant_whitepaper_sdm_121413.pdf
- [9] O. CNX, “Reflection, refraction, and dispersion.” [Online]. Available: <https://courses.lumenlearning.com/boundless-physics/chapter/reflection-refraction-and-dispersion/>
- [10] K. Walkowiak, *Modeling and Optimization of Cloud-Ready and Content-Oriented Networks*, ser. Studies in Systems, Decision and Control. Cham: Springer International Publishing, 2016, vol. 56. [Online]. Available: <http://link.springer.com/10.1007/978-3-319-30309-3>
- [11] SDxCentral, “What is the cloud.” [Online]. Available: <https://www.sdxcentral.com/cloud/definitions/what-is-cloud/>
- [12] M. Al-Fares, A. Loukissas, and A. Vahdat, “A scalable, commodity data center network architecture,” in *ACM SIGCOMM Computer Communication Review*, vol. 38, no. 4. ACM, 2008, pp. 63–74.
- [13] D. Klonidis, F. Cugini, O. Gerstel, M. Jinno, V. Lopez, E. Palkopoulou, M. Sekiya, D. Siracusa, G. Thouénon, and C. Betoule, “Spectrally and spatially flexible optical network planning and operations,” *IEEE Communications Magazine*, vol. 53, no. 2, pp. 69–78, 2015.
- [14] K. Walkowiak, P. Lechowicz, M. Klinkowski, and A. Sen, “Ilp modeling of flexgrid sdm optical networks,” in *Telecommunications Network Strategy and Planning Symposium (Networks), 2016 17th International*. IEEE, 2016, pp. 121–126.
- [15] G. Keiser, *Optical fiber communications*. Wiley Online Library, 2003.
- [16] R. Buyya, C. S. Yeo, S. Venugopal, J. Broberg, and I. Brandic, “Cloud computing and emerging it platforms: Vision, hype, and reality for delivering computing as the 5th

- utility,” *Future Generation computer systems*, vol. 25, no. 6, pp. 599–616, 2009.
- [17] Z. Zhu, S. J. B. Yoo, Z. Li, and N. Fontaine, “Optical networks in cloud computing [Guest Editorial],” *IEEE Network*, vol. 27, no. 6, pp. 4–5, Nov. 2013.
- [18] H. Yuan, C.-J. Kuo, and I. Ahmad, “Energy efficiency in data centers and cloud-based multimedia services: An overview and future directions,” in *International Conference on Green Computing*, Aug. 2010, pp. 375–382.
- [19] Cyberpedia, “What is data center: An overview of data centers.” [Online]. Available: <https://www.paloaltonetworks.com/cyberpedia/what-is-a-data-center>
- [20] S. B. Saja Al Mamoori, Arunita Jaekel, “Robust data center network design based on space division multiplexing,” in *Optical and Grid Computing, Accepted for publication 2018, International Conference on Computing, Network and Communications. ICNC*, 2014, pp. 1–4.
- [21] G. P. Agrawal, “Optical Communication: Its History and Recent Progress,” in *Optics in Our Time*, M. D. Al-Amri, M. El-Gomati, and M. S. Zubairy, Eds. Cham: Springer International Publishing, 2016, pp. 177–199. [Online]. Available: https://doi.org/10.1007/978-3-319-31903-2_8
- [22] I. G. Engineering360, “Wavelength Division Multiplexers (WDM) Information | Engineering360.” [Online]. Available: https://www.globalspec.com/learnmore/optics_optical_components/fiber_optics/fiber_optic_wavelength_division_multiplexers
- [23] S. Al Mamoori, *Resilient Resource Allocation Schemes in Optical Networks*. Scholarship at UWindsor, 2017.
- [24] A. Paul, Q. Rahman, S. Bandyopadhyay, and Y. P. Aneja, “An optimal and a heuristic algorithm for solving the route and spectrum allocation problem in OFDM

- networks,” *Photonic Network Communications*, vol. 30, no. 2, pp. 280–289, Oct. 2015. [Online]. Available: <https://doi.org/10.1007/s11107-015-0516-0>
- [25] J.-L. Izquierdo-Zaragoza, P. Pavon-Marino, and M.-V. Bueno-Delgado, “Distance-adaptive online rsa algorithms for heterogeneous flex-grid networks,” in *Optical Network Design and Modeling, 2014 International Conference on*. IEEE, 2014, pp. 204–209.
- [26] L. Velasco, A. Castro, M. Ruiz, and G. Junyent, “Solving Routing and Spectrum Allocation Related Optimization Problems: From Off-Line to In-Operation Flexgrid Network Planning,” *Journal of Lightwave Technology*, vol. 32, no. 16, pp. 2780–2795, Aug. 2014.
- [27] C. Carboni and G. Li, “Novel applications of space-division multiplexing,” *Frontiers of Optoelectronics*, vol. 9, no. 2, pp. 270–276, Jun. 2016. [Online]. Available: <https://doi.org/10.1007/s12200-016-0607-2>
- [28] Multicom, “Single mode vs. multi-mode fiber optic cable.” [Online]. Available: <https://www.multicominc.com/training/technical-resources/single-mode-vs-multi-mode-fiber-optic-cable/>
- [29] J. M. Simmons, “On determining the optimal optical reach for a long-haul network,” *Journal of Lightwave Technology*, vol. 23, no. 3, pp. 1039–1048, Mar. 2005.
- [30] A. Muhammad, G. Zervas, D. Simeonidou, and R. Forchheimer, “Routing, spectrum and core allocation in flexgrid sdm networks with multi-core fibers,” in *Optical Network Design and Modeling, 2014 International Conference on*. IEEE, 2014, pp. 192–197.
- [31] Y. Wang, X. Cao, and Q. Hu, “Routing and spectrum allocation in spectrum-sliced elastic optical path networks,” in *Communications (ICC), 2011 IEEE International*

- Conference on.* IEEE, 2011, pp. 1–5.
- [32] M. Jinno, H. Takara, and B. Kozicki, “Dynamic optical mesh networks: drivers, challenges and solutions for the future,” in *Optical Communication, 2009. ECOC’09. 35th European Conference on.* IEEE, 2009, pp. 1–4.
- [33] Y. Li, N. Hua, and X. Zheng, “Routing, wavelength and core allocation planning for multi-core fiber networks with MIMO-based crosstalk suppression,” in *2015 Opto-Electronics and Communications Conference (OECC)*, Jun. 2015, pp. 1–3.
- [34] J. Perell, J. M. Gen, A. Pags, J. A. Lazaro, and S. Spadaro, “Flex-grid/SDM backbone network design with inter-core XT-limited transmission reach,” *IEEE/OSA Journal of Optical Communications and Networking*, vol. 8, no. 8, pp. 540–552, Aug. 2016.
- [35] A. Muhammad, G. Zervas, and R. Forchheimer, “Resource Allocation for Space-Division Multiplexing: Optical White Box Versus Optical Black Box Networking,” *Journal of Lightwave Technology*, vol. 33, no. 23, pp. 4928–4941, Dec. 2015.
- [36] B. Shariati, P. S. Khodashenas, J. M. Rivas-Moscoso, S. Ben-Ezra, D. Klionidis, F. Jimnez, L. Velasco, and I. Tomkos, “Evaluation of the impact of different SDM switching strategies in a network planning scenario,” in *2016 Optical Fiber Communications Conference and Exhibition (OFC)*, Mar. 2016, pp. 1–3.
- [37] P. S. Khodashenas, J. M. Rivas-Moscoso, D. Siracusa, F. Pederzolli, B. Shariati, D. Klionidis, E. Salvadori, and I. Tomkos, “Comparison of Spectral and Spatial Super-Channel Allocation Schemes for SDM Networks,” *Journal of Lightwave Technology*, vol. 34, no. 11, pp. 2710–2716, Jun. 2016.
- [38] S. Fujii, Y. Hirota, H. Tode, and K. Murakami, “On-demand spectrum and core allocation for reducing crosstalk in multicore fibers in elastic optical networks,” *IEEE/OSA*

Journal of Optical Communications and Networking, vol. 6, no. 12, pp. 1059–1071, Dec. 2014.

- [39] H. Tode and Y. Hirota, “Routing, spectrum and core assignment for space division multiplexing elastic optical networks,” in *2014 16th International Telecommunications Network Strategy and Planning Symposium (Networks)*, Sep. 2014, pp. 1–7.
- [40] Y. Hirota, Y. Hatada, T. Watanabe, and H. Tode, “Dynamic spectrum allocation based on connection alignment for elastic optical networks,” in *2015 10th Asia-Pacific Symposium on Information and Telecommunication Technologies (APSITT)*, Aug. 2015, pp. 1–3.
- [41] W. He, J. Fang, and A. K. Somani, “A p-cycle based survivable design for dynamic traffic in WDM networks,” in *GLOBECOM '05. IEEE Global Telecommunications Conference, 2005.*, vol. 4, Nov. 2005, pp. 5 pp.–.
- [42] S. Shirazipourazad, C. Zhou, Z. Derakhshandeh, and A. Sen, “On routing and spectrum allocation in spectrum-sliced optical networks,” in *2013 Proceedings IEEE INFOCOM*, Apr. 2013, pp. 385–389.
- [43] IBM, “CPLEX Optimizer | IBM.” [Online]. Available: <https://www.ibm.com/analytics/cplex-optimizer>

VITA AUCTORIS

NAME: Dhruvi Patel

PLACE OF BIRTH: Gujarat, India

YEAR OF BIRTH: 1995

EDUCATION: The H. M. Patel English Medium School
Gujarat, India, 2012
Charotar University of Science and Technology
Gujarat, India, 2016
University of Windsor, M.Sc
Windsor, ON, 2018