

Fall 2018

# H.F. Hauff Electric Pruner Drive Train

Grady Graff  
graffg@cwu.edu

Follow this and additional works at: <https://digitalcommons.cwu.edu/undergradproj>

 Part of the [Applied Mechanics Commons](#), [Computer-Aided Engineering and Design Commons](#), and the [Other Mechanical Engineering Commons](#)

---

## Recommended Citation

Graff, Grady, "H.F. Hauff Electric Pruner Drive Train" (2018). *All Undergraduate Projects*. 76.  
<https://digitalcommons.cwu.edu/undergradproj/76>

This Undergraduate Project is brought to you for free and open access by the Undergraduate Student Projects at ScholarWorks@CWU. It has been accepted for inclusion in All Undergraduate Projects by an authorized administrator of ScholarWorks@CWU. For more information, please contact [pingfu@cwu.edu](mailto:pingfu@cwu.edu).

# H.F. Hauff Electric Pruner

## Drive Train



By

**Grady Graff**

Wyley Stewart  
Brian Woolery

<https://gradygraff.wixsite.com/electricpruner>

# Contents

Abstract .....	7
INTRODUCTION .....	8
Motivation:.....	8
Function Statement: .....	8
Function Statement (Drive Train):.....	8
Requirements: .....	8
Requirements (Drive Train):.....	8
Engineering Merit: .....	9
Success Criteria:.....	9
Scope of Effort:.....	9
DESIGN & ANALYSIS .....	10
Approach:.....	10
Innovation Methods: .....	10
Design Description: .....	10
Benchmark: .....	11
Tree-Lion: .....	11
H.F. Hauff Pruner 2016: .....	11
Performance Predictions: .....	12
Description of Analyses:.....	12
Self-Reversing Ball Screw Analysis:.....	12
Requirements:.....	12
Analysis: .....	12
Design Parameters:.....	14
Documentation: .....	14
Drill Torque: .....	14
Ball Nut Analysis:.....	14
Press Fit Cover Analysis:.....	15
Adapter Tube Analysis: .....	15
Adapter Analysis:.....	15
Pin Analysis: .....	16
Drive Shaft Analysis: .....	16
Device: .....	17
Tolerances: .....	17

Technical Risks Analysis:.....	17
Safety Factors: .....	18
METHODS & CONSTRUCTION .....	19
Construction Description: .....	19
Self-Reversing Threaded Shaft:.....	19
Ball Nut:.....	19
Press Fit Cover:.....	19
Adapter Tube: .....	19
Adapter: .....	20
Drive Shaft:.....	20
Manufacturing issues: .....	20
Self-Reversing Threaded Shaft:.....	20
Ball Nut:.....	20
Press Fit Cover:.....	21
Adapter Tube: .....	21
Adapter: .....	21
Drive Shaft:.....	21
Assembly: .....	22
Assembly Issues:.....	22
Benchmark Comparison: .....	22
Body Design: .....	22
Drive Train Design:.....	23
TESTING METHOD .....	24
Efficiency Test Plan:.....	24
Efficiency Test Documentation and Deliverables: .....	24
Weight Test Plan:.....	24
Weight Test Documentation and Deliverables: .....	24
Duty Cycle Test Plan (Lead Screw): .....	24
Duty Cycle Documentation and Deliverables (Lead Screw):.....	25
General Testing Plan (Lead Screw): .....	25
General Testing Documentation and Deliverables (Lead Screw): .....	25
Movement with Force Test Plan:.....	25
Movement with Force Documentation and Deliverables: .....	26
PROJECT MANAGEMENT .....	27

Cost and Budget:.....	27
Cost and Budget Changes: .....	27
Schedule:.....	27
Schedule Revisions: .....	28
Physical Resources: .....	28
Software Resources:.....	28
Human Resources: .....	28
Management:.....	29
Safety: .....	29
DISCUSSION.....	29
Design Evolution: .....	29
Project Risk:.....	29
Next Phase: .....	30
CONCLUSION.....	30
ACKNOWLEDGEMENTS.....	30
H.F. Hauff Company: .....	30
Central Washington University: .....	31
Dr. Craig Johnson: .....	31
Charles Pringle:.....	31
Matt Burvee: .....	31
Tedman Bramble:.....	31
Chris Scarlett:.....	31
Roger Beardsley:.....	31
Appendix A – Innovation Ideas .....	32
A1: Chain.....	32
A2: Cam.....	32
A3: Ball Screw .....	33
A4: Self-Reversing Ball Screw .....	33
A5: Decision Matrix .....	34
Appendix B - Benchmark .....	35
B1: Tree-Lion: .....	35
B2: 2016 H.F Hauff Electric Pruner: .....	35
APPENDIX C – ANALYSIS .....	36
C1: Power Efficiency Transfer .....	36

C2: Drill Torque.....	38
C3: Self-Reversing Threaded Shaft .....	39
C4: Ball Nut .....	40
C5: Adapter Tube.....	44
C6: Adapter.....	47
C7: Pin .....	49
C8: Drive Shaft .....	50
C9: Pin Connector.....	54
C10: Press Fit Cover .....	55
APPENDIX D - Drawings .....	56
Drawing Tree: .....	56
D1: Self-Reversing Threaded Shaft .....	57
D2: Ball Nut.....	58
D3: Press Fit Cover.....	59
D4: Adapter Tube .....	60
D5: Adapter.....	61
D6: Drive Shaft.....	62
D7: Pin .....	62
D8: O-Rings .....	64
D9: Welding.....	65
D10: Drive Train Assembly.....	66
APPENDIX E – Job Travelers/Setup Sheets .....	67
E1: Self-Reversing Threaded Shaft: .....	67
E2: Ball Nut .....	68
E3: Press Fit Cover .....	69
E4: Adapter Tube.....	70
E5: Adapter .....	71
E6: Drive Shaft .....	72
APPENDIX F – Parts List and Costs.....	73
Appendix G – Schedule .....	74
Fall Quarter: .....	74
Winter Quarter: .....	74
Spring Quarter:.....	76
APPENDIX H – Efficiency Test .....	77

APPENDIX I – Weight/Fitting Test .....	79
APPENDIX J – Movement with Force Test.....	81
APPENDIX K – Assembly.....	85
APPENDIX L – Resume .....	87

## Abstract

The H.F. Hauff Company invests a large amount of money in developing a quality pruner used in everyday agriculture. Modern electric pruners tend to be expensive while manual tree pruning is very physically demanding. A battery assisted pruner that is light-weight, ergonomic, inexpensive to build and powerful enough to cut branches that a nominal apple tree would possess is the direct affiliation that H.F. Hauff devotes its funding too. A team of engineering students from Central Washington University developed a product with consideration to each of these circumstances. Since hand drills have proven to be user friendly and of abundance in the agricultural industries due to the nature of machinery, the pruner is an attachment to a hand drill. An innovative self-reversing ball screw converts the rotational energy to linear energy driving the cutting blade utilizing a power efficiency of 90% and allows the drive train to reciprocate providing an unassisted return of the blade to the open position. Calculations prove that the average torque of a common drill nears 450 inch-pounds of torque fostering a linear force of nearly 1000 pounds. This Linear force satisfies the testing needed to cut a 1.5 inch branch which commonly occurs on the average apple tree. The pruner assembly costs \$300 for material and manufactures using tool commonly found in industry keeping the price under \$500 compared to competitive electric pruners upwards of \$1000.

**Keywords:** ergonomic, inexpensive, efficiency, unassisted



# INTRODUCTION

## Motivation:

Eastern Washington is a major farming area that is growing very rapidly and one of its main products is the produce, apples to be specific. H.F. Hauff Company Inc. is a company out of Yakima making chemical wind machines used in apple orchards and innovating agricultural machinery. The combination of Washington being home to the apple capital of the world and H.F. Hauff Co Inc.'s agricultural innovations, the motivation of this project is to design and build a convenient electric pruning device that exceeds the cutting potential of the devices used today. An average orchard contains thousands of trees and to keep apple trees alive, they must be pruned annually. Electric pruning devices used now are only able cut specimens under an inch and a half. Invented for pruning grape vines, it does not cut large enough branches nor is it durable enough for pruning apple orchards which forces workers to prune by hand. Manual pruning is very physically demanding and requires many workers to complete an orchard costing farmers more money. Workers need a device that is capable of pruning trees throughout a work day of work that doesn't require the physical strain that the devices in modern agriculture do.

## Function Statement:

A battery power device that is light enough not to strain the user and able to cut apple tree limbs throughout a day's work without malfunctioning.

## Function Statement (Drive Train):

An actuator that connects an electric motor to a pruning blade making it cut and return to the open position.

## Requirements:

- Capable of cutting a 2 inch diameter tree branch.
- Cutting blade must be at least 30" away from trigger.
- Must weigh less than 3 lbs.
- All components combined must cost less \$500.

## Requirements (Drive Train):

- The blade must re-open unassisted by the user.
- Must attach to a standard drill clamp.
- All parts must withstand 443 in-lbs. of torque and 1000 lbs. of linear force without deflecting more than 0.25".
- Must have a 90 % or higher power transfer efficiency in order to provide 900lbs of force to the blade (to cut a 2" branch).
- Drive train must convert rotational motion to linear motion.
- Must be at least 24" long
- Must connect the motor to the blade.
- Must completely open and close the blade.
- Must fit within a 1" diameter housing tube.
- Drive train itself must weigh less than 1.25 pounds.

### Engineering Merit:

The ergonomics of this pruner is the emphasis of this project. Overall weight, length, power transfer efficiency and Blade geometry will be the factors that contribute to this pruner rivaling its benchmarks.

The drive train is responsible for overall power transfer efficiency and the systems duty cycle. The formula that will be used to find the duty cycle rating is  $D.C. = (T_c / T_o) * 100$ , where  $T_c$  = Time of cycle and  $T_o$  = time in between cycles. The drive train uses the convenience of a self-reversing ball screw that is capable of returning the blade to open unassisted. This makes the time in which it will take to cut a branch much faster as well as the time to return the blade to the open position. As for the power transfer efficiency, the lead angle will be one that is steep enough to be able to cross paths, require less rotations but still provide optimal power and efficiency aspects of a ball screw. Trigonometry and the general ball screw equation of  $Linear\ Force = (2\pi * Torque) / (Lead\ Angle)$  will be used to optimize dimensions.

Engineering merit is also present in the selection of materials. Stress equations:  $\sigma = F/A$ ;  $\Delta L = (Force * Length) / (Area * E)$ ;  $T = (\tau_{max} * r)/J$  and  $P = A * S_y * (1 - (S_y * SR^2)/(4\pi^2 * E))$  are used for average shear, tensile, torsional and buckling stress in the power system components helping establish dimensions and material in which are optimal for weight and durability. Material selection is critical for each component in order to meet weight and strength requirements while also keeping cost down. Well Calculated attributes will be the difference in the merit of this pruner and its benchmark.

### Success Criteria:

The success of this project will be judged on whether or not the main requirements are achieved. Evidently, the pruner must be able to open and close electrically. Power efficiency, cutting ability, convenience, cost and weight requirements have been set to ultimately compete with other electric pruning devices.

### Scope of Effort:

The Focus of this design is to effectively transfer rotational energy to linear energy without compromising the power that the impact drill is providing while also returning the blade to the open position autonomously. With minimal power loss, the drill will use its energy most efficiently and autonomous return provides convenience/minimal physical strain to the concept of the pruner.

## DESIGN & ANALYSIS

### Approach:

As stated before, the difficulty with manual pruners is the physical strain, time consumption and the cutting force that loppers are capable of. The approach to simplifying the pruning occupation is a lightweight, electric lopper that eliminates the manual cutting action of pruning. The device cuts with the press of a button requiring the user to simply place the pruner where need be. This approach uses much of the same technology as the Tree lion because it is a well-designed device but built accounting for the pruning of apple trees which include limbs that exceed 1.5 inches in diameter. A larger motor will provide more linear force and allow the device to cut through larger branches. This process incorporates a further efficient blade (Wyley Stewart) contributing to the power transfer efficiency. The housing of the pruner (Brian Woolery) incorporates the overall weight of the device keeping it under 3 pounds.

### Innovation Methods:

Several different ideas arose for converting rotational energy to linear energy in order to run the blade efficiently while keeping the system as light as possible. The first idea came to be a blade run by a chain and sprocket. The pros to this setup was by far cost and weight. A short chain and simple sprocket attached to the impact hammer would provide linear movement and a pulling force to the blade to make it close as shown in [Appendix A1](#). The problem of this idea was its durability and power efficiency loss. The chain would become slack within the housing and a sturdy spring must be attached in order to return the blade open. This would all compromise power which is one of the main scope of efforts in the design of the drive train.

The next idea that sprouted was the thought of taking the impact hammer concept the same down to the head. A shaft would attach to the gun just as a drill bit would making it easy to install and remove. It would then have a cam at the end that would strike through a lever arm on the head as shown in [Appendix A2](#). Again, to make the blade self-retract, a spring would need to be in place which fights against the cutting power losing power efficiency. The shaft would be the heaviest part of the system which could be tampered with the material used and thickness of it. The main factor that doesn't work about this concept is the bulky area near the head for the cam to rotate. Also, with the impact happening at the head, the parts would ware quickly.

After examining the competition, the most efficient way was discovered in the form of a ball screw [Appendix A3](#). The ball screw would attach straight to the impact hammer just as the cam concept would making it easy to attach and detach. However, the ball screw converts the rotational energy to linear energy much like that of the chain and sprocket idea. The shaft material could be tampered with similar to that of the cam concept in order to account for weight but not have the bulk housing at the head. Essentially, the ball screw contains the respectable attributes of the other two concepts making it the ideal energy transfer system for the device. This decision can be justified by the decision matrix occurring in [Appendix A](#) as well.

### Design Description:

Due to requirement allocations, a self-reversing ball screw is certain to incorporate all the qualities of a ball screw while returning the blade to the open position without the operators help. The design of this pruner drive train is shown below:

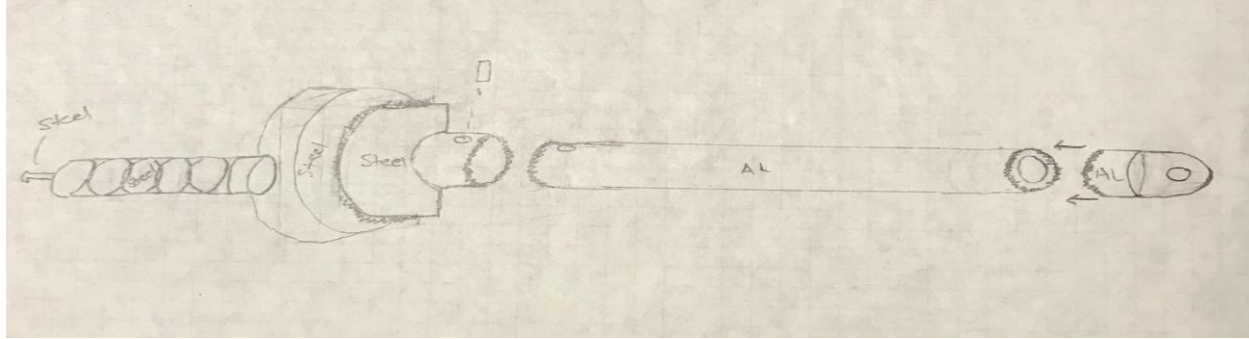

The cutting cycle is initiated by a single pull of the hand trigger. As the motor is engaged, the ball screw turns rotational energy into linear energy. The pruning blade is fully closed as the ball screw reaches the end of its cycle. The end of the thread curves perfectly into the opposite path of the ball screw and the drive train will begin to lengthen and open the blade. Once the blade is completely open, the ball screw is then at full path capacity and begins to transfer paths in order to begin another cut.

### **Benchmark:**

#### **Tree-Lion:**

The benchmark for the design of this electric pruner power system is the current power system found in the Tree-Lion D45-900 electric pruner. The Tree-Lion pruner is shown below.



This pruner is manufactured by Pellenc, a French agricultural company. [Appendix B](#) shows the linear actuator and linkage to driving rod found in the D45-900. The actuator is also manufactured, in-house, by Pellenc. This model has a reach of roughly 1 ½' and the capability to cut branches up to 1.5 inches in diameter.

Pellenc uses an electric actuator equipped with a limit switch. The actuator rotates a ball screw altering rotational motion to linear motion. As the blade closes, the limit switch is activated revering the polarity of the motor returning the blade to the open position. This approach is effective yet costly making the device \$1,950.00 USD.

#### **H.F. Hauff Pruner 2016:**

The 2016 Pruner team's model uses similar attributes of the Tree-Lion including a ball screw and rotational motor. Improvements attempted were:

- Larger trigger
- Motor that does not overheat
- Longer reach
- Lighter weight

This attempt turned out bulky and unappealing but did cut larger branches using an impact drill. The impact drill proved to run more efficient and did not overheat. However, no other requirements were reached that allowed the pruner to outperform the Tree-Lion. The Drive system of the pruner can be seen in [appendix B](#).

### **Performance Predictions:**

With the design at hand, it is assumed that the device will perform better than the benchmarks that have been stated while being cheaper and built more efficiently. The pruner will cut 2 inch diameter branches which is a larger specification than both benchmarks. Efficiency in the duty cycle will be increased due to the mechanical reverse of motion rather than reversed manually. Also with such a steep lead angle compared to the other ball screws, the power transfer will be much greater than the competition. Considering the limitations of project, the motor and battery pack will not outperform the Tree-lion but is predicted to be superior by incorporating innovations in the blade design and power-system. Also it is predicted that the housing is sleeker and ergonomically more efficient than the 2016 H.F Hauff pruner.

### **Description of Analyses:**

Starting the analysis, the power transfer efficiency will be calculated setting the parameter for the rest of the project. With the calculated force applied to the blade through the lead angle of the ball screw, analysis can then be done to ensure that the rest of the system may be rated to the torque and forces that are being applied.

Considering the trail of the self-reversing ball screw, these parameters that the analysis provides may be skewed. Further testing of the self-reversing ball screw may determine more accurate results possibly changing the dimensions of the power system. Proper documentation allows the analysis process to be recreated efficiently and effectively if the results of the ball screw become so abstract that the failure analysis of certain parts need to be re-done.

### **Self-Reversing Ball Screw Analysis:**

#### **Requirements:**

An actuator must convert rotational energy to linear mechanical motion while utilizing at minimum 90% of the rotational power providing the blade with 900 lbs. of cutting force. The actuator must also switch direction under its own power without the assistance of the user and withstand 185 in-lbs. of torque. A displacement far enough to completely open and close the blade of the pruner is required while keeping a diameter under 1" in order to fit in the housing.

#### **Analysis:**

Covered in the innovation methods, a ball screw is the lightest and most efficient way to convert rotational energy to linear motion. To incorporate these qualities, A self-reversing ball screw that switches linear motion mechanically is ideal. Since rolling

bearings are highly efficient, a 90% power transfer may be achieved. Oil lubricant contribute to this factor as well.

Since the system will theoretically produce 1000 lbs. of linear force, the ball screws efficiency will provide at least 900 lbs. of that force to the blade. This force is enough to cut through a 2 inch branch which requires 600 lbs. of force.

Since original ball screws aren't unassisted in switching directions, a self-reversing (double threaded) ball screw solves this predicament because the screw will change direction at the end of its thread length, therefore, changing linear direction.

The shaft containing the threads will be taking the torsion forces of the system from the impact drill. Its design withstands a 185 in-lbs. of torque without deflecting more than .025 inches (.5° angle of twist). This is critical in the fact that a surplus of deflection could throw off the route of the ball bearings.

Since the displacement of the blade needs to be 2 inches, the ball screw threads need to cover 2 inches in linear motion before switching directions. This will allow the blade to completely open and close ensuring it will fit at least a 2" branch within the blade and completely cut through it.

Calculations are made to ensure that the ball shaft may stay under a 1" diameter but still be rigid enough not to deflect. Material analysis in [appendix C3](#) selects the correct rigidity in order to fulfill these requirements. Enough clearance within the housing to allow it to move freely.

Clearance fit for a free running shaft analysis will ensure that the ball nut slides freely up and down the shaft without leaving too much space that the bearings still engage both the threaded shaft and the ball nut. Another is done with the OD to ensure that a reasonable amount of radial pressure on the bearing is met so that the bearings do not float freely within the slots.



### Design Parameters:

The shaft will have a diameter of 0.5 inches in order to withstand 185 in-lbs. of the torque that the impact drill will provide which can be seen on the drawing in [appendix D1](#). The double threaded shaft will have threads with a pitch of 0.5 inches so that the forward and return paths are able to cross one another effectively. Since the blade needs a displacement of 2 inches, the ball screw threads cover 2 inches in linear motion before switching directions. Oil lubrication will be used in the self-reversing ball screw in order to allow 90% of the rotational force to be transferred to linear force.

### Documentation:

The force analysis for the self-reversing threaded shaft can be seen in [Appendix C3](#). As for the 90% efficiency power transfer, reference [Appendix C1](#).

### Drill Torque:

The Makita drill being provided for this project is capable of generating 450 in-lbs. of torque according to the specs on the Makita web site. Through the force seems inaccurately high, it would provide over 1500lbs of linear force to the blade with a  $27.2^\circ$  lead angle requiring the drive shaft to withstand larger forces than expected. Part dimensions simply are too large to account for weight causing the materials to be stronger and lighter, yet more expensive.

Around 1000lbs of linear force is adequate for cutting the size branches at hand which converts to 185 in-lbs. which can be seen in [Appendix C2](#). By rating the drive train to withstand this force, much less material surface area is needed and common materials may be used to manufacture the pruning system.

### Ball Nut Analysis:

Unlike regular ball screws, the ball nut of this ball screw must allow the bearings to switch paths while still allowing them to roll and stay firmly in the threaded paths. The best bearing orientation is a total of 3 ball bearings, one fixed and two with long slots allowing them to move as the path of the thread switches direction. A representation is shown below:

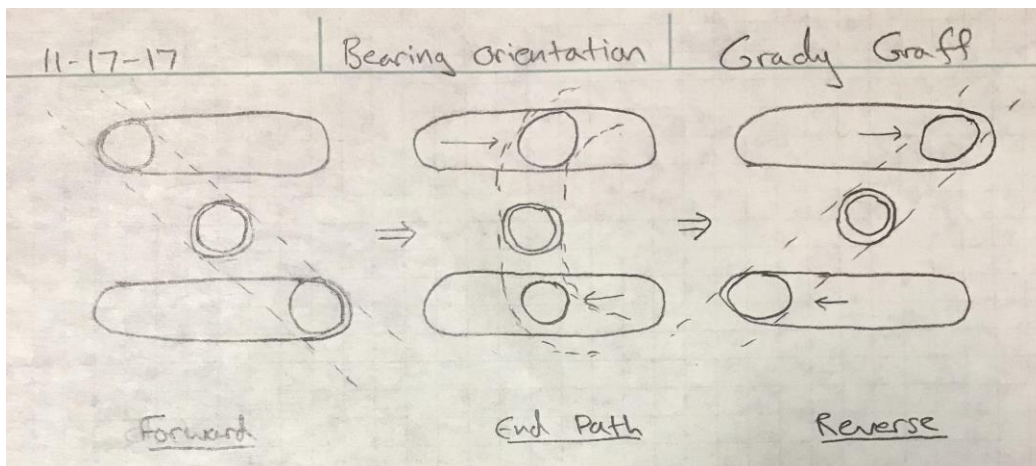

The thickness of the ball nut is the piece that is most likely to fail given the fact that it is the least amount of material that must withstand the applied forces. The minimum surface area needed to withstand this force was found using the torsional shear equation which came out to be  $0.0011 \text{ in}^2$ . The surface area required is less than that of the surface area needed to snugly fit the  $3/32$ " ball bearings which was  $0.546 \text{ in}^2$  which is calculated in [Appendix C4](#). The base of the ball nut that was originally designed to mate with the adapter tube had a T max of 172 psi which also withstands the applied torque.

The designed slots in the ball nut must fit a standard  $3/32$  inch ball bearing while allowing them to spin freely between the ball nut and ball screw shaft. A comfortable amount of space between the walls of the designed slots and the bearing is critical in attaining completely free bearings. Every slot is drilled with a .048 radius giving the bearing a couple thousandth of an inch clearance depending on the tolerance in which the parts are made too.

The long slots that allow the bearings to switch path directions must be long enough to complete the bearing path movement with no interference. Each long slot is oriented  $45^\circ$  from the static bearing so that the exact circumference of the bottom of the thread path could be determined. Knowing the circumference and the lead angle, trigonometry can be used to find the exact slot length of 0.21 inches. These dimensions are documented on the drawing in [Appendix D2](#).

After manufacturing started, it was noticed that the tolerances of the sliding fit were not accounted for. Since the ball nut is required to slide with ease, a medium running fit tolerance fulfilled the full clearance while keeping the maximum bearing engagement true. This analysis can be seen in [Appendix C4](#). (Picture 4)

### **Press Fit Cover Analysis:**

It is vital that the cover supply an adamant amount of radial pressure to the bearings within the ball nut. A small interference fit analysis was done because it compresses the O-rings while sliding completely over them while not twisting or binding them.  $0.001$ " ( $0.002$ " in diameter) is the resultant tolerance.

### **Adapter Tube Analysis:**

The Adapter tube gives the ball screw the ability to move linearly while the Ball nut is stationary and the self-reversing ball screw shaft rotates. The tube must have complete clearance of the moving shaft. An Inside diameter of 0.846 inches within a .8" outside diameter 1020 cold rolled steel tube is required to accommodate shaft clearance and housing clearance described on the drawing in [Appendix D4](#). Both the adapter and ball nut will be welded to this tube making 1020 cold rolled steel ideal for the design. Steel is also rated to withstand the tensile and compressive forces that it will experience from the action of the device calculated in [Appendix C5](#).

### **Adapter Analysis:**

The adapter purpose is to transition the self-reversing ball screw to the drive shaft so that the drive shaft isn't obligated to be  $0.85$ ". The adapter must reduce a  $0.85$ " diameter to a  $0.5$ " diameter while withstanding the 1000lb. force and 185 in-lb. forces acting on it. Since the ball



screw is 1020 cold rolled steel and the drive shaft is 6061 aluminum, it is logical to pin the two eliminating the hassle of welding the two materials. The adapter must include a 0.25" pin hole.

Since the inside diameter of the drive shaft is 0.334", the adapter will extrude at that diameter fitting inside the drive shaft far enough to surpass the pin hole by 0.25". The pin hole orientation is also 0.25" from the edge of the drive shaft meaning the hole orientation of the adapter must match that in order for the adapter to mesh against the shaft. The base of the adapter needing enough room to weld to the adapter tube is 0.1" and has a diameter of 0.85" fitting flush with the adapter tube. The dimensions of the adapter can be seen on the drawing in [Appendix D5](#). The dimensions are set to accommodate fitting parameters but are ensured to withstand the applied forces through calculation. These Calculations can be seen in [Appendix C7](#).

To ensure that the concentricity with the adapter was good, a quick clearance analysis was don't so that the fit between the adapter, ball nut and adapter tube was done. This clearance gave the parts a snug fit but easy to install.

### **Pin Analysis:**

Since steel and aluminum are not easily welded together, a pin connection is the most efficient connection method. The pin will connect the aluminum shaft to the steel adapter and withstand the 1000 pound linear force of the drive train. A safety factor of 1.5 was put on the double shear pin design to ensure stability and design life. The normal stress equation is used then to determine that a ¼" standard 316 stainless steel pin is appropriate for the situation provided. These calculations can be seen in [Appendix C7](#) while the dimensions are documented in [Appendix D8](#).

### **Drive Shaft Analysis:**

The shaft must withstand 1000 pounds of tensile and compressive forces deflecting no more than .025 inches. An excel spreadsheet [Appendix C8](#) containing the required information to calculate deflection of a shaft with axial load compares steel, aluminum and carbon fiber tubing. The optimal combination for a light weight shaft is determined by surface area and type of material. The Shaft will be made of aluminum and have a diameter of .5 inches and a wall thickness of .334 inches. This is a standard size and allows it to fit within a 1" diameter housing and fulfills a surface area of .05 in<sup>2</sup> ensuring that the shaft will not deflect more than .025 in with tensile, torsion and compressive forces act upon it.

The equation also takes into account the length of the shaft. The shaft must be long enough to connect the adapter to the blade minus the length of the pin connector. This distance must be 24 inches to fulfill its ergonomic requirements. The optimal shaft length is 25 inches. With the ball screw contraction being 4.45 inches, 25 inches will allow the shaft to keep the arm of the pruner at least 30" long and still connect the ball screw to the blade. This dimension can be seen on the drawing in [Appendix D6](#).

The shaft is connected to the adapter by a dowel pin determined to be ¼" diameter. The pin whole is coordinated with the adapter to be .25 inches from the end of each rod and drilled all the way through. The hole must have enough interference with the pin in its set tolerance in order

to press fit the pin ensuring immovability. 0.003” on either side is enough interference making the hole diameter .244”.

The responsibility of the pin connector is to attach the drive shaft to the blade linkage. The linkage includes a hole diameter of 0.25” subsequently requiring the pin connector to have the same. The linkage must be able to move freely without interference and have enough base in order to weld straight to the drive shaft. The pin connector must also withstand the 1000lb linear force and 185-in-lb torque being applied without malfunctioning.

Two linkage pieces are set 1/8” apart demanding an extruded pin hole with a thickness of 0.125”. This attribute to the pin connector is the weakest point in the piece only attaining the smallest shear plain yet still theoretically withstands the applied forces which can be seen in [Appendix C10](#). A fillet radius of 0.1” allows the linkage to move freely with the pin hole set 0.25” from the bottom of the fillet. A 0.4” base provides an adequate space for the weld to the drive shaft and contains diameter of 0.5” giving the weld a flush surface. These dimensions can be seen on the drawing in [Appendix D7](#).

The wear on the pin at the end of the drive train is substantial because the connecting pieces rotate creating friction between the two. Keeping this in mind, the pin connection allows a cheap and easy replacement.

#### **Device:**

The device is shaped as if it is an extension of the hand drill. A simple actuator connected to the drive shaft leads to the blade assembly. All of the components fit into a carbon fiber tube with an ID of 1” giving the design a slim sleek look. By creating a cover that matches the drill cover, the device will hardly be noticeably connected.

#### **Tolerances:**

The tolerances for the drive train are very tight considering the actuator is a hand machined ball screw. Multiple clearance fit analysis were done to ensure the parts fit within one another and operate. An interference fit analysis was calculated for the press fit cover as well to ensure the tolerance supplied the correct amount of radial pressure. There is also one on the shoulders of the ball nut and adapter to ensure a tight fit for welding.

As for the bearing tolerances go, as long as the bearings fit into the slots and threaded path, it is counted as a pass because of the dependence on the tool. The same concept is for the sliding fit as well because it is dependent of the accuracy of the reamer.

#### **Technical Risks Analysis:**

The risk behind inventing this actuator is having a working device at the end. The geometric aspect of the device is analyzed to theoretically move back and forth but whether or not the bearings stay in the correct path and withstand the torque being applied. Without testing, the analysis is tough because the forces could cause the actuator to not work as desired.

**Safety Factors:**

With the limited space and size constraints within the design itself, the contraption is calculated and designed to spec and a safety factor is foreseen afterward. No safety factor came to be 1 but throughout each analysis, the factors varied from 1.3 to 4. Some part dimensions ended larger than needed due to some of their attributes that required larger stock such as the drive shaft.

If a part on the drive assembly were to fail in torsion, it would be the linkage tab on the drive shaft because it is the skinniest piece and under the most torsion. Although it is designed to withstand the forces, its safety factor is the lowest at 1.3. Taking this into account, the drive shaft was pinned to the adapter and not welded making it easy to replace if it ever did fail.

## METHODS & CONSTRUCTION

### Construction Description:

Setup sheets of each part have been made to ensure the tracking of production rates and proper manufacturing of the piece. No saw setup sheets are available due to the simplicity of the machine and concept of dimension. Job traveler sheets are major in the construction on the CNC machines confirming safety and building efficiency.

### Self-Reversing Threaded Shaft:

Forged from 1/2" leaded steel rod, the shaft is cut using the CNC lathe. The part OD stock is to specification. Clamping less than 0.4" the CNC program starts the path at the end of the thread slowly turning the part with the speeds and feeds that are set accordingly. The path reaches 2" then turns back creating a cross threaded path. Each pass reduces .002" then levels the cut as it returns to the start position. This path is cut the spec depth and all burs are removed from the edges of the path to ensure smooth travel of the ball bearings [Appendix E1](#). The shaft is sawed to 4 inches and placed in an 1/2" collate socket hex holder. A 4 tooth plunging cutting faces the shaft to depth and the socket is loosened, rotated 1 surface and repeated. Once the hex portion is milled, the part is made concentric on the manual lathe and the chamfers and bearing groove are cut to finish the part.

### Ball Nut:

Forged from 7/8" low carbon steel rod, the ball nut is cut on the manual lathe and manual mill. The part is faced and reduced to shoulder depth. The front portion of the piece is then reduced further to spec with a form cutting tool. After, a wide groove tool is used to reduce the back OD of the part with 2 cuts. Groove tools are switched and the O-ring grooves are reduced to spec. A hole is drilled to a diameter of 3/8" through the middle of the part then to 31/64". A 1/2" reamer is used to obtain the correct tolerance of the free sliding dimension. The manual mill cuts the single bearing hole through one side of the part. The chuck is rotated 45° from the single bearing hole and the slot will be started in the middle. The .125" diameter mill swipes side to side until the slot is spec length. The same process is used for the second slot 45° on the opposite side. The adapter is welded to the adapter tube. [Appendix E2](#).

### Press Fit Cover:

Forged from a 7/8" dia. aluminum rod, the cover is drilled to a diameter of 3/8" and then 3/4" and reamed to spec on a manual lathe. The part is then faced as needed the outside diameter is then reduced to spec. A square form tool separates the part from the rod. The mechanical press fits the cover to the ball nut proceeding the insertion of the ball bearings. [Appendix E3](#)

### Adapter Tube:

Forged from 1" round tube with .12" wall thickness and is made on the manual lathe. The tube is faced as needed and the OD is reduced to spec. The Stock is removed form the mill and the part is removed with the saw. Both the adapter and ball nut will be welded completely around the diameter of this tube. [Appendix E4](#)

**Adapter:**

Forged from 7/8" steel rod, the adapter will be made on the manual lathe and mill. The part is faced and the shoulder diameter is reduced to specification. Keeping the transition from the front base to the shoulder base perpendicular, the front base is reduced to spec with a form cutting tool. After, a wide groove tool is used to reduce the back OD of the part with 2 cuts. The part is removed and the 1/4" hole is then drilled in the small base using the manual mill. The adapter will be welded to the adapter tube. [Appendix E5](#)

**Drive Shaft:**

The shaft is a standard size, 9/16" aluminum rod and cut to spec on the band saw. The 1/4" hole will be drilled on the manual mill using a 1/4" drill bit. The part is flipped and the linkage connecting tab is cut on the manual mill. Calculations off the 3/8" mill are made to ensure dimensions of the fillets are correct. A 1/4" drill bit makes the pin hole after the part is rotated. The shaft is pinned to the adapter and the linkage of the blade. [Appendix E6](#)

**Manufacturing issues:****Self-Reversing Threaded Shaft:**

Manufacturing the self-reversing threaded shaft with aluminum is far easier than steel. Aluminum being easier to machine, there is no deflection in the radius tool as it makes its pass and worked well for a trail run. However, with carbon steel, the hand ground tool shears as the program reached half its depth destination. By using 41L40 steel (Easy to Machine) the path successfully manufactured.

The radius tool plays a major role in a successful ball screw. Since the hand ground tool sheared due to deflection, a radius tool holder and radius tool were invested in. With the 41L40 steel, there is still deflection in the tool as it reaches its final depth but withstood 3 operations without fail and provided a smooth, crisp path.

Heavier forces than expected occurred as the machining of the initial hex of the drive bit went underway. The part continued to slip inside the collet and plane of cut was lost on a side of the hex. Also, the force to cut the groove where the ball bearings in the drill rotate sheared one of the hex bits off and did not cut smoothly on the other shafts.

Tighter clamping force in the collet and a sharper radius tool solves the manufacturing issues for the drive bit. Also, although the tool index deflected far more than expected, a less aggressive cut may be made to possibly avoid the unwanted forces acting on the tool.

**Ball Nut:**

The ball nut is the highest tolerance part on the drive train accommodating the threaded shaft, bearings and O-rings responsible for the radial pressure in the whole contraption. Both the ID and OD of the ball nut were critical in the ball screw functionality. With a .002" tolerance on the press fit OD and a .003" tolerance on the sliding fit ID, manufacturing issues arose due to armature machining.

The O-ring grooves developed issues first in the tool making and later in the dimensioning. The skinny groove tool must cut 0.067" worth of low carbon steel 3 times resulting in a high temperature, high stress engagement. The O-ring placement is also critical in the fact that theoretically, the O-ring keeps the ball from moving in the slot until it is forced to but if the bearing holes are off, the slots become useless.

By milling the bearing slots first and reducing the OD second, large burrs formed on the edges of these holes making the filing and buffing process a hassle and time consuming. It was later on discovered that the milling process could be don't after the OD and since the bearing tolerances are more important, the changes in the setup sheets have been made.

A shoulder on the side of the ball nut that is welded to the adapter tube is needed to be able to align the two parts to be welded. The previous design is difficult to clamp concentrically. By creating an extrude that fit tightly inside the adapter tube then butted up to a shoulder that has the same OD of the adapter tube, the part was welded successfully.

#### **Press Fit Cover:**

The only issue with the cover was the tight tolerance in the ID. However, the correct reamer was found on hand which allowed the manufacturing process to be quick. The design of the press fit did not go as planned. The press fit did compress the O-rings as designed but also twisted and displaced the O-rings as it was pressed to place as seen in [Appendix L](#). A shaft collar is more ideal in the situation as seen on the working ball screw video representation with a hose clamp.

#### **Adapter Tube:**

No manufacturing issues with the adapter tube. However, the operation turned out easier and more efficient to cut with the saw and not part from the lathe.

#### **Adapter:**

The same concentricity problem occurred with the adapter yet was fixed with the same solution as the ball nut. Both ends welded concentrically and neatly to the adapter tube once this configuration change initiated. The Pin hole is the next manufacturing issue with the adapter because of the difficulty to align a drill bit in the exact center of the rod. Although, when the hole alignment is slightly off, the pin manages to be press fit in. Lastly, by using a 9/16 drill bit, the whole is not quite large enough to accommodate the raw material of the drive shaft. Since the tolerance is not crucial, it is decided that a 37/64 drill bit has enough clearance yet not too large to manufacture the part to the correct dimension.

#### **Drive Shaft:**

The drive shaft dimensions required one redesign to fit the assembly length. The part is built at 36" (raw material length) for safe measure. Once the assembly is made, measurements are taken to make the cut as precise as possibly. The same problem as the

adapter occurred with the drive shaft where the two meet but since it is made after, a wobble stick is used for more of a precise hole dimension. To end the manufacturing process, the end pin connecting tab fillets need to be ground to spec but it is not allowed to grind aluminum in the Central Washington University machine shop. This manufacturing issue was solve with a file.

### Assembly:

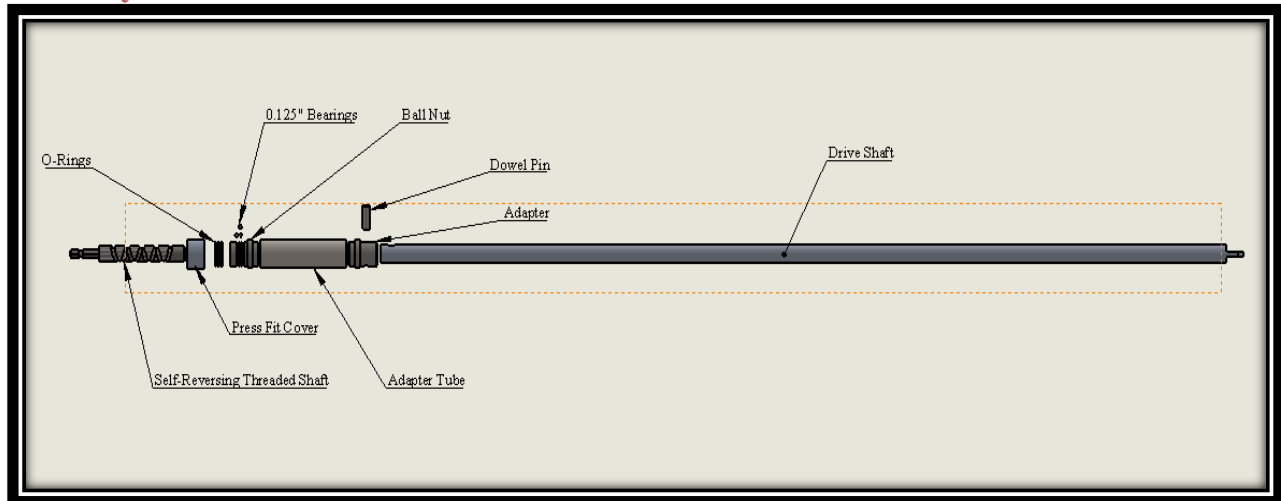

Assembly instructions and notes may be seen in [Appendix D9](#).

Full Pruner assembly may be seen in [Appendix L](#).

### Assembly Issues:

Some assembly issues arose as the pruner was being put together. The Housing and blade took 1 hour to make function while the drive train took 2.

The shaft was initially too long and was cut proceeding a full assembly measurement. The problem was fixed by removing 5.3" of the shaft. The shaft was then successfully assembled.

The press fit cover failed as it was manufactured to the correct dimensions but still pinched and bound the O-rings in an unwanted fashion as seen in [Appendix L](#). Earlier tests revealed that a hose clamp that could be evenly tightened around the O-rings. This configuration worked flawlessly yet the hose clamp does not fit within a 1" diameter. The solution to this problem is a shaft collar. McMaster-Carr does not sell clamps that are small enough to work. The plan is to manufacture one.

### Benchmark Comparison:

#### Body Design:

The motor connection is far sleeker than the previous attempt and the carbon fiber tube is much smaller making the pruner lighter and more ergonomic than the 2016 edition. This is achievable through the design of the actuator being under a 1" diameter. The bulk of the blade housing includes much less excess metal than the previous attempt as well.

**Drive Train Design:**

Since the first attempt of the self-reversing ball screw did not cut, it failed to outperform the 2016 edition that uses a regular ball screw. Although the manufacturing and materials is much cheaper and the concept is less complicated while achieving more requirements than a regular ball screw, more testing and analysis is needed to allow the ball screw to handle the axial load needed to cut a 2" branch.



## TESTING METHOD

### Efficiency Test Plan:

90 percent power transfer efficiency is the first test that the electric pruner drive train is put through. The linear force created from the rotating impact drill is measured using the tensile testing machine. The pruner is rigidly mounted while the end of the drive train that connects to the blade is mounted to the tensile testing machine. The drill will be activated and a graph will appear showing the displacement and force in which is happening linearly.

The results of the test are compared to the theoretical data composed through dynamic calculations. At 100% efficiency, the calculated linear force that the pruner is rated for is 1000 pounds. Therefore, the requirement is set to be provide a linear force of 900 lbs. pounds. The test is passed if the tensile machine reads a force that is greater than or equal to 900 lbs. pounds.

### Efficiency Test Documentation and Deliverables:

The efficiency test plan is not able to be conducted until the proper O-ring configuration is determined. The efficiency data is based on the amount of output power compared to the amount of input power.

### Weight Test Plan:

A scale accurate to a tenth of a pound is used to weigh the drive train as a whole. Since the drive train is all rigidly connected, the weighing process is simple.

The results of the test will be a pass fail outcome. If the drive train is under 1 pound, the test will be passed, if the drive train is over a pound, adjustments will have to be made in order to fulfill the requirement.

### Weight Test Documentation and Deliverables:

The overall weight of both drive systems came under 1.25 inches. This concluded that from last year's product, it is possible to fit the drive system within a small housing improving the ergonomics. It was also found that the lead screw was far easier to install because of its variable length compared to that of the exact, 2 inch path of the self-reversing ball screw. Overall, the construction of the drive systems and dimensional design was effective.

### Duty Cycle Test Plan (Lead Screw):

A stopwatch accurate to a tenth of a second is used to specifically time the interval in which the pruner spends cutting a 2 inch branch. The time starts immediately after the trigger of the motor is engaged and stops immediately after the blade has cut through the whole branch but has yet to start its return. The stopwatch is then used to time the interval in which the blade starts a cut and returns to the open position. The formula  $D.C. = (T_c / T_o) * 100$ , where  $T_c$  = Time of cycle and  $T_o$  = time in between cycles is then used to calculate the official duty cycle.

The results of the test are a pass fail outcome in which the duty cycle is higher or lower than that of the competition.

### **Duty Cycle Documentation and Deliverables (Lead Screw):**

	2018	2016
Trial	Cycle Time (Sec)	Cycle Time (Sec)
1	4.56	5.01
2	4.62	4.95
3	4.35	4.97

These data results reflect a larger lead angle than the 2016 product. This improved the speed of the blade opening and closing under no load.

### **General Testing Plan (Lead Screw):**

The general test of this pruner is its ability to cut branches up to 2 inches in diameter. A caliper measures the size of the branch ensuring the branch is to maximum specification. The branch is rigidly attached while the pruning device is engaged.

The test is passed if the device completely amputates a tree limb. Any branch under 2 inches is assumed to be manageable for the pruner if the first attempt passes.

### **General Testing Documentation and Deliverables (Lead Screw):**

The general test did not happen with the self-reversing ball screw. As for the lead screw, the test was successful but with unfortunate endings. With the original housing, the pruner cut a ½ inch branch effectively but broke near the drill housing as a ¾ inch branch was attempted to be cut. A reinforced, thicker housing was printed, assembled and tested up to a .75" branch with positive results. No further testing was done before an accident occurred and broke the housing again. All in all, the pruner worked effectively with the lead screw but problems occurred with the strength of the highly ergonomic housing.

### **Movement with Force Test Plan:**

The Ball Screw is tested for movement capabilities. Whether or not the slots are long enough to allow the contraption to sweep back and forth on its own. No forces are applied in this test, just enough to keep the ball nut from spinning with the shaft. The test is pass/fail on whether or not it moves within its path.

The axial force test will decide if the self-reversing ball screw is capable of withstanding axial force without malfunctioning and just how much it will be able to pull and push. This test will include multiple configurations of the ball nut that include different dimensioning of the O-ring depth and placement to try and make the balls act as they should.

The threaded shaft is spun on a lathe while a pull scale is connected to the ball nut to keep it from spinning. As the ball screw follows its path, resistance is applied measuring the force in pounds on the scale. The test is over when the ball screw crosses over to the wrong path.

By testing multiple configurations, It can be decided which alignment and depth is best for the ball screw performance.

**Movement with Force Documentation and Deliverables:**

The movement test, conducted multiple times came to be the most accurate test that was able to be ran during the project. Movement was successful in every configuration constructed. It is aware now that the self-reversing ball screw is meant for radial loaded apparatuses rather than axial loaded. The geometric design of the ball nut makes it difficult to hold axial load without impeding the ball bears of their efficiency. These tests were documented graphically and are able to be seen on the [website testing](#) portion.

## PROJECT MANAGEMENT

### Cost and Budget:

The entire pruner must cost under \$500 in all. By keeping the drive train total material and tool list under \$70, the requirement is more attainable which can be seen in the parts list included in [Appendix F](#). However, labor of this project is not included which would increase the price of the drive train substantially considering the self-reversing ball screw is made from scratch in house. Many of the tools needed are resources that the CWU machine shop already attains making the supplies needed far less expensive. H.F. Hauff Company has taken responsibility for the funding of the project donating nearly all materials and supplies needed. No budget is set but cheapest solutions are required as well as simplistic and logical approaches.

Testing materials are also attained in the CWU facilities. No further funding is needed in order to test the project in comparison to its requirements. Once again, labor is not incorporated in the cost calculation.

### Cost and Budget Changes:

The only reorder that came about during the manufacturing process was 0.125" ball bearings. Being very small. Some were lost in the assembly process. All other raw materials, O-rings, and pins worked well. The total cost of the extra bearings is \$5.00.

As seen in the testing videos, the self-reversing does not excel in axial load in which is needed to operate the electric pruner. The device could possibly evolve to be able to handle the axial force upon further testing however, this is a major problem is the time frame of testing the electric pruner.

Regular ball screws are very expensive running over \$100 which would put the budget highly over. To keep under the budget cap, the ball screw from the 2018 prototype is being put to work for testing purposes. The ball screw allows the pruner to cut branches and test the housing and blade. As for the self-reversing ball screw, further testing will continue as its own project.

The total cost of this project so far is \$60.00. This is very under budget proceeding the self-reversing ball screw. Further testing and modifications to the pruner as it is now may go over budget.

### Schedule:

The main schedule for this project is proved in the form of a Gantt chart. The Gantt chart in [Appendix G](#) is split into 3 sections, [Fall Quarter](#), [Winter Quarter](#) and [Spring Quarter](#) which represents the 3 phases of this project. The 1<sup>st</sup> phase is the proposal with general design and analysis. The 2<sup>nd</sup> phase is the manufacturing phase including the full assembly of the project. The 3<sup>rd</sup> and final phase includes the testing and advertising portion of the project.

The 1<sup>st</sup> phase of this project shows each section of this proposal, when it was worked on and the duration of the effort.

The circles on the 2<sup>nd</sup> phase indicate when the part or material is scheduled to arrive. The stars indicate the week that the part is scheduled to be finished. The self-reversing threaded shaft and ball nut are scheduled to be produced first because they are the most complicated pieces of this project and may require extra time to fix complications and improve the overall design.

The 3rd phase of this project shows the test being performed each few weeks and the duration of the effort to perform it. It also includes the time spent presenting the idea during the SOURCE activity.

Milestones for this project include:

- Finished proposal: 12-06-2017
- Finished Product: 03-16-2018
- Finished requirement testing: 06-08-2018

### **Schedule Revisions:**

Materials were very late. The first revision of the parts list did not include part number but described where they were located. A second revision allowed Mr. Hauff to find the parts quickly and easily and the part showed up 2 weeks into the quarter putting the schedule 2 weeks behind. However, as stated in the progress reports, much of the pre-manufacturing actions took place in this 2 weeks allowing construction to develop rapidly as the raw materials began to filter in.

The first two milestones have been met minus the working device. A new milestone has been set to accommodate this:

- Working device: 04-14-2018

As two resources were backed up being Matt Burvee and Ted Bramble, Other parts were started and not done in the order of the Gantt chart. When personal schedule lined up, manufacture of complicated parts went under way and were finished before the due date. In general, the project stayed on schedule, just not in an orderly fashion.

### **Physical Resources:**

- Hogue Technology Building machine shop
- Hogue Technology Building materials lab
- Hogue Technology Building computer lab
- Hogue Technology Building foundry

### **Software Resources:**

- Microsoft Word
- Dassault SOLIDWORKS 2016
- Microsoft Excel
- Wix.com

### **Human Resources:**

See [Acknowledgments](#).

### **Management:**

Accountability is handled by the H.F. Hauff pruner team themselves making sure that milestones are met and the project is dispersed through the entire construction time. Each partner develops the assigned portion of the pruner working together ensuring the device is efficiently built.

### **Safety:**

All members of the team are trained in the safety attributes of the machine shop, all of its equipment and is referenced by the resume below. These safety precautions are also clearly posted in the Hogue Technology Building machine shop. Activities should not be performed that an individual is not qualified to do etc. One shall not weld if a welding certification is not present.

## **DISCUSSION**

### **Design Evolution:**

Through the design phase of this project, many ideas arose about transferring energy from the motor to the cutting blade. As seen in the innovation methods and benchmark, the ball screw is the paramount design for the circumstances at hand. Since the original ball screw does not fulfill all the requirements set, the self-reversing ball screw idea emerged to later be made reality although much more testing and analysis can be made to improve this part. However, this aspect is not the only attribute to evolve throughout the project.

Material changes happened proceeding the design of the rest of the drive train. An example being the weight of the device and the joining of certain parts being taken into account. Originally, the project plan was to weld the drive train completely but aluminum and steel do not easily weld. Therefore, the ball screw and adapters are all made of one material allowing them to simply be welded and efficient. Yet to keep the drive train under 1.0 pounds, the drive shaft was made aluminum and pinned to the adapter.

The power system rating is another evolutionary aspect of this project. The Makita impact drill used provides 480 in-pounds of torque creating a part failure dilemma. The weight of all the parts that are built to withstand this force exceeded the requirement as well as the linear force and cost of material. The decision arose to rate the pruner for 1000 pounds of linear force tracing back to a total of 185 in-pounds of torque keeping the drive train within requirement specs but still effective.

### **Project Risk:**

A major risk of this project was the time constraint set within the school year. Developing a self-reversing ball screw takes a major analysis to incorporate all of the circumstances that could make the piece as efficient as possible such as lubricant, material, tolerances and geometry. Many tests have been run for original ball screws revealing the most efficient methods to build them but with the time constraint at hand, only a few attempts could be made. This caliber of innovations requires much more testing and attempts.

Another risk is the ability to mass produce a product like this. Under the tool constraints of the university, a make-shift drive system as in an impact drill is used adding far too much weight and bulk to the project. Though the focus is more on the power efficiency side of the project, using an impact drill in a mass produced pruner is not ideal. Also, without the capability to add luxury such as rubber grip or a sleek plastic form housing, the pruner turns out slightly bulky and unappealing to the eye.

#### **Next Phase:**

The next phase of this project is to make the pruner work. It is known that the self-reversing ball screw has its own testing capabilities and needs work. Without a drive train, the housing and the blade have no way of being tested. The plan is to use a regular ball screw on the pruner and continue to test the self-reversing ball screw by itself.

## **CONCLUSION**

Many analysis contributed to the success of this project. As requirements became relevant, original ideas faded as correct solutions evolved in order to achieve the desired product. The main innovation through this project is the construction of a self-reversing ball screw. Having the ability to switch linear motion mechanically while incorporating the efficiency of a ball screw majorly contributed to the efficiency test of this product. However, there is many tests and improvements that can be made in order to maximize potential of the self-reversing ball screw.

The performance of the H.F. Hauff Electric Pruner has the expectation of cutting a 2” diameter branch using minimal physical contribution from the user. Physically, the pruner turned out to be very light allowing most operators to lift it with ease. Also, since the device cuts with the push of a button, operational skills are minimal as well.

Many of the requirements have been obtained even with the new drive train in place. The Pruner will not open unassisted since the self-reversing ball screw failed to produce but the overall design of the pruner is lightweight, powerful and ergonomic. Further testing may allow the pruner to obtain all the requirements. The new ball screw will slow the duty cycle but it is expected that it will not be by much.

## **ACKNOWLEDGEMENTS**

#### **H.F. Hauff Company:**

Provided the group with the opportunity to expand knowledge on the engineering merit process through the electric pruner project. A tour of an industrial style building inspired the team in tackling this project with ambition. H.F. Hauff Company also funded the majority of the project making its completion possible. Through consultation and teaching, Neil Hauff specifically provided much support in the self-reversing ball screw approval and decision making within the project parameters.

**Central Washington University:**

Provided the logistics, references and facilities to begin, progress and conclude the project. The welding/machine shop and computer lab played major roles in a successful engineering merit experience.

**Dr. Craig Johnson:**

Expertise in failure analysis and material selection. Professor holds the group accountable for project progression and proposal accuracy.

**Charles Pringle:**

Expertise in system design and documentation. Professor also holds the group accountable for project progression and proposal accuracy.

**Matt Burvee:**

Assistance with access to Hogue Technology Building machine shop and acquiring materials/parts for the project. Matt also welded much of the power system helping the drive train take shape through construction.

**Tedman Bramble:**

Expertise with machine shop technology and solid works. Provided time and effort into helping develop the innovation of a self-reversing ball screw. Accredited for machine training and the precision of the products manufactured.

**Chris Scarlett:**

Solid Works expertise providing the solution to the reversing path solution during the design phase of the self-reversing ball screw.

**Roger Beardsley:**

Expertise in dynamics providing feedback of power transition efficiency and lead angle design of the self-reversing ball screw.



# Appendix A – Innovation Ideas

## A1: Chain

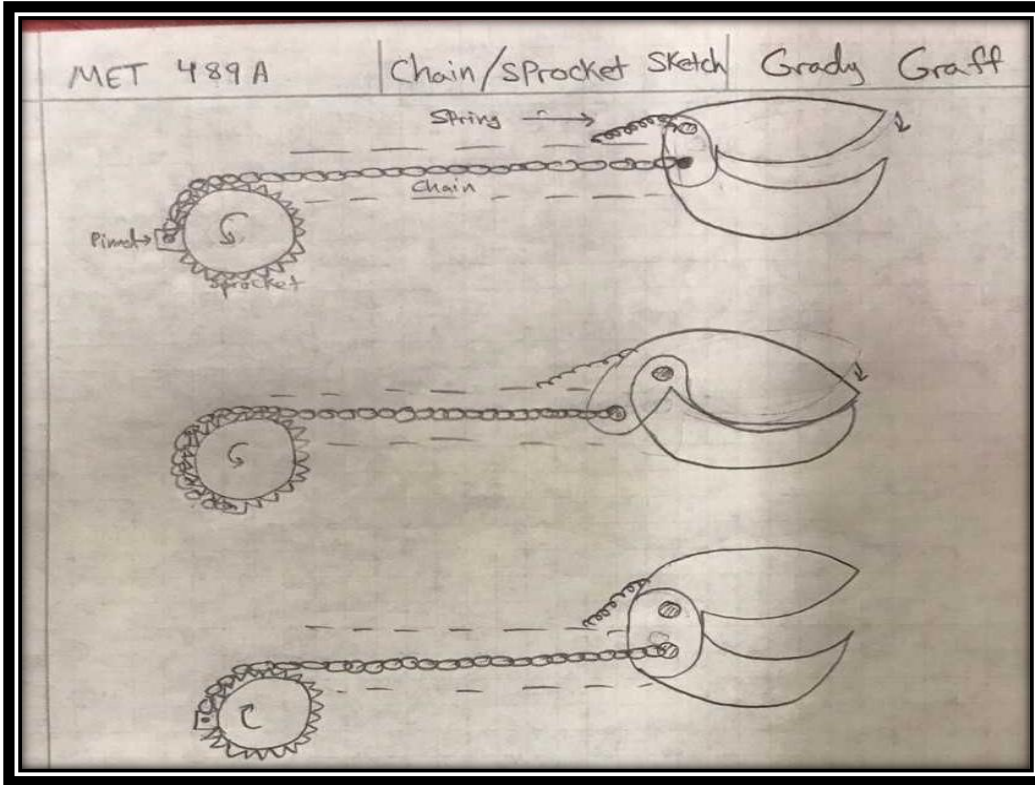

## A2: Cam

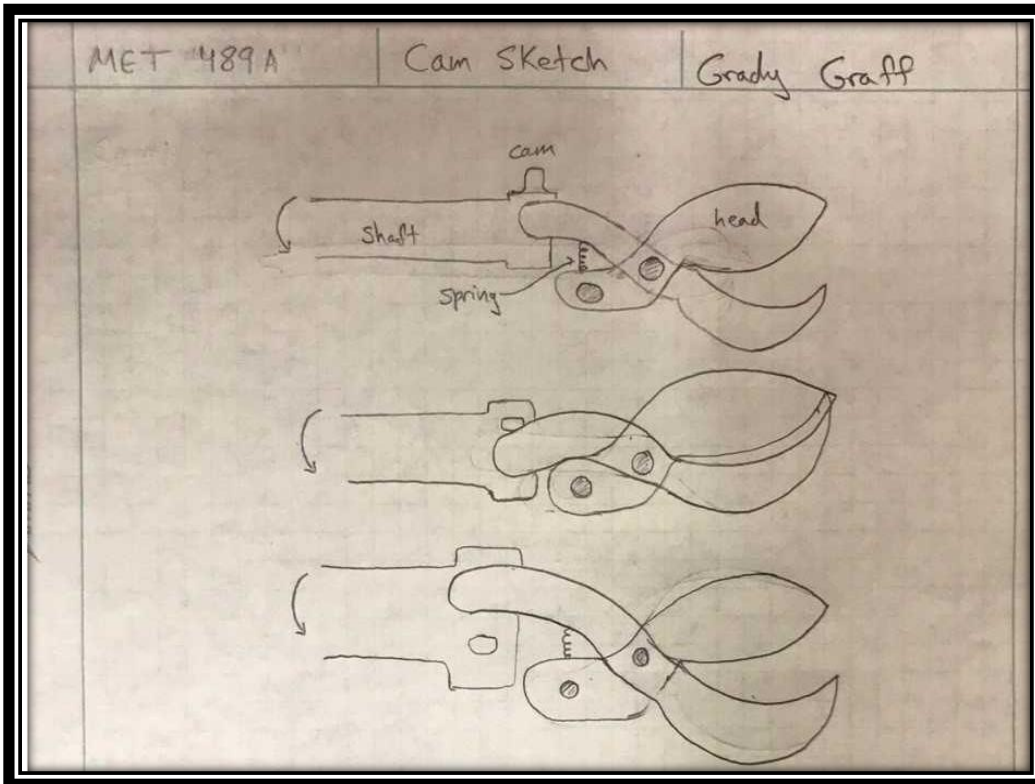

### A3: Ball Screw

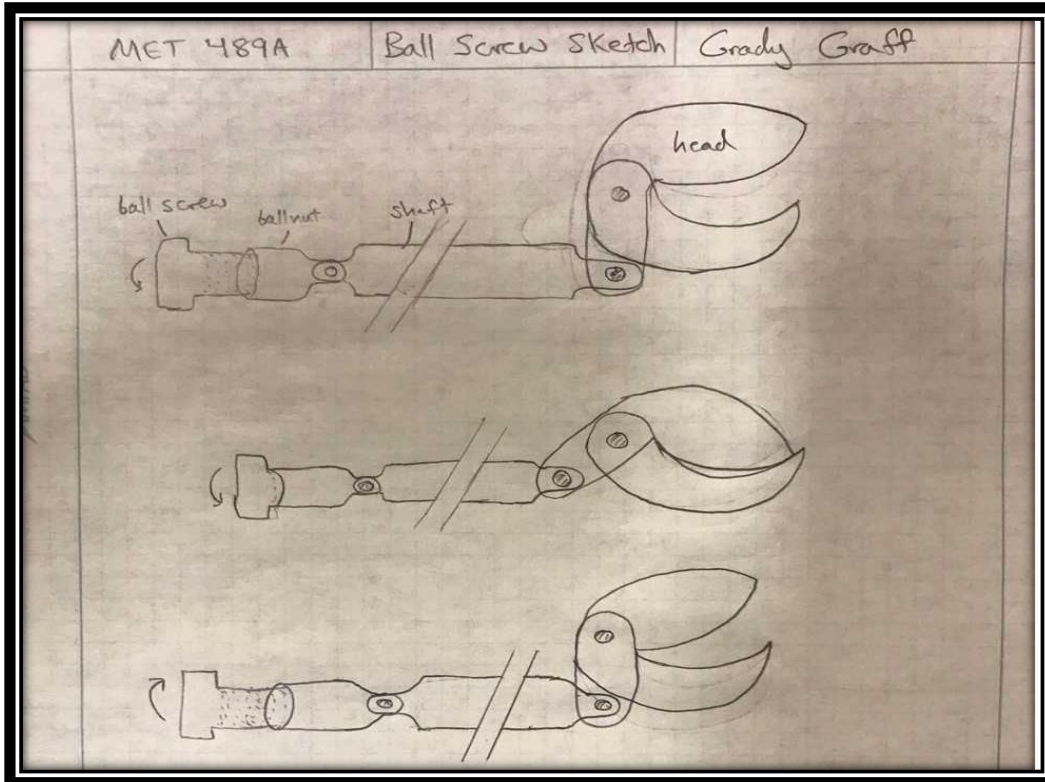

### A4: Self-Reversing Ball Screw

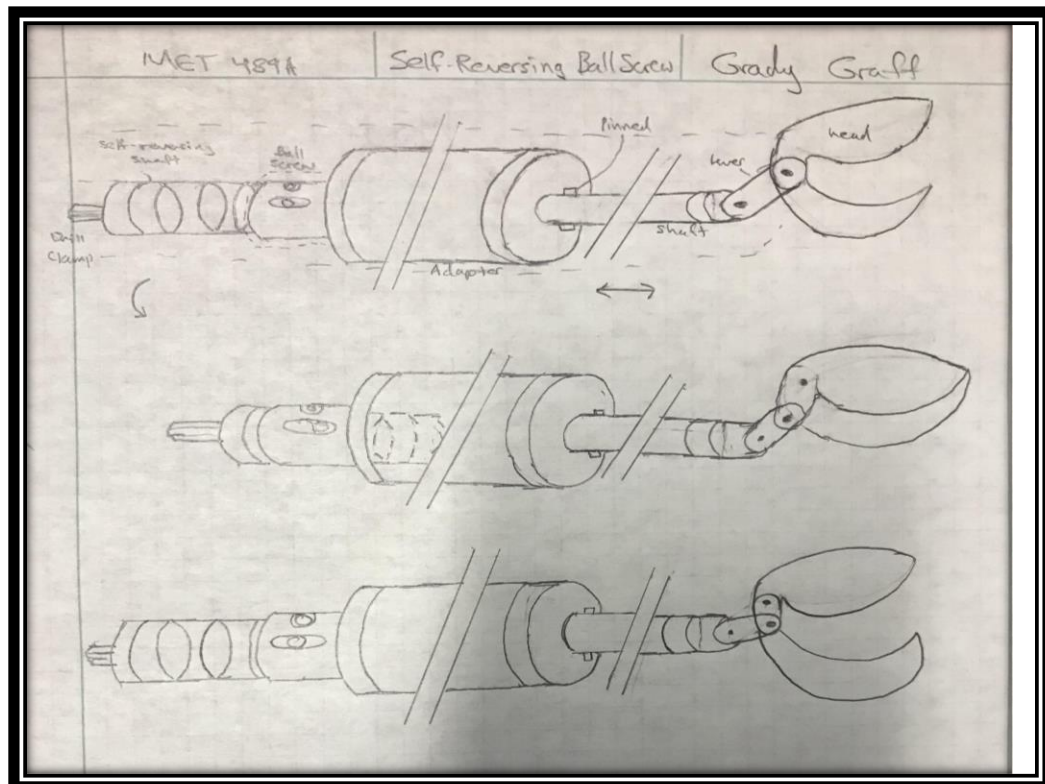

## A5: Decision Matrix

Senior Project Decision Matrix Spreadsheet: Drive Train Choices for Hauff Pruner									
Score: 0 to 3 (best)									
Criterion	Weight	3	Cam	Chain		Ball Screw			
	1 to 3 (must)	Best Possible	Score x Wt		Score x Wt	Score x Wt			
Cost	2	6	2	4	3	6	1	2	
Durability	3	9	2	6	1	3	3	9	
Weight	3	9	2	6	3	9	2	6	
Moving Parts	1	3	2	2	1	1	3	3	
Effectiveness	2	6	1	2	1	2	3	6	
Simplicity	1	3	1	1	1	1	3	3	
<b>Total</b>	<b>12</b>	<b>36</b>	<b>21</b>		<b>22</b>			<b>29</b>	
Normalized Data			1/N	Score x Wt					
			2.777778	58.333333		61.11111		80.555556	Percent
								66.666667	Average
								12.108053	Std Dev.
Good Bias: Standard Deviation is two or more digits meaning the bias factor is correct.									
<b>Weighting/Scoring Scale</b>									
1 Worst (too many moving parts, expensive, too heavy, efficiency of movement, etc.)									
2 Median Values, or Unsure of actual value									
3 Best (Low Cost, lightweight, simple, efficient)									
<b>Criterion</b>									
Cost	Judged by the cost of the mechanisms making up the energy transfer.								
Durability	Judged by how much force the mechanism can handle.								
Weight	Judged by how much weight the mechanism adds to the pruner.								
Moving Parts	Judged by how many parts are moving (likeliness to break down).								
Effectiveness	Judged by how much energy is lost through movement.								
Simplicity	Judged by the concept of the energy transfer								
<b>Comments:</b>									
<p>1) The 3 different drive train ideas have been brainstormed in order to transfer energy from the impact hammer to the cutting blade. All three would achieve the desired movement but some more efficient than others. The Ball screw is by far the best energy transfer system for what is being asked. Pending the decision on housing and cutting</p>									
<p>2) While The Ball screw was the best energy transfer option, it is also the most expensive. Since the cost is not outrageous at around \$100 and the weight is much of the same of the other two options, it seems to be the most logical option. the chain and Sprocket is inexpensive but has to many moving parts for to many things to go wrong along with having to fight a spring which deducts efficiency. As for the cam, the concept works but parts would ware quite fast and make the head of the pruner larger requiring more housing consequently adding more weight.</p>									
<p>3) The Bias in this experiment was significant (2.8), with a standard deviation of (12.1). This shows that the material with the highest value is the clear choice, therefore another trial is not needed. Attributes may be added and the bias would grow but since it is in double digits, the decision to use a ball screw can be made.</p>									

## Appendix B - Benchmark

**B1: Tree-Lion:**

<https://www.hydralada.com/nz/products/battery-tools/>



**B2: 2016 H.F Hauff Electric Pruner:**

<http://wellingtonandco.wixsite.com/home>



# APPENDIX C – ANALYSIS

## C1: Power Efficiency Transfer

MET 489 A | Power Transfer Efficiency | Grady Graff

$G_i$  - Torque  
 - Angle



$F_i$  - FBD  
 - Linear Force Equation  
 - Linear Force

$A$  = Drill Force ( $F_D$ )  
 $B$  = Resultant Force ( $F$ )  
 $B_y$  = Linear Force ( $F_L$ )  
 $B_x$  = Drag Force ( $F_D$ )  
 $C_y$  = Friction/Other Drag forces ( $\mu$ )

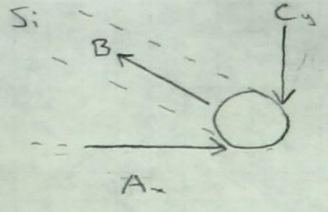
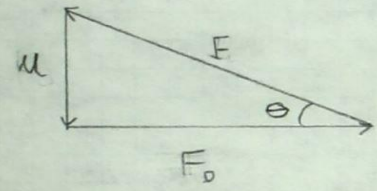
$\cos \theta = \left( \frac{T}{F} \right)$   
 $F = \left( \frac{\mu T}{\cos \theta} \right)$   
 $\sin \theta = \left( \frac{\mu}{F} \right)$   
 $\mu = F \sin \theta$   
 or  
 $\mu = T \tan \theta$

- $A_x = B_x$
- $C_y = B_y$

Therefore:

$F_L = F \sin \theta$   
 or  
 $F_L = F_D \tan \theta$

MET 489A

Grady Graff

Lever Arm

$$r_c = r_s - r_b \quad r_c = 0.155$$

$$r_c = (.25") - (.095") \quad \phi_c = 0.31$$

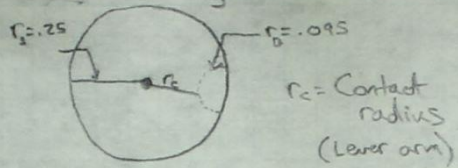

Lead Angle

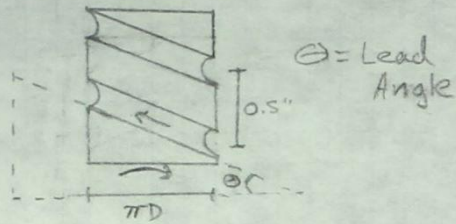
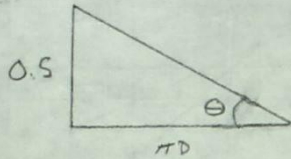

$$\tan \theta = \left( \frac{0.5"}{0.31 \pi} \right)$$

$$\theta = \tan^{-1} \left( \frac{0.5"}{0.31 \pi} \right)$$

$$\theta = 27.2^\circ$$

Torque to Force

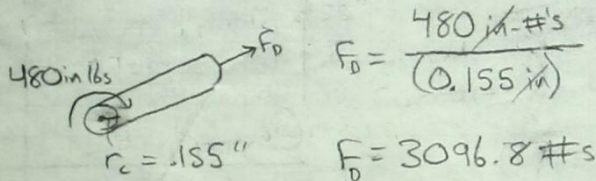

$$F_D = \frac{480 \text{ in} \cdot \text{#}'s}{(0.155 \text{ in})}$$

$$F_D = 3096.8 \text{ #'s}$$

Linear Force

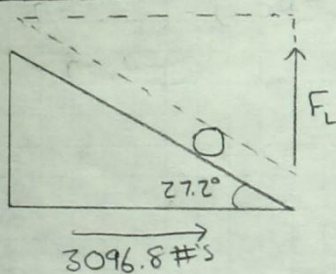

$$\tan(27.2^\circ) = \left( \frac{F_L}{3096.8 \text{ #'s}} \right)$$

$$F_L = (3096.8 \text{ #'s}) \tan(27.2^\circ)$$

$$F_L = 1591.5 \text{ #'s}$$

- Assuming 100% Efficiency

90% Efficiency

$$F_L = (1591.5 \#) (.9) \Rightarrow F_L = 1432.4 \text{ #'s}$$

## C2: Drill Torque

MET 489 A

Max Drill Torque

Grady Graff

G: Linear Force = 1000 #'s

F: Max Drill Torque output

• Moment arm = .095"  
-(center to contact point) ( $r_c$ )

S:

Lead Angle

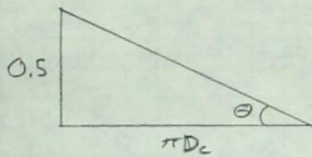

$$\tan \theta = \left( \frac{0.5''}{0.31\pi} \right)$$

$$\theta = \tan^{-1} \left( \frac{0.5''}{0.31\pi} \right)$$

$$\theta = 27.2^\circ$$

Linear Force

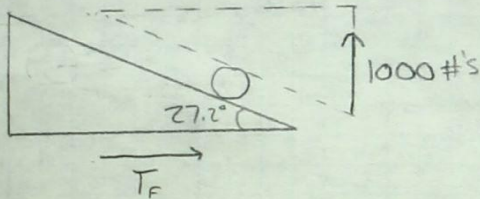

$$\tan(27.2^\circ) = \left( \frac{1000 \text{ #'s}}{F_F} \right)$$

$$F_F = \left( \frac{1000 \text{ #'s}}{\tan(27.2^\circ)} \right)$$

$$F_F = 1945 \text{ #'s}$$

Force To Torque

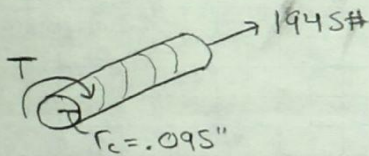

$$T = F \cdot d$$

$$T = (1000 \text{ #'s})(.095'')$$

$$T = 185 \text{ in-lbs}$$

### C3: Self-Reversing Threaded Shaft

MET 489 A	Torsional Shear	Grady Graff
G: 1020 steel bar (50,800 psi) ✓		F: Best Shaft Material
- 6061 Aluminum bar (12,000 psi) ✗		
- ABS Plastic bar ( ) ✗		
- Torsional Moment of 185 in-lbs		
- $\phi = .31$ "		
S:		
$\gamma_{max} = \frac{T r}{J_{solid}}$		$J = \frac{\pi \phi^4}{32} \Rightarrow J = \frac{\pi (.31)^4}{32}$
$T = \frac{\tau_{max} J_{solid}}{r}$		$J = 0.00091 \text{ in}^4$
<u>steel</u>		<u>Aluminum</u>
$T = \frac{(50,800 \text{ psi})(.00091 \text{ in}^4)}{(.155 \text{ in})}$		$T = \frac{(12,000 \text{ psi})(.00091 \text{ in}^4)}{(.155 \text{ in})}$
$T = 298.24 \text{ in-lbs}$ ✓		$T = 70.45$ ✗
1.6 Safety factor		
$\tau_{max} = \dots$		
Use $\frac{1}{2}$ in 1020 steel bar		



## C4: Ball Nut

MET 489 A	Ball Nut	Grady Graff
-----------	----------	-------------

G:  $\Delta L = .025 \text{ in}$   
 $L = 0.75 \text{ in}$   
 $E = 27000 \text{ ksi}$  (1020 cold rolled)  
 $F = 1000 \text{ #'s}$

F:  $A \rightarrow$  Thickness of walls

S: Surface Area

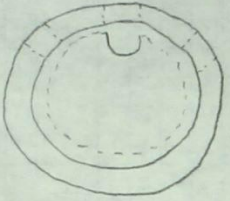
$$A = \frac{FL}{\Delta L E}$$
$$A = \frac{(1000 \text{ #'s})(0.75 \text{ in})}{(.025 \text{ in})(27000 \text{ ksi})}$$
$$A = .0011 \text{ in}^2$$

Thickness

Threaded shaft =  $0.5 \text{ in}$

Inside  $\phi$  must be  $0.505$  to move freely

$$A_1 = \frac{\pi D^2}{4}$$
$$A_2 = \frac{\pi (.505 \text{ in})^2}{4}$$
$$A_1 = 0.200$$
$$A_2 + A = A_0$$
$$(0.200 \text{ in}^2) + (0.0011 \text{ in}^2) = A_0$$
$$A_0 = .2011$$
$$D_0 = \sqrt{\frac{4 A_0}{\pi}} \Rightarrow \boxed{D_0 = .506}$$

- Must have a wall thickness of  $.001 \text{ in}$
- Using  $\frac{3}{32} \text{ in}$  bearings ( $0.094 \text{ in}$ )
- required  $D_0$  to fit bearings = ( $0.546 \text{ in}$ ) ✓

MET 489A

Ball Nut Continued

Grady Graff

Ball Nut Torque

$T = 185 \text{ in-}\#s$

$D = 0.546 \text{ in}$

$T_{\text{max}} = 50,800 \text{ ksi}$

$$J_{\text{hollow}} = \frac{\pi}{2} (.546^4 - .505^4)$$

$J = .038 \text{ in}^4$

$$T = \frac{T_{\text{max}} J_{\text{hollow}}}{r} \Rightarrow T = \frac{(50,800 \text{ psi})(.038 \text{ in}^4)}{(0.273 \text{ in})}$$

$$T = 7071 \text{ in-lbs} \quad \checkmark$$

Ball Nut Base Torque

$T = 185 \text{ in-}\#s$

$D = .85 \text{ in}$

$T_{\text{max}} = 10,400 \text{ ksi}$

$$J_{\text{hollow}} = \frac{\pi}{2} (.85^4 - .505^4)$$

$J = .457 \text{ in}^4$

$$T = \frac{(50,800 \text{ psi})(.457 \text{ in}^4)}{(.425 \text{ in})}$$

$$T = 54,624.9 \quad \checkmark$$

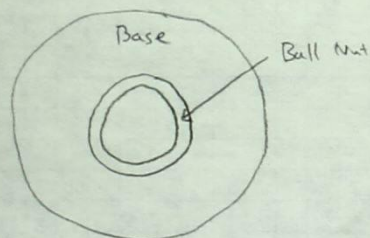

MET 489A

Length of Bearing Slots

Grady Graff

G: Thread Pitch = 0.5"  
Shaft  $\phi$  = 0.5"

F: Slot length

S: Path Length

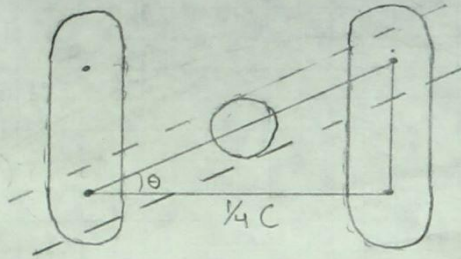

$\theta$  = lead angle

$$D = D_{\text{shaft}} - .048'' \text{ thread} = .452''$$

Slot length

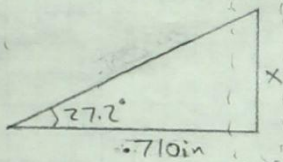

travel path

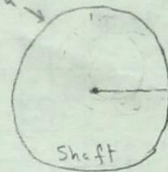

$$C = 2\pi r$$

$$C = \frac{2.84}{4}$$

$$= .710 \text{ in}$$

$$\tan(27.2^\circ) = \frac{x}{.710 \text{ in}}$$

$$x = (.710 \text{ in})(\sin 27.2^\circ)$$

$$x = .210 \text{ in}$$

- The slots are only present on an eighth of the circle.

- Slot is 45° from center bearing.

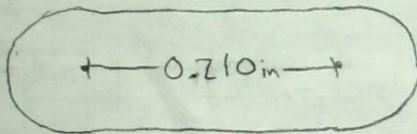
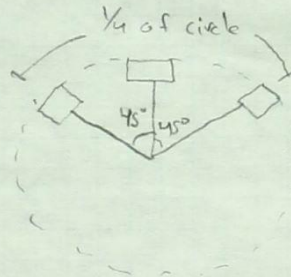

MET 489 A

Ball Nut Clearance

Grady Graff

G: shaft  $\phi = 0.5''$ 

- Repeating oscillations and rotation
- Basic Hole
- Fast moving

F: Class fit  
- limits of size

S: RC 5 (medium running fit)

	Hole	shaft
max	+1.0	-1.2
min	-0	-1.9

Limits of size

$$\begin{array}{l|l} 0.50'' + 0.001'' & 0.50'' - 0.0012 \\ 0.50'' - 0.000'' & 0.50'' - 0.0019 \end{array}$$

	Hole	shaft
max	0.501	0.499
min	0.500	0.498

Limits of clearance

$$\text{min hole} - \text{max shaft} \Rightarrow 0.500'' - 0.499'' = 0.001''$$

$$\text{max hole} - \text{min shaft} \Rightarrow 0.501'' - 0.498'' = 0.003''$$

- shaft = 0.498'' and will not change

- Hole max/min:

$$\frac{0.500}{0.503}$$

## C5: Adapter Tube

MET 489A	Adapter Tube	Grady Graff
----------	--------------	-------------

$G_i \cdot \Delta L_{max} = .025 \text{ in}$   $F_i$ : Appropriate Surface Area

- $F = 1000 \text{ \#s}$
- $E = 27000 \text{ Ksi}$
- $L = 3.5 \text{ in}$
- 1020 cold rolled steel

$\Delta L = \frac{FL}{AE}$

$A = \frac{FL}{\Delta L E}$

$A = \frac{(1000 \text{ \#s})(3.5 \text{ in})}{(.025 \text{ in})(27000 \text{ Ksi})}$

$A = .0051 \text{ in}^2 \rightarrow \text{required}$

- Using OD .85 in round steel tube reduced to 0.85" ID

OD = .85 in  
Surface Area = .0051 in<sup>2</sup>

$A_0 = \frac{\pi (.85)^2}{4}$

$A_0 = .567 \text{ in}^2$

$A_I = A_0 - \text{Surface Area}$   
 $= 0.567 \text{ in}^2 - 0.0051 \text{ in}^2$

$A_I = .562 \implies D_I = \sqrt{\frac{4(.562 \text{ in}^2)}{\pi}} \implies D_I = .846 \text{ in}$

- closest standard size

1 in round .12 in walls

MET 489A

Adapter Tube

Grady Graff

Torque

G:  $T_{max} = 50,800 \text{ psi}$

F:  $T_{max}$

•  $\phi = 0.85''$  (.12 in walls)

• 1020 cold rolled Steel Pipe

• must not exceed 185 in/lb

S:

$$T_{max} = \frac{T r_o}{J_{hollow}}$$

$$r_o = 0.425'' \quad r_i = .38''$$

$$T = \frac{T_{max} J_{hollow}}{r_o}$$

$$J_{hollow} = \frac{\pi}{2} \left( (.425'')^4 - (.38'')^4 \right)$$

$$T = \frac{(50,800 \text{ psi})(.0185'')}{(.425'')}$$

$$J_{hollow} = .0185 \text{ in}^4$$

$$T = 2211 \text{ in-lb}$$
 ✓

Buckling

G: 1020 Steel -  $L = 3.5''$

F:  $P_{crit}$

•  $\phi_o = .85'' \quad \phi_{in} = .76''$

- must exceed 1000 lbs

•  $S_y = 42 \text{ Ksi}$

•  $E = 27,000 \text{ Ksi}$

•  $K = 1.0$

S:

$$L_e = KL \Rightarrow L_e = (1.0)(3.5'') \Rightarrow L_e = 3.5''$$

$$I = \frac{\pi(D^4 - d^4)}{64}$$

$$A = \frac{\pi(.85)^2}{4} \Rightarrow A = .567 \text{ in}^2$$

$$= \frac{\pi((.85)^4 - (.76)^4)}{64}$$

$$A_{in} = \frac{\pi(.76)^2}{4} \Rightarrow A_{in} = .454 \text{ in}^2$$

$$I = .0092 \text{ in}^4$$

$$A_o = .567 \text{ in}^2 - .454 \text{ in}^2 \Rightarrow A_o = .113$$

$$r = \sqrt{\frac{I}{A}} \Rightarrow r = \sqrt{\frac{(.0092 \text{ in}^4)}{(.113 \text{ in}^2)}} \Rightarrow r = .285$$

MET 489 A

Adapter Tube

Grady Graff

Slenderness Ratio

$$SR = l_c / r_{min}$$

$$SR = 3.5' / 0.285$$

$$SR = 12.28$$

Column Constant

$$C_c = \sqrt{\frac{2\pi^2 E}{S_y}}$$

$$C_c = \sqrt{\frac{2\pi^2 (270000 \text{ Ksi})}{42 \text{ Ksi}}}$$

$$C_c = 117.65$$

<

Short Column

$$P_{cr} = A (S_y) \left( 1 - \frac{S_y (SR)^2}{4\pi^2 E} \right)$$

$$P_{cr} = (0.113 \text{ in}^2) (42 \text{ Ksi}) \left( 1 - \frac{(42 \text{ Ksi}) (12.28)^2}{4\pi^2 (270000 \text{ Ksi})} \right)$$

$$P_{cr} = 4718 \text{ #'s}$$



## C6: Adapter

MET 489A	Adapter	Grady Graff
----------	---------	-------------

Adapter Base Torque

G:  $T = 185 \text{ in-lbs}$        $F = 1000 \text{ lbs}$       F: T  
 $\phi = 0.85 \text{''}$        $L = 0.75 \text{''}$   
 $T_{\text{max}} = 5800 \text{ lbs}$   
- must not exceed 185 in-lbs  
 $E = 27,000 \text{ ksi}$

S:  $T = \frac{(50,800 \text{ psi})(0.425 \text{ in}^4)}{(0.82 \text{ in})}$        $J = \frac{\pi}{2} (0.85 \text{''})^4$   
 $J = 0.820$

$T = 26329 \text{ in-lbs}$  ✓

Adapter Extrude Torque

$T = \frac{(50800 \text{ psi})(0.17 \text{ in}^4)}{(0.021 \text{ in})}$        $J = \frac{\pi}{2} (0.34 \text{''})^4$   
 $J = 0.021$

$T = 411.2 \text{ in-K#}$  ✓

Tensile analysis

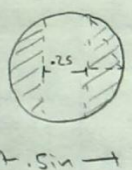
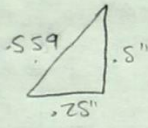
   $\text{Surface Area} \approx 0.25 \text{ in}^2$  ✓

$A = \frac{(1000 \text{ #s})(0.75 \text{''})}{(0.025 \text{ in})(27,000 \text{ ksi})} \Rightarrow A = 0.001 \text{ in}^2 \text{ required}$



2-8-18

Clearance Fits

Grady Graff

Gi: -ID (Adapter Tube) = 0.76"

Fi: Fitting size and tolerance.

- Adapter/Ball Nut must fit up to shoulder in order to ensure it is concentric and be welded.

Si: RC7 (Free Running Fit)

	Hole	shaft
max	+0.35	-4.5
min	0	-6.5

Limits of size

$$\begin{array}{l} 0.76" + 0.0035" \\ 0.76" - 0.000" \end{array} \left| \begin{array}{l} 0.76" - 0.0045" \\ 0.76" - 0.0065" \end{array} \right.$$

	Hole	shaft
max	0.7635"	0.7555"
min	0.760"	0.7535"

Limits of Clearance

min hole - max shaft  $\Rightarrow 0.76" - 0.7555" = 0.0045"$

max hole - min shaft  $\Rightarrow 0.7635" - 0.7535" = 0.010"$

shaft:  $0.76 - 0.0045 = 0.7555$

$0.76 - 0.010 = 0.75$

$\frac{0.7555}{0.75}$
-----------------------

## C7: Pin

MET 489A

Pin Shear (Adapter)

Grady Graff

- G: Double shear Pin
- $F = 1000 \text{ #}'s$
  - $S_y = 84 \text{ Ksi}$  (316 stainless steel)

$F$ :  $\phi$  of Pin

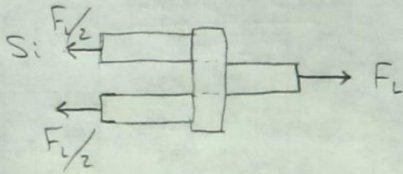

$$F_L/2 = \frac{1000 \text{ #'s}}{2} = 500 \text{ #'s}$$

• Double shear:

$$S_y = 84 \text{ Ksi} \Rightarrow S_{ys} = S_y/2 = 42 \text{ Ksi}$$

• yield strength in shear:

$$S_{ys} = 42 \text{ Ksi} (.5)$$

$$\sigma = 21 \text{ Ksi}$$

Endurance factor  
(safety factor of 2)  
- Equation 5-5 MOTT

$$\sigma = \frac{F_L}{\left(\frac{\pi D^2}{4}\right)}$$

$$D = \sqrt{\frac{F_L}{\sigma (.75)}}$$

$$D = \sqrt{\frac{(1000 \text{ #'s})}{(21,000 \text{ psi}) (.75)}}$$

$$D = 2.46 \text{ in}$$

Use Pin  $\phi$  0.25

C8: Drive Shaft

MET 489A

Shaft

Grady Grady

Axial Load

$$\Delta L = \frac{FL}{AE}$$

F = Force (lbs)  
 L = Length (in)  
 A = area (in<sup>2</sup>)  
 E = Modulus of Elasticity (Pa) (psi)

$$\Delta L = \frac{(16s)(in)}{(in^2)(\frac{16s}{in^2})}$$

$$\Delta L = in$$

Example

G: F = 1000 lbs  
 L = 24 in  
 A = .1 in<sup>2</sup>  
 E = 10,000,000 psi

F: ΔL

$$S: \Delta L = \frac{(1000 \text{ lbs})(24 \text{ in})}{(.1 \text{ in}^2)(10,000 \text{ Kpsi})}$$

- See Material vs Size chart in Appendix

$$\Delta L = .024 \text{ in}$$

Appropriate Surface Area

$$\Delta L = \frac{FL}{AE}$$

$$A = \frac{FL}{\Delta L E}$$

$$A = \frac{(1000 \text{ lbs})(24 \text{ in})}{(.025 \text{ in})(10,000 \text{ Kpsi})}$$

$$A = 0.096$$

MET 489A

Shaft

Grady Graff

Thickness

$$OD = .5''$$

$$\text{Surface Area} = .096 \text{ in}^2$$

$$A_{OD} = \frac{\pi D^2}{4}$$

$$A_{OD} = \frac{\pi (.5'')^2}{4}$$

$$A_{OD} = .196 \text{ in}^2$$



$$A_{ID} = A_{OD} - \text{Surface Area}$$

$$A_{ID} = (.196 \text{ in}^2) - (.096 \text{ in}^2)$$

$$A_{ID} = 0.1 \text{ in}^2$$

$$A_{ID} = \frac{\pi D_{ID}^2}{4} \Rightarrow D_{ID} = \sqrt{\frac{4 A_{ID}}{\pi}}$$

$$D_{ID} = .357 \text{ in}$$

$$\text{Wall Thickness} = D_{OD} - D_{ID}$$

$$= (.5'') - (.357 \text{ in})$$

$$= .143 \text{ in} / 2 \text{ walls}$$

$$\text{Thickness} = .012 \text{ in}$$

Use Standard:  $\frac{1}{2}$  in round ID = .334

MET 489 A

Shaft

Grady Graff

Torque

$$G: -T_{max} = 12000 \text{ psi}$$

$$F: T_{max}$$

-1/2" round 6061 Aluminum tube

$$-\phi = .5" \text{ (.083" walls)}$$

-cannot exceed 185 in-lbs

$$S: \tau_{max} = \frac{T r_o}{J_{hollow}}$$

$$r_o = .25 \quad r_i = .167$$

$$J_{hollow} = \frac{\pi}{2} ((.25)^4 - (.167)^4)$$

$$T = \frac{\tau_{max} J_{hollow}}{r_o}$$

$$J_{hollow} = .0049 \text{ in}^4$$

$$T = \frac{(12000 \text{ psi})(.0049 \text{ in}^4)}{(.25")}$$

$$T = 235.2 \text{ in-lbs} \quad \checkmark$$

Buckling

G: -6061 Aluminum

$$F: P_{crit}$$

$$-\phi_o = .5 \quad \phi_i = .334$$

$$-E = 10,000 \text{ ksi}$$

$$-S_y = 11 \text{ ksi}$$

$$-K = 1.0$$

$$L = 25"$$

$$S: l_e = KL \Rightarrow l_e = (1.0)(25") \Rightarrow l_e = 25"$$

$$I = \frac{\pi (.5^4 - .334^4)}{64}$$

$$A = \frac{\pi (.5^2)}{4} \Rightarrow A = .196 \text{ in}^2$$

$$A_{in} = \frac{\pi (.334)^2}{4} \Rightarrow A_{i} = .088 \text{ in}^2$$

$$I = .002457$$

$$A_o = .196 \text{ in}^2 - .088 \text{ in}^2$$

$$A_o = .108 \text{ in}^2$$

$$r = \sqrt{\frac{I}{A}} \Rightarrow r = \sqrt{\frac{(.002457 \text{ in}^4)}{(.108 \text{ in}^2)}} \Rightarrow r = .1508$$

MET 489A

Shaft

Grady Graff

Slenderness ratio

$$SR = \frac{L_e}{r_{min}}$$

$$SR = \frac{(25')}{(.1508)}$$

$$SR = 165.78$$

Column Constant

$$C_c = \sqrt{\frac{2\pi^2 E}{S_y}}$$

$$C_c = \sqrt{\frac{2\pi^2 (10000 \text{ ksi})}{11 \text{ ksi}}}$$

$$C_c = 133.95$$

>

Long Column

$$P_{cr} = \frac{\pi^2 E A}{SR^2}$$

$$\Rightarrow P_{cr} = \frac{\pi^2 (10000 \text{ ksi}) (.108 \text{ in}^2)}{(165.78)^2}$$

$$P_{cr} = 1387.8 \#$$



C9: Pin Connector

MET 489A

Pin Connector

Grady Graff

Tensile  
G:

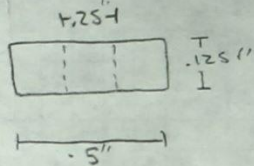

F: Surface Area

$$A = 0.063 \text{ in}^2 \quad \checkmark$$

- F = 1000 lbs
- L = 0.6 in
- $\Delta L = 0.025$  in
- E = 10,000 ksi

S:

$$A = \frac{(1000 \text{ lbs})(0.6 \text{ in})}{(0.025 \text{ in})(10,000 \text{ ksi})} \Rightarrow A = 0.0024 \text{ in}^2 \text{ required}$$

G:

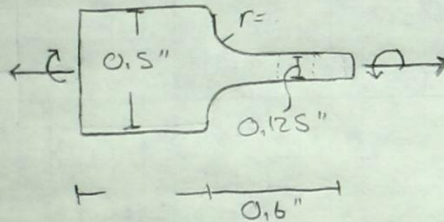

F:

- T = 185 in-lbs
- F = 1000 lbs
- 6061 Aluminum rod
  - $S_{ut} =$
  - $S_{uc} =$

$$K_T = 1.51$$

S:

Torsion

$$T_{max} = \frac{K_T T r}{J}$$

$$J = \frac{\pi D^4}{32} \Rightarrow J = \frac{\pi (0.125 \text{ in})^4}{32}$$

$$J = 0.002 \text{ in}^4$$

$$T_{max} = \frac{(1.51)(185 \text{ in-lbs})(0.063)}{(0.002 \text{ in}^4)}$$

$$T_{max} = 8,729 \text{ psi}$$

# C10: Press Fit Cover

MET 489	Cover Interference Fit	Grady Graft
---------	------------------------	-------------

G: - Light Loads  
- Interference  
- shaft = 0.75

F: - class fit  
- size Limits

S: FN2 (medium Drive Fit)

	Hole	shaft
max	+0.8	+1.9
min	-0	+1.4

Limits of size

$$\begin{array}{l} 0.75'' + 0.0008'' \\ 0.75'' - 0.0000'' \end{array} \left| \begin{array}{l} 0.75'' + 0.0019'' \\ 0.75'' + 0.0014'' \end{array} \right.$$

	Hole	shaft
max	0.7508''	0.7519''
min	0.750''	0.7514''

Limits of Clearance

$$\begin{aligned} \text{min hole} - \text{max shaft} &\Rightarrow 0.750'' - 0.7519'' = -0.0019'' \\ \text{max hole} - \text{min shaft} &\Rightarrow 0.7508'' - 0.7514'' = -0.0006'' \end{aligned}$$

shaft =	+0.7519'' -0.7514''	Ball Nut
---------	------------------------	----------

Hole =	+0.7508 -0.750''	Press Fit Cover
--------	---------------------	-----------------



# APPENDIX D - Drawings

Drawing Tree:

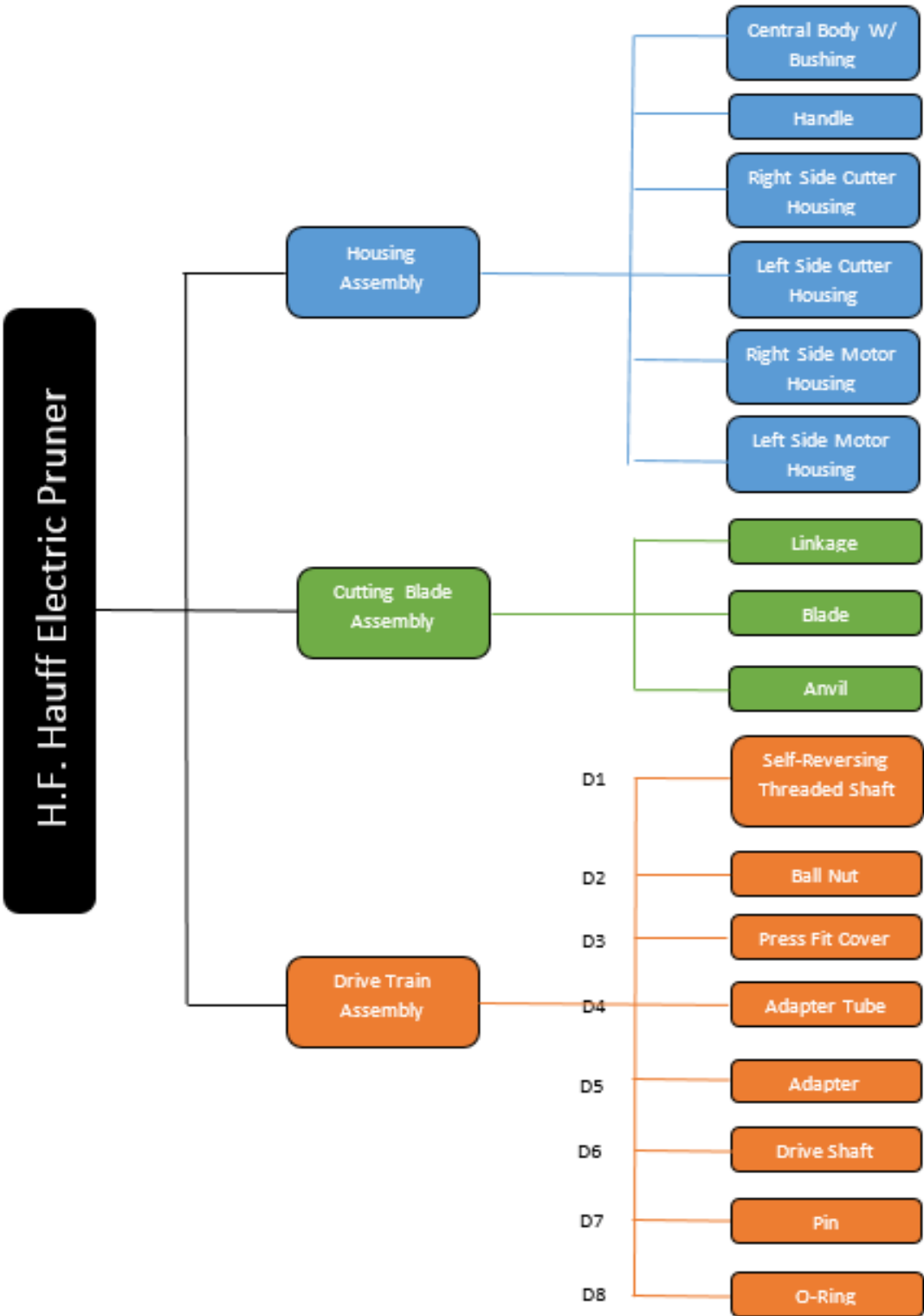

# D1: Self-Reversing Threaded Shaft

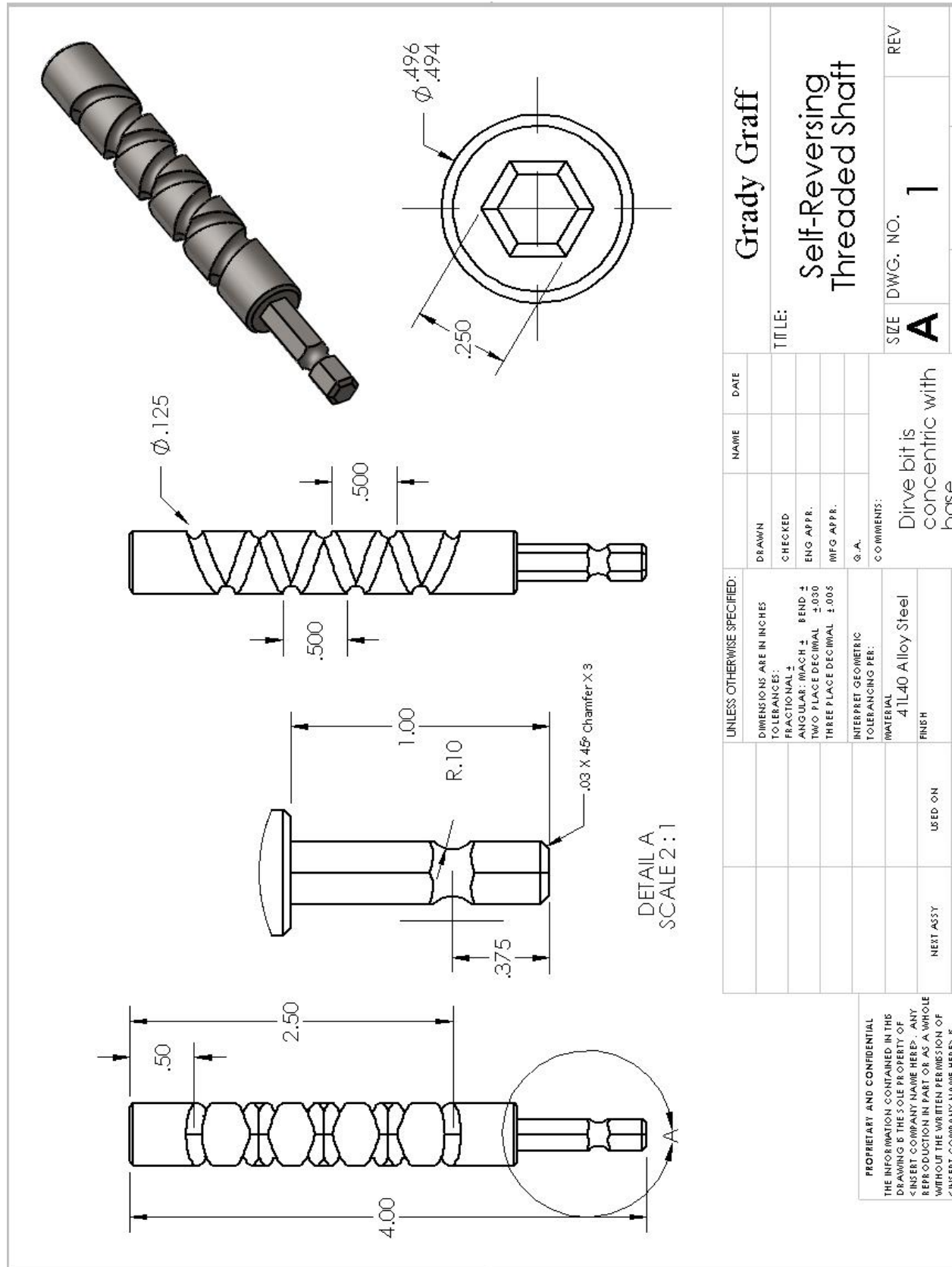

Grady Graff

TITLE:

Self-Reversing Threaded Shaft

SIZE DWG. NO. **A** 1

REV

## D2: Ball Nut

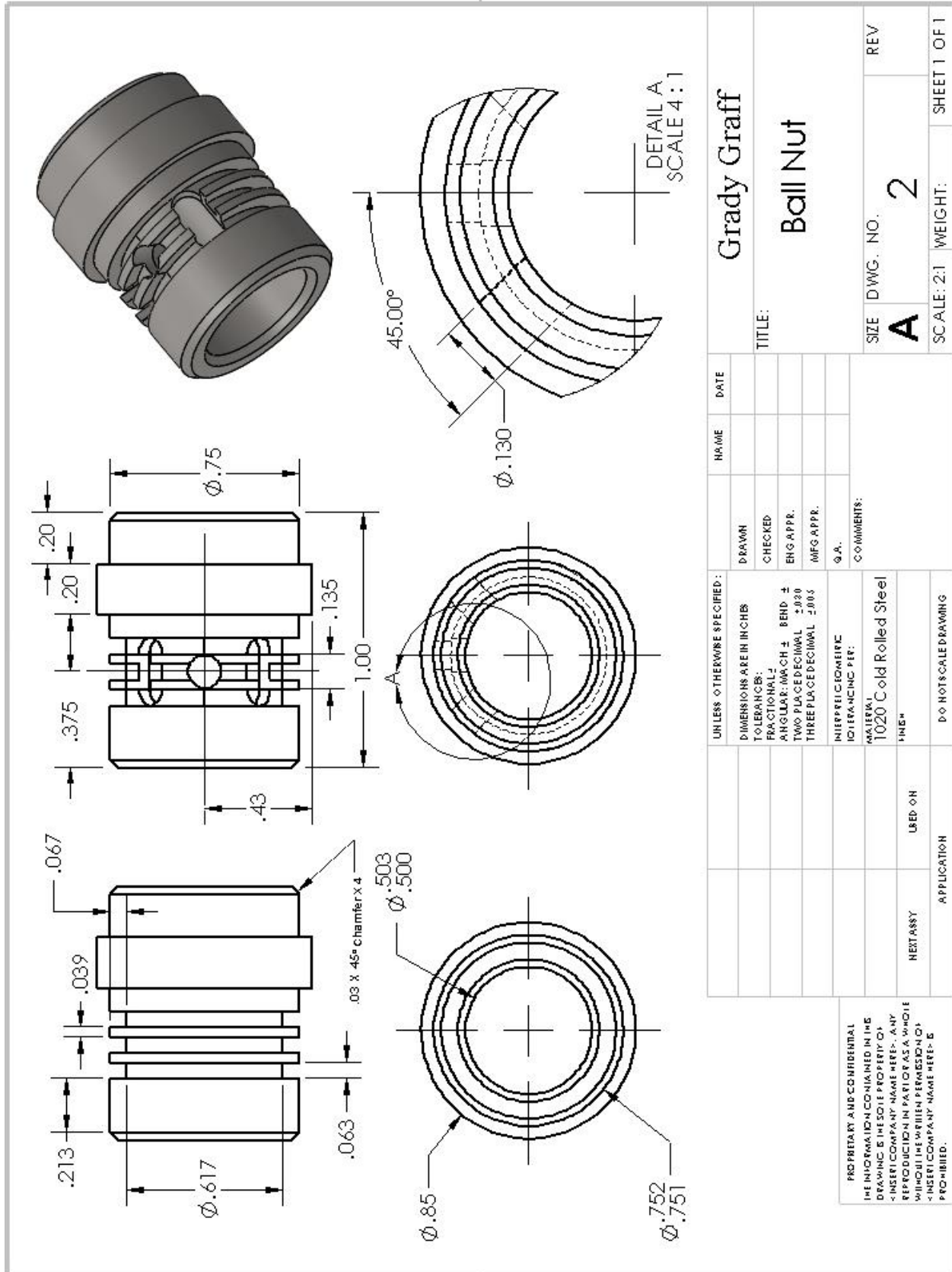

### D3: Press Fit Cover

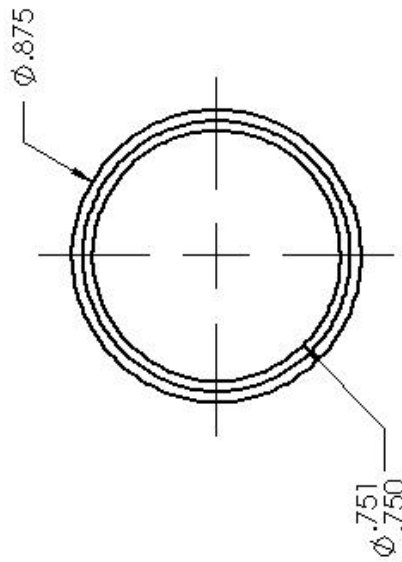
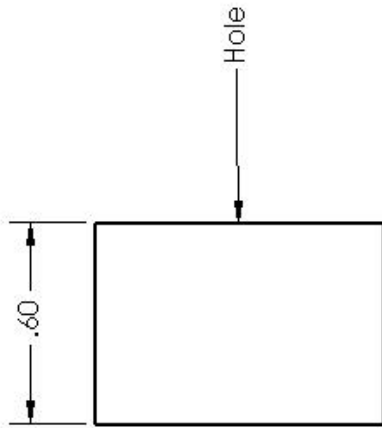

UNLESS OTHERWISE SPECIFIED: DIMENSIONS ARE IN INCHES TOLERANCES: FRACTIONAL: .0005 DECIMAL: .0005 ANGULAR: .0004 BEND: 4 TWO PLACES DECIMAL: .0005 THREE PLACES DECIMAL: .0005		DRAWN	NAME	DATE	Grady Graff
INTERPRETING FIRM: TOLERANCING FIRM:		CHECKED			
MATERIAL: 6061 Aluminum		ENG APPR.			TITLE: Press Fit Cover
FINISH: LUBED ON		MFG APPR.			SIZE: <b>A</b>
NEXT ASSY: APPLICATION		Q. A.			DWG. NO. <b>3</b>
APPICATION		COMMENTS:			REV
DO NOT SCALE DRAWING					SCALE: 2:1
PROPRIETARY AND CONFIDENTIAL THE INFORMATION CONTAINED IN THIS DRAWING IS THE SOLE PROPERTY OF <INSERT COMPANY NAME HERE>. ANY REPRODUCTION IN PART OR AS A WHOLE WITHOUT THE WRITTEN PERMISSION OF <INSERT COMPANY NAME HERE> IS PROHIBITED.					SHEET 1 OF 1

# D4: Adapter Tube

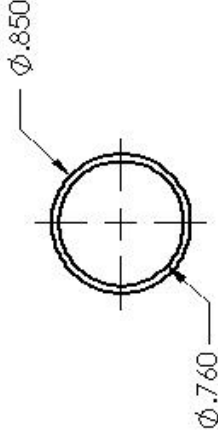
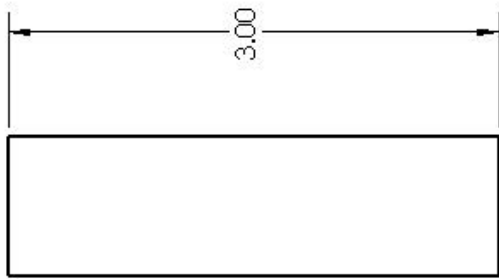

UNLESS OTHERWISE SPECIFIED:		NAME	DATE
DIMENSIONS ARE IN INCHES			
TOLERANCES:			
FRACTIONAL:			
ANGULAR: MACH. BEND ±			
TWO PLACE DECIMAL ±.020			
THREE PLACE DECIMAL ±.005			
INTERPRETATION:			
TOLERANCE PER:			
MATERIAL:			
1020 CR Steel			
FINISH:			
NEW ASSY	USED ON		
APPLICATION			
DO NOT SCALE DRAWING			

  

PROPRIETARY AND CONFIDENTIAL THE INFORMATION CONTAINED IN THIS DRAWING IS THE SOLE PROPERTY OF <INSERT COMPANY NAME HERE>. ANY REPRODUCTION IN PART OR AS A WHOLE WITHOUT THE WRITTEN PERMISSION OF <INSERT COMPANY NAME HERE> IS PROHIBITED.	
---	--

Grady Graff Adapter Tube	
TITLE:	SIZE DWG. NO.
A	4
SCALE: 1:1	WEIGHT:
SHEET 1 OF 1	REV

# D5: Adapter

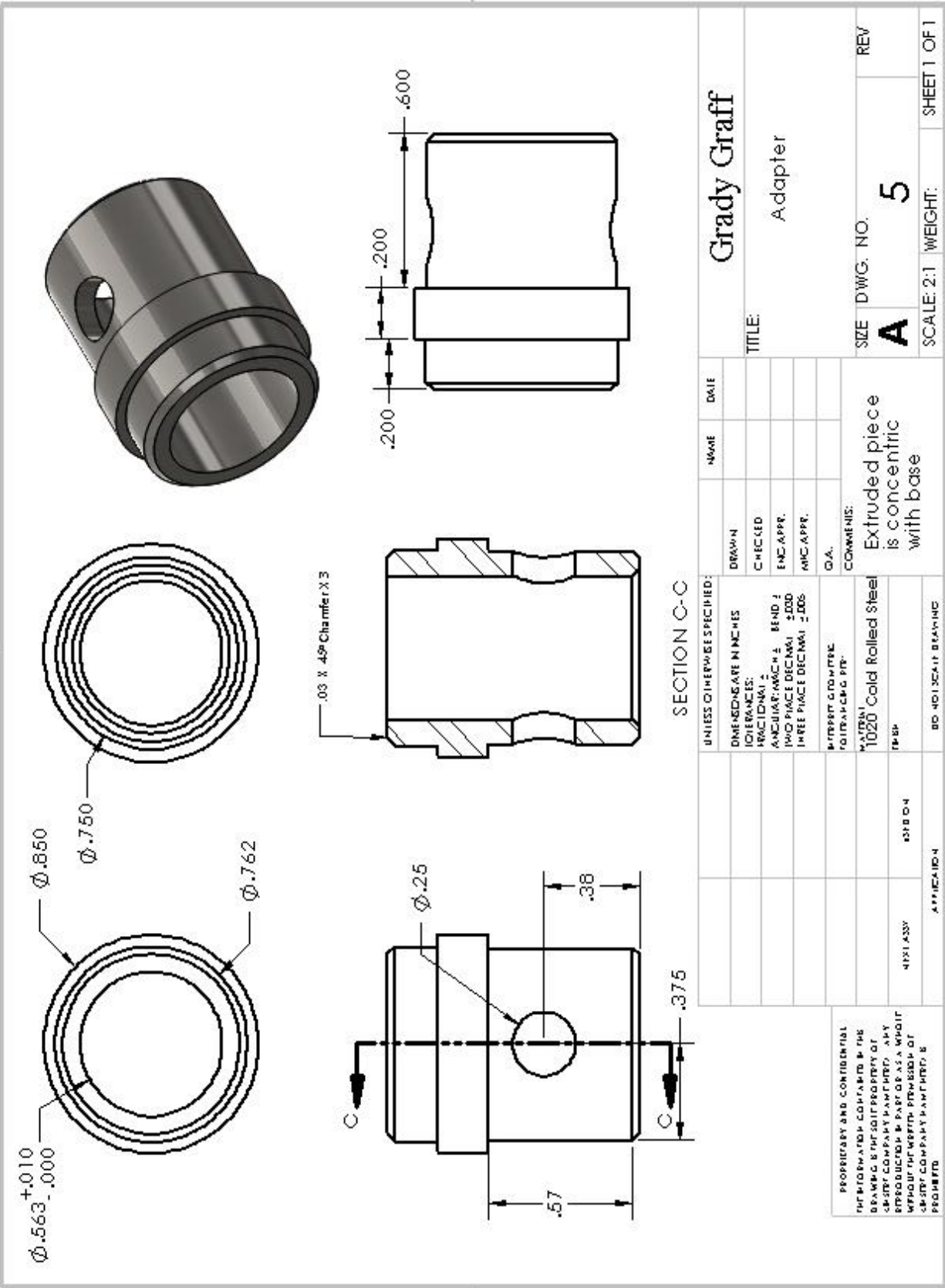

## SECTION C-C

UNLESS OTHERWISE SPECIFIED:		NAME	DATE	Grady Graff	
DIMENSIONS ARE IN INCHES	DRAWN			Adapter	
TOLERANCES:	CHECKED			TITLE:	
FRACTIONAL ±	END APPR.			SIZE DWG. NO. <b>A</b> <b>5</b> REV	
ANGULAR: AMCS ± BEND ±	ENG APPR.			SCALE: 2:1 WEIGHT: SHEET 1 OF 1	
TWO PLACE DECIMAL ±.000	D.A.				
THREE PLACE DECIMAL ±.005	COMMENTS:	Extruded piece is concentric with base			
MATERIAL:	4151 ASSY	1020 Cold Rolled Steel			
FINISH:	03B 0-4	RD 401 SCALIT BEARING			
APPLICATOR:					

PROPRIETARY AND CONFIDENTIAL  
 INFORMATION CONTAINED IN THIS  
 DRAWING IS THE SOLE PROPERTY OF  
 GRADY COMPANY AND SHOULD NOT BE  
 REPRODUCED OR TRANSMITTED IN ANY  
 FORM OR BY ANY MEANS WITHOUT THE  
 WRITTEN PERMISSION OF GRADY  
 COMPANY.

D6: Drive Shaft

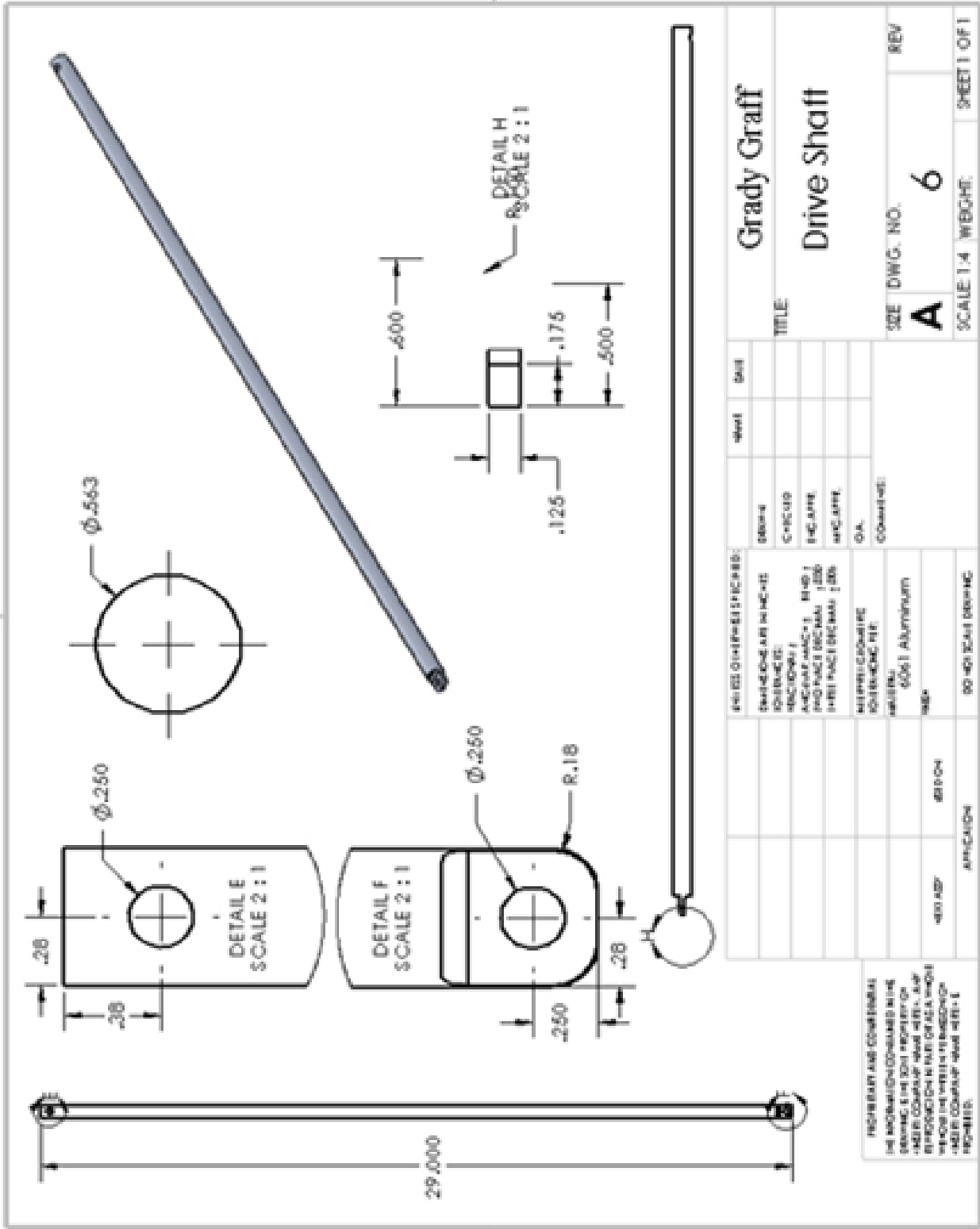

FOR BARS AND COILS (SEE  
 INSTRUCTIONS)  
 FOR COILS (SEE INSTRUCTIONS)  
 FOR COILS (SEE INSTRUCTIONS)  
 FOR COILS (SEE INSTRUCTIONS)  
 FOR COILS (SEE INSTRUCTIONS)

Grady Graff			DATE
Drive Shaft			TITLE
SIZE	DWG. NO.	REV	
A	6		
SCALE 1:4			WEIGHT
SHEET 1 OF 1			

D7: Pin

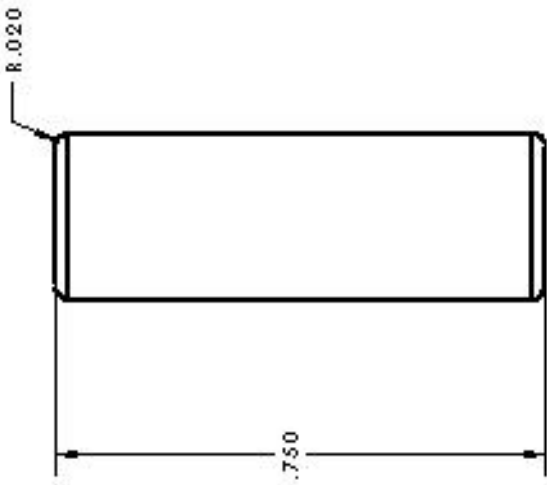

PROPERTY AND CONSTRUCTION ALL DIMENSIONS CONTAINED IN THE DRAWING ARE THE PROPERTY OF MIDWESTERN PARTS AND FABRICATION. ALL DIMENSIONS ARE TO BE AS SHOWN UNLESS OTHERWISE SPECIFIED. ALL DIMENSIONS ARE TO BE IN UNLESS OTHERWISE SPECIFIED.		UNITS DIMENSIONS SPECIFIED: DIMENSIONS ARE IN INCHES FRACTIONS: ANGULAR MEASUREMENTS: TWO PLACE DECIMALS PART PLACE DECIMALS	COMMENTS: ORDERED THROUGH MIC MASTER-CAD	DATE:	PART:	TITLE: Pin	Grady Graff
DRAWN:	CHECKED:	DATE:	SCALE: 4:1	WEIGHT:	SHEET 1 OF 1	SEE DWG. NO. A 7	REV
APP'Y ASSY	WTD QIP	DO NOT SCALE DRAWING					

PROPERTY AND CONSTRUCTION  
 ALL DIMENSIONS CONTAINED IN THE DRAWING ARE THE PROPERTY OF MIDWESTERN PARTS AND FABRICATION. ALL DIMENSIONS ARE TO BE AS SHOWN UNLESS OTHERWISE SPECIFIED.  
 ALL DIMENSIONS ARE TO BE IN UNLESS OTHERWISE SPECIFIED.



# D8: O-Rings

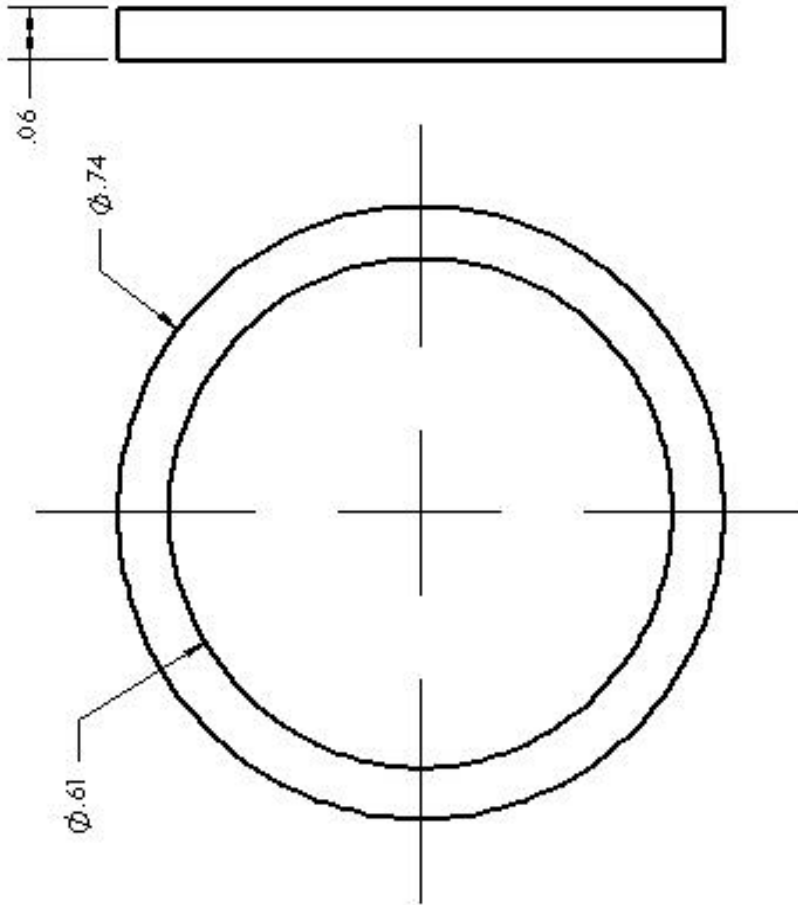

PROPERTY AND CONTENTS ALL INFORMATION CONTAINED IN THIS DRAWING IS THE SOLE PROPERTY OF JUSTY COMPANY. ANY REPRODUCTION IN PART OR AS A WHOLE WITHOUT THE WRITTEN PERMISSION OF JUSTY COMPANY IS PROHIBITED.		DIMENSIONS ARE IN INCHES TOLERANCES: FRACTIONAL ± .005 DECIMAL ± .001 HOLE ± .002 HOLE POSITION ± .005		DRAMP CHPTED PIG APP MFG APP D.A. COMMENTS: Crated Through MICROSTEP-COIT	PART DATE	Grady Graff Square O-Ring
		UNLESS OTHERWISE SPECIFIED	MATERIAL: Silicon Rubber	FINISH: USED ON	APPLICATION	SIZE A
PART ASSY	USED ON	APPLICATION	DO NOT SCALE DRAWING	SCALE: S1	WEIGHT:	SHEET 1 OF 1

# D9: Welding

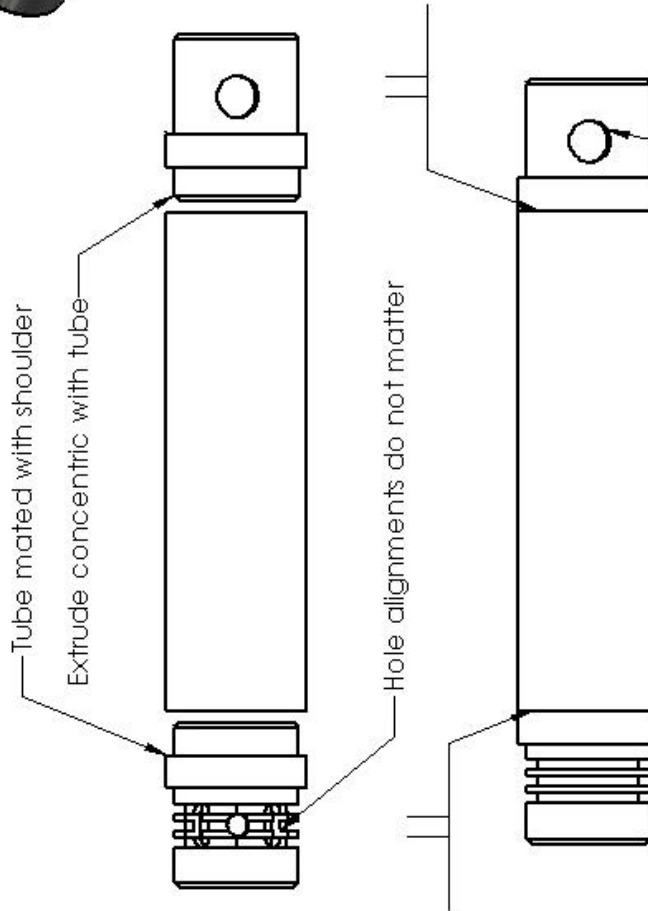

Hole alignments do not matter

UNLESS OTHERWISE SPECIFIED:		DRAWN	NAME	DATE	Grady Graff	
DIMENSIONS ARE IN INCHES		CHECKED			TITLE: Weld	
TOLERANCES:		ENG APPR.			SIZE DWG. NO. <b>A</b> 9	
FRACTIONAL ±		MFG APPR.			SCALE: 1:1 WEIGHT: SHEET 1 OF 1	
ANGULAR: MATCH ± BEND ±		Q.A.			REV	
TWO PLACE DECIMAL ±		COMMENTS:				
THREE PLACE DECIMAL ±		MATERIAL				
INTERFEROMETRIC		FINISH				
IDENTIFYING PER.		USED ON				
APPLICATION						
DO NOT SCALE DRAWING						

PROPRIETARY AND CONFIDENTIAL  
 THE INFORMATION CONTAINED IN THIS  
 DRAWING IS THE SOLE PROPERTY OF  
 INTERCOMPANY NAME HERE. ANY  
 REPRODUCTION IN PART OR AS A WHOLE  
 WITHOUT THE WRITTEN PERMISSION OF  
 INTERCOMPANY NAME HERE IS  
 PROHIBITED.

# D10: Drive Train Assembly

- Ball nut slots (5b) align with threads (6), bearings inserted (4), O-rings (1) set in slots (5a), cover (7) is pressfit to surface.
- Align pin slots (6), (3), and pin (2) flush with the adapter (8)
- (2), (5), are welded and (2), (6), (8) are welded.
- Aluminum: (2) (3) (4) (5) (6) (7)
- Steel: (1) (4) (5) (6) (7) (8)
- Rubber: (8)

DETAIL C  
SCALE 1:2

- Ball nut slots (5b) align with threads (6), bearings inserted (4), O-rings (1) set in slots (5a), cover (7) is pressfit to surface.
- Align pin slots (6), (3), and pin (2) flush with the adapter (8)
- (2), (5), are welded and (2), (6), (8) are welded.
- Aluminum: (2) (3) (4) (5) (6) (7)
- Steel: (1) (4) (5) (6) (7) (8)
- Rubber: (8)

DETAIL A  
SCALE 1.5:1

1	Self-Reversing Threaded shaft
2	Press fit Cover
3	O-Rings
4	Bearings
5	Ball Nut
6	Adapter Tube
7	Pin
8	Adapter
9	Drive Shaft

**Grady Graff**

TITLE: Drive Train Assembly

SIZE: A DWG. NO. 10

SCALE: 2:1 WEIGHT: SHEET 1 OF 1

UNLESS OTHERWISE SPECIFIED:	NAME	DATE
DIMENSIONS ARE IN INCHES	DRAWN	
TOLERANCES:	CHECKED	
FRACTIONAL ±	ENG APPR.	
ANGULAR: MINUS ± BEND ±	ANC APPR.	
TWO PLACE DECIMAL ±.000	O.A.	
THREE PLACE DECIMAL ±.005	COMMENTS:	
±.0005 GROUND		
FILLET RING FIT		
MATERIAL: 6061 Aluminum		
1070 Cold Rolled Steel		
316B Alloy Steel		
FRSP		
4121 ASSY	4121 ASSY	
APPLICATION	DRIVE TRAIN BEARING	

PROPRIETARY AND CONFIDENTIAL  
 INFORMATION CONTAINED IN THIS  
 DRAWING IS THE SOLE PROPERTY OF  
 GRADY COMPANY MANUFACTURE. ANY  
 REPRODUCTION OR PART OR AS A WHOLE  
 WITHOUT THE WRITTEN PERMISSION OF  
 GRADY COMPANY MANUFACTURE  
 PROHIBITED

# APPENDIX E – Job Travelers/Setup Sheets

## E1: Self-Reversing Threaded Shaft:

### Hogue Machine Shop - Job Traveler

PART INFORMATION: Self-Reversing Threaded Shaft			
Name	Part Number	Revision Level	Customer
Grady Graff	18	1	Neil Hauff

MATERIAL INFORMATION		RUN INFORMATION	
Size	Shape	Alloy	Run Quantity
0.5" Ø X 1' Stick	Round Bar	41L40 Alloy Steel	1

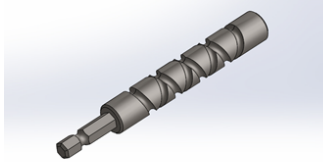

#### SAWING

Saw length	Tolerance
4"	+ .030 - .000

#### MACHINING OPERATIONS

Operation #1  
CNC Lathe (Threads)

Operation #2  
Manual Mill (Hex Drive Bit)

Operation #3  
Saw

Operation #4

Operation #5

Operation #6

Operation #7

#### SPECIAL INSTRUCTIONS

- Saw to 4" after the lathe operations are finished to ensure quality grip while threading.
- Carefully de-bur all threads.
- Raw material should be ±.002" concentric with 4 Jaw Chuck before starting.
- Manual mill has 6 of the exact same setups, 1 for each side. Mill face, rotate, mill face, rotate, etc.

### Hogue Machine Shop - Setup Sheet

Operation # 1 CNC Lathe

Program # O0001

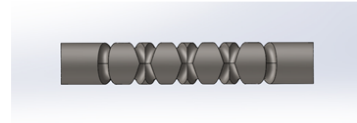

#### TOOLS

T#	Description	Setup Time	1 hr.
1	4 Jaw Chuck		
2	Countersink drill bit		
3	Cutting form tool	Machine Time	1 hr.
4	1/8" Ø carbide lathe cutting tool	Cycle Time	
		Parts per Hour	

#### FIRST ARTICLE INSPECTION REPORT

Dimension	Instrument	Print value and tolerance	Ascend/Reject	Act. Measurement
Raw Steel Ø	Caliper	0.5" ± .005	<input checked="" type="checkbox"/> <input type="checkbox"/>	0.497"
Concentricity	Dial Indicator	± .003"	<input checked="" type="checkbox"/> <input type="checkbox"/>	0.001"
Thread Ø	Depth Micrometer	0.125" ± 0.010 - .000	<input checked="" type="checkbox"/> <input type="checkbox"/>	0.126"
Thread Start	Caliper	1.435" ± .010 (Datum A)	<input checked="" type="checkbox"/> <input type="checkbox"/>	1.435"
Thread End	Caliper	3.565" ± .010 (Datum A)	<input checked="" type="checkbox"/> <input type="checkbox"/>	3.565"
Thread Pitch	Caliper	0.500" ± .005	<input checked="" type="checkbox"/> <input type="checkbox"/>	0.50"
			<input type="checkbox"/> <input type="checkbox"/>	
			<input type="checkbox"/> <input type="checkbox"/>	
			<input type="checkbox"/> <input type="checkbox"/>	

#### SPECIAL INSTRUCTIONS

- Use countersink to full depth to ensure security of the part.
- Angle cutting form tool enough to face the end of the shaft
- Measure thread pitch from edge of the thread to same edge on the next revolution.

### Hogue Machine Shop - Setup Sheet

Operation # 2 Manual Mill

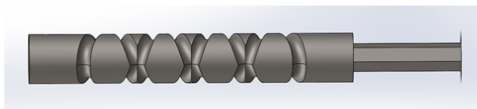

#### TOOLS

T#	Description	Setup Time	1 hr.
1	1/2" collet		
2	Socket fitting a 1/2" collet	Machine Time	2 hr.
3	Table clamp	Cycle Time	
4	1/2" dia. carbide end mill	Parts per Hour	

#### FIRST ARTICLE INSPECTION REPORT

Dimension	Print value and tolerance	Instrument	Ascend/Reject	Act. Measurement	Accept/Reject
Hex Width	Caliper: 0.251" ± .002		<input checked="" type="checkbox"/> <input type="checkbox"/>	0.250"	
Bit Length	Caliper: 1.00" ± .030 (Datum A)		<input checked="" type="checkbox"/> <input type="checkbox"/>	1.010"	
			<input type="checkbox"/> <input type="checkbox"/>		
			<input type="checkbox"/> <input type="checkbox"/>		

#### SPECIAL INSTRUCTIONS

- Hex width is measured each flat side to opposite flat side.
- Hex center is measured from OD to each flat side.
- Face the drive bit with the end mill.

NAME	DATE
Grady Graff	

TITLE: Self-Reversing Threaded Shaft

SEE DWG. NO. 1

REV A

Drive bit is concentric with P.O.C.

UNLESS OTHERWISE SPECIFIED:  
 DIMENSIONS ARE IN INCHES  
 FINISHES: FRACTIONAL, DECIMAL, SURFACE, HOLE, PLUG, TAP, THREAD, SPLICED, SOLDER, WELD, AND ALL OTHERS AS SHOWN  
 HOLE PLUG TOLERANCES: HOLE, PLUG, TAP, THREAD, SPLICED, SOLDER, WELD, AND ALL OTHERS AS SHOWN  
 HOLE PLUG TOLERANCES: HOLE, PLUG, TAP, THREAD, SPLICED, SOLDER, WELD, AND ALL OTHERS AS SHOWN  
 HOLE PLUG TOLERANCES: HOLE, PLUG, TAP, THREAD, SPLICED, SOLDER, WELD, AND ALL OTHERS AS SHOWN

THE INFORMATION CONTAINED ON THIS DRAWING IS THE PROPERTY OF HOUGE MACHINE SHOP AND IS NOT TO BE REPRODUCED OR TRANSMITTED IN ANY FORM OR BY ANY MEANS, ELECTRONIC OR MECHANICAL, INCLUDING PHOTOCOPYING, RECORDING, OR BY ANY INFORMATION STORAGE AND RETRIEVAL SYSTEM.

# E2: Ball Nut

### Hogue Machine Shop - Job Traveler

FAST INFORMATION: Ball Nut

Name	Part Number	Revision Level	Customer
Grady Graff	19	1	Nell Hauff

MATERIAL INFORMATION: RUN INFORMATION

Item	Shape	Alloy	Run Quantity	Due Date
1	Round Bar	1020 Steel	1	1-26-18
2	Roll	Roll		



**SAWING**

Final Length	Tolerance
-	-

**MACHINING OPERATIONS**

Operation #1  
Manual Mill (Top Bearing Hole)

Operation #2  
Manual Mill (Right Slot)

Operation #3  
Manual Mill (Left Slot)

Operation #4  
Manual Lathe (Deburr, Bore, Grooves and Part)

Operation #5

Operation #6

Operation #7

**SPECIAL INSTRUCTIONS**

- When drilling the first hole, make Hole X larger than the final procedure on the hole to show the correct dimension. Hole Y should be carefully machined.
- Withdraw operation 1 without turning in any way except the Z axis.
- Drill and bore on lathe first ensuring correct ID dimension. If not correct, re-cut.
- Drill for enough for bore clearance.
- Leave 1" unchanged for bore clearance.
- Reduce small bore first and continue with the large bore.
- Parting will ensure concentricity.

### Hogue Machine Shop - Setup Sheet

Operation # 1 Manual Mill

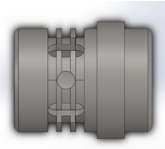

**TOOLS**

#	Description	Setup Time	Run Time
1	Rotating 3 jaw chuck mill vise	1 hr.	
2	1 1/8" end mill	Machine Time	1 hr.

**RUN DATA**

Setup Time	Machine Time	Cycle Time	Parts per Hour

**FIRST ARTICLE INSPECTION REPORT**

Dimension	Requirement	Part Value and Tolerance	Accepted	Rejected	Act. Measurement
Hole Ø	Telescopic Gauge: 0.125" ± .005-.000	0.126"	<input checked="" type="checkbox"/>	<input type="checkbox"/>	0.126"
Hole Depth	Caliper: 0.30"	0.30"	<input checked="" type="checkbox"/>	<input type="checkbox"/>	0.30"
Hole X	Caliper: 0.375" ± .003	0.377"	<input checked="" type="checkbox"/>	<input type="checkbox"/>	0.377"
Hole Y	Caliper: 0.438" ± .005	0.440"	<input checked="" type="checkbox"/>	<input type="checkbox"/>	0.440"

**SPECIAL INSTRUCTIONS**

- Final operation 4, Hole X cannot be measured but should be larger than the stated dimension.
- Use a dial indicator to ensure the slot is parallel with the table.
- Secure the table Y by touching off on datum B and adjusting 0.438".
- Drill to the small Ø end mill, cut should not exceed 0.30" in a time.
- As the middle hole is reached finish, leave the X and Y axis the exact while starting setup 2.

### Hogue Machine Shop - Setup Sheet

Operation # 2 Manual Mill

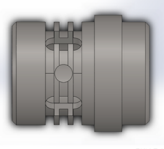

**TOOLS**

#	Description	Setup Time	Run Time
1	Rotating 3 jaw chuck mill vise	1 hr.	
2	1 1/8" end mill	Machine Time	1 hr.

**RUN DATA**

Setup Time	Machine Time	Cycle Time	Parts per Hour

**FIRST ARTICLE INSPECTION REPORT**

Dimension	Requirement	Part Value and Tolerance	Accepted	Rejected	Act. Measurement
Start Slot	Caliper: 0.241" ± .005 (Datum A)	0.241"	<input checked="" type="checkbox"/>	<input type="checkbox"/>	0.241"
End Slot	Caliper: 0.508" ± .005 (Datum A)	0.510"	<input checked="" type="checkbox"/>	<input type="checkbox"/>	0.510"
Width	Telescopic Gauge: 0.125" ± .005-.000	0.126"	<input checked="" type="checkbox"/>	<input type="checkbox"/>	0.126"
Slot Depth	Caliper: 0.30"	0.30"	<input checked="" type="checkbox"/>	<input type="checkbox"/>	0.30"

**SPECIAL INSTRUCTIONS**

- Rotate the chuck 45° clockwise from the last operation.
- Feeds 0.2" into the slot starting in the middle with the same B and F coordinates as operation 1.
- Swive back and forth to slot dimensions carefully not loading the end mill too much.

### Hogue Machine Shop - Setup Sheet

Operation # 3 Manual Mill

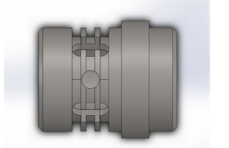

**TOOLS**

#	Description	Setup Time	Run Time
1	Rotating 3 jaw chuck mill vise	1 hr.	
2	1 1/8" end mill	Machine Time	1 hr.

**RUN DATA**

Setup Time	Machine Time	Cycle Time	Parts per Hour

**FIRST ARTICLE INSPECTION REPORT**

Dimension	Requirement	Part Value and Tolerance	Accepted	Rejected	Act. Measurement
Start Slot	Caliper: 0.241" ± .005 (Datum A)	0.246"	<input checked="" type="checkbox"/>	<input type="checkbox"/>	0.246"
End Slot	Caliper: 0.508" ± .005 (Datum A)	0.507"	<input checked="" type="checkbox"/>	<input type="checkbox"/>	0.507"
Width	Telescopic Gauge: 0.125" ± .005-.000	0.126"	<input checked="" type="checkbox"/>	<input type="checkbox"/>	0.126"
Slot Depth	Caliper: 0.30"	0.30"	<input checked="" type="checkbox"/>	<input type="checkbox"/>	0.30"

**SPECIAL INSTRUCTIONS**

- Rotate the chuck 90° counterclockwise from last operation.
- Complete the slot with the same procedure.

### Hogue Machine Shop - Setup Sheet

Operation # 4 Manual Lathe



**TOOLS**

#	Description	Setup Time	Run Time
1	Countersink drill bit	1 hr.	
2	5/8" Ø drill bit	Machine Time	2 hrs.
3	Boring tool	Cycle Time	
4	Lathe cutting form tool	Cycle Time	
5	1/16" square groove	Cycle Time	
6	Square groove	Parts per Hour	

**RUN DATA**

Setup Time	Machine Time	Cycle Time	Parts per Hour

**FIRST ARTICLE INSPECTION REPORT**

Dimension	Requirement	Part Value and Tolerance	Accepted	Rejected	Act. Measurement
Small Outside Ø	1" Mic: -0.751" ± 0.752"	0.752"	<input checked="" type="checkbox"/>	<input type="checkbox"/>	0.752"
Large Outside Ø	1" Mic: 0.850" ± .005	0.851"	<input checked="" type="checkbox"/>	<input type="checkbox"/>	0.851"
Inside Ø	1" Mic: Square Stock: -0.500" ± 0.503"	0.501"	<input checked="" type="checkbox"/>	<input type="checkbox"/>	0.501"
Small Bore Length	Caliper: 0.20" ± .030	0.21"	<input checked="" type="checkbox"/>	<input type="checkbox"/>	0.21"
Large Bore Length	Caliper: 0.60" ± .030	0.603"	<input checked="" type="checkbox"/>	<input type="checkbox"/>	0.603"
1 <sup>st</sup> Groove	Caliper: 0.245" ± .001	0.244"	<input checked="" type="checkbox"/>	<input type="checkbox"/>	0.244"
2 <sup>nd</sup> Groove	Caliper: 0.334" ± .001	0.334"	<input checked="" type="checkbox"/>	<input type="checkbox"/>	0.334"
3 <sup>rd</sup> Groove	Caliper: 0.445" ± .001	0.446"	<input checked="" type="checkbox"/>	<input type="checkbox"/>	0.446"
Hole X	Caliper: 0.375" ± .005	0.377"	<input checked="" type="checkbox"/>	<input type="checkbox"/>	0.377"

**SPECIAL INSTRUCTIONS**

- Bore for enough to part the part on the lathe.
- Bore is critical, tolerance is tight and important.

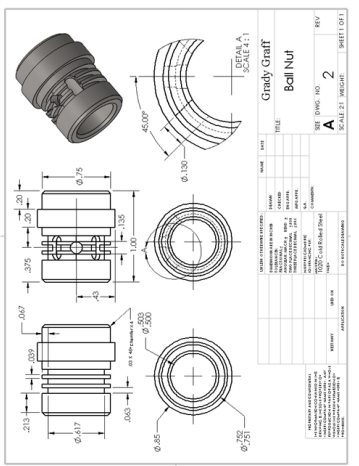

**Grady Graff**  
Ball Nut

REV: 2  
SCALE: 2X  
SHEET 01 OF 1

DATE: 1/26/18  
DRAWN BY: G. GRAFF  
CHECKED BY: G. GRAFF  
APPROVED BY: G. GRAFF

REVISIONS:

NO.	DATE	DESCRIPTION
1	1/26/18	Initial Release

# E3: Press Fit Cover

## Hogue Machine Shop - Job Traveler

PART INFORMATION: Press Fit Cover			
Name	Part Number	Revision Level	Customer
Grady Graff	20	1	Neil Hauff

MATERIAL INFORMATION		RUN INFORMATION	
Size	Shape	Alloy	Run Quantity
7/8" $\phi$ X 6"	Round Bar	6061	1
Stick		Aluminum	

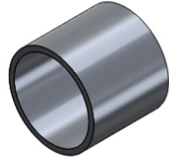

SAWING	
Saw Length	Tolerance

MACHINING OPERATIONS	
Operation #1	Manual Lathe (Drill, Bore and Parted)
Operation #2	
Operation #3	
Operation #4	
Operation #5	
Operation #6	
Operation #7	

SPECIAL INSTRUCTIONS	
<ul style="list-style-type: none"> <li>Piece will be parted by a square form tool for accuracy instead of saw.</li> <li>Clamp 2" from the end of the part for drill and tool clearance.</li> </ul>	

## Hogue Machine Shop - Setup Sheet

Operation # 1 Manual Lathe

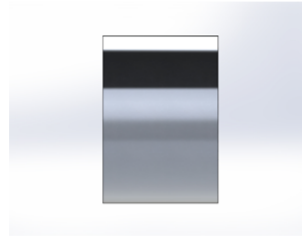

TOOLS		RUN DATA	
#	Description	Setup Time	
1	3 Jaw Chuck	5 hr.	
2	Lathe cutting form tool	Machine Time	1 hr.
3	Countersink drill bit	Cycle Time	
4	5/8" $\phi$ drill bit	Parts per Hour	
5	37/64 $\phi$ drill bit		
6	Square groove		

FIRST ARTICLE INSPECTION REPORT				Inspector: Grady Graff
Dimension	Instrument	Print value and tolerance	Accept/Reject	Act. Measurement
Outside $\phi$	1" Mic	0.875" $\pm$ .005	<input checked="" type="checkbox"/> $\square$ 0.876"	
Inside $\phi$	Caliper/Spring Stick	0.75" $\pm$ .000 $\pm$ .005	<input checked="" type="checkbox"/> $\square$ 0.748	
Length	Caliper	0.6" $\pm$ .000 $\pm$ .010	<input checked="" type="checkbox"/> $\square$ 0.6"	

SPECIAL INSTRUCTIONS	
<ul style="list-style-type: none"> <li>Drill far enough for boring tool clearance.</li> <li>Ensure there .001" of interference with ball nut dimension.</li> </ul>	

UNLESS OTHERWISE SPECIFIED:		NAME	DATE
DIMENSIONS ARE IN INCHES			
TOLERANCES:			
FRACTIONAL			
ANGULAR: DECIMAL			
TWO PLACE DECIMAL			
THREE PLACE DECIMAL			
INTERFERENCE FIT:			
DRIFTCING FIT:			
MATERIAL:	6061 Aluminum		
FINISH:			
APPROVALS:			
DESIGNED BY:			
CHECKED BY:			
ENG APPR:			
MFG APPR:			
Q.A. COMMENTS:			
DATE:			
SCALE:			

<b>Grady Graff</b> TITLE: <b>Press Fit Cover</b>	
SIZE: <b>A</b>	DWG. NO. <b>3</b>
SCALE: 2:1	WEIGHT: SHEET 1 OF 1

# E4: Adapter Tube

## Hogue Machine Shop - Job Traveler

PART INFORMATION: Adapter Tube				
Name	Part Number	Revision Level	Customer	
Grady Graff	21	1	Neil Hautt	
MATERIAL INFORMATION		RUN INFORMATION		
Size	Shape	Alloy	Run Quantity	Due Date
1" Stock 1" round 0.125" wall thickness	Steel Tube	1020 Steel	1	2-09-18

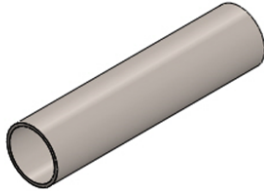

SAWING	
Saw length	Tolerance
3.0"	±.01

MACHINING OPERATIONS	
Operation #1	Manual Lathe (Face, Reduce, Part)
Operation #2	Saw
Operation #3	
Operation #4	
Operation #5	
Operation #6	
Operation #7	

SPECIAL INSTRUCTIONS	

## Hogue Machine Shop - Setup Sheet

Operation # 1 Manual Lathe



TOOLS		RUN DATA	
T#	Description	Setup Time	Machine Time
1	Form cutting tool	0.5 hr.	
2	Parting tool		1 hr.
		Cycle Time	
		Parts per Hour	

FIRST ARTICLE INSPECTION REPORT			Inspector: Grady Graff	
Dimension	Instrument: Print value and tolerance	Accept/Reject	Act.	Measurement
OD	Caliper: 0.850" ± .005	<input checked="" type="checkbox"/> / <input type="checkbox"/>	0.852"	
Length	Caliper: 3.00" ± .030	<input checked="" type="checkbox"/> / <input type="checkbox"/>	2.988"	
ID	Caliper: 0.760" ± .005	<input checked="" type="checkbox"/> / <input type="checkbox"/>	0.761"	
		<input type="checkbox"/> / <input type="checkbox"/>		
		<input type="checkbox"/> / <input type="checkbox"/>		
		<input type="checkbox"/> / <input type="checkbox"/>		
		<input type="checkbox"/> / <input type="checkbox"/>		

SPECIAL INSTRUCTIONS	
<ul style="list-style-type: none"> <li>Secure Part before parting.</li> </ul>	

<small>           PROPRIETARY AND CONFIDENTIAL            THE INFORMATION CONTAINED IN THIS DRAWING IS THE SOLE PROPERTY OF HOGUE MACHINE SHOP. ANY REPRODUCTION IN ANY FORM OR BY ANY MEANS WITHOUT THE WRITTEN PERMISSION OF HOGUE MACHINE SHOP IS PROHIBITED.         </small>		<small>UNLESS OTHERWISE SPECIFIED:</small> DIMENSIONS ARE IN INCHES FRACTIONS ANGLES - DECIMAL DEGREES TWO PLACE DECIMAL - .00 THREE PLACE DECIMAL - .000		DRAWN: _____ CHECKED: _____ ENG APPR: _____ MFG APPR: _____	NAME: _____ DATE: _____
		MATERIAL: 1020 CR Steel		Q.A. _____ COMMENTS: _____	TITLE: <b>Adapter Tube</b>
NECESSARY: _____ USED OR: _____ APPLICATION: _____	DO NOT SCALE DRAWING	SIZE DWG. NO.: <b>A 4</b>	REV: _____	SCALE: 1:1 WEIGHT: _____ SHEET 1 OF 1	Grady Graff

## E5: Adapter

### Hogue Machine Shop - Job Traveler

PART INFORMATION: Adapter			
Name	Part Number	Revision Level	Customer
Grady Graff	22	1	Neil Hauff
MATERIAL INFORMATION			
Size	Shape	Alloy	Run Quantity
1" stick 7/8" $\phi$	Round Bar	CR 1020 steel	1
			Due Date
			2-16-18

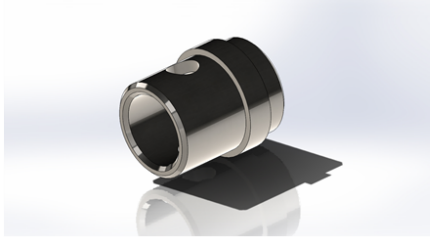

#### SAWING

Saw length	Tolerance

#### MACHINING OPERATIONS

Operation #1

Manual Mill (Hole)

Operation #2

Manual Lathe (Reduce, Bore)

Operation #3

Saw

Operation #4

Operation #5

Operation #6

Operation #7

#### SPECIAL INSTRUCTIONS

- Hole should be drilled past dimension and corrected with facing on the lathe.
- Clamp 2" from the end to ensure tool clearance.

### Hogue Machine Shop - Setup Sheet

Operation # 1 Manual Mill

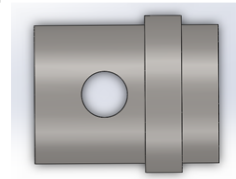

#### TOOLS

I#	Description	Setup Time	Machine Time	Cycle Time	Parts per Hour
1	1/4" drill bit	0.5 hr.	0.5 hr.		

#### FIRST ARTICLE INSPECTION REPORT

Dimension	Instrument: Print value and tolerance	Accept/Reject	Act. Measurement
Hole $\phi$	Telescopic Gauge: .250 -.000 +.005	<input checked="" type="checkbox"/> <input type="checkbox"/>	0.252"
Hole Y	Caliper: 0.38 $\pm$ .030 (Datum B)	<input checked="" type="checkbox"/> <input type="checkbox"/>	0.378"
Hole X	Caliper: 0.37 $\pm$ .030 (Datum A)	<input checked="" type="checkbox"/> <input type="checkbox"/>	0.372"
		<input type="checkbox"/> <input type="checkbox"/>	
		<input type="checkbox"/> <input type="checkbox"/>	
		<input type="checkbox"/> <input type="checkbox"/>	
		<input type="checkbox"/> <input type="checkbox"/>	

#### SPECIAL INSTRUCTIONS

- Datum listed is measuring reference to the center of the hole.

### Hogue Machine Shop - Setup Sheet

Operation # 2 Manual Lathe

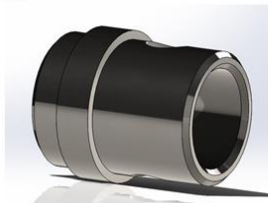

#### TOOLS

I#	Description	Setup Time	Machine Time	Cycle Time	Parts per Hour
1	Countersink drill bit	1 hr.			
2	5/8" $\phi$ drill Bit		1 hr.		
3	Boring tool				
4	Lathe cutting form tool				
5	Square groove				

#### FIRST ARTICLE INSPECTION REPORT

Dimension	Instrument: Print value and tolerance	Accept/Reject	Act. Measurement
Small Outside $\phi$	1" Mic: 0.75" $\pm$ .030	<input checked="" type="checkbox"/> <input type="checkbox"/>	0.775"
Large Outside $\phi$	1" Mic: 0.850" $\pm$ .005	<input checked="" type="checkbox"/> <input type="checkbox"/>	0.853"
Inside $\phi$	Caliper/Spring Stick: 0.563" -.000 +.005	<input checked="" type="checkbox"/> <input type="checkbox"/>	0.565"
Small Base Length	Caliper: 0.75" $\pm$ .030	<input checked="" type="checkbox"/> <input type="checkbox"/>	0.752"
Large Base Length	Caliper: 0.25" $\pm$ .030	<input checked="" type="checkbox"/> <input type="checkbox"/>	0.254"
		<input type="checkbox"/> <input type="checkbox"/>	
		<input type="checkbox"/> <input type="checkbox"/>	
		<input type="checkbox"/> <input type="checkbox"/>	

#### SPECIAL INSTRUCTION





# E6: Drive Shaft

## Hogue Machine Shop - Job Traveler

PART INFORMATION: Drive Shaft			
Name:	Part Number:	Revision Level:	Customer:
Grady Graff	23	1	Niel Hunt
MATERIAL INFORMATION			
Material:	Stock:	Qty:	Order Code:
3" stock 316	Round bar	6061	2-22-18
round	Aluminum rod	1	

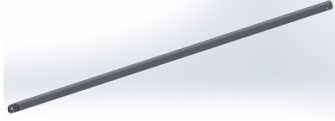

### SAWING

Saw length	Tolerance
31"	±.002-.000

### MACHINING OPERATIONS

#### Operation #1

#### Manual Mill (Cuts end Face)

#### Operation #2

#### Manual Mill (End Pin Hole)

#### Operation #3

#### Manual Mill (Deburring Pin Hole)

#### Operation #4

#### Grinder (Y-Lens)

#### Operation #5

#### Operation #6

#### Operation #7

### SPECIAL INSTRUCTIONS

- Both drilled holes are parallel.
- Hole cuts are perpendicular to the pin hole.
- Fillets are ground to approximate radius.

## Hogue Machine Shop - Setup Sheet

Operation # 1 Manual Mill

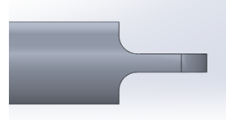

ID	Description	RUN DATA	
		Setup Time	1 hr.
1	3/8" End Mill	Machine Time	1 hr.
		Cycle Time	
		Parts per Hour	

FIRST ARTICLE INSPECTION REPORT		Inspector: Grady Graff	
Dimension	Instrument: Print value and tolerance	Accept/Reject	Act. Measurement
Outer Diameter	Caliper: 0.600 ± .005	<input type="checkbox"/> O	0.603"
Pin Hole Diameter	Caliper: 0.125 ± .005	<input type="checkbox"/> O	0.128"
		<input type="checkbox"/> X	
		<input type="checkbox"/> R	
		<input type="checkbox"/> A	
		<input type="checkbox"/> S	
		<input type="checkbox"/> C	
		<input type="checkbox"/> P	
		<input type="checkbox"/> F	
		<input type="checkbox"/> D	
		<input type="checkbox"/> T	
		<input type="checkbox"/> B	
		<input type="checkbox"/> M	
		<input type="checkbox"/> L	
		<input type="checkbox"/> K	
		<input type="checkbox"/> J	
		<input type="checkbox"/> I	
		<input type="checkbox"/> H	
		<input type="checkbox"/> G	
		<input type="checkbox"/> F	
		<input type="checkbox"/> E	
		<input type="checkbox"/> D	
		<input type="checkbox"/> C	
		<input type="checkbox"/> B	
		<input type="checkbox"/> A	

### SPECIAL INSTRUCTIONS

## Hogue Machine Shop - Setup Sheet

Operation # 2 Manual Mill

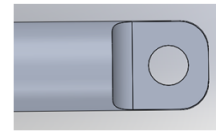

ID	Description	RUN DATA	
		Setup Time	1 hr.
1	1/4" drill bit	Machine Time	1 hr.
		Cycle Time	
		Parts per Hour	

FIRST ARTICLE INSPECTION REPORT		Inspector: Grady Graff	
Dimension	Instrument: Print value and tolerance	Accept/Reject	Act. Measurement
Hole O	Telescopic Gauge: 0.250 ± .005	<input type="checkbox"/> O	0.251"
Hole X	Caliper: 0.38 ± .030	<input type="checkbox"/> O	0.385"
Hole Y	Caliper: 0.28 ± .030	<input type="checkbox"/> O	0.286"
		<input type="checkbox"/> X	
		<input type="checkbox"/> R	
		<input type="checkbox"/> A	
		<input type="checkbox"/> S	
		<input type="checkbox"/> C	
		<input type="checkbox"/> P	
		<input type="checkbox"/> F	
		<input type="checkbox"/> D	
		<input type="checkbox"/> T	
		<input type="checkbox"/> B	
		<input type="checkbox"/> M	
		<input type="checkbox"/> L	
		<input type="checkbox"/> K	
		<input type="checkbox"/> J	
		<input type="checkbox"/> I	
		<input type="checkbox"/> H	
		<input type="checkbox"/> G	
		<input type="checkbox"/> F	
		<input type="checkbox"/> E	
		<input type="checkbox"/> D	
		<input type="checkbox"/> C	
		<input type="checkbox"/> B	
		<input type="checkbox"/> A	

### SPECIAL INSTRUCTIONS

## Hogue Machine Shop - Setup Sheet

Operation # 3 Manual Mill

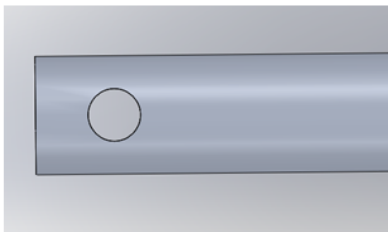

ID	Description	RUN DATA	
		Setup Time	0.5"
1	1/4" drill bit	Machine Time	0.5"
		Cycle Time	
		Parts per Hour	

FIRST ARTICLE INSPECTION REPORT		Inspector: Grady Graff	
Dimension	Instrument: Print value and tolerance	Accept/Reject	Act. Measurement
Hole O	Telescopic Gauge: 0.250 ± .005	<input checked="" type="checkbox"/> O	0.253"
Hole X	Caliper: 0.38 ± .030	<input checked="" type="checkbox"/> O	0.385"
Hole Y	Caliper: 0.28 ± .030	<input checked="" type="checkbox"/> O	0.279"
		<input type="checkbox"/> X	
		<input type="checkbox"/> R	
		<input type="checkbox"/> A	
		<input type="checkbox"/> S	
		<input type="checkbox"/> C	
		<input type="checkbox"/> P	
		<input type="checkbox"/> F	
		<input type="checkbox"/> D	
		<input type="checkbox"/> T	
		<input type="checkbox"/> B	
		<input type="checkbox"/> M	
		<input type="checkbox"/> L	
		<input type="checkbox"/> K	
		<input type="checkbox"/> J	
		<input type="checkbox"/> I	
		<input type="checkbox"/> H	
		<input type="checkbox"/> G	
		<input type="checkbox"/> F	
		<input type="checkbox"/> E	
		<input type="checkbox"/> D	
		<input type="checkbox"/> C	
		<input type="checkbox"/> B	
		<input type="checkbox"/> A	

### SPECIAL INSTRUCTIONS

REV	DATE	DESCRIPTION
1		
2		
3		
4		
5		
6		

SEE DWG. NO. **A** SCALE 1:1 WEBORT SHEET OF 1

REVISIONS AND COMMENTS:  
 ALL DIMENSIONS UNLESS OTHERWISE SPECIFIED ARE IN INCHES.  
 UNLESS OTHERWISE SPECIFIED, ALL DIMENSIONS ARE TO BE MAINTAINED WITHIN THE TOLERANCES SHOWN ON THIS DRAWING.  
 UNLESS OTHERWISE SPECIFIED, ALL DIMENSIONS ARE TO BE MAINTAINED WITHIN THE TOLERANCES SHOWN ON THIS DRAWING.

## APPENDIX F – Parts List and Costs

Part Ident	Part Description	Source	Cost	Part #	Disposition
6061 Aluminum Rod	6" stick 7/8" round	McMaster-Carr	\$4.28	<a href="#">8974K12</a>	Donated
	3' stick 9/16" round	McMaster-Carr	\$7.89	<a href="#">8974K46</a>	Donated
Easy-to-Machine 41L40 Alloy Steel	1' stick 1/2" round	McMaster-Carr	\$4.44	<a href="#">6776T13</a>	Donated
Low Carbon Steel Rod	1' stick 7/8" round	McMaster-Carr	\$8.10	<a href="#">8920K215</a>	
Low-Carbon Steel Round Tube	1' Stick 1" round 0.12" wall thickness	McMaster-Carr	\$5.07	<a href="#">7767T371</a>	Donated
Tight-Tolerance Hard Ware-Resistant E52100 Alloy Steel Balls	1/8" ball bearings  Quantity: 1 Pack (5)	McMaster-Carr	\$2.92	<a href="#">9528K45</a>	Donated
316 stainless steel dowel pin	1/4" dia. X 3/4" long Quantity: 1 pack (10)	McMaster-Carr	\$11.99	<a href="#">97395A485</a>	Donated
Square-Profile High-Temperature Silicone O-Ring	1/16" wide X 5/8" ID X 3/4" OD Quantity: 1 Pack (25)	McMaster-Carr	\$10.01	<a href="#">1182N016</a>	Donated
Total	-	-	\$54.7		-

Tool Ident	Tool Description	Source	Cost	Disposition
Band Saw	-	Hogue Machine Shop	-	Resource
CNC Lathe	-	Hogue Machine Shop	-	Resource
Form Cutting Tools	0.125" dia. cutting form tool Machine able cutting tool	Wildcat Shop	\$4.00	Pocket
		Wildcat Shop	\$4.00	Pocket
Boring Form Tool	Boring tool < 0.5" dia.	Hogue Machine Shop	-	Resource
	Boring tool > 0.5" dia.			
Square Groove	1/16" wide			
CNC Mill	-	Hogue Machine Shop	-	Resource
End Mill	1/2" dia. carbide end mill 1/8" dia. carbide 4 flute 1/2" long square end mill	Hogue Machine Shop	-	Resource
		McMaster-Carr	\$11.29	CWU
Drill Press	-	Hogue Machine Shop	-	Resource
Drill Bit	1/2" dia.	Hogue Machine Shop	-	Resource
	1/4" dia.	Hogue Machine Shop	-	Resource
Press	-	Hogue Machine Shop	-	Resource
File/Deburring Tool	-	Hogue Machine Shop	-	Resource
Welder	Aluminum/Steel	Hogue Machine Shop	-	Resource
Scale	.01 sec capable	Hogue Material Lab	-	Resource
Tensile Tester	>1000 lbs. force	Hogue Material Lab	-	Resource
Stopwatch	.01 sec capable	Hogue Material Lab	-	Resource
Measuring Instruments	Caliper Depth Micrometer Dial Indicator	Hogue Machine Shop	-	Resource
		Hogue Machine Shop	-	Resource
		Hogue Machine Shop	-	Resource
Total	-	-	\$19.29	-







## APPENDIX H – Efficiency Test

The self-reversing ball screw is engineered to act as a normal ball screw and transfer rotational energy to linear energy. The engineering behind this ball screw suggests that a great amount of the power from the rotating drill will be transferred into linear force. Requirements that will determine this product test successful include:

- Ball screw transfers 90% or more of the drill torque into linear force.

The measured amount of force in pounds is the perimeter of interest in this test. Since specs on the drill may be used to find the amount of torque that is provided, calculations may be made to figure out what 90% of linear force will need to be transferred. The test is set to begin on week 28 taking place in the Hogue Foundry using vises and a scale. This test may only be done if the ball nut sufficiently holds axial load.

### Resources:

-1000 Pound Scale  
-2 Vises  
-Gloves

-Connecting Rod  
-Safety Glasses

### Safety:

Since it is university policy, the operator must wear safety glasses for the duration along with gloves. The only safety risk is the possibility of something coming loose while under tension. Beware of any strange noises such as if something is cracking. Seize the test if this is present.

### Overview:

The duration of this test should span under an hour. The setup and data collection is simple and quick. No cost should be needed because of the university supplying extra material for the connecting rod and a 1000 pound scale. This test is present to record the operational limits of the force that the blade is able to apply. After calculations, the pruner should top out around 900 lbs. in linear force because the drill is rated for 443 in pounds of torque. With such a steep lead angle, the linear force is much more than expected.

### Procedure:

1. Accumulate necessary safety gear and appropriate Hogue Foundry open hours.
2. Firmly clamp the drill of the pruner into a vise so that the trigger is able to be reached.
3. Firmly clamp the 1000 pound scale directly across from the pruner.
4. Extend the drive train out past the carbon fiber tubing 3 inches and set the drill in the forward setting so that it rotates clockwise.
5. Attach the pruner to the scale using the connecting rod. The blade and blade housing of the pruner should be removed so that the connecting rod may be pinned directly to the drive shaft.
6. Pull the trigger of the drill until the scale reaches its highest point
7. Record the highest weight that the scale reaches.
8. Repeat steps 6 and 7 ten times for consistent data.
9. Compare collected data to calculated data.

**Conclusion:**

The success of this test is the distinct fact of whether or not the ball screw supplies the sufficient amount of force that is set in the requirement.

## APPENDIX I – Weight/Fitting Test

**Introduction:**

The self-reversing ball screw is engineered to fit within a 1 inch diameter housing while still withstanding the undergoing forces. To make the pruner ergonomic, it need to be light as well. Requirements that will determine this product test successful include:

- Drive Train weighs under 1.25 pounds.
- Connect the motor to the blade.
- Fit within a 1 inch diameter housing.

**Resources:**

- 3 Scales
- Safety Glasses
- Caliper
- Pruner body and blade

**Overview:**

The test is of the overall dimensions of the drive train. Even if the drive train fits within its parameters, it still must be under 1.25 pounds. The test is very simple and data is a pass fail concept. By effectively assembling the pruner and weighing the object as a whole, the ergonomics will prove to be better than last year’s project. The duration of this project is about an hour considering the assembling of the pruner as a whole.

**Safety:**

There are no safety precautions during this test.

Weight Test		
1	1.13 lbs.	
2	1.13 lbs.	
3	1.12 lbs.	
Outcome	Pass <input checked="" type="checkbox"/>	Fail <input type="checkbox"/>

Fitting Test		
	Pass	Fail
Diameter	<input checked="" type="checkbox"/>	<input type="checkbox"/>
Length	<input checked="" type="checkbox"/>	<input type="checkbox"/>



**Procedure:**

<input type="checkbox"/>
<input type="checkbox"/>
<input type="checkbox"/>
<input type="checkbox"/>
<input type="checkbox"/>
<input type="checkbox"/>
<input type="checkbox"/>
<input type="checkbox"/>
<input type="checkbox"/>
<input type="checkbox"/>

10. Accumulate necessary safety gear and appropriate Hogue Machine Shop open hours.
11. Ensure the drive train is completely assembled.
12. Measure the largest diameter on the part ensuring that it is under 1.0 inch. The largest diameter is the welded area between the adapter/adapter tube and the adapter tube/ball nut.
13. Record the pass/fail check box.
14. Turn the spring scale on and switch the units to pounds.
15. Hang the shaft end that connects to the blade from the spring scale.
16. Hang the spring scale from its handle ensuring that no other part of the drive train is touching any foreign objects such as the wall.
17. Wait until the scale beeps and record the weight projected on the screen.
18. Repeat steps 5-8 three times with 3 different scales for accurate data.
19. Assemble the pruner proving whether or not the length of the drive train is correct. If the drive bit fits in the drive while the end of the drive shaft is connected to the blade, the test passes.
20. Record the pass fail check box.

**Conclusion:**

The success of this test is the distinct fact of whether or not the drive train as a whole is underweight while still fulfilling the size requirements. The drive train did successfully pass these requirements.

## APPENDIX J – Movement with Force Test

### Introduction:

The self-reversing ball screw is engineered to act as a normal ball screw and transfer rotational energy to linear energy. The different parameter of interest from a regular ball screw is the concept and ability of reciprocating between opposite linear motions, unassisted.

Requirements that will determine this product test successful include:

- Ball Nut must travel the length of its intended path.
- Ball nut must switch directions using only the intended transition at the end of the path.
- Ball nut must continue the reciprocating motion as radial and axial loads are applied.

The engineering in this product expects the ball screw will move fluently without any hiccups through its initial path and back to its starting point. Hiccups would be defined as a switch in linear direction that does not occur at the end of the path or, a rough, jolting movement between the two parts. This is intended to stay true even through different kinds of loads applied to the ball screw. Although, the testing is meant to set limits to the product defining its standard, these loads are recorded to determine which configuration is the best solution for withstanding applied forces. This design started in September and through the year has evolved numerous times. The final product was manufactured and assembled in the middle of march as seen on the Gantt chart. The product worked, just not with certain loadings. Further configurations and testing will result in a fully functional device.

### Resources:

-Manual Lathe  
-3 Jaw Chuck  
-Gloves

-Spring Scale W/ Clamp  
-Safety Glasses

### Overview:

This experiment will take place in the Hogue machine shop including a simple and timeless setup along with a length of under 30 minutes. As specified on the master schedule, this operation is underway by the 4<sup>th</sup> week of the school quarter. Multiple ball nut configurations will be tested to prove the optimal geometric design. The test begins with a pre limb to see if the device transfers rotational energy to linear energy. The pre-limb consists of applying forces by hand in all directions. The applied loads that work will then be replicated with the spring scale to be recorded. The recorded loads determine the operational limits of the ball screw. The test is run multiple times to ensure accuracy of operational limits. This Data can be directly compared between configurations and applied direction without calculation to analyze the ideal setup of the ball screw.

### Safety:

Since it is university policy, the operator must wear safety glasses for the duration along with gloves due to the possibility of an unwanted change of direction that could possibly expose sharp burs.

### Procedure:

- 21. Accumulate necessary safety gear and appropriate Hogue Machine Shop open hours.
- 22. On a manual lathe, install a 3 jaw chuck and concentrically tighten the jaws to the drive bit portion of the self-reversing threaded shaft.
- 23. Set the parameters for the lathe to low gear and 200 revs/min as specified in red numbering on the head of the lathe.
- 24. As the lathe is started, the ball nut spins with the self-reversing threaded shaft. Hold the ball nut enough to keep it from spinning while not applying any other external forces. This test may be done with one finger to ensure that there are no unwanted forces.
- 25. Record check box if the ball screw follows its path as intended with no unwanted change in direction. If the ball screw does not move as intended, do not test that configuration any further.
- 26. Fully grasp the ball nut. Apply a load perpendicular to the shaft.
- 27. Record check box if the ball screw follows its path as intended with no unwanted change in direction.
- 28. Fully grasp the ball nut. Apply a load parallel to the shaft.
- 29. Record check box if the ball screw follows its path as intended with no unwanted change in direction.
- 30. Any applied load with an un-checked box should not be tested with the spring scale.
- 31. Clamp the spring load to the ball but before turning the lathe on.
- 32. Start the lathe and let the ball screw make 2 reciprocating passes before gradually adding load.
- 33. The operational limit is established when the ball nut switches directions unintentionally or begins to reciprocate in an unorderly fashion as if it were going to fail.
- 34. Record the load in pounds for each type of load.
- 35. Repeat steps 2-14 with every configuration of the ball nut.

### Conclusion:

The success of this test is the distinct fact of whether or not the contraption can handle different applied loads. The configuration that is able to hold the most weight and still function properly is the configuration that is proven best.

[Test](#)

Configurations	Pre-Limb			Operational Limit	
	Path Travel	Perpendicular Load	Parallel Load	Perpendicular Load	Parallel Load
<b>1</b>	☒	☒	☐	37 lbs.	lbs.
<b>2</b>	☒	☒	☐	42 lbs.	lbs.
<b>3</b>	☒	☒	☐	38 lbs.	lbs.
<b>4</b>	☐	☐	☐	lbs.	lbs.
<b>5</b>	☐	☐	☐	lbs.	lbs.

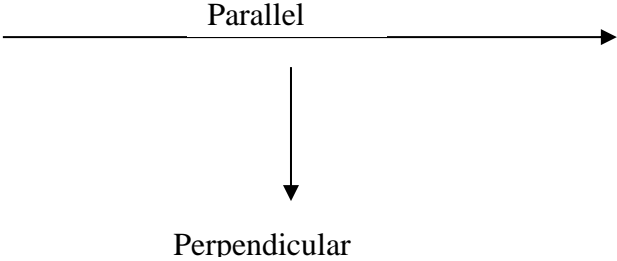
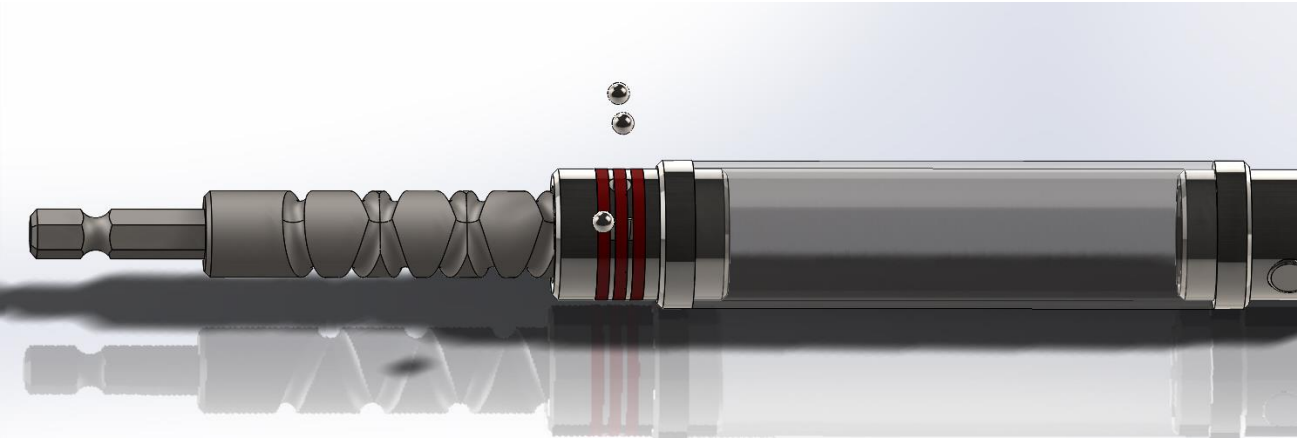

\*Parallel Load opposite of the direction of movement

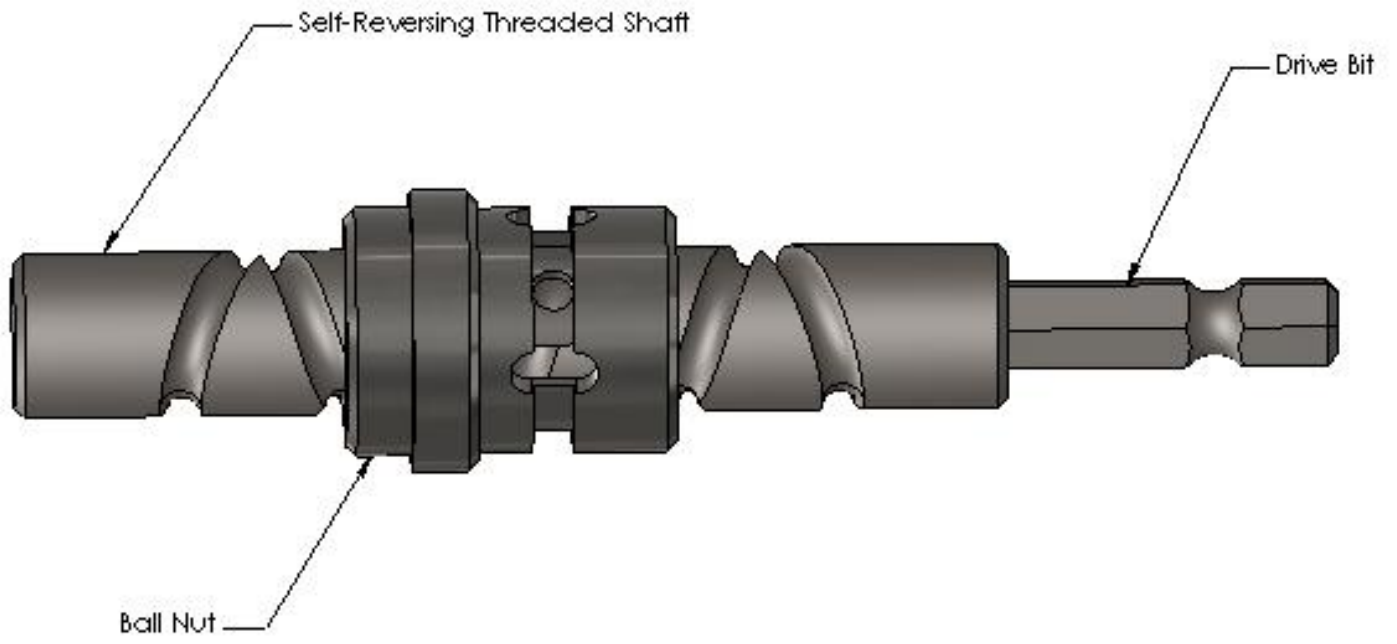

*Configuration 1*

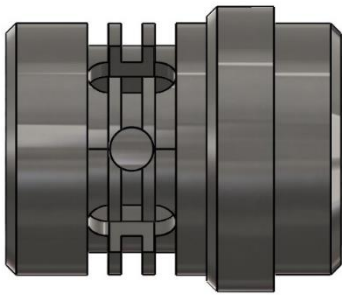

*Configuration 2*

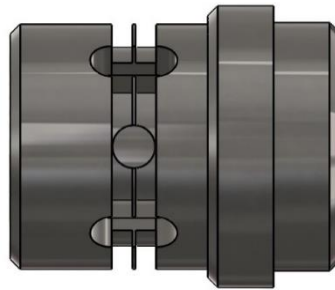

*Configuration 3 Configuration 4*

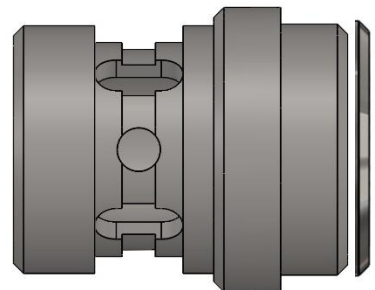

## APPENDIX K – Assembly

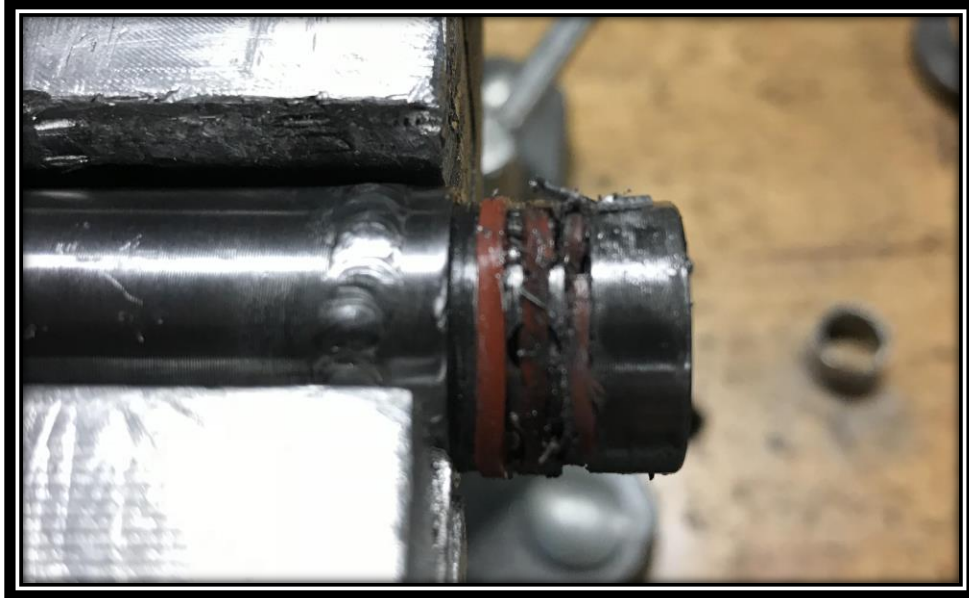

L1: The press fit cover removed showing the torture to the O-rings and ball nut.

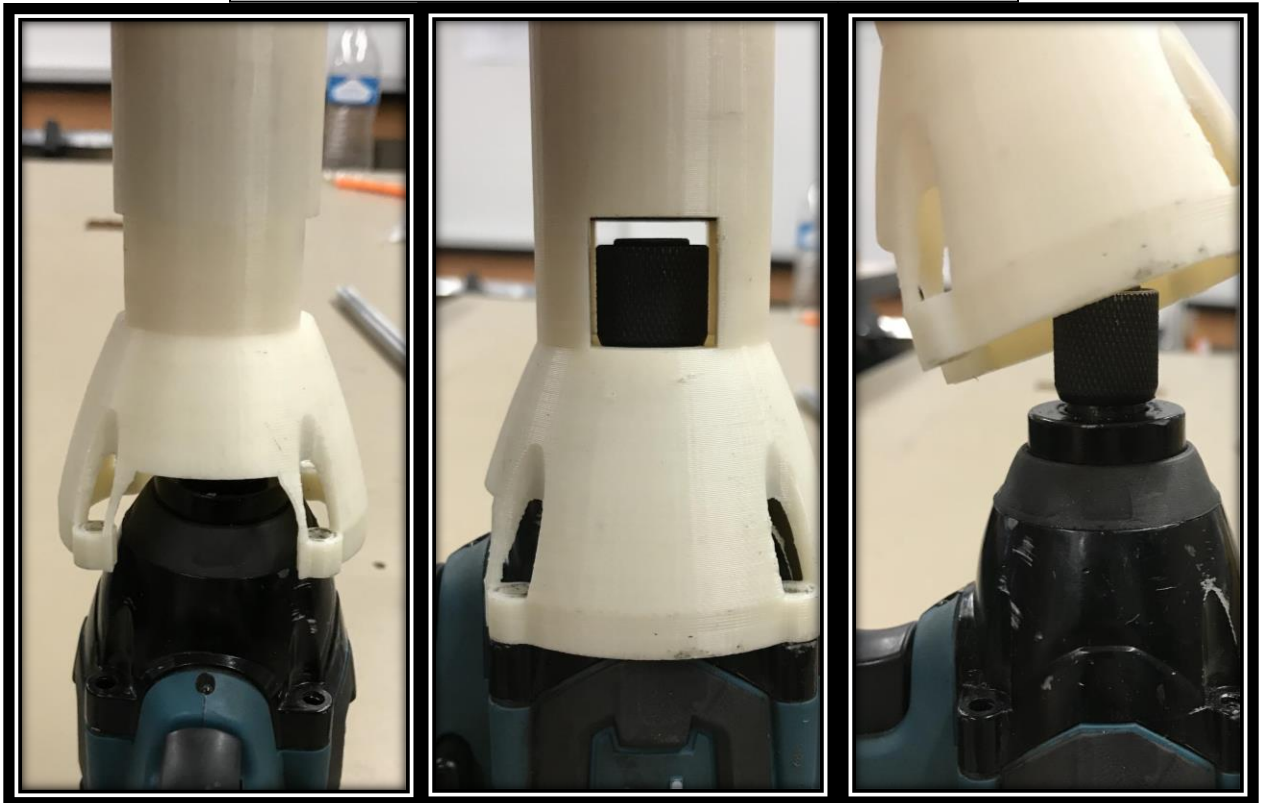

L2: 3D printed motor adapter provides a much sleeker look than the 2016 edition.



L3: Aluminum blade housing and stainless steel blade.



L4: Welded Adapter/Adapter Tube and Ball Nut

# APPENDIX L – Resume

## Grady Graff

414 West 15th Avenue Ellensburg, WA 98926 | (509) 378-1728 | [graffg@cwu.edu](mailto:graffg@cwu.edu)

### Education

#### CENTRAL WASHINGTON UNIVERSITY

- Mechanical Engineering
- Expected Graduation: Fall 2018
- Senior Project Website:  
[gradygraff.wixsite.com/electricrunner](http://gradygraff.wixsite.com/electricrunner)

#### COLUMBIA BASIN COLLEGE

- Running Start 2014

### Intercollegiate Athletics

- 30-40 hours per week including games, practice, meetings, lifts and film study.
- Linebacker/Long snapper

### Certifications

- CPR certified
- Solid Works
- Forklift
- Multiple metal shop machines

### Experience

- Abundance of construction experience (roofing, framing, trusses and pole buildings).
- Little League umpire and high school football camp referee.
- Volunteer work for The Yakima River Cleanup, Mark Twain Elementary, Valley View Elementary and the Chiawana High school link crew.

#### INTERNSHIP (PROJECT MANAGEMENT) | ACME CONCRETE | 07/05/2016-08/20/2016

- Worked a paid internship last summer for engineering and project management. The project was re-building the highway between Elk-Heights and Cle-Elum. Dealt with accidents, management and worked alongside laborers.

Reference: Ben Walker (509) 991-3892

#### SHOP ASSISTANT | RAL-BOY | 03/17/2016-03/25/2016

- Helped grind, cut, torch and weld metal to fabricate many different projects in a scrap metal yard. Learned how to lift heavy objects safely and communicate to machine operators through hand signals.

Reference: Tim ~~Ral~~ (509) 366-2117

#### PIT SECURITY | CROWD MANAGEMENT SERVICES | 06/20/2015-08/10/2015

- Worked stage security for 12-15 hour days at the Gorge Amphitheater for every summer concert dealing with dehydrated and intoxicated fans with little break. Learned how to diffuse stressful situations and tolerate many different kinds of people.

Reference: Matt Christianson (509) 638-9459

#### FARM HAND | WALKING U FARMS | 06/20/2017-08/05/2017

- Drove tractors, changed water and fixed farm equipment such as bailers, ~~swather~~ blades and harrow beds. Many hours of manual labor in the extreme heat and problem solving situations.

Reference: Mike Lowe (509) 899-2745

### School

- College GPA: 3.117
- High School GPA: 3.85
- Honor Society

### Leadership

- CWU Football
- Buddy Club (Chiawana High School)
- ASME Vice President
- High School 3 sport captain and state champion

### Skills

- Proficient in Microsoft products
- Repairing mechanical devices
- Problem solving
- Planning/Bookkeeping