

This dissertation has been  
microfilmed exactly as received 67-11,086

KAMHAWY, Mohamed Sabry Mohamed, 1932-  
THE EFFECT OF TEMPERATURE UPON NEAR IN-  
FRARED SPECTRA ABSORPTIVITIES.

The University of Oklahoma, Ph.D., 1967  
Chemistry, analytical

University Microfilms, Inc., Ann Arbor, Michigan

THE UNIVERSITY OF OKLAHOMA  
GRADUATE COLLEGE

THE EFFECT OF TEMPERATURE UPON NEAR  
INFRARED SPECTRA ABSORPTIVITIES

A DISSERTATION  
SUBMITTED TO THE GRADUATE FACULTY  
in partial fulfillment of the requirements for the  
degree of  
DOCTOR OF PHILOSOPHY

BY  
MOHAMED SABRY MOHAMED KAMHAWY

Norman, Oklahoma

1967

THE EFFECT OF TEMPERATURE UPON NEAR  
INFRARED SPECTRA ABSORPTIVITIES

APPROVED BY

Harold E. Apperung

James C. Colbert

Arthur Bernhart

H. H. Rowley

DISSERTATION COMMITTEE

## ACKNOWLEDGEMENTS

The author is deeply indebted to Dr. Harold E. Affsprung for his guidance, encouragement, patience, and the many hours of counsel throughout the course of this research. The association with Dr. Affsprung has been both stimulating and rewarding, and it will be recalled with gratitude during the years to come. He is also very grateful to Dr. Sherril D. Christian for his helpful suggestions and advice during the course of this investigation.

The author would also like to express his sincere appreciation and thanks to the faculty, staff, and fellow graduate students of the Chemistry Department, their friendliness and helpfulness will never be forgotten.

The author is very grateful for the financial aid received from the Government of The United Arab Republic and to The University of Oklahoma for the Graduate Assistantship in Chemistry.

Finally, the author wishes to express his gratitude to his wife, Fatma, whose encouragement and patience made graduate work possible.

Dedicated to My Parents

TABLE OF CONTENTS

	Page
LIST OF TABLES . . . . .	vi
LIST OF ILLUSTRATIONS . . . . .	ix
Chapter	
I.    INTRODUCTION . . . . .	1
II.   OBJECTIVES . . . . .	15
III.  EXPERIMENTAL . . . . .	16
IV.  METHODS OF CALCULATIONS . . . . .	36
V.   DATA AND RESULTS . . . . .	42
VI.  DISCUSSION AND CONCLUSIONS . . . . .	92
BIBLIOGRAPHY . . . . .	103

LIST OF TABLES

Table	Page
1. Approximate Ratio of Commercial Concentrated Sulfuric Acid ( $d = 1.833$ ) to Water for Various Activities . . . . .	19
2. Variation in the Density of Carbon Tetrachloride with Temperature . . . . .	40
3. Variation in the Density of Toluene with Temperature . . . . .	41
4. Water in Carbon Tetrachloride. Data were used to verify Beer's Law at the indicated Wavelengths and Concentrations. Absorbance Measurements were recorded at $25^{\circ}\text{C}$ . . . . .	50
5. Water in Carbon Tetrachloride. Data were used to evaluate the Absorptivities of Water at the indicated Wavelengths and Temperatures . . . . .	53
6. Water in Carbon Tetrachloride. Best Values of Absorptivities calculated using Computer Least Squares . . . . .	57
7. Water in Carbon Tetrachloride. Best Values for the Change in Absorptivity with Temperature using Least Squares Intercept and Slope . . . . .	58
8. Acetone in Carbon Tetrachloride. Data were used to verify Beer's Law at the indicated Concentrations. Absorbance Measurements were recorded at $25^{\circ}\text{C}$ . . . . .	63
9. Acetone in Carbon Tetrachloride. Data were used to evaluate the Absorptivities of Acetone in Carbon Tetrachloride at indicated Wavelength and Temperature . . . . .	65

Table	Page
10. Acetone in Carbon Tetrachloride. Best Values of Absorptivities calculated using Computer Least Squares . . . . .	66
11. Acetone in Carbon Tetrachloride. Best Values for the Change in the Absorptivity with Temperature using Least Squares Intercept and Slope . . . . .	68
12. Piperazine in Carbon Tetrachloride. Data were used to verify Beer's Law at the indicated Concentrations. Absorbance Measurements for peak at 2948 m $\mu$ were recorded at 25°C . . . . .	71
13. Piperazine in Carbon Tetrachloride. Data were used to evaluate the Absorptivities of Piperazine at indicated Wavelength and Temperatures . . . . .	73
14. Piperazine in Carbon Tetrachloride. Absorptivities of Piperazine calculated at indicated Wavelength and Temperatures . . . . .	74
15. Piperazine in Carbon Tetrachloride. Best Values for the Change in Absorptivity with Temperature using Least Squares Intercept and Slope . . . . .	75
16. Water in Toluene. Data were used to verify Beer's Law at indicated Wavelengths and Concentrations. Absorbances were recorded at 25°C . . . . .	78
17. Water in Toluene. Data were used to evaluate the Absorptivities of Water at indicated Wavelengths and Temperatures . . . . .	81
18. Water in Toluene. Best Values of Absorptivities using Computer Least Squares . . . . .	83
19. Acetone in Toluene. Data were used to verify Beer's Law at indicated Wavelength and Concentrations. Absorbances recorded at 25°C . . . . .	85



Table	Page
20. Acetone in Toluene. Data were used to evaluate the Absorptivities of Acetone at indicated Temperatures . . . . .	87
21. Acetone in Toluene. Best Values of Absorptivities using Computer Least Squares . . . . .	89
22. Acetone in Toluene. Best Values for the Change in Absorptivity with Temperature using Least Squares Intercept and Slope . . . . .	91

## LIST OF ILLUSTRATIONS

Figure	Page
1. Equilibrator . . . . .	33
2. Drying Technique using Equilibrator . . . . .	34
3. Thermostatic Cell Holder . . . . .	35
4. Absorption Spectra of Water in Carbon Tetrachloride at 25°C . . . . .	49
5. Beer's Law Curves for Water in Carbon Tetrachloride at 25°C. Plots repre- sent Absorbance Measurements at 2660 mμ . . . . .	51
6. Beer's Law Curves for Water in Carbon Tetrachloride at 25°C. The Curves represent Absorbance Measurements at 2735 mμ . . . . .	52
7. Peak Height Absorbances at 2660 mμ vs. Concentration of Water in Carbon Tetrachloride at three Temperatures . . . . .	54
8. Base Line Absorbances at 2660 mμ of Water in Carbon Tetrachloride at three Temperatures . . . . .	55
9. Absorbances at 2735 mμ of Water in Carbon Tetrachloride at three Temperatures . . . . .	56
10. Variation of the Absorptivities at 2660 mμ with Temperature for Water in Carbon Tetrachloride . . . . .	59
11. Variation of the Peak Height Absorptivities at 2735 mμ with Temperature for Water in Carbon Tetrachloride . . . . .	60
12. Variation of the Base Line Absorptivities at 2735 mμ with Temperature for Water in Carbon Tetrachloride . . . . .	61

Figure	Page
13. Absorption Spectra of Acetone in Carbon Tetrachloride at 25 <sup>o</sup> C . . . . .	62
14. Beer's Law Plots for Acetone in Carbon Tetrachloride at 25 <sup>o</sup> C . . . . .	64
15. Peak Absorbances at 2890 $\mu$ vs. Concentration of Acetone in Carbon Tetrachloride at three Temperatures . . . . .	67
16. Variation of the Absorptivities with Temperature for the System Acetone in Carbon Tetrachloride . . . . .	69
17. Absorption Spectra of Piperazine in Carbon Tetrachloride at 25 <sup>o</sup> C . . . . .	70
18. Beer's Law Curves for Piperazine in Carbon Tetrachloride at 25 <sup>o</sup> C . . . . .	72
19. Variation of the Absorptivities with Temperature for Piperazine in Carbon Tetrachloride . . . . .	76
20. Absorption Spectra of Water in Toluene at 25 <sup>o</sup> C . . . . .	77
21. Beer's Law Plot for Water in Toluene at 25 <sup>o</sup> C using Peak Height Absorbances for the indicated Wavelengths . . . . .	79
22. Beer's Law Curves for Water in Toluene at 25 <sup>o</sup> C, using Base Line Absorbances at indicated Wavelengths . . . . .	80
23. Absorption Spectra of Acetone in Toluene at 25 <sup>o</sup> C . . . . .	84
24. Beer's Law Curves for Acetone in Toluene at 25 <sup>o</sup> C . . . . .	86
25. Absorbance vs. Concentration of Acetone in Toluene at Two Temperatures . . . . .	88
26. Variation of Absorptivities with Temperature for the System Acetone in Toluene . . . . .	90

THE EFFECT OF TEMPERATURE UPON NEAR  
INFRARED SPECTRA ABSORPTIVITIES

CHAPTER I

INTRODUCTION

In recent years, near infrared spectroscopy has become a versatile and dependable tool not only for analytical chemists but also for physical chemists. When analytical infrared spectrophotometry was introduced, infrared spectroscopists normally obtained spectra over the region from 2 to 15 $\mu$ . The end of the chart that contains the 2 to 3 $\mu$  region failed to attract their attention. This was the case with exception of the observation of the hydroxyl groups at 2.7 $\mu$ . Analytical spectroscopists have started to take a closer look at the neglected region between 1 and 3 $\mu$  which is referred to as the near-infrared region.

Infrared spectra have been widely used as important tools in organic qualitative analysis. It is often admitted as primary evidence for defining new compositions of matter in patent cases. The near-infrared region has a limited value in qualitative analytical work as compared

to the regular infrared. If one tried to evaluate the potentialities of the near-infrared in qualitative analysis, he should realize that most, but not all, of the absorption bands occurring in this region involve hydrogenic stretching vibrations, or combinations of hydrogenic stretching vibrations with other modes of vibrations of the molecule. It is, however, extremely valuable for detecting and then subsequently determining the functional groups.

Near-infrared spectrophotometry is most valuable in the quantitative analysis of organic functional groups. Whenever near-infrared is applicable, it usually takes a short time to prepare a calibration curve, and then samples can be analyzed in a very short time. In quantitative analytical work, Goddu (1) had pointed out that it is seldom possible to measure other than the peak absorbances with any degree of precision because of interference from bands of other compounds or because of uncertain background shapes. For such reasons, peak absorbance measurements have been adopted in this study rather than integrated intensities. Integrated values are usually preferable in the correlation of the structure with intensity. In quantitative analysis it is important that the sample under investigation obeys Beer's law regardless of the method used for measuring the peak absorbance. Two methods are frequently used for measuring the peak absorbance. First, the peak height corresponding to the height from zero absorption

to the maximum peak absorption. Second, the base line absorbance measurements, where a base line is usually drawn across to the base of the peak between two reproducible wavelengths and the height is measured from that line to the maximum absorption of the peak. Both measurements are always taken at the wavelength corresponding to the center of the peak. The absorption values are required to calculate the molar absorptivity for a specific functional group, through the use of Beer's law:

$$A = alc \quad (1)$$

From (1), one can calculate the molar absorptivity "a" as follows:

$$a = \frac{A}{lc} \quad (2)$$

where: "A" is the peak absorption, "l" is the cell length in centimeters and in this work "c" is the concentration of the species which absorbed the light expressed in gram-mole/liter. The absorptivity "a" which is the absorption constant, has been shown to be characteristic of the sample and the frequency of the radiation. This was the case till it was pointed out in the last decade that the absorptivity is apparently a function of temperature as well.

The near-infrared region beside its potentialities as analytical tool, has attracted the attention of physical chemists as a dependable region to detect hydrogen bonding in solutions as well as in the liquid state. In the past

and in recent years this spectral region has been used by chemists not only to detect hydrogen bonding but to determine the thermodynamic properties of hydrogen bonding systems. Such characteristics can be evaluated through absorption measurements of free and the hydrogen bonded associated species. Pimentel (2) in his book "The Hydrogen Bond," gave a detailed discussion about the use of infrared spectroscopy in general for detecting H-bonding and the potentialities of the near-infrared region in particular.

Since infrared spectroscopy has been used for the study of the characteristics of hydrogen bonding systems, spectroscopists, on the other hand, commenced to get a closer look on the factors which might affect the infrared spectra. A major factor was the effect of temperature upon the spectra, and in particular the bands related to associated species. Their studies were mainly concerned with the changes which might happen at sample temperatures lower or higher than room temperatures. Such changes were always reflected on the position, or the intensity, or both, of bands due to associated species. Most of the work reported in the literature was done on the O-H group of alcohols and phenols in the near-infrared region.

Freymann (3), studied the effect of temperature upon both intensity and position of the associated bands in both butyl and benzyl alcohols in the liquid state. He

reported that C-H bands were fairly stable towards temperature changes over the range of  $18^{\circ}$  -  $140^{\circ}\text{C}$ . On the other hand, the O-H band increased in intensity as the temperature was raised. Benzyl alcohol also showed a change in frequency at higher than room temperatures. He attributed such changes in intensity of the O-H band to a decrease in the degree of molecular association as the temperature was raised. Errera (4) conducted similar studies on some aliphatic alcohols in near-infrared region. He also reported that C-H bands resisted changes in frequency and intensity at temperatures up to  $70^{\circ}\text{C}$ , while the band assumed to be due to polymeric species disappeared at  $70^{\circ}\text{C}$ . He reported later on (5), a similar study on alcohols but in solutions of carbon tetrachloride and carbon disulfide. Studying the association of acetic acid, Gillette (6) reported the effect of temperature on the spectra of acetic acid over the range of  $25^{\circ}$  -  $170^{\circ}\text{C}$ . Badger (7) investigated the effect of temperature upon spectra in connection with the association equilibrium in the vapor of acetic acid. He questioned whether the absorption may depend not only on the concentration but also on the pressure and temperature. He ruled out the effect of pressure, but for the temperature, he expected to see some effect by detecting changes in the intensity distribution of the band. In a later publication during the same year, Badger (8), used the effect of temperature upon the associated band for alcohols,



to study hydrogen bonding characteristics. The temperature effect on the infrared spectra of phenol was studied by Brattain (9). This study was made on pure phenol at 25°, 42°, and 101°C. He found that the principal effect of this temperature change was a shift in the position of the three absorption bands found at 3 $\mu$ , 7.4 $\mu$  and 8.2 $\mu$ . The first band shifted to a lower wavelength while the other two shifted to longer wavelengths. References 10, 11, 12, 20 contain similar studies to the ones mentioned above where the effect of temperature upon the near-infrared spectra was used to study the association phenomena in alcohols and phenols. Such studies were mainly carried out on the pure substance rather than in solution.

Davis and Sutherland (13) were the first to report the effect of temperature on the absorptivity of monomeric O-H band for solutions of acids in carbon tetrachloride at various concentrations and temperatures. This effect of temperature on the integrated absorptivities lead to a calculation of the heat of association for the carboxylic acids studied which varied from 6 to 10 kcal/mole. They attributed the difference between their values and the accepted value of 15 kcal/mole, to the variation in the absorptivity coefficient with temperature. A similar variation was reported for the carbonyl group and for the O-H group from measurements of the intensities of the monomeric bands as a function of the temperature. The spectra of

cetyl alcohol in solutions at concentrations low enough to eliminate the possibility of any association was investigated and the conclusion was reached that the dependency of the absorptivity upon temperature was due to a solvent effect on the absorptivity coefficient. A value of 26.2% change in the absorptivity of cetyl alcohol in carbon tetrachloride was calculated over the temperature range of  $18^{\circ}$  -  $74^{\circ}$ C, at a concentration of 0.0033M.

Fox and Martin (14) dealing with the same subject, made an extensive study on the spectra of water in the solid, liquid and vapor phase and in solutions of carbon tetrachloride in the spectral regions of  $3\mu$ ,  $4.7\mu$  and  $6\mu$ . They observed changes in frequency and intensity for the band in the region of  $3\mu$  with temperature for liquid water. For a saturated solution of water in carbon tetrachloride, the effect of temperature on the absorptivity for the two bands observed at  $3705$  and  $3614\text{ cm}^{-1}$  was determined and results showed that the absorptivity dropped from 55 at  $18.3^{\circ}$ C to 38 at  $70^{\circ}$ C. This variation in the absorptivity with temperature represents a value of 30.9%. During the course of the present study we recorded the two bands for water in carbon tetrachloride at  $2660\text{ m}\mu$  and  $2735\text{ m}\mu$  which are assigned to the asymmetric and symmetric stretching modes of water. Greinacher and others (15) have also studied the infrared spectrum of water in carbon tetrachloride and other solvents. In gaseous water two bands are located

at 2728  $\mu$  and 2665  $\mu$  and assigned to symmetric and asymmetric stretching modes respectively. In carbon tetrachloride these two bands are shifted towards longer wavelengths. Solvation by the carbon tetrachloride is the explanation for this effect. Liquid water shows a single broad band in the near-infrared region at 2941 $\mu$ . The shape and position of the two bands of water in carbon tetrachloride reported in our study agrees with those reported by Chulanovskii (16). The temperature dependence of the intensity of infrared bands of liquid water was reported by Slowinskii and Claver (17). They studied the infrared spectra of some liquids such as cyclohexanone, benzene and others as a function of temperature and found as a general rule that as the temperature of the sample is increased the intensities of its absorption bands decrease. After discussing the liquid characteristics which might lead to such a variation in the absorption, they suggested that this effect might involve the so-called "upper-stage" transitions. Another and the more favored suggestion which was made to explain such an effect was to use the force field that a molecule experiences due to its neighbors. Such a field will be a function of the temperature.

No mention was made in the literature about the precautionary measures which should be taken to avoid any mechanical loss that might lead to changes in concentrations of samples being investigated until Huggins and

Pimentel (18) reported that they sealed the cells to avoid evaporation of volatile solvents from the cells. The seal was effective up to four hours. However, they did not mention what sealing material was used. In the present study we report the use of polyethylene as a sealing agent and its effectiveness extends over a long period of time.

Hughes, Martin and Coggeshall observed the change of absorptivity with temperature for alcohols and phenols (19). They used dilute solutions in hexachlorobutadiene as the solvent. They verified that the decrease in intensity with temperature was not due to a chemical change caused by heating, as the absorbance returned to its original values on cooling the sample. A similar technique was followed in the course of the present study by checking the absorbance at 25°C before and after the scan was made over the temperature range. The authors pointed out that their solutions underwent a decrease in the absorbance with temperature due to change in concentration resulting from expansion of the solvent. In the present work, this effect was taken care of by correcting for the density changes. Measuring the absorptivities for the unassociated O-H bands of some phenols and alcohols and the C-H stretching bands for other compounds at two widely separated temperatures, Hughes et al., reported that the O-H absorptivities change by 8 - 15% while the C-H changes by 2 - 5%. It was also pointed out that since the change for the O-H

is greater than for C-H bands it is indicated that the phenomena is not simply related to a change in the dielectric constant or the volume of the solution.

Liddel and Becker (21) briefly mentioned that the absorption band for O-H of methyl alcohol and  $\text{CHCl}_3$  in the  $3\mu$  region was dependent upon temperature. In the first of two reports they reported upon a quantitative study of the intensity of absorption of  $\text{CH}_3\text{OH}$  as a function of concentration in  $\text{CCl}_4$  and  $\text{CS}_2$  and as a function of temperature. They reported that the peak intensity of the free O-H band in dilute solutions was strongly dependent upon temperature. They observed a decrease in intensity of nearly 50% in  $\text{CCl}_4$  over the temperature range  $-10^\circ$  to  $+50^\circ$  which was accompanied by a slight increase in frequency. There was a comparable variation in the absorptivity in  $\text{CS}_2$  solution but with no change in frequency. They attributed the change in absorptivity to be due to specific interactions between the solute and solvent molecules analogous to H-bonding which might be considered to be a weak type of H-bonding. After correcting for density changes and other temperature variables they found the intensity variation to be approximately linear over the temperature range studied. The C-H intensities were again found to be nearly constant with temperature.

In a later publication by the same authors (22), investigations upon the spectra of methanol, ethanol and

t-butanol in the near-infrared region were made in order to calculate thermodynamic properties for the self-association of the alcohols. They reported that the absorbance of 0.005 M-ethanol in  $\text{CCl}_4$  varied linearly with temperature. The temperature range was  $-15^\circ\text{C}$  to  $+60^\circ\text{C}$ , and the absorptivity showed approximately a 30% decrease. The decrease in the absorptivity at lower temperatures in the case of more concentrated solutions was attributed to the depletion of monomers and formation of hydrogen bonded species which absorb at other frequencies.

Kagarise (23) made use of the effect of temperature on the infrared spectra of trifluoroacetic acid vapor to identify bands due to the various species and calculated the thermodynamic properties of the self-association reaction. He pointed out that at room temperature both monomer and dimer molecules were present while at  $100^\circ\text{C}$  the vapor was predominantly monomeric. Finch and Lippincott (24) reported the effect of temperature on the O-H frequency and band intensities of some alcohols and phenols. Their study was made over the temperature range  $30^\circ - 80^\circ\text{C}$  on both the spectra of pure liquids and in solutions of carbon tetrachloride. Their studies were concentrated on the bonded O-H and the effect of temperature on the frequency and intensity of the band.

A study similar to the present was conducted by Cole and Macritchie (25) on 0.022M trans-dihydrocryptol,

where the spectra of the free O-H were recorded at a number of temperatures between 20° and 100°C. Their results showed a decrease of about 10.8% upon increasing temperature of 80°C. This value is not as great as that reported by Liddel and Becker for methanol or ethanol. They also noticed a slight increase in absorption frequency as the temperature rises. They were doubtful that this temperature effect was due to the rupture of a weak type of H-bonding in the usual sense of the term. The explanation given by them was that the effect was due to a lessening of dipole-dipole interaction as the thermal motion of the solute and solvent molecules increased.

Becker (26) utilized the effect of temperature on the intensity of absorption bands corresponding to the complexes formed in alcohol-base systems. Findlay and Kidman (27) have recently used near-infrared spectroscopy to investigate H-bonding between pyridine and aliphatic alcohols in carbon tetrachloride. They noticed that the absorptivity for the monomeric alcoholic O-H stretching band showed a marked decrease with a temperature increase. They accepted the suggestion made earlier by Hughes, Martin and Coggeshall that such an effect is most probably the result of the decrease in the force field produced on a molecule due to its neighbors. As the alcohol concentration was increased, the effect of temperature resulted in an increase of the corresponding absorptivity due to the shift

in equilibrium and the increase in the concentration of the monomeric alcohol. The linearity of the absorptivity with temperature was also observed by Hoeke and Koevoet (28) through their investigation of H-bonding between n-butanol and some ketones.

The most recent work done involving the study of the effect of temperature upon the absorptivities of the spectra in near-infrared region is reported by Motoyama and Jarboe (29). In their study a series of aliphatic alcohols solutions in carbon tetrachloride was used over the temperature range of  $21.7^{\circ}$  -  $48.1^{\circ}$ C and the absorptivity showed a change of 17.5% in the case of methanol. The authors gave no explanation for the variation.

All the work reported in the literature regarding the solvent effect on infrared spectra has been principally directed towards the extent of the shift in frequency of a particular band as well as changes in the intensity. The role of solvent that might be played in the effect of temperature upon absorptivity remains obscure. In the course of the present study, investigations of the effect upon the absorptivity of the O-H of water in both carbon tetrachloride and toluene were made. Most of the previous work reported were studies made of the effects found upon absorptivities in the fundamental region. In this work, experiments were carried out in both the fundamental and the overtone regions. The study in the overtone region



was confined to the first overtone of the carbonyl group of acetone in carbon tetrachloride and toluene. Toluene has not been used often as a solvent in infrared work as it is relatively opaque although Mecke (30) used it in studying the association of phenol. The extent of the effect of temperature was also studied on the fundamental N-H stretching band.

## CHAPTER II

### OBJECTIVES

The objectives of this research were:

1. To study the effect of temperature on the absorptivity of some functional groups in solutions of non-hydroxy solvents.
2. To study the effect of temperature on the stretching frequency of some functional groups in the same solvents.
3. To study the part which might be contributed by the solvent to the above two effects.

## CHAPTER III

### EXPERIMENTAL

#### Solvent and Solute Purification

Spectroscopic investigations in solution require the dissolution of solutes in the proper solvents. Any substance to be used successfully as a solvent should satisfy the following two requirements. First it should be spectroscopically pure, second it should be transparent to light at the wavelength under investigation.

Two solvents were used in this study; carbon tetrachloride and toluene. Each was carefully purified to be of spectroscopic grade. Both chemicals were "Fisher Certified Reagents," a product of Fisher Scientific Company. The carbon tetrachloride was treated according to the method of Krchma and Williams (31). The sulfide impurities that might be present were removed from the carbon tetrachloride by refluxing it in a two liter round bottom flask with a small amount of mercury for a period of eight hours. This was followed by successive washings with concentrated sulfuric acid, dilute potassium hydroxide (about 50%), and distilled water. All these washings were carried out using

a four liter separatory funnel. After the last wash with distilled water, the carbon tetrachloride was then placed over anhydrous calcium sulfate (Drierite, 8 mesh) to dry for a period of twenty-four hours. The final step in the purification was a distillation through a 30-plate Oldershaw column. The reflux ratio of the forerun was 30:1. Out of the original two liters a forerun of 400-500 ml. was discarded and approximately one liter of the solvent was collected at a reflux ratio of 10:1. A delivery flask receiver containing anhydrous calcium sulfate (Drierite) was used to collect and keep the main fraction of the solvent. The boiling point range of the main portion of the solvent was  $75^{\circ}$  -  $76^{\circ}$ C. The receiver containing the carbon tetrachloride was fitted with a tube containing anhydrous calcium sulfate (Drierite). This dehydrating agent was used to insure the removal of the last traces of water.

Toluene the second solvent used in this study was also carefully purified by distillation through a 30-plate Oldershaw column. A forerun of about 400-500 ml. was collected at a reflux ratio of 30:1. This forerun was discarded. The main portion of the solvent was collected at a reflux ratio of 10:1. This portion, about one liter out of a two liter batch, was collected and kept in a delivery flask similar to the one used for carbon tetrachloride. The conditions to keep the toluene from picking up any moisture were the same as those described for carbon

tetrachloride. The main portion of toluene was collected at the constant boiling temperature of  $110^{\circ}\text{C}$ .

Three substances were used as solutes in this study. Each one contained a specific functional group. The three functional groups investigated were: the O-H, the C=O, and the -N-H. A source was sought to contain one and only one of each of the functional groups. In choosing the solutes the following facts were taken into consideration. First, the solute should be soluble in the solvent used, at least to the concentration limits required for this study. Second, the solute should not under any condition associate in any form including inter- and intramolecular types of association.

During preliminary studies methyl alcohol was used as an O-H containing substance. A similar study on alcohols was reported by Liddel and Becker (22). However, alcohols were disregarded as O-H containing substances proper for this study. Water was chosen as a source containing O-H group. Water was introduced in solution using the equilibration technique described by Worley (32). This was done through the use of constant water activity solutions. In this way water was put in solution at a known and controlled concentration. The lesser volatility of water as compared to that of alcohols made it possible to avoid changes in concentration due to volatility. In addition water exists primarily as the monomer in both of

the two solvents used (33). The constant water activity solutions used to put the water into carbon tetrachloride and toluene were prepared as described by Mueller (34). The constant activity solutions were prepared from Malinkrodt Analytical Reagent grade concentrated sulfuric acid. The water activities of these solutions were obtained as follows: A double plot of water activity vs. molality as given by Robinson and Stokes (35) and density vs. molality as obtained from the "Handbook" (36) was prepared. The water activity vs. density could be obtained from the plot. All densities were measured on a density balance calibrated with water at 25°C. This balance was found to have a reproducibility within  $\pm 0.0003$  g./ml. Table 1 lists some relationships useful in obtaining approximate activities, but these activities used were determined accurately by measuring the density (34).

TABLE 1

APPROXIMATE RATIO OF COMMERCIAL CONCENTRATED SULFURIC ACID ( $d=1.833$ ) TO WATER FOR VARIOUS ACTIVITIES

$a_w$	Expected "d" at 25°C	ml. conc. H <sub>2</sub> SO <sub>4</sub> /ml. water
0.950	1.075	155/2000
0.850	1.166	314/1720
0.700	1.249	472/1600
0.550	1.314	620/1500
0.400	1.378	755/1375

Acetone was chosen as the carbonyl containing compound. It was purified by distillation through a 30-plate Oldershaw column. After discarding the forerun, the main portion was collected at the reflux ratio of 10:1. This portion was collected in a round bottom flask of 500 ml. capacity and capped with a polyethylene tube containing anhydrous calcium sulfate (Drierite).

The N-H containing compound used in this study was piperazine (diethylene diamine or hexa-hydropyrazine). It was of practical grade and a product of Coleman and Bell Company and was purified by sublimation. Before purification piperazine was a pale yellow solid. The purified product which was a white crystalline solid had a melting point of 108°C. The purified piperazine was kept in a 50 ml. round bottom flask stoppered with a ground glass stopper and placed in a desiccator containing anhydrous calcium chloride.

#### Preparation of Solutions

The solutions were prepared using 50 ml., 25 ml., and 10 ml. volumetric flasks depending on the concentration required for the investigation. The volumetric flask was first weighed half-filled with the solvent. The liquid (solute) was rapidly pipetted into the flask then the weight was recorded. After that the flask was completed to the mark by the solvent. Piperazine was transferred

to the volumetric flasks by a stainless steel spatula. All weights were made in a very short period of time so as to minimize the amount of water vapor that might be sorbed by the solution. Despite this, equilibrators containing anhydrous calcium sulfate (Drierite) were placed on the flask to insure the removal of the last traces of water which might be picked up during the preparation of the solution. The anhydrous calcium sulfate used throughout this study proved to be an effective dehydrating agent. Other dehydrating agents such as anhydrous magnesium perchlorate and diphosphorus pentoxide were tried during the course of this study, but both were abandoned because they absorbed the solutes to a significant extent. The solutions were usually left in the flasks for at least twelve hours with the drying caps on before transferring to the cell with the proper path length. Drying caps were also placed on the cell as in Figure 2 for a period of twelve hours. The cells were always rinsed out with some of the solution to be used. All preparations and filling of the cells with solutions were done in the minimum amount of time to minimize the amount of moisture that might be taken into the solutions. Finally, all solutions were checked for dryness by tracing the O-H stretching peaks in the region of 2750 - 2600  $\mu$ .

The preparation of solutions where water was the solute followed a different technique than the one mentioned



above. Cells with the proper path length were rinsed with some of the solvent before filling it. The solvents were dried using the same technique as before. Using the O-H stretching peak at 2660  $\mu$ , the dryness of the solvent was always confirmed. When the solvent proved to be dry, an equilibrator containing a constant water activity solution plugged with a small rubber septum so that a closed system was formed as in Figure 2. The time required for equilibrium to be established was of the order of twelve hours. However, equilibration time was extended longer than this to assure the attainment of complete equilibrium. The attainment of equilibrium was assured by scanning the solution at 2660  $\mu$ , the wavelength for the asymmetric stretching of the O-H, at intervals of time until a constant value for the absorbance was obtained. The absorbance values were recorded at 25°C, with the cell placed in the thermostatically controlled cell holder as described later.

### Instrumentation

#### Spectrophotometer

The instrument used in this study was a Beckman Model DK-1 double beam ratio recording spectrophotometer. The operating range of this spectrophotometer lies between 180  $\mu$  in the ultraviolet to 3500  $\mu$  in the near-infrared region of the electromagnetic spectrum. Since this study was carried out in the near-infrared region between 2600  $\mu$

and 3000  $\mu$ , the details applicable to the instrument in this region will be discussed.

The radiation source for the near-infrared region of the spectrum was a 6-volt incandescent tungsten lamp. The prism was cut from a single silica crystal and had a high dispersion in the near-infrared region. The detector was a lead sulfide photoconductive cell. The output of the detector was coupled to a recorder. This recorder was a modified Brown potentiometric strip-chart recorder with one second response. (The recorder was a product of the Brown Instrument Division of Minneapolis Honeywell, Inc.) The chart is driven by a synchronous motor. The recorder was linear in both percent transmittance and absorbance. A germanium filter was placed in the light beam to remove stray light. This filter was opaque and had a cutoff to light of wavelength less than 1900  $\mu$ .

The cells used throughout this study were the products of the Beckman Instruments, Inc. They were of one, two, five and ten centimeter path length. All were of the cylindrical type except the one centimeter cells which were rectangular. The cells were optically matched. The windows of the cells were composed of silica with a high transparency in the near-infrared region. Each cell was equipped with a ground glass-stopper.

### Temperature Control Equipment

Two water baths connected in series were used throughout this study. The first bath which was the main one consisted of an insulated metallic container filled with distilled water to which antifreeze had been added. It was equipped with a cooling coil, a combination heating and stirring tower and a circulatory pump. The temperature was controlled by a "Thermistemp" temperature regulator with a "Thermister" as the sensing element. The temperature in this bath was maintained at  $4^{\circ}\text{C}$ .

The second bath was a Haake Series "F" circulator. This bath was filled with water circulated from the cold bath. It had a filling capacity of 1.2 to 1.7 liters. The temperature could be controlled by two heaters of 100 and 500 watts. The 100 watt heater served for fine heating while for rapid and coarse heating the 500 watt heater was used. The temperature could be set at any desired level by the use of a thermoregulator. The small volume of water allowed rapid heating or cooling so that a large temperature was controlled at  $\pm 0.2^{\circ}\text{C}$ . Water at a specified temperature was circulated from this second bath into the cell holder.

Temperature control in the two, five and ten centimeter cells was accomplished by mounting the cells in a specially constructed thermostatic cell holder. This

thermostatic cell holder, shown in Figure 3, was used throughout this study. It served a two-fold purpose of placing any of the above cells in the light path of the spectrophotometer, and permitting water to be circulated around the cells at a given temperature. This cell holder is constructed of brass and was first designed and used by Melnick (37). Two tubes were built into the cell holder perpendicular to the spectrophotometer's light path to hold the cells in place. The cells fitted the tubes snugly so that there was good contact between the holder and the cells. The cell holder could accommodate cylindrical cells from two to eleven centimeters in length.

Water was circulated from the water bath through the cell holder at a high rate by means of a circulatory pump. The temperature of the water entering and leaving the cell holder was monitored by asbestos insulated side arm test tubes equipped with thermometers in series with the pump and the inlet of the cell holder and between the outlet of the cell holder and the bath in the return line. The thermometers were read to within  $\pm 0.1^{\circ}\text{C}$ . The spectra of solutions were always recorded when there was no difference between the temperature of the water entering and that leaving the cell holder. All temperatures noted in this work were obtained from the monitoring thermometers rather than the bath. Earlier experiments have shown that solutions contained in the cells did not differ significantly

from the circulated water.

The Beckman 92527 Temperature Regulated Cell Holder was used to maintain a constant temperature in the one centimeter cells. This holder was designed to regulate and stabilize the temperature of the sample and reference solutions when scanned in the Beckman DK-1 spectrophotometer. The device consists of two 50-watt heaters wired in parallel and installed in a special block. It can accommodate two Beckman standard one centimeter rectangular cells. The rectangular one centimeter cells could be installed in this cell holder by removing the sample cover and sliding the cells into the rectangular cell recesses. The cells were held firmly in the cell holder by integral retaining springs. When sample and reference cells had been positioned, the entire assembly was placed in the spectrophotometer sample compartment. The temperature was selected and maintained constant by the operation of a thermostat. However, in almost all the work involving the use of this cell holder, the temperature could be maintained equally well by simply circulating water from a constant water bath through the block. This was especially the case when scans were made at temperatures below 30°C. At temperatures above 30°C, the heaters of the cell holder were used to bring the temperature to the desired level in a very short time. The temperature of the cell holder block was monitored by a thermometer placed into a specially designed groove in the

block. Using this cell holder the temperature could be maintained to within  $\pm 0.1^{\circ}\text{C}$  as confirmed by a thermometer.

#### Drying and Equilibration Technique

The solvents as well as solutes, other than water, used in this study show a great tendency to absorb water. A common problem to anyone working with such materials is the elimination of any extraneous water present in solution. This means that solutions must be absolutely dry before recording the spectra. A typical equilibrator used for drying as well as adding a known concentration of water, which is also referred to as drying cap, is shown in Figure 1. It was constructed from a 10 x 30 male ground glass joint which would fit directly into the cell used. The reservoir (A) was filled through (B) with a constant activity solution of sulfuric acid, or with a drying agent such as diphosphorus pentoxide or anhydrous calcium sulfate (Drierite). Small rubber septums were used to plug (B) so that a closed system was formed. In this way the equilibrators could be used to introduce a known amount of water into the solvent (carbon tetrachloride or toluene). If the equilibrator contained a drying agent, it could function as a drying cap to dry out solution. Figure 2 shows a common experimental operation using the equilibrator. It should be noted that in making studies where water was the solute, the reference cell containing the solvent must be

absolutely dry. The dehydrating agent in the equilibrators was frequently replaced by a fresh portion.

### Recording of Spectra

All solutions were scanned on the Beckman DK-1 in the following manner: The instrument was always standardized before recording the spectra of any solution. This was done at the particular wavelength where the functional group showed maximum absorption. Although, the same solutes were used in different solvents, each functional group has its own wavelength where it absorbs the radiation. The sample and the reference cells were filled with the solvent under investigation (carbon tetrachloride or toluene) and capped with the equilibrators containing the drying agent ( $P_2O_5$  or  $CaSO_4$ ). The temperature was adjusted to the desired level and the zero and 100% transmittance adjustments made at the specific wavelength.

Using carbon tetrachloride as the solvent the previous adjustments were made at the following wavelengths:

- a) 2660  $\mu$  corresponding to the asymmetric stretching frequency of the O-H of water,
- b) 2890  $\mu$  wavelength assigned for first overtone of the carbonyl group of acetone,
- c) 2948  $\mu$  assigned for the N-H band in piperazine.

With toluene as the solvent, adjustments were made at the following wavelengths:

- a) 2740  $\mu$  for the absorption of O-H of water,
- b) 2930  $\mu$  for the first overtone of the carbonyl group of acetone. For every solution studied the previous adjustment was made at the specific temperature level. In all cases a zero base line was recorded on the chart. This was done using the sample and reference cells filled with the dry solvent at each temperature.

After standardizing the instrument, the reference cell was removed from the sample beam and replaced by an optically matched cell containing the solution to be scanned. In all cases a period of 20 minutes was allowed for temperature equilibration before recording the spectra. Whenever temperature equilibration was reached, the wavelength selector was turned up to 3500  $\mu$  then brought back to the specific wavelength at which the scan should be started. This was done to eliminate gear backlash. All the spectra were recorded down scale, from high to low wavelength. At the starting point for each scan, the recorder pen and a horizontal chart paper division marker were aligned, the selector was placed on absorbance and the scan started. All the spectra were recorded in terms of absorbance and at the rate of 30  $\mu$ /inch. The scan was considered complete and finished when the wavelength indicator read 100  $\mu$  below the wavelength corresponding to the absorption maximum of



the peak sought. The sensitivity of the instrument was always maximized to give the smallest possible slit width. The slit widths were dependent upon the functional group studied, the solvent used and the cell length. The slit widths corresponding to the absorption maxima of the peaks studied were noted to be:

a) Carbon tetrachloride as the solvent:

<u>Functional Group</u>	<u>Wavelength (<math>\mu</math>)</u>	<u>Mechanical Slit Width (mm)</u>
O-H	2660	0.065
C=O	2890	0.275
N-H	2948	0.21

b) Toluene as the solvent:

<u>Functional Group</u>	<u>Wavelength (<math>\mu</math>)</u>	<u>Mechanical Slit Width (mm)</u>
O-H	2740	1.25
C=O	2930	1.10

For every solution used in this study a qualitative spectra was recorded. This was primarily done to locate the wavelength corresponding to the absorption maximum for each functional group and learn something about the optimum conditions to run a quantitative study. After this was done for each solution and the optimum conditions became known, preparations were made to record the spectra of the solution at different temperatures. The temperature range covered in this study was dependent upon the type of solution. For solutions made up in carbon tetrachloride the temperature range was from  $+10^{\circ}$  to  $+50^{\circ}\text{C}$ . It was from

+10° to +80°C when toluene was used as the solvent.

To record the spectra of solutions at different temperatures precautions must be made to avoid any loss by volatilization which might lead to changes in the concentration of the solutions. This problem was a major part of the work. Such losses of solvent or solute through the ground glass stopper of the cell become important, especially at temperatures above room temperature. The following technique was developed and used during the course of this study. Dry solutions with proper concentrations and ready to be scanned were introduced into the suitable cell. The drying cap (or equilibrator) was removed from the cell containing the solution and the ground glass stopper inserted. Minimizing the time for this replacement was always a necessity. The glass stopper was then sealed. The first sealing material used was pyseal. It proved to be effective as a sealing agent over a short period of time, but it was attacked by the solvent vapor. Carbon tetrachloride vapor attacked the pyseal and a minute amount of it was detected spectroscopically in solution. For this reason its use was discontinued. Molten polyethylene was then used as the sealing material. It proved to be effective over a period of time up to 48-hours. A narrow strap of polyethylene was melted in the Bunsen burner and allowed to drip around the glass stopper of the cell.

For every type of solution studied, a series representing different concentrations was first scanned at 25°C. The absorbance values obtained were used to construct a Beer's Law Plot. A number of solutions with the proper concentrations was chosen to study the effect of temperature on their spectra. In every case a spectrum was always recorded at 25°C before and after the sealing of the cell containing the solution to be studied over a range of temperature. Recording such spectra served two purposes: first to check if the concentration of the solution was altered during the sealing of the cell, second to detect any water which might be sorbed in the solution during the same operation. The instrument (Beckman DK-1) was always adjusted and standardized at every temperature. Solutions in the cells were scanned up and down the temperature scale, and were reproducible. At the end of each run the solution in the sealed cell was scanned at 25°C. This was done to demonstrate the effectiveness of the seal. The use of the polyethylene as a sealing material proved to be a success. The seal can be removed easily after the scan is finished.

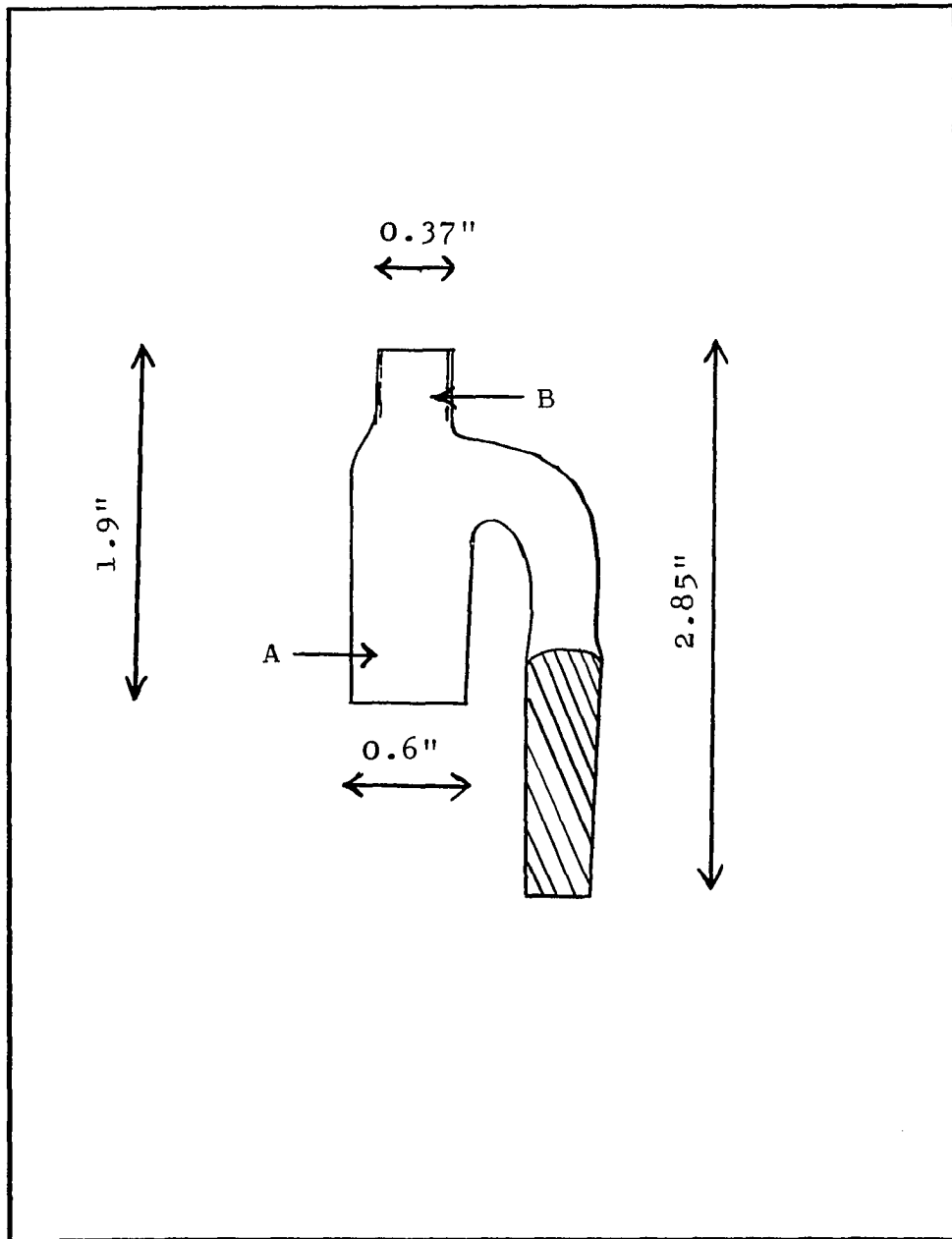

Figure 1. Equilibrator

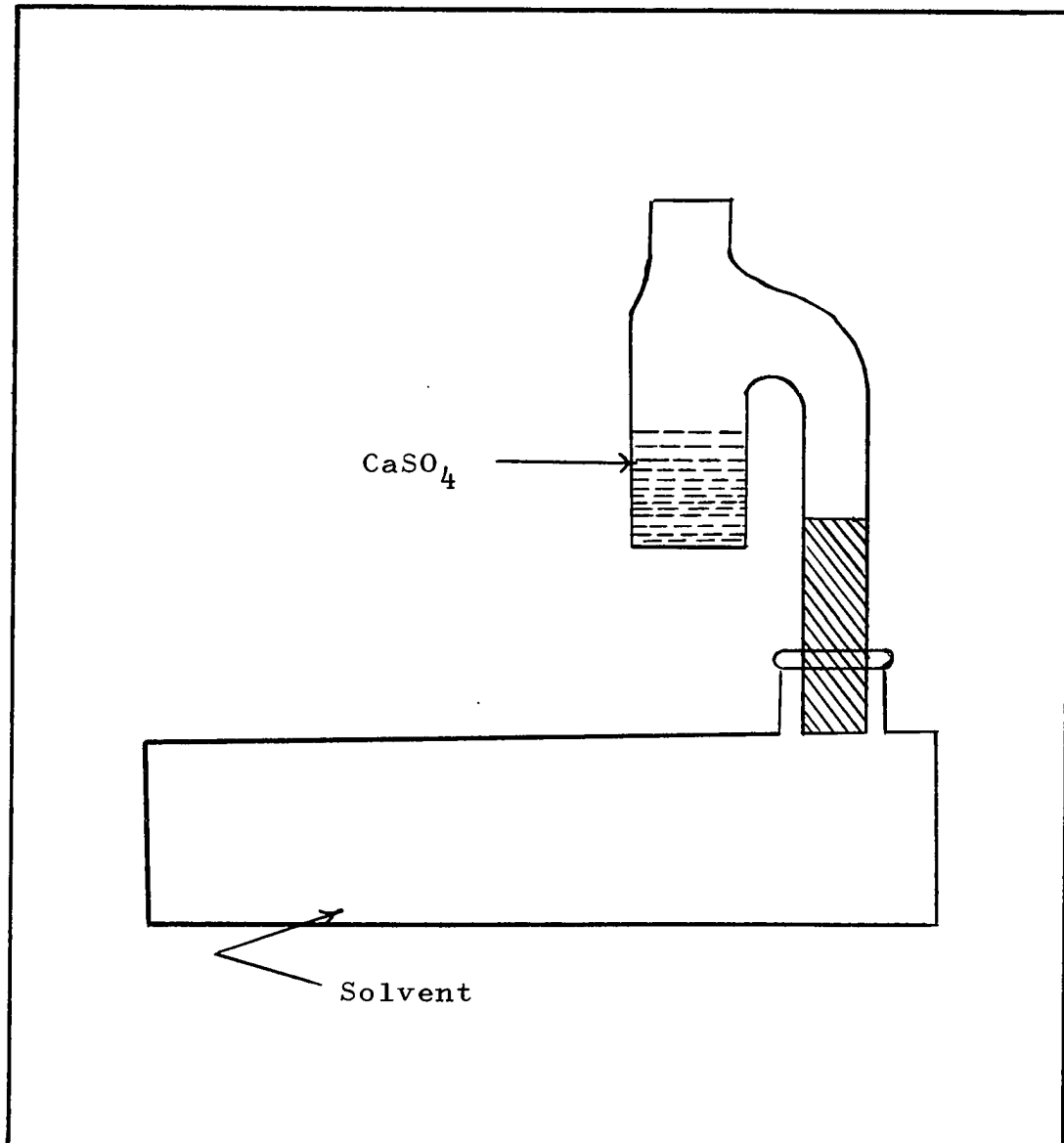

Figure 2. Drying Technique

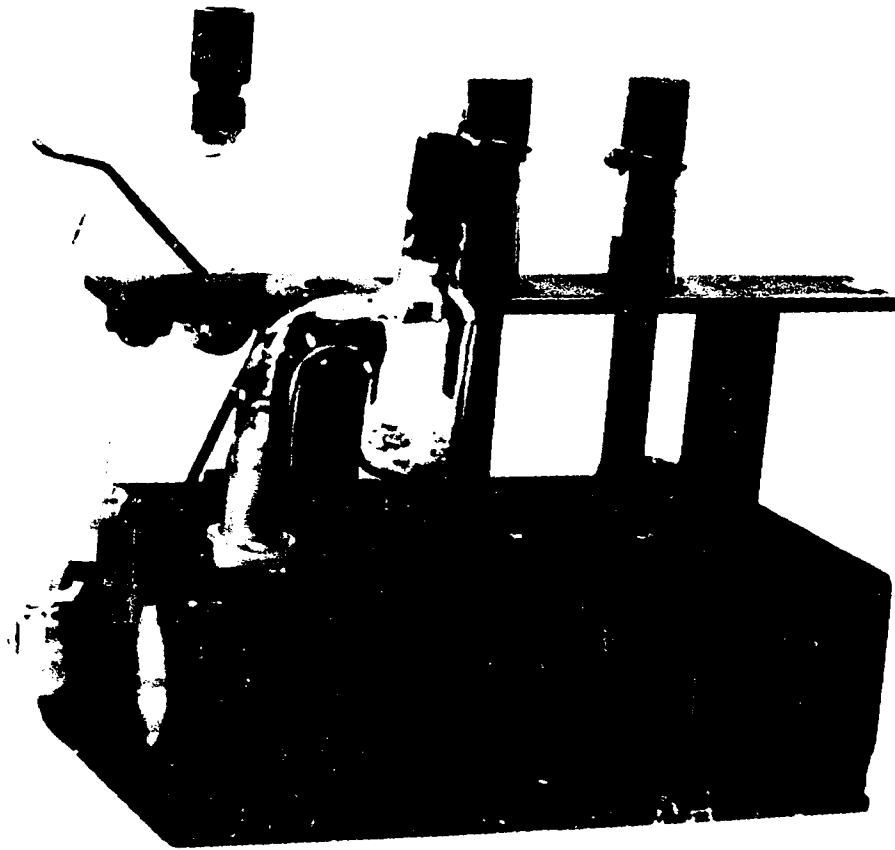

Figure 3. Thermostatic Cell Holder

## CHAPTER IV

### METHODS OF CALCULATION

#### Calculation of the Absorptivity Coefficients

It has generally been assumed that the Beer-Lambert law constitutes the fundamental law for the practice of quantitative spectroscopic analysis. This law which is commonly known as Beer's law can be represented by the following equation:

$$\log I_0/I \equiv \log 1/T \equiv A = abc \quad (1)$$

where:

" $I_0$ " is the intensity of the incident beam of radiation, "I" is the intensity that will pass through a sample of thickness "b"; "c" is the concentration of the sample; and "a", the absorptivity, is the absorption constant characteristic of the sample and the frequency of the radiation. The absorbance

$$A = \log 1/T \quad (2)$$

and

$$A = abc \quad (3)$$

is more simply related to concentration than the

transmittance T. For this reason all the spectra were recorded and reported in terms of absorbance rather than transmittance. From equation (3), the absorptivity "a" can be calculated as follows:

$$a = \frac{A}{bc} \quad (4)$$

For a solution of thickness "b" and concentration "c", the numerical value of "a", the absorptivity, will depend upon the method by which the absorbance "A" is measured. Throughout this study, "A" was measured by two methods. The first using the peak height from the zero absorbance point corresponding to the specific peak absorption maximum. This value was represented by  $A_{PH}$  in the tables of Chapter V. The second method of measuring the absorbance was the base line technique with values represented by  $A_{BL}$ . In some cases more than one base line was drawn and hence more than one base line measurement of the absorbance was reported. These were simply designated by  $A_{BL_1}$  and  $A_{BL_2}$ . In drawing the base line(s), the following scheme was adopted. The first base line (sometimes the only one) was drawn tangent to the peak base and parallel to the zero absorbance line. The second base line was drawn at an angle to the zero absorbance line between two chosen wavelengths. This method is similar to that described by Bauman (38) and referred to as the "hill-and-valley" method. Both base lines were always drawn between



two reproducible points on the spectra of a given system. The base line technique was intended to minimize the background absorption if any. The base line values of the absorbance " $A_{BL}$ " were measured from the base line drawn to the maximum of the peak absorption recorded on the chart.

The absorptivities were calculated for all the solutions studied at 25°C. In addition to this, for solutions whose spectra were recorded over a temperature range, the corresponding absorptivities at each temperature were also calculated. Before calculating the latter absorptivities, the concentration of the solutions were corrected to that at 25°C. This was done to eliminate the changes in the solution density with temperature. All data were fitted by the method of least squares.

#### Correction in the Solution Concentration

Assume that the concentration of the solution at 25°C is  $C_{25^{\circ}}$ ; the density of the solvent at 25°C is  $d_{25^{\circ}}$ , and at  $t^{\circ}$ C is  $d_{t^{\circ}}$ , then the corrected concentration  $c_{t^{\circ}}$  is given by:

$$C_{t^{\circ}} = \frac{d_{t^{\circ}}}{d_{25^{\circ}}} C_{25^{\circ}} \quad (5)$$

The density at a given temperature  $d_{t^{\circ}}$  for both of the solvents carbon tetrachloride and toluene was calculated using (39):

$$d_t = [d_s + 10^{-3} \alpha(t-t_s) + 10^{-6} \beta(t-t_s)^2 + 10^{-9} \gamma(t-t_s)^3] \pm 10^{-4} \Delta \quad (6)$$

The above relation was valid in the range of  $0^\circ - 50^\circ\text{C}$  for carbon tetrachloride and from  $0^\circ$  to  $+99^\circ\text{C}$  for toluene.

For carbon tetrachloride:

$$\begin{aligned} t_s &= 0^\circ\text{C}, & d_s &= 1.6326, \\ \alpha &= -1.9110, & \beta &= -0.690, \\ \gamma &= 0, & 10^4 \Delta &= 1. \end{aligned}$$

For toluene:

$$\begin{aligned} t_s &= 0^\circ\text{C}, & d_s &= 0.8841, \\ \alpha &= 0.92248, & \beta &= +0.0152, \\ \gamma &= -4.223, & 10^4 \Delta &= 2. \end{aligned}$$

The calculated densities using equation (6) for carbon tetrachloride and toluene are listed in Tables 2 and 3 respectively.

TABLE 2

VARIATION IN THE DENSITY OF CARBON TETRACHLORIDE  
WITH TEMPERATURE

<u>t</u> <sup>°C</sup>	<u>d</u>
0.0	1.6326
10.1	1.6132
10.2	1.6130
10.3	1.6129
10.5	1.6124
20.0	1.5941
20.1	1.5939
20.3	1.5935
20.5	1.5931
25.0	1.5844
30.0	1.5747
30.4	1.5739
39.5	1.5560
39.6	1.5558
39.7	1.5556
40.0	1.5551
49.2	1.5369
49.3	1.5367
49.5	1.5363
49.7	1.5359

TABLE 3

VARIATION IN THE DENSITY OF TOLUENE WITH TEMPERATURE

<u>t</u> <sup>°C</sup>	<u>d</u>
0.0	0.8841
10.0	0.8749
11.0	0.8740
20.0	0.8656
25.0	0.8610
30.0	0.8564
39.0	0.8479
40.0	0.8470
48.0	0.8394
49.0	0.8385
50.0	0.8375
60.0	0.8279
70.0	0.8182
80.0	0.8083

## CHAPTER V

### DATA AND RESULTS

The spectra of water in carbon tetrachloride is shown in Figure 4. Two fairly sharp bands are located at 2660  $\mu$  and 2735  $\mu$ . The band at 2660  $\mu$  is due to the asymmetric stretching vibration of the water molecule, while the band at 2735  $\mu$  is related to the symmetric vibrational mode (32). The bands maxima at 2660  $\mu$  and 2735  $\mu$  were made at the spectral slit widths of 3.6  $\mu$  and 3.8  $\mu$  respectively. There was no frequency shift or change in the half-band width for either of these two peaks over a concentration level up to  $8.70 \times 10^{-3}$  moles/liter. This is a strong evidence that water does not self associate in carbon tetrachloride. Except for a tendency for half-band width to increase with temperature the same observation was also made when a series of water solutions in carbon tetrachloride was scanned over a 40°C temperature range. Table 4 contains data which were used to show that Beer's law was obeyed at the above wavelengths and over the concentration range. The absorbance values correspond to the peak absorbances and are expressed in terms

of one centimeter path length. These absorbances were recorded at 25°C. The symbols " $A_{PH}$ " and " $A_{BL}$ " are used to represent peak height and base line absorbance measurements for the particular peak under consideration. Figures 5 and 6 represent Beer's law plots for water in carbon tetrachloride. Both figures show that Beer's law is obeyed by the two peaks located at 2660  $\mu$  and 2735  $\mu$  regardless of the type of measurement used to express the peak absorbance. A series of solutions of water in carbon tetrachloride was scanned over the temperature range +10.3°C to +49.2°C. The data obtained are recorded in Table 5. Such data were used to evaluate the absorptivities of water at the indicated wavelengths and temperatures. Figures 7, 8, and 9 show the relation of the absorbance of the peaks at 2660  $\mu$  and 2735  $\mu$  to the concentration of water in carbon tetrachloride at 10.3°C, 30.1°C and 49.2°C. In all the figures shown throughout this chapter, the lines are calculated, while the points are experimental. The best values for the absorptivities of water in carbon tetrachloride at different temperatures were calculated using least squares. These absorptivities are listed in Table 6. Table 7 shows the change in the absorptivities of water in carbon tetrachloride with temperature as calculated by least squares intercept and slope. Figures 10, 11, and 12 show the variation of the absorptivities of water in carbon tetrachloride with temperature.

Figure 13 shows the absorption spectra of acetone in carbon tetrachloride at 25°C. The peak at 2890 m $\mu$  was assigned to the first overtone of acetone in carbon tetrachloride and was made at a spectral slit width of approximately 13.8 m $\mu$ . Goddu (1) reported a value of 2930 m $\mu$  as the wavelength corresponding to the first overtone of acetone in carbon tetrachloride. Data in Table 8 represent values of the peak absorbances at 2890 m $\mu$  for a set of solutions of acetone in carbon tetrachloride at 25°C. These data were used to construct a Beer's law plot which is shown in Figure 14. The absorbance values of acetone solutions in carbon tetrachloride over the temperature range +10.3°C to +49.6°C are reported in Table 9. These data were used to evaluate the absorptivities of acetone in carbon tetrachloride at the indicated temperatures. The best values of these absorptivities obtained using least squares are listed in Table 10. Figure 15 shows the relation of the absorbance values at 2890 m $\mu$  to the concentration of acetone in carbon tetrachloride at 10.3°C, 30.0°C, and 49.6°C. The change in the absorptivities of acetone in carbon tetrachloride with temperature is shown in Table 11. The values in Table 10 represent the absorptivities which were obtained using least squares intercept and slope. The variation of the absorptivities of acetone in carbon tetrachloride with temperature is shown in Figure 16.

Piperazine in carbon tetrachloride showed a peak absorption maximum at 2948  $\mu$ . The absorption maximum at 2948  $\mu$  corresponds to a spectral slit width of 10.5  $\mu$ . This peak was assigned to the free N-H stretching mode. A broad band was also observed with its center corresponding to 3105  $\mu$ . This broad band grew in apparent height as the concentration of piperazine was increased, and probably due to an associated form of piperazine in carbon tetrachloride. The peak at 2948  $\mu$  corresponding to the free N-H stretching mode is depicted in Figure 17. Table 12 contains data which were used to verify Beer's law for piperazine in carbon tetrachloride at 25°C. When the data were plotted as in Figure 18, it was observed that Beer's law is obeyed up to the concentration level of 0.01 M - piperazine in carbon tetrachloride. Only one solution of piperazine carbon tetrachloride was scanned over the temperature range of +10.5°C to +49.2°C. Table 13 contains data which were used to calculate the absorptivities of piperazine at different temperatures. The calculated absorptivities at the indicated temperature are reported in Table 14 while Table 15 shows the change in the absorptivity of piperazine with temperature. Figure 19 shows the variation of the absorptivity of piperazine with temperature.

Figure 20 depicts the spectra of water in toluene recorded at 25°C. A broad absorption band with a center



at 2740  $\mu$  was assigned for the asymmetric stretching mode of the O-H, while the band at 2766  $\mu$  was related to the symmetric stretching mode of the O-H. The band at 2766  $\mu$  appeared as a shoulder to that at 2740  $\mu$ . The absorption band at 2740  $\mu$  corresponds to a spectral split width of 67.5  $\mu$ . A series of water solutions in toluene was scanned at 25°C. The corresponding data are reported in Table 16. Such data were used to construct Beer's law plots for the two bands at 2740  $\mu$  and 2766  $\mu$ . Figure 21 shows a Beer's law plot for the two bands using peak height measurements for both. Using base line measurements for the absorbance values of the two bands, a second Beer's law plot was made and is shown in Figure 22. From the figure it appears that Beer's law is obeyed over the concentration range studied, and also the frequency of the bands remained unchanged. This is a strong evidence that water exists primarily in the monomeric forms in toluene and confirms what Johnson (33) has reported. Table 17 contains data obtained by scanning a set of water solutions in toluene over the temperature range of 11°C - 80°C. The data were used to evaluate the absorptivities of the two peaks at 2740  $\mu$  and 2766  $\mu$ . The best values of these absorptivities at the indicated temperatures, were calculated using least squares method and are reported in Table 18.

The spectra of acetone solution in toluene recorded

at 25°C is shown in Figure 23. The band obtained possesses a center at 2930  $\mu$  and was made at a spectral slit width of 56.1  $\mu$ . It was assigned to the first overtone of acetone in toluene. The absorbance values corresponding to this band are reported in Table 19 for a series of acetone solutions in toluene. These absorbances are given in terms of peak height and two base line measurements. The data in Table 19 were used to verify Beer's law for acetone in toluene. Figure 24 represents Beer's law curves for acetone in toluene at 25°C. The curves show that when the absorbances represented by both peak height and first base line measurements are related to the concentration of acetone in toluene, there is less scattering in the data as compared to that using second base line measurements. Table 20 contains data obtained by recording the spectra of acetone solutions over the temperature range of 11°C - 60°C. These data were used to evaluate the absorptivities of acetone in toluene at the indicated temperatures. The relation of the absorbance to the concentration of acetone in toluene at 11°C and 60°C is shown in Figure 25. The figure contains three sets of curves, one representing peak height measurements, while the other two correspond to first and second base line measurements. Using least squares method, the best values of the absorptivities of acetone in toluene are reported in Table 21. These absorptivities are reported as function of temperature. Figure

26 shows the variation of the absorptivities with temperature for acetone in toluene. The changes in the absorptivity of acetone in toluene are reported in Table 22. The table contains the best values obtained by the method of least squares intercept and slope. In working with toluene, the one centimeter cell was the only path length used.

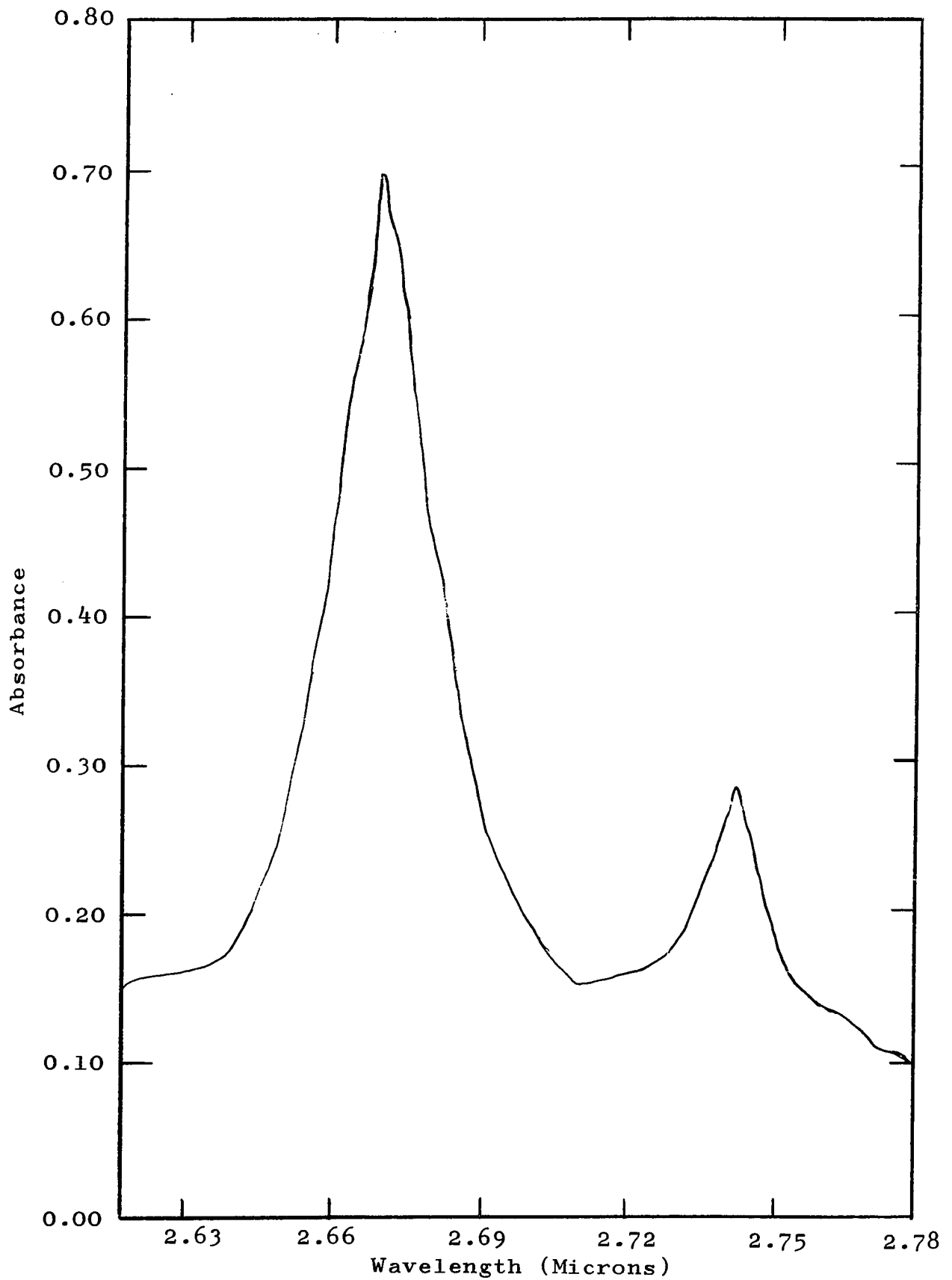

Figure 4. Absorption Spectra of Water in Carbon Tetrachloride at 25°C.

TABLE 4.--Water in carbon tetrachloride. Data were used to verify Beer's Law at the indicated wavelengths and concentrations. Absorbance measurements were recorded at 25°C.

Concentration (Molar Units)	2660 $A_{PH}$	2660 $A_{BL}$	Half Band Width in $\mu$ at 2660 $\mu$	2735 $A_{PH}$	2735 $A_{BL}$
0.00152	0.066	0.052	30	0.027	0.013
0.00218	0.091	0.070	30	0.037	0.018
0.00346	0.139	0.103	30	0.061	0.027
0.00414	0.155	0.120	30	0.066	0.033
0.00477	0.190	0.146	30	0.082	0.039
0.00536	0.216	0.167	30	0.090	0.044
0.00658	0.254	0.197	30	0.106	0.053
0.00822	0.347	0.268	30	0.144	0.068
0.00870	0.371	0.291	30	0.152	0.074

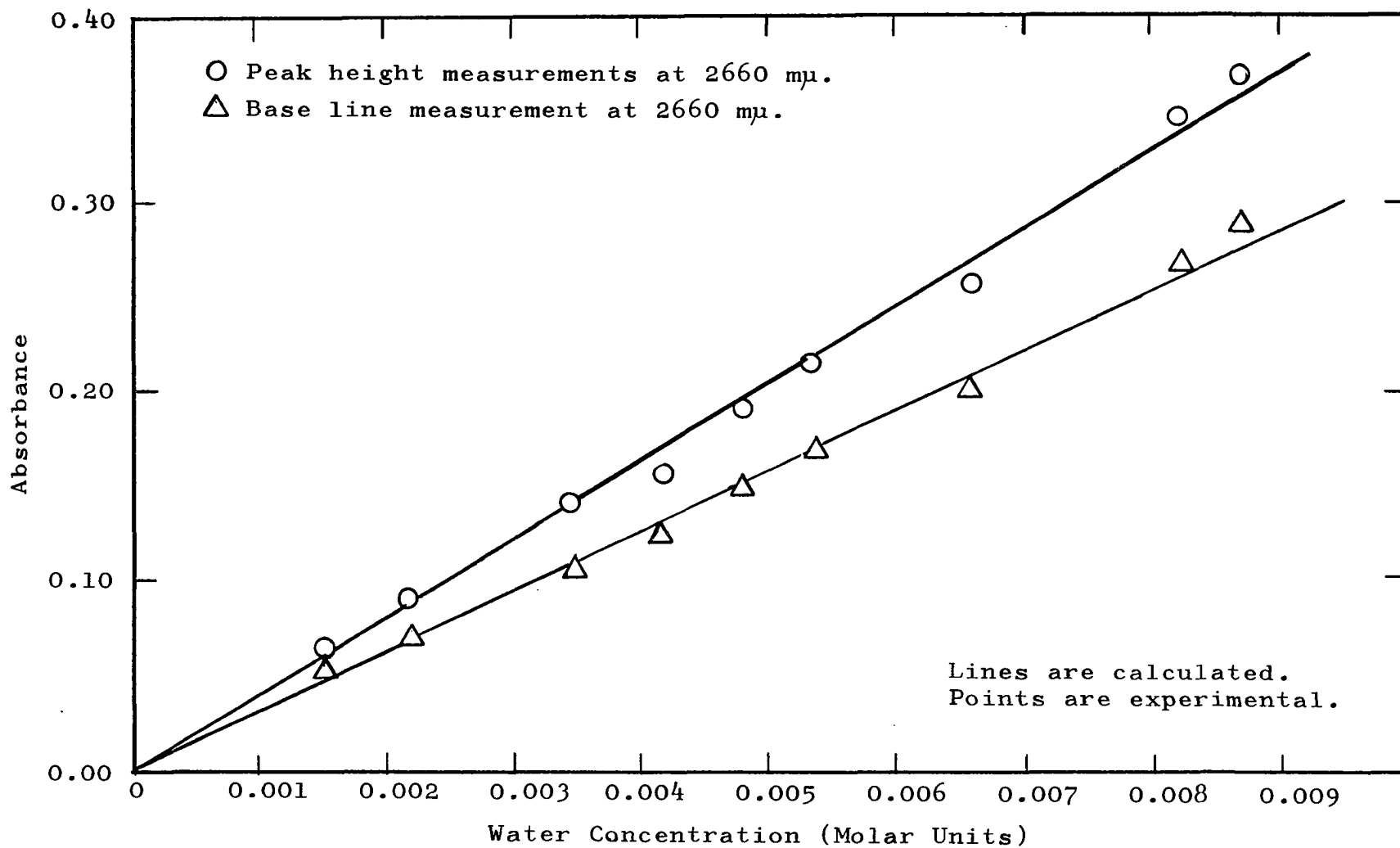

Figure 5. Beer's Law Curves for Water in Carbon Tetrachloride at 25°C.

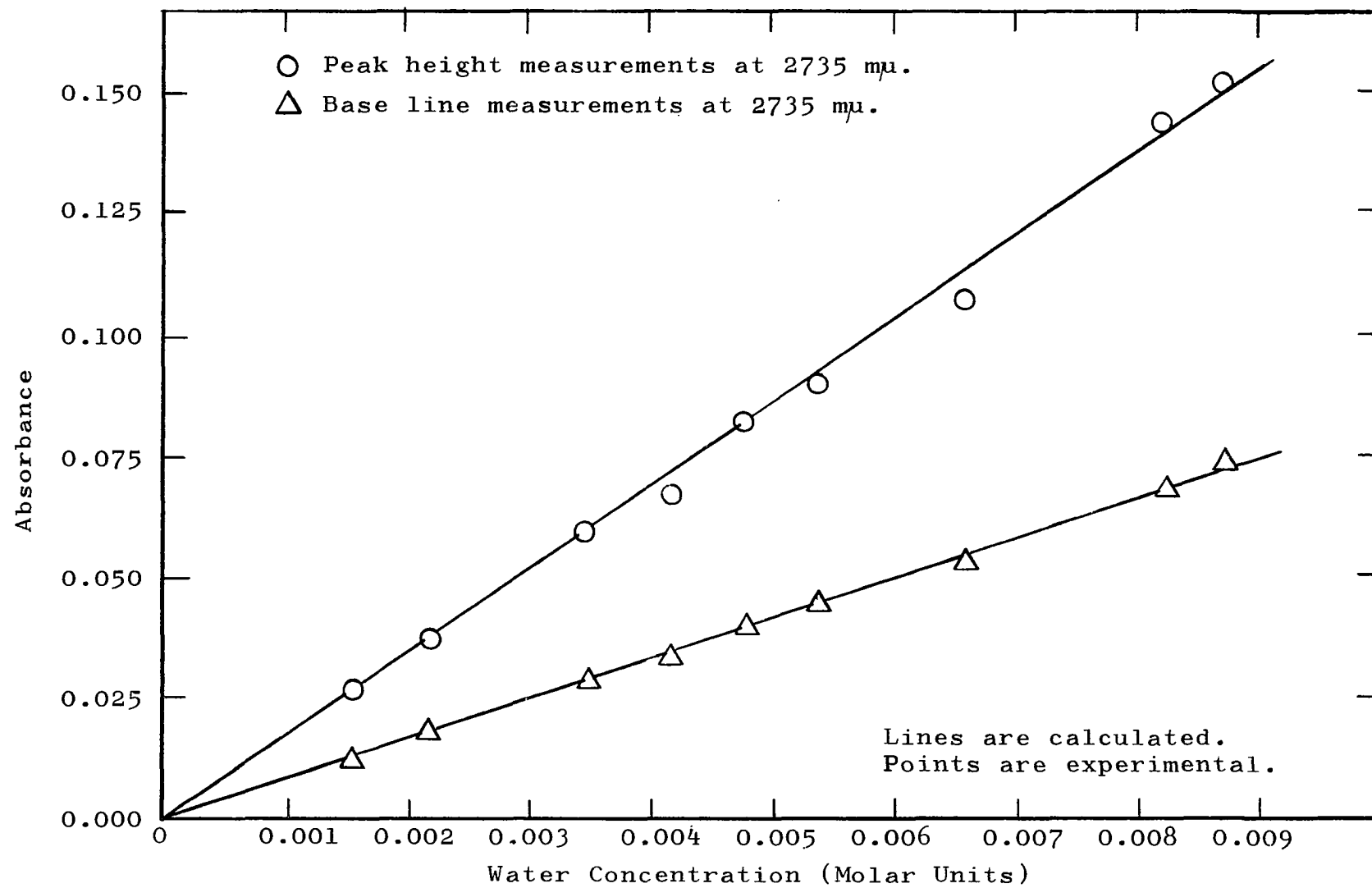

Figure 6. Beer's Law Curves for Water in Carbon Tetrachloride at 25°C.

TABLE 5.--Water in carbon tetrachloride. Data were used to evaluate the absorptivities of water at the indicated wavelengths and temperatures.

Temp. (°C)	Concentration (Molar Units)	2660		Half Band	2735	2735
		A <sub>PH</sub>	A <sub>BL</sub>	Width in mμ at 2660 mμ	A <sub>PH</sub>	A <sub>BL</sub>
10.3	0.00227	0.0967	0.0807	26	0.0372	0.0214
	0.00486	0.210	0.171	28	0.0875	0.0470
	0.00545	0.237	0.187	28	0.0975	0.0515
20.2	0.00224	0.0877	0.0714	27	0.0349	0.0189
	0.00480	0.196	0.155	29	0.0840	0.0430
	0.00539	0.228	0.176	29	0.0945	0.0475
30.1	0.00222	0.0808	0.0638	29	0.0333	0.0165
	0.00474	0.180	0.140	31	0.0770	0.0350
	0.00533	0.212	0.160	32	0.0910	0.0420
	0.00652	0.262	0.202	32	0.115	0.0530
	0.00819	0.285	0.221	31	0.122	0.0550
39.7	0.00219	0.0743	0.0578	30	0.0312	0.0145
	0.00468	0.167	0.127	33	0.0735	0.0320
	0.00526	0.187	0.138	34	0.0815	0.0345
	0.00644	0.242	0.183	32	0.108	0.0460
	0.00807	0.260	0.197	32	0.115	0.0510
49.2	0.00216	0.0682	0.0516	32	0.0296	0.0130
	0.00463	0.154	0.114	34	0.0675	0.0265
	0.00520	0.173	0.123	35	0.0775	0.0315
	0.00636	0.218	0.160	34	0.0990	0.0380
	0.00797	0.238	0.177	34	0.108	0.0420



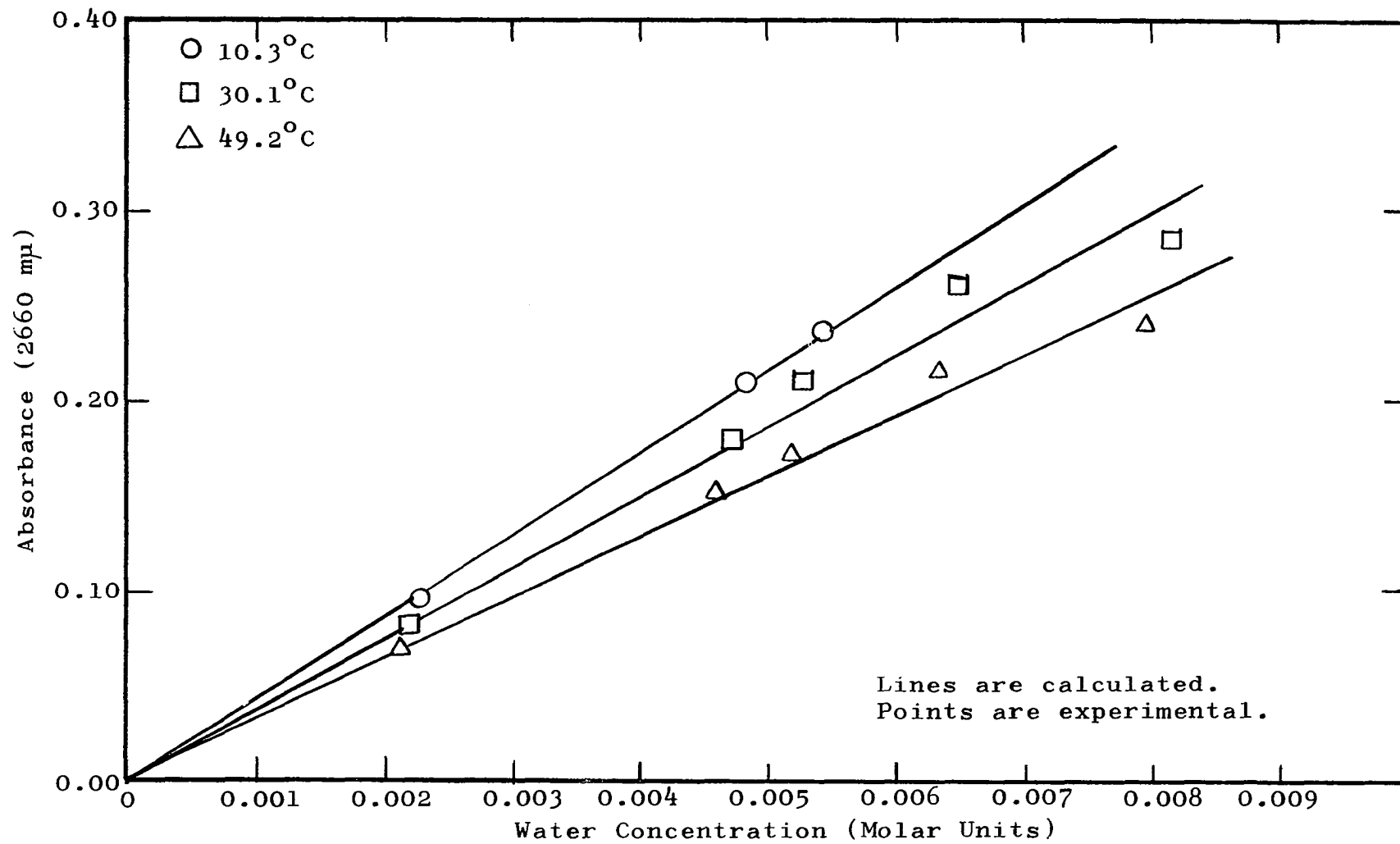

Figure 7. Absorbance vs. Concentration of Water in Carbon Tetrachloride at 10.3°C, 30.1°C and 49.2°C.

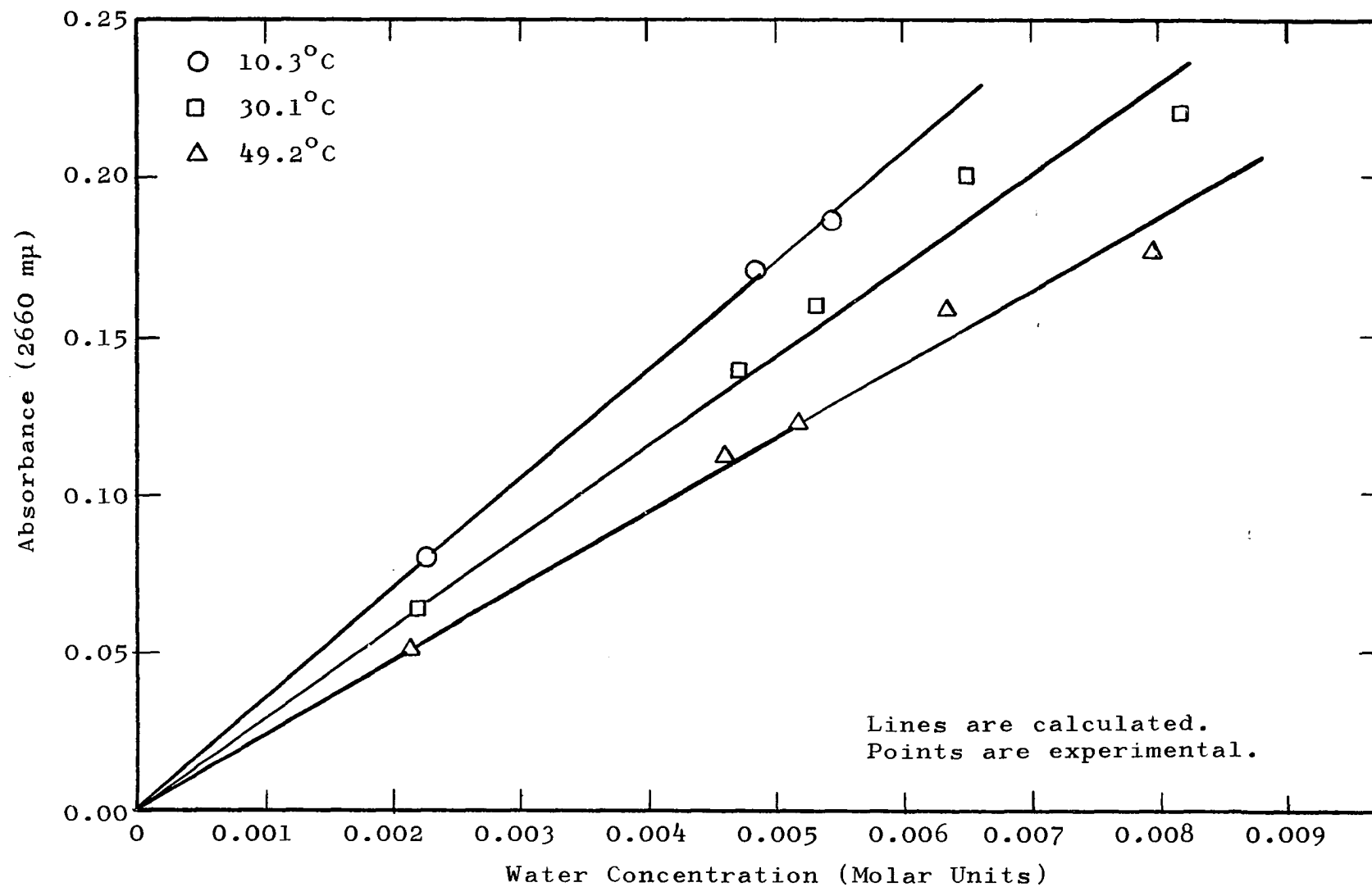

Figure 8. Absorbance vs. Concentration of Water in Carbon Tetrachloride at 10.3°C, 30.1°C and 49.2°C.

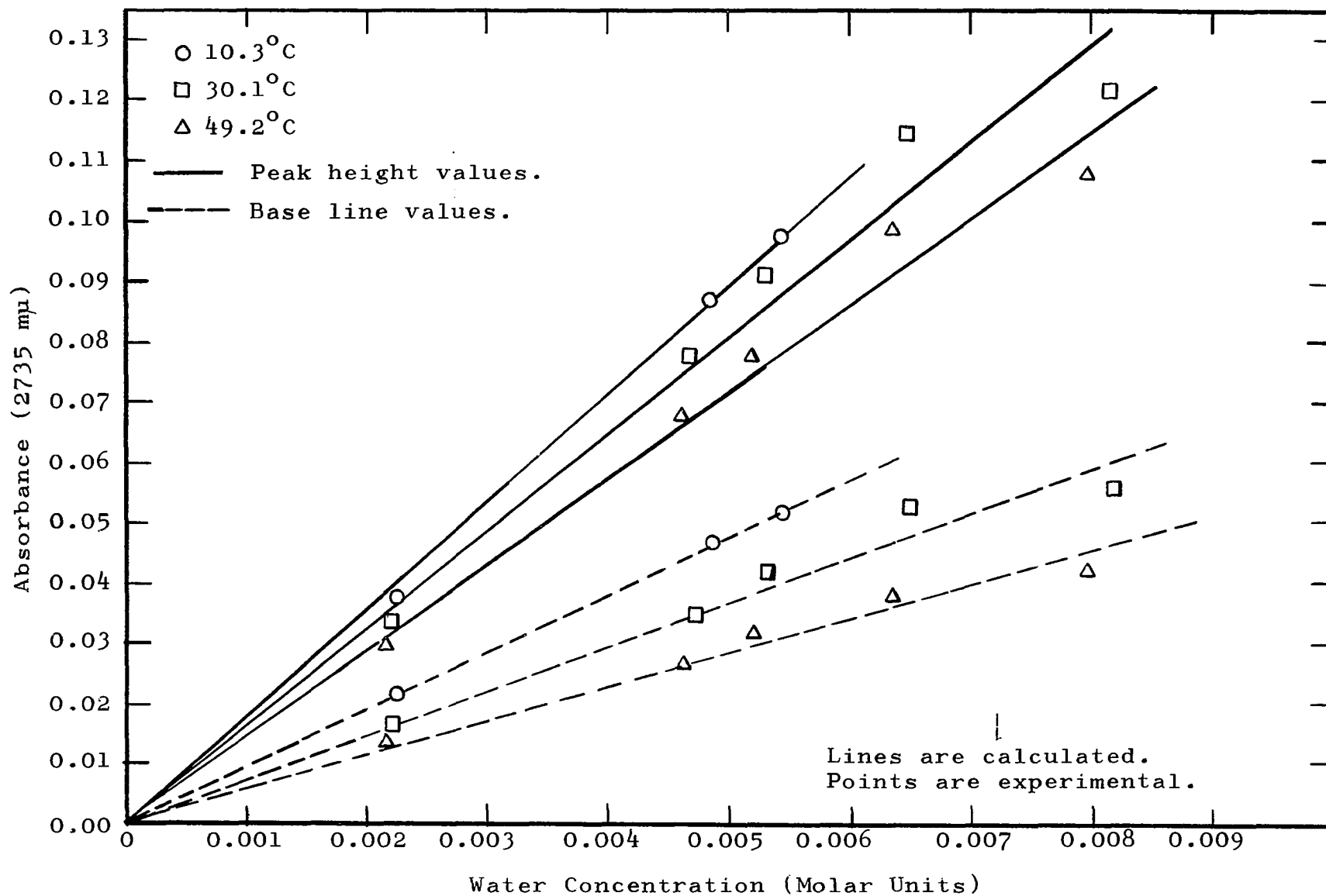

Figure 9. The Absorbance vs. Concentration of Water in Carbon Tetrachloride at 10.3°C, 30.1°C and 49.2°C.

TABLE 6.--Water in carbon tetrachloride. Best values of absorptivities calculated using least squares method.

Temp. (°C)	$2660$ $a_{\text{PH}}^{-1}$ (molar <sup>-1</sup> cm <sup>-1</sup> )	$2660$ $a_{\text{BL}}^{-1}$ (molar <sup>-1</sup> cm <sup>-1</sup> )	$2735$ $a_{\text{PH}}^{-1}$ (molar <sup>-1</sup> cm <sup>-1</sup> )	$2735$ $a_{\text{BL}}^{-1}$ (molar <sup>-1</sup> cm <sup>-1</sup> )
10.3	43.3	34.8	17.8	9.54
20.2	41.4	32.4	17.4	8.84
25.0	41.0	31.8	17.1	8.25
30.1	37.5	28.9	16.1	7.39
39.7	34.7	26.2	15.3	6.65
49.2	32.1	23.5	14.4	5.67

TABLE 7.--Water in carbon tetrachloride. Best values for the change in absorptivity with temperature using least squares intercept and slope.

Absorptivity "a" (molar <sup>-1</sup> cm <sup>-1</sup> )	Change (molar <sup>-1</sup> cm <sup>-1</sup> degree <sup>-1</sup> )
2660 <sub>a</sub> PH	- 0.31 ± 2.4 x 10 <sup>-2</sup>
2660 <sub>a</sub> BL	- 0.30 ± 4.5 x 10 <sup>-3</sup>
2735 <sub>a</sub> PH	- 0.09 ± 6.6 x 10 <sup>-3</sup>
2735 <sub>a</sub> BL	- 0.10 ± 6.2 x 10 <sup>-3</sup>

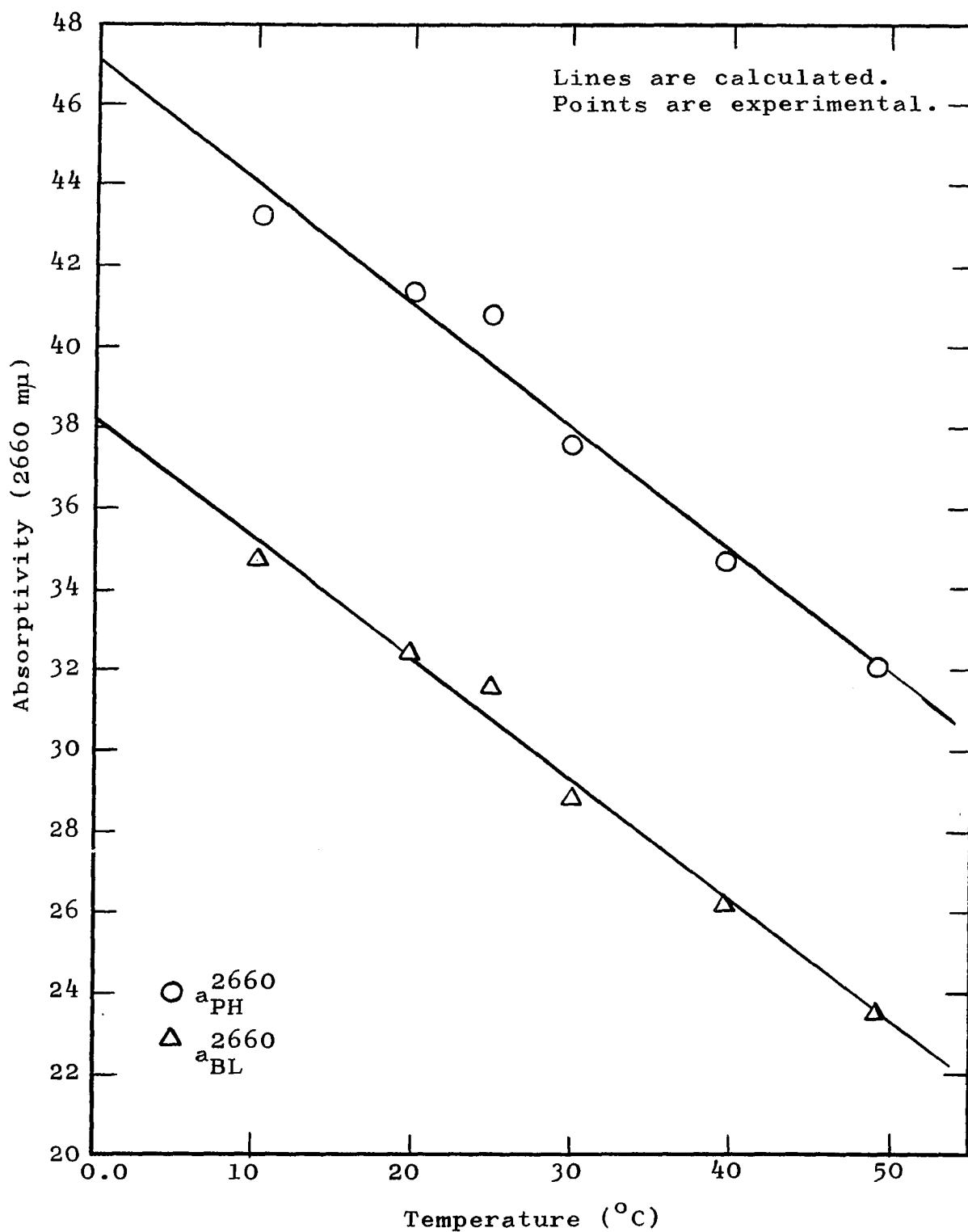

Figure 10. Variation of the Absorptivities with Temperature for Water in Carbon Tetrachloride.

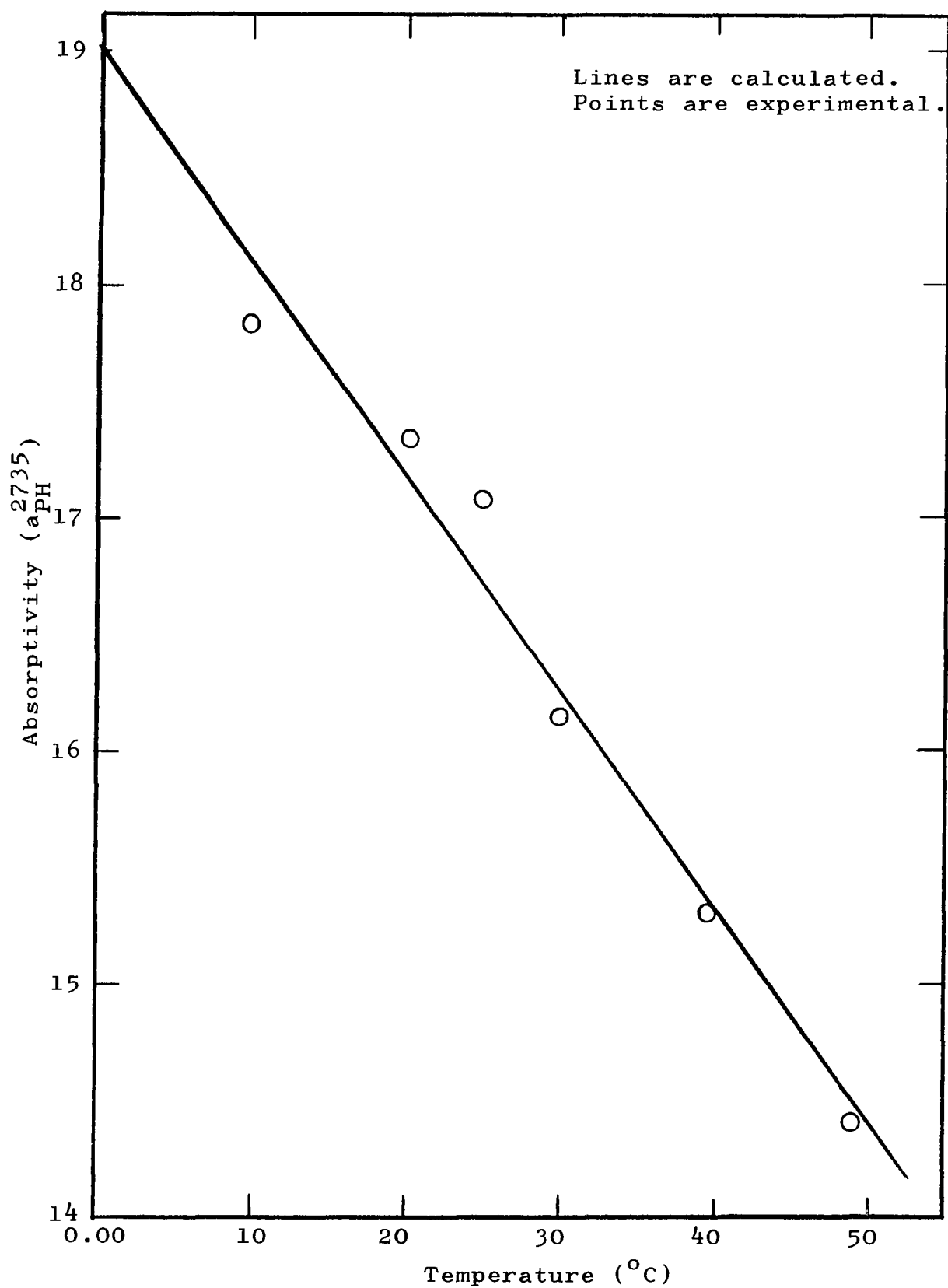

Figure 11. Variation of the Absorptivity with Temperature for Water in Carbon Tetrachloride.

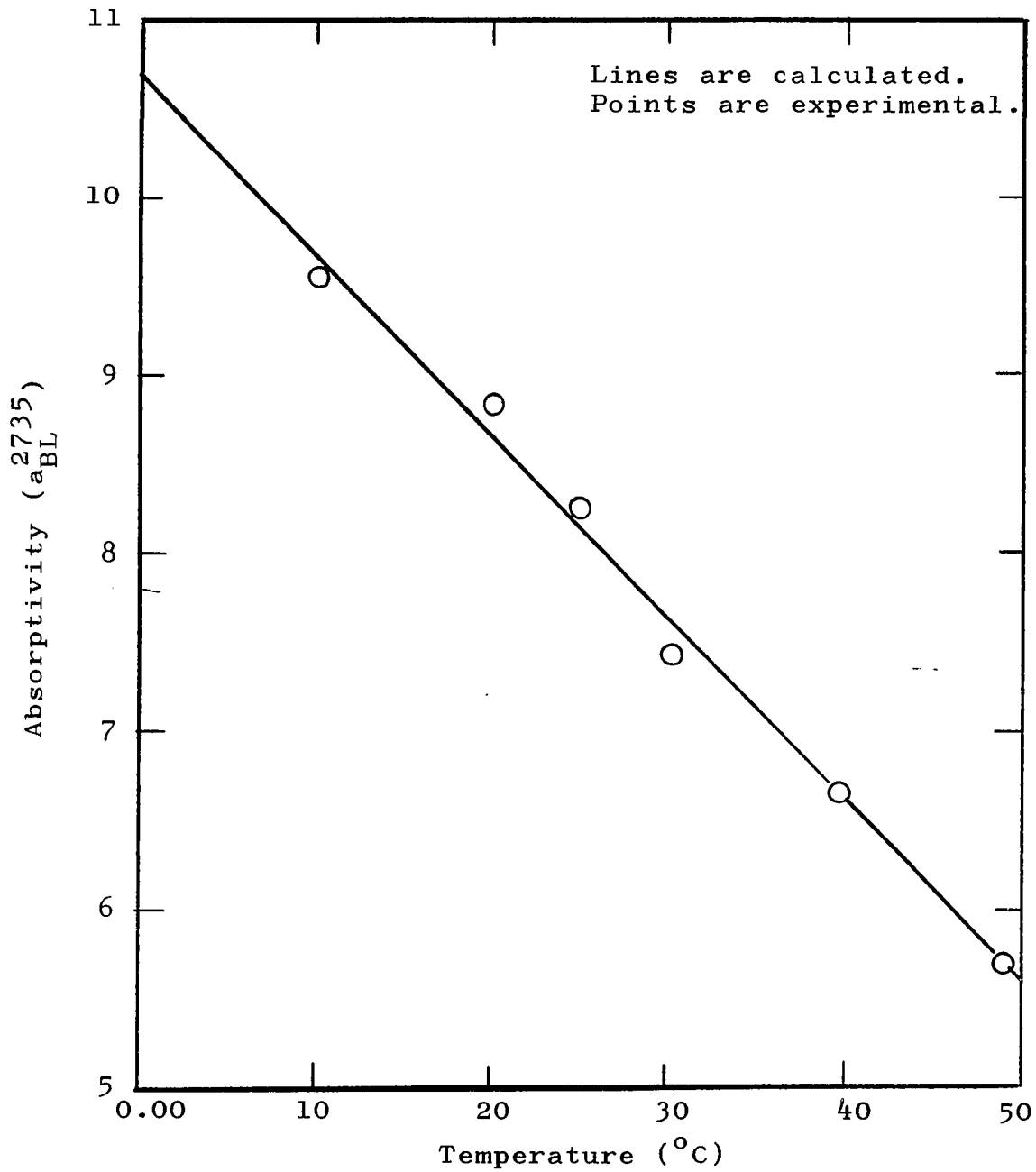

Figure 12. Variation of the Absorptivity with Temperature for Water in Carbon Tetrachloride.



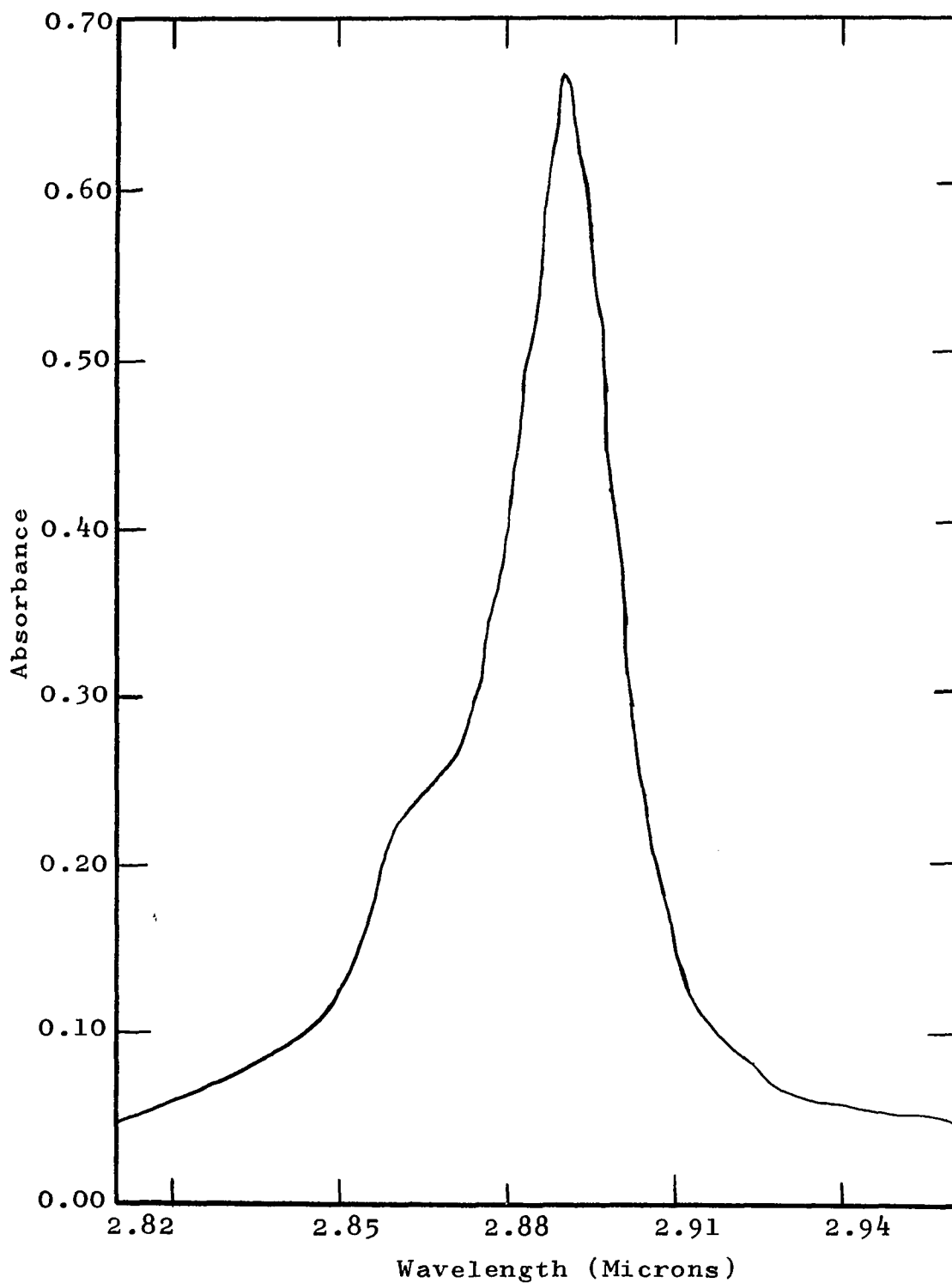

Figure 13. Absorption Spectra of Acetone in Carbon Tetrachloride at 25°C.

TABLE 8.--Acetone in carbon tetrachloride. Data were used to verify Beer's Law at the indicated concentrations. Absorbance measurements were recorded at 25°C.

Concentration (Molar Units)	2890 $A_{PH}$	2890 $A_{BL_1}$	2890 $A_{BL_2}$	Half Band Width in $\mu$ at 2890 $\mu$
0.0054	0.020	0.020	0.017	24
0.0135	0.046	0.046	0.035	24
0.0308	0.107	0.107	0.085	24
0.0406	0.160	0.156	0.123	25
0.0541	0.200	0.190	0.145	27
0.0676	0.237	0.227	0.177	28
0.0811	0.303	0.283	0.215	28
0.103	0.362	0.339	0.260	28

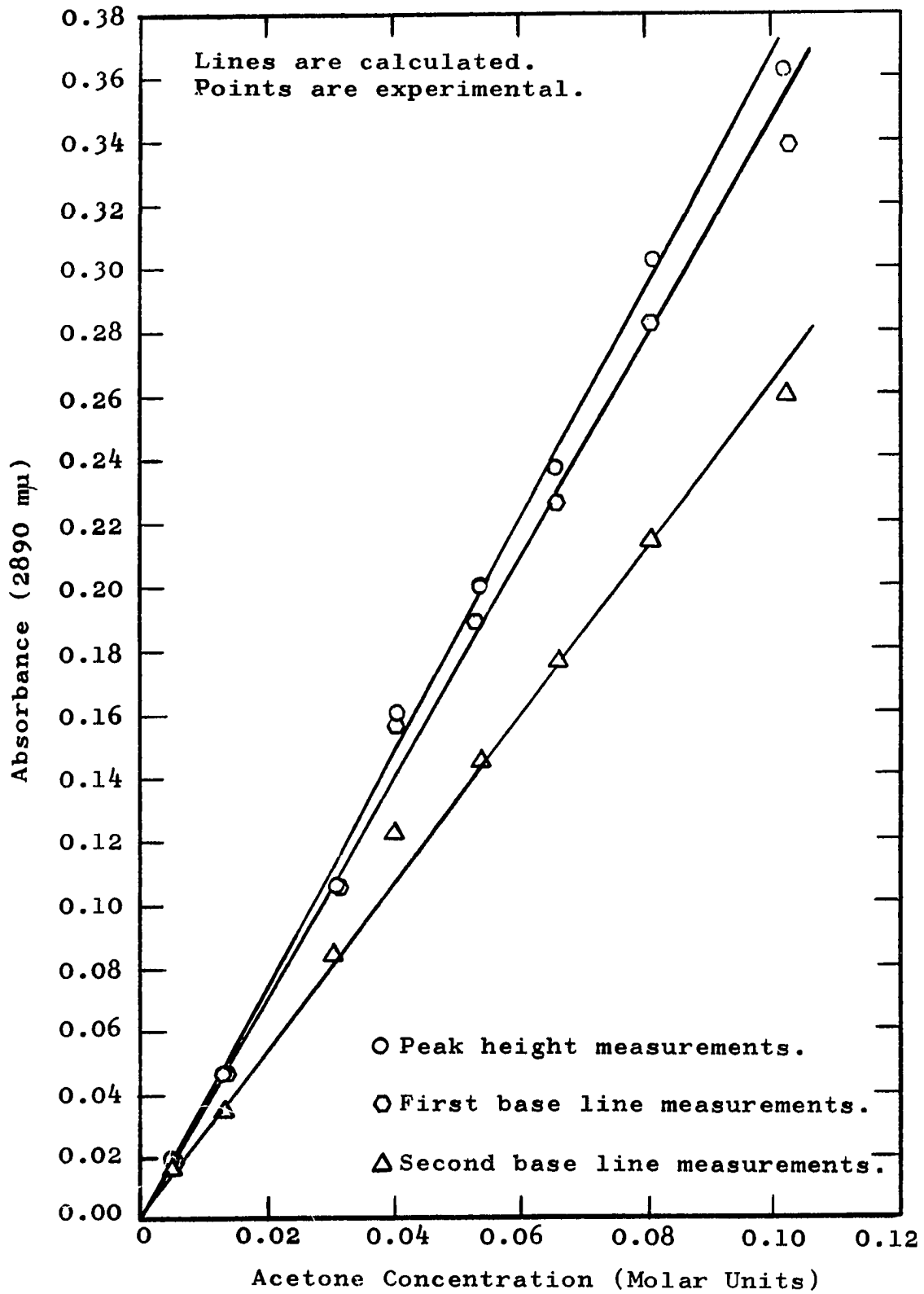

Figure 14. Beer's Law Curves for Acetone in Carbon Tetrachloride at 25°C.

TABLE 9.--Acetone in carbon tetrachloride. Data were used to evaluate the absorptivities of acetone in carbon tetrachloride at the indicated wavelength and temperatures.

Temp. (°C)	Concentration (Molar Units)	2890 $A_{PH}$	2890 $A_{BL_1}$	2890 $A_{BL_2}$	Half Band Width in $\mu$ at 2890 $\mu$
10.3	0.0122	0.0443	0.0433	0.0343	23
	0.0611	0.237	0.225	0.180	24
20.3	0.0121	0.0420	0.0416	0.0340	24
	0.0604	0.230	0.219	0.170	25
30.0	0.0119	0.0404	0.0402	0.0326	26
	0.0596	0.219	0.209	0.159	25
39.5	0.0118	0.0385	0.0385	0.0305	27
	0.0589	0.211	0.200	0.151	27
49.6	0.0116	0.0368	0.0368	0.0293	27
	0.0582	0.209	0.194	0.149	27

TABLE 10.--Acetone in carbon tetrachloride. Best values of absorptivities calculated using least squares method.

Temperature (°C)	2890 <sup>a</sup> PH (molar <sup>-1</sup> cm <sup>-1</sup> )	2890 <sup>a</sup> BL <sub>1</sub> (molar <sup>-1</sup> cm <sup>-1</sup> )	2890 <sup>a</sup> BL <sub>2</sub> (molar <sup>-1</sup> cm <sup>-1</sup> )
10.3	3.87	3.67	2.93
20.3	3.79	3.62	2.81
25.0	3.70	3.57	2.70
30.0	3.66	3.50	2.67
39.5	3.57	3.39	2.56
49.6	3.56	3.32	2.55

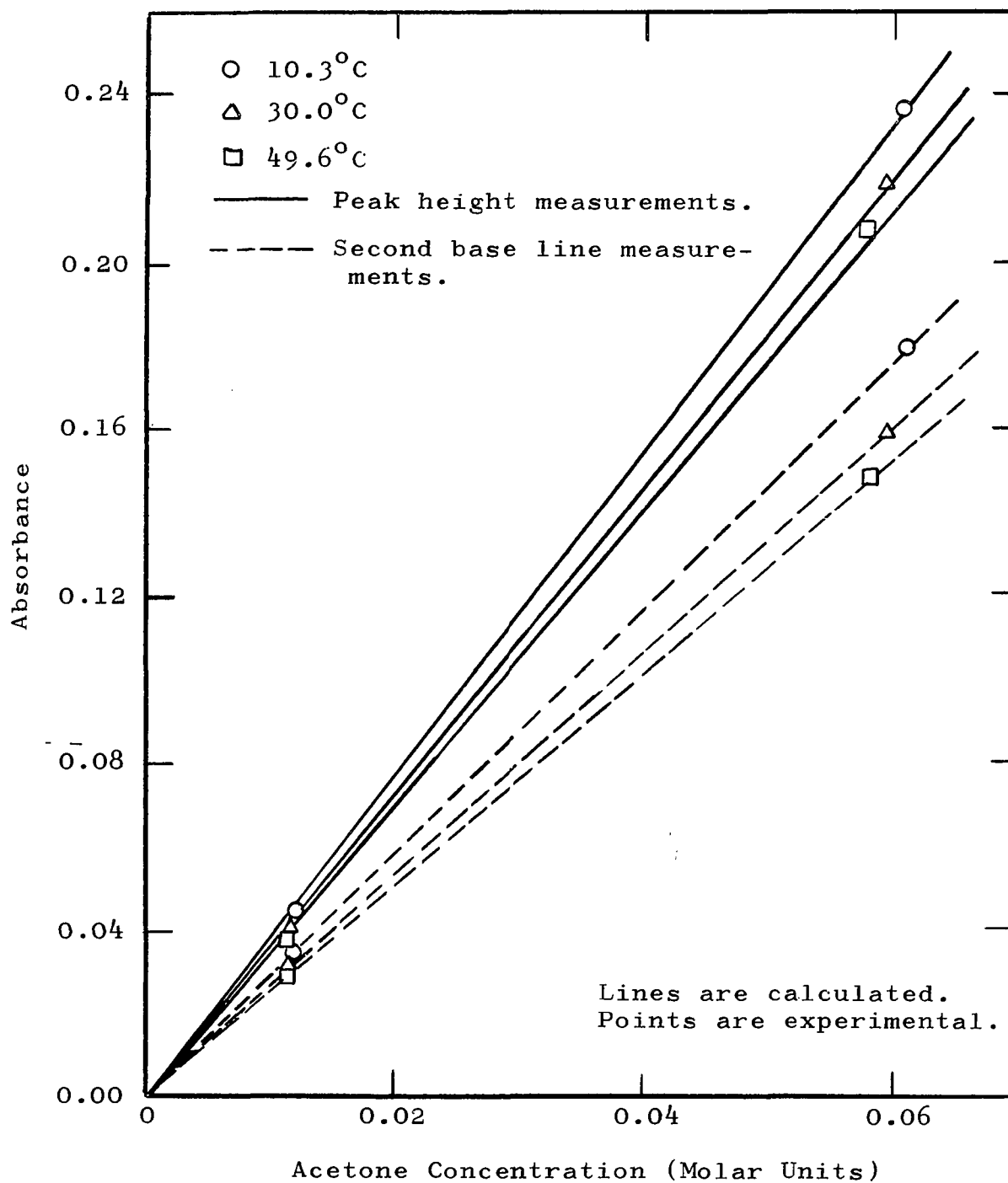

Figure 15. The Peak Absorbance at 2890  $\mu$  vs. Concentration of Acetone in Carbon Tetrachloride at 10.3°C, 30°C, and 49.6°C.

TABLE 11.--Acetone in carbon tetrachloride. Best values for the change in absorptivity with temperature using least squares intercept and slope.

Absorptivity "a" (molar <sup>-1</sup> cm <sup>-1</sup> )	Change (molar <sup>-1</sup> cm <sup>-1</sup> degree <sup>-1</sup> )
<sup>2890</sup> <sub>a</sub> PH	-0.0083 ± 9.8 x 10 <sup>-4</sup>
<sup>2890</sup> <sub>a</sub> BL <sub>1</sub>	-0.0096 ± 5.7 x 10 <sup>-4</sup>
<sup>2890</sup> <sub>a</sub> BL <sub>2</sub>	-0.0098 ± 1.8 x 10 <sup>-3</sup>

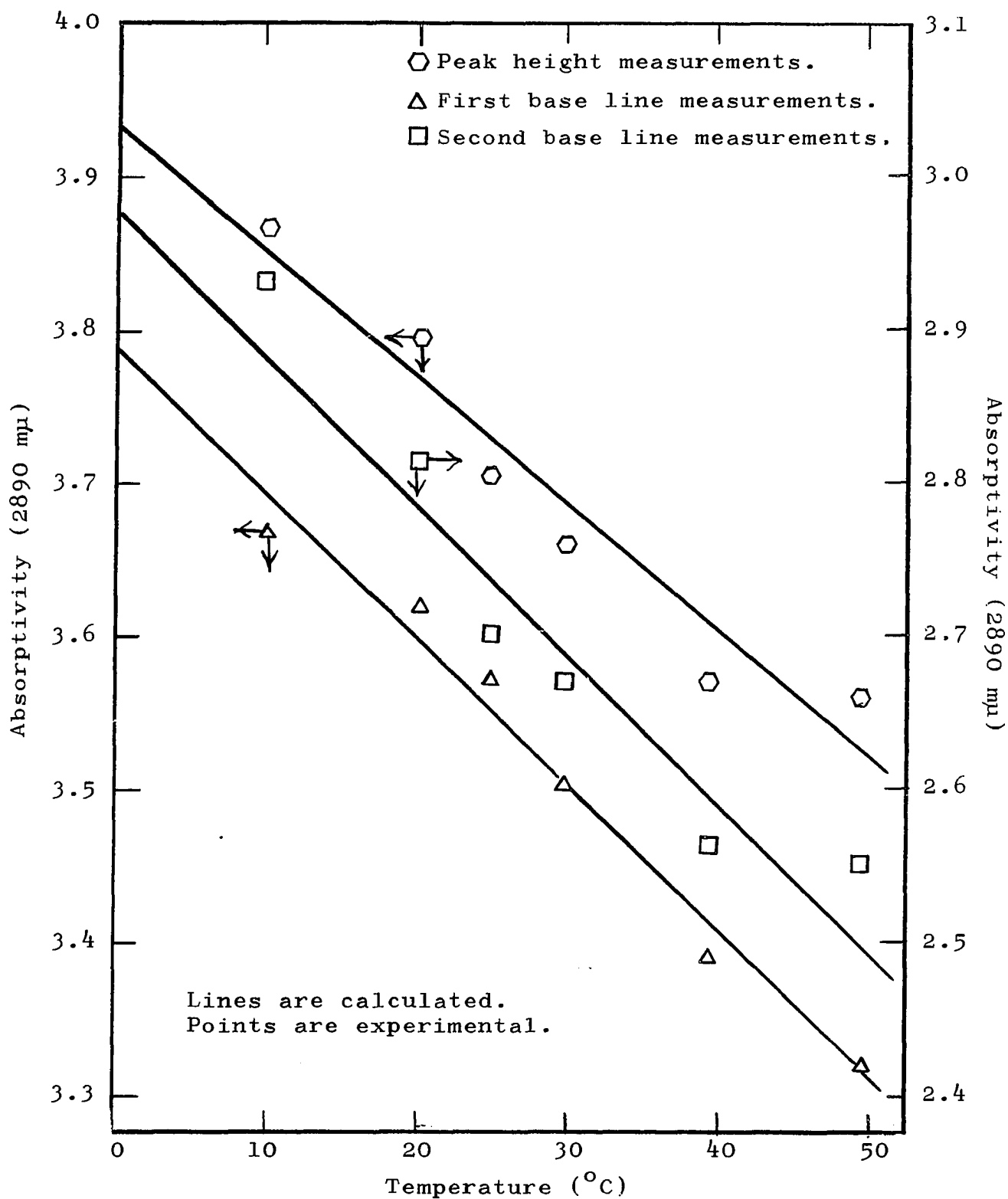

Figure 16. Variation of the Absorptivities with Temperature for the System Acetone in Carbon Tetrachloride.



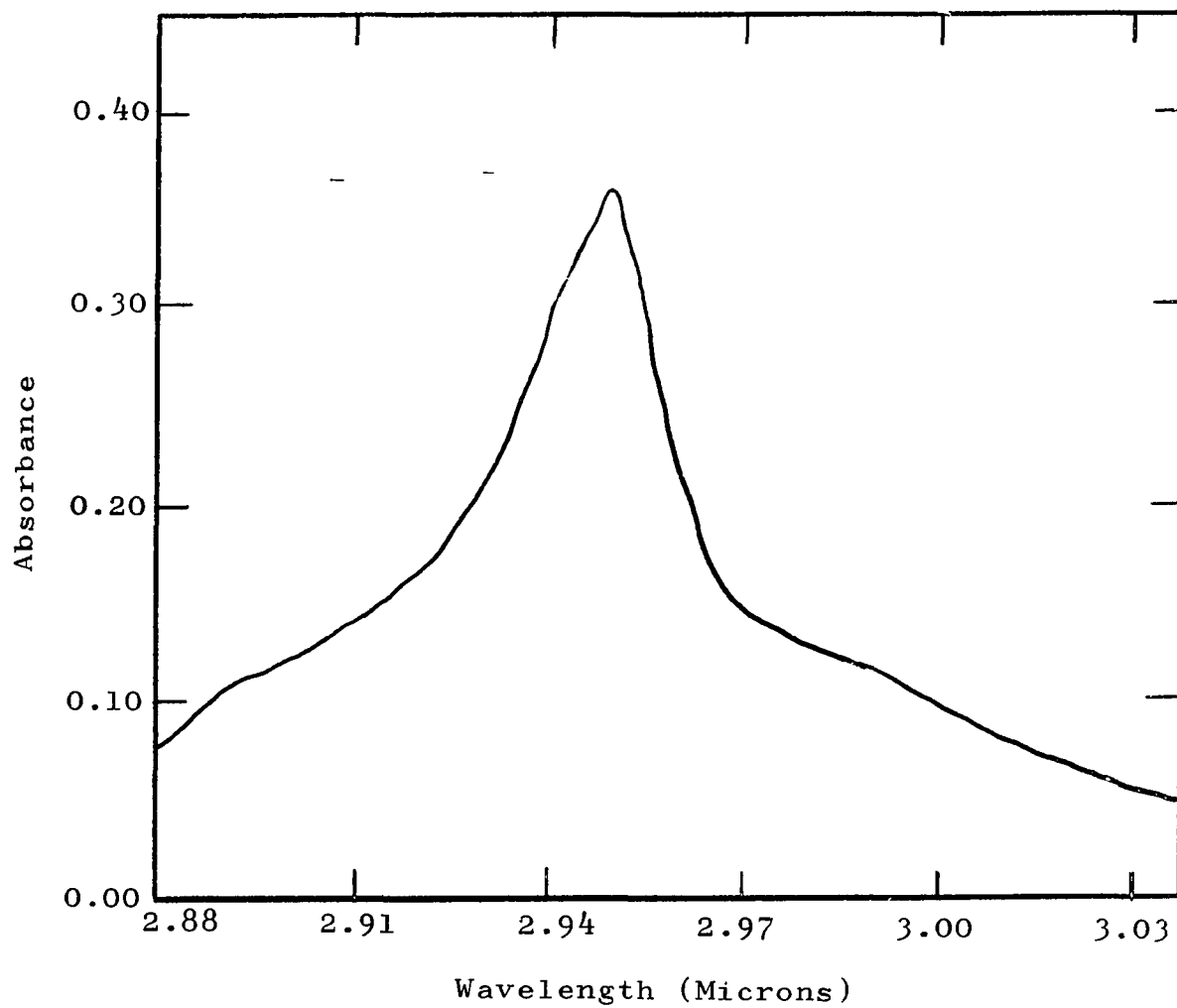

Figure 17. Absorption Spectra of Piperazine in Carbon Tetrachloride at 25°C.

TABLE 12.--Piperazine in carbon tetrachloride. Data were used to verify Beer's Law at the indicated concentrations. Absorbance measurements for the peak at 2948  $\mu$  were recorded at 25°C.

Concentration (Molar Units)	2948 $A_{PH}$	2948 $A_{BL}$	Half Band Width in $\mu$ at 2948 $\mu$
0.00226	0.0112	0.0102	41
0.00438	0.0209	0.0172	42
0.00905	0.0392	0.0327	43
0.0146	0.0577	0.0477	43
0.0213	0.0743	0.0603	43

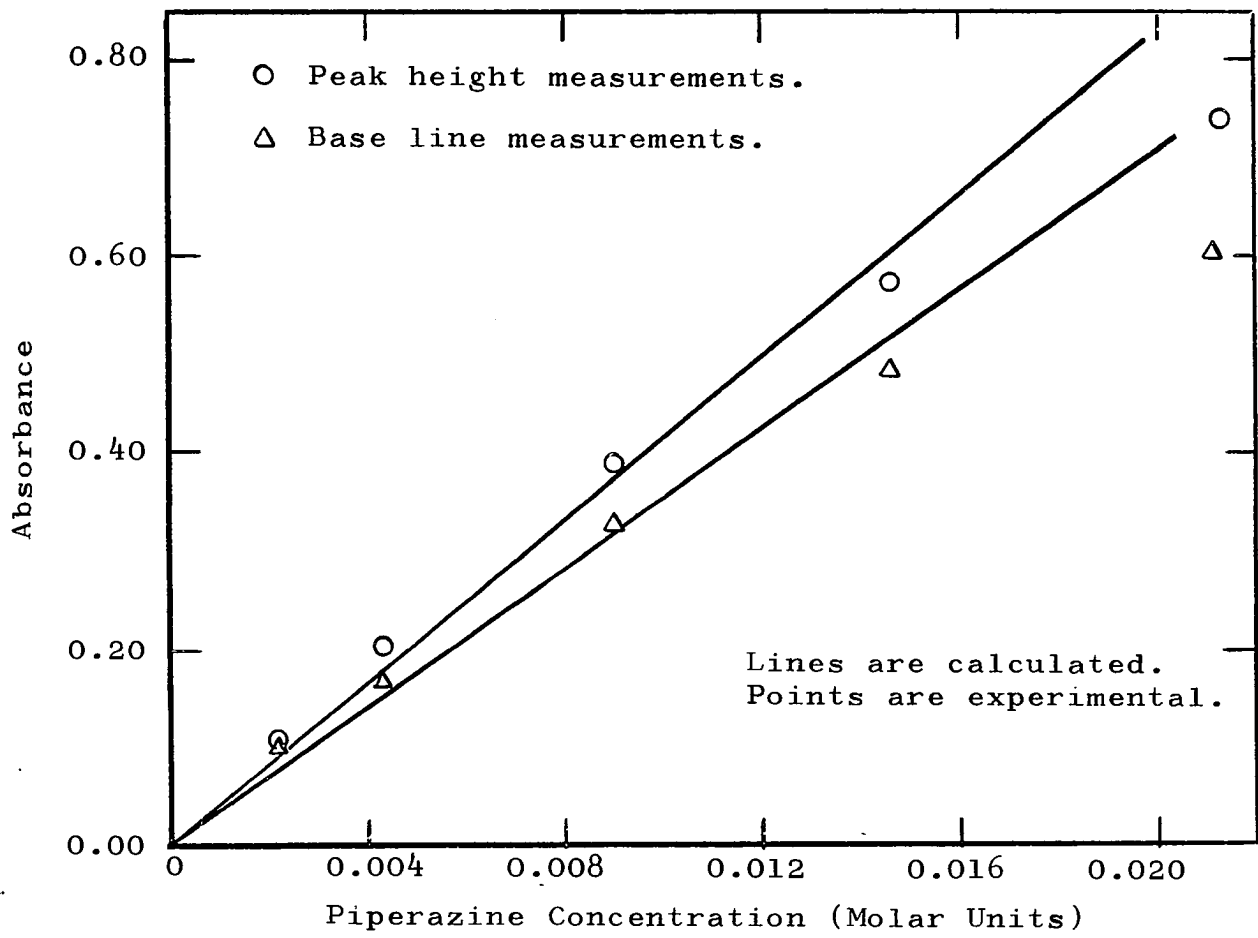

Figure 18. Beer's Law Curves for Piperazine in Carbon Tetrachloride at 25°C.

TABLE 13.--Piperazine in carbon tetrachloride. Data were used to evaluate the absorptivities of piperazine at the indicated wavelength and temperatures.

Temperature (°C)	Concentration (Molar Units)	2948 $A_{PH}$	2948 $A_{BL}$	Half Band Width in $m\mu$ at 2948 $m\mu$
10.5	0.00925	0.0397	0.0351	37
20.5	0.00908	0.0383	0.0337	37
30.0	0.00897	0.0362	0.0315	40
39.7	0.00886	0.0346	0.0304	43
49.2	0.00875	0.0325	0.0285	44

TABLE 14.--Piperazine in carbon tetrachloride. Absorptivities of piperazine calculated at the indicated wavelength and temperatures.

Temperature (°C)	2948 $a_{PH}$ (molar <sup>-1</sup> cm <sup>-1</sup> )	2948 $a_{BL}$ (molar <sup>-1</sup> cm <sup>-1</sup> )
10.5	4.29	3.79
20.5	4.22	3.71
25.0	4.17	3.57
30.0	4.04	3.51
39.7	3.91	3.43
49.2	3.71	3.26

TABLE 15.--Piperazine in carbon tetrachloride. Best values for the change in absorptivity with temperature using least square intercept and slope.

---

---

<u>Absorptivity "a"</u> <u>(molar<sup>-1</sup> cm<sup>-1</sup>)</u>	<u>Change</u> <u>(molar<sup>-1</sup> cm<sup>-1</sup> degree<sup>-1</sup>)</u>
$2948$ $a_{PH}$	$-0.015 \pm 1.1 \times 10^{-3}$
$2948$ $a_{BL}$	$-0.014 \pm 9.2 \times 10^{-4}$

---

---

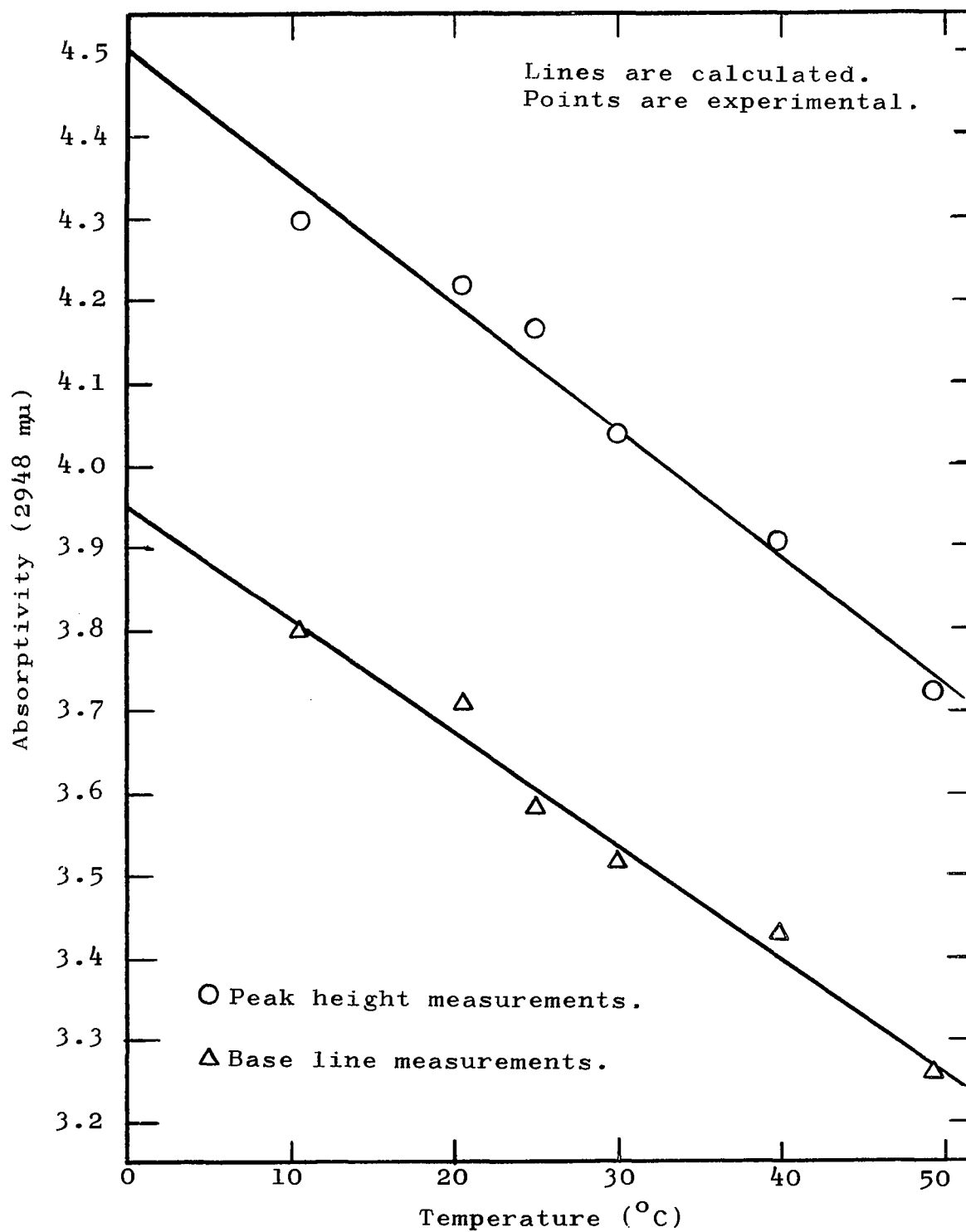

Figure 19. Variation of the Absorptivities with Temperature for Piperazine in Carbon Tetrachloride.

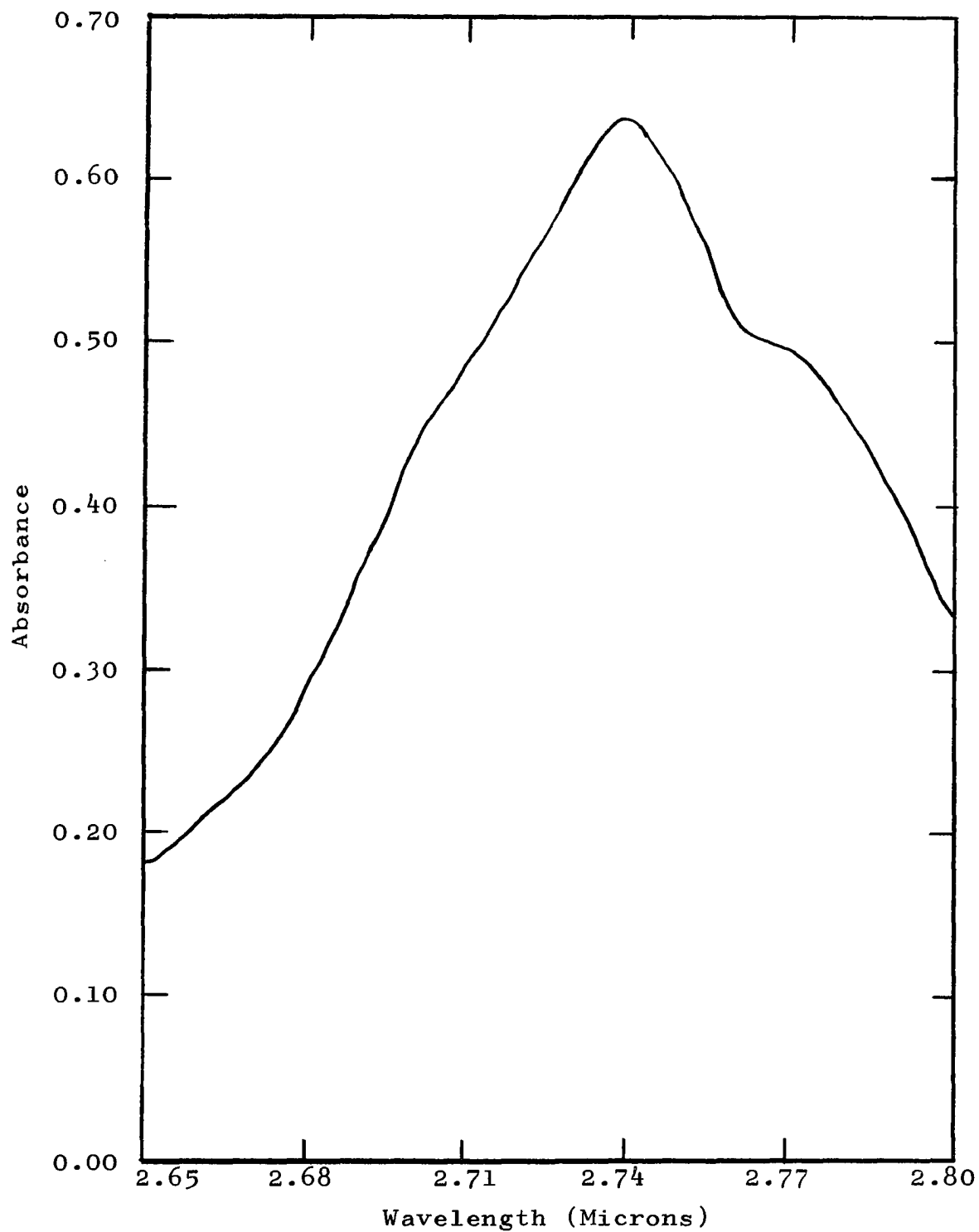

Figure 20. Absorption Spectra of Water in Toluene at 25°C.



TABLE 16.--Water in toluene. Data were used to verify Beer's Law at the indicated wavelengths and concentrations. Absorbance measurements were recorded at 25°C.

Concentration (Molar Units)	2740 $A_{PH}$	2740 $A_{BL}$	2766 $A_{PH}$	2766 $A_{BL}$	Half Band Width in $\mu$ at 2740 $\mu$
0.00618	0.194	0.161	0.136	0.103	103
0.00993	0.294	0.240	0.210	0.156	107
0.0131	0.380	0.305	0.262	0.187	107
0.0172	0.463	0.350	0.345	0.232	111
0.0210	0.560	0.394	0.428	0.274	115
0.0235	0.576	0.391	0.462	0.277	120

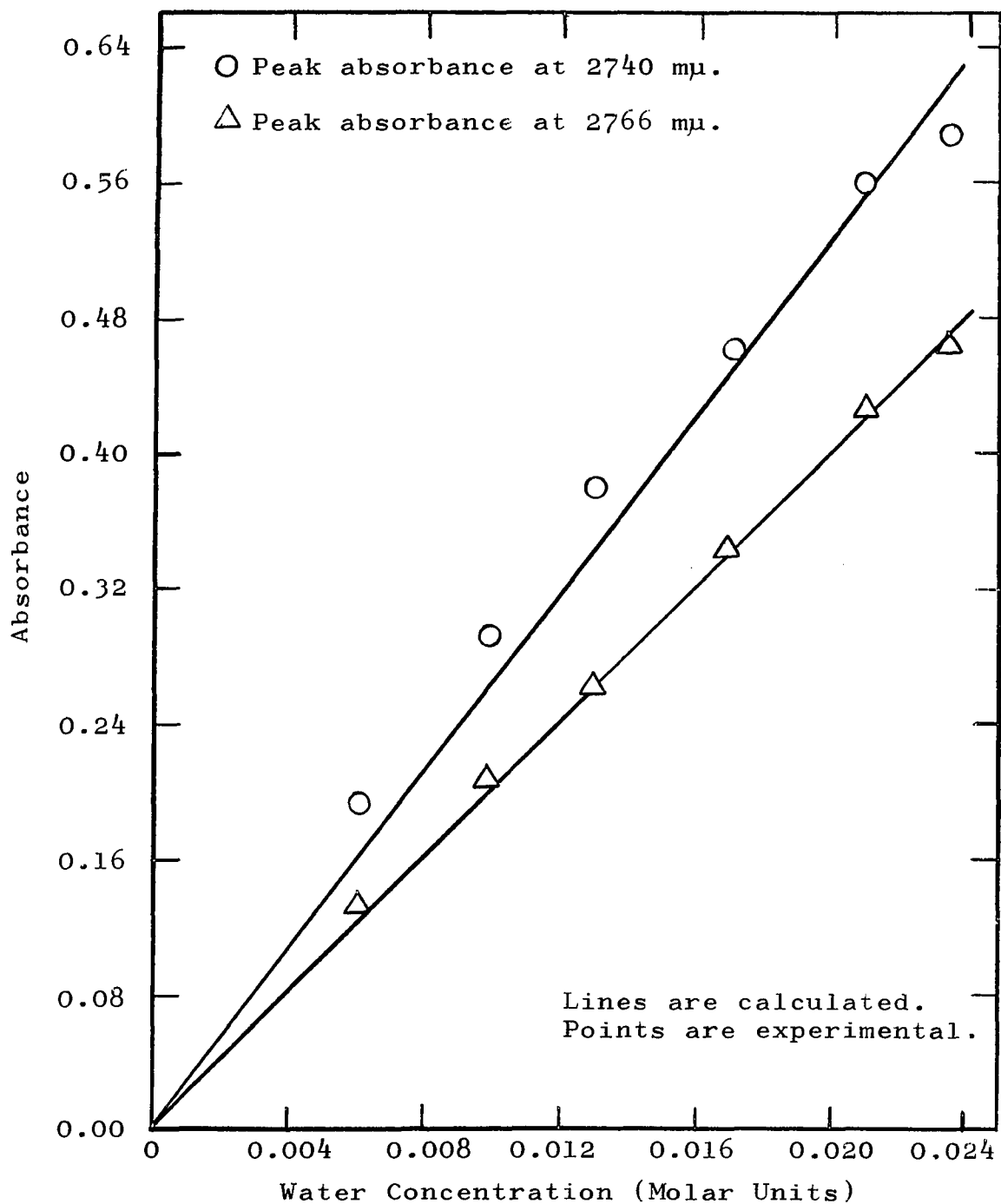

Figure 21. Beer's Law Curves for Water in Toluene at 25°C.

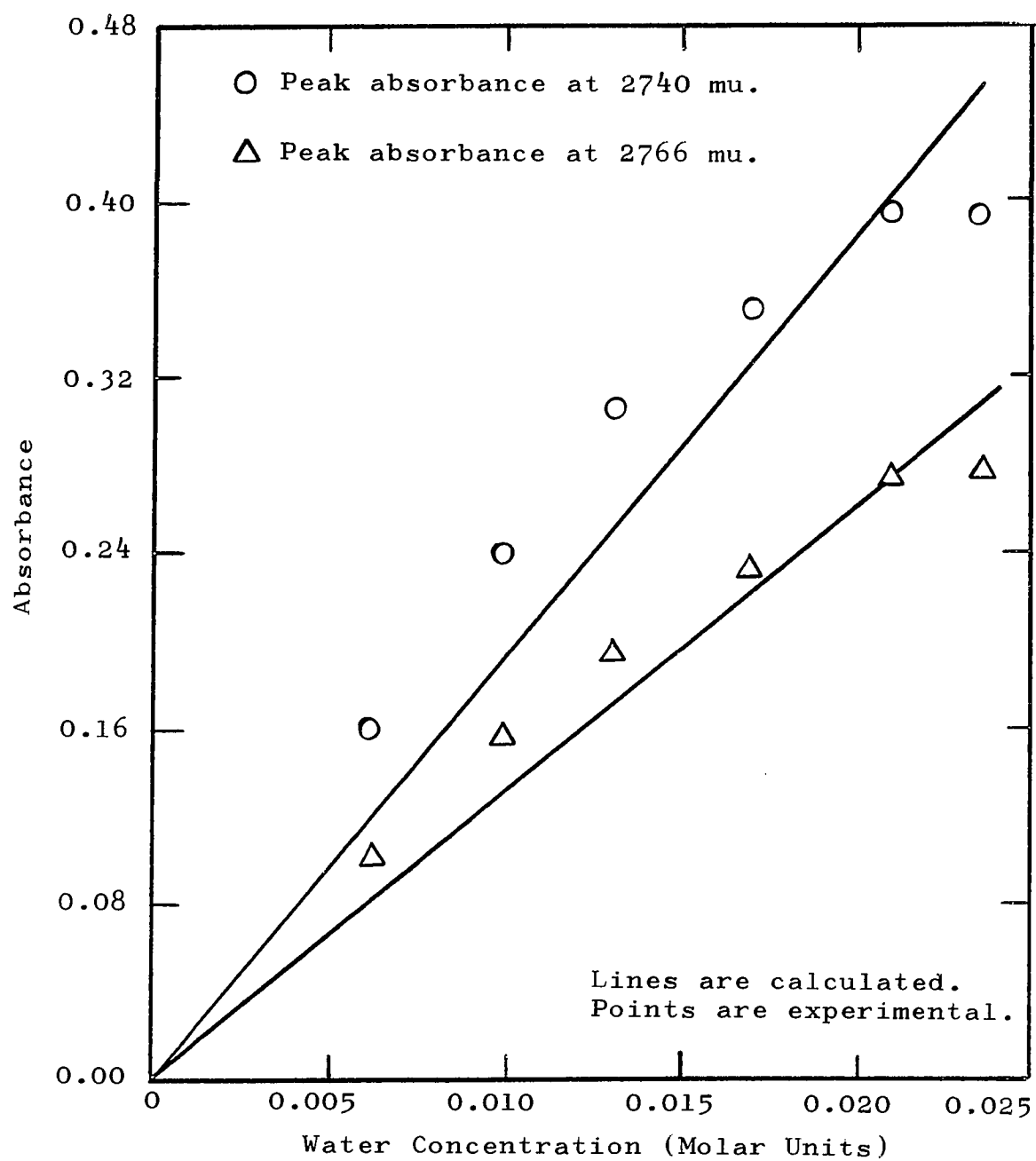

Figure 22. Beer's Law Curves for Water in Toluene at 25°C.

TABLE 17.--Water in toluene. Data were used to evaluate the absorptivities of water at the indicated wavelengths and temperatures.

Temp. (°C)	Concentration (Molar Units)	2740 $A_{PH}$	2740 $A_{BL}$	2766 $A_{PH}$	2766 $A_{BL}$	Half Band Width in $\mu$ at 2740 $\mu$
11.0	0.00627	0.194	0.168	0.137	0.111	102
	0.0101	0.298	0.243	0.217	0.162	107
	0.0133	0.396	0.314	0.292	0.210	110
	0.0174	0.462	0.345	0.347	0.230	111
	0.0213	0.538	0.384	0.420	0.266	120
	0.0239	0.536	0.352	0.450	0.266	130
20.0	0.00623	0.193	0.160	0.136	0.103	104
	0.0100	0.296	0.236	0.213	0.153	107
	0.0132	0.403	0.309	0.300	0.206	110
	0.0173	0.458	0.343	0.346	0.231	111
	0.0212	0.560	0.396	0.435	0.271	118
	0.0237	0.548	0.382	0.438	0.272	120
30.0	0.00614	0.195	0.159	0.145	0.109	105
	0.00987	0.294	0.231	0.212	0.149	107
	0.0130	0.401	0.304	0.294	0.197	110
	0.0171	0.468	0.343	0.355	0.230	112
	0.0209	0.558	0.394	0.430	0.266	118
	0.0234	0.554	0.380	0.440	0.266	120
39.0	0.00609	0.195	0.150	0.144	0.099	106
	0.00977	0.292	0.227	0.212	0.147	109
	0.0129	0.398	0.298	0.294	0.194	111
	0.0169	0.466	0.336	0.349	0.219	112
	0.0207	0.550	0.386	0.424	0.260	117
	0.0232	0.560	0.380	0.440	0.260	120
49.0	0.00601	0.181	0.148	0.131	0.098	104
	0.00966	0.285	0.221	0.208	0.144	109
	0.0127	0.294	0.290	0.290	0.186	111
	0.0167	0.453	0.328	0.337	0.213	112
	0.0205	0.546	0.382	0.418	0.254	115
	0.0229	0.580	0.396	0.445	0.261	118
60.0	0.00594	0.177	0.143	0.129	0.096	104
	0.00955	0.280	0.215	0.205	0.141	109
	0.0126	0.386	0.281	0.286	0.181	111
	0.0165	0.452	0.322	0.340	0.210	112
	0.0202	0.524	0.360	0.397	0.233	115
	0.0226	0.563	0.384	0.432	0.254	117

TABLE 17--Continued

Temp. (°C)	Concentration (Molar Units)	2740 $A_{PH}$	2740 $A_{BL}$	2766 $A_{PH}$	2766 $A_{BL}$	Half Band Width in $m\mu$ at 2740 $m\mu$
70.0	0.00587	0.168	0.133	0.127	0.092	106
	0.00943	0.268	0.203	0.198	0.133	110
	0.0124	0.374	0.272	0.275	0.173	111
	0.0163	0.438	0.308	0.334	0.204	114
	0.0200	0.516	0.352	0.390	0.226	114
80.0	0.00580	0.156	0.126	0.120	0.090	106
	0.00932	0.252	0.189	0.190	0.127	110
	0.0161	0.432	0.295	0.329	0.192	115
	0.0197	0.500	0.337	0.382	0.219	115
	0.0221	0.550	0.370	0.422	0.242	116

TABLE 18.--Water in toluene. Best values of absorptivities calculated using least squares method.

Temp. (°C)	$^{2740}_{a_{PH}}$ (molar <sup>-1</sup> cm <sup>-1</sup> )	$^{2740}_{a_{BL}}$ (molar <sup>-1</sup> cm <sup>-1</sup> )	$^{2766}_{a_{PH}}$ (molar <sup>-1</sup> cm <sup>-1</sup> )	$^{2766}_{a_{BL}}$ (molar <sup>-1</sup> cm <sup>-1</sup> )
11	25.4	18.4	19.8	12.8
20	26.1	19.0	20.1	13.0
25	26.5	19.3	20.1	13.1
30	26.5	19.1	20.4	12.9
39	26.7	19.0	20.4	12.7
49	27.0	19.2	20.4	13.7
60	26.6	18.8	20.1	12.3
70	27.2	19.2	20.4	12.5
80	25.6	17.6	19.6	11.5

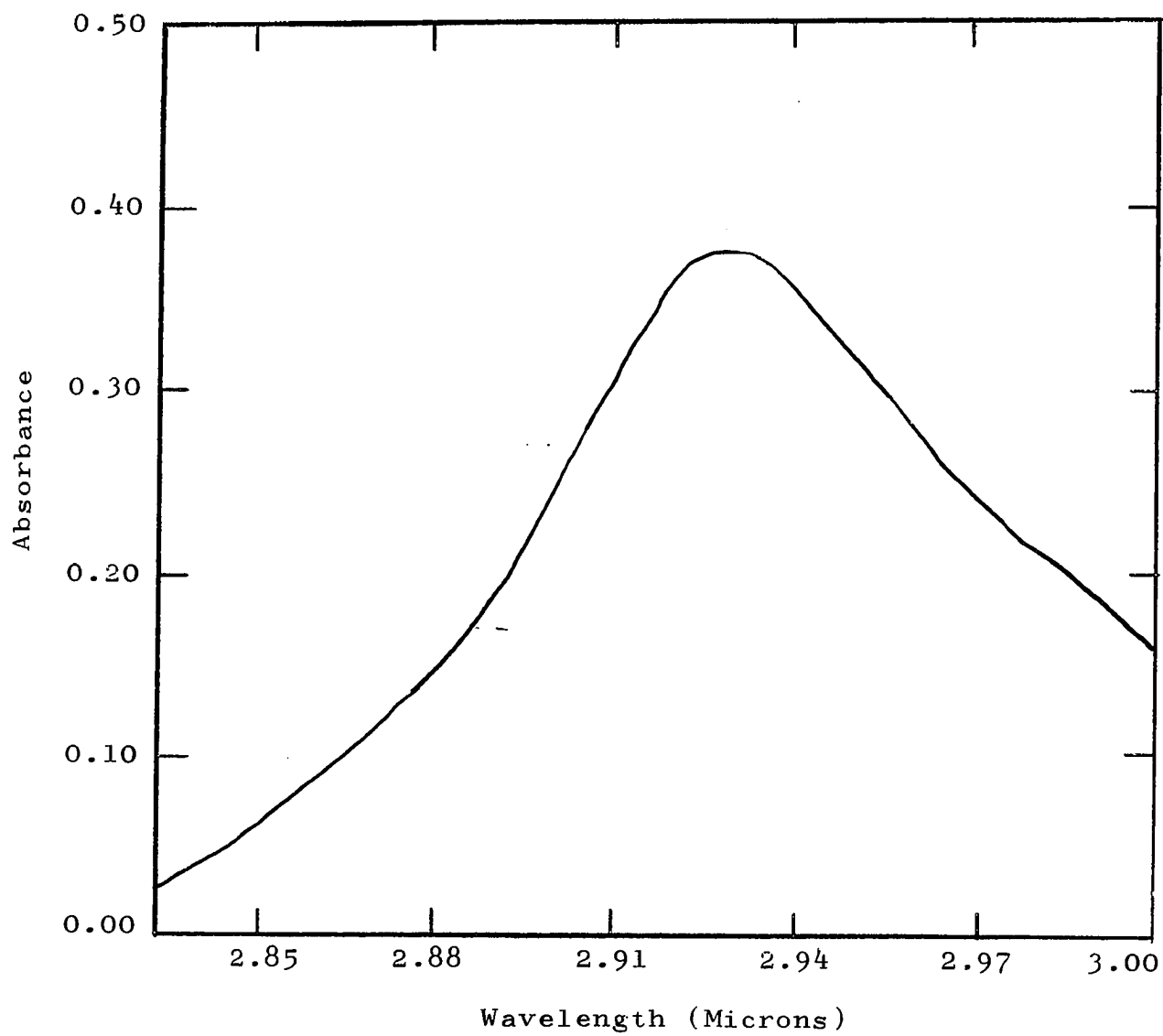

Figure 23. Absorption Spectra of Acetone in Toluene at 25°C.

TABLE 19.--Acetone in toluene. Data were used to verify Beer's Law at the indicated wavelength and concentrations. Absorbance values were recorded at 25°C.

Concentration (Molar Units)	2930 $A_{PH}$	2930 $A_{BL_1}$	2930 $A_{BL_2}$
0.0494	0.093	0.083	0.068
0.0728	0.118	0.118	0.080
0.104	0.147	0.132	0.105
0.151	0.203	0.178	0.146
0.169	0.210	0.200	0.150
0.185	0.230	0.203	0.152
0.198	0.252	0.214	0.174
0.210	0.268	0.223	0.183
0.263	0.300	0.255	0.206



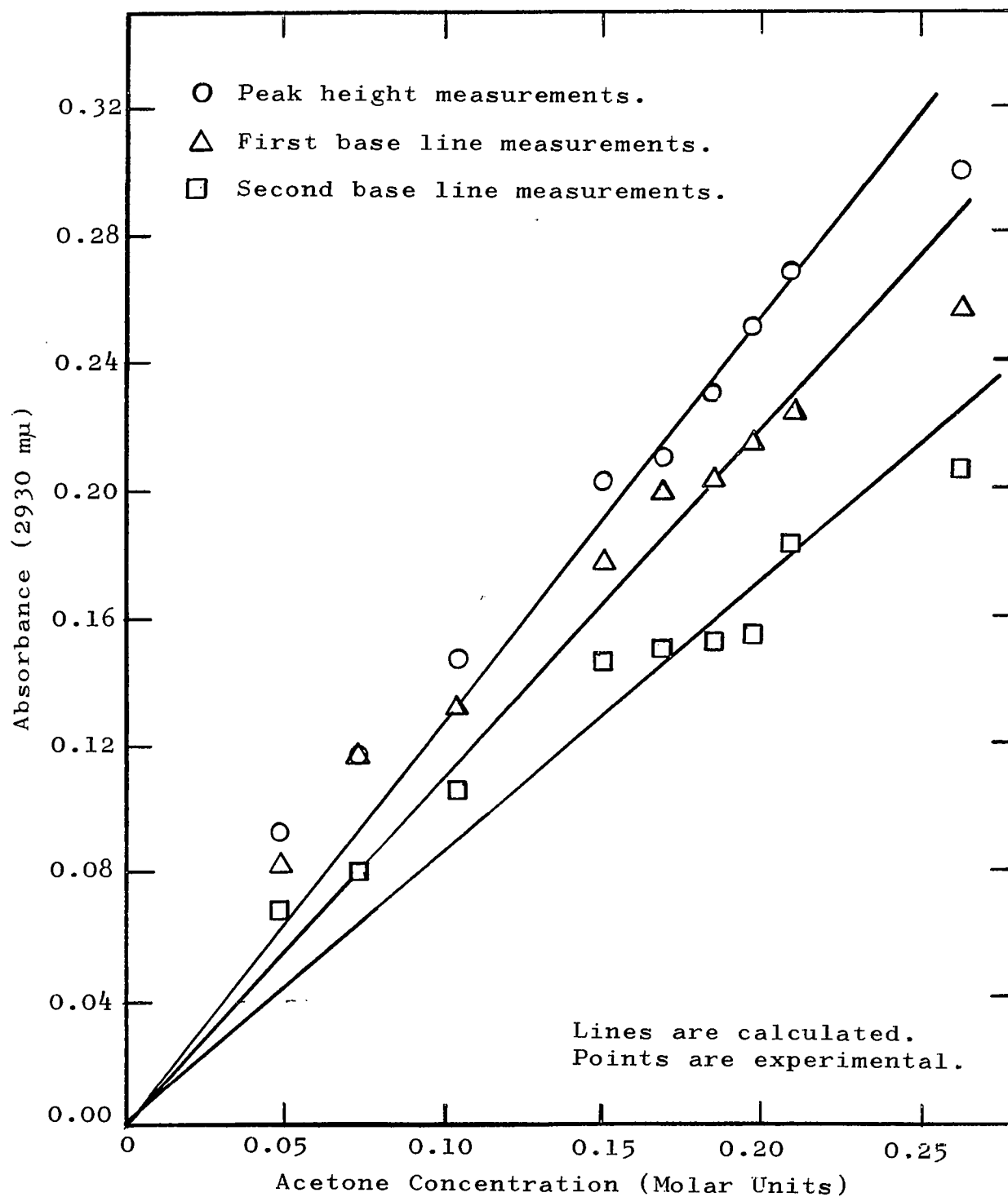

Figure 24. Beer's Law Curves for Acetone in Toluene at 25°C.

TABLE 20.--Acetone in toluene. Data were used to evaluate the absorptivities of acetone at the indicated temperatures.

Temperature (°C)	Concentration (Molar Units)	2930 $A_{PH}$	2930 $A_{BL_1}$	2930 $A_{BL_2}$
11.0	0.0739	0.130	0.126	0.087
	0.161	0.222	0.172	0.126
	0.172	0.212	0.207	0.152
	0.188	0.240	0.210	0.156
	0.201	0.260	0.220	0.172
20.0	0.0732	0.122	0.122	0.082
	0.159	0.223	0.169	0.129
	0.170	0.212	0.202	0.150
	0.186	0.233	0.208	0.153
	0.199	0.263	0.210	0.171
30.0	0.0724	0.120	0.115	0.080
	0.157	0.222	0.167	0.122
	0.168	0.210	0.197	0.142
	0.184	0.232	0.200	0.146
	0.197	0.258	0.205	0.168
40.0	0.0716	0.110	0.110	0.070
	0.156	0.214	0.162	0.119
	0.166	0.205	0.193	0.138
	0.182	0.228	0.196	0.143
	0.195	0.253	0.199	0.158
50.0	0.0708	0.107	0.107	0.067
	0.154	0.207	0.160	0.115
	0.164	0.203	0.183	0.136
	0.180	0.225	0.190	0.140
	0.192	0.246	0.196	0.152
60.0	0.0700	0.104	0.104	0.064
	0.152	0.204	0.158	0.112
	0.163	0.200	0.178	0.123
	0.178	0.210	0.185	0.133
	0.190	0.238	0.193	0.144

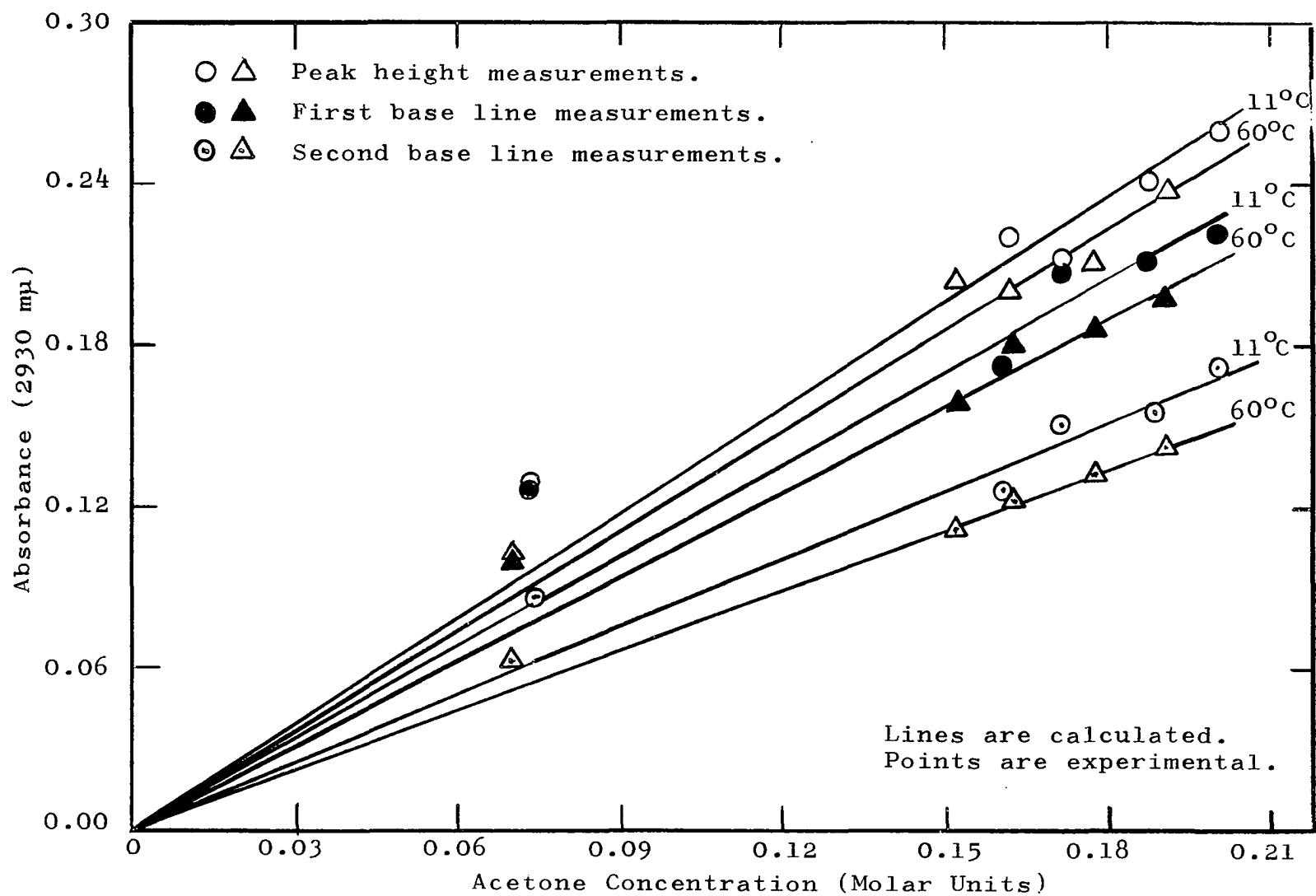

Figure 25. Absorbance vs. Concentration of Acetone in Toluene at 11°C and 60°C.

TABLE 2i.--Acetone in toluene. Best values of absorptivities calculated using least squares method.

Temperature (°C)	2930 $a_{PH}^a$ (molar <sup>-1</sup> cm <sup>-1</sup> )	2930 $a_{BL1}^a$ (molar <sup>-1</sup> cm <sup>-1</sup> )	2930 $a_{BL2}^a$ (molar <sup>-1</sup> cm <sup>-1</sup> )
11	1.31	1.15	0.856
20	1.32	1.13	0.856
25	1.27	1.10	0.865
30	1.32	1.11	0.832
40	1.30	1.09	0.807
50	1.28	1.07	0.793
60	1.25	1.06	0.757

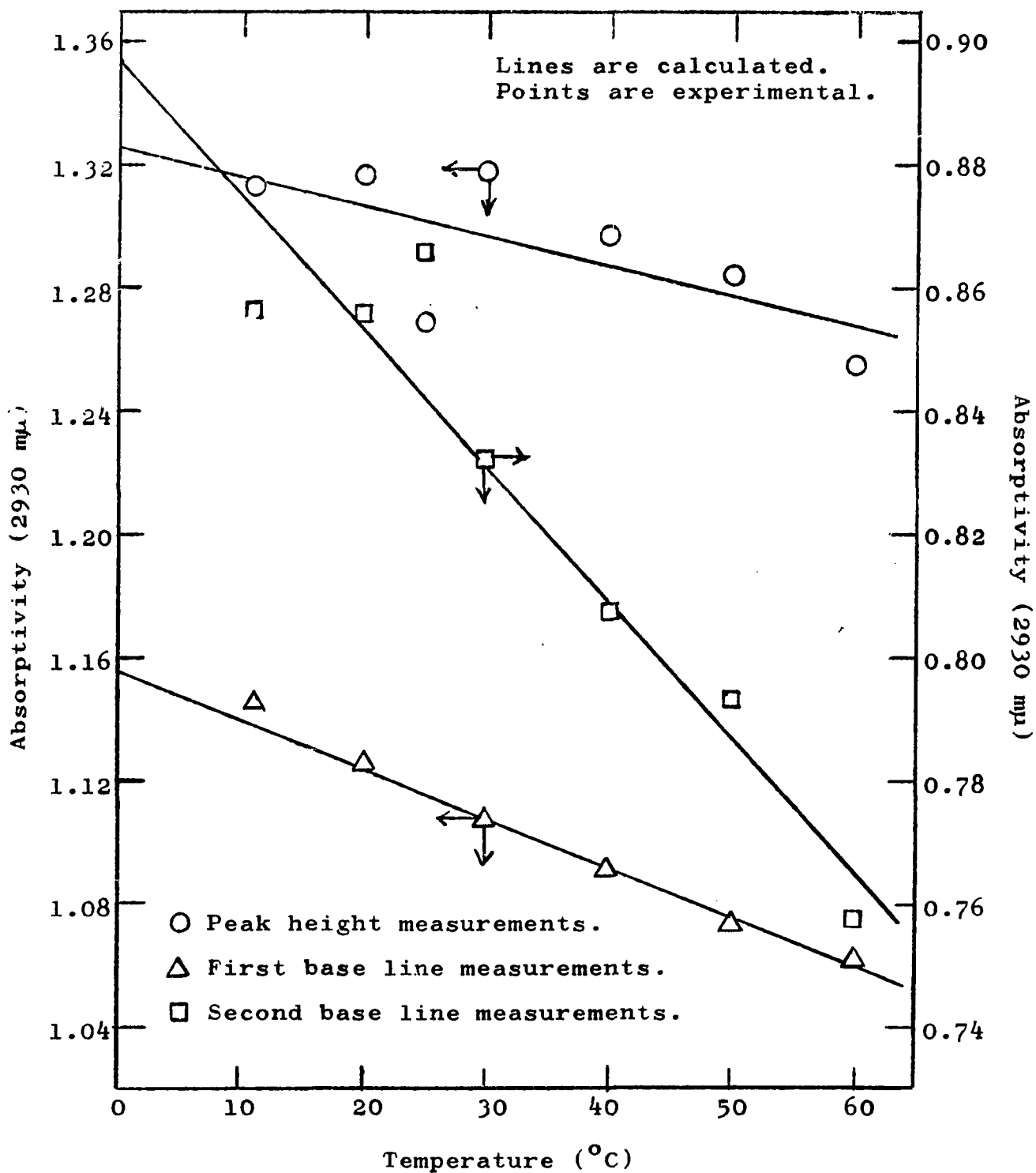

Figure 26. Variation of Absorptivities with Temperature for the System Acetone in Toluene. The Absorptivities correspond to the peak at 2930  $\mu$ .

TABLE 22.--Acetone in toluene. Best values for the changes in absorptivity with temperature using least squares intercept and slope.

Absorptivity (molar <sup>-1</sup> cm <sup>-1</sup> )	Change (molar <sup>-1</sup> cm <sup>-1</sup> degree <sup>-1</sup> )
2930 a <sub>PH</sub>	-0.0010 ± 3.9 x 10 <sup>-4</sup>
2930 <sup>-</sup> a <sub>BL<sub>1</sub></sub>	-0.0016 ± 1.6 x 10 <sup>-4</sup>
2930 a <sub>BL<sub>2</sub></sub>	-0.0022 ± 3.5 x 10 <sup>-4</sup>

## CHAPTER VI

### DISCUSSION AND CONCLUSIONS

The major objective of this research was the quantitative study of the effect of temperature on near infrared absorptivities. Previously workers have reported that the O-H and C=O absorptivities were temperature dependent, while the C-H absorptivity was found to be independent of temperature (19).

Alcohols and phenols have been the most frequently used as sources for the hydroxyl group to carry out such studies, while ketones were used to represent carbonyl containing compounds. Fox and Martin (14) have reported upon a study of the absorption of saturated solutions of water in carbon tetrachloride. In the present study of water in carbon tetrachloride the two peaks are located at 2735  $\mu$  and 2660  $\mu$  and represent the symmetric and asymmetric stretching frequencies respectively. The two frequencies were found to be independent of both the concentration and temperature of the solution. The absorptivities corresponding to the two absorption bands of water at different temperatures are reported in Table 6. The results reported

in Table 6 are represented graphically in Figures 10, 11, and 12, and show that the absorptivities of water vary with the temperature of the solution. This variation was also observed by Fox and Martin (14). They reported that the absorptivity of water dropped from 55 at room temperature (18.3°C) to 38 at 70°C. Similar variation in the absorptivity of O-H with temperature had been also observed with alcohols and phenols in carbon tetrachloride. Hughes, Martin, and Coggeshall (19) reported that the absorptivity of alcoholic O-H is a temperature dependent and decreases as much as 1% per one degree rise in the temperature of the solution. On the other hand Liddel and Becker (21) observed a decrease of nearly 50% in the absorptivity of alcoholic O-H over the temperature range of -10° to +50°C.

The absorptivities of water reported in Table 7 shows a decrease of  $0.31 \text{ (molar-cm)}^{-1}$  per degree rise in temperature for the absorptivity of water in carbon tetrachloride solution. The variation in the absorptivity with temperature was found to be linear over the temperature range of +10° to +49°C. In other words for the four different absorptivities reported in Table 6, there was a systematic decrease as the temperature of the solution was increased. The absorptivities corresponding to the symmetric stretching frequency at 2735  $\mu$  are equally sensitive to temperature as compared to those corresponding to the asymmetric stretching at 2660  $\mu$ . For the peak at 2660  $\mu$ , the absorptivities show a decrease of 0.3



(molar-cm)<sup>-1</sup> per degree for both peak height and base line measurements. The values for the peak at 2735  $\mu$  show a decrease of 0.1 (molar-cm)<sup>-1</sup> per degree, a change which has a nearly equal percentage decrease. The effect of temperature was not experimentally induced since the same absorbance values were recorded after the cell was cooled back to 25°C, as were found at the beginning before the temperature was altered.

The absorption of the carbonyl group has not been as extensively studied as a function of temperature as that of the hydroxyl. This investigation has been made using the first overtone of the carbonyl group of acetone. Goddu (1) reported a value of 2930  $\mu$  corresponding to the maximum of the first overtone of acetone in carbon tetrachloride. The band was recorded at 2890  $\mu$  using carbon tetrachloride as the solvent in our investigation. The absorbance values for this peak plotted as a function of concentration, (Figure 14) shows that Beer's law is obeyed up to concentration of 0.1 molar. The presence of a shoulder at the shorter wave length side of the peak allowed the measurement of the peak absorbances by a second base line tangent to the shoulder and zero absorbance axis. The first base line was drawn parallel to the zero absorbance axis. Table 10 shows the dependency of the absorptivities of acetone upon temperature. These values also show a systematic decrease of the absorptivities

with temperature. The results are shown in Figure 15. The absorptivities corresponding to the first overtone of the carbonyl group shows that they are less sensitive to temperature as compared to the O-H absorptivities in the same solvent. Table 11 lists the magnitude of the change in the absorptivities with temperature for acetone in carbon tetrachloride.

The absorptivity of acetone in carbon tetrachloride obtained from peak height measurements decreases by a value of  $0.0083 \text{ (molar-cm)}^{-1}$  per degree rise in the temperature of acetone in carbon tetrachloride. Using base line methods to calculate the absorptivities, the values of  $-0.0096$  and  $-0.0098 \text{ (molar-cm)}^{-1}$  per degree rise are reported for the change in absorptivities with temperature.

The absorptivity of the N-H group was also investigated in carbon tetrachloride solution over the temperature range of  $+10^{\circ}\text{C}$  to  $+49^{\circ}\text{C}$ . Piperazine was used as a source for N-H containing compound. Table 14 shows the absorptivities of N-H as a function of temperature. The absorptivities show a decrease of  $0.015$  and  $0.014 \text{ (molar-cm)}^{-1}$  per degree rise in temperature for the absorptivity of the N-H calculated using peak height and base line values for the peak absorbances. These values are small compared with those reported for the absorptivity of the asymmetrical peak of water at  $2660 \text{ m}\mu$  and indicate that the absorptivity of N-H group is less sensitive to

temperature than those of the O-H in carbon tetrachloride solution. The variation of the absorptivities with temperature for piperazine in carbon tetrachloride appears to be linear as shown in Figure 19.

Toluene was also used as a solvent in this study. It has not received much attention from workers in this field as compared to solvents universally used such as carbon tetrachloride and carbon disulfide. The opacity of toluene in the near infrared is the reason; however, in the spectral region of prime interest to us, toluene could be used for this study. On the other hand, the opacity of toluene limited the path length to one centimeter. On scanning water solutions in toluene, a broad band was obtained with a maximum at 2740  $\mu$ . This band has a shoulder at 2766  $\mu$ . It is assumed that the maximum at 2740  $\mu$  corresponds to the O-H asymmetric stretching frequency, while the other at 2766  $\mu$  is probably the O-H symmetric stretching frequency. Johnson (33) has shown with an isopiestic investigation that water is monomeric in toluene, and this is confirmed by the observed obedience to Beer's Law, for the two bands at 2740  $\mu$  and 2766  $\mu$  as shown in Figures 21 and 22. The scattering of the experimental points in this case are probably attributable to the very small water concentrations as small absolute errors in concentration could cause the data to scatter in the observed manner. Another factor

that might be added is the overlapping of the two bands; however, a Beer's Law plot, as in Figure 21, using peak height absorbances presents a method for determining quantitatively the water in toluene, a method which is fast and reasonably accurate for water concentrations as small as 0.005 M.

Toluene offered an advantage over carbon tetrachloride in that it could serve as a solvent with a higher boiling point. This allowed the study to cover a wider temperature range, that is, up to 80°C as compared to 50°C limit in the case of carbon tetrachloride. The absorptivities of water in toluene corresponding to the two peaks at 2740  $\mu$  and 2766  $\mu$  were determined over the temperature range of +11°C to +80°C. The results in Table 18 show the absorptivities fluctuate with temperature; however, there is no systematic change with temperature. This observation is made regardless of the method used to measure the absorbances. Unfortunately, the data obtained did not allow any definite conclusion regarding the effect of temperature upon the absorptivities of water in toluene.

In addition to water acetone absorptivities were also studied in toluene. The absorptivity corresponding to the first overtone of the carbonyl group for acetone in toluene was studied over the temperature range of +11°C to +60°C. A set of absorptivities were calculated at the indicated temperatures and are listed in Table 21. The

absorptivities were calculated using peak height and base lines absorbances for the peak at 2930  $\mu$ . They have a linear relationship with temperature as is shown in Figure 26. Using peak height absorbances, the absorptivity underwent a decrease of  $0.001 \text{ (molar-cm)}^{-1}$  per degree rise in temperature. Absorptivities corresponding to base lines values for peak absorbance decrease by 0.0016 and 0.0022  $\text{(molar-cm)}^{-1}$  per degree rise in temperature.

The change in the absorptivity of acetone in toluene with temperature is by far less than the corresponding change for acetone in carbon tetrachloride. In addition to this, the temperature effect upon the absorptivities of water in toluene, if any, is much smaller compared to those in carbon tetrachloride. The observations indicate that the solvent has a great deal to do with such effects.

The second major objective of this investigation was the study of the effect of temperature upon the stretching frequency of the functional groups studied. Throughout the course of this work, no temperature effect was observed upon the frequency corresponding to the functional groups studied in both carbon tetrachloride and toluene.

It is clear from the present investigation that the absorptivities are not only temperature dependent, but are also dependent upon the solvent. In the author's opinion the solvent plays a significant role. The two solvents used in the present study were nonpolar. Tsubomura (40),

Allerhand, and Schleyer (41) had discussed the effect of nonpolar solvents upon the intensity of infrared bands. They assumed that the solute molecule behaves like a polarizable point dipole at the center of a spherical cavity. The effect of the surrounding solvent molecules is considered to be a continuous dielectric medium surrounding the cavity (43). The observed change in absorptivity is due to solvation of the polar groups which in turn is temperature dependent. The degree of solvation is a function of: (I) polar group, (II) solvent, and (III) temperature of the solution. Ritchie (42) indicated the formation of specific solvent-solute complexes in several cases which might be due to local association (46). These complexes were later referred to as collision complexes (51), (52).

The solvation theory is also supported by the work of Bamelis and Huyskens (47) who studied the effect of association of alcohols on the viscosity of solutions. They observed that the viscosities were greater in carbon tetrachloride than in cyclohexane. Bayliss, et. al. (44), (45), indicated that a nonpolar molecule such as  $\text{CCl}_4$  with a zero dipole moment which is the resultant of symmetrically directed strong local dipoles, may well behave as a polar solvent towards a solute molecule in its immediate neighborhood. In addition, Williams (48) and Pullin (50) have considered the role played by solvation and its effect upon both frequency and intensity of infrared bands. They

stated that for nonpolar solvents, in the absence of strongly orientation dependent forces such as H-bonding, dipole induced dipole and dispersion forces are probably most important. Le Fèvre (49) related the bond polarizability to the refractive index of the solvent. Also, it has been shown that band intensities are proportional to the refractive index of the solvent (56).

In addition to the previous discussion one might consider Debye's equation (53), for dilute solutions which relates the molar polarization to the temperature of the solution:

$$P = \frac{4\pi}{3} N \left( \alpha + \frac{u^2}{3kT} \right)$$

Where: P = molar polarization

$\alpha$  = polarizability of the molecule

u = its permanent dipole moment

k = Boltzmann's constant

T = Temperature of the solution

N = concentration (molecules/cc)

The term  $kT$  represents the energy of thermal agitation. It is clear that the molar polarization "P" of polar molecules contained in a nonpolar liquid is a linear function of  $1/T$ . Onsager (54) indicated that since all molecules possess positive polarizability, the dipole moment should not be expected to remain constant.

From the previous discussion it is valid now to interpret the observed change in absorptivity with temperature in terms of solvation of the polar groups of the solutes by the non-polar solvents. The solvation process is a function of temperature. The results reported in this study are in favor of this interpretation. The magnitude of the change in absorptivity with temperature can also be related to the difference in the electronegativities of the atoms forming the functional group. Such differences are as follows (55):

$$\begin{array}{ll} \text{C-H} = 0.4 & \text{N-H} = 0.9 \\ \text{C-O} = 1.0 & \text{O-H} = 1.4 \end{array}$$

The highest difference in electronegativities is reported for the O-H, and the lowest for C-H. In terms of the change of absorptivities per degree rise in temperature, the O-H absorptivity exhibits the largest change compared to that of C-H which in most cases does not show any change with temperature. The more polar groups will be more highly solvated than the less polar and hence their spectral intensities will be more sensitive to temperature changes. The solvation process is temperature dependent, since as the temperature increases thermal agitation of the molecules increases too. The variation in the absorptivities has been shown to be solvent dependent, since the changes in carbon tetrachloride are quite different from



those in toluene. The C-Cl bond of carbon tetrachloride can be more polarized than the C-H or the  $\pi$  electrons in toluene. The O-H absorptivity varies with temperature to a greater degree in carbon tetrachloride as compared to that in toluene. The change per degree in absorptivity of the carbonyl group in carbon tetrachloride is also larger than the corresponding change when toluene was used.

In conclusion, one should have more data to support the solvation theory as the main cause for the change in absorptivity with temperature. More solvents should be used and the study should be extended to more functional groups in both fundamental and overtone regions. It is also suggested that binary mixtures of solvents be used to carry out the same type of study. A comparison of the results with those obtained using the individual solvents of the binary mixture could be made which should show a clear dependence upon "mole fractions." The study should also be extended to other regions of the spectrum. The availability of such information can be of considerable help in understanding this phenomenon due to its tremendous implications in the study of solution equilibria by spectral means. In fact, whenever quantitative measurements are sought, using band absorbances, one should consider such variation in absorptivity with temperature of the solution.

## BIBLIOGRAPHY

1. R. F. Goddu, "Advances in Analytical Chemistry and Instrumentation," Vol. I, Interscience Publishers, Inc., New York, 1960, p. 362.
2. G. C. Pimentel and A. L. McClellan, "The Hydrogen Bond," W. H. Freeman and Co., San Francisco and London, 1960, p. 67.
3. R. Freymann, Compt. Rend., 195, 39 (1932).
4. J. Errera and P. Mollet, Nature, 138, 882 (1936).
5. J. Errera and P. Mollet, Compt. Rend., 204, 259 (1937).
6. R. H. Gillette and F. Daniels, J. Am. Chem. Soc., 58, 1139 (1936).
7. R. M. Badger and S. H. Bauer, J. Chem. Phys. 5, 605 (1937).
8. R. M. Badger and S. H. Bauer, ibid., 5, 839 (1937).
9. R. R. Brattain, J. Chem. Phys., 6, 298 (1938).
10. T. Sidei, Gakuzitu Kyoto, 13, 336 (1938); C. A. 77429 (1940).
11. J. Errera, R. Gaspart and H. Sack, J. Chem. Phys., 8, 63 (1940).
12. J. J. Fox and A. E. Martin, Trans. Farad. Soc., 36, 897 (1940).
13. M. M. Davies and G.B.B. M. Sutherland, J. Chem. Phys., 6, 767 (1938).
14. J. J. Fox and A. E. Martin, Proc. Roy. Soc. (London), 174A, 234 (1940).
15. E. Greinacher, W. Luttke, and R. Mecke, Z. Electrochem., 59, 23 (1955).

16. V. M. Chulanovskii, Doklady Akad. Nauk SSSR, 93, 25 (1953).
17. E. J. Slowinskii, Jr., and G. C. Claver, J. Opt. Soc. Am., 45, 396 (1955).
18. C. M. Huggins and G. C. Pimentel, J. Phys. Chem., 60, 1615 (1956).
19. R. H. Hughes, R. J. Martin, and N. D. Coggeshall, J. Chem. Phys., 24, 489 (1956).
20. J. N. Finch and E. R. Lippincott, J. Chem. Phys., 24, 908 (1956).
21. U. Liddel and E. D. Becker, J. Chem. Phys., 25, 173 (1956).
22. U. Liddel, and E. D. Becker, Spectrochim. Acta, 10, 70 (1957).
23. R. E. Kagarise, J. Chem. Phys., 27, 519 (1957).
24. J. N. Finch and E. R. Lippincott, J. Phys. Chem., 61, 894 (1957).
25. A.R. H. Cole and F. Macritchie, Spectrochim. Acta, 15, 6 (1959).
26. E. D. Becker, Spectrochim. Acta, 17, 436 (1961).
27. T.J.V. Findley and A. D. Kidman, Aust. J. Chem., 18, 521 (1965).
28. M. Hoeke and A. L. Koevoet, Rec. Trav. Chim., 82, 17 (1963).
29. I. Motoyama and C. H. Jarboe, J. Phys. Chem., 70, 3226 (1966).
30. R. Mecke, Disc. Farad. Soc., 9, 161 (1950).
31. J. J. Krchma and J. W. Williams, J. Am. Chem. Soc., 48, 1888 (1926).
32. S. D. Christian, H. E. Affsprung, J. R. Johnson and J. D. Worley, J. Chem. Ed., 40, 419 (1963).
33. James R. Johnson, Ph.D. dissertation. The University of Oklahoma, Norman, Oklahoma, 1966.

34. Delbert D. Mueller, Ph.D. dissertation. The University of Oklahoma, Norman, Oklahoma, 1966.
35. R. A. Robinson and R. H. Stokes, "Electrolyte Solutions," Butterworth Publication Limited, London, England, 1959, p. 477.
36. "Handbook of Chemistry and Physics," 33 ed. The Chemical Rubber Company, Cleveland, Ohio, 1951, p. 1731.
37. Arnold M. Melnick, Ph.D. dissertation. The University of Oklahoma, Norman, Oklahoma, 1963.
38. Robert P. Bauman, "Absorption Spectroscopy," John Wiley and Sons Inc., New York - London, 1962, p. 369.
39. International Critical Tables of Numerical Data: Physics, Chemistry and Technology, McGraw Hill Book Co., Inc., Vol. III, 1928, pp. 27-33.
40. H. Tsubomura, J. Chem. Phys., 24, 927 (1956).
41. A. Allerhand and P. von R. Schleyer, J. Am. Chem. Soc., 85, 371, (1963).
42. C. D. Ritchie, B. A. Bierl and R. J. Honour, J. Am. Chem. Soc., 84, 4687 (1962).
43. P. Mirone, Spectrochim. Acta, 22, 1897 (1966).
44. N. S. Bayliss, A.R.H. Cole and L. H. Little, Aust. J. Chem., 8, 26 (1955).
45. N. S. Bayliss, A.R.H. Cole and L. H. Little, Spectrochim. Acta, 15, 12 (1959).
46. L. J. Bellamy and R. L. Williams, Proc. Roy Soc. (London), A254, 119 (1960).
47. P. Bamelis and Pierre Huyskens, J. Chim. Phys., 62, 158 (1965).
48. R. L. Williams, Ann. Reports Progr. Chem., 58, 34 (1961).
49. R.J.W. Le Fèvre, Austr. J. Chem., 14, 312 (1961).
50. A.D.E. Pullin, Proc. Roy. Soc. (London), A255, 39 (1960).
51. M. Horak and J. Pliva, Spectrochim. Acta, 21, 911 (1965).

52. M. Horak, J. Moravec and J. Pliva, Spectrochim. Acta, 21, 919 (1965).
53. P. Debye, "Polar Molecules," The Chemical Catalog Company, Inc., New York, N. Y. 1929, p. 55.
54. L. Onsager, J. Am. Chem. Soc., 58, 1486 (1936).
55. Linus Pauling, "The Nature of the Chemical Bond," Third Ed., Cornell University Press, 1960, p. 90.
56. A. D. Buckingham, Proc. Roy. Soc. (London) A248, 169 (1958).