

DISTRIBUTION AND MEAN LENGTH OF GIZZARD SHAD  
(DOROSOMA CEPEDIANUM) AND SOME ASPECTS  
OF THE SAMPLING PROBLEM IN LAKE  
CARL BLACKWELL, OKLAHOMA

By

PATRICK JAMES DOWNEY

Bachelor of Science

University of Arkansas

Fayetteville, Arkansas

1974

Submitted to the Faculty of the Graduate College  
of the Oklahoma State University  
in partial fulfillment of the requirements  
for the Degree of  
MASTER OF SCIENCE  
July, 1978



DISTRIBUTION AND MEAN LENGTH OF GIZZARD SHAD  
(DOROSOMA CEPEDIANUM) AND SOME ASPECTS  
OF THE SAMPLING PROBLEM IN LAKE  
CARL BLACKWELL, OKLAHOMA

Thesis Approved:

*Dale W. Joss*

Thesis Adviser

*Michael D. Clady*

*Don Holbert*

*Norman M. Burham*

Dean of the Graduate College

1011866

## PREFACE

The primary objective of this research was to describe horizontal and vertical distribution of larval gizzard shad (Dorosoma cepedianum) in Lake Carl Blackwell, Oklahoma. This information is basic to the study of year-class formation of gizzard shad. Some recommendations for future sampling of the lake are given.

This research would not have been possible without the assistance of several people. I would like to express my gratitude to my major adviser, Dr. Dale Toetz, for his decision to support this research and constructive criticism during preparation of the draft. The assistance of Drs. Don Holbert and Michael Clady during the planning stages was invaluable. Iris McPherson assisted with the computer programs. The field work could not have been completed without the assistance of Tom Lindsey. This research was supported by maintenance money provided to the School of Biological Sciences, by the College of Arts and Sciences, Oklahoma State University.

I would like to express special appreciation for the moral and financial support of my parents, Don and Marie, and Tricia Witherspoon.

## TABLE OF CONTENTS

Chapter	Page
I. INTRODUCTION . . . . .	1
General Aspects of Year-Class Formation . . . . .	5
Water Temperature . . . . .	7
Wind . . . . .	9
Water Levels and Stream Flows . . . . .	9
Abundance and Condition of Spawning Stock . . . . .	10
Predation . . . . .	12
Food Abundance . . . . .	13
Competition . . . . .	14
Possible Factors Affecting Year-Class Formation in Gizzard Shad . . . . .	15
Measuring Abundance of Larval Fish . . . . .	21
II. DESCRIPTION OF STUDY AREA . . . . .	24
III. METHODS AND MATERIALS . . . . .	27
Sampling Gear . . . . .	27
Calibration of Gear . . . . .	34
Field Methods . . . . .	35
Laboratory Methods . . . . .	37
IV. STATISTICAL CONSIDERATIONS . . . . .	39
Experimental Design . . . . .	39
Treatment of the Data . . . . .	43
V. RESULTS . . . . .	47
Seasonal Distribution . . . . .	47
Patchiness . . . . .	52
Vertical Distribution . . . . .	54
Horizontal Distribution . . . . .	61
Horizontal Distribution at 0 m (April 24 to May 31) . . . . .	67
Horizontal Distribution at 3 m (June 7 to June 28) . . . . .	68
Variation of Mean Length . . . . .	70
IV. DISCUSSION . . . . .	75

Chapter	Page
Gear Selectivity . . . . .	75
Normalization of Catch Date . . . . .	75
Vertical Distribution . . . . .	76
Horizontal Distribution . . . . .	76
Variation of Mean Length . . . . .	78
Recommendations for Furture Sampling Efforts . . . . .	81
REFERENCES CITES . . . . .	82
APPENDIXES . . . . .	91
APPENDIX A - METHOD USED FOR CALCULATING THE STANDARD ERROR FOR THE UNBALANCED HIERARCHICAL AOV WHICH WAS USED TO ANALYZE THE VARIABILITY OF THE LENGTH OF SHAD AMONG AREAS . . . . .	92
APPENDIX B - VERTICAL TEMPERATURE PROFILE (°C) IN LAKE CARL BLACKWELL, DURING THE SPRING OF 1977. TEMPERATURE WAS MEASURED NEAR THE DAM (Figure 1) . . . . .	95
APPENDIX C - ANALYSES OF VARIANCE (AOV) OF THE CATCH DATA ON EACH DATE . . . . .	97
APPENDIX D - RESULTS OF ANALYSIS OF VARIANCE OF THE LENGTH OF SHAD AMONG AREAS AND AMONG TRANSECTS WITHIN AREAS . . . . .	103

LIST OF TABLES

Table	Page
I. Percentage of Gizzard Shad Relative to all Other Fish Present in Samples of Fish From Reservoirs in Kansas and Oklahoma . . . . .	3
II. Summary of the Results of Correlation of Mean Catch/ $10^4$ Liter with Standard Deviation from Each Area on Each Date . . . . .	53
III. Secchi Disc Transparency, Wind Direction, and Wind Speed During 12-Hour Period Preceding Sampling on Each Date at Lake Carl Blackwell . . . . .	60
IV. Results of Significant Comparisons of Mean Density of Shad (Numbers/ $10^4$ Liter) Among Groups of Areas . . . . .	62
V. Results of Comparisons of Mean Length (mm) of Larval Shad Among Different Depths . . . . .	71
VI. Results of Comparison of Mean Length (mm) of Larval Shad Among Areas . . . . .	72

## LIST OF FIGURES

Figure	Page
1. Effect of Biotic and Abiotic Factors on Year-Class Formation in the Percids (from Koonce et al., 1977) . . . .	17
2. Effect of Temperature, Predation, and Abundance of Spawning Stock on Year-Class Formation of Percids and Esocids in Windermere, England . . . . .	19
3. Map of Lake Carl Blackwell Showing Location of Weather Station (1) and Approximate Point on the Lake Where Temperature (2) and Secchi Disc Transparency (3) Were Measured . . . . .	25
4. Construction of Net, Cable Depressor, and Collecting Bucket . . . . .	29
5. Photograph of Net, Cable Depressor and Collecting Bucket Used During Study . . . . .	31
6. Photograph of Boat With the Boom, Net, and Cable Depressor in Place . . . . .	33
7. Map of Lake Carl Blackwell Showing How the Lake was Divided up Into Areas for Sampling . . . . .	41
8. Mean Density of Shad ( $\pm$ One Standard Deviation) on Each Data at Lake Carl Blackwell . . . . .	49
9. Composition of the Catch (% Pro-Larvae, Post-Larvae, and Juveniles) on Each Data at Lake Carl Blackwell . . . . .	51
10. Vertical Distribution of Shad Larvae on Each Date in Lake Carl Blackwell . . . . .	56
11. Distribution of Larval Gizzard Shad on Each Date at Lake Carl Blackwell . . . . .	65
12. Mean Length (mm) of Gizzard Shad on Each Sampling Site . . . .	74

## CHAPTER I

### INTRODUCTION

The purpose of this research was to gather information basic to the study of year-class formation in the gizzard shad (Dorosoma cepedianum). Before reporting and discussion the results of this study, I will review and discuss the pertinent literature. The purposes of this review of the literature are: 1) to provide the reader with an understanding of the importance of gizzard shad and gizzard shad year-class formation in the ecology of reservoirs, 2) to describe the results of other studies which have dealt with year-class formation in other species of fresh water fish (excluding the salmonids), and 3) to describe some of the problems associated with measuring the abundance of larval fish. This information will provide a background for the study of year-class formation of gizzard shad in Lake Carl Blackwell, Oklahoma.

The importance of gizzard shad in the ecology of reservoirs is recognized by many authors (Baker and Schmitz, 1971; Bodula, 1966; Cramer and Marzolf, 1970; Jenkins, 1957; Kutkhun, 1957; Miller, 1960; Pflieger, 1975; Wickliff, 1933; Zeller, 1967). Gizzard shad are important as forage to piscivorous fish species in southern reservoirs. For example, in six reservoirs in Oklahoma, gizzard shad comprised 50 to 92% of the total stomach volume of flathead catfish (Pylodictus olivaris) (Turner and Summerfelt, 1970). Gizzard shad in reservoirs



are major items of food for other piscivorous fishes such as largemouth bass (Micropterus salmoides) in Lake Carl Blackwell, Oklahoma (Zweiacker and Summerfelt, 1973), striped bass (Morone saxatilis) in Keystone Reservoir, Oklahoma (Messinger, 1970), and white bass (M. chrysops) in Ozark reservoirs (Olmstead and Kilambi, 1971).

The rapid growth of gizzard shad quickly renders the bulk of a particular cohort unusable as prey (Baker and Schmitz, 1971), so that essentially only the young-of-the-year (YOY) are available as forage (Jenkins, 1957). Gizzard shad also have a tendency to dominate the fish fauna of reservoirs, particularly in older impoundments. Table I lists the percentage of gizzard shad relative to all other fish present in samples of fish from different reservoirs. It is evident from Table I that gizzard shad, by virtue of sheer numbers, must play an important role in the ecology of reservoirs. Published data regarding year-class formation of gizzard shad is scarce. Bross (1968), however, reported that relative abundance of YOY gizzard shad can vary by 40 fold over consecutive years. Gizzard shad in Eufaula Reservoir, Oklahoma, apparently experience year-class failures (Kim Ericson, personal communication). Because of the importance of YOY gizzard shad as forage and the tendency for the species to dominate the fish fauna, the study of year-class formation is warranted.

Detailed descriptions of reproduction of gizzard shad are scarce. Gizzard shad begin spawning when water temperatures reach 15-16°C. Spawning activity peaks when water temperatures reach 19-20°C. Spawning generally takes place over a one-and-a-half to two-month period beginning anywhere from March to July, depending on the latitude (Bodula, 1963; Kilambi and Baglin, 1969; Miller, 1960; Netsch et al.,

TABLE I

PERCENTAGE OF GIZZARD SHAD RELATIVE TO ALL OTHER FISH PRESENT IN  
 SAMPLES OF FISH FROM RESERVOIRS IN KANSAS AND OKLAHOMA

% Total Numbers	% Total Weight	Reservoir	Reference	Sampling Method
53	72	Lake Carl Blackwell, Oklahoma	Okla. Coop. Fish. Unit, Unipub. data	Rotenone
52	-	Canton Reservoir, Oklahoma	Bross, 1967	Seine
85	-	Tuttle Creek Res., Kansas	Cramer and Marzolf, 1970	Rotenone
67	-	Keystone Reservoir, Oklahoma	Messinger, 1970	Gill net & Seine

1971; Taber, 1969).

Gizzard shad seem to have rather non-specific spawning requirements. Spawning takes place in shallow water (less than 1 m in depth), with large aggregations of individuals spawning at once. The small (0.40 to 0.65 mm in diameter) adhesive eggs sink to the bottom, attaching to the first object they touch (Bodula, 1963; Miller, 1960; Pflieger, 1976; Taber, 1969). Eggs hatch after about four or five days. The larvae are about 3.5 mm in length at hatching. The yolk sac is usually absorbed by the time the larvae are 7.0 to 7.5 mm in length. Metamorphosis from post-larvae to juvenile occurs at about 21 mm in length (Miller, 1960; Lippson and Moran, 1974).

Spawning by individuals less than two years of age is uncommon (Bodula, 1963; Kilambi and Baglin, 1969). Gizzard shad are very fecund for their size. After three or four years of age fecundity decreases. For example, a two year old female may produce over 300,000 eggs, while a four year old female may produce only 70,000 eggs (Kilambi and Baglin, 1969; Miller, 1960). Gizzard shad in Oklahoma commonly live for at least seven years (Jenkins, 1957).

During the larval period, shad eat mostly protozoans and zooplankton. As they become juveniles, they begin to select for phytoplankton. By the time they are 30 mm in length, no zooplankton is found in the diet (Cramer and Marzolf, 1970; Kutkuhn, 1957). Thus, gizzard shad begin life as secondary consumers, but soon switch to being primary consumers.

Growth during the larval stages is rapid. For example, in Beaver Reservoir, Arkansas, gizzard shad spawn from late April through June. By mid-July all shad captured in meter nets are juveniles (Houser and

Netsch, 1971).

Having presented some of the basic aspects of the natural history of gizzard shad, I will now turn to a more general discussion of factors which influence year-class formation in fresh water fish.

#### General Aspects of Year-Class Formation

The idea that factors affecting the very early stages in the life history of an organism are critical in determining that the survival of organism was appreciated by Darwin (1878). Hjort (1914) restated this idea to apply specifically to year-class formation in marine fishes by proposing the "critical period" hypothesis. Hjort hypothesized that the period immediately following yolk sac absorption was the "critical period" during which the larval fish must find sufficient food immediately available. Thus in marine fishes, the implied major cause of early mortality was starvation. Gulland (1965) later used the term "critical period" to refer to the time at which year-class strength was determined, but did not use the term in reference to any particular developmental stage.

The existence of a "critical period" (as defined by Hjort) has rarely been demonstrated in marine field studies, and may never be demonstrated due to the immense sampling problems encountered (Gulland, 1965; May, 1974). The "critical period" hypothesis (Hjort) has received some support in the laboratory investigations of fresh water fish (Toetz, 1966). As will become evident in this review, field investigations of year-class formation in fresh water fish have failed to support the "critical period" hypothesis of Hjort.

Even though the "critical period" hypothesis has received little

support from the field, there is still agreement among fishery biologists that year-class formation in fresh water fish is determined by factors affecting the early stages (Forney, 1971; Kramer, 1969). Identifying the underlying factors controlling year-class formation is best accomplished by measuring the abundance of successive cohorts at sequential life stages from hatching to recruitment (Forney, 1976). In order to measure the relative importance of each stage in the early life history, and the effect of various environmental factors on each stage, long term observation is essential. The most extensive long term observations of factors affecting year-class formation have been conducted mainly on percids (especially the walleye, Stizostedion vitreum vitreum and the yellow perch, Perca flavescens), the striped bass, Morone saxatilis, the largemouth bass, Micropterus salmoides, and the smallmouth bass, M. dolomieu. A discussion of factors which influence year-class formation in these groups of fishes will follow.

Many factors have been cited as important in year-class formation in the above mentioned fishes. Most frequently these factors are:

- 1) temperature during the first few months after spawning, 2) wind conditions during hatching of eggs, 3) water levels and stream flows, 4) abundance and condition of parent stock, 5) abundance of food, 6) predation by man and/or other fish, and 7) competition. Each of these factors will be discussed separately. It will become evident that the factors which affect year-class formation depend on the natural history of the organism in question, and the particular set of environmental factors to which the population is exposed.

## Water Temperature

In walleye populations, water temperature during the period of egg hatching is most often found to be the most important factor associated with fluctuations in year-class strength. Koonce et al. (1977) found that patterns of yearly fluctuations in year-class strength in walleye populations were similar in many lakes over a relatively wide geographical area. Strong year-classes were usually associated with above average spring water temperatures and weak year-classes were most often associated with very low temperatures.

Low temperature itself was not considered to be the cause for those fluctuations, however. Busch et al. (1975) found that strong year-classes in western Lake Erie were associated with rapid rates of temperature increase during hatching and weak year-classes were associated with slow rates of temperature increase. This relationship was explained in the following manner. Slow rates of temperature increase during spawning and hatching prolong both the spawning and hatching period, which in turn increases the length of time which the eggs are exposed to destruction by wind. Destruction of eggs on the spawning grounds by wave action generated by the wind was documented by Busch et al. Rapid rates of temperature increase during the spring resulted in a shorter duration of the spawning and hatching period and thereby decreased the duration of exposure to unfavorable meteorological events. Clady (1976) also found that low rates of survival from the egg to pro-larval stages in yellow perch were related to low temperature and high wind.

Busch et al. (1977) posed an interesting hypothesis. Because walleye populations in western Lake Erie have declined dramatically

over the years, and the spawning ground is only a fraction of its former area, reproductive success is dependent on abiotic density-independent "environmental vagaries" during the spawning and incubation period. They further speculated that if more spawning grounds were available, reproductive success would be more stable and early mortality would be more dependent on biotic density-dependent controls. Thus, although year-class strength in walleye populations in western Lake Erie seems to be controlled by water temperature, the actual limiting factor may be the interaction between the number of eggs laid and the speed at which those eggs develop.

In smallmouth bass populations, strong and weak year-classes have been related to high and low water temperatures, respectively (Christie and Regier, 1973; Clady, 1975). A decline in water temperature of 6°C will cause male smallmouth bass to desert the nest, with disastrous consequences for the eggs or young (Pflieger, 1975). Clady (1975) and Christie and Regier (1973) found that spring temperatures accounted for only part of the variability in year-class strength of smallmouth bass. They found that more of the variability in year-class strength was accounted for when both spring and summer temperatures were related to year-class strength. The conclusions of both studies was that, after smallmouth fry disperse from the nest, there is a period of varying duration during which heavy mortality can occur. The relationship between temperature and year-class strength was explained not in terms of direct effect of temperature on mortality, but in terms of the effect of temperature on growth of the fry and food abundance.

Direct relationships between the rate of warming of the water during spring and reproductive success have also been observed in the

lake whitefish, Coregonus clupeaformis (Christie and Reiger, 1973), yellow perch (Eshenroder, 1977; Smith, 1977; Willemsen, 1977), sauger (Walburg, 1972) and perch (Perca fluviatilis) (Le Cren et al., 1977). In all these cases, temperature affected early mortality indirectly by changing the rate of development and thereby affecting the duration of exposure to other causes of mortality such as wind or predation.

#### Wind

Physical destruction of eggs and spawning sites by wind generated waves has been documented in some studies (Busch et al., 1977; Clady and Hutchinson, 1975; Kramer and Smith, 1962) and inferred in others (Summerfelt, 1975). In the case of largemouth bass, physical destruction of the nests by wind generated waves can result in poor reproductive success (Kramer and Smith, 1962). Wind induced turbulence was not found to have adverse effects on the survival of pelagic pro-larval yellow perch in Oneida Lake, New York, but was found to be detrimental to yellow perch pro-larvae before they became pelagic (Clady, 1976a).

#### Water Levels and Stream Flows

The relationship between good reproductive success and high water levels in reservoirs and lakes has been documented (Franklin and Smith, 1963; Nelson and Walburg, 1977; Summerfelt, 1975; Walburg, 1972). Nelson and Walburg (1977) found that strong year-classes of yellow perch in four Missouri River reservoirs were related to high spring water levels and large areas of newly inundated terrestrial vegetation. A similar relationship between water level and year-class strength of largemouth bass was observed by Summerfelt (1975). These results were



presumed to be the result of increased amount of spawning substrate available during periods of high water. Strong year-classes in sauger (Stizostedion canadense) populations in Missouri River reservoirs were found to be partly related to high water level over the spawning beds (Walburg, 1972; Nelson and Walburg, 1977).

Flow rates in streams have been related to year-class strength in striped bass (Stevens, 1977; Turner and Chadwick, 1972) and northern pike, Esox lucius (Franklin and Smith, 1962). High stream flows insure adequate survival of the eggs of striped bass (which are semi-pelagic and must remain suspended in the water to develop) and hence successful reproduction (Turner and Chadwick, 1972). Adequate spawning conditions for northern pike are dependent upon water levels in and flow rates out of spawning marshes (Franklin and Smith, 1962).

Water levels in reservoirs and flow rates in streams affect reproduction in fishes in much the same way that wind does, i.e., by affecting the number of eggs which will hatch. Therefore, one would expect that, in populations of fish for which spawning areas tend to be limited, reproductive success would be heavily dependent on any condition (wind and fluctuations in water level and flow rates) which would alter the availability or suitability of spawning sites.

#### Abundance and Condition of Spawning Stock

If reproductive success is related to factors which affect the number of eggs that hatch, then it is logical to wonder whether the number of eggs laid is of consequence. The number of eggs laid is determined by the size and fecundity of the spawning stock. Generally speaking however, the relationship between year-class strength and the

number of spawning adults (i.e., the number of eggs spawned) is obscure. This is not to say, however, that the size of the parent stock should not be taken into account when considering the factors which influence year-class strength. For example, the walleye populations studied by Busch et al. (1975) and the yellow perch populations studied by Eshenroder (1977) were experiencing a decline in numbers. Year-class formation in these populations was found to be rather sensitive to meteorological conditions (wind and the rate of warming during the spring) during the spawning and hatching period. Forney (1971, 1976, 1977) and Nelson and Walburg (1977) studied percid populations in which the numbers of adults were not dwindling nor did availability of spawning sites appear to be limiting reproduction. In these cases, year-class strength was not found to be related to meteorological conditions during the spawning and hatching period. However, Le Cren et al. (1977) observed that most successful year-classes of perch (P. fluviatilis) occurred when adult biomass was low.

The physical condition of the spawning stock prior to spawning has been cited as having a positive effect on both the quantity and the quality of the sex products of fish (Nikolsky et al., 1973; Zemshaia, 1961). Demonstrating the effect of change in the quantity and quality of reproductive products would, however, be tantamount to demonstrating the relationship between the abundance of the parent stock and year-class strength. It is not surprising then, that the relationship between the condition of the parent stock and year-class formation has not emerged from any of the data. Nikolsky et al. (1973) maintain that variable environments mask the relationship between characteristics of the parent stock and year-class formation. If this

contention is true, then it would seem likely that the abundance and/or condition of the parent stock is of major importance only at the upper and lower extremes of abundance and condition.

### Predation

Year-class failure in largemouth bass due to predation on embryos and fry by stunted centrarchid populations is well documented (Bennet, 1974). The study of year-class formation of walleye in Oneida Lake, New York (Chevalier, 1973; Forney, 1976) has implicated predation as a major factor in determining year-class strength. Forney (1973) found egg and pro-larval mortality to be high but stable from year to year. Cannibalism of young walleye by adults was found to account for much of the variability in year-class size, despite the fact that predation appeared to account for a minor percentage of total mortality of a cohort. The intensity of cannibalism was found to be related to the abundance of yellow perch, with high rates of cannibalism occurring when yellow perch abundance was low. Cannibalism could also explain the observation by Le Cren et al. (1977) that strong year-classes of pike perch occurred when adult biomass was low. Cannibalism appeared to be the main factor associated with year-class strength in walleye populations in Missouri River impoundments (Nelson and Walburg, 1977). In situations where reproductive success does not appear to be limited by meteorological conditions during spawning and hatching, strong year-classes appear to be related to high summer water temperature and rapid growth (Bulkley, 1970; Kipling and Frost, 1977; Koonce et al, 1977; Willemsen, 1977). Rapid growth would be expected to reduce the duration of exposure to heavy predation (Koonce et al., 1977). Reduced

predation due to rapid growth is considered to be the main reason for the relationship between strong year-classes and high summer temperature observed by Clady (1975), Christie and Regier (1973), Willemsen (1977) and Le Cren et al. (1977).

Reproductive success has been found to be related to fishing pressure in some instances. The indirect effect of excessive fishing pressure (i.e., "overharvest") on the reproduction of largemouth bass has received considerable attention (Anderson, 1974). Eshenroder (1977) observed that intensified fishing for yellow perch in Saginaw Bay, Michigan, resulted in a reduction in abundance of the adult stock. He also found that year-class strength was correlated with rates of temperature increase during the spring. He speculated that reduced brood stock rendered reproduction more susceptible to changes in the physical environment (wind and the rate of warming of the water).

Thus, it is evident that predation may affect year-class strength directly by changing the mortality of the young or indirectly through changes in the adult population.

#### Food Abundance

Abundance of food is often cited as being crucial to the survival of larval fish (Barsukov, 1961; Braum, 1967; May, 1974). However, direct field evidence of starvation of larval fish is rare, especially in fresh water. In fact, in my review of the literature, no evidence was found which would indicate that critical food shortages are encountered by populations of larval fish in fresh water.

Food availability after the larval stages may be of somewhat greater importance, however. For example, Momot et al. (1977) have

found that the production of large year-classes of walleye in Hoover Reservoir, Ohio, is related to the biology of the gizzard shad. Walleye fry which were hatched early in the year (April) had no forage in the form of YOY gizzard shad available to them when they (the walleye fry) became piscivorous. Hatchery-reared fry, which were introduced into the reservoir in May found abundant forage (YOY gizzard shad) available at the appropriate time and had good survival.

### Competition

The concept of competition is pivotal to modern ecological theory, and for this reason it is often invoked to explain fluctuations in the abundance of animals (MacArthur, 1972). Competition is often inferred when, in a given habitat, the abundance of one species increases at the same time another decreases (Grant, 1972). An in-depth discussion of competition theory will not be attempted here. Suffice it to say that competition in natural situations is not easily demonstrable (Schoener, 1974) and that great caution should be exercised when attributing observed phenomena to competition (Wiens, 1977). Nonetheless, some authors have presented evidence of fish populations being limited by competition. Forney (1977), for example, has presented data indicating that walleye populations in Oneida Lake, New York increased in abundance due to decreased competition with esocids.

Factors which are important in the formation of year-classes of fresh water fish depend on certain aspects of the natural history and the peculiar facets of the environment of the species in question. Some generalizations are possible, however. If we consider the family percidae as a whole, mortality during the egg stage and/or predation

after the larval stage seem to be the most important factors determining year-class strength. The degree to which these factors are operative depends a great deal on temperature. The higher the temperature during spring and summer, the faster the young percids are able to grow and the faster they are able to "run the gauntlet" of egg destruction and predation. Koonce et al. (1977) furnishes the following diagram (Figure 1) which depicts the way in which temperature affects year-class formation in percids. A similar scheme (Figure 2) is offered by Kipling (1976) and includes the possible effects of abundance of parent stock. These models would seem appealing in describing year-class formation in other groups of fresh water fish as well.

#### Possible Factors Affecting Year-Class Formation in Gizzard Shad

It is difficult to identify factors which may limit the reproductive success of gizzard shad from the preceding discussion. Bross (1967) observed that low abundance of YOY gizzard shad was associated with low water levels and low temperatures during the spring. This observation may indicate that reproduction of shad may be sensitive to meteorological conditions which affect the number of eggs which hatch. The fact that gizzard shad eggs are spawned in shallow water would seem to render them vulnerable to destruction by wind generated waves. Recalling the tendency of shad to dominate the fish fauna and its seemingly non-specific spawning requirements, it is hard to imagine how reproduction of shad could be limited by available spawning areas. Consider these three facts, however: 1) fecundity of shad decreases after three or four years of age, 2) gizzard shad in Oklahoma live for

Figure 1. Effect of biotic and abiotic factors on year-class formation in the percids (from Koonce et al., 1977).

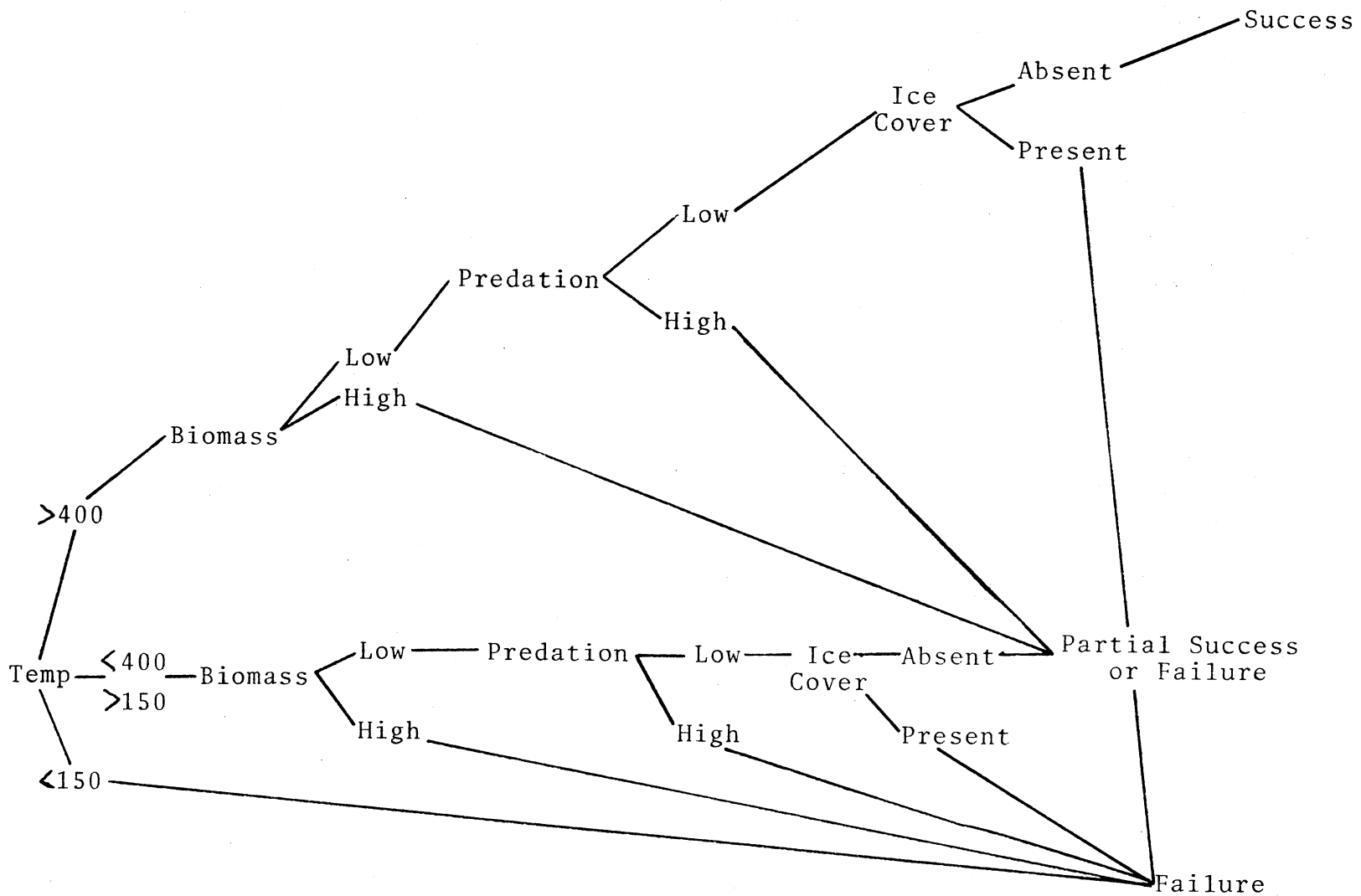
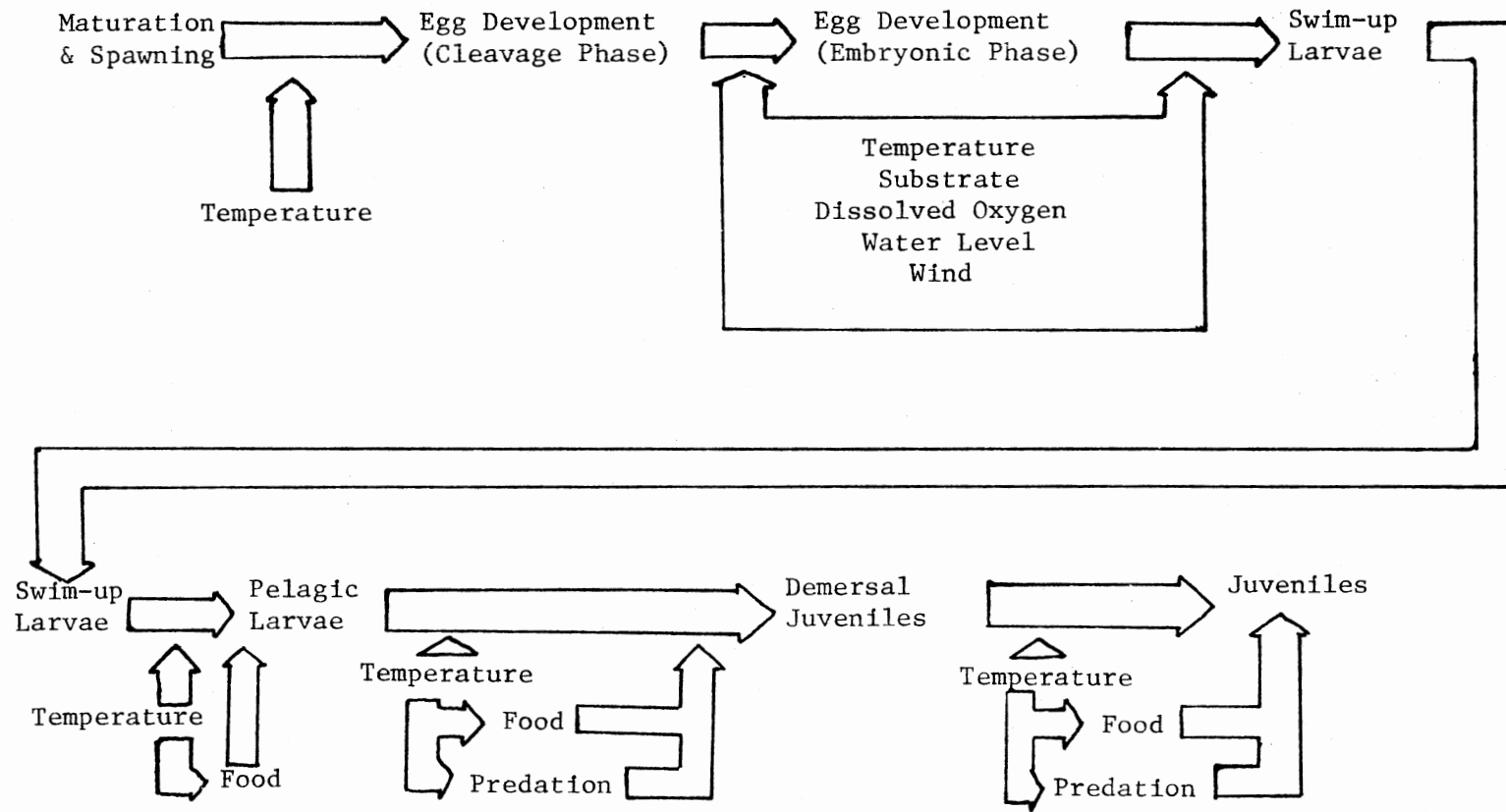



Figure 2. Effect of temperature, predation, and abundance of spawning stock on year-class formation of percids and esocids in Windermere, England. The temperature index (<400, >400, <150, >150) in this diagram is the cumulative total of the number of degrees that the daily temperature readings were above 14°C (from Kipling, 1976).



seven years or more and 3) adult shad are relatively immune to predation or fishing pressure. The possibility of reproductive senility arises. This is to say, populations of gizzard shad would seem to tend to be composed of a large proportion of older, less fecund individuals. The effect of this phenomenon could be to render reproductive success vulnerable to density-independent factors which effect the number of eggs which hatch. Given also the importance of gizzard shad in the diet of many piscivorous fishes, predation on the juveniles could also have some importance in determining year-class strength.

It would seem unlikely that food abundance would have much importance in determining early mortality in gizzard shad. Gizzard shad switch from being secondary consumers to primary consumers upon becoming juveniles. This fact would seem to rule out food availability to the juveniles as having much importance in controlling the abundance of juveniles. Food availability to the larvae may be more important, but given the paucity of information supporting this contention from studies on other species of fish, it would seem unlikely.

Identification of possible factors which may limit reproduction of shad is somewhat speculative at this point. It is evident, however, that the abundance of the larval stages is one of the aspects of year-class formation that must be measured. To determine whether the factors which affect early mortality are operative before, during, or after the larval stages, requires that the abundance of the larval stages be measured.

### Measuring Abundance of Larval Fish

In order to obtain quantitative estimates of abundance of larval gizzard shad, two things must be considered: 1) the accuracy of the estimate and 2) the precision of the estimate. In order to identify the factors which control larval abundance, it is necessary for the investigator to accurately and precisely measure larval abundance. Accurate estimation of abundance of larval fish reduces itself to a problem of gear selectivity (Arron and Collard, 1969; Murphy and Clutter, 1972; Noble, 1968). Precise estimation of larval abundance depends on when, where, and how often the body of water is sampled.

Basic to any sampling program is the concept of the random sample (Gulland, 1966). Completely random sampling is most efficient when the objects being sampled are randomly distributed (Ricker, 1975). For example, if larval gizzard shad in Lake Carl Blackwell, Oklahoma, were distributed randomly throughout the lake, then completely random sampling over the entire lake would yield the best estimate of larval abundance. If the larval shad were concentrated in one section of the lake, and the lake were randomly sampled, then the resulting estimate of abundance would not only show a possible negative bias but also a very high variance. In order to circumvent this difficulty, stratified random sampling is in order.

Stratified random sampling is a variation of completely random sampling in which the sampling effort is concentrated in areas where abundance and/or variability is greatest (Gulland, 1966). For example, if the abundance of larval shad in the northern half of Lake Carl Blackwell were twice that of the southern half, then twice as many samples should be taken from the northern half as the southern half.

In order to stratify the sampling effort, it is apparent that the distribution of the organism in question must be described. This study was concerned with this aspect of maximizing precision.

It is to be expected that larval shad will be present in the lake for a period of about two months. Therefore, an estimate of larval abundance at just one point in time is not appropriate. Larval abundance will have to be measured at several times. In order to stratify the sampling effort each time the lake is sampled, the distribution of shad must either be stable (e.g., the northern half of the lake is always about twice as densely populated as the southern half) or, if the distribution changes, it must do so in a way that is predictable from easily obtainable information.

The single most important factor which governs the horizontal distribution of pelagic larval fish in lakes and reservoirs appears to be currents generated by the wind. Horizontal distribution of a larval whitefish (Coregonus clupeaformis), cisco (C. ortedii), burbot (Lota lota), walleye (S. vitreum vitreum), and yellow perch (P. flavescens) is best explained by wind generated water currents (Clady, 1976b; Faber, 1970; Houde, 1969).

Vertical distribution of larval fish in lakes and reservoirs can be related to either turbulence of the water generated by wind or by turbidity. Larval walleye in Oneida Lake are found deeper when wind generated turbulence is great than when it is low (Houde, 1969). Netsch et al. (1971) found that larval gizzard shad in Beaver Reservoir, Arkansas, were found closer to the surface in the turbid (Secchi disc transparency = 1 m) end of the reservoir than in the less turbid end (Secchi disc transparency = 3 m).

The purpose of this study was to describe the horizontal and vertical distribution of larval gizzard shad in Lake Carl Blackwell, Oklahoma. Of particular interest was whether or not the distribution of shad remained stable, or if it changed in a manner which could be related to easily obtainable information, namely, turbidity or wind speed and direction.

## CHAPTER II

### DESCRIPTION OF STUDY AREA

Lake Carl Blackwell (Figure 3) is an impoundment of Stillwater Creek 13 km west of Stillwater, Oklahoma. The level of the lake exhibits high yearly (and at times monthly) variation resulting in considerable variation in the total area of the lake. Turbidity, as measured by Secchi disc transparency, is high, with transparency measurements ranging from 40 cm to 91 cm during the study.

The lake is commonly stratified between June through August, but periodically destratifies during that period due to high winds (Mauck, 1970). During this study the lake was stratified by May 31 with the depth of the thermocline ranging from 7 to 9 m. The lake was still stratified when the study ended on July 6. Maximum depth of the lake is 12 m at spillway level and the average depth is approximately 3 m. During this study, the maximum depth ranged from 9 to 11 m. Surface temperatures during the study ranged from 14°C in early April to 29°C in late June.

Figure 3. Map of Lake Carl Blackwell showing location of weather station (1) and approximate point on the lake where temperature (2) and Secchi disc transparency (3) were measured.



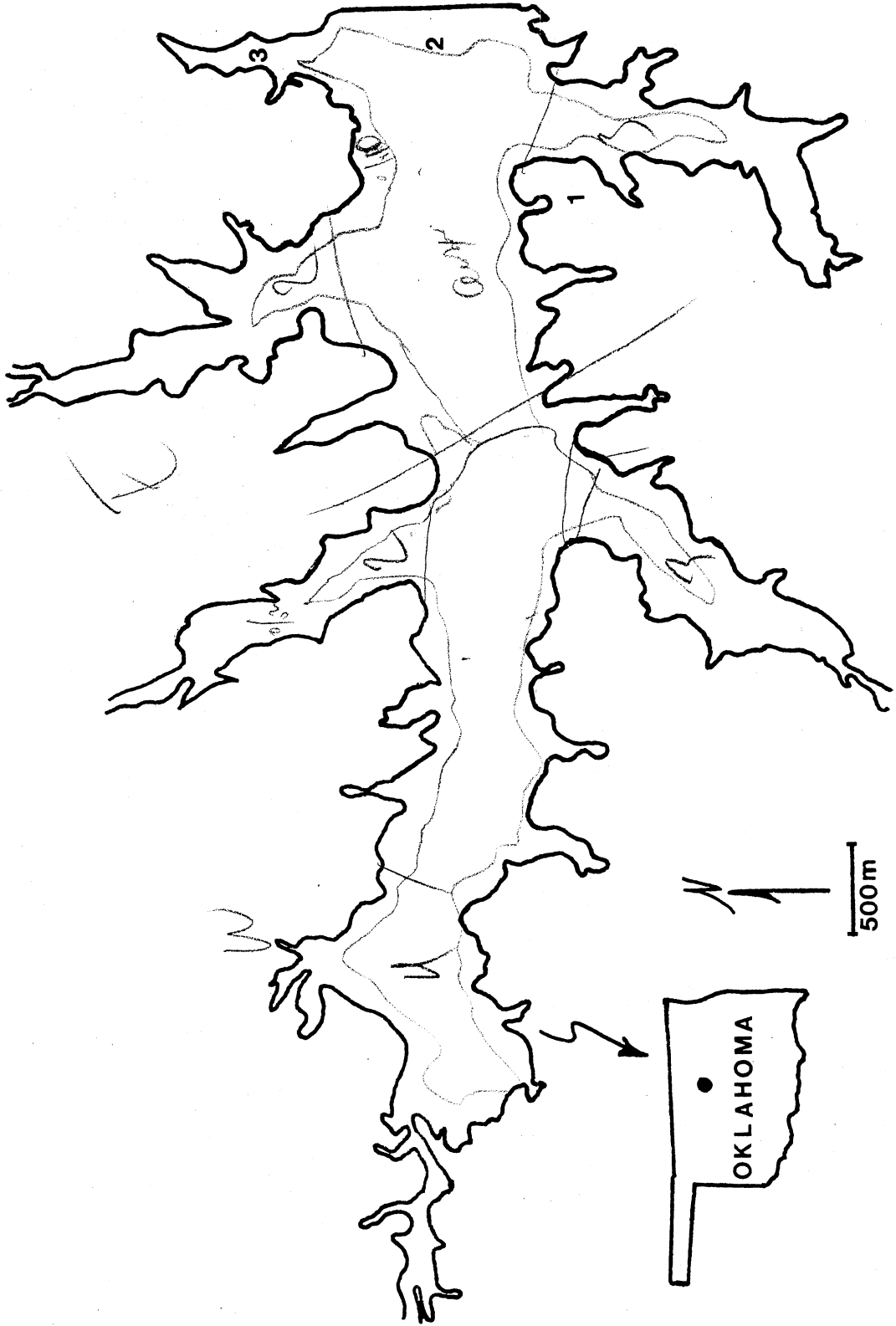

## CHAPTER III

### METHODS AND MATERIALS

#### Sampling Gear

A diagram of the sampling net, cable depressor and collecting bucket construction is presented in Figure 4. The net is similar to that described by Faber (1968). The forward section of the net is composed to coarse (#000 mesh) nylon netting, and acts to entrain the fish. The rear section is composed of #0 mesh nylon netting and is the actual filtering portion of the net. Retrieval of the net using the "lazy line" (Figure 4) allows the net to collapse and prevents contamination of the sample during retrieval. The collecting bucket was made of #40 PVC pipe, threaded male and female PVC adaptors, and a PVC pipe cap. The cable depressor (Figure 4) was made of two metal plates mounted sided by side and weighed approximately 10 kg. A photograph of the net, collecting bucket, and cable depressor is shown in Figure 5.

To avoid towing the net in the wake of the boat, I attached the net and depressor to a 0.3 cm (1/8 inch) steel cable which was played out from a hand-operated winch which was mounted on a boom. The boom projected 2 m over the front of the boat, and was made of 16 ga square (5.1 x 5.1 cm or 2 x 2 in) steel tubing reinforced with 1.3 cm (1/2 in) steel rods (Figure 6). The point of attachment of the net to the cable was 1.0 m above the depressor. I used a 6.5 m (20 ft) aluminum flat bottom boat powered by a 25 h.p. outboard motor.

Figure 4. Construction of net, cable depressor, and collecting bucket.

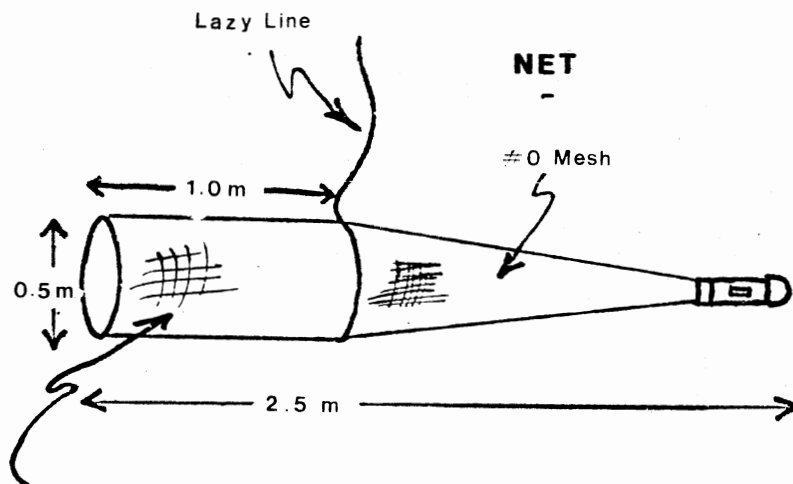

#000 Mesh

**CABLE DEPRESSOR**

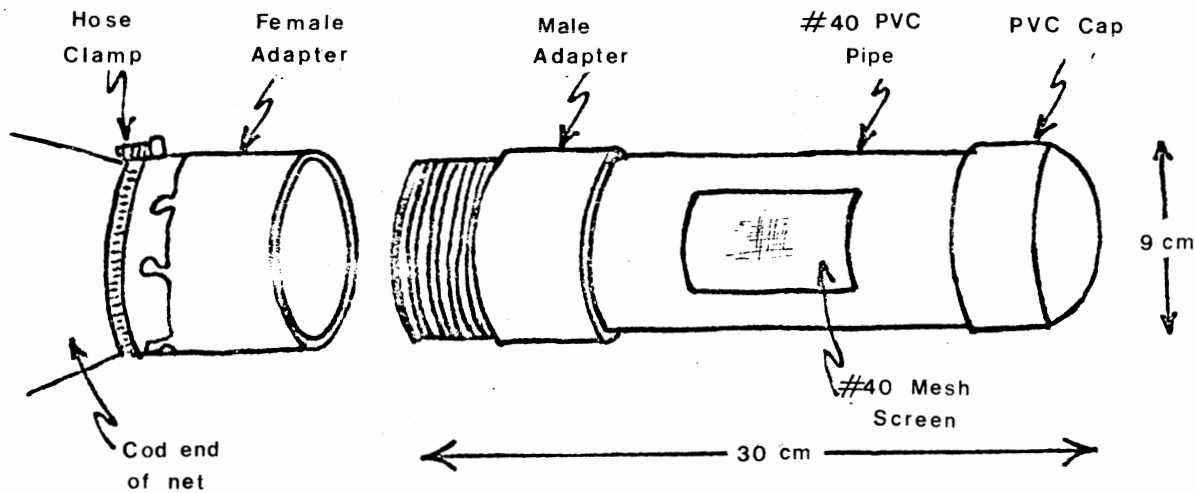
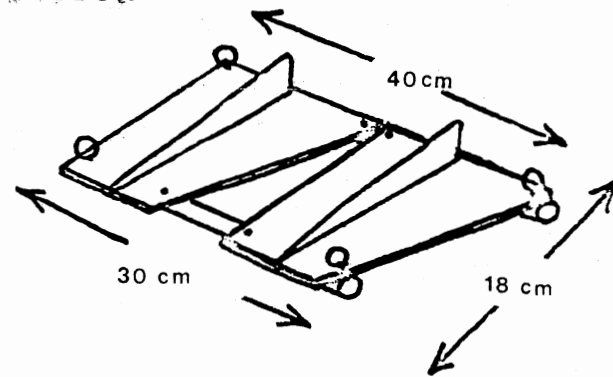

**COLLECTING BUCKET**

Figure 5. Photograph of net, cable depressor and collecting bucket used during study.



Figure 6. Photograph of boat with the boom, net, and cable depressor in place.





### Calibration of Gear

A tachometer was used to keep the speed of the boat constant while sampling was in progress. I calculated the average speed of the boat for a particular throttle setting in the following manner: two buoys were placed in the lake and the distance between them set at 100 m using a 100 m length of string. With the cable depressor and net in the water, the boat was driven at a constant throttle setting between the two buoys. By recording the time required to travel between the two buoys, an estimate of the speed of the boat was possible. To obtain an estimate of the variability of the speed of the boat, I repeated the above procedure ten times. In this manner, I determined that the speed at which the net was pushed through the water during sampling was  $1.8 \pm <0.1$  m/sec. This speed corresponded to a throttle setting of 900 rpm.

In order to standardize the technique, an estimate of the volume of water filtered during each sampling haul was required. To obtain this estimate, I needed an estimate of the distance traveled during each sampling haul and I assumed that the net filtered all of the water which it encountered. This assumption has been shown to be valid for bridled meter nets by Mahnken and Josse (1967). Since the speed of the boat was subject to the effects of wind and erratic engine performance, a flow meter salvaged from a Clarke-Bumpus plankton sampler was used to estimate the distance traveled each time I sampled a particular transect. The flow meter was mounted to the side of the boat. I established the relationship between the number of flow meter counts and distance traveled in the following manner: with the flow meter in the water, I drove the boat at a constant throttle setting between two

buoys 100 m apart and recorded the number of flow meter counts. This procedure provided me with an estimate of the distance traveled per flow meter count. By repeating this procedure ten times, an estimate of the variability of the distance traveled per flow meter count could be made. The distance traveled per flow meter count was  $3.85 \pm 0.03$  m and was constant over a wide range of throttle settings. Since the area of the net aperture was  $0.20 \text{ m}^2$ , the volume of water filtered by the net per flow meter count was  $0.77 \pm 0.01 \text{ m}^3$ .

The length of cable to be played out to sample at a desired depth was determined by measuring the angle of the cable relative to the water while the sampling gear was in operation. Basic trigonometry was used to determine the length of cable to be played out to sample at any desired depth. Neither the precision nor the accuracy of this aspect of the technique could be measured. The angle of the cable appeared to remain quite constant during operation of the gear. The cable depressor could also be felt dragging the bottom in areas of the lake where the depth finder indicated that the sampler should be near the bottom.

#### Field Methods

The lake was sampled at approximately weekly intervals beginning on April 9, 1977 and ending on July 7, 1977. Sampling began one hour after sunset and was often cancelled or delayed due to high winds or thunderstorms.

Transects to be sampled were located using landmarks and a Lowrance Fish-Locator depth finder. Each transect was sampled by pushing the net through the water for two minutes and thirty seconds

at a throttle setting of 900 rpm. A transect sampled in this manner will hereafter be referred to as a "haul".

To initiate a haul, the appropriate length of cable was played out and the reading on the flow meter was recorded. The net, depressor and flow meter were then placed in the water. Each haul was begun from a standing start, and at the end of 2.5 minutes the boat was stopped, the net was retrieved using the "lazy line", and the flow meter reading at the end of the haul was recorded. The catch was washed into 0.5 liter plastic jars containing sufficient formalin to make a 5% solution (final volume). The time required to locate each transect and complete each haul was 10 to 15 minutes.

Shoreline hauls were made by following the shoreline as closely as possible. The distance from the shoreline during these hauls was never greater than approximately 20 m and was limited by water depth and obstructions. Transects sampled in this way will hereafter be referred to as "shoreline hauls". Transects not sampled in this way (i.e., not close to shore) will hereafter be referred to as "offshore hauls". Offshore hauls were never made closer than approximately 50 m from the shoreline.

On each night of sampling, a vertical temperature profile was taken in the deep part of the lake near the dam (Figure 3). A weather station, provided by the National Severe Storms Laboratory in Norman, Oklahoma, was set up near the lake (Figure 3). An anemometer and a wind direction indicator coupled to an Esterline-Angus recorder provided a continuous record of wind speed and direction during the period of the study. Measurements of Secchi disc transparency for Lake Carl Blackwell were made available by the Oklahoma Cooperative Fishery

Research Unit, Stillwater, Oklahoma.

### Laboratory Methods

Larval and juvenile fish were sorted from each sample and counted. Upon removal from the field samples, the fish were preserved in 5% buffered formalin and stored in glass vials.

I measured fish specimens to the nearest 0.1 mm in the following manner: using a bioscope, I projected the image of each specimen on a screen. The projected image was then measured to the nearest mm. The same magnification was used to measure all specimens. The length of the projected image of any specimen was determined empirically to be 20.8 times the actual length of the specimen. Therefore, the actual length of a specimen =  $\frac{1}{20.8}$  x length of projected image. Also, the variance of actual length =  $\frac{1}{20.8^2}$  x variance of length of projected image.

Only larval gizzard shad were measured. In samples containing 50 larval shad or fewer, all larval shad were measured to the nearest 0.1 mm. In samples containing more than 50 larval shad, 50 larval shad were chosen at random and measured. Random subsamples of 50 fish were taken in the following manner: the entire sample was emptied into a transparent dish onto which a numbered grid pattern had been marked. A grid number was chosen at random and the image of each fish whose eyes lay within the boundaries of the chosen grid was measured. Grids were randomly chosen until 50 larval shad had been measured.

To make the catch among hauls comparable, the catch (i.e., the number of fish) was converted from numbers/haul to numbers/ $10^4$  liter. For each haul:

$$\text{numbers}/10^4 \text{ liter} = \text{number of fish/haul} \times \frac{1}{\text{flow meter counts/haul}}$$

$$\times \frac{1 \text{ flow meter count}}{0.77 \text{ m}^3} \times \frac{10 \text{ m}^3}{10^4 \text{ l}}$$

In so converting the data, variation in the catch due to variation in the distance traveled while sampling each transect was eliminated.

The term "catch data" will hereafter refer to those data which consist of the numbers/ $10^4$  liter for each haul.

## CHAPTER IV

### STATISTICAL CONSIDERATIONS

#### Experimental Design

Mayhew (1976) and Netsch et al. (1971) found that the density of larval shad in reservoirs was often greater in the tributary arms than in the main channel. Netsch et al. (1971) and Miller (1960) reported that larval shad first inhabit shallow water or shorelines and move to deeper water as they become older. It was therefore expected that in Lake Carl Blackwell the density of shad in the tributary arms would be different than in the main part of the lake. I also expected that the density of shad on shore would be different from that offshore. These expected differences stated in the form of null hypotheses are as follows:

$H_0$ : The density of larval shad in tributary arms is the same as that in the main part of the lake.

$H_0$ : The density of larval shad onshore is the same as that offshore.

To test these hypotheses, the lake was divided into eight areas (Figure 7); six tributary arms (areas 1, 2, 3, 4, 5, and 6), the main part of the lake (area 7) and the shoreline (area 8). The sampling strategy was to randomly sample each area at the depth at which the density of shad was greatest. For example, if the depth at which the density of shad was greatest was the surface (0 m), then the majority

Figure 7. Map of Lake Carl Blackwell showing how the lake was divided up into areas for sampling. Shaded portions of the map indicate major portions of the lake which could not be sampled. Southerly and northerly winds were assumed to cause greater turbulence than easterly winds in areas 1, 6, and 7. Dotted lines identify shoreline transects.

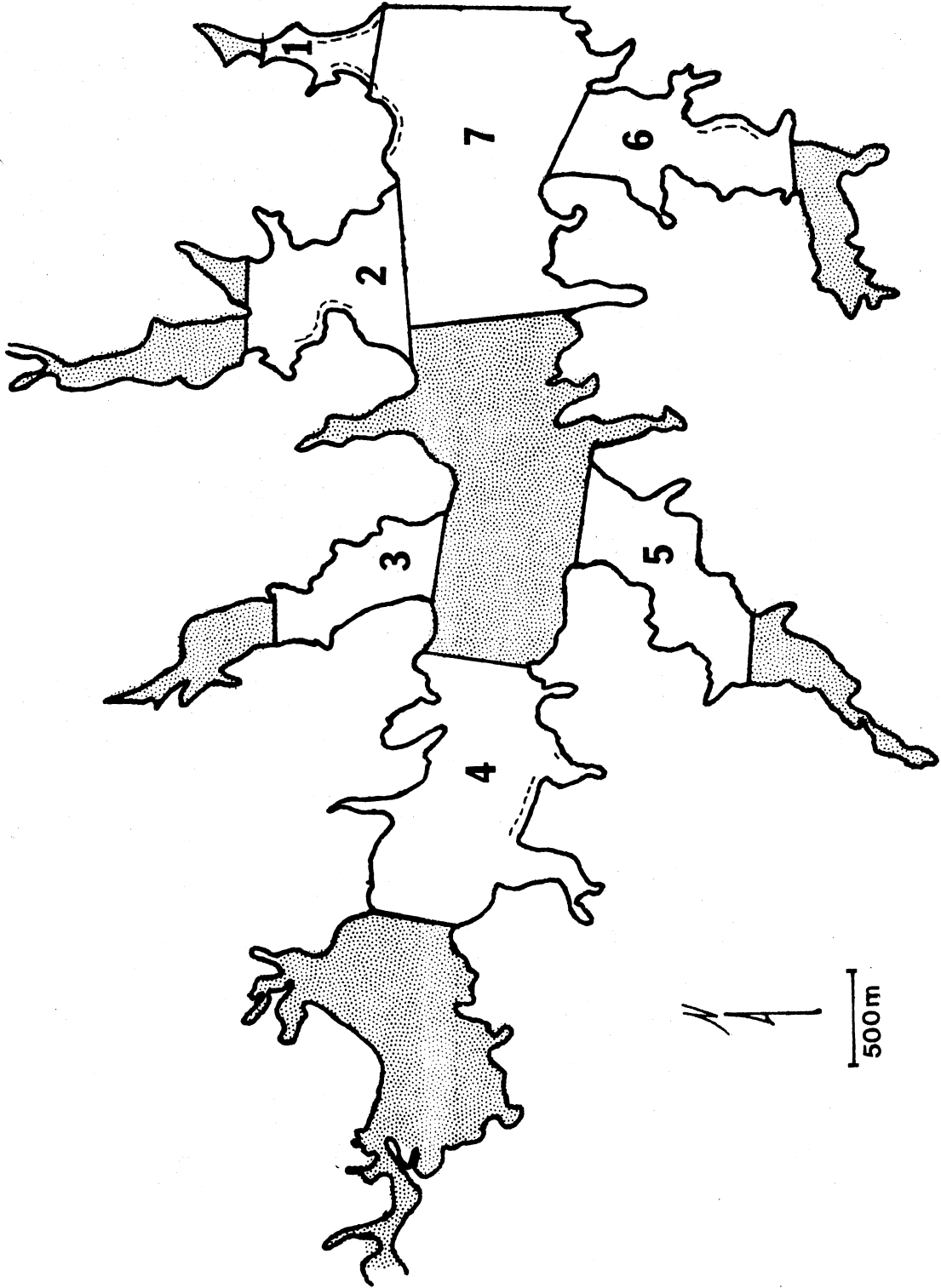



of all hauls in each area would be made at 0 m. Those hauls not made at 0 m would be made at other depths (3, 5, or 7 m) to monitor changes in the vertical distribution of the shad larvae. If the catch data from a particular night indicated a change in vertical distribution, then the depth at which the majority of the hauls would be made on the next scheduled night of sampling was adjusted accordingly. For example, if the catch data of a particular night indicated that the depth at which the density of shad larvae was greatest had changed from 0 m to 3 m, then on the next scheduled night of sampling, each area would be randomly sampled at 3 m instead of 0 m.

Netsch et al. (1971) reported that, early in the spawning season, larval shad were found predominantly near the surface. Therefore, for the first few nights of sampling in this study, the majority of the hauls were made near the surface (0 m). No statistical tests were applied to the catch data to detect changes in vertical distribution: the data were examined graphically.

Offshore transects within each area were chosen by superimposing a grid over a map of the lake and randomly selecting two or three transects from each area. Shoreline transects were selected by choosing six sections of shoreline on the basis of accessibility and ease with which the gear could be operated in each section (Figure 7). Three sections were then randomly selected to serve as shoreline transects to represent the shoreline (area 8). I chose a different set of offshore and shoreline transects for each night of sampling.

This sampling strategy resulted in an unbalanced one-way AOV. To test the null hypotheses previously mentioned, the following comparisons were chosen a priori. Area 7 vs. areas 1, 2, 3, 4, 5, and 6

(main part of the lake vs. tributary arms) and area 8 vs. areas 1, 2, 3, 4, 5, 6, and 7 (shoreline vs. offshore). In addition, I selected other comparisons a priori: areas 1, 2, and 3 vs. areas 5 and 6 (North vs. South) and areas 1, 2, 6, and 7 vs. areas 3, 4, and 5 (East vs. West). Tests for significance for each of these comparisons were made using a two-tailed t-test. When the catch data indicated that other comparisons should be made (e.g., northeast vs. southwest), Scheffe's test (Snedecor and Cochran, 1971) was applied. Bartlett's test of variance homogeneity (Steel and Torre, 1963) was applied to test for equal variance of the catch data within areas. Standard SAS computer programs were used in all analyses of variance.

To test for differences in mean length of shad (among areas and among transects within areas) for each night of sampling, an unbalanced heirarchical AOV was used with transects nested within areas. The Studentized Range/Max Gap test (Snedecor and Cochran, 1971) was used to test for differences in mean length among areas. This test was applied in order to define groups of areas which were alike with respect to the mean length of larval shad captured within them. The method I used for the calculation of the standard error for the unbalanced heirarchical AOV is given in Appendix A. A t-test was used to test for differences in mean length of shad between different depths.

#### Treatment of the Data

Standard statistical procedures may be applied to the catch data if the data are distributed normally. Trawl catches are not normally distributed but usually conform to some contagious distribution. This contagion is the result of non-random spatial distribution of the

organism in question (Gulland, 1966; Houser and Dunn, 1967; Noble, 1968). It is a characteristic of non-normal distributions that the variance is related to the mean. The distribution most likely to describe single species distribution in trawl data is the negative binomial (Noble, 1968). The variance of the negative binomial distribution is related to the square of the mean (Snedecor and Cochran, 1971). To test whether or not the catch data of shad in Lake Carl Blackwell exhibited a negative binomial distribution, the proportionality of the mean to the standard deviation was examined. This procedure was followed by Noble (1968) in examining contagion in yellow perch (Perca flavescens). The catch data for each night of sampling was examined separately for contagion. When the catch of a particular night exhibited contagion, the transformation  $\log_e (\text{catch} / 10^4 \text{ liters} + 1)$  was used (Noble, 1968). I then subjected the transformed data to routine statistical analysis.

Confidence intervals were calculated for the means of the transformed data. Both the means and the upper and lower limits of the confidence interval were then transformed back to the original scale for purposes of summarization. The resulting mean is the geometric mean of the original data and is an underestimate of the arithmetic mean of the original data. With highly variable data, the arithmetic mean may lie outside the confidence interval (Noble, 1968). This phenomenon offers no real problem for the purpose of this research, since no comparisons among different nights of sampling (i.e., no comparisons between transformed and untransformed data) were made.

Wind and Secchi disc transparency data were related to changes in the density of shad among areas (i.e., changes in horizontal distribu-

tion) and changes in vertical distribution by visual inspection of the data. In relating changes in vertical distribution to changes in wind and Secchi disc transparency, I examined only the vertical distribution of shad in areas 1, 6, and 7. These were the only areas of the lake in which hauls deeper than 3 m were possible.

Netsch et al. (1971) reported that larval shad were found closer to the surface in turbid water than in less turbid water. Anticipating a similar response on the part of larval shad in Lake Carl Blackwell, I looked for changes in vertical distribution which occurred concurrently with changes in Secchi disc transparency. Houde (1969) reported that larval walleye (Stizostedion vitreum) were found at greater depths during periods of high wind induced turbulence than during low turbulence. I anticipated that larval shad in Lake Carl Blackwell would react to wind induced turbulence in a similar manner. Since I made no actual measurements of wind induced water turbulence during this study, wind direction and speed were assumed to provide a measure of such turbulence. It was anticipated that winds from southerly and northerly directions would create more turbulence in areas 1, 6, and 7 than would winds from an easterly direction (Figure 7). The average wind speed and direction during the 12-hour period prior to commencement of sampling on each night was used as a measure of wind induced water turbulence. The choice of such a 12-hour period (as opposed to an 18 or 20-hour period) was purely arbitrary, but it would seem to be sufficient time for the larval shad to react to turbulence. I looked for changes in wind speed or direction which occurred concurrently with change in vertical distribution.

To relate horizontal distribution to wind induced currents, I

anticipated that horizontal distribution would roughly correspond to wind direction. For example, I expected that strong southerly winds for a period of two days would result in the shad being more abundant in northern areas of the lake. Again, the choice of the two-day period prior to the time of sampling was entirely arbitrary.

## CHAPTER V

### RESULTS

Larval shad first appeared in the samples on April 27 when the surface lake temperature was 21.0°C. Inclement weather halted sampling on May 3 and prevented sampling between May 9 and May 23. During the period of May 9 to May 23, the lake level rose by approximately 1.5 m. The May 3 data set is not included in this analysis because only three areas were sampled. A total of 29,453 gizzard shad, 85% of which were larvae, were collected between April 27 and July 7. Vertical temperature profiles on each date are given in Appendix B.

#### Seasonal Distribution

Figure 8 shows the changes in density of larval shad as the spawning season progressed. As will be discussed later, the bulk of the sampling effort was concentrated at the surface from May 9 through May 31, when concentrations of shad larvae were actually greatest at 3 m. As a result, the data points for May 9, 23, and 31 on Figure 8 are based on only 3, 2, and 5 hauls, respectively. Peak larval abundance occurred between May 9 and June 13.

Figure 9 depicts the changes in composition of the catch (pro-larvae, post-larvae, and juvenile) during the study. The yolk sac stages (pro-larvae) were not vulnerable to the sampling technique as evidenced by the fact that post-larvae were always 2 to 12 times more

Figure 8. Mean density of shad ( $\pm$  one standard deviation)  
on each data at Lake Carl Blackwell.

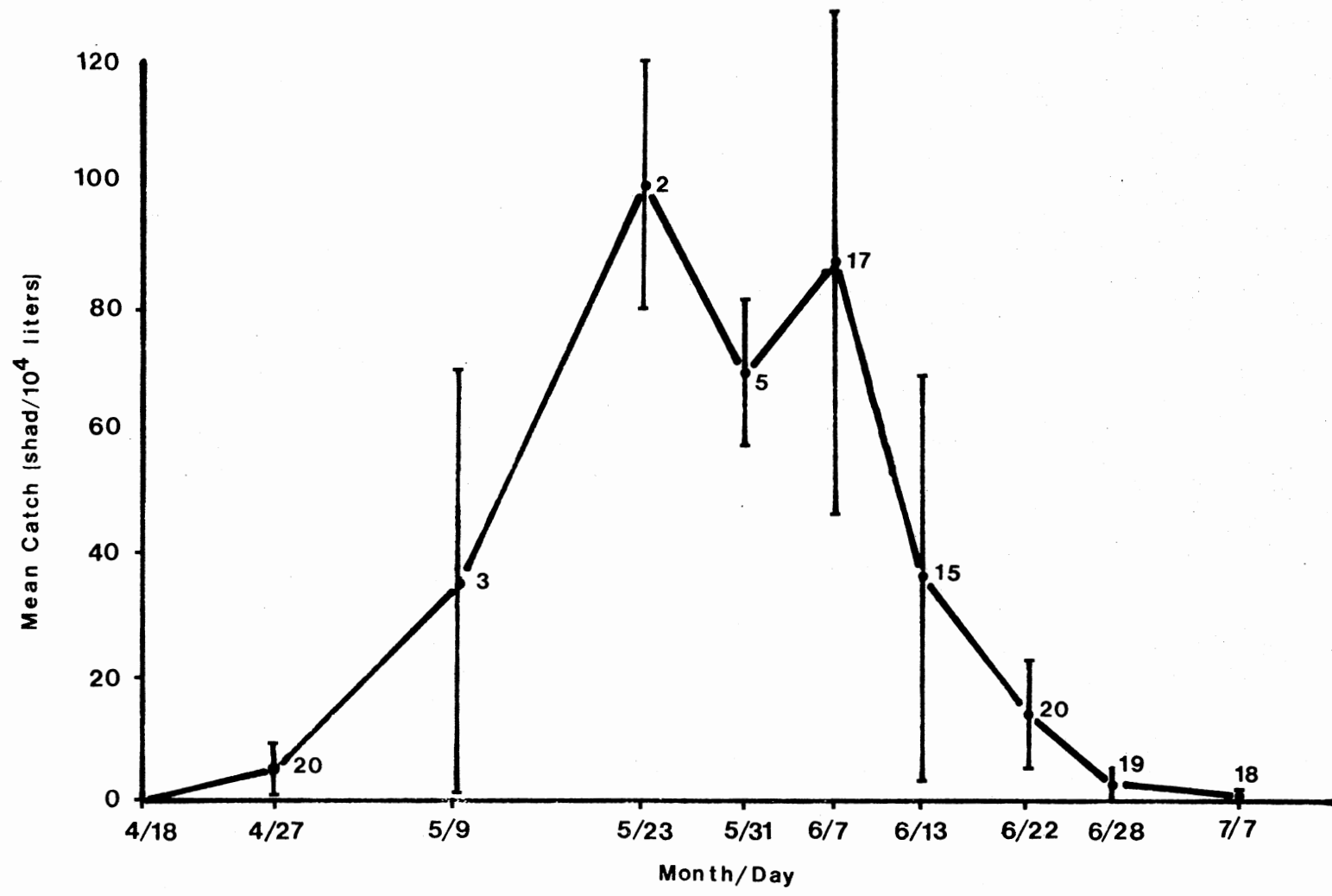
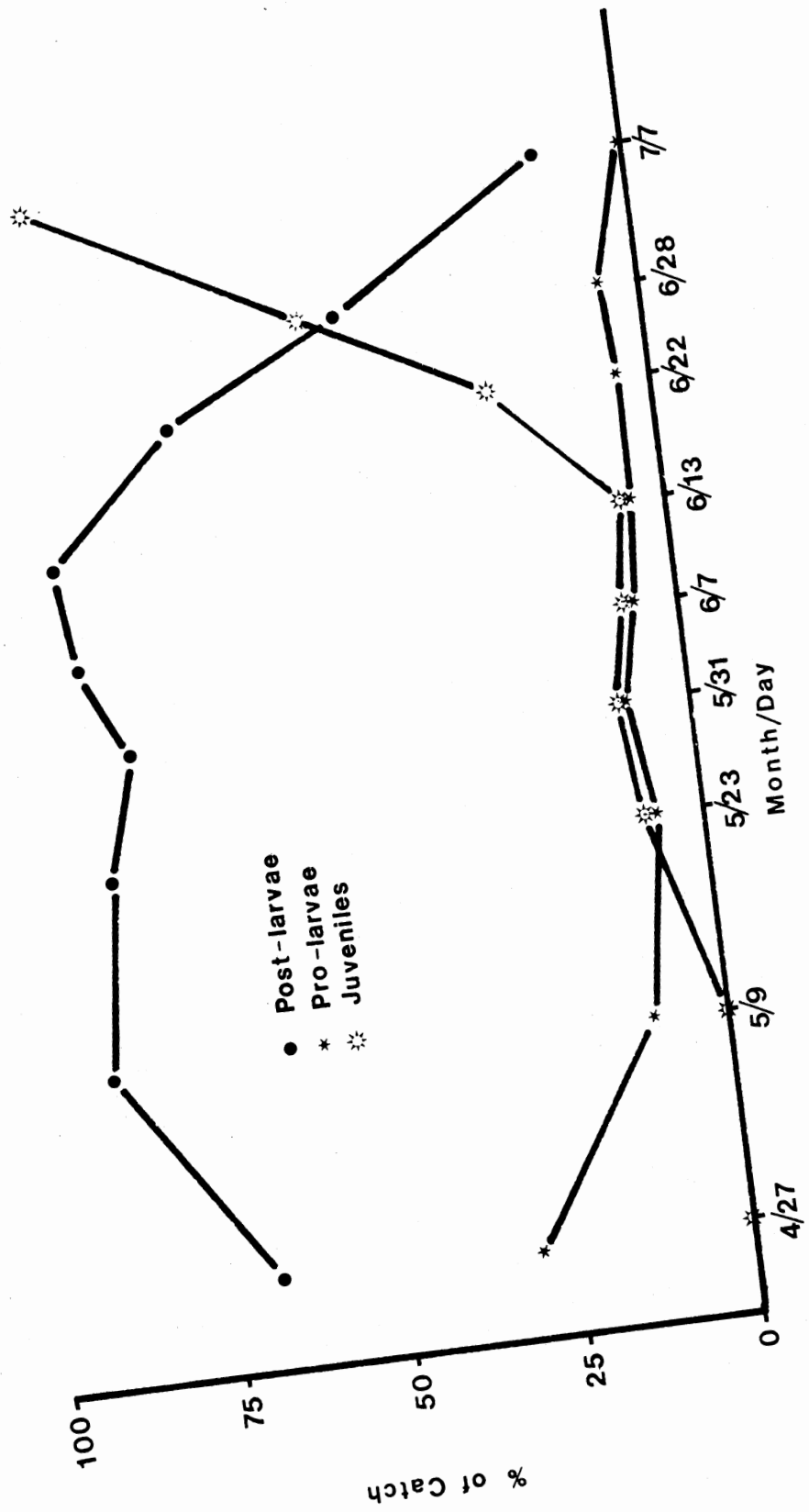



Figure 9. Composition of the catch (% pro-larvae, post-larvae, and juveniles) on each data at Lake Carl Blackwell.



numerous in the catch than pro-larvae. The occurrence of pro-larvae in the catch indicates that the spawning season lasted from sometime shortly before April 27 until shortly after June 28. Hereafter, the catch data of July 7 will not be included in the analysis because larval shad were virtually absent in the lake at this time.

#### Patchiness

In Table II are found the correlation coefficients ( $r$ ), and Student's  $t$ -values of the regression of mean catch vs. standard deviation of each area for each night of sampling. A significant ( $P < 0.10$ )  $r$ -value indicates patchy distribution. According to this criterion, distribution was patchy on April 27, May 23, May 31, and June 28. Changes in the degree of patchiness were not associated with wind direction or speed. For example, winds for the 12-hour period preceding the May 31 sample were 6 to 14 m/sec and extremely variable in direction, while the winds preceding the May 23 samples were 6 to 12 m/sec from a constant east-southeast direction. Distribution was patchy on both dates.

The correlation coefficients and Student's  $t$ -values of the regression of mean catch vs. standard deviation after data transformation are also given in Table II. Even after transformation, the mean and standard deviation showed a significant relationship to one another on May 31 and June 28. The effect of this finding on the validity of statistical procedures will be discussed later.

TABLE II  
 SUMMARY OF THE RESULTS OF CORRELATION OF MEAN CATCH/10<sup>4</sup> LITER  
 WITH STANDARD DEVIATION FROM EACH AREA  
 ON EACH DATE

Date	Untransformed Data			df	Transformed Data		
	r	t	Prob >t		r	t	Prob >t
April 27	0.96	8.491	<0.001	6	0.52	1.642	>0.10
May 9	-0.16	-0.367	>0.50	6			
May 23	0.95	7.245	<0.001	6	0.19	0.473	>0.50
May 31	0.98	9.307	<0.001	4	0.95	6.350	<0.10
June 7	0.17	0.380	>0.50	5			
June 13	0.78	2.134	<0.10	3			
June 22	0.44	1.080	>0.30				
June 28	0.86	3.771	<0.02	5	0.67	2.030	<0.10
July 6	0.48	0.545	>0.4	5			

A significantly high ( $P < 0.10$ ) correlation coefficient ( $r$ ) for untransformed data implies patchy distribution of shad larvae. Significant " $r$ " value for transformed data indicates that the transformation did not normalize the data.

### Vertical Distribution

For purposes of summarization, patterns of vertical distribution of shad larvae are given for areas 2, 4, and 5 vs. areas 1, 6, and 7 (Figure 10). These groups of areas represent shallow (2 to 5 m in depth) vs. deep (6 to 10 m) areas of the lake, respectively.

At the outset of sampling, shad larvae were distributed predominantly near the surface. After April 27, the density of larval shad in areas 2, 4, and 5 was an average of seven times greater at 3 m than at 0 m (Figure 10).

Vertical distribution of shad larvae in areas 1, 6, and 7 was somewhat more erratic. On May 9, vertical distribution in area 1 was similar to that in areas 2, 4, and 5 (i.e., most of the fish were at 3 m), while in areas 6 and 7 the density of shad at the surface was four times greater than at 3 m. After May 9, the depth at which shad density was greatest in areas 1, 6, and 7 changed to 5 m (May 23 and May 31) then to 3 m (June 7 through June 22) and then back to 5 m (June 28; Figure 10).

The changes in patterns of vertical distribution in areas 1, 6, and 7 were not related to wind speed and direction or to Secchi disc transparency. Table III lists the average wind speed for a period of 12 hours before each sample period and Secchi disc transparency in area 1. On days when the wind was from the southwest or northeast (June 7, June 13, and June 22) the fish were nearer the surface than on days in which the wind was from a more easterly direction. Secchi disc transparency in area 1 was greatest (0.5 to 0.8 m) on dates when the larval shad in areas 1, 6, and 7 were nearer the surface. This observation was contrary to what was expected.

Figure 10. Vertical distribution of shad larvae on each date in Lake Carl Blackwell. No hauls greater than 3 and 7 m were made in shallow and deep areas, respectively. In drawing the figure for areas 1, 6, and 7 on June 22, I assumed that very few larvae were living at 0 m.

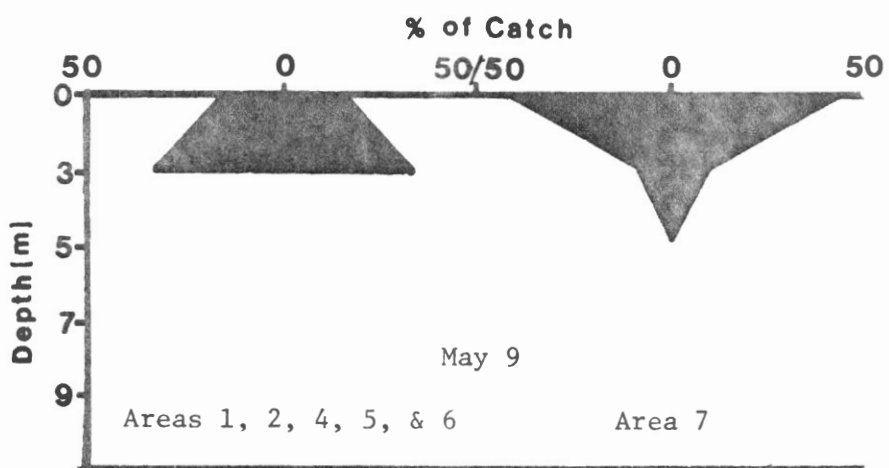
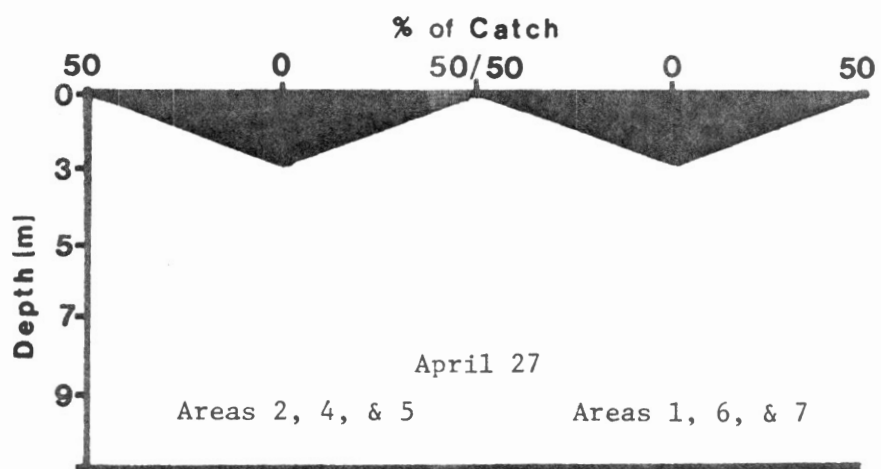

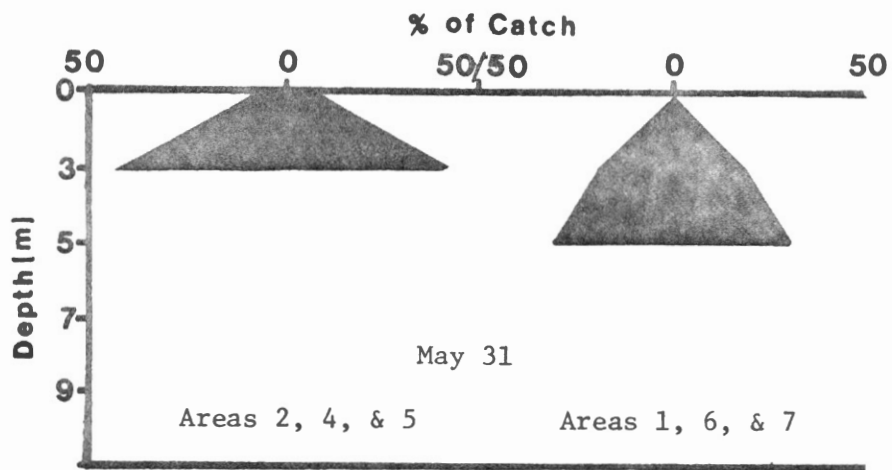
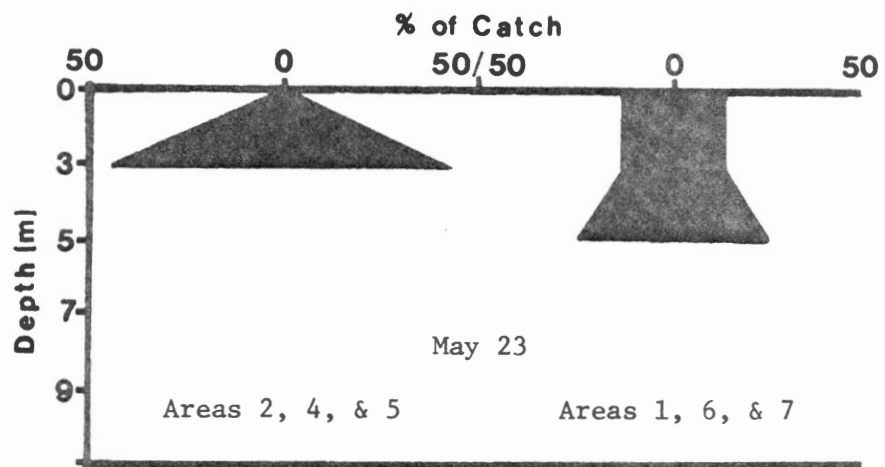

Figure 10 (Continued)



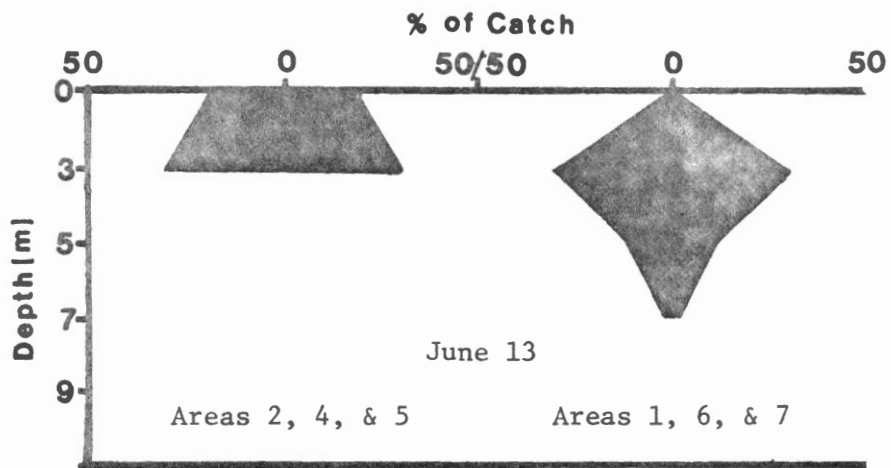
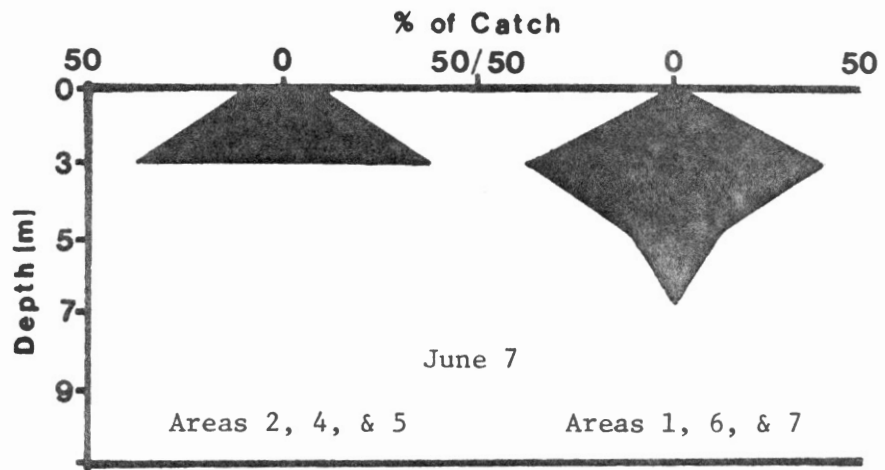
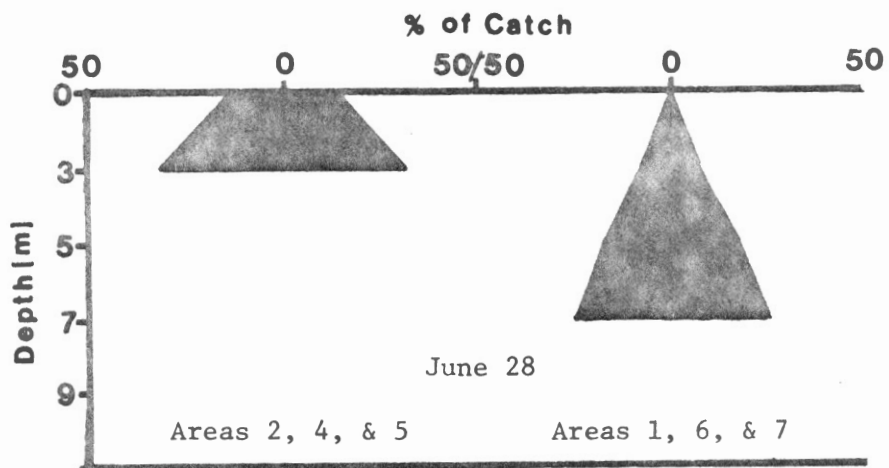
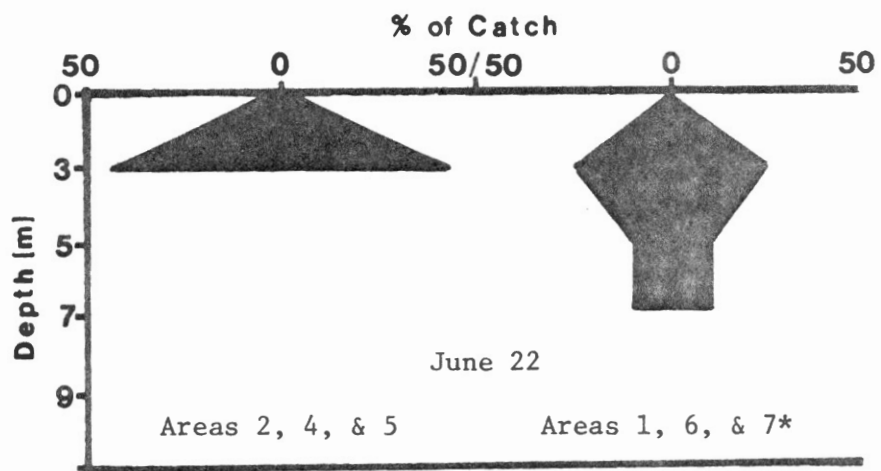

Figure 10 (Continued)



\* = No surface hauls were made on this date in areas 1, 6, & 7.

Figure 10 (Continued)

TABLE III

SECCHI DISC TRANSPARENCY, WIND DIRECTION, AND WIND SPEED  
DURING 12-HOUR PERIOD PRECEEDING SAMPLING ON  
EACH DATE AT LAKE CARL BLACKWELL

Date	Secchi Disc (m)	Wind Speed (m/sec)	Wind Direction
April 26	0.6	10-20	Southwest
May 9	0.8	6-8	East
May 23	0.3	6-10	East-southeast
May 31	0.5	4-6	Southeast
June 7	0.5	6-10	East-northeast
June 13	0.8	4-10	Northeast to Southeast
June 22	0.5	8-12	Southwest
June 28	0.6	6-12	Variable

### Horizontal Distribution

During the period April 25 through May 31 hauls to determine horizontal distribution were made at the surface. From June 7 through July 7, the hauls were made at 3 m. As previously explained, after April 27, the depth at which the density of larval shad was greatest was 3 m. This means that on May 5, 23, and 31, hauls to determine horizontal distribution were not made at the depth at which the density of larval shad was greatest (i.e., 3 m). This deviation from the original sampling strategy was due to the low lake level until May 23, when it became possible to sample at 3 m in all areas of the lake. Nevertheless, some patterns of horizontal distribution are indicated by the data.

Significant differences ( $P < 0.10$ ) in the density of larval shad among areas were observed on May 9 and 23 and on June 13, 22, and 29. Differences among areas on April 27, May 31, and June 7 were not significant. Catch data and the results of the analysis of variance for each night of sampling are given in Appendix C. Results of comparisons between different combinations of areas are given in Table IV. Observed differences in density of larval shad were generally on the order of two to seven fold. Results of comparison among offshore areas are illustrated in Figure 11.

The periods from April 27 to May 31 and June 7 to July 7 are the periods during which hauls to determine horizontal distribution were made at 0 m and 3 m, respectively. For purposes of description of the results, these two periods will be discussed separately.

TABLE IV

RESULTS OF SIGNIFICANT COMPARISONS OF MEAN DENSITY OF SHAD  
(NUMBERS/10<sup>4</sup> LITER) AMONG GROUPS OF AREAS

Date	Comparison	$\bar{X}$		D	OSL	S.E.	95% C.I.
		$\bar{X}_a$	$\bar{X}_g$				
April 27	NS						
May 9	2,3,&4	53.9		34.2	0.050	7.0260	49.7;18.8
	vs.	vs.					
	1,5,6,&7	19.7					
	8	14.9		19.4	0.050	8.3888	38.0;0.98
	vs.	vs.					
	1,2,3,4,5,6,&7	34.4					
	8	14.9		4.8	0.100	9.0265	
	vs.	vs.					
	1,5,6,&7	19.7					
May 23	1,2,&3	42.6	12.1	38.2	0.010	0.4848*	16.1;1.9
	vs.	vs.	vs.				
	5&6	4.45	1.36				
	7	2.9	1.0	24.6	0.050	0.5998*	14.8;0.1
	vs.	vs.	vs.				
	1,2,3,4,5,&6	27.5	7.6				
	8	29.0	16.8	8.9	0.050	0.4994*	8.6;1.1
	vs.	vs.	vs.				
	1,2,3,4,5,6,&7	19.9	4.6				
	8	29.0	2.9	4.5	0.100	0.5298*	4,1;0.2
	vs.	vs.	vs.				
	1,2,3,&4	33.5	2.4				
May 31	NS						
June 7	NS						
June 13	1,2,6,&7	62.9		44.3	0.010	11.0306	69.3;19.4
	vs.	vs.					
	4&5	18.6					

TABLE IV (Continued)

Date	Comparison	$\bar{X}$		D	OSL	S.E.	95% C.I.
		$\bar{X}_a$	$\bar{X}_g$				
June 22	1,2,&7	17.2		12.6	0.050	2.7195	18.5;6.8
	vs.	vs.					
	4,5,&6	4.6					
	7	21.0		12.0	0.050	4.9985	22.9;1.3
	vs.	vs.					
	1,2,4,5,&6	8.9					
	8	2.0		8.9	0.001	1.9315	13.1;4.7
	vs.	vs.					
	1,2,4,5,6,&7	10.9					
June 28	1,2,4,&5	5.9	1.9	5.3	0.025	0.2512*	5.4;1.1
	vs.	vs.	vs.				
	6&7	0.6	0.6				
	7	0.9	0.9	3.4	0.020	0.3521*	4.6;0.2
	vs.	vs.	vs.				
	1,2,4,5,&6	4.9	4.0				
	8	0.3	0.3	3.9	0.010	0.3481*	6.8;0.5
	vs.	vs.	vs.				
	1,2,4,5,6,&7	4.2	3.2				

$\bar{X}_a$  = arithmetic mean;  $\bar{X}_g$  = geometric mean; D = observed difference; OS� = observed significance level; S.E. = standard error of observed difference; 95% C.I. = 95% confidence interval of observed difference; NS = no significant differences between areas; asterisk beside values for standard error indicates standard error for transformed data. Geometric means are given only for comparisons in which the data were transformed.

Figure 11. Distribution of larval gizzard shad on each date at Lake Carl Blackwell. Darkened areas indicate areas of the lake in which density of shad was greatest. Arrows beside each map indicate direction of winds during 48-hour period preceding sampling on each date. Numbers beside each arrow indicate wind speed (m/sec). Depth at which hauls were made (0 m or 3 m) are also given for each date (see text). Dotted lines indicate locations of shoreline transects on each date.

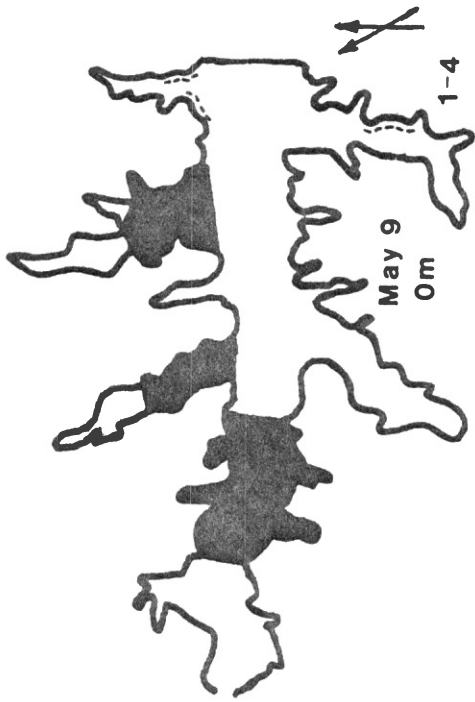



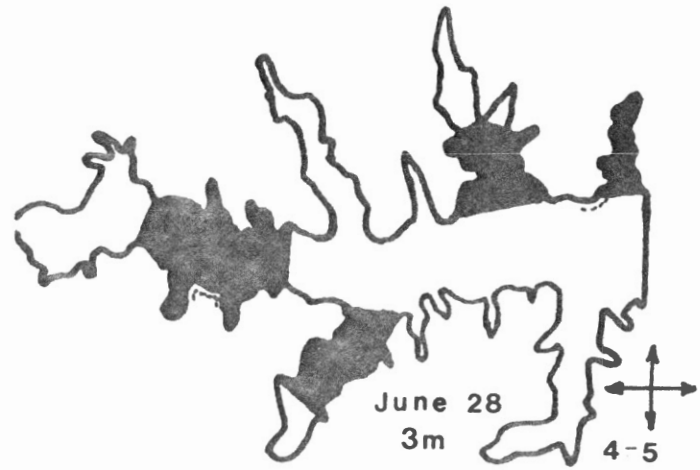
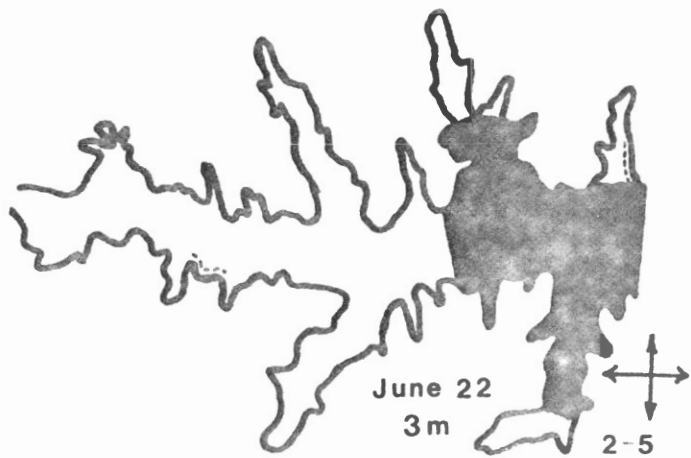
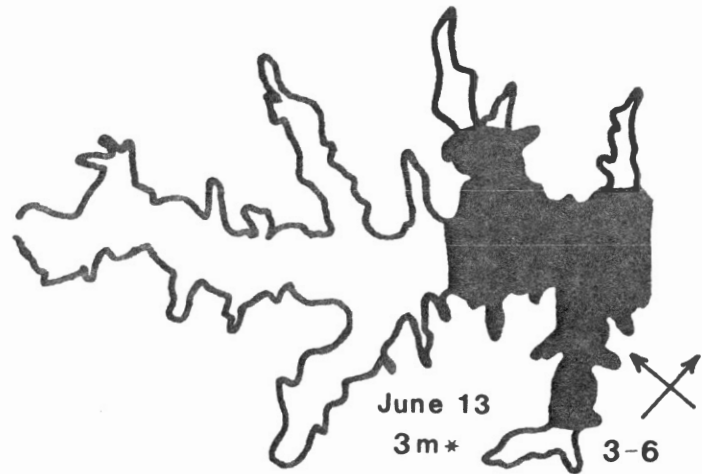
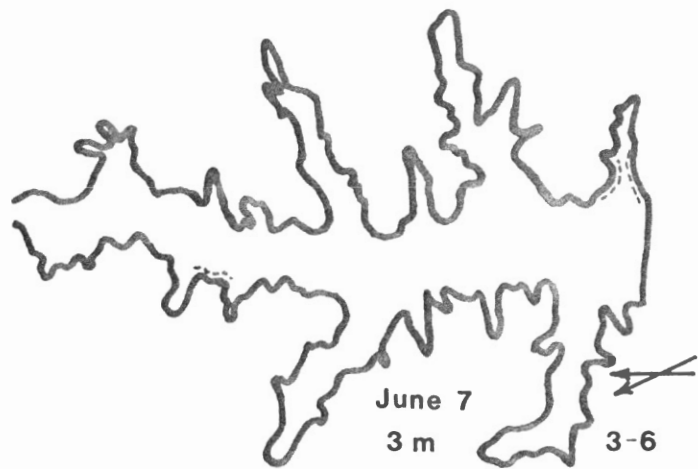

\* = No shoreline transects were sampled

Figure 11 (Continued)

Horizontal Distribution at 0 m(April 24 to May 31)

From Figure 11, it is apparent that the density of larval shad was greater in the northern and western areas of the lake on May 9 and May 23. The density of shad in areas 2, 3, and 4 was 2.3 times greater than that of other areas on May 9. The density of shad in areas 1, 2, 3, and 4 was 1.5 times greater than that of areas 5 and 6 on May 23 (Table IV). Differences in shad density between areas 1, 2, 3, and 4 and areas 5, 6, and 7 were not significant on May 23. On April 27 and May 31 the density of shad was not significantly different among areas (Figure 11).

These differences in the density of shad among areas roughly reflected the wind conditions present during the 48-hour period prior to sampling. Winds preceding sampling were generally from the south-east on May 9 and May 23. The density of shad was greatest in the northern and western areas of the lake on these dates. Winds preceding sampling on May 31 (when no significant differences in the density were found) were extremely variable. The relationship between the distribution of shad and wind was not apparent on April 27. The absence of any significant differences in the density of shad among areas may be due to small sample size, as the mean catch for that date was only 4.7 shad/10<sup>4</sup> liter.

An explanation of the offshore vs. shoreline comparisons in Table IV is necessary. For example, on May 9, the average density of shad in all offshore transects was 2.3 times greater than that of shoreline transects. Reference to Figure 11 shows that shoreline hauls on May 9 were made in areas of the lake in which the density of shad

was least. If the density of shad in areas 1, 5, 6, and 7 (the areas in which the density of shad was least) is compared with density of shad at the shoreline (Table IV), no significant differences are found. A similar situation is found in the data of May 23. The shoreline hauls on May 23 were made in areas in which the density of shad was greatest. If shoreline transects are compared with all offshore transects, the density of shad at the shoreline is found to be 1.5 times greater than that offshore (Table IV). If, however, the shoreline transects are compared with offshore transects in areas 1, 2, 3, and 4 (the areas in which the density was greatest) no significant difference in density of shad is evident (Table IV).

The main part of the lake (area 7) was found to be different in terms of density of shad from tributary arms (areas 1, 2, 3, 4, 5, and 6) only on May 23. At this time, the density of shad in tributary arms was 9.6 times greater than that of the main part of the lake.

#### Horizontal Distribution at 3 m

(June 7 to June 28)

Figure 11 indicates that significant differences in the density of shad among areas did occur between June 7 and June 28. These differences were on the order of three to ten fold (Table IV). The patterns of horizontal distribution on June 13 and June 22 were quite similar, with the density of shad in the eastern half of the lake about 3.5 times greater than that of the western half.

Patterns of horizontal distribution during June changed from week to week. On June 7 there were no differences in the density of shad among areas. On June 28, the pattern of horizontal distribution was

radically different from those of June 13 and June 22 (Figure 11) with the density of shad being greatest in both northeastern and southwestern areas of the lake. These changes in distribution during June were not related to wind conditions present during the 48-hour period prior to sampling (Figure 11). For example, wind conditions preceding sampling on June 22 and June 28 were similar, but the patterns of horizontal distribution were quite different. Patterns of horizontal distribution during June at 3 m were not stable, nor was this instability attributable to wind conditions preceding each night of sampling.

The results summarized in Table IV seem to indicate that offshore vs. shoreline differences in the density of shad occurred during June. These differences, however, are artifacts resulting from the way in which the lake was sampled. For example, during June, most of the offshore hauls were made at 3 m, while the shoreline hauls were still being made at 0 m. Therefore, any differences between offshore and shoreline transects are probably due to differences in the density of shad at 3 m as compared to 0 m. If this contention is true, then it would be expected that on June 7, when offshore hauls were being made at 3 m, the density of shad onshore would be less than that offshore. Instead, there was no significant difference in the density of shad between offshore and onshore transects. The reason for this observation probably lies in the fact that, on June 7, the catch from the shoreline in area 4 was extremely large (158 shad/10<sup>4</sup> liters). A catch that large was extremely unusual during this study. There was no evidence that the density of shad near the shoreline was different from that of offshore areas during June.

The density of shad in the main part of the lake (area 7) was dif-

ferent from that of tributary arms on June 22 and June 28. Density of shad in the main part of the lake was 2.3 times greater than that of tributary arms on June 22. These changes which have been described above reflect the erratic nature of the horizontal distribution of shad larvae at 3 m during June.

#### Variation of Mean Length

Table V summarizes the results of comparisons of mean length of shad between different depths. Generally, mean length was the same between depths. There was a tendency during May and early June for the mean length of shad at 0 m to be less than that at 3 m, but this difference was usually not significant.

Results of the analysis of variance of length of shad among areas are given in Appendix D. Significant differences among areas were observed on all dates except June 8 and 13. Significant differences among transects within areas were observed on May 23, June 7, and June 13. Table VI summarizes the results of comparisons of mean length of shad between areas. Although not always statistically significant, there was a tendency for the smaller shad to be located in area 1. There was a less pronounced tendency for the larger fish to be located in area 7. These tendencies were apparent both at 0 m and 3 m.

The increase in mean length of the entire population during the period of the study is illustrated in Figure 12. A striking feature is the decrease in mean length of the population on May 31. One would expect that the mean length of the population would increase gradually throughout the spawning season. Possible explanations for this phenomenon will be presented later.

TABLE V  
RESULTS OF COMPARISONS OF MEAN LENGTH (MM) OF LARVAL  
SHAD AMONG DIFFERENT DEPTHS

Date	Area	Depth (m)				Significance level
		0	3	5	7	
May 9	1	6.9	<8.3	-	-	0.001
	2	9.7	>8.6	-	-	0.050
	7	9.4	8.3	-	-	
May 23	1	9.7	11.0	-	-	
	2	14.3	>11.3	-	-	0.020
	7	16.4	-	15.4	16.1	
May 31	2	7.8	< 9.6	-	-	0.010
	4	8.4	9.9	-	-	
	5	8.1	<10.5	-	-	0.010
	6	7.4	8.2	11.2	-	0.001
	7	8.7	-	11.2	>8.9	0.020
June 7	2	11.6	12.3	-	-	
	4	11.7	11.6	-	-	
	5	10.2	11.0	-	-	
	6	10.5	10.5	11.2	-	
	7	-	11.8	11.8	-	
June 13	1	-	10.1	11.0	-	
	2	13.8	12.8	-	-	
	4	13.4	14.1	-	-	
	6	13.0	12.9	-	-	
	7	-	12.6	12.6	11.0	
June 22	1	-	12.1	13.1	-	
	4	14.8	14.9	-	-	
	6	-	14.0	12.5	-	
	7	-	16.3	15.1	16.3	
June 28	4	19.7	15.5	-	-	
	6	-	16.5	16.6	-	
	7	-	17.8	16.6	18.2	

Absence of a "greater than" (>) or "less than" (<) symbol between means indicates that the difference between those two means is not significant ( $P>0.05$ ).

TABLE VI  
RESULTS OF COMPARISON OF MEAN LENGTH (MM) OF  
LARVAL SHAD AMONG AREAS

Date		Mean Length of Shad in Each Area							
April 27	Area	<u>4</u>	<u>2</u>	<u>5</u>	<u>3</u>	<u>8</u>	<u>7</u>	<u>1</u>	<u>6</u>
	m.l.	5.1	5.2	5.3	5.4	5.7	5.7	5.9	6.2
May 9	Area	<u>1</u>	<u>4</u>	<u>5</u>	<u>3</u>	<u>6</u>	<u>7</u>	<u>8</u>	<u>2</u>
	m.l.	6.9	7.5	7.6	7.8	9.2	9.4	9.4	9.7
May 23	Area	<u>1</u>	<u>8</u>	<u>4</u>	<u>5</u>	<u>3</u>	<u>2</u>	<u>6</u>	<u>7</u>
	m.l.	9.7	10.4	14.1	14.2	14.3	14.3	14.5	16.7
May 31	Area	<u>8</u>	<u>6</u>	<u>2</u>	<u>5</u>	<u>3</u>	<u>4</u>	<u>7</u>	
	m.l.	6.8	7.4	7.8	8.1	8.4	8.4	8.8	
June 7	Area	<u>1</u>	<u>6</u>	<u>8</u>	<u>5</u>	<u>4</u>	<u>7</u>	<u>2</u>	
	m.l.	10.1	10.5	10.9	11.0	11.6	11.8	12.3	
June 13	Area	<u>1</u>	<u>7</u>	<u>2</u>	<u>6</u>	<u>5</u>	<u>4</u>		
	m.l.	10.1	12.6	12.8	12.9	13.7	14.1		
June 22	Area	<u>8</u>	<u>1</u>	<u>6</u>	<u>5</u>	<u>4</u>	<u>2</u>	<u>7</u>	
	m.l.	11.9	12.1	14.0	14.4	14.9	15.6	16.3	
June 28	Area	<u>1</u>	<u>2</u>	<u>4</u>	<u>6</u>	<u>5</u>	<u>7</u>		
	m.l.	13.1	14.2	15.5	16.5	16.6	17.8		

Mean lengths from each area are ranked from smallest to largest. Solid lines indicate groups of areas which are alike with respect to mean length. Adjacent means which are not connected by a solid line are significantly different at the 0.05 level. m.l. = mean length (mm).

Figure 12. Mean length (mm) of gizzard shad on each  
sampling date.



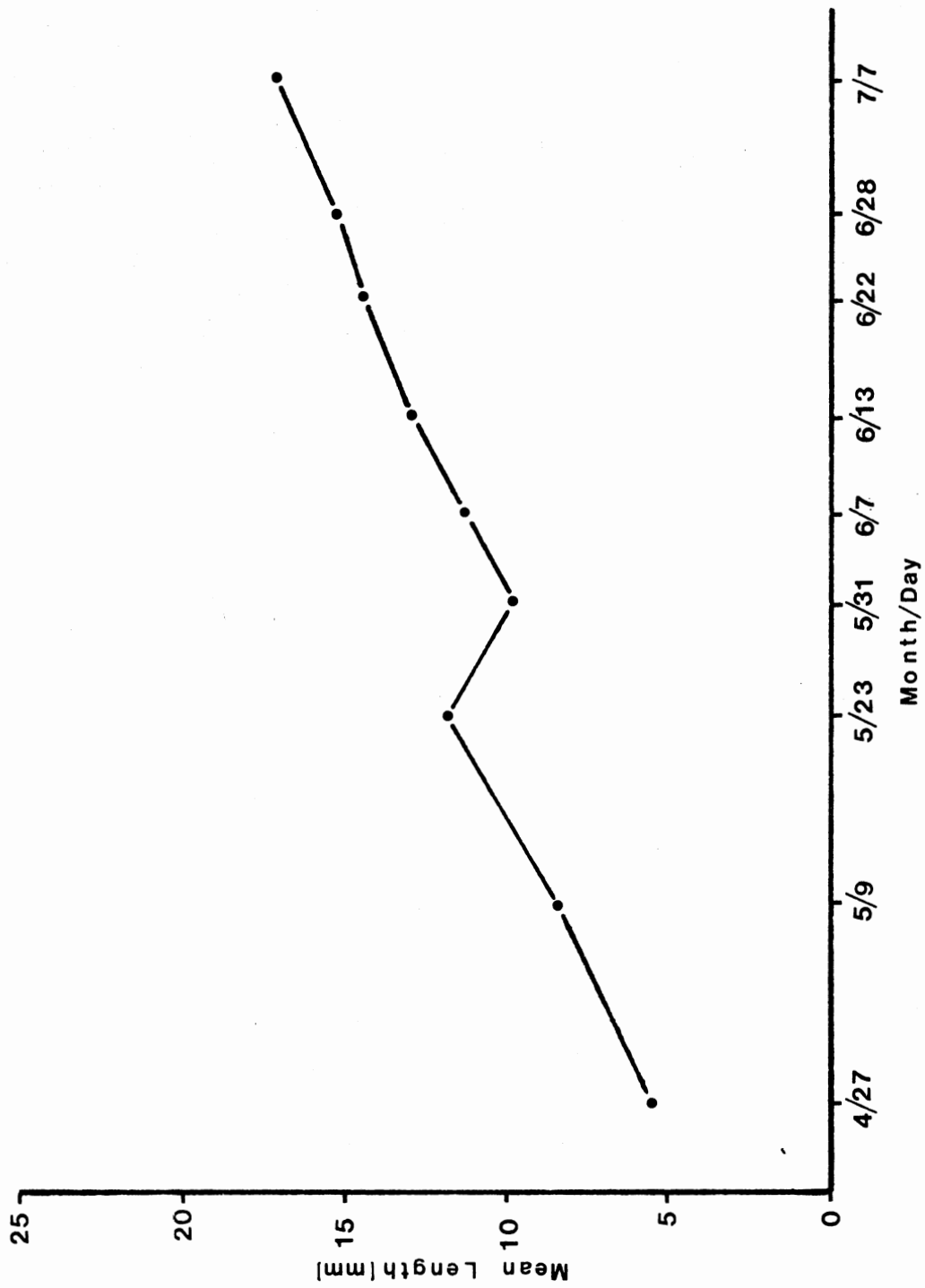

## CHAPTER IV

### DISCUSSION

#### Gear Selectivity

The pro-larval states of shad were not vulnerable to the sampling gear. Such gear selectivity is in all likelihood due to where the pro-larval shad are living rather than to avoidance. If pro-larval shad were living in the water column they would have been vulnerable to the sampling gear. The pro-larvae are probably living on the bottom of the lake where they are not vulnerable to open-water sampling gear.

#### Normalization of Catch Data

The transformation  $\log_e (\text{catch}/10^4 \text{ liter} + 1)$  did not always normalize the data. Failure to meet the assumption of normality generally results in the investigator declaring more significant differences than actually exist. However, I contend that this problem is not present in the catch data for the following reasons: 1) on May 9 and June 28, when the correlation between the mean and standard deviation of the transformed data was high, the observed significance level was only 0.10. This fact would indicate that, on those dates, the transformed data deviated only slightly from normality, 2) Scheffe's test was used to test for differences which were indicated by the data. This test is very conservative in that it requires quite large differences (3 to 4 times larger than the standard error) in order to declare significance. There is good reason to believe, therefore,

that the differences in the density of shad between areas which were declared significant are, in fact, significant at the specified level.

#### Vertical Distribution

Very early in the spawning season, larval shad lived at or near the surface. After this time they were about seven times more abundant at greater depths (3 to 5 m). Netsch et al. (1971) observed a similar pattern in Beaver Reservoir. The changes in the depths at which the density of shad was greatest could not be related to any of the environmental parameters measured in this study. I must point out, however, the Secchi disc data were probably not representative of deep areas of the lake. Those data should have been taken in area 7, or in areas 1, 7, and 6 and then averaged.

Nonetheless, this information is of practical use with regards to the stratification of sampling efforts subsequent to this study. When sampling Lake Carl Blackwell to determine the abundance of larval gizzard shad, the sampling effort should be concentrated at the surface during the first week or so after the larvae first appear. After this time sampling should be concentrated at 3 to 5 m. The implied assumption here is that the pattern of vertical distribution will be the same from year to year.

#### Horizontal Distribution

While horizontal distribution at 0 m roughly reflected wind conditions, distribution at 3 m changed erratically. These erratic changes could not be related to wind conditions. This information is of use in designing subsequent sampling efforts.

In order to efficiently stratify a sampling effort to determine larval abundance, one of the following two conditions must be met: 1) the larvae are concentrated in the same areas(s) week after week, or 2) if the area in which the larval concentration is greatest changes from week to week, then these changes must be predictable. In Lake Carl Blackwell, the pattern of horizontal distribution at 0 m did not remain stable, but it did change roughly in relation to wind conditions. A relatively minor portion of the population was located at 0 m, however. At the depth at which the bulk of the population was located (3 m), horizontal distribution was not only unstable, but it did not change in a way that was predictable from a knowledge of wind conditions. These findings would seem to preclude the possibility of stratified sampling to determine absolute abundance of larval gizzard shad in Lake Carl Blackwell. The fact that statistically significant differences in the density of shad occurred between different areas of the lake would also preclude completely random sampling as an appropriate alternative.

A less quantitative way of measuring the abundance of gizzard shad in Lake Carl Blackwell may be possible, however. Note that in Figure 12, when significant differences in the density of shad did occur between areas, the northern areas (areas 1, 2, and 3) tended to be included in the group of areas in which the density of shad was greatest. Intensive sampling of these northern areas each year could probably give precise estimates of relative abundance from year to year. In such a sampling design, the results of this study indicate that there would be no need to stratify the sampling effort into "shoreline" and "offshore" strata.

### Variation of Mean Length

It is possible to make some inferences regarding the age distribution of larval shad in different parts of the lake by making the assumption that length is a rough measure of the age of a larval fish. By making this assumption and referring to Table V, I conclude that there is no difference in the average age of individuals inhabiting different depths. The results summarized in Table VI would indicate that the youngest fish tend to be located in area 1 while the oldest fish tend to be located in area 7. It is difficult to offer a satisfactory biological explanation for this phenomenon. Area 1 may be a preferred spawning area, but given the fact that the part of the lake has a steeper shoreline than any other part of the lake (recall that gizzard shad spawn in shallow water) this would seem unlikely. It is also difficult to imagine how wind generated currents could affect small larvae differently than larger larvae when there is no difference in the depths at which they live. There is also the possibility that mortality may be higher in area 1 and lower in area 7, but there exists no further information with which to examine this hypothesis.

Regardless of the cause, the fact remains that younger larvae tend to concentrate in area 1 and older larvae in area 7. This finding will have bearing on future sampling efforts if those efforts endeavor to measure larval mortality. If the lake is to be sampled with the intention of measuring mortality, then it must be kept in mind that there may be bias in the estimates depending upon the area of the lake sampled. In this regard it would probably be wise to choose area 1 as the area in which to take samples from which mortality rates are to

be calculated. In this area, the investigator is assured of relatively high larval density, and although the sample may not represent the true age structure of the population, the bias will be consistent and of known direction. In making this recommendation, it is assumed that the occurrence of younger larvae in area 1 is a phenomenon which is consistent annually. This assumption cannot be verified at the present time.

The experimental design used to analyze the variability of length of larval shad requires that the data show a normal distribution. There is little reason, however, to believe that the length frequency distribution of larval shad from Lake Carl Blackwell approximates a normal distribution. Assuming that the length of a larval fish is a rough measure of its age, one would expect that, early in the spawning season, there would be more small (young) individuals than larger (older) individuals. As the spawning season progressed one would expect to find more older fish than younger fish. Therefore, one would not expect the length frequency distribution of larval shad to approach normality except perhaps during the middle of the spawning season

My conclusion regarding the mean length of shad present in different areas of the lake is valid in spite of the high likelihood that the lengths of shad do not follow a normal distribution. My reasoning is as follows. The greatest danger in not meeting the assumption of normality probably occurs when the value of  $F$  is only slightly significant. Referring to Appendix D, it can be seen that differences among areas were usually significant at the 0.025 level or less. Even if there are, in fact, no significant differences among areas, there remains the fairly consistent pattern that the younger larvae tend to

be located in area 1. This finding alone is important enough to warrant consideration in designing a sampling program to measure larval mortality rates.

It is difficult to offer a biological explanation for the fact that there were sometimes differences in the mean length of shad between transects within areas. One explanation would be that larval shad can form schools of individuals of similar size. I do not believe that larval gizzard shad possess this ability. Another explanation could be that larvae of similar sizes can be found together by virtue of the fact that they were spawned in the same vicinity at the same time. This explanation is plausible. The fact that these differences among transects occurred on only three of eight sampling dates would indicate to me, however, that they are of relatively little importance at this stage in the study of year-class formation of gizzard shad.

A possible explanation for the decrease in the mean length of the population is that an increase in spawning activity several days prior to May 31 resulted in a large number of smaller larvae being added to the population. The data summarized in Figure 8, however, do not substantiate this contention. If this contention were true one would expect a peak of larval abundance on May 31. The small sample size from which the data points for May in Figure 8 are derived probably renders the shape of the curve during May unreliable. The only other possible explanations for the decrease in mean length on May 31 would be catastrophic mortality of older larvae, or avoidance of the net by older larvae on May 31 only. Neither of these explanations would seem as likely as the first.

### Recommendations for Future Sampling Efforts

The results of this study have provided information from which future sampling schemes can be designed. This information in the form of a summary of recommendations for future sampling efforts is given below.

- 1) Stratified random sampling of the population of larval gizzard shad is not feasible in Lake Carl Blackwell.
- 2) Future sampling efforts should be aimed at obtaining precise estimates of relative abundance through intensive sampling of the northern areas (notably areas 1 and 2) of the lake.
- 3) The sampling effort should be concentrated near the surface during the first week or ten days after the larvae first appear. After this time the sampling efforts should be about seven times more intense at 3 m than at 0 m. There is relatively little water at 5 m that is amenable to sampling in areas 1 and 2. The 5 m depth should be sampled as practicality allows. The reader should bear in mind that there is nothing sacred about the actual depths of 0, 3, and 5 m.
- 4) Sampling efforts which are designed to measure larval mortality should be conducted in area 1.



#### REFERENCES CITED

- Anderson, R. O. 1974. Influence of mortality rates on production and potential sustained harvest of largemouth bass populations. Pages 18-28 in J. L. Funk, ed. Symposium on overharvest and management of largemouth bass in small impoundments. Spec. Publ. No. 3, N. C. Div., Am. Fish. Soc.
- Arron, W. and S. Collard. 1969. A study on the influence of net speed on catch. *Limnol. Oceanog.* 14:242-249.
- Baker, C. D. and E. H. Schmitz. 1971. Food habits of adult gizzard shad and threadfin shad in two Ozark reservoirs. Pages 3-12 in G. E. Hall, ed. Reservoir fisheries limnology. Spec. Publ. No. 8, Am. Fish. Soc.
- Barsokov, V. V. 1961. Relation of the growth rate of fish to the number of individuals in their year-classes. *Byulleten Instituta Biologi Vodokhranilishch.* 11:37-41. English Translation IPSI Cat. No. 5090.
- Bennett, G. W. 1974. Ecology and management of largemouth bass, *Micropterus salmoides* (Lac.). Pages 10-17 in J. L. Funk, ed. Symposium on overharvest and management of largemouth bass in small impoundments. Spec. Publ. No. 3, N. C. Div., Am. Fish. Soc.
- Bodola, A. 1966. Life history of the gizzard shad, Dorosoma cepedianum (Le Seuer), in Western Lake Erie. U.S. Fish. Wild. Serv., Fish. Bull. 65:391-425.

- Braum, E. 1967. The survival of fish larvae with reference to their feeding behavior and the food supply. Pages 113-131 in S. D. Gerking, ed. The biological basis of freshwater fish production. John Wiley & Sons, Inc., New York. 495 pp.
- Bross, M. C. 1967. Fish samples and year-class strength (1965-1967) from Canton Reservoir, Oklahoma. Proc. Okla. Acad. Sci. 48:194-199.
- Bulkley, R. V. 1970. Feeding interaction between adult bass and their offspring. Trans. Am. Fish. Soc. 99:732-738.
- Busch, W. N., R. L. School, and W. L. Hartman. 1975. Environmental factors affecting strength of walleye (Stizostedion vitreum vitreum) year-classes in western Lake Erie, 1960-1970. J. Fish Res. Board Can. 32:1733-1743.
- Chevalier, J. R. 1973. Cannibalism as a factor in first year survival of walleye in Oneida Lake. Trans. Am. Fish. Soc. 102:739-744.
- Christie, W. J. and H. A. Regier. 1973. Temperature as a major factor influencing reproductive success of fish--two examples. Rapp. Reun. Cons. Int. L'Explor. Mer. 164:57-60.
- Clady, M. D. 1975. Early survival and recruitment of smallmouth bass in northern Michigan. J. Wildl. Manage. 39:194-200.
- Clady, M. D. 1976b. Influence of temperature and wind on the survival of early stages of yellow perch, Perca flavescens. J. Fish Res. Board Can. 33:1887-1893.
- Clady, M. D. 1976b. Distribution and abundance of larval ciscoes, Coregonus artedii, and burbot, Lota lota, in Oneida Lake. J. Internat. Assoc. Great Lakes Res. 2:234-247.
- Clady, M. D. and B. Hutchinson. 1975. Effect of high winds on eggs

- of yellow perch, Perca flavescens, in Oneida Lake, New York. Trans. Am. Fish. Soc. 104:524-525.
- Cramer, J. D. and G. R. Marzolf. 1970. Selective predation on zooplankton by gizzard shad. Trans. Am. Fish. Soc. 93:320-332.
- Darwin, C. 1878. The origin of species by means of natural selection. D. Appleton and Co., New York. 458 pp.
- Erickson, K. 1977. Personal communication. Okla. Dep. Wildl. Conserv.
- Eshenroder, R. L. 1977. Effects of intensified fishing species changes and spring water temperatures on yellow perch (Perca flavescens) in Saginaw Bay. J. Fish. Res. Board Can. 34:1830-1838.
- Faber, D. 1968. A net for catching limnetic fry. Trans. Am. Fish. Soc. 97:61-63.
- Faber, D. 1970. Ecological observations on newly hatched lake whitefish in South Bay, Lake Huron. Pages 481-500 in C. C. Lindsey and C. S. Woods, eds. Biology of coregonid fishes. Univ. Manitoba Press.
- Forney, J. L. 1971. Development of dominant year classes in a yellow perch population. Trans. Am. Fish. Soc. 100:739-749.
- Forney, J. L. 1973. Interaction between yellow perch abundance, walleye predation, and survival of alternate prey in Oneida Lake, New York. Trans. Am. Fish. Soc. 103:15-24.
- Forney, J. L. 1976. Year-class formation in the walleye (Stizostedion vitreum vitreum) population of Oneida Lake, New York, 1966-73. J. Fish. Res. Board Can. 33:783-792.
- Forney, J. L. 1977. Evidence of inter- and intraspecific competition

- as factors regulating walleye (Stizostedion vitreum vitreum) biomass in Oneida Lake, New York. J. Fish. Res. Board Can. 34: 1812-1820.
- Franklin, D. R. and L. L. Smith. 1963. Early life history of the northern pike, Esox lucius L., with special reference to the factors influencing the numerical strength of year classes. Trans. Am. Fish. Soc. 92:91-110.
- Gulland, J. A. 1965. Survival of the youngest stages of fish and its relation to year-class strength. Spec. Publ. ICNAF 6:363-371.
- Gulland, J. A. 1966. Manual of sampling and statistical methods for fisheries biology. Pt. 1: Sampling Methods. FAO Manual No. 3. 100 pp.
- Grant, P. R. 1972. Interspecific competition among rodents. Ann. Rev. Ecol. Syst. 3:79-106.
- Hjort, J. 1914. Fluctuations in the great fishes of northern Europe in the light of biological research. Rap. Proc. Ver. Reun. Cons. Perm. Intern. Explor. Mer. 20:1-228.
- Houde, E. D. 1969. Distribution of larval walleyes and yellow perch in a bay of Oneida Lake and its relation to water currents and zooplankton. New York Fish Game J. 16:184-204.
- Houser, A. and J. E. Dunn. 1967. Estimating the size of the thread-fin shad population in Bull Shoals Reservoir from midwater trawl catches. Trans. Am. Fish. Soc. 96:176-184.
- Houser, A. and N. F. Netsch. 1971. Estimates of young-of-the-year shad production in Beaver Reservoir. Pages 359-370 in G. E. Hall, ed. Reservoir fisheries and limnology. Spec. Publ. No. 8, Am. Fish. Soc.

- Jenkins, R. M. 1957. The effect of gizzard shad on the fish population of a small Oklahoma lake. *Trans. Am. Fish. Soc.* 85:58-74.
- Kilambi, R. V. and R. E. Baglin. 1969. Fecundity of the gizzard shad, Dorosoma cepedianum (Le Sueur) in Beaver and Bull Shoals Reservoirs. *Am. Mid. Nat.* 82:444-449.
- Kipling, C. 1976. Year class strengths of perch and pike in Windermere. *Rep. Freshwater Biol. Assoc.* 44:68-75.
- Kipling, C. and W. E. Frost. 1970. A study of the mortality, population numbers, year-class strength and food consumption of pike, Esox lucius L. in Windermere from 1944 to 1962. *J. An. Ecol.* 39:115-155.
- Koonce, J. F., T. B. Bagenal, R. F. Carline, K. E. F. Hokanson, and M. Nagiec. 1977. Factors influencing year-class strength in percids: a summary and a model of temperature effects. *J. Fish. Res. Board Can.* 34:1900-1909.
- Kramer, R. H. 1969. A preliminary bibliography on extent and causes of early mortality in freshwater fish (diadromous fishes excluded). *FAO Fish. Circ. No. 307.* 20 pp.
- Kramer, R. H. and L. L. Smith. 1962. Formation of year classes in largemouth bass. *Trans. Am. Fish. Soc.* 91:29-41.
- Kutkuhn, J. H. 1957. Utilization of plankton by juvenile gizzard shad in a shallow prairie lake. *Trans. Am. Fish. Soc.* 87:80-103.
- LeCren, E. D., C. Kipling, and J. C. McCormack. 1977. A study of the numbers, biomass and year-class strengths of perch (P. fluviatilis). *J. An. Ecol.* 46:281-307.
- Lipson, A. J. and R. L. Moran. 1974. Manual for identification of early developmental stages of fishes of the Potomac River

- estuary. Environmental Technology Center, Martin Marietta Corp.  
282 pp.
- MacArthur, R. 1972. Geographical ecology. Harper and Row, New York.  
321 pp.
- Mahnken, C. V. W. and J. W. Jossi. 1967. Flume experiments on the hydrodynamics of plankton nets. J. Cons. Perm. Int. Explor. Mer. 31:38-45.
- May, R. C. 1974. Larval mortality in marine fishes and the critical period concept. Pages 3-19 in J. H. S. Blaxter, ed. The early life history of fish.
- Mayhew, J. 1976. Abundance, distribution, mortality, and production of 0-age fish. Ann. Performance Rep., Proj. No. F-88-R-3, July 1, 1975-June 30, 1976, Iowa Conserv. Comm. pp. 90-108.
- Mauck, P. E. 1970. Food habits, length-weight relationships, age and growth, gonadal-body weight relationships and conditions of carp, Cyprinus carpio (L) in Lake Carl Blackwell, Oklahoma. M.S. Thesis, Okla. State Univ., Stillwater. 73 pp.
- Messinger, G. C. 1970. Observations on the striped bass, Morone saxatilis, in Keystone Reservoir, Oklahoma. Proc. Southeast. Assoc. Game Fish Comm. 24:405-414.
- Miller, R. R. 1960. Systematics and biology of the gizzard shad (Dorosoma cepedianum) and related fishes. U.S. Fish Wildl. Serv. Bull. 60:371-392.
- Momot, W. T., J. Erikson, and F. Stevenson. 1977. Maintenance of a walleye, Stizostedion vitreum vitreum, fishery in a eutrophic reservoir. J. Fish. Res. Board Can. 34:1725-1733.
- Murphy, G. I. and R. I. Clutter. 1972. Sampling anchovy larvae with

- a plankton purse seine. Fish. Bull. 70:789-798.
- Nelson, W. R. and C. H. Walburg. 1977. Population dynamics of yellow perch (Perca flavescens), saugar (Stizostedion canadense), and walleye (S. vitreum vitreum) in four main stem Missouri River impoundments. J. Fish. Res. Board Can. 34:1748-1763.
- Netsch, N. F., G. M. Kersh, A. Houser, and R. V. Kilambi. 1971. Distribution of young gizzard and threadfin shad in Beaver Reservoir. Pages 85-94 in G. E. Hall, ed. Reservoir fisheries and limnology. Spec. Publ. No. 8, Am. Fish. Soc.
- Nikolsky, G., A. Bogdanov, and Y. Lapin. 1973. On fecundity as a regulating mechanism in fish population dynamics. Rapp. Reun. Cons. Int. L'Explor. Mer. 164:174-177.
- Noble, R. L. 1968. Mortality rates of pelagic fry of the yellow perch, Perca flavescens (Mitchell), in Onedia Lake, New York, and an analysis of the sampling problem. Ph.D. Thesis, Cornell Univ., Ithaca, New York. 103 pp.
- Olmstead, L. L. and R. V. Kilambi. 1971. Interrelationships between environmental factors and feeding biology of white bass of Beaver Reservoir, Arkansas. Pages 397-409 in E. G. Hall, ed. Reservoir fisheries and limnology. Spec. Publ. 8, Am. Fish. Soc.
- Pflieger, W. L. 1975. Reproduction and survival of the smallmouth bass in Courtios Creek. Pages 231-239 in H. Clepper, ed. Black bass biology and management. Sport Fishing Inst., Washington, D.C.
- Pflieger, W. L. 1976. The fishes of Missouri. Missouri Dep. Conserv.
- Ricker, W. E. 1975. Computation and interpretation of biological statistics of fish populations. Fish. Res. Board Can. Bull.

- No. 191. 382 pp.
- Schoener, T. W. 1974. Resource partitioning in ecological communities. *Science* 185:27-38.
- Smith, L. L. 1977. Walleye (Stizostedion vitreum vitreum) and yellow perch (Perca flavescens) populations and fisheries of the Red Lakes, Minnesota, 1930-75. *J. Fish. Res. Board Can.* 1774-1783.
- Snedecor, G. W. and W. G. Cochran. 1971. *Statistical methods*. The Iowa State Univ. Press, Ames. 593 pp.
- Steele, R. G. D. and J. H. Torrie. 1960. *Principles and procedures of statistics with special reference to the biological sciences*. McGraw-Hill, New York. 481 pp.
- Stevens, D. E. 1977. Striped bass (Morone saxatilis) year class strengths in relation to river flow in the Sacramento-San Joaquin estuary, California. *Trans. Am. Fish. Soc.* 106:34-42.
- Summerfelt, R. C. 1975. Relationship between weather and year-class strength of largemouth bass. Pages 116-174 in H. Clepper, ed. *Black bass biology and management*. Sport Fishing Inst., Washington, D.C.
- Taber, C. A. 1969. The distribution and identification of larval fishes in the Buncombe Creek arm of Lake Texoma with observations on spawning habits and relative abundance. Ph.D. Thesis, Okla. Univ., Norman. 120 pp.
- Toetz, D. W. 1966. The change from endogenous to exogenous sources of energy in bluegill sunfish larvae. *Invest. Indiana Lakes Streams* 7:115-146.
- Turner, P. R. and R. C. Summerfelt. 1970. Food habits of adult flathead catfish, Pylodictus olivorous, in an Oklahoma reservoir.



- Proc. Southeast. Assoc. Game Fish Comm. 22:387-401.
- Turner, J. L. and H. K. Chadwick. 1972. Distribution and abundance of young-of-the-year striped bass, Morone saxatilis, in relation to river flow in the Sacramento-San Joaquin estuary. Trans. Am. Fish. Soc. 101:442-451.
- Walburg, C. H. 1972. Some factors associated with fluctuations in year-class strength of sauger, Lewis and Clark Lake, South Dakota. Trans. Am. Fish. Soc. 101:311-315.
- Wickliff, E. L. 1933. Are newly impounded waters in Ohio suitable for fish life? Trans. Am. Fish. Soc. 62:275-277.
- Wiens, J. A. 1977. On competition and variable environments. Am. Sci. 65:590-597.
- Willemsen, J. 1977. Population dynamics of percids in Lake Ijssel and some smaller lakes in the Netherlands. J. Fish. Res. Board Can. 34:1839-1850.
- Zeller, H. D. and H. N. Wyatt. 1967. Selective shad removal in southern reservoirs. Reservoir Fish. Resource Symposium, Am. Fish. Soc. pp. 405-414.
- Zemshaia, K. A. 1961. On the effect of feeding conditions and abundance of spawners on the amount of progeny produced by Caspian bream. Fish. Res. Board Can., Translation Series No. 438. 10 pp.
- Zweiacker, P. L. and R. C. Summerfelt. 1973. Seasonal variation in food and diel periodicity in feeding of northern largemouth bass, Micropterus salmoides, in an Oklahoma reservoir. Proc. 27th Ann. Conf., Southeast. Assoc. Game Fish Comm. pp. 579-590.

**APPENDIXES**

APPENDIX A

METHOD USED FOR CALCULATING THE STANDARD ERROR  
FOR THE UNBALANCED HIERARCHICAL AOV WHICH  
WAS USED TO ANALYZE THE VARIABILITY  
OF THE LENGTH OF SHAD AMONG  
AREAS

The model used was:

$$\bar{Y}_{ijk} = \mu + \alpha_i + T_{j(i)} + F_{k(ij)}$$

where  $\alpha$  is a fixed area effect,

$T$  is a random transect effect,

$F$  is a random fish effect,

$i$  = area; 1, 2, 3, ..., 8

$j$  = transect; 2 or 3

$k$  = fish; 2 to 50

$$\text{So that } \bar{Y}_{i..} = \frac{1}{n_{i.}} \sum_{j=1}^{2 \text{ or } 3} \sum_{k=1}^{n_{ij}} \left( \mu + \alpha + T_{j(i)} + F_{k(ji)} \right)$$

eg. where  $j = 3$ ,

$$\begin{aligned} \bar{Y}_{i..} &= \mu + \alpha_i + \frac{1}{n_{i.}} \left( n_{i_1} \cdot T_{2_i} + n_{i_2} \cdot T_{2_i} + n_{i_3} \cdot T_{3_i} \right) \\ &\quad + \frac{1}{n_{i.}} \sum_{j=1}^3 \sum_{k=1}^{n_{ij}} F_{k(ji)} \end{aligned}$$

$$\text{Variance of } \bar{Y}_{i..} = 0 + 0 \left( \frac{n_{i_1}}{n_{i.}} \right)^2 \theta_T^2 + \left( \frac{n_{i_2}}{n_{i.}} \right)^2 \theta_T^2 + \left( \frac{n_{i_3}}{n_{i.}} \right)^2 \theta_T^2 +$$

$$\left( \frac{1}{n_{i.}} \right)^2 n_{i.} \theta_F^2 = \left( \frac{n_{i_1}^2 + n_{i_2}^2 + n_{i_3}^2}{n_{i.}^2} \right) \theta_F^2$$

$$+ \left( \frac{1}{n_{i.}} \right) \theta_F^2$$

This parameter is estimated by

$$\left( \frac{n_{i_2}^2 + n_{i_2}^2 + n_{i_3}^2}{n_{i.}^2} \right) s_T^2 + \left( \frac{1}{n_{i.}} \right) s_F^2$$

Therefore the standard error of the difference between the mean length of shad in any two areas  $i$  and  $a$  is

$$\sqrt{\frac{\text{Variance } (\bar{Y}_{i..})}{n_{i.}} + \frac{\text{Variance } (\bar{Y}_{a..})}{n_{a.}}}$$

APPENDIX B

VERTICAL TEMPERATURE PROFILE ( $^{\circ}$ C) IN LAKE CARL  
BLACKWELL, DURING THE SPRING OF 1977.

TEMPERATURE WAS MEASURED NEAR

THE DAM (Figure 1)

<u>Depth (m)</u>	<u>Date (Month/Day)</u>										
	<u>4/5</u>	<u>4/17</u>	<u>4/27</u>	<u>5/9</u>	<u>5/23</u>	<u>5/31</u>	<u>6/7</u>	<u>6/13</u>	<u>6/22</u>	<u>6/28</u>	<u>7/6</u>
0	14.0	18.0	21.0	23.0	22.0	23.5	25.5	25.8	28.0	29.0	27.7
1	14.0	18.0	21.8	23.0	22.0	23.5	25.5	25.8	27.9	29.0	27.8
2	14.0	18.0	21.5	22.9	22.0	23.5	25.3	25.8	27.9	28.4	27.8
3	13.9	17.8	21.4	22.5	22.0	23.5	25.2	25.5	27.2	27.9	27.8
4	13.9	17.5	21.4	22.0	21.3	23.4	24.8	25.3	26.5	27.5	27.8
5	13.9	17.2	21.4	21.3	21.1	23.2	24.5	25.1	25.9	26.0	27.7
6	13.8	17.2	20.9	21.0	21.0	23.2	23.3	24.7	25.0	25.3	27.7
7	13.8	17.0	20.7	21.0	20.2	22.7	22.7	24.3	24.4	24.8	27.0
8	13.7	16.6	20.6	20.9	19.9	20.9	22.1	23.5	23.7	24.0	27.0
9	13.7	16.2	20.5	19.9	19.9	20.3	21.5	21.6	21.9	22.9	26.3
10	13.7	16.0	19.9	18.3	19.9	20.0	20.7	21.0	21.5	22.7	25.0
11	13.7	16.0	19.4	17.8	19.6	20.0	20.1	20.2	20.7	21.6	23.0
12				19.6	19.5	19.8	19.9	19.9	20.0	21.0	22.6

APPENDIX C

ANALYSES OF VARIANCE (AOV) OF THE CATCH  
DATA ON EACH DATE



Given for each area on each date are the number of samples ( $n$ ) and the mean catch (number/ $10^4$  liter) and variance. The mean and variance of the transformed data are given whenever the data set of a particular night required transformation.  $s_B^2$  = variance before transformation,  $s_A^2$  = variance after transformation.

## AOV for April 27 (transformed data)

<u>Source</u>	<u>df</u>	<u>MS</u>	<u>F</u>	<u>Prob &gt; F</u>
Total	19			
Area	7	0.588899	1.423	>0.10
Error	12	0.413518		

<u>Area</u>	<u>n</u>	<u>Mean Catch</u>	<u>Mean <math>\log_e(\text{catch} + 1)</math></u>	<u><math>s_B^2</math></u>	<u><math>s_A^2</math></u>
1	2	2.6	1.3	1.6562	0.352000
2	3	12.7	2.4	133.8604	0.883733
3	2	3.4	1.5	2.1013	0.110450
4	3	6.3	2.0	7.1996	0.137033
5	3	3.3	1.4	0.8684	0.053200
6	2	2.6	1.3	0.0722	0.006050
7	3	2.6	1.2	2.2719	0.244900
8	2	1.4	0.8	1.3778	0.252050

## AOV for May 9

<u>Source</u>	<u>df</u>	<u>MS</u>	<u>F</u>	<u>Prob &gt; F</u>
Total	20			
Area	7	943.905798	5.106	<0.025
Error	12	184.847132		

<u>Area</u>	<u>n</u>	<u>Mean Catch</u>	<u><math>s^2</math></u>
1	2	15.0	52.0200
2	2	53.7	31.5218
3	2	62.7	71.1625
4	3	52.3	132.3370
5	3	28.7	536.7268
6	3	21.9	62.8446
7	1	13.0	-
8	3	14.9	149.3112

## AOV for May 23 (transformed data)

<u>Source</u>	<u>df</u>	<u>MS</u>	<u>F</u>	<u>Prob &gt; F</u>
Total	18			
Area	7	3.934321	6.280	<0.005
Error	11	0.626668		

<u>Area</u>	<u>n</u>	<u>Mean Catch</u>	<u>Mean <math>\log_e</math> (catch + 1)</u>	<u><math>s_B^2</math></u>	<u><math>s_A^2</math></u>
1	2	116.4	4.7	2497.4032	0.3528
2	2	9.1	1.9	3710.2980	2.1013
3	2	2.3	1.2	0.5305	0.0512
4	3	6.4	1.9	19.6393	0.3033
5	3	2.5	1.2	2.7563	2.8083
6	2	0.8	0.6	0.0421	0.0145
7	2	2.9	0.7	9.6291	0.1105
8	3	29.0	2.9	2560.9974	1.5474

## AOV for May 31 (transformed data)

<u>Source</u>	<u>df</u>	<u>MS</u>	<u>F</u>	<u>Prob &gt; F</u>
Total	13	2.755377	2.064	>0.10
Area	5	1.334643		
Error	8			

<u>Area</u>	<u>n</u>	<u>Mean Catch</u>	<u>Mean <math>\log_e</math> (catch + 1)</u>	<u><math>s_B^2</math></u>	<u><math>s_A^2</math></u>
2	2	14.1	2.6	15,776.6752	0.5305
3	2	10.0	2.4	2.3328	0.0200
4	3	13.4	2.6	62.4127	0.3873
5	2	13.0	2.6	56.2861	0.3121
6 & 7	2	6.1	1.9	9.2450	0.1985
8	3	379.1	4.8	309,288.6211	4.4208

## AOV for June 9

<u>Source</u>	<u>df</u>	<u>MS</u>	<u>F</u>	<u>Prob &gt; F</u>
Total	16			
Area	6	395.269717	0.156	>0.10
Error	10	2533.706805		

<u>Area</u>	<u>n</u>	<u>Mean Catch</u>	<u>s<sup>2</sup></u>
1	2	25.0	645.8418
2	2	74.5	522.9378
4	3	82.6	235.5864
5	3	85.4	196.0849
6	2	50.8	4458.5125
7	3	90.7	1167.0350
8	2	82.7	11423.1613

## AOV for June 13

<u>Source</u>	<u>df</u>	<u>MS</u>	<u>F</u>	<u>Prob &gt; F</u>
Total	14			
Area	5	2331.3521	5.988	<0.01
Error	9	389.3604		

<u>Area</u>	<u>n</u>	<u>Mean Catch</u>	<u>s<sup>2</sup></u>
1	2	32.2	1273.6105
2	2	56.2	1057.0802
4	3	16.3	13.7514
5	3	20.8	0.7422
6	1	130.6	-
7	3	32.7	572.2828

## AOV for June 22

<u>Source</u>	<u>df</u>	<u>MS</u>	<u>F</u>	<u>Prob &gt; F</u>
Total	19			
Area	6	174.0811867	5.580	<0.005
Error	13	31.196953		

<u>Area</u>	<u>n</u>	<u>Mean Catch</u>	<u>s<sup>2</sup></u>
1	2	19.1	2.2261
2	3	11.6	52.7961
4	3	8.4	64.0984
5	3	2.3	2.8632
6	3	3.1	6.8329
7	3	21.0	69.7590
8	3	2.0	5.6456

## AOV for June 28 (transformed data)

<u>Source</u>	<u>df</u>	<u>MS</u>	<u>F</u>	<u>Prob &gt; F</u>
Total	18			
Area	6	23.409433	3.098	<0.05
Error	12	7.554654		

<u>Area</u>	<u>n</u>	<u>Mean Catch</u>	<u>Mean log<sub>e</sub>(catch + 1)</u>	<u>s<sub>B</sub><sup>2</sup></u>	<u>s<sub>A</sub><sup>2</sup></u>
1	3	5.6	1.8	19.2943	0.3589
2	3	4.5	1.7	12.3692	0.5841
4	3	5.4	1.8	4.8672	0.1356
5	3	7.8	2.2	8.5603	0.1273
6	3	0.7	0.5	0.1794	0.0730
7	2	0.9	0.6	0.0968	0.0265
8	2	0.3	0.3	0.0181	0.0113

APPENDIX D

RESULTS OF ANALYSIS OF VARIANCE OF THE LENGTH  
OF SHAD AMONG AREAS AND AMONG  
TRANSECTS WITHIN AREAS

$s_A^2$  = Variation attributable to areas.  $s_T^2$  = Variation attributable to transects.  $s_F^2$  = Variation attributable to fish within transects. Beside each data is an indication of the depth (m) at which the samples were taken.

April 27; 0 m

<u>Source</u>	<u>df</u>	<u>Mean Square</u>	<u>Variance Component</u>
Total	348	2.009130	
Areas	7	4.612145	$0.074479 = s_A^2$
Transects	12	1.600152	$-0.021939 = s_T^2$
Error	329	1.968663	$1.968663 = s_F^2$

$$H_0: \theta_T^2 = 0; F = 0.813 \quad P > 0.10$$

$$H_0: \theta_A^2 = 0; F = 2.882 \quad 0.025 < P < 0.05$$

May 9; 0 m

<u>Source</u>	<u>df</u>	<u>Mean Square</u>	<u>Variance Component</u>
Total	882	9.921804	
Area	7	133.169198	$1.090720 = s_A^2$
Transect	11	13.660780	$0.107353 = s_T^2$
Error	864	8.875670	$8.875670 = s_F^2$

$$H_0: \theta_T^2 = 0; F = 1.539 \quad P > 0.10$$

$$H_0: \theta_F^2 = 0; F = 9.748 \quad P < 0.005$$



May 23; 0 m

<u>Source</u>	<u>df</u>	<u>Mean Square</u>	<u>Variance Component</u>
Total	371	20.977990	
Area	7	245.566524	4.610009 = $s_A^2$
Transect	11	52.911223	2.000096 = $s_T^2$
Error	353	15.528658	15.528658 = $s_F^2$

$$H_0: \theta_T^2 = 0; F = 3.407 \quad P < 0.005$$

$$H_0: \theta_A^2 = 0; F = 4.641 \quad 0.025 < P < 0.010$$

May 31; 0 m

<u>Source</u>	<u>df</u>	<u>Mean Square</u>	<u>Variance Component</u>
Total	549	9.941704	
Area	6	45.156573	0.471961 = $s_A^2$
Transect	7	9.739823	0.004778 = $s_T^2$
Error	536	9.548433	9.548433 = $s_F^2$

$$H_0: \theta_T^2 = 0; F = 1.020 \quad P > 0.10$$

$$H_0: \theta_F^2 = 0; F = 4.636 \quad 0.025 < P < 0.05$$

June 7; 0 m

<u>Source</u>	<u>df</u>	<u>Mean Square</u>	<u>Variance Component</u>
Total	728	15.215088	
Area	6	54.225139	$0.150653 = s_A^2$
Transect	9	37.779224	$0.525547 = s_T^2$
Error	713	14.601993	$14.601993 = s_F^2$

$$H_0: \theta_T^2 = 0; F = 2.587 \quad 0.005 < P < 0.010$$

$$H_0: \theta_A^2 = 0; F = 1.435 \quad P > 0.10$$

June 13; 3 m

<u>Source</u>	<u>df</u>	<u>Mean Square</u>	<u>Variance Component</u>
Total	667	22.618418	
Area	5	189.941049	$1.014968 = s_A^2$
Transect	8	78.315153	$1.220333 = s_T^2$
Error	654	20.656654	$20.656654 = s_F^2$

$$H_0: \theta_T^2 = 0; F = 3.791 \quad P < 0.005$$

$$H_0: \theta_A^2 = 0; F = 2.425 \quad P > 0.10$$

June 22; 3 m

<u>Source</u>	<u>df</u>	<u>Mean Square</u>	<u>Variance Component</u>
Total	489	25.670121	
Area	6	173.654974	1.946099 = $s_T^2$
Transect	12	37.262666	0.605279 = $s_A^2$
Error	471	23.489603	23.489603 = $s_F^2$

$$H_0: \theta_T^2 = 0; F = 1.586 \quad 0.05 < P < 0.10$$

$$H_0: \theta_A^2 = 0; F = 4.660 \quad 0.010 < P < 0.025$$

June 28; 3 m

<u>Sourec</u>	<u>df</u>	<u>Mean Square</u>	<u>Variance Component</u>
Total	363	33.618708	
Area	5	145.585405	2.220790 = $s_T^2$
Transect	16	19.938934	-0.596981 = $s_A^2$
Error	348	32.403089	32.403089 = $s_F^2$

$$H_0: \theta_T^2 = 0; F = 0.615 \quad P > 0.10$$

$$H_0: \theta_A^2 = 0; F = 7.302 \quad P < 0.005$$

VITA

Patrick James Downey

Candidate for the Degree of

Master of Science

Thesis: DISTRIBUTION AND MEAN LENGTH OF GIZZARD SHAD (DOROSOMA CEPEDIANUM) AND SOME ASPECTS OF THE SAMPLING PROBLEM IN LAKE CARL BLACKWELL, OKLAHOMA

Major Field: Zoology

Biographical:

Personal Data: Born in Bismarck, North Dakota, September 2, 1951, the son of Donald and Marie Downey.

Education: Graduated from Fayetteville High School, Fayetteville, Arkansas, in May, 1969; received Bachelor of Science degree in Zoology from the University of Arkansas, Fayetteville, Arkansas in May, 1974; completed requirements for the Master of Science degree in July, 1978, at Oklahoma State University, Stillwater, Oklahoma.

Professional Experience: Biological Aid, U.S. Department of Agriculture, Stoneville, Mississippi; Graduate Teaching Assistant, School of Biological Sciences, Oklahoma State University, 1975-77; Graduate Research Assistant, Oklahoma Water Resources Research Institute, Oklahoma State University, 1976-77; Fisheries Technician, U.S. Fish and Wildlife Service, Oklahoma State University, 1978.