

INFORMATION TO USERS

This manuscript has been reproduced from the microfilm master. UMI films the text directly from the original or copy submitted. Thus, some thesis and dissertation copies are in typewriter face, while others may be from any type of computer printer.

The quality of this reproduction is dependent upon the quality of the copy submitted. Broken or indistinct print, colored or poor quality illustrations and photographs, print bleedthrough, substandard margins, and improper alignment can adversely affect reproduction.

In the unlikely event that the author did not send UMI a complete manuscript and there are missing pages, these will be noted. Also, if unauthorized copyright material had to be removed, a note will indicate the deletion.

Oversize materials (e.g., maps, drawings, charts) are reproduced by sectioning the original, beginning at the upper left-hand corner and continuing from left to right in equal sections with small overlaps. Each original is also photographed in one exposure and is included in reduced form at the back of the book.

Photographs included in the original manuscript have been reproduced xerographically in this copy. Higher quality 6" x 9" black and white photographic prints are available for any photographs or illustrations appearing in this copy for an additional charge. Contact UMI directly to order.

UMI

A Bell & Howell Information Company
300 North Zeeb Road, Ann Arbor MI 48106-1346 USA
313/761-4700 800/521-0600

UNIVERSITY OF OKLAHOMA
GRADUATE COLLEGE

A STUDY OF THE SCOPE OF METAL-CATALYZED ALLYLIC AMINATION
OF OLEFINS

and

AN APPROACH TOWARDS SOLID PHASE SYNTHESIS OF
UNSYMMETRICAL TERTIARY PHOSPHINES

A Dissertation

SUBMITTED TO THE GRADUATE FACULTY

in partial fulfillment of the requirements for the

degree of

DOCTOR OF PHILOSOPHY

By

SUMITA SINGH

Norman, Oklahoma

1998

UMI Number: 9839801

UMI Microform 9839801
Copyright 1998, by UMI Company. All rights reserved.

**This microform edition is protected against unauthorized
copying under Title 17, United States Code.**

UMI
300 North Zeeb Road
Ann Arbor, MI 48103

© Copyright by SUMITA SINGH 1998
All Rights Reserved

A STUDY OF THE SCOPE OF METAL-CATALYZED ALLYLIC AMINATION
OF OLEFINS
and
AN APPROACH TOWARDS SOLID PHASE SYNTHESIS OF
UNSYMMETRICAL TERTIARY PHOSPHINES

A Dissertation APPROVED FOR THE
DEPARTMENT OF CHEMISTRY AND BIOCHEMISTRY

BY

K.M. Nicholas
Daniel P. Staffly
Paul S. Liu
Lance Sobba
G. Nicht. Add

ACKNOWLEDGEMENTS

I am dedicating this thesis to my husband, Vivek. I thank him for his constant support, encouragement and understanding in the last fifteen months, and for believing in me when even I was unsure. He has given me the motivation and strength to go on. Thank you, Vivek, for your confidence in me.

This work would never have been possible without the faith of a lot of people. First and foremost my acknowledgements go to my family, old and new. I thank my parents, Drs. S. P. Singh and Uma Singh, who always had high aspirations for me. They have, through their continuous efforts and sacrifices, encouraged me and supported me through all phases of my life. I deeply value the love and affection of my brothers, Sanjeev and Sachin. Growing up with them was an experience and now that we are apart I cherish them even more. I also thank my parents-in-law for their encouragement and patience during my “visits”. My appreciation also goes to the plethora of relatives that I have in India.

I thank Dr. K. M. Nicholas for his patience and guidance as I struggled when nothing was working and for his enthusiasm when they did. Thank you, Sir, for your optimism and confidence.

I thank my committee members, Drs. D. T. Glatzhofer, R. E. Lehr, G. Richter-Addo and L. Lobban, for their guidance and very helpful suggestions. I am also grateful to my colleagues in the laboratory from whom I have learnt a great deal. Especially, I thank Tina Guion, Russell Franks and Billy Davidson for their support and friendship. I will cherish these days. Thank you, Russell, for all the time that you took out to proof-read this work.

During my stay here I have befriended many people. I extend a special thanks to Ritesh Gandhi and Amitabh Kumar for standing by me when I most needed a friend. Thank you, guys, for everything. I thank Drs. Sangamithra Chintapalli, Binita Sinha, Shreeram Deshpande, Bharath Rao and Adwait Sathye for their support, friendship and confidence that I could do this. A special thanks to Dr. David Combs to whom I could always go to with any question or doubt without any hesitation.

TABLE OF CONTENTS

	Page
Chapter 1	
METAL-CATALYZED ALLYLIC AMINATION OF OLEFINS	
1-1 Introduction and Background	1
1-2 Catalytic Allylic Amination of Olefins	12
1-2-1 $L_n\text{Mo}(\text{O}_2)$ -Catalyzed Allylic Amination of Olefins	13
1-2-2 $L_n\text{FeX} / \text{FeX}_{2,3}$ -Catalyzed Allylic Amination of Olefins	19
1-3 Project Objectives	29
Chapter 2	
AN APPROACH TO ENANTIOSELECTIVE ALLYLIC AMINATION OF OLEFINS CATALYZED BY CHIRAL IRON COMPLEXES	
2-1 Introduction and Background	31
2-2 N,N' -Ethylene-bis(salicylideneimine) Ligands	
2-2-1 Introduction and Background	35
2-2-2 Results and Discussions	40
2-2-2-1 Synthesis of N,N' -Ethylene-bis(salicylideneiminato)-Iron(II) Complexes	41
2-2-2-2 Reactions of Olefins with PhNHOH in presence of Fe(II)-salen Complexes as Catalysts	44

2-3	Diamine Oxides and Diphosphine Oxides	
2-3-1	Introduction and Background	48
2-3-2	Synthesis of 1,1'-Biisoquinoline-N,N'-Dioxide	51
2-3-3	Synthesis of 1,2-Bis(diphenylphosphinyl)ethane	54
2-3-4	Attempts at Synthesis of 1,1'-Binaphthyl-2,2'-Bis (diphenylphosphineoxide)	55
2-3-5	Attempts at Asymmetric Fe(II, III)-Catalyzed Amination of Olefins Using Diamine Oxide and Diphosphine Oxide Ligands	60
2-4	Conclusions	62
2-5	Experimental Section	63
Chapter 3	ALTERNATIVE AMINATING AGENTS: USE OF 2,4-DINITROPHENYL HYDROXYLAMINE AND N-HYDROXY BENZENESULFONAMIDE AS REAGENTS FOR IRON-CATALYZED ALLYLIC AMINATION LEADING TO PRIMARY AND SECONDARY ALLYLAMINES	
3-1	Introduction and Background	74
3-1-1	2,4-Dinitrophenyl- (2,4-DNP) as an Amine Protecting Group	75
3-2	Results and Discussions	79
3-2-1	Synthesis of 2,4-Dinitrophenyl Hydroxylamine	79
3-2-2	FeCl _{2,3} -Catalyzed Reaction of 2,4-Dinitrophenyl	

	Hydroxylamine with Olefins	80
3-2-3	Deprotection of the 2,4-DNP-Protected Secondary Allylic Amines	88
	A. Nucleophilic Reagents	89
	B. Acidic Reagents	98
3-2-4	Alkylation of N-(2,4-Dinitrophenyl)-N-Allylamines	100
3-2-5	Deprotection of 2,4-DNP-Protected Tertiary Allyl- amines	104
3-2-6	Attempted Synthesis of 2,4-Dinitrobenzenesulfonyl Hydroxylamine	106
3-2-7	Reaction of N-Hydroxybenzenesulfonamide with α -Methylstyrene	109
3-3	Conclusions	110
3-4	Experimental Section	112
Chapter 4	AN APPROACH TO COPPER-CATALYZED ALLYLIC AMINATION OF OLEFINS	
4-1	Introduction and Background	129
4-1-1	Acyloxylation of Hydrocarbons Catalyzed by Copper Salts	129
4-1-2	Rationale for Copper Catalyzed Allylic Amination of Olefins	136
4-1-4	Synthesis of N-Alkyl- and N-Alkoxyamidines	139
4-2	Results and Discussion	144

4-2-1	Synthesis of N-Alkoxyamidines	145
4-2-2	Attempted Amination of Olefins Using N-Alkoxy- Amidines as Aminating Agents in Cu(I, II)-Catalyzed Reactions	152
4-2-3	Attempted Amination of Olefins with Hydrazine and Amidrazone Derivatives Catalyzed by Cu(I, II)-Chlorides	154
4-3	Conclusions	157
4-4	Experimental Section	158
Chapter 5	SYNTHESIS OF SUBSTITUTED TERTIARY PHOSPHINES VIA NUCLEOPHILIC DISPLACEMENT ON P(III): BACKGROUND AND SIGNIFICANCE	
5-1	Significance of Phosphines in Transition Metal-Catalyzed Organic Reactions	166
5-2	Synthesis of Substituted Phosphines in Solution	169
5-3	Solid Phase Organic Synthesis	172
5-3-1	Solid Phase Split-Mix Method	176
5-3-2	Multiple Parallel Synthesis	180
5-3-3	Solid Phase Synthesis of Catalysts for Asymmetric Reactions	182
5-4	Project Objectives	185

Chapter 6	A NOVEL SOLUTION PHASE SYNTHESIS OF UNSYMMETRICAL TERTIARY PHOSPHINES: SELECTIVE NUCLEOPHILIC SUBSTITUTION ON PHOSPHORUS (III)	
6-1	Introduction and Background	187
6-2	Results and Discussion	188
6-2-1	Synthesis of Ethyl Diphenylphosphinite and Ethyl Chloro- phenylphosphinite	189
6-2-2	Synthesis of N,N-Disubstituted Aminophosphines and Aminochlorophosphines	191
6-2-3	Reactions of Phosphinites and Chlorophosphinites with Grignard Reagents	194
6-2-4	Reactions of Aminophosphines with Organometallic Reagents	196
	A. Reaction of N,N-Dialkylamino Diphenylphosphines and N-Methyl-N-phenylamino Diphenylphosphine with Organometallic Reagents	196
	B. Synthesis of Unsymmetrical Tertiary Phosphines: Selective Sequential Nucleophilic Substitution on Phosphorus (III)	198
6-3	Conclusions	202
6-4	Experimental Section	204
	References	220

LIST OF SCHEMES

	Page
Scheme 1-1 Rh(I)-catalyzed enantioselective isomerization of allylic amines	2
Scheme 1-2 Reduction of propargylic amines	3
Scheme 1-3 Diastereoselective hydroboration-oxidation of allylic amines	3
Scheme 1-4 Os-catalyzed dihydroxylation of allylic amines	4
Scheme 1-5 Synthesis of allylic amines from allylic alcohols via Mitsunobu reaction	5
Scheme 1-6 Synthesis of allylic amines via Overman rearrangement	5
Scheme 1-7 Synthesis of allylic amines via Ritter reaction	6
Scheme 1-8 Synthesis of allylic amines via Gabriel synthesis	6
Scheme 1-9 Synthesis of allylamines from allylic halides catalyzed by Pd(0)-Complexes	7
Scheme 1-10 Synthesis of allylamines from dienes catalyzed by transition Metal complexes	8
Scheme 1-11 Commercial processes to obtain organonitrogen compounds	8
Scheme 1-12 Synthesis of organonitrogen compounds via vicinal aminohydroxylation of olefins	9
Scheme 1-13 Synthesis of allylic amines from olefins	9
Scheme 1-14 Mechanism of reaction of olefins with group VI imides	10
Scheme 1-15 Synthesis of Mo- and W-nitrosoalkane complexes (14)	12
Scheme 1-16 Reaction of Mo-oxaziridine complexes with olefins	13

Scheme 1-17	$L_n\text{Mo}(\text{O}_2)$ -catalyzed allylic amination of olefins	14
Scheme 1-18	Synthesis of the Mo-oxaziridine complex from the Mo-dioxo complex	15
Scheme 1-19	Trapping of free PhNO	16
Scheme 1-20	Reaction of Mo(VI)O complex with PhNO	16
Scheme 1-21	Ene reaction of 2-methyl-2-pentene with nitrosobenzene	17
Scheme 1-22	Reduction of allylhydroxylamine by Mo(IV)-oxo complex	17
Scheme 1-23	Mechanism of $L_n\text{Mo}(\text{O}_2)$ -catalyzed allylic amination	18
Scheme 1-24	$\text{FeCl}_{2,3}$ -catalyzed allylic amination of olefins	19
Scheme 1-25	Reaction of olefins with PhNHOH in presence of DMB	22
Scheme 1-26	Synthesis of Fe(II)-azobenzenedioxide complex (27)	23
Scheme 1-27	Reactions of Fe(II)-azobenzenedioxide complex 27	24
Scheme 1-28	Isolation and reaction of olefin coordinated intermediate 28	26
Scheme 1-29	Proposed mechanism for Fe(II, III)-chloride catalyzed allylic amination	28
Scheme 2-1	Organic transformations catalyzed by chiral transition metal Complexes	32
Scheme 2-2	Catalytic asymmetric amination of olefins	34
Scheme 2-3	Jacobsen's enantioselective epoxidation of olefins	37
Scheme 2-4	Catalytic asymmetric oxidation of sulfides	38
Scheme 2-5	Catalytic asymmetric aziridiantion of olefins	39
Scheme 2-6	Catalytic asymmetric cyclization of 1,3-dichloro-2-propanol	39
Scheme 2-7	Catalytic enantioselective carbonation of 2-bromo-propanol	40

Scheme 2-8	Synthesis of salen ligands	41
Scheme 2-9	Synthesis of Fe(II)-salen complexes	42
Scheme 2-10	Amination of 2-methyl-2-pentene catalyzed by Fe(II)-salen complexes	44
Scheme 2-11	Hetero-Diels-Alder test for the Fe(II)-salen catalyzed allylic amination of olefins	45
Scheme 2-12	Reaction of olefin with PhNO	46
Scheme 2-13	Control reaction on Fe(II)-salen system	47
Scheme 2-14	Reaction of Fe(II)-azodioxide complex with chiral bidentate ligands	49
Scheme 2-15	Synthesis of 1,1'-biisoquinoline	51
Scheme 2-16	Synthesis of 1,1'-biisoquinoline-N, N'-dioxide	52
Scheme 2-17	Synthesis of 1,2-bis(diphenylphosphinyl)ethane	54
Scheme 2-18	Synthesis of 2,2'-bis(diphenylphosphinyl)-1,1'-binaphthyl	56
Scheme 2-19	Synthesis of the diGrignard 29	56
Scheme 2-20	Reaction of the diGrignard 29 with diphenylphosphinic chloride	57
Scheme 2-21	Synthesis of 2,2'-dihalo-1,1'-binaphthyl	58
Scheme 2-22	Reaction of dihalides 34 with diphenylphosphinic chloride	58
Scheme 2-23	Reaction of Fe(II)-azodioxide complex with 23 and 26	61
Scheme 2-24	Reaction of Fe(II)-azodioxide complex 16 with chiral diamides	63
Scheme 3-1	Rationale for alternative aminating agents	75
Scheme 3-2	Protection of amines using 1-fluoro-2,4-dinitrobenzene	76
Scheme 3-3	Deprotection of 2,4-DNP-protected amines	76

Scheme 3-4	Cleavage of the 2,4-DNP group via displacement by primary amines	77
Scheme 3-5	Cleavage of 2,4-DNP group via displacement by 2-mercapto-ethanol	78
Scheme 3-6	Synthesis of 2,4-dinitrophenyl hydroxylamine	79
Scheme 3-7	Synthesis of 2,4-dinitroanisole	80
Scheme 3-8	Reaction of 2-methyl-2-pentene with 2,4-dinitrophenyl Hydroxylamine catalyzed by FeCl ₂ and FeCl ₃	81
Scheme 3-9	Control reaction	83
Scheme 3-10	Synthesis of primary allylamines via N-DNP cleavage	88
Scheme 3-11	Expected mechanism for the displacement of the amine by nucleophiles	89
Scheme 3-12	Attempted cleavage of the 2,4-DNP group using nucleophilic reagents	92
Scheme 3-13	Deprotonation of the N-(2,4-dinitrophenyl)-N-allylamine	93
Scheme 3-14	Delocalization of the amino nitrogen lone pair of electrons into the 2,4-DNP group	96
Scheme 3-15	Formation of the σ complex via attack by the nucleophile	97
Scheme 3-16	Cleavage of 2,4-DNP group promoted by acids	98
Scheme 3-17	Attempted cleavage of the 2,4-DNP group by acids	99
Scheme 3-18	N-Alkylation of N-(2,4-dinitrophenyl)-N-allylamines	101
Scheme 3-19	Attempted N-propylation and N-pentylation of N-(2,4-dinitrophenyl)-N-allylamine	103

Scheme 2-20	Deprotection of N-(2,4-dinitrophenyl)-N-methyl-N-allylamines	105
Scheme 3-21	Attempted deprotection of N-(2,4-dinitrophenyl)-N-benzyl-allylamine	106
Scheme 3-22	Synthesis of secondary amines	107
Scheme 3-23	Planned synthesis of N-hydroxy-2,4-dinitrobenzenesulfonamide	107
Scheme 3-24	Synthesis of primary allylic amines via 2,4-dinitrobenzenesulfonamide	108
Scheme 3-25	Attempted synthesis of N-hydroxy-2,4-dinitrobenzenesulfonamide	109
Scheme 3-26	Reaction of α -methylstyrene with N-hydroxybenzenesulfonamide	110
Scheme 4-1	Kharasch-Sosnovsky reaction	130
Scheme 4-2	Proposed mechanisms for the peroxyester reaction	130
Scheme 4-3	Cu(I)-catalyzed reaction of benzylic substrates with perester	132
Scheme 4-4	Cu(I)-catalyzed reaction of olefinic substrates with peresters	133
Scheme 4-5	Allylic acyloxylation of olefins with exocyclic double bonds	134
Scheme 4-6	Copper catalyzed allylic amination of olefins	137
Scheme 4-7	Postulated mechanism for Cu-catalyzed reaction of olefins with O-hydroxamic acid esters or amidines	138
Schemes 4-8	General routes for synthesis of N-alkylamidines	139
Scheme 4-9	Synthesis of N-alkylamidines from nitriles	140
Scheme 4-10	Synthesis of N-alkylamidines	141
Scheme 4-11	Synthesis of benzamidines from benzamidoximes	141
Scheme 4-12	Synthesis of amidines from amides and their derivatives	142

Scheme 4-13	Synthesis of N-alkoxyamidine salts	144
Scheme 4-14	Cu(I)Cl promoted synthesis of N-alkoxyamidines	145
Scheme 4-15	Synthesis of N-alkoxyamidine salts	148
Scheme 4-16	Prospective reaction of olefins with N-alkoxyamidines catalyzed by Cu(I, II)-chlorides	152
Scheme 4-17	Reaction of N-alkoxyamidine salts with gaseous ammonia	154
Scheme 4-18	Reaction of N-alkoxyamidine salts with aqueous KOH	154
Scheme 4-19	Reaction of α -methylstyrene with 28 catalyzed by Cu(I, II)- chlorides	155
Scheme 4-20	Synthesis of the amidrazone derivative 29	156
Scheme 4-21	Reaction of α -methylstyrene with the amidrazone 29 catalyzed by CuCl	156
Scheme 4-22	Amination of olefins catalyzed by Cu(OTf) ₂	157
Scheme 5-1	Chiral phosphines as ligands in asymmetric organic reactions	166
Scheme 5-2	Solution phase synthesis of substituted phosphines	170
Scheme 5-3	Synthesis of unsymmetrical tertiary phosphines via selective step wise nucleophilic substitution	171
Scheme 5-4	Synthesis of unsymmetrical tertiary phosphines via selective step wise nucleophilic substitutions	172
Scheme 5-5	Merrifield's solid phase peptide synthesis	173
Scheme 5-6	Proposed synthesis of unsymmetrical tertiary phosphines on the solid support	185

Scheme 6-1	Synthesis of tertiary phosphines by displacement of Dialkylamino group	189
Scheme 6-2	Synthesis of ethyl diphenylphosphinite	190
Scheme 6-3	Synthesis of ethyl chlorophenylphosphinite	191
Scheme 6-4	Synthesis of N, N,-dialkylamino diphenylphosphines	192
Scheme 6-5	Synthesis of N-methyl-N-phenylamino diphenylphosphine	192
Scheme 6-6	Synthesis of aminochlorophosphines	193
Scheme 6-7	Reaction of ethyl diphenylphosphinite with Grignard reagent	194
Scheme 6-8	Reaction of ethyl chlorophenylphosphinite with Grignard reagent	195
Scheme 6-9	Reaction of dialkylamino diphenylphosphine with organo- metallic reagents	197
Scheme 6-10	Reaction of N-methyl-N-phenylamino diphenylphosphine with organometallic reagents	198
Scheme 6-11	Synthesis of aminophosphines	199
Scheme 6-12	Synthesis of unsymmetrical tertiary phosphines	201
Scheme 6-13	Synthesis of o-tolylmethylphenylphosphine without isolation of the intermediates	201
Scheme 6-14	Solid phase synthesis of unsymmetrical tertiary phosphines	203

LIST OF FIGURES

	Page	
Figure 1-1	Medicinally important allylamines	1
Figure 1-2	Medicinally important propargylic amines	1
Figure 1-3	ORTEP diagram of Fe(II)-azobenzenedioxide complex 27	23
Figure 1-4	Proposed structure for intermediate 28	27
Figure 2-1	Chiral ligands chosen for Fe(II, III)-catalyzed asymmetric allylic amination of olefins	35
Figure 2-2	N, N'-Ethylene-bis(salicylideneimine)	36
Figure 2-3	¹ H NMR spectra for 4-MeO- and 5-MeO-salen ligands	43
Figure 2-4	Bidentate chiral ligands for Fe(II, III)-catalyzed allylic amination of olefins	50
Figure 2-5	Enantiomers of 1,1'-biisoquinoline-N,N'-dioxide	52
Figure 2-6	¹ H NMR spectra of 23 and 24	53
Figure 2-7	¹ H NMR spectra of binaphthyl and 1,1'-didueterobinaphthyl	59
Figure 3-1	2,4-Dinitrophenylhydroxylamine	78
Figure 3-2	¹ H NMR spectra of 2,4-DNP-allylamine	86
Figure 3-3	ORTEP plot of 2,4-DNP-allylic amine 10b	87
Figure 3-4	Deprotonation of the 2,4-DNP-allylamine 10b in deuterated solvents	94
Figure 3-5	Other potential aminating agents	112
Figure 4-1	¹ H NMR spectra of N-methoxyamidines	146

Figure 4-2	Structures of trialkylaluminum reagents	147
Figure 4-3	¹ H NMR spectra of representative N-alkoxy-N-alkylamidine hydrochloride	151
Figure 4-4	Other potential aminating agents for Cu(I, II)-catalyzed reactions	155
Figure 5-1	Medicinally important “small” organic compounds prepared via combinatorial synthesis	175
Figure 5-2	Solid phase split-mix method	177
Figure 5-3	Halocarbon molecular tags to generate binary synthesis code	179
Figure 5-4	Multiple parallel synthesis	181
Figure 5-5	Pyrrolidinemethanol ligands prepared on the polymer support	182
Figure 5-6	Dipeptide Schiff bases used in Ti(IV)-catalyzed asymmetric addition of TMSCN to epoxide	183
Figure 5-7	Chiral peptide based phosphines	184

LIST OF TABLES

	Page
Table 1-1	Allylic amination of olefins catalyzed by Fe(II, III)-chlorides 21
Table 2-1	Amination of 2-methyl-2-pentene catalyzed by Fe(II)-salen complexes 44
Table 2-2	Hetero-Diels-Alder test for the Fe(II)-salen catalyzed allylic amination of olefins 45
Table 3-1	Optimization studies on the allylic amination reaction of 2-methyl-2-pentene 82
Table 3-2	FeCl _{2,3} -catalyzed allylic amination of olefins using 2,4-dinitro-phenyl hydroxylamine 84
Table 4-1	Allylic acyloxylation of olefins 134
Table 4-2	Perester reaction of olefins with internal double bonds 136
Table 4-3	Reaction of nitriles with (N-alkyl-N-alkoxyamine)dimethyl-aluminum chloride 150
Table 6-1	Synthesis of aminophosphines 199
Table 6-2	Synthesis of unsymmetrical tertiary phosphines 201

LIST OF ABBREVIATIONS

Ac	Acetyl
Acac	Acetylacetone
Aq	Aqueous
Ar	Aryl
BINAP	2,2'-Bis(diphenylphosphino)-1,1'-binaphthyl
BINAPO	2,2'-Bis(diphenylphosphinyloxy)-1,1'-binaphthyl
Boc	<i>tert</i> -Butoxycarbonyl
Bz	Benzoyl
COD	Cyclooctadiene
DEAD	Diethylazodicarboxylate
dedtc	Diethyldithiocarbamate
DIAD	Diisopropyldiazodicarboxylate
dipic	Dipicolinate
DMB	2,3-Dimethyl-1,3-butadiene
DMF	Dimethylformamide
DMSO	Dimethylsulfoxide
ES-MS	Electron Spray Mass Spectrometry
GC	Gas Chromatography
GC-MS	Gas Chromatography-Mass Spectrometry
HMPA	Hexamethylphosphoramide

HPLC	High Performance Liquid Chromatography
IR	Infra Red Spectroscopy
LDA	Lithium diisopropylamide
lut	Lutidine
MALDI	Matrix Assisted Laser Desorption/Ionization
mol	Mole
Ms	Methanesulfonyl
NBD	Norbornadiene
NMMO	N-Methyl-morpholine-N-oxide hydrate
NMR	Nuclear Magnetic Resonance
P	Protecting Group
Pc	Phthalocyanin
PhthNH	Phthalimide
py	Pyridine
R	Alkyl
rt	Room temperature
TBDMS	<i>tert</i> -Butyldimethylsilyl
Tf	Trifluoromethanesulfonyl
THF	Tetrahydrofuran
TPP	Tetraphenylporphyrin
TMP	Trimethylphosphate

ABSTRACT

PART I

The earlier work done in our lab on allylic amination of olefins catalyzed by Fe(II, III)-chlorides demonstrated that the formation of free PhNO is not involved and the structure of the active catalyst was determined (Chapter 1, 27). Attempts were made to develop a catalyst-based enantioselective version of the reaction. The Fe(II)-salen complexes (Chapter 2, 9) showed modest catalytic activity in the reactions of olefins with PhNHOH and involved the formation of free PhNO as the active aminating agent. The diamine oxide (Chapter 2, 24) and the diphosphine oxide (Chapter 2, 26) ligands displaced the azobenzenedioxide ligands from the active complex (chapter 1, 27). However, the new metal species (Chapter 2, 37) formed did not undergo any further reaction.

In order to obtain primary and secondary allylic amines *via* Fe(II, III)-chloride catalyzed reactions, alternative aminating agents were sought. 2,4-Dinitrophenylhydroxylamine (Chapter 3, 6) reacted with olefins to produce the 2,4-DNP-allylamines (Chapter 3, 10) in good yields and high selectivities. Attempts to deprotect the secondary 2,4-DNP-allylamines (Chapter 3, 10) were not successful. Methylation and benzylation of these allylamines yielded the corresponding products (Chapter 3, 14a, b, c and d) in high yields. Cleavage of the 2,4-DNP ring from the tertiary N-methyl-N-(2,4-DNP)-allylamine (Chapter 3, 14b and c) with excess aqueous methylamine yielded the corresponding secondary N-methyl-allylamines (Chapter 3, 15b and c) in moderate yields.

A general route for the synthesis of N-alkoxy-N-alkylamidine hydrochlorides by reaction of organic nitriles with (N-alkyl-N-alkoxyamine)dimethylaluminum chloride (Chapter 4, 26) is described.

PART II

A general route for the solution phase synthesis of unsymmetrical tertiary phosphines, which can be adapted for their solid phase synthesis, was developed. This route involves selective, sequential nucleophilic substitutions on trivalent phosphorus using easily accessible reagents under mild conditions. The starting materials for this methodology, N-methyl-N-phenylaminochloroalkylphosphines (Chapter 6, 12, 13), were prepared in high yields. The unsymmetrical tertiary phosphines (Chapter 6, 18) were obtained by highly selective displacement of the chloride from the aminochlorophosphines by Grignard reagents to yield aminophosphines (Chapter 6, 17), followed by displacement of the N-methyl-anilide by organolithium reagents.

Chapter 1

METAL – CATALYZED ALLYLIC AMINATION OF OLEFINS

1-1: INTRODUCTION AND BACKGROUND

Considerable research effort has been directed towards generation of the allylamine unit due to its importance in organic chemistry. This functional group has medicinal significance since it is present in several alkaloids, various pharmaceuticals (Figure 1-1a),¹ and also in some amino sugar antibiotics (Figure 1-1b).²

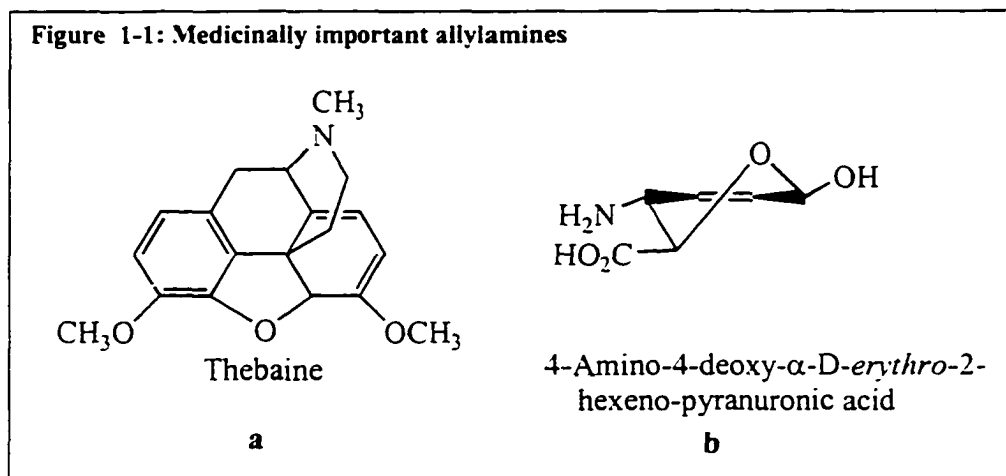

Certain antihypertensives and monoamine oxidase inhibitors bear the propargylamine moiety (Figure 1-2).³ Saturated and unsaturated amines are also commercially important as they are used in the production of petroleum additives, cationic surfactants, fabric softeners, etc.⁴

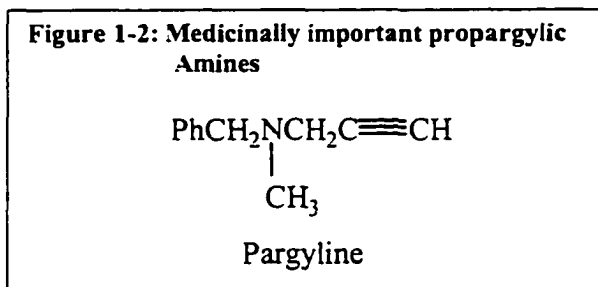

In synthetic organic chemistry allylic and propargylic amines serve as building blocks that lead to other important functional groups. Noyori *et al.* have prepared optically active (E)-enamines (1) by enantioselective isomerization of prochiral secondary and tertiary allylic amines (2) catalyzed by Rh(I) complexes, *via* hydrogen migration.⁵ These enamines were then utilized in the synthesis of chiral terpenes (Scheme 1-1). This method has been developed for the commercial synthesis of menthol.

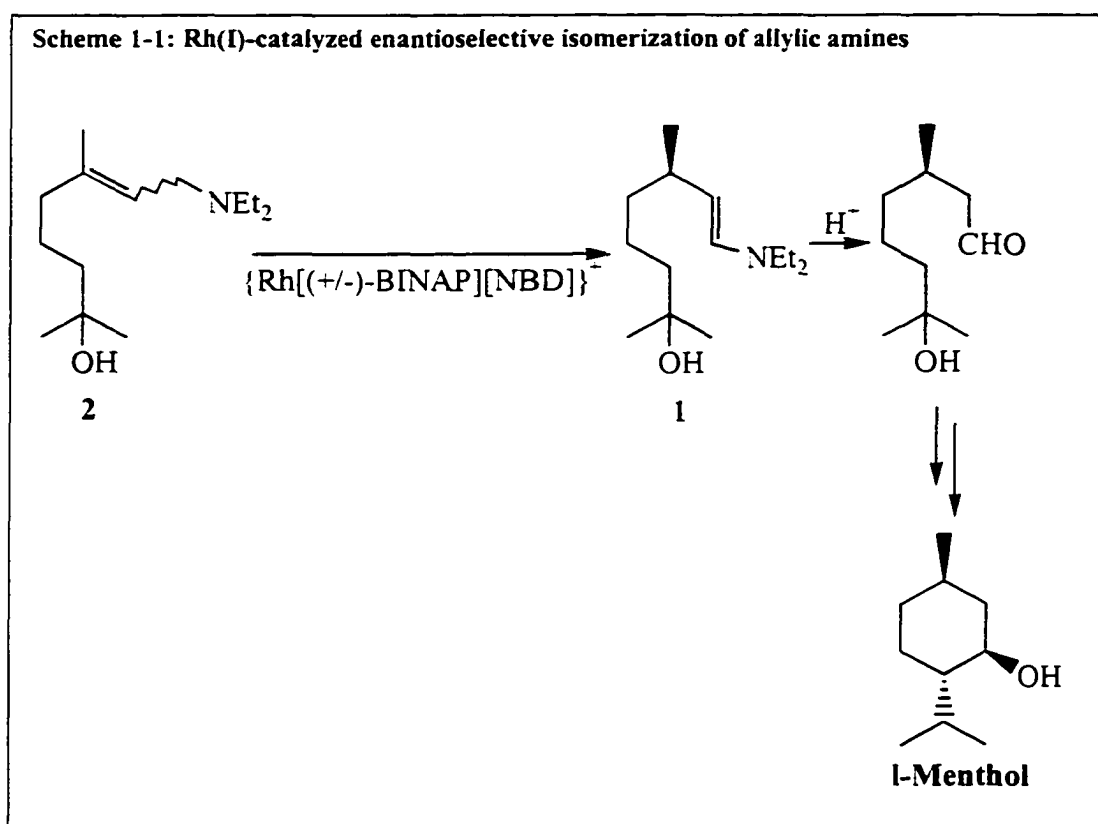

Propargylic amines (**3**) have been reduced to produce allylamines using H_2 /Lindlar's catalyst or LiAlH_4 (Scheme 1-2).⁶

Scheme 1-2: Reduction of propargylic amines

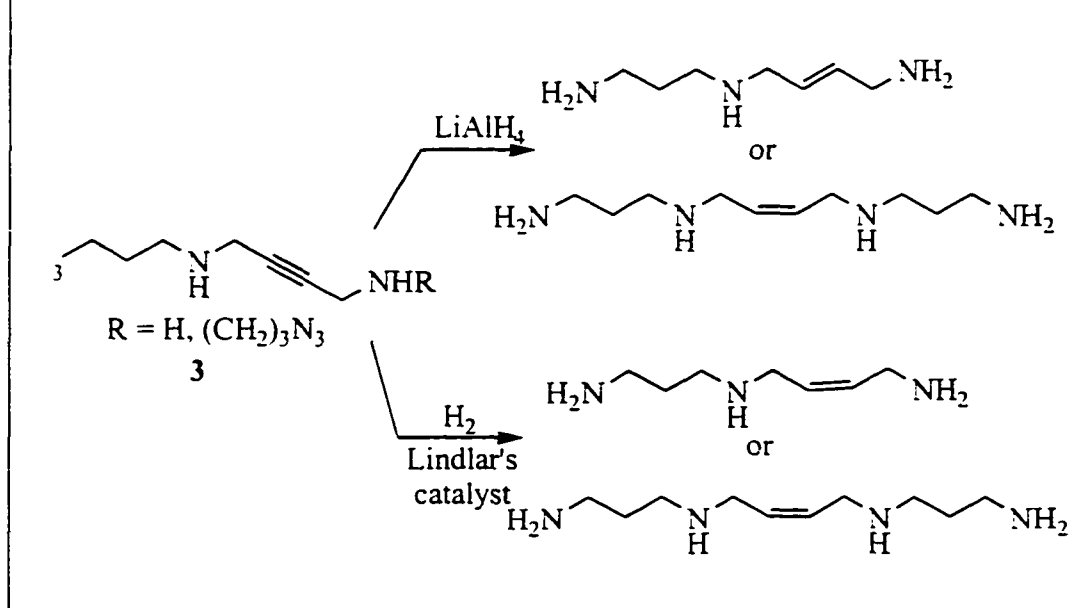

Allylic amines have also been subjected to diastereoselective hydroboration-oxidation of the double bond in the presence of a Rh(I) catalyst (Scheme 1-3).⁷ This transformation is the key step in the synthesis of optically active α , β -disubstituted β -amino acids.⁸

Scheme 1-3: Diastereoselective hydroboration-oxidation of allylic amines

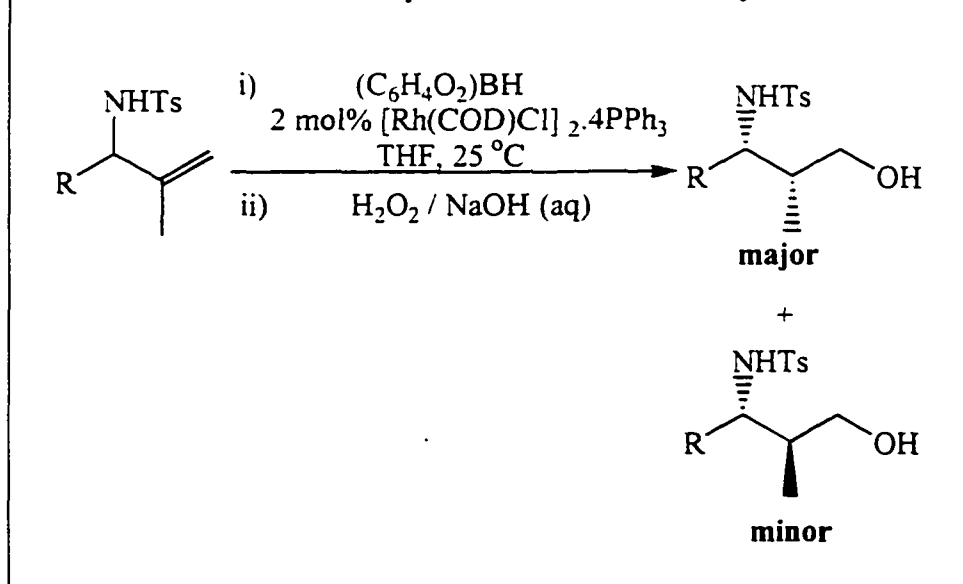

Diastereoselective osmium-catalyzed dihydroxylation of N-protected allylic amines has also been reported (Scheme 1-4).⁹

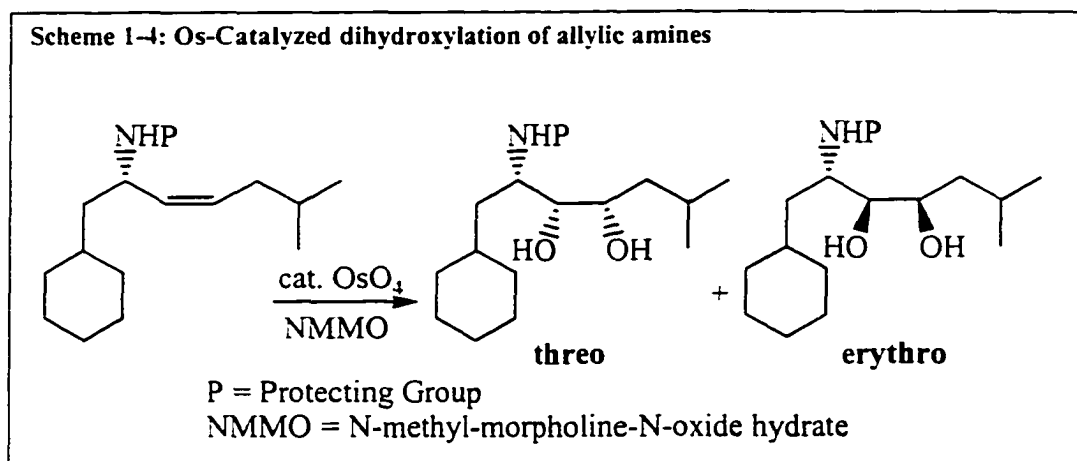

Other reports on the functionalization of allylic amines, including oxygenation,¹⁰ epoxidation¹¹ and halogenation¹² are also available in the literature.

Organonitrogen compounds are usually obtained by functional group interconversions. Allylic alcohols (4) can be converted to allylamines by the Mitsunobu reaction under very mild conditions using various amines as nucleophiles (Scheme 1-5).¹³ The olefin stereochemistry is conserved in this two step sequence.¹⁴

Overman rearrangement¹⁵ also transforms allylic alcohols (4) to the corresponding amines by a [3,3]-sigmatropic shift of the intermediate allylic N-benzoylbenzimidates (5), catalyzed by palladium(II) chlorides (Scheme 1-6).¹⁶ The resulting allylamides are obtained in good yields and selectivities, and can be hydrolyzed to produce the desired allylic amines. Use of this methodology in the synthesis of natural products was reported by Danishefsky.¹⁷

Scheme 1-5: Synthesis of allylic amines from allylic alcohols via Mitsunobu reaction

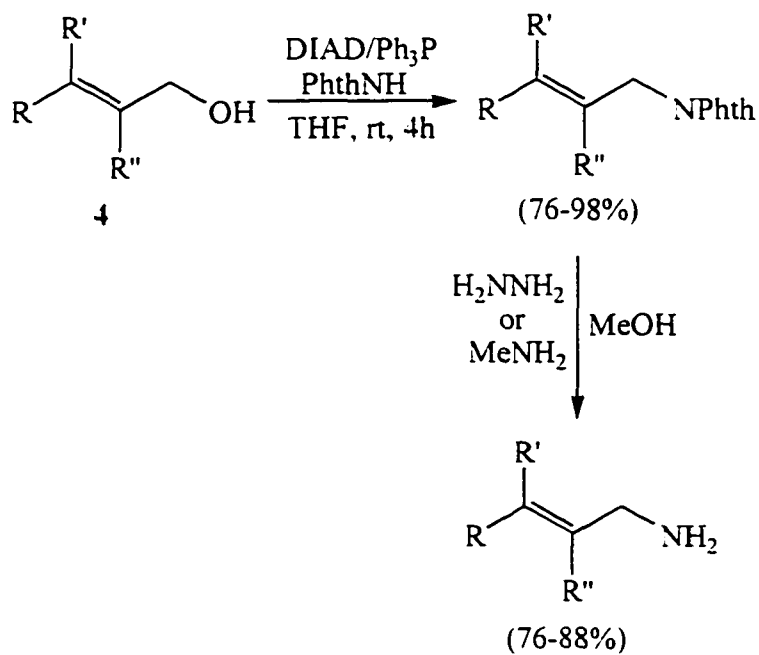

Scheme 1-6: Synthesis of allylic amines via Overman rearrangement

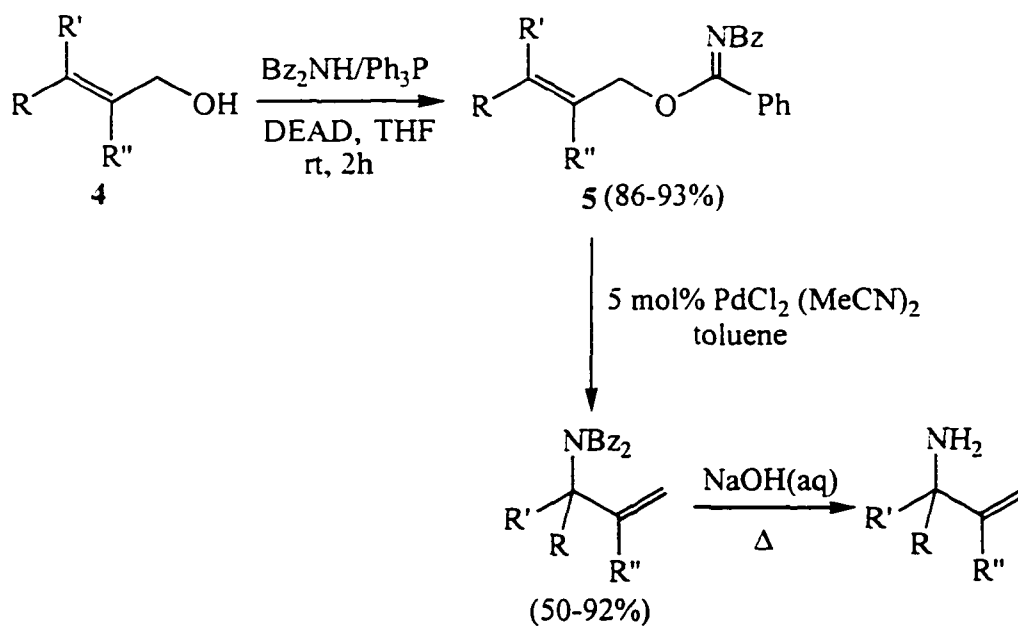

Conversion of allylic alcohols to allylamines catalyzed by cobalt(II) chloride is an improvement to the Ritter reaction, which allows the reaction to be performed under neutral conditions (Scheme 1-7).¹⁸

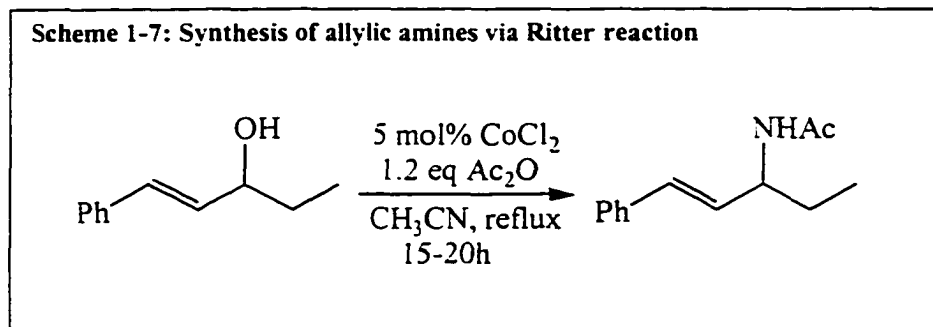

This reaction, however, is not very regio- or stereoselective and results in a mixture of products since it proceeds *via* the formation of an intermediate π -allyl complex.

Allylic halides and acetates can also be converted into allylamines by $\text{S}_{\text{N}}2$ reactions. One of the most common of such methods is the Gabriel synthesis (Scheme 1-8a).¹⁹ The deprotection of the phthalimides produced can then be carried out to yield the amine. A modification of this process involves the reaction of di-*t*-butyliminocarbonate, $[(\text{Boc})_2\text{NH}]$ (6), with primary and secondary halides and mesylates, under very mild conditions, to give high yields of the protected allylamines (7) (Scheme 1-8b).²⁰

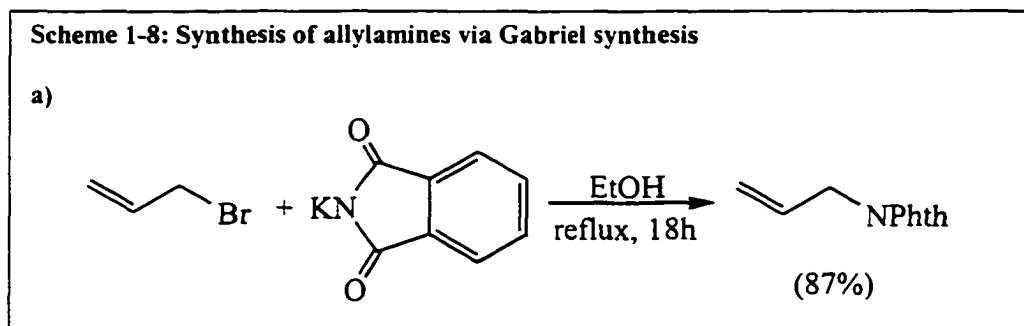

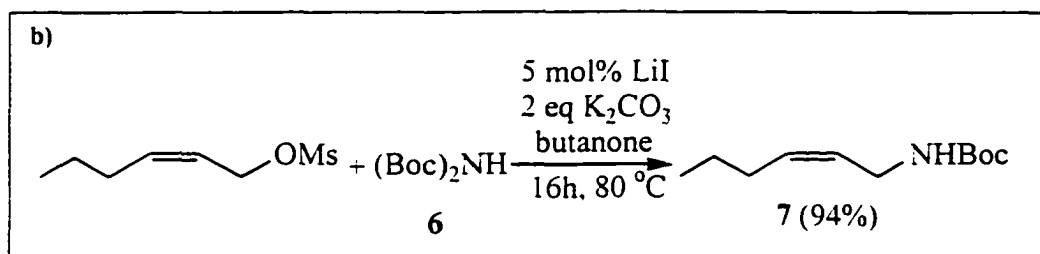

In addition to the transformations mentioned above, allylic amines can also be obtained by palladium-catalyzed substitution reactions of allylic halides, acetates, etc. (Scheme 1-9).²¹

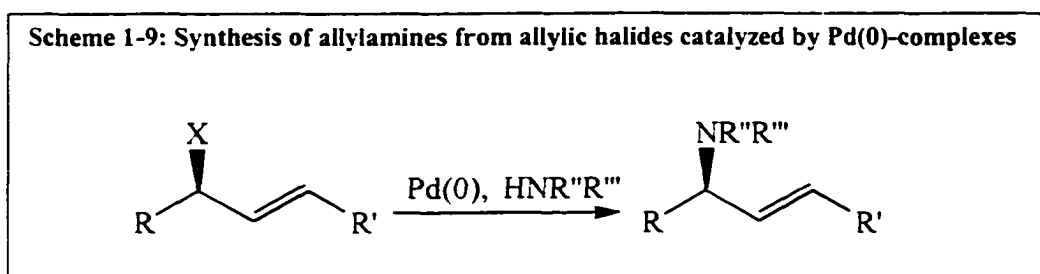

This reaction results in substitution with retention of configuration in the product.²² Enantioselective versions of this reaction using chiral ligands have also been developed and reviewed.²³ Allylic amination of allylic halides and acetates have also been promoted by copper(II)-²⁴ and iron(0)-complexes.²⁵

Direct hydroamination of dienes, catalyzed by complexes of transition metals such as Ni, Rh, Co and Ir, also form allylic amines.²⁶ However, these reactions are not very selective (Scheme 1-10).

Scheme 1-10: Synthesis of allylamines from dienes catalyzed by transition metal complexes

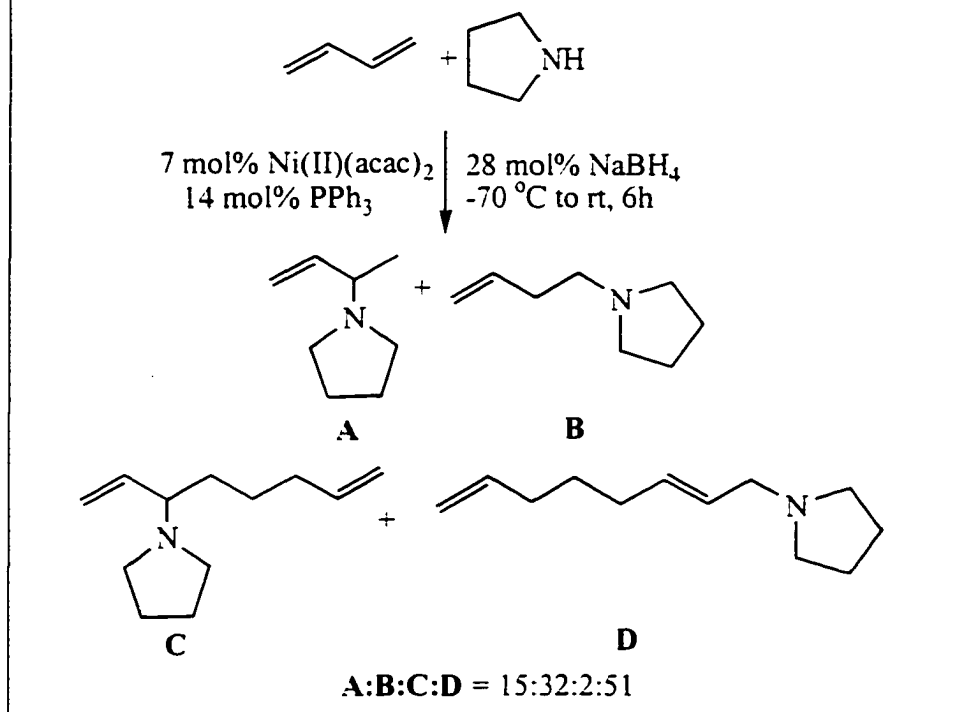

Direct synthesis of organonitrogen compounds from hydrocarbons remains a desirable goal due to the commercial potential of such processes. Also, such routes use very cheap starting materials. Two such industrial processes for the preparation of organonitrogen compounds are the Mo-Bi catalyzed synthesis of acrylonitrile from propylene (SOHIO process)²⁷ (Scheme 1-11a) and the Ni-catalyzed synthesis of adiponitrile from butadiene (DuPont) (Scheme 1-11b).²⁸

Scheme 1-11: Commercial processes to obtain organonitrogen compounds

a) SOHIO process

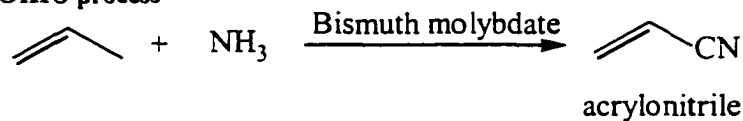

b) DuPont process

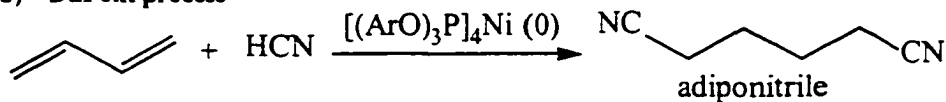

In the laboratory, olefins have been subjected to aminohydroxylation by treatment with osmium-alkylimido complexes (8).²⁹ This method leads to the formation of saturated vicinal aminoalcohols (9) after reductive cleavage of the osmate ester (10) in good yield (Scheme 1-12). The stereochemistry of the addition of the osmium species is always syn and the new C-N bond forms at the less substituted carbon of the double bond.

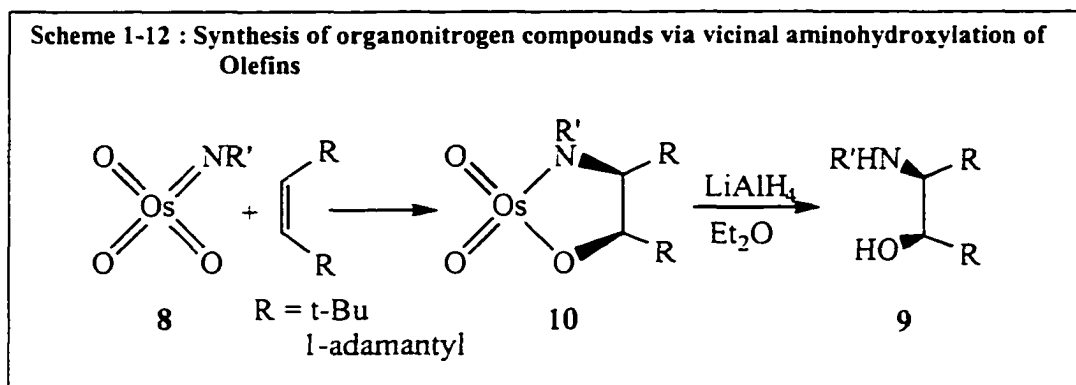

Allylic amines have been prepared in the laboratory directly from olefins by reaction with S- and Se-imides (11),³⁰ diethylazo-dicarboxylate (12) in the presence of a Lewis acid,³¹ and acylnitroso compounds (13) (Scheme 1-13).³²

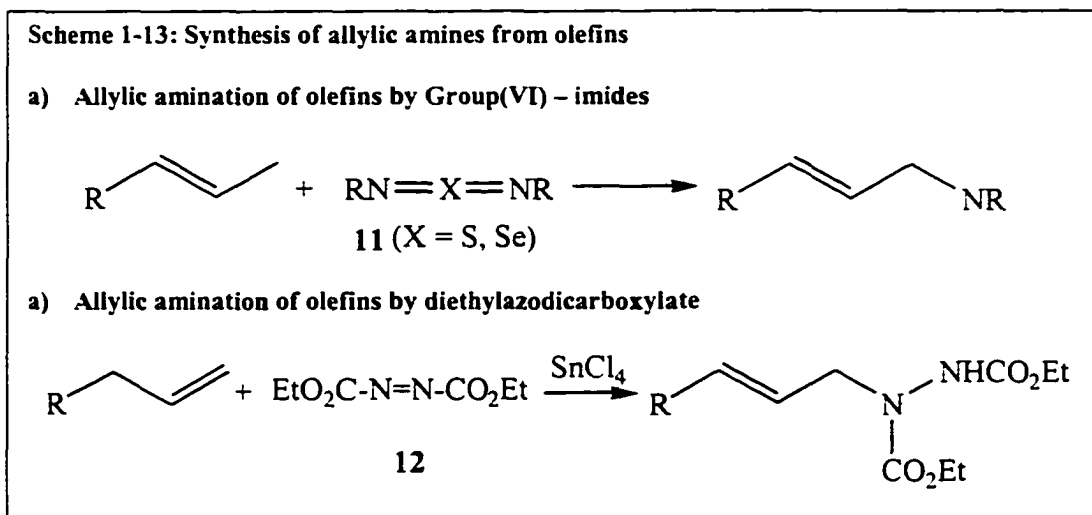

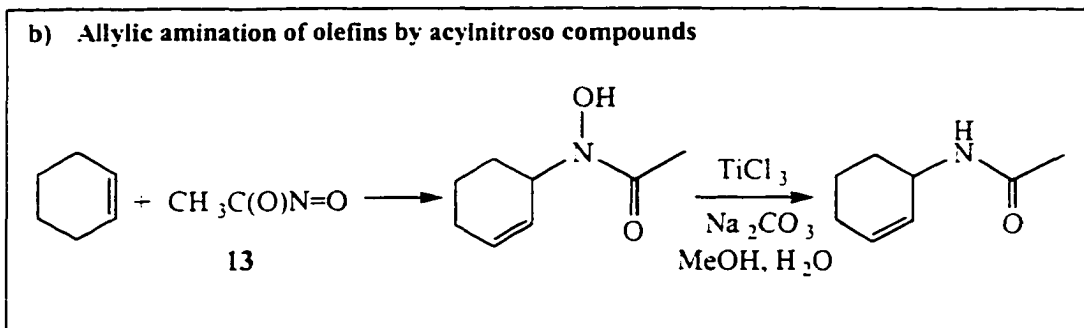

Reactions of olefins with group VI imides result in the formation of allylamines with retention of the double bond position as it proceeds by an ene reaction followed by a [2, 3]-sigmatropic rearrangement (Scheme 1-14).³⁰

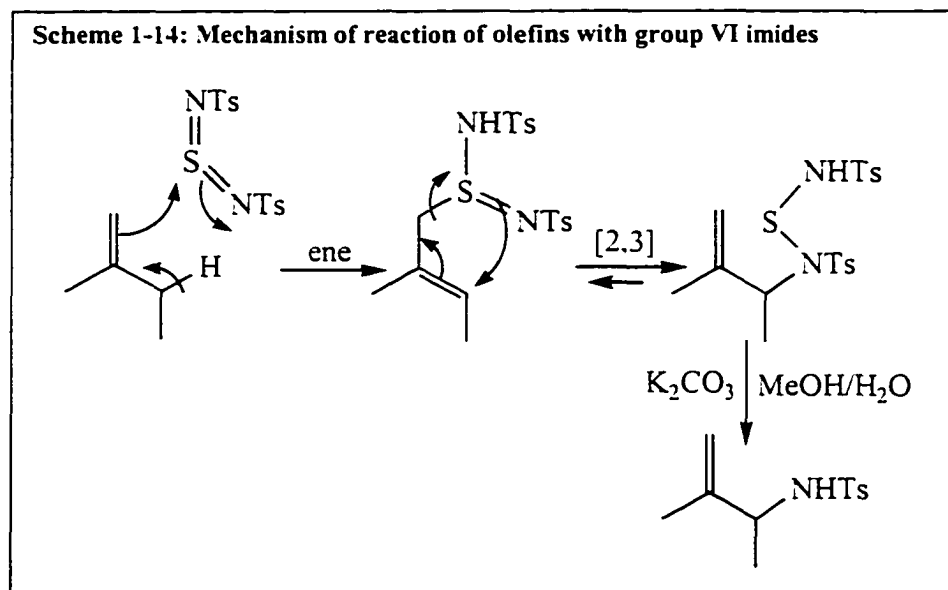

Most olefins and alkynes react with these imido reagents at or below room temperature suggesting that these reagents are very active. The reaction is, however, stoichiometric in the Se- or S-imido compounds.

Reaction of various substituted olefins with diethyl azodicarboxylate (12), catalyzed by Lewis acids, proceeds by an azo-ene reaction (Scheme 1-13b).³¹ As a

result, the products of this process suffer a transposition of the double bond. The reaction does not form the possible diadducts even in the presence of only one molar equivalent of the olefin. Formation of the trans-isomer is preferred. However, the scope of this reaction is unknown since extensive investigation of the substrate structure was not performed. Also, the reaction requires stoichiometric amounts of SnCl₄. These reactions yield amine derivatives and to obtain free allylamines from these products requires appropriate deprotection procedures.

The reactions of olefins with acylnitroso compounds (**13**) also proceeds by an ene-like pathway (Scheme 1-13c).³² The required acylnitroso compound is very reactive and, therefore, is generated *in situ* by pyrolysis of the Diels-Alder adduct of nitrosocarbonylmethane with 9,10-dimethylanthracene at 80-110°C in the presence of the olefin. High yields of the products were obtained. The acylnitroso precursor is prepared by oxidation of acetohydroxamic acid with N(Pr)₄IO₄ in the presence of 9,10-dimethylanthracene. Both inter- and intramolecular pathways were developed. However, this methodology yields products at the amide oxidation state.

Some other routes to obtain allylic amines directly from olefins include reactions with carbamate esters³³ and N-sulfinylcarbamates in presence of SnCl₄.³⁴ However, the aminating agents used in all these processes are not easily accessible, limiting the use of these routes.

General catalytic regio- and stereoselective routes to obtain allylic and propargylic amines directly from olefins and alkynes are needed as these processes will be industrially more feasible and potentially more direct than the aforementioned substitution reactions.

1-2: CATALYTIC ALLYLIC AMINATION OF OLEFINS

The idea of allylic amination of olefins catalyzed by transition metal complexes was based on two separate reports by Sharpless and Mares describing the synthesis of Mo- and W-nitrosoalkane complexes (**14**) from the corresponding dioxo complexes (**15**) (Scheme 1-15).^{35, 36}

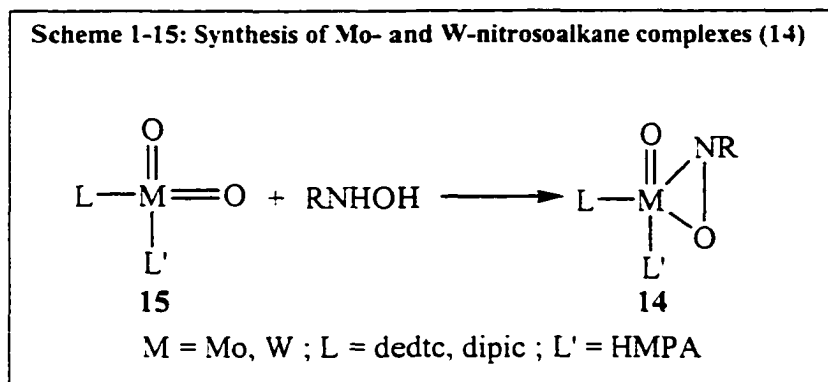

Mo- and W-dioxo complexes react with N-substituted hydroxylamines resulting in excellent yields of the corresponding oxaziridine (or nitrosoalkane) complexes in which the metal has a coordination number of 7 and η^2 -coordination to the RNO group. It was also demonstrated that these oxaziridine complexes (**14**) transfer an RN- unit to certain olefins to form the corresponding allylic amines, regenerating the starting metal-dioxo complex **15** (Scheme 1-16). The allylic amines (**16**) thus obtained were the result of ene-like regioselectivity, i.e. amination occurs with transposition of the double bond. It should be noted that the SOHIO process for conversion of propylene to acrylonitrile involves molybdenum-promoted allylic amination of the olefin in the intermediate stage of the catalytic cycle.

Scheme 1-16: Reaction of Mo-oxaziridine complexes with olefins

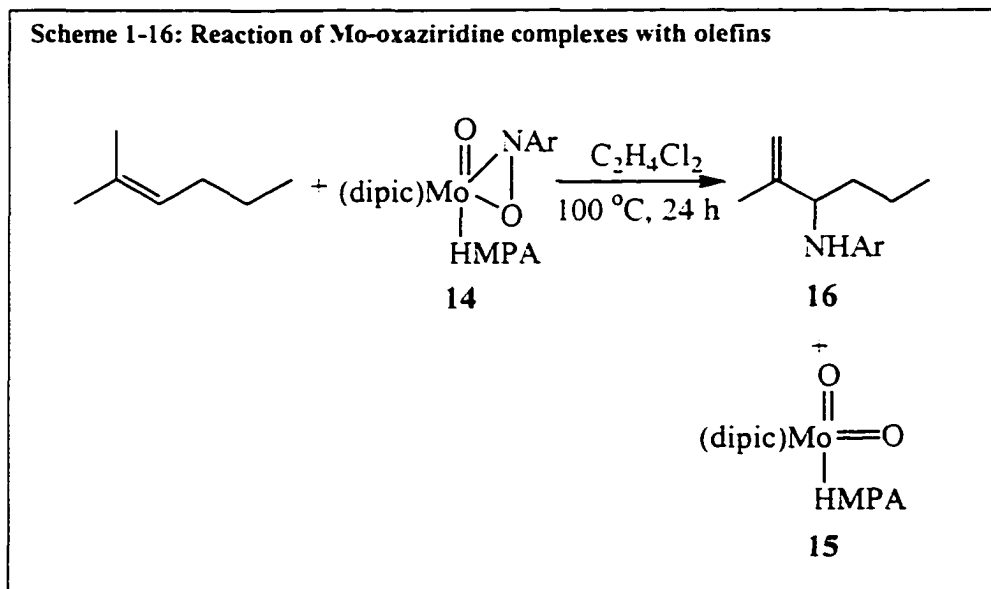

1-2-1: $L_nMo(O)_2$ – CATALYZED ALLYLIC AMINATION OF OLEFINS

Based on these early reports, a new catalytic reaction converting olefins to allylic amines by reaction with arylhydroxylamines was developed in the Nicholas group. Olefins react with phenylhydroxylamine ($PhNHOH$)³⁷ in the presence of catalytic amounts (10 mol%) of $MoO_2(dipic)(HMPA)$ (17a) or $MoO_2(dedtc)_2$ (17b) to produce allylic amines together with aniline and azoxybenzene in varying amounts (Scheme 1-17).³⁸ The desired allylamines were obtained in low to moderate yields (4 – 52%). The reaction resembles an ene reaction in that it is highly regioselective, giving the product upon double bond migration, and the ‘N’-fragment attacks the less substituted carbon atom of the original double bond.

Scheme 1-17: $L_nMo(O)_2$ - catalyzed allylic amination of olefins

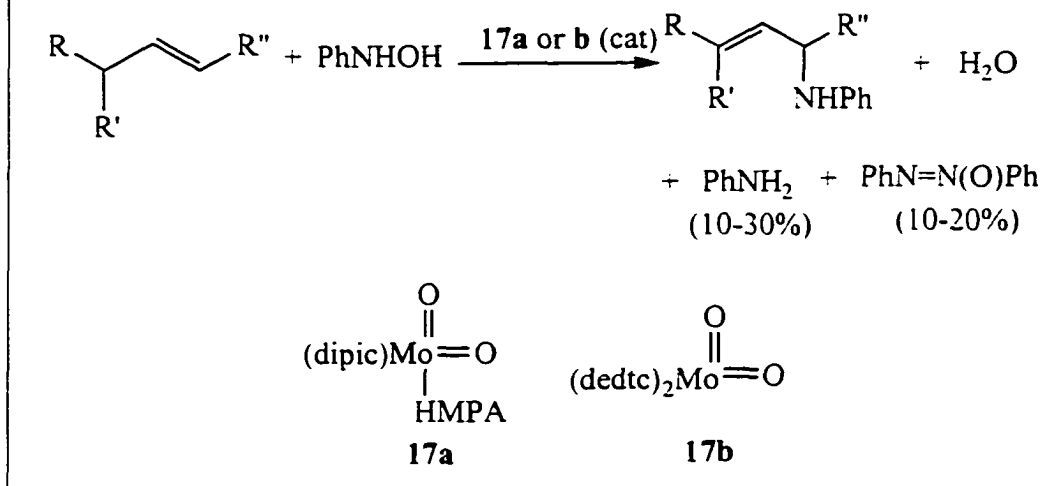

The yields and the chemoselectivity of the reaction depend on the substrate structure with the more substituted olefins, namely the trisubstituted and 1,1-disubstituted olefins, giving the best results. In these reactions the intermediate complexes $L_nMoO(\eta^2\text{-PhNO})$, (**18a, b**), formed by reaction of the corresponding dioxo complex with PhNHOH, were observed by IR, UV-VIS, and could also be isolated during the reaction. The by-products, aniline and azoxybenzene, are formed *via* competing pathways involving thermal self-condensation of PhNHOH and decomposition of the intermediate Mo-nitrosoarene complex.³⁹

The mechanism for this reaction was elucidated.⁴⁰ The first step is the formation of the Mo-oxaziridine (**18**) complex by the reaction of L_nMoO_2 complex (**17**) with PhNHOH (Scheme 1-18).

Scheme 1-18: Synthesis of the Mo-oxaziridine complex from the Mo-dioxo complex

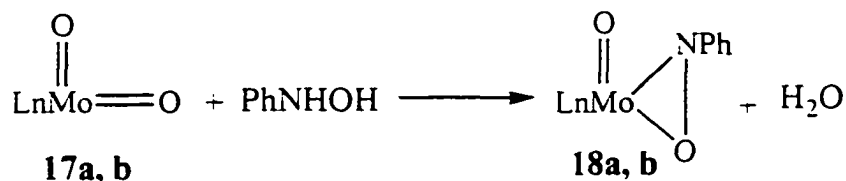

Stoichiometric reaction of olefins with these oxaziridine complexes results in the desired allylic amine with the same regioselectivity as that which was observed in the catalytic reactions. Kinetic studies revealed a first order dependence on the oxaziridine complex (dipic)(HMPA)MoO(η^2 -ONPh) (**18a**) at constant olefin concentration and zero-order dependence on the olefin at constant Mo-oxaziridine complex concentration. This suggests that the Mo-oxaziridine complex is involved in or before the rate-limiting step but that the olefin is not. Hence, olefin coordination to the metal can be disregarded. The rate of the reaction was constant in the presence or absence of ligating additives, such as HMPA, suggesting that initial dissociation of HMPA from the Mo-oxaziridine complex is not involved.

The resemblance of the Mo-catalyzed allylic amination to an ene reaction suggests reaction of the olefin with an enophile, which in this case can be nitrosobenzene (PhNO) obtained by dissociation from the Mo-oxaziridine complex (**18a**). Alkyl- and aryl-nitroso compounds are known to be good reagents in the hetero-Diels-Alder reactions⁴¹ and in ene reactions.^{33, 42} The formation of uncoordinated PhNO as the active intermediate was demonstrated by trapping it by a hetero-Diels-Alder reaction with 2,3-dimethylbuta-1,3-diene (DMB) (Scheme 1-19).

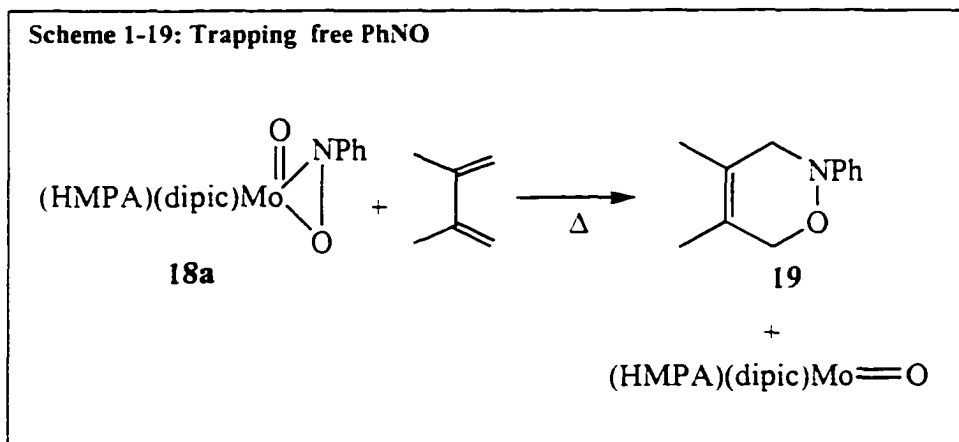

The other organic nitrogen-containing by-products were also observed by GC-MS. Complex **18b** also reacts with free nitrosoarenes to liberate PhNO. The mono-oxo complex, $(\text{dedtc})_2\text{Mo}(\text{IV})\text{O}$ (**20**) formed upon dissociation of PhNO from **18** readily reacts with PhNO at room temperature to produce the corresponding Mo(VI)-oxaziridine complex (**18b**) (Scheme 1-20).

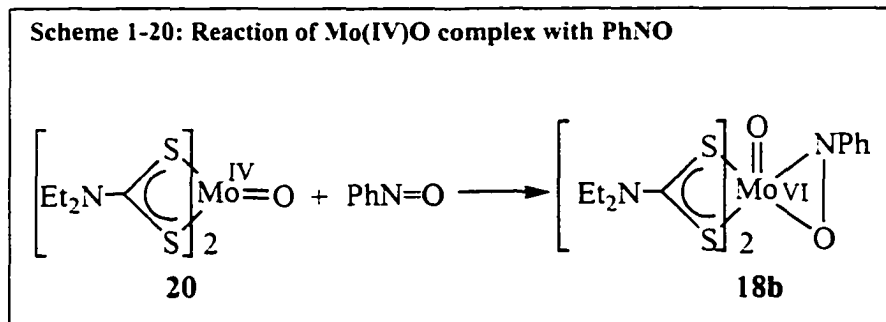

Temperatures of 80 °C or more are required for both the stoichiometric reactions of olefins with the Mo(VI)-oxaziridine complexes (**18a, b**) and the Mo-dioxo catalyzed reaction to occur at a reasonable rate. Hence, based on the above mentioned exchange reaction of Mo(IV)-complex and on the temperature requirement, it was

concluded that the dissociation of PhNO from the oxaziridine complex is the rate-limiting step of the cycle.

The off-metal ene reaction of the olefin with the dissociated PhNO was also established. 2-Methyl-2-hexene reacts with PhNO in dioxane with heating to produce moderate yields of the allylic hydroxylamine (**21**) accompanied by the characteristic double bond migration (Scheme 1-21).

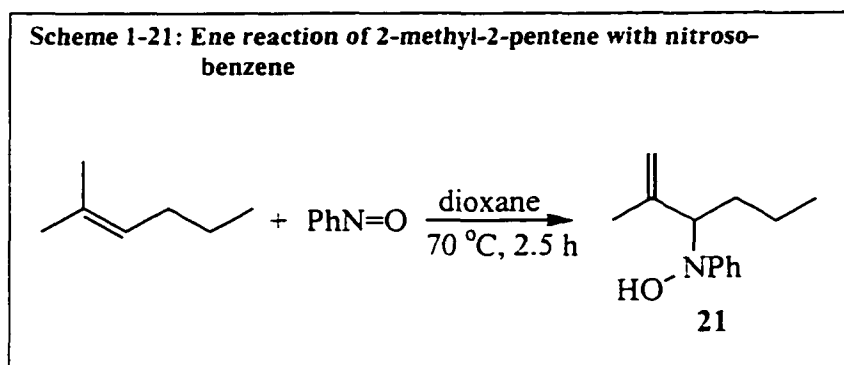

Subsequent reduction of the allyl-hydroxylamine (**21**) by $L_n\text{Mo(IV)O}$ complex (**22**), which would also be formed upon dissociation of PhNO from the Mo(VI)-oxaziridine complexes, was found to be effective (Scheme 1-22) yielding the expected allylic amine (**23**) along with the Mo(VI)-dioxo complex (**17**).

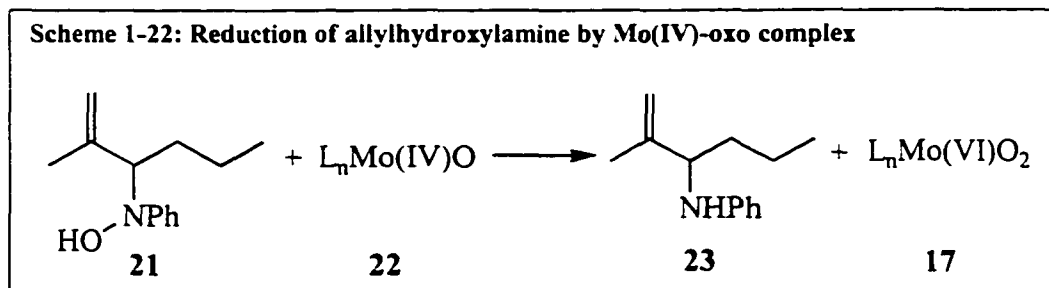

On the basis of these results, the mechanistic cycle for Mo(VI)-dioxo complex-catalyzed allylic amination of olefins was proposed (Scheme 1-23). The main features of the catalytic cycle can be summarized as follows:

- (i) $L_nMo(VI)O_2$ (**17**) reacts with PhNHOH to form the oxaziridine complex $L_nMo(VI)O(\eta^2-ONPh)$ (**18**)
- (ii) Complex **18** dissociates in the reaction medium to liberate PhNO and form $L_nMo(IV)O$ (**22**)
- (iii) PhNO reacts with the olefin in an ene-like fashion outside of the metal coordination sphere to form the allylhydroxylamine (**21**)
- (iv) $L_nMo(IV)O$ reduces the allylic hydroxylamine to the desired allylic amine (**23**), regenerating the Mo(VI)-dioxo complex (**17**).

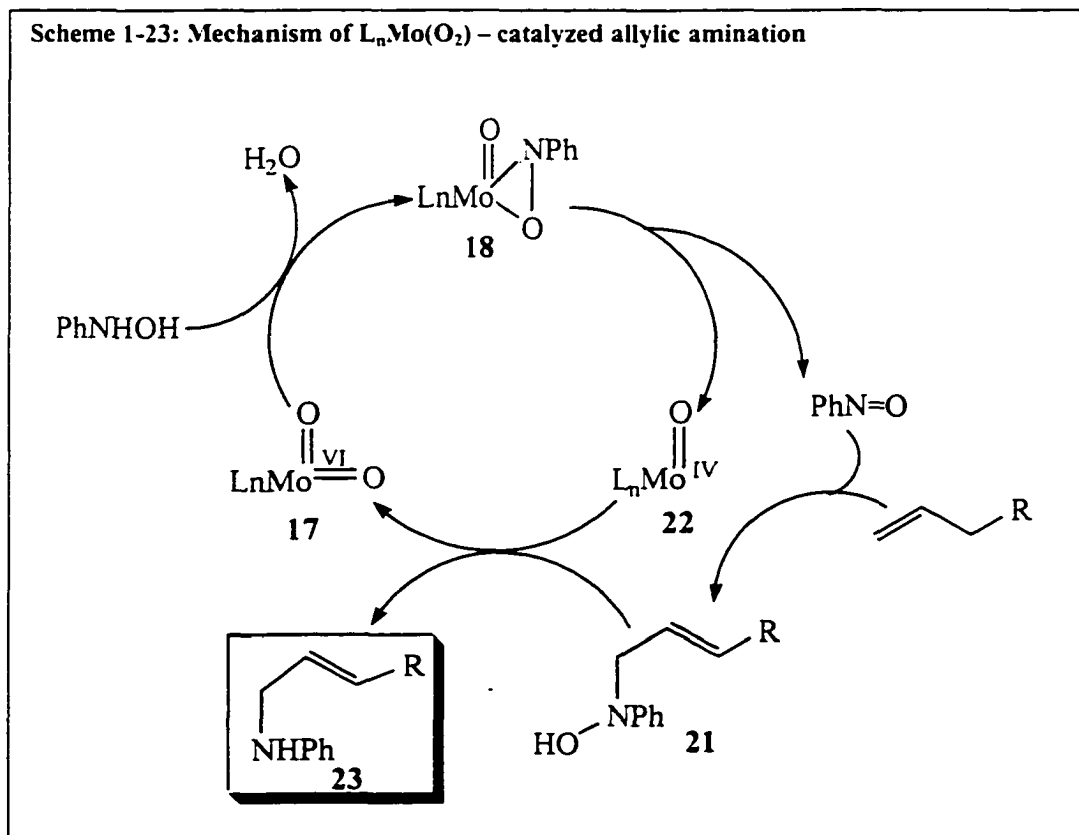

The metal essentially acts as a redox shuttle in this reaction. It oxidizes PhNHOH to PhNO, itself getting reduced from Mo(VI) to Mo(IV) state, and then reduces the allylhydroxylamine formed by the ene reaction outside of the metal coordination sphere to produce the desired allylic amine, itself getting reoxidized to the Mo(VI) state.

It is evident from the mechanism that the actual reaction with the olefin occurs outside the metal coordination sphere. Hence, this system will not be suitable for developing stereoselective reactions via chiral induction by ligands on the metal.

1-2-2: $L_nFeX / FeX_{2,3}$ – CATALYZED ALLYLIC AMINATION OF OLEFINS

Jorgensen *et al.* have reported allylic amination of olefins with PhNHOH using certain iron complexes, namely Fe(Pc), Fe(TPP)Cl.⁴³ They have also shown that these reactions involve the formation of free nitrosobenzene as the reactive intermediate by trapping it by hetero-Diels-Alder reaction.⁴⁴

While the above studies were in progress, in an attempt to increase the efficiency and selectivity of the Mo-catalyzed reaction of olefins with PhNHOH, studies were performed in our lab on the effects of added Lewis acids as co-catalysts. In doing so it was found that iron salts can independently catalyze the reaction to form the desired allylic amines in modest to good yields (Scheme 1-24, Table 1-1).⁴⁵



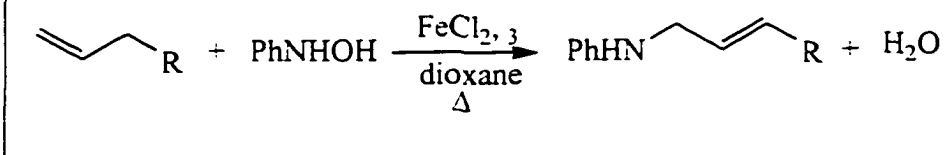





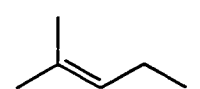
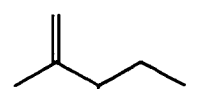
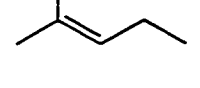
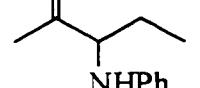

Scheme 1-24: FeCl_{2,3}-catalyzed allylic amination of olefins

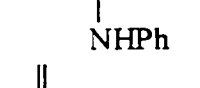
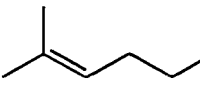
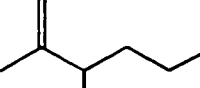
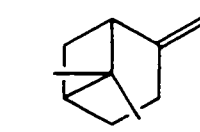
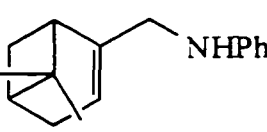
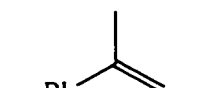
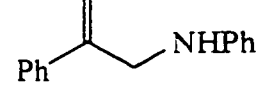
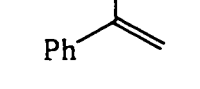
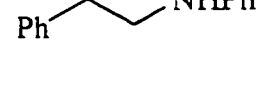
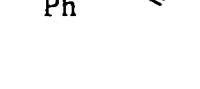

The formation of the N-containing by-products was considerably suppressed. The main by-product, aniline, was obtained in low to moderate yields, while only traces of azoxybenzene and azobenzene were obtained. The allylamines were obtained in > 95% regioselectivity with the product being formed with double bond migration. The yields of the allylamines were dependent on the olefin structure, much like the Mo-catalyzed reactions. Olefins with higher degree of substitution gave enhanced yields. Another significant feature of this system is that the reaction can be catalyzed by both Fe(II) and Fe(III) salts, and also by both anhydrous and hydrated salts, producing similar results. Since the iron salts are quite inexpensive, this system proved to be more attractive.

Apart from the advantages of this system mentioned above, the most important feature is that the reaction was shown not to involve the formation of free PhNO (Scheme 1-25). Free PhNO can be effectively trapped by a diene in the presence of the olefin to give the hetero-Diels-Alder adduct (**24**) as the sole product. However, this adduct was not detected when the mixture of α -methylstyrene and DMB was treated with PhNHOH under the amination reaction conditions. Only the allylic amination product, 2-phenyl-3-(phenylamino)-prop-1-ene (**25**), was produced with traces (<5%) of allylic amination product derived from DMB (**26**).

Table 1-1: Allylic amination of olefins catalyzed by Fe(II, III)-chlorides

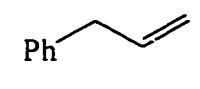
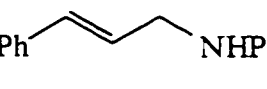
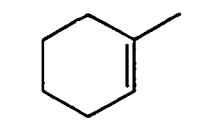
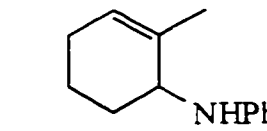
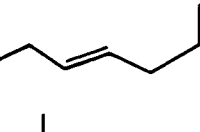
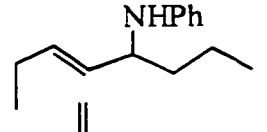
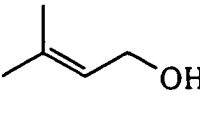
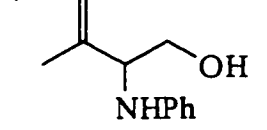
Entry	Olefin	Catalyst	Product	Yield (%) ^a	N-Chemo-selectivity (%) ^b
1		A + B (9:1) ^c		61 (48)	90
2		" + "		72 ^d	>90 ^e
3		C + D (9:1) ^c		23	67
4		A + B (9:1)		50	93
5		A + B (9:1)		43 (29)	82
6		A + B (9:1)		34 (22)	92
7		A		26	76
8		B		29	90
9		FeCl ₂		25	71
10		FeCl ₃		28	62
11		C + D (9:1)		41	80
12		A + B (9:1)		22	40
13		A + B (9:1)		13	42
14		A + B (9:1)		12	48
15		A + B (9:1)		11	40

^a GC yield, naphthalene standard (isolated yield); ^b allylamine / (allylamine + aniline + azobenzene + azoxybenzene); ^c A = FeCl₂·4H₂O, B = FeCl₃·6H₂O, C = Fe(ClO₄)₂·6H₂O, D = Fe(ClO₄)₃·6H₂O; ^d 2.5:1 PhNHOH/olefin; ^e olefin chemoselectivity by GC.

Based on this result, it was concluded that allylic amination reactions catalyzed by iron salts do not involve free PhNO as the active intermediate and possibly occur within the metal coordination sphere.

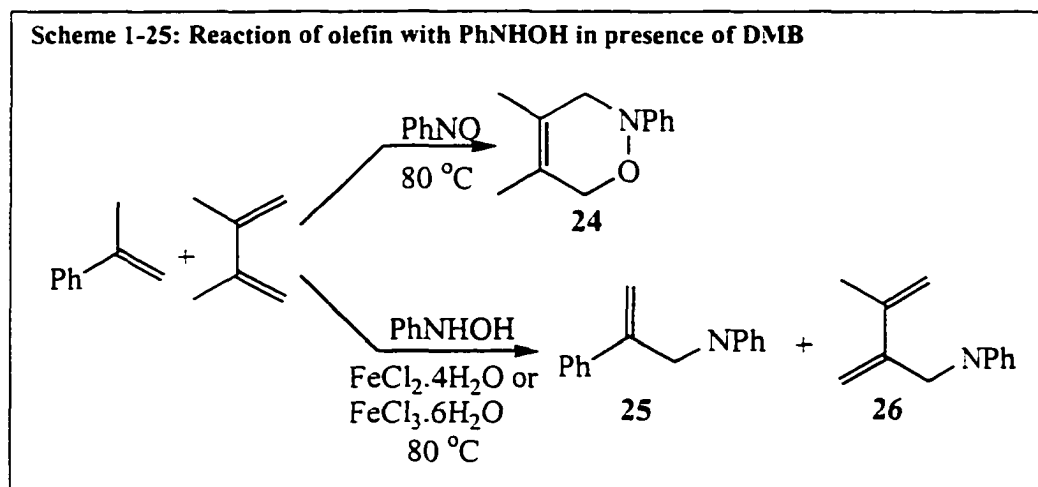

During attempts to elucidate the mechanism of this reaction, a novel Fe(II) complex with azobenzenedioxide ligands was isolated and characterized.⁴⁶ This complex (27) is produced by the reactions of iron chlorides with PhNHOH and PhNO. It can also be isolated during reaction of olefins with PhNHOH in presence of FeCl₂ as catalyst (Scheme 1-26). The structure of the complex was determined by X-ray diffraction (Figure 1-3). Its structure consists of a Fe(II) dication chelated to three azobenzenedioxide ligands. The complex ion has a distorted octahedral geometry, closer to a trigonal prismatic geometry with nearly planar chelate rings. They have relatively constant N-O (1.28 Å av) and N-N (1.29 Å av) bond lengths but somewhat varying Fe-O bond distances ranging from 2.083-2.158 Å. The N-N and N-O bond distances are between those characteristic of sp²-sp² single and double bond lengths suggesting that the electron density is delocalized in the chelate rings.

Scheme 1-26: Synthesis of Fe (II) – azobenzendioxide complex (27)

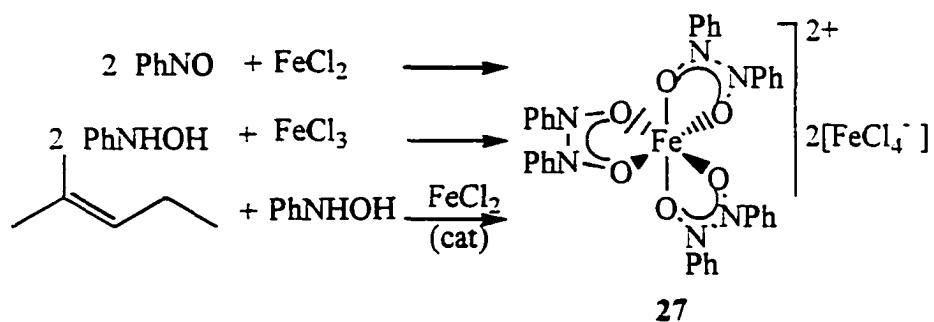
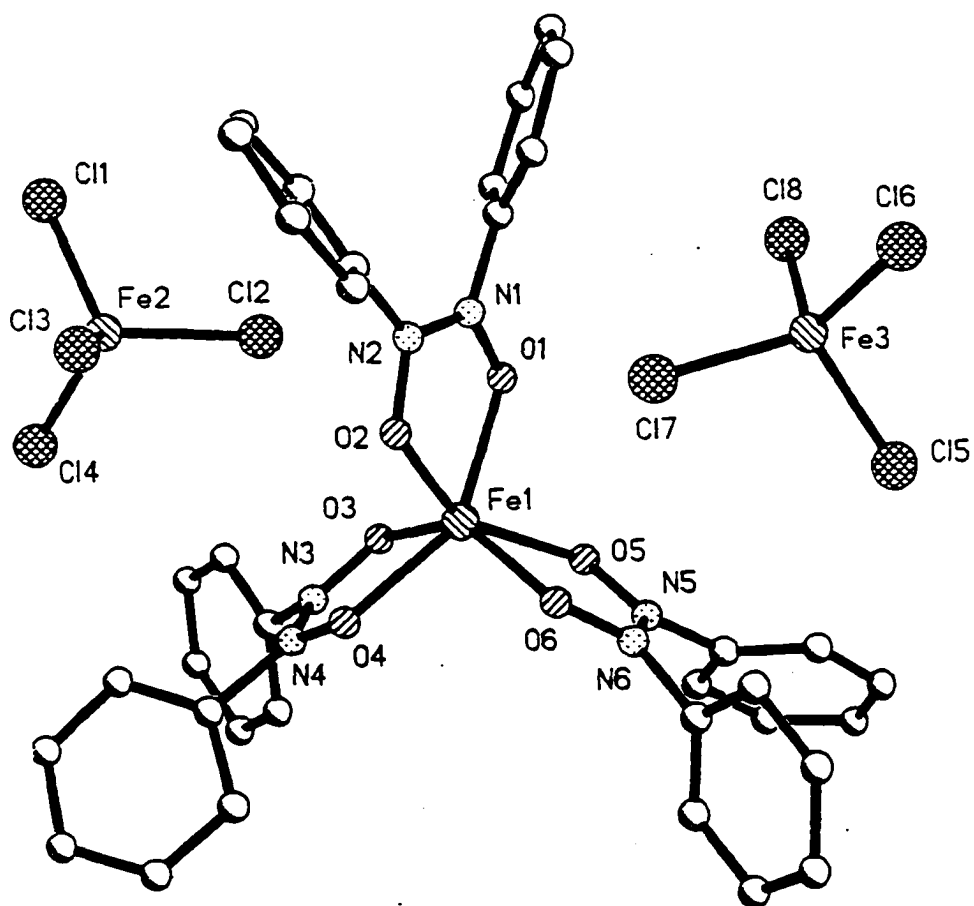
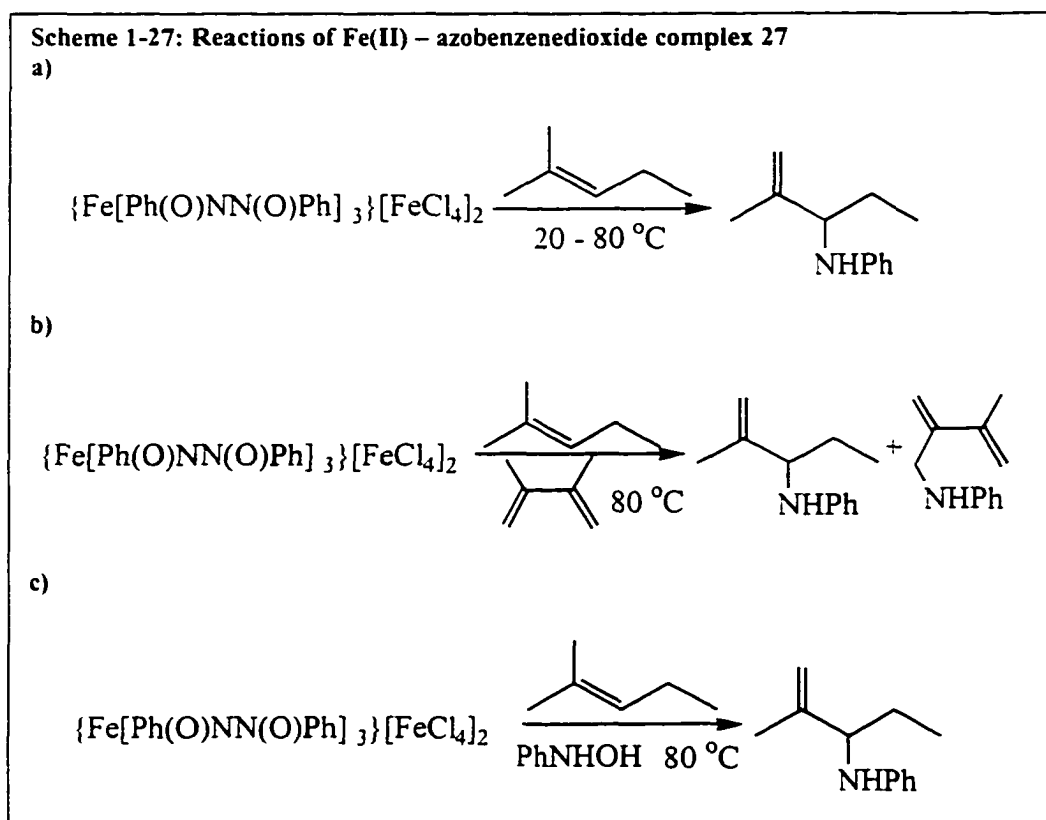

Figure 1-3: ORTEP diagram of Fe(II) – azobenzendioxide complex 27



The fact that the Fe(II)-azodioxide complex (**27**) is the active aminating agent in the Fe-catalyzed aminations of olefins was established. Complex **27** reacted with 2-methyl-2-pentene to form the allylamine in good yield (83%) even at room temperature (Scheme 1-27a). This reaction exhibits the same regioselectivity as that which was observed in the reactions catalyzed by iron salts. Reaction of **27** with 2-methyl-2-pentene in the presence of DMB resulted in the formation of the amination products derived from both the olefin and the diene but no hetero-Diels-Alder adduct was detected. Hence, complex **27** aminates olefins without the intermediacy of free PhNO (Scheme 1-27b). Complex **27** also catalyzed the reaction of 2-methyl-2-pentene with PhNHOH as the aminating agent (Scheme 1-27c).



Kinetic studies were performed on the reaction of the Fe(II)-azobenedioxide complex with olefins by monitoring the initial rate of formation of allylic amine product at low conversion (0 – 10 %) by GC.⁴⁷ The reaction of complex **27** with 2-methyl-2-pentene was found to be first order in the Fe(II)-azobenedioxide complex at constant olefin concentration and first order in the olefin at constant complex **27** concentration. This indicates that both **27** and the olefin are involved either in or before the rate-limiting step. Based on the Eyring analysis on the rate constants obtained between 50 and 90 °C, the following parameters were determined :

$$(i) \Delta H^\ddagger = 19 \pm 2 \text{ kcal / mol}$$

$$(ii) \Delta S^\ddagger = -0.2 \pm 2 \text{ eu}$$

The almost negligible entropy of activation indicates that the rate limiting step is neither very associative nor very dissociative. The rate of the reaction was lowered when an electron withdrawing group was present in the para-substituted α -methylstyrene, while electron donating groups raised the rate relative to that for the reaction of unsubstituted α -methylstyrene. The Hammett ρ value obtained was -3.0 , suggesting a transition state that has substantial positive charge developed at the benzylic position.⁴⁸

Attempts were made to determine the nature of olefin involvement in the transition state (Scheme 1-28). Fe(II)-azobenedioxide complex **27** was allowed to react with 2-methyl-2-pentene, a good amination substrate, and with β -

methylstyrene and styrene, poor amination substrates. Intermediate complexes **28 a**, **b**, and **c** were isolated at low temperatures. Complex **28a**, upon thermolysis, yielded the allylic amine product and all three liberated the free olefin upon treatment with excess of *o*-nitrosotoluene.

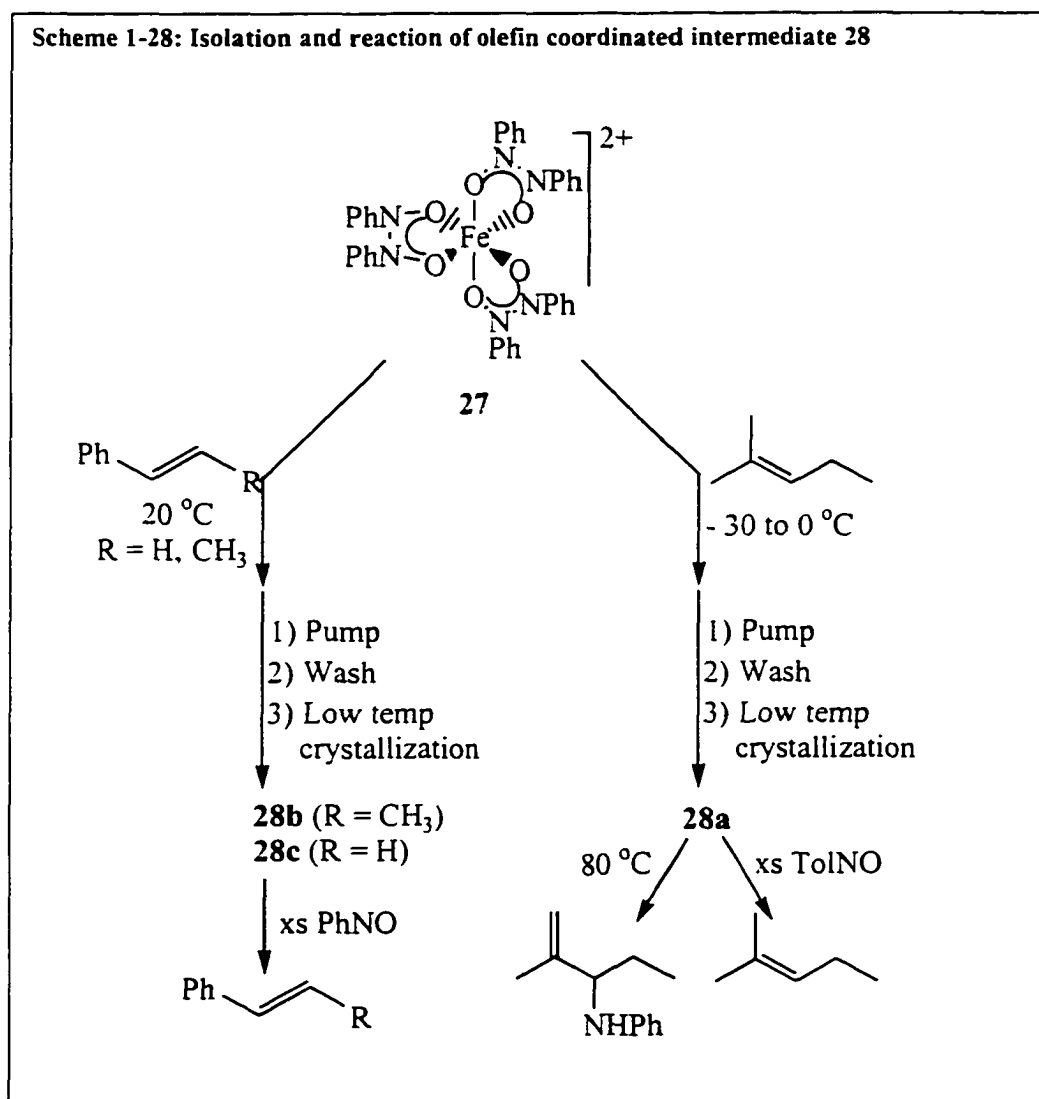

The ¹H NMR spectra of these intermediate complexes showed very broad signals due to the presence of the paramagnetic [FeCl₄]⁻ anion and, possibly, high spin Fe(II)

cation. The important aspect, however, is that even the signals for the olefin were broadened, suggesting coordination of the olefin to the paramagnetic metal. The UV-VIS spectrum of the complex **28a** had a new shoulder at 380 nm and the IR spectrum had a new medium intensity band at 1500 cm^{-1} , assigned to the C=C stretching vibration in the olefin. This large shift in the absorption frequency of the double bond ($100\text{--}150\text{ cm}^{-1}$) could be explained by a strong coordination of the olefin to the metal center. Thus, based on the above information, a structure was proposed for this intermediate species **28** (Figure 1-4).

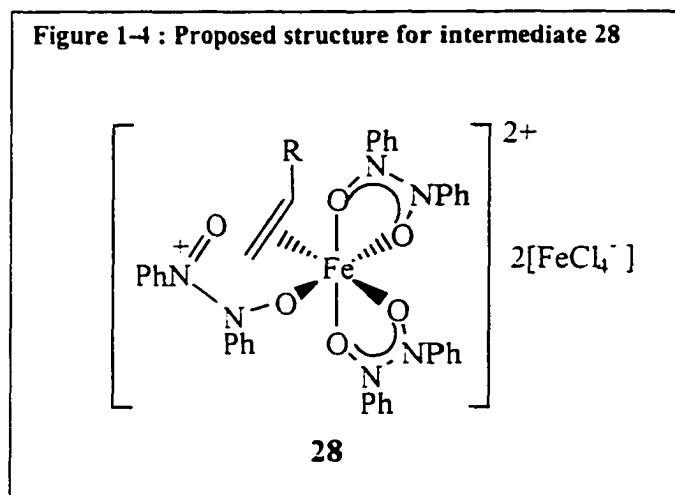

Hence, a tentative mechanism was proposed for allylic amination of olefins by PhNHOH catalyzed by iron salts based on the above mentioned studies (Scheme 1-29). The Fe(II)-azobenzenedioxide complex **27** undergoes dissociation of an arm of one of the bidentate ligands to form a coordinatively unsaturated complex **29**. This coordinates to the olefin to form **28** which can then undergo an intramolecular transfer of an 'RNO' unit to the olefin to produce allylic hydroxylamine **30**. Allylic hydroxylamine can be reduced to the desired allylic amine by an Fe(II) species. The

resulting Fe(III) species (31) can then react with more PhNHOH to yield the active Fe(II)-azobenzenedioxi- complex, 27, continuing the catalytic cycle. This proposed mechanistic cycle is the most probable one based on the kinetic, synthetic and isolation studies. However, the exact nature of 'RNO' transfer to the coordinated olefin is not clear.

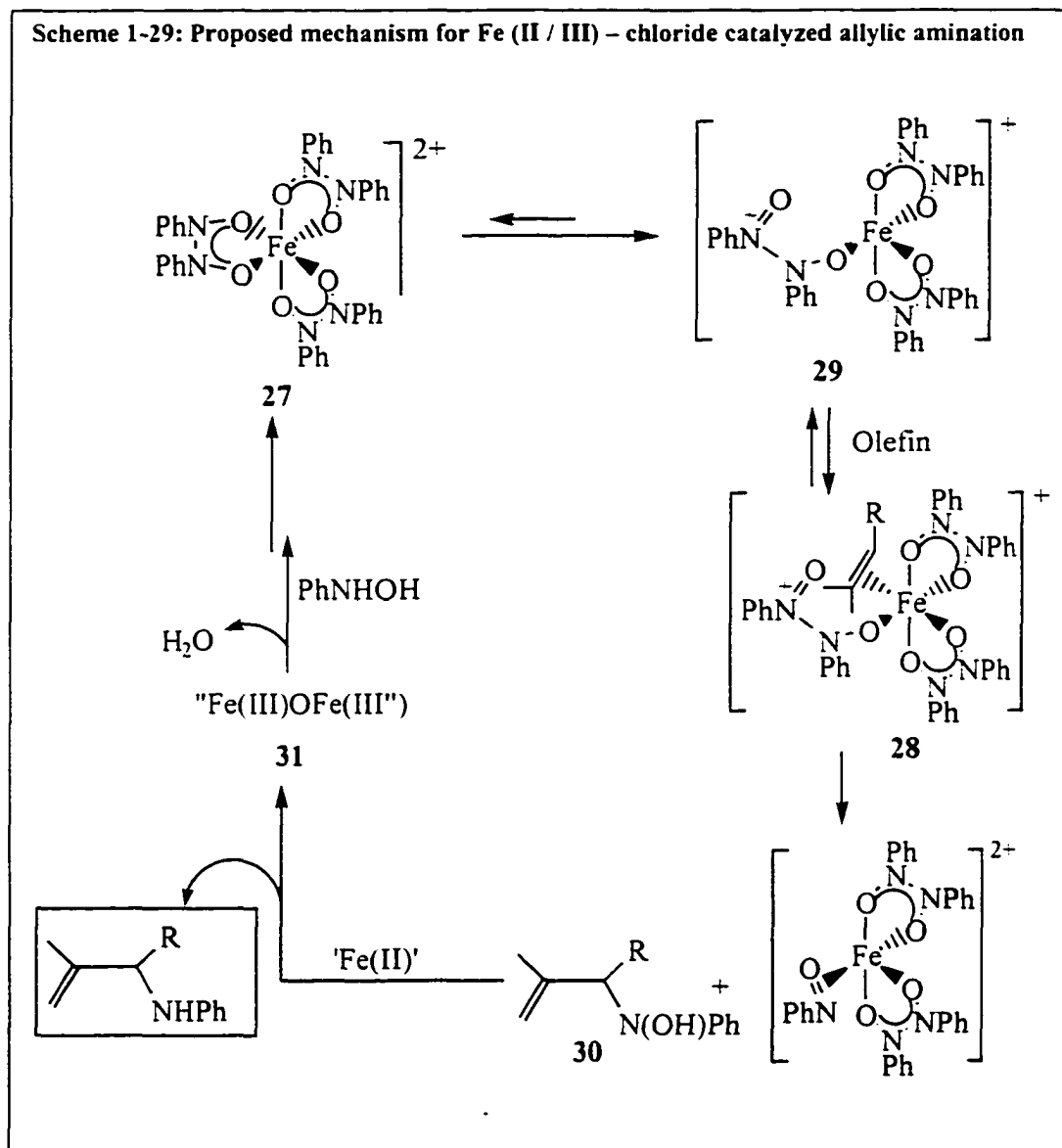

An asynchronous ene-like reaction can be envisioned based on the observed high regioselectivity of amination, the effect of olefin structure on the chemoselectivity, the small entropy of activation, and low isotope effect. In addition, the allylic proton may be more acidic when the olefin is coordinated to the Fe(II)-cationic center than in the uncoordinated state. This would make the olefin more reactive causing the required allylic hydrogen transfer to occur more readily. The azobenedioxide ligand can also be expected to be a better enophile since it is coordinated to the cationic metal center. Hence, the transfer of the N-fragment to the olefin may be occurring via a Lewis acid-catalyzed ene-like reaction.⁴⁹ Work in this area is continuing.

1-3: PROJECT OBJECTIVES

In the case of unsymmetrical olefins, reactions with PhNHOH in the presence of an achiral catalyst produce racemic mixtures of allylamines. Since the allylic amination of olefins catalyzed by iron salts does not involve the formation of uncoordinated PhNO as the active intermediate, it is reasonable to think of enantioselective allylic aminations using chiral catalysts. Hence, one of our objectives was to survey various classes of chiral ligands that may allow catalyst-induced enantioselectivity.

The product from the reaction of olefins with PhNHOH, which has been the aminating agent of choice until now, is a secondary N-phenyl-N-allylamine. Synthesis of other classes of allylic amines, especially primary allylamines, was a

desirable goal. To achieve this we plan to study other hydroxylamines as potential aminating agents.

In addition to the studied Mo- and Fe-catalyzed systems, we wished to look for other efficient catalytic systems for allylic amination of olefins. Hence, we also plan to investigate Cu (I, II) salts as potential catalysts towards this goal.

Chapter 2

AN APPROACH TO ENANTIOSELECTIVE ALLYLIC AMINATION OF OLEFINS CATALYZED BY CHIRAL IRON COMPLEXES

2-1: INTRODUCTION AND BACKGROUND

Molecular asymmetry is an important aspect of contemporary synthetic organic chemistry. The two enantiomers of a chiral compound differ in their interaction towards other optically active substrates. Hence, often it happens that one enantiomer of a compound has important medicinal use while the other is inactive or even detrimental to the human body. As a result, the focus of synthetic organic chemistry has shifted to enantioselective syntheses. There are presently a number of approaches available to achieve this goal, including resolution of a racemic mixture, modification of chiral compounds not affecting the pre-existing stereocenter, stoichiometric inter- and intramolecular chiral induction, and catalytic asymmetric induction.⁵⁰ Of these methods, asymmetric catalysis is currently the topic of considerable research efforts since it is possible to obtain large quantities of enantiopure natural and unnatural compounds, starting with achiral starting materials, by the use of only small amounts of the chiral catalysts. The outcomes of these processes depend upon the three-dimensional environment of the catalyst and the kinetics of the reaction involved. Use of chiral transition metal complexes as homogeneous catalysts provides an easy access into asymmetric organic synthesis. Through years of effort the area of asymmetric catalysis in organic synthesis has

developed tremendously and a large number of stereoselective organic transformations of achiral compounds catalyzed by chiral transition metal complexes are now known. Some examples of such laboratory processes include asymmetric hydrogenation of enamides,⁵¹ asymmetric epoxidation of allylic alcohols,⁵² and asymmetric aziridination of olefins⁵³ (Scheme 2-1). In addition to the examples shown, there is a plethora of other enantioselective catalytic organic reactions in the literature and research in this area is of continued interest.

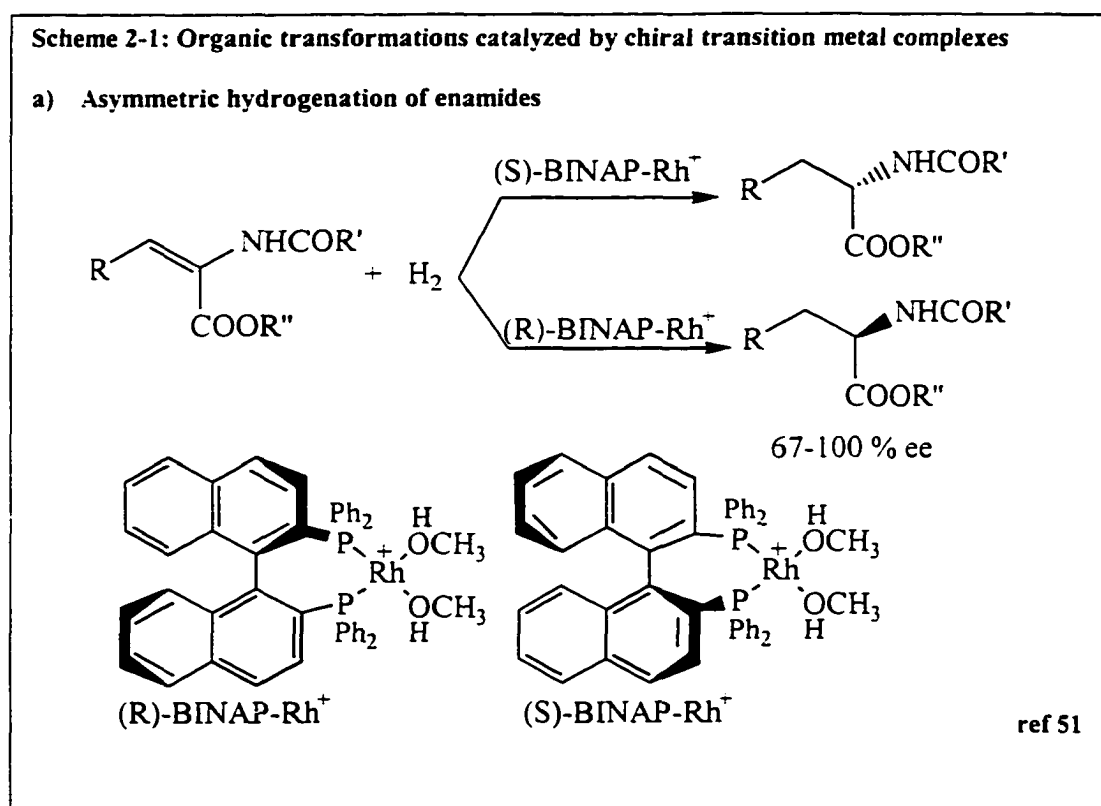

b) Asymmetric epoxidation of allylic alcohols

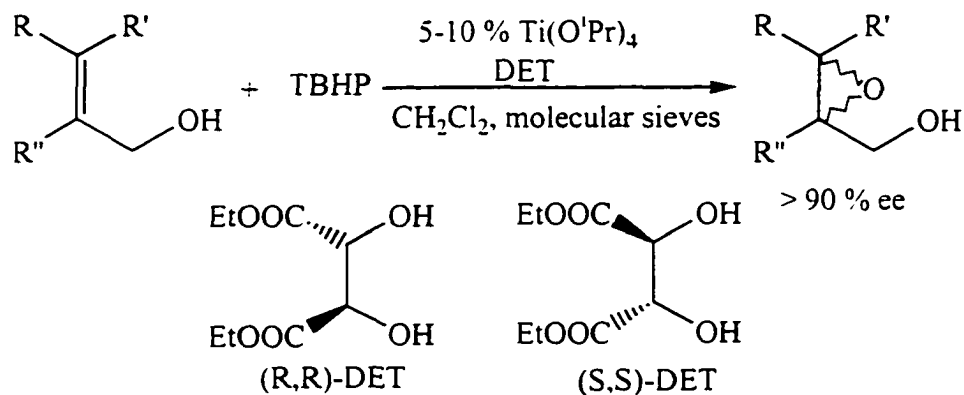

ref 52

c) Asymmetric aziridination of olefins

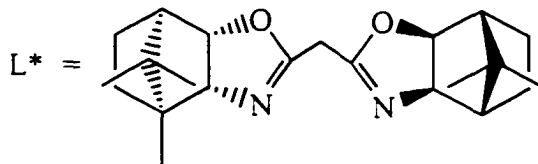
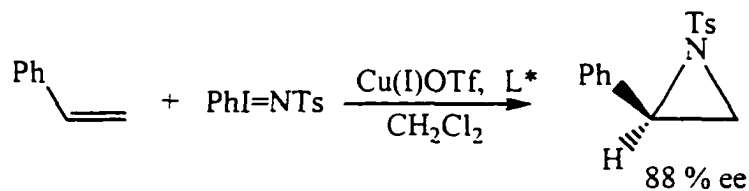

ref 53

As noted earlier, olefins react with PhNHOH in the presence of transition metal catalysts to yield N-phenyl-N-allylamines together with other nitrogen containing by-products, exhibiting ene-like regioselectivity and chemoselectivity. In cases where the olefin substrate is unsymmetrical, a chiral center is generated in the product allylamine (Scheme 2-2).

Scheme 2-2: Catalytic asymmetric amination of olefins

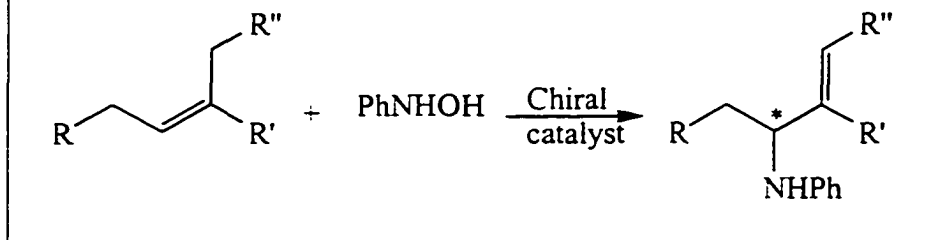

The $L_n\text{Mo(VI)O}_2$ catalyzed reaction was shown to be independent of the catalyst chirality as the actual amination reaction occurred outside of the metal coordination sphere.^{38, 40} However, allylic amination reactions catalyzed by Fe(II, III)-chlorides do not involve the formation of uncoordinated PhNO.^{45, 46, 47} These reactions appear to involve coordination of the olefin substrate and intramolecular transfer of the PhNO unit on the metal center. Hence, this system could potentially be a candidate for developing asymmetric allylic amination of olefins. If the environment around the iron center were chiral, it could lead to enantioselective amination of the coordinated olefin.

When work in this area was initiated, the allylic amination of olefins by PhNHOH catalyzed by iron salts had been established. It was also known that this reaction did not involve the formation of free PhNO (hetero-Diels-Alder test), suggesting a reaction occurring within the metal coordination sphere. However, the exact identity and nature of the actual aminating catalyst was unknown at that time. Hence, homochiral salen ligands (figure 2-1a) were chosen initially to study the feasibility of asymmetric allylic amination. After the active Fe(II)-azobenzenedioxide had been isolated and characterized, and its intermediacy in the

reaction was established, we turned our attention to other ligands that would be structurally and electronically similar to the azobenzenedioxiide ligands and could potentially coordinate to the dicationic iron center in a similar fashion. Hence, diamine-oxides (figure 2-1b) and diphosphine-oxides (figure 2-1c) were chosen for this purpose.

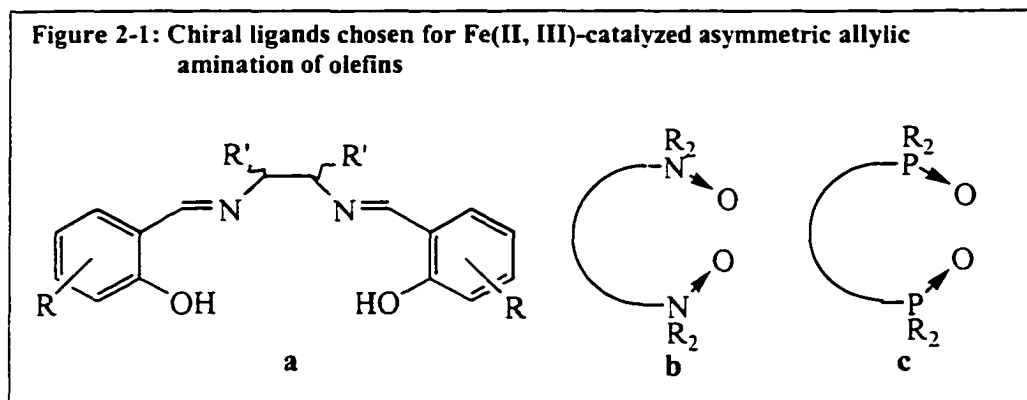

This chapter will discuss the results obtained in studies investigating the aforementioned ligands, and hence, will be comprised of separate sections for each ligand class.

2-2: N,N'-ETHYLENE-BIS(SALICYLIDENEIMINE) LIGANDS

2-2-1: INTRODUCTION AND BACKGROUND

The N,N'-ethylene-bis(salicylideneimine) (salen) ligands (**1**) are tetradentate Schiff's bases (Figure 2-2) that can be obtained by condensation of appropriately substituted salicylaldehydes and corresponding diamines. These compounds have been complexed to several metals including Mn,⁵⁴ Ru,⁵⁵ Co,⁵⁶ Si,⁵⁷ Pd,⁵⁸ Th,⁵⁹ and

Fe.^{54iii, 55, 60} The Fe(II, III)-Schiff's base complexes have been used for investigation of their magnetic properties.^{60i, iv, vi} Floriani *et al.* studied the reduction-oxidation properties of Fe(II)-salen complex in an attempt to understand physiological electron-transport systems.^{60v, 55}

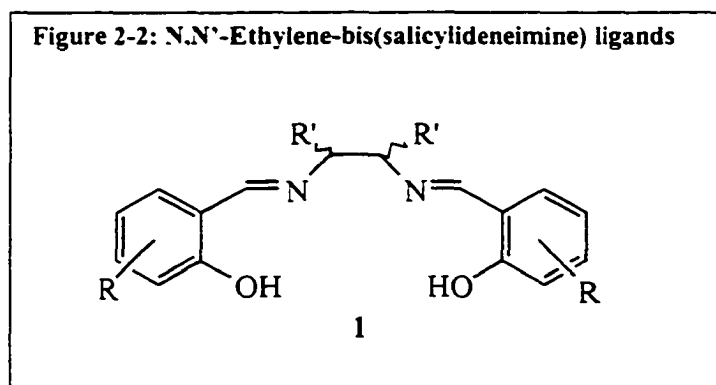

Some metal-salen complexes have also been used in synthetic organic chemistry to develop asymmetric catalytic reactions. The most important of such complexes are the Mn(III)-salen complexes. Jacobsen *et al.* have successfully developed enantioselective epoxidations of cis-conjugated⁵⁴ⁱ and trisubstituted olefins,⁵⁴ⁱⁱ obtaining enantiomeric excesses of > 90% using complexes 2 (Scheme 2-3). They have found that in order to achieve high stereocontrol two structural features of the catalyst are essential. These include –

- i) bulky groups ortho with respect to the hydroxy groups of the ligand in order to prevent approach of the olefin from the side away from the diamine bridge, and
- ii) chirality on the diamine bridge that will favor the approach of the substrate in one preferential orientation.

The steric bulk of the bridge disfavors approach from that side.

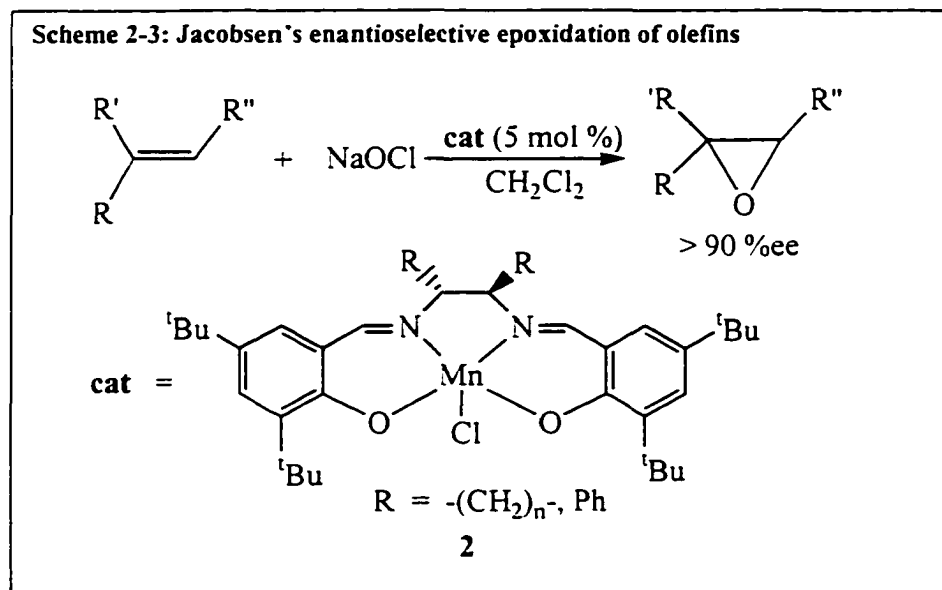

Other transition metal-salen complexes have also been used for developing catalytic systems for asymmetric organic reactions. Ti(IV) and V(IV) complexes of N,N'-disalicylidene-(R,R)-1,2-cyclohexanediimine (**3**) are efficient catalysts for oxidation of sulfides (Scheme 2-4a).⁶¹ However, the enantioselectivity in these cases is only modest, the highest being 53% ee. Oxidation of sulfides is also catalyzed by chiral Mn(III)-(salen)Cl complexes (**4**) using hydrogen peroxide as the oxidizing agent, resulting in 34-68% optical yield (Scheme 2-4b).⁶¹ⁱⁱⁱ

Scheme 2-4: Catalytic asymmetric oxidation of sulfides

a)

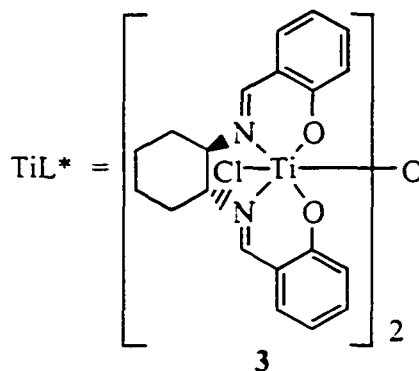
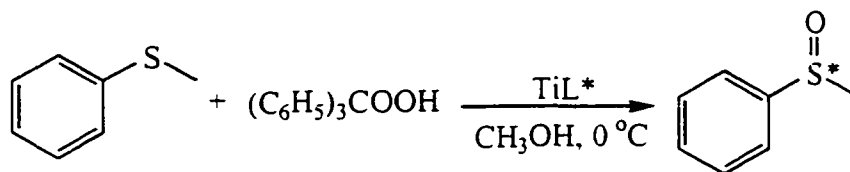

b)

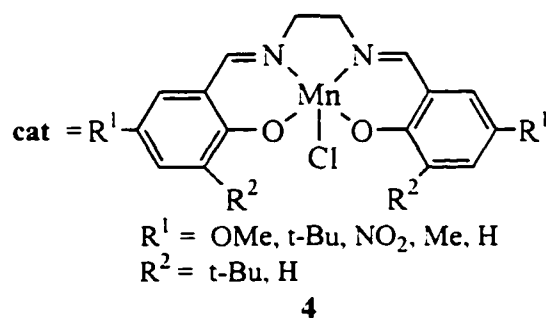
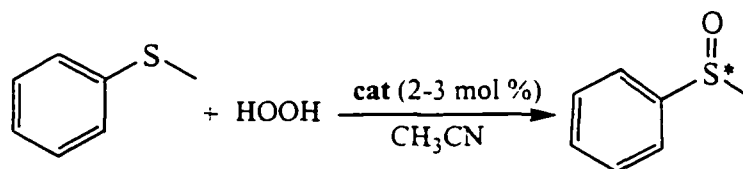

Chiral Mn(III)-(salen)Cl complexes (5) catalyze aziridination of olefins yielding moderate enantiomeric excesses (Scheme 2-5).⁶² Co(II)-salen complexes (6) have been used for asymmetric cyclization of racemic 1,3-dichloro-2-propanol in 67% enantiomeric excess (Scheme 2-6).⁶³

Scheme 2-5: Catalytic asymmetric aziridination of olefins

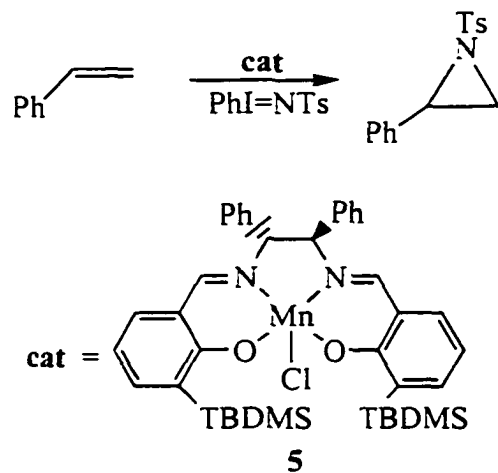

Scheme 2-6: Catalytic asymmetric cyclization of 1,3-dichloro-2-propanol

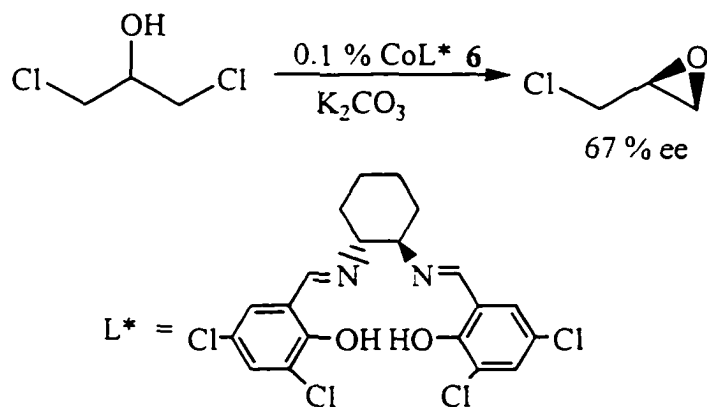

Chiral Co(II)-salen complexes (**7**) have also been used for enantioselective carbonylation of 2-bromopropanol producing propylene carbonate in fair optical yield (Scheme 2-7).⁶⁴

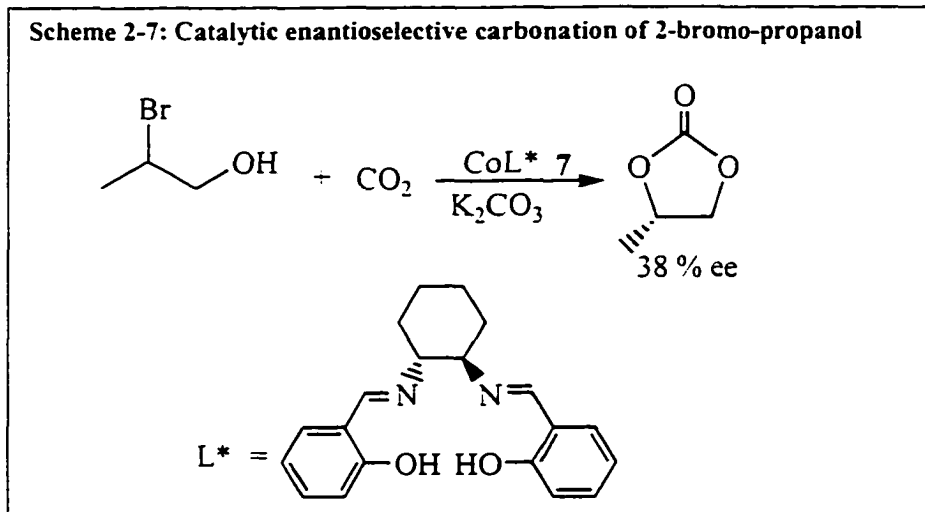

In summary, salen ligands have been used for complexation to several transition metals, including iron, and some of these complexes catalyze asymmetric organic transformations. However, with the exception of the Mn (III)-salen complex, used in enantioselective olefin epoxidation, these complexes have yielded only moderate stereoselectivity.

2-2-2: RESULTS AND DISCUSSIONS

Reactions of olefins with PhNHOH, catalyzed by Fe(II, III)-chlorides, produced allylic amines *via* an ene-like reaction.⁴⁵ This reaction proceeded without the formation of uncoordinated PhNO as the active intermediate. Other mechanistic studies suggest that the reaction possibly occurs within the metal coordination sphere and that the “PhN” fragment and the olefin are coordinated to the metal.^{46, 47} This suggests the possibility of an enantioselective version of the reaction using chiral ligands. Based on this, we initiated our investigation with salen ligands since the use

of these compounds in catalytic asymmetric reactions has literature precedent. This section will, therefore, present the results obtained from these studies.

2-2-2-1: SYNTHESIS OF N,N'-ETHYLENE-BIS(SALICYLIDENEIMINE)

LIGANDS AND N,N'-ETHYLENE-BIS(SALICYLIDENEIMINATO)-IRON (II) COMPLEXES

In order to develop asymmetric allylic amination of olefins catalyzed by Fe(II)-salen complexes, we first needed to explore the catalytic activity of the achiral complex towards the reaction. The salen ligands (**8**) were generally prepared by condensation of the appropriately substituted salicylaldehyde and ethylenediamines (Scheme 2-8).⁵⁶⁻⁵⁹ In some cases the condensation was performed in polar, protic solvents (MeOH, EtOH) wherein the ligand would precipitate and could be collected by filtration. The synthesis could also be performed using benzene as the solvent.⁵⁷ In this case the water formed was azeotropically distilled out and the ligand was then isolated by removal of the residual benzene.

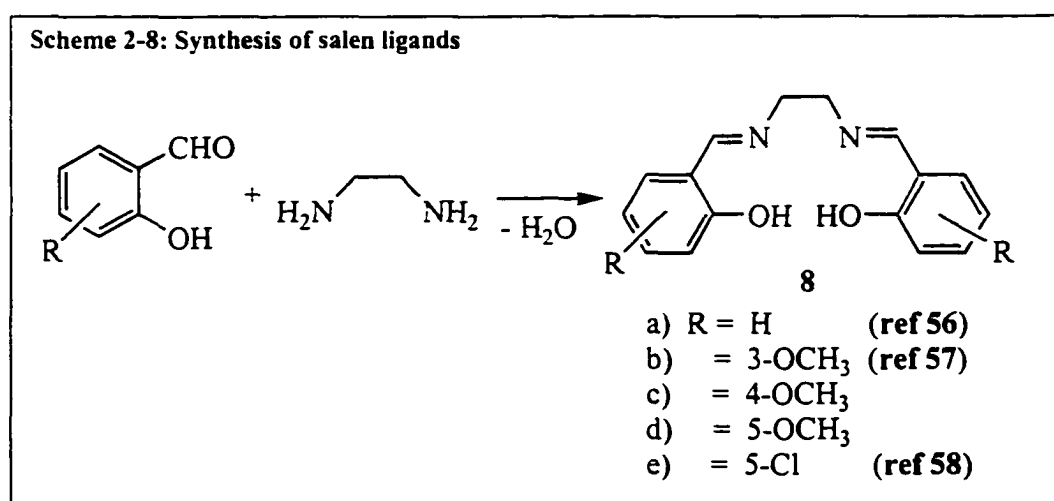

Salen ligands **8c** and **8d** are new compounds, which were prepared to study the electronic effects of the varying substituent positions. All of the salen derivatives were purified by recrystallization and isolated as yellow colored solids. These were characterized spectroscopically. The ^1H NMR spectra show the characteristic resonances for the protons of the bridge, the deshielded proton on the imine carbon, the protons on the di- or tri-substituted phenyl rings, and the phenolic protons observed in the extremely downfield region (Figure 2-3). Characteristic bands for the C=N, C=C, and aromatic and aliphatic C-H stretches were observed in the IR spectra. The O-H bands that are expected to be broad were observed in the high frequency region but of low intensity. Molecular ions were seen in the mass spectra of each ligand.

These ligands were then complexed to Fe(II) following the general procedures reported in literature for the synthesis of complexes **9a**, **9b** and **9e** (Scheme 2-9).^{54iii, 55, 60iv, vi} The complexes **9** can either be formed by displacing the carbonyl ligands in $\text{Fe}(\text{CO})_5$ or by reacting ferrous acetate with the dipotassium salt of the salen ligands.

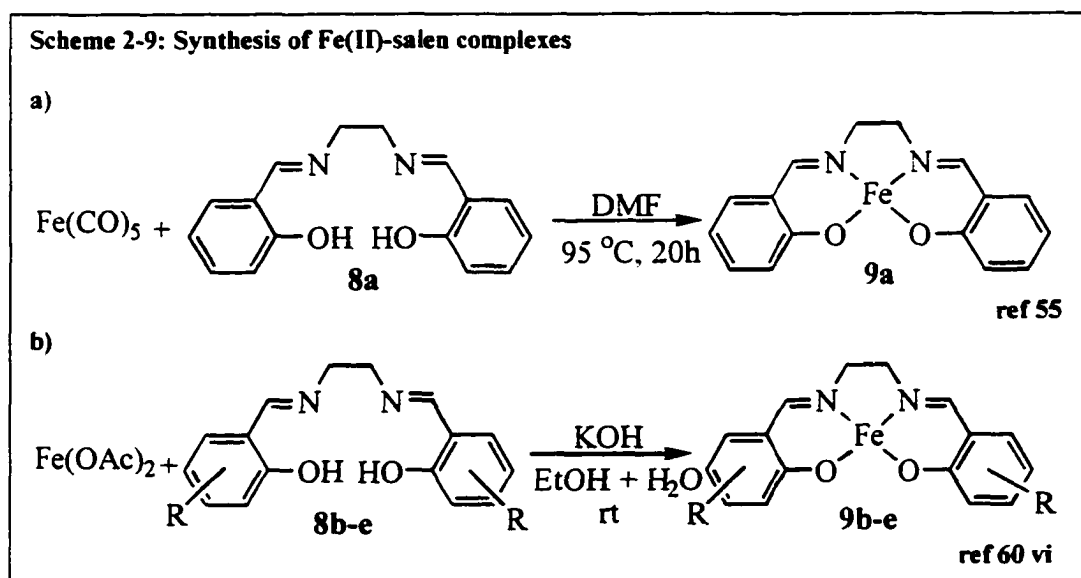

Fe(II)-salen complexes with various substituents on the phenyl ring of the ligand were prepared in order to study the effect of the electronic nature of the complex on the allylic amination of olefins. These complexes were isolated as brown-red solids and the mass spectrum of each complex shows the molecular ion as the base peak. Loss of ethylene from the bridge was observed to be a major fragmentation.

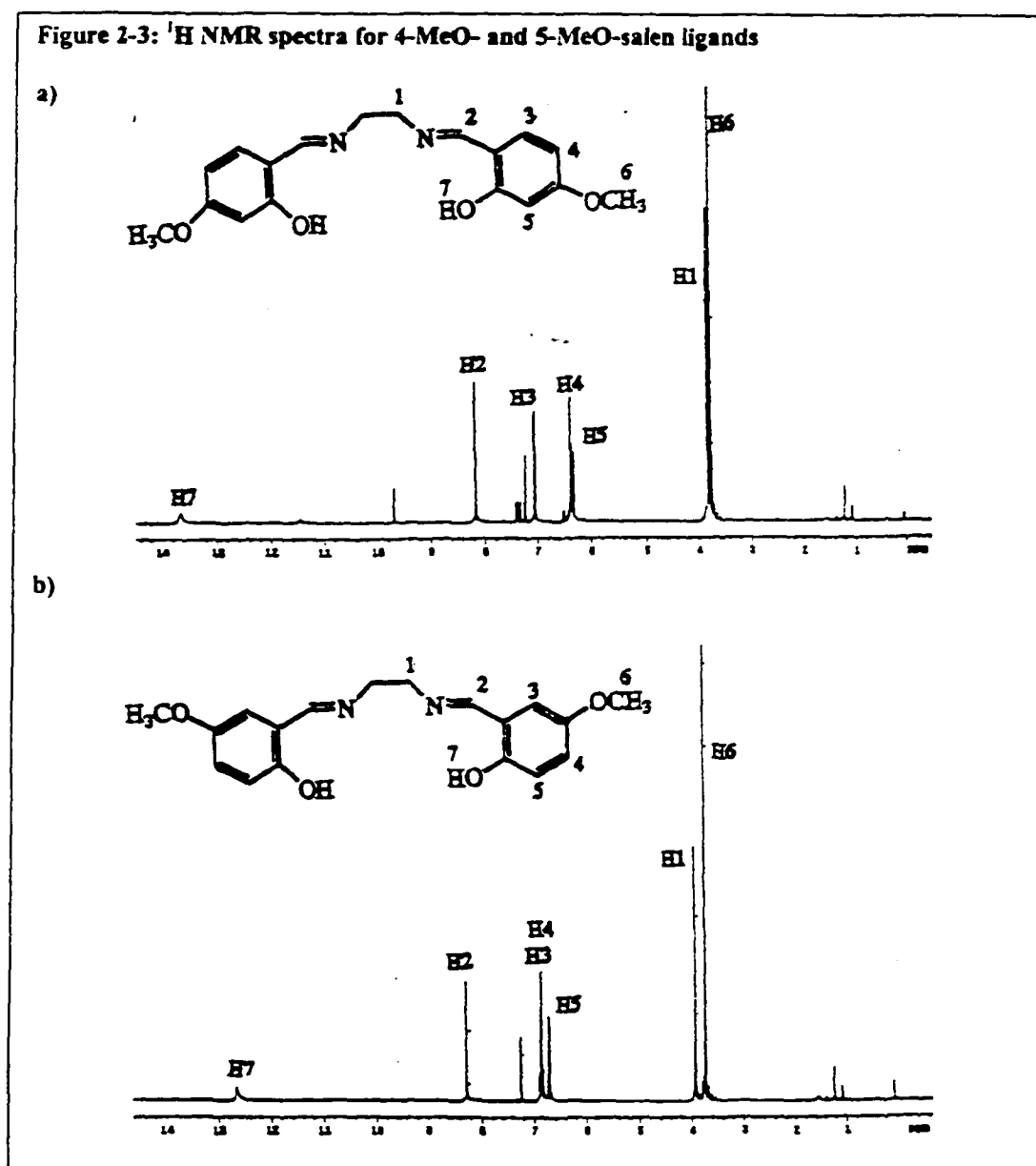

**2-2-2-2: REACTIONS OF OLEFINS WITH PhNHOH IN PRESENCE OF
Fe(II)-SALEN COMPLEXES AS CATALYSTS**

The allylic amination of olefins using Fe(II)-salen complexes (**9**) as catalysts was studied. 2-Methyl-2-pentene reacted with PhNHOH in presence of catalytic amounts of the Fe(II)-salen complexes (**9**) to produce very low yields of the expected allylic amines (**10**) (4-10%) (Scheme 2-10, Table 2-1). In all the cases, aniline was obtained as the major product (10-21%) with traces of azoxybenzene.

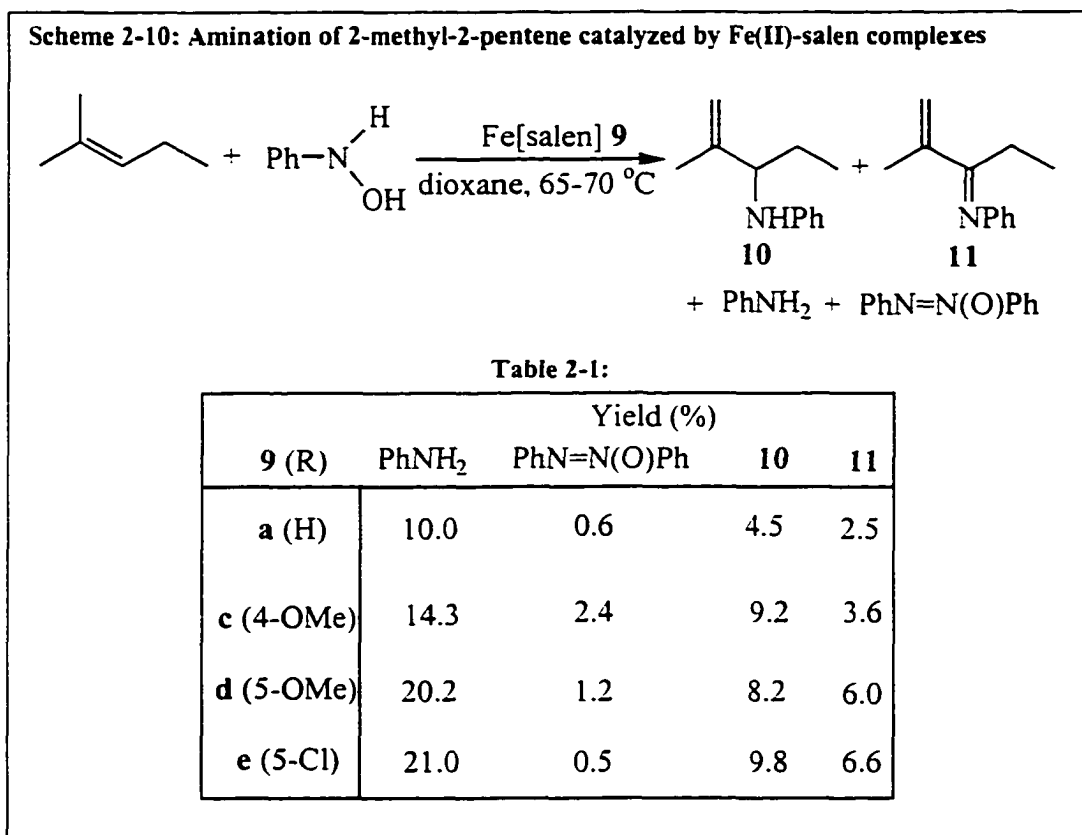

In these reactions, the imine products (**11**) were also observed by GC/MS. All the yields were determined by GC using naphthalene as the internal standard. The much higher yields of aniline, formed by reduction of PhNHOH, relative to the allylamine

10 suggested that PhNHOH may not be coordinated to the metal center. This was confirmed by performing the hetero-Diels-Alder tests on these systems. Equimolar amounts of α -methylstyrene and 2,3-dimethyl-1,3-butadiene were treated with PhNHOH in presence of Fe(II)-salen complexes **9** as catalysts (Scheme 2-11, Table 2-2).

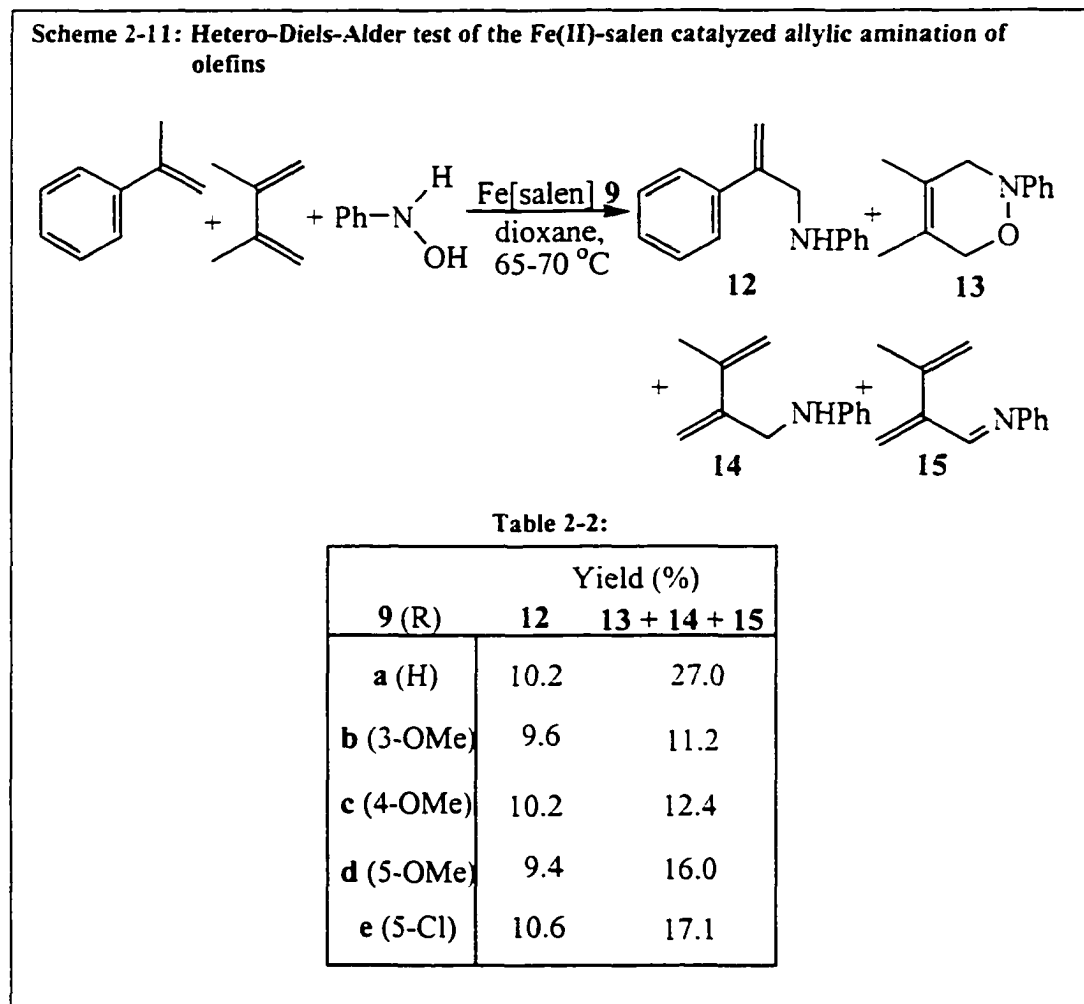

The desired allylic amines (**12**) were obtained in low yields (10%) and this was relatively independent of the electronic character of the catalyst used. The Diels-Alder adduct (**13**), formed via reaction between the 2,3-dimethyl-1,3-butadiene and

PhNO, was also produced. These were accompanied by the allylic amination products from the diene (14). The yields of the Diels-Alder adducts and the amination product derived from the diene could not be separately determined as their retention times on the GC are very similar. They could, however, be distinctly observed by GC/MS, which also showed the allylic imines (15). The main byproducts, aniline and azoxybenzene, were not observed in these reactions.

The formation of the Diels-Alder adducts 13 in about equal amounts as the allylic amines 12 derived from the olefins suggests the formation of some free PhNO. Hence, in these reactions catalyzed by Fe(II)-salen complexes 9 PhNHOH is oxidized to PhNO which then reacts with the olefin outside of the metal coordination sphere to produce the allyl hydroxylamine with transposition of the double bond (Scheme 2-12). The allyl hydroxylamine is then reduced by an Fe(II)-species to the allylic amine.

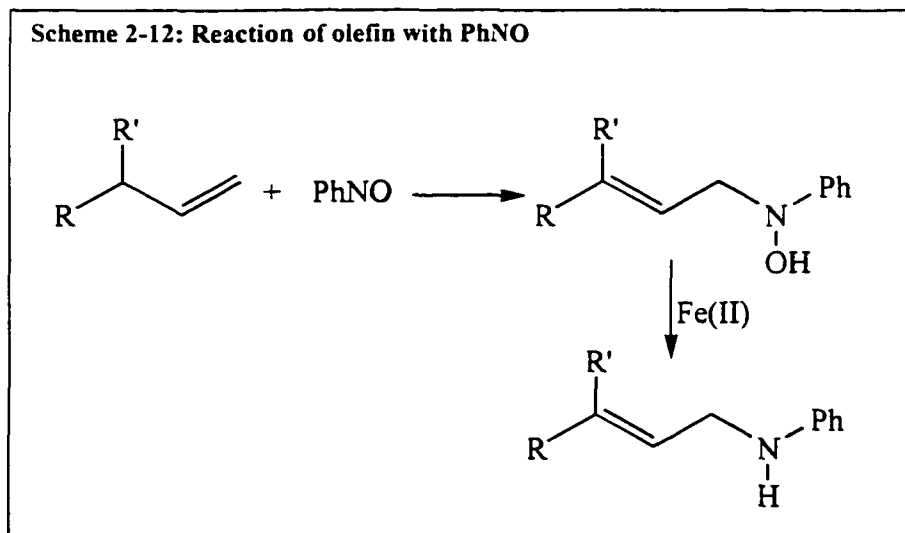

This conclusion is further corroborated by the fact that the electronic nature of the complex **9** has no effect on the yield or selectivity of the reaction. A control reaction to determine the role of the Fe(II)-salen complex, in which equimolar amounts of the olefins and the diene were reacted with PhNO in the presence of Fe(5-MeO-salen) as catalyst, was performed under the same reaction conditions (Scheme 2-13). The results obtained were very similar to those obtained with PhNHOH as the aminating agent. The product distribution was comparable. This experiment demonstrates that the reaction occurring is actually independent of the Fe(II)-salen complexes. Jorgensen *et al.* have also demonstrated the formation of free PhNO as the active aminating agent in reactions catalyzed by Fe(II)-phthalocyanin and Fe(II)-tetraphenylporphyrin complexes.^{43, 44}

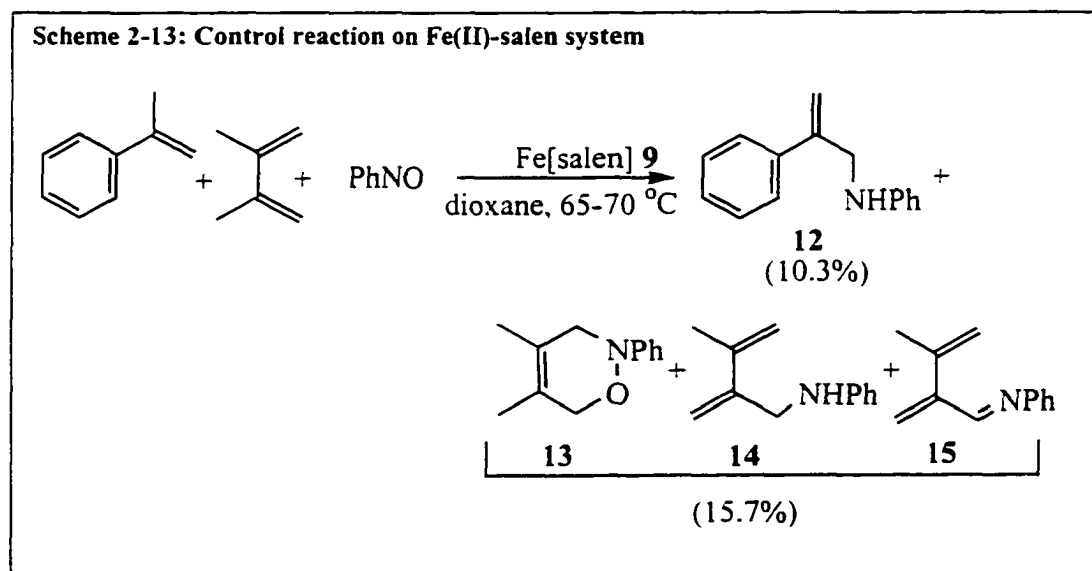

In conclusion, the allylic amination of olefins catalyzed by Fe(II)-salen complexes gives low yields of the amination products and involves the formation of uncoordinated PhNO as the reactive intermediate. This reacts with the olefin outside

the metal coordination sphere in an ene-like fashion. Hence, these complexes would not be useful as catalysts for the enantioselective amination reaction due to their low activity and no possibility of achieving catalyst derived stereocontrol.

2-3: DIAMINE OXIDES AND DIPHOSPHINE OXIDES

2-3-1: INTRODUCTION AND BACKGROUND

As described in the previous chapter, a novel six-coordinate cationic Fe(II)-azobenzenedioxide complex (**16**) was isolated and characterized.^{46, 47} It was also shown that this complex is the active catalyst in the allylic amination of olefins by PhNHOH using catalytic amounts of Fe(II, III)-salts. Various mechanistic studies performed on this system suggest the coordination of the olefin on the cationic metal center and a subsequent transfer of the 'PhNO' unit to the olefin in an ene-like manner. Hence, this system can potentially be useful for the purpose of asymmetric allylic amination as the reaction actually takes place within the metal coordination sphere. If complex **16** is treated with a chiral bidentate ligand, either one or more azobenzenedioxide ligands could potentially be replaced forming a mixed ligand complex with a chiral environment at the metal center (Scheme 2-14).

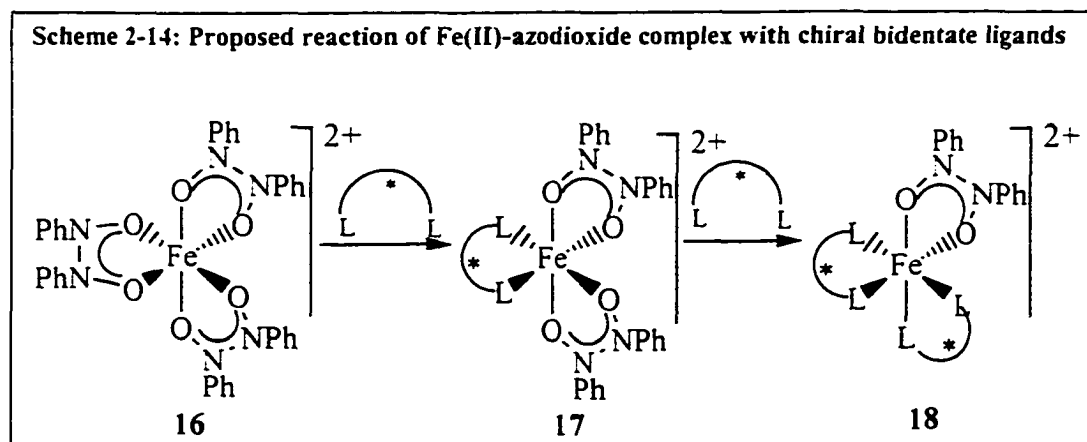

For the amination to be catalyzed by such mixed ligand complexes (**17** and **18**), it is essential that at least one azobenzene-dioxide ligand be present on the metal as the source of the 'PhNO' unit. The number of ligands substituted might be controlled by manipulation of stoichiometry of the chiral ligand used. The chiral environment at the metal center can then promote asymmetric amination of the coordinated olefin.

Hence, in order to achieve asymmetric allylic amination a chiral ligand which is structurally and electronically similar to the azobenzene-dioxide was needed as these ligands will be able to form mixed ligand complexes **17** and **18** that are similar to the Fe-azobenzene-dioxide complex **16** in electronic and geometric properties. Several classes of bidentate ligands were considered, including diphosphites (**19**), diimines (**20**), diamine oxides (**21**) and diphosphine oxides (**22**) (Figure 2-4).

Figure 2-4: Bidentate chiral ligands for Fe(II, III)-catalyzed allylic amination of olefins

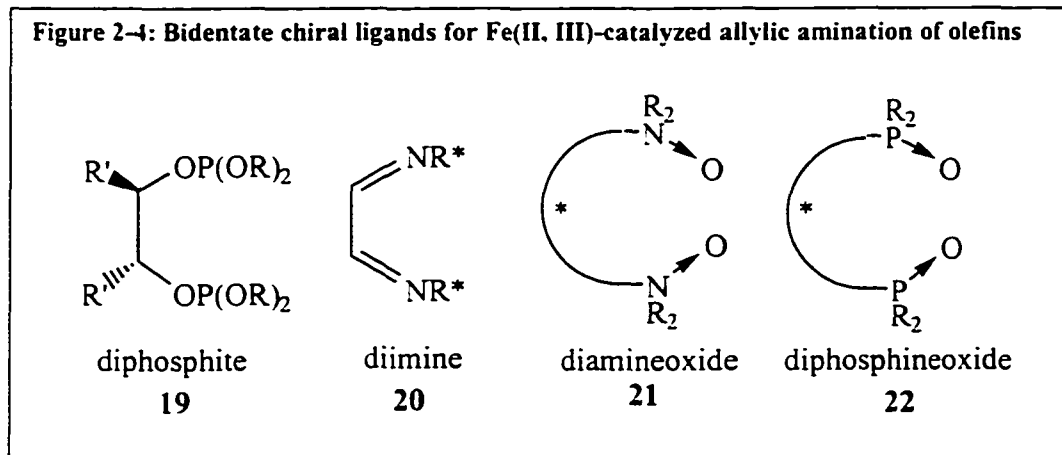

Of these, those most similar to the azobenzenedioxide are the diamine oxides **21** and diphosphine oxides **22**. In these compounds the donor atom would be the formally anionic oxygen, possibly favoring the formation of the mixed ligand complexes **17/18** (Scheme 2-14). Amine oxides and phosphine oxides are also known to coordinate to Fe(II, III).⁶⁵ Some examples of such complexes are $[\text{Fe}(\text{pyNO})_6][\text{ClO}_4]_2$, $[\text{FeCl}_2\text{L}_4][\text{FeCl}_4]$ ($\text{L}=\text{pyNO}$, 2-picNO, 4-picNO, 2,4-lutNO), $[\text{FeCl}_2(\text{OPPh}_3)_4][\text{FeCl}_4]$, $[\text{FeCl}_2(\text{OPCl}_2)_4][\text{FeCl}_4]$ and $[\text{Fe}(\text{TMP})_5\text{H}_2\text{O}][\text{ClO}_4]$.

Therefore, with this background we decided to study these two classes of ligands to develop enantioselective allylic amination of olefins catalyzed by Fe(II, III)-chlorides. The systems that were chosen for initial studies were 1,1'-biisoquinoline-N,N'-dioxide, 1,2-bis(diphenylphosphinyl)ethane and 2,2'-bis(diphenylphosphinyl)-1,1'-binaphthyl. The protocol to be followed for this study was three pronged:

- i) to successfully displace one or two azobenzenedioxide ligands from the complex **16** (Scheme 2-14) using achiral/racemic bidentate ligands,

- ii) to aminate olefins with PhNHOH using these new mixed ligand complexes as catalysts to assess catalytic activity and test for free PhNO, and
- iii) to extend the reaction by using optically pure ligands to form chiral mixed ligand complexes and to use these subsequently to perform asymmetric allylic amination of olefins.

Hence, the above mentioned achiral/racemic ligands were prepared.

2-3-2: SYNTHESIS OF 1,1'-BIISOQUINOLINE-N,N'-DIOXIDE

The dioxide was obtained by oxidation of 1,1'-biisoquinoline (**23**) which was prepared following the procedure reported by Ashby *et al.*⁶⁶ In this procedure, isoquinoline is oxidatively coupled using LDA and HMPA (Scheme 2-15).

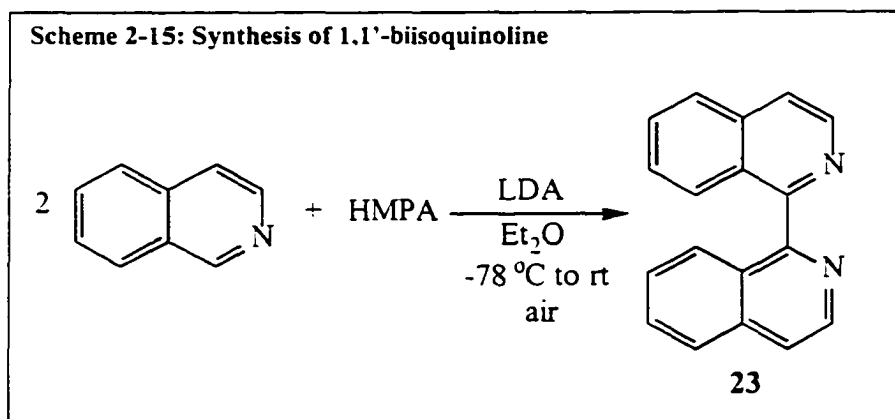

The product was purified by chromatography on grade I basic alumina and was obtained as an orange-yellow crystalline solid in 17% yield (Figure 2-6a). The diamine thus obtained was then oxidized using the conditions described for 2,2'-bipyridine oxidation.⁶⁷ 1,1'-Biisoquinoline **23** was treated with excess aqueous hydrogen peroxide solution and glacial acetic acid (Scheme 2-16). The desired

product. 1,1'-biisoquinoline-N,N'-dioxide (**24**) was obtained as a yellow solid in moderate yields. The product was characterized by ^1H NMR (Figure 2-6b), IR and mass spectroscopy. As is clear from Figure 2-6, the signal pattern and chemical shifts for the protons in 1,1'-biisoquinoline change considerably upon oxidation.

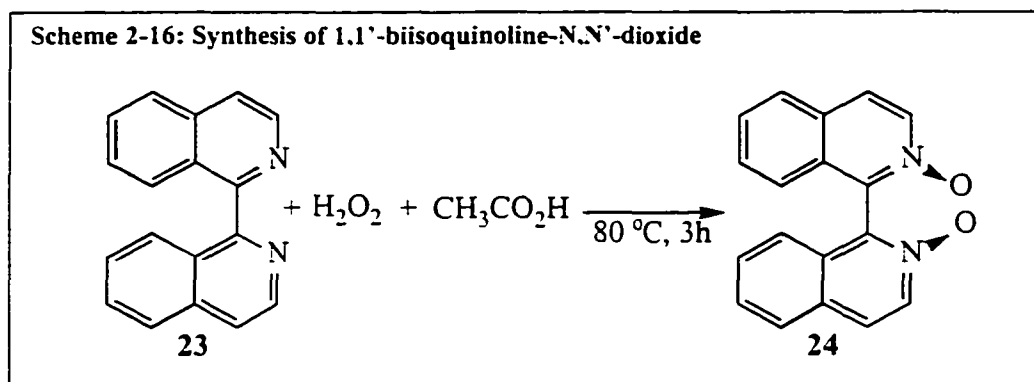

The spectrum for **24** suggests the presence of only one compound, though a racemic mixture (Figure 2-5). In compound **24** proton H3 is expected to be most downfield as it is closest to the electron deficient nitrogen. The other peaks were assigned based on the multiplicities of the signals.

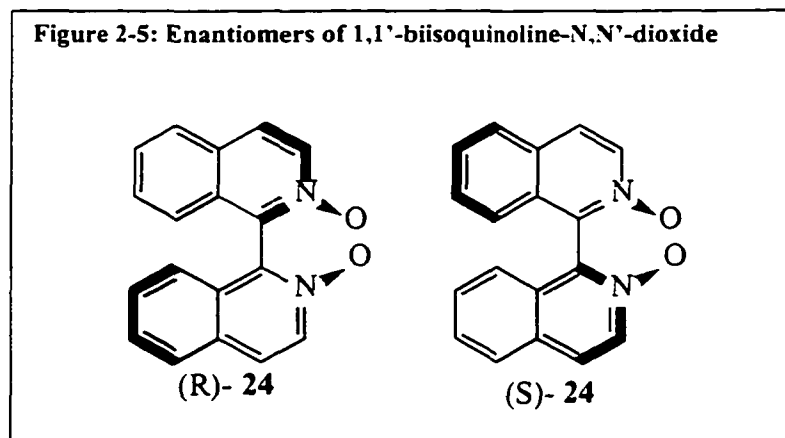

Resolution of a similar compound, 3,3'-dimethyl-2,2'-biquinoline, has been accomplished by complexation with either R- or S-binaphthol.⁶⁸

Figure 2-6

a) ^1H NMR of 23

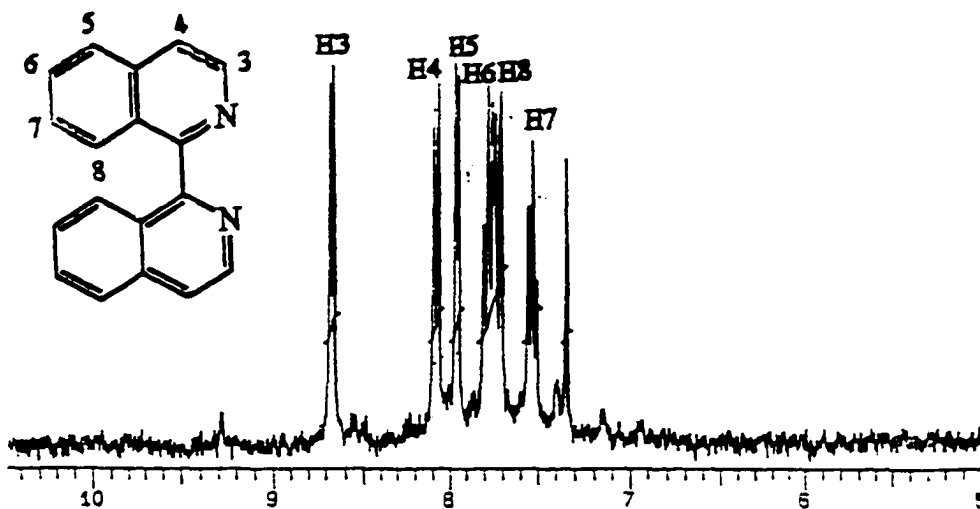

b) ^1H NMR of 24

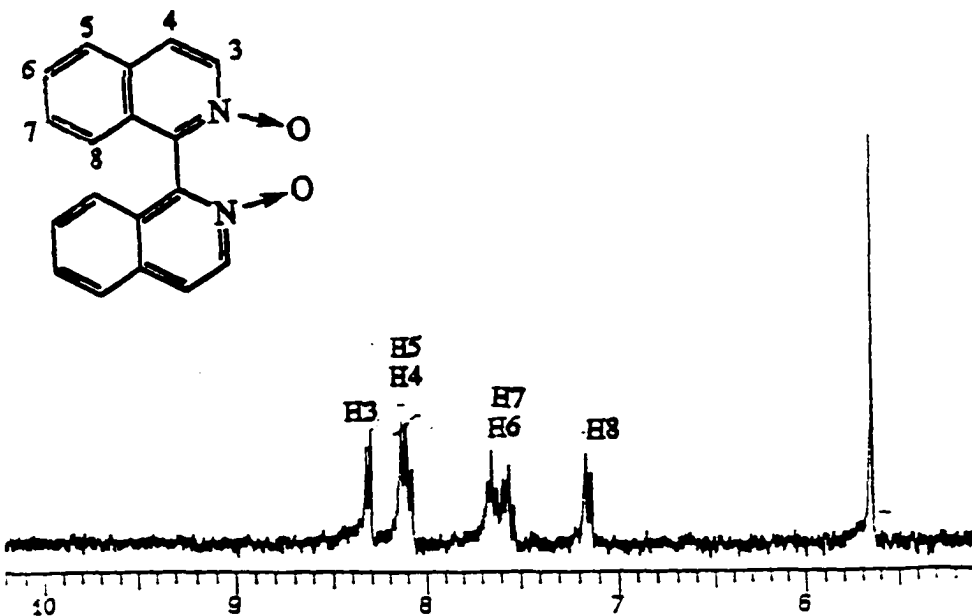

Hence, if the racemic 1,1'-biisoquinoline-N,N'-dioxide 24 proved to be an efficient ligand in achieving allylic amination of olefins after forming the mixed ligand

complex (17/18), then we could potentially resolve it into its enantiomers in order to attempt asymmetric amination.

2-3-3: SYNTHESIS OF ETHYLENEBIS(DIPHENYLPHOSPHINEOXIDE)

An achiral phosphine oxide was prepared to determine if such a ligand will displace either one or two azobenzenedioxide ligands from the complex 16 and to determine if the resulting species will catalyze the allylic amination of olefins. The chiral ligand would then be synthesized if the achiral complex exhibited activity towards the reaction. Ethylenebis(diphenylphosphineoxide) was chosen for this study. This is a known compound and it has been previously prepared by several routes.⁶⁹ We followed an alternative route for its synthesis. Commercially available 1,2-bis(diphenylphosphino)ethane (dppe) **25** was oxidized to produce the corresponding dioxide (dppe-O₂) **26** using the same procedure as for oxidation of **23** to **24** (Scheme 2-17).

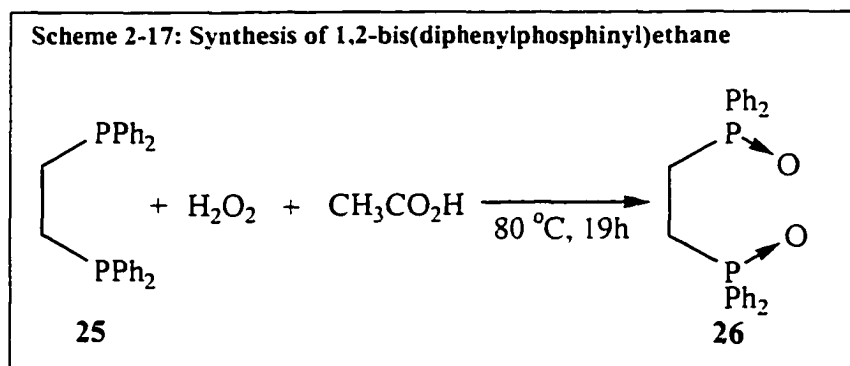

The desired product, ethylenebis(diphenylphosphineoxide) **26**, was obtained as a white solid in 75% yield and was characterized by NMR (¹H, ³¹P), IR and mass spectroscopy. The ¹H NMR spectra of the two compounds **25** and **26** show an

expected downfield shift for the methylene protons and the phenyl protons upon oxidation. Phosphine **25** shows a ^{31}P signal at -13.41 ppm, which is typical for trialkyl- or triaryl phosphines. A ^{31}P signal at $+32.07$ ppm is observed for the oxidation product **26**, the characteristic region for tertiary phosphine oxides.

2-3-4: ATTEMPT AT SYNTHESIS OF 1,1'-BINAPHTHYL-2,2'-BIS(DIPHENYLPHOSPHINE-OXIDE)

Noyori *et al.* have reported a synthesis of 1,1'-binaphthyl-2,2'-bis(diphenylphosphineoxide) (BINAPO) starting from 2,2'-dihydroxy-1,1'-binaphthyl **27** (Scheme 2-18).⁷⁰ In this synthesis, **27** is converted to the corresponding dibromo derivative **28** which is then used for the formation of the di-Grignard **29**. Reaction of this di-Grignard reagent with diphenylphosphinic chloride **30** forms racemic BINAPO **31** in 75% yield. This racemic mixture was resolved using either (-)-2,3-O-dibenzoyl-L-tartaric acid or (+)-2,3-O-dibenzoyl-D-tartaric acid.

However, our attempts to reproduce this synthesis were not successful as 2,2'-dibromo-1,1'-binaphthyl **28** was recovered each time it was treated with magnesium, suggesting that the di-Grignard was not being formed. The magnesium used was activated by scraping the surface and adding a crystal of iodine. No product was obtained even upon heating for long periods of time (20 h). Use of magnesium ribbon (polished) or Reike's magnesium⁷¹ enabled us to form the desired di-Grignard **29**. This was demonstrated by quenching with water, which produces binaphthyl **32** (Scheme 2-19).

Scheme 2-18 : Synthesis of 2,2'-bis(diphenylphosphineoxide)-1,1'-binaphthyl

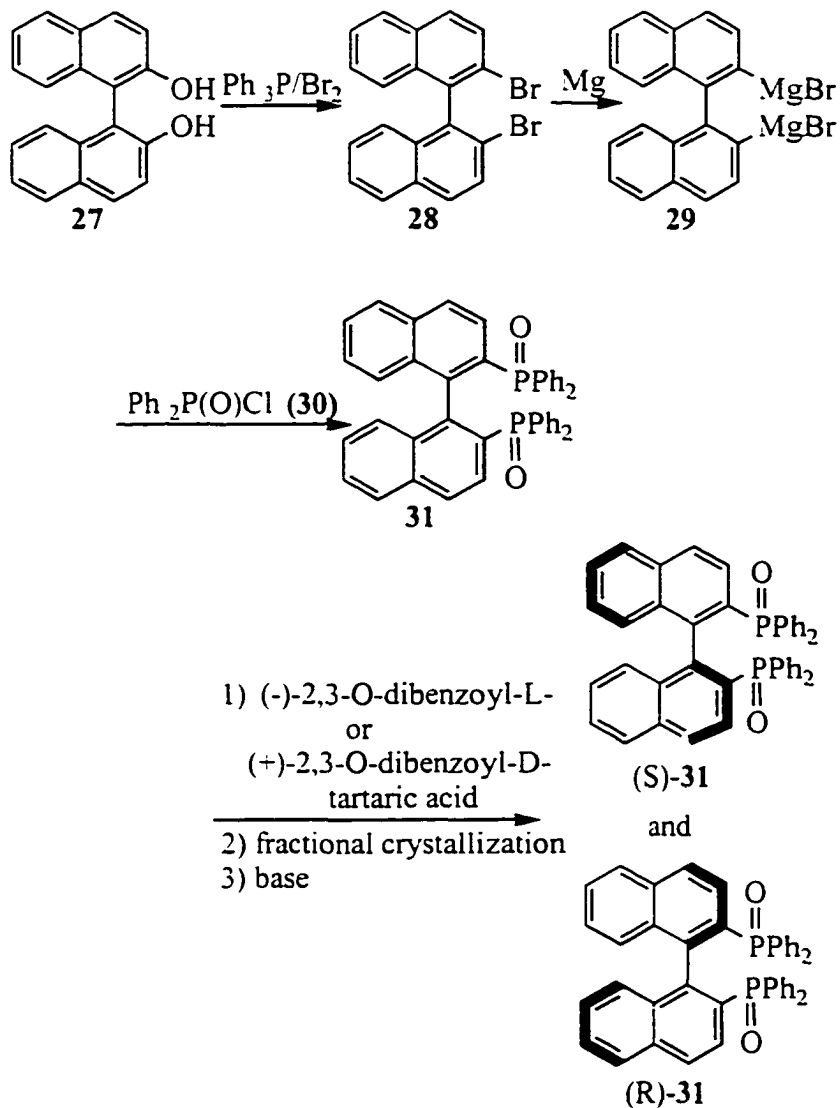

Scheme 2-19: Synthesis of the diGrignard 29

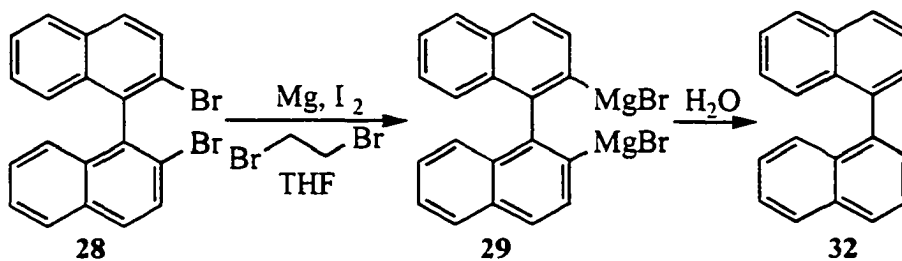

However, reaction of this di-Grignard with diphenylphosphinic chloride gave only partial conversion to 2-diphenylphosphineoxide-1,1'-binaphthyl (**33**) (Scheme 2-20) even upon heating. This was confirmed by ^1H NMR and mass spectrometry.

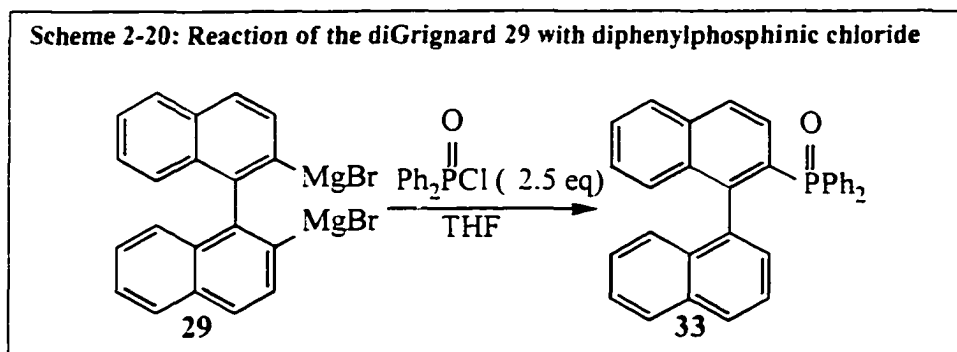

After the unsuccessful attempts to phosphorylate the di-Grignard, we attempted reactions with the dilithiated derivative instead.⁷² The required substrate, 2,2'-dihalo-1,1'-binaphthyl (**34**) was prepared following a procedure reported by Murdoch *et al.* (Scheme 2-21).⁷³ In this sequence, 2,2'-diamino-1,1'-binaphthyl (**35**) is converted into a mercurate salt of the corresponding diazonium ion (**36**) which is then fused with potassium halide to yield **34**. The products were obtained in modest yields.

Scheme 2-21: Synthesis of 2,2'-dihalo-1,1'-binaphthyl

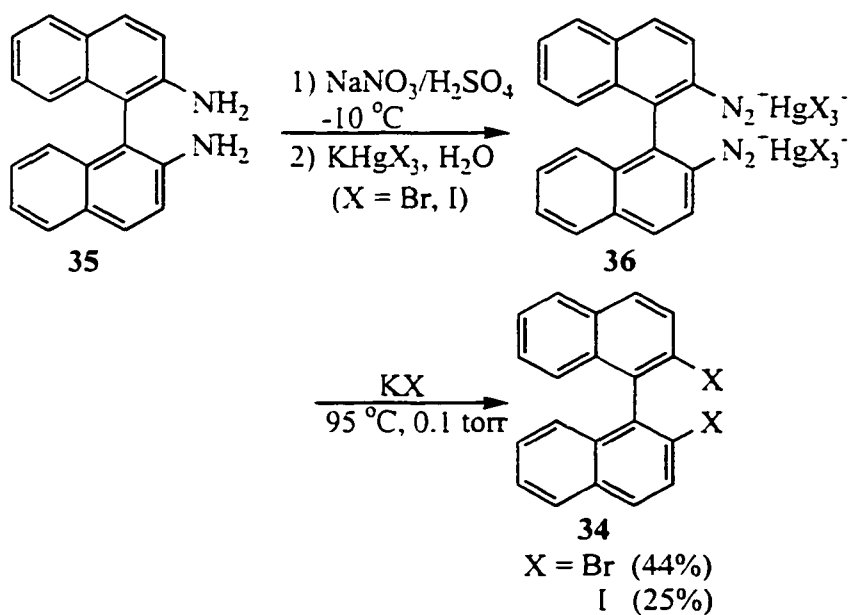

Treatment of the two dihalides **34** with *n*-BuLi (2.2 eq) and subsequent reaction with diphenylphosphinic chloride at low temperature gave a mixture of starting material, binaphthyl (**34**) and the monosubstituted product **33** (Scheme 2-22).

Scheme 2-22: Reaction of dihalides **34** with diphenylphosphinic chloride

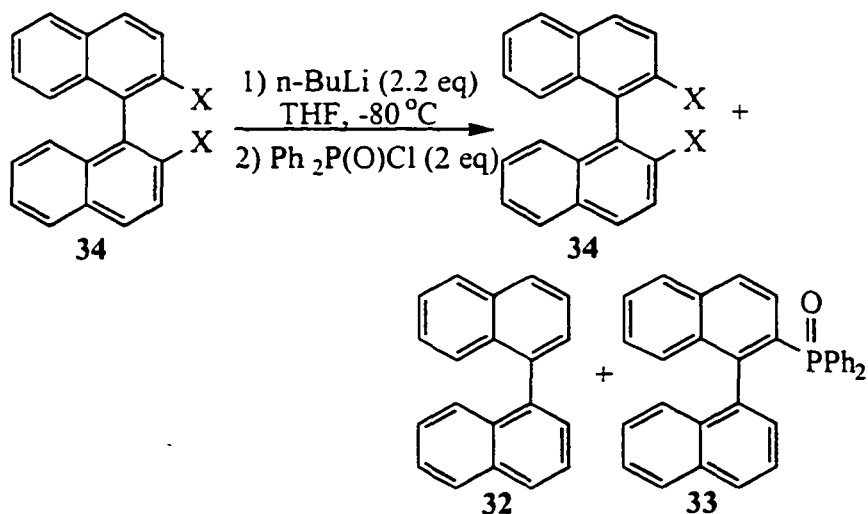

Formation of the desired dilithiated salt was established by protonation and deuteration. As can be seen from the ^1H NMR spectra (Figure 2-7), quenching with $\text{H}_2\text{O}/\text{D}_2\text{O}$ introduces proton/deuterium at the 2, 2'-positions.

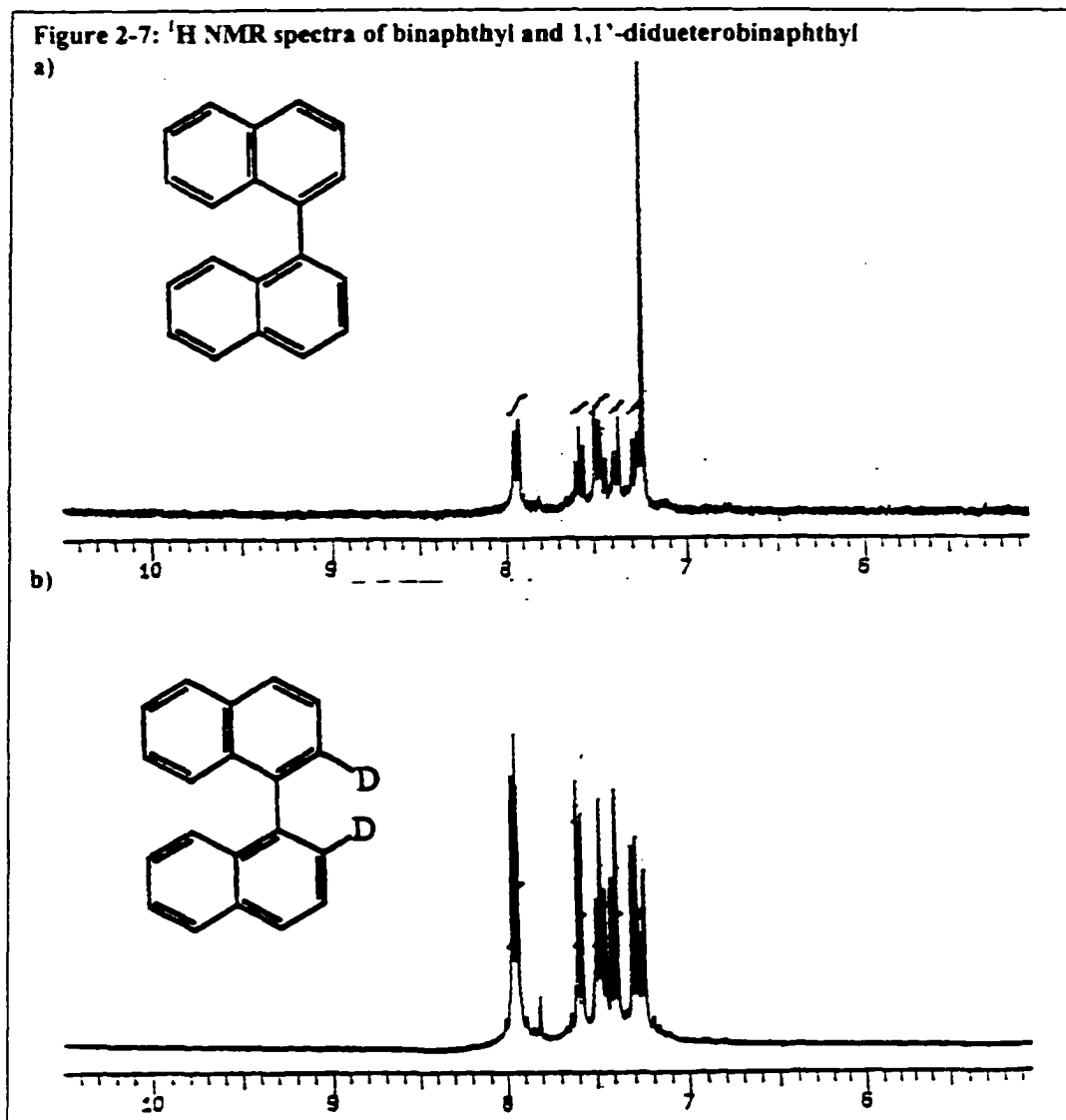

Comparing the two, the deuterated derivative integrates for six protons while the protonated species integrates for seven. Also, the signal at 7.6 ppm in **a** is a triplet, corresponding to H-2, due to coupling with H-1 and H-3. This proton exhibits a doublet in **b** due to coupling with only H-3. Also the doublet at 7.5 ppm overlapping

with the triplet, assigned to H-1 in the protonated compound, is absent in the deuterated derivative. Hence, we were unsuccessful in reproducing the reported synthesis of BINAPO.

2-3-5: ATTEMPTS AT ASYMMETRIC Fe(II, III)-CATALYZED AMINATION OF OLEFINS USING DIAMINE OXIDE AND DIPHOSPHINE OXIDE LIGANDS

After the synthesis of 1,1'-biisoquinoline-N,N'-dioxide (**24**) and 1,2-bis(diphenylphosphinyl)ethane (**26**), their reactions with Fe(II)-azobenzenedioxide complex (**16**) were studied (Scheme 2-23). Both dioxide ligands **24** and **26** react with the complex with displacement of PhNO, as observed by GC and trapping with 2,3-dimethyl-1,3-butadiene. This suggests that the bidentate ligands **24** and **26** do displace the azobenzenedioxide ligands from **16**, possibly forming a mixed ligand complex whose exact structure is not known. Some quantification studies were done. The reaction was performed with only one equivalent of the divalent ligands **24** or **26** in order to displace only one azobenzenedioxide ligand. The number of moles of PhNO formed was determined by comparing its peak area in the GC with that of a known amount of an internal standard, namely naphthalene after correcting for the different response factors. This study suggested the displacement of one bidentate azobenzenedioxide (or 2PhNO) ligand. However, the resulting iron species **37** did not react with olefins even upon heating for long periods of time. Reaction of **37** with another equivalent of the ligands **24** or **26** also showed no further displacement of the PhNO (by GC and trapping experiments). The unreacted ligands could be recovered.

Scheme 2-23: Reaction of Fe(II)-azodioxide complex with 23 and 26

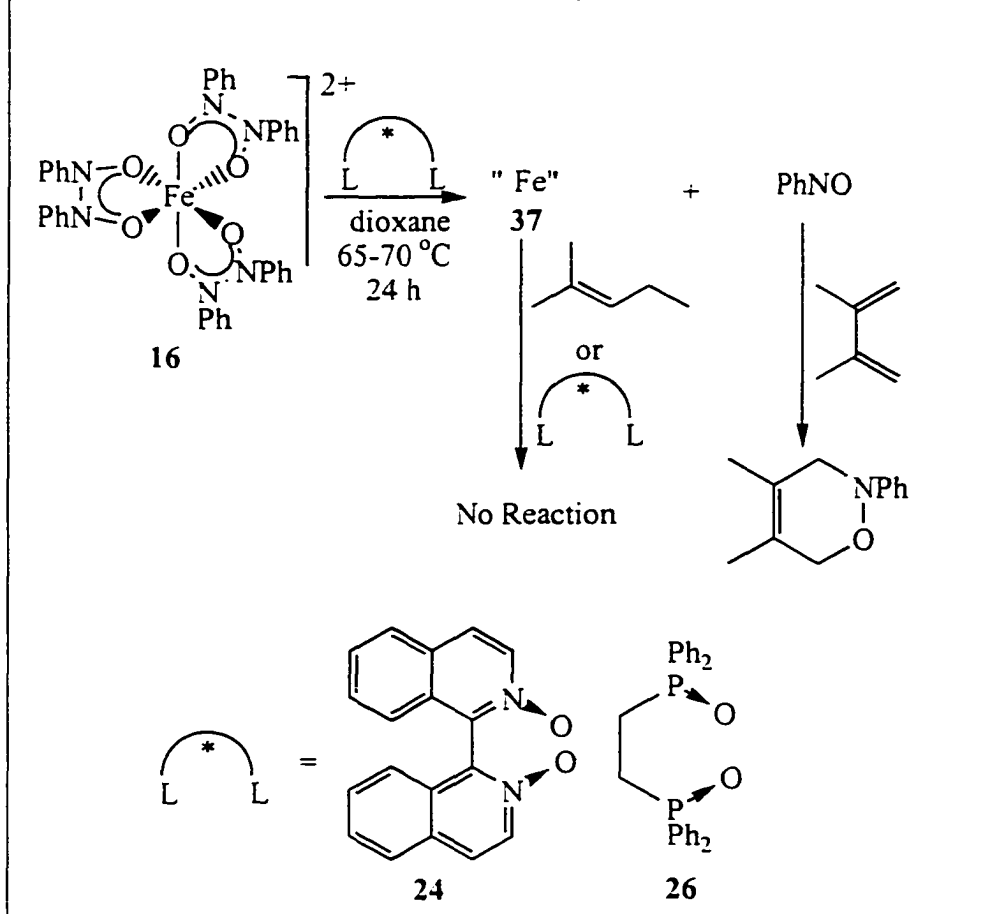

Hence, the results suggest that diaminoxides and diphosphineoxides are strong enough donors to displace PhNO from the complex. The displaced PhNO can either originate from one bidentate azobenzene dioxides ligand or by partial dissociation of two bidentate ligands. But once coordinated to the metal center, further displacement of more azobenzene dioxides ligands, or even dissociation of an arm of this bidentate ligand, does not occur. As a result, amination of olefins by the mixed ligand-iron species produced was not possible. Attempts to determine the structure of the complex were not successful as we were not able to obtain crystals of this compound.

The infra-red spectrum of this new metal species shows medium intensity bands corresponding to C=C, N=N-O (azoxy symmetrical), and aromatic C-H stretches from the azobenzenedioxide ligands. However, the absorption frequencies are shifted to lower frequency. In addition to these bands, a very strong absorption is observed at 1203 cm^{-1} , presumably due to $\text{N}^{\ominus}\text{-O}^{\ominus}$ stretch. An infra-red absorption band for the NO group in $[\text{Fe}(\text{C}_5\text{H}_5\text{NO})_6](\text{ClO}_4)_2$ has been reported at 1218 cm^{-1} .⁷⁴

2-4: CONCLUSIONS

In this section, syntheses of racemic mixtures of various potential chiral ligands were described. These ligands were prepared in order to test whether those ligands might be applicable to achieve enantioselective allylic amination of olefins catalyzed by Fe(II, III) chlorides. Fe(II)-salen complexes do catalyze the amination reaction. However, uncoordinated PhNO is the active intermediate in this system. This could be explained after the isolation and characterization of the active complex **16** (Scheme 2-14). Since the salen ligands coordinate to the metal in a square planar geometry, simultaneous coordination of an azobenzenedioxide ligand is not likely. As a result, amination of olefins cannot occur within the metal coordination sphere. Therefore, modification of the catalyst to make the reaction enantioselective using the salen ligands will not be successful.

Diamineoxide and diphosphineoxide ligands were also synthesized because of their similar electronic and structural characteristics to the azobenzenedioxide ligands in the active aminating catalyst, Fe(II)-azobenzenedioxide complex **16**. These ligands are capable of displacing two equivalents of PhNO which may come either from one

bidentate azobenzenedioxide ligand or by partial dissociation of two ligands from the complex. However, the presumed mixed ligand complex **37** does not react with olefins. Further dissociation of another chelating ligand by reaction with a second equivalent of the chiral ligands was also not observed, suggesting that this new iron complex is a very stable species under the reaction conditions employed.

Hence, other classes of chiral ligands need to be explored. One possible candidate for this purpose is the diamide **38** (Scheme 2-24). This ligand will coordinate to the metal in a tetrahedral geometry and will allow for the simultaneous cis coordination of the bidentate azobenzenedioxide ligand.

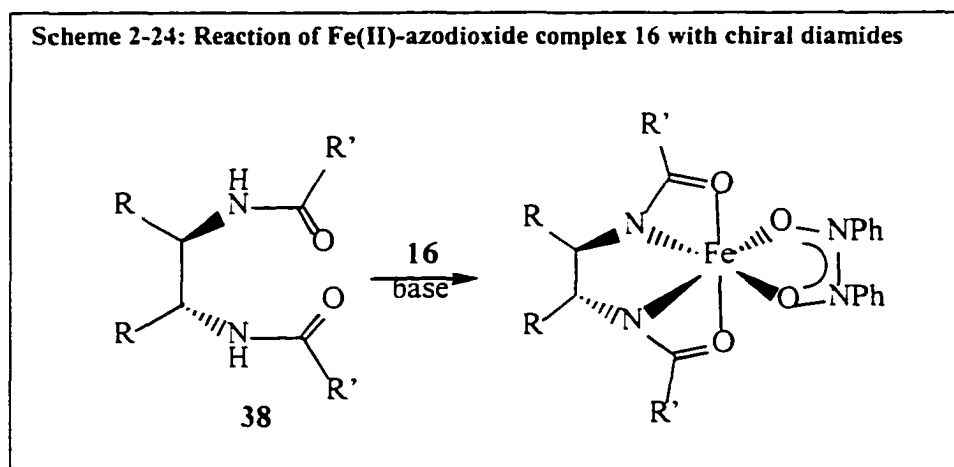

2-5: EXPERIMENTAL SECTION

General: All starting materials were obtained from commercial sources. 1,4-Dioxane and benzene were distilled under nitrogen from sodium and benzophenone. Dichloromethane was distilled also under nitrogen from CaH₂. Anhydrous methanol was used as supplied by Fisher chemical company. All air and moisture sensitive

reactions were performed under nitrogen and all the glassware was oven dried and flushed with nitrogen before use.

^1H NMR, ^{13}C NMR and ^{31}P NMR spectra were obtained using a Varian XL-300 or Varian Unity Inova-400 instrument. The data is given in units of parts per million (ppm) relative to TMS for ^1H NMR and H_3PO_4 for ^{31}P NMR. The residual solvent signals are used for referencing in ^1H NMR. The infra-red (IR) data were recorded on a Bio-Rad FTS-7 FT-IR instrument. A Hewlett Packard 5790A gas chromatograph using a 3m column packed with OV-101 was used for monitoring by GC. The GC-MS and low resolution EI data were obtained on Hewlett Packard 5985A GC/MS system. The melting points reported were measured using a Mel-Temp apparatus and the values are not calibrated. Elemental analyses were performed at the Midwest Microlab (Indianapolis, IN).

2-5-1: SYNTHESIS OF N,N'-ETHYLENE-BIS(SALICYLIDENEIMINE)

LIGANDS (8)

8a) The ligand **8a** was prepared following a literature procedure.⁵⁶ To a solution of salicylaldehyde (18.3 g, 0.150 mol) in methanol (75 mL) was added a solution of ethylenediamine (4.50 g, 0.075 mol) in methanol (50 mL) at room temperature. A dense yellow precipitate formed after 15 min of addition of ethylenediamine. The reaction mixture was stirred for additional 30 min and then cooled in the freezer for complete crystallization. The solid product was filtered, washed with methanol and dried under vacuum. The pure product was obtained as a yellow solid in 78% yield (15.7 g, 0.058mol). mp 127 °C (literature mp 123-125 °C); ^1H NMR (400 MHz,

CDCl_3) δ 3.92 (s, 4H), 6.84 (t, $J = 7.2$ Hz, 2H), 6.92 (d, $J = 8.0$ Hz, 2H), 7.21 (d, $J = 7.6$ Hz, 2H), 7.27 (t, $J = 8.2$ Hz, 2H), 8.34 (s, 2H), 13.18 (br, 2H); ^{13}C NMR (100 MHz, CDCl_3) δ 59.7, 116.9, 118.6, 118.65, 131.46, 132.4, 161.0, 166.5; IR (KBr) 742, 758, 1636, 2864, 2907, 2933, 3020, 3062, 3444 cm^{-1} ; MS (EI 70 Ev DIP, m/z, rel. intensity %) 268 (M^+ , 100), 269 (M^++1 , 8), 148 (55), 134 (61), 132 (54), 122 (39), 121 (55), 120 (52), 118 (32), 107 (100), 93 (20), 91 (19), 77 (73).

8b, c, d) The following ligands were prepared via a published route.⁵⁷ Salen ligand **8b** is a known compound while **8c** and **8d** are new. A solution of the appropriately substituted salicylaldehyde (10.0 g, 0.066 mol) and ethylenediamine (1.98 g, 0.033 mol) in benzene (35 mL) was refluxed for 4 h. The water formed during the condensation reaction was azeotropically removed and additional benzene (5 mL) was added to aid stirring. The residual solvent was then removed using the rotary evaporator resulting in a yellow solid residue. The crude material was recrystallized from methanol. The results for each compound are given below.

8b: Yield 84%; mp 164 °C (literature mp 165 °C)⁵⁷; ^1H NMR (400 MHz, CDCl_3) δ 3.86 (s, 6H), 3.93 (s, 4H), 6.75 (dd, $J = 7.8, 7.6$ Hz, 2H), 6.82 (dd, $J = 7.8, 1.6$ Hz, 2H), 6.88 (dd, $J = 7.6, 1.6$ Hz, 2H), 8.30 (s, 2H), 13.56 (br, 2H); ^{13}C NMR (100 MHz, CDCl_3) δ 56.1, 59.5, 114.1, 118.0, 118.4, 123.1, 148.3, 151.4, 166.7; IR (KBr) 741, 783, 1082, 1251, 1635, 2853, 2939, 3009, 3095, 3434 cm^{-1} ; MS (EI, 70eV DIP, m/z, rel. intensity %) 328 (M^+ , 78), 329 (M^++1 , 7), 177 (41), 164 (25), 162 (23), 152 (43), 150 (100), 148 (24), 137 (72), 135 (29), 122 (41), 108 (15), 106 (25), 104 (26), 92 (20).

8c: Yield 80%; mp 149-155 °C, ^1H NMR (400 MHz, CDCl_3) δ 3.77 (s, 6H), 3.82 (s, 4H), 6.35 (dd, $J = 8.4, 2.0$ Hz, 2H), 6.93 (d, $J = 2.4$ Hz, 2H), 7.06 (d, $J = 8.4$ Hz, 2H), 8.17 (s, 2H), 13.66 (br, 2H); ^{13}C NMR (100 MHz, CDCl_3) δ 55.3, 58.8, 102.1, 106.4, 112.3, 132.7, 163.5, 164.6, 165.4; IR (KBr) 800, 850, 1114, 1223, 1637, 2847, 2939, 2972, 3079, 3423 cm^{-1} ; MS (EI, 70eV DIP, m/z rel intensity %) 328 (M^+ , 42), 329 (M^++1 , 5), 178 (58), 164 (97), 162 (51), 152 (97), 151 (66), 150 (58), 148 (58), 137 (100), 133 (50), 121 (23), 108 (32), 106 (13), 104 (14), 92 (24), 77 (31).

8d: Yield 72%; mp 166 °C, ^1H NMR (400 MHz, CDCl_3) δ 3.73 (s, 6H), 3.91 (s, 4H), 6.71 (d, $J = 2.4$ Hz, 2H), 6.87 (d, $J = 6.8$ Hz, 2H), 6.89 (dd, $J = 8.8, 2.7$ Hz, 2H), 8.28 (s, 2H) 12.66 (br, 2H); ^{13}C NMR (100 MHz, CDCl_3) δ 55.9, 59.8, 114.9, 117.6, 118.2, 119.5, 152.0, 155.1, 166.2; IR (KBr) 1277, 1639, 2837, 2907, 2945, 2966, 3009, 3062, 3412 cm^{-1} ; MS (EI, 70 eV DIP, m/z , rel. intensity %) 328 (M^+ , 68), 329 (M^++1 , 8), 177 (51), 164 (40), 162 (56), 151 (33), 148 (22), 136 (100), 134 (24), 108 (17), 107 (50), 104 (14), 92 (23), 77 (37).

8e) Ligand **8e** is a known compound and was prepared by the literature procedure.⁵⁸ⁱ A solution of 5-chloro-salicylaldehyde (3.76 g, 0.024 mol) and ethylenediamine (0.720 g, 0.012 mol) in acetonitrile (50 mL) was refluxed for 1.5 h. The reaction mixture was cooled and then the solvent was removed on the rotary evaporator to give a yellow solid. The crude product was recrystallized from acetone to afford yellow crystals in 52% yield (2.09 g, 6.22 mmol). mp 286 °C; ^1H NMR (400 MHz, CDCl_3) δ 3.93 (s, 4H), 6.87 (d, $J = 8.8$ Hz, 2H), 7.18 (d, $J = 2.8$ Hz, 2H), 7.22

(dd, $J = 8.6, 2.8$ Hz, 2H), 8.27 (s, 2H), 13.10 (br, 2H); ^{13}C NMR (100 MHz, CDCl_3) δ 59.6, 118.6, 119.3, 123.3, 130.6, 132.3, 159.5, 165.4; IR (KBr) 645, 706, 1635, 2847, 2901, 2945, 3089, 3434 cm^{-1} ; MS (EI, 70eV DIP, m/z , rel intensity %) 336 (M^+ , 35), 338 (M^+-2 , 14), 183 (26), 181 (37), 168 (26), 166 (36), 156 (24), 155 (34), 154 (33), 148 (15), 143 (23), 141 (100), 133 (17), 127 (15), 99 (21), 77 (60).

2-5-2: SYNTHESIS OF N,N'-ETHYLENE BIS(SALICYLIDENEIMINATO)- IRON(II) COMPLEXES (9)

9a) Iron(II)-salen complex was prepared following a previously reported route.⁵⁵ To a solution of $\text{Fe}(\text{CO})_5$ (7.20 g, 0.030 mol) in anhydrous DMF (50 mL) was added the salen ligand **8a** (9.25 g, 0.034 mol). The reaction mixture was heated at 110 °C for 2.5 h and then for an additional 20 h at 95 °C. Gas evolution was observed upon heating. The reaction mixture was then cooled and the purple solid formed was filtered and washed with DMF and toluene under nitrogen. The crystalline product was then dried at 100 °C under vacuum for 2 h. MS (EI 70eV DIP, m/z rel. intensity %) 322 (M^+ , 100), 323 (M^++1 , 6), 324 (M^++2 , 3), 294 (10), 276 (11).

9b-e) $\text{Fe}(\text{CH}_3\text{CO}_2)_2$ (1.56 g, 8.95 mmol) was dissolved in deionized water (16.5 mL) and then diluted with 95% EtOH (66.5 mL) to give a dirty-green solution. In a separate flask, the appropriate salen ligand **8b-e** (3.02 g, 8.95 mmol) and KOH (1.0 g, 17.8 mmol) were dissolved in 95% EtOH (200 mL). This latter solution was heated to reflux and then rapidly added to the iron acetate solution with stirring. The reaction mixture was stirred for 2 h without heating. A red-brown solid formed upon

addition. The solid was then filtered and washed with EtOH and dried under vacuum for 2 h.

9b: MS (EI, 70eV DIP, m/z rel. intensity %) 382 (M^+ , 100), 383 (M^++1 , 4), 367 (15), 339 (24), 191 (13), 162 (16), 148 (30).

9c: MS (EI, 70eV DIP, m/z rel. intensity %) 382 (M^+ , 100), 383 (M^++1 , 5), 385 (M^++3 , 13), 354 (22), 336 (21), 206 (46), 204 (21), 191 (26), 178 (10).

9d: MS (EI, 70 eV DIP, m/z rel. intensity %) 382 (M^+ , 100), 383 (M^++1 , 3), 385 (M^++3 , 15), 367 (66), 207 (17), 204 (10), 191 (17), 176 (21).

9e: MS (EI, 70eV DIP, m/z, rel. intensity %) 390 (M^+ , 100), 391 (M^++1 , 29), 392 (M^++2 , 66), 393 (M^++3 , 12), 394 (M^++4 , 7), 362 (12), 346 (15), 344 (17), 326 (13), 210 (52), 208 (34), 195 (16), 182 (20), 168 (14), 160 (18), 132 (17), 118 (21), 110 (19), 104 (19).

2-5-3: REACTION OF OLEFIN WITH PhNHOH CATALYZED BY Fe(II)-SALEN COMPLEXES

To a solution of 2-methyl-2-pentene (1.26 g, 15.0 mmol) and iron(II)-salen complexes (**9a-e**) (0.150 mmol) in dry dioxane (5 mL) under nitrogen was added a solution of phenyl hydroxylamine (0.164 g, 1.50mmol) in dioxane (10 ml) over 8 h, using a syringe pump, at 70 °C. After the addition was complete the reaction was monitored by GC. Aliquots (1 mL) were taken and the metal complex was precipitated by adding excess hexane. This was filtered and the filtrate was concentrated in a stream of nitrogen. To this was added a known amount of naphthalene as the internal standard (2.00 mmol) and the sample was injected in the

GC. The peaks for the various products were determined by comparison with authentic samples and the yields were determined by comparison with the internal standard.

2-5-4: HETERO-DIELS-ALDER TEST FOR REACTIONS CATALYZED BY Fe(II)-SALEN COMPLEXES

To a solution of α -methyl styrene (1.77 g, 15.0 mmol), 2,3-dimethyl-1,3-butadiene (1.23 g, 15.0 mmol) and the iron(II)-salen complexes (**9a-e**) (0.150 mmol) in dry dioxane (5 mL) was added a solution of phenyl hydroxylamine (0.164 g, 1.50 mmol) in dry dioxane (10 mL) over 8 h at 70 °C using a syringe pump. After the addition was complete the reaction mixture was heated for 24 h and aliquots were withdrawn (1 mL) at regular intervals. The metal complex was precipitated by adding excess of hexane and the filtrate was concentrated under a stream of nitrogen. To the resulting solution, naphthalene (2.00 mmol) was added as the internal standard. The reaction progress was monitored by GC and the yields of the products were calculated by comparison with the internal standard.

2-5-5: SYNTHESIS OF 1,1'-BIISOQUINOLINE (23)

The synthesis of compound **23** has been reported in literature.⁶⁷ To a solution of isoquinoline (5.27 g, 41.0 mmol) and HMPA (7.31 g, 40.8 mmol) in dry ether (60 mL) in a nitrogen atmosphere at -78 °C was added a freshly prepared solution of lithium diisopropylamide (LDA) (20.4 mmol) in ether (10 mL) dropwise over 10 min. The reaction mixture became purple upon addition of the LDA solution. The reaction

mixture was stirred at $-78\text{ }^{\circ}\text{C}$ for 1 h and then warmed to room temperature. It was then stirred for additional 1 h under nitrogen. The reaction mixture was then exposed to air for 17 h, during which time the color changed to orange and a solid formed. This was quenched with water and the ether layer was separated. The organic portion was then extracted with water (3 x 100 mL) and the combined aqueous portion was extracted with ether (3 x 100 mL). The combined organic portion was dried with anhydrous MgSO_4 and the solvent was removed under reduced pressure to give a red liquid. This was chromatographed on grade I basic alumina, using 95% toluene and 5% methanol as the eluting solvent. The first yellow band to elute was collected and the solvent was removed to produce a red liquid. This liquid was dissolved in benzene, hexane was added and the solution was left in the freezer. The product was obtained as a yellow-orange crystalline solid in 17% yield (0.860 g, 3.38 mmol). The spectral data of the product matched those reported in literature⁶⁷.

2-5-6: SYNTHESIS OF 1,1'-BIISOQUINOLINE-N,N'-DIOXIDE (24)

Biisoquinoline (0.860 g, 3.38 mmol) was dissolved in glacial acetic acid (4 mL) to give a clear orange solution. To this was added a 30% aqueous solution of H_2O_2 (0.7 mL). The reaction mixture was heated at $80\text{ }^{\circ}\text{C}$ for 3 h. Additional H_2O_2 (0.5 mL) was added and the solution was heated for another 19 h. The reaction mixture was then cooled and the solvent was removed using the rotary evaporator. The residue was extracted with CH_2Cl_2 (3 x 15 ml). The organic layer was dried with anhydrous Na_2SO_4 and the solvent was removed under reduced pressure to give the product as a yellow solid in 39% yield (0.360 g, 1.30 mmol). mp $265\text{-}267\text{ }^{\circ}\text{C}$ (with

decomposition); ^1H NMR (300 MHz, acetone- d_6) δ 7.12 (d, $J = 7.8$ Hz, 2H), 7.5-7.8 (m, 4H), 8.06 (d, $J = 9.3$ Hz, 2H), 8.09 (d, $J = 7.8$ Hz, 2H), 8.29 (d, $J = 7.2$ Hz, 2H); IR (KBr) 726, 773, 1235, 1557, 3070 cm^{-1} ; MS (EI, 70eV DIP, m/z , rel. intensity %) 288 (M, 85), 271 (48), 259 (21), 245 (45), 242 (42), 231(26),216 (29), 128 (100).

2-5-7: SYNTHESIS OF ETHYLENEBIS(DIPHENYLPHOSPHINEOXIDE) (26)

1,2-Bis-diphenylphosphino ethane (1.00 g, 2.51 mmol) was dissolved in glacial acetic acid (3 mL). To this a 30 wt% aqueous solution of H_2O_2 (1.42 mL, 12.5 mmol) was added. The reaction mixture was heated at 80 $^\circ\text{C}$ for 3 h. At this time additional H_2O_2 (0.420 mL, 3.50 mmol) was added and the reaction mixture was again heated for 19 h. After cooling the clear, colorless solution to room temperature, it was extracted with CH_2Cl_2 (3 x 15 ml). The combined organic extracts were washed with aq. Na_2CO_3 solution (3 x 10 ml). The organic solution was dried with anhydrous Na_2SO_4 , filtered, and the solvent was removed from the filtrate using the rotary evaporator. The solid obtained was dried under vacuum. The product was obtained as a white solid in 75% yield (0.810 g, 1.88 mmol). mp 263-264 $^\circ\text{C}$ (dec.) (literature mp 252-4 $^\circ\text{C}$)^{69t}; ^1H NMR (400 MHz, CDCl_3) δ 2.49 (d, $J = 2.8$ Hz, 4H), 7.40-7.51 (m, 12H), 7.65-7.70(m, 8H); $^{31}\text{P}\{^1\text{H}\}$ NMR (400 MHz, CDCl_3) δ 32.08; IR (KBr) 694, 730, 1176, 1187, 2908, 3053 cm^{-1} ; MS (EI, 70eV DIP, m/z , rel. intensity %) 353 (M^+ -77, 100), 337 (19), 229 (52), 201 (25). Elemental analysis calculated for $\text{C}_{26}\text{H}_{24}\text{P}_2\text{O}_4$: 72.56% C, 5.58% H, 7.44% O, 14.42% P. Found: 70.55% C, 5.54% H, 9.52% O, 14.39% P.

2-5-8: SYNTHESIS OF Fe(II)-AZOBENZENEDIOXIDE COMPLEX (16)⁴⁶

A solution of PhNO (2.03 g, 19.0 mmol) in dry CHCl₃ (20 mL) was added to a suspension of anhydrous FeCl₂ (1.17 g, 0.920 mmol) in dry CHCl₃ under nitrogen. The reaction mixture was stirred for 6 h during which time a brown solid formed. The solid was filtered under nitrogen. The solvent was removed from the filtrate under vacuum and the deep red residue was recrystallized from CH₂Cl₂/hexane. The complex was obtained as a dark brown crystalline solid in 18% yield (0.290 g, 0.270 mmol). The IR spectrum of the product was identical to that of the reported complex 16.⁴⁶

2-5-9: REACTION OF LIGANDS 24 AND 26 WITH Fe(II)-AZOBENZENE-DIOXIDE COMPLEX 16

To a solution of Fe(II)-azobenzenedioxide complex 16 (0.260 g, 0.240 mmol) in CH₂Cl₂ (8 mL) was added a solution of ligands 24 or 26 in CH₂Cl₂ (5 mL) dropwise over 2 h at room temperature under nitrogen. The color of the reaction mixture changed to greenish-brown and a light colored solid formed. Aliquots were withdrawn at regular intervals and injected in the GC after removal of the metal species with hexane and adding an internal standard. The reaction mixture was filtered after 20 h. 2,3-Dimethyl-1,3-butadiene was added to the filtrate and stirred at room temperature and monitored by GC for the disappearance of the PhNO peak and appearance of the hetero-Diels-Alder adduct peak. The solid (37) was suspended in CH₂Cl₂ and an equivalent of ligand 24 or 26 was added under nitrogen. The reaction

mixture was heated at 45-50 °C for 24 h. The reaction was monitored by GC at regular intervals.

**2-5-10: REACTION OF 2-METHYL-2-PENTENE WITH THE MIXED
LIGAND IRON COMPLEX 37**

The complex 37 was suspended in CH₂Cl₂ under an inert atmosphere and heated to 45-50 °C and to this was added an excess of 2-methyl-2-pentene. The reaction mixture was heated for 24 h and the reaction was monitored by withdrawing aliquots at regular intervals of time. The samples were injected in the GC after removing the metal containing species by addition of excess hexane.

Chapter 3

ALTERNATIVE AMINATING AGENTS: USE OF 2,4-DINITROPHENYL HYDROXYLAMINE AND N-HYDROXY BENZENESULFONAMIDE AS REAGENTS FOR IRON-CATALYZED ALLYLIC AMINATION LEADING TO PRIMARY AND SECONDARY ALLYLAMINES

3-1: INTRODUCTION AND BACKGROUND

The aminating agent largely used in the metal-catalyzed reactions of olefins had been phenylhydroxylamine, PhNHOH. This led to the formation of secondary N-phenyl-N-allylamines, and modifications of the product to obtain other classes of allylamines were not possible. Also, the yields obtained in both Mo(VI)- and Fe(II, III)-catalyzed reactions ranged from moderate to low, with substantial formation of the by-products aniline and azoxybenzene. A common problem in these reactions was that of nitrogen mass balance. All of the nitrogen mass could not be accounted for in the products obtained, suggesting that some other unknown pathway was occurring simultaneously with amination.

As a result, we decided to explore other potential aminating agents. We sought a compound, ZNHOH (**1**), in which the Z group could be cleaved after Fe(II, III)-catalyzed amination to yield primary allylic amines (**3**) (Scheme 3-1). Alternatively, the products of the amination **2** could be subjected to alkylation forming **4**, which would then produce secondary allylic amines **5** after cleavage of the Z group. In this way both primary and secondary allylamines could be prepared,

resulting in a considerable increase in the scope and utility of metal-catalyzed allylic amination of olefins.

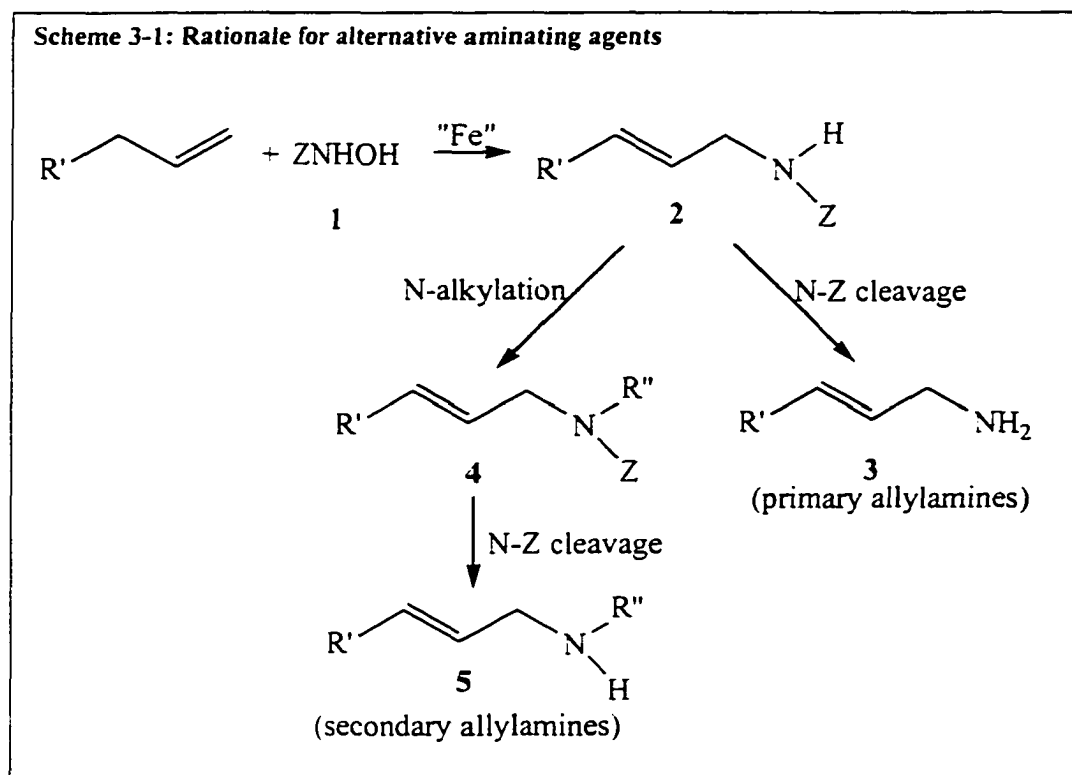

3-1-1: 2,4-DINITROPHENYL- (2,4-DNP) AS AN AMINE PROTECTING GROUP

The 2,4-dinitrophenyl group (2,4-DNP) has been used for protection of amines. Reaction of the free amine⁷⁵ or the ammonium salt⁷⁶ of the aminonucleotides with 1-fluoro-2,4-dinitrobenzene introduces the protecting group (Scheme 3-2). The 2,4-DNP group is stable to acidic conditions, but has been cleaved using several basic and nucleophilic reagents. Wolfrom *et al.* used barium hydroxide in an aqueous medium to effect deprotection (Scheme 3-3a).⁷⁷ Basic ion exchange resins,

Amberlite IRA400(OH) and Dowex I(OH), have also been used successfully to yield the deprotected amines (Scheme 3-3b).^{75, 76, 78}

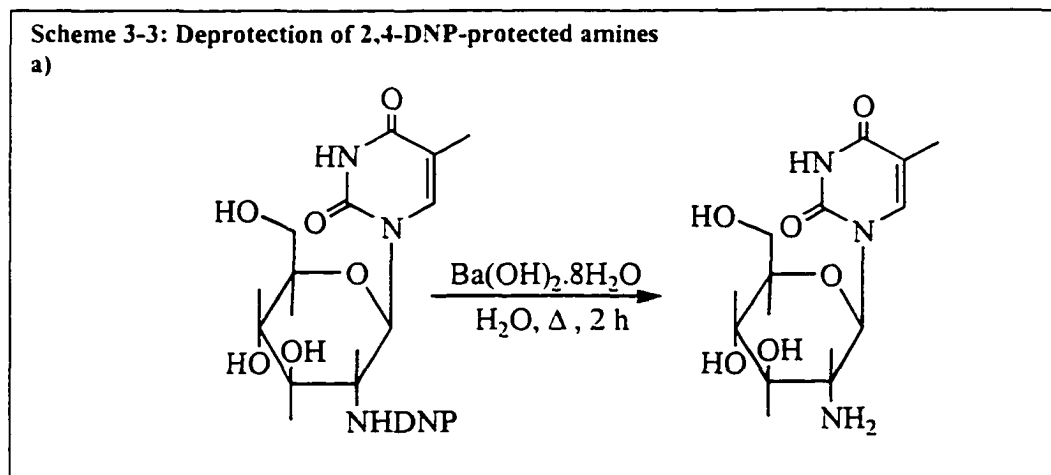
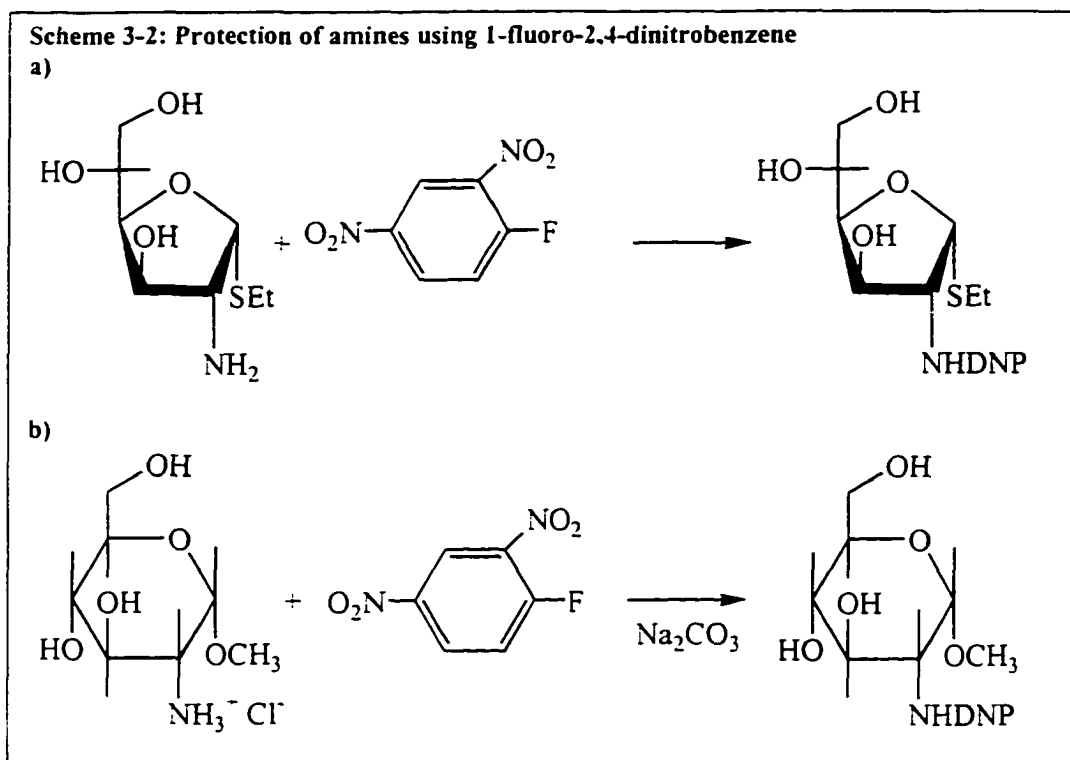

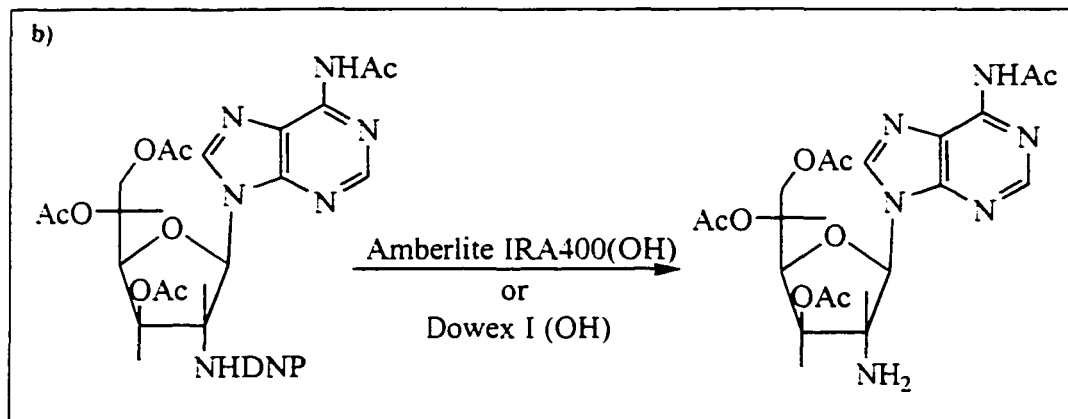

In other reports, the 2,4-DNP group has been cleaved from tertiary amines by nucleophilic aromatic substitution by primary amines in DMSO.⁷⁹ Reaction of 1-dialkylamino-2,4-dinitrobenzenes with various primary amines resulted in the displacement of the dialkylamino group (Scheme 3-4); methylamine gave the best yields of the substitution product (39%).

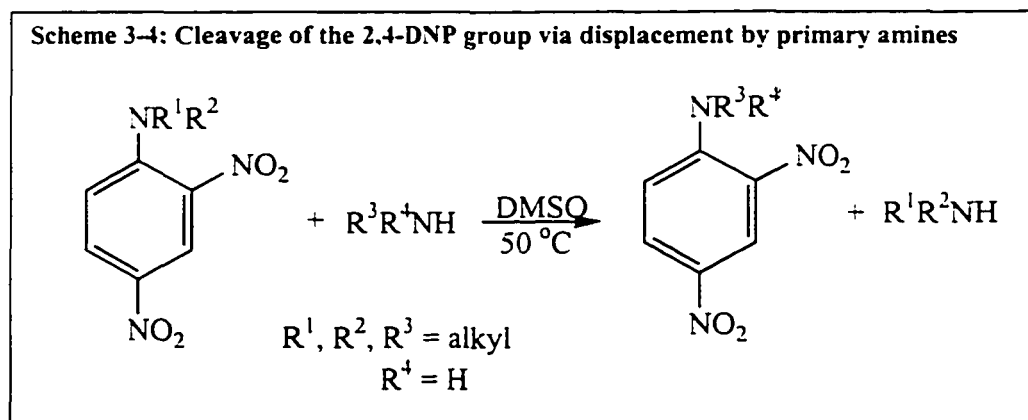

2,4-DNP-protected aminoacids, when reacted with thiols, also suffered deprotected.⁸⁰ Reaction with a large excess of 2-mercaptoethanol, at pH 7-8, results in the cleavage of the 2,4-DNP group by nucleophilic substitution by the thiol to yield the free amine (Scheme 3-5).

Scheme 3-5: Cleavage of 2,4-DNP group via displacement by 2-mercaptoethanol

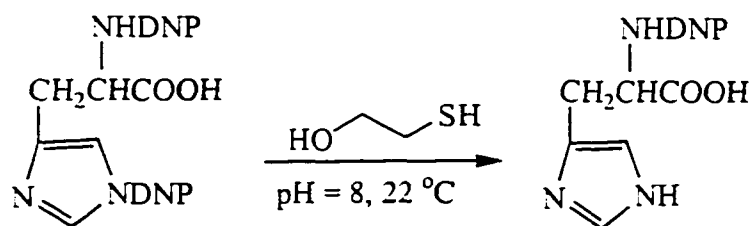

It should be noted, however, that the 2,4-DNP-protected α -amino group in histidine is not affected under these conditions.

Hence, based on the reported use of the 2,4-DNP group for the protection of amines, we decided to explore the reaction of 2,4-dinitrophenyl hydroxylamine (**6**) (Figure 3-1) with olefins catalyzed by Fe(II,III)-salts. 2,4-Dinitrophenyl hydroxylamine was expected to be a good aminating agent as it is a very electro-deficient compound. Since the Fe-catalyzed allylic amination proceeds in an ene reaction-like fashion, the active species derived from 2,4-dinitrophenyl hydroxylamine was expected to be a good enophile and, thereby, facilitate the reaction.

Figure 3-1: 2,4-Dinitrophenyl hydroxylamine

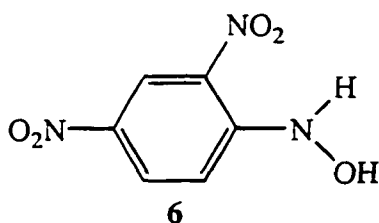

3-2: RESULTS AND DISCUSSION

In order to be able to obtain various classes of allylic amines, including primary and secondary amines, with varying N-substituents, we decided to study the reactivity of 2,4-dinitrophenyl hydroxylamine in the $\text{FeCl}_{2,3}$ -catalyzed reactions. We studied the scope of this reaction in terms of selectivity of reaction and substrate structure. The cleavage of the N-DNP bond after amination was investigated by several methods in order to obtain primary N-allylamines **3**. N-Alkylation of the DNP-protected N-allylamines and subsequent removal of the protecting group to produce secondary allylic amines **5** was also studied. This section will summarize all of the above mentioned results.

3-2-1: SYNTHESIS OF 2,4-DINITROPHENYL HYDROXYLAMINE

The reagent required for the $\text{FeCl}_{2,3}$ -catalyzed allylic amination reactions, 2,4-dinitrophenyl hydroxylamine (**6**), was obtained by a published procedure.³¹ Nucleophilic aromatic substitution by hydroxylamine on 2,4-dinitroanisole (**7**) in refluxing methanol, gives the desired product very efficiently (Scheme 3-6).

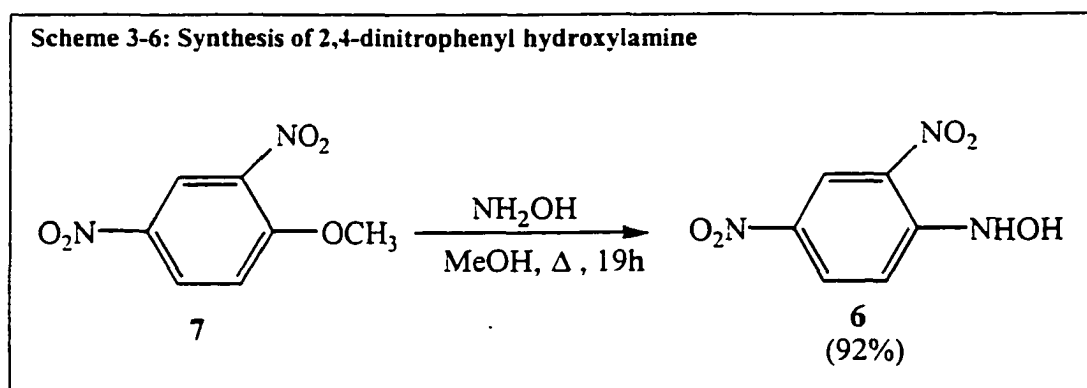

The 2,4-dinitrophenyl hydroxylamine was obtained as an orange-colored solid, stable in air in the solid state for considerable lengths of time, but not very stable in solution. 2,4-Dinitroanisole (7) is a commercially available starting material for this preparation. It can also be prepared very efficiently from 1-chloro-2,4-dinitrobenzene (8) (Scheme 3-7) by reaction with sodium methoxide.

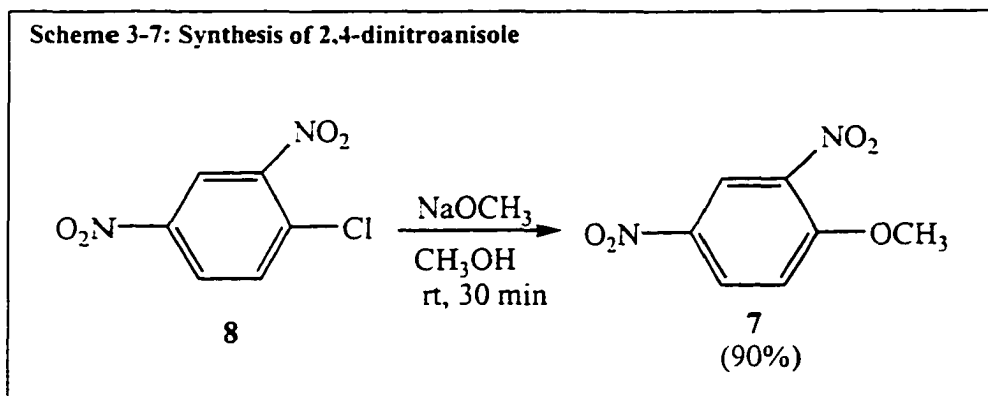

3-2-2: $\text{FeCl}_{2,3}$ - CATALYZED REACTION OF 2,4-DINITROPHENYL

HYDROXYLAMINE WITH OLEFINS

2-Methyl-2-pentene (9) reacts with 2,4-dinitrophenyl hydroxylamine (6) in the presence of 10 mol% of a mixture of FeCl_2 and FeCl_3 to produce the desired allylamine 10a and 2,4-dinitroaniline (11) as the only by-product (Scheme 3-8). Allylamine 10a was purified by column chromatography and characterized spectroscopically. The ^1H NMR spectrum gives the characteristic pattern for the 2,4-DNP group in the aromatic region, two resonances in the vinylic region, as opposed to one in the olefin itself, and a broad N-H resonance in the downfield region. In the IR spectrum of the product only one band is seen in the $3500\text{-}3300\text{ cm}^{-1}$ region,

corresponding to the N-H stretch, in contrast to two in 2,4-dinitrophenyl hydroxylamine. The molecular ion (m/z 265) is seen in the mass spectrum and the fragment corresponding to the loss of an ethyl group (m/z 236) is the base peak. Hence, based on all the spectroscopic data the identity of the allylamine **10a** was established. The reaction occurs in an ene-like manner as the product formed is that derived from migration of the double bond. Also, the N-attack occurs at the less substituted carbon of the double bond in the olefinic substrate. The identity of the by-product **11** was established by comparison with an authentic sample. 2,4-Dinitrophenyl hydroxylamine is unstable when in solution and forms 2,4-dinitroaniline as it decomposes. Another important feature observed in this reaction was that a 100% nitrogen mass balance is obtained.

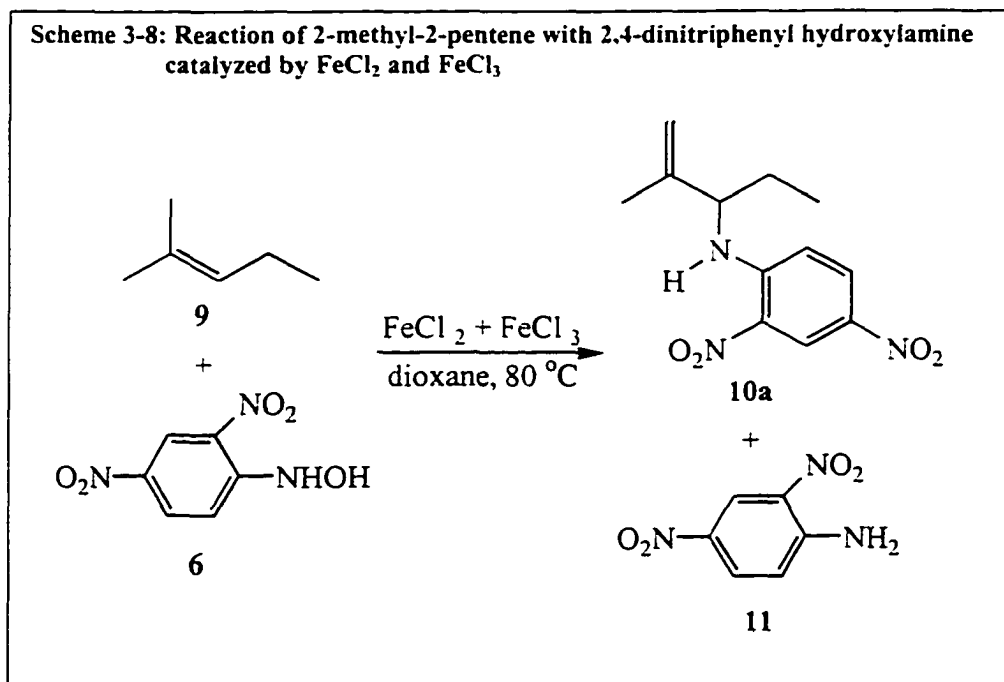

Optimization studies were performed on this system to determine the most useful conditions (Table 3-1). Highest selectivity for the allylamine **10a** was obtained when the solution of 2,4-dinitrophenyl hydroxylamine was added to the reaction mixture containing the olefin and the catalyst over a ten minute period. Slow addition of the aminating agent produced more of the byproduct (entries 1, 2 and 3). This was possibly due to the decomposition of the hydroxylamine **6** upon standing in solution, leading to low yields of the allylic amine. Both anhydrous and hydrated Fe(II, III)-chlorides catalyze the reaction giving comparable yields and selectivities. However, the time required for the reaction to be complete was longer with the hydrated salts (entries 3 and 4). The reaction was most efficient in terms of time and selectivity when the iron salts were taken in a 9:1 ratio of FeCl₂ : FeCl₃ (entry 5). Addition of a suspension of the catalyst in dioxane over a longer time did not produce any improvements to the reaction outcome (entry 6).

Table 3-1: Optimization studies on the allylic amination reaction of 2-methyl-2-pentene

Entry	Time of Addition of DNP-NHOH	Catalyst	Reaction time	Selectivity (10a : 11)
1	4 h	FeCl ₂ + FeCl ₃ (3 : 1)	22 h	3 : 2
2	10 h	"	22 h	1 : 3
3	10 min	"	12 h	3 : 1
4	"	FeCl ₂ .4H ₂ O + FeCl ₃ .6H ₂ O (3 : 1)	22 h	3 : 1
5	"	FeCl ₂ + FeCl ₃ (9 : 1)	8 h	3.6 : 1
6		Added the catalyst over 45 min	22 h	2 : 1

Hence, based on this study it was found that the condition set 5, in which a solution of 2,4-dinitrophenyl hydroxylamine is added over a 10 minute period to the reaction mixture containing a ten-fold excess of the olefin and 10 mol% of a mixture of FeCl₂ and FeCl₃ in a 9:1 ratio, is optimal for best results in the reaction. These conditions were used for all subsequent reactions and analytical thin layer chromatography was used for monitoring the disappearance of 2,4-dinitrophenyl hydroxylamine.

To establish the role of the catalyst in this system, a control reaction was performed. A ten-fold excess of the olefin was heated with 2,4-dinitrophenyl hydroxylamine under the same conditions as the original reaction, but without the iron chlorides (Scheme 3-9). No reaction was observed between the two compounds and only 2,4-dinitrophenyl hydroxylamine was isolated after the reaction mixture had refluxed for 24 h. This result established that the Fe (II, III)-chlorides do indeed catalyze amination of the olefin and were essential for the reaction to occur.

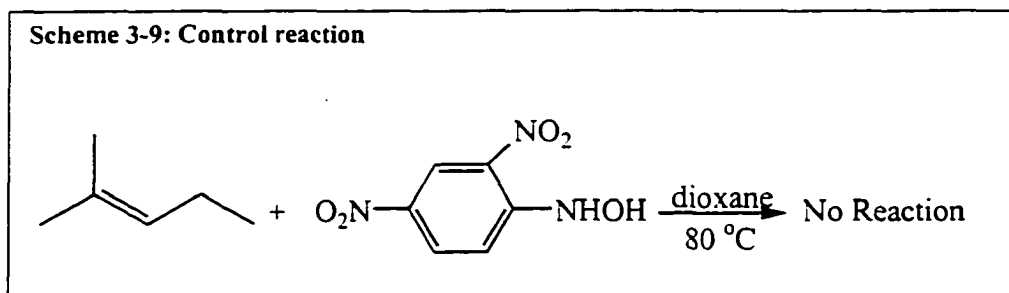

The next step for us was to study the scope of this reaction with respect to olefinic substrates. Several olefins were allowed to react with 2,4-dinitrophenyl hydroxylamine (**6**) and the corresponding allylic amines produced were isolated (Table 3-2). The yields of the allylamines **10** obtained in these reactions were, in

general, higher than those obtained in the corresponding reactions with phenyl hydroxylamine.

Table 3-2: FeCl_{2,3}-catalyzed allylic amination of olefins using 2,4-dinitrophenyl hydroxylamine

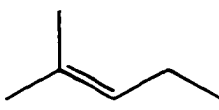
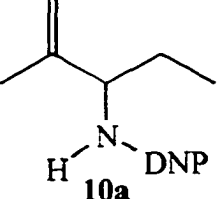
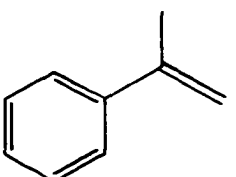
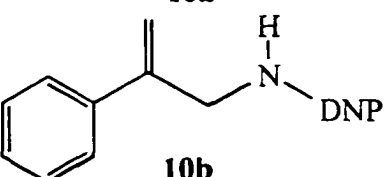
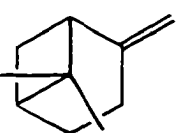
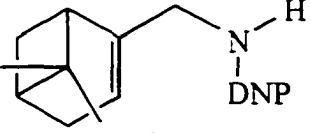
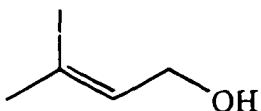
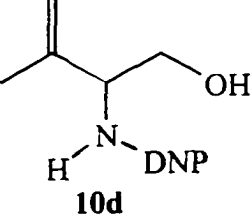
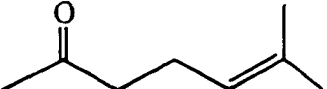
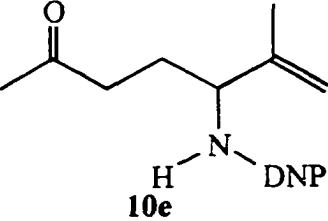
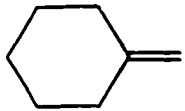
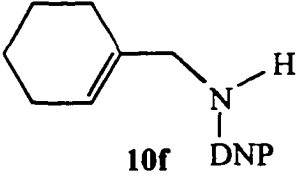
Entry	Olefin	Product	Isolated yield (%)
1		 10a	75
2		 10b	87
3		 10c	65
4		 10d	30
5		 10e	29
6		 10f	22

The products are formed with transposition of the double bond, as is characteristic of the ene-reaction. Hence, this reaction is highly regio- and chemoselective as amination occurs always at the less substituted carbon of the double bond. Several functional groups are tolerated (entries 4 and 5) and only the amination product is obtained.

The allylamines were isolated as air-stable colored solids and were purified by column chromatography, except **10d** and **10e**. Allylic amines **10d** and **10e** could not be separated effectively from the by-product 2,4-dinitroaniline chromatographically. Instead, separation was achieved by sublimation of the by-product. This accounted for the relatively low yield of pure **10e** compared to that in the crude product mixture, in which **10e** was present in a yield of >80% as judged by integral ratios in the ¹H NMR spectrum. The 2,4-DNP-protected allylic amines produced were characterized spectroscopically (Figure 3-2). The ¹H NMR spectra of **10a-f** exhibited the pattern of signals in the aromatic region corresponding to the 2,4-DNP group, the downfield broad signal for the deshielded amino proton, the signals for the vinylic protons with small couplings, and those for the allylic methylene group. The infra red spectra of these compounds show the expected band at high frequency for the N-H stretch, and also those for the C=C, N=O, and N-O stretches. The molecular ion is observed in the mass spectra for each of the allylamines obtained.

Figure 3-2: ¹H NMR spectra of 2,4-DNP-allylamines

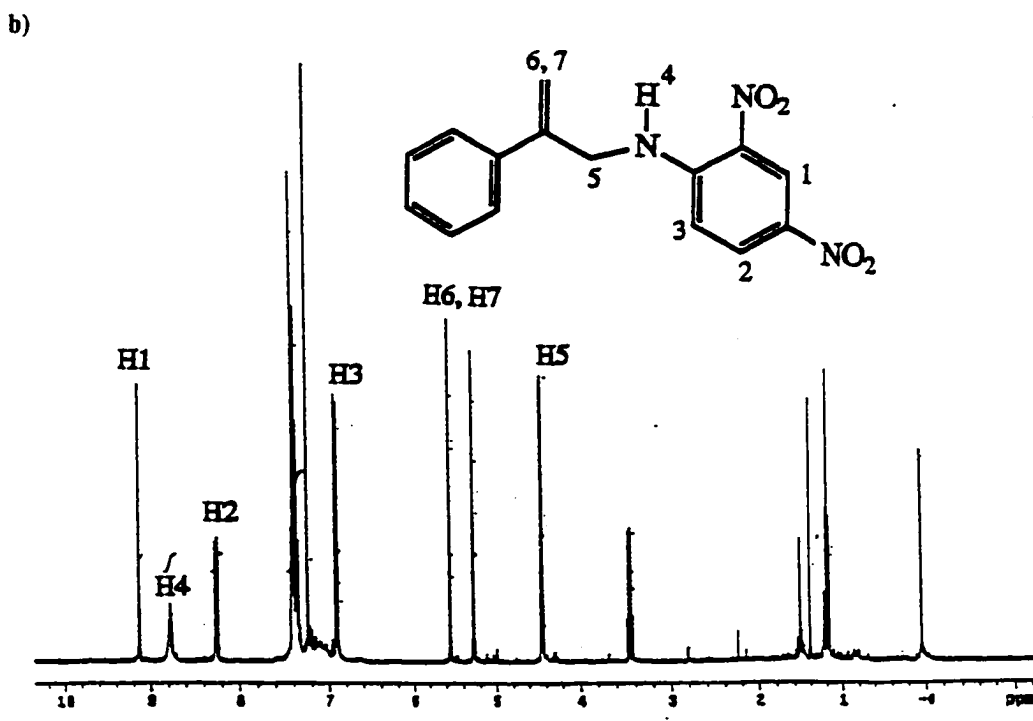
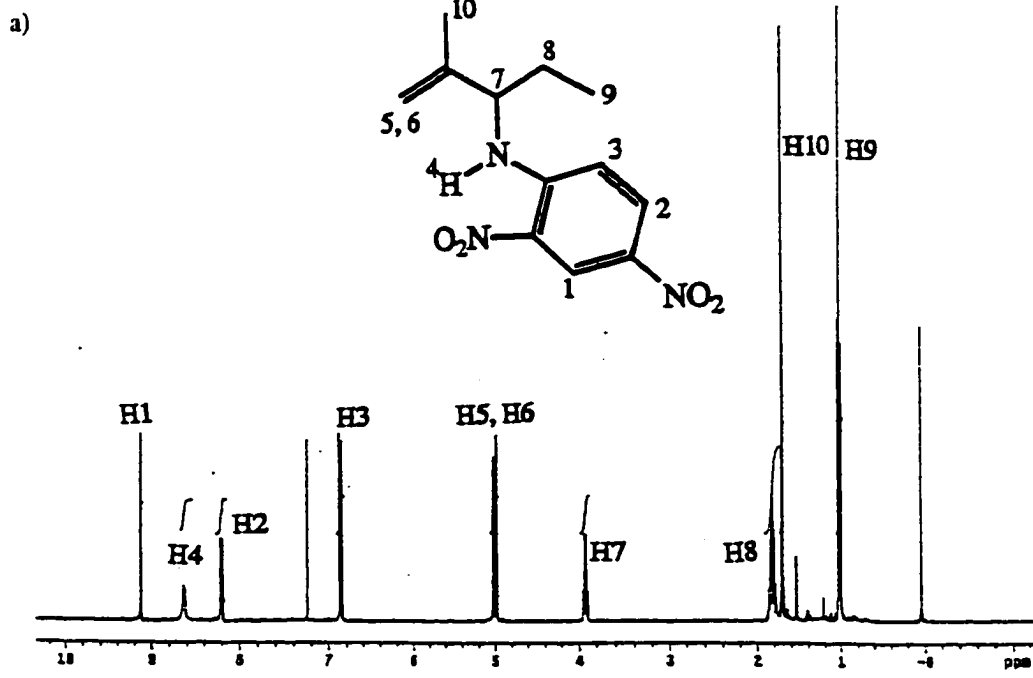

Furthermore, the structure of the allylic amine **10b** was determined by X-ray diffraction (Figure 3-3). The molecule exhibits the expected planarity of the 2,4-DNP ring and attached substituents, as a result of delocalization of the lone pair of electrons on the amino nitrogen; the nitro groups are almost planar with respect to the aromatic ring with small deviations. The nitro group at the ortho position is within hydrogen bonding distance with the amino proton (1.92 Å) and the O1-H-N1 angle is 132°. The two phenyl rings in this compound are inclined at an angle of 69.5° with respect to each other.

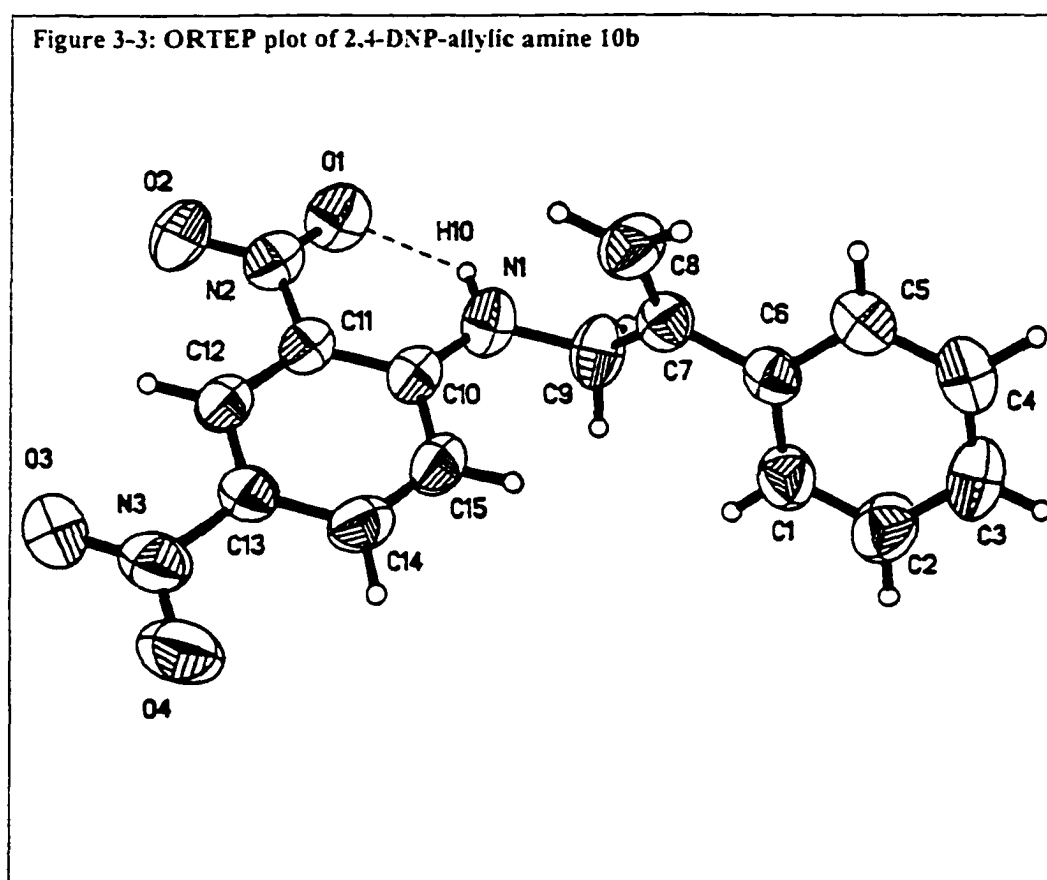

In summary, 2,4-dinitrophenyl hydroxylamine is an efficient reagent for the $\text{FeCl}_2 \cdot 3\text{H}_2\text{O}$ -catalyzed allylic amination of olefins. The products are obtained in good

yields with high regio- and chemoselectivity. The success of this reaction also provides an entry to other classes of allylic amines.

3-2-3: DEPROTECTION OF THE 2,4-DNP-PROTECTED SECONDARY

ALLYLIC AMINES

As noted earlier, the 2,4-DNP group has been used as an amine protecting group for aminonucleotides and amino acids.^{75, 76} Removal of this group has been achieved by nucleophilic displacement of the amine with reagents such as basic ion-exchange resins, Ba(OH)₂, 2-mercaptoethanol and primary amines.^{75, 76, 77, 78} Hence, based on these reports we explored the reactivity of the N-DNP-N-allylamines **10** towards such reagents in an attempt to obtain primary allylic amines (**12**) (Scheme 3-10).

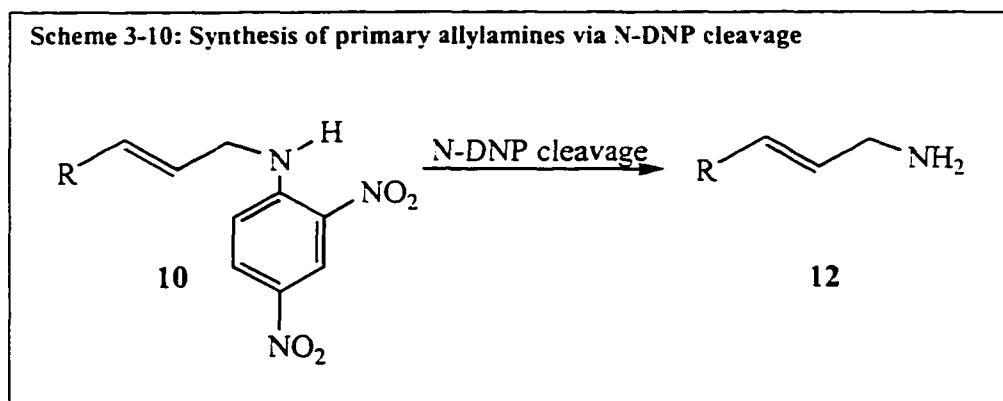

This discussion will be segmented according to the various classes of reagents used.

A: NUCLEOPHILIC REAGENTS

We began our investigation based on the already reported results. Nucleophilic reagents were expected to displace the amines from 2,4-dinitrophenyl unit in protic solvents (Scheme 3-11).

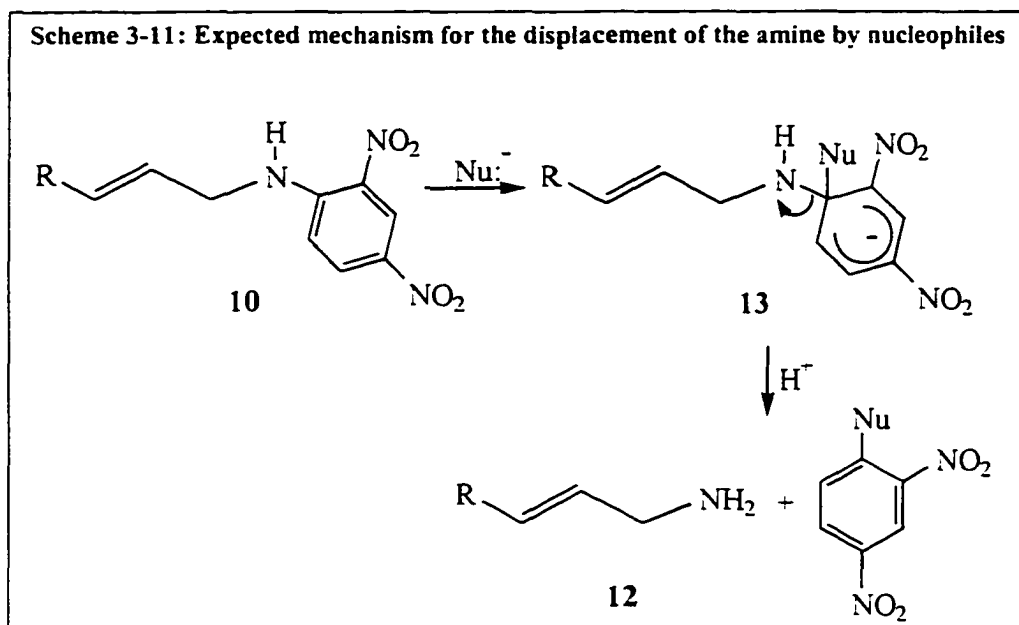

Reagents such as NaOH, KOH, $\text{Ba}(\text{OH})_2$ and basic ion-exchange resins in the hydroxide forms were used in protic media (Scheme 3-12). In reactions with NaOH and NaOCH_3 (entries 1, 2, and 4) complex product mixtures were obtained based on ^1H NMR spectroscopy. The unreacted starting allylamine **10b** was also seen in this mixture of compounds. In reactions with KOH and $\text{Ba}(\text{OH})_2$ (entries 3 and 5), no conversion of the starting material was observed even upon heating the reaction mixture for long periods of time.

Ion exchange resins, Amberlite IRA400(OH) and Dowex 550(OH) (entries 6-12), were also evaluated for deprotection. Both of the above mentioned resins have a polystyrene matrix with 3-5% crosslinking using divinylbenzene. The active unit in these polymers is a tetraalkylammonium hydroxide salt and produces very strongly basic media.⁸² They have been used for a number of organic transformations, such as synthesis of α - and β -lactams,⁸³ condensation of nitroparaffins with carbonyl compounds,⁸⁴ synthesis of isoquinoline alkaloids,⁸⁵ synthesis of esters from carboxylic acids and alkylating agents,⁸⁶ and synthesis of nitriles.⁸⁷ In reactions of the allylamine **10b** with Amberlite IRA400(OH), no products were observed when THF/H₂O was used as the solvent system and only the starting material was recovered. The desired primary allylic amine was produced after the cleavage of the 2,4-DNP group when a very old sample of Amberlite IRA(OH) was used with an acetone/H₂O solvent system. The ¹H NMR spectrum of this compound shows the two signals in the characteristic vinylic region (5.19, 5.39 ppm) and one signal in the allylic region (4.32 ppm). The phenyl region did not exhibit any signals from the 2,4-DNP ring. Only the signals for the vinyl substituted phenyl ring were observed (7.24-7.40 ppm). The primary allylamine was accompanied by condensation products from the solvent in the strongly basic media. Attempts to separate the allylamine from the side products derived from the solvent were not successful. Next, we prepared Amberlite IRA400(OH) from the corresponding chloride form, which is commercially available. Amberlite IRA400(Cl) was washed with a 1N NaOH solution to displace the chloride and then washed with water.⁸³ Some color change was observed when this material was dried under vacuum for a few hours, suggesting

some degradation of the resin. Hence, a similar preparation was carried out without drying the resin under vacuum for long periods of time and it was used as such in future reactions. Allylic amine **10b** was treated with this new batch of resin in different solvent systems. Complex mixtures of compounds were obtained when $\text{CH}_3\text{COCH}_3/\text{H}_2\text{O}$ and $\text{EtOH}/\text{H}_2\text{O}$ solvent systems were used. Signals expected for the desired primary allylic amine were seen accompanied by several other signals. No conversion of **10b** was observed when the reaction was performed in $\text{DMF}/\text{H}_2\text{O}$. Similar results were obtained when Dowex 550(OH) was used in $\text{CH}_3\text{COCH}_3/\text{H}_2\text{O}$ at room temperature. However, reaction in dioxane/ H_2O did not result in any conversion and only the starting material was recovered.

2,4-DNP-allylamine **10b** underwent no reaction when heated with an aqueous solution of methylamine in DMSO (entry 13).⁷⁹ In the published report, cleavage reactions were successful when the nitrogen groups on the tertiary 2,4-DNP-substituted amine were sterically undemanding, such as methyl groups. Reaction of **10b** with thiophenolate, a good nucleophile, also gave no conversion and the starting material was recovered (entries 15 and 16).

Scheme 3-12: Attempted cleavage of the 2,4-DNP group using basic reagents

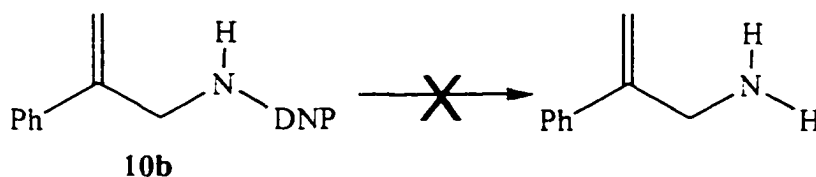

Conditions:

Entry	Reagent	Temp. (°C)	Reaction Time
1	NaOH, MeOH	25	6 h
2	"	60	15 h
3	KOH, THF/H ₂ O	65	60 h
4	NaOCH ₃ , MeOH	60	60 h
5	Ba(OH) ₂ , THF/H ₂ O	65	24 h
6	Amberlite IRA400(OH), THF/H ₂ O	25	6 h
7	"	65	17 h
8	Amberlite IRA400(OH), acetone/H ₂ O	25	15 h
9	Amberlite IRA400(OH), EtOH/ H ₂ O	25	4 h
10	Amberlite IRA400(OH), DMF/ H ₂ O	25	21 h
11	Dowex 550(OH), acetone/H ₂ O	25	18 h
12	Dowex 550(OH), dioxane/ H ₂ O	25	18 h
13	Aq MeNH ₂ , DMSO	60	8 h
14	NH ₃ , MeOH	60	17 h
15	KSPH, THF	25	6 h
16	"	65	17 h

The lack of reactivity observed when the 2,4-DNP-protected allylamine **10b** was treated with bases under certain conditions (entries 3, 4, 5, 13, 14, 15, and 16) can have various explanations. The first cause of unreactivity could be the acidic amino group present (Scheme 3-13). For the deprotection to succeed, the hydroxide attack has to occur at C-1. However, the proton on the amino nitrogen is very acidic ($pK_a = 15.9$ in DMSO)⁸⁸ as it leads to the formation of a very stable amide ion (**14**) in which the negative charge is extensively delocalized in the 2,4-DNP ring. The amide

ion produced, therefore, does not undergo any further reaction. The formation of this ion is suggested by the appearance of a deep red color when the base is added to the allylamine solution.

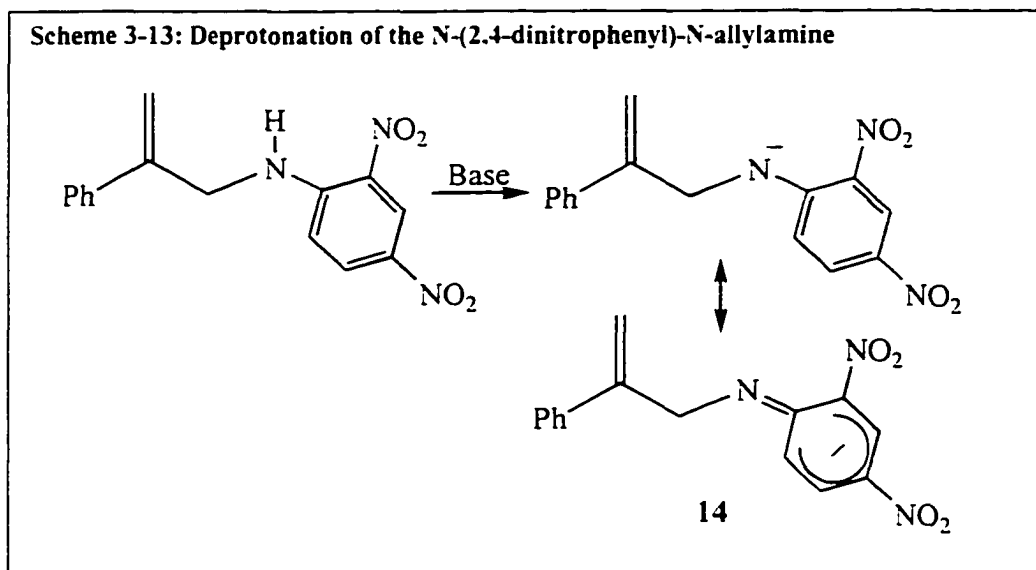

This was also studied by ^1H NMR. In deuterated THF and DMF, NaH reacts with the 2,4-DNP-allylamine **10b** with the formation of bubbles. The broad signal for the amino proton disappeared, the signals for the vinylic and allylic protons were shifted upfield, and signals for the protons on the 2,4-DNP ring shifted according to their position on the ring (Figure 3-4).

Figure 3-4: Deprotonation of 2,4-DNP-allylamine 10b in deuterated solvents

a) Reaction in THF-d₈

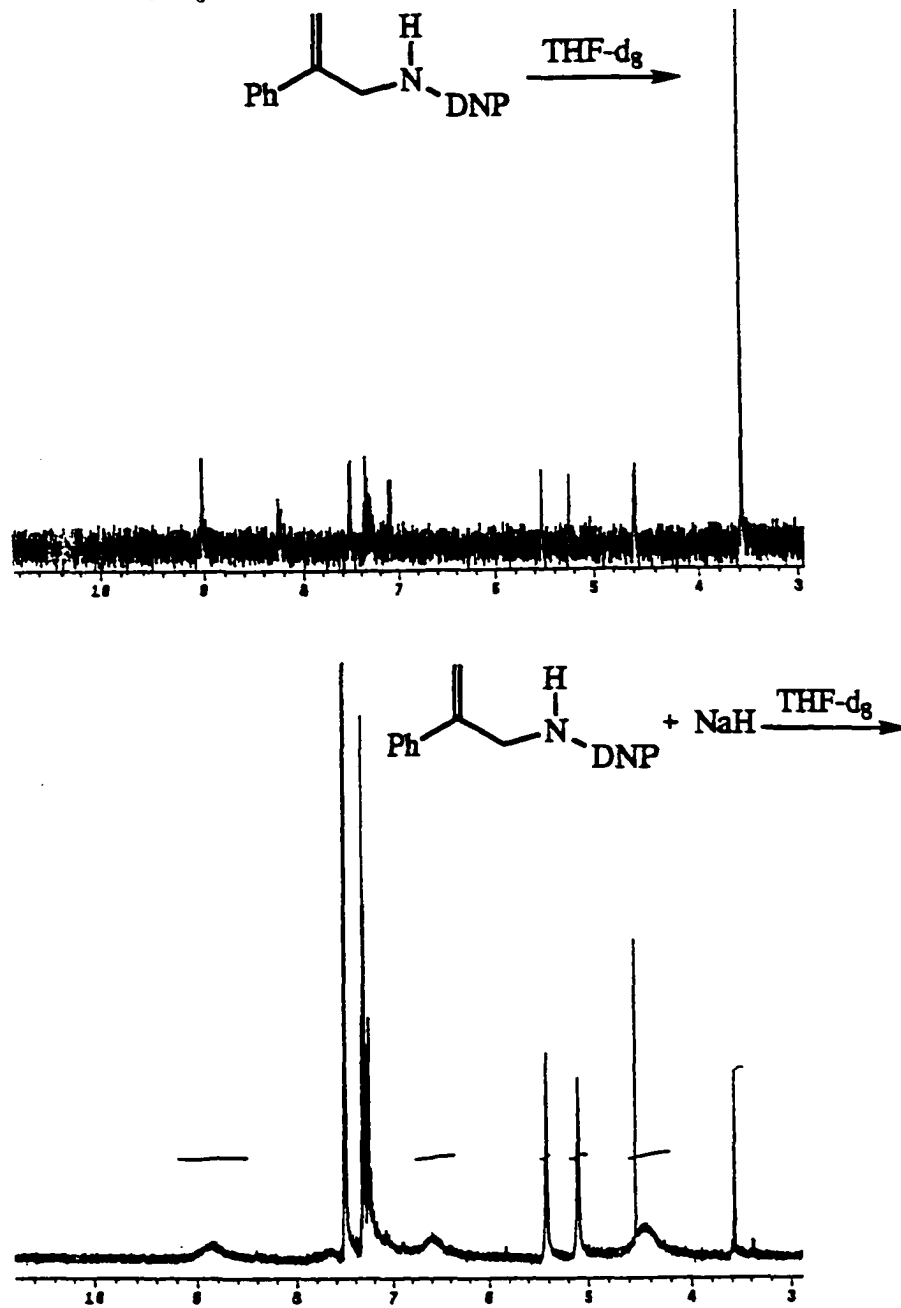

b) Reaction in DMF-d₇

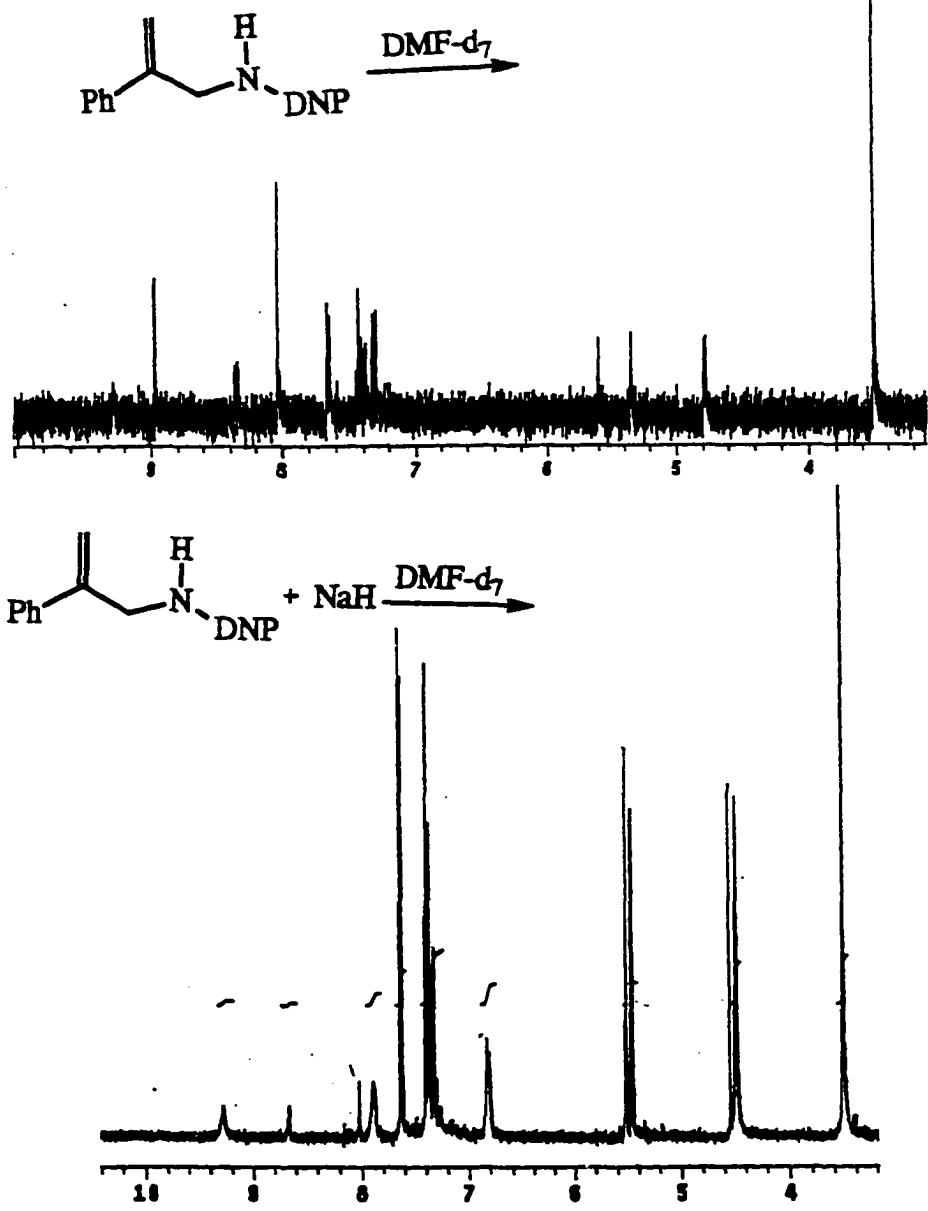

As seen in the figures above, besides the upfield shifts of the N-allyl unit, the signals for the protons on the 2,4-DNP ring are ambiguous, due to unclear integrations and multiplicities, and very broad after treatment with the base. This observation does not

confirm the deprotonation of the amine but does suggest some interactions taking place with the base used. One possibility is that the 2,4-DNP ring is reduced by a one electron process forming a radical anion which would be paramagnetic and show broadening of signals. However, the fact that the amine can be alkylated with the use of the base would suggest deprotonation.

The failure to displace the amine by nucleophiles in our system can also be explained considering the resonance structures of the N-(2,4-dinitrophenyl)-N-allylamines (Scheme 3-14).

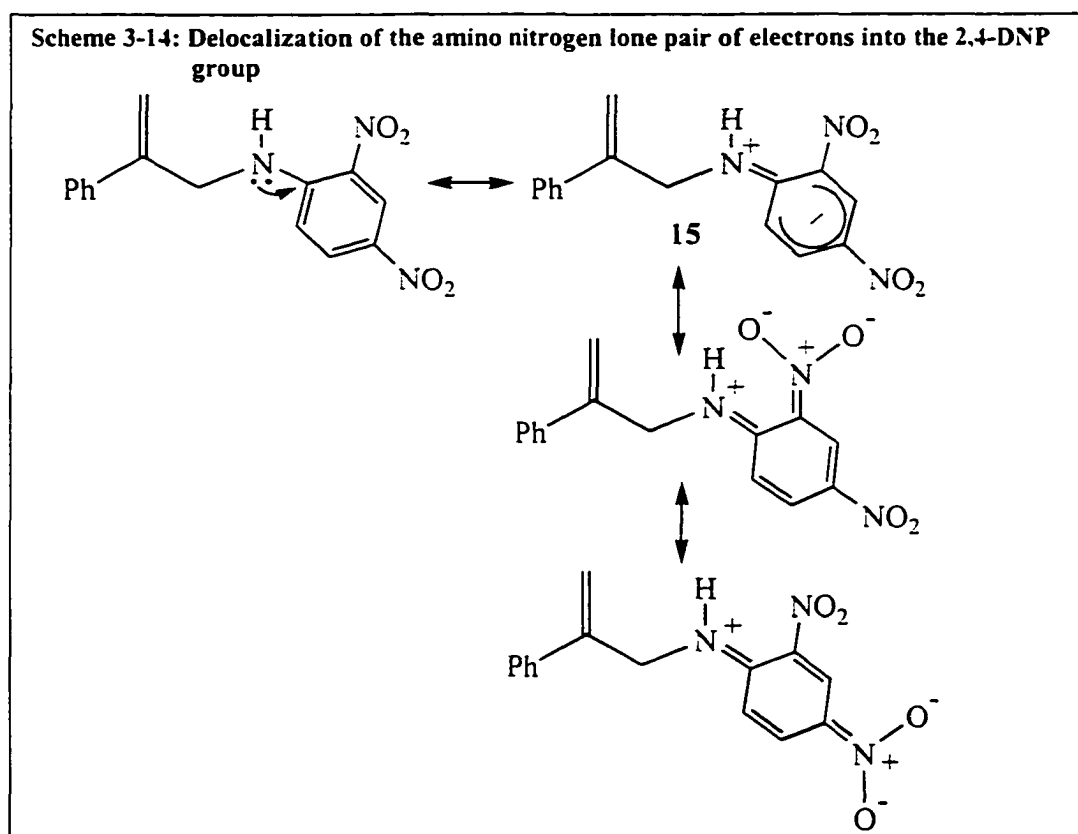

The electrophilicity of C-1 is substantially decreased due to delocalization of the lone pair of electrons on the amino nitrogen, forming 15. This species is stabilized by the

two strongly electron withdrawing nitro groups at the ortho- and para-positions via resonance. As a result, nucleophilic attack at C-1 in these compounds is prevented.

Another reason for lack of reactivity could be that the σ complex (**13**) formed upon attack by the nucleophile at C1 (Scheme 3-11, 3-15a) is a very stable species due to the delocalization of the negative charge in the ring.^{79, 89} As a result, this moiety does not undergo further reaction to displace the amine. Nucleophilic attack can also be envisioned at C-3, which is the more electrophilic site than C-1, forming the σ complex **13'** (Scheme 3-15b). This complex is also stabilized by the electron withdrawing nitro groups. Hence, more selective reagents are required to achieve the N-DNP cleavage.

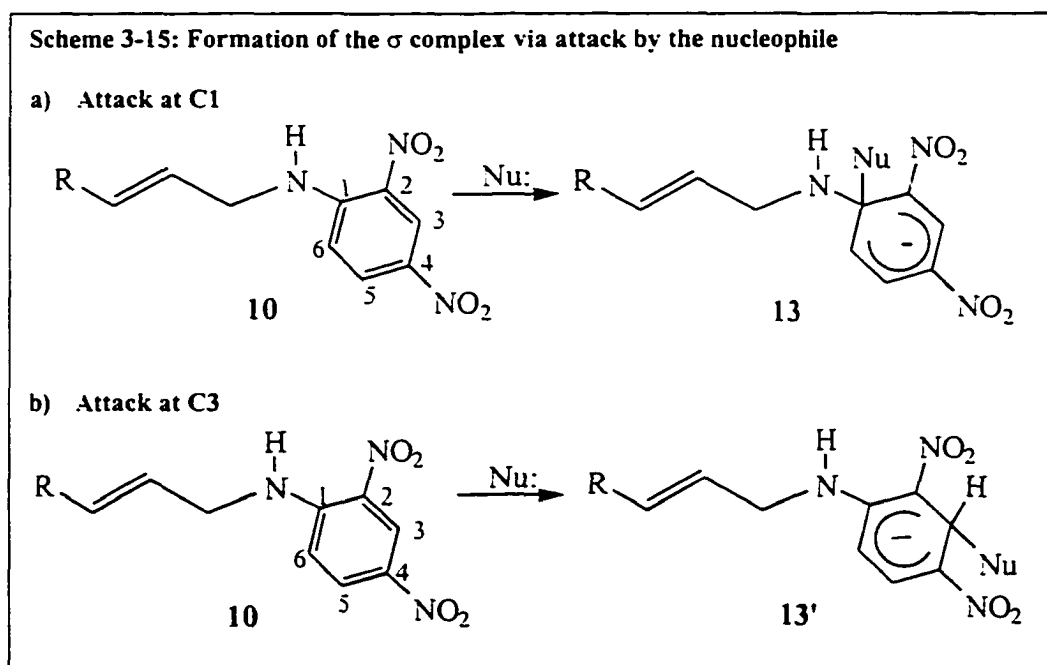

The low selectivity in some other reactions (Scheme 3-12; Entries 1, 2, 8, 9, and 11) could also be a result of more than one electrophilic positions in the 2,4-DNP ring, forming more than one aromatic nucleophilic substitution products.

In summary, attempts to displace the primary allylamine by reaction with nucleophiles were not successful. It should be noted that successful displacement reactions of the 2,4-DNP group from other secondary and tertiary amines are reported in literature.⁷⁵⁻⁸⁰ We cannot provide an explanation for the lack of reactivity or selectivity in our systems with confidence at this time. However, several speculations have been presented. The allyl substituent on the amine could also be the problem area since it is this part of our compound that differs from the examples reported.

B: ACIDIC REAGENTS

Due to the unsuccessful attempts to achieve clean deprotection by using basic and nucleophilic reagents, we decided to study the reaction under acidic conditions. The rationale for this was that the amino nitrogen would be protonated, thus making the amine the leaving group instead of the amide (Scheme 3-16).

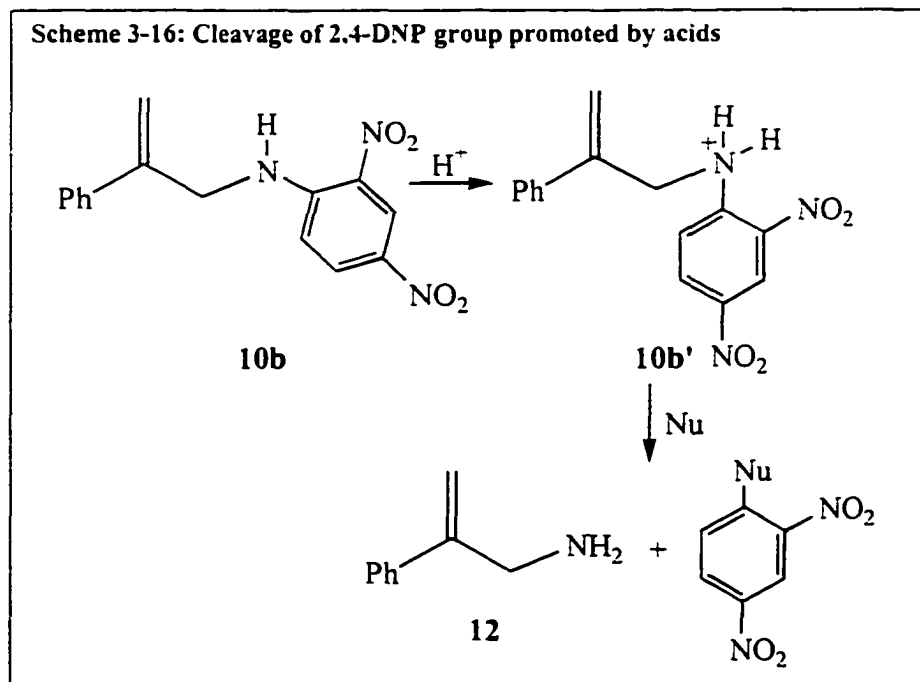

Also, due to protonation of the amine, C-1 of the 2,4-DNP ring will be electrophilic as there will now be no delocalization of the nitrogen lone pair of electrons. Hence, the greater leaving group ability of the amine, as opposed to the amide ion, combined with the relatively greater electrophilic nature of C-1 of the protonated allylamine **10b'** was expected to facilitate substitution by a nucleophile.

With this consideration, several acidic reagents were evaluated for this purpose (Scheme 3-17).

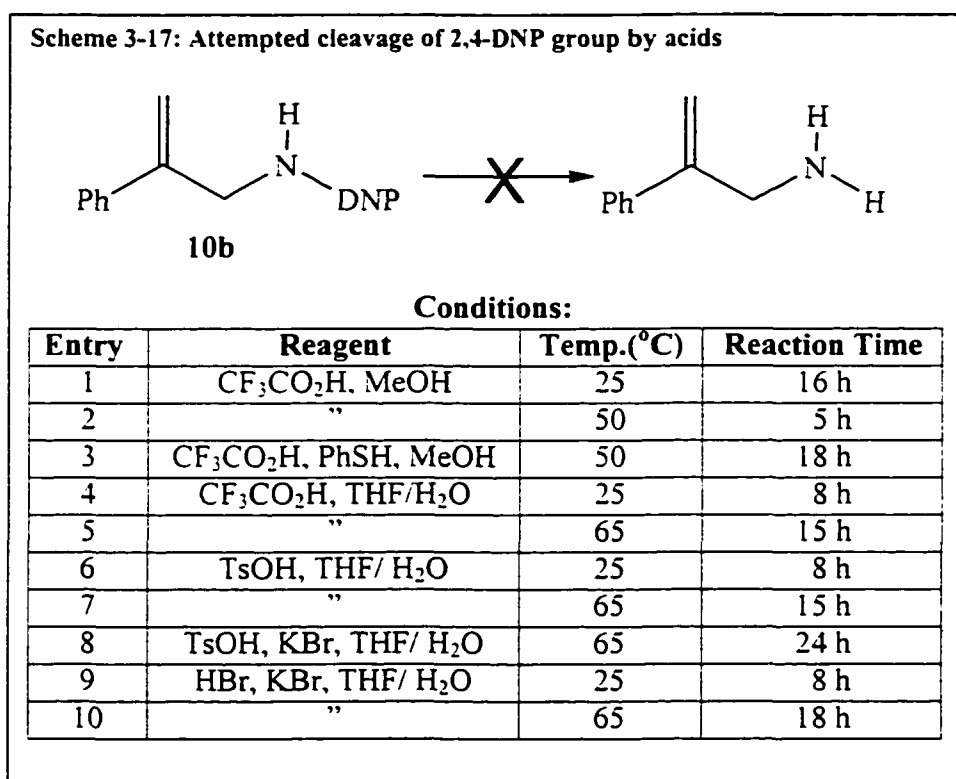

Strong acids like trifluoroacetic acid (Entries 1, 2, 4 and 5), p-toluenesulfonic acid (Entries 6 and 7), and hydrogen bromide (Entries 9 and 10) were used since the allylamine was expected to be a poor base. Acids in presence of good nucleophiles were also used in an attempt to aid the displacement of the amine after protonation

(Entries 3, 8, 9 and 10). However, in each case the allylamine substrate was recovered with no conversion to the product.

We suggest that the lack of reactivity of the 2,4-DNP-allylic amines **10** is due to their low basicity as a result of extensive delocalization of the lone pair of electrons into the 2,4-DNP ring. Hence, in the reactions with acids protonation of the allylamine does not occur readily.

As a summary of our attempts to form primary N-allylamines, efficient and selective cleavage of the 2,4-DNP group to produce primary N-allylamine has not been achieved. The unsuccessful reactions with nucleophiles could be explained by the acidity of the proton on the amine nitrogen, which reacts with nucleophilic bases to form a stable amide ion. Resistance to attack by nucleophiles can also be due to delocalization of the lone pair of electron on the amino nitrogen, which results in a decrease of electrophilicity at the ipso carbon. We do recognize that our results do not agree with those already reported and we do not have an explanation for this contradiction. The 2,4-DNP-allylamines are stable towards acids, again due to the lone pair of electrons on the amino nitrogen not being available for protonation.

3-2-4: ALKYLATION OF N-(2,4-DINITROPHENYL)-N-ALLYLAMINES

N-Alkylation of allylamines **10** can potentially alleviate the problem of abstraction of the amino proton when reacted with a base. It may then be possible to displace the 2,4-DNP group using a basic nucleophile. This process will then lead to the formation of secondary allylic amines, in which the N-alkyl group can be varied.

Alkylation of allylamines **10** was achieved by reaction of the 2,4-DNP-allylamine with alkylating agents under basic conditions (Scheme 3-18).

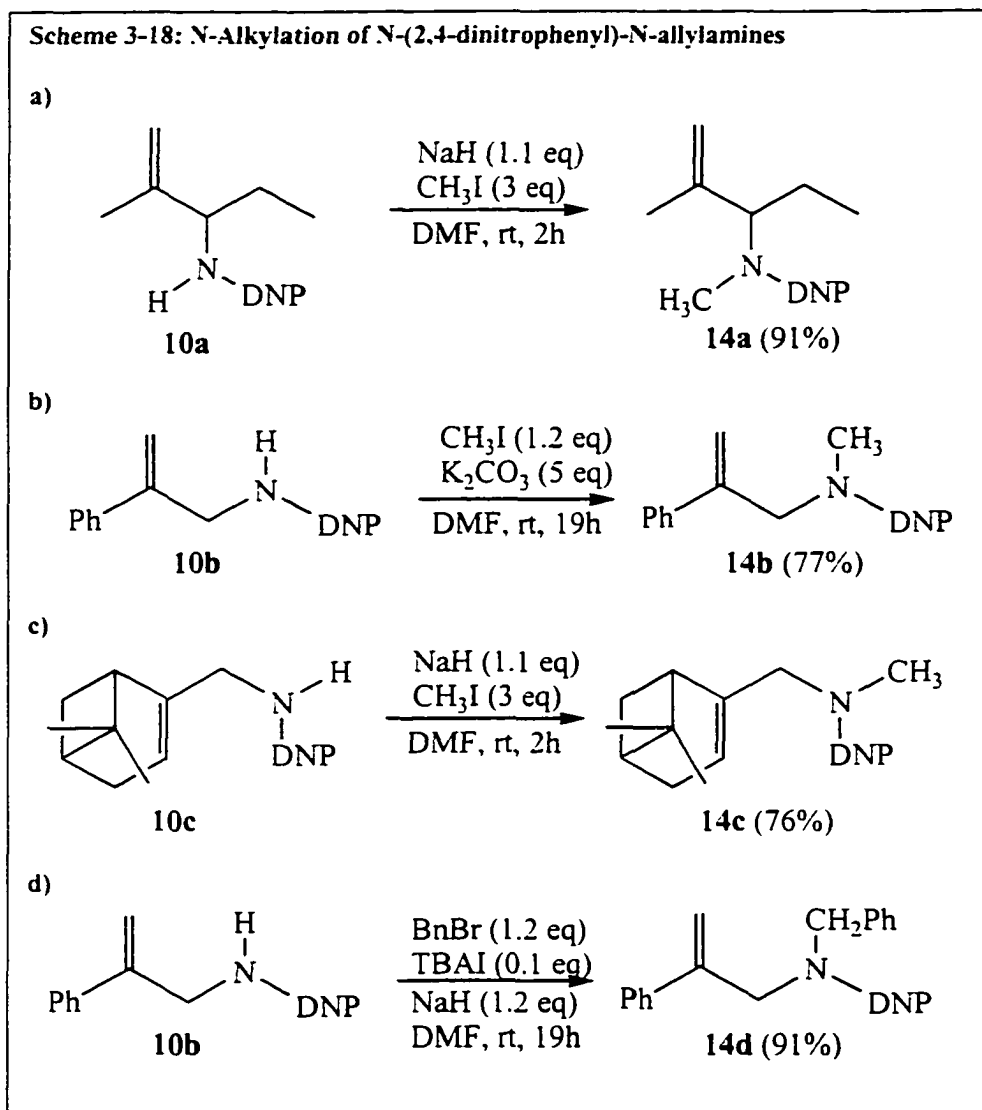

Methylation using CH_3I occurs readily to give high yields of the corresponding N-(2,4-dinitrophenyl)-N-methyl allylamines (Scheme 3-18a, b, c). The allylamines **10a**, and **10c** were first deprotonated by reaction with NaH (Scheme 3-18a, c), as suggested by the appearance of the characteristic deep red color. The amide ion formed was then treated with electrophilic CH_3I to yield the alkylated product.

Methylation performed using K_2CO_3 (Scheme 3-18b) does not involve the formation of the amide ion. This reaction probably occurs with the free amine **10b** attacking the extremely reactive electrophile, namely CH_3I . Reaction of the amide ion formed after deprotonation with benzyl bromide does not give any of the substitution product and the starting material was recovered after aqueous workup. Benzylation was successfully achieved when benzyl bromide was used with catalytic amounts of tetrabutylammonium iodide (TBAI),⁹⁰ resulting in high yields of **14d** (Scheme 3-18d). All the alkylated allylamines **14** were isolated after an aqueous workup of the reaction mixture and were characterized spectroscopically.

Our attempts to introduce a primary alkyl group on the amino nitrogen were unsuccessful (Scheme 3-19). In each attempt the 2,4-DNP-allylamine **10b** was first treated with a base. This resulted in the formation of the deep red color associated with the amide ion formed by deprotonation. However, further reaction of this amide ion with primary alkyl electrophilic reagents (n-PrI, n-PrOTs and n-PnOTf) did not result in any reaction and the 2,4-DNP-allylamine could be recovered. Even with the use of strongly electrophilic reagents (n-PrOTs and n-PnOTf) no conversion of the allylamine was observed. Reactions performed at higher temperatures and extended periods of time were also unsuccessful. In reactions with n-PrOTs the unreacted alkylating reagent was recovered after refluxing in polar solvents suggesting unreactivity of the electrophile. In order to verify the formation of the amide ion, it was also shown by 1H NMR spectroscopy that the allylamine **10b** is deprotonated under the conditions used when the solvent is THF or DMF, but not in CH_2Cl_2 (Figure 3-4). This ion is expected to be a poor nucleophile and, hence, it does not

react with moderately strong electrophiles such as propyl iodide. Strong electrophiles were expected to react with the poor nucleophile formed. However, the electrophile pentyl triflate was shown to react with solvents like THF, DMF and CH₃CN, the solvents in which deprotonation of the allylamine **10b** occurs (Figure 3-4). The solvents which are unreactive towards the electrophile, such as Et₂O and CH₂Cl₂, do not promote the deprotonation of the allylamines, and the free amine is not nucleophilic enough to attack the alkylating agent on its own.

Scheme 3-19: Attempted N-propylation and N-pentylation of N-(2,4-dinitrophenyl)-N-allylamine

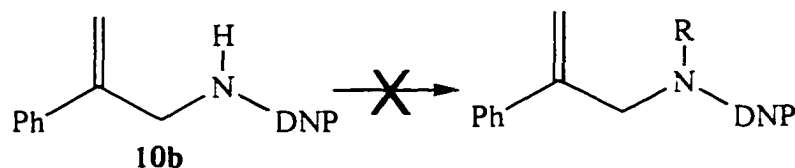

Conditions:

Entry	Reagents	Temp. (°C)	Reaction Time
1	n-PrI, K ₂ CO ₃ (xs), DMF	25	20 h
2	"	85	6 h
3	n-PrI, NaH, THF	25	17 h
4	"	65	24 h
5	n-PrI (xs), KOBu ^t , DMF	25	19 h
6	n-PrI, KH, DMF	25	20 h
7	"	80	18 h
8	n-PrOTs, NaH, THF	25	16 h
9	"	65	6 h
10	n-PrOTs, KH, CH ₃ CN	25	6 h
11	"	80	19 h
12	n-PnOTf, KH, THF	25	19 h
13	n-PnOTf, KH, Et ₂ O	25	23 h
14	n-PnOTf, KH, DMF	25	16 h
15	"	90	6 h
16	n-PnOTf, NaH, CH ₂ Cl ₂	25	22 h
17	"	50	6 h

Therefore, we believe that the amide ion formed upon deprotonation of the 2,4-DNP protected allylic amine **10b** is a very poor nucleophile. As a result, N-alkylation occurs only with the most highly electrophilic reagents. The failure to alkylate with a primary alkyl group using an electrophile as strong as an alkyl triflate was due to its reaction with the solvents in which the amide ion can be formed. On the other hand, with the more inert solvents, such as Et₂O and CH₂Cl₂, the efficient formation of the amide ion is not favored because of the insolubility of the base or the 2,4-DNP-allylamide.

3-2-5: DEPROTECTION OF 2,4-DNP-PROTECTED TERTIARY ALLYL-AMINES

Cleavage of the 2,4-DNP group in N-(2,4-dinitrophenyl)-N-alkyl-N-allylamines **14** would lead to the formation of the corresponding secondary allylamines. Hence, this reaction was explored. A number of nucleophilic conditions were assessed to cleave the 2,4-DNP group from the methylated tertiary allylamines, including KOH, PhSH + KOH, 2-mercaptoethanol and propylamine. But no conversion was observed in these reactions. However, reaction of the N-methylated tertiary allylic amines with an excess of aqueous solution of methylamine in DMSO⁷⁹ at 65-70 °C for about 20 h was successful in cleaving the 2,4-DNP group and the corresponding N-methyl-N-allylamines (**15**) were obtained in moderate yields (Scheme 3-20). The desired products were isolated from the reaction mixture by pouring it in water which causes the by-product, N-methyl-2,4-dinitroaniline, to

precipitate out. The deprotected secondary allylamines were then extracted out of the aqueous solution using an organic solvent such as Et₂O or CH₂Cl₂.

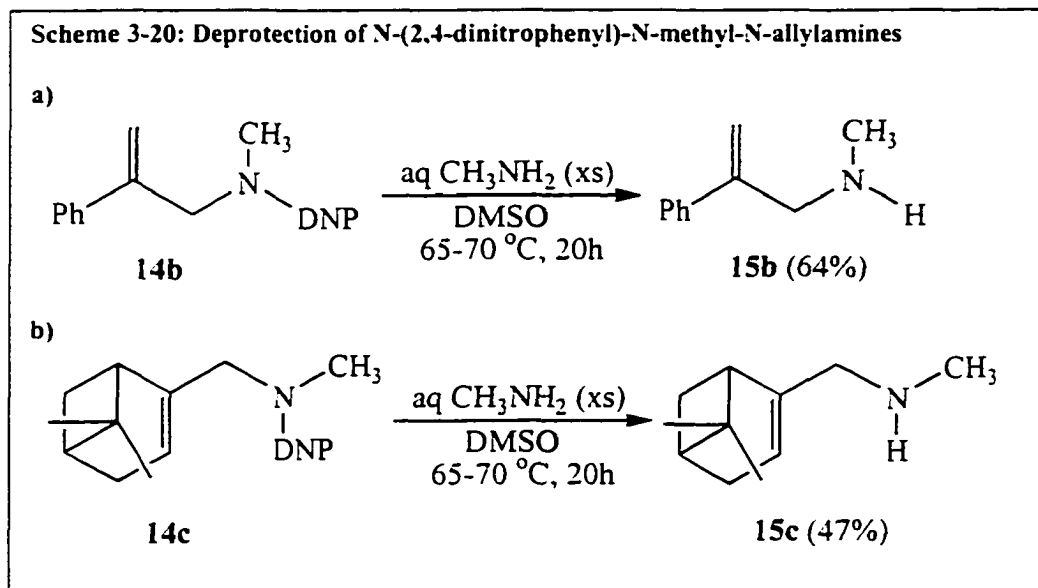

Deprotection of the N-benzylated tertiary allylamine **14d** was not successful, even with the use of a strong nucleophile like hydroxylamine, which would regenerate the original aminating agent (Scheme 3-21). Only the starting material was recovered. This could possibly be a result of the *ipso* carbon not being accessible due to the steric hindrance caused by the benzylic and allylic substituents on the amine nitrogen.

Scheme 3-21: Attempted deprotection of N-(2,4-dinitrophenyl)-N-benzyl-N-allylamine

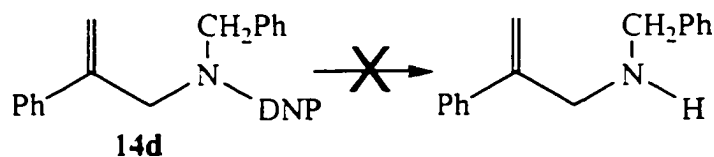

Conditions:

Entry	Reagents	Temp.(°C)	Reaction Time
1	aq MeNH ₂ , DMF	65	22 h
2	NH ₂ OH, MeOH/CH ₂ Cl ₂	25	4 h
3	"	50	18 h
4	NH ₂ OH, DMF	25	5 h
5	"	90	15 h

3-2-6: ATTEMPTED SYNTHESIS OF 2,4-DINITROBENZENE SULFONYL-HYDROXYLAMINE

As another potential aminating agent we investigated the reactivity of N-hydroxy-2,4-dinitrobenzenesulfonamide with olefins catalyzed by iron chlorides. The N-(2,4-dinitrobenzenesulfonyl)-substituted allylic amines produced could lead to primary and secondary allylic amines by displacement of the sulfonyl protecting group. This premise was based on a recent report in which a facile synthesis of secondary amines involving the deprotection of the corresponding 2,4-dinitrobenzenesulfonamides (**16**) was described (Scheme 3-22).⁹¹ In this method, primary amines react with 2,4-dinitrobenzenesulfonyl chloride to form the mono-substituted sulfonamide (**17**), which was then alkylated to yield **16**. The 2,4-dinitrobenzenesulfonyl group was subsequently cleaved by using 2-mercaptoethanol or n-propylamine.

Scheme 3-22: Synthesis of secondary amines

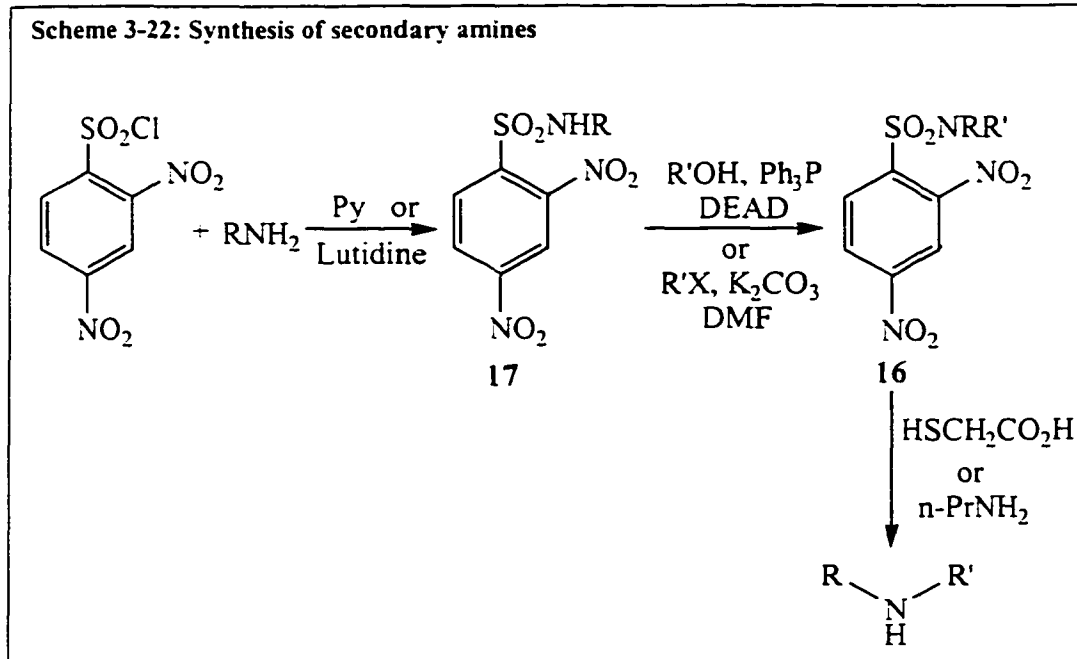

In order to carry out this study, we first had to prepare N-hydroxy-2,4-dinitrobenzenesulfonamide (**18**). We attempted to obtain this compound by reaction of 2,4-dinitrobenzenesulfonyl chloride with hydroxylamine in the presence of a base (Scheme 3-23).

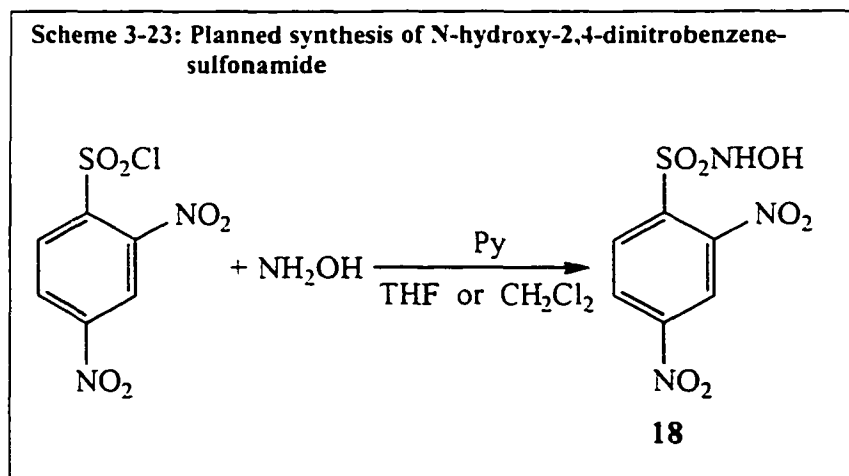

The hydroxylamine **18** once formed could potentially react with olefins in the presence of Fe(II, III)-chlorides as catalysts to produce the corresponding N-(2,4-

dinitrobenzenesulfonyl)-N-allylamines (19). These could then be deprotected under the conditions described in the literature report to yield the desired primary N-allylamines (20) (Scheme 3-24).

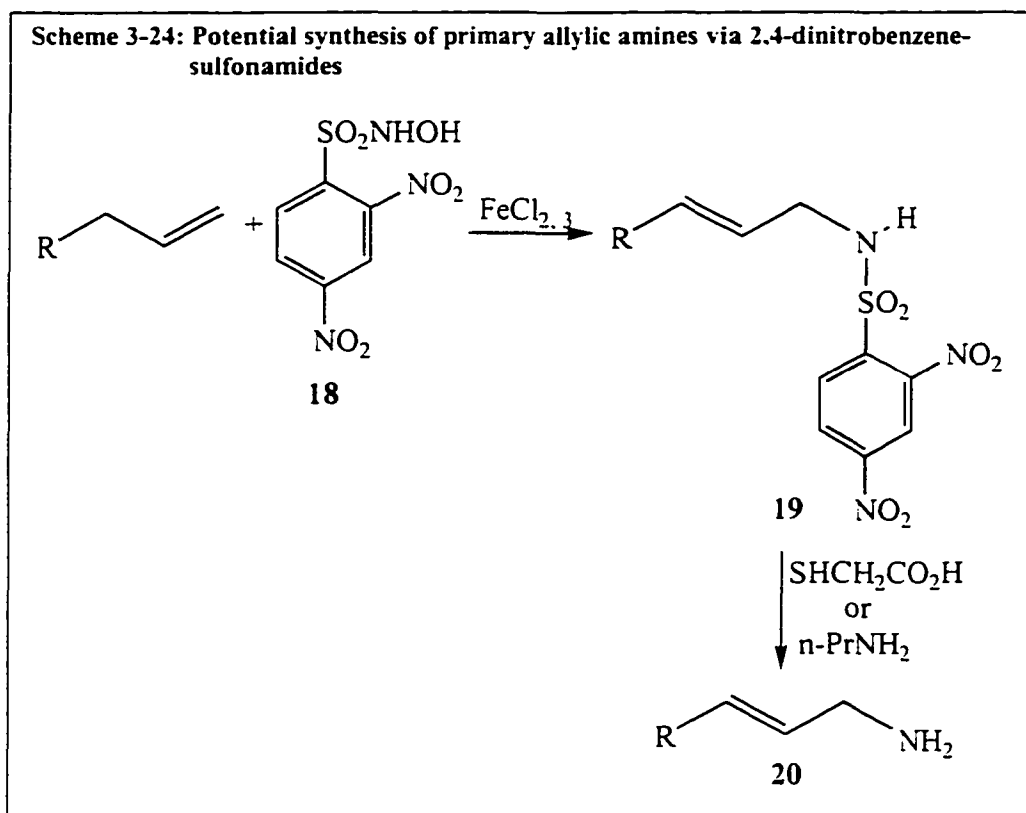

However, we were not successful in obtaining the required N-hydroxy-2,4-dinitrobenzenesulfonamide. The method described above (Scheme 3-23) produced 1-chloro-2,4-dinitrobenzene instead (Scheme 3-25). The identity of this product was established by comparison of its ^1H NMR spectrum with that of an authentic sample. Also the mass spectrum of the product obtained showed the characteristic chloride pattern.

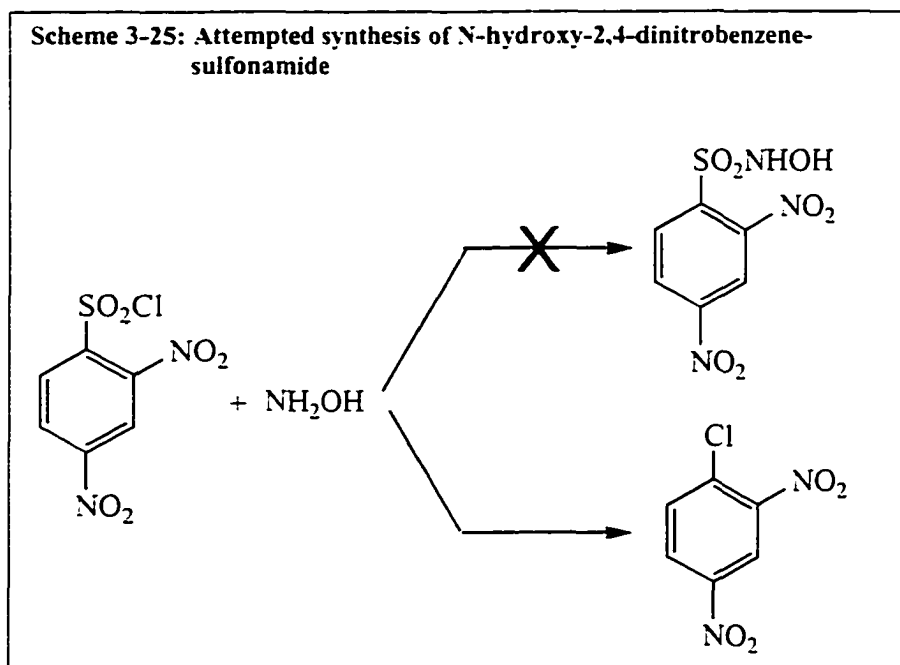

This unusual reaction could possibly occur *via* formation of the desired 2,4-dinitrobenzenesulfonyl hydroxylamine by displacement of the chloride. This could then be followed by a nucleophilic attack by the chloride ion on the ipso carbon of the 2,4-DNP ring resulting in displacement of gaseous SO_2 and NH_2OH . The attack by the moderately nucleophilic chloride ion could be driven entropically due to loss of gaseous SO_2 to form 1-chloro-2,4-dinitrobenzene.

3-2-7: REACTION OF N-HYDROXYBENZENESULFONAMIDE WITH α -METHYLSTYRENE

Pincock *et al.* have reported photolytic cleavage of benzenesulfonyl group from the corresponding sulfonamide derivatives to produce primary and secondary amines.⁹² As a result, we also briefly explored the reactivity of N-hydroxybenzenesulfonamide (21) towards olefins in the presence of iron salts as

catalysts. α -Methylstyrene reacted with **21** in presence of 10 mol% Fe(II, III)-chlorides in refluxing dioxane to produce the corresponding allylic amination product (**22**) but in low yield (7%) (Scheme 3-26). Very slow color changes in the reaction mixture were observed upon heating for 24 h suggesting a very slow interaction of the aminating agent with Fe (II, III)-chlorides to form the active catalyst for the reaction. The unreacted hydroxylamine **21** was present even after this time. The observations suggest that **21** is very unreactive under these conditions resulting in very low yields of the amination product.

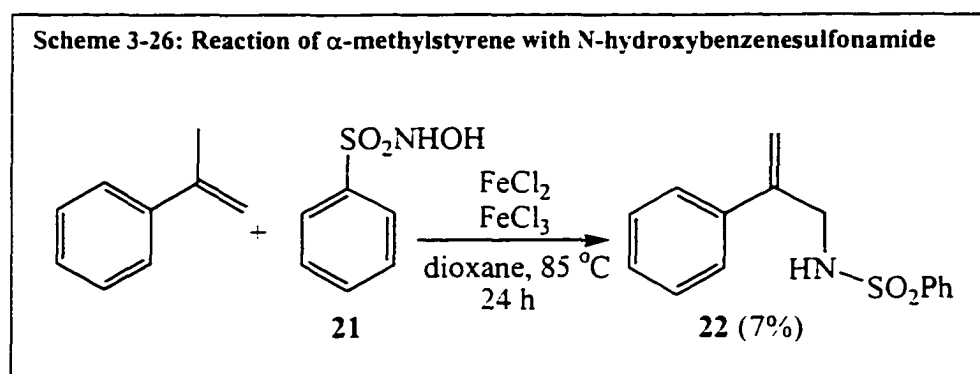

This product was characterized by ^1H NMR and mass spectroscopy. When this N-allylbenzenesulfonamide **22** was irradiated in a protic solvent (i-PrOH) at room temperature in an attempt to deprotect it no reaction was observed and only the starting material was observed by GC.

3-3: CONCLUSIONS

In this chapter the use of 2,4-dinitrophenyl hydroxylamine (**6**) as a new and very efficient reagent for FeCl_{2,3}-catalyzed allylic amination of olefins was described. The hydroxylamine **6** is an air-stable colored solid which is easy to handle.

Amination of olefins in the presence of Fe(II, III)-chlorides as the catalyst produces the corresponding allylamines (**10**) in good yields, relative to reactions using PhNHOH as the aminating agent. These allylic amines were isolated as colored solids in the pure state and characterized spectroscopically. This reaction is highly regio- and chemoselective, displaying ene reaction-like selectivity. 2,4-Dinitroaniline (**11**) is the only by-product formed. The scope of this reaction was also studied.

Efficient cleavage of the 2,4-DNP group from the secondary 2,4-DNP-allylamines **10** to produce the corresponding primary allylic amines was not successful. N-Alkylation of the allylamines was achieved only with the use of very reactive electrophiles and the corresponding N-alkylated tertiary allylamines **14** were obtained in good yields. Removal of the 2,4-DNP group from the N-(2,4-dinitrophenyl)-N-methyl-N-allylamines (**14b, c**) formed the corresponding N-methyl-N-allylamines **15** in good yields.

In the future, development of an efficient synthesis of N-hydroxy-2,4-dinitrobenzenesulfonamide (**18**) could lead to the synthesis of primary allylamines and also secondary allylamines (Figure 3-5). Also, investigation of the reaction of 2,4-dinitro-naphthyl hydroxylamine (**23**) with olefins catalyzed by iron salts and subsequent cleavage of the protecting group via substitution by primary amines⁹³ could provide a pathway into primary allylamines (Figure 3-5).

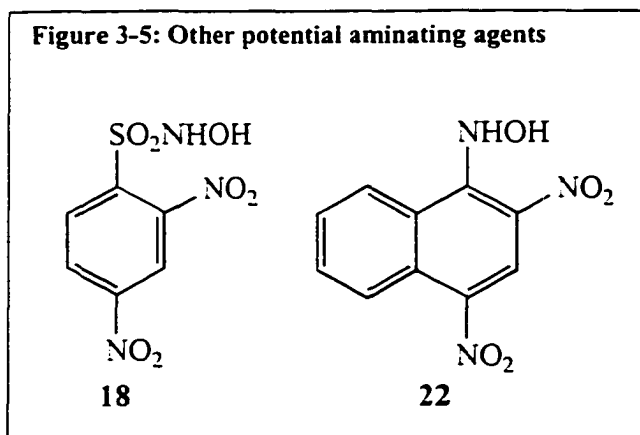

3-4: EXPERIMENTAL SECTION

General: All starting materials were obtained from commercial sources. 1,4-Dioxane and THF were distilled under nitrogen from sodium and benzophenone. Dichloromethane was distilled under nitrogen from CaH_2 . Anhydrous methanol and DMF were used as provided by Fisher and Aldrich chemical companies, respectively. All air- and moisture-sensitive reactions were performed under nitrogen and all such reagents were handled in the dry box. All the glassware was oven dried and flushed with nitrogen before use.

All ^1H and ^{13}C NMR spectra were obtained using a Varian XL-300 or Varian Unity Inova-400 instrument. The data is given in units of parts per million (ppm) relative to TMS. The residual solvent signals are used for referencing. The infrared (IR) spectra were recorded on a Bio-Rad FTS-7 FT-IR instrument. A Hewlett Packard 5790A gas chromatograph using a 3 m column packed with OV-101 was used. The GC-MS and low resolution EI data were obtained on Hewlett Packard

5985A GC/MS system. The melting points were measured using a Mel-Temp apparatus and the values reported are not calibrated. The X-ray diffraction data were collected at room temperature on a Siemens P4 diffractometer using M_oK_{α} ($\lambda=71073$ Å) radiation. The data were corrected for Lorentz and polarization effect.

3-4-1: SYNTHESIS OF 2,4-DINITROANISOLE (7)

2,4-Dinitroanisole is available commercially. It can also be prepared as described below. Small pieces of sodium (0.690 g, 0.030 mol) were added to anhydrous methanol (25 mL) with stirring and cooling the flask in an ice bath. Sodium reacted with methanol exothermically with the evolution of hydrogen gas. Once the reaction was complete, the clear, colorless solution was stirred at room temperature for 15 min. This was added dropwise to a solution of 1-chloro-2,4-dinitrobenzene (4.80 g, 0.024 mol) in anhydrous methanol (15 mL) with stirring at room temperature. The reaction mixture turned light orange with the formation of a white solid. The reaction was monitored by analytical TLC using a 50:50 petroleum ether/ether solvent system. When all the starting material had been consumed, the solid formed was filtered and washed with methanol. Solvent was removed from the filtrate using a rotary evaporator. The residue was dissolved in ether and extracted with H_2O (3 x 20 mL). The organic layer was dried ($MgSO_4$). The solution was concentrated and left in the freezer overnight to obtain very pale yellow fine crystals in 90% yield (4.20 g, 0.021 mol). mp 85 °C; 1H NMR (400MHz, CD_3OD) δ 4.09 (s, 3H), 7.50 (d, J = 9.2 Hz, 1H), 8.50 (dd, J = 9.2, 2.8 Hz, 1H), 8.71 (d, J = 2.8 Hz, 1H);

MS (EI, 12eV DIP, m/z, rel intensity) 198 (M^+ , 100), 199 (M^++1 , 4), 200 (M^++2 , 1), 168 (56), 151 (49).

3-4-2: SYNTHESIS OF 2,4-DINITROPHENYL HYDROXYLAMINE (6)

Hydroxylamine 6 has been prepared previously by the following route.⁸¹ All of the transformations were performed with exclusion of air. Sodium (0.223 g, 9.700 mmol) was added to anhydrous methanol (5 mL) with cooling in an ice bath. When the exothermic reaction had subsided and the hydrogen gas evolution stopped, the solution was stirred at room temperature for 15 min. To this was then added a solution of $NH_2OH \cdot HCl$ (0.682 g, 9.82 mmol) in hot methanol (10 mL) with stirring. An immediate formation of a white solid was observed. This suspension was stirred at room temperature for 30 min. It was then added to a solution of 2,4-dinitroanisole (1.62 g, 8.18 mmol) in hot methanol (15 mL) upon which the clear yellow solution of the anisole derivative turned green. The reaction mixture was then refluxed and the course of the reaction monitored by analytical TLC for the disappearance of 2,4-dinitroanisole. When all the starting material had been consumed (19 h), the reaction mixture was cooled and then filtered. Solvent was removed from the filtrate on the rotary evaporator. The residue obtained was dissolved in ether and extracted with H_2O (3 x 25 mL), the organic portion was dried with Na_2SO_4 and then the solvent was removed. This produced the desired compound as an orange solid in 91% yield (1.49 g, 7.49 mmol). mp 79 °C (dec) (literature mp 80 °C with decomposition)⁸¹; 1H NMR (400 MHz, $CDCl_3$) δ 7.61 (d, $J = 9.6$ Hz, 1H), 8.38 (dd, $J = 9.4, 2.4$ Hz, 1H), 9.09 (d, $J = 2.8$ Hz, 1H); IR (KBr) 819, 1320, 1518, 1623, 3089, 3305, 3450 cm^{-1} ; MS

(EI, 12eV DIP, m/z, rel intensity) 199 (M^+ , 50), 200 (M^++1 , 2) 197 (21), 183 (100), 181 (99), 168 (34), 153 (18), 107 (2).

3-4-3: AMINATION OF OLEFINS WITH 2,4-DINITROPHENYL-HYDROXYLAMINE USING $FeCl_2 + FeCl_3$ AS CATALYST

All transfers were done under nitrogen. Anhydrous $FeCl_2$ (0.011 g, 9.00×10^{-2} mmol) and $FeCl_3$ (0.002 g, 1.00×10^{-2} mmol) were weighed out in the dry box in a dry three-necked flask. To this dry 1,4-dioxane (4 mL) and the olefin (10.0 mmol) were added. The reaction mixture was stirred at 80-85 °C and to this a solution of 2,4-dinitrophenylhydroxylamine (0.200 g, 1.00 mmol) in 1,4-dioxane (15 mL) was added over a period of 10 min. The reaction mixture was then heated and the reaction was monitored for the disappearance of the hydroxylamine. After the reaction was complete, the reaction mixture was cooled and filtered. Solvent was removed from the filtrate using the rotary evaporator and the residue was dried under vacuum in a hot water bath to remove excess olefin. The residue was then purified by flash column chromatography using silica gel as the stationary phase and a 60:40 petroleum ether/ether solvent mixture as the eluent. The first yellow band was collected and solvent was removed from it to give the allylamines **10** as yellow-orange solids. The second yellow band off the column was collected and dried to yield 2,4-dinitroaniline. The allylamines obtained were characterized spectroscopically. Crystals of allylamine **10b** were obtained by dissolving a small quantity in a minimum volume of ether and allowing it to stand in the freezer for two days.

10a) Yield 76%; mp 68-69 °C; ¹H NMR (400 MHz, CDCl₃) δ 1.02 (t, J = 7.6 Hz, 3H), 1.70 (s, 3H), 1.76-1.88 (m, 2H), 3.93 (dd, J = 13.2, 6.8 Hz, 1H), 4.98 (br s, 1H), 5.02 (br s, 1H), 6.86 (d, J = 9.6 Hz, 1H), 8.20 (dd, J = 9.6, 2.8 Hz, 1H), 8.64 (br, 1H), 9.11 (d, J = 2.8 Hz, 1H); ¹³C NMR (100 MHz, CDCl₃) δ 10.4, 17.8, 26.8, 61.3, 114.1, 115.1, 124.2, 130.0, 142.4, 148.0; IR (KBr) 823, 1341, 1540, 1591, 1627, 1884, 1950, 1977, 3122, 3374 cm⁻¹; MS (EI, 12 eV DIP, m/z, rel. intensity) 265 (M⁺, 23), 266 (M⁺+1, 1), 236 (100); High resolution FAB for C₁₂H₁₆N₃O₄ 266.1148 (M⁺+1) (expected 266.2745).

10b) Yield 87%; mp 105-108 °C; ¹H NMR (400 MHz, CDCl₃) δ 4.45 (d, J = 5.6 Hz, 2H), 5.28 (br s, 1H), 5.56 (br s, 1H), 6.91 (d, J = 9.2 Hz, 1H), 7.34-7.46 (m, 5H), 8.25 (dd, J = 9.4, 2.8 Hz, 1H), 8.79 (br, 1H), 9.13 (d, J = 2.8 Hz, 1H); ¹³C NMR (100 MHz, CDCl₃) δ 47.2, 114.3, 114.6, 124.2, 125.9, 128.6, 128.8, 130.3, 137.8, 141.8, 148.2; IR (KBr) 813, 1315, 1340, 1523, 1540, 1523, 1620, 2927, 2971, 3110, 3395 cm⁻¹; MS (EI, 12eV DIP, m/z, rel. intensity) 299 (M⁺, 45), 253 (100), 207 (6), 163 (10), 103 (30); High resolution FAB for C₁₅H₁₄N₃O₄ 300.0998 (M⁺+1) (expected 300.2917).

10c) Yield 63%; mp 100-101 °C; ¹H NMR (400 MHz, acetone-d₆) δ 0.84 (s, 3H), 1.16 (d, J = 8.4 Hz, 1H), 1.27 (s, 3H), 2.08-2.13 (m, 1H), 2.18-2.22 (m, 1H), 2.23-2.30 (m, 2H), 2.40-2.46 (m, 1H), 4.14 (br s, 2H), 5.55 (br s, 1H), 7.20 (d, J = 9.6 Hz, 1H), 8.27 (dd, J = 9.6, 2.6 Hz, 1H), 8.90 (br, 1H), 8.97 (d, J = 2.8 Hz, 1H); ¹³C NMR (100 MHz, acetone-d₆) δ 21.3, 26.3, 31.7, 32.1, 38.7, 41.5, 44.5, 48.3, 116.3, 119.9,

124.2, 130.4, 143.9, 149.6; IR (KBr) 808, 1311, 1339, 1526, 1592, 1621, 2898, 2884, 2927, 2998, 3106, 3376 cm^{-1} ; MS (EI, 12eV DIP, m/z, rel. intensity) 316 (M^+ -1, 19), 282 (28), 271 (100), 196 (27), 134 (24), 133 (55), 119 (24), 105 (59), 91 (62); High resolution FAB for $\text{C}_{16}\text{H}_{20}\text{N}_3\text{O}_4$ 318.1445 (M^+ +1) (expected 318.3501).

10d) Yield 30%; ^1H NMR (400 MHz, acetone- d_6) δ 1.85 (s, 3H), 3.94 (br s, 2H), 4.35 (dd, $J = 11.0, 5.0$ Hz, 1H), 4.45 (br s, 1H), 5.02 (br s, 1H), 5.05 (br s, 1H), 7.07 (d, $J = 9.6$ Hz, 1H), 8.25 (dd, $J = 9.6, 2.8$ Hz, 1H), 8.98 (d, $J = 2.8$ Hz, 1H), 9.11 (br, 1H); ^{13}C NMR (100 MHz, acetone- d_6) δ 19.7, 61.3, 63.5, 113.9, 114.1, 116.8, 124.2, 130.6, 142.5, 149.1; IR (KBr) 830, 1335, 1528, 1594, 1630, 2878, 2932, 3094, 3353, 3465 cm^{-1} ; MS (EI, 12eV DIP, m/z, rel. intensity) 267 (M^+ , 11), 237 (4), 236 (100), 183 (4).

10e) Yield 30%; ^1H NMR (400 MHz, acetone- d_6) δ 1.78 (s, 3H), 2.03-2.05 (m, 2H), 2.15 (s, 3H), 2.69 (t, $J = 7.0$ Hz, 2H), 4.33 (dd, $J = 13.6, 6.8$ Hz, 1H), 5.03 (br s, 1H), 5.07 (br s, 1H), 7.16 (d, $J = 9.6$ Hz, 1H), 8.26 (dd, $J = 9.6, 2.8$ Hz, 1H), 8.64 (br, 1H), 8.97 (d, $J = 2.8$ Hz, 1H); ^{13}C NMR (100 MHz, acetone- d_6) δ 18.0, 27.7, 30.4, 39.8, 59.7, 114.2, 116.5, 116.6, 124.2, 130.6, 144.2, 148.4; IR (KBr) 800, 1261, 1334, 1522, 1591, 1618, 1717, 2851, 2927, 2965, 3110, 3363 cm^{-1} ; MS (EI, 12eV DIP, m/z, rel. intensity) 307 (M^+ , 6), 259 (12), 246 (10), 236 (100), 219 (10), 183 (11), 167 (93), 140 (32), 99 (38).

10f) Yield 22%; mp 98-99 °C; ¹H NMR (400 MHz, CDCl₃) δ 1.54-1.63 (m, 2H), 1.65-1.70 (m, 2H), 1.94-2.00 (m, 2H), 2.00-2.06 (m, 2H), 3.90 (m, 2H), 5.69 (br s, 1H), 6.88 (d, J = 9.6 Hz, 1H), 8.23 (dd, J = 9.6, 2.8 Hz, 1H), 8.67 (br, 1H), 9.13 (d, J = 2.8 Hz, 1H); ¹³C NMR (100 MHz, CDCl₃) δ 22.1, 22.3, 24.9, 26.5, 49.6, 114.4, 124.2, 125.1, 130.2, 131.7, 148.6; IR (KBr) 811, 1330, 1525, 1588, 1622, 2833, 2860, 2924, 3105, 3383 cm⁻¹; MS (EI, 70eV DIP, m/z, rel. intensity) 277 (M⁺, 53), 259 (19), 242 (21), 196 (20), 109 (33), 104 (24), 95 (100), 93 (42), 91 (33), 81 (27), 79 (88), 77 (87), 75 (19), 69 (16), 67 (86), 65 (35).

3-4-4: REACTION OF SECONDARY N-(2,4-DINITROPHENYL)-N-ALLYLAMINES WITH NUCLEOPHILIC REAGENTS

N-(2,4-dinitrophenyl)-N-allylamine **10b** (0.100 g, 0.334 mmol) was dissolved in the given solvent system (10 mL) at room temperature. To this was added the required reagent. The reaction mixture was stirred for the specified time at the specified temperature. The reaction mixture was cooled to room temperature and the solvent was removed under reduced pressure. The residue was dissolved in Et₂O or CH₂Cl₂ and thoroughly washed with deionized H₂O. The organic portion was dried (MgSO₄) and the solvent was removed. The residue was dried under vacuum and analyzed by ¹H NMR spectroscopy.

3-4-5: REACTIONS OF SECONDARY N-(2,4-DINITROPHENYL)-N-ALLYLAMINES WITH ACIDIC REAGENTS

N-(2,4-dinitrophenyl)-N-allylamine **10b** (0.100 g, 0.334 mmol) was dissolved in the given solvent system (10 mL) at room temperature. To this was added the required reagent. The reaction mixture was stirred for the specified time at the specified temperature. After this, the reaction mixture was cooled to room temperature and the solvent was removed on the rotary evaporator. The residue was dissolved in Et₂O or CH₂Cl₂ and thoroughly washed with deionized H₂O. The organic portion was dried (MgSO₄) and the solvent was removed. The residue was dried under vacuum and analyzed by ¹H NMR spectroscopy.

3-4-6: REACTIONS OF ALLYLAMINE **10b WITH NaH IN DEUTERATED SOLVENTS**

Allylamine **10b** (0.015 g, 5.02 x 10⁻² mmol) was placed in a dry NMR tube and transferred into the dry box. To this was added 95% NaH (0.0013 g, 5.520 x 10⁻² mmol) and the deuterated solvent from a 1 mL ampule. The NMR tube was then allowed to stand at room temperature for an hour. ¹H NMR spectra of these samples were obtained and compared to those of the allylamine **10b** in the corresponding deuterated solvents.

3-4-7: SYNTHESIS OF PROPYL TOSYLATE

Propyl tosylate is a known compound and was prepared following a literature procedure.⁹⁴ 1-Propanol (1.50 g, 0.025 mol) was dissolved in distilled pyridine (25

mL) and the clear, colorless solution was cooled to 0 °C. To this p-toluenesulfonyl chloride (9.50 g, 0.05 mol) was added. The reaction mixture was stirred while cooling in the ice bath for 3 h and then left in the freezer for additional 18 h. It was then poured into a mixture of ice and water and stirred. The oil that separated out was taken up in Et₂O and the organic layer was separated. The aqueous layer was washed with Et₂O (3 x 15 mL) and the combined organic portion was washed with dilute HCl solution (3 x 15 mL) followed by H₂O (2 x 10 mL). The ether layer was dried (K₂CO₃ + MgSO₄) and the solvent was then removed from the solution on the rotary evaporator. The residue was dried under vacuum. This residue was dissolved in a minimum amount of pet. ether (≈150 mL), stirred with Norit and filtered. The solvent was removed from the filtrate and the resulting clear, colorless liquid was dried under vacuum and stored in the refrigerator. Yield 78% (4.20 g, 0.019 mol); ¹H NMR (400MHz, CDCl₃) δ 0.88 (t, J = 7.4 Hz, 3H), 1.60-1.69 (m, 2H), 2.43 (s, 3H), 3.97 (t, J = 6.6 Hz, 2H), 7.32 (d, J = 8.8 Hz, 2H), 7.77 (d, J = 8.4 Hz, 2H); MS (EI, 12eV DIP, m/z, rel intensity) 214 (M⁺, 86), 215 (M⁺+1, 6), 216 (M⁺+2, 2), 185 (3), 173 (70), 172 9100), 155 (79).

3-4-8: SYNTHESIS OF PENTYL TRIFLATE

Pentyl triflate was obtained by a known procedure.⁹⁵ A solution of 1-pentanol (1.76 g, 0.020 mol) and distilled pyridine (1.58 g, 0.020 mol) in CH₂Cl₂ (5 mL) was added, dropwise with stirring over 45 min, into a solution of Tf₂O in CH₂Cl₂ (20 mL) at 0 °C. After 15 min the solution was washed with water, dried over Na₂SO₄ and the solvent was removed under vacuum. The resulting pale yellow liquid was then

distilled under vacuum. The product was obtained as a colorless liquid at 49-50 °C (2 mm Hg). Yield 81% (3.59 g, 0.016 mol); ¹H NMR spectrum of this compound matched with that reported in literature.⁹⁵

3-4-9: REACTION OF PENTYL TRIFLATE WITH SOLVENTS

This experiment was done in two ways.

a) To study the reaction in CH₂Cl₂, CH₃CN, and Et₂O, pentyl triflate (0.5 mL) was dissolved in the respective solvent (5 mL) and the solution was stirred at room temperature for 4 h. After this time the solvent was removed under vacuum and the residue thus obtained was analyzed by ¹H NMR spectroscopy and compared to the spectrum of pentyl triflate before this treatment.

b) In order to study the reaction with DMF, 0.03 mL of DMF was dissolved in CDCl₃ in an NMR tube and its ¹H NMR spectrum was taken. To this solution an equimolar quantity of pentyl triflate (0.085 g) was added. The reaction mixture was allowed to stand for 90 min and its ¹H NMR spectrum was again obtained. By comparing the two spectra we were able to determine that pentyl triflate does react with DMF.

3-4-10: SYNTHESIS OF N-(2,4-DINITROPHENYL)-N-METHYL-N-ALLYLAMINES (14a, b, c)

14a): In a dry flask 95% NaH (0.026 g, 1.04 mmol) was weighed out in the dry box and to this anhydrous DMF (20 mL) was added. The cloudy solution thus obtained was stirred at room temperature and the 2,4-DNP-allylamine **10a** (0.250 g, 0.940

mmol) was added. The color of the reaction mixture immediately became very deep red. This solution was stirred at room temperature for 30 min and then MeI (0.4 g, 0.180 mL, 2.80 mmol) was added and the reaction mixture was then stirred for an additional 2 h, during which time the color had changed to brown. Deionized H₂O (25 mL) was added to the reaction mixture and the resulting yellow turbid solution was stirred for 15 min. This was extracted with Et₂O (2 x 20 mL) and the organic layer was washed with H₂O (3 x 15 mL). The combined organic layer was dried (MgSO₄) and the solvent was removed using the rotary evaporator to produce the product as an orange solid in 81% yield (0.213 g, 0.763 mmol). mp 93-94 °C; ¹H NMR (400 MHz, CDCl₃) δ 1.01 (t, J = 7.2 Hz, 3H), 1.77 (s, 3H), 1.93-2.00 (m, 2H), 2.67 (s, 3H), 4.04 (m, 1H), 4.81 (br s, 1H), 5.06 (br s, 1H), 7.05 (d, J = 9.6 Hz, 1H), 8.15 (dd, J = 10.0, 2.4 Hz, 1H), 8.65 (d, J = 2.8 Hz, 1H); ¹³C NMR (100 MHz, CDCl₃) δ 10.7, 11.7, 35.0, 67.9, 113.6, 114.1, 118.2, 123.5, 124.8, 128.0, 141.0, 149.9; IR (KBr) 801, 1024, 1097, 1338, 1523, 1577, 1605, 2966, 3089, 3122 cm⁻¹; MS (EI, 12eV DIP, m/z, rel. intensity) 279 (M, 8), 280 (M+1, 1), 250 (100), 236 (22).

14b) To a solution of 2,4-DNP-allylamine **10b** (0.100 g, 0.334 mmol) and K₂CO₃ (0.230 g, 1.67 mmol) in anhydrous DMF (5 mL) was added MeI (0.070 g, 0.030 mL, 0.501 mmol) under nitrogen. The dark red reaction mixture was stirred for 19 h, during which time the color had become red. Deionized H₂O was added to the reaction mixture and then extracted with Et₂O. The organic layer was washed with water. The ether portion was dried (Na₂SO₄) and the solvent was removed on the rotary evaporator to yield an orange solid. This solid was triturated with hexane to

give the product as a brown solid in 77% yield (0.080 g, 0.256 mmol). mp 124-126 °C; ¹H NMR (400 MHz, acetone-d₆) δ 3.0 (s, 3H), 4.62 (br s, 2H), 5.22 (br s, 1H), 5.57 (br s, 1H), 7.25 (d, J = 9.6 Hz, 1H), 7.32-7.38 (m, 3H), 7.47 (d, J = 7.8 Hz, 2H), 8.20 (dd, J = 9.6, 2.8 Hz, 1H), 8.61 (d, J = 3.2 Hz, 1H); ¹³C NMR (100 MHz, acetone-d₆) δ 41.1, 58.1, 114.4, 119.4, 124.2, 126.9, 128.0, 129.0, 129.3, 139.3, 142.4.

14c) In a dry flask 95% NaH (0.010 g, 0.38 mmol) was weighed out in the dry box and to this anhydrous DMF (5 mL) was added under nitrogen. To this a solution of the 2,4-DNP-allylamine **10c** (0.110 g, 0.347 mmol) in anhydrous DMF (5 mL) was added. The color of the allylamine solution changed from dirty yellow to very deep red. This solution was stirred at room temperature for 30 min. MeI (0.148 g, 0.065 mL, 1.04 mmol) was added. The color of the reaction mixture changed to brown in about 30 min. Deionized H₂O was added and stirred for 15 min. This was washed with Et₂O (2 x 15 mL) and the combined organic layer was washed with water (3 x 20 mL). The organic portion was dried (MgSO₄) and the solvent was removed under reduced pressure. The red viscous liquid thus obtained was dried under vacuum to give the desired product in 76% yield (0.081 g, 0.246 mmol). ¹H NMR (400 MHz, CDCl₃) δ 0.81 (s, 3H), 1.11 (d, J = 8.4 Hz, 1H), 1.26 (s, 3H), 1.95 (m, 1H), 2.12 (m, 1H), 2.18, 2.35 (m, 2H), 2.36-2.45 (m, 1H), 2.90 (s, 3H), 3.86 (m, 2H), 5.35 (br s, 1H), 6.97 (d, J = 9.6 Hz, 1H), 8.14 (dd, J = 9.2, 2.8 Hz, 1H), 8.66 (d, J = 2.8 Hz, 1H); ¹³C NMR (100 MHz, CDCl₃) δ 20.9, 26.0, 31.2, 31.5, 38.2, 40.7, 41.0, 43.4, 58.7, 117.8, 120.4, 124.1, 127.4, 141.4, 148.9; MS (EI, 12eV DIP, m/z, rel. intensity) 331

(M⁺, 2), 314 (10), 285 (100), 282 (21), 270 (14), 239 (9), 217 (13), 215 (24), 210 (47), 194 (16), 189 (22), 178 (12), 133 (27), 119 (18), 91 (43).

3-4-11: SYNTHESIS OF N-(2,4-DINITROPHENYL)-N-BENZYL-N-ALLYLAMINE (14d)

The 2,4-DNP-allylamine **10b** (0.120 g, 0.400 mmol), benzyl bromide (0.082 g, 0.060 mL, 0.480 mmol) and tetrabutylammonium iodide (TBAI) (0.015 g, 0.040 mmol) were dissolved in THF (10 mL) under nitrogen to give an clear orange solution. To this was added 95% NaH (0.014 g, 0.440 mmol) resulting in the appearance of the very dark red color. This solution was stirred at room temperature for 20 h, by which time the color had become brown. Saturated NH₄Cl (20 mL) was added and the reaction mixture was stirred for 10 min. The aqueous layer was separated and then washed with Et₂O (3 x 20 mL). The combined organic layer was washed with brine (2 x 25 mL), dried with MgSO₄, and the solvent was removed on the rotary evaporator. The residue was dried under vacuum in a hot water bath (≈60-70 °C) to give the desired product in 91% yield (0.142 g, 0.364 mmol) as a colored viscous liquid. ¹H NMR (400 MHz, acetone-d₆) δ 4.43 (s, 3H), 4.59 (br s, 2H), 5.30 (br s, 1H), 5.48 (br s, 1H), 7.19 (d, J = 9.6 Hz, 1H), 7.25-7.37 (m, 10H), 8.09 (dd, J = 8.8, 2.8 Hz, 1H), 8.64 (d, J = 3.2 Hz, 1H); ¹³C NMR (100 MHz, acetone-d₆) δ 56.3, 57.9, 117.3, 122.0, 13.9, 127.1, 127.9, 128.5, 128.7, 128.9, 129.2, 129.4, 137.2, 139.4, 144.3, 149.9; IR (KBr) 802, 1029, 1261, 1334, 1522, 1602, 2855, 2923, 2967, 3033, 3096 cm⁻¹; MS (EI, 12eV DIP, m/z, rel. intensity) 389 (M⁺, 3), 372 (16), 343 (85), 270 (14), 118 (34), 105 (12), 91 (100).

3-4-12: DEPROTECTION OF TERTIARY N-(2,4-DINITROPHENYL)-N-METHYL-N-ALLYLAMINES

The N-(2,4-dinitrophenyl)-N-methyl-N-allylamines **14b** and **c** (0.320 mmol) were dissolved in DMSO (5 mL) to give a dark colored solution. A 40 wt% aqueous solution of MeNH₂ was added and the solution was heated to 65-70 °C for 20 h. After this time the reaction mixture was cooled to room temperature and poured into deionized H₂O (≈50 mL) and stirred. The yellow solid that precipitated was filtered and dried. This solid was determined to be N-methyl-2,4-dinitroaniline by ¹H NMR spectroscopy. The aqueous filtrate was extracted with CH₂Cl₂ (2 x 20 mL). The organic layer was then washed with a 1N HCl solution (3 x 50 mL). The aqueous layer was then neutralized with a 2M KOH solution and extracted with Et₂O (3 x 20mL). The organic layer was dried (MgSO₄) and the solvent was removed using the rotary evaporator to yield the desired product.

15b) Yield 64% (0.030 g, 0.204 mmol); ¹H NMR (400 MHz, CDCl₃) δ 2.41 (s, 3H), 3.61 (br s, 2H), 5.21 (br s, 1H), 5.38 (br s, 1H), 7.25-7.45 (m, 5H); ¹³C NMR (100 MHz, CDCl₃) δ 36.0, 56.2, 113.0, 124.3, 126.0, 126.9, 128.2, 129.0 130.8.

15c) Yield 47% (0.017 g, 0.102 mmol); ¹H NMR (400 MHz, CDCl₃) δ 0.82 (s, 3H), 1.16 (d, J = 8.4 Hz, 1H), 1.41 (s, 3H), 2.07-2.12 (m, 1H), 2.21-2.25 (m, 2H), 2.34-2.39 (m, 2H), 3.47 (br s, 2H), 5.36 (br s, 1H); ¹³C NMR (100 MHz, CDCl₃) δ 21.1, 26.1, 29.7, 30.3, 31.2, 31.6, 40.8, 44.3, 56.4, 65.8, 119.1, 125.5; MS (12eV GCMS, m/z, rel. intensity) 165 (M, 94), 166 (M+1, 10), 167 (M+2, 1), 164 (10), 150 (27), 137

(11), 136 (68), 134 (69), 122 (48), 120 (33), 119 (100), 109 (65), 97 (21). 96 (31), 94 (23), 93 (26), 92 (32), 91 (85), 81 911), 44 (56).

3-4-13: ATTEMPTED SYNTHESIS OF N-HYDROXY-2, 4-DINITRO-BENZENESULFONAMIDE (18)

All of the transfers were done under nitrogen. An 80 wt% suspension of NaH (0.305 g, 10.2 mmol) in mineral oil was washed with hexane. To this freshly distilled CH_2Cl_2 (25 mL) was added. Hydroxylamine hydrochloride (0.707 g, 8.48 mmol) was added to this and stirred at room temperature for one hour. This suspension was then added to a solution of 2,4-dinitrobenzenesulfonyl chloride (2.26 g, 8.48 mmol) and pyridine (0.738 g, 0.750 mL, 9.33 mmol) in CH_2Cl_2 (40 mL) at room temperature. The resulting brown reaction mixture was stirred for 21 h. After this time, it was filtered and the solvent was removed from the filtrate to yield an orange material. The crude product was dissolved in CH_2Cl_2 . Hexane was added to this solution and left in the freezer overnight to precipitate all of the soluble pyridinium hydrochloride salt. Solvent was removed from the mother liquor and the residue was dried under vacuum to give a dark yellow liquid in 23% yield (0.51 g). ^1H NMR and mass spectra of this material establish its identity as 1-chloro-2,4-dinitrobenzene. ^1H NMR (400 MHz, CDCl_3) δ 7.78 (d, $J=9.2$ Hz, 1H), 8.38 (dd, $J=8.8, 2.8$ Hz, 1H), 8.74 (d, $J=2.8$ Hz, 1H); MS (EI, 70eV DIP, m/z , rel. intensity) 202 (M, 68), 204 (M+2, 21), 126 (17), 112 (13), 111 913), 110 (62), 107 (17), 86 (23), 84 (29), 75 (100) 63 (32), 62 (19), 61 (10).

3-4-14: REACTION OF α -METHYL STYRENE WITH N-HYDROXY-BENZENESULFONAMIDE IN THE PRESENCE OF FeCl_2 AND FeCl_3 AS CATALYSTS

All of the transformations were done under nitrogen. Anhydrous FeCl_2 (0.110 g, 9.00×10^{-2} mmol) and anhydrous FeCl_3 (0.002 g, 1.00×10^{-2} mmol) were weighed out into a dry three-necked flask in the dry box. Distilled α -methyl styrene (1.18 g, 1.30 mL, 10.0 mmol) and 1,4-dioxane (4 mL) were added to this flask under nitrogen to give a pale yellow solution. The solution was then heated to 80-85 °C. To the reaction mixture a solution of N-hydroxybenzene sulfonamide (0.173 g, 1.00 mmol) in 1,4-dioxane (14 mL) was added over a period of 1 h. No immediate changes were observed. The reaction mixture was then heated for 24 h. The color of the reaction mixture became white after 2 h of heating and then pale yellow after 4 h. The color of the solution became yellow-green after heating for 24 h. After this time it was cooled and filtered. The solvent was removed from the yellow filtrate on the rotary evaporator and the residue obtained was dried under vacuum with heating to remove excess olefin. The crude was purified by preparative TLC using 75:25 petroleum ether/ether solvent mixture. The lowest band was collected and the compound was extracted. Solvent was removed from the solution under reduced pressure to give the expected amination product in 7% yield (0.020 g, 7.32×10^{-2} mmol). ^1H NMR (400 MHz, CDCl_3) δ 4.26 (s, 2H), 5.20 (s, 1H), 5.58 (s, 1H), 7.19-7.24 (m, 5H), 7.41 (t, J = 7.8 Hz, 2H), 7.53 (d, J = 7.6 Hz, 1H), 7.77 (d, J = 7.8 Hz, 2H); MS (EI, 70eV DIP, m/z, rel. intensity) 258 (1), 195 (2), 194 (29), 141 (3) 117 (88), 115 (100), 91 (47), 77 (44).

3-4-15: IRRADIATION OF THE AMINATION PRODUCT FROM α -

METHYL STYRENE AND N-HYDROXYBENZNE SULFONAMIDE

The N-allylbenzene sulfonamide (0.020 g, 0.073 mmol) was dissolved in i-PrOH (2 mL) in a UV-VIS quartz cell. A 400 W Hg-vapor lamp was set up in a quartz well. The sample was irradiated while stirring for 5 h. The reaction progress was monitored by injecting aliquots of the reaction mixture into the gas chromatograph and comparing it to the gas chromatogram of the starting material. No conversion of the starting material was observed.

Chapter 4

AN APPROACH TO COPPER-CATALYZED ALLYLIC AMINATION OF OLEFINS

4-1: INTRODUCTION AND BACKGROUND

In addition to the Mo- and Fe-catalyzed allylic aminations of olefins, we sought to develop other catalytic systems to increase the synthetic scope and utility of the reaction. Such alternate pathways could also potentially provide means for obtaining other classes of allylic amines *via* catalytic routes. Allylic acyloxylation of olefins by peresters, catalyzed by Cu (I, II)-salts, is a well developed reaction. Based on this, we decided to explore the feasibility of an analogous allylic amination reaction.

4-1-1: ACYLOXYLATION OF HYDROCARBONS CATALYZED BY COPPER SALTS

The peroxyester reaction (Kharasch-Sosnovsky reaction), the interaction of an organic perester (1) with a substrate which has an abstractable hydrogen atom catalyzed by copper ions, is well developed (Scheme 4-1).⁹⁶ Unsaturated hydrocarbons, organosilicon compounds, amides, esters, sulfides, and ethers have been used as substrates resulting in the formation of the corresponding esters (2).

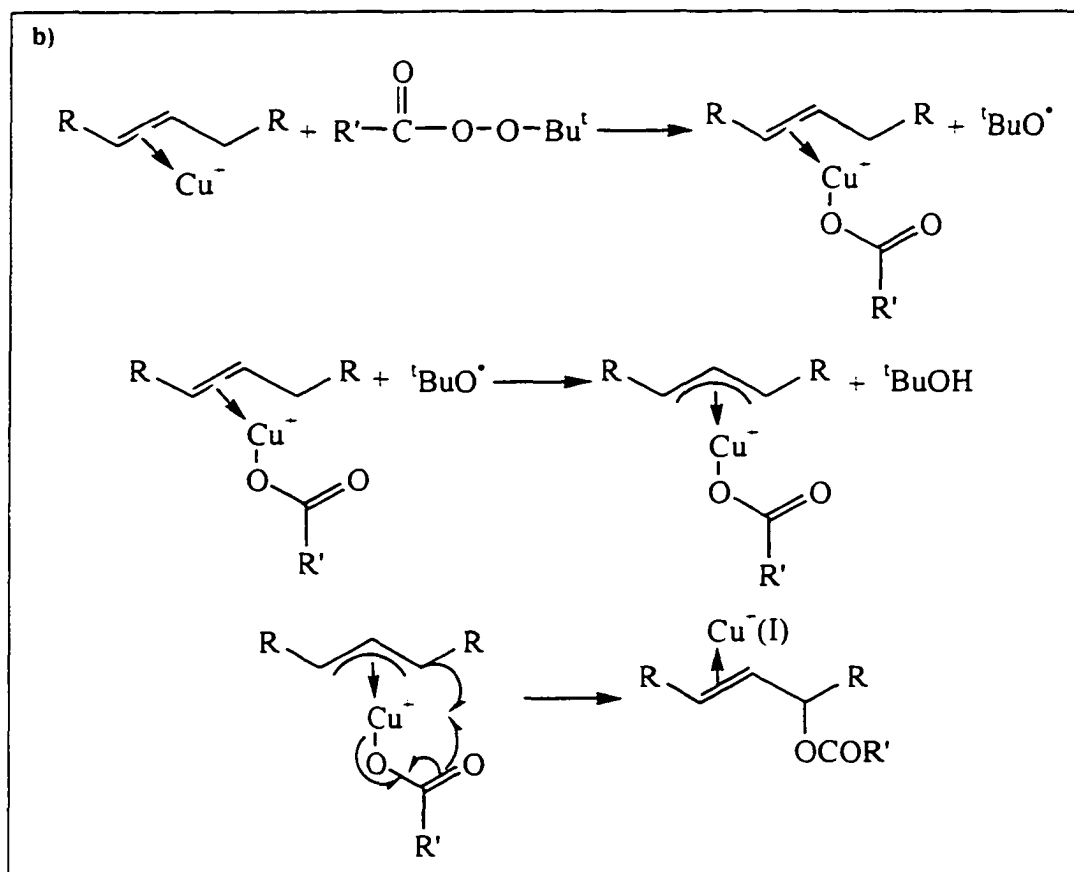

In the first pathway, the reductive peroxy bond dissociation of the perester is catalyzed by cuprous ions forming cupric monoacetate and the alkoxy radical. The radical then abstracts a hydrogen atom from the hydrocarbon substrate to yield an allylic radical. Both free and complexed states for the allyl radical have been suggested. Kochi *et al.* believe that a free allyl radical is involved.⁹⁷ⁱⁱ In another report, Walling and Zavitsas have described the oxidation of this free radical by the cupric ion formed in the first step to give a carbonium ion regenerating the Cu (I) state of the metal.⁹⁷ⁱⁱⁱ The allylic carbocation formed then reacts with the carboxylate ion to yield the acyloxy derivative. Formation of regioisomeric products with olefinic substrates is due to the allylic free radical or the carbonium ion existing as a

resonance hybrid. In another report, Beckwith and Evans invoke a Cu (I)-coordinated olefinic substrate as the starting material (Scheme 4-2b).⁹⁸ This species reduces the perester leading to the formation of cupric monoacetate. The alkoxy radical formed in this step abstracts a hydrogen atom from the coordinated olefin to form a Cu (II)-complex with the allyl and the acyl groups coordinated. This is followed by a reductive elimination of the product with substitution occurring at either terminus of the allyl system, regenerating the cuprous ion. It can also be said that no single mechanism can explain all of the results of the peroxyester reaction. Presumably different mechanisms are involved depending upon the substrate and the reaction conditions employed.

Saturated hydrocarbons and benzene are not good substrates for this reaction. However, peroxyester reactions of benzylic and allylic substrates are well known. Benzylic substrates afford low to moderate yields of the product esters (Scheme 4-3).^{97iii, 99} In all these reactions, the substitution occurs at the benzylic position due to the stability of the intermediate benzylic radical.

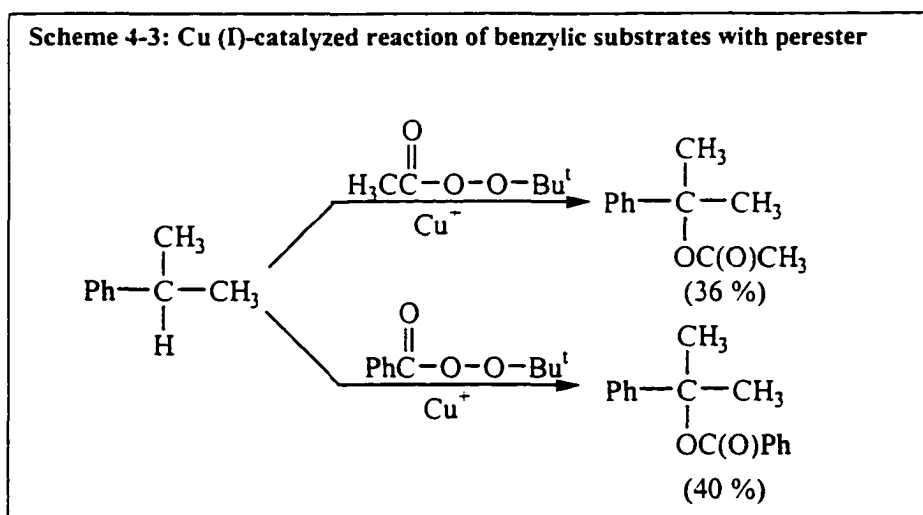

Olefinic hydrocarbons react under these conditions to form allylic esters. The regiochemistry of substitution, however, is variable, depending upon the olefin structure since an allylic radical or the Cu(II)-allyl complex is generated in the intermediate state. This radical may produce regioisomers because it exists as a resonance hybrid, with the more stable canonical form giving the major product (Scheme 4-4). Hence, the allylic acyloxylation can occur with or without double bond migration.

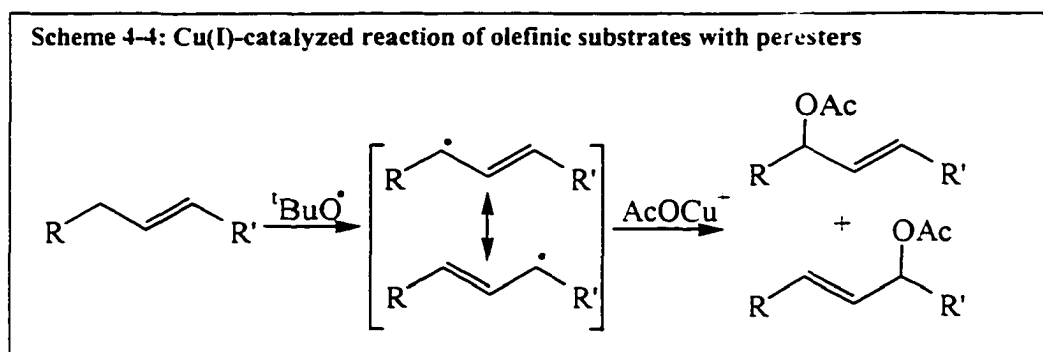

Olefins with terminal double bonds give primarily the 3-acyloxy derivative without transposition of the double bond (Table 4-1). In some cases, the regioisomeric product, 1-acyloxy-2-alkene, was also obtained as the minor product. As a special case, acyloxylation of olefins which have exocyclic double bonds (**3** and **4**) was observed to be very stereospecific. In each case the product was obtained without double bond migration and the allylic acyloxy substituent was anti with respect to the *t*-butyl group (Scheme 4-5).¹⁰³

Table 4-1 : Allylic acyloxylation of olefins

Substrate	Major Product	Selectivity term:int*	Ref
$\text{CH}_3\text{CH}_2\text{CH}=\text{CH}_2$	$\text{CH}_3\text{CH}(\text{OAc})\text{CH}=\text{CH}_2$ OAc (Bz)	89:11	99
$\text{CH}_3\text{CH}_2\text{CH}_2\text{CH}=\text{CH}_2$	$\text{CH}_3\text{CH}_2\text{CH}(\text{OAc})\text{CH}=\text{CH}_2$ OAc (Bz)	89:11	96iii, 99iii 100
$\text{PhCH}_2\text{CH}=\text{CH}_2$	$\text{PhCH}(\text{OAc})\text{CH}=\text{CH}_2$ OAc	100:0	100
$(\text{CH}_3)_3\text{SiCH}_2\text{CH}=\text{CH}_2$	$(\text{CH}_3)_3\text{SiCH}(\text{OBz})\text{CH}=\text{CH}_2$ OBz	100:0	101

* term = terminal olefin, int = internal olefin

Scheme 4-5 : Allylic acyloxylation of olefins with exocyclic double bonds

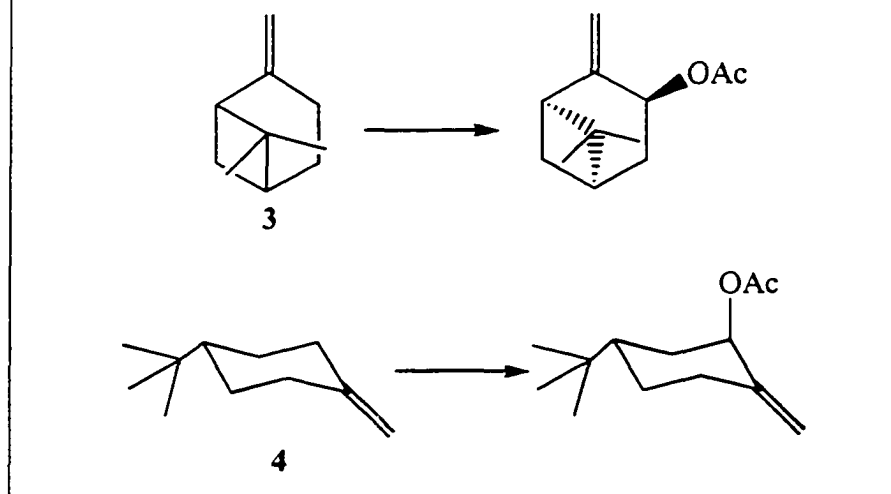

Reaction of olefinic substrates with internal double bonds may or may not result in the migration of the double bond to form the allylic esters (Table 4-2). The formation of 3-acyloxy derivative is favored since the resonance form of the Cu (II)-allyl complex in which the metal is coordinated to the terminal double bond is favored. This is because copper ions are known to form more stable complexes with less substituted olefins (entries 1-4).¹⁰⁴ Acyloxylation of β -methylstyrene (entry 3) resulted in the exclusive formation of 3-acyloxy-3-phenylprop-1-ene causing the double bond to move out of conjugation with the aromatic ring. Reactions of higher internal olefins result in a more complex mixture of allylic esters (entry 4).

Besides benzylic and olefinic hydrocarbons, ether,¹⁰⁵ esters,¹⁰⁵ⁱ aldehydes,¹⁰⁵ⁱ thioethers,¹⁰⁶ and carboxamides¹⁰⁷ have also been used as substrates in the Cu (I, II)-catalyzed peroxyester reaction.

Table 4-2: Perester reaction of olefins with internal double bonds

Entry	Substrate	Major Product	Selectivity term:int*	Ref
1	$\text{CH}_3\text{CH}=\text{CHCH}_3$	$\text{CH}_3\text{CH}(\text{OAc})\text{CH}=\text{CH}_2$ (Bz)	89:11	99
2	$(\text{CH}_3)_2\text{C}=\text{CHCH}_3$	$\text{CH}_2=\text{C}(\text{CH}_3)\text{CH}(\text{OBz})\text{CH}_3$	100:0	104
3	$\text{PhCH}=\text{CHCH}_3$	$\text{PhCH}(\text{OAc})\text{CH}=\text{CH}_2$	71:29	96iii
4	$\text{CH}_3\text{CH}_2\text{CH}=\text{CHCH}_3$	$\text{CH}_3\text{CH}(\text{OAc})\text{CH}=\text{CHCH}_3$ (68 %) + $\text{CH}_3\text{CH}_2\text{CH}(\text{OAc})\text{CH}=\text{CH}_2$ (29 %) + $\text{CH}_3\text{CH}_2\text{CH}=\text{CHCH}_2\text{-OAc}$ (3 %)	29:71	96iii

* term = terminal olefin; int = internal olefin

4-1-2: RATIONALE FOR COPPER CATALYZED ALLYLIC AMINATION OF OLEFINS

We considered an alternative system for allylic amination based on the well documented peroxyester reaction of olefins which produces allylic esters. The starting materials needed in this case were aza-analogs of the peresters, namely O-hydroxamic acid esters (5) and N-alkoxyamidines (6) (Scheme 4-6).

Scheme 4-6: Copper catalyzed allylic amination of olefins

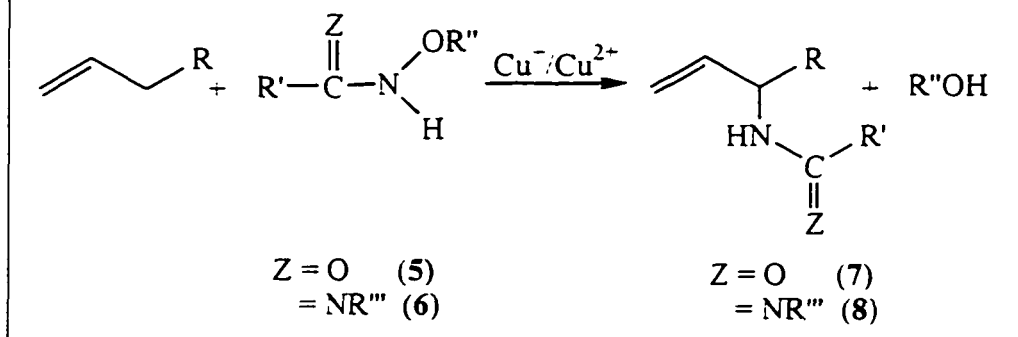

These could potentially undergo a corresponding reaction with olefins to produce allylic amides (7) or allylic amidines (8), with or without double bond migration. These derivatives could potentially be hydrolyzed to produce the corresponding primary N-allylamines, which remain an elusive goal. This would significantly increase the synthetic scope of allylic amination of olefins.

The mechanism of this proposed reaction was expected to be similar to that established for the copper-catalyzed allylic acyloxylation of olefins. The first step would involve Cu^+ assisted homolysis of the expectedly weak N-O bond, producing a reactive alkoxy radical (9) and Cu-amide (10) (Scheme 4-7). The alkoxy radical would then abstract a hydrogen atom from the olefin to generate the allyl radical, which would coordinate to the metal center to form 11. This would undergo rearrangement and reductive elimination to form the desired allylic amide 7 or allylic amidine 8.¹⁰⁸

Scheme 4-7: Postulated mechanism for Cu-catalyzed reaction of olefins with O-hydroxamic acid esters or amidines

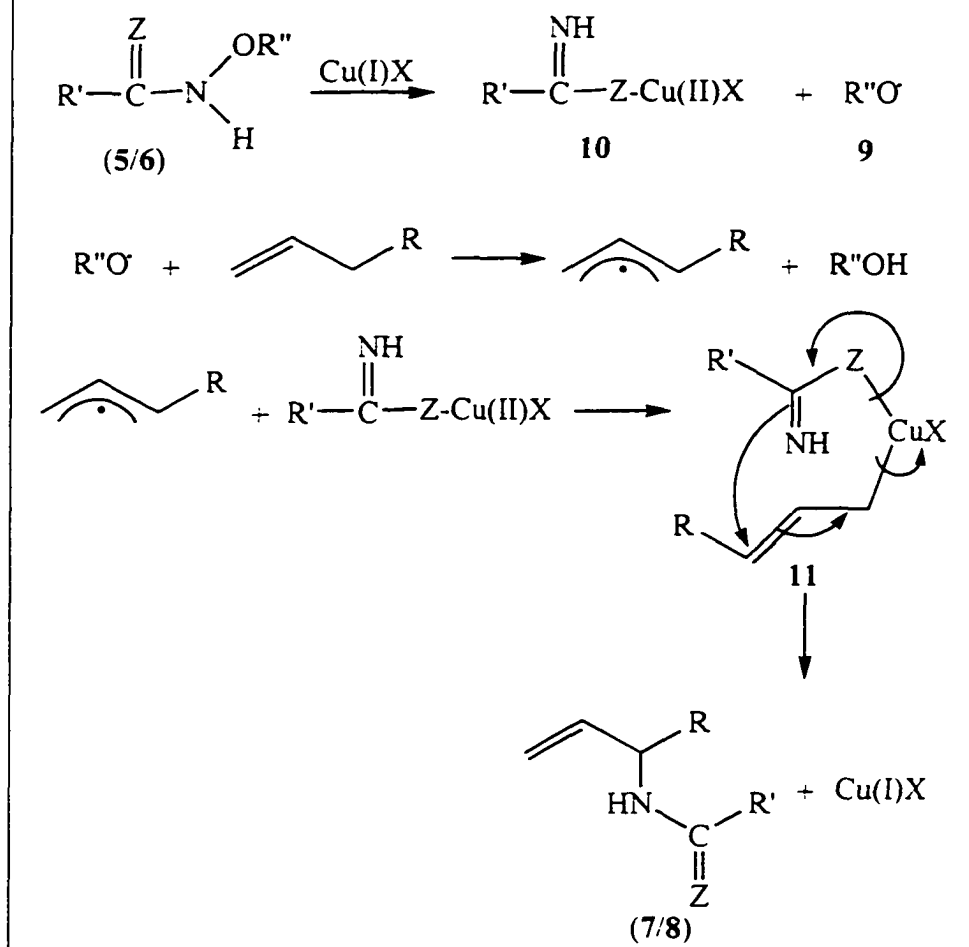

If O-hydroxamic acid esters (5) are used as the aminating agent a question of chemoselectivity (N- vs O-attack) arises, which could result in isomeric products. This potential problem could be overcome by using N-alkoxyamidines (6) as the aminating agent, which will allow only N-attack.

Hence, the success of this proposed Cu(I,II)-catalyzed allylic amination reaction would provide a new and general route to obtain various classes of allylamines, including primary amine derivatives, from olefins.

4-1-3: SYNTHESIS OF N-ALKYL AND N-ALKOXYAMIDINES

N-alkylamidines (**12**) can be prepared in a number of ways.¹⁰⁹ Of these the two most common and general routes are (Scheme 4-8):

- (i) addition of amines to nitriles, and
- (ii) nucleophilic substitution of amides or their derivatives.

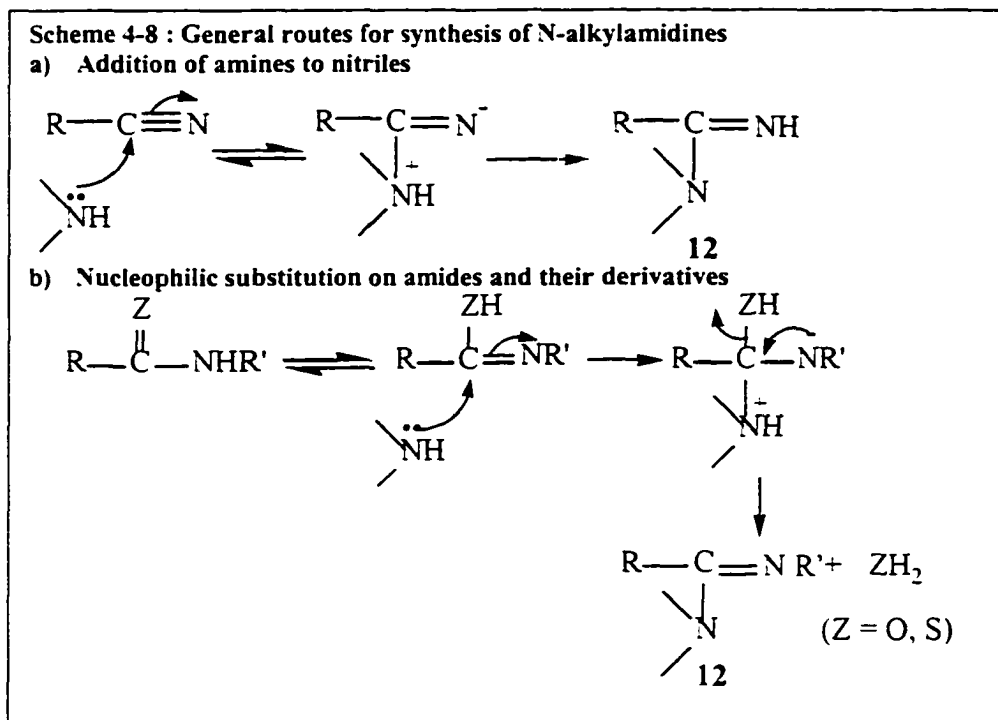

Nitriles react with metal amides, ammonia or amines to yield amidines (Scheme 4-9a, b). Ammonia or free amines react directly to form amidines only when the nitrile is activated by electron withdrawing substituents at the α -carbon.

Another well known method starting from nitriles is the Pinner synthesis which proceeds *via* the formation of imidoester intermediates.¹¹⁰ This is a two step reaction. The first step involves the reaction of nitriles with alcohols to form imidoesters (**13**) which are then condensed with ammonia or amines to form the

amidines in the next step (Scheme 4-9c). Pinner's method is most commonly used for the synthesis of unsubstituted amidines. However, acylnitriles, ortho-substituted aromatic nitriles, and α -naphthonitriles do not form the imidoesters.

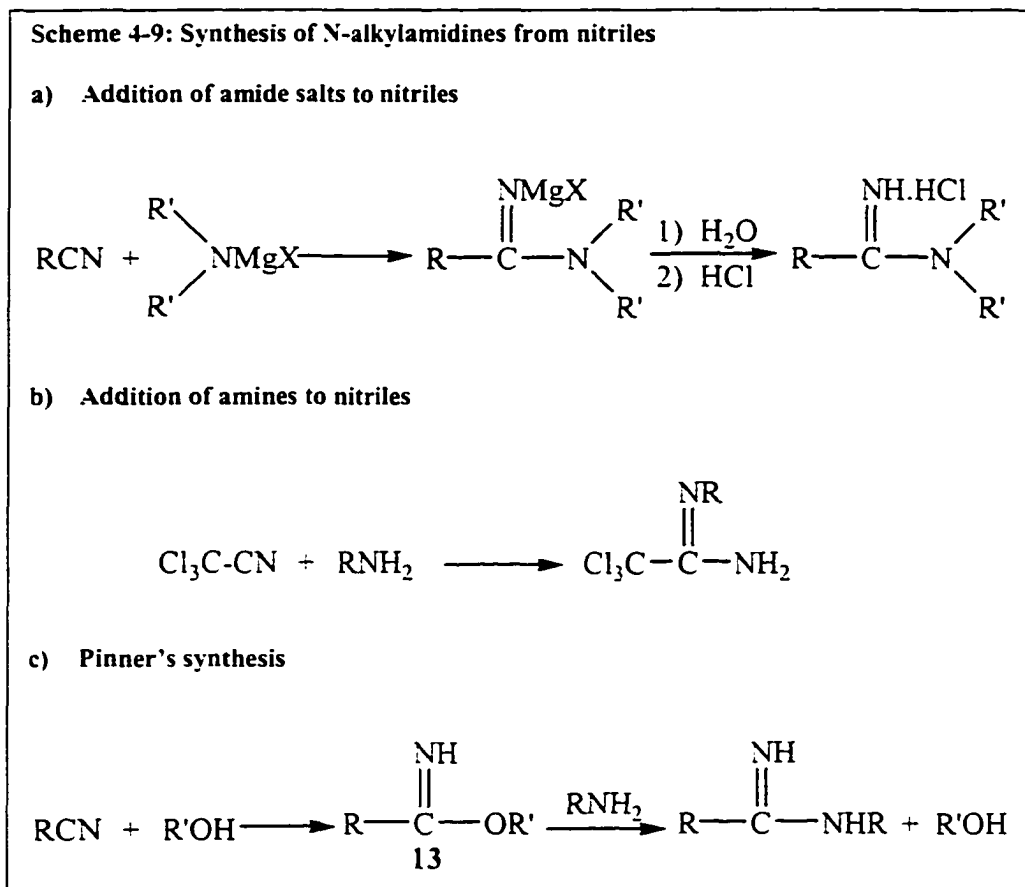

Nitriles also react with primary and secondary amines in the presence of CuCl under mild conditions to yield the corresponding amidines in high yields in one step (Scheme 4-10a).¹¹¹ Amidines can also be obtained by reaction of nitriles with alkylchloroaluminum amides, which are prepared from trimethylaluminum and ammonium chloride or amine hydrochlorides (Scheme 4-10b).¹¹²

Scheme 4-10: Synthesis of N-alkylamidines

a) CuCl promoted reaction of nitriles with amines

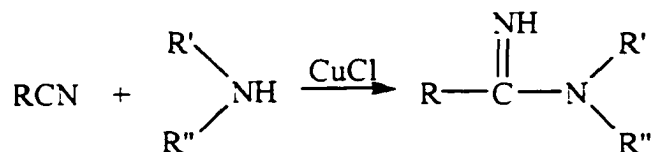

b) Reaction of nitriles with aluminum amide reagents

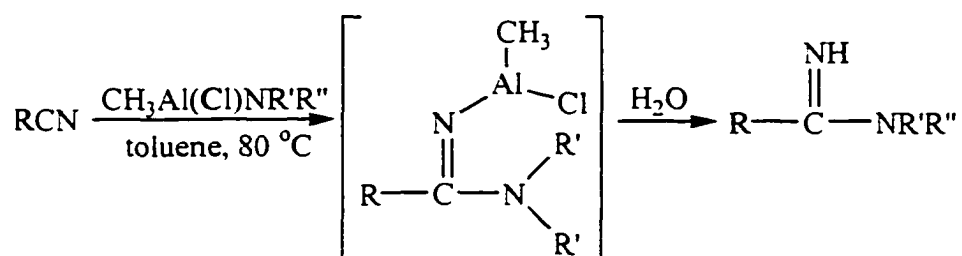
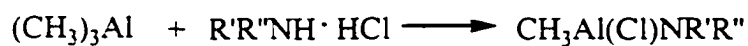

In a more recent report, benzamidines were synthesized by catalytic hydrogenation of the intermediate benzamidoximes (Scheme 4-11).¹¹³

Scheme 4-11: Synthesis of benzamidines from benzamidoximes

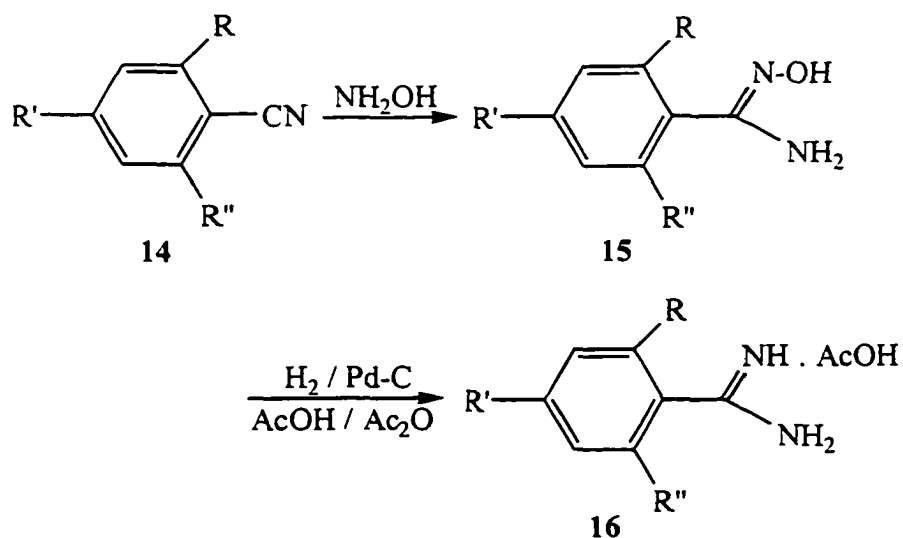

In this synthetic route, substituted aromatic nitriles (14) were transformed to the corresponding amidoximes (15) by reaction with hydroxylamine. The benzamidoximes thus produced were then subjected to hydrogenation to form the benzamidine salts (16) in good yields.

Amides or amide derivatives can also be used as starting materials in the synthesis of N-alkylamidines.¹⁰⁹ Monosubstituted and disubstituted amides produce the corresponding amidines by first reacting with halogenating agents and then displacing chloride by amines or ammonia (Scheme 4-12).

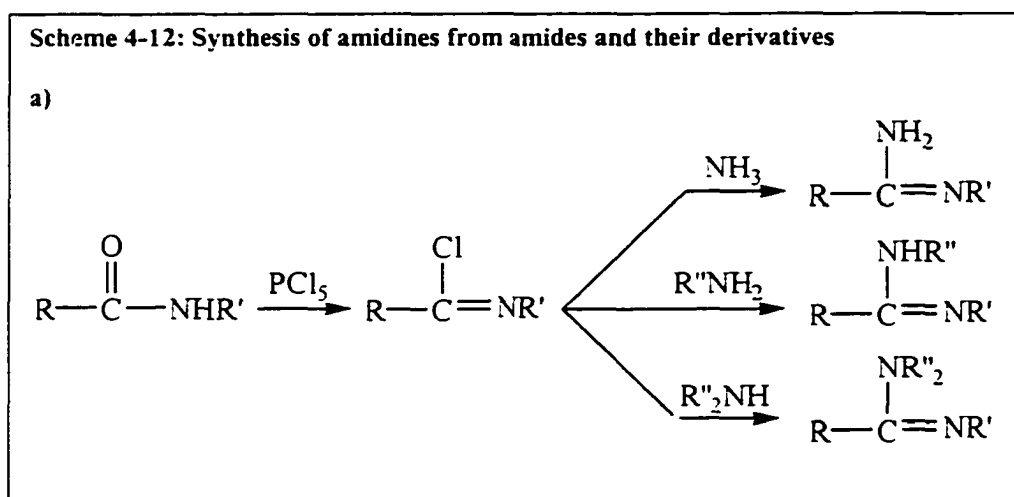

In addition to the methods mentioned here for the synthesis of N-alkylamidines, other miscellaneous routes have also been reported in the literature.¹⁰⁹

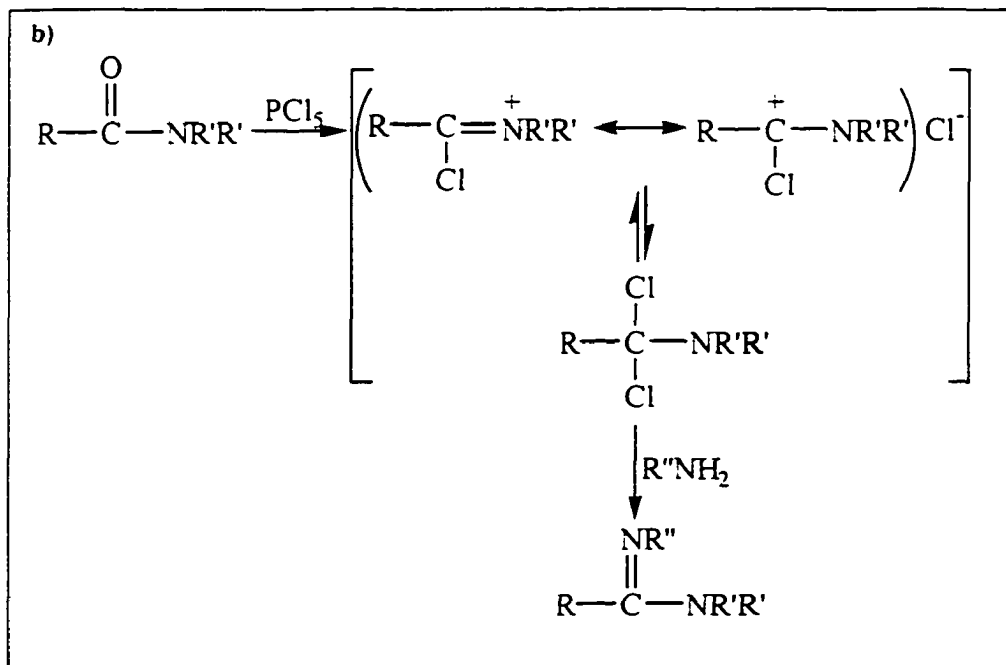

Although, the alkylsubstituted amidines are well studied, the desired N-alkoxyamidines are relatively unknown. Synthesis of some N-alkoxyamidine hydrochlorides (17) has been reported by alkylation of the corresponding amide O-alkyloximes (18), which in turn are prepared by reaction of unsubstituted amidine salts (19) with O-alkylhydroxylamines (Scheme 4-13).¹¹⁴ The alkylation of amide O-alkyloximes occurs at the nitrogen atom bearing the alkoxy group. The yields of the N-alkoxy-N-alkylamidines obtained were good.

Scheme 4-13: Synthesis of N-alkoxyamidine salts

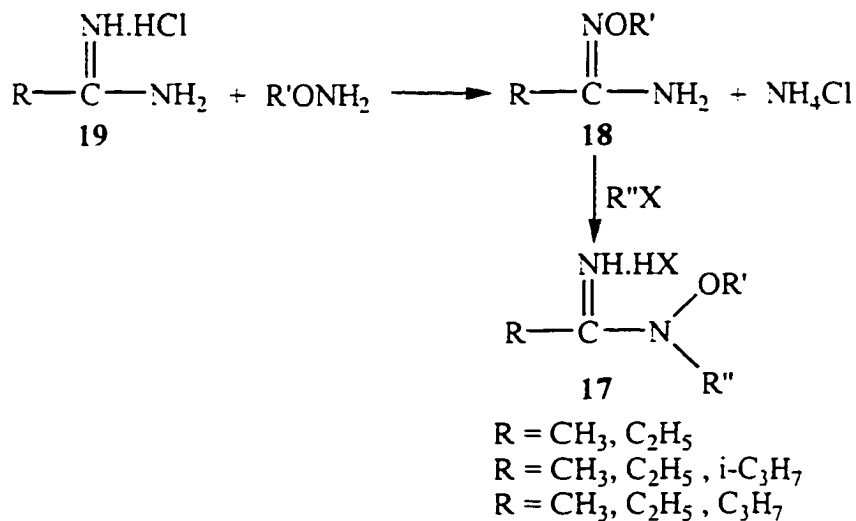

However, application of this reaction is limited because the starting material is an unsubstituted amidine salt, which is not a readily available compound. Only acetamidine hydrochloride and benzamidine hydrochloride are commercially available. Hence, this route does not provide a direct and general entry into the synthesis of N-alkoxyamidines.

4-2: RESULTS AND DISCUSSION

In order to investigate the feasibility of an alternate catalytic system for allylic amination of olefins, the first step was to develop a general and direct route for the preparation of N-alkoxyamidines (6), the aminating agent required. Once we were able to successfully obtain these compounds, their reactivity with olefins in presence of Cu (I, II) salts as catalyst would be tested.

4-2-1: SYNTHESIS OF N-ALKOXYAMIDINES

Based on the very efficient synthesis of N-alkyl- and N,N-dialkylamidines from nitriles and amines promoted by CuCl,¹¹¹ we attempted to prepare N-alkoxy- and N-alkoxy-N-alkylamidines following this route. O-Methylhydroxylamine (**20**) reacts with acetonitrile or benzonitrile in presence of stoichiometric amounts of Cu(I)Cl, at reflux, to produce N-methoxyacetamide (**21**) or N-methoxybenzamide (**22**) (Scheme 4-14).

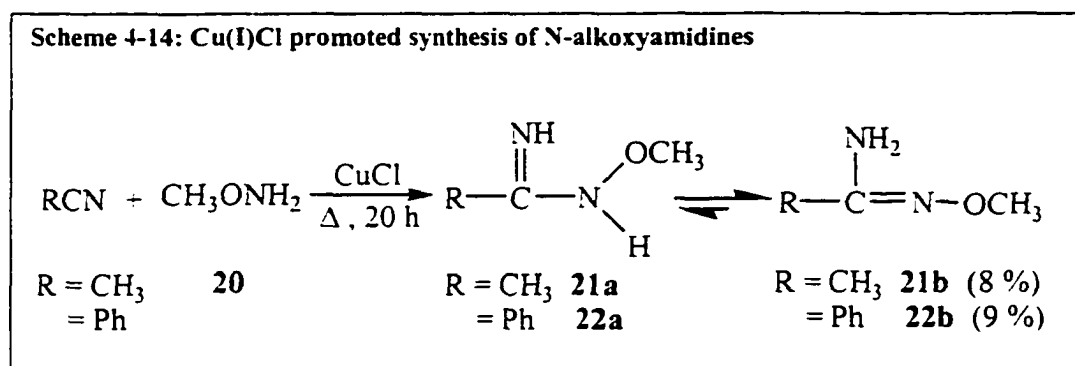

The products were purified chromatographically and were isolated as liquids. The yields of these amidines, however, were very low (8-9%). These compounds may exist in two tautomeric forms (**21a/21b** and **22a/22b**). In the case of monosubstituted N-alkylamidines, the amidoxime form is the favored tautomer.¹¹⁵ The ¹H NMR spectra for **21** and **22** show only single resonances for the protons on the methoxy carbon and for those on the nitrogen (Figure 4-1). If tautomer **21a/22a** were present then two separate resonances for protons on nitrogen could be expected. Also the ¹³C NMR spectra show only one signal for the methoxy carbon for both compounds. This again suggests that only one tautomer is present at room temperature, which is the amidoxime form. However, it is possible that there is a rapid equilibrium at room

temperature and only the time-averaged structure is seen by NMR. This possibility cannot be excluded.

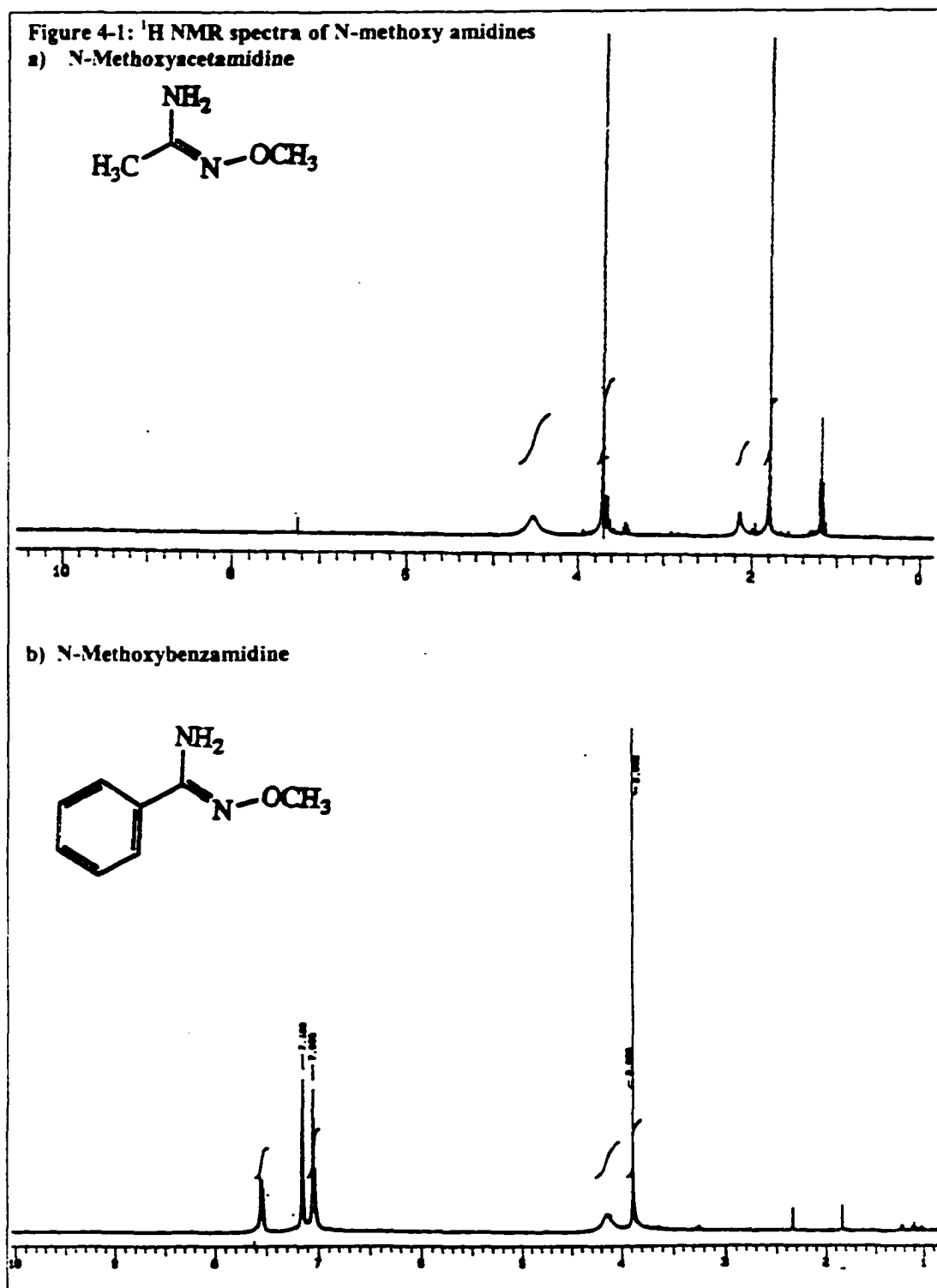

Efficient synthesis of N-alkoxy-N-alkylamidines could not be achieved by this procedure. Hence, a modification of the procedure reported by Garigipati¹¹² was used starting with O-alkylhydroxylamine hydrochlorides instead of alkylamine hydrochlorides. In the previous reports, the reagent used is the product of reaction between trimethylaluminum and alkylamine hydrochlorides and is described as methylchloroaluminum amide, $\text{CH}_3\text{Al}(\text{Cl})\text{NRR}'$.¹¹² However, no attempts at isolation or characterization of this aluminum intermediate were reported. In a more recent report by Sidler *et al.* a different structure for this species was established.¹¹⁶ It is well known that trisubstituted aluminum compounds, which have small groups, exist in dimeric, trimeric or polymeric forms with bridging ligands (Figure 4-2).¹¹⁷ The ^{27}Al NMR spectra of such aggregated compounds give signals at significantly upfield chemical shifts compared to the trivalent aluminum compounds.¹¹⁸ On the other hand, compounds with sterically hindered groups exist predominantly as monomers.¹¹⁹ These give ^{27}Al resonances at 265 ± 5 ppm. Sidler *et al.* have characterized the aluminum species **23** obtained by the reaction of trimethylaluminum and amine hydrochlorides and found aluminum to have tetrahedral geometry (Scheme

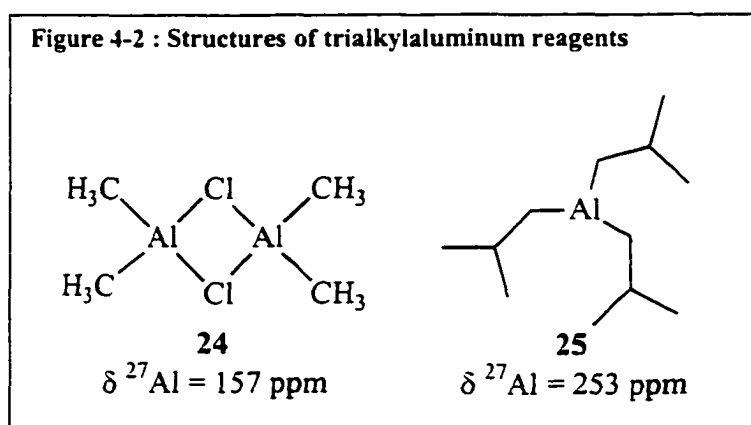

4-15). Coordination of the amine to aluminum in these complexes was shown by infra-red spectroscopy and ^1H NMR spectroscopy

which also demonstrated the presence of two other alkyl substituents by comparison

of integral ratios. Mass spectroscopy was used to establish the presence of chlorine as well. The tetrahedral nature of such compounds was established by ^{27}Al NMR spectroscopy, which showed a single resonance at 160 ppm. It has also been shown that such dialkylchloroaluminumamine complexes exist as monomers in benzene solution.¹¹⁷ⁱ

The reagent required in this synthesis, (N-alkyl-N-alkoxyamine)dimethylaluminum chloride (**23**) was synthesized by reacting trimethylaluminum with O-alkylhydroxylamine hydrochlorides (Scheme 4-15). Subsequent addition of nitriles to this aluminum complex followed by refluxing in benzene produced the desired N-alkyl-N-alkoxyamidines as their hydrochloride salts (**26**) (Scheme 4-15). The products were obtained generally in good yields (Table 4-3).¹²⁰

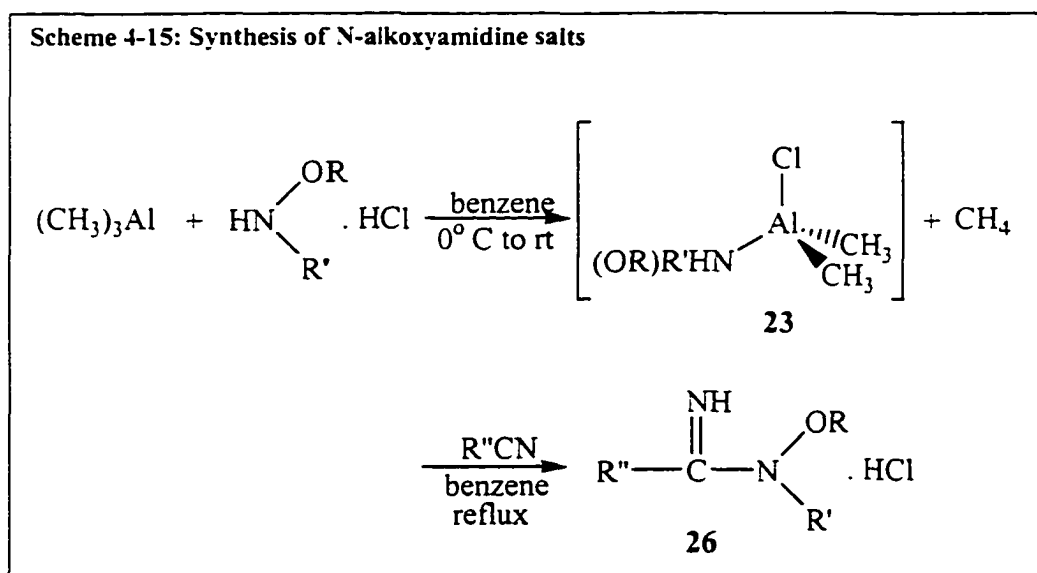

The reactions with N,O-dimethylhydroxylamine hydrochloride (entries 1-5) were most efficient. As expected, electron-deficient p-chlorobenzonitrile (entry 3) resulted

in almost quantitative yield of the corresponding product (**26c**) with very short reaction time (< 2h). In this case, the carbon atom of the nitrile group is highly electrophilic and reacts rapidly and effectively with the nucleophilic aluminum-amide reagent. On the other hand, the electron-rich p-methoxybenzotrile (entry 4) reacted only slowly producing the corresponding amidine salt in moderate yield. The aluminum-amide reagent obtained by reaction with *N*-trityl-*O*-methylhydroxylamine hydrochloride (entry 6) did not yield any amidine product. This is probably due to the hindrance of the approach of the nucleophilic amide reagent by the sterically bulky trityl group. Formation of the aluminum-amide reagent from *O*-methylhydroxylamine hydrochloride (entry 7) does not occur cleanly giving very low yields of the product.

These *N*-alkoxyamidine salts are hygroscopic and have very high polarity as indicated by their solubility in polar solvents (CH₃OH, DMSO) only. All new compounds were characterized by ¹H and ¹³C NMR, IR and mass spectrometric methods. The ¹H NMR spectra of these compounds show single resonances for the methoxy and methyl protons (Figure 4-3). The ¹³C NMR spectra also show single peaks for the methoxy and methyl carbons. As noted earlier, the ¹H and ¹³C NMR spectra for the amidine salt **26g** exhibit only one set of signals for the methoxy protons and methoxy carbon. In addition to these signals, the resonances arising from the alkyl or aryl groups are also seen in their characteristic regions. The mass spectra of these salts show the free amidines as the molecular ions and the loss of the methoxy group on nitrogen is the most common fragmentation seen.

Table 4-3: Reaction of nitriles with (N-alkyl-N-alkoxyamine)dimethylaluminum chloride

Entry	Nitrile	Aluminum Reagent	Product	Yield (%)
1.	CH ₃ CN	$\text{Me}_2\text{Al}(\text{Cl})\text{N} \begin{array}{l} \diagup \text{OMe} \\ \text{H} \\ \diagdown \text{Me} \end{array}$ 23a	$\text{CH}_3-\overset{\text{NH}\cdot\text{HCl}}{\parallel}{\text{C}}-\text{N} \begin{array}{l} \diagup \text{OCH}_3 \\ \diagdown \text{CH}_3 \end{array}$ 26a	94
2.	C ₆ H ₅ -CN	23a	$\text{C}_6\text{H}_5-\overset{\text{NH}\cdot\text{HCl}}{\parallel}{\text{C}}-\text{N} \begin{array}{l} \diagup \text{OCH}_3 \\ \diagdown \text{CH}_3 \end{array}$ 26b	98
3.	p-ClC ₆ H ₄ CN	23a	$\text{p-ClC}_6\text{H}_4-\overset{\text{NH}\cdot\text{HCl}}{\parallel}{\text{C}}-\text{N} \begin{array}{l} \diagup \text{OCH}_3 \\ \diagdown \text{CH}_3 \end{array}$ 26c	96
4.	p-OMeC ₆ H ₄ CN	23a	$\text{p-OMeC}_6\text{H}_4-\overset{\text{NH}\cdot\text{HCl}}{\parallel}{\text{C}}-\text{N} \begin{array}{l} \diagup \text{OCH}_3 \\ \diagdown \text{CH}_3 \end{array}$ 26d	50
5.	 -CN	23a	$\text{C}(\text{CH}_3)_2-\overset{\text{NH}\cdot\text{HCl}}{\parallel}{\text{C}}-\text{N} \begin{array}{l} \diagup \text{OCH}_3 \\ \diagdown \text{CH}_3 \end{array}$ 26e	67
6.	C ₆ H ₅ -CN	$\text{Me}_2\text{Al}(\text{Cl})\text{N} \begin{array}{l} \diagup \text{OMe} \\ \text{H} \\ \diagdown \text{CPh}_3 \end{array}$ 23b	$\text{C}_6\text{H}_5-\overset{\text{NH}\cdot\text{HCl}}{\parallel}{\text{C}}-\text{N} \begin{array}{l} \diagup \text{OCH}_3 \\ \diagdown \text{CPh}_3 \end{array}$ 26f	—
7.	C ₆ H ₅ -CN	$\text{Me}_2\text{Al}(\text{Cl})\text{N} \begin{array}{l} \diagup \text{OMe} \\ \text{H} \\ \diagdown \text{H} \end{array}$ 23c	$\text{C}_6\text{H}_5-\overset{\text{NH}_2\cdot\text{HCl}}{\parallel}{\text{C}}-\text{N} \begin{array}{l} \diagup \text{OCH}_3 \\ \diagdown \text{OCH}_3 \end{array}$ 26g	< 5

Figure 4-3: ^1H NMR of representative N-alkoxy-N-alkylamidinium hydrochlorides

a) 26b



b) 26d

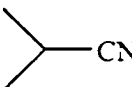
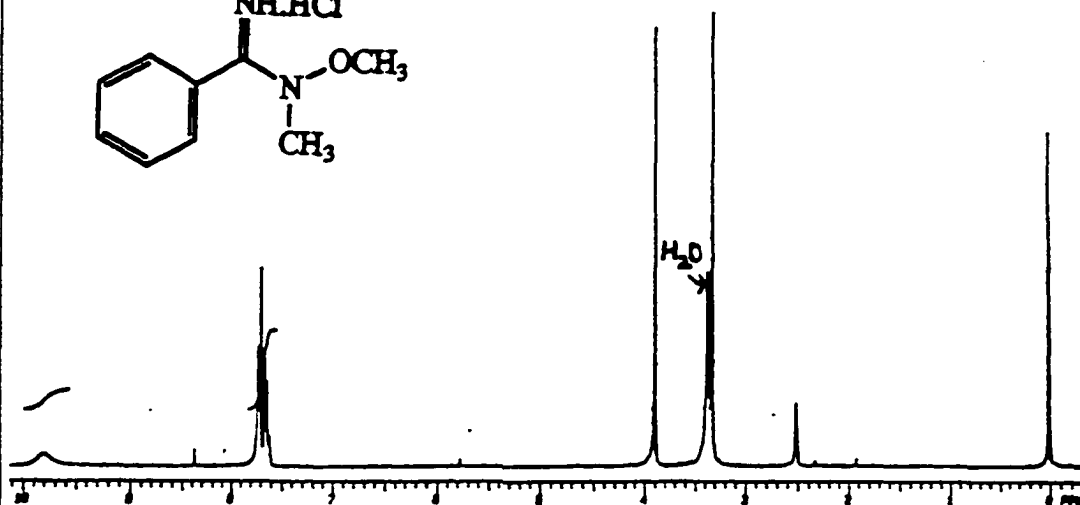
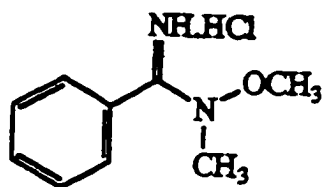
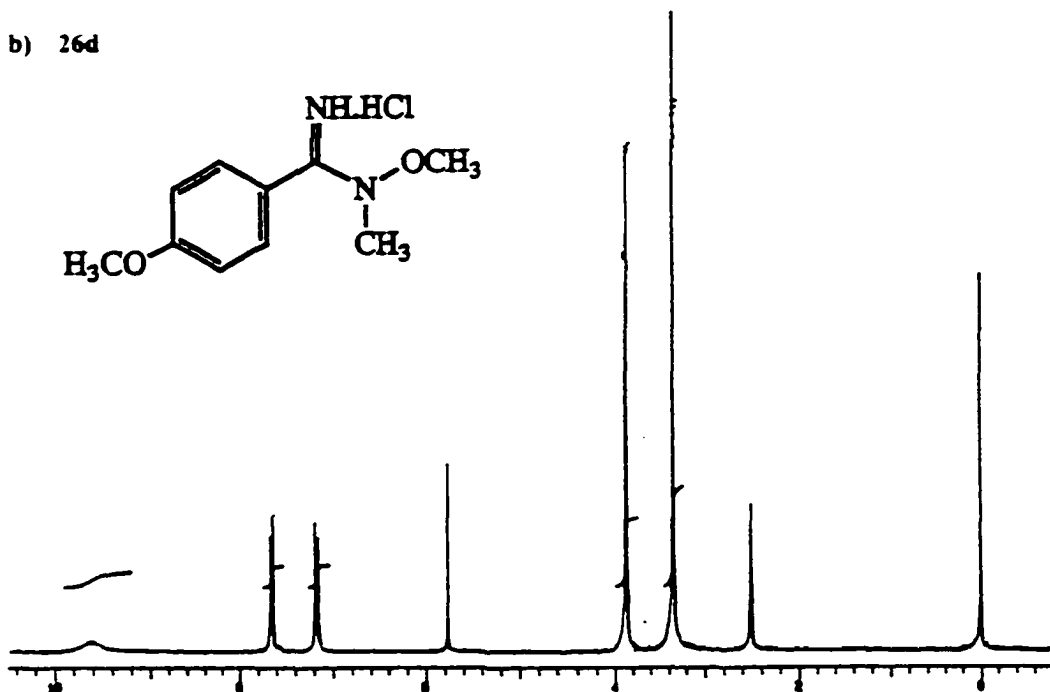
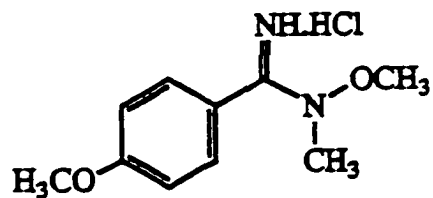

4-2-2: ATTEMPTED AMINATION OF OLEFINS USING N-ALKOXY-AMIDINES AS AMINATING AGENTS IN Cu (I,II)-CATALYZED REACTIONS.

In order to study the reactivity of N-alkoxy amidines, reactions of olefins were attempted in the presence of copper salts as catalyst. Both the N-alkoxy amidines prepared by the copper-promoted synthesis (Scheme 4-16a) and the N-alkoxy amidine salts obtained by the aluminum-promoted reactions (Scheme 4-16b) were investigated.

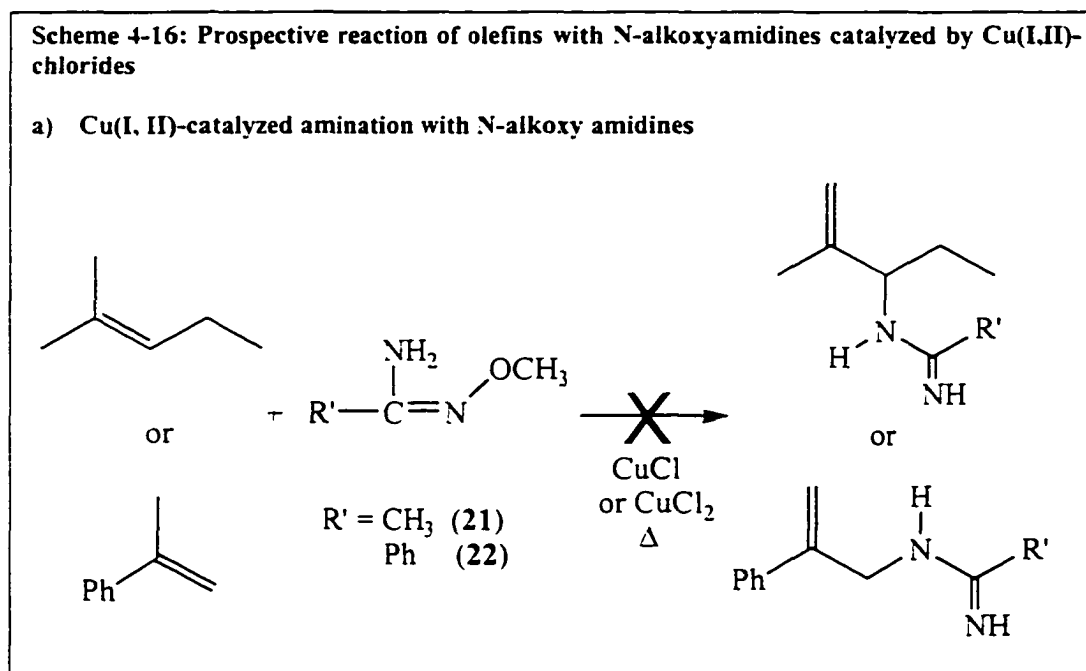

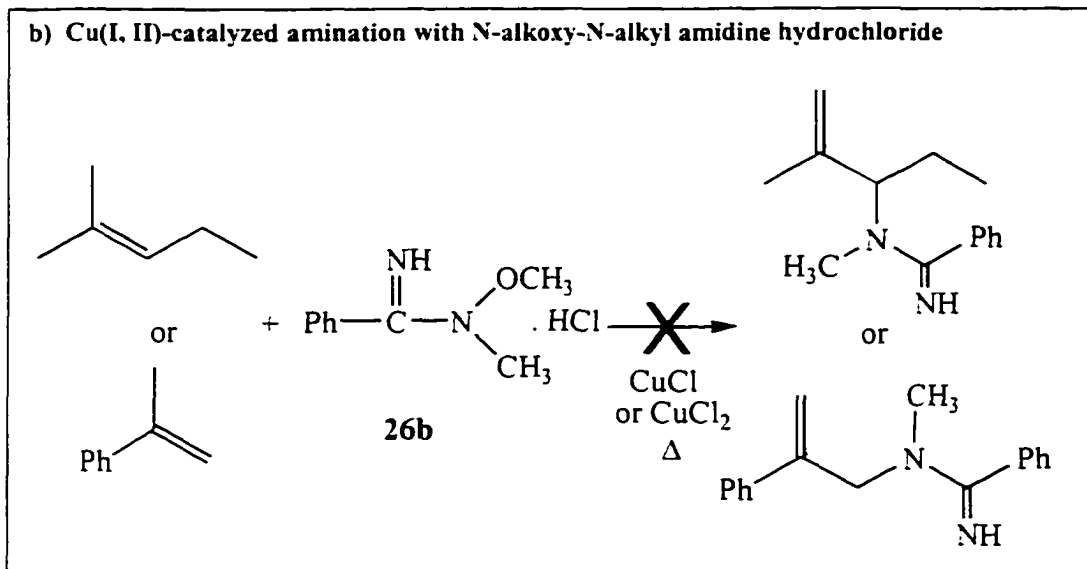

2-Methyl-2-pentene and α -methylstyrene were used as substrates and N-methoxyacetamidine (21), N-methoxybenzamidine (22) and N-methoxy-N-methylbenzamidine (26b) were used as aminating agents. Both cuprous and cupric chlorides were explored for their catalytic activity in refluxing solvents of varying polarity (C₆H₆, 1,4-dioxane, CH₃CN, DMF) for 24 - 48 h. However, in all of these cases no reaction was observed and the starting amidine could be recovered as indicated by mass spectroscopy.

At a later stage it was determined that the N-alkoxyamidines were actually in the form of hydrochloride salts. The elemental analysis data of compounds 26a,b and d suggested the composition of the salts instead of the free amidines. Attempts to liberate the free amidines from the salts were not successful using Na₂CO₃. Use of gaseous ammonia for this purpose results in the formation of the corresponding unsubstituted amidine salt by dissociation of the C-N bond (Scheme 4-17). This process has literature precedence.¹¹⁴

Scheme 4-17: Reaction of N-alkoxyamidine salts with gaseous ammonia

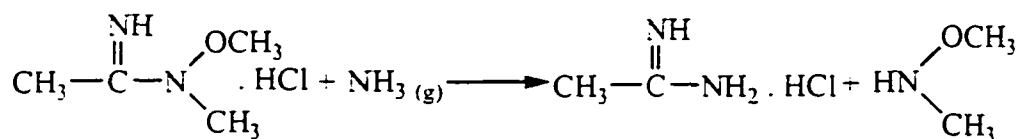

The amidine salts undergo partial hydrolysis to the corresponding amides (27) when treated with aqueous KOH solution (Scheme 4-18).¹¹⁴

Scheme 4-18: Reaction of N-alkoxyamidine salts with aqueous KOH

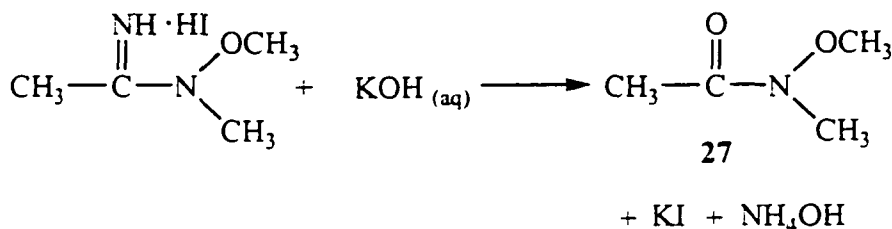

4-2-3: ATTEMPTED AMINATION OF OLEFINS WITH HYDRAZINE AND AMIDRAZONE DERIVATIVES CATALYZED BY Cu(I, II)-CHLORIDES

On the basis of the results described above, it was apparent that the N-O bond was not weak enough to be reductively cleaved by Cu(I). Hence, we then considered the dissociation of the N-N bond under these conditions instead. For this purpose a hydrazine derivative (28) and an amidrazone derivative (29) were chosen (Figure 4-4).

Figure 4-4: Other potential aminating agents for Cu(I, II)-catalyzed reactions

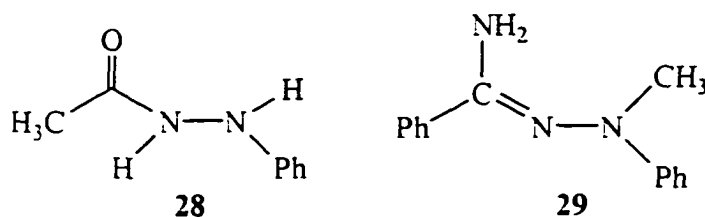

Reaction of olefins with 1-acetyl-2-phenylhydrazine catalyzed by copper salts would, according to the mechanism shown earlier (Scheme 4-7), result in the formation of an allylic amide, while the amidrazone derivative would produce the allylic amidine. Hence, these reactions were investigated.

Treatment of α -methyl styrene with the acylhydrazine **28** in presence of cuprous or cupric chloride (CH₃CN, 75 °C, 24 h) did not result in the formation of the expected product (Scheme 4-19). The expected by-product of the reaction formed by the dissociation of the N-N bond, namely aniline, was also not detected by GC or mass spectrometry. The hydrazine derivative **28** could, however, be detected.

Scheme 4-19: Reaction of α -methyl styrene with **28** catalyzed by Cu(I, II)-chlorides

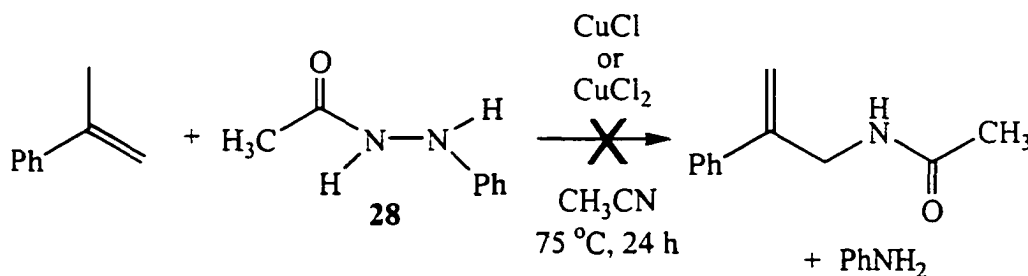

The amidrazone derivative **29** was prepared by a reported procedure (Scheme 4-20).¹²¹

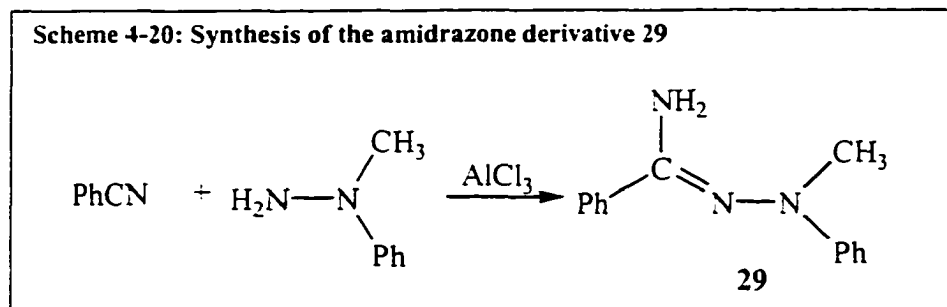

No reaction was observed when α -methyl styrene was treated with this potential aminating agent in the presence of cuprous chloride as the catalyst (Scheme 4-21). Once again, no evidence for dissociation of the N-N bond was detected under the conditions employed, as indicated by the absence of the expected amination product and the by-product N-methyl aniline in the mass spectrum. Unreacted amidrazone **29** was seen in the mass spectrum.

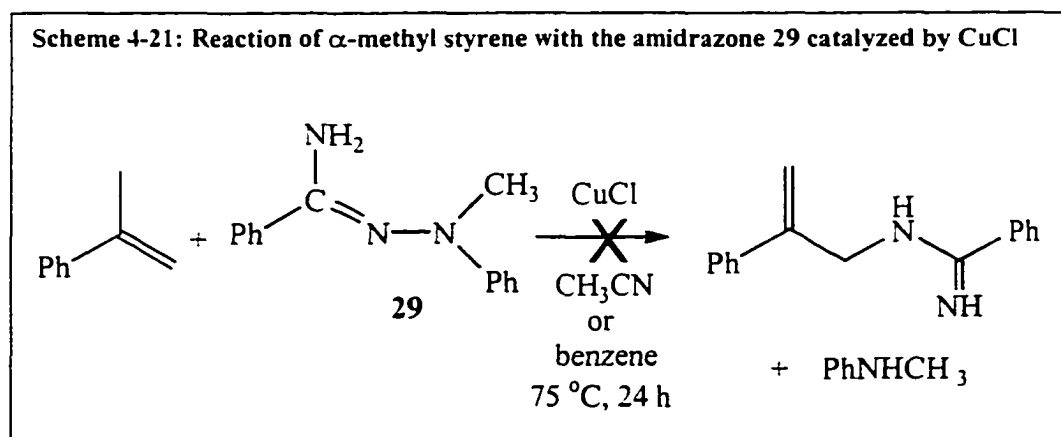

In a control experiment the amidrazone **29** was heated at 75 °C with CuCl in benzene for 24 h. Analysis by GC and mass spectrometry indicated no conversion of **29**.

4-3: CONCLUSIONS

In this chapter, a potentially new catalytic system for allylic amination of olefins has been investigated. A novel synthesis of N-alkoxyamidine salts, expected aminating agents in this proposed system, was developed and its scope was studied.¹²⁰ This route involves the reaction of organic nitriles with (N-alkyl-N-alkoxyamine) dimethylaluminum chlorides (**23**), which are formed by treating N-alkyl-N-alkoxyamine hydrochlorides with trimethylaluminum at low temperature. Preliminary attempts to aminate olefins in presence of Cu (I, II)-chlorides as catalysts have not succeeded. This may be because the aminating agents exist as salts instead of the free base. Attempts to free the amidines from their salts were also not successful. It is also possible that the Cu (I/II) system does not effect reductive dissociation of N-O and N-N bonds under the conditions employed. Comparing the bond energies of the O-O (34 kcal mol⁻¹), N-O (48 kcal mol⁻¹), and N-N (40 kcal mol⁻¹) sigma bonds,¹²² the N-O and the N-N covalent bonds are considerably stronger than the O-O bond.

It should be noted that recently successful benzylic and allylic aminations catalyzed by Cu(II)-triflate have been reported (Scheme 4-22).¹²³

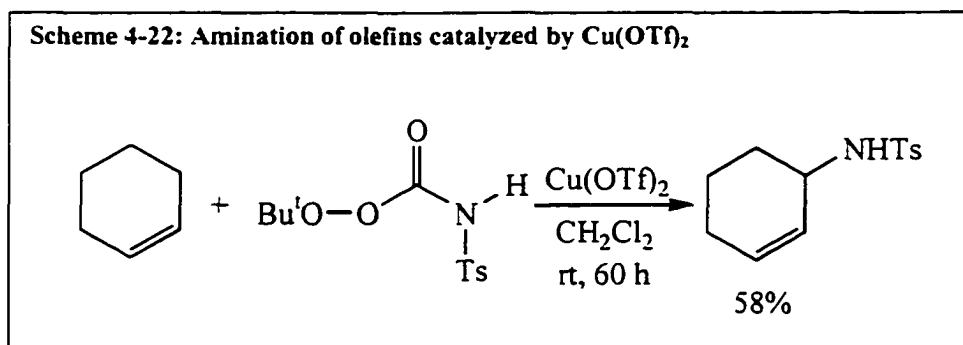

In this reaction t-butyl N-(p-toluenesulfonyl)-peroxycarbamate was used as the aminating agent to produce the corresponding amines in modest yields. This reaction proceeds *via* Cu (II)-promoted dissociation of the peroxy bond. The carbamate ion formed is in equilibrium with CO₂ and the p-toluenesulfonamide ion, which then reacts with the olefin, free or coordinated to Cu (II), to produce the N-tosyl-allylamine.

4-4: EXPERIMENTAL SECTION

General: All starting materials were obtained from commercial sources. 1,4-Dioxane and THF were distilled under nitrogen from sodium and benzophenone. Dichloromethane was distilled under nitrogen from CaH₂. Anhydrous methanol and DMF were used as provided by Fisher and Aldrich chemical companies, respectively. All air- and moisture-sensitive reactions were performed under nitrogen and all such reagents were handled in the dry box. All the glassware was oven dried and flushed with nitrogen before use.

All ¹H and ¹³C NMR spectra were obtained using a Varian XL-300 or Varian Unity Inova-400 instrument. The data is given in units of parts per million (ppm) relative to TMS. The residual solvent signals are used for referencing. The infra red (IR) data were recorded on a Bio-Rad FTS-7 FT-IR instrument. A Hewlett Packard 5790A gas chromatograph using a 3 m column packed with OV-101 was used. The GC-MS and low resolution EI data were obtained on Hewlett Packard 5985A GC/MS

system. The melting points were measured using a Mel-Temp apparatus and the values reported are not calibrated. Elemental analyses were performed at Midwest Microlab (Indianapolis, IN).

4-4-1: SYNTHESIS OF N-METHOXYACETAMIDINE (21) AND N-METHOXYBENZAMIDINE (22) PROMOTED BY CuCl.

N-Methylhydroxylamine was isolated as the free amine by treating MeONH₂.HCl (10.0 g, 0.120 mol) with NaOH (9.96 g, 0.250 mol) in DMF (25 mL). After stirring this solution for 30 min. free MeONH₂ was then distilled from this solution at ambient pressure at 47 °C. Nitrogen gas was bubbled through the distillate for 30 min before use in the next step.

21: O-Methyl hydroxylamine (0.950 g, 20.0 mmol) was dissolved in CH₃CN (10 mL) and was then added to CuCl (2.40 g, 24.0 mmol) under nitrogen. The reaction mixture was heated at 80 °C for 21 h. The color of the reaction mixture changed from blue to orange upon heating. After cooling the reaction mixture it was poured into Et₂O (250 mL) and stirred. A 30 wt% aqueous solution of NaOH (25 mL) was added and stirred for an additional 5 min. The organic layer was separated and dried with MgSO₄. Solvent was removed from the Et₂O solution using the rotary evaporator to obtain the product as a clear liquid in 8% yield (0.150 g, 1.70 mmol). ¹H NMR (300 MHz, CDCl₃) δ 1.79 (s, 3H), 3.70 (s, 3H), 4.55 (br, 2H); ¹³C NMR (75 MHz, CD₃OD) δ 18.9, 58.8, 165.3; IR (nujol) 880, 1060, 1358, 1409, 1437, 1466, 1656, 2817, 2901, 2936, 3340, 3486 cm⁻¹; MS (EI, 70eV GCMS, m/z, rel. intensity) 88 (M⁺, 92), 89 (M⁺+1, 4), 73 (30), 47 (41), 43 (95), 42 (100).

22: N-methoxybenzamidine was prepared following a similar procedure as for **21**, except that MeONH₂ was used in a two-fold excess over PhCN and the reaction was performed in absolute EtOH (15 mL). The reaction mixture was heated at 60 °C for 5 h. After this time the mixture was worked up as for the synthesis of **21**. The crude product was purified by column chromatography using silica gel as the stationary phase and a 95:5 petroleum ether/ether solvent mixture as the eluent to remove the unreacted PhCN. The column was then washed with MeOH to obtain the product in 9% yield (0.280 g, 1.90 mmol). ¹H NMR (300 MHz, C₆D₆) δ 3.88 (s, 3H), 4.32 (br, 2H), 7.00-7.20 (m, 3H), 8.00-8.22 (m, 2H); ¹³C NMR (100 MHz, CDCl₃) δ 60.9, 125.6, 128.2, 129.2, 132.8, 150.7; IR (nujol) 770, 900, 1048, 1065, 1400, 1623, 1638, 2900, 2940, 2968, 3030, 3320, 3445 cm⁻¹; MS (EI, 70eV DIP, m/z, rel. intensity) 150 (M⁺, 77), 151 (M⁺+1, 4), 135 (11), 119 (15), 105 (28), 104 (100), 77 (64), 51 (29).

4-4-2: SYNTHESIS OF (N-ALKYL-N-ALKOXYAMMINE)DIMETHYL-ALUMINUM CHLORIDES (23).

To prepare a 0.67 M solution of the aluminum amide reagent a literature procedure was followed.¹¹² The requisite N,O-dialkyl hydroxylamine hydrochloride salt (0.020 mol) was suspended in distilled benzene (20 mL) at 0-5 °C under nitrogen. A 2 M solution of Me₃Al (10 mL, 0.020 mol) in toluene was added slowly resulting in an exothermic reaction with the evolution of a gas. The reaction mixture was allowed to warm up to room temperature and was stirred for 30 min to 1 h under nitrogen. The reagent thus prepared was used directly in the next step.

4-4-3: SYNTHESIS OF N-ALKYL-N-ALKOXYAMIDINE HYDRO-

CHLORIDES (26)

To the solution of (N-alkyl-N-alkoxyammine)dimethylaluminum chloride prepared above, the organic nitrile (0.018 mol) was added at room temperature and the reaction mixture was refluxed for 2-24 h. The reaction progress was monitored by analytical TLC for the disappearance of the nitrile. After the reaction was complete, the solution was cooled and was slowly added to a silica gel (100 g) slurry in CH₂Cl₂. This was stirred for 5 min, filtered, and the filter cake was washed with MeOH (500 mL). Solvent was removed from the filtrate using the rotary evaporator and the residue was triturated with CH₂Cl₂ to give the pure N-alkoxyamidinium hydrochlorides as solids. Compounds **26e** and **26g** were isolated spectroscopically pure as oils.

26a: Yield 94%; mp 173-174 °C; ¹H NMR (300 MHz, DMSO-d₆) δ 2.28 (s, 3H), 3.40 (s, 3H), 3.74 (s, 3H) 9.32 (br, 2H); ¹³C NMR (100 MHz, DMSO-d₆) δ 16.2, 36.0, 60.8, 161.8; IR (KBr) 749, 785, 907, 988, 1059, 1201, 1382, 1454, 1622, 1683 cm⁻¹; MS (EI, 70eV DIP, m/z, rel. intensity) 102 (M⁺-HCl, 7), 72 (16), 61 (100), 60 (35), 46 (928), 42 (88).

26b: Yield 98%; 176-177 °C; ¹H NMR (300 MHz, DMSO-d₆) δ 3.31 (s, 3H), 3.89 (s, 3H), 7.60-7.80 (m, 5H), 9.81 (br, 2H); ¹³C NMR (75 MHz, CD₃OD) δ 39.0, 62.2, 128.3, 129.9, 131.0, 134.8, 164.8; IR (KBr) 774, 968, 1081, 1241, 1404, 1469, 1613, 1671, 2774, 2861 cm⁻¹; MS (EI, 70eV DIP, m/z, rel. intensity) 165 (M⁺-HCl, 1), 133 (8), 104 (9100), 77 (49), 76 (20), 61 (33), 51 (12).

26c: Yield 96%; mp 152-153 °C; ¹H NMR (400 MHz, DMSO-d₆) δ 3.30 (s, 3H), 3.86 (s, 3H), 7.70 (d, J = 8.0 Hz, 2H), 7.74 (d, J = 8.0 Hz, 2H), 9.90 (br, 2H); ¹³C NMR (100 MHz, DMSO-d₆) δ 30.2, 53.5, 117.7, 121.26, 121.5, 122.9, 123.0, 129.8, 153.5; IR (KBr) 732, 798, 849, 971, 1018, 1090, 1179, 1281, 1409, 1594, 1652, 3009 cm⁻¹; MS (EI, 70eV DIP, m/z, rel. intensity) 167 (3), 140 (35), 138 (100), 111 (28), 102 (18), 75 (25), 61 (83), 46 (10).

26d: Yield 50%; mp 188-189 °C; ¹H NMR (300 MHz, DMSO-d₆) δ 3.33 (s, 3H), 3.85 (s, 3H), 3.86 (s, 3H), 7.15 (d, J = 8.7 Hz, 2H), 7.63 (d, J = 8.7Hz, 2H), 9.61 (br, 2H); ¹³C NMR (100 MHz, DMSO-d₆) δ 38.4, 55.8, 61.3, 114.5, 118.3, 131.0, 162.2, 162.7; IR (KBr) 777, 823, 842, 953, 1014, 1129, 1174, 1190, 1261, 1307, 1405, 1442, 1516, 1606, 1661 cm⁻¹; MS (EI, 70 eV DIP, m/z, rel. intensity) 194 (M⁺-HCl, 2), 134 (100), 91 (18), 61 (27).

26e: Yield 67%; ¹H NMR (300 MHz, DMSO-d₆) δ 1.21 (d, J = 6.9 Hz, 6H), 2.94 (septet, J = 6.9 Hz, 1H), 3.50 (s, 3H), 3.72 (s, 3H), 9.22 (br, 2H); ¹³C NMR (100 MHz, DMSO-d₆) δ 20.2, 30.0, 35.4, 37.9, 62.1, 169.7; IR (KBr) 798, 914, 979, 1023, 1100, 1154, 1340, 1419, 1457, 1472, 1616, 1653, 1683, 1699, 2767, 3459 cm⁻¹; MS (EI, 70 eV DIP, m/z, rel. intensity) 130 (M⁺-HCl, 3), 70 (50), 61 (100), 60 (33), 55 (15).

26g: Yield <5%; ^1H NMR (300 MHz, DMSO- d_6) δ 3.74 (s, 3H), 6.05 (br, 2H), 7.35-7.72 (m, 5H); ^{13}C NMR (100 MHz, CD_3OD) δ 61.2, 127.3, 129.4, 130.9, 134.0, 155.1; IR (nujol) 906, 1029, 1250, 1507, 1560, 1637, 2832, 2942, 3337 cm^{-1} ; MS (EI, m/z, rel. intensity) 150 (M^+-HCl , 35), 104 (100), 77 (56), 51 (45).

4-4-4: REACTION OF OLEFINS WITH N-ALKOXYAMIDINES AND N-ALKOXY-N-ALKYLAMIDINE HYDROCHLORIDES CATALYZED BY Cu (I, II)-CHLORIDES

In a dry flask CuCl or CuCl₂ (0.150 mmol) was weighed out in the dry box. Distilled solvent (benzene, 1,4-dioxane, CH₃CN, DMF) (5 mL) was added to this under nitrogen and stirred at room temperature. The required olefin (2-methyl-2-pentene, α -methyl styrene) (15.0 mmol) was added and the reaction mixture was then heated to 80-85 °C. A solution of the N-alkoxy amidines (**21**, **22**) or the N-alkoxy-N-alkyl amidine hydrochloride (**26b**) (1.50 mmol) in the solvent used (15 mL) was added to the reaction mixture over a 6 h period. The reaction mixture was heated for 24 h. Aliquots were withdrawn from the reaction mixture, the metallic compounds were precipitated by adding excess hexane and the filtrate was concentrated. These samples were analyzed by mass spectrometry.

4-4-5: REACTION OF OLEFINS WITH 1-ACETYL-2-PHENYL HYDRAZINE CATALYZED BY Cu (I, II)-CHLORIDES

Cuprous- or cupric chloride (0.500 mmol) was weighed out in a dry flask in the dry box and α -methyl styrene (5.90 g, 50.0 mmol) and distilled CH₃CN (10 mL)

were added to it under nitrogen. The reaction mixture was heated to 75 °C and a solution of the hydrazine derivative (0.750 g, 5.00 mmol) in CH₃CN (15 mL) was added over a 6 h period. The reaction mixture was refluxed for 24 h. The course of the reaction mixture was monitored by GC for the appearance of aniline. After 24 h, the reaction mixture was cooled and the metal containing compounds were precipitated by adding excess hexane. The solvent was removed using the rotary evaporator and the residue was analyzed by mass spectrometry.

4-4-6: SYNTHESIS OF N-METHYL-N-PHENYL BENZAMIDRAZONE 29

Amidrazone **29** has been prepared previously by the following procedure.¹²¹ PhCN (1.24 g, 0.012 mol) was mixed with 1-methyl-1-phenylhydrazine (1.5 g, 0.012 mol) and to this AlCl₃ was added in small portions with cooling. Water was then added to the solid mixture obtained and the reaction mixture was made basic with 2 N NaOH. This was extracted with CHCl₃ several times. The organic layer was dried (Na₂SO₄) and the solvent was removed. The crude product was dissolved in Et₂O, the insoluble impurities were filtered out, and pet. ether was added. This was left in the freezer overnight to obtain off-white crystalline solid in 38% yield (1.04 g, 4.60 mmol). mp 99-100 °C (literature mp 103-104 °C); ¹H NMR (300 MHz, CDCl₃) δ 3.07 (s, 3H), 5.33 (br, 2H), 6.86 (t, J = 7.4 Hz, 1H), 6.69 (dd, J = 9.0, 1.2 Hz, 2H), 7.20-7.30 (m, 2 H), 7.40-7.52 (m, 3H), 7.85 (dd, J = 8.0, 1.6 Hz, 2H); IR (KBr) 692, 756, 832, 878, 992, 1026, 1049, 1115, 1294, 1495, 1539, 1558, 1575, 1615, 2799, 2873, 2900, 3100 3361, 3466 cm⁻¹.

4-47: REACTION OF OLEFINS WITH THE AMIDRAZONE 29

CATALYZED BY CuCl

Cuprous chloride (0.015 g, 0.150 mmol) was weighed out in a dry flask in the dry box and α -methyl styrene (1.77 g, 15.0 mmol) and the solvent (benzene or CH₃CN) (5 mL) were added under nitrogen. The reaction mixture was heated to 75 °C and then a solution of the amidrazone **29** (0.338 g, 1.50 mmol) in the solvent used (10 mL) was added over a 6 h period. The reaction mixture was refluxed for 24 h. The reaction was monitored by GC for the formation of PhNHCH₃. After 24 h the reaction mixture was cooled and the metal was removed by adding excess hexane. Solvent was removed from the solution and the residue was analyzed by mass spectrometry.

Chapter 5

SYNTHESIS OF SUBSTITUTED TERTIARY PHOSPHINES VIA NUCLEOPHILIC DISPLACEMENT ON P(III): BACKGROUND AND SIGNIFICANCE

5-1: SIGNIFICANCE OF PHOSPHINES IN TRANSITION METAL- CATALYZED ORGANIC REACTIONS

Phosphines, especially tertiary phosphines, constitute a major class of ligands used in transition metal-catalyzed organic reactions,¹²⁴ including stereoselective reactions. Some of the important catalytic asymmetric reactions employing chiral phosphines include isomerization,¹²⁵ asymmetric hydrogenation,¹²⁶ co-dimerization,¹²⁷ allylic alkylation,¹²⁸ and hydroformylation¹²⁹ of olefins (Scheme 5-1).

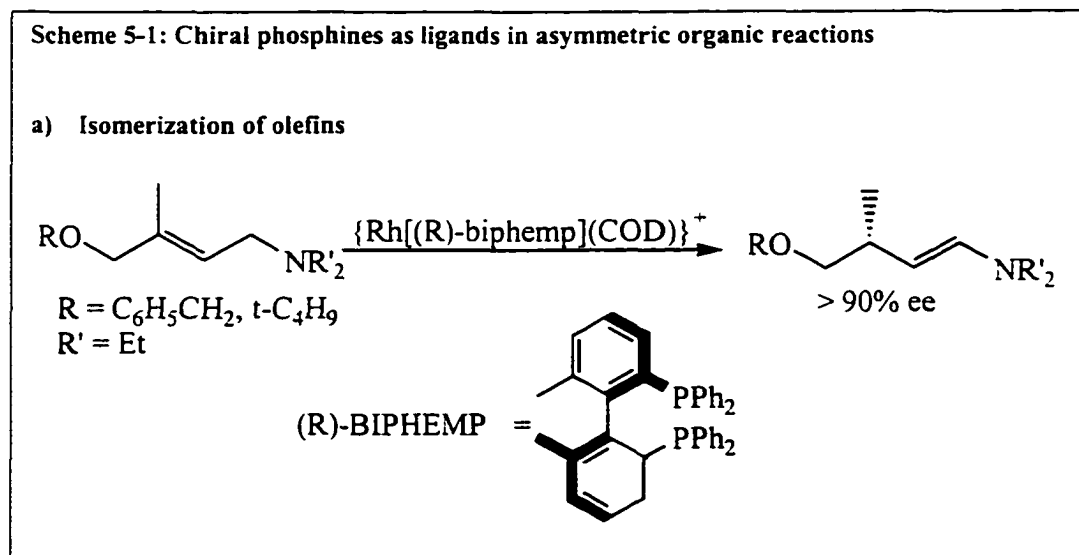

b) Hydrogenation of olefins

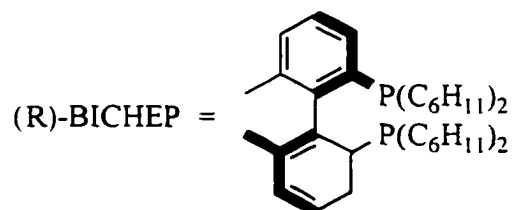
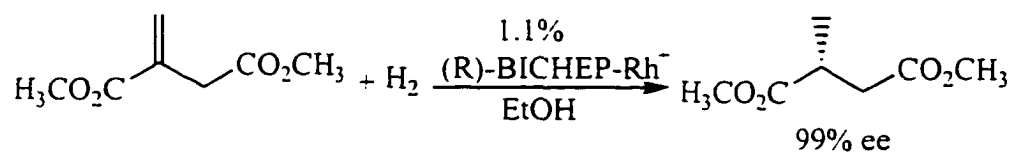

c) Codimerization of olefins

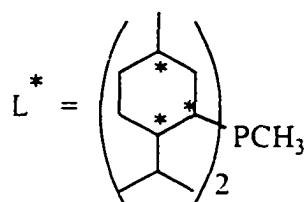
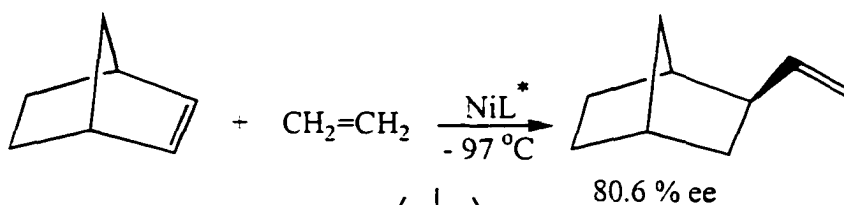

d) Allylic alkylation of olefins

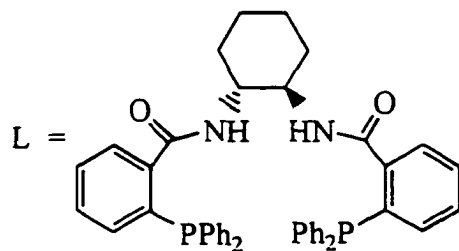
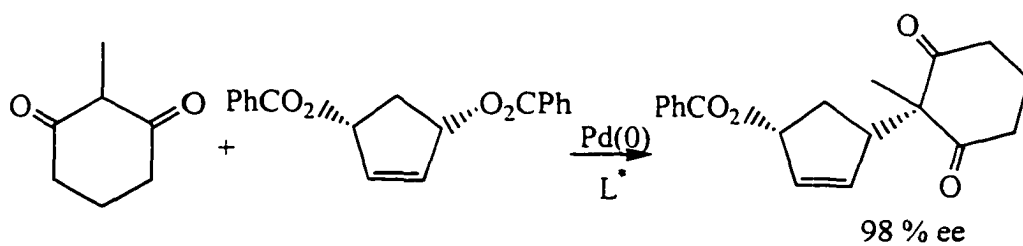

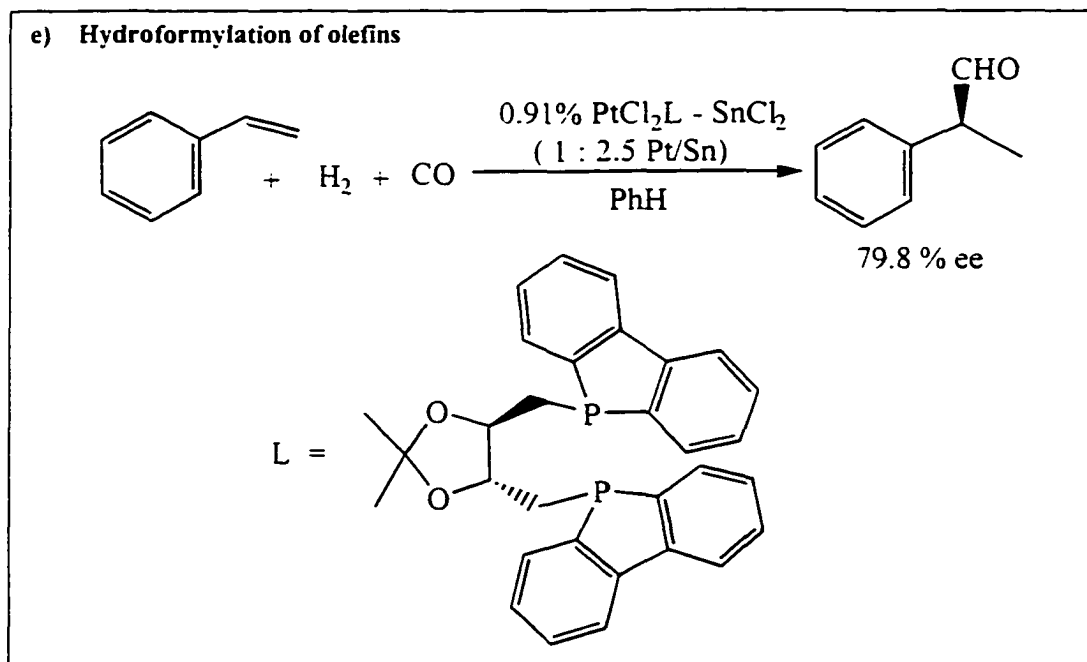

However, the efficiency of these reactions, both synthetic and stereochemical, depends upon the structural and electronic nature of the phosphine ligands. Studies on the effects of phosphine cone angle θ , a steric parameter,^{130, 131} and electronic character, χ ,¹³² on the reaction rates and selectivities have demonstrated that the pattern is rather complex. Steric and electronic properties of the phosphines affect the activity and selectivity of an achiral homogeneous catalyst. For example, studies done on the rhodium-catalyzed hydroformylation of olefins demonstrate the effect of changing θ and χ on the ratio of linear vs. branched aldehydes.¹³³ It has been shown that the selectivity for the linear aldehyde increases with decreasing size of the substituents on the ligating phosphine.¹³⁴ Also, with the steric factor and other reaction conditions being constant, the rate of the hydroformylation reaction and the selectivity for the formation of the linear aldehyde are lower for the more electron donating phosphines.

A similarity can be drawn between drug discovery and catalyst optimization processes. In the former case, a medically important compound is first extracted from its natural sources. This is followed by synthesis of its structural and electronic analogs of *via* classical organic synthetic routes to obtain the compound with the maximum activity. In the same way, in order to obtain the optimum activity/selectivity for a given catalyst, one has to first classically synthesize a collection of tertiary phosphines and then screen each one for best results in the given reaction. This requires an efficient and general route to obtain the desired tertiary phosphines. Also, this process can be very time consuming and not very economical. Just as combinatorial organic synthesis has now provided an economical and less tedious means for obtaining pharmaceutically significant compounds; it can also lead to a similar result in the development of optimum catalytic conditions for various reactions. This technique can be used for the synthesis of libraries containing numerous structurally and electronically diverse phosphines. The effect of various homogeneous catalytic reactions can then be studied leading to a 'hit'. As a result, the entire process can be done in less time and more economically as very small quantities of materials are required. Once the optimum ligand is obtained, it can then be prepared in large quantities by classical routes.

5-2: SYNTHESIS OF SUBSTITUTED PHOSPHINES IN SOLUTION

Synthesis of tertiary phosphines in the solution phase can be achieved through several general routes.¹³⁵ These methods include (a) substitution on P(III) by a

nucleophile, (b) substitution on a carbon electrophile by a phosphide, (c) addition of P-H unit across an unsaturation, and (d) reduction of phosphine oxides (Scheme 5-2).

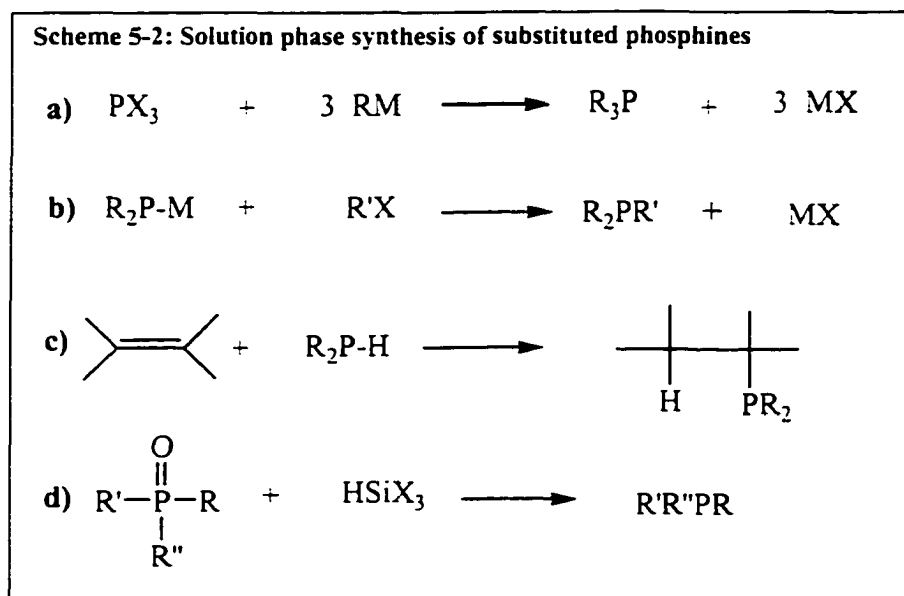

The first method is the most commonly used route to obtain tertiary phosphines. Chloro and alkoxy groups on P(III) can be easily displaced by various nucleophilic organometallic reagents, such as Grignard,¹³⁶ organolithium,¹³⁷ organoboron,¹³⁸ organotin,¹³⁹ organolead,¹⁴⁰ and organocadmium reagents.¹⁴¹ Synthesis of unsymmetrical tertiary phosphines via nucleophilic substitution on P (III) requires selective displacements of one leaving group in the presence of another by taking advantage of different reactivities of the nucleophilic reagents used and different labilities of the leaving groups. Of these functional groups, the P-Cl and P-OR groups are known to be very reactive towards organometallic reagents while the P-NR₂ group reacts in the presence of acids. Selective substitution of one chloro group in the presence of another is possible by using organocadmium and Grignard reagents in sequence (Scheme 5-3a).¹⁴² A variety of racemic tertiary phosphines were

obtained in \approx 80-85% yields via this "one-pot" sequence of substitutions on dichlorophenylphosphine. Substitution of the chloro group in the presence of an alkoxy group has also been achieved by the use of Grignard reagents (Scheme 5-3b).^{136, 11}

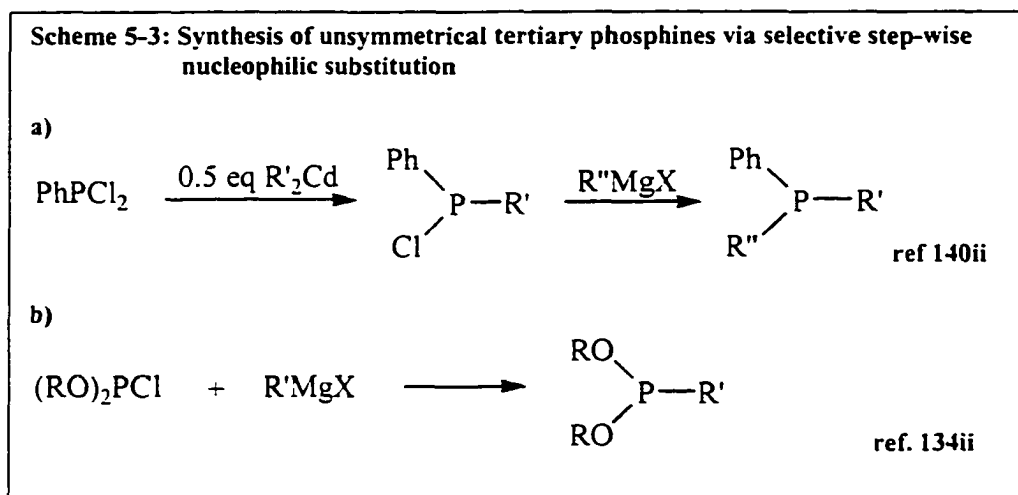

In these reactions appreciable selectivity was achieved by performing the reactions at low temperatures. However, these methods have only limited applicability because they often suffer from polysubstitution (Scheme 5-4a),¹⁴³ require inconvenient organometallic reagents,¹⁴² sometimes involve multiple steps (Scheme 5-4b),¹⁴⁴ and also require careful control of conditions including temperature, stoichiometry and mode of addition.

In order to generate libraries of diverse phosphines to study their activity/selectivity in homogeneous catalytic reactions, we sought to develop their synthesis on the polymer support. However, the limitations mentioned above make the use of these approaches for the solid phase synthesis of homochiral tertiary phosphines unsuitable. Hence, development of a general and efficient route, using

readily available organometallic reagents, in which the use of excess reagents is possible and in which the reaction occurs under ambient conditions, was required.

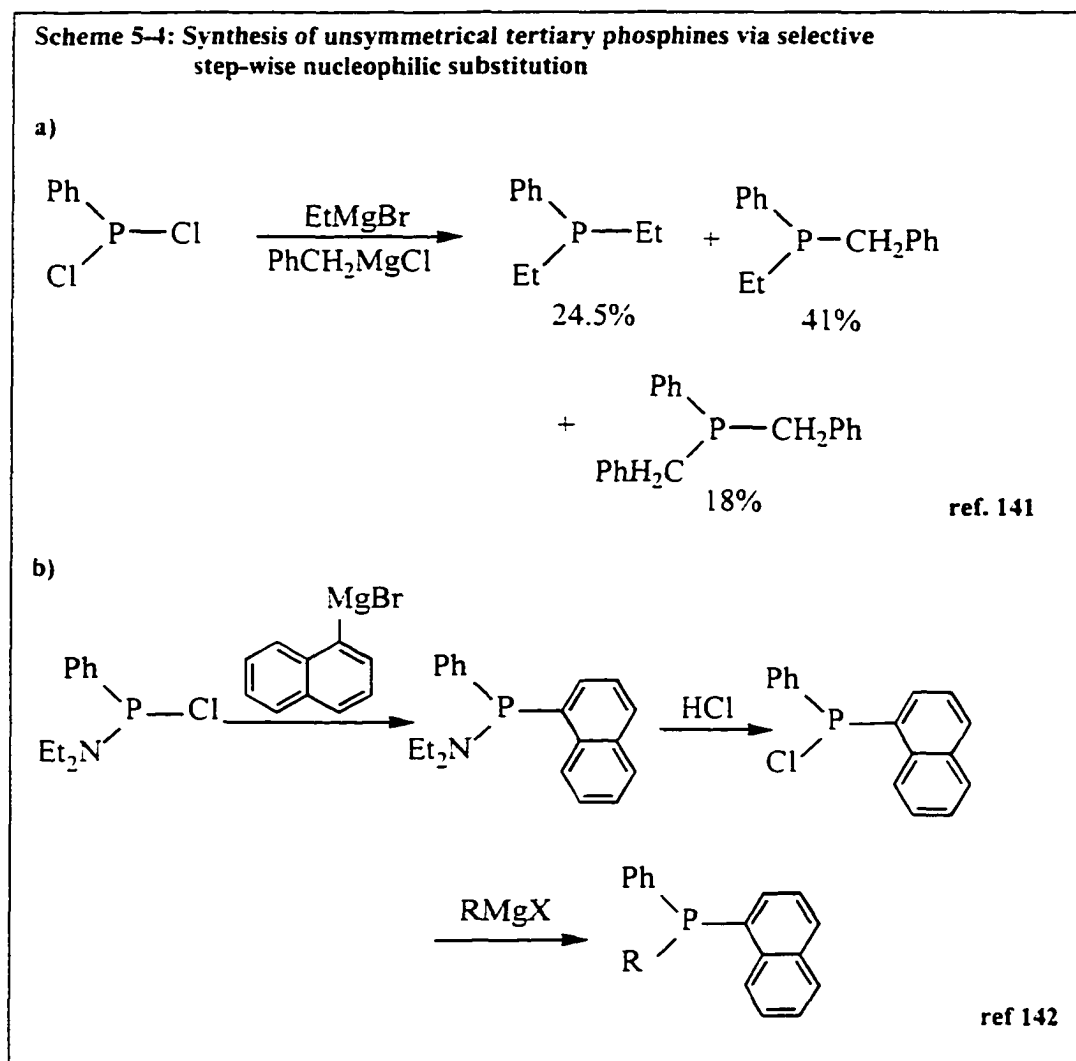

5-3: SOLID PHASE ORGANIC SYNTHESIS

The concept of polymer-supported synthesis as an important synthetic strategy has its origin in the pioneering work by Merrifield in the area of peptide synthesis.¹⁴⁴ He demonstrated the feasibility of organic reactions on solid surfaces in heterogeneous media. In this approach a polypeptide was synthesized in a sequential

manner on a polymer (chloromethylated copolystyrene - 2% divinylbenzene) using the usual procedures of protection and deprotection of functional groups (Scheme 5-5). The growing peptide chain is then cleaved from the polymer in the final step.

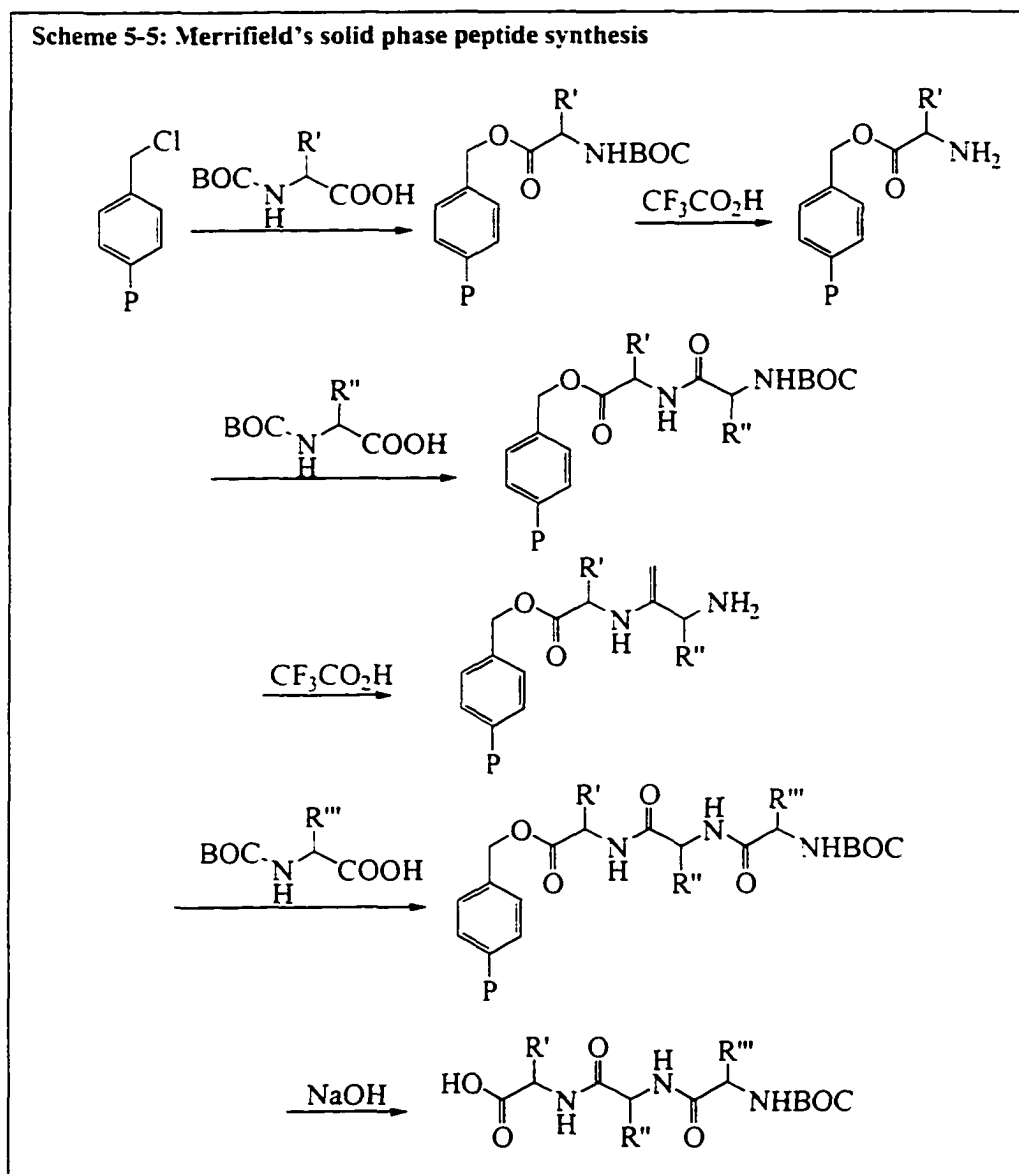

The main advantages of polymer supported organic synthesis¹⁴⁶ over the more classical solution phase synthesis include the following:

- (i) conversion is maximized by using excess reagents

(ii) purification is easy as the product can be separated from excess reagents and by-products by simple filtration and washing with solvents.

The development in solid phase synthesis coupled with the recent advances in robotics and automation, which have made rapid high throughput biological screenings possible, led to the concept of combinatorial chemistry to satisfy the increasing demand for available compounds and structural diversity.

Combinatorial chemistry, defined as “a systematic and repetitive covalent connection of a set of different building blocks of varying structures to each other to yield a large array of diverse molecular entities”,¹⁴⁷ allows for generation of huge libraries of diverse compounds. This methodology was initially developed for synthesis of libraries of peptides,¹⁴⁷ oligonucleotides,¹⁴⁸ polysaccharides,¹⁴⁹ polycarbamates,¹⁵⁰ polyureas,¹⁵¹ and other biopolymers. However, these polymeric compounds have limited pharmaceutical use. This led to the shift in attention towards synthesis of a diverse collection of structurally related non-oligomeric “small” organic molecules via this methodology. Many “small” organic compounds having therapeutic applications have been synthesized using this technique leading to drug discovery (Figure 5-1). Some examples of such compounds include 1,4-benzodiazepines,¹⁵² hydantoins,¹⁵²ⁱⁱⁱ pyrrolidines,¹⁵³ 4-thiazolidinones and 4-metathiazanones.¹⁵⁴

Figure 5-1: Medicinally important "small" organic compounds prepared via combinatorial synthesis

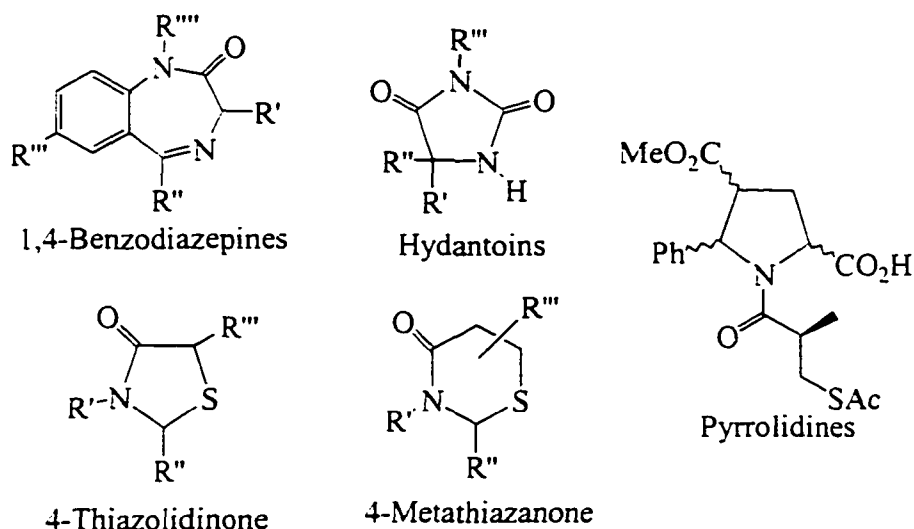

Traditionally, important therapeutic agents are obtained by isolation from their natural animal and plant sources and microbial fermentations, by screening compound databases, and by rational drug design utilizing structure–activity relationships.¹⁵⁵ Once a ‘hit’ is found, it is then synthesized via classical organic synthesis to obtain large quantities of the material. Structural variations are also performed in order to obtain optimum activity. This process of drug discovery is clearly very cumbersome and time consuming. It is here that the concept of combinatorial synthesis gains importance since it allows for the creation of large assemblies of structurally related diverse molecules in a short amount of time which can then be screened via high throughput and automated methods. As a result, the process of drug discovery is made more favorable in terms of time and money.

Ideally, two factors determine the number of possible different compounds, **N**, that one can obtain through a combinatorial approach. These are –

- (i) the number of building blocks in each step, **a**, and
- (ii) the number of synthetic steps in the overall scheme, **m**.

If the synthesis involves an equal number of building blocks in each step, then

$$N = a^m$$

If, on the other hand, each step in the scheme has different number of building blocks (eg. a, b, c in a three step sequence), then

$$N = abc$$

There are two main methodologies used for the simultaneous generation of libraries of diverse compounds, namely –

- (i) solid phase split–mix synthesis, developed by Furka,¹⁵⁶ and
- (ii) multiple parallel synthesis using the ‘pin technology’ first described by Geysen.¹⁵⁷

The first process generates libraries containing a statistical number of different compounds, while the second method forms several individual compounds simultaneously with relatively low randomization.

5-3-1: SOLID PHASE SPLIT – MIX METHOD

This method allows for the construction of molecular assemblies using a strategy that covalently binds the building blocks in all possible combinations. A schematic illustration of this technique is shown in Figure 5-2.

Figure 5-2: Solid phase split-mix method

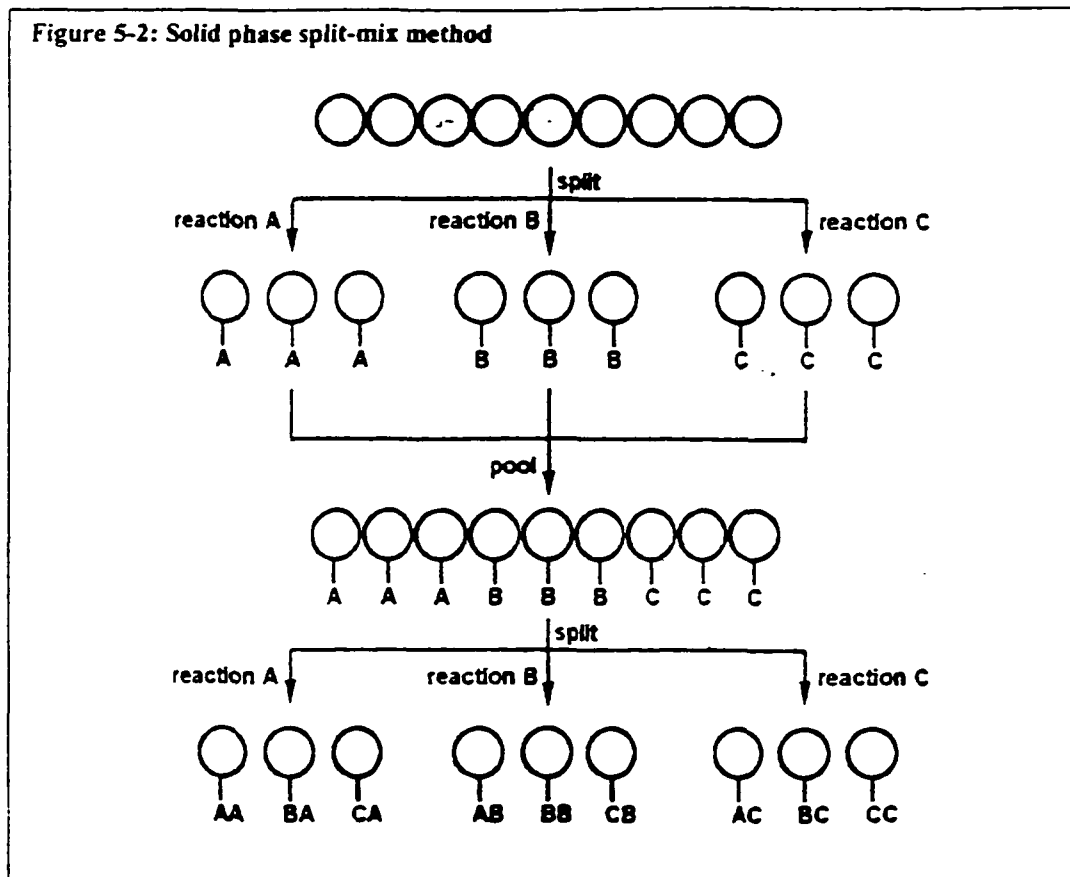

A collection of beads with the desired substrate attached is divided into a specific number of pools. Each of these pools is then treated with specific reagents to attach different building blocks. This is followed by combining all of the separate fractions. The recombined collection is again split into a definite number of portions and each portion is then reacted with the second set of building blocks. This process is repeated, with each portioning–recombining cycle increasing the randomization and diversity of the products obtained. Each bead, however, has only one sequence of building blocks attached to it. Reactions on individual beads can be monitored by a number of spectrometric methods. FT-IR spectroscopy has been useful to monitor resin supported reactions, especially in those instances where a functional group

interconversion or change in hybridization is involved.^{149i, 158} Off-bead¹⁵⁹ and on-bead¹⁶⁰ mass spectrometric microanalysis, including ES-MS, GC-MS, HPLC-MS, and matrix assisted laser desorption/ionization (MALDI) techniques have also been used. Non-destructive gel-phase ¹³C and ¹H NMR techniques using poly(ethyleneglycol)-grafted polystyrene resins as the solid support have also been developed for monitoring reactions on the polymer support.^{161, 162} Look *et al.* have used ¹³C NMR to monitor reactions performed on poly(ethyleneglycol)-grafted polystyrene TentaGel resins using ¹³C enriched building blocks.¹⁶¹

Another method for the purpose of easy identification of the sequence on each bead is the idea of ‘tagging’, as developed by Still.¹⁶³ In this strategy, each synthetic step on a portion of beads is accompanied by or immediately followed by coupling to an identifier tag that encodes both the step number and the chemical reagent used in that step. The analysis of the tags on each bead reflects the sequence of chemical manipulations performed on it. Both chemical and non-chemical tagging agents can be used. Chemical encoding uses oligonucleotides,¹⁶⁴ peptides,¹⁶⁵ halocarbons,¹⁶³ (Figure 5-3) and secondary amines.¹⁶⁶

A rather new technique for generating combinatorial libraries is the “Radiofrequency Encoded Combinatorial (REC) chemistry”, as developed by Nicolaou.¹⁶⁷ This method uses small microelectronic memory semiconductors to record information along a combinatorial synthetic route via remote radiofrequency transmission. This information can be recovered either during or after the synthesis to determine the identity of the compound produced in each microreactor.

Figure 5-3: Halocarbon molecular tags to generate binary synthesis code

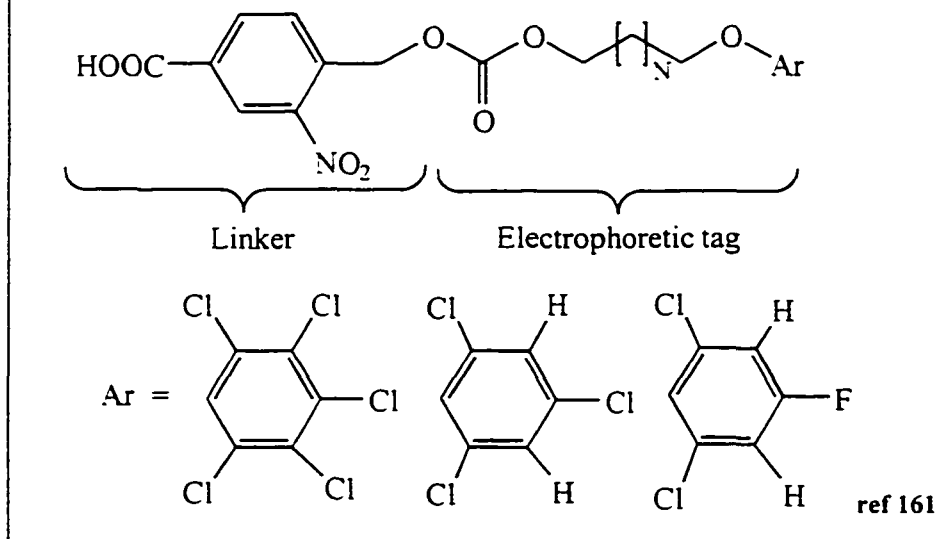

The microreactor used for REC chemistry consists of three parts –

- (i) a porous wall made of polypropylene or fluoropolymer which is chemically inert,
- (ii) polymer resin (25-50mg) on which the reaction occurs, and
- (iii) Single or Multiple Addressable Radiofrequency Tag (SMART)TM semiconductor, protected in a glass encasing, which can receive, store and emit radiofrequency signals.

This method of encoding libraries has advantages over other approaches to determine the structures of the collection of compounds produced because it uses chemically inert radiofrequency signals and micro-memory electronics. Nicolaou and his coworkers have used this methodology to generate a 24-member tetrapeptide library using 96 microreactors via split-mix synthesis.¹⁶⁷ The structures were decoded from the radiofrequency codes and then further established by ES-MS and ¹H NMR. Xiao

et al. used this approach to make a library of taxol derivatives.¹⁶⁸ Ideally, such tagging agents should be unreactive towards the reagents used, should be amenable to high sensitivity detection and decoding, and should have a high information content.

The split-mix technique leads to libraries containing thousands to millions of compounds with very high extent of randomization. However, the amount of each distinct compound obtained is very small.

5-3-2: MULTIPLE PARALLEL SYNTHESIS

This method allows for the target compounds to be simultaneously, but separately, synthesized on a solid support in an array format which uses the 'pin technology' developed by Geysen for multiple parallel synthesis.¹⁵⁷ The two kinds of arrangements used, resin *on* a pin and resin *in* a pin, are shown in Figure 5-4. The sites of reaction are the polypropylene pin-heads (resin *on* a pin) that are immersed into wells containing the desired reagent solutions. Hobbs DeWitt has developed a slight variation of this method by using an apparatus with gas dispersion tubes, called pins, containing the resin on which the reaction occurs (resin *in* a pin).^{152 iii}

The number of distinct compounds obtained via this approach is drastically decreased due to the absence of randomization steps. However, the ability to prepare larger amounts, the ease of monitoring the products, and the determination of the identity of each compound by its position in the apparatus, make this procedure quite attractive.

Figure 5-4: Multiple parallel synthesis

a) Resin on a pin

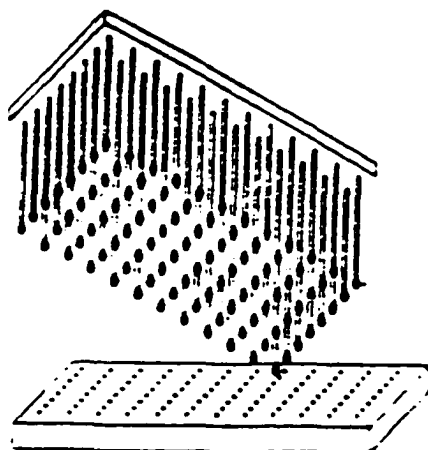

ref 155

b) Resin in a pin

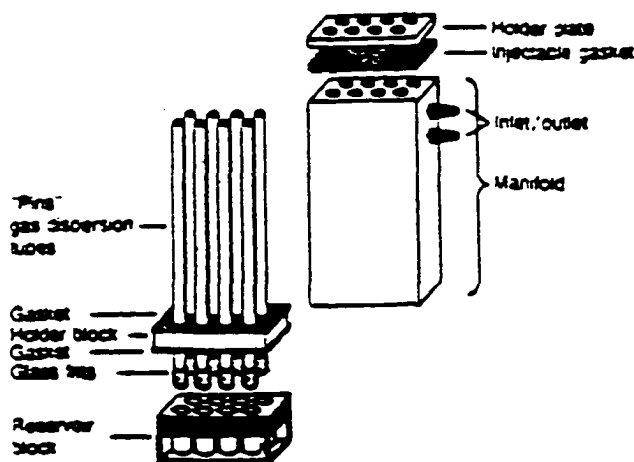

ref 150

Hence, these two techniques differ not only in their experimental arrangements, but also in their outcomes. The split-mix method is useful in cases where an extremely vast library is needed, such as peptides and oligonucleotides. On the other hand, in cases where specific organic molecules are needed for analysis of their biological activities the multiple parallel synthesis is more useful since even by this approach synthesis of several thousand separate compounds is possible.

Another new procedure, double combinatorial chemistry, was recently reported by Nielsen *et al.*¹⁶⁹ Double combinatorial chemistry involves chemically ligating one library of **n** members to another comprising of **m** compounds to yield a new array of **n x m** molecules, thereby causing a tremendous increase in the number of members in the library.

5-3-3: SOLID PHASE SYNTHESIS OF CATALYSTS FOR ASYMMETRIC REACTIONS

Since its initial application for the synthesis of libraries of biopolymers, the technique of combinatorial chemistry has been used in discovering medically important compounds^{152, 169} and catalysts for enantioselective reactions. Ellman first reported the synthesis of a class of 2-pyrrolidinemethanol ligands (Figure 5-5) on the polymer support and demonstrated that these ligands can be used to promote asymmetric addition of diethylzinc to aldehydes.¹⁷⁰

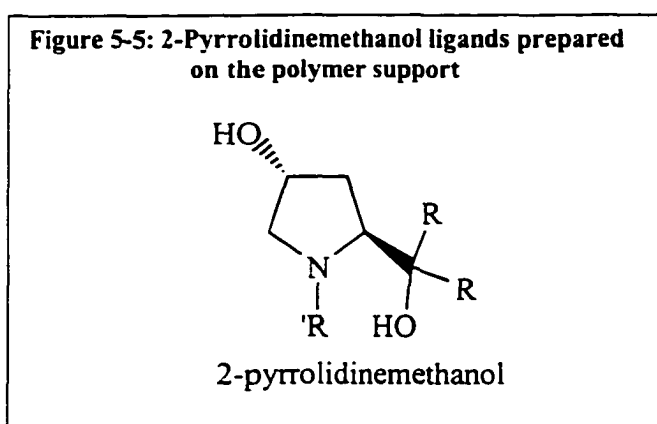

The polymer bound ligands gave comparable enantioselectivities to the free ligands. Enantiomeric excesses of > 80% were observed. Application of this methodology for synthesis of libraries of this ligand class are underway.

Hoveyda *et al.* have used solid phase synthesis to generate a library of dipeptide Schiff's bases *via* the parallel approach (Figure 5-6) and the ligands shown were found to be useful ligands in Ti(IV)-catalyzed asymmetric addition of TMSCN to epoxides, producing cyanohydrins in moderate to good enantioselectivities.¹⁷¹

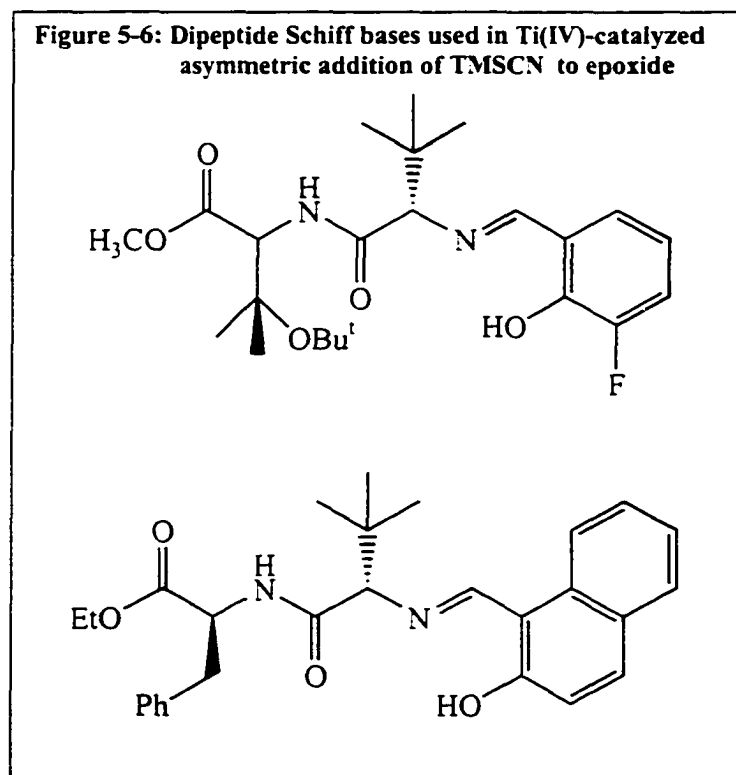

In addition, the split-mix method has been used for the discovery of new metal-ligand complexes,¹⁷² while the multiple parallel approach has been used for determining the most optimum catalysts and conditions for the C-H insertion reactions of carbenes.¹⁷³

Initial results in the synthesis of peptide-derived chiral phosphines via the multiple parallel approach has also been reported recently by Gilbertson.¹⁷⁴ In this report, the authors used the multiple parallel synthetic approach to generate a 63-membered library of chiral phosphines containing peptides (Figure 5-7). These ligands were complexed to Rh(I) while still bound to the solid support and then screened for their activity towards asymmetric hydrogenation of enamides.

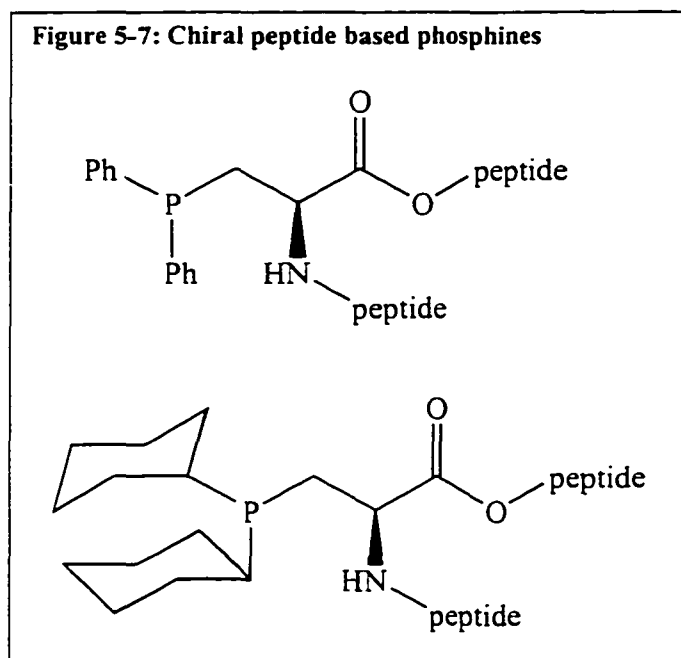

The enantioselectivities obtained were low. However, the feasibility of using this technique for producing libraries of ligands, in particular chiral phosphines, their complexation and subsequent screening towards a reaction without cleaving them from the resin was amply demonstrated.

5-4: PROJECT OBJECTIVES

The goal for this project was to generate moderately sized libraries of mono- and di-phosphines using the multiple parallel methodology. However, a more short-term aim was to develop an efficient and general solution phase route to synthesize a variety of monophosphines which could be effectively translated onto the solid phase synthesis. The approach for the solid phase synthesis was to perform selective nucleophilic substitution reactions on P(III) bound to the polymer in which the more labile group is displaced by the first organometallic reagent used, and the less reactive group is substituted by the second reagent, producing the soluble phosphine and regenerating the polymer (Scheme 5-6).

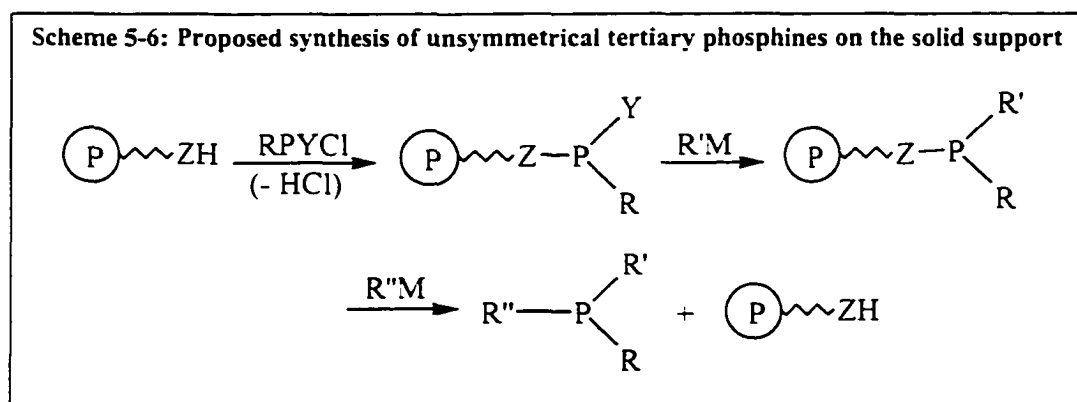

The prerequisite for this scheme to be successful is that the leaving groups, Y and Z, and the two organometallic reagents used, R'M and R''M, should be appreciably different in their reactivities in order to achieve high selectivity. The phosphorus moiety remains bound to the resin until the second alkylation step and allows for easy and effective purification of the reaction products at each stage by simple filtration and washing with the solvent.

Therefore, we first needed to develop an analogous solution phase route for the synthesis of homochiral tertiary phosphines via selective and sequential nucleophilic substitution on a trivalent phosphorus.

Chapter 6

A NOVEL SOLUTION PHASE SYNTHESIS OF UNSYMMETRICAL TERTIARY PHOSPHINES: SELECTIVE NUCLEOPHILIC SUBSTITUTION ON PHOSPHORUS (III)

6-1: INTRODUCTION AND BACKGROUND

As described in the previous chapter, tertiary phosphines have been prepared by four general routes:

- (i) nucleophilic substitution on trivalent phosphorus by organometallic reagents,
- (ii) attack by metal phosphides on electrophilic carbon,
- (iii) reduction of phosphorus (V) oxides, and
- (iv) addition of a P-H unit across a multiple bond.

Of these methods, the first approach is the most convenient for preparing of tertiary phosphines. A range of organometallic reagents, such as Grignard,¹³⁶ organolithium,¹³⁷ organoboron,¹³⁸ organotin,¹³⁹ organolead,¹⁴⁰ and organocadmium reagents¹⁴¹ have been used to displace chloro and alkoxy substituents on trivalent phosphorus compounds to yield the alkylated phosphines. However, the synthesis of unsymmetrical tertiary phosphines via this route has limitations as these reactions suffer from polysubstitution,¹⁴³ require inconvenient organometallic reagents¹⁴² or multiple steps,¹⁴⁴ and require careful control of reaction conditions. The ultimate goal of this project was to develop a polymer-supported synthesis of unsymmetrical tertiary phosphines for the purpose of generating libraries of ligands for homogeneous

catalysis following a multiple-parallel combinatorial synthetic approach. Therefore, the methods mentioned above have only limited application because for a synthesis to be feasible on a solid support the reaction should occur under ambient conditions, the use of excess reagents should be possible, and the reaction should be inherently very selective and efficient. As a result, our first goal was to develop a general and efficient route for the synthesis of tertiary phosphines in the solution phase using readily available reagents which could be easily adapted for synthesis on the polymer support. This chapter will describe our efforts and results towards this objective.

6-2: RESULTS AND DISCUSSION

As described in the literature, P-Cl and P-OR groups are readily displaced by Grignard and organolithium reagents. These organometallic reagents are readily accessible, either commercially or synthetically. Hence, we studied these substitution reactions first to determine the possibility of selective sequential displacement of one leaving group in the presence of the other group. For this purpose, phosphinites and chlorophosphinites were prepared. There is also some literature evidence for the substitution of dialkylamino groups on trivalent phosphorus by Grignard reagents.¹⁷⁵ In these reports, aryl(dialkylamino)phosphines (1) which have an ortho aminoalkyl substituent react with Grignard reagents displacing the dialkylamino group to yield tertiary phosphines (2) (Scheme 6-1). Hence, based on this precedent, we explored the reactivity of N,N-disubstituted aminophosphines towards organometallic reagents. These compounds were prepared following literature procedures.

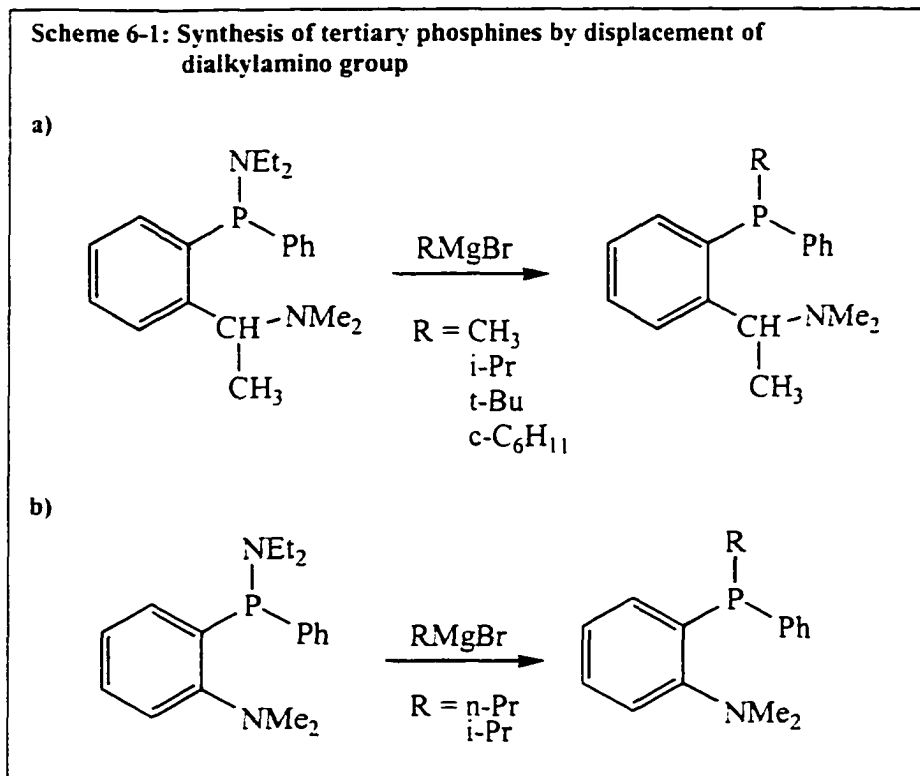

6-2-1: SYNTHESIS OF ETHYL DIPHENYLPHOSPHINITE AND ETHYL CHLOROPHENYLPHOSPHINITE

In order to prepare unsymmetrical tertiary phosphines via sequential displacements of leaving groups on trivalent phosphorus, we investigated the relative labilities of the chloro and alkoxy groups. Ethyl diphenylphosphinite (**3**)¹⁷⁶ was first prepared to determine the conditions required for the displacement of the ethoxy group. It was prepared by literature procedure involving the displacement of chloride from chlorodiphenylphosphine (**4**) by ethanol in the presence of triethylamine (Scheme 6-2). The phosphinite formed was purified by vacuum distillation and was isolated as a colorless liquid.

Scheme 6-2: Synthesis of ethyl diphenylphosphinite

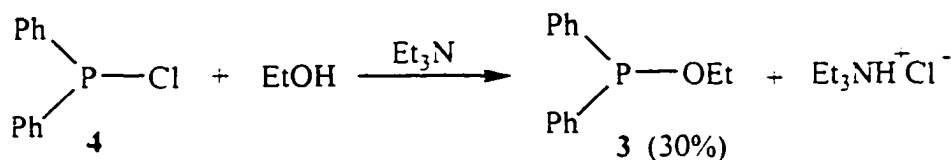

Ethyl chlorophenylphosphinite (**5**) was prepared by three different routes (Scheme 6-3) to establish the most efficient route to it. In the first method, equimolar quantities of dichlorophenylphosphine (**6**) and diethyl phenylphosphinite (**7**) reacted in ether at 0 °C.¹⁷⁷ The second procedure is a modification of that used for the synthesis of **3**. Dichlorophenylphosphine (**6**) reacted with one equivalent of ethanol in the presence of triethylamine. The selective substitution of only one chloro group was facilitated by the slow addition of ethanol at low temperature. The yield of the product obtained at -78 °C was higher than at 0 °C. In another route, dichlorophenylphosphine was treated with NaOEt at -78 °C. This reaction also gave relatively low yields of the desired phosphinite **5**. In all of the attempts, the product was isolated as a clear liquid by vacuum distillation. The chlorophosphinite was characterized by ¹H and ³¹P NMR and mass spectroscopy. Of all the methods described above for the synthesis of ethyl chlorophenylphosphinite, the highest yield was obtained from the disproportionation reaction of dichlorophenylphosphine and diethyl phenylphosphinite. The other routes gave modest yields of the product. All of these reactions require low temperatures for higher selectivity.

Scheme 6-3: Synthesis of ethyl chlorophenylphosphinite

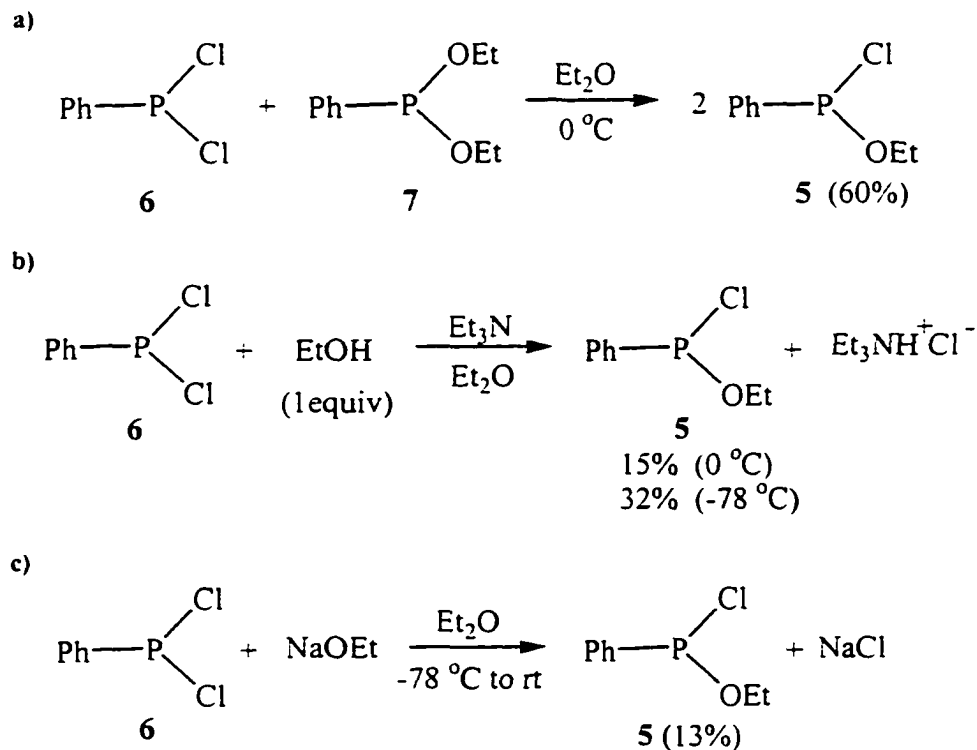

6-2-2: SYNTHESIS OF N,N-DISUBSTITUTED AMINOPHOSPHINES AND AMINOCHLOROPHOSPHINES

Unsymmetrical tertiary phosphines can also be obtained by selective sequential displacement of amide groups and chloride groups from trivalent phosphorus. We investigated the relative leaving group abilities of the P-Cl and P-NR₂ when treated with organometallic reagents. We already know that the displacement of chloride occurs very readily using Grignard and organolithium reagents. In order to determine the conditions required for the displacement of the amide from aminophosphines the N,N-disubstituted aminophosphines, were obtained

by following a literature procedure.¹⁷⁸ Chlorodiphenylphosphine in anhydrous benzene was treated with an excess of the secondary amine at 5-10 °C (Scheme 6-4).

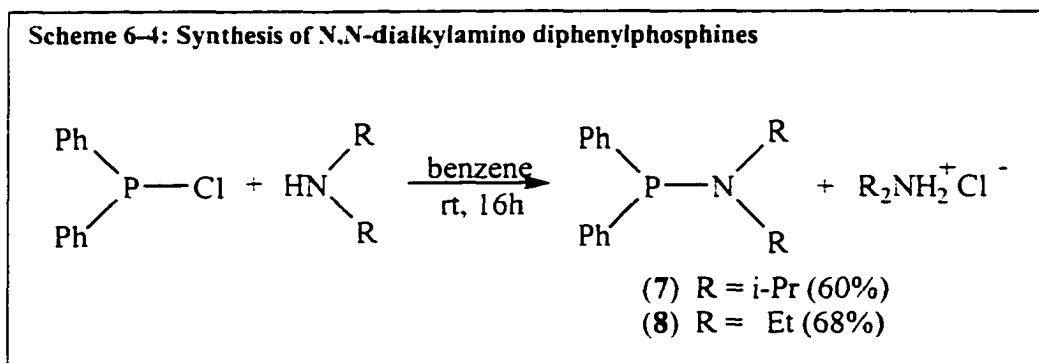

N,N-Diisopropylamino diphenylphosphine (7) and N,N-diethylamino diphenylphosphine (8) were obtained after vacuum distillation of the crude residue. Aminophosphine 7 is a low melting solid. The spectral data for the two compounds correspond to those reported in the literature.

N-Methyl-N-phenylamino diphenylphosphine (9) was also prepared via a known route.¹⁷⁸ N-Methylaniline (10) was deprotonated to form the corresponding lithium-amide salt (11), which was then combined with chlorodiphenylphosphine (Scheme 6-5).

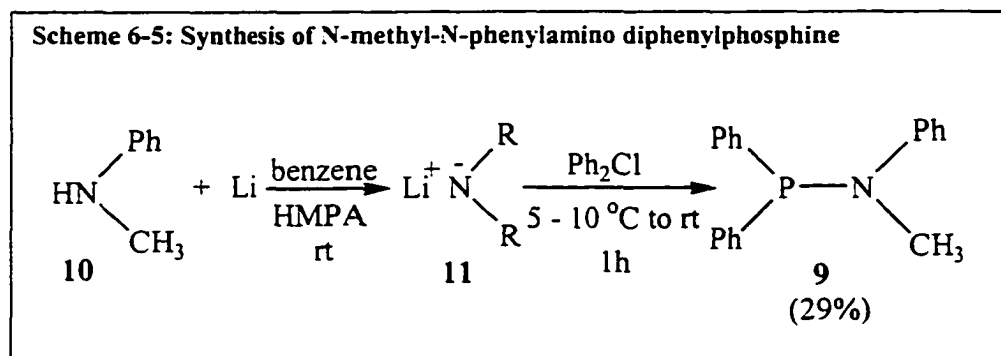

Aminophosphine **9** is a new compound. It was obtained as a white crystalline solid and was characterized spectroscopically. The ^1H NMR spectrum of **9** shows a doublet for the N-CH₃ group (2.60 ppm) due to coupling to the vicinal phosphorus atom. Only one signal is present in the ^{31}P NMR spectrum in the characteristic region for aminophosphines (55.0 ppm). The molecular ion is seen as the base peak in the mass spectrum (m/z 291), confirming the structure of the aminophosphine **9**.

The starting materials required for the investigation of selective nucleophilic substitution on phosphorus to obtain unsymmetrical tertiary phosphines, chloroaminophosphines (**12** and **13**), were prepared by a modification of the procedure used for the synthesis of the aminophosphine **9** (Scheme 6-6).

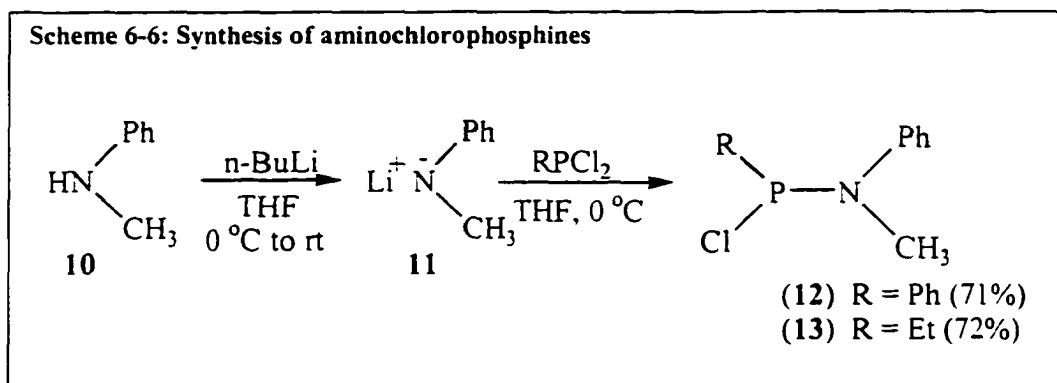

N-Methylaniline was deprotonated and the lithium-amide salt thus formed was then added dropwise to a solution of organodichlorophosphine at 0 °C. The selective substitution of only one chloro group was promoted by the slow addition of the amide reagent at low temperature. The desired chloroaminophosphines **12** and **13** are new compounds and were isolated in good yields as liquids by vacuum distillation of the crude mixture and were characterized by ^1H and ^{31}P NMR and mass spectrometry. These aminochlorophosphines show a doublet for the N-CH₃ protons in the ^1H NMR

spectra due to coupling with the vicinal phosphorus atom. The ^1H NMR spectrum for compound **13** also shows coupling of the CH_2CH_3 methyl protons with phosphorus. The $^{31}\text{P}\{^1\text{H}\}$ NMR spectra give single resonances at very high chemical shifts due to extremely electron withdrawing groups attached to the phosphorus. The mass spectrum (FAB) of **12** shows the molecular ion (m/z 249) with the characteristic chloride pattern.

6-2-3: REACTIONS OF PHOSPHINITES AND CHLOROPHOSPHINITES

WITH GRIGNARD REAGENTS

To prepare unsymmetrical tertiary phosphines in solution by selective stepwise substitution of P-Cl and P-OEt groups, their reactivity towards organometallic reagents was investigated. Ethyl diphenylphosphinite (**3**) reacted with MeMgCl at room temperature to produce methyldiphenylphosphine (**14**) in good yield (Scheme 6-7).

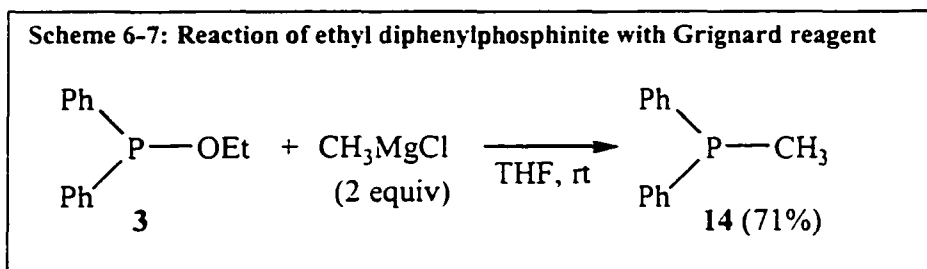

The substitution of the ethoxy group was slow at room temperature as some unreacted phosphinite **3** was present even after 9 h with methyldiphenylphosphine **14**. Complete conversion was obtained after stirring the reaction mixture overnight (21 h). The success of this substitution reaction and the time required for the completion of the reaction suggested the possibility of achieving selective displacement of

chloride in the presence of the alkoxy group. However, chlorophosphinite **5** reacted with one equivalent of MeMgCl at room temperature to give a complex mixture of products, including ethyl methylphenylphosphinite (**15**), the monosubstitution product, and dimethylphenylphosphine (**16**), the disubstitution product (Scheme 6-8), as determined by ^1H and ^{31}P NMR.

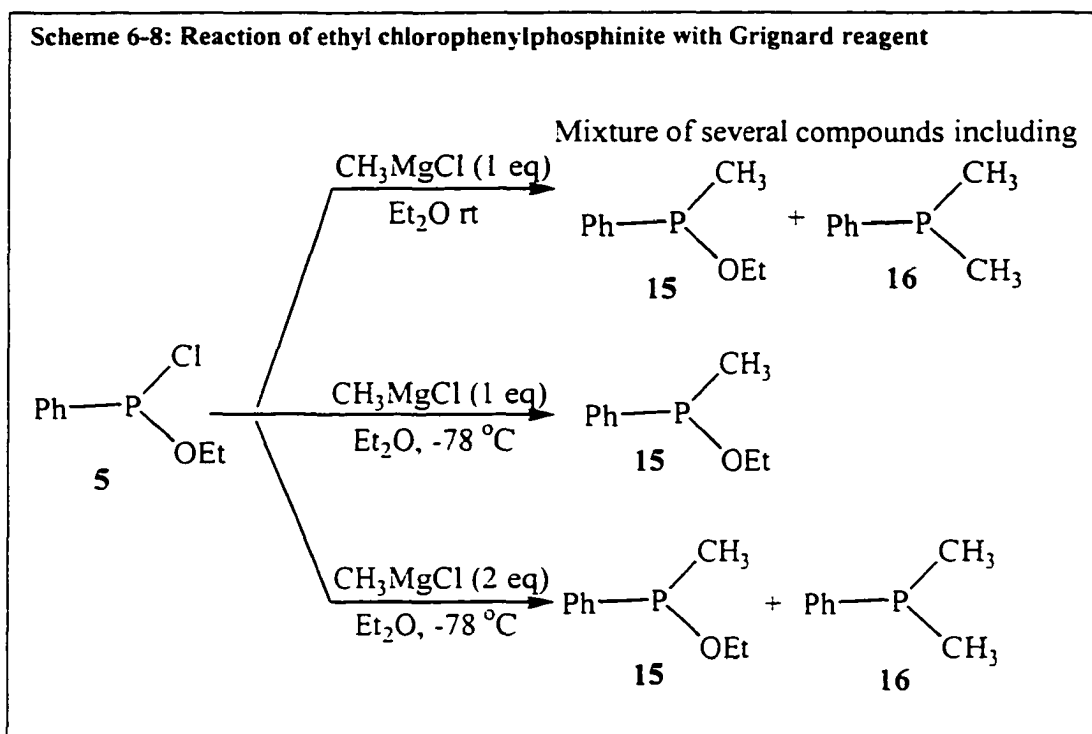

Reaction of chlorophosphinite **5** with one equivalent of MeMgCl at -78°C resulted in the selective formation of the desired monosubstitution product **15**. This selectivity was, however, lost when **5** was treated with two equivalents of the Grignard reagent at low temperature, yielding both mono- and di-substitution products **15** and **16**.

Hence, it is apparent that selective sequential substitution of chloro and alkoxy groups by the use of common organometallic reagents will be possible only with the use of one equivalent of the nucleophilic reagent in the first step at very low

temperature. However, this is not a favorable procedure for solid phase organic synthesis in which the use of excess reagents under ambient conditions is desirable to promote complete conversion. The difference between the leaving group abilities of the chloro and alkoxy substituents is not large enough to allow this. Therefore, extension of this procedure to polymer supports is not expected to be feasible.

6-2-4: REACTIONS OF AMINOPHOSPHINES WITH ORGANOMETALLIC REAGENTS

To explore the reactivity of amino groups bonded to trivalent phosphorus towards organometallic reagents, we studied N,N-dialkyl- and N-methyl-N-phenylaminophosphines. Once general conditions for the substitution of the amino group were determined, selective displacement of chloride in presence of the amino substituent to produce unsymmetrical tertiary phosphines was studied using chloroaminophosphines as the starting material.

A. REACTION OF N,N-DIALKYLAMINO DIPHENYLPHOSPHINES AND N-METHYL-N-PHENYLAMINO DIPHENYLPHOSPHINE WITH ORGANOMETALLIC REAGENTS.

Based on the results provided in the literature report,¹⁷⁵ we studied the reaction of N,N-dialkylaminophosphines **7** and **8** with representative organolithium, Grignard and organoaluminum reagents (Scheme 6-9). These aminophosphines were observed to be unreactive towards all the organometallic reagents used. Reactions

were also attempted at elevated temperatures using excess of the reagent. In all of these cases, the starting aminophosphines were recovered.

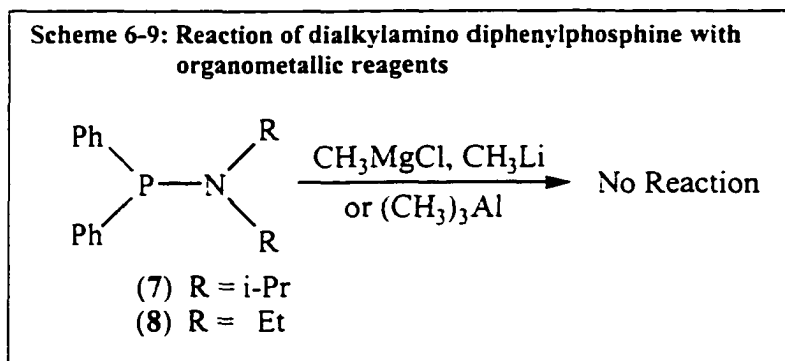

In view of the literature report,¹⁷⁵ the potentially ligating group at the position ortho to the phosphorus appears to be a prerequisite for substitution to occur at phosphorus.

Given the unreactivity of the N,N-dialkylaminophosphines **7** and **8** we decided to study the reaction of N-methyl-N-phenylamino diphenylphosphine (**9**) with organometallic reagents. This aminophosphine was expected to be more reactive because it has a better leaving group, namely N-methylanilide. Aminophosphine **9** reacted with MeMgCl at room temperature, but only slowly, producing the desired methyldiphenylphosphine (**14**) (Scheme 6-10). Complete consumption of the starting material does not occur even upon using a ten-fold excess reagent and heating for two days.

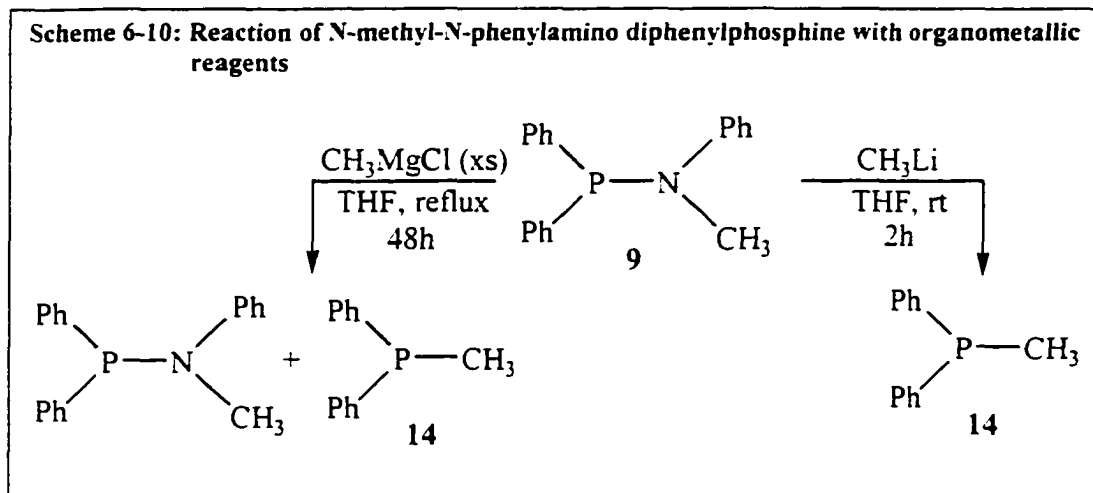

However, reaction of **9** with MeLi proceeded to completion in < 2h at room temperature, yielding the desired phosphine **14** as the only product (Scheme 6-10). This result is significant in that it suggested that we could achieve selective stepwise substitution of the chloro and N-methyl-N-phenylamino groups on trivalent phosphorus using Grignard and organolithium reagents in sequence, under ambient conditions, to yield unsymmetrical tertiary phosphines. A diverse collection of such phosphines could potentially be obtained as a large variety of Grignard and organolithium reagents are readily available.

B. SYNTHESIS OF UNSYMMETRICAL TERTIARY PHOSPHINES: SELECTIVE SEQUENTIAL NUCLEOPHILIC SUBSTITUTION ON PHOSPHORUS (III).

Unsymmetrical tertiary phosphines were prepared by highly selective and sequential nucleophilic substitution reactions on trivalent phosphorus.¹⁷⁹ The chloroaminophosphines **12** and **13** reacted with a range of Grignard reagents (1.5

equiv, THF, 20 °C, 2-3 h) to produce the corresponding aminophosphines (17) in excellent yields and high purity after aqueous workup (Scheme 6-11, Table 6-1).

Scheme 6-11: Synthesis of aminophosphines

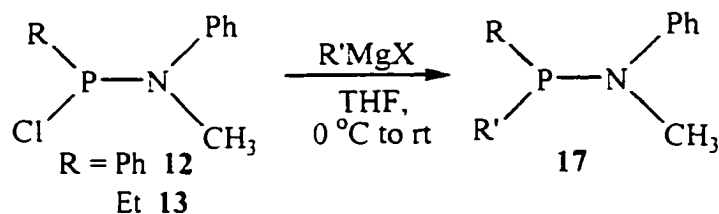

Table 6-1

12/13	R'MgX	17	Yield (%)	$^{31}\text{P}\{^1\text{H}\}$ ppm
12	i-PrMgCl	R = Ph R' = i-Pr a	86	57.4
12	CH ₃ MgCl	R = Ph R' = CH ₃ b	83	42.1
12	MgBr	R = Ph R' = CH=CH ₂ c	95	50.2
12	p-TolMgBr	R = Ph R' = 4-MeC ₆ H ₄ d	94	54.3
12	o-TolMgBr	R = Ph R' = 2-MeC ₆ H ₄ f	96	48.6
12	2,6-Me ₂ C ₆ H ₃ MgBr	R = Ph R' = 2,6-Me ₂ C ₆ H ₃ g	89	49.7
12	TMSCH ₂ MgCl	R = Ph R' = CH ₂ TMS h	87	45.3
13	p-TolMgBr	R = Et R' = 4-MeC ₆ H ₄ i	90	52.0
13	PhCH ₂ MgCl	R = Et R' = CH ₂ Ph j	77	53.7

These new aminophosphines obtained were characterized by ^1H and ^{31}P NMR

spectroscopy. Various substituents, including alkyl, vinyl and aryl, were efficiently incorporated via selective displacement of the chloride.

These aminophosphines, in turn, reacted readily with organolithium reagents in THF at room temperature (2 h) to produce the desired unsymmetrical tertiary phosphines **18** (Scheme 6-12, Table 6-2). References for the previously known tertiary phosphines have been provided in Table 6-2. The products were isolated by precipitating out the lithium N-methylanilide salt produced and unreacted organolithium reagent from a nonpolar solvent (hexane). The isolated yields of the more volatile dialkylarylphosphines were only moderate (Entries **18a-c**). In these cases the separation of the phosphine from the lithium-amide salt was not very effective due to the phosphines being slightly soluble in water and also easily air oxidized. However, diarylalkylphosphines were isolated in high yields, including sterically hindered ones (Entries **18f, g**). The purity of the phosphines obtained was determined by ^1H and ^{31}P NMR spectroscopy and by combustion analysis (for **18f, g**). Phosphine **18h** could not be separated from the byproduct, lithium N-methylanilide salt. Hence, its yield was determined from the ^1H NMR spectrum via integral ratios.

It is also possible to obtain the unsymmetrical tertiary phosphines without isolating the intermediates. Phosphine **18f** was prepared in this way (Scheme 6-13). Commercially available dichlorophenylphosphine was first treated with LiNMePh and then o-tolylMgBr. When the formation of aminophosphine **17f** was complete (1.5 h) the solvent was removed at reduced pressure and the inorganic salts formed and any unreacted Grignard reagent were removed by trituration with benzene.

Scheme 6-12: Synthesis of unsymmetrical tertiary phosphines

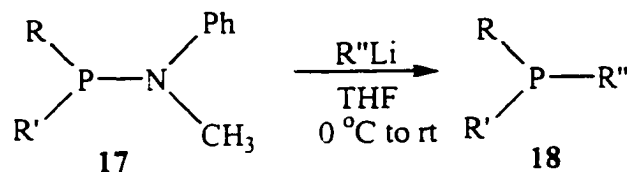
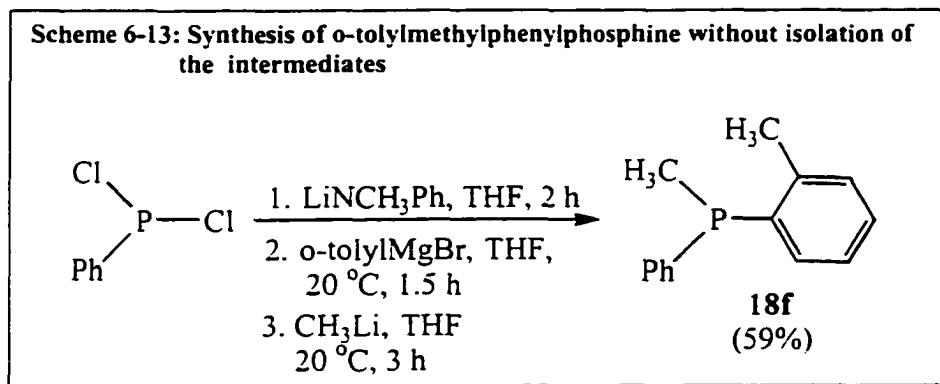

Table 6-2

17	R''Li	18	Yield (%)	³¹ P{ ¹ H} ppm
R = Ph R' = i-Pr a	CH ₃ Li	R = Ph R' = i-Pr R'' = CH ₃ a	16	- 19.7
R = Ph R' = CH ₃ b	t-BuLi	R = Ph R' = CH ₃ R'' = t-Bu b	180 44	- 10.6
R = Ph R' = CH=CH ₂ c	CH ₃ Li	R = Ph R' = CH=CH ₂ R'' = CH ₃ c	181 54	- 31.8
R = Ph R' = 4-MeC ₆ H ₄ d	CH ₃ Li	R = Ph R' = 4-MeC ₆ H ₄ R'' = CH ₃ d	182 95	- 28.5
"	t-BuLi	R = Ph R' = 4-MeC ₆ H ₄ R'' = t-Bu e	76	- 16.3
R = Ph R' = 2-MeC ₆ H ₄ f	CH ₃ Li	R = Ph R' = 2-MeC ₆ H ₄ R'' = CH ₃ f	93	- 36.9
R = Ph R' = 2,6-Me ₂ C ₆ H ₃ g	CH ₃ Li	R = Ph R' = 2,6-Me ₂ C ₆ H ₃ R'' = CH ₃ g	70	- 37.0
R = Ph R' = CH ₂ TMS h	CH ₃ Li	R = Ph R' = CH ₂ TMS R'' = CH ₃ h	98	- 40.6
R = Et R' = 4-MeC ₆ H ₄ i	PhLi	R = Et R' = 4-MeC ₆ H ₄ R'' = Ph i	183 99	- 13.1
R = Et R' = CH ₂ Ph j	PhLi	R = Et R' = CH ₂ Ph R'' = Ph j	184 78	- 14.5

This step was required because otherwise reaction of the aminophosphine 17 with the organolithium reagent did not occur and only unreacted 17 could be isolated from the reaction mixture. The solvent was removed from the benzene solution and the residue was then dissolved in THF. MeLi was then added to yield the phosphine in 59 % overall yield.



6-3: CONCLUSIONS

This chapter describes a novel synthesis of unsymmetrical tertiary phosphines via highly selective sequential nucleophilic substitution reactions on trivalent phosphorus. Chloroaminophosphines (12 and 13) react with Grignard reagents to form the corresponding aminophosphines 17 by substitution of the chloride which then react efficiently with organolithium reagents to produce the tertiary phosphines by displacement of N-methylanilide. These phosphines were obtained in good yields and high purities. In comparison to the prior methods available for synthesis of tertiary phosphines, this route allows for an efficient and general synthesis of unsymmetrical tertiary phosphines using very easily accessible starting materials and reagents. The conditions required are also very mild. Each step is extremely

selective and no polysubstitution is observed even with use of excess of reagents. The reaction times for each stage are short. Hence, this methodology has several obvious advantages over the earlier routes to obtain unsymmetrical tertiary phosphines.

Application of this methodology for the solid phase synthesis of phosphine libraries remains to be investigated. In order to achieve this, the starting chloroaminophosphine (19) will be attached to the polymer. Reaction of this with Grignard reagents will yield the polymer bound aminophosphine (20), which can then react with organolithium reagents to produce the tertiary phosphine (21) and regenerate the original polymer (Scheme 6-14).

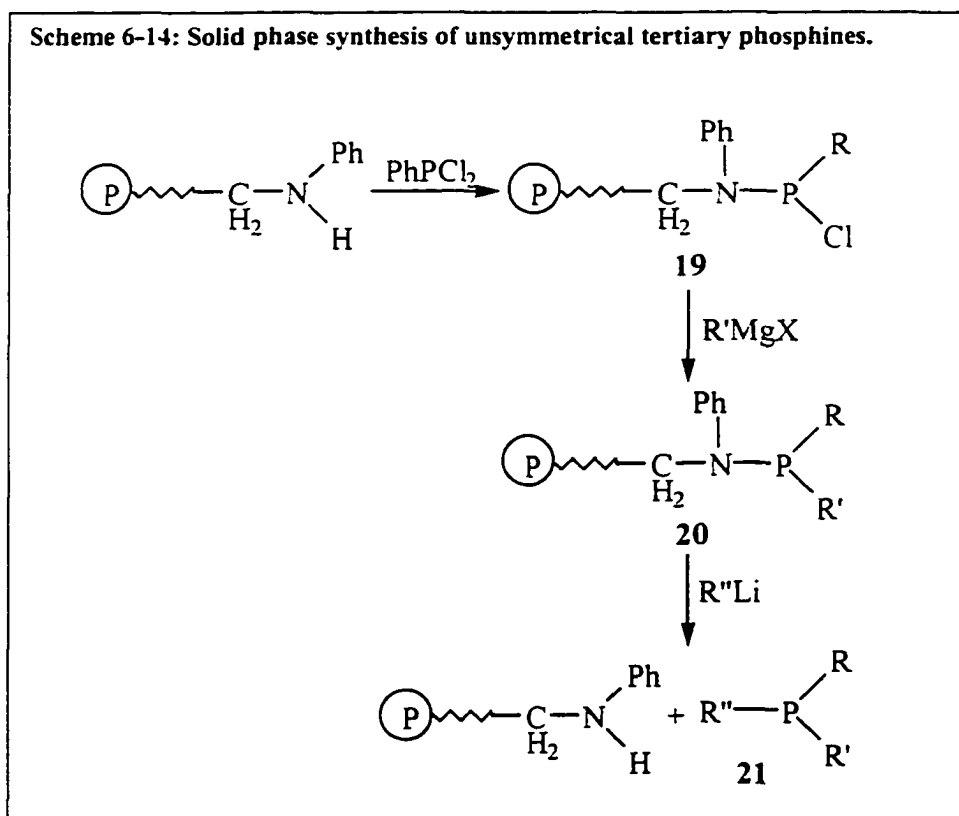

6-4: EXPERIMENTAL SECTION

General: All starting materials were obtained from commercial sources. Diethyl ether, benzene and THF were distilled under nitrogen from sodium and benzophenone. Dichloromethane was distilled under nitrogen from CaH_2 . Anhydrous methanol and DMF were used as provided by Fisher and Aldrich chemical companies, respectively. All air- and moisture-sensitive reactions were performed under nitrogen and all such reagents were handled in the dry box. All the glassware was oven dried and flushed with nitrogen before use.

^1H and ^{31}P NMR spectra were obtained using a Varian XL-300 or Varian Unity Inova-400 instrument. The data is given in units of parts per million (ppm) relative to TMS in ^1H NMR spectra. The residual solvent signals are used for referencing. The signals in the ^{31}P NMR spectra are referenced with respect to H_3PO_4 . The infra-red (IR) data were recorded on a Bio-Rad FTS-7 FT-IR instrument. A Hewlett Packard 5790A gas chromatograph using a 3 m column packed with OV-101 was used. The GC-MS and low resolution EI data were obtained on Hewlett Packard 5985A GC/MS system. The melting points were measured using a Mel-Temp apparatus and the values reported are not calibrated. Elemental analyses were performed at the Midwest Microlab (Indianapolis, IN)

6-4-1: SYNTHESIS OF ETHYL DIPHENYLPHOSPHINITE (3)

Compound 3 has been prepared previously by the route described.¹⁸⁵ Absolute EtOH (10.0 mL) was flushed with nitrogen in a dry round bottom flask. To

this distilled Et₃N (7.58 g, 10.4 mL, 0.075 mol) was added under nitrogen. Chlorodiphenylphosphine (11.0 g, 9.15 mL, 0.050 mol) was added dropwise to this solution at room temperature with stirring. A white solid was formed during this exothermic reaction. The reaction mixture was refluxed for 2 h. After this time the solution was cooled to room temperature and the solid formed was filtered under nitrogen. The solvent was removed from the filtrate under vacuum to yield a pale yellow liquid. The crude residue was distilled under vacuum. The product was obtained as a clear colorless liquid at 108-110 °C (1 mm Hg) in 30% yield (3.50 g, 0.015 mol). ¹H NMR (400 MHz, CDCl₃) δ 1.32 (t, J = 7.2 Hz, 3H), 3.89-3.97 (m, 2H), 7.25-7.40 (m, 6H), 7.45-7.60 (m, 4H); ³¹P{¹H} NMR (162 MHz, CDCl₃) δ 110.2 (literature chemical shift 110.5)¹⁸⁵; IR (nujol) 696, 738, 922, 1046, 1094, 1386, 1435, 1480, 1587, 2876, 2974, 3070, 3090 cm⁻¹; MS (EI, 70eV DIP, m/z, rel. intensity) 230 (M⁺, 34), 201 (100), 77 (17).

6-4-2: SYNTHESIS OF DIETHYL PHENYLPHOSPHINITE (7)

Phosphine **7** is also a known compound.¹⁸⁵ Distilled Et₃N (12.6 g, 17.4 mL, 0.125 mol) and absolute EtOH (30 mL) were added to a dry round bottom flask under nitrogen. To this PhPCl₂ (8.95 g, 6.78 mL, 0.050 mol) was added dropwise at room temperature. This resulted in an exothermic reaction and the formation of a white solid. After the addition of dichlorophenylphosphine was complete, the reaction mixture was refluxed for 2 h. The solution was then cooled, the solid was filtered under nitrogen, and the solvent was removed from the filtrate under vacuum. The pale yellow colored liquid obtained was then distilled under vacuum. The product

was obtained as a clear colorless liquid at 71-72 °C (1 mmHg) in 40% yield (4.03 g, 0.020 mol). ¹H NMR (400 MHz, CDCl₃) δ 1.27 (t, J = 7.0 Hz, 6H), 3.75-3.83 (m, 4H), 3.88-4.00 (m, 4H), 7.30-7.45 (m, 3H), 7.55-7.62 (m, 2H); ³¹P {¹H} NMR (162 MHz, CDCl₃) δ 153.5 (literature chemical shift 153.5).¹⁸⁵

6-4-3: SYNTHESIS OF ETHYL CHLOROPHENYLPHOSPHINITE (5)

The previously prepared chlorophosphinite **5** was obtained *via* the published procedure.¹⁸⁶ Ethyl chlorophenylphosphine (**5**) was prepared by three different routes.

a) A solution of PhPCl₂ (3.58 g, 2.71 mL, 0.020 mol) in Et₂O (15 mL) in a dry flask was cooled in an ice bath. To this a solution of PhP(OEt)₂ (4.02 g, 0.020 mol) in Et₂O (5 mL) was added dropwise with stirring. The reaction mixture was then warmed to room temperature and then stirred for 2 h. The solvent was removed from the reaction mixture under vacuum and the residue was vacuum distilled. The product was obtained as a clear liquid at 68 °C (1 mm Hg) in 60% yield (4.49 g, 0.024 mol). ¹H NMR (400 MHz, C₆D₆) δ 1.51 (t, J = 6.8 Hz, 3H), 4.14-4.31 (m, 2H), 7.60-7.70 (m, 3H), 8.25-8.35 (m, 2H); ³¹P {¹H} NMR (162 MHz, C₆D₆) δ 172.9 (literature chemical shift 177.0),¹⁸⁶ MS (EI, 70eV DIP, m/z, rel. intensity) 188 (M, 14), 190 (M+2, 6), 178 (16), 176 (21), 162 (11), 160 (34), 153 (7), 145 (11), 143 (36), 125 (46), 107 (32), 105 (13), 94 (17), 77 (100), 51 (47), 50 (25), 47 (38).

b) A solution of PhPCl₂ (8.95 g, 6.78 mL, 0.050 mol) and Et₃N (6.06 g, 8.34 mL, 0.060 mol) in Et₂O (25 mL) was cooled in an ice bath to 0 °C. Degassed absolute

EtOH (2.30 g, 2.93 mL, 0.050 mol) was added to this solution dropwise over a 45 minute period with stirring. A white solid formed upon addition of EtOH. The reaction mixture was warmed to room temperature after the addition of EtOH was complete and stirred for 4 h. After this time, the solid formed was filtered and the solvent was removed from the filtrate. The residue was distilled under vacuum to give the product in 15% yield (1.38 g). This procedure when performed at $-78\text{ }^{\circ}\text{C}$ yielded the product in 32% yield. The ^1H and ^{31}P NMR spectra were identical to those reported above.

c) Degassed absolute EtOH (2.30 g, 2.93 mL, 0.050 mol) was mixed with Et_2O (30 mL) in a dry flask under nitrogen. To this freshly cut small pieces of sodium (1.14 g, 0.050 mol) were added with stirring and cooling the flask in an ice bath. Once the exothermic reaction had subsided, the solution was warmed to room temperature and then transferred to a dropping funnel connected to a flask containing PhPCl_2 (8.95 g, 6.78 mL, 0.050 mol) in Et_2O (10 mL) under nitrogen at $-78\text{ }^{\circ}\text{C}$. The NaOEt solution was then added slowly with stirring. After the addition was complete, the reaction mixture was stirred at $-78\text{ }^{\circ}\text{C}$ for 1 h. The solution was warmed to room temperature and was stirred for an additional 2 h. The solid formed was filtered under nitrogen and the solvent was removed from the filtrate under vacuum. The liquid obtained was vacuum distilled to give the product in 14% yield (1.31 g). The spectral data were identical to those obtained above.

6-4-4: SYNTHESIS OF N, N-DIALKYLAMINO DIPHENYLPHOSPHINES (7 AND 8)

The aminophosphines **7** and **8** were prepared by following the published route.¹⁷⁸ Diisopropylamine was distilled over NaOH under nitrogen and diethylamine was distilled over KOH under nitrogen. A solution of R₂NH (R = i-Pr, Et; 0.125 mol) in distilled benzene (70 mL) in a dry flask under nitrogen was cooled using an ice bath to 0-5 °C. To this a solution of Ph₂PCl (9.20 mL, 0.050 mol) in benzene (20 mL) was added dropwise. The reaction mixture was warmed to room temperature and stirred for 16 h. The amine hydrochloride formed was filtered under nitrogen and washed with anhydrous benzene. The solvent was removed from the combined filtrate under vacuum and the pale yellow liquid obtained was distilled at reduced pressure to give the product. The spectral data of the products match with those reported in literature.¹⁷⁸

7) The liquid that distilled under vacuum was a solid at room temperature. Yield 60% (3.65 g, 0.013 mol); mp 52 °C (literature mp 69 °C); ¹H NMR (400 MHz, CDCl₃) δ 1.12 (d, J = 6.6 Hz, 12H), 3.33-3.53 (m, 2H), 7.30-7.40 (m, 6H), 7.50-7.60 (m, 4H); ³¹P{¹H} NMR (162 MHz, C₆D₆) δ 37.2 (literature chemical shift 37.6 ppm); IR (KBr) 699, 744, 849, 868, 966, 1015, 1089, 1154, 1178, 1195, 1309, 1360, 1376, 1386, 1434, 1461, 1478, 1586, 1850, 1966, 3067 cm⁻¹; MS (EI, 70eV DIP, m/z, rel. intensity) 285 (M, 69), 270 (13), 242 (23), 228 (47), 194 (72), 185 (81), 183 (100), 152 (23), 122 (15), 109 (21), 108 (34), 100 (36), 43 (10).

8) The liquid obtained after distillation is unstable to air and to light. Yield 68% (8.75 g, 0.034 mol); ^1H NMR (400 MHz, CDCl_3) δ 0.94 (t, $J = 6.9$ Hz, 6H), 3.02-3.13 (dq, $J = 9.5, 7$ Hz, 4H), 7.30-7.50 (m, 10H); $^{31}\text{P}\{^1\text{H}\}$ NMR (162 MHz, C_6D_6) δ 60.8 (literature chemical shift 61.4 ppm); IR (KBr) 652, 696, 743, 791, 998, 1022, 1068, 1089, 1183, 1197, 1375, 1434, 1461, 1478, 1583, 2855, 2966, 3068 cm^{-1} .

6-4-5: SYNTHESIS OF N-METHYL-N-PHENYLAMINO DIPHENYL-PHOSPHINE (9)

PhNHMe was distilled from KOH under nitrogen before use. In a dry flask, PhNHMe (6.43 g, 6.50 mL, 0.060 mol) and HMPA (10.9 g, 10.6 mL, 0.610 mol) were dissolved in distilled benzene (20 mL) under nitrogen. To this solution small pieces of Li wire (0.400 g, 0.600 mol) were added and the reaction mixture was stirred at room temperature until the Li was consumed. The suspension was cooled to 5-10 $^\circ\text{C}$ using an ice bath. In a separate flask, Ph_2PCl (11.0 g, 9.00 mL, 0.050 mol) was dissolved in benzene (20 mL) under nitrogen. This solution was slowly added to the cooled suspension of the Li-amide reagent with stirring and maintaining the temperature at 5-10 $^\circ\text{C}$. The reaction mixture was warmed to 50 $^\circ\text{C}$ for 1 h to obtain a clear orange solution. After this the reaction mixture was again cooled to 10 $^\circ\text{C}$ and ice (50g) was added slowly. The layers were separated and the aqueous layer was extracted with benzene (2 x 15 mL). The combined organic solution was dried (Na_2SO_4) and the solvent was removed under vacuum. The yellow liquid obtained was triturated with EtOH to produce the white crystalline product in 29% yield (4.21 g, 0.015 mol). mp 53-54 $^\circ\text{C}$. ^1H NMR (300 MHz, C_6D_6) δ 2.60 (d, $J = 1.5$ Hz, 3H),

6.86 (t, $J = 7.2$ Hz, 1H), 7.05-7.12 (m, 5H), 7.20 (d, $J = 7.5$ Hz, 2H), 7.26-7.46 (m, 7H); $^{31}\text{P}\{^1\text{H}\}$ NMR (162 MHz, C_6D_6) δ 55.0; IR (KBr) 697, 740, 751, 866, 1065, 1082, 1178, 1192, 1264, 1284, 1432, 1471, 1496, 1575, 1597, 2816, 2888, 3000, 3060, 3080 cm^{-1} ; MS (EI, 70eV DIP, m/z , rel. intensity) 291 (M, 100), 292 (M+1, 6), 290 (50), 214 (12), 185 (19), 183 (53), 152 (10), 122 (12), 109 (31), 107 (15), 77 (24).

6-4-6: SYNTHESIS OF N-METHYL-N-PHENYLAMINO CHLOROALKYL-PHOSPHINES 12 AND 13

In a dry flask PhNHMe (3.22 g, 3.25 mL, 0.030 mol) was dissolved in distilled THF (5 mL) under nitrogen and the solution was cooled to 0 °C. To this n-BuLi (0.035 mol in hexane) was added slowly and the resulting white suspension was stirred at room temperature for 45 min. The solvent was evaporated and the white solid obtained was dissolved in dry THF (150 mL). This solution was added dropwise to RPCl_2 (R = Ph, Et; 0.025 mol) in THF (20 mL) at 0 °C. The reaction mixture was stirred at room temperature for 2 h. The solvent was removed from the reaction mixture under vacuum and the residue was triturated with distilled CH_2Cl_2 to remove all the inorganic salts formed. These salts were filtered under nitrogen and the solvent was evaporated from the filtrate under vacuum. The crude material was distilled at reduced pressure to produce the products.

12) The product distilled at 115-124 °C (0.4 mm Hg) in 76% yield (4.76 g, 0.019 mol). ^1H NMR (400 MHz, CDCl_3) δ 2.91 (d, $J = 5.6$ Hz, 3H), 7.05-7.15 (m, 1H), 7.30-7.40 (m, 4H), 7.40-7.55 (m, 3H), 7.70-7.80 (m, 2H); $^{31}\text{P}\{^1\text{H}\}$ NMR (162 MHz,

CDCl_3) δ 132.9; MS (EI, 12 eV DIP, m/z, rel. intensity) 249 (M^+ , 100), 251 ($M^+ + 2$, 34), 214 (29), 183 (24), 172 (10), 143 (10), 107 (10).

13) The crude material was quite pure as judged from the ^1H NMR spectrum in 89% yield. Purified product was obtained by distillation at 70-78 °C (0.4 mm Hg) in 72% yield (4.06 g, 0.020 mol). ^1H NMR (400 MHz, CDCl_3) δ 1.12 (td, $J = 19.2, 7.6$ Hz, 3H), 1.96-2.17 (m, 2H), 3.12 (d, $J = 7.2$ Hz, 3H), 7.05-7.35 (m, 5H); $^{31}\text{P}\{^1\text{H}\}$ NMR (162 MHz, CDCl_3) δ 146.3.

6-4-7: REACTION OF PHOSPHINITE 3 WITH ORGANOMETALLIC

REAGENTS

Ethyl diphenylphosphinite (1.00 g, 4.35 mmol) was dissolved in dry THF (8 mL) in a dry flask under nitrogen. To this MeMgCl (3 M in THF, 2.90 mL, 8.70 mmol) was added dropwise at room temperature. The reaction mixture was then stirred at room temperature. Aliquots were withdrawn at regular intervals and worked up by adding a 1 M solution of NH_4Cl and analyzed by ^1H and ^{31}P NMR spectroscopy. The expected product, methyldiphenylphosphine, could be seen along with some unreacted phosphinite 3 even after 9 h. The reaction mixture was stirred under nitrogen overnight (23 h). The reaction mixture was then washed with 1 M NH_4Cl solution (3 x 20 mL) and then with water. The organic layer was dried (MgSO_4) and the solvent was then removed to give the product as a clear colorless liquid in 71% yield (0.620 g, 3.10 mmol). ^1H NMR (400 MHz, CDCl_3) δ 1.61 (d, $J =$

3.6 Hz, 3H), 7.25-7.50 (m, 10H); $^{31}\text{P}\{^1\text{H}\}$ NMR (162 MHz, CDCl_3) δ -27.4 (literature chemical shift -28.0).¹⁸⁵

6-4-8: REACTION OF CHLOROPHOSPHINITE 5 WITH MeMgCl

Ethyl chlorophenylphosphinite (1.31 g, 6.97 mmol) was dissolved in distilled Et_2O (10 mL) in a dry flask at room temperature under nitrogen. A 3 M solution of MeMgCl (2.32 mL, 6.97 mmol) was added dropwise at the specified temperature and the reaction mixture was stirred at that temperature. Aliquots were withdrawn at regular intervals, worked up using a 1 M NH_4Cl solution, and analyzed by NMR spectroscopy for the presence of PhMePOEt (15) and/or PhPMe₂ (16).

15) ^1H NMR (400 MHz, CDCl_3) δ 1.23 (t, $J = 7.0$ Hz, 3H), 1.47 (d, $J = 5.6$ Hz, 3H), 3.65-3.80 (m, 2H), 7.25-7.40 (m, 3H), 7.45-7.60 (m, 2H); $^{31}\text{P}\{^1\text{H}\}$ NMR (162 MHz, CDCl_3) δ 112.6.

16) ^1H NMR (400 MHz, CDCl_3) δ 1.30 (d, $J = 2.2$ Hz, 6H), 7.20-7.40 (m, 5H); $^{31}\text{P}\{^1\text{H}\}$ NMR (162 MHz, CDCl_3) δ -46.0 (literature chemical shift -46.0).¹⁸⁷

6-4-9: REACTION OF N, N-DIALKYLAMINOPHOSPHINES 7 AND 8 WITH ORGANOMETALLIC REAGENTS

In a dry flask the aminophosphine 7 or 8 (5.00 mmol) was dissolved in distilled THF (5 mL) under nitrogen and the required organometallic reagent was added with stirring. The reaction mixture was refluxed for 24 h. Aliquots were analyzed by NMR spectroscopy at regular intervals for the presence of

methyldiphenylphosphine. No reaction was observed and only the aminophosphine was seen.

6-4-10: REACTION OF N-METHYL-N-PHENYLAMINOPHOSPHINE 9 WITH ORGANOMETALLIC REAGENTS

a) The aminophosphine **9** (1.46 g, 5.00 mmol) was dissolved in distilled THF (5 mL) in a dry flask under nitrogen. To this MeMgCl (3 M in THF, 2.50 mL, 7.50 mmol) was added at room temperature and stirred. An aliquot analyzed after 3 h showed only the starting material in the ^1H NMR spectrum. The reaction mixture was refluxed and monitored at regular intervals. No conversion was observed after 3 h of refluxing. Additional MeMgCl (4.00 mL, 12.0 mmol) was added and continued to reflux. The reaction mixture was cooled after a total of 47 h of heating and Et₂O was added. This was washed with 1 M NH₄Cl solution. The organic layer was dried (MgSO₄) and the solvent was then removed. The crude material was analyzed by NMR spectroscopy which showed the presence of the unreacted aminophosphine **9** as the major component and methyldiphenylphosphine as the major product.

b) The aminophosphine **9** (0.730 g, 2.50 mmol) was dissolved in distilled THF (5 mL) in a dry flask under nitrogen. To this was added MeLi (1.4 M in THF, 17.86 mL, 25.00 mmol) at room temperature. The reaction mixture immediately turned yellow. It was stirred and an aliquot was taken after 2.5 h and worked up using 1 M NH₄Cl solution as described above. The sample was analyzed by ^1H and ^{31}P NMR spectroscopy, both of which showed only the product **14** and no starting material **9**.

6-4-11: REACTION OF N-METHYL-N-PHENYLAMINO CHLORO- PHOSPHINES 12 AND 13 WITH GRIGNARD REAGENTS

To a stirred solution of the chloroaminophosphines 12 or 13 in THF (1 M) at 0 °C was added 1.5 equiv of the required Grignard reagent. The reaction mixture was then warmed to room temperature and stirred until all of the starting material had reacted (as determined by ^1H and ^{31}P NMR spectroscopy; 2-3 h). The solution was then cooled in an ice bath and a 1M NH_4Cl solution was slowly added for complete neutralization. The organic layer was separated, dried over Na_2SO_4 , and the solvent was removed under vacuum to produce the pure intermediate aminophosphines 17 as pale yellow liquids in very high yields which were used in the next step without further purification.

17a) Yield 86%; ^1H NMR (400 MHz, CDCl_3) δ 1.11 (dd, $J = 6.8, 2.0$ Hz, 3H), 1.15 (dd, $J = 6.9, 3.0$ Hz, 3H), 2.48-2.62 (m, 1H), 2.75 (d, $J = 1.6$ Hz, 3H), 7.10-7.60 (m, 10H); $^{31}\text{P}\{^1\text{H}\}$ NMR (162 MHz, CDCl_3) δ 57.4.

17b) Yield 83%; ^1H NMR (400 MHz, CDCl_3) δ 1.59 (d, $J = 6.8$ Hz, 3H), 2.83 (d, $J = 2.0$ Hz, 3H), 7.22-7.40 (m, 10H); $^{31}\text{P}\{^1\text{H}\}$ NMR (162 MHz, CDCl_3) δ 42.1.

17c) Yield 95%; ^1H NMR (400 MHz, CDCl_3) δ 2.90 (d, $J = 2.0$ Hz, 3H), 5.85 (ddd, $J = 18.4, 14.2, 2.2$ Hz, 1H), 6.01 (ddd, $J = 32.1, 11.8, 2.0$ Hz, 1H), 6.62 (ddd, $J = 18.6, 11.9, 14.0$ Hz, 1H), 7.20-7.50 (m, 10H); $^{31}\text{P}\{^1\text{H}\}$ NMR (162 MHz, CDCl_3) δ 50.2; IR

(neat) 694, 747, 863, 991, 1027, 1066, 1084, 1177, 1274, 1495, 1597, 1577, 2809, 2890, 2950, 3066 cm^{-1} .

17d) Yield 94%; ^1H NMR (400 MHz, CDCl_3) δ 2.37 (s, 3H), 2.83 (d, $J = 2.0$ Hz, 3H), 7.10-7.50 (m, 14H); $^{31}\text{P}\{^1\text{H}\}$ NMR (162 MHz, CDCl_3) δ 54.3; IR (neat) 679, 693, 749, 807, 860, 992, 1026, 1967, 1089, 1185, 1265, 1434, 1577, 1596, 1652, 2810, 2877, 3065 cm^{-1} .

17f) Yield 96%; ^1H NMR (400 MHz, CDCl_3) δ 2.19 (s, 3H), 2.74 (d, $J = 2.0$ Hz, 3H), 6.82 (m, 1H), 7.05-7.41 (m, 13H); $^{31}\text{P}\{^1\text{H}\}$ NMR (162 MHz, CDCl_3) δ 48.6; IR (neat) 668, 692, 717, 748, 800, 860, 992, 1027, 1085, 1176, 1264, 1434, 1559, 1596, 1652, 1699, 2810, 2884, 2938, 3056 cm^{-1} .

17g) Yield 89%; ^1H NMR (400 MHz, CDCl_3) δ 2.19 (s, 6H), 2.86 (d, $J = 1.6$ Hz, 3H), 6.80-7.40 (m, 13H); $^{31}\text{P}\{^1\text{H}\}$ NMR (162 MHz, CDCl_3) δ 49.7; IR (neat) 690, 754, 808, 860, 1025, 1076, 1263, 1447, 1489, 1596, 1943, 2810, 2960, 3052 cm^{-1} .

17h) Yield 87%; ^1H NMR (400 MHz, CDCl_3) δ 0.02 (s, 9H), 1.07 (dd, $J = 14.0, 8.4$ Hz, 1H), 1.47 (d, $J = 14.0$ Hz, 1H), 2.66 (d, $J = 2.4$ Hz, 3H), 7.10-7.35 (m, 10H); $^{31}\text{P}\{^1\text{H}\}$ NMR (162 MHz, CDCl_3) δ 45.3; IR (neat) 693, 744, 783, 865, 992, 1027, 1067, 1083, 1179, 1249, 1267, 1433, 1495, 1576, 1596, 2811, 2896, 2951, 3068 cm^{-1} .

17i) Yield 90%; ^1H NMR (400 MHz, CDCl_3) δ 1.14 (td, $J = 17.2, 7.6$ Hz, 3H), 1.90 (m, 1H), 2.10 (m, 1H), 2.33 (s, 3H), 2.80 (d, $J = 2.0$ Hz, 3H), 6.80-7.50 (m, 9H); $^{31}\text{P}\{^1\text{H}\}$ NMR (162 MHz, CDCl_3) δ 52.0; IR (neat) 657, 691, 751, 804, 862, 991, 1028, 1067, 1083, 1184, 1278, 1456, 1576, 1597, 2810, 2878, 2927, 2954, 3010, 3028 cm^{-1} .

17j) Yield 77%; ^1H NMR (400 MHz, CDCl_3) δ 1.00 (td, $J = 16.8, 7.8$ Hz, 3H), 1.40-1.53 (m, 1H), 1.80-1.90 (m, 1H), 2.82-2.89 (m, 2H), 2.98 (d, $J = 2.0$ Hz, 3H), 6.70-7.30 (m, 10H); $^{31}\text{P}\{^1\text{H}\}$ NMR (162 MHz, CDCl_3) δ 53.7.

6-4-12: REACTION OF AMINOPHOSPHINES 17 WITH ORGANOLITHIUM REAGENTS: SYNTHESIS OF UNSYMMETRICAL TERTIARY PHOSPHINES 18

To a solution of **17** in THF (1 M) at 0 °C was slowly added 1.5 equiv of the required organolithium reagent. The reaction mixture was then warmed to room temperature and stirred until the reaction was complete as indicated by ^1H and ^{31}P NMR spectroscopy. The solvent was then evaporated under vacuum from the reaction mixture and hexane (30-40 mL) was added under nitrogen. After stirring this for a few minutes, the solid formed was filtered and the solvent was removed from the filtrate under vacuum to yield the pure phosphines.

18a) Yield 16%; ^1H NMR (300 MHz, CDCl_3) δ 0.92 (dd, $J = 14.8, 7.2$ Hz, 3H), 1.04 (dd, $J = 13.8, 6.9$ Hz, 3H), 1.28 (d, $J = 3.0$ Hz, 3H), 1.77 (m, 1H), 7.27-7.57 (m, 5H);

$^{31}\text{P}\{^1\text{H}\}$ NMR (162 MHz, CDCl_3) δ -19.7; MS (12 eV GC-MS, m/z, rel. intensity) 166 (M, 100), 167 (M+2, 10), 151 (6), 124 (80), 123 (6), 108 (3).

18b) Yield 44%, ^{180}H NMR (400 MHz, CDCl_3) δ 0.94 (d, J = 12.0 Hz, 9H), 1.29 (d, J = 4.0 Hz, 3H), 7.30-7.50 (m, 5H); $^{31}\text{P}\{^1\text{H}\}$ NMR (162 MHz, CDCl_3) δ -10.6; MS (12eV GCMS, m/z, rel. intensity) 180 (M^+ , 40), 181 (M^++1 , 4), 124 (100).

18c) Yield 54%, ^{181}H NMR (400 MHz, CDCl_3) δ 1.39 (d, J = 2.8 Hz, 3H), 5.61 (ddd, J = 18.4, 13.0, 2.0 Hz, 1H), 5.77 (ddd, J = 28.8, 11.9, 2.0 Hz, 1H), 6.42 (ddd, J = 18.4, 14.2, 11.8 Hz, 1H), 7.25-7.50 (m, 5H); $^{31}\text{P}\{^1\text{H}\}$ NMR (162 MHz, CDCl_3) δ -31.8.

18d) Yield 95%, ^{182}H NMR (300 MHz, CDCl_3) δ 1.59 (d, J = 3.6 Hz, 3H), 2.34 (s, 3H), 7.10-7.60 (m, 9H); $^{31}\text{P}\{^1\text{H}\}$ NMR (162 MHz, CDCl_3) δ -28.5.

18e) Yield 76%; ^1H NMR (400 MHz, CDCl_3) δ 1.15 (d, J = 12.4 Hz, 9H), 2.34 (s, 3H), 7.15 (d, 2H), 7.30 (m, 3H), 7.40-7.60 (m, 4H); $^{31}\text{P}\{^1\text{H}\}$ NMR (162 MHz, CDCl_3) δ 16.3; IR (neat) 698, 744, 806, 1025, 1091, 1180, 1268, 1362, 1394, 1434, 1496, 1597, 2862, 2852, 3020, 3070 cm^{-1} .

18f) Yield 93%; ^1H NMR (400 MHz, CDCl_3) δ 1.56 (d, J = 4.0 Hz, 3H), 2.36 (s, 3H), 7.10-7.40 (m, 9H); $^{31}\text{P}\{^1\text{H}\}$ NMR (162 MHz, CDCl_3) δ -36.9; IR (neat) 668,

696, 716, 744, 880, 1027, 1132, 1267, 1379, 1434, 2967, 3055 cm^{-1} ; Elemental analysis ($\text{C}_{14}\text{H}_{15}\text{P}$) Calculated C, 78.49%; H, 7.06%; P, 14.45%; Found C, 77.15%; H, 7.08%; P, 15.77%.

18g) Yield 70%; ^1H NMR (400 MHz, CDCl_3) δ 1.73 (d, J = 4.8 Hz, 3H), 2.35 (s, 6H), 7.00-7.30 (m, 8H); $^{31}\text{P}\{^1\text{H}\}$ NMR (162 MHz, CDCl_3) δ -37.0; IR (neat) 694, 743, 772, 874, 905, 1027, 1124, 1377, 1454, 1585, 2852, 2923, 2965, 3053 cm^{-1} ; Elemental analysis ($\text{C}_{15}\text{H}_{17}\text{P}$) Calculated C, 78.92%; H, 7.51%; P, 13.57%; Found C, 78.62%; H, 7.66%; P, 13.72%.

18h) Yield 98%; ^1H NMR (400 MHz, CDCl_3) δ 0.01 (s, 9H), 0.91 (dd, J = 13.6, 2.2 Hz, 1H), 1.01 (dd, J = 13.6, 2.2 Hz, 1H), 1.29 (d, J = 3.2 Hz, 3H), 7.25-7.40 (m, 5H); $^{31}\text{P}\{^1\text{H}\}$ NMR (162 MHz, CDCl_3) δ -40.6; IR (neat) 695, 745, 838, 855, 883, 1042, 1087, 1179, 1249, 1317, 1419, 1434, 1507, 1604, 2815, 2900, 2955, 3062 cm^{-1} .

18i) Yield 99%, 183 ^1H NMR (400 MHz, CDCl_3) δ 1.06 (td, J = 16.8, 7.6 Hz, 3H), 2.01 (apparent quartet, J = 7.7 Hz, 2H), 2.33 (s, 3H), 7.10-7.50 (m, 9H); $^{31}\text{P}\{^1\text{H}\}$ NMR (162 MHz, CDCl_3) δ -13.1.

18j) Yield 78%, 184 ^1H NMR (400 MHz, CDCl_3) δ 0.98 (td, J = 16.0, 7.7 Hz, 3H), 1.60-1.74 (m, 2H), 2.99 (apparent doublet, J = 13.2 Hz, 1H), 3.04 (apparent doublet, J = 13.2 Hz, 1H), 7.00-7.60 (m, 10H); $^{31}\text{P}\{^1\text{H}\}$ NMR (162 MHz, CDCl_3) δ -14.5.

6-4-13: SYNTHESIS OF PHOSPHINE **18f** WITHOUT ISOLATION OF INTERMEDIATES

In a dry flask PhMeNLi (5.00 mmol) was prepared in distilled THF (30 mL) as described earlier. This was added to PhPCl₂ (0.910 g, 0.690 mL, 5.10 mmol) slowly with cooling (see 6-4-6). When the starting material was consumed (2 h, by NMR), o-tolylMgBr (2 M in Et₂O; 3.75 mL, 7.50 mmol) was added at 0 °C and the reaction mixture was warmed to room temperature. When the aminochlorophosphine was consumed (1.5 h by NMR) the solvent was removed under vacuum and the residue was triturated with distilled benzene (50 mL) under nitrogen. The solvent from the filtrate was evaporated and the residue obtained was dissolved in dry THF (10 mL). To this MeLi (1.4 M in Et₂O; 21.4 mL, 30.0 mmol) was added at 0 °C and then stirred at room temperature for 3 h. The phosphine **18f** was then isolated as described for the preparation of **18** above in 59 % yield and characterized.

REFERENCES

- i. a) Burger, A. *Medicinal Chemistry*; Wiley-Interscience: New York, 1970; Vol II, pp 1330-1350.
b) Burger, A. *Medicinal Chemistry*; Wiley-Interscience: New York, 1970; Vol II, pp 1019-1064.
2. a) *Handbook of Antibiotic Compounds*; CRC Press: Boca Raton, FL, 1982; Vol 1.
b) Kennedy, J. F.; White, C. A. *Bioactive Carbohydrates: In Chemistry, Biochemistry and Biology*; Halstead Press: Chichester, 1983; Chapter 12, pp 264-287.
3. a) Rutledge, T. F. *Acetylenic Compounds: Preparation and Substitution Reactions*; Rheinhold: New York, 1968; pp 314-331.
b) Burger, A. *Medicinal Chemistry*; Wiley-Interscience: New York, 1970; Vol II, pp 1041-1042.
4. a) *Surfactant Science and Technology*; VCH Publication: Weinheim, 1988; pp 20, 62-67.
b) *Kirk-Othmer Concise Encyclopedia of Chemical Technology*; Grayson, M., Ed.; Wiley and Sons: New York, 1985; pp 82-87.
5. a) Tani, K.; Yamagata, T.; Akutagawa, S.; Kumobayashi, H.; Taketomi, T.; Takaya, H.; Miyashita, A.; Noyori, R.; Otsuka, S. *J. Am. Chem. Soc.* **1984**, *106*, 5208.

- b) Inoue, S.; Takaya, H.; Tani, K.; Otsuka, S.; Sato, T.; Noyori, R. *J. Am. Chem. Soc.* **1990**, *112*, 4897.
6. Nagarajan, S.; Ganem, B. *J. Org. Chem.* **1987**, *52*, 5044.
7. Burgess, K.; Ohlmeyer, M. J. *J. Org. Chem.* **1991**, *56*, 1027.
8. Burgess, K.; Liu, L. T.; Pal, B. *J. Org. Chem.* **1993**, *58*, 4758.
9. Krysan, D. J.; Rockway, T. W.; Haight, A. R. *Tetrahedron: Asymmetry* **1994**, *5*, 625.
10. Adam, W.; Brunker, H. –G. *J. Am. Chem. Soc.* **1993**, *115*, 3008.
11. a) Luly, J. R.; Dellaria, J. F.; Plattner, J. J.; Soderquist, J. L. *J. Org. Chem.* **1987**, *52*, 1487.
- b) Roush, W. R.; Straub, J. A.; Brown, R. J. *J. Org. Chem.* **1987**, *52*, 5127.
12. a) Overman, L. E.; McCready, R. J. *Tetrahedron Lett.* **1982**, *25*, 4887.
- b) Parker, K. A.; O'Fee, R. *J. Am. Chem. Soc.* **1983**, *105*, 654.
- c) Tamaru, Y.; Harayama, H.; Bando, T. *J. Chem. Soc., Chem. Commun.* **1993**, 1601.
13. Mitsunobu, O. *Synthesis* **1981**, 1.
14. Sen, S. E.; Roach, S. L. *Synthesis* **1995**, 756.
15. a) Overman, L. E. *J. Am. Chem. Soc.* **1976**, *98*, 2901.
- b) Clizbe, L. A.; Overman, L. E. *Org. Synth.* **1978**, *58*, 4.
16. a) Overman, L. E.; Zipp, G. G. *J. Org. Chem.* **1997**, *62*, 2288.
- b) Metz, P.; Mues, C.; Schoop, A. *Tetrahedron* **1992**, *48*, 1071.
17. Danishefsky, S.; Lee, J. Y. *J. Am. Chem. Soc.* **1989**, *111*, 4829.
18. a) Nayyar, N. K.; Reddy, M. M.; Iqbal, J. *Tetrahedron Lett.* **1991**, *32*, 6965.

- b) Mukhopadhyaya, M.; Reddy, M. M.; Maikap, G. C.; Iqbal, J. *J. Org. Chem.* **1995**, *60*, 2670.
19. a) Gibson, M. S.; Bradshaw, R. W. *Angew. Chem. Int. Ed. Engl.* **1968**, *80*, 986.
- b) Osby, J. O.; Martin, M. G.; Ganem, B. *Tetrahedron Lett.* **1984**, *25*, 2093.
- c) Sasaki, T.; Minamoto, K.; Itoh, H. *J. Org. Chem.* **1978**, *84*, 2320.
20. van Benthem, R. A. T. M.; Michels, J. J.; Hiemstra, H.; Speckamp, W. N. *Synlett.* **1994**, 368.
21. a) Godlesky, S. A. In *Comprehensive Organic Synthesis*; 1st ed.; Semmelhack, M. F., Ed.; Pergamon Press: New York, 1991; Vol. 4, p 585.
- b) Trost, B. M. *Angew. Chem.* **1989**, *101*, 119.
22. Trost, B. M.; van Vramken, D. L. *Chem. Rev.* **1996**, *96*, 395.
23. a) Hayashi, T.; Yamamoto, A.; Ito, Y.; Nishioka, E.; Miura, H.; Yanagi, K. *J. Am. Chem. Soc.* **1989**, *111*, 6301.
- b) von Matt, P.; Loiseleur, O.; Koch, G.; Pflatz, A.; Lefeber, C.; Feucht, T.; Helmchen, G. *Tetrahedron: Asymmetry* **1994**, *5*, 573.
- c) Togni, A.; Burckhardt, U.; Gramlich, V.; Pregosin, P. S.; Salzmann, R. *J. Am. Chem. Soc.* **1996**, *118*, 1031.
- d) Burckhardt, U.; Baumann, M.; Trabesinger, G.; Gramlich, V.; Togni, A. *Organometallics* **1997**, *16*, 5252.
- e) Trost, B. M.; Bunt, R. C. *J. Am. Chem. Soc.* **1994**, *116*, 4089.
- f) Trost, B. M.; Radinov, R. *J. Am. Chem. Soc.* **1997**, *119*, 5962.
24. Baruah, J. B.; Samuelson, A. G. *Tetrahedron* **1991**, *47*, 9449.

25. a) Enders, D.; Finkam, M. *Synlett*. **1993**, 401.
b) Enders, D.; Jandeleit, B.; von Berg, S. *Synlett*. **1997**, 421.
c) Silverman, G. S.; Strickland, S.; Nicholas, K. M. *Organometallics* **1986**, *5*, 2117.
26. a) Besson, L.; Gore, J.; Cases, B. *Tetrahedron Lett.* **1995**, *36*, 3857.
b) Baker, R.; Onions, A.; Popplestone, R. J.; Smith, T. N. *J. Chem. Soc., Perkin Trans. 2* **1975**, 1133.
c) Grigg, R.; Sridharan, V.; Xu, L. -H. *J. Chem. Soc., Chem. Commun.* **1995**, 1903.
d) Gasc, M. B.; Lattes, A.; Perie, J. J. *Tetrahedron* **1983**, *39*, 703.
e) Kiji, J.; Sasakawa, E.; Yamamoto, K.; Furukawa, J. *J. Organomet. Chem.* **1974**, *77*, 125.
f) Prinz, T.; Keim, W.; Driessen-Hölscher, B. *Angew. Chem., Int. Ed. Engl.* **1996**, *35*, 1708.
27. Grasselli, R. K. *J. Chem. Educ.* **1986**, *63*, 216.
28. Parshall, G. W.; Ittel, S. D. *Homogeneous Catalysis* 2nd ed.; Wiley-Interscience: New York Publication, 1992; p 42.
29. Sharpless, K. B.; Patrick, D. W.; Truesdale, L. K.; Biller, S. A. *J. Am. Chem. Soc.* **1975**, *97*, 2305.
30. a) Sharpless, K. B.; Hori, T.; Truesdale, L. K.; Dietrich, C. O. *J. Am. Chem. Soc.* **1976**, *98*, 269.
b) Sharpless, K. B.; Hori, T. *J. Org. Chem.* **1976**, *41*, 176.
31. Brimble, M. A.; Heathcock, C. H. *J. Org. Chem.* **1993**, *58*, 5261.

32. Keck, G. E.; Webb, R. R.; Yates, J. B. *Tetrahedron*, **1981**, *37*, 4007.
33. Kresze, G.; Braxmeier, H.; Münsterer, H. *Org. Synth.* **1987**, *65*, 159.
34. Whitesell, J. K.; Yaser, H. K. *J. Am. Chem. Soc.* **1991**, *113*, 3526.
35. Liebeskind, L. S.; Sharpless, K. B.; Wilson, R. D.; Ibers, J. A. *J. Am. Chem. Soc.* **1978**, *100*, 7061.
36. Muccigrosso, D. A.; Jacobson, S. E.; Apgar, P. A.; Mares, F. *J. Am. Chem. Soc.* **1978**, *100*, 7063.
37. Kamm, O. *Org. Synth.* **1925**, *4*, 57.
38. Srivastava, A.; Ma, Y.; Pankayatselvan, R.; Dinges, W.; Nicholas, K. M. *J. Chem. Soc., Chem. Commun.* **1992**, 853.
39. Cameron, M.; Gowenlock, B. G.; Vasapollo, G. *Chem. Soc. Rev.* **1990**, *19*, 355.
40. Srivastava, R. S.; Nicholas, K. M. *J. Org. Chem.* **1994**, *59*, 5365.
41. a) Boger, D. L.; Weinreb, S. N. *Hetero Diels-Alder Methodology in Organic Synthesis*; Academic Press: New York, Chapter. 3, 1987; pp 71-93.
b) Taylor, E. C.; Tseng, C.; Rampla, J. B. *J. Org. Chem.* **1982**, *47*, 552.
c) Knaus, E. E.; Avasthi, K.; Giam, C. S. *Can. J. Chem.* **1980**, *58*, 2447.
42. a) Banks, R. E.; Haszeldine, R. N.; Miller, P. J. *Tetrahedron Lett.* **1970**, 4417.
b) Motherwell, W. B.; Roberts, J. S. *J. Chem. Soc., Chem. Commun.* **1972**, 329.
c) Knight, G. T. *J. Chem. Soc., Chem. Commun.* **1970**, 1016.
43. Johannsen, M.; Jørgensen, K. A. *J. Org. Chem.* **1994**, *59*, 214.

44. Johannsen, M.; Jørgensen, K. A. *J. Org. Chem.* **1995**, *60*, 5979.
45. Srivastava, R. S.; Nicholas, K. M. *Tetrahedron Lett.* **1994**, *35*, 8739.
46. Srivastava, R. S.; Khan, M. A.; Nicholas, K. M. *J. Am. Chem. Soc.* **1996**, *118*, 3311.
47. Srivastava, R. S.; Nicholas, K. M. *J. Am. Chem. Soc.* **1997**, *119*, 3302.
48. March, J. *Advanced Organic Chemistry*, 4th ed.; Wiley: New York, 1992; pp 276-286.
49. Roberts, J. S. In *Comprehensive Organic Chemistry*; Sutherland, I. O., Ed.; Pergamon: Oxford, G. B., 1979; Vol 2, pp 185-217.
50. Noyori, R. *Asymmetric Catalysis in Organic Synthesis*, Wiley Interscience: New York, 1994; pp 1-15.
51. a) Miyashita, A.; Takaya, H.; Yasuda, A.; Toruimi, K.; Ito, T.; Souchi, T.; Noyori, R. *J. Am. Chem. Soc.* **1980**, *102*, 7932.
b) Miyashita, A.; Takaya, H.; Souchi, T.; Noyori, R. *Tetrahedron* **1984**, *40*, 1245.
52. Katsuki, T.; Sharpless, K. B. *J. Am. Chem. Soc.* **1980**, *102*, 5974.
53. a) Lowenthal, R. E.; Masamune, S. *Tetrahedron Lett.* **1991**, *32*, 7373.
b) Evans, D. A.; Woerpel, K. A.; Hinman, M. M.; Faul, M. M. *J. Am. Chem. Soc.* **1991**, *113*, 726.
54. a) Jacobsen, E. N.; Zhang, W.; Muci, A. R.; Ecker, J. R.; Deng, L. *J. Am. Chem. Soc.* **1991**, *113*, 1063.
b) Brandes, B. D.; Jacobsen, E. N. *J. Org. Chem.* **1994**, *59*, 4378.

- c) Earnshaw, A.; King, E. A.; Larkworthy, L. F. *J. Chem. Soc. (A)* **1968**, 1048.
55. Calderazzo, F.; Floriani, C.; Henzi, R.; L'Eplattenier, F. *J. Chem. Soc. (A)* **1969**, 1378.
56. McAllister, R. M.; Weber, J. H. *J. Organomet. Chem.* **1974**, 77, 91.
57. Ghose, B. N. *Synth. React. Inorg. Met.-Org. Chem.* **1984**, 14, 129.
58. a) Kerr, J. M.; Suckling, C. J. *J. Chem. Soc., Perkin Trans. 1* **1990**, 887.
b) Biradar, N. S.; Karajagi, G. V.; Aminabhavi, T. M.; Rudzinsky, W. E. *Inorg. Chim. Acta* **1983**, 74, 39.
59. Hill, R. J.; Rickard, C. E. F.; White, H. E. *J. Inorg. Nucl. Chem.* **1981**, 43, 721.
60. a) Lewis, J.; Mabbs, F. E.; Richards, A. *J. Chem. Soc. (A)* **1967**, 1014.
b) Coggon, P.; McPhail, A. T.; Mabbs, F. E.; McLachlan, V. N. *J. Chem. Soc. (A)* **1971**, 1014.
c) Gerloch, M.; McKenzie, E. D.; Towl, A. D. C. *J. Chem. Soc. (A)* **1969**, 2850.
d) Fitzsimmons, B. W.; Smith, A. W.; Larkworthy, L. F.; Rogers, K. A. *J. Chem. Soc., Dalton Trans.* **1973**, 676.
e) Floriani, C.; Fachinetti, G. *J. Chem. Soc., Chem. Commun.* **1973**, 17.
f) Wells, F. V.; McCann, S. W.; Wickman, H. H.; Kessel, S. L.; Hendrickson, D. N.; Feltham, R. D. *Inorg. Chem.* **1982**, 21, 2306.
61. a) Nakajima, K.; Sasaki, C.; Kojima, M.; Aoyama, T.; Ohba, S.; Saito, Y. Fujita, J.; Nagoya, C.; Okazaki, M. *Chem. Lett.* **1987**, 2189.

- b) Nakajima, K.; Kojima, M.; Fujita, J. *Chem. Lett.* **1986**, 1483.
- c) Palucki, M.; Hanson, P.; Jacobsen, E. N. *Tetrahedron Lett.* **1992**, *33*, 7111.
62. O'Connor, K.; Wey, S.; Burrows, C. J. *Tetrahedron Lett.* **1992**, *33*, 1001.
63. Takeichi, T.; Arihara, M.; Ishimori, M.; Tsuruta, T. *Tetrahedron Lett.* **1980**, *36*, 3391.
64. Takeichi, T.; Ozaki, Y.; Takayama, Y. *Chem. Lett.* **1987**, 1137.
65. a) Goggin, P. L. In *Comprehensive Coordination Chemistry*; Wilkinson, G., Ed.; 1987; Vol 2, pp 494-497.
- b) Goggin, P. L. In *Comprehensive Coordination Chemistry*; Wilkinson, G., Ed.; 1987; Vol 2, pp 497-501.
- c) Hawker, P. N. In *Comprehensive Coordination Chemistry*; Wilkinson, G., Ed.; 1987; Vol 4, p 1237.
66. Ashby, M. T.; Govindan, G. N.; Grafton, A. K. *J. Am. Chem. Soc.* **1994**, *116*, 4801.
67. Simpson, P. G.; Vinciguerra, A.; Quagliano, J. V. *Inorg. Chem.* **1963**, *2*, 282.
68. Nakajima, M.; Sasaki, Y.; Shiro, M.; Hashimoto, S. *Tetrahedron: Asymmetry* **1997**, *8*, 341.
69. a) Issleib, K.; Müller, D. W. *Chem. Ber.* **1959**, *92*, 3175.
- b) Quin, L. D.; Anderson, H. G. *J. Org. Chem.* **1964**, *29*, 1859.
- c) Keough, P. T.; Grayson, M. *J. Org. Chem.* **1962**, *27*, 1817.
70. a) Takaya, H.; Akutagawa, S.; Noyori, R. *Org. Synth.* **1988**, *67*, 20.

- b) Takaya, H.; Mashima, K.; Koyano, K.; Yagi, M.; Kumobayashi, H.; Taketomi, T.; Akutagawa, S.; Noyori, R. *J. Org. Chem.* **1986**, *51*, 629.
71. Rieke, R. D.; Bales, S. E. *J. Am. Chem. Soc.* **1974**, *96*, 1775.
72. Brown, K. J.; Berry, M. S.; Waterman, K. C.; Lingenfelter, D.; Murdoch, J. R. *J. Am. Chem. Soc.* **1984**, *106*, 4717.
73. Brown, K. J.; Berry, M. S.; Murdoch, J. R. *J. Org. Chem.* **1985**, *50*, 4345.
74. Quagliano, J. V.; Fujita, J.; Franz, G.; Hillips, D. J.; Walmsley, J. A.; Tyree, S. Y. *J. Am. Chem. Soc.* **1961**, *83*, 3770.
75. Wolfrom, M. L.; Winkley, M. W. *J. Chem. Soc., Chem. Commun.* **1966**, 533.
76. Lloyd, P. F.; Stacey, M. *Tetrahedron* **1960**, *9*, 116.
77. Wolfrom, M. L.; Bhat, H. B. *J. Org. Chem.* **1967**, *32*, 2757.
78. Wolfrom, M. L.; Garg, H. G.; Horton, D. *J. Org. Chem.* **1965**, *30*, 1556.
79. Sekiguchi, S.; Ishikura, H.; Hirosawa, Y.; Ono, N. *Tetrahedron* **1990**, *46*, 5567.
80. a) Shaltiel, S.; Fridkin, M. *Biochemistry* **1970**, *9*, 5122.
b) Shaltiel, S. *Biochem. Biophys. Res. Commun.* **1967**, *29*, 178.
81. Borche, W. *Chem. Ber.* **1923**, *56*, 1494.
82. Feiser, L. F.; Feiser, M. *Reagents in Organic Synthesis*; Wiley, New York, 1968; vol 1, pp 511-518.
83. Chatterjee, B. G.; Rao, V. V.; Mazumdar, B. N. G. *J. Org. Chem.* **1965**, *30*, 4101.
84. Astle, M. J.; Abbott, F. P. *J. Org. Chem.* **1956**, *21*, 1228.
85. Bobbitt, J. M.; Scola, D. A. *J. Org. Chem.* **1960**, *25*, 560.

86. Cainelli, G.; Manescalchi, F. *Synthesis* **1975**, 723.
87. Gordon, M.; DePamphilis, M. L.; Griffin, C. E. *J. Org. Chem.* **1963**, *28*, 698.
88. Bordwell, F. G.; Algrim, D. J. *J. Am. Chem. Soc.* **1988**, *110*, 2964.
89. a) Bernasconi, C. F.; Gehriger, C. L. *J. Am. Chem. Soc.* **1974**, *96*, 1092.
b) Bernasconi, C. F.; Terrier, F. *J. Am. Chem. Soc.* **1975**, *97*, 7458.
c) Sekiguchi, S.; Bunnett, J. F. *J. Am. Chem. Soc.* **1981**, *103*, 4871.
90. Jin, J.; Weinreb, S. M. *J. Am. Chem. Soc.* **1997**, *119*, 5773.
91. Fukuyama, T.; Cheung, M.; Jow, C.; Hidai, Y.; Kan, T. *Tetrahedron Lett.* **1997**, *38*, 5831.
92. Pincock, J. A.; Jurgens, A. *Tetrahedron Lett.* **1979**, 1029.
93. a) Sekiguchi, S.; Horie, T.; Suzuki, T. *J. Chem. Soc., Chem. Commun.* **1988**, 698.
b) Sekiguchi, S.; Suzuki, T.; Hosokawa, M. *J. Chem. Soc., Perkin Trans. 2* **1989**, 1783.
94. Feiser, L. F.; Feiser, M. *Reagents in Organic Synthesis*; Wiley, New York, 1968; vol 1, pp 1180-1181.
95. Beard, C. D.; Baum, K.; Grakauskas, V. *J. Org. Chem.* **1973**, *38*, 3673.
96. a) Rawlinson, D. J.; Sosnovsky, G. *Synthesis* **1972**, 1.
b) Kharasch, M. S.; Sosnovsky, G. *J. Am. Chem. Soc.* **1958**, *80*, 756.
c) Sosnovsky, G.; Rawlinson, D. J. In *Organic Peroxides* Swern, D., ed., Wiley, Interscience, New York, 1970, vol 1, p 585.
d) Lawesson, S. -O.; Schroll, G. In *The Chemistry of Carboxylic Acids and Esters*; Patai, S., Ed.; Interscience: London, 1969; p 669.

- e) Sosnovsky, G.; Lawesson, S. -O. *Angew. Chem. Int. Ed. Engl.* **1964**, *3*, 269.
97. a) Kochi, J. K. *Science*, **1967**, 415.
b) Kochi, J. K.; Mains, H. E. *J. Org. Chem.* **1965**, *30*, 1862.
c) Walling, C.; Zavitsas, A. A. *J. Am. Chem. Soc.* **1963**, *85*, 2084.
98. Beckwith, A. L. J.; Evans, G. W. *Proc. Chem. Soc. (London)* **1962**, 63.
99. a) Sosnovsky, G. *Tetrahedron* **1965**, *21*, 871.
b) Kharasch, M. S.; Fono, A. *J. Org. Chem.* **1958**, *23*, 324.
c) Kharasch, M. S.; Fono, A. *J. Org. Chem.* **1959**, *24*, 606.
100. a) Kochi, J. K. *J. Am. Chem. Soc.* **1962**, *84*, 3271.
b) Kochi, J. K. *J. Am. Chem. Soc.* **1961**, *83*, 3162.
c) Kochi, J. K. *J. Am. Chem. Soc.* **1962**, *84*, 774.
101. Kharasch, M. S.; Sosnovsky, G.; Yang, N. C. *J. Am. Chem. Soc.* **1959**, *81*, 5819.
102. Sosnovsky, G.; O'Neill, H. J. *Chem. Eng. News* **1961**, *39(50)*, 48.
103. a) Cross, B.; Whitham, G. H. *J. Chem. Soc.* **1961**, 1650.
b) Villenave, J. J.; Francois, H.; Laleande, R. *Bull. Chim. Soc. Fr* **1070**, 599.
104. Basolo, F.; Pearson, R. G. *Mechanism of Inorganic Reactions* Wiley, New York, 1958, p 352.
105. a) Sosnovsky, G.; Yang, N. C. *J. Org. Chem.* **1960**, *25*, 899.
b) Lawesson, S. -O.; Berglund, C.; Gronwall, S. *Acta. Chim. Scand.* **1961**, *15*, 249.
c) Sosnovsky, G. *J. Org. Chem.* **1960**, *25*, 874.

- d) Sosnovsky, G. *Tetrahedron* **1961**, *13*, 241.
- e) Lawesson, S. -O.; Berglund, C.; Gronwall, S. *Acta. Chim. Scand.* **1960**, *14*, 944.
106. a) Lawesson, S. -O.; Berglund, C. *Acta. Chim. Scand.* **1961**, *15*, 36.
- b) Sosnovsky, G.; O'Neill *J. Org. Chem.* **1962**, *27*, 3469.
- c) Sosnovsky, G. *J. Org. Chem.* **1961**, *26*, 281.
107. Sosnovsky, G. *Tetrahedron* **1965**, *17*, 2.
108. Beckwith, A. L. J.; Zavitsas, A. A. *J. Am. Chem. Soc.* **1986**, *108*, 8230.
109. Gautier, J. -A.; Miocque, M.; Farnoux, C. C. In *The Chemistry of Amidines and Imidates*; Patai, S., Ed.; Interscience: Wiley, New York, 1975; vol 1, pp 284-312.
- 110.a) Pinner, A.; Klein, F. *Ber.* **1877**, *10*, 1889.
- b) Moreau, R. C.; Reynaud, P. *Bull. Soc. Chim. Fr* **1964**, 2997.
111. Rousselet, G.; Capdevielle, P.; Maumy, M. *Tetrahedron Lett.* **1993**, *34*, 6395.
112. a) Garigipati, R. S. *Tetrahedron Lett.* **1990**, *31*, 1969.
- b) Levin, J. I.; Turos, E.; Weinreb, S. M. *Synth. Commun.* **1982**, *12*, 989.
- c) Basha, A.; Lipton, M.; Weinreb, S. M. *Tetrahedron Lett.* **1977**, *18*, 4171.
113. Judkins, B. D.; Allen, D. G.; Cook, T. A.; Evans, B.; Sardharwala, T. E. *Synth. Commun.* **1996**, *26*, 4351.
114. Martynov, B. I.; Zhestkov, S. A.; Martynov, I. V. *Zhur. Organ. Khim.* **1991**, *27*, 71.
115. Hafelinger, G. In *The Chemistry of Amidines and Imidates*; Patai, S., Ed.; Interscience: Wiley, New York, 1975; vol 1, p 1

116. Sidler, D. R.; Lovelace, T. C.; McNamara, J. M.; Reider, P. J. *J. Org. Chem.* **1994**, *59*, 1231.
117. a) Laubengayer, A. W.; Smith, J. D.; Ehrlich, G. G. *J. Am. Chem. Soc.* **1961**, *83*, 542.
 b) Hendrickson, C. H.; Eyman, D. P. *Inorg. Chem.* **1967**, *6*, 1461.
 c) Laubengayer, A. W.; Gilliam, W. F. *J. Am. Chem. Soc.* **1941**, *63*, 477.
118. a) van Beelen, D. C.; van der Kooi, H. O.; Wolters, H. *Organomet. Chem.* **1979**, *179*, 37.
 b) Flitcroft, N.; Kaesz, H. D. *J. Am. Chem. Soc.* **1963**, *85*, 1377.
119. a) Pitzer, K. S.; Gutowsky, H. S. *J. Am. Chem. Soc.* **1946**, *68*, 2204.
 b) Hoffmann, E. G. *Ann. Chem.* **1960**, *629*, 104.
 c) Benn, R.; Rufinska, A.; Lehmkuhl, H.; Janssen, E.; Kruger, C. *Angew. Chem. Int. Ed. Engl.* **1983**, *22*, 779.
120. Singh, S.; Nicholas, K. M. *Synth. Commun.* **1997**, *27*, 4021.
121. Von Wolfgang, W.; Weiss, H. *Liebigs Ann. Chem.* **1972**, *758*, 162.
122. Huheey, J. E.; Keiter, E. A.; Keiter, R. L. *Inorganic Chemistry: Principles of Structure and Reactivity*; 4th ed.; Harper Collins College, 1993; pp A31-A32.
123. Kohmura, Y.; Kawasaki, K.; Katsuki, T. *Syn. Lett.* **1997**, 1456.
124. a) Parshall, G. W.; Ittel, S. D. *Homogeneous Catalysis*, 2nd ed.; Wiley, New York; 1992.
 b) Pignolet, L. H. *Homogeneous Catalysis with Metal Phosphine Complexes*; Plenum: New York; 1983.

125. Noyori, R. *Asymmetric Catalysis in Organic Synthesis*; Wiley: New York, 1994; pp 95-121.
126. a) Koenig, K. E. In *Asymmetric Synthesis*; Morrison, J. D., Ed.; Academic Press: New York, 1985; vol 5, pp 71-101.
- b) Noyori, R. *Asymmetric Catalysis in Organic Synthesis*; Wiley: New York, 1994; pp 16-94.
127. Keim, W.; Behr, A.; Roper, M. In *Comprehensive Organometallic Chemistry*; Wilkinson, G.; Abels, J. Eds.; Elsevier: London, 1982; Vol 8, pp 372-462.
128. Trost, B. M. *Acc. Chem. Res.* **1980**, *13*, 385.
129. Collman, J. P.; Hegedus, L. S.; Norton, J. R.; Finke, R. G. *Principles and Applications of Organotransition Metal Chemistry*, 2nd ed.; University Science Books: Mill Valley, CA, 1987; pp 621-632.
130. Lorsbach, B. A.; Bennett, D. M.; Prock, A.; Giering, W. *Organometallics* **1995**, *14*, 869.
131. Tolman, C. A. *Chem. Rev.* **1977**, *77*, 313.
132. Wilson, M. R.; Liu, H.; Prock, A.; Giering, W. P. *Organometallics* **1993**, *12*, 2044.
133. Pignolet, L. H. *Homogeneous Catalysis with Metal Phosphine Complexes*; Plenum: New York, 1983; pp 95-99.
134. Pruett, R. L.; Smith, J. A. *J. Org. Chem.* **1969**, *34*, 327.
135. Gilheany, D. G.; Mitchel, C. M. In *The Chemistry of Organophosphorus Compounds*; Hartley, F. R., Ed.; John Wiley and Sons, 1990; vol 1, pp 151-191.

136. a) Sander, M. *Chem. Ber.* **1960**, *93*, 1220.
b) Kabachnik, M. I.; Tsvetkov, E. N. *Chem. Abstr.* **1958**, *52*, 8070b.
c) Chodkiewicz, W. *J. Organomet. Chem.* **1984**, *273*, C55.
137. a) Aguiar, A. M.; Irelan, J. R. S.; Morrow, C. J.; John, J. P.; Prejean, G. W. *J. Org. Chem.* **1969**, *34*, 2684.
b) Schmidbaur, H.; Schier, A. *Synthesis* **1983**, 372.
c) Chodkiewicz, W.; Jore, D.; Wodzki, W. *Tetrahedron Lett.* **1979**, 1069.
138. Draper, P. M.; Chan, T. H. Harpp, D. N. *Tetrahedron Lett.* **1970**, 1687.
139. a) Vinokurova, G. M. *Zh. Obshch. Khim.* **1967**, *37*, 1652.
b) Novikova, Z. S.; Voronova, N. P. *Chem. Abstracts* **1968**, *69*, 52217v.
140. Kamai, I. G.; Rusetskaya, G. M. *Zh. Obshch. Khim.* **1962**, *32*, 2848.
141. Jore, D.; Guillerme, D.; Chodkiewicz, W. *J. Organomet. Chem.* **1978**, *149*, C7.
142. a) Pankowski, M.; Chodkiewicz, W.; Simonnin, M. –P. *Inorg. Chem.* **1985**, *24*, 533.
b) Chodkiewicz, W.; Guillerme, D.; Jore, D.; Mathieu, E.; Wodzki, W. *J. Organomet. Chem.* **1984**, *269*, 107.
143. McEwen, W. E.; Kumli, K. F.; Blade-Font, A.; Zanger, M.; Vander Werf, C. *J. Am. Chem. Soc.* **1964**, *86*, 2378.
144. Horner, L.; Schedlbauer, F.; Beck, P. *Tetrahedron Lett.* **1964**, 1421.
145. Merrifield, R. B. *J. Am. Chem. Soc.* **1963**, *85*, 2149.
146. a) Leznoff, C. C. *Acc. Chem. Res.* **1978**, *11*, 327.
b) Crowley, J. I.; Rapoport, H. *Acc. Chem. Res.* **1976**, *9*, 135.

147. Gallop, M. A.; Barrett, R. W.; Dower, W. J.; Fodor, S. P. A.; Gordon, E. M. *J. Med. Chem.* **1994**, *37*, 1233.
148. Amarnath, V.; Broom, A. D. *Chem. Rev.* **1977**, *77*, 183.
149. a) Frechet, J. M.; Schuerch, C. *J. Am. Chem. Soc.* **1971**, *93*, 492.
b) Zehavi, U.; Patchornik, A. *J. Am. Chem. Soc.* **1973**, *95*, 5673.
150. Cho, C. Y.; Moran, E. J.; Cherry, S.; Stephans, J.; Fodor, S. P. A.; Adams, C.; Sundaram, A.; Jacobs, J. W.; Schultz, P. G. *Science* **1993**, *261*, 1303.
151. a) Burgess, K.; Linthicum, D. S.; Shin, H. *Angew. Chem. Int. Ed. Engl.* **1995**, *34*, 907.
b) Burgess, K.; Ibarzo, J.; Linthicum, D. S.; Russell, D. H.; Shin, H.; Shitangkoon, A.; Totani, R.; Zhang, A. J. *J. Am. Chem. Soc.* **1997**, *119*, 1556.
152. a) Bunin, B. A.; Ellman, J. A. *J. Am. Chem. Soc.* **1992**, *114*, 10997.
b) Plunkett, M. J.; Ellman, J. A. *J. Am. Chem. Soc.* **1995**, *117*, 3306.
c) Hobbs DeWitt, S.; Kiely, J. S.; Stankovic, C. J.; Schroeder, M. C.; Cody, D. M. R.; Pavia, M. R. *Proc. Natl. Acad. Sci. U.S.A.* **1993**, *90*, 6909.
d) Bunin, B. A.; Plunkett, M. J.; Ellman, J. A. *Proc. Natl. Acad. Sci. U.S.A.* **1994**, *91*, 4708.
153. Murphy, M. M.; Schullek, J. R.; Gordon, E. M.; Gallop, M. A. *J. Am. Chem. Soc.* **1995**, *117*, 7029.
154. Holmes, C. P.; Chinn, J. P.; Look, G. C.; Gordon, E. M.; Gallop, M. A. *J. Org. Chem.* **1995**, *60*, 7328.
155. Patchett, A. A. *J. Med. Chem.* **1993**, *36*, 2051.

156. Furka, A.; Sebestyén, F.; Asgedom, M.; Dibo, G. *Int. J. Pept. Protein Res.* **1991**, *37*, 487.
157. Geysen, H. M.; Meloan, R. H.; Barteling, S. J. *Proc. Natl. Acad. Sci. U.S.A.* **1984**, *81*, 3998.
158. a) Larsen, B. D.; Christensen, D. H.; Holm, A.; Zillmer, R.; Nilesen, O. F. *J. Am. Chem. Soc.* **1993**, *115*, 6247.
b) Russell, K.; Cole, D. C.; McLaren, F. M.; Pivonka, D. E. *J. Am. Chem. Soc.* **1996**, *118*, 7941.
159. a) Metzger, J. W.; Weismüller, K. -H.; Gnau, V.; Brünjes, J.; Jung, G. *Angew. Chem. Int. Ed. Engl.* **1993**, *32*, 894.
b) Metzger, J. W.; Kempter, C.; Wiesmüller, K. -H.; Jung, G. *Anal. Biochem.* **1994**, *219*, 261.
160. Fitzgerald, M. C.; Harris, K.; Shevlin, C. G.; Siuzdak, G. *Bioorg. Med. Chem. Lett.* **1996**, *6*, 979.
161. Look, G. C.; Holmes, C. P.; Chinn, J. P.; Gallop, M. A. *J. Org. Chem.* **1994**, *59*, 7588.
162. Fitch, W. L.; Detre, G.; Holmes, C. P. *J. Org. Chem.* **1994**, *59*, 7955.
163. Ohlmeyer, M. H. J.; Swanson, R. N.; Dillard, L. W.; Reader, J. C.; Asouline, G.; Kobayashi, R.; Wigler, M.; Still, W. C. *Proc. Natl. Acad. Sci. U.S.A.* **1993**, *90*, 10922.
164. a) Brenner, S.; Lerner, R. A.; *Proc. Natl. Acad. Sci. U.S.A.* **1992**, *89*, 5381.
b) Nielsen, J.; Brenner, S.; Janda, K. D. *J. Am. Chem. Soc.* **1993**, *115*, 9812.

165. Kerr, J. M.; Banville, S. C.; Zuckermann, R. N. *J. Am. Chem. Soc.* **1993**, *115*, 2529.
166. Ni, J.; Maclean, D.; Holmes, C. P.; Murphy, M. M.; Ruhland, B.; Jacobs, J. W.; Grovdon, E. M.; Gallop, M. A. *J. Med. Chem.* **1996**, *39*, 1601.
167. Nicolaou, K. C.; Xiao, X. -Y.; Parandoosh, Z.; Senyei, A.; Nova, M. P. *Angew. Chem. Int. Ed. Engl.* **1995**, *34*, 2289.
168. Xiao, X. -Y.; Shi, S.; Nova, M. P. *J. Org. Chem.* **1997**, *62*, 6029.
169. Nielsen, J.; Jensen, F. R. *Tetrahedron Lett.* **1997**, *38*, 2011.
170. Ellman, J. A.; Liu, G. *J. Org. Chem.* **1995**, *60*, 7712.
171. Hoveyda, A.; Snapper, M. L. *Angew. Chem. Int. Ed. Engl.* **1996**, *35*, 1668.
172. Francis, M. B.; Finney, N. S.; Jacobsen, E. A. *J. Am. Chem. Soc.* **1996**, *118*, 8983.
173. Burgess, K.; Lim, H. -J.; Porte, A. M.; Sulikowski, G. A. *Angew. Chem. Int. Ed. Engl.* **1996**, *35*, 220.
174. Gilbertson, S. R.; Wang, X. *Tetrahedron Lett.* **1996**, *37*, 6475.
175. a) Horner, L.; Simons, G. *Phosphorus and Sulfur* **1984**, *19*, 65.
b) Horner, L.; Simons, G. *Phosphorus and Sulfur* **1984**, *19*, 77.
176. Dahl, O. *J. Chem. Soc., Perkin Trans. 1* **1978**, 947.
177. Steininger, E. *Chem. Ber.* **1962**, 2993.
178. Cristau, H. -J.; Chene, A.; Christol, H. *Synthesis* **1980**, 551.
179. Singh, S.; Nicholas, K. M. *J. Chem. Soc., Chem. Commun.* **1998**, 149.
180. a) Baechler, R. D.; Mislow, K. *J. Am. Chem. Soc.* **1970**, *92*, 3090.
b) Chan, T. H. *J. Chem. Soc., Chem. Commun.* **1968**, 895.

- c) Hoffmann, H.; Schellenbeck, P. *Chem. Ber.* **1966**, *99*, 1134.
- d) Lewis, R. A.; Naumann, K.; DeBruin, K. E.; Mislow, K. *J. Chem. Soc., Chem. Commun.* **1969**, 1010.
181. Kabachnik, M. I.; Chang, C.; Tsevetkov, E. N. *Dokl. Akad. Nauk. SSSR* **1960**, *135*, 603.
182. a) Horner, L.; Winkler, H.; Rapp, A.; Mentrup, A.; Hoffmann, H.; Beck, P. *Tetrahedron Lett.* **1961**, 161.
- b) Mann, F. G.; Tong, B. P.; Wystrach, V. P. *J. Chem. Soc.* **1963**, 1155.
183. a) Michaelis, A. *Ann. Chem.* **1901**, *315*, 43.
- b) Wedekind, E. *Chem. Ber.* **1912**, *45*, 2933.
184. a) Horner, L.; Balzer, W. *Tetrahedron Lett.* **1965**, 1157.
- b) Horner, L.; Mentrup, A. *Ann. Chem.* **1961**, *646*, 65.
- c) Harmon, R. E.; Parsons, J. L.; Gupta, S. K. *Org. Preparative Procedures* **1970**, *2*, 19.
- d) Kamai, G.; Khismatullina, L. A. *Dokl. Akad. Nauk. SSSR* **1953**, *92*, 69.
- e) McEwen, W. E.; Kumli, K. F.; Bladé-Font, A.; Zanger, M.; Vander Werf, C. A. *J. Am. Chem. Soc.* **1964**, *86*, 2378.
- f) Meisenheimer, J. *Ann. Chem.* **1906**, *449*, 213.
185. Tolman, C. A. *J. Am. Chem. Soc.* **1970**, *92*, 2956.
186. Andreev, N. A.; Grshina, O. N. *J. Gen. Chem. USSR* **1980**, *50*, 641.
- 187.a) Henderson, Jr., W. A.; Buckler, S. A. *J. Am. Chem. Soc.* **1960**, *82*, 5794.
- b) Mann, B. E. *J. Chem. Soc., Perkin Trans. 2* **1972**, 30.
- c) Deeming, A. J.; Shaw, B. L. *J. Chem. Soc. (A)* **1969**, 597.

IMAGE EVALUATION TEST TARGET (QA-3)

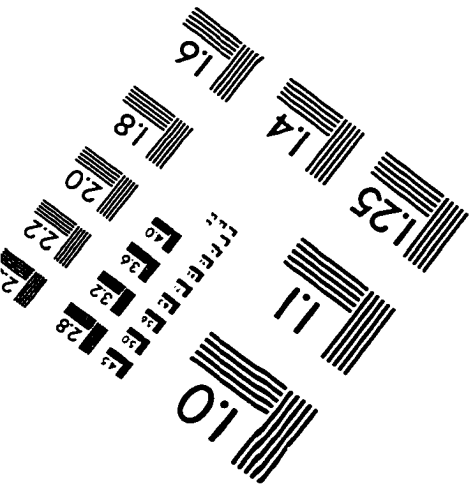
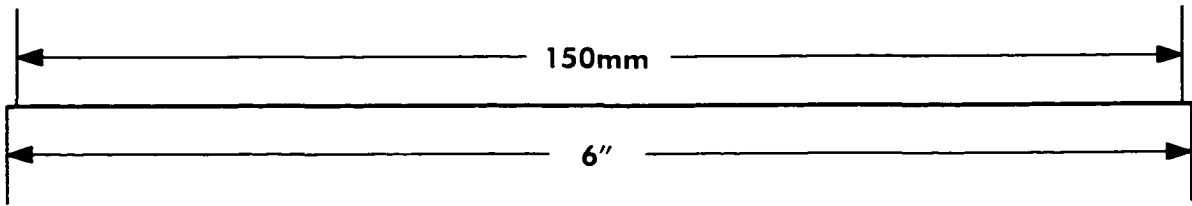
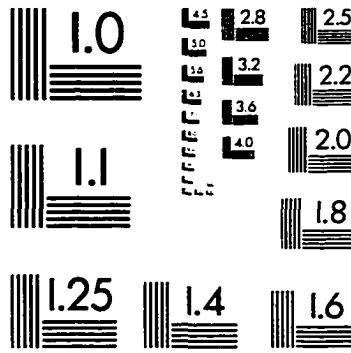
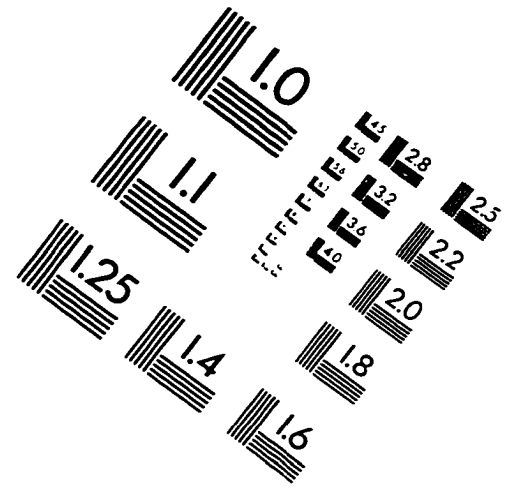
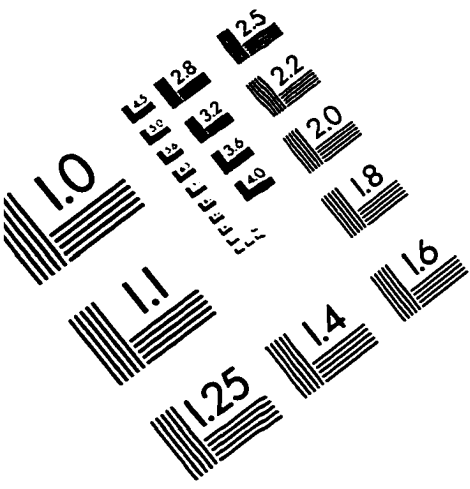

APPLIED IMAGE, Inc
1653 East Main Street
Rochester, NY 14609 USA
Phone: 716/482-0300
Fax: 716/288-5989

© 1993, Applied Image, Inc., All Rights Reserved

