

INFORMATION TO USERS

This was produced from a copy of a document sent to us for microfilming. While the most advanced technological means to photograph and reproduce this document have been used, the quality is heavily dependent upon the quality of the material submitted.

The following explanation of techniques is provided to help you understand markings or notations which may appear on this reproduction.

1. The sign or "target" for pages apparently lacking from the document photographed is "Missing Page(s)". If it was possible to obtain the missing page(s) or section, they are spliced into the film along with adjacent pages. This may have necessitated cutting through an image and duplicating adjacent pages to assure you of complete continuity.
2. When an image on the film is obliterated with a round black mark it is an indication that the film inspector noticed either blurred copy because of movement during exposure, or duplicate copy. Unless we meant to delete copyrighted materials that should not have been filmed, you will find a good image of the page in the adjacent frame.
3. When a map, drawing or chart, etc., is part of the material being photographed the photographer has followed a definite method in "sectioning" the material. It is customary to begin filming at the upper left hand corner of a large sheet and to continue from left to right in equal sections with small overlaps. If necessary, sectioning is continued again—beginning below the first row and continuing on until complete.
4. For any illustrations that cannot be reproduced satisfactorily by xerography, photographic prints can be purchased at additional cost and tipped into your xerographic copy. Requests can be made to our Dissertations Customer Services Department.
5. Some pages in any document may have indistinct print. In all cases we have filmed the best available copy.

University
Microfilms
International

300 N. ZEEB ROAD, ANN ARBOR, MI 48106
18 BEDFORD ROW, LONDON WC1R 4EJ, ENGLAND

8116766

YANG, JUN-YANG CHEN

RESEARCH TO ESTABLISH ECOLOGICAL STANDARDS FOR WATER
RESOURCES DEVELOPMENTS

The University of Oklahoma

PH.D.

1981

**University
Microfilms
International** 300 N. Zeeb Road, Ann Arbor, MI 48106

THE UNIVERSITY OF OKLAHOMA

GRADUATE COLLEGE

RESEARCH TO ESTABLISH ECOLOGICAL STANDARDS

FOR WATER RESOURCES DEVELOPMENTS

A DISSERTATION

SUBMITTED TO THE GRADUATE FACULTY

in partial fulfillment of the requirements for the

degree of

DOCTOR OF PHILOSOPHY

BY

JUNYANG CHEN YANG

Norman, Oklahoma

1981

RESEARCH TO ESTABLISH ECOLOGICAL STANDARDS
FOR WATER RESOURCES DEVELOPMENTS

APPROVED BY

Gen. White

L. E. [unclear]

Robert G. [unclear]

James M. Robertson

DISSERTATION COMMITTEE

ACKNOWLEDGEMENT

I wish to express my gratitude to many individuals who contributed immeasurably to the accomplishment of this research. Andy Lok-ye Law and Gene-pai Chou provided invaluable input in constructing the study. Professor George W. Reid, chairman of my advisory committee, is greatly appreciated for his guidance and encouragement throughout the study.

Appreciation is extended to other members of my committee for their assistance: Dr. Leale E. Streebin, Dr. James M. Robertson, and Professor Robert Goins. Special thanks are in order to the following who have assisted or supplied information for this study: Donald Fitzgerald, Gregory L. Summers, Bob G. Bourlier, Dr. Paul Risser, Sam Johnson and Gary D. Witt.

I am also very grateful to the U.S. Department of Interior, Office of Water Resources Research and Technology for their financial support in pursuit of this study.

Finally, my deep appreciation is given to my parents, Mr. and Mrs. Cheng-li Chen, and husband, William, whose contribution is manifest in their support and understanding.

TABLE OF CONTENTS

| | Page |
|---|------|
| ACKNOWLEDGEMENT | iii |
| LIST OF TABLES | viii |
| LIST OF FIGURES | xi |
| Chapter | |
| I. INTRODUCTION | 1 |
| 1.1 The Need | 1 |
| 1.2 Preservation Philosophy | 2 |
| 1.3 The Approach | 3 |
| 1.4 Objectives | 4 |
| 1.5 The Scope | 6 |
| 1.6 State of the Art Review | 6 |
| II. LAND DEVELOPMENT PATTERNS | 10 |
| 2.1 Introduction | 10 |
| 2.2 Ecological Considerations | 11 |
| 2.3 Uniform Standards | 13 |
| 2.4 Human Involvement | 14 |
| 2.5 Land Use | 16 |
| III. DEVELOPMENT LEVEL INDICATORS | 18 |
| 3.1 Introduction | 18 |
| 3.2 Development Levels | 19 |
| 3.3 Indicators and Their Performance Levels | 21 |
| 3.3.1 Inhabitation Index | 21 |
| 3.3.2 Land Value | 29 |
| 3.3.3 Intensity of Water Use | 36 |
| 3.3.4 Transportation Facility | 42 |
| 3.4 Assignment of Weight to Indicators | 47 |
| 3.5 Determination of Development Level | 51 |
| IV. ECOLOGICAL PARAMETERS | 53 |
| 4.1 Introduction | 53 |
| 4.2 Parameters | 59 |
| 4.2.1 Flora | 59 |
| A. Terrestrial Natural Vegetation | 59 |

| | | |
|-------|--|-----|
| B. | Productivity of Aquatic Flora | 62 |
| C. | Terrestrial Flora Species Diversity | 69 |
| D. | Vegetation Land Use (Aesthetic) | 74 |
| 4.2.2 | Fauna | 83 |
| A. | Dynamic Ratio of Fish Population | 83 |
| B. | Waterfowl Habitat | 88 |
| C. | Terrestrial Fauna | 93 |
| D. | Fauna Species Composition (Aesthetic). | 95 |
| 4.2.3 | Biota | 104 |
| A. | Pest Species | 104 |
| B. | Utilization of Carrying Capacity | 113 |
| C. | Terrestrial Food Web | 118 |
| D. | Aquatic Food Web | 127 |
| V. | METHODOLOGY VALIDATION | 134 |
| 5.1 | Description of Field Test Region | 134 |
| 5.2 | Field Test: Development Level Indicators and Their Performance Levels | 138 |
| 5.2.1 | Inhabitation Index | 138 |
| 5.2.2 | Land Value | 142 |
| 5.2.3 | Intensity of Water Use | 146 |
| 5.2.4 | Transportation Facilities | 146 |
| 5.3 | Determination of Development Levels | 150 |
| 5.4 | Field Test of Mid-Arkansas River Basin: Ecological Parameters | 159 |
| 5.4.1 | Flora | 159 |
| A. | Terrestrial Natural Vegetation | 159 |
| B. | Productivity of Aquatic Flora | 159 |
| C. | Terrestrial Flora Species Diversity | 159 |
| D. | Vegetation Land Use (Aesthetic) | 163 |
| 5.4.2 | Fauna | 163 |
| A. | Dynamic Ratio of Fish Population | 163 |
| B. | Waterfowl Habitat | 175 |
| C. | Terrestrial Fauna Species Diversity | 175 |
| D. | Fauna Species Composition (Aesthetic). | 175 |

| | | |
|----------|---|-----|
| 5.4.3 | Biota | 182 |
| A. | Pest Species | 182 |
| B. | Utilization of Carrying Capacity | 182 |
| C. | Terrestrial Food Web | 189 |
| D. | Aquatic Food Web | 189 |
| 5.5 | Summary of the Field Test Results | 189 |
| VI. | SUMMARY AND CONCLUSIONS | 202 |
| 6.1 | Summary | 202 |
| 6.2 | Limitations | 206 |
| 6.3 | Recommendations | 208 |
| APPENDIX | | |
| A. | Glossary of Ecological Terms | 211 |
| B. | Definitions of Vegetation Land Use | 216 |
| C. | Flora of the Mid-Arkansas River Basin | 219 |
| C-1 | Eighteen (18) Tree Species of the Upland Forest | 219 |
| C-2 | Seven (7) Common Shrubs and Vines Species of the Upland Forest | 220 |
| C-3 | Twenty-seven (27) Common Herbaceous Plant Species of the Upland Forest | 221 |
| C-4 | Twenty-three (23) Tree Species of the Bottomland Forest | 222 |
| C-5 | Fourteen (14) Common Shrubs and Vines Species of the Bottomland Forest | 223 |
| C-6 | Thirty-two (32) Common Herbaceous Plant Species of the Bottomland Forest | 224 |
| C-7 | Forty-five (45) Common Plant Species of the Bluestem Prairies | 225 |
| C-8 | Eleven (11) Rare Plant Species | 226 |
| D. | Fauna of the mid-Arkansas River Basin | 227 |
| D-1 | Mammals | 229 |
| D-2 | Birds | 233 |
| D-3 | Fishes | 260 |
| D-4 | Reptiles | 267 |
| D-5 | Amphibians | 272 |

| | |
|---|-----|
| D-6 Naiads | 274 |
| E. Annual Animal Unit (A.U.) Food Consumption Estimate . | 276 |
| F. Approximate Proportionate Extent of the Soil Associa- tions and their Sites of the M.A.R.B. | 277 |
| BIBLIOGRAPHY | 279 |

LIST OF TABLES

| Table | Page |
|--|------|
| 2-1 U.S. Suburban Population and Housing, 1960 and 1970 | 15 |
| 2-2 Land Use in the U.S. 1959 and 1969 | 15 |
| 3-1 Data Collection and Calculation of Inhabitanace Index Indicator | 30 |
| 3-2 Data Collection and Calculation of Land Value Incicator . . . | 37 |
| 3-3 Data Collection and Calculation of Intensity of Water Use Indicator | 43 |
| 3-4 Data Collection and Calculation of Transportation Facilities Indicator | 48 |
| 4-1 Data Collection and Calculation of Terrestrial Natural Vegetation | 61 |
| 4-2 Characteristics of the Various States of Aquatic Flora . . . | 65 |
| 4-3 Data Collection and Calculation of Aquatic Flora Productivity | 68 |
| 4-4 Data Collection and Calculation of Terrestrial Flora Species Diversity | 75 |
| 4-5 Vegetation Land Use and Weighting Factors | 79 |
| 4-6 Data Collection and Calculation of Vegetation Land Use (Aesthetic) | 81 |
| 4-7 Data Collection and Calculation of Dynamic Ratio of Fish Population | 86 |
| 4-8 Data Collection and Calculation of Waterfowl Habitat | 91 |
| 4-9 Data Collection and Calculation of Fauna Species Diversity. . | 96 |
| 4-10 Data Collection and Calculation of Fauna Species Composition (Aesthetic) | 102 |
| 4-11 Types of Pest Species | 106 |
| 4-12 Data Collection and Calculation of Pest Species | 109 |
| 4-13 Data Collection and Calculation of Utilization of Carrying Capacity | 116 |
| 4-14 Trophic Level Modifiers of Fauna Species | 120 |
| 4-15 Occurrence Modifiers of Fauna Species | 122 |

| | | |
|------|---|-----|
| 4-16 | Data Collection and Calculation of Terrestrial Food Web . . . | 125 |
| 4-17 | Data Collection and Calculation of Aquatic Food Web | 131 |
| 5-1 | Collected Data and Calculated Results of Inhabitation Index Indicator | 139 |
| 5-2 | Collected Data and Calculated Results of Land Value Indicator | 143 |
| 5-3 | Collected Data and Calculated Results of Intensity of Water Use Indicator | 147 |
| 5-4 | Collected Data and Calculated Results of Transportation Facility Indicator | 151 |
| 5-5 | Development Levels of Counties in Oklahoma | 155 |
| 5-6 | Summary of Development Levels of the Mid-Arkansas River Basin | 158 |
| 5-7 | Data Collected on Terrestrial Natural Vegetation | 160 |
| 5-8 | Calculation of Terrestrial Natural Vegetation | 160 |
| 5-9 | Ecological Performance of Terrestrial Natural Vegetation. . . | 162 |
| 5-10 | Data Collected on Terrestrial Flora Species Diversity | 164 |
| 5-11 | Calculation of Terrestrial Flora Species Diversity | 164 |
| 5-12 | Ecological Performance of Terrestrial Flora Species Diversity | 166 |
| 5-13 | Data Collected on Vegetation Land Use (Aesthetic) | 167 |
| 5-14 | Calculation of Vegetation Land Use (Aesthetic) | 168 |
| 5-15 | Ecological Performance of Vegetation Land Use (Aesthetic) . . | 171 |
| 5-16 | Data Collected on Dynamic Ratio of Fish Population | 172 |
| 5-17 | Calculation of Dynamic Ratio of Fish Population | 174 |
| 5-18 | Ecological Performance of Dynamic Ratio of Fish Population. . | 177 |
| 5-19 | Data Collected on Waterfowl Habitat | 178 |
| 5-20 | Calculation of Waterfowl Habitat | 178 |
| 5-21 | Ecological Performance of Waterfowl Habitat | 181 |
| 5-22 | Data Collected (on River-Basin Basis) on Fauna Species Composition (Aesthetic) | 181 |
| 5-23 | Data Collected on Pest Species | 183 |
| 5-24 | Calculation of Pest Species | 184 |
| 5-25 | Ecological Performance of Pest Species | 186 |
| 5-26 | Data Collected on Utilization of Carrying Capacity | 187 |
| 5-27 | Calculation of Utilization of Carrying Capacity | 188 |
| 5-28 | Ecological Performance of Utilization of Carrying Capacity. . | 191 |

| | | |
|------|---|-----|
| 5-29 | Data Collected (on River-Basin Basis) on Terrestrial Food Web | 192 |
| 5-30 | Calculation of Terrestrial Food Web | 193 |
| 5-31 | Ecological Performance of Terrestrial Food Web | 195 |
| 5-32 | Data Collected (on River-Basin Basis) on Aquatic Food Web . . | 196 |
| 5-33 | Calculation of Aquatic Food Web | 197 |
| 5-34 | Ecological Performance of Aquatic Food Web | 199 |
| 5-35 | Summary of Ecological Performances of Mid-Arkansas River Basin | 200 |
| 6-1 | Summary of Proposed Ecological Standards | 205 |

LIST OF FIGURES

| Figure | Page |
|--------|------|
| 1-1 | 5 |
| 1-2 | 8 |
| 3-1 | 27 |
| 3-2 | 28 |
| 3-3 | 32 |
| 3-4 | 34 |
| 3-5 | 35 |
| 3-6 | 40 |
| 3-7 | 41 |
| 3-8 | 46 |
| 4-1 | 55 |
| 4-2 | 63 |
| 4-3 | 70 |
| 4-4 | 73 |
| 4-5 | 76 |
| 4-6 | 82 |
| 4-7 | 87 |
| 4-8 | 92 |
| 4-9 | 97 |
| 4-10 | 103 |
| 4-11 | 111 |
| 4-12 | 117 |
| 4-13 | 126 |
| 4-14 | 132 |

| | | |
|------|---|-----|
| 5-1 | Field Test Region - 4 County Region in Mid-Arkansas River Basin | 135 |
| 5-2 | Folw Diagram of Methodology Validation | 137 |
| 5-3 | Parameter Function Graph of Terrestrial Natural Vegetation . | 161 |
| 5-4 | Parameter Function Graph of Terrestrial Flora Species Diversity | 165 |
| 5-5 | Parameter Function Graph of Vegetation Land Use (Aesthetic). | 170 |
| 5-6 | Parameter Function Graph of Dynamic Ratio of Fish Population | 176 |
| 5-7 | Parameter Function Graph of Waterfowl Habitat | 180 |
| 5-8 | Parameter Function Graph of Pest Species | 185 |
| 5-9 | Parameter Function Graph of Utilization of Carrying Capacity | 190 |
| 5-10 | Parameter Function Graph of Terrestrial Food Web | 194 |
| 5-11 | Parameter Function Graph of Aquatic Food Web | 198 |

RESEARCH TO ESTABLISH ECOLOGICAL STANDARDS
FOR WATER RESOURCES DEVELOPMENTS

CHAPTER I

INTRODUCTION

The system to establish ecological standards for water resources has been developed in this research. This system is a three-component, two-step system. The three components consist of 1) development level indicators, 2) land use development levels, and 3) ecological parameters. The two steps involved are the categorization of development levels of the human environment and the development of the ecological standards in response to the various development levels. The unique feature of this research is the incorporation of human interest determinants into the evaluation of the ecological system.

1.1 The Need

Searches of Water Resources Science Information Center (WRSIC) using General Information Processing System (GIPSY) and current catalogs

of Office of Water Resources and Technology (WRT), and searches of the government reports index for non-water resources research indicate no previous or current efforts relating human interests and ecological requirements within the same standards program.

It is the contention in this research that standards and indicies are both indispensable in any practical programs for environmental protection and enchancement. Unfortunately, attempts to set standards have been largely limited to physical, chemical and human health aspects of the environment. Although these are helpful standards and indicators of aquatic environments, they are nearly useless for land or land-water interface environments. Therefore, there is an obvious need for the development of ecological standards which, while meaningful for the aquatic environment, are essential for the land and land-water interface environment.

1.2 Preservation Philosophy

The alteration of natural ecological systems by man has had deleterious effects on the land and water resources of the nation. The deteriorating quality of the physical environment is easily perceived. Of utmost concern is the condition of certain critical resources necessary for the direct support of human environments. Water is the resource where the greatest concern should lie, since man's survival is directly linked to obtaining adequate supplies of clean water.

The preservation of water resource environments is a major goal of this research. The underlying premise of the study is that water resources must be preserved and protected to insure the continued survival of mankind. The decisions concerning the emphasis and intent of the study which arose during the research were strongly oriented toward insuring the preservation of water resources by establishing ecological standards to reflect the need for high quality supplies of water. This "preservation philosophy" is the basis for the standards established in this research.

1.3 The Approach

In the course of the development of ecological standards, there was the inevitable encounter with the problem of handling non-quantifiable elements, a very difficult problem that has been and continues to face the planner (engineer, biologist, economist, social scientists, etc.). In this research, slightly different approaches--different from the traditional ones--were taken to quantify the "non-quantifiable" environmental elements. In the attempt to quantify the social and economic factors, existing methodologies mostly pursue the traditional measurements of Gross National Product (GNP), income level, employment, population and so forth; while in this research, development level indicators are formulated to estimate the socio-economic factors. This will be discussed in Chapter III. In quantifying the ecological elements, five of the ecological parameters in this study were developed with a "percentage change" approach which is different from the conventional one-point-in-time-estimate approach. The application of the change approach will reduce subjective judgement commonly required in quantifying the environmental elements. The discussion of the various approaches used in quantifying ecological elements will be found in Chapter IV.

In existing standards programs for environmental protection and enhancement, socio-economic factors are often absent or purposely avoided; and if they are present, they are either vaguely or inadequately dealt with. Socio-economic factors, other than the traditional approach of estimating them in terms of monetary values, are commonly quantified in a way which is very similar to that being utilized for environmental parameters. Almost surely, in any existing standards program, there is always the absence of a mechanism that relates the socio-economic and ecological factors. In view of this missing link, this research has taken the task to interconnect these two major components of an ecological community. In developing any standards program, it is no longer sufficient to estimate each environmental element separately. Environmental elements must be treated as interlocking components of a system. Above all, the influence of human interests must be adequately integrated

into the development of standards if they are to be meaningful. Instead of attempting to explain the entire framework of the methodology for the development of ecological standards in a tedious manner, the framework is summarized in a flow diagram, Figure 1-1, Flow Diagram of Methodology Development, which illustrates the major components of an ecological community that are dealt with, the various stages at which they are developed, and finally the stage at which socio-economic factors are incorporated into the decision making process concerning standards.

1.4 Objectives

The primary objective of this water resource research is to develop appropriate minimum ecological standards for water resource utilization and development. The standards are to be developed with the entailment of the following qualities:

- 1) The standards should have the ability to fairly represent adversary interests at a water basin level. Standards developed should have the flexibility to allow reasonable economic development and also the restrictiveness to enhance reasonable environmental preservation at appropriate ecospace.
- 2) The socio-economic criteria and ecological standards developed could be used to judge alternative ecological standards programs.
- 3) The standards and methodology developed could be used at any phase of a water resource project to assess the performance of the environment.
- 4) The standards and methodology developed will require minimum resource from users. Users do not have to be highly trained personnel, because this method is developed so that when using it, only limited subjective judgement will be needed.

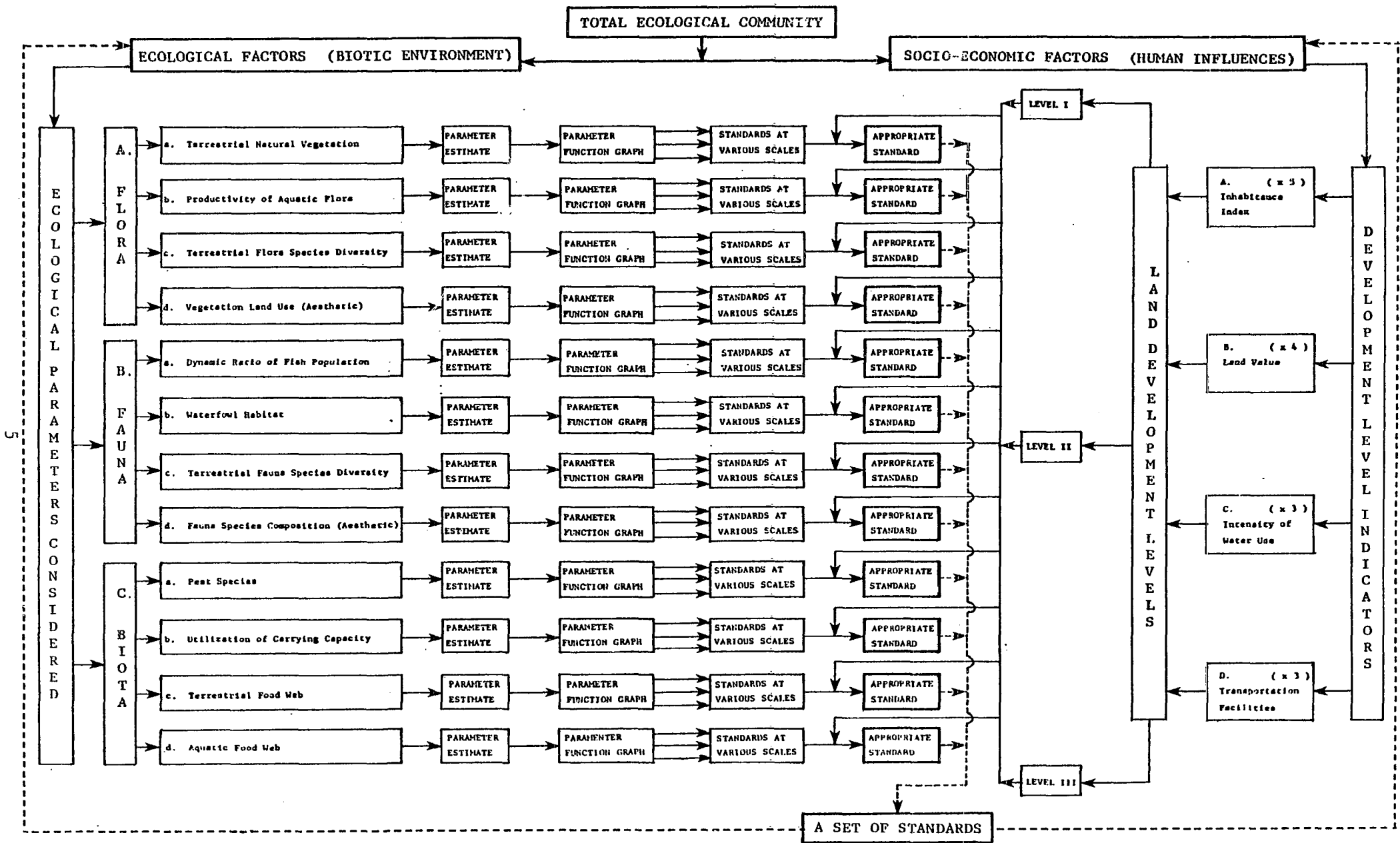

FIGURE 1-1 FLOW DIAGRAM OF METHODOLOGY DEVELOPMENT

1.5 Scope

This research to develop ecological standards for water resources is an initial attempt at setting standards. The preliminary validation test is performed on a 4-county section of the Mid-Arkansas River Basin (M.A.R.B. includes Tulsa, Creek, Osage, and Pawnee counties of Oklahoma). The development of standards was comprehensive, but it is far from being exhaustive, since many areas may have been overlooked or may be recognized but cannot be dealt with due to the resource and time constraints of this project. The standards developed are explicit and reproducible. In the development of the ecological standards, special efforts were taken to ensure that future researchers or users will be able to adopt this methodology on a simple step by step basis. Users should be able to replicate similar results.

When this research is refined to a sufficient degree, future studies conducted on environmental assessment may be able to use this research to solve problems without having to assemble an interdisciplinary team of experts.

1.6 State-of-the-Art Review

The complexity of ecosystems and the value-laden attitudes of the public toward environmental quality make specific definitions of environmental quality difficult. Human attitudes and actions significantly affect ecosystems in general. The development of a method to measure human and ecosystem values in the planning and operation of water resources should begin with a brief review of the present state-of-the-art.

The majority of the methodologies or tools employed to evaluate the environmental conditions of developments were conceived in response to the National Environmental Policy Act of 1969 (NEPA). Figure 1-2 presents a summary of the major components of nine methodologies used in assessing environmental quality.

Four types of approaches are most common in present environmental

assessment methodologies: checklist, matrix, network and overlay mapping. No single best approach exists, rather, the approach applied to any project should be tailored to the requirements of the area to be assessed.

The checklist approaches of Battelle, Stover, the Multi-agency Task Force, and the Tulsa Corps of Engineers are imaginative attempts to evaluate environmental impacts of water resources projects (Figure 1-2). However, certain shortcomings are apparent in incorporating these environmental quality measures in the impact evaluation process. Initially, they suffer from varying degrees of subjectiveness in the assignment of impact evaluations. This tends to reduce the reproducibility of the results obtained in the assessment. Secondly, little attention is given to the influence of human values as reflected in socio-economic conditions. Since regions where environmental assessments are undertaken have varying economic and social conditions, it is crucial for a thorough environmental evaluation to include a socio-economic assessment.

The major difficulty in evaluating environmental quality is not in measuring particular aspects of natural or human systems but in integrating such measurement into a comprehensive, reproducible system. None of the previously discussed methodologies completely satisfy the need for such a system. Each methodology provides impact measurements and evaluates them in terms of environmental quality but all of them fall short of providing man with the ability to evaluate and enhance the natural environment in relationship to the social values which guide environmental policy considerations. In addition, if the natural processes of ecological systems and human value systems were accurately evaluated by present methods there would remain a need to integrate them into a comprehensive quantification of environmental quality. It is the intention of this research to develop ecological standards tailored to the individual regions which are being assessed, to effectively evaluate the environmental quality of water resource developments, thereby, overcoming the disadvantages of present methods.

FIGURE 1-2 A SIMPLIFIED COMPARISON OF ENVIRONMENTAL ASSESSMENT METHODOLOGIES

| METHODOLOGY | APPROACH | ADVANTAGES | DISADVANTAGES |
|---|-------------------------------|---|--|
| 1. Battelle's Environmental Evaluation System for Water Resource Planning | Checklist | <ul style="list-style-type: none"> a. Emphasizes explicit; b. Weights the spatial and temporal aspects of impacts; c. 'Red flag' system | <ul style="list-style-type: none"> a. High resource requirement; b. Socio-economic areas are poorly dealt with. |
| 2. Stover's Environmental Impact Assessment Procedure | Checklist | <ul style="list-style-type: none"> a. Allows flexibility; b. Method for alternative comparison. | <ul style="list-style-type: none"> a. Moderate to high resource requirements; b. Low replicability. |
| 3. Multiagency Task Force's "Guidelines for implementing Principles and Standards for Multiobjective Planning of Water Resources" | Checklist | <ul style="list-style-type: none"> a. Wide applicability; b. No specific resource requirement. | <ul style="list-style-type: none"> a. Relies on too much subjective evaluation, hence highly variable results; b. Does not deal with socio-economic areas; c. Too rural-oriented in impact category design. |
| 4. Tulsa District Corps of Engineers' Matrix Analysis | Checklist with Matrix display | <ul style="list-style-type: none"> a. Flexible data needs; b. Relative rather than absolute impact measurement. | <ul style="list-style-type: none"> a. No clear guidelines on impact measurement; b. Low replicability. |
| 5. Battelle's Environmental Evaluation System for Water Quality Management | Checklist, Matrix and Network | <ul style="list-style-type: none"> a. Comprehensive and explicit in identifying impact; b. High flexibility in data needs; c. Replicability is comparatively higher than any other methods in existence. | <ul style="list-style-type: none"> a. Lack of economic variable; b. Not readily adaptable to other project types. |

FIGURE 1-2 A SIMPLIFIED COMPARISON OF ENVIRONMENTAL ASSESSMENT METHODOLOGIES (CONTINUED)

| METHODOLOGY | APPROACH | ADVANTAGES | DISADVANTAGES |
|--|---------------------------------------|---|---|
| 6. Odum's Optimum Pathway Matrix Analysis | Checklist and statistical tools | <ul style="list-style-type: none"> a. Statistical tool incorporated strengthen the alternatives selection power; b. Analyze wide range of impact types. | <ul style="list-style-type: none"> a. High resource requirements; b. Subjectiveness leads to low replicability; c. Limited to highway projects alternatives evaluation only. |
| 7. Moore's method for evaluating manufacturing E.I.S. for Delaware's coastal zone. | Network | <ul style="list-style-type: none"> a. Networks to display cause-condition-effect; b. Secondary impacts traced; c. Useful for identifying impact. | <ul style="list-style-type: none"> a. Subjective evaluation leading to low reproducibility; b. Limited in applicability; c. Guidelines have to be proposed for defining evaluation categories. |
| 8. Leopold's Interaction Matrix | Open-cell matrix | <ul style="list-style-type: none"> a. Identifies impacts visually; b. Resource requirements very flexible; c. Wide applicability. | <ul style="list-style-type: none"> a. Shortage of guidelines and reliance on subjective judgment leads to ambiguities, consequently low replicability; b. Economic and secondary impacts are not addressed. |
| 9. Krauskopt's Evaluation of Environmental Impact through a Computer Modelling Process | Overlay technique by computer mapping | <ul style="list-style-type: none"> a. Graphic display of impacts and alternatives can be easily understood; b. Readily adaptable in regions and states with data bank system. | <ul style="list-style-type: none"> a. Very high resource requirement; b. Only practical for projects with small geographical area. |

CHAPTER II

LAND DEVELOPMENT PATTERNS

2.1 Introduction

When man established the first permanent settlements several thousand years ago, the considerations which were most crucial to survival concerned the settlement's relationship to the environment. The availability of water was a major factor in the decision to locate each community. The community of early generations was planned and constructed around the natural source of water whatever form of extraction was employed.

Because of the technological progress, the city is no longer constrained by most natural environmental factors. Swamps are drained, hills leveled, and rivers dammed to allow the construction and operation of urban centers. Close proximity to water is no longer a major consideration in the development of urban areas. Conveyance systems now transport water thousands of miles to cities in distant river basins.

2.2 Ecological Considerations

Since cities and all forms of human settlements still depend upon the regional environment to assimilate the waste products of the community, it is most important to consider the relationship of the total environment to human society. Regions which are ecologically different vary in their ability to provide human settlements with energy and assimilate waste materials. Warm and humid regions have varied and rapid biological growth and consequently the greatest biological potential. Regions where the climate is predominantly cold and dry have less potential. This potential is directly related to the rate at which the natural ecological systems assimilate nontoxic biodegradable substances. Each ecological system has a point at which the intensity of the input of these materials exceeds the processing potential. The overloading of recipient ecological systems must be avoided to maintain a stable healthy environment.

Land may be viewed as a medium for the retention or transmission of environmental pollutants, although the effects of land pollution are generally manifested through the action of water. The capacity of a parcel of land to assimilate environmental pollutants is dependent not only upon its physical characteristics but also upon man-made environmental quality standards based on biological, societal, functional, or aesthetic damage criteria.

Land may become polluted as a result of a variety of activities. For example, leachates from livestock feedlots, inappropriately sited sanitary landfills and septic fields, toxic industrial wastes from point and non-point sources, and acid mine drainage can all lead to pollution of the land and water resources. Polluted surface runoff from developed land is a major contributor to the contamination of streams and lakes. The volume and quality of the runoff waters is dependent to a large degree on the capacity of the soil to absorb precipitation. This capacity is significantly affected by extensive paving of urban areas, a condition which frequently leads to the overtaxing of the capacity of adjacent land areas to assimilate pollutants.

Assimilative capacity is dependent on the sensitivity to pollution of the bioecological system supported by a given unit of land. The relative vulnerability of some vegetation to pollution-induced changes in soil alkalinity or acidity and the impact of pesticides on the reproductive cycle of large predatory birds illustrates how the limited adoptive capability of ecological systems is inseparably linked to specific habitats.

The overall goal of environmental enhancement of water resources is dedicated to minimizing the waste materials, especially toxic, non-biodegradable substances, which are disposed of into natural ecological systems or stated in another way, to increase the stability of each ecological system by balancing man's input of materials with each system's capability to assimilate them. Obviously this is an idealistic view, but one which dramatizes the complexity of establishing ecological standards.

In principal, the type and intensity of land development and the attendant waste-generation processes can be matched to the capacity of the land resources in a river basin to assimilate environmental pollutants without degradation of environmental quality. Although the application of technological controls on pollutants to pollution-producing sources may significantly ease the stress on assimilative capacity, nothing less than a "zero discharge" or closed cycle processing technology can eliminate them altogether. The necessity of accepting such limitations in current pollution control technology makes matching land development levels to the assimilative capacities for a variety of pollutants a complex problem.

The regional constraints imposed by ecological characteristics of a given region should be influential in the establishment of the standards. The standards should be flexible enough to be applicable to widely varying conditions. Water resources of different forms have widely varying ecological systems and demand individually tailored standards.

2.3 Uniform Standards

The present trend in the institutional programs for environmental protection as it has developed under EPA, is toward uniform national emission and environmental quality standards. This tendency has been promoted by: (1) the complexity of the problem of developing multi-pollutant standards; (2) equity considerations; (3) the very real need to inhibit a precipitate migration of pollution-producing activities from urban areas (where they represent a major component of the employment and tax base) to "polluter's havens" established by local and state governments seeking advantages from locally lax pollution-control standards. The adoption of uniform, single-pollutant emission and environmental quality standards, whatever their conceptual, administrative, and aesthetic appeal, diminishes the possibility of taking advantage of spatial variations in the capacity to assimilate pollutants or of inducing desirable spatial concentrations of related pollution-producing activities. This limitation of current uniform standards policy might well be eliminated by environmental planning oriented to establishing indices of environmental quality based on spatially oriented standards.

The list of factors which influence the balance and diversity of ecological systems is very long. In actuality, very few ecological systems can be defined or categorized in detail to be the same as another. This "uniqueness property" of ecological systems compounds the problem of setting broad standards to evaluate ecological communities.

Therefore, ecological standards need to be based on some measurement of human involvement or level of modification of the "natural" condition. Since the level of human invasion of ecological systems is an indication of its future assimilation potential or lack thereof, the level of development of human settlements is directly related to the environmental integrity and stability of a region.

In order to establish meaningful and useful ecological standards the first step is to categorize land development levels in a manner which will best define the extent of human modifications of existing ecological system. Next it was determined that no subjective judgement was to be made as to whether the region was suitable for the existing level of

development. The suitability of any parcel of land for human modification is an extremely complex and often emotional issue which was believed to be outside the theoretical limits of this study. Therefore, the standards are based on the existing conditions in a region with no speculation or analysis as to the suitability or prudence of the use of the land.

2.4 Human Involvement

The preservation of natural environments in close proximity to water resources should be a major goal in environment planning. The result of covering thousands of acres with concrete and steel has been the rapid degradation of the land, water and air in some regions. The effects of such pollution from urban areas are experienced in ever increasing distances from the source. The influence of the pollutants is especially critical to water resources since these resources are depended upon to assimilate large quantities of civilization's waste products. Ecological standards must, therefore, be based on the level of human involvement in each ecological system.

This level of human involvement or land development varies widely throughout the nation. There are ecological communities existing today that are scarcely modified by human action. Many acres of wilderness exist despite the late awakening to our ecological conditions.

The majority of land in the nation is in a condition somewhere between isolated wilderness and crowded urban conglomerations. The majority of this land is used for agricultural purposes. Substantial portions of these land areas also support forests and deserts. Although man's actions have modified the ecological communities in these areas, they maintain, in general, sufficient diversity and stability for their continual survival.

Tables 2-1 and 2-2 provide an overview of the nation's land use data. It is apparent from this data that the size of the areas consumed by urban growth is increasing. As the nation's population continues to increase, and a larger percentage of Americans choose to live near urban

TABLE 2-1 U.S. SUBURBAN POPULATION AND HOUSING, 1960 AND 1970 (IN MILLIONS)

| | <u>1960</u> | <u>1970</u> | <u>Percent Change</u> |
|-------------------------|-------------|-------------|-----------------------|
| Total Metropolitan Area | | | |
| Population | 120 | 139 | +17 |
| Housing Units | 39 | 46 | +20 |
| Central Cities | | | |
| Population | 61 | 64 | + 5 |
| Housing Units | 20 | 23 | +11 |
| Suburbs | | | |
| Population | 59 | 76 | +28 |
| Housing Units | 18 | 24 | +31 |

Source: U.S. Bureau of the Census 1970.

TABLE 2-2 LAND USE IN THE U.S. 1959 AND 1969 (IN MILLIONS OF ACRES)

| | <u>1959</u> | <u>1969</u> | <u>Percent Change</u> |
|-------------------------------------|-------------|-------------|-----------------------|
| Urban Areas | 27.2 | 34.6 | + 7.3 |
| Transportation Areas | 24.7 | 26.0 | + 1.3 |
| Recreation and Wildlife | 61.5 | 81.4 | +19.9 |
| Public Installations and Facilities | 27.5 | 27.4 | - .1 |
| Farmsteads | 10.1 | 8.4 | - 1.7 |

Source: U.S. Department of Agriculture 1969

centers, the cities will continue to expand. Previously, much of this growth has taken place in a haphazard and uncontrolled manner, destroying many areas of natural scenic beauty and ecological integrity. Ecological standards should be designed to enhance the environmental conditions of a region regardless of its proximity to human settlements.

Given the dilemma of attempting to establish ecological standards for water resources in the wide spectrum of environments that exist, it became obvious that some method of differentiating between environmental conditions was necessary. To set a standard of minimum D.O., for example, at 8 mg/l would be realistic for a river which drains a wilderness area. Conversely, a D.O. standard of 8 mg/l would be unrealistic for the urban situation. A description of land use, condition and the associated human involvement is a prerequisite for the establishment of ecological standards.

2.5 Land Use

Traditional land use descriptions and categories are not applicable to developing ecological standards for water resources. For example, to breakdown land use into categories such as urban, suburban fringe, agricultural, forests, etc. is not practical for standardized evaluation.

An alpine meadow in a national forest used for summer grazing and a pasture on an urban fringe which supports dairy cattle year round, might both be categorized as agricultural land use, but there is very little relationship between their conditions in the ecological system. The factors which influence one ecological system would not be the same factors which influenced the other. A major difference is the proximity of one area to a high concentration of population or human involvement in the urban ecological condition.

The development of ecological standards is, therefore, concentrated on two levels. The first is defining the degree of human influence over the related water resources environment. By measuring certain socio-economic indicators, it is possible to define with some

consistency the human influence in terms of development levels of the land in the water resource's region. Secondly, the ecological standards are developed in response to the existing level of development in order to reflect society's intrusion upon the ecological system of the water resource. In this manner, it is possible to overcome many of the problems inherent in developing a broad methodology to be applied to a highly variable problem. This approach allows the investigator to use a standard, objective means to assess any water resource development in terms of the ecological system, while maintaining the flexibility required of any approach which describes the infinitely varied ecological conditions throughout the nation.

CHAPTER III

DEVELOPMENT LEVEL INDICATORS

3.1 Introduction

Ecological standards applied to an area should be closely related to the intensity of use of natural resources. In a highly developed area, the natural environment is said to be disturbed, abused and exploited by man. As a consequence little space and resources are left for the growth and survival of the natural vegetation and animals. In order to allow efficient economic development, more flexible ecological standards should be employed in these highly developed areas to allow reasonable use of the natural resources. On the other hand, more restrictive ecological standards should be applied to the undeveloped areas to protect the natural environment from further disturbance and deterioration.

In order to tailor the ecological standards to individual regions with varied ecological communities, the socio-economic characteristics of a region were employed to indicate the degree of development of an area. Where man constructs cities, the surrounding regional environment is depended upon to assimilate many of the waste products of society or to serve as a buffer zone between man and his wilderness. The capacity of ecological systems to assimilate such materials varies with each system's

spatial location.

In areas with high population concentrations, the natural environment is modified to support human systems. Such modification by which stresses were placed upon the natural environment often results in a reduction of the natural diversity and stability of ecological systems. The health and stability expected of natural ecological systems is dependent upon the degree of human interaction in the system.

To assign uniform ecological standards to systems with such a great variation in assimilation potential is difficult. A more reasonable approach would be to consider similar ecological systems together and develop standards for these groupings. It seems reasonable that urbanized areas should not be expected to develop ecological communities of similar stability and diversity as wilderness areas. For these reasons, the research procedure was designed to delineate regions of ecological similarity.

Three natural divisions of environmental regions were identified after a thorough study of human environment. These regions correspond to the level of development of human systems (cities) in the environment. The preferred procedure is one where the level of development is measured by the socio-economic indices of the region. The level of development of a given region reflects the degree of human involvement (urbanization) in the natural environment. This level of human involvement in natural environments is then used to determine the strictness of the ecological standards that should be applied to a region.

3.2 Development Levels

Three levels of development were identified in this study to represent the environmental condition of the region under consideration. The least disturbed environments are designated as level I areas. A level I area is assigned the strictest ecological standards in order to preserve the area for the enhancement and protection of wildlife and flora communities. In any given study area the land which exhibits a low level of human involvement and integration in the ecological community is desig-

nated as a level I conservation area.

The level II areas are designated by an intermediate level of human involvement in the ecological communities. Frequently, this land may be used for agricultural or recreational purposes. The standards for level II area are designed to allow more human interaction in the environment reflecting the necessity of utilizing ecological systems in these areas to assimilate the by-products of human society or to serve as a buffer zone to alleviate the tension man imposed on his environment. The level II standards are less restrictive than level I standards and therefore should not be applied to areas where conservation or preservation is a major goal as they allow some degree of disruption of ecological systems in the area.

Areas where large concentrations of population are located are designated as level III environments and the standards applied to these areas should be more tolerant of pollutants in the ecological systems. This tolerance should not exceed the capacity of the ecological systems in a region to assimilate society's by-products. The level III condition is characterized by an environment which is highly human oriented but which still preserves the stability and diversity of the natural ecosystems present in the region.

An area of land which has not been disturbed by man and has remained in its natural condition is ideal to be used as the basis for determining the land development levels. But because of the rapid pace of population growth and economic development, all the natural environments are disturbed more or less by man and it is unlikely to identify the undisturbed or virgin land. The objective of this research is to develop ecological standards by which natural environments may be preserved or enhanced so that future generations may be able to live in a livable environment. The difficulty arises when it is necessary to determine whether a piece of land has the value to be preserved for natural vegetations and wildlives, or should it be allowed for economic development or simply occupied by man. Because it is impossible to identify undisturbed land, such decisions can only be made on a relative base, or by simple comparison. Therefore, in order to accomplish such a task, it is suggested here that, in any study area, its level of human

involvement in the ecological community be compared with those of other areas in the same geographical or political region, measured, quantified and used to make such decisions. It is, however, left to the decision of the users to determine the size of the region in which the comparison can be based.

A set of indicators were devised in this research to quantitatively measure the development level of an area and they can be used to express statistically the level of human involvement in a region. The indicators proposed by this study are inhabitation index, land value, intensity of water use, and transportation facility. It is not intended that these four indicators be exhaustive; users should feel free to employ additional indicators for their study area. All the estimates of the indicator are transformed into their corresponding indicator performance level by comparing it with the maximum value in the region. They are then weighted in proportion to their relative importance. The indicator performance levels are multiplied by their relative weights to obtain the weighted indicator performance levels which are then summed to obtain the development level estimates. The cutoff points on these development level estimates are determined to differentiate level I, II, and III regions.

3.3 Indicators and Their Performance Levels

3.3.1 Inhabitation Index

The economic growth or development of an area is primarily derived from human needs. In any economic activity, man plays a dual role as consumer and producer. Because man is such an important component of economic activities, indicators developed in terms of population measurement will appropriately describe the development levels.

Population density has been traditionally used as indicators of human settlement and socio-economic development. In reality, they are not capable of indicating the development level or describing the settle-

ment pattern of an area. The ingrained qualities of these indicators can be very misleading when they are applied to choosing the ecological standards. A high population density in a given region can result in two different settlement patterns, highly concentrated and evenly distributed. Considering two regions with the same land areas and population, in the first region the population is concentrated on a very small part of land in an urban area, while there are few inhabitants in the rest of the region. Since population density is expressed as the average population for a given land area, the population density is represented as X people per square mile. The same population density would be recorded for a second region where the same sized population is evenly distributed over the region.

Consequently, if population density is used as an indicator of human disturbance of the ecological communities, the standards arrived at would be the same even though the settlement patterns, and therefore, the environmental condition of the regions are different.

To amend the ineptitude of these commonly used indicators, an indicator termed Inhabitation Index (I.I.) is developed.

Inhabitation index is an indicator that explains the development level of a region in terms of its population size and their settlement pattern. There are many variables that affect inhabitation index and the function of inhabitation index can be expressed as follows:

$$\text{Inhabitation Index} = f(P_t, P_r, P_u, A_t, A_r, A_u, D_t, D_r, D_u \dots) \quad (3-1)$$

Where P_t = Total population

P_r = Rural population

P_u = Urban population

A_t = Total land area

A_r = Rural land area

A_u = Urban land area

D_t = Total population density

D_r = Rural population density

D_u = Urban population density

Some of these factors are not disjointed, but each has its own effect on the inhabitation index. The unit of population density is the number of persons per unit area. Thus if density is used as a variable, then using land area and population will be redundancy. With all the P's and A's discarded, the function of inhabitation index becomes:

$$\text{Inhabitation Index} = f(D_t, D_r, D_u, \dots)$$

In the remaining three variables, total density reflects the total number of persons using natural resources on a given land area, rural population density is used to describe the settlement pattern, or in a more precise manner, it has a direct relationship with population dispersion and environmental disturbance. For example, considering two regions with similar total population density, the one with higher rural population density carries more population in the rural area, meaning higher dispersion of population; consequently, there will be a greater chance of the natural environment being disturbed and stressed (see also Example A in the discussion that follows). Urban population density, as a variable, does not possess such property to reflect the level of disturbance of the natural environment. Comparatively, D_t and D_r have much more accountable effect on the inhabitation index; hence D_u is discarded from the function. Therefore:

$$\text{Inhabitation Index} = f(D_r, D_t) \tag{3-2}$$

$$= (D_r)^x \cdot (D_t)^y \tag{3-3}$$

In the formula, exponents x and y are used to express the relative importance of total population density and rural population density. In this study, the use of data from Oklahoma counties showed that substitution of both x and y with a value of one will adequately reflect the development levels of the counties. Therefore:

$$I = (D_r) \cdot (D_t) \tag{3-4}$$

where I = Inhabitation index

In other regions, users of this formula can accordingly choose the x and y value with respect to the region's particular situation.

The properties and interrelationships of the three components of the equation will be discussed by using the following three examples.

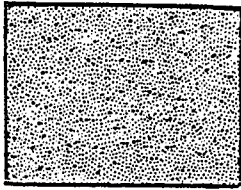

(a)

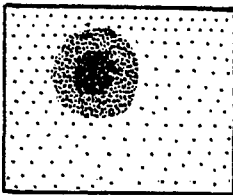

(b)

Example A. This example illustrates the importance of rural population density in expressing settlement pattern. Consider two regions (a) and (b) having given conditions as follows:

$$\text{Total area: } A_{ta} = A_{tb}$$

$$\text{Total population: } P_{ta} = P_{tb}$$

$$\text{Thus, total population density: } D_{ta} = D_{tb}$$

If region (b) has an urban center, obviously, it will have a lower rural population density.

That is:

$$\text{Rural population density: } D_{ra} > D_{rb}$$

Under this condition, as seen in figures on the above, most of the land in region (a) is very likely to be developed and used while in region (b) fewer people will be disturbing the natural environment. Naturally, the development level in region (b) can be said to be lower, and hence, more crucial to preserve. This is expressed in notations as:

$$(D_{ta}) \cdot (D_{ra}) > (D_{tb}) \cdot (D_{rb})$$

Thus,

$$I_a > I_b$$

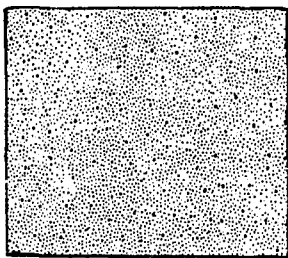

(c)

Example B. This example illustrates the importance of the total population in defining the development level. Consider two regions (c) and (d) having given conditions as follows:

$$\text{Total area: } A_{tc} = A_{td}$$

$$\text{Rural population density: } D_{rc} = D_{rd}$$

$$\text{Total population: } P_{tc} < P_{td}$$

If the rural population density of the two

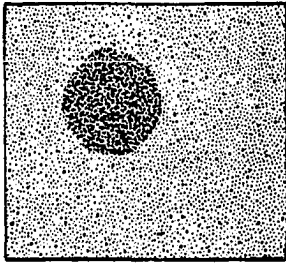

(d)

regions are the same and the total population of region (d) is greater than region (c)'s, there must be an urban center in region (d). And if the two areas are the same, the total population density of region (d) will be greater than that of region (c). That is,

$$\text{Total population density: } D_{tc} < D_{td}$$

When the total population density in region (c) is lower than that in region (d), the intensity of natural resource utilization will also be lower and consequently adaptable to a lower development level. When

$$D_{tc} < D_{td}, \text{ then}$$

$$(D_{tc}) \cdot (D_{rc}) < (D_{td}) \cdot (D_{rd})$$

Thus,

$$I_c < I_d$$

Example C. This example demonstrates the misconception that a high development level is associated with an urban area. Consider region (e) and (f) having given conditions as follows:

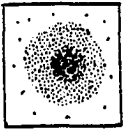

(e)

$$\text{Total area: } A_{te} < A_{tf}$$

$$\text{Total population: } P_{te} = P_{tf}$$

Thus,

$$\text{Total population density: } D_{te} > D_{tf}$$

$$\text{Rural area: } A_{re} < A_{rf}$$

$$\text{Rural population: } P_{re} = P_{rf}$$

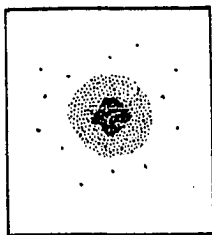

(f)

Thus,

$$\text{Rural population density: } D_{re} > D_{rf}$$

The total area of region (f) is larger than region (e), but both have a similar size urban center and urban fringe beyond which there are few inhabitants. Apparently, the total and rural population density of region (f) is smaller than that of region (e). Proportionally, region (f) has more land that is undisturbed, and thus, it should be assigned a lower development level.

From the above inequalities,

$$(D_{te}) \cdot (D_{re}) > (D_{tf}) \cdot (D_{rf})$$

Thus,

$$I_e > I_f$$

When the inhabitanace index is plotted against its indicator performance level, their relationship can be shown in Figure 3-1.

Theoretically, the development level tends to follow the same direction as the inhabitanace index. At the beginning, the slope is steep. Every unit increase in I value will increase the indicator performance level a great deal. As the I value increases, this phenomena becomes less pronounced. Finally, when the I value is very high, the curve will become almost level. That is to say, when the I value is extremely high, any change in the I value will no longer affect the indicator performance level.

If this is plotted on a semi-log paper, a straight line curve should result as shown in Figure 3-2.

The maximum of the scale of x-axis is the maximum I value in the region involved. Because of the linear relationship, the indicator performance level of any area in a region can be determined by the following formula:

$$P_i = \frac{\text{Log } I_i}{\text{Log } I_{\max}} \times N \quad (3-5)$$

$$= \frac{\text{Log } I_i}{\text{Log } I_{\max}} \times 10 \quad (3-6)$$

Where P_i = Indicator performance level of area i, dimensionless

I_i = Inhabitanace index of area i, dimensionless

I_{\max} = Maximum inhabitanace index in the entire region,
dimensionless

N = Maximum of the scale on indicator performance level,
 $N = 10$ in this study

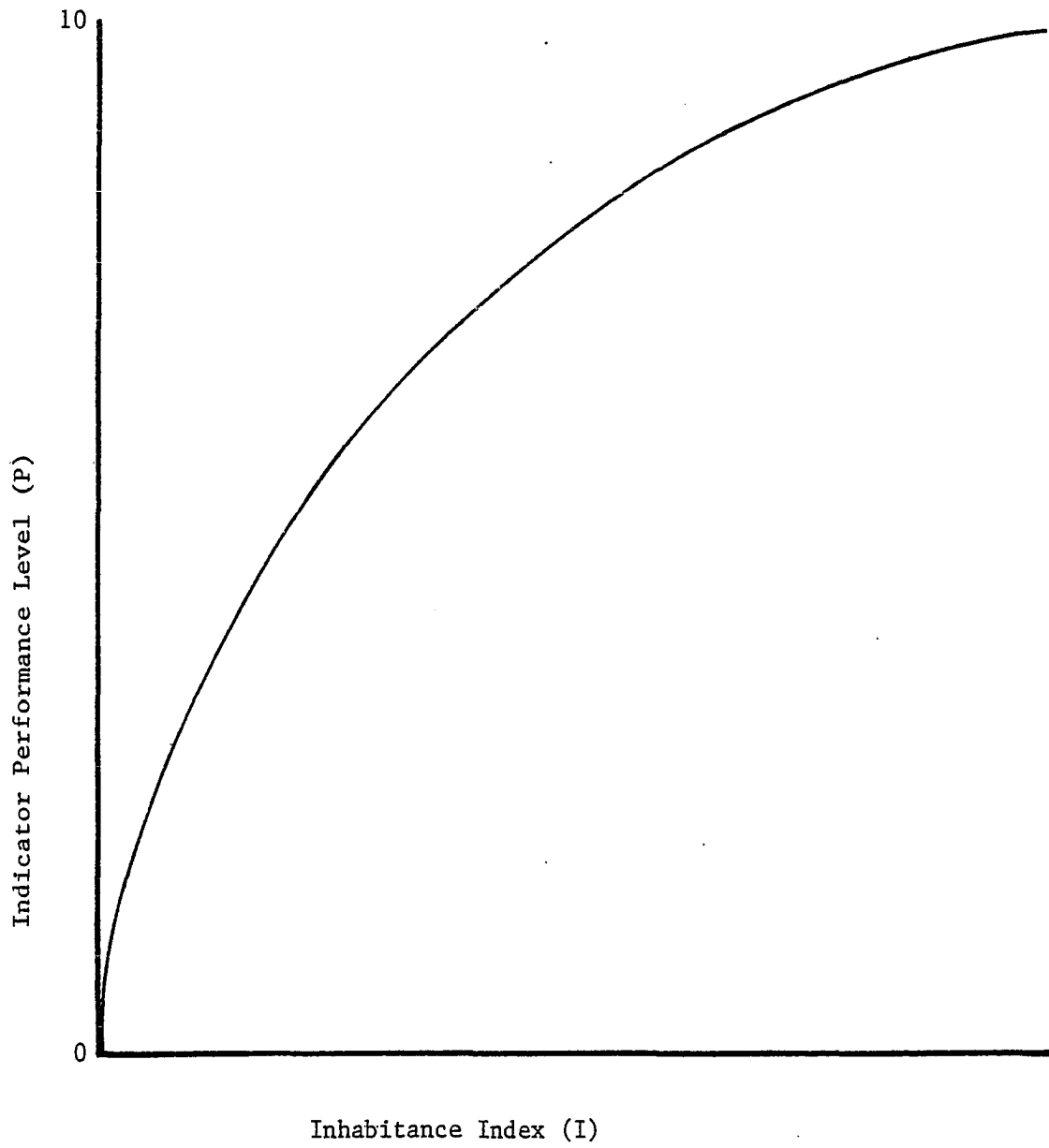

FIGURE 3-1 INDICATOR FUNCTION GRAPH OF INHABITANCE INDEX

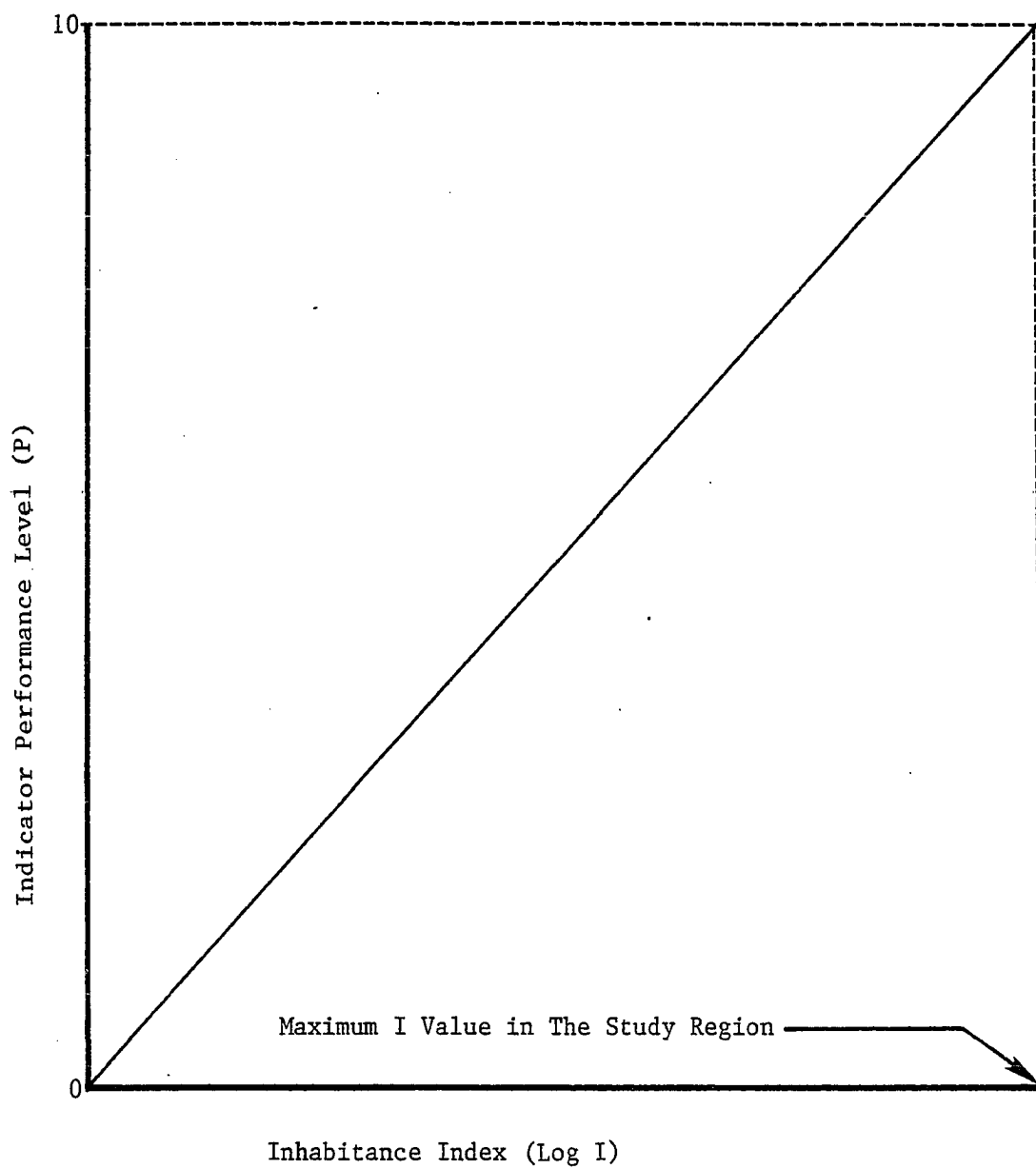

FIGURE 3-2 INDICATOR FUNCTION GRAPH OF (Log) INHABITANCE INDEX

The following two formula are used prior to the determination of the performance level of inhabitation index:

$$D = \frac{P}{A} \quad (3-7)$$

where D = Population density, persons/square mile

P = Population, number of persons

A = Land area, square miles

and

$$I = (D_r) \cdot (D_t)$$

Where I = Inhabitation index, dimensionless

D_r = Rural population density, persons/square mile

D_t = Total population density, persons/square mile

The data required includes total population, percentage of rural population, total and rural land area. The former two can be obtained from the local chamber of commerce or the U.S. Census of Population, while the latter two can be obtained from the U.S. Department of Agriculture, Census of Agriculture or the Soil Conservation Service. These data requirements along with the steps of determining the performance level of the inhabitation index are shown in Table 3-1.

3.3.2 Land Value

The interrelationship between man and land is complex. The value of land has changed countless times as the role of land changed through history. In the past, man shedded blood in protecting and acquiring land, and at times land was considered to be more valuable than human life. Today, the relationship may not be that drastic, but it is still very fundamental and significant because man's survival is based upon the wise use of land.

Economists refer to land along with labor, capital and management as one of the basic factors of production. Land resources did not become a matter of serious economic significance until people began to

TABLE 3-1 DATA COLLECTION AND CALCULATION OF INHABITANCE INDEX INDICATOR

| Item to be Determined | Data Required | Source | Calculation |
|--|--|--|---|
| 1) Rural population density of area i (D_{ri}) | (i) Percentage of rural population in area i (ii) Rural land area of area i (A_{ri}) (iii) Total population of area i (P_{ti}) | U.S. Census of Population Census of Agriculture or Soil Conservation Service U.S. Census of Population | $D_{ri} = \frac{(i) \times (iii)}{(ii)}$ |
| 2) Total population density of area i (D_{ti}) | (iv) Total land area of area i (A_{ti}) | Census of Agriculture | $D_{ti} = \frac{(iii)}{(iv)}$ |
| 3) Inhabitation index of area i (I_i) | | Calculated | $I_i = (D_{ri}) \cdot (D_{ti})$ $= (1) \cdot (2)$ |
| 4) Performance level of inhabitation index in area i (P_i) | (v) Maximum value of inhabitation index in the study region (I_{max}) | Calculated | $P_i = \frac{\text{Log } I_i}{\text{Log}(v)} \times 10$ |

systematically exploit it in competing with other people for its use or control, and in doing so, a definite price or value was attached to it.

The operation of value or a price system in economics is attributed to two major forces: supply and demand. In allocating land resources, it is necessary to emphasize the effective demand (i.e., the willingness and ability to buy land) rather than the unattainable needs or desires. Contrary to most products or goods, there is a natural limit on the land supply. Under free market conditions, prices are established through the interaction of demand and supply. This interaction is depicted in Figure 3-3. In this model, SS' represents the schedule of increasing quantities of land that the sellers would offer in the market at a series of rising prices. DD' represents the schedule of increasing quantities of land that the buyers would take in the same market at a series of decreasing prices. It can be noted that there is a physical limit of expansion FF' set by the world's fixed land area. With these supply and demand schedules, P, the intersection between SS' and DD', will be the only possible equilibrium price at which the quantity of land offered by sellers and the quantity that buyers are willing to buy are equal.

Land resources tend to be used in such a manner that will yield a higher return to the operator. In this society, land can usually earn a higher return when used for commercial or industrial purposes. Residential uses have the next priority, followed by various other types of use: cropland, pasture, grazing, forest and other land. Urban land area which includes very large sectors of commercial, industrial and residential areas have the greatest human modification. Land in urban areas is relatively scarce in supply compared to that in rural areas because more people are competing in a smaller land space. The high capitalized values on urban land thus are commanded by the price system which in turn is governed by the forces of supply and demand. It can be deduced from here that the higher the development level, the more intensely people compete for land, consequently, giving rise to higher land values. Therefore, land value is capable of being a significant indicator of the development level of a region.

Graphically, land value indicator performance level (P) tends

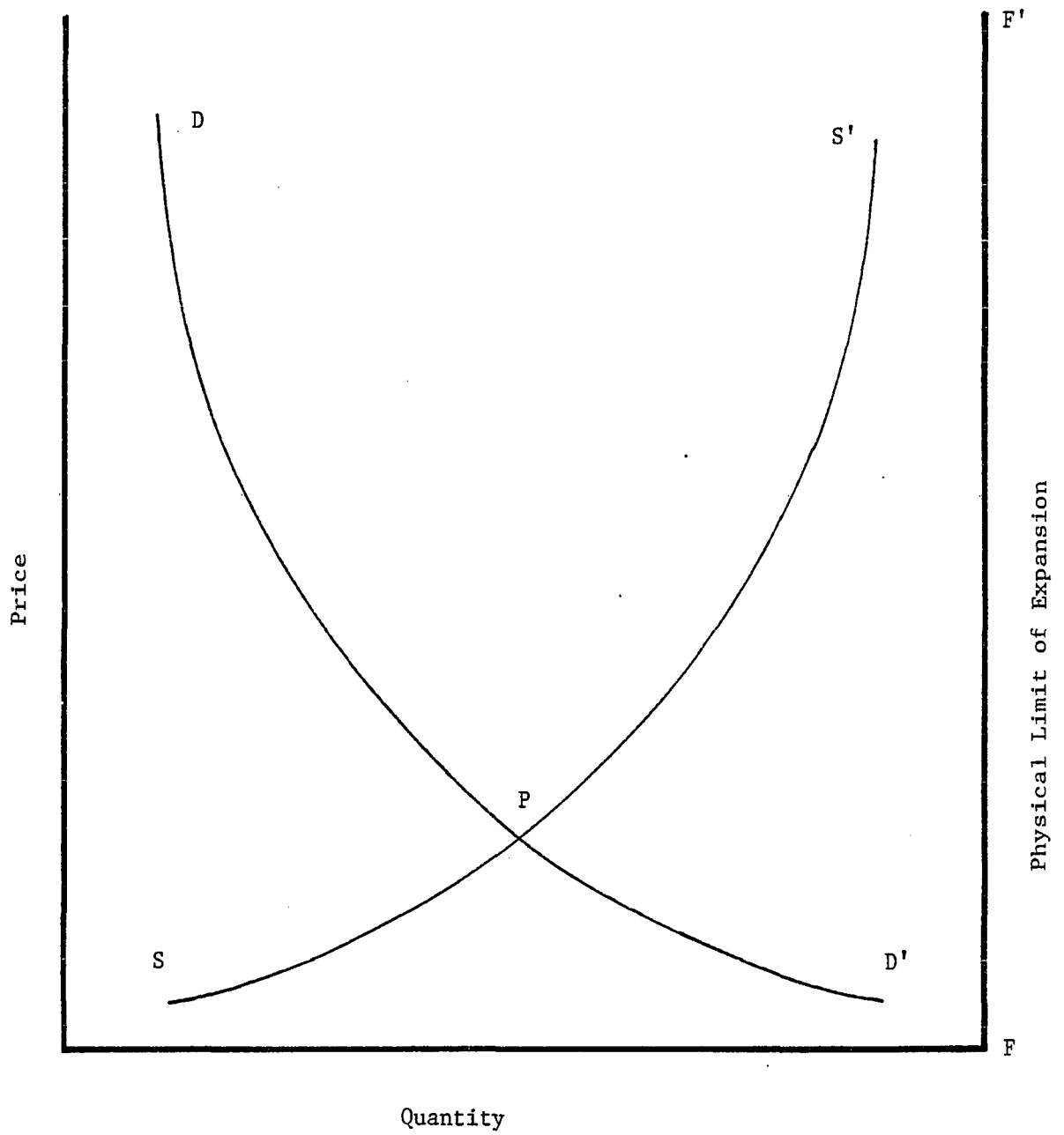

FIGURE 3-3 INTERACTION OF SUPPLY AND DEMAND FACTORS IN DETERMINING LAND PRICE UNDER FREE MARKET CONDITIONS

to follow the same direction as land value per acre (L). The indicator function graph, as shown on Figure 3-4, is very similar to that of the inhabitation index. At the beginning, the slope is steep; every unit increase in the L value will increase the performance level drastically. As the L value increases, the rate of increase of P decreases. When the L value is very high, the curve becomes horizontal. This means that when the L value is very high, increases in the L value will have a very slight influence on increasing the indicator performance level. If this graph is plotted on the semi-log paper, a straight line should result as shown in Figure 3-5. The maximum of the scale of the X-axis is the maximum L value in the study region.

In many cases, data is available only in forms of rural land value and urban land value. The average land value can be determined by using the following equation:

$$L_i = L_{ui} \cdot A_{ui} + L_{ri} \cdot A_{ri} \quad (3-8)$$

where L_i = Average land value of area i, dollars per acre

L_{ui} = Urban land value of area i, dollars per acre

A_{ui} = Percentage of urban land in area i

L_{ri} = Rural land value of area i, dollars per acre

A_{ri} = Percentage of rural land in area i

Because of the linear relationship of Log L and the indicator performance level, the land value indicator performance level of an area in a region can be determined by the following formula:

$$P_i = \frac{\text{Log } L_i}{\text{Log } L_{\max}} \times N \quad (3-9)$$

$$= \frac{\text{Log } L_i}{\text{Log } L_{\max}} \times 10 \quad (3-10)$$

where P_i = Indicator performance level of area i, dimensionless

L_i = Average land value of area i, dollars per acre

L_{\max} = Maximum average land value in the study region,
dollars per acre

N = Maximum of the scale on the axis of indicator performance level, N = 10 in this study

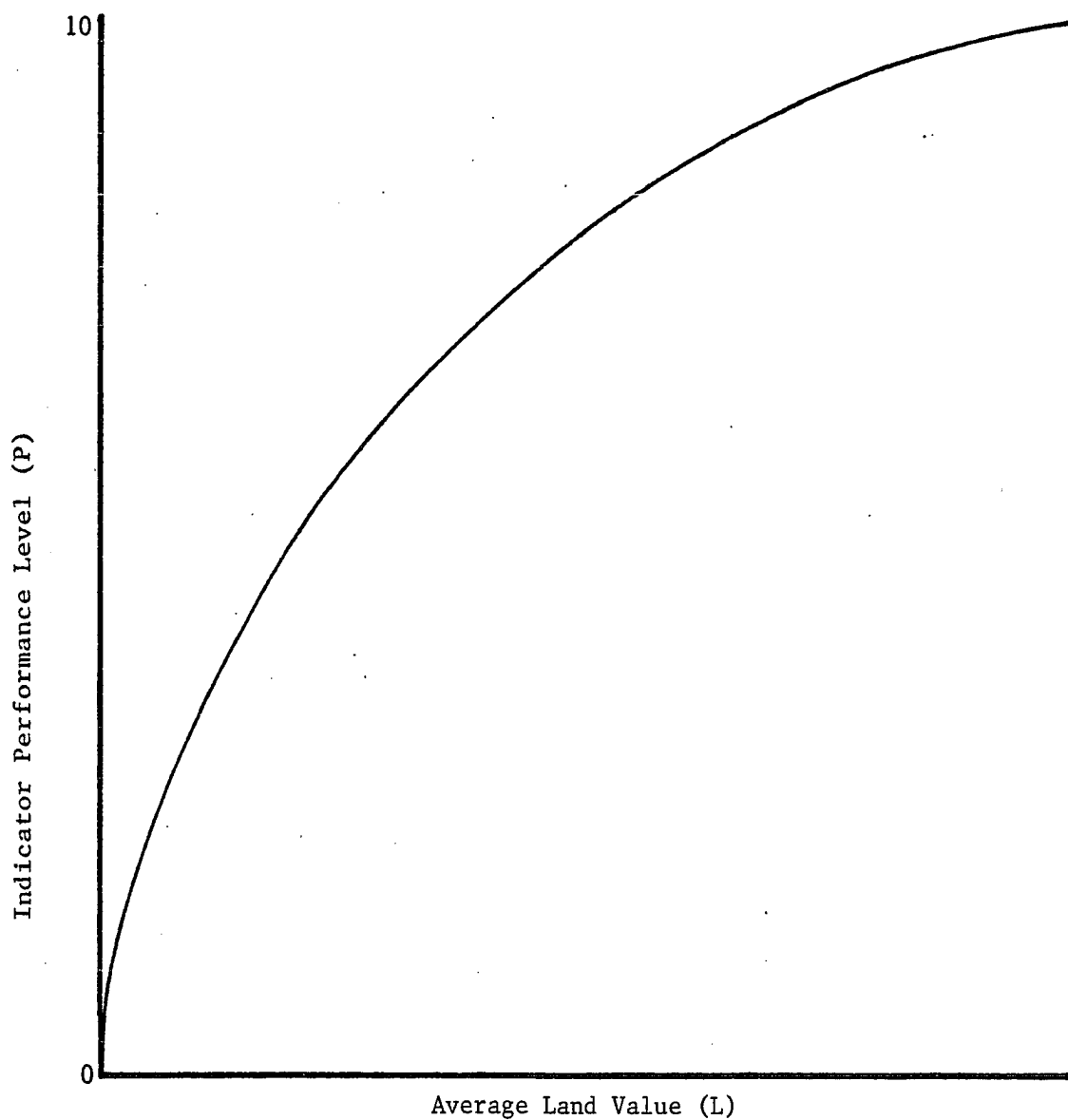

FIGURE 3-4 INDICATOR FUNCTION GRAPH OF LAND VALUE

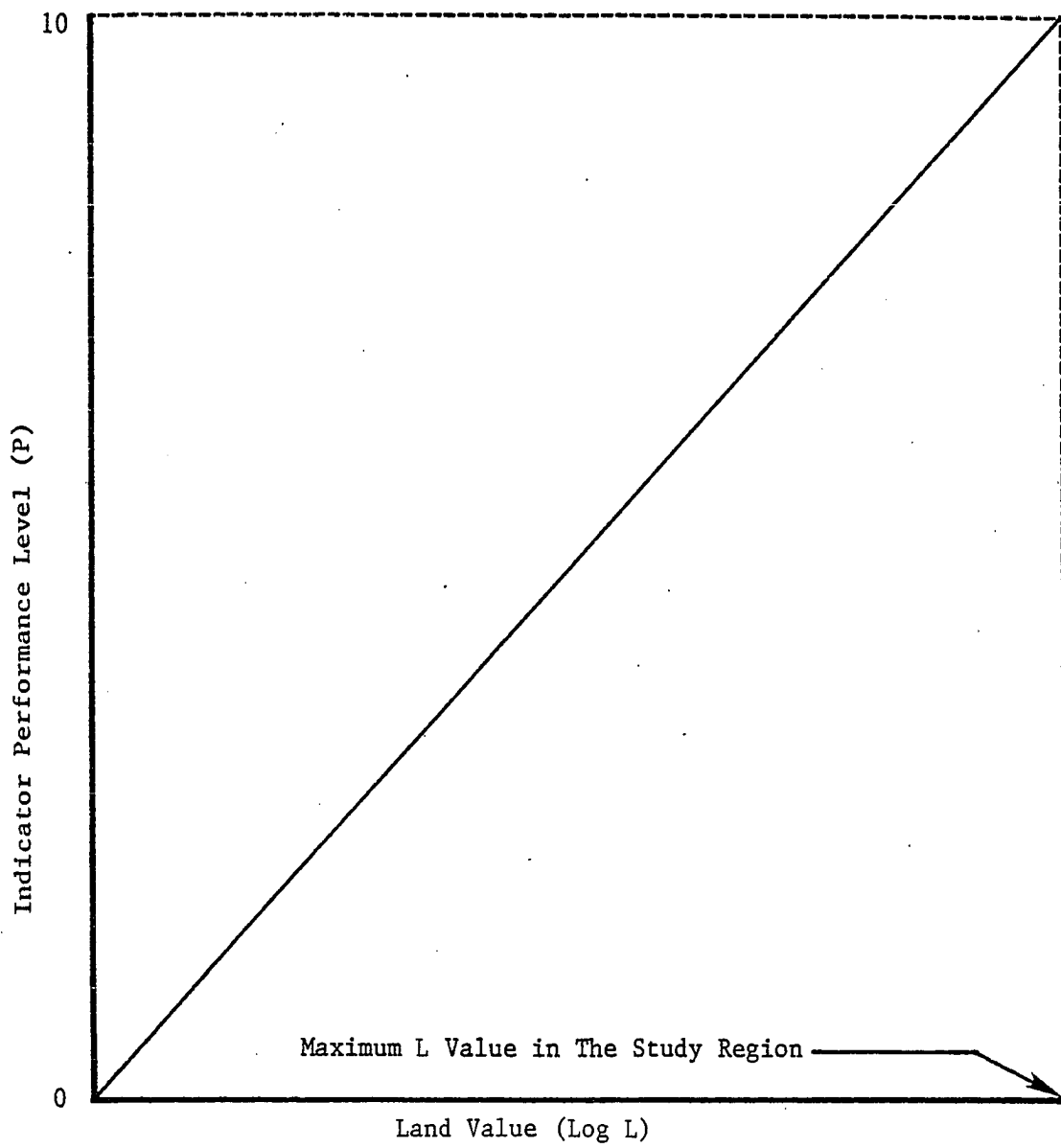

FIGURE 3-5 INDICATOR FUNCTION GRAPH OF (Log) LAND VALUE

The only data requirement is average land value which may be obtained through the State Tax Commission. If only rural land value and urban land value are available, the percentages of rural land and urban land are also needed for computing average land value, and can be obtained from the Census of Agriculture or the Soil Conservation Service. The data requirements along with data source and steps of determining the land value indicator performance level are listed in Table 3-2.

3.3.3 Intensity of Water Use

Land and water are often referred to as inseparable natural resources because both of them underlie economic growth and provide all the necessary elements of man's survival.

Since water is essential to all living organisms for their survival and growth, it is required for human consumption and the growth of agricultural products. In addition to meeting the consumptive requirement of living organisms, water may serve as a medium on which goods can be transported. Flowing water may be used to provide a source of power. The same main course may also provide a habitat for fish and wildlife on which man feeds and hunts for sports. Water may also provide the setting required to satisfy man's aesthetic and recreational needs. Water may serve as a means of diluting and purifying wastes from cities and industries, as well as the means of cooling in industrial production. Influence of water on human life has not always been beneficial: the uncontrolled river may be very destructive, flood control or prevention then becomes necessary.

All beneficial uses of water resources can be categorized into two major groups: consumptive uses and non-consumptive uses. Consumptive use implies that water is taken from its natural course and used on the land. Irrigation, municipal and industrial uses are among this type of water use. Non-consumptive uses are those uses in which water is used and remains in its natural channel. These include navigation, hydro-

TABLE 3-2 DATA COLLECTION AND CALCULATION OF LAND VALUE INDICATOR

| Item to be Determined | Data Required | Source | Calculation |
|--|--|--|--|
| | (i) Average land value of area i (L_i) | State Tax Commission | |
| if(i) is not available (1) Average land value of area i (L_i) | (ii) Urban land value of area i (L_{ui}) (iii) Percentage of urban land in area i (A_{ui}) (iv) Rural land value of area i (L_{ri}) (v) Percentage of rural land in area i (A_{ri}) | State Tax Commission Census of Agriculture or Soil Conservation Service State Tax Commission Census of Agriculture or Soil Conservation Service | $L_i = (ii) \times (iii) + (iv) \times (v)$ |
| (2) Land value indicator performance level (P_i) | (vi) Maximum value of land value in study region (L_{max}) | Calculated | $P_i = \frac{\text{Log } L_i}{\text{Log } (vi)} \times 10$ |

electric power, recreation, fish and wildlife. Water used for consumptive purposes and electricity can be appropriated, metered and sold in measurable units. It can be sold as a commodity in relation to the demands of users who are willing to pay the market price.

In this country, water resources development has been an issue in public policy at local, state and federal levels of government for over a century. However, it was not until the late 1940's and early 1950's that economics was applied to issues in water policy. Economists played a dominant role in the early work of water resources development planning. By the late 1950's and early 1960's, a wider professional concern with public investment in water resources grew. It was also then that an emerging awareness of water as a controlling factor in economic growth was suggested by large numbers of government reports and conferences devoted to this subject. A good example is Senate Document No. 97, Policies, Standards, and Procedures in the Formulation, Evaluation, and Review of Plans for Use and Development of Water and Related Land Resources. It is stated in this document that "water and related land resources development and management are essential to economic development and growth . . ." (90).

There are many variables affecting the intensity of water use. Their relationship can be expressed in the following function:

$$\text{Intensity of water use} = f(M, I, A, N, H, R, F \dots) \quad (3-11)$$

Where M = Municipal water use
I = Industrial water use
A = Agricultural water use
N = Navigation
H = Hydroelectric power
R = Recreational water use
F = Flood control

In this study, water used for domestic, municipal and industrial purposes per unit area is used as the measurement of the intensity of water use indicator, and can be obtained by the following formula:

$$W = \frac{M + I}{A} \quad (3-12)$$

where W = Intensity of water use, acre-feet/square mile-year
M = Annual municipal water use, acre-feet/year
I = Annual industrial water use, acre-feet/year
A = Total land area, square miles

In this equation, all the non-consumption water uses are excluded because they are presently not quantifiable. The existing methods of quantifying these water uses require subjective judgements and tend to be biased. Among the consumptive uses, irrigation is not included since the amounts of water needed for irrigation purposes vary from region to region because of the different climate. Within the same region, because of the difference in the crops cultivated, the amount of irrigative water used will again vary. It is obvious that the attempt to compare uses of irrigation water on an equal basis is a very difficult task. In essence, measurements on domestic, municipal and industrial water uses are sufficient for indicating development level.

Municipal and industrial consumptive uses of water are the primary requirements of any human society. In any region an enormous amount of this type of water use is often associated with high population density or intensive economic activities, and, thus, higher development level and vice versa. From this, one may conclude that intensity of water use (W) and its performance level tends to follow the same direction. Their relationship is shown in Figure 3-6. The slope of the curve is very steep at the beginning, then, as the W value increases, the rate of increase of P decreases. Finally, when the W value is very high, the curve approaches horizontal. When this graph is plotted on semi-log paper, a straight line will result as shown in Figure 3-7. The maximum of the scale of the X-axis on both graphs is the maximum W value in the study region. Because of the linear relationship of log W and indicator performance level, the intensity of water use indicator performance level can be obtained by the following formula:

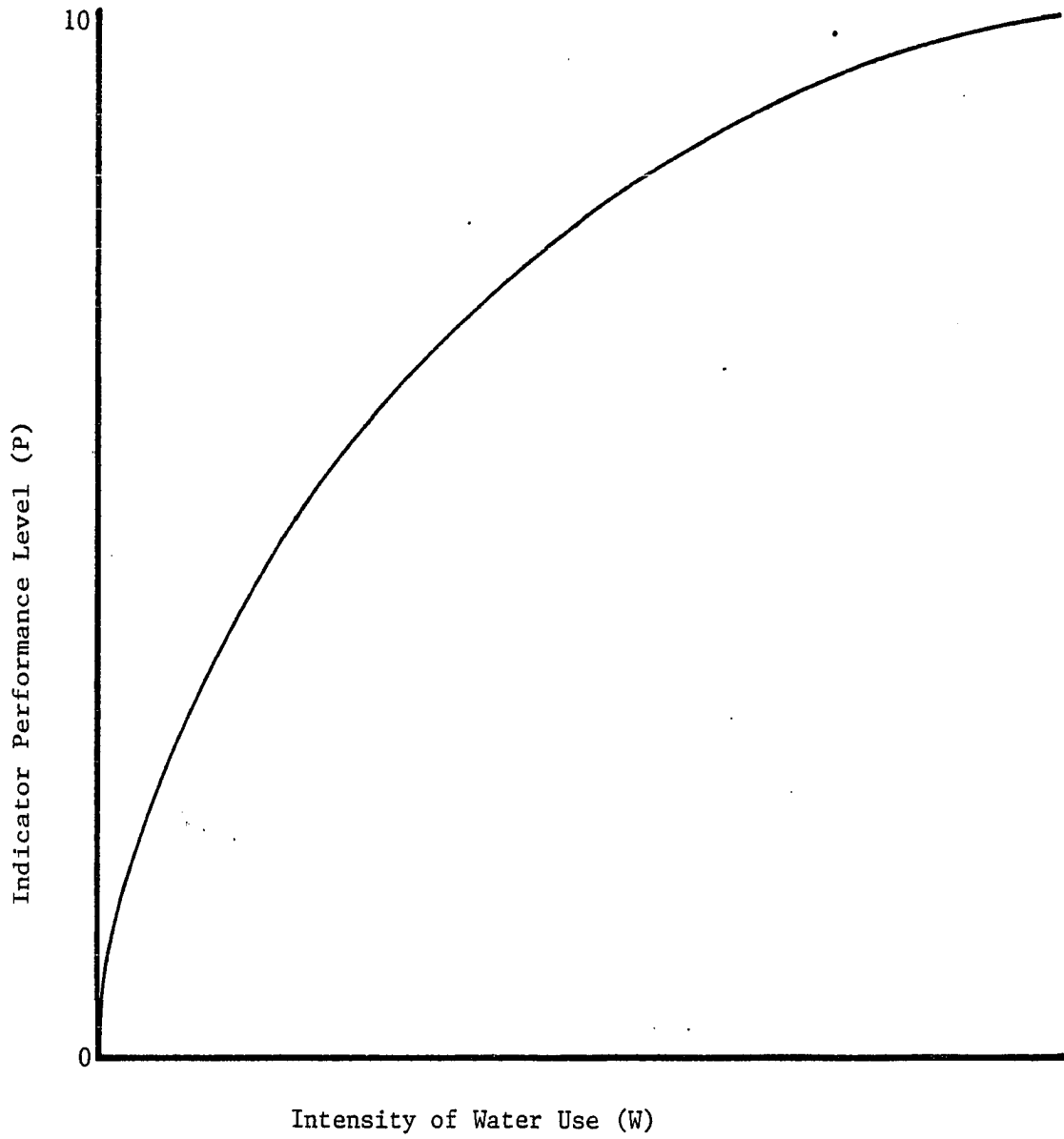

FIGURE 3-6 INDICATOR FUNCTION GRAPH OF INTENSITY OF WATER USE

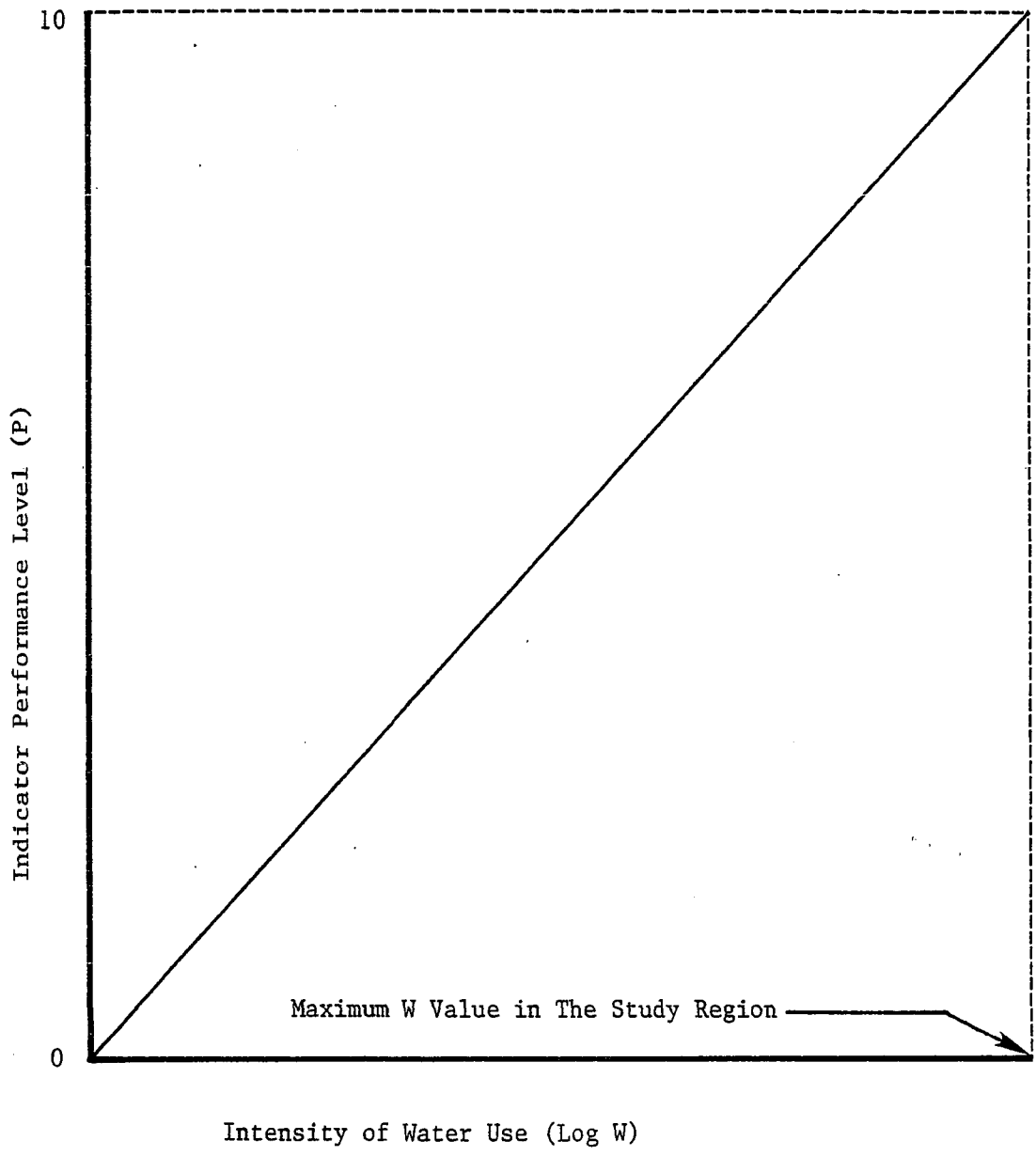

FIGURE 3-7 INDICATOR FUNCTION GRAPH OF (Log) INTENSITY OF WATER USE

$$P_i = \frac{\text{Log } W_i}{\text{Log } W_{\text{max}}} \times N \quad (3-13)$$

$$= \frac{\text{Log } W_i}{\text{Log } W_{\text{max}}} \times 10 \quad (3-14)$$

where P_i = Indicator performance level of area i , dimensionless

W_i = Intensity of water use of area i , acre-feet/square mile

W_{max} = Maximum value of intensity of water use in the study region, acre-feet/square mile

N = Maximum of the scale on the axis of indicator performance level, $N = 10$ in this study

The data requirements include annual municipal and industrial water use and total land area. They can be obtained from the state water resources planning agency and the Census of Agriculture, respectively. Data requirements, data sources and calculation of indicator performance levels are listed on Table 3-3.

3.3.4 Transportation Facilities

Location factors have been important in affecting natural resources development. Land resources which are readily accessible always have the first priority to be modified and developed by human action. In the past, the inadequacy of transportation facilities has presented great limitations to land resources development, yet its improvements have greatly extended the margins of land development. Numerous examples of this kind can be found in the history of American land settlement. High transportation costs were a real problem to the farmers in the southern colonies. Decades ago, most farmers tended to locate their farms along navigable streams. Since then, the development of highways, canals, and railroads has notably facilitated the develop-

TABLE 3-3 DATA COLLECTION AND CALCULATION OF INTENSITY OF WATER USE INDICATOR

| Item to be Determined | Data Required | Source | Calculation |
|--|---|---|---|
| 1) Intensity of water use of area i (W_i) | (i) Annual municipal water use of area i (M_i) (ii) Annual industrial water use of area i (I_i) (iii) Total land area of area i (A_i) | State Water Resources Planning Agency State Water Resources Planning Agency Census of Agriculture | $W_i = \frac{(i) + (ii)}{(iii)}$ |
| 2) Performance level of intensity of water use indicator of area i (P_i) | (iv) Maximum value of intensity of water use in study region (W_{max}) | Calculated | $P_i = \frac{\text{Log } W_i}{\text{Log (iv)}} \times 10$ |

ment of many frontier areas which were once conceived as "no man's land". The opening of the Erie Canal made the cost of shipping products from Albany to Buffalo drop from \$88 to \$6 a ton (3). This encouraged the development of western New York and many lands farther west. Railroad construction made it economically feasible for the farmers in the South and West to sell their products in the East where the industrial centers were located.

Besides being very influential on rural agricultural development, transportation facilities have very important effects on urban growth and urban land use.

Since the beginning of urban center development, urban growth has been favored by the locations along ocean and lake harbors, near the mouths of navigable streams, and at intersections of land trade routes. The development of railroads, highways, and air travel have brought the advantages of good transportation facilities to many new areas. These developments have also enhanced the advantages enjoyed by cities with good locations. The growth of great port cities such as Boston, New York, and San Francisco can be attributed both to the world trades and to the industries and commercial establishments located in these cities because of the transshipment of goods and materials taking place in these cities. Inland cities such as Chicago, St. Paul and Dallas have comparable advantages because of their location as railroad and highway centers. In contrast, many towns by-passed by railroads and early highways have virtually disappeared.

Urban growth calls for the transportation facilities within the urban area. The fourfold classification of commercial, industrial, residential and service uses is adequate for almost all urban land use.

The success of a commercial establishment often depends upon the choice of a business location which is often found in the central business district at or near the site most likely to be visited by the greatest number of potential customers. Industrialists try to maximize their returns by minimizing the transportation costs of transferring the materials and products to and from the production sites. Residents prefer to live in areas which are convenient for them to get to their working places, to the shopping areas, and to the places for satisfac-

tion of various wants. Service areas need to be so located that they are readily accessible to their clients. Since these needs for transportation facilities are proportional to the size of the urban area, large cities usually have large total mileage of streets.

From here, one may soundly conclude that transportation facilities are indispensable for the development of both rural and urban areas and thus can be a meaningful indicator of development level. In this study, average mileage of highways and streets per square mile of land is used as the measurement of this indicator because it is the primary as well as the most dominant type among all types of transportation facilities. Railways no longer possess the significance they had in the past because of a lack of mobility. Harbors and airports generally come into existence after highways and streets do. An area with very dense transportation facilities such as highways and streets is inevitably associated with a high development level.

The measurement of transportation facilities indicator can be obtained by using the following equation:

$$T_i = \frac{H_i + S_i}{A_i} \quad (3-15)$$

where T_i = Transportation facilities indicator of area i ,
miles per square mile

H_i = Total mileage of highways in area i , miles

S_i = Total mileage of streets in area i , miles

A_i = Land area of area i , square miles

There is a directly proportional relationship between transportation facilities indicator and its indicator performance level from which the development level is determined. This relationship is illustrated on Figure 3-8. Again, the upper limit of X-axis is the maximal value of transportation facilities indicator in the entire region.

Because of the direct proportional relationship of the transportation facilities indicator and indicator performance level, the indicator performance level of an area can be calculated from the

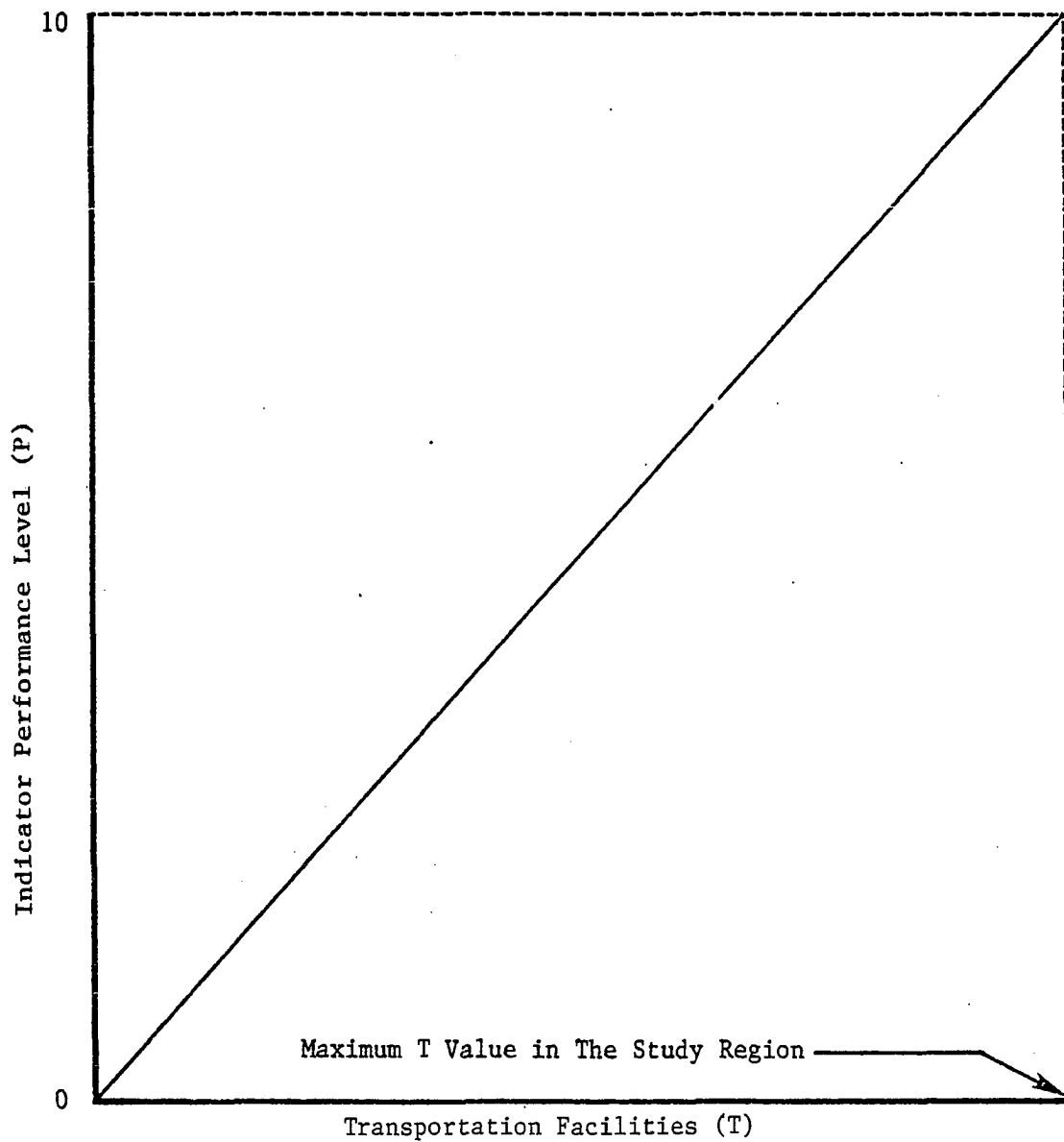

FIGURE 3-8 INDICATOR FUNCTION GRAPH OF TRANSPORTATION FACILITIES

following equation:

$$P_i = \frac{T_i}{T_{\max}} \times N \quad (3-16)$$

$$= \frac{T_i}{T_{\max}} \times 10 \quad (3-17)$$

where P_i = Indicator performance level of area i , dimensionless

T_i = Transportation facilities indicator of area i ,
miles per square mile

T_{\max} = Maximal value of transportation facilities indica-
tor in the entire region, miles per square mile

N = Maximum value on the scale of indicator performance
level, $N = 10$ in this study

Data required to compute the transportation facilities indicator include mileage of highways and streets, and total land area. The former can be collected from the State Highway Department, the later from the Census of Agriculture or the Soil Conservation Service. Data requirements, data source and calculation of this indicator and its performance level are listed in Table 3-4.

3.4 Assignment of Weight to Indicators

The weights assigned to development level indicators of this chapter, even though subjective, are actually determined from very objective reasoning. By comparing the relative importance of the indicators, weights are accordingly assigned.

Among the four development level indicators, inhabitation index possesses, most probably, the highest potential in revealing the development level of an area. Economic activities and development of an area are the inherent results of human needs. A piece of land uninhabited is very unlikely to have any economic activity, let alone development and utilization of the natural resources in the locality. Apart from the

TABLE 3-4 DATA COLLECTION AND CALCULATION OF TRANSPORTATION FACILITIES INDICATOR

| TO BE DETERMINED | DATA REQUIRED | DATA SOURCE | CALCULATION |
|--|---|--|--|
| 1) Transportation facilities indicator of area i (T_i) | (i) Total mileage of highways in area i (H_i) (ii) Total mileage of streets in area i (S_i) (iii) Total land area of area i (A_i) | State Highway Department State Highway Department Census of Agriculture or Soil Conservation Service | $T_i = \frac{(i)+(ii)}{(iii)}$ |
| 2) Transportation facilities indicator performance level (P_i) | (iv) Maximum value of transportation facilities indicator in area i (T_{max}) | Calculated | $P_i = \frac{T_i}{T_{max}} \times 10$ $= \frac{(1)}{(iv)} \times 10$ |

size of population, the degree of development of natural resources of an area is also greatly affected by the settlement pattern. If an area is evenly inhabited and without dense inhabitant clusters, it is very likely that every piece of land in the region will be utilized by man. The result is a high development level for the region. In this study, the inhabitation index not only considered the size of population inhabiting an area, it also took into consideration the settlement pattern of the inhabitants (see the earlier discussion). Because the inhabitation index is estimated in terms of the essence of economic development --- humans, who are also the most important component of the entire ecological community, it is thus assigned to greatest weight.

Land resources are another required element of economic development. Historically, the history of economic evolution and development can be just as accurately termed the history of man's exploitation and utilization of land resources (or, equally, the history of the relationship between man and land resources). The intensity of the economic activity of a region, or the intensity of the exploitation of land resources normally and directly can be reflected by the land values of the region. Thus, a weight of reasonably high value was assigned to land value indicators, but it should be lower than that assigned to the inhabitation index indicator. The rationale here is that in any economic activity, man is the active participant, while land is the passive participant, and while the inhabitation index indicator estimates in terms of population, the land value indicator estimates development level in terms of land resources. It is obvious, when the two are compared, that slightly smaller weight should be assigned to the land value indicator.

Water and land as resources for human use are very similar in nature, but not identical. Both exist as natural resources, and neither can be neglected; because they are both primary requirements for human survival. For any piece of land, the soil types and locality determine the uniqueness of that land. Land is an immobile commodity; the unique feature of a piece of land can significantly affect the development of an area and vice versa. But, because of advances in scientific and engineering technology, water resource, once a localized commodity like land resource, has become a mobile commodity. Interbasin transfer of

water supply is no longer an insurmountable task, and with today's technology, water shortage in a region can be solved with certainty. The degree of development of an area is no longer solely controlled by the available water resources in the area. In this respect, the intensity of water use, which is capable of accurately reflecting the level of development is relatively less effective as an indicator than the land value indicator. Hence, a slightly smaller weight is assigned.

Transportation facilities (as an indicator, is measured in terms of mileage of highways and streets) at one time were major factors in the development of an area. But like water resources, they are not as direct and effective as the inhabitation index or land value indicators in assessing the development level of an area. The quantity of transportation facilities in particular mileage of highways and streets, is strictly speaking, not sufficient to reflect development level, it merely reflects the potential for development. The frequency of use of the transportation facilities is another important factor that should be included. For example, in two areas that have the same mileage of highways and streets, the area that has a higher frequency of use of its highways and streets definitely has a higher development level. The use of frequencies of highways and streets are important, but useable data is seldom available. Data that is available is usually fragmented and incomplete; and to do traffic counts for all the highways and streets of a region is beyond reason due to high data cost. The impossibility of including the frequency of use in this indicator has caused it to become less significant as an estimate of development level. A weight, equal to that assigned to the intensity of water use, is thus given.

Conclusively, from the above rationale, the relative weights assigned to the four indicators are as follows:

| <u>Development Level Indicator</u> | <u>Relative Weight</u> |
|------------------------------------|------------------------|
| Inhabitation index | 5 |
| Land value | 4 |
| Intensity of water use | 3 |
| Transportation facilities | 3 |

The weighted indicator performance level can be obtained by using the following formula:

$$P'_j = P_j \times W_j \quad (3-18)$$

where P'_j = Weighted indicator performance level of indicator j , dimensionless

P_j = Indicator performance level of indicator j , dimensionless

W_j = Weight assigned to indicator j , dimensionless

when $j = 1$, P_j = Indicator performance level of inhabitation index

$$W_j = 5$$

$j = 2$, P_j = Indicator performance level of land value

$$W_j = 4$$

$j = 3$, P_j = Indicator performance level of intensity of water use

$$W_j = 3$$

$j = 4$, P_j = Indicator performance level of transportation facilities

$$W_j = 3$$

3.5 Determination of Development Level

In order to determine the development level of an area, it is necessary to compute the development level estimate of each area in the entire region, which is defined by the following equation:

$$E_i = \sum_{j=1}^4 P'_{ij} \quad (3-19)$$

$$= \sum_{j=1}^4 P_{ij} \cdot W_j \quad (3-20)$$

where E_i = Development level estimate of area i
 P'_{ij} = Weighted indicator performance level of indicator
 j in area i
 P_{ij} = Indicator performance level of indicator j in
 area i
 W_j = Weight assigned to indicator j
 $i = 1, 2, 3, \dots, n$. n is the number of areas in the
 study region

After obtaining the development estimates of all areas in the study region, their mean and standard deviation can be determined. Any area with a development level estimate within the range of mean \pm standard deviation is considered as level II area, below this range as level I area, and above this range as level III area.

CHAPTER IV

ECOLOGICAL PARAMETERS

4.1 Introduction

In this research, twelve ecological parameters are developed for the purpose of environmental evaluation. These twelve parameters can be evenly grouped into three categories:

- A. Flora
 - a. Terrestrial Natural Vegetation
 - b. Productivity of Aquatic Flora
 - c. Terrestrial Flora Species Diversity
 - d. Vegetation Land Use (Aesthetic)
- B. Fauna
 - a. Dynamic Ratio of Fish Population
 - b. Waterfowl Habitat
 - c. Terrestrial Fauna Species Diversity
 - d. Fauna Species Composition (Aesthetic)
- C. Biota
 - a. Pest Species
 - b. Utilization of Carrying Capacity
 - c. Terrestrial Food Web
 - d. Aquatic Food Web

To assess the environment or to determine how well each component of the environment performs, a measuring scale was set up in this research. This scale ranges from -1 to 0 and from 0 to +1. A zero value is designated as the standard value. A scale value of -1 denotes extremely poor environmental performance, while excellent performance is represented by +1 scale value. The performance of the ecological communities are assigned a scale value between the two extremes.

This assignment is based upon the idea of preservation and enhancement of ecological systems. An ecological performance with a value of greater than zero is considered to be a performance that will enhance or improve the condition of the environment. At the zero value, the standard is considered to be set, i.e., the level of ecological performance is sufficient to preserve the existing ecological systems. Any measure of performance that scores a scale value of less than zero is said to be below the acceptable level of environmental preservation.

An advantage of this approach is that it allows a comparison of different parameters on the same scale. This is because all parameters are expressed by the same ecological performance scale of a value between -1 and +1. This is especially significant to those who are concerned with the writing of environmental impact statements which involves handling of the non-quantifiable elements of the environment.

An example of a parameter function graph that illustrates the ecological performance scale is given in Figure 4-1.

In view of the limitations of existing environmental parameters (see Chapter I) the choosing, formulating, and developing of the aforementioned parameters in this research were based upon the following principles:

- 1) All parameters must be able to accurately describe the whole ecological community without overlooking the major components of the ecosystem or being redundant.

The biological components of the ecological community are composed of flora, fauna, and their interlocking components. For this reason the parameters developed for the evaluation of ecological systems are divided into three areas, i.e., flora, fauna, and biota. To determine the parameters of these three areas, three criteria were suggested,

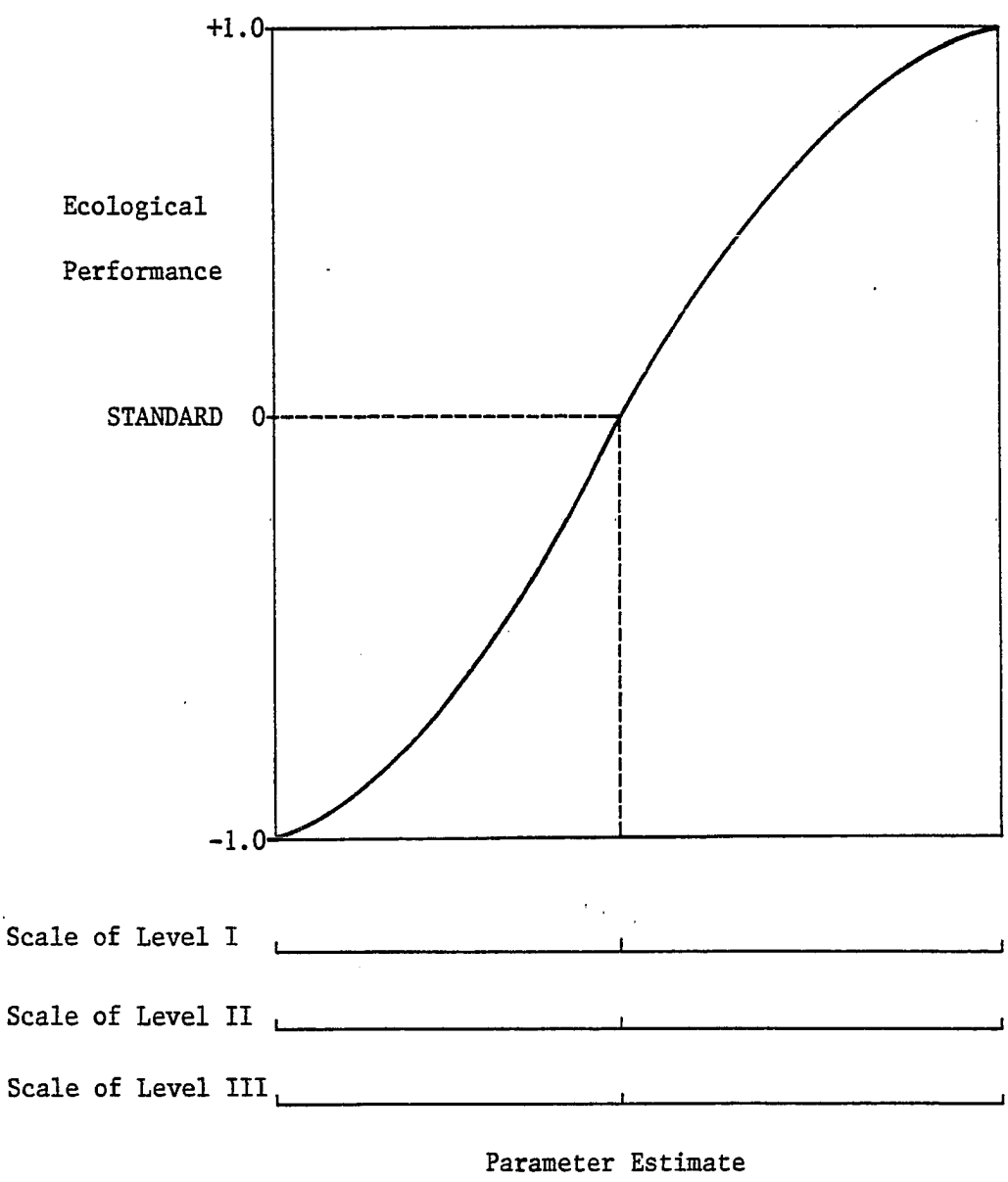

FIGURE 4-1 EXAMPLE OF PARAMETER FUNCTION GRAPH

namely land-use, species and production.

The following is a summary of the three criteria that are utilized in the development of each parameter.

The terrestrial natural vegetation and productivity of aquatic flora parameters are respectively applied to evaluating the terrestrial and aquatic plant production. The parameter of terrestrial natural vegetation measures the percentage change in the areal extent of land managed for natural vegetation. Productivity of aquatic flora is measured in terms of the characteristics that are commonly associated with various conditions of the aquatic flora production. Fish population and waterfowl habitat are used as parameters to depict the production of fauna species.

Terrestrial and aquatic species diversity parameters are both used to determine the variation of species in the environment. When more species are present in an ecological community there are more interconnections, which ultimately knit all the elements of the system tightly together and enhance the ecological stability(71).

Parameters that evaluate the aesthetic value of flora and fauna were also developed. The aesthetic value of fauna species is estimated by the temporal change of fauna species composition; while the aesthetic value of flora is measured by the parameter of vegetation land use which is determined by the weighted sum of the percentage change of vegetation land use.

Pest species (primarily referring to those pests that cause damages to the various types of farming) include not only weeds and plant pests, but also those pests that affect animals. Therefore, the pest species parameter is not classified in either the flora or fauna but in the biota category. The utilization of carrying capacity parameter measures the number of grazers that are consuming the available food of an acre of grazing land. This is basically an observation of the supply and demand relationship between plants and animals. Both pest species and carrying capacity parameters are more than mere evaluations of the ecological community. The desired decrease in pest species or increase in production of grazers may not necessarily contribute to the stability of the total ecosystem. Rather, these two parameters

emphasize the preservation of man-altered ecological systems in agricultural environments.

In order that the interrelationships of flora and fauna be sufficiently evaluated, the food web parameter was introduced. The patterns of prey-predator food chains in the terrestrial and aquatic environments differ; therefore, the parameter of food web is sub-divided into terrestrial and aquatic food web.

2) All parameters must be non-specific in nature. Non-specificity allows wider range of parameter application. Frequently, parameters developed become too specific which inherently limit their applicability and their purpose of correct interpretation of the ecosystem. The parameters of crops, and game birds, in the Battelle study for instance, are both overemphasized to meet the economic and recreation demands of man (15). No clear indication of significant influence of these parameters over the total survival and stability of the ecosystem exists. Rare and endangered species are in dire need of protection, but the ecological performance of these species, measured in terms of the increase or decrease in their numbers, rarely have an accountable influence on the environment. Programs for the protection of rare and endangered species are undertaken or planned by various government agencies, and as long as these "sensitive" species are protected from extinction by proper management programs, there is no need to include them in the discussion of this research.

3) All parameters must be developed in accordance with the criteria that data required for implementation could be obtained without great difficulty. Ideal parameters are those that require commonly available data such as the data that is provided by U.S. Department of Agriculture (USDA) Census of Agriculture, Soil Conservation Services, Wildlife Conservation Services, etc. There are existing parameters that have high data requirements and some require field collection of data in order to evaluate the parameter. These kinds of parameters involve high data cost, and in many projects this will create tremendous financial problems thus rendering these parameters highly undesirable.

Among twelve parameters, the standards of four parameters are developed by the principle of non-negative percentage change over time

approach. This approach involves at first the consideration of the availability of data. The choosing of an environmentally significant period of time during which significant change in the environment may occur is also greatly dependent on the data available. Recent issues of Census of Agriculture showed that census are performed once every five years. This then is chosen as the observation period in this study. In these four parameters, data periods are represented by Δt which allows the users of this methodology to determine the data period according to the availability of local data. The calculation of percentage change over time is shown in formulas 4-1, 4-6, 4-8 and 4-11. The Common objective condition of these four parameters is the prevention of further environmental deterioration. When this objective is achieved the future environmental condition will be better than or at least as good as the present condition. Numerically, these percentage values will be positive or at least zero. Therefore, when the parameter estimate is a non-negative percentage change, ecological performance will also be above the standard. One of the major reasons for adopting such an approach is that using of "one-point-in-time" data will not allow objective judgement because of the absence of an objective reference. Besides, estimations based upon trends rather than "one-point-in-time" data allow lesser probability of erroneous result.

Three different scales (X-axis) were proportionally developed for each of the twelve parameters reflecting the levels of restriction (see Chapter III, Land Development Level). In the calculations (with the exception of productivity of aquatic flora) the data can be directly substituted into the formula. The results obtained can be applied to the appropriate scale of a study region whose level of development was previously determined from its socio-economic evaluation. By interpolation, the ecological performance of a parameter in a study region can be derived. For example, in the parameter of dynamic ratio of fish population, the data required is simply fish standing crop data. By first separating the fish population into forage fish and carnivorous fish, and then entering them into F/C ratio formula, the result obtained will be the parameter estimate. Applying this to the appropriate scale corresponding to the level of development to which this particular body of water

belongs (standards are at 1.5 to 10, 1.3 to 11.8, and 0.7 to 14.8 ranges) one may observe whether the Ecological Performance (E.P.) of this body of water meets the standard.

4.2 Parameters

4.2.1 Flora

A. Terrestrial natural vegetation

A measure of terrestrial natural vegetation is important in assessing the magnitude of the diversity of the food web in any given ecological system. Diversity of the biological and structural components of the ecological system has been identified as indicative of a highly stable ecological system in general (52). Such a highly stable and diverse ecological system is desirable since it provides a potentially larger food web and consequently a more balanced terrestrial ecological community.

The premise of this parameter is that land managed in natural forms of vegetation have a superior capability to support a more diversified and balanced ecological system than land which is managed to produce a single crop. Areas of natural vegetation play a crucial role in maintaining many forms of flora and fauna that are unable to adapt to America's modern agricultural landscapes. Modern agriculture often destroys the natural diversity of habitats to maintain a genetic monoculture on large tracts of land. Such areas are supported to a large extent by fertilizers and pesticides which reduce the stability and assimilating potential of the environment. Therefore areas of natural vegetation are important because they provide habitats for a variety of species which would not otherwise reside in a region.

(a) Methodology

The measurement of terrestrial natural vegetation is described as the percentage change in the areal extent of land managed for natural vegetation. This includes woodland, pastureland and rangeland which is

not improved. As land in any region is converted from natural vegetation to urban or agricultural uses, a reduction in the environmental quality of the region occurs. Conversion of land from a natural state to a more developed condition is tolerable where such a conversion does not reduce an ecological system's ability to assimilate energy and waste to a point where the system becomes unstable. Therefore, this parameter's intention is to identify areas where a reduction of natural vegetation beyond a certain level, where the ecological system cannot remain stable and diverse, is not acceptable for the maintenance of the ecological community.

The percentage change of natural vegetation areas for the recent Δt -year in a certain study region can be calculated with the formula below.

(b) Formula

$$\begin{aligned}
 V_{\Delta t} &= \text{Percentage change of natural vegetation in } \Delta t \text{ years} \\
 &= \frac{\{\text{the condition of natural vegetation now growing}\} - \{\text{the condition of natural vegetation t-year ago}\}}{\{\text{the condition of natural vegetation t-year ago}\}} \times 100\% \\
 &= \frac{\{\text{acreage of natural vegetation now growing}\} - \{\text{acreage of natural vegetation t-year ago}\}}{\{\text{acreage of natural vegetation t-year ago}\}} \times 100\% \\
 &= \frac{A_o - A_t}{A_t} \times 100\% \tag{4-1}
 \end{aligned}$$

$$\text{PARAMETER ESTIMATE} = V_{\Delta t}$$

(c) Data collection and calculation

Data on the current acreage of natural vegetation and that of the past years are needed in the calculation. The source used is from the Census of Agriculture by the Department of Agriculture and it is shown in Table 4-1.

(d) Parameter function graph

The key to judge the ecological performance (E.P.) of this parameter is the non-negative percentage change approach, which was originated

TABLE 4-1 DATA COLLECTION AND CALCULATION OF TERRESTRIAL NATURAL VEGETATION

| ITEM TO BE DETERMINED | DATA REQUIRED | SOURCE | CALCULATION |
|--|--|----------|---|
| Percentage change of natural vegetation in Δt years ($V_{\Delta t}$) | i) Total woodland including woodland pasture now growing | U.S.D.A. | $V_{\Delta t} = \frac{A_o - A_t}{A_t} \times 100\%$ |
| | ii) Pastureland and rangeland not improved now growing | U.S.D.A. | |
| | iii) Total woodland including pasture t-year ago | U.S.D.A. | $= \frac{[(i)+(ii)] - [(iii)+(iv)]}{(iii)+(iv)} \times 100\%$ |
| | iv) Pastureland and rangeland not improved t-year ago | U.S.D.A. | |

from the preservation philosophy (see Chapter I). In any given situation, when the acreage of natural vegetation is diminished to a smaller area than the preceding year, often the reduction in natural vegetation area or bio-habitat is due to human action. As a result, the stability and diversity of the ecosystem are being disturbed and consequently E.P. will fall below standard.

On the parameter function graph (see Figure 4-2), the second inflection point from the left is the critical point or the standard. The sloping down of the curve to the left of the standard is at first gentle, because the influence on the habitat of species has just begun and the ecosystem is only slightly disturbed. However, if the negative percentage change becomes severe and it arrives to the point when the minimum area necessary from the maintenance of ecological stability is trespassed (the first inflection point from the left), then E.P. deteriorates rapidly. Beyond this point, the curve gently levels out again because in the extremely disturbed ecosystem it makes no great difference how the environment performs.

To the right of the standard, in the positive change area, the curve rises steadily because as the food supply for the wild species increases, the food web becomes more stable too.

(e) Ecological standards

| Level | I | II | III |
|---------------------|--------------------------------|----|-----|
| Item | | | |
| Ecological Standard | NON-NEGATIVE PERCENTAGE CHANGE | | |

B. Productivity of aquatic flora

Normal ecological succession in bodies of water takes place gradually and over a long period of time. When man tampers with nature, the process of succession is often accelerated. As bodies of water age, they become warmer and shallower. Both factors tend to increase the amount of algae and other aquatic plants. When the productivity of the water has reached the adequate nourishment stage, the body of water is

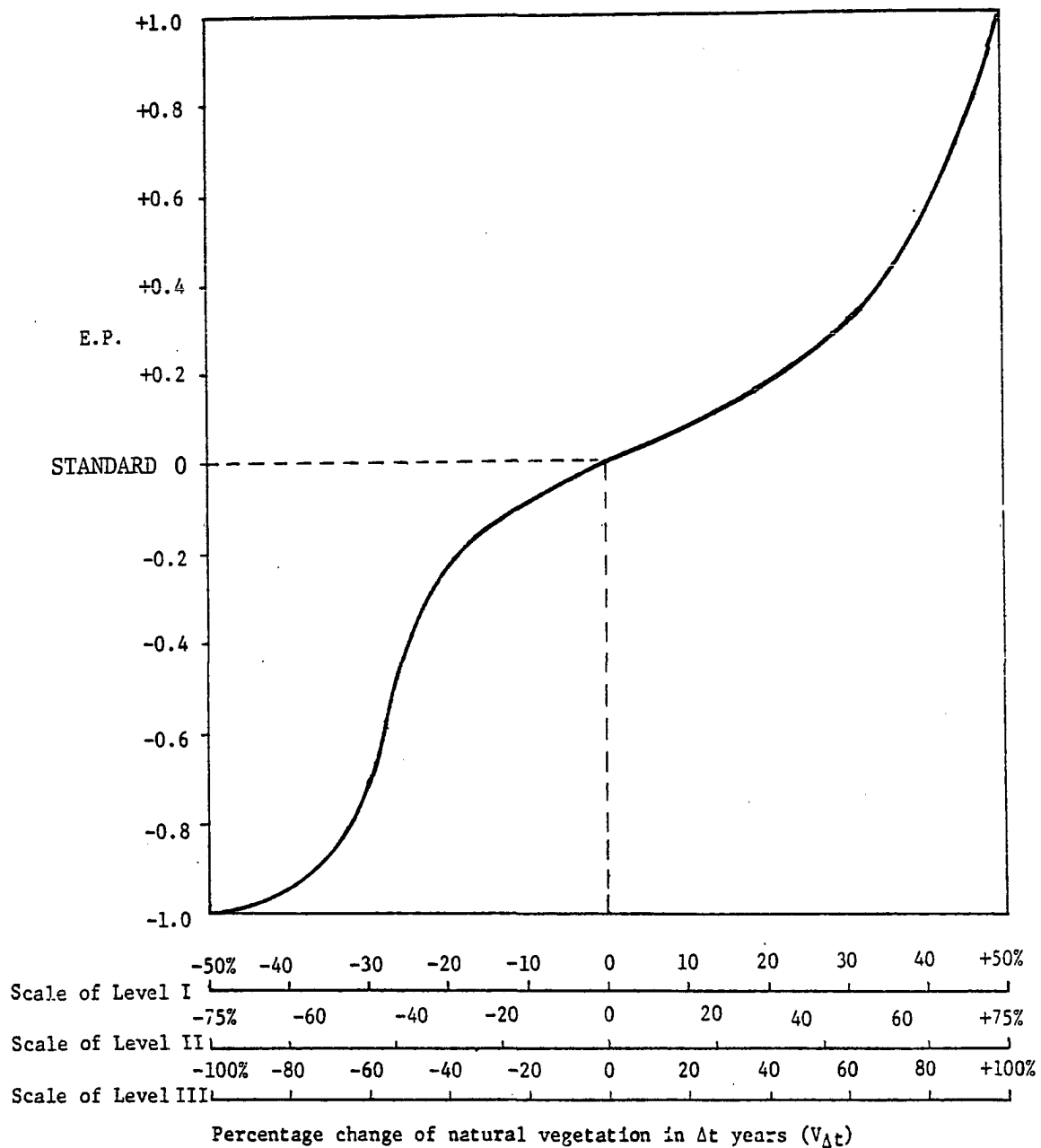

FIGURE 4-2 PARAMETER FUNCTION GRAPH OF TERRESTRIAL NATURAL VEGETATION

termed eutrophic (17). The process of increasing productivity is called eutrophication.

Eutrophication might at first seem to be a desirable situation, since ultimately fish and other aquatic animals are dependent upon the food which the algae and aquatic plants supply. This growth of algae, however, chokes the open waters and makes the water nonpotable. Subsequently the algae decompose, foul the air, and consume the deep water dissolved oxygen so vital for fish and animal life. The balance of the body of water is ultimately upset, because the bacteria are unable to convert the dead organic matter into plant and animal food. The balance is upset more in northern or temperate zones, because bacteria grow only during the summer, while pollutants, e.g., sewage and garbage, are dumped all year round (29).

A number of factors affect the aquatic nutrient productivity if other characteristics of two bodies of water are closely similar. They are fertility of the drainage basin, water depth and slope of shore, form of shore line, temperature, water turnover, light and water age, etc. (92).

Evidence of rapid eutrophication can be found by examining the presence or change in communities of aquatic plants and animals, such as the fish species preferring warm and shallow water; overabundant algae, coliform bacteria, and perhaps zooplankton. A common case is that fish families over a considerable period of time will gradually change from trout to warm bass and perch, then to plant-eating types, and finally to bottom feeders.

(a) Methodology

The aquatic flora condition of bodies of water can usually be identified along a gradient from the oligotrophic, with low nutrient content and productivity, through the mesotrophic to the eutrophic, with high nutrient levels and productivity. Hypertrophic condition indicates unusual or forced eutrophication and is the more polluted type of water beyond the eutrophic (92).

Table 4-2 summarizes the selected meaningful characteristics that are commonly associated with the various state of aquatic flora of bodies of water. These characteristics, besides being meaningful, are

TABLE 4-2 CHARACTERISTICS OF THE VARIOUS STATE OF AQUATIC FLORA

| Characteristics | Stage of Aquatic Flora Condition | | | |
|---|----------------------------------|------------------|-----------|-------------------|
| | Oligo- trophic | Meso- trophic | Eutrophic | Hyper- trophic |
| Net primary productivity, g/m ² /yr | 15-50 | 50-150 | 150-500 | >500 |
| Total organic matter, ppm | 1-5 | 2-10 | 10-100 | >100 |
| Light penetration ¹ , m | 20-120 | 5-40 | 3-20 | <3 |
| Total phosphorus, ppb | <1-5 | 5-10 | 10-30 | >30 |
| Inorganic nitrogen, ppb | <1-200 | 200-400 | 300-650 | >650 |
| Total inorganic solutes, ppm | 2-20 | 10-200 | 100-500 | >500 |

¹Light penetration is the estimated depth to which 1% of sunlight penetrates at midday.

selected because they are commonly measured. Typical ranges of them for different stages of aquatic flora condition are also given. It shows trends in many of the characteristics, and particularly the characteristic of key concern to man--productivity. But some of them are less strongly correlated than the table may suggest (92).

In this parameter, the standard of Level I development, which is the most restrictive, corresponds to the upper bound of the oligotrophic condition. The standard of Level II development is indicated by the upper bound of mesotrophic conditions. In a similar manner, Level III development's standard is indicated by the upper margin of the eutrophic condition.

To determine a workable standard for each level of development, the range of each characteristic of the bodies of water will have to be adjusted. In more specific terms, each standard proposed is actually the sum of upper limits of the ranges of each characteristic, with the range being modified to commensurate numerals prior to the summation. This is summarized in the following:

- 1) Calculation of multiplying factors (M_i) - This is obtained as ratio of the maximal number in each column on Table 4-2 to the upper bound of each range.
- 2) Determination of the standards - The upper limit of the range of each characteristic is then modified to commensurate numerals by using M_i . The sum of the upper limits thus modified in each column then becomes the standard for a development level.

Using the same concept, data collected from a study region can be modified so as to compare with the standards. Data collected on each characteristic of a study region must first be multiplied by M_i . This will allow a preliminary comparison with the set range. The ultimate comparison of the sum of the modified data and the sum of the upper bounds will indicate whether or not the aquatic flora productivity of the study region meets the standard.

(b) Formula

$$\begin{aligned}
 P_x &= \text{Aquatic flora productivity of a level X region} \\
 &= \frac{N}{n} \cdot \sum_{i=1}^n C_{ix} \cdot M_{ix} \quad (4-2)
 \end{aligned}$$

Where

C_{ix} = Measured data of i th characteristic of the level X region¹

M_{ix} = Multiplying factor for i th characteristic of the level X region

N = Total number of characteristics of aquatic flora condition
 $N = 6$ in this study

i = Characteristic of aquatic flora condition

$i = 1$ for net primary productivity

$i = 2$ for total organic matter

$i = 3$ for light penetration

$i = 4$ for total phosphorus

$i = 5$ for inorganic nitrogen

$i = 6$ for total inorganic solutes

n = The available number of characteristics in the study region
PARAMETER ESTIMATE = P_x

(c) Data collection and calculation

Data and informations needed in the determination of this parameter could generally be obtained as water quality data from relevant governmental agencies or as aquatic data from academic and research institutes of the area concerned. In some instances, a study region may not have available data on each of the six characteristics mentioned in this research. This is why the $\left(\frac{N}{n}\right)$ factor is introduced. In other instances, the data collected may not be readily useable. In those situations, the raw data will need to be refined or transformed prior to actual calculation. Table 4-3 shows the data required and calculations.

The result of data collection and calculation from one body of water shall not be applied to the entire river basin. Study regions having more than one dominant body of water may use a weighted average in determining the type of aquatic succession of the whole river basin, or professional judgement will have to be solicited.

¹For the inequality of M_i values in different levels, the level of each study region should be identified before any data being used in this formula.

TABLE 4-3 DATA COLLECTION AND CALCULATION OF AQUATIC FLORA PRODUCTIVITY

| ITEM TO BE DETERMINED | DATA REQUIRED | SOURCE | CALCULATION | | | | | | | | | | | | | | | | | | | | | |
|--|---|-----------------------|---|-------------------|---------------------|-----------------------|---|-----|-----|----|----|-----|-----|----|------|----|----|------|---|---|---|----|---|-----|
| Aquatic flora productivity of a level x region (P_x) | Measured data of the following characteristics: Net primary productivity, g/m ² /yr. Total organic matter, ppm Light penetration, m Total phosphorus, ppb Inorganic nitrogen, ppb Total inorganic solutes, ppm | Previous research | a) Multiplying factors of each level: <table style="margin-left: auto; margin-right: auto;"> <thead> <tr> <th style="text-align: center;">I (M_{iI})</th> <th style="text-align: center;">II (M_{iII})</th> <th style="text-align: center;">III (M_{iIII})</th> </tr> </thead> <tbody> <tr> <td style="text-align: center;">4</td> <td style="text-align: center;">2.7</td> <td style="text-align: center;">1.3</td> </tr> <tr> <td style="text-align: center;">40</td> <td style="text-align: center;">40</td> <td style="text-align: center;">6.5</td> </tr> <tr> <td style="text-align: center;">1.7</td> <td style="text-align: center;">10</td> <td style="text-align: center;">32.5</td> </tr> <tr> <td style="text-align: center;">40</td> <td style="text-align: center;">40</td> <td style="text-align: center;">21.7</td> </tr> <tr> <td style="text-align: center;">1</td> <td style="text-align: center;">1</td> <td style="text-align: center;">1</td> </tr> <tr> <td style="text-align: center;">10</td> <td style="text-align: center;">2</td> <td style="text-align: center;">1.3</td> </tr> </tbody> </table> b) $P_x = \frac{N}{n} \cdot \sum_{i=1}^n C_{ix} \cdot M_{ix}$ | I (M_{iI}) | II (M_{iII}) | III (M_{iIII}) | 4 | 2.7 | 1.3 | 40 | 40 | 6.5 | 1.7 | 10 | 32.5 | 40 | 40 | 21.7 | 1 | 1 | 1 | 10 | 2 | 1.3 |
| I (M_{iI}) | II (M_{iII}) | III (M_{iIII}) | | | | | | | | | | | | | | | | | | | | | | |
| 4 | 2.7 | 1.3 | | | | | | | | | | | | | | | | | | | | | | |
| 40 | 40 | 6.5 | | | | | | | | | | | | | | | | | | | | | | |
| 1.7 | 10 | 32.5 | | | | | | | | | | | | | | | | | | | | | | |
| 40 | 40 | 21.7 | | | | | | | | | | | | | | | | | | | | | | |
| 1 | 1 | 1 | | | | | | | | | | | | | | | | | | | | | | |
| 10 | 2 | 1.3 | | | | | | | | | | | | | | | | | | | | | | |

PARAMETER ESTIMATE = P_x

(d) Parameter function graph

The graph of this parameter, as shown in Figure 4-3, is S-shaped and asymmetrical. In the beginning of the process of eutrophication, the quality of water does not necessarily deteriorate even though water is starting on its process of becoming non-potable. At that stage, the nutrient level in the water is gradually rising and the supply of food for the aquatic life will be adequately consumed. At the onset of these various processes, the uprise of aquatic flora productivity does not manifest itself clearly and the curve slopes down very gently. As eutrophication continues, the aquatic food supply soon becomes over-abundant, and the condition turns unfavorable.

As the curve comes near the point of the standard (standards for Level I, II and III areas are respectively located at 1,200, 2,400, and 3,900) it drops rapidly down, indicating the procession of the body of water into the next stage of succession. This is inevitable as prolonged abundance of nutrients naturally leads to proliferation of aquatic life, especially aquatic plant life. If the pollution of water is not arrested algae will in the end choke the open water.

At the final stage, when the body of water is in the marsh or bog stage, further influence on ecological performance (E.P.) becomes minimal and the curve levels out again. The two extremities of each scale of level are designated by ϵ and ∞ which represents respectively infinitesimal and infinity.

(e) Ecological standards

| LEVEL ITEM | I | II | III |
|---------------------|--------|--------|--------|
| Ecological Standard | <1,200 | <2,400 | <3,900 |

C. Terrestrial flora species diversity

Species diversity, the indication of stability enhancement in ecosystems, relates simply to the "richness" of a community or geographi-

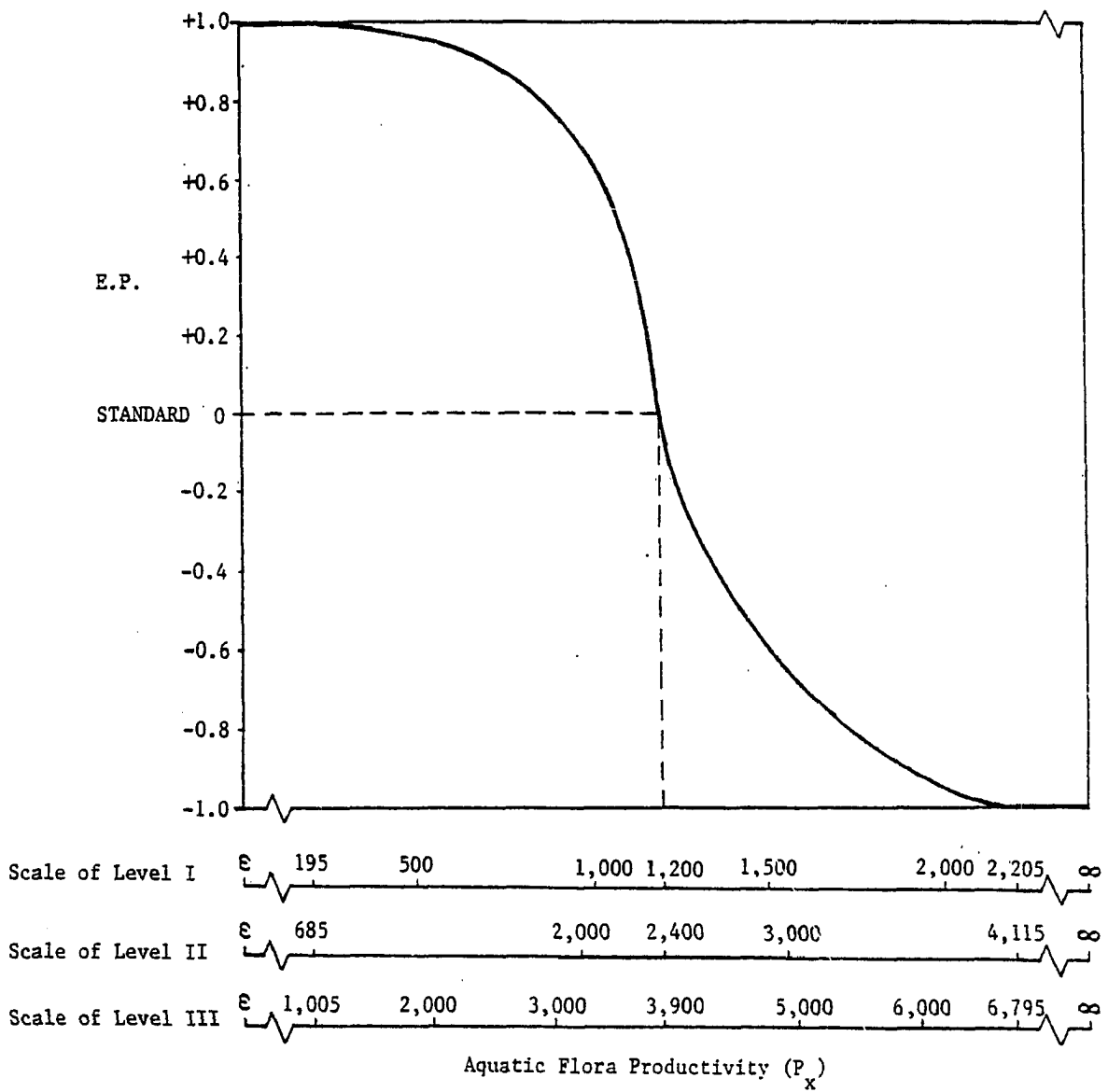

FIGURE 4-3 PARAMETER FUNCTION GRAPH OF PRODUCTIVITY OF AQUATIC FLORA

cal area in species. It reflects in part the diversity in the physical environment. The greater the variation in the environment, the more numerous are the species, since there are more microhabitats available and more niches to fill. With more species (species diversity), there are more interconnections, which ultimately tie all elements of the system tightly together (71).

Frequent mention is made in the literature of an increase in species diversity from:

- 1) successional communities to climax communities;
- 2) extreme environmental conditions to optimum environmental conditions; and
- 3) temperate communities to tropical communities (45).

Species diversity may be measured on the basis of numbers of species in sample units, large enough to include some minor species. In terrestrial communities, relations of species numbers to sample areas are complex; but within limits, numbers of species increase approximately as the logarithm of sample area. It is not feasible in most cases to obtain all the species from the community, and comparing members of species in sample quadrats of equal area is the most convenient way to compare diversities in different communities.

(a) Methodology

Species diversity, the relationship between the number of species and the number of individuals, has been approached in a variety of ways¹. One or both variables may be expressed in terms of square root or logarithmic functions and their relationships may be expressed as a ratio or as an entropy measure.

In this study, the relationship between the number of accumulated species and the logarithm of the number of individuals will be used in determining the diversity. The species diversity values will be obtained by the regression of the number of species against the logarithm of the number of individuals.

¹For example: Gleason 1922; Fisher, Corbet and Williams 1973; Preston 1948; Goodal 1952; Margalef 1957; Patten 1962; Williams 1964.

The diversity values of each habitat type in different communities are calculated and compared by using the formulas listed below.

(b) Formulas

$$1) \log Y = \alpha + \beta X \quad (4-3)$$

where Y = The number of individuals

α = The number of individuals at which one
flora species intersects

β = The slope of the regression line

X = The number of flora species

This equation is presented in graphical form shown on Figure 4-4 as an example. The linear regression lines are plotted on a graph with the number of flora species in each habitat versus the logarithm of the number of individuals of each habitat. Calculating the differences in species diversity between the habitat types is accomplished by determining the number of species one would expect to encounter per 1,000 individuals, i.e., the number of flora species at which the regression line intersects 1,000 individuals (X_i).

2) D = Weighted flora species diversity in each study community

$$= \sum_{i=1}^n (X_i \cdot T_i) \quad (4-4)$$

where X_i = Flora species diversity of the ith habitat type

T_i = Percentage of the ith flora habitat type in the whole study community

n = number of flora habitat types in the study community

i = flora habitat type

i = 1 for upland forest

i = 2 for bottomland forest

i = 3 for prairie

PARAMETER ESTIMATE = D

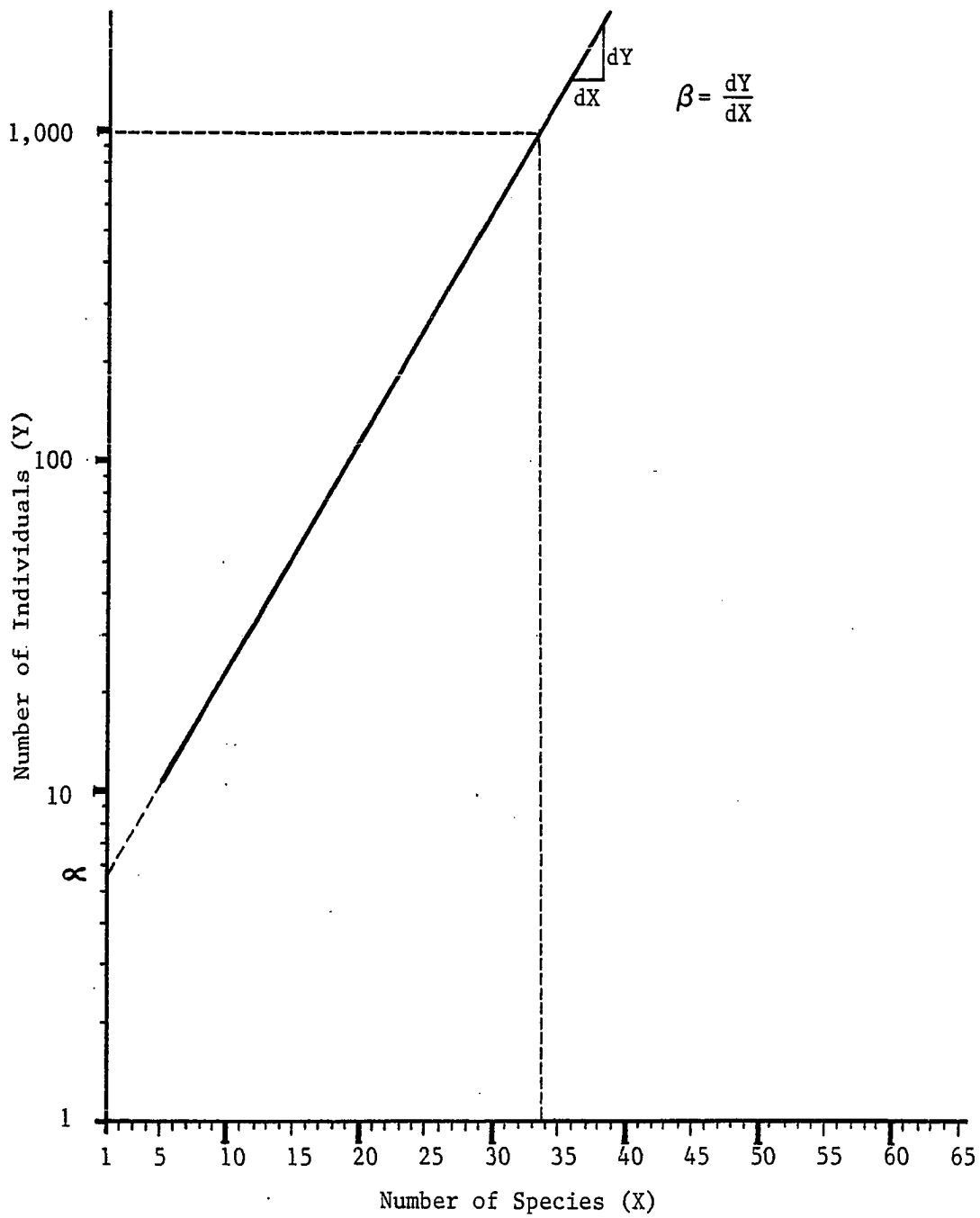

FIGURE 4-4 AN EXAMPLE OF SPECIES DIVERSITY REGRESSION LINE FOR A CERTAIN HABITAT TYPE

Source: 45

(c) Data collection and calculations

The terrestrial vegetation data representing each habitat type are used to examine the intra-community type species diversities. The stands within each flora habitat type should be selected at random and accumulated number of flora species and logarithm of accumulated number of individuals are to be obtained. Data from each stand are usually collected by the quarter method (14) and only individuals ≥ 10.16 cm d.b.h. (diameter at breast height) are considered (45). Such information could be provided by State Department of Agriculture or local universities. However, in most cases the data will have to be acquired in the field. The data to be collected are shown in Table 4-4.

(d) Parameter function graph

The function of terrestrial flora species diversity visus ecological performance (E.P.) is shown in Figure 4-5. The positive linear function denotes that ecological performance is enhanced with the improvement in flora species diversity.

(e) Ecological standards

| LEVEL ITEM | I | II | III |
|---------------------|-------------|-------------|-------------|
| Ecological Standard | ≥ 30.5 | ≥ 23.0 | ≥ 15.5 |

D. Vegetation land use (aesthetic)

The design of this parameter is human oriented, in particular with respect to the aesthetic viewpoint of man. The importance of this parameter in the evaluation of the ecological system lies in the fact that environmental components of high aesthetic quality (or visually pleasing) are necessities for satisfying the emotional and mental needs of men. Inversely, the health and well-being of men are imperative to the stability of the ecological system because men, after all, are great manipulators of the environment.

Generally, land predominated in highly desirable vegetation types are considered to be visually more pleasing and thus having higher

TABLE 4-4 DATA COLLECTION AND CALCULATION OF TERRESTRIAL FLORA SPECIES DIVERSITY

| TO BE DETERMINED | DATA REQUIREMENT | SOURCE | CALCULATION |
|---|---|--------------------------------------|---|
| 1) Flora species diversity of each habitat type | (i) Accumulated number of individuals (Y) (ii) Accumulated number of flora species (X) | U.S.D.A. or Corps of Engineers | A regression line is fitted to the data on the graph with X vs. log Y X_i = number of flora species in 1,000 individuals |
| 2) Weighted flora diversity in each study community (D) | (iii) Percentage of each flora habitat type in the whole community (T_i) | U.S.D.A.- S.C.S | $D = \sum_{i=1}^n (X_i \cdot T_i)$ |

PARAMETER ESTIMATE = D

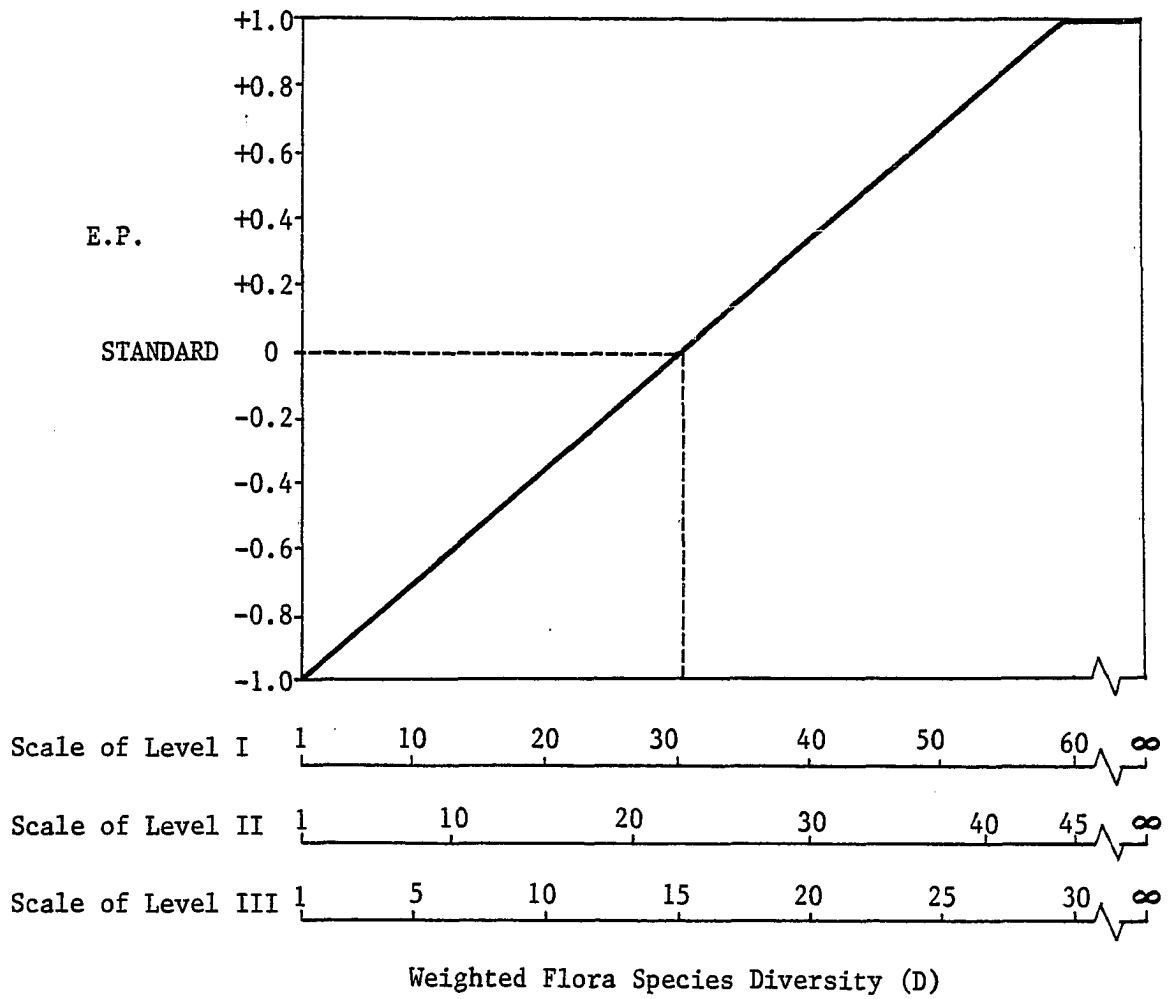

FIGURE 4-5 PARAMETER FUNCTION GRAPH OF TERRESTRIAL FLORA SPECIES DIVERSITY

aesthetic quality than land having less desirable vegetation types. In this parameter, forest areas or trees are considered to be most visually pleasing and most worthy of protection and preservation, however, it is not intended here to mean that a landscape with just trees and no other vegetation is highly desired. Land cultivated with a good proportion of highly desirable vegetation types, and with provisions for a reasonable heterogeneity, is considered to be most desired and possessing a high aesthetic quality. This concept also compromises for the intrinsic diversity requirement of a stable ecosystem. Thus, the unique feature of this parameter is that it is developed with the aesthetic viewpoint approach, but it does not exclude considerations concerning ecological stability.

(a) Methodology

The measured result of this parameter is expressed as the weighted sum of the percentage change of vegetation land use types. A study region showing a positive percentage change is said to have improved in aesthetic quality and achieved a higher overall ecological performance. One that scores a negative percentage change value, is degrading in aesthetic quality, and its ecological performance may be falling short of meeting the standard.

For this parameter, land use for various vegetation is divided into the following categories:

- 1) Forestland
- 2) Cropland
- 3) Rangeland
- 4) Pastureland
- 5) Others (little to no vegetation)

Definitions of vegetation land uses are included in Appendix B.

The assignment of weighting factors is based on a pairwise comparison approach and the following rationale. Land with little to no vegetation is assigned a value of 1 as of being visually least pleasing. The most desirable vegetation land use, forestland, is given a value 10. Rangeland is considered to be the mid-point, i.e., 5. Range is defined as the land on which the natural potential (climax) plant cover is composed principally of native grasses, forbs and shrubs valuable for

forage. Included in rangeland are also natural grasslands and savannahs. Comparatively, rangeland has more variations than pastureland and consequently possesses higher aesthetic value. Thus, pastureland is assigned a value of 4 because it is slightly less desirable than rangeland. Finally, cropland is assigned 6, because in most instances, its orderly symmetrical pattern (different from monotony) of cultivation is considered to be more visually pleasing than rangeland (which consists of randomly grown vegetation). To summarize, weights assigned to various vegetation land uses are shown in Table 4-5.

To calculate vegetation diversity, the following formula may be used:

(b) Formulas

- (1) P_{it} = Percentage of the *i*th type vegetation land use in a study region in year *t*

$$= \frac{V_{it}}{T_t} \times 100\% \quad (4-5)$$

where

V_{it} = Acreage of the *i*th type of vegetation land use in year *t*

T_t = Acreage of total land of a study region in year *t*

- (2) $S_{\Delta t}$ = Weighted sum of percentage change of various land uses in Δt years

$$= \sum_{i=1}^n \Delta P_{i\Delta t} \cdot W_i \quad (4-6)$$

where

$\Delta P_{i\Delta t}$ = Percentage change of the *i*th type vegetation land use over Δt years

W_i = Aesthetic weight assigned to the *i*th type of land use

Δt = Change over time, an interval of 5 to 10 years is recommended

n = Total number of types of land use

n = 5 in this study

TABLE 4-5 VEGETATION LAND USE AND WEIGHTING FACTORS

| VEGETATION LAND USE TYPE | WEIGHTING (W_i , $i=1,2,3,4,5$) |
|----------------------------------|-------------------------------------|
| Forestland | $W_1 = 10$ |
| Cropland | $W_2 = 6$ |
| Rangeland | $W_3 = 5$ |
| Pastureland | $W_4 = 4$ |
| Others (little to no vegetation) | $W_5 = 1$ |

i = Type of land use

i = 1 for forestland

i = 2 for cropland

i = 3 for rangeland

i = 4 for pastureland

i = 5 for others (little to no
vegetation)

$$\text{PARAMETER ESTIMATE} = S_{\Delta t}$$

(c) Data collection and calculation

To determine the measurement of vegetation land use, the essential data requirements are the land areas of each specific type of use over a certain length of time (5 to 10 years intervals), because it is basically a measurement of change over time. Such data can usually be obtained from the Soil Conservation Service, Census of Agriculture, local universities or agencies of land use research as shown in Table 4-6.

(d) Parameter function graph

The functional graph of vegetation land use is linear as shown in Figure 4-6. The ecological performance (E.P.) of a study region, rated from an aesthetic viewpoint, is directly proportional to the overall percentage change of vegetation land use weighted. Within a study boundary, there may be certain change of land uses, for instance, the change of a part of forest land to range land and a portion of pastureland to cropland. When the overall percentage change is zero or positive, the study region is said to have met the standard. When negative, it is then not meeting the standard. The critical point of the curve is at zero percentage change at which the overall E.P. rating is zero. The functioning curve of the three development levels are located at scales -50 to +50 (level III), -25 to +25 (level II) and -10 to +10 (level I). Any percentage change outside the scale are said, accordingly, to have E.P. of +1 or -1.

TABLE 4-6 DA
(A)

TABLE 4-6 DA DA DA DA DA DA DA DA

| ITEM TO BE DETERMINED |
|---|
| 1) Percentage of <i>i</i> th type vegetation land use in a study region in year <i>t</i> (P_{it}) |
| 2) Weighted sum of percentage change of various vegetation land uses ($S_{\Delta t}$) |

| SOURCE | LOCATION |
|------------------|----------|
| 1. UNITED STATES | 1900 |
| 2. | 1 |
| 3. | 1 |
| 4. | 1 |
| 5. | 1 |
| 6. | 1 |
| 7. | 1 |
| 8. | 1 |
| 9. | 1 |
| 10. | 1 |

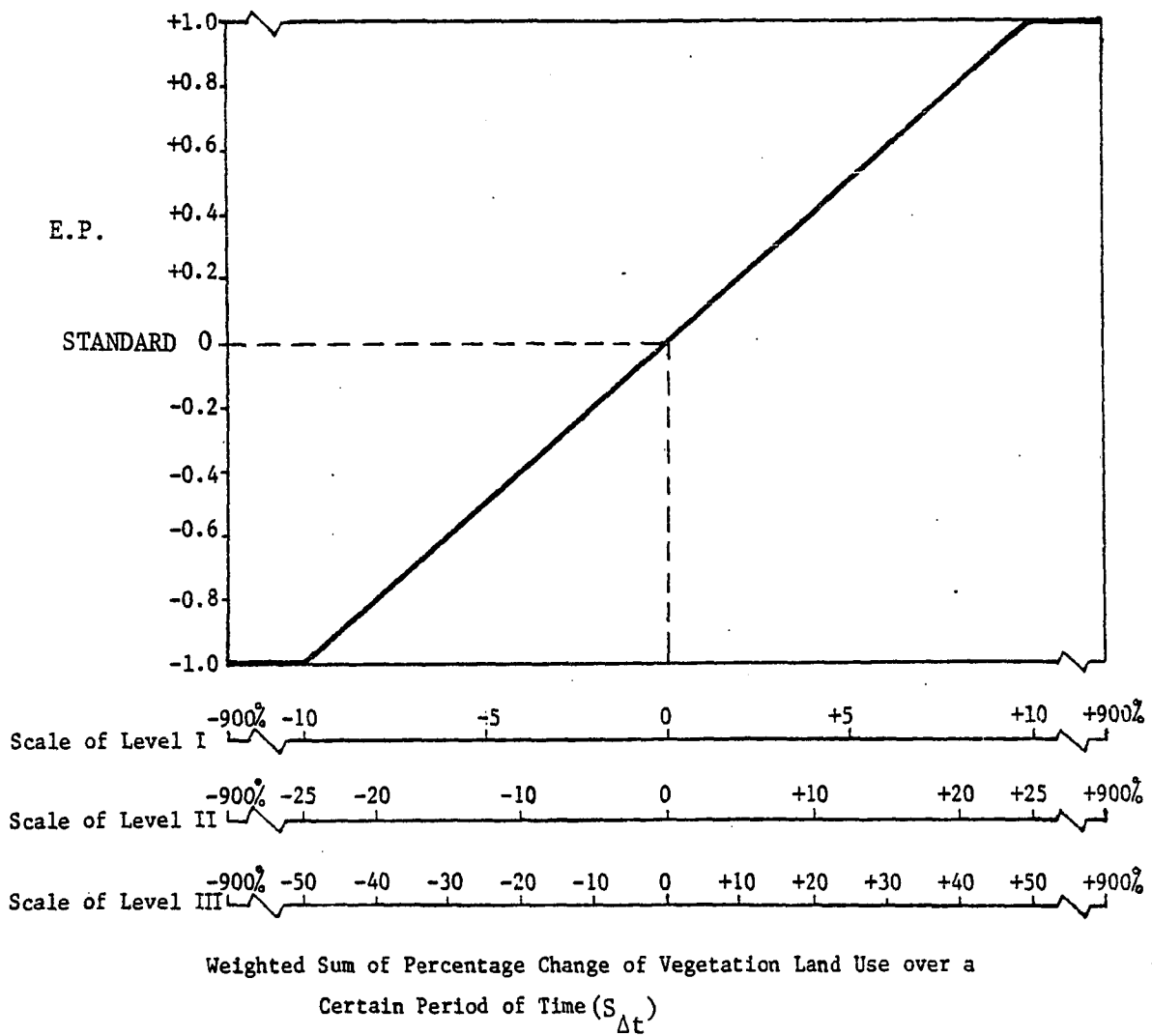

FIGURE 4-6 PARAMETER FUNCTION GRAPH OF VEGETATION LAND USE (AESTHETIC)

(e) Ecological standards

| LEVEL ITEM | I | II | III |
|---------------------|--------------------------------|----|-----|
| Ecological Standard | NON-NEGATIVE PERCENTAGE CHANGE | | |

4.2.2 Fauna

A. Dynamic ratio of fish population

Fish and wildlife resources presently provide outdoor recreation for about 40% of the nation's population. In 1965 people in the United States spent 575 million activity-days pursuing recreational fishing activities in both fresh and saltwater bodies. The value of the total 1965 commercial fresh-water related catch in the conterminous U. S. came to \$265 million (24). These foregoing facts point out the need for better fish management programs. A prerequisite for improved fish management programs is a better understanding of the critical parameters which determine the stability of aquatic ecological systems. Two of the most critical parameters influencing the fish in an ecosystem are the concepts of balanced fish population and the effects of fish harvests.

The interrelationships in fish populations are satisfactory if the population yields satisfactory crops of harvestable fish consistently, considering the fertilities of the bodies of water containing these populations. Such populations are considered to be balanced populations and the species within such a population are in balance.

Unbalanced fish populations are those that are unable to produce succeeding annual crops of harvestable fish. This may be because of their inability to provide sufficient replacement individuals to maintain satisfactory utilization of the potential food supply or, more commonly, because of over-crowding.

Usually, the data on fish population are more or less static

figures which represent the particular population only at that instant or period of time when the census was made. The live population, however, is not static, but dynamic. Dynamic populations are constantly changing in individuals and in relative composition due to growth, predation, removal, mortality and reproduction.

(a) Methodology

A great number of techniques for measuring populations are being used extensively each year. However, there is little uniformity in the method of interpreting or comparing the information obtained.

Swingle (79) grouped the various species into forage fish (F) and carnivorous fish (C). He defined the F/C ratio as the ratio of the total weight of all forage fishes to the total weight of all carnivorous (piscivorous) fishes in a population. The values he obtained were relatively higher than other measuring alternatives because the F/C ratio is confined to the weights of various species of fishes.

The summary of Swingle's experimental report (78), which measured 89 separate well-established fish population from 2 to 30 years old, concluded that the range of F/C ratios in balanced populations is from 1.4 to 10.0. Populations with $F/C = 1.4$ to 2.0 are overcrowded with carnivorous species. The most desirable populations are those with F/C ratios between 3.0 and 6.0. All populations with F/C ratios above 10.0 are unbalanced.

In this parameter, the F/C ratio will be used as the function estimate to determine the dynamic condition of the fish population. The classification of fish is as follows:

"C" class: composed of species that feed principally upon other fishes and that cannot attain normal adult size without such food;

"F" class: composed of all other species in the population that feed principally upon plants, plankton, water insects, and other small aquatic invertebrates.

The F/C ratio is a relatively stable value, remaining almost constant despite variations in the rates of fishing for F and C species.

(b) Formula

$$\begin{aligned} F/C &= \text{Dynamic ratio of fish population} \\ &= \frac{\text{Total weight of all forage fishes}}{\text{Total weight of all carnivorous}} \end{aligned}$$

$$= \frac{\sum_{f=1}^n W_f}{\sum_{c=1}^m W_c} \quad (4-7)$$

where

W_f = Investigated total weight of fth forage species,
lb/acre

W_c = Investigated total weight of cth carnivorous species,
lb/acre

n = Total number of forage species found in the study
region

m = Total number of carnivorous species found in the
study region

PARAMETER ESTIMATE = F/C

(c) Data collection and calculation

The separate compositions in weights of each fish specie of each reservoir can be compiled from fish standing crop data which is primarily being collected by the Fishery Research Laboratory of State Wildlife Conservation Department, City Water Department and State Cooperative Fishery Unit. Local universities may have also collected such data for some of the regions. The data required and calculations are shown in Table 4-7.

(d) Parameter funciton graph

The level of ecological performance (E.P.) in this parameter is directly determined by the F/C ratio of the study region (see Figure 4-7). The construction of the curve is based on conclusions drawn from the frequency distribution of F/C ratio in balanced and unbalanced population in Swingle's report (79).

TABLE 4-7 DATA COLLECTION AND CALCULATION OF DYNAMIC RATIO OF FISH POPULATION

| TO BE DETERMINED | DATA REQUIRED | SOURCE | CALCULATION |
|--|---|--------------------------------|---|
| Dynamic Ratio of Fish Population (F/C) | i) Investigated total weight of <u>fth</u> forage species (W_f) | Dept. of Wildlife Conservation | $\frac{F}{C} = \left(\sum_{f=1}^n W_f \right) / \left(\sum_{c=1}^m W_c \right)$ |
| | ii) Investigated total weight of <u>cth</u> carnivorous species (W_c) | Dept of Wildlife Conservation | |

PARAMETER ESTIMATE = F/C

Parameter Function Graph

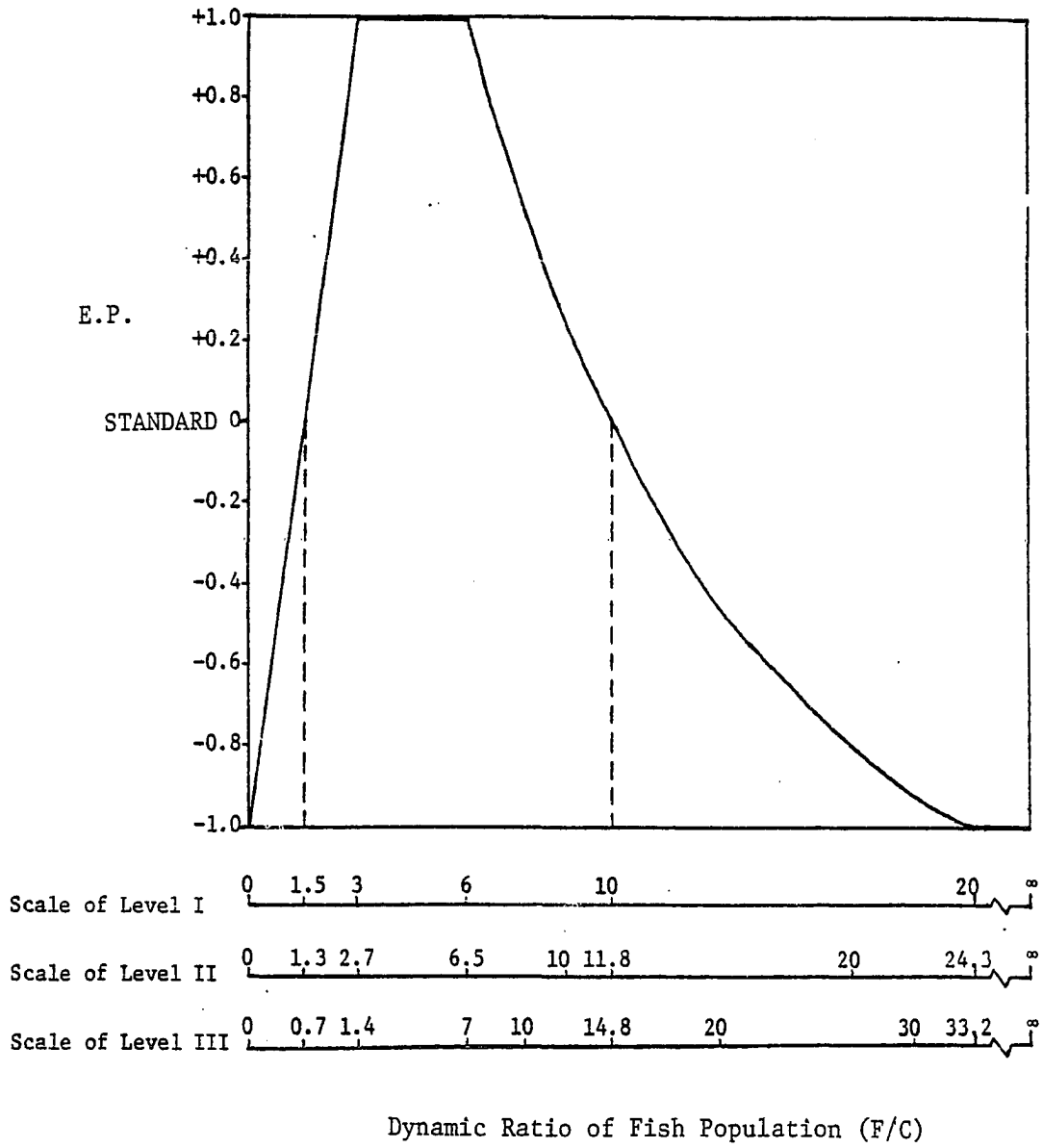

FIGURE 4-7 PARAMETER FUNCTION GRAPH OF DYNAMIC RATIO OF FISH POPULATION

In the most restricted region (level I), the best ecological performance is set at F/C ratio from 3 to 6. Within this range of F/C ratio, the fish population is a balanced one, and populations with F/C ratio below 3 and above 10.0 are usually unbalanced. These are conclusions derived from Swingle's experimental data. When the F/C ratio is between 3 and 6, the E.P. is the best, and consequently all values within this range are assigned plus one E.P. value. In the less restricted region (level II) the best F/C ratio was expanded to a wider range of 2.7 to 6.5 to accommodate for a less restrictive standard. From 0.06 to 2.7, the F species are disappearing under C species' predation. This is an undesirable condition because overcrowded C species would inevitably result in reducing total production. For level III, general development area, the best F/C ratio was further loosened to the 1.4 to 7 scale range. According to Swingle's Report (79), the scale of 1.4 to 7 is still within the balanced fish population range.

(e) Ecological standards

| LEVEL ITEM | I | II | III |
|---------------------|----------|------------|------------|
| Ecological Standard | 1.5 ↔ 10 | 1.3 ↔ 11.8 | 0.7 ↔ 14.8 |

B. Waterfowl habitat

The term "waterfowl" applies to any member of the family Anatidae, which includes swans, geese and ducks among others. The great majority of waterfowls are birds of fresh water and, with few exceptions, breed on inland water even though they may winter on the seashore.

There are many variations of waterfowl habitat, and each is susceptible to alteration. The fast moving streams, which are of low biotic productivity, fuse into larger and slower streams eventually, which produce water areas of other types, such as isolated ox-bows and sloughs. These new remnants of the stream meanders are favored breeding areas for

waterfowls along large streams.

Broad silted deltas, located where the large streams meet the lakes or the sea, are often the sites of large marshes. Extensive coastal marshes usually form a major waterfowl habitat, especially for wintering birds. In general, many small water areas are more productive than larger, less diverse areas because of their greater length of shorelines (91).

The impact of man on waterfowl habitat has been so immense that it directly affects the presence and abundance of waterfowl. The declining of the waterfowl population throughout the world is a well-known and well-proven fact, and is generally attributed to loss of habitat, especially breeding ground, and to overharvest.

Data on habitat losses are alarming. In Sweden, some researchers have shown that one major watershed lost 88% of its water area because of drainage (21, 94). In New Zealand, there are only 1,000 acres of one 60,000 acre marsh now remain and that many similar marshes had been lost (2). In the United States, around 45 million acres of an original 127 million acres of water have been drained (70).

There are at least 4 species of recent waterfowl of the world now believed extinct and more than 11 species being listed as rare species in Scott's report, 1957 (69).

Based upon the foregoing facts, the preservation of natural water areas has become a primary objective of waterfowl management.

(a) Methodology

The percentage loss in the areal extent of waterfowl habitat, which is usually termed wetland area, is used for the evaluation of waterfowl declines in this parameter. Wetlands include swamps, marshes, bogs, and any other places where the land surface is almost always covered to some degree by water. Whenever the land in the study region converted from wet surface to any other dry-form surface, a reduction in the environmental performance takes place. In other words, any decrease of wetland which causes less available habitat for waterfowl will not be acceptable for the maintenance of the ecological community.

(b) Formula

$$\begin{aligned}
W_{\Delta t} &= \text{Percentage change of waterfowl habitat in } t \text{ years} \\
&= \frac{(\text{Current waterfowl habitat}) - (\text{Waterfowl habitat } t \text{ years ago})}{(\text{Waterfowl habitat } t \text{ years ago})} \\
&\quad \times 100\% \\
&= \frac{(\text{Current wetland area}) - (\text{Wetland area } t \text{ years ago})}{(\text{Wetland area } t \text{ years ago})} \times 100\% \\
&= \frac{A_0 - A_t}{A_t} \times 100\% \tag{4-8}
\end{aligned}$$

$$\text{PARAMETER ESTIMATE} = W_{\Delta t}$$

(c) Data collection and calculation

The current wetland area and that of t-year ago can usually be provided by the State Water Resources Board or the Corps of Engineers. If unavailable, the areas of several land types can be used to estimate the size of water area. The Conservation Needs Inventory Report and Soil Survey Report from State Soil Conservation Service of State Department of Agriculture normally has the required information. In this research, such data obtained are itemized in Table 4-8.

(d) Parameter function graph

The graph of this parameter (Figure 4-8) is similar to that of the terrestrial natural vegetation, both using the concept of non-negative percentage change to develop standards. When there is only slight reduction of wetland area the ecological performance would not drastically decrease, because some waterfowls may migrate to neighboring similar and familiar environments. But when a certain water surface area decreases suddenly, waterfowls may completely discard the area to migrate to an entirely different wetland. The stability of the original ecosystem will then be noticeably disturbed, causing the graph to slope downward quickly. In the final condition, all the available habitat is destroyed creating a very immense ecological stress.

When the wetland area steadily increases, waterfowl will be less affected by other physical factors because choices of habitable spaces

TABLE 4-8 DATA COLLECTION AND CALCULATION OF WATERFOWL HABITAT

| ITEM TO BE DETERMINED | DATA REQUIRED | SOURCE | CALCULATION |
|---|--|--------------------------------|---|
| 1) Current total wet land area (A_o) | i) Size of study region ii) Current total land area ¹ | U.S.D.A. S.C.S. U.S.D.A. | $A_o = (i) - (ii) + (iv)$ |
| 2) Total wet land area t years ago (A_t) | iii) Total land area t year ago iv) Current small water area ² | U.S.D.A. U.S.D.A. | $A_t = (i) - (iii) + (v)$ |
| 3) Percentage change of waterfowl habitat in t years ($W_{\Delta t}$) | v) Small water area t years ago | U.S.D.A. | $W_{\Delta t} = \frac{A_o - A_t}{A_t} \times 100\%$ |

$$\text{PARAMETER ESTIMATE} = W_{\Delta t}$$

¹Total land area does not include water area of 40 acres or more in size or streams of 1/8 mile or more in width.

²Small water area include water areas less than 40 acres in size or streams less than 1/8 mile in width.

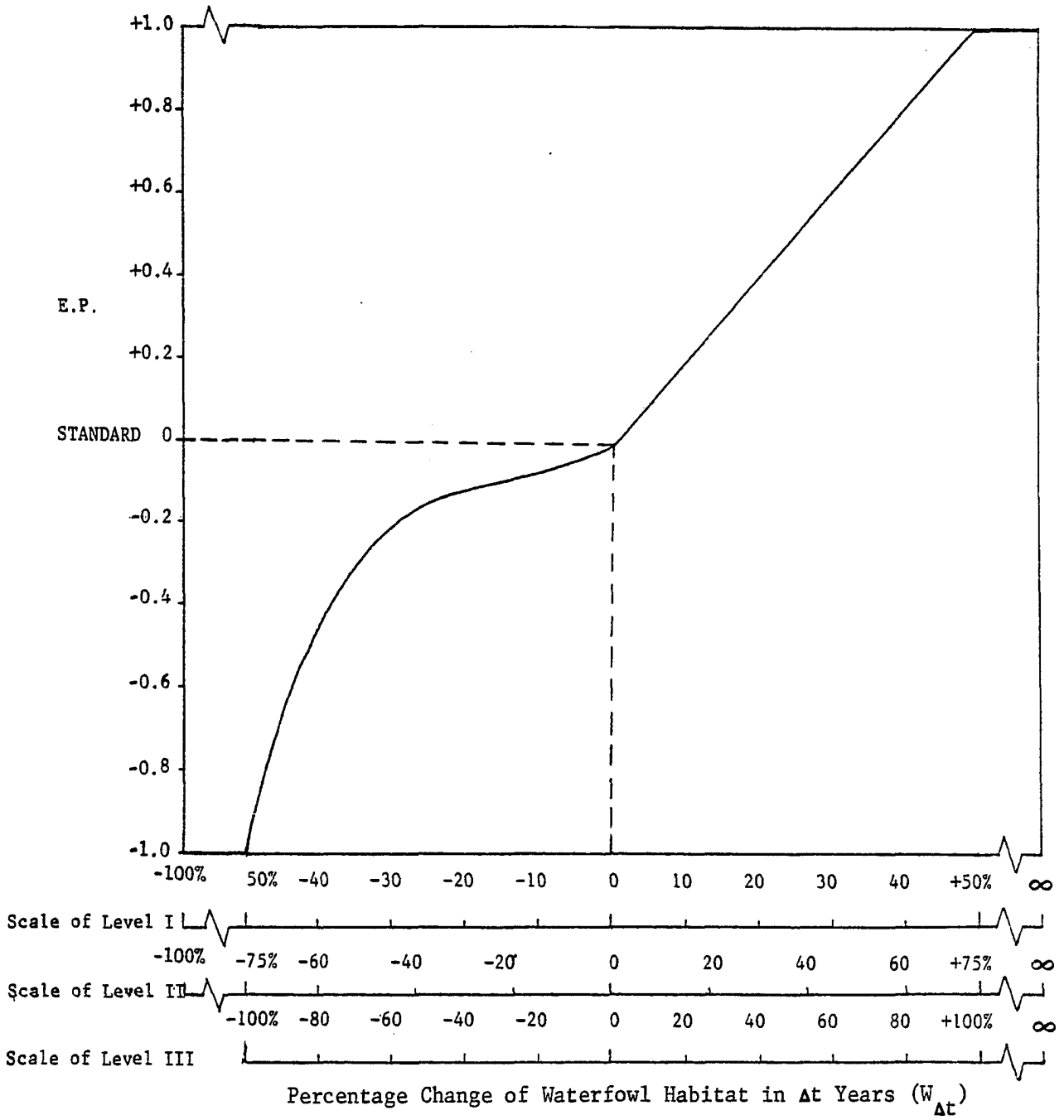

FIGURE 4-8 PARAMETER FUNCTION GRAPH OF WATERFOWL HABITAT

have increased and consequently E.P. rises almost linearly.

(e) Ecological standards

| ITEM \ LEVEL | I | II | III |
|---------------------|--------------------------------|----|-----|
| Ecological Standard | NON-NEGATIVE PERCENTAGE CHANGE | | |

C. Terrestrial fauna species diversity

During the past two decades interest in wildlife species diversity has greatly increased among ecologists, perhaps because man is so rapidly reducing natural diversity to the point of raising serious doubt as to whether this trend is in his own best interest.

Species diversity is very much influenced by the functional relationships between the trophic levels. Moderate predation often reduces the density of dominants, thus providing fewer competitive species with a better chance to use space and resources. Paine (15) in his report concluded that local species diversity is directly related to the efficiency with which predators prevent monopolization of major environmental requisites by one species.

Relative stability in communities results from the population function of individual species and small set of interacting species. Environments that are stable may permit many species to survive in interaction with one another in a complex community (38). Individual species may then have relatively stable populations because of density-dependent relationships. Community complexity may not necessarily produce community stability, yet environmental stability permits the evolution of a complex community.

(a) Methodology

The fauna species diversity value in each habitat type is obtained by the regression of the number of fauna species against the

logarithm of the absolute fauna density, or against the number of individuals. The results obtained from this are then multiplied by the land area percentage of each habitat type, and after summation, it becomes the weighted species diversity. The stability of ecosystem can then be determined from the magnitude of the weighted species diversity. The more stable the community, the better will be the environmental performance.

(b) Formulas

$$(1) \log Y = \alpha + \beta X \quad (4-9)$$

where Y = Number of individuals

α = Number of individuals at which one fauna species intersects

β = Slope of the regression line

X = Number of fauna species

This equation is presented in graphical form. The linear regression lines are plotted on a graph with the number of fauna species in each habitat versus the logarithm of the number of individuals of each habitat. Calculating the differences in species diversity between the habitat types is accomplished by determining the number of fauna species one would expect to encounter per 1,000 individuals, i.e., the number of fauna species at which the regression line intersects 1,000 individuals (X_i).

$$(2) D = \sum_{i=1}^n (X_i \cdot T_i) \quad (4-10)$$

where X_i = Fauna species diversity of the ith habitat type

T_i = Percentage of the ith fauna habitat type in the whole study community

n = Number of fauna habitat type in the study community

i = Fauna habitat type¹

PARAMETER ESTIMATE = D

¹See Appendix D for fauna habitat type

(c) Data collection and calculations

The terrestrial wildlife data representing each habitat type are used to examine the intra-community type species diversities. The stands within each habitat type should be selected at random and the accumulated number of fauna species and logarithm of accumulated number of individuals are to be obtained. Such information can be obtained from the State Department of Wildlife Conservation Service or local universities. However, in most cases the data will have to be acquired in the field. The data to be collected are shown in Table 4-9.

(d) Parameter function graph

The function of terrestrial fauna species diversity versus ecological performance (E.P.) is shown in Figure 4-9. The positive linear function expresses that ecological performance is enhanced with the improvement in fauna species diversity.

(e) Ecological standards

| ITEM \ LEVEL | I | II | III |
|---------------------|-------|-------|-------|
| Ecological Standard | ≥30.5 | ≥23.0 | ≥15.5 |

D. Fauna species composition (aesthetic)

Through the wake of large scale environmental reconnaissance to the recent enactment of environmental laws, aesthetics has acquired increasing importance. In discussions of the environment, it becomes inseparable among terms like ecology, pollution, and human interest. In the parameter of vegetation land use, aesthetic quality measured was of a static nature, in contrast, aesthetic quality measured by fauna species composition possesses a dynamic nature.

Things encountered in daily life will create aesthetic impacts that are felt directly by all individuals, but not all individuals will react in the same manner and to the same extent. Different individuals will make different value judgements of the same aesthetic feature as a

TABLE 4-9 DATA COLLECTION AND CALCULATION OF FAUNA SPECIES DIVERSITY

| TO BE DETERMINED | DATA REQUIRED | SOURCE | CALCULATION |
|---|---|---|---|
| 1) Fauna species diversity of each habitat type (X_i) | (i) Accumulated number of individuals (Y) (ii) Accumulated number of fauna species (X) | U.S.D.A. or Corps of Engineers U.S.D.A. or Corps of Engineer | A regression line is fitted to the data on the graph with X vs. log Y X_i = number of fauna species in 1,000 individuals |
| 2) Weighted fauna species diversity in each study community (D) | (iii) Percentage of each fauna habitat type in the whole community (T_i) | U.S.D.A. - S.C.S. | $D = \sum_{i=1}^n (X_i \cdot T_i)$ |

PARAMETER ESTIMATE = D

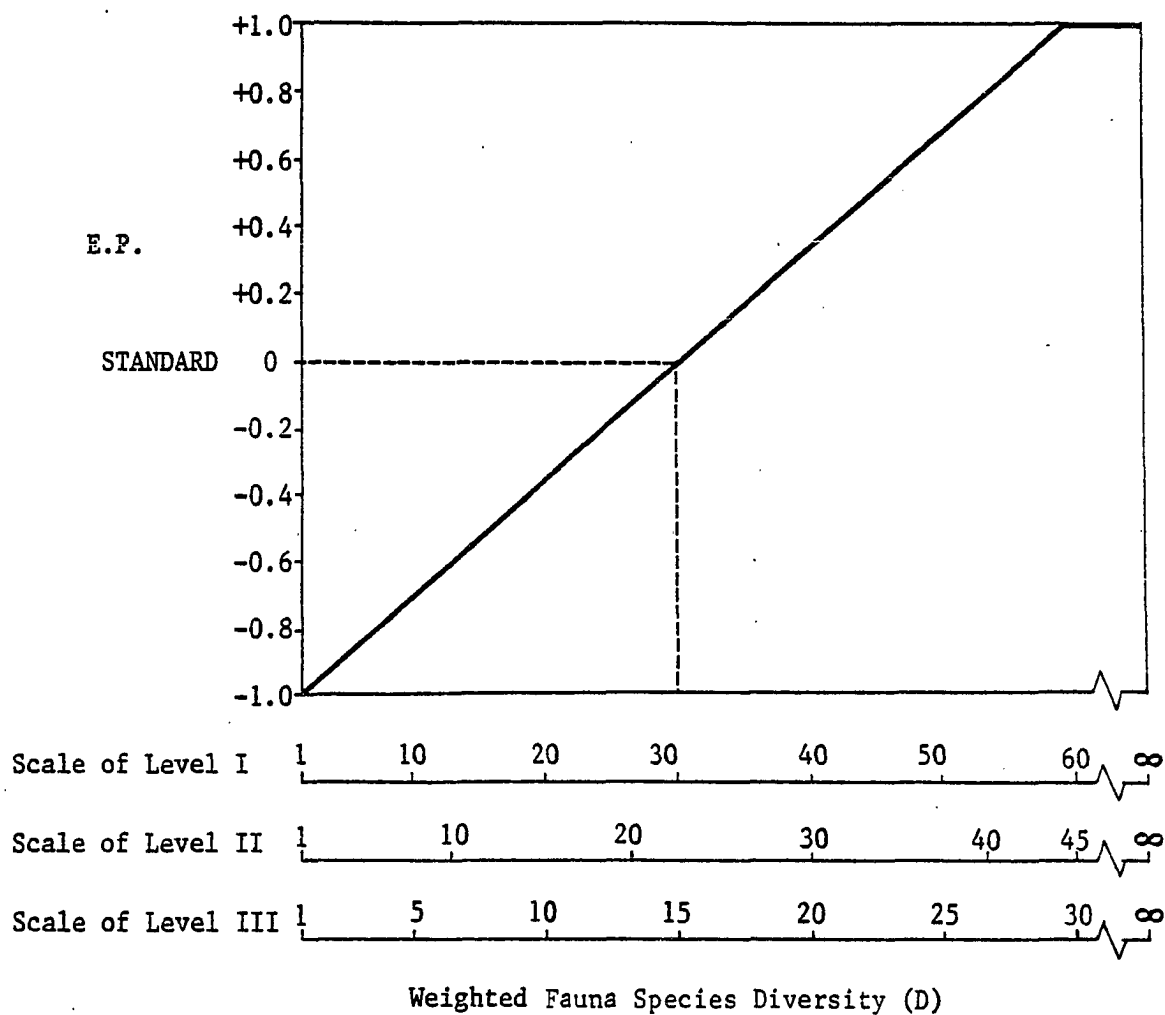

FIGURE 4-9 PARAMETER FUNCTION GRAPH OF TERRESTRIAL FAUNA SPECIES DIVERSITY

result of their own different upbringing, cultural background, social background, etc., but above all, the result of one's personal experience in life. Large beautiful animals (considered by the researchers as beautiful), like elk, leopard, and polar bear will please immensely the eyes of most beholders, but it might elicit no favorable response from any other persons. Therefore, it is almost impossible to fairly bestow the comment of beauty to something expecting unanimous responses.

It is difficult to establish absolute values about what is pleasing no matter how much one knows about what is a pleasant animal to look at or to be around. The methodology developed here attempts to create a balanced trade-off of these considerations without neglecting the highly important natural stability of the ecosystem. It was also decided that measurements of change rather than absolute value is a more reasonable approach to determine aesthetic values.

The composition change of fauna species commonly will reveal conspicuously the fauna change which will indirectly alter man's aesthetic judgement towards them. Therefore, it is suggested to be used to measure the desired change of aesthetic value.

Generally, annual surveys of existing wildlife species and their populations is an unsurmountable task, other than being impractical. Consistent surveys within 5 or 10-year interval will roughly show the fluctuation of a species population size. This kind of change in population size will cause a composition change in the fauna community creating different visual impact on man. Thus, the weighted composition change over a certain period of time will be used as the relative aesthetic value estimate in this parameter.

(a) Methodology

It is indispensable in the discussion of species composition to consider the proportions of existing population of the species. The immediate problem here lies in the fact that substantial quantitative information of wildlife species are often inaccessible, most likely they are scarce in existence. The most common form of information is a relative comparison in "quantitative" terms like common, occasional and rare. In this parameter, the assignment of occurrence modifiers (M_j) is used to differentiate the relative importance of the appearance of species.

| Per Unit Change of Species, (j) | Occurrence Modifier (M_j , $j = 1,2,3,4$) |
|------------------------------------|--|
| Total number in a class | $M_1 = 10$ |
| Common | $M_2 = 3$ |
| Occasional | $M_3 = 2$ |
| Rare | $M_4 = 1$ |

The assignment of occurrence weightings as modifiers is in much smaller magnitude than that of the parameters of the food web index discussed in sections 4.2.3-C and 4.2.3-D. In the food web index parameter, it is necessary to assign weightings closely resembling the actual existence of various species, i.e., at least weightings for common species should be large enough to illustrate their dominance. With respect to aesthetic value of the species here, the point of emphasis is the change of the species composition. Decrease in common species will upset people; similarly, abundance of rare species will also please many. Consequently, the weightings of 3, 2, and 1 are only intended for indicating the increase or decrease of the rate of appearance of the wildlife. The change of the total number of species in any animal class is the most crucial and is thus assigned a value of 10. Within a region, the discovery of a new species will excite people and the extinction of a species will displease people.

Like the parameter of vegetation land use, pairwise comparison approach is also applied here for assignment of aesthetic weightings to each animal class. Mammals, in spite of size, are all considered to be attractive. In general, when encountering wildlife in open environment, the feeling portrayed by mammals is much more pleasant than that shown by the reptiles. Birds in the sky and fish in the water are both considered to possess intermediate aesthetic qualities because of their short and temporary appearance which prohibits people from prolonged observation of their lifeforms. Commonly, the aesthetic value of birds is considered to be higher than that of fish. Except for a special group of people, like zoologists, etc., encounters with amphibians are not usually pleasant;

hence, amphibians have the lowest aesthetic value. Naids are seldom encountered by people except divers at benthic regions; consequently, they are not considered.

| Fauna Class (k) | Aesthetic Weightings of Fauna Species (A_k , k = 1,2,3,4,5) |
|-----------------|--|
| Mammals | $A_1 = 5$ |
| Birds | $A_2 = 4$ |
| Fishes | $A_3 = 3$ |
| Reptiles | $A_4 = 2$ |
| Amphibians | $A_5 = 1$ |

(b) Formula

$F_{\Delta t}$ = Aesthetic value of fauna species composition change over
t years

$$= \sum_{k=1}^n \sum_{j=1}^m \Delta S_{tjk} \cdot M_j \cdot A_k \quad (4-11)$$

where

ΔS_{tjk} = Number of wildlife species change in kth animal
class with jth occurrence over t years

M_j = Occurrence modifiers

A_k = Aesthetic weightings of fauna species

t = Change over time, an interval of 10 to 20 years
is recommended

n = Number of classes of wildlife species, n=5 in this
study

k = Class of wildlife species

k = 1 for mammals

k = 2 for birds

k = 3 for fish

k = 4 for reptiles

k = 5 for amphibians

m = Number of occurrence status of wildlife species

m = 3 in this study

j = occurrence status of wildlife species

j = 1 for total number in an animal class

j = 2 for common occurrence

j = 3 for occasional occurrence

j = 4 for rare occurrence

PARAMETER ESTIMATE = $F_{\Delta t}$

(c) Data collection and calculation

The data required in this parameter are the occurrences of the various wildlife species in the study region. Both current and dated data are required because this parameter is a measurement of change over time. Normally, government agencies like the State Department of Wildlife Conservation, the Corps of Engineers or biological stations of local universities can provide this information. Table 4-10 shows the data required and the calculations.

(d) Parameter function graph

The relationship between fauna species composition and ecological performance (E.P.) is that of a linear nature as shown on Figure 4-10. The increase in fauna species' number and population will provide greater visual pleasure and the decrease of which is smaller. The intensity of aesthetic feeling is also considered in here by the aesthetic weightings (A_k) designed. Data of fluctuation of species population size over years, modified by occurrence modifiers (M_j) and aesthetic weightings (A_k) will become the parameter function estimate on the X-axis. This aesthetic value when increased will also increase the E.P. The relationship is thus directly proportioned.

If, in the most restricted area (level I), any one of the wildlife species become extinct, the result is an intolerable E.P. Even when there is increase in population size in some species, the change and effect is incomparable to that one specie lost. Hence, the worst E.P. of level I is assigned with a $F_{\Delta t}$ value of -10 which is the weight for a unit

TABLE 4-10 DATA COLLECTION AND CALCULATION OF FAUNA SPECIES COMPOSITION (AESTHETIC)

| TO BE DETERMINED | DATA REQUIRED | SOURCE | CALCULATION |
|--|--|---|--|
| Aesthetic value of fauna species composition change over t years (F_t) | i) Number of fauna species in each animal class with their respective occurrence t years ago (S_{tjk}) II) Number of fauna species in each animal class with respective occurrence in exist (S_{ojk}) | Dept. of Wildlife Conservation or Corps of Engr. Same as above | a) $\Delta S_{tjk} = S_{ojk} - S_{tjk}$ b) $F = \sum_{k=1}^n \sum_{j=1}^m \Delta S_{tjk} \cdot M_j \cdot A_k$ |

PARAMETER ESTIMATE = $F_{\Delta t}$

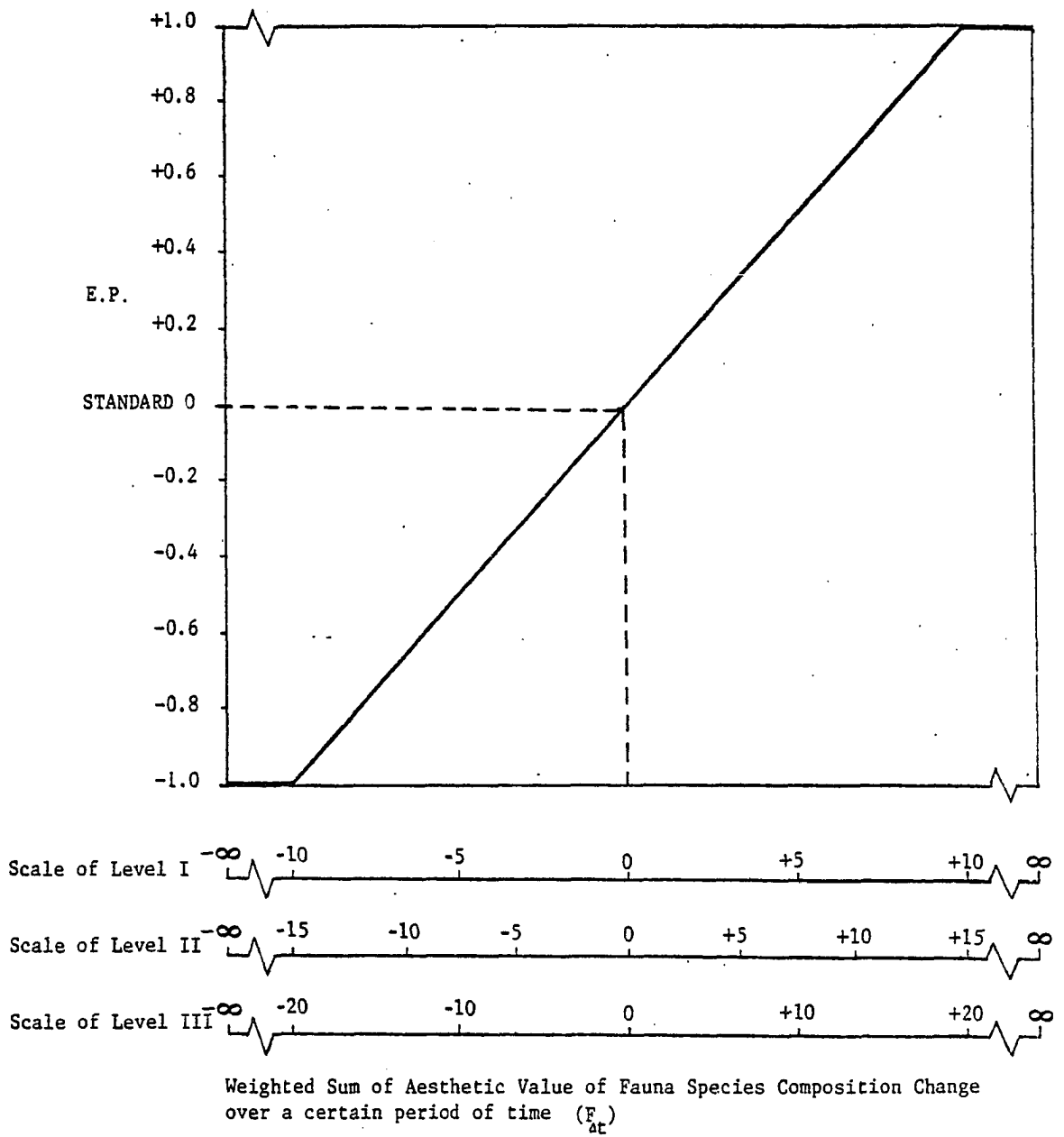

FIGURE 4-10 PARAMETER FUNCTION GRAPH OF FAUNA SPECIES COMPOSITION (AESTHETIC)

of change of total species. The worst $F_{\Delta t}$ value of Level III is assigned at -20, a value equivalent to the disappearance of more than one species or the large scale reduction of desirable species. In Level II area, an intermediate value of -15 is assigned.

(e) Ecological standards

| ITEM \ LEVEL | I | II | III |
|---------------------|--------------------------------|----|-----|
| Ecological Standard | NON-NEGATIVE PERCENTAGE CHANGE | | |

4.2.3 Biota

A. Pest species

Pest species have been defined as the species which are annoying or harmful to man or his crops, livestock, or game animals (5). Those pests could be either in the form of animals (i.e., insects, mites, nematodes, fish, rodents, and mammalian predators) or plants (such as weeds, algae, or other higher plants unwelcome to man). They are generally regarded as enemies of man because they not only compete with man for the natural resources of the earth, e.g., space, light, nutrients, water, etc., but they are also instrumental in spreading many of the deadliest diseases in the ecosystem. In the United States, some 10,000 insect species are classified as pests.

Crop pests have become a serious world economic problem only within the last two centuries. In recent years, the cultivation of a single crop on vast areas of land seemed to be the trend of agricultural development in many countries. Damages incurred by pest species on these monoculture farms are especially phenomenal because once a pest specie infested a monocultivated area it will rapidly spread to the entire region. Canada's grain growing states expect average annual losses ascribed to

weeds of 10 to 15 percent. The United States, despite her full use of modern chemical weapons, suffers an annual loss valued at four to five billion dollars (5).

(a) Methodology

In estimating this parameter, pests are first being divided into two major types: plant and animal species. They are then sub-divided into six categories according to the nature of the species and the type of habitat (Table 4-11).

To determine or estimate the pest species population in an infested area is an almost impossible task and data in this area are deficient. Perhaps, the most objective method to determine the extent or degree of infestation by pest species is to estimate in terms of the area infested. It is extremely difficult to decide to what extent a piece of land should be infested before one can say that it is harmful. This is very much like a philosophical treatise, to draw the line between good and evil is no easy matter. Rather than fruitlessly trying to decide which is harmful or which is not, it was decided that the change over time approach should be used. This will allow one to observe if there is improvement or deterioration of the condition which is showed by the decrease or increase of infested area over a period of time.

When the percentage of infestation of each of the six categories is determined, they are summed and compared with similarly calculated figures determined from data in previous years. This will tell the trend over these years.

The percentage of improvement (positive or negative) can then be estimated by formula (4-17) listed below.

(b) Formulas

- 1) S_o = Total percentage of area infested by various pest species present

$$= \sum_{i=1}^n \frac{P_{io}}{T_{io}} \times 100\% \quad (4-12)$$

where

P_{io} = Current acreage infested by *i*th pest species

TABLE 4-11 TYPES OF PEST SPECIES

| <u>CATEGORY</u> | <u>INTERPRETATION</u> |
|---------------------|---|
| Plant Species | |
| Weeds | Any undesirable or noxious plants in harvested cropland. |
| in crops | |
| in pasture | Any undesirable or noxious plants in all pastureland. |
| Diseases | Smuts, rusts, root rots, etc. |
| Animal Species | |
| Pests | Any annoying animal species on harvested cropland. |
| on crops | |
| on haycrops | Any annoying animal species on cropland which is being used for pasture or grazing. |
| Diseases & Carriers | All diseases caused or carried by animals. |

T_{io} = Current total acreage where ith pest species may inhabit

n = Total number of categories of pest species, $n=6$ in this study

i = type of pest species

$i = 1$ for plant weeds in crops

$i = 2$ for plant weeds in pastureland

$i = 3$ for plant diseases

$i = 4$ for animal pests on crops

$i = 5$ for animal pests on haycrops

$i = 6$ for animal diseases & carriers

2) S_t = Total percentage of area infested by various pest species t years ago

$$= \sum_{i=1}^n \frac{P_{it}}{T_{it}} \times 100\% \quad (4-13)$$

where

P_{it} = Acreage infested by ith pest species t years ago

T_{it} = Total acreage where ith pest species may inhabit t years ago

3) $C_{\Delta t}$ = Percentage change of pest species infestation over t years

$$= \frac{S_o - S_t}{S_t} \times 100\% \quad (4-14)$$

PARAMETER ESTIMATE = $C_{\Delta t}$

(c) Data collection and calculation

Data on the proportion of the terrestrial area within the study region inhabited or infested by the pest species as well as the percentage of diseased animal units are needed. Data of this nature are seldom collected. A set of practical alternative data that can be used here

(except for the sixth category, animal diseases and carriers) is the acreage on which agricultural chemicals are being used to control various pests. This will enable the determination of the exact area infested by pests. This is based upon the assumption that follows. In general, when there is proper management and adequate supply of agricultural chemicals, any outbreak of pests will be controlled by use of agricultural chemicals. Under that assumption, estimation of the area of infestation by pest species can be performed by estimating cropland and pastureland area on which agricultural chemicals were applied.

In the category of animal diseases and carriers, it is impossible to estimate infestation in terms of area, so expense used for treatment of infestation (dollar value) or the number of livestock treated externally for control of insects is used. This data is available from the responsible government agencies, e.g., state agriculture department and county extension offices, or local universities. U.S.D.A.'s Census of Agriculture has the required data of economic class 1-5 farms, which are defined as the farms with sales of \$2,500 and over. This is the desired agricultural information because the farms from which these data are gathered are the ones that have more economic value. Consequently, they are also the ones that have higher ability and potential of applying agricultural chemicals for pest control. The farms considered here will thus to some degree give indication of the conditions of surrounding farms that have less economic value. Table 4-12 shows the data required and the calculations.

(d) Parameter function graph

A linear function is used to describe the percentage change of area of pest infestation over time (see Figure 4-11). The ecological performance (E.P.) value will decrease with increasing percentage change of area impinged, indicating a rise in pests population. The maintenance of zero percentage change of pests over time in Level I or II region is not a satisfactory condition, it merely indicates that either the infested areas are not treated or treatment is insufficient. It is only when the pest are reduced in an infested area, showing signs of improvement that the condition can be called desirable. Therefore ecological standards are set at the beginning of non-positive percentage change. In Level III

TABLE 4-12 DATA COLLECTION AND CALCULATION OF PEST SPECIES

| TO BE DETERMINED | DATA REQUIRED | SOURCE | CALCULATION |
|---|--|----------|---|
| 1) Total Percentage of area infested by various pest species now (S ₀) | (a) Plant weeds in crops (i=1) (i) Acreage of harvested cropland in Class 1-5 Farms (T ₁₀) (ii) Acreage on which agricultural chemicals are used to control weeds or grass in crops (P ₁₀) | U.S.D.A. | $\frac{P_{10}}{T_{10}}$ $=(ii)/(i)$ |
| | (b) Plant weeds in pasture (i=2) (iii) Acreage of total pastureland (all types) in Class 1-5 Farms (T ₂₀) (iv) Acreage on which agricultural chemicals are used to control weeds or brush in pasture (P ₂₀) | U.S.D.A. | $\frac{P_{20}}{T_{20}}$ $=(iv)/(iii)$ |
| | (c) Plant diseases (i=3) (v) Same as (i) (T ₃₀) (vi) Acreage on which agricultural chemicals are used to control diseases in crops and orchards (P ₃₀) | U.S.D.A. | $\frac{P_{30}}{T_{30}}$ $=(vi)/(v)$ |
| | (d) Animal pests on crops (i=4) (vii) Same as (i) (T ₄₀) (viii) Acreage on which agricultural chemicals are used to control insects on other crops (P ₄₀) | U.S.D.A. | $\frac{P_{40}}{T_{40}}$ $=(viii)/(vii)$ |
| | (e) Animal pests on hay crops (i=5) (ix) Acreage of cropland used only for pasture or grazing in class 1-5 Farms (T ₅₀) (x) Acreage on which agricultural chemicals are used to control insects on hay crops (P ₅₀) | U.S.D.A. | $\frac{P_{50}}{T_{50}}$ $=(x)/(ix)$ |
| | (f) Animal diseases & carriers (i=6) (xi) Class 1-5 farm production expenses (\$) on feed for livestock and poultry (T ₆₀) (xii) Farm expenses (\$) on agricultural chemicals for insect control on livestock and poultry (P ₆₀) | U.S.D.A. | $\frac{P_{60}}{T_{60}}$ $=(xii)/(xi)$ |

TABLE 4-12 (Continued)

| TO BE DETERMINED | DATA REQUIRED | SOURCE | CALCULATION |
|---|--------------------------------|----------|--|
| | | | $S_o = \sum_{i=1}^n \frac{P_{i0}}{T_{i0}} \times 100\%$ $= ((1)+(2)+(3)+(4)+(5) + (6)) \times 100\%$ |
| 2) Total Percent- age of Area Infested by various pest species t-yr ago (S_t) | Same data as above of t-yr ago | U.S.D.A. | $S_t = \sum_{i=1}^n \frac{P_{it}}{T_{it}} \times 100\%$ |
| 3) Percentage change of pest species infesta- tion over Δt years ($C_{\Delta t}$) | | | $S_{\Delta t} = \frac{S_o - S_t}{S_t} \times 100\%$ $= \frac{(1) - (2)}{(2)} \times 100\%$ |

110

PARAMETER ESTIMATE = $C_{\Delta t}$

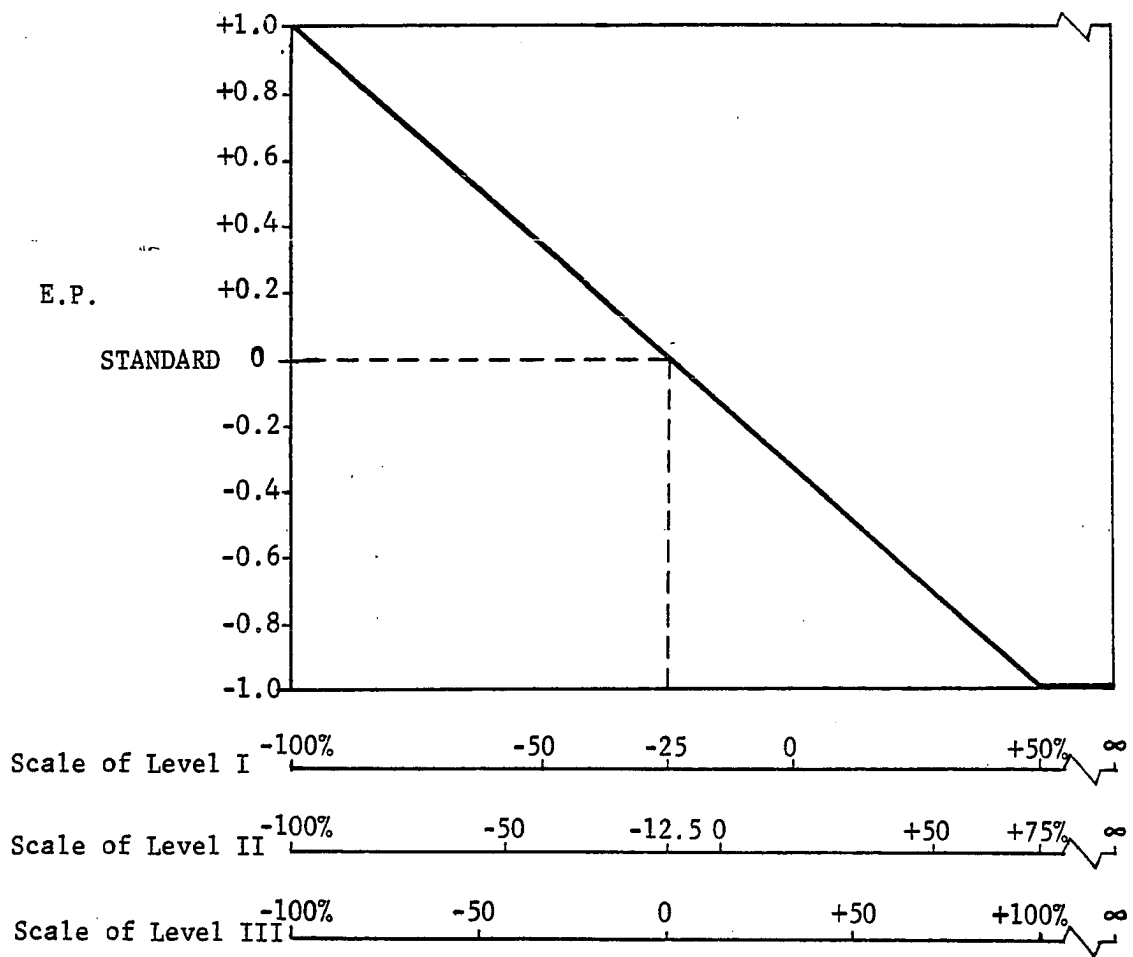

Percentage Change of Pest Species Infestation over Δt Years ($C_{\Delta t}$)

FIGURE 4-11 PARAMETER FUNCTION GRAPH OF PEST SPECIES

region, zero percentage change is accepted as standard. An exception occurs when a piece of land not infested initially does not fall in this calculation category. This is because in such situation, the denominator in the formula will become zero, resulting in infinite percentage change which in any development level will fall in the scale value of worst ecological performance.

Figure 4-11 shows that the zero percentage changes of the three levels are at or below standard. The best conditions of all three levels are set at -100% being the maximum of improvement because complete reduction of infested area is the most desired condition. The worst condition of Level I region is set at +50%. In the most restricted region, when the infested area increases up to 50% within several years, it not only seriously affects the yield and quality of normal reproduction of animals and plants, but also makes the task of treatment extremely difficult. On the other hand, when agricultural pest-control chemicals have to be persistently applied, ecological components and organisms will also be damaged.

The worst condition of Level III is a +100% increase while that of Level II, a +75% increase.

(e) Ecological standards

| LEVEL ITEM | I | II | III |
|---------------------|--------|----------|------|
| Ecological Standard | ≤ -25% | ≤ -12.5% | ≤ 0% |

B. Utilization of carrying capacity (terrestrial)

Carrying capacity of a specified area is the number of grazers, which includes cattle, horses, sheep, and other livestock as well as the wild herbivores that could be supported on this land if they consumed all the net annual plant production. Grazers are considered as dominant constituents of many terrestrial ecosystems and their quantitative existence is a significant indication of the general stability of the environment. In the human-oriented ecosystem, their role in food resource and recreation is of great importance.

Many relative and compensating factors are inherent in contemplating and analyzing the interaction between the livestock and its environment. Because of such considerations, the idea of carrying capacity is best approached as a concept rather than a simple, definable entity. Carrying capacity can be used to quantify this relationship in a very practical manner.

(a) Methodology

Utilization of carrying capacity, measured as the ratio of the estimated total animal units to the carrying capacity of the study area, expressed as percentage, will be used to evaluate the environmental quality in this study.

A basic consideration in the calculation of carrying capacity is that both the requirements of the animal and the supply of grass must be known before the calculation can be completed. Carrying capacity can be expressed in animal-unit-years into the available acreage of grazing area. These calculations are made on a pasture (or hay) base, by using the pasture (or hay) requirements of an animal unit to determine the amount of food that needs to be ingested.

Before calculation, three assumptions should be made as follows:

- 1) One animal unit (A.U.) is based on the food consumption of a cow (9,600 lb fresh pasture per year), i.e., annual animal unit food consumption = 9,600 lb/AU-year.
- 2) Weight of dry hay = $\frac{1}{2}$ weight of fresh grass (dehydration loss during haying process)
- 3) On the basis of pasture consumption of a cow, one horse is estimated as 1.28 A.U.; one sheep as 0.06 A.U.; one deer as

0.03 A.U.; one rabbit as 0.025 A.U.; (see the calculation on Appendix E) and all the amount of livestock will be converted to Animal Units in these proportions.

The estimated net grass production, the amount of grassland requirements of each animal unit and the utilization of carrying capacity will be calculated with the formulas listed below.

(b) Formulas

1) $P = \text{Estimated net hay production}$
 $= \frac{\text{Weight of hay harvested in the study region}}{\text{Acreage of hay harvested in that region}} \quad (4-15)$

2) $S = \text{Supporting ratio}$
 $= \frac{\text{Annual animal unit food consumption}}{\text{Estimated net grass production}}$
 $= \frac{9,600 \text{ lb/A.U./year}}{2P} \quad (4-16)$

3) $C = \text{Carrying capacity of the study region}$
 $= \frac{\text{Acreage of grazing area}}{\frac{\text{Annual animal unit food consumption}}{\text{Estimated net grass production}}}$
 $= \frac{\text{Acreage of grazing area}}{S} \quad (4-17)$

4) $N = \text{Total animal units occurring in the study region}$
 $= \# \text{ Cows} + (\# \text{ Horses} \times 1.28) + (\# \text{ Sheep} \times 0.06) +$
 $(\# \text{ Deer} \times 0.03) + (\# \text{ Rabbits} \times 0.025) + \dots \quad (4-18)$

5) $U = \text{Utilization of carrying capacity}$
 $= \frac{\text{Total animal units occurring in the study region}}{\text{Carrying capacity of the study region}} \times 100\%$
 $= \frac{N}{C} \times 100\% \quad (4-19)$

PARAMETER ESTIMATE = U

(c) Data collection and calculations

Data on the weight and acreage of hay harvested and the acreage on the grazing area are needed in this parameter. State Department of

Agriculture and local universities may supply such information. U.S.D.A. Census of Agriculture and Soil Conservation Service have some of the data as shown in Table 4-13.

(d) Parameter function graph

The function of utilization of carrying capacity versus environmental performance (E.P.) is shown in Figure 4-12.

In a Level III region, E.P. rises with the increase in utilization of the potential grazing areas prior to the 50% utilization and maximum performance is achieved at 50-60%. Beyond this range, the stability of the ecosystem is considered to be interrupted and E.P. begins to degrade rapidly. A minimum of 40% of the annual plant production must remain in the ecosystem because this is necessary for rejuvenation of the system. The 40% is inclusive of that required for continuous plant growth, replenishment of consumption or other causes of loss. Thus, it is clear that any use exceeding 60% of annual plant production will result in serious degradation of the E.P. of the ecosystem.

In a Level II region, the range of E.P. is determined by proportional expansion of 80% of the E.P. range of Level III, while the starting point of the best performance stays on 50%. Because of the difference in the decreasing rate of the curve, the limits of the range can be expanded to 58% toward the overgrazing sides. In a like manner, 60% of the E.P. range of Level III region is applied to Level I range determination. The expanded limits of best performance range are from 50% to 56%.

(e) Ecological standards

| ITEM \ LEVEL | I | II | III |
|---------------------|-------|-------|-------|
| Ecological Standard | ≤ 68% | ≤ 74% | ≤ 80% |

TABLE 4-13 DATA COLLECTION AND CALCULATION OF UTILIZATION OF CARRYING CAPACITY

| ITEM TO BE DETERMINED | DATA REQUIRED | SOURCE | CALCULATION |
|---|---|--|---|
| 1) Estimated net hay production (P) | (i) Acreage of hay harvested (excluding sorghum hay) in all farms. (ii) Tonage of hay harvested (excluding sorghum hay) in all farms | U.S.D.A. | $P = (ii) / (i)$ |
| 2) Supporting Ratio (S) | - | | $S = \frac{9,600}{2P}$ |
| 3) Carrying Capacity (C) | (iii) Acreage of total pasture land and rangeland | U.S.D.A.- S.C.S. | $C = \frac{(iii)}{S}$ |
| 4) Total animal units occurring (N) | (iv) Number of cattle and calves in all farms (v) Number of horses and ponies in all farms (vi) Number of sheep and lambs in all farms (vii) Number of other grazers in the study area | U.S.D.A. Dept. of Wildlife Conservation | $N = (iv) + (v) \times 1.28 + (vi) \times 0.06 + \dots$ |
| 5) Utilization of carrying capacity (U) | - | | $U = \frac{N}{C} \times 100\%$ |

PARAMETER ESTIMATE = U

$$= \frac{(iv) + (v) \times 1.28 + (vi) \times 0.06 + (vii) \times \dots}{\frac{(iii)}{9600}} \times 100\%$$

$$= \frac{(iii)}{(ii)/(i)}$$

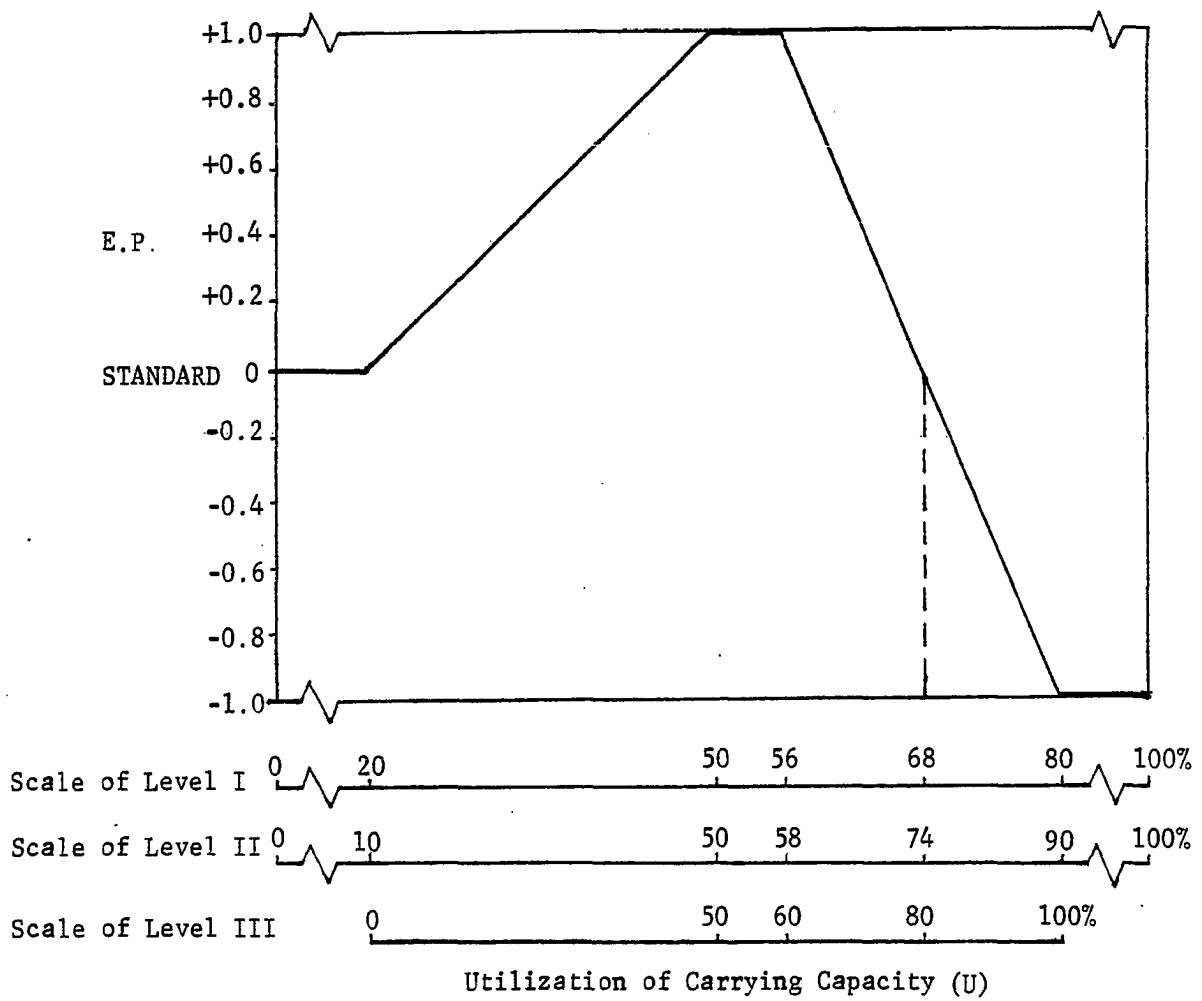

FIGURE 4-12 PARAMETER FUNCTION GRAPH OF UTILIZATION OF CARRYING CAPACITY

C. Terrestrial food web

In any given community the circulation of food is an interwoven system of feeding interrelations. The whole system is termed the food web, and the separable strands of food and feeder are termed food chains. A food chain, as such, is an arbitrary device for studying a few directly related portions of the food web. Instead of considering each link in the chain to be composed of one species, it is often best, when studying the food web, to group together the organisms with similar trophic levels. Food web is defined as a group of organisms whose food is obtained from plants by the same number of steps as follow:

| TROPHIC LEVEL | FOOD SOURCES |
|--|---|
| Detritivores (Organisms) | decompose detritus that enter the ecosystem |
| Primary Producers (Green Plants or Autotrophs) | fixed sunlight energy |
| Primary Consumers (Herbivores) | feed upon primary producers |
| Secondary Consumers (Carnivores) | feed upon primary consumers and primary producers |
| Tertiary Consumers (Higher Carnivores) | feed upon all the lower levels |

The size classes of animals form a "pyramid of numbers", where lower level animals have a higher reproductive potential than larger ones. Since the energy value of food eaten must eventually balance the physiological energy expended in obtaining this food, predators generally eat animals in the next lowest size level to conserve this energy expenditure (52).

The balance among the three animal levels, herbivores, carnivores and higher carnivores is important if adequate regulation of the

system is to be achieved. A system out of balance is characterized by over population and subsequent sudden decrease in the unregulated populations.

In the ecological food web, despite the fact that some species rely on both terrestrial and aquatic food sources, the majority of species (see Appendix D) are surviving in very dissimilar environments of the same ecosystem; in other words, they either depend entirely upon food supply from terrestrial source or from aquatic source. Thus, in the discussion of ecological performance, the food web is broken down into two major webs, the terrestrial web and the aquatic web. In doing so, the exact nature of food webs in terrestrial communities can be better and more precisely understood.

(a) Methodology

Terrestrial food webs can be examined quantitatively by counting or estimating the number of animals present per given area or volume of environmental medium. An ecological community will achieve greater stability as food webs become more complex, providing more interconnected prey-predator relationships. Because there is a relative difference in the role of each animal trophic level in the food web, it is necessary to establish a weighting value to represent the relative importance of the various trophic levels. In this parameter, a weighting factor called trophic level modifier (L_1) is established according to the degree of dominance in predation. Their relative weights are summarized in Table 4-14.

The assignment of the heaviest weight to the tertiary consumers is based upon the following assumptions:

(i) The size of lower level animals are usually controlled by their predators, while the larger carnivores are limited by the supply of their essential resources. Great numbers of higher carnivores imply stronger prey-predator relationships which in turn will smoothen the food cycle.

(ii) Because of the limitations of survival requirements, lower trophic level animals generally have little influence on the food web. A weighting one third of the tertiary's is assigned to the primary consumers because of their passive and predator-limited role in the food web. Primary producers and detritivores can not prey upon other animals; they

TABLE 4-14 TROPHIC LEVEL MODIFIERS OF FAUNA SPECIES

| Animal Trophic Level | Trophic Level Modifier (L_i , $i=1, 2, 3$) |
|----------------------|--|
| Primary Consumers | $L_1 = 0.33$ |
| Secondary Consumers | $L_2 = 0.67$ |
| Tertiary Consumers | $L_3 = 1.00$ |

are completely passive in the food web. Therefore, zero weights are assigned.

(iii) Secondary consumers are carnivores that consume the herbivores and the weight assigned to them is two thirds of the tertiary's.

The occurrence modifier (R_j), which is a weighted estimate of the relative occurrence of the existing species is shown in Table 4-15.

In this study, the estimations of individuals in the various species (rare and common) are not absolute values. The common or rare concept is used only to reflect the number of each species that could be expected under normal observational conditions. The weightings of occurrence are assigned so as to represent the actual quantitative existence of the various species; these are not the actual number of animals existing. The intention is to assign enough weight to commonly occurring species to illustrate their dominance. In the calculations that follow, one will observe that whether the assignment of occurrence ratio is 50:5:1 or 200:20:1, the result calculated will not be much different from that using a ratio of 100:10:1. Another reason in choosing the 100:10:1 ratio is that it reflects the energy level of the food chain. Each link of the trophic level in the food chain decreases the available energy by about one order of magnitude (order of ten) (52).

The total weighted number of terrestrial animal species divided by the total number of terrestrial species which is only modified by a single occurrence modifier will be the estimated food web index in a specific area. The formulas used are listed below.

(b) Formulas

1) T_{ij} = Total number of terrestrial species with ith trophic level and jth occurrence

$$= \sum_{k=1}^c S_{ijk} \quad (4-20)$$

where

S_{ijk} = Number of species in kth animal class with ith trophic level and jth occurrence

TABLE 4-15 OCCURRENCE MODIFIERS OF FAUNA SPECIES

| Occurrence | Interpretation | Occurrence Modifier (R_j , $j = 1, 2, 3$) |
|------------|--|--|
| Common | Occurring in many localities in large numbers | $R_1 = 100$ |
| Occasional | Occurring in several localities in small numbers | $R_2 = 10$ |
| Rare | Highly localized, restricted by scarcity of habitat or low numbers | $R_3 = 1$ |

c = Number of the classes of animal species that consume terrestrial food supply, c=4 for this study

K = Class of animal species

k = 1 for amphibians

k = 2 for reptiles

k = 3 for birds

k = 4 for mammals

2) W = Total weighted number of terrestrial animal species (weighted density estimate)

= (Total number of terrestrial species with their respective trophic level and occurrence) x (trophic level modifier) x (occurrence modifier)

$$= \sum_{i=1}^m \sum_{j=1}^n (T_{ij} \cdot L_i \cdot R_j) \quad (4-21)$$

where

m = Number of trophic levels, m=3 in this study

i = Trophic levels

i = 1 for primary consumers

i = 2 for secondary consumers

i = 3 for tertiary consumers

n = Number of occurrence status, n=3 in this study

j = Occurrence status of each species

j = 1 for common occurrence

j = 2 for occasional occurrence

j = 3 for rare occurrence

3) V = Total number of terrestrial species modified by the occurrence (unweighted total density estimate)

$$= \sum_{i=1}^m \sum_{j=1}^n (T_{ij} \cdot R_j) \quad (4-22)$$

4) F = Terrestrial food web index

$$\begin{aligned}
 &= \frac{\text{Weighted density estimate}}{\text{Unweighted total density estimate}} \times 100\% \\
 &= \frac{W}{V} \times 100\% \qquad (4-23)
 \end{aligned}$$

$$\begin{aligned}
 &= \frac{\sum_{i=1}^m \sum_{j=1}^n (T_{ij} \cdot L_i \cdot R_j)}{\sum_{i=1}^m \sum_{j=1}^n (T_{ij} \cdot R_j)} \times 100\% \qquad (4-24)
 \end{aligned}$$

PARAMETER ESTIMATE = F

(c) Data collection and calculations

Numbers of terrestrial animal species with their respective trophic level and occurrence in each animal class are needed for this parameter. Because of the lack of absolute quantitative data, the relative occurrence of each species estimated by the State Department of Wildlife Conservation or Corps of Engineers can be used instead (88). The statistical trophic level of each terrestrial species may be provided by local universities or inquiries into various biological dictionaries and handbooks (see Table 4-16).

(d) Parameter function graph

The relationship of food web and ecological performance (E.P.) is that of a linear nature as shown in Figure 4-13. In any ecosystem, the stronger the dominance of tertiary consumers species among the various trophic levels in existence, the stronger will be the interconnecting power of food web. This directly proportional relationship also leads to a more stable ecosystem and, consequently, higher E.P.

From observing the formulas developed in the previous section, the condition of the weakest food web can be found occurring at 33.3%, at which nearly all species are dependent on the primary consumers for survival. Conditions as such will greatly hamper the efficiency and balance

TABLE 4-16 DATA COLLECTION AND CALCULATION OF TERRESTRIAL FOOD WEB

| ITEM TO BE DETERMINED | DATA REQUIRED | SOURCE | CALCULATION |
|--|---|---|--|
| 1) Total number of terrestrial species with their respective trophic level and occurrence (T_{ij}) | Number of species in each terrestrial animal class with their respective trophic level and occurrence (S_{ijk}) | Dept. of Wildl. Conservation or Corps. of Engr. | $T_{ij} = \sum_{k=1}^c S_{ijk}$ |
| 2) Total weighted number of terrestrial animal species (W) | | | $W = \sum_{i=1}^m \sum_{j=1}^n (T_{ij} \cdot L_i \cdot R_j)$ |
| 3) Total number of terrestrial species modified by the occurrence (V) | | | $V = \sum_{i=1}^m \sum_{j=1}^n (T_{ij} \cdot R_j)$ |
| 4) Terrestrial food web index (F) | | | $F = \frac{W}{V} \times 100\%$ |

PARAMETER ESTIMATE = F

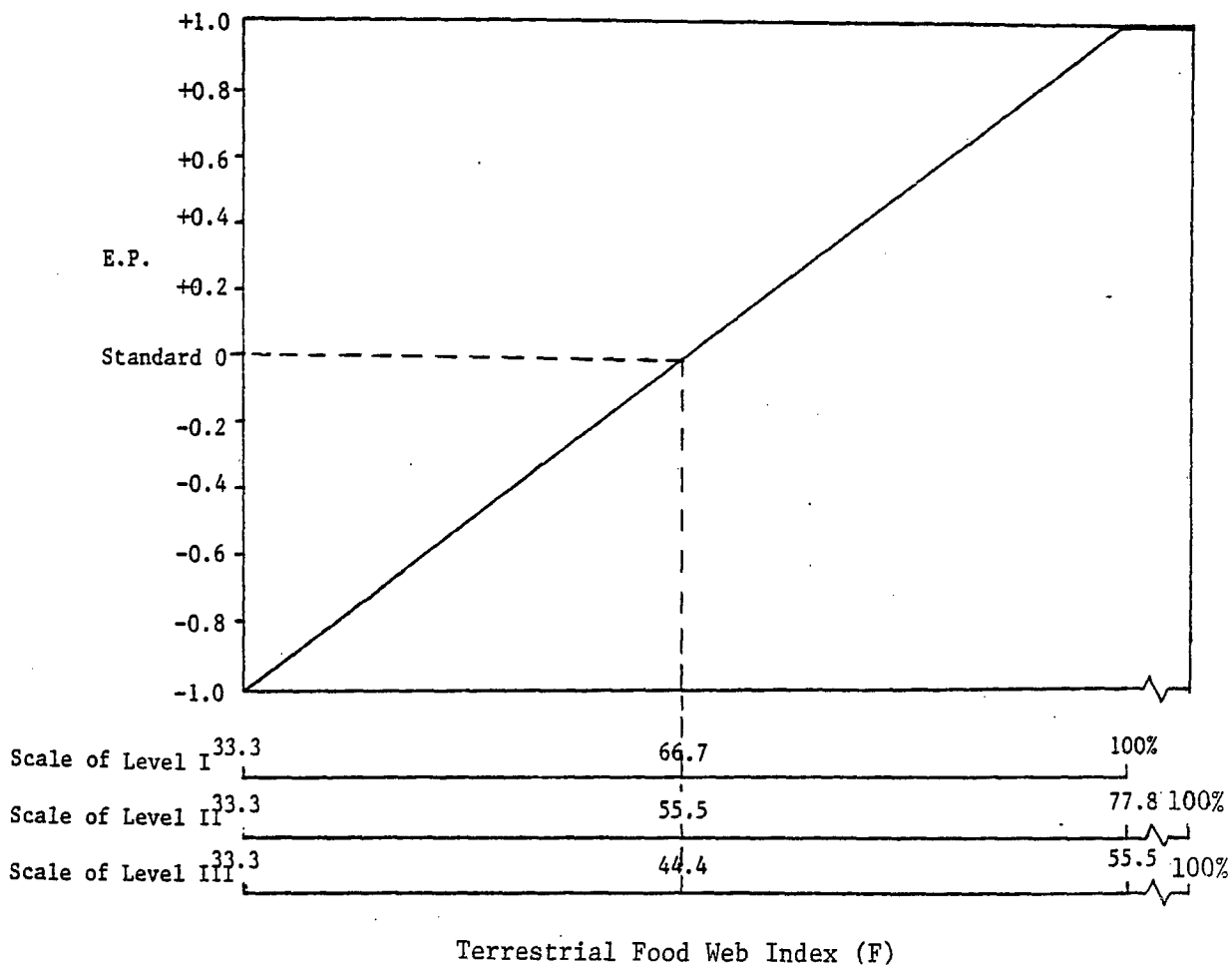

FIGURE 4-13 PARAMETER FUNCTION GRAPH OF TERRESTRIAL FOOD WEB

of a biological cycle, thus the minimal E.P. occurs at 33.3%. The three desired optimal conditions of level I, II and III development are located respectively, corresponding to each one's degree of restriction or allowance, at 66.7%, 55.5% and 44.4%. These are also the ecological standards for each development level.

(e) Ecological standards

| ITEM \ LEVEL | I | II | III |
|----------------------|---------|---------|---------|
| Ecological Standards | ≥ 66.7% | ≥ 55.5% | ≥ 44.4% |

D. Aquatic food web

The trophic relationships existing in the aquatic system are similar to that in the terrestrial communities. Dissolved nutrients enter the water and are incorporated into organic substances of primary producers, i.e., autotrophic bacteria, phytoplankton, and aquatic weeds. These may die and by bacterial action become incorporated in the ooze at the bottom, or they may be eaten by primary consumers, such as zooplankton, larvae, and worms. The primary consumers are preyed upon by bottom-living insects and small carnivores such as minnows, water beetles, small game fish. These are termed secondary consumers. The secondary consumers are preyed upon by the larger carnivores (the tertiary consumers) such as big game fish, fish-eating birds. Finally, if they are not themselves preyed upon by other animals, they will die and contribute to the ooze (6).

These food chains are linked together by other side chains into aquatic food webs which has the same stretch sequence as that in the terrestrial communities (see Terrestrial Food Web parameter in the previous section). To enhance the stability of the aquatic ecological system, the aquatic food web system should be maintained as a large and complex organic structure that will mitigate the perturbations of the physical environment. This may be facilitated by increasing the complexity of

the interconnected prey-predator relationships.

(a) Methodology

The methodology of this parameter is comparable to the terrestrial food web index, except that six classes of animals are involved in the aquatic food web. Besides naiads and fishes, limnic amphibians, reptiles, birds and mammals are included. Therefore, any animals that regularly take as part of their food diet aquatic life should be included. Because of this consideration many animals that ingest both terrestrial and aquatic food will be counted twice in both the terrestrial food web parameter and in this parameter.

The total weighted number of aquatic and limnic species divided by the total number of aquatic and limnic species which is only modified by the single occurrence modifier will be the estimated aquatic food web index in a specific area. The formula is essentially the same as that in the terrestrial parameter.

(b) Formula

- 1) T_{ij} = Total number of aquatic and limnic species with ith trophic level and jth occurrence

$$\sum_{k=1}^c S_{ijk} \quad (4-25)$$

where

S_{ijk} = Number of species in kth animal class with ith trophic level and jth occurrences

c = Number of the classes of animal species that consume aquatic food supply. $c=6$ in this study

k = Class of animal species that consume aquatic food supply

$k = 1$ for limnic amphibians

$k = 2$ for limnic reptiles

$k = 3$ for limnic birds

$k = 4$ for limnic mammals

k = 5 for naiads

k = 6 for fishes

2) W = Total weighted number of aquatic and limnic animal species (weighted density estimate)

= (Total number of aquatic and limnic species with their respective trophic level and occurrence) x (Trophic level modifier) x (Occurrence modifier)

$$= \sum_{i=1}^m \sum_{j=1}^n (T_{ij} \cdot L_i \cdot R_j) \quad (4-26)$$

where

m = Number of the trophic levels, m=3 in this study

i = Trophic level

i = 1 for primary consumers

i = 2 for secondary consumers

i = 3 for tertiary consumers

n = Number of occurrence status, n=3 in this study

j = Occurrence status of each species

j = 1 for common occurrence

j = 2 for occasional occurrence

j = 3 for rare occurrence

3) V = Total number of aquatic and limnic species modified by the occurrence (unweighted total density estimate)

= (Total number of aquatic and limnic species with their respective trophic level and occurrence) x (occurrence modifier)

$$= \sum_{i=1}^m \sum_{j=1}^n (T_{ij} \cdot R_j) \quad (4-27)$$

4) F = Aquatic food web index

$$\begin{aligned}
 &= \frac{\text{Weighted density estimate}}{\text{Unweighted total density estimate}} \times 100\% \\
 &= \frac{W}{V} \times 100\% \qquad (4-28)
 \end{aligned}$$

$$\begin{aligned}
 &= \frac{\sum_{i=1}^m \sum_{j=1}^n (T_{ij} \cdot L_i \cdot R_j)}{\sum_{i=1}^m \sum_{j=1}^n (T_{ij} \cdot R_j)} \times 100\% \qquad (4-29)
 \end{aligned}$$

PARAMETER ESTIMATE = F

(c) Data collection and calculations

Data on the number of aquatic and limnic animal species with their respective trophic levels and occurrence in each animal class are needed for this parameter. Because of the lack of absolute quantitative data, the relative occurrence of each species as estimated by the State Department of Wildlife Conservation and the Corps of Engineers can be used instead. The statistical trophic level of each aquatic species may be provided by local universities or inquiries into various biological dictionaries and handbooks. Table 4-17 shows this information.

(d) Parameter function graph

The relationship of aquatic food web and ecological performance (E.P.) is the same as that of terrestrial food web index as shown in Figure 4-14. In any aquatic ecosystem, the stronger the dominance of tertiary consumer species among the various trophic levels in existence, the stronger will be the interconnecting prey-predator correlations of food web. The increase of this directly proportional relationship will lead to a more stable ecosystem and consequently high E.P.

From observing the formula developed in the previous section, the condition of weakest food web can be found occurring at 33.3%, at which nearly all species are dependent on the primary consumers for survival. Conditions as such will greatly hamper the efficiency and

TABLE 4-17 DATA COLLECTION AND CALCULATION OF AQUATIC FOOD WEB

| ITEM TO BE DETERMINED | DATA REQUIRED | SOURCE | CALCULATION |
|---|--|---|---|
| 1) Total number of aquatic and limnic species with their respective trophic level and occurrence (T_{ij}) | Number of species in each aquatic and limnic animal class with their respective trophic level and occurrence (S_{ijk}) | Dept. of wildl. Conservation or Corps. of Engr. | $T_{ij} = \sum_{k=1}^c S_{ijk}$ |
| 2) Total weighted number of aquatic and limnic animal species (W) | | | $W = \sum_{i=1}^m \sum_{j=1}^n (T_{ij} \cdot L_i \cdot R_j)$ |
| 3) Total number of aquatic and limnic species modified by the occurrence (V) | | | $V = \sum_{i=1}^m \sum_{j=1}^n (T_{ij} \cdot R_j)$ |
| 4) Aquatic food web index (F) | | | $F = \frac{W}{V} \times 100\%$ $= \frac{\sum_{i=1}^m \sum_{j=1}^n (T_{ij} \cdot L_i \cdot R_j)}{\sum_{i=1}^m \sum_{j=1}^n (T_{ij} \cdot R_j)} \times 100\%$ |

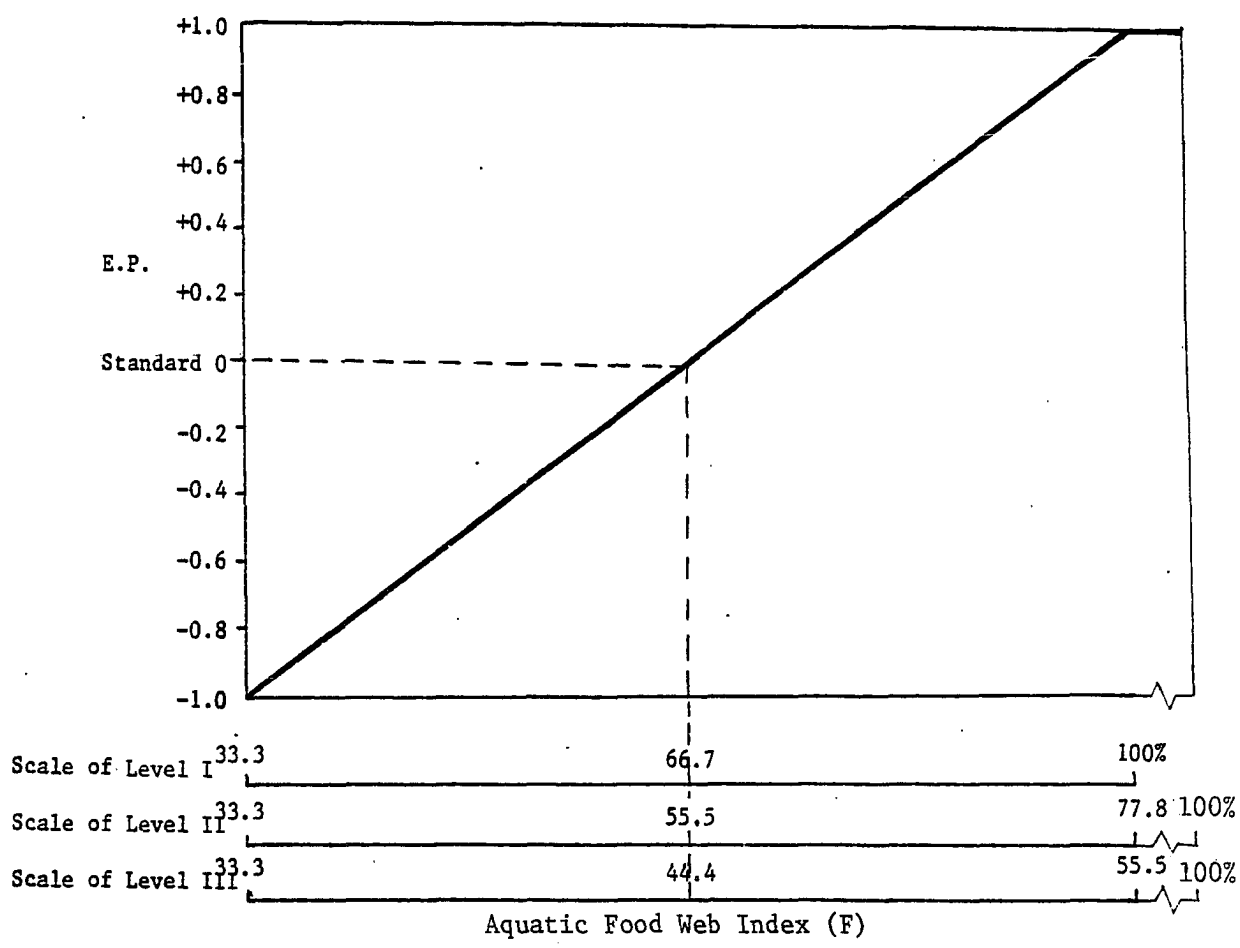

FIGURE 4-14 PARAMETER FUNCTION GRAPH OF AQUATIC FOOD WEB

balance of a biological cycle, thus the minimal E.P. occurs at 33.3%. The three desired optimal conditions of Level I, II and III development are located respectively, corresponding to each one's degree of restriction or allowance, at 66.7%, 55.5% and 44.4%. These are also the ecological standards for each development level.

(e) Ecological standards

| ITEM \ LEVEL | I | II | III |
|---------------------|--------|--------|--------|
| Ecological Standard | ≥66.7% | ≥55.5% | ≥44.4% |

CHAPTER V

METHODOLOGY VALIDATION

5.1 Description of The Field Test Region

The field test region of this research is the Mid-Arkansas River Basin (M.A.R.B.) in north-central Oklahoma. The selected test area (Figure 5-1) includes Pawnee, Creek, Osage and Tulsa counties. Of the total 2.8 million acres of land in the test region only about 374,400 acres are developed. The majority of the developed land lies within the Tulsa metropolitan area. The remaining 2.5 million acres of land are managed in agriculture and to a lesser extent forestry. The 1970 population in the four-county area was 489,000 with the 1980 projected population expected to reach 554,000.

The topography of the Mid-Arkansas River Basin consists of rolling terrain of the Great Plains with broken hills and broad river valleys. Broad, cuestas type ridges slope gently to the west with their east-facing escarpments dissected by headward erosion into a series of short valleys and ravines. The bedrock consists mainly of shales and limestones with occasional lenticular sandstone beds of the Permian age.

Man has greatly altered the natural vegetation over most of the test area by placing over 60 percent of the land under cultivation.

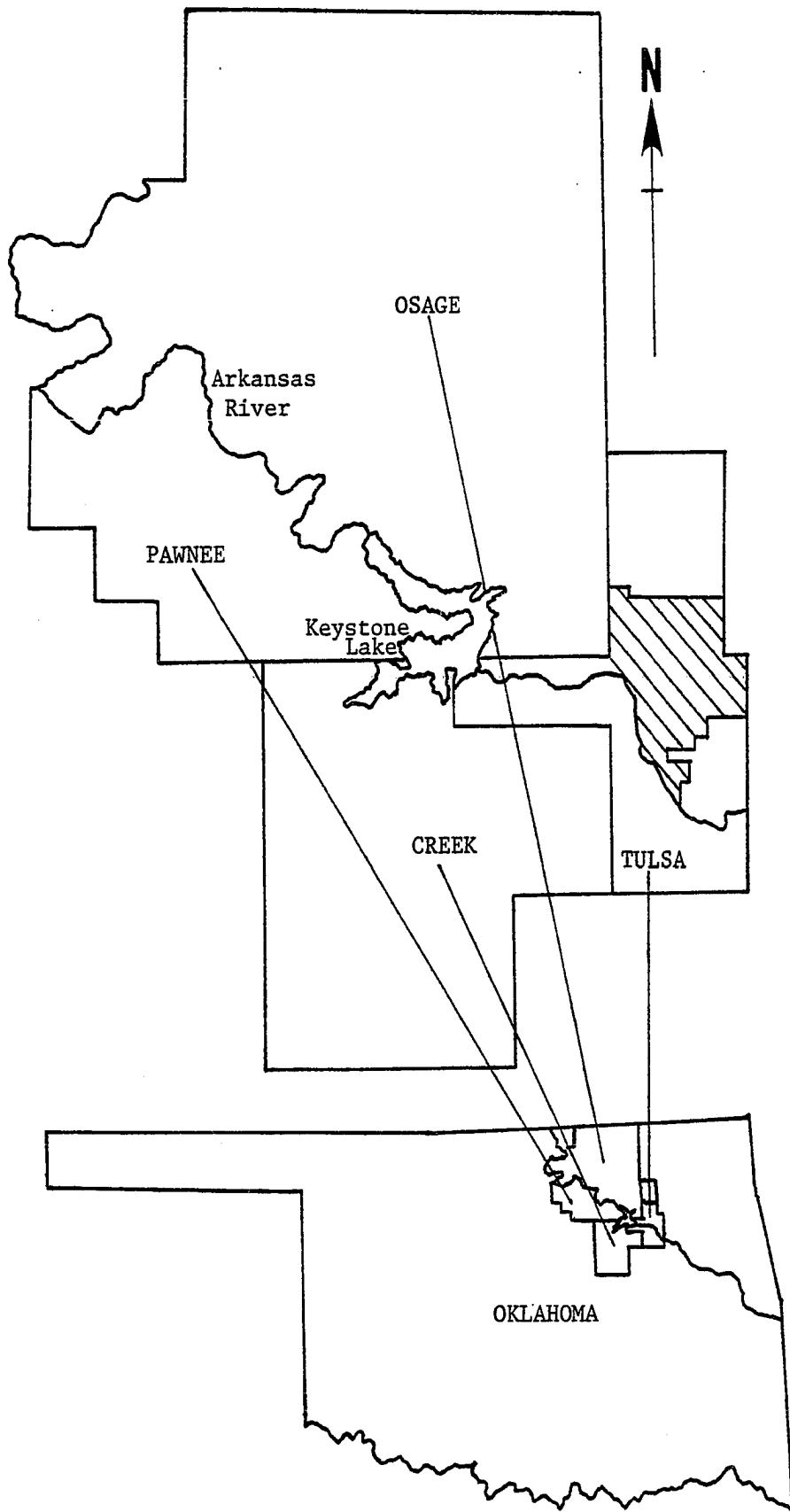

FIGURE 5-1 FIELD TEST REGION: FOUR-COUNTY REGION IN MID-ARKANSAS RIVER BASIN
135

The remaining land falls into three types of natural vegetation with the following percentages: bluestem prairie 52.6%, upland (post-oak black-jack) forest 30.2%, and bottomland (floodplain) forest 17.2%. Investigators have carried out extensive studies of the region's vegetation (88). A list of plant species of the test area is shown in Appendix C-1 to C-8.

The Arkansas River between the Kansas border and Tulsa has an estimated average annual runoff of 3,273,000 acre-feet that is equivalent to an average discharge of 4,521 cubic feet per second (cfs). A minimum monthly flow of 15 cfs is estimated to have occurred over the past 43 years (34).

Tributaries of the Arkansas in the four-county region include the Cimarron River, Black Bear Creek and the Salt Fork of the Arkansas River. The multipurpose Keystone Reservoir is located on the Arkansas River at its confluence with the Cimarron River 14 miles west of Tulsa. Keystone reservoir stores 663,000 acre-feet of water at a conservation pool elevation of 723 feet above mean sea level, with a total surface area of 26,300 acres and a shoreline of 330 miles. At flood control pool elevation there are 1,879,000 acre-feet of water stored with a surface area of 55,400 acres.

The Mid-Arkansas River Basin is characterized climatically by long warm summers and mild winters. Annual average temperature is 58°F with an average of 34°F in January and 81°F in July. Average annual precipitation for the region is 38 inches with over 70 percent of this occurring between April and September.

The validation or field test procedures of this methodology is done by the three steps delineated in sections 5.2, 5.3 and 5.4. Sections 5.2 and 5.3 concern with development level indicators and their performance levels. Section 5.4 deals with the ecological parameters, which finally leads to a set of values of ecological performance and their comparison with the standards of the region. Figure 5-2 is a flow diagram of methodology validation.

Seventy-seven counties in Oklahoma is used as the comparison base when determining the development level of the field test area. Data on these counties are collected and discussed in the following two sections.

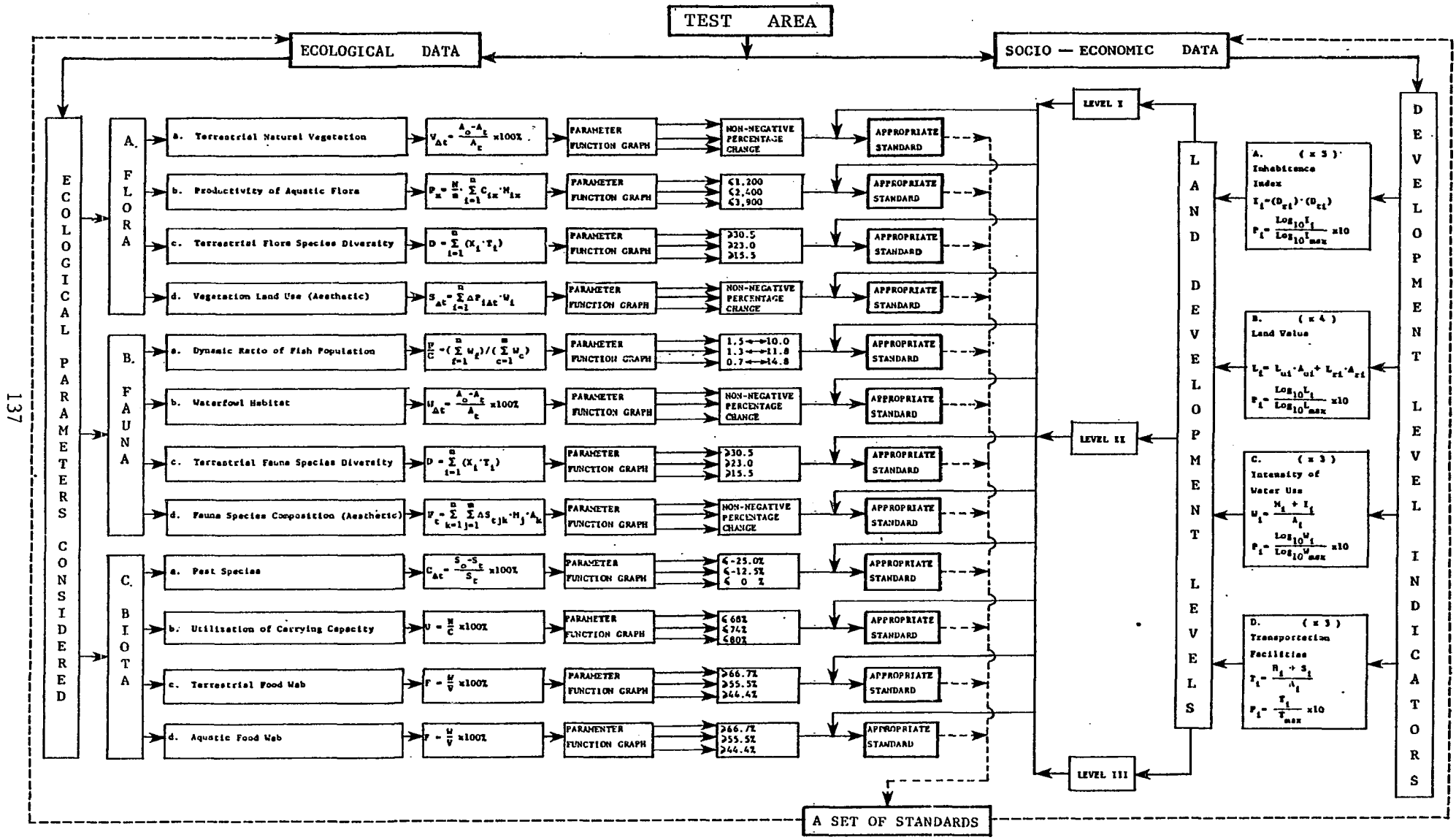

FIGURE 5-2 FLOW DIAGRAM OF METHODOLOGY VALIDATION

5.2 Field Test: Development Level Indicators
and Their Performance Levels

5.2.1 Inhabitation Index

In order to compute inhabitation index of each county in Oklahoma, the following information was collected on the county basis, listed also are the data sources:

- (i) percentage of rural population
- (ii) rural land area: Soil Conservation Service, Oklahoma Conservation Needs Inventory 1970
- (iii) total population: U.S. Census of Population, 1970
- (iv) total land area: Census of Agriculture, 1969

Rural population density (D_{ri}), total population density (D_{ti}) and inhabitation index (I_i) for each county were obtained by substituting the collected data into the following equations:

$$D_{ri} = \frac{(i) \times (iii)}{(ii)}$$

$$D_{ti} = \frac{(iii)}{(iv)}$$

$$I_i = (D_{ri}) \times (D_{ti})$$

All the collected data and computation results are shown on Table 5-1. It can be noted that the inhabitation index ranges from 5.06 of Cimarron County to 38,232.39 of Oklahoma County which is the maximum value in Oklahoma (I_{max}); and I_{max} is then used to determine the inhabitation index indicator performance level (P) of each county by substituting into the equation below:

$$P_i = \frac{\log I_i}{\log I_{max}} \times 10$$

The results are also shown in Table 5-1.

TABLE 5-1 COLLECTED DATA AND CALCULATED RESULTS OF INHABITANCE INDEX INDICATOR

| County | Total Population | Total Land Area (mile ²) | Population Density (pop/mile ²) | Percent of Rural Population | Rural Population | Rural Land Area (mile ²) | Rural Density (pop/mile ²) | Inhab- itance Index | Indicator Performance Level |
|-----------|------------------|--------------------------------------|---|-----------------------------|------------------|--------------------------------------|--|---------------------------|-----------------------------------|
| Adair | 15144 | 570 | 26.60 | 100 | 15141 | 570 | 26.60 | 707.56 | 6.22 |
| Alfalfa | 7224 | 868 | 8.32 | 100 | 7224 | 868 | 8.32 | 69.22 | 4.02 |
| Atoka | 10972 | 991 | 12.04 | 68.4 | 7505 | 941 | 7.89 | 95.02 | 4.32 |
| Beaver | 6282 | 1790 | 3.51 | 100 | 6282 | 1790 | 3.51 | 12.32 | 2.38 |
| Beckham | 15754 | 907 | 17.37 | 36.1 | 5687 | 872 | 6.52 | 113.22 | 4.48 |
| Blaine | 11794 | 917 | 12.86 | 70.1 | 8268 | 882 | 9.38 | 120.60 | 4.54 |
| Bryan | 25552 | 889 | 28.74 | 56.5 | 14437 | 869 | 16.61 | 477.24 | 5.85 |
| Caddo | 28931 | 1272 | 22.74 | 77.3 | 22364 | 1223 | 18.28 | 415.68 | 5.71 |
| Canadian | 32245 | 897 | 35.95 | 18.9 | 6094 | 844 | 7.22 | 259.61 | 5.27 |
| Carter | 37349 | 830 | 45.00 | 44.1 | 16471 | 783 | 21.05 | 947.10 | 6.50 |
| Cherokee | 23174 | 756 | 30.65 | 60.1 | 13928 | 734 | 18.97 | 581.35 | 6.03 |
| Choctaw | 15141 | 778 | 20.03 | 56.0 | 8479 | 753 | 11.27 | 225.65 | 5.14 |
| Cimarron | 4145 | 1843 | 2.25 | 100 | 4145 | 1843 | 2.25 | 5.06 | 1.54 |
| Cleveland | 81839 | 527 | 155.29 | 16.6 | 13585 | 494 | 27.50 | 4270.33 | 7.92 |
| Coal | 5525 | 526 | 10.50 | 100 | 5525 | 526 | 10.50 | 110.25 | 4.46 |
| Comanche | 108144 | 1084 | 99.76 | 11.3 | 12220 | 1012 | 12.07 | 1204.31 | 6.72 |
| Cotton | 6832 | 650 | 10.51 | 59.9 | 4092 | 608 | 6.73 | 70.78 | 4.04 |
| Craig | 14722 | 764 | 19.27 | 60.3 | 8877 | 733 | 12.11 | 233.38 | 5.17 |
| Creek | 45532 | 935 | 48.70 | 48.2 | 21946 | 914 | 24.02 | 1169.69 | 6.70 |
| Custer | 22665 | 980 | 23.13 | 28.3 | 6414 | 944 | 6.79 | 157.11 | 4.79 |
| Delaware | 17767 | 707 | 25.13 | 100 | 17767 | 707 | 25.13 | 631.52 | 6.11 |
| Dewey | 5656 | 1018 | 5.56 | 100 | 5656 | 1018 | 5.56 | 30.91 | 3.25 |
| Ellis | 5129 | 1242 | 4.13 | 100 | 5129 | 1242 | 4.13 | 17.06 | 2.69 |
| Garfield | 55365 | 1054 | 52.53 | 19.4 | 10741 | 995 | 10.79 | 566.89 | 6.01 |
| Garvin | 24874 | 814 | 30.56 | 62.4 | 15521 | 781 | 19.88 | 607.43 | 6.07 |
| Grady | 29354 | 1096 | 26.78 | 51.8 | 15205 | 1059 | 14.36 | 384.54 | 5.64 |
| Grant | 7117 | 1007 | 7.08 | 100 | 7117 | 1007 | 7.08 | 50.13 | 3.71 |
| Greer | 7979 | 633 | 12.60 | 49.1 | 3918 | 622 | 6.30 | 79.42 | 4.15 |
| Harmon | 5136 | 545 | 9.42 | 36.5 | 1875 | 519 | 3.61 | 34.04 | 3.34 |
| Harper | 5151 | 1041 | 4.95 | 100 | 5151 | 1041 | 4.95 | 24.50 | 3.03 |
| Haskell | 9578 | 602 | 15.91 | 100 | 9578 | 602 | 15.91 | 253.13 | 5.24 |

TABLE 5-1 COLLECTED DATA AND CALCULATED RESULTS OF INHABITANCE INDEX INDICATOR (Continued)

| County | Total Population | Total Land Area (mile ²) | Population Density (pop/mile ²) | Percent of Rural Population | Rural Population | Rural Land Area (mile ²) | Rural Density (pop/mile ²) | Inhabitation Index | Indicator Performance Level |
|------------|------------------|--------------------------------------|---|-----------------------------|------------------|--------------------------------------|--|--------------------|-----------------------------|
| Hughes | 13228 | 807 | 16.39 | 61.4 | 8122 | 789 | 10.30 | 168.82 | 4.86 |
| Jackson | 30902 | 810 | 38.15 | 25.0 | 7726 | 752 | 10.28 | 392.24 | 5.66 |
| Jefferson | 7125 | 780 | 9.13 | 100 | 7125 | 780 | 9.13 | 83.36 | 4.19 |
| Johnson | 7870 | 638 | 12.34 | 67.6 | 5320 | 622 | 8.55 | 105.56 | 4.42 |
| Kay | 48791 | 950 | 51.36 | 22.4 | 10929 | 890 | 12.28 | 630.62 | 6.11 |
| Kingfisher | 12857 | 904 | 14.22 | 68.0 | 8742 | 868 | 10.07 | 143.23 | 4.70 |
| Kiowa | 12532 | 1027 | 12.20 | 62.6 | 7845 | 999 | 7.86 | 95.84 | 4.32 |
| Latimer | 8601 | 737 | 11.67 | 100 | 8601 | 737 | 11.67 | 136.19 | 4.66 |
| LeFlore | 32137 | 1560 | 20.60 | 68.4 | 21982 | 1533 | 14.34 | 295.31 | 5.39 |
| Lincoln | 19482 | 973 | 20.03 | 73.6 | 15449 | 940 | 15.25 | 305.46 | 5.42 |
| Logan | 19645 | 751 | 26.16 | 51.3 | 10078 | 717 | 14.06 | 367.78 | 5.60 |
| Love | 5637 | 513 | 10.99 | 100 | 5637 | 513 | 10.99 | 120.78 | 4.54 |
| McClain | 14157 | 573 | 24.71 | 70.6 | 9995 | 535 | 18.69 | 461.75 | 5.81 |
| McCurtain | 28642 | 1800 | 15.91 | 68.9 | 19734 | 1793 | 11.01 | 175.19 | 4.90 |
| McIntosh | 12472 | 608 | 20.51 | 75.8 | 9454 | 607 | 15.59 | 319.71 | 5.47 |
| Major | 7529 | 963 | 7.82 | 62.2 | 4683 | 924 | 5.07 | 39.64 | 3.49 |
| Marshall | 7682 | 366 | 20.84 | 63.8 | 4901 | 352 | 13.93 | 290.38 | 5.37 |
| Mayes | 23302 | 648 | 35.95 | 69.7 | 16241 | 637 | 25.49 | 916.40 | 6.46 |
| Murray | 10669 | 423 | 25.22 | 57.7 | 6156 | 412 | 14.94 | 376.67 | 5.62 |
| Muskogee | 59542 | 818 | 72.79 | 37.3 | 22209 | 749 | 29.65 | 2158.28 | 7.28 |
| Noble | 10043 | 743 | 13.52 | 43.9 | 4409 | 720 | 6.13 | 82.85 | 4.19 |
| Nowata | 9773 | 537 | 18.20 | 63.2 | 6177 | 545 | 11.33 | 206.24 | 5.05 |
| Okfuskee | 10683 | 637 | 16.77 | 73.0 | 7799 | 621 | 12.57 | 210.72 | 5.07 |
| Oklahoma | 526806 | 700 | 752.58 | 2.7 | 14224 | 525 | 27.08 | 20380.07 | 9.40 |
| Okmulgee | 35358 | 700 | 50.51 | 39.3 | 13896 | 670 | 20.74 | 1047.78 | 6.59 |
| Osage | 29750 | 2272 | 13.09 | 69.7 | 20736 | 2220 | 9.34 | 122.28 | 4.56 |
| Ottawa | 29800 | 464 | 64.22 | 44.7 | 13321 | 438 | 30.43 | 1954.15 | 7.18 |
| Pawnee | 11338 | 561 | 20.21 | 77.3 | 8764 | 557 | 15.73 | 317.83 | 5.46 |
| Payne | 50654 | 694 | 72.99 | 23.8 | 12056 | 658 | 18.32 | 1337.07 | 6.82 |
| Pittsburg | 37521 | 1241 | 30.23 | 49.9 | 18723 | 1251 | 14.97 | 452.61 | 5.80 |
| Pontotoc | 27867 | 714 | 39.03 | 46.7 | 13014 | 692 | 18.79 | 733.57 | 6.25 |

TABLE 5-1 COLLECTED DATA AND CALCULATED RESULTS OF INHABITANCE INDEX INDICATOR (Continued)

| County | Total Population | Total Land Area (mile ²) | Population Density (pop/mile ²) | Percent of Rural Population | Rural Population | Rural Land Area (mile ²) | Rural Density (pop/mile ²) | Inhab- tance Index | Indicator Performance Level |
|---------------------|------------------|--------------------------------------|---|-----------------------------|------------------|--------------------------------------|--|--------------------|-----------------------------|
| Pottawatomie | 43134 | 794 | 54.32 | 31.3 | 13501 | 762 | 17.73 | 963.08 | 6.51 |
| Pushmataha | 9385 | 1420 | 6.61 | 71.4 | 6701 | 1409 | 4.76 | 31.44 | 3.27 |
| Roger Mills | 4452 | 1140 | 3.91 | 100 | 4452 | 1140 | 3.91 | 15.29 | 2.58 |
| Rogers | 28425 | 685 | 41.50 | 68.1 | 19537 | 662 | 29.26 | 1214.37 | 6.73 |
| Seminole | 25144 | 630 | 39.91 | 47.5 | 11943 | 603 | 19.81 | 790.81 | 6.32 |
| Sequoyah | 23370 | 696 | 33.58 | 78.7 | 18392 | 648 | 28.39 | 953.31 | 6.50 |
| Stephens | 35902 | 891 | 40.29 | 35.1 | 12602 | 832 | 15.15 | 610.21 | 6.08 |
| Texas | 16352 | 2062 | 7.93 | 53.3 | 8715 | 2007 | 4.34 | 34.44 | 3.35 |
| Tillman | 12901 | 901 | 14.32 | 50.2 | 6476 | 836 | 7.74 | 110.90 | 4.46 |
| Tulsa | 401610 | 573 | 700.89 | 6.1 | 24498 | 449 | 54.55 | 38232.39 | 10.00 |
| Wagoner | 22163 | 563 | 39.37 | 67.4 | 14938 | 544 | 27.46 | 1081.27 | 6.62 |
| Washington | 42277 | 424 | 99.71 | 20.8 | 8794 | 397 | 22.15 | 2208.64 | 7.30 |
| Washita | 12141 | 1009 | 12.03 | 66.1 | 8025 | 974 | 8.24 | 99.11 | 4.36 |
| Woods | 11920 | 1298 | 9.18 | 37.7 | 4493 | 1237 | 3.63 | 33.33 | 3.32 |
| Woodward | 15537 | 1251 | 12.42 | 43.9 | 6820 | 1202 | 5.67 | 70.45 | 4.03 |
| The Whole MARB Area | 488230 | 4341 | 112.47 | 15.6 | 75944 | 4140 | 18.34 | 2063.15 | 7.23 |

5.2.2 Land Value

Data on average land value for each county in Oklahoma is not available, but the following information is available from various sources:

- (i) assessed urban land value: Oklahoma Tax Commission, Ad Valorem, unpublished information, 1974
- (ii) percentage of urban land: Soil Conservation Service, Oklahoma Conservation Needs Inventory, 1970
- (iii) assessed rural land value: Oklahoma Tax Commission, Ad Valorem, unpublished information, 1974
- (iv) percentage of rural land: Soil Conservation Service, Oklahoma Conservation Needs Inventory, 1970

Average land value of each county (L_i) is obtained by using the following formula:

$$L_i = (i) \times (ii) + (iii) \times (iv)$$

The maximum value of average land value (L_{\max}) is 8883.45 dollars per acre of Oklahoma County. It is then used to determine the indicator performance level (P_i) by substitution into the following equation:

$$P_i = \frac{\log L_i}{\log L_{\max}} \times 10$$

The collected data, computed average land value, and indicator performance level for each county are listed in Table 5-2.

TABLE 5-2 COLLECTED DATA AND CALCULATED RESULTS OF LAND VALUE INDICATOR

| County | Assessed Urban Land Value (\$/acre) | Percent of Urban Land | Assessed Rural Land Value (\$/acre) | Percent of Rural Land | Average Assessed Land Value (\$/acre) | Indicator Performance Level |
|-----------|---|--------------------------|---|--------------------------|---|-----------------------------------|
| Adair | 389.45 | 2.29 | 6.72 | 97.71 | 15.48 | 4.00 |
| Alfalfa | 165.40 | 3.39 | 29.89 | 96.61 | 34.49 | 5.22 |
| Atoka | 228.40 | 1.65 | 7.33 | 98.35 | 10.98 | 3.53 |
| Beaver | 177.60 | 2.05 | 6.46 | 97.95 | 11.93 | 3.65 |
| Beckham | 259.45 | 2.82 | 10.99 | 97.18 | 18.00 | 4.26 |
| Blaine | 236.75 | 3.21 | 20.73 | 96.79 | 27.66 | 4.89 |
| Bryan | 456.30 | 2.41 | 11.79 | 97.59 | 22.51 | 4.59 |
| Caddo | 291.45 | 2.86 | 17.13 | 97.14 | 24.98 | 4.74 |
| Canadian | 972.80 | 4.60 | 25.73 | 95.40 | 69.30 | 6.25 |
| Carter | 736.35 | 5.55 | 9.52 | 94.45 | 49.86 | 5.76 |
| Cherokee | 805.50 | 2.87 | 8.77 | 97.13 | 31.64 | 5.09 |
| Choctaw | 327.35 | 2.51 | 6.93 | 97.49 | 14.98 | 3.99 |
| Cimarron | 402.15 | 1.37 | 7.73 | 98.63 | 13.13 | 3.80 |
| Cleveland | 2168.70 | 7.74 | 23.82 | 92.26 | 189.84 | 7.73 |
| Coal | 123.60 | 2.10 | 8.10 | 97.90 | 10.53 | 3.47 |
| Comanche | 676.10 | 6.09 | 10.77 | 93.93 | 51.28 | 5.80 |
| Cotton | 106.15 | 3.40 | 16.52 | 96.60 | 19.57 | 4.38 |
| Craig | 681.20 | 4.06 | 15.38 | 95.94 | 42.42 | 5.52 |
| Creek | 459.75 | 3.99 | 13.43 | 96.01 | 31.23 | 5.07 |
| Custer | 462.40 | 3.86 | 16.78 | 96.14 | 33.98 | 5.20 |
| Delaware | 221.10 | 2.27 | 11.18 | 97.73 | 15.95 | 4.08 |
| Dewey | 115.35 | 2.15 | 10.08 | 97.85 | 12.34 | 3.70 |
| Ellis | 341.90 | 2.31 | 9.23 | 97.69 | 16.92 | 4.17 |
| Garfield | 1339.25 | 5.56 | 25.12 | 94.44 | 98.18 | 6.76 |
| Garvin | 452.60 | 3.92 | 15.21 | 96.08 | 32.35 | 5.12 |
| Grady | 754.35 | 2.95 | 13.37 | 97.05 | 35.23 | 5.25 |
| Grant | 201.25 | 3.09 | 24.20 | 96.91 | 31.30 | 5.08 |
| Greer | 469.95 | 2.42 | 12.46 | 97.58 | 22.53 | 4.66 |
| Harmon | 251.80 | 2.47 | 11.45 | 97.53 | 17.39 | 4.21 |
| Harper | 129.60 | 2.13 | 7.84 | 97.87 | 10.43 | 3.46 |

TABLE 5-2 COLLECTED DATA AND CALCULATED RESULTS OF LAND VALUE INDICATOR (Continued)

| County | Assessed Urban Land Value (\$/acre) | Percent of Urban Land | Assessed Rural Land Value (\$/acre) | Percent of Rural Land | Average Assessed Land Value (\$/acre) | Indicator Performance Level |
|------------|---|--------------------------|---|--------------------------|---|-----------------------------------|
| Haskell | 174.40 | 2.17 | 5.83 | 97.86 | 9.44 | 3.31 |
| Hughes | 202.00 | 2.57 | 7.92 | 97.43 | 12.91 | 3.77 |
| Jackson | 729.15 | 3.66 | 15.44 | 96.34 | 41.12 | 5.48 |
| Jefferson | 136.00 | 2.00 | 12.94 | 98.00 | 16.40 | 4.12 |
| Johnston | 122.15 | 2.18 | 8.95 | 97.82 | 11.41 | 3.59 |
| Kay | 434.45 | 5.53 | 38.50 | 94.47 | 60.40 | 6.05 |
| Kingfisher | 706.10 | 2.91 | 24.68 | 97.09 | 44.51 | 5.60 |
| Kiowa | 196.90 | 3.19 | 18.69 | 96.81 | 24.37 | 4.71 |
| Latimer | 609.85 | 2.46 | 5.07 | 97.54 | 19.95 | 4.41 |
| LeFlore | 280.20 | 2.19 | 6.56 | 97.81 | 12.56 | 3.73 |
| Lincoln | 218.85 | 3.35 | 8.65 | 96.65 | 15.69 | 4.06 |
| Logan | 220.25 | 3.95 | 15.17 | 96.05 | 23.23 | 4.64 |
| Love | 599.05 | 2.34 | 8.42 | 97.66 | 22.24 | 4.57 |
| McClain | 315.00 | 4.26 | 14.65 | 95.74 | 27.45 | 4.88 |
| McCurtain | 1150.60 | 1.76 | 11.23 | 98.24 | 31.28 | 5.08 |
| McIntosh | 177.65 | 3.11 | 10.91 | 96.89 | 16.09 | 4.10 |
| Major | 337.05 | 2.23 | 14.75 | 97.77 | 21.94 | 4.55 |
| Marshall | 251.05 | 2.25 | 8.59 | 97.75 | 14.05 | 3.90 |
| Mayes | 499.85 | 3.43 | 12.45 | 96.57 | 29.16 | 4.97 |
| Murray | 251.00 | 2.85 | 7.82 | 97.15 | 14.75 | 3.97 |
| Muskogee | 647.40 | 6.14 | 14.52 | 93.86 | 53.38 | 5.86 |
| Noble | 192.10 | 3.23 | 21.89 | 96.77 | 27.38 | 4.88 |
| Nowata | 201.80 | 2.81 | 10.39 | 97.19 | 15.77 | 4.07 |
| Okfuskee | 205.55 | 2.56 | 8.41 | 97.44 | 13.45 | 3.83 |
| Oklahoma | 3343.05 | 25.50 | 41.57 | 74.50 | 883.45 | 10.00 |
| Okmulgee | 303.60 | 4.25 | 11.12 | 95.75 | 23.33 | 4.64 |
| Osage | 223.70 | 2.23 | 9.10 | 97.77 | 13.89 | 3.88 |
| Ottawa | 1250.25 | 5.40 | 19.11 | 94.96 | 81.16 | 6.48 |
| Pawnee | 332.95 | 3.60 | 17.93 | 96.40 | 29.27 | 4.98 |
| Payne | 607.45 | 4.87 | 12.97 | 95.13 | 41.92 | 5.51 |

TABLE 5-2 COLLECTED DATA AND CALCULATED RESULTS OF LAND VALUE INDICATOR (Continued)

| County | Assessed Urban Land Value (\$/acre) | Percent of Urban Land | Assessed Rural Land Value (\$/acre) | Percent of Rural Land | Average Assessed Land Value (\$/acre) | Indicator Performance Level |
|------------------------|---|--------------------------|---|--------------------------|---|-----------------------------------|
| Pittsburg | 400.90 | 3.62 | 6.35 | 96.38 | 20.63 | 4.46 |
| Pontotoc | 748.85 | 3.68 | 10.01 | 96.32 | 37.20 | 5.33 |
| Pottawatomie | 311.35 | 4.22 | 22.04 | 95.78 | 34.25 | 5.21 |
| Pushmataha | 362.30 | 0.97 | 6.18 | 99.03 | 9.63 | 3.34 |
| Roger Mills | 63.85 | 2.64 | 8.14 | 97.36 | 9.62 | 3.34 |
| Rogers | 668.50 | 5.98 | 13.95 | 94.02 | 53.10 | 5.86 |
| Seminole | 489.80 | 3.77 | 12.97 | 96.23 | 30.95 | 5.06 |
| Sequoyah | 347.40 | 3.17 | 8.07 | 96.83 | 18.82 | 4.33 |
| Stephens | 519.15 | 6.22 | 11.22 | 93.78 | 42.81 | 5.54 |
| Texas | 337.10 | 2.39 | 11.88 | 97.61 | 20.61 | 4.46 |
| Tillman | 185.55 | 2.88 | 21.81 | 97.12 | 26.53 | 4.83 |
| Tulsa | 3813.20 | 21.22 | 41.54 | 78.78 | 841.89 | 9.93 |
| Wagnor | 168.15 | 3.39 | 16.55 | 96.61 | 21.69 | 4.54 |
| Washington | 713.50 | 6.49 | 14.82 | 93.51 | 156.56 | 7.45 |
| Washita | 127.15 | 3.30 | 18.17 | 96.70 | 35.74 | 5.27 |
| Woods | 404.40 | 2.63 | 12.60 | 97.37 | 22.91 | 4.62 |
| Woodward | 1068.50 | 2.41 | 10.15 | 97.59 | 35.65 | 5.27 |
| The Whole MARB Area | | | | | 128.92 | 7.16 |

5.2.3 Intensity of Water Use

Data requirements and data sources for computing intensity of water use indicator for each county in Oklahoma are listed below:

- (i) annual municipal water use: Oklahoma Water Resources Board, Reported Water Use in Oklahoma, 1974
- (ii) annual industrial water use: Oklahoma Water Resources Board, Reported Water Use in Oklahoma, 1974
- (iii) total land area: Census of Agriculture, 1969.

Intensity of water use (W_i) is obtained by substituting collected data into the following formula:

$$W_i = \frac{(i) + (ii)}{(iii)}$$

Intensity of water use indicators of counties in Oklahoma range from 0.04 of Delaware County to 153.89 of Tulsa. The latter as W_{\max} is then used to determine the indicator performance level (P_i) by substituting into the equation as follows:

$$P_i = \frac{\log W_i}{\log W_{\max}} \times 10$$

There are 17 counties whose intensities of water use are less than 1. It can be noted that their Log values will be negative, and hence, negative indicator performance levels will result. This is inadmissible; therefore, a zero value indicator performance level is used as a substitute for a negative indicator performance level in these cases. All the collected data and computed results are shown in Table 5-3.

5.2.4 Transportation Facilities

Data requirements along with their sources to calculate transportation facilities indicator for each county in Oklahoma are listed

TABLE 5-3 COLLECTED DATA AND CALCULATED RESULTS OF INTENSITY OF WATER USE INDICATOR

| County | Municipal Water Use (acre feet) | Industrial Water Use (acre feet) | Total M&I (acre-feet) | Total Land Area (sq. miles) | Intensity of Water Use (acre feet/ square mile) | Indicator Performance Level |
|-----------|---------------------------------------|--|--------------------------|-----------------------------------|--|-----------------------------------|
| Adair | 5588 | 2 | 5590 | 570 | 9.81 | 4.53 |
| Alfalfa | 1075 | 0 | 1075 | 868 | 1.24 | 0.43 |
| Atoka | 64 | 209 | 273 | 991 | 0.28 | 0 |
| Beaver | 685 | 213 | 1098 | 1790 | 0.50 | 0 |
| Beckham | 1760 | 225 | 1985 | 907 | 2.19 | 1.56 |
| Blaine | 1312 | 156 | 1468 | 917 | 1.60 | 0.93 |
| Bryan | 2606 | 124 | 2730 | 889 | 3.07 | 2.23 |
| Caddo | 5794 | 4122 | 9916 | 1272 | 7.80 | 4.08 |
| Canadian | 3614 | 821 | 4435 | 897 | 4.94 | 2.98 |
| Carter | 6277 | 20002 | 26279 | 830 | 31.66 | 6.86 |
| Cherokee | 3904 | 0 | 3904 | 756 | 5.16 | 3.26 |
| Choctaw | 1098 | 0 | 1098 | 778 | 1.41 | 0.68 |
| Cimarron | 721 | 52 | 773 | 1843 | 0.42 | 0 |
| Cleveland | 12203 | 0 | 12203 | 527 | 23.16 | 6.24 |
| Coal | 253 | 0 | 253 | 526 | 0.48 | 0 |
| Comanche | 21529 | 1346 | 22875 | 1084 | 21.10 | 6.05 |
| Cotton | 715 | 0 | 715 | 650 | 1.10 | 0.19 |
| Craig | 1406 | 0 | 1406 | 764 | 1.84 | 1.21 |
| Creek | 3222 | 41 | 3263 | 935 | 3.49 | 2.48 |
| Custer | 5528 | 86 | 5614 | 980 | 5.73 | 3.34 |
| Delaware | 27 | 0 | 27 | 707 | 0.04 | 0 |
| Dewey | 135 | 192 | 327 | 1018 | 0.32 | 0 |
| Ellis | 268 | 0 | 268 | 1242 | 0.22 | 0 |
| Garfield | 4532 | 82 | 4614 | 1054 | 4.38 | 2.93 |
| Garvin | 2731 | 18 | 2749 | 814 | 3.38 | 2.42 |
| Grady | 4876 | 33 | 4909 | 1096 | 4.48 | 2.98 |
| Grant | 690 | 0 | 690 | 1007 | 0.69 | 0 |
| Greer | 460 | 0 | 460 | 633 | 0.73 | 0 |
| Harmon | 1598 | 0 | 1598 | 545 | 2.93 | 2.13 |
| Harper | 1120 | 156 | 1276 | 1041 | 1.23 | 0.41 |
| Haskell | 1209 | 63 | 1272 | 602 | 2.11 | 1.48 |
| Hughes | 334 | 0 | 334 | 807 | 0.41 | 0 |
| Jackson | 5104 | 851 | 5955 | 810 | 7.35 | 3.96 |

TABLE 5-3 COLLECTED DATA AND CALCULATED RESULTS OF INTENSITY OF WATER USE INDICATOR (Continued)

| County | Municipal Water Use (acre feet) | Industrial Water Use (acre feet) | Total M&I (acre-feet) | Total Land Area (sq. miles) | Intensity of Water Use (acre feet/ square mile) | Indicator Performance Level |
|--------------|---------------------------------------|--|--------------------------|-----------------------------------|--|-----------------------------------|
| Jefferson | 487 | 0 | 487 | 780 | 0.62 | 0 |
| Johnston | 638 | 10 | 648 | 638 | 1.02 | 0.04 |
| Kay | 10931 | 36136 | 47067 | 950 | 49.54 | 7.75 |
| Kingfisher | 1930 | 599 | 2529 | 904 | 2.80 | 2.04 |
| Kiowa | 1638 | 13 | 1651 | 1027 | 1.61 | 0.95 |
| Latimer | 1929 | 0 | 1929 | 737 | 2.62 | 1.91 |
| LeFlore | 5127 | 0 | 5127 | 1560 | 3.29 | 2.36 |
| Lincoln | 2876 | 78 | 2954 | 973 | 3.04 | 2.21 |
| Logan | 266 | 212 | 478 | 751 | 0.64 | 0 |
| Love | 271 | 23 | 294 | 513 | 0.57 | 0 |
| McClain | 300 | 23 | 323 | 573 | 5.52 | 0 |
| McCurtain | 11073 | 29807 | 40880 | 1800 | 1.23 | 6.20 |
| McIntosh | 1215 | 0 | 1215 | 608 | 5.08 | 1.38 |
| Major | 5238 | 73 | 73 | 963 | 0.56 | 3.39 |
| Marshall | 274 | 177 | 177 | 366 | 22.71 | 0.41 |
| Mayes | 3245 | 0 | 0 | 648 | 2.00 | 3.23 |
| Murray | 1560 | 6813 | 8373 | 423 | 19.79 | 5.93 |
| Muskogee | 10662 | 103079 | 113741 | 818 | 139.06 | 9.80 |
| Noble | 1055 | 0 | 1055 | 743 | 1.42 | 0.70 |
| Nowata | 884 | 659 | 1543 | 537 | 2.08 | 1.45 |
| Okfuskee | 721 | 614 | 1335 | 637 | 2.09 | 1.46 |
| Oklahoma | 52784 | 22400 | 75184 | 700 | 107.41 | 9.29 |
| Okmulgee | 6506 | 0 | 6506 | 700 | 9.29 | 4.43 |
| Osage | 2255 | 3070 | 5325 | 2272 | 2.34 | 1.69 |
| Ottawa | 4468 | 288 | 4756 | 464 | 10.25 | 4.62 |
| Pawnee | 1457 | 0 | 1457 | 561 | 2.60 | 1.90 |
| Payne | 7814 | 4 | 7818 | 694 | 11.27 | 4.81 |
| Pittsburg | 3863 | 86 | 3949 | 1241 | 3.18 | 2.30 |
| Pontotoc | 10586 | 3051 | 13637 | 714 | 19.10 | 5.86 |
| Pottawatomie | 3496 | 0 | 3496 | 794 | 4.40 | 2.94 |
| Pushmataha | 778 | 0 | 778 | 1420 | 0.55 | 0 |
| Roger Mills | 300 | 0 | 300 | 1140 | 0.26 | 0 |
| Rogers | 4382 | 7549 | 11931 | 685 | 10.47 | 0 |

TABLE 5-3 COLLECTED DATA AND CALCULATED RESULTS OF INTENSITY OF WATER USE INDICATOR (Continued)

| County | Municipal Water Use (acre feet) | Industrial Water Use (acre feet) | Total M&I (acre-feet) | Total Land Area (sq. miles) | Intensity of Water Use (acre feet/ square mile) | Indicator Performance Level |
|------------------------|---------------------------------------|--|--------------------------|-----------------------------------|--|-----------------------------------|
| Seminole | 6747 | 22941 | 29688 | 630 | 47.12 | 7.65 |
| Sequoyah | 1958 | 3039 | 4997 | 696 | 7.18 | 3.91 |
| Stephens | 6890 | 0 | 6890 | 891 | 7.73 | 4.06 |
| Texas | 2589 | 521 | 3110 | 2062 | 1.51 | 0.82 |
| Tillman | 1306 | 0 | 1306 | 901 | 1.45 | 0.74 |
| Tulsa | 81773 | 6406 | 88179 | 573 | 153.89 | 10.00 |
| Wagoner | 1555 | 0 | 1555 | 563 | 2.76 | 2.02 |
| Washington | 1583 | 0 | 1583 | 424 | 3.73 | 2.61 |
| Washita | 1269 | 3 | 1272 | 1009 | 1.26 | 0.46 |
| Woods | 1757 | 0 | 1757 | 1298 | 1.35 | 0.60 |
| Woodward | 2860 | 1997 | 4857 | 1251 | 3.88 | 2.69 |
| The Whole MARB Area | 88707 | 9517 | 98224 | 4341 | 22.63 | 6.19 |

below:

- (i) total mileage of highways: Oklahoma State Department of Highways, unpublished data, 1974
- (ii) total mileage of streets: Oklahoma State Department of Highways, unpublished data, 1974
- (iii) total land area: Census of Agriculture, 1969

The transportation facility indicator (T_i) can be obtained by the following equation:

$$T_i = \frac{(i) + (ii)}{(iii)}$$

Indicators of counties in Oklahoma range from 0.67 of Pushmataha County to 5.54 of Oklahoma County. The latter as T_{\max} is then used to determine the indicator performance level (P_i) with the following formula:

$$P_i = \frac{T_i}{T_{\max}} \times 10$$

The data and computation results are shown on Table 5-4.

5.3 Determination of Development Levels

The four development indicators, inhabitation index, land value, intensity of water use, and transportation facilities, are assigned weights of 5, 4, 3, and 3 accordingly. The weighted indicator performance levels are obtained by multiplying the performance levels with their weights. They are then summed to obtain the development level estimate. This is expressed in equation as follows:

$$\begin{aligned} E_i &= \sum_{j=1}^4 P'_{ij} \\ &= \sum_{j=1}^4 P_{ij} \cdot W_j \end{aligned}$$

TABLE 5-4 COLLECTED DATA AND CALCULATED RESULTS OF TRANSPORTATION FACILITY INDICATOR

| County | City Streets (miles) | Highways (miles) | Total | Total Land Area (sq. mi.) | Highways & Streets per Sq. Mile | Indicator Performance Level |
|-----------|-------------------------|---------------------|---------|---------------------------------|---------------------------------------|-----------------------------------|
| Adair | 17.88 | 841.27 | 859.15 | 570 | 1.51 | 2.7 |
| Alfalfa | 50.65 | 1481.04 | 1531.69 | 868 | 1.76 | 3.2 |
| Atoka | 32.09 | 948.54 | 980.63 | 991 | 0.99 | 1.8 |
| Beaver | 28.61 | 2324.87 | 2353.48 | 1790 | 1.31 | 2.4 |
| Beckham | 88.07 | 1413.27 | 1501.14 | 907 | 1.66 | 3.0 |
| Blaine | 72.00 | 1466.82 | 1538.82 | 917 | 1.68 | 3.0 |
| Bryan | 115.05 | 1182.77 | 1297.82 | 889 | 1.46 | 2.6 |
| Caddo | 85.59 | 2180.28 | 2265.87 | 1272 | 1.78 | 3.2 |
| Canadian | 98.11 | 1618.42 | 1716.53 | 897 | 1.91 | 3.4 |
| Carter | 189.70 | 1196.83 | 1386.53 | 830 | 1.67 | 3.0 |
| Cherokee | 77.41 | 1162.07 | 1239.48 | 756 | 1.64 | 3.0 |
| Choctaw | 66.06 | 957.64 | 1023.70 | 778 | 1.32 | 2.4 |
| Cimarron | 30.45 | 1836.61 | 1867.06 | 1843 | 1.01 | 1.8 |
| Cleveland | 156.86 | 936.76 | 1093.62 | 527 | 2.08 | 3.8 |
| Coal | 37.65 | 576.73 | 614.38 | 526 | 1.17 | 2.1 |
| Comanche | 294.20 | 1486.49 | 1780.69 | 1084 | 1.64 | 3.0 |
| Cotton | 43.42 | 1095.32 | 1138.74 | 650 | 1.75 | 5.2 |
| Craig | 45.08 | 1152.54 | 1197.62 | 764 | 1.57 | 2.8 |
| Creek | 158.73 | 1253.09 | 1411.82 | 935 | 1.51 | 2.7 |
| Custer | 101.09 | 1647.70 | 1748.79 | 980 | 1.78 | 3.2 |
| Delaware | 31.80 | 1304.89 | 1336.69 | 707 | 1.89 | 3.4 |
| Dewey | 35.38 | 1279.32 | 1314.70 | 1018 | 1.29 | 2.3 |
| Ellis | 37.46 | 1450.57 | 1488.03 | 1242 | 1.20 | 2.2 |
| Garfield | 284.01 | 2102.99 | 2387.00 | 1054 | 2.26 | 4.1 |
| Garvin | 106.16 | 1211.30 | 1317.46 | 814 | 1.62 | 2.9 |
| Grady | 124.99 | 1701.68 | 1826.67 | 1096 | 1.67 | 3.0 |
| Grant | 47.69 | 1932.30 | 1979.99 | 1007 | 1.97 | 3.6 |
| Greer | 47.41 | 943.09 | 990.50 | 633 | 1.49 | 2.7 |
| Harmon | 26.22 | 826.69 | 852.91 | 545 | 1.56 | 2.8 |
| Harper | 30.38 | 1203.68 | 1234.06 | 1041 | 1.19 | 2.1 |
| Haskell | 41.67 | 757.77 | 799.44 | 602 | 1.33 | 2.4 |
| Hughes | 71.40 | 1005.13 | 1076.53 | 807 | 1.33 | 2.4 |
| Jackson | 101.00 | 1345.34 | 1445.34 | 810 | 1.79 | 3.2 |

TABLE 5-4 COLLECTED DATA AND CALCULATED RESULTS OF TRANSPORTATION FACILITY INDICATOR (Continued)

| County | City Streets (miles) | Highways (miles) | Total | Total Land Area (sq. mi.) | Highways & Streets per Sq. Mile | Indicator Performance Level |
|--------------|-------------------------|---------------------|---------|---------------------------------|---------------------------------------|-----------------------------------|
| Jefferson | 56.37 | 835.55 | 691.92 | 780 | 1.14 | 2.1 |
| Johnston | 57.20 | 691.32 | 748.52 | 638 | 1.17 | 2.1 |
| Kay | 204.19 | 1671.46 | 1875.65 | 950 | 1.97 | 3.6 |
| Kingfisher | 47.13 | 1659.61 | 1706.74 | 904 | 1.89 | 3.4 |
| Kiowa | 187.04 | 1758.98 | 1946.02 | 1027 | 1.89 | 3.4 |
| Latimer | 32.93 | 574.58 | 607.51 | 737 | 0.82 | 1.5 |
| Le Flore | 290.02 | 1713.00 | 2003.02 | 1560 | 1.28 | 2.3 |
| Lincoln | 72.34 | 1672.25 | 1744.59 | 973 | 1.79 | 3.2 |
| Logan | 102.11 | 1290.61 | 1392.72 | 751 | 1.85 | 3.3 |
| Love | 22.07 | 570.86 | 592.93 | 513 | 1.16 | 2.1 |
| McClain | 98.84 | 844.11 | 941.95 | 573 | 1.64 | 3.0 |
| McCurtain | 85.61 | 1674.08 | 1759.69 | 1800 | 0.98 | 1.8 |
| McIntosh | 64.27 | 890.27 | 954.54 | 608 | 1.57 | 2.8 |
| Major | 30.15 | 1400.10 | 1430.25 | 963 | 1.49 | 2.7 |
| Marshall | 46.03 | 502.67 | 548.70 | 366 | 1.50 | 2.7 |
| Mayes | 80.69 | 1133.69 | 1214.38 | 648 | 1.87 | 3.4 |
| Murray | 65.15 | 413.13 | 478.28 | 423 | 1.13 | 2.0 |
| Muskogee | 213.17 | 1404.16 | 1617.33 | 818 | 1.98 | 3.6 |
| Noble | 50.54 | 1315.45 | 1365.99 | 743 | 1.84 | 3.3 |
| Nowata | 43.76 | 828.52 | 872.28 | 537 | 1.62 | 2.9 |
| Okfuskee | 51.23 | 883.91 | 935.14 | 637 | 1.47 | 2.7 |
| Oklahoma | 2328.43 | 1547.41 | 3875.84 | 700 | 5.54 | 10.0 |
| Okmulgee | 190.79 | 1084.80 | 1275.59 | 700 | 1.82 | 3.3 |
| Osage | 128.46 | 1926.69 | 2055.15 | 2272 | 0.90 | 1.6 |
| Ottawa | 138.46 | 875.80 | 1014.26 | 464 | 2.19 | 4.0 |
| Pawnee | 58.30 | 929.15 | 987.45 | 561 | 1.76 | 3.2 |
| Payne | 149.28 | 1293.64 | 1442.92 | 694 | 2.08 | 3.8 |
| Pittsburg | 206.30 | 1338.00 | 1544.30 | 1241 | 1.24 | 2.2 |
| Pontotoc | 83.80 | 964.91 | 1048.71 | 714 | 1.47 | 2.7 |
| Pottawatomie | 176.82 | 1280.83 | 1457.65 | 794 | 1.84 | 3.3 |
| Pushmataha | 27.80 | 925.40 | 953.20 | 1420 | 0.67 | 1.2 |
| Roger Mills | 25.05 | 1380.75 | 1405.80 | 1140 | 1.23 | 2.2 |
| Rogers | 107.20 | 1133.02 | 1240.22 | 685 | 1.81 | 3.3 |

TABLE 5-4 COLLECTED DATA AND CALCULATED RESULTS OF TRANSPORTATION FACILITY INDICATOR (Continued)

| County | City Streets (miles) | Highways (miles) | Total | Total Land Area (sq. mi.) | Highways & Streets per Sq. Mile | Indicator Performance Level |
|------------------------|-------------------------|---------------------|---------|---------------------------------|---------------------------------------|-----------------------------------|
| Seminole | 72.82 | 1054.51 | 1127.33 | 630 | 1.79 | 3.2 |
| Sequoyah | 28.20 | 978.86 | 1007.06 | 696 | 1.45 | 2.6 |
| Stephens | 156.08 | 1345.59 | 1501.67 | 891 | 1.69 | 3.1 |
| Texas | 97.86 | 2953.08 | 3050.94 | 2062 | 1.48 | 2.7 |
| Tillman | 74.67 | 1555.85 | 1630.52 | 901 | 1.81 | 3.3 |
| Tulsa | 1628.51 | 1302.40 | 2939.91 | 573 | 5.12 | 9.2 |
| Wagoner | 88.50 | 1020.30 | 1108.80 | 563 | 1.97 | 3.6 |
| Washington | 138.74 | 613.10 | 751.84 | 424 | 1.77 | 3.2 |
| Washita | 61.54 | 1808.64 | 1870.18 | 1009 | 1.85 | 3.3 |
| Woods | 54.11 | 1595.54 | 1649.65 | 1298 | 1.27 | 2.3 |
| Woodward | 68.08 | 1635.66 | 1703.74 | 1251 | 1.36 | 2.5 |
| The Whole MARB Area | 1974.00 | 5420.33 | 7394.33 | 4341 | 1.70 | 3.1 |

where

E_i = Development level estimate of county i

P'_{ij} = Weighted indicator performance level of indicator j
in county i

P_{ij} = Indicator performance level of indicator j in
county i

W_j = Weight assigned to indicator j

i = The number of counties in Oklahoma. In this study,
i = 1, 2, 3, . . . 77.

Indicator performance levels, weighted indicated performance levels and development level estimate for each county in Oklahoma are listed on Table 5-5. The development level estimates range from 28.30 of Cimarron County to 147.32 of Tulsa County. The mean and standard deviation of the development level estimates are found to be 62.08 and 20.82 respectively. 62.08 ± 20.82 then are used as the cutoff points to differentiate three levels of development. This is summarized as follows:

| | Level I | Level II | Level III |
|-----------------------------|-----------|-------------|--------------|
| Development Level Estimates | 0 - 41.26 | 41.26-82.90 | 82.90-150.00 |

The development levels of counties in Oklahoma are also shown in Table 5-5. Among the seventy-seven counties, eight are level I areas fifty-nine level II, and ten level III. The development levels of the four counties in the field test area, along with that of the entire M.A.R.B. area are summarized in Table 5-6.

TABLE 5-5 DEVELOPMENT LEVELS OF COUNTIES IN OKLAHOMA

IPL - Indicator Performance Level

WPL - Weighted Performance Level

| County | Inhabitation Index | | Land Value | | Intensity of Water Use | | Transportation Facility | | Development Level Estimate | Development Level |
|-----------|--------------------|-------|------------|-------|------------------------|-------|-------------------------|------|----------------------------|-------------------|
| | IPL | WPL | IPL | WPL | IPL | WPL | IPL | WPL | | |
| Adair | 6.22 | 31.10 | 4.00 | 16.00 | 4.53 | 13.59 | 2.7 | 8.1 | 68.79 | 2 |
| Alfalfa | 4.02 | 20.10 | 5.22 | 20.88 | 0.43 | 1.29 | 3.2 | 9.6 | 51.87 | 2 |
| Atoka | 4.32 | 21.60 | 3.53 | 14.12 | 0 | 0 | 1.8 | 5.4 | 41.12 | 1 |
| Beaver | 2.38 | 11.90 | 3.65 | 14.60 | 0 | 0 | 2.4 | 7.2 | 33.70 | 1 |
| Beckham | 4.48 | 22.40 | 4.26 | 17.04 | 1.56 | 4.68 | 3.0 | 9.0 | 53.12 | 2 |
| Blaine | 4.54 | 22.70 | 4.89 | 19.56 | 0.93 | 2.79 | 3.0 | 9.0 | 54.05 | 2 |
| Bryan | 5.85 | 29.25 | 4.59 | 18.36 | 2.23 | 6.69 | 2.6 | 7.8 | 62.10 | 2 |
| Caddo | 5.71 | 28.55 | 4.74 | 18.96 | 4.08 | 12.24 | 3.2 | 9.6 | 69.35 | 2 |
| Canadian | 5.27 | 26.25 | 6.25 | 25.00 | 2.98 | 8.94 | 3.4 | 10.2 | 70.49 | 2 |
| Carter | 6.50 | 32.50 | 5.76 | 23.04 | 6.86 | 20.58 | 3.0 | 9.0 | 85.12 | 3 |
| Cherokee | 6.03 | 30.15 | 5.09 | 20.36 | 3.26 | 9.78 | 3.0 | 9.0 | 69.29 | 2 |
| Choctaw | 5.14 | 25.70 | 3.99 | 15.96 | 0.68 | 2.04 | 2.4 | 7.2 | 50.90 | 2 |
| Cimarron | 1.54 | 7.70 | 3.80 | 15.20 | 0 | 0 | 1.8 | 5.4 | 28.30 | 1 |
| Cleveland | 7.92 | 39.60 | 7.73 | 30.92 | 6.24 | 18.72 | 3.8 | 11.4 | 100.64 | 3 |
| Coal | 4.46 | 22.30 | 3.47 | 13.88 | 0 | 0 | 2.1 | 6.3 | 42.48 | 2 |
| Comanche | 6.72 | 33.60 | 5.80 | 23.20 | 6.05 | 18.15 | 3.0 | 9.0 | 83.95 | 3 |
| Cotton | 4.04 | 20.20 | 4.38 | 17.52 | 0.19 | 0.57 | 3.2 | 9.6 | 47.89 | 2 |
| Craig | 5.17 | 25.85 | 5.52 | 22.08 | 1.21 | 3.63 | 2.8 | 8.4 | 59.96 | 2 |
| Creek | 6.70 | 33.50 | 5.07 | 20.28 | 2.48 | 7.44 | 2.7 | 8.1 | 69.32 | 2 |
| Custer | 4.79 | 23.95 | 5.20 | 20.80 | 3.34 | 10.02 | 3.2 | 9.6 | 64.37 | 2 |
| Delaware | 6.11 | 30.55 | 4.08 | 16.32 | 0 | 0 | 3.4 | 10.2 | 57.07 | 2 |
| Dewey | 3.25 | 16.25 | 3.70 | 14.80 | 0 | 0 | 2.3 | 6.9 | 37.95 | 1 |
| Ellis | 2.69 | 13.45 | 4.17 | 16.68 | 0 | 0 | 2.2 | 6.6 | 36.73 | 1 |
| Garfield | 6.01 | 30.03 | 6.76 | 27.04 | 2.93 | 8.79 | 4.1 | 12.3 | 78.18 | 2 |
| Garvin | 6.07 | 30.35 | 5.12 | 20.48 | 2.42 | 7.26 | 2.9 | 8.7 | 66.79 | 2 |
| Grady | 5.64 | 28.20 | 5.25 | 21.00 | 2.98 | 8.94 | 3.0 | 9.0 | 67.14 | 2 |
| Grant | 3.71 | 18.55 | 5.08 | 20.32 | 0 | 0 | 3.6 | 10.8 | 49.67 | 2 |
| Greer | 4.15 | 20.75 | 4.66 | 18.64 | 0 | 0 | 2.7 | 8.1 | 47.49 | 2 |
| Harmon | 3.34 | 16.70 | 4.21 | 16.84 | 2.13 | 6.39 | 2.8 | 8.4 | 48.33 | 2 |
| Harper | 3.03 | 15.15 | 3.46 | 13.84 | 0.41 | 1.23 | 2.1 | 6.3 | 36.52 | 1 |
| Haskell | 5.24 | 26.20 | 3.31 | 13.24 | 1.48 | 4.44 | 2.4 | 7.2 | 51.08 | 2 |
| Hughes | 4.86 | 24.30 | 3.77 | 15.08 | 0 | 0 | 2.4 | 7.2 | 46.58 | 2 |
| Jackson | 5.66 | 28.30 | 5.48 | 21.92 | 3.96 | 11.88 | 3.2 | 9.6 | 71.70 | 2 |

TABLE 5-5 DEVELOPMENT LEVELS OF COUNTIES IN OKLAHOMA (Continued)

IPL - Indicator Performance Level

WPL - Weighted Performance Level

| | Inhabitation Index | | Land Value | | Intensity of Water Use | | Transportation Facility | | Development Level | Development Level |
|--------------|--------------------|-------|------------|-------|------------------------|-------|-------------------------|------|-------------------|-------------------|
| | IPL | WPL | IPL | WPL | IPL | WPL | IPL | WPL | Estimate | |
| Jefferson | 4.19 | 20.95 | 4.12 | 16.48 | 0 | 0 | 2.1 | 6.3 | 43.73 | 2 |
| Johnston | 4.42 | 22.10 | 3.59 | 14.36 | 0.04 | 0.12 | 2.1 | 6.3 | 42.88 | 2 |
| Kay | 6.11 | 30.55 | 6.05 | 24.20 | 7.75 | 23.25 | 3.6 | 10.8 | 88.80 | 3 |
| Kingfisher | 4.70 | 23.50 | 5.60 | 22.40 | 2.04 | 6.12 | 3.4 | 10.2 | 62.22 | 2 |
| Kiowa | 4.32 | 21.60 | 4.71 | 18.84 | 0.95 | 2.85 | 3.4 | 10.2 | 53.49 | 2 |
| Latimer | 4.66 | 23.30 | 4.41 | 17.64 | 1.91 | 5.73 | 1.5 | 4.5 | 51.17 | 2 |
| LeFlore | 5.39 | 26.95 | 3.73 | 14.92 | 2.36 | 7.08 | 2.3 | 6.9 | 55.85 | 2 |
| Lincoln | 5.42 | 27.10 | 4.06 | 16.24 | 2.21 | 6.63 | 3.2 | 9.6 | 59.57 | 2 |
| Logan | 5.60 | 28.00 | 4.64 | 18.56 | 0 | 0 | 3.3 | 9.9 | 56.46 | 2 |
| Love | 4.54 | 22.70 | 4.57 | 18.28 | 0 | 0 | 2.1 | 6.3 | 47.28 | 2 |
| McClain | 5.81 | 29.05 | 4.88 | 19.52 | 0 | 0 | 3.0 | 9.0 | 57.57 | 2 |
| McCurtain | 4.90 | 24.50 | 5.08 | 20.32 | 6.20 | 18.60 | 1.8 | 5.4 | 68.86 | 2 |
| McIntosh | 5.47 | 27.35 | 4.10 | 16.40 | 1.38 | 4.14 | 2.8 | 8.4 | 56.29 | 2 |
| Major | 3.49 | 17.45 | 4.55 | 18.20 | 3.39 | 10.17 | 2.7 | 8.1 | 53.92 | 2 |
| Marshall | 5.37 | 26.85 | 3.90 | 15.60 | 0.41 | 1.23 | 2.7 | 8.1 | 51.78 | 2 |
| Mayes | 6.46 | 32.30 | 4.97 | 19.88 | 3.23 | 9.69 | 3.4 | 10.2 | 72.07 | 2 |
| Murray | 5.62 | 28.10 | 3.97 | 15.88 | 5.93 | 17.79 | 2.0 | 6.0 | 67.77 | 2 |
| Muskogee | 7.28 | 36.40 | 5.86 | 23.44 | 9.80 | 29.40 | 3.6 | 10.8 | 100.04 | 3 |
| Noble | 4.19 | 20.95 | 4.88 | 19.52 | 0.70 | 2.10 | 3.3 | 9.9 | 52.47 | 2 |
| Nowata | 5.05 | 25.25 | 4.07 | 16.28 | 1.45 | 4.35 | 2.9 | 8.7 | 54.58 | 2 |
| Okfuskee | 5.07 | 25.35 | 3.83 | 15.32 | 1.46 | 4.38 | 2.7 | 8.1 | 53.15 | 2 |
| Oklahoma | 9.40 | 47.00 | 10.00 | 40.00 | 9.29 | 27.87 | 10.0 | 30.0 | 144.87 | 3 |
| Okmulgee | 6.59 | 32.95 | 4.64 | 18.56 | 4.43 | 13.29 | 3.3 | 9.9 | 74.70 | 2 |
| Osage | 4.56 | 22.80 | 3.88 | 15.52 | 1.69 | 5.07 | 1.6 | 4.8 | 48.19 | 2 |
| Ottawa | 7.18 | 35.90 | 6.48 | 25.92 | 4.62 | 13.86 | 4.0 | 12.0 | 87.68 | 3 |
| Pawnee | 5.46 | 27.30 | 4.98 | 19.92 | 1.90 | 5.70 | 3.2 | 9.6 | 62.52 | 2 |
| Payne | 6.82 | 34.10 | 5.51 | 22.04 | 4.81 | 14.43 | 3.8 | 11.4 | 81.97 | 2 |
| Pittsburg | 5.80 | 29.00 | 4.46 | 17.84 | 2.30 | 6.90 | 2.2 | 6.6 | 60.34 | 2 |
| Pontotoc | 6.25 | 31.25 | 5.33 | 21.32 | 5.86 | 17.58 | 2.7 | 8.1 | 78.25 | 2 |
| Pottawatomia | 6.51 | 32.55 | 5.21 | 20.84 | 2.94 | 8.82 | 3.3 | 9.9 | 72.11 | 2 |
| Pushmataha | 3.27 | 16.35 | 3.34 | 13.36 | 0 | 0 | 1.2 | 3.6 | 33.31 | 1 |
| Roger Mills | 2.58 | 12.90 | 3.34 | 13.36 | 0 | 0 | 2.2 | 6.6 | 32.86 | 1 |
| Rogers | 6.73 | 33.65 | 5.86 | 23.44 | 0 | 0 | 3.3 | 9.9 | 66.99 | 2 |

TABLE 5-5 DEVELOPMENT LEVELS OF COUNTIES IN OKLAHOMA (Continued)

IPL - Indicator Performance Level

WPL - Weighted Performance Level

| County | Inhabitation Index | | Land Value | | Intensity of Water Use | | Transportation Facility | | Development Level Estimate | Development Level |
|---------------------|--------------------|-------|------------|-------|------------------------|-------|-------------------------|------|----------------------------|-------------------|
| | IPL | WPL | IPL | WPL | IPL | WPL | IPL | WPL | | |
| Seminole | 6.32 | 31.60 | 5.06 | 20.24 | 7.65 | 22.95 | 3.2 | 9.6 | 84.39 | 3 |
| Sequoyah | 6.50 | 32.50 | 4.33 | 17.32 | 3.91 | 11.73 | 2.6 | 7.8 | 69.35 | 2 |
| Stephens | 6.08 | 30.40 | 5.54 | 22.16 | 4.06 | 12.18 | 3.1 | 9.3 | 74.04 | 2 |
| Texas | 3.35 | 16.75 | 4.46 | 17.84 | 0.82 | 2.46 | 2.7 | 8.1 | 45.15 | 2 |
| Tillman | 4.46 | 22.30 | 4.83 | 19.32 | 0.74 | 2.22 | 3.3 | 9.9 | 53.74 | 2 |
| Tulsa | 10.00 | 50.00 | 9.93 | 39.72 | 10.00 | 30.00 | 9.2 | 27.6 | 147.32 | 3 |
| Wagoner | 6.62 | 33.10 | 4.54 | 18.16 | 2.02 | 6.06 | 3.6 | 10.8 | 68.12 | 2 |
| Washington | 7.30 | 36.50 | 7.45 | 29.80 | 2.61 | 7.83 | 3.2 | 9.6 | 83.73 | 3 |
| Washita | 4.36 | 21.80 | 5.27 | 21.08 | 0.46 | 1.38 | 3.3 | 9.9 | 54.16 | 2 |
| Woods | 3.32 | 16.60 | 4.62 | 18.48 | 0.60 | 1.80 | 2.3 | 6.9 | 43.78 | 2 |
| Woodward | 4.03 | 20.15 | 5.27 | 21.08 | 2.69 | 8.07 | 2.5 | 7.5 | 56.80 | 2 |
| The Whole MARB Area | 7.23 | 36.15 | 7.16 | 28.64 | 6.19 | 18.57 | 3.1 | 9.3 | 92.66 | 3 |

TABLE 5-6 SUMMARY OF DEVELOPMENT LEVELS OF THE MID-ARKANSAS RIVER BASIN

| Counties included in M.A.R.B. Region | Development Level |
|--------------------------------------|-------------------|
| Pawnee County | II |
| Creek County | II |
| Tulsa County | III |
| Osage County | II |
| Entire M.A.R.B. Area | III |

5.4 Field Test: Ecological Parameters

5.4.1 Flora

A. Terrestrial natural vegetation

The acreage of woodland, including woodland pasture, pastureland and rangeland not improved of four Oklahoma counties collected from 1969 U.S. Census of Agriculture are shown in Table 5-7.

By using the formula 4-1, which is presented in Chapter IV, the results of the terrestrial natural vegetation parameter estimate are shown in Table 5-8. These results are then plotted on Figure 5-3. The ecological performances of the four counties tested are then derived by interpolation. These figures are shown in Table 5-9. Among the three counties of level II, Pawnee has displayed the best ecological performance (E.P.). Tulsa county has an E.P. value of -0.09, very close to that of Creek county (-0.08) in spite of the great difference of parameter estimates between them (-12.3% compared to -18.0%). This is because of their different development levels (see section 5.2). By this method all of the four counties in M.A.R.B. region failed to meet the standards in this respect (see Section 4.2.1.A).

B. Productivity of aquatic flora

The data required to calculate the aquatic flora productivity are the six characteristics listed in Table 4-2. In M.A.R.B. water quality data are primarily recorded for water quality control to see if the water meets potable or municipal water quality criteria. This particular set of data cannot be used in the evaluation of this parameter. The data required here can very likely be obtained from unpublished or published academic researches from local universities. The job of validation shall be accomplished by other researchers who have access to the necessary set of data.

C. Terrestrial flora species diversity

The accumulated number of terrestrial vegetation species and individuals at each stand of the mid-Arkansas River Basin, and the percentage of each habitat type in the same region are needed for evaluating

TABLE 5-7 DATA COLLECTED ON TERRESTRIAL NATURAL VEGETATION

| ITEM TO BE DETERMINED | DATA | | | | |
|--|--|---------|---------|--------|---------|
| | On County Basis | Pawnee | Creek | Tulsa | Osage |
| Percentage change of natural vegetation in 5 Years (V ₅) | i) Total woodland including woodland pasture of 1969 (acres) | 33,765 | 114,005 | 16,068 | 145,356 |
| | ii) Pastureland and rangeland not improved of 1969 (acres) | 154,760 | 109,094 | 34,322 | 766,133 |
| | iii) Total woodland including woodland pasture of 1964 (acres) | 43,200 | 153,714 | 12,667 | 159,335 |
| | iv) Pastureland and rangeland not improved of 1964 (acres) | 151,367 | 100,581 | 48,784 | 834,894 |

TABLE 5-8 CALCULATION OF TERRESTRIAL NATURAL VEGETATION

| ITEM TO BE DETERMINED | FORMULA | RESULT | | | |
|--|--|-------------|------------|-------------|------------|
| | | Pawnee (II) | Creek (II) | Tulsa (III) | Osage (II) |
| Percentage change of natural vegetation in 5 years (V ₅) | $V_5 = \frac{A_0 - A_t}{A_t} \times 100\%$ $= \frac{(i)+(ii) - (iii)+(iv)}{(iii)+(iv)} \times 100\%$ | -3.1% | -12.3% | -18.0% | -8.3% |

Pawnee: - - - - -
 Creek: - · - · - · -
 Tulsa: - · · · - · · · -
 Osage: - · · · · - · · · · -

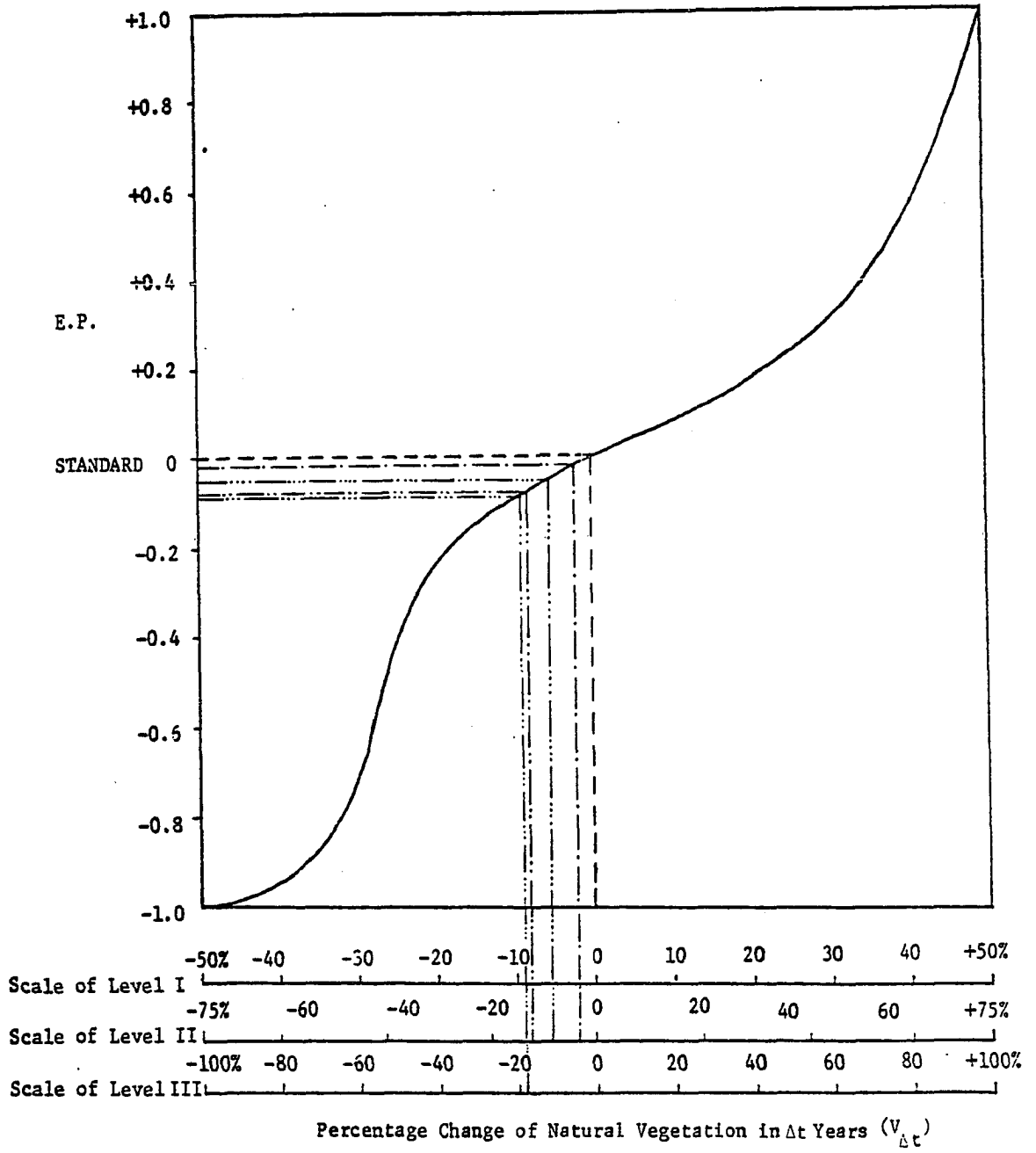

FIGURE 5-3 PARAMETER FUNCTION GRAPH OF TERRESTRIAL NATURAL VEGETATION

TABLE 5-9 ECOLOGICAL PERFORMANCE OF TERRESTRIAL NATURAL VEGETATION

| ITEM | COUNTY | Pawnee | Creek | Tulsa | Osage |
|------------------------|--------|--------|-------|-------|-------|
| | LEVEL | II | II | III | II |
| Ecological Performance | | -0.02 | -0.08 | -0.09 | -0.05 |

the species diversity of terrestrial flora. Data collected from the field test, the results of previous research, and the Soil Survey Report of Oklahoma State Department of Agriculture are shown in Table 5-10. The results calculated by formula 4-4 are presented in Table 5-11. By interpolating these points on Figure 5-4, Pawnee has shown the highest E.P. value ($D = 19.1$) in the three counties of Level II. But it still falls in the undesired condition (the standard of Level II is at $D = 23$). Tulsa county, according to its level-III scale, has a positive E.P. value, which is above the standard (at $D = 15.5$). All the E.P. values are shown in Table 5-12.

D. Vegetation land use

The acreage of each vegetation land use type and the total land area of the four counties tested in 1958 and 1967 are collected from U.S.D.A.-Oklahoma Conservation Needs Inventory Report, 1970 (Table 5-13). The details of the calculations with two formulas used (4-5 and 4-6) are shown in Table 5-14. The results of S_9 calculated shows that only Creek and Osage meet the standard of non-negative percentage change. Parameter function graph and E.P. values of these four counties are presented in Figure 5-5 and Table 5-15, respectively.

5.4.2 Fauna

A. Dynamic ratio of fish population

Fish standing crop data of Keystone Lake in 1971-1973 (shown in Table 5-16) was obtained from unpublished file data supplied by the Oklahoma Fishery Research Laboratory of the Wildlife Conservation Department. These standing crops, or fish stocks, are the expanded estimates based on one acre cove rotenone samples taken in 1971-1973. Each number represents the average value for three coves. The units have been converted back from kilogram per hectare to pounds per acre to be consistent with other measurements.

The calculations of F/C ratio of fish population by using formula 4-7 are shown in Table 5-17. None of the three years' data falls in the intervals of standards, which were determined in Section

TABLE 5-10 DATA COLLECTED ON TERRESTRIAL FLORA SPECIES DIVERSITY

| ITEM TO BE DETERMINED | DATA | | | | |
|--|--|--------|-------|-------|-------|
| | On County Basis | Pawnee | Creek | Tulsa | Osage |
| 1) Species Diversity of Each Habitat Type (#Species / 1,000 individuals) | Upland Forest $X_1=7.2$ | | | | |
| | Bottomland Forest $X_2=25.0$ | " | " | " | " |
| | Prairie $X_3=21.0$ | | | | |
| 2) Weighted Species Diversity in each Study Community (D) | Percentage of each flora habitat type in the whole community | | | | |
| | Upland Forest (T_1) | 17.3% | 53.6% | 16.0% | 34.0% |
| | Bottomland Forest (T_2) | 13.2% | 19.6% | 22.0% | 14.0% |
| | Prairie (T_2) | 69.5% | 26.8% | 62.0% | 52.0% |

TABLE 5-11 CALCULATION OF TERRESTRIAL FLORA SPECIES DIVERSITY

| ITEM TO BE DETERMINED | FORMULA | RESULT | | | |
|---|------------------------------------|-------------|------------|-------------|------------|
| | | Pawnee (II) | Creek (II) | Tulsa (III) | Osage (II) |
| Weighted Species Diversity in Each Study Community (D) (#Species / 1,000 individuals) | $D = \sum_{i=1}^n (X_i \cdot T_i)$ | 19.1 | 14.4 | 19.7 | 16.9 |

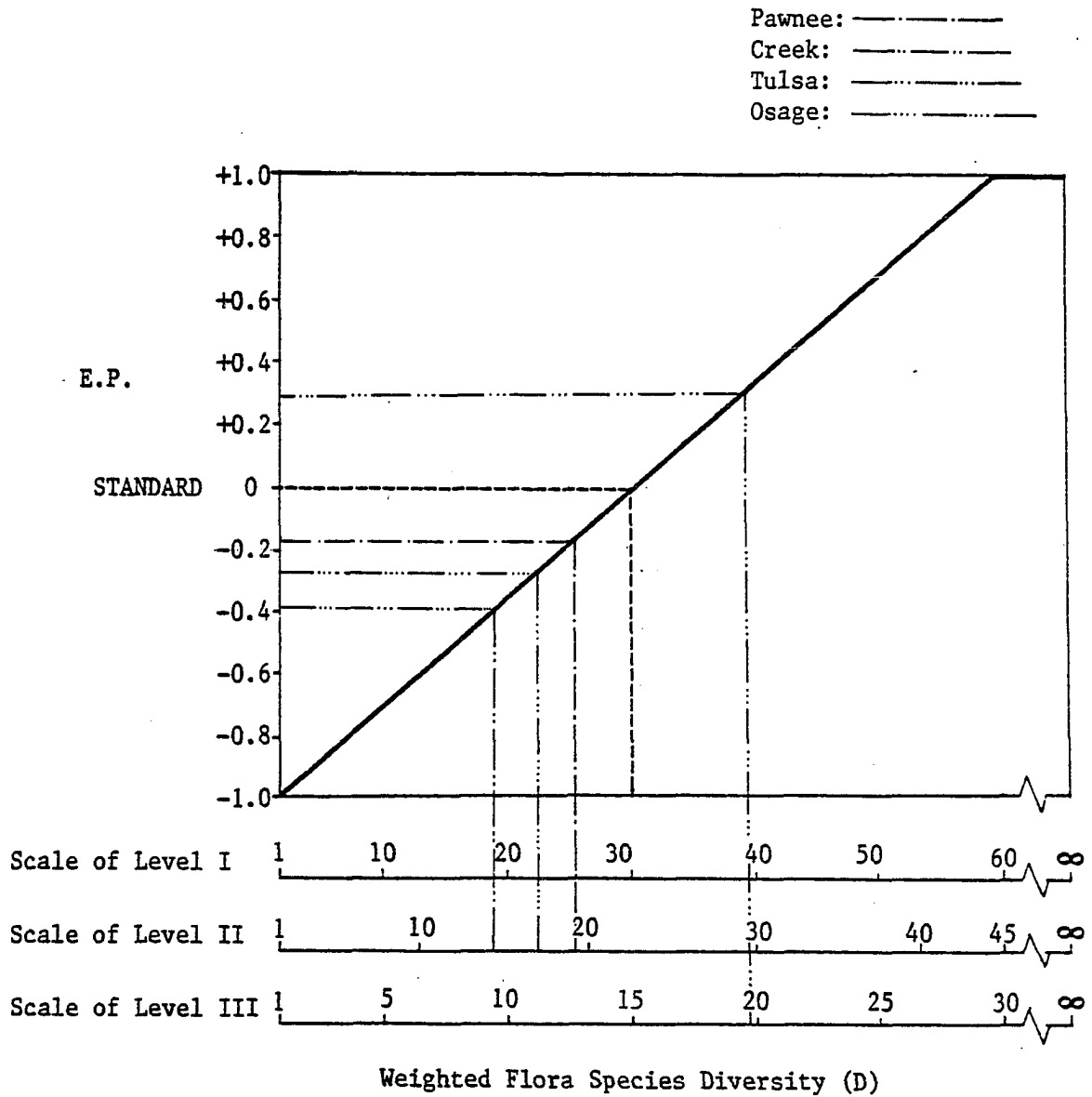

FIGURE 5-4 PARAMETER FUNCTION GRAPH OF TERRESTRIAL FLORA SPECIES DIVERSITY

Table 5-12 Ecological Performance of Terrestrial Flora Species Diversity

| ITEM | COUNTY | Pawnee | Creek | Tulsa | Osage |
|------------------------|--------|--------|-------|-------|-------|
| | LEVEL | II | II | III | II |
| Ecological Performance | | -0.18 | -0.39 | +0.29 | -0.28 |

TABLE 5-13 DATA COLLECTED ON VEGETATION LAND USE (AESTHETIC)

| ITEM TO BE DETERMINED | On County Basis | Pawnee | | Creek | | Tulsa | | Osage | |
|--|--|---------|---------|---------|---------|---------|---------|-----------|-----------|
| | | 1958 | 1967 | 1958 | 1967 | 1958 | 1967 | 1958 | 1967 |
| Percentage of various types of vegetation land use in 1958 & 1967 (P_{it}) (P_{it}) | 1) Acreage of each type of vegetation land use in 1958 & 1967 (V_{it}) | | | | | | | | |
| | Type 1 (Forest-land) | 69,409 | 72,897 | 261,988 | 221,988 | 39,759 | 45,922 | 407,744 | 445,497 |
| | Type 2 (Crop-land) | 94,830 | 74,856 | 92,969 | 74,325 | 121,634 | 80,693 | 166,536 | 123,807 |
| | Type 3 (Range-land) | 162,193 | 167,453 | 86,611 | 176,218 | 64,093 | 42,203 | 762,090 | 703,020 |
| | Type 4 (Pasture-land) | 11,172 | 251,391 | 28,886 | 90,787 | 66,797 | 106,057 | 20,000 | 81,525 |
| | Type 5 (Others, little to no vegetation) | 7,487 | 6,076 | 97,818 | 5,489 | 7,229 | 8,091 | 10,322 | 14,683 |
| | ii) Acreage of total land in 1958 & 1967 (T_t) | 345,091 | 346,673 | 568,272 | 568,807 | 299,512 | 282,966 | 1,366,692 | 1,368,532 |

TABLE 5-14 CALCULATION OF VEGETATION LAND USE (AESTHETIC)

| ITEM TO BE DETERMINED | FORMULA | Pawnee (II) | | Creek (II) | | Tulsa (III) | | Osage (II) | |
|--|--|-------------|------|------------|------|-------------|------|------------|------|
| | | '58 | '67 | '58 | 67 | '58 | '67 | '58 | '67 |
| 1) Percentage of various types of vegetation land use in 1958 & 1967 (P _{it}) : | $P_{it} = \frac{V_{it}}{T_t} \times 100\%$ $= \frac{(i)}{(ii)} \times 100\%$ | | | | | | | | |
| Type 1 (%) | | 20.1 | 21.0 | 46.1 | 39.0 | 13.3 | 16.2 | 29.8 | 32.5 |
| Type 2 (%) | | 27.5 | 21.6 | 16.4 | 13.0 | 40.6 | 28.5 | 12.2 | 9.0 |
| Type 3 (%) | | 47.0 | 48.3 | 15.2 | 31.0 | 21.4 | 14.9 | 55.7 | 51.4 |
| Type 4 (%) | | 3.2 | 7.3 | 5.1 | 16.0 | 22.3 | 37.5 | 1.5 | 6.0 |
| Type 5 (%) | | 2.2 | 1.8 | 17.2 | 1.0 | 2.4 | 2.9 | 0.8 | 1.1 |
| 2) Weighted sum of Percentage change of the various vegetation land uses (S _g) : | | | | | | | | | |
| | a) $\Delta P_{19} = P_{i-67} - P_{i-58}$ | | | | | | | | |
| Type 1 (%) | | +0.9 | | -7.1 | | +12.9 | | +2.7 | |
| Type 2 (%) | | -5.9 | | -3.4 | | -12.1 | | -3.2 | |
| Type 3 (%) | | +1.3 | | +15.8 | | -6.5 | | -4.3 | |
| Type 4 (%) | | +4.1 | | +10.9 | | +15.2 | | +4.5 | |
| Type 5 (%) | | -0.4 | | -16.2 | | +0.5 | | +0.3 | |

TABLE 5-14 CALCULATION OF VEGETATION LAND USE (AESTHETIC) continued

| | | | | | |
|------------|--|-------|--------|--------|-------|
| | b) $\Delta P_{i9} \cdot W_i$ | | | | |
| Type 1 (%) | = (a) x 10 | +9.0 | -71.0 | +29.0 | +27.0 |
| Type 2 (%) | = (a) x 6 | -35.4 | -20.4 | -72.6 | -19.2 |
| Type 3 (%) | = (a) x 5 | +6.5 | +79.0 | -32.5 | -21.5 |
| Type 4 (%) | = (a) x 4 | +16.4 | +43.6 | +60.8 | +18.0 |
| Type 5 (%) | = (a) x 1 | -0.4 | -16.2 | +0.5 | +0.3 |
| | c) $S_g = \sum_{i=1}^5 P_{i9} \cdot W_i$ = \sum_1^5 (b) | -3.9% | +15.0% | -15.6% | +4.6% |

Parameter Function Graph

Pawnee: —·—·—·—
 Creek: —·—·—·—
 Tulsa: —·—·—·—
 Osage: —·—·—·—

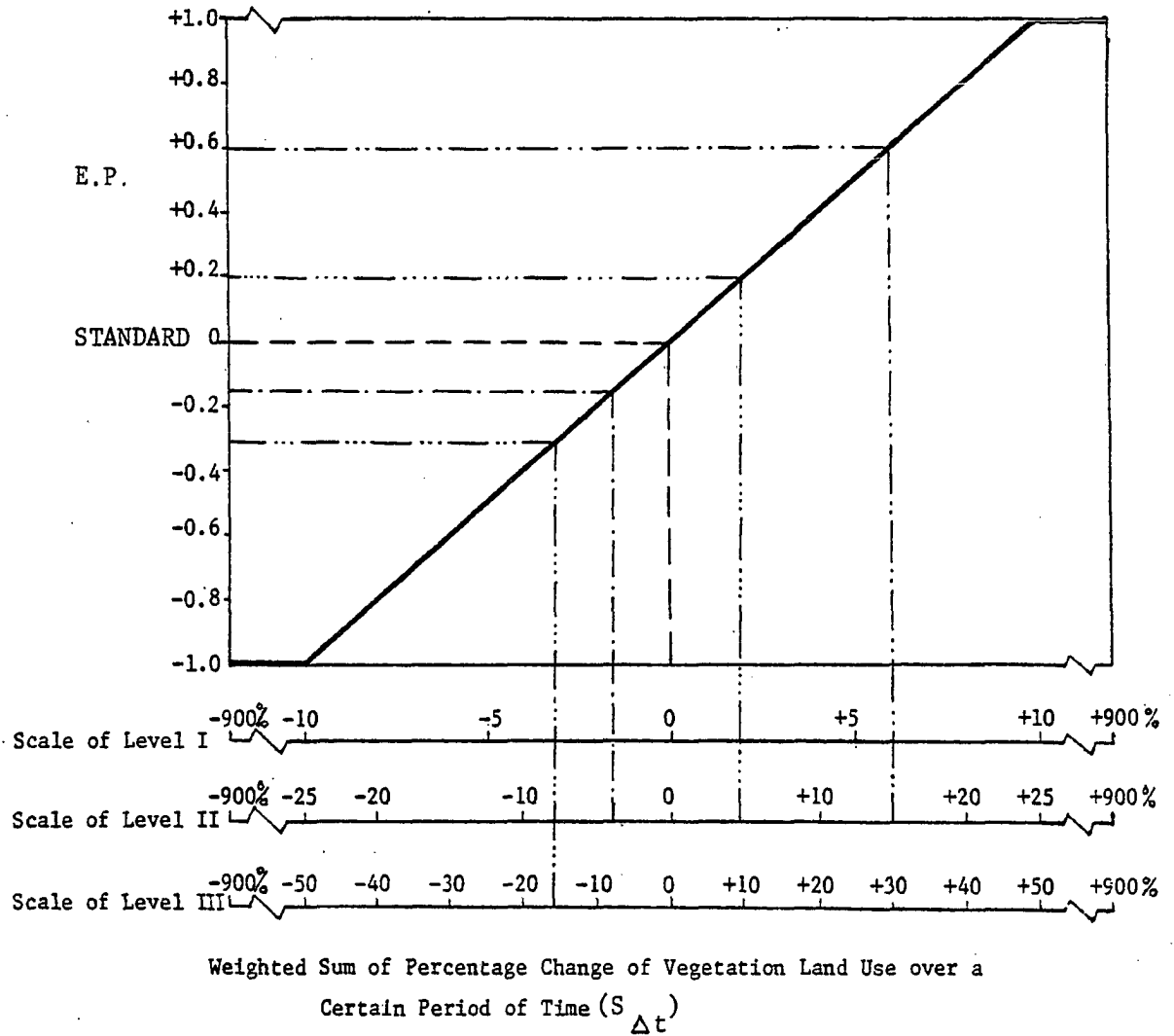

FIGURE 5-5 PARAMETER FUNCTION GRAPH OF VEGETATION LAND USE (AESTHETIC)

TABLE 5-15 ECOLOGICAL PERFORMANCE OF VEGETATION LAND USE (AESTHETIC)

| ITEM | COUNTY | Pawnee | Creek | Tulsa | Osage |
|------------------------|--------|--------|-------|-------|-------|
| | LEVEL | II | II | III | II |
| Ecological Performance | | -0.16 | +0.60 | -0.31 | +0.18 |

TABLE 5-16 DATA COLLECTED ON DYNAMIC RATIO OF FISH POPULATION

| ITEM TO BE DETERMINED | WEIGHT (lb/acre) SPECIES | YEAR | DATA | | |
|--|------------------------------------|---------------|---------------|---------------|------|
| | | | 1971 | 1972 | 1973 |
| Dynamic Ratio of Fish Population (F/C) | 1) Principal Forage Fish Species: | | | | |
| | Crappie (<4 oz or <8 inches) | 2.31# | 2.54 | 6.67# | |
| | Channel catfish (<2lb.or <18 inch) | 12.91 | 10.13 | 10.0 | |
| | Blue catfish (<3 lb or <20 inches) | 0 | 0 | 0 | |
| | Blue gill | 22.10 | 25.21 | 23.32 | |
| | Long-ear sunfish | 7.52 | 10.61 | 4.41 | |
| | Orange spotted sunfish | 2.02 | 4.24 | 2.61 | |
| | Red-ear sunfish | 0 | 0.02 | 0 | |
| | Green sunfish | 5.45 | 10.93 | 0.19 | |
| | Warmouth Carp | 1.53 54.70 | 1.67 53.22 | 6.92 51.92 | |

TABLE 5-16 DATA COLLECTED ON DYNAMIC RATIO OF FISH POPULATION (Continued)

| ITEM TO BE DETERMINED | WEIGHT (lb/acre) SPECIES | YEAR | | |
|-----------------------|--|-------------------|--------|-------------------|
| | | 1971 | 1972 | 1973 |
| | Buffalo | 98.82 | 97.89 | 32.85 |
| | Bullhead | Trace | 0.04 | 0.11 |
| | Yellow bullhead | T | 0 | 0.11 |
| | Speckled bullhead | 0 | 0 | 0 |
| | Flathead catfish (<8 lb. or <26 in.) | 8.83 ³ | 0.26 | 7.58 ³ |
| | Gizzard shad | 1175.09 | 259.31 | 611.73 |
| | Gambusia | 0 | 0 | 0.05 |
| | Goldfish | 0.05 | 0.04 | T |
| | Strump knocker | 0 | 0 | 0 |
| | Golden shiner | 0 | 0 | 0 |
| | Chub sucker | 0 | 0 | 0 |
| | Spotted sucker | 0 | 0 | 0 |
| | Eel | 0 | 0 | 0 |
| | Others ¹ | 88.31 | 77.31 | 42.49 |
| | ii) Principal Carnivorous Fish Species: | | | |
| | Large-mouth black bass | 11.28 | 2.71 | 6.54 |
| | Spotted bass | 0 | 0.12 | T |
| | Crappie (4oz. or ≥8 in.) | 1.72 ³ | 1.89 | 5.04 ³ |
| | Channel catfish (≥21b. or ≥18 in) | 8.55 | 6.71 | 6.62 |
| | Blue catfish (≥31b. or ≥20 in.) | 0 | 0 | 0 |
| | Flathead catfish (≥8 lb. or ≥26 in) | 5.88 ³ | 0 | 5.06 ³ |
| | Gar | 0.33 | T | 0.76 |
| | Pickereel | 0 | 0 | 0 |
| | Others ² | 9.04 | 13.43 | 2.18 |

¹ Primarily freshwater drum, river carpsucker, Mississippi silversides, hybrid sunfish, etc.

² Primarily striped bass, white bass, etc.

³ These data are estimated by using the ratio between "F" and "C" species of 1972 data, since the raw data of fish size distributions in 1971 and 1973 are not available.

TABLE 5-17 CALCULATION OF DYNAMIC RATIO OF FISH POPULATION

| ITEM TO BE DETERMINED | FORMULA | DATA | | |
|--|---|---------|--------|--------|
| | | 1971 | 1972 | 1973 |
| Dynamic ratio of fish population (F/C) | $a) \sum_{f=1}^{24} W_f = \text{Total weight of forage fish species}$ $= \sum_{1}^{24} (i)$ | 1479.66 | 553.43 | 800.96 |
| | $b) \sum_{c=1}^9 W_c = \text{Total weight of carnivorous fish species}$ $= \sum_{1}^9 (ii)$ | 30.80 | 24.86 | 26.20 |
| | $c) F/C = \frac{\sum_{f=1}^{24} W_f}{\sum_{c=1}^9 W_c} = \frac{(a)}{(b)}$ | 40.21 | 22.26 | 30.57 |

4.2.2.A. This is possibly because of the inadequate sampling method, i.e., based on one acre cove rotenone samples. A more satisfactory result might be obtained by measuring the fish stocks in the whole open water area directly above the sampling cove. This task of evaluating this parameter is suggested to be accomplished by other researchers who have access to other available information. The same curve as the one shown in Figure 4-5 is presented on Figure 5-6. Table 5-18 shows the E.P. values of Keystone Lake in three years. All of them are lower than the desired situation.

B. Waterfowl habitat

Sizes of the four Oklahoma counties in Mid-Arkansas River Basin are given in the Soil Survey Reports of Soil Conservation Service. Data on total land area and small water area are collected from the Oklahoma Conservation Needs Inventory Report, 1970. Table 5-19 lists all the data collected. The detailed calculations are shown in Table 5-20. The calculation of W_9 is from formula 4-8 of section 4.2.2.B. The results of the four counties vary greatly from +47.7% to -16.1%. By plotting on the graph in Figure 5-7, Creek county shows a great ecological performance (+0.64) in the M.A.R.B. region, while Tulsa does not meet the standard of non-negative percentage change. All the E.P. values are listed in Table 5-21.

C. Terrestrial fauna species diversity

The data needed to fit the regression lines of species diversity in each habitat type are sets of accumulated numbers of fauna individuals (Y) and species (X). Information of this nature for M.A.R.B. were either fragmented or inaccessible, and there seemed to be an absence of regression analysis in previous research on M.A.R.B. It is thus impossible to proceed beyond the first step of the field test. It is also not possible to determine the number of habitat type which had to be determined by the regression analysis. However, the possible habitats of all the wildlife are listed in Appendix D. The job of validation can only be accomplished by future researchers who have the access to the necessary sets of data.

D. Fauna species composition (aesthetic)

The most current data of fauna species number in each class and their occurrence in M.A.R.B. are collected by the Corps of Engineers of

Parameter Function Graph

1971 DATA: — · — · —
 1972 DATA: — · · — · —
 1973 DATA: — · · · — · —

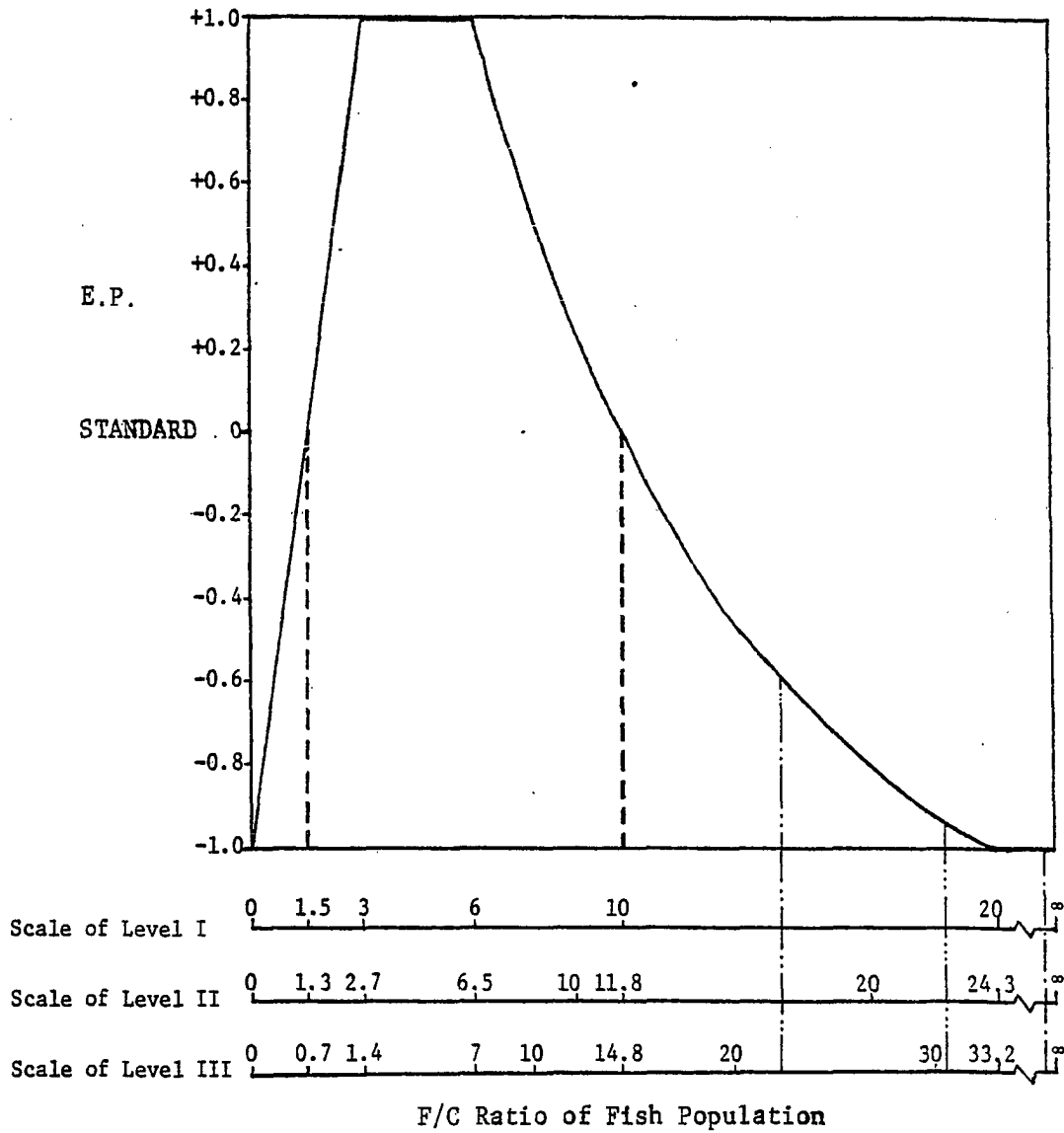

FIGURE 5-6 PARAMETER FUNCTION GRAPH OF DYNAMIC RATIO OF FISH POPULATION

TABLE 5-18 ECOLOGICAL PERFORMANCE OF DYNAMIC RATIO OF FISH POPULATION

| | YEAR | 1971 | 1972 | 1973 |
|------------------------|-------|-------|-------|-------|
| ITEM | LEVEL | III | III | III |
| Ecological Performance | | -1.00 | -0.60 | -0.94 |

TABLE 5-19 DATA COLLECTED ON WATERFOWL HABITAT

| ITEM TO BE DETERMINED | DATA | | | | |
|---|--------------------------------------|---------|---------|---------|-----------|
| | On County Basis | Pawnee | Creek | Tulsa | Osage |
| Percentage Change of Waterfowl Habitat in 9 Years (W_9) | i) County Size (acres) | 378,240 | 622,080 | 374,400 | 1,467,520 |
| | ii) Total Land Area of 1967 (acres) | 369,970 | 609,110 | 364,840 | 1,453,090 |
| | iii) Total Land Area of 1958 (acres) | 370,010 | 613,140 | 362,479 | 1,452,755 |
| | iv) Small Water Area of 1967 (acres) | 4,945 | 1,600 | 2,425 | 32,596 |
| | v) Small Water Area of 1958 (acres) | 745 | 925 | 2,368 | 32,056 |

TABLE 5-20 CALCULATION OF WATERFOWL HABITAT

| ITEM TO BE DETERMINED | FORMULA | RESULT | | | |
|---|--|-------------|------------|-------------|------------|
| | | Pawnee (II) | Creek (II) | Tulsa (III) | Osage (II) |
| Percentage Change of Waterfowl Habitat in 9 Years (W_9) | a) Large Water Area of 1967 (acres) = (i)-(ii) | 8,270 | 12,970 | 9,560 | 14,430 |
| | b) Large Water Area of 1958 (acres) = (i)-(iii) | 8,230 | 8,940 | 11,921 | 14,765 |

TABLE 5-20 CALCULATION OF WATERFOWL HABITAT (Continued)

| ITEM TO BE DETERMINED | FORMULA | RESULT | | | |
|-----------------------|--|-------------|------------|-------------|------------|
| | | Pawnee (II) | Creek (II) | Tulsa (III) | Osage (II) |
| | c) $A = \text{Total Wet Land Area of 1967 (acres)}$ $= (a) + (iv)$ | 13,215 | 14,570 | 11,985 | 47,026 |
| | d) $A_t = \text{Total Wet Land Area of 1958 (acres)}$ | 8,975 | 9,865 | 14,289 | 46,821 |
| | e) Improvement of Wet Land in 9 years $= (c) - (d)$ | +4,240 | +4,705 | -2,304 | +205 |
| | f) $W_9 = \text{\% Change of Wet Land in 9 Years}$ $= (e) / (d)$ | +47.2% | +47.7% | -16.1% | +0.4% |
| | $= \frac{A_o - A_t}{A_t} \times 100\%$ $= \frac{(iii) - (v) - (ii) + (iv)}{(i) - (iii) + (v)} \times 100\%$ | | | | |

Parameter Function Graph:

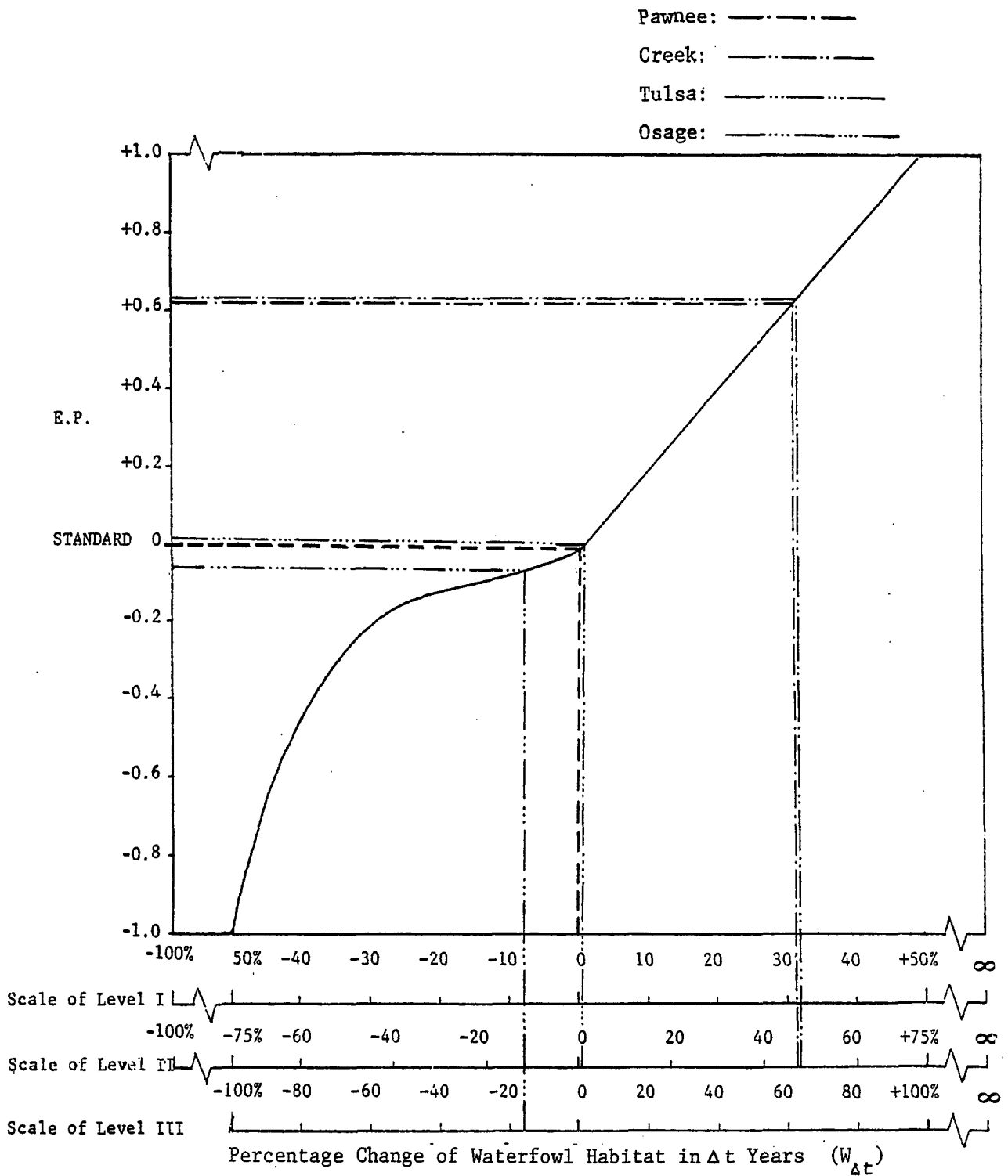

FIGURE 5-7 PARAMETER FUNCTION GRAPH OF WATERFOWL HABITAT

TABLE 5-21 ECOLOGICAL PERFORMANCE OF WATERFOWL HABITAT

| Item | County | Pawnee | Creek | Tulsa | Osage |
|------------------------|--------|--------|-------|-------|-------|
| | Level | II | II | III | II |
| Ecological Performance | | +0.63 | +0.64 | -0.05 | +0.01 |

TABLE 5-22 DATA COLLECTED (ON RIVER-BASIN BASIS) ON FAUNA SPECIES COMPOSITION (AESTHETIC)

| Fauna Class, No. of Species (S_{tjk}) | Occurrence (M_j) | | Total ($M_1=10$) | | Common ($M_2=3$) | | Occasional ($M_3=2$) | | Rare ($M_4=1$) | |
|---|----------------------|-----------|--------------------|-----------|--------------------|-----------|------------------------|-----------|------------------|-------|
| | Year (t) | | Current | Dated | Current | Dated | Current | Dated | Current | Dated |
| | | | | | | | | | | |
| Mammals ($A_k=5$) | 56 | S_{t11} | 26 | S_{t21} | 25 | S_{t31} | 5 | S_{t41} | | |
| Birds ($A_k=4$) | 288 | S_{t12} | 130 | S_{t22} | 106 | S_{t32} | 52 | S_{t42} | | |
| Fishes ($A_k=3$) | 77 | S_{t13} | 26 | S_{t23} | 26 | S_{t33} | 25 | S_{t43} | | |
| Reptiles ($A_k=2$) | 45 | S_{t14} | 11 | S_{t24} | 29 | S_{t34} | 5 | S_{t44} | | |
| Amphibians ($A_k=1$) | 19 | S_{t15} | 6 | S_{t25} | 11 | S_{t35} | 2 | S_{t45} | | |

the Tulsa District (see Appendix D). But earlier data, 10 or 20 years into the past, were not available. This crippled the field test on this parameter because necessary processes like calculation and plotting of parameter function graph were impossible. Table 5-22 contains data collected thus far, future researchers may use actual data to complete this task.

5.4.3 Biota

A. Pest species

The acreage on which agriculture chemicals are used to control various categories of pests, the total acreage where pests species may inhabit, and the expenses of chemicals used for insect control on animals are all collected from USDA Census of Agriculture, 1964 and 1969. The complete set of required data are shown in Table 5-23. Formulas 4-12, 4-13 and 4-14 are used in the calculations of percentage change of pest species infestation over five years, which are shown in Table 5-24. All the results in four counties show the increase of infested land area and animals. It can be seen from Figure 5-8 that all the four counties are below standards. The ecological performances of the four counties are listed in Table 5-25.

B. Utilization of carrying capacity

The estimated net grass production, the amount of grassland requirements of each animal unit, the existing acreage of grazing area, and the total number of animal units occurring in the study region are all used to evaluate the utilization of carrying capacity of the land. Data collected from USDA Census of Agriculture, 1969, and Oklahoma Conservation Needs Inventory Report, 1970, are shown in Table 5-26. The animal listed in the (vi) row of item (4) is only the deer estimate. The population of rabbits or other grazers is not available in this study region. Five formulas, i.e., from 4-15 to 4-19, are used in the calculations of utilization of carrying capacity. All the calculations are shown in Table 5-27. The results from the four counties are very close to each other and all are in the intervals of standard (see Section

TABLE 5-23 DATA COLLECTED ON PEST SPECIES

| ITEM TO BE DETERMINED | On County Basis | DATA | | | | | | | |
|--------------------------------|---|-------------|---------|-----------|---------|-------------|---------|-------------|-----------|
| | | Pawnee | | Creek | | Tulsa | | Osage | |
| | | 1964 | 1969 | 1964 | 1969 | 1964 | 1969 | 1964 | 1969 |
| (1) Plant Weeds in Crops | (i) Acreage of harvested cropland in Class 1-5 Farms | 44,107 | | 18,206 | | 30,961 | | 68,682 | |
| | (ii) Acreage on which agricultural chemicals are used to control weeds or grass in crops | | 43,390 | | 18,199 | | 38,146 | | 70,977 |
| (2) Plant Weeds in Pasture | (iii) Acreage of total pastureland (all types) in Class 1-5 Farms | 198,973 | | 213,185 | | 86,731 | | 1,044,027 | |
| | (iv) Acreage on which agricultural chemicals are used to control weeds or brush in pasture | | 230,277 | | 241,435 | | 100,506 | | 1,055,058 |
| (3) Plant Diseases | (v) Same as (i) | | | | | | | | |
| | (vi) Acreage on which agricultural chemicals are used to control diseases in crops and orchards | 215 | | 10 | | 74 | | 128 | |
| (4) Animal pests on Crops | (vii) Same as (i) | | | | | | | | |
| | (viii) Acreage on which agricultural chemicals are used to control insects on other crops | | | | 257 | 212 | | | 18 |
| (5) Animal Pests on Hay Crops | (ix) Acreage of cropland used only for pasture or grazing in Class 1-5 Farms | | | | | | | | |
| | (x) Acreage on which agricultural chemicals are used to control insects on hay crops | | 408 | | 213 | 2,042 | | | 1,932 |
| (6) Animal Diseases & Carriers | (xi) Class 1-5 farm production expenses (\$) on feed for livestock and poultry | 55,962 | | 54,135 | | 36,867 | | 160,755 | |
| | (xii) Farm expenses (\$) on agricultural chemicals for insect control on livestock and poultry | \$1,177,648 | | \$941,892 | | \$1,085,926 | | \$3,288,663 | |
| | | 38,871 | | 37,983 | | 22,569 | | 138,889 | |
| | | \$10,966 | | \$3,848 | | \$4,885 | | \$26,232 | |

TABLE 5-24 CALCULATION OF PEST SPECIES

| ITEM TO BE DETERMINED | CATEGORY | FORMULA | RESULT | | | | | | | |
|--|---|---|---------|--------|---------|--------|----------|--------|---------|--------|
| | | | Pawnee | | Creek | | Tulsa | | Osage | |
| | | | 1964 | 1969 | 1964 | 1969 | 1964 | 1969 | 1964 | 1969 |
| 1) & 2) Total Percent- age of Area Infested by Various Pest Species in 1964 & 1969 (S ₅ & S _o) | (1) Plant Weeds in Crops | $\frac{P_1}{T_1} = \frac{(ii)}{(i)}$ | 0.0146 | 0.0566 | 0.0364 | 0.0319 | 0.0422 | 0.1394 | 0.0354 | 0.0590 |
| | (2) Plant Weeds in Pasture | $\frac{P_2}{T_2} = \frac{(iv)}{(iii)}$ | 0.0064 | 0.0041 | 0.0183 | 0.0055 | 0.0306 | 0.0066 | 0.0047 | 0.0244 |
| | (3) Plant Diseases | $\frac{P_3}{T_3} = \frac{(vi)}{(v)}$ | 0.0049 | — | 0.0005 | 0.0141 | 0.0024 | 0.0056 | 0.0019 | 0.0003 |
| | (4) Animal Pests on Crops | $\frac{P_4}{T_4} = \frac{(viii)}{(vii)}$ | — | 0.0113 | — | 0.0117 | — | 0.0535 | — | 0.0272 |
| | (5) Animal Pests on Hay Crops | $\frac{P_5}{T_5} = \frac{(x)}{(ix)}$ | 0.0203 | 0.0010 | — | 0.0001 | 0.0216 | 0.0058 | 0.0372 | 0.0021 |
| | (6) Animal Deseases & Carriers* | $\frac{P_6}{T_6} = \frac{(xii)}{(xi)}$ | 0.6946 | 0.0093 | 0.7016 | 0.0041 | 0.6122 | 0.0045 | 0.8640 | 0.0080 |
| | | $S_5 = \sum_{i=1}^6 \frac{P_{i5}}{T_{i5}} \times 100\%$ | 4.62% | | 5.52% | | 9.68% | | 7.92% | |
| | $S_o = \sum_{i=1}^6 \frac{P_{io}}{T_{io}} \times 100\%$ | | 7.30% | | 6.33% | | 21.09% | | 11.30% | |
| 3) Percentage Change of Pest Species Infesta- tion over 5 years (C ₅) | | $C_5 = \frac{S_o - S_5}{S_5} \times 100\%$ | +58.01% | | +14.67% | | +117.87% | | +42.68% | |

* These figures are not counted since the data are not comparable.

Parameter Function Graph

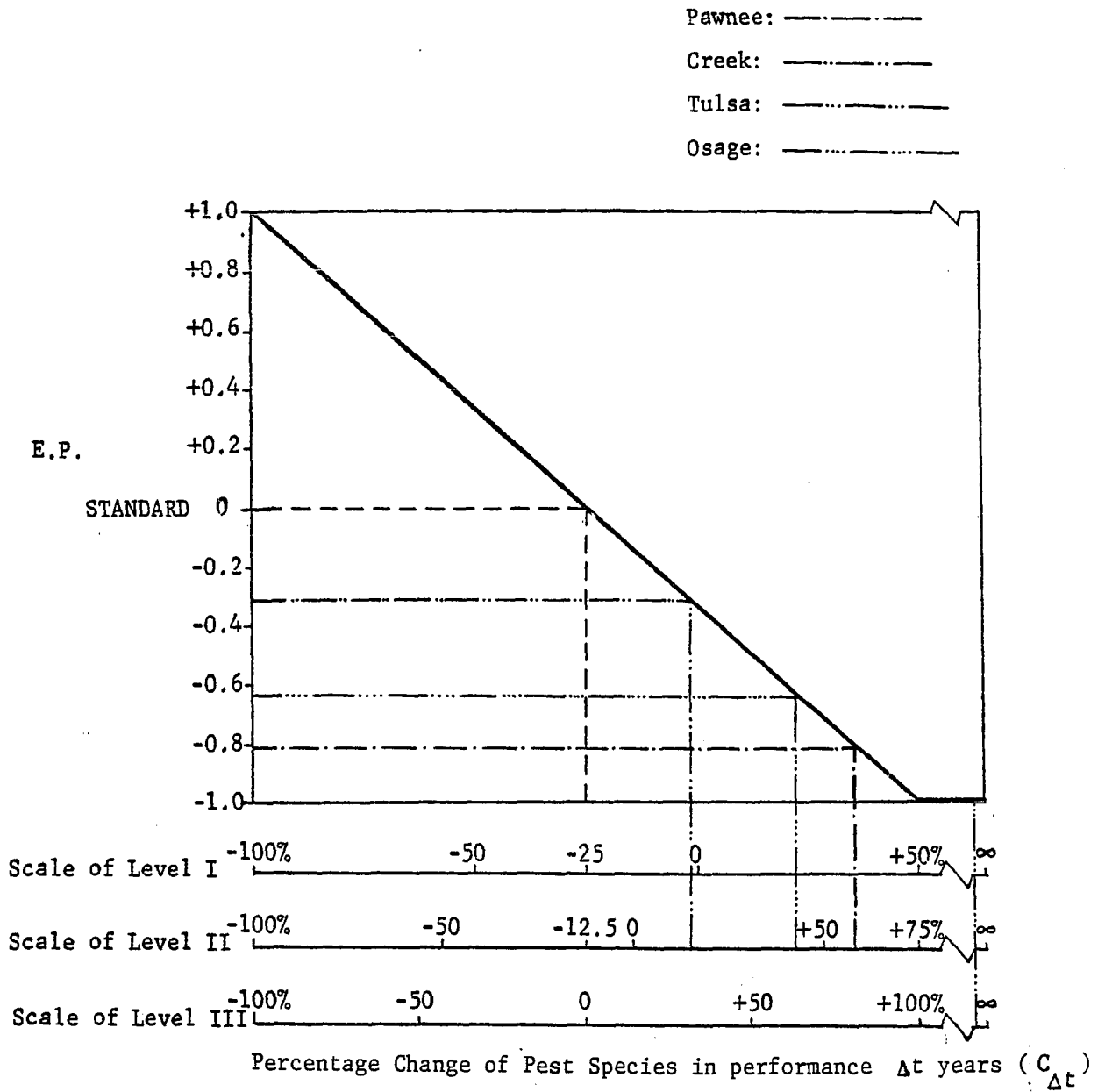

FIGURE 5-8 PARAMETER FUNCTION GRAPH OF PEST SPECIES

TABLE 5-25 ECOLOGICAL PERFORMANCE OF PEST SPECIES

| ITEM | COUNTY | Pawnee | Creek | Tulsa | Osage |
|------------------------|--------|--------|-------|-------|-------|
| | LEVEL | II | II | III | II |
| Ecological Pergormance | | -0.81 | -0.31 | -1.00 | -0.63 |

TABLE 5-26 DATA COLLECTED ON UTILIZATION OF CARRYING CAPACITY

| ITEM TO BE DETERMINED | D A T A | | | | |
|-------------------------------------|---|----------------------|---------------------|----------------------|----------------------|
| | (On County Basis) | Pawnee | Creek | Tulsa | Osage |
| 1) Estimated net hay production (P) | (i) Acreage of hay harvested (excluding sorghum hay) in all farms of 1969 | 14,240 | 16,898 | 19,380 | 35,145 |
| | (ii) Amount of hay harvested (excluding sorghum hay) in all farms of 1969 (lbs) | 5.35x10 ⁷ | 5.5x10 ⁷ | 8.29x10 ⁷ | 1.25x10 ⁸ |
| 2) Supporting ratio(S) | | | | | |
| 3) Carrying capacity (C) | (iii) Total Acreage of pasture land and rangeland of 1967 | 192,844 | 267,005 | 148,260 | 784,545 |
| 4) Total animal units occurring | (iv) Number of cattle and calves in all farms of 1969 | 54,143 | 45,027 | 30,997 | 156,227 |
| | (v) Number of horses and ponies in all farms of 1969. | 889 | 2,229 | 2,372 | 2,372 |
| | (vi) Number of sheep and lambs in all farms of 1969 | 636 | 153 | 227 | 646 |
| | (vii) Estimated number of other grazers in the county*: | | | | |
| | deer of 1974 | 524 | 1,470 | 42 | 3,280 |
| | rabbit of 1974 | N.A. | N.A. | N.A. | N.A. |
| | | | | | |

187

*Oklahoma State Department of Wildlife Conservation estimated actual number of deer to be about ten times the reported deer kills.

TABLE 5-27 CALCULATION OF UTILIZATION OF CARRYING CAPACITY

| ITEM TO BE DETERMINED | FORMULA | Result | | | |
|---|---|----------------|---------------|----------------|---------------|
| | | Pawnee (II) | Creek (II) | Tulsa (III) | Osage (II) |
| 1) Estimated net hay production (lbs/acre/year) | $P = (ii)/(i)$ | 3,759 | 3,257 | 4,276 | 3,549 |
| 2) Supporting ratio (Acres/A.U./year) | $S = 9,600/2P$ | 1.28 | 1.47 | 1.12 | 1.35 |
| 3) Carrying capacity (A.U.) | $C = (iii)/S$ | 150,660 | 181,636 | 132,375 | 581,145 |
| 4) Total animal units occurring (A.U.) | $N = (iv) + (v) \times 1.28 + (vi) \times 0.06 + (vii) \times 0.03$ | 55,335 | 47,934 | 34,048 | 159,400 |
| 5) Utilization of carrying capacity | $U = \frac{N}{C} \times 100\%$ | 36.7% | 26.4% | 25.7% | 27.4% |

4.2.3.B.). But none of them falls in the optimal utilization range. The parameter function graph and ecological performances are shown in Figure 5-9 and Table 5-28, respectively.

C. Terrestrial food web

Data on the number of terrestrial animal species with their respective occurrence in each animal class in the Mid-Arkansas River Basin are derived from the previous study on the Mid-Arkansas Region by the Corps of Engineers (see Appendix D). One of the major reasons of applying this parameter to the whole river basin, instead of separate counties, is that the animal species data of individual counties are not available. Another limitation is that these data are dynamic rather than static. Therefore, a larger sampling area is necessary for obtaining more accurate information. Trophic level and diet of each species are compiled from various animal handbooks (40). Table 5-29 shows the data collected. As shown on Table 5-30, the terrestrial food web index for entire M.A.R.B. is calculated to be 74.9%. The E.P. is above the standard (see Figure 5-10 and Table 5-31).

D. Aquatic food web

Data on the number of aquatic animal species with their respective occurrence in each animal class in the Mid-Arkansas River Basin are derived from the previous study by the Corps of Engineers (see Appendix D). The reasons for selecting the whole river basin as the basis of data collection are the same as the ones described in the terrestrial food web parameter. Trophic level and diet of each aquatic species are compiled from various animal handbooks (40). Table 5-32 shows the data collected. The result from Table 5-33 is 71.7%. It is slightly lower than the terrestrial food web index, but large enough to be located in the optimal E.P. region (see Figure 5-11 and Table 5-34).

5.5 Summary of the Field Test Results

The ecological performances of the twelve parameters presented above are summarized in Table 5-35. Among the twelve parameters, six are tested by counties, three by the whole M.A.R.B. region. The remain-

Parameter Function Graph

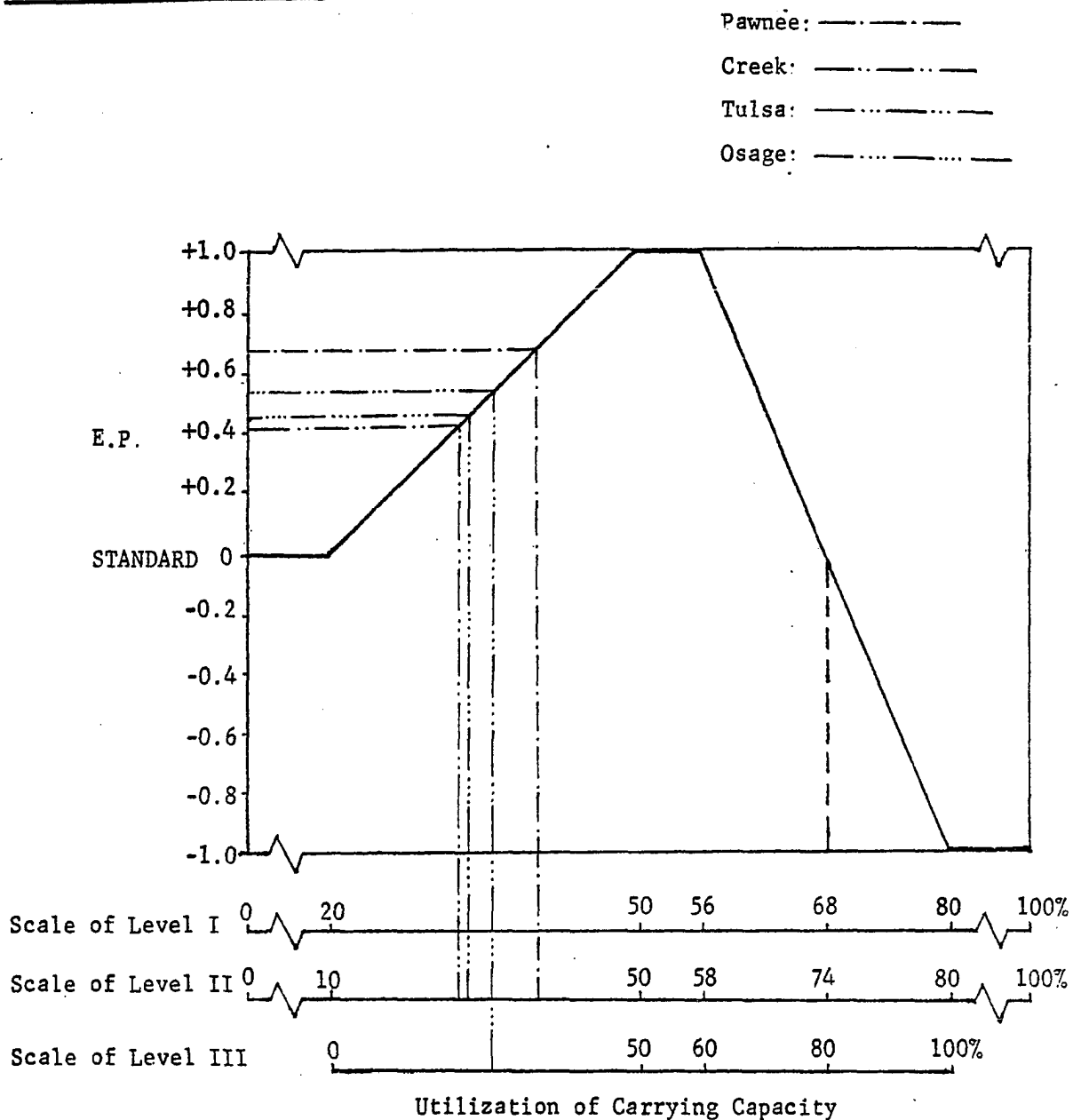

FIGURE 5-9 PARAMETER FUNCTION GRAPH OF UTILIZATION OF CARRYING CAPACITY

TABLE 5-28. ECOLOGICAL PERFORMANCE OF UTILIZATION OF CARRYING CAPACITY

| ITEM | COUNTY | Pawnee | Creek | Tulsa | Osage |
|------------------------|--------|--------|-------|-------|-------|
| | LEVEL | II | II | III | II |
| Ecological Performance | | +0.67 | +0.41 | +0.51 | +0.44 |

TABLE 5-29 DATA COLLECTED (ON RIVER-BASIN BASIS) ON TERRESTRIAL FOOD WEB

| Trophic Level (L_i) Occurrence (R_j) # of Species s_{ijk} Animal class $k=1-4$ | Primary Consumers ($L_1=0.33$) | | | Secondary Consumers ($L_2=0.67$) | | | Tertiary Consumers ($L_3=1.00$) | | |
|---|-------------------------------------|-----------------|-------------|---------------------------------------|-----------------|-------------|--------------------------------------|-----------------|-------------|
| | Common | Occa- sional | Rare | Common | Occa- sional | Rare | Common | Occa- sional | Rare |
| | ($R_1=100$) | ($R_2=10$) | ($R_3=1$) | ($R_1=100$) | ($R_2=10$) | ($R_3=1$) | ($R_1=100$) | ($R_2=10$) | ($R_3=1$) |
| Terrestrial Amphibians ($k=1$) | 0 | 0 | 0 | 6 | 11 | 1 | 1 | 4 | 0 |
| Terrestrial Reptiles ($k=2$) | 0 | 0 | 0 | 7 | 11 | 3 | 16 | 16 | 4 |
| Birds ($k=3$) | 2 | 3 | 1 | 94 | 45 | 35 | 35 | 59 | 16 |
| Mammals ($k=4$) | 11 | 7 | 0 | 11 | 11 | 3 | 4 | 7 | 2 |

TABLE 5-30 CALCULATION OF TERRESTRIAL FOOD WEB.

| TROPIC LEVEL (L_i) Occurrence Result FORMULA | Primary Consumers ($L_1=0.33$) | | | | Secondary Consumers ($L_2=0.67$) | | | | Tertiary Consumers ($L_3=1.00$) | | | |
|---|-------------------------------------|-------------------|------------------|---------------------------------|---------------------------------------|-------------------|------------------|---------------------------------|--------------------------------------|-------------------|------------------|---------------------------------|
| | C ($R_1=100$) | O ($R_2=10$) | R ($R_3=1$) | $\sum_{j=1}^3 T_{1j} \cdot R_j$ | C ($R_1=100$) | O ($R_2=10$) | R ($R_3=1$) | $\sum_{j=1}^3 T_{2j} \cdot R_j$ | C ($R_1=100$) | O ($R_2=10$) | R ($R_3=1$) | $\sum_{j=1}^3 T_{3j} \cdot R_j$ |
| 1) Total # Animal Species $T_{ij} = \sum_{k=1}^4 S_{ijk}$ | 13 | 10 | 1 | 1,401 | 118 | 78 | 42 | 12,622 | 56 | 86 | 22 | 6,482 |
| 2) Weighted # Animal Species $T_{ij} \cdot L_i \cdot R_j$ | 433.3 | 33.3 | 0.3 | | 7,866.7 | 520 | 28 | | 5,600 | 860 | 22 | |
| $\sum_{j=1}^3 (T_{ij} \cdot L_i \cdot R_j)$ | 466.9 | | | | 8,414.7 | | | | 6,482 | | | |
| Total Weighted # Animal Species $W = \sum_{i=1}^3 \sum_{j=1}^3 (T_{ij} \cdot L_i \cdot R_j)$ | | | | | | | | | 15,364 | | | |
| 3) Total # Species Modified by the Occurrence $V = \sum_{i=1}^3 \sum_{j=1}^3 (T_{ij} \cdot R_j)$ | | | | | | | | | 20,505 | | | |
| 4) Food Web Index (F) $F = \frac{W}{V} \times 100\%$ | | | | | | | | | 74.9% | | | |

Parameter Function Graph

Mid-Arkansas River Basin

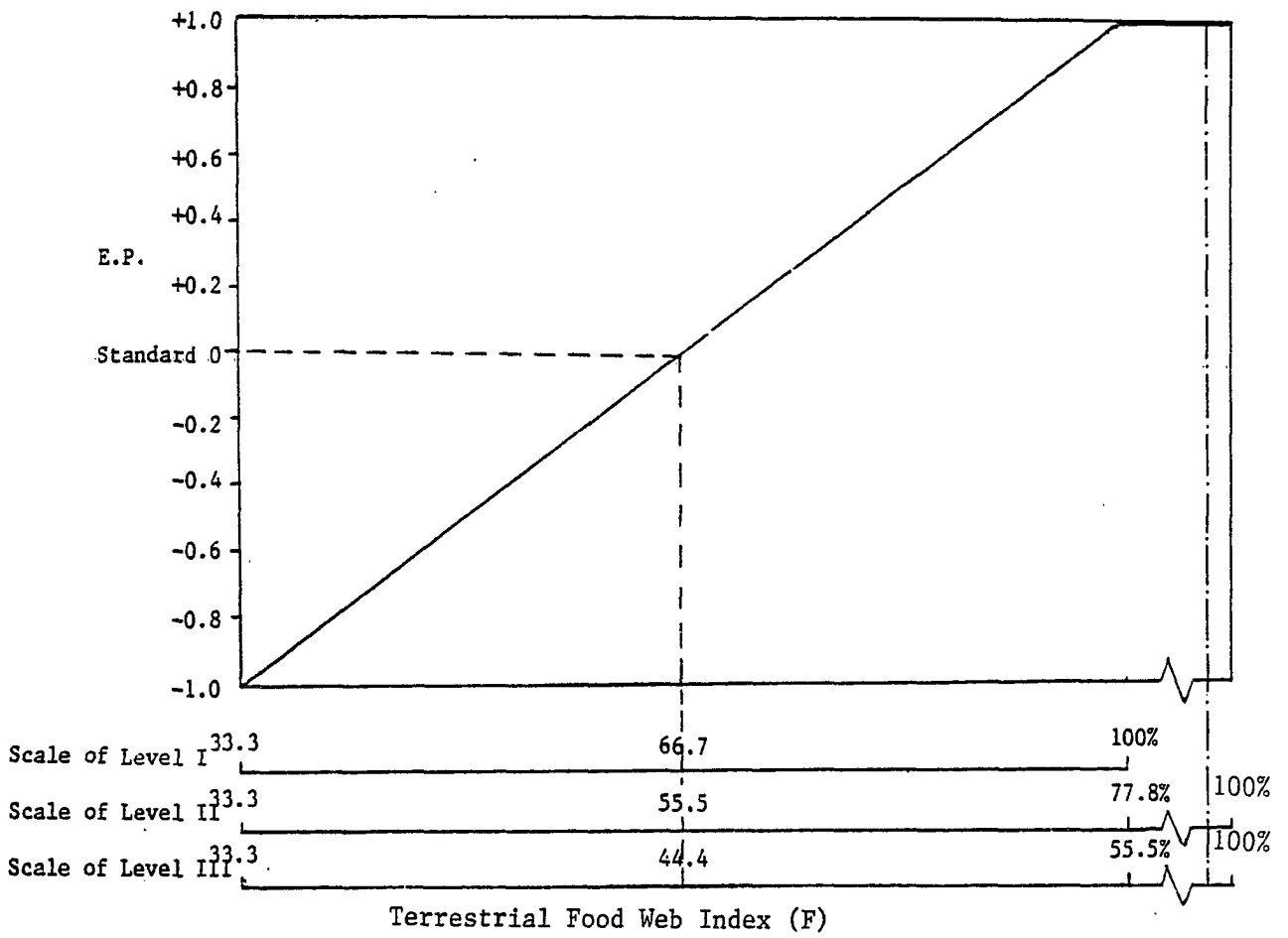

FIGURE 5-10 PARAMETER FUNCTION GRAPH OF TERRESTRIAL FOOD WEB

TABLE 5-31 ECOLOGICAL PERFORMANCE OF TERRESTRIAL FOOD WEB

| REGION | Mid-Arkansas River Basin |
|------------------------|--------------------------|
| ITEM | LEVEL III |
| Ecological Performance | +1.0 |

TABLE 5-32 DATA COLLECTED (ON RIVER-BASIN BASIS) ON AQUATIC FOOD WEB

| Trophic Level (L_i) No. of Occurrences (S_{ijk}) Species (R_j) Animal Class $k=1\sim 6$ | Primary Consumers ($L_1=0.33$) | | | Secondary Consumers ($L_2=0.67$) | | | Tertiary Consumers ($L_3=1.00$) | | |
|---|-------------------------------------|---------------------------------|---------------------|---------------------------------------|---------------------------------|---------------------|--------------------------------------|---------------------------------|---------------------|
| | Common ($R_1=100$) | Occa- sional ($R_2=10$) | Rare ($R_3=1$) | Common ($R_1=100$) | Occa- sional ($R_2=10$) | Rare ($R_3=1$) | Common ($R_1=100$) | Occa- sional ($R_2=10$) | Rare ($R_3=1$) |
| | Amphibians ($k=1$) | 0 | 0 | 0 | 2 | 3 | 0 | 1 | 3 |
| Reptiles ($k=2$) | 0 | 0 | 0 | 3 | 5 | 1 | 5 | 6 | 0 |
| Birds ($k=3$) | 1 | 1 | 1 | 21 | 16 | 9 | 9 | 25 | 5 |
| Mammals ($k=4$) | 0 | 0 | 0 | 2 | 0 | 0 | 2 | 2 | 0 |
| Naiads ($k=5$) | 13 | 8 | 7 | 0 | 0 | 0 | 0 | 0 | 0 |
| Fishes ($k=6$) | 0 | 0 | 0 | 30 | 22 | 27 | 10 | 6 | 5 |

TABLE 5-33 CALCULATION OF AQUATIC FOOD WEB

| TROPIC LEVEL (L_i) Occurrence Result | Primary Consumers ($L_1=0.33$) | | | | Secondary Consumers ($L_2=0.67$) | | | | Tertiary Consumers ($L_3=1.00$) | | | |
|--|--|-------------------|------------------|-----------------------------|---------------------------------------|-------------------|------------------|-----------------------------|--------------------------------------|-------------------|------------------|-----------------------------|
| | C ($R_1=100$) | O ($R_2=10$) | R ($R_3=1$) | $\sum_1^3 T_{1j} \cdot R_j$ | C ($R_1=100$) | O ($R_2=10$) | R ($R_3=1$) | $\sum_1^3 T_{2j} \cdot R_j$ | C ($R_1=100$) | O ($R_2=10$) | R ($R_3=1$) | $\sum_1^3 T_{3j} \cdot R_j$ |
| FORMULA | | | | | | | | | | | | |
| 1) Total # Animal Species $T_{ij} = \sum_{k=1}^4 S_{ijk}$ | 14 | 9 | 8 | 1,498 | 58 | 46 | 37 | 6,297 | 27 | 42 | 10 | 3,130 |
| 2) Weighted # Animal Species $T_{ij} \cdot L_i \cdot R_j$ | 466.7 | 30 | 2.7 | | 3,866.7 | 306.7 | 24.7 | | 2,700 | 420 | 10 | |
| $\sum_{j=1}^3 (T_{ij} \cdot L_i \cdot R_j)$ | 499.4 | | | | 4,198 | | | | 3,130 | | | |
| Total Weighted # Animal Species | $W = \sum_{i=1}^3 \sum_{j=1}^3 (T_{ij} \cdot L_i \cdot R_j)$ | | | | 7,827.4 | | | | | | | |
| 3) Total # Species Modified by the Occurrence | $V = \sum_{i=1}^3 \sum_{j=1}^3 (T_{ij} \cdot R_j)$ | | | | 10,925 | | | | | | | |
| 4) Food Web Index | $F = \frac{W}{V} \times 100\%$ | | | | 71.7% | | | | | | | |

Parameter Function Graph

Mid-Arkansas River Basin — — — — —

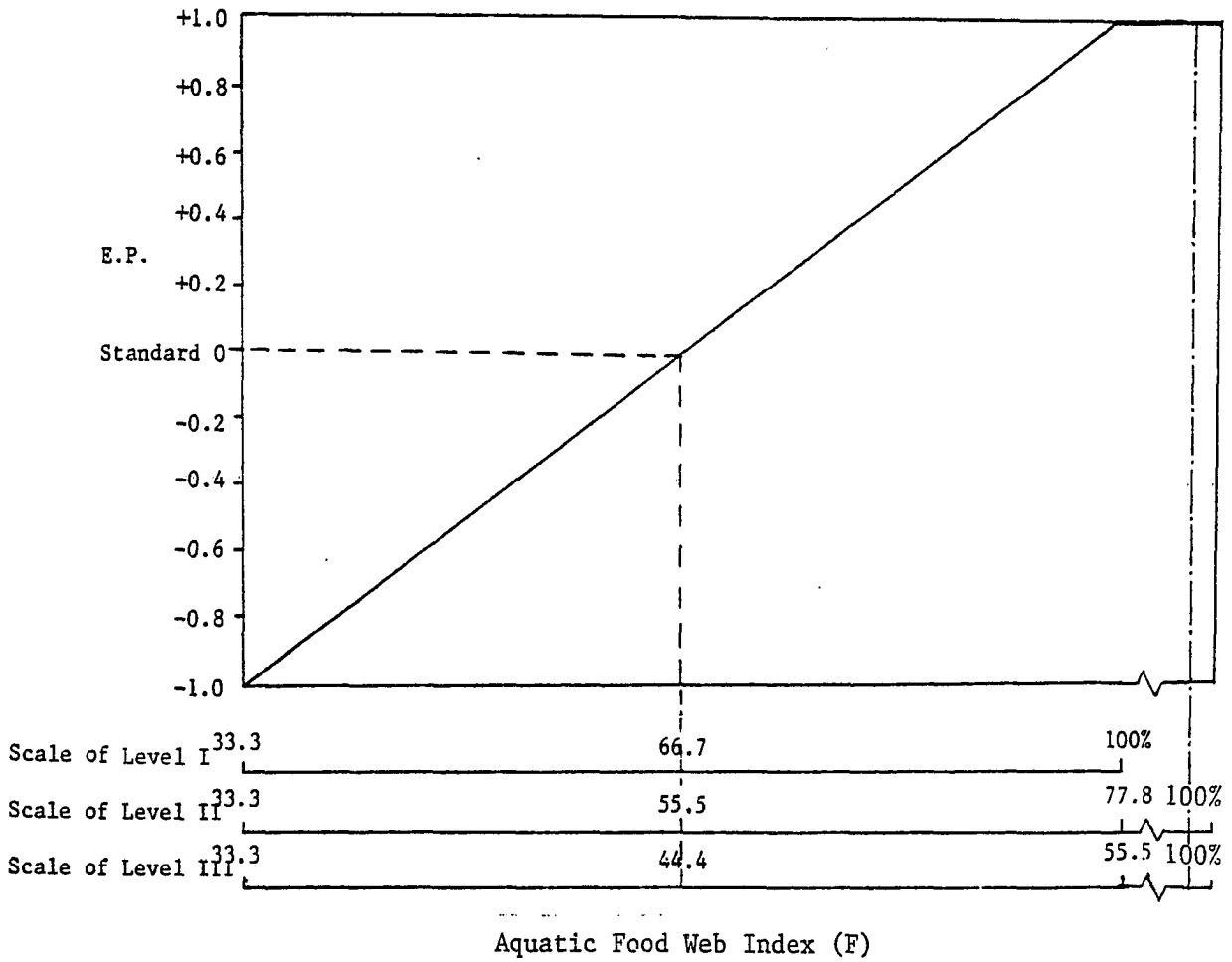

FIGURE 5-11 PARAMETER FUNCTION GRAPH OF AQUATIC FOOD WEB

TABLE 5-34 ECOLOGICAL PERFORMANCE OF AQUATIC FOOD WEB

| | |
|------------------------|------------------------------------|
| ITEM | REGION Mid-Arkansas River Basin |
| | LEVEL III |
| Ecological Performance | +1.0 |

TABLE 5-35 SUMMARY OF ECOLOGICAL PERFORMANCES OF MID-ARKANSAS RIVER BASIN

| RESULT PARAMETER | STUDY AREA | The Whole M.A.R.B Area | Pawnee | Creek | Tulsa | Osage |
|---|------------|-------------------------------------|--------|-------|-------|-------|
| | LEVEL | III | II | II | III | II |
| <u>Flora</u> | | | | | | |
| a. Terrestrial Natural Vegetation | | | -0.02 | -0.08 | -0.09 | -0.05 |
| b. Productivity of Aquatic Flora | | | - | - | - | - |
| c. Terrestrial Flora Species Diversity | | | -0.18 | -0.39 | +0.29 | -0.28 |
| d. Vegetation Land Use (Aesthetic) | | | -0.16 | +0.60 | -0.31 | +0.18 |
| <u>Fauna</u> | | | | | | |
| a. Dynamic Ratio of Fish Population | | -1.00(71) -0.60(72) -0.94(73) | | | | |
| b. Waterfowl Habitat | | | +0.63 | +0.64 | -0.05 | +0.01 |
| c. Terrestrial Fauna Species Diversity | | | - | - | - | - |
| d. Fauna Species Composition (Aesthetic) | | | - | - | - | - |
| <u>Biota</u> | | | | | | |
| a. Pest Species | | | -0.81 | -0.31 | -1.00 | -0.63 |
| b. Utilization of Carrying Capacity (Terrestrial) | | | +0.67 | +0.41 | +0.51 | +0.44 |
| c. Terrestrial Food Web | | +1.0 | | | | |
| d. Aquatic Food Web | | +1.0 | | | | |

ing three parameters are either partially tested or not tested at all because of the unavailability of the required data at the present.

CHAPTER VI

SUMMARY AND CONCLUSIONS

The methodology developed in this research is one of the pioneer efforts in formulating the ecological standards. Its development is based on the best information, and it allows criticism, future studies, and experience to lead to amendments, substitutions and modifications.

In this concluding chapter, a summary of the methodology is first presented; and then, two major areas are discussed, namely, limitations and recommendations.

6.1 Summary

Two steps were undertaken in this research to establish ecological standards. The first one is the categorization of development levels of natural environment by measuring specific socio-economic factors which are capable of delineating the human modification of the ecological system. The second one is the development of the ecological standards in response to various development levels so as to reflect the human influence on the ecological system.

Three levels of development were identified in this study to represent the environmental condition of the region under consideration. The least disturbed environments are designated as level I areas. A level I area is assigned the strictest ecological standards in order to preserve the area for the enhancement and protection of wildlife and flora communities. The level II areas are designated by an intermediate level of human involvement in the ecological communities. The standards for the level II area are designed to allow more human interaction in the environment. Areas where large concentrations of population are located are designated as level III environments and the standards applied to these areas should be more tolerant of pollutants in the ecological systems.

Four socio-economic indicators were proposed to quantitatively measure the degree of human involvement in the natural environment: inhabitation index, land value, intensity of water use, and transportation facility. Inhabitation index is an indicator that explains the development level in terms of population size and settlement pattern. It is defined as the result of total population density multiplied by rural population density. Average land value (in dollars per acre) is a significant indicator of the development level of a region because the higher the development level, the more people compete for land, thus, giving rise to higher land values. The indicator of intensity of water use is expressed in terms of domestic, municipal and industrial water use (in acre-feet/sq mile-year). Because the inadequacy of transportation facilities presents great limitations to land resources development, transportation facilities (miles of streets and highways per acre) can be a significant indicator.

It is not intended that these four indicators be exhaustive; users should feel free to employ additional indicators for their study area. All the estimates of the indicator are transformed into their corresponding indicator performance level by comparing it with the maximum value in the region. They are then weighted in proportion to their relative importance. The relative weights assigned to the four indicators are as follows:

| <u>Indicator</u> | <u>Relative Weight</u> |
|---------------------------|------------------------|
| Inhabitation index | 5 |
| Land value | 4 |
| Intensity of water use | 3 |
| Transportation facilities | 3 |

The indicator performance levels are multiplied by their relative weights to obtain the weighted indicator performance levels which are then summed to obtain the development level estimates. The cutoff points on these development level estimates are determined to differentiate level I, II, and III regions.

Twelve parameters were employed to assess the ecological performance of the natural environment. For each parameter, a parameter function graph was developed, which illustrates the relationship between the parameter estimate (X-axis) and ecological performance (Y-axis). A measuring scale was set up to determine how well each parameter performs. This scale ranges from -1 to 0 and from 0 to +1. A zero value is designated as the standard value, while -1 and +1 represent the extremely poor and excellent performances respectively.

Three different scales (X-axis) were proportionally developed for each of the twelve parameters reflecting the three levels of restriction. Formulas were also developed for calculating the parameter estimates. The parameter estimate obtained can be applied to the appropriate scale of a study region whose level of development was previously determined from its socio-economic evaluation. By interpolation, the ecological performance of a parameter in a study region can be derived. If the ecological performance is ≥ 0 , it is meeting or above the standards. Table 6-1 is a summary of the ecological standards developed by this research.

The validation of the methodology is accomplished by using data from the Mid-Arkansas River Basin, including Pawnee, Creek, Tulsa, and Osage counties of Oklahoma.

A unique and significant feature of this study is the combination of both socio-economic and environmental considerations in the

TABLE 6-1 SUMMARY OF PROPOSED ECOLOGICAL STANDARDS

| Ecological Parameter | Level | | |
|--|------------------|------------|------------|
| | I | II | III |
| <u>FLORA</u> | | | |
| a. Terrestrial natural vegetation | NPC ¹ | NPC | NPC |
| b. Productivity of aquatic flora | ≤1,200 | ≤2,400 | ≤3,900 |
| c. Terrestrial flora species diversity | ≥30.5 | ≥23.0 | ≥15.5 |
| d. Vegetation land use (aesthetic) | NPC | NPC | NPC |
| <u>FAUNA</u> | | | |
| a. Dynamic ratio of fish population | 1.5 - 10 | 1.3 - 11.8 | 0.7 - 14.8 |
| b. Waterfowl habitat | NPC | NPC | NPC |
| c. Terrestrial fauna species diversity | ≥30.5 | ≥23.0 | ≥15.5 |
| d. Fauna species composition (aesthetic) | NPC | NPC | NPC |
| <u>BIOTA</u> | | | |
| a. Pest species | ≤-25% | ≤-12.5% | ≤0% |
| b. Utilization of carrying capacity | ≤68% | ≤74% | ≤80% |
| c. Terrestrial food web | ≥66.7% | ≥55.5% | ≥44.4% |
| d. Aquatic food web | ≥66.7% | ≥55.5% | ≥44.4% |

¹NPC = Non-Negative Percentage Change

evaluation of the ecological system. The potential applications of the standards developed are as follows:

(1) The standards will add a new and useful dimension to the decision-making process of water resources development planning. Up to now, the existing standards for the water resources developments are based on two criteria, namely, economic efficiency and environmental enhancement. They are largely limited to physical, chemical and human aspects of the environment. The standards developed here incorporate socio-economic considerations into the ecological aspects of the environment. They are meaningful for and applicable to all the aquatic, land and land-water interface environments. Theoretically, this methodology is applicable to the water resources development project of any size as long as the data required are available.

(2) The socio-economic criteria and ecological standards developed can be used to judge alternative ecological standards programs.

(3) The standards and methodology developed can be used at any phase of a water resource project to assess the performance of the environment.

6.2 Limitations

The limitations of the ecological standards that were developed need to be assessed. These limitations stem from constraints on the scope of this research, data acquisition and reliance on institutional boundaries. While the limitations suggest areas of further research, they do not reduce the viability of the research effort.

By definition of the research problem, ecological standards were developed for water resource developments. Since water resources do not exist in isolation from the remainder of the terrestrial environ-

ment, the land resources of a region must also be included in any research considering aquatic environments. The body of ecological data and information on land-water interfaces is limited. Those studies that are available limit themselves in general to specific locations allowing little chance to draw general conclusions about the relationships of the flora and fauna in the interface environments. Consequently, many of the ecological standards are based on either aquatic or terrestrial indicators. While the theory and concept of these indicators is perfectly adaptable to the research, a logical extension of the project would lie in developing more indicators of the ecological conditions in the land-water interface environments.

The availability of ecological data was a second limiting factor. Much of the data required for formulation of ecological standards for different types of environments is limited to specific sites. The Mid-Arkansas River Basin in Oklahoma is one of the most frequently studied basins in the southwestern United States, yet the data necessary for accurate evaluation of the ecological systems was not readily available. Particular difficulty was encountered by the author in acquiring the uniform ecological data for each county unit. Much of the data available is not uniform in type or region covered, rendering comparison almost impossible. Uniform, standardized data on the ecological systems in each river basin would improve the accuracy and applicability of the ecological standards.

The reliance on institutional boundaries (i.e., county, city, state) for socio-economic data in the formulation of the development levels was a limitation in the establishment of the ecological standards. This limitation stems from the use of county level data to determine socio-economic levels while utilizing ecological data based on the river basin as the unit of measure. Since the river basin is a geographical unit and the county a political unit, it is difficult to compare the results of the measurements and arrive at a meaningful comparison because the river basin often includes portions of several counties. The counties of the Mid-Arkansas River Basin utilized in this research were fairly uniform in the composition of their socio-economic patterns. Consequently, generalizations interpreted from the county data could be

applied to the water resources under study without sacrificing accuracy. The problem of varying units of measurement will not be resolved until more accurate and uniform methods of establishing the socio-economic characteristics of river basins are developed and implemented.

6.3 Recommendations

In the course of development of this methodology, many difficulties were encountered but remained unresolved. In addition to this, at the final stage of the research, some inadequately dealt with areas began to emerge as guidelines for future researches. Some of the recommendations for future studies are outlined below:

(1) Further validation of the methodology. This is perhaps the most urgent area that needs to be further studied. In this research, the scope of examination of land development levels is the state. Generally, to divide land development into three levels is adequate to show the difference in development within a state, but great disparity in development may occur across the political boundaries of states. For this reason, conflicting results may appear when evaluating river basin regions that encompassed more than one state. In future studies, further validation and more meaningful results may be accomplished and obtained by considering larger study regions, e.g., an entire river basin or a geographic region. This task which involves an astronomical amount of data may be facilitated by the aid of a computer program. When this is accomplished, then many areas of the methodology may be appropriately adjusted and refined.

(2) Modifications of development level indicators and ecological parameters. This includes the following:

(a) Expansion of the list of 4 development level indicators and 12 ecological parameters. The indicators and parameters developed were not intended to be exhaustive, even though they are the best lists possible at the present time. As this methodology is refined and more data become available, more meaningful and representative indicators and parameters may be developed in addition to replacement of existing ones.

(b) Contraction of the list of indicators and parameters. In this research, because of the small size of the lists, very little overlapping is observed in depicting the environmental elements. In future studies, when the lists are expanded, correlation analysis will be needed to expose the redundancy of the indicators or parameters which will effectively condense the lists to ones that are precise and accurate.

(c) Updating of indicators and parameters when data become available in the future.

(d) Minimize the constraints on the ecological parameters. In some of the parameters, assumptions were made in their development so that many constraints were inherited as a result. Because of this, these parameter development methodologies will only be correct under the conditions of the assumptions stated. The use of assumption was often a result of the use of indirect data¹. Thus, to be rid of the assumptions and consequently the constraints, more direct data should be collected.

(3) Further discussion of the relative weight of the parameters and the possible development of a total E.P. value. In this study, all 12 E.P. values determined were treated as if they carried the same importance. But in practice, there is a definite existence of priorities among the parameters. To study this area is not within the scope of this research, but future researchers may venture into this area which may lead to the development of a total ecological performance scale.

(4) Cooperative and systematic collection of ecological data. Like the EPA collecting pollution or quality control data in the stored systems, responsible government agencies may form a cooperative data bank in which ecological data are stored for future researchers to retrieve when necessary. At the present time, many basic ecological data are still lacking, fragmented or even unpublished. A system for orderly accumulation of ecological data is needed; the development of which will greatly assist future studies, especially the further validation of this methodology.

¹Data that cannot be used directly as raw data, but required implications and assumptions in using them are termed indirect data.

A P P E N D I C E S

APPENDIX A

GLOSSARY OF ECOLOGICAL TERMS¹

- AUTOTROPH (PRIMARY PRODUCER).** An organism that synthesizes organic compounds from inorganic ones (such as water, carbon dioxide, and salts) with the aid of an external supply of energy. The energy comes either from light (in photosynthesis) or from the breakdown of inorganic substances (in chemotrophs). Includes some bacteria, algae and green plants.
- BIOMASS.** Weight of living material, usually expressed as a dry weight, in all or part of an organism, population, or community. Commonly expressed as weight per unit area, a biomass density.
- BIOTA.** Species of all the plants (flora) and animals (fauna) occurring within a certain area or region.
- BIOTIC.** Living.
- BIOTIC COMMUNITY.** All of the populations of organisms that exist and interact in a given area.
- CARNIVORE (SECONDARY CONSUMER).** A flesh-eating animal that feeds on herbivores (primary consumers) to obtain its energy; e.g. a lion that feeds on a zebra.

¹Source: 30, 64, 68, 77.

CARRYING CAPACITY (K). Number of individuals that the resources of a particular habitat of the environment can support.

COMMUNITY. Group of populations of plants and animals interacting in a given place; ecological unit used in a broad sense to include groups of various sizes and degrees of integration.

COMPETITION: Individuals or populations interact in an aggressive manner to gain possession of a similar resource which may or may not be in short supply.

CONSUMERS. Organisms that derive their nutrition directly from plants (herbivores) or indirectly from the producer by way of the herbivore (carnivores).

CYCLE. A sequence of events that recur regularly in a certain pattern.

DETRITUS. Freshly dead or partially decomposed organic matter.

DETRITUS FEEDERS. Organisms that feed by ingesting small pieces of dead plant and animal material.

DIGESTION. Chemical breakdown of food into a form that can be assimilated by an organism.

DIVERSITY. A measure of the variety of species in a community that takes into account the relative abundance of each species.

DOMINANCE (GENETIC). Ability of a genetic trait (allele) to mask the expression of an alternative form of the same gene when both are present in the same cell (that is, in a heterozygote).

DONIMANCE. Condition in communities or in vegetational strata in which one or more species, by means of their number, coverage, or size, have considerable influence or control upon the conditions of existence of associated species.

DOMINANT. A species of plant that exerts a major influence on an ecosystem, and whose removal would radically alter the whole association. In a particular succession or climax, one (or several) of these dominant species is the most prominent plant, and the succession or climax may be called after it.

DYNAMICS. In population ecology the study of the reasons for changes in population size, contrast with statics.

ECOLOGICAL PYRAMID. A diagram showing the numbers, or mass, of the individuals in the different trophic levels of an ecosystem.

ECOLOGICAL SUCCESSION. The dynamic process by which ecosystems change over time.

ECOLOGY. The study of animals and plants and the interrelations between them, considered in relation to their nonliving environment; the study of ecosystems and biomes.

ECOSYSTEM. System of living organisms and the media through which they exchange matter and energy.

ENVIRONMENTAL GRADIENT. A continuum of conditions ranging between extremes as the gradation from hot to cold environments.

EUTROPHIC. Referring to a body of water with abundant nutrients and high productivity.

EUTROPHICATION. "Aging" process in aquatic communities where productivity increases with a gradual increase in nutrient input, which primarily is caused by sewage and runoff from fertilized agricultural land.

FOOD CHAIN. A linear chain of organisms in which each link in the chain feeds on the one before and is eaten by the one after. At the start of the chain are the primary producers; at the end, the carnivores.

FOOD WEB. All the interrelated food chains in an ecosystem. The sum total of all the feeding habits of all the organisms in an ecosystem.

GRASSLANDS. Regions where the climax vegetation is grass and there are few trees. Tropical grasslands are often known as savannas; temperate grasslands include the prairies, pampas, steppes and veld.

HABITAT. Place where an animal or plant normally lives, often characterized by a dominant plant form or physical characteristic (i.e., the stream habitat, the forest habitat).

HERBIVORE (PRIMARY CONSUMER). An organism that feeds on primary producers (autotrophs), i.e., plants.

INTERFERENCE. Direct antagonism between individuals by behavioral or chemical means.

LIFE FORM. Characteristic structure of a plant or animal.

LOG-NORMAL SPECIES DISTRIBUTION. Frequency distribution of species

abundances in which the X axis is expressed on a logarithmic scale, X axis is (Log) number of individuals represented in sample, Y axis is number of species.

MONOCULTURE. A farming system based on a single crop, grown year after year.

NICHE. The habitat of an organism and the role it plays in the ecosystem.

NUTRIENT. Any substance required by organisms for normal growth and maintenance (mineral nutrients usually refer to inorganic substances taken from soil or water).

OLIGOTROPHIC. Referring to a body of water with a low nutrient content and low productivity, usually characterized by extremely clear water.

OMNIVORE. An organism whose diet is broad, including both plant and animal foods.

PHOTOSYNTHESIS. The process by which carbon dioxide, water, sunlight, and chlorophyll are utilized to produce glucose in plant cells.

PHYTOPLANKTON. Plant portion of the plankton, the plant community in marine and freshwater situations which floats free in the water and contains many species of algae and diatoms.

PLANKTON. Microscopic floating aquatic plants (phytoplankton) and animals (zooplankton).

POLLUTION. Sediments, foodstuffs, poisons, and heat that are entering an ecosystem at a rate exceeding the normal ability of the ecosystem to process and distribute them.

POPULATION. A group of individuals of a single species living in a given area.

PREDATION. A type of interaction between two species in which one species (the predator) attacks and kills another species (the prey).

PRIMARY CONSUMER. See Herbivore.

PRIMARY PRODUCER. See Autotroph.

PRIMARY PRODUCTION. Assimilation (gross) or accumulation (net) of energy and nutrients by green plants and other autotrophs.

PRODUCERS. Organisms that can convert the radiant energy from the sun into chemical energy by producing energy-rich carbon compounds.

PRODUCTION. Amount of energy (or materials) formed by an individual, population, or community in a specific time period.

PYRAMID OF ENERGY. A diagram showing the energy available per unit time in a trophic level. Usually expressed as kilocalories per square meter per year ($\text{kcal/m}^2/\text{yr}$).

SECONDARY CONSUMER. See Carnivore.

SPECIES DIVERSITY. Refers to the number of different species occupying the same area.

STABILITY. Inherent capacity of any system to resist change.

STANDING CROP. Amount of biomass present at a particular time.

STATICS. In population ecology the study of the reasons of equilibrial conditions or average values; contrast with dynamics.

STRATIFICATION (IN ECOLOGY). The arrangement of an ecosystem into layers, such as forest canopy, understory, shrubs, herbaceous plants, mosses, and so on. It also includes the animals that live in these layers.

SUCCESSION. Replacement of one kind of community by another kind, the progressive changes in vegetation and animal life that may culminate in the climax.

SYSTEM. A collection of parts or events (called components, elements, or subsystems) that can be seen as a single whole thing because of the consistent interdependence and interaction of those parts or events.

TERTIARY CONSUMER. An organism that feeds on secondary consumers. For instance: the cod (tertiary consumer) eats herring (secondary consumer), which eat copepods (primary consumers), which eat sea-water diatoms (primary producers).

TROPHIC. Pertaining to food or nutrition.

TROPHIC LEVEL. A division of the food chain defined from other levels by the method of obtaining food: primary producer, primary consumer, secondary consumer, tertiary consumer.

WETLANDS. Areas of shallow water, often with much vegetation growing in it.

ZOOPLANKTON. Animal portion of the plankton; the animal community in marine and freshwater situations which floats free in the water, independent of the shore and the bottom, moving passively with the currents.

APPENDIX B

DEFINITIONS OF VEGETATION LAND USE¹

- 1) Cropland : Land in tillage rotation, orchards, and land formerly in such uses as described below:
 - i) Tillage Rotation
 - A. Field crops
 - a. All row corps - Includes corn and sorghums for all purposes whether grown in rows or broadcast and all other row crops.
 - b. Close grown crops - Small grains and other close-seeded crops not usually grown in rows and tilled. Includes such crops used for temporary hay or pasture.
 - c. Summer fallow - Cropland in semi-arid areas that is being fallowed.
 - B. Rotation hay and pasture - Grasses or legumes used for hay or pasture as part of the crop rotation.
 - C. Hayland - Land permanently used for forage on which occasional seed bed preparation or other measures are used to improve the stand; other perennial grasses and legumes for which hay

¹Source: Oklahoma Conservation Needs Inventory, March, 1970.

or seed is harvested and then pastured or allowed to grow forage.

D. Conservation use only - Cropland in grasses, legumes, or small grains not harvested or pastured. All open acreage diverted from crops under Federal programs; other such land not under Federal programs. All diverted acres including diverted acres under annual programs (except summer fallow). Does not include land that may be defined as forest.

E. Temporarily idle cropland - Acreage not in any of the uses described above, but which was in such uses during one or more of the three years immediately preceding 1967.

- ii) Orchards, Vineyards, and Bush Fruit - Fruit or nut orchards (regardless of intertilling or pasturing), bush fruit, blueberries and similar fruit crops.
- iii) Open Land Formerly Cropped - Same as Temporarily Idle Cropland except that the land has been idle more than the three years, and is not purposely being converted to another use.

2) Federal Land: Federally owned land except cropland operated under lease or permit, and Indian lands under trusteeship but owned by individuals or tribes.

3) Forest Land: Lands which are (a) at least 10 percent stocked by forest trees of any size and capable of producing timber of other wood products, or capable of exerting an influence on the water regime; (b) lands from which the trees described in (a) have been removed to less than 10 percent stocking and which have not been developed for other uses; (c) afforested (planted) areas; and (d) chaparral areas.

Commercial - The land is capable of producing at least 20 cubic feet of industrial wood per acre per year.

Noncommercial - Includes acres incapable of producing industrial wood products because of adverse site conditions.

4) Forest Land Grazed: Acreage of commercial or non-commercial forest grazed by livestock.

5) Irrigated Land: Land on which irrigation water is applied by an adapted irrigation method on a recurring basis as an integral part

of crop production.

- 6) Other Land: Non-Federal rural land not classified as cropland, pasture, range, forest, or urban and built-up areas.

In Farms - Other land considered locally as part of a farm.

Not In Farms - Other non-Federal rural land which is not part of a farm.

Not In Inventory - Water area, urban and built-up areas, and Federal land (except cropland).

- 7) Pasture: Lands producing forage plants, principally introduced species for animal consumption.
- 8) Range: Land on which the natural potential (climax) plant cover is composed principally of native grasses, forbs and shrubs valuable for forage. This includes natural grasslands and savannahs.
- 9) Total Inventory Acreage: The acreage after Federal land, urban and built-up areas, and water areas are deducted from the total land area.
- 10) Total Land Area: Land area given in the 1964 Census of Agriculture, adjusted as necessary, to exclude areas inundated by construction of new reservoirs, lakes, and ponds since April 1, 1960. Land area excludes water areas larger than 40 acres and rivers wider than 1/8 mile.
- 11) Urban and Built-up Areas: Areas that include cities, villages, and built-up areas of more than ten acres; industrial sites (except strip mines, borrow and gravel pits), railroad yards, cemeteries, airports, golf courses, shooting ranges, institutional and public administrative sites and similar types of areas.
- 12) Water Areas: Include ponds and lakes of more than two acres and not more than 40 acres and rivers and streams that are less than 1/8 mile wide.

APPENDIX C FLORA OF THE MID-ARKANSAS RIVER BASIN

APPENDIX C-1

EIGHTEEN (18) TREE SPECIES OF THE UPLAND FOREST
IN THE MID-ARKANSAS RIVER BASIN AREA*

| Common Name | Scientific Name |
|------------------------|------------------------------|
| Shell-bark Hickory | <u>Carya ovata</u> |
| Black Hickory | <u>Carya texana</u> |
| Rough-leaved Hackberry | <u>Celtis occidentalis</u> |
| Red Bud | <u>Cercis canadensis</u> |
| White Ash | <u>Fraxinus americana</u> |
| Honey Locust | <u>Gleditsia tricanthos</u> |
| Black Walnut | <u>Juglans nigra</u> |
| Red Mulberry | <u>Morus rubra</u> |
| Ironwood | <u>Ostrya virginiana</u> |
| Burr Oak | <u>Quercus macrocarpa</u> |
| Blackjack Oak | <u>Quercus marilandica</u> |
| Chinquapin Oak | <u>Quercus muehlenbergii</u> |
| Southern Red Oak | <u>Quercus rubra</u> |
| Texas Spotted Oak | <u>Quercus shumardii</u> |
| Post Oak | <u>Quercus stellata</u> |
| Black Oak | <u>Quercus velutina</u> |
| American Elm | <u>Ulmus americana</u> |
| Red Elm | <u>Ulmus rubra</u> |

* Source: Rice and Penfound, 1959, and Wells and Mosley, 1964.

APPENDIX C-2

SEVEN (7) COMMON SHRUBS AND VINES SPECIES OF THE UPLAND
FOREST IN THE MID-ARKANSAS RIVER BASIN AREA*

| Common Name | Scientific Name |
|------------------|------------------------------------|
| Indigobush | <u>Amorpha fruticosa</u> |
| Virginia Creeper | <u>Parthenocissus quinquefolia</u> |
| Winged Sumac | <u>Rhus copallina</u> |
| Smooth Sumac | <u>Rhus glabra</u> |
| Poison Ivy | <u>Rhus radicans</u> |
| Riverbank Grape | <u>Vitis riparia</u> |
| Frost Grape | <u>Vitis vulpina</u> |

* Source: Kennedy, 1973.

APPENDIX C-3

TWENTY-SEVEN (27) COMMON HERBACEOUS PLANT SPECIES OF
THE UPLAND FOREST IN THE MID-ARKANSAS RIVER BASIN AREA*

| Common Name | Scientific Name |
|--------------------------|-----------------------------------|
| Common Yarrow | <u>Achillea millefolium</u> |
| Common Ragweed | <u>Ambrosia artemisiifolia</u> |
| Big Bluestem | <u>Andropogon gerardi</u> |
| Little Bluestem | <u>Andropogon scoparius</u> |
| Plantainleaf Pussytoes | <u>Antennaria plantaginifolia</u> |
| Azure Aster | <u>Aster azureus</u> |
| Skydrop Aster | <u>Aster patens</u> |
| Plains Wildindigo | <u>Baptisia leucophaca</u> |
| Sedge | <u>Carex spp.</u> |
| Umbrella-sedge | <u>Cyperus ovularis</u> |
| Poverty Crowfootgrass | <u>Danthonia spicata</u> |
| Daisy Fleabane | <u>Erigeron strigosus</u> |
| White Avens | <u>Geum canadense</u> |
| Pinweed | <u>Lechea tenuifolia</u> |
| Trailing Lespedeza | <u>Lespedeza procumbens</u> |
| Violet Woodsorrel Oxalis | <u>Oxalis violacea</u> |
| Panicum | <u>Panicum dichotomum</u> |
| Slimleaf Panicum | <u>Panicum linearifolium</u> |
| Roundseed Panicum | <u>Panicum shaerocarpon</u> |
| Black-eyed Susan | <u>Rudbeckia hirta</u> |
| Fewflower Razonsedge | <u>Scleria pauciflora</u> |
| Small Skillcap | <u>Scutellaria parvula</u> |
| Indiangrass | <u>Sorghastrum nutans</u> |
| Pencilflower | <u>Stylosanthes biflora</u> |
| Hedgeparsley | <u>Torlisis arvensis</u> |
| Purpletop | <u>Tridens flavus</u> |
| Baldwin Ironweed | <u>Vernonia Baldwinii</u> |

* Source: Kennedy, 1973

APPENDIX C-4

TWENTY-THREE (23) TREE SPECIES OF THE BOTTOMLAND FOREST
IN THE MID-ARKANSAS RIVER BASIN AREA*

| Common Name | Scientific Name |
|------------------------|-------------------------------|
| Box Elder | <u>Acer negundo</u> |
| Silver Maple | <u>Acer saccharinum</u> |
| Chittam Wood | <u>Bumelia lanuginosa</u> |
| Bitternut Hickory | <u>Carya cordiformis</u> |
| Pecan | <u>Carya illinoensis</u> |
| Catalpa | <u>Catalpa speciosa</u> |
| Southern Hackberry | <u>Celtis laevigata</u> |
| Rough-leaved Hackberry | <u>Celtis occidentalis</u> |
| Red Bud | <u>Cercis canadensis</u> |
| Green Ash | <u>Fraxinus pennsylvanica</u> |
| Coffee Tree | <u>Gymnocladus dioica</u> |
| Red Mulberry | <u>Morus rubra</u> |
| Sycamore | <u>Platanus occidentalis</u> |
| Cottonwood | <u>Populus deltoides</u> |
| Mexican Plum | <u>Prunus mexicana</u> |
| Burr Oak | <u>Quercus macrocarpa</u> |
| Chinquapin Oak | <u>Quercus muehlenbergii</u> |
| Texas Spotted Oak | <u>Quercus shumardii</u> |
| Post Oak | <u>Quercus stellata</u> |
| Black Willow | <u>Salix nigra</u> |
| Chinaberry | <u>Sapindus drummondii</u> |
| American Elm | <u>Ulmus americana</u> |
| Red Elm | <u>Ulmus rubra</u> |

* Source: Rice, 1962

APPENDIX C-5

FOURTEEN (14) COMMON SHRUBS AND VINES SPECIES OF THE
BOTTOMLAND FOREST IN THE MID-ARKANSAS RIVER BASIN AREA*

| Common Name | Scientific Name |
|--------------------------|------------------------------------|
| Ohio Buckeye | <u>Aesculus glabra</u> |
| Pawpaw | <u>Asimina triloba</u> |
| American Bittersweet | <u>Celastrus scandens</u> |
| Red Bud | <u>Cercis canadensis</u> |
| Small Flowered Dogwood | <u>Cornus drummondii</u> |
| Burning Bush | <u>Euonymus atropurpureus</u> |
| Virginia Creeper | <u>Parthenocissus quinquefolia</u> |
| Carrionflower Greenbrier | <u>Smilax herbacea</u> |
| Bamboo Greenbrier | <u>Smilax tamnoides</u> |
| American Bladdernut | <u>Staphylea trifolia</u> |
| Coralberry | <u>Symphoricarpos orbiculatus</u> |
| Sweet Winter Grape | <u>Vitis cinera</u> |
| Riverbank Grape | <u>Vitis riparia</u> |
| Frost Grape | <u>Vitis vulpina</u> |

*Source: Koch, 1970

APPENDIX C-6

THIRTY-TWO (32) COMMON HERBACEOUS PLANT SPECIES OF THE
BOTTOMLAND FOREST IN THE MID-ARKANSAS RIVER BASIN AREA*

| Common Name | Scientific Name |
|------------------------|---------------------------------|
| Wing-stem | <u>Actinomeris alternifolia</u> |
| Giant Ragweed | <u>Ambrosia trifida</u> |
| Canada Brome | <u>Bromus purgens</u> |
| American Bellflower | <u>Campanula americana</u> |
| Sedge | <u>Carex davissii</u> |
| Spreading Chaenostoma | <u>Chaerophyllum procumbens</u> |
| Mapleleaf Goosefoot | <u>Chenopodium hybridum</u> |
| Dutchman's-Breeches | <u>Dicentra cucullaria</u> |
| Ellisia | <u>Ellisia nyctelea</u> |
| Virginia Wildrye | <u>Elymus virginicus</u> |
| White Snakeroot | <u>Eupatorium rugosum</u> |
| Catchweed Bedstraw | <u>Galium aparine</u> |
| White Avens | <u>Geum canadensis</u> |
| Woodnettle | <u>Laportea canadensis</u> |
| Common Yellow Oxalis | <u>Oxalis stricta</u> |
| Pennsylvania Pellitory | <u>Parietaria pennsylvanica</u> |
| Sweetwilliam Phlox | <u>Phlox divaricata</u> |
| American Lopseed | <u>Phryma leptostachya</u> |
| Littleleaf Buttercup | <u>Ranunculus abortivus</u> |
| Limestone Ruellia | <u>Ruellia strepens</u> |
| Canada Sanicle | <u>Sanicula canadensis</u> |
| Wall Burcucumber | <u>Sicyos angulatus</u> |
| Starry Silene | <u>Silene stellata</u> |
| Virginia Tovar | <u>Tovara virginina</u> |
| Broadleaf Uniola | <u>Uniola latifolia</u> |
| Bigstring Nettle | <u>Urtica dioica</u> |
| White Verbena | <u>Verbena urticifolia</u> |
| White Crownbeard | <u>Verbesina virginica</u> |
| Butterfly Violet | <u>Viola papilionacea</u> |
| Golden Zizia | <u>Zizia aurea</u> |

*Source: Koch, 1970

APPENDIX C-7

FORTY-FIVE (45) COMMON PLANT SPECIES OF THE BLUESTEM PRAIRIE
IN THE MID-ARKANSAS RIVER BASIN AREA*

| Common Name | Scientific Name |
|------------------------|-----------------------------------|
| Western Yarrow | <u>Achillea lanulosa</u> |
| Winter Bentgrass | <u>Agrostis hyemalis</u> |
| Western Ragweed | <u>Ambrosia psilostachya</u> |
| Leadplant | <u>Amorpha canescens</u> |
| Big Bluestem | <u>Andropogon gerardii</u> |
| Silver Bluestem | <u>Andropogon saccharoides</u> |
| Little Bluestem | <u>Andropogon scoparius</u> |
| Broom-sedge Bluestem | <u>Andropogon virginicus</u> |
| Prairie Threeawn | <u>Aristida oligantha</u> |
| Heath Aster | <u>Aster ericoides</u> |
| Sideoats Grama | <u>Bouteloua curtipendula</u> |
| Blue Grama | <u>Bouteloua gracilia</u> |
| Japanese Brome | <u>Bromus japonicus</u> |
| Sedge | <u>Carex spp.</u> |
| Bigflower Coreopsis | <u>Coreopsis grandiflora</u> |
| Wooly Croton | <u>Croton capitatus</u> |
| Illinois Bundleflower | <u>Desmodium illinoensis</u> |
| Canada Wildrye | <u>Elymus canadensis</u> |
| Flowering spurge | <u>Euphorbia corollata</u> |
| Milk-purslane | <u>Euphorbia supina</u> |
| Bedstraw | <u>Galium texense</u> |
| Annual Broomweed | <u>Gutierrezia dracunculoides</u> |
| Wild Lettuce | <u>Lactuca ludoviciana</u> |
| Fall Witchgrass | <u>Leptoloma cognatum</u> |
| Korean Lespedeza | <u>Lespedeza stipulacea</u> |
| Black medic | <u>Medicago lupulina</u> |
| Rock Muhly | <u>Muhlenbergia sobolifera</u> |
| Celestial Lily | <u>Nemastylis geminiflora</u> |
| Common Yellow Oxalis | <u>Oxalis stricta</u> |
| Scribner Panicum | <u>Panicum scribnerianum</u> |
| Switchgrass | <u>Panicum virgatum</u> |
| Purple Prairie clover | <u>Petalostemum purpureum</u> |
| Prairie Groundcherry | <u>Physalis pumila</u> |
| Kentucky Bluegrass | <u>Poa pratensis</u> |
| Wild Alfalfa | <u>Psoralea tenuiflora</u> |
| Ruellia | <u>Ruellia humilis</u> |
| Azure Sage | <u>Salvia azurea</u> |
| Catclaw Sensitivebrier | <u>Schrankia nultalii</u> |
| Green Bristlegrass | <u>Setaria viridis</u> |
| Missouri Goldenrod | <u>Solidago missouriensis</u> |
| Indiangrass | <u>Sorghastrum nutans</u> |
| Tall Dropseed | <u>Sporobolus asper</u> |
| Wild Bean | <u>Strophostyles leiosperma</u> |
| Purpletop | <u>Tridens flavus</u> |
| Baldwin Ironweed | <u>Vernonia baldwinii</u> |

*Source: Risser and Kennedy, 1972

APPENDIX C-8

ELEVEN (11) RARE PLANT SPECIES IN THE MID-ARKANSAS RIVER BASIN AREA*

| Species | R1 | R2 | Habitat |
|--|----|----|------------------------------|
| <i>Bromus mollis</i> (Soft Brome) | | X | Disturbed areas |
| <i>Diarrhea americana</i> (American Beakgrain) | X | | Creek bottoms |
| <i>Hystrix patula</i> (Bottle brushgrass) | | X | Rich woods |
| <i>Cenchrus incertus</i> (Coast Sandbur) | | X | Sandy soil |
| <i>Uvularia grandiflora</i> (Big Merrybells) | | X | Rich woods |
| <i>Tripsacum dactyloides</i> (Eastern Gamagrass) | | X | Lowland and prairie |
| <i>Chenopodium pallescens</i> (Goosefoot) | | X | Dry sandy or stony hills |
| <i>Phaseolus polystachios</i> (Thicket Bean) | X | | Dry woods |
| <i>Montropa uniflora</i> (Indianpipe) | | X | Rich woods |
| <i>Vernonia crinita</i> (Bur Ironweed) | | X | Rich lowlands and open woods |
| <i>Vernonia fasciculata</i> (Western Ironweed) | | X | Prairies |

R1 - Rare

R2 - Abundant elsewhere but rare in Oklahoma

*Source: Snook and Crockett, 1973

APPENDIX D

FAUNA OF THE MID-ARKANSAS RIVER BASIN

ABBREVIATIONS

HABITAT

Mammals:

- G = Grassland
- UF = Upland forest
- LF = Lowland forest
- U = Ubiquitous in habitat

Birds:

- L = Limnic: Generally associated with lakes or ponds

- G = Grassland: Open fields prairie, or scrubby vegetation
- W = Woodland: Densely vegetated areas of oak-hickory, elm-cottonwood, or coniferous forest

Fishes:

- M = Mainstream
- I = Impoundment (reservoir or pond)
- T = Tributary

Reptiles:

- A = Aquatic
- B = Brush or shrub vegetated areas

FAUNA OF MID-ARKANSAS RIVER BASIN (Continued)

Reptiles: (cont'd)

- P = Prairie grassland or open woods
- R = Riparian or lowlands with moist soil
- S = Sparse or low scanty vegetation

Amphibians:

- T = Terrestrial: Land areas not associated with water
- C = Caves: Inside or near entrances
- R = Running water: Streams and springs
- P = Permanent: Stationary bodies of water
- B = Temporary bodies of water

Naiads:

- G = Gravel
- M = Mud
- S = Sand

OCCURRENCE

- C = Common: Generally abundant throughout the region, occurring in many localities in large numbers
- O = Occasional: Occurs at several localities in small numbers
- R = Rare: Highly localized, restricted in range and abundance

TROPHIC LEVEL

- 1 = Primary consumer
- 2 = Secondary consumer
- 3 = Tertiary consumer

APPENDIX D-1

MAMMALS OF THE MID-ARKANSAS RIVER BASIN

| NAME | HABITAT | OCCUR- RENCE | TROPHIC LEVEL | DIET |
|--|---------|-----------------|------------------|--|
| CHIROPTERA | | | | |
| <u>Myotis lucifugus</u> (Little brown bat) | U | O | 2 | Small insects (two-winged flies) |
| <u>Myotis velifer</u> (Cave bat) | U | O | 2 | Flies, beetles, moths |
| <u>Myotis grisescens</u> (Gray bat) | U | O | 2 | " |
| <u>Myotis solidalis</u> (Indiana bat) | U | R | 2 | " |
| <u>Myotis subulatus</u> (Small-footed bat) | U | O | 2 | Flies, beetles, moths |
| <u>Lasionycteris noctivagans</u> (Silver-haired bat) | LF | O | 2 | Insects |
| <u>Pipistrellus subflavus</u> (Eastern pipistrel) | U | O | 2 | Flies, small beetles |
| <u>Lasiurus borealis</u> (Red bat) | UF/LF | C | 2 | Insects, beetles |
| <u>Eptesicus fuscus</u> (Big brown bat) | U | O | 2 | Beetles, moths |
| <u>Lasiurus cinereus</u> (Hoary bat) | U | O | 2 | Large beetles and moths |
| <u>Nycticebus humeralis</u> (Evening bat) | LF | O | 2 | Insects, moths |
| <u>Plecotus townsendi</u> (Eastern big-eared bat) | U | R | 2 | Small insects |
| <u>Tadarida brasiliensis</u> (Mexican freetail bat) | U | O | 2 | Insects |
| CARNIVORA | | | | |
| <u>Procyon lotor</u> (Raccoon) | HF/LF | C | 3 | Freshwater turtles, frogs, fish, crayfish, shellfish, vegetable, aquatic animals |
| <u>Mustela frenata</u> (Longtail weasel) | U | O | 3 | Rats, mice, moles, small birds and frogs |
| <u>Mustela vison</u> (Mink) | LF | O | 3 | Rabbits, small birds and frogs, carrion |
| <u>Lutra canadensis</u> (River otter) | LF | O | 3 | Fish, birds, mammals, frogs, vegetables |
| <u>Spilogale putorius</u> (Spotted skunk) | UF | F | 3 | Insects, fruit, eggs, small birds, frogs |
| <u>Mephitis mephitis</u> (Striped skunk) | U | C | 3 | Insects, snakes, crayfish |
| <u>Canis latrans</u> (Coyote) | U | C | 3 | Small rodents, snakes, rabbits, carrion, vegetables and fruit |
| <u>Vulpes fulva</u> (Red fox) | UF/LF | O | 3 | Rats, mice and moles, vegetables, grass and fruit |

MAMMALS OF THE MID-ARK REGION (Continued)

| NAME | HABITAT | OCCUR- RENCE | TROPHIC LEVEL | DIET |
|---|---------|-----------------|------------------|---|
| CARNIVORA (Continued) | | | | |
| <u>Urocyon cinereoargenteus</u> (Gray fox) | U | C | 3 | Rats, mice and moles, vegetables, grass and fruit |
| <u>Lynx rufus</u> (Bobcat) | U | O | 3 | Mammals, birds |
| RODENTIA | | | | |
| <u>Spermophilus tridecemlineatus</u> (Thirteen striped ground squirrel) | G | R | 3 | Insects, mice, frogs, eggs, vegetables |
| <u>Tamias striatus</u> (Eastern chipmunk) | UF | O | 1 | Seeds, grain, nuts, berries |
| <u>Sciurus niger</u> (Fox squirrel) | UF/LF | C | 2 | Birds, insects, eggs, nuts, seeds, berries, bark, sap |
| <u>Sciurus carolinensis</u> (Gray squirrel) | UF/LF | C | 2 | Beechmast, nuts, berries, fungi, eggs, small birds, carrion |
| <u>Glaucomys volans</u> (Flying squirrel) | UF/LF | C | 2 | Nuts, fruits, leaves, insects, small animals |
| <u>Geomys bursarius</u> (Plains pocket gopher) | G | C | 1 | Bulbs, roots, vegetables |
| <u>Perognathus hispidus</u> (Hispid pocket mouse) | G | C | 1 | Seeds, grasses |
| <u>Castor canadensis</u> (Beaver) | LF | C | 1 | Bark of aspen and willow |
| <u>Reithrodontomys montanus</u> (Plains harvest mouse) | G | O | 1 | Seeds, grass |
| <u>Reithrodontomys fulvescens</u> (Golden harvest mouse) | U | C | 1 | Seeds, grass |
| <u>Peromyscus leucopus</u> (White-footed mouse) | UF/LF | C | 1 | Vegetable, nuts, fruit, berries |
| <u>Rattus norvegicus</u> (Norway rat) | U | C | 2 | Little known |
| <u>Mus musculus</u> (House mouse) | U | C | 2 | Cereals, |

MAMMALS OF THE MID-ARK REGION (Continued)

| NAME | HABITAT | OCCUR- RENCE | TROPHIC LEVEL | DIET |
|---|---------|-----------------|------------------|---|
| RODENTIA (Continued) | | | | |
| <u>Peromyscus maniculatus</u> (Deer mouse) | G | C | 1 | Vegetables |
| <u>Peromyscus boylei</u> (Brush mouse) | LF | C | 1 | Vegetables |
| <u>Onychomys leucogaster</u> (Grass-hopper mouse) | G | O | 3 | Grasshoppers, beetles, scorpions, lizards, mice, grass and seed |
| <u>Neotoma floridana</u> (Eastern wood rat) | UF/LF | C | 1 | Nuts, berries, herbage |
| <u>Oryzomys palustris</u> (Rice rat) | G/LF | O | 1 | Grass, grains |
| <u>Sigmodon hispidus</u> (Cotton rat) | U | C | 2 | Grass, sedges, roots, seeds, eggs, insects, fish, crabs |
| <u>Microtus ochrogaster</u> (Prairie vole) | G | O | 1 | Grass, vegetables |
| <u>Microtus pinetorum</u> (Pine vole) | UF/LF | O | 1 | Grass, vegetables |
| <u>Ondatra zibethica</u> (Muskrat) | UF/LF | O | 3 | Water plants, fish, frogs, mussels |
| <u>Zapus hudsonius</u> (Meadow jumping mouse) | G | O | 1 | Seeds |
| LAGOMORPHA | | | | |
| <u>Lepus californicus</u> (Blacktailed jack-rabbit) | G | O | 1 | Grass, herbage |
| <u>Sylvilagus floridanus</u> (Cottontail rabbit) | G/LF | C | 1 | Grass, herbage |
| <u>Sylvilagus aquaticus</u> (Swamp rabbit) | LF | C | 1 | Grass, herbage |
| ARTIODACTYLA | | | | |
| <u>Odocoileus virginianus</u> (White-tail deer) | U | C | 1 | Leaves, herbs, grass |

MAMMALS OF THE MID-ARK REGION (Continued)

| NAME | HABITAT | OCCUR- RENCE | TROPHIC LEVEL | DIET |
|--|---------|-----------------|------------------|---|
| EDENTATA | | | | |
| <u>Dasypus novemcinctus</u> (Armadillo) | U | O | 2 | Insects |
| MARSUPIALIA | | | | |
| <u>Didelphis marsupialis</u> (Opossum) | UF/LF | C | 2 | Fruit, roots, birds, small mammals, crayfish, eggs, carrion |
| INSECTIVORA | | | | |
| <u>Cryptotis parva</u> (Least shrew) | G | C | 2 | Insects or other animal matter |
| <u>Blarina brevicauda</u> (Short-tailed shrew) | U | C | 2 | Insects, earthworms, small molluscs, plants |
| <u>Notiosorex crawfordi</u> (Gray shrew) | LF | R | 2 | Earthworms, insects, vegetables |
| <u>Scalopus aquaticus</u> (Eastern mole) | G | C | 2 | Insects, earthworms, some plants |

APPENDIX D-2

BIRDS OF THE MID-ARKANSAS RIVER BASIN

| NAME | HABITAT | OCCUR- RENCE | TROPHIC LEVEL | DIET |
|---|---|-----------------|------------------|---|
| HAWKS, EAGLES, FALCONS AND VULTURES | | | | |
| <u>Accipiter cooperii</u> (Cooper's hawk) | Open woodland. | O | 3 | Birds, fish, mammals, insects |
| <u>Circus cyaneus</u> (Marsh hawk) | Common migrant and WR. | O | 3 | " |
| <u>Buteo jamaicensis</u> (Red-tailed hawk) | Open woodland; uplands. | C | 3 | " |
| <u>Accipiter striatus</u> (Sharp-shinned hawk) | Open woodland; common migrant and WR | O | 3 | " |
| <u>Falco sparverius</u> (Sparrow hawk) | | C | 3 | " |
| <u>Coragyps atratus</u> (Black vulture) | Possible SR in Kansas; northern limit of range in southeastern Kansas | R | 3 | Carrion, offal, eggs, seabirds |
| GROUSE AND QUAIL | | | | |
| <u>Tympanuchus cupido</u> (Greater prairie chicken) | Prefers bluestem prairies | R | 2 | Granivorous, grass, insects. |
| <u>Phasianus colchicus</u> (Ring-necked pheasant) | Cultivated areas and brushy vegetation. | R | 2 | Insects, invertebrates, seeds, berries, leaves |
| <u>Meleagris gallopavo</u> (Turkey) | More common in Oklahoma; most populations result from recent introductions. | O | 3 | Vegetable, seeds, insects, crustaceans, amphibians, reptiles |
| <u>Colinus virginianus</u> (Bobwhite) | Open woodland | C | 3 | " |
| <u>Charadrius vociferus</u> (Killdeer) | Chiefly in open areas and around ponds and marshes; rare in winter. | C | 3 | Animals, invertebrates, vegetable |
| PIGEONS AND DOVES | | | | |
| <u>Columba livia</u> (Rock dove) | Generally around buildings in populated areas; introduced. | C | 2 | Seeds, fruits, berries, buds, vegetable, small snails, invertebrate animals |
| <u>Zenaidura macroura</u> (Mourning dove) | Inhabits open and edge areas; uncommon in winter. | C | 2 | " |

| NAME | HABITAT | OCCUR- RENCE | TROPHIC LEVEL | DIET |
|--|---|-----------------|------------------|---|
| CUCKOOS AND ROADRUNNERS | | | | |
| <u>Geococcyx californianus</u> (Roadrunner) | Scrubby vegetation; only in Oklahoma | O | 2 | Insects, molluscs, vertebrates, fruits |
| OWLS | | | | |
| <u>Typo alva</u> (Barn owl) | Open woodland | O | 3 | Rodents, insects, earthworms, crabs, fish, reptiles, birds, mammals |
| <u>Strix varia</u> (Barred owl) | | C | 3 | " |
| <u>Bubo virginianus</u> (Great horned owl) | | C | 3 | " |
| <u>Asio otus</u> (Long-eared owl) | | C | 3 | " |
| <u>Aegolius acadium</u> (Saw-whet owl) | | R | 3 | " |
| <u>Otus asio</u> (Screech owl) | | C | 3 | " |
| <u>Asio flammeus</u> (Short-eared owl) | Marshy and edge habitats; more numerous in the winter | O | 3 | " |
| KINGFISHERS (Piscivorous) | | | | |
| <u>Megaceryle alcyon</u> (Belted kingfisher) | Nests in holes in bare riverbanks, hillsides; less common in winter | C | 2 | Crustaceans, aquatic insects, invertebrates, small vertebrates |
| WOODPECKERS | | | | |
| <u>Dendrocopos pubescens</u> (Downy woodpecker) | Resident in most woody situations | C | 2 | Insects, fruits, nuts, sap of trees |
| <u>Dendrocopos villosus</u> (Hairy woodpecker) | | C | 2 | " |
| <u>Dryocopus pileatus</u> (Pileated woodpecker) | Southwestern limit of range; prefers extensive forests | R | 2 | " |
| <u>Centurus carolinus</u> (Red-bellied woodpecker) | Western limit of range | C | 2 | " |

| NAME | HABITAT | OCCUR- RENCE | TROPHIC LEVEL | DIET |
|---|--|-----------------|------------------|--|
| WOODPECKERS (Continued) | | | | |
| <u>Melanerpes erythrocephalus</u> (Red-headed woodpecker) | Open woodland; less common in winter | C | 2 | Insects, fruits, nuts, sap of trees |
| <u>Colaptes auratus</u> (Yellow-shafted flicker) | Open woodland | C | 2 | " |
| LARKS | | | | |
| <u>Eremophila alpestris</u> (Horned lark) | Most common in croplands with short vegetation | C | 2 | Vegetables, insects |
| JAYS AND CROWS | | | | |
| <u>Cyanocitta cristata</u> (Blue jay) | | C | 3 | Fruits, insects, small animals |
| <u>Corvus brachyrhynchos</u> (Common crow) | Local populations may increase in winter | C | 3 | Animals and vegetables |
| CHICKADEES AND TITMICE | | | | |
| <u>Parus atricapillus</u> (Black-capped chickadee) | Southern limit of range | C | 2 | Insects, small invertebrates, seeds |
| <u>Parus carolinensis</u> (Carolina chickadee) | Northern limit of range | C | 2 | " |
| <u>Parus bicolor</u> (Tufted titmouse) | Western limit of range | C | 2 | " |
| NUTHATCHES AND CREEPERS | | | | |
| <u>Sitta carolinensis</u> (White-breasted nuthatch) | Found in well-developed forest; prefers oaks | O | 3 | Insects, spiders, small animals, seeds |
| WRENS | | | | |
| <u>Thryothorus ludovicianus</u> (Carolina wren) | Inhabits edge situations; western limit of range | C | 2 | Insects |

| NAME | HABITAT | OCCUR- RENCE | TROPHIC LEVEL | DIET |
|---|---|-----------------|------------------|------------------------|
| MOCKINGBIRDS AND THRASHERS | | | | |
| <u>Mimus polyglottos</u> (Mockingbird) | Open woodland | C | 2 | Invertebrates, fruits |
| THRUSHES, SOLITAIRES, AND BLUEBIRDS (Frugivorous or insectivorous) | | | | |
| <u>Sialia sialis</u> | Open woodland; decreasing numbers except locally where bird houses are provided | C | 2 | Insects, worms, snails |
| <u>Turdus migratorius</u> (Robin) | Generally moves from populated areas to woods in winter | C | 2 | Insects |
| SHRIKES | | | | |
| <u>Lanius ludovicianus</u> (Loggerhead shrike) | Edge habitat and open country. | C | 3 | Insects, reptiles |
| STARLINGS | | | | |
| <u>Sturnus vulgaris</u> (Starling) | Most common on farmlands and populated areas; introduced | C | 2 | Fruit, pests |
| WEAVER FINCHES | | | | |
| <u>Passer domesticus</u> (House sparrow) | Most numerous in populated or farm areas | C | 1 | Seeds |
| BLACKBIRDS AND ORIOLES | | | | |
| <u>Molothrus ater</u> (Brown-headed cowbird) | Less common in winter | C | 2 | Insects, fruit |
| <u>Sturnella magna</u> (Eastern meadowlark) | Prefers wetter fields than next species | C | 2 | " |
| <u>Agelaius phoeniceus</u> (Red-winged blackbird) | Principally around wet fields or marshes | C | 2 | " |
| <u>Sturnella neglecta</u> (Western meadowlark) | Local in upland fields | O | 2 | " |

| NAME | HABITAT | OCCUR- RENCE | TROPHIC LEVEL | DIET |
|---|--|-----------------|------------------|--|
| GROSBEAKS, FINCHES, SPARROWS, AND BUNTINGS | | | | |
| <u>Spinus tristis</u> (American goldfinch) | Woodland edge inhabitant | C | 2 | Seeds and insects |
| <u>Richmondia cardinalis</u> (Cardinal) | Prefers dense shrubby areas | C | 3 | 70% vegetable matter, such as seeds, berries; 30% insects spiders, small invertebrates |
| <u>Pipilo erythrophthalmus</u> (Rufous-sided sparrow) | | O | 2 | Seeds, wild fruit, and insects |
| <u>SUMMER RESIDENTS</u> | | | | |
| GREBES | | | | |
| <u>Podilymbus podiceps</u> (Pied-billed grebe) | Common migrant | O | 3 | Small fish, crayfish, insect (1:1:2) |
| <u>Phalacrocorax auritus</u> (Cormorants) | Southern limit of range | O | 3 | Fish (90%), amphibians, crustaceans |
| HERONS | | | | |
| <u>Botaurus lentiginosus</u> (American bittern) | Near marshes | O | 3 | Fish, amphibians, crustaceans, mollusks and insects |
| <u>Ixobrychus exilis</u> (Least bittern) | Marshes | O | 3 | Small fish, amphibians, insects, leeches |
| <u>Bubulcus ibis</u> (Cattle egret) | Generally around prairies, marshes and mud flats, recently naturalized | O | 3 | Insects, small fish, small mammals, spiders, a few ticks and earth worms |
| <u>Casmerodius albus</u> (Common egret) | Local; near streams and marshes. Western limit of range in eastern Kansas and Oklahoma | O | 3 | All kinds of aquatic animals, snakes |

| NAME | HABITAT | OCCUR- RENCE | TROPHIC LEVEL | DIET |
|--|--|-----------------|------------------|---|
| HERONS (Continued) | | | | |
| <u>Leucophoyx thula</u> (Snowy egret) | Northern limit of range | O | 3 | Fish, insects |
| <u>Nycticorax nycticorax</u> (Black-crowned night heron) | | O | 3 | " |
| <u>Ardea herodias</u> (Great blue heron) | Permanent resident of Oklahoma | C | 3 | Fish, amphibians, snakes, leeches. |
| <u>Butorides virescens</u> (Green heron) | May only be late summer and fall wanderers in Kansas | O | 3 | Fish, reptiles, amphibians |
| <u>Hydranassa tricolor</u> (Louisiana heron) | Postbreeding visitant only | R | 3 | Small marine fish, grasshoppers |
| <u>Nyctanassa violacea</u> (Yellow-crowned night heron) | Also found in riparian habitat. | O | 2 | Same as most herons |
| <u>Plegadis chihi</u> (White-faced ibis) | Near marshes | O | 3 | Crayfish, insects, amphibians, worms, mollusks, and some fish |
| SURFACE DUCKS | | | | |
| <u>Anas discors</u> (Blue-winged teal) | | O | 2 | Aquatic plants, grasses, rice, corn and 30% animal matter |
| <u>Anas fulvigula</u> (Mottled duck) | | R | 2 | " |
| <u>Aix sponsa</u> (Wood duck) | Nests in trees in wooded ponds and streams; western limit of range | O | 1 | Tree and shrub seeds, grasses, aquatic plants |
| HAWKS, EAGLES, FALCONS, AND VULTURES | | | | |
| <u>Buteo platypterus</u> (Broad-winged hawk) | Found in riparian habitats; western limit of range | O | 3 | Large insects, frogs, toads, reptiles, some rice |

| NAME | HABITAT | OCCUR- RENCE | TROPHIC LEVEL | DIET |
|--|---|-----------------|------------------|--|
| HAWKS, EAGLES, FALCONS, AND VULTURES (Cont.) | | | | |
| <u>Buteo lineatus</u> (Red-shouldered hawk) | | O | 3 | Frogs, snakes, crayfish, large insects, mice and shrews |
| <u>Buteo swainsoni</u> (Swainson's hawk) | | O | 3 | Large insect, grasshopper some mammals and other vertebrate |
| <u>Ictinia mississippiensis</u> (Mississippi kite) | Feeds over grassland and nests in trees along streams or shelter belts; may be locally common | O | 3 | Large insects, such as dragonflies and grasshoppers |
| <u>Cathartes aura</u> (Turkey vulture) | Forages in fields | C | 3 | Carrion, small living animals |
| RAILS | | | | |
| <u>Laterallus jamaicensis</u> (Black rail) | Occurrence is local | R | 2 | Insects and some seeds of plants, isopods |
| <u>Rallus elegans</u> (King rail) | Rare WR | O | 2 | Invertebrates (crayfish, insects, leech, worms, slug) and some plant food |
| <u>Gallinula chloropus</u> (Common gallinule) | Found in marshy areas | O | 2 | Underwater plants, grass, herbs, seeds and berries some insects, snails, worms |
| <u>Porphyryla martinica</u> (Purple gallinule) | Northern limit of range | R | 3 | Rice, grain, seeds and insects, mollusks, amphibians |
| SANDPIPERS | | | | |
| <u>Actitis macularia</u> (Spotted sandpiper) | | C | 3 | Animal matters (mainly aquatic insects, small crustaceans, fish) |

| NAME | HABITAT | OCCUR- RENCE | TROPHIC LEVEL | DIET |
|---|--|-----------------|------------------|--|
| GULLS AND TERNS | | | | |
| <u>Sterna albigrans</u> (Least Tern) | Nests primarily on sandbars | O | 3 | Crustaceans, worms, fish, and mollusks |
| CUCKOOS AND ROADRUNNERS | | | | |
| <u>Coccyzus americanus</u> (Yellow-billed cuckoo) | | C | 2 | Almost entirely insects |
| GOATSUCKERS | | | | |
| <u>Caprimulgus carolinensis</u> (Chuck-will's widow) | | C | 2 | Moths, grasshoppers, ants, and other insects |
| <u>Chordeiles minor</u> (Common nighthawk) | Often in population areas in fields | C | 2 | Entirely insects caught on the wing |
| <u>Phalaenoptilus nuttallii</u> (Poor-will) | Only in zeric, ricky scrubland; eastern limit of range | R | 2 | Moths, beetles, chinch bugs, locusts and other insects |
| <u>Caprimulgus vociferus</u> (Whip-poor-will) | | C | 2 | Moths, grasshoppers, ants, and other insects |
| SWIFTS AND HUMMINGBIRDS | | | | |
| <u>Chaetura pelagica</u> (Chimney swift) | Often in populated areas | C | 2 | All kinds of small flying insects |
| <u>Archilochus colubris</u> (Ruby-throated hummingbird) | Western limit of range | O | 2 | Nectar of flowers and tiny insects |
| FLYCATCHERS | | | | |
| <u>Empidonax virescens</u> (Acadian flycatcher) | Riparian forest; western limit of range | O | 3 | Almost entirely insects and spiders |

| NAME | HABITAT | OCCUR- RENCE | TROPHIC LEVEL | DIET |
|---|--|-----------------|------------------|--|
| FLYCATCHERS (Continued) | | | | |
| <u>Tyrannus tyrannus</u> (Eastern kingbird) | Open woodlands | C | 2 | Mainly insects, 10% fruits and seeds |
| <u>Sayornis phoebe</u> (Eastern phoebe) | Common around bridges and culverts | C | 3 | Insects and spiders |
| <u>Contopus virens</u> (Eastern wood pewee) | | C | 3 | " |
| <u>Myiarchus crinitus</u> (Great crested flycatcher) | Western limit of range | C | 2 | 90% insects and 10% small wild fruits |
| <u>Sayornis saya</u> (Say phoebe) | | R | 2 | Insects |
| <u>Muscivora forficata</u> (Scissor-tailed flycatcher) | Eastern and northern limit of range | C | 2 | Insects |
| SWALLOWS | | | | |
| <u>Progne subis</u> (Purple martin) | Mainly urban areas in birdhouses | C | 2 | Insects |
| <u>Riparia riparia</u> (Bank swallow) | Riparian; usually nests in high, cut banks | C | 2 | Insects |
| <u>Hirundo rustica</u> (Barn swallow) | Often in populated areas | C | 2 | Insects caught in air |
| <u>Steogidopteryx ruficollis</u> (Rough-winged swallow) | | C | 2 | " |
| WRENS | | | | |
| <u>Thryomanes bewickii</u> (Bewick's wren) | Rare WR | O | 3 | Insects and spiders |
| <u>Troglodytes aedon</u> (House wren) | Common in urban areas | C | 3 | Grasshopper, beetle, bugs, spiders and other small invertebrates |

| NAME | HABITAT | OCCUR- RENCE | TROPHIC LEVEL | DIET |
|--|---|-----------------|------------------|--|
| MOCKINGBIRDS AND THRASHERS | | | | |
| <u>Toxostoma rufum</u> (Brown thrasher) | Rare WR | C | 2 | 60% animal matter (insects and few invertebrates), and fruits, nuts, seeds |
| <u>Dumetella carolinensis</u> (Catbird) | | C | 3 | 55% vegetable matter and insects, spiders |
| THRUSHES, SOLITAIRES, AND BLUEBIRDS | | | | |
| <u>Hylocichla mustelina</u> (Wood thrush) | Western limit of range; inhabits mature shady forests | C | 2 | Insects, worms, small invertebrates; 30% plant food |
| GNATCATCHERS | | | | |
| <u>Polioptila caerulea</u> (Blue-gray gnatcatcher) | | C | 2 | Almost all insects |
| VIREOS | | | | |
| <u>Vireo gilvus</u> (Warbling vireo) | Riparian forest and farmyards with tall open-spaced trees | C | 3 | Insects, a few spider |
| <u>Vireo griseus</u> (White-eyed vireo) | Local; few found west of eastern Kansas and Oklahoma | C | 3 | Insects, spiders, and small invertebrates |
| <u>Vireo flavifrons</u> (Yellow-throated vireo) | | O | 2 | Insects |
| WARBLERS | | | | |
| <u>Mniotilta varia</u> (Black and white warbler) | Western limit of range | O | 2 | Insects |
| <u>Dendroica cerulea</u> (Cerulean warbler) | Western limit of range | O | 2 | Insects |
| <u>Wilsonia citrina</u> (Hooded warbler) | Riparian, heavy forest | R | 2 | Insects |
| <u>Oporonis formosus</u> (Kentucky warbler) | | O | 2 | Insects and some berries |

| NAME | HABITAT | OCCUR- RENCE | TROPHIC LEVEL | DIET |
|---|---|-----------------|------------------|--|
| WARBLERS (Continued) | | | | |
| <u>Parula americana</u> (Parula warbler) | Western limit of range | C | 3 | Insects, larvae and eggs, spiders |
| <u>Dendroica discolor</u> (Prairie warbler) | Western limit of range | O | 3 | Insects and few spiders |
| <u>Protonotaria citrea</u> (Prothonotary warbler) | Riparian; western limit of range | O | 3 | Insects, spiders, small invertebrates |
| <u>Limothlypis swainsonii</u> (Swainson's warbler) | Riparian; northern and western limit of range | R | 3 | Insects, spiders |
| <u>Geothlypis trichas</u> (Yellowthroat) | Riparian; northern and western limit of range | R | 3 | Insects, spiders |
| <u>Dendroica dominica</u> (Yellow-throated warbler) | Limited to Neosho drainage in SE Kansas; western limit of range | R | 2 | Mainly insects |
| <u>Seiurus motacilla</u> (Louisiana water-thrush) | Riparian | C | 3 | Insects, spiders, invertebrate, few seeds |
| <u>Setophaga ruticilla</u> (American redstart) | | O | 3 | Insects, seeds, berries, few spiders, invertebrates |
| <u>Icteria virens</u> (Yellow-breasted chat) | | C | 2 | Insects, berries and wild fruit |
| BLACKBIRDS AND ORIOLES | | | | |
| <u>Quiscalus quiscula</u> (Common grackle) | Generally in edge habitat; some winter records in Kansas and Oklahoma | C | 2 | Omnivorous, plants and animal matter |
| <u>Icterus glabula</u> (Baltimore oriole) | | C | 2 | 80% insects, small invertebrates, fruit, berries, nectar |

| NAME | HABITAT | OCCUR- RENCE | TROPHIC LEVEL | DIET |
|---|--|-----------------|------------------|--|
| TANAGERS | | | | |
| <u>Piranga olivacea</u> (Scarlet tanager) | Western limit of range | O | 2 | 85% insects and invertebrates, 15% berries, seeds |
| <u>Piranga rubra</u> (Summer tanager) | Western limit of range | C | 2 | Insects, invertebrates, berries, seeds |
| GROSBEAKS, FINCHES, SPARROWS, AND BUNTINGS | | | | |
| <u>Passerina cyanea</u> (Indigo bunting) | Along wooded margins | C | 2 | Seeds, grains, vegetable matter, and insects in the summer |
| <u>Calamospiza melanocorys</u> (Lark bunting) | Eastern limit of range; prairies | R | 2 | Weed, seeds, grains and insects |
| <u>Passerina ciris</u> (Painted bunting) | Edge habitat; northern limit of range | O | 2 | Seeds and insects |
| <u>Spiza americana</u> (Dickcissel) | Woodland-grassland edge | C | 2 | Seeds, grains, and insects |
| <u>Guiraca caerulea</u> (Blue grosbeak) | Edge and scrub habitat | R | 2 | Seeds, wild berries, and fruit |
| <u>Pheucticus ludovicianus</u> (Rose-breasted grosbeak) | Very rare west of Neosho River Basin | R | 3 | Insects, spiders, and wild seeds, fruits |
| <u>Spizella pusilla</u> (Field sparrow) | Edge habitat: PR in Oklahoma, rare WR in Kansas | C | 2 | Seeds and 40% insects in summer |
| <u>Ammodramus savannarum</u> (Grasshopper sparrow) | | C | 2 | Seeds and insects |
| <u>Passerherbulus henslowii</u> (Henslow's sparrow) | Rare in Oklahoma; western limit of range | O | 2 | Seeds and insects |
| <u>Chondestes grammacus</u> (Lark sparrow) | Edge and scattered scrub | C | 2 | Weed, grass, seeds, grain and grasshoppers and insects |
| <u>Aimophila ruficeps</u> (Rufous-crowned sparrow) | Rough country and high weeds; found in Grand River Basin only in Cherokee County, Oklahoma | R | 2 | Seeds and some insects |

| NAME | HABITAT | OCCUR- RENCE | TROPHIC LEVEL | DIET |
|--|---|-----------------|------------------|---|
| <u>WINTER RESIDENTS</u> | | | | |
| GEESE | | | | |
| <u>Branta canadensis</u> (Canada goose) | Local SR. Found on large reservoirs and in croplands | C | 2 | Aquatic plants, grain, grass, and some small invertebrates |
| SURFACE DUCKS | | | | |
| <u>Anas rubripes</u> (Black duck) | Local PR; numbers increasing but variable | C | 3 | 75% vegetable matter (aquatic plants, grass) 25% animal matter (insects, small fish) |
| <u>Anas platyrhynchos</u> (Mallard) | Local PR; numbers increasing but variable | C | 2 | Aquatic vegetation, grains grass, berries, acorns, and some insects, mollusks |
| DIVING DUCKS | | | | |
| <u>Mergus merganser</u> (Common merganser) | | C | 2 | Fish and some mollusks, insects, aquatic plants |
| HAWKS, EAGLES, FALCONS, AND VULTURES | | | | |
| <u>Accipiter gentilis</u> (Goshawk) | Present only in some winters | R | 3 | 60% of birds and 0% mammals |
| <u>Buteo harlani</u> (Harlan's hawk) | | O | 3 | 80% mammals (rodents) and some birds, insects |
| <u>Buteo lagopus</u> (Rough-legged hawk) | | O | 3 | Rodents, mice |
| <u>Haliaeetus leucocephalus</u> (Bald eagle) | Most common near impoundments | O | 3 | Fish major, rodents, ducks coots |
| <u>Falco peregrinus</u> (Peregrine falcon) | Usually around marshes; nearly extinct in central and eastern North America | R | 3 | 50% birds, and mammals, some insects |

| NAME | HABITAT | OCCUR- RENCE | TROPHIC LEVEL | DIET |
|--|--|-----------------|------------------|---|
| OWLS | | | | |
| <u>Nyctea scandiaca</u> (Snowy owl) | Open country habitat - some but not most winters | R | 3 | Lemmingo, some rodents, rabbits, squirrels |
| NUTHATCHES AND CREEPERS | | | | |
| <u>Certhia familiaris</u> (Brown creeper) | | C | 3 | Insects, spiders, and small invertebrates |
| WRENS | | | | |
| <u>Troglodytes troglodytes</u> (Winter wren) | Local in heavy cover | R | 3 | Beetles, spiders, ants and other insects |
| THRUSHES, SOLITAIRES, AND BLUEBIRDS | | | | |
| <u>Myadestes townsendi</u> (Townsend's solitaire) | Edge habitat; not present most winters | R | 2 | Wild fruit, seeds, and insects |
| <u>Sialia currucoides</u> (Mountain bluebird) | Open woodland; generally a casual stray | R | 2 | Flowers, berries, fruits, insects and invertebrates |
| WAXWINGS | | | | |
| <u>Bombycilla cedrorum</u> (Cedar waxwing) | Rare in Kansas SR | R | 2 | 80% berries, fruits, flowers, and 20% insects |
| BLACKBIRDS AND ORIOLES | | | | |
| <u>Euphagus cyanocephalus</u> (Brewer's blackbird) | | O | 2 | Omnivorous |
| GROSBEAKS, FINCHES, SPARROWS, AND BUNTINGS | | | | |
| <u>Loxia curvirostra</u> (Red crossbill) | | O | 1 | Seeds, conifers |
| <u>Loxia leucoptera</u> (White-winged crossbill) | | R | 2 | Seeds of coniferous trees, berries, fruits and some insects |

| NAME | HABITAT | OCCUR- RENCE | TROPHIC LEVEL | DIET |
|--|-------------------------------------|-----------------|------------------|---|
| GROSBEAK, FINCHES, SPARROWS, AND BUNTINGS (Continued) | | | | |
| <u>Calcarinus ornatus</u> (Chestnut-collared longspur) | | O | 2 | Weed seeds, grass seeds and 80% insects in summer |
| <u>Calcarius lapponicus</u> (Lapland longspur) | Irregular | C | 2 | Most seeds and some insects in summer |
| <u>Calcarius pictus</u> (Smith's longspur) | Irregular | R | 2 | " |
| <u>Acanthis flammea</u> (Common redpoll) | | R | 2 | " |
| <u>Hesperiphona vespertina</u> (Evening grosbeak) | Irregular | O | 1 | Seeds and leaves |
| <u>Spinus pinus</u> (Pine siskin) | Irregular SR in Kansas and Oklahoma | O | 2 | Seeds and insects |
| <u>Junco hyemalis</u> (Slate-colored junco) | Open woodland and fields | C | 2 | " |
| <u>Passerella iliaca</u> (Fox sparrow) | | C | 2 | Seeds and insects in summer |
| <u>Zonotrichia querula</u> (Harris' sparrow) | | C | 2 | Seeds and insects, small invertebrates |
| <u>Melospize melodia</u> (Song sparrow) | Riparian; possible local SR | C | 2 | Mainly grasses, seeds and insects |
| <u>Spizella arborea</u> (Tree sparrow) | | C | 2 | " |
| <u>Zonotrichia leucophrys</u> (White-crowned sparrow) | | C | 2 | Seeds and insects, mainly seeds for winters |
| LOONS | | | | |
| <u>Gavia immer</u> (Common loon) | | O | 3 | Mainly fish and crustaceans mullusks, insects and some aquatic plants |

| NAME | HABITAT | OCCUR- RENCE | TROPHIC LEVEL | DIET |
|---|--|-----------------|------------------|--|
| GREBES | | | | |
| <u>Podiceps caspicus</u> (Eared grebe) | | O | 2 | 90% of both land and aquatic insects and invertebrates |
| <u>Podiceps auritus</u> (Horned grebe) | | O | 3 | 99% of aquatic animals |
| PELICAN | | | | |
| <u>Pelecanus erythrorhynchos</u> (White pelican) | | C | 3 | Mainly fish |
| SWANS | | | | |
| <u>Olor columbianus</u> (Whistling swan) | Rare now, formerly common | R | 1 | Aquatic plants (major) and some grasses |
| GEESE | | | | |
| <u>Chen caerulescens</u> (Blue goose) | | C | 1 | Waterweeds, grain, grass, sedges |
| <u>Anser albifrons</u> (White-fronted goose) | | O | 2 | Nuts, grain, berries, leaves and some aquatic insects |
| SURFACE DUCKS | | | | |
| <u>Mareca americana</u> (American widgeon) | Also WR | C | 2 | Aquatic plants, grass and some insects, mollusks |
| <u>Anas cyanoptera</u> (Cinnamon teal) | | R | 2 | Same as Pintail |
| <u>Anas strepera</u> (Gadwell) | Also WR; occasional SR in the northern part of the Basin | C | 2 | Aquatic plants, grass, grains, nuts and 10% of animal matter |

| NAME | HABITAT | OCCUR- RENCE | TROPHIC LEVEL | DIET |
|--|--|-----------------|------------------|---|
| SURFACE DUCKS (Continued) | | | | |
| <u>Anas acuta</u> (Pintail) | Also WR; occasional SR in the northern part of the Basin | C | 2 | Aquatic plants, grass, weeds, and some insects, mollusks |
| <u>Spatula clypeata</u> (Shoveler) | | C | 2 | " |
| BAY AND SEA DUCKS | | | | |
| <u>Bucephala albeola</u> (Bufflehead) | Also WR | O | 3 | 80% of insects, crustaceans, mollusks, fish and rest of aquatic plants |
| <u>Aythya valisineria</u> (Canvasback) | Sometimes a WR in Oklahoma | O | 3 | 80% vegetables (aquatic plants) and some fish, insects |
| <u>Bucephala clangula</u> (Common goldeneye) | Also WR | O | 3 | Mainly animal, fish, insects, and mollusks |
| <u>Aythya marila</u> (Greater scaup) | | R | 2 | 50% vegetables (aquatic plants, grasses) and 50% animal (insect, mollusks, crustaceans) |
| <u>Aythya affinis</u> (Lesser scaup) | Also WR in Kansas and Oklahoma | C | 2 | More vegetarian than greater scaup |
| <u>Clangula hyemalis</u> (Oldsquaw) | Rare WV | R | 3 | Mainly animal matter (insects, mollusks, fish) |
| <u>Aythya collaris</u> (Ring-necked duck) | Also WR in Kansas | O | 2 | 80% vegetation (aquatic plants, grass) and some insects, mollusks |
| <u>Aythya americana</u> (Redhead) | Rare WR; rarely breeds locally in Kansas | O | 2 | Mostly vegetables, seeds, grass, aquatic plants |

| NAME | HABITAT | OCCUR- RENCE | TROPHIC LEVEL | DIET |
|---|------------------------------------|-----------------|------------------|--|
| BAY AND SEA DUCKS (Continued) | | | | |
| <u>Melanitta perspicillata</u> (Surf scoter) | | R | 2 | 60% Mollusks, and some vegetable matter |
| <u>Melanitta deglandi</u> (White-winged scoter) | Unusual | R | 2 | Mollusks, oysters, clams insects and small amount of plant |
| DIVING DUCKS | | | | |
| <u>Lophodytes cucullatus</u> (Hooded merganser) | Rare WV | O | 3 | Mainly animal food (fish, amphibians, crustaceans, insects); some vegetable matter (grain, grasses, weeds) |
| <u>Mergus serrator</u> (Red-breasted merganser) | | O | 3 | Fish, mollusks, crustaceans, and aquatic insects |
| <u>Oxyura jamaicensis</u> (Ruddy duck) | Local SR in Kansas; WV in Oklahoma | C | 2 | 75% vegetable food (weeds, sedges, grass) 25% insects, shellfish |
| HAWKS, EAGLES, FALCONS, AND VULTURES | | | | |
| <u>Pandion haliaetus</u> (Osprey) | Irregular | O | 3 | Fish, some vertebrates, offal |
| <u>Falco columbarius</u> (Pigeon hawk) | Open woodland; rare WR | O | 3 | 60% small birds, and some insects, small animals |
| <u>Falco mexicanus</u> (Prairie falcon) | Rare WV | R | 3 | Some mammals, insects |
| CRANES | | | | |
| <u>Crus canadensis</u> (Sandhill crane) | Open fields and marshes | R | 3 | Roots, seeds, grain and worm, insects, fish, amphibians, reptiles |

| NAME | HABITAT | OCCUR- RENCE | TROPHIC LEVEL | DIET |
|--|---|-----------------|------------------|--|
| CRANES (Continued) | | | | |
| <u>Crus americana</u> (Whooping crane) | Principal migration route over central Kansas and Oklahoma. | R | 3 | Animal matter and some plant food |
| RAILS AND COOTS | | | | |
| <u>Fulica americana</u> (American coot) | Irregularly winters and/or nests in Kansas and Oklahoma. | C | 3 | Vegetable matter, fish, tadpoles, snails, worms and crustaceans |
| <u>Porzana carolina</u> (Sora) | Local SR in Kansas | O | 2 | Seeds of aquatic plants, mollusks, worms, insects |
| <u>Rallus limicola</u> (Virginia rail) | Local SR in Kansas | O | 3 | Worms, aquatic insects, slugs, mollusks, amphibians, small fish and some seeds |
| <u>Coturnicops noveboracensis</u> (Yellow rail) | Found around marshes. | R | 2 | small snails |
| PLOVERS AND TURNSTONE | | | | |
| <u>Pluvialis dominica</u> (American golden plover) | Open fields and plowed ground; rarely lemnic | C | 2 | Insects, major worms, crustaceans, mollusks |
| <u>Squatarola aquatarola</u> (Black-bellied plover) | Shorelines and mudflats. | O | 2 | " |
| <u>Charadrius semipalmatus</u> (Semipalmated plover) | | C | 2 | Small crustaceans, mollusks, insects, worms |
| <u>Arenaria interpres</u> (Ruddy Turnstone) | Along stony and pebbly shorelines | O | 2 | small mollusks |
| WOODCOCKS AND SNIPES | | | | |
| <u>Philohela minor</u> (American woodcock) | Riparian and forest; rare SR in Kansas and Oklahoma. | O | 2 | Earthworms, insect larvae and some seed |

| NAME | HABITAT | OCCUR- RENCE | TROPHIC LEVEL | DIET |
|---|---|-----------------|------------------|--|
| WOODCOCKS AND SNIPES (Continued) | | | | |
| <u>Capella galinago</u> (Common snipe) | Occasional WR | O | 2 | Insects, aquatic forms, larvae, crustaceans, worms snail |
| SANDPIPERS | | | | |
| <u>Numenius borealia</u> (Eskimo Curlew) | Formerly a spring transient; nearly extinct | R | 2 | Berries and insects |
| <u>Numenius americanus</u> (Long-billed curlew) | More common in spring than fall. | O | 3 | Insects, worms, toads, crustaceans |
| <u>Limodromus scolopaceus</u> (Long-billed dowitcher) | Shorelines and mudflats. | C | 2 | Aquatic insects, larvae marine animals |
| <u>Limnodromus griseus</u> (Short-billed dowitcher) | Shorelines and mudflats. | R | 2 | Insects, marine animals and some seeds |
| <u>Limosa Haemastica</u> (Hudsonian godwit) | Shorelines and mudflats. | C | 2 | Insects, worms, small crustaceans, small mollusks |
| <u>Limosa Fedora</u> (Marbled godwit) | Shorelines and mudflats. | O | 2 | Aquatic food, mollusks, insects, worms |
| <u>Totanus melanoleucus</u> (Greater yellowlegs) | Shorelines and mudflats | C | 3 | Small fish, insects, worms |
| <u>Totanus flavipes</u> (Lesser yellowlegs) | Shorelines and mudflats. | C | 3 | Insects, small crustaceans, small fish and worms |
| <u>Erolia alpina</u> (Dunlin) | Shorelines and mudflats | O | 2 | Small mollusks, insects, crustaceans and some other plants |
| <u>Calidris canutus</u> (Knot) | Sandy shorelines | R | 2 | " |

| NAME | HABITAT | OCCUR- RENCE | TROPHIC LEVEL | DIET |
|--|---|-----------------|------------------|---|
| SANDPIPERS (Continued) | | | | |
| <u>Crocethia alba</u> (Sanderling) | Sandy shorelines and bars. | O | 2 | Small crustaceans, insects worms, and some invertebrates |
| <u>Bartramia longicauda</u> (Upland plover) | Abundant in the Flint hills where it is a summer resident. | C | 2 | Animal matter (insects) seeds |
| <u>Catoptrophorus semipalmatus</u> (Willet) | Shorelines, meadows, and mudflats. | O | 2 | Insects, small marine animals and some vegetable matter |
| <u>Steganopus tricolor</u> (Wilson's phalarope) | Southern limit of breeding range. | C | 2 | Insects, crustaceans, aquatic plants seeds |
| <u>Erolia bairdii</u> (Baird's sandpiper) | Shorelines and mudflats. | C | 2 | Insects, small crustaceans |
| <u>Trynigites subruficollis</u> (Buff-breasted sandpiper) | Often in alfalfa fields. | O | 2 | Insects, few seeds |
| <u>Erolia minutilla</u> (Least sandpiper) | Shorelines, mudflats, and wet meadows. | C | 2 | Insects and crustaceans |
| <u>Erolia melanotos</u> (Pectoral sandpiper) | Shorelines, mudflats, and wet meadows. | C | 2 | Insects and crustaceans |
| <u>Ereunetes pusillus</u> (Semipalmated sandpiper) | Sandy shorelines and mudflats | C | 2 | Insects, small marine animals |
| <u>Tringa solitaria</u> (Solitary sandpiper) | Wet meadows, ponds and mud. | C | 2 | Aquatic insects, small crustaceans |
| <u>Micropalama himantopus</u> (Stilt sandpiper) | Shorelines and mudflats | C | 2 | Insects, aquatic animals 30-10 vegetable matter |
| <u>Erolia fuscicollis</u> (White-rumped sandpiper) | Shorelines and mudflats | C | 2 | Insects, small mature animals |

| NAME | HABITAT | OCCUR- RENCE | TROPHIC LEVEL | DIET |
|--|--|-----------------|------------------|---|
| GULLS AND TERNS | | | | |
| <u>Larus philadelphia</u> (Bonaparte's gull) | | R | 2 | Insects, worms and some invertebrates |
| <u>Larus pipixcan</u> (Franklin's gull) | Near water, and especially plowed fields | C | 2 | Mostly insects, worms and some invertebrates |
| <u>Larus argentatus</u> (Herring gull) | Around Lakes | O | 2 | Marine animals, small mammals, vertebrates |
| <u>Larus delawarensis</u> (Ring-billed gull) | Usually near water or plowed fields | O | 3 | Insects, worms, fish and small mammals |
| <u>Chlidonias niger</u> (Black tern) | More common in central Kansas and Oklahoma | C | 3 | Aquatic insects, spiders, leeches, small fish and frogs |
| <u>Hydroprogne caspia</u> (Caspian tern) | | O | 3 | Fish, worms |
| <u>Sterna hirundo</u> (Common tern) | | O | 3 | Small fish, insects, and small marine invertebrates |
| <u>Sterna forsteri</u> (Forster's tern) | Local SR | C | 3 | Insects, fish, mollusks |
| OWLS | | | | |
| <u>Speotyto cunicularia</u> (Burrowing owl) | | R | 3 | Insects, small mammals, rodents |
| CUCKOOS AND ROADRUNNERS | | | | |
| <u>Coccyzus erythrophthalmus</u> (Black-billed cuckoo) | Rare SR | O | 2 | Insects |
| WOODPECKERS | | | | |
| <u>Sphyrapicus varius</u> (Yellow-billed sapsucker) | Local SR | O | 2 | Berries, fruits, insects |

| NAME | HABITAT | OCCUR- RENCE | TROPHIC LEVEL | DIET |
|---|---|-----------------|------------------|---|
| FLYCATCHERS | | | | |
| <u>Empidonax minimus</u> (Least flycatcher) | Open woodlands | C | 3 | Insects, spiders |
| <u>Epidonas traillii</u> (Traill's flycatcher) | Riparian and forest edge | O | 2 | Insects |
| <u>Empidonas flaviventris</u> (Yellow-bellied flycatcher) | | O | 3 | 97% insects, spiders; 3% berries, seeds |
| <u>Contopus sordidulus</u> (Western weed pewee) | Open woodlands; probably only in Kansas and Oklahoma | R | 2 | Insects |
| SWALLOWS | | | | |
| <u>Petrochelidon pyrrhonota</u> (Cliff swallow) | Usually near water, cultivated fields and pastureland; local SR | C | 3 | Insects and spiders, a few berries |
| <u>Iridoprocne bicolor</u> (Tree swallow) | Often near water and open fields | C | 2 | 80% insects and some vegetable food |
| NUTHATCHES AND CREEPERS | | | | |
| <u>Sitta canadensis</u> (Red-breasted nuthatch) | Local WR; prefers conifers | O | 3 | Pine seeds, insects and spiders, fruits, nuts |
| WRENS | | | | |
| <u>Telmatodytes palustris</u> (Long-billed marsh wren) | Occasional WR in Oklahoma | O | 2 | Mostly insects and a few fruits |
| <u>Cistothorus platensis</u> | Local SR in Kansas | R | 2 | " |
| THRUSHES AND BLUEBIRDS | | | | |
| <u>Hylocichla minima</u> (Grey cheeked thrush) | | C | 2 | 75% insects and invertebrates, 25% plant food such as seeds and berries |

| NAME | HABITAT | OCCUR- RENCE | TROPHIC LEVEL | DIET |
|---|--|-----------------|------------------|---|
| THRUSHES AND BLUEBIRDS (Continued) | | | | |
| <u>Hylocichla guttata</u> (Hermit thrush) | | O | 3 | 65% insects, spiders, snails, 35% vegetable food |
| <u>Hylocichla ustulata</u> (Swainson's thrush) | | C | 2 | 50% animal matter (insects, etc.), and 50% rest of vegetable food (seed, berries) |
| <u>Hylocichla fuscescens</u> (Veery) | Generally rare in Kansas | O | 2 | 60% animal matter, 40% vegetable food |
| WAXWINGS | | | | |
| <u>Bombycilla garrulus</u> (Bohemian waxwing) | Edge habitat; WV; southern limit of winter range | R | 2 | Insects in summer and berries in winter |
| KINGLETS | | | | |
| <u>Regulus satrapa</u> (Golden-crowned kinglet) | Uncommon WR | C | 2 | Insects, invertebrates, and few berries, seeds |
| <u>Regulus calendula</u> (Ruby-crowned kinglet) | Usually in woodland edges; rare WR | C | 2 | Little known |
| PIPITS | | | | |
| <u>Anthus spragueii</u> (Sprague's pipit) | Open country | O | 2 | Insects |
| <u>Anthus spinoletta</u> (Water pipit) | Open country | O | 2 | Insects |

| NAME | HABITAT | OCCUR- RENCE | TROPHIC LEVEL | DIET |
|--|------------------------------------|-----------------|------------------|---|
| VIREOS | | | | |
| <u>Vireo philadelphicus</u> (Philadelphus vireo) | | 0 | 3 | Insects, spiders, small vertebrates, berries (10%) |
| <u>Vireo solitarius</u> (Solitary vireo) | | 0 | 3 | 95% insects, spiders, small vertebrates; 5% berries |
| WARBLERS | | | | |
| <u>Dendroica auduboni</u> (Audubon's warbler) | | 0 | 3 | 85% insects and spiders, 15% vegetable food |
| <u>Dendroica castanea</u> (Bay-breasted warbler) | | 0 | 3 | Insects and some spiders |
| <u>Dendroica fusca</u> (Blackburnian warbler) | | 0 | 3 | Mostly insects and a few spiders, berries |
| <u>Dendroica striata</u> (Blackpoll warbler) | | C | 3 | " |
| <u>Dendroica virens</u> (Blackthroated green warbler) | | 0 | 3 | " |
| <u>Vermivora pinu</u> (Blue-winged warbler) | Probably SR in Kansas and Missouri | 0 | 3 | Insects and spiders |
| <u>Wilsonia canadensis</u> (Canada warbler) | | 0 | 2 | Almost all insects |
| <u>Dendroica tigrina</u> (Cape May warbler) | | R | 2 | Mostly insects and some fruit |
| <u>Dendroica pensylvanica</u> (Chestnut-sided warbler) | | 0 | 2 | Insects and seeds |
| <u>Oporonis agilis</u> (Connecticut warbler) | | 0 | 3 | Insects and spiders, fruit |
| <u>Vermivora chrysoptera</u> (Golden-winged warbler) | Observed only in spring | R | 2 | Insects |

| NAME | HABITAT | OCCUR- RENCE | TROPHIC LEVEL | DIET |
|--|---------------------------------|-----------------|------------------|--|
| WARBLERS (Continued) | | | | |
| <u>Oporonis tolmiei</u> (MacGillivrey's warbler) | | R | 2 | Insects major |
| <u>Dendroica magnolia</u> (Magnolia warbler) | | O | 3 | Insects, spiders and some small invertebrates |
| <u>Oporonis philadelphia</u> (Mourning warbler) | | C | 2 | Mainly insects and some vegetable matter |
| <u>Dendroica coronata</u> (Myrtle warbler) | Rare WR | C | 2 | Insects, seeds, berries and other fruits |
| <u>Vermivora ruficapilla</u> (Nashville warbler) | | C | 2 | Insects, some invertebrate |
| <u>Vermivora celeta</u> (Orange-crowned warbler) | Occasional WR in Kansas | C | 2 | Mainly insects |
| <u>Dendroica palmarum</u> (Palm warbler) | | O | 3 | Insects, spiders and some invertebrates |
| <u>Dendroica pinus</u> (Pine warbler) | PR in Cherokee County, Oklahoma | O | 3 | Insects, spiders, pine, seeds berries and fruits |
| <u>Vermivora peregrina</u> (Tennessee Warbler) | | C | 2 | Insects, some small invertebrate, fruit, seeds |
| <u>Wilsonia pusilla</u> (Wilson's warbler) | | C | 2 | Insects, flower parts |
| <u>Helmitheros vermivorus</u> (Worm-eating warbler) | Possible Sr | R | 2 | Insects mainly |
| <u>Seiurus noveboracensis</u> (Northern waterthrush) | Generally in wet woodlands | O | 2 | Insects, worms, small invertebrates, some seeds |
| <u>Seiurus aurocapillus</u> (Ovenbird) | Possibly rare SR in Kansas | O | 2 | Insects, snails, worms, invertebrates, seeds berries fruit |

| NAME | HABITAT | OCCUR- RENCE | TROPHIC LEVEL | DIET |
|--|---|-----------------|------------------|---|
| BLACKBIRDS AND ORIOLES | | | | |
| <u>Euphagus carolinus</u> (Rusty blackbird) | Wooded swamps; local Wr | C | 2 | Insects, invertebrates weed seeds, fruit vegetable matter |
| <u>Xanthocephalus xanthocephalus</u> (Yellow-headed blackbird) | Inhabits fields and marshes; often around cattails, local SR in Kansas. | O | 2 | Grain, seeds, and some insects, small invertebrates |
| GROSBEAKS, FINCHES, SPARROWS, AND BUNTINGS | | | | |
| <u>Carpodacus purpureus</u> (Purple Finch) | WV | O | 3 | Seeds, plants, insects, spiders and other small invertebrates |
| <u>Ammodramus bairdii</u> (Baird's sparrow) | | R | 2 | Seeds and some insects |
| <u>Spizella passerina</u> (Chipping sparrow) | Principally in towns, rare, local SR | C | 2 | Seeds, insects, seeds |
| <u>Passerherbulus caudacutus</u> (LeConte's sparrow) | Local WR | C | 2 | Seeds, insects |
| <u>Melospiza lincolni</u> (Lincoln's sparrow) | Uncommon WR | C | 2 | Insects, small invertebrates seeds, weeds |
| <u>Passervulus sanwicensis</u> (Savannah sparrow) | Rare WR | C | 2 | Grass, seeds, insects, small invertebrates |
| <u>Ammospiza caudacuta</u> (Sharp-tailed sparrow) | Riparian edge | R | 3 | Insects, spiders, small invertebrates, snails, weeds, seeds |
| <u>Zonotrichia albicollis</u> (White-throated sparrow) | Rare WR | C | 2 | Weeds, seeds, insects |
| <u>Melospiza georgiana</u> (Swamp Sparrow) | Riparian: occasional WR | C | 2 | Insects, seeds |

APPENDIX D-3

FISHES OF THE MID-ARKANSAS RIVER BASIN

| NAME | HABITAT | OCCUR- RENCE | TROPHIC LEVEL | DIET |
|---|--|-----------------|------------------|--|
| FISHES | | | | |
| <u>Polyodon spathula</u> (Paddlefish) | I/M | C | 2 | Aquatic plants |
| <u>Lepisosteus osseus</u> (Longnose gar) | M/T | C | 3 | Other fishes |
| <u>Lepisosteus platostoma</u> (Shortnose gar) | M | C | 3 | " |
| <u>Lepisosteus oculatus</u> (Spotted gar) | M/I | O | 3 | " |
| <u>Anguilla rostrata</u> (American eel) | M/T: Probably no longer present in MID-ARK Region. Dams impede migrations. | R | 3 | " |
| <u>Dorosoma cepedianum</u> (Gizzard shad) | I/M: Widely distributed | C | 2 | Crustaceans, fry of fish |
| <u>Dorosoma petenense</u> (Threadfin shad) | I/M | R | 2 | " |
| <u>Esox lucius</u> (Northern pike) | I: Introduced to reservoir | O | 3 | Other fishes |
| <u>Hiodon alosoides</u> (Goldeye) | M/I | R | 2 | Planktonic organisms |
| <u>Cyprinus carpio</u> (Carp) | I/M/T: Introduced | C | 2 | Molluses |
| <u>Hybopsis amblops</u> (Bigeye chub) | T: Western limit of range | C | 2 | Aquatic insect and planktonic organisms |
| <u>Semotilus atromaculatus</u> (Creek chub) | T | R | 2 | " |
| <u>Hybopsis x-punctata</u> (Gravel chub) | M: Western limit or range | R | 2 | Little known |
| <u>Nocomis biguttatus</u> (Hornyhead chub) | T: Declining in numbers | O | 2 | Aquatic animals, plant |
| <u>Hybopsis storeriana</u> (Silver chub) | M: Mainly in large rivers with sandy bottoms. | R | 2 | Little known |
| <u>Phoxinus erythrogaster</u> (Southern redbelly dace) | T: Small streams; pools. | R | 2 | Siatom, algae other vegetation |
| <u>Carassius auratus</u> (Goldfish) | I/T: Introduced | R | 2 | Shrimp |

| NAME | HABITAT | OCCUR-- RENCE | TROPHIC LEVEL | DIET |
|---|-----------------------------|------------------|------------------|--|
| FISHES (Continued) | | | | |
| Pimephales notatus (Bluntnose minnow) | T | C | 2 | Algae, small animal |
| Pimephales vigilax (Bullhead minnow) | M | R | 2 | Algae, snail, other small animals |
| Pimophales promelas (Fathead minnow) | T | O | 2 | Vegetation, adults eat animal, insects too |
| Hybognathus placitus (Plains minnow) | M: Large sandy rivers | R | 2 | " |
| Pimephales tenellus (Slim minnow) | T: High-gradient streams | R | 2 | " |
| Notropis boops (Bigeye shiner) | T: High-gradient streams | C | 2 | " |
| Notropis camurus (Bluntface shiner) | T: High-gradient streams | O | 2 | " |
| Notropis pilsbryi (Duckystripe shiner) | T: Western limit of range | O | 2 | " |
| Notropis atherinoides (Emerald shiner) | M: Large, sandy rivers | R | 2 | Plankton |
| Notropis buechanani (Ghost shiner) | M | O | 2 | " |
| Notemigonus crysoleucas (Golden shiner) | T/I: Common in impoundments | O | 2 | Algae, plants, and entomostracans |
| Notropis volucellus (Mimic shiner) | T | O | 2 | Dipteran, amphipod |
| Notropis lutrensis (Red shiner) | M/T/I | C | 2 | " |
| Notropis umbratilus (Redfin shiner) | T | C | 2 | Algae, insects |
| Notropis rubellus (Rosyface shiner) | T | O | 2 | |

| NAME | HABITAT | OCCUR- RENCE | TROPHIC LEVEL | DIET |
|---|--------------------------------------|-----------------|------------------|--------------------|
| FISHES (Continued) | | | | |
| Notropis stramineus (Sand shiner) | T: Western limit of range | 0 | 2 | " |
| Notropis spilopterus (Spotfin shiner) | Western limit of range | 0 | 2 | " |
| Notropis whipplei (Steelcolor shiner) | M: Western limit of range | R | 2 | " |
| Notropis chrysocephalus (Striped shiner) | T: Western limit of range | R | 2 | " |
| Notropis topeka (Topeka shiner) | T: Southern limit of range | R | 2 | Little known |
| Campostoma anomalum (Stoneroller) | T | C | 2 | Plant Materials |
| 262 Ictiobus cyprinellus (Bigmouth buffalo) | M/T | C | 2 | Insect, vegetation |
| Ictiobus niger (Black buffalo) | M/I | C | 2 | " |
| Ictiobus bubalus (Smallmouth buffalo) | M/I | C | 2 | " |
| Carpiodes velifer (Highfin carpsucker) | M/I: Last record, in Kansas, 1958 | R | 2 | " |
| Carpiodes carpio (River carpsucker) | M/T/I | C | 2 | Invertebrates |
| Hypentelium nigricans (Northern hog sucker) | T: Western limit of range | 0 | 2 | " |
| Moxostoma dugesnei (Black redhorse) | T: Western limit of range | C | 2 | " |
| Moxostoma erythrurum (Golden redhorse) | T/M | C | 2 | " |
| Moxostoma macrolepidotum (Northern redhorse) | T/M | C | 2 | Insect & animals |

| NAME | HABITAT | OCCUR- RENCE | TROPHIC LEVEL | DIET |
|---|--|-----------------|------------------|---|
| FISHES (Continued) | | | | |
| Moxostoma carinatum (River redhorse) | T: No recent records | R | 2 | " |
| Cycleptus elongatus (Blue sucker) | M: Western limit of range | R | 2 | Invertebrates |
| Minytrema melanops (Spotted sucker) | T: Decreasing abundance. Intolerant of high tur- bidity and siltation. | R | 2 | " |
| Catostomus commersoni (White sucker) | T: Southern limit of range | O | 2 | " |
| Ictalurus melas (Black bullhead) | M/I/T | C | 2 | Everything available |
| 263 Ictalurus natalis (Yellow bullhead) | T | O | 2 | " |
| Ictalurus punctatus (Channel catfish) | M/T | C | 3 | " |
| Pylodictis olivaris (Flathead) | M/I | C | 3 | " |
| Noturus noeturnus (Freckled madtom) | Sluggish streams with aquatic vegetation | R | 3 | " |
| Noturus exilis (Slender madtom) | Western limit of range | O | 3 | " |
| Noturus gyrinus (Tadpole madtom) | Usually associated with aquatic vegetation. Western limit of range | R | 3 | " |
| Noturus flavus (Stonecat) | T/M Southern limit of range | C | 2 | Mostly animal, insect sometimes vegetation |

| NAME | HABITAT | OCCUR- RENCE | TROPHIC LEVEL | DIET |
|---|--|-----------------|------------------|-----------------------------------|
| FISHES (Continued) | | | | |
| Fundulus kansae (Plains killifish) | T: Eastern limit of range | 0 | 2 | insect, algae |
| Fundulus catenatus (Northern studfish) | M/T: Western limit of range | R | 2 | " |
| Fundulus olivaceus (Blackspotted topminnow) | T: Western limit of range | 0 | 2 | " |
| Fundulus notatus (Blackstripe topminnow) | T | C | 2 | " |
| Fundulus sciadicus (Plains topminnow) | T: Southern limit of range | R | 2 | " |
| Gambusia affinis (Mosquitofish) | T/M: Widely distributed | C | 2 | " |
| Labidesthes sicculus (Brook silverside) | M/T: Basically in streams, but invade lakes | C | 2 | Small organisms |
| Morone chrysops (White bass) | I/M | C | 3 | " |
| Morone saxatilis (Striped bass) | I | 0 | 3 | " |
| Micropterus salmoides (Largemouth bass) | T/M/I: Widely distributed | C | 3 | All kinds of animals |
| Micropterus dolomieu (Smallmouth bass) | T: Western limit of range | R | 3 | Minnow, insect |
| Micropterus punctulatus (Spotted bass) | | C | 3 | " |
| Lepomis macrochirus (Bluegill) | T/I: Mainly lakes and im- poundments | C | 2 | Mainly animal, also plant food |
| Pomoxis nigromaculatus (Black crappie) | T/I: Mainly lakes and im- poundments | C | 3 | Animal life |
| Pomoxis annularis (White crappie) | T/I/M: Mainly lakes and im- poundments | C | 3 | " |
| Lepomis cyanellus (Green sunfish) | T/I | 0 | 2 | All kinds of insect |

| NAME | HABITAT | OCCUR- RENCE | TROPHIC LEVEL | DIET |
|---|-----------------------------|-----------------|------------------|-------------------------------|
| Fishes (Continued) | | | | |
| Lepomis megalotis (Longear sunfish) | T/I | C | 2 | " |
| Leopmis humilis (Orangespotted sunfish) | T/I | C | 2 | Small crustaceans, insects |
| Lepomis microlophus (Redear sunfish) | T/I | O | 2 | " |
| Lepomis gulosus (Warmouth) | T/I | R | 3 | " |
| Etheostoma cragini (Arkansas darter) | T: Eastern limit of range | R | 2 | " |
| Etheostoma zorale (Banded darter) | T/M: Eastern limit of range | C | 2 | Little known |
| Etheostoma chlorosomum (Bluntnose darter) | T/I: Western limit of range | O | 2 | " |
| Percina copelandi (Channel darter) | T: Western limit of range | O | 2 | " |
| Etheostoma flabellare (Fantail darter) | T: Western limit of range | C | 2 | Small insect and animals |
| Etheostoma blennoides (Greenside darter) | T: Western limit of range | O | 2 | Little known |
| Etheostoma nigrum (Johnny darter) | T: Western limit of range | R | 2 | " |
| Etheostoma microperea (Least darter) | M/T: Western limit of range | R | 2 | Aquatic animal life |
| Etheostoma spectabile (Orangethroat darter) | T | C | 2 | Little known |
| Etheostoma whipplei (Redfin darter) | T | O | 2 | " |
| Percina shumardi (River darter) | M: Western limit of range | R | 2 | " |
| Percina phoxocephala (Slenderhead darter) | T/M | C | 2 | " |

| NAME | HABITAT | OCCUR-- RENCE | TROPHIC LEVEL | DIET |
|--|---------------------------|------------------|------------------|-------------------|
| Fishes (Continued) | | | | |
| Etheostoma gracile (Slough darter) | T | R | 2 | " |
| Etheostoma stigmaeum (Speckled darter) | T: Western limit of range | R | 2 | " |
| Etheostoma punctulatum (Stippled darter) | T: Western limit of range | O | 2 | " |
| Percina caprodes (Logperch) | T | C | 2 | Algae, insects |
| Perca flavescens (Yellow perch) | I: Introduced | R | 2 | Snails |
| Stizostedion canadense (Sauger) | I: Introduced | O | 3 | Worms, minnow |
| Stizostedion vitreum (Walleye) | I: Introduced | O | 3 | " |
| Aplodinotus grunniens (Freshwater drum) | M/I | C | 3 | " |
| Cottus carolinae (Banded sculpin) | T: Western limit of range | O | 2 | Small crustaceans |

APPENDIX D-4

REPTILES OF THE MID-ARKANSAS RIVER BASIN

| NAME | HABITAT | OCCUR- RENCE | TROPHIC LEVEL | DIET |
|---|---|-----------------|------------------|--|
| SNAKES | | | | |
| <u>Ancistrodon contortrix</u> (Copperhead) | B/R/W | C* | 3 | Small rodents, birds, frogs |
| <u>Agkistrodon piscivorus</u> (Cottonmouth) | A | C* | 3 | " |
| <u>Sistrurus catenatus</u> (Massasauga) | R | O* | 3 | Rodents, frogs, toads, birds, insects, crayfish, fish |
| <u>Coluber constrictor</u> (Racer) | P/W | C | 3 | Small mammals, batrachians, snakes, lizards |
| <u>Crotalus atrox</u> (Western diamondback rattlesnake) | B/P/S | R* | 3 | Rodents, birds |
| <u>Crotalus horridus</u> (Timber rattlesnake) | W: Wooded hills with limestone outcrops | R* | 3 | Toads, mice, insects, small snakes, birds |
| <u>Sistrurus miliarius</u> (Pigmy rattlesnake) | W: Marshy areas | R | 3 | Mammals, lizards, insects, small birds, frogs |
| <u>Carphophis amoenus</u> (Worm snake) | R/W | C | 2 | Insects, earthworms, slugs, snails |
| <u>Carphophis vermis</u> (Western worm snake) | R | C | 3 | Earthworms, insects, small snakes |
| <u>Diadophis punctatus</u> (Ringneck snake) | P/W: Moist rocky hillsides | C | 3 | Insects, earthworms, salamanders, frogs, reptiles |
| <u>Heterodon platyrhinos</u> (Eastern hognose snake) | R/S: Sandy river bottoms | O | 3 | Toads, salamanders, fish, snakes, lizards, insects, worms, birds, frogs, mice, chipmunks |

| NAME | HABITAT | OCCUR- RENCE | TROPHIC LEVEL | DIET |
|--|--|-----------------|------------------|--|
| REPTILES (Continued) | | | | |
| <u>Heterodon nasicus</u> (Western hognose snake) | P/S:Prefers sandy areas | O* | 3 | Toads, frogs, shrews sparrows, rats, mice lizards, garter snakes |
| <u>Opheodrys aestivus</u> (Rough green snake) | B/P/R | O | 3 | Insects, spiders, snails, frogs |
| <u>Masticophis flagellum</u> (Coachwhip snake) | P: dry, open areas with brush | C* | 2 | Rodents, lizards, snakes young birds, frogs |
| <u>Elaphe guttata</u> (Corn snake) | P/W:well drained grasslands | C | 3 | Mammals, bats, birds, insects |
| <u>Elaphe obsoleta</u> (Black ratsnake) | B/W | C | 3 | Mammals, lizards, birds, amphibians |
| <u>Pituophis melanoleucus</u> (Pine snake) | P: well drained grasslands | C | 3 | Rats, mice, small mammals, bird's eggs |
| <u>Lampropeltis calligaster</u> (Prairie kingsnake) | P:well drained grasslands | O | | Mice, birds, moles, gophers, lizards, frogs, fish, toads, small snakes |
| <u>Lampropeltis getulus</u> (Common speckled kingsnake) | R/W: Mostle woodlands/moist valleys | C | 3 | Snakes, turtle eggs, rat, mice, sparrows, lizards, amphibians, insects, spiders |
| <u>Lampropeltis triangulum</u> (Milk snake) | P/R/W | O | 3 | Small mammals, snakes, frogs |
| <u>Cemophora coccinea</u> (Scarlet snake) | W | R* | 3 | Lizards, small snakes, mice,insects, slugs, salamanders, turtle eggs, birds |

| NAME | HABITAT | OCCUR- RENCE | TROPHIC LEVEL | DIET |
|--|--|-----------------|------------------|---|
| REPTILES (Continued) | | | | |
| <u>Sonora episcopa</u> (Ground snake) | P: Dry sandy soils of grasslands | O* | 2 | Ants, insects, small invertebrates |
| <u>Tantilla gracilis</u> (Flat-headed snake) | P/W: Dry hillside (wooded or grasslands) | O | 2 | Insects, sowbugs, slugs |
| <u>Natrix erythrogaster</u> (Plain bellied watersnake) | A/R | C | 3 | Fish, crayfish, frogs, salamanders |
| <u>Natrix sipedon</u> (Common water snake) | A/R | C | 3 | Fish, frogs, salamanders, crustaceans, insects, small mammals |
| <u>Regina grahami</u> (Graham's water snake) | A/R: marshy areas (standing water) | O | 3 | Earthworms, minnows, slugs, frogs, toads, salamanders |
| <u>Storeria dekayi</u> (Brown snake) | B/R/W: Woodlands with moist areas | O | 3 | Earthworms, slugs, snails, insects, treefrogs, fish |
| <u>Storeria occipitomaculata</u> (Red-Bellied snake) | W | O | 2 | Slugs, earthworms, insects, snails |
| <u>Virginia striatula</u> (Rough earth snake) | W: moist woodlands | C | 3 | Frogs, toads, lizards, baby mice |
| <u>Virginia Valeriae</u> (Western earth snake) | W | O* | 2 | Earthworms, insects, snails |
| <u>Thamnophis sirtalis</u> (Common garter snake) | A/B/R/W | C | 3 | Frog, mice, toads, insects, fish, salamanders, mammals |
| <u>Thamnophis radix</u> (Plains garter snake) | A/R | O* | 3 | Fish, frog, toads, earthworms, insects, carrion |
| <u>Natrix rhombifera</u> (Diamond-backed water snake) | A/R | C | 3 | Frogs, toads, fish, cray fish, turtles |

| NAME | HABITAT | OCCUR-- RENCE | TROPHIC LEVEL | DIET |
|---|--------------------|------------------|------------------|--|
| REPTILES (Continued) | | | | |
| <u>Thopidoclonion lineatum</u> (Central lined snake) | W: Moist woodlands | C | 3 | Frog, toads, insects, mice |
| <u>Tantilla nigriceps</u> (Blackheaded snake) | R/B/P | O | 3 | Insects, earthworms, spiders |
| <u>Tropidoclonion lineatum</u> (Central lizard snake) | P | O* | 2 | Insects, earthworms, sowbugs |
| TURTLES | | | | |
| <u>Chelydra serpentina</u> (Snapping turtle) | A | C | 2 | Some vegetation & dead animals |
| <u>Macrolemys temmincki</u> (Alligator snapping turtle) | A | | 2 | Insects & some vegetation |
| <u>Sternotherus odoratus</u> (Stinkpot) | A | R* | 2 | Dead fish & grass |
| <u>Kinosternon subrubrum</u> (Mississippi mud turtle) | A | O* | 2 | Mainly small animals & some vegetable matter |
| <u>Terrapene carolina</u> (Box turtle) | W | C | 2 | Worms & some vegetable matter |
| <u>Terrapene ornata</u> (Western Box turtle) | G | C | 2 | Worms & some vegetable matter |
| <u>Graptemys geographica</u> (Map turtle) | A | O | 2 | Insects & worms |
| <u>Pseudemys floridana</u> (Saw toothed slider) | A | O | 2 | Small animal & some vegetable matter |
| <u>Pseudemys scripta</u> (Red eared turtle) | A | C | 2 | More vegetable than animal matter |
| <u>Trionyx muticus</u> (Smooth softshell turtle) | A | O | 2 | Unknown |

| NAME | HABITAT | OCCUR- RENCE | TROPHIC LEVEL | DIET |
|---|------------------------------|-----------------|------------------|--|
| TURTLES (Continued) | | | | |
| <u>Trionyx spiniferus</u> (Spiny soft shell) | A | 0 | 2 | Unknown |
| LIZARDS | | | | |
| <u>Crotaphytus collaris</u> (Collared lizard) | P/R | 0 | 3 | Grasshoppers, spiders, beetles, moths, small lizards, flowers, tender leaves |
| <u>Sceloporus undulatus</u> (Eastern fence lizard) | P/S | C* | 2 | Ants, grasshoppers and other insects |
| <u>Phrynosoma cornutum</u> (Texan horned lizard) | S: Dry open areas | O* | 2 | Ants, arthropods, other small insects |
| 271 <u>Lygosoma laterale</u> (Ground skink) | R/W | 0 | 2 | Insects & insect larvae |
| <u>Eumeces anthracinus</u> (Coal skink) | R/W:Wooded areas with litter | R* | 2 | Insects & insect larvae |
| <u>Eumeces fasciatus</u> (Five-lined skink) | R/W | C | 3 | Insects & insect larvae spider, earthworms |
| <u>Eumeces laticeps</u> (Broad-headed skink) | W | O* | 3 | insects, earthworms |
| <u>Eumeces obsoletus</u> (Great plains skink) | P:Grasslands area | O* | 3 | Insects, insect eggs & larvae, spiders |
| <u>Eumeces septentrionalis</u> (Prairie skink) | P: Entirely grassland | O* | 3 | Insects, snails & arthropods |
| <u>Cnemidophorus sexlineatus</u> (Six-lined racerunner) | B/P/S | R | 2 | Insects majorly & other arthropods |
| <u>Ophisaurus attenuatus</u> (Slender grass lizard) | B/P : well drained grassland | 0 | 3 | Insects, larvar, spider & other arthropods |

APPENDIX D-5

AMPHIBIANS OF THE MID-ARKANSAS RIVER BASIN

| NAME | HABITAT | OCCUR- RENCE | TROPHIC LEVEL | DIET |
|---|---------------------------------------|-----------------|------------------|--|
| SALAMANDERS | | | | |
| <u>Ambystoma annulatum</u> (Ringed salamander) | T(P-B) | O* | 2 | Earthworms, small inver- tebrates |
| <u>Ambystoma texanum</u> (Small-mouthed salaman- der) | T(P-B) | O* | 2 | " |
| <u>Ambystoma tigrinum</u> (Tiger salamander) | T(P-B) | O | 2 | " |
| <u>Plethodon cinereus</u> (Quachita red-backed salamander) | T | O | 2 | Worms, small insects, spiders |
| <u>Phethodon dorsalis</u> (Ozark red-backed salamander) | C | O* | 2 | " |
| <u>Diemictylus viridescens</u> (Central newt) | T(B) | O* | 3 | Earthworms, insects, snails, baby frogs and other small animals. |
| <u>Necturus maculosus</u> (Mudpuppy) | T(B) | O | 2 | Insects, worms, slugs, etc. |
| FROGS | | | | |
| <u>Acris crepitans</u> (Blanchard cricket frog) | P(R) | C | 2 | Insects, snails, cray- fish, small vertebrates |
| <u>Acris gryllus</u> (Cricket frog) | T(B) | O | 2 | Small insects. |
| <u>Hyla versicolor</u> (Eastern gray tree frog) | T: Aboreal | O | 2 | Any living creature of suitable size |
| <u>Pseudacris clarki</u> (Spotted chorus frog) | T(B): Frequents marshes and swamps | C | 2 | Insects |
| <u>Rana aerolata</u> (Northern crayfish frog) | T(B): Lowland thickets/water- ways | R* | 2 | Crayfish, insects |
| <u>Rana catesbeiana</u> (Bullfrog) | P(R) | C | 2 | Insects, ants |
| <u>Rana clamitans</u> (Green frog) | P(R/B) | O | 2 | Small fish, insects |
| <u>Rana pipiens</u> (Leopard frog) | p(R/B) | C | 2 | " |

| NAME | HABITAT | OCCUR- RENCE | TROPHIC LEVEL | DIET |
|---|--------------------------------|-----------------|------------------|---------------------------------|
| TOAD | | | | |
| <u>Bufo americanus</u> (American toad) | T(B): moist woodlands | C* | 3 | Spiders, insects, small lizards |
| <u>Bufo cognatus</u> (Great plains toad) | T(B): moist woodlands | O | 3 | " |
| <u>Bufo speciosus</u> (Sonorum toad) | T(B): moist woodlands | O* | 3 | " |
| <u>Bufo woodhousei</u> (Rocky mountain toad) | T(B/R): moist woodlands | O | 3 | " |
| <u>Gastrophryne olivacea</u> (Great plains narrow-mouthed toad) | T(B): Mainly subterranean | O* | 2 | Insects, small invertebrates |
| <u>Scaphiopus bombifrons</u> (Plains spadefoot) | T(B): moist soil | O | 2 | Insects |
| <u>Scaphiopus hurteri</u> (Hurter's spadefoot) | T(B): woodlands and grasslands | C* | 2 | Insects |

* The species whose range terminates in the Mid-Arkansas region.

APPENDIX D-6

NIADS OF THE MID-ARKANSAS RIVER BASIN

| NAME | HABITAT | OCCUR- RENCE | TROPHIC LEVEL | GLOCHIDIA HOST |
|---|--------------------------------|-----------------|------------------|---|
| NIADS | | | | |
| <u>Fusconaia flava</u> (Wabash pig-toed mussel) | G/M - | C | 1 | - |
| <u>Megalonais gigantea</u> (Giant washboard mussel) | M: Deep water | O | 1 | Shad, crappie, white Bass, Bowfin, flathead |
| <u>Crenodonta peruviana</u> (Bluepoint mussel) | G/M: Deep water | O | 1 | White crappie, black Crappie |
| <u>Crenodonta costata</u> (Three ridged mussel) | G/M: Pools | C | 1 | - |
| <u>Quadrula quadrula</u> (Maple leaf mussel) | G/M/S - | C | 1 | Catfish |
| <u>Quadrula pustulosa</u> (Pimble backed mussel) | G/M/S: Shallow water | R | 1 | Channel catfish |
| <u>Quadrula nodulata</u> (Warty-backed mussel) | G/M - | R | 1 | White crappie |
| <u>Quadrula notanerva</u> (Monkey-faced mussel) | G/S: Inhabits swift rivers | O | 1 | Bluegill, sauger |
| <u>Tritogonia verrucosa</u> (Buckhorn mussel) | G/M: Small streams and creeks | O | 1 | - |
| <u>Pleurobema cordatum</u> (Round pig-toed mussel) | G/M: Small streams and creeks | R | 1 | - |
| <u>Elliptio dilatatus</u> (Lady finger mussel) | G/M/S: " | C | 1 | - |
| <u>Unio merus tetralasmis</u> (Pond-horn mussel) | M: Resistant to pollution | C | 1 | - |
| <u>Lasmigona complanata</u> (White heel-splitter) | G/M: Usually burrows | C | 1 | - |
| <u>Anodonta grandis</u> (Floater) | M/S: Prefers quiet, deep water | C | 1 | Green sunfish |
| <u>Anodonta imbecilis</u> (Floater) | M/S: " " | O | 1 | - |
| <u>Strophitus rugosus</u> (Squaw-foot mussel) | M/S: " " | O | 1 | - |

| NAME | HABITAT | OCCUR- RENCE | TROPHIC LEVEL | GLOCHIDIA HOST |
|---|---|-----------------|------------------|---|
| NAIDS (continued) | | | | |
| <u>Obliquaria reflexa</u> (Three-horned wart-backed mussel) | G/M/S: Large streams | 0 | 1 | Many develop without parasitism |
| <u>Truncilla truncata</u> (Deer toe) | G/M: " " | R | 1 | " |
| <u>Leptodea fragilis</u> (Fragile paper mussel) | G/M/S: quiet areas | C | 1 | - |
| <u>Leptodea laevisissima</u> (Paper shell mussel) | G/M/S" " | R | 1 | Drum, white crappie |
| <u>Proptera purpurata</u> (Purple shell mussel) | M: deep water | C | 1 | Drum |
| <u>Carunculina parva</u> (Lilliput mussel) | M: small streams with sluggish currents | C | 1 | - |
| <u>Ligumia recta</u> (Black sand mussel) | G: large sandy streams | 0 | 1 | Bluegill, white crappie |
| <u>Ligumia subrostrata</u> (Common pond mussel) | M: ponds and creeks | C | 1 | - |
| <u>Lampsilis anodontoides</u> (Yellow sandshell mussel) | G/M: " " | R | 1 | Long-nose gar, catrarchids |
| <u>Lampsilis radiata</u> (Fat mucket) | G/M: " " | C | 1 | Yellow perch, bluegill, walleye |
| <u>Lampsilis ovata</u> (Plain pocket book mussel) | C/S: " " | C | 1 | White crappie, sauger |
| <u>Actinonaisas crinata</u> (Mucket) | C/M/S: riffles and rocky areas | R | 1 | Green sunfish, bluegill, small mouth bass |

APPENDIX E

ANNUAL ANIMAL UNIT (A.U.) FOOD CONSUMPTION ESTIMATE (56)(67)(95)

| Grazer Item | Cattle | Horse | Sheep | Deer | Rabbit |
|---|---|-------------------------------------|-----------------------------|-----------------------------------|--------------------|
| 1. Animal Sample | 2-year cow | light-work farm horse | commercial ewe | does or bucks | does or bucks |
| 2. Regular Forage | | | | | |
| { Fresh Pasture | 25lb/day/animal or 1.5-2.0 lb/ day/100lb of liveweight | — | — | 0.6 lb/day/100 lb of livestock | — |
| { Hay | — | 1.25 lb/day/100 lb of liveweight | 300 lb/year/animal | — | 0.32 lb/day/animal |
| { Grain | — | 0.50 lb/day/100 lb of liveweight | — | — | — |
| { Shelled Corn | — | — | 1.5 bushels/ year/animal | — | — |
| 3. Average weight per Animal | 1,200 lb | 1,340 lb | 140 lb | 135 lb | 6.5 lb |
| 4. Annual Hay Consumption per Animal | — | 6,100 lb | 300 lb | — | 120 lb |
| 5. Annual Fresh Pasture Con- sumption per Animal | 9,600 lb | 12,200 lb | 600 lb | 300 lb | 240 lb |
| 6. Corresponding "Animal Unit" (based on the food consump- tion of a cow) | 1 A.U. | 1.28 A.U. | 0.06 A.U. | 0.03 A.U. | 0.025 A.U. |

APPENDIX F

APPROXIMATE PROPORTIONATE EXTENT OF THE SOIL ASSOCIATIONS AND THEIR SITES OF THE M.A.R.B.

| County | Soil Site | Soil Associations | Cover Area | |
|--------|-------------------|---|---------------------|--------------|
| | | | Total Area (%) | Subtotal (%) |
| PAWNEE | Upland Forest | Darnell - Talihina - Stephenville Dougherty - Eufaula | 15.4 1.9 | 17.3 |
| | Bottomland Forest | Port - Yahola - Dale - Brewer | 13.2 | 13.2 |
| | Prairie | Dennis - Bates - Talihina - Sogn Renfrow - Zaneis - Vernon - Lucien Norge - Teller - Vanoss | 35.8 24.0 9.7 | 69.5 |
| CREEK | Upland Forest | Darnell - Pottsville - Stephenville - Cleburne Dougherty - Stidham - Eufaula | 49.2 4.4 | 53.6 |
| | Bottomland Forest | Mason - Pulaski - Reinach - Roebuck | 19.6 | 19.6 |
| | Prairie | Dennis - Okemah - Bates - Collinsville - Talihinna Choteau - Teller - Vanoss - Neosho Okemah - Woodson | 22.0 3.9 0.9 | 26.8 |
| TULSA | Upland Forest | Hector - Denton Dougherty - Stidham - Hanceville | 9.9 6.1 | 16.0 |
| | Bottomland Forest | Verdigris - Lonok Yahola - Brewer Lightning - Miller - Osage - Perry | 9.2 6.8 6.0 | 22.0 |
| | Prairie | Bates - Parsons - Collinsville - Talihinna Summit - Newtonia Teller - Fitzhugh - Cherokee | 47.1 7.9 7.0 | 62.0 |

APPENDIX Approximate proportionate extent of the soil associations and their sites (Continued)

| County | Soil Site | Soil Associations | Cover Area | Subtotal (%) |
|--------|-------------------|---|---|--------------|
| | | | Total Area (%) | |
| OSAGE | Upland Forest | Darnell - Windthorst - Stephenville Dougherty - Eufaula | 30.0 4.0 | 34.0 |
| | Bottomland Forest | Verdigris - Mason - Cleora Reinach - Dale - Lincoln | 12.0 2.0 | 14.0 |
| | Prairie | Steedman - Colinsville - Bates Dennis - Parsons - Bates Sogn - Summit - Kipson Summit - Labette - Newtonia Vernon - Sogn - Renfrow Norge - Teller - Vanoss | 16.0 12.0 10.0 6.0 5.0 3.0 | 52.0 |

B I B L I O G R A P H Y

BIBLIOGRAPHY

1. Amoss, H. L. and McNickle, R. L., editors. Land and Water: Planning for Economic Growth. Boulder, Colorado: University of Colorado Press, 1961.
2. Balham, R. W. "Grey and Mallard Duck in the Manawatu District, New Zealand." *Emu* 52: 163-191 (1952).
3. Barlowe, Raleigh. Land Resources Economics. Englewood Cliffs, New Jersey: Prentice-Hall, Inc., 1958.
4. Billings, W. D. Plants and the Ecosystem. Belmont, California: Wadsworth Publishing, Company, 1964.
5. Borgstrom, George. Too Many. New York: Collier Books, 1971.
6. Brown, A. Leadley. Ecology of Freshwater. Cambridge, Mass.: Howard University Press, 1971.
7. Brown, Richard E. and Mueller, Geoffrey. Plan Formulation and Evaluation Studies - Recreation, 5 Volumes. Fort Belvoir, Virginia: U. S. Army Institute for Water Resources, June, 1974.
8. Bureau of Reclamation. "Cache Creek Project, Oklahoma." Reconnaissance Report. Washington, D. C.: U.S. Department of the Interior, April, 1971.
9. Bureau of Reclamation. "Wilburton Project: Oklahoma." Appraisal Report. Washington, D. C.: U. S. Department of the Interior, May, 1973.
10. Bureau of Water and Environmental Resources Research. "The Evaluation of Water and Related Land Resource Projects: A Procedural Test." Norman, Oklahoma: University of Oklahoma, 1970.
11. Bureau of Water Resources Research. Water, Oklahoma's Number One Problem. Norman, Oklahoma: University of Oklahoma.
12. Christman, R. F., et. al. The Natural Environment: Wastes and Control.
13. Clawson, Marion. America's Land and Its Uses. Baltimore: Johns Hopkins Press, 1972.

14. Cottam, G. and Curtis, J. T. "The Use of Distance Measures in Phytosociological Sampling." Ecology, 37, p. 451-60, 1956.
15. Dee, Norbert, et. al. Environmental Evaluation System for Water Resources Planning. Columbus, Ohio: Battelle Memorial Institute, 1972.
16. Dee, Norbert, et. al. Planning Methodology for Water Quality Management: Environmental Evaluation System. Columbus, Ohio: Battelle Memorial Institute, 1973.
17. Del Giorno, B. J. and Tissair, M. E. Environmental Science Activities Handbook for Teachers. West Nyack, New York: Parker Publishing Company, Inc., 1975
18. Department of Pollution, State of Oklahoma. Comprehensive Water Quality Plan: Lower Arkansas Basin (Priority Basin #2). 1972.
19. English, Paul W. and Mayfield, Robert C., editors. Man, Space, and Environment. New York: Oxford University Press, 1972.
20. Environmental Protection Agency. "Quality of Life Indicators (A Review of State-of-the-Art and Guidelines Derived to Assist in Developing Environmental Indicators)." 1972.
21. Errington, P. L. "An American Visitor's Impression of Scandinavian Waterfowl Problems." Journal of Wildlife Management, pp. 109-130 (1961).
22. Fox, Karl A. Social Indicators and Social Theory. New York: John Wiley and Sons, Inc., 1974
23. Friendmann, John and Alonso, William, editors. Regional Development and Planning. Cambridge, Mass.: The M.I.T. Press, 1965.
24. Geraphty, J. J., Miller, D. W., Van der Leeder, F. and Troise, F. L. Water Atlas of the U. S. Plate 74 and Plate 17. New York: Water Information Center Publications, 1973.
25. Hidore, John J. Physical Geography: Earth Systems. Glenview, Illinois: Scott, Foresman and Company, 1974.
26. Indian Nations Council of Governments. "Regional Pollution Study: Inventory and Analysis Phase II." Tulsa: Department of Housing and Urban Development, September, 1973.
27. Isard, W. Methods of Regional Analysis: An Introduction to Regional Science. Cambridge, Massachusetts: The M.I.T. Press, 1960.
28. Johnson, Michael P.; Mason, Larry G.; Raven, Peter H. "Ecological Parameters and Plant Species Diversity". American Naturalist 102: 297-306.

29. Klotz, John W. Ecology Crisis. St. Louis: Concordia Publishing House, 1971.
30. Krebs, C. J. Ecology. New York: Harper and Row, Publishers, 1972.
31. Krauskopf, Thomas M. and Bunde, Dennis C. "Evaluation of Environmental Impact through a Computer Modelling Process". Environmental Impact Analysis: Philosophy and Methods. Editors Robert Ditton and Thomas Goodale. Madison, Wisconsin: University of Wisconsin Sea Grant Program, 1972.
32. Kulp, Earl M. Rural Development Planning: Systems Analysis and Working Method. New York: Praeger Publishers, Inc., 1970.
33. Lee, R. "Potential Insolation as a Topoclimatic Characteristic of Drainage Basins". Bulletin of the International Association of Scientific Hydrology, Year 9, 27-41.
34. Leopold, Luna B, et. al. A Procedure for Evaluating Environmental Impact. Geological Survey Circular 645. Washington: Government Printing Office, 1971.
35. Leopold, Luna B. "Quantitative Comparison of Some Aesthetic Factors Among Rivers (Geological Survey Circular 620)." Washington D. C.: Government Printing Office, 1969.
36. Level, Charles L. and Read, R. B. "A River, a Region and a Research Problem." St. Louis: Institute for Urban and Regional Studies, Washington University, July 1971.
37. Lewis, S. A.; Hopkins, K. D. and White, T. F. Average Growth Rates and Length-Weight Relationships of Sixteen Species of Fish in Canton Reservoir, Oklahoma. Oklahoma Department of Wildlife Conservation, 1971.
38. May, R. M. "Stability in Multispecies Community Models." Mathematical Biosciences 12: 59-79, 1971.
39. McAllister, Donald M., editor. "Environment: A New Focus for Land Use Planning." Washington, D.C.: National Science Foundation, October, 1973.
40. McHarg, Ian. Design with Nature. Philadelphia: Natural History Press, 1969.
41. McKee and Wolf. "Water Quality Criteria." Sacramento, California: The Resources Agency of California, State Water Quality Control Board, 1963.
42. Mertes, J. D., et. al. "The Trinity River Greenway: A Prototype." Lubbock, Texas: U. S. Army Corps of Engineers. June, 1972.
43. Meta Systems, Inc. An Operational Framework for Coastal Zone Management Planning. Cambridge, Massachusetts: Meta Systems, Inc., 1975.

44. Moen, Aaron N. Wildlife Ecology, An Analytical Approach. San Francisco: W. H. Freeman and Company, 1973.
45. Monk, C. D. and McGinnis, J. T. "Tree Species Diversity in Six Forest Types in North Central Florida." Ecology 68, 341-4, 1965.
46. Moore, John L., et. al. A Methodology for Evaluating Manufacturing Environmental Impact Statements for Delaware's Coastal Zone. Columbus, Ohio: Battell Memorial Institute, 1973.
47. Moreau, David H., et. al. "Regional Water Resource Planning for Urban Needs: Part 1." Water Resources Research Institute, University of North Carolina, March 1973.
48. Multiagency Task Force, Bureau of Reclamation. Guidelines for Implementing Principles and States for Multiobjectives Planning of Water Resources. Washington, D. C.: Bureau of Reclamation, 1972.
49. National Academy of Sciences. Eutrophication: Causes, Consequences, Correctives. Washington, D. C.
50. National Goals Research Staff. "Toward Balanced Growth: Quantity with Quality". Washington, D. C.: U. S. Government Printing Office, 1970.
51. Nichols C. W. "Feeding the Ewe Flock". O.S.U. Extension Facts No. 3750. Stillwater, Oklahoma: Oklahoma State University.
52. Odum, Eugene P. Fundamentals of Ecology, 3rd Edition. Philadelphia: W. B. Saunders Company, 1971.
53. Odum, E. P. Optimum Pathway Matrix Analysis Approach to the Environmental Decision Making Process. Test Case: Relative Impact of Proposed Highway Alternatives. Athens, Georgia: Institute of Ecology, University of Georgia.
54. Oklahoma State Department of Wildlife Conservation Report. "Big Game Report". 1974.
55. Oklahoma Water Resources Board. Appraisal of the Water and Related Land Resources of Oklahoma, Region IX and X. 1969.
56. Oklahoma Water Resources Board. Reported Water Use in Oklahoma. 1974.
57. Oklahoma Water Resources Board. "Reported Water Use in Oklahoma, Publication 61, 1974". 1975
58. Ortolano, Leonard and Hill, William. "An Analysis of Environmental Statements for Corps of Engineers Water Projects." Virginia: Institute for Water Resources, Springfield, Department of the Army, June 1972.

59. Patrick, R. "Aquatic Communities as Indices of Pollution". Indicators of Environmental Quality, W. A. Thomas, Editor, New York: Plenum Press, 1972.
60. Pereira, H. C. Land Use and Water Resources. Cambridge: Cambridge University Press, 1973.
61. Pollak, Franklin S. (Editor). Resources Development: Frontiers for Research. Boulder, Colorado: University of Colorado Press, 1960.
62. Real Estate Research Corporation. The Cost of Sprawl: Environmental and Economic Costs of Alternatives Residential Development Patterns at the Urban Fringe. Washington, D. C.: U.S. Government Printing Office, April 1974.
63. Reid, G. W., et. al. "Environmental Study Task Force Report, Arkansas-Verdigris River System in Oklahoma and Arkansas." Prepared for the Governor's Study Committee on the Arkansas Verdigris Waterway, 1970.
64. Reid, K.; Lauwerys, J. Joffe and Tucker, A. Man, Nature and Ecology. Garden City, New York: Doubleday and Company, Inc., 1974.
65. Reilly, William K., Editor. The Use of Land: A Citizens Policy Guide to Urban Growth. New York: Thomas V. Cromwell, 1973.
66. Reitze, Arnold, Jr. "Environmental Planning: Law of Land and Resources." Washington, D. C.: North American International, 1974.
67. Richardson, Curtis W., et. al. "Dairy Nutrient Requirements and Feed Composition Data". O.S.U. Extension Facts No. 4002, Stillwater, Oklahoma: Oklahoma State University.
68. Ricklefs, R. E. Ecology. Newton, Massachusetts: Chiron Press Inc., 1973.
69. Scott, P. "A Coloured Key to the Wildfowl of the World". Wildfowl Trust, London, 91 pp., 1957.
70. Shaw, S. P. and Fredine, C. G. "Wetlands of the United States". U.S. Fish and Wildlife Service Circular No. 39, Washington, D. C., 1956.
71. Smith, Robert L. Ecology and Field Biology. New York: Harper and Row, 1966.
72. Soil Conservation Service, U.S.D.A. Oklahoma Conservation Needs Inventory. Stillwater, Oklahoma: Soil Conservation Service, State Office, 1970.
73. Soil Survey Service, U.S.D.A. Soil Survey Report of Creek County, Oklahoma. Soil Survey Series 1950, No. 5. U.S.D.A. in Cooperation with the Oklahoma Agriculture Experiment Station.

74. Soil Survey Service, U.S.D.A. Soil Survey Report of Pawnee County, Oklahoma. Soil Survey Series 1952, No. 4. U.S.D.A. in Cooperation with the Oklahoma Agriculture Experiment Station.
75. Soil Survey Service, U.S.D.A. Soil Survey Report of Tulsa County, Oklahoma. Soil Survey Series 1935, No. 22. Issued February 1942. U.S.D.A. in Cooperation with the Oklahoma Agriculture Experiment Station.
76. Stover, Lloyd V. Environmental Impact Assessment: A Procedure. Miami, Florida: Sanders and Thomas, Inc., 1972.
77. Sutton, D. B. and Harmon, N. P. Ecology: Selected Concepts. New York: John Wiley and Sons, Inc., 1973.
78. Swingle, H. S. Relationships and Dynamics of Balanced and Unbalanced Fish Populations. Bulletin No. 274, Agricultural Experiment Station. Auburn, Alabama: Alabama Polytechnic Institute, 1950.
79. Swingle, H. S. and Smith, E. V. "Experiments on the Stocking of Fish Ponds." Fifth North American Wildlife Conference Transcript, 1940.
80. The Oklahoma Department of Highways. Oklahoma Total Road Mileage. Oklahoma Department of Highways, Planning Division and the Bureau of Public Roads, 1974.
81. Thomas, W. A.; Goldstein, G. and Wilcox, W. H. Biological Indicators of Environmental Quality, a Bibliography of Abstracts. Ann Arbor, Michigan: Ann Arbor Science Publishers, Inc., 1973.
82. Thorne, Wynne, Editor. Land and Water Use. Washington, D. C.: American Association for the Advancement of Science, 1963.
83. U.S. Army Corps of Engineers. "Hugo Lake, Kiamichi River, Oklahoma." Final Environmental Statement from the Tulsa District Corps of Engineers, February 1974.
84. U.S. Army Corps of Engineers. "Keystone, Dam and Lake, Oklahoma." Brochure from the Tulsa District Corps of Engineers, 1974.
85. U.S. Army Corps of Engineers. Matrix Analysis of Alternatives for Water Resource Development. Draft Technical Paper from the Tulsa District of the Corps of Engineers, 1972.
86. USDA - Soil Conservation Service Test Team. Report of Testing Special Task Force Evaluation Procedures Water Resource Council for Poteau River Watershed, Scott County, Arkansas and Le Flore County, Oklahoma. Soil Conservation Service, 1969.

87. U.S. Department of Agriculture. U.S. Census of Agriculture-County Data. Washington, D. C., 1970.
88. University of Oklahoma: School of Civil Engineering and Environmental Science and Oklahoma Biological Survey. "Mid-Arkansas River Basin Study Effects Assessment of Alternative Navigation Routes from Tulsa Oklahoma to the Vicinity of Wichita, Kansas." Prepared for the Tulsa District, Corps of Engineers.
89. Water Resources Council. "Water and Related Land Resources- Establishment of Principles and Standards for Planning". Federal Register (Vol. 38, No. 147, Pt. III), Washington, D. C.: U.S. Government Printing Office, 1973.
90. Water Resources Council. Policies, Standards and Procedures in the Formulation, Evaluation and Review of Plans for Use and Development of Water and Related Land Resources. Washington, D. C.: U.S. Government Printing Office, 1962.
91. Weller, Milton W. "The Waterfowl of the World". Conservation and Management, Volume 4 by Jean Delacour, London: County Life Limited, 1964.
92. Whittaker, Robert H. Communities and Ecosystems. New York: MacMillan Publishing Company, Inc., 1975.
93. Wolfe, Donald H. Wildlife for Tomorrow. Forest Service, U.S. Department of Agriculture, Washington, D. C.: U.S. Government Printing Office, 1972.
94. Wolfe, P. "Utditad Civilisation." Glerups, Malmo, 1956.
95. Woll, F. W. Lippincott's Farm Manuals, Productive Feeding of Farm Animals. Philadelphia: J. B. Lippincott Company, 1925.
96. Wollman, Nathaniel. The Value of Water in Alternative Uses. Albuquerque: The University of New Mexico Press, 1962.
97. The American Museum of Natural History. The Larousse Encyclopedia of Animal Life. New York: McGraw-Hill Book Company, 1967.
98. Burton, Maurice. Systematic Dictionary of Mammals of the World. New York: Thomas Y. Crowell Company, 1962.
99. Carr, Archie. Handbook of Turtles, the Turtles of U.S., Canada, and Baja, California. New York: Comstock Publishing Associated, a Division of Cornell University Press, 1952.

100. Choate, Ernest Alfred. Dictionary of American Bird Names. Boston: Gambit Company, 1973.
101. Cochran, Doris M. and Goin, Coleman J. The New Field Book of Reptiles and Amphibians. New York: G.P. Putnam's Sons, 1970.
102. Ditmars, Raymond L. Snakes of the World. New York: The Macmillan Company, 1937.
103. Eddy, Samuel and Underhill, James C. Northern Fishes (Third Edition) Minneapolis: University of Minnesota Press, 1974.
104. Grasse, Pierre-Paul (Editor). Encyclopedia of the Animal World. New York: Larousse and Company, Inc., 1975.
105. Huheey, James E. and Stupka, Arthur. Amphibians and Reptiles of Great Smoky Mountains National Park. Knoxville: The University of Tennessee Press, 1967.
106. Oliver, James A. The Natural History of North American Amphibians and Reptiles. New York: D. Van Nostrand Company, Inc., 1955.
107. Schmidt, Karl P. and Inger, Robert F. Living Reptiles of the World. New York: Hanover House, 1957.
108. Stebbins, Robert Cyril. A Field Guide to Western Reptiles and Amphibians. Boston: Houghton Mifflin, 1966.
109. Herald, Earl S. Fishes of North America. New York: Doubleday and Company.
110. Moore, John A. (Editor). Physiology of the Amphibia. New York: Academic Press, 1964.
111. Pritchard, Peter C. H. Living Turtles of the World. New Jersey: T.F.H. Publications, Inc., 1967.
112. Thomson, A. Landsborough. A New Dictionary of Birds. New York: McGraw-Hill Book Company, 1964.
113. Walker, Ernest P., et. al. Mammals of the World. Baltimore: Johns Hopkins Press, 1968.
114. Wright, Albert H. and Wright, Anna A. Handbook of Snakes of the United States and Canada. New York: Comstock Publishing Associates, Division of Cornell University Press, 1957.
115. Wright, Albert Hazer (Editor) and Smith, Robert M. Handbooks of American Natural History: Handbook of Lizards. New York: Comstock Publishing Company, 1946.