

# **INSTITUTO TECNOLÓGICO Y DE ESTUDIOS SUPERIORES DE OCCIDENTE**

Reconocimiento de validez oficial de estudios de nivel superior según acuerdo secretarial 15018, publicado en el Diario Oficial de la Federación el 29 de noviembre de 1976.

---

Departamento de Electrónica, Sistemas e Informática

ESPECIALIDAD EN SISTEMAS EMBEBIDOS



**TRAILER REVERSE ASSIST**

**OPTICAL FOLLOW ME**

Tesina para obtener el grado de:  
ESPECIALISTA EN SISTEMAS EMBEBIDOS

Presentan: Alejandro Salcido Zarco

Efraín Márquez Gutiérrez

Director: Dr. José Luis Pizano Escalante

San Pedro Tlaquepaque, Jalisco. Julio 2017.



# ACKNOWLEDGMENTS

I dedicate this work to my grandmother, **Yolanda Zarco**, who was not able to see the realization of this work, however, supported and encouraged me to complete it even during adverse situations.

Additionally, owe a deep sense of gratitude to **CONACYT** for providing the economic aid required to complete my postgraduate studies, **Continental** for allowing me to use their IP in the development of this work, and last but not least, **ITESO** for providing the required guidance and expertise to steer the development of this project through the right path.

~Alejandro Salcido

First and foremost, I thank **my parents** Efrain and Leticia for their unconditional love and support, and for providing the encouragement to pursue my goals and showing me the beautiful side of the life.

I would like thank to **Conacyt** the valuable support for the educational and technological development in favor of our nation. As well for the sponsorship provided for the achievement of this specialization.

Especially, I thank the **ITESO** and all its kindly personnel who guided and helped me through this postgraduate program. I appreciate **Continental** for the support provided and willingness to pursue the continuous intellectual and professional development of their workers.

~Efrain Márquez



# ABSTRACT

*Backing-up a trailer is a difficult task even for experienced users, and thus, solutions exist for assisting the steering of a vehicle-trailer system by just requiring the input of the desired trailer's trajectory. Nevertheless, the problem is not entirely solved as the selected trajectory clearance while reversing a trailer is not completely available due to visibility obstructions, making reversing a trailer an unsafe maneuver. The objective of this work is to perform a proof-of-concept of a system which aids the user in the process of backing up a trailer through the desired trajectory where limited visibility is present. This was accomplished by developing an add-on feature capable of tracking a helping person. The new feature provides the required information so that existing compatible trailer reversing solutions can steer and accelerate the vehicle to follow the tracked person while also keeping a safe distance. Moreover, potential collisions are prevented by the addition of a close proximity object detection functionality. For this, a scaled prototype of the proposed system was developed by applying the "Vee Model" methodology where the requirements, architecture, solution design, implementation, and validation steps were followed. A successful proof-of-concept was accomplished after validating the capacity of the prototype to both identify and follow a person, while maintaining a safe distance, and to detect objects in the vehicle's path. In addition, the documentation of the system's design, development, and validation was achieved rendering the feature ready for full scale development. In conclusion, the "Trailer Reverse Assist - Optical Follow Me" system add-on can further assist in the process of backing-up a trailer safely in environments where the visibility is limited while also preventing collisions with nearby objects.*

## RESUMEN

*Conducir en reversa con un remolque es una tarea difícil incluso para usuarios experimentados. Debido a esto, existen soluciones que ayudan a dirigir el sistema vehículo-remolque solamente requiriendo el input de la dirección deseada del remolque. Sin embargo, el problema aún no está solucionado debido a que no es posible conocer si la trayectoria elegida está despejada debido a obstrucciones en la visibilidad, convirtiendo esto en una maniobra insegura. El objetivo de este trabajo es realizar la prueba de concepto de un sistema que ayude al usuario durante el proceso de conducir en reversa un remolque a través de la trayectoria deseada, en el que las condiciones de visibilidad limitada están presentes. Esto fue completado al desarrollar una funcionalidad complementaria capaz de seguir a una persona guía que establezca la trayectoria a seguir. Esta nueva funcionalidad provee la información requerida para que las soluciones compatibles de ayuda para retroceder con un remolque puedan mover el volante y acelerar el vehículo para seguir a la persona rastreada mientras se mantiene una distancia segura. Con ello, posibles colisiones son evitadas al añadir una funcionalidad de detección de objetos cercanos. Para ello, se desarrolló un prototipo a escala del sistema propuesto aplicando la metodología del “Ciclo Ve”, en la cual los pasos de definición de requerimientos, arquitectura, diseño de la solución, implementación y la validación son seguidos. La prueba de concepto se adquirió con éxito después de validar la capacidad del prototipo para identificar y seguir a una persona mientras se mantiene una distancia segura, así como la detección de objetos en el camino del vehículo. Adicionalmente, la documentación del diseño del sistema, su desarrollo y validación fueron obtenidos preparando con ello al sistema para el desarrollo a escala real. En conclusión, la funcionalidad complementaria “Trailer Reverse Assist – Optical Follow Me” es capaz de ayudar al usuario durante el proceso de conducción en reversa con un remolque de manera segura en ambientes donde las condiciones de visibilidad son limitadas previniendo también colisiones con objetos cercanos.*

# LIST OF FIGURES

|                                                                                                                                           |    |
|-------------------------------------------------------------------------------------------------------------------------------------------|----|
| <b>Figure 1-1:</b> Ford target sticker detection [3].                                                                                     | 5  |
| <b>Figure 1-2:</b> Ford Knob HMI [3].                                                                                                     | 6  |
| <b>Figure 1-3:</b> Ford trailer assembly measurements [3].                                                                                | 6  |
| <b>Figure 1-4:</b> Continental target-less trailer detection.                                                                             | 7  |
| <b>Figure 1-5:</b> TRA - Optical Follow Me component architecture.                                                                        | 9  |
| <b>Figure 1-6:</b> TRA – Optical Follow Me use-case.                                                                                      | 10 |
| <b>Figure 2-1:</b> Vee Model diagram [6].                                                                                                 | 12 |
| <b>Figure 2-2:</b> Prototypes of Harr-like features [10].                                                                                 | 15 |
| <b>Figure 2-3:</b> Influence of Nbhd in Detection Results [10].                                                                           | 17 |
| <b>Figure 2-4:</b> OpenMV Cam M4 - OV7725 [14].                                                                                           | 18 |
| <b>Figure 2-5:</b> The simple car has three degrees of freedom, but the velocity space at any configuration is only two-dimensional [16]. | 20 |
| <b>Figure 2-6:</b> Radiation pattern types of an ultrasonic sensor [17].                                                                  | 22 |
| <b>Figure 2-7:</b> Devantech SRF08 Ultrasonic Sensor [20].                                                                                | 23 |
| <b>Figure 2-8:</b> SHARP GP2Y0A21YK0F infrared sensor [22].                                                                               | 24 |
| <b>Figure 2-9:</b> Hall Effect sensor principles [23].                                                                                    | 25 |
| <b>Figure 2-10:</b> SAM V71 Ultra Evaluation Kit PCB [24].                                                                                | 26 |
| <b>Figure 2-11:</b> RTOS cost vs time.                                                                                                    | 27 |
| <b>Figure 2-12:</b> Comparison between FreeRTOS license products [26].                                                                    | 28 |
| <b>Figure 2-13:</b> An event group containing 24-event bits, only three of which are in use [27].                                         | 30 |
| <b>Figure 2-14:</b> Example of 8-bit data sequence [30].                                                                                  | 31 |
| <b>Figure 2-15:</b> ISO 11898 architecture [35].                                                                                          | 33 |
| <b>Figure 2-16:</b> Traxxas Ford F-150 Raptor overview [36].                                                                              | 34 |
| <b>Figure 2-17:</b> Traxxas Ford F-150 Raptor internal components [37].                                                                   | 35 |
| <b>Figure 3-1:</b> Level 1 boundary diagram - vehicle.                                                                                    | 39 |
| <b>Figure 3-2:</b> Level 2 boundary diagram - TRA system.                                                                                 | 41 |
| <b>Figure 3-3:</b> Level 3 boundary diagram - OFM system.                                                                                 | 42 |
| <b>Figure 3-4:</b> Vehicle assembly.                                                                                                      | 44 |
| <b>Figure 3-5:</b> Technical architecture - L1 TRA-OFM system.                                                                            | 45 |
| <b>Figure 3-6:</b> Technical architecture - L2 sensorics.                                                                                 | 46 |
| <b>Figure 3-7:</b> Technical architecture - L2 control unit.                                                                              | 46 |
| <b>Figure 3-8:</b> Technical architecture - L2 Traxxas truck platform.                                                                    | 47 |
| <b>Figure 3-9:</b> Technical architecture - L1 sensorics P-Diagrams.                                                                      | 48 |
| <b>Figure 3-10:</b> Technical architecture - L1 control unit P-Diagram.                                                                   | 49 |
| <b>Figure 3-11:</b> Technical architecture - L1 Traxxas truck P-Diagram.                                                                  | 49 |
| <b>Figure 3-12:</b> Technical architecture L1 power units P-Diagram.                                                                      | 50 |
| <b>Figure 3-13:</b> TRA-OFM House of Quality diagram.                                                                                     | 51 |
| <b>Figure 3-14:</b> Camera system SW architecture.                                                                                        | 54 |
| <b>Figure 3-15:</b> Camera system logic flowchart.                                                                                        | 58 |

|                                                                                      |     |
|--------------------------------------------------------------------------------------|-----|
| <b>Figure 3-16:</b> DMA controller (XDMAC) block diagram [39].....                   | 59  |
| <b>Figure 3-17:</b> SAMv71 software architecture. ....                               | 60  |
| <b>Figure 3-18:</b> Control unit sequence diagram.....                               | 63  |
| <b>Figure 3-19:</b> SPI inter-system communication flowchart. ....                   | 66  |
| <b>Figure 3-20:</b> SAMv71 SPI diagram block [38].....                               | 67  |
| <b>Figure 3-21:</b> Timer counter implementation flowchart.....                      | 68  |
| <b>Figure 3-22:</b> Analog front end implementation flowchart. ....                  | 69  |
| <b>Figure 3-23:</b> SAMv71 analog front-end controller block diagram [38]. ....      | 70  |
| <b>Figure 3-24:</b> System State task logic flowchart. ....                          | 71  |
| <b>Figure 3-25:</b> Kinematic Lateral Control task flowchart. ....                   | 72  |
| <b>Figure 3-26:</b> Kinematic Longitudinal Control task flowchart. ....              | 73  |
| <b>Figure 3-27:</b> Dynamic Motion Control task flowchart. ....                      | 74  |
| <b>Figure 3-28:</b> Camera system PCB - electrical diagram.....                      | 76  |
| <b>Figure 3-29:</b> Control unit PCB electrical diagram. ....                        | 80  |
| <b>Figure 4-1:</b> TRA-OFM OS task execution sequence. ....                          | 84  |
| <b>Figure 4-2:</b> TRA-OFM OS periodical task execution.....                         | 84  |
| <b>Figure 4-3:</b> Hall-Effect sensor placement. ....                                | 86  |
| <b>Figure 4-4:</b> Traxxas truck power train ratios. ....                            | 87  |
| <b>Figure 4-5:</b> ESC/Steering signal characterization.....                         | 88  |
| <b>Figure 4-6:</b> Modified Traxxas truck - right view. ....                         | 90  |
| <b>Figure 4-7:</b> Modified Traxxas truck - left view. ....                          | 90  |
| <b>Figure 4-8:</b> Modified Traxxas truck - front view.....                          | 91  |
| <b>Figure 4-9:</b> Modified Traxxas truck - rear view. ....                          | 91  |
| <b>Figure 4-10:</b> Modified Traxxas truck -top view.....                            | 92  |
| <b>Figure 4-11:</b> Modified Traxxas truck - top (no cover) view. ....               | 92  |
| <b>Figure 4-12:</b> Control unit PCB result. ....                                    | 93  |
| <b>Figure 4-13:</b> Camera system PCB result.....                                    | 94  |
| <b>Figure 4-14:</b> Test-room overview. ....                                         | 95  |
| <b>Figure 4-15:</b> Camera system - length identification test results.....          | 96  |
| <b>Figure 4-16:</b> Camera system - person face tracking results. ....               | 98  |
| <b>Figure 4-17:</b> Camera system -no false positives on face detections. ....       | 99  |
| <b>Figure 4-18:</b> Camera system - single person tracking results. ....             | 100 |
| <b>Figure 4-19:</b> Vehicle - person following test-case. ....                       | 102 |
| <b>Figure 4-20:</b> Vehicle - collision avoidance - static obstacle test-case. ....  | 104 |
| <b>Figure 4-21:</b> Vehicle - collision avoidance - moving obstacle test-case.....   | 105 |
| <b>Figure 4-22:</b> Vehicle - collision avoidance - distance keeping test-case. .... | 106 |



# LIST OF TABLES

|                                                                          |    |
|--------------------------------------------------------------------------|----|
| <b>Table 3-1:</b> System functional requirements. ....                   | 38 |
| <b>Table 3-2:</b> Level 1 boundary diagram - components description..... | 40 |
| <b>Table 3-3:</b> Level 2 boundary diagram - signals description.....    | 41 |
| <b>Table 3-4:</b> Level 3 boundary diagram - blocks description. ....    | 42 |
| <b>Table 3-5:</b> Control unit flow chart components. ....               | 64 |
| <b>Table 3-6:</b> Sensor data processing sources.....                    | 65 |
| <b>Table 3-7:</b> SAMv71 SPI bit polarity configuration [38].....        | 66 |
| <b>Table 3-8:</b> Camera system 8 byte data frame.....                   | 67 |
| <b>Table 4-1:</b> Traxxas truck signals characterization.....            | 88 |
| <b>Table 4-2:</b> Haar Cascade Classifier configurations.....            | 96 |

# LIST OF ABBREVIATIONS AND ACRONYMS

| Acronym | Definition                                                                                                                 |
|---------|----------------------------------------------------------------------------------------------------------------------------|
| 2D      | Two Dimension                                                                                                              |
| 3D      | Three Dimension                                                                                                            |
| ADC     | Analog to Digital Converter                                                                                                |
| AFEC    | Analog Front End Controller                                                                                                |
| AG      | From the German: "Aktiengesellschaft". Legal classification for companies which stands for "Anonymous Society" in English. |
| AHB     | AMBA High-performance Bus                                                                                                  |
| ANSI    | American National Standards Institute                                                                                      |
| ARM     | Advanced RISC Machine                                                                                                      |
| AUTOSAR | AUTomotive Open System Architecture                                                                                        |
| CAN     | Controller Area Network                                                                                                    |
| CDB     | Common Data Base                                                                                                           |
| CLK     | Clock                                                                                                                      |
| cm      | Centimeter                                                                                                                 |
| CMOS    | Complementary Metal–Oxide–Semiconductor                                                                                    |
| CONACYT | From the Spanish: Consejo Nacional de Ciencia y Tecnologia                                                                 |
| CPU     | Central Processing Unit                                                                                                    |
| CUV     | Crossover Utility Vehicle                                                                                                  |
| DAC     | Digital to Analog Converter                                                                                                |
| DC      | Direct Current                                                                                                             |
| DIO     | Device Input Output                                                                                                        |
| DMA     | Direct Memory Access                                                                                                       |
| DMC     | Dynamic Motion Controller                                                                                                  |
| EBS     | Electronic Braking System                                                                                                  |
| ECU     | Electronic Control Unit                                                                                                    |
| EEPROM  | Electrically Erasable Programmable Read Only Memory                                                                        |
| EPS     | Electronic Power Steering                                                                                                  |
| ESC     | Electronic Speed Control                                                                                                   |
| EUI-48  | 48-bit Extended Unique Identifier                                                                                          |
| FMEA    | Failure Mode and Effects Analysis                                                                                          |
| FOV     | Field of View                                                                                                              |
| FP      | False Positive                                                                                                             |
| FPU     | Floating Point Unit                                                                                                        |
| GPIO    | General Purpose Input/Output                                                                                               |
| HCC     | Haar Cascade Classifier                                                                                                    |
| HMI     | Human Machine Interface                                                                                                    |

| <b>Acronym</b> | <b>Definition</b>                                                           |
|----------------|-----------------------------------------------------------------------------|
| HoQ            | House of Quality                                                            |
| HW             | Hardware                                                                    |
| I2C/IIC        | Inter-Integrated Circuit                                                    |
| IC             | Integrated Circuit                                                          |
| IDE            | Integrated Development Environment                                          |
| IO, I/O        | Input-Output                                                                |
| ISR            | Interrupt Service Routine                                                   |
| ITESO          | From the Spanish: Institute Tecnologico de Estudios Superiores de Occidente |
| kHz            | Kilo Hertz                                                                  |
| KLaC           | Kinematic Lateral Controller                                                |
| KLoC           | Kinematic Longitudinal Controller                                           |
| LED            | Light Emitting Diode                                                        |
| LiPo           | Lithium Polymer                                                             |
| m              | Meter                                                                       |
| MB             | Mega Byte                                                                   |
| MCP            | MicroChiP                                                                   |
| MHz            | Mega Hertz                                                                  |
| MISO           | Master Input Slave Output                                                   |
| MIT            | Massachusetts Institute of Technology                                       |
| MOSI           | Master Output Slave Input                                                   |
| Nbhd           | Neighbors number                                                            |
| Nbhd           | Neighbors number                                                            |
| NiMH           | Nickel-Metal Hydride                                                        |
| NMI            | Non-Maskable Interrupt                                                      |
| OEM            | Original Equipment Manufacturers                                            |
| OFM            | Optical Follow Me                                                           |
| OpenMV         | Open Machine Vision                                                         |
| OS             | Operating System                                                            |
| PCB            | Printed Circuit Board                                                       |
| PWM            | Pulse-Width Modulation                                                      |
| QSPI           | Queued Serial Peripheral Interface                                          |
| QVGA           | Quarter Video Graphics Array                                                |
| RC             | Radio Control                                                               |
| RFC            | Radio Frequency Control                                                     |
| ROI            | Region of Interest                                                          |
| RPM            | Revolutions Per Minute                                                      |
| RSAT           | Rotated Summed Area Table                                                   |
| RTE            | Real Time Environment                                                       |
| RTOS           | Real Time Operating System                                                  |

| <b>Acronym</b> | <b>Definition</b>                           |
|----------------|---------------------------------------------|
| SA             | System Architecture                         |
| SAT            | Summed Area Table                           |
| SCCB           | Serial Camera Control Bus                   |
| SCK            | Serial Clock                                |
| SCL            | Serial Clock                                |
| SD             | Secure Digital                              |
| SDA            | Serial Data                                 |
| SDIO           | Secure Digital Input Output                 |
| SDRAM          | Synchronous Dynamic Random Access Memory    |
| SE             | Systems Engineering                         |
| SEMA           | Specialty Equipment Market Association      |
| SL             | Slew Rate                                   |
| SPI            | Serial Peripheral Interface                 |
| SR             | System Requirements                         |
| SS             | Slave Select                                |
| SUV            | Sport Utility Vehicle                       |
| SW             | Software                                    |
| TC             | Timer Counter                               |
| TP             | True Positive                               |
| TRA            | Trailer Reverse Assists                     |
| UART           | Universal Asynchronous Receiver-Transmitter |
| USB            | Universal Serial Bus                        |
| VDD            | Voltage Drain Drain                         |
| WDT            | Watch-Dog Timer                             |
| XDMAC          | eXtensible Direct Memory Access Controller  |

# LIST OF DEFINITIONS

| Concept             | Definition                                                                                                                                                                                                           |
|---------------------|----------------------------------------------------------------------------------------------------------------------------------------------------------------------------------------------------------------------|
| ARM                 | Family of reduced instruction set computing (RISC) architectures for computer processors, configured for various environments.                                                                                       |
| bit                 | Basic and physical unit of information in computing and digital communications.                                                                                                                                      |
| Boolean             | Datatype capable of holding only two values.                                                                                                                                                                         |
| Boundary Diagrams   | Graphical illustration of the relationships between the components within the object under analysis as well as the interfaces with its neighboring systems and environments.                                         |
| byte                | Unit of digital information consisting of eight bits.                                                                                                                                                                |
| C99                 | Informal name for ISO/IEC 9899:1999, a past version of the C programming language standard.                                                                                                                          |
| Chebyshev distance  | Vector space where the distance between two vectors is the greatest along any coordinate dimension.                                                                                                                  |
| dashcam             | Portable specialized camera that continuously records video through the vehicle's windshield. Its footage can be of aid during legal disputes in cases of vehicle vandalism or accident.                             |
| Intelligent Sensors | Intelligent sensor takes some predefined action when it senses the appropriate input.                                                                                                                                |
| Jackknifing         | The act of placing a vehicle-trailer system at an angle in which if additional reverse motion is performed, it will cause the angle to only increase disregarding the direction or the amount of steering performed. |
| light-trucks        | CUVs, SUVs, vans or utilitarian vehicles.                                                                                                                                                                            |
| P-Diagrams          | Parameter Diagram.                                                                                                                                                                                                   |
| Target-less         | Without the need for a specific object or pattern for identification.                                                                                                                                                |
| Tier 1 Supplier     | A tier one company is the most important member of a supply chain, supplying components directly to the original equipment manufacturer (OEM) that set up the chain.                                                 |
| Tier 1 Supplier     | Direct supplier of components for the OEM                                                                                                                                                                            |
| trailers            | Vehicle attachable platforms such as moving houses, boats, toy haulers, etc.                                                                                                                                         |
| UNIX                | Family of multitasking, multiuser computer operating systems that derive from the original AT&T Unix.                                                                                                                |

# INDEX

|                                                                          |             |
|--------------------------------------------------------------------------|-------------|
| <b>Instituto Tecnológico y de Estudios Superiores de Occidente .....</b> | <b>i</b>    |
| <b>Acknowledgments .....</b>                                             | <b>iii</b>  |
| <b>Abstract.....</b>                                                     | <b>v</b>    |
| <b>Resumen .....</b>                                                     | <b>vi</b>   |
| <b>List Of Figures.....</b>                                              | <b>vii</b>  |
| <b>List of Tables .....</b>                                              | <b>ix</b>   |
| <b>List of Abbreviations and Acronyms .....</b>                          | <b>x</b>    |
| <b>List of Definitions .....</b>                                         | <b>xiii</b> |
| <b>Index.....</b>                                                        | <b>xiv</b>  |
| <b>Introduction.....</b>                                                 | <b>1</b>    |
| <b>1. Background .....</b>                                               | <b>5</b>    |
| 1.1. CURRENT MARKET.....                                                 | 5           |
| 1.1.1 Ford F-150 Pro Trailer Backup Assist .....                         | 5           |
| 1.1.2 Continental Trailer Reverse Assist.....                            | 7           |
| 1.2. TRAILER REVERSE ASSIST – OPTICAL FOLLOW ME .....                    | 8           |
| <b>2. Conceptual Framework.....</b>                                      | <b>11</b>   |
| 2.1. PROJECT LIFE CYCLE MODEL.....                                       | 11          |
| 2.1.1 Vee Model.....                                                     | 12          |
| 2.2. SYSTEM REQUIREMENTS DEFINITION .....                                | 13          |
| 2.3. ARCHITECTURE DEFINITION PROCESS .....                               | 14          |
| 2.4. HAAR CASCADE CLASSIFIER FOR FACE DETECTION .....                    | 14          |
| 2.4.1 Detection Procedure .....                                          | 16          |
| 2.5. COMPUTER VISION OPENMV BOARD.....                                   | 18          |
| 2.6. KINEMATICS OF A SIMPLE CAR SYSTEM.....                              | 19          |
| 2.7. SENSORS.....                                                        | 21          |
| 2.7.1 Ultrasonic Sensors.....                                            | 21          |
| 2.7.2 Infrared Sensors .....                                             | 24          |
| 2.7.3 Hall-Effect Sensors .....                                          | 25          |
| 2.8. ATMEL SAM V71 .....                                                 | 26          |
| 2.9. REAL-TIME OPERATING SYSTEM CONCEPT .....                            | 27          |
| 2.9.1 FreeRTOS .....                                                     | 27          |
| 2.9.2 RTOS Events.....                                                   | 30          |
| 2.9.3 RTOS Messages.....                                                 | 30          |

|                                                                      |            |
|----------------------------------------------------------------------|------------|
| 2.10. COMMUNICATION PROTOCOLS .....                                  | 31         |
| 2.10.1 Universal Asynchronous Receiver-Transmitter .....             | 31         |
| 2.10.2 Inter-Integrated Circuit.....                                 | 31         |
| 2.10.3 Serial Peripheral Interface.....                              | 32         |
| 2.10.1 Contoller Area Network.....                                   | 32         |
| 2.11. TRAXXAS FORD F-150 RAPTOR MODEL .....                          | 34         |
| <b>3. Design and Development .....</b>                               | <b>37</b>  |
| 3.1. SYSTEM FUNCTIONAL REQUIREMENTS .....                            | 38         |
| 3.2. SYSTEM ARCHITECTURE.....                                        | 39         |
| 3.2.1 Level 1 Boundary Diagram “Vehicle View” .....                  | 39         |
| 3.2.2 Level 2 Boundary Diagram “TRA System”.....                     | 40         |
| 3.2.3 Level 3 Boundary Diagram “OFM System” .....                    | 42         |
| 3.3. SOLUTION.....                                                   | 43         |
| 3.3.1 System Technical Architecture .....                            | 45         |
| 3.3.2 Technical Architecture P-Diagrams .....                        | 48         |
| 3.3.3 Technical Solution HoQ Diagram.....                            | 51         |
| 3.4. IMPLEMENTATION .....                                            | 52         |
| 3.4.1 Software Architecture and Design .....                         | 52         |
| 3.4.2 Hardware Architecture and Design.....                          | 75         |
| <b>4. Results and Discussion.....</b>                                | <b>83</b>  |
| 4.1. SW ARCHITECTURE VERIFICATION .....                              | 83         |
| 4.2. VEHICLE ADAPTATION .....                                        | 85         |
| 4.2.1 Addition of the Hall Effect Sensor .....                       | 85         |
| 4.2.2 Characterization of Signals .....                              | 88         |
| 4.2.3 Vehicle Adaptation Connections.....                            | 89         |
| 4.3. CONTROL UNIT CONNECTIONS .....                                  | 93         |
| 4.4. CAMERA SYSTEM CONNECTIONS .....                                 | 93         |
| 4.5. SYSTEM VALIDATION .....                                         | 95         |
| 4.5.1 Person Face Identification and Tracking.....                   | 96         |
| 4.5.2 Vehicle - Person Following.....                                | 101        |
| 4.5.3 Vehicle – Stop before Collision .....                          | 103        |
| <b>5. Conclusions .....</b>                                          | <b>107</b> |
| 5.1. SYSTEM DESCRIPTION .....                                        | 107        |
| 5.2. “TRA - OPTICAL FOLLOW ME” IMPLEMENTATION .....                  | 108        |
| 5.3. “TRA – OPTICAL FOLLOW ME” VALIDATION AND PROOF OF CONCEPT ..... | 108        |
| 5.4. FUTURE WORK .....                                               | 109        |
| <b>APPENDIX .....</b>                                                | <b>111</b> |
| A. L2 TECHNICAL ARCHITECTURE P-DIAGRAMS .....                        | 113        |
| <b>REFERENCES.....</b>                                               | <b>123</b> |





# INTRODUCTION

In the automotive world, safety is a major topic. The inclusion of safety features in new technology development has been strongly encouraged in order to reduce potential risks. Reversing a vehicle with some sort of attachable platforms such as moving houses, boats, toy haulers, etc., commonly referred to as trailers, can be a challenging task. This is not only a result of the added weight but also because of the non-intuitive way in which the steering wheel must be moved in order to achieve a specific trajectory. All these problems combined, often result in both fear to operate such a system and cause accidents because of the lack of experience among drivers.

According to a study conducted by the Specialty Equipment Market Association (SEMA) in North America, 16.3% of the CUVs, SUVs, vans or utilitarian vehicles sold from 2007-2012, and commonly referred to as Light-Trucks, were used to tow trailers [1]. However, with the appropriate equipment, almost any car can be adjusted to tow a trailer. Nevertheless, even with the large percentage of the population practicing this activity, many drivers are not properly trained and/or do not have adequate experience to back-up a vehicle-trailer system. The complex dynamics involved in driving in reverse while also pushing a load make even experienced drivers sometimes struggle with backing unfamiliar or difficult trailers. In addition, rear blind zones that do not allow adequate sight angles for the driver to properly back-up without assistance have become commonplace. All the above-mentioned problems are very likely to end up in some type of property damage or even in personal injury. Therefore, a considerable part of the global vehicle market is in need of some kind of assistance system to perform these tasks.

Original Equipment Manufacturers (OEMs) already provide few products that try to ease this challenge. These solutions include the elimination of the requirement to invert the steering

direction, provide visual support using the rear view camera or even prevent *jackknifing*<sup>1</sup> the vehicle [2]. Yet, these solutions do not completely solve the problem of having a reduced or obstructed field of view. For example, objects in the path of a vehicle remain difficult to detect when turning around tight corners or in the presence of rear-view mirror obstruction. A common practice is to have a person stand behind the trailer and signal directions to the driver in order to guide the trajectory or warn of possible obstacles. Though this might be able to help, the possibility remains that instructions could go unheard or even the helper could be run over because of miscommunication issues. Bearing in mind all the above mentioned, it is clear that the problem of safely backing-up a trailer is not completely solved.

The objective of this work is to propose a system that contributes to the existing trailer reversing assistance products by enhancing the drivers' visibility, and increasing safety. In order to achieve this, the system will include a way to detect objects that are collision-prone, and an automatic optical tracking feature will be added so a signaling assistant without the driver's intervention can conduct the vehicle through the right path. The collaboration of the existing systems, together with the proposed additions strives not only to increase the safety of the backing maneuvers, but will also provide the driver with ease of mind by increasing the range of view while reassuring that the system will prevent possible collisions. Finally, the proposed solution will further reduce the training currently required to operate a vehicle-trailer system.

- The focus of the project is on the optical tracking of a person as well as the collision avoidance by near object detection. In order to do so, the following tasks are accomplished:
  - Description of the system's functional and technical requirements
  - Description of the system architecture
    - Software architecture
    - HW architecture
  - Implementation of the optical tracking

---

<sup>1</sup> Jackknifing: The act of placing a vehicle-trailer system at an angle in which if additional reverse motion is performed, it will cause the angle to only increase disregarding the direction or the amount of steering performed.

- Implementation of the near object detection
- Implementation of the control strategy
- Adaptation of an electrical scale-vehicle
- Integration of additional systems into a scale-vehicle
- Execution of system test runs in order to perform a proof of concept

The motivation of this degree project was to contribute to the automated drive technological development branch of Continental AG related projects while at the same time solving a real-world problem such as the limited visibility in vehicle-trailer systems. The project was carried out at ITESO in the Department of Electronics, Systems and Computer Sciences for the Specialization in Embedded Systems as part of the CONACYT Postgraduate with the Industry Agreements.

- Alejandro Salcido Zarco
  - CVU: 787874
- Efrain Marquez Gutierrez
  - CVU: 788238



# 1. Background

## 1.1. Current Market

In order to address the problem that arises when reversing a trailer, some solutions are slowly making their way into the market. Several are still in development while others have already been included as features by some OEMs. These solutions solve the steering part by automatically moving the steering wheel and detecting in some way the trailer articulation angle, however, none address the poor visibility or object detection in the motion path. The most relevant solutions for improving the poor visibility or object detection when reversing a vehicle are described below and also compared with this project's proposal, the "TRA-Optical Follow Me".

### 1.1.1 Ford F-150 Pro Trailer Backup Assist

The "Ford F-150 Pro Trailer Backup Assist" system uses the vehicle's rear view camera in order to identify a pattern sticker placed on the trailer's hitch assembly, as shown in Figure 1-1. With the sticker position information, this system is able to determine the trailer articulation angle when moving backwards.



*Figure 1-1: Ford target sticker detection [3].*

## 1. BACKGROUND

The user's desired trajectory is selected by turning a small knob (Figure 1-2) placed next to the steering wheel. Both the user selection and the current trailer articulation angle are used in a control loop that controls the steering wheel [3]. Both the throttle and the brake pedals must be controlled by the user. This concept has already been patented [4].



Figure 1-2: Ford Knob HMI [3].

A great disadvantage of the Ford system is the requirement of manual measurements and calibration stages that must be performed by the user. These include having the user manually measure the trailer's wheelbase as well as the hitch assembly characteristics (Figure 1-3). All this information is then introduced to the vehicle's information display. Then, after placing the sticker, the driver needs to ensure that it is being correctly detected.

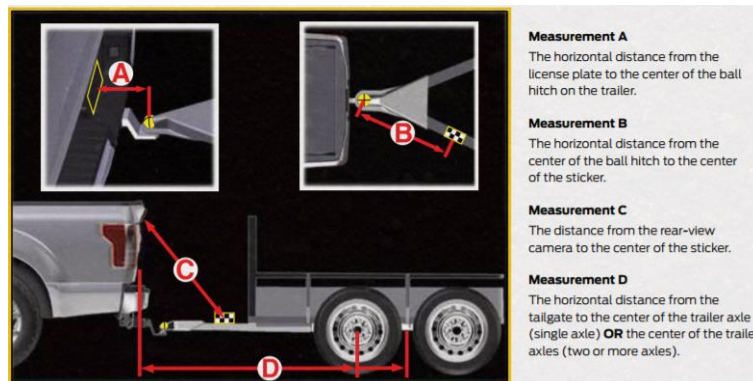
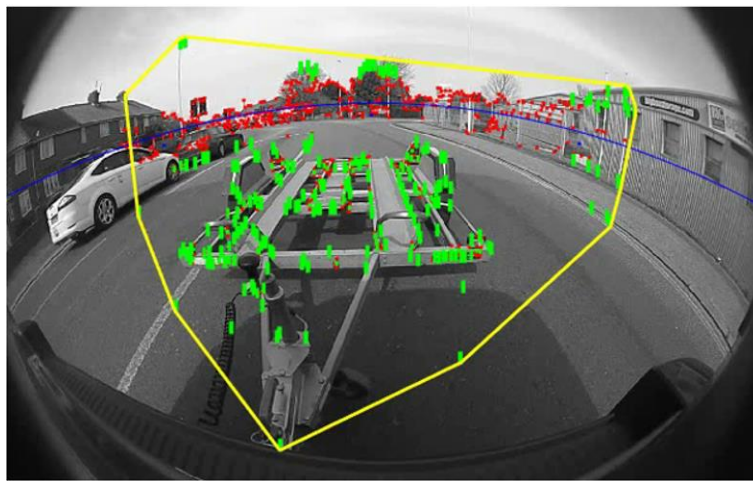

Figure 1-3: Ford trailer assembly measurements [3].

## 1. BACKGROUND

### 1.1.2 Continental Trailer Reverse Assist

Similar to Ford's "Trailer Backup Assist", Continental's solution called "Trailer Reverse Assist" (TRA) relies on the rear view camera of the vehicle in order to detect the trailer's articulation angle. However, in contrast with the F-150, the user does not need to perform any manual measurements. Continental's "target-less" system is able to identify the trailer's articulation angle without the need of any sticker as seen in Figure 1-4. Additionally, the trailer's wheelbase, as well as the hitch assembly lengths, are automatically determined by the system. In order to do so, the system must travel forward a small distance and make at least one left or right turn.



*Figure 1-4: Continental target-less trailer detection.*

Also, the user must input the desired path of the trailer also by using a knob. The path that the trailer will follow is marked on the rear view camera video feed; however, because the trailer is placed behind the camera, then this trajectory is not that useful. The user must also control the throttle and brake pedals, yet, Continental's solution implements a jackknife protection feature. This feature stops the vehicle before the system can no longer be controlled and operates when the user is steering manually. The knob control system on its own prevents the jackknife condition by itself. The combination of these features further increases the user's trust while reversing.

## **1. BACKGROUND**

An additional advantage of the Continental system compared to Ford, is that since Continental is a “Tier 1 Supplier” and not an OEM, then, the “Trailer Reverse Assist” system can be added to any OEM willing to acquire the system. All this is possible since Continental is the owner of the system’s patent [5].

Nevertheless, the driver still needs to manually control the acceleration and brake pedals (except during the jackknife protection where the system will automatically apply the brakes before reaching the jackknife condition). Furthermore, for big trailers, the rear-view camera becomes partially (if not totally) obstructed, meaning that it is not as useful to the driver during a maneuver.

### **1.2. Trailer Reverse Assist – Optical Follow Me**

The contribution of the “TRA – Optical Follow Me” to the existing Continental TRA system is to remove the knob needed by the user to input the trailer’s desired path when reversing. Instead, a helping person positioned behind the trailer will be detected using a camera and the system will calculate the angle between them in order to replace the knob input. This person will then be followed by the “TRA - Optical Follow Me” system while maintaining a fixed distance between the person and the back of the trailer. As a result, the need for the driver to use the truck’s mirrors and reverse camera, which are normally obstructed by the trailer or other objects, is eliminated. Proximity sensors located on the back of the trailer prevent collisions with objects in the system’s path. This allows easily backing up the truck-and-trailer system in narrow paths or where the visibility is poor while also preventing possible collisions. The basic architecture of the proposed system can be observed in Figure 1-5.



## 1. BACKGROUND

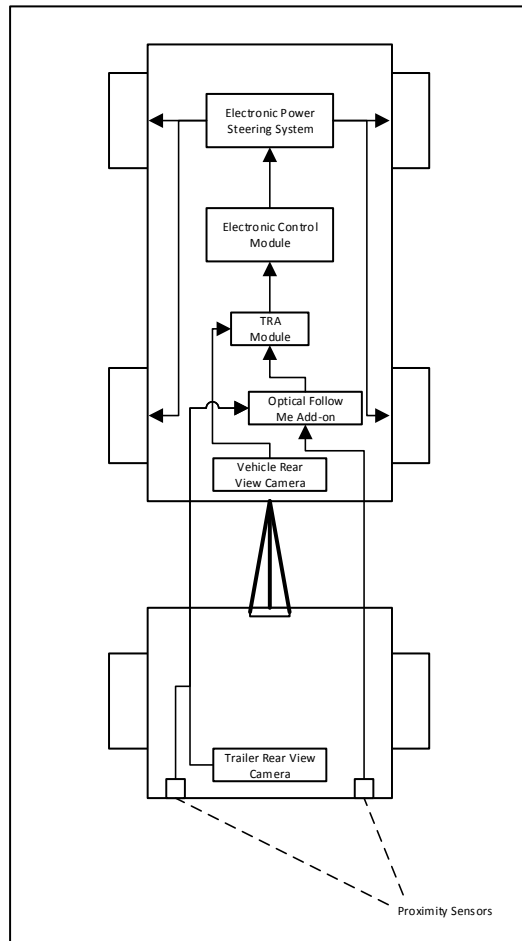

Figure 1-5: TRA - Optical Follow Me component architecture.

The proposed “TRA – Optical Follow Me” would be an add-on to the current TRA system instead of a replacement. Additional to solving the standard TRA disadvantages, the “TRA – Optical Follow Me” system can be used for other means not related to reversing maneuvers. These could include adding visibility to the user when changing lanes or even act as a rear view *dashcam*<sup>2</sup> in order to assist in crash disputes as evidence. Moreover, by having a camera behind the trailer, the user would be confident that the system is working properly since the user would be able to see the direction where the trailer is heading.

---

<sup>2</sup> Dashcam: Portable specialized camera that continuously records video through the vehicle’s windshield. Its footage can be of aid during legal disputes in cases of vehicle vandalism or accident.

## 1. BACKGROUND

The basic UseCase of the “TRA – Optical Follow Me” system can be observed in Figure 1-6 and is described below:

- 1) A helping person placed behind the trailer is identified.
- 2) The driver confirms the correct helper identification and enables the “TRA-Optical Follow Me” system.
- 3) The system moves towards the helping person by keeping a fixed distance and adjusting the trajectory as needed.
- 4) In case that any nearby object is deemed to be a collision hazard, then the system will decide if the brakes need to be applied and will cease the movement, if required.
- 5) The helping person moves towards the direction where the vehicle-trailer system will move. Once the system is at the desired spot, the helper stops moving.
- 6) Since the distance from the system to the helper is no longer increasing, the vehicle will automatically stop.
- 7) The driver disables the “TRA – Optical Follow Me” system.

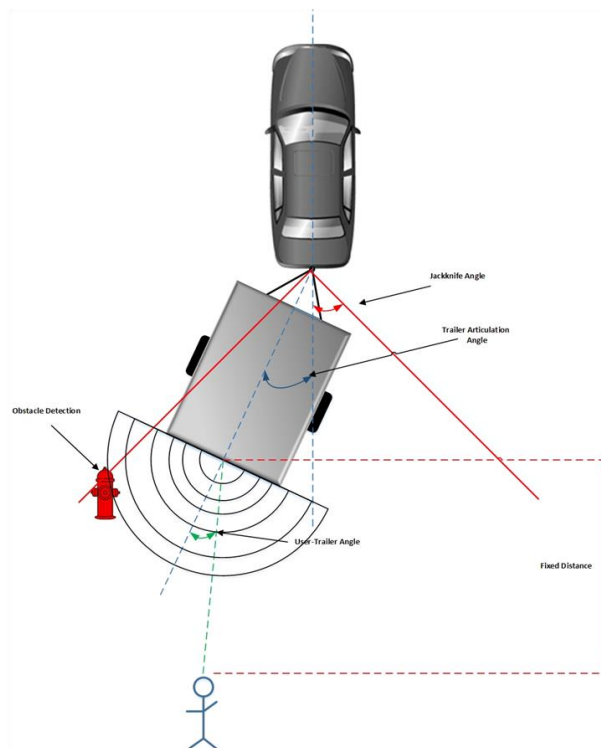

Figure 1-6: TRA – Optical Follow Me use-case.

## **2. Conceptual Framework**

In this section, some of the fundamental concepts needed to understand the work achieved in this project will be addressed. Firstly, Systems Engineering (SE) topics will be described such as, the Project Life Cycle Model, System Architecture (SA) and System Requirements (SR). Secondly, key computer vision concepts are briefly commented such as, the Haar Cascade Classifier and its implementation in the OpenMV board using Python scripting. Thirdly, the basic concepts of the vehicle kinematics for a traditional car are explained. Fourthly, a brief presentation of the used object detection sensors, both ultrasonic and infrared, is performed. Finally, a description of the Atmel SAM v71 platform is provided, together with fundamental Embedded SW Engineering concepts such as, Direct Memory Access, C Language, ISR, RTOS events and messages, and communication protocols.

### **2.1. Project Life Cycle Model**

A “Project Life Cycle Model” is a visual tool used to depict the start and stop points of the activities throughout a project. Most of these type of models tend to be seen as a linear approach, however, special attention to their iterative nature needs to be taken. Feedback loops are required in order to ensure the correct communication, learning and decision making throughout the process. For example, the stakeholder requirements might change and thus, adaptations to the SA, SR, and design need to be decided and communicated to the development team [6].

## 2. CONCEPTUAL FRAMEWORK

Sequential methods offer a systematic approach in order to guarantee the completeness of the work-products. These include correct documentation, requirements traceability and its corresponding verification. The advantages of these models are the high levels of predictability, stability and repeatability that can be achieved. This type of methods can be summarized in three words:

- Standardization
- Measurement
- Control

### 2.1.1 Vee Model

The Vee Model is a sequential method, which provides an illustration of the key areas in the stages of SE throughout the life cycle process. Its success rate depends on the continuous validation with stakeholders, together with risk and opportunity assessments. As shown in Figure 2-1, the time and maturity of the process goes from left to right and therefore, the development advances can only occur along the arrows and is done from a low to a high level of detail in the tasks. It is key to perform checkpoints at each stage in order for the subsequent stages to have a stable starting point. [6]

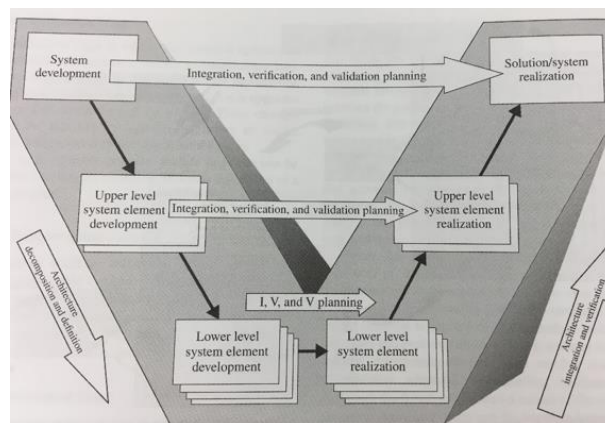

Figure 2-1: Vee Model diagram [6].

## **2. CONCEPTUAL FRAMEWORK**

Once the Vee Model has reached the final stage, it might be necessary to repeat as many Vee Models as needed in order to correct any findings through the validation process or to allocate any requirements changes that might have arisen.

### **2.2. System Requirements Definition**

Requirement analysis is the first step in the Vee cycle model and it implies the definition of desired capabilities and characteristics or attributes of the system in terms of the final user. A good set of requirements should be concise, unambiguous, and verifiable. Commonly, system requirements definition implicates the translation of a non-technical point of view of a desired functionality into a technical description omitting implementation details. Also requirements can derive from other system requirements creating system/subsystem dependencies. Requirements constitute the base of the Vee Model process and it is important to clearly state the objectives of the project at all system levels in favor of creating a solid work scheme based on the stakeholders' operational needs. However, changes in the requirements may appear during the life cycle of the project, although changes in requirements may be expected, when they occur in advanced stages of the project life cycle they might have a significant impact on cost, including the risk of cancellation. For this reason every output must be compared for traceability purposes in order to maintain consistency with stakeholder requirements [7].

## **2. CONCEPTUAL FRAMEWORK**

### **2.3. Architecture Definition Process**

The architecture definition process creates one or more system architecture global-solutions aimed to satisfy the system requirements and constraints. Architecture definition can be described as two complementary activities, system architecture and design. While system architecture is focused on the high-level global structure system and oriented to operational concepts, this is an abstract task. In contrast, system design is technology oriented and focuses on the structural and environmental implementation of the system. During the architecture definition process it is essential to provide flexibility to the design, prioritizing the compatibility with other technologies and other system features by facilitating the integration and ease of future changes. This process requires the participation of the system architects and support by specialists in the subject, in order to obtain relevant information to perform a deeper analysis of the overall architectural process [8].

### **2.4. Haar Cascade Classifier for Face Detection**

The ability to precisely detect the eyes or the face of a person is crucial in many Human Machine Interface (HMI) systems. A human face is a rather challenging 3D flexible object to accurately detect in a 2D image. The reason for this, is that the human face has a wide variety of structural disturbances such as glasses, make-up and/or hair as well as plenty of personal facial features, which hinder the detection task. Additionally, the pose or the expression add complexity since many variations need to be taken into account.

Extensive research has been done in order to find a precise and efficient algorithm which can provide facial detections. One of the most reliable methods is the Haar Cascade Classifier (HCC). However, in order for this method to work properly, a proper initialization is required. This includes providing a Region of Interest (ROI) in the image where a face is more likely to be found as well as the in-plane rotation and the scale of the image. Specifically, the HCC detector proposed

## 2. CONCEPTUAL FRAMEWORK

by P. Viola and M. Jones combines three key-points in order to achieve a high detection rate [9]. These key points are:

- Apply a set of features that can be processed in a predictable way, and thus, reduce the computational variability.
- Apply a boosting algorithm for simultaneous identification of standing-out features.
- Gradually increase complexity of the classifiers.

We can define a Haar-like feature in a pixel window by the formula  $feature = \sum_{i=1}^N \omega_i * RecSum(r_i)$ ; where  $\omega_i$  is a weighting factor,  $RecSum$  is the sum of the pixel intensity values of a rectangle inside the detection window, and  $r$  is a parameter configuration including the rectangle upper left corner coordinates, and the dimensions and rotation angle of the mentioned rectangle. By using the  $r$  set of parameters, we can obtain an almost infinite number of features. Therefore, in order to achieve an efficient computation, a set of constrains needs to be applied.

These constrains are:

- The sum of pixels between two rectangles is allowed.
- The weighting values shall be used to adjust the differences in area between two rectangles.
- The early stage features shall be similar to those of the human vision pathway.

Said constrains result in 14 prototype features which can be observed in Figure 2-2.

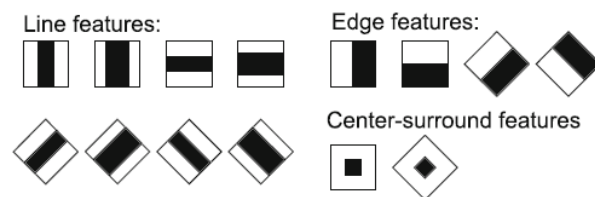

Figure 2-2: Prototypes of Harr-like features [10].

After the features have been selected, they need to be evaluated. This is done in two ways. The first, “Summed Area Table” (SAT) sums the pixel intensities of the upright rectangles. The

## 2. CONCEPTUAL FRAMEWORK

second, “Rotated Summed Area Table” (RSAT) takes into account the pixel intensity considering a rotation of up to 45 degrees.

In order to make the classification more efficient, non-relevant object regions need to be discarded. This is done by applying  $N$  classifier stages to distinguish a detected object from the background. This results in True Positive ( $TP_{\text{cas}}$ ) and False Positive ( $FP_{\text{cas}}$ ) ratios “ $p$ ” and “ $f$ ”, respectively. Each positively classified object is passed to the next subsequent classifier in a cascade way. This results in an exponential overall detection ratio of the cascade given by:

$$TP_{\text{cas}} = \prod_{i=1}^N p_i \approx p^n \quad (2-1)$$

$$FP_{\text{cas}} = \prod_{i=1}^N f_i \approx f^n \quad (2-2)$$

As can be observed, the further the classification stage, the more challenging is the task to identify the differences and successfully reach and maintain the  $p$  and  $f$  ratios.

### 2.4.1 Detection Procedure

Regardless of scale, the Haar-like features can be calculated with the same SAT and RSAT. In addition, any sum of rectangles can be computed in a constant number of iterations. This means that already computed information can be reused. The feature detection is performed by fixing a minimum scaling factor, which must be larger than the original cascade detection window, then, it can be scaled up as required. It is common that a single region of interest triggers several



## 2. CONCEPTUAL FRAMEWORK

individual object detections. In order to group these detections and produce a single one, the following criteria can be used:

- The Chebyshev distance between the rectangle's upper-left corners shall not exceed the first rectangle width by a factor of 0.2.
- The width of a rectangle shall not exceed the width of other rectangle by a factor of 1.2.

If the above-mentioned criteria are met, then the cluster of detection rectangles is averaged out in order to form a merged region of interest. The number of merged rectangles is called the Neighbors number (Nbhd) and can be used to measure the certainty of a detection. A threshold can be fixed to the Nbhd in order to consider a detection to be valid, and setting the right threshold is critical for the correct performance of the algorithm. [10]. An example of the Nbhd merge effect is shown in Figure 2-3.

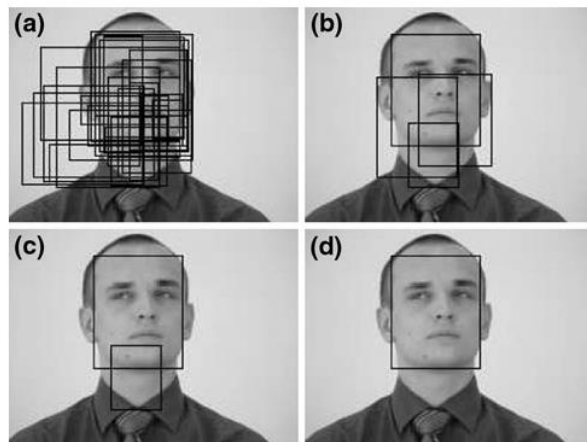

*Figure 2-3: Influence of Nbhd in Detection Results [10].*

## 2. CONCEPTUAL FRAMEWORK

### 2.5. Computer Vision OpenMV Board

The Open Machine Vision (OpenMV [11]) is a compact platform developed for simple Computer Vision Tasks (Figure 2-4). It was created by Kwabena Agyeman and Ibrahim Abdelkader as a Kickstarter project, which took place in the month of January 2015 [12]. The platform includes a powerful ARM Cortex M4 microprocessor, a Color CMOS OV7725 camera module, and an Arduino compatible pin layout. The board is capable of several communication protocols such as I2C, SPI, CAN, and UART, while also including support for controlling Servo Motors using PWM. Furthermore, ADC and DAC pins are available for analog operations.

The OpenMV Camera can be programmed in high level Python scripts based on the MicroPython Operating System [13]. This is possible by downloading the free IDE, where simple image processing libraries are available and allow operations such as:

- Blob object detection
- Haar Cascade feature identification
- Image statistics calculation

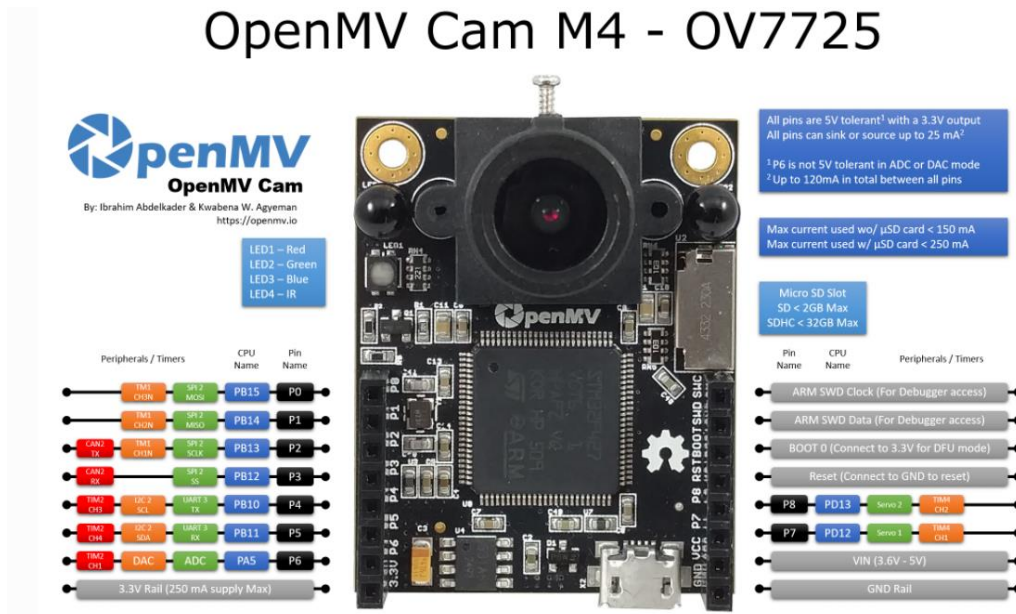

Figure 2-4: OpenMV Cam M4 - OV7725 [14].

## 2. CONCEPTUAL FRAMEWORK

### 2.6. Kinematics of a Simple Car System

An under-actuated vehicle can be defined as a system, which possesses fewer action variables than degrees of freedom. This can be applied to the simple car model from Figure 2-5 since its wheels are designed to roll in the direction they are pointing. The wheels, at least from a kinematics point of view, roll sideways. For this specific system, only the front wheels can rotate up to certain degree.

In order to define the vehicle configuration  $q = (x, y, \theta)$ , we place a frame of reference at the rear axle of the vehicle. The positive x-axis will point towards the front of the vehicle. We denote the following parameters:

- $\varphi$ : Steering angle
- $L$ : Distance between the front and rear wheel axis.
- $\rho$ : Radius of the circular trajectory of the vehicle caused by the steering angle.

The parameters that can be controlled by the driver in a normal car are steering and speed. Therefore, we can, define the action vector  $u = (u_s, u_\varphi)$  where the speed and steering angle are controlled by  $u_s$  and  $u_\varphi$ , respectively. By doing so, we obtain the configuration transition equations for the simple car as:

$$\dot{x} = u_s \cos(\theta) \quad (2-3)$$

$$\dot{y} = u_s \sin(\theta) \quad (2-4)$$

$$\dot{\theta} = \frac{u_s}{L} \tan(u_\varphi) \quad (2-5)$$

It is important to mention that  $\varphi$  shall be constrained to the interval  $[-\pi/2, \pi/2]$ , otherwise, the front wheels would collide with the front wheel axle. [15]

## 2. CONCEPTUAL FRAMEWORK

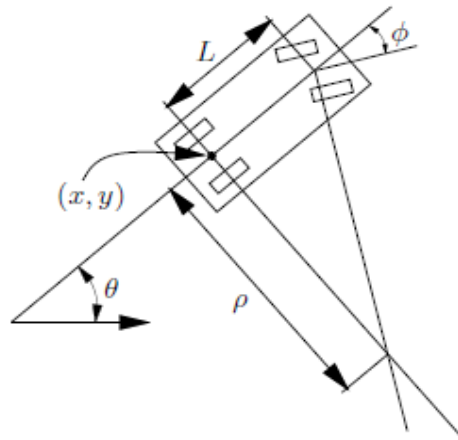

*Figure 2-5: The simple car has three degrees of freedom, but the velocity space at any configuration is only two-dimensional [16].*

## 2. CONCEPTUAL FRAMEWORK

### 2.7. Sensors

Sensors play a key role in today's technological systems. They measure environmental variables and translate them into electrical signals. These signals can later be processed in order to determine the characteristics of the medium or the object of interest.

#### 2.7.1 Ultrasonic Sensors

Ultrasonic sensors are able to measure physical properties by the wave propagation phenomenon, and thus, are classified as Intelligent Sensors (when certain input is received, they are able to communicate a signal based on logical functions and instructions). The two types of ultrasonic sensors are:

- Propagation Path
  - These sensors detect changes in the propagation of the emitted ultrasonic signal in order to determine characteristics of the medium such as, temperature, pressure, or fluid concentration.
- Distance Sensors
  - After emitting an acoustic wave, the sensor waits for the reflected echo from nearby objects. This echo is then analyzed in order to determine the characteristics of the object that caused the reflection.

The most important part of an ultrasonic sensor is the electronic transducer. This part is made either from piezoelectric or magnetostrictive materials normally placed in layers. The manufacturing of the electronic transducer will determine the frequency of the sensor, which can be between 30-500 kHz. The electronic transducer will also determine the radiation pattern (see Figure 2-6) for the sensor; this is, if it will have a wide field of view or a long-distance detection.

## 2. CONCEPTUAL FRAMEWORK

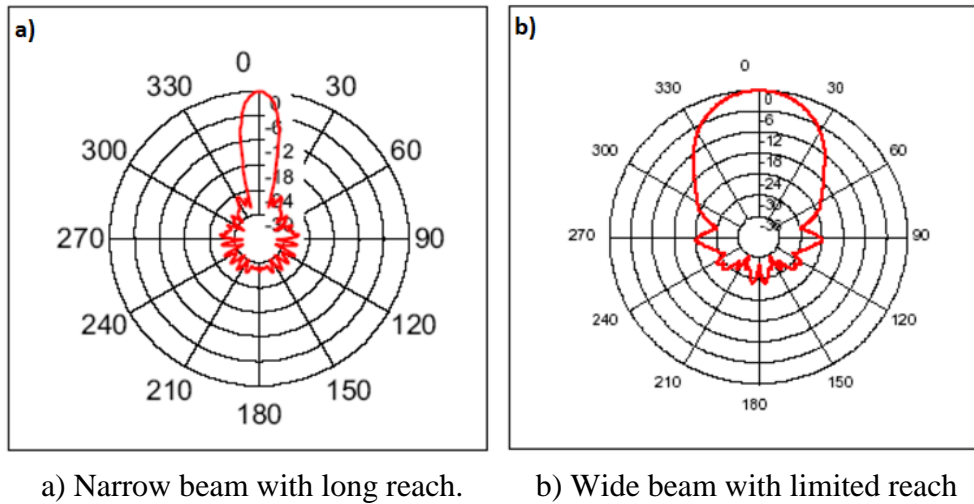

Figure 2-6: Radiation pattern types of an ultrasonic sensor [17].

The advantages of ultrasonic sensors are described below:

- Production of stable results once calibrated.
- Relatively low power consumption.
- A directional beam.
- Do not require direct contact with the object to be measured.
- A large bandwidth, while also not disturbing nearby human beings (the operational frequency is outside of the human audible range) because of its ultrasonic nature.

Its disadvantages are:

- They cannot be used for long distances because of the exponential degradation of the signal's intensity.
- A tradeoff between resolution (high frequency) and range/noise resistance (low frequency) must be determined.
- Changes in the medium, such as temperature or humidity can affect the results and might require additional calibrations in order to compensate these conditions.

The ultrasonic sensors can be used not only to detect the presence of an object. Object profiles can be created in order to identify or differentiate the bodies that are detected. However,

## 2. CONCEPTUAL FRAMEWORK

this is only possible if the sensor has a high enough resolution. This additional identification must be performed by the signal-processing device and will require large amounts of processing power, which is proportional to the desired precision [18].

The ultrasonic sensor that was employed in the project is the “Devatech SRF08 UltraSonic Ranger” Figure 2-7 [19]. This high performance sensor has the following characteristics:

- Range from 3cm to 6m.
- Completely digital device which interface is IIC.
- Configured to report either in time of echo, centimeters or inches.
- Up to 17 echoes can be registered after every emission.



*Figure 2-7: Devatech SRF08 Ultrasonic Sensor [20].*

## 2. CONCEPTUAL FRAMEWORK

### 2.7.2 Infrared Sensors

The infrared sensors are also an easy way to obtain data from the medium in order to act upon certain specific conditions. In contrast with the already mentioned ultrasonic sensors, infrared sensors have a limited range where they remain accurate. However, they are able to work in short ranges below 0.5m, which their ultrasonic counterparts cannot do. Thus, this sensor tends to be employed for proximity detection only, rather than for distance measurement, meaning that their output is binary.

The composition of infrared sensors is chiefly an infrared light source such as a LED and a photodiode. Therefore, the accuracy of the sensor proportionally depends on both, the energy output of the light source and the sensitivity of the transducer (the photodiode). [21]

For the “Trailer Reverse Assist – Optical Follow Me Project”, three infrared sensors were employed. The chosen sensor model was the GP2Y0A21YK0F model from the manufacturer SHARP. This analog sensor is capable of accurately operating in the range of 10-80cm while also having a low power consumption. The output signal is an analog voltage, inversely proportional to the proximity of the object within range. [22]



*Figure 2-8: SHARP GP2Y0A21YK0F infrared sensor [22].*



## 2. CONCEPTUAL FRAMEWORK

### 2.7.3 Hall-Effect Sensors

The Hall Effect is a conduction phenomenon that produces a voltage difference across an electrical conductor with the presence of a perpendicular magnetic field. This effect takes the name of its first modeler, the U.S. physicist Edwin Herbert Hall. This effect is widely used in practical applications such as position sensing and velocity or directional movement [23].

Furthermore, the Hall-Effect is approached by sensors commonly named “Effect-Hall Sensors”, which are activated by external magnetic fields as shown in Figure 2-9, providing a non-intrusive current sensing capable of isolating the detection of high current levels. The output signal, called the “Hall Voltage”, is in function of the magnetic field density around the device. This means that it is directly proportional to the strength of the magnetic field passing through the semiconductor material.

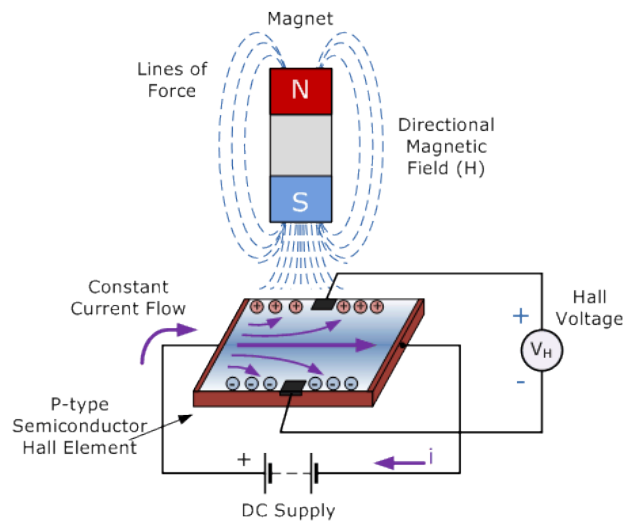

Figure 2-9: Hall Effect sensor principles [23].

## 2. CONCEPTUAL FRAMEWORK

### 2.8. Atmel SAM V71

SAM V71 Xplained Ultra Evaluation Kit (Figure 2-10) is a development platform equipped with an Automotive-grade high performance 32-bit ARM Cortex-M7 processor. SAM V71 is supported by its vendor, Atmel, with a free IDE and ready to use driver libraries and examples [24].

- Key features:
  - ATSAMV71Q21 microcontroller
  - One mechanical reset button
  - One power switch button
  - Two mechanical user pushbuttons
  - Two yellow user LEDs
  - Supercap backup
  - 12.0 MHz crystal
  - 32.768 kHz crystal
  - 2 MB SDRAM
  - 2 MB QSPI Flash
  - AT24MAC402 256KByte EEPROM with EUI-48 address
  - ATA6561 CAN Transceiver
  - SD Card connector with SDIO support
  - Camera interface connector
  - Arduino due compatible shield connectors
  - External debugger connector
  - USB interface, device and host mode
  - Embedded Debugger
  - External power input (5-14V)
  - USB powered



*Figure 2-10: SAM V71 Ultra Evaluation Kit PCB [24].*

## 2. CONCEPTUAL FRAMEWORK

### 2.9. Real-time Operating System Concept

A real-time operating system (RTOS), is an operating system (OS) designed to provide and guarantee deterministic execution timings and is intended for real time applications. Some characteristics attributed to the RTOS include the support of a scheduling method that guarantees response time. Also, times constraints should be known, like interrupt latency and context switching. Furthermore, RTOS should support task synchronization mechanisms and task priorities. RTOS can be distinguished by its timing requirements, from soft to hard real-time systems. Soft real-time systems attend a few critical tasks that require real-time reactions over non real-time tasks and, in the hard real-time systems every task is critic and not completing the execution deadlines results in a catastrophic failure of the system [25]. In Figure 2-11 an example of the cost vs time process in a RTOS is depicted.

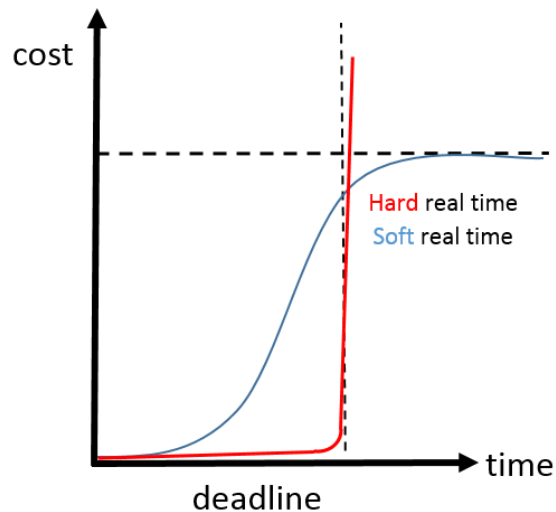

Figure 2-11: RTOS cost vs time.

#### 2.9.1 FreeRTOS

FreeRTOS is a truly free (Figure 2-12 shows the FreeRTOS Open Source license) real-time operative system (RTOS) kernel intended for embedded systems. The Operative System (OS) is an essential part of the embedded software development, especially when handling several resources in an efficient way, this system is required in order to meet deadlines. Even though an OS is not necessarily the best performance solution for all embedded systems, the evaluation of

## 2. CONCEPTUAL FRAMEWORK

this alternative is the responsibility of the SW system architect according to the needs of the final product in terms of scalability, portability, maintenance, and performance. RTOS usually offer well-proven services and solutions like task scheduling and memory management among others, otherwise, the programmer must implement a similar solution to accomplish the same objective. Additionally, the FreeRTOS community offers support for the SAM V71 Xplained Ultra Evaluation Kit, for this reason, this system is beneficial for the development of this project.

|                                                                                       | FreeRTOS<br>Open Source License                  | OpenRTOS<br>Commercial License              |
|---------------------------------------------------------------------------------------|--------------------------------------------------|---------------------------------------------|
| Is it free?                                                                           | Yes                                              | No                                          |
| Can I use it in a commercial application?                                             | Yes                                              | Yes                                         |
| Is it royalty free?                                                                   | Yes                                              | Yes                                         |
| Is a warranty provided?                                                               | No                                               | Yes                                         |
| Can I receive professional technical support on a commercial basis?                   | No, FreeRTOS is supported by an online community | Yes                                         |
| Is legal protection provided?                                                         | No                                               | Yes, IP infringement protection is provided |
| Do I have to open source my application code that makes use of the FreeRTOS services? | No                                               | No                                          |
| Do I have to open source my changes to the RTOS kernel?                               | Yes                                              | No                                          |
| Do I have to document that my product uses FreeRTOS?                                  | Yes if you distribute source code                | No                                          |
| Do I have to offer to provide the FreeRTOS code to users of my application?           | Yes if you distribute source code                | No                                          |

Figure 2-12: Comparison between FreeRTOS license products [26].

## 2. CONCEPTUAL FRAMEWORK

FreeRTOS provides several services designed specifically for small embedded systems where the following characteristics<sup>3</sup> are highlighted:

- Free RTOS scheduler - preemptive, cooperative and hybrid configuration options, with optional time slicing.
- The SafeRTOS derivative product provides a high level of confidence in the code integrity.
- Includes a tickless mode for low power applications.
- RTOS objects (tasks, queues, semaphores, software timers, mutexes and event groups) can be created using either dynamically or statically allocated RAM.
- Tiny footprint.
- Supports both real time tasks and co-routines.
- Direct to task notifications, queues, binary semaphores, counting semaphores, recursive semaphores and mutexes for communication and synchronization between tasks, or between real time tasks and interrupts.
- Innovative event group (or event flag) implementation.
- Mutexes with priority inheritance.
- Efficient software timers.
- Powerful execution trace functionality.
- Stack overflow detection options.

The following sub-sections describes the features for the TRA-OFM software implementation.

---

<sup>3</sup> These FreeRTOS characteristics where taken from [46].

## 2. CONCEPTUAL FRAMEWORK

### 2.9.2 RTOS Events

Events are a common RTOS service, which basically consist in Boolean flags that serve as indicators for internal/external occurrences. They are used for inter-task communications and to activate, block or resume tasks. These mechanisms define the order and timing in which tasks are executed [27].

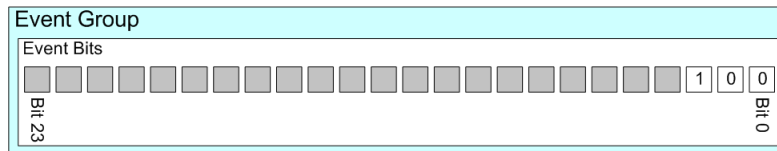

Figure 2-13: An event group containing 24-event bits, only three of which are in use [27].

### 2.9.3 RTOS Messages

An important characteristic of RTOS tasks is the ability to share information with other system tasks, providing the chance to synchronize activities and implement desired system behaviors. Usually RTOS provides safe mechanisms to send and receive information without compromising the correct thread executions [28].

## 2. CONCEPTUAL FRAMEWORK

### 2.10. Communication Protocols

#### 2.10.1 Universal Asynchronous Receiver-Transmitter

The Universal Asynchronous Receiver/Transmitter (UART) is a device that controls serial communications; it is usually integrated within microcontrollers but can be found separately as an Integrated Circuit (IC). Serial ports are distinguished by the use of a single bus line for receiving/transmitting data in comparison with their counterpart Parallel protocols, which use more than one line as a data bus. Serial sends individual bits as a sequence (as shown in Figure 2-14) and the receiver re-assembles these bits into bytes to complete the data transfer. [29]

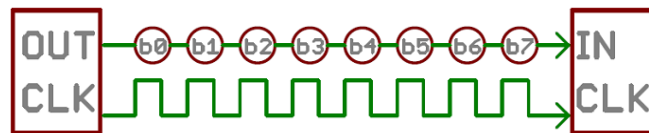

Figure 2-14: Example of 8-bit data sequence [30].

#### 2.10.2 Inter-Integrated Circuit

Invented by Philips Semiconductors in 1982, Inter-Integrated Circuit (I2C) is a two-wired serial protocol interface intended to connect different circuit parts (e.g. connect a microcontroller with external peripherals). It was designed to be easily implemented in HW by requiring only two signal lines, Serial Clock (SCL) and Serial Data (SDA). Both lines needed a pull up resistor for its correct operation. [31]

Main characteristics:

- Protocol supports Multi-Master mode
- Can be implemented without special HW, only two GPIO are needed
- Practically unlimited number of devices can be connected
- 8-bit data packages
- Every slave in the bus should have a unique address

## **2. CONCEPTUAL FRAMEWORK**

- Clock frequency up to 100Khz, 400Hkz(Fast Mode),3.4MHz(High Speed mode) and 5MHz (Ultra-fast mode)

### **2.10.3 Serial Peripheral Interface**

Serial Peripheral Interface (SPI) is a synchronous full-duplex interface bus used to communicate controllers and devices with each other. SPI consists of 4 signals, Serial Clock (SCK), Master In Slave Out (MISO), Master Out Slave In (MOSI), and Slave Select (SS). [32]

The master is in charge of generating the Clock Signal (SCK) as well as selecting the slave device by using the SS signal to initiate communication. The master can talk with any slave device in the bus while slaves can only talk with the master. [33]

Main characteristics:

- Full duplex communication.
- High speed up to 10MHz.
- Simple HW connection.
- Unlimited data length transmission.
- Multi slave support.
- Effective for short distances.

### **2.10.1 Controller Area Network**

Controller Area Network (CAN) is a two wired half duplex high speed serial communication protocol developed by Robert Bosch GmbH in 1985 with the primary intention of reducing wire connections and creating a robust and secure solution. These days CAN is present in the entire automotive industry thanks to its capabilities and low cost of implementation. The protocol was designed to allow communication between devices without using host intermediaries by implementing a broadcast strategy. This means that all the devices connected to the bus can



## 2. CONCEPTUAL FRAMEWORK

“listen” to each sent message. Furthermore, some noteworthy characteristics of CAN to note are that messages are priority-based in combination with non-destructive arbitration, which helps with data traffic mitigation, also, the fact that it provides error-free transmission where each node checks for errors during a transmission operation. For further details see CAN specifications [34].

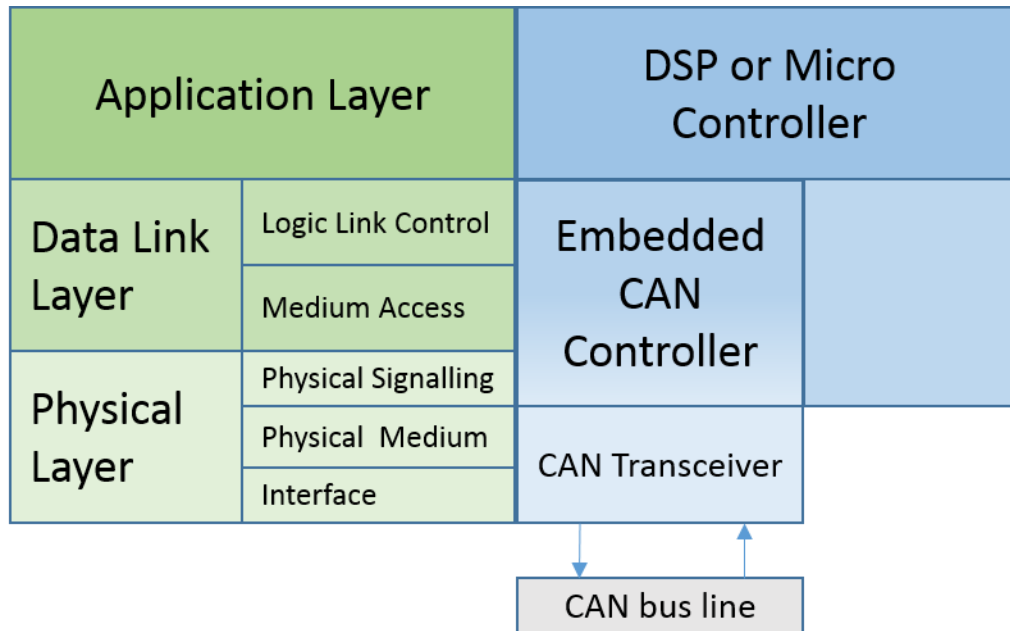

Figure 2-15: ISO 11898 architecture [35].

## 2. CONCEPTUAL FRAMEWORK

### 2.11. Traxxas Ford F-150 Raptor Model

The Traxxas Ford F-150 Raptor (Figure 2-16) is a 1/10 scale model of the real Ford-150 truck. This model is actuated by an efficient brushed DC motor and has a precise steering system controlled by a servomotor. It can achieve high speeds of up to 30 mph thanks to its heavy duty Electronic Speed Control (ESC) unit which senses the current spikes of the DC motor coils in order to precisely adjust the speed by having as reference, a PWM signal. Moreover, the system is powered by a NiMH 7-cell battery which provides 8.4v and can store 3000mAh of energy. The control is made through a 2.4GHz 2-channel control which is capable of long reach transmission. Furthermore, the vehicle is fitted with an antenna receptor for the steering control of the servomotor and the ESC. Lastly, the electric system is completely waterproof. [36]



*Figure 2-16: Traxxas Ford F-150 Raptor overview [36].*

## 2. CONCEPTUAL FRAMEWORK

Moreover, the motor's output passes through a transmission system, which provides additional torque to the vehicle. Also, the transmission includes a clutch that prevents any damage to the motor if the wheels were to become stuck. Also, the vehicles possess a differential mechanism that permits smooth turning. Likewise, the vehicle's suspension is composed of 4 shock absorbers which prevent any damage to the chassis, the powertrain or the control system while traversing through rough terrain [37]. The placement of the vehicle's components can be observed in Figure 2-17.

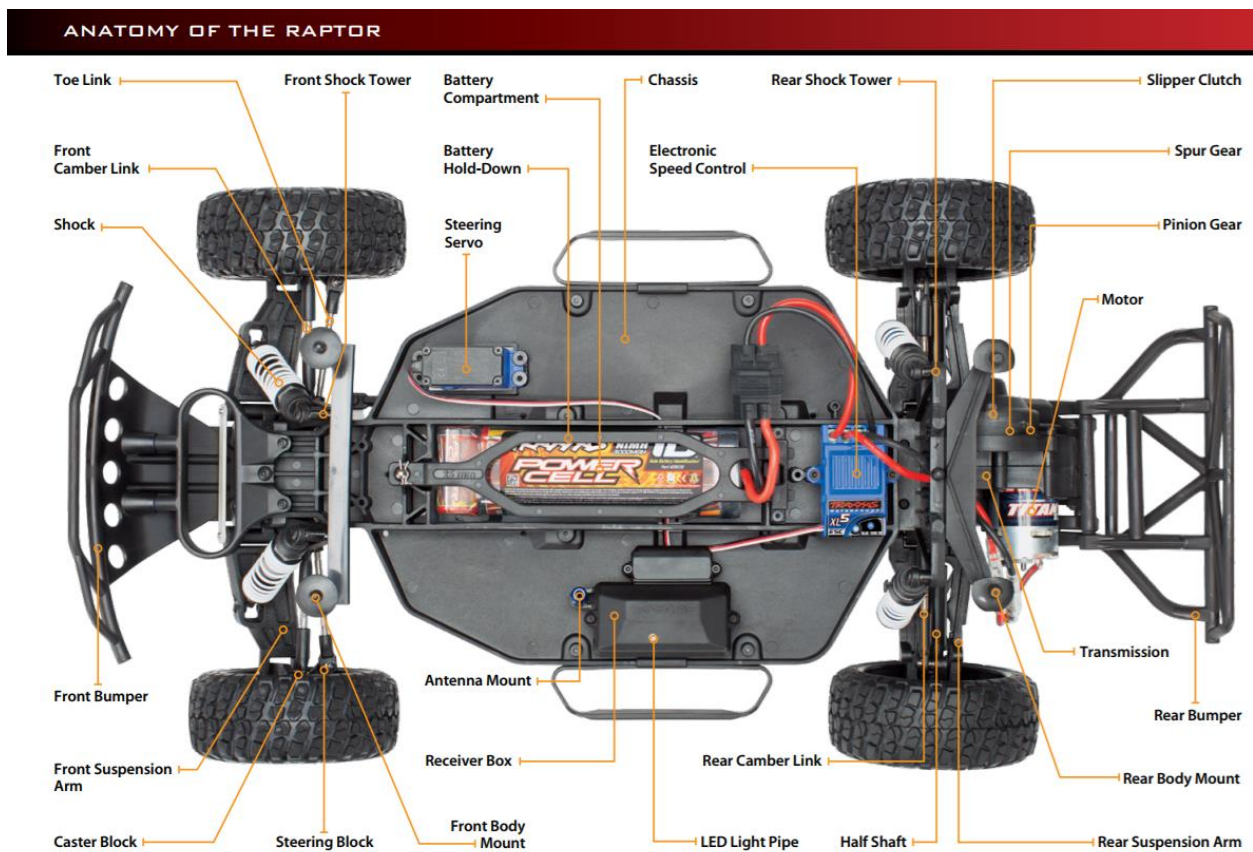

Figure 2-17: Traxxas Ford F-150 Raptor internal components [37].

The Traxxas Ford F-150 Raptor model is an easy to modify platform that permits an easy lateral and longitudinal control for custom vehicle applications since the control signals use standard PWM which most microcontrollers are able to provide nowadays.

## **2. CONCEPTUAL FRAMEWORK**

### **3. Design and Development**

The focus of this document is in the definition and development of the add-on “Optical Follow Me” for the existing Trailer Reverse Assist project. Therefore, only the relevant system parts of the TRA-OFM are mentioned. In addition, the development of a platform where the proof of concept of the TRA-OFM can be performed is described. This platform will not include the trailer’s kinematics or dynamics since these are already considered in the original TRA project. Instead, it includes a simple-car system where the TRA-OFM main functions can be tested while reversing. By developing the system in this way, a high level of independence between the TRA and the OFM can be achieved, making the OFM able to work with similar systems to the TRA by just making the required adjustments in the interfaces.

The chosen development process for the project is the Vee Model (described in section 2.1.1). Therefore the design and development were performed from the general to the specific system concepts.

Firstly, the system requirements were defined. Secondly, the system architecture was elicited from the system requirements. For the system architecture, the theoretical interfaces were defined using boundary diagrams for the different levels of the components. In addition, the “House of Quality” of the proposed solution was drafted. Thirdly, the first steps of the FMEA were taken by filling P-Diagrams for the main system components.

Finally, for the solution, the architecture of the SW and HW was defined together with the logic and components needed based on the system requirements and system architecture. Special focus was placed on the SW since the logic and data flow are explained in detail for the two main components, the control unit and the camera system.

### 3. DESIGN AND DEVELOPMENT

#### 3.1. System Functional Requirements

When developing a system, it is critical to first define the inputs and outputs as well as the expected behavior of the system. All this information was placed in the system functional requirements, where “what” is defined. The “how” will later be addressed in the solution section of the project. In the case that some design constraints need to be passed down to the solution design, then, they can be added to the system requirements in a separate section. The TRA-OFM’s system requirements can be found in Table 3-1.

Table 3-1: System functional requirements.

| Project Name |         | TRA- Optical Follow Me                                                                                                                                                                                                                                                                                                             |           |             |          |                |          |         |            |              |              |            |                                                                       |            |  |  |  |  |
|--------------|---------|------------------------------------------------------------------------------------------------------------------------------------------------------------------------------------------------------------------------------------------------------------------------------------------------------------------------------------|-----------|-------------|----------|----------------|----------|---------|------------|--------------|--------------|------------|-----------------------------------------------------------------------|------------|--|--|--|--|
| Authors:     |         | Alejandro Salcido<br>Erain Marquez                                                                                                                                                                                                                                                                                                 |           |             |          |                |          |         |            |              |              |            |                                                                       |            |  |  |  |  |
|              |         |                                                                                                                                                                                                                                                                                                                                    | Necessary | Unambiguous | Feasible | Implementation | Complete | Concise | Consistent | Maintainable | Traceable to | Verifiable | Extra requirement traceability information<br>Comments and deviations |            |  |  |  |  |
| Id           | Section | Requirements                                                                                                                                                                                                                                                                                                                       |           |             |          |                |          |         |            |              |              |            | Comments 1                                                            | Comments 2 |  |  |  |  |
| <b>1</b>     |         | <b>Inputs</b>                                                                                                                                                                                                                                                                                                                      |           |             |          |                |          |         |            |              |              |            |                                                                       |            |  |  |  |  |
| SyR-OFM-001  |         | The “TRA – Optical Follow Me” system shall receive an “Enabling Flag” as an input.                                                                                                                                                                                                                                                 | Y         | Y           | Y        | Y              | Y        | Y       | Y          | Y            | Y            | Y          | none                                                                  |            |  |  |  |  |
| SyR-TSS-002  |         | The “TRA – Optical Follow Me” system shall receive the “Following Distance” configuration as an input.                                                                                                                                                                                                                             | Y         | Y           | Y        | Y              | Y        | Y       | Y          | Y            | Y            | Y          | none                                                                  |            |  |  |  |  |
| SyR-OFM-002  |         | The “TRA – Optical Follow Me” system shall receive the “Rear View Image of the Trailer’s Environment” from a camera.                                                                                                                                                                                                               | Y         | Y           | Y        | Y              | Y        | Y       | Y          | Y            | Y            | Y          | none                                                                  |            |  |  |  |  |
| SyR-TSS-003  |         | The “TRA – Optical Follow Me” system shall receive the “Rear View Image of the Trailer’s Environment” periodically as a video feed.                                                                                                                                                                                                | Y         | Y           | Y        | Y              | Y        | Y       | Y          | Y            | Y            | Y          | none                                                                  |            |  |  |  |  |
| SyR-OFM-003  |         | The “TRA – Optical Follow Me” system shall receive the “Distance to the Nearby Objects behind the Trailer”.                                                                                                                                                                                                                        | Y         | Y           | Y        | Y              | Y        | Y       | Y          | Y            | Y            | Y          | none                                                                  |            |  |  |  |  |
| SyR-TSS-004  |         | The “TRA – Optical Follow Me” system shall receive the “Vehicle’s Longitudinal Speed”.                                                                                                                                                                                                                                             | Y         | Y           | Y        | Y              | Y        | Y       | Y          | Y            | Y            | Y          | none                                                                  |            |  |  |  |  |
| SyR-OFM-004  |         | The “TRA – Optical Follow Me” system shall receive information regarding “Objects in close proximity of back of the trailer flag”.                                                                                                                                                                                                 | Y         | Y           | Y        | Y              | Y        | Y       | Y          | Y            | Y            | Y          | none                                                                  |            |  |  |  |  |
| SyR-TSS-005  |         | The “TRA – Optical Follow Me” system shall receive the “Instantaneous Intended Trailer’s Motion Path” as an input.                                                                                                                                                                                                                 | Y         | Y           | Y        | Y              | Y        | Y       | Y          | Y            | Y            | Y          | none                                                                  |            |  |  |  |  |
| <b>2</b>     |         | <b>Outputs</b>                                                                                                                                                                                                                                                                                                                     |           |             |          |                |          |         |            |              |              |            |                                                                       |            |  |  |  |  |
| SyR-TSS-006  |         | The “TRA – Optical Follow Me” system shall provide a “Person detected flag” as an output.                                                                                                                                                                                                                                          | Y         | Y           | Y        | Y              | Y        | Y       | Y          | Y            | Y            | Y          | none                                                                  |            |  |  |  |  |
| SyR-TSS-007  |         | The “TRA – Optical Follow Me” system shall provide the “Required Trailer Angle” in order to follow the helping person, as an output.                                                                                                                                                                                               | Y         | Y           | Y        | Y              | Y        | Y       | Y          | Y            | Y            | Y          | none                                                                  |            |  |  |  |  |
| SyR-TSS-008  |         | The “TRA – Optical Follow Me” system shall provide the “Required Vehicle’s Acceleration” as an output.                                                                                                                                                                                                                             | Y         | Y           | Y        | Y              | Y        | Y       | Y          | Y            | Y            | Y          | none                                                                  |            |  |  |  |  |
| <b>3</b>     |         | <b>Behavior</b>                                                                                                                                                                                                                                                                                                                    |           |             |          |                |          |         |            |              |              |            |                                                                       |            |  |  |  |  |
| SyR-TSS-009  |         | The “TRA – Optical Follow Me” system shall process the “Rear View Image of the Trailer’s Environment” and determine if a person is present in the image.                                                                                                                                                                           | Y         | Y           | Y        | Y              | Y        | Y       | Y          | Y            | Y            | Y          | none                                                                  |            |  |  |  |  |
| SyR-TSS-010  |         | If a person is present in the “Rear View Image of the Trailer’s Environment”, the “TRA – Optical Follow Me” system shall identify the position of the person’s face in the image.                                                                                                                                                  | Y         | Y           | Y        | Y              | Y        | Y       | Y          | Y            | Y            | Y          | none                                                                  |            |  |  |  |  |
| SyR-TSS-011  |         | Based on the position of the person’s face in the image and the “Distance to the Nearby Objects behind the Trailer”, the “TRA – Optical Follow Me” system shall determine the angle formed between the person detected behind the Trailer and the Longitudinal Axis of the Trailer, and report it in the “Required Trailer Angle”. | Y         | Y           | Y        | Y              | Y        | Y       | Y          | Y            | Y            | Y          | none                                                                  |            |  |  |  |  |
| SyR-TSS-012  |         | If the “Required Trailer Angle” can be calculated, the “TRA – Optical Follow Me” system shall set the “Person detected flag” as active.                                                                                                                                                                                            | Y         | Y           | Y        | Y              | Y        | Y       | Y          | Y            | Y            | Y          | none                                                                  |            |  |  |  |  |
| SyR-TSS-013  |         | If the “Person detected flag” is active, the “TRA – Optical Follow Me” system shall calculate the “Required Vehicle’s Acceleration” in order to maintain the “Following Distance” from the rear of the trailer to the detected person using the “Vehicle’s Longitudinal Speed”.                                                    | Y         | Y           | Y        | Y              | Y        | Y       | Y          | Y            | Y            | Y          | none                                                                  |            |  |  |  |  |
| SyR-TSS-014  |         | The “TRA – Optical Follow Me” system shall provide the “Required Vehicle’s Acceleration” as invalid if the “Enabling Flag” is inactive.                                                                                                                                                                                            | Y         | Y           | Y        | Y              | Y        | Y       | Y          | Y            | Y            | Y          | none                                                                  |            |  |  |  |  |
| SyR-TSS-015  |         | The “TRA – Optical Follow Me” system shall use the “Objects in close proximity of back of the trailer flag”, the “Rear View Image of the Trailer’s Environment” and the “Instantaneous Intended Trailer’s Motion Path” to determine if an object is in risk of being collided with by the trailer if the motion is maintained.     | Y         | Y           | Y        | Y              | Y        | Y       | Y          | Y            | Y            | Y          | none                                                                  |            |  |  |  |  |
| SyR-TSS-016  |         | In case that an object is in risk of being collided with, the “TRA – Optical Follow Me” system shall request the “Required Vehicle’s Acceleration” in order to stop the vehicle before the collision occurs.                                                                                                                       | Y         | Y           | Y        | Y              | Y        | Y       | Y          | Y            | Y            | Y          | none                                                                  |            |  |  |  |  |
| <b>4</b>     |         | <b>Design Constraints</b>                                                                                                                                                                                                                                                                                                          |           |             |          |                |          |         |            |              |              |            |                                                                       |            |  |  |  |  |
| SyR-TSS-017  |         | The camera used in the “TRA – Optical Follow Me” shall be monoscopic.                                                                                                                                                                                                                                                              | Y         | Y           | Y        | Y              | Y        | Y       | Y          | Y            | Y            | Y          | none                                                                  |            |  |  |  |  |
| SyR-TSS-018  |         | The “Distance to the Nearby Objects behind the Trailer” shall be determined by ultrasonic sensors placed behind the trailer.                                                                                                                                                                                                       | Y         | Y           | Y        | Y              | Y        | Y       | Y          | Y            | Y            | Y          | none                                                                  |            |  |  |  |  |
| SyR-TSS-019  |         | The information regarding the “Objects in close proximity of back of the trailer flag” shall be determined by ultrasonic or infrared sensors.                                                                                                                                                                                      | Y         | Y           | Y        | Y              | Y        | Y       | Y          | Y            | Y            | Y          | none                                                                  |            |  |  |  |  |

### 3. DESIGN AND DEVELOPMENT

#### 3.2. System Architecture

Once the SR have been defined, it is possible to define the “System Architecture” (SA). It is here where the interfaces between the different system components can be specified. The “Boundary Diagrams” are commonly used to specify the systems architecture in different levels of detail depending on the target component. The interfaces can be defined based on their type or by directly mentioning their name.

##### 3.2.1 Level 1 Boundary Diagram “Vehicle View”

This level is focused on the vehicle interfaces and the external actuators of interest for the TRA-OFM. The specific interface names are not included, instead the type of interface is mentioned as shown in Figure 3-1. In addition, Table 3-2 contains the definition of each block used in the Level 1 diagram.

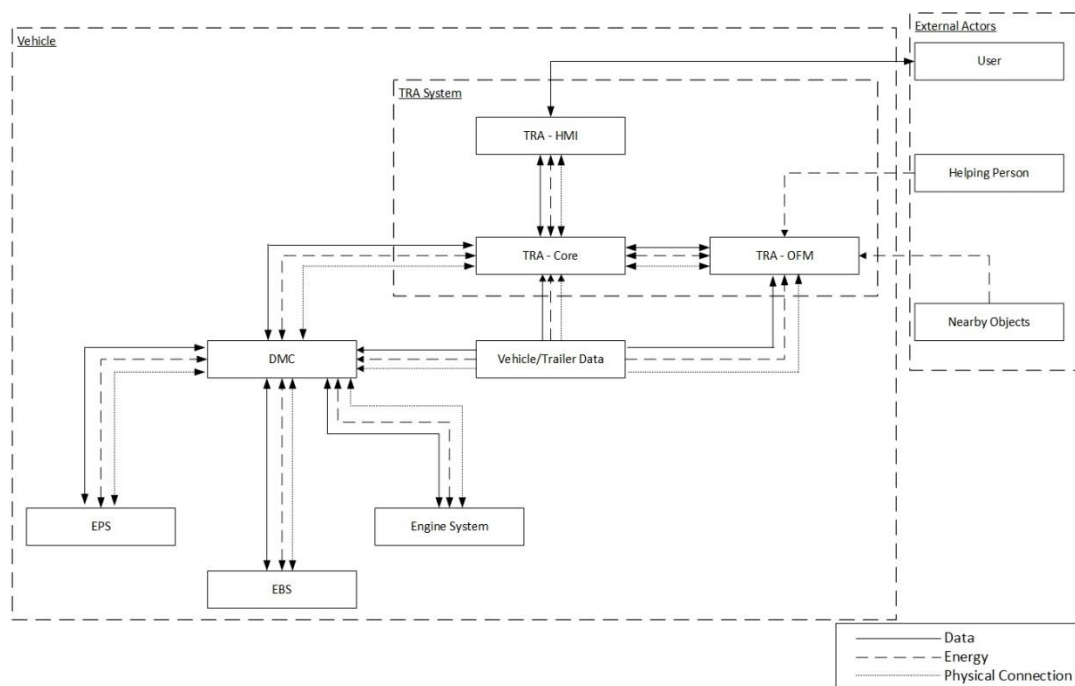

Figure 3-1: Level 1 boundary diagram - vehicle.

### 3. DESIGN AND DEVELOPMENT

*Table 3-2: Level 1 boundary diagram - components description.*

| <b>Block's Name</b>  | <b>Description</b>                                                                                                                                  |
|----------------------|-----------------------------------------------------------------------------------------------------------------------------------------------------|
| EPS                  | Electronic Power Steering system of the vehicle, automatically moves the steering wheel.                                                            |
| EBS                  | Electronic Braking System of the vehicle, automatically activates or releases the brakes.                                                           |
| Engine System        | Engine of the vehicle, which provides the longitudinal actuation.                                                                                   |
| DMC                  | Dynamic Motion Control system of the vehicle, which translates the CAN signals into the required format for the EPS, EBS and Engine System to work. |
| Vehicle/Trailer Data | Information provider regarding the current status of the vehicle's speed and trailer articulation angle.                                            |
| TRA-Core             | Basic Trailer Reverse Assist system for the translation of the desired trailer trajectory to the required steering and speed of the vehicle.        |
| TRA-HMI              | Interface between the system and the user.                                                                                                          |
| TRA-OFM              | Optical Follow Me add-on for helping person tracking and collision prevention.                                                                      |
| User                 | Person seated in the driver's seat in charge of enabling/disabling the TRA system.                                                                  |
| Helping Person       | Person located at the back of the trailer which will be followed once the TRA-OFM system is enabled.                                                |

#### 3.2.2 Level 2 Boundary Diagram “TRA System”

The Level 2 boundary diagram is focused on the contents of the “Trailer Reverse Assist” system including the “Optical Follow Me” add-on. In Figure 3-2 the inputs and outputs of the OFM as defined on the SR are shown. Furthermore, the interfaces between each block can be observed in Table 3-3.



### 3. DESIGN AND DEVELOPMENT

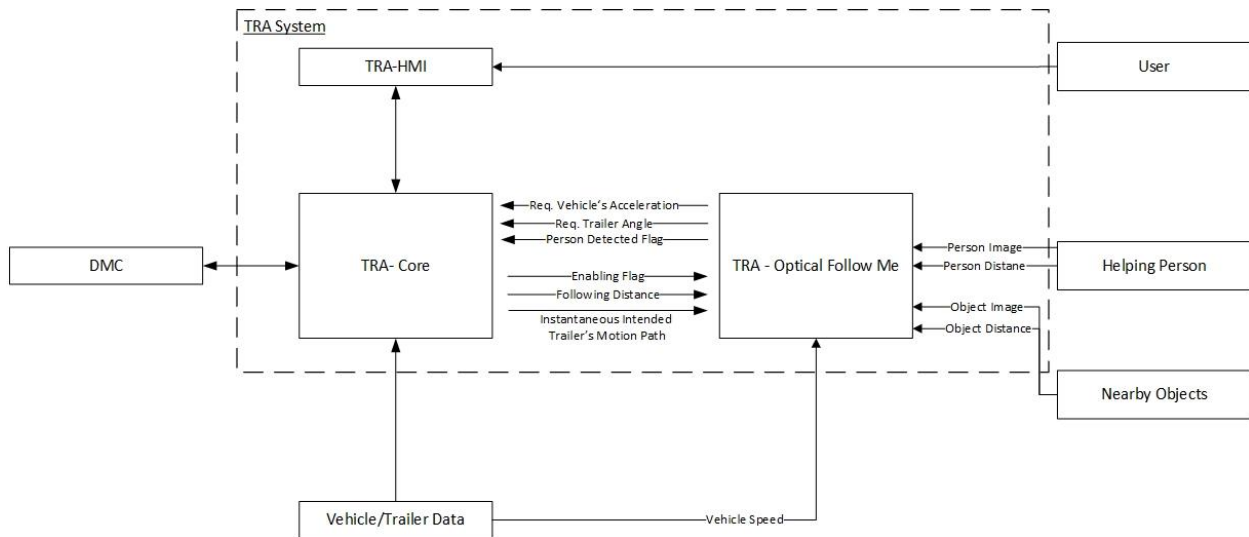

Figure 3-2: Level 2 boundary diagram - TRA system.

Table 3-3: Level 2 boundary diagram - signals description.

| Signal Name                                  | Description                                                                                                                  |
|----------------------------------------------|------------------------------------------------------------------------------------------------------------------------------|
| Req. vehicle's Acceleration                  | Needed acceleration of the vehicle in order to keep a fixed distance between the back of the trailer and the helping person. |
| Req. Trailer Angle                           | Calculated angle required to correct the trajectory of the trailer in order to follow the helping person.                    |
| Person Detected Flag                         | Reporting flag to inform if a person has been detected behind the trailer.                                                   |
| Enabling Flag                                | TRA-OFM system enabling flag.                                                                                                |
| Following Distance                           | Selected distance that must be kept between the trailer's back and the helping person.                                       |
| Instantaneous intended Trailer's Motion Path | Current steering angle being applied to the vehicle by the TRA-Core system for the specified trailer's trajectory.           |
| Person image                                 | Image of the person captured by the trailer's rear camera.                                                                   |
| Object image                                 | Image of nearby objects captured by the trailer's rear camera.                                                               |
| Person Distance                              | Measured distance between the trailer's rear and the helping person.                                                         |
| Object Distance                              | Measured distance between the trailer's rear and the nearby objects.                                                         |
| Vehicle Speed                                | Vehicle's longitudinal speed.                                                                                                |

### 3. DESIGN AND DEVELOPMENT

#### 3.2.3 Level 3 Boundary Diagram “OFM System”

Once all the external interfaces have been defined, it is possible to allocate each interface to a specific internal component of the “Optical Follow Me” add-on as can be observed in Figure 3-3. Each internal component will then be in charge of processing a specific set of inputs or outputs in accordance to the system requirements. The description of each TRA-OFM internal blocks can be observed in Table 3-4.

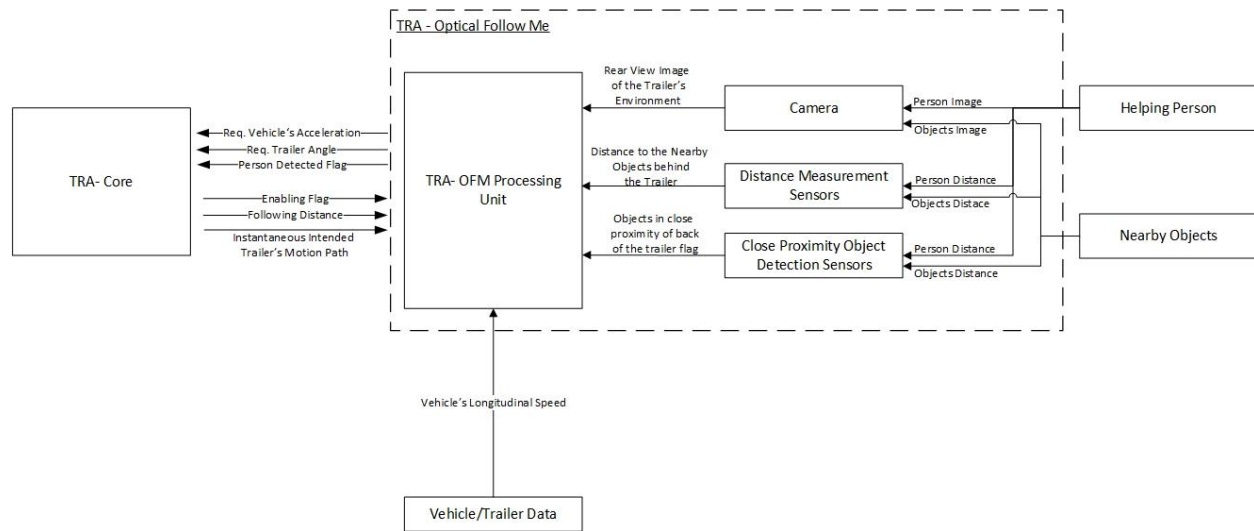

Figure 3-3: Level 3 boundary diagram - OFM system.

Table 3-4: Level 3 boundary diagram - blocks description.

| Block's Name                             | Description                                                                                            |
|------------------------------------------|--------------------------------------------------------------------------------------------------------|
| TRA-OFM Processing Unit                  | ECU in charge of processing the camera, sensors, and TRA-Core data according to the TRA-OFM's logic.   |
| Camera                                   | Camera located at the rear of the trailer, which provides the image of the trailer's rear environment. |
| Distance Measurement Sensors             | Trailer's rear sensors capable of measuring the distance to nearby objects.                            |
| Close Proximity Object Detection Sensors | Trailer's rear sensors capable of detecting if an object is present in close proximity of the trailer. |

### 3. DESIGN AND DEVELOPMENT

#### 3.3. Solution

Using the SA and design constraints, a solution for the system is proposed. For the solution, it is important to verify that all the SR are also met. A technical architecture was created to specify the technical components as well as the technical interfaces.

Furthermore, for each technical component in the architecture, an analysis of the undesired by-products or failure points was performed. This comes in handy in later stages of the design since the possible error states can be mitigated or removed. This analysis is documented in the “P-Diagrams” section of each component.

Moreover, after the system characteristics have been defined, an importance analysis was performed in a “House of Quality” diagram. In order to determine the importance of each characteristic, a weight was assigned based on the characteristic’s difficulty and the customers’ expected level of quality. Depending on the type of product that is being designed, it is also possible to perform a benchmark between the existing products and the one being designed.

Nonetheless, it is important to mention the platform where the TRA-OFM system was implemented. For this specific solution, a scaled RC vehicle was modified so that the longitudinal and lateral movements could be controlled. The chosen vehicle was a Traxxas Ford F-150 Raptor model. The signals that go into the ESC and the steering servo unit were externally controlled by a SAM v71 development board. The person’s face identification was performed by an OpenMV board. The OpenMV board was also connected to an ultrasonic sensor which points in the same direction as the camera in order to determine the distance to the person. The used camera as well as the distance sensors are limited in measuring capacity and therefore, they need to be directly pointing at to the target in order to be effective. This problem was solved by mounting the camera and the ultrasonic sensor into a pan-tilt assembly controlled by servomotors. This way the OpenMV board can control the pointing direction of the camera by commanding the servomotors. Three infrared sensors were placed in the posterior part of the vehicle in order to detect objects in close proximity. Finally, the communication between the SAM v71 board and the OpenMV board

### 3. DESIGN AND DEVELOPMENT

was done by an SPI interface. Figure 3-4 shows both the lateral and aerial views of the proposed assembly of the Traxxas truck, sensors, and camera.

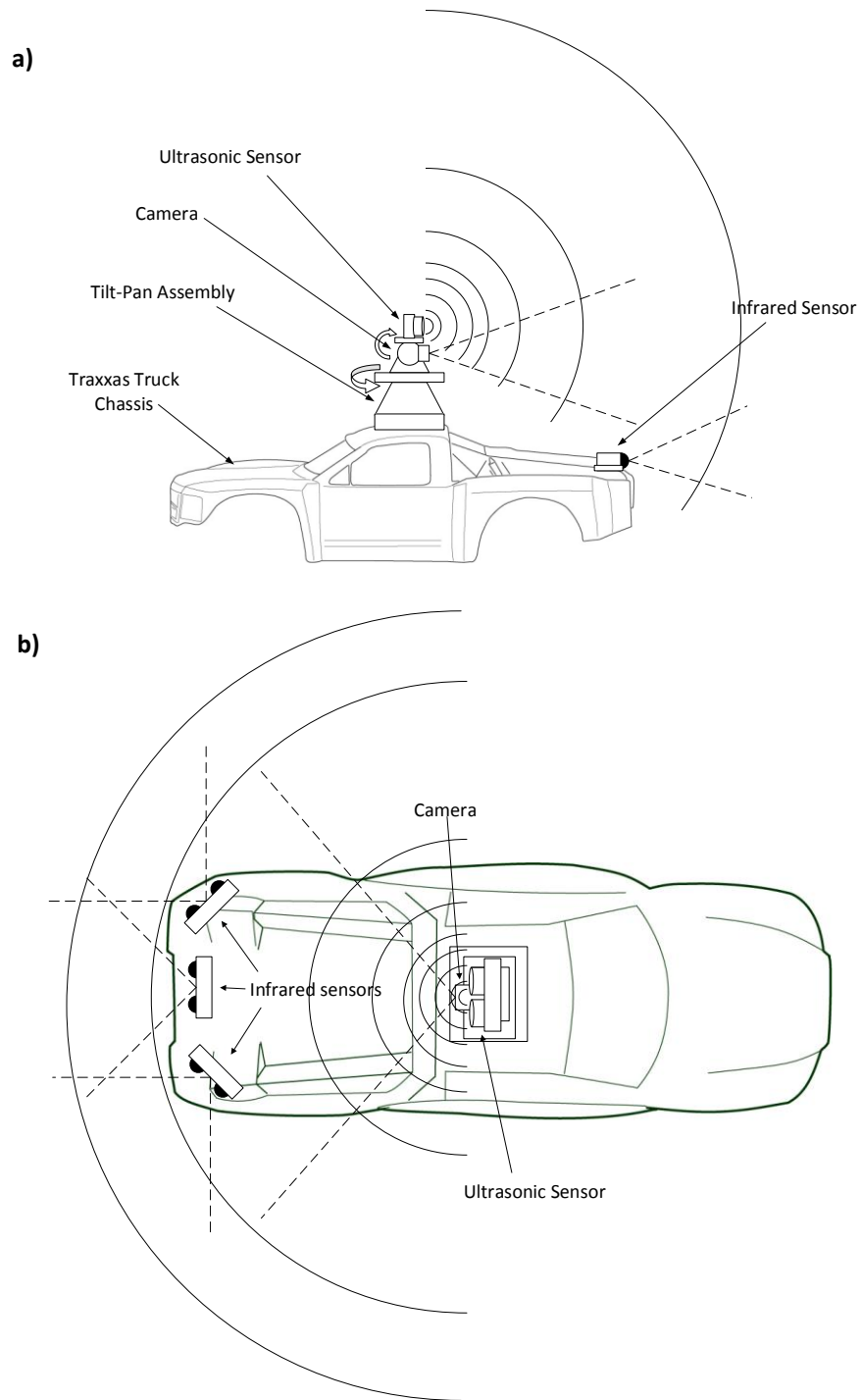

*Figure 3-4: Vehicle assembly.*

*a) Lateral view b) Aerial view*

### 3. DESIGN AND DEVELOPMENT

#### 3.3.1 System Technical Architecture

In a similar way as the functional architecture, the technical architecture is defined using boundary diagrams in different levels depending on each specific subsystem/component. For the first level (Figure 3-5), the basic elements of the TRA-OFM system together with the interfaces and the outside actors are shown. In this case, the user and the objects in the path.

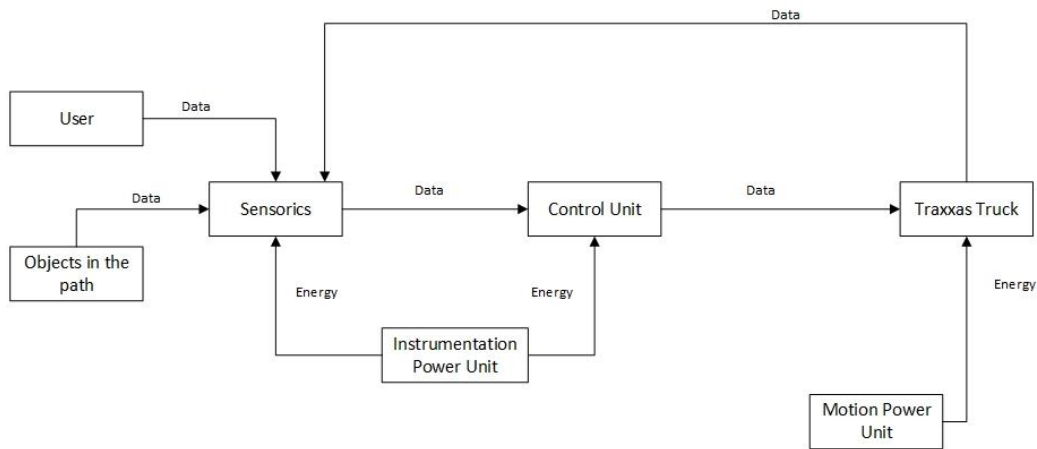

Figure 3-5: Technical architecture - LI TRA-OFM system.

For the next level, we describe the definition of the internal components of the sensor elements (Figure 3-6). These elements include the camera, the object detection sensors, the distance measurements sensors, the wheel encoders (for speed calculation,) and the needed elements for the correct operation, such as the power source voltage regulator and the system enabling switch.

### 3. DESIGN AND DEVELOPMENT

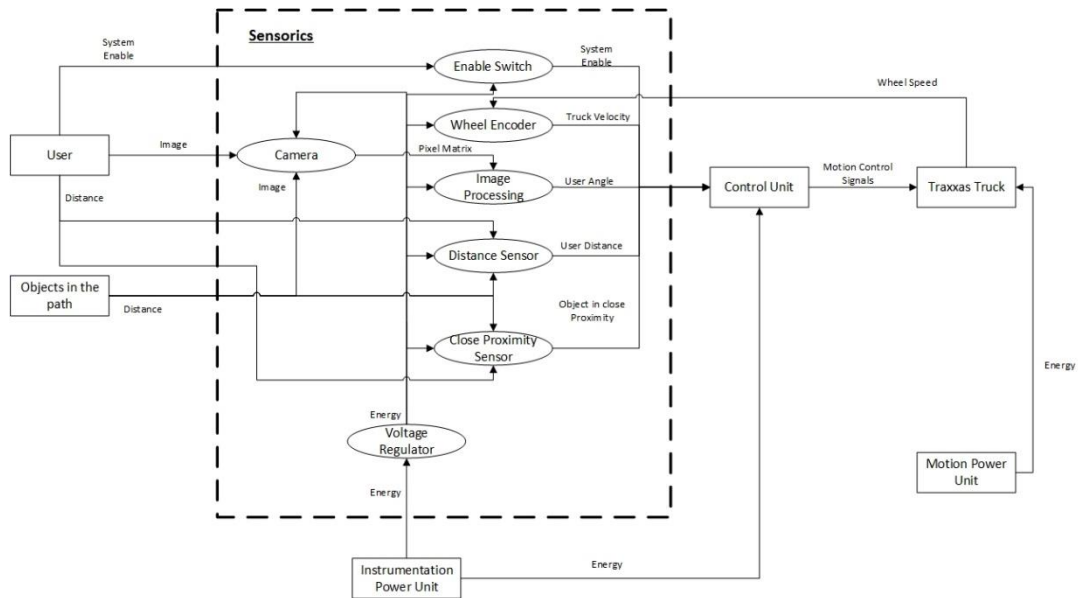
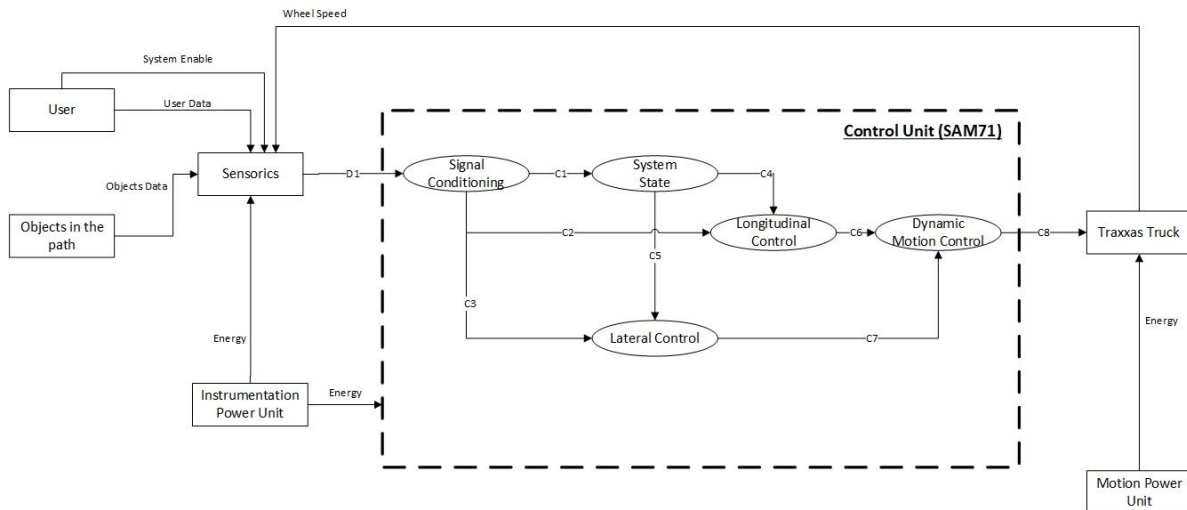

Figure 3-6: Technical architecture - L2 sensorics.

In a similar way, the control module implemented inside the SAM v71 board, is defined in Figure 3-7. For this diagram the logic components that will be in charge of processing the information provided by the sensors and sending the required commands to the Traxxas truck in order to obtain the required longitudinal and lateral motion are specified.



**Data Description**

- |                                                                                                               |                                                                                                               |                                                |                          |                                |                                      |                                    |                                                                               |
|---------------------------------------------------------------------------------------------------------------|---------------------------------------------------------------------------------------------------------------|------------------------------------------------|--------------------------|--------------------------------|--------------------------------------|------------------------------------|-------------------------------------------------------------------------------|
| <b>D1</b><br>-System Enable<br>-Truck Velocity<br>-User Angle<br>-User Distance<br>-Object in close Proximity | <b>C1</b><br>-System Enable<br>-Truck Velocity<br>-User Angle<br>-User Distance<br>-Object in close Proximity | <b>C2</b><br>-Truck Velocity<br>-User Distance | <b>C3</b><br>-User Angle | <b>C4, C5</b><br>-System State | <b>C6</b><br>-Required Vehicle Speed | <b>C7</b><br>-Required Wheel Angle | <b>C8</b><br>-Encoded Steering Servo Signal<br>-Encoded DC Motor Power Signal |
|---------------------------------------------------------------------------------------------------------------|---------------------------------------------------------------------------------------------------------------|------------------------------------------------|--------------------------|--------------------------------|--------------------------------------|------------------------------------|-------------------------------------------------------------------------------|

Figure 3-7: Technical architecture - L2 control unit.

### 3. DESIGN AND DEVELOPMENT

Finally, the specification of the internal components from the RC model can be observed in Figure 3-8. These components include both the electrical and mechanical parts involved in the motion of the platform. These are, the servomotor, which controls the steering of the vehicle and the Electronic Speed Control (ESC) unit that powers the brushless DC motor for the longitudinal movement after passing through the vehicle's transmission. It is important to mention that the "Power Phase" of the system is energized by the "Motion Power Source" while the "Logic Phase" composed by the sensors and the "Control Unit" are powered by the "Instrumentation Power Unit". By doing so, problems that might arise because of voltage/current spikes are prevented.

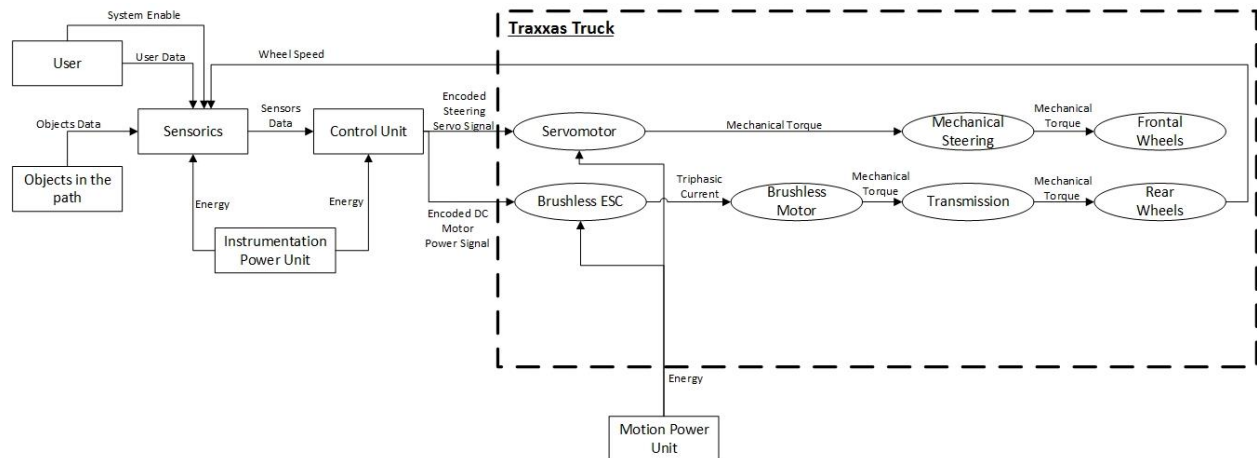

Figure 3-8: Technical architecture - L2 Traxxas truck platform.

### 3. DESIGN AND DEVELOPMENT

#### 3.3.2 Technical Architecture P-Diagrams

In order to consider the error states, noise levels and control factors of the technical architecture components, several P-Diagrams were made, one for each element of the technical architecture. The level 1 P-Diagrams can be observed in Figure 3-9 through Figure 3-12. For the level 2 P-Diagrams, refer to the Appendix A: “L2 Technical Architecture P-Diagrams”.

#### Sensorics

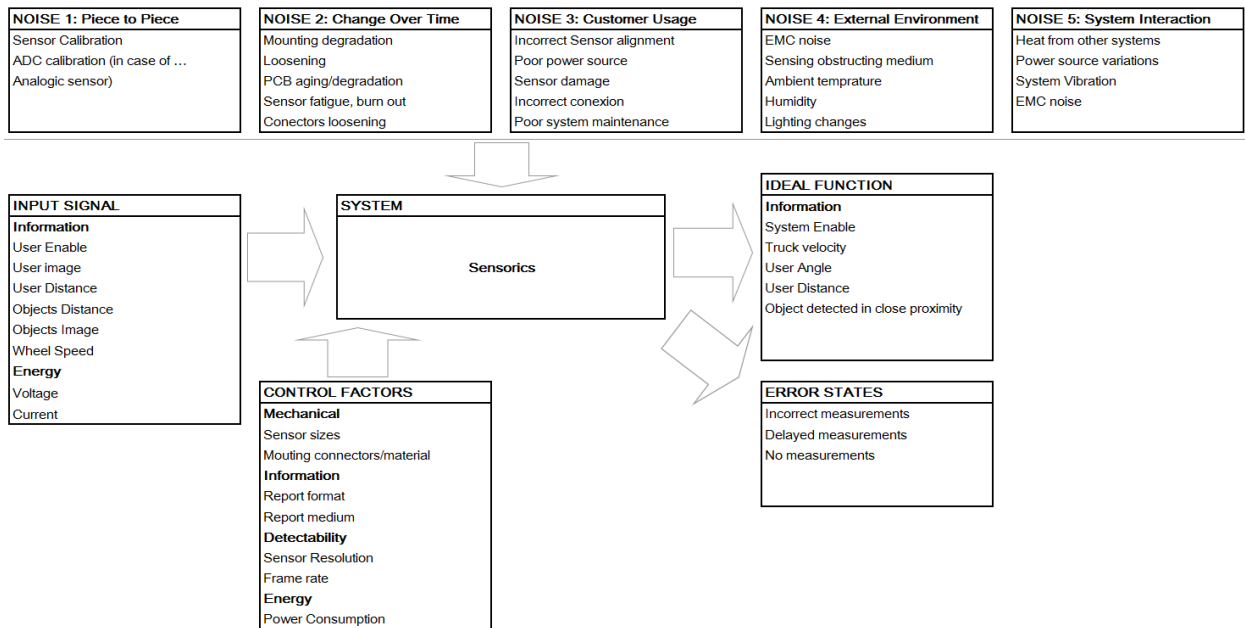

Figure 3-9: Technical architecture - L1 sensorics P-Diagrams.



### 3. DESIGN AND DEVELOPMENT

#### Control Unit

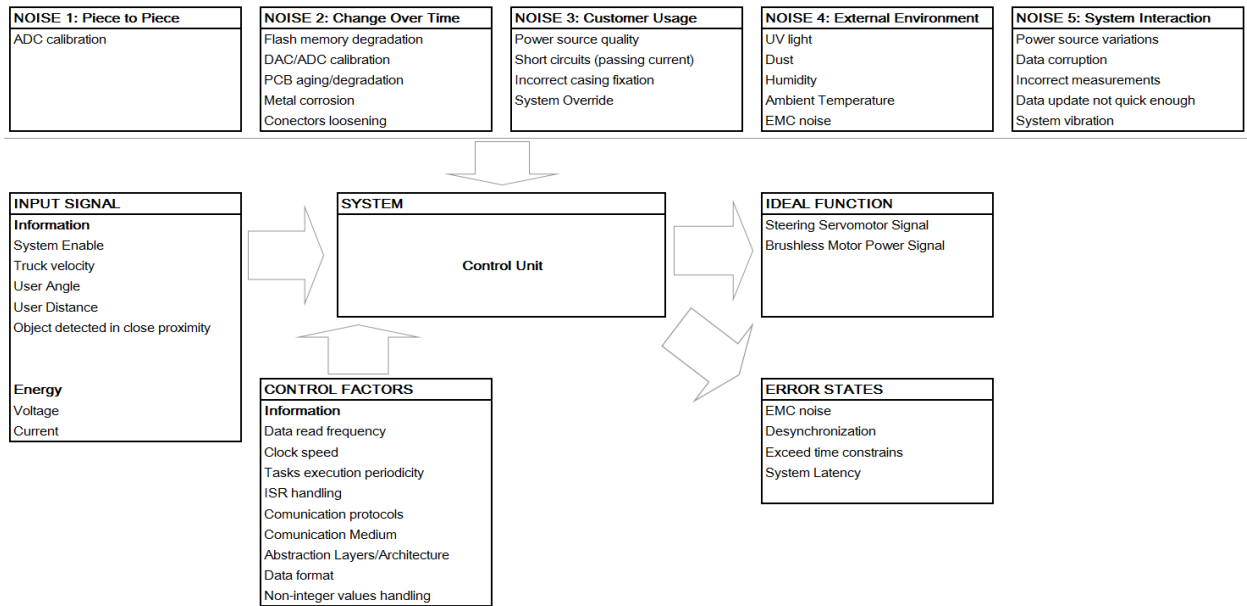

Figure 3-10: Technical architecture - L1 control unit P-Diagram.

#### Traxxas Truck

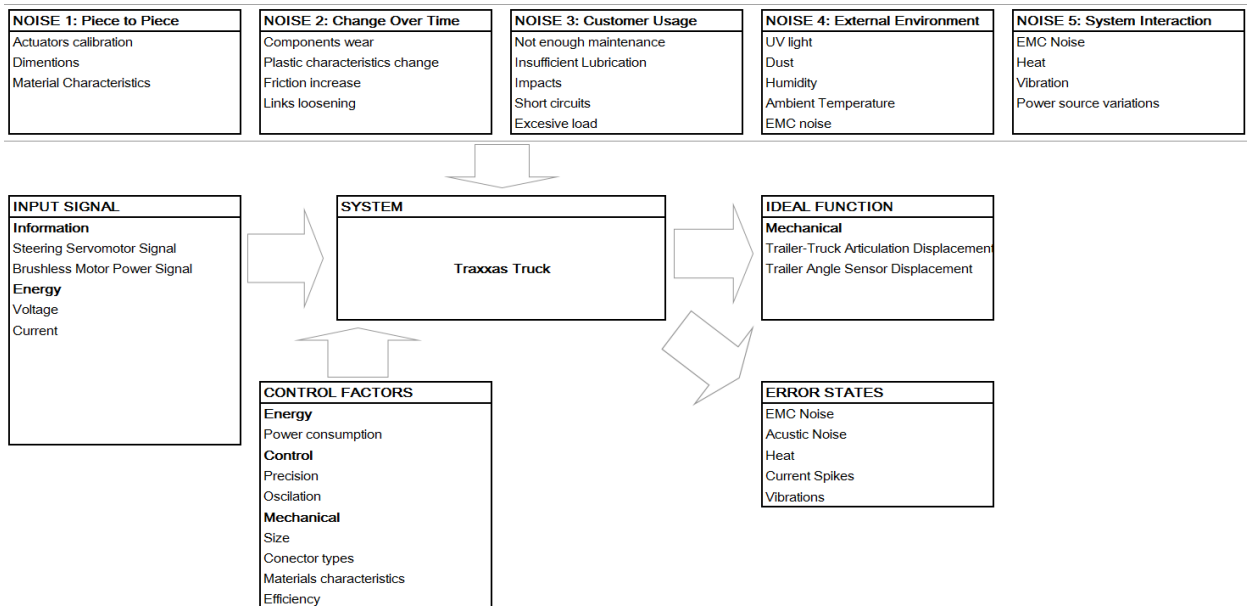

Figure 3-11: Technical architecture - L1 Traxxas truck P-Diagram.

### 3. DESIGN AND DEVELOPMENT

#### Electric Power Units

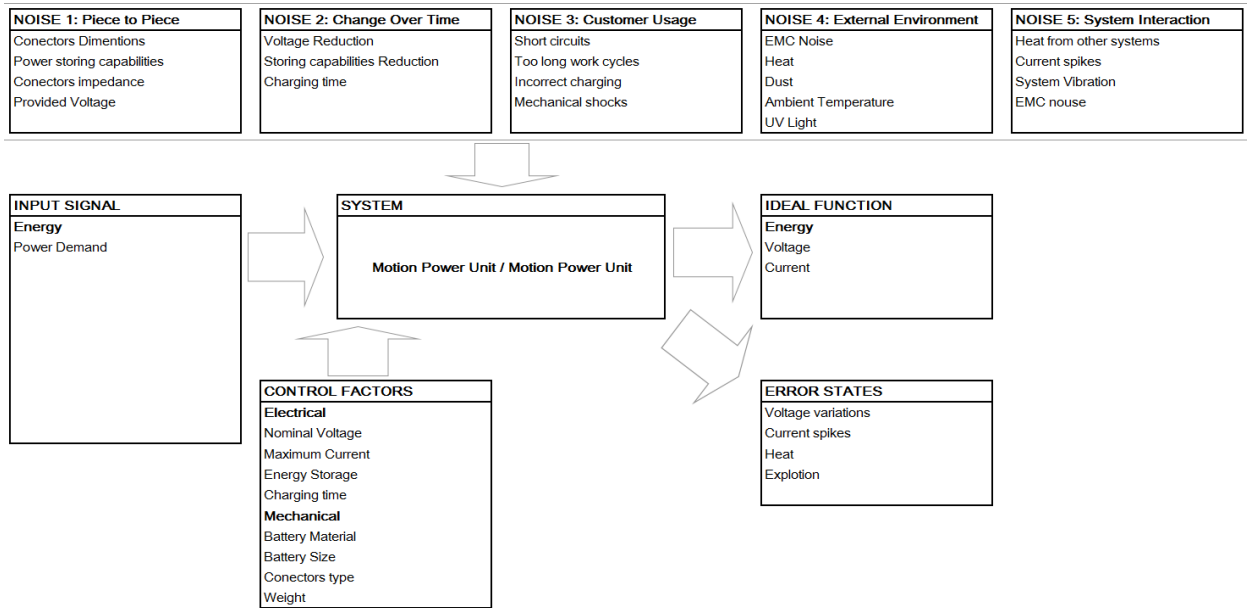

Figure 3-12: Technical architecture L1 power units P-Diagram.

### 3. DESIGN AND DEVELOPMENT

#### 3.3.3 Technical Solution HoQ Diagram

The HoQ Diagram shown in Figure 3-13 tracks the “Whats” and “Hows” of the proposed system solution as well as their relationships. It is important to know what the level of relevance for each characteristic as well as how difficult or time consuming it is to achieve the characteristic. For this specific system, no competitor benchmark was done since the proposed system is not in the market.

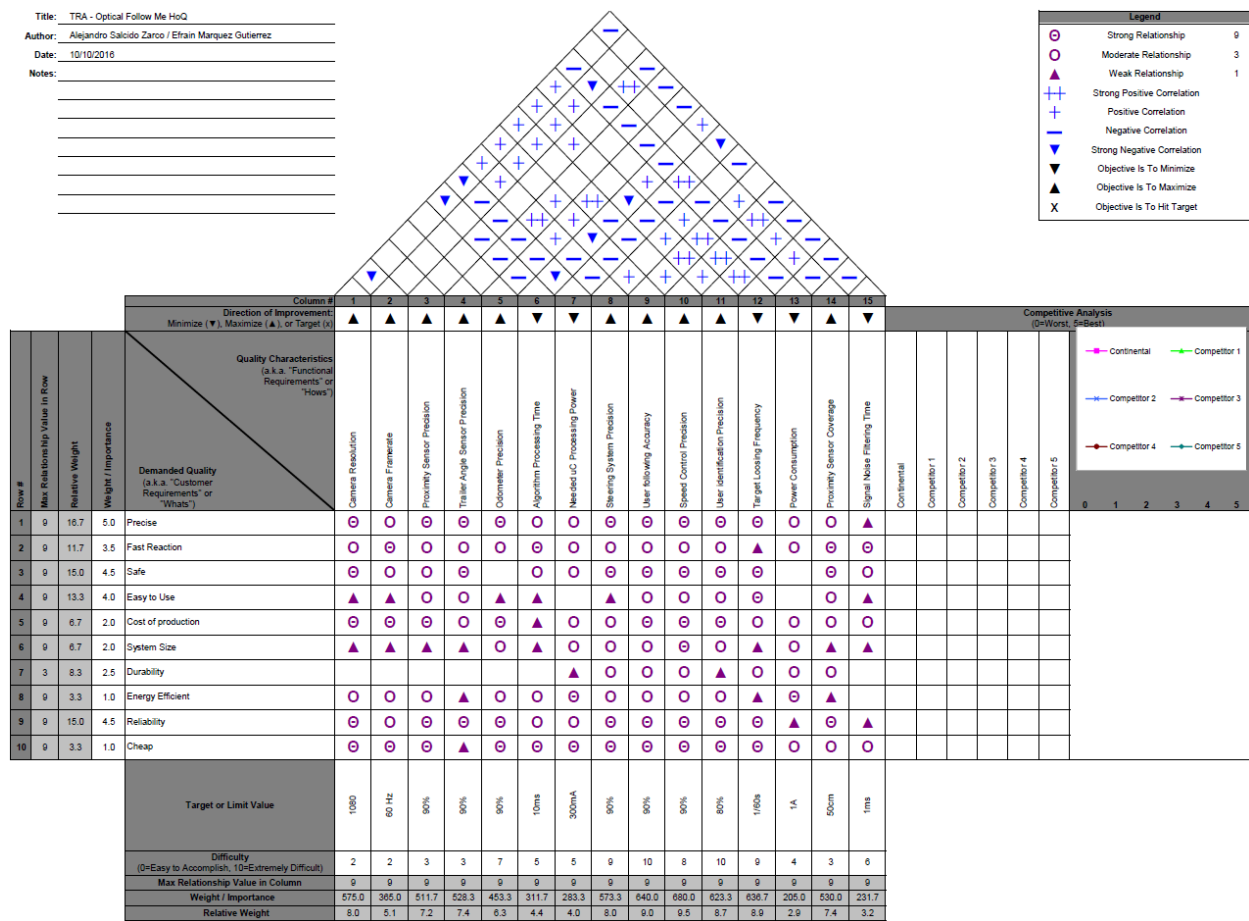

Figure 3-13: TRA-OFM House of Quality diagram.

### **3. DESIGN AND DEVELOPMENT**

#### **3.4. Implementation**

Once the system architecture and the solution have been defined, it is possible to design the implementation of the components that will integrate the system. These components belong to the HW and SW disciplines. For the hardware, we have the electric diagrams and list of components. In contrast, for the software we have the software architecture, the logic of the internal modules in the form of flow charts, and the flow of data in the form of sequence diagrams.

##### **3.4.1 Software Architecture and Design**

The software of the system is composed of two parts. The first part is the image processing, distance tracking, and control of the pan-tilt servomotors of the camera assembly. This was implemented inside the OpenMV platform and programmed in Python scripting.

The second part is the control unit responsible for calculating the vehicle speed, determining if an object is in close proximity, steering and providing the required acceleration or deceleration of the vehicle. This part was implemented inside the SAM v71 board and programmed in C language. Finally, both the SAM v71 board and the OpenMV platform are interfaced using SPI, being slave and master respectively.

### 3. DESIGN AND DEVELOPMENT

## Camera System

### Architecture

The OpenMV platform's SW architecture was designed in ascending levels of abstraction for the different system elements. The abstraction was done in a bottom-up approach where the lower elements corresponded to HW components inside the micro-controller, going up through the low-level drivers, followed by the external component abstraction and finally ending in the application elements of the logic. In detail, the abstraction of the ultrasonic sensor, camera sensor, and external control unit was done by their required communication protocols I2C, SCCB and SPI respectively. The servomotors of the tilt-pan assembly were abstracted by the I/O interfaces, specifically in the PWM interfaces. Other used I/O interfaces include the DIO, TC and FPU drivers.

The OpenMV platform makes use of the MicroPythonOS implemented inside an Atmel Cortex M4, therefore the corresponding "System Services" are included. These are the "ECU State Manager", "MicroPythonOS", "OpenMV Image Classifier" and "Watchdog Timer". Moreover, the different abstraction and "System Services" layers are linked to the application by calls to the RTE. In a similar way, each application module can only set variables from the CDB or make RTE calls. This design guarantees the atomicity of each part of the architecture. The camera system architecture can be observed in Figure 3-14.

### 3. DESIGN AND DEVELOPMENT

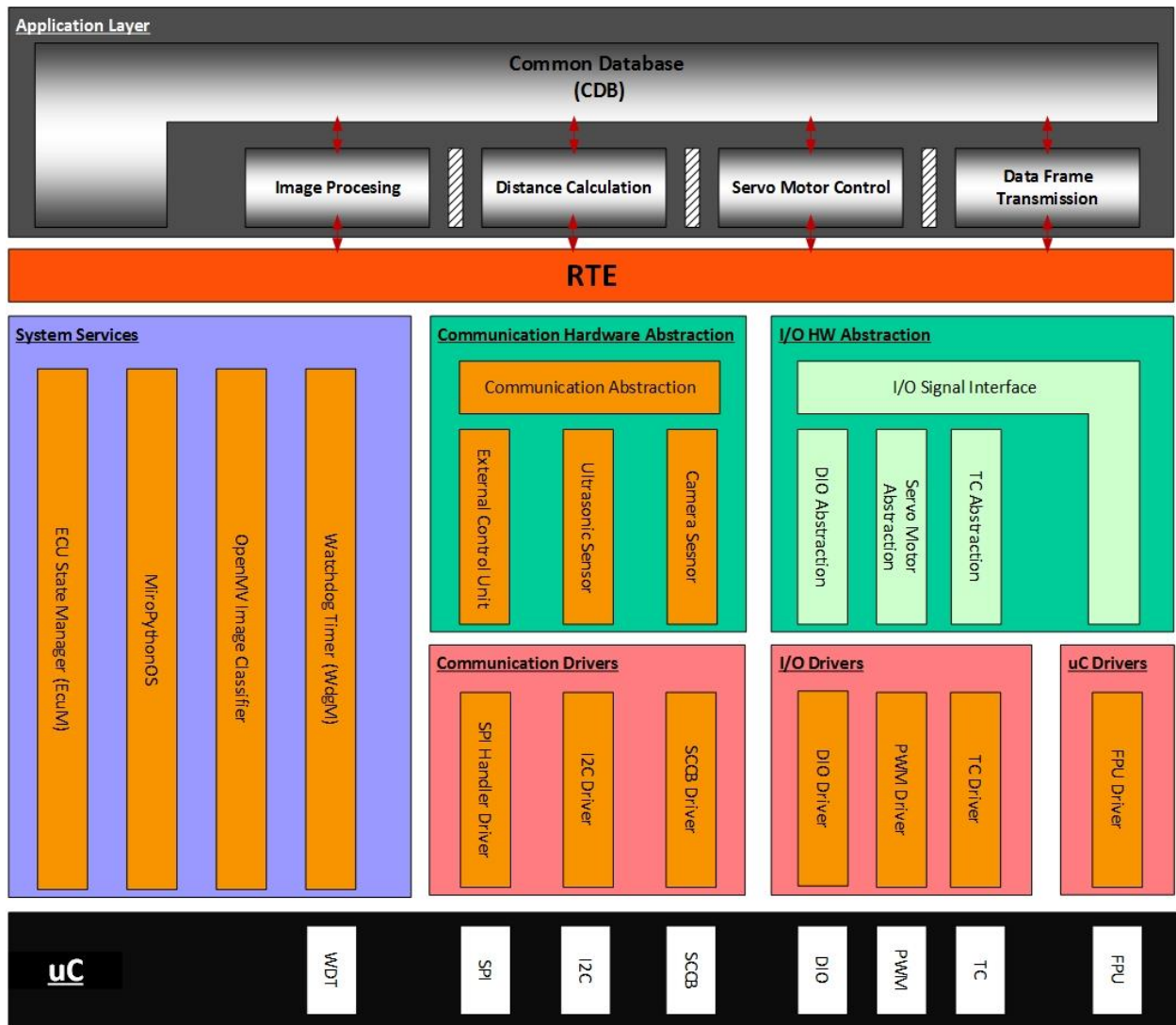

Figure 3-14: Camera system SW architecture.

### 3. DESIGN AND DEVELOPMENT

#### Logic

The logic of the camera system consists of 4 application tasks, “Image Processing”, “Distance Calculation”, “Servomotor Control”, and “Data Frame Transmission”. The management of communications and low-level drivers are handled by the provided libraries from both OpenMV and MicroPython.

Firstly, the “Image Processing” consists in creating a “Haar Cascade Classifier” for the face of a person at the initialization of the system. Then, a snapshot of the camera’s visualization is taken. This snapshot is composed of a 320x240 (QVGA) image in greyscale. Next, the image is processed using the created “Haar Cascade Classifier” in order to identify any human faces present in the image. In the case that the classifier reports a successful identification of a person’s face, then the provided coordinates of the center of the face are saved. In the case that more than one face is detected, only the first identification is used.

Secondly, the “Distance Calculation” consists in using an ultrasonic sensor for the measurement of nearby objects. The ultrasonic sensor is configured at initialization so that only the first echo is processed and the data is reported in centimeters. At the beginning of the loop execution, a measurement command is issued to the sensor. The sensor then emits an ultrasonic wave and waits for any incoming echoes. The time difference from the wave emission to the echo reception is computed in order to determine the object’s distance, and thus, some time is required for the actual measurement to be ready. During this time other tasks can be executed in the system, therefore, the measurement tasks are stopped and the processor is yielded. Once the other tasks are finished, the control is returned back to the “Distance Calculation” so that it can complete its measurement. In order to do this, a report command is sent to the ultrasonic sensor. The sensor then transmits back 2 bytes of information containing the distance in centimeters for the first detected object in case that any exist. This information is then saved into a circular buffer of 5 positions. The actual value used in later stages is the average of the buffer’s content. Therefore, the distance measurement is filtered by a “Moving Average” filter with a sample window of 5 positions.

### 3. DESIGN AND DEVELOPMENT

Thirdly, the “Servo Motor Control” task is executed after the “Image Processing” task and consists in determining the tilt and pan angles that the camera would require to be moved in order to point at the center of the detected person’s face. After calculating the required angles, the servomotors are instructed to move by changing the duty-cycle of their PWM signals. Since the ultrasonic sensor is moved together with the camera by the servomotor assembly, then the ultrasonic sensor would also be re-directed to face the person’s face and thus would be able to achieve a better distance measurement.

Finally, the “Data Frame Transmission” task is executed once the other three tasks are finished. Since the required pan adjustment has already been determined during the “Servo Motor Control” tasks and the distance to the detected person was calculated in the “Distance Calculation” task, then what remains is to transmit the data to the SAM V71 control unit. In order to do so, a data frame is prepared. The data frame is composed of 8 bytes, and has the following format:

[“#”, <Distance Data>, “\$”, <Angle Data>, “%”, <Message Counter>, “&”, “\n”]

- #: Start of frame identifier.
- Distance Data: Distance measurement to the identified person.
- \$: Distance Data separator.
- Angle Data: Measured angle between the longitudinal axis and the identified person.
- %: Angle Data separator.
- Message Counter: Number of messages sent.
- &: Message counter separator.
- \n: End of frame identifier.

After each data frame is transmitted, a message counter is incremented (and reset back to 1 once it reached its maximum value of 250). This message counter was added so that the control unit could determine that no new messages have been received since the counter is not being



### **3. DESIGN AND DEVELOPMENT**

increased. It is important to mention that in the case that a person's face is not identified by the "Image Processing" task, then the "Distance" and "Angle Data" would be returned to their default values.

After all tasks have been executed, the logic loops back and is executed again as can be observed in Figure 3-15.

### 3. DESIGN AND DEVELOPMENT

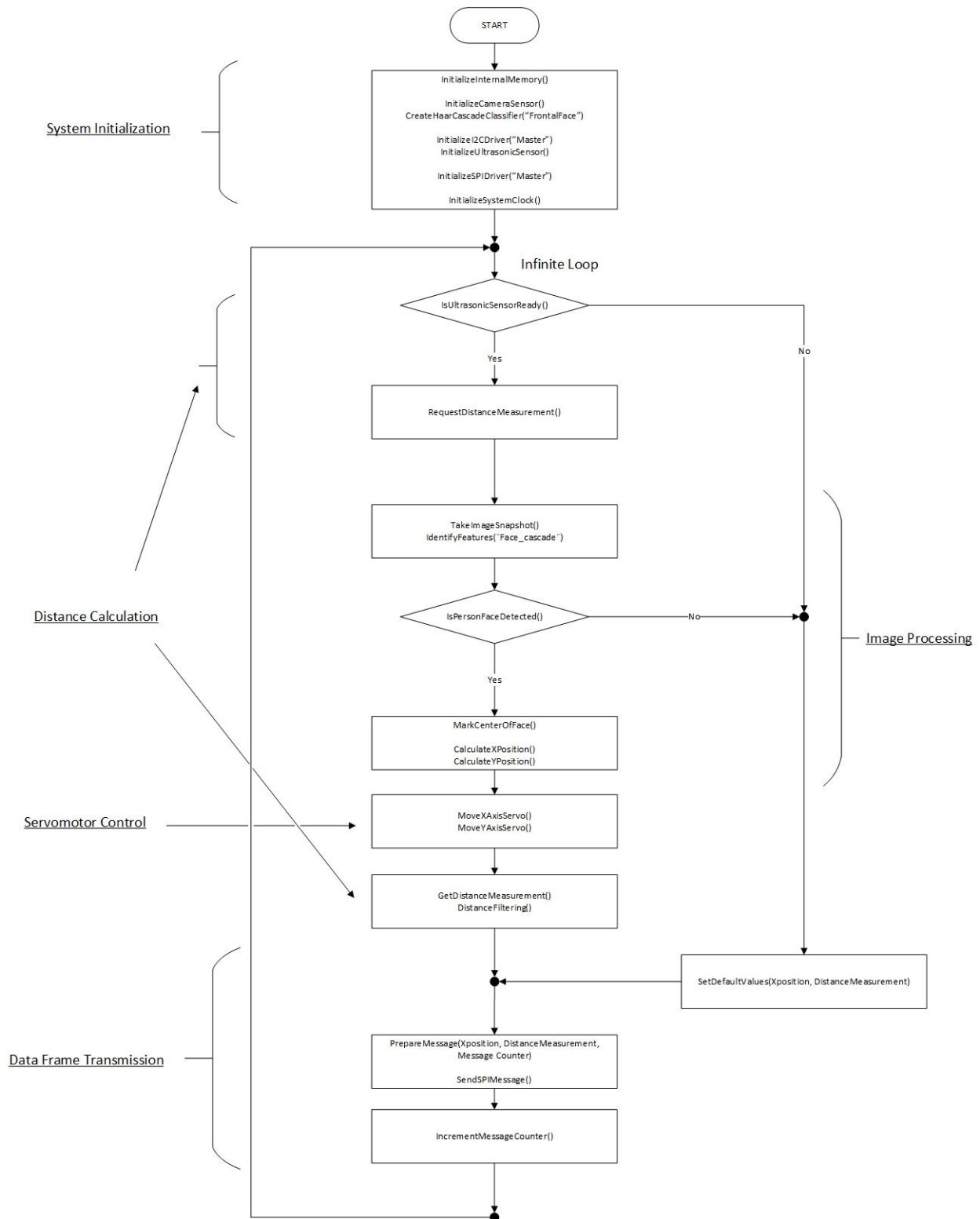

Figure 3-15: Camera system logic flowchart.

### 3. DESIGN AND DEVELOPMENT

## Control Unit

### Architecture

The control unit of the system is implemented in the SAMv71 platform's embedded software and is responsible for managing the proximity sensor input signals and data output from the camera system by means of an SPI protocol in order to generate the PWM signals to control the Traxxas truck. The system software implements the FreeRTOS real time operating system together with the low-level drivers provided by Atmel which serve as a basis for the next abstraction layers and these include SPI, UART, timer counter, analog front end and PWM, all of them approaching the embedded DMA capabilities in order to reduce CPU overload and enhance processor performance.

According to the Atmel datasheet [38], "The DMA Controller (XDMAC) is an AHB-protocol central direct memory access controller. It performs peripheral data transfer and memory move operations over one or two bus ports through the unidirectional communication channel. Each channel is fully programmable and provides both peripheral and memory-to-memory transfers. The channel features are configurable at implementation." [39]. The DMA controller topology can be observed in Figure 3-16.

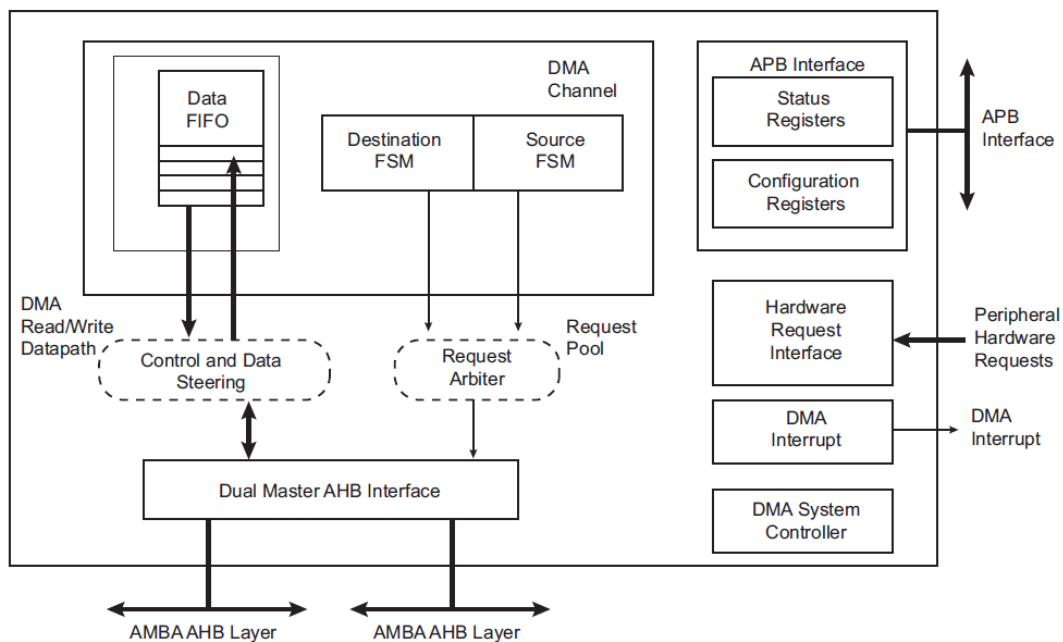

Figure 3-16: DMA controller (XDMAC) block diagram [39].

### 3. DESIGN AND DEVELOPMENT

A top level view of the architecture is shown in Figure 3-17. In general terms three major layers are distinguished, “System Services”, “Drivers Layer” (composed of low-level drivers in red and HW abstraction layers in green) and “Application Layer”. These three layers are described below.

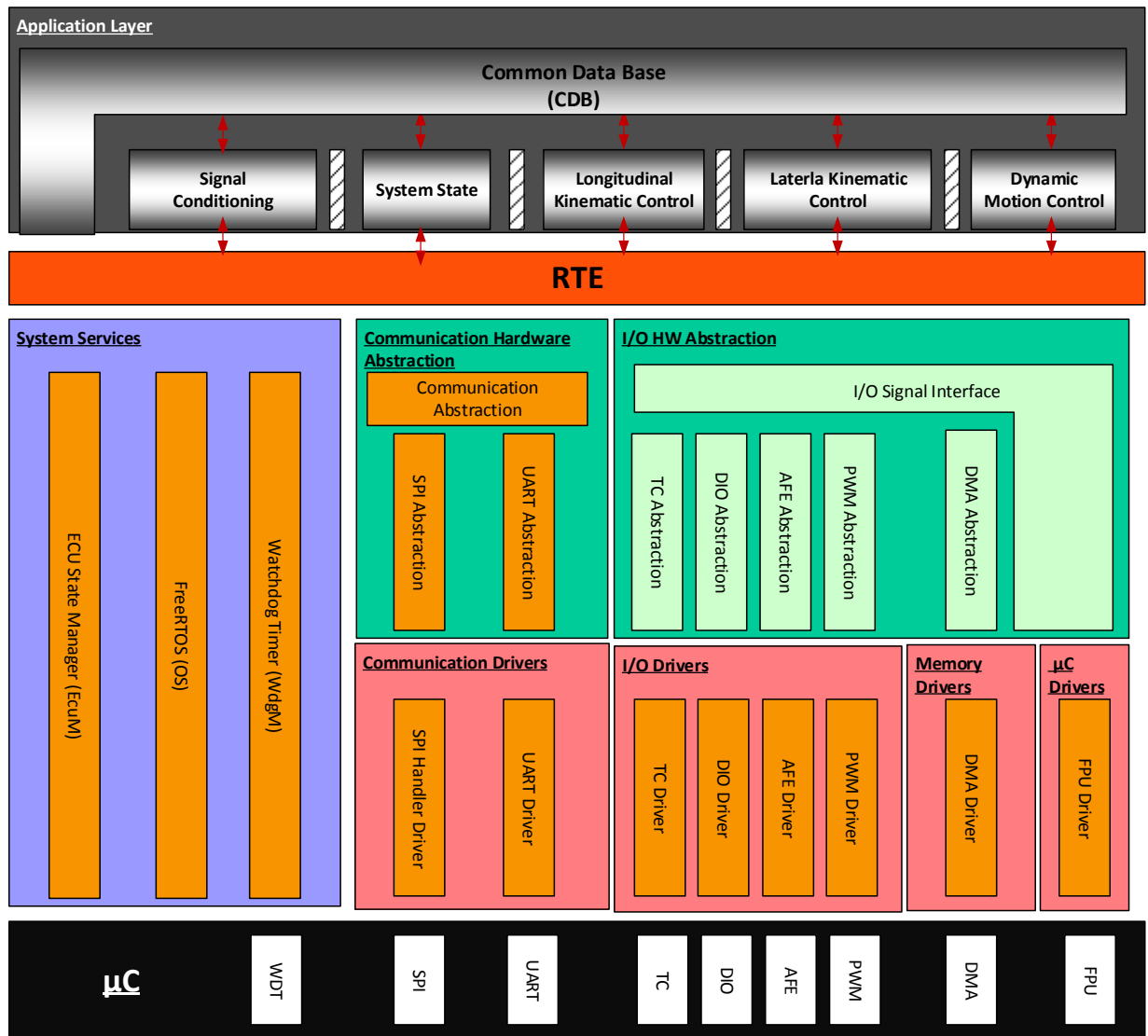

Figure 3-17: SAMv71 software architecture.

### 3. DESIGN AND DEVELOPMENT

**Drivers Layer** This layer is composed of the set of Atmel’s low level driver directly over the target hardware. It includes the “Communication Hardware Abstraction” layer and “I/O HW Abstraction” layer. For the project, all low-level drivers were configured to use the DMA.

Components:

- Low-level drivers
  - SPI handler driver (SPI)
  - UART driver (UART)
  - Timer Counter driver(TC)
  - Device Input Output driver(DIO)
  - Analog Front End driver
  - Pulse-Width Modulation driver
  - Direct Memory access driver
  - Floating-point unit
- HW abstraction layer
  - SPI abstraction
  - UART abstraction
  - Timer counter abstraction
  - Analog Front End abstraction
  - Pulse-Width Modulation abstraction

**System Services** The “System Services” layer serves as an abstraction of some of the driver layer details. This abstraction allows the isolation of the hardware specifics of the functional input/output features. Another way to explain the rational of this layer is searching for the equivalence with the “Sensor and Actuator Software Components” in the AUTOSAR architecture [40].

Components:

- ECU State Manager
- FreeRTOS

### 3. DESIGN AND DEVELOPMENT

- Watchdog Timer

Functional Application Layer      This layer contains the logic that is performed by the application features. It interacts with the “System Services” layer and driver layer in order to drive most of the input/output peripherals.

Components:

- Signal conditioning
- System State
- Longitudinal Kinematic Control
- Lateral Kinematic Control
- Dynamic Motion Control

### 3. DESIGN AND DEVELOPMENT

#### Sequence Diagrams

This section provides the logic and interaction sequence between system modules and architecture layers. In Figure 3-18, the OS task activation sequence and module interaction is represented. The entire process has a 10 millisecond pacing period.

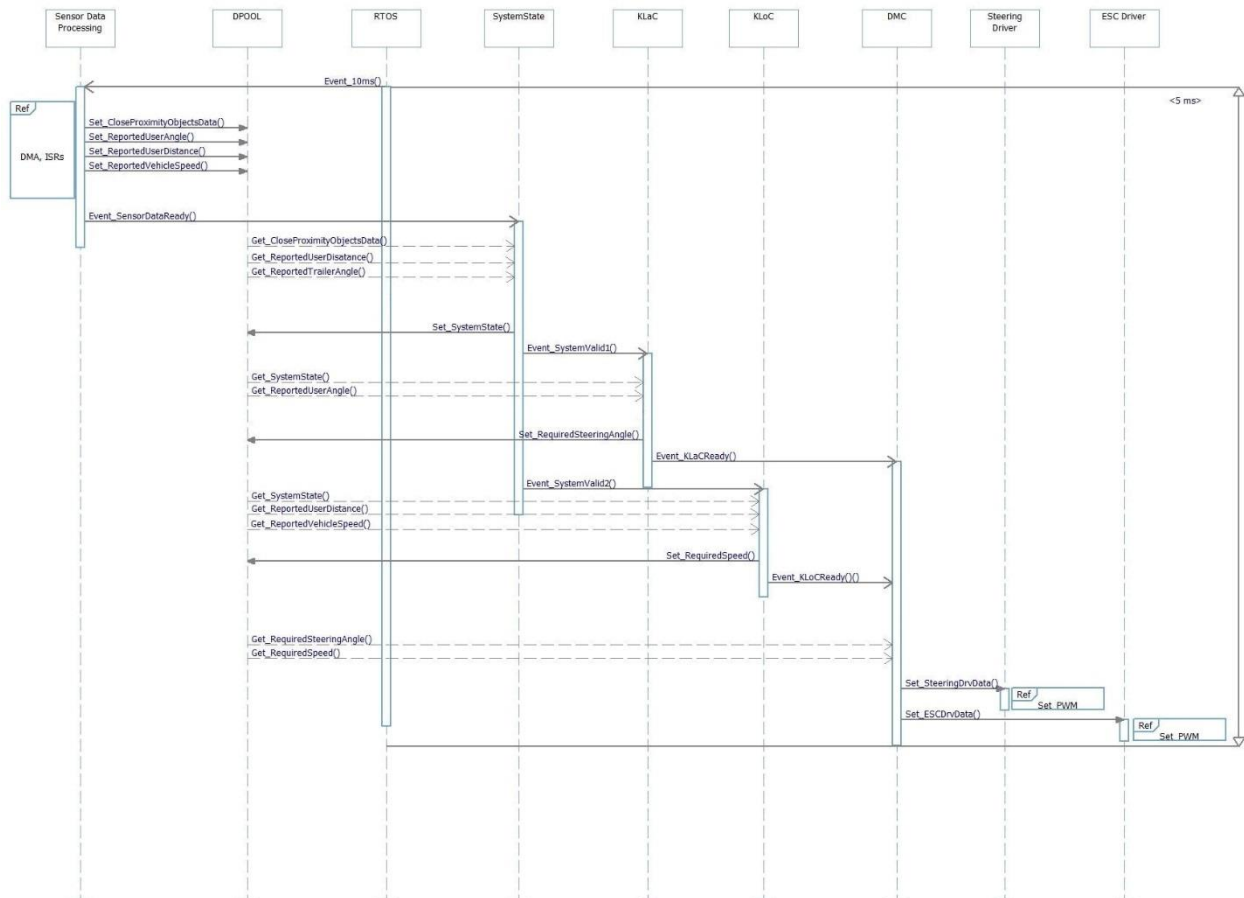

Figure 3-18: Control unit sequence diagram.

### 3. DESIGN AND DEVELOPMENT

#### Logic

The control unit's logic is composed of 9 components that are executed in sequence in order to control the Traxxa's truck longitudinal and lateral motion. Even though the low-level drivers are continuously refreshing the data from the sensors, the application logic and corresponding components execution is triggered only when a valid message is received from the OpenMV board via SPI. Each one of the 9 components is explained in detail below. A brief summary of each component can be found in Table 3-5 below.

*Table 3-5: Control unit flow chart components.*

| <b>Component</b>       | <b>Type</b>                 | <b>Description</b>                                                          |
|------------------------|-----------------------------|-----------------------------------------------------------------------------|
| Sensor data processing | Driver layer component      | Set of drivers in charge of acquiring data from IO and communication busses |
| Common data base       | Application layer component | Data is managed                                                             |
| FreeRTOS               | System service component    | Real Time Operative System                                                  |
| System State           | OS task                     | Validates available data                                                    |
| KLaC                   | OS task                     | Process data for generating required steering angle                         |
| KLoC                   | OS task                     | Process data for generating required speed                                  |
| DMC                    | OS task                     | Waits for KLaC and KLoC in order to set steering and ESC driver data        |
| Steering driver        | Reference                   | DMC set PWM value for Traxxas truck Steering                                |
| ESC driver             | Reference                   | DMC set PWM value for Traxxas truck speed                                   |



### 3. DESIGN AND DEVELOPMENT

#### Sensor Data Processing

The “Sensor Data Processing” entity is comprised by the driver abstraction modules. These modules are in charge of collecting and presenting all the necessary data used by the application. Furthermore, the data collection is performed each 10 milliseconds and is triggered by an OS event. Data is obtained from different sources as showed in the Table 3-6.

*Table 3-6: Sensor data processing sources.*

| <b>Source</b>    | <b>Data</b>                                                      |
|------------------|------------------------------------------------------------------|
| SPI              | Reported user angle<br>Reported user distance<br>Message counter |
| Timer counter    | Reported vehicle speed                                           |
| Analog front end | Close proximity object data                                      |

#### SPI

##### SPI Source Flowchart

The following flow chart (Figure 3-19) shows the logic applied for the SPI data acquisition.

### 3. DESIGN AND DEVELOPMENT

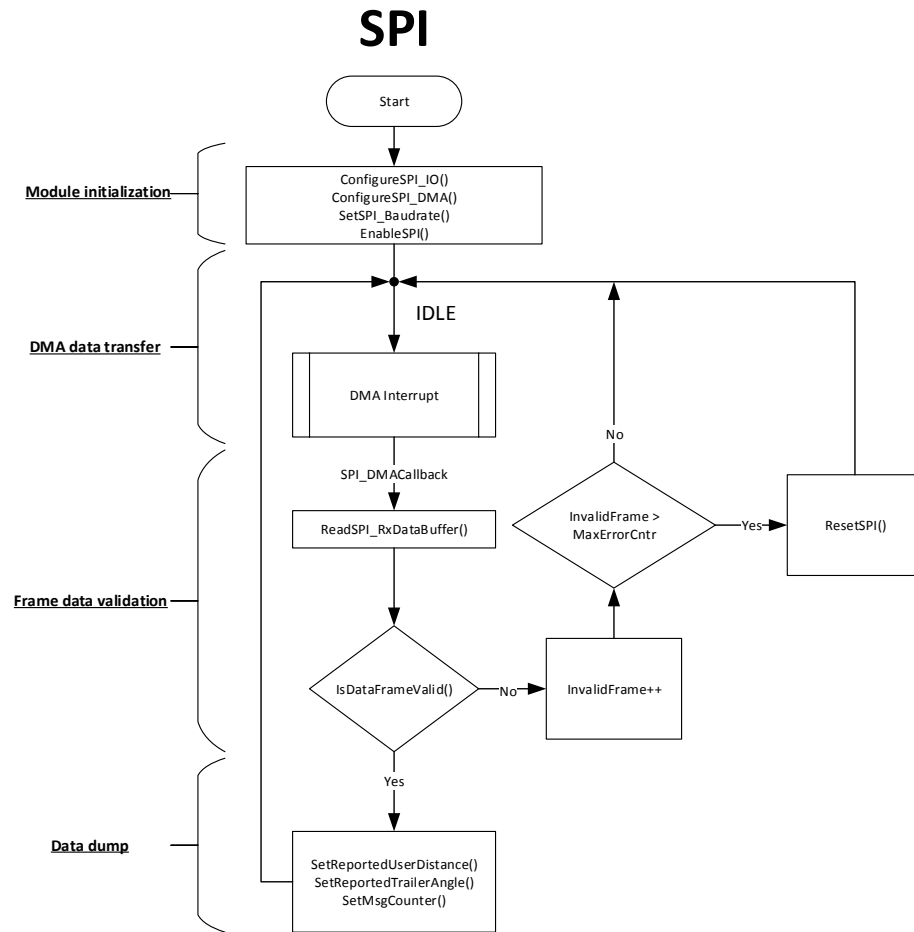

Figure 3-19: SPI inter-system communication flowchart.

#### Module Initialization

The IO lines MISO and NSS (Slave Select) are configured for only one slave (Camera system) with the bus speed at 187500 bauds, also the clock polarity and phase is configured in mode 0 as shown in Table 3-7. Furthermore, the DMA is configured to transfer data directly to the RAM buffer whenever the data is received from the slave device (see Figure 3-20).

Table 3-7: SAMv71 SPI bit polarity configuration [38].

| SPI Mode | CPOL | NCPHA | Shift SPCK Edge | Capture SPCK Edge | SPCK Inactive Level |
|----------|------|-------|-----------------|-------------------|---------------------|
| 0        | 0    | 1     | Falling         | Rising            | Low                 |
| 1        | 0    | 0     | Rising          | Falling           | Low                 |
| 2        | 1    | 1     | Rising          | Falling           | High                |
| 3        | 1    | 0     | Falling         | Rising            | High                |

### 3. DESIGN AND DEVELOPMENT

In the below Figure 3-20 is depicted the SPI diagram block and its connection with the DMA peripheral are shown.

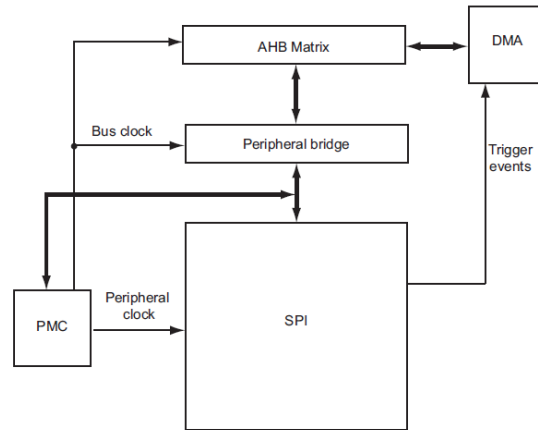

Figure 3-20: SAMv71 SPI diagram block [38].

#### DMA Data Transfer

At this point the DMA triggers an interrupt to the CPU indicating that data is available in the internal buffer, then the frame data validation process is started.

#### Frame Data Validation

The frame data is composed of three values of 1 byte, each one separated by a special token, the camera system reports user angle, user distance and a message counter that indicates the number of messages sent. The validation is successful when the data frame contains all the tokens in the correct sequence and the message counter was incremented since the last reading. If data is invalid an error counter is incremented and when the error counter reach maximum allowed value the SPI driver is reset. The data frame structure is showed in Table 3-8.

Table 3-8: Camera system 8 byte data frame.

| Start-Token1 | Data1        | Token2 | Data2     | Token3 | Data3          | End-Token4 |
|--------------|--------------|--------|-----------|--------|----------------|------------|
| #            | UserDistance | \$     | UserAngle | %      | MessageCounter | &          |

### 3. DESIGN AND DEVELOPMENT

#### Data Dump

Once the data was validated, data results are set in the common data base.

#### **Timer Counter**

In the next sequence diagram (Figure 3-21), the event chain that drives the timer counter logic is shown.

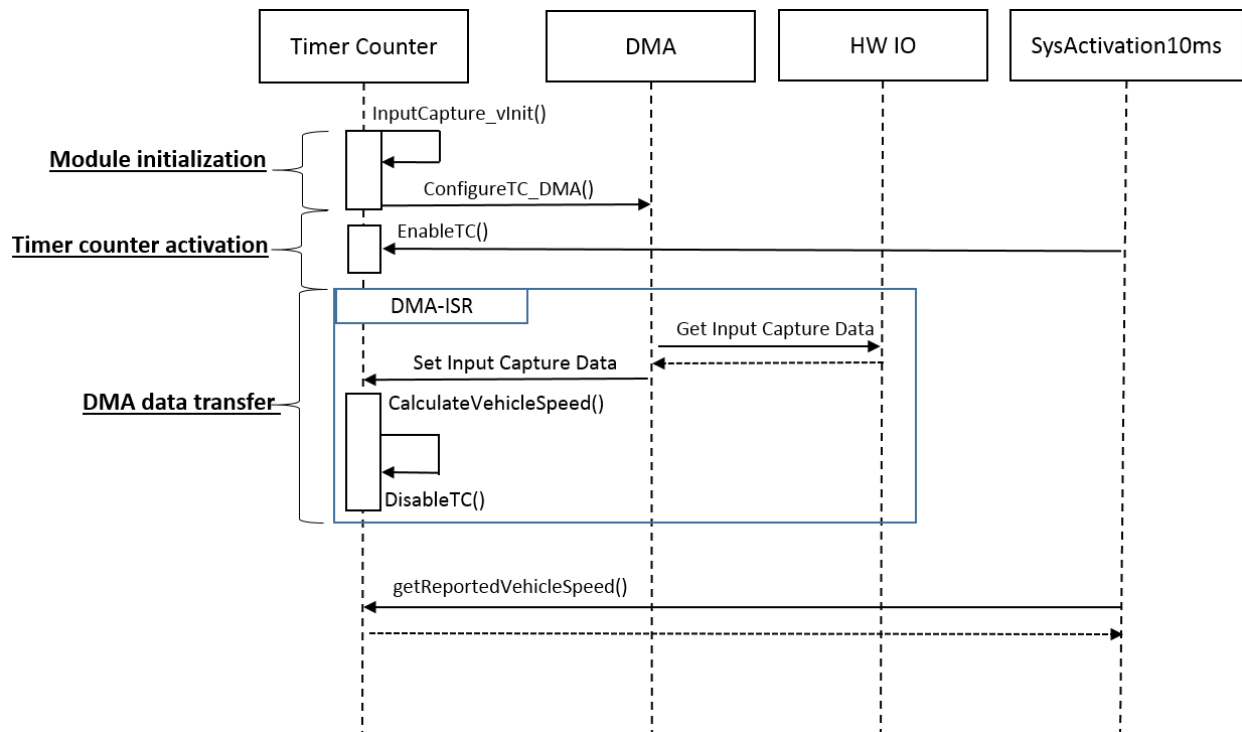

Figure 3-21: Timer counter implementation flowchart.

#### Module Initialization

Timer counter implements an input capture strategy in order to obtain the RPM of the motor, based on the signal of a Hall Effect sensor that is connected directly to the Traxxas truck engine.

### 3. DESIGN AND DEVELOPMENT

#### Timer Counter Activation

The timer counter is active only when the 10ms system event is triggered, given that TC-DMA interrupt can block the CPU due the fast spinning of the truck's engine. Only one cycle is needed to obtain the rotation frequency.

#### DMA Data Transfer

DMA triggers an interrupt indicating data input capture data is ready, also a callback is executed calculating the vehicle speed and setting the information in the common data base.

#### Analog Front End

For the analog front end, the next logic sequence (see Figure 3-22) was used for the data obtention.

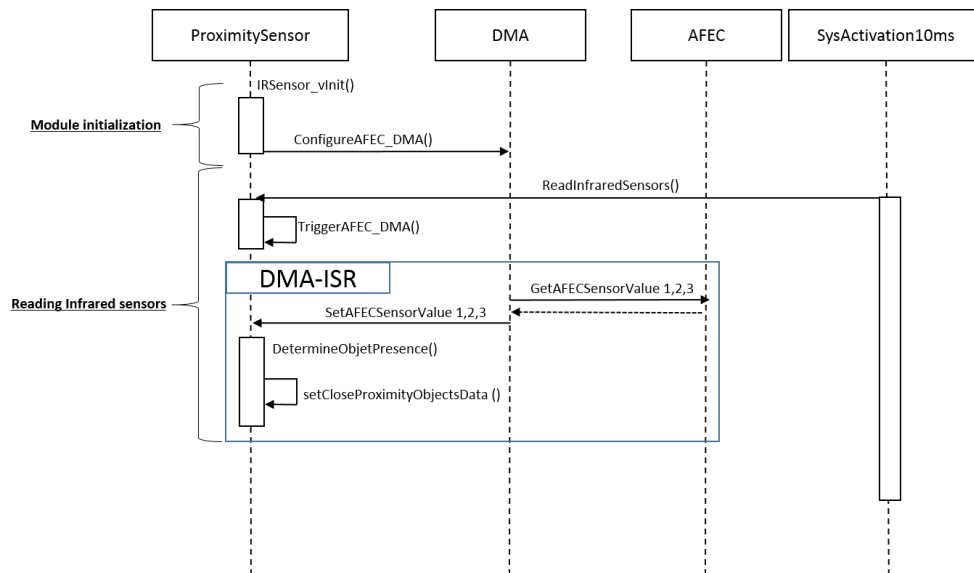

Figure 3-22: Analog front end implementation flowchart.

### 3. DESIGN AND DEVELOPMENT

#### Module Initialization

Three IO lines are configured as analog inputs in order to read the infrared sensors, also the DMA is configured to manage the analog front end registers and also to count the data acquisition. In Figure 3-23, the diagram block for the analog front end and the connection with the DMA peripherals are shown.

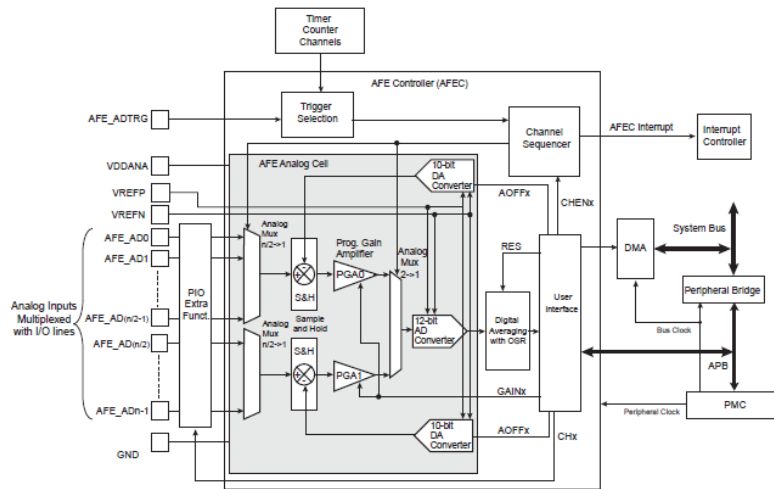

Figure 3-23: SAMv71 analog front-end controller block diagram [38].

#### Reading Infrared Sensors

Analog reading is triggered by the system event. Since the DMA is configured for reading the analog values, it will trigger and interrupt the CPU at the end of the data acquisition from the three sensors. In addition, the analog values are transformed to the physical values (centimeters) and are sent to the common data base.

#### **Common Data Base**

As shown in Figure 3-17, the SAMv71 software architecture element “Common Data Base” is part of the application layer, it serves as a data pool, and this means that all data needed by the application is set globally by the lower layers and is available as read-only.

### 3. DESIGN AND DEVELOPMENT

#### RTOS

The operative system sends an event every 10 milliseconds.

#### System State

The “System State” task is activated by the Event “Sensor Data Ready”. This task performs a system validation in accordance with the data contained in the common data base. In addition, this task will also set two events used by the KLaC and KLoC tasks. In Figure 3-24, a flowchart is shown with the complete logic contained the “System State”.

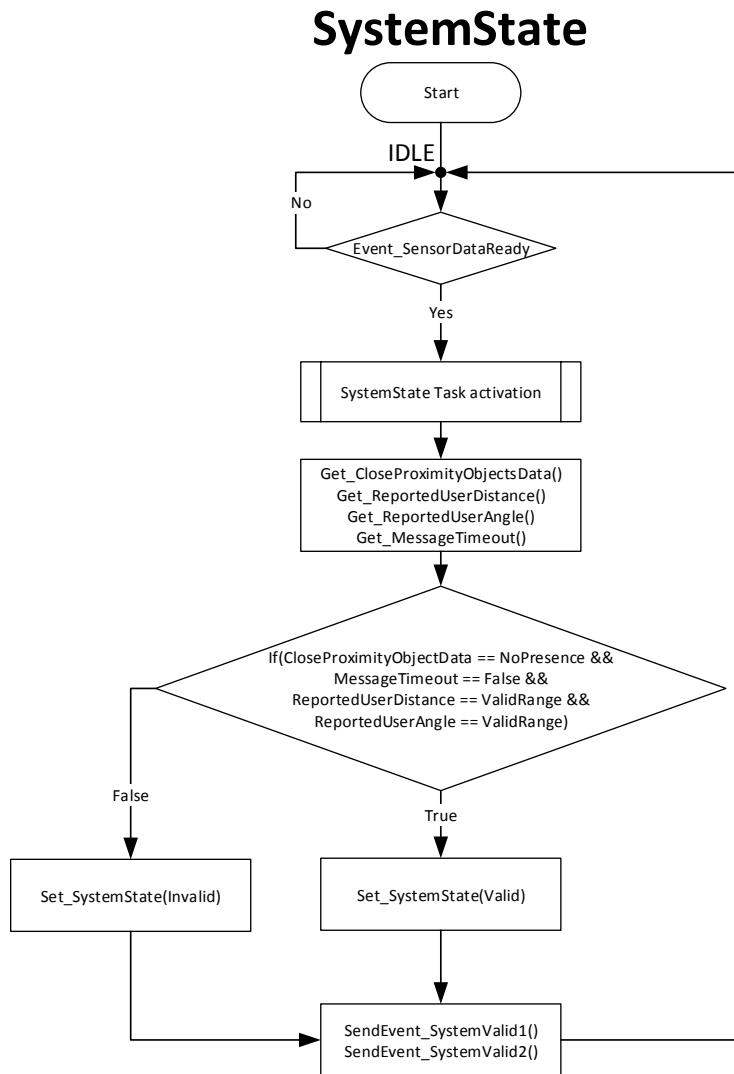

Figure 3-24: System State task logic flowchart.

### 3. DESIGN AND DEVELOPMENT

#### Kinematic Lateral Control

The “Kinematic Lateral Control” (KLaC) is implemented as a system task and is activated by the event “SystemValid1”. This task performs the calculation of the required steering angle output for the Traxxas truck. If the system state is invalid, then, the KLaC task will maintain the last sent steering angle, otherwise, it will update its value. Figure 3-25 contains the KLaC logic’s flowchart.

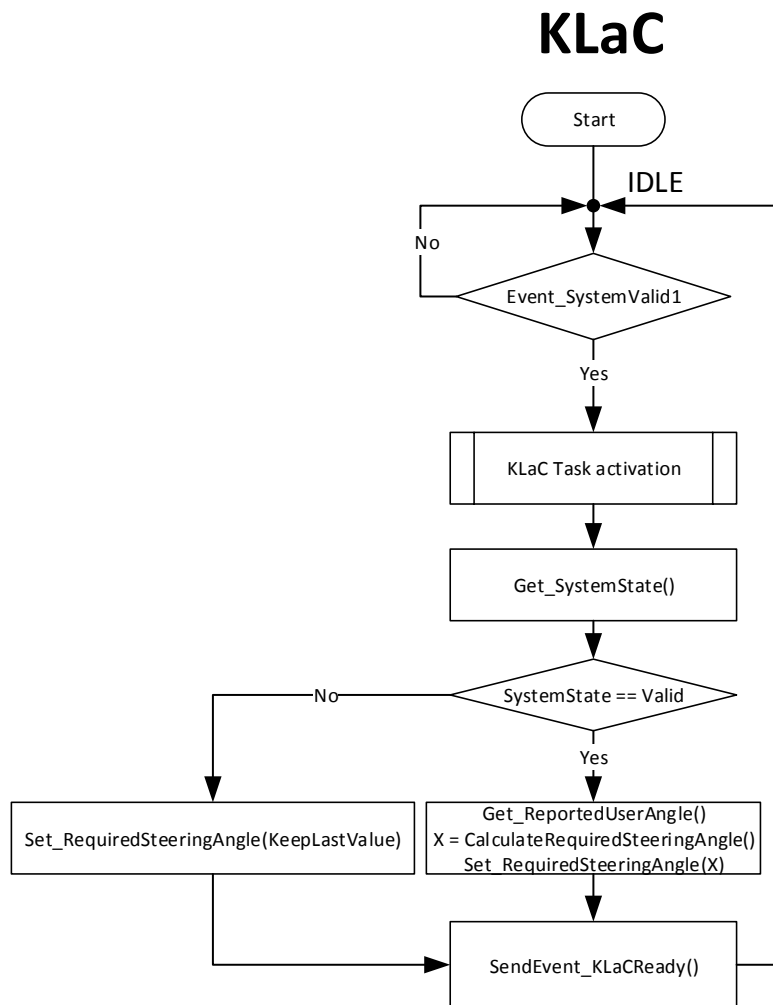

Figure 3-25: Kinematic Lateral Control task flowchart.



### 3. DESIGN AND DEVELOPMENT

#### Kinematic Longitudinal Control

The “Kinematic Longitudinal Control” (KLoC) task is also implemented as a system task, and is activated by the event “SystemValid2”. This task performs the calculation of the required speed output for the Traxxas truck. If the system state is invalid, then, the required speed will be set to zero in order to stop the vehicle, otherwise a new required speed will be set. Figure 3-26 displays the KLoC logic’s flowchart.

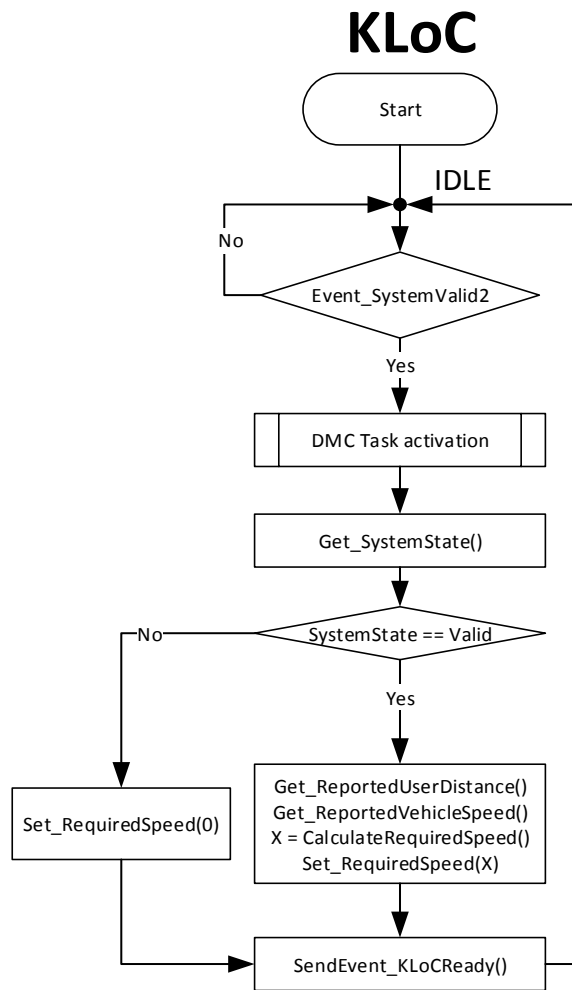

Figure 3-26: Kinematic Longitudinal Control task flowchart.

### 3. DESIGN AND DEVELOPMENT

#### Dynamic Motion Control

The “Dynamic Motion Control” (DMC) is implemented as a system task and is activated when both the “KLaCReady” and “KLoCReady” events are active. These two events respectively indicate that the required angle and speed are available. This task is in charge of the data translation from the physical values of angle and speed into the required PWM values. Figure 3-27 illustrates the DMC’s logic flowchart.

## Dynamic Motion Control (DMC)

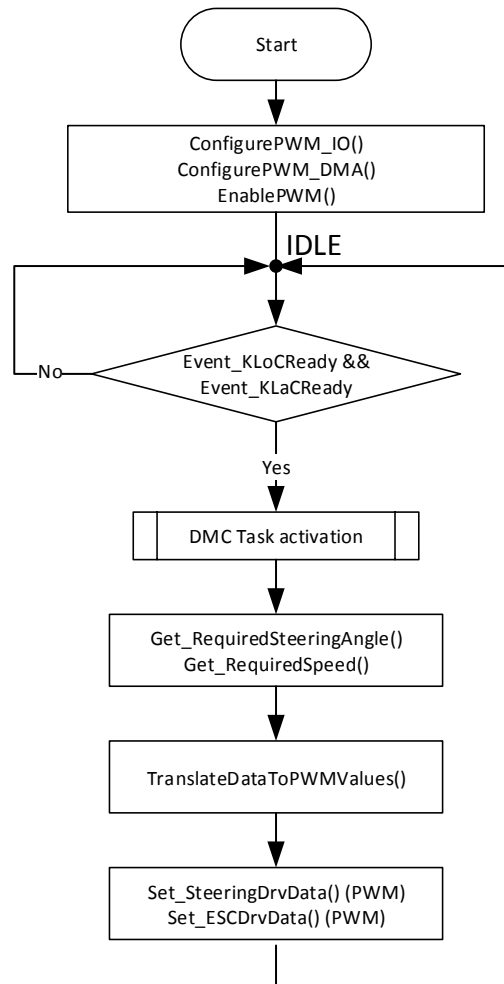

Figure 3-27: Dynamic Motion Control task flowchart.

### **3. DESIGN AND DEVELOPMENT**

#### **3.4.2 Hardware Architecture and Design**

Similar to the software architecture, the TRA-OFM HW implementation is also composed of two parts. One for the camera system and one for the control unit. Aside from the respective OpenMV and SAM v71 boards, two separate PCBs were required in order to allocate all the interconnections between the sensors, the boards themselves and the passive components such as voltage regulators, switches, resistors, capacitors etc.

#### **Camera System**

The camera system PCB is composed of 5 sections, the “Power Source Regulation”, the “Servomotors Connections”, the “Ultrasonic Sensor Connections”, “The Control Unit Connections”, and the optional “CAN interface Connections”. The array of the PCB is shown in Figure 3-28. Each PCB component has been labeled and therefore will be mentioned by its diagram name in the descriptions that follow. In addition, the connections between the camera system’s PCB and the OpenMV board will make reference to the pin interfaces shown in Figure 2-4 from section 2.5. Each of the 5 mentioned sections is described below.

### 3. DESIGN AND DEVELOPMENT

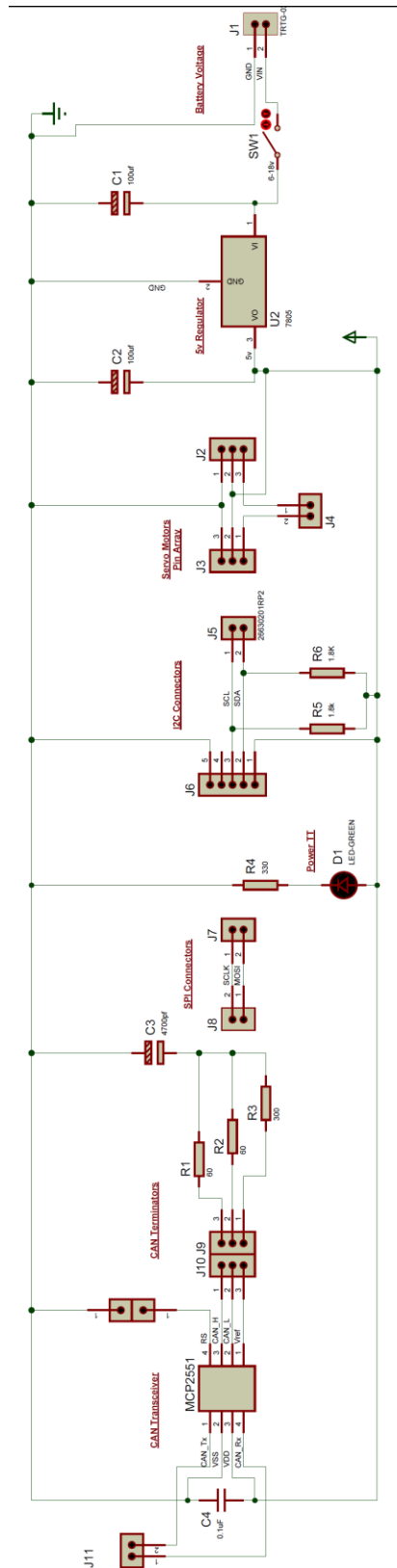

Figure 3-28: Camera system PCB - electrical diagram.

### **3. DESIGN AND DEVELOPMENT**

#### Power Source Regulation

Both the camera system and the control unit are energized through an external LiPo 3-cell 11.1v battery. However, most of the system components work with a potential difference of 5v. Therefore, a voltage regulation must be made in order to reduce the battery voltage to the needed levels. For the camera system, this task is done with a simple 7805 voltage regulator (U2) together with two 100uF capacitors (C1 and C2). The battery is connected through the J1 connector to a switch (SW1) which when closed, energizes the U2 regulator. Additionally, resistor R4 and LED D1 function as a visual indicator for the user to know when the system is energized.

#### Servomotors Connections

The used servomotors in the tilt-pan assembly are energized through the camera system PCB. In order to facilitate the connection, not only the power signals but also the reference signals pass through the PCB and are then connected to the OpenMV board. In order to do so, the J3 and J2 pin arrays are used to connect the 3-cable connector of each servomotor. Pins J3.3 and J2.1 are connected to ground, while J3.2 and J2.2 are connected to the 5v line. Also, the reference signals are connected to the J4 pin array by interfacing J3.1 with J4.2 and J2.3 with J4.1. Finally, J4.2 is connected to the OpenMV board pin P7 and J4.1 to pin P8. Both pins P7 and P8 were specifically designed in the OpenMV board to drive standard servomotors by PWM.

#### Ultrasonic Sensor Connections

The interface between the OpenMV board and the ultrasonic sensors is done through the I2C protocol. Therefore, 2 pull-up resistors R5 and R6 are used to drive high the SCL and SDA lines. The 5 pin J6 connector is designed to match the ultrasonic sensor pin array by having J6.5 connected to ground, J6.3 and J6.2 connected to SCL and SDA respectively, and finally, J6.1 connected to the 5v rail. The pin J6.4 is left unconnected since it is used by the ultrasonic sensor

### 3. DESIGN AND DEVELOPMENT

for debugging purposes. The OpenMV I2C interfaces are SDA (P5), and connects to pin J5.1 and SDA (P6) which is linked with J5.2.

#### Control Unit Connections

In order to connect the camera system and control unit PCBs, a SPI interface was utilized. Since the communication is performed only between the master (camera system) and one slave device (control unit) and only single-directionally from master to slave, then, no chip select (SS) or master input (MISO) pins were required. This leaves only the SCLK which is performed from OpenMV's pin P2 to J8.2 to J7.1, and finally, to PD22 in the SAM v71 board. MOSI goes from OpenMV's pin P0 to J8.1 to J7.2 and finally to PD21 in the SAM board. The control unit is responsible of driving its own SS continuously low so that the communication can take place.

#### CAN Interface Connections

At the time of the project's development, the CAN interface was not completely supported in the OpenMV board libraries. However, this interface is planned for later firmware revisions. Therefore, the camera system's PCB has been prepared to make use of the CAN interface as soon as it becomes available. The OpenMV board possesses a CAN protocol controller, however it lacks an internal transceiver to produce the required differential voltage of the protocol. Thus, an MCP2551 IC was added to the PCB. The CAN\_Tx and CAN\_Rx from the MCP2551 are connected to the J11.2 and J11.1 pins respectively. These pins could be connected to the OpenMV P2 and P3 respectively by replacing the SPI interface that was implemented. Additionally, the MCP2551 VSS and VDD pins require a filtering capacitor of 0.1uF (C4). Furthermore, the CAN\_H, CAN\_L and Vref pins can be optionally connected together through resistors R1, R2 and R3 respectively via jumpers in the case that a CAN line terminator is required. The filtering capacitor C3 of 4700pF is required in the common node of the R1, R2 and R3 resistors. Finally, the RS pin can be optionally connected to ground by a jumper to disable the slew rate limiting of the IC.

### **3. DESIGN AND DEVELOPMENT**

#### **Control Unit**

The control unit's PCB is integrated by 5 sections, the "Power Source Regulation", "Low Voltage Regulation", "Infrared Sensors Connections", "Wheel Speed Sensor Connections", and "Steering and Longitudinal Control Connections". The PCB for the Control Unit can be observed in Figure 3-29. Every component of the PCB has been labeled and therefore, they will be mentioned by their diagram name in the explanations that follow. Furthermore, the connections between the PCB and the SAM v71 board will make reference to the pin interfaces from the SAM v71 user guide [41]. The sections that integrate the control unit PCB are described below.

##### Power Source Regulation

Similar to the PCB from the camera system, the control unit's PCB has also a voltage regulation phase in order to adjust the voltage to a steady 5v. This is accomplished by a 7805 regulator (U2), two 100uF capacitors (C2 and C1) and a switch (SW1). The power source is also the 3-cell LiPo battery which is interfaced to the J1 connector. Specifically, the J1.1 is connected to the ground and the J1.2 to the source.

##### Low Voltage Regulation

The "Wheel Speed" sensor requires a low voltage of 3 volts for its correct operation. Therefore an additional 3-volt regulator was needed. The 3 volt regulator (U3) is a small PCB which possesses all the required components for the correct operation of a variable regulator LM2596. It was set to output 3 volts by adjusting its calibration resistor.

### 3. DESIGN AND DEVELOPMENT

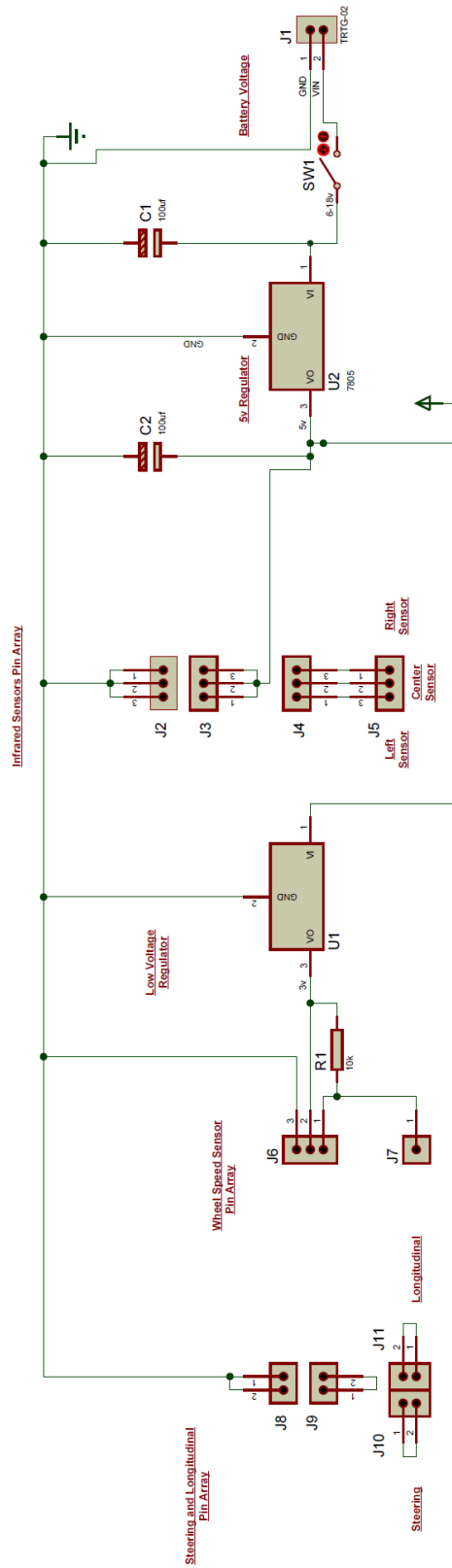

Figure 3-29: Control unit PCB electrical diagram.



### **3. DESIGN AND DEVELOPMENT**

#### Infrared Sensors Connections

In order to determine if an object is in close proximity to the rear of the vehicle, 3 infrared sensors report analogically the intensity of the infrared light reflection. Inside the SAM v71, the analog signals are compared to a fixed threshold in order to stop the vehicle when an object is detected. The sensors are connected through a 3-cable connector having one cable for the 5v power source, one for the ground and one for the analog signal output. From the connector J2, all three pins are connected to ground. In a similar way, all three pins from connector J3 are connected to the 5 v rail. The pins from connector J4 are connected to the pins in J5 in order to serve as the interface between the sensor and the SAM board. Pins from J2, J3 and J4 connectors are the ones where the 3-cable wire of each sensor is linked. The J5 goes to the SAM v71 analog pins. Specifically, J5.3, J5.2 and J5.1 connect to the left, center and right sensors and in turn to the SAM v71 pins PB03, PB02 and PA18 respectively.

#### Wheel Speed Sensor Connections

The vehicle's wheel speed is measured using a Hall Effect sensor and a built in neodymium magnet attached to the Traxxas truck's main transmission gear. Each time the gear makes a revolution, the sensor provides a pulse which is then measured by the input capture of the SAM v71. The Hall Effect sensor needs to be energized with 3 volts. Therefore, the output from the U1 regulator is connected to the J6.2 pin. The J6.3 pin connects to ground and the J6.1 connects to the J7.1 pin. The wheel speed sensor's connector is also of the 3-cable type which is linked to the J6 connector. The output pin of the sensor needs to be driven high through a 10k resistor (R1). The J7.1 pin is linked to the SAM v71 digital pins PE0 and PE1 which measure the rising and falling edges of the signal respectively.

### **3. DESIGN AND DEVELOPMENT**

#### Steering and Longitudinal Control Connections

The steering and longitudinal movement of the vehicle are controlled by the Traxxas truck embedded servomotor and Electronic Speed Control (ESC) unit respectively. Both have the standard 3-cable connector and therefore interface to the J8, J9, J10 and J11 2-pin connectors. The ground of both components is connected to the J8.2 and J8.1 pins. Power source of the ESC comes directly from the “Motion Power Unit” (NiMH 8.4v battery) and therefore the J9.1 and J9.2 pins are linked together so that the ESC can power the steering servo unit. Furthermore, the steering servomotor signal input is connected to the J10.1 pin then to the J10.2 pin and finally reaches the PD00 output PWM enabled in of the SAM v71 board. Lastly, the ESC signal input is connected to the J11.1 pin then to the J11.2 pin and finally reaches the SAM v71 PD24 output pin which is also PWM enabled.

## 4. Results and Discussion

The results from this project’s design and development include the verification of the SW from the control unit according to the defined execution sequence of the tasks as mentioned in the SW architecture. In addition, the results include the adaptations done to the Traxxas Ford F-150 Raptor platform in order to integrate the “TRA- Optical Follow Me” add-on both for the camera system and the control unit subsystems as well as the elaboration of the required interfaces such as the PCBs for the interconnection of the different components. The resulting adaptations and interconnections are mentioned in detail during this section. Furthermore, in order to prove the concept of the “TRA – Optical Follow Me”, some component and system validation tests were developed. These include the person’s face recognition and tracking by the camera system, the interface between the different sub-systems in order to move the vehicle and the cease of motion caused by detection of objects in close proximity or because the distance to the tracked person had reached the defined threshold.

### 4.1. SW Architecture Verification

In order to verify that the SW from the control unit was compliant with the defined architecture from Figure 3-18 in section 3.4.1 - “Software Architecture and Design”, it was required to perform a task execution analysis on the SW inside the SAM v71. This was done using the “Tracealyzer” tool for FreeRTOS [42] which allowed to graphically check the OS tasks execution sequence. The created graph was then be compared to the design’s architecture in order to perform the verification.

The results from the validation can be observed in Figure 4-1 where it is shown that an event called “SYSEV10MS” was triggered every 10 milliseconds. The execution of these events triggered the first task named “SYSSTATE” where the first input validation was performed.

#### 4. RESULTS AND DISCUSSION

Secondly, the tasks “KLaC” and “KLoC” were simultaneously activated and executed until end. Finally, the “DMC” task responsible of the outputs to the PWM drivers is run.

As can be seen in the extended execution graph in Figure 4-2, the process repeated its execution every 10 milliseconds with plenty of time to finish between each cycle.

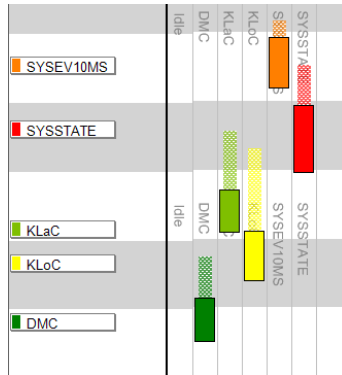

Figure 4-1: TRA-OFM OS task execution sequence.

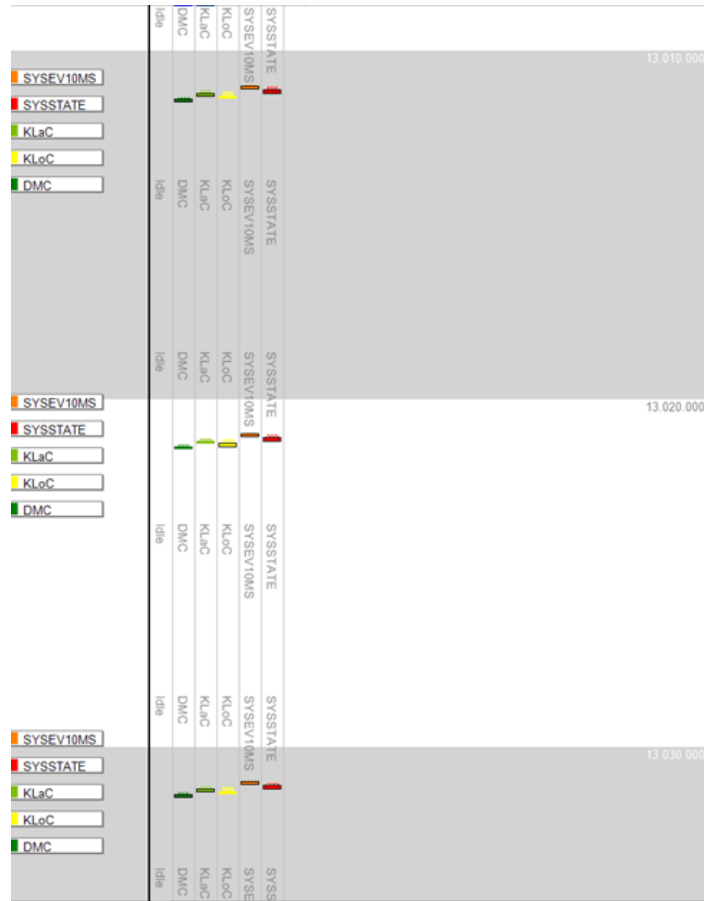

Figure 4-2: TRA-OFM OS periodical task execution.

## **4. RESULTS AND DISCUSSION**

Only a couple of difficulties arose during the implementation of the software architecture and design. The first one was the implementation of the DMA in all the low-level drivers, although the drivers were prepared to be easily configurable DMA channels, the activation of the data cache affected the output signal of the PWM. The data cache was needed by the UART driver and therefore a conflict of drivers occurred. It was difficult to identify the root-cause of the anomaly for the PWM driver since in order to identify the source of the problem, the code needed to be integrated into the project piece by piece. This method allowed the obtention of a trace for the PWM signals after each change, and therefore, debug the issue. The resulting solution was to enable the data cache, flush it and then disable it.

Another difficulty that was presented during the development was in the pin port configuration of the PWM, even though the same configuration was used for other pins, it was not possible to configure all the available channels in the SAMv71 board. To solve this problem, each PWM pin was tested individually to confirm its correct functionality, and thus, select only the working pins.

### **4.2. Vehicle Adaptation**

The vehicle adaptation included the addition of a Hall-Effect sensor to the transmission gear in order to measure its RPMs, characterization of the longitudinal and lateral control signals for later replication as well as the interconnections for the Control Unit, and mounting of the developed PCBs and Camera Assembly over the truck's chassis.

#### **4.2.1 Addition of the Hall Effect Sensor**

By adding a magnet to the vehicle's transmission gear as well as a Hall-effect sensor in the transmission housing, it was possible to detect the passing of the magnet near the sensor each time the gear completed a revolution. By doing so, no mechanical connection was required in order to

#### 4. RESULTS AND DISCUSSION

obtain the gear's angular speed. Also, by knowing how many rotations of the gear equal a rotation of the vehicle's wheels, together with the radius of the wheel, it was possible to calculate the longitudinal speed of the vehicle assuming no wheel slip occurred. In order to place the Hall-Effect sensor, the "Traxxas Truck" right rear wheel as well as the transmission casing had to be removed. Then, a small neodymium magnet was attached to the bigger gear of the transmission using a custom housing. Furthermore, the Hall-effect sensor was placed in the inside of the transmission cover so that when reassembled, the magnet would pass quite close to the sensor. The placement of the Hall-effect sensor over the transmission gear is shown in Figure 4-3.

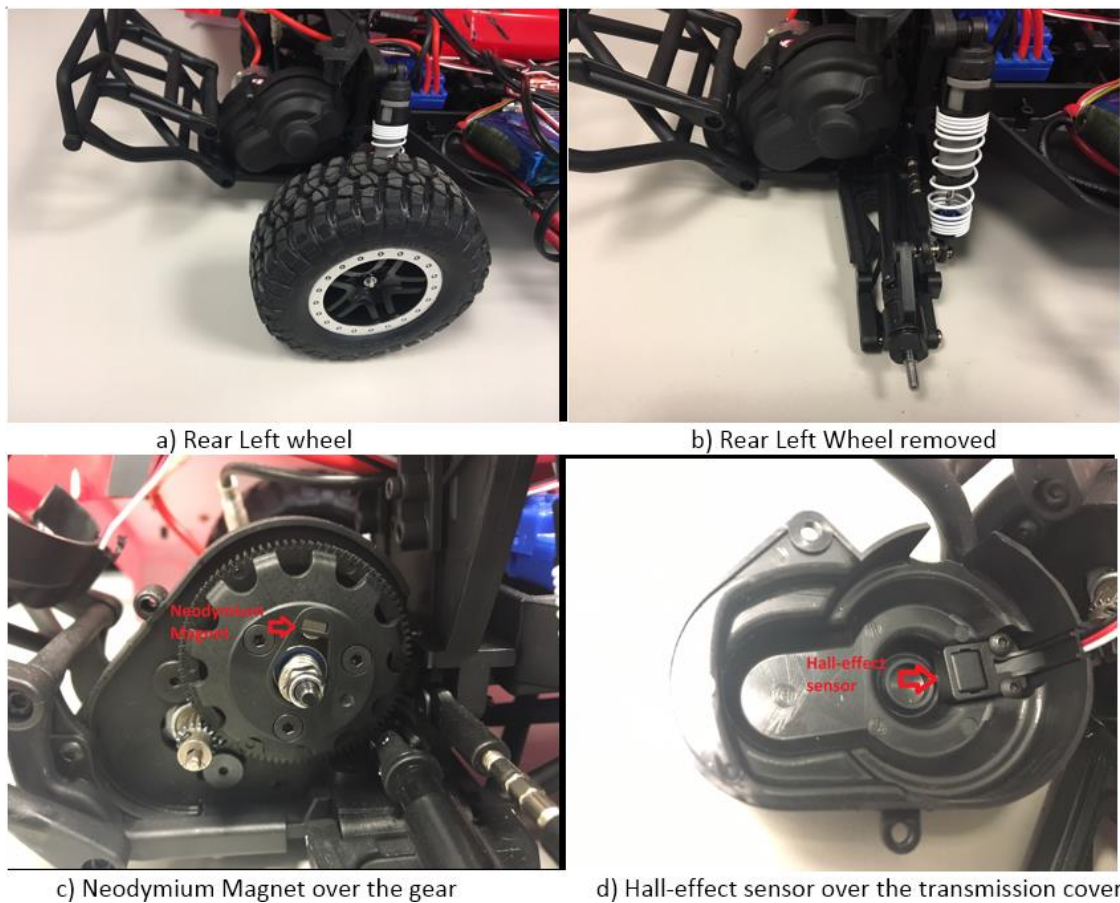

*Figure 4-3: Hall-Effect sensor placement.*

After measuring the complete power train ratios from the DC motor, passing through the transmission, the differential, the Cardan-joint and finally reaching the rear wheels, it was determined that the input to output ratio was of  $1:16/205 \approx 0.07804$  as observed in Figure 4-4.

#### 4. RESULTS AND DISCUSSION

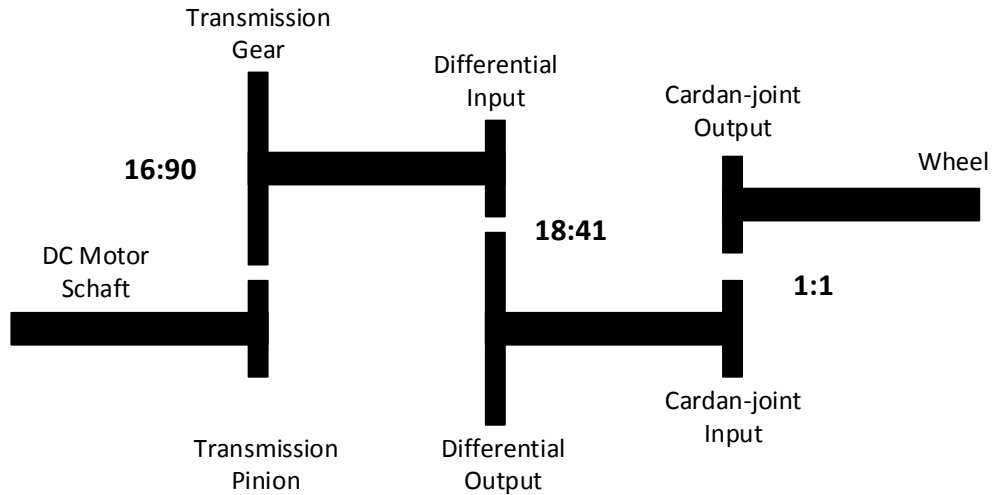

Figure 4-4: Traxxas truck power train ratios.

By knowing that the Hall Effect sensor is located on the transmission gear (gear to wheel ratio of 18:41), and that the vehicle's wheel had a radius of 5.588cm, then each pulse of the Hall-effect sensor was equal to :

$$Distance\ per\ pulse = 2 * \pi * (5.588cm) * \left(\frac{18}{41}\right) = 15.414cm$$

With this information, it was possible to determine the instantaneous speed of the vehicle by measuring the difference in time between pulses.

$$Vehicle\ Speed = \frac{0.15414\ m}{\Delta pulse\ time} \quad (4-1)$$

## 4. RESULTS AND DISCUSSION

### 4.2.2 Characterization of Signals

In order to control the steering servo and the ESC of the Traxxas truck, the first step was to characterize the signals that were being sent by the RFC Receiver. This characterization included the type of wave, its voltage, frequency or period, duty cycle and zone of no operation (Dead Zone). This characterization was easily made using an oscilloscope. The observed signals can be seen in Figure 4-5. It was observed that both the ESC and the steering Servomotor signal were of the standard PWM type commonly used in normal servomotors applications. With this information it was possible to replicate the signals using the DMA in two DIO pins of the SAM v71 board. The results from this characterization are shown in Table 4-1.

*Table 4-1: Traxxas truck signals characterization.*

| Component           | Type   | Voltage | Command               | Duty Cycle | Signal Period | Dead Zone from Center   |
|---------------------|--------|---------|-----------------------|------------|---------------|-------------------------|
| ESC                 | Square | 0-3v    | Full Forward Throttle | 20%        | 10ms          | Forward: 1.5 - 1.55 ms  |
|                     |        |         | Neutral               | 15%        |               | none                    |
|                     |        |         | Full Reverse Throttle | 10%        |               | Backward: 1.5 - 1.45 ms |
| Steering Servomotor | Square | 0-3v    | Full Right            | 20%        | 10ms          | none                    |
|                     |        |         | Center                | 15%        |               |                         |
|                     |        |         | Full Left             | 10%        |               |                         |



a) Neutral position: 1.5ms

b) Full Reverse or Left: 1.0ms



c) Full Forward or Right: 2.0ms

*Figure 4-5: ESC/Steering signal characterization.*



## **4. RESULTS AND DISCUSSION**

Furthermore, the signal provided by the Hall Effect sensor was of the same type as the one from ESC and steering servomotor. The only differences were that the period changed depending on the angular speed of the transmission's gear. When the magnet was right above or quite near of the Hall Effect sensor, the observed voltage was of 3v, otherwise, the voltage was 0v. By measuring the delta of time between Falling edges, it was possible to accurately measure the vehicle's speed as described in Equation 4-1.

### **4.2.3 Vehicle Adaptation Connections**

In order to control the Traxxas truck, the camera system, the control unit, its corresponding auxiliary PCBs, and the proximity sensors had to be mounted on the truck's chassis. Also, some connections had to be performed in the vehicle's actuators including the addition of the instrumentation LiPo battery. All this was done with the help of several sets of screws, nuts and hot glue. The right, left, front, rear, top and top without cover views of the final truck with adaptations can be seen in Figure 4-6, Figure 4-7, Figure 4-8, Figure 4-9, Figure 4-10, and Figure 4-11 respectively.

#### 4. RESULTS AND DISCUSSION

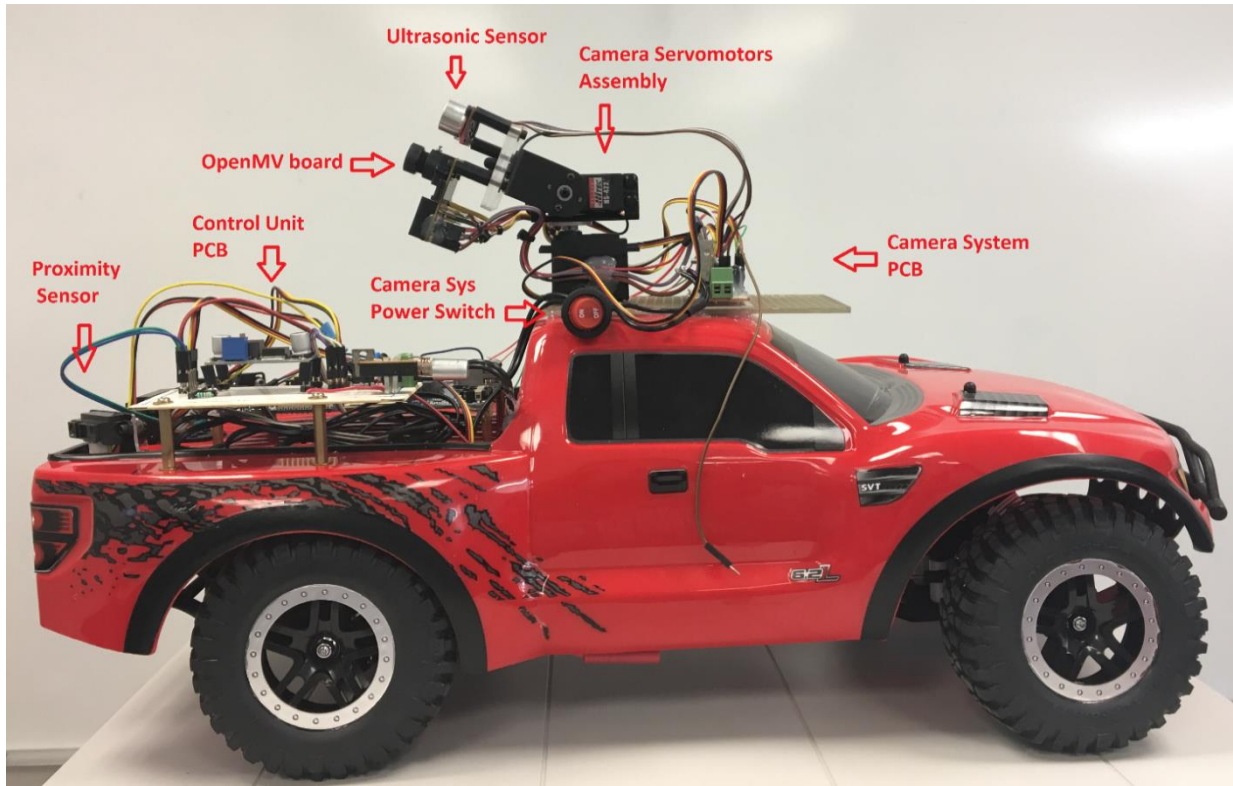

Figure 4-6: Modified Traxxas truck - right view.

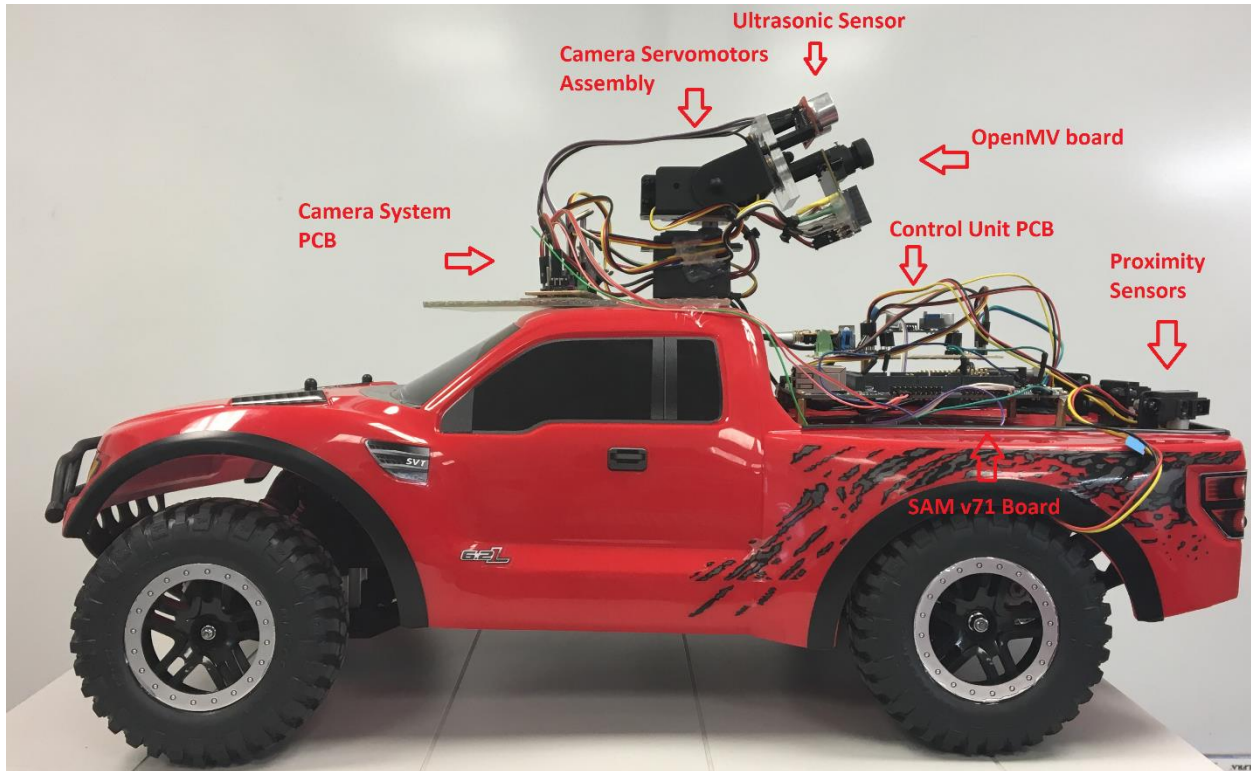

Figure 4-7: Modified Traxxas truck - left view.

## 4. RESULTS AND DISCUSSION



Figure 4-8: Modified Traxxas truck - front view.

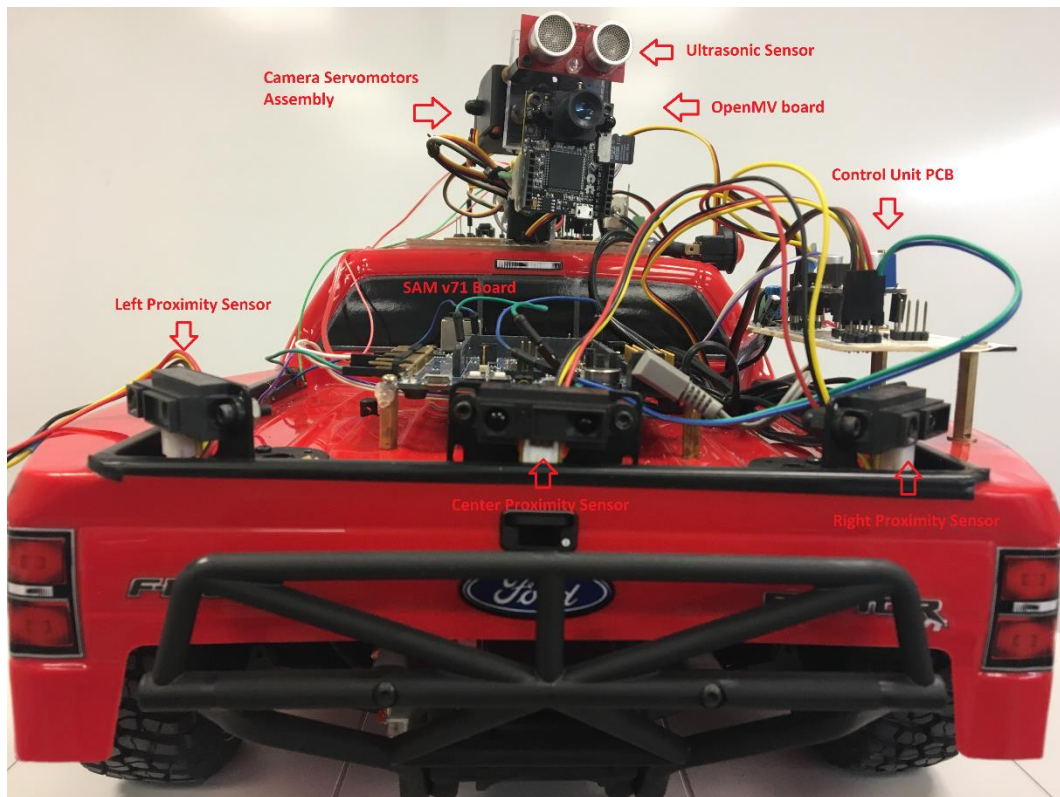

Figure 4-9: Modified Traxxas truck - rear view.

#### 4. RESULTS AND DISCUSSION

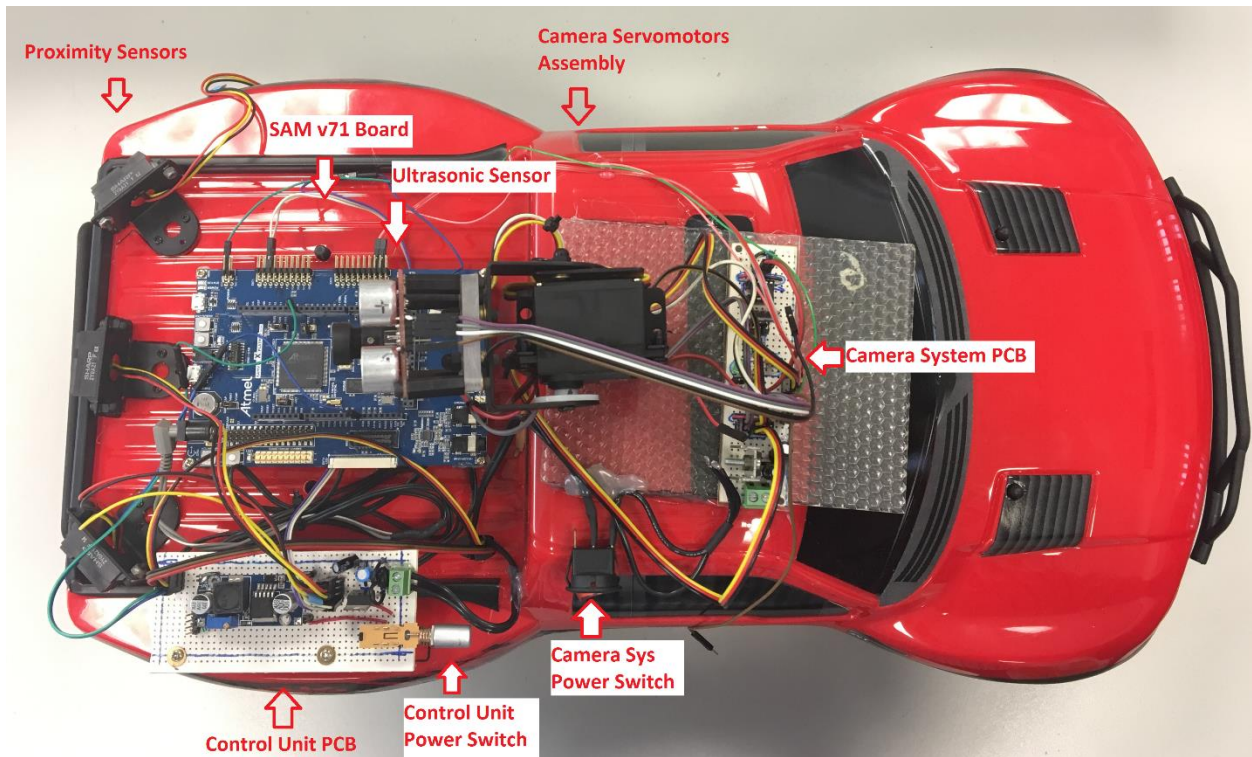

Figure 4-10: Modified Traxxas truck -top view.



Figure 4-11: Modified Traxxas truck - top (no cover) view.

## 4. RESULTS AND DISCUSSION

### 4.3. Control Unit Connections

In order to link the Control Unit (SAM v71 board), to the infrared sensors, the hall-effect sensor, the ESC and steering servomotor as well as to have a way to power each one of these components, it was necessary to build a PCB that could serve as an interconnection bridge. The resulting PCB for the control unit can be observed in Figure 4-12. The reference for the function of each component was discussed in detail in section 3.4.2 – “Hardware Architecture and Design”. The resulting PCB was designed to be bigger than required in order to have space for expansions in future works.

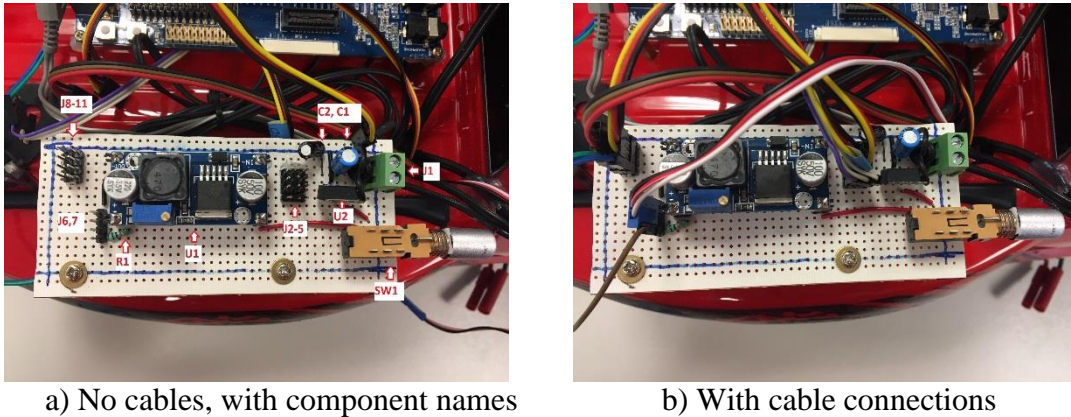

Figure 4-12: Control unit PCB result.

After the PCB was constructed, it was thoroughly verified for errors using a multi-meter for continuity checks. This verification proved to be quite useful since more than one mistake was found and corrected and damage to the electric components was prevented.

### 4.4. Camera System Connections

The camera system includes the interface to several components such as the ultrasonic sensor, the servomotors from the pan-tilt assembly, the SPI interface for communication with the

#### 4. RESULTS AND DISCUSSION

control unit, and the CAN transceiver for future expansions. All these connections could not be performed in an efficient way solely by the OpenMV board since the mentioned components needed to also be powered by 5v, which is not the same potential difference that the instrumentation power source provides. In order to solve the problem, an independent camera system PCB was constructed. It was quite similar in design to the PCB from the control unit. The built camera system PCB can be observed in Figure 4-13. Similar to the control unit's PCB, the explanation to each component can be found in section 3.4.2 – “Hardware Architecture and Design”.

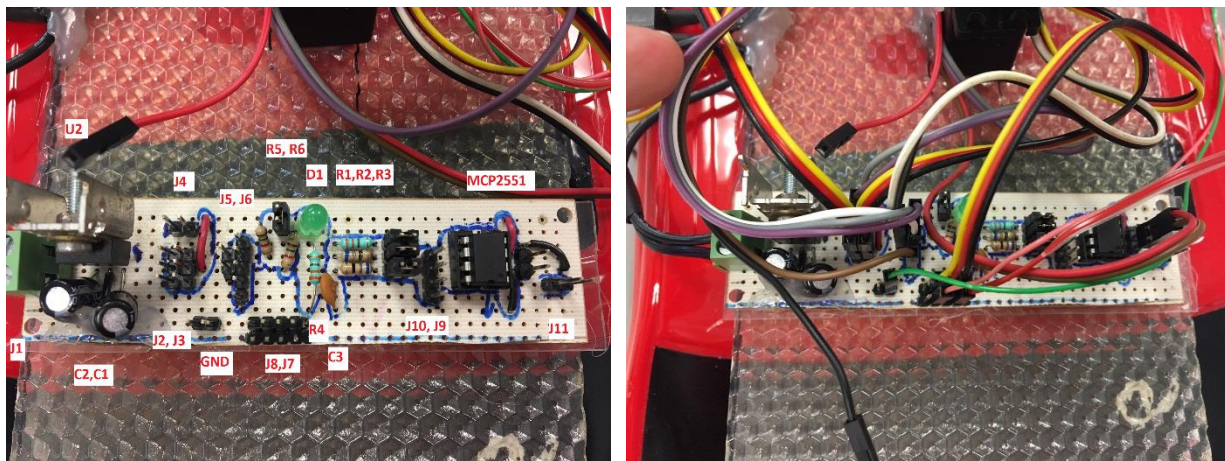

a) No cables, with component names.

b) With cable connections

*Figure 4-13: Camera system PCB result.*

It is important to mention that the pin connectors J7 and J8 were made larger in order to easily allocate additional interfaces. Furthermore, the voltage regulator (U2) required a heat sink since during the testing stages its temperature became quite high within just a few minutes of operation. Moreover, as previously discussed, the MCP CAN transceiver was included in the PCB so that when the OpenMV firmware is updated to support CAN, then it would already have the required hardware to do the communications switch from SPI to CAN for the interface between the control unit and the camera system. Finally, it is important to mention that the switch SW1 of the camera system's PCB cannot be seen on the image since it is located on the side of the vehicle as can be observed in Figure 4-10.

## 4. RESULTS AND DISCUSSION

### 4.5. System Validation

The proof of concept of the “TRA- Optical Follow Me” add-on was done through a series of system tests for the main functionalities that the system was intended to carry out. These tests included in first instance, the verification of the person’s face and correct tracking only with the camera system, and secondly, the person’s tracking and corresponding standstill reach by the vehicle when a near object was detected or when the person was too close. These second set of tests were performed in a room with controlled light in order to prevent disturbances to the person’s tracking system. The room has also a grid on the ground in order to ease the identification of the vehicle’s movement (Figure 4-14). In the following subsections, each of the performed tests results will be explained.



*Figure 4-14: Test-room overview.*

## 4. RESULTS AND DISCUSSION

### 4.5.1 Person Face Identification and Tracking

By using the Haar Cascade Classifier for the detection of a person's face and setting the configurations as described in Table 4-2, it was possible to obtain the best results for an QVGA image in grayscale with almost 100% detectability. Furthermore, the characteristics of the lens used for the camera was a telephoto-lens of 12mm with a FOV of 29 degrees. As previously mentioned, the Haar Cascade Classifier was included in the OpenMV internal libraries.

*Table 4-2: Haar Cascade Classifier configurations*

| Classifier Configurations | Value |
|---------------------------|-------|
| Classifier Stages         | 25    |
| Scale Factor              | 1.2   |
| Threshold                 | 65%   |

The first test performed with the camera system was to verify that the camera was able to detect the person within the required range of 2m to 5m. As seen in Figure 4-15, the detectability of the camera proved to be from 1.8m to 5.1m with the telephoto-lens. In order to identify the correct detection, the camera system was programmed so that a white square was drawn around the detected person's face. Also, a white cross was placed in the center of the said square so that a coordinate could be used for the tracking. The square and the cross can only be seen when the OpenMV board was connected to the computer.



a) Person Identification at 1.8m

b) Person Identification at 5.1m

*Figure 4-15: Camera system - length identification test results.*



#### **4. RESULTS AND DISCUSSION**

Secondly, it was necessary to validate if the camera was able to track a person while it was moving with the refresh rate of 160ms imposed by all the tasks that needed to be performed inside the camera system. The validation consisted on asking a person to slowly walk into the camera's fixed field of view. Once inside the field of view, the person was asked to move horizontally and vertically, including being partially out of the field of view.

The results showed that the person was only detected by the system when the face was completely inside the field of view of the camera. Furthermore, the tracking could be clearly seen when the person moved side to side or up and down. Finally, the results from the mentioned test can be observed in Figure 4-16 sections a-g.

#### 4. RESULTS AND DISCUSSION

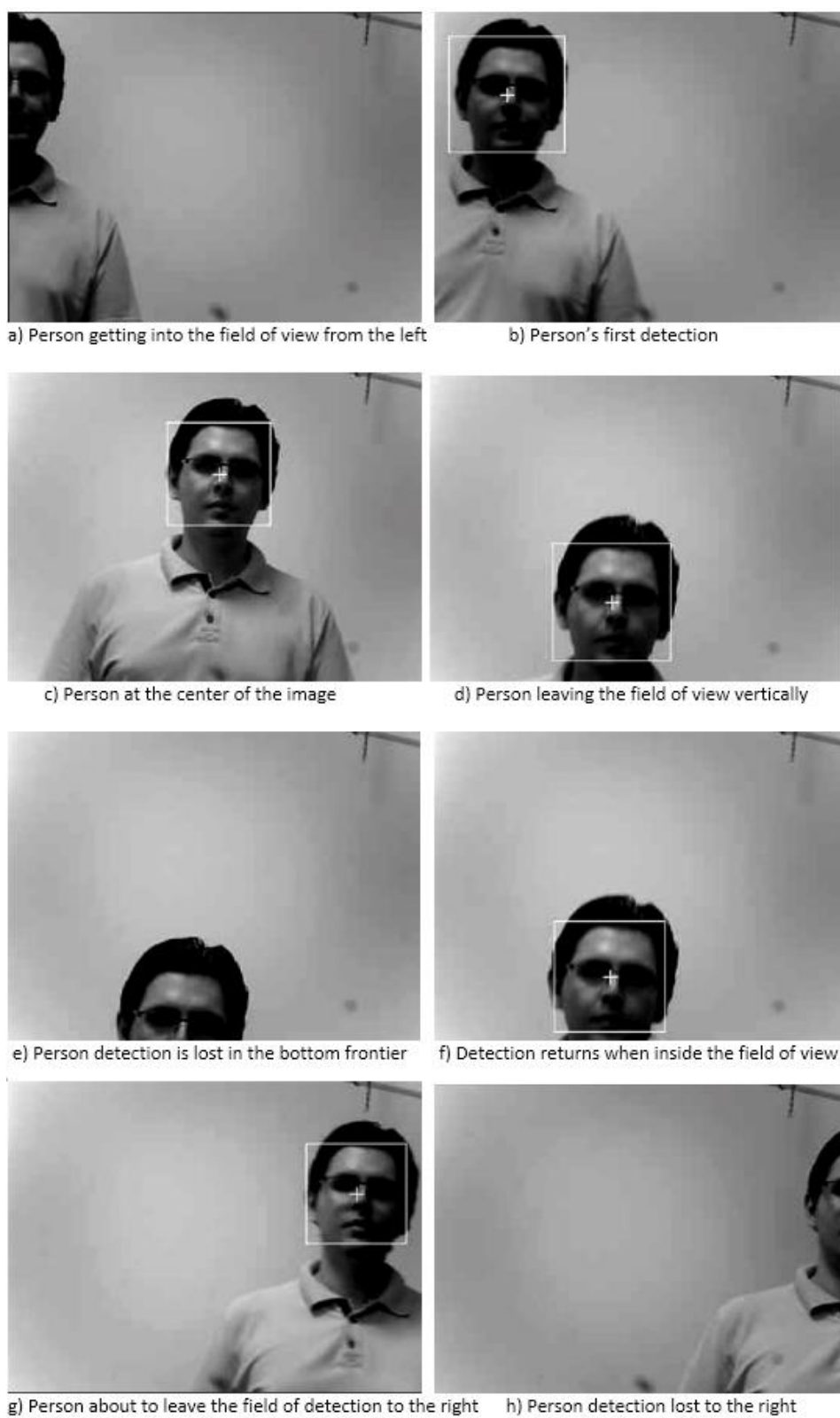
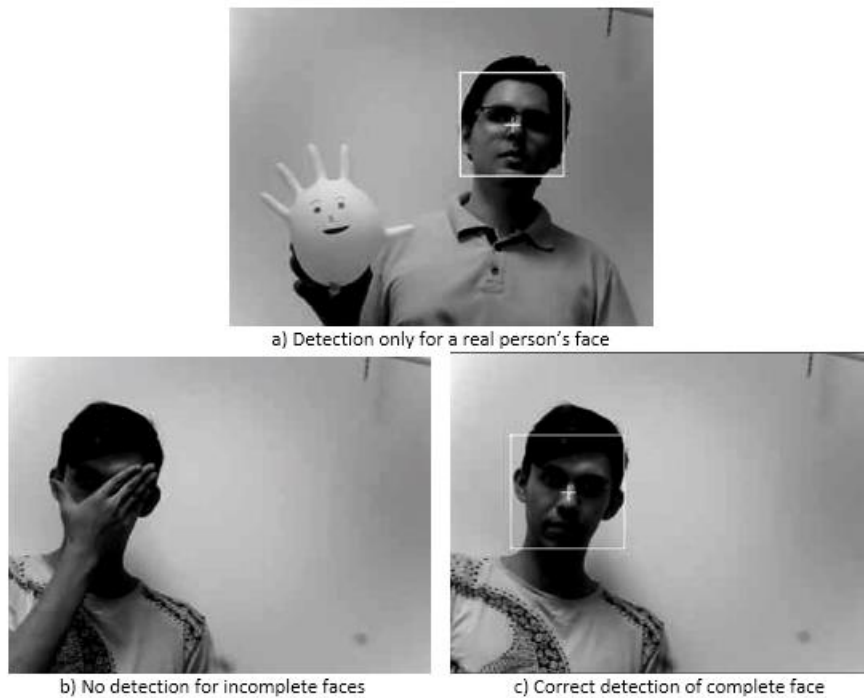

*Figure 4-16: Camera system - person face tracking results.*

#### 4. RESULTS AND DISCUSSION

The third camera test consisted in validating that the Haar Cascade Classifier was only identifying a complete real person's face and that it was not reporting false positives. In addition, if two persons are identified on the field of view, then only one shall be tracked. In order to do so, a drawn face was added to the field of view together with a real person. The camera system was programmed so that a square was drawn around each detected person's face, however, the white cross was only placed on the single tracked person.

The results from the third test were successful with the configurations from Table 4-2, zero false positive detections were present and the tracking was only made with a single person, even for more than 1 detection. The results of the false negative test can be observed in Figure 4-17, while the single person detection can be observed in Figure 4-18.



*Figure 4-17: Camera system -no false positives on face detections.*

#### 4. RESULTS AND DISCUSSION

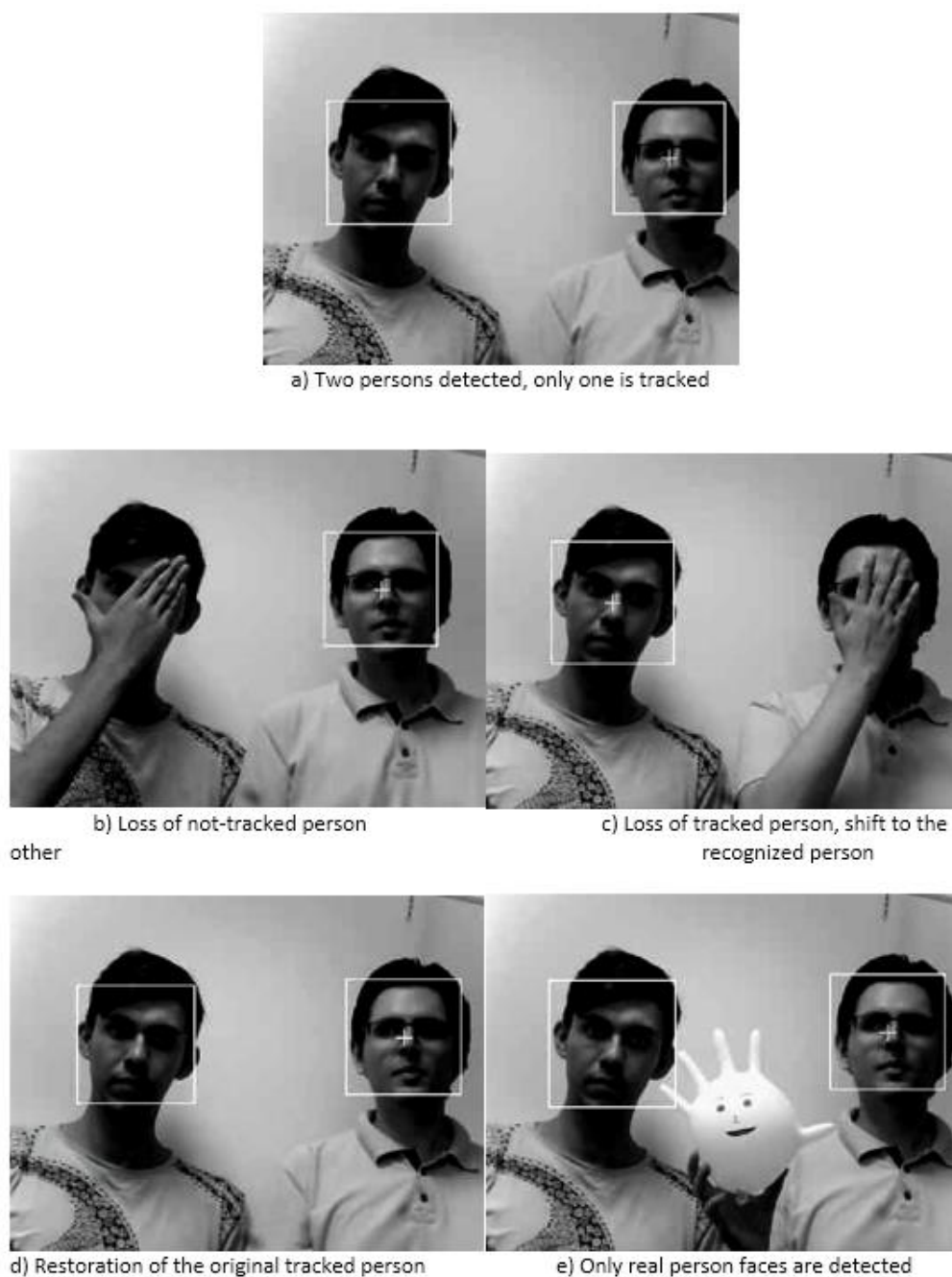

*Figure 4-18: Camera system - single person tracking results.*

It is important to mention that the validation of the camera recognition and tracking was made with the available testing samples/subjects at the time of the testing. Future validations in order to certify the level of quality of the detection on a wide variety of image samples are suggested.

## 4. RESULTS AND DISCUSSION

### 4.5.2 Vehicle - Person Following

One of the key features of the “TRA-Optical Follow Me” is the vehicle’s ability to move backwards and steer towards the location of the person after being detected. Once a person’s face is identified, then a measurement is taken of how far the person is located either to the left or right compared to the center of the camera’s image. Since the camera is centered on the vehicle’s longitudinal axis, then, it can be assumed that any deviation from the center of the camera’s image is a deviation from the longitudinal axis of the vehicle. In this particular case, the vertical deviation is also measured so that, together with the horizontal deviation, the camera and ultrasonic sensors can be tilted and panned in order to point directly at the person’s face.

The servomotor assembly is responsible for performing the necessary rotations to guarantee that the camera and ultrasonic sensors are pointing in the correct direction. Moreover, since the servomotors are controlled through a PWM signal, which represents an angle, then the same angle can be transmitted to the control unit (SAM v71 board) through SPI so that the steering of the vehicle can also be adjusted.

Also, since the movement of the vehicle is at low speeds and the camera system only updates the position of the person every 160ms, then, no significant oscillations were detected in neither the servomotor assembly nor the vehicle’s steering. However, some error in the stationary state could be observed.

The resulting tracking of a person can be observed in Figure 4-19 where multiple photos of a person being followed by the vehicle can be seen.

#### 4. RESULTS AND DISCUSSION



a) Person is detected and the vehicle starts to move backwards.



b) Person moves to the left, the vehicle starts steering accordingly in order to follow the person.



c) Person moves to the other direction, and the vehicle follows accordingly.



d) Start of a sharp turn.



e) Sharp turn being performed.



f) Sharp turn successfully completed.

*Figure 4-19: Vehicle - person following test-case.*

## 4. RESULTS AND DISCUSSION

### 4.5.3 Vehicle – Stop before Collision

The second key feature that the system must possess is the ability to detect nearby objects that the vehicle can collide with if the backwards movement were to continue and based on that information, stop before a collision occurs. In order to prevent said collisions, a set of infrared sensors were strategically placed at the back of the Traxxas truck. In addition, the control unit was calibrated so that if any object got closer to a defined threshold, then the signal to the ESC would not be sent and in consequence the vehicle would stop. It is important to mention that the Traxxas Ford F-150, being a model, does not include a braking feature. However, because of all the power train friction, the vehicle was able to stop within an acceptable distance from the moment that the ESC motion command was removed.

In order to test this feature, two test-cases were developed. In the first, the person passed over an obstacle while being followed by the vehicle. The vehicle continued its motion towards the person, however, the motion was ceased when the obstacle was detected to be in close proximity to the back of the car, and thus, a collision was prevented. The second test-case consisted in moving an object towards the vehicle's path when it was following a person. Once the vehicle stopped, the obstacle was removed in order to allow the vehicle to continue moving.

The results from test-case 1 can be observed in Figure 4-20. The vehicle successfully stopped before colliding with the static obstacle, and even when the person continued to walk backwards, the vehicle did not move again.

Finally, in Figure 4-21 the results from the test-case can be verified. As soon as the obstacle appeared behind the truck, then, the vehicle stopped. Once the obstacle was removed, the backwards movement was resumed and the system continued to follow the person.

#### 4. RESULTS AND DISCUSSION



a) The vehicle starts to follow the person. A far away obstacle is present on the vehicle's path.



b) The person passes over the obstacle.  
The vehicle continues its movement towards the user.



c) The vehicle stops right before colliding with the obstacle.

*Figure 4-20: Vehicle - collision avoidance - static obstacle test-case.*



#### 4. RESULTS AND DISCUSSION

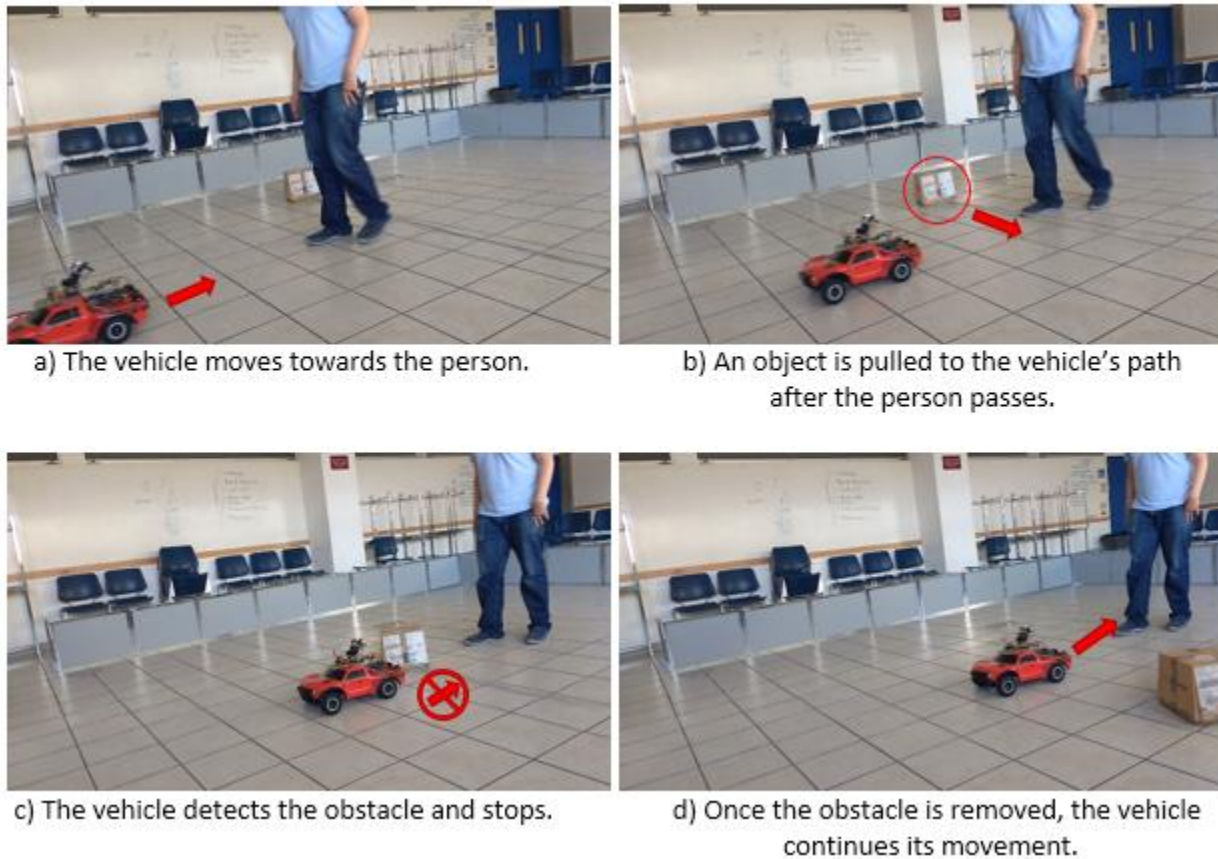

*Figure 4-21: Vehicle - collision avoidance - moving obstacle test-case.*

In addition to the object's detection, the vehicle shall try to keep a fixed distance to the person that is being followed making use of the ultrasonic sensor. In order to meet this requirement, the vehicle accelerated if it sensed that the identified person was still far away. Otherwise, if the person was deemed to be closer than a defined threshold, then the system stopped sending power to the motor, and therefore, the vehicle eventually stopped because of the power train friction. This behavior can be observed in Figure 4-22.

#### 4. RESULTS AND DISCUSSION



a) The vehicle accelerates after detecting a person's face, and determining that the person is far away.



b) The person stops. When the distance threshold is reached, the vehicle ceases its movement.

*Figure 4-22: Vehicle - collision avoidance - distance keeping test-case.*

## **5. Conclusions**

### **5.1. System Description**

Throughout subsections 3.1-“System Functional Requirements” and 3.2-“System Architecture” the system requirements and architecture of the “TRA – Optical Follow Me” add-on were defined. Specifically, for the requirements, the required inputs, outputs, system behavior, and design constraints were specified. These requirements are implementation independent and therefore, they apply for any vehicle where a basic TRA-Core system or similar is integrated. In a similar way, the described system architecture considers the basic components that are present in any trailer towing vehicle with the addition of the actors that would interact with the “TRA – Optical Follow Me” system such as the user’s HMI, helping person, and nearby objects in the vehicle’s path.

In order to perform a system proof of concept, a specific solution was proposed in subsection 3.3-“Solution”. This solution involves of installing the “TRA-Optical Follow Me” in a 1:10 scale vehicle model. The objective of this solution was to only evaluate the inputs, outputs, and behavior of the TRA-OFM and therefore the basic TRA system was out of scope. An additional result was to derive the technical architecture from the functional one based on the solution defined components. Also, the scope of the solution considers the usage of didactic components instead of automotive level components. Therefore, a way to direct the sensors and camera of the system directly towards the user had to be included. This workaround would not be needed in an automotive implementation since the automotive components would have a high enough resolution as to not require any movement.

Moreover, based on the technical architecture, the first steps of an FMEA were taken by defining the P-Diagrams for the suggested components as well as an analysis of the system’s functional vs technical characteristics inside a House of Quality Diagram.

## **5. CONCLUSIONS**

### **5.2. “TRA - Optical Follow Me” Implementation**

The system-level functional and technical architectures were used as a foundation to define the discipline specific architectures for both SW and HW. In the case of SW, the logic for the subsystems was also described in a high level using flowcharts and sequence diagrams. All these were specified on 3.4-“Implementation”. The implementation was designed so that the system could be integrated in two main components, the SAM v71 platform for the control unit, and the OpenMV board for the camera system. Both were designed to be mounted on the Traxxas Ford F-150 1:10 scale model. And thus, the design included the required interfaces to communicate with the longitudinal and lateral movement actuators of the scale model.

### **5.3. “TRA – Optical Follow Me” Validation and Proof of Concept**

Throughout Chapter 4 - “Results and Discussion”, the outcomes of the Traxxas truck model modifications are presented. These modifications include the mounting of both the camera system and the control unit over the model’s chassis, the re-routing of the ESC and steering servo reference signals from the RF receptor to the control unit’s PWM output pins, and the description of all the interconnections done between the PCB bridges and the camera system together with the control unit. In addition, since the most critical part of the system is the SW, then the results of the SW verification are included together with the observed problems encountered during the development accompanied by its corresponding solution.

Section 4.5 focuses on the validation of the system for its main functional objectives which are to steer the vehicle in order to track a person by identifying its face using a camera, preventing collisions with nearby objects by detecting them using the close proximity sensors, and keeping a fixed distance between the vehicle and the tracked person by measuring their distance with an ultrasonic sensor.

## **5. CONCLUSIONS**

Each one of the “TRA-Optical Follow Me” objectives were successfully validated and therefore, the proof of concept of the proposed system was accomplished. Evidence for each one of the objective’s realization was presented as images with their corresponding explanation and discussion. Therefore, it was proved that the TRA-OFM can be used as an alternative for the angle reference in Continentals TRA system for the situations where it is easier to be guided by a person outside of the vehicle instead of the current usage of a knob to specify the desired trailer’s trajectory manually.

### **5.4. Future Work**

The communication between the camera system and the control unit had to be done using SPI since the OpenMV board did not completely support CAN communication. A future work would be to implement the CAN protocol in order to approach more to the real world automotive solutions where the CAN interface is usually the norm.

Furthermore, the scope of this project was the definition, design, implementation and validation of the “TRA-Optical Follow Me” system in a provisional platform which is the Traxxas truck model. The next step would be to integrate the TRA-OFM into a system where the basic Trailer Reverse Assist system is already implemented. In order to perform this integration, the solution of the TRA-OFM would need to be modified for the usage of automotive level components where CAN is the mandatory communications protocol.

Finally, after the integration between the basic TRA and TRA-OFM systems, a thorough safety analysis such as a complete FMEA should be performed in order to identify critical failure points and subsequent system degradation or system safety states. This would prevent user injury or property damage in case of failure.

## 5. CONCLUSIONS

# APPENDIX





# A. L2 TECHNICAL ARCHITECTURE P-DIAGRAMS

## Sensorics

|                                                                                                                                                           |                                                                                                                                              |                                                                                                                                       |                                                                                                          |                                                                                                                                             |
|-----------------------------------------------------------------------------------------------------------------------------------------------------------|----------------------------------------------------------------------------------------------------------------------------------------------|---------------------------------------------------------------------------------------------------------------------------------------|----------------------------------------------------------------------------------------------------------|---------------------------------------------------------------------------------------------------------------------------------------------|
| <b>NOISE 1: Piece to Piece</b><br>Small variations in power consumption<br>Small variations in internal impedance<br>Small variations in provided voltage | <b>NOISE 2: Change Over Time</b><br>Impedance variations<br>Delivered voltage variations<br>Carcas material degradation<br>Dust accumulation | <b>NOISE 3: Customer Usage</b><br>System Overvoltage<br>Temperature shocks<br>Mechanical impacts<br>System overheat<br>Short circuits | <b>NOISE 4: External Environment</b><br>EMC noise<br>Ambient temperature<br>Humidity<br>Dust<br>UV Light | <b>NOISE 5: System Interaction</b><br>Heat from other systems<br>Power source variations<br>System Vibration<br>EMC noise<br>Current Spikes |
|-----------------------------------------------------------------------------------------------------------------------------------------------------------|----------------------------------------------------------------------------------------------------------------------------------------------|---------------------------------------------------------------------------------------------------------------------------------------|----------------------------------------------------------------------------------------------------------|---------------------------------------------------------------------------------------------------------------------------------------------|

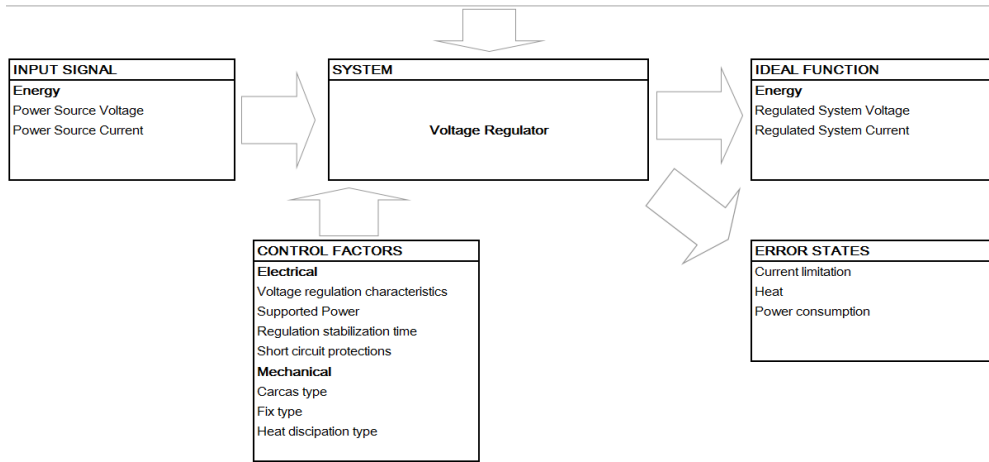

|                                        |                                                                                                                                                     |                                                                                                                                                                                                |                                                                                                                                                                                  |                                                                                                                           |
|----------------------------------------|-----------------------------------------------------------------------------------------------------------------------------------------------------|------------------------------------------------------------------------------------------------------------------------------------------------------------------------------------------------|----------------------------------------------------------------------------------------------------------------------------------------------------------------------------------|---------------------------------------------------------------------------------------------------------------------------|
| <b>NOISE 1: Piece to Piece</b><br><NA> | <b>NOISE 2: Change Over Time</b><br>Lenses degradation<br>Loss of focus<br>Mounting degradation<br>Loosening<br>Information/power conductos degrada | <b>NOISE 3: Customer Usage</b><br>Not cleaning the camera lenses<br>Not alligning the camera to the trailer<br>Crashing which would result in...<br>... deformation of the rear of the trailer | <b>NOISE 4: External Environment</b><br>Rain/fog (light obstructing medium)<br>Lighting changes<br>Debrils/condensation covering the lenses.<br>EMC noise<br>Ambient Temperature | <b>NOISE 5: System Interaction</b><br>Heat from other systems<br>Power source variations<br>System Vibration<br>EMC noise |
|----------------------------------------|-----------------------------------------------------------------------------------------------------------------------------------------------------|------------------------------------------------------------------------------------------------------------------------------------------------------------------------------------------------|----------------------------------------------------------------------------------------------------------------------------------------------------------------------------------|---------------------------------------------------------------------------------------------------------------------------|

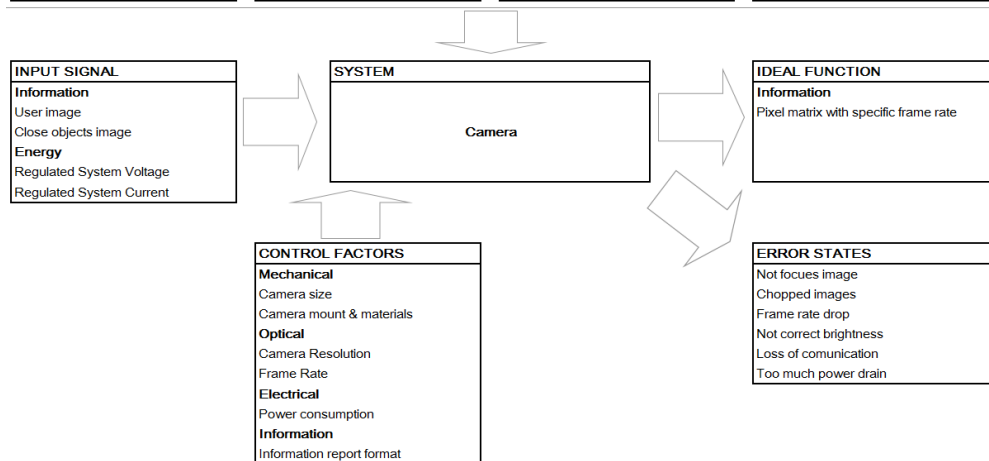

|                                                                                                                          |                                                                                                                           |                                                                                                                 |                                                                                                     |                                                                                                 |
|--------------------------------------------------------------------------------------------------------------------------|---------------------------------------------------------------------------------------------------------------------------|-----------------------------------------------------------------------------------------------------------------|-----------------------------------------------------------------------------------------------------|-------------------------------------------------------------------------------------------------|
| <b>NOISE 1: Piece to Piece</b><br>Contacts electric characteristics<br>Dimensions differences<br>Carcas color variations | <b>NOISE 2: Change Over Time</b><br>Dielectric degradation<br>Contacts wear<br>Plastic carcas wear<br>Plastic degradation | <b>NOISE 3: Customer Usage</b><br>Too much force applied<br>Scratch the carcas<br>Apply force in wrong diretion | <b>NOISE 4: External Environment</b><br>EMC noise<br>Heat<br>Dust<br>Voltage variations<br>Humidity | <b>NOISE 5: System Interaction</b><br>Heat<br>Vibration<br>Voltage variations<br>Current Spikes |
|--------------------------------------------------------------------------------------------------------------------------|---------------------------------------------------------------------------------------------------------------------------|-----------------------------------------------------------------------------------------------------------------|-----------------------------------------------------------------------------------------------------|-------------------------------------------------------------------------------------------------|

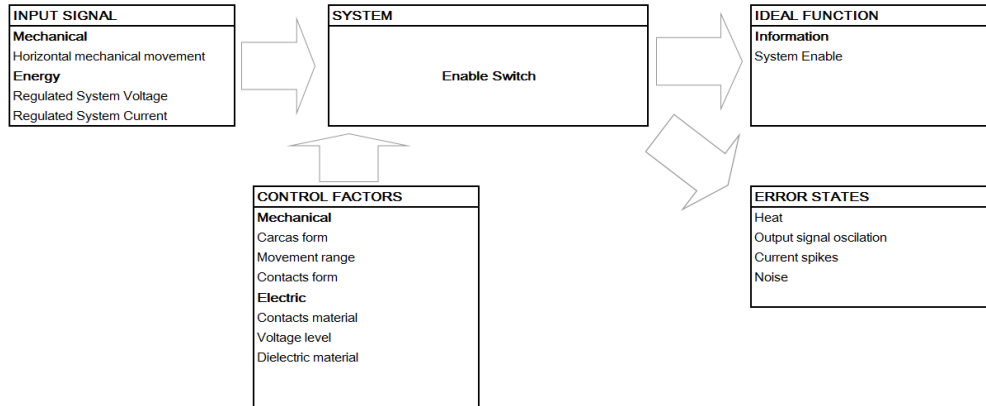

|                                                      |                                                                                                                     |                                                                                                                                          |                                                                                                          |                                                                                                                         |
|------------------------------------------------------|---------------------------------------------------------------------------------------------------------------------|------------------------------------------------------------------------------------------------------------------------------------------|----------------------------------------------------------------------------------------------------------|-------------------------------------------------------------------------------------------------------------------------|
| <b>NOISE 1: Piece to Piece</b><br>Sensor Calibration | <b>NOISE 2: Change Over Time</b><br>Displacement<br>Sensor fatigue, burn out<br>Conectors degradation<br>Loosenning | <b>NOISE 3: Customer Usage</b><br>Power source quality<br>Short circuits<br>Sensor damage<br>Incorrect connection<br>Incorrect alignment | <b>NOISE 4: External Environment</b><br>Dust<br>Condensation<br>Rain<br>EMC noise<br>Ambient temperature | <b>NOISE 5: System Interaction</b><br>Power source variations<br>EMC noise<br>System Vibration<br>Heat<br>Tire skidding |
|------------------------------------------------------|---------------------------------------------------------------------------------------------------------------------|------------------------------------------------------------------------------------------------------------------------------------------|----------------------------------------------------------------------------------------------------------|-------------------------------------------------------------------------------------------------------------------------|

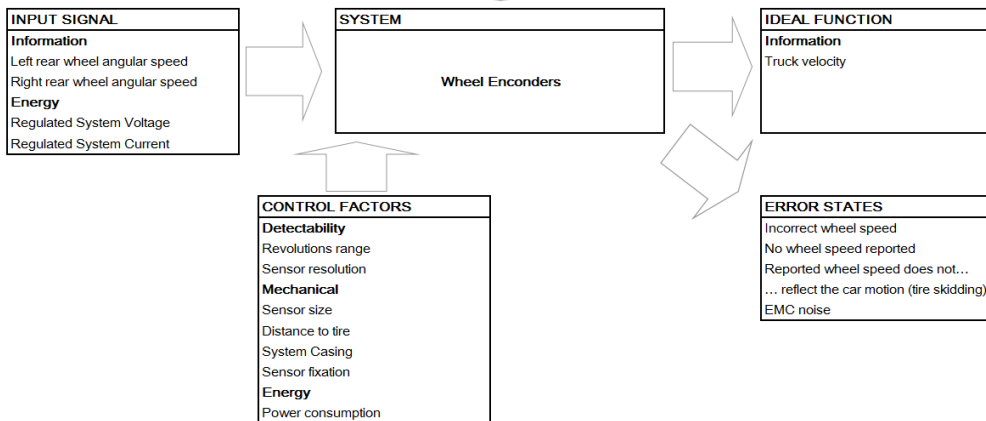

|                                        |                                                                                                                                                                    |                                                                                                                         |                                                                                                          |                                                                                                                                                            |
|----------------------------------------|--------------------------------------------------------------------------------------------------------------------------------------------------------------------|-------------------------------------------------------------------------------------------------------------------------|----------------------------------------------------------------------------------------------------------|------------------------------------------------------------------------------------------------------------------------------------------------------------|
| <b>NOISE 1: Piece to Piece</b><br><NA> | <b>NOISE 2: Change Over Time</b><br>Flash memory degradation<br>Heat dissipation insufficiency<br>PCB aging/degradation<br>Metal corrosion<br>Connectors loosening | <b>NOISE 3: Customer Usage</b><br>Power source quality<br>Short circuits (passing current)<br>Incorrect casing fixation | <b>NOISE 4: External Environment</b><br>UV light<br>Dust<br>Humidity<br>Ambient Temperature<br>EMC noise | <b>NOISE 5: System Interaction</b><br>Power source variations<br>Not focused image<br>Incorrect frame rate<br>Not appropriate lighting<br>System vibration |
|----------------------------------------|--------------------------------------------------------------------------------------------------------------------------------------------------------------------|-------------------------------------------------------------------------------------------------------------------------|----------------------------------------------------------------------------------------------------------|------------------------------------------------------------------------------------------------------------------------------------------------------------|

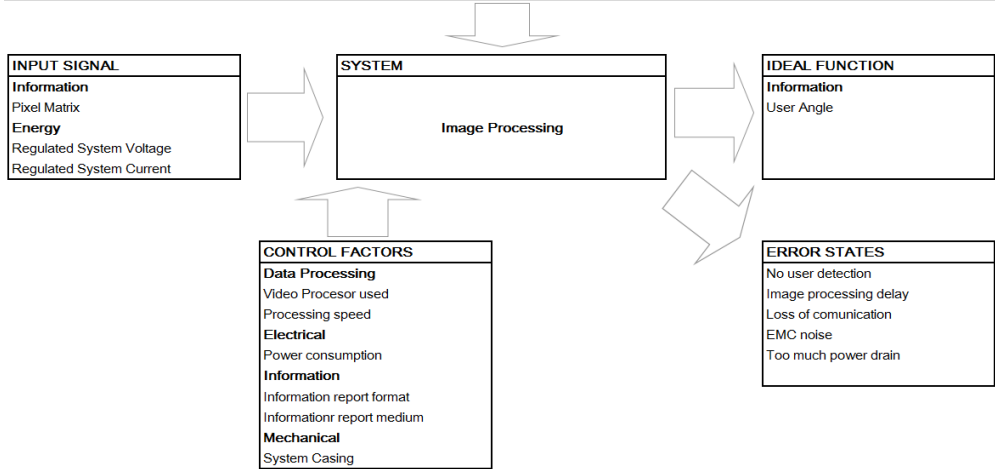

|                                                      |                                                                                                                             |                                                                                                                   |                                                                                                          |                                                                                                |
|------------------------------------------------------|-----------------------------------------------------------------------------------------------------------------------------|-------------------------------------------------------------------------------------------------------------------|----------------------------------------------------------------------------------------------------------|------------------------------------------------------------------------------------------------|
| <b>NOISE 1: Piece to Piece</b><br>Sensor Calibration | <b>NOISE 2: Change Over Time</b><br>Mounting degradation<br>Sensor fatigue, burn out<br>Connectors degradation<br>Loosening | <b>NOISE 3: Customer Usage</b><br>Power source quality<br>Short circuits<br>Sensor damage<br>Incorrect connection | <b>NOISE 4: External Environment</b><br>Dust<br>Condensation<br>Rain<br>EMC noise<br>Ambient temperature | <b>NOISE 5: System Interaction</b><br>Power source variations<br>EMC noise<br>System Vibration |
|------------------------------------------------------|-----------------------------------------------------------------------------------------------------------------------------|-------------------------------------------------------------------------------------------------------------------|----------------------------------------------------------------------------------------------------------|------------------------------------------------------------------------------------------------|

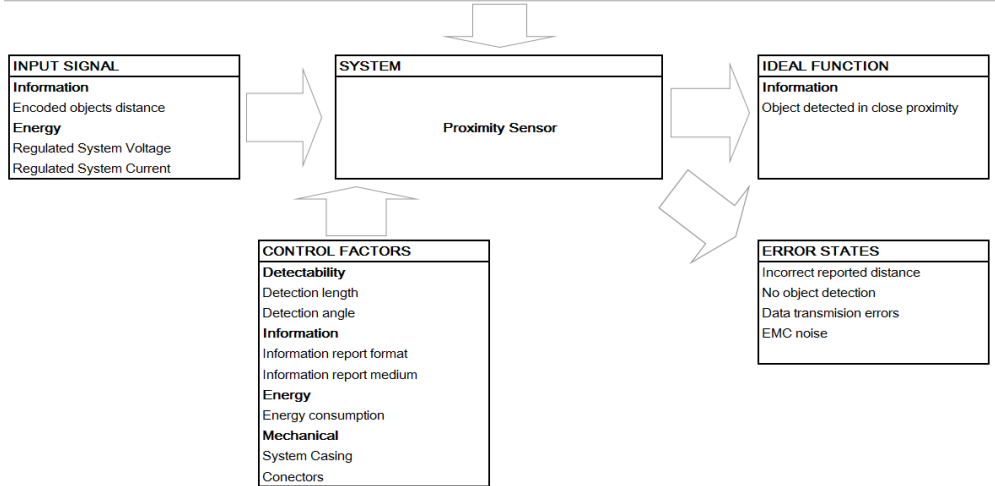

# Control Unit

|                                        |                                                     |                                                            |                                                   |                                                                                                                         |
|----------------------------------------|-----------------------------------------------------|------------------------------------------------------------|---------------------------------------------------|-------------------------------------------------------------------------------------------------------------------------|
| <b>NOISE 1: Piece to Piece</b><br><NA> | <b>NOISE 2: Change Over Time</b><br>ADC calibration | <b>NOISE 3: Customer Usage</b><br>Low power source quality | <b>NOISE 4: External Environment</b><br>EMC noise | <b>NOISE 5: System Interaction</b><br>Corrupt Data<br>Power Loss<br>Loss of communication<br>Too much noise on signals. |
|----------------------------------------|-----------------------------------------------------|------------------------------------------------------------|---------------------------------------------------|-------------------------------------------------------------------------------------------------------------------------|

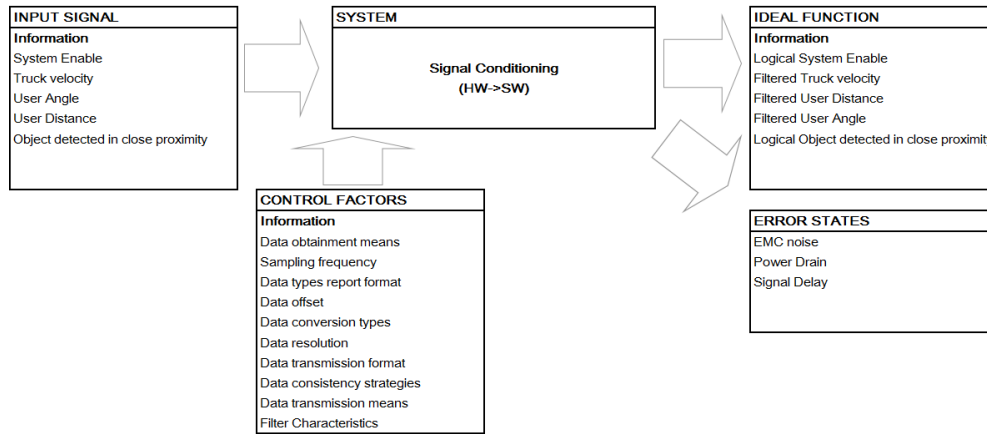

|                                        |                                          |                                        |                                              |                                            |
|----------------------------------------|------------------------------------------|----------------------------------------|----------------------------------------------|--------------------------------------------|
| <b>NOISE 1: Piece to Piece</b><br><NA> | <b>NOISE 2: Change Over Time</b><br><NA> | <b>NOISE 3: Customer Usage</b><br><NA> | <b>NOISE 4: External Environment</b><br><NA> | <b>NOISE 5: System Interaction</b><br><NA> |
|----------------------------------------|------------------------------------------|----------------------------------------|----------------------------------------------|--------------------------------------------|

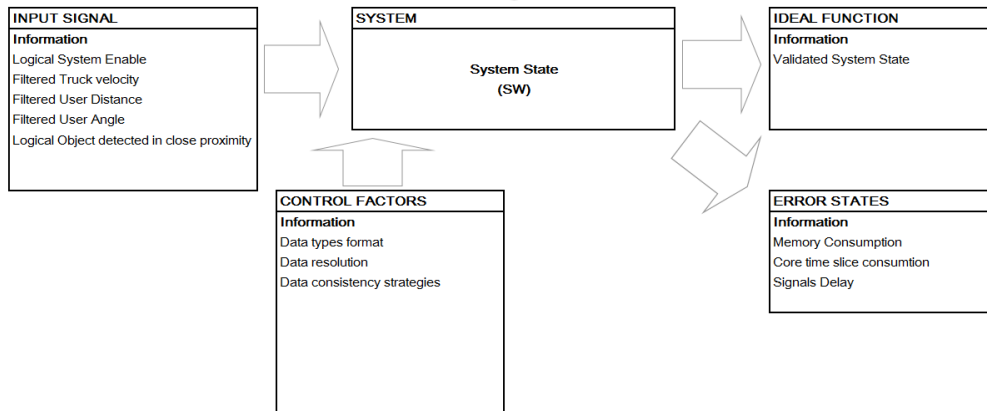

|                                |                                  |                                |                                      |                                    |
|--------------------------------|----------------------------------|--------------------------------|--------------------------------------|------------------------------------|
| <b>NOISE 1: Piece to Piece</b> | <b>NOISE 2: Change Over Time</b> | <b>NOISE 3: Customer Usage</b> | <b>NOISE 4: External Environment</b> | <b>NOISE 5: System Interaction</b> |
| <NA>                           | <NA>                             | <NA>                           | <NA>                                 | <NA>                               |

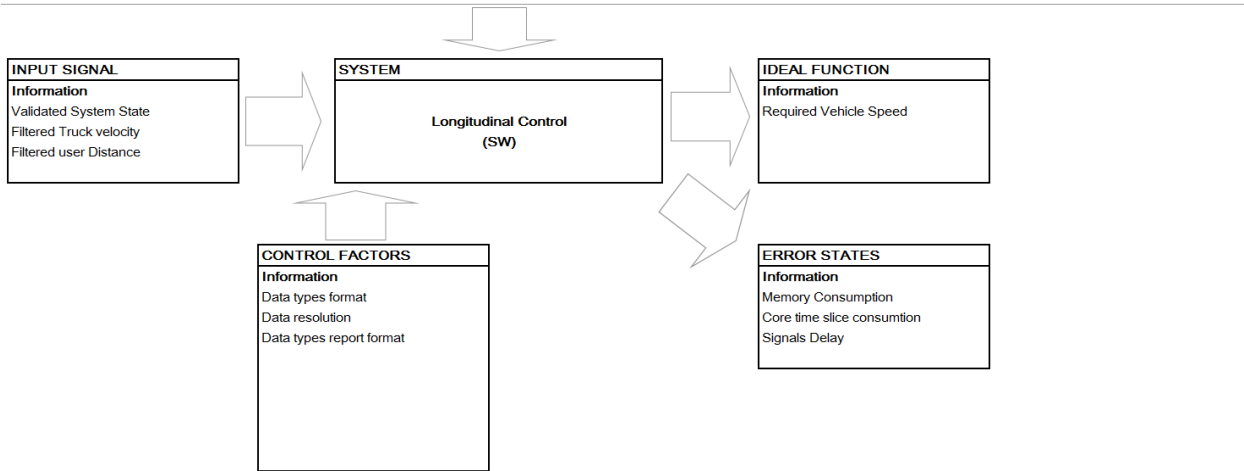

|                                |                                  |                                |                                      |                                    |
|--------------------------------|----------------------------------|--------------------------------|--------------------------------------|------------------------------------|
| <b>NOISE 1: Piece to Piece</b> | <b>NOISE 2: Change Over Time</b> | <b>NOISE 3: Customer Usage</b> | <b>NOISE 4: External Environment</b> | <b>NOISE 5: System Interaction</b> |
| <NA>                           | <NA>                             | <NA>                           | <NA>                                 | <NA>                               |

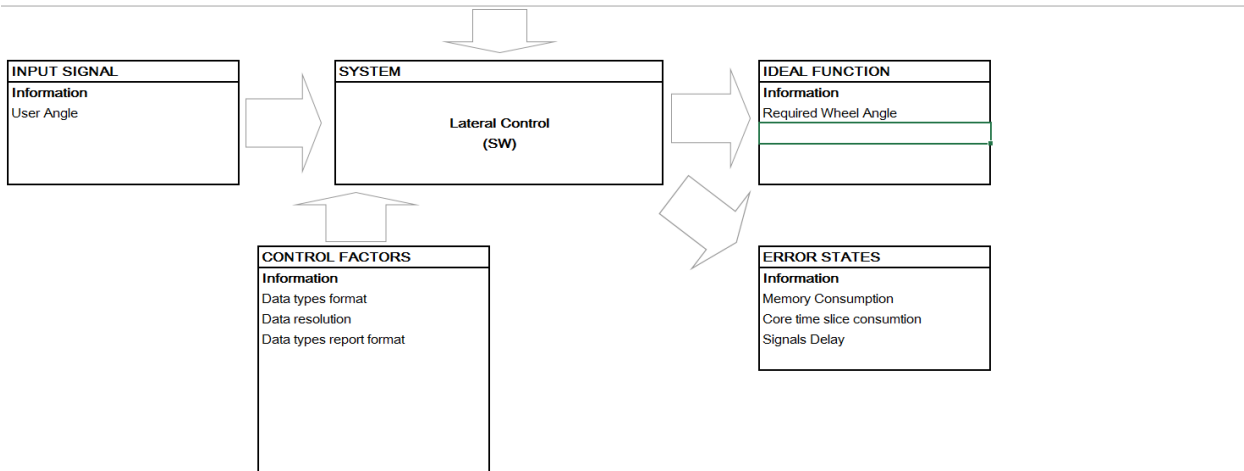

|                                            |                                              |                                                            |                                                   |                                                                                           |
|--------------------------------------------|----------------------------------------------|------------------------------------------------------------|---------------------------------------------------|-------------------------------------------------------------------------------------------|
| <b>NOISE 1: Piece to Piece</b><br><br><NA> | <b>NOISE 2: Change Over Time</b><br><br><NA> | <b>NOISE 3: Customer Usage</b><br>Low power source quality | <b>NOISE 4: External Environment</b><br>EMC noise | <b>NOISE 5: System Interaction</b><br>Corrupt Data<br>Power Loss<br>Loss of communication |
|--------------------------------------------|----------------------------------------------|------------------------------------------------------------|---------------------------------------------------|-------------------------------------------------------------------------------------------|

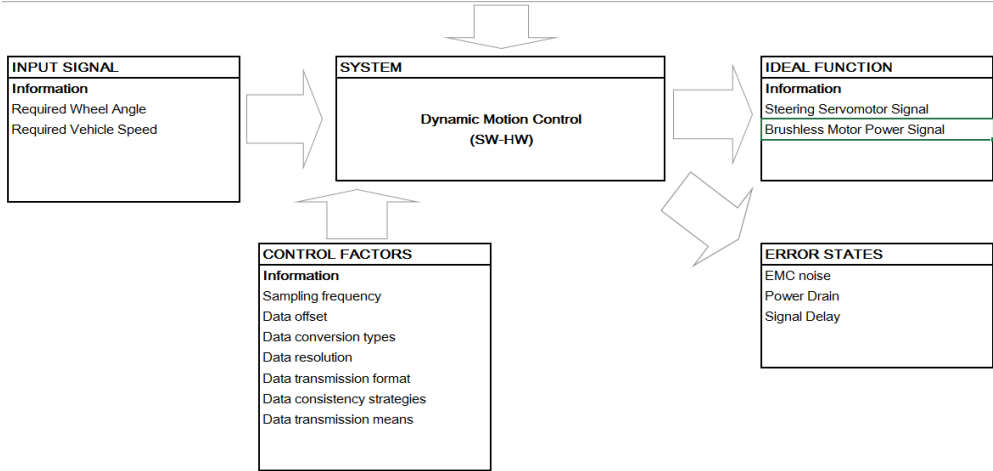

# Traxxas Truck

|                                                          |                                                                                                          |                                                                                                                                            |                                                                                                          |                                                                                                     |
|----------------------------------------------------------|----------------------------------------------------------------------------------------------------------|--------------------------------------------------------------------------------------------------------------------------------------------|----------------------------------------------------------------------------------------------------------|-----------------------------------------------------------------------------------------------------|
| <b>NOISE 1: Piece to Piece</b><br>Zero point calibration | <b>NOISE 2: Change Over Time</b><br>Gears teeth wear<br>DC motor wear<br>DC motor magnetic field changes | <b>NOISE 3: Customer Usage</b><br>Not enough maintenance<br>Insufficient lubrication<br>Too much mechanical effort<br>Power source quality | <b>NOISE 4: External Environment</b><br>UV light<br>Dust<br>Humidity<br>Ambient Temperature<br>EMC noise | <b>NOISE 5: System Interaction</b><br>EMC noise<br>Control signal out of phase<br>Vibration<br>Heat |
|----------------------------------------------------------|----------------------------------------------------------------------------------------------------------|--------------------------------------------------------------------------------------------------------------------------------------------|----------------------------------------------------------------------------------------------------------|-----------------------------------------------------------------------------------------------------|

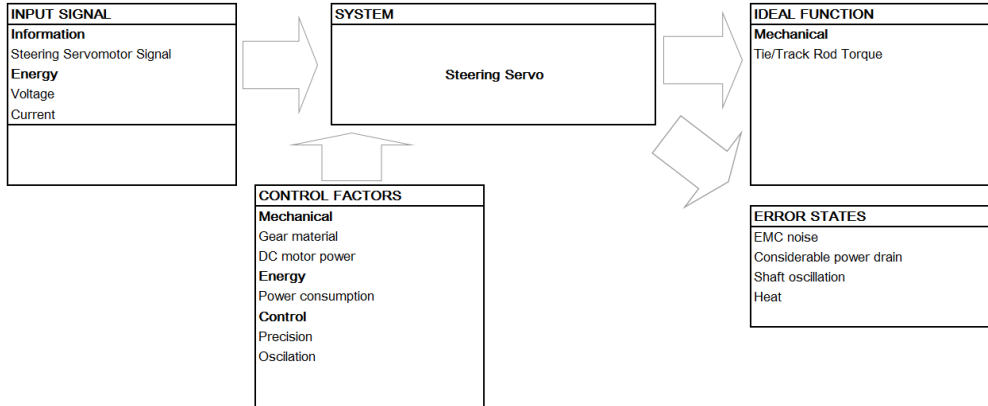

|                                              |                                                                                                                                   |                                                                                                                          |                                                                                                          |                                                                                         |
|----------------------------------------------|-----------------------------------------------------------------------------------------------------------------------------------|--------------------------------------------------------------------------------------------------------------------------|----------------------------------------------------------------------------------------------------------|-----------------------------------------------------------------------------------------|
| <b>NOISE 1: Piece to Piece</b><br>Dimintions | <b>NOISE 2: Change Over Time</b><br>Material fatigue<br>Material cracks<br>Links wear<br>Dry-up of lubrication<br>Links loosening | <b>NOISE 3: Customer Usage</b><br>Incorrect system maintenance<br>Insufficient lubrication<br>Too much mechanical effort | <b>NOISE 4: External Environment</b><br>UV light<br>Dust<br>Humidity<br>Ambient Temperature<br>Vibration | <b>NOISE 5: System Interaction</b><br>Vibration<br>Heat<br>Excessive torque<br>Friction |
|----------------------------------------------|-----------------------------------------------------------------------------------------------------------------------------------|--------------------------------------------------------------------------------------------------------------------------|----------------------------------------------------------------------------------------------------------|-----------------------------------------------------------------------------------------|

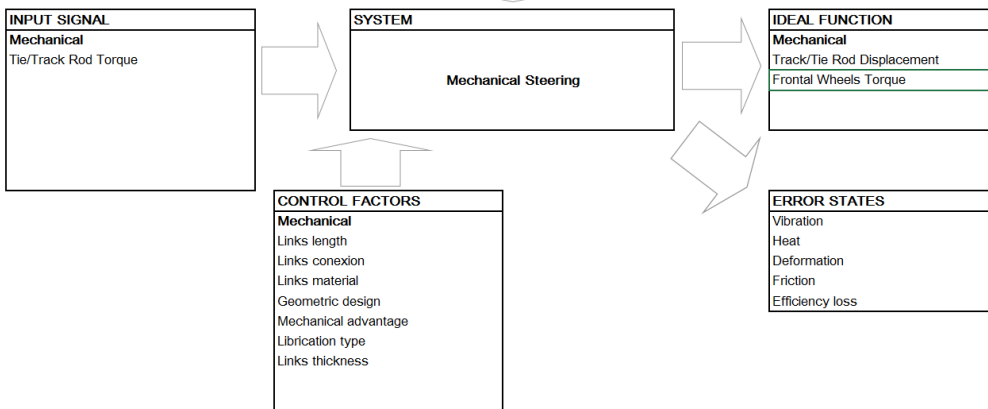

|                                                                        |                                                                                                                           |                                                                                                   |                                                                                                                                                   |                                                                                         |
|------------------------------------------------------------------------|---------------------------------------------------------------------------------------------------------------------------|---------------------------------------------------------------------------------------------------|---------------------------------------------------------------------------------------------------------------------------------------------------|-----------------------------------------------------------------------------------------|
| <b>NOISE 1: Piece to Piece</b><br>Dimentions<br>Rubber characteristics | <b>NOISE 2: Change Over Time</b><br>Material fatigue<br>Material cracks<br>Links wear<br>Rubber dry-up<br>Links loosening | <b>NOISE 3: Customer Usage</b><br>Not proper maintenance<br>Roll system through abrasive surfaces | <b>NOISE 4: External Environment</b><br>Vibration<br>Contact surface friction<br>Ambient Temperature<br>Contact surface abrasiveness.<br>Humidity | <b>NOISE 5: System Interaction</b><br>Vibration<br>Heat<br>Friction<br>Excessive torque |
|------------------------------------------------------------------------|---------------------------------------------------------------------------------------------------------------------------|---------------------------------------------------------------------------------------------------|---------------------------------------------------------------------------------------------------------------------------------------------------|-----------------------------------------------------------------------------------------|

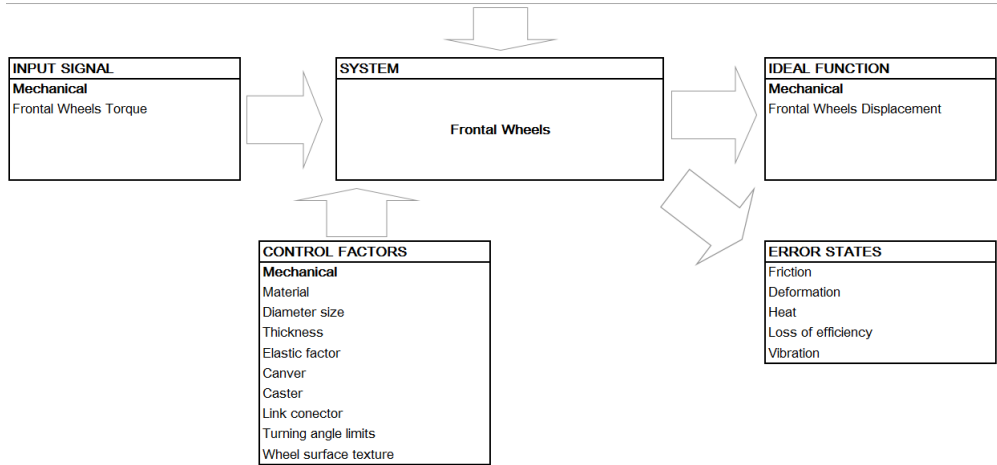

|                                        |                                                                                                                                                                |                                                                                                           |                                                                                             |                                                                                                 |
|----------------------------------------|----------------------------------------------------------------------------------------------------------------------------------------------------------------|-----------------------------------------------------------------------------------------------------------|---------------------------------------------------------------------------------------------|-------------------------------------------------------------------------------------------------|
| <b>NOISE 1: Piece to Piece</b><br><NA> | <b>NOISE 2: Change Over Time</b><br>Heat disipation insufficiency<br>PCB aging/degradation<br>Metal corrosion<br>Conectors loosening<br>Dielectric degradation | <b>NOISE 3: Customer Usage</b><br>Power source quality<br>Short circuits (passing current)<br>Motor stall | <b>NOISE 4: External Environment</b><br>UV light<br>Dust<br>Humidity<br>Ambient Temperature | <b>NOISE 5: System Interaction</b><br>EMC Noise<br>Heat<br>Vibration<br>Power source variations |
|----------------------------------------|----------------------------------------------------------------------------------------------------------------------------------------------------------------|-----------------------------------------------------------------------------------------------------------|---------------------------------------------------------------------------------------------|-------------------------------------------------------------------------------------------------|

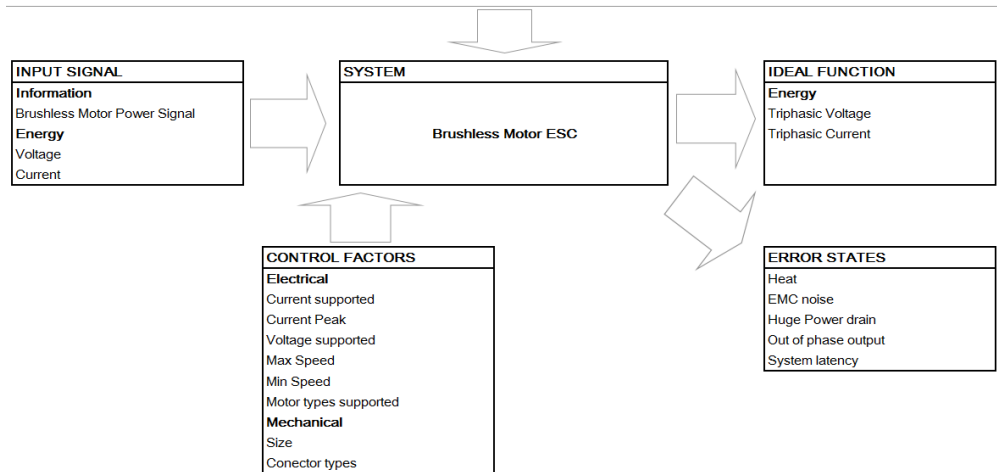



|                                                                  |                                                                                                                                            |                                                                                                                                   |                                                                                                          |                                                                                                 |
|------------------------------------------------------------------|--------------------------------------------------------------------------------------------------------------------------------------------|-----------------------------------------------------------------------------------------------------------------------------------|----------------------------------------------------------------------------------------------------------|-------------------------------------------------------------------------------------------------|
| <b>NOISE 1: Piece to Piece</b><br>Rotor Magnetic characteristics | <b>NOISE 2: Change Over Time</b><br>Magnetic fields change<br>Shaft supports wear<br>Coil magnetic characteristics<br>Coil insulation wear | <b>NOISE 3: Customer Usage</b><br>Excessive torque<br>Not enough maintenance<br>Too long use sessions<br>Insufficient Lubrication | <b>NOISE 4: External Environment</b><br>UV light<br>Dust<br>Humidity<br>Ambient Temperature<br>EMC noise | <b>NOISE 5: System Interaction</b><br>EMC Noise<br>Vibration<br>Heat<br>Power source variations |
|------------------------------------------------------------------|--------------------------------------------------------------------------------------------------------------------------------------------|-----------------------------------------------------------------------------------------------------------------------------------|----------------------------------------------------------------------------------------------------------|-------------------------------------------------------------------------------------------------|

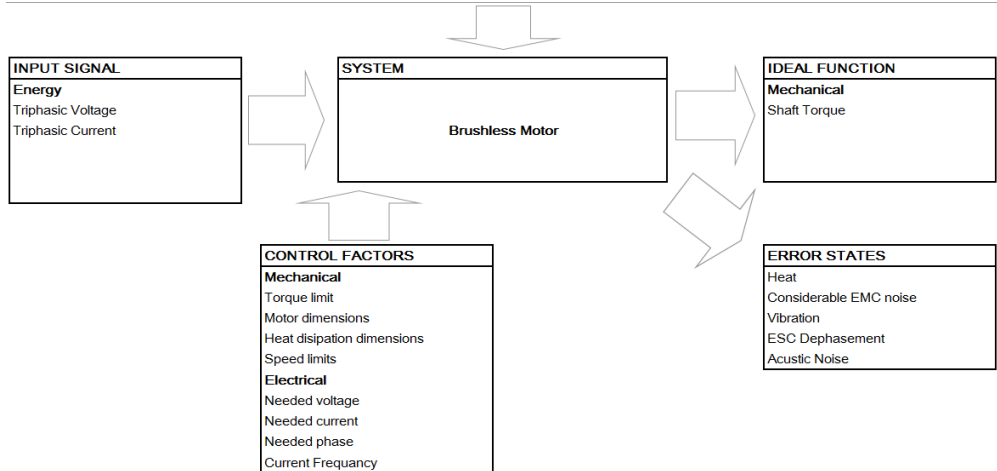

|                                        |                                                                                                           |                                                                                                                    |                                                                                                          |                                                                                         |
|----------------------------------------|-----------------------------------------------------------------------------------------------------------|--------------------------------------------------------------------------------------------------------------------|----------------------------------------------------------------------------------------------------------|-----------------------------------------------------------------------------------------|
| <b>NOISE 1: Piece to Piece</b><br><NA> | <b>NOISE 2: Change Over Time</b><br>Lubrication dry-up<br>Gears wear<br>Casing wear<br>Fixtures loosening | <b>NOISE 3: Customer Usage</b><br>Not enough maintenance<br>Insufficient lubrication<br>Too much mechanical effort | <b>NOISE 4: External Environment</b><br>UV light<br>Dust<br>Humidity<br>Ambient Temperature<br>Vibration | <b>NOISE 5: System Interaction</b><br>Vibration<br>Heat<br>Excessive torque<br>Friction |
|----------------------------------------|-----------------------------------------------------------------------------------------------------------|--------------------------------------------------------------------------------------------------------------------|----------------------------------------------------------------------------------------------------------|-----------------------------------------------------------------------------------------|

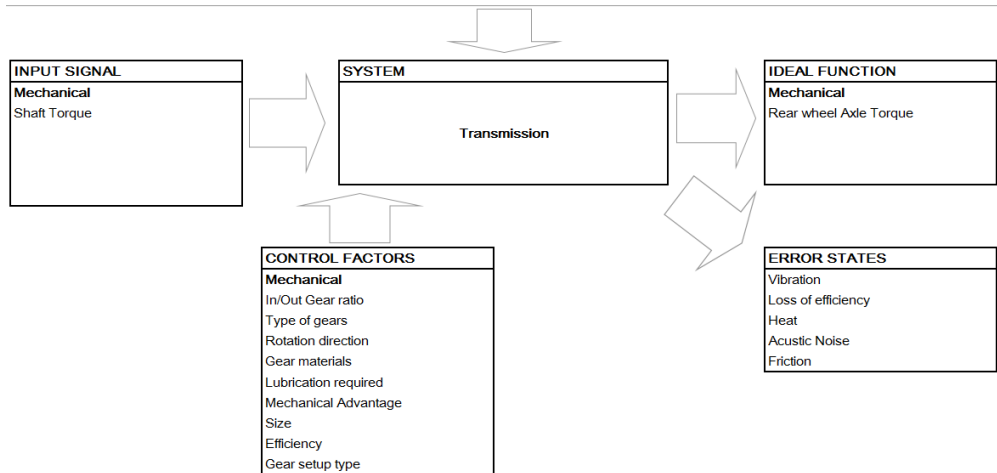

|                                                                         |                                                                                                                           |                                                                                                   |                                                                                                                                                   |                                                                                         |
|-------------------------------------------------------------------------|---------------------------------------------------------------------------------------------------------------------------|---------------------------------------------------------------------------------------------------|---------------------------------------------------------------------------------------------------------------------------------------------------|-----------------------------------------------------------------------------------------|
| <b>NOISE 1: Piece to Piece</b><br>Dimenitions<br>Rubber characteristics | <b>NOISE 2: Change Over Time</b><br>Material fatigue<br>Material cracks<br>Links wear<br>Rubber dry-up<br>Links loosening | <b>NOISE 3: Customer Usage</b><br>Not proper maintenance<br>Roll system through abrasive surfaces | <b>NOISE 4: External Environment</b><br>Vibration<br>Contact surface friction<br>Ambient Temperature<br>Contact surface abrasiveness.<br>Humidity | <b>NOISE 5: System Interaction</b><br>Vibration<br>Heat<br>Friction<br>Excessive torque |
|-------------------------------------------------------------------------|---------------------------------------------------------------------------------------------------------------------------|---------------------------------------------------------------------------------------------------|---------------------------------------------------------------------------------------------------------------------------------------------------|-----------------------------------------------------------------------------------------|

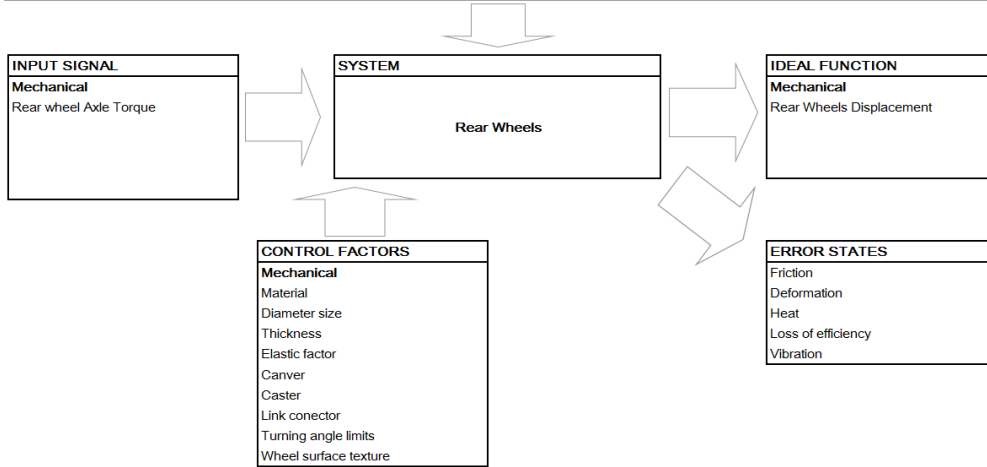

# REFERENCES

- [1] Specialty Equipment Market Association, «SEMA Annual Market Report,» [www.SEMA.org/research](http://www.SEMA.org/research), 2013.
- [2] M. H. Philip, "SYSTEM AND METHOD FOR MANEUVERING A VEHICLE-TRAILER UNIT IN REVERSE TRAVEL". US Patent 9,321,483 B2, 26 April 2016.
- [3] Ford, «Ford Service Content,» August 2016. [En línea]. Available: [http://www.fordservicecontent.com/Ford\\_Content/Catalog/owner\\_information/2017-F150-TBA-QSG-Version-1\\_QG\\_EN-US\\_08\\_2016.pdf](http://www.fordservicecontent.com/Ford_Content/Catalog/owner_information/2017-F150-TBA-QSG-Version-1_QG_EN-US_08_2016.pdf). [Último acceso: 15 Junio 2017].
- [4] D. S. R. e. al, «Trailer path curvature control for trailer backup assist». US Patente US20120271515 A1, 25 October 2012.
- [5] P. M. Headley, «System and method for maneuvering a vehicle-trailer unit in reverse travel». US Patente US20120185131 A1, 13 January 2011.
- [6] INCOSE, «Life Cycle Approaches,» de *Systems Engineering Handbook*, San Diego, CA, Wiley, 2015, pp. 32-36.
- [7] INCOSE, «System Requirements Definition Process,» de *SYSTEMS ENGINEERING HANDBOOK*, San Diego, CA, WILEY, 2015, pp. 57-58.
- [8] INCOSE, «Architecture Definition Process,» de *SYSTEMS ENGINEERING HANDBOOK*, San Diego, CA, WILEY, 2015, pp. 64-65.
- [9] P. Viola y M. Jones, «Rapid Object Detection using boosted cascade of simple features.,» de *Proceedings of the IEEE conference on computer vision and pattern recognition*, Kauai, HI, 2001.
- [10] A. Kasinski y A. Schmidt, «The architecture and performance of the face and eyes detection system based on the Haar cascade classifiers,» *Pattern Analysis and Applications*, pp. 197-211, 3 March 2009.
- [11] Pixel Union, «OpenMV About,» Professional Pixel Manipulators, 2017. [En línea]. Available: <https://openmv.io/pages/about>. [Último acceso: 15 May 2017].
- [12] KickStarter PBC, «KICKSTARTER,» 26 January 2015. [En línea]. Available: <https://www.kickstarter.com/projects/botthoughts/openmv-cam-embedded-machine-vision?lang=en>. [Último acceso: 04 June 2017].
- [13] D. George, «MicroPython,» George Robotics Limited, 2014-2017. [En línea]. Available: <https://micropython.org/>. [Último acceso: 06 06 2017].

- [14 Pixel Union, «OpenMV QuickReference,» Professional Pixel Manipulators, 2017. [En línea]. Available: <http://docs.openmv.io/openmvcam/quickref.html>. [Último acceso: 17 June 2017].
- [15 S. M. L. Valle, de *Planning Algorithms*, Illinois, Cambridge University Press, 2006, pp. 722-726.
- [16 S. M. L. Valle, de *Planning Algorithms*, Illinois, Cambridge University Press, 2006, p. 723.
- [17 Devantech Limited, «Robot Electronics,» [En línea]. Available: [https://www.robot-electronics.co.uk/htm/sonar\\_faq.htm](https://www.robot-electronics.co.uk/htm/sonar_faq.htm). [Último acceso: 17 June 2017].
- [18 V. Mágori, «Ultrasonic Sensors in Air,» de *1994 ULTRASONICS SYMPOSIUM*, Munich, Germany, 1994.
- [19 J. Pahl, «Roboter Teile,» 21 01 2009. [En línea]. Available: <http://www.roboter-teile.de/datasheets/srf08.pdf>. [Último acceso: 05 06 2017].
- [20 WARBURTON TECHNOLOGY, «WARBURTON TECHNOLOGY SRF8 Ultrasonic Sensor,» Warburton Internet, 31 July 2014. [En línea]. Available: <http://www.warburtech.co.uk/products/sensors/rangefinder/devantech.srf08.ultrasonic.rangefinder/>. [Último acceso: 17 June 2017].
- [21 P. Novotny y N. Ferrier, «Using Infrared Sensors and the Phong Illumination Model to Measure Distances,» de *International Conference on Robotics & Automation*, Detroit, Michigan, 1999.
- [22 SHARP, «SHARP World,» 01 12 2006. [En línea]. Available: [http://www.sharp-world.com/products/device/lineup/data/pdf/datasheet/gp2y0a21yk\\_e.pdf](http://www.sharp-world.com/products/device/lineup/data/pdf/datasheet/gp2y0a21yk_e.pdf). [Último acceso: 06 06 2017].
- [23 ElectronicsTutorials, «Hall Effect Sensor,» [En línea]. Available: <http://www.electronicstutorials.ws/electromagnetism/hall-effect.html>.
- [24 Atmel, «Atmel SAM V71 Xplained Ultra Evaluation Kit,» Atmel, [En línea]. Available: <http://www.atmel.com/tools/atsamv71-xult.aspx>.
- [25 R. E. Kowalski, «Real-Time Operating Systems (RTOS) 101,» NASA, [En línea]. Available: [https://www.nasa.gov/sites/default/files/482489main\\_4100\\_-\\_RTOS\\_101.pdf](https://www.nasa.gov/sites/default/files/482489main_4100_-_RTOS_101.pdf). [Último acceso: 11 07 2017].
- [26 FreeRTOS, «Free RTOS License Details,» Real Time Engineers Ltd., 2016. [En línea]. Available: <http://www.freertos.org/a00114.html>. [Último acceso: 17 June 2017].
- [27 FreeRTOS, «FreeRTOS Event Bits (or flags) and Event Groups,» Real Time Engineers Ltd., 2016. [En línea]. Available: <http://www.freertos.org/FreeRTOS-Event-Groups.html>. [Último acceso: 17 June 2017].

- [28 FreeRTOS, «FreeRTOS Queue Management,» Real Time Engineers Ltd., 2016. [En línea]. Available: <http://www.freertos.org/a00018.html>. [Último acceso: 17 June 2017].
- [29 U. Nanda y S. K. Pattnaik, «Universal Asynchronous Receiver and Transmitter (UART),» de *Advanced Computing and Communication Systems (ICACCS)*, Coimbatore, India, 2016.
- [30 Jimb0, «SparkFun Serial Communication,» SparkFun Electronics, [En línea]. Available: <https://learn.sparkfun.com/tutorials/serial-communication>. [Último acceso: 17 June 2017].
- [31 I2C Info, «I2C Bus,» I2C Info, 2017. [En línea]. Available: <http://i2c.info/>. [Último acceso: 17 June 2017].
- [32 Cypress Semiconductor Corporation, «Serial Peripheral Interface (SPI) Master 2.10,» 30 November 2010. [En línea]. Available: <http://www.cypress.com/file/132071/download>. [Último acceso: 17 June 2017].
- [33 MICROCHIP, «SPI TM,» 2017. [En línea]. Available: <http://ww1.microchip.com/downloads/en/devicedoc/spi.pdf>. [Último acceso: 17 June 2017].
- [34 R. B. GbmH, «CAN specification 2.0,» Robert Bosch GbmH, 01 09 1991. [En línea]. Available: <http://esd.cs.ucr.edu/webres/can20.pdf>.
- [35 N. Instruments, «Controller Area Network (CAN) Overview,» National Instruments, 01 08 2014. [En línea]. Available: <http://www.ni.com/white-paper/2732/en/>.
- [36 TRAXXAS, "F-150 Ramptor Overview," TRAXXAS, 2017. [Online]. Available: <https://traxxas.com/products/models/electric/58064fordraptor>. [Accessed 29 June 2017].
- [37 TRAXXAS, «TRAXXAS F-150 Ford Raptor Owner's Manual. Model 28064-1,» [En línea]. Available: <https://traxxas.com/sites/default/files/58064-1-OM-EN-R01.pdf>. [Último acceso: 29 June 2017].
- [38 Atmel, «Atmel | SMART ARM-based Flash MCU - Datasheet,» 12 October 2016. [En línea]. Available: [http://ww1.microchip.com/downloads/en/DeviceDoc/Atmel-44003-32-bit-Cortex-M7-Microcontroller-SAM-V71Q-SAM-V71N-SAM-V71J\\_Datasheet.pdf](http://ww1.microchip.com/downloads/en/DeviceDoc/Atmel-44003-32-bit-Cortex-M7-Microcontroller-SAM-V71Q-SAM-V71N-SAM-V71J_Datasheet.pdf). [Último acceso: 30 June 2017].
- [39 Atmel, «DMA Controller (XDMAC),» de *Atmel | SMART ARM-based Flash MCU - DataSheet*, San Jose, CA, Atmel Corporation, 2016, pp. 479-525.
- [40 AUTOSAR, «Layered Software Architecture,» 31 July 2015. [En línea]. Available: [http://www.autosar.org/fileadmin/files/standards/classic/4-2/software-architecture/general/auxiliary/AUTOSAR\\_EXP\\_LayeredSoftwareArchitecture.pdf](http://www.autosar.org/fileadmin/files/standards/classic/4-2/software-architecture/general/auxiliary/AUTOSAR_EXP_LayeredSoftwareArchitecture.pdf). [Último acceso: 30 June 2017].

- [41] Atmel, "Atmel Products SAM v71 Xplained Ultra Evaluation Kit - User Guide," September 2015. [Online]. Available: [http://www.atmel.com/Images/Atmel-42408-SAMV71-Xplained-Ultra\\_User-Guide.pdf](http://www.atmel.com/Images/Atmel-42408-SAMV71-Xplained-Ultra_User-Guide.pdf). [Accessed 29 June 2017].
- [42] Percepio AB, «Tracealyzer for FreeRTOS,» 2017. [En línea]. Available: <https://percepio.com/tz/freertos/trace/>. [Último acceso: 04 July 2017].
- [43] D. M. Ritchie, "C History," Bell Labs, [Online]. Available: <https://www.bell-labs.com/usr/dmr/www/chist.html>.
- [44] S. W. Smith, «The Scientist and Engineer's Guide to Digital Signal Processing Chapter 28,» California Technical Publishing, 2011. [En línea]. Available: <http://www.dspguide.com/ch28/5.htm>. [Último acceso: 17 June 2017].
- [45] D. Summerville y T. Mitchell, «Interrupt Synchronization,» de *Embedded Systems Interfacing for Engineers using the Freescale HCS08 Microcontroller II: Digital and Analog Hardware Interfacing*, Dallas, TX, US, Morgan & Claypool, 2009, p. 34.
- [46] FreeRTOS, "Features Overview," Real Time Engineers Ltd., 2016. [Online]. Available: [http://www.freertos.org/FreeRTOS\\_Features.html](http://www.freertos.org/FreeRTOS_Features.html). [Accessed 11 July 2017].