



2005

2005 Ruby Yearbook

Kevin Sylvester
Ursinus College

Britton Bongaardt
Ursinus College

Ursinus College Senior Class
Ursinus College

Follow this and additional works at: <https://digitalcommons.ursinus.edu/ruby>

 Part of the [Higher Education Commons](#), [Liberal Studies Commons](#), and the [Social History Commons](#)

[Click here to let us know how access to this document benefits you.](#)

Recommended Citation

Sylvester, Kevin; Bongaardt, Britton; and Senior Class, Ursinus College, "2005 Ruby Yearbook" (2005). *The Ruby Yearbooks*. 109.
<https://digitalcommons.ursinus.edu/ruby/109>

This Book is brought to you for free and open access by the Ursinusiana Collection at Digital Commons @ Ursinus College. It has been accepted for inclusion in The Ruby Yearbooks by an authorized administrator of Digital Commons @ Ursinus College. For more information, please contact aprock@ursinus.edu.



STRUCTURE



*All are architects of Fate,
Working in these walls of Time;
Some with massive deeds and great,
Some with ornaments of rhyme*

*Nothing useless is, or low;
Each thing in its place is best;
And what seems but idle show
Strengthens and supports the rest.*

*For the structure that we raise,
Time is with materials filled;
Our todays and yesterdays
Are the blocks with which we build.*

Henry Wadsworth Longfellow

Table of Contents

Cornerstone 4

Student Life

Supports 108

Greeks

Design 30

Special Events

Foundation 128

Faculty and Staff

Formation 58

Sports

Apex 148

Seniors

Infrastructure 82

Clubs and Organizations

Benefactors 198

Advertisements

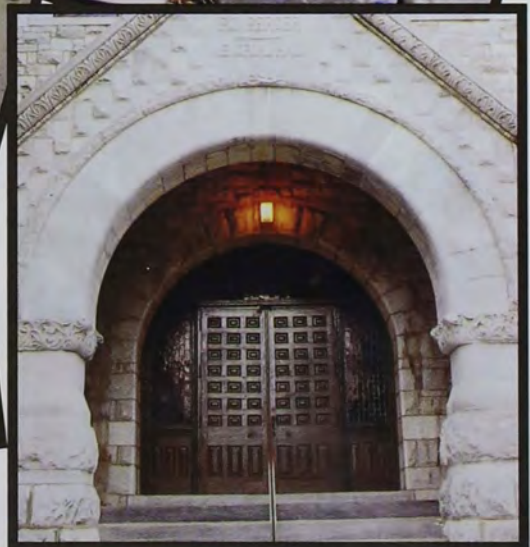
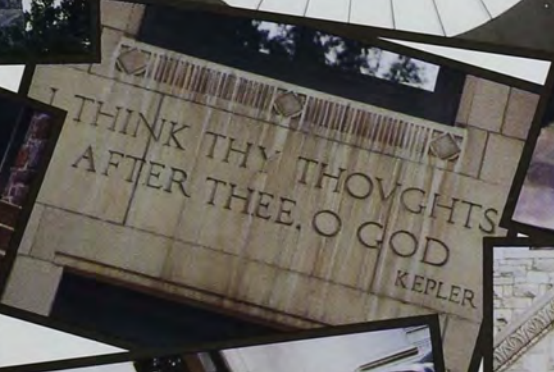
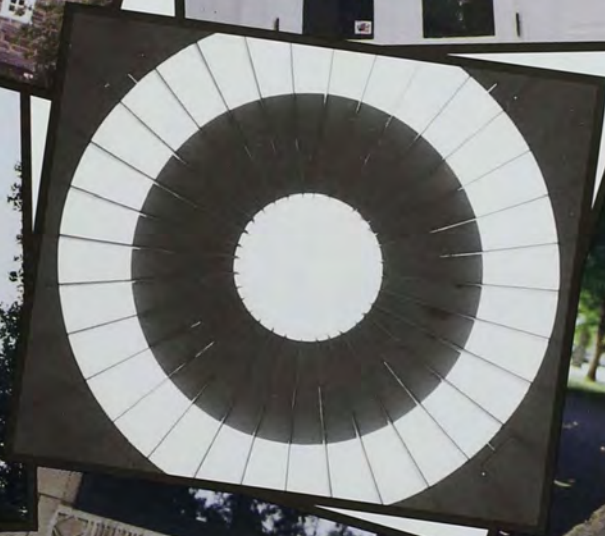
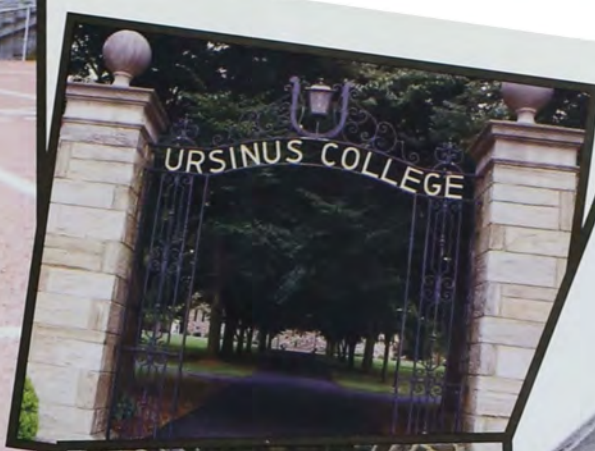

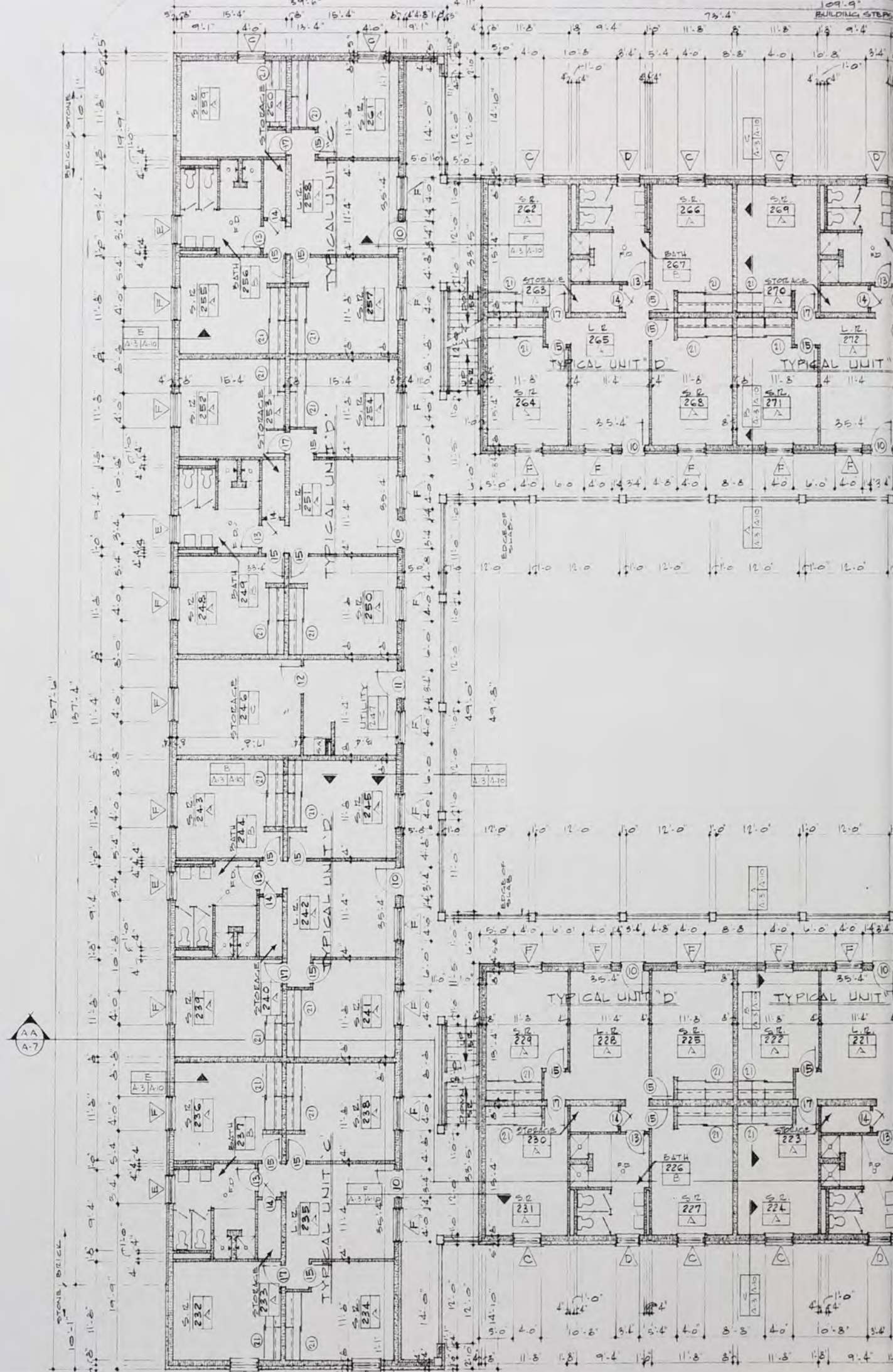

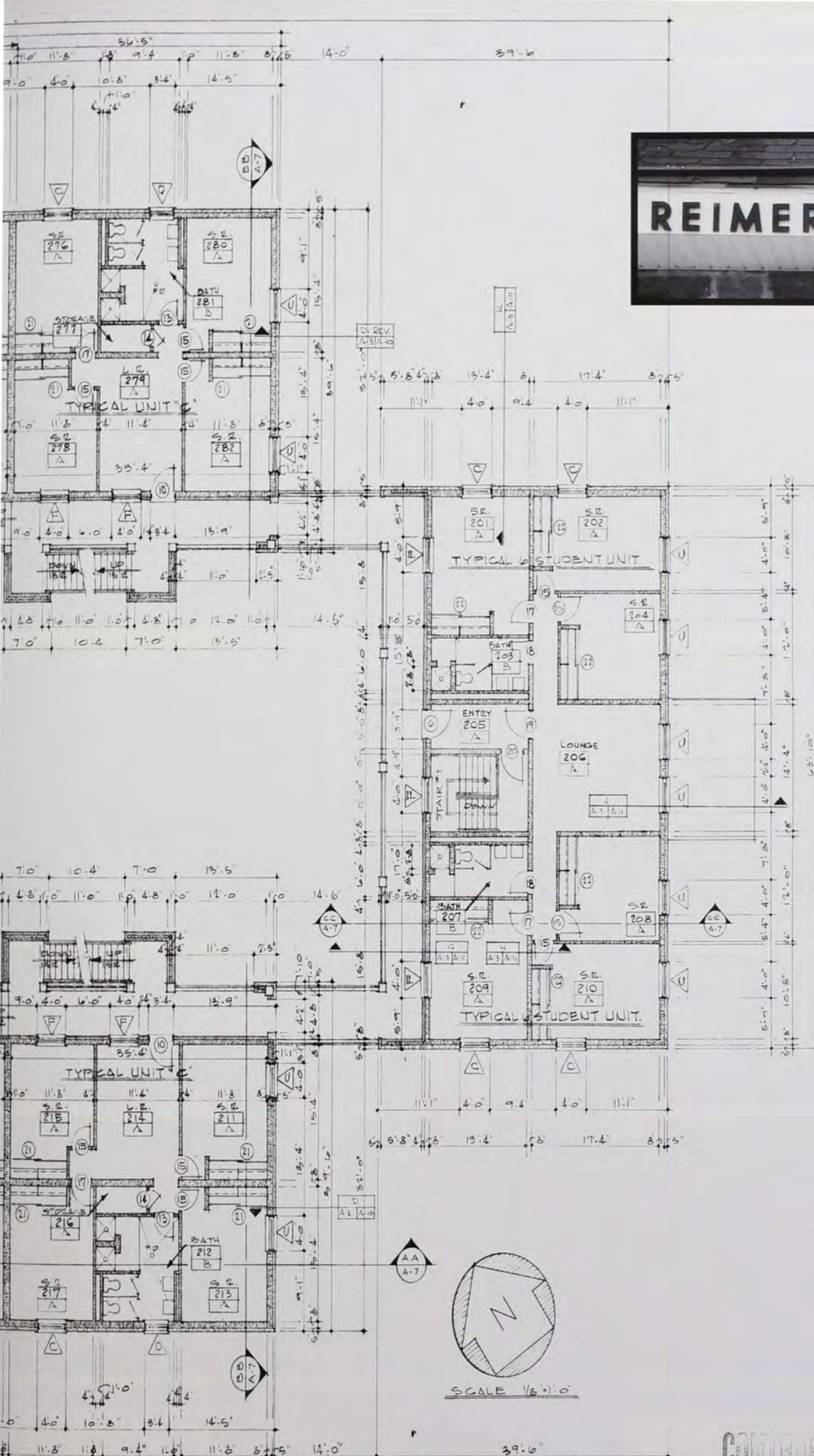

SCALE 1/8" = 1'-0"

CONTRACT DOCUMENT

DO NOT DESTROY OR ALTER



C a n d S



Juniors

As perfect strangers, we came to Ursinus looking forward to whatever came our way. We've made countless memories with friends that we'll never forget. As senior year looms ahead, we are forced to plan for our futures, while cherishing the present as best we can. Before we know it, our college days will be behind us, but the memories we have will impact our lives forever.

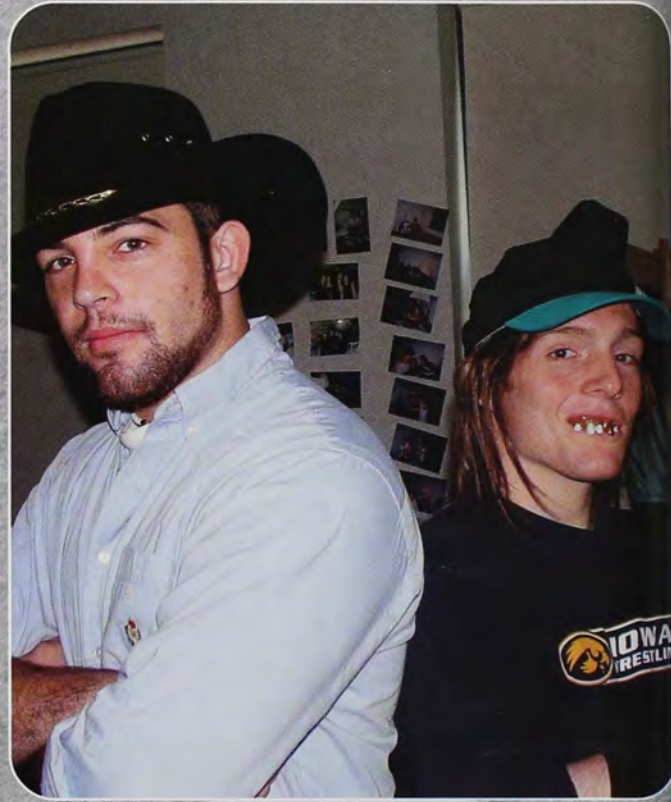

Can you believe Matt and Brian actually go out to parties on campus like this? That takes guts!



104 21st Birthday Bash!



This is just a typical Sunday afternoon with Dan, Bret, Mike, Brian and John at Maples, watching the E-A-G-L-E-S!



Jaime, Jess, and Britton coming back from a typical Ursinus night of mudsliding.



Adam, Chris, and John strumming away at 944.



Julia, Patty, and Cory lounging around.



Cory, Brian, John, and Steve out supporting the field hockey team.



Gina, Eileen, Wendy, Alison, and Jill. Those 201 girls go everywhere with each other!

Sophomores



Effie and Heather hanging out in North Hall!

Embracing each other with their Sophomore love as they climb the ladders of academic success!



One year ago they came to Ursinus with the 'freshman jitters' and now that phrase is no longer a part of their vocabulary. With freshman year and its 'jitters' now a mere memory, let the festivities and of course, studying continue. It is within this year that majors are declared, future career plans are laid out, and friendship bonds are strengthened. To think a year ago, you were just meeting those who have become your best friends and influenced your life in so many ways. Now out of the "freshman dorms," the Quad and BWC, sophomores now reside in Reimert, Main Street houses, and those lucky few that got into Richter-North. Now that they are no longer at the bottom of the totem poll, these sophomores are out having fun and enjoying every minute of it.



While Julian studies Spanish in the Library...



Aaron, Chris and Bailey study how beer floats in cups of ice!



Melissa Buckley and Courtney Megar representing O Chi, Courtney still suffers from the night before.



Sophomore RA Dana Yancey poses with her right-hand man Kenneth and her suitemates Arleigh and Caitlyn.



Josh Frear, Dave Thomas and Brett Kuras are maxing and relaxing in their common room.



Jocabed, Erin, Marlena and friends enjoy a Dance Presentation in Wismer Lower Lounge



Ursinus Ballers Dana, Mary-Kate and Molly hang out with their suitemate Mallory before an excruciating practice! GET 'EM GIRLS! GO UC BEARS!!!

Freshmen



Left: Watch out ladies...here we come!!! (J. Winnington and K. Wallace)

The newest editions to Ursinus College came to campus ready to go. They went from the top of their game to low man on the totem pole almost overnight. Everyone arrived with the hopes of making new friends and were very anxious for all the freedom that the college life has to offer.

After moving in and making their adjustments, the class of 2008 have taken their place as a part of the Ursinus family. These next four years should prove to be very interesting!!!

Left: New friends mean lots of big smiles!!! (H. Haag, C. Haines)



Above: This freshman gets a little help from fellow football players, Josh Kemp and Adam Schmidt. On freshman move-in day, the football players are kind enough to help carry their now-fellow students belongings.

The class of 2008 are having fun and dancing the night away!!!!



Are these two going to be another Ursinus College marriage statistic???(A. Higgins, C. Curley)

Below: These newcomers to Ursinus are anxiously waiting for the entertainment to come on stage.

Bottom: This new group of buddies are all smiles at the Freshmen dance during orientation weekend! (L. Glace, A. Stouch, T. Maginnis, R. Greenly, K. Gumz)



Summer Adventures

Right: Erony Whyte's project involved planning for a campus drainage basin.

Below: Jonathan Collier's research centered on the development of the American family in relationship to the Tony Kushner play *Angels in America*.



Always on the Move...

Above Right: Stephanie Guiliano, left, and Courtney Root, right, are all smiles with mentor Dr. Principe, middle, on the effects of false memories of preschoolers under testimony in court.

Right: A senior is busy at work with a microscope.

Far Right: Azizahmen Shindel is busy recording data for his *C. elegans* organism research.

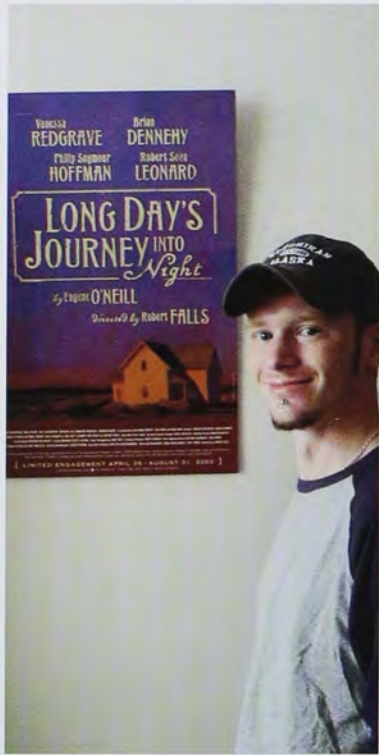

Above: Ryan Matty sampled the waters of the nearby Skippack Creek for his project with his mentor, Prof. Peter Small, Biology.

Left: A smiling Barbara Hale happily works with goldfish for her summer fellowship.



The range of what Ursinus students do over the summer is truly amazing. Fellowships at Ursinus range from laboratory experiments to writing novels to just about anything a student finds interesting. The students also have guidance from a professor in a field that interests them. Summer learning at Ursinus is not just limited to the Collegeville area, but also as far away as Peru, Mexico, and Ireland. Internships vary just as widely in chosen fields. The Ursinus community is definitely in the constant pursuit of wisdom whether on the campus or beyond.



James Teixeira, left, traveled to Peru to study "The Acceptance and Promotion of Secondary Education in the Peruvian District of Huaylas."



Above: Jade Garcia is with youngsters in her summer fellows in Peru.



Left: Chantell Johnson and Sue Yong side by side as always in front of the Gardens of the Fota House in Fota, Republic of Ireland. The gardens are also all walled in by stone.



Once upon a time there was peace and quiet on the grounds of Ursinus College but than came long **Move in Day**, which made the campus a full house...



Dad has the right idea, he made his job a whole lot easier.



As Chris makes his way up the stairs, he is carrying a few necessities that are required in College, a microwave and a blanket.



Ryan Matty is standing in front of his room about to turn the key to start the beginning of a semester.



Jennifer Peterson smiles for the camera because this is her Junior year here at Ursinus and she got to move in early and only needed a few things from home.

...On August 29, 2004 the upper classmen of Ursinus College were officially allowed to move back on campus and into their dormitories. The majority of the day was spent splitting time between unpacking and arranging rooms so that everything fit perfectly and reuniting with those friends that were not seen over summer break. Everyone was ready to catchup with everything they missed in one another's lives but were quickly disappointed when they remembered that classes started the next day and their freetime would be shortlived.



Lauren is carrying much more than she can handle but she wants to make as less trips as possible on this particular day.



Alison "Dubz" Walker holds on to an arm full of her belongs but carries the most important bag on her back, her basketball bag



This mom and daughter team up to carry an extremely long tub up the stairs of a house on Main Street.

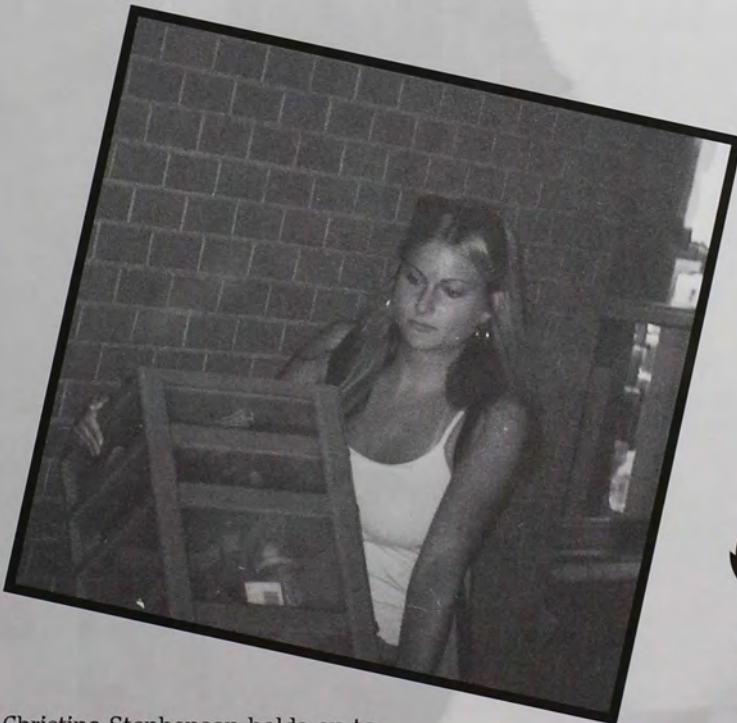

Christina Stephenson holds on to what seems to be something important as she makes her way through the walk ways of Reimert.



Family Day!



Above: Everyone was entertained by the musical stories of the country fair musician



Above: Students help out decorating!



Above: Austin Duckett, Lauren Brophy, Lynn Jusinski, Julie Lickfield and Vince Rossomando welcome the families.

It was a cold and dreary day in early October 2004, but that didn't stop parents and siblings from coming to Ursinus for the annual Family Day event. For many, this is the first day that college students are able to see their family since they returned to school for the fall semester. Family Day offers many events that Ursinus students can enjoy with their parents and siblings from cheering on UC sports onto victory, getting faces painted, and to sharing a candlelight dinner prepared in Wismer. All in all, Family Day is always a huge success enjoyed by both parents and student alike.



Left: Dr. Jaroff talks to students about their Summer Fellows Projects.

Below: Kelly Hozo, Daniel Waeger, Tia Larese and Britton Bongaardt share their student's views with families.



Below: Lesley Davidvon, Jen Katz, Brett Scipioni and Meghan Jarrett sell lemonade for a good cause.





Left: Young ones demonstrate their ability to overcome obstacles



Below: UC Students help each other out.



Below: Dr. Strassburger converses with students about their experience in study abroad



Left: Little ones have fun at the petting zoo



Below: Lacrosse Team share family time by having a barbecue.



Resident Assistants

Here at Ursinus, Resident Assistants, more fondly known as RA's, are some of the most outgoing, friendliest, and busiest people on campus. Not only do these men and women have their own coursework to do, but they also deal with the cares and concerns of their residents. When not manned with a walkie-talkie on duty, you may find them lending an ear, teaching kickboxing, performing in a play, painting, playing lacross, swimming laps, doing research, or just hanging out with their friends.

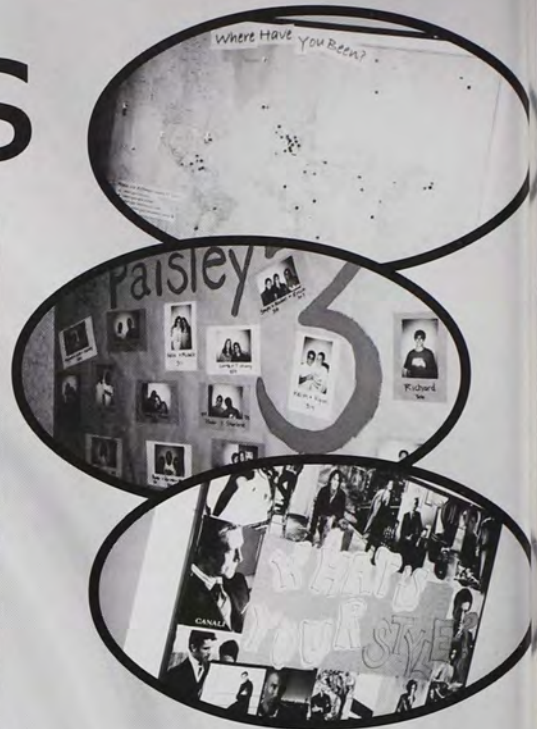

How Pretty! (above): Hall bulletin boards by Erony Whyte, Blaine McEvoy, and Joyce Anne Koubaroulis

BPS RA's

right: Kevin Metz, Arianna Brewer, Joyce Anne Koubaroulis, Colm McCarthy, Alex Frey, Shelby Cochran, and DiAndra Thompson



The Quad's the Place (above): Kaitlyn Allen, Dan Manela, Shelby Cochran, and Rob Ellison



Reimert RA's

left: Kristin Carter, Kjisten Torkelson, Amanda Howard, Gerry Hess, Larry Barr, Jr., Dana Yancey, and James Teixeira, RD: Corinthian Ridgeway



Happy People (above): Vanessa McGrath, Jason Brown, Kristin Carter, and Kjisten Torkelson

Upper Main Street RA's

right: Eric Sulock, Shane Borer, Lauren Segal, Evan Diblassio, Brooke Swalm, Heidi Liivamagi, Matt Wolf, Carla D'Olio, and Cris Mathew



Lower Main Street RA's

left: Brenden Connor, Joshua Smedley, Caroline Biswanger, Meghan Jarrett, Katie Lehman, Oksana Yaworsky, Jason Brown, Rachael Nagourney, Mike Conner, and Vanessa McGrath



BWC RA's

right: Laura Bickert, Monica Cray, Brandon Peer, Tilly Rosen, Matty Sender, and Jeff Teigler



Richter-North RA's

left: Blaine McEvoy, Erony Whyte, Alex Miron, Lydia Sanchez, Sara Kessler, Heather Kaczor, and Katie McLaughlin, RD: Corinthian Ridgeway



Sara Shaw and Regina Walsh diligently due their homework in the library.

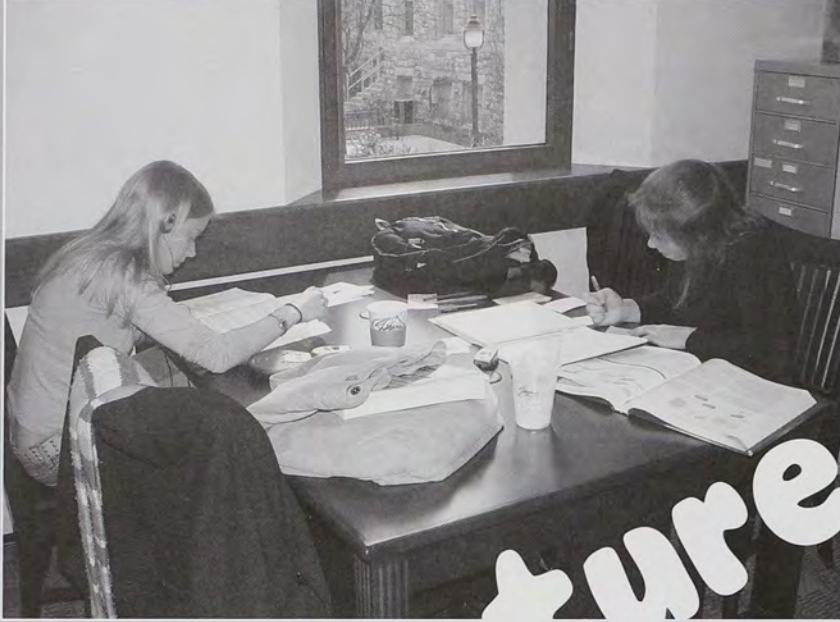

Structure of a Day

Dave Kiefer and Dan Dean procrastinate doing work after a long day by playing some video games.

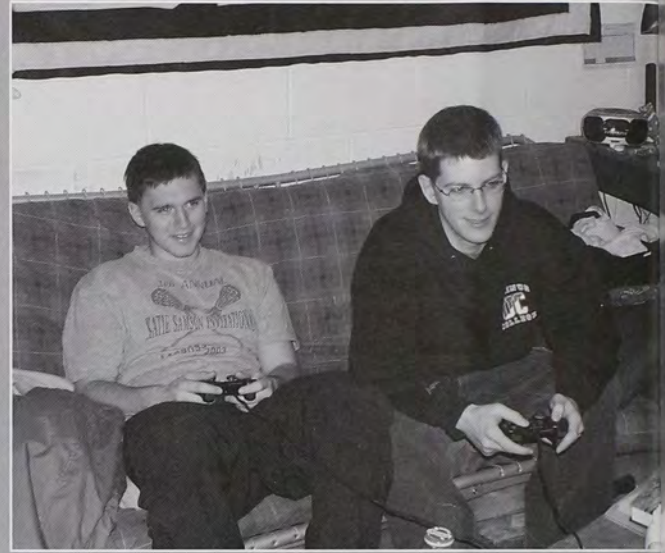

library

video games

Structure

wisner

The boys of Beta Sig enjoy lunch together in wisner.



Whether alone or with friends, in the library, the gym, class, wisner, or their rooms, school related or fun related, Usinus students always find something to occupy the time in between when their morning alarm goes off to the moment they climb into their beds.

sports

parties

watching tv

It's poker night with the guys of Beta Sig



poker

Tom Moulder and Chris Weller lounge and watch some tv in reimert 102.



Junior Brian Boland spends a few hours at the gym.

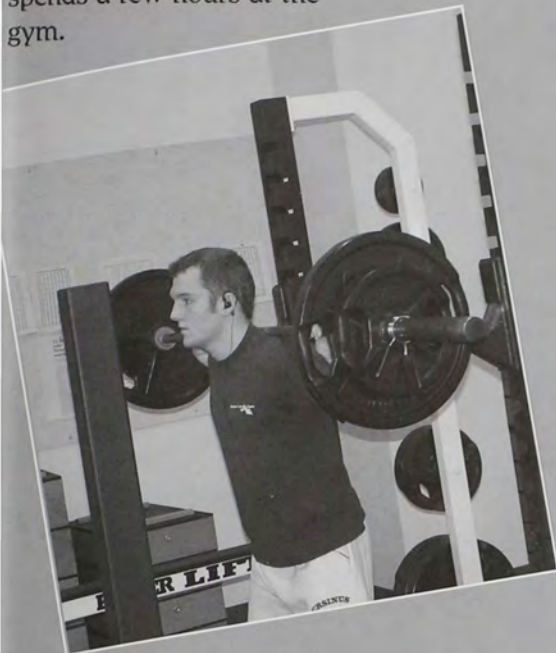

**W
o
r
k
i
n
g
o
u
t**

These girls spend their afternoon doing cardiovascular workout in the gym.

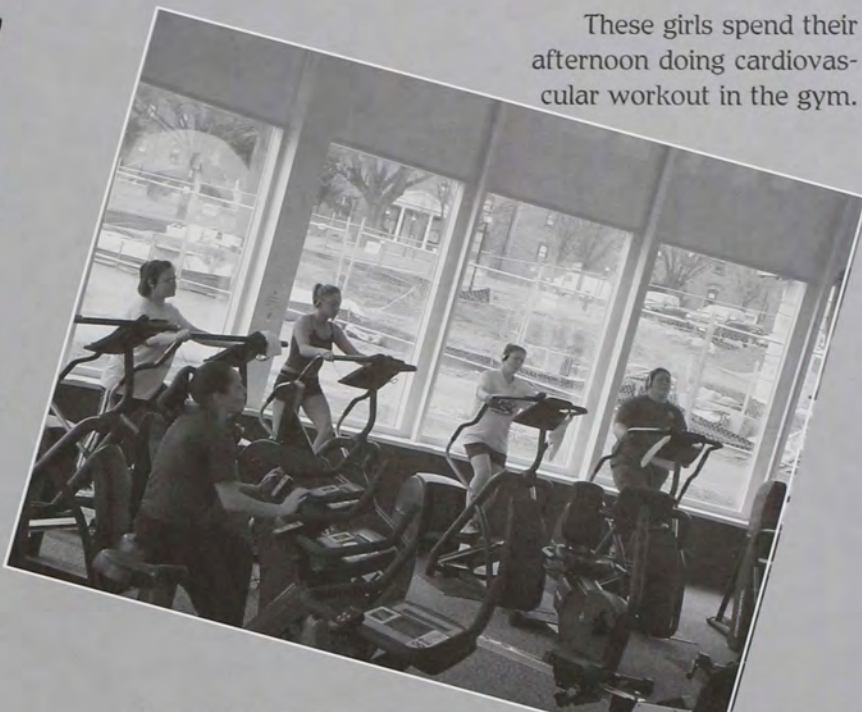

Jared Allred crames for his business test.

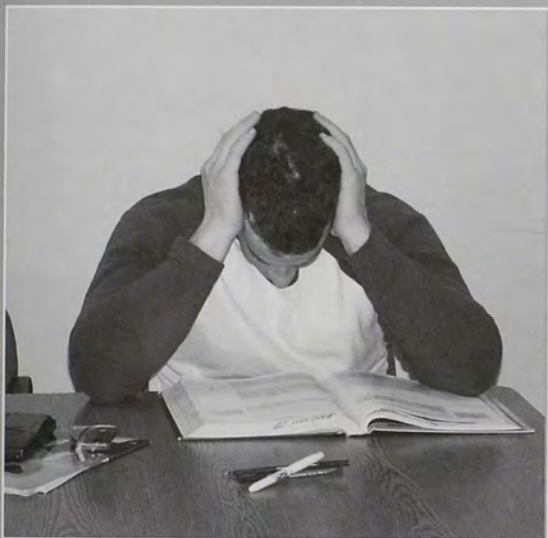

studying

The girls of 104 Reimert hang out and update each other on the days events.



Friends Michelle Hoffman and Nick Peacock talk outside of 310 Reimert

hanging

**o
u
t**



Kate Conner and Julia Lickfield try not to distract each other as they do their homework.

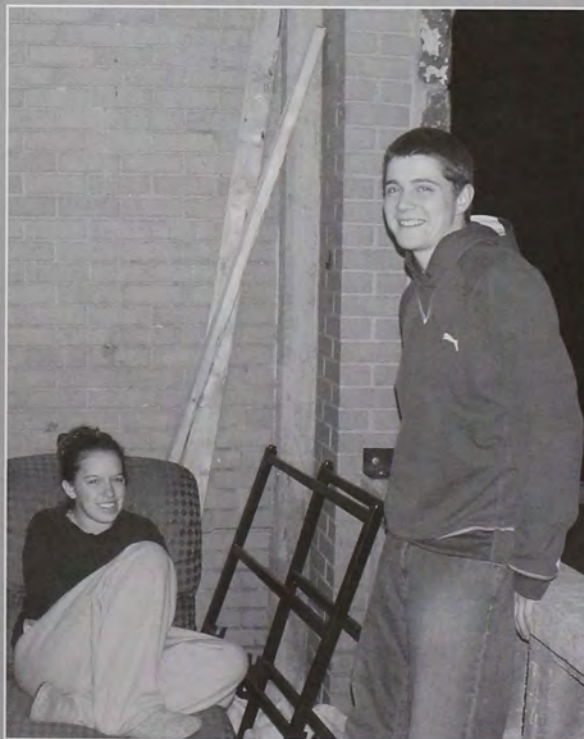

HOME COMING



(Top) Plenty of spectators were on hand to support the UC football team.



(Left) The homecoming candidates anxiously await the crowning of King and Queen.

(Below) Smiles all around as Homecoming King Jared "Goody" Good and Queen Sara Kessler pose for a picture.

October 30th, 2004 was a perfect day for football, and fans of all ages came out to show their support. As the Bears took on the team from Johns Hopkins, other athletic events and group gatherings made campus a bustle of activity from dawn until dark. Alumni and students alike shared in the festivities, and there was plenty of UC pride to go around!





(Above) Whether cheering for the football team or hammin' it up for the camera, these fans were ready for a good time.

(Right) Some Beta Sig guys catch up with alumni at the game.



(Bottom left) This group of girls didn't seem to mind that there was standing room only; besides, standing at the fence meant they were even closer to the game.

(Bottom right) Even the youngest fans were in attendance.





Halloween



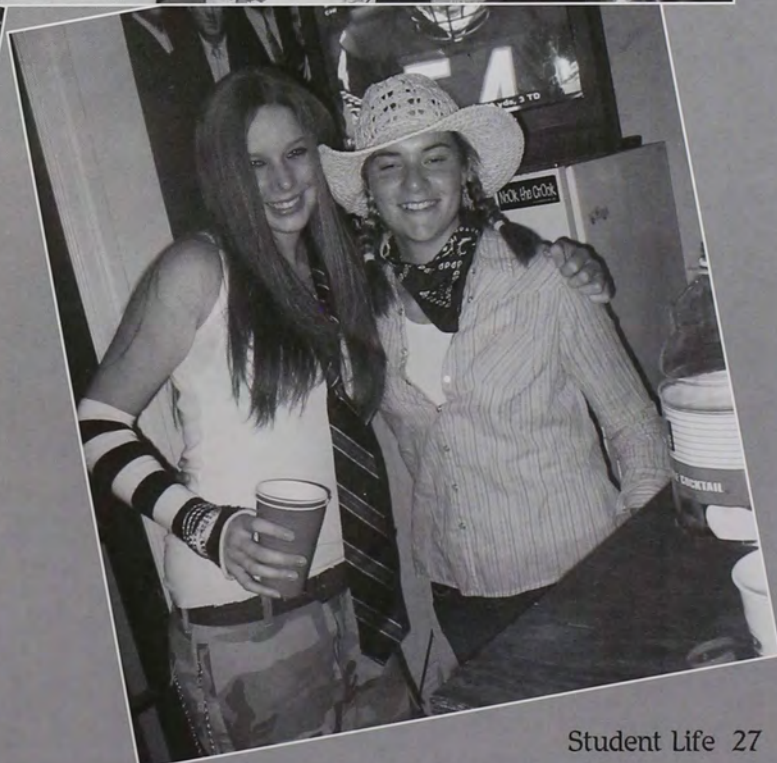
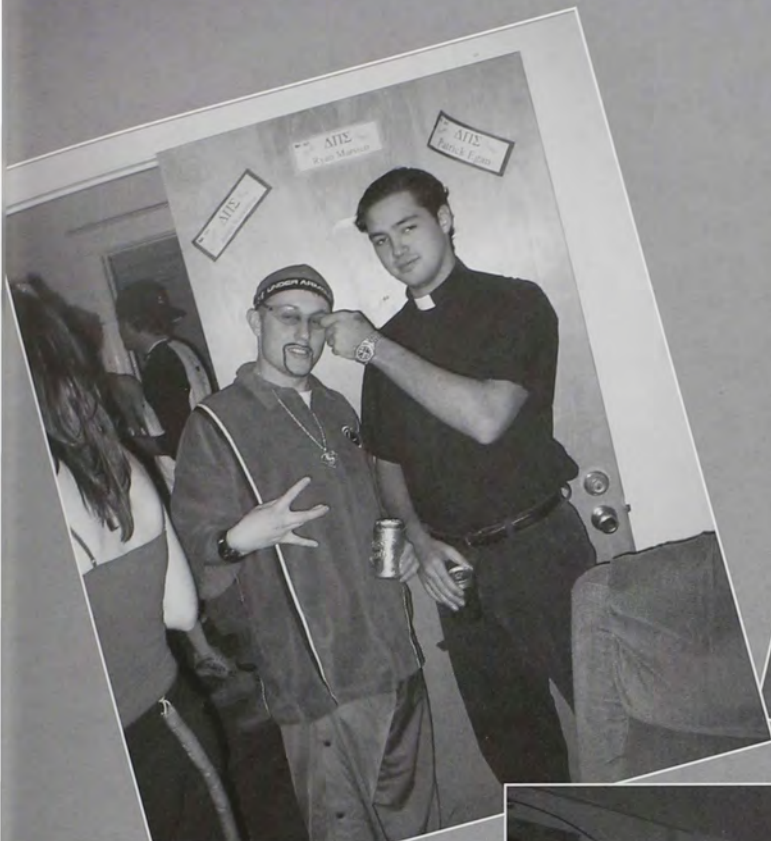

The Performing Arts Center



Above: Artist's rendering of the Ursinus Performing Arts Center which will officially open on April 21, 2005.

The Performing Arts Center has been an ongoing project on the Ursinus College campus since 2003. This newest facility will strengthen the growing reputation of the performing arts at Ursinus. Progress on the construction has been very visible and the official opening will be on April 21, 2005. Legendary jazz artist, Wynton Marsalis will give a free concert to officially open the The Kaleidoscope. With the commissioning of the Performing Arts Center, the structure of the Ursinus campus has slightly been changed, but the value that is placed on the fine arts could not be more apparent.



Above: Early work on the Performing Arts Center involved the clearing of some parking and grass with bulldozers and backhoes.



Above: Rising in the background of the artist's rendering of the PAC is the vertical supports for the structure.



Above: Despite the snow, construction progressed on time with the vertical supports being added to the foundation of the building.

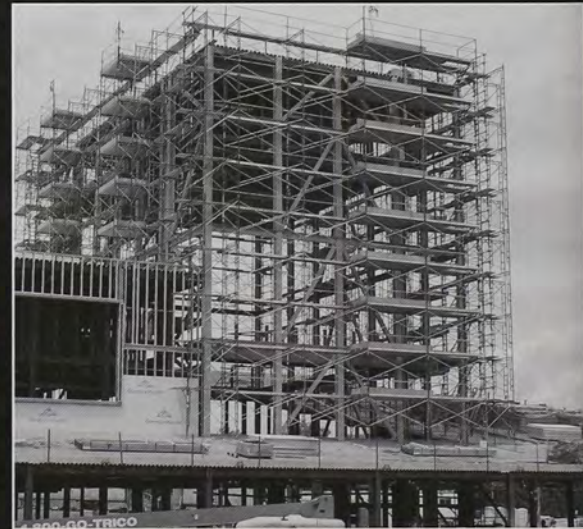

Above: The infrastructure of the highest part of the building is being constructed which will house the auditorium.

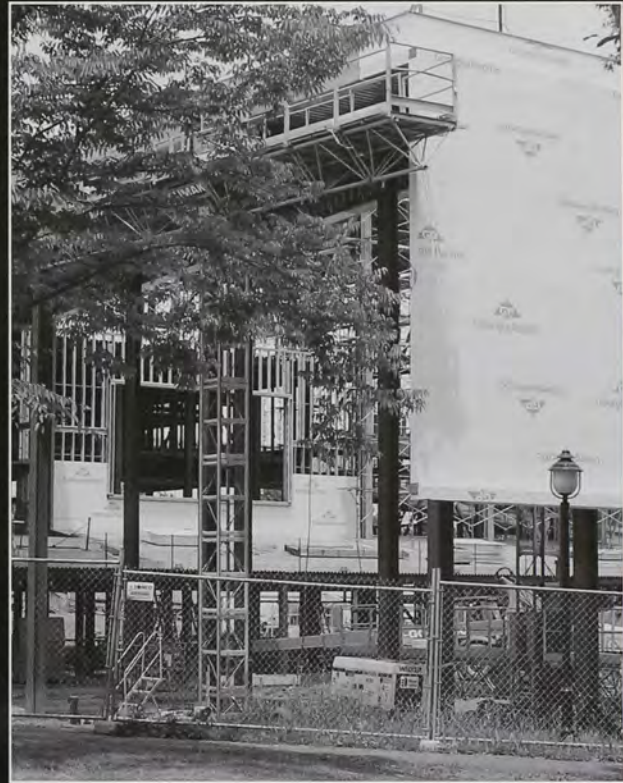
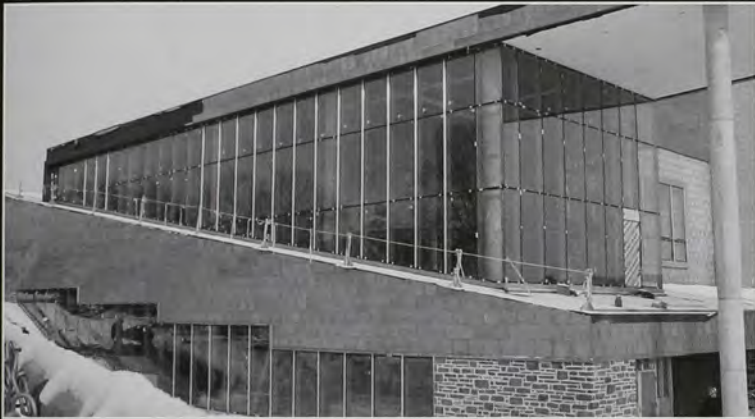

Above: Picture of the side of the PAC. The large open windows will provide ample light for the interior of the building.

Top Left: View of the entire building from the outside. Inside the PAC are classrooms, an auditorium, as well as another small theatre.

Top Right: Construction of the entire support system has been finished. The next step involved the addition of insulation and walls.

Above: View through the trees during the early phase of construction.

The Kaleidoscope

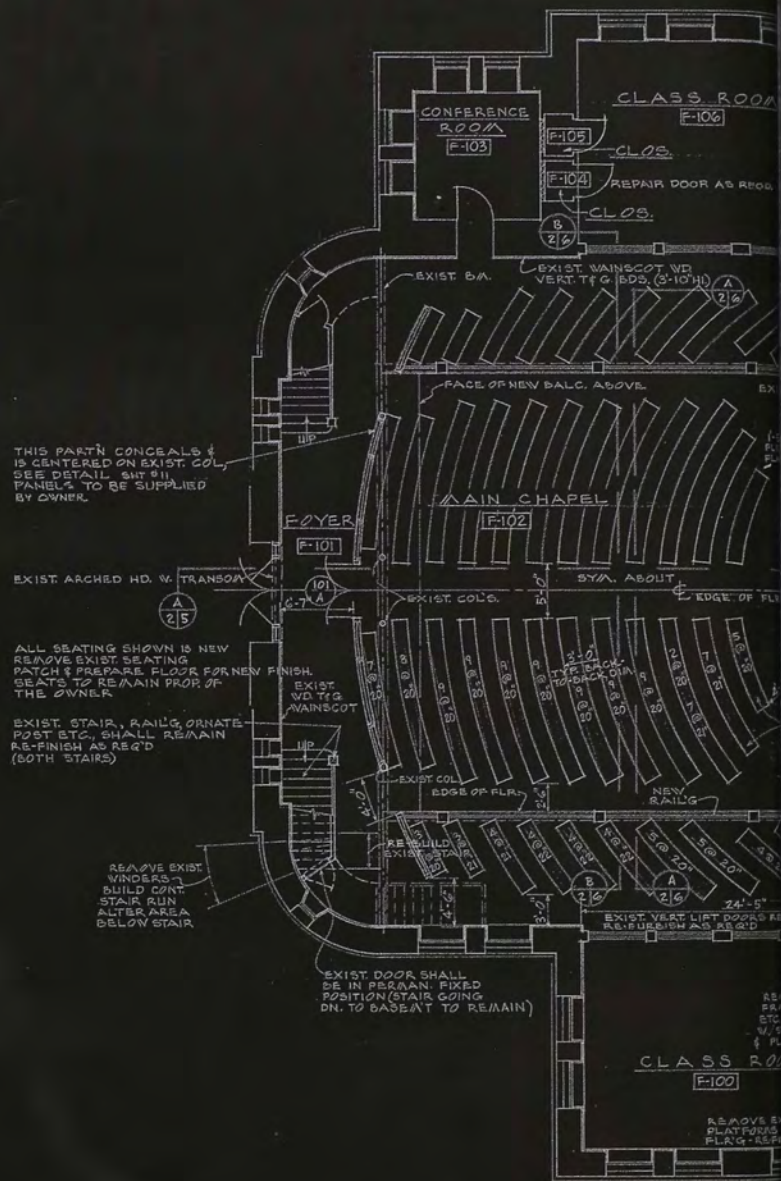

THIS PARTN CONCEALS & IS CENTERED ON EXIST COL. SEE DETAIL SMT #11. PANELS TO BE SUPPLIED BY OWNER.

ALL SEATING SHOWN IS NEW REMOVE EXIST SEATING PATCH & PREPARE FLOOR FOR NEW FINISH SEATS TO REMAIN PROP OF THE OWNER.

EXIST STAIR, RAILS, ORNATE POST ETC. SHALL REMAIN RE-FINISH AS REQ'D (BOTH STAIRS)

REMOVE EXIST VANDERS BUILD CONT STAIR RUN ALTER AREA BELOW STAIR

EXIST DOOR SHALL BE IN PERMAN. FIXED POSITION (STAIR GOING DN. TO BASEMT TO REMAIN)

REMOVE PLATFORM FLAG-RS PH

FIRST FLOOR
SCALE: 1/8" = 1'

bond & miller associates AIA
 architects & planners
 no. 1 lehigh parkway north, allentown, pennsylvania 18103 tel. 215-435-7447

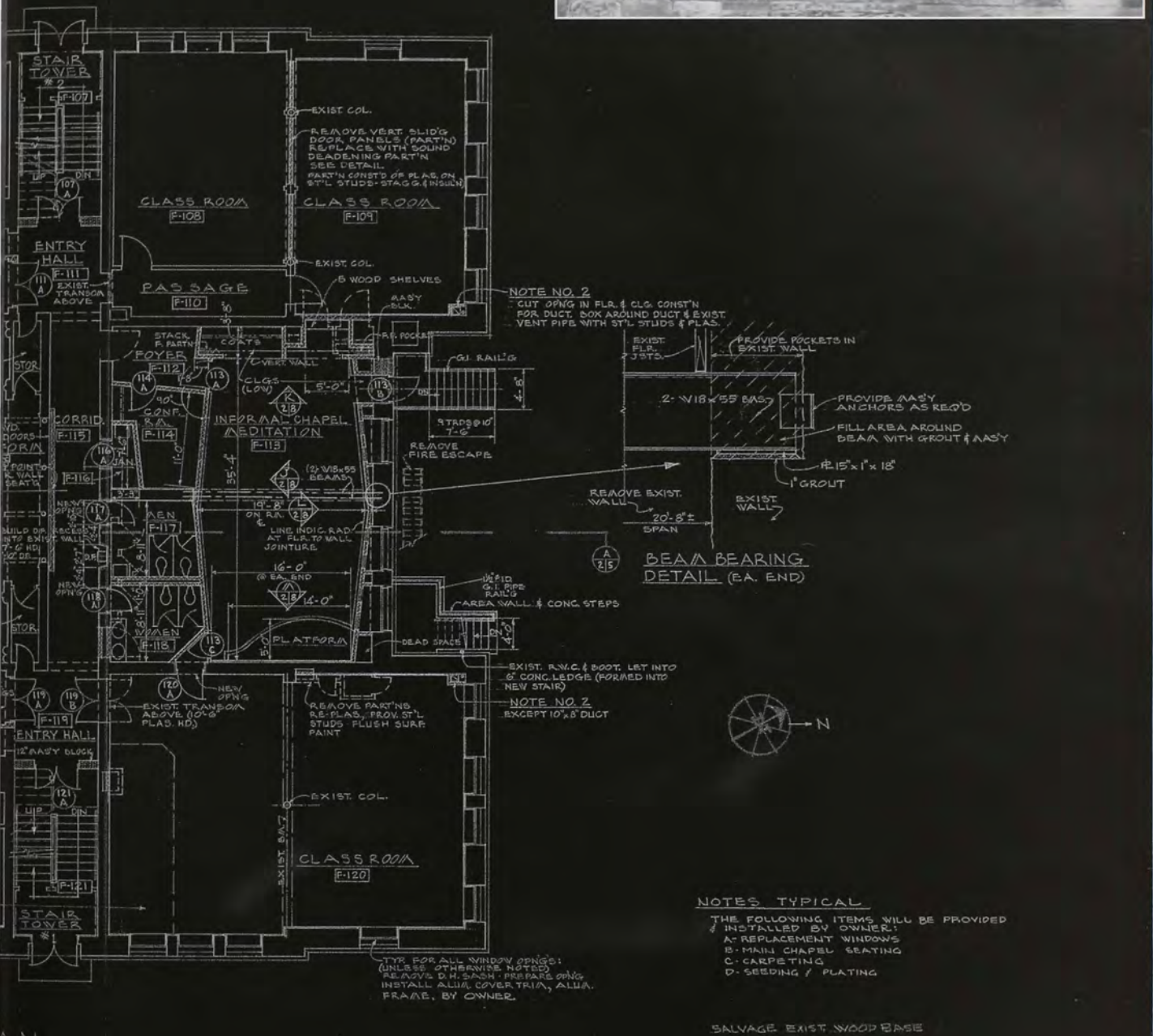

NOTES TYPICAL

THE FOLLOWING ITEMS WILL BE PROVIDED & INSTALLED BY OWNER:
 A- REPLACEMENT WINDOWS
 B- MAIN CHAPEL SEATING
 C- CARPETING
 D- SEEDING / PLATING

SALVAGE EXIST. WOOD BASE

FIRST FLOOR PLAN

revisions

**ALTERATIONS & ADDITIONS
 TO BOMBERGER HALL
 URSINUS COLLEGE
 COLLEGEVILLE, PA.**

NOTE:—
 These plans shall be checked by each contractor against general, mechanical and electrical plans. Proper location and space is to be provided for all chases, recesses, girders, ducts, pipes, conduits, wires, switches, etc. as required for each contractor.

contractor shall verify all measurements at the bldg.

comm. no.
 7004-B
 date issued
 6-9-72

scale AS NOTED
 date 6-9-72
 dwn. W.Y.
 ckd. S.C.B.

sheet no.
 2
 of 12



Mystery Night in Berman



1

Left: Students select their name tags and put their names in a lottery for roles in the skit later in the evening.



2

Above: Sara Kauffman, Liz Bollinger, and Lauren Perotti host the Mystery Night at Berman. They greet participants with name tags.



3

Left: In costume Nicole Borocci, Ryan Matti, Laura Bickert, and Whitney Roper start the festivities with some refreshments



4

Right: Megan Bickel is in costume and all smiles.



5

Above: Students socialize and prepare for a night of fun.

6

Left: Students perform as everyone else is watching and listening for clues as to who the murderer is.



7

Right: Lindsay Nicolo plays her character journalist Abigail Klein.



8

Above: The cast poses for a picture after the performance.



9

Left: Students perform as the audience speculates who the murderer is.



10

Right: The audience writes who they think the murderer is.



11

Above: Students read over their lines for the performance.

World Youth Peace Vigil



Left: Everyone got together to sign the banner that eventually hung in wisner for all to see



Above: Felicia gets everything ready so that the vigil is a success!! (F. Chou)



Left: Jason and Nathan performed an interpretive skit called "Bulls on Parade" to show their support and entertain the crowd. (N. Dawley and J. Comcowich)



Students, Faculty, Staff and Collegeville residents picked a spot on the lawn to watch the performances.

Cedra McMillan performed a dance to "Allez" by Abdou Seck.



Right: To wind up the show, the band played two songs and even included the crowd. (B. Brown, F. Chou, P. Correa, P. Giavis)



Left: John reads a poem by Matthew Arnold "Dover Beach". (John Culler)

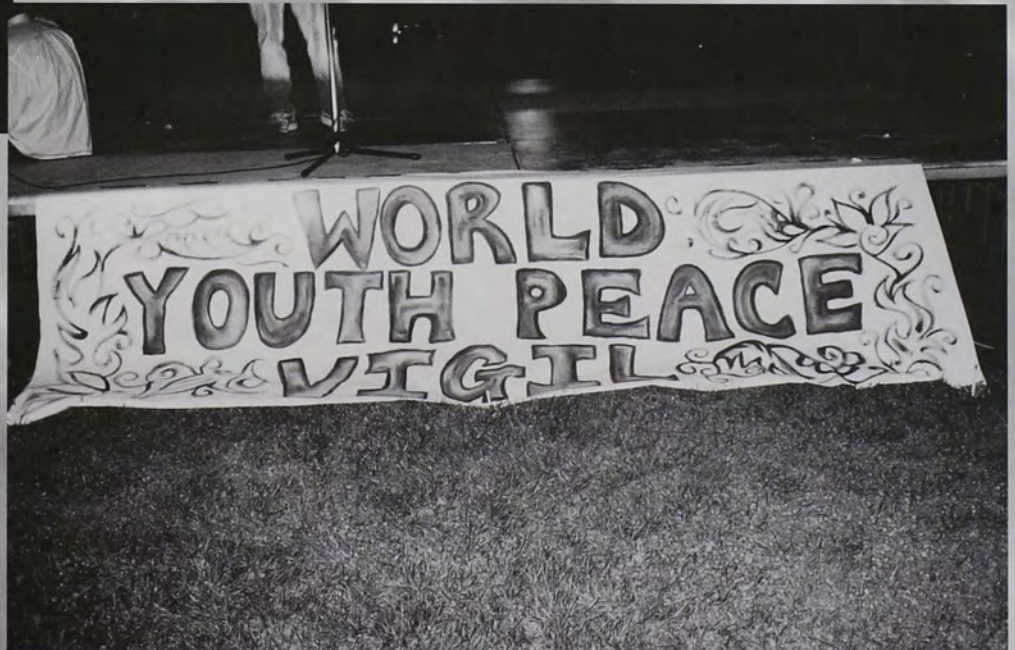

Battle of the Bands



1

"Hopes and Dreams" of Pen Argyl, PA were one of the featured bands of the evening.



2

Pat, aren't you a little old to be dressing like Barney? (P. Egan)

3

Right: Michelle and Rebecca take time out to pose for a picture (M. Noreski and R. Jones)

4

These guys are showing some support for some friends in the band. (G. Keresztury, R. Matty and N. Borocci)



5

Tex and his crew look like trouble!!





6

Left: Everyone gathers on the steps of Reimert to get a good view

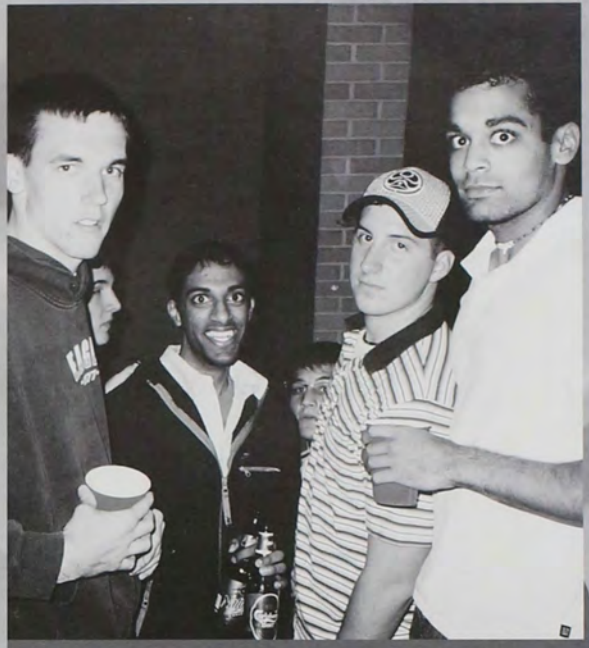

8

The boys of Beta Sig stand together outside their suite for the festivities.



7

Hanging out and having FUN!!!

9

The Bands played for hours and kept everyone entertained in the courtyard of Reimert



10

Aren't we so cute??
(C. D'olio and L. Brophy)

Fall Festival & Other Fall Fun



Left: Ed Gildea shows off his strength for the UC students



Above: Rob Ellison does a pretty good job of staying on that bull!!



Above: Painting pumpkins brings out the giggles in Tamar!! (R. Nagourney, T. Sternberg and K. McNeely)

Left: Even Steve Larson's little boy Riley gets in on the action.

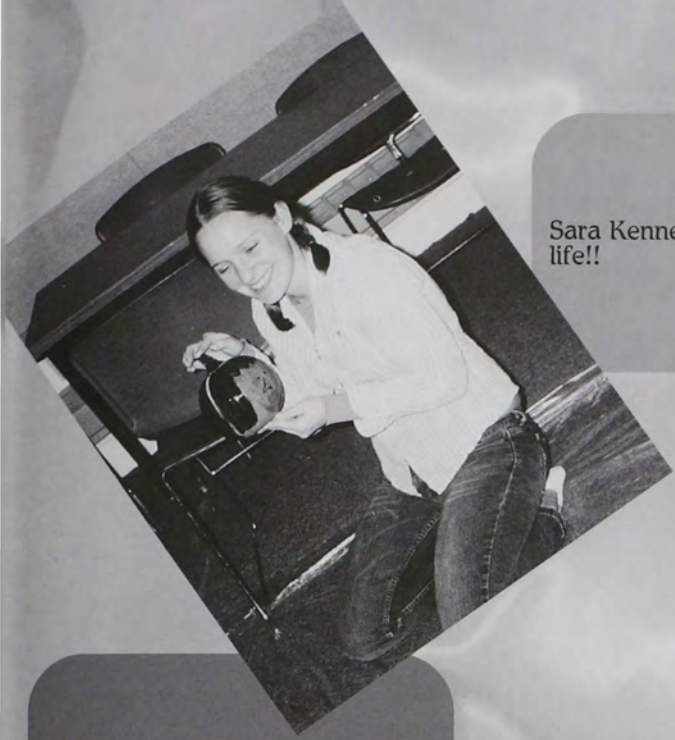

Sara Kennedy holds on for dear life!!



Kristen Muetener has no problem showing off her pretty pumpkin!

"Hey guys, look at me...I didn't fall off yet!!! (J. Lickfield)



Shelby Cochran and the bull didn't seem to get along too well.



Mardi Gras Homecoming Dance



1

Left: The members of the Campus Activities Board who put together the Mardi Gras themed Homecoming Dance smile for the camera. From left to right, Secretary Amanda D'Amico, Vice President Cris Mathew, Secretary Sarah Kennedy, and President Vincent Rossomando.



2

Above: Lynnsey Zweier and Jaynine Vado are at the Mardi Gras Dance in theme and ready for a fun night.



3

Left: Students enjoy the night dressed up and in costume.

4

Right: Friends Dana Piraino, Lindsay Kulovitz, and Kathleen Parkman are having a fun time.



5

Above: Students and friends jam on the dance floor.

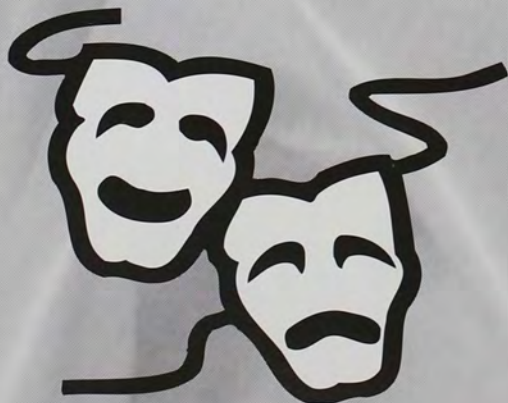



6

Left: Students enjoy an assortment of food that was offered throughout the night.



7

Right: Jason Hobson and Sarah Kennedy stand for a picture at the entrance to the transformed Helfferich gym.



8

Above: Friends Jill Reganato and Johanna Engel enjoy the dance floor.



Left: Melissa Mancini, Alaina Cara, Jenna Sychterz, and Julie Balko dine to music.

9



11

Above: Freshman Sarah Stanley, Alex Gaustad, and Ali Wagner are all smiles.

10

Right: Kjisten Torkelson and Vanessa McGrath start the night off with the right attitude.

Exam Breakers



Above: Everynight in the library was a popular time for Ursinus to socialize and snack courtesy of the library staff.



Left: Ursinus students had a number of ways of relieving stress from studying for exams; like a Voices in Praise concert.

Right: Students construct impressive gingerbread houses in Wismer Lower during this popular exam breaker. The delicious houses had names like "Goldilocks and the Three Bears," "Meet the Flintstones," and "Gummy Mansion."



Left: Apple, chocolate chip, and banana pancakes were a welcome break at Pancake Night in the gym.

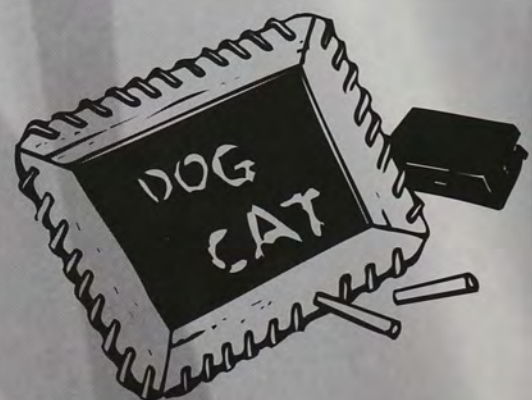



Above: Alex Miron, Katie McLaughlin, Heather Kaczor, and Blaine McEvoy put on the RA exam breaker in the first floor lobby of North Hall.

Right: Students enjoy coloring as they watch the movie "Mona Lisa Smile" on the second floor of the Berman Museum.

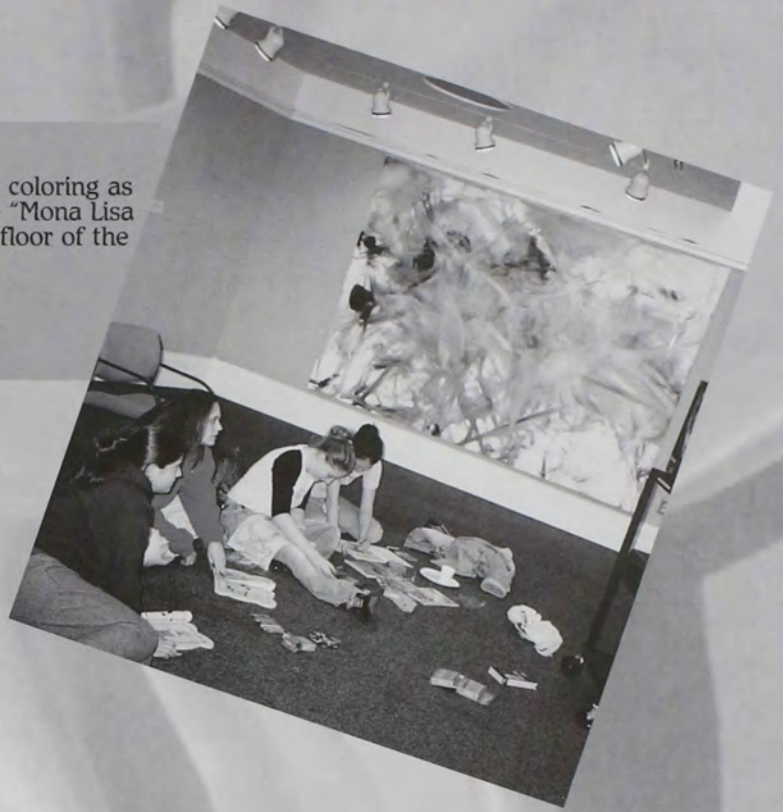

Left: At the Pancake Night students enjoyed extended hours in the gym and pool to get their minds off exams.



Right: Ian O'Neill, Lauren Segal, and Abby Loefflad find it more fun to build gingerbread houses in a group.



Above: Maureen McCarthy and Brandon Zapalac enjoy constructing and eating their gingerbread house.

Winter Around the World



Left: Jullien Serfoss, President of the German Club got everyone into the Christmas mood with the evening's events that she organized.



Left: Students enjoy the Christmas festivities of the night as they get ethnic food from around the world.



Right: Who can resist Santa?



Above: Student, Rami Farag serves ethnic Islamic food.



Left: Candace Thomas explains the significance of Kwanzaa to everyone.



Right: Defne Sarsilmaz shows everyone a winter belly dance.



Above: Tia Larese and Camila Gabriel serve up traditional German food for a cold Christmas.



Left: The Germab Club sings "Stille Nacht, Heilige Nacht" or "Silent Night, Holy Night."



Right: Four students from Tai Chi class preform Taijiquan 24 Form.



Above: President of the Japanese Club Josh Smedley, member Jon Gagas, and Andrew Larsen, Treasurer serve up some delicious Japanese tea and soup.

Open Mic Night



Left: Brandon Brown is jamming on his guitar with an attentive crowd.

Above: Monday night means hearing some great music from talents like David Kupstow.



Left: Students chill as they enjoy the Fritztopia or Fritz's awesomely cool apartment in Richter-North 001.

Left: Josh Rucci, always a fixture at the Fritztopia on Monday night, shares some of his songs.



Monday nights mean guitar playing, singing, and poetry jamming at 10 pm in the coolest suite at Ursinus.



Left: Heather Morris plays some beautiful music.



Above: Students enjoy the late night snacks courtesy of Fritz.



Left: Trevor and Jon create some jams.



Above: Richard Schott jams his poetry.

Right: Mike Dolan pleases the crowd with some great music

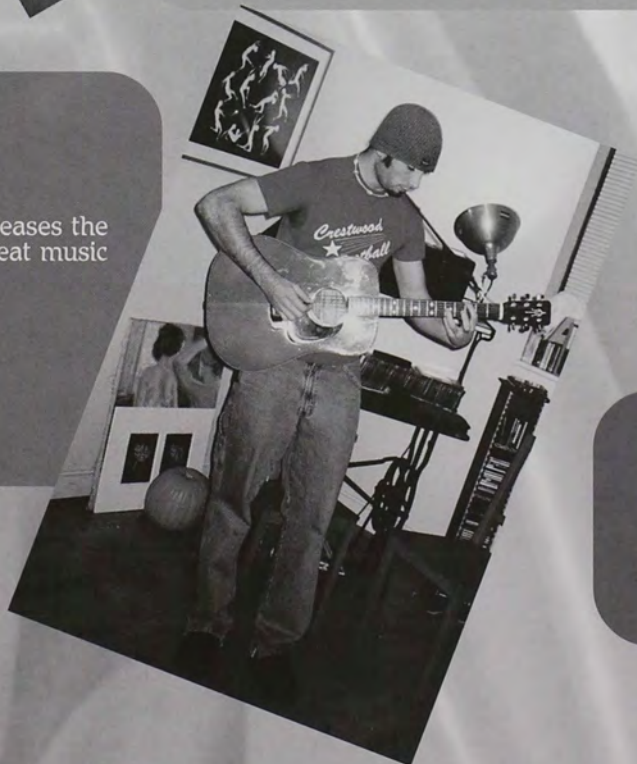

Date Auction



1

Left: Professor Edwards lends herself to the charity and puts on some dance moves. Her husband smartly has the highest bid for \$40.



2

Above: Masters of Ceremonies James and Shane get the crowd rallied-up for the date auction benefiting the tsunami relief fund.

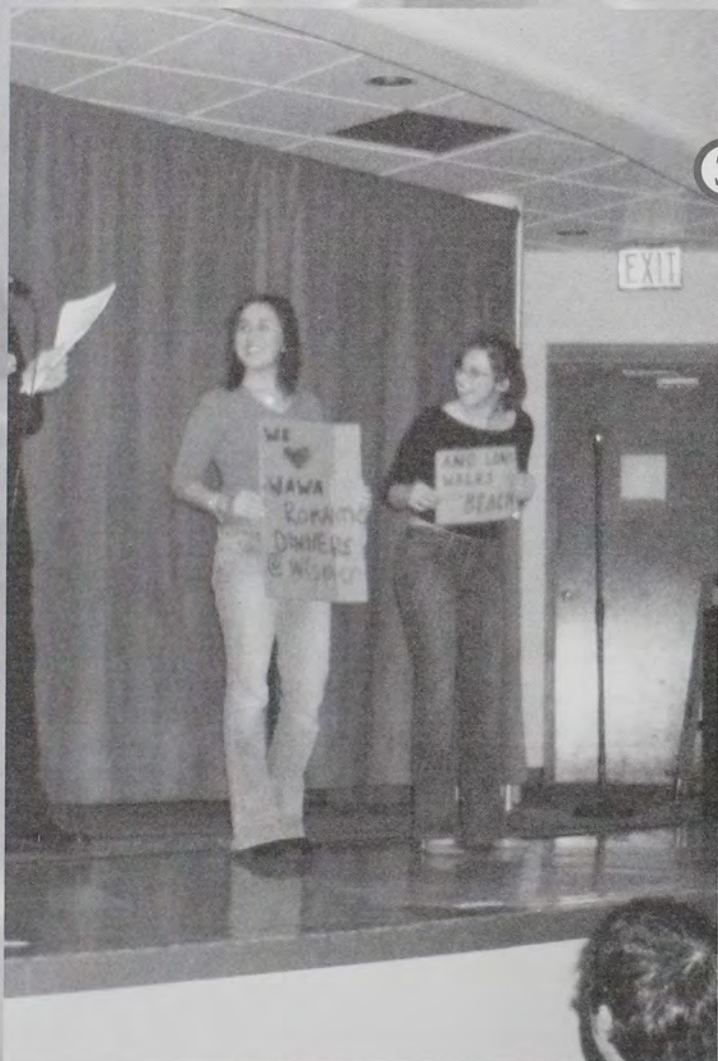

3

Left: These girls come with signs with ideas for a romantic date at Wawa.

4

Right: Brandon Peer is a crowd pleaser and gets a high bid at the auction.



5

Above: Wesley Harden, Dominic Spaventa, and Lenoard Trappanese lend themselves to the date auction.

6



Left: Director of Campus Safety Mike "Mack" Ditty comes to impress with flowers for his lucky date. He is so popular girls pool money for him.

7



Right: Anna King is another popular bid.

8



Above: These pledges of Alpha Sigma Nu Sorority received the highest bid of \$80 all going to the tsunami relief charity.

9



Left: After winning the bid you get some time to get to know, lounge, and make plans with your bid like Rachel here.



10



Right: Corey Bolander and Emily Livesey auction themselves for a good cause.

11

Above: All these pledges from the Phi Kappa Sigma Fraternity come at a bargain for the lucky bidder.

Dance

Concert

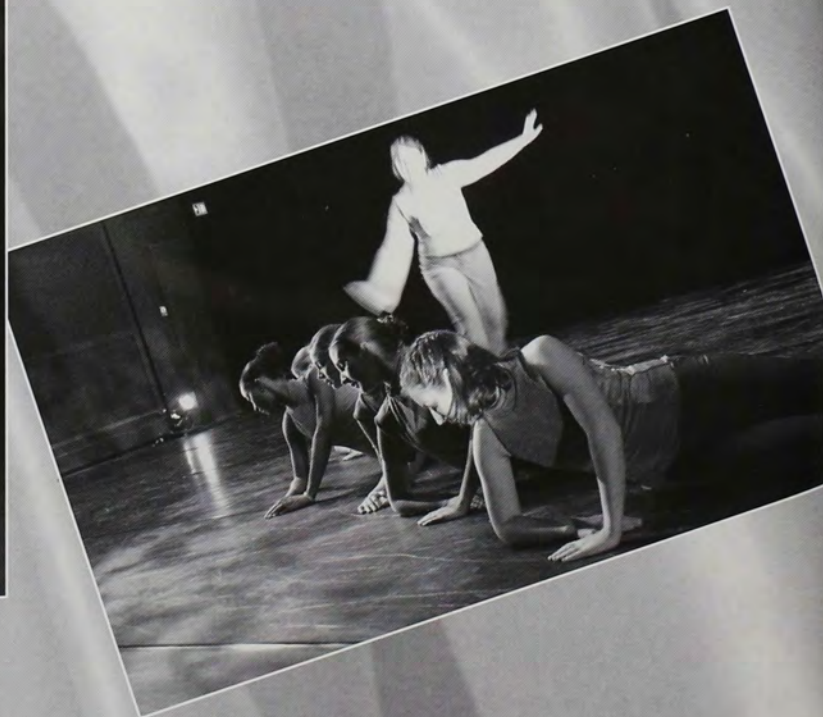

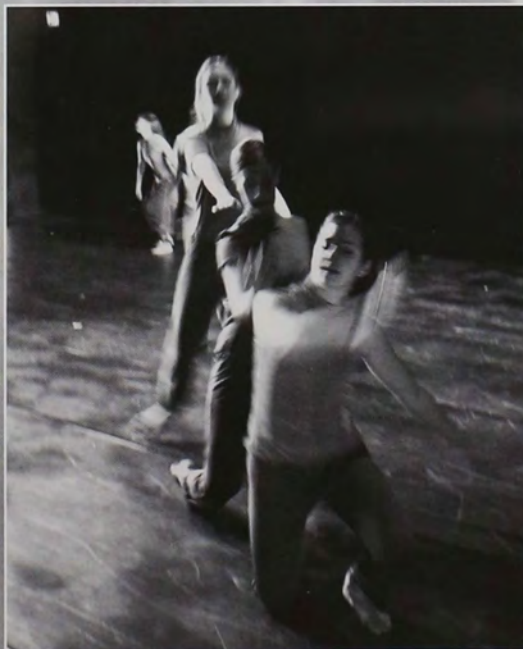
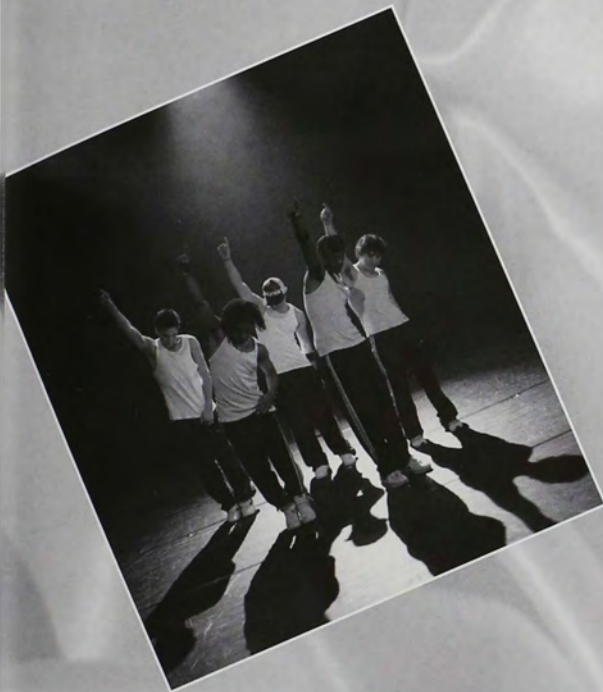
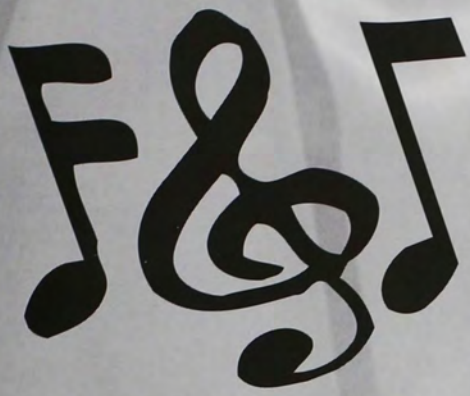

“What the Moon Saw”





Poe on Poe





Fun at Ursinus

BEST of TIMES



Left: John Bera struts his stuff at the Drag Show to benefit tsunami victims.

Right: Brandon Peer at the microphone is masters of ceremonies of the drag show.



Left: Jeanine, Drew, and Raymond Class of 2007 put on an event in Wismer Lower.



Above: For her birthday this girl gets a walk on stage.

Left: Students are treated to some late-night pancakes to benefit tsunami victims.

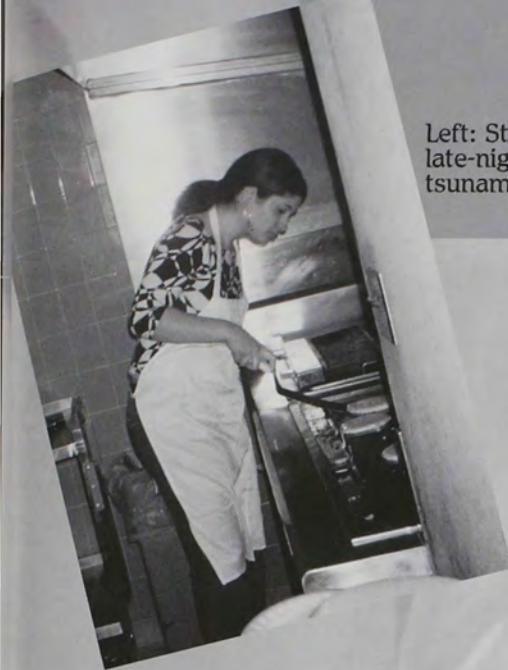

Above: Students enjoy pancakes and bagels all for a dollar and a good cause.



Left: Late-night pancakes are a welcome break before students go off for spring break to say their goodbyes.



Right: Brandon Brown is jamming on his guitar with an attentive crowd.



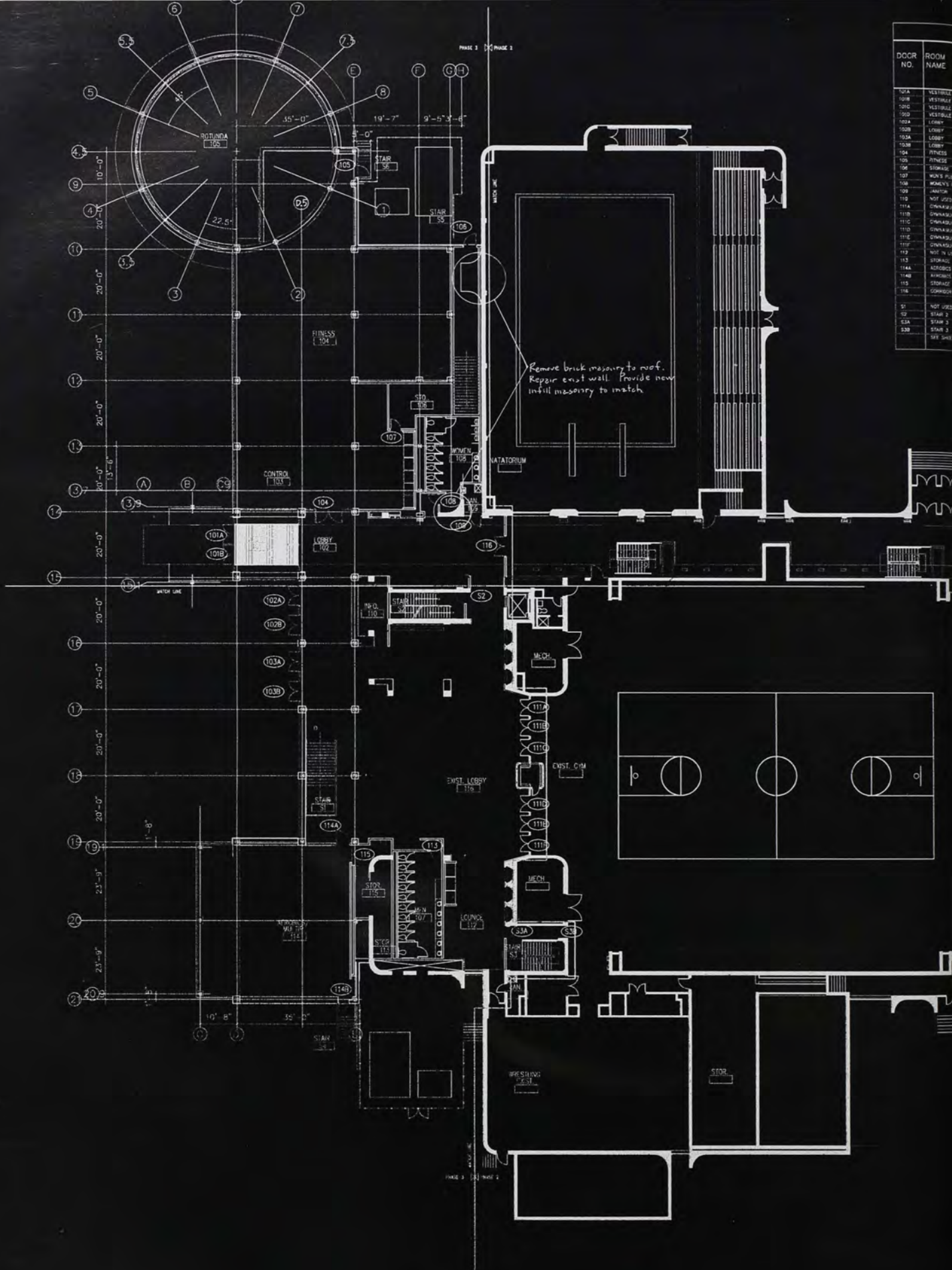

DCOR NO.	ROOM NAME
101A	VESTIBULE
101B	VESTIBULE
102	VESTIBULE
102A	VESTIBULE
102B	LOBBY
103	LOBBY
103A	LOBBY
103B	LOBBY
104	FITNESS
105	FITNESS
106	STORAGE
107	MAN'S PUB
108	WOMEN'S PUB
109	JANITOR
110	NOT USED
111A	CHANGING
111B	CHANGING
111C	CHANGING
111D	CHANGING
111E	CHANGING
111F	CHANGING
112	NOT USED
113	SHOWER
114	LOCKER
114B	LOCKER
115	STORAGE
116	COMMON
117	NOT USED
118	STAIR 2
119	STAIR 3
120	STAIR 1
121	STAIR 1

1 PHASE 3 ENTRY LEVEL—FLOOR PLAN
SCALE: 1/16" = 1'-0"

© 1997, CDM, Inc. All rights reserved. This document is the property of CDM, Inc. and is not to be reproduced, stored in a retrieval system, or transmitted in any form or by any means, electronic, mechanical, photocopying, recording, or by any information storage and retrieval system, without the prior written permission of CDM, Inc.

URSINUS COLLEGE
ATHLETIC FACILITIES

NO.	ROOM	FLOOR	BASE	WALLS				CEILING	REMARKS
				NORTH	EAST	SOUTH	WEST		
100	RESTRIE								
101	LOBBY								
102									
103									
104									
105									
106									
107									
108									
109									
110									
111									
112									
113									
114									
115									
116									
117									
118									
119									
120									
121									
122									
123									
124									

NO.	ROOM	FLOOR	BASE	WALLS				CEILING	REMARKS
				NORTH	EAST	SOUTH	WEST		
100	RESTRIE								
101	LOBBY								
102									
103									
104									
105									
106									
107									
108									
109									
110									
111									
112									
113									
114									
115									
116									
117									
118									
119									
120									
121									
122									
123									
124									



CS,
TION

ONE CENTER PLAZA
BOSTON, MASSACHUSETTS 02108
(617) 742-5440

VE REVISIONS

12/11/00

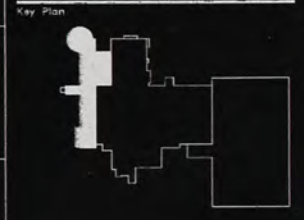

Revision	Date
Issue Date	
Drawing Title	
ENTRY LEVEL PLAN DOOR SCHEDULE ROOM SCHEDULE	
Drawn by	Checked by
Project No.	Scale
Drawing No.	

A-102

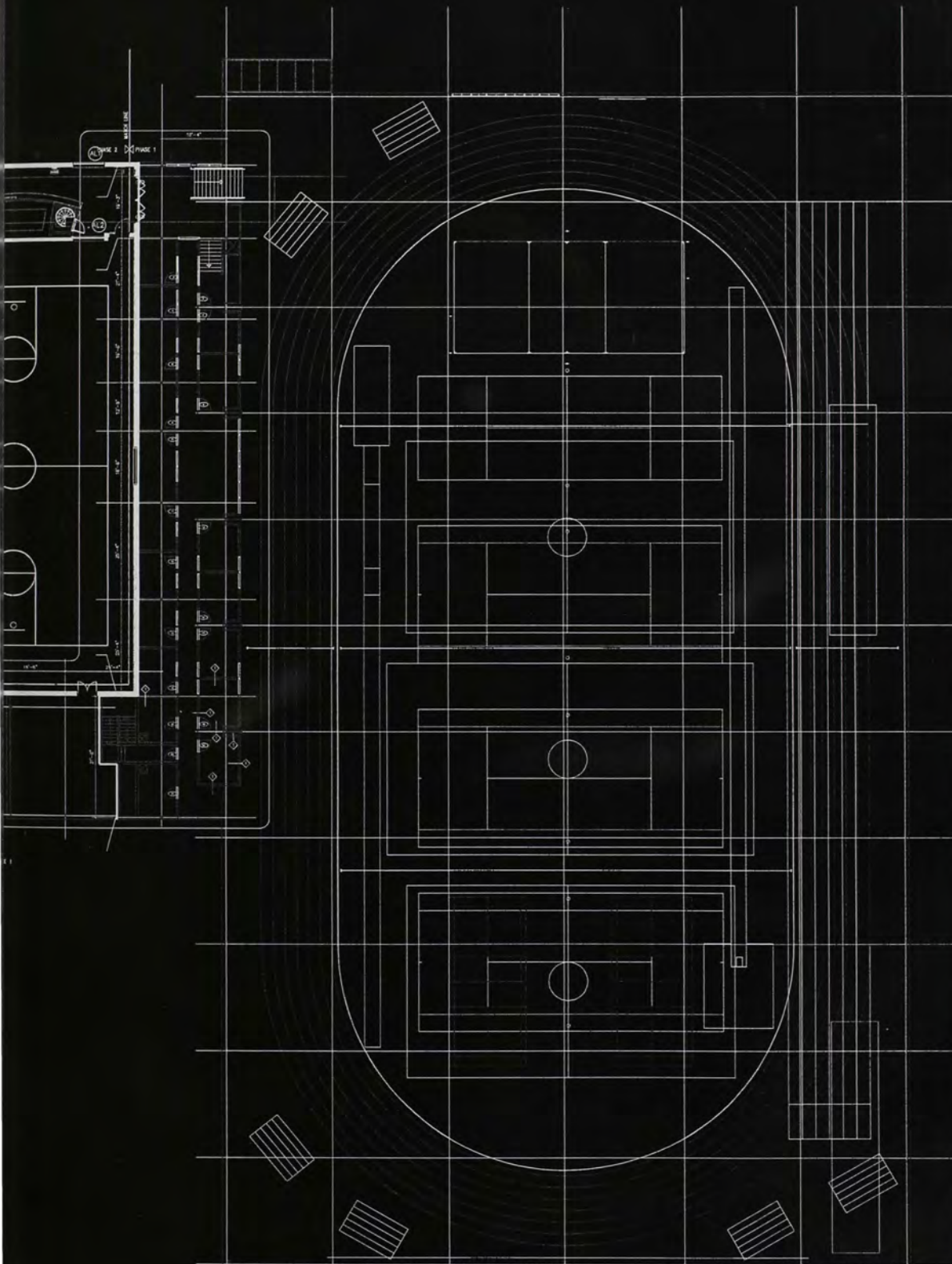

FIELD HOCKEY



Above: Kristen Pearson gets set to put the ball back into play.



Top Right: Allison Douth (front) and Melissa Buckley (back) get a breather while the ball's at the other end of the field.



Right: The defense stifles another failed attack.

Bottom Right: Joyce Anne Koubaroulis and Allison Douth await the ensuing breakaway.

Bottom Left: Marissa Rotz, Karen Wendler, and Joyce Anne Koubaroulis congratulate each other on their team's goal.





Above: Coaches Gabe and Laura Moliken look on intently from the sideline.

The team watches as Ashley Ettinger (left) and Karen Wendler (right) prepare for the start of the game.



Crystal McCarney, Allison Doult, Lindsay Cappa, Marissa Rotz, Karen Wendler, Abby Loefflad, Meredith Stabley, Melissa Buckley, Joyce Anne Koubaroulis, Kristen Pearson, Ashley Ettinger, Kelly Stevens, Emily Godfrey, Lisa Weiser, Jamie Doperak, Jess Rogers, Jessica Lamina, Erin Under

2004 Schedule & Results

Opponent	Score
@ TCNJ	W 2 - 1
@ Misericordia	W 3 - 0
Bryn Mawr	W 11 - 0
Messiah	L 1 - 2
Lebanon Valley	W 6 - 2
@ Dickinson	W 6 - 0
@ West Chester	W 2 - 1 (OT)
Washington	W 2 - 0
@ F&M	W 4 - 1
McDaniel	W 2 - 1 (OT)
Rowan	W 2 - 1 (2OT)
@ Haverford	W 8 - 1
@ Swarthmore	W 4 - 0
@ Elizabethtown	W 4 - 1
Muhlenberg	W 5 - 2
@ Gettysburg	W 3 - 1
E. Mennonite	W 9 - 1
Johns Hopkins	W 1 - 0
Gettysburg	W 4 - 1
(C-C Semifinals)	
F&M	W 4 - 3 (OT)
(C-C Finals)	
Maine	
Farmington	W 3 - 0
(NCAA 2nd Round)	
William Smith	L 1 - 5
(NCAA 3rd Round)	



Above: Marcus Ressler readies himself for a clearing pass.

Right: Tommy Hanlin grabs a pass and heads on a breakaway to the goal.



2004 Schedule & Results

Opponent	Score
@ Alvernia	W 2 - 1
Goucher	L 1 - 2 (OT)
Delaware Valley	W 1 - 0
@ Philadelphia Bible	W 2 - 0
@ Eastern	L 0 - 3
Dickinson	L 1 - 4
@ Haverford	L 2 - 3 (2OT)
Gettysburg	L 0 - 3
@ West Chester	L 1 - 3
Cabrini	L 1 - 2
@ McDaniel	L 0 - 2
@ Richard Stockton	L 0 - 6
@ F & M	L 1 - 2
@ Washington	L 0 - 1
Johns Hopkins	L 0 - 1
Swarthmore	L 1 - 2
Muhlenberg	L 0 - 4

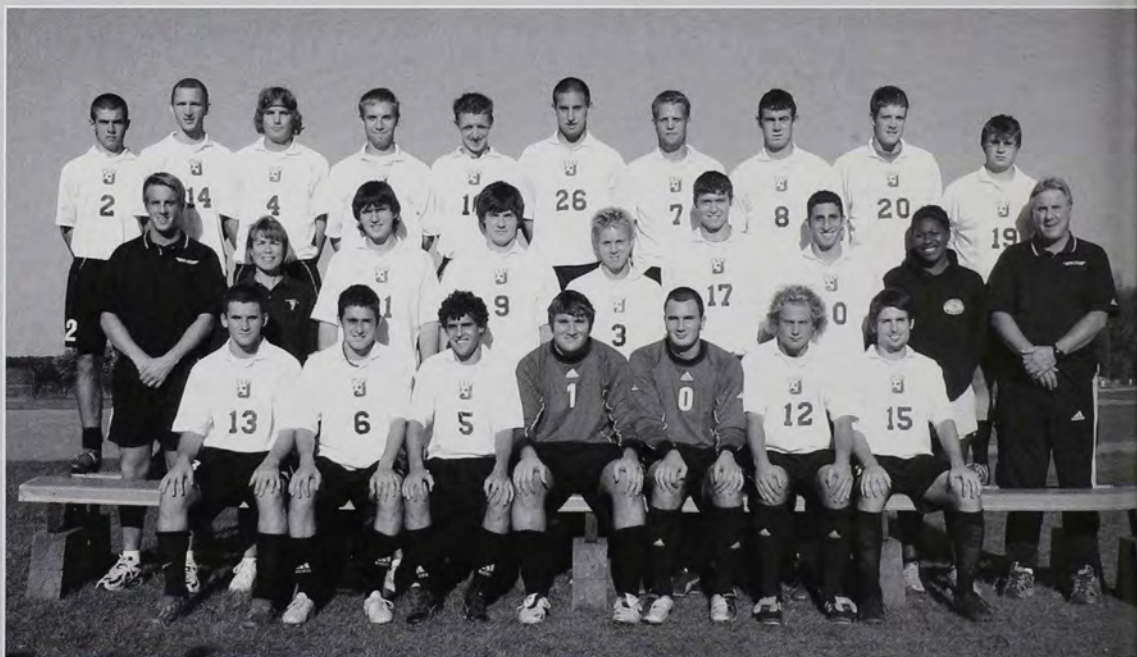

Justin Bobal, Brian Berkowitz, Dean Kelly, Tom Moulder, Jonathan Herting, Dan Callahan, Tyler Johnson, Steve Morris, Kevin Murphy, Chris Hood, Corey Goldberg, Dave Kiefer, Tom Hanlin, Christopher Bascom, Karl Kelchner, Josh Finger, Dan Urban, Doug Van Allman, Eric Requa, Christopher Fratz, Marcus Ressler, Kevin Domanski, Zach Coale

MEN'S SOCCER



Above: Kevin Murphy jukes an opponent to gain an advantage.

Top Left: Dan Urban runs down yet another opponent.

Left: Brian Berkowitz makes another dynamite save.

Bottom Left: Steve Morris corrals another loose ball away from an opposing player.

Bottom Right: Josh Finger makes his turn at lightning speed to go after the ball.



WOMEN'S SOCCER



Above Left: Aubrey Andre crosses the ball to her teammates.



Above Right: The team watches as Audrey McKenna breezes past the opposition.



Right: The bench celebrates a goal on the field.

Bottom Right: Chelsea Morin weaves in between two defenders.

Bottom Left: Sarah Weddle fakes out an opposing player.





Top: Jessica Hartline sneaks one past the opposition.

Left: The team celebrates a hard-fought win.



Imme McCormick, Ashley Potter, Corinne Coates, Chelsea Morin, Elaine DiFelicantonio, Paula Keller-Lee, Jessica Hartline, Kristen Papenberg, Lauren Washam, Amanda Ose, Katie Zurich, Audrey McKenna, Debbie Jensen, Gina Serago, Jen Cohen, Aubrey Andre, Sara Weddle, Cori Turkowski, Sarah Gardner, Logan Conklin, Kristen Hildebrand, Alia Dixon

2004 Schedule & Results

Opponent	Score
Immaculata	W 8 - 1
@ Delaware Valley	W 4 - 1
Houghton	L 0 - 2
@ Cabrini	W 4 - 1
DeSales	W 1 - 0
@ Gettysburg	L 0 - 2
@ Moravian	L 0 - 2
Dickinson	W 3 - 2 (OT)
Washington	W 1 - 0
@ Johns Hopkins	L 0 - 3
@ Swarthmore	W 2 - 1
@ Haverford	W 8 - 1
@ Swarthmore	W 2 - 1
@ F & M	W 3 - 2 (2OT)
Widener	W 4 - 0
@ Elizabethtown	T 1 - 1 (2OT)
Bryn Mawr	W 1 - 0
@ McDaniel	L 1 - 2
@ Haverford	L 1 - 3
Muhlenberg	W 3 - 2
@ Muhlenberg	W 1 - 0
(C-C 1st Round)	
@ Gettysburg	L 0 - 2
(C-C 2nd Round)	



Above: Randy Taylor is kept from the ball by his defender.

Right: The offensive unit prepares for a march towards the end zone.



2004 Schedule & Results

Opponent	Score
Susquehanna	L 19 - 43
Catholic	W 39 - 0
@ Albright	L 34 - 51
McDaniel	L 10 - 50
La Salle	L 19 - 21
@ Muhlenburg	L 3 - 17
@ Gettysburg	L 0 - 14
Johns Hopkins	L 14 - 20
@ F & M	L 21 - 28
@ Dickinson	L 7 - 10

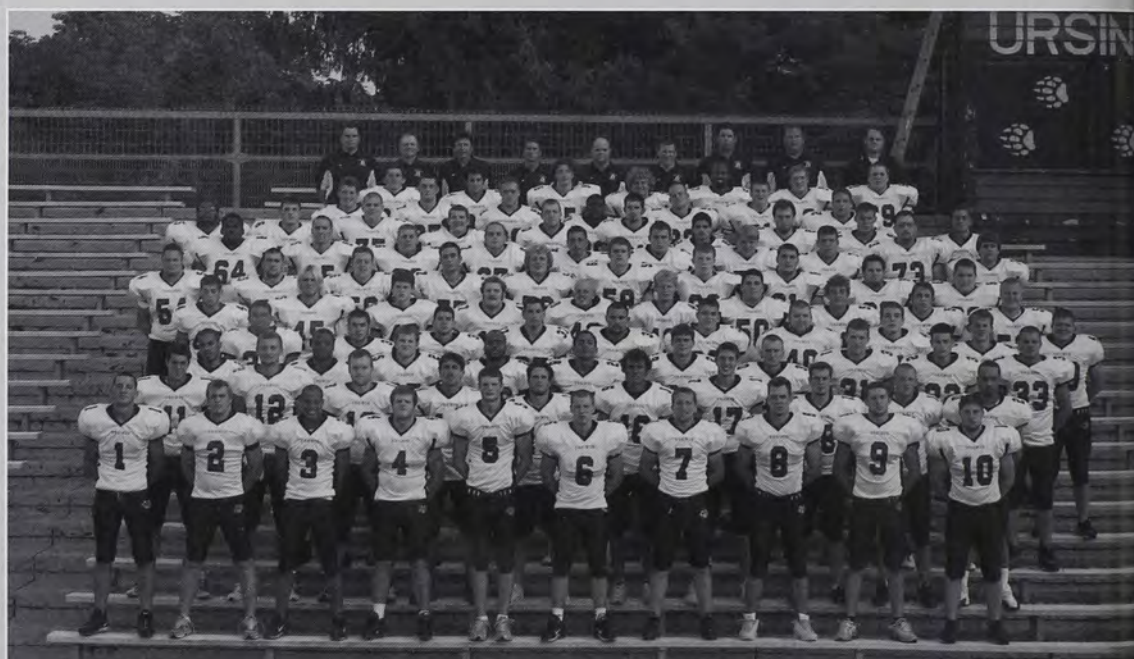

J. Hannum, R. Taylor, M. Duppel, B. Evans, A. Schmidt, D. Kupstow, V. Gallagher, L. DeMark, D. Duffy, S. Markoe, T. Wallingford, R. Graham, E. DiBlassio, K. Gorman, M. Wolf, M. Pastor, J. Ziegler, R. Graver, E. Rembert, J. Kemp, D. Ashworth, R. VanWright, R. Peterson, J. Edwards, E. Pearson, I. Muhl, D. Silvestri, S. Phillips, J. Teixeira, B. Evans, J. Cannon, K. Stahler, F. LaSasso, J. Repko, F. Hales, M. Herm, I. Bell, D. Scaffid, A. Jones, D. Concannon, J. Gantner, R. Tole, J. Wissler, N. Wagner, J. Sproule, J. Milligan, S. Ordog, B. Hryncyszyn, M. Crowley, A. Bonsall, K. Cavanagh, S. Wallace, B. Hasse, Z. Arnhold, J. Rinkus, K. Lynn, R. Iacobucci, W. McRae, A. Hendershot, D. Marcheski, M. Dolan, F. Dimeglio, M. Curran, C. Gentile, F. Rothenberger, D. Witmer, B. Schemery, P. Wigfall, J. Joyce, T. Beers, J. Traino, J. Conte, D. Talley, M. Weyrauch, M. Goldhagen, M. Jones, M. Trio, C. Greco, S. Ciabattoni, K. Mazonkey, T. Pugh, C. Carthan, R. Gibson, K. Folwer, C. Carey, B. Devlin, F. Mallon, M. Lebo, W. Katinowsky, J. Ellis, J. Kelly, M. Kimpel



Above: Brandon Evans makes a rush up the sideline.

Above Left: The offense confers about the upcoming play.



Left: Kieran Gorman and the rest of the offense celebrate a timely touchdown.

Bottom Left: Vince Gallagher contemplates his options while his offensive line holds back the opposition.

Bottom: Vince Gallagher mans the offense behind Andrew Bonsall and the rest of his offensive line.

FOOTBALL



VOLLEYBALL

Right: The team discusses the game plan in the huddle before their match.

Bottom Right: Leah Rosin-Pritchard, Amanda Morello, and Erin O'Hara ready themselves for the pending attack.

Bottom: Leah Rosin-Pritchard watches on as Jill Alspach attempts a block against Swarthmore.



Jill Alspach, Leah Rosin-Pritchard, Juliet Bronstein, Allison Hitchens,

Meghan Little, Katelyn Gerrity, Kimberly Newton, Amanda Morello,

Michelle Finney, Erin O'Hara, Melissa George

Head Coach: Shawn Ganter

Opponent	Score
Kean	(W) 3-0
@ F & M	(L) 0-3
Brockport (@F&M)	(L) 1-3
Dickinson (@F&M)	(L) 1-3
Albright	(L) 1-3
Alvernia	(L) 0-3
Wilkes	(L) 0-3
Johns Hopkins	(L) 1-3
@ Elizabethtown	(L) 1-3
St. Joseph's	(W) 3-0
Moravian	(L) 0-3
@ F & M	(L) 0-3
@ DeSales	(L) 2-3
McDaniel	(L) 1-3
@ Arcadia	(L) 1-3
@ Immaculata	(L) 1-3
@ Dickinson	(L) 0-3
@ Haverford	(L) 0-3
Rowan	(L) 0-3
Washington	(L) 2-3
Muhlenburg	(L) 0-3
@ Swarthmore	(L) 0-3
@ Gettysburg	(L) 0-3
Bryn Mawr	(W) 3-0



Carissa Jessey, Barbara Hale,
Felicia McGill, Jenna Sychterz,
Sharon Belove, Alaina Cara,
Kristin Carter, Tiffany
Friedman, Courtney Moser, Erin
Padovani, Christine Ragsdale,
Julie Balko, Karissa Higman,
Melissa Mancini, Brittany Perry,
Ryan Romberger, Danielle
Zupanovich



CHEERLEADING

CROSS-COUNTRY



Women: Christina Cooper, Lynne Erickson, Britiany Gilbert, Maureen McCarthy, Sara McNally, Meghan Murphy, Kathleen Parkman, Christina Stephenson, Allison Stouch, Eden Swick, Regina Willett

Men: Larry Barr, Christopher DeLeon, Kevin Metz, Pat O'Neill, Mark Robidoux, Azizahmed Shaikh, Nicholas Smart-Coulter, Luke Sullivan, Joesph Szymanski, Jeffrey Teigler, Eric Wickersham, Brandon Zapalac

@ Lebanon Valley Invitational
men-12th / women-14th
@ Muhlenburg Invitational
CCD-weather
@ Philadelphia Metro Championships
men-6/20 / women- 8/18
@ Belmont Classic
men-3/15 / women-8/17
@ Goldey-Beacom Classic
men-4/14 / women-6/15
@ Haverford Invitational
non-scoring
CC Championships @ McDaniel
men-9/9 / women 10/10
NCAA Regional Qualifier @ Allegheny
men-29/34 / women-29/35
NCAA Regional Championships @ Eau Claire
TBA



Above: Sara McNally breaks away towards the finish.



Above Right: Jeff Teigler, Nicholas Smart-Coulter and Brandon Zapalac break away around the turn.

Right: Kevin Metz and Brandon Zapalac celebrate a hard fought meet.

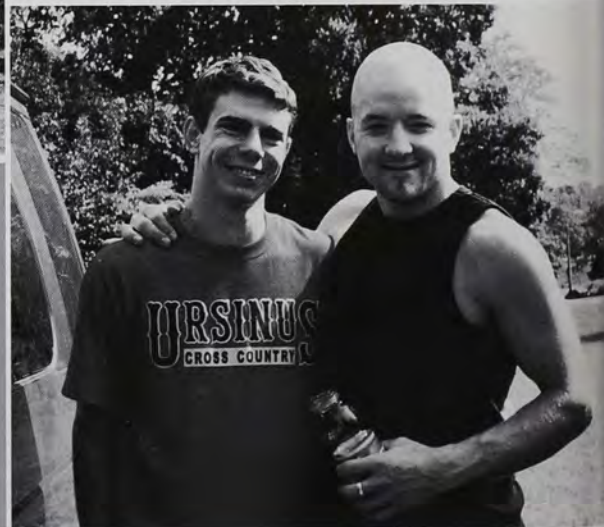



Will Bosma, L. Clark Boyd, Jason Brown, Ramon Clark, Ryan Daley, Jack Dillon, Chris Frazier, Andrew Hollis, Zach Ichter, Bo Maguire, Alan Newmaster, Matt Orlando, Ryan Pauline, Brian Schultz, Craig Stevenson, Anthony Tori, Andrew Wood



3
Franklin & Marshall
Invitational
9th/17 (322)

5
The Jay Classic
8th/15 (308)



23
Cavanaugh Fall Invitational
9th/19 (316)



27
Cannon Valley Invitational
17th/19 (341)



31
Schlenker Fall Classic
8th/11 (369)

GOLF

WOMEN'S BASKETBALL



Above Left: Sarah Hennessey hustles back on defense to stop the fast break.



Above Right: The team congratulates Kelly Borrell as she gets a rest after her hard work on the floor.



Right: Kelly Borrell (22) communicates with Molly Guntli as to where the opposition is.

Bottom Right: Liz Munn prepares to catch and shoot a wide-open 3-point shot.

Bottom Left: Julia Tramontana readies herself to cut to an open space in between the defense.



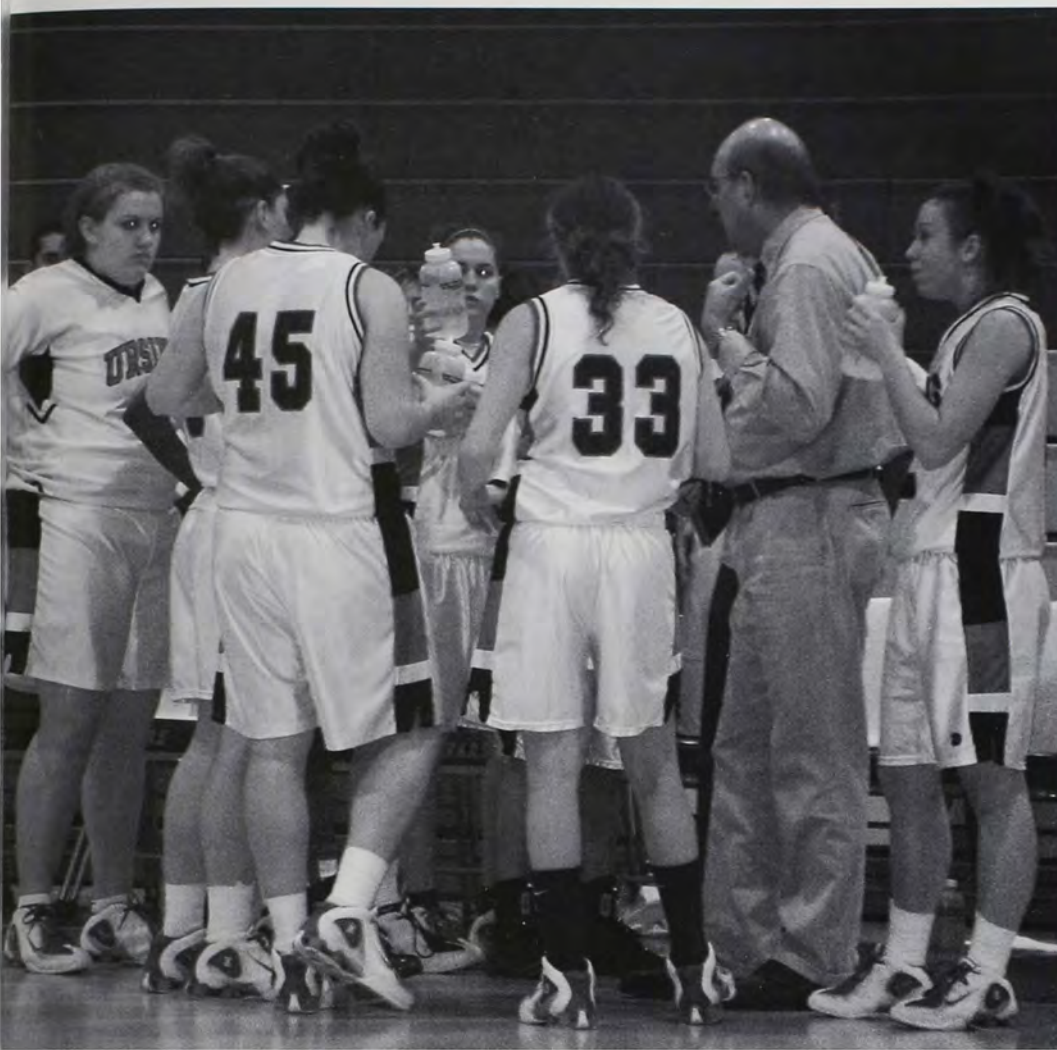

Top: Alison Walker watches as Mary Kate Daley sinks yet another free throw.

Left: Coach Jim Buckley talks it over with the team as they capitalize on a much needed rest.



Phanie Cavalier, Alison Walker, Dana Alf, Liz Munn, Kelly Borrell, Mary Kate Daley, Sarah Messey, Tracy Maginnis, Julia Tramontana, Molly Guntli, Manager: Lindsay Garavel
 Head Coach: Jim Buckley Assistant Coaches: Kara Miller, Kristen Sullivan

2004-2005 Schedule & Results

Opponent	Score
Susquehanna	L 65-74
William Patterson	W 68-67
Gettysburg	L 85-94
Swarthmore	L 49-63
@ Moravian	L 71-77
@ Phila Biblical	W 61-47
@ Del. Valley	L 56-68
Albright	W 65-42
@ Haverford	W 75-55
F & M	W 71-60
@ Dickinson	L 63-66
McDaniel	L 44-62
@ Johns Hopkins	L 41-73
Wilkes	W 62-44
Bryn Mawr	W 71-33
@ Swarthmore	L 30-66
Muhlenberg	W 70-60
@ McDaniel	L 39-65
@ Washington	W 74-39
@ F & M	L 62-71
@ Bryn Mawr	W 63-40
Dickinson	L 54-62
Haverford	
Johns Hopkins	
@ Muhlenberg	



Above: Brian McEvily rises above his man to knock down another clutch jumper.

Right: Mike McGarvey and Tim Smith try to trap their opposition before he gets over half-court.



2004-2005

Schedule & Results

Opponent	Score
@ Trinity	L 66-91
Rhode Island	W 124-117
@ Eastern	W 94-61
@ Lebanon Valley	L 59-70
Swarthmore	W 82-68
@ Washington	L 70-71
@ Drew	W 73-33
Cal St. Monterey Bay	L 49-77
SUNY New Paltz	L 75-83
@ Haverford	L 75-86
F & M	W 91-82
@ Dickinson	W 90-68
McDaniel	W 92-70
@ Johns Hopkins	L 69-70
Gettysburg	L 63-71
@ Swarthmore	W 75-61
Muhlenberg	W 86-75
@ McDaniel	W 89-81
Washington	W 89-80
@ F & M	L 60-91
@ Gettysburg	W 69-64
Dickinson	W 84-74
Haverford	W 76-68
Johns Hopkins	W 80-77 OT
@ Muhlenberg	W 76-71
Gettysburg*	W 87-72
F & M*	W 72-70
NYC Tech^	L 66-68

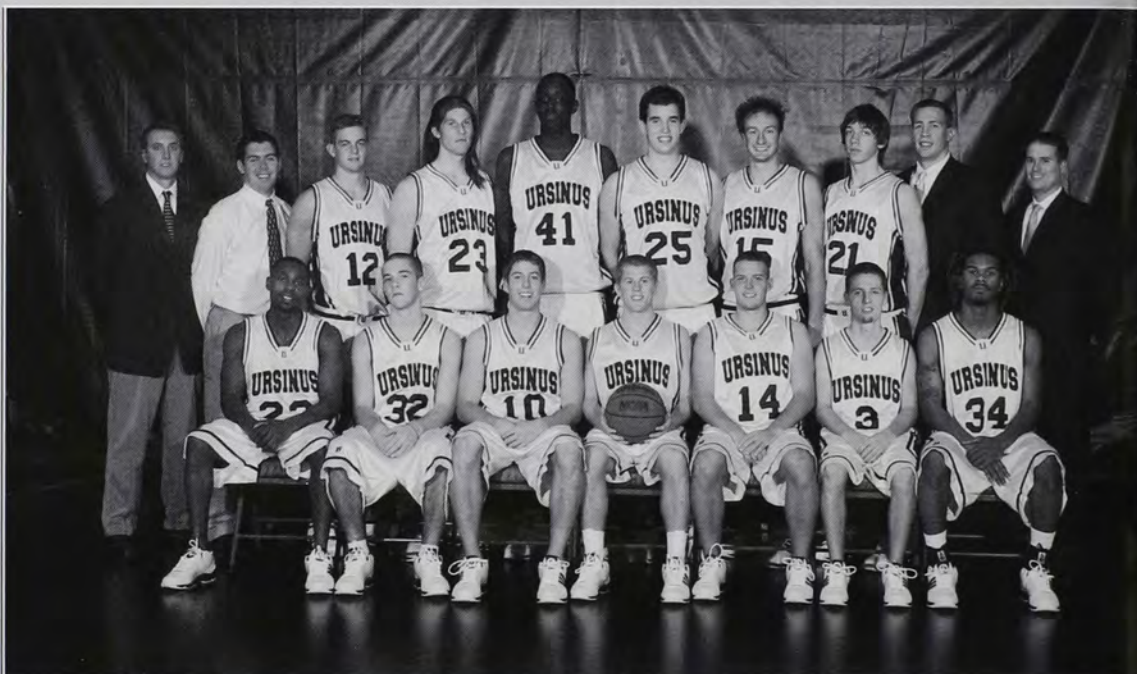

Luke Marlow, Bret Jenkins, Mike McGarvey, Brian McEvily, Ted Piotrowicz, Matt Fabian, Nick Shattuck, Olalekan Popoola, Joe Scholz, Will Furey, Tim Smith, Naquan Williams, Michael Sherrill
 Manager: Chris Young

Head Coach: Kevin Small

Assistant Coaches: Joe Rulewich, Steve Erfle, Dennis Stanton

* Centennial Conference Playoffs

^ NCAA Division III Playoffs



Above: Teddy Piotrowica gets the outlet pass to a guard after he grabs down another solid rebound.

Top Left: Coach Small gets the team back on the same page during a time-out.

Left: Naquan Williams drives past his opponent on his way to another easy lay-up.

Bottom Left: Bret Jenkins looks for the best way to make his entry pass into the post.

Bottom Right: Lekan Popoola goes up for a fast-break lay-up after his steal.



MEN'S BASKETBALL

WRESTLING

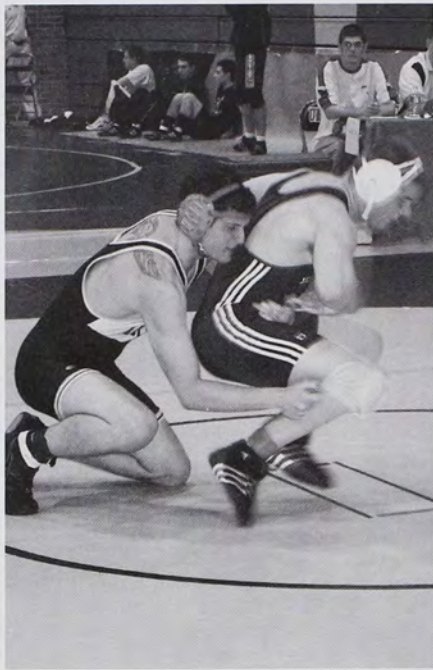

Above Left: Tyler Shartel struggles to keep his advantage over his opponent.



Above Right: Jason Sabol works to tie up his opponent and stay in the match.



Right: Eddie Murray punishes his opponent down to the mat in preparation for another NCAA tournament.

Bottom Right: Jared Allred works over his opponent and tries to find the winning combination.

Bottom Left: All-American Mike Troutman readies his opponent up for the easy pin.

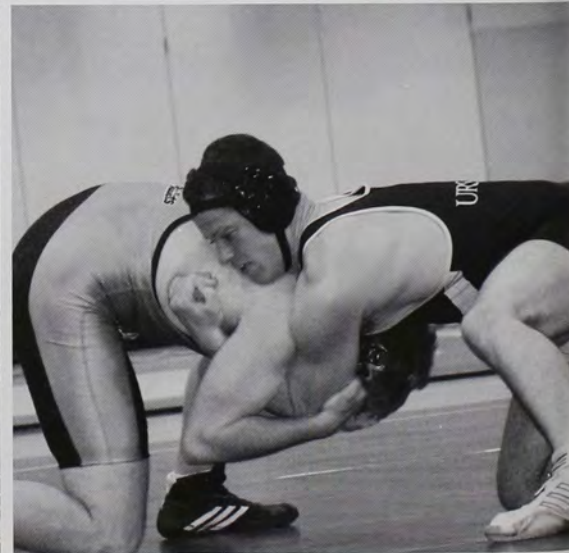

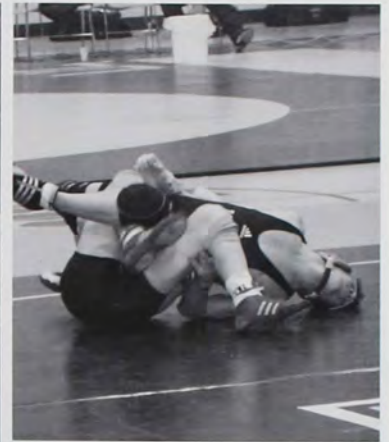
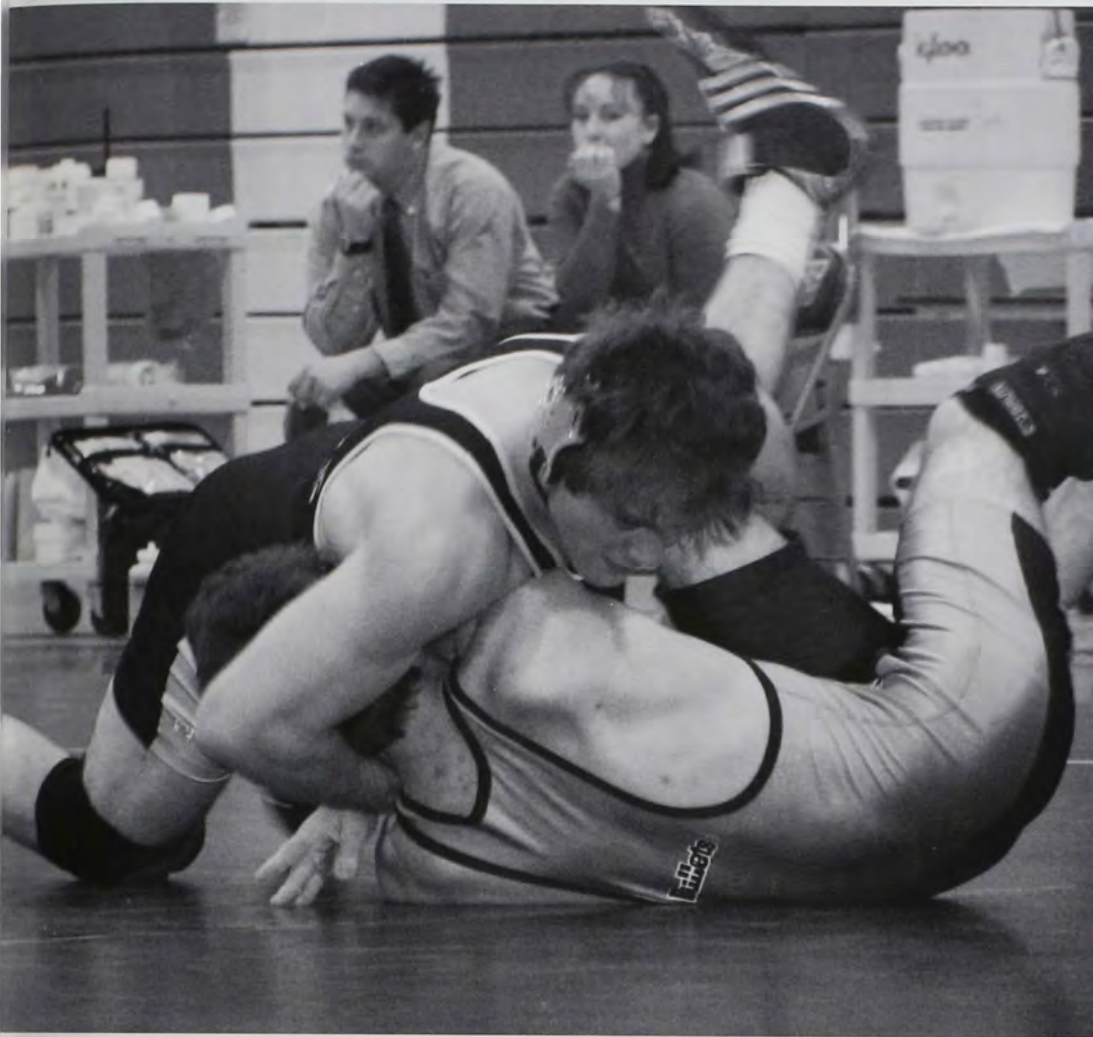

Top: Eddie Murray ties up his opponent who seems to be in a world of hurt.

Left: All-American senior Scott Roesch, the Ursinus all-time leader in career wins, takes down yet another adversary.



red Allred, Boris Bayder, Mark Barber, Brian Boland, Kyle Capella, Mike Cox, James Domesticco, ean Donahoe, Ben Griswold, Frank Hales, Willie Katinowsky, Andy Lane, Mike Lane, Eddie Murray, cott Roesch, Jason Sabol, Josh Sabol, Jeff Scholth, Dan Shaw, Elliot Simon, Brendan Smith, ach Stewart, Jim Swiggard, Steve Tomczuk, Mike Troutman, Anthony Valles, J. J. Weltler, att Williams, Matt Wolf

2004-2005 Schedule & Results

Opponent	Score
@ Messiah Invit.	1 out of 11
@ Monarch Invit.	1 out of 11
Fall Brawl	No Score
@ Petrofes Invit.	6 out of 12
@ Citrus Open	5 out of 13
Rose Hulman*	W 37-6
Case Western*	W 33-9
SUNY Cortland*	W 34-7
MIT^	W 35-16
Trinity^	W 31-12
Bridgewater State^	W 33-12
Western N. England^	W 40-10
Brute-Adidas Tourn.	1 out of 9
@ Johns Hopkins	W 31 - 9
Baptist Bible @ JHU	W 42-12
Gettysburg	W 34 - 9
Waynesburg	W 46 - 6
W & J	W 37-13
Gallaudet	W 60 - 0
Muhlenberg	W 24-19
@ Albright	W 46 - 7
@ NYU	W 29 - 6
Stevens (@ NYU)	W 45 - 9
CC Championships	1 out of 8
NCAA Championships (MN)	
* - Citrus Open	
^ - North/South Duals	

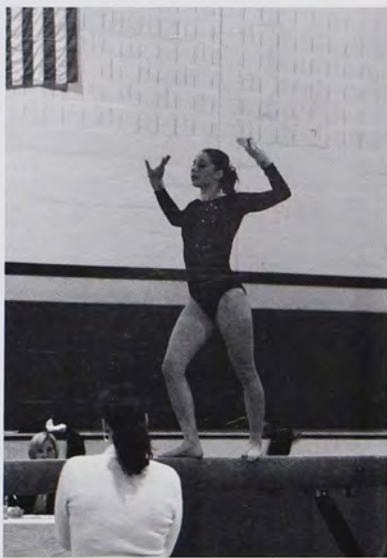

Above: Laura Davis pauses for a moment while on the balance beam.

Right: Briana Morrissey holds on to the bar while doing a flip.



2004-2005 Schedule & Results

Opponent	Score
@ MIT (vs. Wilson, Rhode Island, and MIT)	1 out of 4
UW-Oshkosh/Temple	2 out of 3
@ Temple	3 out of 3
@ Penn	2 out of 4
@ Towson Invitational	4 out of 5
@ Temple	3 out of 4
@ Rutgers	4 out of 4
Wilson	
W 184.475 - 167.975	
ECAC Regionals @ Springfield	
NCCA Nationals (@ UW-Lacrosse)	



Melissa Garman, Laura Davis, Jennifer Rae Fouse, Jessica Furman, Kristen Grimmel, Gillian Harnitchek, Megan Hollern, Emily Marques, Briana Morrissey, Victoria Langton, Amanda Wellbaum

Head Coach: Jeff Schepers

Assistant Coach: Adrienne Carver



Left: Sophomore Jessica Furman, goes over her uneven bar routine during practice.

Right: Freshman Emily Marques performs her vault while Head Coach Jeff Schepers spots

Bottom: Senior Captain, Kristen Grimmel executes a stunt during her balance beam routine.

GYMNASTICS

SWIMMING

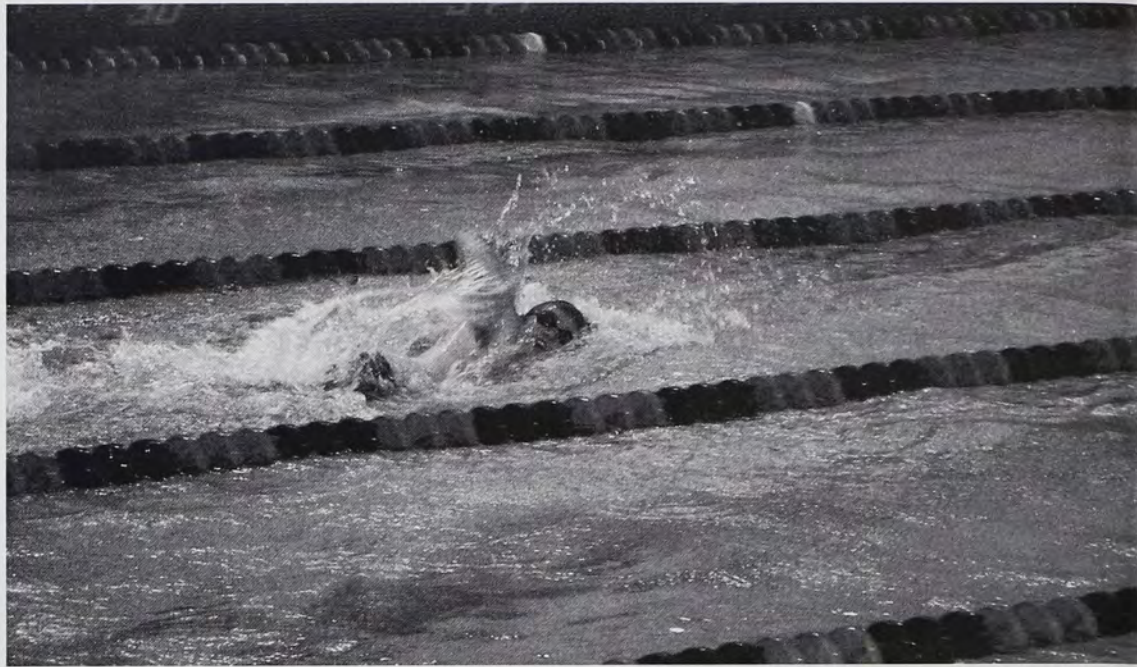

Above: Sophomore Patrick Waldron tries to get the lead in the 4 x 100 relay.

Right: Senior Captain, Carla D'Olio shows us her best breaststroke.

Below: Senior Steve Rote prepares himself for fast start off the block.





The four seniors, Steve Rote, Lauren Carrescia, Carrla D'Olio, and Lindsi DeArment, smile for a picture with Head Coach Nancy Herb before their final home meet against Franklin & Marshall.



Lauren Carrescia, Lindsi DeArment, Carrla D'Olio, Jessica Fean, Kristin Gorman, Caitie Hanlon, Monelle Hedrick, Chanelle Houston, Joanna Kramer, Caitlin McHugh, Katie Perkins, Valery Schartel, Kate Snyder, Allison Stouch, Sarah Tax, Lauren Wise, Clay Lewis, Steven Malagari, Andy Miller, Brandon Peer, Steve Rote, Patrick Waldron, Andy Will
 Head Coach: Nancy Herb Assistant Coach: Matt Wahl

2004-2005 Schedule & Results

Opponent	Score
@ Washington	M: L 49 - 133 W: L 78 - 116
@ Drew	M: L 68 - 78 W: W 128.5-69.5
@ Gettysburg	M: L 49 - 118 W: L 66 - 112
Swarthmore	M: L 80 - 118 W: L 114 - 134
@ Dickinson	M: L 39 - 144 W: L 63 - 132
Arcadia	M: W 93-61 W: W 121 - 79
@ York	M: L 55 - 122 W: W 114 - 90
McDaniel	M: L 79 - 80 W: L 93 - 102
Franklin & Marshall	M: L 47-116 W: L 81 - 106
@ Bryn Mawr	W: L 124 - 127



Egress Plan - Ground Floor

SCALE: 1/16" = 1'-0"



WISMER CENTER

College Store Addition - Ursinus Col

Collegeville, Pennsylvania

2" / PERSON)
REQUIRED 3"
PROVIDED 32"

EXIT
TOTAL OCCUPANTS 252 (0.2" / PERSON)
DOOR EGRESS WIDTH REQUIRED 51"
DOOR EGRESS WIDTH PROVIDED 64"



No. Date Revision

No.	Date	Revision

Keprt Shatken Sharon Architects
337 Witherspoon Street
Princeton, NJ 08542 USA
609-921-1131

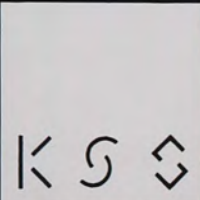

Project No.: 9640
Issued: 29 January 1998

Ground Floor Egress
Plan

A001

Clubs & Organizations

Academic:

Beardwood Chemical Society



President: Raymond DeHont (NP), Vice President: Daniel Iwaniuk, Treasurer: Mohammad Abdo, Secretary: Jess Gallagher, Kevin Sylvester, Catrina Patrick, Zoi Zeo, David Hamalian, Emily Maksimak, Alex Beatty, Kelsey McNeely, and Cristina Polinsky

Exercise & Sports Science Club



President: Lauren Segal, Vice President: Ashley Ettinger, Secretary: Marissa Rotz, Treasurer: Joyce Anne Koubaroulis

Brownback-Anders Pre-Medical Society



President: Josh Pregnar, Vice President: Jaynine Vado, Secretary: Lindsay Goffredo, Treasurer: Lisa Injaian, Editor: Larry Barr, Brittany Perry, Laurie Rodio, Renee Chiodo, Cynthia Ortiz, Jeff Teigler, Joe Eisele, Vicki Matter, Priya Patel, Helena Libis, Julie Bodkin, Dana Yancey, Erica Kaminski, Bradley Bowen, Joseph Santora, Kenton Woodard, Stacey Garcia, Rebecca Rowley, Jess Burgoyne, Dan Dean, Matt Meeker, Christina Stephenson, Logan Conklin, Lauren Washam, Josh Eikenberg, Gina Serago, Casey Joy, Jenn Murphy, Suzanne Smith, Sarah Schott, Julie Balko, Jack Dillon, Nancy Fernandez, Mark Robidoux, Mohsin Ali, Regina Walsh, Brianne Kaminski, Sally Brosnan, Ama Este, Stephanie Sapok, Aseem Balhara, and Alina Bishop

Haines-Barnard Pre-Legal Society



President: Patricia Ciucci, Vice President: Tori Langton, Secretary: Lauren Wise, Treasurer: Michelle Stranen
Jennifer Damelio, Tara Baker, Heather Kennedy, Heather Leshner, Gerry Hess, Nick Smart-Coulter, Emily Landgraf-Kimball, Meggie Porrini, Lauren Davila, Alex Mison, Sherrell Dandy, Sage Corwin, Andrew Larsen, Scott Krysa, Julian Wright, and Kenneth Warren

International Relations Club



President: Evan Diblassio, Vice President: Kyla Mocharnuk, Recording Secretary: Amanda D'Amico, Corresponding Secretary: Kelly Horst, Treasurer: Lauren Wise, Prianka De, and Alexandra Hunter, Advisor: Joe Melrose

Psychology Club



President: Heather Morris, Vice President: Susan Buttigieg, Secretary: Jennifer McQuate, Treasurer: Joelle Turner, Publicist: Nick Dobkowski, Historian: Stacia Detter, USGA Representative: Chris McLaughlin, Sarah Terrible, Jan Cohen, Alissa Smith, Valentina LoPiccolo, Andrea Mack, Sheila Marrero, Jenna Filipkowski, Kristina Cerchiaro, Chantell Johnson, Tara Kyser, Kenton Woodward, Karen Todd, Emily Landgraf-Kimball, Steph Guiliano, and Kelayne Minus, Advisor: Dr. Kneia DaCosta

Activities:

Berman Buddies



President: Sarah Kauffman, Vice President: Liz Bollinger, Secretary: Doren Peterson, Treasurer: Jen McQuate, Kate Rettstadt, Trevor Strunk, Jen Romer, Shannon Santillo-Herbert, Jenny Kerschner, and Jen Mingoello

Chess Club



John Hanford, Drew Mangler, David Burns, Katie Blanchard, and Brian Hesselbach

Dance Dance Revolution Club



President: Josh Krill, Vice President: Jon Gagas, Secretary: Jacob Wojnar, Treasurer: Lei VanDyke, David Burns, Deidre Delpino, Armen Bakalian, and Amanda Bryman

Investment Club



President: Dan Uba, Vice President: Jeff Vicki, Secretary: Steve McNabb and Adam Davis (NP), Treasurer: Ghadir Eshgaidef, Advisor: Dr. Economopoulos

Students for Creative Anachronism



President: Matthew Keck, Vice President: Rebecca Rowley, Secretary: Sara Campbell, Arts & Sciences: Matt Sundheim

Ursinus College SCUBA Dive Team



President: Erony Whyte, Vice President: Jullien Searfoss, Secretary: Emily McGrath, Treasurer: Josh Kistner
Jessica Gallagher, Casey Joy, Amanda Bryman, Colin McDermott, Defne Sarsilmaz, Neal Cooper, and Sally Brosnan

Ursinus Table Tennis Association



President: Ghadir Eshqaidef, Vice President: Isa Muqattash, Yan Liang, Mark Dennis, Julian Stine, Rami Farag, Mohsin Ali, and Haitham Mansour

Women's Rugby



President: Stephanie Guyger, Treasurer: Kari Sears, Secretary/Captain: Alexandra Hunter, Captains: Nicole Taormina, Rachel Margolis, Nicole Loesch, Nina Graham, Tarah Pearson, Emily Files, Laurie Rodio, Sarah Schott, Carolyn Vogt, Michelle Noreski, Lauren Gibson, Sarah Jarvis, Jaime Malarchik, Janine Herring, Claire de Rosen, Candice Esparra, Jennifer Damelio, Caitlin O'Connor, Karen Guardiani, Kristen Brown, Caitie Hanlon, Sara Marshall, Samantha Erle, Amber Howard, Juliet Emas, Amy Hollaman, and Defne Sarsilmaz

Men's Rugby



President: Chris J. Long, Vice President: Cris Mathew, Captain: Jared Good, Medic/Doctor: Colm McCarthy, Match Secretary: Robert Farley, Cole Racich, Alex Ernst, Klaus Yoder, Bill Eppler, Matthew Sander, Dan Shaw, Rob Ellison, Brenden Shaw, Thor Osgood, Jack Teed, Dray Smith, Clay Hazelett, Mike Antonelli, Jason Every, Dan Devlin, Zachary Poe, Benjamin Schumacher, Patrick Mulhern, Rob Ebling, and Dan Iwaniuk

Arts:

Bearitones



President: Cris Mathew, Vice President: Chris Fratz, Secretary: Patrick Waldron, Treasurer: John Darmon, Librarian: Xander Goldberg, Performance Coordinator: Nathan Dawley, Lauren Canas, Aseem Balhara, Larry Barr, Rob Ellison, Elliot Simon(NP), Patrick Wigfall, Alex Gaustad, and Dereck Lafontant

College Concert Band



Stevie Bastinck, Amy Lynch, David Chamberlain, Kirsten Schuck, Stephen Buss, Lisa Injaian, Ashley Bender, Carolyn Faris, Katie Fritz, Sarah Keck, Nirali Amin, Joshua Solomon, Ryan Golowski, Laura Blauch, Dereck Lafontant, Joshua Kistner, Julian Stine, and Tommy Richter

Ursinus Folksong Society



President: Peter Bregman, Vice President: Heather Morris (NP), Secretary: Meredith Kleiber, Treasurer: Ashley McIntosh, Laura Glace, Kristina Cerchiaro, Kaitlyn Allen, Katie Fritz, Hallie Andrew, Nick Dobkowski, Dan Sergeant, Ali Wagner, Felicia Chou, Georgia Julius, Julian Stine, Brandon Brown, Megan Helzner, Justin Donovan, Chris Curley, Ashley Higgins, Tiffany Sparagana, Laura Cruz, Bridget Taylor, Trevor Strunk, Jon Kieran, Perrin Moses, Ashley Drogalis, Richard Newby, and Dan Nichols

Jazz Ensemble



Ethan Benedict, Sarah Keck, Lisa Injaian, Joshua Solomon, Bill Schomp, Chuck Blackledge, Adam Gaines, Mike Platchek, Ryan Golowski, Ned Cooper, and Joshua Kistner

Ursinus Music Society



President: Lisa Injaian, Vice President: Megan Jones, Secretary: Stefanie Bastinck, Treasurer: Chantell Johnson, Historian: Sarah Keck

Voices of Praise- Gospel Choir



President: Joshua Smedley, Vice President: April Eakin, Secretary: Jennifer Peterson, Treasurer: Kelly Ireland, Historian: Shonn Shearlds, Chaplin: Darron Harley, Director: Michael Adenaike ('00), Musician: Rayshawn Davidson, Dana Yancey, Britiany Gilbert, Candace Thomas, Martha Nielsen, Shawntee Rudd, Amber Howard, Chanelle Houston, Leah Davila, Latisha Sharper, Eboni Heyward, DiAndra Thompson, Arley Styer, Marisa Meana, Kaitlyn Allen, Katie Fritz, Sara Marshall, Brianne Kaminski, Andy Miller, Lindsey Kunkel, Melyssa Flythe, and Larry Barr

Cultural:

German Club



President: Jullien Searfoss, Vice President: Kerstin Saal, Secretary: Tia Larese, Treasurer: Greg Russo, Laura Glace, and Andy Miller

Association of Latinos Motivated to Achieve



President: Nuria Caraballo, Vice President: Karina Campbell, Secretary: Shawntee Rudd, Treasurer: Larry Barr, Historian: Karen Todd, Activities Chair: Larissa Cordova, Jessika Rendon, Angela Tucker, DiAndra Thompson, Felicia McNeill, Sarah Yemane, Jaynine Vado, Alison Walker, Chanelle Houston, Amber Howard, Claudia DeCoursey, Dana Yancey, Julian Wright, Kenneth Warren, Latisha Sharper, Lindsey Rodriguez, Leah Davila, Shonn Sheralds, Jennifer Peterson, Eboni Heyward, Darron Harley, Ethel Richards, Daniela Paul, Virginia Santo, Dennis Kearney, Josh Kemp, Graciela Gallo, Marisa Meana, Kelly Ireland, and Nancy Fernandez

Japan Club



President: Joshua Krill, Vice President: Daniel Bruno, Secretary: Armen Bakalian, Treasurer: Jacob Wagner, Amanda Bryman, Samantha Cole, Karen LaRocca, Anette Thomas, Matthew Short, Tadeusz Kroll, David Burns, Greg Russo, Crystal Parsons, Jason Davis, Kori Weinberger, and Marisa Meana

Sankofa Umoja Nia (SUN)



President: Sarah Yemane, Vice Presidents: Monique Spencer & Candace Thomas, Treasurer: Dana Yancey, Recording Secretary: Angela Tucker, Corresponding Secretary: Amber Howard, Historian: DiAndra Thompson, Activities Chair: Karina Campbell, Tiffany McFadden, Chantell Johnson, Brittany Bell, Virginia Santos, Cedria McMillian, Nuria Caraballo, David Burns, Shawntee Rudd, Jennifer Peterson, Amber Howard, Eboni Heyward, Darron Harley, Joshua Kemp, Kelly Ireland, Chanelle Houston, Heather Saunders, Latisha Sharper, Shonn Shearlds, Shannon Brown, Christian Wynne, Christina Cooper, Britiany Gilbert, Daniel Paul, Ashia Downing, Patrick Wigfall, and Julian Wright, Advisor: Paulette Patton

Southeast Asian Student Association (SASA)



President: Prianka De, Vice President: Mona Singh, Secretary: Sarat Duggirala, Treasurer: Joshua Kistner, Social Chair: Menaka Gopalan, Historian: Yan Liang, Josh Bhattacharya, Kirsten Schuck, Reena Koodathil, Ali Wagner, Akina Toyokura, Seiko Shiraishi, Jess Burgoyne, Sylvania Tang, Yukie Hirao, Priya Patel, Shunichiro Seiwa, Mohsin Ali, Rohit Rajoria, Defne Sarsilmaz, Casey Joy, Sori Linda Kim, Felicia Chow, and Mohannad Abdo

Honor Societies:

Beta Beta Beta- Biology Honors



President: Ashley Willow, Vice President: Caroline Biswanger, Secretary: Cristina Polinsky, Treasurer: Mary Anne Murrow (NP), Events Coordinator: Matt Meeker, Lynnsey Zweier, Vishal Thaker, Kathryn Matthias, Dan Dean, Regina Walsh, Megan Jones, Matt Sundheim, Erony Whyte, John Millili, Dray Smith, Alex Beatty, Mohannad Abdo, Brett Scipioni, Lydia Sanchez, Zach Ichter, and Jack Dillon

Phi Kappa Epsilon- ESS Honors



President: Joyce Anne Koubaroulis, Vice President: Marissa Rotz, Secretary: Lisa Jones, Treasurer: Erikah Weir
Gina Salvi, Ashley Ettinger, Marci Logan, Shannon O'Malley, Ellie Knise, and Jim Swiggard

Psi Chi- Psychology



President: Carla D'Olio (NP), Vice President: Angela Tucker, Secretary: Sarah Yemane, Treasurer: Heather Kaczor (NP), Megan Aiello, Heather Pugh, and April Eakin

Sigma Tau Delta- English Honors



Shane Borer, Fallon Szarko ('04), Laura Bickert, Susannah Fisher, Whitney Roper, Stephanie Bradberry ('04), and Melanie Scriptunas ('04)

Political Action:

College Democrats



President: Dennis Vondran, Vice President: Tia Larese, Secretary: Rebecca Cohen, Treasurer: Dan Devlin, Publications Editor: Janine Herring, Clay Lewis, Julie Toth, Priya Patel, Katie Cantwell, Tara Baker, Laura Cruz, Josh Eikenberg, Rachael Sussman, Sam Brody, Erin Pollard, Bailey Turner, David Shack, Lauren Wise, Dan Sergeant, Matt Flyntz, and Ashley Eisenberg

Gay-Straight Alliance



President: Amy Hollaman, Vice President: Heather Pugh, Secretary: April Eakin, Historian: Sarah Kauffman, Mandy Sanborn, Karen Todd, Abby Hare, Cyndi Shimer, Robin Pierce, Hallie Andrew, Jen Mingoello, Nirali Amin, Courtney Stary, Nickie Tamny, Michael Wells, Andy Miller, and Lane Taylor

Media:

The Ruby- Yearbook



Editors: Kevin Sylvester & Britton Bongaardt, Lindsay Goffredo, Jade Garcia, Ashley Willow, Shawntee Rudd, Latisha Sharper, Jason Minutoli, John O'Donnell, Larissa Codora, and Zoha Karmali

UCTV News



Nicole Borocci, Sarah Stanley, Heather Turnbach, Sabir Peele, and David Marcheskie

Religious:

Newman Society



President: Maureen Smeltz, Vice President: Jeff Vicki, Treasurer: Patrick Waldron, Social Chair: Stephanie Guiliano (NP), Christina Liberatore, Amanda D'Amico, Julie Balko, Mark Dennis, Maria DeOliveira, Heather Turnbach, Craig Stevenson, Christine Keough, Allison Stouch, John O'Donnell, Sara McNally, Maureen McCarthy, Kirsten Schuck, Erin Pollard, Lisa Weiser, Meghan Maguire, Amy Guminski, Andrew Larsen, Dane Mangin, Brain Devlin, and Dana Piraino

InterVarsity Christian Fellowship



Executive Member: Nick Dobkowski, Kaitlyn Allen, Hallie Andrew, Brianne Kaminski, Kristina Cerchiaro, Antoinette Gardner, Laura Blauch, Sarah Keck, Amy Lynch, Katie Fritz, Damaris Hunziker, Felicia Chow, Dave Thomas, Joshua Frear, Jessica Kim, Linda Kim, and Maureen McCarthy, Advisor: Jennifer Bartholomew

Service:

Best Buddies



President: Erica Kehler, Vice President: Jennifer McQuate, Secretary: Abby Hare, Treasurer: Meghan Murphy, Activities Coordinator: Stephanie Guilliano, Crystal Parsons, Kimberly Bean, Priya Patel, Mikala Pacifique, Vickie Rosi, Emily Maksimak, Julie Bodkin, Corinne Beyers, Mary Ellen Flynn, Erin McHugh, Jessica Kim, Chris Frazier, Mike Malone, Erin Pollard, Sage Corwin, Joe Im, Tim Kim, Chung Kwon, Carolyn Vogt, and Sarah Schott

Students Together Against Rape (STAR)



President: Jessica Soto, Vice President: Mona Singh, Secretary: Jessica Gallagher, Treasurer: Zak Benziger, Nick Dobkowski, Caitlin Cleary, Lauren Davila, Effie Gray, Rachel Durphy, Stacie Wohar, Zach Tobias, Kelly Lacey, Danielle Langdon, Sabir Peele, Jenny Kerschner, and Emily Landgraf-Kimball, Advisor: Corinthian Ridgeway

Student Emergency Response Volunteers (SERV)



Chief: Mike Roberts, Assistant Chief: Rachel Nagourney, Secretary: Caroline Biswanger, Treasurer: Ryan Lenhart, Infectious Control Officer: John Millili, Ashley McCaleb, Regina Walsh, Jeanine Mahle, Laura Davis, Kenton Woodard, Dan Cojocar, Steve Malagari, Josh Pregnar, Mona Singh, Jessica Soto, Jess Kremenak, Jason Silverman, Marissa Kletsko, Amber Adkins, Sarah Spencer, Martha Nielsen, Eric Smith, Michelle Noreski, Neal Cooper, Stacey Garcia, Jenna Krier, Megan Hollern, Maureen Smeltz, Becky Rowley, Kristin Blaser, Alex Miron, Priya Patel, Kirsten Schuck, Shannon Santillo-Herbert, Nicole Taormina, Kari Sears, Claire de Rosen, Alex Frey, Brianne Kaminski, Kim Daloisio, Jeff Teigler, Mark Dennis, Damaris Hunziker, Ashley Eisenberg, Megan Eleftherion, and Sarah Shaw

Writing Center Tutors



Jon Coller, Shane Borer, Sarah Weddle, Holly Poorman, Maureen McCarthy, Amy Guminski, Katie O'Brien, Julie Gentile, Klaus Yoder, Shannon Santillo-Herbert, Deidre Delpino, Alison Shaffer, Cynthia Shimer, Raymond DeHont, Meredith Kleiber, Jason Knapp, Shelby Cochran, Vanessa McGrath, Doren Peterson, Whitney Roper, Jason Minutoli, Sarah Kauffman, Caitlin McGuire, Josh Rucci, Kari Sears, April Eakin, and Katy Diane, Advisor: Francis Fritz

Governance:

Greek President's Council



Ryan Curley, Matt Meeker, Steve Rote, Chris Gross, Lauren Carrescia, Josh Rucci, Dana Fillo, Lauren Allen, Tyler Schartel, Kelayne Minus, James Lawson, Brooke Swalm, Melody Mumbauer, Chris Weir, and Caroline Biswanger, Advisor: Austin Duckett

Residence Hall Association (RHA)



President: Maureen Smeltz, Vice President: Julia Lickfield, Treasurer: Lauren Segal, and Recording Secretary: Kate Conner, Advisors: Steve Larson & Natissa Kultan

Campus Activities Board (CAB)



President: Greg Keresztury, Vice President: Heather Leshner (NP), Corresponding Secretary: Stephanie Guilliano (NP), Recording Secretary: Tia Larese, Treasurer: Matt Sundheim Advertising Chairs: Tasheia Walker (NP) & Julia Lickfield Katie Cantwell, Kevin Metz, Katie Ringler, Allison Stouch, Rachael Greenly, Jen Romer, Andrea Mack, Jenny Kerschner, Chris Rosci, Regina Walsh, Megan Jones, Kate Conner, Jessica Kim, Erin McHugh, Katey Gumz, Stephen Edelman, Jason Sabol, and Steve Tomczuk

Ursinus Student Government Association (USGA)



President: Vince Rossamndo, Vice President: Cris Mathew, Corresponding Secretary: Sarah Kennedy, Recording Secretary: Amanda D'Amico, and Treasurer: Lisa Injaian

Class of 2005 Council

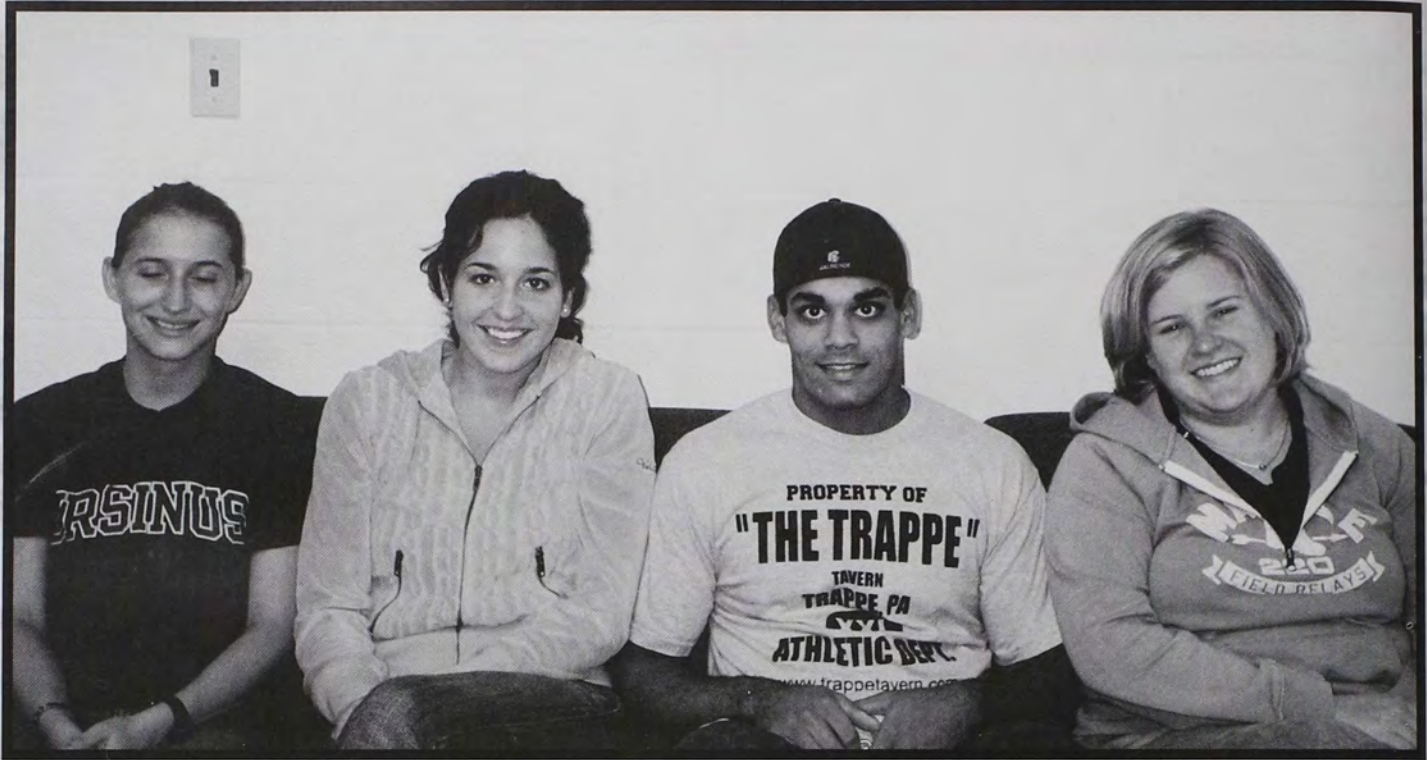

President: Samit Patel, Vice President: Joelle Turner, Secretary: Catrina Patrick, Treasurer: Jennifer Bolton (NP), and Social Chair: Lauren Brophy

Class of 2006 Council

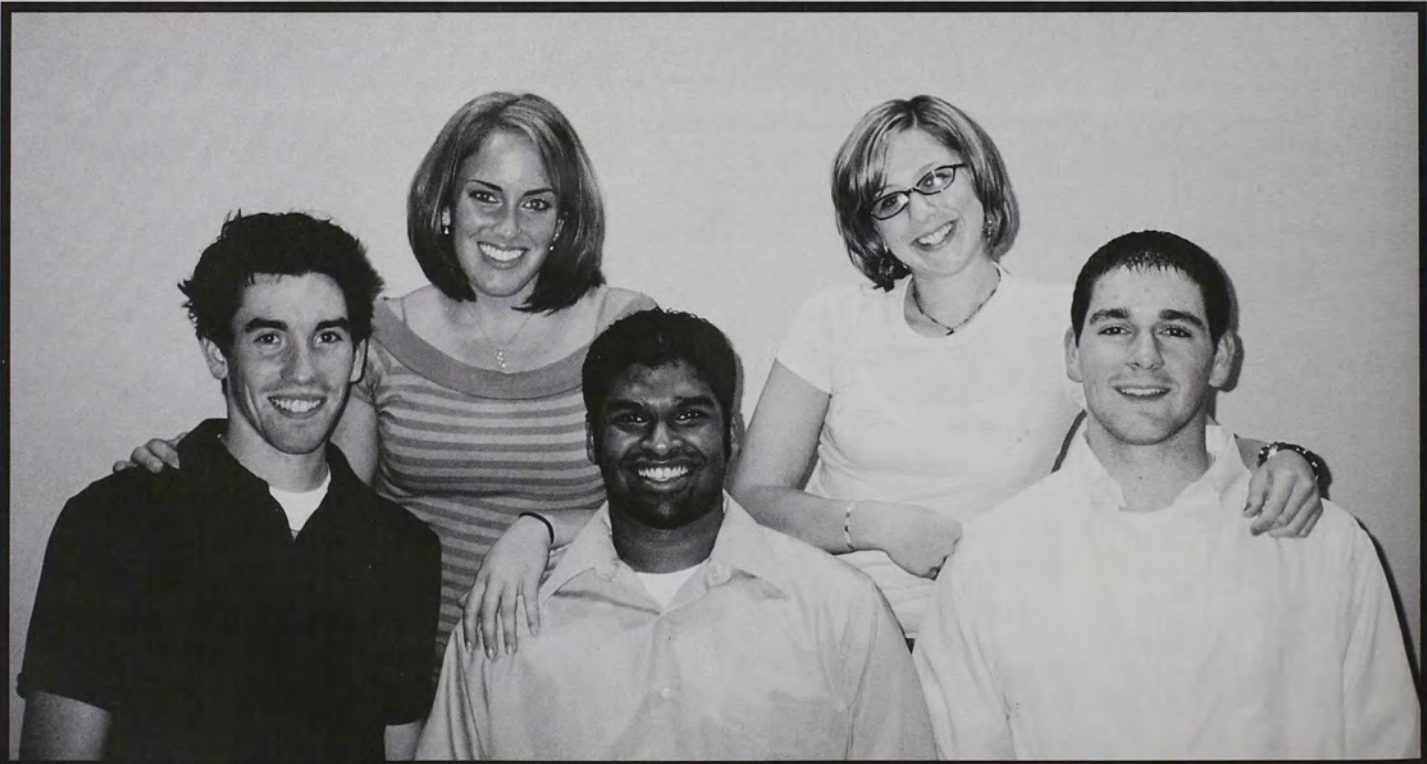

President: Cris Mathew, Vice President: Mike Conner, Secretary: Vanessa McGrath, Treasurer: Kelly Debow, and Social Chair: Vince Rossomando

Class of 2007 Council



President: Ramon Clark, Vice President: Lou De Mark, Secretary: Janine Herring, Treasurer: Caitlin Massey, and Social Chair: Mikala Pacifique

Class of 2008 Council



President: Rob Ellison, Vice President: Ivy McDaniels, Secretary: Megan Helzner, Treasurer: Stacie Wohar, and Social Chair: Sage Corwin

REMOVE BATH DOOR
CONSTRUCT MATCHING
SILL TO MATCH THE
PREPARE OPENING TO
NEW WTRW - SEE

DEMOLISH EXTL. BATH.
REMOVE ALL EXTL. FIXTURES
AND SALVAGE FOR OWNER

BATH 206

ROOF

REMOVE EXISTING ROOF DOWN
TO SUBSTRATE. REPAIR SUBSTRATE
TO RECEIVE NEW MEMBRANE
ROOF (N.I.C.)

BEDROOM
203

STAINED GLASS
WINDOW. PROVIDE
INT. STORM WDW.
SEE DTL.

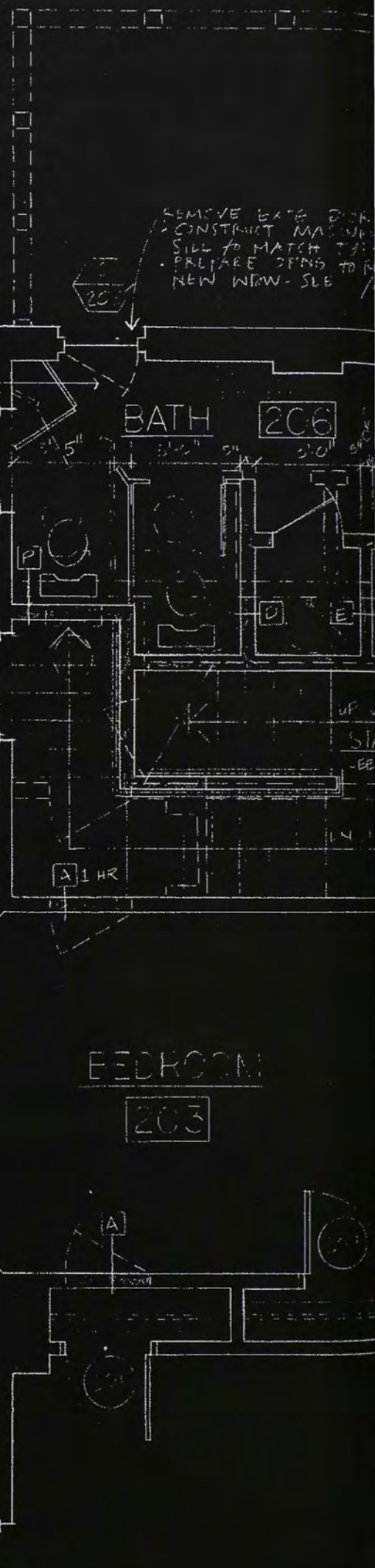



K
T
R
A
B

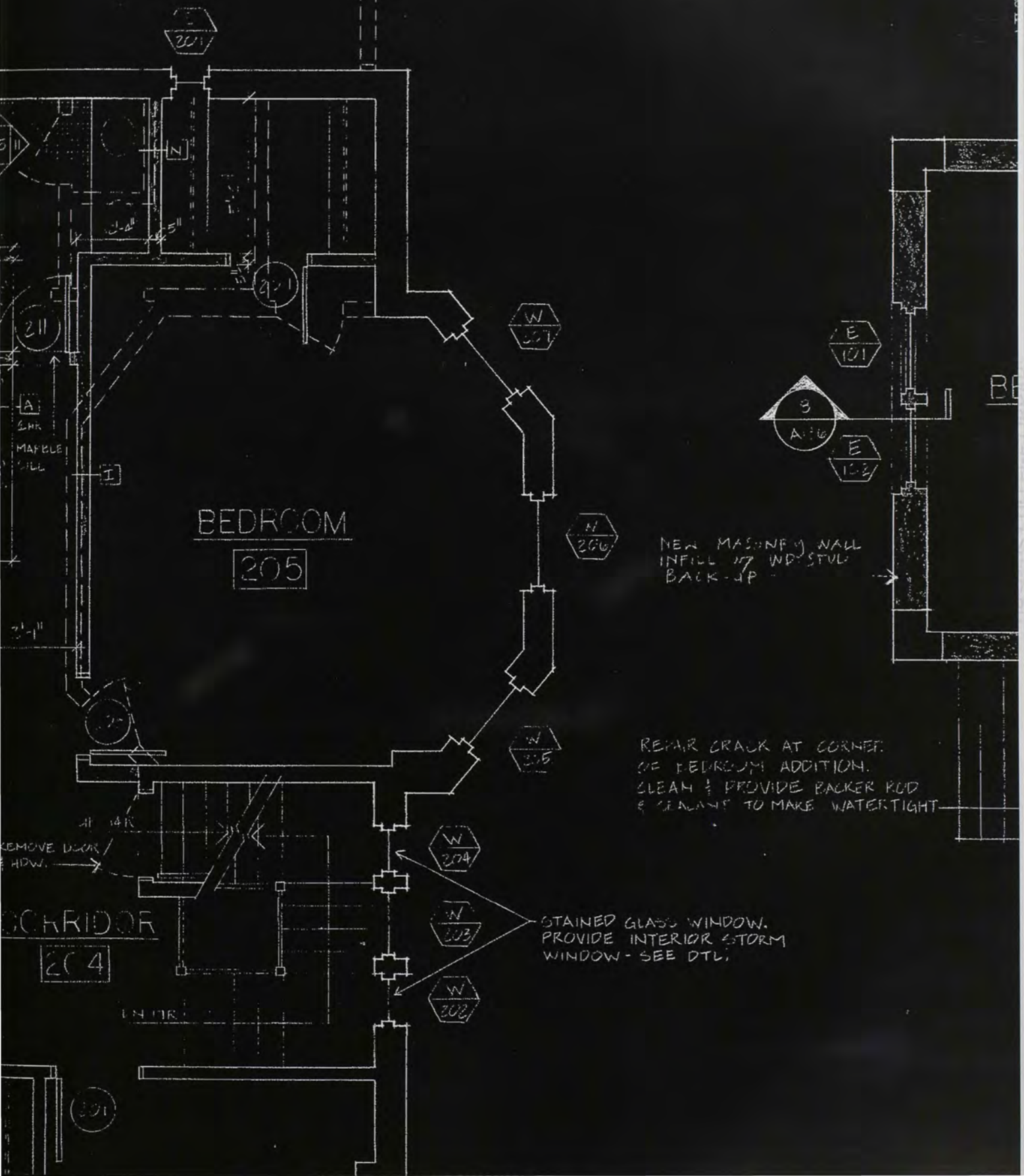

BEDROOM
205

A
2HR
MAPLE
DILL

NEW MASONRY WALL
INFILL 1/2" WD. STUCCO
BACK-UP

REPAIR CRACK AT CORNER
OF BEDROOM ADDITION.
CLEAN & PROVIDE BACKER ROD
& SEALANT TO MAKE WATERTIGHT

STAINED GLASS WINDOW.
PROVIDE INTERIOR STORM
WINDOW - SEE DTL.

CORRIDOR
204

ENTR

201

BE

Alpha Phi Epsilon



2004-2005 BROTHERS:

Brian Boland, Andrew Bonsall, Kyle Borreggine, Kyle Capella, Keith Cohen, John Cowden, Matt Fralen, Justin Frassoni, Evan Gallo, Nick Grose, Matt Jost, John Katch, Adam Longino, David Marcheskie, Eddie Murray, Scott Roesch, Keven Rowles, Anthony Russo, Tyler Schartel, Mike Troutman, Adam Vasquez, Charles Wenger

Alpha Sigma Nu

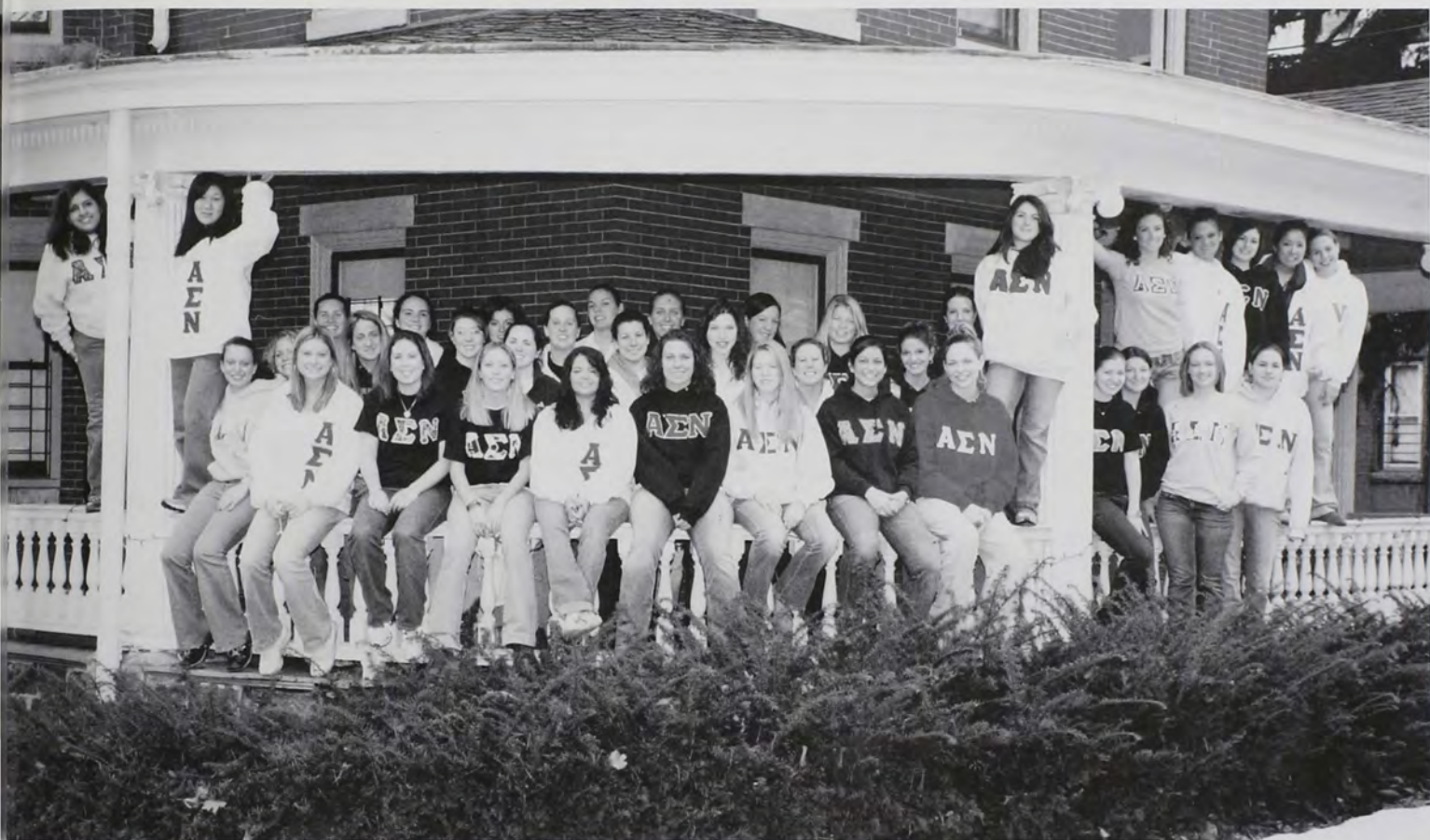

4-2005 SISTERS:

Margaret Alberts, Kari Baker, Kristen Bell, Kathryn Bergan, Noelle Bolletino, Arianna Brewer, Juliet Bronstein, Jessica Burgoyne, Caitlin
 y, Lauren Davila, Stacia Detter, Allison Doult, Kelly Eves, Daniella Falkowski, Keri Ferrar, Kelly Field, Jenna Filipkowski, Michele
 y, Stacey Garcia, Melissa George, Lauren Goldstein, Michaela Gorman, Janine Herring, Jennifer Hicks, Mallory Jones, Kimberly Kask,
 ner Kennedy, Sara Kessler, Esther Kim, Joyce Koubaroulis, Jenna Krier, Caitlin Massey, Caitlin McHugh, Amanda Morello, Erin
 neier, Christine Ragsdale, Allie Rainey, Brandie Saleneri, Stephanie Sapok, Natalie Schroeter, Mona Singh, Jacqueline Slakoper,

Sarah Smethie, Christine Snyder,
 Margaret Sperow, Christina
 Stephenson, Kelly Sullivan, Brooke
 Swalm, Jenine Weber



BETA

Beta Sigma Lambda



2004-2005 BROTHERS:

Omar Almallah, Mayur Amin Seth Bakes, Tim Corey, Ryan Curley, Dan Dean, Ron Donato, Bill Eppler, Joel Ford, Brian Giuliani, Jay Hobson, Dave Kiefer, Tj Mann, Tom Mathai, Samit Patel, Nick Peacock, Andrew Pepin, Jon Pometto, Mike Romeo, Tim Seibert, Pete Shoemaker, Zach Stewart



Delta Mu Sigma



2005 BROTHERS:

Borsky, James Foehrenbach, Sam Greenfield, Karl Michener, Pat Roesle, Steve

Delta Pi Sigma



2004-2005 BROTHERS:

Nick Armendariz, John Bame, John Bojazi, William Castan, Mike deLaurentis, Pat Ege, Riley Gilbert, Ryan Griffiths, Loric Haxhiu, Brian Kennedy, James Lawson, Frank Ma, Ryan Marsico, Dan Matthews, Dan Ortiz, Chris Primavera, Adam Schmidt, James Teixeira, Joe Wasserkrug

Kappa Delta Kappa



2004-2005 SISTERS:

Aime Biswanger, Sharlene Brown, Kristin Carter, Sherrell Dandy, Tracey Ferdinand, Terina Fusco, Sonia Gonzalez, Rebecca Gotwals, Shadiqua Hinson, Casey Joy, Marissa Ko, Heidi Liivamagi, Meghan Maguire, Kelsey McNeely, Mary Ann Murrow, Rachel Turney, Jocabed Ortiz, Marlena McMahon-Purk, Lauren Perotti, Sarita Sackie, Virginia Os, Tamar Sternberg, Erin Vanselous, Cecilia Wilson



Omega Chi



2004-2005 SISTERS:

Lauren Allen, Julia Azambuja, Corey Bolander, Jen Bolton, Kate Bradley, Jen Brook, Melissa Buckley, Natalie DiFelicantonio, Emily Diloia, Jamie Doperak, Kate Durso, Courtney Egan, Lisa Elphick, Melissa Fatale, Heather Frazier, Karen Guardiani, Amelia Heck, Michelle Hofmann, Jen Johnson, Gloria Kandrick, Elisabeth Lane, Kate Lehman, Ashley Little, Emily Livesey, Kelly Magnin, Martha Nielsen, Tarah Pearson, Caitlin Quinn, Blair Reddish, Kate Rickerl, Liane Roberts, Hollie Schwarz, Erin Skinner, Shanna Spiro, Jaime Stanton, Brenda Stevens, Eden Swick, Oksana Yaworsky



ΦΑΨ

Phi Alpha Psi



2004-2005 SISTERS:

Arber, Gina Barbieri, Sharon Belove, Charity Bishop, Marina Bitar, Ashley Bryson, Alaina Cara, Cristiana Costa, Mariana Chacoff, Barb Donald, Liz e, Denise Dunchick, Megan Eleftherion, Johanna Engel, Jennifer Rae Fouse, Laura Freitag, Tiffany Friedman, Kristin Gorman, Sarah Gowell, ra Hale, Kimberly Haslip, Chanelle Houston, Carissa Jessey, Tavenner Karlson, Caitlyn Kennedy, Annamira King, Arliegh King, Jenn Knapp, Julie inski, Tori Langton, Steph Levitsky, Corinne Licchetto, Jenn McCann, Kyla Mocharnuk, Kristen Muentener, Melody Mumbauer, Melina Muscarella, airn, Cynthia Ortiz, Erin Padovani, Callie Pagano, Katie Perkins, Brittany Perry, Kristen Ricciardi, Ryan Romberger, Lydia Sanchez, Kate Schilling, la Sterner, Michelle Stranen, Jenna Sychterz, Marina Torres, Erin Walsh, Amanda Wilson, Aimee Wright, Danielle Zupanovich



Phi Kappa Sigma



2004-2005 BROTHERS:

John Bera, Bart Brooks, Brandon Brown, David Chamberlain, Adam Davis, Thomas Group, Jason Knapp, Jess Kremenak, Dereck Lafontant, Ryan Lenhart, Chris Long, Steve Malagari, Mather Miehlung, Ryan Norris, Josh Rucci, Jack Scott, Azizahmend Shaikh, Andrew Shindel, Jason Silverman, Brad Smith, Eric Smith, Luke Sullivan, Jeff Teigler, David Thomas, Elkan Weis, Jon Yoder



Pi Omega Delta



2004-2005 BROTHERS:

Bosik, Lardner Clark Boyd IV, Ray Clark, Ted Friel, Mark Iacolucci, Greg Ley, Mike
 enstein, Josh Lovewell, Chris Paciente, Adam Potulski, Dom Singson, Aaron
 antino, Chris Weir, Hugh Wildrick



Sigma Rho Lambda



2004-2005 BROTHERS:

Mike Bongarzone, Jason Brown, Dave Campeau, Damian Canosa, Kyle Cleaver, Brendon Conn, John Cooper, Ryan Daley, Travis Damm, Justin Donovan, Sarat Duggirala, Rob Ebling, Robert Ellison, Chris Frazier, Santiago Guillen, James Hunt, Mike Lane, Robert Maguire, Cris Mathew, Blaine McEvoy, Matt Meeker, Alex Miron, Dan Newcomb, Ryan Pauline, Rohit Rajoria, Terry Reilly, Nick Shriver, Dominic Spaventa, Len Trappenese, Owen Weaver, Jimmy Wittenberg

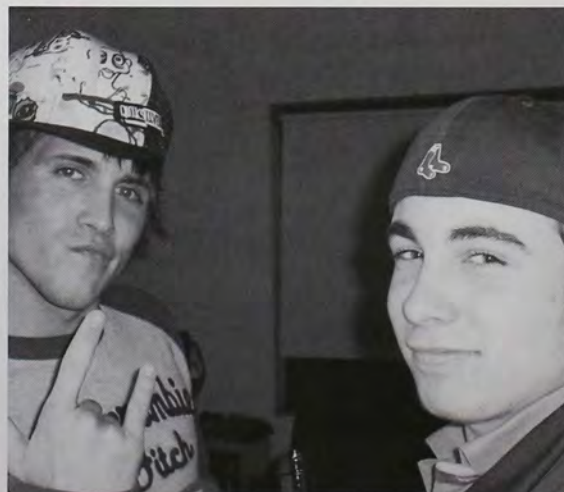
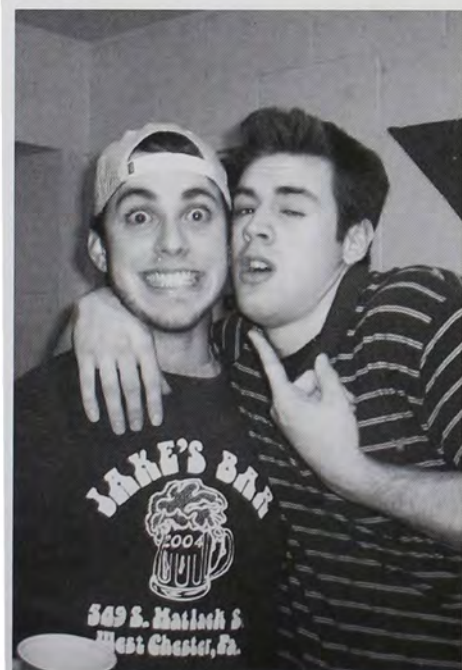

Sigma Sigma Sigma



2004-2005 SISTERS:

Er Adkins, Samantha Aly, Nirali Amin, Ashely Basla, Shannon Berndtson, Sarah Bollinger, Rachel Bower, Caroline Boyer, Mia Ciucci, Katelynd D'Andrea, Kimberly Daloisio, Lesley Davidson, Juliet Emas, Dana Fillo, Nicole Frates, Jocelyn Gaspar, Laura , Rachel Greenly, Abby Hare, Gillian Harnitchek, Megan Helzner, Jacqueline Jacobs, Meghan Jarrett, Erica Kaminiski, Zoha ali, Jennifer Katz, Jessica Kerber, Helena Libis, Sara Maioli, Meghan Murphy, Kate O'Neill, a Paulhill, Heather Pugh, Lauren Rees, Jocelyn Samolewicz, Nicole Santoro, Christina o, Heather Trefsger, Ali Wagner



Tau Sigma Gamma



2004-2005 SISTERS:

Aubrey Andre, Nicole Beck, Alison Blum, Erin Brand, Lauren Brophy, Amanda D'Amico, Carla D'Olio, Lauren Carrescia, Jen Cohen, Logan Conklin, Katherine Connor, Monica Delaney, Melissa Dunn, Lynne Erickson, Samantha Erle, Jessica Fean, Melissa Fean, Wendi Frank, Melody Gray, Rayna Grube, Caitlin Hanlon, Alex Hendershot, Debbie Jenson, Lynn Jusinski, Heather Kaczor, Kyle Kauffman, Christina Liberatore, Julia Lickfield, Anna Mazor, Kelly McCloskey, Jaimie McCormick, Mikala Pacifique, Catri Patrick, Jen Pfaff, Jill Reganato, Kate Rettstadt, Victoria Rosi, Gina Salvi, Valery Schartel, Lauren See, Maureen Smeltz, Kathryn Spillane, Christina Spivey, Alison Wagner, Lauren Washam, Lauren W



Upsilon Phi Delta



4-2005 SISTERS:

Buszowski, Sara Campbell, Felicia Chou, Rebecca Cohen, Michelle Heayn, Chantell
on, Tia Larese, Kelayne Minus, Lindsay Nicolo, Christina Rosci, Claire de Rosen,
cca Rowley, Tasheia Walker, Maedea Watson-Bey



Greek Life





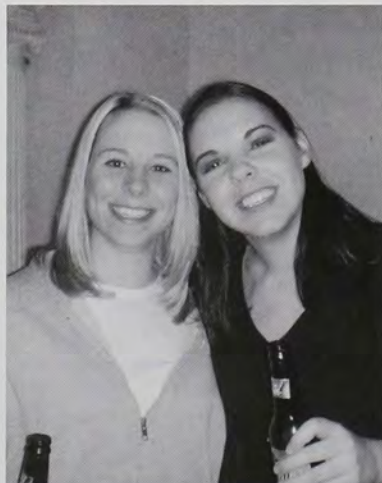



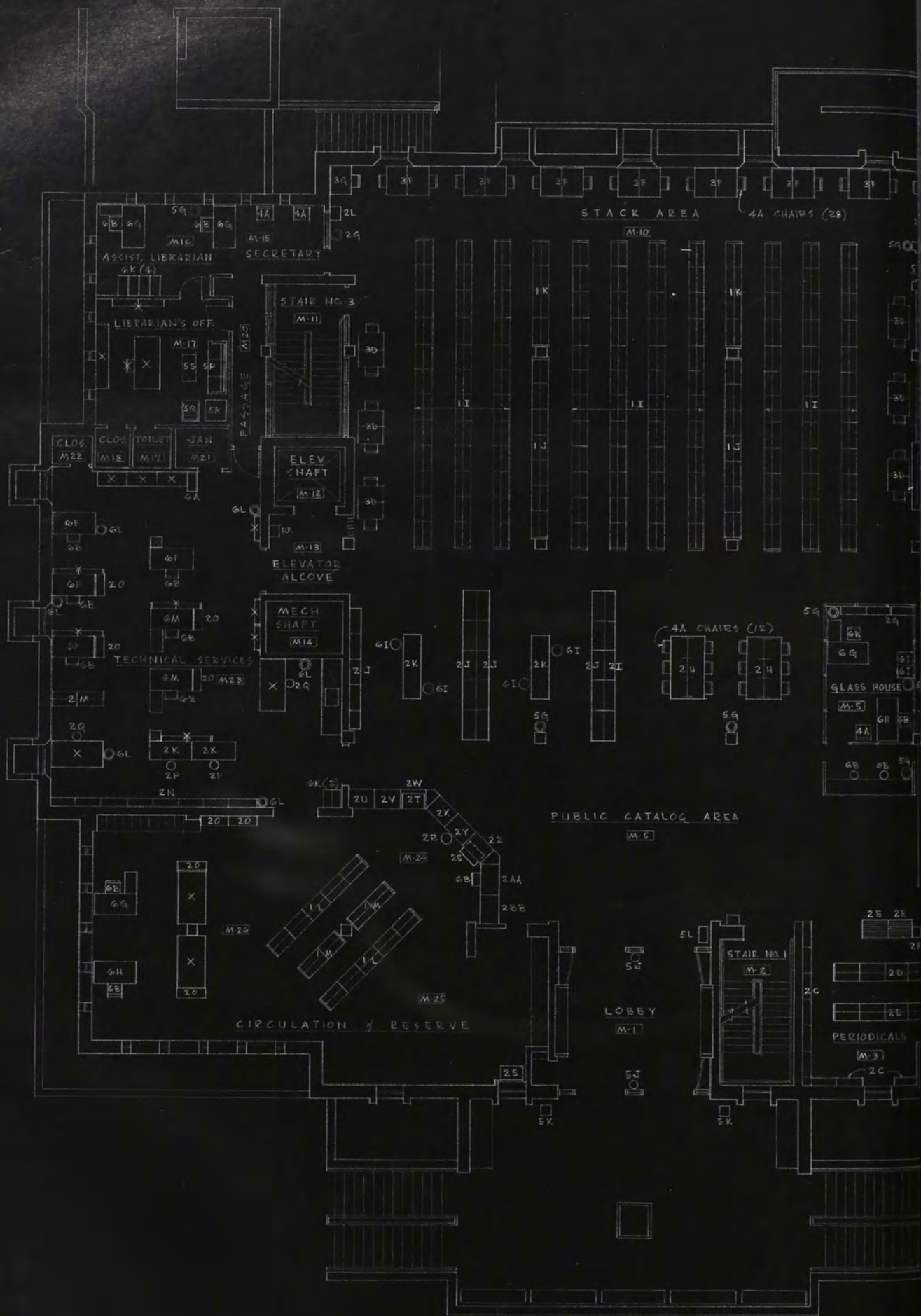

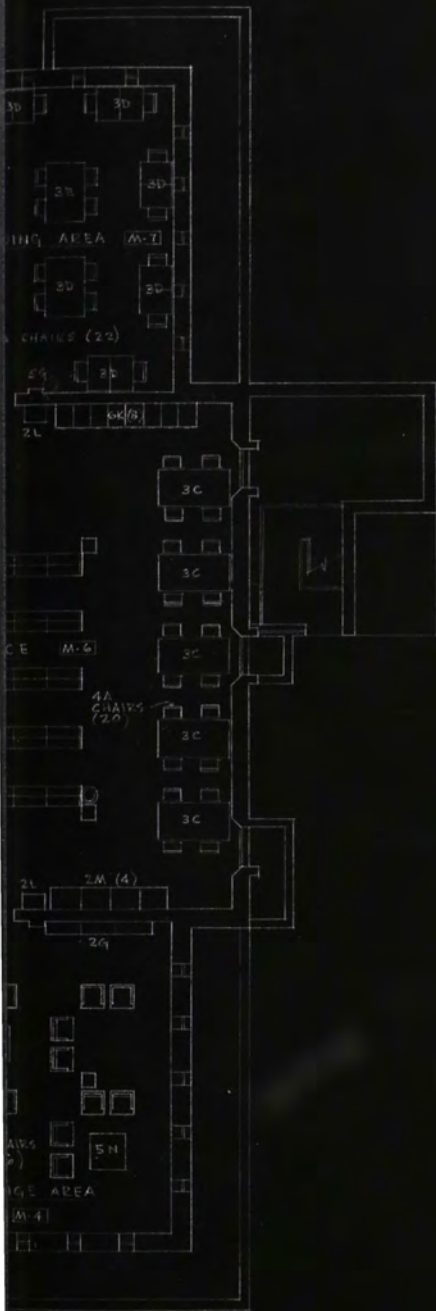

X = PROVIDED BY OWNER

FURNITURE LAYOUT

MAIN FLOOR PLAN

LIBRARY
 URSINUS COLLEGE
 COLLEGEVILLE, PA.



NOTE:-

These plans shall be checked by each contractor against general, mechanical and electrical plans. Proper location and space is to be provided for all chases, recesses, grilles, ducts, pipes, conduits, wires, switches, etc., as required for each contractor.

contractor shall verify all measurements at the bldg.

bond & miller
 registered architects

1 lehigh parkway • north drive
 allentown, penna. 435-7447

scale 1/8" = 1'-0"
 date 5-13-1969
 dwn W. J. Y.
 ckd L. S.

comm 6608-C sheet 2 of 4

Faculty and Staff

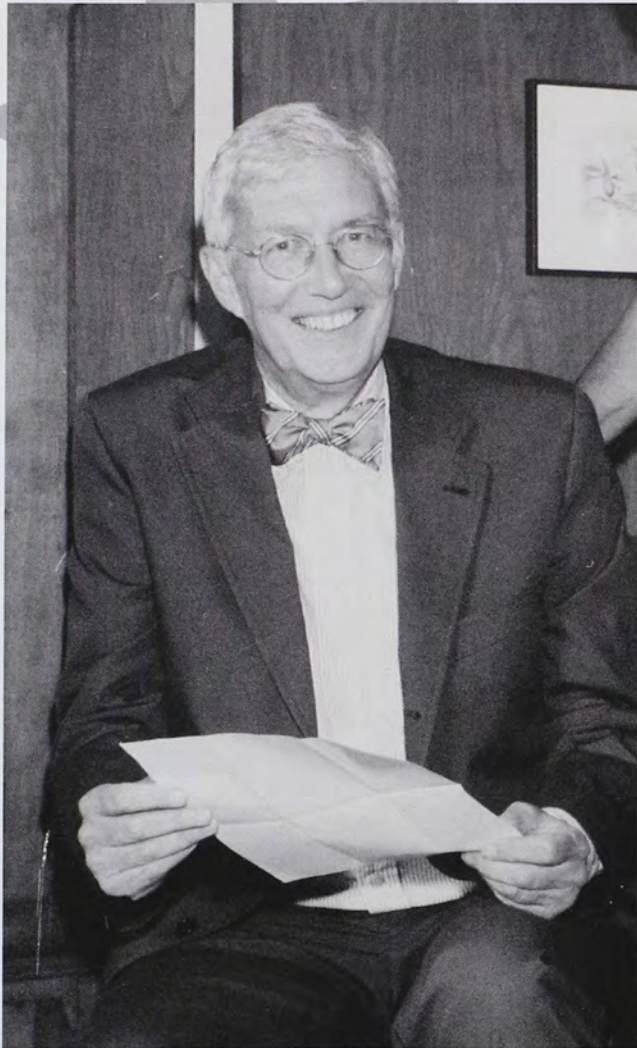

President
John Strassburger

President's Office
Linda Korenkiewicz



Secretary
Eileen Hughes



Academic Affairs

Jay Miller
Debbie Nolan
Edward Gildea
Judith Levy
Seana E. Zimmer
Annette Lucas
Cheryl Wager
Jan Lange
Valerie Nelson



Vice President of Academic Affairs
Judith Levy

Vice President of Finance and Administration
Winfield Guilmette

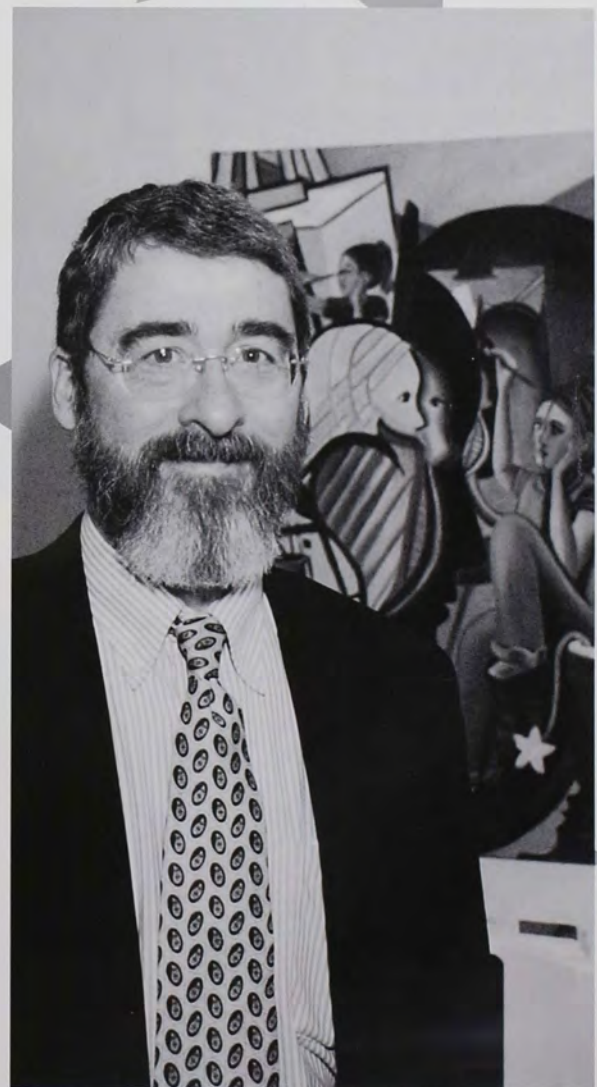



Student Financial Services

Tracey Berton
 Mona Chylack
 Patricia Keebler
 Heidi Linkenhoker
 Tracy Long
 Ginny Elizandro
 Suzanne Sparrow

Computer Services

Susan Helfand
 Alison L. Bettinger
 Rick Bogdan
 Stacy Gawrys
 John King
 Paula Laholt
 Tracey Nelson
 Eric Ordway
 Dee Rhoad
 James Shuttlesworth
 Susan Smith
 Ruth Sprague
 Ray Stitt
 Lesa Surman
 Joe Trump



Registrar's Office

Rosemary Angeloni
 Barbara Boris
 Rachel Rott
 Carol Williams



Admissions Office
 Paul Cramer
 Lauren M. Cyrsky
 Erin E. Dickerson
 Richard DiFeliciano
 Jamal Elliott
 Sloane Gibb
 Diane Hammer
 Jane McLaughlin
 Barbara Mulroy
 Sandra Pinter
 Joseph Rulewich
 Sue Thomas
 Patricia Gauger

Development Office

James Baer
 Steffie Crowther
 Mary Ellen Dewane
 Sue Donato
 Georgette Druckenmiller
 Kathryn Forberger
 Diane Hoffman
 Michele Kielkoph
 Patricia Phillips
 Ken Schaefer
 Nina Simoncavage
 Christina P. Sockeo
 Camela Vail
 Cheryl Walborn



Business Office

James Cooper
 Betty Davidson
 Joanne Drzewicki
 Stephanie Frangiosa
 Mary Mulholland
 Sharon Pearson



Residence Life
 Brian Stephenson
 Natissa K. Kultan
 Steve Larson
 Corinthian Ridgeway
 Lynda Manz

Myrin Library
 Maureen Damiano
 Judith Fryer
 Charles Jamison
 Doreen Kopycinski
 Linda Marchetti
 David Mill
 Cara Nageli
 Joan Rhodes
 Kimberly Sando
 Theresa Tuscano
 Carolyn Weigel
 Jane Whitman



Multicultural Services
 Paulette Patton
 Carolann Johnson
 Jackie Haring (International
 Student Advisor)





Career Services

Maria Beazley
Jennifer Potson
Nancy Reilly
Carla Rinde

"Don't be afraid to give your best to what seemingly are small jobs. Every time you conquer one it makes you that much stronger. If you do little jobs well the big ones tend to take care of themselves."

Dale Carnegie

Campus Safety

Michael Ditty, Director
Gary Hodgson
Dwight Rhodes
Tony Salvo
Bill Snively
Ray Stitt
Christopher Wilcox





College Communications

Blanche Allen
 Joan Brandon
 Wendy Greenberg
 Sally Widman
 Jim Yamma

Physical Plant

Russel Baum
 Dave Bennette
 Scott Bessemer
 Michael Birmingham
 Michael Degler
 Robert Eberz
 Stephen Gehringer
 Ted Geigus
 Timothy Ray Grater
 Jeff Henry
 Carylon Klee
 Fred Klee
 Perry Kline
 Thomas Krumenacker
 Sue Levengood
 Randall Markley
 Carol McMillan
 Gary Meikrantz
 Jay Murphy
 Charles Musselman
 George Myers
 Ray Peppeo
 Douglas Perry
 Rick Porter
 Robert Powel
 Elizabeth Robb
 Leonard Ruth
 Gary White
 Jeffrey Williams





Anthropology and Sociology

Laurian R. Bowles
 Diane P. Carbone
 Thomas Gallagher
 Regina Smith Oboler, Chair
 Maggie Ussery

Art Department

Donald Camp
 Ted Xaras, Chair
 Stacey Bohanak
 Roger Chavez
 Alex Hromych
 Peter Kalb
 Krista Steinke



Biology Department

A. Curtis Allen
 Beth Bailey
 Ellen Dawley
 Robert Dawley
 Mary Fields
 Kathryn Goddard-Doms
 Susan Kingsley
 Rebecca Kohn
 Richard Kohn
 Anthony Lobo
 Rebecca Lyczak
 Timothy Morton
 Nicholas Principe
 Rebecca Roberts
 Lori Scharneck
 Nancy Schek
 James Sidie
 Peter Small





Business and Economics
Cathey Bogusky
Stephen Bowers
Victor Brown
Carol Cirka
Andrew Economopoulos
Deborah Economopoulos
Peyton Ferrier
Cindy Harris, Chair
Brian Kohute
Michelle McLennan
Shannon Mudd
Heather O'Neill
Karen Randall
Robert Unger

“Education’s purpose is to replace an empty mind with an open one.”

Malcolm Forbes



Center for Continuous Learning
Victor Brown
Beverly Gaydos
Jan Levensgood
Gwen Marshall
Ellen Matthews



Chemistry
 Sandra Brown
 Danielle Goken
 Ronald Hess, Chair
 Marian Knechel
 Carl Ohrenberg
 Brain Pfennig
 Codrina Popescu
 Andrew Price
 Colleen Regan
 Barry Robinson
 Thomas Ruttledge
 Victor Tortorelli
 Eric Williamsen



Classics Department
 Yvon Kennon
 Ann Scott
 John Wickersham, Chair



**Media and Communication
Stuđies**

Stacey Bohanak
 Jeanine Czubaroff, Chair (Fall)
 Lynne Edwards, Chair (Spring)
 Marcia Stein Goldberg
 Sheryl Goodman
 Rebecca Jaroff
 Jennifer Levy
 Jay Miller
 Margaret Rakus
 Robert Spicer
 Louise Woodstock

Theater and Dance

Christopher Aiken
 Stacy Bohanak
 Lisa Jo Epstein
 Perry Fertig
 Domenick Scudera, Coordinator
 Cathy Young



Education Department

Julie Droluk
 Del Engstrom, Director
 Cheryl Everett
 Don Hillegas
 Vivian Loewenstern
 Susan Masciantonio
 Albert Mauthe
 David McCaig
 John Menichiello
 Karin Sconzert
 Rebecca Skulnick
 Judith Stryker
 Carol Royce



English Department

Jane Agostinelli
 Nancy Bates
 Larry Cionca
 Margie Connor
 Carol Dole, Chair (Spring)
 Amy Friedman
 Francis Fritz
 Rebecca Jaroff
 Michelle Nzadi Keita
 Matthew Kozusko
 Joyce Lionarons
 Peter Perreten
 Patricia Schroeder, Chair (Fall)
 Jon Volkmer
 Philip Zwerling

History Department

Hugh Clark
 Margie Connor
 S. Ross Doughty
 Walter Greason
 C. Dallett Hemphill
 Richard King, Chair



Mathematics and Computer Science

Leah Berman
 Sandra Brown
 Roger Coleman, Chair
 Michelle Doman
 Thomas Goebeler
 Peter Jessup
 April Kontostathis
 John R. Liston
 Jeffrey Neslen
 Rosemarie Wait
 Mohammed Yahdi



Modern Language

Rudy Aguilar
 Paula Alvarez
 Cindy Biel
 Douglas Cameron, Chair
 Misako Chapman
 Robin Clouser
 Juan Ramon de Arana
 Melissa Hardin
 Miho Iwakuma
 Yvon Kennon
 Peter Luborsky
 Annett  Lucas
 Benita Luttcher-Hoorfar
 Matthew Mizenko
 Hanae Nakamura
 Frances Novack
 Xochitl Shuru
 Judy Smythe
 Giovanna Steyaert
 Colette Trout
 Henry Virgilio

Philosophy and Religion

Roger Florka
 Edward Gildea
 Stewart Goetz, Chair
 Claudia Highbaugh
 Yvon Kennon
 Nathan Rein
 Charles Rice
 Kelly Sorenson



Chair of Physics Department
Douglas Nagy (To the left)

Physics and Astronomy
Chris Cellucci
Daniel Lipper
Lewis Riley



Politics and International Relations
Cathy Bogusky
Rebecca Evans
Gerard Fitzpatrick
Steven Hood
J. Houghton Kane
Joseph Melrose
Paul Stern, Chair
Samuel Winslow



Psychology Department
Catherine Chambliss, Chair
Kneia DaCosta
George Fago
Tracey Hansell
Gabrielle Principe
Kenneth Richardson
Bruce Rideout

People who do not understand themselves have a craving for understanding

Wilhelm Stekel



Environmental Studies

Leah Joseph

Richard Wallace, Director

Sarah Willig

**"Searching is everything -
going beyond what you
know. And the test of the
search is really in the things
themselves, the things you
seek to understand. What is
important is not what you
think about them, but how
they enlarge you."**

Wynn Bullock

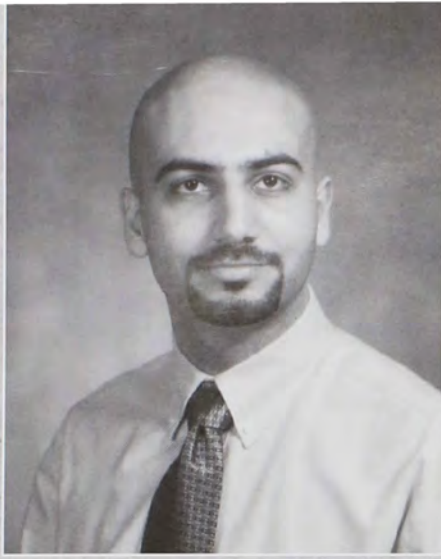

Majd A.
Abdelqader

Physics and
Mathematics
Amman, Jordan

Mohannad M. Abdo

BCMB
Amman, Jordan

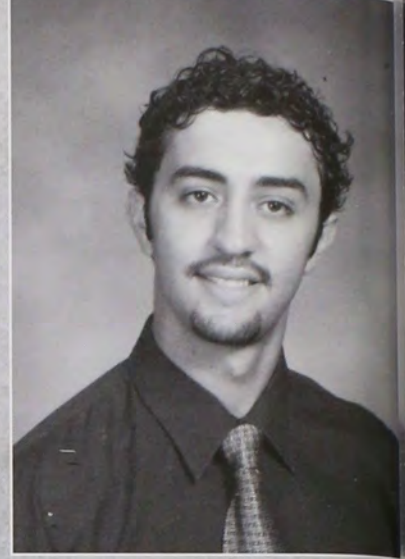

Megan C. Aiello

Psychology
Minor: Spanish
Hershey, PA



Margaret "Molly"
Rose Alberts

Psychology
Wilmington, DE



Alpha Sigma Nu: "A part
of you has grown in me
And so you see, it's you
and me together forever
and never apart, maybe
in distance, but never
heart." -Unknown

Lauren Elizabeth
Allen

Spanish
Minors: Biology &
Sociology
Baltimore, MD

May the friends of our
youth be the
companions of our old
age.

Nirali Amin

Business & Economics
and Spanish
Lumberton, NJ

"Go confidently in the
direction of your
dreams. Live the life you
have imagined."
-Henry David Thoreau





Aubrey P André

Art
Minor: English
Brentwood, TN



Scott B. Arakelian

Business & Economics
Kimberton, PA

Glenn Ashford

Psychology
Philadelphia, PA



Kari F. Baker

Biology
Allentown, PA



Alex C. Beatty

BCMB
Bethlehem, PA

Nicole Beck

Politics
Minors: Chemistry and
Education
Chichester, PA

"Education is the ability
to listen to almost
anything without losing
your temper or your
self-confidence."





Tyrone R. Beers

Computer Science &
Mathematics
Walnutport, PA

Kristin L. Bell

Business & Economics
Conshohocken, PA



Zachary J. Benziger

Mathematics
Lawrenceville, PA

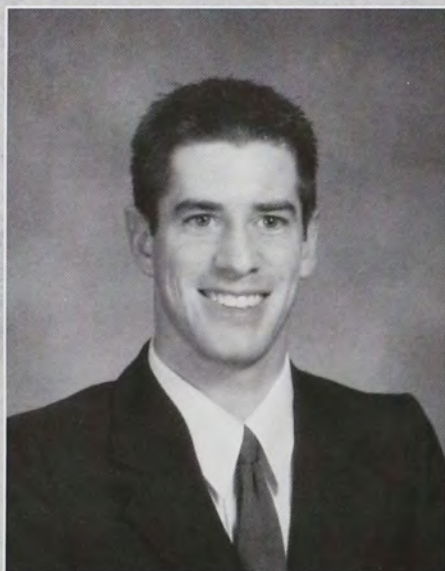

Kathryn Mary
Bergan

English
Minor: Secondary
Education
Brick, NJ

"Don't be dismayed
goodbyes. A farewell
before you can meet a
And meeting again aft
moment or a lifetime
certain for those who
friends." - Bach



Shannon E.
Berndtson

English
Medford, NJ

James F. Berry

Chemistry
Roebling, NJ

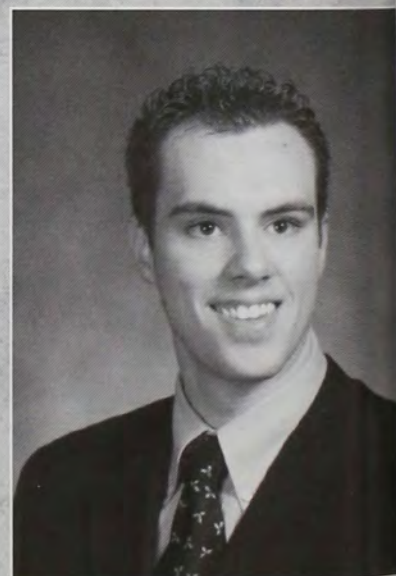



Laura Lee Bickert

English
Minor:
Communications
Nazareth, PA

"Says she misses is bad,
those were the best
times she ever had. She
said 'give it hell 'til the
end.'"



Caroline V.
Biswanger

Biology
Bryn Mawr, PA



Asmyn N.
Blueford

Business & Economics
Sparks, MD



Noelle Bolletino

Communication
Studies & Theatre
Berlin, NJ

"The game of life is alot
like football. You have to
tackle your problems,
block your fears, and score
your points when you get
the opportunity."

AΣN...no 1 in team
To both families: Thanks
for your unconditional love
and support!



Jennifer Elizabeth
Bolton

International
Relations and Business
& Economics
Minor: Politics
Jim Thorpe, PA

"I keep my ideals,
because in spite of
everything, I still believe
that people are really
good at heart."

Shane Borer

English
Scranton, PA

"We know what we are,
but know not / what we
may be." -Hamlet 4.5

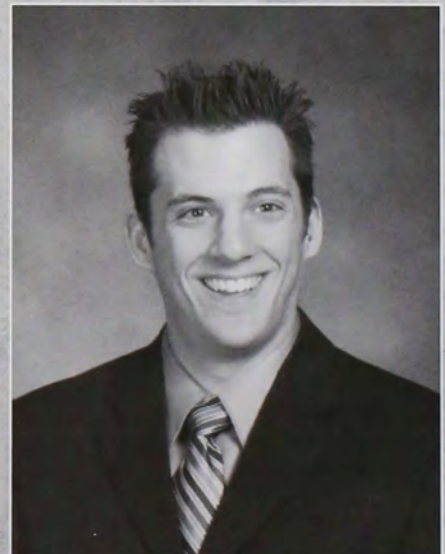



Nicole Angeline
Borocci

Communication
Studies & Theatre and
Spanish
Swoyersville, PA

"Life is about not knowing,
having to change, taking the
moment and making the best
of it- without knowing what's
going to happen next:
delicious ambiguity."



Joseph Bosik

Business & Economics
Hockessin, DE

Erin Elizabeth
Brand

Politics
Pottstown, PA

Tau Sigma Gamma
"Pork Fest '04...
p.s...mom I'll tell you
about it later"



Arianna Brewer

Biology and Spanish
Phoenixville, PA

"True friends can trav
in different direction
yet always remain sic
by side"



Lauren Janice Brophy

Psychology
Philadelphia, PA

Dad, Mom, Chuck, and Nana:
Words cannot express how
grateful I am.
Proud to be your Mamma

Say goodnight, not goodbye
You will never leave my heart
behind

Like the path of a star
I will be anywhere you are.

Daniel Wynne
Bruno

English
Bucks County, PA

"Only small minds
expect consistency."

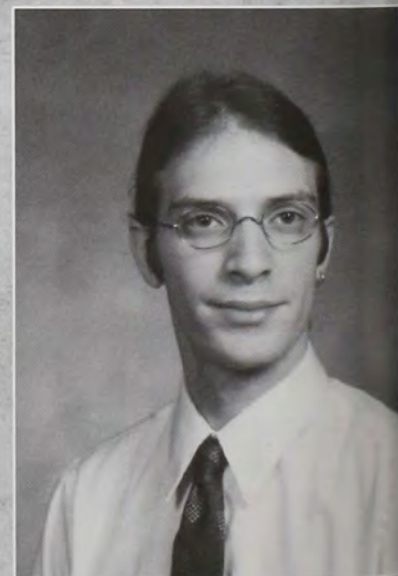

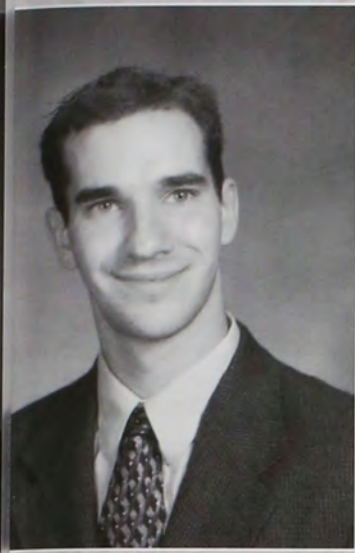

Douglas Budzyn

Biology
Minor: Accounting
Mt. Laurel, NJ

Karina Micaela
Campbell

Psychology
Minor: Communications
Gaithersburg, MD

"Obstacles are those
frightful things you see
when you take your
eyes off your goal."
-Henry Ford



Maria Caraballo

Biology and Spanish
Philadelphia, PA

"La felicidad no es un
puerto al que se
llega...sino una manera
de navegar." -Khotan
Fernandez

My family especially
my mom and dad,
thank you for all of your
love and constant
support. I love you all!!!



Lauren E. Carrescia

Psychology
Minors: Coaching and
Secondary Education
Pen Argyl, PA

"Go confidently in the
direction of your dreams.
Live the life you have
imagined." -Henry David
Thoreau

Blessed to have my family,
friends, swim kids and Tau
Sig along the way -thank
you, love you!
These are the days...



Christopher S.
Carrington

French
Washington, DC

Desiree L. Cinelli

English
Middle Island, NY





Jennifer Lynn
Cohen

Communication
Studies & Theatre
Woolwich Township, NJ

"Dream as if you'll live
forever. Live as if you'll
die today" -James Dean



Keith A. Cohen

Business & Economics
Minor: Sociology
Philadelphia, PA

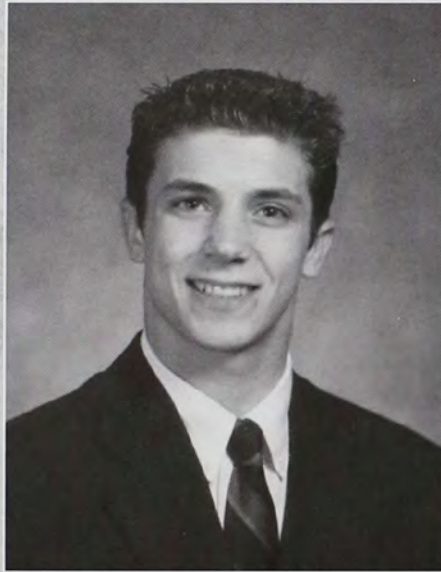

Michael R. Cox

Exercise & Sport
Science
Limerick, PA



Carla Marie D'Olio

Psychology
Minor Concentration:
Human Behavioral
Development
Minor: Secondary
Education
Springfield, PA

Inside I was a child
That could not mend a broken
wing
Outside I looked for a way
To teach my heart to sing
And I'll remember
The love that you gave me
Now that I'm standing on my
own



Kimberly Daloisio

Communication Studies &
Theatre
Minors: Business
Management and East
Asian Studies
Moorestown, NJ

Here's to the crazy ones. The
ones who see things
differently. You can praise
them, disagree with them,
quote them, or vilify them.
About the only thing you
can't do is ignore them.
While some may see them as
the crazy ones, we see
genius. Because the people
who are crazy enough to
think they can change the
world, are the ones who do.
-Apple Computers



Lesley Taitz
Davidson

Mathematics
West Simsbury, CT

"We do not change as
we grow older; we just
become more clearly
ourselves." -Lynn Hall



Sarah K. Darmon

BCMB
Aston, PA



Prianka De

Psychology
Voorhees, NJ

"The path I walk validates itself with every step I take."



Lindsa A.
DeArment

Biology
Elizabethtown, PA



Raymond F.
De Hont

Chemistry
Minor: Physics
Gilbertsville, PA

"You see, one thing is, I can live with doubt and uncertainty and not knowing. I think it's much more interesting to live not knowing than to have answers which might be wrong."
- Richard Feynman



Monica Delaney

Communication
Studies & Theatre
Philadelphia, PA

"It was as good as good goes." -Dave Matthews
"Other things may change us, but we start and end with family."



Jeremy M.
Desiderio

Mathematics
Minor: Accounting
Philadelphia, PA

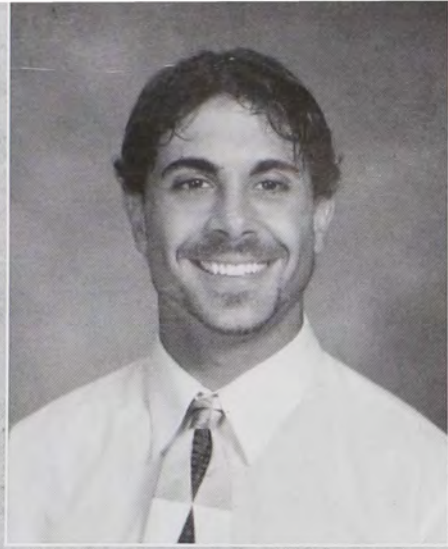

Evan M. DiBlassio

Business & Economics
and International
Relations
King of Prussia, PA



Antonia DiBona

Biology
Glassboro, NJ



Emily A. Diloia

Business & Economics
and Communication
Studies & Theatre
Glen Mills, PA



Elizabeth M.
Donze

Communication
Studies & Theatre
West Chester, PA

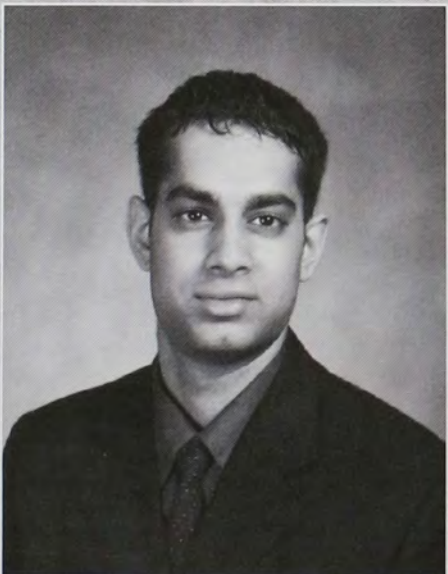

Sarat C. Duggirala

Psychology
Wynnewood, PA



Denise A.
Dunchick

Politics
Minor: Media Studies
and Management
New Philadelphia, PA



Elizabeth E. Dunn

Exercise & Sport
Science
Strasburg, PA



April C. Eakin

Psychology and
Spanish
Linthicum, MD

Trick J. Egan

Business & Economics
Blandon, PA



Ghadir Eshqaidef

Business & Economics
Minors: Math and
Computer Science
Amman, Jordan

And among His Signs is
the creation of the
heavens and the earth,
and the difference of
your languages and
colors. Verily, in that
are indeed signs for men
of sound *knowledge*.
Qur'an 30:22



Kelly Eves

Biology
Phoenixville, PA

Be who you are and say
what you want, because
those who mind
don't matter and those
who matter don't mind.-
Dr. Seuss
Thanks to all my friends
and family.
Yo Sig Nu kick it one
time boy!

Melissa E. Fean

Spanish
Wenonah, NJ





Keri Ferrar

Politics
Orwigsburg, PA

True, we love life, not because we are used to living, but because we are used to loving. There is always some madness in love, but there is also always some reason in madness.



Dana A. Fillo

French and
International Relations
East Petersburg, PA

Susannah M.
Fisher

English
Harrisburg, PA



Jennifer R. Fouse

English
Aliquippa, PA



Nicole Michele
Frates

Communication
Studies & Theatre
Minor: English
Mantua, NJ

"Go confidently in the direction of your dreams. Live the life you imagined."
-Henry David Thoreau

Edward J. Friel

Psychology
Horsham, PA

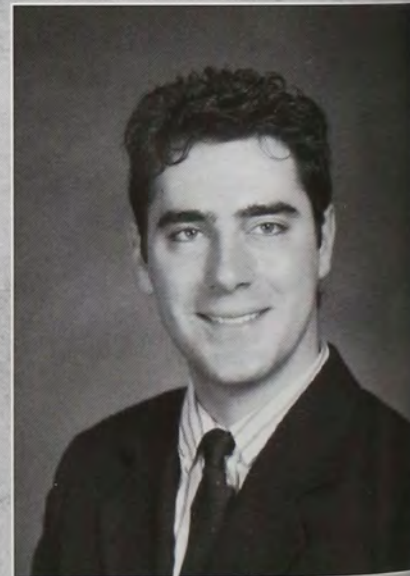



Lindsey Fund

English and American
Studies
Lititz, PA

"Don't cry because it's
over. Smile because it
happened."



Cameron E.
Furman

Politics
Lititz, PA

Amila Gabriel

Psychology
Wallingford, CT

ng those whom I like
admire, I can find no
common denominator, but
ng those whom I love,
all of them make me
laugh."

-W.H. Auden
most wasted of all
ys is one without
laughter."
E.E. Cummings



Nichole D. Gannett

Business & Economics
Minor: Communications
Allentown, PA



Jocelyn Grace Gaspar

Business & Economics
and Mathematics
Minor: Statistics
Quakertown, PA

"I don't know where this road
will lead- all I know is where
we've been and what we've
been through." TriSigma, IO8,
UC friends- I will treasure the
memories forever. My family-
thanks for
fostering my dreams, love
you always.

Lindsay Elizabeth
Goffredo

Biology
Minor: Spanish
Pen Argyl, PA

"Desire is the key to
motivation, but it's
determination and
commitment to an
unrelenting pursuit of your
goal - a commitment to
excellence - that will
enable you to attain the
success you seek."
-Mario Andretti





Ryan P. Golowski

Politics
Reading, PA

Jared Good

English
Brunnerville, PA

"I would say you're going to regret that when you get old, but I think you're gonna regret it in about a week"
-Crazy Tim D'Andrea

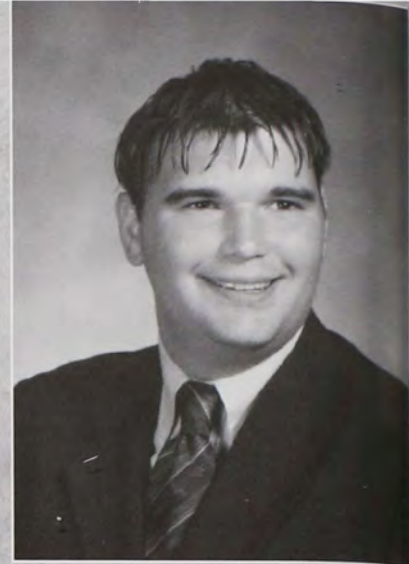

Rebecca Marie Gotwals

History
Minor: Management
West Chester, PA

"The first step to getting the things you want out of life is this: decide what you want."
-Ben Stein



Sarah A. Gowell

Communication
Studies & Theatre
Sabattus, ME



Ryan R. Griffiths

Politics
Allentown, PA

Kristen Nicole Grimmel

Communication Studies &
Theatre
Minor: Elementary
Education
Kingsville, MD

"No love, no friendship can cross the path of our destiny without leaving some mark on it forever."
-Francois Muriac
Thank you to Ursinus and my friends, old and new.
UC Gymnastics: Forever in my heart!
Us 4-4 Life
Mom: You're my inspiration!





Christopher R.
Gross

Biology
Schnecksville, PA

Bryn E. Grothmann

Exercise & Sport
Science
West Chester, PA



Stephanie E.
Guyger

Spanish
Philadelphia, PA



Gillian Harnitchek

Mathematics
Philadelphia, PA



Kimberly F. Haslip

Chemistry
Phoenixville, PA

Lorid Haxhiu

Biology
Philadelphia, PA



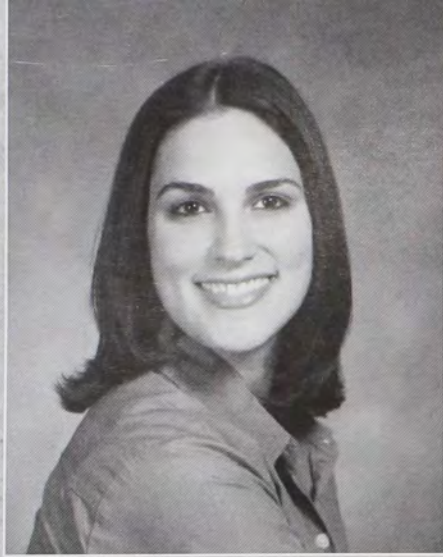

Alexandra Nicole
Hendershot

Sociology
Minor:
Communications
Palmyra, NJ

"The wind of heaven is
that which blows
between a horse's ears"
-Arab Proverb



Brian J. Hesselbach

Psychology
Newfane, VT

Jennifer Dawn
Hicks

Mathematics
Conshohocken, PA

"Bottom line, even if you
see 'em coming, you're
not ready for the big
moments. The big
moments are gonna come.
You can't help that. It's
what you do afterwards
that counts. That's when
you find out who you are."
-Whistler



Amy Hollaman

Gender & Women's
Studies
and Spanish
Stratford, CT

"If I didn't define myself
for myself, I would be
crunched into other
people's fantasies for me
and eaten alive."
-Audre Lorde



Kelly Ann Horst

International Relations
Baltimore, MD

"Now this is not the end.
It is not even the begin-
ning of the end. But it is,
perhaps, the end of the
beginning"
-Winston Churchill

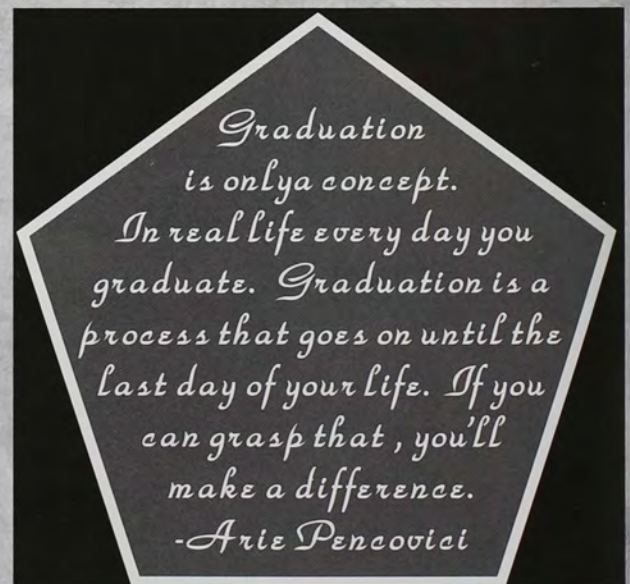



Kelly P. Ireland

Business & Economics
Baltimore, MD

Meghan S. Jarrett

Communication
Studies & Theatre
Minor: International
Relations
Folsom, PA

"Many people will walk in
and out of your life,
but only true friends leave
footprints in your heart"
Thanks to my friends for the
memories, to my family for
loving and supporting me,
especially Brian... even
though you're gone, you'll
always be in my heart.



assa Jessey

Biology
Lghorne, PA

the meaning of life
ant trees, under
e shade you do not
ect to sit."
on Henderson



Chantell Veronica
Johnson

Neuroscience
Minor: Biology
Philadelphia, PA

When hard times seem to
weigh you down,
Do not frown, because
God is always watching
down.
He will lift you up above
all of your problems
And give you the
knowledge needed to solve
them.



Jennifer R. Johnson

International
Relations, Business &
Economics, and
German
Riegelsville, PA

Thank you Mom, Dad,
Jamie, and Greg. I
couldn't have done it
without you.

Turquoise Johnson

Communication
Studies & Theatre
Minor: English
Riegelsville, PA





Lisa M. Jones

Exercise & Sport Science
Minor: Psychology
Lehigh, PA

Forever thanks to the best
parents one could have. Love
you with all of my heart.

We've shared many smiles
and tears, but nothing beats
the laughter. Thank you for
all those silly times. I love
you.



Rebecca C. Jones

Business & Economics
and Spanish
Philadelphia, PA



Lynn M. Jusinski

English
Minor: Women's
Studies
Ringtown, PA



Heather Kaczor

Psychology
Philadelphia, PA

"The past is the past
I must let it go, for
it's my time to flourish
and grow." -Me



Jennifer L. Katz

Communication
Studies & Theatre
Minor: Management
Newtown, PA

"Don't be dismayed at good-
byes. A farewell is necessary
before you can meet again.
And meeting again after a
moment or lifetime is certain
for those who are friends."
-Richard David Bach



Kyle M. Kauffman

Communication
Studies & Theatre
Boyertown, PA

The fireworks begin today. Each diploma is a lighted match, each one of you is a fuse.

-Ed Koch

Matthew Z. Keck

Physics
Mechanicsville, MD



Greg Keresztury

Politics
Medford, NJ

"And if you wanna find me I'll be out in the sandbox. Just wonderin' where the Hell all the love has gone. Just playin' my guitar and building castles in the sun, and I'll be singing fun fun fun."



Catherine A. Kelley

Psychology
Gloucester, NJ



Sara Kessler

Chemistry
Nescopeck, PA

"To be upset over what you don't have is to waste what you do have. We all live under the same sky, but we don't all have the same horizon."

-Konrad Adenauer



Anna Mira King

Communication
Studies & Theatre
Narberth, PA



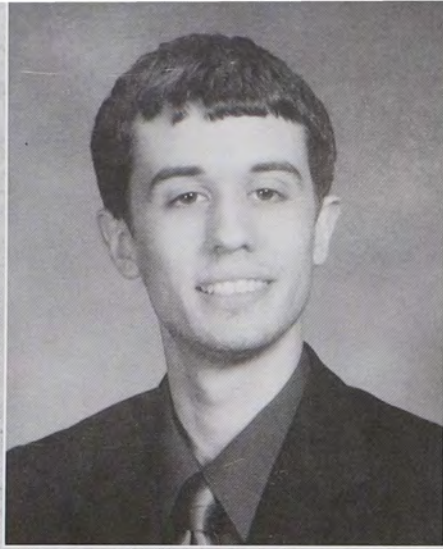

Joshua R. Kistner

BCMB and Philosophy
& Religion
Chalfont, PA

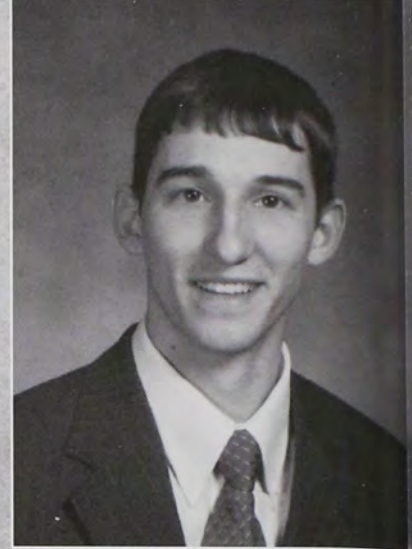

Michael Klingler

Biology
Allentown, PA

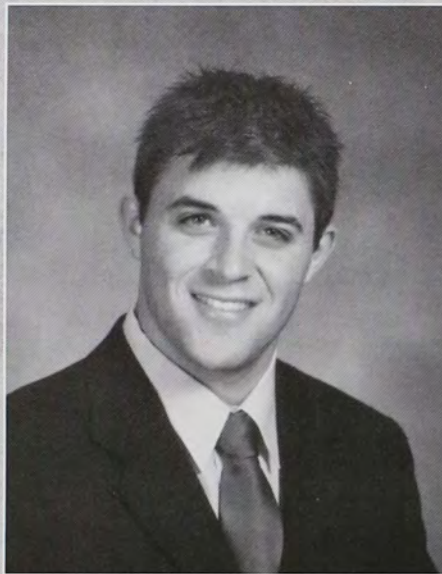

Joseph P. Krivda

Biology
Levittown, PA

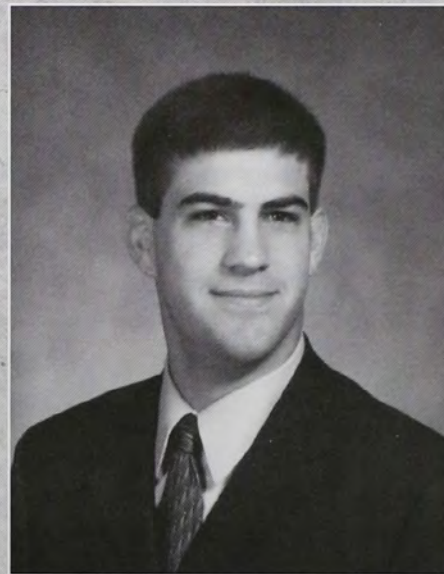

Michael T. Lane

Business & Economics
Wayne, PA



Tia Delora Larese

Communication
Studies & Theatre
Minor: German
Mertztown, PA

"A bird doesn't sing
because it has an
answer, it sings because
it has a song."
-Maya Angelou

Andrew Larsen

History
Bethesda, MD

May I be a man for others.
Then as it was, then again
it will be
and though the course
may change sometimes
Rivers always reach the
sea.

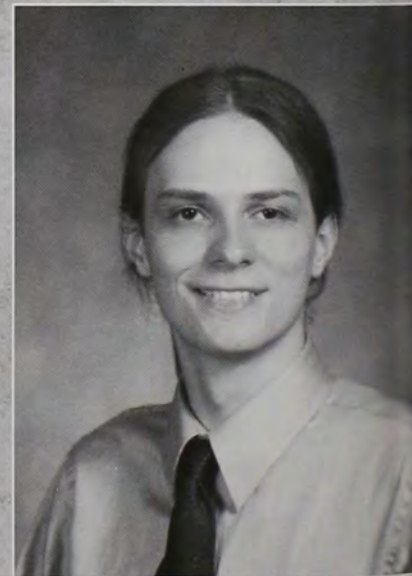



Desiree N. Lassiter

Exercise & Sport
Science
Burlington, NJ



James F. Lawson

Communication
Studies & Theatre
Wellesley, PA

Kathryn-Helene
R. Lehman

Communication
Studies & Theatre
Minor: Elementary
Education
Bethlehem, PA



Robert J. Lemma

Psychology
Philadelphia, PA



Heather Leshner

Politics
Minor: History
Allentown, PA

"Success doesn't come to
you...you go to it."
-Marva Collins

Yan L. Liang

Chemistry
Philadelphia, PA



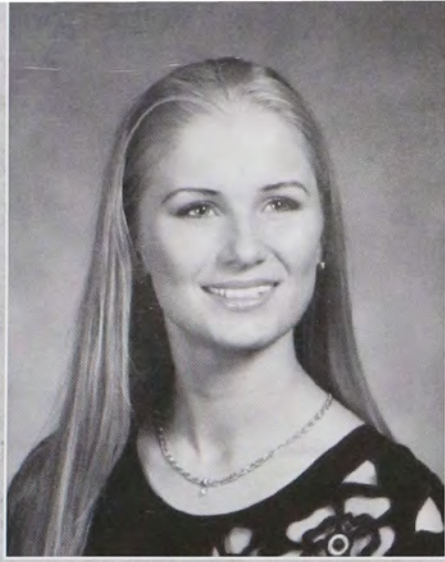

Heidi Liivamagi

International Relations
Minor: Business
Administration
Tartu, Estonia

Don't be afraid of the space
between your dreams and
reality. If you can dream it, you
can make it so. -Belva Davis



Brianna R. Lindsay

Biology
Riegelsville, PA



Emily E. Livesey

Biology and
Environmental Studies
Archbald, PA



Christopher J. Long

Computer Science
Hummelstown, PA



Christopher S. Long

Computer Science
Perkasie, PA

Emily Ann
Maksimak

Chemistry
Minor: Art
Danville, PA

"Ars Longa, Vita Brevis"
-"Art [is] Long, Life [is]
Short" -Hippocrates





Matthew W.
Manning

Business & Economics
and History
Lancaster, PA

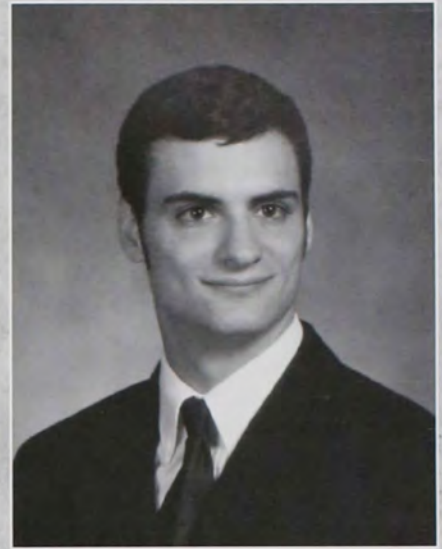

Michael A.
Martynenko

Psychology
Trenton, NJ

Lauren P. Matter

Politics
Spring City, PA



Kathryn A.
Matthias

Biology
Minor: Religion
Bear, DE

"Living life is just a
game so they say/All
the games we used to
play fade away/We may
now enjoy the dreams
we shared so long ago."
- Chicago



Ryan Michael
Matty

Biology
Minor: Environmental
Studies
Kimberton, PA

"When you are good to
others, you are best to
yourself."
-Ben Franklin

Anna M. Mazor

Biology
Philadelphia, PA





Crystal Dawn
McCarney

Communication
Studies & Theatre
Minor: Elementary
Education

Cape May Court House, NJ

"The path to our destination is not always a straight one. We go down the wrong road, we get lost, we turn back. Maybe it doesn't matter which road we embark on. Maybe what matters is that we embark." -Barbara Hall

Kelly McCloskey

Exercise & Sport
Science
Haledon, NJ

Thanks to my family, especially my Mom and Dad. I wouldn't have made it this far without your love and support.

ΤΣΓ.



Casey A.
McCullough

Communication
Studies & Theatre
Minor: Spanish
Somerdale, NJ



Tiffany D.
McFadden

Politics
Carlisle, PA

We are what we repeatedly do. Excellence, then, is not an act, but a habit. -Aristotle



Ashley E. McIntosh

German and
History
York, PA

Cedria D. McMillian

Anthropology/
Sociology
Minor: French
Philadelphia, PA





Steven R. McNabb

Business & Economics
Shillington, PA

Kelsey McNeely

Chemistry
Minor: German
Birdsboro, PA

"In the buffet of life there are
no second helpings"

-Fred Flintstone

"You cannot teach a man
anything; you can only help
him find it within himself"

-Galileo Galilei

"Dream lofty dreams, and as
you dream, so shall you
become. Your vision is the
promise of what you shall
one day be." -James Allen



Lauren M. Melton

Politics
Manorville, NY



John J. Millili

Biology
Deptford, NJ



Kyla Janelle
Mocharnuk

French and
International Relations
Melbourne, FL

Erica C. Molina

Anthropology/
Sociology
Maple Glen, PA





Amanda Marie Morello

Exercise Sport and Science
Norristown, PA

"Eventually all the pieces fall into place. Until then, laugh at the confusion, live for the moment, and know that everything happens for a reason."

Mom, Dad, Kate, Kristie-
Thanks for the Love and Support.

Sig Nu-The Memories will Last a Lifetime!



Kristen L.
Muentener

Politics
Hopewell, NJ

Melody Mumbauer

Business and Economics
Zionhill, PA

Mom & Dad – Thank you for your continuous support and encouragement. I love you. Sisters, remember why you said yes. I will remember you forever.
PALS



Elizabeth M. Muntener

Business & Economics
and Spanish
Philadelphia, PA

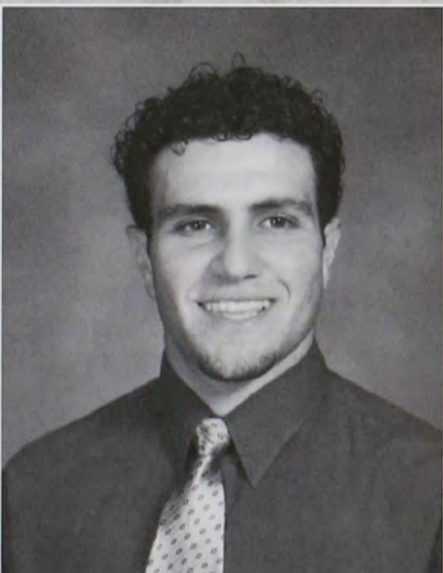

Isa M. Muqattash

Computer Science and
Mathematics
Amman, Jordan

Kevin Murphy

Media Studies &
Communication
Riverton, NJ

We make a living by what we get, we make a life by what we give.

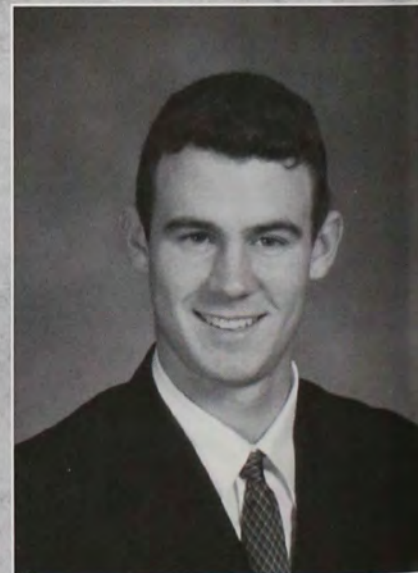



Mary Ann Christina
Murrow

Biology
Magnolia, NJ

Thanks Mom and Dad for
always being there for
me; I love you! To my
KDK sisters and all of my
friends- thanks so much
for all of the great memo-
ries, I'll miss you all!

Patrick M. Nagel

Computer Science and
East Asian Studies
Doylestown, PA

"Like a thorn that goes
into the hand of a
drunkard, is a proverb in
the mouth of fools."
Proverbs 26:9



ffany T. Nguyen

English
Jamison, PA



Michelle Anne Noreski

Biology and Spanish
Philadelphia, PA

Mom and Dad, without your
love I would not be where I
am today. John, my soul
mate, thanks for always
being there. To my friends,
no matter what the future
holds I know the bonds we
have are everlasting.



Erin C. O'Hara

Mathematics
Annapolis, MD

Christopher S.
Paciente

Business & Economics
Media, PA





Kristen J.
Papenberg

Psychology
Riverton, NJ

Crystal Parsons

International Business
and East Asian Studies
Minor: Japanese
Stillwater, NJ

"What lies behind us and
what lies in front of us
pales in comparison to
what lies within us."
-Ralph Waldo Emerson



Samit Patel

Biology
Voorhees, NJ

"Honor is what no man
can give ye, and no one
can take away. Honor is a
man's gift to himself."

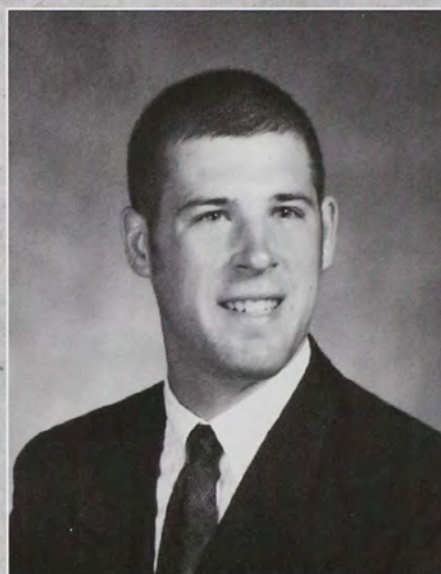
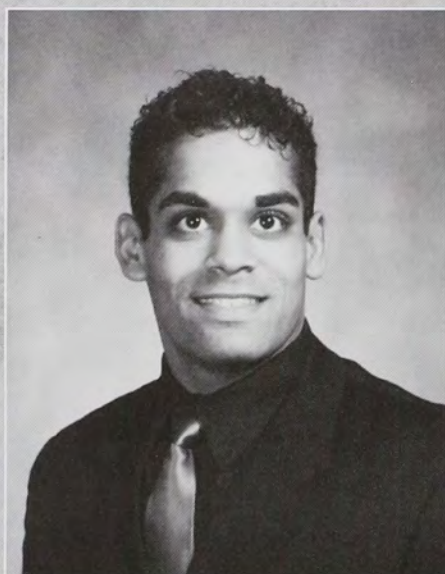

John Miller Paton

Business & Economics
Worcester, PA

"I have the simplest
tastes. I am always
satisfied with the best."
-Oscar Wilde



Catrina J. Patrick

Chemistry
Oaks, PA

Nicholas Peacock

Biology
Durham, PA

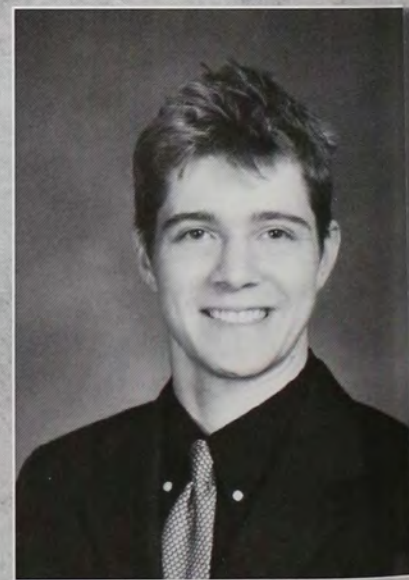



Kristen E. Pearson

Business & Economics
Bridgeport, PA

Theodore P. Piotrowicz

Economics
Plymouth Meeting, PA

Thanks to everybody who has been there for me over the past four years I couldn't have done it without you: Mom, Dad, Patty, John, Megan and Kevin, all my relatives, professors, coaches, teammates, and friends.



Cristina M. Polinsky

Biology
Minor: Chemistry
Langhorne, PA



Holly Poorman

History
Rosemont, PA

"There is more day to dawn.
The sun is but a morning
star." -Thoreau



Adam Potulski

Business & Economics
Minor: Exercise &
Sports Science
Wall, NJ

"In order to achieve
what you need, you can
never give up."
-Royce Gracie

Heather Lynne Pugh

Psychology
Pottsville, PA

When one door closes
another opens. But often
we look so long so
regretfully upon the
closed door that we fail to
see the one that has
opened for us.
-Alexander Graham Bell





Thomas A. Pugh

Business & Economics
York, PA

LeeAnn C. Rafferty

Biology
Minor: Art
Smithtown, NY

If you want to be
someone else, change
your mind.



Rohit S. Rajoria

BCMB
Glen Gardner, NJ

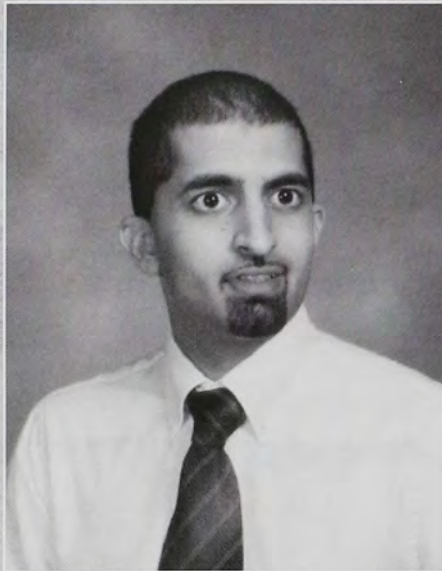

Diana L. Ramo

Spanish
Minor: Education
Bellmawr, NJ



Andrew J. Reber

Computer Science
Minor: Mathematics
Harleysville, PA

Ryan D.
Regensburg

Exercise & Sports
Science
Pottstown, PA

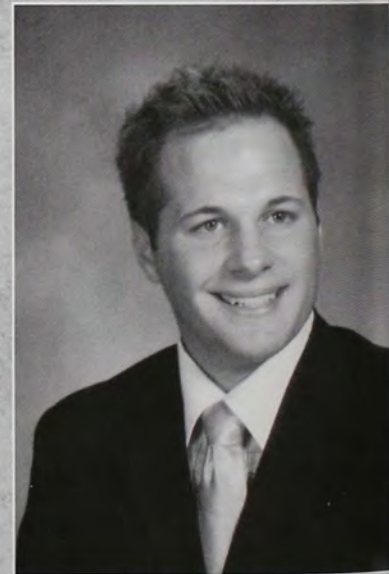



Terrence G. Reilly

Exercise & Sports
Science
Succasunna, NJ



Marcus G. Ressler

Biology
Royersford, PA

Thel Kibibbi-Akua
Richards

Biology
Philadelphia, PA

"No matter how you react,
you still have to do it."

Thank you, Curt and Stink!
Thanks Mom/G-mom hang in
there. Much love to
Muga'mama and Little
Man!

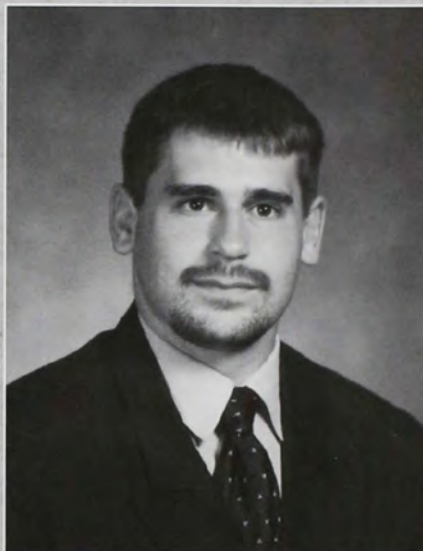

Rick T. Roberts

Chemistry
Ottsville, PA

"The tragedy of life is
not that it ends so soon,
but that we wait so long
to begin it."

-W.M. Lewis



Shayne Michael
Roberts

Chemistry
York, PA

"Every new beginning
comes from some other
beginnings end."

-Semisonic

Natalie M. Rocus

Computer Science
Souderton, PA



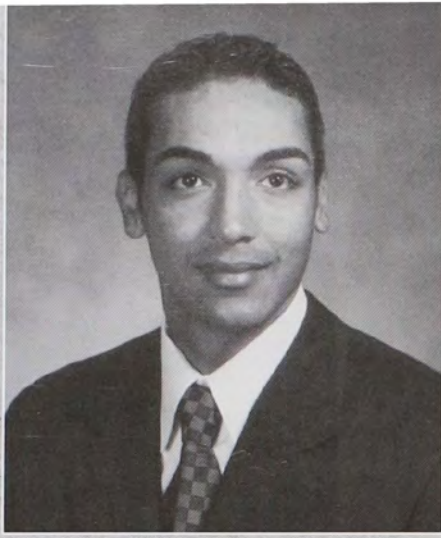

Victor E. Rodriguez

International Relations
Guaynabo, PR

Scott Roesch

Exercise & Sports
Science
Egg Harbor City, NJ

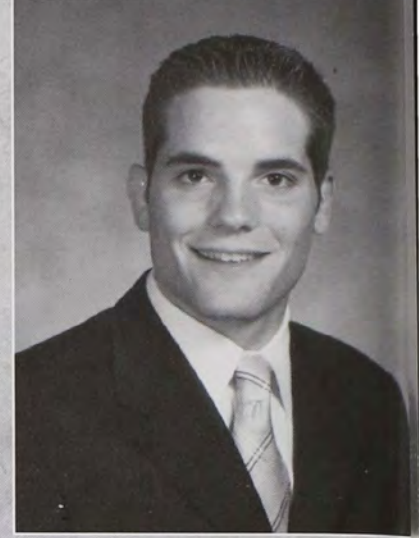

Gerard B. Rogers

History
Philadelphia, PA

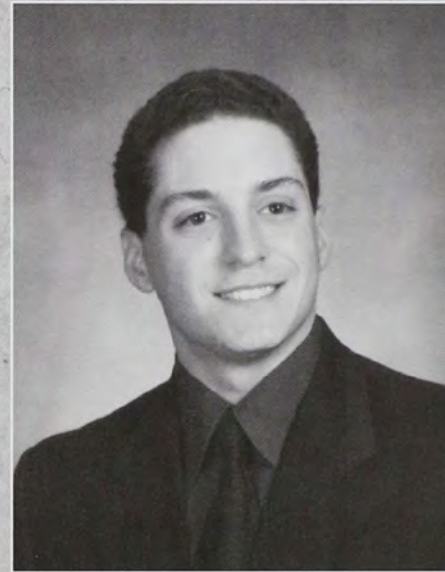
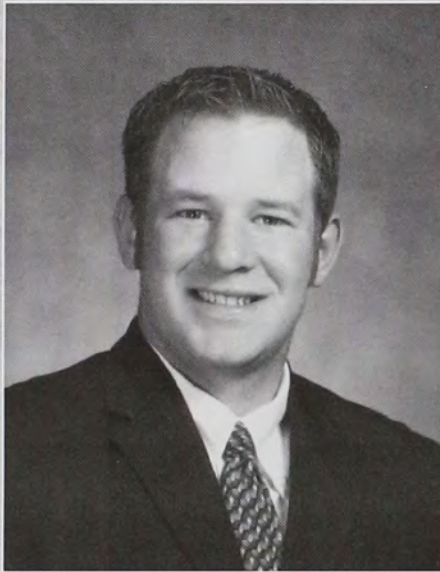

Michael T. Romeo

History
Bensalem, PA



Whitney Roper

English
Minor: Communications
York, PA

After the final no there
comes a yes
And on that yes the future
world depends.
-Wallace Stevens

Stephen S. Rote

History and
Environmental
Studies
Oreland, PA

"And the feeling, it gets left
behind
all the innocence lost at one
time
significant behind the eyes
there's no need to hide
we're safe tonight"
-Pearl Jam

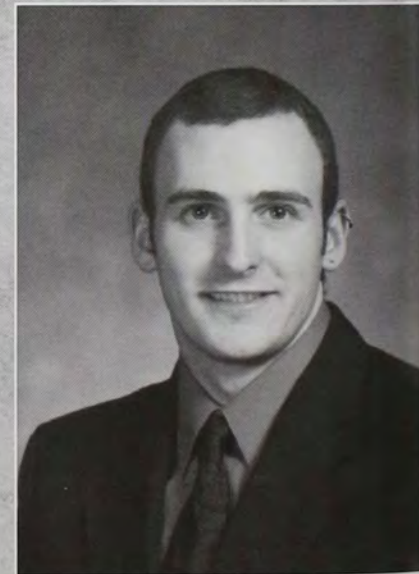



Marissa E. Rotz

Exercise & Sports
Science
Allentown, PA

Josh Rucci

Politics
Downingtown, PA

"Life is what happens to
you while you're busy
making other plans"
-John Lennon



Anthony L. Russo

Psychology
Middletown, NJ

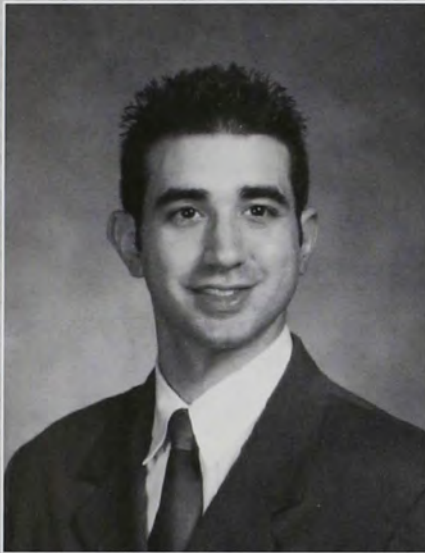

Jason T. Sabol

Exercise & Sports
Science
Mt. Laurel, NJ

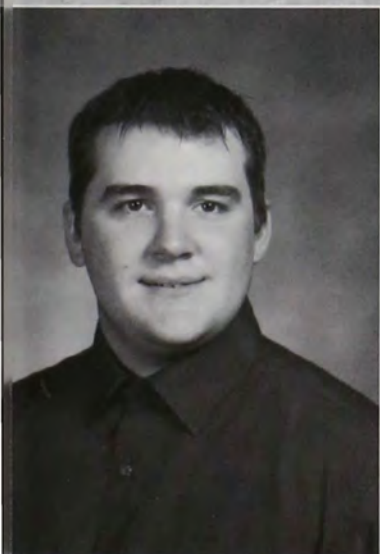

Christopher T.
Salber

History
Philadelphia, PA

Brandie Elizabeth
Salenetri

English and
Communications Studies &
Theatre
Crosswicks, NJ

"Sometimes the lights are shining
on me. Other times I can barely
see. Lately it occurs to me, what a
long, strange trip it's been."
-Grateful Dead.

Much love and thanks to my
family!

Alpha Sigma Nu: Do it ladies!





Marie N. Santoro

Chemistry
Minor: Spanish
Radnor, PA

Erin Sawchuk

Business & Economics
Minor: Exercise &
Sports Science
Pottstown, PA



Richard D. Schott

International Relations
Stroudsburg, PA

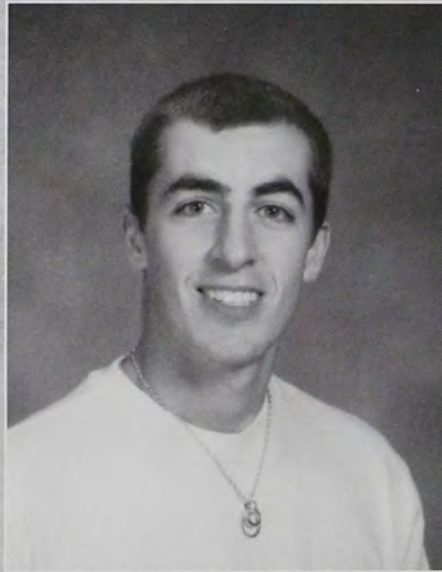

Brett Scipioni

Biology
Myerstown, PA



Jullien Brook
Searfoss

International Relations
Minor: German
Wernersville, PA

"Peace cannot be kept by
force. It can only be
achieved by
understanding"
-Albert Einstein

Lauren Regina
Segal

Exercise & Sport
Science
Bristol, PA

"Life's a bowl of punch
so go ahead
and spike it."
-311

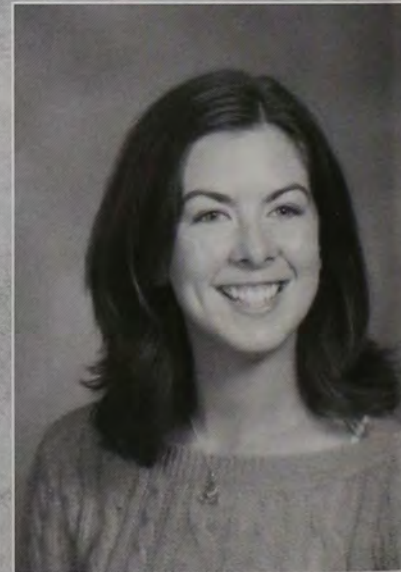



Michelle Segalov

Biology
Philadelphia, PA

Alison Shaffer

Religion & Philosophy
Minor: Creative
Writing
Lancaster, PA

"To every man is given
the key to the gates of
heaven; the same key
opens the gates of hell."
-Buddhist proverb



Azizahmed M.
Shaikh

BCMB
Bensalem, PA



Peter T. Shoemaker

History
Wilmington, DE



Wayne M.
Siegwarth

Biology
Leonardo, NJ

Mona Singh

Psychology
Minor: Sociology
Upper Darby, PA

I never asked for it to end,
but then again I never asked
for it to begin. For that's
the way life is, some of the
most beautiful days come
completely by chance, but
even those beautiful days
eventually have their
sunsets.



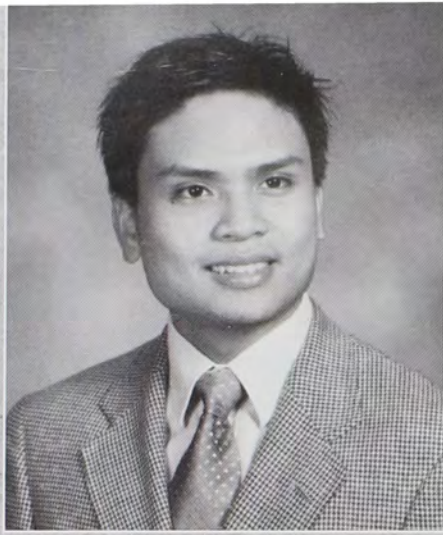

Dominic R.
Singson

Business & Economics
Hockessin, DE

Jacqueline Helene
Slakoper

Biology
Pennel, PA

"There are places I'll remember
All my life though some have
changed
Some forever not for better
Some have gone and some
remain
All these places have their
moments
In my life I've loved them all"
-The Beatles



Jenni Smagala

Biology
Wilmington, DE

"The future is not some
place we are going to, but
one we are creating."
-John Schaar



Joshua E. Smedley

Anthropology/
Sociology and Political
Philadelphia, PA

Maureen Elizabeth
Smeltz

Exercise & Sports
Science
Selinsgrove, PA

There is no greater joy nor
greater reward than to make
a fundamental difference in
someone's life.

By: Sister Mary Rose
McGeady

Thank you to everyone who
has made a difference in my
life!

Kristen Smith

Biology
Atco, NJ

"Twenty years from now
you will be more
disappointed by the things
that you didn't do than by
the ones you did do. So
throw off the bowlines. Sail
away from the safe harbor.
Catch the trade winds in
your sails. Explore.
Dream. Discover."
-Mark Twain





Jessica Soto

Biology and Sociology
Philadelphia, PA

"Celebrate we will, for
life is short but sweet
for certain."

Monique Elizabeth
Spencer

Biology
Minor: Biostatistics
Germantown, MD

Emancipate yourselves
from mental slavery,
but ourselves can free
our minds.
-Bob Marley



Margaret Betz
Sperow

Biology
Minor: Neuroscience
Philadelphia, PA

Education is a
progressive discovery of
our own ignorance.
-Will Durant



Tamar
Sternberg

Psychology
Minor: Education
Fogelsville, PA



E. Zachary Stewart

Spanish
Phoenixville, PA

Michelle J. Stranen

Communication
Studies & Theatre
Minor: French
Wallingford, PA





Christina C. Straub

Spanish
Minor: Education
Kingston, PA

Kelly A. Sullivan

Exercise & Sports
Science
Carmel, NY



Brooke Swalm

BCMB

Hummelstown, PA

Thanks to all my friends and family for all the wonderful memories over the past four years; I am truly blessed!

"Go confidently in the direction of your dreams. Live the life you have imagined"

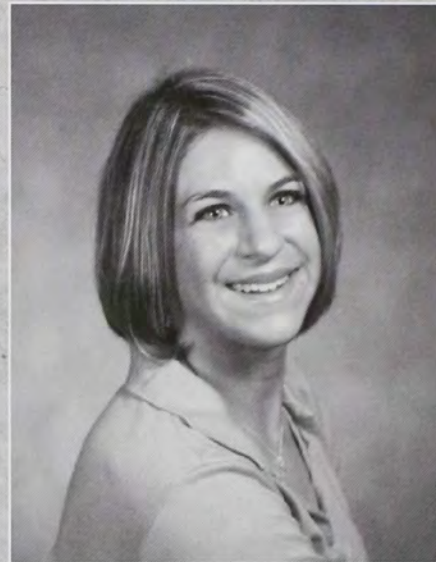

Eden Terry Swick

Media Studies
Minor: Creative
Writing
York Springs, PA

And now I'm glad I didn't know
The way it all would end,
The way it all would go
Our lives are better left to
chance
I could have missed the part
But I'd have had to miss the
dance...

Couldn't do it without
you...Mom, Dad, Rachel,
Kendra



James J.
Swiggard, Jr.

Exercise & Sports
Science
Harleysville, PA

Kevin T. Sylvester

Chemistry
Minor: Biology
Jamison, PA

"Ability is what you're capable of doing. Motivation determines what you do. Attitude determines how well you do it." -Lou Holtz

Thanks to my family for all of their support and encouragement over the past four years.

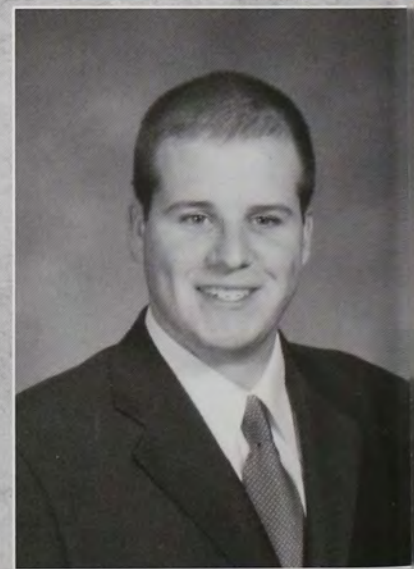



Nicole Taormina

Spanish
York, PA

What lies behind us and
what lies before us are
small matters compared
to what lies within us.
Thank you all for your
support!



Candace J. Thomas

Communication
Studies & Theatre
Willingboro, NJ

Aren Lynette Todd

Psychology
Minor: Sociology
Philadelphia, PA

Obstacles are those
rightful things you see
when you take your
eyes off your goals.
-Unknown



Kjisten Torkelson

Exercise & Sport
Science and French
Stockton, NJ

Be the change you wish
to see in the world
-Chandi



Tonya L. Towles

English
Minor: Spanish
Reading, PA

Its been 4 years of misery and
strife. I hate the institution
but I have to thank God and
my family for helping me
along. Love for Keita,
DeArana, and Schroeder.
I'm done, and not looking
back. So long suckers!

Heather M. Trefsgar

Communication
Studies & Theatre
Mount Carmel, PA





Judith M. Troegner

Business & Economics
Minors: Education and
Exercise & Sports
Science
Titusville, NJ

Angela B. Tucker

Psychology
Minor:
Communications
Germantown, MD

In order to succeed,
your desire for success
should be greater than
your fear of failure.
-Bill Cosby



Joelle W. Turner

Psychology
Cambersburg, PA

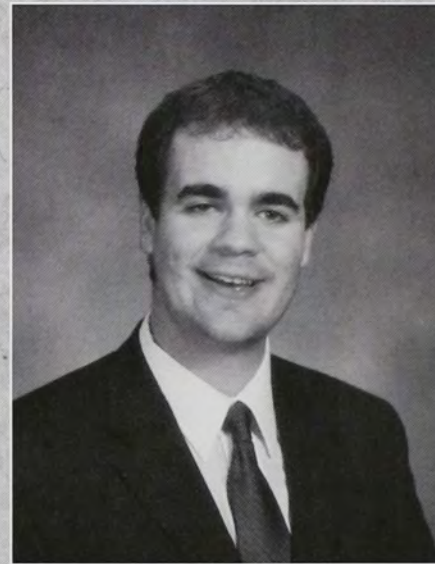

Jeffrey Michael
Vicki

Business & Economics
and Spanish
Jessup, PA

"I may not have gone
where I intended to go
but I think I ended up
where I needed to be

Tasheia She'ryl
Walker

Neuroscience
Minor: Spanish
Bensalem, PA

Courage is not the
absence of fear, but
rather the realization that
something else is more
important than fear. The
brave may not live
forever, but the cautious
do not live at all.

Erin M. Walsh

Biology
Olivebridge, NY

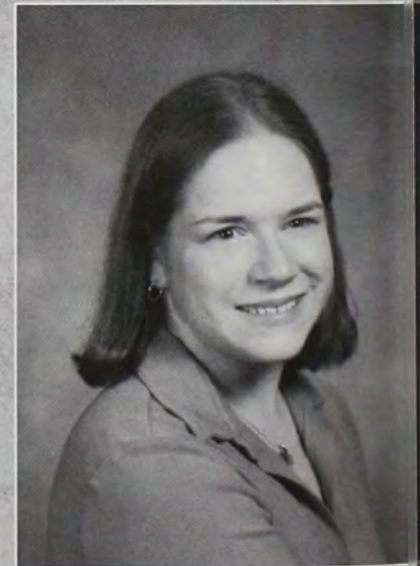



Maedea C.
Watson-Bey

Mathematics
Lansdale, PA



Christopher J. Weir

Environmental Studies
and Psychology
Flourtown, PA

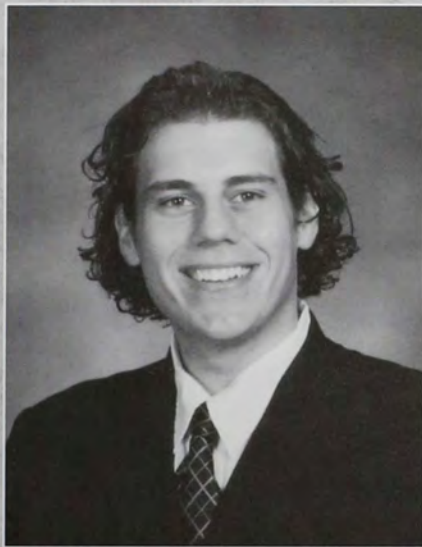

Charles W. Wenger

English
Philadelphia, PA



Erony Whyte

Environmental Studies
and Biology
Brunswick, ME

To dream a dream is to
awaken your inner self.
Your wants, your
desires, your passions
are given life.



Regina L. Willett

Business & Economics
Springfield, PA

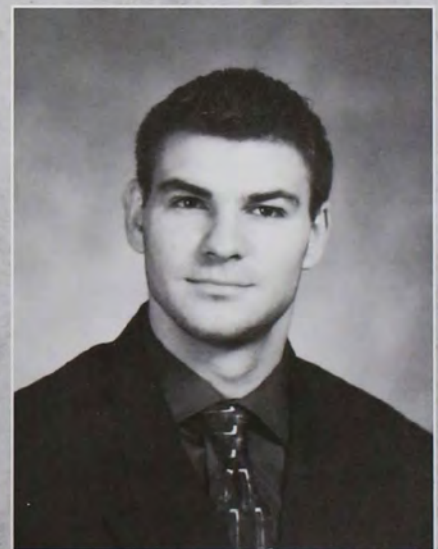

Daniel F. Williams

Biology and Philosophy
Lehigh, PA



Danielle Williams

Sociology
Philadelphia, PA

On this day a new pin-
nacles has been reached
Look down and be proud
of all you have
accomplished
Look up and anticipate all
you have yet to achieve
Live this moment, Your
moment
Class of 2005

Jill Marie Williams

English
Minor: Business
York, PA

"Wake up to find out
that you are the eyes of
the world. But the heart
has its beaches, its
homeland and thoughts
of its own. Wake now,
discover that you are
the song that the
morning brings."
R. Hunter, J. Garcia



Ashley N. Willow

Biology
Dover, PA

"Eventually all the pieces fall
into place. Until then, laugh
at the confusion, live for the
moment and know that
everything happens for a
reason."

Mom & Dad: I wouldn't have
made it without you. Thank
you for this experience and
your unwavering faith in me.
I love you!



Fallon M. Wilson

Psychology
Pottstown, PA

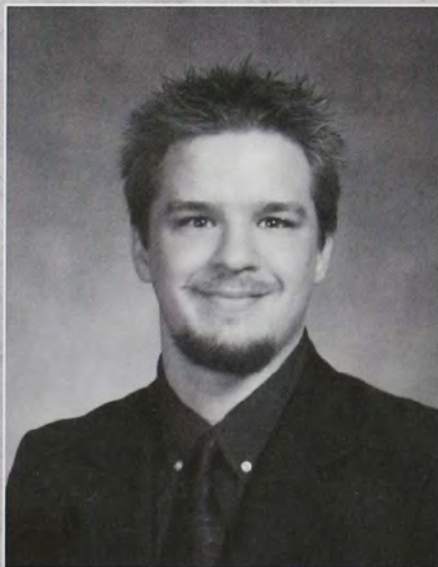

Scott B. Woodring

Politics
Northampton, PA

Oksana Yaworsky

International Relations
and Eastern European
Studies
Bensalem, PA

Mama, Tato, Natalia, Dido,
and Rodyno- Your prayers,
encouragement and ceaseless
support have guided me
these past four years. My
success is our success.
Thank you! Love you! Tsiom.
Friends- Thank you for a
wonderful four years. You
will always be in my hearts
and our memories always in
my thoughts.





Sarah Yemane

Psychology
Minor: Communication
Studies
Philadelphia, PA

"The big secret in life is
that there is no big
secret. Whatever your
goal, you can get there if
you're willing to work."
-Oprah Winfrey



Jonathan A. Yoder

Spanish
Minor: Latin
Carbondale, PA

Brandon E. Zapalac

Business & Economics
Eagleville, PA



*"You have
brains in your head.
You have feet in your shoes. You can steer yourself in any
direction you choose. You're on your own. And you know
what you know. You are the guy who'll decide
where to go." -Dr. Seuss*

Seniors Not Pictured

Omar Adam Almallah

Adam James Harbaugh

Hiroshi Nishida

Nicolas G Armendariz

Wesley Rennie Harden

Mary Kathryn O'Brien

Jackson Ryan Barber

Elliott B. Hulley

Erin Cathleen O'Hara

Bradford Hunter Berry

Angela Interrante

Drew Tyson Perry

Michael Joseph Bojazi

Daniel P. Iwaniuk

Tyler James Pittenger

Nikita Alexei Borovik

Judson Sydney Kane

Ryan Jeffrey Polk

Lardner Clark Boyd

Zoha Aqil Karmali

Olalekan Popoola

Peter Alexander Bregman

Sarah Theresa Kauffman

Joseph Harold Potts

William James Castan

Meredith Anne Kleiber

Thomas Winter Salvo

Jonathan Randall Coller

Gregory Thomas Ley

Erin Elizabeth Skinner

Alan Francis Connelly

Timothy Burdette Mabrey

Andrew Michael Smith

Ryan Patrick Curley

Jessica Lynn Mackey

Tabatha Patricia Spencer

Joseph Charles Davido

Michelle Lindsay Maio

Anthony Thomas Virtue

Indro Kumar De

Daniel Nicholas Matthews

Naquan Wycliffe Williams

Danielle Marie DeKovitch

Michael Louis Mergott

Brianna Lorraine Worley

Joseph Carl Eisele

Abigail Frances Munro

Hugh William Wynne

Robert Michael Farley

Michael M.B. Nesbit

Peter Joseph Yaskowski

Adam Jeremy Gordon

Daniel H. Newcomb

Sue Jung Yong

Scott Peter Newitt

Candid Shots



As you climb the ladder of success, check occasionally to make sure it is leaning against the right wall.

— Unknown

Education is the process by which the individual relates himself to the universe, gives himself citizenship in the changing world, shares the race's mind and enfranchises his own soul. — John H. Finley



Candid Shots

Candid Shots



I have learned this at least by my experiment: that if one advances confidently in the direction of his dreams and endeavors to live the life he has imagined, he will meet with success unexpected in common hours. — Henry David Thoreau

You are educated. Your certification is in your degree. You may think of it as the ticket to the good life. Let me ask you to think of an alternative. Think of it as your ticket to change the world. – Tom Brokaw

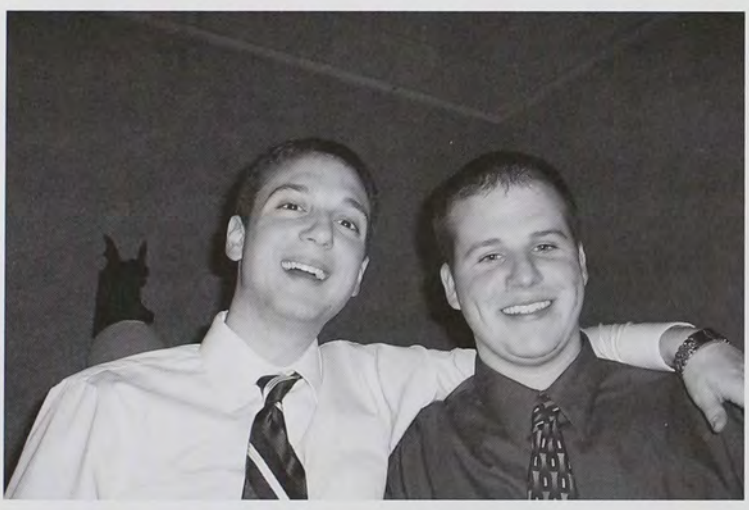

Candid Shots

Candid Shots



To those of you who received honors, awards and distinctions, I say well done. And to the C students, I say you too may one day be president of the United States. — President George W. Bush

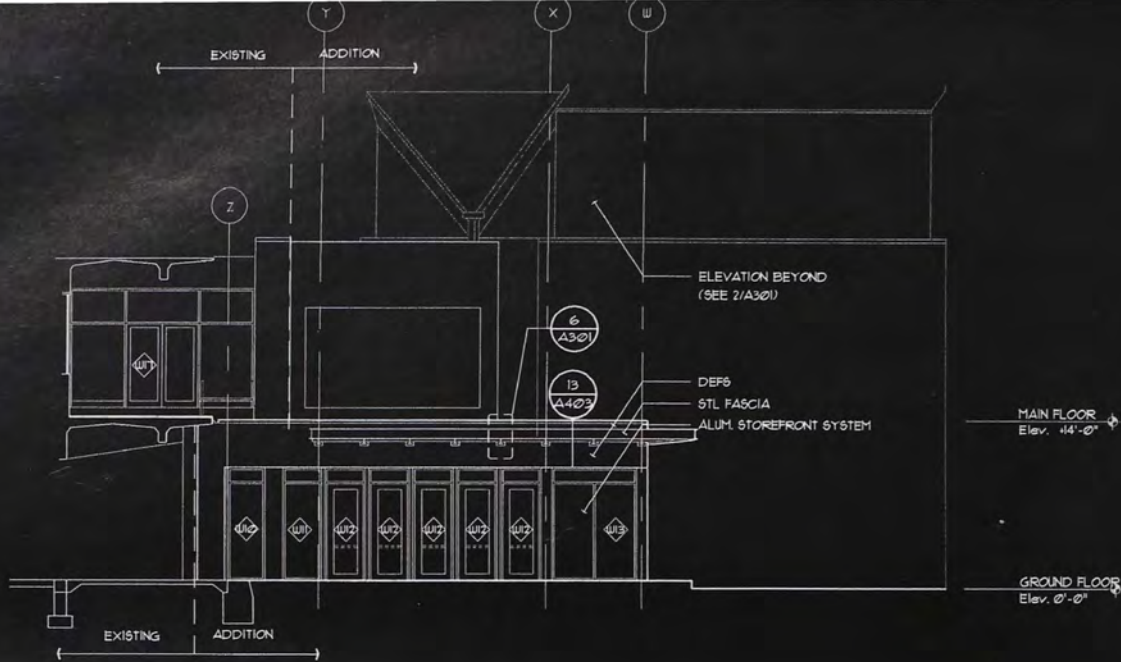

1 Elevation
A301 SCALE: 1/8"=1'-0"

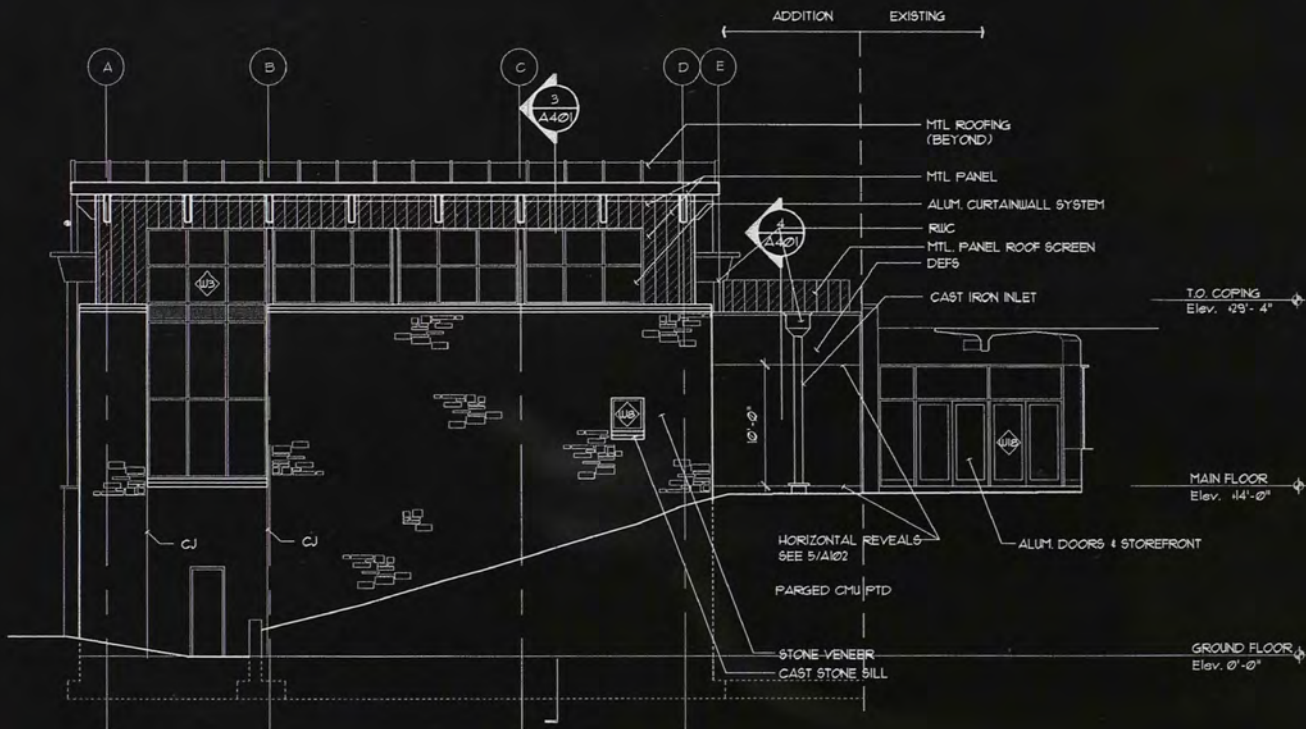

3 Elevation
A301 SCALE: 1/8"=1'-0"

4 A301

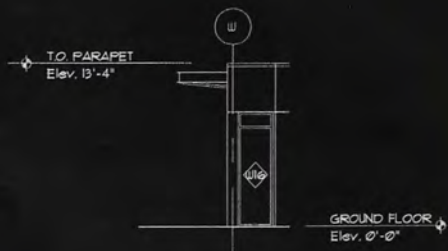

T.O. PARAPET Elev. +3'-4"

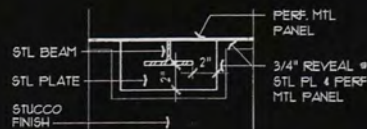

5 Elevation
A301 SCALE: 1/8"=1'-0"

6 Elevation - Beam Penetration @ Canopy
A301 SCALE: 1/8"=1'-0"

7 A301



URSINUS COLLEGE
BOOKSTORE
A SERVICE OF BARNES & NOBLE COLLEGE BOOKSELLERS

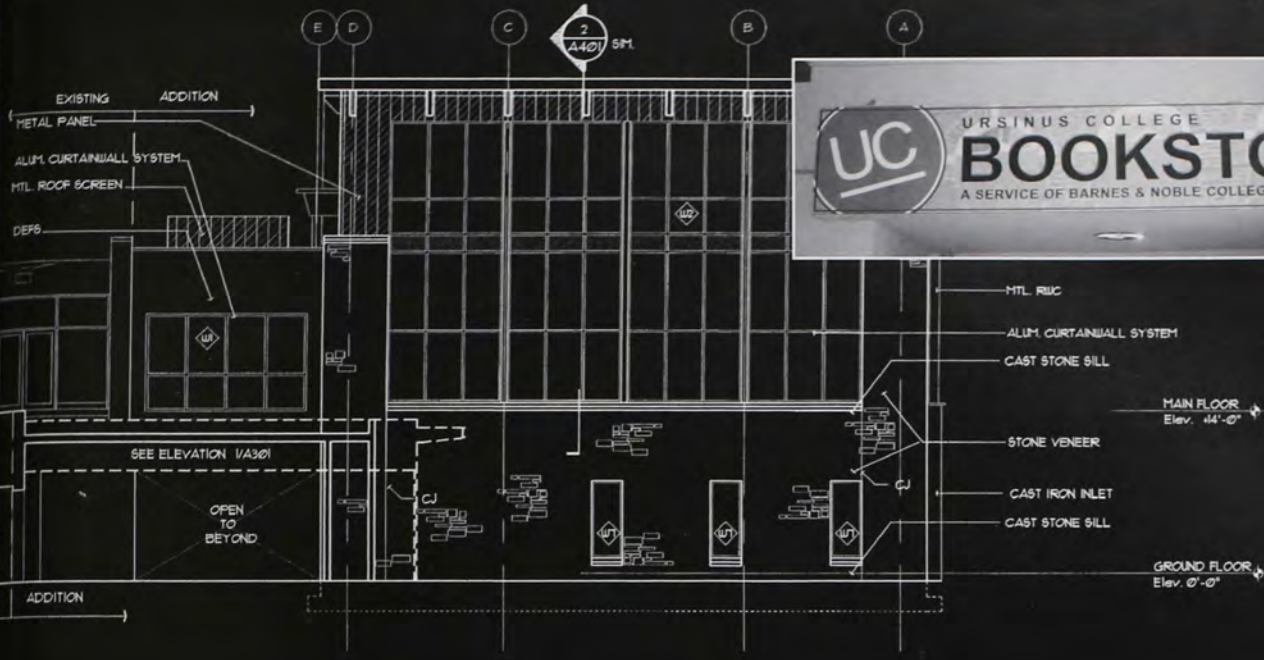

College Store Addition - Ursinus College

Collegeville, Pennsylvania

Elevation
SCALE: 1/8"=1'-0"

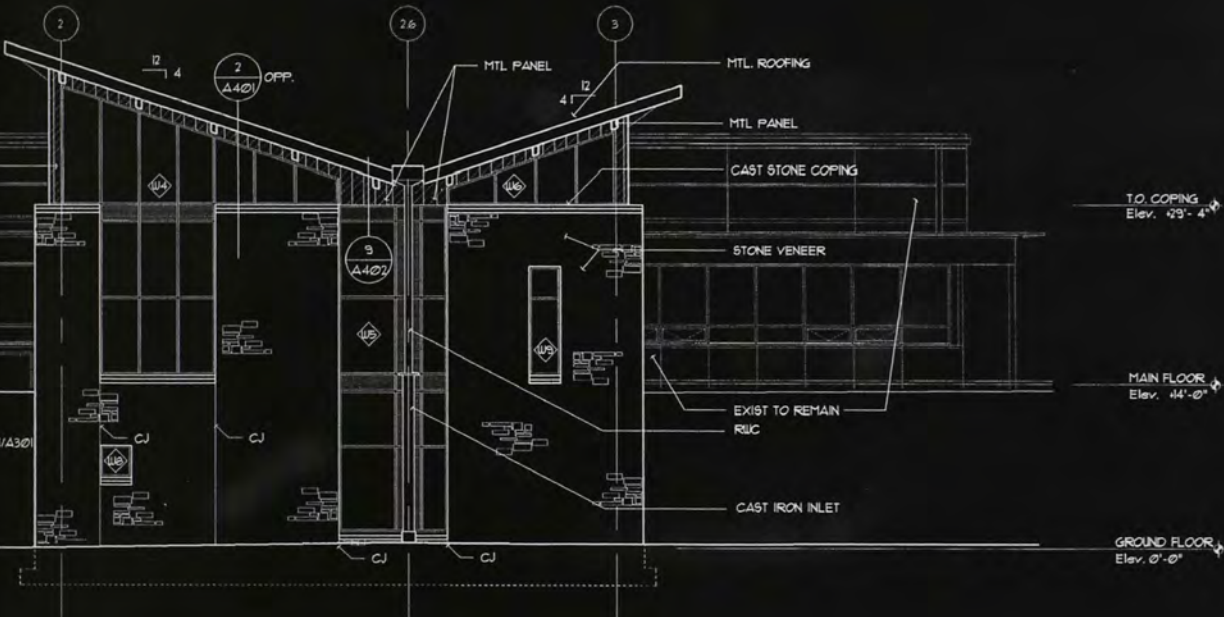

No.	Date	Revision

Kohrt Shatken Sharon Architects
337 Witherspoon Street
Princeton, NJ 08542 USA
609-921-1131

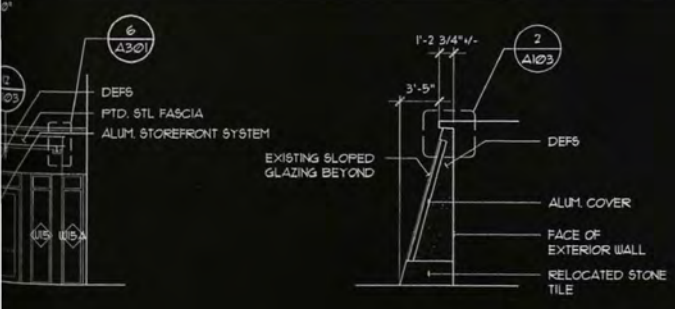

Elevation
SCALE: 1/8"=1'-0"



Project No.: 9640
Issued: 29 January 1998
Elevations

A301

CONGRATULATIONS NICK

*From VA to Today
Our Home has been Your Home*



*No matter where you go in life
The lights will always be on.*

*Love,
The Lawson Family
Nina, Tom, James, Samantha, & Winston*



May 14th, 2005



Jacqui,

It's your day! Take time to stand back and savor what you have just accomplished in another chapter of your life! It's a day of mixed emotions knowing it is now time to start another new and exciting chapter in your book of life. You have accomplished so much and have so much more to do. Treasure the times you have had during your Ursinus years—especially the friends, your Sig Nu sisters, the adventures, and don't forget the Wawa runs! Look forward to conquering the dreams and goals you have set for yourself.



You have grown from that shy little girl into a strong, intelligent, determined, adventurous young woman who never ceases to amaze us. Thank you for sharing your life and experiences with us. We can't begin to tell you how proud we are of you. We ask that you continue to hold tight to your dreams and never stop reaching and exploring.



*With all our love,
Mom, Dad and Jenni*



***Congratulations
Kari Baker!!!***

***We are proud
of you!!!***

DEAR SISSY LYNN,

**I AM SO PROUD OF
YOU!**

**LOVE,
MOM**

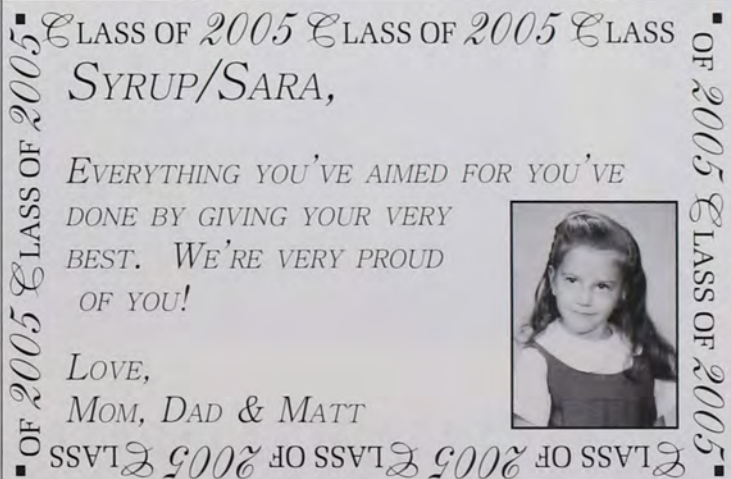

CLASS OF 2005 CLASS OF 2005 CLASS OF 2005 CLASS OF 2005 CLASS OF 2005
SYRUP/SARA,

**EVERYTHING YOU'VE AIMED FOR YOU'VE
DONE BY GIVING YOUR VERY
BEST. WE'RE VERY PROUD
OF YOU!**

**LOVE,
MOM, DAD & MATT**





~ IF YOU GO TO WORK ON YOUR GOALS, YOUR GOALS WILL GO TO WORK ON YOU. IF YOU GO TO WORK ON YOUR PLAN, YOUR PLAN WILL GO TO WORK ON YOU. WHATEVER GOOD THINGS WE BUILD END UP BUILDING US. ~
--JIM ROHN

JESSICA SOTO
KYLE KAUFFMAN
KAREN TODD
LAUREN CARRESCIA
SAMIT PATEL
DANA FILLO
CEDRIA MCMILLIAN

MONA SINGH
MELISSA FEAN
CARLA D'OLIO
NIKKI BECK
BRETT SCIPIONI
LINDSAY GOFFREDO

JEN COHEN
MONICA DELANEY
LAUREN BROPHY
LESLEY DAVIDSON
KERI FERRAR
NICOLE BOROCCI

BEST WISHES AS YOU LEAVE URSINUS AS THE CLASS OF 2005, AND ENTER THE WORLD AS BEAUTIFUL INDIVIDUALS! THANK YOU FOR ALL OF YOUR HARD WORK AND DEDICATION.

SINCERELY,

THE ADMISSIONS OFFICE

Congratulations to the Class of 2005!

We are proud of you!

The Student Life Staff:

Campus Safety Officers

- Mike Ditty
- Austin Duckett
- Jackie Haring
- Carolann Johnson
- Natissa Kultan
- Steve Larson
- Lynda Manz
- Todd McKinney
- Deborah Nolan
- Phyllis Osisek
- Paulette Patton
- Jennifer Potson
- Nancy Reilly
- Corinthian Ridgeway
- Carla Rinde
- Brian Stephenson
- Denise Walsh



Amanda Marie Morello '05
Congratulations, Amanda!

*We are so proud of you and of all of your
accomplishments!*

*Continue to reach for the stars
And the whole world will be yours.*

*We wish you a future filled with
Success & Happiness!*

*Love, Dad & Mom, Kate, Kristie,
Grandmom and all the Morellos*

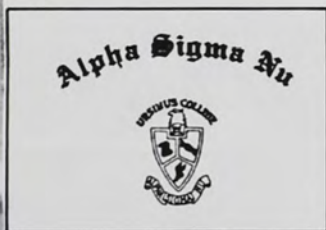



Zach,

Seventeen years ago, you walked out our front door on to your first day of kindergarten. You have since proven to be more of a person, more of a man, than we could have ever dreamed.

We are confident when you walk off the campus of Ursinus College in May of 2005, you will not only have achieved another one of your many dreams, but will begin the next chapter of your life knowing that you've made your parents very proud while doing it.

Zach, walk on, walk proud, and walk knowing how much you are loved.

**Love,
Mom, Dad & Nicole**

CLASS OF 2005 CLASS OF 2005 CLASS

**CONGRATULATIONS,
LAUREN BROPHY!**

We've watched you grow into an incredible young woman during your years at Ursinus. We're all very proud of your accomplishments! However, it's time for Wendy to leave behind the "Never Land" (where you don't have to grow up) and the "lost girls" of Tau Sigma Gamma. It's time for grad school and then a job helping the future Peter Pans of the world!

*With much love,
Mom, Dad, Chuck & Nana*



OF 2005 CLASS OF 2005

CLASS OF 2005 CLASS OF 2005 CLASS



Dear Brandie,

As you embark on the next phase in your life, we know you will embrace all the challenges and rewards that come your way with the same zeal you have shown in the past. We know you will never cut the Sig Nu cord and those great friends will be a strong influence in your life for years to come. We can only hope that the education you received at Ursinus will be just as strong an influence. It has been a pleasure watching you grow from a timid first day freshman to a mature confident and learned graduate.

God luck, God Bless and remember your family will always be there to love and support you.

Love,

Mom, Dad & Nikki



LISA MARIE JONES



CONGRATULATIONS!

You've dreamed of accomplishing great things, and then you did your best to make your dreams come true....

You've earned every success that's come your way, and you should be filled with pride and all the happiness you deserve....

We are so very proud of you!

Love,
Mom, Dad & Eric



Best of luck in
Grad School!

CONGRATULATIONS SENIORS '05!

From the Residence Life Staff

Kari Baker
Laura Bickert
Caroline Biswanger
Shane Borer
Arianna Brewer
Carla D'Olivo
Evan DiBlassio
Meghan Jarrett
Chantell Johnson
Heather Kaczor
Sara Kessler
Anna Mira King
Joyce Anna Koubaroulis
Tia Larese
Katie Lehman
Heidi Liivamagi
Joe Potts
Lauren Segal
Josh Smedley
Brooke Swalm
Kjisten Torkelson
Erony Whyte
Oksana Jaworsky

From the poetry slam,
silver swan, and talent
show on your only hope
own, to the nightingale,
creek trestle, Londinium
cuckoo queen stone
circle gap watching, and
all those field and game
banners - we couldn't be
prouder.

We love you, Lizzy.

Mom, Pops & Sally



ANDREW,

*You are climbing
the ladder
of success!*

*Mom
Dad
Eric
Chris
Kristy
Sydney*

**Congratulations
to the
CLASS OF 2005!**



BILL STRAUB
(610) 247-5415
bill.straub@jostens.com



'A MOTHER TO ME'

She is everything a mother should be. Her gentleness makes my heart calm and warm. She is like a general, keeping me in line, as she waves from in the stands saying- "You Can Do It!!!" She supports me tremendously, making me REACH for my momentum. To finish that last stride. When I watch a friend give another friend a sympathetic HUG!!! I'm reminded of my mother's GREAT understanding of me and the world we live in.

How much kindness my mother portrays is uncharitable. The many times, I've seen her let others cry on her shoulder and weep their sorrow to her, while saying words of ENCOURAGEMENT. As a teacher stands between a fight, my mother's fairness shines through her eyes.

*She is everything a mother should be- ALWAYS THERE FOR ME...
-Crystal Dawn McCarney*



Lower Cape May



*Out of the mouths of babes
Every breath I take!!!!
Crystal, You're the best. Always believe in yourself. All my
love, hugs & kisses, Mom*



**Good Luck
Senior
Gymnastics!!**



Erony,
Petal,
Pretzel,
Dood,
Erony-Berony-Boo,

You're a crazy, cool, patient, tough,
beautiful, scientific, persevering,
dancing, tumbling, curious, hard
working, kind, funny, daring,
courageous, world saving, dreaming,
energetic, sexy, loving, smart, all
woman, world citizen, beer-chugging
gal.

We love you! *Zerin*, Mom
Dad

*Dearest Lauren,
Smart women...
can do anything!
Congratulations and Good Fortune*



☺ The current year will bring you much happiness. ☺

☺ You will be unusually successful in business. ☺

☺ You have an active mind and a keen imagination. ☺

☺ You think that it is a secret, but it never has been one. ☺

Soon you will encounter a whole new world of opportunity.

☺ You are heading in the right direction. ☺

☺ You find beauty in ordinary things. Do not lose this ability. ☺

☺ You are the master of every situation. ☺

Something wonderful is about to happen to you.

☺ The great pleasure in life is doing what people say you cannot do. ☺

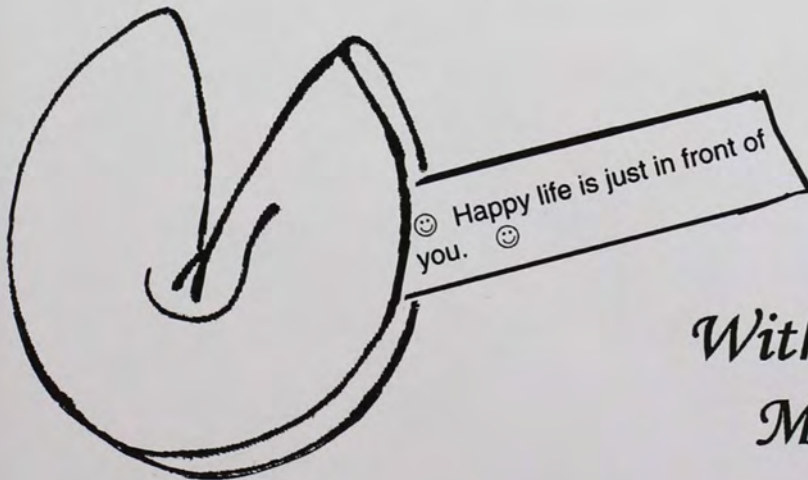

you can.
*With pride and much love,
Mom, Dad and Matt*

Ashley,

*It is with utmost pride that we dedicate this page to you.
You have been the best daughter any parent could ask for.*

*As a result of your dedication and perserverence, your
accomplishments are many.*

*We are very proud of you and your committment to doing your
best.*

Always believe in yourself!



*As you continue on your lifelong journey, may each and every
day be filled with faith, hope and love.*

*Our wish for you is that you see each day of your future as one
filled with possibilty and promise.*

Remember,

*"The future belongs to those who believe in the beauty of their
dreams." Eleanor Roosevelt*

Ashley, never stop dreaming!

Love,

Mom and Dad



Goody

Ever bright-eyed,
Full of fun,
Our wild and crazy son!

You've always
Been a GIFT and a JOY!

May you forever maintain
Your passion and intensity,
Living Life to the fullest
To the very end,
And thinking not
Of Holden's epitaph,
(however appealing it may be)

But, rather,
"Wow, What a ride!"
And keeping in mind
Along the way,
The terrible secret
Of Seymour's fat lady.

Love and Squalor,
The Family—Mom, Doody, Jacy,
And all the rest
Of grandparents, aunts, and uncles
Who LOVED you BEST
And think the World of our Goody-Bub!



The Sprank Tank
Beware all ye
Who enter therein!



UC's Finest!
May the Bearcock's
Legend Live On!



To Our Erica,

Looking at the photographs of you from when you were born up until today, it is like watching a flower sprout and grow into the most beautiful flower in the garden. Erica, you have made us so proud. You are a kind, understanding, loving young woman, and with these qualities you will have a great future that will bring much happiness to your life and to others. How lucky we are to be part of your life. Congratulations on your graduation!

*With all our love,
Mom and Dad*



Mr. and Mrs. Lester Jones

**Congratulations on
another success.**

**We are very proud of you,
Rebecca C. Jones.**

**Best Wishes
Kimberly.**

*We are proud of
you!*

*The Daloisio
Family*



*"It is not enough to have a good
mind. The main thing is to use it
well."*

-Rene Descartes

Congratulations Brian!



Love, Mom & Dad

van,



you always loved (and still do!) to receive gifts but now you have given your family the best gift- your hard work, dedication, and personality as a graduate of Ursinus College, Class of '05!

Good luck in all you do.

*With love and pride,
Mom, Dad, and Jaime*

CONGRATULATIONS HEATHER...

The first step of your life-long dreams has been completed.
Now on to the final phase of becoming:

ATTORNEY HEATHER DEANNA LESHER



We are so PROUD of you. REMEMBER...Keep your confidence and BELIEVE in yourself, your dream is becoming your reality.

Love, Mom, Dad, & Todd

Melissa E. Fean



Proud of you then



Proud of you now

*Love always,
Mom, Dad, Jessica, Steve,
and Ryan*

A wonderful journey of 22 years together we have come-

Many activities you're tried- singing, dancing, softball, soccer, basketball and tennis- to name only some-

You've expanded experiences and social conscience at Ursinus- from Rugby to Study in Spain to Marching on Washington- and we know it's just begun!



Proud of you, Mom, Dad, Josh, and Grandma



Dear Erica,

A bright tomorrow!

Love, Grandpa and Uncle Eric

Finally, proudly we are happy to say, sixteen years completed and on your way.

You have worked very hard, we are so proud of you.

Our love to you, Rebecca.

Mom and Dad

*Congratulations
Carissa Jessey*



Dear Carissa,

We are so proud.

Good luck, always.

Love,

Dad, Mom, and Family

***Dear Alex,
Congratulations on your accomplishments.
We're so proud of you! As you go through life,
remember it's the journey, not the destination!***



Love, Mom, Dad, Antony, and your "King"

~Kristen Nicole Grimmel~



*So take the photographs and
still frames in you mind..
Hang them on a shelf in good
health and good time.
We hope you had the time of
your life!*

Kristen,
Thanks for the memories.
We've enjoyed sharing the journey.
We are so very proud of you!

Love,
Mom, Michelle, Lindsey & Melissa



CONGRATULATIONS TO THE CLASS OF 2005! THE LAWSONS



Dear Adam,

It doesn't seem possible that this chapter is now complete. We are so proud of you and your accomplishments. You have made many life long friends at Ursinus. Cherish them. The future is yours, make the most of it. We love you. *"If you can imagine it, you can achieve it. If you can dream it, you can become it."* - William Arthur Ward

Love, Always,
Mom, Dad, & Stephanie

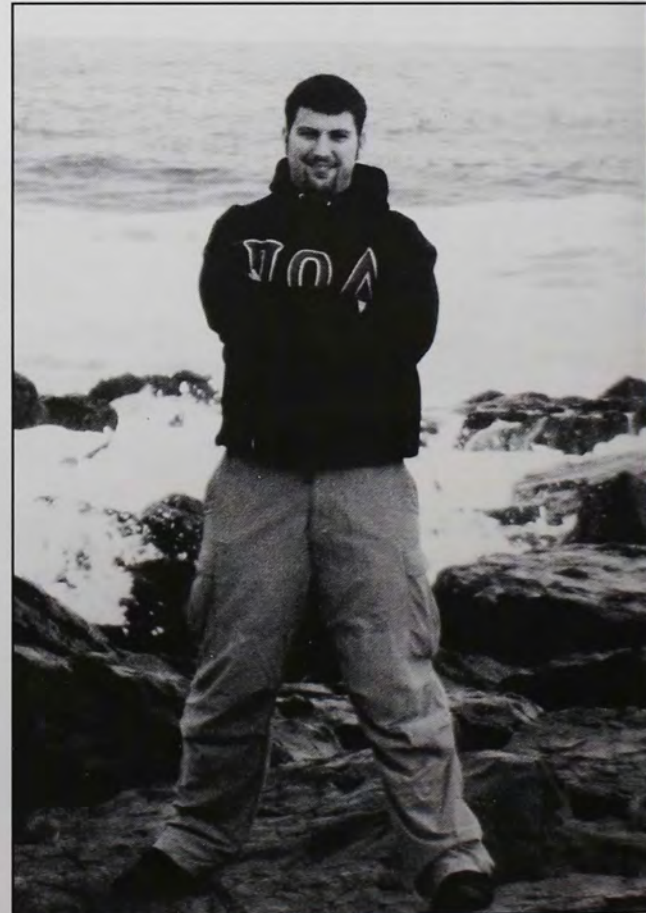



HATS OFF
TO THE CLASS OF 2005

FROM
THE CAREER SERVICES OFFICE
CARLA RINDE
MARIA BEAZLEY
JEN POTSON
&
NANCY REILLY



Steve and Christie Weller

*Keep up the Good
Work, Christopher!*

Olympic Oil Heating and A/C

We keep the torch lit for you

Cathi Marcheskie

Vice President

237 North Charlotte Street
Pottstown, Pa. 19464

Phone: 610-326-2889

Fax: 610-705-0595

E-mail: Olympic95@aol.com

**Josh, you have made us so
proud! You will make a
great professor.**

We love you!

**Love, Mom, Dad, Becky, and
Chris**

Congratulations!

*Way to go
Katie O*

Mom & Dad



"Maris", "China Girl", "Pig Pen", "Sissy"... you've been called many names by many people...but now you may also be called a "College Graduate" ---Wow!



PROUD cannot even start to describe how we feel about your accomplishments---YOU are one of the two greatest wonders of our lives. Now, go conquer the World!

Love,
Mommy & Daddy
(Parents of Marissa Rotz)

CONGRATULATIONS JAMES

Today is your day.
You're off to great places!
You're off and away

You have brains in
your head.
You have feet in
your shoes
You can steer
yourself
any direction
you choose.

You're on your own.
And you know
what you know.
And YOU are the
guy who'll decide
where to go.



And will you succeed?
Yes! You will, indeed!

(98 and 3/4 percent guaranteed.)

JAMES, YOU'LL MOVE MOUNTAINS!

So...

be your name Lawson or Lixby or Lay
or Mordecai Ali Van Allen O'Shea,
you're off to Great Places!

Today is your day!

Your mountain is waiting.

So...GET ON YOUR WAY!

You'll look up
and down streets.
Look 'em over
with care.
About some you
will say,
"I don't choose
to go there."
With your head
full of brains
and your shoes
full of feet,
you're too smart to
go down any not-
so-good street.

We're very proud of you!

Love, Dad, Mom, Patric, Sam, & Winston



Kevin-

"Don't worry about what the world wants from you, worry about what makes you come alive. Because what the world really needs, are people who are more alive."

Congratulations on reaching your college graduation! A moment hasn't gone by that we haven't been proud of you! You always dare to challenge yourself and manage to come out on top! You have become such an incredible young man, and we know that there is a great big future waiting in front of you- we can only imagine what you will accomplish! We love you so much!

Love always,

Mom, Dad, Kristen, Karen and Kimmy

Congratulations Class of 2005

Biology Majors



Kari Baker
Caroline Biswanger
Arianna Brewer
Douglas Budzyn
Nuria Caraballo
Lindi DeArment
Antonia DiBona
Kelly Eves
Lindsay Goffredo
Christopher Gross
Lorid Haxhiu
Carissa Jessey
Michael Klingler
Joseph Krivda
Brianna Lindsay
Emily Livesey
Kathryn Matthias
Ryan Matty
Anna Mazor
John Millili

Mary Ann Murrow
Michelle Noreski
Samit Patel
Nicholas Peacock
Cristina Polinsky
LeeAnn Rafferty
Marcus Ressler
Jennifer Rhodes
Ethel Richards
Brett Scipioni
Michelle Segalov
Wayne Siegwarth
Jacqueline Slakoper
Jenni Smagala
Kristen Smith
Jessica Soto
Monique Spencer
Margaret Sperow
Anthony Virtue
Erin Walsh
Erony Whyte
Daniel Williams
Ashley Willow

Tiffany Diane McFadden



I am so proud of you, Tiff. You will go far. From Mom

Best Wishes in all your endeavors, Tippy-Toppy. From: Dad

Tiffany, your graduation is a great accomplishment. From: Aunt Rose

You did it duh-duh. From: Lydia

Tiff, you finished!!! From: Marilyn

Hooray for Aunt Tiffany! From: Isa, Oceana, & Amari

**WE LOVE YOU TIFFANY
CONGRATULATIONS!**

*Kelsey,
You have graced the world
with your beauty,
intelligence, and genuine
compassion for the human
spirit. May you always be
blessed with joy and all you
dream possible.*

*I am so proud of you!
Love you tons, Mom*

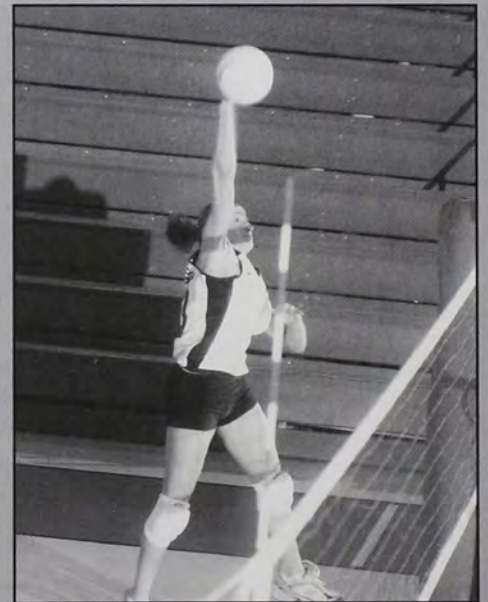

Dear Noelle,

*You reached high success, you worked hard!
Success is yours !!!!
We're so proud of you.*

Love Mom, Greg & Francis

Congratulations to our Anna,



*Love, Mommy, Abi, Stefany, Rosemary,
May-May, & Soleil*

Congratulations to the
Tau Sigma Gamma
Seniors!



Approximately 21



Dirty Dozen

- Avril
- Beard Run
- Blah
- Bug-eyed Bonnie
- Colorblind Picasso
- Cindy Lou Who
- Count Revorg
- Edible
- Flee
- Flounder
- Mil Nay Nay
- Offering
- Spazz
- Steven Segal
- Phonaphobic Choir
- Rhonda
- Vomit Meister
- [www.cockycohen.](http://www.cockycohen.com)



Through sophomore, junior, senior year, and all eternity

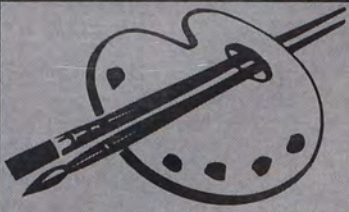

The Berman Museum of Art
Congratulates and sends our sincere appreciation
to our graduating seniors

Majd Abdelqader
Mohannad Abdo
Sarah Kauffman
Holly Poorman
Jeffrey Vicki

Best wishes and we will miss all of you!
Lisa Hanover, Susan Shifrin, and Sue Calvin

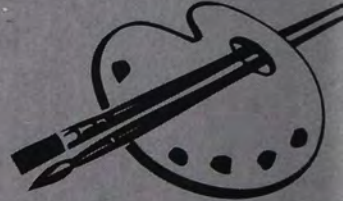

***The Ruby Yearbook Staff wants
to extend its sincerest wishes of
congratulations to the***

CLASS OF 2005

***Good luck in all your future
endeavors and leave your
footprints where ever the future
takes you!***



**The Ruby Yearbook
Staff would like to
thank all of you for your
support and
continued readership.**

