

James Madison University
JMU Scholarly Commons

Senior Honors Projects, 2010-current

Honors College

Spring 2018

Design of a homeopathic solution for chronic cough

Jacob Ziemke
James Madison University

Follow this and additional works at: <https://commons.lib.jmu.edu/honors201019>

 Part of the [Biomedical Devices and Instrumentation Commons](#), [Investigative Techniques Commons](#), and the [Other Analytical, Diagnostic and Therapeutic Techniques and Equipment Commons](#)

Recommended Citation

Ziemke, Jacob, "Design of a homeopathic solution for chronic cough" (2018). *Senior Honors Projects, 2010-current*. 548.
<https://commons.lib.jmu.edu/honors201019/548>

This Thesis is brought to you for free and open access by the Honors College at JMU Scholarly Commons. It has been accepted for inclusion in Senior Honors Projects, 2010-current by an authorized administrator of JMU Scholarly Commons. For more information, please contact dc_admin@jmu.edu.

Design of a Homeopathic Solution for Chronic Cough

An Honors College Project Presented to
the Faculty of the Undergraduate
College of Engineering
James Madison University

by Jacob Ziemke

Accepted by the faculty of the Department of Engineering, James Madison University, in partial fulfillment of the requirements for the Honors College.

FACULTY COMMITTEE:

HONORS COLLEGE APPROVAL:

Project Advisor: Dr. Keith Holland

Bradley R. Newcomer, Ph.D.,
Dean, Honors College

Reader: Dr. Erin Kamarunas

Reader: Dr. Callie Miller

PUBLIC PRESENTATION

This work is accepted for presentation, in part or in full, at the Honors Symposium on April 18, 2018.

Table of Contents

<i>Acknowledgements</i>	2
<i>Abstract</i>	3
<i>Background</i>	4
<i>Introduction</i>	6
<i>Methods and Materials</i>	8
<i>Design Process</i>	10
Application of Vibration to the Neck	10
Electronics Housing	13
Electronics Testing and Calibration.....	14
Comfort and Functionality.....	19
<i>Conclusion and Recommendations</i>	23
<i>Appendices</i>	24
Appendix A.....	24
Appendix B.....	27
Appendix C.....	28
Appendix D.....	30
Appendix E.....	31
<i>Bibliography</i>	33

Acknowledgements

Many individuals were involved in this project, all of whom were essential for its success. I would like to thank Dr. Erin Kamarunas and Dr. Christy Ludlow for the opportunity to help design this biomedical device and for their continued expertise throughout the entire process. I would also like to thank Dr. Keith Holland for his technical support and mentorship throughout my entire undergraduate career. His guidance and encouragement were paramount to my success on this project and as an engineering student. The opportunities and assistance provided by Mary Lou Bourne and Patricia Higgins are greatly appreciated. Special thanks to Patrick McQuown for his entrepreneurial direction and Dr. Graham Mott for his valuable advice. Finally, I would like to thank Nahom Fissaha for his dedication to the success of this project and unwavering friendship throughout my undergraduate career. This project has only seen success because of this team and I look forward to moving this idea and device forward.

Abstract

Chronic cough is most commonly defined as a cough that persists for more than eight weeks and is estimated to affect more than 30 million people in the United States at any given time. Diseases contributing to the onset of chronic cough include asthma, pulmonary fibrosis, lung cancer, postnasal drip, gastroesophageal reflux disease (GERD), and bronchitis, and may include lifestyle choices such as smoking. For those who seek medical advice, pharmaceuticals and speech therapy are two common methods of combating chronic cough but serve to mask the symptoms rather than treat the problem; frequently, chronic cough is misdiagnosed or cannot be treated. Chronic cough negatively impacts an affected individual's quality of life and often makes sleeping, eating, working, and speaking difficult. New hypotheses suggest hypersensitivity of the airway is the root cause of chronic cough in a large number of individuals. Though patients may experience different symptoms provoked by certain irritating factors such as postnasal drip, and GERD, it is hypothesized hypersensitivity is the link between a large quantity of chronic cough cases. The purpose of this research project was to design a prototype based on the patent pending method developed by Dr. Christy Ludlow to further investigate the relationship between hypersensitivity and chronic cough. The device enables researchers to control and monitor varying levels of vibration stimulus applied to the tracheal region of the neck with the goal of suppressing the urge to cough in persons with idiopathic cough. Through multiple iterations of user-centered design, a non-invasive wearable prototype was created for the first round of participant testing to assess the feasibility of the technology. Further testing and refinement of the device will validate vibration stimulus treatment for coughing.

Background

Chronic cough is most commonly defined as a cough that persists for more than eight weeks and is estimated to affect 9%-33% of the population [1]. One study in the United Kingdom reported 12% of the more than 4,000 people interviewed suffered a cough attack at least once a week; 7% said the cough interfered with daily activities [2]. Within the United States it is estimated that 27.4 million adults suffer from varying levels of chronic cough at any given time [3]. Coughing is also the most common reason people visit primary care physicians and respiratory specialists [4]. Chronic cough may be a symptom of underlying issues such as asthma, pulmonary fibrosis, lung cancer, postnasal drip, gastroesophageal reflux disease (GERD), or bronchitis, or a result of lifestyle choices like smoking [5,6]. For those who seek medical advice, it has been shown that misdiagnosis and failure of treatment occur 12%-44% of the time [5]. These failures occur for many reasons. To diagnose a cough effectively, the patient must endure several expensive and time-consuming tests, such as chest radiography and spirometry [7]. Since coughing is such a common problem, most physicians use strategies such as “treat sequentially” and “treat all” instead. Physicians who use “treat sequentially” will diagnose a patient based on what they believe is a single cause. If the patient returns with recurring or new symptoms, the physician will then diagnose and treat the new symptoms. A physician using the “treat all” strategy will prescribe medication for a range of possible diagnosis based on the present symptoms. The physician can then avoid laborious tests and prescribe treatment options for the symptoms that are present at that time, but many times miss the underlying problem, leading to idiopathic diagnoses [7].

The treatment options commonly associated with chronic cough include decongestants, antihistamines, inhaled asthma medication, antibiotics, and cough suppressants, all of which

have side effects and can lead to serious health issues if abused or taken for too long [9].

Furthermore, treatment of the common causes of cough, such as postnasal drip and GERD, can take up to six months. This can result in patients taking the wrong pharmaceuticals for long periods of time, suffering the side effects while gaining no comfort [7].

Introduction

New studies have suggested an overlying cause of chronic cough could be the hypersensitivity of the cough reflex sensory system [4]. New hypotheses suggest there is a relationship between hypersensitivity and certain irritating factors such as postnasal drip, GERD, and others [4,10]. Though patients may experience different symptoms provoked by one or more of these factors, hypersensitivity of the cough reflex could be a link between a large quantity of chronic cough cases [4,10]. Recent studies have also shown that up to 40% of people with chronic cough also experience voice problems [4]. To combat both hypersensitivity and voice problems, speech therapy has become a new addition to the treatment regime for chronic cough, though few studies have shown its true efficacy in the successful treatment and cure of chronic cough [4,7,11]. Speech therapy is used to teach cough suppression techniques and retrain the cough reflex as well as help patients with their voice issues.

Though effective in some cases, drugs treat the symptoms of a cough and come with lasting side effects. Speech therapy has been successful in retraining the cough reflex but can be time consuming and expensive. A new solution is required for those suffering from chronic cough due to hypersensitivity of the cough reflex. Recent studies investigated the effects of using vibration to reduce the urge to cough in adults. Specifically, vibration was applied to the cervical trachea during inhalation of nebulized citric acid, an irritant commonly used to evoke coughing. The vibration was applied to the neck as the concentration of citric acid was increased. At each of the citric acid concentrations, vibration always reduced the urge to cough in healthy males [12]. Furthermore, excessive coughing is positively linked to a heightened cortical response in the brain and using vibration on the neck reduced this cortical response [13, 14]. The purpose of this report is to explain the process of creating a device capable of applying and monitoring

vibration to a patient's neck. Chronic cough negatively effects many people's quality of life; thus, it is important this device must remain functional and discrete during day to day activities while also suppressing cough.

Methods and Materials

Initial discussion with Dr. Ludlow and Dr. Kamarunas helped to set benchmarks for the design of this device. In 2015, Dr. Ludlow submitted a method patent for suppressing cough using vibration applied to the tracheal region of the neck. Dr. Ludlow employed the engineering department to help design a physical prototype to test the process laid out in the patent. Based on previous experience, it was important to Dr. Ludlow that the device applied a vibration between 50 and 300 Hz for up to 60 seconds at a time. The user also needed to have control over the frequency of vibration and force at which the vibration was applied to the neck.

Computer aided design (CAD) was used heavily for creating ideas which could be printed in three-dimensions using JMU engineering facilities. The process of designing the device began with deciding how the vibration would be applied to the neck at varying levels of force. Once the method of applying force had been devised, the average geometry of the female neck was used as a guide for the shape of the device since chronic cough is significantly more prevalent in women. CAD was used to develop drawings and print prototypes, which Nahom Fissaha, another engineering student, and I wore to ensure comfort and that the vibration was firmly applied to the neck. The final device includes three separate electronic devices. To measure the frequency of vibration and monitor cough frequency, a 500 g Kistler accelerometer is used. Brushless coin vibration motors are used as the source of vibration and Honeywell FSG force sensors monitor the force applied to the patient's neck. The electronic components are housed in a single 3-D printed piece which is adjusted using a screw mechanism mounted to a larger housing secured to the neck.

LabVIEW was used for initial testing of the electrical components and all necessary wires were run through a National Instruments 9232 input module. Initial feasibility tests with

individuals suffering from chronic cough will be completed beginning in the Summer of 2018 using LabVIEW and National Instruments 9232 input module to power and control the applied vibration. The user control system utilizes a 100 k Ω rotary potentiometer and MOSFET circuit. The force sensor output and accelerometer data are compiled and analyzed using LabChart and a PowerLab 16/35 DAQ system.

Design Process

Application of Vibration to the Neck

The design of the device began with brainstorming the best method for applying vibration to the neck. Many ideas were sketched, but a screw mechanism was chosen due to its simplicity and ability for easy user control (Appendix A1). One such method was using a dial that could screw and click into certain positions, which could have been used as a guide for applying the correct amount of force (Appendix A2-3). This idea was changed to a simple screw for maximum user control and simplicity of design. A screw would thread through a nut and external housing which was secured to the neck using straps. The screw would then push another housing out against the neck, making contact with the force sensitive resistor (FSR) (Figure 1). When deciding on the method of measuring force, the two options included an air pressure bulb or a FSR. The FSR was originally chosen because it was easily integrated into the smaller housing and did not require any additional external measuring device other than the computer and DAQ system.

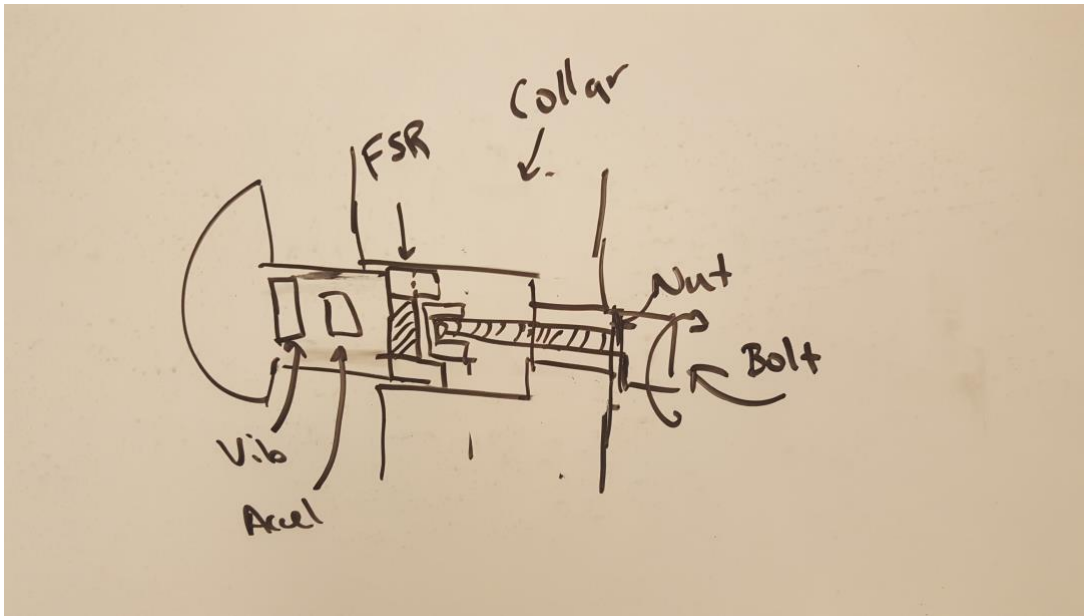

Figure 1: Drawing of screw mechanism pushing up against smaller housing, which contains the FSR, vibrator, and accelerometer and made contact with the individuals neck. As the bolt was turned it would thread through the nut and push the smaller housing out, applying a greater force to the neck. The FSR would record the force applied.

Design of Neck Piece

After deciding on a method to apply vibration to the neck, the larger neck housing was designed to support applying the vibration and the geometry of the neck. An initial device was printed using a 3D printer with a slight curvature to test the best curvature for overall comfort and fit of the device. After Nahom and I wore the device, it became apparent this device was too bulky and uncomfortable (Figure 2), so a cylinder with a circumference of 14.5 inches was used as a guide to create the curvature of the neck piece to ensure the proper fit (Figure 3, Appendix B1-2). Much of the bulk was also removed from the initial concept to form a more winged shaped design. This was done to decrease the weight of the device and to allow users to hide the device more easily.

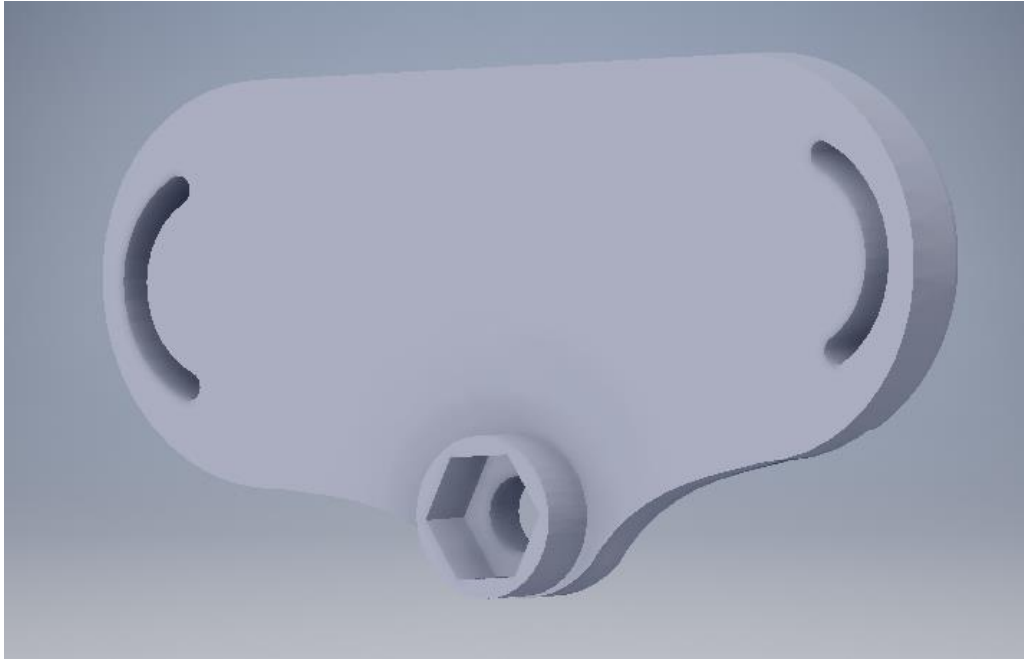

Figure 2: Original neck piece concept, which included the hexagonal hole for the nut which the bolt threaded through and two strap holes for a single neck strap.

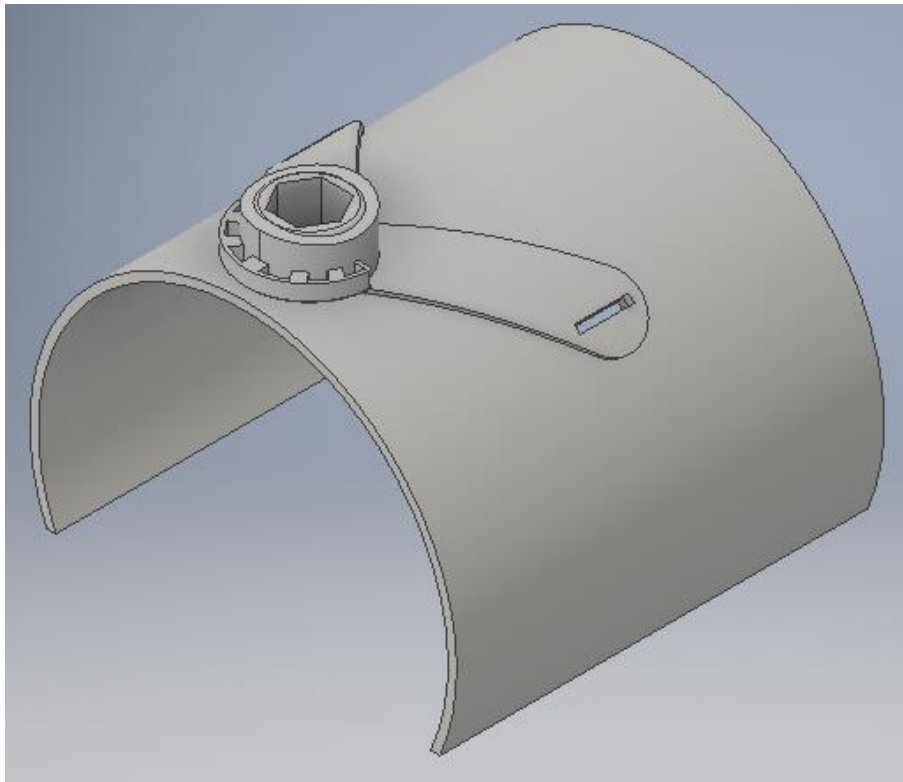

Figure 3: The average women's neck circumference was used as a template for creating the curvature of the neck piece. The half cylinder represents the curvature of the neck, which was used as a guide for creating the curve of the wing shaped piece mounted to it.

Electronics Housing

After the initial wing-shaped housing was designed, a housing insert for the electronic components was designed to fit inside the larger, wing-shaped housing. The thought process behind this smaller housing was to position the vibrator as close to the neck as possible to ensure the amplitude of vibration was sufficient to suppress cough. The accelerometer was placed directly behind the vibrator to save space. Finally, the FSR was behind the accelerometer, but with a wall between the two since the FSR was absorbing the force of the screw (Figure 4, 5). The FSR was sandwiched between the wall of the housing and a smaller square insert that applied the force directly to the contact surface of the FSR. This small insert was square to keep it from spinning while the screw was threaded through the neck piece. It was crucial each component had a tight fit to keep the components from moving or interfering with the accelerometer data, thus the housing was redesigned a few times to create the best fit for each component.

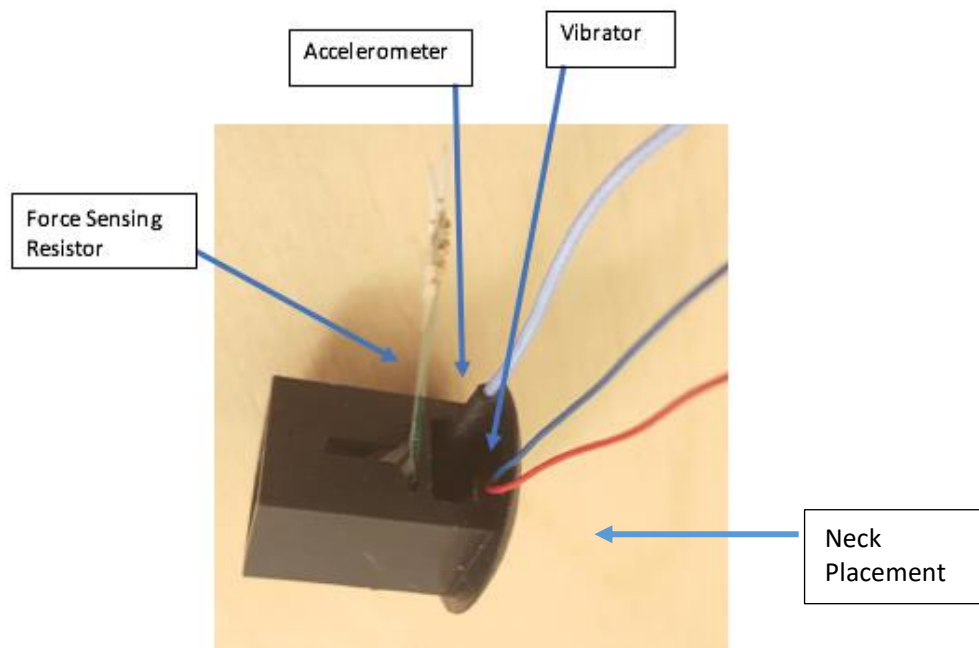

Figure 4: Electronics housing with the vibrator, accelerometer, and FSR all in respective locations. This housing fits inside the larger wing-shaped neck piece.

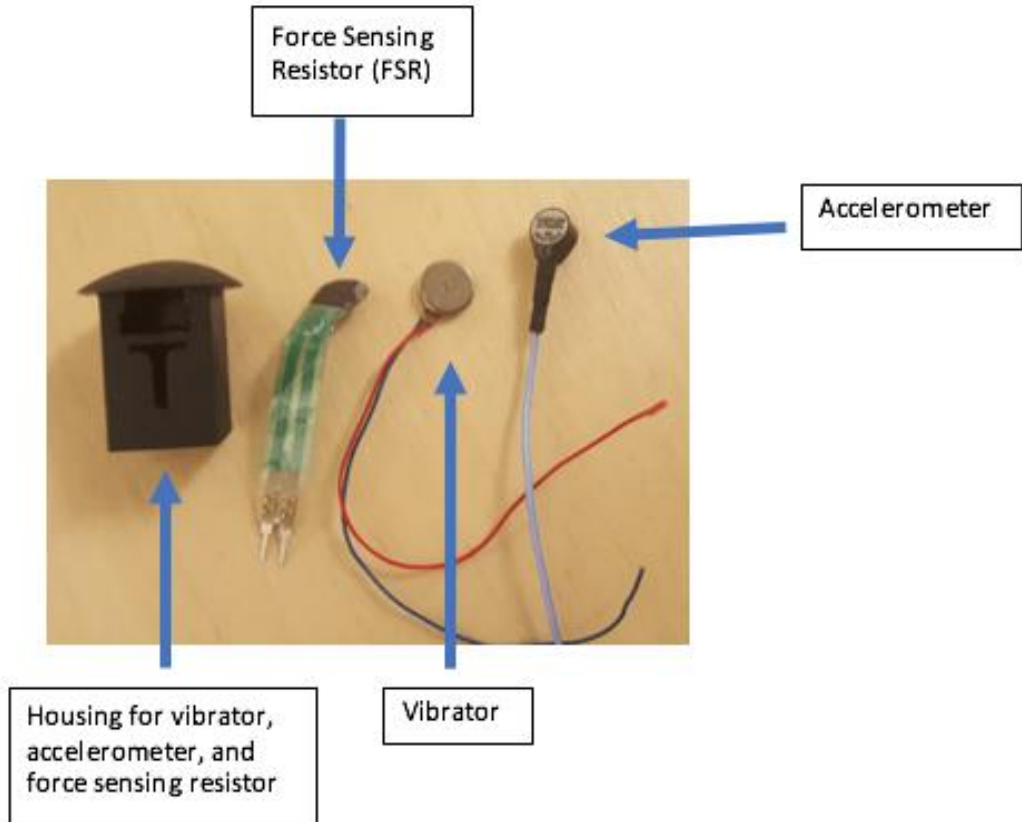

Figure 5: Electronics housing provides support for the individual electronic components used in device.

Electronics Testing and Calibration

Once the electronics fit well inside the housing and the screw mechanism pushed the housing towards the neck, the next step was to test the vibrator and accelerometer outputs. The concern with these tests was whether or not the accelerometer could distinguish a cough while the vibration was on. The tests were designed to help clarify whether separate accelerometers were needed to distinguish between vibration and coughing. Nahom wore the device and ran through multiple scenarios in order to test these the accelerometer response to the vibrator with and without coughing. In order to answer these questions, Nahom performed five different tests outlined in Table 1.

For test one, Nahom coughed ten times, once every ten seconds (Appendix C1). This test was completed to show the recorded acceleration of coughing without any vibration present. On average, a cough generated between 0.005 and 0.007 g's. The second test included Nahom reading a few lines from a book to observe the accelerometer output while speaking; the speaking generated another graph with an average acceleration of only 0.002 g's (Appendix C2). Because speaking generated acceleration values that were significantly less than the coughing acceleration values, these two tests showed cough could be distinguished from speaking. During the third test, Nahom wore the device while the vibration frequency was increased by 10% every ten seconds until it reached 100%. The graph generated showed acceleration values from 0 to 0.02 g's, depending on the frequency of vibration (Appendix C3). To generate data including both cough and vibration, the fourth test began at 0% of the total frequency and increased by 10% every ten seconds. Beginning at the five second mark, Nahom coughed once every ten seconds. The graph generated shows an increase in vibration frequency with visual spikes at 5, 15, 25, 35, 45, 55, and 65 seconds, representing Nahom's coughs (Figure 6). After 65 seconds, or 60% of the maximum frequency, the data became convoluted. This showed that vibration and coughs are not easily distinguishable beyond a sixty percent frequency level, or about 150 Hz. Finally, Nahom read the same passage as the vibration frequency was increased from 0% to 100% (Appendix C4). This graph had no distinguishable characteristics between speaking and increasing vibration frequency.

Table 1: Test number and description; testing accelerometer output response to vibration, speaking, and coughing

Test	Description
1	One cough every ten seconds for ten coughs; no vibration
2	Read passage from book without vibration
3	Start vibration at 0% of maximum frequency; increase by 10% every 10 seconds until 100% is reached
4	Start vibration at 0% of maximum frequency; increase by 10% every 10 seconds until 100% is reached; Nahom coughs every 10 seconds starting at 5 second mark
5	Start vibration at 0% of maximum frequency; increase by 10% every 10 seconds until 100% is reached; Nahom will read passage from book until 100% is reached

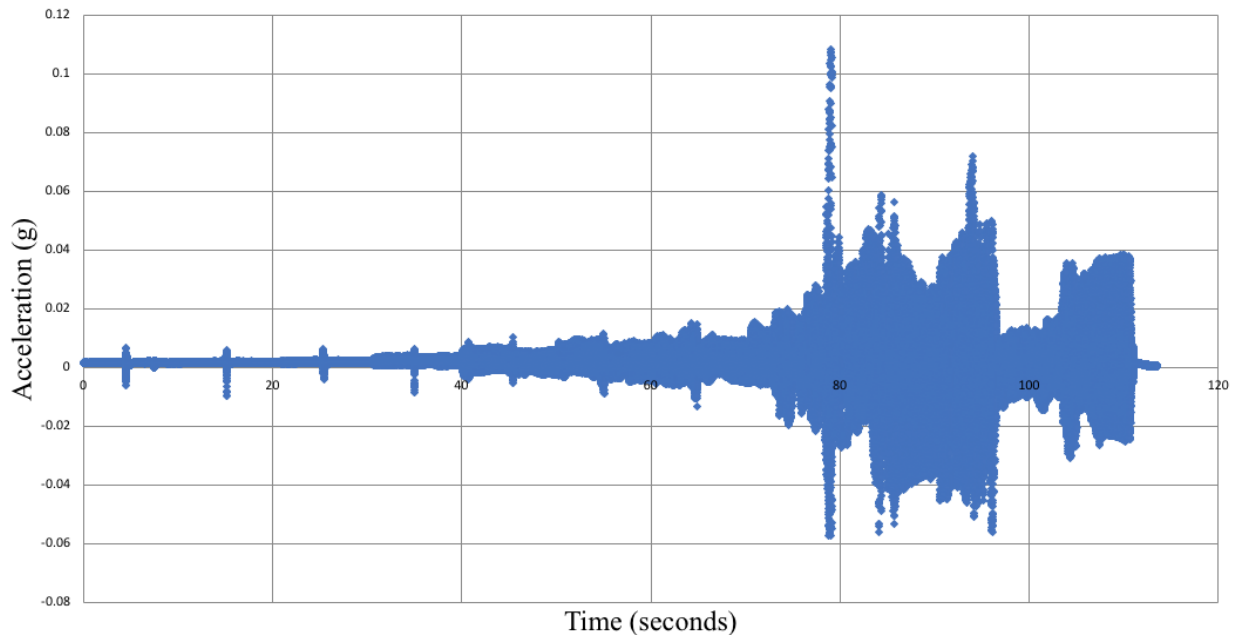

Figure 6: Graph showing cough peaks while increasing the vibration frequency; cough peaks are distinguishable until 65 seconds.

Following the analysis of the vibrator and accelerometer relationship, the FSR needed to be calibrated to give a force output. Without manipulation, this sensor gave an output in the form of voltage; calibrated weights were used to find a function that represented the relationship between voltage and force applied to the neck. During this process, it became obvious that calibrating the sensor would be very difficult. Since the FSR worked by pushing down on a

certain region of the resistor, any change in where the force was applied drastically changed the output voltage (Figure 7). Although the square insert allowed the screw to push on the FSR in a specific point each time, any movement at all, especially during use by a person, would skew the data. For this reason, it became apparent that a new force measuring device was needed. The new sensor would need a defined contact point that could withstand movement by the user without skewing the force applied data. These characteristics were found in a Honeywell FSG force sensor, which worked similarly to the FSR, but had a plunger that applied force to an internal force sensitive resistor (Figure 8). This way, the user could move around, but a change in the point of contact on the sensor would not change the output recorded.



Figure 7: FSR application area is highly sensitive. If the distribution of force moves around on the application area, the output changes drastically.

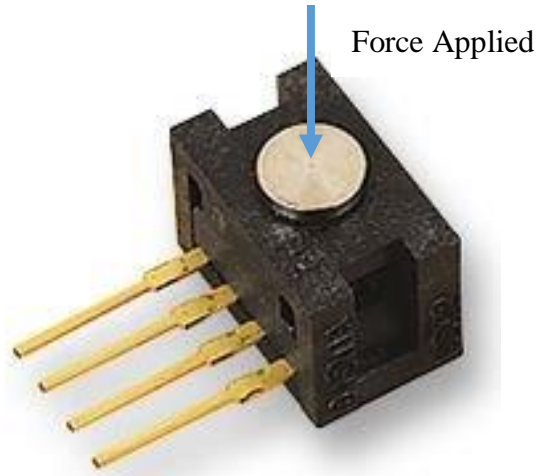

Figure 8: The force is applied to the silver plunger at the center of the Honeywell FSG force sensor.

Since the new force sensor was larger, the electronics housing needed to be redesigned. A larger compartment was cut for the FSG with a raised base that centered the sensor directly on the incoming screw (Figure 9). At this point, the leads on the sensor remained longer for testing purposes.

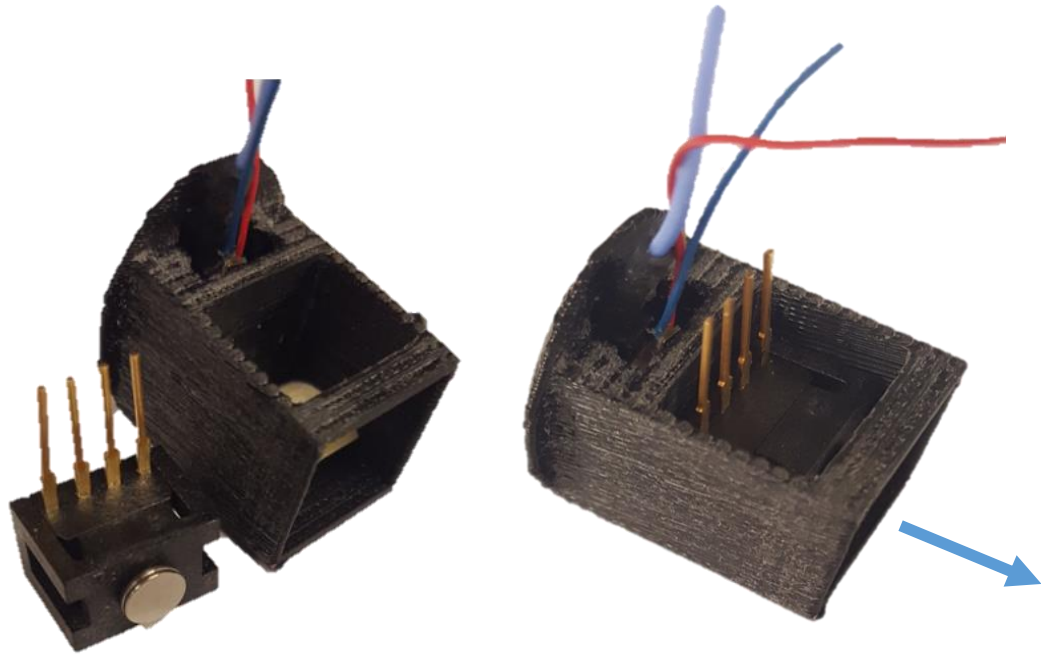

Figure 9: The Honeywell FSG force sensor sat snugly inside the electronics housing. The plunger faced in the direction of the blue arrow in order to accept the force of the incoming screw.

With all the electronics in place, calibrating the FSG ensured this force sensor could provide the precision required of the device. Calibrated weights were again used to find a function that represented the relationship between voltage and force applied to the neck. In this case, weights up to 440 grams were stacked up on the FSG and the output voltage was recorded; a trendline was fit to the resulting data to capture the relationship (Figure 10). A weight of 440 grams is much larger than the weight patients have felt discomfort in past studies according to Dr. Ludlow, therefore the calibration exceeds the maximum force that will be applied to any individual.

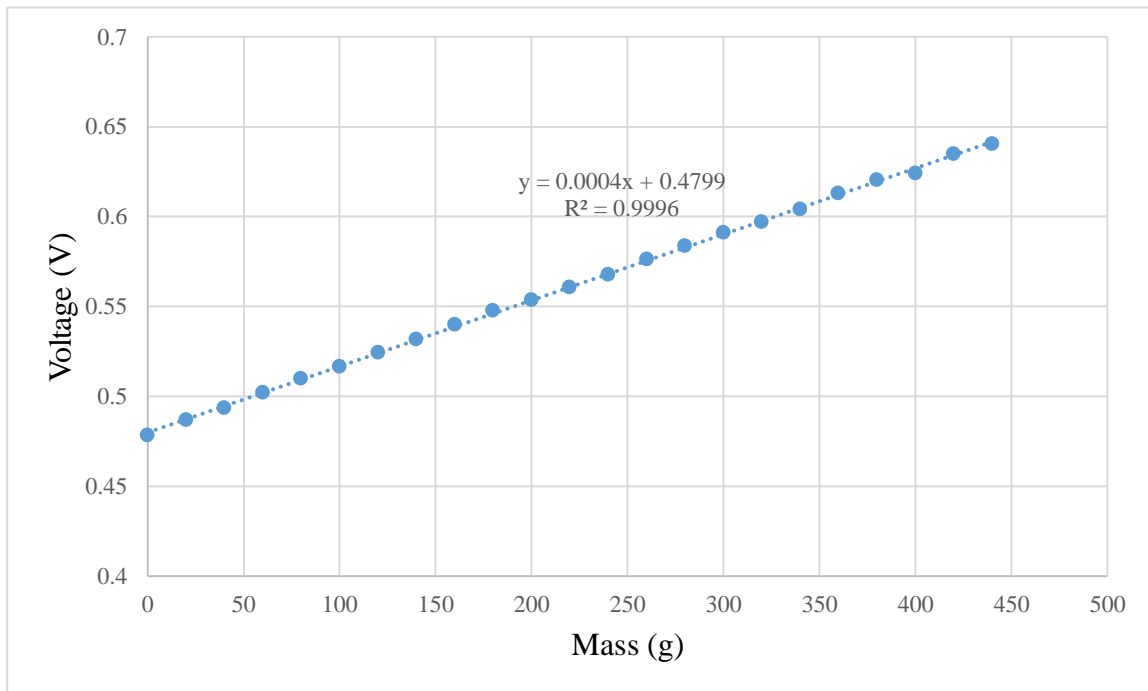

Figure 10: Calibration data for FSG force sensor, where $mass = \frac{voltage - 0.4799}{0.0004}$

Comfort and Functionality

After calibration, it was important to wear the device to ensure all pieces fit together well and the device was comfortable. One crucial aspect of the design was ensuring the electronics housing remained against the neck at all times in order to properly apply the vibration to the

tracheal region. The tracheal region is depressed slightly into the neck, making application difficult. While wearing the device, it was apparent the electronics housing was not being pulled against the neck properly due to the placement of the straps on the outer housing (Appendix D1-2). The straps previously pulled from a point almost flush with the neck. After moving the strap points further away from the neck, the device made more solid contact with the correct area of the neck (Figure 11a-b).



Figure 11: Change in strap attachment location; moved from flush with the neck (a) to further away from the neck (b).

With the strap locations repositioned, the device was almost ready for preliminary testing. The device was printed using a stronger, but more comfortable resin (Figure 12). The wires leaving the device were all soldered and placed in a single connector for ease of use during testing (Figure 13). A potentiometer was placed in a 3D printed control box so the individual can easily control and turn off the vibration during testing (Figure 14).



Figure 12: Final prototype printed using tough resin; this material is stronger and more comfortable for the user

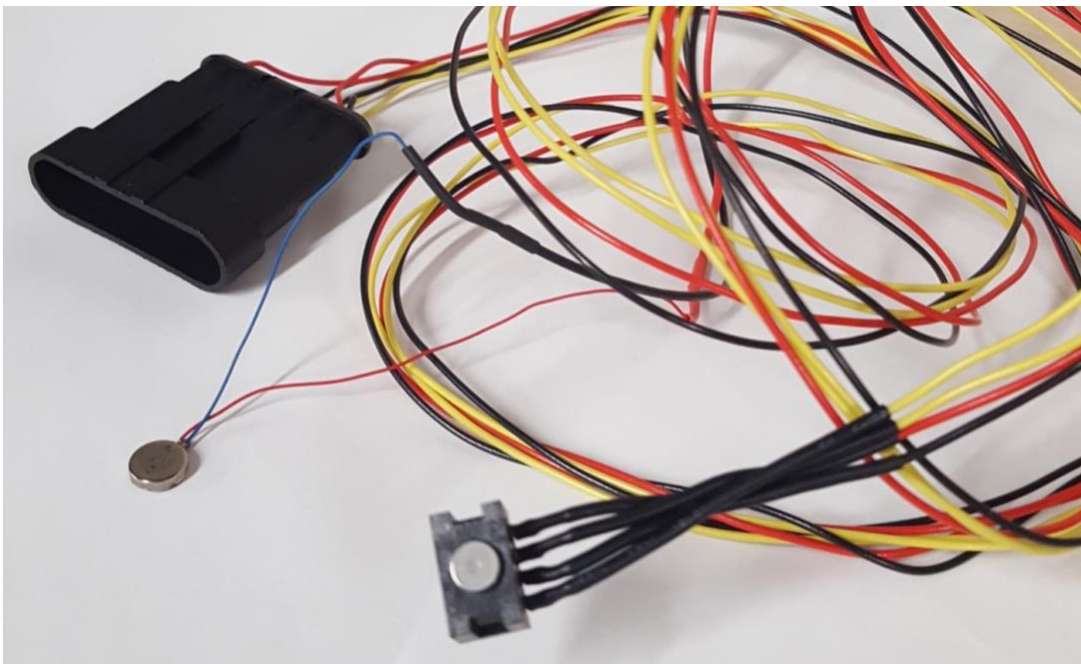

Figure 13: the FSG sensor and vibrator were soldered to longer wires and inserted into a connector. The other end of the connector is wired to all the required power sources and data acquisition systems with all wires connected to one connection.



Figure 14: The potentiometer controller was placed in a box to keep all wires away from the user and give the user a firm box to hold on to. The knob allows the user to easily adjust and click off the vibration frequency.

Conclusion and Recommendations

The next step is to use this device to test the efficacy of the process laid out in the method patent. Testing of the device has IRB approval at both JMU and Sentara Rockingham Memorial Hospital. In order to begin testing, the organization of the wiring and LabVIEW program need to be finalized. The device will then be fully ready to test on individuals.

During testing, the vibrator and force sensor will both be powered by LabVIEW through the National Instruments DAQ. The accelerometer and force sensor output will run through the PowerLab 16/35 DAQ system to another computer running LabChart software, which will track all incoming data with respect to time. LabChart will track acceleration from the accelerometer, voltage output from the force sensor, electromyography, and respiration. These outputs combined will assist in building relationships between vibration and suppressing cough in individuals who are tested. After completing the tests, the individuals will be asked a series of questions regarding the comfort and fit of the current device (Appendix E1-3). The survey will help answer questions about the strap placement and comfort, how long the device could be worn comfortably, discreetness of the device, and opinion on additional features that may be necessary. The data and survey questions will help guide redesign and addition of features to make the device functional and comfortable for everyday use.

Appendices

Appendix A

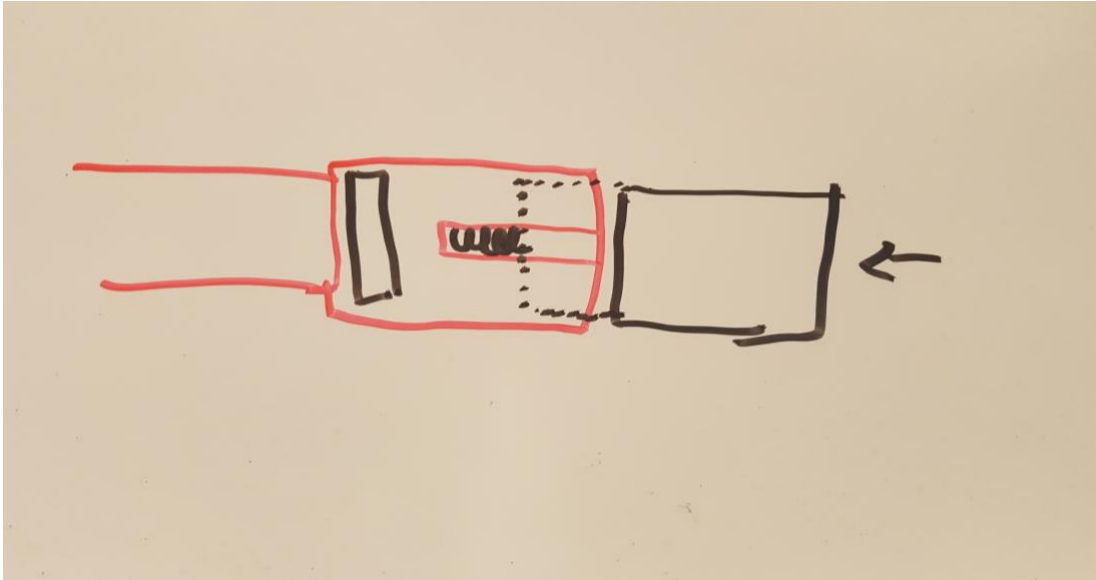

Figure A1: Rough sketch of force application method; the tension of the spring would keep the vibrator pushed against the neck.

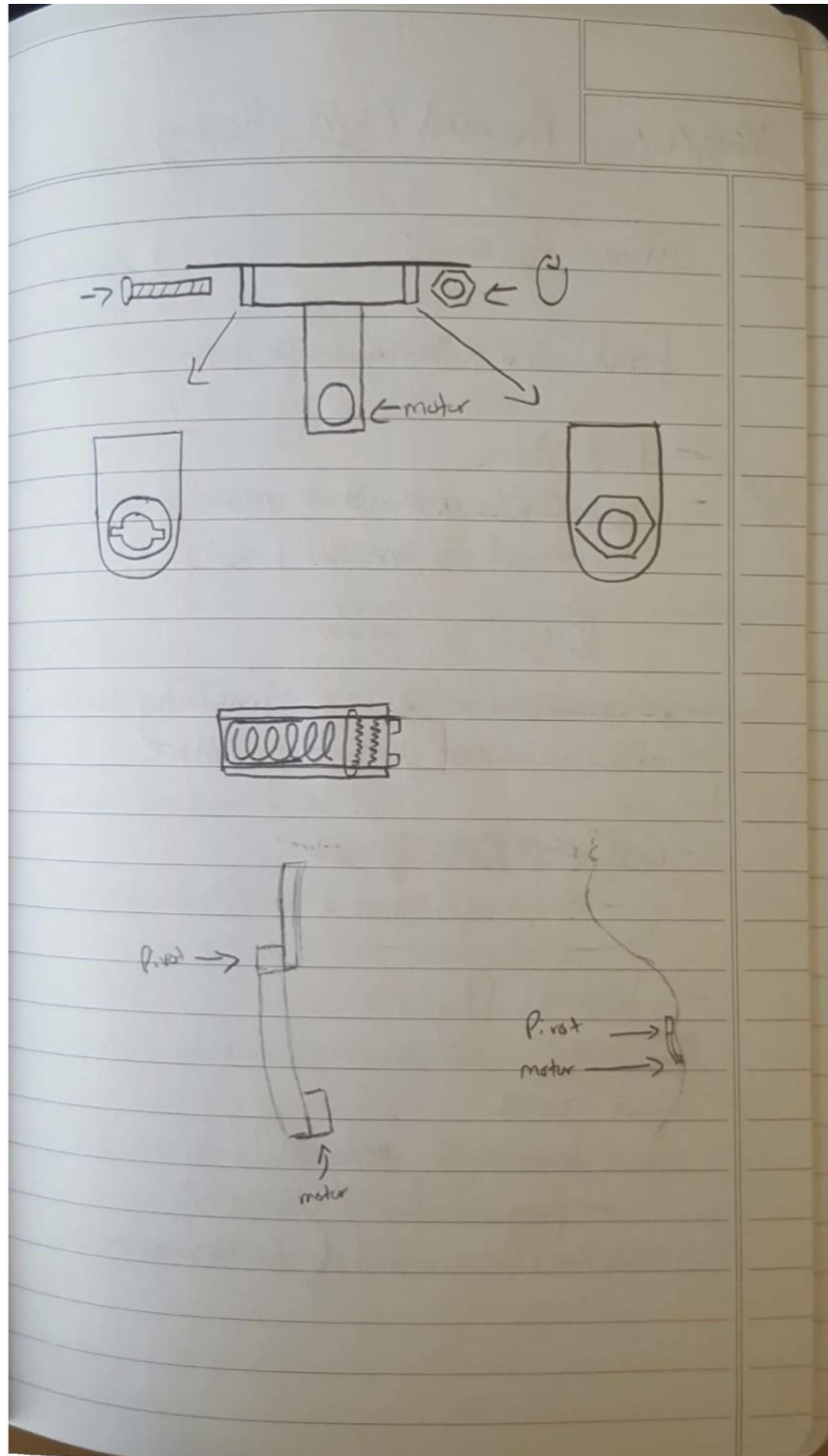

Figure A2: Sketch of lever mechanism for applying force to the tracheal region of the neck. The mechanism uses two sets of teeth that interlock when tightened. The user could loosen the teeth with the knob, adjust the lever closer or further from the neck, then tighten the teeth back together to keep the lever in the correct position.

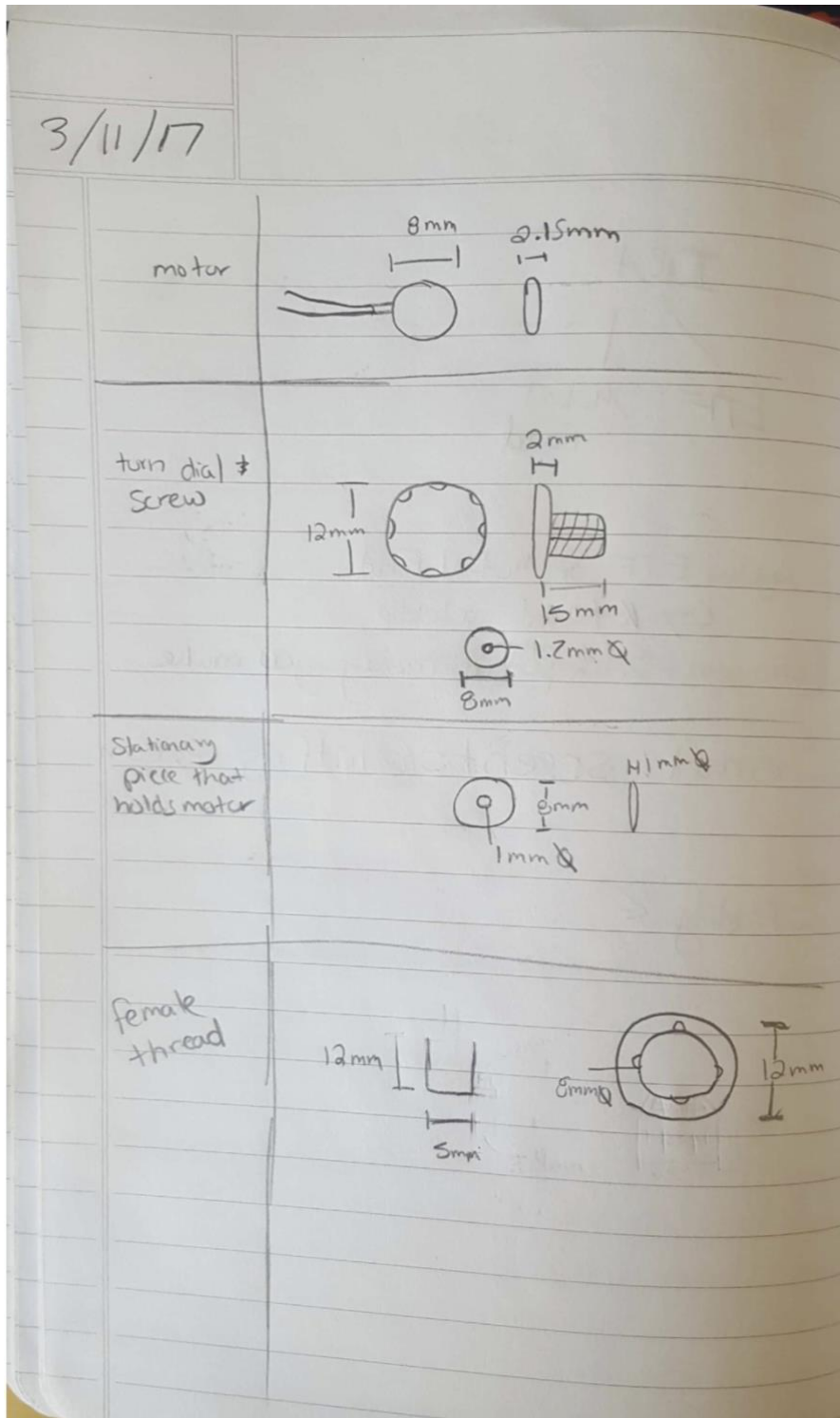

Figure A3: Drawing of method for applying vibration to neck. In this drawing, the user turned a knob that would thread the screw through the neck piece and up against the smaller housing, thus pushing on the neck. In this design, the threading also included small clicks to generate positions the user could use as a guide.

Appendix B

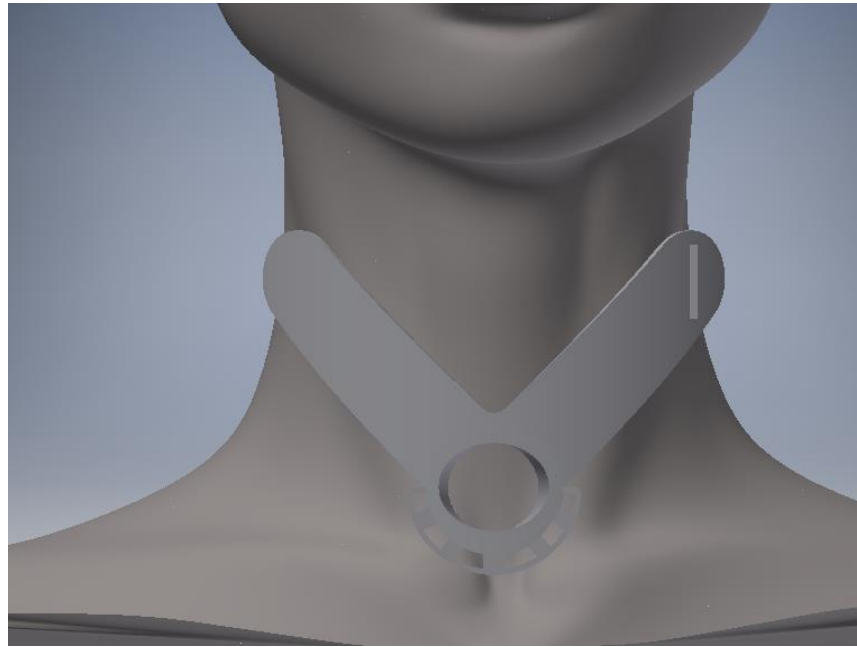

Figure B1: Computer aided design of device using neck as model (front view)

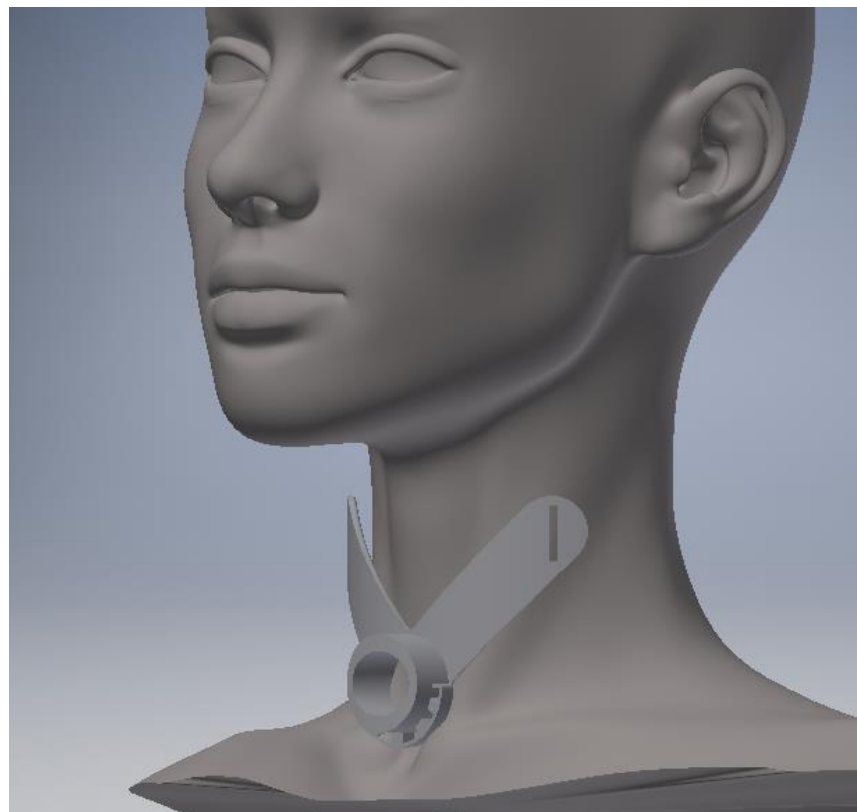

Figure B2: Computer aided design of device using neck as model (side view)

Appendix C

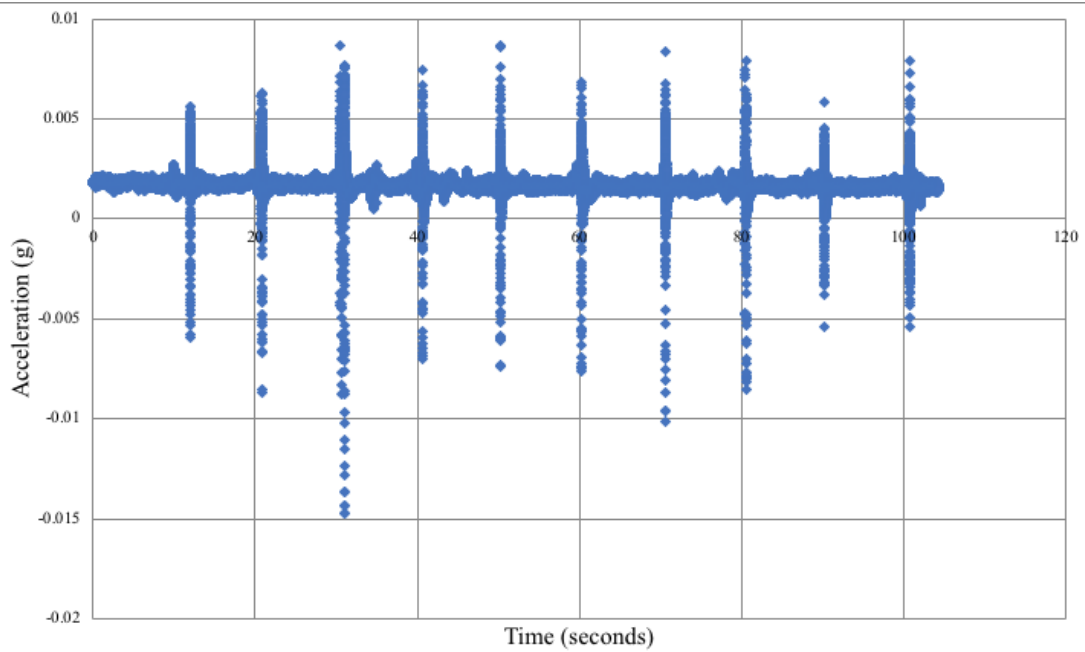

Figure C1: Relationship between acceleration (g's) and coughing for Test 1. The data showed large peaks for coughs, showing that coughs will be easily disguisable using the accelerometer.

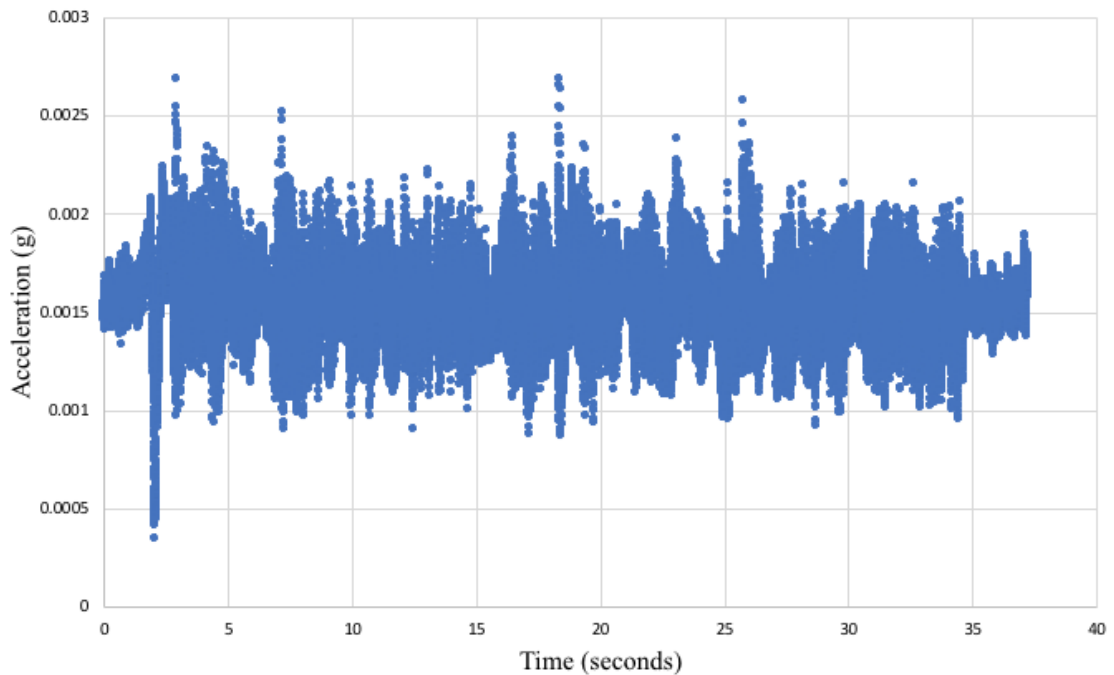

Figure C2: Relationship between acceleration (g's) and speaking for Test 2. Speaking created less g's than coughing, showing that a cough can be determined over a conversation.

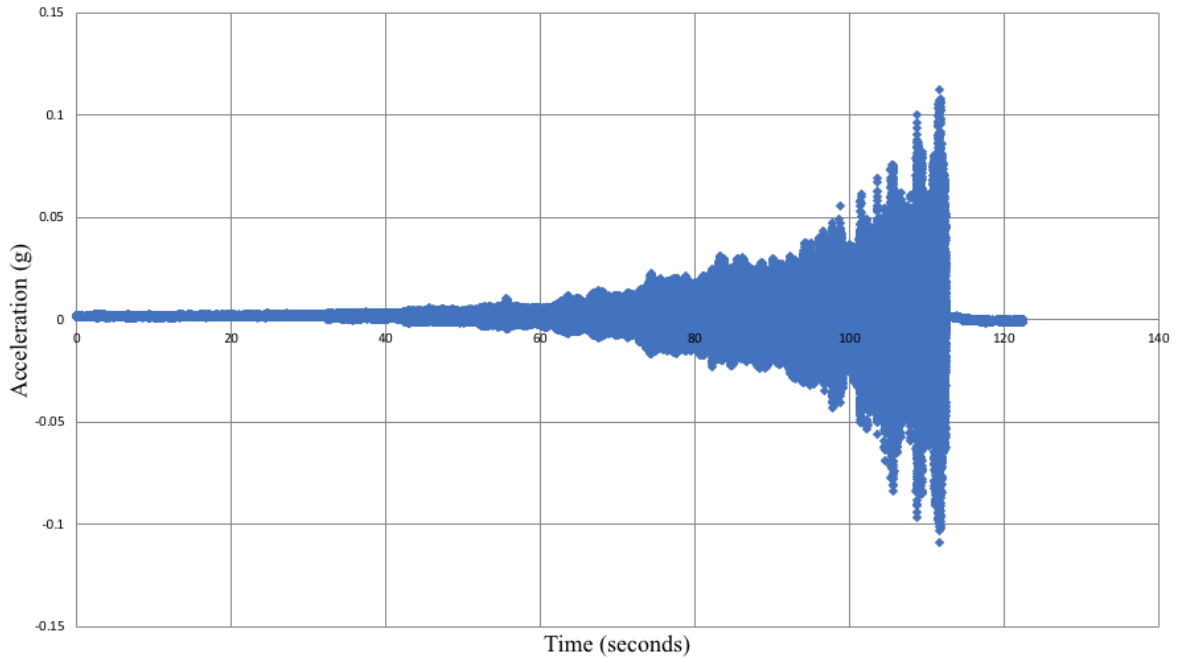

Figure C3: Relationship between acceleration (g's) and vibration frequency for Test 3, which showed a consistent increase in acceleration as vibration frequency is increased.

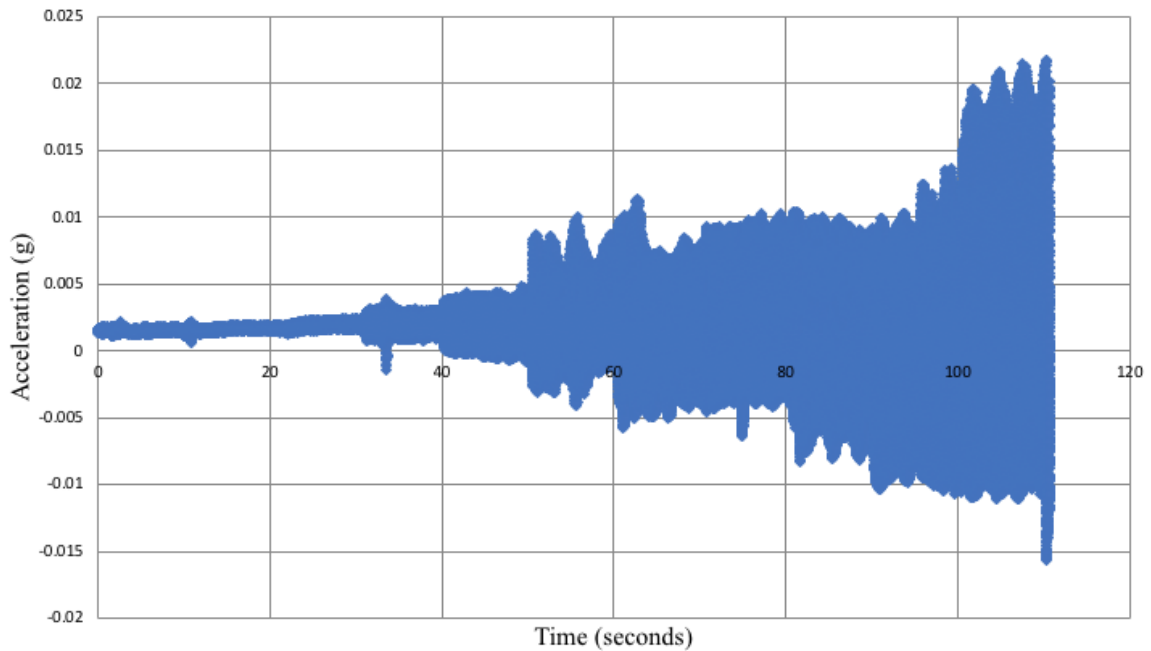

Figure C4: Relationship between acceleration (g's) and speaking with vibration for Test 5. This test showed speaking has no distinguishable characteristics while the vibration is on.

Appendix D



Figure D1: Two straps hold the device in place. The top strap secures the device to the neck while the bottom strap pulls the device into the tracheal region.



Figure D2: Side view of device being worn with two straps; the bottom strap is flush with neck, which was later changed to improve the pull towards the tracheal region of the neck

Appendix E



Figure E1: Close up image of device with two straps and screw mechanism.



Figure E2: Close up image of wing-shaped piece with threaded nut



Figure E3: Full view of wing-shaped piece with two straps attached at mounting locations.

Bibliography

- [1] Spina, D., & Page, C. P. (2013). Regulating cough through modulation of sensory nerve function in the airways. *Pulmonary Pharmacology & Therapeutics*, 26(5), 486. doi:10.1016/j.pupt.2013.03.011
- [2] AH Morice Department of Cardiovascular, Respiratory Studies, University of Hull, Castle Hill Hospital, Cottingham, East Yorkshire, & UK.REVIEW SERIES: Chronic cough doi:10.1177/1479972307084252
- [3] Song, W., Chang, Y., Faruqi, S., Kim, J., Kang, M., Kim, S., . . . Morice, A. H. (2015). The global epidemiology of chronic cough in adults: A systematic review and meta-analysis. *European Respiratory Journal*, 45(5), 1479-1481. doi:10.1183/09031936.00218714
- [4] Ryan, N. M., & Gibson, P. G. (2014). Recent additions in the treatment of cough. *Journal of Thoracic Disease*, 6(Suppl 7), S739. Retrieved from <http://www.ncbi.nlm.nih.gov/pubmed/25383209>
- [5] Song, W., Chang, Y., Faruqi, S., Kang, M., Kim, J., Kang, M., . . . Morice, A. H. (2016). Defining chronic cough: A systematic review of the epidemiological literature. *Allergy, Asthma & Immunology Research*, 8(2), 146-155. doi:10.4168/aair.2016.8.2.146
- [6] Morice, A. H., Jakes, A. D., Faruqi, S., Birring, S. S., McGarvey, L., Canning, B., . . . Dicpinigaitis, P. (2014). A worldwide survey of chronic cough: A manifestation of enhanced somatosensory response. *European Respiratory Journal*, 44(5), 1149-1155. doi:10.1183/09031936.00217813
- [7] Iyer, V. N., & Lim, K. G. (2013). Chronic cough: An update. *Mayo Clinic Proceedings*, 88(10), 1115. Retrieved from <http://www.ncbi.nlm.nih.gov/pubmed/24079681>
- [8] Kian Fan Chung, & Ian D Pavord. (2008). Chronic cough 1: Prevalence, pathogenesis, and causes of chronic cough. *The Lancet*, 371(9621), 1364. Retrieved from <http://search.proquest.com/docview/198996341>
- [9] Chronic Cough. (2016, April 27). Retrieved from <http://www.mayoclinic.org/diseases-conditions/chronic-cough/diagnosis-treatment/treatment/txc-20201848>
- [10] Escamilla, R., & Roche, N. (2014). Cough hypersensitivity syndrome: Towards a new approach to chronic cough. *European Respiratory Journal*, 44(5), 1103-1106. doi:10.1183/09031936.00150614

- [11] Chamberlain, S., Birring, S., & Garrod, R. (2014). Nonpharmacological interventions for refractory chronic cough patients: Systematic review. *Lung*, 192(1), 75-85. doi:10.1007/s00408-013-9508-y
- [12] Kashiwazaki, N., Ebihara, S., Gui, P., Katayama, N., Ito, K., Sato, R., . . . Kohzuki, M. (2013). Inhibitory effect of cervical trachea and chest wall vibrations on cough reflex sensitivity and perception of urge-to-cough in healthy male never-smokers. *Cough* (London, England), 9(1), 22. 10.1186/1745-9974-9-22 Retrieved from <http://www.ncbi.nlm.nih.gov/pubmed/24088411>
- [13] Brooks, S. M. (2011). Perspective on the human cough reflex. *Cough* (London, England), 7(1), 10. 10.1186/1745-9974-7-10 Retrieved from <http://www.ncbi.nlm.nih.gov/pubmed/22074326>
- [14] Ludlow, C. (2017). US2017/0007497 A1. Print.