

MPRA

Munich Personal RePEc Archive

Growth analysis in developing countries: empirical issues and a small dynamic model

P. Ruben Mercado and Martin Cicowiez

UNDP, UNLP

March 2013

Online at <https://mpra.ub.uni-muenchen.de/58017/>

MPRA Paper No. 58017, posted 25 August 2014 00:26 UTC

Growth Analysis in Developing Countries: empirical issues and a small dynamic model

P. Ruben Mercado* and Martin Cicowiez**

March 2013

UNDP/Arg/BP13-01

Most developing countries are small open economies; they have quite limited absorptive capacity for new physical and human capital; face credit constraints in international financial markets; and, last but not least, they are usually far from the steady state. Thus, transitional dynamics starting from actual initial conditions matters, and matters a lot. To account for these features in the simplest way, we develop a small intertemporal model suitable for growth analysis in developing countries. We discuss each model equation, variable and parameter from an empirical point of view; we analyze the model's main dynamic features; and we present illustrative simulations for a "typical" developing economy.

We find a rich transitional dynamics induced by the existence of absorptive capacity functions and a foreign debt constraint. We also find that for many relevant variables and parameters there are still problems of lack of data and estimates. Thus, a good deal of empirical work on these issues is needed to make growth analysis in developing countries operational for applied policy analysis.

Keywords: Economic growth modeling; Developing countries

JEL classification: O11, O41

* Senior Economist, United Nations Development Program (UNDP), Argentina. (The Analysis and recommendations in this article do not necessarily express the opinions of the UNDP, its Executive Board or its member states). Corresponding author: ruben.mercado@undp.org

** University of La Plata, Argentina. martin@depeco.econo.unlp.edu.ar

1. Introduction

Contrasting with the numerous advances in growth and development theory, applied long run growth analyses and policymaking in many developing countries are still mostly based on qualitative judgments or discussions, or quantitatively grounded on accounting type models with ad-hoc -if any- intertemporal dynamics.¹ In the past, a number of constraints accounted for these shortcomings: the lack of enough and reliable data, the high cost of computational capacity, and the relative lack of domestic technical capacity.²

Some of these constraints have become less binding over the years. While still lacking, data collection, quality and availability has improved thanks to lower processing costs and also to the efforts of national official agencies and international organizations.³ The cost of computers has fallen and their processing speed has increased dramatically, while the quality and diversity of software for economic modeling also improved significantly. And technical capacity also improved in developing countries, since they have now more economists trained in quantitative analysis and, to a lesser extent, in computational economics, a relatively new field of economic analysis.⁴

From a practical policymaking point of view, the most general starting point to engage in growth analyses and projections has to do with generating, in a systemic way, long and very long run growth scenarios for highly aggregate variables such as per capita output, consumption and investment; human and physical capital; and the foreign debt, the current account and the trade balance.

¹ For decades, one of the most influential accounting type models has been the World Bank's Revised Minimum Standard Model (RMSM).

² Also, the relatively frequent structural change and the lack of institutional continuity in strategic planning bodies in developing economies - mostly due to political volatility - are in some cases problems for empirical modeling. To cope with them, it may be wise to avoid working with large models. Instead, a modeling strategy focused on small size models such as the one presented below would pay off, since they are easier to modify, re-estimate or re-calibrate; their main features are relatively easy to communicate to policymakers; and they do not require many resources to be maintained and in that sense they may be easier to sustain in a changing institutional and political environment.

³ A number of international data bases on growth, health, education and the environment are now readily available from international organizations such as the UN, UNDP, The World Bank, OECD, IADB, ECLAC, etc., as well as from now classical references as the Penn World Tables, Angus Maddison, and Barro and Lee.

⁴ Kendrick, Mercado and Amman (2006).

The canonical way of performing these exercises in a consistent manner -that is, taking into account intra and inter-temporal trade-offs and transversality conditions- is to frame them within a Ramsey-Cass-Koopmans model. However, most of the empirical work using this framework sets out closed economy steady-state models, thus missing some very basic features of developing countries: they are small open economies; have quite limited absorptive capacity for new physical and human capital; are credit constrained in international financial markets; and, last but not least, they are usually far from the steady state. Thus, transitional dynamics starting from actual initial conditions matters, and matters a lot.

To account for those features in the simplest way, in what follows we present an intertemporal Ramsey-Cass-Koopmans small open economy model with physical and human capital accumulation, with relatively simple absorptive capacity functions and a straightforward foreign debt constraint. We discuss each model equation, variable and parameter from an empirical point of view, paying particular attention to problems of information availability and parameter estimation issues for developing economies. We derive the equations of motion and the steady state conditions of the model, and we analyze its main dynamic features while performing illustrative simulations for a “typical” developing economy.⁵

2. The growth model: variables, equations and empirical issues

Scheme 1 shows the main features of the model in a snapshot. We can see that the stock of factors of production (capital (K), labor (L), human capital (H) and technology (A)) generates a flow of output. Part of this output is consumed (C) by the workforce, and the part that is not consumed (i.e., saved) can be invested in physical capital (I_K) or in human capital (I_H). Both types of investment are mediated by absorptive capacity functions (G_K and G_H) to determine the proportion of each that can be transformed effectively in increases in the stock of physical and human capital. The expansion of the

⁵ This model is meant as a starting point for long run applied counterfactual policy analysis in developing economies. It attempts to capture in a relatively simple way some basic dynamic features of those economies. Developing countries display, of course, other relevant features (Agenor and Montiel, 2008; Ray, 1998; Ros, 2001) and a number of them (i.e. poverty traps, structural imbalances, or the significant role played by natural resources) can be accommodated within the model. For instance, natural resources such as land can be easily incorporated as fixed factors in the production function, and non renewable resources such as oil can be represented by means of depletion equations; structural imbalances can be generated using multi-sectoral and multi-stage production functions, including input-output matrices; and poverty traps can be generated using production functions with increasing returns to scale.

stock of physical and human capital in turn helps to increase output in the next period, and so on. Since this is an open economy, a share of output takes the form of net exports (XN) (the difference between exports and imports), and the sign of the same means either an increase or a decrease in foreign debt (D), whose dynamics also depends on the international interest rate (R).

Scheme 1
The Growth Model in a Snapshot

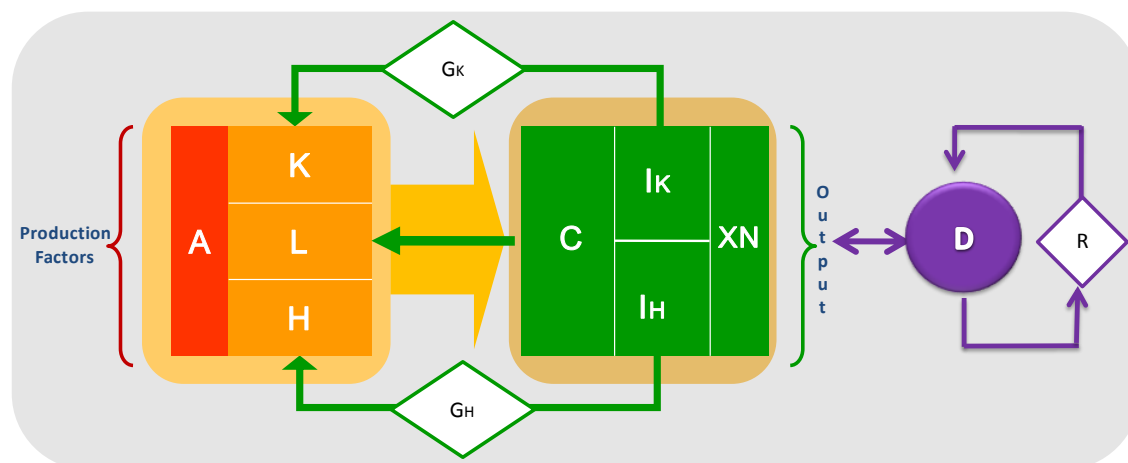

We turn now to the mathematical representation of the model, as well as to the empirical issues related to the measurement of variables and the estimation of parameters.

2.1 The production function

Output Y_t is produced with physical capital K_t , human capital H_t and raw labor L_t , given the stock of technology A_t :

$$2.1) \quad Y = K_t^\alpha H_t^\beta (A_t L_t)^{1-\alpha-\beta}$$

where α and β are the shares of physical and human capital in value added, respectively.

The production function is a Cobb-Douglas function with constant returns to scale (shares add up to one), and technical change increases the efficiency of labor (it is labor augmenting, or Harrod-neutral). These assumptions are widely used in growth studies,

since they play a crucial role in generating a growth behavior consistent with the famous Kaldor's stylized facts.⁶ Recent influential studies (Acemoglu, 2003; Jones, 2005) claim that a proper specification for the production function is that of a constant elasticity of substitution (CES) with a less than unitary elasticity of substitution. However, they show also that even if in the short run the production function is CES, in the long run it will resemble a Cobb-Douglas function with constant returns to scale.

The measurement and estimation of the variables and parameters in this function presents some specific features in the case of developing countries, as seen in what follows.

2.1.1 Measurement of the capital stock

By and large, two methods can be employed to estimate reproducible capital stocks (i.e., non natural and non-human): an evaluation of the stock of capital through direct surveys, or the more indirect perpetual inventory method (PIM). The first method is more expensive to implement. Furthermore, in the absence of accurate market information on rental and second hand prices, it is not clear whether surveys are more accurate than indirect procedures (Nehru and Dharehwar, 1993). Thus, the PIM is the method adopted by most OECD countries and researchers to estimate capital stocks (World Bank, 2011).

In essence, the PIM argues that the stock of capital is the accumulation of the stream of past investments. Analytically,

$$2.2) \quad K_t = \sum_{i=0}^{t-1} I_{k,t-i} (1 - \delta_k)^i + K_0 (1 - \delta_k)^t$$

where K_t is the aggregate physical capital stock value in year t , I_{kt} is the value of investment at constant prices, δ_k is the depreciation rate, and K_0 is the initial stock of capital. The PIM requires data on the assets service life or accumulation period and depreciation patterns. Unfortunately, data on the depreciation rate is scant and is available for only a few countries. Similarly, data on the service life of capital assets is equally scarce. In equation 2.2, following the standard practice, a geometric depreciation pattern is assumed. In Nehru and Dharehwar (1993) some alternatives for estimating the initial capital stock are reviewed.

⁶ Remember that those facts are: the investment to capital ratio, the capital output ratio, the rate of return of capital, and the shares of capital and labor are all constant; and the capital labor ratio, the output labor ratio, and the real wage all grow at a constant rate.

In World Bank (2011) total wealth for 152 developed and developing countries is computed as the discounted value of a 25 year consumption stream.⁷ In turn, physical capital stocks (i.e., machinery, equipment, and structures) are estimated by using the PIM. The World Bank estimates assume that the accumulation period (or service life) is 20 years, and to avoid comparability problems, do not use data on initial capital stocks (World Bank, 2011). In addition, the depreciation pattern is assumed to be geometric with $\delta_k = 0.05$, constant across countries and over time.

2.1.2 Measurement of labor and the human capital stock

Population stocks and growth rates can be easily obtained from national sources or from international organizations like the UN Population Division.⁸ However, in order to make our growth model operational, along with the initial stock of physical capital, the initial stock of human capital or human capital wealth is needed. The measurement of the value of human capital entails the valuation of the knowledge obtained through education and accumulated experience. Generally speaking, there are no official statistics referred to the stock of human capital, despite being one of the main components of a nation wealth (see Barro, 1999).

The estimation method used for measuring human capital is quite different from that conventionally used for physical capital, where in the latter the directly available information covers the quantity of new capital goods added to the existing capital stock. Thus, as explained above, the magnitude of the stock can be indirectly derived using the PIM. For human capital, it is the value of labor services that is directly observable (from labor market transactions), and the stock of human capital can be directly estimated from the present value of discounted lifetime labor income streams.

The measurement of human capital can be done following the lifetime labor income approach methods proposed by Jorgenson and Fraumeni (1989, 1992a, 1992b). The Jorgenson-Fraumeni lifetime labor income approach measures human capital per capita for a given sex/education/age group as the discounted present value of expected lifetime labor income per capita for that group. The expected income streams are derived from using current cross-sectional information on labor incomes, employment rates, and school participation rates. The lifetime labor incomes are projected by backward recursion, which works as follows: an individual's present value of his lifetime income is equal to the current period income plus the present value of

⁷ See <<http://data.worldbank.org/data-catalog/wealth-of-nations>>.

⁸ See <<http://www.un.org/esa/population/>>.

his lifetime income in the next period. Of course, the present value of his lifetime income in next period is not readily available and has to be estimated. By working backwards from the lifetime income of individuals with the highest level of education and oldest working age, the present value of an individual's next period income can be derived.

The Jorgenson-Fraumeni model assumes that the value of time spent in unpaid household production or at leisure for any given age/sex/education group is the same as the value of time spent working. This choice attracts understandable criticism. Consequently, in order to avoid these complications, most authors provide estimates of human capital that are confined to market labor activities. This makes comparison with physical capital stock measures easier.

Recently, there has been an increase in the number of countries for which estimates of human capital exist, primarily because of the OECD human capital project, which has constructed Jorgenson-Fraumeni human capital stocks estimates for eleven countries (see Lui, 2011). On the other hand, in World Bank (2011) a residual approach is used to estimate the size of the human capital stock. For non-OECD countries, the Jorgenson-Fraumeni approach was implemented for Argentina (Coremberg, 2010), China (World Bank, 2011), India (Goldar, 2010), among others. In general, studies find that the human capital stock is larger than the stock of physical capital.

So far we dealt with the measurement of the total stock of human capital. However, in production function 2.1 we distinguish between raw labor and “pure” human capital. The former can be computed as the unskilled labor (for example, an individual with less than completed primary education) lifetime income times the size of the unskilled labor force. In turn, the stock of “pure” human capital can be computed as the difference between the total human capital stock and the stock of raw labor.

2.1.3 Measurement of shares

The (total) labor and capital shares of the production function can be directly estimated from National Accounts data, under the assumption that the social marginal products can be measured by observed factor prices. In fact, these shares are reported in a portion of the national income and product accounts (NIPA) often referred to as the “functional distribution of income”. Specifically, in the national accounts, gross operating surplus is the portion of income derived from production by incorporated enterprises that is earned by the capital factor. It is calculated as a balancing item in the generation of income account of the national accounts.

A similar concept for unincorporated enterprises (e.g., small family businesses like farms and retail shops or self-employed taxi drivers, lawyers and health professionals)

is gross mixed income, a very relevant category for developing countries. Since in most such cases it is difficult to distinguish between income from labor and income from capital, the balancing item in the generation of income account is "mixed" by including both, the remuneration of the capital and labor (of the family members and self-employed) used in production. Consequently, in order to allocate the mixed income between labor and capital, Gollin (2002) proposes estimating the labor share as

$$2.3) \quad \left(\frac{\text{employee compensation}}{\text{number of employees}} \text{ total workforce} \right) / \text{GDP}$$

where the implicit assumption is that self-employed individuals earn the same wages as salaried workers.⁹ The author finds that the mean labor share for a sample of 31 developed and developing countries ranges between 0.745 and 0.654, depending of the adjustment performed.

As discussed, production function 2.1 decomposes total human capital into raw labor and "pure" human capital. Consequently, the labor share estimated from the NIPA has to be further decomposed into the corresponding two components. The raw labor share is the share of unskilled labor income in total labor income; this component can be computed using a household or labor force survey. In turn, the share corresponding to "pure" human capital is computed as a residual.

Rodriguez and Ortega (2006) estimated labor and capital shares for 112 countries using UNIDO (United Nations Industrial Development Organization) and OECD data, which are based on corporate manufacturing enterprise and establishment surveys and censuses. The UNIDO database includes measures of aggregate value added and wages and salaries for 136 countries, allowing estimating capital shares defined as one minus the ratio of wages and salaries to value added. In addition, the UNIDO database excludes self-employed and unincorporated enterprises. The authors find that developed economies have manufacturing capital shares that are on average approximately 10 percentage points higher than middle income economies and 20 percentage points higher than low income economies. On average, the capital share in developing countries is 0.7, compared to 0.54 in developed countries. In fact, the authors find a significantly negative cross-sectional relationship between capital shares and per capita income. In contrast, conventionally estimated capital shares in developing and developed countries are, on average, 0.38 and 0.58, respectively.¹⁰

⁹ The author also proposes two more methods to estimate the portion of value added that is earned by the labor factor.

¹⁰ See Barro and Sala-i-Martin (2004) and the references therein.

2.1.4 Measurement of technological progress¹¹

By and large, given the impossibility of measuring technological progress directly, the growth rate of technology is measured “indirectly” as the growth rate in GDP that cannot be accounted for by the growth of the observable inputs, that is, as “residual growth.” The growth accounting methodology allows for the breakdown of observed growth of GDP into components associated with changes in factor inputs and in production technologies. The basics of growth accounting were presented in Solow (1957), Kendrick (1961), and Jorgenson and Griliches (1967). Certainly, the accounting exercise does not attempt to explain the forces that drive the growth rates of each of the inputs or factor shares. The growth rate of output can be partitioned into components associated with factor accumulation and technological progress. For a simple model with two factors (labor and physical capital) the growth accounting equation can be written as

$$2.4) \quad \frac{\Delta Y}{Y} = s_K \frac{\Delta K}{K} + s_L \frac{\Delta L}{L} + g$$

where y is real GDP, K is real capital stock, L is employed labor force, s_K is the share of capital in output, s_L is the share of labor in output, and g is total factor productivity growth. Thus, the growth accounting exercise is related to the computation of factor shares and stocks described previously, while the growth rate of GDP and factor inputs can be computed empirically. Then, the contribution of technological progress to growth can be calculated from equation 2.4 as a “residual” or difference between the actual growth rate of GDP and the part of the growth rate that can be “accounted for” by the growth rate of capital and labor. In the Cobb–Douglas case, the factor shares would be constant over time, and would correspond to the exponents in the production function.

The early applications of the growth accounting methodology used a weighted sum of the growth rate of capital and the growth rate of hours worked. The weights equaled the shares of each input in total income and were often assumed to be constant over time. The subtraction of the weighted sum of input growth rates from the growth rate of aggregate output then yielded an estimate of the TFP growth rate. In more recent applications of the growth accounting methodology, changes in the quality of factor inputs are taken into consideration (Hulten, 2010). For example, the literature proceeds to decompose the wage bill between the component representing the

¹¹ The relationship between the rate of growth of the efficiency of labor (λ) and the growth rate of total factor productivity (g) is given by $\lambda = \frac{g}{1-\alpha-\beta}$.

payments to “raw” labor and the component representing the payments to the quality or “human capital” component. Accordingly, recent TFP growth estimates represent a direct implementation of equation 2.4 but extended to include multiple types of capital and labor.

The KLEMS Framework aims at estimating growth and productivity accounts for different countries; it was first applied at 25 countries of the European Union (Timmer, Inklaar, O'Mahony and van Ark, 2010).¹² Currently, the KLEMS Framework has been extended to other regions such as Latin America (Argentina, Brazil, Chile, and Mexico), China, Russia, and India.

In the case of Asia, Young (1995) reports TFP growth rates for the period 1966-1990 that range between 0,2% (Singapore) and 2.6% (Taiwan). For Latin American countries, Elias (1990) reports TFP growth rates for the period 1940-1990 between -0.6% (Peru) and 1.38% (Chile). In Gutierrez (2005), the growth accounting exercise for the period 1960-2002 is performed for the six largest Latin American countries: Argentina, Brazil, Chile, Colombia, Mexico, and Venezuela. The author uses annual shares of labor and physical capital for each of the six countries during 1960-2002; his estimates range from -1.13% (Venezuela) to 1.35% (Chile).

2.2 Physical capital accumulation

The accumulation of physical capital is given by

$$2.5) \quad \dot{K}_t = G_{Kt} - \delta_K K_t$$

where δ_k the rate of depreciation of the physical capital stock, and indicates the decline in the aggregate capital stock arising from its use in production; and where G_{kt} is the absorptive capacity, that is the level of investment that can be transformed into effective additions to the capital sock.

In general, it is not feasible to increase the capital stock in large proportions within a given period of time. This is especially true in developing countries. Thus, from a modeling perspective, it is necessary to constrain how much investment (I_{Kt}) -financed by domestic savings or by foreign savings in the form of capital inflows or development aid- can be transformed into effective additions to the capital stock K_t within a single

¹² See <<http://www.worldklems.net>>.

time period. One way of doing this in a very simple way is by means of a concave absorptive capacity function of the form¹³

$$2.6) \quad G_{Kt} = I_{Kt} \left(1 + \frac{1}{m_K} \frac{I_{Kt}}{K_t} \right)^{-1}$$

The m_K parameter controls the asymptotic value, and $m_K \geq 0$. Graph 1 shows some examples. The forty-five degree line represents the case of perfect absorption, while the other two lines show functions with different asymptotic value parameters ($m_K = 0.5$ and $m_K = 0.1$). The last case shows that while an increase in the capital stock of about 5% is likely to be achieved with no serious problems of absorption -say, within one year-, increases beyond 10% within a year will likely be impossible no matter how much investment is made since the absorptive capacity of the economy would be saturated.

Graph 1
Absorptive Capacity Function

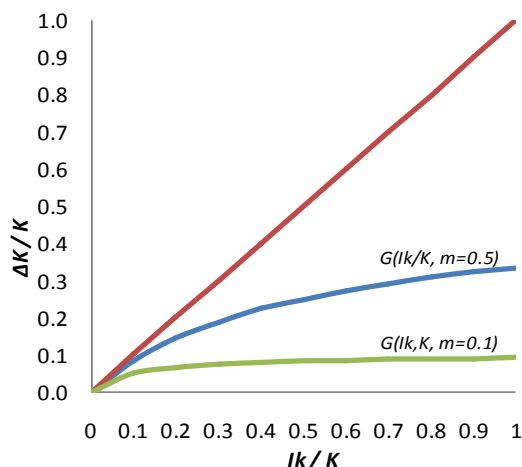

¹³ Notice that we are modeling absorptive capacity in such a way that it applies to gross investment. This is a simpler version (with curvature parameter equal to one) of the absorptive capacity function

$$G_{Kt} = m_K K_t \left(1 - \left(1 + \frac{\varepsilon_K I_{Kt}}{m_K K_t} \right)^{-\frac{1}{\varepsilon_K}} \right)$$

where the ε_K parameter controls the curvature of the function, while the m_K parameter controls its asymptotic value. This function was first introduced by Kendrick and Taylor in their pioneering dynamic multisectoral growth model (Kendrick and Taylor, 1970; Mercado, Lin and Kendrick, 2003).

Most studies and models of investment behavior in developed countries use adjustment cost functions, following the pioneering work of Eisner, Abel, Hayashi, and others (for a survey, see Kahn and Thomas, 2008). While from a mathematical point of view the adjustment cost and absorptive capacity functions are mostly equivalent, the concept of absorptive capacity is closer to the tradition of analysis and modeling of developing economies. During the golden years of development theory and planning (1950s and 1960s), there were a number of discussions around the problem of absorptive capacity led by scholars such as Chenery, Eckaus, Rosenstein-Rodan and others (for a survey, see Eckaus, 1987). These discussions dealt with a range of development issues well beyond the microeconomic problem of adjustment cost at the level of the firm. Those issues involved institutional, complementarities and coordination problems. Thus, the concept of absorptive capacity has a stronger link to problems and discussions on growth and development in developing countries.¹⁴

We have to mention that besides being useful to formalize a sensible limitation in the process of capital accumulation, absorptive capacity or adjustment cost functions are used also to mitigate the problem of infinite velocity of adjustment typical of small open economy Ramsey models such as the one we are dealing with. Indeed, unless there is a restriction on investment, in these models the capital stock will instantaneously jump from any initial condition to its steady-state level due to the unlimited supply of foreign savings at the given interest rate.

2.2.1 Measurement of absorptive capacity

A simple way of measuring a country's absorptive capacity function would be to compare the historical (and effective) increases in the path of the capital stock against the historical path of investment. However, the capital stock is usually computed by means of the perpetual inventory method, being itself a result of accumulated investment.

Anyway, a very simple and rough way to determine the upper limit of the absorptive capacity function would be to look at the highest rate of increase in the capital stock which a country can achieve on a sustained basis. A proxy for that could be the average growth in the capital stock observed during the past five or ten years in that country or

¹⁴ From the 1990s and on, the use of the concept of absorptive capacity has come back but mainly in connection with issues related to learning, innovation and knowledge spillovers at the firm level (see Cohen and Levinthal, 1990; see also Keller, 1996 and Leahy and Neary, 2007). Also recently, there has been a renewed interest on the issue of the absorptive capacity of foreign aid or a windfall of natural resource revenues (see Bourguignon and Sundberg, 2007; Guillaumont and Guillaumont Jeanneney, 2007; Van der Ploeg and Venables, 2010).

in a group of best performing countries analogous to the one being modeled. In their pioneering work, Chenery and Strout (1966) found that a 15% to 20% increase in investment was a plausible upper limit. However, the measurement of absorptive capacity has been controversial (for a survey, see OECD, 1983), and it is an area where a good deal of creative empirical work is yet to be done to find good proxies. Alternatively, there is some work done to estimate adjustment cost functions at the level of the firm.¹⁵ However, most of the empirical work on adjustment cost functions has been carried out for developed countries and the results are also controversial (for a survey, see Kahn and Thomas, 2008).

2.2.2 Estimation of the depreciation of physical capital

The economic depreciation can be measured as the change in the market value of capital over a given period; the market price of the capital at the beginning of the period minus its market price at the end of the period.

The traditional methodologies for measuring economic depreciation rates use market transaction data on asset resale or rental prices. A large number of studies (Hulten and Wykoff, 1981; Oliner, 1996; Fraumeni, 1997), which were based on vintage asset prices, estimated the economic depreciation rates for various classes of assets in different U.S. and Canadian industries. However, these approaches require the existence of thick resale or rental markets, which is lacking for most developing countries.

On the other hand, Bu (2006) estimates manufacturing physical capital depreciation rates using manufacturing firm level data from seven developing countries. He finds that fixed capital stocks depreciate at higher rates in developing than advanced industrial countries. Combining his estimates with those from the Penn World Table for non-manufacturing capital stocks, Bu estimates aggregate capital stocks depreciation rates in the range of 9.2% (Kenya) (1993-1994), 23% (Philippines) (1996-1999) and 60.7% (Indonesia) (1997-98).

In Nehru and Dhareshwar (1993) and World Bank (2011), 4 and 5 percent depreciation rates are used to estimate capital stocks of several countries using the PIM, respectively. In a recent paper, Schundeln (2007) estimates depreciation rates of physical capital in the Indonesian manufacturing sector, using establishment-level data. He finds the depreciation rate to be between 8 and 14 percent, a range that is comparable to estimates for the U.S.

¹⁵ In Section A.6 of Appendix 1 we present a convex adjustment cost function that could be used in the model as an alternative to the concave capacity function, and follow through the corresponding model modifications.

2.3 Human capital accumulation

The accumulation of human capital is given by

$$2.7) \quad \dot{H}_t = G_{Ht} - \delta_H H_{Ht}$$

where δ_h is the rate of depreciation of the human capital stock and G_t^h is the level of investment (in education and skill acquisition) that can be transformed into effective additions to the stock of human capital.

As in the case of physical capital we dealt with above, here is also sensible to assume that it will not be feasible to increase the stock of human capital in large proportions within a given period of time. Thus, in the same fashion as in the case of physical capital, we use a very simple absorptive capacity function to determine how much of each unit of investment in human capital (I_{Ht}) will become an effective addition to the stock of human capital. Here too the m_H parameter controls the asymptotic value and $m_h \geq 0$.

$$2.8) \quad G_{Ht} = I_{Ht} \left(1 + \frac{1}{m_H} \frac{I_{Ht}}{H_t} \right)^{-1}$$

While data on investment in physical capital are readily available from the national accounts, that is not the case with investment in human capital. From a conceptual point of view, this kind of investment includes expenditures in skill accumulation such as formal education, informal education and on the job training. While data on informal education and on the job training are not usually available, most countries have data on formal education, in general as an item of government expenses, and they can be used as a proxy for investment in human capital.

Concerning the estimation of human capital absorptive capacity functions, empirical work is lacking. However, it is likely that the absorptive capacity for human capital will be much more limited for human than for physical capital since, as pointed by Barro and Sala-i-Martin (2004), the educational process cannot be greatly accelerated without encountering a significant falloff in the rate of return of investment.¹⁶

The depreciation parameter δ_h opens the door to an interesting and relatively new link between health and economic growth.¹⁷ Indeed, in this parameter we can include the

¹⁶ For a line of work that points to estimate human capital adjustment cost using Tobin's q theory see Kam-Ki Tang and Yi-Ping Tseng (2004).

¹⁷ For a comprehensive coverage of the subject, see Lopez-Casasnovas, Rivera and Currais (2007).

mortality rate of the population: the higher this rate the higher the investment in human capital necessary to replace the loss knowledge and skills that goes away with the deceased. We can also include the burden of disease, since when people are sick they are temporarily out the stock of usable human capital.

2.3.1 Measurement of the human capital depreciation rate

The human capital depreciation rate can be estimated from the mortality rate combined with a quantification of the burden on people imposed by diseases. For instance, in Barro (1996) a higher mortality rate is related to a higher human capital depreciation rate.

To account for the mortality rate we can use the Crude Death Rate (CDR), which is the total number of deaths per year per 1000 people. In addition, two alternative measures can be used to account for the burden on people imposed by diseases. The years of potential life lost (YPLL) is an estimate of the number of years that a person's life was shortened due to a disease. However, the YPLL indicator does not account for how disabled a person is before dying, so the measurement treats a person who dies suddenly and a person who died at the same age after decades of illness as equivalent. The disability-adjusted life years (DALY) indicator is similar, but takes into account whether the person was healthy after diagnosis. In addition to the number of years lost due to premature death, this measurement adds part of the years lost to being sick. Thus, unlike YPLL, DALY shows the burden imposed on people who are very sick, but who live a normal lifespan. The World Health Organization (WHO) provides health statistics, including YPLL and DALY, for its member countries.¹⁸

The human capital depreciation rate for our growth model can be computed as the mortality rate plus the human capital depreciation induced by disease. In turn, the last can be computed as the ratio between the DALY per capita and life expectancy. In terms of data, the WHO provides estimates on the DALY, while the UN provides estimates on the other required pieces of information.¹⁹ The human capital depreciation rates computed in this fashion range between 0.3 percent for the United Arab Emirates and 3.3 percent for Zimbabwe.

¹⁸ See <http://www.who.int/healthinfo/global_burden_disease/estimates_country/en/index.html>.

¹⁹ See <http://esa.un.org/wpp/unpp/panel_population.htm>.

2.4 Foreign debt accumulation and foreign debt constraint

The foreign debt D_t evolves according to

$$2.9) \quad \dot{D}_t = rD_t - NX_t$$

where r is the international interest rate and NX_t are net exports.

Strictly speaking, D_t should account for the resident's stock of net assets. However, here we interpret it in a more restricted way as the country's foreign debt. For many developing countries, residents hold a substantial amount of their wealth in the form of assets abroad, usually in real estate property, banks accounts and even as foreign currency they keep "under the mattress". They hold these assets as stores of value due to a number of reasons (lack of confidence in their domestic institutions, tax evasion, etc.), and they are unlikely to ever bring them back to their country. Thus, concerning the country's macroeconomic dynamics, these assets in fact "do not exist", and cannot be netted out from the country foreign debt. In view of what we just said, the term rD_t represents interest payments.²⁰

Unlike developed countries, developing country access to international financial markets is quite constrained, permanently or periodically. From a modeling perspective, this feature can be introduced in several ways. We choose one that is at the same time very simple and consistent with one of the most common criteria used to characterize the debt burden: the debt/output ratio, and assume that this ratio cannot exceed a certain ceiling χ . Then we add to the model the following inequality constraint:

$$2.10) \quad \frac{D_t}{Y_t} < \chi$$

Unlike other variables and parameters examined above, the measurement of debt stocks, interest rates and net exports flows does not present particular challenges since

²⁰ Having to restrict the scope of net assets to the foreign debt leaves us with a current account composed by interest payments and net exports only. However, foreign direct investment profit remissions to home countries may be a substantial part of the current account in many developing countries. To account for this feature, a simple but ad-hoc procedure could be used, consisting in adding into the debt equation the term ψK_t (where the ψ parameter represents the ratio of profit remissions to the physical capital stock), so that the new term amounts to the remissions' flow. The implicit assumption would be that stock of foreign direct investment increases in the same proportion as the overall capital stock, and so does the remissions' flow. Thus, by adding this term to the debt equation, changes in the foreign debt would reflect changes in the current account more properly.

it is readily available from the national accounts or from international organizations such as the International Monetary Fund.

2.5 Intertemporal welfare

So far we presented the production and accumulation equations that characterize the dynamics of the economy. Now we need an optimization criterion to deal with intra and intertemporal tradeoffs implicit in the many possibilities of allocation of resources in this economy. Following the standard procedure in growth models, we set as the optimization criterion the maximization of an additively separable intertemporal welfare function W of the form

$$2.11) \quad W = \int_{t=0}^{\infty} \frac{\left(\frac{C_t}{L_t}\right)^{1-\theta} - 1}{1-\theta} e^{nt} e^{-\rho t} dt$$

where ρ is the rate of time preference²¹; n is the rate of growth of the labor force or, equivalently, of the population²²; and where the elasticity of intertemporal substitution (EIS) in per capita consumption $\frac{C_t}{L_t}$ at any two points in time is constant and equal to $1/\theta$.²³

2.5.1 Estimation of ρ and the EIS

One of the most important and most contentious parameters in an empirical growth model is the elasticity of intertemporal substitution. The EIS reflects the sensitivity of consumption (and therefore savings) to changes in intertemporal prices (i.e., the consumption interest rates), with higher values indicating greater sensitivity. On one hand, empirical investigations of the EIS using aggregate consumption data, such as Hall (1988), generally indicate that the EIS is very small, perhaps near zero. On the

²¹ The use of this parameter is controversial. From an ethical point of view, there is no reason to treat successive generations differently. However, from an empirical point of view, estimated values are mostly positive. Finally, from a technical point of view, for the welfare function integral to be convergent ρ has to be greater than zero.

²² Including n as a parameter in the welfare function means that the size of the future generations is taken into account when maximizing welfare.

²³ Thus utility derives from consumption through a constant elasticity of substitution function. This functional form, together with the Cobb-Douglas form for the production function, ensures that the "canonical" form of the Ramsey-Cass-Koopmans model has a steady state.

other hand, many proponents of real business cycle models argue that the EIS is closer to one - see Gunning et al. (2008) and the references therein.

In Ogaki et al. (1996), the EIS is estimated for 85 countries, including 67 low and middle income countries. The authors find that the EIS rises with the level of income when low and middle income countries are compared; the estimates for middle and high income countries show less of a difference. The range of variation for the EIS is wide, from a low value of about 0.05 (e.g., Uganda and Ethiopia) to a high of about 0.64 (e.g., USA). For the case of Argentina, Ahumada and Garegnani (2004) estimate an EIS in the range between 0.204 and 0.345. For the case of Brazil, Isser and Piqueira (2000) found, using annual data, the EIS to be in the range between 0.192 and 0.217.

A related parameter, the rate of time preference or, equivalently, the discount factor, describes the preference for present consumption over future consumption. There is little empirical evidence on the appropriate choice for this parameter. The available estimates for high-income countries range between 0.001 (Ziliak and Kneisner, 2005) and 0.02 (Jorgenson and Yun, 2001). In turn, Fullerton and Rogers (1993) select a value of 0.005 in order to generate a realistic capital stock. For Argentina, Ahumada and Garegnani (2004) estimate a rate of time preference ranging between 0.0264 and 0.0482.

2.6 The resource constraint

Finally, a resource constraint establishes that within each time period output has to be equal to consumption, investment and net exports:

$$2.12) \quad Y_t = C_t + I_{Kt} + I_{Ht} + NX_t$$

3. The complete model in efficiency units

We transform all model's variables and equations into intensive form²⁴, and we eliminate time subscripts to save notation. The equations of the full model are listed below.

²⁴ Given the assumption of Harrod-neutral technical change, each variable X_t is transformed such that

$$x_t = \frac{X_t}{A_t L_t}$$

$$3.1) \quad \text{Max } W = \int_{t=0}^{\infty} \frac{c^{1-\theta}-1}{1-\theta} e^{-vt} dt$$

subject to the accumulation equations

$$3.2) \quad \dot{k} = g_k - \gamma_k k \quad 3.3) \quad \dot{h} = g_h - \gamma_h h \quad 3.4) \quad \dot{d} = \varphi d - nx$$

and the resource and foreign debt constraints

$$3.5) \quad y = c + i_k + i_h + nx$$

$$3.6) \quad \frac{d}{y} \leq \chi$$

given the production function

$$3.7) \quad y = k^\alpha h^\beta$$

and the concave absorptive capacity functions

$$3.8) \quad g_k = i_k \left(1 + \frac{1}{m_k} \frac{i_k}{k}\right)^{-1} \quad 3.9) \quad g_h = i_h \left(1 + \frac{1}{m_h} \frac{i_h}{h}\right)^{-1}$$

and where

$$3.10) \quad v = \rho - n - (1 - \theta)\lambda \quad 3.11) \quad \gamma_k = \delta_k + n + \lambda$$

$$3.12) \quad \gamma_h = \delta_h + n + \lambda \quad 3.13) \quad \varphi = r - n - \lambda$$

where A_t and L_t are the efficiency and the stock of labor respectively. By the same token, each variable \dot{X}_t becomes

$$\dot{x}_t + x_t (n + \lambda)$$

where n is the population growth rate and λ is the growth rate of the efficiency of labor. Finally, the expression

$$\left(\frac{C_t}{L_t}\right)^{1-\theta}$$

becomes $c_t^{1-\theta} A_0^{1-\theta} e^{\lambda(1-\theta)t}$, where A_0 is not relevant since it's a constant.

with initial conditions

$$3.14) \quad k_0 = \bar{k} \qquad 3.15) \quad h_0 = \bar{h} \qquad 3.16) \quad d_0 = \bar{d}$$

and transversality conditions

$$3.17) \quad \lim_{t \rightarrow \infty} \mu_1 k e^{-vt} = 0 \qquad 3.18) \quad \lim_{t \rightarrow \infty} \mu_2 h e^{-vt} = 0$$

$$3.19) \quad \lim_{t \rightarrow \infty} \mu_3 d e^{-vt} = 0$$

and where, from 3.7, 3.8 and 3.9, we have the following derivatives:

$$3.20) \quad \frac{\partial y}{\partial k} = \alpha k^{\alpha-1} h^\beta \qquad 3.21) \quad \frac{\partial y}{\partial h} = \beta h^{\beta-1} k^\alpha$$

$$3.22) \quad \frac{\partial g_k}{\partial i_k} = \left(1 + \frac{1}{m_k} \frac{i_k}{k}\right)^{-2} \qquad 3.23) \quad \frac{\partial g_h}{\partial i_h} = \left(1 + \frac{1}{m_h} \frac{i_h}{h}\right)^{-2}$$

$$3.24) \quad \frac{\partial g_k}{\partial k} = \frac{1}{m_k} \left(\frac{i_k}{k}\right)^2 \left(1 + \frac{1}{m_k} \frac{i_k}{k}\right)^{-2} \qquad 3.25) \quad \frac{\partial g_h}{\partial h} = \frac{1}{m_h} \left(\frac{i_h}{h}\right)^2 \left(1 + \frac{1}{m_h} \frac{i_h}{h}\right)^{-2}$$

We assume that condition $r > n + \lambda$ applies, otherwise the intertemporal welfare integral will be unbounded; and condition $r \leq \rho + \lambda\theta$ applies also, otherwise the country would eventually accumulate enough assets to violate the small economy assumption.

4. Steady-states and dynamics

The model displays "two step" transitional dynamics: it has two different steady-states and Euler equations depending on whether the foreign debt constraint is or not binding (see Appendix 1 for the derivations). When the constraint is not binding, the dynamics of consumption is ruled by the following Euler equation (equation A9 in Appendix 1), which is typical in standard open economy models:

$$4.1) \quad \frac{\dot{c}}{c} = \frac{1}{\theta} [r - (\rho + \lambda\theta)]$$

We can see that the rate of growth of consumption is constant, since it is a function of a set of parameters supposed to be constant. The steady-state equation for physical capital is (equation A14 in Appendix 1)

$$4.2) \quad r = \frac{1}{q_1} \frac{\partial y}{\partial k} + \frac{\partial g_k}{\partial k} - \delta_k$$

where the variable q_1 is Tobin's "q" (see equation A10 in Appendix 1). Remember that in a standard model all assets must yield the same return in equilibrium. Thus, the interest rate and the return on capital (i.e., the marginal productivity of capital net of depreciation) must be equal. Here we can see that the existence of an absorptive capacity constraint implies some adjustments to the return of capital. The right-hand side of the equation is the total rate of return for paying q_1 to hold a unit of physical capital. This in turn is equal to the marginal productivity of capital $\left(\frac{\partial y}{\partial k}\right)$ deflated by q_1 (which is equal to $\left(\frac{\partial g_k}{\partial i_k}\right)^{-1}$, that is the inverse of the marginal increase in absorptive capacity when i increases given k); plus $\frac{\partial g_k}{\partial k}$, that is the marginal increase in absorptive capacity when k increases given i ; minus the depreciation rate (δ_k).

The steady-state equation for human capital is (equation A17 in Appendix 1)

$$4.3) \quad r = \frac{1}{q_2} \frac{\partial y}{\partial h} + \frac{\partial g_h}{\partial h} - \delta_h$$

where the variable q_2 is the analogous of Tobin's "q" but in this case for human capital, and where the equation interpretation is similar to the one just given for physical capital. When the constraint is binding, the Euler equation for consumption becomes a more complex expression (see equation A20 in Appendix 1):²⁵

$$4.4) \quad \frac{\dot{c}}{c} = \left\{ \rho + \lambda\theta + \delta_k - \frac{\partial g_k}{\partial k} + \frac{1}{q_1} \frac{\partial y}{\partial k} [1 + \chi(\rho + \lambda\theta - r)] - \frac{q_1}{q_1} \right\} \left(-\frac{1}{\theta} \right) \left(1 - \frac{1}{q_1} \chi \frac{\partial y}{\partial k} \right)^{-1}$$

and the steady-state equations for physical and human capital become respectively (equations A21 and A25 in Appendix 1)

$$4.5) \quad \rho + \lambda\theta = \frac{1}{q_1} \frac{\partial y}{\partial k} [1 + \chi(\rho + \lambda\theta - r)] + \frac{\partial g_k}{\partial k} - \delta_k$$

$$4.6) \quad \rho + \lambda\theta = \frac{1}{q_2} \frac{\partial y}{\partial h} [1 + \chi(\rho + \lambda\theta - r)] + \frac{\partial g_h}{\partial h} - \delta_h$$

²⁵ Alternatively, in terms of human capital the expression for the Euler equation when the constraint is binding is (see equation A24 in Appendix 1)

$$\frac{\dot{c}}{c} = \left\{ \rho + \lambda\theta + \delta_h - \frac{\partial g_h}{\partial h} + \frac{1}{q_2} \frac{\partial y}{\partial h} [1 + \chi(\rho + \lambda\theta - r)] - \frac{q_2}{q_2} \right\} \left(-\frac{1}{\theta} \right) \left(1 - \frac{1}{q_2} \chi \frac{\partial y}{\partial h} \right)^{-1}$$

Comparing the steady-state equations for physical and human capital for the constrained case (equations 4.2 and 4.3) against the ones for the unconstrained case (equations 4.5 and 4.6) there are two differences. Equations 4.5 and 4.6 contain an extra term (between brackets) which depends on the credit constraint parameter χ . But notice also that the left hand sides of the equations differ. In equations 4.2 and 4.3 is the exogenous international interest rate r the value that the total rate of return in the right hand side has to be equal to. However, in equations 4.5 and 4.6 we find $\rho + \lambda\theta$ in place of the interest rate. Thus, when the constraint is binding, the steady state capital stocks in the small open economy behave, in a way, in a similar fashion as in the case of a closed economy, where the discount rate is the determinant of the rate of return on assets.

We will now analyze the dynamics of the economy in two cases: when $r = \rho + \lambda\theta$, and when $r < \rho + \lambda\theta$. To do so, we parameterized the model choosing parameter values that could be roughly assimilated to those of a “typical” developing country. In that sense, we use a relatively high capital share since it includes small scale informal activities, a low elasticity of intertemporal substitution in consumption, and low absorptive capacity parameters in physical and human capital accumulation. Specifically, we assume that

$$\begin{array}{lll}
 \alpha = 0.5 & \beta = 0.15 & \lambda = 0.025 \\
 \theta = 2.33 & \rho = 0.025 & n = 0.02 \\
 \delta_k = 0.075 & \delta_h = 0.015 & m_k = 0.5 \\
 m_h = 0.35 & r = 0.06 & \chi = 0.6
 \end{array}$$

In addition, we assign the following initial values (in efficiency units):

$$\begin{array}{lll}
 k_0 = 8 & h_0 = 8 & d_0 = 1
 \end{array}$$

Thus, we will assume that the economy starts from a situation in which the foreign debt constraint is not binding.

Studies of the empirical values of the elasticity of intertemporal substitution (θ), and of the time preference parameter (ρ), are particularly lacking in developing countries. The same applies to the values of m_k and m_h , the parameters of the absorptive capacity functions for physical and human capital, respectively. To mitigate these problems, we perform stochastic simulations assuming standard deviations of 20% for each of those parameters. The panels in the following sections report the results corresponding to the average trajectories and the average standard deviations of each model variable values for one thousand runs.

Case 1: $r = \rho + \lambda\theta$

The steady-state values for k, h, i_k, i_h are obtained by solving the steady-state equations for k and h (equations 4.2 and 4.3) simultaneously with their accumulation equations (equations 3.2 and 3.3, setting \dot{k} and \dot{h} equal to zero) and the absorptive capacity equations 3.8 and 3.9. Then y can be obtained from the production function equation 3.7. (See Appendix 2 for a complete list of steady state values).

Still we have to solve for three variables: c, nx and d , but inspecting the model equations in Section 3 we see that we are left only with two equations to do so (equations 3.4 and 3.5). However, following the standard procedure for small open economy models, we can obtain c as follows.

Since $r = \rho + \lambda\theta$, from the Euler equation 4.1 we obtain

$$4.7) \quad \frac{\dot{c}}{c} = 0$$

Thus, we get the well known result that consumption is constant along the optimal path, and its optimal level is reached immediately (consumption “jumps” into it) thanks to the possibility of unconstrained borrowing from abroad.²⁶

To get consumption’s optimal level, integrating the debt accumulation equation 3.4 and using the debt transversality condition (equation 3.19) we obtain

$$4.8) \quad \int_0^{\infty} c e^{-vt} dt = \int_0^{\infty} (y - i_k - i_h) e^{-vt} dt - d_0 = nw_0$$

Thus, consumption present discounted value is equal to net wealth at time zero (nw_0), that is, the present discounted value of net output minus initial debt. Since we know that consumption is constant along the optimal path, we solve the left hand side integral in the equation above to obtain

²⁶ Jumps are a well known problematic feature of standard small open economy models. Capital stocks jump to the steady state immediately, unless some constraints are imposed for example as absorptive capacity or adjustment cost functions. Jumps are also problematic in models with production functions with physical and human capital like the one we are dealing with: these variables will jump to their steady-state ratio immediately, unless some constraints are imposed, once again using absorptive capacity or adjustment cost functions, or restricting investment in physical and human capital to be non-negative. Finally, if we want to simulate the transitional dynamics of the economy starting from actual initial conditions for all its variables, jumps in consumption may also be problematic if they imply instantaneous and unfeasible large changes in that variable. This could be dealt with in an ad-hoc fashion, introducing an upper limit to the rate of growth of consumption, or in a more sophisticated way using a “habit” function (see Fuhrer, 2000).

$$4.9) \quad c = c_0 = v n w_0$$

Once we get c , we can obtain $n x$ from equation 3.5, and finally obtain d from equation 3.4 (setting \dot{d} equal to zero).

Notice that from equation 4.8 $n w_0$ is a function of the initial level of debt d_0 , and also of the initial levels physical and human capital, since from the production function (equation 3.7) y_0 depends on k_0 and h_0 . Thus, the steady-state is “hysteretic”, a typical feature of standard intertemporal small open economy models.²⁷

Panel 1 displays the behavior of the main model’s variables expressed in efficiency units. We can see from the debt/output ratio (Panel 1.9) that the foreign debt constraint becomes binding in period 13. Up to that period, k and h (Panel 1.6 and 1.7) increase towards the unconstrained steady-state. At the same time, c reaches its steady-state constant level immediately and stays there until the constraint becomes binding (Panel 1.2).

As it is well known, in a simple standard open economy model investment jumps up in the first period so that the capital stock reaches its steady state immediately. In the next period, investment falls down to its steady state level. In our model, we can see from Panel 1.3 and 1.4 that the behavior of investment in physical and human capital is more complex due to the existence of absorptive capacity functions and a foreign debt constraint.

Panel 1
Case 1: $r = \rho + \lambda\theta$

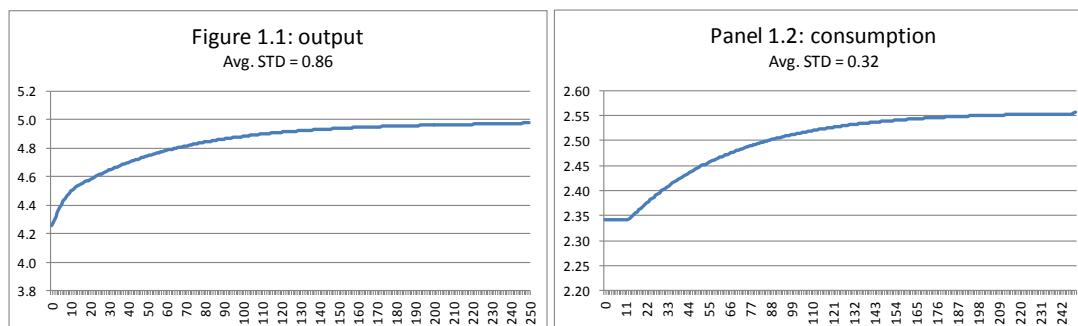

²⁷ See Heijdra and Van der Ploeg (2003) and Giavazzi and Wyplosz (1984) (in this article, see also the suggesting comments by Paul Krugman concerning the relevance of transitional dynamics).

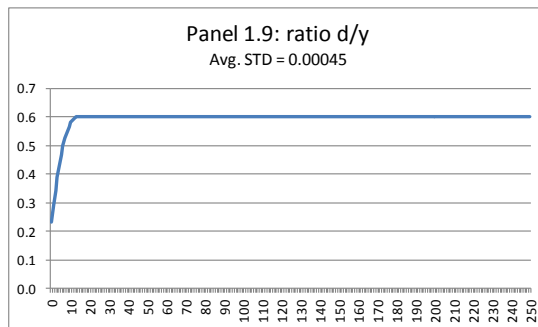
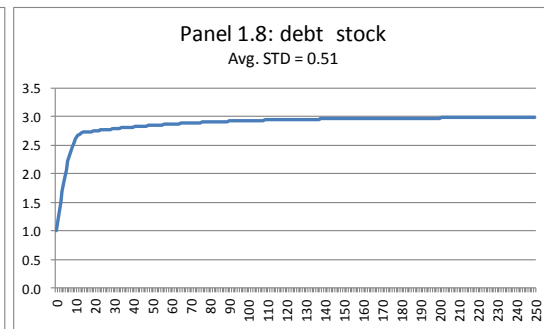
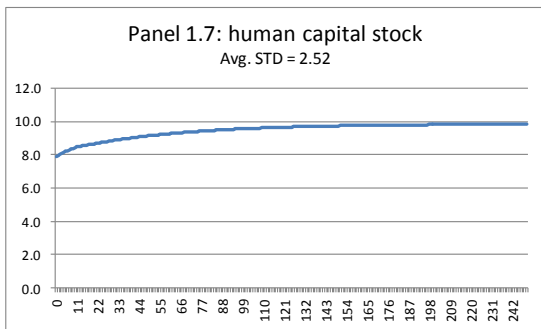
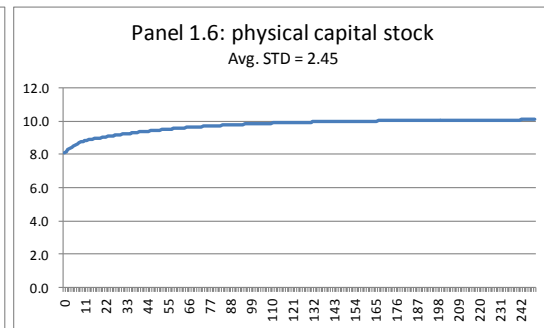
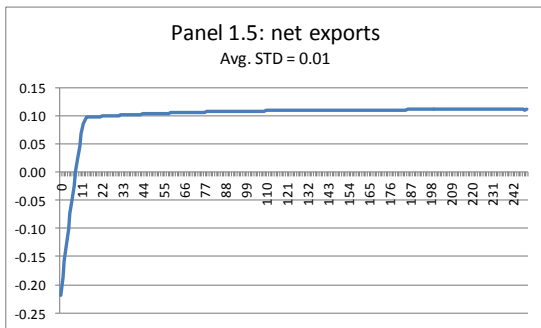
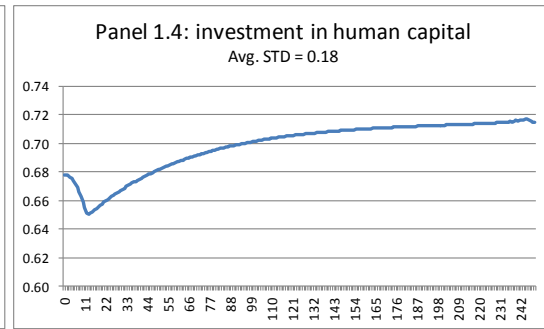
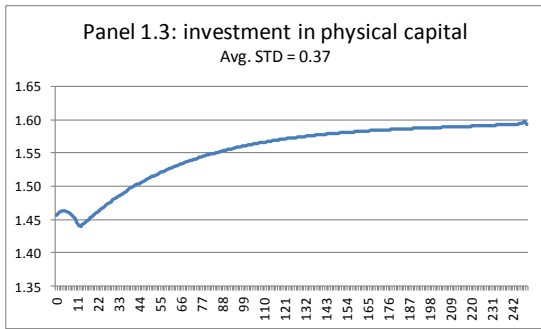

Once the foreign debt constraint becomes binding in period 13, the dynamics of the model will “switch” and all model variables will move towards the constrained steady-state. The constrained steady-state values for k, h, i_k, i_h are obtained, in a similar fashion as before, by solving equations 4.5, 4.6, 3.2, 3.3, 3.8 and 3.9 simultaneously, and then y is obtained from 3.7.²⁸ However, solving for the remaining variables is in a way simpler than in the case of the unconstrained model. Indeed, from the foreign debt constraint (equation 3.6) we can obtain d , then from equation 3.4 (setting \dot{d} equal to zero) we obtain nx and finally from equation 3.5 we obtain c .

Notice also that the constrained steady-state is not hysteretic: it does not contain variables whose steady-state values depend on initial conditions. The steady-state is a function of the model parameters only (including the χ parameter). Thus, we can see that the existence of a foreign debt constraint induces a non-hysteretic steady state once the constraint becomes binding. However, notice that we do not introduce that constraint into the model as an artifact to get rid of hysteresis. We just do so because a foreign debt constraint is a fact faced by most developing countries.²⁹

We can see from Panel 1.6 and 1.7 that the behavior of k and h changes once the constraint becomes binding in period 13. We can also see (Panel 1.2) that after that period c is no longer constant since the Euler equation 4.7 will not rule its behavior anymore; its dynamics will derive from the more complex Euler equation 4.4.

Case 2: $r < \rho + \lambda\theta$

The equality $r = \rho + \lambda\theta$ is very unlikely to be observed in practice, since there is no reason for the international interest rate to coincide with a specific combination of structural parameters of a small economy. Thus, it is worth considering a case like this one. For this case, we assign the value 0.06 to r , which is lower than the value of $\rho + \lambda\theta$ (which is 0.08325) derived from the values assigned previously to the corresponding parameters.

²⁸ Notice that since $r = \rho + \lambda\theta$, the binding constraint steady-state equation for physical capital (4.5) becomes identical to the not binding constraint equation 4.2, and the same happens with the human capital steady-state equations 4.6 and 4.3.

²⁹ Hysteresis is a matter of concern for computing business-cycle dynamics is the way that is done in RBC type stochastic macro models, since it means that variables such as assets or consumption are non-stationary (their unconditional variance is infinite). Thus, to obtain a stable stochastic steady state in a stochastic small open economy model, a number of additional assumptions or restrictions are sometimes imposed (see Schmitt-Grohe and Uribe, 2003), and a credit constraint may well be one of them.

Panel 2
Case 2: $r < \rho + \lambda\theta$

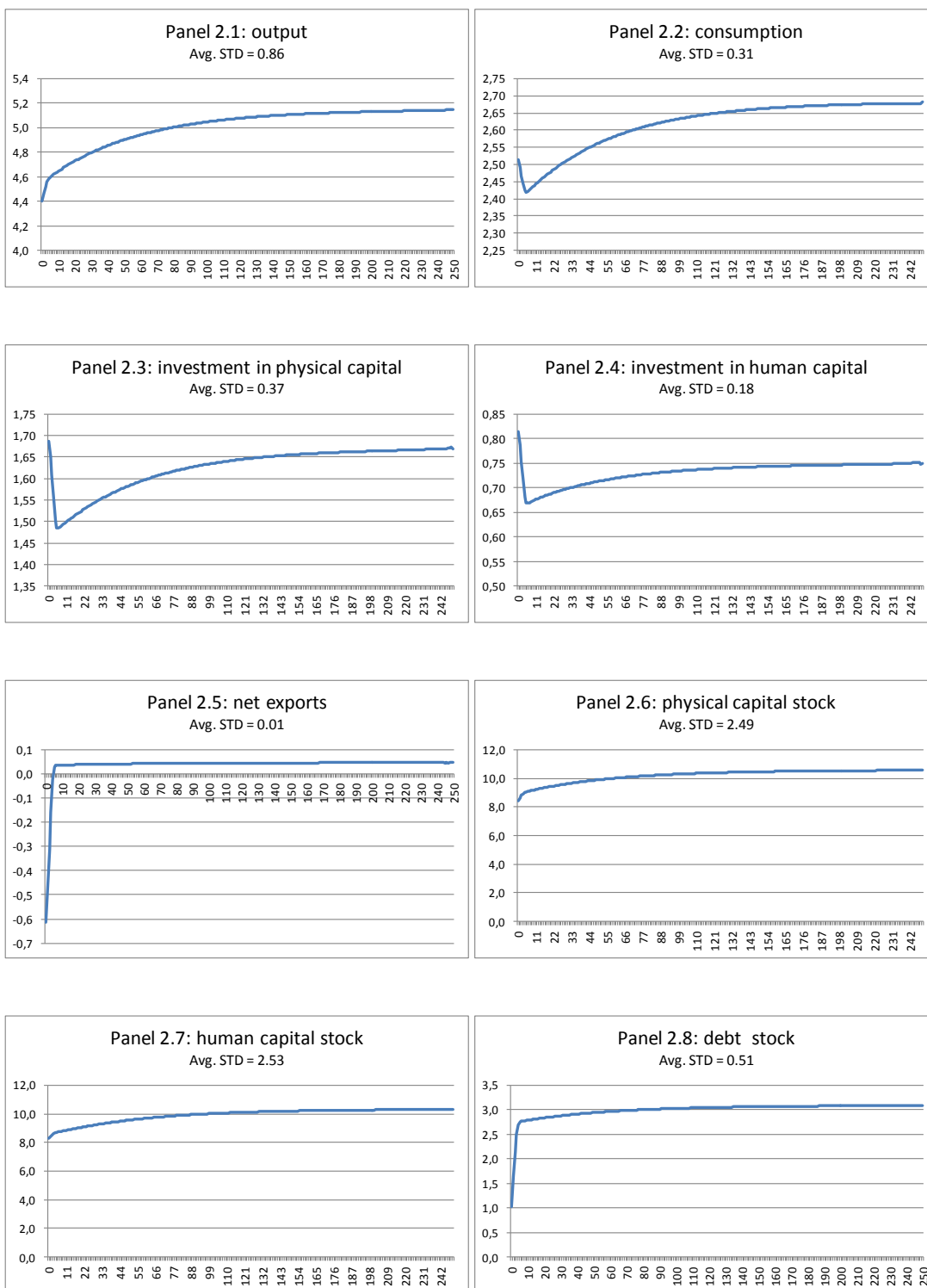

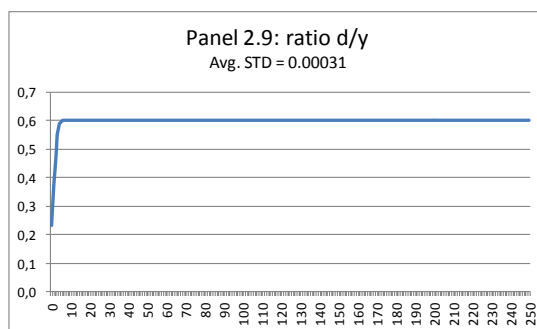

The steady-state values for k, h, i_k, i_h are obtained solving simultaneously 4.2, 4.3, 3.2 (setting \dot{k} equal to zero), 3.3 (setting \dot{h} equal to zero), 3.8 and 3.9, and y is obtained from 3.7. We can see from Panel 2.9 that the constraint becomes binding in period 8, and also from Panel 2.3 and 2.4 that up to that period k and h increase towards their unconstrained steady-state levels. However, given that $r < \rho + \lambda\theta$, from the Euler equation 4.1 we now obtain

$$4.10) \quad \frac{\dot{c}}{c} < 0$$

Thus, starting from the initial value c_0 consumption will decrease and move asymptotically to zero, as can be seen in Panel 2.2. Since it is an “impatient” country, it will borrow from abroad in order to have a high level of consumption early on, at the cost of low consumption growth later on. Also, given this behavior for consumption, from equation 3.5 we can infer that nx will reach a steady state value asymptotically, and from equation 3.4 so will d .

Once the foreign debt constraint becomes binding in period 8, the dynamics of the model will “switch” and its variables will move to the constrained steady-state. Also as in Case 1, the steady-state values for k, h, i_k, i_h are obtained simultaneously from 4.5, 4.6, 3.2, 3.3, 3.8 and 3.9, then y is obtained from equation 3.7, d from equation 3.6, nx from equation 3.4 (setting \dot{d} equal to zero) and finally c from equation 3.5. That change in dynamics for k and h can be clearly appreciated from Panel 2.6 and 2.7.

Notice from Panel 2.2 that once the constraint becomes binding, consumption stops moving asymptotically to zero and begins to move to its steady-state value. This is so because consumption follows now the dynamics dictated by the Euler equation 4.4, since it is no longer possible to continue borrowing at will to enjoy a high level of consumption early on.

In short, when $r = \rho + \lambda\theta$ (Case 1), the economy will move towards the unconstrained steady state, while at the same time the level of consumption will jump immediately to

its steady-state level. Once the foreign debt constraint is reached, the economy will move towards the constrained steady state, while consumption will move gradually towards the constrained steady state level. When $r < \rho + \lambda\theta$ (Case 2) the economy will move towards the unconstrained steady state, while consumption will move gradually to zero. Once the foreign debt constraint is reached, the economy will move towards the constrained steady state, while consumption will move gradually to its constrained steady state level.³⁰

5. Concluding comments

We presented a small open economy growth model to capture the main long run dynamic interactions and transitional dynamics amongst flow variables such as output, investment, consumption and net exports, and stock variables such as physical capital, human capital and the foreign debt. We introduced into the model absorptive capacity functions and a foreign debt constraint, and we tried to do so in the simplest possible ways. We derived analytic results and we simulated the model parameterized with values roughly similar to those of a “typical” developing economy. We found a rich transitional dynamics induced by the existence of absorptive capacity functions and a foreign debt constraint.

A number of basic experiments can be carried out with this model, linking parametric changes to institutional or policy changes. The most obvious one is to simulate an improvement in the national system of innovation as an increase in the rate of growth of technological change. As it is well known, for this kind of models the steady state growth rate of per capita output will be equal to the rate of growth of technological change. However, it is most interesting to explore the impact of this experiment in the transitional dynamics. Also, changes in perception from international creditors can be simulated as changes in the foreign debt constraint; improvements in infrastructure or in the management capacity of the country as increases in the absorptive capacity of physical capital; improvements in the educational system as increases in the absorptive capacity of human capital; and improvements in the health system as reductions in the depreciation rate of human capital.

³⁰ Notice that the previous analyses correspond to the dynamics of the model’s variables expressed in intensive form. If we analyze their behavior in per capita or in absolute levels, steady-states become balanced growth paths, and changes in direction of motion may well become changes in the speeds of growth.

We also discussed data availability and empirical estimates for each model's variables and parameters, with particular interest in those for developing countries. We found that for many relevant variables and parameters there are still problems of lack of data and estimates, or plausible ranges or variation for them. Thus, a good deal of empirical work on these issues is still needed to make growth analysis in developing countries operational for applied policy analysis.

Bibliography

Acemoglu, D. (2003). Labor- and Capital- Augmenting Technical Change. *Journal of the European Economic Association*, Vol. 1, No. 1, pp. 1-37.

Agenor, P. and P. Montiel (2008). *Development Macroeconomics*. Princeton University Press.

Ahumada, H. and M. Garegnani (2004). An Estimation of Deep Parameters Describing Argentine Consumer Behaviour. *Applied Economics Letters*, Vol 11, No. 11, pp. 719-723.

Barro, R. J. and X. Sala-i-Martin (2004). *Economic Growth*. Second edition. The MIT Press.

Barro R. J. (1996). Health and Economic Growth. Pan American Health Organization.

Barro, R. J. (1999). Human Capital and Growth in Cross-Country Regressions. *Swedish Economic Policy Review*, Vol. 6 No. 2, p.: 237-77.

Bourguignon, F. and M. Sundberg (2007). Absorptive Capacity and Achieving the MDGs. Research Paper No. 2006/47, UNU-Wider.

Goldar, Bishwanath (2010). India KLEMS. The first WORLD KLEMS Conference.

Bu, Yisheng (2006). Fixed Capital Stock Depreciation in Developing Countries: Some Evidence from Firm Level Data. *Journal of Development Studies*, Vol. 42, No. 5.

Chenery, H. and A. Strout (1966). Foreign Assistance and Economic Development. *American Economic Review*, Vol. 56, No. 4, pp. 679-733

Cohen, W. M. and D. A. Levinthal (1989). Innovation and Learning: The Two Faces of R&D. *The Economic Journal*, Vol. 99, No. 397, pp. 569-596.

Coremberg, A. (2010). The Economic Value of Human Capital and Education in an Unstable Economy: the case of Argentina. 31st General Conference of the International Association for Research in Income and Wealth.

Eckaus, R. S. (1987). Absorptive Capacity. In J. Eatwell, M. Milgate and P. Newman (eds.). *The New Palgrave: A Dictionary of Economics*, Vol. 1, London: Macmillan.

Elias, V. J. (1990). *Sources of Growth: A Study of Seven Latin American Economies*. San Francisco: ICS Press.

Fraumeni, B. (1997). The Measurement of Depreciation in the U.S. National Income and Product Accounts. *Survey of Current Business*, July, pp. 7-23.

Fuhrer, J. (2000). Habit Formation in Consumption and its Implications for Monetary Policy. *American Economic Review*, Vol. 90, No. 3, pp. 367-390.

Fullerton, D. and D. L. Rogers (1993). *Who Bears the Lifetime Tax Burden?* Washington, D.C.: The Brookings Institution.

Giavazzi, F. and C. Wyplosz (1984). The Real Exchange Rate, the Current Account, and the Speed of Adjustment. In Bilston and R. Marston (eds.). *Exchange Rate Theory and Practice*, NBER Books, University of Chicago Press.

Gollin, D. (2002). Getting Income Shares Right. *Journal of Political Economy*, Vol. 110, No. 2, pp. 458-474.

Guillaumont, P. and S. Guillaumont Jeanneney (2007). Absorptive Capacity: More Than the Volume of Aid, its Modalities Matter. CERDI Etudes et Documents E2007.02.

Gunning, T., J. Diamond and G. Zodrow (2008). *Selecting Parameter Values for General Equilibrium Model Simulations*. James A. Baker III Institute for Public Policy. Rice University.

Gutierrez, M. A. (2005). Economic Growth in Latin America: The Role of Investment and Other Growth Sources. Serie Macroeconomía del Desarrollo 36. CEPAL.

Hall, R. (1988). Intertemporal Substitution in Consumption. *Journal of Political Economy*, Vol. 96 No. 2, pp. 339-357.

Heijdra, B. and F. Van Der Ploeg (2002). *The Foundations of Modern Macroeconomics*. Oxford University Press, Chapter 15.5.6.

Hulten, C. R. and F. Wykoff (1981). The Estimation of Economic Depreciation Using Vintage Asset Prices: An Application of the Box-Cox Power Transformation. *Journal of Econometrics*, Vol. 15, No. 3, pp. 367-396.

Hulten, Charles R. (2010). Growth Accounting. In Bronwyn H. Hall and Nathan Rosenberg (eds.). *Handbook of the Economics of Innovation*. North-Holland.

Isser, J. V. and N. Scotto Piqueira (2000). Estimating Relative Risk Aversion, the Discount Rate, and the Intertemporal Elasticity of Substitution in Consumption for Brazil Using Three Types of Utility Function. *Brazilian Review of Econometrics*, Vol 20, No 2, pp. 201-239.

Jones, C. (2005). The Shape of Production Functions and the Direction of Technical Change. *The Quarterly Journal of Economics*, Vol. 120, No. 2, pp. 517-549.

Jorgenson, D. and B. Fraumeni (1989). The Accumulation of Human and Nonhuman Capital. In R. E. Lipsey and H. Stone Tice (eds.). *The Measurement of Saving, Investment and Wealth*. NBER Studies in Income and Wealth, pp. 1948–84, Chicago: University of Chicago Press.

Jorgenson, D. and B. Fraumeni (1992a). Investment in Education and U.S. Economic Growth. *Scandinavian Journal of Economics*, Vol. 94, Supplement, pp. S51–70.

Jorgenson, D. and B. Fraumeni (1992b). The Output of the Education Sector. In Zvi Griliches (ed.). *Output Measurement in the Service Sectors*. NBER Studies in Income and Wealth, Chicago: University of Chicago Press.

Jorgenson, D. and Kun-Young Yun (2001). *Investment: Lifting the Burden: Tax Reform, the Cost of Capital, and U.S. Economic Growth*. Cambridge: MIT Press.

Jorgenson, D. W., and Z. Griliches (1967). The Explanation of Productivity Change. *The Review of Economic Studies*, Vol. 34, No. 3, pp. 249–280.

Kahn, A. and J. Thomas (2008). Adjustment Cost. In S. Durlauf and L. Blume (eds.). *The New Palgrave Dictionary of Economics, Second Edition*. Palgrave Macmillan.

Keller, W. (1996). Absorptive Capacity: On the Creation and Acquisition of Technology in Development. *Journal of Development Economics*, Vol. 49, No. 1, pp. 199-227.

Kendrick D. and L. Taylor (1970). Numerical Solution of Nonlinear Planning Models. *Econometrica*, Vol. 38, No. 3, pp. 453-467.

Kendrick, D., P. R. Mercado and H. Amman (2006). *Computational Economics*, Princeton University Press.

Kendrick, J. W. (1961). *Productivity Trends in the United States*. Princeton. New Jersey: Princeton University Press.

Leahy D. and P. Neary (2007). Absorptive Capacity, R&D Spillovers and Public Policy. *International Journal of Industrial Organization*, Vol. 25, No. 5, pp. 1089-1108.

Lopez-Casasnovas G., Rivera B. and Currais L. (eds.) (2007). *Health and Economic Growth*. The MIT Press.

Lui, Gang (2011). Measuring the Stock of Human Capital for Comparative Analysis: An Application of the Lifetime Income Approach to Selected Countries. Organization for Economic Co-operation and Development, Statistics Directorate, Working Paper 41.

Mercado, P.R., L. Lin and D. Kendrick (2003). Modeling Economic Growth with GAMS. In A. Dutt and J. Ros (eds.). *Development Economics and Structuralist Macroeconomics: Essays in Honor of Lance Taylor*. Edward Elgar.

Nehru, V., and A. Dhareshwar (1993). A New Database on Physical Capital Stock: Sources, Methodology and Results. *Revista de Analisis Economico*, Vol. 8, No. 1, pp. 37-59.

OECD (1983). Absorptive Capacity in the Sahel Countries. Organization For Economic Cooperation and Development.

Ogaki, M., C. Reinhart and J. Ostry (1996). Saving Behavior in Low- and Middle-Income Developing Countries: A Comparison. *IMF Staff Papers*, 43, (1), pp. 38-71.

Oliner, S. (1996). New Evidence on the Retirement and Depreciation of Machine Tools. *Economic Inquiry*, Vol. 34, No. 1, pp. 57-77.

Ray, D. (1998). *Development Economics*. Princeton University Press.

Ros, J. (2001). *Development Theory and the Economics of Growth*. The University of Michigan Press.

Schmitt-Grohe, S. and M. Uribe (2003). Closing Small Open Economy Models. *Journal of International Economics*, Vol. 61, No. 1, pp. 163-185.

Schundeln, Matthias (2007). Appreciating Depreciation: A Note on Physical Capital Depreciation in a Developing Country. Mimeo.

Solow, R. M. (1957). Technical Change and the Aggregate Production Function. *The Review of Economics and Statistics*, Vol. 39, No. 3, pp. 312-320.

Tang, Kam-Ki and Yi-Ping Tseng (2004). Constructing a Measure of Industry-Specific Human Capital using Tobin's q Theory. *Economics Bulletin*, Vol. 10, No. 1, pp. 1-7.

Timmer, M. P., R. Inklaar, M. O'Mahony and B van Ark (2010). *Economic Growth in Europe: A Comparative Industry Perspective*, Cambridge University Press.

Van der Ploeg, F. and A. Venables (2010). Absorbing a Windfall of Foreign Exchange: Dutch disease dynamics. OxCarre Research Paper 52, Oxford Centre for the Analysis of Resource Rich Economies, University of Oxford, October.

World Bank (2011). *The Changing Wealth of Nations: Measuring Sustainable Development in the New Millennium*. Washington, D.C.: The World Bank.

Young, A. (1995). The Tyranny of Numbers: Confronting the Statistical Realities of the East Asian Growth Experience. *The Quarterly Journal of Economics*, Vol. 110, No. 3, pp. 641–680.

Ziliak, J. P. and T. J. Kniesner (2005). The Effect of Income Taxation on Consumption and Labor Supply. *Journal of Labor Economics*, Vol. 23, No. 4, pp. 769-796.

Appendix 1

A.1 First Order Conditions

Given de model equations in Section 3 of the article, the present value Lagrangean for the problem is

$$\mathcal{L} = \frac{c^{1-\theta} - 1}{1-\theta} + \mu_1 (g_k - \gamma_k k) + \mu_2 (g_h - \gamma_h h) + \mu_3 (d \varphi - nx) \\ + \omega_1 (y - c - i_k - i_h - nx) + \omega_2 (\chi y - d)$$

From the set of derivatives of \mathcal{L} w.r.t. the controls equalized to zero ($\frac{\partial \mathcal{L}}{\partial c} = 0$, $\frac{\partial \mathcal{L}}{\partial i_k} = 0$, $\frac{\partial \mathcal{L}}{\partial i_h} = 0$, and $\frac{\partial \mathcal{L}}{\partial nx} = 0$) we obtain, respectively

$$\text{A1.} \quad \omega_1 = c^{-\theta} \qquad \text{A2.} \quad \omega_1 = \mu_1 \frac{\partial g_k}{\partial i_k}$$

$$\text{A3.} \quad \omega_1 = \mu_2 \frac{\partial g_h}{\partial i_h} \qquad \text{A4.} \quad \omega_1 = -\mu_3$$

From the set of equations of motion for the co-states (μ_1, μ_2, μ_3) we have

$$\text{A5.} \quad \dot{\mu}_1 = -\frac{\partial \mathcal{L}}{\partial k} + v\mu_1$$

thus,

$$\text{A5'}. \quad \dot{\mu}_1 = -\mu_1 \left(\frac{\partial g_k}{\partial k} - \gamma_k - v \right) - \omega_1 \frac{\partial y}{\partial k} - \omega_2 \chi \frac{\partial y}{\partial k}$$

and substituting A2 into A5' we obtain

$$\text{A5''}. \quad \dot{\mu}_1 = -\mu_1 \left(\frac{\partial g_k}{\partial k} - \gamma_k - v + \frac{\partial g_k}{\partial i_k} \frac{\partial y}{\partial k} \right) - \omega_2 \chi \frac{\partial y}{\partial k}$$

We also have

$$\text{A6.} \quad \dot{\mu}_2 = -\frac{\partial \mathcal{L}}{\partial h} + v\mu_2$$

thus,

$$A6'. \quad \dot{\mu}_2 = -\mu_2 \left(\frac{\partial g_h}{\partial h} - \gamma_h - v \right) - \omega_1 \frac{\partial y}{\partial h} - \omega_2 \chi \frac{\partial y}{\partial h}$$

and substituting A3 into A6' we obtain

$$A6''. \quad \dot{\mu}_2 = -\mu_2 \left(\frac{\partial g_h}{\partial h} - \gamma_h - v + \frac{\partial g_h}{\partial i_h} \frac{\partial y}{\partial h} \right) - \omega_2 \chi \frac{\partial y}{\partial h}$$

And finally we have

$$A7. \quad \dot{\mu}_3 = -\frac{\partial \mathcal{L}}{\partial d} + v\mu_3$$

thus, we obtain

$$A7'. \quad \dot{\mu}_3 = -\mu_3(\varphi - v) + \omega_2$$

Equations A5'', A6'' and A7', together with the accumulation equations 3.2, 3.3 and 3.4 form the "canonical system" of first order differential equations that characterizes the motion of the model's variables.³¹

In what follows, we will solve for the steady-state conditions of the model. Since it's simpler, we will begin by the unconstrained case and later move on to the constrained one.

A.2 Solving for the steady-state when the debt constraint is not binding

If the constraint is not binding, then $\omega_2 = 0$. Thus, we set $\omega_2 = 0$ in A7' to obtain

$$A8. \quad \frac{\dot{\mu}_3}{\mu_3} = v - \varphi$$

Substituting for μ_3 using A1 and A4, and substituting for v and φ using 3.10 and 3.13, we obtain the Euler equation for consumption:

$$A9. \quad \frac{\dot{c}}{c} = \frac{1}{\theta} [r - (\rho + \lambda\theta)]$$

³¹ The first order conditions are completed with the set of equations of motion for the states (setting the derivatives of \mathcal{L} w.r.t. the co-states equal to the derivatives of the states w.r.t. time, which yields equations 3.2, 3.3 and 3.4); the set of derivatives of \mathcal{L} w.r.t. to the Lagrange multipliers ω_1, ω_2 equalized to zero, which yields constraints v and v_i ; and the set of transversality conditions (equations 3.17, 3.18 and 3.19).

We will now redefine some co-state variables in order to obtain results that can be interpreted in a more familiar way. We substitute $-q_1\mu_3$ for μ_1 , and from A2 and A4 we obtain

$$\text{A10.} \quad q_1 = \left(\frac{\partial g_k}{\partial i_k} \right)^{-1}$$

and we substitute $-q_2\mu_3$ for μ_2 , and from A3 and A4 we obtain

$$\text{A11.} \quad q_2 = \left(\frac{\partial g_h}{\partial i_h} \right)^{-1}$$

Thus, q_1 is Tobin's q for physical capital while q_2 is the equivalent of Tobin's q for human capital.³² In what follows, we will apply the same trick when obtaining the steady-state for physical and human capital.

Steady-state for k

Substitute $-q_1\mu_3$ for μ_1 in A5'' and use A10 (and remember that $\omega_2 = 0$ for the unconstrained case), to obtain

$$\text{A12.} \quad \frac{\dot{\mu}_3}{\mu_3} = \gamma_k + v - \frac{1}{q_1} \frac{\partial y}{\partial k} - \frac{\partial g_k}{\partial k} - \frac{q_1}{q_1}$$

Equalizing A8 and A12, substituting for v , γ_k , and φ using 3.10 and 3.11 and 3.13, and simplifying we obtain

$$\text{A13.} \quad r = \frac{1}{q_1} \frac{\partial y}{\partial k} + \frac{\partial g_k}{\partial k} + \frac{q_1}{q_1} - \delta_k$$

Finally, to obtain the steady-state equation for k set $\dot{q}_1 = 0$:

$$\text{A14.} \quad r = \frac{1}{q_1} \frac{\partial y}{\partial k} + \frac{\partial g_k}{\partial k} - \delta_k$$

Steady-state for h

Substitute $-q_2\mu_3$ for μ_2 in A6'' and use A11 (and remember that $\omega_2 = 0$ for the unconstrained case) to obtain

$$\text{A15.} \quad \frac{\dot{\mu}_3}{\mu_3} = \gamma_h + v - \frac{1}{q_2} \frac{\partial y}{\partial h} - \frac{\partial g_h}{\partial h} - \frac{q_2}{q_2}$$

³² Notice that we are modeling absorptive capacity in such a way that it applies to gross investment. Thus, Tobin's q will not be equal to one in the steady-state.

Equalizing A8 and A15, substituting for v , γ_h , and φ using 3.10 and 3.12 and 3.13, and simplifying we obtain:

$$A16. \quad r = \frac{1}{q_2} \frac{\partial y}{\partial h} + \frac{\partial g_h}{\partial h} + \frac{q_2}{q_2} - \delta_h$$

Finally, to obtain the steady-state for h set $\dot{q}_2 = 0$:

$$A17. \quad r = \frac{1}{q_2} \frac{\partial y}{\partial h} + \frac{\partial g_h}{\partial h} - \delta_h$$

A.3 Solving for the steady states when the debt constraint is binding

Steady-state for k

Substituting A2 and A4 into A7' and rearranging:

$$A18. \quad \omega_2 = - \left(\mu_1 \frac{\partial g_k}{\partial i_k} \right) - \mu_1 \frac{\partial g_k}{\partial i_k} (\varphi - v)$$

Substituting A18 into A5'' and rearranging:

$$A19. \quad \frac{\mu_1 - \left(\mu_1 \frac{\partial g_k}{\partial i_k} \right) \chi \frac{\partial y}{\partial k}}{\mu_1} = - \frac{\partial g_k}{\partial k} + \gamma_k + v - \frac{\partial g_k}{\partial i_k} \frac{\partial y}{\partial k} + \chi \frac{\partial y}{\partial k} \frac{\partial g_k}{\partial i_k} \varphi - \chi \frac{\partial y}{\partial k} \frac{\partial g_k}{\partial i_k} v$$

Substituting $-q_1 \mu_3$ for μ_1 in A19, using A10 and A1 and A4, and substituting for γ_k and v and φ using 3.10 and 3.11 and 3.13, we obtain an alternative expression for the "Euler" equation for consumption:

$$A20. \quad \frac{\dot{c}}{c} = \left\{ \rho + \lambda \theta + \delta_k - \frac{\partial g_k}{\partial k} + \frac{1}{q_1} \frac{\partial y}{\partial k} [1 + \chi (\rho + \lambda \theta - r)] - \frac{q_1}{q_1} \right\} \left(-\frac{1}{\theta} \right) \left(1 - \frac{1}{q_1} \chi \frac{\partial y}{\partial k} \right)^{-1}$$

Setting \dot{c} and q_1 equal to zero, equalizing to zero the term between curly brackets, and rearranging we obtain the steady-state for k when the foreign debt constraint is binding.

$$A21. \quad \rho + \lambda \theta = \frac{1}{q_1} \frac{\partial y}{\partial k} [1 + \chi (\rho + \lambda \theta - r)] + \frac{\partial g_k}{\partial k} - \delta_k$$

Steady-state for h

Substituting A3 and A4 into A7' and rearranging:

$$A22. \quad \omega_2 = - \left(\mu_2 \frac{\partial g_h}{\partial i_h} \right) - \mu_2 \frac{\partial g_h}{\partial i_h} (\varphi - v)$$

Substituting A22 into A6'' and rearranging:

$$A23. \quad \frac{\mu_2 - \left(\mu_2 \frac{\partial g_h}{\partial i_h}\right) \chi \frac{\partial y}{\partial h}}{\mu_2} = -\frac{\partial g_h}{\partial h} + \gamma_h + v - \frac{\partial g_h}{\partial i_h} \frac{\partial y}{\partial h} + \chi \varphi \frac{\partial y}{\partial h} \frac{\partial g_h}{\partial h} - \chi v \frac{\partial y}{\partial h} \frac{\partial g_h}{\partial h}$$

Substituting $-q_2 \mu_3$ for μ_2 in A23, using A10 and A1 and A4, and substituting for γ_h and v and φ using 3.10 and 3.12 and 3.13, we obtain another alternative expression for the "Euler" equation for consumption:

$$A24. \frac{c}{c} = \left\{ \rho + \lambda \theta + \delta_h - \frac{\partial g_h}{\partial h} + \frac{1}{q_2} \frac{\partial y}{\partial h} [1 + \chi (\rho + \lambda \theta - r)] - \frac{q_2}{q_2} \right\} \left(-\frac{1}{\theta} \right) \left(1 - \frac{1}{q_2} \chi \frac{\partial y}{\partial h} \right)^{-1}$$

Setting c and q_2 equal to zero, equalizing to zero the term between curly brackets, and rearranging, we obtain the steady-state for h when the foreign debt constraint is binding.

$$A25. \quad \rho + \lambda \theta = \frac{1}{q_2} \frac{\partial y}{\partial h} [1 + \chi (\rho + \lambda \theta - r)] + \frac{\partial g_h}{\partial h} - \delta_h$$

A.4 An alternative model with convex absorptive capacity functions

If instead of the concave absorptive capacity functions

$$3.8) \quad g_k = i_k \left(1 + \frac{1}{m_k} \frac{i_k}{k} \right)^{-1} \quad 3.9) \quad g_h = i_h \left(1 + \frac{1}{m_h} \frac{i_h}{h} \right)^{-1}$$

we use the convex functions³³

$$3.8') \quad z_k = i_k \left(1 + \frac{a_k}{2} \frac{i_k}{k} \right) \quad 3.9') \quad z_h = i_h \left(1 + \frac{a_h}{2} \frac{i_h}{h} \right)$$

(where $a_k \geq 0$ and $a_h \geq 0$) then we have to introduce some modifications in the model specification. First, the physical and human capital accumulation equations

³³ This quadratic form is the most popular mathematical form for the convex adjustment cost function, because in standard investment models it yields linear decision rules for firm's investment. However, the concave absorptive capacity function has one parameter (m) which allows us to control the asymptotic value, thus generating plausible functions such as the case $m = 0.1$ in Graph 1 (see Section 2 in the article). This is equivalent to say that beyond a given value of the investment/capital ratio, the adjustment cost becomes infinite, something impossible to obtain with a quadratic function.

$$3.2) \quad \dot{k} = g_k - \gamma_k k$$

$$3.3) \quad \dot{h} = g_h - \gamma_h h$$

become

$$3.2') \quad \dot{k} = i_k - \gamma_k k$$

$$3.3') \quad \dot{h} = i_h - \gamma_h h$$

Second, the resource constraint equation

$$3.5) \quad y = c + i_k + i_h + nx$$

becomes

$$3.5') \quad y = c + z_k + z_h + nx$$

Finally, the derivatives of the adjustment cost functions are

$$3.22') \quad \frac{\partial z_k}{\partial i_k} = 1 + a_k \frac{i_k}{k}$$

$$3.23') \quad \frac{\partial z_h}{\partial i_h} = 1 + a_h \frac{i_h}{h}$$

$$3.25') \quad \frac{\partial z_h}{\partial h} = -\frac{a_h}{2} \left(\frac{i_h}{h}\right)^2$$

$$3.24') \quad \frac{\partial z_k}{\partial k} = -\frac{a_k}{2} \left(\frac{i_k}{k}\right)^2$$

The Lagrangean is then

$$\mathcal{L} = \frac{c^{1-\theta} - 1}{1-\theta} + \mu_1 (i_k - \gamma_k k) + \mu_2 (i_h - \gamma_h h) + \mu_3 (d\varphi - nx) \\ + \omega_1 (y - c - z_k - z_h - nx) + \omega_2 (\chi y - d)$$

Given the previous changes, to capture their impact in the model dynamics we have to proceed as follows: in Tobin's q equations A10 and A11, in the steady-state equations A14, A17, A21 and A25, and in the Euler equations A9, A20 and A24, we have to substitute $\frac{\partial g_k}{\partial i_k}$ and $\frac{\partial g_h}{\partial i_h}$ by $\left(\frac{\partial z_k}{\partial i_k}\right)^{-1}$ and $\left(\frac{\partial z_h}{\partial i_h}\right)^{-1}$ respectively, and the terms $-\frac{\partial g_k}{\partial k}$ and $-\frac{\partial g_h}{\partial h}$ by the terms $+\frac{\partial z_k}{\partial k} \left(\frac{\partial z_k}{\partial i_k}\right)^{-1}$ and $+\frac{\partial z_h}{\partial h} \left(\frac{\partial z_h}{\partial i_h}\right)^{-1}$ respectively.

Appendix 2

*Table of steady state values (in efficiency units)
computed for the mean values of model parameters*

Variable	Case 1 Unconstrained	Case 1 Constrained	Case 2 Unconstrained	Case 2 Constrained
y	4.966	4.966	8.631	5.129
c	2.403	2.576	0.000	2.699
i_k	1.574	1.574	3.335	1.649
i_h	0.702	0.702	1.658	0.735
nx	0.286	0.114	3.633	0.046
k	9.971	9.971	21.125	10.443
h	9.690	9.690	22.891	10.148
d	7.823	2.980	242.208	3.078