

No reprints Available

MASTER COPY

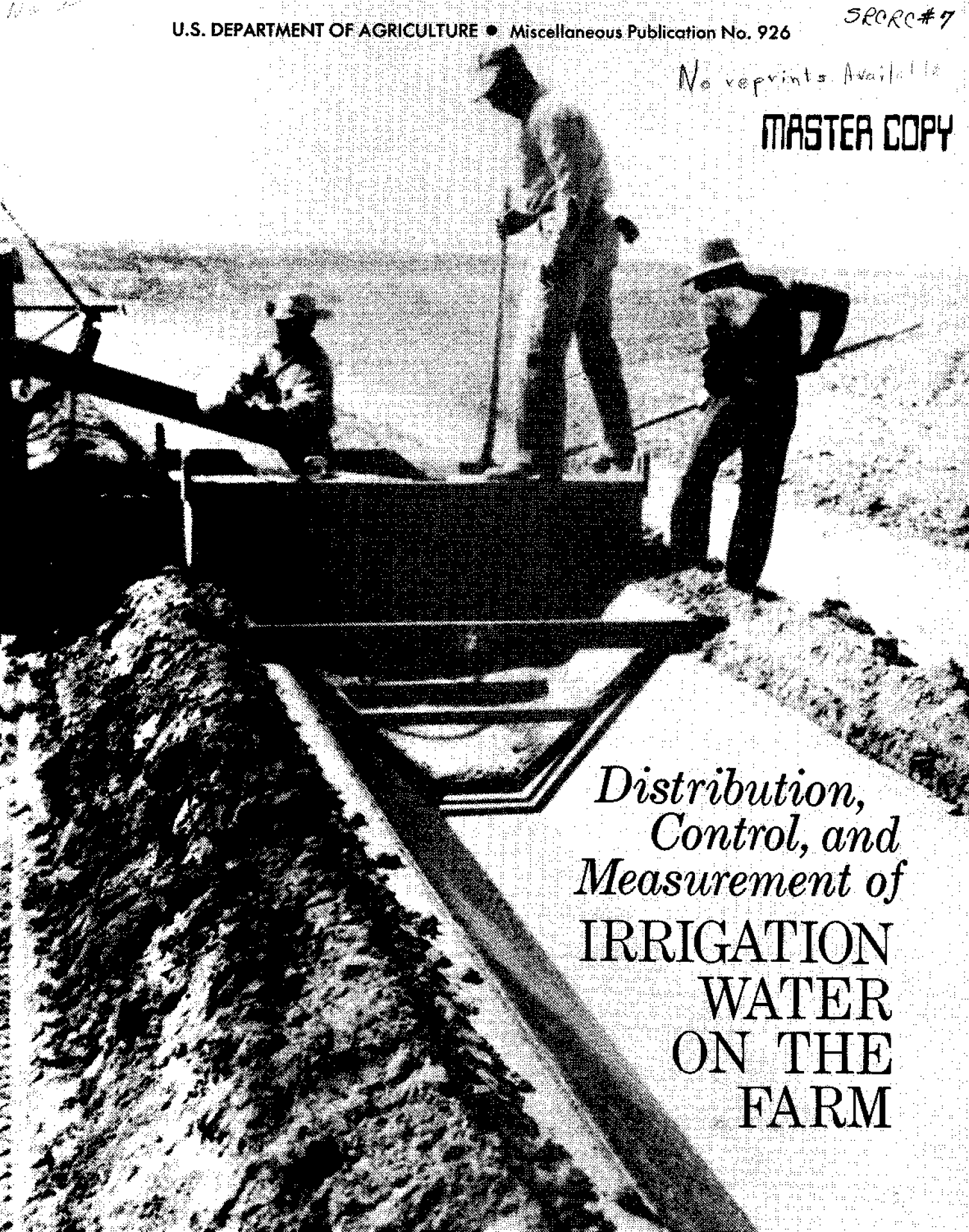

*Distribution,  
Control, and  
Measurement of*  
**IRRIGATION  
WATER  
ON THE  
FARM**

# CONTENTS

	Page
Distribution.....	3
Unlined ditches.....	3
Lined ditches.....	3
Buried pipelines.....	6
Surface pipelines.....	7
Tubing.....	7
Small farm reservoirs.....	7
Structures for open ditches.....	8
Conveyance structures.....	8
Crossing structures.....	9
Erosion control structures.....	10
Water control structures.....	11
Structures for irrigation pipelines.....	13
Inlet structures.....	13
Vents.....	15
Control structures.....	17
Outlets.....	20
Water measurement.....	24
Open channels.....	24
Pipes.....	27

*Illustrations in this publication were supplied as follows: By Portland Cement Association, figures 2, 3, 8, 9, 10, 18, 20; by Ivan D. Wood, figures 6, 11; by J. A. Corry, University of California, figure 7; by W. E. Code, Colorado State University, figure 22; by A. F. Pillsbury, University of California, parts of figures 37, 38, 39; by A. J. Ryan, figure 45; by C. W. Thomas, U.S. Bureau of Reclamation, figure 46; and by Dr. V. H. Scott, University of California, figure 47. The other illustrations are from the files and personnel of the Agricultural Research Service and Soil Conservation Service, U.S. Department of Agriculture.*

# Distribution, Control, and Measurement of IRRIGATION WATER ON THE FARM

By A. R. ROBINSON, C. W. LAURITZEN, and D. C. MUCKEL, Soil and Water Conservation Research Division, Agricultural Research Service, and J. T. PHELAN, Soil Conservation Service.

An irrigation system should be designed to provide correct *distribution*, *control*, and *measurement* of the irrigation water.

Usually a farmer takes his irrigation water from a canal through a headgate. Or he may receive it from a pipeline

regulated by a valve, or perhaps from his own well and pump. Open ditches are most commonly used to carry the water to the fields. Water control structures are used to get it out of the ditches and onto the fields. Measurement devices are needed so the farmer can tell how much water he has applied to his

field at any irrigation or over the season.

Several types of structures are used to divert, convey, control, or measure irrigation water. Some of these are described, and their functions discussed, in this publication.

## DISTRIBUTION

### Unlined Ditches

Unlined ditches are the most common means of conveying irrigation water from its source to the various fields on the farm. Unlined ditches can be easily built and maintained with farm equipment, and are preferred by many farmers because of their low cost. However, they have disadvantages that may make them less desirable than lined ditches or pipelines.

Unlined ditches on porous soils may lose considerable quantities of water by seepage. They often occupy much land area. Sometimes weeds on the ditchbanks produce seeds that can be carried to the fields by the irrigation water. Any open ditch is an obstruction to cross with farm equipment or produce.

Figure 1 illustrates some of the problems caused by unlined ditches. In some areas, farmers prefer to form new ditches just before the start of the irrigation season and remove them

before harvest to eliminate part of the weed and crossing problem.

### Lined Ditches

Farm ditches often are lined to reduce the amount of seepage loss or to

prevent the ditch from eroding. Linings are also helpful in reducing the amount of land occupied by the ditches, and they may provide some control against damage by rodents or burrowing animals.



Figure 1.—Irrigation ditch in sandy soil that is badly eroded and filled with weeds.

BN-12706-X

Concrete made from portland cement is a popular type of lining material. Limited use has been made also of asphaltic materials, membranes, chemical sealants, and impervious earth materials. Linings made of any of these will serve their purpose if they are properly constructed and selected for site conditions.

The selection and adaption of a lining should be governed by the availability of the material and equipment needed for its installation, the size of the ditch, the climatic and foundation conditions encountered, and whether

the irrigation stream is continuous or intermittent.

Some materials are not resistant to erosion and should not be used in ditches having rapid flows unless special protection is provided. Trampling by livestock, or fluctuating water tables, may damage linings made of some materials. Vegetation may damage some of the linings unless steps are taken to control growth.

### Concrete

Portland cement concrete linings have many fine qualities. When they are properly constructed, and where site conditions are favorable, the linings will give long service with minimum repair and maintenance cost. They withstand high stream velocities and are resistant to mechanical damage. Special resistant types of portland cement should be used when the irrigation water or the soil contains high concentrations of sulfates.

Figure 2 shows a slip form being used to construct a concrete lining. When a slip form is used, side slopes can be as steep as 1 horizontal to 1 vertical if the height is not over 3 feet.

Flatter slopes are required for deeper ditches. Figure 3 shows a complete lining.

When concrete is hand placed and the ditch is not over 2 feet deep, side slope can sometimes be as steep as  $\frac{3}{4}$  horizontal to 1 vertical. Special care must be exercised in controlling the concrete mix when steep slopes are used.

In some instances it is convenient to set guide forms and pour alternate panels as the first step. When the concrete has set, the guides are removed and the intervening area is poured. Figure 4 shows this type of construction.

When steeper slopes or vertical side-walls are desired, forms are necessary to hold the concrete in place until it sets. Nonreinforced concrete linings with vertical sides should not be used for depths of more than  $1\frac{1}{2}$  feet.

In some instances, concrete linings of pneumatically applied mortar are used. This type of construction requires special machines and careful control of the concrete mix. When properly applied at an adapted location, a strong, durable lining results.



BN-12705-X

Figure 2.—Concrete lining being placed with slip form. The form is pulled along the ditch by a heavy tractor.

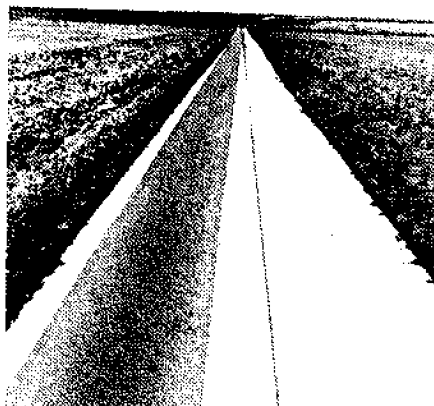

BN-12712-X

Figure 3.—Concrete lining after completion.



BN-12711-X

Figure 4.—Concrete lining being constructed by the alternate-panel method.

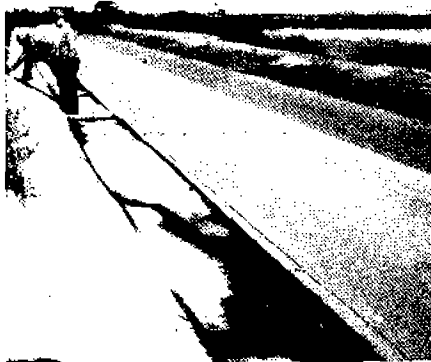

BN-12714-X

**Figure 5.—Asphaltic-concrete lining.**  
The smooth, uniform finish is a result of using a slip form.

### *Asphaltic concrete*

Asphaltic concrete consists of sand and gravel cemented together with asphaltic cement. This lining is similar in many ways to portland cement concrete. It has a shorter service-life expectancy and its permissible stream velocities are lower. It is also subject to mechanical damage, and the subgrade must be sterilized to prevent vegetation from growing through the lining and causing its destruction.

Asphaltic concretes may be hand placed in a manner similar to that described for portland cement concrete. Special equipment is needed to blend and place the hot materials. Figure 5 shows an asphaltic lining that was placed by the slip-form method.

### *Exposed membranes*

Impervious, tough membranes may be placed in the bottom of a shaped ditch to reduce seepage losses and control erosion. These membranes must be flexible and strong enough to withstand mechanical damage. One such material is asphalt-coated jute sacking. It is supplied in rolls. Widths of this lining may be joined by heating both sides of the overlapping edges and pressing them together. Figure 6 shows a ditch being lined with this material.

Thin film linings are sometimes used in ditches that are plowed out and re-



BN-12759

**Figure 6.—This asphalt-coated jute liner can be installed by the farmer. The joints are sealed by heating.**

established each year. When these polyethylene or black vinyl films are used, they are replaced each season. A ditch lined with a thin film is shown in figure 7.

### *Buried membranes*

To protect membranes from mechanical damage, the ditch may be overexcavated and the lining placed and then covered with soil or gravel. Plastic film, rubber sheeting, or sprayed asphalts are sometimes used in this manner.

The life of the membrane is considerably increased by the protection from light and mechanical damage that the covering affords. However, the earth cover must be carefully selected and placed on the membrane so that damage does not occur during construction.

Weeds may pierce and damage the membrane, and sometimes a sterilizing agent is used on the subgrade before the membrane is placed.

Buried-membrane linings may be damaged also by ditch-cleaning opera-

tions unless the maintenance work is very carefully done.

### *Chemical sealants*

The use of chemical sealants to make ditch subgrades relatively impervious to water shows considerable promise. Many chemicals have been



BN-12717-X

**Figure 7.—Ditch lined with polyethylene film. This type of lining is replaced each season.**



BN-12701-X

Figure 8.—Prefabricated concrete pipe installation. Riser to accommodate alfalfa valve is being placed.

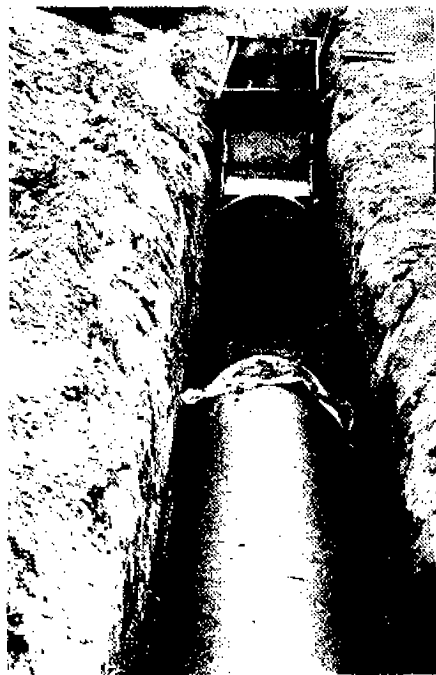

BN-12702-X

Figure 9.—Cast-in-place concrete pipe. Completed pipe in foreground; slip form for casting concrete pipe in background.

tested. Some have not proved satisfactory because of short life, high cost, or their toxic effect on animals or crops. Several types of chemical sealants are commercially available.

### *Impervious earthen materials*

One of the oldest methods of reducing seepage losses in ditches is to remove the porous earth and replace it with material more suitable for ditch construction. When impervious earthen materials are located near the ditch, this may be one of the best ways of solving the problem. If the material is slightly moist, is placed in thin layers, and is rolled or compacted, the effectiveness of the lining will be greatly increased.

Bentonite is sometimes used to seal ditches. This material swells greatly when wet. It may be placed as a blanket in ditch bottoms if it is protected by a covering of about 6 inches of soil or gravel. It may also be mixed with the surface layer of soil by working it in with a disk or spike-tooth harrow.

Bentonite may be applied by thoroughly mixing it with the irrigation

water. When the bentonite-water mixture is turned down the ditch, the liquid finds the cracks and porous areas. As the water seeps away, the bentonite is deposited, sealing the leaks. This is a quick way of sealing a ditch but the service life may be comparatively short.

### **Buried Pipelines**

One of the most desirable types of conveyance medium is underground pipe. It eliminates the problems inherent in surface ditches and provides excellent control of the water. Pipelines do not interfere with farming operations, and when properly installed have long life and low maintenance costs.

Prefabricated nonreinforced concrete pipe is commonly used when the pipe is not subject to high pressures. Figure 8 shows an installation of this kind. Concrete pipe with rubber gaskets for a flexible joint can be used if settlement is expected. This prevents breakage that occurs with rigid mortar joints.

Another development is cast-in-place concrete pipe for low pressures. Fig-



BN-12720-X

Figure 10.—Gated aluminum pipe conveying water from an underground pipe system. Gates are adjustable for different amounts of flow.

ure 9 shows a cast-in-place pipeline under construction.

When high water pressures are encountered, reinforced concrete pipe with special joints can be used. When concrete pipe is installed in areas hav-



BN-16817

Figure 11.—Flexible tubing attached to a hydrant being used to deliver water to individual furrows. Clamps may be used to adjust the flow of each outlet.

ing concentrations of sulfates, it is important that the pipe be made with special, sulfate-resistant cements.

Steel pipe is adapted for use with both high and low water pressures. When used in corrosive soils, protective coatings are needed to guard against rapid deterioration. Coatings or linings may also be placed inside the pipe when the quality of irrigation water is such that the pipe may be affected.

Asbestos-cement pipe is another material used for construction of buried pipelines. It can be easily installed, has a long service life, and is adapted to a wide range of water pressures.

Wood-stave pipe is useful in some areas. Depending upon size, this pipe is available in a prefabricated form or in the form of staves and bands that are assembled on the job.

Plastic pipes and pipes made of thermoplastic resins are available in diameters up to 12 or 14 inches. They are especially useful in the smaller diameters for high-pressure underground systems.

### Surface Pipelines

Most surface pipe is of the portable type, which can be moved from field to field. For this reason, it is necessarily lightweight and usually is equipped with quick-coupling joints. Light-

gage steel and aluminum are the materials most commonly used for such pipe.

The pipe is capable of withstanding pressures as high as may be required for the sprinkler method of irrigation. When used for surface methods, the pipe is often equipped with slide gates that can be adjusted to deliver water into each individual furrow. Figure 10 shows water being delivered by gated aluminum pipe.

### Tubing

Tubing fabricated from plastic film, canvas, or butyl sheeting is available for conveying irrigation water. Such tubing is portable and may be equipped with outlets to permit delivery of water to individual furrows as shown in figure 11. Because of the difficulty of precisely regulating the flow at the outlets under high-pressure conditions, it is best adapted to sites where the pressure will not vary greatly along its length. It is subject to mechanical damage and requires moderate care in transportation and storage.

### Small Farm Reservoirs

It is often desirable to provide small reservoirs for short-period storage of the irrigation water. When the irri-



BN-12700-X

Figure 12.—Vinyl-film lining being installed in a farm reservoir. The section of lining shown is 61 by 300 feet and is fabricated in one piece.

gation streams are small, it is often practical to collect the water in a reservoir and withdraw a large stream when irrigating. Water delivered at night may be collected and used the following day. Surface waste from irrigating may be collected, stored, and utilized on lower-lying fields or pumped back into the higher ditch. Use of small farm reservoirs may provide for better water utilization and be effective in reducing the labor required for irrigating.

To keep seepage losses to a minimum, it is desirable to build reservoirs on sites where the soil is relatively impervious. A reservoir of a given volume should be made as deep as possible so that the area contributing to seepage and evaporation losses is kept small. Earth fills used in conjunction with reservoirs should be carefully placed, and may need cut-off trenches extending through any porous underlying material.

Where permeable soils exist, it may

be necessary to line the reservoir. Any material used for lining ditches may be used for lining reservoirs. Concrete, asphaltic materials, membranes, impervious earthen materials including bentonites, or chemical sealants may be used. A large reservoir being lined with a plastic film is shown in figure 12. In some areas, the soils are such that mixing common salt or polyphosphates into the reservoir walls and bottom will create an alkaline condition that greatly reduces seepage.

## STRUCTURES FOR OPEN DITCHES

Various kinds of structures are used with open ditches to convey and control the water on the farm. The purpose of the farm distribution system is to safely carry the required irrigation stream from the headgate or source to the individual furrow or border. The system must provide a means of control, so that labor required for irrigating is held to a practical minimum. Good irrigation structures are an essential part of an efficient irrigation layout.

### Conveyance Structures

It is often necessary to carry water across draws or swales, or to convey it

along steep hillsides. Special conveyance structures are used to overcome these natural obstacles.

### Flumes

Channels constructed of wood, metal, or concrete and supported by a substructure are used to carry water across areas where earthen ditches are not practical. These channels should be of adequate capacity to carry the full discharge of the ditch, and the substructure should be of ample strength to support the channel when loaded with water.

Substructures of flumes are commonly built of timber, steel, or concrete. If

timber is used, it should be treated with a preservative to extend its life. Steel substructures should be painted to prevent rust. Concrete and steel have the advantage of not being readily damaged by fire.

The channel part of the flume, or the flume lining, is built of wood, metal, or concrete. Since it is subject to alternate wetting and drying, it is difficult to keep a wooden lining in a watertight condition. Reinforced concrete linings nearly always have concrete substructures.

Instead of linings, pipes are sometimes supported by the substructure. To insure full capacity the pipe should

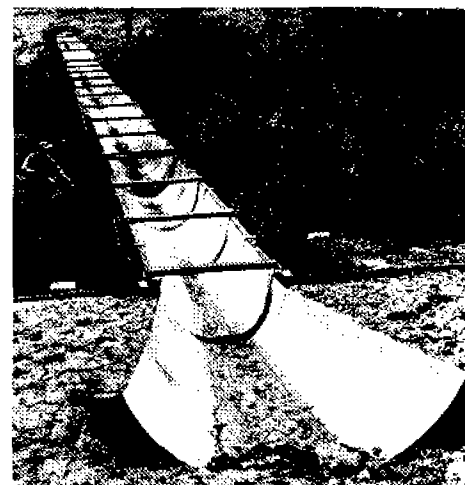

Figure 13.—Two types of flumes used to carry water across ditches and depressions.

BN-16813, BN-16810



be placed a sufficient distance below the water surface in the canal so it will flow full. If the pipe has enough strength, it can be simply placed on the supports. If it cannot support itself over the distance between piers, trusses are needed to carry it. Different types of flumes are shown in figures 13 and 14.

### **Elevated ditches**

In many instances it may be practical to build an elevated ditch to carry water across a shallow depression, or to deliver water by open ditch to a higher part of the field as shown in figure 15. This is done by constructing a dike to the proper elevation and then building the ditch on top of the dike. The fill material should be of a type that will compact readily but will not crack when dry.

Elevated ditches require careful maintenance because a break in the bank may cause serious washouts. The higher the fill, the greater the potential damage from breaks or holes caused by burrowing animals. In many cases, the ditch is lined with some durable material to lessen the problem of breaks and to reduce seepage losses.

### **Inverted siphons**

Pipes can also be used as inverted siphons to convey water across deep, wide depressions. Inverted siphons are different from culverts in that the top of the pipe is lower than the water surface and the pipe is under some pressure. The amount of water an inverted siphon can carry depends on the size and kind of conduit and on the difference in elevation between the water surface at the inlet and outlet.

A properly installed inverted siphon requires little maintenance. Since the conduit is underground it is well protected from fire and wind damage, and it is not likely to be damaged by flood water. On the other hand, inverted siphons may be more expensive to install than flumes and, should damage occur, they are more difficult to repair.



Figure 14.—Bench flumes are used to carry flow along steep or rocky hill-sides. BN-16811



Figure 15.—Built-up, elevated ditches are used for crossing shallow depressions in the field. BN-16812

A sketch of an inverted siphon used as a crossing is shown in figure 16.

### **Crossing Structures**

Open ditches must be equipped with crossing structures so farm produce and equipment can readily be taken on or off the fields. Culverts are most often used for this purpose. Corru-



Figure 17.—Concrete-block drop structures being used in an earth ditch. A stilling basin below each drop helps to prevent erosion. BN-16802

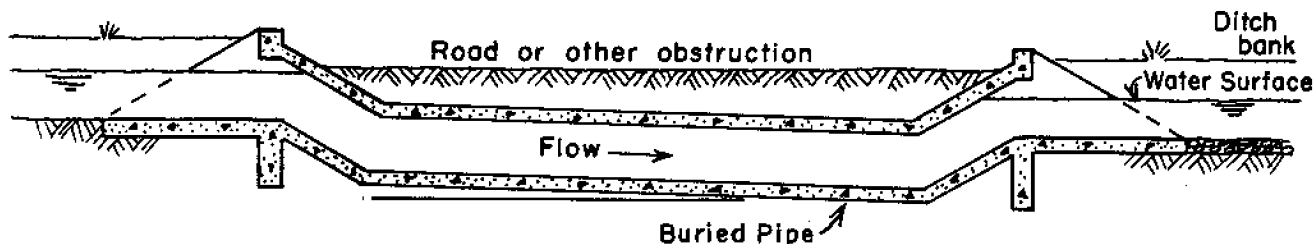

Figure 16.—Inverted siphon. The capacity depends on the diameter, length, and difference in elevation of the upstream and downstream water surfaces. BN-12676

gated metal, steel, or concrete pipe is most commonly used for culverts on farm ditches. The pipe should be long enough for the roadway over the top to be maintained to an adequate width, and should be covered deep enough to protect the pipe from concentrated loads.

### Erosion Control Structures

It is often necessary to build irrigation ditches down hillsides so steep that the water will cut gullies if allowed to flow uncontrolled. To prevent such damage, drops or chutes are used to keep the ditches from eroding.

#### Drops

A drop is used to discharge water in a ditch from one level to a lower one, as shown in figure 17. Special provision must be made to prevent the force of the falling water from undermining the structure on the downstream side. On small drops, a simple apron made of an erosion-resistant material such as concrete is usually adequate. For higher drops or bigger streams, more elaborate methods of dissipating the energy in the falling water are necessary. Figure 18 shows a specially designed apron equipped with blocks to slow down the water.

Open drop structures usually are constructed of timber, concrete, or con-

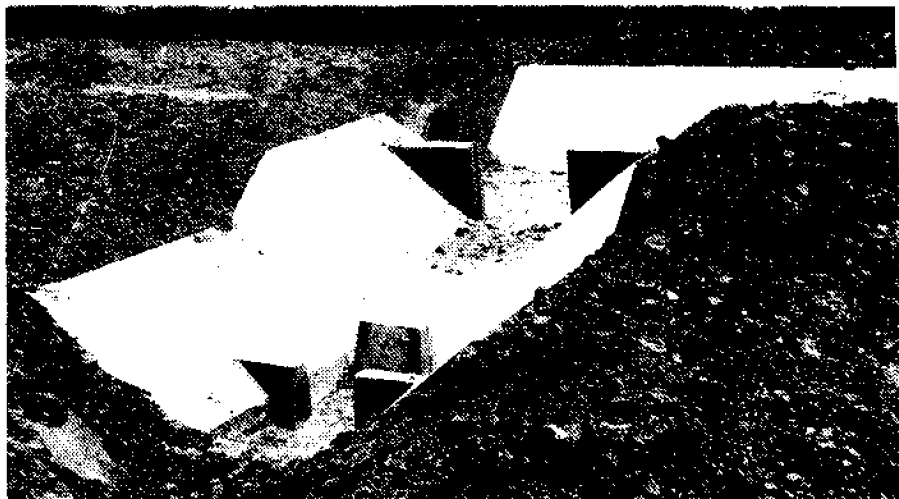

BN-12708-X

Figure 18.—Drop structure combined with turnout. This structure contains blocks to slow the velocity of the water before it enters the earth ditch.

crete or clay tile. Prefabricated structures made of steel or aluminum are also available. It is well to select the materials for a long life; for this reason, timber should be treated against rot, and metal against corrosion. Special cements and alloys may be required where chemical concentrations in the soil might cause high maintenance costs.

Sometimes pipes with a short right-angle elbow (fig. 19) are used as drops. These pipe drops are commercially available and are especially adapted to small ditches that have small streams. This type of structure is more easily

plugged by trash than the open type, but it can easily be combined with an extra length of pipe to provide a crossing if needed. Corrugated metal, steel, or precast concrete or clay pipe is commonly used.

Drop structures often set up eddy currents in the irrigation stream, and these currents tend to cause sloughing of the ditchbanks. Where this occurs, rock riprap is often used for protection. Locations especially vulnerable to erosion of this type are at the lower end of open drop structures, at the inlet of pipe drops, and where sharp bends occur in the ditch alignment.

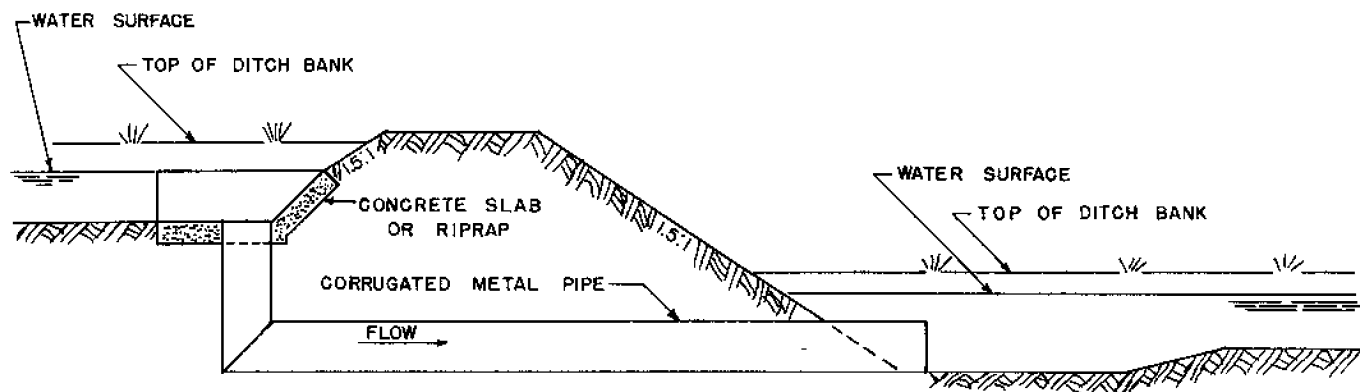

BN-18982

Figure 19.—Typical pipe drop structure, showing the correct setting. In many cases riprap or other protection is required at the inlet to prevent erosion.



BN-12708-X

Figure 20.—Series of drops being used in a ditch on a steep slope.

Figure 20 shows a long slope where it was necessary to construct a series of drop structures to lower the irrigation water without excessive velocities.

### Chutes

On steep slopes, drop structures would need to be so close together that it may be more practical to use a paved ditch to lower the water. Such a ditch is made of a material that will stand the high velocity of the water, and is known as a chute.

Water in chutes travels at high velocities and must be slowed down before it can be turned into a farm ditch or into the earth ditch at the lower end of the structure (fig. 21). Chutes are most often constructed of concrete. Because of their cost and difficulty of design, special engineering assistance should be obtained to insure proper operation.

### Water Control Structures

Water control structures are necessary for easy, accurate application of irrigation water. Good control of the water will reduce the labor required to irrigate and will help make the best use of the water supply.

### Division boxes

In carrying water to different parts of the farm, it is usually necessary for the farm laterals to distribute to two or

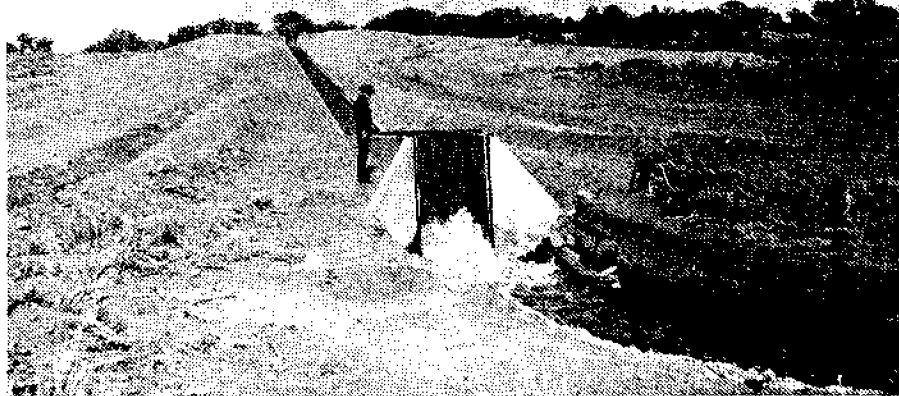

BN-16815

Figure 21.—Chute spillway with stilling basin discharging into an earth ditch.

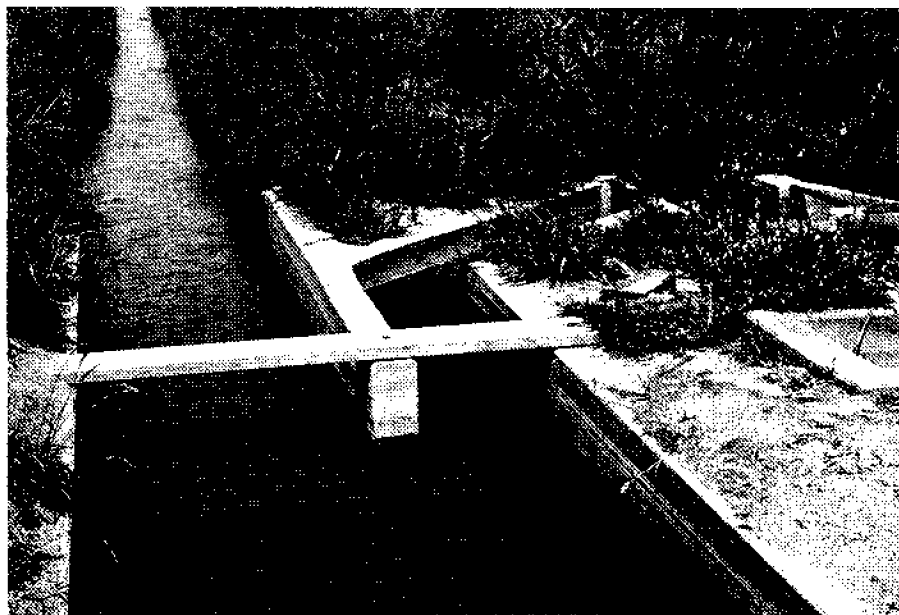

BN-16816

Figure 22.—A divisor to distribute the flow between ditches. Note the gate on the smaller section to control the amount of flow.

more ditches, and at each fork a structure is required to divide or switch the stream into the proper ditches (fig. 22).

### Checks

A check is a structure placed in a ditch to form an adjustable dam to control the elevation of the water surface above the structure. It usually is equipped with grooves to receive boards or with metal slide gates, which control

the level of the water upstream by permitting overflow at some predetermined level. Sometimes checks are placed in each of two forking ditches instead of using a division box to divide the water.

A variety of types of checks are available for use in lined ditches. They are designed to partially block the channel, and may have wheel or lever adjustments to control the water level as shown in figure 23. Also shown in fig-

ure 23 is a common design of check for an earth ditch. A concrete apron is provided to prevent scour under the overpour from the check.

### Turnouts

When water is to be taken from a lateral and put into a ditch, or taken from a ditch and turned onto a field, a turnout is used. Turnouts may be open structures or they may be equipped with flashboards or gates to control the flow of water. Several types of turnouts equipped with gates are shown in figure 24. Turnouts can best be installed in lined ditches at the time of construction.

### Portable devices

Many portable devices are commercially available that serve the purpose of

checks and turnouts. Plastic or canvas dams are widely used to check the water in unlined ditches. These may be made of heavy plastic or canvas supported on a pipe or wooden cross-piece. Many have some sort of adjust-

ment to permit precise control of the water level. These materials are relatively short lived, since the plastic may be cut or torn and the canvas may deteriorate. Some portable checks are made of sheet metal that is driven into

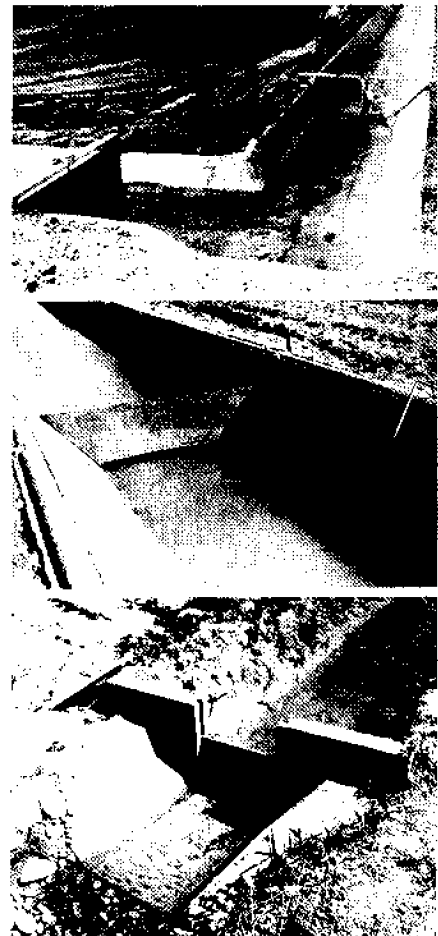

BN-16796, BN-12725-X, BN-16814  
**Figure 23.**—Three types of check structures for farm ditches.

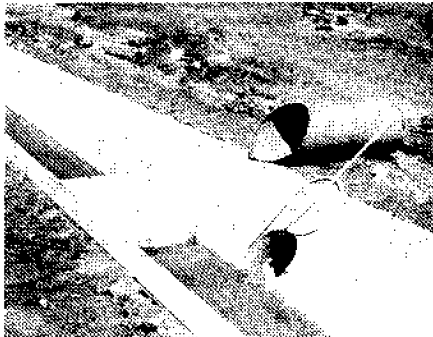

BN-12710-X, BN-16803, BN-16800  
**Figure 24.**—Turnouts used for farm ditches. They are equipped with gates for controlling the amount of flow.

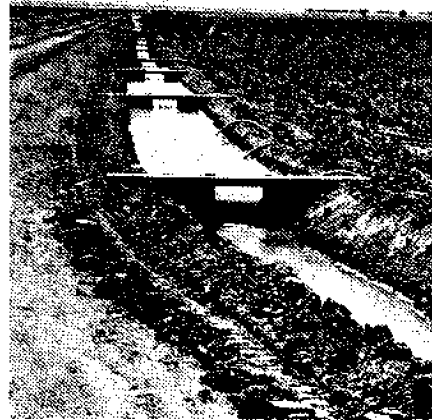

BN-16797, BN-12718-X, BN-12698-X  
**Figure 25.**—Portable dams, checks, and siphon tubes for controlling the flow and delivering water to the crops.

the ditchbanks to form a seal. Portable checks are also available for lined ditches. Figure 25 shows several of these devices.

Siphon tubes are widely used to carry water from a ditch onto the field (fig. 25). They are made of plastic or metal and are commercially available. They come in a wide range of sizes that permit control of streams as small as 1 or 2 gallons per minute and as large as 2 cubic feet per second.

#### **Automatic devices**

Operation of surface irrigation systems using automatic gates is being practiced to a limited extent. Automatic systems require sensing or timing devices to control self-operating gates. The fields must be properly prepared, usually for flooding methods using

borders. The gates are designed to irrigate a bordered field in sequence. When the proper amount of water has been applied to the first border, the check gate is released. This stops the flow to the first border. The next gate closes automatically, and the flow is started into the second border.

#### **Combined structures**

Where possible, it is usually advantageous to combine checks and turnouts with the construction of drops or other structures. Check walls can easily be installed in drops as is shown in figure 18. Combined structures usually require less material than the same devices installed separately. Figure 26 shows a structure that has combined a chute, drop, checks, turnout, and a measuring flume.

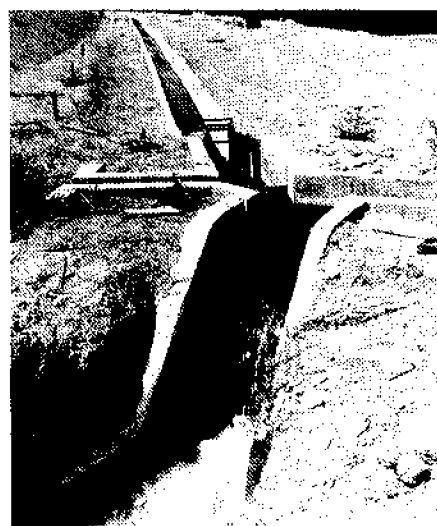

BN-16801

Figure 26.—A combination structure containing features for measuring, checking, dividing, and dropping the stream.

## **STRUCTURES FOR IRRIGATION PIPELINES**

When pipelines are used to convey irrigation water, specialized structures must be used to control the water and protect the pipeline from damage. Pipes made of different materials have different physical properties, so it is to be expected that the required structures or devices would also vary widely. For example, a pipeline made of steel and operating under high pressure would need protective devices entirely different from those needed by a low-pressure line made of nonreinforced concrete pipe.

Most of the special equipment needed for the control of water on high-pressure lines is available only through commercial sources and is normally provided by the installer of the pipeline. Therefore, the principal emphasis in the following discussion will be on the structures most commonly used with low-pressure lines.

### **Inlet Structures**

Water may enter a pipeline by gravity from a ditch, or it may be pumped into a line from a stream or well. An inlet structure is needed to develop the full flow capacity, to insure that excessive pressures do not cause damage, and to keep trash from entering the pipe.

#### **Pump stands**

A vertical pipe extending above ground and connected to the buried line is known as a stand. Pumped water should enter a pipeline through a stand that is somewhat larger than the line. The stand should be larger so any air entrained by the high-velocity stream coming from the pump will have an opportunity to escape. Should the entrained air be carried into the pipeline, it will tend to collect in pockets that reduce the amount of wa-

ter the pipe can carry. Entrained air accumulations can also cause a surging flow condition, and may contribute to the development of excessive pressures. Figures 27 and 28 show two different types of pump stands.

The stand must extend upward to a point where it will not overflow except when unusual pressures occur. This sometimes happens when a pump is started, and the pipeline could be broken if the stand did not overflow.

If the pump stand must be high, it can be capped and vented with a smaller-diameter pipe as in figure 28. Flexible couplings between the pump and the stand are recommended; these prevent pump vibration from damaging the stand.

#### **Gravity inlets**

When water enters the pipeline from an open ditch, a structure such as that

shown in figure 29 is used. The inlet should be equipped with a guard to keep trash out of the line. The top of the stand should be provided with a cover to prevent accidents and to keep trash from blowing in.

### *Sand traps*

If the irrigation water contains appreciable quantities of sand, a trap can be built into the inlet structure to remove most of the suspended material. To accomplish this, the stand has an extra-large diameter to insure low veloc-

ity of the water, and the bottom is set some distance below the bottom of the pipeline. Stands used as sand traps should be at least 30 inches in diameter so they can be entered periodically for cleaning. The pump stand shown in figure 27 can be made to function as a sand trap by increasing the depth of the concrete base to at least 2 feet below the outlet pipe.

### *Debris screens*

Irrigation water that has been conveyed over an open canal system often

carries considerable quantities of debris and weed seed. The deposition of the weed seed on the field can create a difficult farming problem, and often the seed and debris are in such quantity that they interfere with the adjustment of gates and outlets.

Much of this difficulty can be eliminated by the use of debris screens to clean the water before it enters the pipeline. Commonly, the stream is allowed to fall through a fine screen into a gravity inlet. The screen will need frequent cleaning unless it is placed

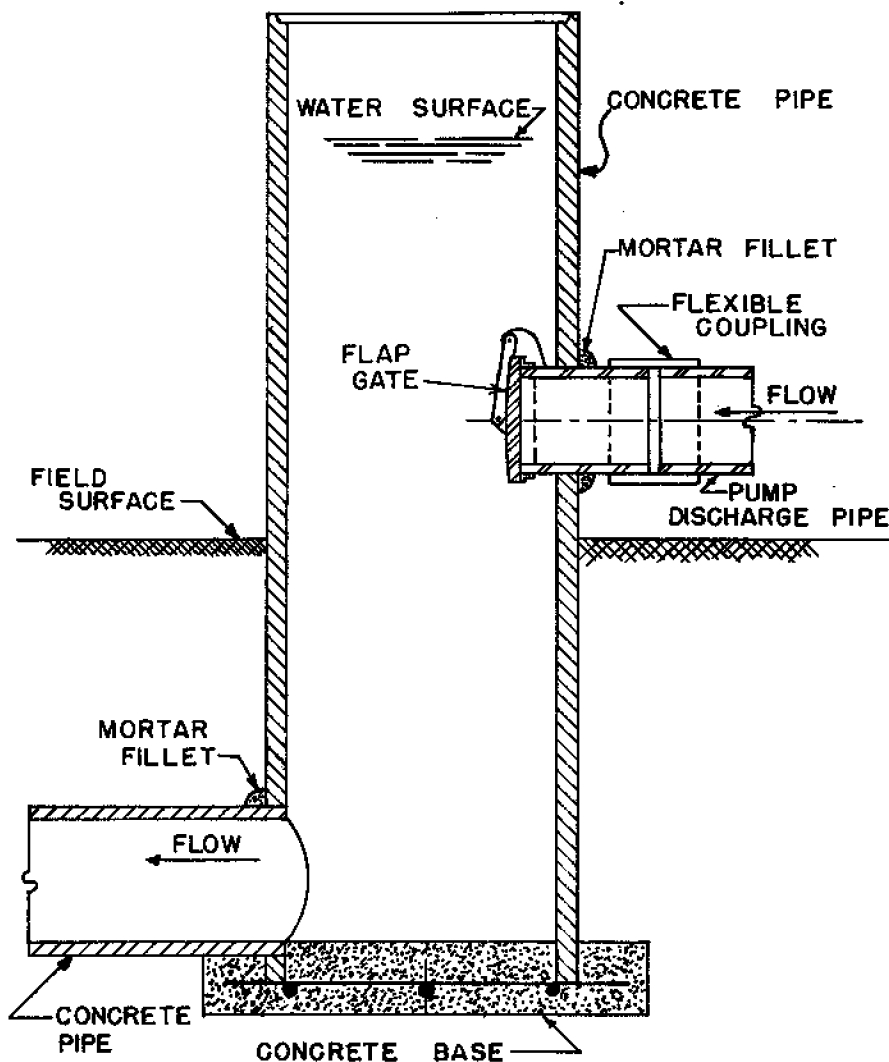

Figure 27.—Pump stand. The flexible coupling is needed to absorb vibrations from the pump; the flap gate prevents backflow to the pump.

BN-18933

above the ground level, as in the case of the structure shown in figure 31. Here, the screen is self-cleaning and the debris is deposited at the side of the structure.

**Vents**

Every pipeline needs vents for relieving pressure and releasing air. Stands built for other purposes will also serve

as vents. Vents should be provided at all high points of a line, at points where the slope of the pipeline sharply increases in the direction of flow, at sharp turns in the line, at the end of the line, and directly below any structure that entrains air in the flowing water.

These vents allow the air to escape and permit the pipeline to carry more water. They also serve to relieve

surges and prevent them from damaging the line when gates or valves are opened or closed. They prevent a vacuum from causing the pipe to collapse when the line is drained.

The area of the vent pipe in contact with the pipeline should not be less than half the area of the line. This can be further reduced as shown in figure 30 until the area of the small pipe is not

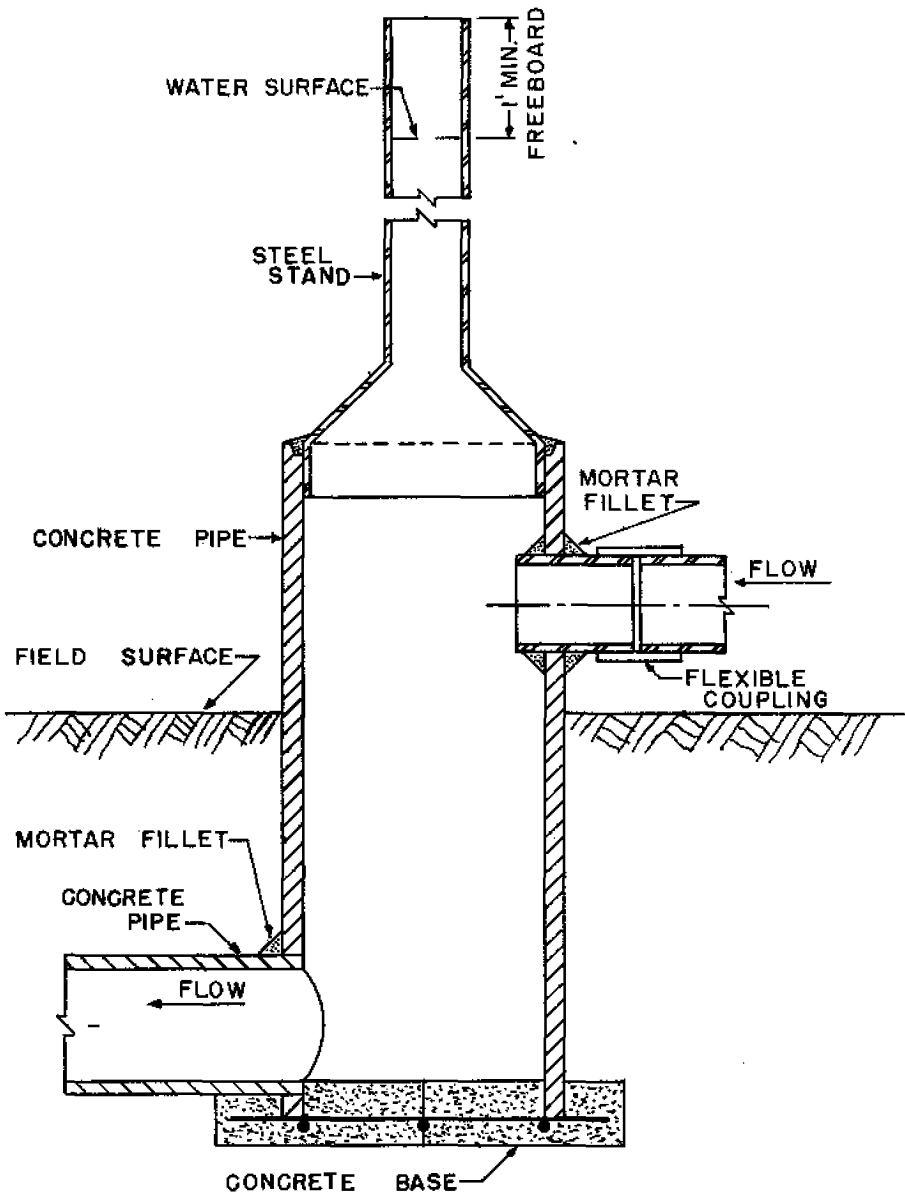

Figure 28.—High-head tapered pump stand. With this type, a check valve is used on the incoming pipeline to prevent back-flow to the pump.

BN-18934

less than one-sixtieth of the area of the main line. In no case should the diameter of the small pipe be less than 2 inches.

All vents should extend at least 4 feet above the ground, or as high as neces-

sary to prevent overflow when the line is operating normally.

In some instances it is desirable to reduce the height of a vent stand by installing an air-relief valve on the small pipe at some convenient height above

the ground. Such a valve will permit air to escape or enter but will not allow water to pass. Air-relief valves should not be used in any location where it may be necessary to relieve momentary high-pressure surges.

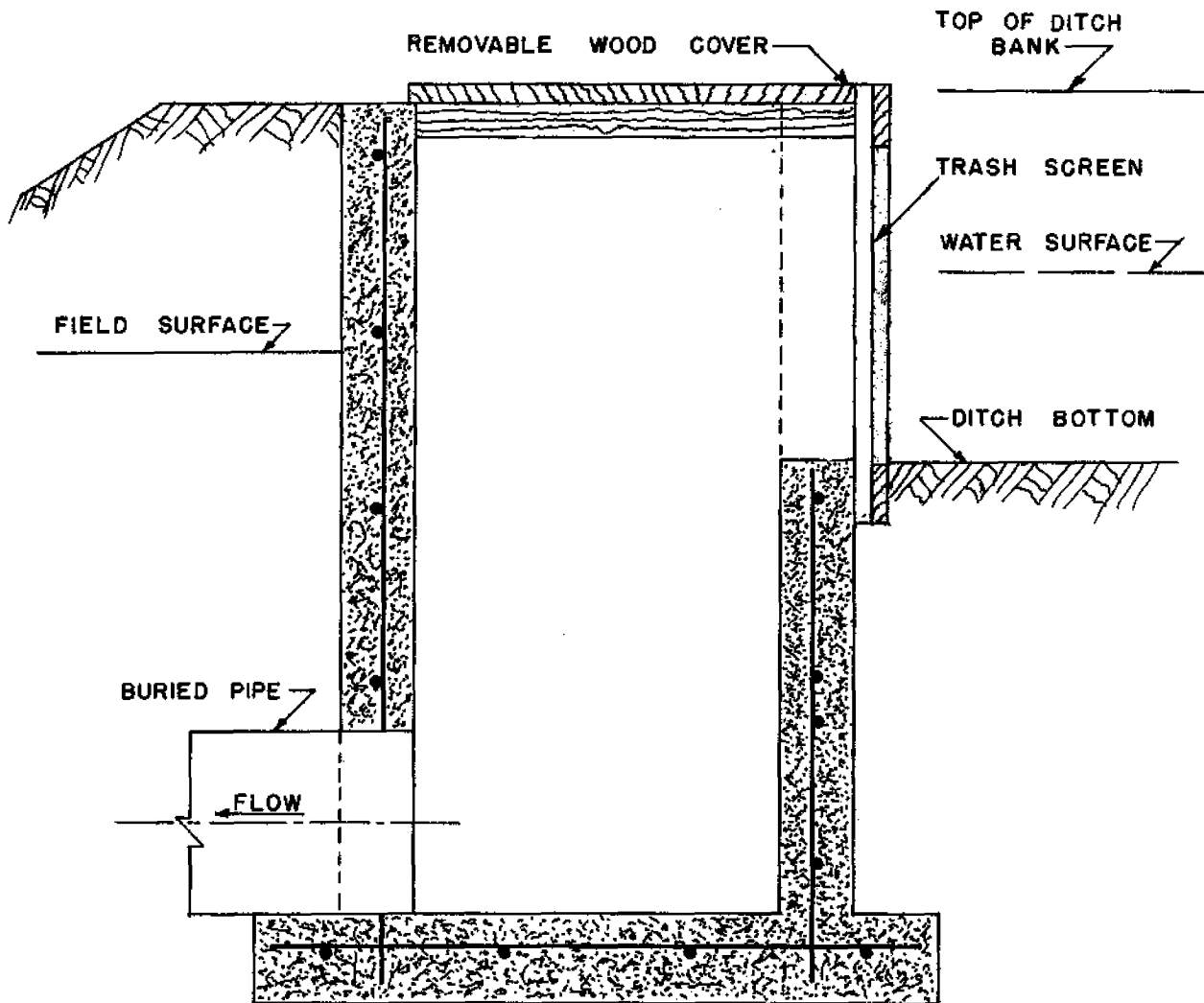

BN-18935

Figure 29.—An inlet for taking water from a ditch into a buried pipeline.



## Control Structures

Control structures are needed on irrigation pipelines to regulate the flow into branching lines, to allow for the removal of entrained air, and to prevent

momentary high pressures from damaging the pipeline.

### Gate stands

Gate stands are used to control the flow into laterals or to increase the pres-

sure upstream. The increase in pressure may be needed to force water from valves that are upstream from the stand. Gate stands also prevent high pressures, and act as air vents and surge chambers.

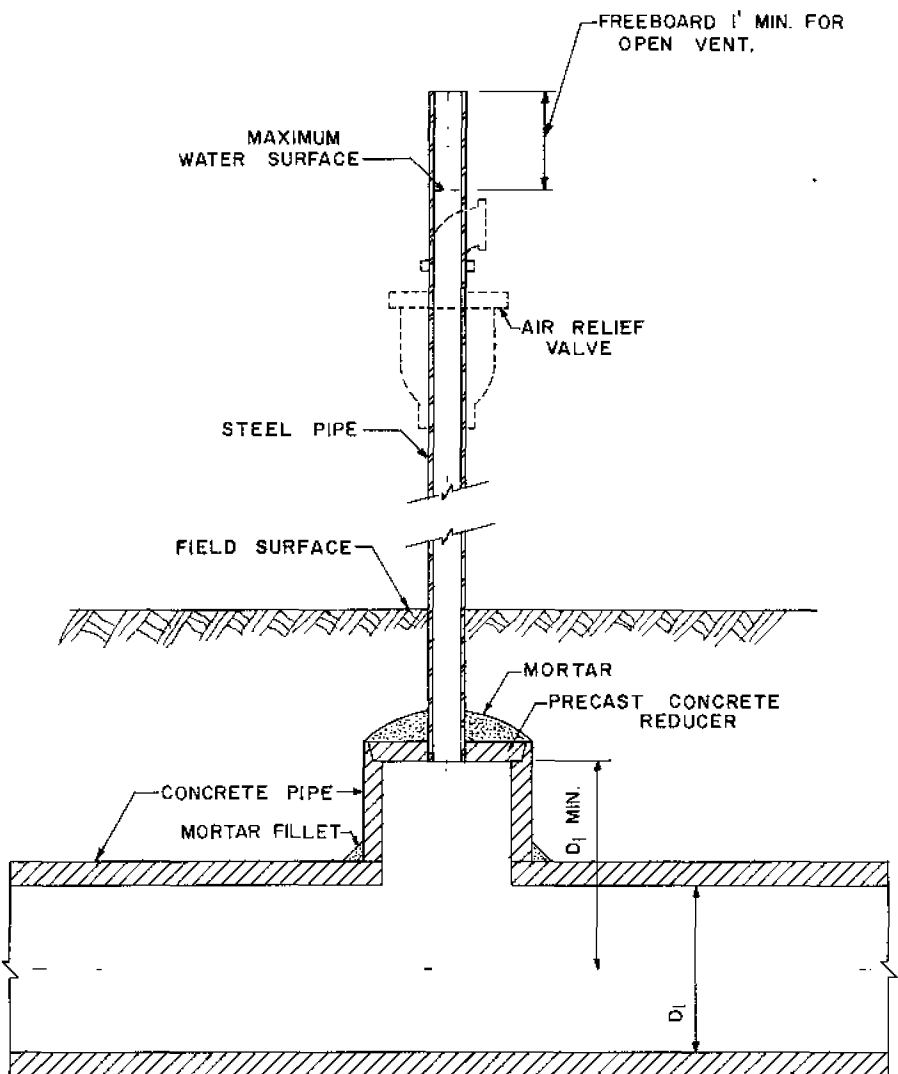

Figure 30.—Typical vent for underground pipelines.

BN-18926



BN-18805

Figure 31.—Debris screen on a gravity inlet to a buried pipeline. This device removes weed seed, is self cleaning, and helps to eliminate the problem of clogging of valves in underground pipe systems.

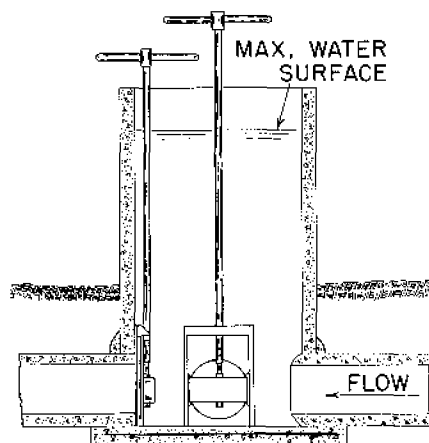

BN-16790

Figure 32.—Simple gate stand used to control the flow into several laterals.

When installed as illustrated in figure 32, gates can be partially closed to create upstream water pressure to make water flow from outlets at upstream points. If laterals take off at the structure, gates in the stand may be opened or closed to divert water as desired. Figure 32 shows the gates installed inside the stand and on the outlet laterals. The stand must be large enough to accommodate the gates to be used and to

permit access for maintenance and repair.

Some installations substitute line gates in each lateral line for the gates inside the stand. This permits the operation of the gates from the ground instead of from the top of the stand.

### Overflow stands

In areas where slopes are so great that excessive pressures can be de-

veloped downstream, overflow stands can be used to limit the head developed and still permit the water to be withdrawn from outlets near the upper end of the line. The principles of an overflow stand are illustrated in figure 33.

An overflow stand serves as both a check and a drop structure. It has the disadvantage that often the falling water entrains air and, under certain conditions, can set up surges in the

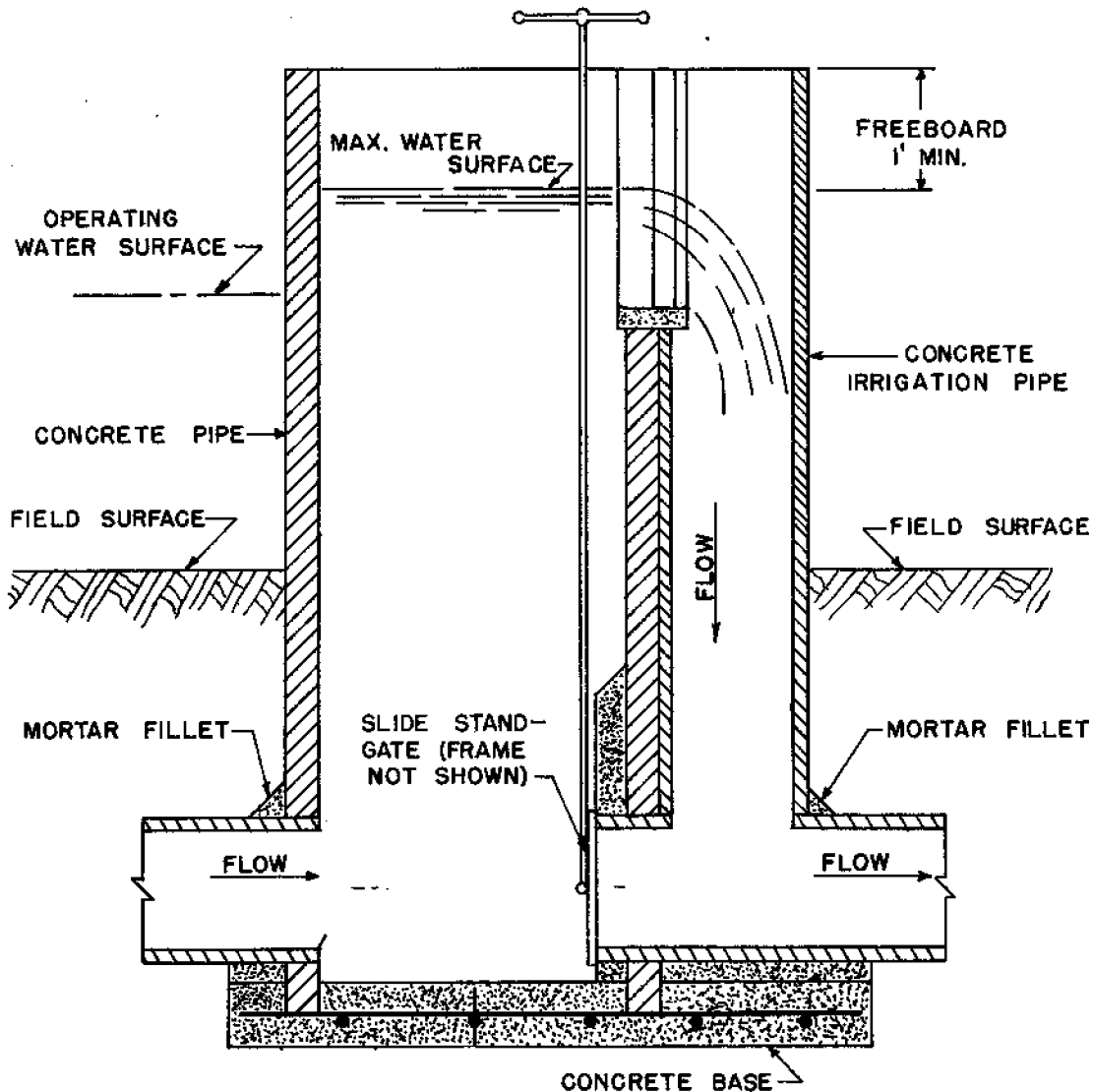

Figure 33.—Concrete overflow gate stand used for regulating pressures. With additional gates, it may also be used to control the water flow into several laterals.

BN-18987

pipeline. It is recommended that the gate be provided between the chambers as shown in figure 33 so that, when upstream pressure is not necessary, the gate can be opened and the water will pass directly downstream without falling over the check wall.

It is frequently necessary to install a vent directly below an overflow stand to remove the air entrained by the falling water.

### Float-valve stands

Stands can be equipped with float valves as illustrated in figure 34. These valves open when the pressure downstream falls to some predetermined level, allowing more water to pass to meet the needs. Should the lower outlets be closed, the float valve will automatically close and prevent excessive

pressures from developing at the lower end.

Float-valve stands are usually installed at intervals of about 10 feet of drop in the line. They are especially good when a line is served directly from storage, in which case full control of the water can be maintained from the lower end of the line. Float-valve stands eliminate the need for many high stands of

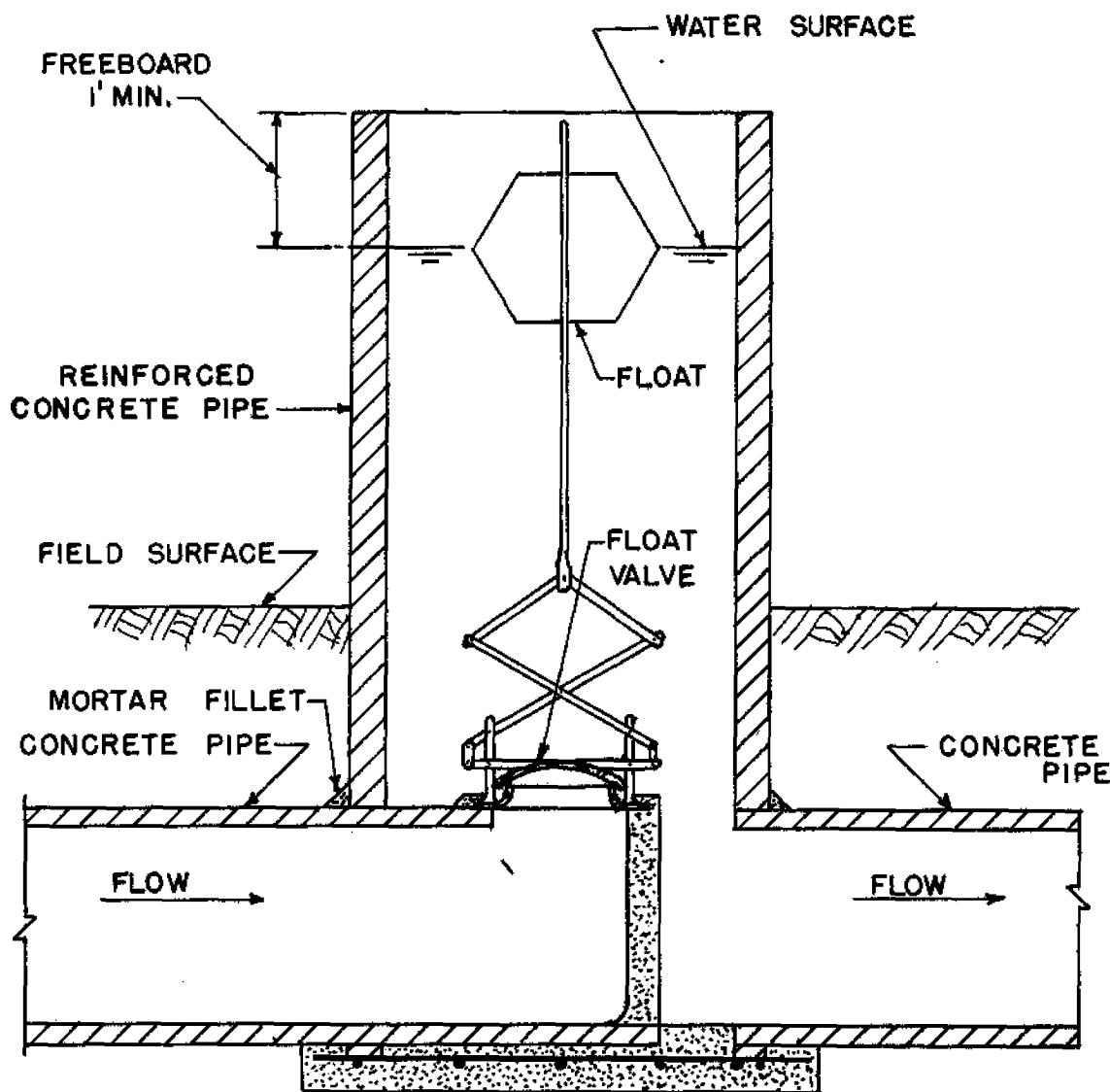

Figure 34.—Float-valve stand. The pressure and flow in the line is automatically regulated by the float valve.

BN-16938

the overflow type when a line serves a steep slope as shown in figure 35.

## Outlets

Outlets are necessary in pipelines to deliver the water from the pipeline to the land surface or into some distributing device. They consist of risers built from vertical sections of pipe. The

risers are saddled over openings in the pipeline as shown in figure 8. Valves or gates are installed in the risers to regulate discharge.

### *Alfalfa valves*

Alfalfa valves are used to distribute water directly into border strips, basins, or ditches. They are grouted to the top of a pipe riser (fig. 36). The valve

top should be placed 3 or 4 inches below the ground level to minimize interference with farming operations and to reduce erosion from the irrigation stream.

Alfalfa valves can be fitted with hydrants to connect to surface pipe. These hydrants are portable and are so constructed that the opening of the valve can be adjusted with the hydrant in

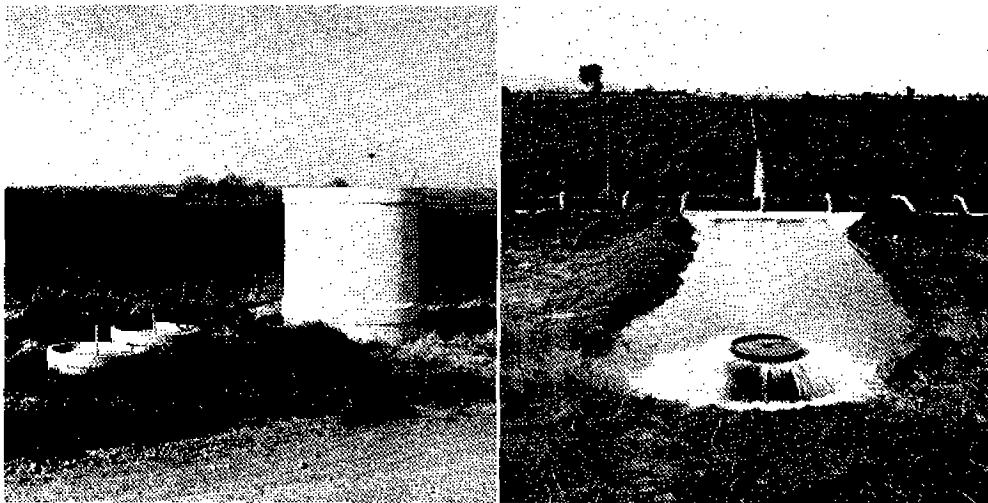
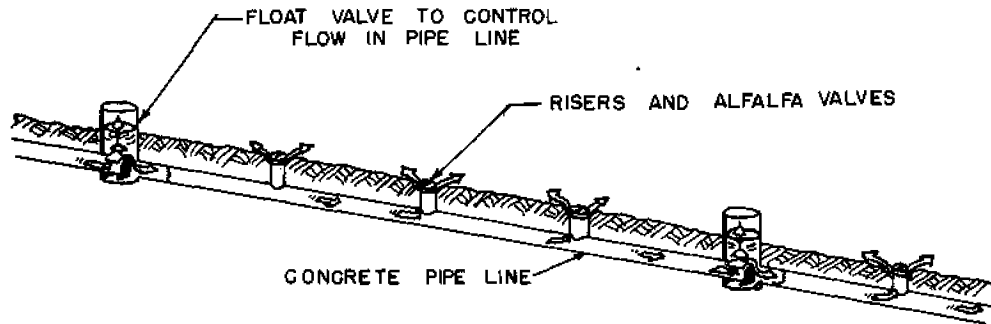

BN-16795, BN-16807, BN-16808

Figure 35.—A pipeline system showing float-valve stands and alfalfa valves.

place. When they are connected to gated surface pipe or tubing, water can be delivered to individual furrows or corrugations (fig. 10).

A hydrant may also be used to deliver water to a temporary field ditch. Siphon tubes can then be used to carry the water from the ditch to the furrows.

### Orchard valves

Orchard valves are commonly used instead of alfalfa valves when smaller flows are acceptable. They are less likely to cause scour around the riser, but have lower capacity.

The top of the riser in which orchard valves are placed should be level with the ground surface. If desired, an

additional length of pipe with an opening in one side can be placed above the ground line to direct the flow.

Hydrants and sheet-metal stands are available for fitting to orchard valves when it is desired to deliver water into surface pipe or ditches.

Figure 37 shows an orchard valve installed in a concrete-pipe riser.

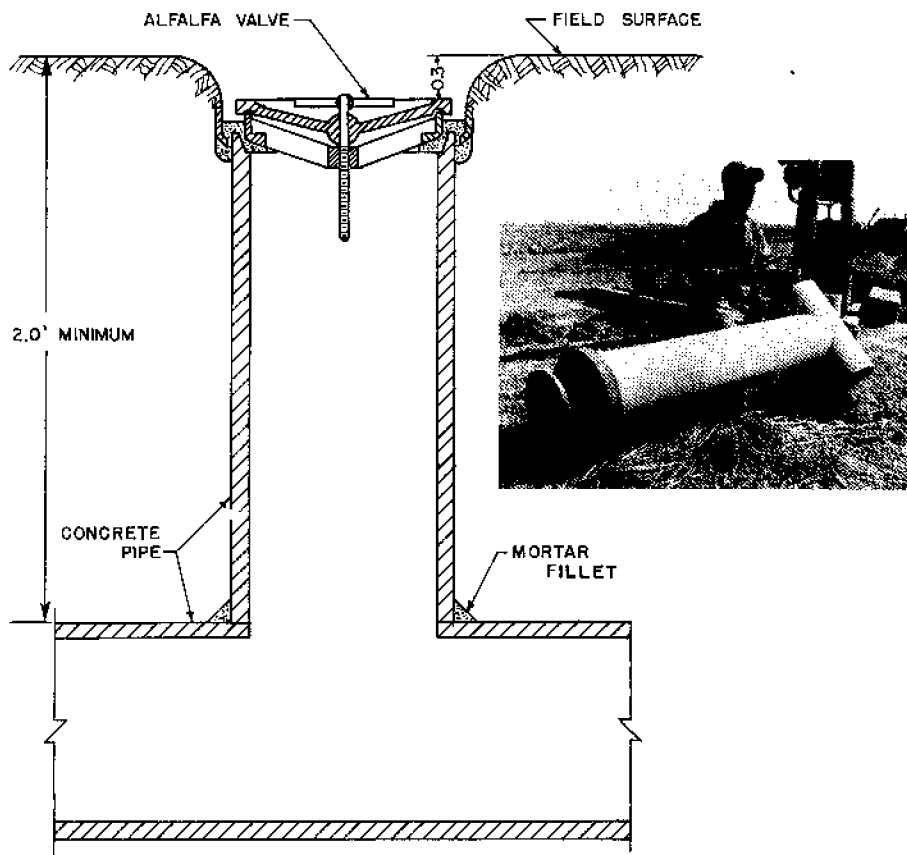

Figure 36.—Typical alfalfa valve installation. In some cases, the riser is factory cast to a short section of the main pipeline to simplify installation.

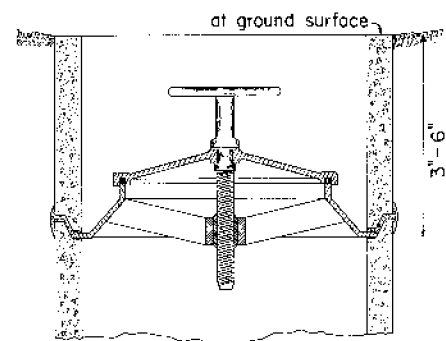

Figure 37.—Orchard-valve hydrant. The valve is sometimes placed at the top or bottom of the riser, but the position shown is generally recommended.

### **Swivel-arm distributor outlet**

A special outlet is available for delivering small flows of water to furrows in orchards and some row crops. This consists of an outlet connected to a steel riser having two arms of gated pipe that swivel around the riser. The arms are chained in a vertical position so they are out of the way during cultivation. When irrigation is required, the arms are lowered to deliver water directly into the furrows.

A valve in the outlet permits control of the flow.

These outlets must be spaced not more than 25 feet apart, so the length of the arms will not be excessive.

### **Open-pot outlets**

In some instances, the riser may extend above the ground surface and may be equipped with two or more slide-gate tubes to distribute water to furrows. Figure 38 illustrates this type

of outlet. Note that the slide gates are placed inside the riser.

When line pressures are low enough, a valve is not needed in the riser and the entire control is made at the slide gates. When higher pressures are in the line, the riser is equipped with an orchard valve to prevent overflow.

### **Capped-riser or pot outlet**

A riser may be capped and equipped with two or more slide gates to deliver water to furrows. In these instances,

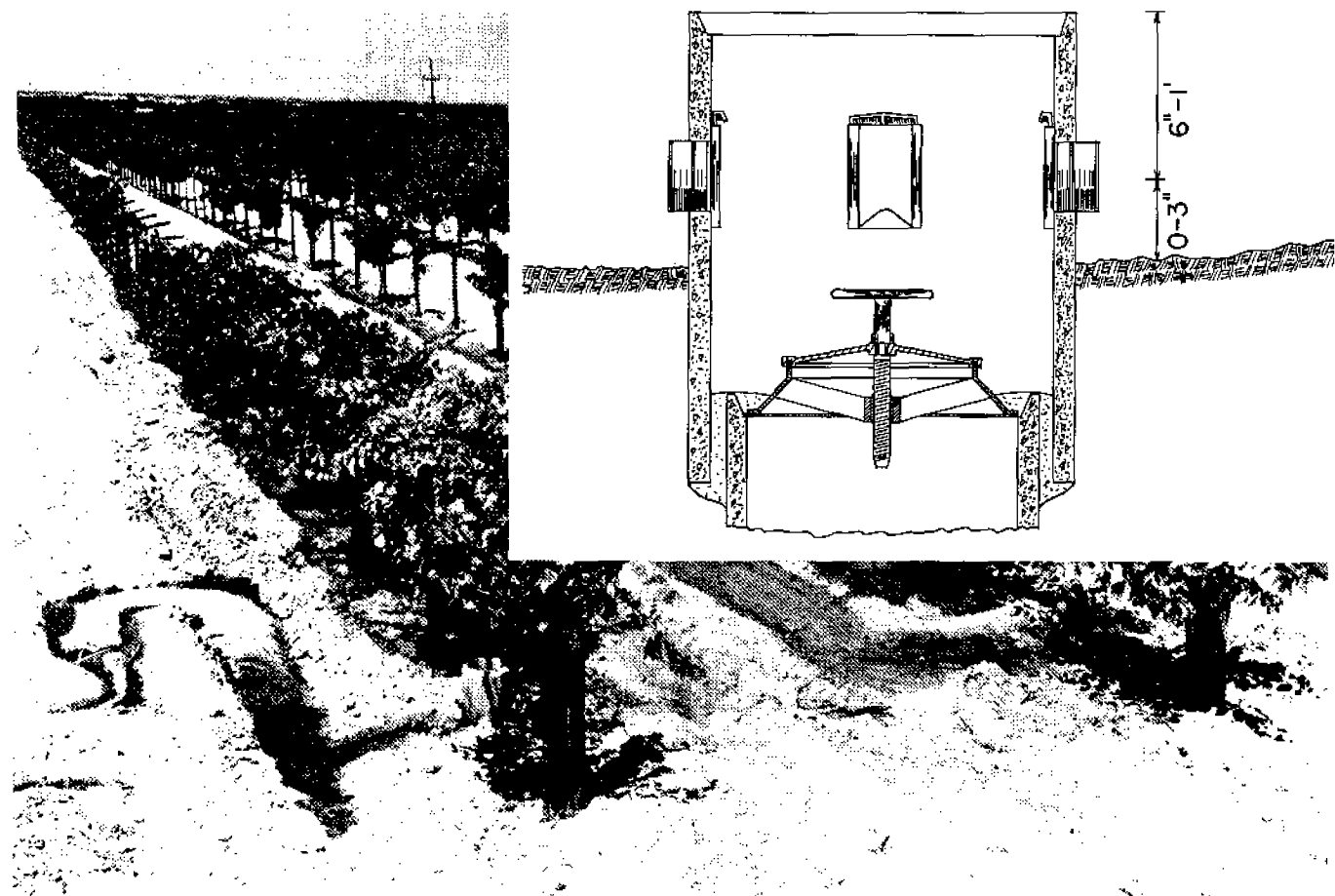

Figure 38.—Open-pot hydrant that has orchard-valve and slide-gate control.

BN-12674, BN-16798

the gates must be installed outside the riser. Flow is controlled by adjustment of line pressure and by the slide gates.

Capped pot outlets have the advantage of not allowing leaves or debris to enter the riser and clog the slide gates. They are adapted to installations where the pressure will not be more than 1 or 2 feet above the ground surface. Because of the pressure, the jet of water from the slide gate is sometimes ero-

sive; special screw-type valves are available to eliminate this.

The use of capped pot outlets is confined to orchards and permanent crops where small flows are distributed to the individual furrows.

### Surface-pipe outlets

Surface-pipe outlets are used to connect the pipeline to a surface pipe without the use of a hydrant, as shown in figure 39. They are essentially a riser

that extends high enough to produce the required pressure in the surface pipe and are equipped with tubes or connections for attachment of the surface line.

Surface-pipe outlets may be equipped with orchard valves to prevent the riser from overflowing if the pressure in the pipeline is more than required. In some low-pressure installations, the connecting tube may be equipped with a gate, or the slide gates at the individual furrows may be used as the control.

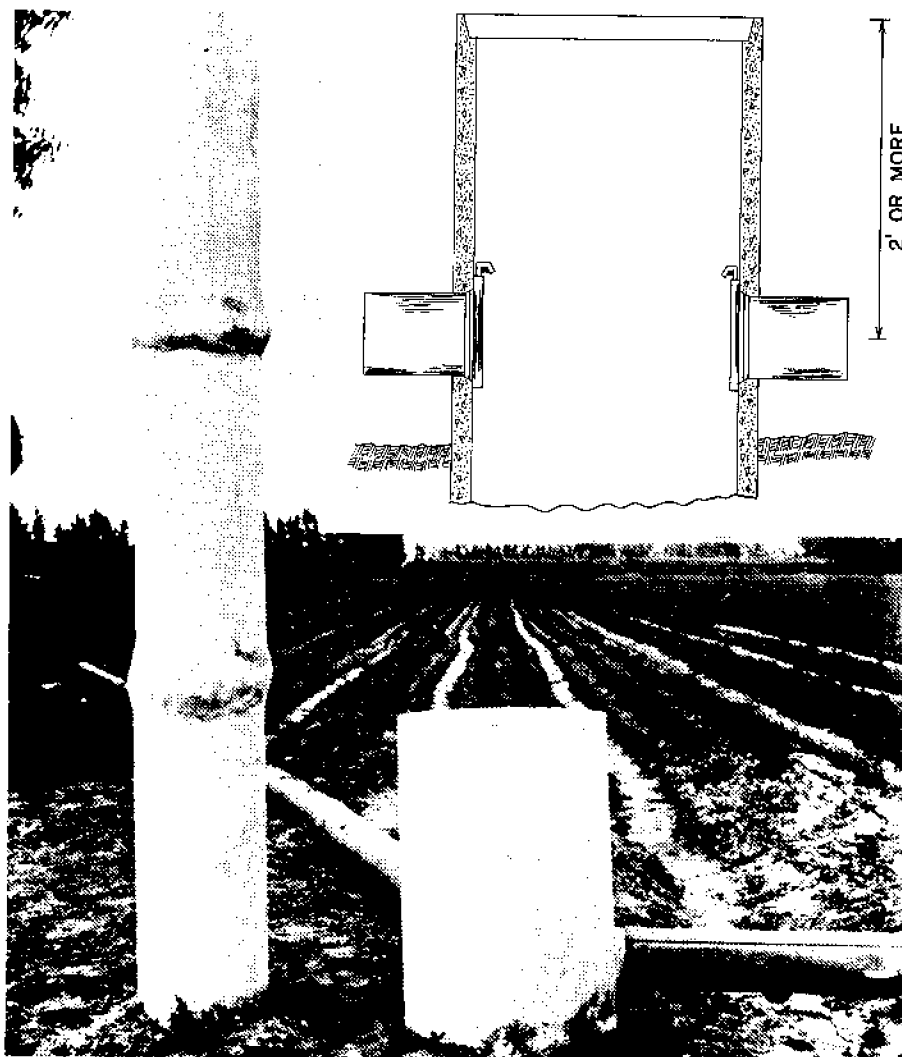

BN-16788, BN-12697-X

Figure 39.—Surface-pipe hydrant for low-pressure lines. For high pressure, an orchard valve is inserted into the riser.

Irrigation water must be measured if it is to be used efficiently. Just as it is necessary for the farmer to know how much seed he plants, how much fertilizer he applies, and how much crop he harvests, proper management of his water supply requires a knowledge of how much water was applied on each field, at each irrigation, and over the season. Most water-measuring devices indicate the rate of flow as gallons per minute or cubic feet per second. Intelligent use of irrigation water requires a conversion of the flow rate to the volume applied; measurement is accomplished by considering the time the flow continued.

For purposes of managing irrigation water, the irrigator needs to know how many acre-feet or acre-inches of water have been applied to a field. This conversion can easily be made by remembering that 1 cubic foot per second

(450 g.p.m.) flowing for 1 hour will very nearly cover an acre with an inch of water.

Recommendations on the amounts of water needed to produce certain crops are available from the Soil Conservation Service or State Extension Service offices.

Water-measuring devices are available that are easily installed and simply operated. They usually are reliable, and their cost can be very reasonable. With most of these devices, it is necessary only to read a gage and find the amount of flow by means of a table. Special knowledge or complicated equipment is not necessary to determine the amount of water that is flowing in a small canal or farm lateral.

## Open Channels

### Weirs

Weirs are probably the most common

devices for measuring water in ditches; they are accurate if properly attended.

Regardless of the type of weir used, the blade should be fairly sharp on the upstream side. The downstream water surface must be low enough to allow the stream of water to fall some distance. Water downstream should never be as high as the blade if good measurement is to be obtained. It is necessary that a pond be formed upstream from the weir.

*Rectangular weirs.*—The rectangular weir shown in figure 40 is widely used. It can be made of wood, steel, or even canvas; it has a steel blade. This type can be used also as a combination drop for the ditch. The openings usually are in widths of 1, 1½, 2, or 3 feet; rating tables are available for these openings.

Some distance must be maintained between the top of the weir blade and the bottom of the ditch, and between the sides of the opening and the ditchbanks. To determine the discharge, it is necessary to find the depth of water over the weir crest, measured upstream from the weir. This is usually done with a staff gage as indicated in figure 40. Meas-

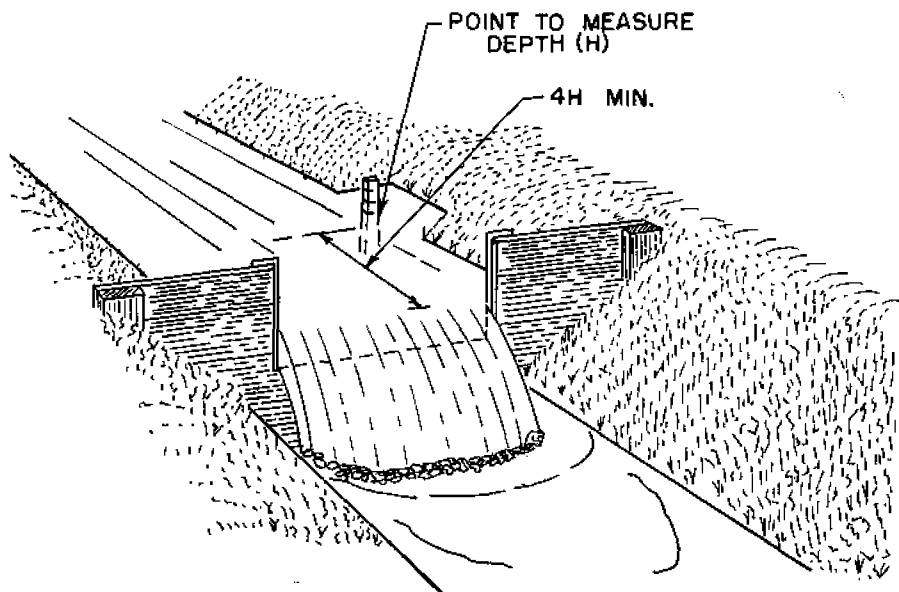

BN-16787

Figure 40.—Rectangular weir that can be used as a combination drop and weir.

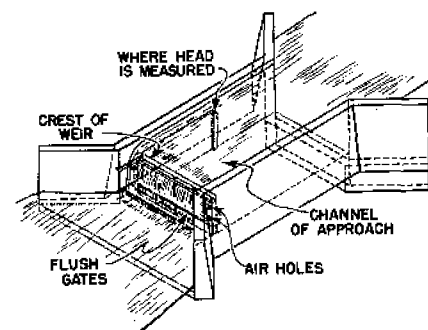

BN-12692-X

Figure 41.—Rectangular suppressed weir. This weir requires more construction and different tables than the one shown in figure 40.



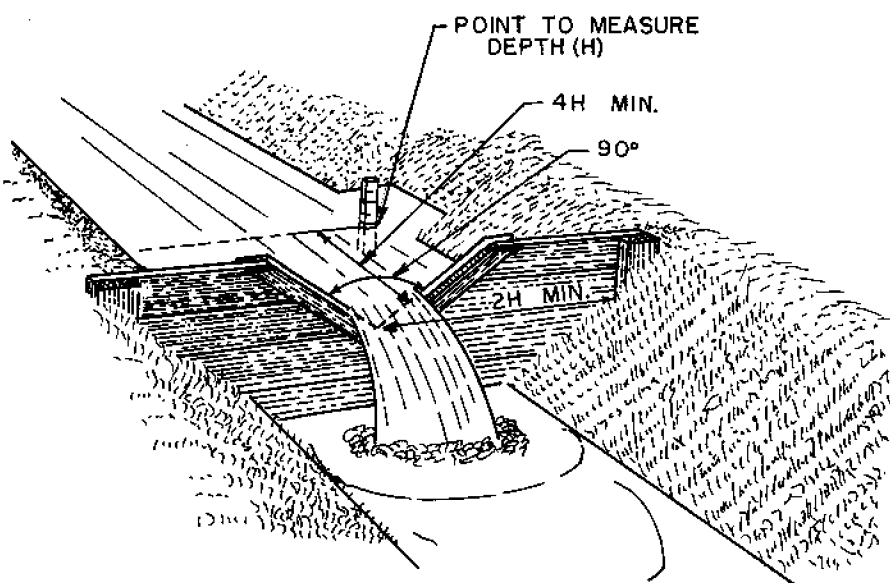

Figure 42.—Ninety-degree V-notch weir. It is easy to construct and install; will give accurate measurements.

BN-16789



Figure 43.—Parshall measuring flume. These flumes can be constructed of metal or concrete, or of wood specially treated to prevent swelling and rotting.

BN-16789

urement can be made at one side of the weir on the bulkhead, but not less than 12 inches from the opening. A scale can be fastened at either location, with its zero at the blade elevation to permit a direct reading of depth.

Figure 41 illustrates another type of rectangular weir, called a suppressed weir. This requires discharge tables different from those in the rectangular weir just discussed. The part of the weir's length that is upstream from the weir blade should be 10 times the length of the crest; ventilation must be provided on the downstream side, under the water flowing over the weir crest.

*V-notch weir.*—The 90-degree V-notch weir shown in figure 42 measures low flows very accurately, and can handle a large range of flows. Its shape makes it easy to construct and install with the aid of a carpenter's square and level.

### Measuring flumes

*Parshall flume.*—The Parshall flume shown in figure 43 is commonly used to measure flows in ditches and

canals. Unlike the weir, which requires an appreciable drop between upstream and downstream water surfaces, the Parshall flume will measure accurately when there is very little difference in those levels. This device is self-cleaning and usually will not silt up. It can easily be constructed of wood, metal, or concrete. Plans and calibrations are available for sizes ranging from 1 inch to several feet in width.

The flume must be checked for accurate width of throat, and must be level and plumb. It must be set high enough so the tail water does not affect the operation.

*Trapezoidal flume.*—A different type of measuring flume that has some advantages over the Parshall-type flume is the trapezoidal flume (fig. 44). It has sidewalls that are sloping, instead of vertical as with the Parshall.

The general shape of this flume fits the common ditch shape better, particularly when it is used in a lined ditch that has sloping sidewalls, like the one shown in figure 43. In this case the

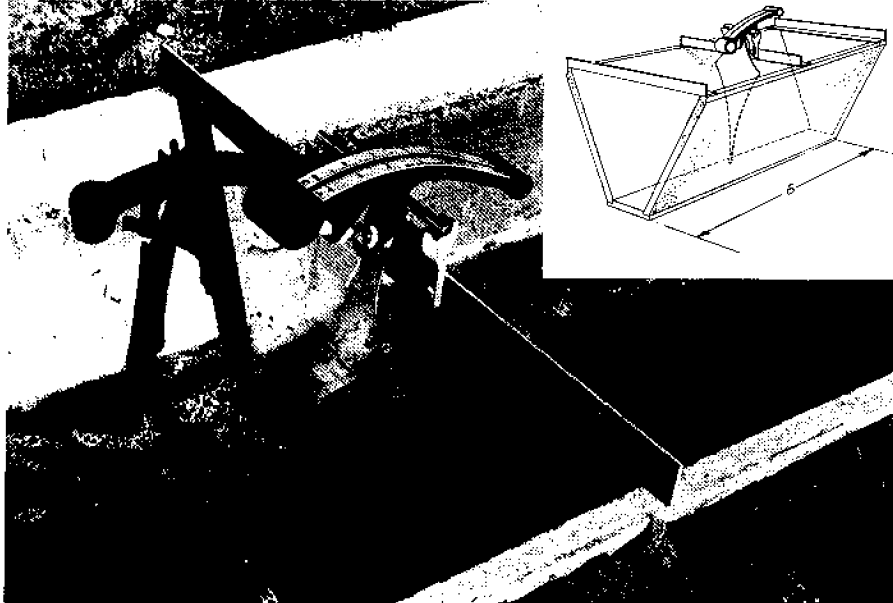

Figure 44.—Trapezoidal measuring flume. In this picture there is also a trash rack downstream on the inlet to an underground pipe system.

BN-12788

flume could have the same sidewall slope as the ditch.

Instruments are available for use on flumes and weirs to make a continu-



BN-16809, BN-16793

Figure 45.—Vane meter for measuring flow. Discharge is determined directly from the scale mounted on top.

ous record of water depth. These are easy to install, and are useful where the amount of flow in a ditch varies over short periods of time. When a recorder is used, a record of all irrigations over a period of years can be maintained simply by filing the charts.

#### Miscellaneous devices

**Floats.**—Floats are sometimes used to estimate the quantity of flow in a ditch. This is done by selecting a straight section of ditch of uniform shape, and timing the travel of a float on the water between two points that are a known distance apart. This gives a velocity greater than the average, because the surface flow is faster, so that the float velocity should be multiplied by about 0.8. This corrected velocity, times the average area of the water flow, gives an approximate measurement of discharge.

**Vane meters.**—Figure 45 shows a measuring device that gives the amount of flow as a direct reading. It consists of a vane that is suspended in the flow and mounted in a section of prescribed

size. The vane is deflected by the flowing water. The amount of flow can be read directly from a scale opposite an indicator mounted on the meter. This device gives reasonably accurate meas-

urement. The meter is portable and can be used at several locations.

**Orifices.**—In measuring irrigation water, two general types of orifices have been used—those having fixed openings, and those having adjustable openings. For both types, the discharge depends on the area of opening and the water depth. If the opening is not submerged by the height of the downstream water level, the depth is measured from the center of the orifice opening to the surface of the water on the upstream side. If the level of the water on the downstream side is above the orifice opening, depth is measured as the difference between the upstream and downstream water levels.

All water-measuring structures require some drop in water level, or "loss of head." In some irrigated sections, the head available for water measurement is so small that a combination headgate and measuring device is sometimes used.

**Commercial gates.**—Headgates are available that both control and measure the amount of water passing. They may be purchased in a variety of

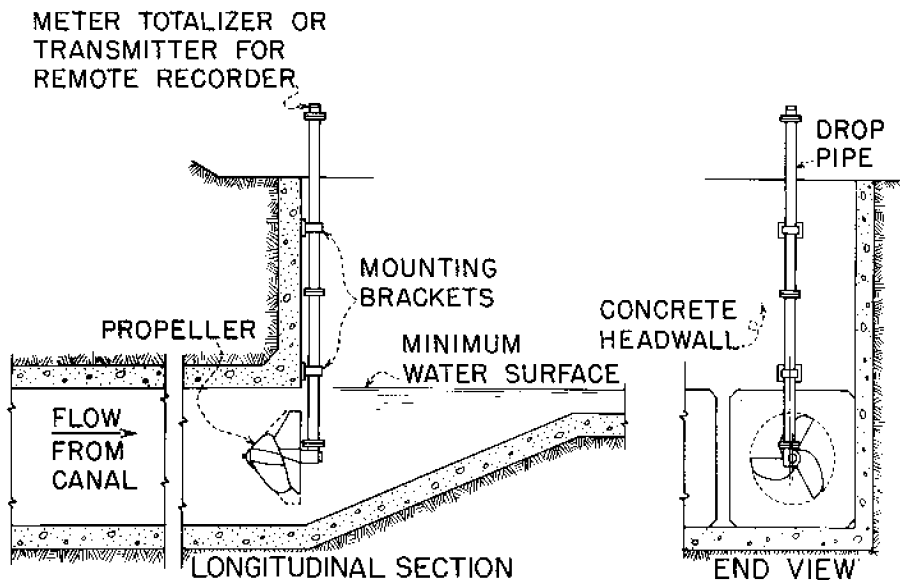

Figure 46.—Open-flow-type meter on farm turnout.

BN-16792

sizes, with installation instructions and calibrations. Two measurements are necessary to find the discharge—the amount of gate opening, found by measuring the length of rod coming through the handwheel; and the difference in elevation of upstream and

downstream water surfaces. When these measurements are known, tables or curves supplied by the manufacturer of the gate may be used to find the discharge.

**Commercial meters.**—Figure 46 shows a measuring device used on irrigation turnouts. It works by means of a propeller connected by a gear train to a dial that records the total volume of flow regardless of fluctuations in the stream. These meters can be used in closed-pipe systems, or they can be adapted for measurement in canals that use a structure such as shown in figure 46.

various designs, from the disk type often used for small-diameter lines to the propeller types used for larger lines. Some types are relatively easy to install in existing lines. All are subject to clogging if debris is carried in the flow.

### Miscellaneous devices and methods

**Coordinate method.**—A simple method, but not very accurate, is to measure the distance out and down from the pipe outlet to some point on the issuing jet where the pipe discharges freely. The amount of flow can be estimated from the pipe size and the measurements shown on figure 49 with the aid of available tables.

**End orifices.**—In many instances, a plate having an orifice hole of smaller diameter than the pipe can be attached to the discharge end of the pipe and used as a measuring device. Commercial pump suppliers will furnish information about this device. The basic equipment and design of the end orifice is shown in figure 50. If properly installed and used, this device gives a very accurate measure of discharge.

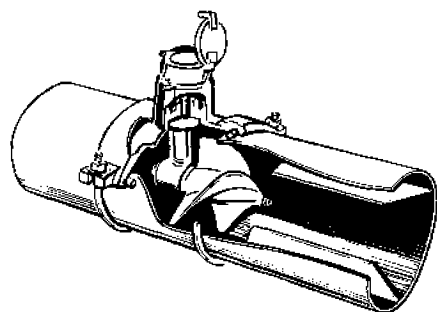

BN-12687-X

Figure 47.—Propeller-type meter for use in pipes.

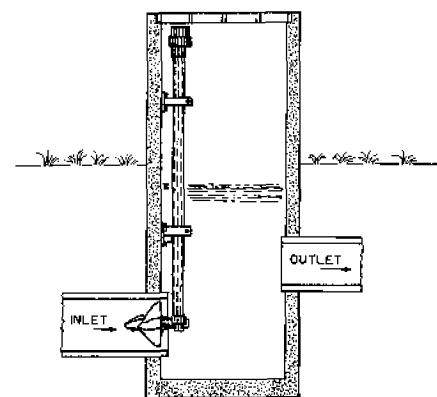

BN-18791

Figure 48.—An open-flow meter installed in an underground pipe system.

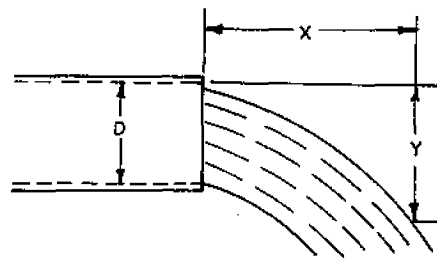

BN-18794

Figure 49.—Required measurements to obtain flow from horizontal pipes.

### Pipes

Measurement of flow in pipes is more complicated than that in open ditches. A common method is to measure the flow by one of the devices previously discussed, after the water is discharged into a ditch. The following devices and methods also give fairly accurate measurement for pipes.

### Commercial meters

Several types of meters, such as those shown in figures 47 and 48, register a direct measure of flow in pipes by means of a dial. These meters are of

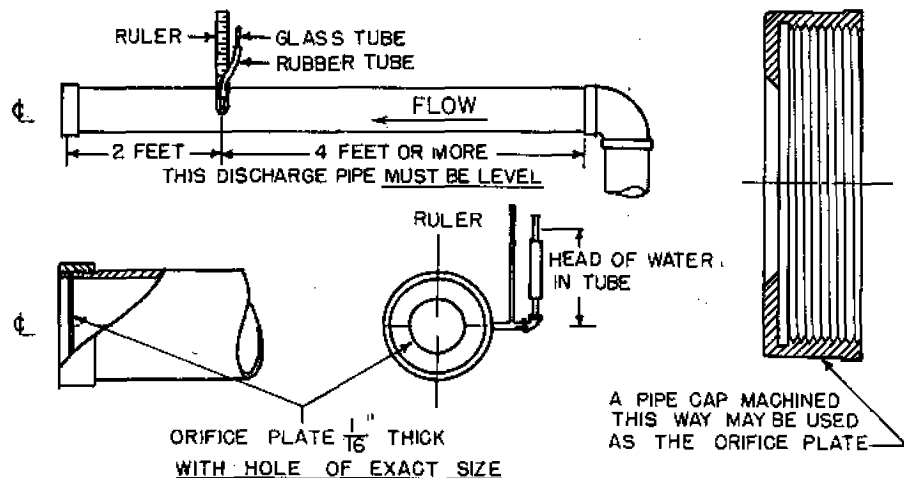

BN-18939

Figure 50.—Circular end orifice for discharge measurement for pipes.