

THE NATURE OF WHITE LIGHT.

by

Chester Long,
A. B., Univ. of Kansas, '22.

Submitted to the Department
of Physics and Astronomy and
the Faculty of the Graduate
School of the University of
Kansas in partial fulfillment
of the requirements for the
degree of Master of Arts.

Approved by:

Instructor in Charge.

A handwritten signature in cursive script, reading "F. E. Hester".

Head of Department.

November 1, 1923.

CONTENTS.

PART ONE: HISTORY OF THE DEVELOPMENT OF THE
DIFFERENT CONCEPTIONS OF WHITE LIGHT.

	page.
Introduction - - - - -	1
Undulatory Hypothesis - - - - -	1
Experiments of Newton — The undulatory hypothesis — Experiment of Fizeau and Foucault.	
Pulse Hypothesis - - - - -	2
Gouy's conception of white light — Gouy on the experiment of Fizeau and Foucault — Lord Rayleigh's conception — Type of impulse constituting white light — Rayleigh on experiment of Fizeau and Foucault — Poincare's criticism of Gouy's ideas — Gouy's and Schuster's reply to same.	
Hypothesis of Damped Vibrations - - - - -	7
Garbasso's suggestion — Theoretical test of the conception by Carvalho — Gouy's objection — Carvalho's reply — Suggested acoustical test experiment.	
Experiments on Light Beats - - - - -	10
Corbino's and Righi's experiments and Corbino's interpretation of results.	
Interference Phenomena on the Basis of the Pulse Hypothesis - - - - -	11
Schuster's treatment — His conception of White light in agreement with that of Gouy and Rayleigh — Action of Grating — Action of prism — Experiment of Fizeau and Foucault — Doubled white source — Difficulty of accounting for observed interference pattern due to doubled white source on basis of pulse hypothesis — Resonance effects in eye and photographic plate as possible explanation — Theoretical determination of interference pattern (from Lyod's mirror arrangement) when total radiation is considered.	

CONTENTS.

PART TWO: INTERFERENCE PATTERN GIVEN

BY A DOUBLED WHITE SOURCE . (experimental).

	page
Introduction - - - - -	21
Apparatus - - - - -	21
Details and construction of bolometer — Galvanometer — Fresnel mirrors — Slit — Source of white light to illuminate slit — Coblentz's curves for the radiation given by the type of source used — Micrometer eyepiece — Arrangement of apparatus — Working conditions — Precautions.	
Procedure - - - - -	27
Method employed in securing galvanometer deflections — Ex- perimental justification of method — Explanation of interference pattern with bolometer, employing (1) total radiation, (2) radia- tion passed by 1 cm. of water, (3) radiation passed by 1 cm. of cupric chloride, 2.5 per cent solution — Coblentz's curves for the transmission of water and cupric chloride solutions — Differ- ent slit widths — Repetition of runs — Examination of complete radiation furnished by the separate mirrors — Narrower fringes and the examinations of the new interference pattern — Determina- tion of effect of varying potential difference applied applied to lamp — Effect of varying slit width — Check on sensitivity of galvanometer.	
Data and Results - - - - -	30
Average sample of data taken — Curves showing results ob- tained — Discussion of curves — Comparison of experimental curve showing interference pattern given by doubled white source with theoretical curve derived by Schuster — Width of slit used.	
Conclusions - - - - -	44
Schuster's theoretical curve for interference pattern given by doubled white source verified in general character — Whence white light may be regarded as made up of sinusoidal disturbances— Results with cupric chloride and water absorbing screens show that resonance effects need not be assumed in order to account for in- terference pattern observed by eye and photographic plate — White light to be regarded as made up of sine wave trains of unknown ori- gin — These sine wave trains not arbitrary — Their duration (in- finite or finite) — Real origin at source or analytical existence— Little choice between hypotheses — Conclusion and possible means of testing hypotheses.	

CONTENTS.

	page.
Summary - - - - -	50
Bibliography - - - - -	53

PART ONE

HISTORY OF THE DEVELOPMENT OF THE DIFFERENT

CONCEPTIONS OF WHITE LIGHT.

INTRODUCTION.

The exact nature of white light has long been an open question. By "white light" as the term is employed here and elsewhere in this paper will be understood the total radiation from a "black body" at a certain very high temperature, due to temperature alone. It includes the visible, infra-red, and ultra-violet radiation. Until a comparatively recent date, only the visible portion of the radiation received much attention. It is well to keep this in mind when considering the earlier studies conducted in this field.

UNDULATORY HYPOTHESIS.

Before the time of Newton it was held that white light was in itself without color, the colors of the spectrum observable upon passage of the light through a prism, for example, being produced by the dispersive piece itself. Newton devised a number of experiments which apparently showed that the colors were not added by the dispersive piece, but were present in the original light. White light then came to be regarded as made up of various colored lights, or more properly, after the advent of the wave theory a little later, of luminous disturbances of various periodicities, the proportions being such that for the eye no one color predominated over another, the prism or grating merely serving to separate more or less completely these components of white light, but never so completely for lack of resolving power, as to leave gaps in the spectrum, the spectrum being in consequence continuous. That is, white light came

to be regarded as made up of simple periodic disturbances sinusoidal in character, differing by extremely small steps and having a real and independent origin at the source. This is the undulatory hypothesis.

It was assumed that in connection with interference phenomena and the like each sinusoidal wave train might be studied wholly independently of its neighbors, and the total effect in any given case would be given as the aggregate of the effects of the individual wave trains. It was further assumed that these periodic disturbances suffered frequent alterations in phase, since the light from two different sources could not be made to interfere. The question arose as to how long the phase of a given wave train remained sensibly unchanged. Fizeau and Foucault devised an experiment to test this. Placing the slit of a spectroscope of high resolving power in the interference pattern produced by the artificial doubling of a narrow white source, they observed a spectrum crossed by dark bands. By this means interference effects were observed by them with white light when the path difference was some 7000 wave lengths. This finding was taken to indicate that white light consists of regular wave trains which suffer no appreciable change of phase for at least 7000 complete periods.

PULSE HYPOTHESES.

¹Gouy was the first to question this conclusion, showing fairly conclusively that the experiment of Fizeau and Foucault shows nothing whatever as to the regularity of white light, the allowable path difference depending wholly on the resolving power of the spectroscope employed.

Gouy suggests that white light be regarded as a sequence of entirely
¹Journ. de Phys., 5, p. 354, 1886.

irregular impulses, a conception first employed by Young² in explaining the action of the grating, but receiving little attention thereafter. Each of these impulsive disturbances Gouy imagines resolved into sinusoidal components in accordance with Fourier's theorem.

The following is an extract from Gouy's treatment of the question. (The incident rays are considered parallel).

"Soit un plan fixe M normal a ces rayons, a l'entree du systeme optique donne. Soit

$$(2) \quad v = f(t)$$

la vitesse vibratoire sur le plan M. La fonction $f(t)$ definit le mouvement incident, et nous allons en deduire les effets du systeme optique donne.

Nous considererons le mouvement lumineux pendant un intervalle de temps $2T$, pris arbitrairement. Prenons pour origine du temps le commencement du cet intervalle. Pour toutes les valeurs de t comprises entre zero et $2T$, nous avons, par la formule de Fourier,

$$(3) \quad f(t) = Q + \frac{1}{T} \sum_{n=1}^{\infty} (A_n \sin n\pi t/T + B_n \cos n\pi t/T).$$

en posant

$$(4) \quad \begin{aligned} Q &= 1/2T \int_0^{2T} f(t) dt. \\ A_n &= \int_0^{2T} f(t) \sin n\pi t/T dt. \\ B_n &= \int_0^{2T} f(t) \cos n\pi t/T dt. \end{aligned}$$

Q will be negligible if T is large.

"En posant

$$\theta_n = 2T/n,$$

le second membre de (3) s'ecrit

$$(5) \quad F(t) = 1/T \sum_{n=1}^{\infty} (A_n \sin 2\pi t/\theta_n + B_n \cos 2\pi t/\theta_n).$$

Ainsi le mouvement $F(t)$ peut être regardé comme formé par la superposition de mouvements simples, dont l'équation générale est

$$(6) V_n = 1/T (A_n \sin 2\pi t/\theta_n + B_n \cos 2\pi t/\theta_n).$$

Ces mouvements sont d'une durée indéfinie et d'une régularité absolue, il nous pouvons leur appliquer immédiatement les formules de la théorie ondulatoire."

If the illumination is constant Gouy writes for the average luminous intensity at any point P

$$I = 1/2T \int_0^{2T} v'^2 dt \\ = 1/2T^3 \int_0^{2T} \left(\sum_1^{\infty} \left\{ Q(\theta_n) [A_n \sin 2\pi(t/\theta_n + X_n) + B_n \cos 2\pi(t/\theta_n + X_n)] \right\} \right)^2 dt,$$

(θ_n) and X_n being constant calculated from the period θ_n of the simple movement.

Gouy's conception of white light may be termed the pulse hypothesis. According to it no sinusoidal disturbances are sent out by the source, but only impulsive disturbances or pulses, the character (note, however, the modification made by Rayleigh in his treatment of the question) and sequence of which are arbitrary, but each having its own proper effect independent of the others. Each of these pulses has the same form, moreover, as if it were the resultant of a number---the number infinite in general---of sinusoidal disturbances. The spectroscopist, being unable to detect the difference, will treat these sinusoidal components precisely as though they had an origin at the source, and hence will give a spectrum, bright line or continuous, depending on the difference in periodicity of neighboring components and the resolving power of the instrument. The total effect in any given case will be given as the aggregate effect of the individual sine wave trains which the individual pulses yield upon the analysis of Fourier. This exposition is not quite

rigorous, but it will serve to give a fairly correct notion of the pulse hypothesis.

Lord Rayleigh³ agrees with Gouy in conceiving white light as made up of impulsive disturbances, and even goes so far as to say that the conception of regular white light is nonsensical, but points out that the impulses themselves cannot be arbitrary in character, otherwise there would be no room for distinguishing the radiations of different temperatures. Rayleigh seeks to find a definite type of impulse such that an arbitrary aggregation of them will represent complete radiation, it being required merely that these impulses be similar and not necessarily equal.

He selects the impulse $Q(X)$ met with in the theory of errors, viz.,

$$Q(X) = \frac{1}{\sigma\sqrt{2\pi}} e^{-\frac{1}{2}\left(\frac{X}{\sigma}\right)^2}.$$

Taking as limits for X $-\infty$ and $+\infty$ (differing in this respect from Gouy, who treats the impulsive disturbance as ultimately periodic), Rayleigh then resolves this disturbance into a sine and cosine series in accordance with Fourier's theorem, a single pulse giving

$$\int_{-\infty}^{+\infty} e^{-2c^2x^2} dx = \frac{1}{c^2} \int_0^{\infty} e^{-u^2/2c^2} du.$$

The intensity corresponding to the limits u and $u+du$ is then

$$c^{-2} e^{-u^2/2c^2} du,$$

and this, u and n being proportional, is of the form

$$Ae^{-a^2n^2} dn,$$

Weber's law for the distribution of energy in the spectrum. In the aggregate disturbance the average energy over a relatively long period of time, which is what we actually observe, will still be distributed in accord-

³Phil. Mag. 27, P. 460, 1889.

ance with this law.

That is, an arbitrary aggregation of these impulses of arbitrary sign will, according to Rayleigh's reasoning, represent complete radiation in accordance with Weber's law. Some other type of impulse might be determined such as to satisfy some other law for the distribution of energy in the spectrum.

Rayleigh is also in accord with Gouy as regards the experiment of Fizeau and Foucault, holding that the number of bands observable is limited solely by the resolving power of the spectroscope, nothing at all being proved as to the regularity or otherwise of the vibrations of the original light.

Poincaré⁴ criticizes Gouy's conception of white light both from an experimental and mathematical standpoint. Since the sinusoidal components representing the impulsive disturbance on the basis of Fourier's analysis ^{extend} to infinity in both directions, being of invariable amplitude and periodicity, they ought to appear in the spectrum furnished by the spectroscope not only after extinguishing the light at the slit of the instrument but even before it has been lighted, a manifest absurdity. Poincaré held further that the experiment of Fizeau and Foucault indicated a high degree of regularity in the disturbances constituting white light.

Gouy⁵ replied to these objections, to the latter by repeating his former arguments, to the former by pointing out that the resolving of the spectroscope not being infinite, the actual luminous intensity at any

⁴Compt. Rendus, 120, p.757, 1895.

⁵Compt. Rend., 120, p. 915, 1895.

given point will be the resultant of a number of sinusoidal disturbances, differing but little in periodicity, and while each sinusoidal disturbance will be of infinite duration, nevertheless, they may combine so that their resultant will have the desired zero value when no light enters the slit of the spectroscope.

Schuster⁶ also replies to Poincare, referring to a previous paper on interference phenomena⁷ by himself, in which he develops the ideas of Gouy, offering a theoretical and mathematical treatment of various types of interference. It will be more convenient to postpone until a little later a detailed treatment of this paper on interference phenomena.

HYPOTHESIS OF DAMPED VIBRATIONS.

Another conception of white light was offered by Garbasso⁸, who regarded it as made up of heavily damped vibrations of the form

$$f(t) = e^{-kt} \sin ht.$$

In solids and liquids, which alone radiate white light, the vibrations of the emitting electrons might easily be heavily damped in this manner. This is the hypothesis of damped vibrations.

Carvallo⁹ tested this conception from a theoretical viewpoint by expanding the expression representing the damped vibration in accord-

⁶Compt. Rend., 120, p.987, 1895.

⁷Phil. Mag., June, 1894.

⁸Arch de Geneve, Vol.4, p.105, 1897.

⁹Compt. Rend. 130, p.79, 1900.

ance with Fourier's theorem. Putting

$$f(t) = e^{-kt} \sin ht \quad (\text{for } t > 0, \text{ but } f(t) = 0, \text{ for } t < 0).$$

and developing by Fourier's theorem,

$$f(t) = 1/\pi \int_0^{\infty} h dq / \sqrt{(q^2 - h^2 - k^2)^2 + 4k^2q^2} \cos [qt - \arctan 2kq / (q^2 - h^2 - k^2)].$$

The intensity of vibration of period $2\pi/q$ is, putting $k^2 = a^2 h^2$

$$\text{and } q^2 = (1+a^2)h^2u^2,$$

$$Y = 1/(1+a^2) (u-1/u)^2 / 4a^2.$$

Carvallo then constructed a curve of intensities plotted against $\log \lambda$. The curve did not agree well with the experimental curves obtained by Mouton and Langley, which was taken by Carvallo as proving the theory of damped vibrations non-permissible. Carvallo was also of opinion that a grating would yield a band of white light instead of a spectrum, if the incident light consisted solely of damped vibrations, the damped vibrations being treated by the grating ^{precisely} as is the undamped sine wave.

Gouy¹⁰ takes objection to Carvallo's treatment in that the limits employed were $-\infty$ and $+\infty$, which gives an indefinite function, a condition not realizable in practise. Gouy proposes to limit the disturbances to a small number N , as would be the case if the vibration were heavily damped, and concludes that the disturbance at a given point will have the periodicity calculated from the ordinary laws of the grating, rather than as claimed by Carvallo the periodicity of the original vibration.

¹⁰Comp. Rend., 130, p. 241.

Carvallo¹¹ replies that he employed as limits 0 and ∞ , not $-\infty$ to ∞ , and had, therefore, a definite function (that this is the case will appear at once on reference to his treatment). For the rest, he repeats his former arguments, and proposes an acoustical experiment to test the question. For the source of light a large electrically driven tuning fork is to be substituted. The waves from this are to be received by a large concave grating constructed of slats with open spaces between them. So long as the vibrations continue there will be at the focus of the grating points of maximum of sound of the same pitch as the fork with spaces of silence between them. If the exciting current now be turned off, the vibration of the fork will be damped (and this damping can be regulated). If now Carvallo's view be the correct one, conditions should remain precisely as before, points of maximum intensity with silent spaces between, or at most in the former silent places a faint sound of the same pitch as the fork. On the other hand, if Gouy's opinion is correct, there should now exist a sound spectrum at the focus of the grating. So far as the author is aware this experiment has never been performed.

¹¹Comp. Rend., 130, p. 401.

EXPERIMENTS ON LIGHT BEATS.

Corbino¹² has advanced the opinion that the phenomenon of light beats obtained by any of the methods due either to Righi¹⁵ or himself is opposed to the pulse hypothesis. If the light from a narrow white source be divided into two streams and these allowed to fall upon the slit of a spectroscope, the spectrum is crossed by dark bands (experiment of Fizeau and Foucault). Suppose now the periodicity of one of these streams be altered (actually both were altered by equal amounts and in opposite directions), as by Righi's resolving Nicol method. According to Corbino, on the basis of Gouy's hypothesis, each sinusoidal wave train in the altered pencil will take the place of its neighbor so to speak, interfering with the train from the unaltered pencil with which its neighbor formally interfered and the fringes will remain unchanged. On the other hand, suppose in accordance with the undulatory hypothesis that the sinusoidal disturbances have an independent origin at the source, then a given wave train in ^{the} altered pencil will be capable of interfering only with that wave train in the unaltered pencil which had the same wave length previous to the alteration, and beats will result, giving rise to moving fringes, which is the phenomenon actually observed.

Now on the basis of the pulse hypothesis the sinusoidal disturbances into which a prism or grating resolves the pulses constituting white light,

¹² Compt. Rend., 133, p.412, 1901.

¹⁵ Journ. de Phys., 2, p.437, 1883.

since they have a common origin, ought to be capable of interfering with each other producing beats, that is, beats should be produced upon uniting two streams of light from adjacent points of the spectrum. Corbino maintains that the experiment with light beats shows that beats are not obtained by uniting the light from two adjacent points of the spectrum, and hence the pulse hypothesis is rendered untenable.

INTERFERENCE PHENOMENA ON THE BASIS OF THE PULSE HYPOTHESIS.

Schuster in his account of interference phenomena⁷ agrees with Gouy and Rayleigh in conceiving white light to be made up of a series of pulses.

1. GRATING.— He accounts for the action of the grating in the following manner.

"In fig. 1 let L_1 and L_2 be two lenses, H_1 H_2 and K_1 K_2 two screens in their focal plane having small apertures at the foci G and F . If ACB is a grating, a disturbance passing through G will produce a certain effect at F . In general the optical lengths of rays such as GBF , GCF , GAF , will not be the same,

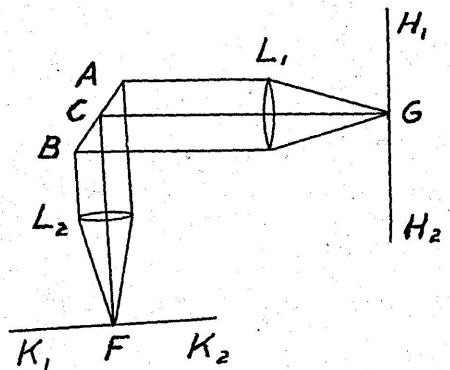

FIG. 1

⁷Phil. Mag., June, 1894.

consequently an instantaneous impulse at G will not remain an instantaneous impulse at F, but the light reflected from each line of the grating will reach F at certain intervals of time, and a disturbance will be set up at F, which will last during a finite time. -----" The fact that in a dispersive system an instantaneous impulse entering the system is changed into a disturbance lasting through a finite time is of fundamental importance. It is easily seen that this is brought about in the case of a grating, but the fact is equally true if the dispersion is due to refraction, as will be pointed out further on."

A familiar analogy to this action of the grating is the case of a sharp sound falling on a flight of stairs or picket fence producing a sound of definite pitch, the pitch varying with the position of the observer.

2.PRISM.— The following is taken from Schuster's treatment of the prism.

"In the case of a grating it is easy to see how a solitary impulse is spread out into a disturbance lasting a finite time—it is not so clear that the same holds for a prism. The easiest way to assure ourselves that a prism acts in the same way as a grating, is to cease to consider only homogeneous waves and to follow through the prism a group of waves involving, as it always does, oscillations of different periods.

"Let us imagine a train of waves made up of a finite number of oscillations, each following the law of a simple pendulum. The analytical representation of such a group will introduce wave-lengths which do not differ much. The front or rear of such a train of waves may be taken to pass through a medium like glass with a definite velocity, which is

the group velocity corresponding to the given range of wavelengths. In fig. 4 (fig. 2 of this paper) let AB be the direction of the front of the incident wave, DC that of the emergent wave, then as the group velocity in the prism is smaller than the wave velocity, the front of the group will after emergence be parallel to some

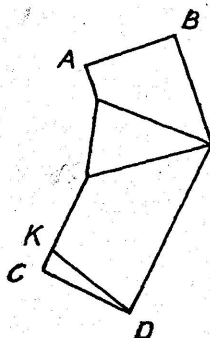

FIG. 2

such direction as DK. If the light is concentrated by means of a lens, the position of the focus is determined by the condition of agreement of phase: that is to say, the optical length from all points CD to the focus must be the same, but in that case the optical length from the different points of KD will not be the same,--- in other words, the front of the wave will take some time to pass through the focus, just as it would if the spectrum were produced by a grating. The same holds for the rear of the group and for any disturbance, account being taken of the different group velocities for different regions of the spectrum."

Schuster in his last paper on the subject¹⁴ considers a dispersive medium, the dispersion of which is represented by the formula

$$V = a + b \lambda .$$

¹⁴Boltzmann's Festschrift, p. 569, 1904.

$dV/d\lambda$ is a constant, and the group velocity is independent of the wavelength. The group may have the form shown in fig.3, the mathematical expression for which is

$$V = h^2/h^2 + x^2,$$

and its successive appearances as it advances through a medium of dispersion $V = a + b\lambda$ are as shown.

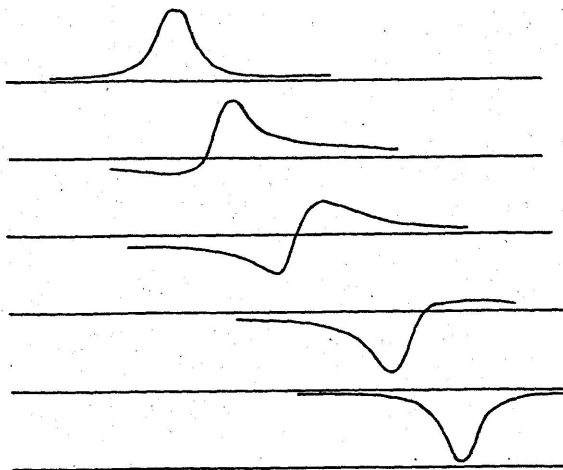

FIG. 3.

In point of fact no known medium possesses the dispersion formula assumed but the problem is simplified by this assumption.

Obviously, if a prism be constructed of this hypothetical medium, the pulse will leave the second surface with an impressed periodicity, that is, at certain points it will emerge in its original form and in other places in its inverted form. From the point of view under con-

sideration, this inversion of the group form previous to its reestablishment is of fundamental importance in considering the action of dispersive media upon white light.

3. EXPERIMENT OF FIZEAN AND FOUCAULT. Schuster in his paper on interference phenomena agrees with Gouy and Rayleigh in holding that the experiment of Fizean and Foucault proves nothing as to the regularity of white light in case the resolving power of the spectroscope is steadily increased, but thought a difference might appear if it be steadily decreased. On calculation, however, he finds the result to be the same whether white light is taken to be regular or irregular in character.

4. DOUBLED WHITE SOURCE. There still remained, however, a phenomenon that offered difficulties for explanation on the basis of the pulse hypothesis, namely, the interference pattern obtained upon the simple, artificial doubling of a narrow white source, as by two slits, Lyod's mirror arrangement, Fresnel bi-prism, or Fresnel mirrors. To the eye this interference pattern appears as a central bright band bordered on either side by colored fringes separated by narrow regions of comparative darkness. This interference pattern can also be photographed. How are these appearances to be accounted for on the basis of the pulse hypothesis, remembering that according to this way of looking at the matter, the disturbance passing a given point in the plane of the fringes will consist essentially of two pulses separated by an interval depending on the position selected? That this is the case, will at once be clear, if we let S_1 and S_2 , fig.4, be sources produced by the arti-

ficial doubling of S , say by means of Fresnel mirrors. The light from the source S falling on the two mirrors inclined at a small angle will give rise to the two virtual sources S_1 and S_2 . In the shaded region the streams of light, which may be looked on as coming from S_1 and S_2 overlap, and interference effects will be observed. In particular, a pulse originat-

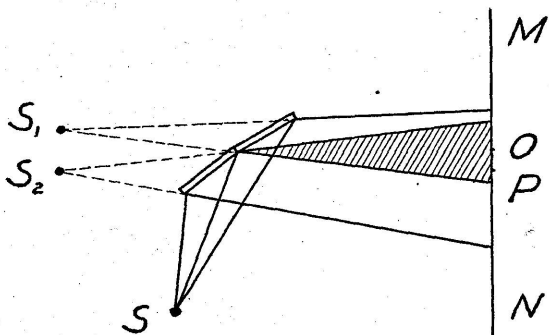

FIG. 4.

ing at S and falling on the mirrors will be doubled, and the effect (neglecting diffraction effects) will be that of identical pulses starting from S_1 and S_2 at the same instant. The pulses will arrive at the same instant at a point O in the plane MNO , $S_1 O$ being equal to $S_2 O$. At some other point P in the plane MNO the pulses will succeed each other separated by an interval depending on the position of P .

How on this basis are we to account for the interference pattern that is recorded by the eye and the photographic plate? Schuster proposes that in each case the phenomenon be regarded as a resonance effect. That the eye and the photographic plate favor some wave lengths above others, that is, show selective absorption, is a proof argues Schuster, that their absorbing elements resonate to the favored periodicities. Such being the case, it is easy to see how if a pulse starts an effect in a resonator, say a simple vibration, the period of which of course depends solely on the resonator, the effect continuing over a number of periods; a second pulse arriving at the resonator with-

in the limits of the effects of the first, may be so timed as to annul these effects, double them (amplitude is thought of here), increase, decrease, or leave them unchanged. Thus two pulses separated by an interval corresponding to a whole number of wave-lengths of red light will upon entering the eye give rise to the sensation of red by virtue of constructive interference in the resonating elements of the eye, and at the same time due to destructive interference suppress all other color sensations more or less completely. The action is the same in the case of the photographic plate, except that here there is no sensation. The interference effects observed upon the doubling of a white source may thus seemingly be accounted for on the basis of the pulse hypothesis, and are due according to this way of looking at the matter not at all to any regularity in the original white light, but depend solely on the resonance effects shown by the elements of the eye and photographic plate, the eye and the plate thus in a manner producing the interference pattern they record.

Suppose, now, we explore the region of this interference pattern with an instrument unbiased by resonance. A blackened bolometer strip fulfills this condition, at least approximately; if it shows any resonance effects at all, it at least resonates to all periodicities about equally well. What should we now find? Schuster gives an extended theoretical treatment of this question.

He assumes the vibratory velocity at any point due to each source separately to be given as functions of the time $F(t)$ and $Q(t)$. Then the excess of the kinetic energy due to the combination over the sum of the separate energies is proportional to

$$[f(t) + \mathcal{Q}(t)]^2 - [f(t)]^2 - 2f(t)\mathcal{Q}(t).$$

The value of

$$2 \int_{-\infty}^{+\infty} f(t) \mathcal{Q}(t) dt$$

may be taken as a measure of the interference.

If the functions f and \mathcal{Q} are equal, as is the case in simple doubling of the source, Schuster through the analysis of each train of waves by Fourier's theorem writes for the excess of energy E

$$\pi/2 E = \int_0^{\infty} (A^2 + B^2) \cos 2kt dk,$$

where $(A^2 + B^2)dk$ is proportional to that part of the energy which lies within the range dk . Accordingly, Schuster maintains that the amount of interference depends on the distribution of energy only, and not on any assumption respecting the regularity or irregularity of white light.

Schuster makes a special application of his result, employing the law for the distribution of energy in the spectrum suggested by Michelson, and writes for the energy $S dk$, where

$$S = Ck^4 e^{-a^2 k^2}.$$

The excess of energy is obtained proportional to

$$\int_0^{\infty} k^4 e^{-a^2 k^2} \cos 2ktdk = \sqrt{\pi}/8a^2 e^{-t^2/a^2} (4t^4 + 3a^4 - 12a^2 t^2).$$

The excess of energy $(E - 2E_0)$ due to the double source is then given

by

$$E - 2E_0 = 2/3E_0 e^{-z^2} (4z^4 + 3 - 12z^2),$$

where $z = t/a$. The retardation t may be expressed in terms of the distances of the two sources from each other and from the screen.

Schuster then constructs the curves shown in fig. 5. The line A gives the assumed illumination of the screen due to one source only. The source being doubled the line B gives the resulting illumination,

assuming no interference. The curve C gives the illumination calculated on the basis of Michelson's law of distribution of energy. The difference between the ordinates of curves B and C may be regarded as a measure of the amount of interference. The curve D shows the assumed distribution of energy in the grating spectrum, the abscissae being wave-lengths, the particular values of which are placed at that point of the screen at which the corresponding homogeneous radiation would have its first principal maximum. Curves C and D are given analytically by

$$Y = 2 + \frac{2}{3} e^{-z^2} (4z^4 + 3 - 12z^2), \quad (C)$$

$$Y = \frac{1}{z^6} e^{-\pi^2/z^2}, \quad (D)$$

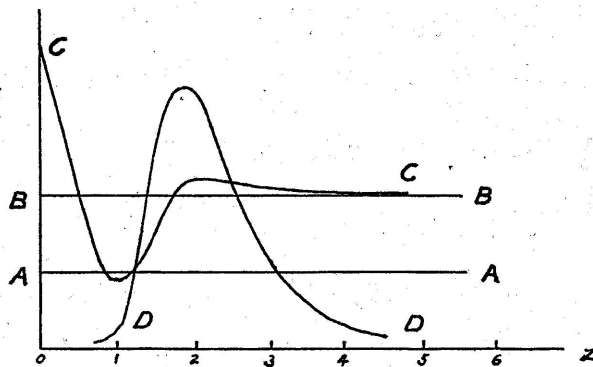

FIG. 5.

Assuming the illumination due to one source only to be E_0 , the illumination represented by the curve C exhibits these special features.

- (1) For $z = 0$ the illumination is a maximum and equals $4 E_0$.
- (2) For $z = 0.959$ the illumination is a minimum, being equal to $0.78 E_0$.
- (3) Another maximum of illumination not very pronounced, its value

being $2.24 E_0$, occurs when $z = 2.02$.

(4) The illumination decreases and gradually approaches the value $2E_0$.

Our alternate bright and dark bands disappear when the total radiation is considered. "There would be no interference at all," remarks Schuster, "in the sense the word is used here, if we could have a source of light giving out all radiations with equal intensities. The fact that white light shows any objective interference at all, without the artificial introduction of regularity, is due to the prevalence of certain wave-lengths over others. Whatever regularity there is in the light is intimately connected with the distribution of intensity in the spectrum."

Schuster's final conclusion is then that we ought to accept without reservation the ideas of Gouy and Rayleigh, that is, the pulse hypothesis of white light.

PART TWO

INTERFERENCE PATTERN GIVEN BY

A DOUBLED WHITE SOURCE.

(experimental).

INTRODUCTION.

It was thought it might be worth while to investigate experimentally by means of a blackened bolometer strip the problem of the artificially doubled white source treated theoretically by Schuster, as (1) Schuster's conclusions might either be confirmed or shown to be in error, (2) by employing absorbing screens to obtain a comparison between the behavior of the bolometer and the eye, and (3) the results obtained might especially favor some one hypothesis of white light.

APPARATUS.

The bolometer used in the exploration of the interference pattern is shown diagrammatically in fig. 6. It was constructed as follows: A piece of hard rubber ^c was turned down as shown to fit one end of a micrometer eye-piece. Through holes bored lengthwise of the piece were inserted heavy copper lead-in wires *b*, No. 18, arranged as pictured. A second piece of hard rubber *f* fitted with binding posts, to which were secured the lead-in wires, was screwed firmly onto the back of the first. The silver having been removed from a length of Wollaston wire by means of a dilute solution of nitric acid, the fine platinum wires γ and γ' , diameter .003 mm., were soldered onto the projecting ends of the copper lead-in wires, care being taken that the opposing wires were as nearly equal in length, each

each about 1.5 cms., and alike in other respects as possible, and that they were straight. Each wire had a resistance of about 240 ohms. After protecting the other parts with shellac, the platinum wires were coated electrolytically with platinum black, using a dilute solution of platonic chloride. The process was continued until both wires appeared a dull black. The whole was now inserted in the micrometer eye-piece, and to minimize the effects of air currents a thin microscope specimen glass c, 0.15 mms. thick, well cleaned, was sealed over the end. By this means the platinum wires were enclosed in a dead air space, as the eye-piece lens closed the other end of the tube (see fig. 8). Two thicknesses of heavy black paper q were mounted so as to shield one of the wires from direct radiation.

The platinum wires were made the two arms of a balanced Wheatstone bridge as shown in fig. 7. A moving needle type galvanometer, well armored to minimize magnetic disturbances, fitted with high resistance coils wired in parallel, was employed. It had a period, as used, of 13.7 sec. Fresh dry cells were used to furnish the bridge current, which was maintained at about 12.0 milliamperes.

Fresnel mirrors were employed to furnish the interference pattern. This choice was made because by this means dispersion is eliminated, diffraction minimized, and a symmetrical pattern on the two sides of the central bright band secured. The mirrors, 3.3 cms. on the edge, were blackened and were adjustable for pitch, parallelism, etc. They were mounted on an adjustable optical bench standard and illuminated by a vertical slit S, height 3.2 cms., adjustable for width by a horizontal screw fitted with

Fig. 6.

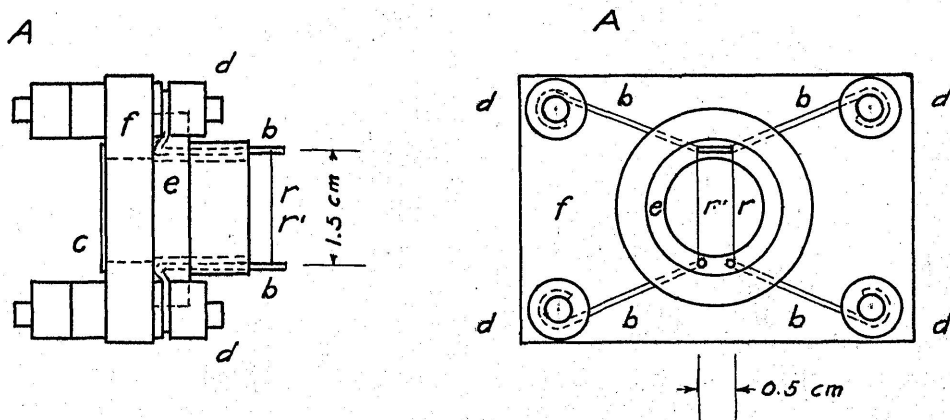

- A. The entire piece (bolometer).
 r, r'. Blackened platinum wires soldered to b.
 b. Copper lead-in wires.
 c. Thin microscope specimen glass sealed to f.
 d. Binding posts.
 e and f. Hard rubber pieces.

Fig. 7.

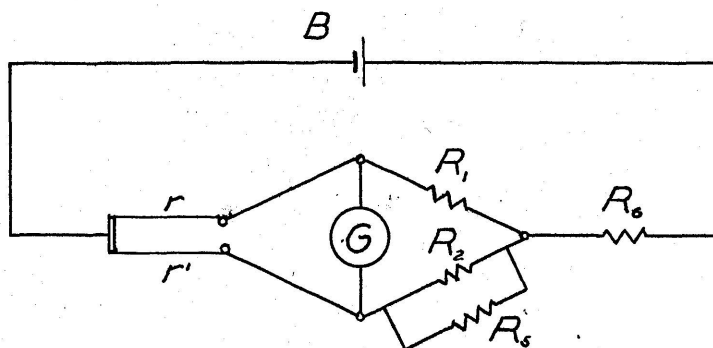

$$R_1 = 240; R_2 = 242; R_3 = 8540; R_4 = 470 \text{ ohms.}$$

Fig. 8.

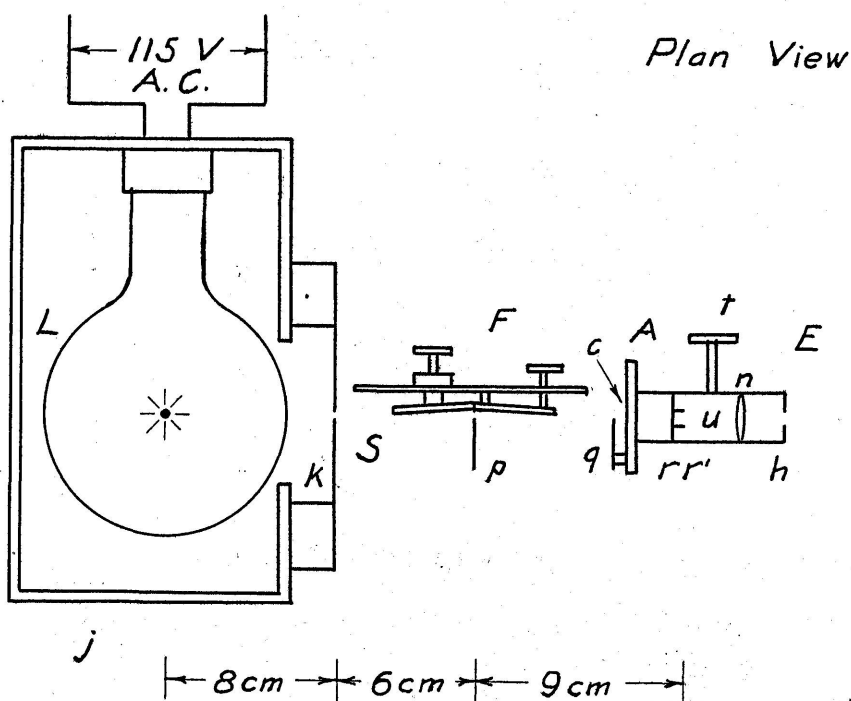

- L. 200 watt, gas filled, tungsten lamp, filament vertical.
- j. Light tight box.
- k. Space for 1 cm. absorption cell.
- S. Vertical slit.
- F. Fresnel mirrors.
- p. Metal shield.
- E. Micrometer eye-piece.
- A, c, r, r', as in Fig. 6., r and r' vertical.
- h. Brass tube.
- n. Eye lens.
- u. Dead air space.
- q. Heavy black paper shield.
- t. Scale and drum.

a drum for reading. See fig. 8 for the set-up of the apparatus. The source of white light employed to illuminate the slit was a 200 watt, 115 volt, tungsten, gas filled, helical filament, incandescent lamp, operating on 60 cycle alternating current. This was mounted with its filament vertical just back of the slit, in a light tight box j, the slit being attached to the face of the box with just enough space between it and the lamp for the insertion of a glass absorption cell 1cm. in thickness, having glass walls 2 mms. in thickness. The tungsten gas filled lamp does not give quite black body radiation, there being a slight deficiency in the infra-red radiation. The difference is not enough to concern us much, however, as the general character of the energy distribution curve is unchanged. The curves shown in fig. 9, which are due to Coblenz¹⁵, show the energy distribution, O from the outside of the helical tungsten filament, I from the inside, and B from a black body at such a temperature that the maxima of B and I coincide. The complete radiation from the filament would be represented by a curve lying somewhere between curves O and I and intermediate in form.

The Fresnel mirrors were moved as near the slit as possible, in order to obtain good illumination, and adjusted to give sharp interference bands. The micrometer eye-piece E, carrying the bolometer wires and arranged to travel horizontally across the vertical interference bands, positions being noted by scale and drum, was moved into the region of the interference pattern and as near the mirrors as possible, in order to obtain greater sensibility. See fig. 8 for approximate distances.. To cut down air cur-

¹⁵Bureau of Standards, Bull.14,p.115-131, 1917.

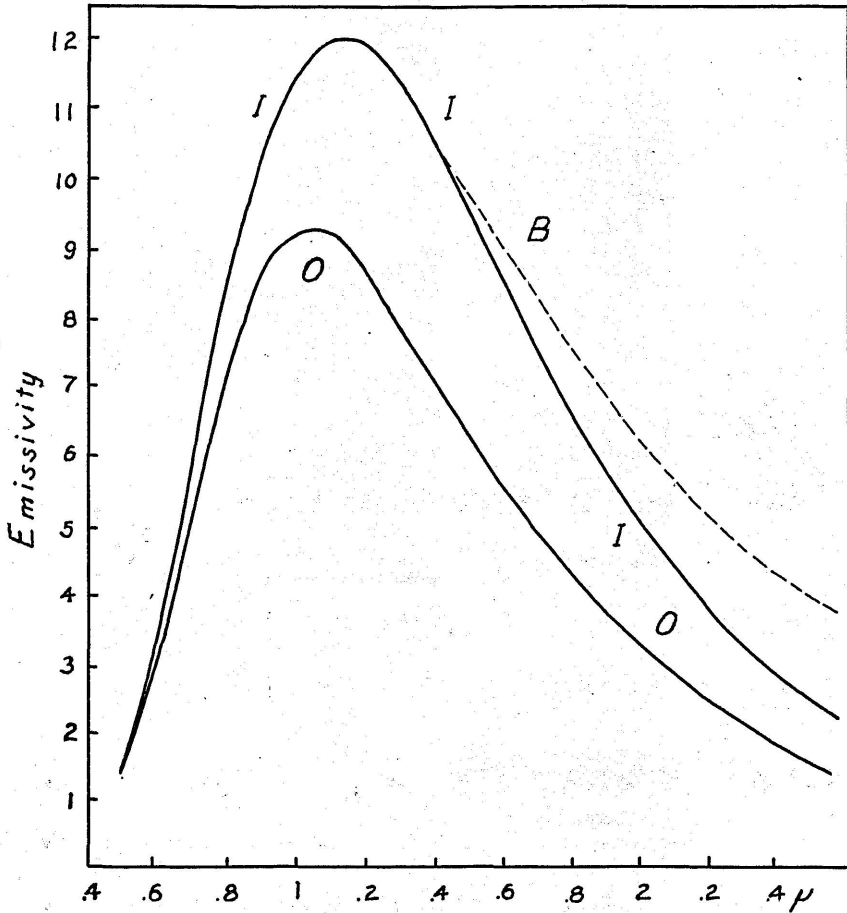

Fig. 9.

Distribution of Energy Radiated from a Helical
Filament of Tungsten, Gas Filled Lamp. (Coblentz).

- I. Radiation from the inside of the turn, $\lambda_m = 1.115 \mu$.
- O. Radiation from the outside of the turn, $\lambda_m = 1.06 \mu$.
- B. Radiation from a black body at the temperature
($T = 2600^\circ\text{A}$), which gives the same $\lambda_m (= 1.115)$,
as observed for I.

Curve 1 gives the transmission of a 10 per cent solution (2 gr. $\text{CuCl}_2 + 18 \text{ cc H}_2\text{O} + 2$ drops of cupric chloride. Curve 2 gives the transmission of a 10 per cent solution containing 0.5 cc of 20 per cent HCl. Curve 3 gives the transmission of a 5 per cent solution; curve 4 a 2.5 per cent solution and curve 5 a 1 per cent solution.

Glass absorption cell 2.1 cms. in thickness, the glass walls being 2 mms. in thickness.

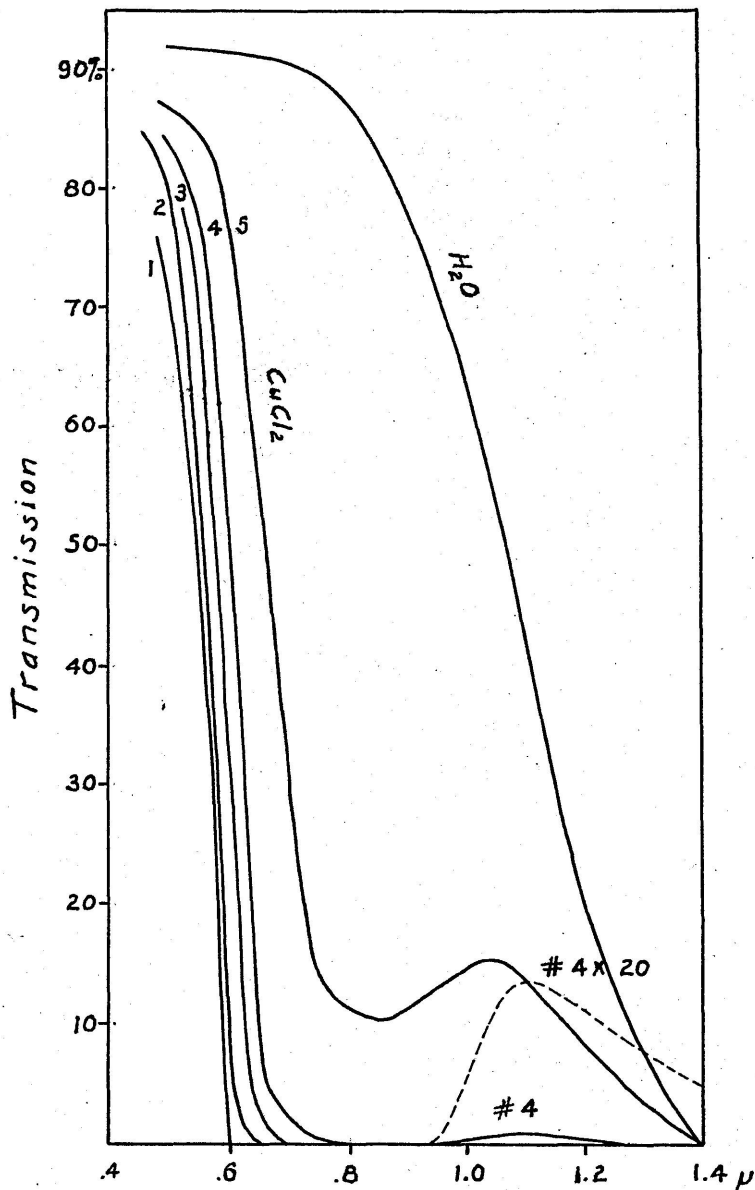

Fig. 10.

Absorption Characteristics of Solutions of Cupric Chloride, $\text{CuCl}_2 + 2\text{H}_2\text{O}$ and of Water, H_2O (Coblentz).

rents and eliminate stray light, the eye-piece and mirrors were surrounded with several thicknesses of black cloth. The room was darkened, closed against outside disturbances, and remained at a nearly uniform temperature throughout the experiment (being situated in the basement). When all was in good working order the galvanometer showed less than 0.5 mm. oscillation on a scale 6.9 meters distant. It exhibited a very slow drift, which, however, gave no trouble. The bridge was rebalanced from time to time. Also from time to time the zero position of the galvanometer was readjusted by altering the control magnets.

PROCEDURE.

The whole of the interference pattern was carefully explored, the bolometer wire being moved across the field and readings taken at suitable intervals. The following method was employed. With the galvanometer at rest its position was noted, the circuit through the illuminating lamp L made, the potential difference at the terminals of the lamp read, the ~~terminals of the lamp read,~~ the end of the galvanometer swing recorded and at the same instant the circuit broken, and the end value of the galvanometer swing in the opposite direction observed. The difference between the second and third galvanometer readings was set down as the galvanometer deflection. By this method larger deflections were secured, and the effects of unsteadiness and drift of the galvanometer minimized. That the deflections so secured are proportional to their corresponding steady deflections

in the case of the bolometer as employed was proved by placing the bolometer wire in the central bright band and varying the slit width, noting the usual deflections and the corresponding steady deflections. The same proportionality and also proportionality to change in resistance in the bridge arm was proved for abrupt variation of the resistance in the shunt (see fig 7) R_5 in such a manner as to secure deflections in the same sense as before, the steady deflection and the value of the resistance variation being noted in addition to the usual readings. Fig. 15 shows the straight line relationships observed, curve 19 giving for the bolometer steady deflections of the galvanometer against deflections as observed, and curve 20 the same when the resistance of the shunt is varied. It will be noted that the galvanometer is operating in conjunction with the bolometer almost, but not quite ballistically, assuming ballistic action in the case of abrupt variation of the resistance in the shunt R_5 , which is fair enough. In view, however, of the straight line relationship and the very slight departure from true ballistic action, this discrepancy need not concern us much.

The interference pattern was examined with the bolometer (1) when formed by the total radiation from the lamp serving as "black body", (2) when formed by the radiation that passed 1 cm. of distilled water (the glass absorption cell being placed between the slit and the lamp as noted), and (3) when formed by the radiation that passed a 2.5 per cent solution of cupric chloride 1 cm. in thickness. The thickness of water used cuts off all radiation beyond 1.4μ and absorbs strongly the neighboring shorter wavelengths. The radiation passed by the cupric chloride solution corresponds very closely to that to which the eye is sensitive, as this solution cuts off rather sharply in the neighborhood of 0.65μ , passing only the visible and some of the ultra-violet, which latter would be largely absorbed by the glass of

the container. The curves given in fig. 10, which are due to Coblentz¹⁶, show the absorption character^{istics} of pure water and of cupric chloride solutions of varying concentrations. The procedure outlined was repeated so far as possible for three different widths of slit. Several runs were repeated as a check. In every case the curves obtained by repetition agreed very closely in general character with the original curves, although the absolute values sometimes differed slightly. In order to avoid so far as possible any confusion, these curves are not shown on the curve sheets.

Curves were obtained for the complete radiation (no absorbing screens) furnished by each mirror separately in the region of the interference pattern for one width of slit (intermediate width). This was accomplished by moving the first mirror (the one next the slit) parallel to itself until the light from it fell entirely without the field. The illumination furnished by the second mirror was then examined with the bolometer, the first mirror moved back to its former position (as noted by scale and drum), the second mirror swung back out of line, so that light from it was without the field, and the illumination given by the first mirror examined.

This examination showed it to be necessary, in order to obtain the full interference effect, to cross the separate illuminations given by the individual mirrors somewhat more, that is, to increase the angle between the mirrors, which also narrows the fringes. This was accord-

16. Bureau of Standards, Bul. 7, pp. 619-63, 1911.

ingly done, and the previous procedure repeated for one width of slit (intermediate width).

The effect of varying the potential difference applied to the lamp was examined for each of the three conditions of illumination by setting the bolometer wire in the middle of the central bright band and securing the galvanometer deflections corresponding to different applied potential differences. This data made it possible to correct with fair accuracy for variation in potential.

The effect of varying the slit width was observed both when opening and closing the slit (total radiation only), the bolometer wire being set on the center (approx.) of the central bright band and the galvanometer deflections for different widths of slit noted.

The sensitivity of the galvanometer was checked from time to time by noting the galvanometer deflections corresponding to changes in the resistance of the shunt R_5 (see fig.7), the resistances in R_1 , R_2 , R_3 , etc., being noted at the same time. The sensitivity remained practically constant.

DATA AND RESULTS.

The following is a sample of the data taken, and represents average working conditions with the exception that the potentials are a little low. The pitch of the micrometer eye-piece screw is $\frac{1}{2}$ mm., 100 div. on drum. Galvanometer deflections are corrected to 115 volts. For all

data taken a difference of 1 mm. in the averaged and corrected galvanometer deflections may be regarded as representing in most cases a real difference.

Extract from data for curve 1, fig. 11; total radiation; slit at 25.0; narrow fringes; July 28th, 1923.

Region explored (visual).	Micrometer eye-piece. Scale. drum.	Pot. Diff. across lamp.	Gal. defl. observed.	Corrected gal. defl.
Central bright band.	4 77.5	111	6.7	7.05
		111	6.6	
		111	6.6	
		115	6.9	
		Av.112.0	6.70	
Central bright band	4 90	111	5.8	6.33
		110	5.8	
		110	5.8	
		110	5.9	
		Av.110.2	5.82	
1st dark bd. to rt.	4 65	112	4.0	4.23
		112	3.9	
		110	3.8	
		110	4.1	
		Av.111.0	3.95	
1st bt. bd. to rt.	4 90	109	2.5	2.81
		111	2.6	
		110	2.5	
		109	2.7	
		Av.109.8	2.58	
1st bt. bd. to rt.	4 92.5	111	2.6	2.77
		109	2.5	
		111	2.5	
		110	2.6	
		Av.110.2	2.55	
1st bt. bd. to rt.	4 95	111	2.5	2.73
		111	2.5	
		111	2.6	
		112	2.6	
		Av.111.2	2.55	

The following curves, figs. 11 to 15 inclusive, constructed from data of a similar character show the results obtained.

INTERFERENCE PATTERN GIVEN BY DOUBLED WHITE SOURCE

Slit reading 25.0.

Fig. 11.

- 1. Total Radiation.
- 2. Radiation passed by 1cm. of water.
- 3. Total Radiation from 2nd mirror.
- 4. " " " " 1st "
- 5. Sum of 3 and 4, assuming no interference.

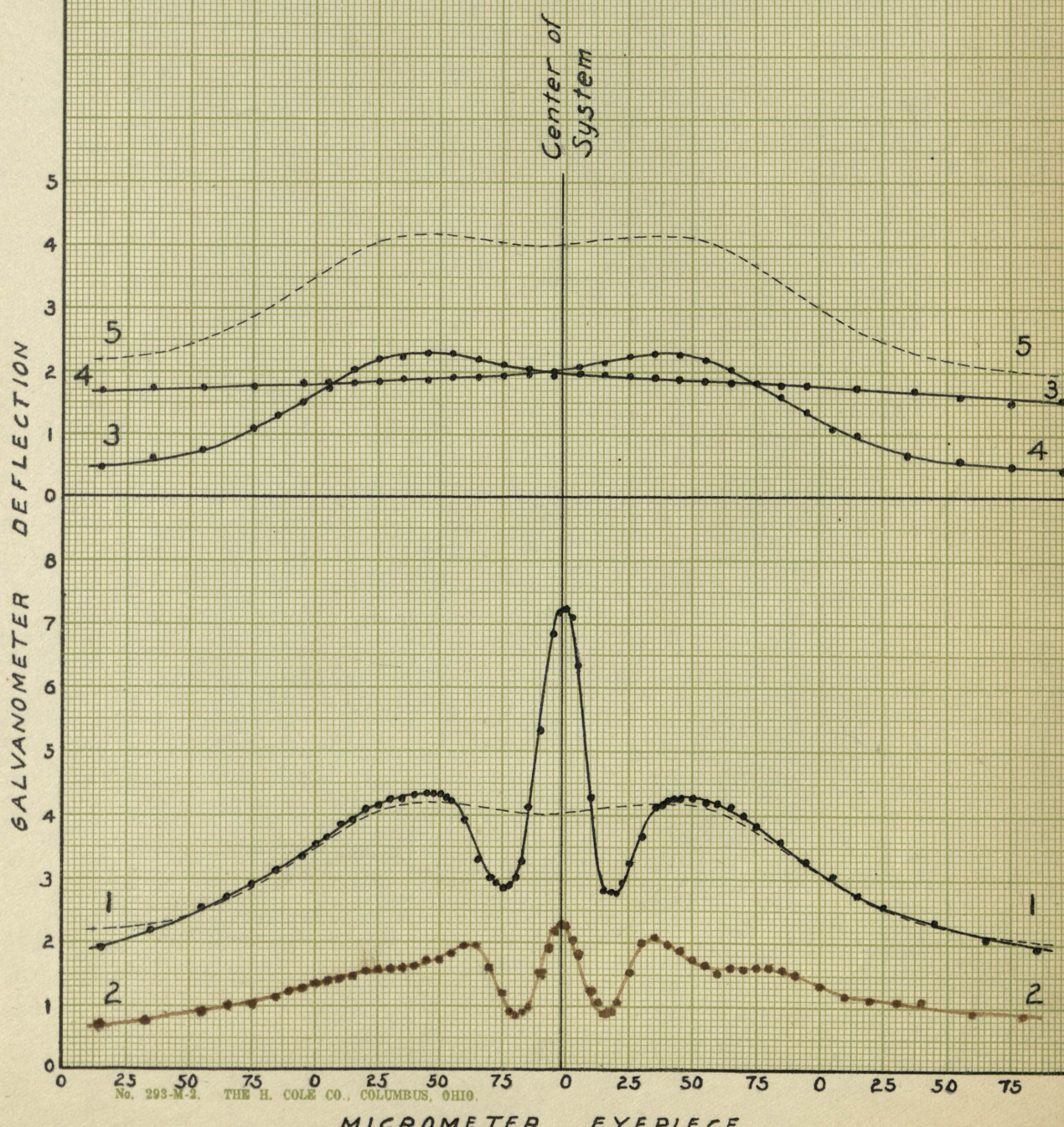

INTERFERENCE PATTERN GIVEN BY DOUBLED WHITE SOURCE

Slit reading 25.0.

Fig. 12.

- 6. Total Radiation.
- 7. Radiation passed by 1cm. of water.
- 8. Total Radiation from 2nd mirror.
- 9. " " " 1st "
- 10. Sum of 8 and 9, assuming no interference.

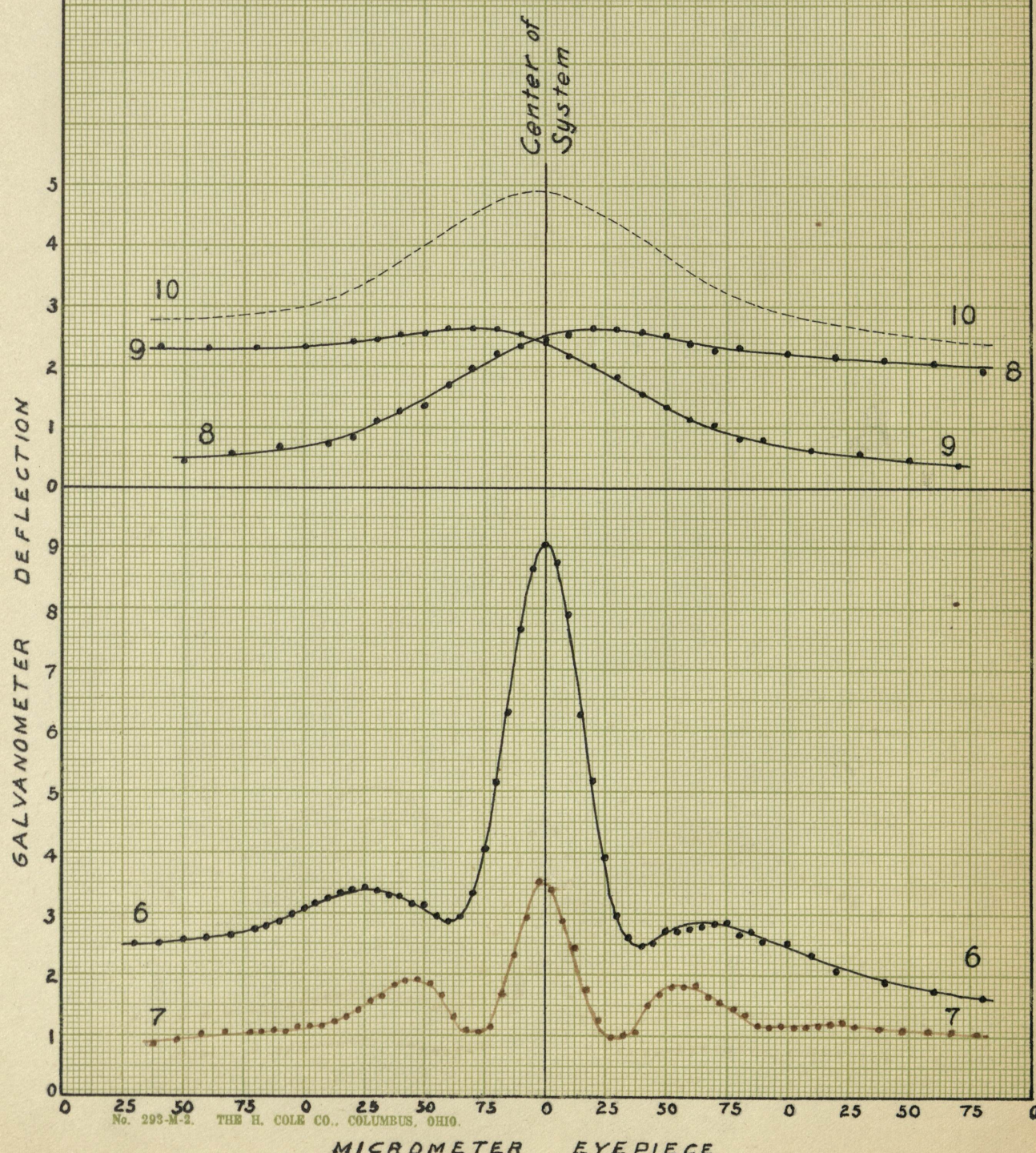

INTERFERENCE PATTERN

GIVEN BY DOUBLED WHITE SOURCE

Fig. 13.

- 6. Total Radiation, slit reading 25.0.
- 11. " " " " 32.8.
- 12. " " " " 22.8.
- 13. Radiation passed by 1cm. of water, slit at 32.8.
- 14. " " " " " cupric chloride, 2.5 per cent solution, slit at 32.8.

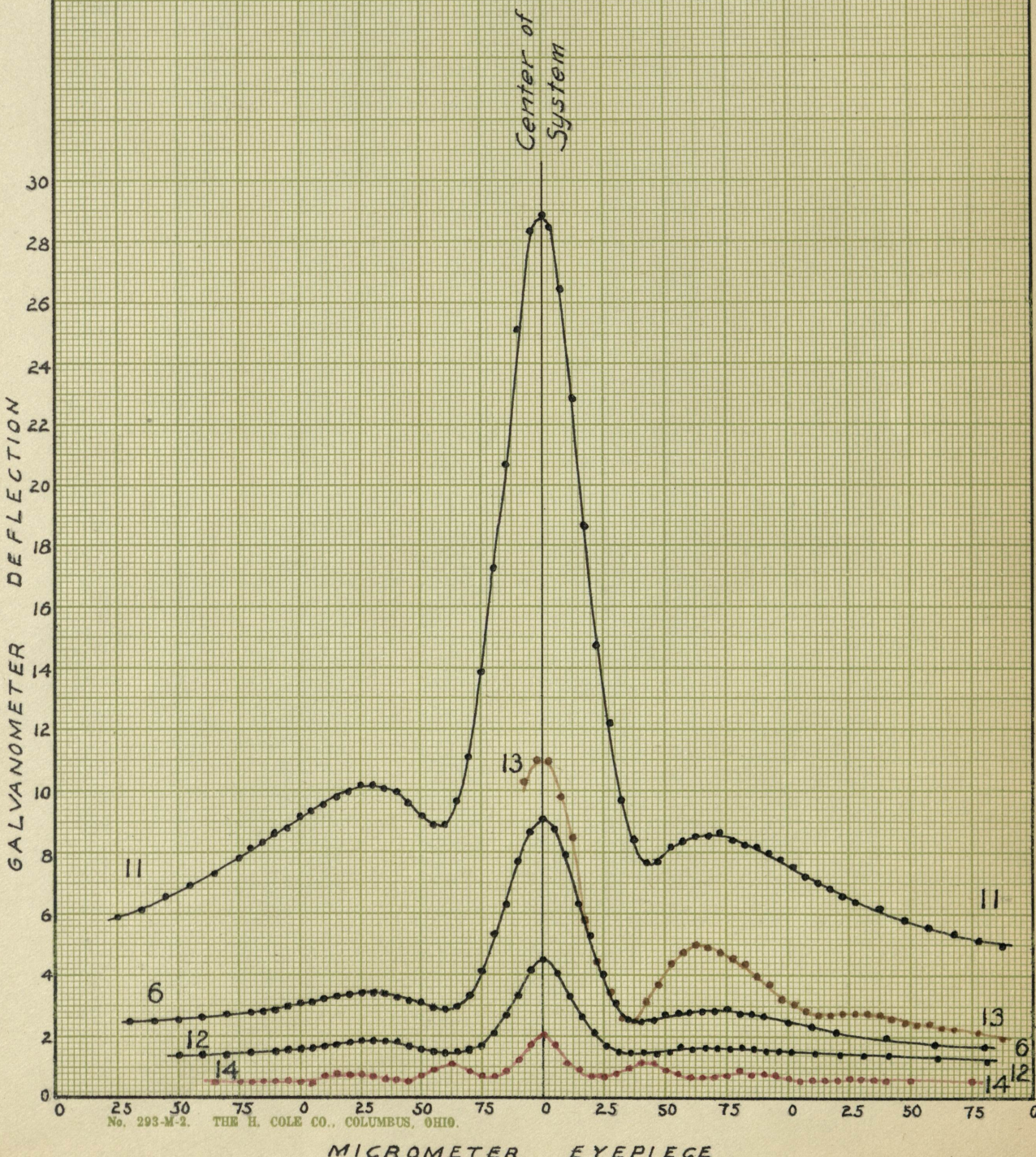

POTENTIAL VARIATION CURVES

Slit reading 32.8.

- 16. Total Radiation.
- 17. Radiation passed by 1cm. of water.
- 18. Radiation passed by 1cm. of cupric chloride, 2.5 per cent solution.
- 18'. Curve 18 after multiplying the ordinates by 4.

Fig. 14.

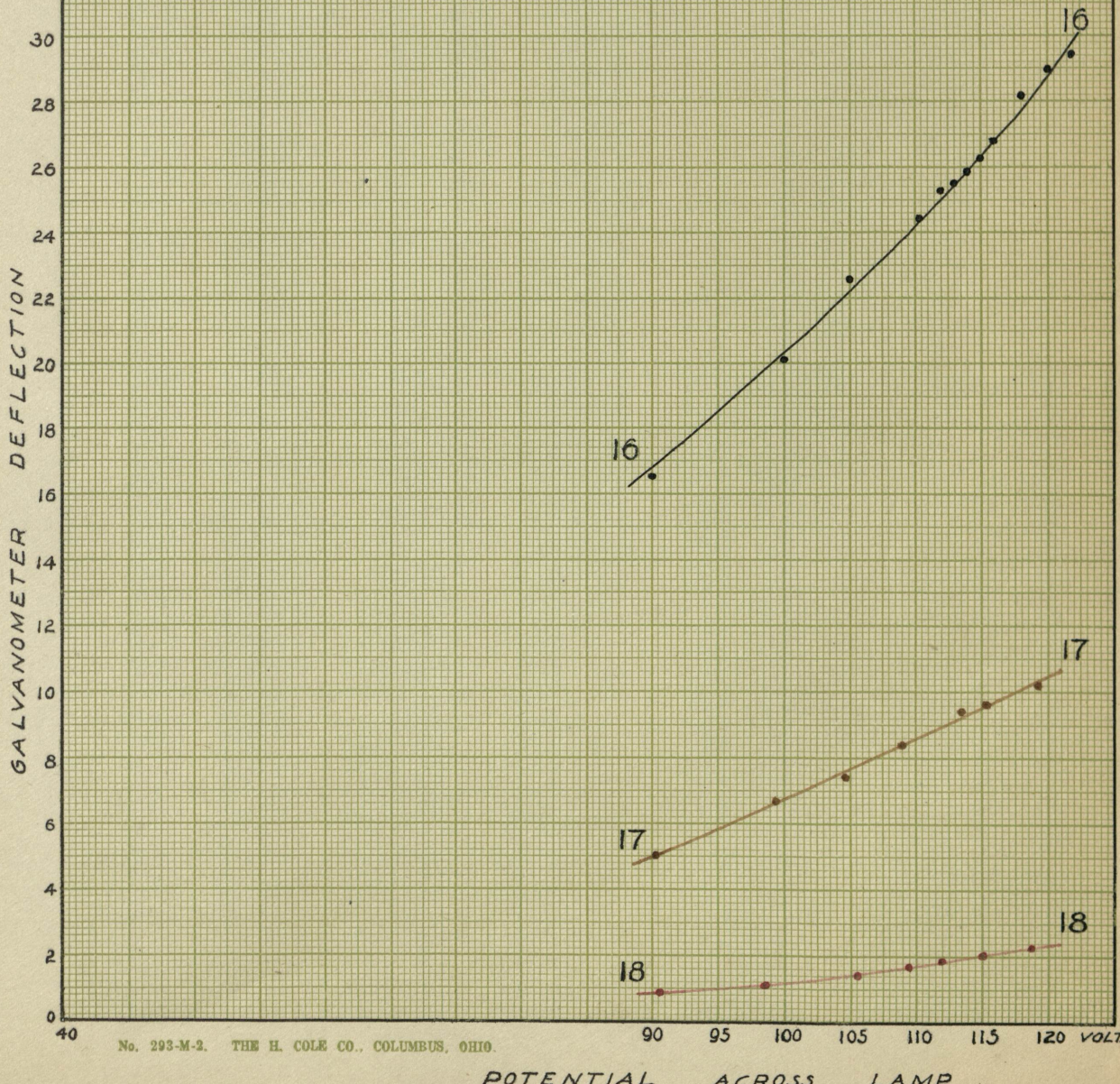
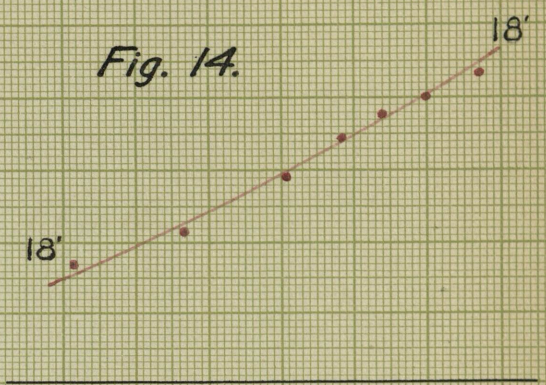

COMPARISON OF GAL DEFLS

VARIATION OF SLIT WIDTH

- 19. Bolometer as used.
- 20. Variation of resistance in shunt R_s .
- 21. Same as 20 but showing galvanometer deflections against resistance changes.

- 22. Closing slit.
- 23. Opening slit.

Fig. 15.

Note: A change of resistance of 1 ohm in shunt R_s gives change of 0.76×10^{-3} ohm in bridge arm.

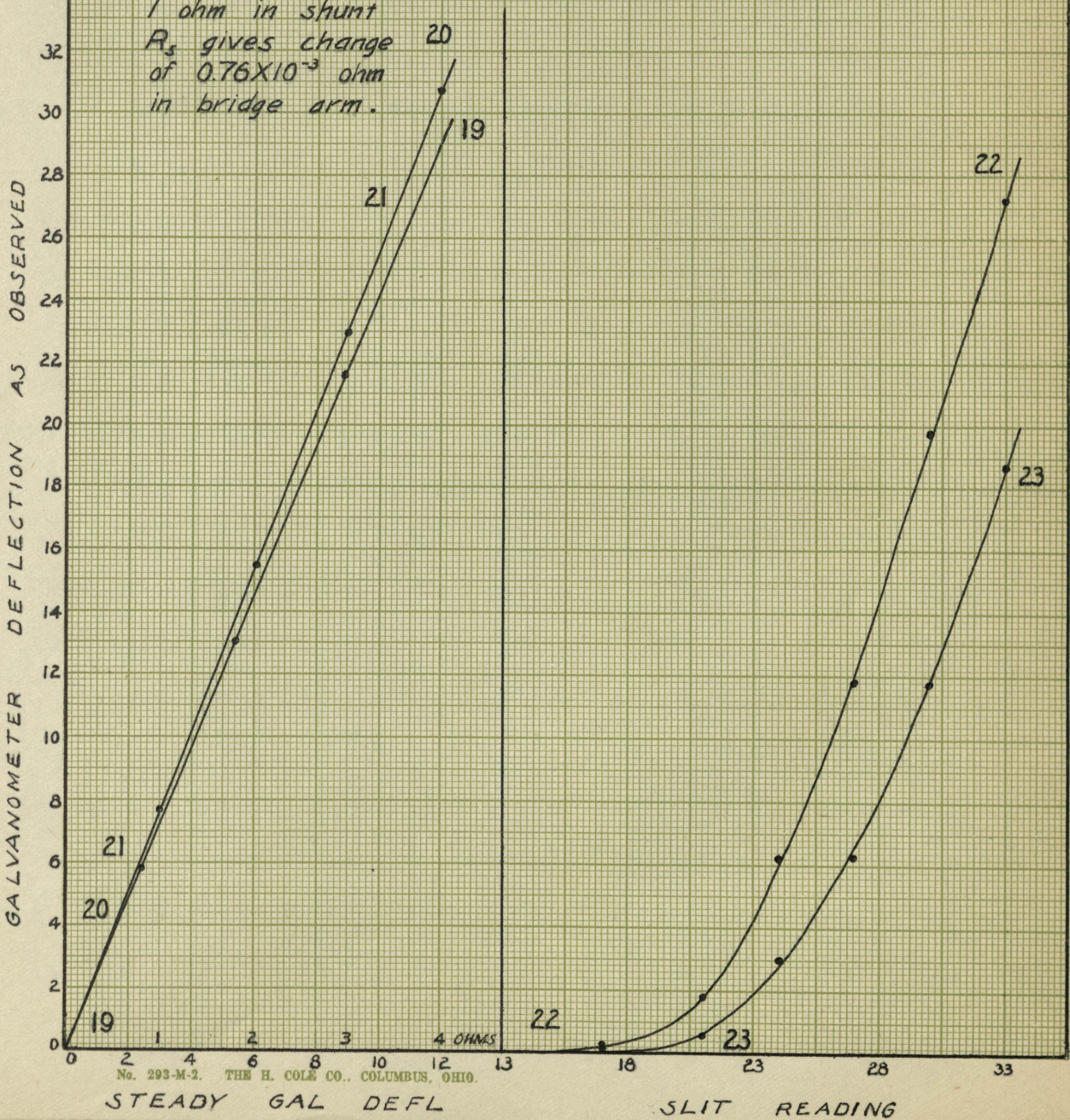

The chief points of interest of the various curves shown in figs. 11, 12, 13, 14, and 15 are as follows. Curves 3 and 4, fig. 11, show the total intensities furnished by the separate mirrors, or what amounts to the same thing, the separate virtual sources, in the region of the interference pattern for the condition of narrow fringes and intermediate slit width. The intensities due to the separate sources are nowhere quite equal, except at the center of the system, but are nearly enough equal for practical purposes up to the position say of the second maximum of curve 1, fig. 11, from the center, if it existed. More nearly ideal conditions would have been secured by crossing these illumination distributions yet more, that is, by employing narrower fringes, but the results obtained in this case could not well differ much or in any very important respect from those represented by curve 1. For this reason, and because narrower fringes were too fine for best adjustment with the eye, this step was not taken. The shape of curves 3 and 4 is probably what it is owing to the diffraction effects introduced by the inner edges of the mirrors. If this reasoning be correct, it is evident that the interference pattern furnished by Fresnel mirrors is modified somewhat by diffraction effects, to just what extent the curves will show. This effect is just what might be expected from theoretical considerations.

Curve 5, fig. 11, is the simple sum of the illumination curves 3 and 4, calculated on the basis of no interference. The difference at any point in the ordinates of this curve and curve 1, fig. 11, which represents the intensity actually observed with the bolometer when the intensity of total radiation due to the separate sources is that indicated by

curves 3 and 4, may be taken as a measure of the amount of interference at that point when complete radiation is employed.

Curve 1 is of special interest, as it shows the interference pattern actually given by the total radiation constituting white light upon artificial doubling of the source.

(1) It shows a maximum at the center of the system or at the middle of the central bright band of just a little under 4 times the energy furnished by one source, or a little under 2 times the simple sum of the energies (see curve 5).

(2) This gives way on either side to a minimum of something like $1 \frac{1}{2}$ times the intensity of either source or about $\frac{2}{3}$ the simple sum of the intensities.

(3) The curve rises on either side to a maximum not very pronounced, it being a little greater in value than the simple sum of the energies from the two sources (see comparison with curve 5).

(4) The minimum on either side is located about midway between the maxima.

(5) Beyond this first maximum from the center the energy gradually approaches that given by the simple sum of the intensities due to the two sources and shows no further indication of maxima or minima. The slightly unequal distances between maxima on the two sides may be explained as due to some unavoidable shift of the parts of the apparatus, as it is not present in the other curves.

Comparison of this curve (curve 1) with the theoretical one derived by Schuster, fig. 5, page 19, will show that they agree very closely in general character. The chief difference to be noted is that the minimum

found experimentally is not nearly so marked as that predicted by Schuster. Had true black body radiation been employed, the observed minimum would have been still less pronounced (the difference would be slight, however) due to the additional infra-red radiation, or looking at it another way, due to the broadening of the energy distribution curve. The difference noted is probably due in large part to the fact that Schuster used Michelson's law for the distribution of energy in the spectrum, whereas some other law (Wein's or Planck's) would probably fit the facts better. Again, the depth of this minimum will vary somewhat with the temperature of the source, increasing as the temperature rises. Schuster does not state the temperature for which his theoretical curve is derived and the temperatures for the theoretical and experimental curves may differ considerably. Any remaining difference can easily be accounted for as *the departure of experimental conditions from* arising from ideal conditions-- diffraction effects, etc., Other differences such as the failure of the observed central maximum to attain quite 4 times the intensity due to either source may be accounted for on the same basis, i.e., the departure of real from ideal conditions. On the whole it may be said that the experimental and theoretical curves agree very closely, such differences as occur being easily accounted for. Indeed, in general character they are almost identical and the curve predicted by Schuster may be considered verified.

Curve 6, fig. 12, also curve 11 and curve 12, fig. 13, shows the same general characteristics as 1 with the modifications to be expected due to the nature of the illumination furnished by the separate sources as indicated by curves 8 and 9, fig. 12. The character of the illumination is also responsible for the slight asymmetry of 6 and the other curves

for the same set of fringes.

Curves 6, 11, and 12, fig. 13, for total radiation show the effect of altering the width of slit. The amount of interference remains essentially the same, as does the distance between maxima, etc., the only difference being that narrowing the slit elevates slightly the first maximum and the curve beyond with reference to the central maximum. This phenomenon is probably due to the flattening of the illumination curves given by the separate mirrors upon decreasing the width of slit. This would give the effect observed when the field is illuminated as shown by curves 8 and 9, fig. 13; with the field illuminated as indicated by curves 3 and 4, fig. 11, the effect should be different and at the same time not so marked. There would seem to be no difficulty in accounting for the observed effect as depending on the character of the illumination furnished by the individual mirrors.

Curve 2, fig. 11, for the radiation passed by 1 cm. of water under the same conditions that gave for total radiation curve 1 shows the effect of eliminating in part the infra-red radiation (complete absorption beyond 1.4μ and considerable absorption of neighboring shorter wavelengths). The chief points to be noted are:

(1) There is a slight indication of a second maximum and minimum on either side of the central maximum.

(2) The first maximum and the entire curve beyond is elevated with reference to the central maximum. The reason for this is evident when it is remembered that the light has been rendered more nearly monochromatic, and monochromatic light would give maxima of equal height.

(3) The distance between maxima is decreased (due to change in energy

distribution).

(4) There is an increase in the amount of interference (due to the narrowing of the energy distribution curve). The faintness even here of the second maximum and minimum in comparison with the first shows that in the case of total radiation a second maximum and minimum of any distinctness were not to be expected. Curve 7, fig. 12, also curve 13, fig. 13, shows the same general characteristics as curve 2. The curves for and absorbing screen of water are intermediate in every respect between those for total radiation and those for a cupric chloride absorbing screen, which curves we shall now discuss.

Curves 11, 13, and 14, fig. 13, show for a given slit width the interference pattern given by, 11 total radiation, 13 the radiation passed by 1 cm. of water, and 14 the radiation passed by 1 cm. of a 2.5 per cent cupric chloride solution. Curve 14 exhibits these special points of interest.

(1) The interference bands correspond almost exactly in position, spacing, extent, distinctness, intensity values, etc., to the visible bands.

(2) There is a marked second maximum and minimum and an indication of a third maximum and minimum.

(3) The first maximum and points beyond is elevated with reference to the central maximum by comparison with the total radiation and water absorption curves.

(4) The amount of interference is considerably greater than that given by total radiation or the radiation passed by the water absorbing screen. Were the illumination to the field that indicated by curves 3, 4, and 5, the amount of interference would be considerably increased.

Curves 16, 17, 18, and 18', fig. 14, show the variation in galvanometer deflection with the potential difference across the lamp for the different conditions of illumination and require no special comment. By means of them it was possible to correct approximately for variation in potential.

Curves 19 and 20, fig. 15, have already been discussed in connection with the experimental procedure. They show the galvanometer deflections as observed to be directly proportional to their corresponding steady deflections, the multiplying factor being for curve 19, 2.4, and for curve 20, 2.55. Curve 21 shows the observed deflections to be proportional to the changes in resistance in the bridge arm. These curves establish the legitimacy of the method employed, as already pointed out.

Curves 22 and 23, fig. 15, show the variation of galvanometer deflection with slit width, the bolometer wire being at the center of the interference pattern (approx.), 22 when closing the slit and 23 when opening it. The slit readings given else where correspond to those for curve 22.

The width of slit used in obtaining the different curves was calculated as follows. Examination showed that the slit closed when the reading on the drum was 13.0 (approx., see curves 22 and 23, fig. 15). The pitch of the screw was $\frac{1}{2}$ mm., hence the slit widths employed were as shown in the following table.

Slit Reading	32.8	25.0	22.8
Slit Width	0.099 mm.	0.060 mm.	0.049 mm.

CONCLUSIONS.

As already pointed out Schuster's theoretical curve for the interference pattern given by total radiation upon simple, artificial doubling of the source may be considered verified as regards general character. The employment of a more nearly correct law for the distribution of energy in the spectrum than that assumed by Schuster and more nearly ideal conditions of illumination from the separate sources, etc., should bring yet closer agreement. Aside from indicating a certain distribution of energy in the spectrum, this result proves nothing as to the nature of white light, other than that it can be regarded as made up of sinusoidal disturbances, which upon doubling of the source interfere with their doubles, producing the observed maxima and minima. This is the assumption Schuster is forced to make in his theoretical deductions, and is the assumption that must always be made, if there is to be any objective interference of the character dealt with here. Whether the sinusoidal disturbances originate at the source, or have as imagined by Gouy only an analytical existence, cannot be decided by this means.

By using an absorbing screen of cupric chloride in conjunction with white light interference curves have been obtained with the bolometer that correspond in position, spacing, extent, and intensity value to the interference bands observed with the eye. From this we may infer that, if the bolometer wire does not absorb by resonance, and there has been no radical change in the nature of the light, the fringes observed

by the eye are not necessarily due to resonance effects in the eye-- the explanation offered by Schuster from the standpoint of the pulse hypothesis. That is to say, the eye would see the interference pattern it does, though it were not sensitive to certain periodicities owing to resonance. The sensitiveness might be due to some other cause. By extension the same remarks may be made with fair safety with regard to the photographic plate, as the curve obtained by using an absorbing ~~water~~ screen of water is intermediate between the curve under consideration and the total radiation curve, and the proposal made becomes a mere extrapolation. There is still a difficulty, however, from the viewpoint of the pulse hypothesis, in that it is not known how an absorbing screen would treat a simple impulsive disturbance. The most reasonable assumption is that it would leave it an impulsive disturbance, simply altering the amplitude and shape. In this case, on the basis of the pulse hypothesis, like pulses succeeding each other separated by a small interval affect the bolometer wire ^{in the same manner as the eye} and the above argument follows. The possibility of the absorbing screen introducing periodicity other than that just described would seem to be slight, so that the most probable state of affairs is that outlined. Yet these pulses could only interfere in the manner observed, provided they might be regarded as made up of sinusoidal components that interfere. Or to make a more general statement, it seems necessary to ascribe the observed interference phenomenon to the interference of sine wave trains, which means, that that portion of the total radiation passed by the cupric chloride absorbing may be regarded as made up of sine waves. It seems improbable that

the absorbing screen should give rise to any new regularity in the light it lets through, hence these sine wave trains must have been at least analytically present in the original light and capable of producing their own proper effect independently of their neighbors. This view seems inescapable when we add to this that it was found necessary to regard the total radiation as the aggregate of sinusoidal waves capable of interfering independently, in order to explain the observed interference effects.

It would seem, then, that even though it should turn out that white light is merely the aggregate of disturbances impulsive in character, nevertheless, we may as well cease to regard the effect of successive pulses on the eye--and photographic plate--and consider only the effect of the component sine wave trains. This is an important consideration and has general application, not being limited to these particular instances. Indeed, if, as is the most probable assumption, especially when a brilliant source is employed, the impulsive disturbances constituting the original white light on the basis of the pulse hypothesis succeed one another separated by very short intervals, treatments based on the effect of separate pulses, as pulses, have neither the virtue nor simplicity imagined, owing to the confusion arising from the superposition of many trains of pulses--not sine wave trains-- of the same periodicity but arbitrary phase, and the consideration of sine waves is to be preferred to say the least. If when dealing with the effects of white light we confine our attention to the sine wave trains into which it is resolvable, we can say at once that the interference bands observed by the eye upon doubling of the source are not necessarily due to resonance effects in the eye; we

need only consider the effects of sinusoidal wave trains, whatever these effects may be. That in this case too the sensitiveness is supposed to be due to resonance does not concern us, as it might be due to some other cause and the interference pattern observed would remain unaltered. The same remarks apply to the photographic plate.

These component sinusoidal disturbances going to make up white light which are thus forced upon our attention, whether originating at the source or having only an analytical existence, cannot be arbitrary, which necessitates, especially in the light of the pulse hypothesis, that the resolution interval be in any given case somehow fixed within certain limits, otherwise the instruments we employ would not give the invariable average results they do, but would give now one result, now another.

The question arises as to how long a duration is to be assigned to these component disturbances--finite or infinite. If infinite, Poincaré's objection must be answered that a spectroscope would give a spectrum for ^{the source of white light illuminating} an infinity of time both before lighting and after extinguishing the slit of the spectroscope. Gouy's answer that the resolving power is finite and that wave trains of neighboring periodicities, though themselves of infinite duration, might interfere to produce light for the required length of time and darkness for an infinity before and after is hardly satisfactory. The difficulties of realizing such a state of affairs would seem to be insurmountable. More than this, it appears absurd to suppose these wave trains to exist before there is a disturbance in the medium, for a spectroscope, though its resolving power were as great as you like, would never discover anything in such a hypothetical existence. After the disturbance has passed entirely through the spectroscope the instrument would again yield nothing but darkness, no matter what its

resolving power, for there is now no disturbance in the medium, and the spectroscope can deal only with actual disturbances. Could it do otherwise, it would be a strange state of affairs indeed. From this, it would seem that in practice only a finite duration of these sinusoidal wave trains can be legitimately considered.

The question as to whether these sinusoidal disturbances have a real origin at the source, or have only an analytical existence, cannot be answered except in terms of slender probabilities, until we have more facts at hand. Possibly considerations similar to the preceding and the experiments of Corbino¹² and Righi¹³ with light beats would lead us to incline slightly toward the undulatory theory of white light. For though any disturbance can over any chosen interval be regarded in accordance with Fourier's theorem as the sum of sine and cosine terms, yet, these sinusoidal components extend to infinity in both directions (supposing we have the right to extend them beyond the resolution interval, which is doubtful, though Gouy and others have deemed it permissible) the function accordingly being rendered ultimately periodic and the disturbance infinite in duration. Also, except in special cases the series is infinite. Again, the sine wave trains suffer no change of phase or any change at ^{all} over the interval, bearing over the entire interval definite phase relations the one to the other and Corbino is of opinion that this last has been shown not to hold for the disturbances constituting white light, though his interpretation of the experimental facts is somewhat doubtful.

¹² Compt. Rend., 133, p. 412, 1901.

¹³ Journ. de Phys., 2, p. 437, 1883.

If, however, we regard the source emitting the white light, the pulse hypothesis seems the easiest assumption to make. Yet there is little difficulty in imagining the sine wave trains to have a real origin at the source. It is not at all necessary, as is commonly done, to suppose an enormous number of electrons, 30,000 or more, all vibrating at the same time with different periods. A given periodicity may be part of the time present and part of the time absent in the radiation constituting white light, and with the means at present at our disposal we should never detect the difference, being able to observe only the average effect over intervals of time exceedingly great from the viewpoint of the behavior of the emitting electrons. Thus the number of electrons vibrating at any given instant with different periodicities may be reduced to any desirable figure, the observed spectral distribution of energy being only an average effect. This leaves the undulatory hypothesis in about as good a position from the standpoint of the source emitting the white light as the pulse hypothesis, the observed distribution of energy in the spectrum being about equally difficult and equally easy to explain from either viewpoint. Consequently, on the whole one hypothesis is about as good, and as bad as the other. The supposition that the sinusoidal disturbances constituting white light have a real origin at the source is about as good as the supposition that they have only an analytical existence, and vice versa. Possibly both sorts of radiation are present in white light and in some respects this is the most reasonable assumption.

In conclusion it may be said that we know nothing as to the nature of white light beyond the fact that we can regard it as made up of sinusoidal disturbances of a wide range of periodicities differing by exceedingly small

steps and that we know the distribution of energy in the spectrum. Whether these sine wave trains have a real origin at the source, or only an analytical existence, we do not know, and either supposition is about equally probable in view of the facts at present in hand. It is, however, and unwarranted presumption to say (as some have said) that we can never know more. On the basis of the hypotheses suggested is the actual disturbance of the medium identical in the two cases? If not, then it may be possible to devise tests based on this difference. That it is not altogether the same might be inferred from the circumstance that upon resolving^a a succession of impulsive disturbances into sine wave trains the sinusoidal components of the Fourier analysis of different periodicities bear a definite phase relation to each other, while no such definite phase relationship exists, if the sine wave trains originate independently at the source. This difference might be made the basis of a number of differentiating tests. Corbino's and Righi's experiments with light beats are based on this difference. The results as interpreted decide in favor of the undulatory hypothesis, but the interpretation is somewhat doubtful. There are also other differences that might be made the basis of experimentation.

SUMMARY.

The interference pattern given by a doubled white source has been explored with a blackened bolometer strip. Fresnel mirrors, a narrow slit, and the total radiation from a tungsten, gas filled, helical filament, incandescent lamp were employed to furnish the interference pattern. The

experimental curves agree very closely with the theoretical one derived by Schuster and may be regarded as verifying Schuster's curve in general character. The observed interference pattern permits us to infer two things, a certain distribution of energy in the spectrum and that white light may be regarded as made up of sinusoidal disturbances. Using a cupric chloride absorbing screen, an interference pattern has been explored with the bolometer that corresponds very closely in every respect to that observed by the eye, and, using a water absorbing screen, curves intermediate between the cupric ^{chloride} and total radiation curves have been examined. These results permit us to infer with a fair degree of certainty that, whatever the actual nature of white light, it is wholly unnecessary to suppose resonance effects in the eye and photographic plate (the explanation suggested by Schuster on the basis of the pulse hypothesis) in order to account for the interference patterns observed, inasmuch as the same interference patterns would be observable in their absence. Also, the proposition that white light may be regarded as made up of sine wave trains is further strengthened. The origin of these sine wave trains, whether they have a real origin at the source or only an analytical existence, is left undetermined by these experiments and by all others that have ever been conducted with one or two very doubtful exceptions. In view of all the facts at present in hand one supposition is about as good as the other. However, it seems not impossible to devise tests that will differentiate between the rival hypotheses.

In conclusion the author wishes to express his obligation to and to thank most warmly Dr. Kester for his kindly assistance and many helpful suggestions in connection with these researches and also Dr. Austin Bailey, whose suggestions first lead him to undertake these investigations.

Blake Physical Laboratory,
University of Kansas.

BIBLIOGRAPHY.

Young, Phil. Trans., 1801.

Gouy, "Sur le Mouvement Lumineux", Journ. de Phys., 5, p. 354, 1886.
 "Sur le Regularite du Mouvement Lumineux", Comptes Rendus, 120, P. 915,
 1895.

"Constitution of White Light", Compt. Rend., 130, p. 241, 1900.

Rayleigh, "Wave Theory", 1886, Enc. Brit. "Complete Radiation at a Given
 Temperature", Phil. Mag., 27, p. 460, 1889.

Poincare, "Sur le Spectre Cannele", Compt. Rend., 120, p.757, 1895.

Schuster, "Interference Phenomena", Phil. Mag., 37, p.509, 1894.

"Sur le Spectres Canneles", Compt. Rend., 120, p.987, 1895.

Boltzmann's Festschrift, p. 569, 1904.

Garbasso, (Damped Vibrations), Arch. de Geneve, Vol.4, p.105, 1897.

Carvallo, "Nature of White Light", Compt. Rend., 130, p.79, 1900; p.401, 1900.

Corbino, "Constitution of White Light", Compt. Rend., 133, p.412, 1901.

Righi, "Battements Lumineux", Journ. de Phys., 2, p.437, 1883.

Rovida, "Monochromatic Light as a Damped Vibration", Rivista Scientifica,
 30, p.225, 1898.

Voigt, "Effect of Medium upon Wave Form of Light", Wied. Annalen, 68. 3.
 p.598, 1899.

Planck, "Nature of White Light", Ann. d. Physik, 7. 2. p.390, 1902.

Eagle, "Constitution of White Light", Phil. Mag., 18, p.787, 1909.

Krelschmann, "Effect of the Planck Oscillators on the Spectral Energy Distri-
 bution of the Radiation Field", Ann. d. Physik, 65. 4. p.310, 1921.

Coblentz, "Radiometric Investigation of Water of Crystallization, Light
 Filters, and Standard Absorption Bands", Bureau of Standards, Bul.7,
 pp.619-63, 1911.

"Emissivity of Straight and Helical Filaments of Tungsten", Bureau of
 Standards, Bull.14, pp.115-131, 1917.

Wood, "Physical Optics", Macmillan Company, 1905, pp. 280-81 and 498-512.