

Nova Mediates Experience Dependent Processing of Orb2A mRNA

By

©2013
Jason Singh Gill

Submitted to the graduate degree program in Molecular and Integrative Physiology and the Graduate Faculty of the University of Kansas in partial fulfillment of the requirements for the degree of Doctor of Philosophy

Co-Chair: Kausik Si

Co-Chair: Dr. Steven LeVine

Dr. Peter Baumann

Dr. Marco Blanchette

Dr. Scott Hawley

Dr. Hiroshi Nishimune

Date Defended: July 1st, 2013

The Dissertation Committee for Jason Singh Gill certifies that this is the approved version of the following dissertation:

Nova Mediates Experience Dependent Processing of Orb2A mRNA

Co-Chair: Kausik Si

Co-Chair: Dr. Steven LeVine

Date Approved: July 1st, 2013

Abstract

Memory serves the vital function of associating disparate stimuli to modify future behavior for fitness. For instance, *Drosophila melanogaster* can learn to associate neutral odors with sweet metabolically available sugars and remember this association for days. Memory formation is thought to rely on stable changes in synaptic strength dictated by the internal state of the organism and the nature of the external stimuli it encounters. In flies, long-term memory requires the efficient oligomerization of the translation regulator Orb2, a process that is dependent on the protein isoform Orb2A. The mechanisms that regulate Orb2A protein levels will therefore determine which experiences become lasting memories. Here we show that Orb2A mRNA exists in a non-protein coding form in the brain via intron retention. Upon exposure to external stimuli sufficient to induce long-term memory, the amount of protein coding Orb2A mRNA increases. Furthermore, the protein coding form of Orb2A mRNA requires the *Drosophila* homologue of Nova-1/2, a well characterized mammalian nervous system specific alternative splicing factor. Our results implicate mRNA processing as a regulatory step in memory formation via the Nova dependent maturation of Orb2A mRNA.

Dedication

To Bikram Singh Gill

My dad and my first scientific mentor, who made my career both inevitable and entirely of my choosing; my doctoral career begins as yours reaches its brilliant sunset.

Acknowledgments

I would like to thank my dissertation mentor, Kausik Si, for bearing with the ebbs and flows of this project, and having faith that I would be able to pull through even when things looked simply hopeless; I am sometimes amazed that he decided to have a second graduate student, after having me as his first.

I would like to thank my lab mates, past and present, who have been instrumental in coming to my aid in scientific times of need. Erica Grindley-White was the first colleague in the lab, and was my touchstone during my rotation. Amitabha Majumar was my first bay mate, and we had many a long discussion in my early days in the lab. Ed Choi, was my second bay mate and did much to add levity and fun to the lean years of my research, when I was famished for results. My final bay mate, JP McGinnis, was a great help in the final push for results and did well to fill in for Ed when I needed an excuse to step out from lab. Liying Li and Repon Khan were the graduate students who followed me in the lab, and I look forward to seeing their work come to completion. Fengzhen Ren has been an important part of the lab from my first day here, and has been indispensable both in keeping the lab running and getting experiments going. There are many technicians and summer students who have been fantastic and who have provided the vigor that a jaded graduate student needs.

I would also like to thank my lovely wife, Annita Achilleos, who made this dissertation possible in so many ways, and my family, who have always supported me.

Table of contents

Chapter I: Introduction.....	1
Chapter II: Orb2 in the Brain.....	34
Chapter III: What Makes a Memory	
Part I: Orb2A-pc.....	47
Part II: Beyond Orb2.....	62
Chapter IV: Nova mediated regulation of Orb2A mRNA processing.....	72
Chapter V: Material and Methods.....	84
Chapter VI: Discussion.....	93
References.....	102

Chapter I: The Synapse and the Neuron

Introduction: The molecular biology theory of memory

In the evolution of eukaryotes, the advent of the nervous system marks a seminal developmental milestone. While there are various feedback processes in different cell types that allow physiological reactions to external stimuli, the nervous system is unique in its ability to integrate responses across organ systems as well as, importantly, to adapt responses across time and space through the storage of information. The latter capacity, the ability to store information, is commonly referred to as memory and our present understanding is that memory is a result of stable changes in the strength of synaptic connections. Prior to investigating the molecular basis of synaptic memory, a digression on memory processes is in order.

It is a notorious challenge to reduce the complexity of human thought and emotion to a process as simple as changing the nature of connections between various cells, whether neuron to neuron, or neuron to muscle, gland or epithelium. Yet in our discourse, it is second nature to attribute emotional states to cell types that rely heavily on neuronal feedback, and in fact it may be the ability of the nervous system to integrate sensory afferents, even from within our own body, that underlies our colloquial descriptions. The heart skipping a beat, butterflies in the stomach, being on pins and needles are all things that lead to a nervous energy of one sort or another and all represent sensation, communicated though the nervous system, and response, whether in the form of cold sweats or manic tapping. But what is remarkable is that what in our youth may have

elicited a certain response, over time changes; what once may have been a monster in the basement comes to be a comfortable chair, worn from late nights with our books; and what may previously have been quotidian, over time elicits exquisite responses; a wool blanket that previously was nothing more than warmth, now elicits anguish and longing when you have no one to share it with. We can all understand the simple frights of our youth being overcome by wisdom, and nostalgia emerging from the simplest things. But what we perhaps do not realize is that the quickened pace of the heart, cold sweats, the hair rising on the nape of our neck are very well characterized responses generated by our autonomous nervous system and understanding that shadows in the basement are artifacts of the night is a profound example of how experience can temper emotional responses, how experience can lead to dampened excitation of acetylcholinergic neurons, how experience can modulate future behavior through memory. From here, it is easy to imagine that very complex emotional states and high order thought can be generated from experience through the modulation of neural networks when we realize that sympathetic and parasympathetic responses represent only a fraction, quantitatively and qualitatively, of the neuronal resources that comprise our nervous system. Through this digression I hope it is evident that the coordination and integration of simple neuronal networks can have profound implications on even very seemingly complex emotional states and that experience can modulate these responses.

Having clearly understood that experience can modulate our responses to given stimuli over time, and that this modulation can have a profound impact on both our emotional and behavioral responses, the question arises: What underlies these experience dependent

adaptations that we call memory? The theory with the most currency, and one that is widely accepted and brooks no reasonable alternatives, is that changes in the nature of connections between neurons are the cellular correlates to memory (*1*). To use the above example we can formulate it as follows: When we are young and a shadow is looming in the night we have an instinctive reaction/reflex whereby the sympathetic nervous system is activated and acetylcholine is released by preganglionic neurons. The acetylcholine binds to nicotinic (or muscarinic) receptors on postganglionic adrenergic neurons, which then release epinephrine or norepinephrine and elicit the reactions we associate with fear, including quickened heart rate, piloerection and cold sweats caused by the simultaneous constriction of blood vessels and activation of sweat glands. As we gain cognitive understanding through experience, the synaptic theory of memory suggests that synapses that raise the excitation threshold of the cholinergic pre-synaptic neurons are strengthened. This is a very simplistic view, and the integration of cognitive information to modulate fear responses is not well understood, but it is widely held that on or upstream of the preganglionic cholinergic neurons, it is the strengthening of inhibitory synapses that serves to modulate responses over time, in much the same way that motor reflexes of newborns are eliminated as central inhibition strengthens during early development. As a coherent behavioral response, then, we can be confident that changes in synaptic strength can be a viable mechanism for experience dependent behavioral adaptation over time, or memory. For the present discussion it is more important to focus for the time being on the individual synapses and move away from circuit level analysis. Prior to shifting the discussion, however, the assumption will be made that regardless of the qualitative nature of the synapse, inhibitory or excitatory, sympathetic or

parasympathetic, or its function—autonomic, cognitive or kinesthetic—that the mechanisms that the neuron uses for strengthening a given synapse are conserved across neuronal cell types on the molecular level.

Discussing memory as an emergent property of alterations in synaptic strength can easily accommodate the temporal descriptions we use to describe the cognitive experience of memory. Transient changes in synaptic strength, and formation of new synapses, correlate to learning. Stable, non-permanent consolidation of these changes correlate to intermediate term memory and induction of lasting, more permanent processes underlie long-term memory. In humans, enormous amounts of information are learned on an on-going basis, while less of that information is remembered for even a few hours and only a small fraction of all experience will be remembered for months or years. In our own consciousness, memory is experienced as a fluid process and gives continuity to our lives. However, studying memory formation in model organisms has provided evidence that discrete stages of memory exist, each with molecular hallmarks that are tractable to investigation (2-4).

Memory at the Individual Synapse

Short-term memory, or learning, is defined by covalent modifications to existing proteins and independence from protein synthesis. Prior to delving into the molecular details of synaptic learning, a brief description of synapse formation is in order. Initially, it is not clear from experimental evidence whether there is a single and discreet path towards the

primary formation of a synapse, which is to say the connection of an axonal, pre-synaptic terminal to its dendritic, post-synaptic partner. Various groups have advanced competing but not necessarily exclusive hypotheses including physical proximity, pre-synaptic vesicle release, stochastic dendritic budding and genetically programmed synapse formation as potential components of the initial formation of synaptic connections (5). For the present interrogation of learning, the initial formation of synaptic connections will be ignored while focusing on the maintenance of alterations to synaptic connections; we will assume that the proximity of the post-synaptic terminal to the pre-synaptic terminal is sufficient to respond to the pre-synaptic vesicle release.

In this case, upon stimulation of a given neural pathway, activity is propagated such that the action potential reaches the axonal terminals. This activity induces the release of pre-synaptic neurotransmitters that bind their post-synaptic receptors. This initiates 2 events 1) the induction of signaling through activation of pre-synaptic G-protein coupled receptors (GPCRs) (1) and 2) depolarization of the dendritic compartment through influx of Na^+ and Ca^{2+} ions (6). Upon activation of pre-synaptic GPCRs, which are associated with adenylate cyclase (AC) or phospholipase C (PLC), a signal transduction cascade is initiated that begins with the synthesis of cyclic AMP (cAMP) from ATP via calmodulin kinase (CAMKII) or AC (7, 8). cAMP synthesis then leads to the activation of Protein Kinase A (PKA). On the other hand, the activation of PLC by the GPCR leads to conversion of phosphatidylinositol bisphosphate (PIP3) into inositol triphosphate (IP3) and diacylglycerol (DAG), which leads to activation of protein kinase C (PKC) (9-12). The dual activation of PKA and PKC leads to modulation of the potassium current

generated by the firing of the action potential and a concomitant increase in the Ca^{2+} influx into the pre-synaptic site (13, 14). This increased pre-synaptic Ca^{2+} level serves to lengthen the action potential as well as lowering the current needed to initiate subsequent action potentials. A second effect of PKA and PKC activation is enhanced release of pre-synaptic vesicles (15, 16). Combined, these changes at the pre-synaptic terminal both increase the likelihood that the action potential on the pre-synaptic neuron will fire the synapse and increase the amount of neurotransmitter released at the potentiated synapse when it fires.

On the post-synaptic side Ca^{2+} influx leads to activation of protein kinases which act through small molecule signaling cascades (GTPase activating proteins (GAPs), guanine exchange factors (GEFs) and GTPases) to modulate actin polymerization and alter spine morphology (17), which includes the recruitment of additional neurotransmitter receptors to alter the efficacy of synaptic transmission (6). The post-synaptic compartment also relies on many of the same kinases, including PKC, PKA and CAMKII, to transduce the pre-synaptic action potential (18). Two major differences between short term changes in the post-synaptic compartment and the pre-synaptic terminal are the need to alter structure in the former and the need to alter firing potential in the latter. In addition, the pre-synaptic compartment increases firing strength through increased vesicle release. Together these changes are referred to as early long-term potentiation (E-LTP) and are the cellular correlate to memory formation, or learning.

In order for the newly formed memory to persist beyond the order of tens of minutes synthesis of new mRNA and proteins is required (2, 19, 20). Thus, long-term memory is described as protein-synthesis dependent. Protein synthesis dependent memory can be further divided into intermediate and late phases (I-LTP and L-LTP, respectively). The translation of pre-existing mRNA is sufficient for I-LTP, while L-LTP is dependent on new transcription (2, 4). One of the initial events in the initiation of LTP is the increase in number of AMPA receptors in the post-synaptic membrane (21-24). This is an important step as it is independent of transcription and can increase the efficacy of LTP formation in that the increased AMPA mediated Ca^{2+} influx will expedite signaling through NMDA receptors, which is necessary for the induction of L-LTP (25). Combined the general time window for all of these changes is roughly equivalent from invertebrates to mammals, with E-LTP encompassing 1-3 hours post stimulation, I-LTP from 3-5 hours post stimulation and L-LTP lasting beyond 24 hours (1, 26, 27).

CPEB: Persistent Memory

While the molecular transitions from E-LTP to L-LTP have been thoroughly investigated, an open question remains regarding molecular mechanisms that allow L-LTP to persist beyond 24 hours; in other words, when the average half-life of a protein is on the scale of hours how can an individual synapse maintain a unique alteration in efficacy for years.

A candidate protein and putative molecular mechanism that may fulfill this role can be found in studies regarding the cytoplasmic polyadenylation element binding protein

(CPEB) family of proteins. The CPEB family includes 2 classes of proteins, which can be regarded as class I (including vertebrate CPEB1) and class II (including vertebrate CPEB2-4) (28, 29). CPEB1 was the first to be characterized as a regulator of translation in the *Xenopus* oocyte. There, CPEB1 allows for temporally defined control of protein expression prior to zygotic transcription (28, 30). In its unphosphorylated form CPEB1 acts as an inhibitor of translation in the *Xenopus* oocyte. CPEB1 binds nascent mRNA via a conserved CPE element in the 3'UTR and inhibits translation initiation via interaction with Maskin and the poly(A) ribonuclease (PARN). Maskin binds to eukaryotic initiation factor 4E (eIF4E) and prevents its interaction with the eukaryotic initiation factor 4G (eIF4G) binding site (30) and eIF4G interaction with eIF4E is necessary for delivery of the 40S ribosomal subunit to the AUG start codon (30). Additionally, PARN outcompetes the poly(A) polymerase germ-line development factor 2 (Gld2) to prevent polyadenylation of the mRNA (30). Following extracellular increases in progesterone, a signaling cascade is induced that results in the phosphorylation of CPEB by Aurora A kinase (30). This phosphorylation causes the displacement of PARN, which allows for Gld2 mediated polyadenylation of the nascent mRNA (30). The elongating poly(A) tail is then bound by poly(A) binding protein (PABP) which helps eIF4G displace Maskin, bind eIF4E and initiate translation (30). CPEB1 has also been shown to mediate activity dependent polyadenylation in the nervous system, leading to the translation of α -CAMKII, a molecule that is important for LTP (31). This function of CPEB1 in the nervous system will be discussed in greater detail later in the dissertation. Together these findings implicate CPEB1 as an important player in altering protein composition in response to external (non-cell autonomous) activity. In the case of the developing oocyte

external activity arrives in the form of increased extracellular progesterone and induction of translation of maternally deposited mRNA. In the case of the neuron, it is binding of neurotransmitters across the synaptic cleft and depolarization of the neuronal cell membrane. In both cases spatio-temporal control of gene expression is a critical component of the system and is achieved by translational control via CPEB I. However, CPEB1 fails to provide a mechanism by which changes in protein composition could be stably maintained over long periods of time. Class II CPEBs may, however, provide candidate proteins that can achieve both the spatio-temporal control of CPEB I as well as offer a mechanism for the perdurance of induced translational changes.

The second class of CPEB proteins have until recently been less extensively characterized, show preferential localization in the nervous system in both vertebrates and invertebrates, and offer a potential mechanism for persistent LTP. Like class I CPEBs, class II CPEBs have an N-terminal 'regulatory' domain and a RNA binding domain (RBD) consisting of 2 RNA recognition motifs and 2 zinc-finger domains (28, 32). Despite sharing homologous RBDs, selected evolution of ligands by exponential enrichment (SELEX) experiments have indicated that while class II CPEBs bind to 3' untranslated regions (UTRs) they do not bind to CPEs (32). Class II CPEBs have nonetheless been characterized as playing a role in activity dependent translation of a number of neuronal mRNAs, including the α -amino-3-hydroxy-5-methyl-4-isoxazolepropionic acid (AMPA) receptor mGluR2 (32). Furthermore CPEBs 3 and 4 have been shown to be localized to synapses in mammalian dissociated hippocampal cultures (32). In most invertebrates there is only a single class II CPEB, including

ApCPEB in the sea snail *Aplysia* and Orb2 in *Drosophila* (33, 34). In *Aplysia*, serotonin pulses applied to cultured neurons L-LTP have been shown to increase ApCPEB protein concentration in a spatially restricted manner, and this local increase in ApCPEB protein is necessary for the maintenance but not initiation of the *Aplysia* correlate to L-LTP, long term facilitation (LTF) (33). Furthermore, ApCPEB appears to have the capacity to adopt different conformational states, and this capacity is dependent on the N-terminal ‘regulatory’ domain that is analogous to prion like domains found in yeast (34).

Interestingly, the *Drosophila* ortholog of ApCPEB, Orb2, also contains a Q/N rich prion-like domain. Of the two isoforms encoded by *orb2*, Orb2A expresses only 9 amino acids N-terminal of the prion-like domain, thus ‘exposing’ it; while the other isoform, Orb2B, expresses 161 amino acids N-terminal to the prion-like domain, thus ‘hiding’ it (Figure 1A) (35, 36). In the *Drosophila* nervous system, the predominant Orb2 isoform is Orb2B, which displays constitutively high levels of protein and mRNA at all stages of development (36, 37). On the other hand, Orb2A is expressed at high levels in the male germline, but is expressed at low to undetectable levels in the adult head (37). Flies homozygous for a deletion at the Orb2 genomic locus display reduced brood size with considerable lethality as larvae, with escapers to adulthood being sterile and displaying deficits in locomotion (35, 37). A single copy of Orb2 can rescue the lethality, sterility and locomotor defects, but these animals display specific deficits in long term, but not short term, memory formation (36, 38). Further an allele containing a deletion of the Q/N domain (Figure 1B) phenocopies the Orb2 +/- flies (36), suggesting that the Q/N rich prion-like domain plays a central role in memory formation. In fact, further studies have

indicated that the prion-like oligomerization of Orb2A plays a critical role in the stabilization of long term memory.

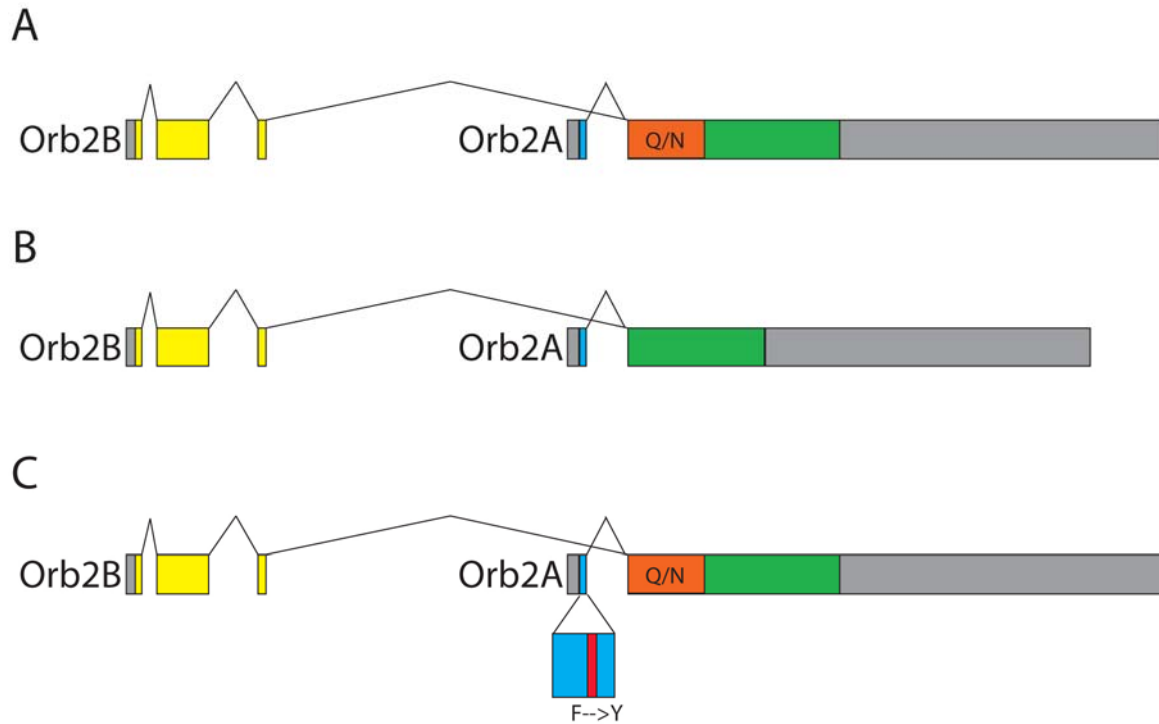

Figure 1. Genetic Manipulations of Orb2. (A) The wildtype genomic locus of Orb2, where yellow indicates Orb2B specific exons, blue indicates Orb2A specific exons and orange indicates the Q/N rich region which is a part of the common Orb2 exon indicated in green. Gray portions indicate UTRs. (B) The $\Delta 80$ construct, where the Q/N region of Orb2 is deleted from a 30+ kB BAC that encompasses the genomic locus, which is then inserted in a pre-determined attP site. (C) The Orb2A-F5Y mutant, which was inserted using a similar strategy as described in B.

Upon neural stimulation by temperature sensitive TrpA1 channel or by ingestion of the neurotransmitters tyramine or octopamine, Orb2 forms amyloid-like oligomers (38, 39). This is similar to the observation that stimulation with serotonin induces SDS-resistant prion-like oligomerization of the *Aplysia* CPEB protein (40). A screen in *Drosophila*

Schneider 2 (S2) cell culture revealed a point mutation—which results in a substitution of phenylalanine by tyrosine at the fifth position (F5Y) of Orb2A (Figure 1C)—that reduces as well as changes the nature of the Orb2A oligomers (38). Expression of Orb2-F5Y in the genomic context extended this finding *in vivo*; flies expressing Orb2A-F5Y, or flies lacking the Orb2A transcript, but not wildtype (WT) Orb2A, showed delayed or absent high molecular weight oligomers formation upon ingestion of a solution containing 10mM tyramine hydrochloride and 2% sucrose (38, 39). Together, these results suggest that a prion-like form of Orb2 results from increased neural activity and that this process is dependent upon Orb2A. Finally, behavioral testing revealed that Orb2A deletion flies showed a deficit in long term memory (24 hours), while Orb2A-F5Y flies were able to form short-term as well as long term memory (at 24 hours) but showed a specific deficit in the persistence of long term memory (>36 hours) (38). These data show conclusively the requirement for Orb2A in long-term memory, and that the capacity of Orb2A to oligomerize Orb2B is a critical component of the persistence of long term memory.

As a summary, it is well established 1) how neural activity can lead to the local, transient changes at a synapse that correspond to learning 2) how these changes can lead to local protein translation and the structural changes that underlie the formation of memory and 3) with CPEB, how the induction of Orb2A mediated oligomerization provides for the highly stable, activity responsive mediation of translation via regulation of the Class II CPEB, Orb2.

mRNA Regulation: Connecting the Synapse to the Cell

Heretofore, the role of changes in synaptic stability in memory formation has been broadly discussed. This includes the role of activity at a synapse causing immediate, intermediate and lasting changes to the synapse where activity has occurred. Over time, where permanent learning occurs—a child losing fear of shadows, or remembering how to ride a bike—the efficacy of certain synapses is essentially permanently maintained. Although the precise mechanisms that allow for permanent maintenance of altered synaptic efficacies are not known, CPEB, via prion like oligomerization, stands out as an enticing candidate. This, however satisfying a hypothesis as it may be, still begs the question of how synapse specificity is achieved. That is to say, in a neuron with thousands of synapses, how can a unique change involving the synthesis of new proteins be achieved at only a single, or a subset, of synapses on that cell? Conceptually, this is referred to as synaptic capture and/or synaptic tagging.

Synaptic Capture

In the context of Orb2 and long term memory the conundrum of synaptic capture and long term memory can be envisioned as such: the induction of long term memory as it relates to a single memory is an event that occurs at a single synapse out of thousands in a temporally defined manner. This event is thought to be independent of lasting nuclear events or other events at the cell soma, such as recombination based information storage such that happens in the immune system. At some point during the stabilization of the

synapse for long term memory storage the synapse signals to the cell body for the induction of long term memory specific mRNA to be transcribed. These genetic messages are then shuttled back to the synaptic compartment where they are translated at the synapse of interest, *but not at any other synapses*. This becomes somewhat more perplexing in the context of immanent activity in the brain and along the dendritic compartment. How is it that mRNA encoding proteins needed for long-term memory can be specified for and translated only at long term memory synapses? In regards to Orb2, the model would implicate the oligomerization of Orb2 as both the tag and the capture mechanism for the marked synapse. In this context, activity to the level of induction of stable long-term memory would lead to the translation of Orb2A, which would serve to oligomerize Orb2 and mark the synapse. The trouble with this model is that it fails to capture the subtle but non-trivial distinction between I-LTP and L-LTP, or between intermediate and persistent memories; if Orb2A mRNA is present at the synapse and ready to be translated, why aren't all translation dependent memories long-lasting; if Orb2A mRNA needs to be transcribed, how is the specified synapse marked? An exciting solution to this hypothesis would be that Orb2A mRNA undergoes post-transcriptional regulation, which introduces a new regulatory step that could gate the transition between protein synthesis dependent memory and transcription dependent memory. However, prior to exploring this possibility it is necessary to investigate the state of our understanding of RNA binding protein regulation of mRNA in the nervous system as well as alternative splicing (a key mechanism for post-transcriptional mRNA processing) in the nervous system. Prior to delving into the specifics it is necessary to contextualize mRNA regulation in both the nervous system and the general life of a gene.

Post-Transcriptional Regulation

The evocation of the biological potential of a gene can be generally described as follows: the gene coded in DNA is transcribed into a messenger RNA by transcription via RNA polymerase in the nucleus. This messenger RNA is rapidly processed by removal of its introns into a mature mRNA transcript. The mature mRNA is then shuttled outside of the nucleus where it is translated into its constitutive amino acids across the membrane of the endoplasmic reticulum to form the polypeptide chain that will be folded into the functional protein; canonically: transcription, processing, translation. However, since the solving of the structure of DNA and the decoding of the amino acid code, while the canonical process of transforming genetic information into biologically active proteins has maintained its rough outline, massive layers of complexity have been introduced that both offer many and various levels of regulatory opportunity and also help to explain the enormous cellular phenotypic diversity that can be generated in a complex eukaryotic organism out of the single trove of genetic information stored in the organism's DNA. In the nervous system, while interesting hypotheses regarding epigenetic modifications (that will not be addressed in the present dissertation) exist, the neuron can be considered as a terminally differentiated cell that relies only on transcription, mRNA processing and translation as points of differential regulation. In addition to post-translational modifications of proteins such that have already been described as occurring at the synapse, these four processes should be theoretically sufficient to explain the remarkable capacity of the neuron to maintain both plasticity and to carry out various translational

programs across sub cellular compartments. As has been previously mentioned, transcription has the difficulty of being a non-compartmentalized process available, indiscriminately, to the entire cell, while translation is hyper specific in the case of the synapse, or as indiscriminate as transcription in the case of translation in the cell soma. This leaves mRNA processing as the level at which information has both the resource of the entire genome as well as the specificity provided by local translational machinery. As such, post-transcriptional regulation is an outstanding area whence to consider key regulatory events in the stabilization of long-term memory.

Alternative Splicing: Nova in the Neuron

In general after transcription of a gene from DNA into mRNA, the vast majority of immature, unprocessed mRNA (pre-mRNA) contain introns (sequences of RNA that are excised prior to translation) in between exons (RNA sequences that are included in the transcript that will eventually be translated). For a long period of time, the purpose and origin of introns was not well understood (41); however, several interesting lines of evidence regarding the need for introns have come to light. Initially, it is important to note that the majority of introns are constitutively and rapidly excised, or spliced, from the mRNA. Usually in the process of this splicing, a complex called the exon junction complex (EJC) is deposited at the exon-exon junction (42-44). A compelling body of recent evidence has indicated that the EJC deposition, a residue of splicing, is critical for mRNA localization. In particular, *oskar* mRNA, which encodes a protein required for embryonic development, requires the post splicing deposition of the EJC in order for

proper localization and function (44). Accordingly, even constitutive splicing is an important procedural step in proper spatio-temporal protein expression. However, an emerging area of post-transcriptional regulation is alternative splicing. Alternative splicing is considered to be the generation of multiple mature mRNA, each of which encode different protein products, from a single pre-mRNA via the inclusion, skipping, choice between or retention of introns or exons (Figure 2). Using this mechanism a single annotated gene can generate sometimes hundreds of different protein products (45, 46).

In the case of *Drosophila* DsCam, it is estimated that the single gene locus can generate

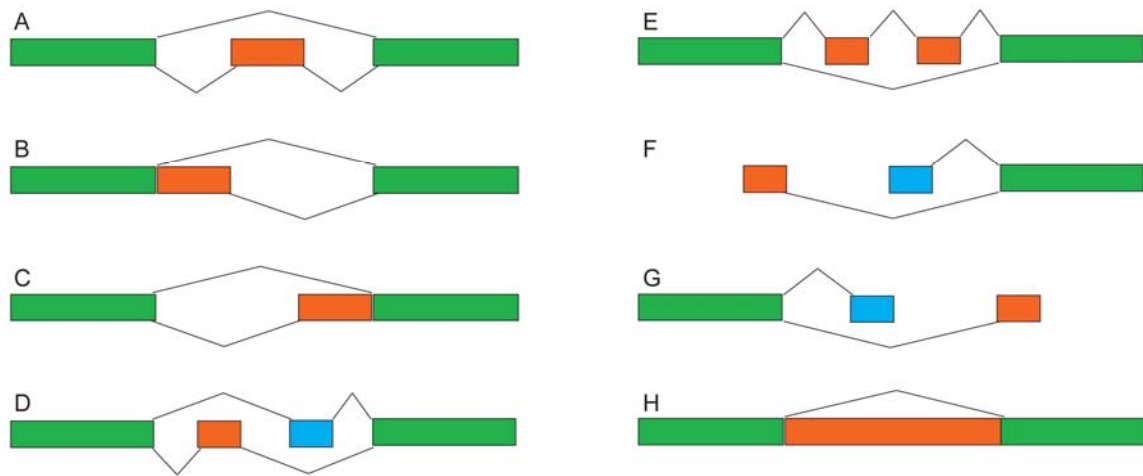

Figure 2. Alternative Splicing events regulated by Nova (49): Adapted from Brooks et al., (A-H) Green represents exons common among all splice variants. Orange and blue represent alternative exons, of which one must be included. In the cases where only orange is shown, the alternative splicing decision will be to include or exclude all orange exons.

over 38,000 unique protein products (47). Accordingly, alternative splicing is posited as a putative mechanism for the generation of both diversity between and uniqueness among neuronal populations. However, despite the outstanding interest of the field in understanding the sequence codes that define alternative splicing choices in different cell types or under different environmental conditions, such a code has as yet eluded our

understanding (48). Even so, if the analysis is moved away from the mRNA sequence that undergoes alternative splicing and rather focuses on the trans-acting RNA binding proteins (RBPs) that are the effectors or potentiators of alternative splicing, more headway has been made. In this case, certain proteins that are required for alternatively spliced transcripts have been identified. And using genetic knockouts in combination with single gene or genome wide analysis alternative splicing can be analyzed.

One protein in particular has been of outstanding interest to both the alternative splicing and neuroscience communities for its nervous system specificity as well as its central role in alternative splicing, Neuro-Oncological Ventral Antigen1/2 (NOVA). Nova was first identified in a series of studies that sought to understand a paraneoplastic syndrome (Paraneoplastic Opsoclonus/Myoclonus Ataxia; POMA) that manifests in patients suffering from breast and lung cancers that express an antigen that causes an immune mediated generation of the Ri antibody (50). The Ri antibody, in addition to recognizing the tumor, recognizes a 55 kD nervous system specific protein. The antigenicity of the Ri antibody is such that it binds to the nuclei of neurons and causes neuronal dysfunction (51). Leaving aside the generation of the Ri-antibody by the developing tumor, and its subsequent neurologic sequelae, the Ri-antibody was found to react with a nervous system specific RNA binding protein, Nova (50, 52). Mice lacking Nova-1 are viable at birth, but die postnatally and exhibit motor cell death in the spinal cord and brain stem neurons (53). Gene expression analysis in the knockout mice also implicates Nova-1 as being essential for the proper mRNA processing of at least 2 major neuronal receptors, Glycine receptor- α 2 (GlyR- α 2) and GABA_A receptor (53). This is consistent with later

studies that implicate Nova as being important for LTP associated with slow inhibitory postsynaptic current but not excitatory LTP (54). As an aside, in mammals the Nova protein family contains two paralogs, Nova 1 and 2, which are both targets of the Ri antibody but which are expressed in the ventral portion of the brain and cortical areas, respectively. With the advent of genome wide gene expression analysis technology, the effect of Nova 1/2 on nervous system wide splicing was analyzed using knockout animals; this analysis led to the generation of a splicing regulatory map that revealed that Nova was involved in the regulation of alternative splicing of mRNA that encoded proteins involved in synapse function and axon guidance (55). Furthermore, in the mouse, Nova was found to bind to the degenerate sequence YCAY such that binding on intronic YCAY clusters led to the splicing of the intron via potentiated U1 ribonucleoprotein (RNP) binding while binding to exonic YCAY clusters led to the inhibition of U1 RNP binding and blocked the inclusion of the bound exon into the mature mRNA (56, 57).

The identification and characterization of Nova has been an exciting step forward in the understanding of both combinatorial control of alternative splicing as well as the dynamic generation of alternative transcripts during synaptic activity (54, 58, 59). However, much of this work has been conducted using mammalian systems or patient samples. Only recently have efforts been undertaken to identify the role of Nova in invertebrate development and brain function. The initial characterization of Nova in *Drosophila* came in 2001 describing *Pasilla*, the *Drosophila* homolog to Nova 1/2 (from here Nova will be used to reference all homologs of Nova 1/2 in all model systems), as a protein important

for salivary gland secretion via apical vesicle release (60). This was consistent with a potential role in motor neuron dysfunction via loss of neurotransmitter release that would mimic the salivary gland secretion defect. Furthermore, the study found that Nova was localized in the nuclei of salivary gland cells, again consistent both with the then described function, in splicing, and localization described in mammalian systems. On the other hand, the authors of the 2001 study noted that during embryonic development Nova was entirely absent from the CNS (60). In the subsequent decade, much work has built off of Nova studies carried out in the mammalian systems to describe the role of Nova in alternative splicing regulation across phyla (49, 61, 62). It has been noted that Nova RNA binding and splicing can be achieved in mammalian cells by transfection of orthologous Nova proteins, even from Nova isolated from invertebrate species (61). Furthermore, the binding sequence and the activation and inhibition of alternative splicing patterns is conserved from mammals to *Drosophila*, even though the specific target genes are not (49); this analysis offers the interesting insight that in an evolutionary context, the nature of the regulatory events conducted by trans-acting RBPs is less mutable than the targets of the RBPs. Despite this conservation, however, it has to date been unclear as to whether Nova acts in the nervous system of mature invertebrates. On one hand, it seems clear that during early *Drosophila* development Nova is excluded from the CNS (61), on the other hand Nova has been implicated in activity dependent splicing and increases in sodium currents in the larval *Drosophila* brain (63). However, to date, localization of Nova protein in the *Drosophila* nervous system has not been visualized by immunohistochemistry and gene expression has not been assayed via *in situ* hybridization in larval or adult fruit flies. In summary Nova represents a very well characterized

regulator of alternative splicing in the nervous system in a variety of species. Furthermore, alternative splicing is an important regulatory mechanism that can generate a great deal of protein diversity out of a relatively limited genome. While this ends the present discussion on alternative splicing, it is important to note that both SR family proteins as well as hnRNPs are well characterized, non-tissue specific alternative splicing factors that likely also play an important role even in nervous system alternative splicing, despite their more ubiquitous expression (64, 65).

mRNA at the Synapse: How and When?

In the scheme of protein expression, post-transcriptional modification via alternative splicing stands as an important mechanism that can 1) generate diversity in a dynamic manner and in response to neuronal activity and 2) provide a putative mechanism for identity switching at a given synapse by specific alterations in, for instance, receptor composition via the inclusion or exclusion of peptide sequences. However, the conundrum of how an mRNA that is alternatively spliced in response to activity finds its way to a specific synapse where activity occurs is not solved by the presence of alternative splicing in the nucleus. For mechanisms that might help explain how transcripts are targeted to a specific synapse, we can turn to RNA binding proteins that shuttle mature mRNA to the dendritic or axonal compartments. There are, generally speaking, four well characterized RBPs that are involved in this process, zip-code binding protein (ZBP1), fragile-X mental retardation protein (FMRP), CPEB1 and, recently,

Nova. Although the role of the EJC in localizing *oskar* mRNA was briefly mentioned, it will not be covered in greater depth.

Zipcode Binding Protein

The idea that proteins may contain distinct domains that help target them to subcellular compartments won the Nobel Prize in 1999 with Gunther Blobel's signal peptide hypothesis. Since that discovery in the early 1980s, it has become clear that targeting information present in biological macromolecules is an important principle. And in fact it has become evident that mRNA also contain information that allows trans-acting RBPs to target them to distinct compartments. One important example of such a protein-RNA interaction comes from the discovery of localization elements and the zipcode binding protein (ZBP). The importance of the zipcode targeted by ZBP-1 was actually identified prior to ZBP itself (66), when it was shown that discrete base pair sequences in the 3' UTR were sufficient to confer localization to any mRNA that contained the 3'UTR. In this case the zipcode containing mRNA was necessary for localization of β -actin mRNA to the leading edge of fibroblast lamellipodia as well as sufficient to localize β -galactosidase activity to the leading edge of the fibroblast lamellipodia when the β -galactosidase mRNA was appended with the β -actin 3'UTR. In principle this series of experiments showed both that mRNA could be targeted prior to their translation, and that this targeting relied on discrete base pair sequences in UTRs. Several years later, the protein that bound the zipcode, ZBP, was identified (67). It was further found that a ZBP protein complex was involved in zipcode binding, and that ZBP contained several

canonical RNA binding domains—RRMs and K homology domains—that are found in many of the proteins that have been, and will be, discussed in the present dissertation. Cooperative binding for localization specificity is a concept raised by the ZBP study that holds across many different protein-RNA interactions. The early ZBP studies described so far were conducted in fibroblasts, yet it turns out, perhaps not surprisingly, that ZBP carries out a similar function in the nervous system (68). Two studies in the early 2000s established an unequivocal role for ZBP in dynamic nervous system function. Initially it was shown that ZBP1 was localized in puncta in the cell soma, the dendritic compartment and at synapses (69). Independent of transcription or translation of ZBP, the amount of ZBP in the dendritic compartment and at synapses rapidly increased after KCL mediated depolarization of cultured hippocampal neurons (69), the depolarization also increased the association of ZBP to β -actin mRNA. A second study also implicated ZBP mediated β -actin mRNA localization in the growth and density of dendritic filopodia (synaptic precursors) (70). The ZBP- β -actin mRNA interaction stands as an instructive case study regarding a rather ubiquitous protein-RNA interaction that has currency in many cell types but that also has a role in activity dependent synaptic function. The next RNA binding protein that will be discussed has the additional element of having an important role in human nervous system dysfunction, and stands as perhaps the most well studied nervous system RNA binding protein, namely FMRP.

Fragile-X Mental Retardation Protein

Although FMRP is ubiquitously expressed in the organism, the highest levels of the protein are found in the central nervous system. Similarly, while the main factor contributing to the morbidity of individuals suffering from Fragile-X syndrome is nervous system related (low-IQ, seizures, autism spectrum disorders, developmental delays), these individuals also suffer from a variety of non-CNS symptoms including macro-orchidism, low muscle tone and characteristic facies (71). Presently, though, the focus of the discussion will be on the role of FMRP in synaptic plasticity, which will ignore emerging roles of the protein in CNS development as well as other somatic functions of the protein in RNA regulation.

Like ZBP, FMRP contains several canonical, conserved RNA binding domains including 2 KH domains as well as an RGG box (a series of arginine and glycine residues). This particular series of RNA binding domains positions FMRP as a classical heterogeneous nuclear RNP (hnRNP) protein (72). As was mentioned previously, both in the context of hnRNPs in alternative splicing as well as in the discussion of the various phenotypes of Fragile-X syndrome, this status as a classical hnRNP probably defines FMRP as having many other roles in the general metabolism of RNA, but here we will focus on the role of FMRP in synaptic plasticity mediated through mRNA transport in the neuron. While a large fraction of FMRP is cytoplasmic, various lines of evidence indicate that it can be localized to the nucleus, including immunohistochemistry and the presence of a nuclear localization signal (NLS) on FMRP (73, 74) in addition to a nuclear export signal (NES).

In fact, there are alternatively spliced isoforms of FMRP that lack the NES and remain nuclear throughout the lifespan of the protein. In addition, disruption of one of the KH domains leads to increased frequency of shuttling between the nucleus and cytoplasm (75). FMRP also binds with a Ran binding protein, which provides a potential mechanism for shuttling (76). Nonetheless, it is important to note that with the exception of the isoform lacking the NES, FMRP was first characterized as, and largely is, a cytoplasmic protein that is constantly shuttling mRNA out of the nucleus and into the dendritic compartment (73).

Some of the earliest descriptions of FMRP in the nervous system noted that fragile-X patients and FMRP knockout mice both showed an increased number of dendritic spines in the cortex (77-79). Strikingly, this is opposite the phenotype seen when ZBP function is disrupted. Furthermore, FMRP is involved in the transport of RNP particles along the dendrite and to synapses in response to the activation of metabotropic glutamate receptors (mGluR) (80). In fact activity dependent translation mediated by mGluRs in *in vitro* preparations requires FMRP (81). The role of FMRP in transport to the synapses is not absolute, as it was seen that while some FMRP cargo mRNA are significantly less abundant in synaptic areas in mice lacking FMRP, other mRNA are unaffected (82). To date, the precise sequence requirements for FMRP binding on mRNA are unknown; however, both the protein complexes of which FMRP is a part of as well as some of the targets of FMRP regulation have been characterized. Several major studies involved in defining the FMRP RNP identified various important synaptic activity mediated/mediating proteins in complex with FMRP, including CAMKII, actin-regulated

cytoskeleton associated (ARC) protein, kinesin, dynein and ZBP (83-85). The combination of FMRP's inclusion in large protein complexes and the lack of precise RNA binding sites associated with FMRP combine to form a working model where rather than targeting specific mRNA to the dendritic compartment, FMRP is involved in activity dependent combinatorial targeting and translational regulation. A recent study provided a mechanism by which this could occur in showing that FMRP is responsible for the stalling of a variety of synaptic mRNA on the translating polyribosome, implicating FMRP as a brake on translation of synaptic proteins (86). This observation fits in nicely with the observation that FMRP knockout mice show an overall increase in brain protein synthesis (87). However, it is not currently clear whether all of the increased protein synthesis is a direct result of the alleviation of translational inhibition by FMRP, or whether there are additional downstream effects. As was mentioned previously FMRP is involved in regulation of mGluR mediated synaptic plasticity, in addition, FMRP was recently implicated in regulation of the NMDA receptor pathway, which also mediates certain forms of synaptic plasticity (88). Finally, FMRP null mice as well as patients show major disruptions in many of the second messenger pathways that relay activity at the synapse into stabilization; molecules involved in learning (89-91). Combined, it is easy to imagine a large cascading effect on brain function in general and synaptic function in particular when FMRP function is disrupted. As perhaps the most well characterized neuronal RNA binding protein, FMRP is instructive in the wide range of its regulatory capacities as well as the specificity with which its disruption attacks the nervous system. It is important to remember that despite the massive changes in protein

synthesis and exuberant dendritic spine growth seen in FMRP knockouts and fragile-X patients, overall viability/survival and basal neuronal function is preserved.

CPEB: Again

As was alluded earlier, class I CPEBs also have a role in binding and regulating mRNA in the neurites. Many of the molecular interactions discovered in the early zygotic studies of CPEB1 function still hold in regards to the neuronal function of CPEB1. There are, however, many other important neuron specific partners to CPEB1 that help it to achieve a role in activity dependent translation regulation. As mentioned earlier, a critical component of CPEB1 function in the nervous system is its ability to regulate translation of CAMKII, an important mediator of activity-dependent synaptic modifications. As opposed to the zygote, where progesterone levels lead to the activation of Aurora kinase A, in the neuron it is activation of glutamatergic receptors that leads to either Aurora Kinase A or CAMKIIa and the subsequent phosphorylation of CPEB1 (27, 92, 93). Furthermore, various lines of evidence suggest that CPEB acts locally at the synapse, including co-localization of CPEB1 in the dendrites as well as pull down in the post synaptic density fraction in neurosomes in the rat (31, 92). Recent studies have also shown the class II CPEB Orb2 to be enriched in the dendritic compartment of the *Drosophila* brain (38, 39). Consistent with these two lines of evidence, numerous studies have implicated CPEB1 as being necessary for LTP, learning and memory (94-97). Together with the previously described roles of CPEB 1 in the oocyte and CPEB 2-4, and

its orthologs in invertebrates, the 3' UTR binding proteins found in the CPEB family of proteins offer numerous opportunities for candidates of synaptic translational regulation.

Nova: Again

Finally, we will address the role of Nova not as an alternative splicing factor but rather describe its more recently elucidated role in mRNA transport. In particular two recent papers from Robert Darnell's group have implicated Nova in mRNA transport out of the nucleus, and mediation of nonsense mediated decay of mRNA transcripts in the cell soma after seizure related neural activity (98, 99). In the first study, a 2010 paper published by Racca and colleagues, the localization of Nova in mammalian cells was well characterized (99). Initially they showed that Nova protein is present in both nuclear as well as cytoplasmic fractions using synaptosome preparations as well as immunofluorescence. Interestingly, for a splicing factor, a large portion of Nova protein (68%) was present in the cytoplasm, when normalized to volume. Subsequent analysis showed that Nova protein contains an NES that is necessary for export of the protein from the nucleus as well as an NLS, which is necessary for stabilizing the nuclear localization of Nova. To further characterize the localization of Nova, Racca and colleagues used electron micrographs. They found that Nova localizes to chromatin along the periphery of the nucleus as well as to nuclear pores but is absent in the nucleolus. Further, in the neurites, they found staining at the synapses, but no staining in the axons. To further characterize Nova localization, co-localization of Nova with synapsin (pre-synaptic) and gephyrin (post-synaptic, inhibitory) using immunofluorescence and electron microscopy

was used. Nova was found to be localized to the post-synaptic (dendritic) compartment of inhibitory (gephyrin positive) synapses. Having established the cell biological localization of Nova, Racca and colleagues next looked to see whether targets of Nova mediated alternative splicing are also transported to the synapse by Nova. As they knew that Nova was localized to the post-synaptic compartment of inhibitory synapses, the group looked at known Nova target mRNA, mGlyR α , and Nova protein co-localization. Indeed, they found that Nova and mGlyR α mRNA had overlapping immunofluorescence staining in the cell soma as well as in the dendritic compartment. They also found co-localization of mGlyR α as well as a second channel whose function was known to be perturbed in Nova knockdown experiments, GIRK2. Finally the group showed that the putative GIRK2 YCAY Nova binding site was important for transport into the dendritic compartment via a minigene reporter assay. In sum, the Racca study showed in nice detail evidence that points toward a potential dual role of Nova in both the processing of pre-mRNA as well the transport of the message to the site of later translation, the dendritic compartment.

The Darnell group followed the Racca study with a manuscript detailing physiological shuttling of mRNA from the nucleus to the cytoplasm in response to seizures, and regulation of transport through the presence of cryptic exons that mediate nonsense mediated decay (98). Using genomic scale analysis and a novel HITS-CLIP technique, the Eom study initially described a validated data set of mRNA whose stability/abundance relied on Nova (using Nova-1/2 double knock out mice) (98, 100). Additionally they made the observation that the majority of binding by Nova in the

nucleus was to intronic regions, while the majority in the cytoplasm was to 3'UTR sequence elements. They did, however, make the surprising observation that there were some cytoplasmic intronic elements that were bound by Nova. However, it was not clear to the Eom group whether these represented contamination from the nuclear fraction, were non-coding RNA or represented intron retention or stable, partially processed pre-mRNA. They next turned their attention to a single Nova-mRNA interaction, focusing on *Dlg3*, the mRNA that showed the largest reduction in abundance in the Nova double knockout animals. They found that both mRNA as well as protein levels were consistent with the HITS-CLIP data, showing a reliance on Nova protein for proper *Dlg3* expression. Interestingly, using RT-PCR the Eom group found that the loss of *Dlg3* mRNA was due to the inclusion of an unannotated splice variant that led to a frameshift that introduced a premature stop codon. This led to nonsense mediated decay that was confirmed by rescue with knockdown of UPF1 as well as accumulation of nonsense transcripts through treatment with emetine. To understand the opposite situation, in which Nova was necessary to suppress steady state levels of mRNA expression, the Eom group turned towards the gene that showed the largest increase in the Nova DKO mice, *Scn9*. In the case of *Scn9*, the situation was almost the precise converse of *Dlg3*: *Scn9* showed two splice forms in the WT brain, the larger of which contained an unannotated exon that was nonetheless conserved, yet introduced a nonsense codon into the transcript. In the DKO mice this alternatively spliced form was lost. And this loss could be rescued by both emetine as well as *Upf1* knockdown. To assay the physiological relevance of dynamic Nova regulation of NMD exon inclusion or exclusion in the brain, rather than in culture as the previous experiments did, the Eom study used pilocarpine induced seizure

activity. In the case of Scn9 as well as other mRNAs, they found that seizures produced changes in alternative splicing consistent with a role for Nova in activity dependent regulation at 2 and 4 hours, but not at 24 hours post seizure induction. Subsequently the group looked at changes in Nova protein itself at 2, 4 and 24 hours post seizure. They found a large shift of the protein to the cytoplasmic compartment by 2 hours, which persisted in some, but not all animals 24 hours post seizure. Finally, as mentioned in the Nova section on alternative splicing, Nova was found to regulate a large number of genes involved in autism and synaptic function at the level of alternative splicing (55). In a rather interesting turn, the Eom study also found that Nova regulated the steady state level of a large number of synaptic genes, yet out of the 229 steady state, Nova regulated synaptic genes, and the ~800 alternatively spliced, Nova regulated synaptic genes, only 18 genes emerged in both analyses. Together with the alternative splicing analysis and the Racca study, the Eom study furthers the interest in Nova as a mediator of activity dependent brain function as well as a key player in the synaptic dynamism that is central to neuronal health as well as learning and memory.

At the Synapse and Back: A Synthetic Model of Synaptic Stabilization and Memory

Having sketched a rough picture of the life of a synapse from ephemeral intraneuronal connection to stable site of network connectivity it is now possible to contextualize individual molecules in the formation of a working memory. In the initial vignette we considered the suppression of reflexive fear of the dark and it was posited that this was mediated by inhibition of pre-ganglionic acetylcholinergic neurons. If we ignore the

physiology of the network and sketch a simple model where memory, in the form of cognitive understanding, inhibits the reflexive fear of the dark and suppresses activation of the sympathetic nervous system, and that memory takes the form of the long term potentiation of an inhibitory synapse, a clear picture emerges. Initially there is little to no inhibition of fear. Repeated stimulation—understanding that things don't change in the night, which the door is locked, that monsters don't roam the night—increases the likelihood that our inhibitory synapse will fire through changes in actin polymerization at the dendritic spine and pre-synaptic modulation of the Ca^{2+} current. There is also increased inhibition of the sympathetic nervous system because of increased pre-synaptic vesicle release. As time passes and experience further solidifies our understanding, local translation leads to increases in the number of receptors that can respond to the pre-synaptic firing, which increases the chance that the synapse will raise the excitation threshold of the pre-ganglionic neuron and prevent activation of the fear response. At this point all of the changes are local and reversible. Through some mechanism these changes that represent an intermediate memory will become solidified and roughly permanent. One mechanism that could explain this is the oligomerization of CPEB 2-4 at the synapse of interest. This may lead to an altered translational program at the 'permanent' synapse that can capture mRNA that are being shuttled through the dendritic compartment by proteins such as ZBP, FMRP, CPEB and Nova. And it is this unknown window, the moment where the transient, local synaptic change undergoes a shift and becomes a permanent change—where experience solidifies a behavioral response—that the present dissertation seeks to identify. Looking back, there are various regulatory points. For one, we know that Orb2A (and perhaps CPEB 2-4 (*101*)) is required for memory and acts via

the hetero-oligomerization of Orb2B. Further, we understand that RNA binding proteins can mediate alternative splicing in response to activity and can shuttle mRNA into the dendritic compartment. Therefore we can hypothesize a model where activity—which can trigger local translation, alternative splicing and mRNA transport—mediates the splicing and transport of Orb2A mRNA to the site of intermediate memory, where it is translated, oligomerizes Orb2B and forms a synaptic mark that is stable over time and capable of initiating a translational program at a discrete sub-cellular (synaptic) location. In the present dissertation evidence that supports this model will be presented. We will show that Orb2A mRNA is present in a non-protein coding form in the adult fly brain, that experience sufficient to produce memory leads to an increase in the protein coding form of Orb2A mRNA in relation to Orb2B mRNA, and that Nova binds to the intronic region of Orb2A mRNA, as well as the 5'UTR and exonic sequences. Furthermore we will show that knockdown of Nova protein in the fly CNS is capable of reducing the amount of protein coding Orb2A mRNA in the basal state. Additionally, we will include a pilot screen that may identify other splicing and gene expression changes that may occur in the early stages of LTP formation, when the foundation for L-LTP is being set.

Chapter II: Expression of Orb2A in the brain.

Orb2 was first described as a neuronal CPEB with the potential to regulate synaptic plasticity in the early 2000s (29, 32). It was noted that the sequence homology between mouse CPEB 2-4 and Orb2 was higher than that between mouse CPEB1 and mouse CPEB 2-4. This observation indicated the potential of a distinct and conserved role for Orb2 in memory formation, as Orb2 was also noted to share similarities, on the amino acid level, to apCPEB, which had a unique prion-like mechanism (33, 34). Further analysis of Orb2 via *in situ* hybridization indicated that it had enriched expression in the nervous system (36), furthering the case that it may, like CPEB2-4 and apCPEB, be involved in memory. In fact, this was the case, as flies lacking the glutamine rich region of Orb2 showed deficits in long term memory formation, but not learning, both in trans with a wild type allele of Orb2 as well as when homozygous (36). The requirement of the glutamine rich domain for long-term memory in the Keleman study was consistent with the prion hypothesis of memory stabilization. However, the Keleman group did not pursue characterization of the molecular mechanism at play, or differentiate the roles of the 2 major protein isoforms, Orb2A and B, in long-term memory (36).

In 2010 our group published two studies that were the first to characterize Orb2A in depth (35, 40). We found that Orb2A was able to form homo-oligomers in response to application of serotonin in a heterologous system (*Aplysia*) (40). Further, Orb2A had a unique set of binding partners when over expressed in the brain as compared to Orb2B (35). The over expression and use of a heterologous system were necessary because of the extremely low levels of Orb2A protein in the adult fly brain, as well as the small

unique peptide sequence expressed by Orb2A (9 amino acids) (37, 38). The *orb2* gene locus is rather complex, containing 2 protein families (Orb2 and Orb2-CG43113) with

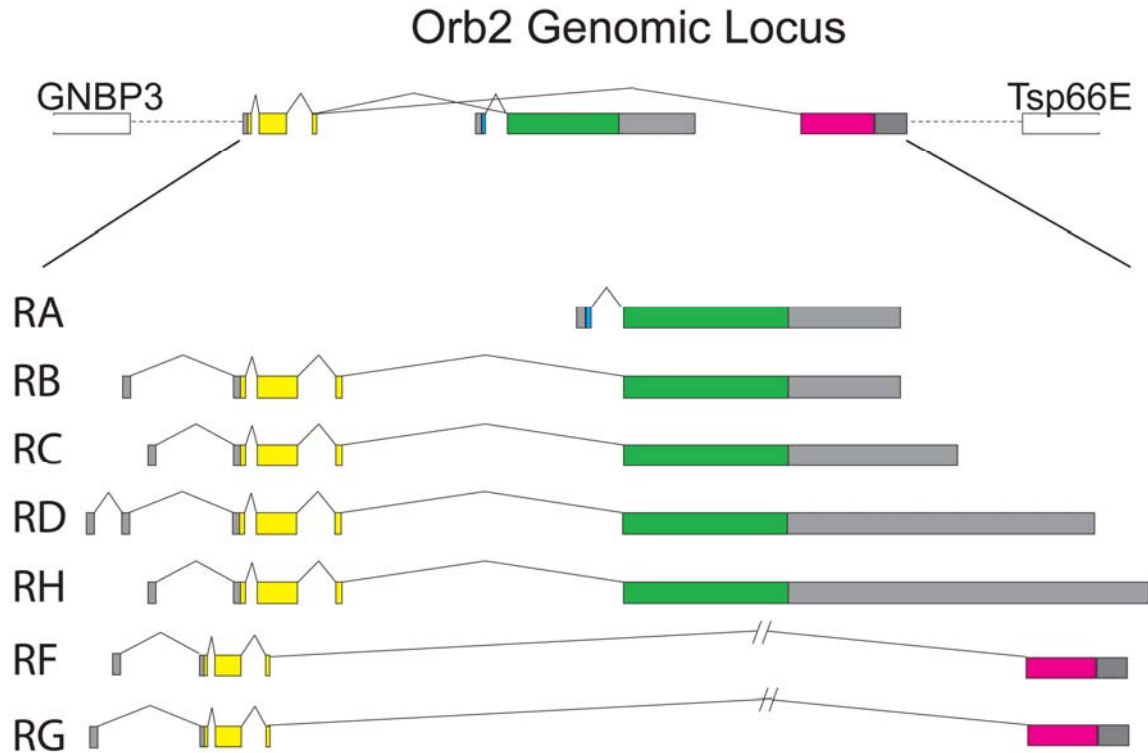

Figure 3 Orb2 genomic locus. Clear boxes represent non-Orb2 genes, colored boxes Orb2 exons, and gray boxes are UTRs. Solid lines represent introns/splicing choices, while dotted lines are intergenic regions that are not to scale. Upper panel: Genomic locus, including neighboring genes, GNBP3 is 5' of the Orb2 promoter, Tsp66E is downstream. Lower panel: Yellow exons represent Orb2B specific exons, as well as those shared by both Orb2 and the hybrid protein Orb2-CG43113. The blue exon represents the unique Orb2A exon. The green exon is common to all Orb2 mRNA. The magenta exon is common to all hybrid Orb2-CG43113 isoforms. It should be noted that the magenta exon does not show all splice variants, exon and intron, possible from the hybrid Orb2-CG43113 locus. RB, C, D and H are all referred to as Orb2B mRNA unless specified in the text.

the hybrid Orb2-CG43113 protein family containing a unique C-terminal ORF that shares no homology with the CPEB2-4 proteins (Fig. 3) (37). We will not discuss Orb2F or Orb2G subsequently. Of the Orb2 protein family (A-D, H) the mRNA encodes 2 proteins Orb2A and Orb2B-D,H. Orb2B-D,H encode a protein that will be referred to as Orb2B and 4 different mRNA that differ in their 5 and 3 prime UTRs. For the present study we will consider Orb2B-D,H mRNA as a single mRNA species that will be referred to as

Orb2B. Because of the low abundance of Orb2A mRNA, it has been reported that protein coding Orb2A mRNA are only observed in the testes (37). The mRNA expression is further obfuscated by the presence of the unique Orb2A exon inside of an Orb2B intron (Fig. 3). Due to our group's observations of a memory phenotype correlated directly to Orb2A (38), which was verified by the Keleman group (39), we sought to further interrogate the Schedl group's claim that Orb2A mRNA expression was restricted to the testes.

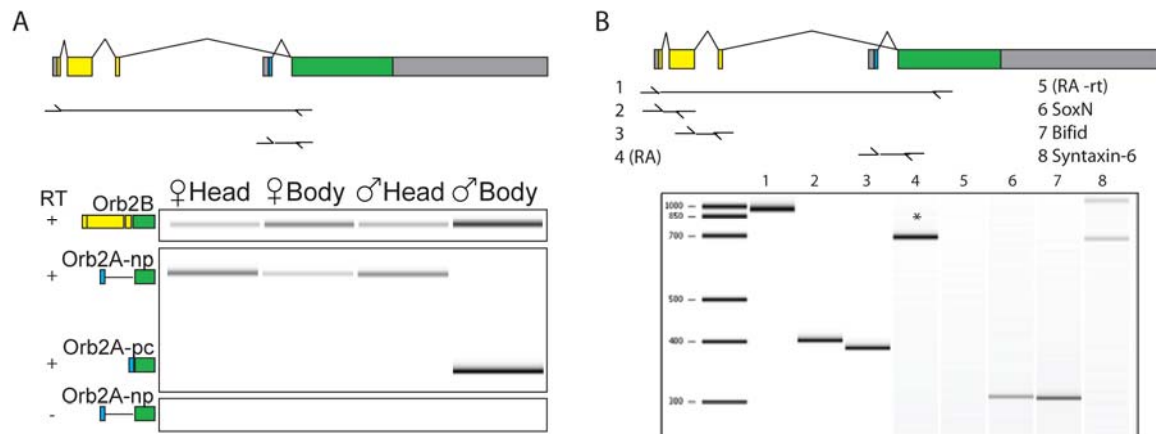
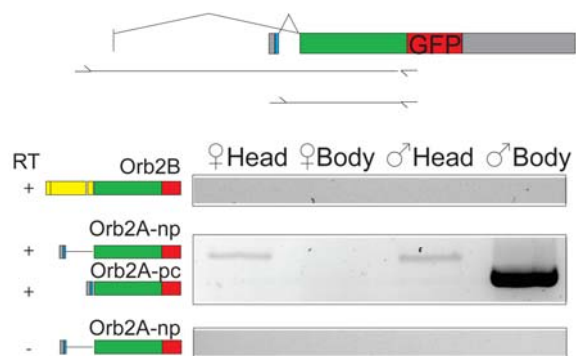

Figure 4 Orb2 splicing profile. (A,B) Splicing schematics are as described in figure 1. All gels were run using Agilent Bioanalyzer as described in methods. (A) Tissue distribution and relative abundance of Orb2 mRNA. Upper panel, Orb2B, run at 24 cycles. Amplified region includes all Orb2B exon-exon junctions. Expression is highest in male body, roughly equivalent in female and male head, and slightly higher in female body. Center panel, Orb2A mRNA (30 cycles). Orb2A-np is the predominant isoform expressed in the male and female head as well as the female body. Orb2A-pc is the predominant isoform expressed in the male body. Relative expression indicates highest levels of Orb2-pc in the male body, where as expression of Orb2A-np is highest in the male and female head, with lower expression in the female body. Lower panel, minus reverse transcriptase control indicates that Orb2A-np is a mRNA transcript rather than genomic contamination. (B) cDNA generated from single female fly head. All primers are intron spanning. As shown all major spliced introns are constitutively spliced. The U12 spliced gene syntaxin-6 displays partial intron retention. Orb2A displays full intron retention. 1. All Orb2B exon-exon junctions. 2. Orb2B Exon 1 - Exon 2 junction. 3. Orb2B Exon 2 – Exon 3 junction. 4. Orb2A 5. Orb2A – RT 6. Neuronal transcription factor SoxN. 7. Neuronal Transcription factor Bifid. 8. Minor spliced mRNA syntaxin-6 displaying partial retention of its intron.

mRNA expression experiments were conducted after isolation of total RNA from single fly, whether whole head or whole body, as indicated in the text or figures. Using RT-PCR, we found that the expression of mature Orb2A mRNA was in fact restricted to the male body, presumably the testes as the Schedl study claimed (Fig 4A). However, we made the interesting observation that Orb2A mRNA was expressed in a non-protein coding form in male and female fly heads via retention of the single intron (Fig 4B). We were able to confirm that this was not a technical artifact of genomic contamination via a control reaction in which the reverse transcriptase was omitted (Fig 4A/B). Additionally, we found that the level of expression of the non protein coding transcript was highest in the fly head (Fig 4A). It is important to note that we think that the seeming lack of expression of the retained form in the male body, as seen in the female body, is likely an artifact of the extremely high level of expression of the protein coding form from the male testes. It is also of note that the relative abundance of the two transcripts is such that Orb2B is seemingly higher in body, male and female, while the expression of the non-protein coding form of Orb2A is higher in the head than in the body (Fig 4A).

To further characterize the intron retention seen in the adult fly head Orb2A mRNA, we first asked whether the other exon-exon junctions of Orb2B displayed a similar retention (Fig 4B). We found that in Orb2B in which the intron is of similar length to Orb2A was efficiently spliced (Fig 4B 2,3). We were unable to ask a similar question of the large intron, due to its large size, which would prevent PCR based analysis. We looked at 2 additional neuronal mRNA and verified that randomly sampled exon-exon junctions are likely to display constitutive splicing (Fig 4B 6,7). We also asked whether, in the head,

the appearance of the non-protein coding form could be explained by potential splicing through the minor U12 dependent spliceosome, a rate limiting set of snRNA that are used on a small percentage (<1%) of intronic splicing events (102). To do this we asked whether known U12 dependent spliceosome mediated splicing events also exhibited intron retention. We found that Syntaxin-6, a known target of the U12 dependent spliceosome (103, 104), in fact showed retention of its intron, although this could be due simply to a gating effect caused by limited abundance of U12 dependent spliceosomal components, a known mechanism of limiting gene expression (Fig. 4B8) (105). We cannot exclude the possibility of splicing through the U12 dependent spliceosome as being a component in the retention of the Orb2A intron (See pg 47 for further discussion), yet the near absence of protein coding Orb2A mRNA suggest additional mechanisms affecting the retention of the Orb2A intron.



As was briefly mentioned previously, the presence of the Orb2A exonic sequence within an intron of the much more highly expressed Orb2B

Figure 5 Orb2A is an independent transcriptional unit. Top: schematic of Orb2 pCasper construct in which all sequences upstream of Orb2A are deleted. Primers amplify all the way to 3' GFP to assure no overlap with native genomic locus. Upper gel pCasper has no transcription from Orb2B locus. Middle gel, Orb2A is an independent transcriptional unit that expresses Orb2A-np in the male and female fly head, but not in the female body, where it is not expressed at all, or male body, where the Orb2A-pc form is expressed. Bottom gel, minus RT control to ensure Orb2-np in male and female head is not a artifact of genomic contamination.

transcript leads to the complicating possibility that Orb2A was not expressed as a non protein coding form, but rather was not transcribed at all in the basal state, and that the

detection of ‘non-protein coding’ transcript was simply an artifact of Orb2B pre-mRNA. To address this possibility, we turned toward a genomic construct in which the promoter and coding sequences for Orb2B were deleted (pCasper) from a bacterial artificial chromosome (BAC) that contained a large fragment encompassing the Orb2 gene locus. Using bacterial recombineering (106), large genomic fragments (the BAC containing the Orb2 locus is 18kb (38)) can be easily manipulated. Further, the engineered BAC can be inserted into a stereotyped genomic location, which mitigates variation due to random insertion. In addition to a deletion of the Orb2B promoter and coding sequence, GFP was appended to the 3’ end of the Orb2 shared exon (Fig. 5, top). Using this construct, we were able to use 5’ primers from either the unique Orb2A exon or the deleted Orb2B region. We verified that there was no transcription from the Orb2B promoter by looking at mature Orb2B GFP in the deletion construct (Fig. 5 Orb2B). On the other hand, we saw that the Orb2A specific 5’ primer in conjunction with a 3’ GFP primer was able to amplify the intron retained Orb2A non protein coding transcript (Fig 5 Orb2A-np) in both the male and female fly head. Interestingly, we were unable to amplify Orb2A-np in the female body. We confirmed that this expression was not due to genomic contamination via minus reverse transcriptase control (Fig 5, bottom). We also amplified the Orb2A-pc form from the male body, which confirms normal expression/transcription of Orb2A in the male body/testes (Fig. 5 Orb2A-pc). Combined with the data obtained from wildtype animals, the pCasper analysis provides a strong case that Orb2A mRNA is derived from a unique transcriptional unit, and that the vast majority of Orb2A mRNA is maintained, in some manner, in the non-protein coding form via intron retention.

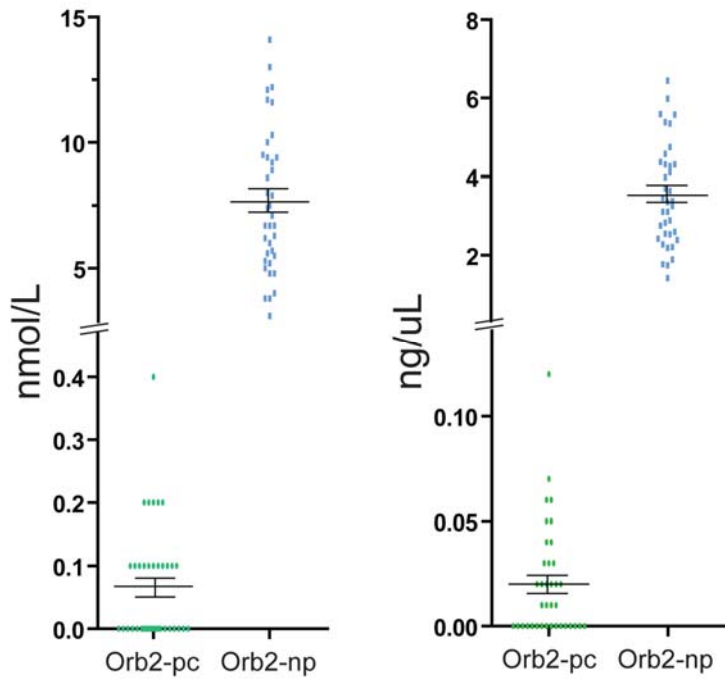

This led us to ask what the ‘basal’ level of Orb2A protein coding transcript is. To do this we turned to PCR analysis using the Agilent 2100 bioanalyzer, which is capable of sensitive detection of PCR fragments compared to conventional ethidium

Fig 6 Orb2-np/pc ratio. Using the bioanalyzer and the same probes used in figure 4, lane 4, 40 fly heads were isolated and analyzed using RT-PCR. The bioanalyzer has a larger dynamic range than ethidium bromide, agarose gel analysis. Left, product abundance for OrbA-pc (green) and np (blue) plotted with correction for size (molar). Orb2-np is 2 orders of magnitude more abundant than Orb2-pc. It should be noted that half of the samples failed to amplify any Orb2-pc product. Right, same samples were measured, but were plotted using the more sensitive concentration measurement. In this case, 24 out of 40 samples had detectable Orb2-pc detection. As an average Orb2-np is about 100 fold more abundant than Orb2A-pc, however it should be noted that the sensitivity of this assay, while better than agarose gel analysis, is weak in the range at which Orb2-PC is expressed.

bromide agarose gel detection. This would allow for detection and relative quantification of Orb2A-np and -pc forms. Using this detection method we used the same primers that were used in figure 4B lane 4 and amplified Orb2A cDNA from 40 samples from individual fly heads of animals that were raised under normal fly stock conditions. Considering only the sample in which we were able to detect a product we found that Orb2-np is roughly two orders of magnitude more abundant than Orb2-pc when normalized for either molecular weight or mass (Fig. 6). Out of the 40 samples, Orb2A-

pc was undetectable in 16 fly heads via this method of detection when using mass as calculation (a more sensitive reading on the bioanalyzer).

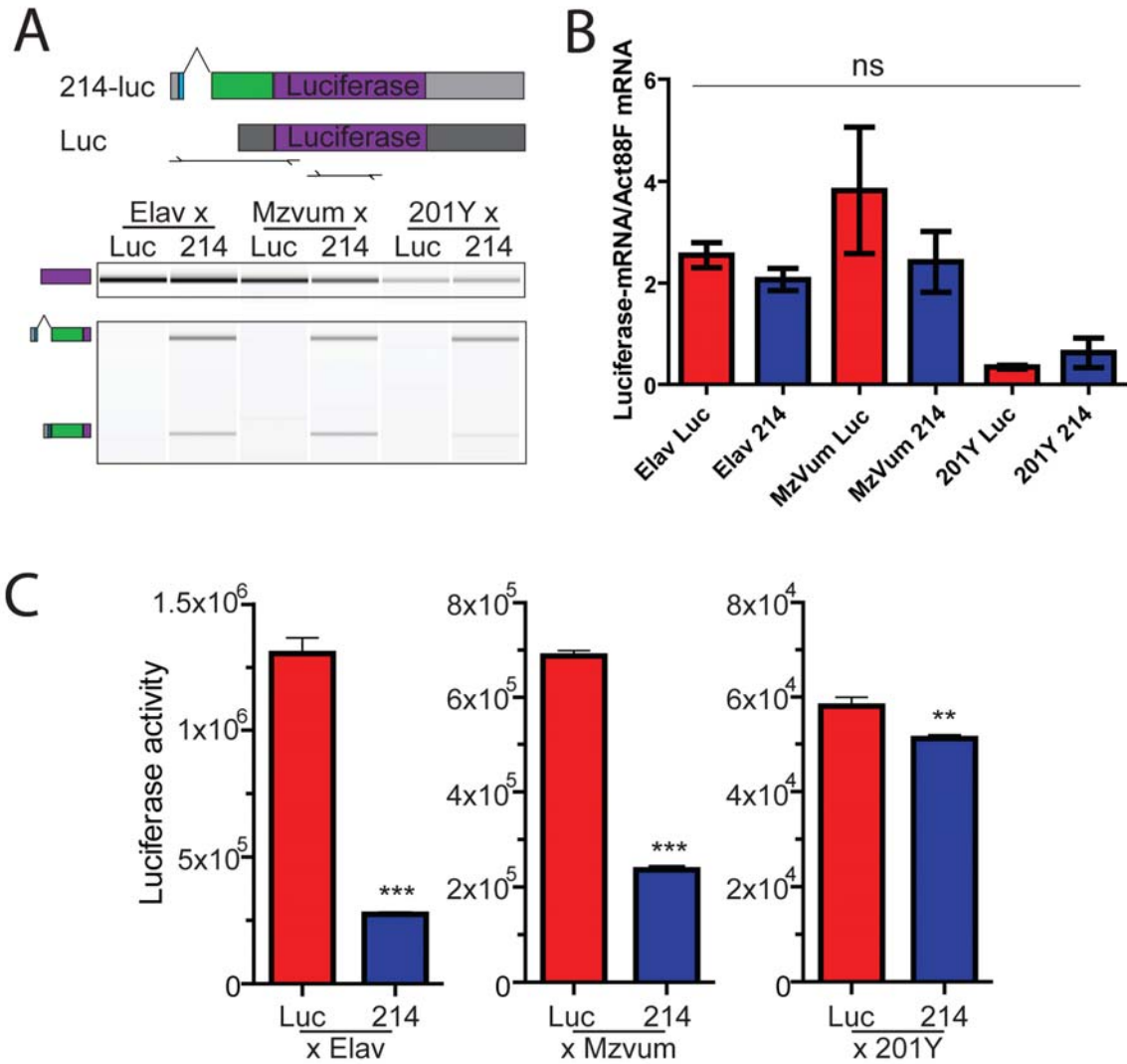

Fig 7 Orb2A sequence is sufficient to suppress gene expression, retain intron. (A) Top, schematic of 214-luciferase construct (214) and luciferase control (Luc). Upper gel, levels of transcription of the two constructs under various neuronal drivers. Transcription is roughly equivalent. Lower gel, addition of Orb2A 5'UTR, exon, intron and proximal 214 bps is sufficient to lead to intron retention. (B) n=4 for all bars; there are no significant differences between any pairs (Luc:214) of UAS driven by a given driver. (C) Orb2A 214 sequence significantly limits luciferase activity. (Elav x Luc/214 n=24; Mzvim x luc n= 40, 214 n = 24; 201Y x luc n = 36, 214 n= 30) For * p values see methods.

Because of the extreme scarcity of the Orb2A-pc transcript in the fly head, and the exceptionally low level of Orb2A protein, we decided that it would be useful to build a transgenic protein reporter that could help us further understand the nature of the regulation on splicing and protein expression introduced by the Orb2A intronic sequence. To do this we built a minigene reporter in which the 5'UTR, first exon, Orb2A intron and first 214 amino acids of Orb2A were fused in frame to the firefly luciferase gene. This was put in a UAS construct and integrated randomly to generate a UAS-214luc fly line (107). We initially asked whether inclusion of the Orb2A 5' sequences, but not sequences downstream of base pair 214 of the shared exon or those of the 3' UTR were sufficient to lead to intron retention on the minigene mRNA. Indeed we found that while overall transcriptional activation of the UAS by various Gal4 drivers was indistinguishable between the 214-luciferase minigene and a UAS-luciferase containing only the ORF of luciferase (Fig 7A top 2 panels, Fig 5B), the 214-luciferase construct showed retention of the intron (Fig 7A bottom panel). Furthermore, we asked whether the inclusion of the Orb2A intron was sufficient to limit gene expression. To do this we measured the luciferase activity from single fly heads that were expressing either UAS-214-luciferase or UAS-luciferase under various Gal4 drivers, either pan-neuronal drivers generated from the *ElaV* promoter, a circuit promoter (*Mzvim-Gal4*) that our lab identified as being potentially important for Orb2 mediated memory and activity dependent synaptic changes, and *201Y-Gal4*, which is expressed in the mushroom body, an important anatomical structure in the fly brain that is often considered as the analog to the hippocampus (108). We found that in every case, there was significant reduction in

luciferase activity (Fig 7C), despite no significant differences in mRNA abundance (Fig 7A,B).

Having established that Orb2A mRNA exhibits intron retention, and that this intron retention limits gene expression, we turned towards analysis of the Orb2A sequence to determine whether the intron is sufficient to limit protein expression. Because of the unique nature of the observation, almost full retention of the intron, and the literature on the U12 dependent spliceosome and its role in limiting gene expression, we sought to

Fig 8 Orb2A has non canonical intronic sequence elements. Upper panel, Orb2 gene schematic, and zoom of Orb2A shared 3' splice site (SS). Green indicates elements shared with well characterized U12 dependent mRNA, NHE3. Red indicates elements shared with U2 dependent intron from an adenovirus mRNA. Underlined is the branch site. Lower panel, 5' SS, putative branch site and 3' SS of NHE3 (U12), Orb2A, Orb2B and adenovirus (U2). Green highlight indicates similarities between 5' SS of Orb2A with U12 5' SS and yellow highlight of those between 5' SS of Orb2B with U2 5' SS. Bold A indicates branch point adenosine of characterize U2 and U12 branch sites and putative Orb2A branch site.

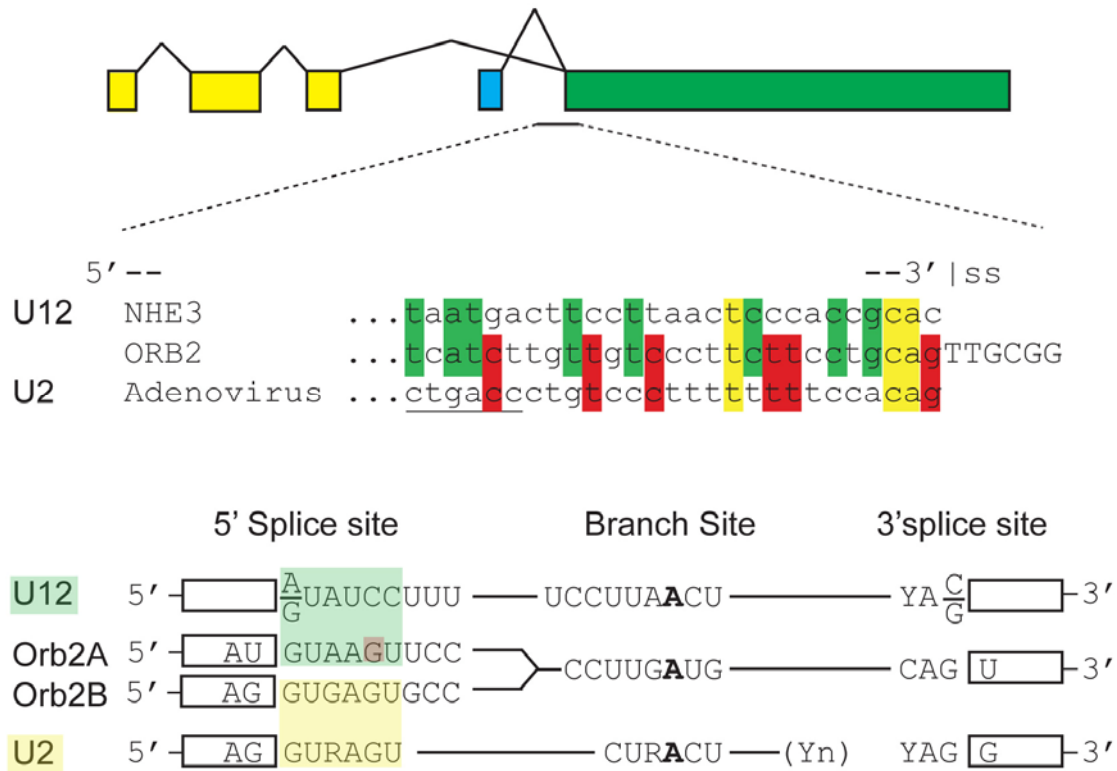

determine whether through sequence analysis there was any evidence that the Orb2A intron might utilize the U12 dependent spliceosome. Before proceeding a small digression on the U12 dependent spliceosome is necessary to clarify the origin of our hypothesis of U12 dependent spliceosomal control of Orb2A splicing.

The U12 dependent spliceosome was identified in the early 90s via the preliminary identification of introns with non-canonical splice sites (109). It was subsequently found that this class of introns utilized analogous but divergent and conserved spliceosomal machinery for excision (110, 111). However, the AT-AC sequence that was at the heart of the initial finding of minor introns were found to not be as highly conserved as originally thought, and were not sufficient to identify the splicing machinery used at a given intron (112). Rather it was the branch site that was the most highly conserved and predictive element of minor introns (113, 114). It has been shown that while the U12 dependent spliceosomal machinery is of far lower abundance than that of the major spliceosome this is not the contributing factor to its limiting effect on gene expression (105, 115). Furthermore, recent studies regarding the evolutionary conservation, role in alternative splicing and role in human disease of the U12 spliceosome have furthered our understanding of U12 splicing (116), but have yet to reveal a cohesive picture regarding the precise role of the U12 spliceosome in a global, regulatory sense.

As mentioned, following the coupled observations that Orb2A seems to exhibit an mRNA processing mediated limit on gene expression, and that intron retention is the mechanism by which this seems to occur, we asked whether intronic sequence elements could explain this phenomenon. Initially, sequence analysis seems to indicate that the Orb2A intron has both fewer 3' pyrimidines in general, and especially a large substitution of thymine/uracil with cytosine, with thymine/uracil being the preferred pyrimidine in functional poly-pyrimidine tracts (Fig. 8 middle panel) (117). Additionally, the putative Orb2A branch site seems to share more sequence homology with consensus U12 branch sites than the canonical U2 branch site (Fig. 8, lower panel), notably the non-consensus nucleotide, an A to G substitution, is the most frequent substitution in U12 branch point sequences, while the CCUU sequence just upstream is the most conserved, along with the defining adenosine (116). An interesting note, and confounding factor, is the presence of an alternative 5' exon (Orb2B) for the 3' splice site of the Orb2A intron. While the dynamics of minor splicing choice verse major splicing choice are not well established, and in the case that they are, they suggest that minor verse major splicing choices in alternative splicing are usually made at the 3' splice site, it is nonetheless interesting to note that while the 5' splice site of Orb2B shares precise homology with the consensus U2 5' splice site, the Orb2A sequence is more degenerate and shares certain, if not all, features with the consensus U12 5' splice site (Fig 8 bottom). To ask whether a functional U12 dependent spliceosome is required for splicing of Orb2A, we turned to a p-element insertion in U6atac snRNA, which is the only U12 dependent snRNA (U11, U12, U6atac, U4atac) that is viable as larvae. In this case, preliminary data seems to indicate that at least U6atac may be necessary for expression of Orb2A-pc (Fig 9). Further and more

tightly controlled analysis using our current understanding of Orb2A expression in the male testes, including at larval stages, and techniques that will be described subsequently,

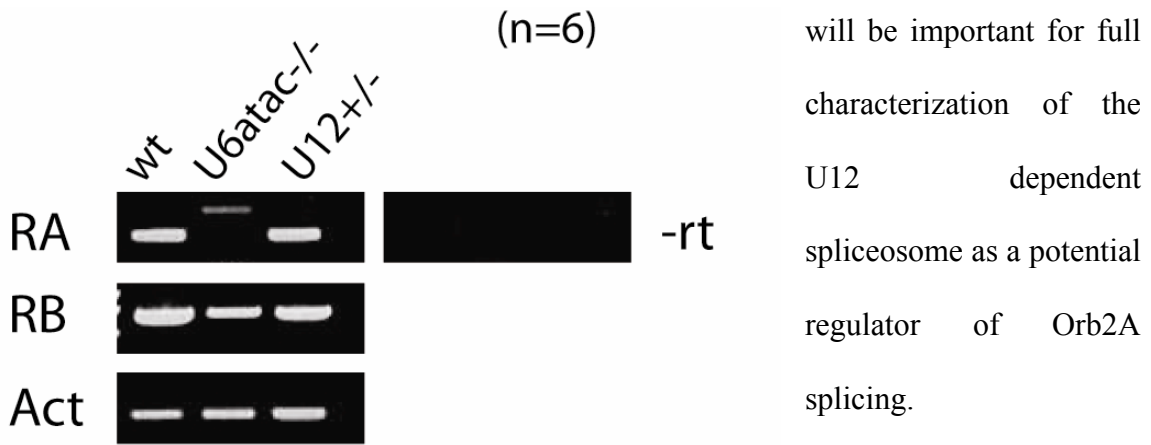

Fig 9 Knockdown of U12 spliceosomal components may disrupt Orb2A mRNA processing. Upper left is Orb2A-pc, seen in WT and heterozygote larval cDNA (which is predominant form in male larvae). In the U12 knockdown, U6atac ^{-/-}, Orb2A-np is pre-dominant. Middle and lower show no difference between genotypes when looking at Orb2B or Act88F. n=6 represent biological replicates not shown.

Chapter III: What Makes a Memory?

Part I: Orb2A-pc

The results of our analysis of Orb2A mRNA in the fly brain are thought provoking for a number of reasons. Initially, they uncover a potential novel mechanism for mRNA regulation in memory processes, specifically intron retention. Second, it is entirely consistent with the putative prion-like seeding capacity that has been proposed and dissected by our lab and others (38-40) in that it greatly limits the chance of spurious translation of the prion-like seed. In other notable examples, excessive or misregulated prions can cause exceptional pathology and death in humans and other mammals (118). Although there is no link between CPEB 2-4 to disease in humans, the propensity for Orb2A to form oligomers makes it a predictable target for both stringent post-transcriptional regulation as well as tight transcriptional control, both of which seem to be at play given the analysis in chapter II. A third level of interest generated by the study undertaken in the second chapter is that perhaps Orb2A could be used as a read out of *when* a long term memory will form, and could therefore be seen of as a type of marker for the way that external stimuli interact to produce long term memory in an organism. Furthermore, if this were the case, it could be used to dissect different components of behavioral experiences to ask the question of how various stimuli and external factors combine to influence the memory of individuals. On the level of health, this has widespread implications, as post traumatic stress disorder, drug abuse and other disorders of addiction can all be considered as pathological memory states.

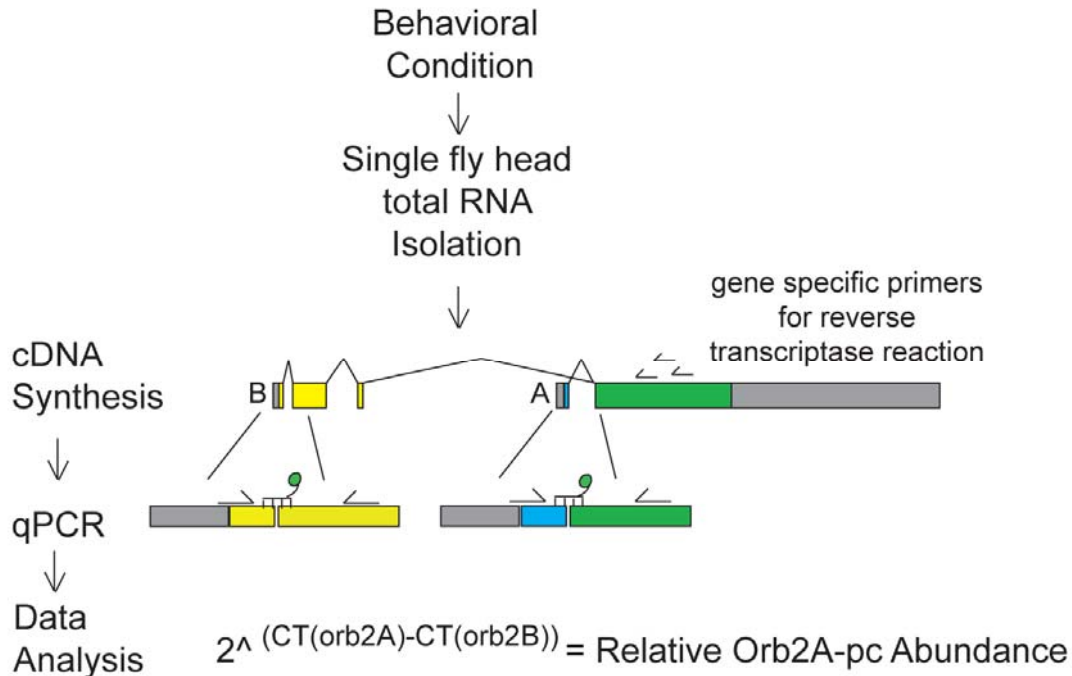

Fig 10 Schematic of RNA isolation, qPCR strategy. Flies from a given behavioral condition are frozen in nitrogen, RNA from individual fly heads is isolated, followed by use of gene specific primers to generate cDNA composed only of mRNA isoforms transcribed from the Orb2 locus. Subsequently a qPCR assay is conducted that only detects amplification of either spliced Orb2B or Orb2A-pc. Finally, we use the $2^{-(\Delta \Delta CT)}$ method (120) to generate a linear ratio of Orb2A-pc to Orb2B.

However, a large obstacle standing in the way of this analysis is the exceptionally low abundance of Orb2A-pc in the adult fly brain coupled with the relatively high abundance of Orb2A-np. The ~100 fold difference (Fig 6) makes detection of Orb2A-pc even more difficult as the more abundant unspliced form could potentially act as a sink that could prevent detection of the Orb2A-pc transcript. To avoid this issue, we sought to design an assay that could specifically detect Orb2-pc. To do this we turned towards the probe based quantitative PCR (qPCR) Taqman assay (119). Briefly, this technique takes advantage of the 5'-3' exonuclease activity of Taq polymerase and a probe that includes a fluorophore and quencher dye. In this assay the quenched fluorophore is annealed to an oligonucleotide probe that binds to the exon-exon junction of Orb2A-pc. Upon initiation

of the polymerase chain reaction (PCR) the Taq polymerase binds to the Orb2A-pc and np cDNA and begins to synthesize a complementary strand for both Orb2-pc and Orb2-np. However, rather than post-hoc quantification of the two amplified DNA products via ethidium bromide staining and image analysis (agarose gel electrophoresis) or optical imaging of a proprietary gel (Agilent Bioanalyzer), this method detects overall

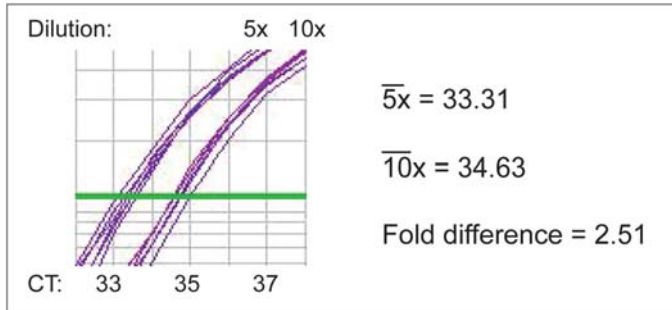

Fig 11 a 5x dilution of single fly head generated cDNA is in the dynamic range of Orb2A-pc detection. Shown are the CT amplification curves and the shift that is seen after a 2x dilution, from 5x to 10x. The expected fold difference is 2, while a fold difference of 2.5 is observed. From 2 samples, this difference shows very little alteration.

fluorescence activity, which should only increase in response to the separation of the bound fluorophore from the bound quencher oligonucleotide probe by the Taq polymerase (Fig 10). In this way, irrespective of the relative concentrations of

Orb2A-pc and np, we should get a specific measurement of the abundance of Orb2A-pc. To verify that the amplification of Orb2A-pc, given its low abundance and the inability to detect any of product after traditional PCR using standard or high sensitivity techniques (Figs 6, 7, 8), we sought to validate the detection of the probe using a serial dilution. Although we know that Orb2A-pc is near the low end of detection, but because we only have a limited supply of cDNA per fly head (20µl see methods) we used a 5x and 10x dilution and sought to determine whether there was a 1 CT shift, which would be indicative of a 2 fold change in concentration of the product being detected. Indeed we found that the qPCR assay we designed could reproducibly detect a 2x dilution (from 5x to 10x dilution of the cDNA sample generated from a single fly head) (Fig 11). It should

be noted that we were unable to validate our qPCR assay using random hexamers for the generation of our cDNA library, which precludes our options for experimental controls. Instead we have chosen to use a set of three gene specific reverse primers that sit on the shared exon (see methods; Fig 10). In summary, our assay for detection includes the isolation of total RNA from a single fly head, generation of cDNA using reverse transcriptase and gene specific primers, Taqman qPCR detection of Orb2A-pc and mature Orb2B transcripts, and generation of a ratio (fold difference) between Orb2A-pc and Orb2B mRNA using the $2^{(-\Delta \Delta CT)}$ method (120). We can then compare the change in the fold difference of Orb2A relative to Orb2B. We believe that this analysis is valid on two levels. Initially, we have RNA sequencing data that indicates that Orb2B does not significantly change over various behavioral conditions (see below). However, even if the amount of Orb2B does change in a given condition, the prion hypothesis of Orb2 would dictate that the most important factor in persistent memory is the hetero-oligomerization of Orb2, which should be dependent on the number of propagons (Orb2A) in the cell (121, 122).

Having established a method whereby we can assay changes in Orb2A-pc abundance, we can now move into an analysis of the behavioral paradigms that are sufficient to generate memory in *Drosophila*, our organism of interest. There are many types of learning that occur in *Drosophila*, from male aggression, male courtship suppression, olfactory association (aversive as well as appetitive), heat box avoidance assay and various types of visual learning (123). While all of these paradigms are useful to assay learning in fruit flies, not all of the stimuli are capable of producing long lasting memory in the flies,

which we consider to be 24 hours or longer. Of the well characterized paradigms, the ones that have been used most extensively in the study of lasting memory have been courtship conditioning and appetitive olfactory association (124, 125). A more recent and intriguing paradigm has been developed that involves EtOH association in flies, but that will not be addressed in any detail (126). In general terms, we have gravitated towards courtship suppression and appetitive olfactory association not only for their ability to produce long lasting memory, but also because they offer their own unique benefits.

For courtship suppression, the behavior is both social, which increases its etiological relevance—if the memory is dictated entirely by the interaction of flies, it almost *must* be significant—as well the analytical possibilities. We can reliably gauge the learning on a single fly level, and subsequently analyze those flies. Moving forward with our analysis, it will be of extreme importance to validate the effect that olfactory memory training has on Orb2A-pc in the courtship suppression paradigm for these reason. However, in the present study we have focused on appetitive olfactory association due to the technical hindrance that our assay relies on detection of Orb2A-pc, which is expressed at very high levels in the male testes. Through the course of experiments, we came to find that even in the isolation of single male fly heads there was a non trivial incidence of contamination from either the sperm or the testes such that the level of Orb2A-pc showed enormous increases in abundance. Moving forward, we believe that it will be possible to differentiate between samples that have been contaminated, and those that are free of contamination from male sex organs, however, in the present study we have not pursued this possibility any further.

Appetitive olfactory association also offers several advantages. While it is an extremely abstracted iteration of natural behavior, it is nonetheless, in our opinion, more relevant to natural fly behavior than electric shock or tethered place learning. Furthermore, while the abstraction has made it less etiologically relevant—it is hard to imagine a fly in nature encountering a 1M sucrose solution and a neutral odor in proximity—the abstraction has also made it an extremely tractable paradigm where the individual components of memory formation can be deconstructed and analyzed individually. The components of memory formation can be simply enumerated as such: memory requires a motivation, and two stimuli to be associated.

In humans this can come in many forms. In the case of pathological learning, such as extreme stress and traumatic events, as is the case in PTSD in combat, the internal state and external events are clear. In other cases, say a motor vehicle accident, the internal state is less clear, but perhaps the nature of the external cue is so strong, an exceptional alteration of a habituation, that a powerful memory is nonetheless generated. In other cases, like drug addiction, the neural circuitry may be affected by application exogenous compounds that work on the level of neural circuitry and bypass the normal mechanisms that control memory formation. On the other hand, in situations where learning is consciously sought—notoriously, while studying for an exam—perhaps the motivation is too artificial to induce a strong memory. Intriguingly, a method that was used by the ancient Greeks to bypass this technical difficulty in academic learning was to co-opt the innate memory systems, in this case, what we have since learned to be hippocampal place

learning, by abstracting the object of learning (a grammatical article becomes, say, an orange) and placing it in a physical place in a mental map in the mind, as humans are extremely adept at remembering the visual representation of physical places (perhaps the inside of your house). In this way, even in our own minds we can use tricks of innate behavior to learn, and remember, information that we perhaps weren't evolutionarily adapted to recall. In the case of the fruit fly we can similarly take advantage of innate mechanisms to create an artificial system.

In appetitive olfactory association we are taking advantage of the fact that flies are likely to need to remember where they have previously found food sources in order to have a continued source of nutrition over time. In this way, we can make the flies hungry by starving them, which increases their motivation to seek food. We can subsequently offer them an odor, that is otherwise not attractive to the fly, in the presence of sugar, and they will remember to seek that odor in future instances of hunger. To make the paradigm an assay, we also offer the fly a second neutral odor coupled with water, and use it as an alternative choice when they are hungry. Using this paradigm, a significant majority of flies will seek the odor that was paired with sugar rather than water when they are hungry. Now in a straightforward way a tractable paradigm has been produced, where the nature of the motivation—length of starvation, genetic manipulation of starvation signaling in the brain—nature of the sugar—which in this case is the unconditioned stimulus, meaning that it has a predetermined valence to the fly—and the nature of the odor—the conditioned stimulus—can be manipulated.

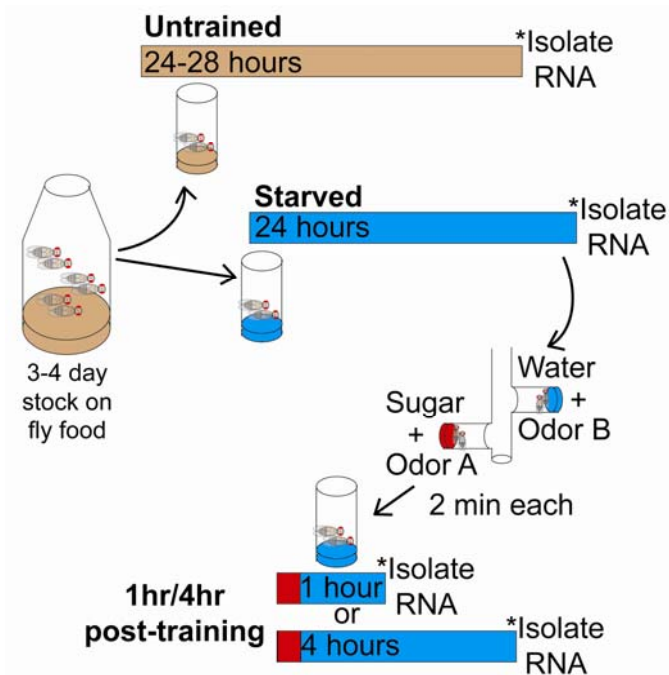

Fig 12 Behavioral training/RNA isolation paradigm. Flies considered to be untreated are nonetheless shifted to a smaller bottle to account for the mechanical stress of jostling. The 24-28 hour window is a time control for age dependent differences that might happen after starvation (24 hours) and 4 hours post training (28 hours total). Starved flies are transferred to water soaked tissue (blue). Flies are then trained (red) by being exposed to either MCH or OCT and either water or a sugar. The coupling with either odor is randomized to prevent confounding odor specific results. Flies are restarved after training is complete.

how the nature of the conditioned stimulus affected the fly's 1) ability to remember and 2) the levels of Orb2A-pc. This line of thought was also spurred on by the work of Scott Waddell's group when they showed that flies were far more adept at remembering odors that were paired with sweet and nutritious (metabolically available) sugars as opposed to sweet non-nutritious sugars or non-sweet metabolically available carbohydrates (128). Additional studies by Waddell's group looked at the manner in which hunger affected

One of the early areas to be analyzed in fly appetitive behavior was the innate preference that flies have for various forms of sugar (127). Although Dethier's work on the blowfly made a huge contribution to the field of fly behavior, one of the areas that was dissected in great detail in his book, *The Hungry Fly*, was what innate preference flies had for various sugars. This caught our attention in that it could provide a simple variable that we could alter in order to understand

appetitive olfactory associative learning in the fly (129, 130). It was established that flies required starvation initiated food seeking behavior in order to efficiently remember the association of odor with sugar (130). This was in line with work in many systems linking feeding behavior with starvation (131).

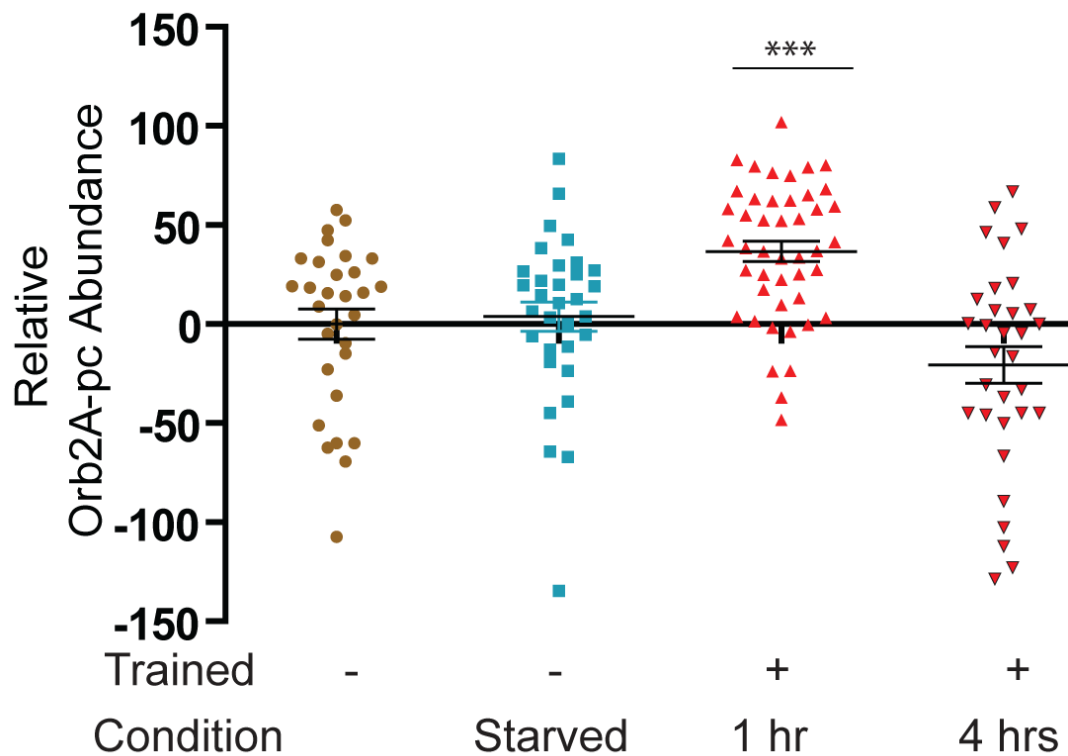

Fig 13 The ratio of Orb2A-pc to Orb2B is significantly increased 1 hour post training. The Y axis represents fold difference normalized to the mean fold difference seen in untreated flies (n=30, brown, see Fig 3). Starved flies (n=32, blue, see fig 3) are similar to untreated flies. 1 hour after training with sucrose there is a significant increase in the amount of Orb2A-pc relative to Orb2B ($p < .001$, n= 45, red, see Fig 3 1hour). 4 hours post training, the ratio of Orb2A-pc relative to Orb2B returned to the levels seen in untreated flies, the deflection seems to trend towards a refraction, but is not significantly different from what is seen in untreated flies (n=32, red, black outline, see Fig 3 4 hours). All statistical tests were assuming unpaired samples.

Combined these two tractable components of the appetitive olfactory associative learning paradigm led us to ask how they contributed to the level of Orb2A-pc transcript. We reasoned that there were multiple distinct possibilities. Because studies regarding Orb2A

have implicated the protein as being the important part of memory formation (38, 39), we cannot be sure whether Orb2A-pc mRNA regulation is only one step in the process of generating Orb2A protein at the synapse or whether it is the essential step. In the case of the former, we could imagine starvation, or induction of motivation, to prime the neuron for memory via Orb2A-pc levels. In the case of the latter, it would only be upon exposure to the stimuli that should be recorded, or associated as it were, that the Orb2A-pc levels increased. To begin dissecting the appetitive olfactory associative learning paradigm we turned to our Orb2A-pc assay and designed the study as follows (Fig 12): We took flies from bottles where individual had began eclosing 3 days prior (such bottles are how flies are collected for memory training) and put the flies either in vials with the standard fly food (see methods), or vials with tissue soaked in water for starvation. After 24 hours flies from some of the vials stored with water were trained in the appetitive olfactory associative learning paradigm, while others were frozen in liquid nitrogen. The trained flies were then re-placed on water soaked tissue for 1 or 4 hours and then frozen. Meanwhile, the flies that were placed on standard fly food were frozen in the 24-28 hour window, to serve as paired, non-treated controls. As an aside I will note that all the experiments outlined in this chapter have been conducted on female flies in order to avoid the contamination issues that I outlined earlier in the chapter. We reasoned that the time window of 1 to 4 hours post training might be sufficient to capture the gene regulatory events of long-term memory formation, in this case Orb2A splicing, because studies have implicated this time window as being important for induction of L-LTP (132). We found that there was no difference in the ratio of Orb2A-pc to Orb2B when flies were starved (Fig 13). However, 1 hour after behavioral training there was a

significant increase in the amount of Orb2A-pc transcript relative to Orb2B transcript in the fly head (Fig 13). By 4 hours post-training the levels of Orb2A-pc returned to the relative baseline that was seen in untrained flies kept on fly food. This series of experiments answered a few questions. Namely, it seems as though starvation, while it may have a gating effect on learning and memory via the induction of food-seeking behavior, does not seem to act on the level of competency of Orb2A mRNA translation, as post starvation the Orb2A mRNA was still mostly in the Orb2A-np form. Additionally, it seems as though Orb2A-pc levels rise relative to Orb2B in the rough time window that

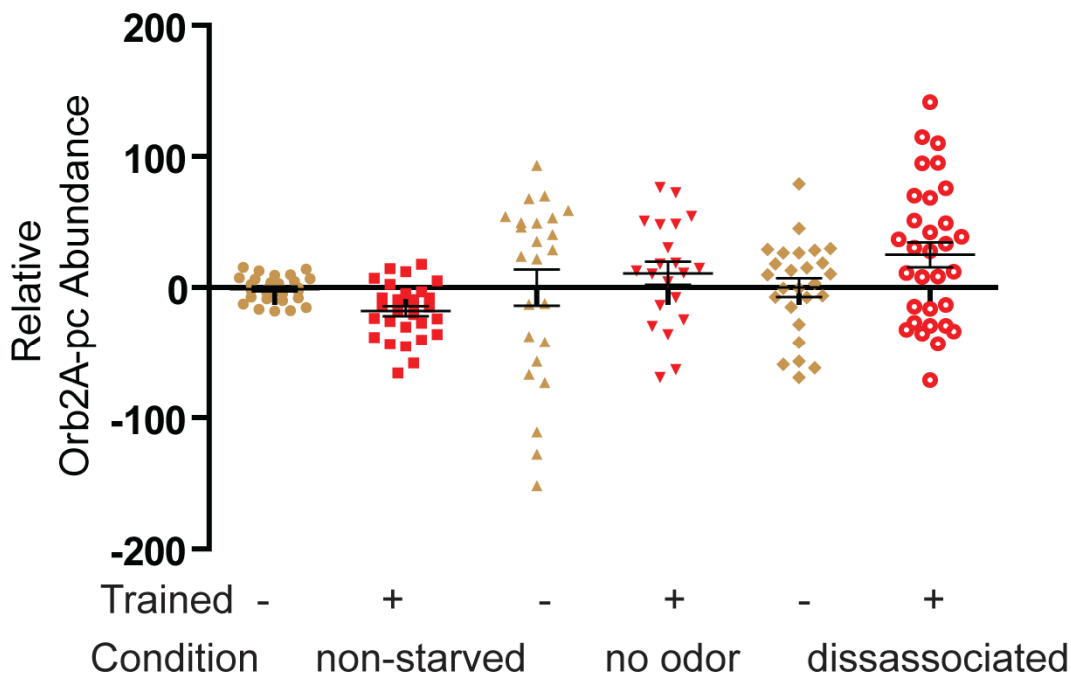

Fig 14 1 hour post training increase in Orb2A-pc to Orb2B ratio is dependent on motivation and conditioned stimulus. In the absence of starvation, trained flies (red squares, non-starved, n= 30) do not show a significant difference from flies of the same population that were untreated (brown circles, n=28). After starvation, but without a conditioned stimulus (odor) training fails to elicit a significant change after 1 hour (red inverted triangle, n=21) as compared to flies of the same population that were untreated (brown triangles, n=24). If flies were starved and trained with sucrose, but the odor was applied to the flies 5 minutes after exposure to sucrose a increase that was not quite significant (p=.1496, clear red circles, n= 31) as compared to flies of the same population that were untreated (brown diamonds, n=26). The non-significant but noticeable increase in the disassociated flies may be the result of association in a subset of flies with the odor, but this was not assayed behaviorally. All statistical test were conducted assuming paired samples.

is believed to be necessary for induction of L-LTP and fall back to the normal levels by the time that the critical period has ended (132).

Having established an experience dependent regulation of Orb2A-pc level, we sought to use the components of the appetitive olfactory associative learning paradigm as a method to dissect how different aspects of the memory paradigm interact with the molecular machinery that underlie memory. First we turned to starvation, which we have discussed at some length. The experiment in figure 13 indicates that starvation is not sufficient to induce Orb2A-pc. We know, however, that starvation is necessary to induce memory in the appetitive olfactory associative learning paradigm, so we next sought to ask whether starvation was necessary to induce the training responsive change that was identified in figure 13. In fact, we found that to be the case. When flies were placed on normal fly food for 24 hours, then trained and subsequently placed on water soaked tissue for 1 hour, they showed the same ratio of Orb2A-pc to Orb2B as did flies that were placed on normal fly food but not trained (Fig 14). It is interesting to note that there may be a slight, non-significant negative deflection in the ratio of Orb2A-pc to Orb2B, similar to what is seen in the case of flies 4 hours post training. In both case there are potential explanations, in the case that these non-significant results are in fact real trends in the data. In the case of the refraction four hours post-training, it is possible that Orb2A-pc levels are brought down in order to prevent spurious associations generated by translation at synapses not involved in the network that would recall the learned association. Alternatively, this could be an artifact of degradation of Orb2A-pc transcripts. In the case of the deflection in the non starved animals, this explanation would not suffice, as there is

no Orb2A-pc increase from which to refract. In this case it may be that the female flies want to avoid learning. Gravid females tend to avoid sucrose rich media as it is not an ideal site for egg-laying (133). As we use only female flies in our analysis, perhaps it is that the pathways that generate Orb2A-pc post training are actively suppressed in the case of an aversive cue.

The next question we wanted to address is whether the flies need to have an associated stimulus (conditioned) alongside the unconditioned stimuli in order to show an increased ratio of Orb2A-pc to Orb2B. This experiment has the caveat that we are only considering odor as the conditioned stimulus, we can not control for other stimuli that may serve the same role, such as visual or sensory cues. Our results indicate that there is no significant change in Orb2A-pc 1 hour post training in flies that are not exposed concomitantly to an

Fig 15 Sweet sugars that induce learning are sufficient to increase the ratio of Orb2A-pc relative to Orb2B. (A) Flies trained with fructose, a potent inducer of memory, showed a significant increase in the ratio of Orb2A-pc to Orb2B (red squares, $p < .05$, $n=36$) as compared to flies of the same population that were untreated (brown circles, $n=39$). Xylose, which can induce learning and a low level of memory, seemed to increase, but not significantly the Orb2A-pc/Orb2B ratio (inverted red triangles, $p = .26$, $n=36$) as compared to flies of the same population that were untreated (brown triangles, $n=38$). In the case of sorbitol, which is unsweet, but provides energy to the fly, there is no change, or perhaps a slight negative change (clear red circles, $n= 37$) as compared to flies of the same population that were untreated (brown diamonds, $n=32$). In (A) all statistical test were conducted assuming paired samples. (B) We see that both L-arabinose (Red square, $n= 30$, $p < .001$) and sorbose ($n=32$, $p < .01$) show significant increases in Orb2A-pc/Orb2B ratio as compared to flies of the same population that were untreated (brown circles, $n=30$). All statistical tests were assuming unpaired samples.

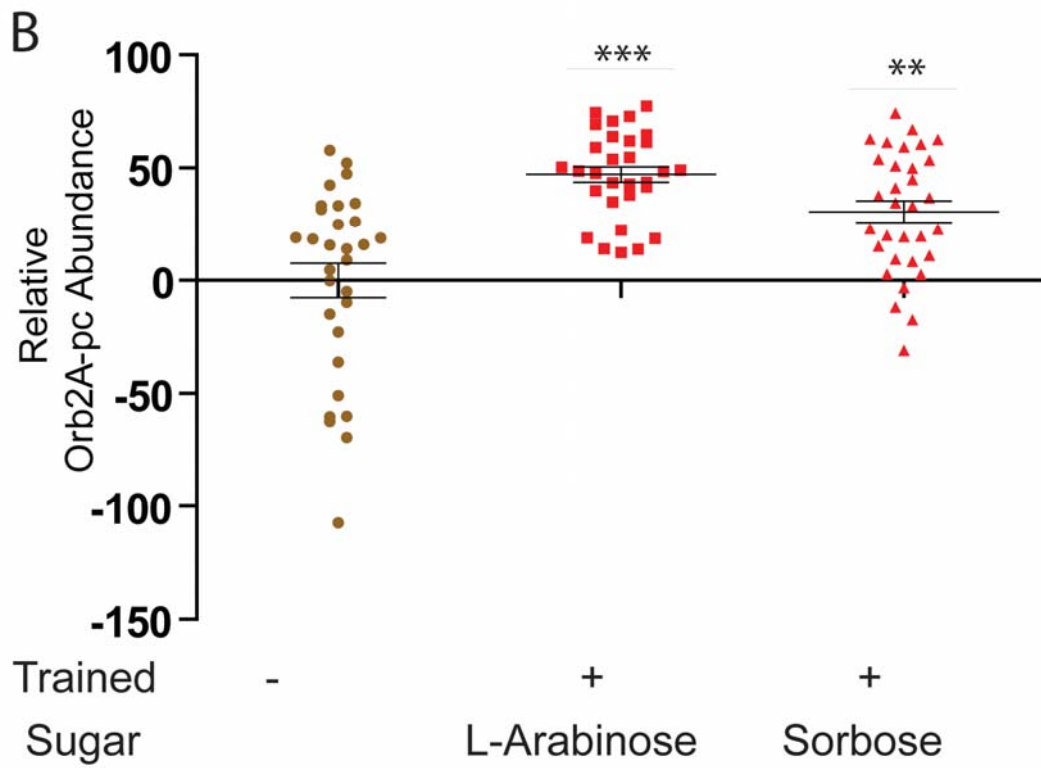
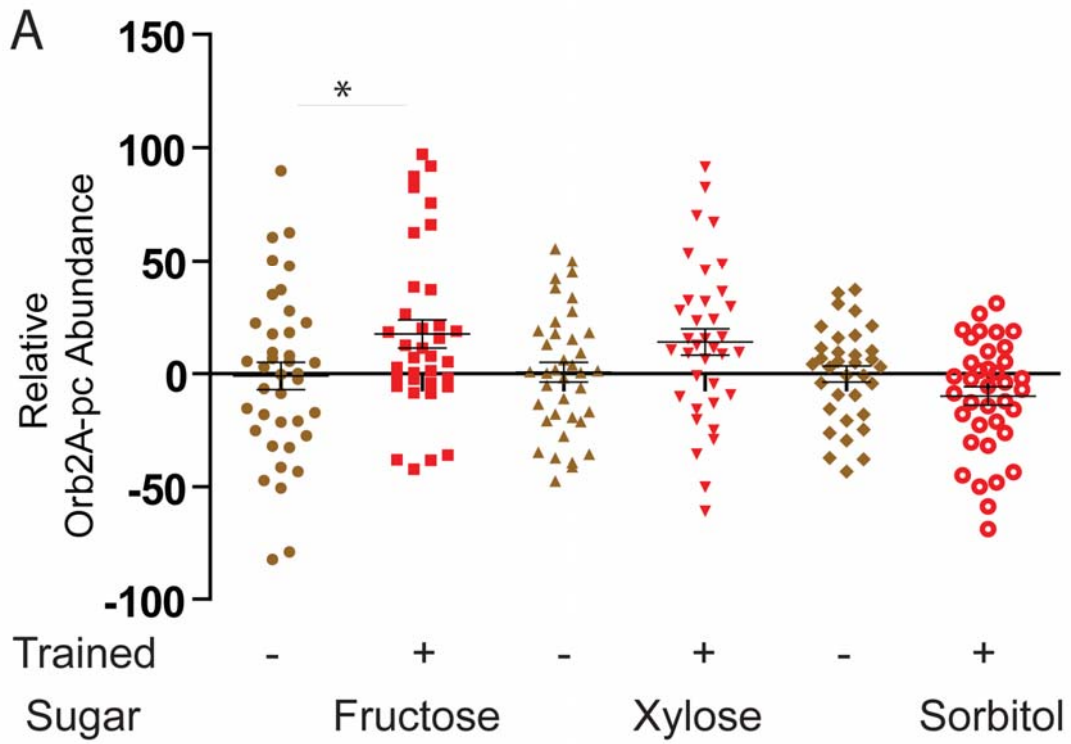

odor (Fig. 14). We do, however see a mild positive deflection, which is not significant. Finally, we sought to disassociate the odor and the sugar. To do so, we starved flies as normal, and then put them in the training apparatus and exposed them to sucrose, but without an associated odor. After waiting 5 minutes, we placed them in the training apparatus and exposed them to an odor. We saw that there was an increase that was very close to statistical significance (Fig. 14). This could be due to the unconditioned stimulus falling into the window at which LTP can still be induced (134-136). Together our results suggest a model whereby certain components of the appetitive olfactory associative learning paradigm are necessary for both memory as well as Orb2A-pc increases relative to Orb2B mRNA. However, in other cases, it is more ambiguous, such as the necessity of the conditioned stimulus, and the window required for coupling the two stimuli.

The subsequent aspect of the appetitive olfactory associative learning paradigm that we sought to dissect was the type of carbohydrate that was sufficient to reduce the training dependent increase in Orb2A-pc. Following the Waddell study (128), we reasoned that we could train flies with carbohydrates that possessed various efficacies in memory induction and assay their effect on Orb2A-pc levels (Fig. 15). We found that there was indeed a correlation between those sugars that could induce learning and a certain level of Orb2A-PC increase. The Orb2A-pc induction is more responsive to sweetness as a cue than nutrition. There is a significant difference between the induction of memory produced by sucrose and fructose and that produced by xylose and sorbose (Fig 16) (128). However, we see that the increase in the ratio of Orb2A-pc doesn't co-relate with

ability form long-term memory and in fact the induction of Orb2A-pc seen with L-arabinose and sorbose is comparable to that seen with fructose (Fig. 15).

Part II: Beyond Orb2

In our thinking about the dissection of the memory paradigm and the differential effect on Orb2A-pc transcript abundance of sugars that had differential effects on memory

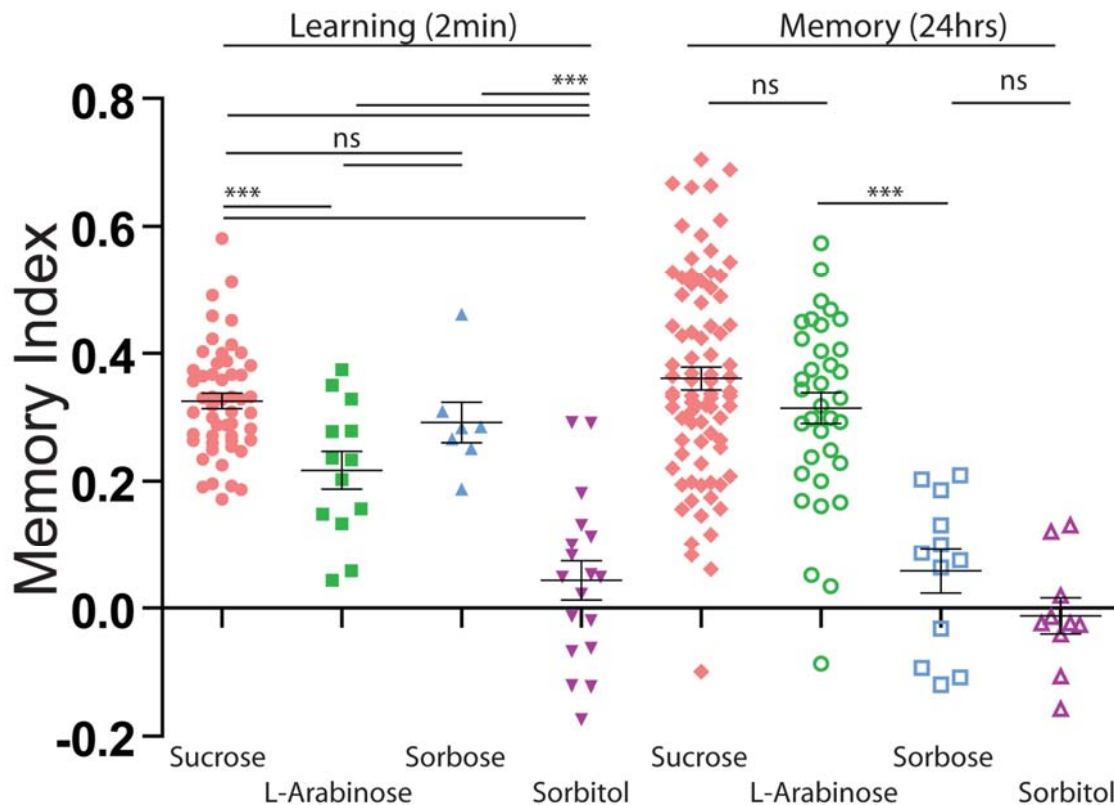

Fig 16 Differential effects of sweetness and nutrition on learning and memory (courtesy of Huoqiang Jiang). Sucrose (n= 52) is able to induce learning in flies similar to that seen in Sorbose (n=7), but more so than is seen in L-arabinose (n=13). Sorbose and L-arabinose are sweet, non nutritious sugars. Sorbitol, which is not sweet, does not induce learning in flies (n=18). Sucrose is also able to induce memory in flies at 24 hours (n=81), as is L-arabinose (n=35), which actually shows a higher memory score than it does a learning score. Sorbose on the other hand, does not show memory (n=12), nor does Sorbitol (n=10).

formation, we expanded on the sugar analysis done by Burke et al., by including several L as well as D sugars. The majority of natural sugars are synthesized by living organisms

as D-isomers. As a result, most likely, higher organisms have evolved to metabolize D-sugars, while L-isomers remain as metabolically unavailable. However, perhaps surprisingly, L-sugars are perceived identically to D-sugars, at least in humans. In the course of our thinking about the effect that metabolic availability has on learning in

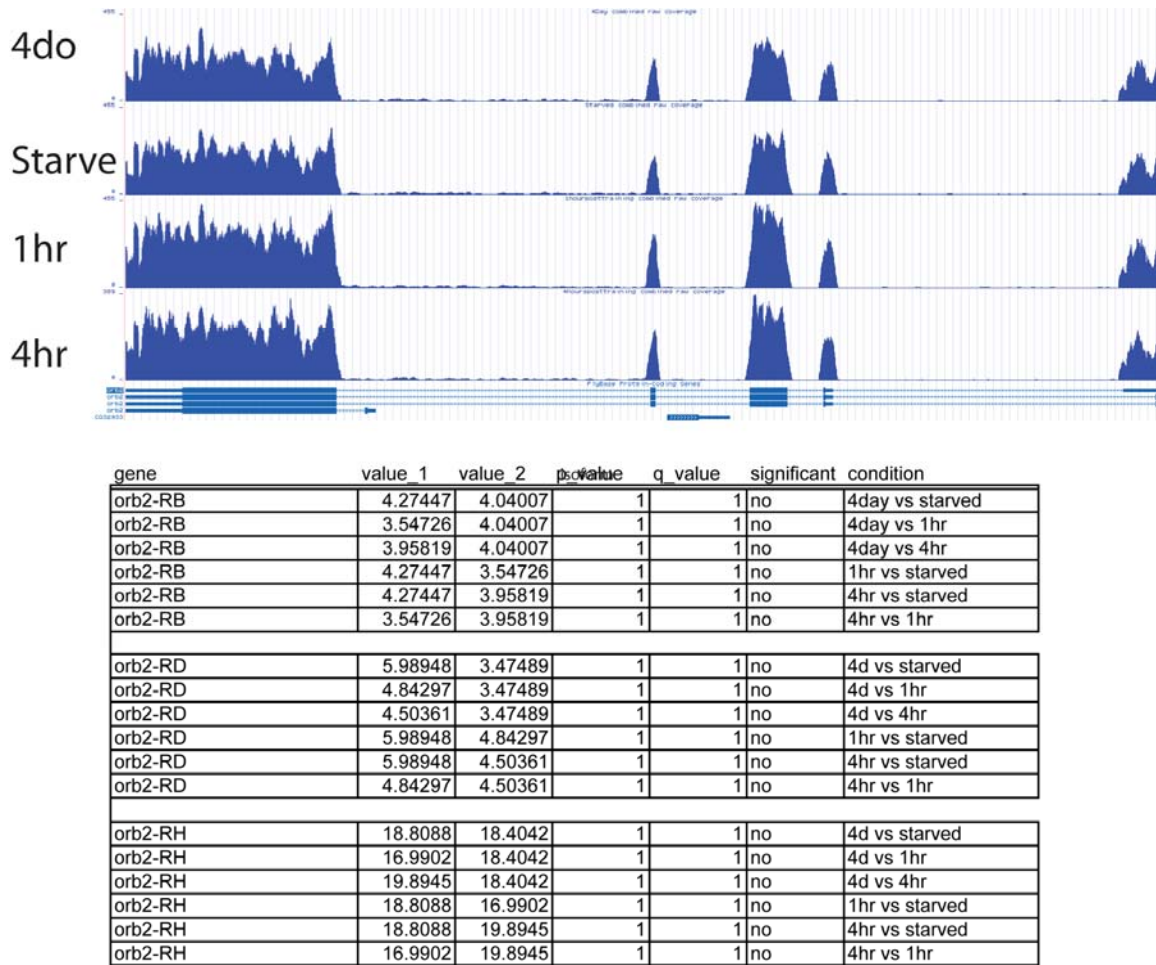

Fig 17. Orb2B does not significantly change after behavioral conditions. Top, summed reads from RNA sequencing samples (4do n=5; Starve n=5; 1hr n=6, 4hr n=5). Y axis has been normalized. Bottom table, mean scores for different Orb2B transcripts. Orb2B RG and RH show small, but not significant decrease in Orb2B at 1-hr post training as compared to untreated (4do) flies. OrbB-RD, on the other hand, shows a small increase.

combination with sweetness, we reasoned that the L-sugars might serve as an outstanding control for the hypothesis that nutrient availability is a critical component of memory formation in flies. Again, consistent with this idea is the Burke study that noted that while

sweet sugars were all equally competent at producing learning, only sweet, nutritious sugars could produce memory. To further the Burke study, we looked at the effect of L-arabinose on memory formation. To our surprise it turned out that L-arabinose was more effective at memory formation than it was at inducing learning, and was significantly better at inducing long term memory than other sweet non-nutritious sugars (Fig 16).

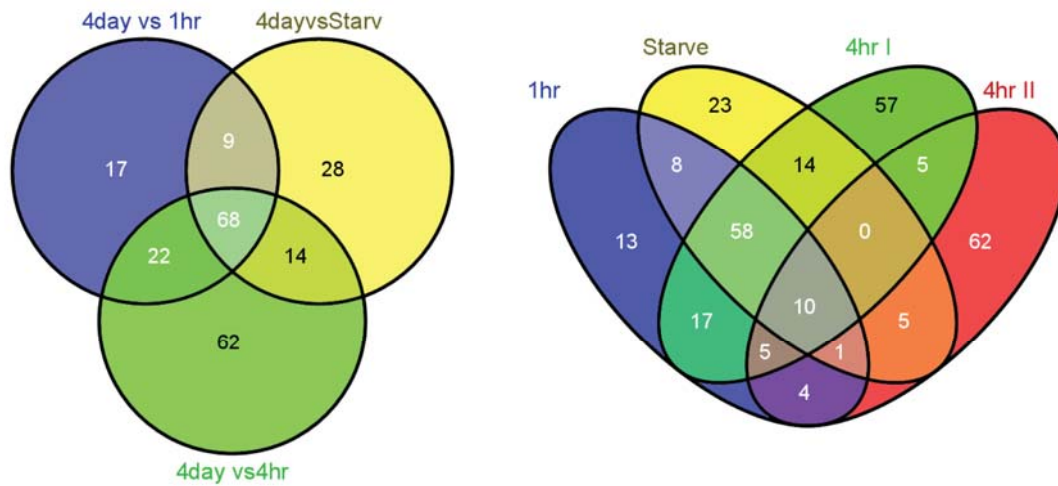

Fig 18 Venn diagram of genes that were common among various conditions. Left, genes whose expression was altered 1 hr post training with sucrose (purple, 4day vs 1hr), starved (yellow, 4dayvsStarv) or 4 hr post training with sucrose (green, 4day vs4hr). Each condition represents genes that were altered in the described condition as compared to untreated flies. Right, same as left with the addition of 4 hour post training with sucrose flies where genes were changed as compared to flies trained with odor but no sugar.

Subsequent analysis of the literature revealed that L-arabinose was a component of pectin, a component of cell walls that is especially abundant in fruit (137). The observation that L-arabinose produced memory, but was not nutritious in combination with our thinking outlined in part I of chapter III led us to hypothesize that 4 hours post training with sucrose and L-arabinose, but not with sorbose would lead to changes in gene expression of proteins that are important for memory formation. We further reasoned that if we took the conditions outlined in Part I of this chapter combined with

the expertise that we developed in isolating high quality RNA from single fly heads, we could conduct a powerful behavioral experiment in which we isolated and deep-sequenced the total RNA from untrained, starved, 1 hour post-sucrose trained flies and 4 hours post-sucrose, L-arabinose, sorbose trained flies or flies trained without sugar 4 hours post training.

To conduct this experiment we isolated single fly head total RNA from females of the described conditions (as shown in figure 12). We then used the Stowers Institute core facilities to verify the quality of the RNA, create the library and submit the samples for single read HiSeq Illumina sequencing of 50 bp fragments. We collaborated with Alex Garruss for analysis of the sequencing data and obtained data for both gene expression as well as transcript level analysis.

We first looked at expression of Orb2 transcripts. We found that Orb2B transcripts do not change across any of the conditions outlined in figure 12 (Fig 17). We attempted to analyze Orb2A-pc as well, but the coverage of the Orb2A specific exon was too low for

Gene Name	GO TERM BP FAT	GO TERM CC FAT
1hr post training		
Dmel_CG11086	intracellular signaling cascade, protein kinase cascade, stress-activated protein kinase signaling pathway	
Dmel_CG11459	proteolysis.	
Dmel_CG17032		
Dmel_CG1887	defense response, cell adhesion, biological adhesion.	plasma membrane
Dmel_CG3348	polysaccharide metabolic process	extracellular region
Dmel_CG34054		
Dmel_CG6910	inositol metabolic process, carbohydrate catabolic process	
Ets at 21C	dendrite development, regulation of transcription, dendrite morphogenesis, regulation of RNA metabolic process	
Heat shock protein 23	response to hypoxia, response to temperature stimulus, response to heat	
prolyl-4-hydroxylase-alpha NE2	cellular amino acid derivative metabolic process, oxidation reduction	endoplasmic reticulum
rolling stone	syncytium formation by plasma membrane fusion, syncytium formation	plasma membrane

Table 1. Genes altered only 1 hour post training with sucrose

sufficient analysis. Furthermore, we were unable to identify significant expression of the Orb2A-np transcript as well, potentially due to our use of poly(A) purification when isolating the total RNA in order to reduce contamination from ribosomal RNA that would hinder our analysis and decrease meaningful coverage. It is possible that the Orb2A-np transcript, as a putatively immature mRNA, lacks a poly(A) tail.

Having looked at the Orb2 expression, which can be thought of as a reverse genetics approach to understanding memory formation, we formulated the RNA sequencing experiment as an unbiased forward genetics approach to identifying novel candidates for genes that are involved in memory formation and synapse stabilization. We should note the caveat here that because we used poly(A) purification prior to sequencing the approach we adopted is not entirely unbiased as it will leave out all non-coding RNA as well as any pre-mRNA (see previous paragraph). Our initial goal sought to identify genes whose expression was enriched only in flies 1 hour after training, which would correspond to genes in the same class as Orb2A-pc and CREB (*132*). We found 13 genes that showed changes 1 hour post training as compared to normal, untreated flies, but were not changed after starvation or 4 hours after training. These included a variety of genes with functions ranging from intracellular signaling via kinase activity to host defense response and cytoskeletal remodeling (Fig. 18, Table 1). Subsequently we sought to look at genes that were changed in post training, but not post starvation. This class of genes included 22 genes if we include only the first set of 4 hours post training flies, and 5 genes if we include both the 4 hour post training flies normalized to untreated flies as well as those from the set normalized to starved and those trained with odor but not sugar

4 hours post training. It is unclear if the differences arise from natural biological variation in post training flies, or if the odor trained flies represent an important control. Nonetheless, we were surprised to find that if we analyzed the positive hits using David (138, 139), the types of genes that were most enriched (between 14-25% enrichment) became even more enriched (60%) with the increased stringency of the repeat experiment (Fig 18, Table 2). The majority of the genes that met the most stringent analytical criteria were involved in immune response and were also generally extracellular. Initially, this could be seen as perhaps a confusing finding; however, there has been much recent work

Table 2. Genes altered 1 or 4 hours post training with sucrose

Category	Term	Count	%	PValue
1st RNA Seq				
INTERPRO	Attacin, C-terminal region	4	19.04761905	1.36E-08
GOTERM BP FAT	defense response to bacterium	5	23.80952381	1.06E-06
GOTERM BP FAT	response to bacterium	5	23.80952381	1.92E-06
GOTERM BP FAT	antibacterial humoral response	4	19.04761905	4.15E-06
INTERPRO	Attacin, N-terminal region	3	14.28571429	5.19E-06
INTERPRO	Attacin, N-terminal	3	14.28571429	5.19E-06
PIR SUPERFAMILY	attacin	3	14.28571429	1.33E-05
GOTERM BP FAT	defense response	5	23.80952381	4.13E-05
GOTERM CC FAT	extracellular space	4	19.04761905	4.73E-05
GOTERM BP FAT	antimicrobial humoral response	4	19.04761905	7.54E-05
SP PIR KEYWORDS	antibiotic	3	14.28571429	9.65E-05
GOTERM BP FAT	humoral immune response	4	19.04761905	1.26E-04
SP PIR KEYWORDS	Antimicrobial	3	14.28571429	2.84E-04
GOTERM CC FAT	extracellular region part	4	19.04761905	2.94E-04
GOTERM CC FAT	extracellular region	5	23.80952381	5.93E-04
GOTERM BP FAT	immune response	4	19.04761905	0.001019405
SP PIR KEYWORDS	innate immunity	3	14.28571429	0.001660223
SP PIR KEYWORDS	Secreted	4	19.04761905	0.001690669
SP PIR KEYWORDS	immune response	3	14.28571429	0.001786751
GOTERM BP FAT	innate immune response	3	14.28571429	0.005629795
UP_SEQ FEATURE	signal peptide	4	19.04761905	0.009940228
SP PIR KEYWORDS	signal	4	19.04761905	0.011827004
GOTERM BP FAT	defense response to Gram-negative bacterium	2	9.523809524	0.037181924
SP PIR KEYWORDS	cleavage on pair of basic residues	2	9.523809524	0.048581483
Combined RNA Seq				
INTERPRO	Attacin, C-terminal region	3	60	1.73E-06
GOTERM BP FAT	antibacterial humoral response	3	60	3.34E-05
GOTERM BP FAT	defense response to bacterium	3	60	2.22E-04
GOTERM BP FAT	antimicrobial humoral response	3	60	2.29E-04
GOTERM CC FAT	extracellular space	3	60	2.90E-04
GOTERM BP FAT	response to bacterium	3	60	2.99E-04
GOTERM BP FAT	humoral immune response	3	60	3.22E-04
GOTERM CC FAT	extracellular region part	3	60	9.89E-04
GOTERM BP FAT	immune response	3	60	0.001333284
GOTERM BP FAT	defense response	3	60	0.001396861
GOTERM CC FAT	extracellular region	3	60	0.011424474

detailing the interaction between the microbiome, the gut, the immune system and behavior (140-143). Furthermore, one of the most numerous brain cell populations, microglia, are in fact derivatives of the immune lineage that have a recently defined role in synaptic modification (144). Together, the sucrose learning analysis offers some candidates for connecting gut, immune and memory processes.

Table 3. Genes altered 1 or 4 hours post training with sucrose

Gene	Length	Orb2 microarray	Synaptosome proteomics	Fold change	log2(fold change)
Post-training					
AttA	221aa	yes		20	-4.32524
CG9505	652aa			3.3	-1.72563
CG7214	142aa			-43	5.3959
CG10621	331aa			-20	4.35625
CG16772	311aa			4.1	-2.06308
CG1942	352aa			35	-5.02076
DplB	120aa	yes		27	-4.76342
CG13422	152aa		yes	13.7	-3.77596
CG5932	399aa			24.6	-4.60931
CG5840	273aa		yes	-2.6	1.38828
RpS19b	155aa			-46.6	5.45847
to	249aa	yes		-2.5	1.34662
AttC	241aa			19.6	-4.29098
AttB	218aa			8.2	-3.0322
CG32512	436/208/233aa			3.3	-1.7554
CG34291	61aa			-10	3.32501
CG43085	255aa			-11.6	3.55134

Independent of the enrichment for the immune proteins that came with the second analysis, if we look only at the genes that were altered after training, but not after starvation there are several candidates that overlapped in their change with experiments previously conducted by our group (Table 3). In particular, looking at altered gene expression via microarray analysis of Orb2 knockout flies revealed candidates that were regulated by Orb2. Additionally we previously conducted proteomics on proteins isolated in the synaptic fraction of fly head synaptoneuroosomes. Both of these methods yielded proteins that were also altered after training with sucrose (Table 3). These proteins are the

same as those analyzed in the David analysis outlined in the upper panel of table 2. Here we can see the almost uniformly small size of the peptides that were identified.

Having obtained a robust candidate list of those genes that are upregulated in response to sucrose training, we wanted to move one step further in our analysis and see if we could differentiate between genes involved in memory but not learning. To do this we analyzed genes upregulated 4 hours post training with sucrose and arabinose but not sorbose, all controlled against gene expression in flies that were trained with no sugar. We found 4 genes whose expression was altered in the sucrose and arabinose trained flies, but not in flies trained with sorbose (Fig 19, left; Table 4). If we included those flies collected 4 hours post training with sucrose that were controlled against untrained flies from the first RNA-seq experiment, 2 of the 4 genes survived (Fig 19, right; Table 4: CG9505, Obp99a).

Interestingly, using a BLAST search (145), we found that proteins with homology to CG9505, including endothelin converting enzyme-1 and neprilysin, have been identified as potential therapeutic targets for Alzheimer's related dementia (146).

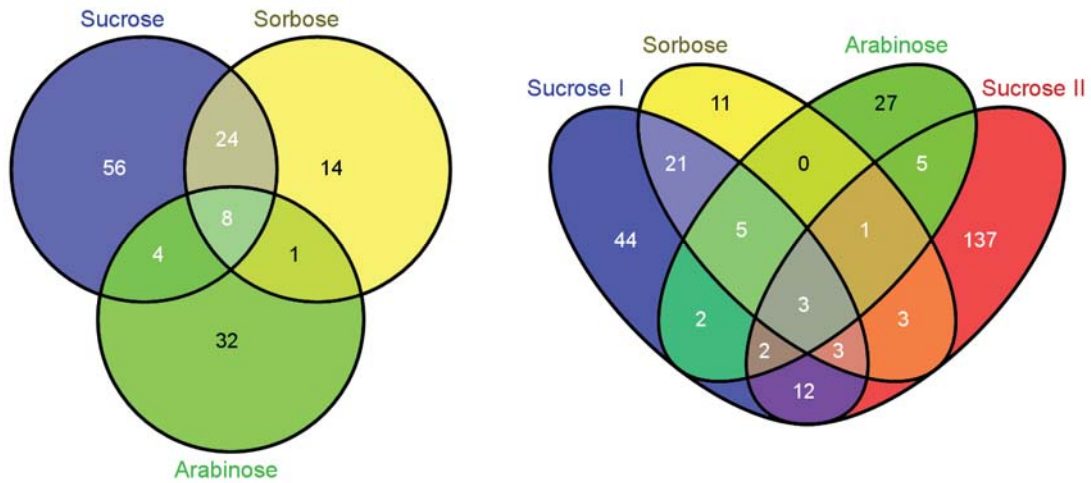

Fig 19 Venn diagram of genes that were common among various conditions. Left, genes whose expression was altered 4 hr post training with sucrose (purple, Sucrose), sorbose (yellow, Sorbose), or L-arabinose (green, Arabinose). Each condition represents genes that were altered in the described condition as compared to flies trained with odor but no sugar. Right, same as left with the addition of 4 hour post training with sucrose flies where genes were changed as compared to untreated flies.

Using deep sequencing of poly(A) purified RNA from single fly heads after training, we were able to confirm that there was no statistically significant change in Orb2B expression after training. Interestingly, there was a trend towards decreases in Orb2B mRNA expression (Fig 17), while there was a trend towards increased Orb2A-pc mRNA expression (Table 5). Together, while the coverage prevents us from making solid conclusion based on the RNA sequencing data alone, the trend would be consistent with

Table 4. Genes altered 4 hours post training with sucrose or L-arabinose

Gene Name	GOTERM BP FAT	GOTERM CC FAT
Arabinose - 4hrs		
Dmel CG9505	proteolysis	
Odorant-binding protein 99a	sensory perception of chemical stimulus, response to organic substance, olfactory behavior, neurological system process, cognition	extracellular region
Probable cytochrome P450 309a1	oxidation reduction	membrane fraction, extrinsic to membrane, vesicular fraction
mutagen-sensitive 209	cellular component morphogenesis, cellular response to stres	PCNA complex

the findings outlined in part I of this chapter, whereby the ratio of Orb2A-pc to Orb2B mRNA seems to increase one hour after training in the appetitive olfactory association paradigm.

Furthermore, using RNA sequencing of fly head RNA after various behavioral manipulations as a forward genetics screening approach, we have identified candidates for further analysis, including a large group of small immuno-peptides that may help elucidate the interaction between the immune system and memory, or even between the gut and the brain, given the critical role of ingestion and, putatively, metabolism of carbohydrates in the learning paradigm used. Finally, the L-arabinose RNA sequencing analysis may have uncovered an important enzyme (CG9505) that has been shown to have an interaction with Alzheimer’s dementia in human populations. By uncovering it in our unbiased screen we may have identified it as a player in non-pathogenic memory processes.

Table 5. Orb2A-pc levels at various behavioral points.

Condition	Mean Transcript Abundance	Mean Transcript Variation
4day mean	1.43763252	3.82086812
Starved mean	1.24704543	1.530067191
1hr mean	3.65561824	2.542321858
4hr mean	2.43223517	1.247669245

Chapter IV: Nova mediated regulation of Orb2A mRNA processing

As was outlined in chapter I, RNA binding proteins play a critical role at various steps of both mRNA processing and memory formation: after transcription, RBPs regulate the processing of mRNA into various alternatively spliced transcripts, which can yield proteins with exceptional differences in function from a single genomic locus; they can bind to the UTRs of mRNA to target them to subcellular loci; they can repress or activate the translation of the proteins that are encoded by the mRNA; they can target the mRNA for nonsense mediated decay (NMD), which will eliminate the protein, at least temporarily, from the toolkit available to the cell. Having understood that Orb2A mRNA is critical for memory processes, that it is alternatively spliced, or regulated, at the pre-mRNA level, that it has a putative localization in a subcellular compartment, and that its translation must be tightly controlled, we speculated that a biased screen of mRNA

binding proteins would yield potential targets

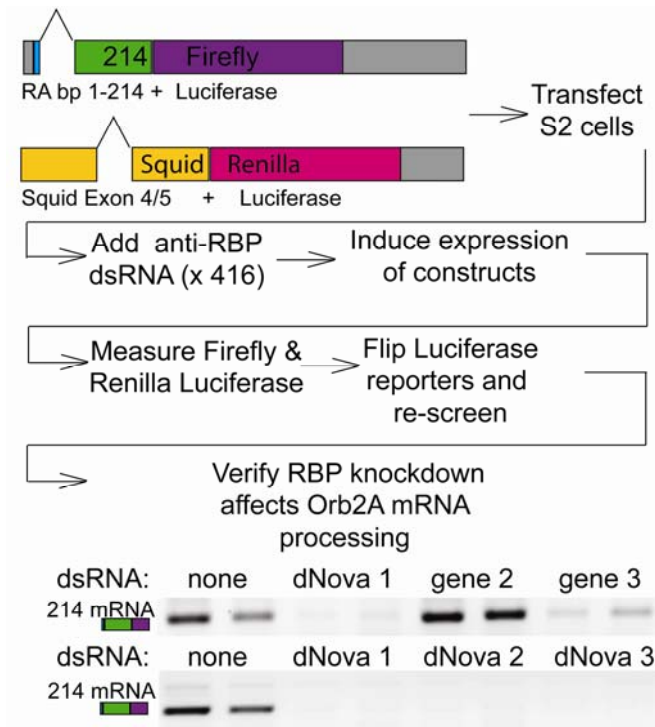

Figure 20 Screen to identify trans-acting RBPs. Top, two constructs used in screen. 214-Luc (see chapter II Fig 5) and Squid Renilla, a intronic control. The two constructs were transfected into S2 cells under an inducible promoter. Two rounds of dsRNA targeting individual RBP were added to cell media over 4 days, and constructs were then induced. Firefly and Renilla luciferase activity was assayed, and positive hits were those that affected Firefly but not Renilla luciferase. The Firefly and Renilla cassettes were then flipped, and the screen repeated. Of the positive hits, mRNA was then examined to verify specificity of knockdown. Bottom – top gel, RT-PCR of 214 transfected cells with no dsRNA, dsRNA targeting Nova, or the other positive hits. The direction of knockdown (increased luciferase activity in the absence of gene 2, decreased in the case of gene 3). Bottom – bottom gel, the original anti Nova dsRNA as well as 2 additional dsRNA all knock down 214-luciferase mRNA.

for RBPs that were critical to both Orb2A mRNA regulation as well as memory processes in general.

To this end we constructed a minigene reporter containing the intronic region of Orb2A fused to firefly (FF) luciferase and a renilla (Ren) luciferase construct containing a constitutively spliced intron as a control (Fig. 20). Dr. Marco Blanchette provided a library of 390+ double stranded RNAs (dsRNAs) targeting individual RBPs (For details on the screen refer to the methods section).

We identified three RBPs—Nova, eIF5, and Squid—that significantly affected FF luciferase as compared to Ren luciferase activity, which indicated that those RBPs may play a role in Orb2A mRNA processing. To confirm that the change in FF luciferase activity was due to alterations in mRNA processing rather than translation, we looked at the level of the reporter construct mRNA (Fig. 20). Of the positive hits, we chose to direct our analysis towards Nova protein and confirmed the specificity of Nova knockdown by using dsRNA targeted to 2 other portions of the Nova transcript (Fig. 20). As was described in Chapter I, Nova carries great interest as a neural specific alternative splicing factor: Studies have implicated Nova as being involved in combinatorial control of many alternative splicing events in the mammalian nervous system (56), as being involved in activity dependent transport of mRNA out of the nucleus (98, 99), as being involved in mediating NMD of transcripts involved in activity dependent responses in the brain via alternative splicing of cryptic exons (98), and, furthermore, NOVA2 knockout mice showed defects in a certain form of LTP

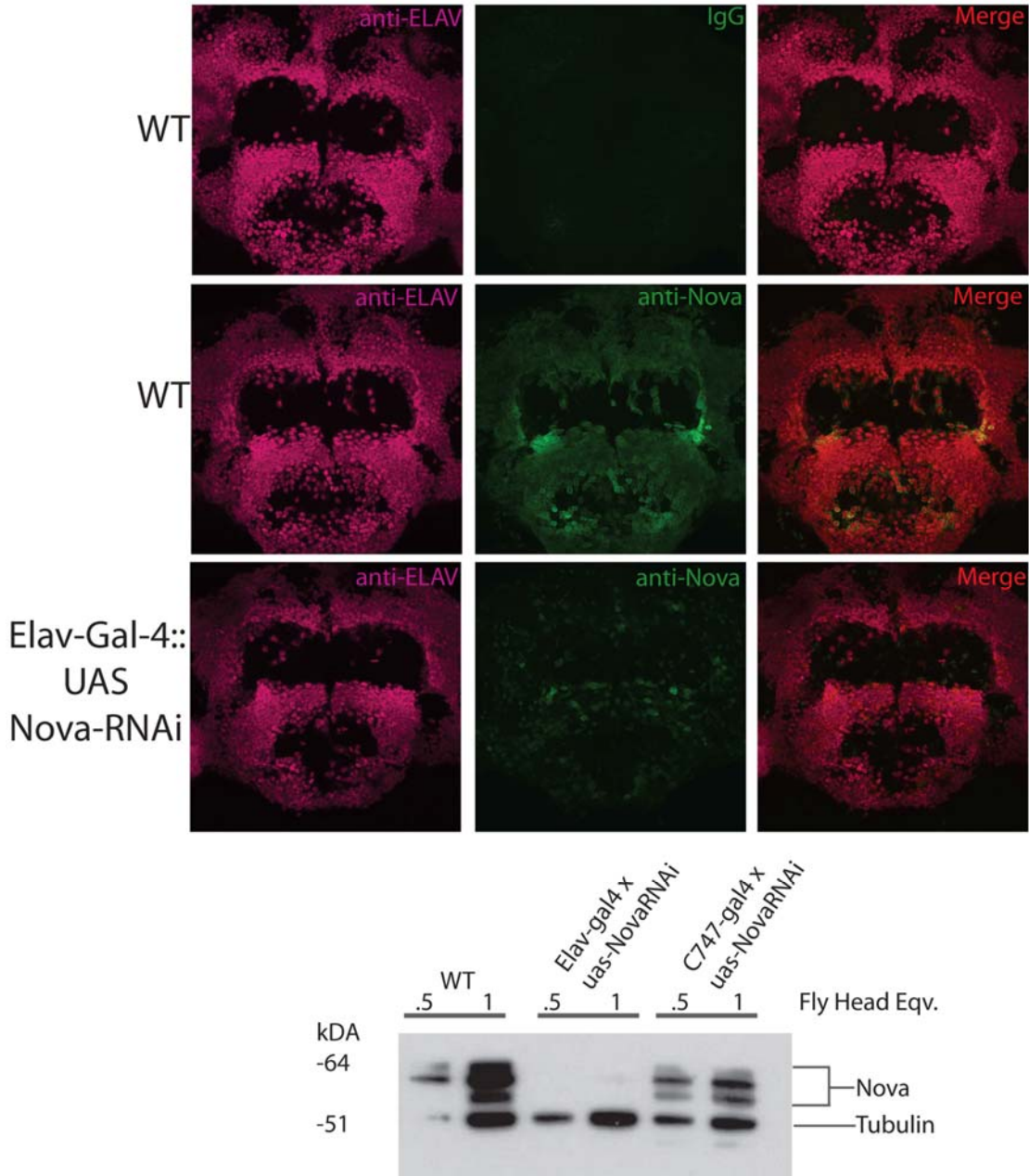

Figure 21. Nova is expressed in the Adult *Drosophila* brain. (A) Upper panel Wildtype adult brain stained with α -Elav, which is expressed in all neurons (left, magenta) and rabbit IgG (center, green). The merged image is shown on the right. Center panel, Wildtype adult brain stained with α -Elav, which is expressed in all neurons (left, magenta) and α -Nova (center, green). The merged image is shown on the right. Elav-gal4::uas-NovaRNAi adult brain stained with α -ELAV (left, magenta) and α -Nova (center, green). The merged image is shown on the right. (B) Western blot indicates relative abundance of Nova expressed in wildtype (left), in pan-neuronal RNAi knockdown of Nova (center) or in the mushroom body (right). The lower band (Tubulin) in each lane serves as a loading control.

(54). For these reasons, we chose to focus our analysis on Nova, rather than eIF5 and Squid.

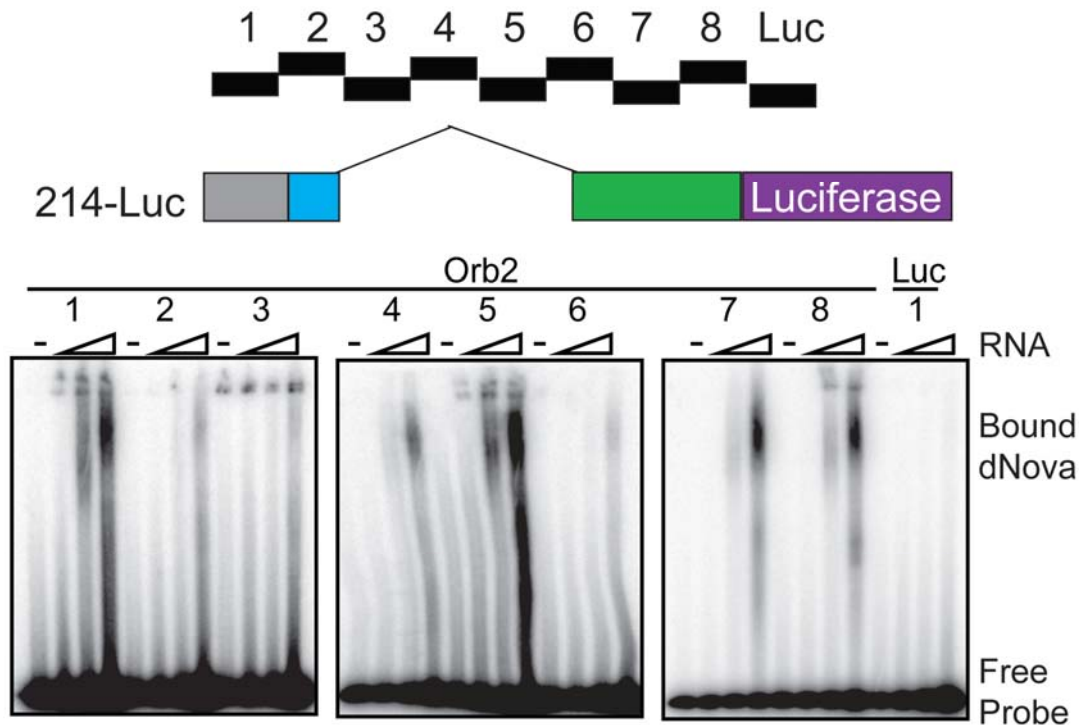

Figure 22 Nova binds to Orb2A mRNA sequence elements *in vitro* Top schematic of 214-luciferase construct and the 25-50 bp fragments that were used in the gel shift assay. 1-8 + Luc correspond to the RNA that was loaded into the lanes, in increasing amounts from left to right for each fragment. Lanes 1 and 5 show the most robust binding and correspond to the 5' UTR and the intronic region just upstream of the 3' SS. The exonic region just downstream of the 3' SS also shows moderate binding to Nova protein (7 & 8). There is also a low level of binding to the other Orb2A sequence elements (2,3,4 and 6) but no binding to the luciferase sequence element that was used (Luc). Gel Shift assay was completed by Scot Harms.

Reviewing the literature on Nova in *Drosophila*, we were immediately concerned with reports in the literature that Nova was excluded from the *Drosophila* nervous system (60, 61). As Nova is an important alternative splicing factor, and through our collaboration on the screen, Dr. Marco Blanchette also carried a great interest in Nova function in the fruit fly. As a result we initiated a full fledged collaborative effort to understand how

Nova protein functions in *Drosophila*. To verify whether or not Nova was expressed in the *Drosophila* CNS, Dr. Blanchette's group raised an anti-Nova antibody in rabbit. We then stained the adult fly brain for Nova protein (Fig. 21) using generic rabbit IgG as a control (Fig 21). We found robust expression in the entire fly brain, and had a two fold assurance of specificity 1) The anti-Nova antibody had an exceptionally high signal as compared to generic IgG from the same species (Fig 21; upper panels). Also, RNAi mediated knock down of Nova (UAS-NovaRNAi) when driven by a pan neuronal driver (ElaV-Gal-4) significantly decreased the signal generated by the anti-Nova antibody in the adult brain as well as on a Western blot of fly head whole protein. We also noted residual staining in the adult brain, which we speculate could be caused by either expression in glial cells or incomplete knockdown of Nova protein by the UAS-NovaRNAi construct.

Having determined that Nova is necessary for normal Orb2A mRNA processing in S2 cells, and that it is expressed in the fly brain, we next wanted to ask whether there was a direct interaction between Nova protein and Orb2A sequence elements. To do this we turned to our collaboration with the Blanchette lab. Using a gel shift assay, they found that Nova protein, when incubated with different ~25 base pair fragments of the 214 luciferase minigene construct, bound to various sequence elements that were derived from Orb2A, but not those derived from the luciferase sequence, which served as probe specificity control (Fig 22). Interestingly, Nova bound to regions of the Orb2A sequence (5'UTR, in the intron 5' of the 3' splice site, and on the exonic sequence) that have been characterized in other analyses (56, 100). Furthermore, Nova was found to bind to a

similar region (intronic) as to that which regulated activity dependent NMD and maintenance of steady state splicing choices (98). It is precisely this scenario by which Orb2A mRNA could be regulated: Orb2A-np could be spliced into a conformation that includes a cryptic NMD exon in the steady state, while activity leads to splicing into the Orb2A-pc form. This is purely speculative, but this nature of regulation would be consistent with the literature and the results outlined in figure 4. Additionally, it is important to note that alternative splicing events such that have been outlined in other studies (49) conducted in *Drosophila* as well as mammalian systems have implicated Nova in both possible alternative splicing events that could generate Orb2A-pc from the Orb2 genomic locus, including alternative 5' promoter choice, as well as intron retention (Fig 2 F,H). While we have shown that Orb2A is an independent transcriptional unit that displays intron retention, and therefore focused on Orb2A-pc as a result of Orb2A-np intron excision, the implication of Nova in the Orb2A regulation allows for the possibility of derivation of Orb2A from Orb2B via alternative promoter choice, putatively in an activity dependent manner (49).

Figure 23 Nova is needed for normal Orb2A-pc expression in male testes. All gels are RT-PCR bands from single male fly bodies. (A) Nanos Gal-4::UAS-Nova RNAi (center gel) leads to a laddering, or shadow corresponding to two peaks of approximately 10 and 20 extra base pairs. Normal splicing is seen when UAS-NovaHA is driven by Nanos Gal-4 or in wildtype males. Representative electropherograms corresponding to the gels are shown below. Quantification of the 'minor' and 'major' bands is to the left. (B) A similar pattern, but to a lesser extent is seen when assaying the Orb2B exon-exon junction that shares a common 3'SS with Orb2A. Representative electropherograms corresponding to the gels are shown below. Quantification of the 'minor' and 'major' bands is to the left. To verify that not all exon-exon junctions were affected, we assayed Act88F, and saw normal splicing in Nanos Gal-4::UAS-NovaRNAi flies. (C) Genotype controls, showing specificity of knockdown.

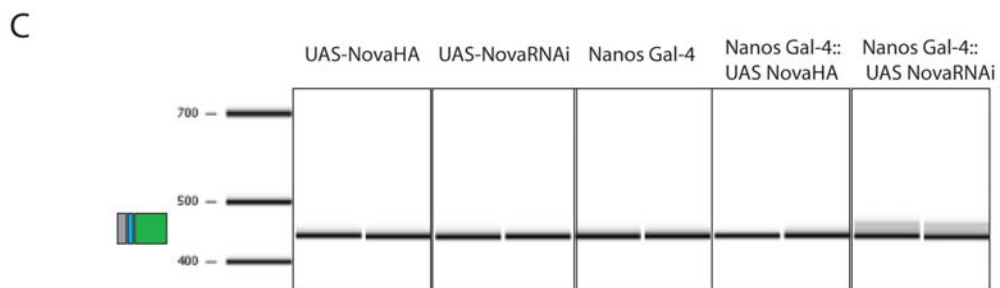
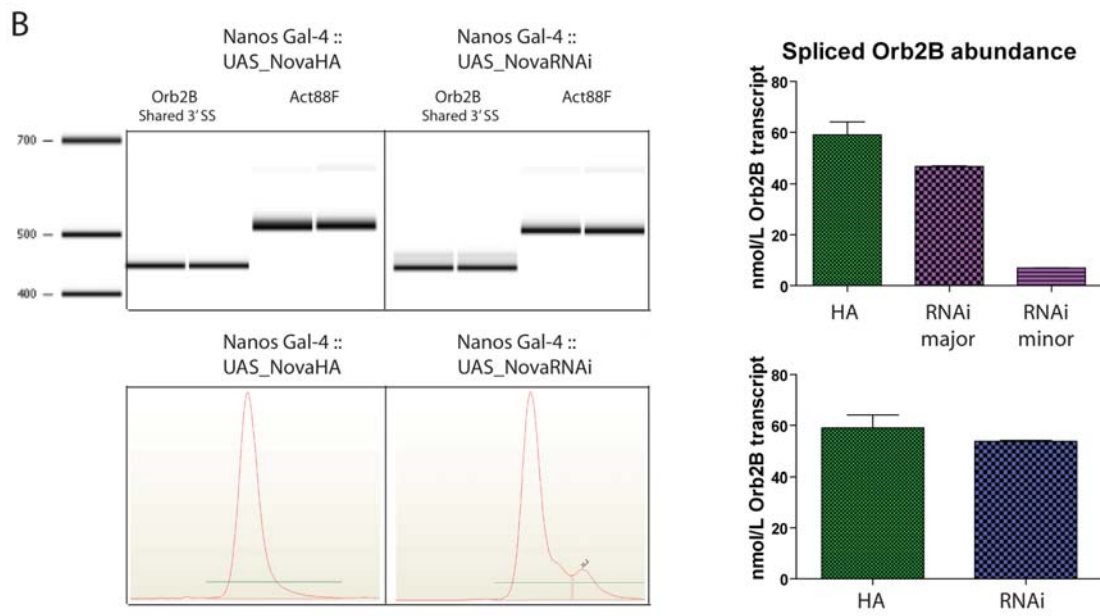
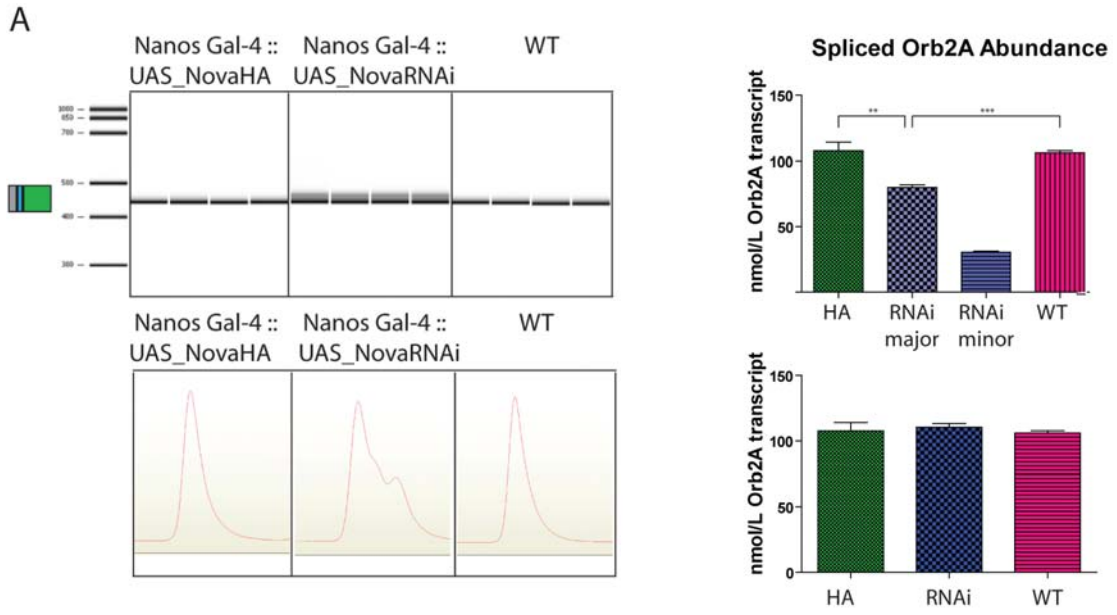

At this point we have established that Nova is required for the protein coding form of a minigene reporter in S2 cells, that Nova is expressed in the fly brain, and that Nova can bind to sequences found in the 5'UTR, the intron and the 3'splice site proximal exonic sequences of Orb2A. What we have not demonstrated is an effect on Orb2A mRNA processing *in vivo*. To do this, we turned towards the male testes as a laboratory of sort for understanding regulation of Orb2A-pc. To analyze the effects of Nova knockdown on Orb2A-pc mRNA, we expressed NovaRNAi in the male testes by driving the UAS-NovaRNAi construct under the Nanos-Gal-4 promoter (147). We found that driving the UAS-NovaRNAi construct in the male testes led to a peculiar laddering effect that generated two additional peaks on the bioanalyzer (Fig 23A, center panel). We were not able through multiple attempts to sequence these additional peaks. Assuming that the peaks represented a mis-splicing event, we quantified the major product, which sequencing verified was Orb2A-pc and the minor peaks and found that Nova RNAi led to a significant reduction in Orb2A-pc (Fig 23A, upper right). We also noted that the overall level of transcription did not change, as a summation of the major and minor products was equivalent in expression to Orb2A-pc in wildtype and NovaHA (overexpression) flies. Because Orb2A-pc shares a common 3' splice site with Orb2B, we next wanted to verify that the knockdown of Nova specifically affected splicing of Orb2Am but not Orb2B transcripts. When analyzing the Orb2B splice site, we were surprised to note that there was a similar laddering effect and generation of dual peaks at the Orb2B splice junction (Fig 23B, left panel). Interestingly, the minor peaks generated at the Orb2B splice junction accounted for roughly half of the reduction seen in Orb2A, perhaps indicating that Nova acts on the shared 3' splice site, but does not regulate the 5' end of

the intron (Fig 23A & B). Closer analysis will need to be carried out to verify both whether the similar in nature but different in extent effect on Orb2A and Orb2B splicing is real or an artifact of abundance of the transcript. Additionally, it would behoove us to attempt alternative methods of sequencing the minor products in order to understand their nature. As was alluded to prior, the role of Nova in regulating steady state levels of alternatively spliced transcripts through introduction of cryptic splice sites would lead us to speculate that the minor peaks, perhaps represent precisely this type of regulation on Orb2A and perhaps Orb2B mRNA processing. This would give us a putative mechanism for the regulation of Orb2A mRNA.

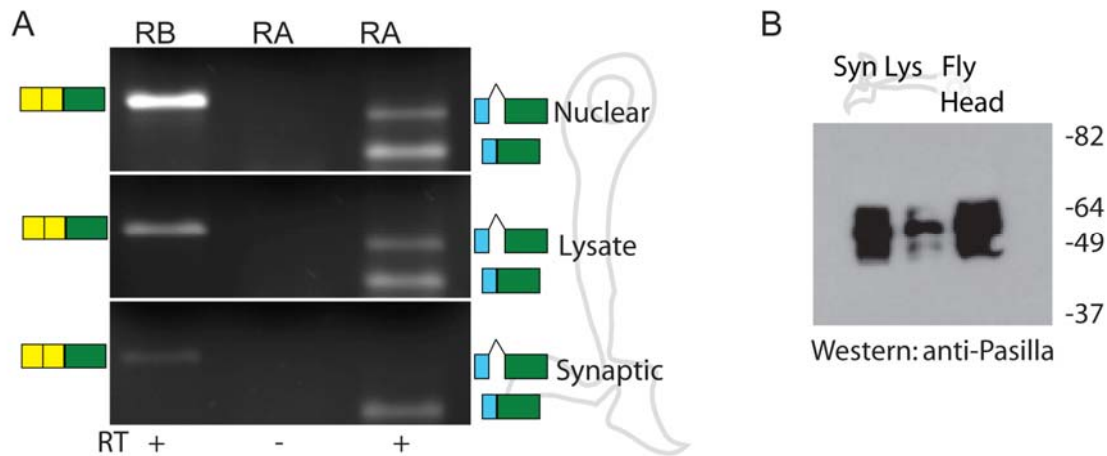

Figure 24 Nova protein and Orb2A-pc are both enriched in the synaptic compartment. (A) Synaptosome preparation followed by RNA isolation and reverse transcriptase reaction from pooled fly heads. PCR of cDNA generated from RNA isolated from the nuclear fraction is run on the top, the cytoplasmic, or lysate, in the middle and the synaptic at bottom. There is a gradual decrease in relative Orb2B (RB) transcript levels, and a gradual increase in Orb2A-pc enrichment. **(B)** Western blotting of the whole fly head lysate, the lysate (cytoplasmic) fraction, and the synaptic fraction is shown. There is an enrichment of Nova protein in the synaptic fraction as compared to the cytoplasmic fraction. Additionally, it would appear that a majority of Nova protein is synaptic. Synaptosome in (B) was completed by Amitabha Majumdar, Western blot by Fengzhen Ren.

If indeed there is an association between Nova and Orb2A-pc, and given Nova's dual role in splicing and mRNA transport, we would predict that Nova and Orb2A-pc co-localize at the synapses. However, due to the low level of Orb2A-pc and the significant overlap with Orb2B mRNA sequence, and the high levels of Nova throughout the *Drosophila* brain (Fig 21), we turned to biochemical fractionation to determine potential co-localization. To do this, we used a synapto-neurosomes preparation by which sucrose gradients coupled with high speed centrifugation allow for the separation of the nuclear, cytoplasmic and membrane fractions, the latter of which should, in the brain, enrich for the synaptic membranes. Because we do not have an Orb2A specific antibody, we produced cDNA from the various fractions that we isolated and subsequently used PCR to amplify Orb2A and Orb2B. We found a high level of enrichment of Orb2B mRNA in the nuclear fraction and decreasing levels in the cytoplasmic (lysate) and synaptic fractions (Fig 24A). However we noticed a different distribution in Orb2A mRNA, where there were approximately equivalent levels of Orb2-np in the nuclear and cytoplasmic fractions, but a specific enrichment of Orb2A-pc in the synaptic compartment, as well as a loss of Orb2A-np (Fig 24A). Furthermore, while the nuclear portion amplified relative levels of Orb2 transcripts as seen in fly heads, the synaptic fraction had a specific enrichment of Orb2A-pc (Fig 24A). It must be noted that due to the exceptional level of starting material required, we cannot exclude potential contamination from male testes contributing to some of the Orb2A-pc fraction. Regarding Nova, we found Nova protein in both the cell body fraction as well as the synaptic compartment (Fig 24A). These data are consistent with Nova as a trans acting regulator of Orb2A mRNA responsible for splicing of Orb2A and transport into the dendritic compartment. However, presently we

only have data consistent with this observation, rather than direct evidence of this process.

We next sought to understand whether Nova protein regulates the processing of mature Orb2A and Orb2B mRNA. Taking advantage of the ability of the Taqman probe to uniquely measure Orb2A-pc (see chapter II), we looked at the absolute levels of Orb2A-

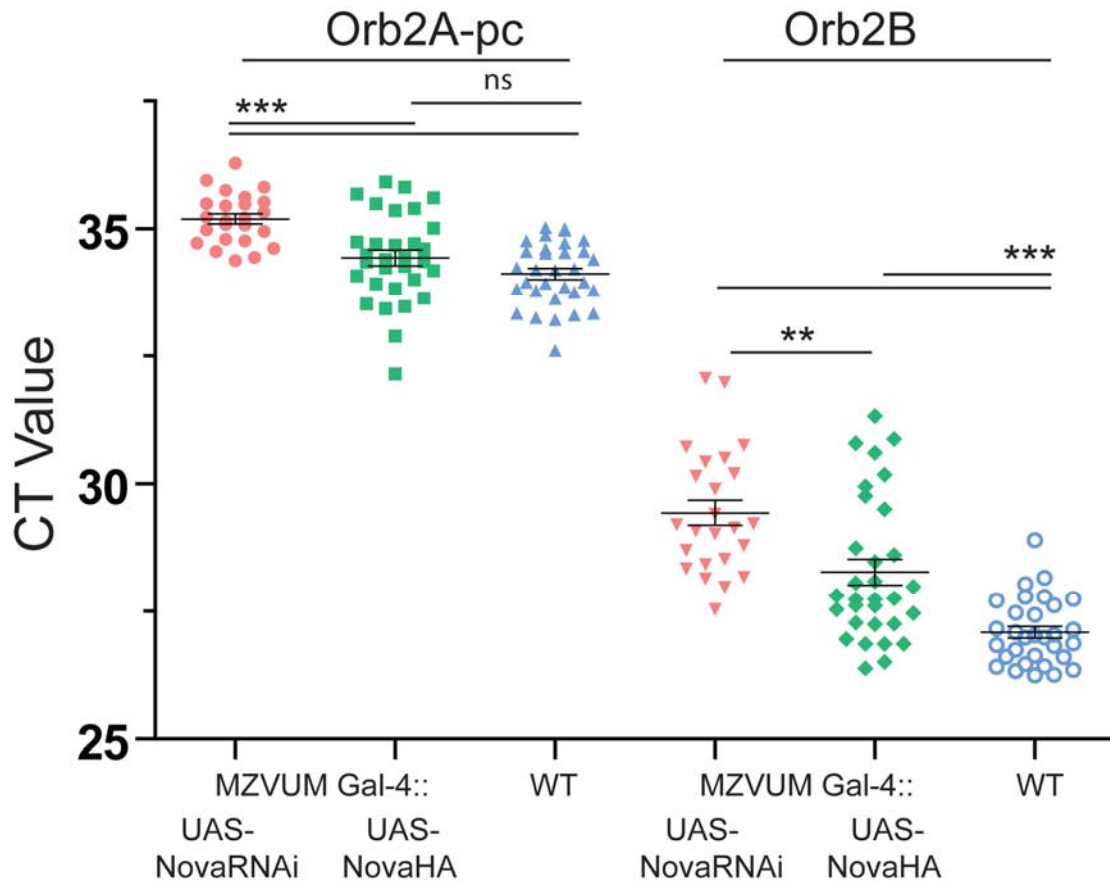

Figure 25 Nova leads to a decrease in absolute Orb2 levels. Mzvim, which is necessary for Orb2 mediated memory in the courtship suppression paradigm, Gal-4 driving NovaRNAi (n=24) is leads to a significant reduction of Orb2A-pc as well as Orb2B levels as compared to either Mzvim Gal-4::UAS NovaHA (n=32) or wildtype (n=32) flies. In the Mzvim Gal-4::NovaRNAi there was significantly less Orb2A-pc ($p < .001$) than Mzvim Gal-4::NovaHA or WT flies, while there was no difference between Mzvim Gal-4::NovaHA and WT flies. In the case of Orb2B Mzvim Gal-4::NovaRNAi had significantly less expression than both Mzvim Gal-4::NovaHA ($p < .01$) and WT ($p < .001$). In this case there was also a significant difference between Mzvim Gal-4::NovaHA and WT ($P < .001$).

pc and Orb2B in untreated fly heads (Fig. 25). We found that absolute levels of Orb2A-pc and Orb2B decreased significantly in flies in which NovaRNAi had been driven in a subset of neurons (Fig 25). However, it must be noted that the specificity of the knockdown is difficult to assay, as data not shown here confirmed to us that there is leaky transcription of the UAS-NovaRNAi construct when not in the presence of a Gal-4 driver via Western blot. A caveat to this analysis is that because we used gene specific primers, we are unable to ask whether Nova knockdown leads to global decrease in transcription, which results in decreases in Orb2 mRNA levels. This is an experiment that will be important in the future. We also found that over expression of Nova via the UAS-NovaHA flies also showed a decrease in Orb2B levels, although, compared to wildtype, there was no decrease in Orb2A-pc levels.

In summary, our analyses of Nova in *Drosophila* revealed a number of interesting observations. Initially, we confirmed, for the first time using specific antibodies rather than functional studies, that Nova is expressed in *Drosophila* brain neurons (Fig 21). We also found that Nova is capable of binding to Orb2A-pc sequence elements *in vitro*, and that WT levels of Nova protein are required in the male testes for normal splicing patterns of Orb2A-pc. We made the intriguing observation that Orb2A-pc mRNA and Nova protein are both enriched in synaptic fractions in the fly brain, and that Nova is required for normal levels of Orb2A-pc in female fly heads. Together, our analysis solidifies the presence of Nova in the fly brain, and suggests a potential interaction between Nova and Orb2 mRNA processing.

Chapter V: Materials and Methods

Total RNA Isolation: After indicated behavioral treatment, flies were flash frozen in liquid nitrogen. Single animals were then isolated on dry ice to avoid thawing and collected in 1.5 mL Eppendorf tubes, which were immediately replaced in liquid nitrogen. The flies were then vortexed to separate heads from bodies and collected. RNA was then collected as per the Maxwell® 16 LEV simplyRNA Tissue Kit (Promega). Briefly, the given tissue was homogenized in 50ul of Homogenization Buffer for 15 seconds using Rnase/Dnase free pestle (VWR) and electric pestle mixer (VWR) an additional 150ul of Homogenization Buffer was then added followed by addition of 200ul of Lysis Buffer. Samples were then vortexed for 15 seconds and spun down. The samples were then added to the provided cartridges according to the provided protocol with elution in 30ul of nuclease free water. After completion of the RNA isolation protocol samples were placed in a vacuum centrifuge for 8 minutes to achieve a volume of 5-7ul.

Reverse Transcriptase – PCR for total fly cDNA: cDNA was created from isolated total RNA as described in the SuperScript™ II Reverse Transcriptase (Invitrogen) protocol, reagents below are provided by Invitrogen unless otherwise noted. Briefly, 5-8 ul of total RNA was added to a single tube in an 8-tube PCR strip (Genemate). 2ul of random hexamers and 1 ul of dNTP mix were then added to the RNA sample. The tubes were placed in an Eppendorf thermal cycler for 5 minutes at 70° C and 5 minutes at 20° C. 1ul of RNase Out, 2 ul of 10x Buffer, 2ul of .01M DTT and 4 ul of MgCl₂ were then added to the sample and brought to 42° C for 2 minutes, at which time 1 ul of superscript II reverse transcriptase was added. The sample was then incubated at 42° C for 50 minutes. 1ul RNase H was then added to the sample and incubated for 37° C for 30 minutes. PCR

was then performed using a 30 second elongation step. Primers sequences follow: RA Forward (F): GTGTGTGATTGT GAGTGTCCG; Reverse NAÏVE: GTGCATATTGCCATAGATAGCTGTG); RB full (F: ATGGA CTGCTCAAGTTAC CAA; R: RA Reverse); RB1 (F: RB full Forward; R: CATGCATCTGGGGCTG CGATG); RB2 (F: CATCGCAG CCCAGATGCATG; R: GCGCAGACTAACTTCGTG); Syntaxin-6 (F: AGATGGCCACATGCACTGCTGGT GG; R: GTTTCGCCACGTACCTATGACTCGGAC

Reverse Transcriptase – PCR for gene specific PCR (qPCR assay): cDNA was created from isolated total RNA as described in the PrimeScript™ 1st strand cDNA Synthesis Kit (Clontech) protocol, reagents below are provided by Invitrogen unless otherwise noted. Briefly, 5-8 ul of total RNA was added to a single tube in an 8-tube PCR strip (Neptune). .7 µl of each of three different Orb2 specific primers (RA: GTGCATATTGCCATAGAT AGCTGTG; cDNAI: CTATGGCCATAGCATCGGCCTCGC; cDNAII: GCAGGAAGG CATATCCCTTGGGC and 1 ul of dNTP mix were then added to the RNA sample. The tubes were placed in an Eppendorf thermal cycler for 5 minutes at 65° C. .5ul of RNase Out, 4ul 5x Buffer, 4.5 ul of H₂O and 1 µl of reverse transcriptase were then added to the sample and brought to 50° C for 50 minutes and subsequently raised to 95°C for 5 minutes.

Bioanalyzer: Data was obtained following the standard published protocol, which can be found at: http://www.chem.agilent.com/Library/usermanuals/Public/G2938-90014_KitGuideDNA1000Assay_ebook.pdf .

qPCR assay: We used the Taqman gene expression system (Applied Biosystems) for analysis of Orb2B and Orb2A-pc. 2 µl of 5x diluted cDNA were added to 8 µl of master

mix (per reaction: .32 μ l 10mM forward primer; .32 μ l 10mM reverse primer, .2 μ l 10 μ M probe primer, 5 μ l 2x Taqman gene expression master mix (Applied Biosystems), 2.5 μ l H₂O). Primers/Probes used for Orb2B (Orb2B Forward GCCATGGACTCGCTCAAGTT; Orb2B Reverse: CG GACAGGTTGCTGTTGCT; Orb2B probe: 6FAM-CCAAAGGCCAACAGTGCCA CCAG; Orb2A Forward: TGTGTGTGATTGTGAGTGTCCTG; Orb2A Reverse: GGG CGGCTTGTTGAGATTGAGATT; Orb2A probe: 6FAM-TTAATTTTCATTTGCGGT GGCCTGCCG). 10 μ L reactions in triplicate for each sample were loaded using an automated setup with a CAS-4200 qPCR loading robot from Corbett Life Science. RT-PCR reactions were performed in 384-well formats on a 7900HT Fast Real-Time PCR System from Applied Biosystems.

Data analysis: All raw data from the 7900HT was compiled and exported to a .txt document using ABI 7900HT Sequence Detection Systems software version 2.4. Data analysis was conducted in a Microsoft Excel spreadsheet using a modified version of the $2^{(-\Delta \Delta CT)}$ method (120). Briefly, the triplicate CT values of a given sample were averaged for Orb2A and Orb2B primer/probe readings. A fold difference of each sample was calculated using the equation $2^{(CT^{Orb2A} - CT^{Orb2B})}$. For a given set of 14-16 samples, unless specified, approximately half of the samples were untreated and half were treated in a given condition. The average of the untreated fold difference was then calculated. All differences were then subtracted from the mean generated by averaging the fold differences of the untreated sample. In this way, the untreated samples were always a distribution with a mean of 0, while the treated samples had a mean correlating to the

alteration in Orb2A-pc to Orb2B ratio caused by the behavioral condition as compared to the mean. Each set of ~16 samples was analyzed in this manner, with post-hoc compilation of data. Tukey test was used to eliminate outliers prior to statistical analysis.

Statistical Analysis: All statistical tests were conducted using GraphPad Prism for Windows v. 5.02. All analysis was done using a two-tailed, unpaired T-test with 95% confidence interval with the exception of qPCR samples in which the sample was normalized to an untreated population, in which case a paired T-test was used, due to the assumption that untreated and treated flies represented a random sampling of the population with the only variable being the behavioral treatment. On graphs * = $P < 0.05$, ** = $P < 0.01$ and *** = $P < 0.001$ and represents a comparison of means.

RNA-seq: Samples were all collected using RNA isolation as described above on single female fly heads. For each condition the number of samples in the analysis were as follow (Untreated: 5 individual heads; starved: 5 individual heads; 1 hour post training (Sucrose): 6 individual heads; 4 hours post training (Sucrose): 5 individual heads; 4 hours post training (Sucrose II): 6 individual heads; 4 hours post training (Sorbose): 6 individual heads; 4 hours post training (L-arabinose): 4 individual heads; 4 hours post training (Odor only): 6 individual heads). Library preparation and submission was conducted by the Molecular Biology Core at the Stowers Institute. For analysis of the data we used a protocol described by Trapnell et al., (148). Briefly, RNA-seq analysis was done using TopHat v1.4.1 (Trapnell et al., 2010) and Bowtie v0.12.7. Only uniquely mapping reads to fly genome UCSC dm3 were used. Fly transcript annotations were from

Ensembl 65. Differentially expressed genes were called with an adjusted p value (FDR) < 0.05 by cuffdiff v1.3.0.

Screen Protocol: Day 1: 50mL of S2 cells were collected at concentration of 2×10^6 cells/mL. Transfection mix was made according to Effectene transfection reagent (Qiagen) protocol (96ul of reporter construct 1(Fluc); 96 ul of reporter construct 2(Rluc); 2.7 mL EC buffer; 153.6 ul Enhancer (followed by vortex); 486 ul of Effectene (followed by vortex)) Transfection mix was added to 22mL of collected S2 cells and agitated briefly. Transfected cells were then pooled in a trough and distributed in a 96well plate (75ul/well). dsRNA from RBP targeted 96 well plate (contact Dr. Marco Blanchette) was then added to each well (1ul/well). Plates were then stored at 25° C. Day 3: 1ul of dsRNA was added to each well. Day 4: 1mL of .7M CuSO₄ was added to 14mL of endotoxin free water. 1 ul of this solution was added to each well. Day 5: [Dual-Glo® Luciferase Assay System](#) was conducted according to protocol (Promega) using PerkinElmer VICTOR3™ V Multilabel Counter model 1420. Each individual dsRNA mediated RBP knockdown was conducted in triplicate. The resulting data, which measured the luciferase activity of the renilla and firefly reporter constructs, was then added to an excel spreadsheet. For each individual well a ratio of Fluc/Rluc was determined and the log base 2 was applied to the ratio to normalize decimal values so as to accord equal weight to specific increases AND decreases in luciferase activity. The average of 3 plates was used for each dsRNA RBP 96 well plate and average Fluc/Rluc fold change was created. The average Fluc/Rluc fold change from the two wells per plate to which no dsRNA was added was then subtracted from the given RBP knockdown Fluc/Rluc fold change to generate a fold

change in the absence of a given RBP compared to fold change due to random variation in expression. A type 2, 2 tailed student's T-test was then conducted using the three normalized ratios of a given dsRNA and the entire dataset of ratios to ask whether there was statistical significance in the variation of all three well given a single knock RBP knockdown. This was repeated with 5 plates comprising dsRNA targeting 392 individual RBPs. Out of this primary screen, there were 47 RBPs that affected the luciferase activity of the FF construct significantly differently than the Ren construct. To eliminate and effects of FF verse Ren luc, we then switched the FF and Ren sequences in the Fluc and Rluc constructs and repeated the screening methodology with the flipped transcripts. Three positive hits emerged and subsequent screening is described in the text.

Western Blot and Immunoprecipitation. For all biochemical analysis freshly prepared head extracts were used. For Western blot analysis, 20 fly heads were homogenized (2-4 μ L of buffer/head) in a NP-40 buffer and protease inhibitors (Roche). The total homogenate was centrifuged at 10,000 \times g for 10 min, and the cleared supernatant was collected. Equal volume 2x loading dye was added to samples, which were then boiled for 10 minutes. 1/40th of the volume or 1/20th of the volume for a given sample was then added to a 4-12% gradient SDS-PAGE (Invitrogen), which was then electroblotted onto PVDF membrane for 16-18hrs at 30mV at 4°C. The membranes were blocked in 5% non-fat dry milk in TBS-Tween-20 buffer and incubated with indicated affinity purified antibodies for 12-16 hours at 4° C with constant agitation. The antibody-antigen interaction was visualized by chemiluminescence using HRP-coupled anti-rabbit (Pasil) or anti-mouse (tubulin) secondary antibody.

Histology and imaging: For whole mount preparation of adult brain the cuticle and eyes were removed using forceps in PBS and fixed for 45 minutes in 4% paraformaldehyde in PBS. Isolated brains were then washed 4 times for 20 minutes in .3% triton in PBS (wash buffer) at room temperature followed by an overnight wash and 3 more 10 min washes in wash buffer. The samples were then blocked for 1 hour in 10% goat serum in wash buffer. Samples were then incubated with 1:500 of rabbit anti-Pasilla antibody and 1:1000 mouse anti-Elav antibody in blocking solution overnight at 4°C. Following 3 20 minute washes in wash buffer, samples were incubated with 1:1000 anti-rabbit 555 and 1:1000 anti-mouse 488 at 4°C overnight. Samples were then washed 3 times for 20 minutes at room temperature in wash buffer. Finally samples were mounted on coverslips using vectashield (Vector Labs) Images were acquired using a LSM 5.0 Pascal Confocal Microscope (Carl Zeiss, Germany). High resolution Z stack images of the fly brain at 512 x 512 pixels (1 µm step) were acquired. To avoid cross excitation 488 and 555 wavelengths images were acquired in a multi track mode.

Fly Synaptosome: Fly synaptosome purification is based on the protocols used in mouse, Aplysia, and Drosophila membrane preparation ([Chin et al., 1989](#), [Ehlers, 2003](#) and [Venkatesh et al., 1980](#)). All Sucrose solutions were made in Buffer A (10 mM Tris-HCl [pH 7.5]). Tyramine-stimulated adult fly heads were crushed in 0.32 M sucrose buffer (2 ml/0.5 gm of head) and centrifuged twice at 1000 × g for 20 min to separate the nucleus and other heavier cellular components from the membrane and soluble proteins. The supernatant (T) was centrifuged at 15,000 × g for 15 min, and the resulting pellet was resuspended and centrifuged again 15,000 × g for 10 min to obtain washed crude

synaptosome fraction (P1). The P1 fraction was resuspended in 0.32 M sucrose buffer, and 1 ml of the resuspended pellet was loaded on top of a 9.9 ml 0.5 M, 0.8 M, and 1.2 M sucrose buffer step gradient and centrifuged at $100,000 \times g$ for 3 hr in a Beckman SW40 rotor. The interface between 0.8 and 1.2 M sucrose was collected, diluted to 8 ml with 0.32 M sucrose, loaded on top of 4 ml 0.8 M sucrose buffer, and centrifuged at $230,000 \times g$ for 22 min in SW40 rotor to obtain purified synaptosome (P2). The pellet was extracted with 1% NP40 and 1% Triton X-100, 10 mM Tris-HCl (pH 7.5) buffer. The resuspended pellet was centrifuged $15,000 \times g$ for 15 min, and the supernatant was used as soluble synaptic fraction. The pellet containing purified synaptic membrane was extracted with buffer containing 1% NP40, 1% Triton X-100, and 1% SDS, 10 mM Tris-HCl (pH 7.5) (P3).

Olfactory-Appetitive Conditioning: Flies were food deprived for 16 to 20 hr before conditioning in glass vials containing Kimwipes paper saturated with water. The wall of the training tube was covered with a Whatman filter paper saturated with 1M sucrose (positive conditioning stimuli, +CS) that was allowed to dry prior to the training session. Another tube was also prepared with a filter paper soaked in water to provide the negative conditioning stimuli (-CS), allowing it to dry before use. Flies starved for 18 hr were introduced into the elevator of a T maze and tested in groups of $n=100$. Flies were transferred to the -CS tube and exposed to an odor for 2 min. After 30 s of air stream, the flies were relocated in the elevator and shifted to the +CS tube in the presence of the second odor for 2 min. Memory was tested 2 min, 1 hr, 3 hr, or 24 hr after training. Flies were kept in test tubes with cotton plugs in a humidified chamber when memory tests

were less than 3 hr. For the 24 hr test, flies were given standard cornmeal food for 6 to 7 hr after training. They were transferred to test tubes containing a Kimwipe soaked with water and starved for 17 hr before testing. For the 48 hr memory test, flies were given standard cornmeal food for 18–24 hr after training and then were starved for 24–30 hr prior to testing. During the memory test, flies were introduced into the elevator and transported to a point where they have to choose between two air streams, one carrying the reward odor and the other with the control odor. Animals were given 2 min to choose between the two odors. Different group of flies were trained in a reciprocal experiment in where the –CS/+CS odor combination were reversed (3-Octanol or 4-Methylcyclohexanol). The performance index (PI) is calculated as the number of flies in the reward odor minus the number of flies in the control odor, divided by the total number of flies in the experiment. A single PI value is the average score of the first and the reciprocal experiment. Test odorants were delivered by bubbling air bottles containing odor dilutions in 50 ml of mineral oil and the air flow was monitored using a flowmeter at 4.5 psi (Allied Healthcare Products, Inc., St. Louis, MO, USA). The odor concentration used for the experiments were: 1.08×10^{-3} for 3-OCT and 1.1×10^{-3} for 4-MCH. The spontaneous response to odors and sucrose were assayed in the T maze. Naive flies were given 2 min to choose between two airstreams, one carrying the test odor (3-Octanol or 4-Methylcyclohexanol) and the other carrying no odor.

Chapter VI: Discussion

Memory is the critical component of life. Here, memory refers to the storage of information over time. In this way, even our DNA is a memory device that reflects experience and by the wiles of chance propagates across time. But DNA as a memory device has the benefit of autonomy; as soon as it replicates, the two DNA molecules have two independent fates, which may or may not be intertwined, or come to be so. Within an organism, there are also various types of memory, notably in the immune system, where B and T cells undergo recombination to generate antibodies to clear foreign pathogens and also to recognize self-antigens. The recombined antibodies, if effective at host defense, are then stored by the body and reactivated in the case of re-infection via cell division. Defects in immune memory can lead to debilitating autoimmune conditions as well as difficulty in combating infections. As in the nervous system, this immune memory can be strengthened by reinforcement, as booster vaccines will prevent the memory of a given pathogen from being lost. Yet, again, this system of memory has the benefit of using DNA as a sort of book, within which to inscribe the learned information, that can be copied in the form of cell proliferation. In the nervous system, where the term memory is most commonly used, post mitotic neurons render DNA not a book with blank pages, but a code written in stone, that contains the information needed to generate an enormously complex cell that can maintain distinct domains and integrate information on the fly, that can act as the substrate, in a network, for so much of the depth and complexity that gives us joy and meaning. What the present dissertation has sought to do is to perhaps offer some insight into a few lines of the wisdom written in our genetic

code, to understand what mechanisms the organism has to manage the complexity of the neuron and the requisite signaling that allows for information to be processed and stored at a synapse far away from the cell body, all the while relying on the nucleus for support.

Regulation on the edge of a knife

In the introduction, the central role of the synapse in the present theory of memory formation was established. Furthermore, the concept of the synaptic tag was introduced, whereby the site of altered input, and only that site, is able to maintain a unique change over time. Theoretically, it has been proposed that such a mechanism would render neighboring synapses subject to ‘capture’ when a temporally linked stimuli that would otherwise have generated only a transient alteration would ‘hijack’ the machinery employed by the tag. In fact, this was experimentally confirmed (*1*). In the early 2000s Si and colleagues postulated that a prion like mechanism may fulfill the role of synaptic tag through the dual property of prions to be both self perpetuating and able to adopt alternate conformations. The former property would help overcome the reality of the transience of protein half-lives and provide a mechanism for lasting change, while the latter property would provide a potential mechanism for information storage, the conformational change acting as a binary switch.

There is no doubt as to the property of prions to be exceptionally durable, nor their capacity to propagate information in the form of dominant induction of conformational change. Prions were first described almost 25 years ago as a protein based infectious

particle, and in fact a large part of the controversy about this claim stemmed from the fact that, prior to this discovery, it was thought that the only device for propagation of information across time and space was nucleic acid, namely DNA with minor exceptions for some RNA viruses. Since the initial claim, however, the concept of prion as a heritable infectious agent is now accepted without hesitation. Despite this acceptance of the prion and its pathogenic mechanism, it is still, generally, held as a one-off, a kind of biological anomaly rather than being viewed of as a mechanism of information storage and propagation available in the eukaryotic biological toolkit. This may be a small irony, as perhaps the prime test of information storage is the propagation of information across time and space, which the pathological prion does exceptionally well. In this way, it is perhaps only a minor leap to consider the prion-like mechanism of self-perpetuation and binary switching as a prime mechanism for the intra-cellular storage of information, such as the synaptic tag demands.

If we accept that the prion-like mechanism is a good candidate for the synaptic tag, it begs the question of what molecule can function in such a way in the neuron. In the early 2000s, Si et al described the prion like properties of the *Aplysia* ortholog of CPEB, which shared homologous structure with Orb2 in *Drosophila* and human CPEBs 2-4. Our group has subsequently verified that Orb2 has prion like properties in the nervous system of *Drosophila*, an observation that has recently been verified by other groups. Orb2 seems to function through hetero-oligomerization of Orb2 isoforms Orb2B and Orb2A. Looking at both protein and mRNA levels, Orb2B is many times more abundant than Orb2A, and the capacity of Orb2A protein to induce oligomers of Orb2B has also been well

established. In the present dissertation we have highlighted a gating mechanism on Orb2A protein levels, where the pre-mRNA of Orb2A potentially possesses both the accessibility of a transcribed mRNA as well as the regulatory potential of a pre-processed mRNA. If we consider the pathogenicity of the canonical prions and the propensity of Orb2A to oligomerize, its stickiness, then perhaps post-transcriptional regulation—where steady state Orb2A mRNA is either unprocessed or contains a cryptic NMD intron via Nova splicing—would be a critical regulatory element suspending Orb2A between its enormous potential for dynamic information storage and pathogenicity.

In fact, the vast majority of neurodegenerative disorders have an element of protein aggregation as a central hallmark of their pathology, from neurofibrillary tangles, amyloid plaques and Lewy body dementia to protein aggregation in Huntington's chorea, many, if not most, non-oncological neurological diseases have protein aggregation at their core. While it is not clear that these are the pathogenic mechanisms of the given neurodegenerative condition or residual to neuronal dysfunction of dying cells, it is difficult to imagine that this is in every case coincidental. In fact, as we have presented an extensive discussion of the neuron specific alternative splicing factor Nova, it is important to note that a wide array of protein aggregation neurodegenerative conditions (sporadic AD, sporadic Frontotemporal Lobar Degeneration (FTLD) with Tau DNA binding protein (TDP), FTLD-tau or familial FTLD-TDP with progranulin mutations) showed down-regulation of Nova and alternative splicing changes in over 5000 exons in genes with neuron specific functions. We believe that the RBP-mRNA interaction of Nova and Orb2A-np/pc may be a case study in the tight regulation of genes with prion-

like ('sticky') propensities. Furthermore, perhaps in aging individuals (often sporadic disease) gradual mis-splicing might create feedback loops (consider the binding of Orb2 to its own 3' UTR) that over time generate gene expression changes sufficient to cause pan-neuronal dysfunction. From there it is perhaps not hard to imagine inter-neuronal spread of aggregation, given the ability of prions to induce a neurodegenerative state through oral routes, surviving the digestive tract, entering systemic circulation and crossing the blood brain barrier (excepting the possibility of lymphatic or retrograde neuronal spread to the CNS). As a result, perhaps understanding Nova, and other post-translational alternative splicing regulators, as a checkpoint on mRNA with exceptional potential would be instructive. As an aside, it has been described in the literature that individuals with FTLD may have a creative explosion as part of their initial pathogenesis. An interesting example is the composition of Bolero by Ravel, which was a departure from his previous work, highly repetitive and articulated. Yet it has nonetheless captivated audiences for generations. This type of post-hoc interpretation is clearly problematic on many levels, but is nonetheless interesting: perhaps, misregulation of proteins that 'gate' memory can have profound impacts, in diverse ways, prior to terminal pathology.

When Memories?

A second area of interest that the present work has broached is the concept that memory is an emergent phenomenon of the interaction of various internal and external stimuli in co-incidence. When considering memory as the stabilization of changes in synaptic

efficacy, a critical problem arises in our understanding of the process. On the one hand the molecular studies do well to detail the manner in which certain artificial stimuli induce molecular changes that most likely underlie physiological changes occurring in the intact organism, this can be confirmed via mutant analysis. On the other hand, we do not understand what behavioral conditions correspond to the artificial stimuli that induce STP vs LTP. While we can use mutation analysis to understand that certain genes may be responsible for STP, E-LTP, I-LTP or L-LTP, what the nature of the stimuli that induce any of these distinct phenomena is at this point not well understood. This point may be brought to the fore by the observation that even in the most robust long term memory paradigms in *Drosophila* only 30 to 40% of the flies go on to form long-term associations. Our present analysis has sought to use Orb2A-np/pc splicing as molecular marker for this process, which led to our analysis of the effect of various sugars on memory formation which in turn led us back to ask how the organism interprets the information that it faces as relevant for memory formation or not. The power of this manner of thinking is that we can start to think of the component parts of the behavior, rather than the molecular components of the memory trace itself, and in this way we can revisit the molecular level and obtain a more clear understanding of the entire process.

One of the interesting findings that we noted is that starvation is a critical component of the increase in Orb2A-pc relative to Orb2B elicited by training with sucrose. In this capacity we can think of starvation as altering the internal state of the organism and providing motivation for food seeking behavior. What is more interesting than the rather trivial observation that food deprivation elicits food seeking behavior, is that starvation

can lead to the fly having a better chance of remembering where the food was located that it encountered. While it may be on its face straightforward to think in this manner, it is not immediately obvious that a fly shouldn't always want to remember the location of a food source. On the other hand, when we think of potential pathogens and predators that may inhabit food rich locations, this is a more reasonable observation. However, rather than ethology, we are interested in the physiology of memory and when memories are elicited. To this end our RNA sequencing experiments identified a subset of genes whose expression is altered only in flies that are putatively in the process of learning, those trained with sucrose. We found that in the case of learning, there seems to be induction of a number of genes that have previously been implicated in immune defense. This is on its face confusing, however, a recently burgeoning field of study is the role of the immune system, and microglia in particular, in modulating synapses. It will be of considerable interest to investigate these targets further. We can envision a scenario by which various small extracellular peptides of the type identified in our 'screen' are induced by sugar ingestion (whether via signaling through metabolic sensors (ie insulin like peptide in *Drosophila*) or metabolism by gut flora) and make their way to mark newly formed, or growing synapses. Subsequent, unknown, reinforcement of these new connections may allow for clearance, or not, of the new synapses. In this scenario it is important to note that the immune peptides came from sugars that are learned, without controlling for learning where memory is not formed.

A second interesting result of the RNA sequencing experiments comes from the well controlled series of experiments in which the only variable was whether the sugar

presented could elicit memory, specifically, but not learning. In this way we could disambiguate the processes of learning from memory and the genes that are involved in those processes. It is intriguing that a *Drosophila* ortholog of genes that have been implicated in dementia were identified. Perhaps more intriguing, is that those genes have been implicated more in vascular health than brain health in their pathogenesis. Perhaps there is a less well-appreciated function of these genes in the initiation of dementia and/or the maintenance of normal brain function. As mentioned above, the genes identified from the sorbose/L-arabinose RNA sequencing experiment were noticeably different in their classification, pertaining to sensation and morphogenesis more so than immune function. Perhaps, using our two-level analysis, we were able to make an inroad towards understanding the molecular nature of the ‘decision’ of whether to learn or also remember.

Final Thoughts

One of the aspects that most intrigued me as I initially got into the literature on the topic was the remarkable inversion of gene expression that followed the initial signaling towards memory formation at the synapse. Rather than the canonical order of transcription, translation, post-translational modification towards gene expression, synapse stabilization—from learning to memory—operated as post-translational modification, translation, transcription. To me it seemed that, as is often the case, evolution had utilized an impeccable logic where by a precise end was attained; it seemed by reversing the order of gene expression, the exquisite selectivity required of memory

could be achieved. In light of this thought, perhaps it is not surprising that pre-mRNA regulation slots so nicely in the order, between intermediate-LTP and long-LTP, between translation and transcription, between an idea that will disappear and one that will persist.

References

1. E. R. Kandel, The molecular biology of memory storage: a dialogue between genes and synapses. *Science* **294**, 1030 (2001).
2. R. J. Kelleher, 3rd, A. Govindarajan, S. Tonegawa, Translational regulatory mechanisms in persistent forms of synaptic plasticity. *Neuron* **44**, 59 (2004).
3. C. R. Bramham, D. G. Wells, Dendritic mRNA: transport, translation and function. *Nat Rev Neurosci* **8**, 776 (2007).
4. J. D. Richter, E. Klann, Making synaptic plasticity and memory last: mechanisms of translational regulation. *Genes Dev* **23**, 1 (2009).
5. C. N. Giachello, P. G. Montarolo, M. Ghirardi, Synaptic functions of invertebrate varicosities: what molecular mechanisms lie beneath. *Neural plasticity* **2012**, 670821 (2012).
6. R. Lamprecht, J. LeDoux, Structural plasticity and memory. *Nat Rev Neurosci* **5**, 45 (2004).
7. V. F. Castellucci, A. Nairn, P. Greengard, J. H. Schwartz, E. R. Kandel, Inhibitor of adenosine 3':5'-monophosphate-dependent protein kinase blocks presynaptic facilitation in *Aplysia*. *J Neurosci* **2**, 1673 (1982).
8. L. Bernier, V. F. Castellucci, E. R. Kandel, J. H. Schwartz, Facilitatory transmitter causes a selective and prolonged increase in adenosine 3':5'-monophosphate in sensory neurons mediating the gill and siphon withdrawal reflex in *Aplysia*. *J Neurosci* **2**, 1682 (1982).
9. O. Braha, B. Edmonds, T. Sacktor, E. R. Kandel, M. Klein, The contributions of protein kinase A and protein kinase C to the actions of 5-HT on the L-type Ca²⁺ current of the sensory neurons in *Aplysia*. *J Neurosci* **13**, 1839 (1993).
10. T. C. Sacktor, J. H. Schwartz, Sensitizing stimuli cause translocation of protein kinase C in *Aplysia* sensory neurons. *Proc Natl Acad Sci U S A* **87**, 2036 (1990).
11. W. S. Sossin, J. H. Schwartz, Selective activation of Ca(2+)-activated PKCs in *Aplysia* neurons by 5-HT. *J Neurosci* **12**, 1160 (1992).
12. S. Sugita, J. R. Goldsmith, D. A. Baxter, J. H. Byrne, Involvement of protein kinase C in serotonin-induced spike broadening and synaptic facilitation in sensorimotor connections of *Aplysia*. *J Neurophysiol* **68**, 643 (1992).
13. D. A. Baxter, J. H. Byrne, Serotonergic modulation of two potassium currents in the pleural sensory neurons of *Aplysia*. *J Neurophysiol* **62**, 665 (1989).
14. J. H. Byrne, E. R. Kandel, Presynaptic facilitation revisited: state and time dependence. *J Neurosci* **16**, 425 (1996).
15. M. Klein, B. Hochner, E. R. Kandel, Facilitatory transmitters and cAMP can modulate accommodation as well as transmitter release in *Aplysia* sensory neurons: Evidence for parallel processing in a single cell. *Proc Natl Acad Sci U S A* **83**, 7994 (1986).
16. O. Braha *et al.*, Second messengers involved in the two processes of presynaptic facilitation that contribute to sensitization and dishabituation in *Aplysia* sensory neurons. *Proc Natl Acad Sci U S A* **87**, 2040 (1990).

17. T. Saneyoshi, D. A. Fortin, T. R. Soderling, Regulation of spine and synapse formation by activity-dependent intracellular signaling pathways. *Curr Opin Neurobiol* **20**, 108 (2010).
18. G. R. Owen, E. A. Brenner, Mapping molecular memory: navigating the cellular pathways of learning. *Cellular and molecular neurobiology* **32**, 919 (2012).
19. C. R. Bramham, Local protein synthesis, actin dynamics, and LTP consolidation. *Curr Opin Neurobiol* **18**, 524 (2008).
20. R. S. Zukin, J. D. Richter, C. Bagni, Signals, synapses, and synthesis: how new proteins control plasticity. *Front Neural Circuits* **3**, 14 (2009).
21. R. A. Chitwood, Q. Li, D. L. Glanzman, Serotonin facilitates AMPA-type responses in isolated siphon motor neurons of *Aplysia* in culture. *The Journal of physiology* **534**, 501 (2001).
22. Q. Li, A. C. Roberts, D. L. Glanzman, Synaptic facilitation and behavioral dishabituation in *Aplysia*: dependence on release of Ca²⁺ from postsynaptic intracellular stores, postsynaptic exocytosis, and modulation of postsynaptic AMPA receptor efficacy. *J Neurosci* **25**, 5623 (2005).
23. R. C. Malenka, M. F. Bear, LTP and LTD: an embarrassment of riches. *Neuron* **44**, 5 (2004).
24. H. W. Kessels, R. Malinow, Synaptic AMPA receptor plasticity and behavior. *Neuron* **61**, 340 (2009).
25. G. Collingridge, Synaptic plasticity. The role of NMDA receptors in learning and memory. *Nature* **330**, 604 (1987).
26. J. DeZazzo, T. Tully, Dissection of memory formation: from behavioral pharmacology to molecular genetics. *Trends Neurosci* **18**, 212 (1995).
27. Y. S. Huang, M. Y. Jung, M. Sarkissian, J. D. Richter, N-methyl-D-aspartate receptor signaling results in Aurora kinase-catalyzed CPEB phosphorylation and alpha CaMKII mRNA polyadenylation at synapses. *EMBO J* **21**, 2139 (2002).
28. R. Mendez, J. D. Richter, Translational control by CPEB: a means to the end. *Nat Rev Mol Cell Biol* **2**, 521 (2001).
29. M. Theis, K. Si, E. R. Kandel, Two previously undescribed members of the mouse CPEB family of genes and their inducible expression in the principal cell layers of the hippocampus. *Proc Natl Acad Sci U S A* **100**, 9602 (2003).
30. J. D. Richter, CPEB: a life in translation. *Trends Biochem Sci* **32**, 279 (2007).
31. L. Wu *et al.*, CPEB-mediated cytoplasmic polyadenylation and the regulation of experience-dependent translation of alpha-CaMKII mRNA at synapses. *Neuron* **21**, 1129 (1998).
32. Y. S. Huang, M. C. Kan, C. L. Lin, J. D. Richter, CPEB3 and CPEB4 in neurons: analysis of RNA-binding specificity and translational control of AMPA receptor GluR2 mRNA. *EMBO J* **25**, 4865 (2006).
33. K. Si *et al.*, A neuronal isoform of CPEB regulates local protein synthesis and stabilizes synapse-specific long-term facilitation in *aplysia*. *Cell* **115**, 893 (2003).
34. K. Si, S. Lindquist, E. R. Kandel, A neuronal isoform of the *aplysia* CPEB has prion-like properties. *Cell* **115**, 879 (2003).
35. T. Mastushita-Sakai, E. White-Grindley, J. Samuelson, C. Seidel, K. Si, *Drosophila* Orb2 targets genes involved in neuronal growth, synapse formation, and protein turnover. *Proc Natl Acad Sci U S A* **107**, 11987 (2010).

36. K. Keleman, S. Kruttner, M. Alenius, B. J. Dickson, Function of the Drosophila CPEB protein Orb2 in long-term courtship memory. *Nat Neurosci* **10**, 1587 (2007).
37. N. Hafer, S. Xu, K. M. Bhat, P. Schedl, The Drosophila CPEB Protein Orb2 Has a Novel Expression Pattern and is Important for Asymmetric Cell Division and Nervous System Function. *Genetics*, (2011).
38. A. Majumdar *et al.*, Critical Role of Amyloid-like Oligomers of Drosophila Orb2 in the Persistence of Memory. *Cell* **148**, 515 (2012).
39. S. Kruttner *et al.*, Drosophila CPEB Orb2A mediates memory independent of Its RNA-binding domain. *Neuron* **76**, 383 (2012).
40. K. Si, Y. B. Choi, E. White-Grindley, A. Majumdar, E. R. Kandel, Aplysia CPEB can form prion-like multimers in sensory neurons that contribute to long-term facilitation. *Cell* **140**, 421 (2010).
41. M. Chorev, L. Carmel, The function of introns. *Frontiers in genetics* **3**, 55 (2012).
42. M. J. Moore, From birth to death: the complex lives of eukaryotic mRNAs. *Science* **309**, 1514 (2005).
43. H. Le Hir, B. Seraphin, EJC's at the heart of translational control. *Cell* **133**, 213 (2008).
44. O. Hachet, A. Ephrussi, Splicing of oskar RNA in the nucleus is coupled to its cytoplasmic localization. *Nature* **428**, 959 (2004).
45. D. L. Black, Mechanisms of alternative pre-messenger RNA splicing. *Annual review of biochemistry* **72**, 291 (2003).
46. Q. Pan, O. Shai, L. J. Lee, B. J. Frey, B. J. Blencowe, Deep surveying of alternative splicing complexity in the human transcriptome by high-throughput sequencing. *Nature genetics* **40**, 1413 (2008).
47. D. Schmucker *et al.*, Drosophila Dscam is an axon guidance receptor exhibiting extraordinary molecular diversity. *Cell* **101**, 671 (2000).
48. C. J. David, J. L. Manley, The search for alternative splicing regulators: new approaches offer a path to a splicing code. *Genes Dev* **22**, 279 (2008).
49. A. N. Brooks *et al.*, Conservation of an RNA regulatory map between Drosophila and mammals. *Genome Res* **21**, 193 (2011).
50. R. J. Buckanovich, J. B. Posner, R. B. Darnell, Nova, the paraneoplastic Ri antigen, is homologous to an RNA-binding protein and is specifically expressed in the developing motor system. *Neuron* **11**, 657 (1993).
51. R. B. Darnell, J. B. Posner, Paraneoplastic syndromes involving the nervous system. *The New England journal of medicine* **349**, 1543 (2003).
52. R. J. Buckanovich, R. B. Darnell, The neuronal RNA binding protein Nova-1 recognizes specific RNA targets in vitro and in vivo. *Mol Cell Biol* **17**, 3194 (1997).
53. K. B. Jensen *et al.*, Nova-1 regulates neuron-specific alternative splicing and is essential for neuronal viability. *Neuron* **25**, 359 (2000).
54. C. S. Huang *et al.*, Common molecular pathways mediate long-term potentiation of synaptic excitation and slow synaptic inhibition. *Cell* **123**, 105 (2005).
55. J. Ule *et al.*, Nova regulates brain-specific splicing to shape the synapse. *Nature genetics* **37**, 844 (2005).

56. J. Ule *et al.*, An RNA map predicting Nova-dependent splicing regulation. *Nature* **444**, 580 (2006).
57. C. Zhang *et al.*, Integrative modeling defines the Nova splicing-regulatory network and its combinatorial controls. *Science* **329**, 439 (2010).
58. M. Yano, Y. Hayakawa-Yano, A. Mele, R. B. Darnell, Nova2 regulates neuronal migration through an RNA switch in disabled-1 signaling. *Neuron* **66**, 848 (2010).
59. S. E. Allen, R. B. Darnell, D. Lipscombe, The neuronal splicing factor Nova controls alternative splicing in N-type and P-type CaV2 calcium channels. *Channels* **4**, 483 (2010).
60. P. Seshaiiah, B. Miller, M. M. Myat, D. J. Andrew, pasilla, the Drosophila homologue of the human Nova-1 and Nova-2 proteins, is required for normal secretion in the salivary gland. *Dev Biol* **239**, 309 (2001).
61. M. Irimia *et al.*, Stepwise assembly of the Nova-regulated alternative splicing network in the vertebrate brain. *Proc Natl Acad Sci U S A* **108**, 5319 (2011).
62. N. Jelen, J. Ule, M. Zivin, R. B. Darnell, Evolution of Nova-dependent splicing regulation in the brain. *PLoS genetics* **3**, 1838 (2007).
63. W. H. Lin, C. Gunay, R. Marley, A. A. Prinz, R. A. Baines, Activity-dependent alternative splicing increases persistent sodium current and promotes seizure. *J Neurosci* **32**, 7267 (2012).
64. M. Chen, J. L. Manley, Mechanisms of alternative splicing regulation: insights from molecular and genomics approaches. *Nat Rev Mol Cell Biol* **10**, 741 (2009).
65. T. W. Nilsen, B. R. Graveley, Expansion of the eukaryotic proteome by alternative splicing. *Nature* **463**, 457 (2010).
66. E. H. Kislauskis, X. Zhu, R. H. Singer, Sequences responsible for intracellular localization of beta-actin messenger RNA also affect cell phenotype. *J Cell Biol* **127**, 441 (1994).
67. A. F. Ross, Y. Oleynikov, E. H. Kislauskis, K. L. Taneja, R. H. Singer, Characterization of a beta-actin mRNA zipcode-binding protein. *Mol Cell Biol* **17**, 2158 (1997).
68. J. K. Yisraeli, VICKZ proteins: a multi-talented family of regulatory RNA-binding proteins. *Biology of the cell / under the auspices of the European Cell Biology Organization* **97**, 87 (2005).
69. D. M. Tiruchinapalli *et al.*, Activity-dependent trafficking and dynamic localization of zipcode binding protein 1 and beta-actin mRNA in dendrites and spines of hippocampal neurons. *J Neurosci* **23**, 3251 (2003).
70. T. Eom, L. N. Antar, R. H. Singer, G. J. Bassell, Localization of a beta-actin messenger ribonucleoprotein complex with zipcode-binding protein modulates the density of dendritic filopodia and filopodial synapses. *J Neurosci* **23**, 10433 (2003).
71. V. Mercaldo, G. Descalzi, M. Zhuo, Fragile X mental retardation protein in learning-related synaptic plasticity. *Molecules and cells* **28**, 501 (2009).
72. C. Bagni, W. T. Greenough, From mRNP trafficking to spine dysmorphogenesis: the roots of fragile X syndrome. *Nat Rev Neurosci* **6**, 376 (2005).
73. Y. Feng *et al.*, Fragile X mental retardation protein: nucleocytoplasmic shuttling and association with somatodendritic ribosomes. *J Neurosci* **17**, 1539 (1997).

74. D. E. Eberhart, H. E. Malter, Y. Feng, S. T. Warren, The fragile X mental retardation protein is a ribonucleoprotein containing both nuclear localization and nuclear export signals. *Hum Mol Genet* **5**, 1083 (1996).
75. K. De Boulle *et al.*, A point mutation in the FMR-1 gene associated with fragile X mental retardation. *Nature genetics* **3**, 31 (1993).
76. R. P. Menon, T. J. Gibson, A. Pastore, The C terminus of fragile X mental retardation protein interacts with the multi-domain Ran-binding protein in the microtubule-organising centre. *J Mol Biol* **343**, 43 (2004).
77. V. J. Hinton, W. T. Brown, K. Wisniewski, R. D. Rudelli, Analysis of neocortex in three males with the fragile X syndrome. *American journal of medical genetics* **41**, 289 (1991).
78. T. A. Comery *et al.*, Abnormal dendritic spines in fragile X knockout mice: maturation and pruning deficits. *Proc Natl Acad Sci U S A* **94**, 5401 (1997).
79. S. A. Irwin *et al.*, Abnormal dendritic spine characteristics in the temporal and visual cortices of patients with fragile-X syndrome: a quantitative examination. *American journal of medical genetics* **98**, 161 (2001).
80. L. N. Antar, R. Afroz, J. B. Dichtenberg, R. C. Carroll, G. J. Bassell, Metabotropic glutamate receptor activation regulates fragile x mental retardation protein and FMR1 mRNA localization differentially in dendrites and at synapses. *J Neurosci* **24**, 2648 (2004).
81. I. J. Weiler *et al.*, Fragile X mental retardation protein is translated near synapses in response to neurotransmitter activation. *Proc Natl Acad Sci U S A* **94**, 5395 (1997).
82. K. Y. Miyashiro *et al.*, RNA cargoes associating with FMRP reveal deficits in cellular functioning in Fmr1 null mice. *Neuron* **37**, 417 (2003).
83. F. Zalfa *et al.*, The fragile X syndrome protein FMRP associates with BC1 RNA and regulates the translation of specific mRNAs at synapses. *Cell* **112**, 317 (2003).
84. Y. Kanai, N. Dohmae, N. Hirokawa, Kinesin transports RNA: isolation and characterization of an RNA-transporting granule. *Neuron* **43**, 513 (2004).
85. O. Rackham, C. M. Brown, Visualization of RNA-protein interactions in living cells: FMRP and IMP1 interact on mRNAs. *EMBO J* **23**, 3346 (2004).
86. J. C. Darnell *et al.*, FMRP stalls ribosomal translocation on mRNAs linked to synaptic function and autism. *Cell* **146**, 247 (2011).
87. M. Qin, J. Kang, T. V. Burlin, C. Jiang, C. B. Smith, Postadolescent changes in regional cerebral protein synthesis: an in vivo study in the FMR1 null mouse. *J Neurosci* **25**, 5087 (2005).
88. J. Schutt, K. Falley, D. Richter, H. J. Kreienkamp, S. Kindler, Fragile X mental retardation protein regulates the levels of scaffold proteins and glutamate receptors in postsynaptic densities. *J Biol Chem* **284**, 25479 (2009).
89. D. J. Kelley *et al.*, The cyclic AMP cascade is altered in the fragile X nervous system. *PLoS One* **2**, e931 (2007).
90. E. Berry-Kravis, P. Sklena, Demonstration of abnormal cyclic AMP production in platelets from patients with fragile X syndrome. *American journal of medical genetics* **45**, 81 (1993).

91. S. E. Newey, V. Velamoor, E. E. Govek, L. Van Aelst, Rho GTPases, dendritic structure, and mental retardation. *Journal of neurobiology* **64**, 58 (2005).
92. C. M. Atkins, N. Nozaki, Y. Shigeri, T. R. Soderling, Cytoplasmic polyadenylation element binding protein-dependent protein synthesis is regulated by calcium/calmodulin-dependent protein kinase II. *J Neurosci* **24**, 5193 (2004).
93. C. M. Atkins, M. A. Davare, M. C. Oh, V. Derkach, T. R. Soderling, Bidirectional regulation of cytoplasmic polyadenylation element-binding protein phosphorylation by Ca²⁺/calmodulin-dependent protein kinase II and protein phosphatase 1 during hippocampal long-term potentiation. *J Neurosci* **25**, 5604 (2005).
94. J. M. Alarcon *et al.*, Selective modulation of some forms of schaffer collateral-CA1 synaptic plasticity in mice with a disruption of the CPEB-1 gene. *Learning & memory* **11**, 318 (2004).
95. J. Berger-Sweeney, N. R. Zearfoss, J. D. Richter, Reduced extinction of hippocampal-dependent memories in CPEB knockout mice. *Learning & memory* **13**, 4 (2006).
96. J. E. Bestman, H. T. Cline, The RNA binding protein CPEB regulates dendrite morphogenesis and neuronal circuit assembly in vivo. *Proc Natl Acad Sci U S A* **105**, 20494 (2008).
97. M. McEvoy *et al.*, Cytoplasmic polyadenylation element binding protein 1-mediated mRNA translation in Purkinje neurons is required for cerebellar long-term depression and motor coordination. *J Neurosci* **27**, 6400 (2007).
98. T. Eom *et al.*, NOVA-dependent regulation of cryptic NMD exons controls synaptic protein levels after seizure. *eLife* **2**, e00178 (2013).
99. C. Racca *et al.*, The Neuronal Splicing Factor Nova Co-Localizes with Target RNAs in the Dendrite. *Front Neural Circuits* **4**, 5 (2010).
100. C. Zhang, R. B. Darnell, Mapping in vivo protein-RNA interactions at single-nucleotide resolution from HITS-CLIP data. *Nature biotechnology* **29**, 607 (2011).
101. C. Vogler *et al.*, CPEB3 is associated with human episodic memory. *Frontiers in behavioral neuroscience* **3**, 4 (2009).
102. A. Levine, R. Durbin, A computational scan for U12-dependent introns in the human genome sequence. *Nucleic Acids Res* **29**, 4006 (2001).
103. H. K. Pessa *et al.*, Gene expression profiling of U12-type spliceosome mutant Drosophila reveals widespread changes in metabolic pathways. *PLoS One* **5**, e13215 (2010).
104. C. Schneider, C. L. Will, J. Brosius, M. J. Frilander, R. Luhrmann, Identification of an evolutionarily divergent U11 small nuclear ribonucleoprotein particle in Drosophila. *Proc Natl Acad Sci U S A* **101**, 9584 (2004).
105. A. A. Patel, M. McCarthy, J. A. Steitz, The splicing of U12-type introns can be a rate-limiting step in gene expression. *EMBO J* **21**, 3804 (2002).
106. K. J. Venken, Y. He, R. A. Hoskins, H. J. Bellen, P[acman]: a BAC transgenic platform for targeted insertion of large DNA fragments in *D. melanogaster*. *Science* **314**, 1747 (2006).
107. A. H. Brand, N. Perrimon, Targeted gene expression as a means of altering cell fates and generating dominant phenotypes. *Development* **118**, 401 (1993).

108. R. L. Davis, Traces of *Drosophila* memory. *Neuron* **70**, 8 (2011).
109. S. L. Hall, R. A. Padgett, Conserved sequences in a class of rare eukaryotic nuclear introns with non-consensus splice sites. *J Mol Biol* **239**, 357 (1994).
110. P. A. Sharp, C. B. Burge, Classification of introns: U2-type or U12-type. *Cell* **91**, 875 (1997).
111. W. Y. Tarn, J. A. Steitz, A novel spliceosome containing U11, U12, and U5 snRNPs excises a minor class (AT-AC) intron in vitro. *Cell* **84**, 801 (1996).
112. R. C. Dietrich, R. Incorvaia, R. A. Padgett, Terminal intron dinucleotide sequences do not distinguish between U2- and U12-dependent introns. *Mol Cell* **1**, 151 (1997).
113. J. E. Brock, R. C. Dietrich, R. A. Padgett, Mutational analysis of the U12-dependent branch site consensus sequence. *RNA* **14**, 2430 (2008).
114. K. Gao, A. Masuda, T. Matsuura, K. Ohno, Human branch point consensus sequence is yUnAy. *Nucleic Acids Res* **36**, 2257 (2008).
115. H. K. Pessa, A. Ruokolainen, M. J. Frilander, The abundance of the spliceosomal snRNPs is not limiting the splicing of U12-type introns. *RNA* **12**, 1883 (2006).
116. J. J. Turunen, E. H. Niemela, B. Verma, M. J. Frilander, The significant other: splicing by the minor spliceosome. *Wiley interdisciplinary reviews. RNA* **4**, 61 (2013).
117. C. J. Coolidge, R. J. Seely, J. G. Patton, Functional analysis of the polypyrimidine tract in pre-mRNA splicing. *Nucleic Acids Res* **25**, 888 (1997).
118. S. Yusa, J. B. Oliveira-Martins, Y. Sugita-Konishi, Y. Kikuchi, Cellular prion protein: from physiology to pathology. *Viruses* **4**, 3109 (2012).
119. A. D. Medhurst *et al.*, The use of TaqMan RT-PCR assays for semiquantitative analysis of gene expression in CNS tissues and disease models. *Journal of neuroscience methods* **98**, 9 (2000).
120. K. J. Livak, T. D. Schmittgen, Analysis of relative gene expression data using real-time quantitative PCR and the 2(-Delta Delta C(T)) Method. *Methods* **25**, 402 (2001).
121. L. J. Byrne *et al.*, The number and transmission of [PSI] prion seeds (Propagons) in the yeast *Saccharomyces cerevisiae*. *PLoS One* **4**, e4670 (2009).
122. B. Cox, F. Ness, M. Tuite, Analysis of the generation and segregation of propagons: entities that propagate the [PSI+] prion in yeast. *Genetics* **165**, 23 (2003).
123. J. L. Pitman *et al.*, There are many ways to train a fly. *Fly* **3**, 3 (2009).
124. G. U. Busto, I. Cervantes-Sandoval, R. L. Davis, Olfactory learning in *Drosophila*. *Physiology* **25**, 338 (2010).
125. B. J. Dickson, Wired for sex: the neurobiology of *Drosophila* mating decisions. *Science* **322**, 904 (2008).
126. K. R. Kaun, R. Azanchi, Z. Maung, J. Hirsh, U. Heberlein, A *Drosophila* model for alcohol reward. *Nat Neurosci* **14**, 612 (2011).
127. V. G. Dethier, *The hungry fly : a physiological study of the behavior associated with feeding*. (Harvard University Press, Cambridge, Mass. ; London, 1976), pp. [11],489p.,plate.
128. C. J. Burke, S. Waddell, Remembering nutrient quality of sugar in *Drosophila*. *Curr Biol* **21**, 746 (2011).

129. M. J. Krashes *et al.*, A neural circuit mechanism integrating motivational state with memory expression in *Drosophila*. *Cell* **139**, 416 (2009).
130. M. J. Krashes, S. Waddell, Rapid consolidation to a radish and protein synthesis-dependent long-term memory after single-session appetitive olfactory conditioning in *Drosophila*. *J Neurosci* **28**, 3103 (2008).
131. C. B. Saper, T. C. Chou, J. K. Elmquist, The need to feed: homeostatic and hedonic control of eating. *Neuron* **36**, 199 (2002).
132. P. V. Nguyen, T. Abel, E. R. Kandel, Requirement of a critical period of transcription for induction of a late phase of LTP. *Science* **265**, 1104 (1994).
133. C. H. Yang, P. Belawat, E. Hafen, L. Y. Jan, Y. N. Jan, *Drosophila* egg-laying site selection as a system to study simple decision-making processes. *Science* **319**, 1679 (2008).
134. S. Frey, J. Bergado-Rosado, T. Seidenbecher, H. C. Pape, J. U. Frey, Reinforcement of early long-term potentiation (early-LTP) in dentate gyrus by stimulation of the basolateral amygdala: heterosynaptic induction mechanisms of late-LTP. *J Neurosci* **21**, 3697 (2001).
135. K. G. Reymann, J. U. Frey, The late maintenance of hippocampal LTP: requirements, phases, 'synaptic tagging', 'late-associativity' and implications. *Neuropharmacology* **52**, 24 (2007).
136. U. Frey, R. G. Morris, Synaptic tagging and long-term potentiation. *Nature* **385**, 533 (1997).
137. D. Mohnen, Pectin structure and biosynthesis. *Current opinion in plant biology* **11**, 266 (2008).
138. W. Huang da, B. T. Sherman, R. A. Lempicki, Systematic and integrative analysis of large gene lists using DAVID bioinformatics resources. *Nature protocols* **4**, 44 (2009).
139. W. Huang da, B. T. Sherman, R. A. Lempicki, Bioinformatics enrichment tools: paths toward the comprehensive functional analysis of large gene lists. *Nucleic Acids Res* **37**, 1 (2009).
140. J. A. Bravo *et al.*, Ingestion of *Lactobacillus* strain regulates emotional behavior and central GABA receptor expression in a mouse via the vagus nerve. *Proc Natl Acad Sci U S A* **108**, 16050 (2011).
141. E. Okun, K. J. Griffioen, M. P. Mattson, Toll-like receptor signaling in neural plasticity and disease. *Trends Neurosci* **34**, 269 (2011).
142. D. G. Baker, C. M. Nievergelt, D. T. O'Connor, Biomarkers of PTSD: neuropeptides and immune signaling. *Neuropharmacology* **62**, 663 (2012).
143. P. W. Burnet, Gut bacteria and brain function: the challenges of a growing field. *Proc Natl Acad Sci U S A* **109**, E175; author reply E176 (2012).
144. H. Kettenmann, F. Kirchhoff, A. Verkhratsky, Microglia: new roles for the synaptic stripper. *Neuron* **77**, 10 (2013).
145. S. F. Altschul, W. Gish, W. Miller, E. W. Myers, D. J. Lipman, Basic local alignment search tool. *J Mol Biol* **215**, 403 (1990).
146. N. N. Nalivaeva, L. R. Fisk, N. D. Belyaev, A. J. Turner, Amyloid-degrading enzymes as therapeutic targets in Alzheimer's disease. *Current Alzheimer research* **5**, 212 (2008).

147. J. B. Duffy, GAL4 system in *Drosophila*: a fly geneticist's Swiss army knife. *Genesis* **34**, 1 (2002).
148. C. Trapnell *et al.*, Transcript assembly and quantification by RNA-Seq reveals unannotated transcripts and isoform switching during cell differentiation. *Nature biotechnology* **28**, 511 (2010).