

Bryant C. Freeman, Ph.D.
University of Kansas

HAITIAN CREOLE - ENGLISH

ENGLISH - HAITIAN CREOLE

MEDICAL DICTIONARY

With Glossary of Food and Drink



La Presse Evangélique
Port-au-Prince

- Carrié Paultre, *Tonton Libin: Annotated Edition for Speakers of English*, ed. Bryant C. Freeman. Port-au-Prince: Editions Boukan, 1982.
- Lyonel Desmarattes, *Mouché Défas*, ed. Bryant C. Freeman. Port-au-Prince: Editions Créolade, 1983. 2e Edision, 1984.
- L[odewijk] F[rederik] Peleman, *Gesproken Taal van Haïti met Verbeteringen en Aanvullingen / Ti Diksyonnè Kréyòl-Nélandè ak yon ti Dégi*, rev. ed. Bryant C. Freeman. Port-au-Prince: Bon Nouvèl, 1984.
- Bryant C. Freeman, *Chita Pa Bay: Elementary Readings in Haitian Creole, with Illustrated Dictionary*. Port-au-Prince: Editions Bon Nouvèl, 1984. Revised edition, 1990.
- L[odewijk] F[rederik] Peleman, *Afzonderlijke Uitgave: Verbeteringen en Aanvullingen van de Gesproken Taal van Haïti / Yon ti Dégi Kréyòl-Nélandè*, ed. Bryant C. Freeman. Port-au-Prince: Edision Bon Nouvèl, 1986.
- Bryant C. Freeman, *Ti Koze Kreyòl: A Haitian-Creole Conversation Manual*. Port-au-Prince: Editions Bon Nouvèl, 1987.
- Pierre Vernet ak Bryant C. Freeman, *Diksyonè Olograf Kreyòl Ayisyen*. Pòtoprens: Sant Lengwistik Aplike Inivèsite Leta Ayiti, 1988.
- Bryant C. Freeman, *Dictionnaire inverse de la Langue créole haïtienne / Diksyonè lanvè Lang kreyòl ayisyen an*. Port-au-Prince: Centre de Linguistique Appliquée de l'Université d'Etat d'Haïti, 1989.
- Pierre Vernet et Bryant C. Freeman, *Dictionnaire préliminaire des Fréquences de la Langue créole haïtienne*. Port-au-Prince: Centre de Linguistique Appliquée de l'Université d'Etat d'Haïti, 1989.
- Bryant C. Freeman, *Survival Creole*. With tape. Port-au-Prince: La Presse Evangélique, 1990. Second edition, 1992.
- Bryant C. Freeman, *Survivre en Créole*. Avec cassette. Port-au-Prince: La Presse Evangélique, 1990.
- Bryant C. Freeman, *Überleben auf Kreolisch*. Mit Kasette. Port-au-Prince: La Presse Evangélique, 1990.
- Bryant C. Freeman, *Third-World Folk Beliefs and Practices: Haitian Medical Anthropology*. New York: Garland Publishing, Inc. Port-au-Prince: La Presse Evangélique, 1992.
- Bryant C. Freeman, *Haitian - English Medical Phraseology: For Doctors, Dentists, Nurses, and Paramedics*. With tapes. Port-au-Prince: La Presse Evangélique. In preparation.
- Bryant C. Freeman and Jowel Laguerre, *Haitian Creole - English Dictionary*. In preparation.
- Bryant C. Freeman and Jowel Laguerre, *English - Haitian Creole Dictionary*. In preparation.

Bryant C. Freeman, Ph.D.
University of Kansas

With the collaboration of
Catherine C. McGowan, M.D.

Haitian Creole - English

English - Haitian Creole

Medical Dictionary

With Glossary of Food and Drink

Medicine in Haiti II

La Presse Evangélique
Port-au-Prince
1992

R00244 98217

**Copyright © 1992
by Bryant C. Freeman**

Available in the United States from:

**Mount Oread Bookshop
University of Kansas
Lawrence, Kansas 66045**

**Cover: "Study of a Black" (possibly in preparation for an
Adoration of the Magi), by Paolo Veronese (1528-1588).**

TABLE OF CONTENTS

Preface	6
Pronunciation Guide	9
Human Body	10
Face	10
Front	11
Rear	12
Arm and Hand	13
Leg and Foot	14
Teeth	15
Eye	16
Abbreviations	16
Haitian Creole-English Medical Dictionary	17
English-Haitian Creole Medical Dictionary	95
Glossary of Food and Drink: Haitian Creole-English	177
Glossary of Food and Drink: English-Haitian Creole	188
Days	196
Months	196
Seasons	196
Colors	196
Numbers	196

PREFACE

The present bilingual medical dictionary is intended for the many English-speaking physicians, dentists, nurses, and paramedics treating Haitian patients. It is meant to serve as a corollary both to our *Haitian-English Medical Phraseology* and to *Third-World Folk Beliefs and Practices: Haitian Medical Anthropology*. The original intention was to present all three as a single work, but as the material grew, it became advisable to separate the parts into three more easily manageable volumes.

SOURCES. The basic source of this dictionary is the exhaustive Haitian-English English-Haitian dictionary by Jewel Laguerre and myself, soon to appear. However, many additional terms came to my attention while working in various rural Haitian hospitals and clinics, and in studying some forty medical and hygiene texts in Haitian Creole, such as the Haitian translation of David Werner's *Where There Is No Doctor*, Beth Weaver and Helen Welle's *Chan ak Istwa: pou Edikasyon Sante*, Paul Antoine's *Kò Moun*, and madan Jan Bena's *Timoun Se Richès*.

SPELLING. The spelling system used here is the official one promulgated by the Haitian government in 1979, and in which practically all material published in Haitian Creole now appears. This system has been officially endorsed not only by the Haitian Ministry of National Education, the State University of Haiti, and the Haitian National Institute of Pedagogy, but also by the Catholic Adult Education Program and the Protestant Literacy Program.

PRONUNCIATION. Included is a brief guide to Haitian Creole pronunciation, stressing those sounds which could initially present a problem to speakers of English.

FRENCH VS. HAITIAN CREOLE. A major problem in preparing an often technical dictionary of this kind is to ascertain what is truly Haitian Creole, and what is merely French masquerading as Haitian Creole - often termed "French-fried Creole." The real test is to establish what would be understood by a monolingual Haitian Creole speaker with very little or no contact with French, Haiti's other official language. Simply rewriting a given French word using Haitian Creole phonology is hardly an acceptable solution, for only those who speak French as well would understand it - thereby excluding the some 85% of Haiti's population who speak only Haitian Creole. Thus, after consultation with various Haitian health professionals, we have supplied when necessary in the English-Haitian Creole section, short self-explanatory paraphrases avoiding technical terms.

ACCEPTABLE TERMINOLOGY. Another problem concerns that of register, or level of language. A medical practitioner in any culture is expected to use terms in keeping with his/her professional status, and so-called gutter slang referring, for example, to various parts of the human anatomy, is deemed inappropriate. Accordingly, in the English-Haitian Creole section we attempt to present only the one, two or perhaps three terms least likely to occasion either surprise or mirth, while being universally understood. On the other hand, the medical practitioner has no control concerning the level of language which may be used by a given patient. Therefore, in the Haitian Creole-English section we have endeavored to present all terms which might be used, however technical, or however familiar.

MAKE-UP. Somewhat surprisingly, the two sections are almost equal in length, but not because one is simply the reverse of the other. The Haitian Creole-English section, with some 6,000 entries, has a number of familiar names for parts of the body, Voodoo expressions of direct concern to physical and mental well-being, and the many synonymous terms for Haiti's major ailments, such as malnutrition, tuberculosis, diarrhea, anemia, and malaria. The English-Haitian Creole section, with some 6,100 entries, is on the other hand lengthened chiefly by specific terminology usually expressed in Haitian Creole by a combination of everyday words.

FOODS. Since questions concerning eating and drinking habits often constitute an integral part of medical consultations, we have attempted to compile a relatively comprehensive glossary of the foods and beverages found in Haiti, from Pétion-Ville, to the most isolated rural regions. Our principal source was again the bilingual dictionary in preparation with Jowel Laguerre, to which we have added items found in a number of Haitian cookbooks, as well as other items gleaned directly from various Haitian cooks. Naturally it is highly unlikely that any one person will be familiar with the some 900 foods and drinks listed in the Haitian Creole-English section, or the some 675 in the English-Haitian Creole part, but it was felt that as full a listing as possible would be desirable. Nevertheless, cooking is an inexhaustible domain for human ingenuity, and we have no illusions that this list is in any way more complete than are the medical sections.

ACKNOWLEDGMENTS. We wish to give special thanks to Jowel Laguerre, originally of Saint-Georges, Haiti, without whose constant assistance a major portion of the work in Haitian Creole done at the University of Kansas during the past nine years would have been all but impossible. Thanks are also due his wife, Camille, of La Vallée-Jacmel, who confirmed - or set straight - many a term. We wish to acknowledge as well our special debt to the Reverend Roger

Désir, director of the masterful translation of both the Old and New Testaments in Haitian Creole, who served as final arbiter for numerous difficult expressions.

Our guide in the more arcane realms of medical terminology was Catherine C. McGowan, M.D., who after beginning her Haitian studies at the University of Kansas, went on to work in Haiti, completed the medical degree at her alma mater, and later returned for a time to work in the Haitian medical world. We would never have attempted this work without her assistance.

We wish to thank Mr. William Dunn, administrator of the Hôpital Albert Schweitzer in Deschappelles - founded and directed by Dr. and Mrs. Larimer Mellon, Jr. - as well as Dr. Michel Jean-Baptiste, its medical director, and Dr. Jacqueline Gautier. Thanks are also due Dr. William Hodges, director for more than thirty years of the Hôpital Le Bon Samaritain in Limbé, and Dr. Brinson McGowan of the Centre Médical Emmanuel of Cayes-Jacmel. In addition, we wish to express our gratitude to Jacmel's unforgettable nonagenarian physician, Dr. Abel Gousse; to our former University of Kansas student Gail M. Boaz, of La Vallée-Jacmel; and to Dr. Reynold Monsanto of the Hôpital pour les Yeux in Cayes. For dental terms, we wish particularly to thank Dr. Roger Larose of Saint-Marc and the Hôpital Albert Schweitzer. Finally, for invaluable assistance in the preparation of this text, we wish to thank Pam LeRow and Stephanie Lynn Freeman.

Lawrence, Kansas
May 1992

Bryant C. Freeman

PRONUNCIATION GUIDE

The pronunciation of Haitian Creole is not a great problem for speakers of English. First, the language has few of the seemingly exotic (for Americans!) sounds of French; and secondly, its almost phonetic spelling system is a clear guide.

HAITIAN CREOLE IS SPELLED AS IT IS PRONOUNCED - AND PRONOUNCED AS IT IS SPELLED. EACH LETTER IS PRONOUNCED - AND EACH SOUND IS WRITTEN ONLY ONE WAY. Naturally to acquire a good accent, one will need to work with tapes and/or a Haitian teacher. You will find however that Haitians are flattered by those who want to learn their true language, and are only too willing to help.

Sounds which could initially puzzle the speaker of English are:

ch - as in show: **chache** (to look for)

ò - as in paw, saw: **fò** (strong)

e - as in aim: **ede** (to help)

ou - as in food: **ou** (you)

è - as in leg: **mèsi** (thank you)

r - not rolled, very soft, pronounced at back of throat: **respire** (to breathe)

g - always "hard," as in go: **gen** (to have)

s - always pronounced as an "s," never like a "z": **prese** (in a hurry)

i - as in bee: **Isit** (here)

y - as in yes: **pye** (foot), **zòrèy** (ear)

j - avoid a "d" in front: **jou** (day)

o - as in toe: **zo** (bone)

NASAL SOUNDS are pronounced partially through the nose, but without the "n" itself pronounced. There are no real English equivalents, but are close to:

an - somewhat like aims: **dan** (tooth)

en - as in the name Chopin: **pen** (bread)

on - somewhat like don't: **bon** (good)

NOTES:

1) When a nasal sound is followed by a second "n" or by an "m," pronounce the nasal sound as usual, plus the "n" or "m" separately: **venn** (vein), **janm** (leg).

2) When the letters **an**, **en**, or **on** are not meant to indicate a nasal sound, a grave accent (`) is placed over the vowel: **pàn** (mechanical breakdown), **Ayisyèn** (Haitian woman), **mòn** (hill, mountain).

3) The combination **in** never indicates a nasal sound.

HUMAN BODY / KÒ MOUN

Haitian Creole is generally a very direct language. Names for many of the body parts will be easier to learn if one is aware of a few simple component words:

bò - side
 bwa - wood, stick
 do - back
 gwo - big, fat
 je - eye
 pla - flat

po - skin
 pwent - point, tip
 sak - sack, bag
 ti - small, little
 twou - hole
 zo - bone

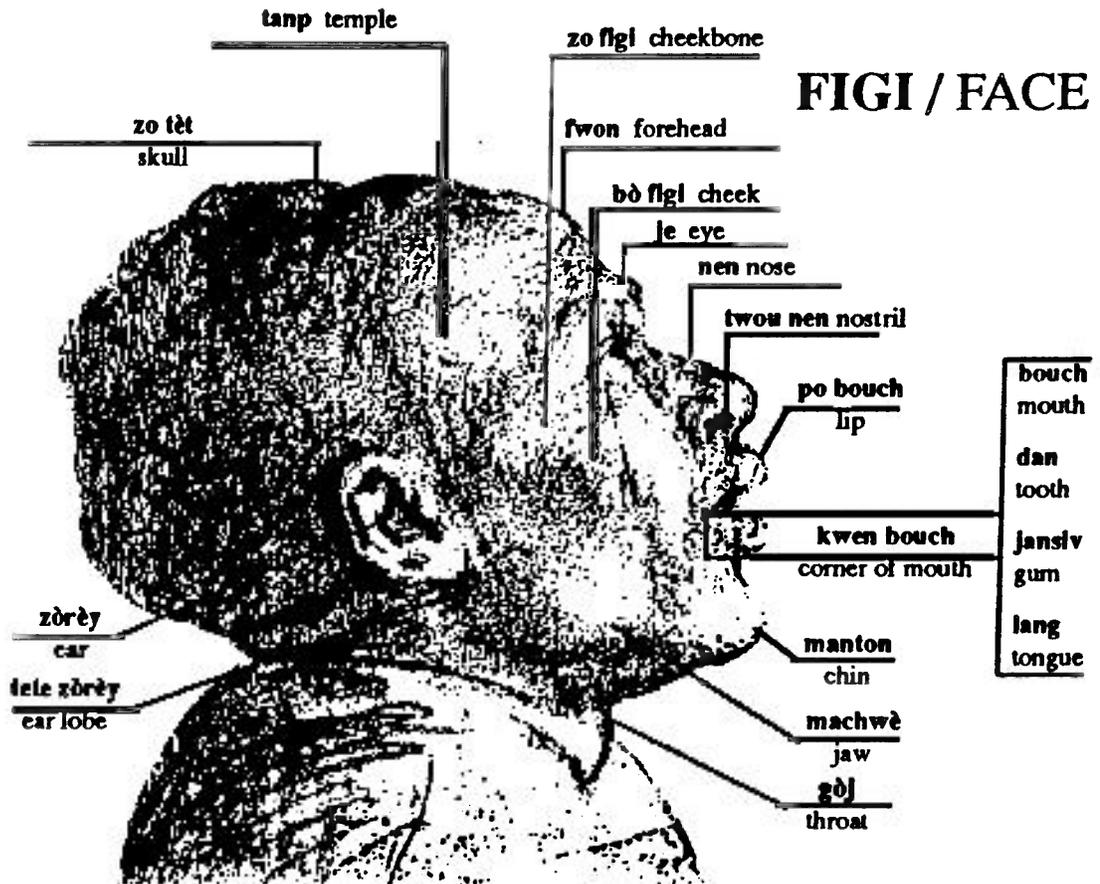

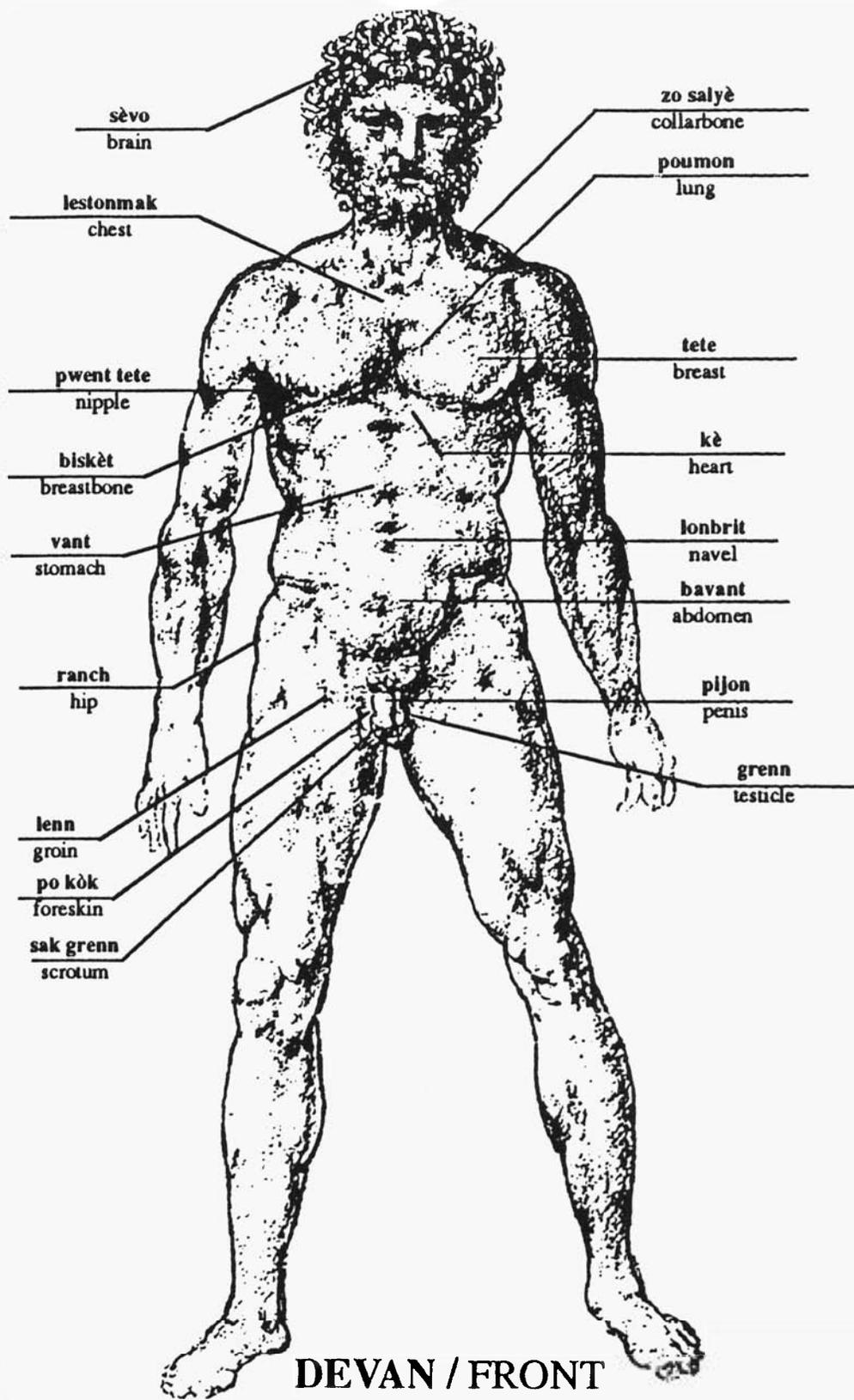

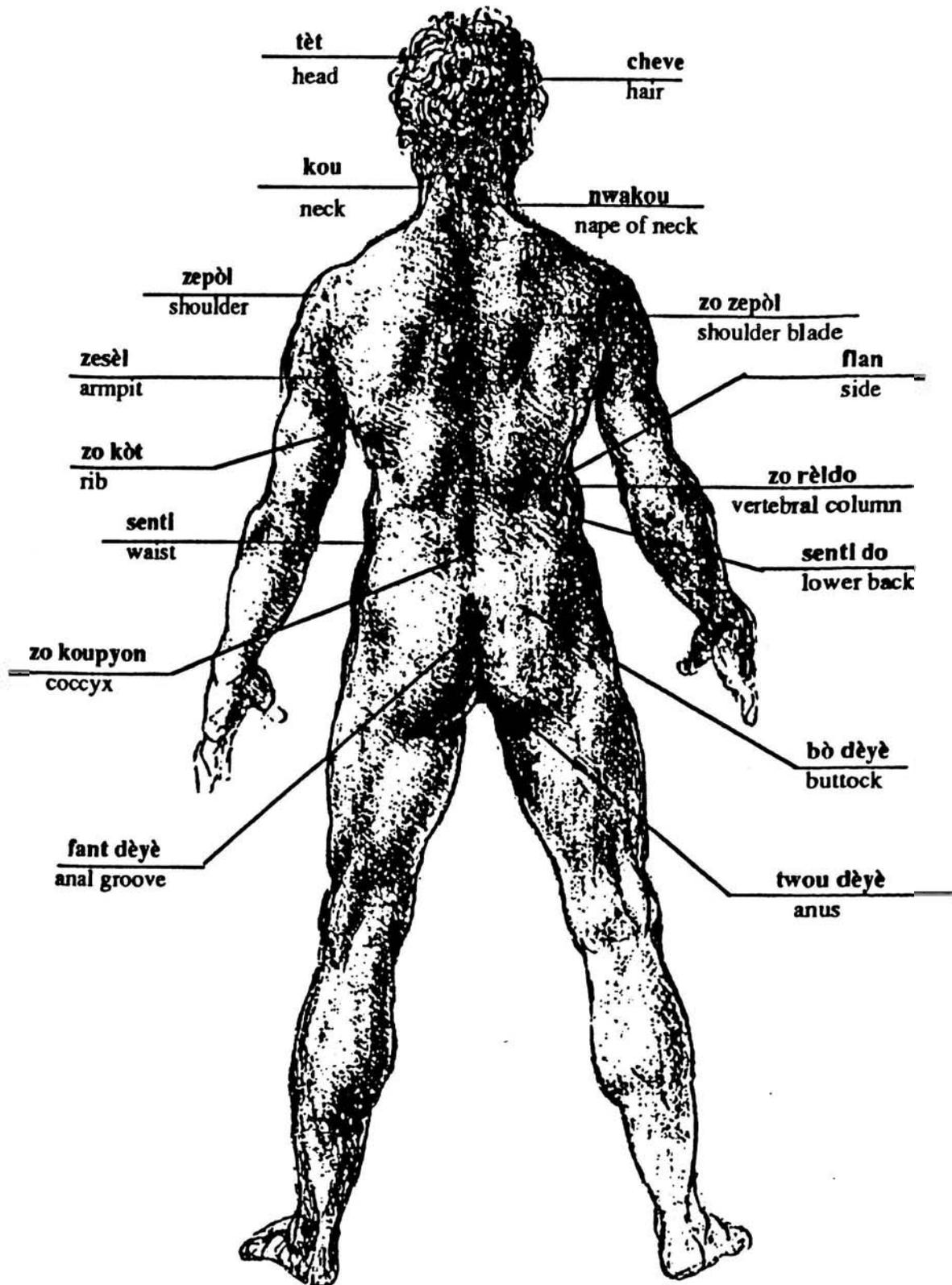

DO / BACK

BRA ak MEN / ARM and HAND

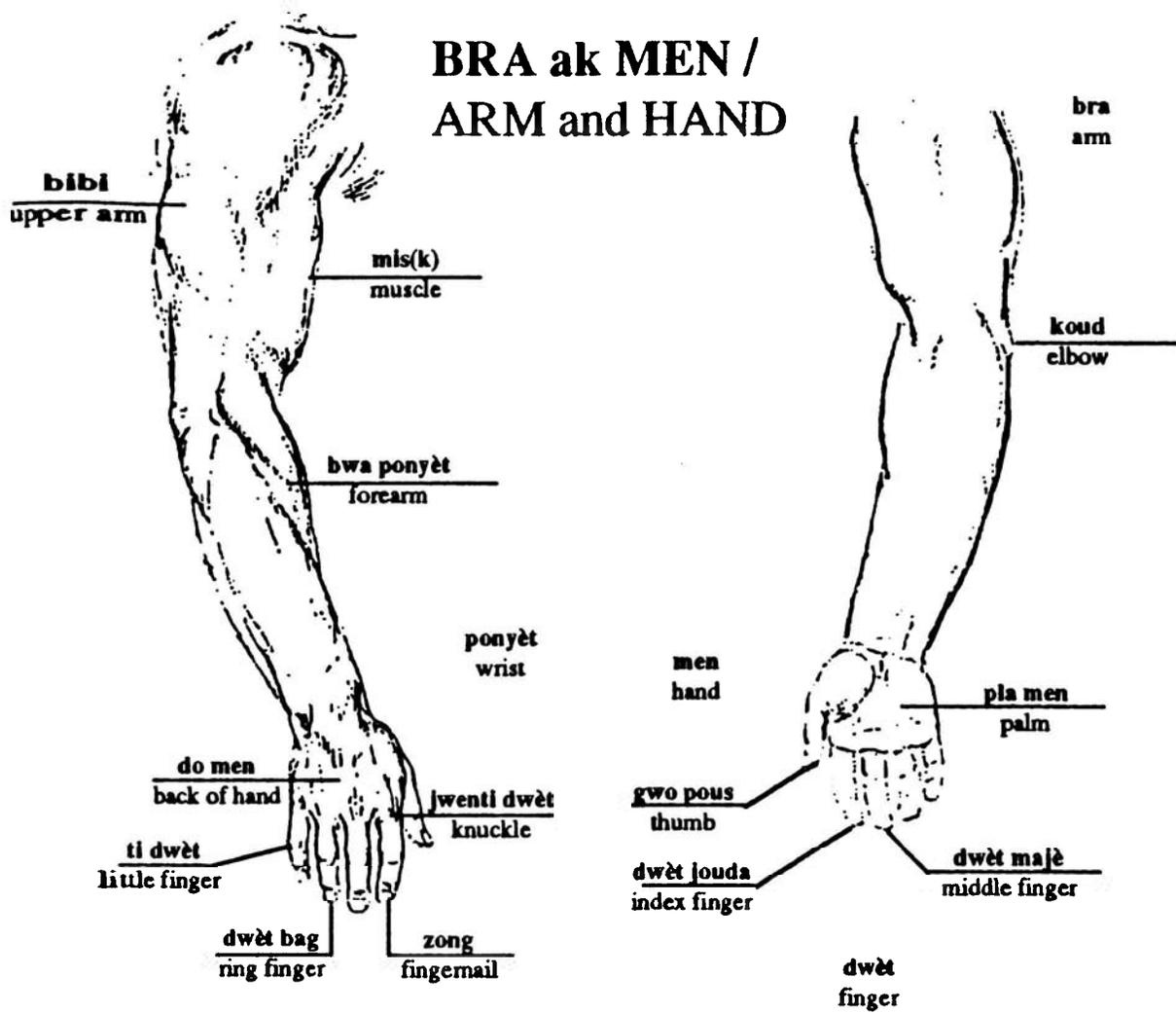

JANM ak PYE / LEG and FOOT

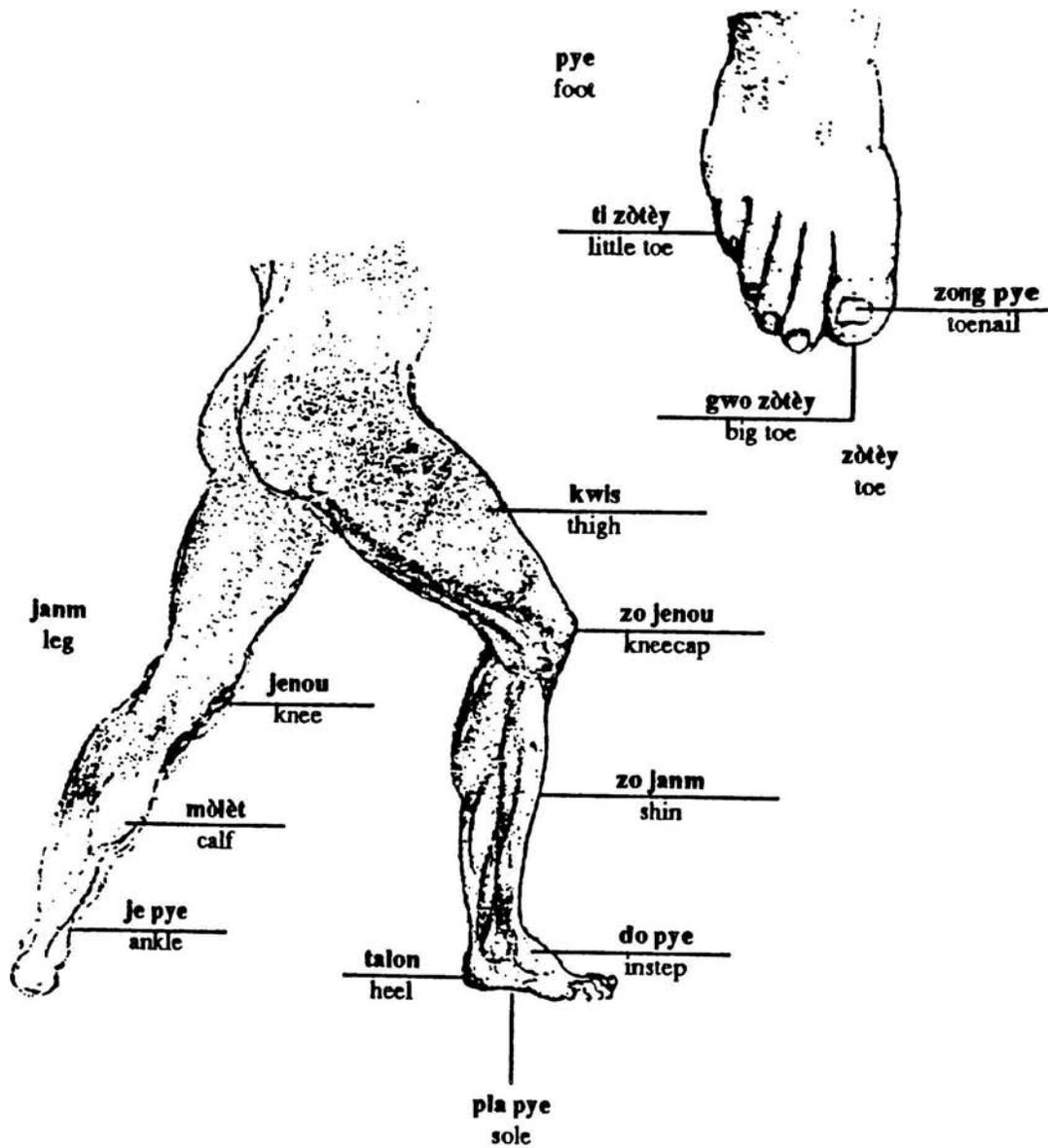

**DAN TIMOUN/
DAN LÈT
BABY TEETH**

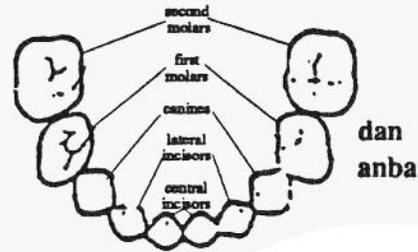
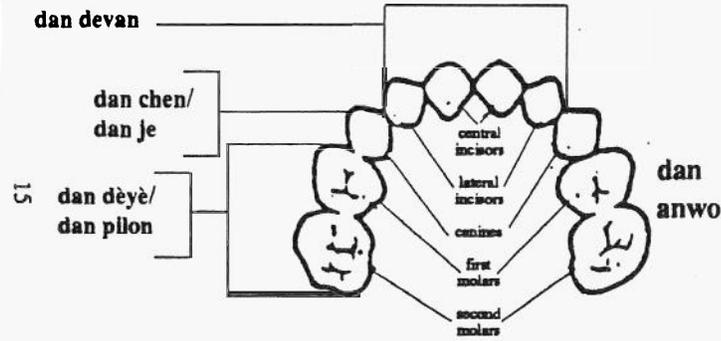

**DAN GRANMOUN
ADULT TEETH**

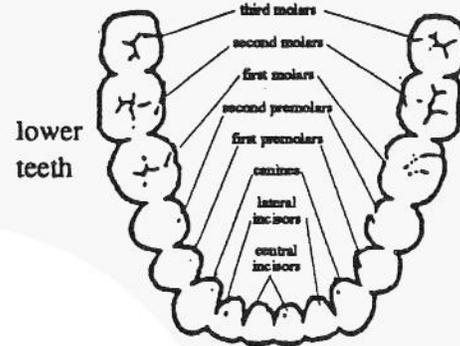
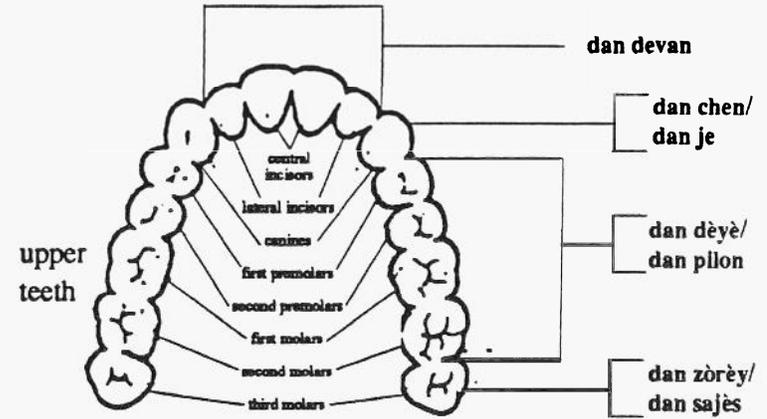

JE / EYE

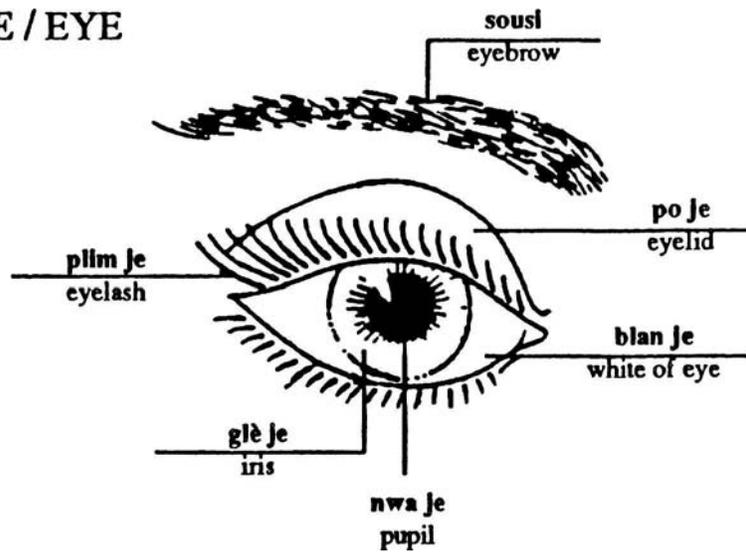

ABBREVIATIONS

adj. - adjective
adv. - adverb
esp. - especially
fam. - familiar
fem. - feminine
Fr. - French
mas. - masculine
med. - medical
n. - noun

occ. - occasionally
pej. - pejorative
pl. - plural
prep. - preposition
sh. - short
s.o. - someone
usu. - usually
v. - verb
var. - variety

HAITIAN CREOLE - ENGLISH

MEDICAL DICTIONARY

A

- a** the; to, at, in, on
a, ava, va (future tense indicator)
 shall, will
abèslang tongue depressor
abimen to damage
abitàn farmer; peasant
abitid habit
abitye to be used to, accustomed
 to; to accustom
ablye to dress; to get dressed
about tired, exhausted, worn-out
abriti dazed, stunned
absan absent
abse, apse abscess; boil
absòban absorbent
absòbe to absorb
abyenfè pregnant
achich hashish
achivis record-keeper (clinic etc.)
achte to buy
adezif adhesive tape
administrasyon administration
administratè administrator
adokte see adopte
adoktif see adoptif
adonnen to be very involved in;
 addicted (to)
adopsyon adoption
adopte, adokte to adopt
adoptif, adoktif adoptive, adopted
adousi to relieve, alleviate; to
 calm, pacify
adrenalin adrenalin
adrès address
adwat on the right; skillful
afè, zafè matter, affair; belongings;
 situation; genitals
an ~ ak to have sexual
 relations with
fè ~ to live together
afebli to weaken, grow weak
afeblisman enervation
afese depressed
afich poster
afliksyon affliction
afon deeply, thoroughly
afre gluttonous, voracious
agasan irritating, provoking
agoch, agòch left, on the left;
 awkward, clumsy
agoni agony, extreme anguish;
 death throes; to be dying
agrandi to widen, enlarge
agравan aggravating
agравe to aggravate
agreyab agreeable, pleasant
ajaks scouring powder, cleanser
ajan lasante community health
 worker; paramedic
aje aged, elderly
ajen on an empty stomach, before
 breakfast
ajenou kneeling
mete ~ to kneel (down)
aji to act, behave
~ sou to affect, act upon
ajite to shake, shake up; to agitate,
 excite, disturb; restless
ajiwòl eye drops
ajoute to add (to)
ak with; and
aka itch mite (causing scabies)
akable sad, overwhelmed; tired,
 weary
akamil (AK-1000) baby food (2
 parts cereal to 1 part bean, finely
 ground and cooked in water with
 seasonings)
akasan corn-based milky-like gruel
aki at what
akoklye, rakoklye to curl up
 (body), hunch up (back)
akonpaye, akonpayen to
 accompany, go with
akote beside; secondary
akouche to give birth, deliver
 (baby)
akouchèz midwife
akouchman childbirth, delivery
~ anvan lè premature delivery

movèz ~ miscarriage; painful
 labor or delivery
akoukouman to curl up (body);
 fetal position
akoupi, koupi to crouch (down),
 squat
aksidan accident
aksidante accident victim
al see **ale**
alanbik heavy drinker
alastrim smallpox
alawonnbadè without exception,
 inclusively, completely
albimen albumin
albinòs albino
ale, al to go, go away, leave,
 depart, disappear; to pass away,
 die
 ~ **bwa chat** to kick the
 bucket, die
 ~ **chache** to go (and) get
 ~ **nan** to have sexual relations
 with
 (kl) ~ **vini** intermittent
alè on time; in time; punctual
alèji allergy; allergic reaction;
 allergic
alèjman, alèjman relief
aleka aside, apart
alemye improvement
alèn, alenn, zalenn breath
alèz comfortable; draw-sheet
allmèt (safety) match
allte bedridden
alkasètzè Alka-Seltzer; (any)
 antacid
alkòl alcohol; rubbing alcohol
almanak calendar
 kite ~ to be older than 31
alonje, lonje to hold out, stretch
 out
alveyòl alveolus; (tooth) socket
amak, ramak hammock
amalgam (permanent) dental
 filling, amalgam
pòt-~ amalgam carrier
amè bitter; sour; see **anmè**
amelyore to improve
ameriken, meriken (adj.)
 American

Ameriken, Meriken American
 (male)
Amerikèn, Merikèn American
 (female)
amiò amoeba; amoebic
amigdal, amidal, anmidal
 tonsil; tonsillitis
amigdallit tonsillitis
amnyotik amniotic
amonya ammonia
amonyak ammoniac
 sèl ~ ammonium chloride
amwa (standing) wardrobe
an year; the; in; of, made of
analfabèt illiterate
anliz analysis; laboratory analysis,
 test
anlizè to analyze, examine
anatomi anatomy
anba below, underneath; down;
 lower; under; genitals (female)
anbabra armpit, underarm, axilla
anbavant, anbativant abdomen
anbazay infancy; young child
anbetan, enbetan annoying,
 troublesome, bothersome
anbilans ambulance
anboli embolism, stroke, cerebro-
 vascular accident
anbonmen to embalm
anbriyon embryo
anbrizi sickly
anch hip; pelvis
andedan, andèdan, andldan,
anndan inside, interior;
 internally
 ~ **kò moun** viscera
andèwò see **andeyò**
andèy in mourning
andeyò, andèwò country(side),
 backwoods, rural area
andezay, andezaj, antdezay
 middle-aged
andldan see **andedan**
andikape handicapped
andòm to put to sleep; to
 anesthetize; to hypnotize; asleep
andonmaje to cripple; to damage,
 injure

andoye to offer a prayer for infant dying without baptism
 ~ **yon kadav** to prepare a body for burial
anemi anemia; anemic
 ~ **falsifòm** sickle-cell anemia
anemye to become anemic
anestezi anesthesia; anesthetic
bay ~ to anesthetize
anestezi anesthetist
anfante to give birth to
anfas across, opposite, in front of; directly, in person
anfen finally, at last
anfizèm, anfizema emphysema
anflamasyon, enflamasyon swelling, inflammation
anfle to swell; swollen; inflamed; suffering from kwashiorkor; swelling
maladi ~ kwashiorkor
anfleman swelling, tumescence
anfletl(s) swelling (often from kwashiorkor); inflammation
anfòm in (great) shape, in top form, fit
anfraje to fracture, split, crack
anfrajele to strike hard; to wound
angaje to hire; to need to use the restroom; in trouble
angiz instead of
angle English
angòje to engorge, become engorged (with blood); to obstruct
angoudi to become numb, go to sleep, have pins and needles (arm, leg etc.); numb
angoudisman numbness
angwosi to make pregnant; to make fat
anilè ring-finger
animatè community development worker, agricultural extension agent
animatris fem. community health worker
anjeli eczema
anjin quinsy; tonsillitis
 ~ **pwatrin** angina pectoris
ankachèt secretly, in hiding
ankadrema frames (of eyeglasses)
ankave to fester
ankè, antye, antyè entire, whole; complete, thorough
ankese to endure, put up with
ankilòstòm hookworm
ankiloz ankylosis
ankò again, still
(ki)sa ~ what else
pa ~ no longer, (not) any longer; no more, (not) any more
ankouraje to encourage; to stimulate
ankourajman encouragement
anlè top, upper part; high; up, above; elevated; difficult or strained (breathing)
 ~ ~ short of breath, uncomfortable
pa ~ pa atè anxious, nervous, edgy
anmandreng hunched up
annè, amè bitter; sour
bouch mwen ~ I have no appetite
annègdan, annèdan irritating, annoying; troublesome
annfizema emphysema
annidal tonsil; tonsillitis
annnezi amnesia
annwèl annwesekou!
annwèl! help!
ann sh. form **annou** let's
annafè (ak) to be sleeping (with), be having sex (with)
annanfans senile (dementia), Alzheimer's disease
annannan(t) see **kannannan**
annaryè behind; backwards
annndan see **andedan**
anne year
anneta in good shape
annik, nik only, just
annou let's
anofèl anopheles (malaria-bearing mosquito)
anòmali abnormal
anòmali abnormality

anpàn to break down, be out of order (mechanical)
anpeche to prevent
anpeste to stink up
anpetre lethargic, indolent
anpil much, many, plenty (of), a lot (of); very
anpire, ranpire to worsen, get worse; to make worse
anplat, anlak (mustard) plaster; plaster cast
anpoul light bulb; ampoule, vial
anprent pye footprint (of neonate)
anpwazonnen, pwazonnen, pwezonnen to poison; poisonous, poisoned, toxic
anpwazonnman poisoning
 ~ **plon** lead poisoning
anraje to be(come) enraged, get mad or angry; to be raving mad; rabid
mande ~ to have a temper tantrum
anrasinen deep-rooted, deep-seated; endemic
anreta late, tardy; slow (clock)
anrimen to have a cold
ansanm together
ansasinen to murder, slay; to mutilate, maim, disfigure
ansefallit encephalitis
ansent pregnant; pregnancy; to impregnate
 ~ **gwo vant** in an advanced state of pregnancy
answit next, afterwards
ant, antre between, among
antdezay middle-aged
antèman, lantèman funeral, burial
antere, tere to bury
anterit (gastro)enteritis
antete stubborn
antibiyotik, antibiyotik antibiotic
antikò antibody
antipwazon antidote; antivenin
antiseptik antiseptic
antistamin, antlyistamin antihistamine
antitoksin antitoxin

antò guilty; wrong
antòch, antòs sprain (ankle, foot)
antonwa, antonnwa funnel
antòs see **antòch**
antranp soaked
antre to enter, penetrate; entrance; see **ant**
 bèl ~ missing a few front teeth
antrejanm crotch (of trousers)
antre-nman training
antreprenè undertaker
antyalèji antihistamine
antye, antyè entire, whole; complete, thorough
anvan, avan before; previously; pre-
anvl to feel like, want; birthmark; alive
 ~ **kochon** harelip, cleft lip; hairy black birthmark
 ~ **krab** harelip, cleft lip
 ~ **mouton** birthmark of white area on skin, depigmentation
 ~ **pyebèf** harelip, cleft lip
 ~ **rejete, vèse, vonml** nausea
 ~ **zago bèf** cleft palate
anvllimen to get worse; to make worse; to become infected; to fester
anwe hoarse
anwo top; up there; upper; upstairs; up, on, upon, above
anyen nothing
 sa pa fè ~ I don't mind, never mind
ap, ape, pe -ing (indicates present progressive or immediate future of verb)
apa aside, apart
 mete ~ to place in isolation
aparèy device, instrument, apparatus, machine; dressing (on wound); (surgical) plaster cast; artificial limb; leg brace; braces (teeth); penis; IUD (intrauterine device)
apatandojodi, apatidejodi a from now on
ape see **ap**

apèn see **apenn**
apendis appendix (body)
apenn, apèn hardly, just
apennsisit appendicitis
apeti appetite
apeze to lessen, diminish, subside;
to quench
apezman relief, respite, subsidence
apik steep
apiye to prop up; to lean on
apla flat, lying down
aplikatè applicator
apopleksi apoplexy
kriz ~ stroke
aprann to learn; to teach
aprantri beginner, novice
apre after; post-
apremidi afternoon
apse abscess; boil
apsedlenn inguinal abscess
apye on foot
arebò on the side of; rim, edge
arekè cardiac arrest; heart attack
arenyen spider
~ (a)krab tarantula
~ bounda/tchou wouj very
small dangerous field spider
arete to stop, check; to have reached
one's full growth
arimen to have a cold
arive see **rive**
ase enough; only
asid acid; gastric reflux; acidic
heartburn, gastritis
soufri ~ to have stomach
ulcers
asidite acidity
asistan attendant; assistant
askaris ascaris, roundworm
asma asthma
asoupi to doze off; to relax
(muscles etc.)
aspèsyon spraying (for lice etc.)
aspire to inhale
aspirin aspirin
astinen, asteni to abstain
astrenjan astringent
asyèt plate, dish
atache to attach, fasten
atak attack, seizure
atake to attack
atann to expect; to look forward to
atansyon! careful!
atè artery; down
~ **mlyò** cheap sleeping-mat
mete ~ to give birth
atèl splint
atèmlyò cheap sleeping-mat
atifisyèl artificial
atout although
atrapan, trapan contagious;
infectious
atrape to catch (sickness)
atrapman contagion
atriti arthritis
ava (future tense indicator) shall,
will
avan before; previously; pre-
avanbra forearm
avanse to come closer, put closer
avantay advantage
avè with; and
avèg blind; blind person
avegle to blind
avègleman blindness
avèk, ak, avè with; and
avètisman warning
avòtman abortion
avril April
ayè, yè yesterday
ayèl ancestor; grandparent
aylk well-fed; sick from overeating;
exhausted
aylsyen (adj.) Haitian
Aylsyen Haitian (male)
Aylsyèn Haitian (female)
Ayiti Haiti
ayovi tiny child
azil, lazil (insane) asylum
~ **kominal** insane asylum
azobato weak, feeble, frail
azoumounou conjunctivitis; weak
and indecisive person

B

ba low, short; very sick, weak;
depressed, discouraged; see **bay**
mete li nan ~ to put in a
straitjacket

- pa ~ from the rectum
 vant ~ lying flat; to be flat on
 one's back, be in bad shape
 bab, labab beard, whiskers
 fè ~ to shave (face)
 krèm ~ shaving cream
 babay bye-bye
 babich goatee
 babin double chin
 badjonnen to smear, spread
 badin cane, walking stick
 bag ring, wedding-ring
 bagay thing, object; situation;
 sexual relations; genitals;
 thingumajig
 fè ~ to have sex
 bagèt legede skinny, skin and
 bones
 bak reverse (car)
 fè (yon) ~ to regress
 pa ~ backwards
 baka infected sore; small demon or
 evil spirit
 bakteri bacteria
 bal ball; bullet
 pran ~ Il ofon to endure,
 suffer without complaining
 balaf scar, gash
 balans scales (weight)
 ~ ak kwòk (hanging) baby-
 scales
 balanse to centrifuge
 bale broom; to sweep
 balenn, balèn (white) candle
 balonnen bloated, distended, upset
 balonnman bloated stomach
 balote to toss (about), shake
 (about), jolt
 ban bench; see bay
 banbou bamboo; large penis
 ~ janm tibia, shinbone
 bandaj, banda bandage; arm
 sling
 bande to bandage; to have an
 erection
 bandlèt armband (for mourning)
 bankal bowlegged
 bann group, bunch; band, strip (of
 cloth etc.); strap; erection
 ~ lonbrlt, ~ vant umbilical
 binding (worn for 3 months by
 newborn against cold)
 pèdl ~ (ll) to be lost; to be
 impotent
 bare to stop, hinder, obstruct
 barèm graph
 baryè gate; gap (between teeth)
 basen bedpan, chamber pot; tub
 (zo) ~ pelvis
 basinen to rub lightly; to bathe
 (sores)
 basinèt basin
 baskil scales (weight)
 bastengal truss
 bat to beat, strike; to defeat,
 overcome; to fight, struggle; to
 pulse, pulsate; to have
 convulsions
 ~ ba to give in, admit defeat
 ~ je to blink; to wink
 ~ lakanpany to be dying
 ~ laponyèt to masturbate
 pa ~ kò ou take it easy, don't
 worry
 batèm baptism
 batistè birth certificate
 batize to baptize; to take a little bit
 (of something); to sprinkle with
 salt
 batje to blink; to wink
 batman pulsation, throbbing;
 pulse; beat, stroke
 ~ je blink (of eye)
 ~ kè pulse, heartbeat; (heart)
 palpitations; tremor (of fear)
 ~ (venn) pulse
 baton stick; cane, walking stick
 ~ koumbe spinal column
 sou ~ to have to walk with a
 cane
 batri battery (car etc.); evil fetish,
 ensemble of charms or spells
 (Voodoo)
 bav saliva; slobber, drivel
 bavant abdomen
 bave to slobber, drool
 bavèt bib
 bay, ba, ban to give; to pass
 (blood, worms etc.)

bayakou person who cleans privies
 or outhouses
baye yawn; to yawn
baz basis
bazaj:
 an ~ very young, of tender
 years
bebe:
 ~ **lèt** weak or flabby baby
 ti ~ baby
bèbè mute
bebidòl night gown
Bedè Pont-Beudet insane asylum
bedeng potbelly, paunch
bege(ye) to stutter, stammer
bèj beige
bèk foreskin, prepuce
 ~ (**de**) **lyèv** harelip, cleft lip;
 cleft palate
beki, bekin crutch
bèl beautiful, handsome; pretty
 fè ~ to stand up without
 support (baby); to progress; to
 be pregnant
beladonn belladonna
bèlen small sore or cut
bèlfl daughter-in-law; stepdaughter
bèlmè mother-in-law; stepmother
bèlsè, bèlsò sister-in-law;
 stepsister
bèlte see **bote**
bèlwotè tall
bendeng potbelly, paunch
bendouk pregnancy
 mare yon ~ to get knocked
 up (become pregnant)
benwa bathtub; washtub
beny bath, shower
 ~ **bouch** mouth wash
 ~ **cho** hot bath (esp. after
 giving birth)
 ~ **fèy** (Voodoo) ritual bath,
 herbal bath
 ~ **vapè** herbal bath
benyè undertaker; washer of corpses
benyen to bathe
berè surgeon's cap
herejèn eggplant; woman able to
 bear only one child
bès decrease
 an ~ faltering, going downhill;
 decreasing
bese to lower, go down; to bow,
 stoop, lean over; to diminish,
 decline; to become emaciated
 ~ **devan kochon** to have the
 shits or trots
Beseje BCG vaccine (against
 tuberculosis)
bèso cradle, crib
bèt animal, beast; insect, bug;
 stupid
 fè ~ to swarm; to be spoiled,
 be full of bugs
 ti ~ bug, insect
betiz silliness, kidding; dirty word;
 stupidity
 pase nan ~ to make fun of,
 tease
bezwen need, want; to need, want
 fè ~ to go to the bathroom
 ti ~ genitals of small boy
bibl biceps, upper arm; ailing,
 unwell
bibit erection
bibilyotèk library
bibon, bibwon baby bottle
bldas belly
bidèt bidet
 fè ~ to douche
bigay gnat, tiny mosquito
bigoudl hair-curler; to fix one's
 hair
bije see **obilje**
bikabonat, bikabonak
 bicarbonate of soda, baking soda
blkòs lump (on head), swelling
bil bile
 pòch ~ gallbladder
blp bip beating of one's heart
birinen to drill (a tooth)
bis bus; bust, head and shoulders
bisèp biceps
biskèt, zo biskèt sternum,
 breastbone
 ~ **tonbe** to have a sore chest;
 to be incapacitated (above
 waist); to suffer epigastric
 discomfort

demonte ~ to wear down physically (person)
kè li sou ~ to be scared, be worried, be afraid
bistonnen to castrate
bistouri scalpel
bitay, bitaj stumble, slip, fall
bite to stumble
bivab drinkable, potable
biwo office; desk
biyoloji biological
blyòt support under woman's hips during childbirth (same as **choukèt**)
bizawèl great-grandparent, ancestor
blad balloon; blister
 ~ **pipl**, ~ **pise** bladder
blag joke
 hay ~ to chat, talk amiably, make small talk; to tell jokes, kid
blakawout power outage, electrical failure
blam blame
blame, blanmen to blame
blan white (color or person); foreigner (of any race); empty; imported
blanch white (color); white woman; empty
blanchi to fade; to be graying, turn gray
blanm, blam blame
blanmen, blame to blame
ble blue; wheat
blenm, blèm pale, sallow
blenorajl gonorrhea
blese to wound, injure, hurt; to hurt (s.o.'s) feelings, offend; wound, injury; sore; cut; bruise; wounded, injured (person)
blesl wound, injury; sore; cut
blewo shaving brush
blije see **oblje**
blije to forget
blokay, blokaj blockage, obstruction, occlusion
bloke to block, obstruct; constipated
blon blond
blouz lab coat
bo kiss; to kiss; to sting (bee etc.)
bò side; edge; near, around, in the vicinity of
bobo kiss; vagina (fam.); to sting
bòbòt vagina (fam.)
 gwo po ~ labia majora
 ti po ~ labia minora
bòf see **bòfrè**
bofls, bofl son-in-law; stepson
bòfrè, bòf brother-in-law; stepbrother
bòk enema bag
bokal jar
bòkè see **bòkyè**
boklt (metal or plastic) bucket, pail
bòkò Voodoo sorcerer and healer
bòkyè, bòkè perlèche, crack or sore at corner of mouth; dried saliva (at corner of mouth)
bòl bowl, dish
bon good, fine
 ~ **mache** cheap, inexpensive
 fè de ~ to show signs of pregnancy
bonbe distended
bonda see **bounda**
bonde crowded
Bondye God
 ~ **benl ou!** God bless you!
 sa ~ **ban mwen** female genitals
 si ~ **vle** God willing
bonè early; happiness; good fortune
bonjou good morning
bonkonprann understanding, intelligence
bonkou much, many
bonmache cheap, inexpensive
bonnanj:
 gwo ~ "animating spirit," "soul"
 ti ~ "guardian angel"
bonnè surgeon's cap
bonsans common sense
bonswa (used from noon until midnight) good afternoon, good evening, good night
bòpè, bopè father-in-law; stepfather

- bòs** craftsman, artisan; bump, bruise; hump, bulge
bosí hunchback; hunchbacked; to bend
bosko hump; hunchback; hunchbacked
bote, bèlè beauty
 tou ~, twou ~ dimple
bouboun bottom part; woman's genitals
 twou ~ vagina; anus
bouch mouth; orifice, aperture
 bò ~ corner of mouth
 ~ anba upside down
 ~ chire, ~ manje sores at corner of mouth
 ~ dlo salivation
 ~ fann harelip, cleft lip; cleft palate
 ~ li anmè, ~ li pa bon, ~ li pa gou to have no appetite
 ~ li fè dlo to make one's mouth water; to slaver, slobber, drool
 ~ li gou to have a good appetite
 ~ santi bad breath, halitosis
 fè ti ~ to pick at one's food; to be fastidious
 gen bon ~ to have a good appetite
 lave ~ li to brush one's teeth
 olon ~ lip(s)
 po ~ lip
 tèt ~ philtrum
bouche to be stopped up, be congested; to cover (eye etc.); mouthful (of food)
bouchon stopper, plug
bouda see bounda
bouden ass, buttocks
boudonnman buzzing or ringing in ears
boudouye to mumble
boufi puffed up, swollen
bouji (colored) candle
bouk village; buckle, clasp; curl, ringlet, lock of hair
boukannen scalded
boukante to swap, trade, exchange
 pye li ~ to alter one's menstrual cycle; to start giving birth to boys rather than to girls, or vice versa
bouke tired out, exhausted (physically)
boukle barren, sterile (woman); curly, wavy (hair)
boul ball, glob, mass; clot; lump, bump, swelling; tumor (breast)
 ~ dlo blister
 ~ nan do hunchback
 ~ nan kou goiter
 fè ~ to clot (blood); to curdle (milk)
bouldemas, bouldimas medicine to prevent swelling
boule to burn; to irritate; to cauterize; burn, irritation
 ap ~ to be getting along fine
boulèt kneecap
 ~ pye ankle
boulgrenn testicle, testis
 po ~ scrotum
boulvèse to upset, be upset
bounda, bonda, bouda ass, buttocks; rear; bottom, base
 arèt ~ tailbone, coccyx
 bò ~ buttocks
bourik donkey
bous scrotum
bousòl blister; bump; hump; hives
bousoufle to bloat, puff up
boustouklouz louse (pl. lice)
bout stump, stub (of limb)
boutèy bottle
bouton button; pimple, boil, pustule; wart; rash; scabies; impetigo
 ~ chalè heat rash
 ~ chen wart
 ~ grate scabies
 ~ lafyèv fever blister
 ~ tete nipple (breast)
 ~ vant belly button, navel, umbilicus
 gwo ~ acne, pimples; smallpox
 ti ~ kwasans acne, pimples

bouyl to boil; boiling; rumbling
 (in stomach)
bouyòt hot-water bottle; foot-warmer
bòy one-eyed person
boyo intestines, entrails, guts; genitals of small girl
bòz 'pot,' marijuana
bra arm
bragèt fly (of trousers)
brànany see **branrany**
branka stretcher
brankadye stretcher-bearer
branlan shaky, unsteady
brannen to budge; to tremble, shake
branrany sterile, barren (woman)
braslè bracelet; identification bracelet
 ~ **mont, mont** ~ wrist-watch
bray, bway (small) boy
brè see **bwè**
brèf brief
breng healthy young adult
brèt see **bwat**
bretèl suspenders
bri noise
bridj (dental) bridge
brille to burn, scorch; to burn, irritate
brilfè, brisfè hyperactive child
brisak belly
brital brutal, violent, rough
bwa wood; penis
bay ~ to beat; to have sex (man)
 ~ **chèch** marasmus, extreme undernourishment
 ~ **linèt** frames (of eye-glasses)
 ~ **nen** nasal bone
 ~ **ponyèt** (upper) arm; biceps
pran ~ to have sex (woman)
bwadan toothpick; brushstick (piece of stem or wood used as toothbrush)
bwapiwo "beanpole," very tall person
bwason, bweson beverage, drink
bwasonnyè drunkard, alcoholic

bwat, brèt, bwèt box; (tin) can; carton; trash-bin
 ~ **frlgo** cooler
 ~ **gaz** gas sterilizer
 ~ **savon** soap-dish
bwate see **bwete**
bwatèt, zo ~ skull, cranium
bway, bray (small) boy
bwè, brè to drink
 ~ (yon) **grenn** to take a pill
bweson see **bwason**
bwèt see **bwat**
bwete, bwate to limp; lame
mache ~ to limp
bwochl brochure, pamphlet
bwonch, bwonchit bronchial tube, bronchi; bronchitis
bwòs brush
 ~ **dan** toothbrush
 ~ **tèt** hairbrush
bwòsadan toothbrush
bwose to brush
bwouselosis brucellosis
bwouya mist, haze
byen fine; well; very, really, quite
 ~ **mal** quite ill
byenpòtan healthy, robust
byenvini to be of average height or better, be well-developed
byochimi biochemistry

CH

chabon charcoal
maladi ~ anthrax
chache, chèche to look for; to try to
chagren sorrow, grief, heartbreak; depression; depressed, sorrowful, sad; homesick
chaj see **chay**
chaje to load, burden; to be troubled, be upset
lestonmak ~ upset stomach
tèt ~ worries, troubles
chak each, every
chaistan charlatan, quack
chalè heat, warmth; irritation; temperature; energy
boufe ~ hot flashes

gran ~ urethral discharge,
 vaginal discharge
 chalimò (drinking-)straw
 chan operatory area (on body)
 chanday sweater
 chanje to change
 chanjman change, difference
 chank chancre, skin ulcer; canker;
 cold sore; impetigo
 ~ lèt, chankalèt thrush, oral
 infection, oral candidiasis
 ~ sifills soft chancre
 chanm room (of house etc.);
 bedroom; sterile drape
 ~ twalèt bathroom
 chanpou shampoo
 chans chance; opportunity; good
 fortune; bad luck
 chanse lucky, fortunate
 chante song; to sing
 chantlyon sample, specimen
 chape to escape, survive; past the
 critical stage (during which
 many young children die);
 independent, of age
 chapèl chapel
 chaplèt club (weapon); cradle cap
 chapo hat
 ale nan peyl san ~ to kick
 the bucket, die
 chaponnen to castrate
 charanpyon, saranpyon
 chickenpox
 charèt cart
 charyo dolly; cart, wagon
 chat cat; (female) genitals
 chatouyèt, satouyèt tickling; to
 tickle
 chatray castration
 chatre to castrate; to perform a
 vasectomy
 chay, chaj load; burden, problem
 chè flesh, tissue; dear, sweetheart;
 expensive, costly
 ~ nan gòj tonsil; tonsillitis
 ~ nan je pterygium
 ~ nan nen nasal polyp
 chèch, sèch dry; skinny,
 emaciated; to dry up, become
 dry; dehydrated
 ~ kouwè bagèt legede thin
 as a rail
 men ~ withered hand
 cheche see seche
 chèche see chache
 chèchekò thin person
 chèdpoul, chèdepoul goose
 flesh, goose bumps
 chemen lasante road-to-health
 chart, child's weight and
 vaccination record, weight chart
 chèmèt-chèmètrès master, owner,
 proprietor
 chemiz shirt
 ~ de nwí night gown
 chemizèt undershirt (without
 sleeves)
 ~ ak manch T-shirt
 chen dog; child born preceding
 twins
 chenèt gap between two front teeth
 chenn chain; necklace
 ~ do backbone
 cherl darling, dear
 chetif sickly, puny; stunted,
 underdeveloped
 cheval see chwal
 cheve, chive hair (on head)
 chevè head of a bed
 chevl ankle; tarsus
 chevrèt liquid excrement
 chèz chair
 ~ woulan wheelchair
 mete ~ nan salon to start
 teething
 chif number
 chifon rag, scrap
 chik tick; chigger
 chikata person infested with
 chiggers
 chiklèt chewing gum
 chimerik irritable, cross, cranky;
 fanciful, whimsical
 chimi chemistry
 chimik chemical (adj.)
 chini do spine, backbone
 chire to tear, tear up, rip; to skin
 (knee etc.)
 chiriji surgery; surgical ward
 ~ bouch oral surgery

gwo ~ major surgery
chirijyen surgeon
chit fall, tumble; collapse;
 prolapse; loss (hair); relapse
chita to sit down; sitting, seated;
 butt, rear
 ~ **sou** to be chronic
san ~ restless
chitatann slow-acting poison
chive, cheve hair (on head)
cho hot, warm; spicy; excited;
 sexually aroused
chode to scald; to heat; to be
 prematurely old (child); bruised
 (psychologically)
chòdpls gonorrhea
chodwon cauldron, large kettle;
 boiler
chodyè cast-iron cooking pot
chofe to heat up, warm up; to
 encourage, stimulate; to get
 warm, get hot; excited
chofl heat rash; athlete's foot
 ~ **kouchèt** diaper rash
chofrèt chills; fever and chills with
 high temperature [usually
 malaria or TB]
chèk shock, bump, impact; trauma
 ~ **nan tèt** cerebral
 hemorrhage; stroke, cerebro-
 vascular accident (CVA)
chèkanretou backlash, whiplash
 injury
chonje to remember
chosèt sock (for foot)
choson baby's bootie
chèt shorts, cut-offs; short circuit
chètdeben bathing suit (man's or
 woman's)
chouchoun woman's genitals
chouchout penis (fam.)
chouk stump (tree; human limb)
 ~ **dan** stub of tooth
choukèt tree stump (used as stool);
 support under woman's hips
 during childbirth; short person
chèv bald
chwal, cheval horse; Voodooist
 (while in trance)
ti ~ unbaptized baby

chwazi to choose
chwi to reach orgasm
chye to shit

D

dabltid usually
dabò first (of all)
dada ass (rear)
dakò to be in agreement, agree;
 agreed!
dan tooth
bay kout ~ to bite
chouk ~ stub of tooth
 ~ **anba** lower teeth
 ~ **anwo** upper teeth
 ~ **bonbon** decayed tooth
 ~ **chen** canine tooth, eyetooth,
 cuspid
 ~ **devan** front tooth, incisor
 ~ **dèyè** molar
 ~ **doukla** two teeth in same
 position
 ~ **fè mal** toothache
 ~ **gate** decayed tooth
 ~ **granmoun** adult tooth
 ~ **je** eye tooth, canine tooth,
 cuspid
 ~ **kraze** broken tooth
 ~ **lèt** baby tooth
 ~ **lò** gold tooth
 ~ **marasa** two teeth growing
 in same position (not an
 impacted tooth)
 ~ **moul** wisdom tooth
 ~ **moulen** molar
 ~ **plke** decayed tooth
 ~ **pilon** molar
 ~ **rachèt** short or stunted
 tooth
 ~ **sajès** wisdom tooth
 ~ **slrèt** sensitive or sore tooth
 ~ **souke** loose tooth
 ~ **tchaka, ~ tyaka** teeth set
 far apart
 ~ **timoun** baby tooth
 ~ **vise** (dental) bridge
 ~ **zòrèy** wisdom tooth
fè ~ to be teething
fo ~ false tooth

frechl ~ gum abscess
gwo ~ molar
kout ~ bite
manje ~ grinding of the teeth
san nan ~ pyorrhea
sou ~ to be in bad shape
wete nè/vè nan ~ to perform
 root canal surgery
dane deeply embedded (splinter etc.)
danfèmal toothache
danje danger
danjere dangerous
dantè dental
dantis dentist; dentistry
dantisyon teething
daou August
dapre according to; because, since
darati old person; senile person;
 runt, shrimp
dat date (calendar); eczema, rash;
 herpes
datant:
sal ~ waiting room
davans ahead of time
dawou August
dayè besides
debabouye to wash the face, clean
 (oneself) up
debada to rant, rave (esp. before
 death); shabby, run down
debat to struggle
ap ~ to be trying, be getting
 along, be all right
debòde to overflow, spill over; out
 of control
debòdman san hemorrhage
debonde to overflow; to clear, free
 from obstruction; to have bowel
 movement (after constipation)
debou see debout
debouche to decongest, unstop
deboukle to unbuckle
debout, debou standing; upright
deboutonnen to unbutton
debwate to disjoint, dislocate
 (bone)
debyen fine, honest, upright,
 worthy, respectable; reliable
dechaj see dechay

dechaje to unload, empty; to
 ejaculate
dechaj, dechaj ejaculate, sperm,
 semen; discharge
sak ~ seminal vesicles
dechikete to cut to pieces, slash,
 hack
dechire to tear, lacerate
dechose to lose weight, become
 emaciated or cachectic; to
 remove (one's) shoes
dechte to lose weight
dedete DDT insecticide
defalkaw dizzy
defans defense, protection; defense
 mechanism
defè see defèt
defen deceased, the late
defèt, defè to undo, take down; to
 unstitch, break; to be in
 declining health, be on the
 wane; torn, undone (seam)
defibrilatè defibrillator
defigire to disfigure; to distort; to
 spoil, mar; to change (for the
 worse), look sick
defini to define; to be emaciated;
 definite
defo defect, flaw; vice, bad habit
defòmasyon defect, deformity,
 malformation
defòme to deform; to be deformed
defouke to tear the crotch (of
 pants); slovenly or negligent
 person
defyans mistrust, distrust
dega damage
degad on duty
degaje, degajèt to get by,
 manage; to go to the bathroom
degl, dyegl extra measure, (little
 bit) extra
degobe to burp, belch
degonfle to deflate, reduce in size;
 to find relief from indigestion
degoudi to warm slightly (water
 etc.); to remove stiffness or
 numbness
degout drop, drip
degoutan disgusting

degoute to dribble, drip
degrade to damage; to deteriorate, get worse
degre degree (on thermometer)
degrennen to fall out (hair, teeth)
degrese to lose weight, slim down
degwosl to lose weight; to smooth out
deja already
dejene, dejnen breakfast; to eat breakfast
dejwentaj dislocation (bone), luxation
dejwente to disjoint, dislocate (bone)
dekale to peel, peel off, flake off
dekloke to disjoint, dislocate (bone)
dekole to loosen, decongest; to disjoint, dislocate (bone); to detach
dekòmande to cancel, rescind, annul, revoke
dekonjesyonne to decongest, relieve congestion
dekonnekte to disconnect, unplug (IV tube etc.)
dekonpoze to faint, pass out; to have a seizure; to make nauseous; to sadden, discourage, make listless; unresponsive; unconscious; upset, flustered, disturbed; nauseated
dekonpozisyon (mild) fainting spell; seizure; decomposition
 ~ **gwo chalè** heat exhaustion; hyperthermia
dekontaminasyon
 decontamination
dekoud to unstitch; to become undone at seams, rip
dekoupe to dilute
dekourajan discouraging, depressing
dekouraje to discourage, disappoint; to be discouraged, be disappointed
dekouvri to discover; to uncover
dekrase to clean, take dirt off, scour
dekrepi decrepit
dekwennen scalded
dekwote to remove mud; to scrub, scour; to comb and braid hair
delè delay
delika delicate; refined, sensitive; feeble, weak, infirm
dellvrans afterbirth, placenta
dellivre to expel the placenta; to deliver
dèlko electric generator
delonje to disjoint, dislocate (bone)
delwen far
delye to dilute, be diluted
demanbre to dismember; weak, paralyzed
demanjezon itch(ing)
demantibile to smash up; to dislocate (bone)
demen see **denmen**
demi half
demidèy half-mourning
demigrè tipsy, befuddled, shaky
demijan large water bottle (on stand)
demoute, demonte to take apart; to disjoint, dislocate (bone)
denèfle to desensitize, numb; apathetic
deng ass, butt
 po ~ rough or dry skin
denmen, demen tomorrow
 apre ~ day after tomorrow
 dimanch ~ next Sunday (etc.)
dènye last
dènyèman recently, lately
depafinl to ruin; to be ruined; to waste away; to deteriorate; to exhaust
depale to rant, rave; to be delirious; delirium
depane to repair, fix (machinery)
depanse to spend, consume
depase to exceed, go beyond
depasyante to lose patience, be impatient; to cause to lose patience
deperi to lose weight; to decline, go downhill; to waste away, wither, dehydrated
depi since (temporal)

deplase to move (s.o.); dislocated
 (bone, shoulder etc.)
deploge to unplug
deplonbe to remove the filling
 (tooth)
deplòtonnen to unroll, unravel
depo depot, storehouse; deposit;
 abscess
depotwa garbage dump
depre near
depresyon physical exhaustion;
 chronic fatigue; depression
 ~ nè nervous breakdown
deranche to have a broken hip
deranje to disturb, interrupt; to
 upset (stomach); to injure (part
 of body); to be out of order
 (mechanical); dislocated (bone)
deranjman disturbance, trouble;
 aching, malaise; intestinal
 disorder
dereffize to refuse, reject
deregle out of order
derespektan insolent
derezonnen to talk irrationally,
 talk nonsense
derisen:
 lwil ~ castor oil
dèryè see dèyè
desan decent, modest
desanm December
desann to descend, go down; to
 subside; to take down, let down,
 lower (pants etc.); to get worse,
 worsen
 ~ kabann to get out of bed
desè decease, death; dessert
desere to loosen, untie; to unscrew;
 to have regular stools (after
 constipation)
desèvis on duty
deside to decide
desiskole homosexual;
 homosexuality; sixty-six
desose skinny, emaciated
desounen apathetic; apathy; to
 separate a dead person from
 his/her protective Voodoo spirit
dèt debt, loan
detache to detach, untie, unfasten
detann to relax
detanzantan from time to time, at
 times
detay detail
detèjan detergent
dezepe DPT vaccine
detete DDT (insecticide)
detire to stretch (oneself); to jerk
 (as in convulsions), have tonic
 clonic movements
detrake crackpot, eccentric, nut
detravè crosswise, sideways
detri to destroy
devan, douvan front; before, in
 front of (position); genitals
devere to worm
devise to unscrew
devlope to develop
dewoule to unroll, unwind
dèy mourning; mourning clothes
dèyè, dèryè bottom, buttocks;
 rear; rectum; behind, back (of)
 (prep.)
 bò ~ buttocks
 fant ~ anal groove, crease
 between buttocks
 koutl ~ perineum
 tou ~, twou ~ anus
dèyèkay rump
deyò outside; external, outer
dezablye to undress; nightgown
dezagrafe to unhook, undo,
 unfasten
dezagreyab disagreeable,
 unpleasant
dezanfle to reduce swelling
dezavantaj, dezavanta
 disadvantage
dezekilib imbalance
dezekilibre to become unbalanced;
 unsteady; looney, crazy
dezenfektan disinfectant
dezenfekte to disinfect
dezespere to despair; desperate,
 hopeless
dezidratasyon dehydration
dezidrate to dehydrate
dezipe to unzip

dezòd disorder, misbehavior;
 confusion, mess; sexual
 misconduct; prostitution
dezoryante disoriented
dezose to become emaciated or
 cachectic
dezyèm second
di to say; to tell; hard, firm;
 resistant; tough; difficult;
 intense, severe
ale ~ to be constipated
vln ~ hardening; sclerosis; to
 freeze
dife fire, flame
 ~ **volan** blister (esp. caused by
 shoe)
difejennès acne
diferan different
difisil difficult
difòm deformed, distorted
difteri diphtheria
dijere to digest
dijès easily digestible
dijesyon digestion; digestive
dilatasyon abortion; dilation;
 enlargement
dilatatè dilator
dimançh Sunday
dmaten a.m., in/of the morning
dminye, dminwe to reduce,
 diminish, lessen, decrease
dnamo dynamo, electric generator
dne dinner, large meal; luncheon,
 noonday meal
dnrab durable, lasting; solid; chronic
dire duration; to last, endure
dirèk direct, straight; directly
direktè director
disantri dysentery
dsklè to discuss
disloke dislocated (shoulder etc.)
dispansè dispensary, infirmary
disparèt to disappear
dispozab disposable
distile, distiyè to distill; to
 purify (water etc.)
dswa p.m., in/of the evening
ditepè DTP vaccine
ditou (used as a negative only) at all
pa ... ~! not ... at all!

divòse to divorce, separate
dilyte dignity; penis
dizèt famine, hunger
djab devil, malevolent creature
djabèt diabetes
djabetik diabetic
djagnostik, dyagnostik
 diagnosis; diagnostic
djanm, dyanm robust; steady,
 firm; lively
djapòt, dyapòt jackpot; slot
 machine; puke, vomit
bay ~, fè ~ to puke, throw
 up, vomit
djare see **dyare**
djèp see **gèp**
djesèlmevwa masturbation
djip jeep
djòb, dyòb job, position
djoke to bewitch, hex, jinx
djòl, dyòl (fam.) mouth; mug,
 face
 ~ **flobop, ~ fobop, ~ fòj,**
 ~ **fòy** toothless
djondjon mushroom
maladi ~ fungal infection
dlo water; liquid; tear(drop)
ale ~ to have a (very) watery
 stool
 ~ **blan(ch)** discharge,
 secretion
 ~ **bouch** saliva
 ~ **dous** fresh (unsalty) water
 ~ **je** tear(drop)
 ~ **konpoze** concoction of
 herbs etc.
 ~ **lolo** watery
 ~ **nan je** tearful, in tears
 ~ **nan vant** ascites
 ~ **oksljène** hydrogen peroxide
 ~ **pòt** vaginal bath after giving
 birth
 ~ **si** gastric reflux, acidic belch
fè ~, kouri ~ to water, tear
gate ~, jete yon ~ to
 urinate (fam.)
nan ~ in bad shape, in a fix
ti ~ discharge
dlo!lolo, dyololo watery
do back

chenn ~ backbone
 ~ **ba** round-shouldered
 ~ **chamo** hunchback
 ~ **fè mal** back pain
 ~ **koko mons veneris**
 ~ **louvri**, ~ **ouvè** sprained back
 ~ **mangay** ulcerated back (donkey etc.)
kase sou ~ to be in an advanced state of pregnancy
palèt ~ general shoulder area
ravin ~ exterior depression along backbone
règ ~, **zo** ~ backbone
dodo to sleep (baby word)
doktè, dòk, dòktè doctor, physician
 ~ **dan** dentist
 ~ **fèy** faith-and-herb healer, folk healer
 ~ **fl** woman physician
 ~ **Leta** government physician
 ~ **pakoti** quack
 ~ **zo** bone-setter; orthopedist
dola dollar
domaj see **donmaj**
domaje see **donmaje**
domen back or dorsum of hand
dòmí to sleep; to go to bed; sleep; latent
 ~ **anlè** to sleep on a bed
 ~ **ap pete je li** to be unable to keep one's eyes open
 ~ **blanch** to go to bed hungry
 ~ **chat** cat nap, short doze
 ~ **di** to be sound asleep, sleep soundly
 ~ **konsa** to go to bed hungry
 ~ **nan je li** to be sleepy
 ~ **pran li** to fall asleep
 ~ **tèt ba** to sleep without a pillow
fè ~ to put to sleep, put to bed
gen ~ **nan je** to be sleepy
leve nan ~ to wake up
nan ~ asleep, sleeping; indolent
dòmichat cat nap, short doze

dòmídi to be sound asleep, sleep soundly
Dominikani Dominican Republic
donmaj, domaj, donmay damage, injury; birth defect; deformity; too bad! what a shame!
 ~ **nan nesans** birth defect
 ~ **nan sèvo** cerebral hemorrhage; stroke, cerebrovascular accident (CVA)
donmaje, domaje to damage, injure, harm; to cripple, handicap; defective
bebe ~ deformed or handicapped infant
donmajman handicap; deformity; physical injury; damage
donmay see **donmaj**
donnen to produce, yield (crops); to have a pimple; to have a malignant growth; to form a scar; ingrained, deep-seated, endemic
 ~ **sou** to overcome; to be chronic or long-lasting
dopye instep, dorsum of foot
dore golden
dosa girl born after birth of twins
 ~ **anvan** girl born preceding twins
dosou boy born after birth of twins
 ~ **anvan** boy born preceding twins
dosye medical record; hospital chart
dòt other
dou docile, nice, gentle, mild
doub double
 wè ~ to have double vision
doubout standing, upright
douch shower (bath); (vaginal)
douche
douk bump; hump
fè ~ to be swollen
doulè pain, ache; sorrow; labor contractions; rheumatism
dous sweet, pleasant, agreeable
dousman slowly; quietly, softly; calmly, gently
dout doubt

douvan see **devan**
douzèn dozen
dòz dose, dosage
 ~ **rapèl** booster shot
dozafè pubic area or region
dra (bed) sheet; bedclothes
 anba ~ to be in bed sick
dramamin dramamine
drandran var. of tiny parasite
 je ~ conjunctivitis, pink-eye
drenaj draining, drainage
drene to drain
drese to straighten
drèt see **dwat**
dri often; repeatedly; rapidly;
 profusely
drill mechanical drill
dtan of time
dwat right (opposite of left);
 straight; righteous, upright
 tou ~ straight ahead
dwat, drèt straight
 tèt ~ sane; proud
dwe to owe; must, have to
 ta ~ should, ought
dwèt finger
 bout ~ stub (of a finger)
 ~ **anlè**, ~ **bag** ring finger
 ~ **jlda**, ~ **jouda**, ~ **bouwo**
 index finger, forefinger
 ~ **jimo**, ~ **marasa** extra
 finger or toe
 ~ **majè**, ~ **mitan** middle
 finger
 ~ **pous** thumb
 ~ **pye** toe
 fant ~ space between fingers
 or toes
 gwo ~ thumb
 pwent ~, **tèt** ~ finger tip
 tl ~ little finger
dwòg (illegal) drug
dwoge to protect through magic
 power; to be under the influence
 of illicit drugs, be high; drug
 addict
dwòl funny; strange; pregnant
dyabèt, djabèt diabetes
dyabetik, djabetik diabetic
dyafram diaphragm

dyagnostik, djagnostik
 diagnosis; diagnostic
dyanm see **djanm**
dyann wail, cry (of baby)
dyapòt see **djapòt**
dyare, djare diarrhea
 ~ **anwo** vomiting
 ~ **masisl** AIDS
 ~ **pa ba** diarrhea
 ~ **pa wo** vomiting
 gwo ~ **san** dysentery
Dye, Bondye God
 ~ **benis** Bless you! (when
 someone sneezes)
 si ~ **vle** God willing
dyègl see **degl**
dyèp see **gèp**
dyesèlmevwa, djesèlmevwa
 masturbation
dyèt diet
dyòb, djòb job, position
dyòl see **djòl**
dyololo watery

E

e and
è hour
ebete, enbete stupid, dumb;
 senile; mentally retarded
echantlyon, chantlyon sample,
 specimen
echap arm sling
echèk failure
èd aid, help, assistance; helper, aide,
 assistant
ede, ide, rìde to help, assist
edèm edema
edmi and a half; thirty (minutes),
 half past (the hour)
efò effort, attempt
efranjít swollen feet (and legs),
 edema (of lower extremities)
egal equal
egare disoriented
egou, regou (covered) sewer, drain
egwi see **zegwi**
egzamen examination
egzamínen to examine
egzanp example, pattern; precedent

pa ~ for example, for instance
 egzante, ekzante to avoid, keep
 away from, abstain from
 egzat, ekzat exact, accurate,
 precise
 egzkite, ekzekite to execute,
 carry out (orders); to kill
 ~ yon preskripsyon to fill a
 prescription
 egzema, ekzema eczema, rash;
 athlete's foot; jock itch
 egzèse, ekzèse (yon misk) to
 restrain (a muscle)
 egzèsis, ekzèsis exercise
 fè ~ to exercise
 egzeyat, ekzeyat medical
 discharge or release
 egzeyate, ekzeyate to discharge
 or be discharged from hospital
 egzijan, ekzijan demanding,
 exacting, hard to please; delicate,
 needing much care or attention
 ejakile to ejaculate
 eka quarter (past the hour); a fourth
 (of a monetary unit)
 ekari see kari
 ekatè dental probe
 ekilib balance, equilibrium
 ekip team; staff
 ekipe see okipe
 ekla splinter, fragment
 eklanmezi, eklanpsl eclampsia
 eklate to rupture, burst
 eklatman rupture
 eklis see klis
 èkondisyone air-conditioning
 ekoulman urethral discharge;
 gonorrhea
 ekri to write
 eksepte except, but
 eksitan stimulant
 eksite to provoke, annoy; to
 stimulate
 ekspè, espè expert
 eksplike, esplike to explain
 ekstraksyon extraction
 ekzante see egzante
 ekzat see egzat
 ekzekite see egzkite
 ekzema see egzema

ekzèse see egzèse
 ekzèsis see egzèsis
 ekzeyat see egzeyat
 ekzeyate see egzeyate
 ekzijan see egzijan
 elastik, lastik elastic; rubber
 band
 elektrik, lektrik electric
 elektrisite, lektrisite electricity
 elèv pupil, student
 elevatè (dental) elevator
 ematimèt hemacytometer
 ematokrit hematocrit
 emay enamel
 emoglobin hemoglobin
 emoraji, moraji bleeding,
 hemorrhage; great pain
 emosyon shock, emotion
 fè ~ to be emotional,
 overwrought
 emowoyld hemorrhoids, piles
 enbetan, anbetan annoying,
 troublesome, bothersome
 enbete see ebete
 endèks index finger
 endijès indigestible
 endijesyon indigestion
 endikasyon indication, sign
 endispoze to faint, pass out; to
 make nauseous, upset;
 unconscious
 endispozisyon fainting spell;
 delirium; shock
 enèji energy, spirit
 enfeksyon, enfèksyon infection
 ~ (nan) bwonch pneumonia
 ~ nan jwentl septic arthritis
 ~ nan san sepsis
 ~ nan zo osteomyelitis
 fè ~ to be or become infected,
 have an infection
 enfekte, enfèkte to infect
 enfim crippled; frail, sickly
 enfimite handicap, disability;
 cripple
 enfimye (male) nurse
 enfimye (female) nurse; nursing
 enflamasyon, anflamasyon
 swelling, inflammation
 enfòmasyon information

enganm, engam able-bodied,
 firm, strong; spry, active, agile
èni hernia
 ~ (e)trangle strangulated
 hernia
enik eunuch
enka one-fourth
enkibatè incubator
enkonvalesan in ill health
enkyè worried, uneasy, anxious
enkyete to worry, be anxious
enkyetld anxiety, agitation
ennan one year
ennèvan irritating, bothersome
enpe a little, some
enpèmeyab plastic sheet;
 waterproof
enpetigo impetigo
enpòtan important
enpòtans, pòtans importance
enzoze to prevent, stop
enptipe a little bit
enpwòp unclean, slovenly
ensektisld insecticide
ensilin insulin
ensizyon incision
ensten instinct; intuition
enstitl institute
enstriman instrument
entansif intensive
entatad senile; spastic
entèn resident, intern (medical)
entèna internship
entènen, entène to hospitalize,
 admit (to hospital); to be
 hospitalized
entènis internist
entèprèt interpreter, translator
entesten intestine
entestinal intestinal
entete stubborn; senile; to have
 Alzheimer's disease
entoksikasyon toxemia
entyè one-third
epatit hepatitis
epè thick
epeng see zepeng
epesè thickness; density
epesl to thicken
epl and

epidèm epidermis
epidemi epidemic
epiglòt epiglottis
epinyè spinal
epizman fatigue, exhaustion
epòl see zepòl
eponj sponge
epwouvèt, epouvèt test tube
erè, èrè error, mistake
ereditè hereditary
esepte, eksepte except, but
eseye see seye
eska bedsore
eskalye stairs
eskavatè (dental) spoon excavator
èske (interrogative marker for yes-
 no question)
eskèlèt skeleton
eskize to excuse, forgive
esklzofrèn schizophrenic
eskòlyoz scoliosis
eskòpyon scorpion
ESNEM acronym for Service
 National des Epidémies
 Majeures (essentially, the
 national malaria-control
 program)
esoufle out of breath, breathless
espatil (dental) cement spatula
espè, ekspè expert
espedisyon evil spell or
 preparation (Voodoo)
espektoran expectorant
espèm sperm
espèmatozoyld spermatozoon, pl.
 spermatozoa
espere to hope (for); to wait (for);
 to expect
espesyal special, particular
espesyalis specialist; technician
espesyalite specialty
espesyalman especially
esplike, eksplike to explain
espre on purpose
espwa hope
estanda standard
estènen, estène, esténye to
 sneeze
esteril sterile

esterilè IUD (intrauterine device),
 loop, (contraceptive) coil
 esterilizasyon sterilization
 esterilizatè sterilizer
 ~ vapè autoclave
 esterilize to sterilize (sanitize;
 desex)
 estetoskòp stethoscope
 estewoyid steroid
 estòk stock, supply
 estoke to store
 estrèmonsyon last rites, extreme
 unction
 estrèptokòk streptococcus
 estwope to injure, cripple, maim;
 cripple; lame, disabled
 eta condition, state
 etann to extend, stretch out, spread
 out
 etanp temple (head)
 etasvil office where births,
 marriages and deaths are recorded
 Etazini, Ozetazini United States
 of America
 etè ether
 etenn to put out, extinguish, turn
 off
 eti see plètill
 etidye to study
 etikèt label
 etoufman, retoufman
 suffocation, asphyxia; choking;
 shortness of breath; dyspnea;
 asthma; emphysema
 etrangle strangulated
 etriye stirrups (for pelvic exam)
 etwat narrow
 evantay (hand-) fan
 evapore to evaporate
 evite to avoid
 ewoyin heroin

F

fa make-up (lipstick etc.)
 fab detergent
 fache annoyed, upset, angry
 fafouten, pafouten sideburns
 fal chest, stomach

famasi, fanmasi, fonmasi
 pharmacy, drugstore
 famasyen, fonmasyen
 pharmacist, druggist
 fanm woman; common-law wife
 ~ chay midwife
 ~ chay diplome government-
 trained midwife
 ~ deyò mistress
 ~ kay principal common-law
 wife
 ~ lib loose woman
 ~ saj, ~ say midwife
 ~ sou kote mistress
 mach ~ menstruation;
 menstrual problems
 fanmasi see famasi
 fanmi family; relative(s); extended
 family
 ti ~ distant relative
 fanmsay, fanmsaj midwife
 fann to slit, split; to lance; to
 crack; to flake, be scaly; cut
 ~ vant to perform a Caesarean
 section
 fant crack, split, fissure; opening,
 gap; space between (fingers etc.)
 ~ deyè anal groove, crease
 between buttocks
 ~ janm groin
 farennay(t) Fahrenheit
 fastil easy; easygoing; easily
 fatig fatigue, weariness
 gwo ~ exhaustion
 fatigan tiring, fatiguing
 fatige tired; to tire out
 fatra trash, garbage, waste
 faya to faint; very weak (from
 hunger); deadly
 tonbe ~ to starve
 fè iron; stirrups (for pelvic exam);
 to make; to do; to cause; to give
 birth, have (a baby); to have
 sex; to have a bowel movement
 ~ ~ to have s.o. do something
 ~ mal to harm; to hurt, pain;
 to ache, be sore
 fèb weak, feeble, infirm; dull
 fèblan tin can
 feblès, fèblès weakness; anemia

maladi ~ malnutrition
tonbe ~ to faint, pass out; to be exhausted
febil to weaken, become weak
fejennès, difejennès, fedjennès acne
fèk, fenk to have just (done something)
fekal:
matyè ~ excrement, fecal matter
fekondasyon fecundation
fekonde to fecundate, impregnate
fele to crack; crack, break, fissure
fèm firm, solid, steady
fèmen to close, shut; to close up (fontanel); to form scar tissue, cicatrize; shy, bashful
~ a(k) kle to lock
fenèt, fennèt window
fenk see fèk
fènwa, fènwè darkness
fenyan cowardly
fès buttocks
~ sotl hemorrhoids
tou ~, twou ~ anus
fèt to be born; done, completed
~ de pye devan breech delivery
~ nan ta to be born late in a woman's life
~ pou should, must, be supposed to
~ tèt anlè breech delivery
~ tou mourl stillborn
fetis fetus; fetal
fetoskòp fetoscope
fevrye February
fèy leaf
~ renmèd medicinal herb
~ zòrèy (external) ear
gwo ~ labia majora
pèdl anpil ~ to be really nuts or crazy
pèdl yon/kèk ~ to be a little crazy or looney
tl ~ labia minora
feyaj foliage, leaves
al nan ~ to consult a faith-and-herb healer

fi, fly girl, woman; daughter
~ lib loose woman
pitit ~ daughter
vyèy ~ old maid, spinster
fibwòm fibrous tumor, fibroma; hard mass of spoiled blood within the womb
fich slip, card; bill, itemized account
fildèl faithful; compliant (medically); faithfully, regularly
fif, fiftiwann, fiftiwonn ass, butt
twou ~ anus
fìgl face
bò ~ cheek(s)
po ~ complexion, face
zo ~ cheekbone
fìkse to fasten; to stare at; to focus
fìksyonnen to rub vigorously with lotion, alcohol etc.
fìl wire, thread, string; hymen; fiber; stitch; suture; gaunt; scrawny, emaciated
~ dantè, ~ pou dan dental floss
pwent ~ projecting end of stitch
filaman filament (light bulb); IUD (intrauterine device), loop, (contraceptive) coil
fìlaryoz filariasis
fìle sharp
fìlèt, fìlè hymen; string of the tongue, frenum; hair-net
fìlt, fìltè filter
fìltre to filter, strain
papyè ~ filter paper
fìmen to smoke (cigarette, pipe etc.)
fìmye manure, fertilizer
fìn see fìnl
fìneray, fìnlray funeral, burial
fìnl, fìn to finish, end, complete; to become, end up
fìnlray see fìneray
fìnlisman end, completion
fìsèl string
fìt, fwit leak
fly see fi

flyanse, fyanse fiancé(e); to get engaged, be engaged
flyèl, flyòl godchild, godson, goddaughter
flyèt little girl
flyòl see flyèl
fizik physical condition
fizyoloji physiology
flach flashlight
flak hungry
flakon small bottle, vial, flask
flan side, flank; diaphragm (anatomy)
flè flower; menstruation, menstrual period
flèasezon neurotic
flègèdèk old; skinny; dying
flèm, flenm phlegm, snot, sputum, mucus
flengen frail child
flerí to flower; to menstruate
flit insect spray; spray gun (for insecticide)
flite to spray, fumigate
flitè inhalor
fliyorid fluoride
flobop see fobop
floche to flush (toilet)
fo false, artificial
fò strong, powerful; acute; loud; intelligent, clever; see fòk
pl ~ most, the majority of
fobop, flobop:
djòl ~ toothless
fòk, fò (the subject follows) to have to, it is necessary that, must
fòl crazy
foll craziness, insanity
folik folic
fòmasyon formation; puberty
fòme, fòmen to form; to reach puberty or menarche; to menstruate; pubescent; mature
fòmil (infant's) formula
fòmòl formaldehyde
fon forehead; deep; bottom (container etc.)
pa ~ shallow
fungis fungus
fonmasi pharmacy, drugstore
fonmasyen pharmacist, druggist
fonmi see foumi
fonn to melt; to dissolve; to dilute
fonse dark (color)
fontanèl fontanel
fontenn, fwontenn forehead; fontanel; fountain
~ tèt forehead; fontanel
fòs strength, force, power, stamina
~ pirlji tetanus, lockjaw
fòse to force; to compel
fòsèp forceps
foseyè grave-digger
fòsfò phosphorus
fòskouch, fòskouch miscarriage
fè ~ to miscarry
fòskouray, fòskouraj physical strength, brawn
fòsponyèt (physical) strength
fòt, fot fault, mistake, error
fote, fwote to rub; to scrub (up)
fòtifyan tonic; vitamin; nutritious
fòtifye to strengthen, fortify
fou crazy, insane; maniac; oven, stove
~ dou slightly demented, eccentric
~ gaz gas stove
fouchèt fork (eating)
foufoun vulva (of a child)
fouk crotch; crotch of pants
foul crowd; to fill; full
foula scarf, kerchief
foulay sprain; non-specific pain or ache
foule sprained, hurt; to strain, pull (muscle)
foull sprain
foulwa (dental) condenser
foumi, fonmi, fwomi ant
gen ~ **nan potchanm** to have sugar in one's urine, be diabetic
fouti:
pa ~ not to be able at all (to do something)
frajli fragile; frail
frakti fracture, rupture, break; physical shock, trauma, injury

fraktire to injure; to fracture
frape to strike, hit, bump, knock
fre cool
frè brother; half-brother; (male)
 friend; expenses, fee
frechè coolness; fresh air; chill (in
 part of body); arthritis;
 rheumatism
frechl see **fresl**
 ~ **dan** gum abscess
fredl cold (temperature); chill;
 arthritis; rheumatism
gen ~ to have tuberculosis
pran ~ to catch a chill
fredite cold (temperature)
frendeng ass, butt
frendling intestine(s); insides,
 interior
frengal pang of hunger; large
 appetite
fresl liver
 ~ **dí** liver
 ~ **mou** lung(s)
frèt cold (temperature); calm, quiet
freyè, frèyè fright
frijidè refrigerator, frigidaire
frikasyon massage
frikasyonnen to rub, massage; to
 be massaged
frison chills; shiver, shudder
frissonnen to shiver, shudder
fwa time, instance; liver; epigastric
 area; faith
fè ~ to have a liver problem or
 hepatic disease
 ~ **dí** liver
 ~ **mou** lung(s)
gen ~ **ll chaje** to have a
 coated or furred tongue
gwo ~ hepatitis
fwarad liquid stool, diarrhea
fwit leak
fwoml see **fouml**
fwon forehead, brow
fwontenn see **fontenn**
fwote, fote to rub; to scrub (up)
fwotl(s) smear (blood, vaginal etc.)
fwotman rubbing, friction
fyanse see **flyanse**
fyè (justifiably) proud

fyèl gallbladder; stamina, endurance,
 resistance; patience
tlyo ~ cystic duct
fyèv fever; see **lafyèv**
fyòl vial, flask

G

gache to waste, ruin
gad protective charm or amulet;
 marks or scratches for magical
 protection
gade, gad to look, look at; to
 watch over, take care of; to keep
gaga dumb; retarded; senile; dazed;
 woozy, disoriented; to stun, daze
gagann throat, gullet, esophagus;
 chest area, neck and shoulders
banbou ~, **tib** ~ throat,
 gullet, esophagus
gagarl gargling; to gargle
gal scabies, seven-year itch
galon gallon (measure; container)
gan glove
gangan Voodoo priest
gangrenn gangrene
gason man, fellow; boy; waiter;
 male; sexually active
 ~ **fanm** male homosexual
 (passive role)
 ~ **makomè** effeminate male;
 male homosexual
pa ~ impotent
vye ~ old bachelor
gasplyay, gasplyaj, gaspyay
 waste, wastefulness
gate to spoil, decay
 ~ **dlo** to urinate
gawa ass (buttocks)
gaya robust, healthy, fit; healed;
 fellow; to recover completely
 (from a sickness)
 ~ **vivan** vigorous, dynamic
gaye to spread
mache ~ to spread rapidly
gaz ache or pain (anywhere in
 body); gasoline; gas, flatulence;
 gas (for cooking etc.); gauze;
 sharp hunger pain
fè ~ to urinate (fam.); to fart

~ nan tout kò rheumatism
 ~ operasyon ether
 rann ~ to burp, belch
 twal ~ gauze
gazon lawn
 ti ~ pubic hair
gazòy diesel fuel
Gede mischievous Voodoo spirits
 of death
gedj gauge
gen see **genyen**
gèn see **genn**
genlè apparently, probably, likely
genn, gèn girdle
gentan already
genyen, gen to have; there is/are;
 to earn, get; to be (with
 expressions of age); ago
 ~ pou to have to, must
 (Kl)sa ou ~? What's wrong?
gèp, djèp, dyèp, gyèp wasp
 ~ panyòl yellowjacket
geri to heal; to cure; to get well
 pa ~ incurable
gerisab curable
gerisè faith-and-herb healer
gerizon recovery (from illness),
 healing
gigt penis (fam.)
glann gland, lymph node; swollen
 lymph node; ganglion, tumor
gen ~ to have swollen gland(s)
 ~ anbavant adrenal glands
 ~ gòj adenoids
 ~ kriye tear or lacrimal glands
 ~ nan kou thyroid gland
glas ice; mirror; pane of glass; see
je
glase to chill; cold, iced
glason ice-cube
glasyè, glasye ice-box; cooler,
 ice-chest; ice-maker (machine)
glè phlegm, mucus
bay ~ to have mucus stools
kontwòl ~ mucus method
 (contraception)
watè ~ mucus stool
glikoz glucose
glisan slippery, slick
glliserin nitroglycerin
glòb blister
 ~ dlo blister
 ~ san blood clot
glibil globule; blood cell
 maladi ~ blan leukemia
glokòm glaucoma
glòs lip salve
goblè specimen cup
gobye to burp, belch
gòch, goch left; clumsy, awkward
goche, gòche left-handed
gode small cup; specimen cup
gòj throat; opening, mouth
 banbou ~ throat, gullet,
 esophagus
 boul nan ~ goiter
 ~ fè mal, ~ sere sore throat
grate ~ ll to clear one's throat
gwo ~ esophagus, gullet
 ti ~ windpipe, trachea
 tou ~, twou ~ opening of
 the throat
gòje swallow, gulp, mouthful (of
 liquid); throat
gòjèt throat, gullet
 (gwo) ~ mou esophagus,
 gullet
 (ti) ~ di windpipe, trachea
gòjfemal sore throat
gondole to limp very noticeably
gonfle to have indigestion; to cause
 indigestion; to swell up; to
 bloat; to inflate
gonfleman, gonfliman
 indigestion
gonokòk gonococcus
gonore gonorrhea
gou taste, flavor; tasty
 bouch/djòl ll ~ to have a
 good appetite
 bouch pa ~ loss of appetite
goud gourde (Haitian monetary unit
 formerly equivalent to \$.20
 U.S.)
goudwon meconium
goumen (ak) to fight, struggle,
 resist
gout drop, drip
goute snack; to taste

gouyang-gouyang hobbling, limping
gra fat; overweight
gradoub large intestine
grafik graph, diagram
grafliyen, grafouyen scratch, abrasion; to scratch, scar
graj sore, rough (throat esp.)
graje to fidget, squirm; to writhe (in pain)
gram gram
gran old; big; main; large; wide; great; mature
grandl to grow; to grow up; to expand, enlarge
grandisman growth, expansion, development
grangou hunger, famine; hungry
mourl ~ to be excessively hungry; to starve
granmè madam (when addressing an elderly woman); grandmother
granmèsì, gremesì thanks, gratitude
pou ~ without thanks, for nothing, in vain; disinterestedly
Granmèt God
granmoun adult, grown-up; old person; elderly, old; in a late or developed stage
 ~ **tl tay** wizened old person
tl ~ elderly person; precocious child
grann grandmother, granny
gran ~ great-grandmother
grannchalè see **grantchalè**
grannèg VIP, big shot
grannì granny
granpapa grandfather
gran ~ great-grandfather
granpè grandfather
grantay tall
grantchalè, grannchalè, grennchalè venereal disease; gonorrhea
grasa thanks to
 ~ **Dye** thank God
grasèt plump
grate to scratch; to itch; to scale (teeth); itching
gratèl itch, rash, skin irritation; jock itch; allergy
gratèl, lagratèl jellyfish
gratis free, gratis
gratiyen scratch (on arm etc.)
gratwa scaler, scraper
grav grave, serious, critical (condition); malignant
grave scratch; to scratch, scar; to worsen
 ~ **vèrèt** pockmark
gravman gravely, seriously
gravte, gravlte seriousness, graveness
grèf (po) skin graft
grefe to do a skin graft
gremesì see **granmèsì**
greenn grain; single unit or piece (of anything); pill, tablet, capsule; lozenge; birth-control pill; lump; testicle; young woman; alone; granular; kinky (hair)
fè ~ to be lumpy
gen ~ to have courage
 ~ **chalè** see **grantchalè**
 ~ **dechay** spermatozoa
 ~ **dlrl** baby tooth
 ~ **planln** birth-control pill
 ~ **swè** bead of perspiration
 ~ **tous** cough drop
 ~ **vant** kidney
gwo ~ hydrocele
kòd ~, **majò** ~ scrotum and testicles
po ~, **sak** ~ scrotum
san ~ eunuch
grennen to scatter, spread; to fall, become detached
 ~ **pltit** to have/father one baby after another
grennvant kidney
grès fat, excess flesh
grl gray
grlj line of anus
grljl to wrinkle (skin)
grlnbak U.S. dollar
grip, lagrip cold, flu, grippe
 ~ **lasezon** hayfever
gwo ~ influenza; tuberculosis
gripe suffering from a cold or flu

griyen to snarl, growl; emaciated
gwat goiter
gwo big, fat, large; swollen;
 important, great; acute
 ~ **gra** fat and healthy
gwodon, goudwon, gwòdon
 meconium
gwògmann lush, drunkard
gwogòj esophagus, gullet
gwonde buzzing or ringing in ears
gwopans belly, stomach
gwopye elephantiasis; lymphedema
gwòs to make pregnant; pregnant
 (fam.)
pran yon ~ to become
 pregnant (fam.)
gwòsè, gwosè size
gwosès, gwòsès pregnancy
 maladi ~ morning sickness
pwazon ~ eclampsia
gwosì to grow larger, gain weight;
 to swell; to expand, enlarge; to
 exaggerate
gwoup group
gwovant pregnant; big belly
gwozo big for one's age
gyadya giardia
gyèp see **gèp**

H

hanch hip; pelvis
hòkèt, òkèt, wòkèt hiccup(s)
houngan Voodoo priest

I

lde to help, assist; see **lde**
ljan urgent
 ka ~ emergency
ljenik, lyyenik, jenik clean,
 hygienic, sanitary
 papye ~ toilet paper
llyèn, lyyenn, llyèn, llyenn
 hygiene, health practices
llyenik see **ljenik**
llyenn see **llyèn**
lìsè ulcer
imè mood, humor
imèn hymen

lmeris humerus
imid humid, damp, wet
iminize to immunize
inèdtan an hour
inlè unit
inlil useless, unnecessary
lpeka ipecac
lpinotize to hypnotize
lpinoz hypnosis
lèt urethra
lirin urine
lirinwa urinal
liris iris (of eye)
liritan irritant
liritasyon irritation, inflammation
lirite to irritate, annoy, exasperate
lìsit, lsi here
 ane ~ this year
 ~ **la** right here, over here
 ~ **la menm** in this very place
lteris uterus
lìtkè hives
lìtli useful, profitable, beneficial
lityole antiseptic (for cuts etc.)
lwoloji urology
lyòd, yòd iodine
lyòde, yòde iodized
lze to wear out; worn-out, tired, old
lzo to quarantine, isolate

J

jaden (cultivated) field
jan kind, type, sort; manner, way;
 process; how, as
 move ~ ill-tempered
 yon (ti) ~ a little (bit),
 somewhat, rather
janbe to cross, cross over
jandam, jandanm policeman;
 soldier
janm leg; ever
 antre ~ crotch
bagèt ~ skinny legs
banbou ~ tibia, shinbone
bwa ~ leg bone; leg; shin,
 tibia
 ~ **kana**, ~ **kounan**, ~ **sizo**
 knock-kneed
 ~ **louvri**, ~ **ouvè** bowlegged

pa ~ never
 zo ~ shin, tibia
 zo bwa ~ leg
 janmè never
 jansiv, jansib, zansiv gum(s)
 (of mouth)
 ~ anfle gingivitis
 jansyàn vyolèt gentian violet
 janti nice, pleasant
 jantiyès kindness
 janvyè January
 jarèt, jare hock, calf (of leg)
 bout ~ calf (of leg)
 java highly malignant open sore or
 wound, serious skin ulcer
 jayl to gush forth, spurt out
 je, zye eye
 anndan po ~ inner side of
 eyelid
 bat ~ to blink
 blan ~ white of the eye, sclera
 boul ~ eyeball
 chè nan ~ pterygium
 dlo ~ tear(drop)
 doktè ~ eye specialist,
 ophthalmologist; optometrist
 dòml nan ~ (II) to be sleepy
 gen bon ~ to have good
 eyesight
 gla(s) ~ cornea
 glè ~ iris (of eye)
 grenn ~ pupil (of eye)
 ~ ap febli to have failing
 eyesight
 ~ bouche swollen eye; black
 eye
 ~ boukannen eyelids without
 eyelashes, ptilosis
 ~ bòy one-eyed
 ~ chat hazel-colored eyes
 ~ drandran pinkeye, (epidemic
 hemorrhagic) conjunctivitis
 ~ fon deep-set eyes
 ~ grlye eyelids without
 eyelashes, ptilosis
 ~ kaka eye filled with eye-
 matter
 ~ klere blind; clever, smart
 ~ koud elbow

~ krab round sore (usu. on
 sole of foot)
 ~ lanvè cross-eyed; lazy eye,
 strabismus
 ~ lasi eye filled with eye-
 matter
 ~ ll tounen to faint; to die
 ~ lòlòj nystagmus
 ~ louch squinting
 ~ nan tou bags under the eyes
 ~ pete blind person
 ~ plchon chronic eye disease
 involving lid and lash changes
 ~ plchpich beady eyes;
 swollen or squinting eye(s)
 ~ pye ankle; tarsus
 ~ sotl protruding eyes
 ~ tawèt, ~ twèt squinting
 ~ tounen cross-eyed
 ~ vèt green eyes; light-colored
 eyes; Caucasian (person)
 ~ vewon cross-eyed
 ~ vlre giddy, dizzy
 ~ wouj pinkeye; black-eye;
 bloodshot
 kaka ~ eye matter, sleep
 kalalou ~ optic fluid
 klou nan ~ sty
 lave ~ to wash one's face; to
 have intercourse too soon after
 delivery
 maladi nan ~ conjunctivitis
 manman ~, nannan ~ pupil
 (of eye)
 move ~ evil eye
 nwa ~ pupil (of eye)
 pllm ~, pwal ~, pwèl ~
 eyelash(es)
 po ~ eyelid
 pòch ~ eyesocket
 sak dlo ~ lachrymal gland
 tansyon nan ~ glaucoma
 tou ~, twou ~ pupil (of eye);
 lens (of eye)
 vwal nan ~ blurred vision
 jedl Thursday
 jefò, jèfò effort
 jelatln plastic (adj.)
 jete jelly
 ~ petwòl petroleum jelly

jèm sperm, ejaculate; germ; bacillus
 ~ (maladi) germ; bacillus
kouzen sou ~ second or distant cousin
jeml to groan, moan
jen June
jèn young; fast, fasting
 fè ~ to fast
jenan bothersome, irritating
jene to fast
jeneral general
jeneratè generator
jenès, jennès youth, adolescence; prostitute
jenetik genetic
jenik see ljenik
jenital genital
jènjan, jennjan young man
jenn young; gene
jennen to bother, annoy; embarrassed, shy; narrow
jennès see Jenès
jennjan see jènjan
jennman discomfort; stricture
jennmoun young person; teenager, adolescent
jennonm young man
jenou, jounou knee
 boulèt ~, kakòn ~, zo ~ kneecap, patella
jepete blind person
jepye ankle
jete to throw; to throw away; to exude
 ~ plitit to abort, have an abortion
 ~ vè to pass worms; to vomit worms
 ~ yon dlo to urinate (fam.)
ji juice
jigote to wriggle, squirm; to have a seizure or fit
jilèt razor blade
jlmo twins (of same sex)
 fo ~ fraternal twins
 vre ~ identical twins
jinekòlòg gynecologist; obstetrician
jip skirt
jipon petticoat, underskirt, slip

jis just, fair; tight
jiske until
jistemán exactly; that's right!
jiwòf cloves
jiyè July
jodl a today
joj small graduated vial
jòn yellow
 ~ abriko orange (color)
jònís, lajònís jaundice; yellow fever; hepatitis
jou day; daylight
 (de) ~ an ~ day after day; gradually, steadily
 depl de twa ~ recently
jouk until, up to
jounou see Jenou
jous until, till
jwe to play; to move, flex
 ~ lakomedi to put on an act
jwenn to find; to regain (health)
jwenti joint, articulation
 doulè ~ arthritis
 ~ dwèt knuckle
 ~ pye ankle-joint
jwèt toy
jwl to enjoy; to reach orgasm
jwif Jewish

K

ka quarter, fourth; quart (measure; container); problem, jam, fix; case, instance; see kapab; see kay
 ~ ijan, ~ presan, ~ prese emergency
 ~ madan Viktò john, toilet
 ~ pèdl beyond recovery
kab see kapab
kaba to finish
kabann bed
 chofe ~ to stay in bed (late)
 desann ~ to get out of bed
 doulè ~ morning soreness from bad bed
 ~ pou timoun crib
 ~ woulèt gurney, wheeled stretcher
 monte ~ to get into bed

pran ~ to be sick
 ranje ~ lan to make the bed
 tèt ~ headboard (of bed)
 kabannen to remain in bed; bed-
 ridden
 kabare tray
 kablcha nap; to take a nap
 kabine, kabinè feces
 kabinèt cabinet
 kabòch (tèt) (fam.) head, noggin
 kabòs bump, bruise
 kach cash; foreskin, prepuce
 koupe ~, wete ~ to
 circumcise
 kache to hide; tablet (of aspirin)
 kachimbo clay (smoking) pipe
 kad frame, stretcher, stand; cot
 kadav, kadavkò cadaver, corpse
 kadè moment; second child born in
 family
 kadejak rape
 fè ~ sou to rape
 kadjak see kadyak
 kadna padlock
 kado gift, present, tip; white spot
 in fingernail
 kadyak, kadjak cardiac
 Kafenòl var. of aspirin
 kafeyln caffeine
 kage to lean back
 kagou sad, depressed, ailing
 kahlnk-kahank tuberculosis
 kaka shit, dung; to shit, crap
 ~ dan tartar
 ~ je sleep, eye matter
 ~ nen booger, (dried) snot
 ~ zòrèy earwax
 pran yon ~ san savon to
 become pregnant without being
 married to or living with the
 father
 kakadè see kakatwè
 kakalanga rooster
 kakarat, katarak cataract
 kakarèl liquid excrement; diarrhea
 kakas carcass; frame, skeleton
 kakatwè, kakadè person who
 defecates on himself
 kakòn:
 ~ jenou kneecap, patella

~ pye, zo ~ ankle; tarsus
 kal bit, piece; dandruff; callus,
 bunion; scab, scale; calm, quiet
 fè ~ to be(come) scaly (skin)
 kalanbè smegma
 kalbas calabash, gourd
 ~ pete to break water (in
 childbirth)
 ~ tèt head, noggin
 tl ~ hydrocele
 kale to skin, scrape
 kallmèt straw (for drinking)
 kallte, kalte kind, sort, type;
 quality; quantity
 kalkè plaque (on tooth)
 kalm respite, let-up
 kalma to calm (down), ease up;
 respite, let-up
 kalman tranquilizer; sedative; pain
 killer, pain pill; bromide
 kalme to calm down, cool off, quiet
 kalomèl trouble, mess; calomel,
 powerful (sometimes dangerous)
 purgative
 kalori calorie
 kalson (male's) boxer shorts
 kalsyòm calcium
 kalte see kallte
 kamarad, kanmarad companion;
 friend
 kamizòl see kanmizòl
 kamoken quinine; subversive,
 dissident
 kamomln camomile
 kamyon truck; any large vehicle for
 public transportation
 mal ~ carsickness, motion
 sickness
 Kanada, Okanada Canada
 kanadyen (adj.) Canadian
 Kanadyen Canadian (male)
 Kanadyèn Canadian (female)
 kanal see kannal
 kanbral bowlegged
 kanf camphor
 kanfre camphorated
 kangrenn, gangrenn gangrene
 kangrennen to become gangrenous
 kanhi-kanhan so-so, poorly;
 repeated coughing

kanif pocketknife
kanll needle (of syringe); cannula
kank canker
kankannen scalded
kankou, tankou like, as, as if
kanmarad see **kamarad**
kanmizòl, kamizòl undershirt;
 patient's gown; small baby's
 upper garment
kannal, kanal canal, channel,
 tract, duct; urethra; vagina
 ~ **dan** cavity
 ~ **dèyè** anal groove, crease
 between buttocks
 ~ **fi** vagina
 ~ **lè** respiratory system
 ~ **plpl** urethra; urinary tract
 ~ **rèldo** exterior depression
 along backbone
 ~ **tande** ear canal
 ~ **ze** Fallopian tube(s)
kannannan, annannan(t)
 mentally retarded, feeble-minded;
 dumb, stupid, idiotic
kanpe to stand, stand up; to put up,
 place in a vertical position; to
 stop; standing; in good shape
kanpelwen liquid ammonia; foul-
 smelling liquid (used as spell to
 keep people away)
kanpo rest, respite
kansè cancer; tumor
kanson trousers, pants, slacks
 bout ~, **tèt** ~ shorts, cut-offs
kanta (pou) as for, concerning
kantite, lakantite amount;
 supply; quantity
kap kite; dandruff; cradle cap; sh.
 form **kapab**
kapab, ka, kab, kap to be able,
 can; might, liable to; capable,
 competent
kapilè capillary
kapòt condom, rubber
 ~ **pou fanm**, ~ **pou fi**
 diaphragm
kapsil capsule
karako woman's typical peasant
 dress (with high waistline and
 full skirt); nightgown

karaktè character, personality
karang louse, lice
karantèn quarantine
karapas, karapat tick (parasite)
karl cavity; caries; decay (tooth,
 gum)
karl, ekarl breadth of shoulders,
 back and shoulders
karye to decay; to be decayed
kas (plaster) cast
kasan breakable
kase to break, fracture; to break off;
 to injure; to lose weight
 ~ **lezo** to break water (in
 childbirth)
 ~ **lezo nan bouch** to suffer
 from disjointed teeth and jaws
 after childbirth
 ~ **pou grandf** to gain in
 height and lose in weight
 (growing child)
 ~ **pye** to stumble
kasèt cassette, tape
kaskèt cap (for head)
kat card; map; four
 ~ **chemen lasante** road-to-
 health chart
 ~ **vaksen** immunization record
kata head cold; to be done for, be
 finished; sickly, puny; retarded,
 slightly mentally defective
katarak, kakarat, katakat,
katarat cataract
katatè, katetè catheter
katchoupln ass, buttocks
katkat, tl katkat kid, child,
 infant
katolik Catholic
katrach AIDS
kawòtchou, kawoutchou
 rubber; tire; catheter
 ~ (**bòk**) enema tube
kawotid carotid (artery)
kay, ka house, hut; building;
 office; at the home of; in the
 case of
 ~ **blanch** place of isolation
 (room, house etc.) for TB
 victims
 ~ **madan Viktò** john, toilet

maladi ti ~ tuberculosis
 moun ~ family; person who
 frequents a house; regular
 customer
 tèt ~ roof
kaye notebook; to coagulate, jell,
 clot; to be in full force; filled,
 congested; chronic (disease)
kayo clot
kazak baby dress or gown
ke tail, end; tail, ass
kè, tchè heart; stomach; courage
 anba ~ epigastric; epigastrium
 bri (nan) ~ heart murmur
 doulè anba ~ chest pain
 gwo ~ heavy heart; sad
 ~ boule heartburn, indigestion
 ~ cho heartburn; acidic
 stomach
 ~ fèb weak heart; nausea
 ~ grenn sad, depressed
 ~ kase shocked; concerned
 ~ kòde great physical suffering
 ~ kontan happy, glad
 ~ li konn bat to have a high
 heart rate at times
 ~ li sote to be afraid, be
 alarmed
 ~ li tounen to be physically
 revolted, be nauseated
 ~ mare sadness, depression;
 anxiety
 ~ plè heartburn
 ~ plen upset stomach, nausea;
 disgust
 ~ pòpòz carefree
 ~ poze peace (of mind)
 ~ sansib sympathetic
 ~ sere sadness, depression;
 anxiety
 ~ si heartburn
 ~ sote startled, scared
 ~ sou biskèt anxiety, worry
 ~ tòde great physical suffering
 ~ tounen nausea
 kenbe ~, pran ~ to take
 heart; not to be afraid; to endure,
 tolerate
 kriz ~ heart attack
 mal anba ~ epigastric distress

kèd lukewarm
 kèk, kèlke some, a few, several
 nan ~ some of
keksyon, kesyon question;
 matter
 poze yon ~ to ask a question
keksyonè questionnaire
 kèlke see kèk
kenbe to endure; to make out, get
 along; to hold, support; to keep;
 to keep down, retain (food etc.)
 ~, pa lage! Hang in there!
 Keep the faith! Don't get
 discouraged!
 ~ rèl to wail
kenedl second-hand clothes
kenpòt see nenpòt
kent irritating cough
kèplen upset stomach, nausea;
 disgust
keratit keratitis
kesyon see keksyon
kewozin kerosene
ki which, what; that, who
 a ~ lè? at what time? when?
 ~ bò? where? which direction?
 ~ jan? how? how come? what?
 ~ kote? where?
 ~ lè? when?
 ~ moun? who? whom?
 (~)sa? what?
kibitit ulna
kichòy thing, something
kidan toothpick
kikilik penis (fam.)
kilblite to stumble, trip, fall
kilès? which one? which? who?
 whom?
kiilo, killogram kilogram
kiidòt panties; diaper for weighing
 child from hanging scale
kim foam, lather, froth
 fè ~ to foam, lather, froth
kimen, tchimèn to foam, lather,
 froth
kinin quinine
kirèt curet
kis cyst; sty

kitaj, kitay dilatation and
curettage, "D and C"; abortion
(euphemism)
kite to leave; to leave alone; to let,
permit, allow
~ **tonbe** to drop
kitès, kitèks fingernail polish
kitip cotton swab, Q-tip
kivatèt scalp
kivèt washbasin
kiyè, kouyè spoon
gwo ~ tablespoon, large spoon
gwo ~ san tiyon level
tablespoonful
~ **plen** spoonful
ti ~ teaspoon
ti ~ san tiyon level
teaspoonful
kiyere spoonful
kizin, koujin, kwizin kitchen
kizinyè, kouziyè, kwizinyè
(male) cook
kizinyèz, kouziyèz, kwizinyèz
(female) cook
klanps (large metal) clamp
klasè file folder; card holder; filing
cabinet
kle key; bottle opener; can opener
(etc. - tools used to open
something); wrench, pliers
~ **anglèz** monkey wrench
~ **paspatou** master key
klè clear, transparent; bright; light
(color)
pa ~ in bad shape
kleren raw (white) rum
klete to lock
klinik clinic
klls, eklls splinter, sliver; partial
crown; inlay (tooth)
kllsbwa splinter
klitoris clitoris
klò chlorine
klòch bell
klòk pimple, small bump
klorin chlorine
klou (metal) nail; boil, pimple; sty
~ **nan je sty**
klowofòm chloroform

klowokin, klowoken
chloroquine
klowòks, klowòs bleach, clorox
kò body; (reflexive pronoun); corn,
callus
anndan ~ **moun** viscera
~ **akable**, ~ **dezole**, ~ **kraz**
general weakness, malaise;
exhaustion, weariness
~ **gason** penis
~ **kraze** see **kòkraz**
~ **labouyi** flabby body
~ **lage** weakness; apathetic or
lethargic person
~ **likld** weak, frail; indecisive
~ **lòkò** flabby body
~ **mò** paralyzed
~ **mòl** weary, tired
~ **moun** human body,
anatomy
~ **mouri** indolent, lethargic
(maladi) ~ **rèd** tetanus,
lockjaw
pou ~ **li** alone, by oneself
kòb Haitian cent (fam. for 1/100 of
a gourde); money, cash (fam.)
senk ~ equivalent of 1 cent
U.S., penny
kòblya, kòbya hearse
kòche to skin; to scratch; scratch,
slight cut, abrasion
kochma nightmare
kòd rope
~ **lonbrit** umbilical cord
~ **vokal** vocal cords; larynx
mare ~ to tie the tubes,
perform a tubal ligation
ti ~ string
kodak camera
kòde to writhe, double up (in pain);
to twist, knot; scrawny
kodeyin codeine
kòdon, kòdwon strip, band;
umbilical cord
kòf chest (of body)
~ **kòt** rib cage
~ **latrin** seat of latrine
~ **lestonmak** chest, thorax,
rib cage
kòk rooster, cock; penis (fam.)

~ san bèk two front teeth
 missing
 po (tl) ~, po tèt ~ foreskin,
 prepuce
 tèt ~ glans penis
 kokad hair ribbon
 kokayin cocaine
 koke see kwoke
 kokennchenn huge, enormous,
 gigantic
 koklich whooping cough,
 pertussis; chronic cough
 kòkmò, kwòkmò undertaker;
 apathetic or lethargic person
 koko female genitals (fam.)
 kout ~ cupping glass
 kokobe to cripple; cripple;
 paralyzed, crippled, lame,
 handicapped
 kòkòt (North) genitals (female)
 kòkòwòs skull, cranium
 kokoye coconut
 ~ nan pye large calf muscle
 kòkraz, kòkraze lethargic person;
 worn-out, exhausted
 kòksidyòz coccidiosis
 kòksis coccyx
 kòl cervix; (neck)tie
 kola (extremely sweet) soft drink
 (boutèy) ~ soft drink bottle,
 pop bottle (used as measure)
 kolan sticky; tiresome, annoying;
 stubborn (fever)
 kolasyon breakfast
 kolasyonnen to have or eat
 breakfast
 kole to stick (to), cling (to); to
 coagulate; sticky, gluey; collar
 kòlè anger, rage, fury
 fè ~ to be angry
 (momentarily); to have repressed
 anger
 kolera cholera
 kolerin, kolorin dysentery
 kòlèt collar; chest; neck area
 kòlgat toothpaste; Colgate
 koll parcel, package
 kolik menstrual cramps, abdominal
 pains; colic; stomach ache
 kollzyon head-on collision

kolonn, kolòn column
 ~ vètebral vertebral column
 kolorin, kolerin dysentery
 kolostwòm colostrum, foremilk
 kolye necklace
 kòm, konm since, because; as,
 like
 koma coma
 kòman see kouman
 kòmande, konmande,
 koumande to command; to
 order, direct; poisoned
 kòmanse, konmanse,
 koumanse to begin, start
 kòmè, konmè, makòmè (fem.)
 good and close friend
 (tl) ~ girl, young woman
 Kòmillo Comme Il Faut (brand of
 Haitian cigarettes)
 komlsyon genitals (female)
 komòd latrine, toilet; outhouse,
 privy; convenient
 kòmst as if, as though
 kon, kou like, as; when
 konbat to combat, fight off
 konben, konbe, konbyen how
 much, how many
 konbine, konblinen to combine,
 put together, join together
 konbyen see konben
 kondanse to condense; to evaporate
 kondlsyon condition, state
 konekte to connect, plug in; to
 insert (IV tube etc.)
 kònen to ring (in ears)
 konfò comfort; toilet
 ~ modèn flush toilet
 konfonn to confuse, mistake one
 thing for another
 konfyan confident
 konfyans, lakonfyans
 confidence, trust, faith
 konik chronic
 konje day off
 jou ~ holiday
 konjektivité see konjonktivité
 konjesyon congestion
 ~ serebral stroke, cerebro-
 vascular accident (CVA)
 konjonktiv conjunctiva

konjonktivit, konjektivit conjunctivitis, pinkeye
konkav concave
konkonm cucumber; swelling or bump on head
konm see **kòm**
konman see **kouman**
konmande see **kòmande**
konmanse see **kòmanse**
konmè see **kòmè**
konn to be in the habit of, usually do something, do something regularly
konnen, konn to know, know how; to be familiar with; to recognize; to understand; to believe firmly
konesans consciousness
 gen ~ to be conscious
 gen bon ~ to be alert
 pèdl ~ to faint, pass out
 san ~ unconscious
konngout medicine-dropper, eye-dropper
konpa beat, rhythm
 kenbe ~ to have a regular heartbeat or pulse
 pa sou ~ irregular
 pèdl ~ to be irregular (pulse)
konpare to compare
konpatl to sympathize
konpè, monkonpè (male) buddy, friend
 ti ~ boy, young man
konpetan competent, capable
konplèt complete, total
konplete to complete
konplikasyon complication; side effect(s)
konplike to complicate; complicated, difficult
konpliman congratulations; compliment, praise
konpòs compost heap, mulch pit
konpòte to behave, act
konpòtman behavior, conduct
konpoze to mix, prepare (medicine); mixture, preparation
konpozisyon potion, preparation
konprann to understand; to believe
 bon ~ common sense, understanding, intelligence
konprès compress; pad
konpreyansyon comprehension, understanding; considerate-ness
konprime pill, capsule, tablet
konsa, kousa like that, like this, in that way, so, thus;
 approximately, more or less
 ~ ~ so-so
konsantl to consent
konsantman approval, consent
konsantre tense (adj.); concentrated
konsekan important; influential; consistent
konsekans consequence, result
konsepsyon conception, fertilization
konsève to conserve, keep
konsèy advice
konseye to advise; adviser, counselor
konseyè adviser, counselor
konsiltasyon consultation; medical examination
konsilte to consult; to have a medical check-up; to examine (a patient); to auscultate
konsolasyon consolation, comfort
konsole to console, comfort; to resign oneself
konsonmsyon consumption, pulmonary tuberculosis
konstipasyon constipation
konstipe constipated; to constipate
konsyan conscious; aware
kont enough; a lot of; against; tale, story; explanation; dispute
 ~ kò, ~ li one's fill, plenty, enough
 pou ~ li alone, on one's own
kontajye, kontajyèz contagious
kontajyon contagion
kontak sexual intercourse, coitus, copulation
 gen ~ to be sexually active
 (vè) ~ contact lenses
kontaminasyon contamination

kontaminen, kontamine to contaminate; to be contaminated; contagious
kontan happy, content, glad; satisfied; cash
konte to count
kontgout, konngout medicine-dropper, eye-dropper
kontinans continence
kontinye to continue
kontòsyon contortion, twisting, torsion
kontpwazon antidote; antivenin
kontraksyon contraction
kontrakte to contract
kontrè contrary, opposite; unfavorable
kontrekou repercussions, backfire
kontwòl control; check, inspection
 fè ~ to do a follow-up
 ~ Jou apre règ rhythm method (family planning)
kontwole to control; to inspect, examine
konvalesans convalescence
konvèks convex
konvenk to convince, persuade
konwè just like
konyapls nymphomaniac
konyen to fuck
kooperan foreign volunteer worker
kopl copy
koramln digitalis
kore stuffed (with food)
korèk proper, correct
 mete li ~ to fill one's stomach
korije to correct
kòryas hard, tough
kosmetik cosmetic
 operasyon ~ plastic surgery
kot? where?
kòt rib; shore; rag; rags used for mattress; ragged, shabby
 bò ~ side (of body)
 ~ a ~ side by side
kote place, area; side; near, beside; where
 a ~ aside, beside, by, next to

kl ~? where? which direction?
mete sou ~ to put aside, save
kotè cautery, cauterization
kotèks sanitary napkin
kòtizòn cortisone
kòtlèt rib (animal or human)
koton cotton
 ~ wat cotton for dressing wound
kou neck; blow, strike, hit; shock; drink; course, class; as soon as; when; as, like
banbou ~ throat, gullet, esophagus
bon ~ much, many
bwa ~ neck
dèyè ~, nwa ~ nape
gwo ~ goiter
~ manman vant cervix
~ rete nan kabann to have a crick (in one's neck)
~ souprann unexpected event; shock
~ vire stiff neck
koube to bend, bow, slouch
koubi to stoop, bend over
kouch layer; childbirth, delivery
 fos ~, movèz ~ miscarriage
pen sou ~ to be in good shape, well off
kouche to lie down, recline, go to bed; bedridden; horizontal
mete ~ to put to bed
kouchèt diaper
koud to sew; to stitch up (wound etc.); elbow
Je ~, ~ bra, zo ~ elbow
~ lanp, ~ poud, ~ zè
 Voodoo hex
koudabra elbow
koudè chill
koujln, kizln kitchen
koukouman, akoukouman to curl up (body); fetal position
koukoun woman's genitals
koule to sink; to flow; to leak, discharge, run; to strain, filter, sift; leaky
koulè color
pèdl ~ discolored, faded

koulout prick, penis
koulwa hall, corridor, passage
koulye a now
kouman, kòman, konman how
 ~ fè? how come?
koumande see kòmande
koumanse see kòmanse
kounan bowlegged (outward
 curvature)
kounde ass (anus)
kounye a, koulye a now
koupe to cut; to amputate; to cut
 off, interrupt; to dilute; to
 perform an episiotomy; cut,
 laceration; amputation
 ~ an **tranch** to slice
koupl, akoupl to crouch (down),
 squat
koupyon rump, hindquarters
 zo ~ sacrum
kouraj see kouray
kouraje courageous, brave
kouran current, flow; electric
 current, electricity; electric
 shock; usual, ordinary, everyday
kourandè draft, breeze
kouray, kouraj strength, force;
 courage, willpower,
 determination
kourl to run, flow; collective
 hysteria
 bouch II ~ dlo to salivate,
 water
kousa see konsa
kousen cushion
 ~ elektrik heating pad
kousl to shorten
kout scab; short
 ~ dan bite
 ~ klòch warning sign
 ~ lè chill
koutan obedient
koutdan bite
 bay ~ to bite
koute to listen (to); to cost
kouti stitch (wound etc.); scar
 ~ dèyè perineum
koutmen assistance, help
kouto knife; operation
 ~ operasyon scalpel

mete ~ (sou) to operate on
koutpye kick
koutpyout smallpox
koutsan stroke, cardiovascular
 accident (CVA); seizure
kouvètl cover; blanket; lid
kouvèz incubator
kouvrell bedspread
kouvrepla (metal or plastic) dish-
 cover
kouvri to cover
kouwè, konwè just like
kouwòn (dental) crown
kouyè see klyè
kouzen (male) cousin
 ~ jèmen first cousin
 ~ sou jèm second or distant
 cousin
kouzln (female) cousin
kouzlyè (male) cook
kouzlyèz (female) cook
kòwonpl to corrupt; stagnant
kòz cause; to cause
koze to talk, chat; subject, concern,
 matter
 vye ~ bullshit, nonsense
krab crab; yaws; yaws lesion
 ~ arenyen, ~ banbara
 tarantula
 ~ chèch, ~ dlo, ~ mou, ~
 vèt var. of yaws
kracha sputum
krache to spit; to spit up, cough
 up; spit; tiny bit
krachwa spittoon
krake to crack; to crack up, have a
 nervous breakdown
kran guts, courage, backbone
kràn, kranntèt see kràntèt
kranp cramp; ache, pain
kranponnen to have cramps or
 pains
kràntèt, kràn, kranntèt (interior
 of the) brain
 zo ~ skull
krap cartilage
kras dirt, filth
 ~ vant last-born child
 tl ~ (a) tiny bit, (a) very little
kravat (neck)tie

kraze fragment, crumb; small amount of money; to crush, break; to do (something) with gusto or force; to chew; to fuck; battered; shabby
kre hollow
krè see **kwè**
krebete scrawny, weak (child)
kredl credit
krèk clitoris
krèm, krenm cream; ice-cream; lotion, ointment; spermicide, contraceptive foam
 ~ **pou bab** shaving cream
kretyen Christian
 ~ **vivan** human being
kretyèn Christian woman
krevas split, crack, fissure
 gen ~ to be chapped
kreve to perforate; to lose her virginity, break the hymen
kreyòl Haitian Creole (language)
kreyon pencil
kri cry, yell; raw, uncooked
krich (earthenware) pitcher or jug
kristè enema
kritik critic; criticism; grave, critical
kriye to cry, weep
kriz emotional crisis, hysteria; fainting spell; convulsions, fit, seizure; spasm; eclampsia; epilepsy
 ~ (de) **nè** emotional crisis
 ~ **fwa** liver problem
 ~ **kè** heart attack
kwachyòkò, kwachòkò, kwatchòkò kwashiorkor
kwaf caul
kwafè barber
kwak although
kwann, kwenn pork rind
 ~ **figl** cheek(s) (face)
 ~ **janm** fatty part of thigh
 ~ **tèt** scalp
kwape to stop, prevent
kwasans puberty; period, menstruation; increase, growth, development
kwatchòkò see **kwachyòkò**

Kwa-Wouj Red Cross
kwayans belief
 vye ~ superstition
kwazad crusade, campaign
kwè, krè to believe; to trust; to think
kwen corner
kwenn see **kwann**
kwl leather; gourd bowl
 (po) ~ **tèt** scalp
kwis thigh; lap; genital area (of woman)
 zo ~ femur, thighbone
kwit to cook
kwiv copper
kwizin, kizin kitchen
kwizinyè (male) cook
kwizinyèz (female) cook
kwochl to bend; crooked, bent
mache ~ to limp
kwòk hook; long tooth
 ~ **dan** tooth (pej.); canine tooth; fang
kwoke, koke to hang up, hook up; to hang (until dead); to hug; to fuck; (reflexive) to hang oneself, commit suicide
kwòkmò see **kòkmò**
kwonk chronic
kwout crust; scab
 ~ **jòn** calculus (on teeth)
kyèd, tyèd lukewarm, tepid

L

l' see **li**
la the; alive; there; here
 ~ **a** right here
M' ~ I'm OK
laba there, over there
labab, bab beard
fè ~ to shave (face)
labèlvi (the) good life
Labib Bible
labo(ratwa) lab(oratory)
labou mud
labouyi lanmidon purgative made of laundry starch, sugar and cinnamon

- lach** loose, slack; to have loose stools
- lache** to loosen, release, untie; to let go; to relax (muscle etc.); to be incontinent (stools); to subside, go away (fever, headache etc.); to fart
- lachè** flesh, (human) body
- ladan, ladann** inside, within
- laffmen** smoke
- laffliksyon, affliksyon** affliction
- lafwerad** indigestion, upset stomach, diarrhea
- lafyèv, fyèv, lafyèb** fever
- gwo** ~ bad fever
- ~ **apre akouchman** postpartum fever, puerperal fever
- ~ **cho, ~ chwal** high fever
- ~ **deng** dengue fever
- ~ **epatik** hepatitis
- ~ **eskalatin** scarlet fever
- ~ **frèt, ~ frison** fever and chills; malaria; sensitivity to cold; general malaise
- ~ **grip** flu
- ~ **jòn** yellow fever; jaundice; hepatitis
- ~ **kabann** same as ~ **apre akouchman**
- ~ **lasezon hayfever**
- ~ **malarya** malaria
- ~ **malta** brucellosis, undulant fever, Malta fever
- ~ **nan san** same as ~ **frèt**
- ~ **nan zo** rheumatic fever
- ~ **nouris** mastitis
- ~ **palidis** malaria
- ~ **pete nan bouch** to have oral blisters
- ~ **rimatis** rheumatic fever
- ~ **san frèt** chills
- ~ **sèvo** brain fever
- ~ **sezon hayfever**
- ~ **sizè** malaria
- ~ **tifo** typhus
- ~ **tifoyid, ~ tifreyis** typhoid fever
- ~ **tranble** same as ~ **frèt**
- lagal** scabies, seven-year itch
- lage** to untie, undo; to let go, release; to exhale; to open up (nasal passages esp.); to drop out; limp, floppy
- lagoni, agoni** agony, extreme anguish; death throes; to be dying
- lagoum** pilegm; bad cold
- lagratèl** jellyfish
- lagrip** see grip
- laj** age; wide, broad; roomy
- antre nan ~** to begin menopause; to get old
- lajan** money
- lajè** width, breadth
- laji** to enlarge, widen
- lajònlis** jaundice; yellow fever; hepatitis
- lajounen** day(time)
- lakantite** see kantite
- lakat:**
- pèdl ~** to be (somewhat) crazy
- lakay** home; at home
- lakizin, lakwizin** kitchen
- fè ~** to cook
- lakòl** glue, paste
- lakonfyans** see konfyans
- lakou** yard; compound; community
- lakoutim** custom, practice
- lakòz, lakoz** reason, cause
- lakranp, kranp** cramp; ache, pain
- lakwizin** see lakizin
- lalèp, lèp** leprosy
- lalin** moon; menstruation
- wè ~ li** to menstruate
- lalwa** law; regulations
- lalwèt** uvula
- anndan ~** vocal cords
- ~ **tonbe** tonsillitis; acute respiratory distress
- lam** slide (for microscope)
- lamarye** bride
- lamè** elderly woman, old lady
- lamedsin** medical science
- fè ~** to practice medicine
- lamègrè, mègrè** skinny person
- lamègzò, mègzò** skinny person, skin and bones
- lamèl** cover glass (for microscope)
- lamemwa** memory

lamisyon mission, missionary
 post
lamizè see mizè
lamò see lanmò
lamwa (standing) wardrobe
lan the; slow; slowly; in
landrèt, landwat right side, face
 (of clothing or fabric)
lanfizèm emphysema
lang tongue; language
 ~ **ll sotl** to be about to die
 pale sou ~ to lisp
langèt clitoris
lanmè sea, ocean; womb, uterus
 bouch ~, kòl ~, kou ~,
 pòt ~ cervix
 ~ **tonbe** prolapsed uterus
 mal ~ seasickness
lanmen handshake
 bay ~ to shake hands
lanmò, lamò death
 ~ **Bondye** death from natural
 causes
 ~ **sou ll** apparently near death
lanmou love, affection
lanne, anne year
lannwit night; at night, nocturnal
 e ~ la? Did you sleep well?
lanouritl, nouritl food,
 nourishment
lanp lamp
 ~ **bòbèch, ~ tèt gridap**
 small oil lamp (made from tin
 can and without glass chimney)
 ~ **etènèl, ~ pèpetyèl** lamp
 formed by a wick floating on oil
 ~ **vè** oil lamp (with glass
 chimney)
lanse to throw, hurl; to throb,
 sting, burn
lansman stinging, smarting,
 irritation
lant, lan slow; slowly
lanteman slowly
lantèman, antèman funeral,
 burial
lanvè wrong side (of clothing or
 fabric); inside out
laparatomi exploratory surgery;
 laparotomy
lapè fear; peace
lapenn, lapèn sorrow, pain, grief;
 effort, trouble
 fè ~ to distress, grieve
laperèz, laperè fear; anxiety;
 paranoia; phobia
lapli rain
 gen ~ it's raining
lapolis police; policeman; police
 station
laponyèt:
 bat ~ to masturbate
lapòs mail; post office
lapoula right away, immediately
lapousyè dust
 metrès ~ epilepsy
lapriyè prayer; to pray
lapwòpte cleanliness; sanitation
laraj rage, fury; rabies
larat spleen; pancreas
 ~ **ll pete, ~ ll pran chòk**
 ruptured spleen
larelèv, relèv
 relief, shift (work)
 pran ~ to relieve, take over
larim mucus, snot, phlegm
de ran ~ runny nose
larivyè river; stream, brook
las asthma; phlegm, mucus; tired,
 worn out, exhausted
lase to tie up; to lace (up);
 exhausted
lasante health
lasenk arsenic
lasèt shoelace
lasl wax; sleep, eye matter;
 conjunctival discharge
laslnl arsenic; hemlock
lasistans assistance, help
lastik, elastik elastic; rubber
 band
laswè sweat, perspiration
laswenyaj, laswenyay (good)
 care, treatment
lasyès nap, snooze, siesta
latcha ass, buttocks
latchoulou diarrhea
lateng ringworm; dry (skin, lips)
latètopye from head to foot
latonm tomb, grave

latoudlin, toudlin dizziness, giddiness
latounay dizziness, giddiness (often connected with hyperthermia)
latous, tous cough
latranblad, tranblad trembling; convulsions; cerebral palsy
latrin latrine, toilet; privy, outhouse
latyouloulout diarrhea
lavabo sink, washbasin
lavaj see lavay
lavalas deluge, downpour, torrential rain
lavaryòl smallpox
lavay, lavaj washing; irrigation (of wound)
lave to wash; to irrigate (wound)
 ~ **bouch II** to brush one's teeth
 ~ **tèt II** to become dead drunk
lavi life, existence
lavman enema
lavolonte will, desire; will power
lavwa voice
lawoujòl, woujòl measles
 ~ **alman, tì** ~ German measles, rubella
lawoull (tèt) dizziness, vertigo
 ~ **kè, ~ lestonmak** nausea
lazil see azil
le every (habitual)
lè time (hour); air; attitude; appearance; when, while
 anvan ~ premature
 gen ~ to seem, appear, look like
 kannal ~ windpipe, trachea
 ~ **sa a** then, at that time
 pran ~ to get a breath of fresh air; to catch a chill
lèd ugly
ledven, lelven, leven yeast
legal legal
legede:
 bagèt ~ skinny, skin and bones
 janm ~ very thin and skinny legs
legliz church
lejè light (weight); mild, slight
lekòl school
lekti reading
 ~ **sou bouch** lip reading
lektrik, elektrik electric
lektrisite, elektrisite electricity
lelven yeast
lemajè middle finger
lemarye groom (in a marriage)
lematen, lèmaten in the mornings
 tou ~ every morning
lemò dead spirits, the departed
lemonl pneumonia
lèn see lenn
lendèks index finger, forefinger
lendèn lindane
lendi Monday
lene eldest child
lenfanjlt elephantiasis; lymphedema
lenj sanitary napkin
le-nml enemy, foe
lenn, lèn wool; blanket; groin
 bò ~ inguinal region
 gwo ~ hydrocele
lèp, lalèp leprosy
lepè old man, granpa
leptèm comb-like object placed in hair to ward off headaches
lepll rainy season
lepre leper
lesèk dry season
lesiv laundry, wash
leson lesson
lestonmak, lestomak chest; heart
 ~ **boule** heartburn, indigestion
 ~ **chaje** nausea
 ~ **louvri** same as **blskèt tonbe**
 ~ **plen** revulsion (at food)
 manyen ~ CPR, cardiopulmonary resuscitation
leswa in the evening(s)
lèt letter (alphabet; correspondence); milk
 ~ **an poud, ~ famasi, ~ sinistre** powdered milk

- ~ chèch, ~ pase mother's
 milk dried up
 ~ gate, move ~ spoiled
 (mother's) milk
 ~ jòn colostrum
 ~ monte nan tèt dried
 mother's milk accompanied by
 seizures
 ~ rapò colostrum, foremilk
 pòch ~, sak ~ "milk sack"
leta state, government; government
 officials
letajl see letèjl
letanp temple (head)
letèjl, letajl lethargy, drowsiness,
 sluggishness
lèv lip; (good) works
 gwo ~ labia majora
 ti ~ labia minora
leve to get up, arise; to wake, wake
 up, awaken; to resuscitate; to
 raise, lift, elevate; to appear
 (boil etc.); to relieve, replace
 (s.o. on duty)
 ~ chita to sit up
 ~ kanpe to stand up, get up
leven yeast
levit coat, jacket
leyèt layette
lèz strip (skin, cloth etc.)
lezo, lwezo amniotic fluid; bag of
 waters
lèzòd order, command
lezofaj esophagus
lèzòm -
 maladi ~ sickness caused by
 ill will of another person
li to read
 ~ (sou) bouch to lip read
li, l' he, she, it; his, her, its; (to)
 him, (to) her, (to) it; (reflexive
 pronoun)
 ~ menm himself, herself,
 itself
 pa ~ his, hers, its
lib free
 vant ~ diarrhea
lide, lide mind; idea; intention
 chanje ~ to change one's mind
lidekan camp bed, folding bed
llgati (twonp) tubal ligation
lljyèn, llyèn, llyenn, lljyenn
 hygiene, health practices
llkid liquid; loose, fluid, flexible
 santl ~ sl to have an acidic
 belch or gastric reflux
llm file (tool); nail file
llmyè light; vision; light bulb;
 electric current
lln menstrual period
linèt (pair of eye)glasses
 bwa ~, manch ~ frames (of
 eyeglasses); pair of (eye)glasses
 ~ bifokal bifocal lens
llnte unit
lls list, roll; smooth
llt liter
llte to struggle
llv book; pound
lly line (of persons)
llzay, llzaj manners, courtesy;
 proper hygiene
 fè ~ to be a big drinker/user of
 coffee/tobacco etc.
lò gold
lòbyè bile, gall
lòd order, discipline
lodè, lòdè see odè
lòdonans (drug) prescription
lojman lodging, shelter
lòk rag(s), tatters; strong purgative;
 locked
loke crazy, insane
lòlòj, lòlòy mental stability,
 levelheadedness
lonbray, lonbraj shadow, shade
lonbrit, lonbrik, nonbrit
 navel; umbilical cord
 gwo ~, van nan ~
 protruding umbilicus; umbilical
 hernia
 kòd ~ umbilical cord
londjè, longè length
long long
longan ointment, salve; liniment
longè, londjè length
lonje, alonje to hold out, stretch
 out
lontan for a long time
loptal hospital

Lopital Dechapèl Albert
 Schweitzer Hospital
 (Deschapelles)
Lopital Jeneral General Hospital
 of the State University of Haiti
 (Port-au-Prince)
lopyòm, opyòm opium
loray, loraj thunder
lospis shelter (for elderly or sick)
lòt other; another
lota rash
lou heavy; difficult; impure (water)
lougawou vampire-like witch
louk welt, swelling
loulou(t), youyou tapeworm
loup magnifying glass; crystalline
 lens (of eye)
louvri, ouvri to open (up); to
 begin; to turn on (radio etc.);
 sore (adj.)
lwa law, rule; Voodoo spirit
afè ~ Voodoo religion
 ~ **tèt** (one's) protective Voodoo
 spirit
maladi ~ supernatural illness
pran ~ to make one's heart
 beat faster
sèvi ~ to practice the Voodoo
 religion
lwe to rent; to rent out; to hire
lwen far, distant
lwezo see lezo
lwil oil (cooking, lubricating etc.);
 lubricant
 ~ **fwa de morl** cod-liver oil
 ~ **jiwòf**, ~ **pou dan** oil of
 cloves, eugenol

M

m' see mwen
ma seedy
 watè ~ seedy stool
mach menstruation; gait
mache open market; to walk; to
 work, function (of machine); to
 work out, succeed
bon ~ cheap, inexpensive
 ~ **ak** to bring

~ **bwete** to limp
 ~ **gaye** to spread rapidly
 ~ **kwochi** to stumble
 ~ **pado** to walk backwards
machè (fem.) my dear (used only in
 direct address)
machin machine; car; dentist's drill
 ~ **a ekri** typewriter
machwè, machwa jaw
 ~ **dejwente** dislocated jaw
 ~ **rèd**, ~ **sere** lockjaw,
 tetanus
mal ~ mumps
zo ~ jawbone
madam see madanm
madan Mrs. (title)
 ~ **sara** woman who transports
 and sells merchandise
madanm, madam (legal) wife
ti ~ male homosexual (passive
 role)
madi Tuesday
madichon curse, hex, jinx
madivlnèz lesbian
madmwazèl, matmwazèl young
 lady; miss (title)
madoda homosexual
madougou(n) hydrocele
madoulè abused or neglected
 person; battered, dilapidated;
 ugly, misshapen
sèkèy ~ cheap or badly built
 coffin
mafi (my) daughter, girl (used only
 in direct address)
maflore, mafflori mature woman
 with very sporadic or no
 menstruation; to be amenorrheic
mafweze, mafwezi, mofwezi
 physically retarded, puny,
 misshapen
magazen store, shop; warehouse,
 depot
magoul mug, kisser, face; double
 chin
magre, malgre in spite of
majè of age; mature, adult
majik magic
majò grenn scrotum and testicles
mak scar, mark, spot; tattoo

- makawon** ugly; mean; vicious;
 fierce; severe; bad-tasting; awful,
 disgusting
make to mark, indicate; to spot
 (between menstrual periods); to
 tattoo
maklouklou hydrocele
makoklen self-sufficient bachelor;
 male homosexual
makòmè, kòmè, konmè (fem.)
 good and close friend
 (tl) ~ girl, young woman
makoubl crooked, twisted (fingers
 etc.)
makwall bad-looking person;
 deformed, misshapen
mal evil; harm, hurt; wrong;
 sickness, illness; trunk,
 footlocker; large suitcase; male;
 bad; badly
 (an) ~ **makak** hangover
 fè ~ to hurt, harm, injure; to
 ache, hurt
 fè tèt li ~ to harm oneself; to
 attempt suicide; to commit
 suicide
 ~ **damou** lovesickness
 ~ **dan** toothache
 ~ **do** backache
 ~ **gòj** sore throat
 ~ **kamyon, ~ machin**
 carsickness, motion sickness
 ~ **lanmè** seasickness
 ~ **makak** hangover
 ~ **mouton** mumps
 ~ **pou ...** to have difficulty
 (in doing something)
 ~ **tèt** headache
malad sick, ill, diseased; sick
 person, patient, invalid; sore,
 wound; sore (adj.)
 ~ **kouche** bedridden
maladi sickness, illness, ailment,
 disease; sick person, patient,
 invalid
gwo ~ malignancy
 ~ **anfle** kwashiorkor
 ~ **Bondye** natural illness (as
 opposed to supernatural)
 ~ **chabon** anthrax
 ~ **chèch** pellagra
 ~ **djondjon** fungal infection
 ~ **do** backache
 ~ **doktè** natural illness (as
 opposed to supernatural)
 ~ **finl anwo de pye**
 tuberculosis
 ~ **gate vanyan!** Don't worry!
 You'll get better soon!
 ~ **gwo kou** goiter
 ~ **kenhenk, ~ kenkenk**
 tuberculosis
 ~ **kò anfle** kwashiorkor
 ~ **kò chèch** marasmus
 ~ **kokobe** polio
 ~ **kò rèd** tetanus
 ~ **kriz fit**, seizure
 ~ **(la)tranblad** cerebral palsy;
 trembling; convulsions
 ~ **lèzòm** sickness caused by ill
 will of another person
 ~ **lwa** supernatural illness
 ~ **machwè (sere)** lockjaw,
 tetanus
 ~ **malouk** sickness caused by
 evil spirit (Voodoo)
 ~ **Moylz** hemorrhoids
 ~ **natrèl, ~ peyl** natural
 illness (as opposed to
 supernatural)
 ~ **pa tete** tetanus
 ~ **poumon, ~ pwatrin, ~**
pye chèch, ~ san fanmi
 tuberculosis
 ~ **sik** diabetes
 ~ **tèt** headache
 ~ **tèt anfle** meningitis
 ~ **tl kay** tuberculosis
 ~ **timoun anfle** kwashiorkor
 ~ **tonbe** epilepsy
 ~ **touse** tuberculosis
 move ~ tuberculosis;
 malignancy
 pase ~ to be sick
maladi! sickly, chronically ill
malangi to stunt (one's growth); to
 become stunted; sickly, rundown
malarya malaria
malbouch perlèche, crack or sore at
 corner of mouth

malchans bad luck
maidan toothache
maidanfans labor (pains)
maidevope to be stunted
maldezo rheumatism
maldjòk, maldyòk evil eye, evil spell, hex
maldo backache
maldyòk see **maldjòk**
malè misfortune, disaster; accident, mishap
fè yon ~ sou to injure (someone) severely
malediksyon curse, hex, jinx
maleng (infected) sore, (ulcerating, weeping) lesion
malere poor, unfortunate, destitute; poor or unfortunate man
malerèz, malèrèz poor woman, unfortunate woman
malèt suitcase
malèz discomfort
malfektè evildoer
malfèt badly made; deformed, misshapen
malfezans dirty trick; witchcraft, sorcery
malfòmè deformed, misshapen
malgòj sore throat
malgre, magre in spite of
malkadl epilepsy
malmakak hangover
malman not so well, rather badly, poorly, barely
malmanje malnutrition; malnourished
malmouton mumps
malniri see **malnouri**
malnitrisyon malnutrition
malnouri, malniri malnourished, undernourished
malodan toothache
maloje, malozye conjunctivitis, pinkeye
malouk repulsive, ugly, disgusting; deplorable; bad, serious, grave; quite difficult, tough; coarse, harsh; badly made, badly done
malozye see **maloje**

malpas postpartum tetanus
malpwòp messy, dirty, unclean
malpwòpte filth, dirt; excrement
malsen unhealthy, unwholesome
malsite misery, poverty, misfortune, deprivation
malswen sickly person; careless person; ugly or slovenly man
maltèt headache
malvant stomach ache
malvi incurable
malvini puny, stunted; underdeveloped, undernourished
malzòrèy earache
mamòte to mumble, mutter
manbo Voodoo priestess
manbre strong, hefty, strapping
manch handle; sleeve
 ~ **linèt** temples (of eye-glasses)
 ~ **pilon** pestle
manchèt machete; cuff
mande to ask, ask for; to require, need
 ~ **padon** to apologize, ask forgiveness
mangonmen, mongonmen to get worse; complicated; critical, grave
manjab edible
manje food; meal; to eat; to irritate, chafe; to mutilate; to kill, destroy
fè ~ to cook
gwo ~, ~ chodyè (cooked) adult food
 ~ **aswè** supper, dinner, evening meal
 ~ **dan** to grind or grit one's teeth
 ~ **gate** food poisoning
 ~ **maten** breakfast
 ~ **mizè** to suffer greatly
 ~ **ranje** (deliberately) poisoned food; food poisoning
 ~ **sote** to eat only when one can (afford it)
manjèdtè geophagist, earth eater
manjezon itching sensation; pain

mank mistake; lack, deficiency; to lack
manke to nearly, just about, almost (do something); to fail, miss; to lack
mankman lack, need
manm member; limb (arm, leg); strength
 gen ~ to be solid or strong
 ~ **mò** paralyzed limb
 pran ~ to regain strength, put on weight
manman mother
 ~ **pltit** common-law wife
 ~ **vant** placenta, afterbirth
manmzèl woman, lady; she, her; miss; the lady in question
mànòk tobacco
mantal mental
mantl, **mantò** lie, falsehood; to lie, tell lies
manton chin
 tl ~ receding chin
manyè, **menyè**, **mèyè** rather, sort of, somewhat, more or less, a little
mànyè masseur; bone-setter
manyen to touch, feel, handle; to palpate; to massage; palpation, manipulation
mànyèz masseuse; bone-setter (fem.)
manzè miss; (respectful title for older unmarried woman)
maras marasmus
marasa twin(s)
 ~ **kat** quadruplet(s)
 ~ **kl pa sanble** fraternal or dissimilar twin(s)
 ~ **kole** Siamese or conjoint twin(s)
 ~ **senk** quintuplet(s)
 ~ **tèt koupe** identical twin(s)
 ~ **twa** triplet(s)
mare to attach, fasten, tie; overcast (weather); in trouble; in a fix; clumsy, awkward
marengwen mosquito
marenn godmother
marl (legal) husband
marfjàn, **marlwana** marijuana
maryaj, **maryay** wedding, marriage
marye, **maye** married
 ~ **ak** to marry, get married to
mas mask (for surgeon or patient); March
masay, **masaj** massage
 bay ~, **fè** ~ to massage
 pran ~ to be massaged
mase to massage; to be massaged
masè nun; sister (within a given faith); masseur
masèz masseuse
masisl male homosexual, gay
masketi, **maskiti**, **maskreti**, **maskriti** castor-oil plant
 lwil ~ castor-oil
masòkò misshapen, ill-formed
matant, **tant**, **tantann** aunt; (title of address for elderly woman)
 ~ ~ great-aunt
maten morning
 bon ~ early morning, before sunrise
matènite maternity hospital or ward
matl extreme suffering, torture
 pase ~ to suffer
matla mattress (made of cotton, foam rubber etc.; cf. **payas**)
matlòt co-wife, women who share same man
matmwazèl see **madmwazèl**
mato hammer
matris womb, uterus
 bouch ~, **kòl** ~, **kou** ~, **pòt** ~ cervix
 tib ~ Fallopian tube(s)
matwon male nurse (esp. for birthing)
matwòn government-trained midwife
matyè matter; material; subject; discharge, pus, matter, exudate
 ~ **fekal** excrement, fecal matter
mawon brown
mayas foot odor

maye see **marye**
mayezi milk of magnesia
mayezyòm magnesium
mayilò dizziness, wooziness
mayo T-shirt (with sleeves)
mche see **msye**
me May
mè(vant) placenta, afterbirth
mèb furniture
 mete ~ **nan koutl** to start
 teething
meble to furnish
 ~ **bouch ll** to acquire a
 denture
mèch lock (of hair); wick
mechan, mïchan mean, cruel,
 evil; naughty; big; persistent;
 difficult
medam women, ladies
 ti ~ young ladies, girls
medikal medical
medikaman medicine, medication
medsen physician, doctor
medsin medical science; see
 metsin
mefyan mistrustful, suspicious
mèg skinny, gaunt, lean, thin
mègrè, lamègrè skinny person
megrì to lose weight, grow thin
mègzo, lamègzo skinny person,
 skin and bones
mèkl mercury
mèkondoleyans my condolences
mekontan unhappy
mèkredl Wednesday
mekte to moisten, dampen
melanj mix, mixture, blend,
 variety
melanje to mix; to mess up; to
 confuse
mele to mix, blend; to be in trouble
 kl ~ **m'**! What do I care! So
 what!
mèlkiwokòm mercurochrome
memwa, menmwa memory
men hand; handful; here is, here are;
 there is, there are (pointing out);
 but, yet
 do ~ back of hand
 pla ~ palm (of hand)

sere ~ to wring one's hands
menaj see **mennaj**
menaje to spare, protect, treat
 kindly
menasan threatening
menay see **mennaj**
menm even; self; same, identical
 pa ... ~ not at all
menmwa see **memwa**
mennaj, menaj, menay
 boyfriend, girlfriend
mennen to take, lead
mennenjlt meningitis
menopòz, menopoz menopause
mens slim, thin, slight
menyè see **manyè**
meriken American
Merikèn American woman
merite! you're welcome!
mesaj message
mesajè, mesaje messenger
mèsi thanks, thank you
mesken (regional word) warts
mesye mister; sir; man, companion
 (ti) ~ (young) man, guy
met see **mete**
mèt master; school teacher; owner;
 meter (measure); tape measure;
 may (permission)
Gran Mèt God
 ~ **kò, ~ mò** person
 responsible for the deceased
 ~ **vant** placenta, afterbirth
metal metal
mete, met to lay, put; to put on
 (clothes); to place; to take
 (time); to start to
 ~ **apa** to quarantine, isolate
 ~ **atè** to give birth
 ~ **deyò** to excrete
metòd method, procedure, process
 ~ **tanperatl** rhythm method
mètri, metri to bruise
metsin, medsin laxative,
 purgative
 ~ **chwal** potent medicine
mètvant placenta, afterbirth
metye trade, occupation
 nan ~ homosexual
mè(vant) placenta, afterbirth

meyè better
mèyè see **manyè**
mezanmi! wow! man! good grief!
mezl measurement; size (clothing);
 measure, quantity; as much (as);
 all (the); enough
mezlre to measure
ml wall; ripe
michan see **mechan**
midl noon, midday; break, time-out
migrènn, mlgrèn (any) serious
 headache; migraine
mikèz mucous membrane
mikte, mekte to moisten, dampen
mikwòb microbe, germ, bacteria,
 organism
mikwòkòp microscope
ml (one) thousand; mile
milat (male) mulatto
milatrès (female) mulatto
milèt mule; sterile woman (pej.)
milligram milligram
millit milliliter
millmèt millimeter
milpat, milpye centipede
mitipliye to multiply
miml **miml, fè** to see spots (in
 front of one's eyes)
min facial appearance, countenance;
 wrinkle, furrow
 mare ~ to frown
minab wretched, pitiful; shabby,
 seedy
minè minor, adolescent
minen to wear down, weaken; to
 sap, drain, undermine
mineral mineral
minit minute (time)
minwl, minwlt midnight
mirak miracle
mis (female) nurse; lady, miss
mis, misk muscle; coccyx
 ~ **dèyè, zo** ~ coccyx
 ~ **tonbe** to have lower-back
 pain
mistè Voodoo spirit(s); spirit
 retribution
misye see **msye**
misyonè, misyonnè missionary
mitan middle

miwa mirror
miyò, meyè better
mize to dillydally, linger, dawdle,
 waste time; to bet, stake
mizè, lamizè poverty, misery,
 suffering
bat ~ to have a hard life
fè pase ~ to mistreat; to
 torture
pase ~ to suffer, have a hard
 time
mizèrikòd mercy
tl ~ small boy's penis
mo word
gwo ~ dirty word, foul word;
 foul language
mò corpse, cadaver; evil spirit; dead;
 numb
 ~ **rèd** rigor mortis
voye ~ to cast an evil spell
modan toothache
mòde to bite; to sting; to hurt, be
 painful; to succeed, be
 successful; bite, sting
 ~ **dan** to bite down
 ~ **lage** to be intermittent,
 spasmodic, feel intermittent pain
modtèt headache
mòfln morphine
moŵezl see **mafweze**
mòg morgue; funeral parlor
mòko deaf; very stubborn
mòl soft, tender; languid, indifferent
molas listless, apathetic
molè molar
molekil molecule
mòlèt calf (of leg)
moll to soften, weaken
mòlòkòy lethargic, sluggish
mòltonn tired, weak, languid
molyann softening, mollescent
moman moment, instant, second
mòn mountain, small mountain;
 hill
monchè (mas.) my friend; man!
 (used only in direct address)
mòne stillborn
mongonmen see **mangonmen**
monkonpè see **konpè**

monnen change, small change
 (money); coin
monnonk uncle
monpè father, reverend (address);
 priest
mont watch (timepiece)
monte, moute to climb, mount;
 to go up; evil, magic (adj.)
 ~ **kabann** to go to bed
montl mount (horse etc.); frames
 (of eyeglasses)
montre, moutre to show, point
 out; to teach
monyon stump (of arm, leg); dull
 knife
mòp mop
mòpyon pubic louse, crab
moraji, emoraji bleeding,
 hemorrhage; great pain
moso, mòso piece, part, fraction
mòsovít slide (for microscope)
mòtallite death; mortality rate
motè motor, engine
mòtèl mortal, deadly, lethal
motèt headache(s)
mou soft; tender; flaccid
mouch fly (insect)
mouche see **msye**
 ~ **nen ll** to blow one's nose
mouchwa handkerchief; kerchief,
 headscarf
mouda, mounda ass, buttocks;
 genitals (female); base, bottom
 (fam.)
moulen mill, grinder; to chew
moun person; people; family,
 friends; human (adj.)
kl ~? who? whom?
 ~ **andeyò** country folk
 ~ **vlnl** outsider, stranger
tout ~ everyone
mounda see **mouda**
mouran dying
mouri to die; to become numb, go
 to sleep, have pins and needles
 (arm, leg etc.); to numb; dead,
 lifeless
bò ~, demi ~ partially
 paralyzed
 ~ **bon mò** to die a natural
 death
 ~ **frèt** to drop dead, die
 suddenly
 ~ **grangou** to starve
 ~ **kite** durable, sturdy,
 resistant, long-lasting
 ~ **kò** to keep quiet, calm down
 ~ **tèt nwè** to die a violent
 death
mous (contraceptive) foam
mousa weak, wobbly
moustach mustache
moustik small mosquito, gnat
moustikè mosquito net(ting)
moute see **monte**
mouton sheep
 mal ~ mumps
moutre see **montre**
mouvman movement, motion
fe ~ to move, be in motion
mouye to wet; to dampen, moisten;
 wet, damp
 ~ **kanson** to come in one's
 pants
 ~ **kilòt** to have a vaginal
 discharge
move bad; cross, irritable; angry,
 furious; ill-tempered; evil;
 unpleasant; nasty
movèz (fem.) see **move**
movezalèn bad breath, halitosis
movezè, movèzespri evil spirit
movèz(kouch) miscarriage
mozaylk tile floor
msye, mche, mlsye, mouche
 mister; sir; gentleman; husband;
 he, his, him
mwa month; period, menstruation
gen ~ to menstruate, have
 one's period
mwal see **mwèl**
mwatye half; half way; middle;
 one-fourth (of rum bottle)
mwayen means
manke ~ to lack the means (to
 pay)
mwazi see **mwezi**
mwèl, mwál bone marrow; core;
 backbone; courage, strength

manman ~, ~ **tèt** brain
mwèn, m' I, my, (to) me;
 (reflexive pronoun)
 ~ **ou** if I were you
mwens, mwèn minus, less
mwezl, mwazi moldy; mold
mye better
fè ~ to recover, get better
myèl bee
siwo ~ honey
myòp nearsighted, myopic

N

n' see **nou**
nad nothing (as object)
 ~ **marinad** impotent
nan, lan the; in; through
nandòmí asleep
nanm soul
 move ~ evil spirit (Voodoo)
nannan interior, recesses, insides
 (of); spunk; food (baby talk);
 female genitals; to eat (baby
 talk)
 ~ **je** pupil (of eye)
nanpwèn there is/are no, there
 is/are none
napkin paper napkin, paper cloth
nat sleeping-mat
natí nature, character
 ~ (yon fi) vagina
natirèl natural
natirèlman naturally, of course
nawè eye
n' a wè see you, good-bye
ne knot (string; plant, wood etc.);
 loop; to be born
 ~ **gòjèt** Adam's apple
 ~ **pijon** dorsal vein of penis
nè nerve; neuro-; nerves,
 nervousness
nechèl ladder
nèf new, recent
nefretik nephritic
nefrít nephritis
nèg man, male; black man; guy
gran ~ big shot, VIP
gwo ~ big shot, VIP; big
 strong man

negatif negative
nègès, nègè woman, girl; black
 woman
ti ~ young woman, woman
neglijans negligence, carelessness
nemoni pneumonia
nen nose; dwarf, midget
anndan ~ nasal passage(s)
bwa ~ nasal bone; nose
do ~ nasal ridge
 ~ **jako** aquiline nose
 ~ **kankan** turned up nose
 ~ **koule** runny nose
tou ~, **twou** ~ nostril
zèl ~ (sides of) nostrils; nose
zo (bwa) ~ nasal bone; nose
nennenn godmother
nènpòt, kènpòt anyone,
 whatever, no matter (what)
 ~ (kl) **jan** however
 ~ (kl) **kote** wherever
 ~ (kl) **lè** whenever, anytime
 ~ (kl) **moun** anyone;
 who(m)ever, no matter who(m)
nesans birth; heredity
nesesè necessary
net neutral
nèt clean; quite, completely,
 thoroughly
nètale completely, thoroughly,
 totally, utterly
netwayab washable
netwayaj cleaning (of teeth)
netwaye, netye to clean
 ~ **gòj li** to clear one's throat
neve, nìve nephew
ti ~ great-nephew
nève nervous
nevralji neuralgia
neye, nwaye to drown
ni naked, nude; bare
nik only, just
nikotín nicotine
nimewo number; size (clothing)
nirítí food, nourishment
nitrat ajan silver nitrate
nitrisyon nutrition
nitrisyonis nutritionist
nìve nephew
noma noma

nòmai normal, natural
nòmaiman normally
non no; name
 ~ **batèm** Christian name
 ~ **fabrik**, ~ **mak** brand name
 ~ **gate**, ~ **jwèt** nickname
 ~ **kalite** generic name
 ti ~, **vye** ~ nickname
nonbrit see **lonbrit**
nonk uncle
nonm man, guy; (common-law) husband
nou, **n'** we, our, (to) us; (to) you (plural), your (plural); (reflexive pronoun)
nouri to nourish; to feed
nouris mother in breast-feeding; wet-nurse
 gwo ~ nursing mother whose child has begun to walk
 ti ~ nursing mother whose child has not yet begun to walk; confinement or lying-in period (after giving birth)
nourisan nourishing, nutritious
nouriti, **lanouriti**, **niriti** food, nourishment
nouvo new; modern
novanm November
noze nausea
nwa, **nwè** black; dark, darkness; testicles (fam.)
 li fè ~ it is dark
 wè tout ~ to be giddy or dizzy
nwakou neck bone, cervical spine; nape
nwaye, **neye** to drown
nwè see **nwa**
nwi to annoy, harm
nwit night
 ~ **blanch** sleepless night
nwizib annoying, bothersome, obnoxious, deleterious
nyès niece
 ti ~ great-niece; little niece

○

ò, **lò** gold

santim ò U.S. cent, U.S. penny
obeyi to obey
obeyisan obedient, docile
oblilje, **bije**, **bilje** to be obliged to, required to, have to; to compel, force
òdanje out of danger, off the critical list
odè, **lodè**, **lòdè** odor, scent; (bad) smell; perfume, fragrance
òdinè ordinary, usual
òdonans, **lòdonans** (drug) prescription
òfelen (male) orphan
òfellin (female) orphan
òfelina orphanage
òfraje to get hurt; to wreck, demolish
ògàn organ (body); voice
òganik organic
ogmante to increase
okabine, **okabinen** stool, excrement; to have a bowel movement
Okanada, **Kanada** Canada
okazyon occasion
oke OK, all right
okenn (not) any
òkèt, **hòkèt**, **wòkèt** hiccup(s)
òkipe, **ekipe** to take care of; to manage; to pay attention to, take notice of; busy; occupied, taken
òklizyon entestinal intestinal obstruction
òksid kabòn carbon monoxide
òksijèn oxygen; oxygen tank
òksilyè paramedic, practical nurse, nurse's aide, public health nurse, auxiliary, primary health worker
òksiyi pinworm, threadworm, enterobius
òktòb October
òlidmò (on one's) deathbed
òlye instead of, rather than; toilet, outhouse; to go to the bathroom
òmòn, **òmòn** hormone
òmoplat shoulder blade, scapula
òmwen, **òmwen** at least

onè, onnè anybody home?
onè? ... respè! honor (to
 announce one's desire to enter a
 home) ... respect (the reply to
 enter)
ons ounce
opak opaque
operasyon surgery; operation
fè ~ to undergo surgery
fè (yon moun) ~ to operate
 (on someone), perform surgery
on
opere to undergo surgery; to operate
 on, perform surgery
opresyon shortness of breath;
 asthma; hyperventilation;
 anxiety; oppression, abuse
opsèvasyon observation
optik optic, optical
optiswen to be cared for, be well
 looked after
optisyen optician
opyòm opium
oral oral
oranj orange (color)
orevwa good-bye
oreye pillow; see **zdrye**
oreyèt auricle (of heart)
orizontal horizontal
ose, wose to raise, make higher
oslon or
oslè knuckle
oswa or (either)
ote see **wote**
otesl acidic belch, gastric reflux
otit otitis, ear infection
òtopedl orthopedics
òtopedis orthopedist
otopsl, topsl autopsy; to do an
 autopsy
otoskòp otoscope
ou (to) you (singular), your (of one
 person); (reflexive pronoun); or
oubli oversight, omission,
 forgetting
oubyen or
oungan Voodoo priest
ouvè to open; sore
ouvètl opening, hole, orifice
ouvri see **louvri**

ovè ovary
ovli ovule
ovilasyon ovulation
Ozetazini, Etazini United States
 of America

P

pa step; share, portion; not; by; per;
 (possessive indicator)
 ~ **ankò** no longer, (not) any
 longer; no more, (not) any more
 ~ **bak** backwards, in reverse
 ~ **li** his, hers, its
 ~ **mwen** mine
 ~ **nou** ours; yours (plural)
 ~ **ou** yours (singular)
 ~ **yo** theirs
pachman badly washed; badly
 done
maleng ~ skin sore
pafen perfume
pafouten, fafouten sideburns
pafwa sometimes
paj page
pakèt package, bundle
 yon ~ much, many
pal pale, faded; light shade (of color)
pale to speak, talk
 ~ **ba** to whisper
 ~ **nan dan** to mumble
 ~ **sou lang** to lisp
 ~ **tranble** to have a wavering
 voice
palèt palate; back of the throat
 ~ **do** general shoulder area
ti ~ spatula; tongue depressor
pall to become pale
palldis malaria
pàn breakdown (machinery)
 leve ~ to fix or repair
 (machinery)
pa gen ~ (there is) no
 problem; you're welcome
pran ~ to break down, stop
 functioning (machinery)
panari, pannari felon, whitlow
panche to lean (over), bend over
pandan while, during

pandje, pandye to hang, hook;
 hanging; sloping
pandri clothes rack; closet
pandye see **pandje**
pankreyas pancreas
panmen to cry very loudly; to
 almost faint from crying
pann to hang (up); to hang down
 ~ **vant** paunch, potbelly
pannarí, panarí felon, whitlow
pans belly, stomach
manman ~ rumen; belly,
 stomach
panse to think, believe; to bandage,
 dress a wound; thought
pansman bandage, surgical
 dressing; band-aid
tl ~ band-aid
pantalèt panties
pantalon pants, trousers
bout ~, ~ **kout** shorts
pantan to jump, be startled; scared;
dazed
pantouf (bedroom) slipper; sandal
panye, panyen basket
panyòl Spanish; Hispanic
Panyòl Dominican Republic;
 Dominican citizen; Hispanic
 person
papa father; huge; man! wow!
 ~ **pitit** common-law husband;
 father of one's child
papèl goiter; double chin
papl pop, dad, daddy
paplyon butterfly; moth
 ~ **adezif** 'butterfly' bandage
papye paper; legal document,
 certificate
 ~ **ljenik, ~ jenik** toilet
 paper
paralezi, paralizi paralysis
 ~ **enfantil** infantile paralysis
 ~ **serebral** cerebral palsy
paralitik paralytic; paralyzed
paralize to paralyze, be paralyzed
paralizi see **paralezi**
paran parent; relative; derivative
paravan folding screen
parazit (andan) (internal) parasite
pare to be ready; to get ready,
 prepare; ready, prepared
parenn godfather
parès laziness, sloth; lack of energy
parese lazy
parèt to appear, show up
parèy like, similar
pas lockjaw, tetanus
pasaj, pasay passage, opening
nan ~ location of baby about
 to be born
pase to pass; to pass by; to pass,
 spend (time); to smear on; to
 have experienced, have already
 suffered, have been through
 already; to happen; last, past;
 than; because
 ~ **dat** to be expired, be past
 expiration date, be out of date
paske, pase because
pastè pastor, Protestant minister,
 preacher
pasterize to pasteurize, sterilize
pastil drop, lozenge, pastille
paswa strainer, sieve; leaky
pasyan (n./adj.) patient
pasyante to be patient
patapouf fatso, butterball
patdan(tifris) toothpaste
patè funeral wake
patil part; section; genitals
lespri ~, **tèt** ~ crazy
 ~ (**sansib**) genitals, private
 parts (male); penis
vwal twou ~ **yon fl** hymen
pay straw; misery, suffering
payas straw mattress
pazapa step by step, gradually
pe see **ap**
pè priest; pair; old man (affectionate
 title); fear; to fear, be afraid (of);
 to be nervous
fè ~ to frighten; to enter
 priesthood
 ~ **savann** unordained or
 informal priest
pran ~ to become frightened
pèdans loss, deficit; miscarriage;
 continual flow of menstrual
 fluids, menorrhagia

pederas, **pede** homosexual
pedevi, **petevi**, **potovi** sickly
undersized child; runt,
weakling; frail, puny
pèdl to lose; to get lost, be lost
ka ~ beyond recovery
~ **fil** to regress, go backward
~ **konnésans** to lose
consciousness, faint
~ **pye** to lose ground
pediki pedicure
pèdlsyon continual flow of
menstrual fluids, menorrhagia;
false pregnancy; (non-apparent)
miscarriage; unusual menstrual
periods and/or general pelvic
discomfort
pedyat pediatrician
pedyatrik pediatric
pekto(wo) pectoral muscles
gwo ~ barrel-chested
pelagra pellagra
pellsilin, **penlsilin** penicillin
peman payment
pèmanan permanent
pèmèt to permit, allow
pèmlyson permission,
authorization
penlb painful; distressing
penis penis
penisilin, **pellsilin** penicillin
penn pain, difficulty; grief, sorrow
pens pincers, tweezers; pliers;
tongs; forceps (med.); hair pin;
clothes pin
pensèt tweezers; tongs; cotton
pliers
peny comb
penyen to comb
pèp people, nation
peple to bear children; to multiply,
breed
pèrèz, **perèz** fright, fear; fearful,
skittish; shy, timid
perl to perish; to waste away; to
drown
peritonit peritonitis
perizl pleurisy
peryòd period, time; period,
menstrual cycle
pèse to pierce, perforate
pèsekisyon persecution
pèsistan persistent, stubborn
pèsonèl, **pèsonnèl** personal;
private
pès-zòrèy earwig (parasite)
pèt loss; discharge; vaginal
discharge
~ **dlo** dehydration
petadò (frequent) farter
pete to crack, split, rupture, break
open, burst; to blow up,
explode; to puncture, perforate;
to fart; to break out, burst out
(doing something)
~ **fyèl** backbreaking
~ **je** to blind
petèt, **pètèt** perhaps, maybe
petevi see **pedevi**
pèvès perverse, perverted, depraved
peye to pay
peyl country, nation, land; region,
district
ale nan ~ **san chapo** to die,
pass away
~ **a** Haiti
voye nan ~ **san chapo** to
kill
pèz scales (weight); weight; value,
importance; burden
pran ~ to weigh, judge,
examine
pezape gradually, little by little
pezay weighing
peze to weigh; to press, squeeze,
push down; to compress
pezlb peaceful
pl well (water); pus, discharge; pure;
more (comparative); most
plchkannen to pinch
plchplch to squint
pideml epidemic
plga see **plnga**
plgatlf commercial laxative
plj purge, purgative; pus; secretion
pljama pyjamas
pije see **prije**
pljon, **(ti)pljon** penis
pikan thorn; sting

- pike** to hurt, be painful; to burn (sun, medicine etc.); to sting, prick; to inoculate; to stab, wound; to swipe, steal; to kill by magical means; sting, prick; spicy, hot; strong (alcohol); decayed (tooth)
- plki** injection, inoculation, shot
~ **planing** contraceptive injection
~ **rapèl** booster shot
- plkiris** injectionist
- plkotman, plkòtman** itch, prickly sensation, tingling; smarting, stinging; allergic reaction
- pil** pile, heap; pill (medicine); battery (radio etc.);
yon ~ many
- pile** to crush, grind, pound; to eat heartily
- pilll** pill
- pin** peg, pin; penis
- pinèz** bedbug
- pinga, plga** don't (you) ever, watch out for (negative), take care (not to)
~ **seren** slow-acting poison
- plnokyo** hard-on (erect penis)
- pip** pipe (for smoking)
- pipcho** penis (vulgar)
- pipèt** pipette (chemistry)
- pipl** urine; to urinate; to drip, dribble
aparèy ~ urinary tract
blad ~ bladder
chemen ~, **kannal** ~ urinary tract; urethra
fè ~ to urinate
gen yon ~ **ki kenbe II** to have an urgent need to urinate
~ **chat** a few drops
~ **dous** to have sugar in one's urine, be diabetic
~ **jòn** jaundice
~ **nètale** incontinent; incontinence
~ **nwa** black-water fever
~ **rapid** frequent urge to urinate
~ **wouj** dark urine; jaundice
sak ~ bladder
tou ~, **twou** ~ meatus (of penis)
- pipich, pipit** penis (fam.)
- pipils** more; most
- pire** to squeeze, extract juice; to leak, discharge; purulent
- pirifye** to purify
- piriji:**
fòs ~ tetanus, lockjaw
- pls** flea
- plsa** urine
- plsannit** bed-wetter
- plsans gason** virility
- plse** to piss; piss; (fam. form of **pipl**, q. v.)
- plske** since, because
- piston** penis (fam.); plunger (of syringe)
- plswa** urinal
- plta** later
- plten** whore, slut
- plti** small, little
~ ~ gradually
vin ~ to lose weight
- pltit** child; young person
fè ~ to have children
jete ~ to abort, have an abortion
manman ~ (unwed) mother; mother of one's children
~ **deyò** illegitimate child; child born outside of one's present union
~ **fi** daughter (of any age)
~ **gason** son (of any age)
~ **ki pa rekonèt** illegitimate child; fatherless child
~ ~ grandchild; offspring
~ ~ **fi** granddaughter
~ ~ **gason** grandson
~ ~ ~ great-grandchild
~ **sòyèt, sòyèt** poverty-stricken, deprived or underprivileged person
premye ~ eldest child
- plitral** prolific, fertile, fecund (male or female)
- pito** to prefer; rather

pitwit hayfever
pltye pity
plyore pyorrhea
pla dish, course (food)
plafon ceiling
plak patch, spot; disc; welt;
 dentures; coating, film
plakèt vè glass slab (dental)
plaksan (blood) platelet
plamen, planmen palm (of hand)
planche (wooden) floor; ceiling
planin, planing family planning,
 planned parenthood
 fè ~ to practice birth-control or
 family planning
planmen palm (of hand)
planpye see **plapye**
planton orderly (hospital)
plapye, planpye sole (of foot),
 plantar surface
plas space, place
plasaj, plasa common-law
 marriage, cohabitation
plase to contract a common-law
 marriage, live together
plasenta, plasenta placenta,
 afterbirth
plasma plasma
plastè poultice, plaster (medical);
 adhesive tape
plastik plastic
 operasyon ~ plastic surgery
plat flat; thin, emaciated; even,
 smooth; horizontal; plaster cast
plata to wipe out, kill off
plati to flatten, even off
plato surgical instrument tray
plè to please; sore, injury
plede to persist in, do something
 continually
plen to fill; full; swollen
 kè ~ nausea
plenn to moan, groan; to grunt (in
 respiratory distress)
plènsenti pregnant (advanced state)
plient complaint
 fè ~, pote ~ to make a
 complaint against, lodge a
 complaint

plenyen to complain, lament,
 moan
plerèz (female) mourner
pierezi pleurisy
plètli, etli yes? (polite reply); I
 beg your pardon? What did you
 say?
plèv pleura
plezante to kid, joke
plezi pleasure, amusement;
 satisfaction; party, bash, shindig
 fè ~ to please, cause pleasure;
 to satisfy, reward
 pran ~ ak to tease, annoy; to
 make love with
pli wrinkle, crease, fold
plim body hair; pubic hair;
 (writing-)pen
 pouse ~ to reach puberty
plimen to harm; to screw, fuck
plimje eyelash(es)
pliplip movements of fetus in
 womb
plis more; most
plise to fold, crease; to wrinkle
 (face, skin)
pliske, pliske since, because
pllye, ploye, plwaye to bend,
 fold
plizoumwèn(s) more or less
plizyè several, various; many
plòg plug, socket; IUD (intrauterine
 device)
ploge to plug in, connect
plon lead (metal); (dental) filling
 ~ **gaye** buckshot; broad-
 spectrum
plonba (dental) filling
plonbe to fill (a tooth)
plonbri plumbing
plonbye, bòs plonbye plumber
plòt glob, plug (excrement; spittle;
 phlegm); flabby, slack
ploup-ploup sound of fetus
 kicking in womb
ploye, plwaye to bend, fold
po skin; specimen cup; pitcher;
 chamber pot, bedpan
 ~ **ak zo** skin and bones,
 emaciated

~ bouch, ~ djòl lip
 pò port, harbor; pore (of skin)
 pobab probable
 poban small bottle, small jar, vial
 poblèm see pwoblèm
 pobouch lip
 pòch pocket; pouch; pack (of
 cigarettes); scrotum
 ~ lèt "milk sack"
 ~ pl abscess
 ~ san hematoma
 ~ ze ovary
 podenwi, podnwi chamber pot,
 bedpan
 podjòl lip
 pofite see pwofite
 pogrè progress
 pogrenn scrotum
 pogrese, pwogrese to progress
 poje eyelid
 andan ~ inner side of eyelid
 pòk crippled, deformed, lame (hand)
 poko not yet
 pokòk foreskin, prepuce
 polenn pollen
 poll to polish (teeth etc.); polite,
 kind
 polyo polio
 pomad, ponmad pomade;
 ointment, salve, cream
 pomon lung(s)
 pon (dental) bridge
 ~ pantalon fly of trousers
 Ponbedè Pont-Beudet insane
 asylum
 ponmad see pomad
 ponmdadan Adam's apple
 ponmen round and chubby (face)
 ponmnen nose (fam.)
 ponmnik tuberculosis
 ponp pump
 ~ nen suction bulb
 ponpe to pump (up), inflate
 ponya dagger
 blesl ~ stab wound
 ponyèt, pwayè wrist; forearm;
 upper-arm; upper-arm
 circumference
 bande ~ to flex one's (arm)
 muscles
 bwa ~ force of one's arm;
 forearm
 gen ~ to have strength, be
 effective
 gwo zo ~ humerus
 pòpyè eyelid
 pòs de rasanbleman (informal
 temporary) clinic
 posesyon trance; Voodoo
 possession
 posib possible
 fe ~ li to do one's best
 postat prostate
 postè poster
 postl posture
 postim pus, discharge
 postiyon spray of saliva
 posyon potion, dose; solution,
 preparation, mixture
 pòsyon portion, part
 pot see pote
 pòt door
 potab drinkable, potable
 pòtans, eupòtans importance
 potasyòm potassium
 potchanm chamber pot
 pote, pot to carry, bring; to
 forebear, endure; to affect, strike
 (sickness)
 ~ nan tèt to disturb, upset
 potestan Protestant
 potèt scalp
 poteyln, pwoteyln protein
 pòtle strong, in good shape
 Pòtoprens Port-au-Prince
 potorik big and husky, rugged
 potovl see pedevl
 pòtray breadth of shoulders; size
 pòt-sewòm intravenous (IV) pole
 pou (to express necessity or
 obligation); louse, lice; pulse;
 in order to; for
 gen ~ to have to, must
 se ~ it is necessary
 poubèl trash basket; garbage can,
 trash can
 poud powder; cocaine; magic
 powder (Voodoo)
 ~ dakte remedy for skin rash
 ~ detal talcum powder

~ elevasyon, ~ levasyon
 baking powder
 ~ jòn flè pollen
pouf swollen; bloated; flabby, soft
poukisa why
poul chicken; pulse
 se ~ li ye to go to bed with
 the chickens (i.e., early)
poumon, pomon lung(s)
poupou stool, excrement, dung; to
 have a stool, defecate
 ~ **dlo** to have watery stools
 ~ **san** to have bloody stools
pouri to rot, spoil, decay
pouriti rot, decay
pous thumb; inch
 gwo ~ thumb
pose to push, bear down
pousyè dust
poutèt because of
pòv poor, impoverished
povant midriff; belly
povizyon, pwovizyon
 provisions, food, supplies
pòz pause, break, time-out
 fè ~ to take a break
poze to rest, pause, take a break;
 calm, sober
 ~ **san li** to relax, calm down
pozisyon position
 san ~ restless, anxious; excited
pozitiv, pozitif positive; you
 bet! definitely!
pral(e) to be going to; to be dying
pran to take, get
pre near
prekosyon precaution; preventive
 measure(s)
premye first; eldest
premyèman first (of all)
prepare to prepare
près almost
presan pressing, urgent
presblt farsighted, presbyopic
prese to be in a hurry; urgent
prèske, près almost
preskri to prescribe
preskripsyon prescription
presyon pressure
prete to lend; to borrow

prèv proof, evidence
 bay ~ to demonstrate
prevansyon prevention
prezan present, in attendance
prezante to present
prezève to preserve, protect
pri price
pridan prudent, cautious
prije, piye to squeeze, press juice
 out of; to purge
priz electric power; electric outlet
 ~ **san** blood sample
pwa bean; pea; weight
pran ~ to gain weight
santi yon ~ senkant sou
lestonmak to feel a tightness
 in or a weight upon one's chest
pwal, pwèl pubic hair
pwaljè eyelash(es)
pwatray breadth of shoulders; size
pwatrin chest (of body);
 tuberculosis
 ~ **tonbe** same as **biskèt**
tonbe
pwatrinè tubercular; tuberculosis
 victim
pwatrinen to suffer from
 tuberculosis
pwayè see **ponyèt**
pwazon, pwezon poison
pwazonnen, anpwazonnen,
 pwezonnen to poison;
 poisonous, poisoned, toxic
pwèl, pwal pubic hair
pwen fist; magical power (Voodoo)
 mare ~ to make a fist
 ~ **nwa** blackhead
pwent point, tip, end
 ~ **tete, ~ tètèt** nipple
pwente to aim, point
pwès thick; rough, coarse
 watè ~ loose stool
pwezon poison
pwezonnen see **pwazonnen**
pwobab, pobab probable
pwoblèm, poblèm problem,
 difficulty, trouble
 pa gen ~ you're welcome
pwoche to approach
pwochè, pwochènn next

pwofil profile
pwofite, poflité to make the most (out of), take advantage of; to thrive, develop (child); to gain weight
pwogram program, plan
pwogrè, pogrè progress
pwogrese, pogrese to progress
pwolonje to prolong
pwomès, pwonmès promise
pwomèt, pwonmèt to promise
pwòp clean; fit, able; own; suitable
for
pwòpte cleanliness; to clean; to scrub (up)
pwostat prostate
pwotèj protection; condom
 ~ **fanm** diaphragm (contraceptive)
 ~ **gason** condom
pwoteje to protect; immune
pwoteksyon protection; immunity
pwotestan, potestan Protestant
pwoteyin protein
pwotèz denture
pwouve to prove
pwovizyon, povizyon provisions, food, supplies
pyan yaws
pyange to walk like someone who has yaws, walk very slowly
pyas (familiar term for) Haitian gourde (formerly \$.20 U.S.); scalp infection, tinea; ringworm
pye foot; lower leg; foot (12 inches); tree; plant; menstrual period
bwa ~ lower leg
de ~ **devan** feet first, dead
do ~ **instep, dorsum**
gen ~ **kout** to have a short labor (birthing)
gen ~ **long** to have a long hard labor (birthing)
gwo ~ elephantiasis; lymphedema
kase ~ to stumble, slip
pla ~, **plan** ~ sole (of foot)
pwent ~ ball of foot; tiptoe
 ~ **atè** barefoot; poor

~ **bankal** bowlegged
 ~ **bòt** clubfoot
 ~ **bwa** tree
 ~ **chik** infected sole (of foot)
 ~ **dous** tender or sensitive foot
 ~ **fann** yaws lesion (on foot)
 ~ **kabann** stirrups (for pelvic exam)
 ~ **kanbre** bowlegged
 ~ **kanna** slew-footed
 ~ **kwochl** bowlegged; pigeon-toed; slew-footed
 ~ **li mache** to have one's menstrual period
 ~ **plat** flat feet
 ~ **tòde** clubfoot
 ~ **tòtòy** bowlegged
wè ~ to menstruate
pyè flint
 ~ **nan fyèl, ~ nan (kannal)** bil gallstone
 ~ **nan ren** kidney stone
pyebwa tree
pyore pyorrhea; purulent discharge

R

ra rare, unusual
rabi stunted, rachitic
rabougri stunted, underdeveloped, puny
rache to pull out, extract
rachitik dwarfish, stunted, scrawny; rachitic
rachòt stunted; decayed (tooth)
rad clothes, (piece of) clothing
radi insolent
radiyis radius (bone)
radjoloji radiology
radyografi, radjografi x-ray
rafrechi booster shot; cool (herbal) drink
rafredi to cool
raj rabies; madness
rajent to look younger; to make someone feel younger
rakle to cry (as in agony or despair); to suffer from emphysema; to utter a death rattle or agonal respirations

rakleman loud cry; death rattle, agonal respirations
rakokiye, akokiye to curl up (body), hunch up (back)
rakousi, kousi to shorten
ral wheezing, wheeze
 gen ~ to wheeze
ralanti to slow down
rale to pull, drag; to crawl, hobble; to inhale; to suck in phlegm; to massage; to utter a death rattle or agonal respirations; drawn, shrunken (face); massage
 ~ anlè to be short of breath
 ~ (gwo) souf to take a (deep) breath
 ~ lè to breathe deeply
 ~ sou yon pye to limp
ramak hammock
raman seldom, rarely
ramoll to soften
ran line (of persons)
ranch, anch, hanch hip; pelvis
randevou appointment, date, meeting
 kase yon ~, pase (yon) ~ to make an appointment or date
ranfòse to reinforce, strengthen
ranje to repair, fix; poisoned; evil, magic
 ~ kabann to make the bed
 ~ zo to reduce a fracture
ranmase to gather up; to be forming (pus etc.)
 ~ kò li to contract, tighten up
rann to give back; to throw up, vomit; to give off, secrete
 anvi ~ nausea
 ~ fyèl li to heave, vomit repeatedly
 ~ san to have blood in one's stools
 ~ vè to have worms in one's stools
rannman effect, result
ranpire, anpire to worsen, get worse; to make worse
ranplasan substitute, replacement
ranplase to replace, relieve
ranpli to fill (up)

rantre to enter, penetrate
ranvèse to knock over; to vomit
ranvwaye, ranvoye to send away; to postpone
 ~ mò to pay one's last respects (to dead person)
rapèl booster shot
rapid rapid, fast
rapò report; sexual relations; colostrum, foremilk; burp, belch
 fè ~ to have an acidic belch or gastric reflux
 gen ~ to have sexual relations
rasl dwarf, midget; stale; stunted; experienced; chronic, deeply rooted
rasin root; origin
rasire to reassure
rasyonnen to ration
rat rat
rate to fail, miss, lose out
ratelye denture, false teeth
ratresl to shorten; to shrink, contract
ravaJ, ravay ravages; epidemic
ravèt cockroach
ray rage, madness
rayl to hate
raylsman hatred; persecution
raze to shave (off); to have sex (fam.)
razè broke, penniless
razwa razor; razor blade
rebay to give again, repeat (dosage etc.)
rebitan sickening, disgusting (food); satiating (food)
rebò side, edge
rechap escape; cure
 san ~ incurable, terminally ill
rechit relapse, setback
rechite to have a relapse
recho burner, grill, stove
rechofman heating up; feverish state
rechte, rejte to vomit; to reject
 anvi ~ nausea
rèd stiff, rigid; tough; difficult; stubborn, severe, acute

redi to struggle, slave away; to resist; to stiffen, harden
malad! ~ tetanus, lockjaw
rediksyon reduction
fè ~ to reduce a fracture
redisman hardening; stiffness
redòm! to go back to sleep, fall asleep again
redwi to decrease, diminish
refè to do again; to get well, recover, recuperate; to heal
refl refusal
refize to refuse, reject
reflèks reflex
refwad! to cool (off)
refwadisman chill, cold
règ rule; menstruation, menses, menstrual flow
 ~ do backbone
wè ~ to have one's period, menstruate
regilye regular, consistent
regilyèman regularly, consistently
regle to settle, arrange; to menstruate
pa ~ byen to have irregular menses
regleman menstruation
regou (covered) sewer, drain
regrè, regre regret(s), sorrow
regrese to regress
regrèt, regrete to regret, be sorry
rejete to reject; to vomit
rejetman vomiting
rejim stalk or stem (bananas, plantains); diet
fè ~ to go on a diet
rejis register, entry book; registration
rejte see rechte
rèkè runt, shrimp; underdeveloped, small for one's age
rekòmande to recommend
rekòmanse to begin again
rekonesans gratitude
rekonèt to recognize
rekonpanse to reward
rekouche to go back to bed
rekoud to sew back up
rekte to vomit bile
rèl shout, yell; scream; wail
fè ~ to begin mourning, weeping, wailing
kenbe ~ to mourn, weep, wail
 ~ do backbone, vertebrae
relache to utter, say; to fart
relakse to relax
relasyon sexual relations, coitus, copulation
rèdo backbone, vertebrae
rele to cry (out), yell; to scream; to call; to be named
relèv see larelèv
relljyon religion
remak, renmak mark, sign, symptom; trace, spot (blood etc.)
remake to observe, notice
remèd, rèmed see renmèd
remedye to give or take medicine
remès! to thank
remete to bring back; to give back
remonte, remoute to go up again; to cheer up; to invigorate, fortify
ren kidney; waist; loin(s), hips; lower back
doulè nan ~ lower-back pain
gen ~ bloke, **gen** ~ frèt to lose one's virility
gen ~ louvri to have a sprained back; to be barren (woman)
gen ~ pitit to be able to father children
tlyo ~ ureter
zo ~ hip
renmak see remak
renmèd, remèd, rèmed remedy, medicine, medication; medicinal
 ~ fèy herbal remedy, home remedy, folk medicine
san ~ incurable
renmen to love, like
rense to rinse; to wash lightly in soapy water; rinse
rente to exhaust, tire out; stunted
repa meal, repast
repanse to rebandage
reparasyon repair

repare to repair; to mend; to restore
repete to repeat
repl respite, rest
repliyans nausea
replè hefty, stocky, heavy-set
repo rest; peace, quiet
reponn to answer, reply
repons answer, response, reply
repoze to rest; rest
repran, reprann to take back; to improve, recover, get well, feel better; to begin again, come back, return
 ~ **san II** to calm down, regain one's composure
rès remainder, residue, rest
resanblans, sanblans resemblance, likeness
resevwa to receive, get
resl to succeed; receipt
respèl erysipelas
reskonsab, responsab responsible (for); person in charge
respirasyon respiration, breathing
aparèy ~ respiratory system
 ~ **atfisyèl** artificial respiration
respiratè respirator
respiratwa respiratory
respire to breathe
responsab see **reskonsab**
restavèk unpaid live-in servant
ret see **rete**
reta delay; mental retardation
 an ~ late, tardy
retabl to recover, get well
rete, ret to stop, stay, remain; to live, reside; to have left, still have; to reach menopause, be past menopause; rest period, break
retin retina
 ~ **dekole** detached retina
retire to remove; to take off, take out
retoudaj, retouday reliving of the past; second childhood
retoufman see **etoufman**
retounen to return, give back, bring back; to go back
retresl, tresl to shrink, contract
retrete to retire, be retired
rèv dream
revèy (any type of) clock; alarm clock
reveye to awake, wake up; to get up
revini, revni to regain consciousness
reyabilitasyon rehabilitation
reyajl to react, respond
reyaksyon reaction
reyini to gather, assemble
reyinyon meeting
reyisi, resl to succeed
rezèv reserves, stores, provisions
rezèvwà dlo water tower; water tank
rezilta result, outcome
rezistan resistant, strong
rezistans resistance; stamina, endurance
reziste to resist
rezilyasyon resignation, submissiveness
rezlyen, rezlye to resign oneself, acquiesce, give up
rezoll resolute, firm
rezon reason, cause
 gen ~ to be right
rezonab reasonable, logical
rezoud to resolve
ri street; laugh; to laugh
ribeyòl German measles, rubella
rich rich
ride, ede to help, assist
ridikil ridiculous
rido curtain
rigòl drain; open sewer, ditch; stream (perspiration, tears etc.)
rim (common) cold; mucus, snot, phlegm
 ~ **chalè** hayfever
 ~ **sèvo** head cold
 ~ **sezon** hayfever, allergy
rimatis, womatis rheumatism; arthritis
lafyèv ~ rheumatic fever

~ defòmen rheumatoid
 arthritis
 rinen to ruin; to urinate
 ris risk
 rlskan risky, uncertain
 riske to risk; risky
 rive, arive to arrive (at), reach; to
 happen, occur

S

sa this, that (pronoun); to be able
 (to do something); true
 pa ~ wrong, incorrect
 ~ a this, that (adj.)
 ~ yo these, those
 sou ~ to be willing to do
 something, feel like doing
 something; to want sex, be
 horny
sub sand
sache, sachè sachet, packet (paper,
 plastic)
sàdepan that depends, it all depends
saj wise, sensible; well-behaved;
 good, obedient
sajès wisdom; good behavior
sajfam midwife
sak sack, bag
 gwo ~, gwo ~ pay belly
 ~ dechay seminal vesicles
 ~ dlo lachrymal gland
 ~ grenn scrotum
 ~ lèt "milk sack"
 ~ manje stomach
 ~ pitit womb, uterus
 ~ tete bra(ssiere)
 ~ vant abdominal cavity
 ~ ze ovary
 ~ zòrye pillowcase
 tl ~ (any) repository of liquids
 (in human body)
sakaje to torment (someone)
 ~ kò li to be restless
sakatafya lush, sot
sakit small purse; sac, pocket (of
 pus etc.)
sakpay, saktrip belly
sakreman sacrament
 dènye ~ last rites

sal room; hospital ward; dirty; to
 dirty, soil
 ~ datant, ~ pou tann
 waiting room
 ~ dijans emergency room
 ~ doperasyon operating room
salamanje dining room
salbadl lice-powder
saldeben bathroom
salisan easily soiled
saliv saliva
salopete, salope to dirty, soil
salte dirt
salyè collarbone, clavicle;
 collarbone area
samdi Saturday
san blood; heredity; (one) hundred;
 without
 aparèy ~ circulatory system
 bay ~ to bleed; to give a blood
 transfusion; to give a blood
 sample; to donate or sell blood
 boul ~ blood clot
 kout ~ sudden surge of blood;
 stroke
 manke ~, pa gen ~ to be
 pale and anemic
 pa gen ~ li to fail to
 menstruate
 pa sou ~ li to be in a bad
 mood
 rann ~ to vomit blood; to
 have blood in one's stool; to
 have vaginal bleeding
 ~ cho menstrual period at an
 earlier than normal age
 ~ dlo hemophilia
 ~ frèt chills
 ~ gate blood poisoning
 ~ grate itch, rash, skin
 irritation
 ~ lè to be almost ready to
 ~ li tounen dlo to be anemic
 tèss ~ blood test; blood count
 tip ~ blood type, blood group
sana(toryòm) sanatorium
sanblan (ak) similar
 fè ~ to pretend, fake
sanblans resemblance, likeness

sanble to gather together; to seem, appear
 ~ **ak** to resemble, look like
 ~ **janm** to put one's legs together
 ~ **tèt koupe (ak)** to be the spitting image (of)
sandal sandal; slipper
sandriye ashtray
sanfwa cool, calm (noun)
sangen bloody
sangwen filthy person; slovenly, dirty, shameless
santlè sanitary; hygienic
 ajan ~, ofisyè ~ public hygiene officer
sankoutcha unkempt, slovenly; shameless
sanmande rape
 fè ~ sou to rape
sann (dlfe) ashes, cinder
sanpwèl (member of) secret society of evildoers
sans sense; sense (of touch etc.); meaning; direction
 bon ~ sanity
sansa otherwise
sansasyon sensation, feeling
sanse sane, logical
sansl leech, bloodsucker
sansib sensitive, tender, sore; ticklish
sant center; smell, odor; stench
sante health
 an ~ healthy, in good shape
santl to smell; to stink; to feel; foul-smelling, smelly, fetid
 ~ **cho** to have hot flashes
santlous sickly-sweet smell
santigrad centigrade
santilit centiliter
santim (Haitian) centime (1/100 of a gourde; 1/5 of a U.S. cent)
 ~ **ò** U.S. cent, penny
santiman feeling
santimèt centimeter; tape measure
santrifij centrifuge
santrifije to centrifuge
sanzatann suddenly
sapat sandal; slipper

~ **tach** yaws lesion (on foot)
saranpyon, charanpyon
 chickenpox
Saridon brand of aspirin
satouyèt, chatouyèt, zatouyèt
 tickling; to tickle
savon soap
savonnen to soap, lather
se to be
 ~ **pou** it is necessary; to have to; must
 ~ **pou sa** therefore
sè sister; nun
sèch see **chèch**
seche, cheche to dry, dry up; to lose weight, become emaciated; to be dehydrated
sechwa dryer
segondè secondary
segretè, sekretè helper, assistant, aide; secretary
sèk circle; dry; skinny; brittle; sharp
sèkèy coffin, casket
sèkilasyon circulation (blood)
sèkille to circulate (blood); to sleep with various women
sekòm caecum, cecum
sekou help, relief
 bay/pote/prete ~ to lend a helping hand
sekouris first-aid worker, paramedic
sekretè see **segretè**
seksyèl sexual
sektanm, septanm September
sekwa proud, haughty
sèl salt; purgative; stool, feces (for lab work); single; alone
dlo ~ water containing salt (not seawater)
goute ~ to lose one's virginity; to have something to eat; to awaken (zombi)
gwo ~ coarse-grained salt
 ~ **fanm** Glauber's salts
 ~ **gason** Epsom salts
sèdepsonn Epsom salts
selibatè single, unmarried (man or woman)
sèll cell (of plant or animal)

~ san corpuscle
 sèlman only
 selon according to
 semans seed
 ~ gason sperm, ejaculate
 semèl, senmèl sole (of shoe)
 semèn, senmenn week
 sen breast, bosom; saint; holy
 bay ~ to breast-feed
 ~ e sòf safe and sound
 senmèl, semèl sole (of shoe)
 senmenn, semèn week
 senp magic cure; simple
 senpleman simply, only
 senti waist; lower back; woman's
 belt; strip; strap; band; truss
 an plenn ~ in full pregnancy
 ~ do lower back
 ~ fè mal lower-back pain
 ~ louvri, ~ ouvè sprained
 back
 sentiwon man's belt
 sentòm symptom
 senyen to bleed; to draw blood
 fè ~ to let blood
 senyman bleeding
 sèp straitjacket
 separe to separate; to share, divide
 (up)
 septanm, sektanm September
 septiseml septicemia
 sere to save, put away, keep; to
 store; to tighten; tìgt;
 constipated
 ~ men to make a fist
 seren damp night air, mist
 sereng syringe
 seri lock; series
 serye serious, earnest; reliable
 sèso coat hanger
 sèten certain, sure
 sètifika certificate
 sevè strict
 sèvèl brain
 gaye ~ to blow out one's
 brains
 sèvl to serve, be of use
 ~ ak to use
 sèvis favor, service
 ~ prese urgency

sèvltè Voodooist; disciple
 sèvo brain; brains, intelligence
 enfeksyon ~ meningitis
 sevraj, sevray weaning
 sevre to wean
 sèvyèt towel, hand towel; (cloth)
 napkin
 sewòm serum; intravenous fluid
 (IV); intravenous tube
 mete ~ to run an IV
 ~ djare, ~ nan bouch, ~
 oral, oral rehydration solution
 (ORS)
 ~ nan venn intravenous fluid
 (IV)
 sewopozitif HIV positive
 seye, eseye to try, attempt; to
 test, experiment
 sezaryèn Caesarean section
 sezi to seize, grab; astonished,
 surprised
 sezisman surprise, astonishment;
 shock; violent emotion;
 emotional crisis, hysteria
 fè ~, pran ~ to become
 emotionally upset
 sezon season
 si if; sure, certain; sour; so, so
 much; eye matter, sleep
 sibi to undergo; to suffer, endure
 siblt sudden
 sibltman suddenly
 SIDA AIDS (acquired immune
 deficiency syndrome)
 sidòrye pillowcase
 sifilis syphilis
 sifoke, sivoke to suffocate, choke
 siga cigar
 sigarèt cigarette
 Signo Sigueneau (TB sanatorium
 near Léogane)
 sik sugar
 fè ~ to be diabetic
 maladi ~ diabetes
 sikanaliz psychoanalysis
 sikatrl psychiatry
 sant ~ psychiatric ward; insane
 asylum
 sikatris scar

sikilasyon, sèkilasyon
 circulation (blood)
sikile, sèkile to circulate (blood);
 to sleep with various women
sikològ psychologist
sikoloji psychology
sikolojik psychological
sikonbe to succumb, yield, fail
sikonsi to circumcise
sikonslyon circumcision
siksè success
sikyat psychiatrist
sikyatri psychiatry
sila this, that
 ~ a this, that
 ~ yo these, those
silans silence; be quiet!
silfa sulfa
silfat sulfur; sulfate
silvoupè please
siman cement, concrete; (dental)
 cement filling; surely
simenaj, simenay overwork,
 over-exertion
simltyè cemetery, graveyard
sin see sly
sinaps mustard plaster
singo to doze, doze off, nod
sinis sinus; ashen (color)
sinistre emergency-relief food;
 disaster victim
sinizlt sinusitis, sinus trouble or
 inflammation
sipestlyon, sipèltyon
 superstition
sipèvize to supervise
siplre to fester, discharge pus
sipòtan long-suffering, patient;
 supportive
sipòte to bear, put up with; to
 tolerate; to hold up, support
sipozitwa suppository; vaginal
 insert
siprann sudden, surprising; acute
siprime to stunt (one's growth); to
 prevent one's sexual
 development; to prevent normal
 menstruation
si se see sou se

siseptib touchy, thin-skinned;
 sensitive; susceptible,
 vulnerable
sispann to quit, stop, cease
sistèm system, network
sisyon aspirator, saliva ejector
sitèn cistern, reservoir, water tower
sitlyasyon, sitirasyon situation
sitou especially
siveyan monitor; watchman
siveye to monitor, check out
sivokan suffocating, stifling
sivokasyon suffocation
sivoke to suffocate, choke
sivouplè, souple please
siwo syrup; liquid medicine
 ~ fòtifyan tonic
siwon wood louse, mite
siwoz cirrhosis
sly, sin sign, indication;
 symptom; beauty mark, small
 growth (on skin), mole
siyat last name, family name;
 signature
slye to wipe (off), dry
slyen to sign (one's name)
sizo scissors
silp (male's) briefs, underpants
sm. abbreviation for centimeter
sò sister; (female) friend (term of
 affection or respect)
sòb sober (not a heavy drinker);
 moderate
sodyòm sodium
sòf, sof safe; except
solèy, sole, sòlèy sun
 atak ~, kout ~ sunstroke;
 sunburn
solid solid, durable
sollsyon solution, remedy;
 infusion
soloba snack
somèy sleep
 gwo ~ deep sleep
son sound, noise
sonday, sonda check-up
sonde to probe, test; to diagnose; to
 auscultate; to verify; diagnosis
sonj dream
sonje, chonje to remember

sonm somber; gloomy
sonn stethoscope; probe; (dental) explorer
aparèy ~ speculum
sonnen to sound, reverberate
sòs sauce; secretion, discharge; (liquid) snot
bay ~ to secrete, discharge
fè ~ to ooze
sot see **sotl**
sòt dumb, stupid; ignorant; sort, kind; to have just (done something); see **sotl**
sote to start, jump, be startled; to skip, omit; to explode
kè ~ worries
sotl, sot, sòt, sòtl to go out (from), leave; to have just (done something)
sou drunk; on, over; under (for regime)
~ sa horny (sexually)
soud deaf
~ bèbè deaf mute
soude to solder, join together
soudè deaf person; deafness
souf breath; breathing; respite, pause; sulfur
aparèy ~ respiratory system
gen ~ to have caught one's breath; to have a breather, find respite
kannal ~ windpipe, trachea
kenbe ~ to hold one's breath
lage ~ to exhale
pa gen ~, **pèdl** ~ to be out of breath, be short of breath
pran ~ to breathe in, inhale
~ anlè wheezing; bronchitis; to be short of breath, breathe with difficulty
~ kout, ~ wo shortness of breath, rapid breathing
~ poud Voodoo hex
tlyo ~ windpipe, trachea
soufle to breathe; to blow
~ anlè to be short of breath, breathe with difficulty, wheeze
soufrans suffering, distress
soufri to suffer; to endure; weakling
soufrisken undernourished person
soujèm second cousin; distant cousin
souke to shake; shaken, startled; loose (tooth)
~ kò to move (body); to move in one's sleep
soukekouche cheap sleeping-mat
soukoup saucer
soukous shock, blow; jerking or jolting movement; labor contraction(s)
soulaje to relieve, ease, alleviate
soulajman relief, consolation
soulay dizziness, wooziness, light-headedness
soule drowsy; drunk; to make dizzy or dazed; to be dizzy or dazed
soulezon light-headedness; tipsiness, slight intoxication
solve to lift, raise
soulye shoe
soup soup; supple; docile
soupap valve
soupe supper; to eat supper
soupi sigh
souplre to sigh
souple, silvoulè, sivooulè please
tanpri ~! please!
souplès suppleness
souri smile; to smile
sourit mouse
souriyan smiling
sous spring (of water); source, origin
souse, sise to suck; to suck the blood from a young child (witch); to abuse; sucking
sousèt pacifier (baby)
sousi eyebrow; care, worry, anxiety
sousoupannan listless, dull
soutni to support, hold up, back up
soutyen bra(ssiere)
souvan often
souye to soil, dirty; to wipe (off)
sòve to run away, escape; to save, rescue; safe; in good shape

soyèt see plitit soyèt
 swa silky, soft, smooth
 cheve ~ straight hair
 swaf, swèf thirst; thirsty
 swanye, swaye see swenyen
 swe, sye to sweat, perspire; to
 secrete; sweat, perspiration;
 secretion
 swè wish; evening; sweat,
 perspiration; secretion
 swèf, swaf thirst; thirsty
 swen care, attention; to care for,
 take care of; to support; well-
 nourished
 pran ~ to care for, take care of
 premye ~ first aid
 swente to seep (out), ooze (out); to
 have a discharge; to wet one's
 pants
 swenyay, laswenyay,
 laswenyay (good) care,
 treatment
 swenyen, swanye, swaye to
 care for, look after, nurse, treat
 (medically)
 switch light switch
 swiv to follow
 ~ doktè, ~ loplital to have
 periodic medical check-ups; to
 be under medical care
 ~ tretman to undergo
 treatment
 swivan next, following
 sye see swe
 syès, lasyès nap, snooze, siesta

T

ta would; late
 tab table; operating table; pubic area
 or region
 ~ de nwl nightstand
 ~ konsiltasyon examining
 table
 tabak tobacco
 ~ an poud snuff
 tablèt tablet, pill
 ~ vajinal spermicidal
 suppository

tablo bulletin board; eye chart
 tabourè (foot) stool
 tach stain; spot; scar; blemish
 ~ kl leve rash
 tl ~ freckle
 tachan easily soiled
 tache to fasten, attach; to spot, soil
 tafya booze, moonshine, liquor,
 alcohol
 tafyatè drunkard, alcoholic
 tak (tiny) drop, spot
 take to latch, bolt, hook (door,
 window)
 takèt bolt, latch
 talè, titalè, toutalè soon, in a
 moment
 ~ a a moment ago, a little
 while ago
 talk talc, talcum
 talon heel
 ~ fann crack in skin of heel
 tamaren dark yellow-brown
 tan time; weather; while
 tandans tendency
 tande to hear; to understand; inner
 ear, eardrum; hearing (auditory)
 kannal ~ ear canal
 ~ di to be hard of hearing
 ~ (zòrèy) eardrum
 tandrès tenderness, fondness
 tankou, kankou like, as, as if
 tanmen to begin to, start to
 tann to wait, wait for, expect;
 tender, soft
 tannman (di) hearing
 (impairment)
 tanp, bò tanp temple (head)
 tanperaman temperament,
 character
 tanperati temperature
 metòd ~ rhythm method
 (family planning)
 tanpèt storm
 tanpon tampon
 tanponnen to sponge, bathe
 (wound); to dampen (with
 washcloth); to mop up
 tanpri please
 ~ souple! please!

tansyomèt blood pressure apparatus
tansyon blood pressure; high blood pressure, hypertension; low blood pressure, hypotension; tension, strain
aparèy ~ blood pressure apparatus
fè ~, gen ~ to have high blood pressure
sou ~ tense (adj.)
~ nan je glaucoma
tant, tantann aunt; (title of address for elderly woman)
tante to attempt, try; to tempt
tanzantan, detanzantan from time to time, at times
tape to tap (on); to strike, hit
taptap rapid, quick, fast; small passenger truck
tas cup
tat plaque (on tooth)
tata poop; to poop, have a bowel movement
tatapyout smallpox
tate to touch, feel
tay size; height; waist; lower back
gran ~ tall
~ fè mal lower-back pain
~ louvri, ~ ouvè chronic lower-back pain; sprained back
taye to cut, trim, clip
tayzong nail clippers
tchatcha, tyatya (euphemism for kaka) do-do, poop
tchaw unappetizing food
tchè see **kè** (heart; stomach; courage)
tchèd, tyèd lukewarm, tepid
tchèk check, verification; OK, yes
fè yon ~ to check (out), verify
tcheke to check (out), verify
tchimèn, kimen to foam, lather, froth
tchèbòl trouble
tchènèl parasite (insect; person)
tchotcho penis (fam.)
tchou bottom; ass, tail, rear
tchoule to regress, degenerate; to age, get old
tchouloulou(t) diarrhea
tchwe see **touye**
te tea; infusion; (past tense indicator)
~ nan je white opacity of cornea, leukoma
tè soil, ground, earth
bay ~ a to die; to leave
se ~ ki pou geri li hopeless case
~ lonbrit place of birth, real home
tebe TB, tuberculosis; tubercular
tèdoreye, tèdòreye pillow-case
teknik technique
teknisyen technician
teknoloji technology
tèktèk eccentric, a bit off
teledyòl, teledjòl grapevine, word-of-mouth, "coconut wireless"
telefòn telephone
telefonnen to telephone, call
tèm sound, healthy (body); sane; term
anvan ~ premature (infant)
tèminal adj. terminal
tèmìne to terminate, finish, end
tèmomèt thermometer
~ bouch oral thermometer
~ twou dèyè rectal thermometer
tèmòs thermos (bottle)
temwaye to testify; to attend, observe, witness (at childbirth)
ten complexion, coloring
bon ~ young for one's age, well-preserved
move ~ prematurely old
tenay, tennay pliers, pincers; tongs
tenbal plastic or aluminum cup
tenès, tennès piles, hemorrhoids; tenesmus
bay ~ to constipate
tenis tennis; (pair of) tennis shoes
tennay see **tenay**
tennès see **tenès**

tenpan eardrum
 tentanòs, tetanòs tetanus,
 lockjaw
 tentidjòd, tentidjòd tincture of
 iodine
 te-nya tapeworm
 tep adhesive tape
 tepe to tape (up)
 tere, antere to bury
 terebantln turpentine
 terib terrible
 tèss test
 testaman will, testament
 teste to check out, try out, test
 testikll testicle (Fr.)
 testostewòn testosterone
 tèt head; hair; mind, brain;
 (reflexive pronoun)
 chaje ~ ll to worry
 fè ~ ll mal to harm oneself;
 to attempt or commit suicide
 gwo ~ large head; mongolism,
 mongoloid, Down's Syndrome
 kalbas ~, kòkòwos ~ skull
 maladl ~ anfle meningitis
 nannan ~ brain
 pran ~ ll to persuade someone
 santi ~ vld to feel an overall
 weakness; to feel like one is
 losing one's mind
 seye fè ~ ll mal to attempt
 suicide
 ~ bouch philtrum
 ~ byen sane
 ~ chaje worry, cares; stress
 ~ chankre receding forehead
 ~ chèz headrest (dentist's chair
 etc.)
 ~ cho loony, cracked
 ~ fele loony, cracked
 ~ fè mal headache; migraine
 ~ kalbas having an unusually
 large head; stupid
 ~ ll gaye/vld to be slightly
 off, be not quite right (in the
 head)
 ~ ll patl to go crazy, be
 insane
 ~ lòbliz deformed head

~ lou drowsy, lethargic,
 sluggish
 ~ louvri unclosed fontanel
 ~ pa anplas loony
 ~ pa byen insane
 ~ souke crazy
 ~ vire dizziness, vertigo
 venn ~ fontanel
 zo (kokolo) ~ skull, cranium
 tetanòs, tentanòs, tètanòs
 tetanus, lockjaw
 tete breast; nipple, teat; to breast-
 feed, nurse, suckle
 bay ~ to breast-feed, nurse
 bouch ~, bouton ~ nipple
 nan ~ to be in breast-feeding
 pran ~ to suckle, take the
 breast
 pwent ~ nipple, teat
 rale ~ to suckle, take the
 breast
 sak ~ bra(ssiere)
 ~ doubout firm erect breasts
 ~ (ran)gòje breasts overly
 full of milk
 ~ tonbe inverted nipple
 ~ zòrèy earlobe
 vòlè ~ to return
 (surreptitiously) to the breast
 after weaning
 wonn ~ areola (of nipple)
 tètfe'mal headache
 tetin nipple (bottle); pacifier
 ti little, small; poor, disadvantaged
 tib tube; thin pipe; catheter
 ~ nan nen naso-gastric (NG)
 tube
 ~ van poumon trachea
 tibebe baby, infant
 ~ kl fenk fèt newborn,
 neonate
 tibèkilloz tuberculosis, esp.
 advanced active pulmonary
 tuberculosis
 tibèt insect, bug
 tibourik support under woman's
 hips during childbirth
 tibout short and fat
 tibya tibia
 tidevan child's genitals (either sex)

tifè heat rash
tifi girl; virgin; term of affection;
 unpaid servant girl
tifis typhus
tifoïd, lafyèv tifoïd,
tifreyis typhoid fever
tigason boy
tigòj trachea, windpipe
tik tick (parasite); tic, involuntary
 twitching
tikal small bit, small piece
tikay:
 maladi ~ tuberculosis
tikè ticket
tikraze skinny
til (wire) screen
Tilenòl Tylenol
timè tumor
timid timid, shy
timoun child, baby
 gwo ~ **chape** child who has
 survived the high-risk age;
 grown-up child
 ~ **anfle kwashiorkor** (victim)
 ~ **(kl rete ak moun)** child
 serving as a live-in unpaid
 domestic servant; any live-in
 unpaid domestic servant
 ~ **piti** infant
tinouris confinement or lying-in
 period (after giving birth);
 nursing mother whose child has
 not yet begun to walk
tipik typical
tip san blood type, blood group
tire to pull; to stretch; to jerk (in
 convulsions); to shoot at
 ~ **sou** to border on, verge on,
 be almost
tisi tissue (animal, plant)
titit baby, toddler
tivant lower abdomen
 anba ~ genitals
tivewòl smallpox
tiwa drawer (table, chest etc.)
tiwoïd thyroid
tlye see **touye**
tlyo water-pipe; fountain; spigot
 gwo fè ~ pipeline
tlyon overflow, spillage

san ~ level (teaspoonful etc.)
tizann, tizàn herbal tea; broth
tò wrong
 gen ~ to be wrong
tòchon cloth, rag
tòde, tòdye to twist; to sprain; to
 wring (out); to writhe (in pain);
 crooked, bent
toke crazy, loony, nuts
tòktòk loony, nuts
tonbe to fall; to start (doing
 something)
 ~ **feblès** to become weak; to
 collapse
 ~ **leve** to persist, persevere
tonbo, tonm, latonm tomb,
 grave
tonton uncle; old man
 ~ ~ great uncle
topsi, otopsi autopsy; to do an
 autopsy
toraks thorax
tòs torso
total total
tòtòt to suck; breast (baby talk)
tou hole, opening; perforation;
 socket (tooth etc.); drain; leak;
 also, too; quite
 ~ **bote** dimple
 ~ **dèyè, ~ fès** anus
 ~ **kaka** asshole
 ~ **le, ~ lè** every, all
 ~ **(nan dan)** cavity
 ~ **nen** nostril
 ~ **nwa** pupil (of eye)
touche to touch, feel; touch
toude both
toudenkou suddenly
toudi to stun, daze; giddy, dizzy
toudisman, toudlin dizziness,
 giddiness, vertigo, light-
 headedness
toudlin dizziness, giddiness
toudren slip, fall (affecting waist
 area); sprained back
toudwat straight ahead; upright,
 vertical
toufe to suffocate, smother, choke,
 gag; to strangle
toujou always, ever; still

toule every, each
toulede, toude both
toulejou everyday; daily
touman(t) torment, pain;
restlessness
toumante to torment; to disturb;
restless, agitated
~ **kò li** to shake one's body;
to be restless
tounen nostril; to return, come
back; to become, change into; to
turn sour, curdle, go bad
~ **dèyè** to regress; to go astray,
come to no good
touni see **toutouni**
toupatou everywhere
tous, latous cough
touse to cough; cough, coughing;
to have tuberculosis
maladi ~ tuberculosis
moun ~ tuberculosis victim
touswit right away
tout all, every; whole; everything
toutan all the time, constant(ly)
toutotou around
toutoun female pubic region, vulva
toutouni, touni naked, nude;
half-dressed, in one's underwear
touye, tchwe, tlye to kill; to put
out, extinguish (lamp, fire)
seye ~ **tèt li** to attempt
suicide
~ **moun** to murder
~ **tèt li** to commit suicide
tradiksyon translation
tradiktè translator, interpreter
tradwi to translate, interpret
traka cares, worry, trouble
pase ~ to suffer
trakase to trouble, bother
trakoma trachoma
tranblad, latranblad trembling;
convulsions; cerebral palsy
tramble to tremble, shake, shiver;
trembling
maladi ~ Parkinson's disease
trambleman trembling, tremor
tranche to slice, cut off; to cause
abdominal pain; labor
contractions or pains; abdominal
pains
tranchmann vant stomach pains;
menstrual cramps
trangle to strangle, choke, gag; to
strangulate
trangleman strangulation
trankil quiet, calm
trankilite quiet, calm; peace of
mind
trankilize to calm down, quiet
tranpe to soak
transfere to transfer
transflizyon (san) (blood)
transfusion
transmèt to transmit
transparan transparent
transpire to perspire
transplante to transplant
transpò transportation; strong
emotion
trapan, atrapan contagious;
infectious
trape, atrape to catch, contract
(sickness)
tras trace, vestige, streak
travay work, job; labor, childbirth;
to work
travayè lasante community
health worker, paramedic
tray suffering, misery; turmoil,
anxiety
trè very
trebiche, tribiche to stumble,
trip, slip
trennen to drag; to crawl around,
drag oneself
trepas death, dying
trepase to be dying; to die
très braid, plait (of hair)
tresayi to give a jump (from
surprise); to quiver; to shudder
(from fear); to wince
tresi to shrink, contract
trète to treat (medically), care for
tretman, trètman medical
treatment
nan ~ therapy
tribiche see **trebiche**

trichin whipworm; threadworm;
 trichinosis
trikosefal whipworm
trip bowels, guts, intestines,
 entrails; triple
dènye bout gwo ~ rectum
gwo sak ~ stomach (pej.)
gwo ~ large intestine
mèt ~ umbilical cord
ti ~ small intestine
 ~ **kòde**, ~ **tòde** abdominal
 pains; hunger pains
tripay guts, intestines
tripote to bother, annoy
tris sad
triyaj, **triyay** triage, screening;
 sorting, selection
triyal sinew, tendon
triye to screen, sort out, choose,
 select
twal, **twèl** cloth, fabric; sanitary
 napkin or pad
 ~ **gaz** gauze (bandage)
twalèt bathroom, toilet; washing,
 grooming
fè ~ **deba** washing of pubic
 region (woman esp.)
fè ~ (li) to wash up (oneself
 or someone else)
sal ~ restroom
 ~ **fi** ladies'/women's restroom
 ~ **gason** (gentle)men's
 restroom
twazyèm third
twèl see **twal**
twenzi to squint; to blink
twò too, excessively
twòn toilet seat
 sou ~ to be on the toilet
twonp Fallopian tube(s)
twonpe to deceive, trick; to be
 mistaken
twòp too much, too many,
 excessively
twopikal tropical
twou hole, opening; perforation;
 socket (tooth etc.); drain; leak
 ~ **bote** dimple
 ~ **dèyè**, ~ **fès** anus
 ~ **kaka** asshole

~ (nan dan) cavity
 ~ **nen** nostril
 ~ **nwa** pupil (of eye)
twoub murky, blurred, clouded
wè ~ to have blurred vision
twouble to trouble, bother
twoubote, **toubote** dimple
twounen, **tounen** nostril
twouse to roll up, tuck up (sleeves
 etc.)
tyatya, **tchatcha** (euphemism for
kaka) do-do, poop
tyè third
tyèd, **kyèd**, **tchèd** lukewarm,
 tepid
tyedl to become/make lukewarm

V

va (future tense indicator) shall, will
vagabon see **vakabon**
vajen vagina
bouch ~ vulva
vajinal vaginal
vakabon, **vagabon** good-for-
 nothing, bum
vakans vacation
vaksen vaccine, serum;
 vaccination, immunization
kat ~ immunization record
vaksinasyon vaccination, shots,
 immunization
vaksinen, **vaksine** to vaccinate
vale to swallow; valley
valè value, worth; stock, supply;
 numerous
van wind; fart; sprain
fè ~ to fart; to fan
 ~ **nan kou** sore neck
 ~ **nan lestonmak** intestinal
 gas
 ~ **nan lonbrit** umbilical
 hernia
 ~ **nan tèt** headache
 ~ **nan zòrèy** buzzing or
 ringing in ears; headache
vandredi Friday
vann to sell
vant stomach, belly; abdomen;
 womb; diarrhea

fè ~ to get a swollen belly
 gen ~ to have diarrhea
 grenn ~ ovary
 gwo ~ pregnant; big belly
 manman ~ uterus, womb
 mè ~ afterbirth, placenta
 sak ~ abdominal cavity
 ti ~ lower abdomen
 tranchmann ~ stomach
 pains; menstrual cramps
 ~ ba afflicted, distressed
 ~ bouyi, ~ kondwi, ~
 kouri, ~ llb, ~ mennen, ~
 pase, ~ pouri, ~ rale, ~
 tchouloulou(t) diarrhea
 ~ fè mal stomach ache,
 indigestion
 ~ mòde acute and intermittent
 abdominal pain
 ~ sere constipated
vantay hand-fan
vantaye to fan (with hands); to
 blow on (with mouth)
vante to fan; to evaporate; stale
vantfèmal stomach ache,
 indigestion
vantllatè fan (machine)
vantize to apply a cupping-glass to
 someone, cup (a patient)
vantouz cupping-glass
vantre to stab; to eviscerate
vantrikil ventricle
vanyan robust, sturdy;
 hardworking; courageous
 Maladi gate ~! "Don't
 worry, you'll get better soon!"
vapè vapor, steam
vapore, evapore to evaporate
vaporizatè vaporizer
varis varicose veins
varisèl chickenpox
varye to vary; to rot, spoil; crazy,
 nuts
varyòl, lavaryòl smallpox
vav valve
vaz chamber pot, bedpan
vazektomi vasectomy
vazlin vaseline, petroleum jelly
vè glass (substance; drinking);
 (eye)glasses; lens; nerve; worm;

maggot; green; around, about;
 toward(s); approximately
 gwo ~ won roundworm,
 ascaris
Jete ~, **pase** ~ to pass worms
kriz ~ parasitic infestation
manman ~ very large worm
poze ~ to apply a cupping-
 glass (to someone)
rann ~ to vomit worms; to
 pass worms
ti ~ kwòk hookworm
 ~ akwòk hookworm
 ~ kontak contact lens
 ~ nan gòj to have worms
 ~ solitè(s) tapeworm;
 threadworm, pinworm
 ~ zepeng pinworm,
 threadworm
vèble acne
vèdegrl misery, suffering
vèf widower
vegle to blind; to dazzle
vèj (Fr.) penis
vèmlfij vermifuge
vèmln vermin; parasite; worm;
 louse
venen venom
veneryèn venereal
vènl cavity varnish (sealer)
venn vein; artery; tendon; blood
 vessel; muscle; twenty
 gwo ~ nan Janm varicose
 veins
 ~ chantrèl vocal cords
 ~ dèyè pye Achilles tendon
 ~ fole swollen lymphatics
 ~ foule bruise, contusion
 ~ sansib sensitive point,
 tender spot; male appendage,
 penis
 ~ tèt fontanel
vere worm-ridden
vèrèt smallpox
 grave ~ pockmark
verf wart
verifye to check, verify, inspect
vèse to vomit; to pour
 ~ anba to have a vaginal
 discharge

~ san to shed blood
 vesl bladder
 vèsman vomit; vomiting
 veso container (for cooking and eating); blood vessel
 vèt green
 vètè earthworm
 veterinè veterinarian; veterinary
 vètij dizziness, light-headedness
 vèv widow
 vèy (funeral) wake
 veyatif watchful, careful, attentive
 veye to watch over; to watch out for; funeral wake
 veyèz night-light
 vi life, existence
 vid empty; empty spot; emptiness
 vide to empty; to secrete, drain; to collapse, cave in; to be run down, be emaciated
 vigè vigor
 viktim victim
 vilv (Fr.) vulva
 vini, vin to come; to become; to ejaculate, reach orgasm (byen) ~ to grow or develop satisfactorily
 ~ mwens, ~ pi piti to decrease
 viray dizziness, giddiness
 vire to turn; to turn around
 tèt li ~ he/she is dizzy or giddy
 viris virus
 vit quickly, fast
 vitamin vitamin
 vitès speed; rate, rapidity
 viv to live
 vivan alive, living
 kreyen ~ human being
 vizib visible, clear
 vizit visit
 vizite to visit
 vizitè visitor
 vizyon vision, dream; vision, (sense of) sight
 vle to want, wish
 ~ di to mean, signify, prove
 vlen membrane; tendon, sinew
 vlimè phlegm, mucus

vlope to envelope, cover
 vo to be worth
 vòl theft; flight
 vòlè, volè, vòlò thief, robber; to steal
 volonte, lavolonte will, desire; will power
 volontè volunteer; stubborn
 vomì see vonmi
 vomisman see vonmsman
 vonmi, vomì vomit; to vomit
 anvì ~ nausea
 ~ fyèl li to vomit repeatedly
 ~ kouwè ma kafe/goudwon to have gastric hemorrhaging
 vonmsman, vomisman
 vomiting; vomit
 vonmiste vomit
 vonmitif emetic
 voye to send; to throw; to ejaculate; to reach a climax (male or female); ejaculation
 ~ ale to dismiss, send away
 ~ chache to send (s.o.) for
 ~ deyò to practice the withdrawal method or coitus interruptus
 ~ jete to throw away
 ~ nan dòmi nocturnal emission, wet dream
 vre true, real
 pa ~ isn't that so?
 vwa voice
 vwal veil
 ~ twou pati yon fi hymen
 vwazen neighbor
 vwazin female neighbor
 vwazinay, vwazinaj neighbor; neighborhood
 vyann meat; flesh, tissue; muscle
 fil ~ tendon, sinew; ligament
 ~ dan gum(s)
 vye old; worn-out; worthless; disgusting
 vyèj, vyèy virgin
 vyepti mild, benign
 vyeyès old age
 vyeyi to age, get old, grow old
 vyòl rape
 vyolan violent

vyole to rape
vyolèt purple

W

wanga (tangible) Voodoo fetish (for evil effects)
watè toilet, latrine; bowel movement, feces, stool, excrement; to have a bowel movement
fè ~ to have a bowel movement, defecate; to build an outhouse
~ dlo to have watery stools
~ ma to have seedy stools
~ pwès to have loose or thick stools
watè-klozèt (flush) toilet
wè to see; (sense of) sight
~ de (bagay), ~ doub, ~ tout bagay an de to have double vision
~ delwen to be farsighted, be presbyopic
~ depre to be nearsighted, be myopic
~ règ to menstruate
~ twoub to have blurred vision
wete, wet to remove, take off, take out, take away
wi yes
men ~ yes indeed, certainly
wo high; tall
wòb dress, gown
~ de chanm dressing-gown, bathrobe
wòbînèt faucet, tap, spigot
wòch rock; calculus
~ nan ren kidney stone
~ pou file sharpening stone
woga short of breath
wòk hoarse, raucous, harsh
woke to hiccup
wòkèt, hòkèt, òkèt hiccup(s)
womatis see rlmatis
won round, circular
wonfle to snore; snoring
wong sterile male

wont shame; ashamed
wòs instep, dorsum of foot
wose, ose to raise, make higher
wote, ote to belch, burp
~ si to have an acidic belch or gastric reflux
wotè height, stature
wotesi, otesi acidic belch, gastric reflux
wou wheel
woubewòl German measles, rubella
wouj red; bloodshot
vin ~ to blush
woujat reddish; very light-skinned
wouji to blush
woujòl see lawoujòl
woule to roll
woulib (free) ride, lift
woulman rotation
woulo roll (bandages, paper etc.)
woy! hey!
woz pink, rose
(ti) ~ menstruation, menstrual period
Wozita brand of laundry bar soap

Y

yaya type of dance
kòde ~ to twist the upper body in pain; to suffer, be in misery
ye to be (used only at end of phrase or sentence)
yè, ayè yesterday
~ swa last night
yenyen to whine, complain
yò (plural definite article) the; they, their, (to) them; (reflexive pronoun)
yòd, lyòd iodine
yòde, lyòde iodized
yon a, an
youn, yonn (pronoun) one
youyou, loulou(t) tapeworm
yoyo penis

Z

zafè see afè

movèz ~ miscarriage
 zalenn breath
 zalimèt safety match
 zan years
 zandò sores on tips of toes (from
 stumbling etc.)
 zanml friend
 zannimo animal
 zanno earring
 zanpoud, zanpoul blister; callus;
 wart
 zanslv, janslv gum(s) (of mouth)
 ~ anfle gingivitis
 zantray intestines, entrails, guts;
 stomach; bosom
 zatouyèt, satouyèt tickling; to
 tickle
 ze egg; ovum
 zè hours
 zèb grass; herb; marijuana
 zèdtan hours
 zege variety of tiny insect; shrimp,
 runt (person); puny or sickly
 child
 zègrè, zegrè heartburn
 zegwí, egwí needle
 kout ~ stitch (wound etc.),
 suture
 zekriblch scorpion
 zekwèl scrofula; stiff neck
 zèl wing
 ~ nen (sides or ala of) nostrils;
 nose
 zenglen (fragment of) broken glass
 zepeng, epeng pin
 ~ atache safety pin
 ~ kouchèt, ~ kwochèt, ~
 kwòk (large) safety pin
 ~ ti tèt straight pin
 zepenglèt small safety pin
 zepòl, epòl shoulder
 ~ kare tuberculosis
 zo ~ shoulder blade, scapula;
 clavicle
 zesèl armpit, axilla
 zewo zero
 zigonnen to bother, pester; to
 tickle
 zip zipper
 zipe to zip

zo bone; skinny, thin
 doktè ~ bone-setter (folk
 medicine); orthopedist
 gwo ~ big for one's age
 san ~ lithe, supple
 ~ ak po skin and bones,
 emaciated
 ~ basen pelvis
 ~ bwanen nasal bone
 ~ bwatèt skull, cranium
 ~ chenn do backbone,
 vertebral column; spine, spinal
 cord
 ~ dèyè tèt occipital region
 ~ dèyè tonbe to have lower-
 back pain
 ~ fligl cheekbone
 ~ frèt weak muscles
 ~ jenou kneecap, patella
 ~ (kokolo) tèt skull,
 cranium
 ~ kòt rib
 ~ koupyon coccyx, tailbone;
 sacrum
 ~ krap cartilage
 ~ kraze extreme fatigue, pains
 and stiffness in joints
 ~ machwè anba mandible
 ~ machwè anwo maxilla
 ~ make kase hairline fracture
 ~ marasa bone consorts: tibia
 and fibula, radius and ulna
 ~ mis tonbe to have lower-
 back pain
 ~ rachitik rickets.
 ~ ranch ilium, hipbone
 ~ rèldo backbone, spine,
 vertebral column
 ~ salyè collarbone, clavicle
 ~ tèt skull, cranium
 ~ zepòl shoulder blade,
 scapula
 zoban skeleton-like; walking
 skeleton
 zobop wound on foot caused by a
 stake
 zòbòy bunion, callus, corn
 zòdi dirt, filth, dung
 zòkò skeleton-like; walking
 skeleton

zomangay skin and bones, walking skeleton
zòn zone, area, region
zona shingles
zonbi zombi
 tl ~ low birth-weight baby
zong fingernail; toenail
 anba ~ quick (of nail)
 chè nan ~, ~ **enkane**, ~
 nan vyann, ~ (**rantre**) **nan**
 chè ingrown nail
 po ~ cuticle
 ~ **men** fingernail
 ~ **pye** toenail
zonyon onion; sore (which leaves scar)
zoranj, zorany orange (color; fruit)
zòrèy ear
 anndan ~, **fon** ~, **nannan**
 ~ middle ear; inner ear
 fèy ~ external ear, auricle,
 pinna
 gen ~ **dí** to be hard of hearing
 gwo ~ big shot
 kaka ~, **kras** ~, **tata** ~
 earwax, cerumen
 mal ~ earache
 tete ~ earlobe
 tou ~, **twou** ~ middle ear;
 inner ear
 ~ **dí** hard of hearing
 ~ **fèmal** earache
 ~ **kourí dlo** to have otorrhea
 ~ **sonnen** ringing in ears,
 tinnitus
zòrye, oreye, zòreye pillow
 sak ~, **tèt** ~ pillowcase
 tl ~ cushion
zosman bones (skeleton); walking skeleton, skin and bones
zotèt skull, cranium
zòtèy toe
 dwèt ~ toe
 gwo ~ big toe
 pwent ~, **tèt** ~ tip of toe
 tl ~ little toe
zotobre big shot, VIP
zouk pimple
zouti tool; penis

zozo penis (familiar)
zwinge to pinch; to sting
zye eye; see **Je**

ENGLISH - HAITIAN CREOLE

MEDICAL DICTIONARY

N.B. We have attempted to place here as first choice(s) the term(s) most easily understood, but not considered obscene; the 'Frenchified' term (which will be understood only by a minority) is given last, if at all.

A

- a, an yon
abdomen bavant, anbavant,
 anbativant
 lower ~ tivant
abdominal cavity sak vant
abdominal pains kolik, trip kòde,
 trip tòde, tranche, vantfèmal
 cause ~ ~ v. tranche
able, be v. kapab, ka, kab, kap
able-bodied enganm, engam
abnormal pa nòm, anòm
abnormality anòmali
abort v. jete pitit
abortion avòtman, dilatasyon
 have an ~ v. jete pitit
 spontaneous ~ pèdans,
 fòskouch
abortionist doktè ki pratike avòtman
about vè
above anlè, anwo
abrasion grafiyen, grafouyen, kòche
abscess abse, absè, pòch pi, depo
 inguinal ~ apsedlenn
absent pa la, absan
absorb v. absòbe
absorbent absòban
abstain v. astinen, asteni
abuse opresyon
accident aksidan, malè
 ~ victim aksidante
accompany v. akonpaye, akonpayen
according to selon, dapre
accurate egzat, ekzat
accustom v. abitye
- ache doulè
ache v. fè mal
Achilles tendon venn dèyè pye
acid asid
acidic belch or gastric reflux dlo
 si, wotesi, otesi
 have an ~ ~ v. santi likid si, fè
 rapò, wote si
acidic stomach kè cho
acidity lestonmak si, dlo si sou
 lestonmak, lestonmak boule
acne fejennès, fedjennès, difejennès, ti
 bouton kwasans, bouton nan figi,
 vèble
acoustic nerve nè tande
acquiesce v. reziyen, reziye
acrocyanosis koulè ble nan men ak
 pye
across anfas
act v. aji, konpòte
 ~ upon v. aji sou
active enganm, engam
acupuncture tretman chinwa, tretman
 ak zepeng
acute fò, rèd, gwo; siprann
Adam's apple ponmdadan, ne gojèt
add v. ajoute
addict (drug) dwoge
address adrès
adenoids glann gòj
adhesive tape tep, adezif, plastè
adjustment, period of peryòd
 gerizon
administration administrasyon
administrator administratè

admit (to hospital) v. entènen,
entène
adolescence jenès
adolescent jennmoun
adopt v. adopte, adokte
adopted adoptif, adoktif
adoption adopsyon
adoptive adoptif, adoktif
adrenal glands glann anbavant
adrenalin adrenalin
adult granmoun
~ **cooked food** manje chodyè
advantage avantay
advice konsèy
advise v. konseye
adviser konseyè, konseye
affair afè, zafè
affect v. aji sou
affection lanmou, rennen
afflicted vant ba
affliction lafliksyon, mizè
afraid (of) v. pè
be ~ kè li sote
after apre
afterbirth mè(t) vant, manman vant,
delivrans
afternoon apremidi
good ~ bonswa
afterwards answit
again ankò
against kont
age laj
age v. vyeyi
aged aje, granmoun
aggravate v. agrave, fè pi mal
aggravating agravan
agile enganm, engam
agitate v. ajite
agitated toumante
agitation enkyetid
ago genyen, gen
agonal respirations rakleman
agony lagoni, agoni
agree v. dakò
agreeable agreyab, dous
agreed! dakò!

agreement, be in v. dakò
aid èd, sekou
aide èd, segretè, sekretè
**AIDS (acquired immune
deficiency syndrome) SIDA**
ailing pa byen
ailment maladi
air lè
~ **conditioning** èkondisyone
ala zèl nen
alarm clock revèy
alarmed, be v. kè li sote
albino albinòs
albumin albimen
alcohol alkòl
rubbing ~ alkòl
alcohol, liquor tafya
alcoholic n. tafyatè, bwasonnyè
alcoholism bwè kleren
alert, be v. gen bon konnesans
alive la, anvi, vivan
all tout
~ **right** oke
allergic reaction pikotman,
pikòtman
allergic to, be v. san li pa ale ak,
alèji (ak)
allergy alèji; gratèl; rim sezon
alleviate v. soulaje, fè ou santi ou
pi byen
allow v. kite, pèmèt
almost prèske, près
~ **(do something) v.** manke
alone pou kont li, sèl
already deja, gentan
also tou
although kwak, atout
alveolus alveyòl
always toujou
Alzheimer's disease annanfans
A.M. di maten
amalgam amalgam
~ **carrier** pòt-amalgam
ambulance anbilans
ambulatory kab mache pou kont li

amenorrhoeic, be v. maflöre, maflori
American ameriken, meriken
 ~ (female) Amerikèn, Merikèn
 ~ (male) Ameriken, Meriken
ammonia amonya
 liquid ~ kanpelwen
ammoniac amonyak
ammonium chloride sèl amonyak
amnesia bliye tout bagay, amnezi
amniotic amnyotik
 ~ fluid lezo, lwezo
amoeba amib
amoebic amib
 ~ dysentery move dyare, dyare danje
among ant, antre
amount kantite, lakantite
ampoule anpoul
amputate v. koupe
amputation koupe
amputee:
 arm ~ moun yon sèl bra
 leg ~ moun yon sèl janm
amulet gad, wanga
amusement plezi
an yon
anal twou dèyè
 ~ groove fant dèyè, kannal dèyè
analgesic grenn doulè
analysis analiz
 laboratory ~ analiz
analyze v. analize
anatomy (human) kò moun
and epi, e, avèk, ak
anemia manke san, feblès, fèblès, anemi
 sickle cell ~ anemi falsifòm
anemic, be v. manke san, soufri feblès, san li tounen dlo
anesthetic:
 (general) ~ anestezi (jeneral)
 (local) ~ anestezi (lokal)
anesthetist moun ki travay ak anestezi
anesthesiologist doktè anestezi
anesthetize v. andòmi, bay anestezi
aneurysm san kaye
anger kòlè
 have repressed ~ v. fè kòlè
angina pectoris anjin pwatrin
angry fache, move
 be ~ (momentarily) v. fè kòlè
 get ~ v. anraje
anguish, extreme lagoni, agoni
animal bèt, zannimo
ankle jepye, (zo) kakòn pye, chevi
 ~ -joint jwenti pye
ankylosis ankiloz
annoy v. jennen, nwi, irite, tripote
annoyed fache
annoying anbetan, enbetan
annual chak ane
annul v. dekadmande
anomaly sa ki pa nòmral
anopheles (malaria-bearing mosquito) anofèl
anorexia maladi refize manje
another lòt
answer repons
answer v. reponn
ant founi, fonmi, fwomi
antacid renmèd asid, alkasètèzè
anthrax maladi chabon
antibiotic antibiyotik
antibody antikò
anticoagulant renmèd ki enpoze san fè boul
antidote kontpwazon, antipwazon
antihistamine antistamin, antyalèji
anti-malarial kont (lafyèv) malarya
antiseptic antiseptik
 ~ (for cuts etc.) ityole
anti-shock treatment tretman anti-chòk
antitoxin sewòm antipwazon
antivenin kontpwazon, antipwazon
anus twou dèyè, tou dèyè, twou fès

anxiety kè sere, kè mare, kè sou
 biskèt, tray, sousi, laperèz, laperè,
 enkyetid
 anxious enkyè
 be ~ v. enkyete
 any:
 (not) ~ more, not ~ longer
 pa ankò
 anyone nenpòt (ki) moun
 anytime nenpòt (ki) lè
 aorta gwo atè ki soti nan kè
 apart apa
 apathetic denèfle, desounen
 ~ person kò lage
 apathy desounen
 aperture ouvèti, bouch
 apologize v. mande padon
 apoplexy apopleksi
 apparatus aparèy
 apparently genlè
 appear v. parèt, sanble, gen lè
 ~ (boil etc.) v. leve
 appearance lè
 appendectomy wete apendis
 appendicitis apendisit
 appendix (body) apendis
 appetite apeti
 have a good ~ v. gen bon
 bouch, bouch/djòl li gou
 have no ~ v. bouch li anmè,
 bouch li pa bon, bouch/djòl li pa
 gou
 loss of ~ bouch pa gou
 applicator aplikatè
 appointment randevou
 make ~ v. pase (yon) randevou,
 kase yon randevou
 approach v. pwoche
 approval konsantman
 approximately konsa, kousa, vè
 April avril
 area kote
 areola (of nipple) womn tete
 arise v. leve
 arm bra
 ~ muscle bwa ponyèt

~ sling echap
 upper ~ bibi, bwa ponyèt
 armband (for mourning) bandlèt
 armpit anbabra, zesèl
 around toutotou, bò, vè
 arrange v. regle
 arrhythmia batman kè ki pa nòmal
 arrive (at) v. rive
 arsenic lasenik
 arteriosclerosis atè ki vin di
 artery venn, atè
 arthritic gen doulè jwenti, gen atritis
 arthritis doulè jwenti, frede, frechè,
 atritis, rimatis, womatis
 rheumatoid ~ rimatis defòmen
 arthrosis rimatis
 articulation, joint jwenti
 artificial atifisyèl, fo
 ~ respiration respire bouch nan
 bouch, respirasyon atifisyèl
 artisan bòs
 as kòm, konm, kou, kon, tankou, jan
 ~ for kanta (pou)
 ~ if kòm si, tankou
 ~ much (~) mezi
 ~ soon ~ kou
 ~ though kòm si
 ascaris gwo vè won, askaris
 ascites dlo nan vant
 aseptic byen pwòp, klin
 ashamed wont
 ashes sann (dife)
 ashtray sandriye
 aside apa, a kote
 ask, ask for v. mande
 ~ a question v. poze yon
 keksyon
 asleep andòmi, nandòmi
 asphyxia etoufman
 aspirate v. wete ak yon zegwi
 aspirator sisyon
 aspirin aspirin
 assemble v. reyini
 assist v. ede, ide, ride
 assistance èd, koumen, lasistans
 assistant segretè, sekretè, asistan, èd

asthma etoufman, opresyon, las,
 asma
astigmatism defòmasyon nan gla(s)
 je
astonished sezi
astonishment sezisman
astrigent astrenjan
asylum, insane azil, lazil
at a
 ~ least omwen, omwens
athlete's foot egzema, ekzema,
 chofi
atrophy manm ki pa sèvi ankò
atropine atwopin
attach v. mare, tache, atache
attack atak
attack v. atake
attempt efò
attempt v. seye, eseye, tante
attendance, in prezan
attendant asistan
attention swen
attentive veyatif
attenuate v. diminye, apeze, bese
attitude lè
auditory nerve nè tande
August dawou
aunt matant, tant, tantin
auricle (of ear) fèy zòrèy
 ~ (of heart) oreyèt
auscultate v. sonde, konsilte
authorization pèmisyon
autoclave esterilizatè vapè
autopsy (o)topsi
 do an ~ v. topsi, otopsi
auxiliary oksilyè
avoid v. evite, egzante, ekzante
awake v. reveye
awaken v. leve
aware konsyan
away pala
awful makawon
awkward mare, gòch, goch, agòch,
 agoch
 (la zesèl, anbabra

B

baby tibebe, titit, timoun
 ~'s bootee choson
 ~ dress or gown kazak
 ~ food akamil
 ~ tooth grenn diri
low birth-weight ~ timoun
 piti anpil, ti zonbi
newborn ~ tibebe ki fenk fèt
premature ~ tibebe ki fèt anvan
 tèm
unbaptized ~ ti chwal
weak or flabby ~ tibebe lèt
bachelor pa marye, selibatè
bacillus jèm
back n. do
 ~ of hand do men
lower ~ senti do, tay, ren
sprained ~ do ouvè, tay ouvè,
 toudren
ulcerated ~ (donkey etc.) do
 mangay
backache maldo, do fè mal, maladi
 do
backbone (zo) rèldo, zo do, zo chenn
 do
backbreaking pete fyèl
backfire kontrekou
backlash chòkanretou
backward, go v. pèdi fil
backwards pa bak
bacteria, bacterial mikwòb, jèm
bad move, mal, malouk
 ~ luck malchans
 ~-tasting makawon
be in ~ shape sou dan
badly mal
 ~ done malouk
 ~ made malfèt
bag sak
 ~ of waters lezo
bagassosis maladi poumon moun ki
 koupe kann
baking powder poud elevasyon,
 poud levasyon

baking soda bikabonat, bikabonak
 balance ekilib
 bald chòv
 ball boul, bal
 ~ of foot pwent pye
 balloon blad
 band (of cloth etc.) bann, kòdon,
 kòdwon, senti
 bandage pansman
 bandage v. panse
 band-aid ti pansman
 baptism batèm
 baptize v. batize
 barber kwafè
 barbiturate kalman, renmèd pou
 kalme moun
 barefoot pye atè
 barrel-chested gwo pektowo
 barren (woman) branrany
 base bounda, bonda, bouda, mouda,
 mouda
 bashful timid, fèmen
 basin basinèt, kivèt
 basis baz
 basket panye, panyen
 bath beny
 herbal ~ beny vapè
 hot ~ (esp. after giving
 birth) beny cho
 take a ~ v. pran yon beny
 bathe v. benyen
 ~ (sores) v. basinen
 bathing suit (man's or woman's)
 chòtdeben
 bathrobe wòb de chanm
 bathroom chanm twalèt, twalèt,
 sakdeben
 go to the ~ v. fè bezwen,
 olye, degaje, degajèt
 bathtub benwa
 battered kraze
 battery (car etc.) batri
 battery (radio etc.) pil
 be (with expressions of age) v.
 genyen, gen
 bead (of perspiration) grenn swè

bear v. sipòte
 beard bab, labab
 beast bèt
 beat, pulsation batman
 beat v. bat, bay bwa
 beautiful bèl
 beauty bèlte, bote
 ~ mark siy, sin
 because paske, pase, kòm, konm
 ~ of poutèt
 become v. vin, fin, tounen
 bed kabann
 ~-ridden kabannen, (malad)
 kouche, alite
 ~-wetter pisannit
 get out of ~ v. desann kabann
 go to ~ v. al kouche, monte
 kabann
 head of a ~ chevè
 make the ~ v. ranje kabann lan
 put to ~ v. mete kouche
 remain in ~ v. kabannen
 bedbug pinèz
 bedclothes dra
 bedpan vaz, basen, podenwi, podnwi
 bedroom chanm
 bedsore maleng kabann, eska
 bedspread kouvrel
 bedtime lè dòmi
 bee myèl
 before (time) anvan, avan
 ~ (in front of) devan, douvan
 begin v. kòmanse, konmanse,
 koumanse
 ~ again v. rekòmanse, repran
 beginner apranti
 behave v. aji, konpòte
 behavior konpòtman
 behind dèyè, dèryè
 belge bèj
 belch wote
 acidic ~ dlo si
 belch v. degobe, gobyè, wote, ote
 belief kwayans
 believe v. kwè, krè, panse, konprann
 ~ firmly v. konnen

bell klòch
belladonna beladonn
belly vant, pans, gwopans, manman
pans, bidas, povant
~ **band (for baby)** bann
lonbrit, bann vant
~ **button** bouton vant
belongings afè, zasè
below anba
belt:
man's ~ sentiwon
woman's ~ senti
bench ban
bend v. pliye, ploye, koube, kwochi,
bosi
~ **over** v. panche, koubi
beneficial itil
benign vyepiti, pa grav
bent kwochi, tòde, tòdye
beside kote, a kote
besides dayè
best pi bon, pi byen
bet v. mize
better pi byen, miyò, meyè, mye
get ~ v. fè mye
between ant, antre
beverage bwason
bewitch v. djoke
bib bavèt
Bible Labib
bicarbonate of soda bikabonat,
bikabonak
biceps bibi, bisèp, bwa ponyèt
bicuspid dan dèyè, dan pilon
bidet bidèt
bifocal lens linèt bifokal
big gwo, gran
~ **and husky** potarik
~ **(for one's age)** gwozo
~ **shot** gwonèg, grannèg,
zotobre, gwo zòrèy
bile bil, lòbyè
bill, itemized account fich
birth nesans
~ **certificate** batistè
~ **control** planin
~ **control pill** grenn (planin)
~ **defect** donmaj (nan nesans)
give ~ v. akouche
practice ~ **control or family**
planning v. fè planing
birthmark anvi
bit kal
bite koutdan
bite v. bay koutdan, mòde
~ **down** v. mòde dan
bitter anmè, amè
black nwa, nwè
~ **eye** je bouche
~ **water fever** pipi nwa
blacken v. blanchi
blackhead pwen nwa
bladder blad pipi, blad pise, sak pipi,
vesi
loss of ~ **control** pa ka kenbe
pipi
blame blanm, blam
blame v. blanmen, blanme
bland ki pa pike
blanket lenn, lèn, kouvèti
bleach klowòks, klowòs
bleed v. bay san, rann san, senyen
~ **s.o.** v. fè yon moun senyen
bleeding senyman, emoraji, moraji
blemish tach
blend melanj
blend v. mele
blepharitis anflamasyon poje
Bless you! (when someone
sneezes) Dye benis!
blind avèg, je klere, je pete
~ **person** (moun ki) avèg
blind v. pete je, vegle
blindness avègleman
blink v. bat je
blink (of eye) batman je
blister zanpoud, zanpoul, boul dlo,
bousòl, glòb (dlo)
~ **(esp. caused by shoe)** dife
volan
bloat v. gonfle
bloated balonnen, pouf

block v. bloke
blockage blokay, blokaj
blond blon
blood san
 ~ bank bank san
 ~ cell globil
 ~ clot boul san, glòb san
 ~ count tè san
 ~ donor moun ki bay san
 ~ group tip san
 ~ poisoning san gate
 ~ pressure tansyon
 ~ pressure apparatus aparèy
 tansyon, tansyomèt
 ~ sample priz san
 ~ sugar sik (nan san)
 ~ test tè san
 ~ transfusion transfizyon san
 ~ type tip san
 ~ vessel veso (san), venn
 donate or sell ~ v. bay san
 give a ~ sample v. bay san
 give a ~ transfusion v. bay
 san
 have ~ in one's stool v.
 poupou san
 high ~ pressure tansyon (wo)
 let ~ v. fè senyen
 low ~ pressure tansyon ba
 sudden surge of ~ kout san
 take a ~ sample v. pran san
 take ~ (for transfusion) v.
 retire (enpe nan) san
bloodshot (eyes) wouj, plen ak ti
 venn san
bloodstained tache ak san
bloodsucker sansi
bloody sangen
blouse chemiz
blow, hit kou, soukous
blow v. soufle
 ~ one's nose v. mouche nen li
 ~ up v. pete
blue ble
blurred vision vwal nan je
 have ~ ~ v. wè twoub

body kò
 flabby ~ kò labouyi, kò lòkò
 human ~ kò moun
boll abse, absè, bouton, klou
boil v. bouyi
boiler chodwon
boiling bouyi
bolt (lock) takèt
bolt (lock) v. take
bone zo
 ~ marrow mwèl, mwal
 ~-setter manyè, doktè zo
 ~-setter (fem.) manyèz
bones (skeleton) zosman
booger kaka nen
book liv
booster shot (piki) rapèl, dòz rapèl,
 rafrechi
border on v. tire sou
born, be v. fèt, ne
borrow v. prete
bosom sen, gagann
both toulede, toude
bother v. jennen, twouble
bothersome anbetan, enbetan, jenan
bottle boutèy, kola
 baby ~ bibon, bibwon
 ~ opener kle (boutèy)
 hot water ~ bouyòt, boutèy dlo
 cho
 small ~ poban
bottom dèyè, dèryè, bounda, bonda,
 bouda, mouda, mounda
 ~ part bouboun
bottom (container etc.) fon
bow v. bese, koube
bowel trip, entesten
 ~ movement watè
 ~ obstruction blokay trip
 have a ~ movement v. watè,
 poupou, okabine, okabinen
 have a ~ movement (after
 constipation) v. debonde
bowl bòl

bowlegged	bankal, kounan, janm louvri, kanbral, pye kanbre, pye tòtòy, pye kwochi	bad ~	bouch santi, movezalèn
bow tie	wozèt	be out of ~	v. pèdi souf
box	bwat	hold one's ~	v. kenbe souf
boxer shorts	kalson	short(ness) of ~	opresyon, woga
boy	gason, ti konpè, tigason	take a (deep) ~	rale (gwo)
boyfriend	menaj, mennaj	souf, rale lè, respire fò	
brace (leg etc.)	aparèy	breathe	v. soufle, respire
bracelet	braslè	~ deeply	v. rale lè
braces (teeth)	aparèy	~ in	v. pran souf
braid	très	~ with difficulty	v. soufle anlè
brain	sèvo, sèvèl, nannan tèt, mwèl tèt	breathing	souf, respirasyon
(Interior of the) ~		rapid ~	souf kout, souf wo
brand name	non fabrik, non mak	breathless	esoufle
bra(ssiere)	soutyen, sak tete	breathlessness	opresyon
brave	kouraje	breech delivery	fèt tèt anlè, fèt de pye devan
brawn	fòskouraj, fòskouraj	breed	v. peple
breadth	lajè	bride	lamarye
break	fele, frakti	bridge (dental)	pon, dan vise, bridj
break	v. kase, kraze, defèt, defè	brief	brèf
~ down (mechanical)	v. pran pàn, anpàn	briefs, underpants	slip
~ off	v. kase	bright	klè
~ open	v. pete	Bright's disease	maladi ren
~ out	v. pete	bring	v. pote, pot, mache ak
~ water (in childbirth)		~ back	v. remete, retounen
v. kase lezo		brittle	sèk
take a ~	v. fè pòz, fè yon ti rete	broad	laj
break, pause	pòz	~-spectrum	plon gaye
breakable	kasab	brochure	bwochi
breakdown (car, machine etc.)		broke, penniless	razè
pàn		broken	kase
nervous ~	depresyon nè	bromide	kalman
breakfast	manje maten, dejene, dejnen, kolasyon	bronchi	bwonch, bwonchit
eat ~	v. dejene, dejnen, kolasyonnen	bronchial tube	bwonch, bwonchit
breast	tete, sen	bronchitis	souf anlè, bwonch, bwonchit
~ (baby talk)	tòtòt	bronchopneumonia	nemoni nan bwonch ak poumon
~-feed	v. bay tete, bay sen	brook	larivyè
take the ~	v. pran tete, rale tete	broom	bale
breastbone	biskèt	broth	tizann, tizàn
breath	souf	brother	frè
		~-in-law	bòfrè, bòf
		brow	fwon

brown mawon
 brucellosis lafyèw nan san, lafyèw
 malta, bwouselosis
 bruise venn foule, blese
 bruise v. mètri, metri
 bruised (psychologically) chode
 brush bwòs
 brush v. bwose
 ~ one's teeth v. lave bouch li
 brushstick (piece of stem or
 wood used as toothbrush)
 bwadan
 brutal brital
 bucket (metal or plastic) bokit
 buckshot plon gaye
 buck teeth dan griyen
 buddy (mas.) konpè, monkonpè
 bug tibèt
 building (gwo) kay
 bulb, light anpoul
 bulge bòs
 bullet bal
 bulletin board tablo
 bullshit vye koze
 bum vakabon, vagabon
 bump boul, bòs, bousòl, douk, kabòs
 small ~ (pimple) klòk
 bump, shock chòk
 bump v. frape
 bunch bann
 bundle pakèt
 bunion kal, zòbòy
 burden chay, chaj
 burial lantèman, antèman, finiray,
 fineray
 burn boule
 burn v. boule, brile
 ~ (sun, medicine etc.) v.
 pike
 burner recho
 burp wote
 burp v. wote, ote, degobe, gobyè
 bursitis anflamasyon zepòl oubyen
 koud
 burst v. pete

~ out (doing something) v.
 pete
 bury v. tere, antere
 bus bis
 bust bis
 busy okipe
 but men
 buttock bò dèyè, fès, bò bounda,
 dèyèkay
 crease In ~s fant dèyè, kannal
 dèyè
 button bouton
 buy v. achte
 buzzing or ringing in ears van
 nan zòrèy, gwonde, boudonman
 by a kote, pa
 bye-bye babay
 bypass (heart) operasyon kè

C

cabinet kabinèt
 cadaver kadav, kadavkò, mò
 caecum sekòm
 Caesarean section sezaryèn
 perform a ~ section v. fann
 vant
 caffeine kafeyin
 calcaneus zo talon
 calcified vin di (kou wòch)
 calcium kalsyòm
 calculus wòch
 ~ (on teeth) kwout jòn
 calf (of leg) jarèt, jare, bout jarèt,
 mòlèt
 large ~ muscle kokoye nan pye
 call rèl
 call v. rele
 callus kal, kò, zanpoud, zanpoul,
 zòbòy
 calm n. sanfwa, trankilite
 calm adj. poze, trankil, kal, frèt
 calm down v. poze san li, rebran san
 li, kalme, kalma, mouri kò,
 trankilize
 calmly dousman

calorie kalori
 camera kodak
 camomile kamomin
 camp bed lidekan
 campaign kwazad
 Campaign against
 Tuberculosis (CAT) Kwazad
 Antiübèkiloz
 camphor kanf
 camphorated kanfre
 can, be able v. kapab, ka, kab, kap
 can (tin) bwat
 ~ opener kle (bwat)
 Canada Okanada, Kanada
 Canadian kanadyen
 ~ (female) Kanadyèn
 ~ (male) Kanadyen
 canal kannal, kanal
 cancel v. dekdòmande
 cancer, cancerous kansè
 candidiasis, oral chank lèt,
 chankalèt
 candle (white) balenn, balèn
 ~ (colored) bouji
 cane, walking stick baton
 canine tooth dan chen, dan je
 canker kank, chank
 cannula kanil
 cap (for head) kaskèt
 cap (for tooth) kouwòn
 capable konpetan
 capillary ti veso san, kapilè
 capsule kapsil, konprime, grenn
 car machin
 carbohydrates sik ak viv
 carbon monoxide oksid kabòn
 carbuncle abse, bouton, klou
 carcass kakas
 card kat, fich
 cardiac kadyak, kadjak
 ~ arrest arèdkè
 cardiogram tès kè
 cardiologist espesyalis kè, doktè kè
 cardiopulmonary kè ak poumon
 ~ resuscitation manyen
 lestonmak

cardiovascular kè ak venn
 ~ accident koutsan
 carditis anflamasyon kè
 care for, treat v. swenyen, swanye,
 (pran) swen, trete
 care, good swen, swenyay,
 laswenyaj
 care, worry souzi
 carefree kè pòpòz
 careful veyatif
 careful! atansyon!
 carelessness neglijan
 cares, worries tèt chaje, traka
 carles kari
 carotid kawotid
 carrier moun ki gen ...
 carry v. pote, pot
 ~ out (orders) v. egzekite,
 ekzekite
 car sickness mal kamyon, mal
 machin
 cart charyo, charèt, kabann woulèt
 cartilage zo krap
 carton bwat
 case, instance ka
 case, patient malad
 cash kach, kontan
 casket sèkèy
 cassette kasèt
 cast, plaster plat, aparèy, anplat, kas
 castor oil lwil masketi, lwil derisen
 castrate v. chaponnen, bistonnen,
 chatre
 castration chatray
 casualty viktim (aksidan)
 catalyst katalizè
 cataract katarak, kakarat, katakat,
 katarat
 catarrh move rim
 catch (sickness) v. trape, atrape
 catheter kata tè, katètè, kawòtchou,
 kawoutchou, tib
 Catholic katolik
 caul kwaf
 cauldron chodwon
 cause lakòz, lakoz, rezon

cause v. kòz, fè
 cauterization kotè
 cauterize v. boule
 cautery kotè
 cavity (body) vid
 cavity (tooth) twou (nan dan),
 kannal dan, kari
 ~ varnish (sealer) vèni
 cease v. sispann
 cecum sekòm
 ceiling plafon
 cell (of plant or animal) sèlil
 cement siman
 ~ filling siman
 cemetery simityè
 center sant
 centigrade santigrad
 centiliter santilit
 centime, Haltian (1/100 of a
 gourde; 1/5 of a U.S. cent)
 santim
 centimeter santimèt
 centipede milpat, milpye
 centrifuge santrifij
 centrifuge v. balanse, santrifije
 cerebral:
 ~ hemorrhage donmaj nan sèvo
 ~ palsy maladi latranblad,
 paralezi serebral
 cerebro-vascular accident (CVA)
 chòk nan tèt, donmaj nan sèvo,
 konjesyon serebral
 certain sèten, si
 certificate papye
 cerumen tata zòrèy, kaka zòrèy, kras
 zòrèy
 cervix kou manman vant, kòl
 (matris), pòt matris
 Cesarean see Caesarean
 chafe v. manje
 chain chenn
 chair chèz
 chamber pot vaz, basen, podenwi,
 podnwi, potchanm
 chance chans
 chancre chank

soft ~ chank sifilis
 change chanjman
 ~ one's mind v. chanje lide
 small ~ (money) monnen
 change v. chanje
 channel kannal, kanal
 chapel chapèl
 chapped, be v. gen krevas
 character karaktè, tanperaman
 charcoal chabon
 charlatan chalatan
 charley horse ti foulay
 charm or amulet, protective gad
 chart, eye tablo
 chart, hospital dosye
 chat v. koze, bay blag
 cheap bonmache
 check tchèk, kontwòl
 ~ out v. fè yon tchèk, tcheke,
 teste, siveye
 ~up sonday, sondaj
 cheek(s) (face) bò figi, kwann figi
 cheekbone zo figi
 cheer up v. remonte, remoute
 chemical adj. chimik
 chemistry chimi
 chemotherapy trètman kansè
 chest (of body) lestonmak,
 lestomak, kòf (lestonmak),
 pwatrin, kòlèt, fal
 ~ area gagann
 ~ cold rim lestonmak
 ~ pain doulè anba kè
 have a sore ~ v. biskèt tonbe
 chew v. moulen, kraze
 chewing gum chiklèt
 chicken poul
 chickenpox saranpyon, charanpyon
 chigger chik
 child timoun, pitit
 eldest ~ premye pitit, lene
 illegitimate ~ pitit deyò
 last-born ~ dènye pitit, kras
 vant
 sickly undersized ~ pedevi,
 petevi

tiny ~ ayovi
 childbirth akouchman, kouch, travay
 children, have v. fè pitiit
 chill fredì, kout lè, koudè,
 refwadisman
 ~ (in part of body) frechè
 chill v. glase
 chills (lafyèv) san frèt, fyèv frèt,
 chofrèt, frison
 chin manton
 double ~ babin, magoul
 receding ~ ti manton
 chiropodist doktè pye
 chlorine klò, klorin
 chloroform klowofòm
 chloroquine klowokin, klowoken
 chlorox klowòks, klowòs
 choke v. toufe, trangle, sifoke,
 sivoke
 choking etoufman
 cholera kolera
 cholesterol grès nan san
 choose v. chwazi
 chorea maladi tranble
 Christian kreyen
 ~ woman kreyèn
 chronic dirab, ki la lontan, rasi,
 kwonik, konik
 be ~ or long-lasting v. chita
 sou, donner sou
 church legliz
 cicatrize v. fèmen
 cigar siga
 cigarette sigarèt
 cinder sann (dife)
 circle sèk
 circuit, short chòt
 circular adj. won
 circulate (blood) v. sikile, sèkile
 circulation (blood) sikilasyon
 circulatory system aparèy san
 circumcise v. koupe kach, wete
 kach, sikonsi
 circumcision sikonsizyon
 circumference, upper-arm bwa
 ponyèt

cirrhosis of the liver maladi fwa,
 siwoz
 cistern rezèvwa dlo
 clamp, large metal klanps
 class klas, kou
 clavicle (zo) salyè, zo zepòl
 clean pwòp, ijenik, ijyenik, jenek
 clean v. pwòpte, netwaye, netye
 cleaning (of teeth) netwayaj
 cleanliness pwòpte, lapwòpte
 cleanser ajaks
 clear klè, vizib
 cleft:
 ~ lip bouch fann, bèk (de)lyèv,
 anvi kochon, anvi krab, anvi
 pyebèf
 ~ palate anvi zago bèf, bèk
 (de)lyèv, bouch fann
 clever fò
 climax, reach a (male or female)
 v. voye
 climb v. monte, moute
 cling (to) v. kole (ak)
 clinic klinik
 Informal temporary ~ pòs de
 rasanbleman
 clinician doktè
 clip klanps
 clip v. taye
 clitoris langèt, krèk, klitoris
 clock (any type of) revèy
 close v. fèmen
 closet pandri
 clot kayo, boul
 clot v. kaye
 ~ (blood) v. fè boul
 cloth twal, twèl
 clothes rad
 ~ pin pens
 ~ rack pandri
 second-hand ~ kenedi
 clothing, piece of rad
 clouded twoub
 cloves jiwòf
 clubfoot pye tòde, pye bòt

clumsy mare, gòch, goch, agoch,
 agòch
 coagulant renmèd ki fè san rete
 coagulate v. kaye, kole
 coarse malouk, pwès
 coat levit
 ~ hanger sèso
 coating plak
 cocaine kokayin, poud
 coccidiosis koksidyòz
 coccyx zo koupyon, zo mis, arèt
 bounda, kòksis
 cockroach ravèt
 codeine kodeyin
 cod-liver oil lwil fwa de mori
 coffin sèkèy
 cohabitation plasay, plasaj
 coil (contraceptive) esterilè,
 filaman
 coltus relasyon, kontak
 ~ Interruptus voye deyò
 practice ~ Interruptus v.
 voye deyò
 cold (common) rim (sèvo),
 refwadisman, grip, lagrip
 bad ~ gwo grip, lagoum
 catch a ~ v. atrape yon rim
 ~ sore chank
 have a ~ v. anrimen, gripe
 head ~ rim sèvo
 cold (temperature) n. fred; adj.
 frèt, glase
 colectomy wete (yon moso nan) gwo
 trip
 colic kolik
 colitis anflamasyon gwo trip
 collapse chit
 collapse v. tonbe (feblès)
 collar kòlèt, kole
 collarbone, collarbone area (zo)
 salyè
 collision (head-on) kolizyon
 colon gwo trip
 color koulè
 ~ blind (moun) ki pa wè koulè
 colostomy mete tib pou watè

colostrum lèt jòn, kolostwòm
 column kolonn, kolòn
 coma koma
 comatose nan koma
 comb peny
 comb v. penyen
 combat v. konbat
 combine v. konbine, konbinen
 come v. vini, vin
 ~ back v. tounen, rebran,
 rebran
 ~ back, recover v. refè
 ~ closer v. avanse
 comfort konsolasyon, konfò
 comfort v. konsole
 comfortable alèz
 command lòd, lèzòd
 command v. kòmande, konmande,
 koumande
 common sense bon konprann
 communicable trapan, atrapan,
 kontajyèz
 ~-disease control sèvis kont
 maladi kontajyèz, ESNÈM
 community n. lakou
 ~ development worker
 animatè
 ~ health worker travayè lasante;
 fem. animatris
 ~ medicine pwogram (la)sante
 kominotè
 community adj. kominotè
 companion kamarad, kanmarad
 compare v. konpare
 compel v. oblije, bije, fòse
 competent konpetan
 complain v. plenyen
 complaint plent
 file a ~ fè plent, pote plent
 complaint, sickness maladi,
 pwoblèm
 complete konplèt, ankè, antye
 complete v. konplete, fini, fin
 completed fèt
 completely nètale, alawonnbadè
 complexon po figi, ten

compliance tande/swiv lòd doktè
compliant (medically) fidèl
complicate v. konplike
complicated manganmen,
 mongonmen, konplike
complication konplikasyon
compliment konpliman
compost heap konpòs
comprehension konpreyansyon
compress konprè
compress v. peze
concave konkav
conceive, become pregnant v.
 vin ansent
conception, impregnation vin
 ansent
concern, matter koze
concerned kè kase
concrete siman
concussion (of brain) gwo kou
 nan tèt
condensed kondanse
condenser (dental) foulwa
condition eta, kondisyon
condolences, my mèkondoleyans
condom pwochèj (gason), kapòt
conduct konpòtman
confidence konfyans, lakonfyans
confident konfyan
**confinement period (after giving
 birth)** tinouris
confuse v. melanje, konfonn
confusion dezòd
congenital fèt tou ...
congested kaye, bouche
congestion konjesyon
 relieve ~ v. debouche, dekolè,
 dekonjesyonne
congratulations konpliman
conjunctiva konjonktiv
conjunctival discharge lasi
**conjunctivitis (epidemic
 hemorrhagic)** je drandran,
 maloje, malozye, azoumounou,
 maladi nan je, konjonktivit,
 konjektivit

connect v. konekte, plogè
conscious konsyan
 be ~ v. gen konnesans
consciousness konnesans
 lose ~ v. pèdi konnesans
 regain ~ v. revini, revni
consent konsantman
consent v. konsanti
consequence konsekans
conserve v. konsève
considerateness konpreyansyon
consistent regilye
consistently regilyèman
consolation soulajman,
 konsolasyon
console v. konsole
constant toutan
constipate v. bay tenès, konstipe
constipated (want) sere, bloke,
 konstipe
 be ~ v. ale di
constipation maladi sere,
 konstipasyon
consult v. konsilte
consultation konsiltasyon
consume v. depanse
consumption konsonmsyon
contact lens vè kontak
contagion kontaminasyon, atrapman
contagious trapan, atrapan,
 kontajye, kontajyèz
**container (for cooking and
 eating)** veso
contaminate v. kontaminen,
 kontamine
contamination kontaminasyon
content adj. kontan
continual san rete
continue v. kontinye
contortion kontòsyon
contraception planin(g)
contraceptive:
 ~ foam krèm, mous
 ~ injection piki planing
 ~ pill grenn (planin)
contract, catch (sickness) v. trape

contract, shrink v. kontrakte,
 (re)kresi
contract, tighten up v. ranmase
 (kò li)
contraction tranche, kontraksyon
contraindicated sa pou ou egzante,
 sa k' pa bon pou ou
contrary kontrè
control kontwòl
control v. kontwole
contusion venn foule
convalesce v. refè
convalescence konvalesans
convalescent k' ap refè
convenient komòd
convex konvèks
convince v. konvenk
convulsions kriz, latranblad,
 tranblad
 have ~ v. bat
cook v. fè manje, fè lakizin, kwit
cook (female) kizinyèz, kouziyèz,
 kwizinyèz
cook (male) kizinyè, kouziyè,
 kwizinyè
cool fre
cool v. rafredi
 ~ (off) v. refwadi
cooler n. bwat glas, bwat frigo,
 glasyè, glasye
coolness frechè
coordination, muscular misk k' ap
 travay byen ansanm
copper kwiv
copulation relasyon, kontak
copy kopi
cord kòd
 ~ presentation fèt kòd lonbrit
 soti anvan
 umbilical ~ (kòd) lonbrit, (kòd)
 lonbrik, mèt trip
core mwèl, mwal
corn (on foot etc.) kò, zòbòy
cornea gla(s) je
 white opacity of ~ te nan je
corner kwen
coronary kè
 ~ bypass operation operasyon
 kè
corpse kadav, kadavkò, mò
corpulent gwo, gra
corpuscle sèlil san
correct korèk
correct v. korije
corridor koulwa
corrupt v. kòwonpi
cortisone kòtizòn
cost v. koute
costly chè
cot kad
cotton koton
 ~ for dressing wound koton
 wat
 ~ gauze twal gaz
 ~ pliers pensèt
 ~ swab kitip
cough tous, latous, touse
chronic ~ koklich
 ~ drop pasti (la)tous
 ~ syrup siwo (la)tous
hacking ~ tous sèch
irritating ~ kent
persistent ~ tous ki pa vle ale
cough v. touse
 ~ up v. krache
coughing touse
counselor konseyè, konseye
count v. konte
countenance min
counter, oppose v. goumen ak
country peyi
 ~ folk moun andeyò
 ~(side) andeyò, andèwò
courage kouray, kouraj, kran
courageous vanyan, kouraje
course, series seri
courtesy lizay, lizaj
cousin kouzen
 distant ~ kouzen sou jèm
 female ~ kouzin
 male ~ kouzen
cover kouvèti

glass ~ for microscope lamèl
 cover v. kouvri, vlope, bouche
 cowardly fenyan
 crab krab
 public ~ mòpyon
 crack fele, fant, krevas
 ~ or sore at corner of mouth
 bòkyè, bòkè
 crack v. fann, fele, krake, pete
 crackpot detrake
 cradle bèso
 ~ cap kap, chaplèt
 cramp lakranp, kranp
 menstrual ~ s tranchmann
 vant, kolik
 cramps or pains, have v.
 kranponnen
 cranium zo (bwa)tèt, (zo) bwatèt, zo
 kokolo tèt, kòkòwòs
 craving gwo anvi
 crawl v. rale
 craziness foli
 crazy fou, fòl, loke, toke, tèt souke,
 dezekilibre
 cream krèm, pomad, ponmad
 crease pli
 ~ between buttocks fant dèyè,
 kannal dèyè
 crease v. plise
 credit kredi
 cremate v. boule
 Creole, Haitian (language)
 kreyòl
 crib kabann pou timoun, bèso
 ~ death lanmò sibat yon tibebe
 crick (in one's neck), have a v.
 kou rete nan kabann
 cripple kokobe, estwopye, enfim,
 enfimite
 cripple v. kokobe, estwopye,
 donmaje
 crippled kokobe
 ~ (hand) pòk
 crisis kriz; dènye degre yon maladi
 critic kritik

critical, grave grav, mangonnen,
 mongonnen, kritik
 off the ~ list òdanje
 criticism kritik
 crooked kwochi, tòde, tòdye
 ~ (fingers etc.) makoubi
 cross, angry move
 cross-eyed je vewon, je lanvè, je
 tounen
 cross (over) v. janbe
 crosswise detravè
 crotch fouk, antrejanm
 ~ of pants fouk
 crouch (down) v. akoupi, koupi
 croup gwo tous
 crowd foul
 crowded bonde
 crown (on tooth) kouwòn
 partial ~ klis, ekliis
 cruel mechan, michan
 crusade kwazad
 crush v. kraze
 crust kwout
 crutch beki, bekin
 cry, yell rèl
 cry, weep v. kriye
 ~ (as in agony or despair) v.
 rakle
 ~ (out) v. rele
 cuff manchèt
 cup tas
 plastic or metal ~ gode
 cup (a patient), apply a cupping
 glass to someone v. vantize,
 poze vè
 cupping glass vantouz, kout koko
 curable gerisab
 curdle (milk) v. fè boul, tounen
 cure v. geri
 cure (magic) senp
 curet kirèt
 curettage kitaj, kitay
 curl n. bouk
 curl up (body) v. akokiye,
 rakokiye, koukouman,
 akoukouman

curly, wavy boukle
 current kouran
 curse madichon
 curtain rido
 cushion kousen, ti zòrye
 cuspid dan chen, dan je
 custom lakoutim
 cut blesi, blese, koupe, fann
 small or slight ~ bèlen, kòche
 cut v. koupe, taye
 ~ off v. tranche, koupe
 cuticle po zong
 cut-offs bout kanson, tèt kanson,
 chèt
 CVA koutsan
 cycle peryòd
 cyst kis, boul
 cystic duct tiyo fyèl
 cystic fibrosis maladi timoun ki
 gen glann yo kata osinon
 maldevlope
 cystitis enfeksyon blad pipi

D

dally toulejou
 damage donmajman, donmaj, domaj,
 dega
 damage v. donmaje, abimen, degrade
 damp imid, mouye
 dampen v. mouye, mikte, mekte
 "D and C" operation kitaj, kitay
 dandruff kal, kap
 danger danje
 out of ~ òdanje
 dangerous danjere
 dark nwa, nwè
 ~ (color) fonsè
 darkness fènwa, fènwè, nwa, nwè
 darling cheri
 date (calendar) dat
 daughter (of any age) pitit fi, fi,
 fy
 ~-in-law bèlfi
 dawdle v. mize
 day jou

 ~ after ~ (de) jou an jou
 ~ off konje
 daylight jou
 day(time) lajounen
 daze v. gaga, toudi
 dazed, be v. pantan
 dazzle, blind v. vegle
 dead mouri, mò
 ~ person mò, (kadav)kò
 drop ~ v. mouri frèt
 deadly mòtèl
 deaf soud
 ~ mute soud bèbè
 ~ person soudè
 deafness soudè
 dear chè, cheri
 death lanmò, lamò, mòtalite
 ~ blow kou mòtèl
 ~ certificate papye lantèman
 ~ from natural causes lanmò
 Bondye
 ~ rattle rakleman
 ~ throes lagoni, agoni
 (on one's) ~ bed olidmò
 utter ~ rattle or agonal
 respirations v. rakle
 debt dèt
 decay pouriti
 ~ (tooth, gum) kari
 decay v. pouri, gate, karye
 decayed, be v. karye
 decayed (tooth) rachòt, pike
 deceased defen
 decelve v. twonpe
 December desanm
 decent desan
 decide v. deside
 decline v. deperi, bese
 decomposition dekonpozisyon
 decongest v. debouche, dekolè,
 dekonjesyonne
 decontamination dekontami- nasyon
 decrease bès
 decrease v. vini mwens, vini pi piti,
 diminye, diminwe
 decreasing an bès

decrepit dekrepî
 deep fon
 ~seated anrasinen
 deeply rooted rasi, nan yon kote
 lontan, anrasinen
 defeat v. bat
 admit ~ v. bat ba
 defecate v. pou pou
 defect defòmasyon, defo
 defective donmaje
 defense, defense mechanism
 defans
 defibrillator defibrilatè
 deficiency mank
 deficit pèdans
 define v. defini
 definite klè, defini
 definitely! pozitif! pozitif!
 deflate v. degonfle
 deform v. defòme
 deformed malfèt, malfòme, difòm
 ~ (hand) pòk
 ~ infant bebe donmaje
 deformity defòmasyon, donmajman,
 donmaj, donmay
 degenerate v. tchoule
 degenerative ki vin pi grav piti piti
 degree (on thermometer) degre
 dehydrate v. dezidrate, pedi dlo (nan)
 kò
 dehydrated chèch, sèch, deperi
 be ~ v. manke dlo, seche,
 cheche
 dehydration pèt dlo, dezidratasyon
 dejected chagren, kè grenn, kagou
 delay reta, delè
 deleterious nwizib
 delicate egzijan, ekzijan, delika
 delirious, be v. depale
 delirium depale, endispozisyon
 deliver (baby) v. akouche
 delivery akouchman, kouch
 breach ~ fèt tèt anlè
 premature ~ akouchman anvan
 lè
 delouse v. wete vèmin

deluge lavalas
 delusions of ..., have v. gen foli
 ...
 demanding egzijan, ekzijan
 dementia foli
 senile ~ annanfans
 demonstrate v. bay prèv
 dengue fever lafyèv deng
 denigrate v. blanchi
 dental dantè
 ~ assistant asistan doktè dan
 ~ floss fil dantè, fil pou dan
 ~ hygienist oksilyè dantè
 dentist dantis, doktè dan
 ~'s drill machin
 dentistry dantis
 dentition fè dan
 denture fo dan, pwotèz, ratelye, plak
 depart v. ale, al
 depigmentation anvi mouton
 depilatory likid oubyen krèm pou
 derasinen plim
 deplorable malouk
 deposit depo
 depot magazen, depo
 depressant gwo kalman
 depressed ba, chagren, kè grenn,
 kagou
 depressing dekourajan
 depression kè sere, kè mare,
 chagren, depresyon
 deprivation malsite
 derivative paran
 dermatitis maladi po
 dermatologist espesyalis po, doktè
 po
 descend v. desann
 desensitize v. denèfle
 desire volonte, lavolonte
 desk biwo
 despair v. dezespere
 desperate dezespere
 destitute malere
 destroy v. detri
 detach v. detache
 detail detay

detergent fab, detèjan
deteriorate v. depafini, degrade
determination kouraj, kouraj
develop v. devlope
development kwasans, grandisman
device aparèy
diabetes maladi sik, dyabèt, djabèt
diabetic dyabetik, djabetik
 be a borderline ~ v. prèske fè sik
 be ~ v. fè sik
diagnose v. sonde
diagnosis rezilta sonday, sonde, dyagnostik, djagnostik
diagnostic dyagnostik, djagnostik
diagram grafik
diaper kouchèt
 ~ rash chofi kouchèt
diaphragm (anatomy) flan
diaphragm (contraceptive) kapòt pou fanm, pwotèj fanm
diarrhea dyare, djare, vant bouyi, vant kondwi, vant kouri, vant lib, vant mennen, vant pase, vant pouri, (vant) tchoulou- lou(t), latyouloulou(t), kakarèl, fwarad, lafwerad
die v. mouri, ale, al
 ~ a natural death v. mouri bon mò
 ~ a violent death v. mouri tèt nwè
 ~ suddenly v. mouri frèt
diesel fuel gazòy
diet rejim, dyèt
 bland ~ manje ki pa pike
 diabetic ~ manje pou moun ki fè sik
 go on a ~ v. fè rejim
 liquid ~ manje likid
 low calorie ~ manje ki pa gen anpil kalori
 low fat ~ manje ki pa gen anpil grès
 low salt ~ manje ki pa gen anpil sèl

salt-free ~ manje ki pa gen sèl menm
difference chanjman
different diferan
difficult rèd, di, difisil, lou, komplike, mechan, michan
 ~ (breathing) anlè
 quite ~ malouk
difficulty pwoblèm, penn
digest v. dijere
digestible (easily) dijès
digestion dijesyon
digestive dijesyon
 ~ fluid(s) dlo dijesyon, likid dijesyon
 ~ system aparèy dijesyon
 ~ tract kannal dijesyon, kannal kap dirije manje
digestals koramin
dilapidated kraze nèt, an ranyon
dilatation and curettage kitaj, kitaj
dilation dilatasyon
dilator dilatatè
dillydally v. mize
dilute v. koupe, dekoupe, delye, fonn
diminish v. bese, diminye, diminwe, apeze
dimple toubote, twoubote
dining room salamanje
dinner, supper soupe, manje aswè
 ~ (main meal) dine
diphtheria difteri
 ~-pertussis-tetanus vaccine (DPT) detepe
direct dirèk
direct v. kòmande, konmande, kourmande
direction sans
directly dirèk
director direktè
dirt, dirtiness kras, salte, malpwòpte
dirty sal, malpwòp, sangwen
dirty v. souye, sal
disability enfimite

disabled estwopye, kokobe
disadvantage dezavantaj, dezavantaj
disagreeable dezagreyab
disappear v. disparèt, ale, al
disappoint v. dekouraje
disappointed, be v. dekouraje
disaster malè
 ~ victim sinistre
disc plak
discharge (from hospital)
 egzeyat, ekzeyat
discharge, secretion matyè, sòs,
 dlo blan(ch)
 ~ (pus) pi, postim
 urethral or vaginal ~ gran
 chalè, ekoulman
discharge, secrete v. bay sòs,
 swente, koule
 ~ pus v. sipire
**discharge or be discharged (from
 hospital)** v. egzeyate, ekzeyate
discipline lòd
discolored pèdi koulè
 ~ (teeth) vin jòn
discomfort malèz, jennman
disconnect v. dekonnekte
discourage v. dekouraje, dekonpoze
discouraged ba
 be ~ v. dekouraje
discouraging dekourajan
discover v. dekouvri
discuss v. diskite
disease maladi
diseased malad
disfigure v. defigure
disgusting malouk, degoutan,
 makawon, vye
 ~ (food) rebitan
dish bòl, asyèt
 metal or plastic ~-cover
 kouvrepla
disinfect v. dezenfekte
disinfectant dezenfektan
disinterestedly pou granmèsi
**disjoint or dislocate (bone,
 joint)** v. dejwente, debwate,
 demoute, demonte, deklòke,
 dekole, delonje
disk (in back) zo nan rèdo
herniated ~ eklatman nan (zo)
 rèdo
slipped ~ deplasman nan (zo)
 rèdo
dislocation dejwentaj
dismember v. demanbre
dismiss v. voye ale
disorder dezòd
disorder, sickness maladi
disoriented dezoryante, egare, gaga
dispensary dispansè
disposable dispozab
dispute kont
dissolve v. fonn
distant lwen
distended balonnen, bonbe
distension balonnen
distill v. distile, distiye
distort v. defigure
distorted difòm
distress soufrans
distress v. fè lapenn
distressed vant ba
distressing penib
district peyi
distrust defyans
disturb v. deranje, toumante, ajite
disturbance deranjman
disturbed dekonpoze
ditch rigòl
diuretic ki fè ou pipi
diverticulitis anflamasyon nan gwo
 trip
divide (up) v. separe
divorce v. divòse
dizziness tèt vire, toudisman,
 lawouli (tèt), latounay, soulay,
 viray, vètij, toudlin, mayilò
dizzy toudi, je vire, defalkaw
make or be ~ or dazed v.
 soule
do v. fè
 ~ again v. refè

~ one's best v. fè posib li
 ~ something regularly or often v. konn
doc dòk
docile dou, obeyisan
doctor doktè, dòktè, medsen
 leaf ~, faith-and-herb ~
 doktè fèy
 Western-type ~ doktè
 loptal/dispensè
 woman ~ doktè fi
dollar dola
dolly charyo
Dominican citizen Panyòl
Dominican Republic Panyòl, Dominikani
done fèt
donkey bourik
don't (you) ever pinga, piga
door pòt
dorsum of foot dopye, wòs
dosage dòz
dose dòz, posyon
double doub
 ~ chin papèl
 ~ up (in pain) v. kòde
 have ~ vision v. wè de (bagay), wè tout bagay an de, wè doub
doubt dout
douche v. fè bidèt
douche (vaginal) douch, lavay bouboun
down anba, atè
downpour lavalas
Down's Syndrome gwo tèt
dozen douzèn
doze off v. asoupi, singo
DPT vaccine detepe
draft (current of air) kourandè
drag v. rale
drain twou, egou, regou, rigòl
drain v. vide, drene
drainage drenaj
draining drenaj
dramamine dramamin
drape, sterile chanm
draw blood v. senyen
drawer (table, chest etc.) tiwa
drawn rale
draw-sheet alèz
dream rèv, sonj, vizyon
dress wòb
dress v. abiye
 ~ (a wound)panse
dressing (on wound) pansman, aparèy
dressing-gown wòb de chanm
dribble v. pipi ti tak ti tak, degoute
drill (dentist) v. sèvi ak machin
drill (dentist's) machin
drink bwason, bweson, kou
drink v. bwè
drinkable bivab, potab
drip degout, gout
drip v. degoute
drivel bav
drool v. bave
drop (liquid) degout, gout
 tiny ~ tak
drop v. kite tonbe
 ~ out v. lage
 ~ out rate kantite ki lage
dropper, medicine konngout, kontgout
drops, eye ajiwòl, gout
dropsy anfleman pye
drown v. neye, nwaye
drowsiness letèji, letaji
drowsy tèt lou
drug (illegal) dwòg
 be under the influence of
 illicit ~s v. dwoge
 ~ abuse nan dwòg
 ~ addict dwoge
druggist famasyen, fonmasyen
drugstore famasi, fanmasi, fonmasi
drunk sou, soule
drunkard tafyatè, bwasonnyè
dry sèk, chèch, sèch
 ~ season lesèk
 ~ (skin, lips) lateng

~ up v. seche, cheche
 dryer n. sechwa
 duct kannal, kanal
 ductless glands giann ki pa gen
 kannal
 dull (pain etc.) fèb
 dumb sòt, ebete, enbete, gaga,
 kannannan
 dung poupou, kaka
 duodenum ti trip
 durable dirab, solid
 duration dire
 during pandan
 dust (la)pousyè
 duty, on desèvis, degad
 dwarf rasi, nen
 dwarfish rachitik
 dying mouran
 be ~ bat lakanpany, lagoni,
 agoni, trepase, pral(e)
 dynamic gaya vivan
 dynamo dinamo
 dysentery gwo djare san, kolorin,
 kolerin, disantri
 dyslexia defòmasyon nan sèvèl li ki
 fè li pa wè tankou tout moun lè l'
 ap li
 dysmenorrhea règ difisil
 dyspnea etoufman
 dysuria doulè lè ou pipi

E

each chak, toule
 ear zòrèy
 ~ canal kannal tande
 ~ infection otit
 external ~ fèy zòrèy
 inner ~, middle ~ anndan
 zòrèy, fon zòrèy, nannan zòrèy,
 twou zòrèy, tou zòrèy
 earache zòrèy fèmal, malzòrèy
 eardrum tande (zòrèy), tenpan
 earlobe tete zòrèy
 early bonè
 earn v. genyen, gen

earnest serye
 earring zanno
 earth tè
 earwax tata zòrèy, kaka zòrèy, kras
 zòrèy
 earwig (parasite) pès-zòrèy
 earthworm vètè
 ease v. soulaje
 ~ up v. kalma
 easily fasil
 easy fasil
 take it ~ pa bat kò ou
 easygoing fasil
 eat v. manje
 ~ (baby talk) v. nannan
 eccentric detrake, fou dou
 eclampsia kriz, pwazon gwosès,
 eklanmezi
 ectopic pregnancy yon gwosès ki
 pa nan matris
 eczema dat, egzema, ekzema
 edema anfleman, edèm
 ~ (of lower extremities)
 efranjit
 edematous anfle
 edge arebò, rebò, bò
 edible manjab
 effect rannman
 effort jefò, jèfò, efò, lapenn, lapèn
 egg ze
 ejaculate dechaj, dechaj, jèm
 ejaculate v. voye, dechaje, ejakile
 ejaculation voye
 extravaginal ~ voye deyò
 premature ~ voye twò vit
 elastic lastik, elastik
 elbow (je) koud, zo koud
 elderly granmoun, aje
 eldest premye
 electric lektrik, elektrik
 ~ current kouran, limyè
 ~ outlet priz
 ~ shock kouran
 electrical outage blakawout
 electricity kouran, lektrisite,
 elektrisite

electrocardiogram tès kè
 electrolysis wete plim ak yon zegwi
 elektrik
 elephantiasis gwo pye
 elevate v. leve (pi wo)
 elevated anlè
 elevator (dental) elevatè
 eliminate, excrete v. watè,
 poupou
 emaciated zo ak po, chèch, sèch,
 defini, griyen, dezose, vide
 become ~ or cachectic v.
 seche, cheche, dezose, dechose
 embalm v. anbonnen
 embarrassed jennen
 embolism anboli
 embryo anbriyon
 emergency ka prese, ka presan, ka
 ijan
 ~relief food sinistre
 ~ room sal dijans
 emetic vomitif
 emotion emosyon
 strong ~ transpò
 emotional crisis kriz (de) nè,
 sezisman
 emotional or overwrought, be v.
 fè emosyon
 emphysema etoufman, anfizèm,
 lanfizèm
 suffer from ~ v. rakle
 emptiness vid
 empty vid, blan, blanch
 empty v. vide, dechaje
 enamel emay
 encephalitis anflamasyon mwèl tèt,
 ansefalit
 encourage v. ankouraje
 encouragement ankourajman
 end v. fini, fin, tèmine
 end, completion fen, finisman
 end, extremity pwent
 endemic domnen, anrasinen
 endocarditis anflamasyon kè
 endocrine glands glann ki pa gen
 karnal

endodontics wete nè/vè nan dan
 endurance rezistans, fyèl
 endure v. sibi, souffri, dire, kenbe
 enema lavman, kristè
 ~ bag bòk
 ~ tube kawòtchou (bòk)
 enemy le-nmi
 energy enèji, chalè, fòs
 enervation afeblisman
 engaged, be or get v. fyanse,
 fyanse
 engine motè
 English angle
 engorge v. angòje
 enlarge v. gwosi, (a)grandi, laji
 enlargement dilatasyon
 enormous kokennchenn
 enough ase, kont kò, kont (li), mezi
 enraged, be(come) v. anraje
 enter v. antre
 enteric zantray, entestinal
 enteritis anterit
 enterobius oksiyi
 entire ankè, antye
 entrails zantray, trip, boyo
 entrance antre
 entry book rejis
 envelope v. vlope
 environment lantiray
 ephemeral ki pa dirab
 epidemic ravaj, ravay, pidemi,
 epidemi
 epidermis epidèm
 epigastric anba kè
 ~ discomfort biskèt tonbe
 ~ distress mal anba kè
 epigastrium anba kè
 epiglottis ti chè dèyè lang, epiglòt
 epilepsy malkadi, maladi tonbe, kriz
 epileptic n. moun ki gen malkadi
 ~ fit or seizure kriz malkadi
 episiotomy, to perform an v.
 koupe
 epistaxis nen senyen
 Epsom salts sèldepsonn, sèl gason
 equal egal

equilibrium ekilib
 erection bann, bibit
 have an ~ v. bande
 error fòt, fot, erè, èrè
 erysipelas egzema wouj ak lafyèv,
 resipèl
 escape v. chape, sove
 esophagus banbou gòj, (banbou)
 gagann, tib gagann, gwogòj, (gwo)
 gòjèt mou, lezofaj
 especially sitou, espesyalman
 estrogen òmonn fi
 ether gaz operasyon, etè
 eugenol lwil pou dan, lwil jiwòf
 eunuch san grenn, enik
 euphoria gran kontantman
 Eustachian tube kannal anndan
 zòrèy
 euthanasia touye moun ki pa gen
 lespwa refè
 evaporate v. vante, vapore, evapore
 even menm
 ~ off v. plati
 evening swè
 ~ meal manje aswè
 good ~ bonswa
 in the ~ diswa
 in the ~(s) leswa
 ever janm
 every chak, toule, tout
 ~ (habitual) le
 everyday toulejou
 everyone tout moun
 everything tout
 everywhere toupatou
 evidence prèv
 evil mal, move, mechan, michan
 cast an ~ spell v. voye mò
 ~ eye maldjòk, maldyòk
 ~ spell maldjòk, maldyòk
 ~ spirit mò
 exact egzat, ekzat
 exacting egzijan, ekzijan
 exactly jisteman
 exaggerate v. gwosi
 examination egzamen

medical ~ konsiltasyon
 examine v. egzaminen, analize,
 kontwole, pran pèz
 ~ (a patient) v. konsilte
 example egzanzp
 for ~ pa egzanzp
 exasperate v. irite
 exceed v. depase
 except sòf, sof, esepite, eksepte
 excessively twò, twòp
 excise v. koupe, wete
 excite v. ajite
 excited cho, chofe
 excrement okabine, okabinen, watè,
 malpwòpte, pou pou, matyè fekal
 liquid ~ kakarèl
 excrete v. mete deyò
 excuse v. eskize
 exercise egzèsis, ekzèsis
 exercise v. fè egzèsis
 exhale v. lage souf
 exhaust v. rente, depafini
 exhausted, be v. tonbe feblès
 exhausted (physically) kòkraz,
 kòkraz, bouke
 exhaustion kò dezole, kò kraz, gwo
 fatig
 existence lavi
 expand v. gwosi, grandi
 expansion grandisman
 expect v. atann, tann, espere
 expectorant renmèd pou fè ou krache
 rim/flem, espektoran
 expenses frè
 expensive chè
 experienced rasi
 experiment v. seye, eseye
 expert espè, ekspè
 expiration date, past pase dat
 expired, be v. pase dat
 explain v. esplike, eksplike
 explanation kont
 explode v. pete, sote
 explorer (dental) sonn
 extend v. etann
 extended care swenysay pou lontan

external deyò
 extingulsh (lamp, fire) v.
 etern, touye
 extract (pus) v. prije, piye, pire
 extract (tooth) v. rache
 extraction ekstraksyon
 do an ~ v. rache dan, fè
 ekstraksyon
 extreme unktion estrèmonsyon
 extrovert moun ouvè
 exudate matyè
 exude v. jete
 eye je, zye; (see also Je entries in
 Haitian Creole-English section)
 ~ chart tablo
 ~ dropper konngou, kontgout
 ~ drops ti dlo pou je,
 medikaman pou je
 ~ matter kaka je, lasi
 ~ specialst espesyalis je, doktè
 je
 ~ strain fatig nan je
 lazy ~ je lanvè
 protruding ~s je soti
 eyeball boul je
 eyebrow sousi
 eye-dropper konngout, kontgout
 eyeglasses linèt, vè
 eyelash(es) plimje, pwalje, pwèlje
 eyelid poje, pòpyè
 inner side of ~ anndan poje
 eyesight je, vizyon, limyè
 have falling ~ v. je ap febli
 have good ~ v. gen bon je
 eyesocket pòch je
 eyetooth dan chen, dan je
 eyewash dlo lave je

F

fabric twal, twèl
 face figi
 ~ (of clothing or fabric)
 landrèt, landwat
 fade v. blanchi
 faded pèdi koule, pal

Fahrenheit farennay(t)
 fall v. rate, manke
 failure echèk
 faint v. endispoze, faya, tonbe febliès,
 dekonpoze, pèdi konmesans
 fainting spell dekonpozisyon,
 endispozisyon, kriz
 fair jis
 faith fwa, konfyans, lakonfyans
 ~-and-herb healer doktè fèy
 faithful fidèl
 faithfully fidèl
 fake v. fè sanblan
 fall chit
 ~ (affecting waist area)
 toudren
 fall v. tonbe
 ~ off (in weight) v. dechte
 ~ out (hair, teeth) v.
 degrennen
 Fallopian tube(s) kannal ze, tib
 matris, twonp
 false fo
 falsehood manti, mantò
 faltering an bès
 familiar wìth, be v. konnen
 family fanmi, moun
 extended ~ fanmi
 ~ name siyati
 ~ planning planin, planing
 famline grangou
 fan v. vante, fè van
 fan, hand- evantay, vantay
 fan (machine) vantilatè
 far lwen
 farmer abitan
 farsighted (ki) wè delwen, presbit
 fart van, gaz
 fart v. pete, lache, fè van
 farter (frequent) petadò
 fast n. jèn
 fast adv. vit, rapid
 fast v. fè jèn
 fasten v. mare, tache, atache, fikse
 fasting jèn
 fat n. grès

fat adj. gra, gwo
 ~ and healthy gwo gra
 fatal ki (ka) touye moun
 fatally mòtèlman
 father papa
 ~-in-law bòpè, bopè
 ~ (priest) monpè, pè
 fatigue fatig
 faucet wòbinèt
 fault fòt, fot
 favor sèvis
 fear lapè, pè, laperèz, laperè, pèrèz,
 perèz
 fear v. pè
 fearful pèrèz, perèz
 febrile ki gen lafyèv
 February fevrye
 fecal matter matyè fekal
 feces kabine, kabinè, watè, sèl
 fecund pititral
 fecundation fekondasyon
 fee frè
 feeble fèb, delika
 ~ -minded kannannan
 feed v. nourri
 feel v. santi (li)
 feel like, want v. anv
 feel, touch v. manyen, tate, touche
 ~ an overall weakness v.
 santi tèt vid
 ~ like doing something v.
 sou sa
 feeling sansasyon, santiman
 fellow gason
 felon, whitlow pannari, panari
 female, woman nègès, fi, fanm
 femur zo kwis
 fertile pititral
 fertilization fekondasyon
 fertilizer fimye
 fester v. sipire, anvlimen, ankave, fè
 pi
 fetal fetis
 ~ position akoukouman
 fetid santi
 fetish wanga

fetoscope fetoskòp
 fetus fetis
 movements of ~ in womb
 plichip
 fever lafyèv, lafyèb, fyèv; (see also
 lafyèv entries in Haitian Creole-
 English section)
 bad ~ gwo lafyèv
 ~ and chills lafyèv frison,
 lafyèv frèt, lafyèv nan san, lafyèv
 tranble
 ~ blister bouton lafyèv, chank
 high ~ lafyèv cho, lafyèv chwal
 high ~ and chills chofrèt
 low-grade ~ ti fyèv
 postpartum ~, puerperal ~
 lafyèv apre akouchman, lafyèv
 kabam
 stubborn ~ lafyèv kolan
 feverish ki gen lafyèv
 ~ state rechofman
 few, a kèk, kèlke
 flancé(e) fyanse, fyanse
 fiber fil
 fibroma fibwòm
 fierce makawon
 fight v. goumen, bat
 ~ off v. konbat, goumen (ak)
 filariasis filaryoz
 file folder klasè
 file (tool) lim
 filing cabinet klasè
 fill v. plen, foul
 ~ (a tooth) v. plonbe
 filling (dental) amalgam, plonbaj,
 plon
 do a ~ v. plonbe
 permanent ~ amalgam
 temporary ~ bagay pou bouche
 dan ki p' ap rete lontan
 film, coating plak
 filter filt, filè
 ~ paper papyè filtre
 filter v. filtre
 filth kras, salte, malpwòpte
 filthy person sangwen

finally anfen
 find v. jwenn
 fine byen, debyen, bon,
 anfòm
 finger dwèt
 ~ tip pwent dwèt, tèt dwèt
 index ~ dwèt jouda, lendèks
 little ~ ti dwèt
 middle ~ dwèt mitan, lemajè
 ring ~ dwèt bag, (dwèt) anilè
 flagerball zong (men)
 ~ polish kitès, kitèks
 white spot in ~ kado
 finish v. fini, fin, kaba, tèmine
 fire dife
 firm, hard di, fèm
 firm, healthy engann, engam,
 djanm, dyanm
 firm, resolute rezoli
 first premye
 ~ aid premye swen
 ~-aid worker sekouris
 ~ (of all) dabò
 fissure, crack fele, fant, krevas
 fist pwen
 make a ~, clench one's ~ v.
 mare pwen
 fistula fo kannal nan dèyè (etsetera)
 fit, healthy gaya
 fit, seizure kriz
 have a ~ v. dekonpoze
 fix v. ranje
 ~ (machinery) v. leve pàn,
 depare
 fix (bad) ka
 flabby mou
 flaccid mou
 flake (off) v. dekalè
 flame dife
 flank flan
 flashes, hot boufe chalè
 have hot ~ v. santi chalè (nan
 tout kò)
 flashlight flach
 flat plat
 ~ feet pye plat
 flatten v. plati
 flatulence gaz
 flavor gou
 flaw defo, donmay
 flea pis
 flesh vyann, lachè, chè
 flex v. jwe
 flexible likid
 flight vòl
 floaters (in eye) ti bagay ki fè
 mimi mimi devan je
 floor (wooden) planche
 floppy lage
 floss fil pou dan, fil dantè
 floss v. sèvi ak fil pou dan
 flow kouran
 flow v. koule
 flower flè
 flu (lafyèv) grip, lagrip
 have the ~ v. gripe
 fluid likid
 fluoride fliyorid
 flush (toilet) v. floche
 flustered dekonpoze
 fly (insect) mouch
 fly (of trousers) bragèt
 foam kim
 contraceptive ~ krèm
 foam v. kimen, tchimen, fè kim
 focus v. fikse
 foe le-nmi
 fold pli
 fold v. pliye, ploye, plise
 folding bed lidekan
 folding screen paravan
 folle folik
 folk healer doktè fèy
 folk medicine renmèd fèy
 follow v. swiv
 do a ~-up v. fè kontwòl
 fondness tandrès
 fontanel fontenn, fwontenn, fontanèl
 unclosed ~ tèt louvri
 food manje, nouriti, lanouriti,
 pwovizyon, povizyon
 adult ~ gwo manje

(deliberately) poisoned ~
 manje ranje
 ~ (baby talk) nannan
 ~ poisoning manje gate
foot pye
 ~ odor mayas
 ~-warmer bouyòt
 on ~ apye
foot (12 inches) pye
footbath beny pye
footlocker mal
footprint (of neonate) anprent pye
for pou
force fòs, kouraj, kouraj
 ~ of one's arm bwa ponyèt
force v. fòse, oblije, bije
forceps (med.) pens, fòsèp
forearm avanbra, (bwa) ponyèt
forefinger dwèt jouda, lendèks
forehead fwon, fon, fontenn tèt
 receding ~ tèt chankre
foreign body bagay
foreigner (of any race) blan
foremilk lèt jòn, kolostwòm
foreskin pokòk, po (ti) kòk, kach,
 bèk
forget v. bliye
forgive v. eskize
fork (eating) fouchèt
form v. fòme, fòmèn
form, blank papye
 in top ~ anfòm
formaldehyde fòmòl
fortify v. remonte, remoute, fòtifye
fortunate chance
fortune, good bonè, chans
foul-smelling santi
fountain tiyo, fontenn, fwontenn
fourth ka
 ~ (of a monetary unit) eka
fraction moso
fracture kase, frakti
 comminuted ~ zo kase nan
 plizyè kote
 compound ~ zo kase ki parèt
 hairline ~ zo make kase

reduce a ~ v. ranje zo
fracture v. kase, fraktire, anfraje
fragile frajil
fragment kraze, ekla
fragrance odè, lodè
frail frajil, enfim
frame kad
frames (of eyeglasses) bwa linèt,
 ankadreman, monti
freckle ti tach
free lib, gratis
freeze v. vin di
frenum filèt, filè
frequency chak ki lè
frequent adj. ki rive souvan, rapid
fresh (unsalty) water dlo dous
Friday vandredi
friend zanmi, kamarad, kanmarad
 (female) ~ konmè, makonmè
 (male) ~ konpè, monkonpè, frè
fright pèrèz, perèz, freyè, frèyè
frighten v. fè pè
frightened, become v. pran pè
frigidare frijidè
front devan
 in ~ of devan
froth kim
froth v. kimen, tchimen, fè kim
frown v. mare min
full plen, foul
fumigate v. flite
function v. mache
fundus fon
funeral lantèman, antèman, finiray,
 fineray,
 ~ parlor mòg
fungus infection maladi djondjon
fungus fongis, djondjon
funnel antonwa, antonnwa
funny bone, hit one's v. santi
 elektrisite nan bra, frape koud bra
furlous move
furrow min
furuncle abse, absè, bouton, klou
fury laraj

G

gag, choke v. toufe, trangle
 gain weight v. pran pwa, vin pi
 gwo
 gait mach
 gall lòbyè
 gallbladder fyèl, pòch bil
 gallon (measure, container)
 galon
 gallstone pyè nan (kannal) bil, pyè
 nan fyèl
 ganglion gwoup nè
 gangrene kangrenn, gangrenn
 gangrenous ki gen
 kangrenn/gangrenn
 become ~ v. kangrennen
 gap fant
 ~ between two front teeth
 chenèt
 garbage fatra
 ~ can poubèl
 ~ dump depotwa
 gargle v. gagari
 gargling gagari
 gas (for cooking etc.) gaz
 ~ stove fou gaz
 gas (gastrointestinal) gaz, van nan
 lestonmak
 pass ~ v. ram gaz
 gash balaf
 gasoline gaz
 gastric hemorrhaging, have
 v. vonmi kouwè ma
 kafe/goudwon
 gastric juice(s) dlo dijasyon, likid
 dijasyon
 gastric reflux dlo si, asid
 have a ~ ~ v. fè rapò
 gastritis asid
 (gastro)enteritis anterit
 gastrointestinal vant ak trip
 gather together v. sanble, reyini
 gauge gedj
 gaunt mèg, fil
 gauze (bandage) (twal) gaz

gay (male homosexual) masisi
 gene jenn
 general jeneral
 generator (electrical) dèlko,
 jeneratè, dinamo
 generic name non kalite
 genital area (of woman) kwis
 genitals pati (sansib), afè, zafè,
 devan, douvan, bagay
 child's ~ (either sex) tidevan
 ~ of small boy ti bezwen
 ~ of small girl boyo
 ~ of woman anba, komisyon,
 naman, sa Bondye ban mwen
 gentian violet jansyàn vyolèt
 gentle dou
 gentleman msye
 gently dousman
 geophagist manjèdtè
 geophagy manje tè
 geriatrics lasante vye granmoun
 germ jèm (maladi), mikwòb
 German measles ribeyòl
 get v. pran, resevwa, gen(yen)
 ~ along v. kenbe
 ~ angry v. anraje
 ~ better v. fè mye
 ~ by v. degaje, degajèt
 ~ up v. leve, reveye
 ~ up onto v. monte sou
 ~ well v. refè, geri, retabli
 giardia gyadya
 giddiness latounay, toudisman,
 viray, toudlin
 giddy je vire, toudi
 ~ or dizzy, be v. wè tout nwa
 gift kado
 gigantic kokennchenn
 gingivitis jansiv anfle, jansiv
 senyen
 girdle genn, gèn
 girl tifi, fi, fiy, (ti) konmè
 ~ (used only in direct
 address) mafi
 girls ti medam
 small ~ fiyèt

girlfriend menaj, mennaj
 give v. bay, ba, ban
 ~ again, repeat (dosage etc.)
 v. rebay
 ~ back v. rann, retounen, remete
 ~ in v. bat ba
 ~ off v. rann
 ~ up v. reziyen, reziye
 glad (kè) kontan
 gland glann
 glans penis tèt pìjon
 glass (substance; drinking) vè
 fragment of broken ~ zenglen
 ~ slab (dental) plakèt vè
 pane of ~ glas
 glasses (eye) linèt, vè
 Glauber's salts sèl fanm
 glaucoma tansyon nan je, glokòm
 glob (excrement, spittle,
 phlegm) plòt
 globule globil
 glomerulonephritis anflamasyon
 nan ren
 gloomy sonm
 glove gan
 glucose sik, glikoz
 glue lakòl
 gluttonous afre
 gnat bigay
 go v. ale, al
 be going v. pral(e)
 ~ (and) get v. ale chache
 ~ away v. ale, al
 ~ away (fever, headache
 etc.) v. lache
 ~ back v. retounen
 ~ down v. desann
 ~ out (from) v. soti, sot
 ~ up v. monte, moute
 ~ up again v. remonte,
 remoute
 goatee babich
 God Bondye, Gran Mèt
 ~ bless you! Bondye beni ou!
 ~ willing si Bondye vle
 godchild fiyèl, fiyòl

goddaughter fiyèl, fiyòl
 godfather parenn
 godmother marenn, nennenn
 godson fiyèl, fiyòl
 going to, be v. pral(e)
 goiter (maladi) gwo kou, boul nan
 kou, boul nan gòj, gwat, papèl
 gold ò, lò
 golden dore
 gonorrhea ekoulman, chòdpis,
 grantchalè, grannchalè, grennchalè,
 gonore, gonokòk, blenoraji
 good bon, saj
 ~ behavior sajès
 ~-bye babay, orevwa
 ~-for-nothing vakabon,
 vagabon
 goose flesh chèdpoul
 gourd bowl kwi
 gourde (Haitian monetary unit
 formerly equivalent to \$.20
 U.S.) goud
 gout anflamasyon nan jwenti pye
 government leta
 ~ officials leta
 gown wòb
 patient's ~ kanmizòl
 grab v. sezi
 gradually piti piti, pazapa, (de) jou
 an jou
 graft (skin) grèf (po)
 do a ~ v. grefe
 grain grenn
 gram gram
 grandchild pitit pitit
 granddaughter pitit pitit fi
 grandfather granpapa, granpè
 grandmother grann, granmè
 grandson pitit pitit gason
 granule ti grenn
 grapevine teledyòl, teledjòl
 graph grafik
 gratis gratis
 gratitude rekonesans
 grave, critical grav, malouk,
 mangonmen, mongonmen, kritik

grave, tomb tonm, latonm
 gravely gravman
 graveness gravte
 graveyard simityè
 gray gri
 graying, be v. blanchi
 great gran, gwo
 ~-aunt matant matant, tantin
 tantin
 ~-grandchild pitit pitit pitit
 ~-grandfather gran granpapa
 ~-grandmother gran grann
 ~-nephew ti neve
 ~-niece ti nyès
 ~-uncle tonton tonton
 great! anfòm (nèt)!
 green vèt
 grief lapenn, lapèn, chagren, penn
 grieve v. fè lapenn
 grill recho
 grind v. pile
 ~ one's teeth v. manje dan
 grinder moulen
 grippe grip, lagrip
 groan v. plenn, jemi
 groin lenn, lèn
 groom (in a marriage) lemariye
 ground tè
 group bann, gwoup
 grow (up) v. grandi
 ~ larger v. gwosi
 ~ or develop satisfactorily
 v. (byen) vini
 growing pains doulè grandi
 growl v. griyen
 grown-up granmoun
 growth kwasans, grandisman
 small ~ (on skin) siy, sin
 grunt (in respiratory distress) v.
 plenn
 guilty antò
 gullet banbou gòj, (banbou) gagann,
 tib gagann, gwogòj, (gwo) gòjèt
 mou
 gulp gòje

gum(s) (of mouth) jansiv, jansib,
 zansiv
 ~ abscess frechi dan
 ~ disease maladi jansiv
 gunshot wound blesi bal
 gurney kabann woulèt
 gush forth v. jayi
 gut zantray, tripay, trip, boyo
 guy nèg
 gynecologist doktè pou fanm,
 jinekòlòg
 gynocology pwoblèm fi

H

habit abitud
 bad ~ defo
 hair (on head) cheve, chive
 body ~ plim
 ~-curler bigoudi
 ~-net filè(t)
 ~ pin pens
 ~ ribbon kokad
 public ~ pwal, pwèl, ti gazon
 hairbrush bwòs tèt
 Haiti Ayiti, peyi a
 Haitian ayisyen
 ~ cent (1/100 of a gourde)
 (fam.) kòb
 ~ Creole kreyòl
 ~ (female) Ayisyèn
 ~ (male) Ayisyen
 half n. mwatye
 half adj. demi
 ~-dressed toutouni, touni
 ~-mourning (clothing)
 demidèy
 ~-way mwatye
 halitosis bouch santi, movezalèn
 hall koulwa
 hallucinations pran yon bagay pou
 yon lòt
 hammer mato
 hammock amak, ramak
 hamstring muscles misk dèyè kwis
 hand men

back or dorsum of ~ domen
 ~ towel sèvyèt
 shake ~s v. bay lanmen
 wring one's ~s v. sere men
bandful men
handicap donmajman, enfimite
handicap v. donmaje
handicapped kokobe, donmaje,
 andikape
handkerchief mouchwa
handle manch
handle v. manyen
handsome bèl
hang v. pandje, pandye
 ~ down v. pann
 ~ up v. kwoke, koke, pann
hanging pandje, pandye
hangnail po sou kote zong
hangover (an) malmakak
happen v. rive, pase
happiness bonè
happy (kè) kontan
hard di, kòryas
 be ~ of hearing v. tande di
harden v. redi
hardening redisman, vin di
hardly apenn, apèn
hard-working vanyan
harellp bouch fann, bèk (de)lyèv, anvi
 pyebèf, anvi krab, anvi kochon
harm mal
harm v. fè mal, donmaje, nwi
 ~ oneself v. fè tèt li mal
harsh malouk
hashish achich
hat chapo
hate v. rayi
hatred rayisman
have v. gen(yen)
 ~ just (done something) v.
 fèk, sòt, fenk
 ~ to v. dwe, fòk, fò, gen(yen)
 pou, se pou
hayfever lafyèv (la)sezon, grip
 lasezon, rim lasezon, rim chalè,
 pitwit
he li, l'
head tèt
headache tèt fèmal, maltèt, modtèt,
 van nan tèt, van nan zòrèy
headboard (of bed) tèt kabann
head cold kata
headrest tèt chèz
headscarf mouchwa
heal v. geri, refè
healer, faith-and-herb doktè fèy,
 gerisè
healing gerizon
health (la)sante
 community or village ~
 worker ajan lasante
 ~ care tretman doktè
 ~ education enfòmasyon sou
 lasante
 ~ practices liyèn
 Ministry of Public ~ and
 Population Ministè Sante
 Piblik ak Popilasyon
 primary ~ worker oksilyè
healthy gaya, byenpòtan, an (bon)
 sante
heap pil
hear v. tande
hearing (auditory) tande
 be hard of ~ v. gen zòrèy di
 ~ aid aparèy pou tande
 ~ impairment tannman di
hearse kòbiya, kòbya
heart kè
 congestive ~ failure kè bloke
 ~ attack kriz kè, arèdkè
 ~ failure pwoblèm kè
 ~ murmur bri (nan) kè
 ~ palpitations batman kè
 ~ rate vitès batman kè
 ~ trouble pwoblèm kè, maladi
 kè
 rheumatic ~ disease maladi
 rimatis nan kè
heartbeat batman kè
 have an irregular ~ v. pèdi
 konpa

have a regular ~ v. kenbe
 konpa
 heartbreak chagren
 heartburn zègrè, zegrè, lestonmak si,
 dlo si sou lestonmak, lestonmak
 boule, asid, kè cho, kè boule, kè
 pile, kè si
 heat chalè
 ~ exhaustion dekonpozisyon
 gwo chalè
 ~ rash bouton chalè, tifè
 prickly ~ pikotman chalè
 heat v. chode
 ~ up v. chofe
 heating pad bouyòt; kousen elektrik
 heating up rechofman
 heave (in vomiting) v. rann fyèl
 li
 heavy lou
 heel talon
 crack in skin of ~ talon fann
 hefty manbre
 height wotè, tay
 have reached one's full ~ v.
 arete
 help sekou, èd, lasistans, koutmen
 help! anmwe! anmweskoul
 help v. ede, ide, ride
 helper segretè, sekretè, èd
 hemacytometer ematimèt
 hematocrit ematokrit
 hematology etid san
 hematoma pòch san
 hematuria pipi san, san nan pipi
 hemoglobin emoglobin
 hemophilia san dlo
 hemophiliac moun ki gen san dlo
 hemorrhage debòdman san, emoraji,
 moraji
 cerebral ~ chòk nan tèt
 hemorrhage v. senyen anpil
 hemorrhoid fès soti, tenès, tennès,
 maladi Moyiz, emowoyid
 hepatitis gwo fwa, maladi fwadi,
 lajònis, lafyèv epatik, epatit
 her, to her li, l'

herb, medicinal fèy renmèd
 herbal remedy renmèd fèy
 here isit, la
 ~ is, ~ are men
 hereditary ereditè
 heredity san, nesans
 hernia èni
 strangulated ~ èni (e)trangle
 heroin ewoyin
 herpes dat
 hers pa li
 herself li menm
 hex madichon, wanga, maldjòk,
 maldyòk
 hex v. djoke
 hey! woy!
 hiccup v. gen òkèt, woke, wòkèt
 hiccup(s) òkèt, hòkèt, wòkèt, woke
 hide v. kache
 hiding, in ankachèt
 high anlè, wo
 ~ (on drugs) dwoge
 high blood pressure tansyon
 have ~~~ v. fè tansyon
 hill mòn
 him, to him li, l'
 himself li menm
 hinder v. bare
 hip (bone) ranch, hanch, (zo) ren
 have a broken ~ v. deranche
 hire v. angaje
 his li, l', pa li
 Hispanic panyòl
 ~ person Panyòl
 history (medical) istwa lasante ou
 hit kou
 hit v. frape
 hives bousòl, itikè
 HIV positive jèm/viris ki ka bay
 SIDA, sewopozitif
 hoarse anwe, wòk
 hobbling gouyang-gouyang
 hock jarèt, jare
 hold v. kenbe
 ~ out v. lonje, alonje
 ~ still v. pa souke kò li

~ up v. soumi
 hole twou, tou, ouvèti
 holiday jou konje
 hollow kre
 holy sen
 home lakay
 at ~ lakay
 ~ remedy renmèd fèy
 homesick chagren
 homosexual:
 female ~ madivinèz
 male ~ masisi, pede(ras), gason
 makomè
 honest debyen
 hook n. kwòk
 hook v. pandje, pandye
 ~ (door, window) v. take
 ~ up v. kwoke, koke
 hookworm vè akwòk, ti vè kwòk,
 ankilòstòm
 hope espwa
 hope (for) v. espere
 hopeless dezespere
 horizontal kouche
 hormone òmonn
 horny (sexually) sou sa
 horse chwal
 hospital lopital
 ~ chart dosye
 ~ ward sal
 hospitalize v. entènen, entène
 hospitalized, be v. entènen, entène
 hot cho
 get ~ v. chofe
 have ~ flashes santi cho
 ~ (splcy) pike
 ~ water bottle bouyòt, boutèy
 dlo cho
 hour è
 an ~ inèdtan
 hours zè, zèdtan
 house kay
 how kouman, kòman, konman, jan
 how? ki jan?
 however nenpòt (ki) jan

how many, how much konben,
 konbe, konbyen
 huge kokennchenn
 human adj. moun
 ~ being kretyen vivan
 ~ body kò moun
 humerus gwo zo ponyèt, imeris
 humld imid
 hump bosko, bòs, douk
 hunchback bosì, bosko, boul nan
 do, do charno
 hunchbacked bosì, bosko
 hunch up (back) v. akokiye,
 rakokiye
 hundred (one) san
 hunger grangou
 ~ pains gaz, trip kòde, trip tòde
 hungry grangou
 hurl v. lanse
 hurry, be in a v. prese
 hurt mal, foule
 hurt v. fè mal, pike, mòde, blese
 ~ oneself v. blese kò li, fraktire
 kò li
 ~ (s.o.'s) feelings v. blese
 husband msye
 ~ (common-law) nonm
 ~ (legal) mari
 hydrocele maklouklou,
 madougou(n), gwo grenn, gwo
 lenn
 hydrogen peroxide dlo oksijene
 hydrophobia laraj, raj
 hygiene ijyèn, ijyenn, liyèn, liyenn
 hygienic ijenik, ijyenik, jenik,
 sanitè
 hymen filèt, filè, vwal vyèj
 break the ~ v. kreve
 hyperacidity twòp asid
 hyperactive child brifè, brisfè
 hyperglycemia twòp sik nan san
 hypertension tansyon (wo)
 hyperthermia dekonpozisyon gwo
 chalè
 hyperventilation opresyon
 hypnosis ipnoz

hypnotize v. andòmi
 hypochondriac moun ki gen maladi
 imajinè
 hypodermic anba po
 ~ needle zegwi, egwi
 hypoglycemia mank sik nan san
 hypotension tansyon ba
 hysterectomy wete matris
 hysteria kriz
 collective ~ kouri
 hysterical, be v. fè yon kriz

I

I mwen, m'
 ice glas
 ~-box, ~-chest glasyè, glasye
 ~-cube glason
 ~-maker (machine) glasyè,
 glasye
 ~-pack ti sak glas
 iced glase
 ICU sal swenyay espesyal
 idea lide, ide
 identical menm
 identification bracelet braslè
 idiotic kannannan
 if si
 ignorant sèt
 illum zo ranch
 ill malad
 chronically ~ maladi
 ~-formed masòkò
 ~-tempered move
 quite ~ byen mal
 illiterate analfabèt
 illness maladi, mal
 natural ~ maladi Bondye, maladi
 doktè, maladi natirèl
 supernatural ~ maladi lwa
 imbalance dezekilib
 immediately lapoula
 immobile ki pa fè mouvman
 immobilize v. mete nan aparèy
 immune (to) pwoteje (kont), kenbe
 èt (ak)

immunity (to) pwoteksyon (kont)
 immunization vaksinasyon, vaksen
 ~ record kat vaksen
 immunize v. bay vaksen
 impact chòk
 impacted antre nan
 impatient, be v. depasyante
 impetigo bouton (maleng), chank,
 enpetigo
 implant v. mete nan
 importance enpòtans, pòtans
 important enpòtan, gwo, konsekan
 impotent pa gason
 be ~ v. pèdi bann (li)
 impoverished pòv
 impregnate v. ansent
 improve v. rebran, rebrann,
 amelyore
 improvement alemye
 impure (water) lou
 in nan
 ~ order to pou
 inch pous
 incipient ki fèk konmansè
 incision (aksyon) koupe, ensizyon
 incisor dan devan
 incontinent (stools) lache
 incontinent (urine) pipi toutan,
 pise a lib
 incorrect pa sa
 increase kwasans
 increase v. ogmante
 incubator kouvèz, enkibatè
 incurable san remèd, malvi, pa
 gerisab
 index finger endèks
 indicate v. make
 indication siy, sin, endikasyon
 indigestible endijès
 indigestion gonfleman, gonfliman,
 kè boule, lafwerad, endijesyon
 cause or have ~ v. gonfle
 indolent kò mouri
 induce v. fòse
 inexpensive bonmache
 infancy anbazay

infant tibebe, timoun piti, (ti) katkat
deformed ~ bebe donmaje
infantile paralysis polyo, maladi
 paralezi pou timoun, maladi
 kokobe, paralezi enfantil
infect v. enfekte, enfèkte
infected, be or become v. fè
 enfeksyon, anvlimen
 ~ eye je lasi
infection enfeksyon, enfeksyon
 have an ~ v. fè enfeksyon
 oral ~ chank lèt, chankalèt
infectious ki bay enfeksyon
infertile:
 ~ man gason ki pa ka fè pitit
 ~ (woman) branrany
infestation, parasitic kriz vè
infirm fèb, delika
infirmmary dispansè
infirmity enfimite
inflamed anfle
inflammation anflamasyon,
 enflamasyon, anfle(s), iritasyon
inflammatory ki fè anfle
inflate v. gonfle, ponpe
influential konsekans
influenza gwo grip
information enfòmasyon
infusion te, solisyon
ingrained donnen
ingrown see nail
inguinal region bò lenn
inhale v. rale souf
inhalor flitè
inject v. pike
injection piki
 contraceptive ~ piki planin(g)
 give an ~ v. bay yon piki
injectionist pikiris
injure v. fè mal, kase, blese,
 donmaje, estwope
injury blezi, blese, donmaj, domaj,
 plè, frakti
inlay (tooth) (e)klis
inner anndan
inoculate v. pike

inoculation piki
 professional giver of ~s
 pikiris
inoperable yo pa ka opere/wete
inpatient malad lopital
insane fou, tèt pa byen, loka
 ~ asylum lazil (pou) moun fou
insanity foli
insect tibèt
 ~ spray flit
insecticide ensektisid
insert v. mete
 ~ (IV tube etc.) v. konekte
inside andedan, ladan, ladann
 ~ out lanvè
insides (of) nannan
insolent radi, derespektan
insomnia pa ka dòmi
inspect v. kontwòle
inspection kontwòl
instance fwa, ka
 for ~ pa egzanp
instant moman
instead of olye, angiz
instep dopye, wòs
instrument enstriman, aparèy
insulin ensilin
intelligence bonkonprann, sèvo
intelligent fò
intense di
intensive entansif
 ~ care swenyay espesyal lopital
 ~ care unit sal swenyay
 espesyal
intention lide, ide
intercourse relasyon, kontak
 to have ~ gen relasyon, fè
 kontak
interior andedan
intermittent ki ale vini
 be ~ v. mòde lage
 feel ~ pain v. mòde lage
intern, resident (medical) entèn
internal, internally andedan
internal medicine maladi anndan
internist entènès

Interpret v. tradwi
 Interpreter entèprèt, tradiktè
 Interrupt v. koupe, deranje
 Intestinal entestinal
 ~ disorder deranjman
 ~ obstruction
 oklizon entestinal
 Intestine(s) zantray, tripay, trip,
 boyo, frending, entesten
 large ~ gwo trip, gradoub
 small ~ ti trip
 Intolerant (to a drug), be v. bay
 konplikasyon
 Intoxicated sou, soule
 Intoxication anpwazonnman
 Intractable pa gerisab
 Intrauterine device esterilè,
 filaman, aparèy
 Intravenous nan venn
 ~ fluid (IV) sewòm (nan venn)
 ~ pole pòt-sewòm
 Introvert moun dosil, moun timid,
 pè moun
 Invalid kokobe, estwopye, enfim
 Invigorate v. remonte, remoute
 Involuntary san kontwòl
 Iodine (i)yòd
 Iodized (i)yòde
 Ipecac ipeka
 Iris (of eye) glè je, iris
 Iron fè
 corrugated ~ tòl
 ~ lung aparèy poumon atifisyèl
 Irreducible ki pa ka geri
 Irregular pa sou konpa
 be ~ (pulse etc.) v.
 pèdi konpa
 Irreversible ki pa ka rete (sou) kous
 li, san lespwa gerizon
 Irrigate (wound) v. lave
 Irrigation (of wound) lavay
 Irritable move, chimerik
 Irritant iritan
 Irritate v. manje, boule, irite
 Irritated irite, boule
 Irritating jenan, agasan

Irritation chalè, boule, iritasyon
 Isolate v. mete apa, izole
 Isolation, place in v. mete apa
 Isolation ward sal pou izole malad
 It, to It li, l'
 Itch, Itching gratèl, (san) grate,
 pikotman, pikòtman, (de)manjezon
 ~ mite (causing scabies)
 aka
 Itch v. grate
 Itchy ap grate
 Its li, l', pa li
 Itself li menm
 IUD (Intrauterine device) esterilè,
 filaman, aparèy
 IV, run an v. mete sewòm, bay
 sewòm

J

Jacket levit
 January janvyè
 Jar bokal
 small ~ poban
 Jaundice lajònis, jònis, pise jòn, pise
 wouj
 Jaw machwè, machwa
 dislocated ~ machwè dejwente
 Jawbone zo machwè
 Jeep djip
 Jell v. kaye
 Jelly jele
 Jellyfish (la)gratèl
 Jerk (In convulsions) v. (de)tire
 Jerking or jolting movement
 soukous
 Jewish jwif
 Jinx madichon
 Jinx v. djoke
 Job djòb, dyòb, travay
 Jock Itch egzema, ekzema, gratèl
 Join together v. konbine,
 konbinen, soude
 Joint (of bones) jwenti
 Joke blag
 Joke v. bay blag

jolt v. balote
judge v. pran pèz
jug (earthenware) krich
jugular vein gwo venn nan kou
juice ji
July jiyè
jump v. sote
June jen
just jis, annik, nik, apenn, apèn
 ~ like kouwè, konwè

K

keep v. kenbe, konsève, sere, gade
 ~ down (food etc.) v. kenbe
keratitis anflamasyon gla(s) je
kerchief foula, mouchwa
kerosene kewozin
kettle, large chodwon
key kle
kick koutpye
kid v. bay blag
kid (child) (ti) katkat
kidney ren, grenn vant
 ~ stone wòch nan ren, pyè nan ren
kill v. touye, voye nan peyi san chapo
 ~ by magical means v. pike
kilogram kilo, kilogram
kind n. jan, kalite, kalte
kind adj. janti
kindness jantiyès
kiss n., v. bo
kitchen lakizin, lakwizin, kizin, koujin, kwizin
knee jenou, jounou
 ~ jerk reflèks jenou
kneecap zo jenou, kakòn jenou, boulèt jenou
kneel (down) v. mete ajenou
kneeling ajenou
knife kouto
knock v. frape
 ~-kneed janm kana, janm kounan, janm sizo

~ over v. ranvèse
knot (string; plant, wood etc.)
 ne
knot v. kòde
know v. konnen
 ~ how v. konnen
knuckle jwenti dwèt, oslè
kwashiorkor maladi (kò) anfle, maladi timoun anfle, maladi malmanje anfle, kwachyòkò, kwachòkò, kwachòkò
 suffering from ~ anfle

L

label etikèt
labia fèy, lèv
 ~ majora gwo fèy, gwo lèv
 ~ minora ti fèy, ti lèv
labor tranche
 false ~ fo tranche
 forced ~, induced ~ tranche
 fòse
 ~ contractions or pains tranche, maldanfans
 normal ~ tranche nòmàl
 premature ~ tranche anvan lè, tranche anvan tèm
 stimulate ~ v. chofe tranche a, ankouraje tranche a
lab(oratory) labo(ratwa)
 ~ coat blouz
lacerate v. (de)chire
laceration koupe
lachrymal gland sak dlo
lack mank
lack v. manke, mank
lactate v. bay lèt
lactation bay lèt
ladder nechèl
lady dam
 ladles medam
 old ~ lamè
lame kokobe, estwopye, bwate, bwete
 ~ (hand) pòk
lament v. plenyen

lamp lanp
 small oil ~ tèt gridap
 lance v. fann
 land peyi
 language lang
 lap kwis
 laparotomy operasyon nan bavant,
 laparatomy
 large gran, gwo
 laryngitis anflamasyon kòd vokal
 larynx kòd vokal
 lassitude kò kraz
 last dènye, pase
 ~ night yè swa
 last v. dire
 lasting dirab
 latch takèt
 latch v. take
 late ta, anreta
 lately dènyèman
 latent dòmi
 later pita
 lather kim
 lather v. kimen, tchimen, savonnen,
 fè kim
 latrine latrin, komòd, olye
 laugh ri
 laugh v. ri
 laundry lesiv
 law lalwa, lwa
 laxative metsin, medsin
 lay, put v. mete
 layer kouch
 laziness parès
 lazy parese
 lead v. mennen
 lead (metal) plon
 ~ poisoning anpwazonnman
 plon
 leaf fèy
 leak twou, fit, fwit
 leak v. koule
 leaky koule, paswa
 lean mèg
 lean (over) v. panche, bese
 ~ back v. kage

 ~ on v. apiye
 learn v. aprann
 leather kwi
 leave v. ale, al, soti, sot
 leave (takes direct object) v.
 kite
 lectulum anba zong
 leech sansi
 left gòch, goch, agoch, agòch
 ~-handed goche, gòche
 leg (bwa) janm
 ~ bone bwa janm
 lower ~ (bwa) pye
 wooden ~ janm de bwa
 legal legal
 ~ document papye
 lend v. prete
 length longè, londjè
 lens vè
 crystalline ~ loup
 ~ of eye twou je
 leper lepre
 leprosy lalèp, lèp
 lesbian madivinèz
 lesion blesi, blese
 ulcerating or weeping ~
 maleng
 less mwens, mwen
 lessen v. diminye, diminwe, apeze
 lesson leson
 let v. kite
 ~ go v. lage, lache
 let's ann (sh. form of annou)
 ~-up kalma, kalm
 lethal mòtèl, k' ap touye ou
 lethargic tèt lou, kò kraze
 ~ person kò kraz, kò kraze
 lethargy kò kraz, letèji
 letter (alphabet; correspondence)
 lèt
 leukemia maladi globil blan
 leukoma te nan je
 level (teaspoonful etc.) san tiyon
 levelheadedness lòldj, lòldy
 library bibliyotèk
 lice pou, vèmin, karang

~-powder salbadi
lid kouvèti
lie down v. kouche
lie on one's back v. kouche sou do
lie, prevaricate v. (bay) manti,
 manti
life lavi
lifeless mouri
lift v. leve, souleve
lift, ride woulib
ligament fil vyann
ligature wire fil ligati
light limyè
 ~ bulb limyè, anpoul
 ~ (color) klè, pal
 ~ switch switch
 ~ (weight) lejè
 very ~-skinned woujat
light-headed je vire, toudi
light-headedness soulay,
 toudisman, toudlin, vètij
like, as kòm, konm, tankou, kon,
 kou
 ~ that, ~ this konsa, kousa
like v. renmen
likely genlè
likeness resanblans, sanblans
limb (arm, leg) manm
 artificial ~ aparèy
 paralyzed ~ manm mò
limp adj. lage
limp v. (mache) bwate, (mache)
 bwete, mache kwochi, rale sou yon
 pye
 ~ very noticeably v. gondole
lindane lendèn
line (of persons) ran, liy
linger v. mize
liniment longan
lip po bouch, lèy
 ~ read v. li (sou) bouch
 ~ salve glòs
liquid dlo, lèt, likid; bwason, bweson
 ~ medicine siwo
liquor tafya
lisp v. pale sou lang

list lis
listen (to) v. koute
listless, make v. dekonpoze
liter lit, twa boutèy kola
lithe soup, san zo
little ti, piti
 a ~ enpe
 a ~ bit yon ti kras, yon ti jan
 a ~ while ago talè a, titalè a
live v. viv
 ~, dwell v. rete
 ~ together v. plase
lively djanm, dyanm
liver fwa (di), fresi (di)
 ~ problem kriz fwa
living vivan, la
load chay, chaj
loan dèt
local, topical espesyal
localized yon sèl kote
lock seri
 ~ (of hair) mèch
lock v. klete, fèmen a(k) kle
locked lòk, klete, fèmen a(k) kle
lockjaw (maladi) kò rèd, (maladi)
 machwè sere, machwè rèd, maladi
 redi, tetanòs, tentanòs
lodging lojman
logical rezonab
loin(s) ren
long long
 for a ~ time lontan
 ~-suffering sipòtan
look v. gade, gad
 ~ after v. swenyen, swanye
 ~ at v. gade, gad
 ~ for v. chache, chèche
 ~ forward to v. atann
 ~ like v. sanble ak, gen lè
loop ne
 (contraceptive) ~ filaman,
 esterilè
loose lach, likid
 ~ (tooth) souke, sekwe
loosen v. lache, desere, dekolè
lose v. pèdi

~ ground v. pèdi pye
 ~ out v. rate
 ~ weight v. degrese, degwosi,
 dechte, vin piti
 loss pèt, pèdans
 (hair) ~ chit
 lost, be or get v. pèdi
 lotion pomad, krèm
 loud fò
 louse, lice pou, vèmin, karang
 love lanmou, renmen
 love v. renmen
 lovesickness mal damou
 low ba
 lower anba
 lower v. bese, desann
 have ~-back pain v. (zo) mis
 tonbe, zo dèyè tonbe
 ~ back senti (do)
 ~-back pain tay fè mal, senti fè
 mal, doulè senti, doulè nan ren,
 doulè nan anba do
 lozenge grenn
 lubricant lwil
 lucky chance
 lukewarm tyèd, tchèd, kyèd
 become or make ~ v. tyedi
 lumbago tay fè mal
 lumbar puncture, do a v. retire
 enpe dlo nan do pou, wè si gen
 enfèksyon nan sèvo
 lump boul, grenn
 lunacy foli
 luncheon dine
 lung(s) poumon, fresi mou, fwa mou
 luxation dejwentaj
 lying down kouche
 lying-in period (after giving
 birth) tinouris
 lymph node glann
 swollen ~ glann
 lymphatics, swollen venn fole
 lymphedema gwo pye

M

machete manchèt
 machine machin
 mad, get v. anraje
 be raving ~ v. anraje
 madness raj, ray
 maggot vè
 magic majik
 ~ powder (Voodoo) poud
 magnesium mayezyòm
 magnifying glass loup
 mail lapòs
 malm v. estwopye
 main gran
 major adj. (pi) gwo, (pi) gran
 majority of, the pifò
 make v. fè
 ~ out, get along v. kenbe
 make-up (lipstick etc.) fa
 malaise kò dezole, kò kraz, fyèb nan
 san, fyèb frèt, deranjman
 malaria (lafyèb) malarya, (lafyèb)
 palidis, lafyèb frison, lafyèb frèt,
 lafyèb nan san, lafyèb tranble
 male, man gason, nèg
 malformation defòmasyon
 malignancy gwo maladi, move
 maladi
 malignant grav
 malnourished malmanje, malnouri,
 malniri
 malnutrition (maladi) malmanje,
 malnitrisyon, maladi feblès
 malocclusion dan mal plase
 Malta fever lafyèb malta
 man nèg, gason, mesye
 old ~ lepè
 young ~ jennonm, jènan,
 jennjan
 manage v. degaje, degajèt, okipe
 mandible zo machwè anba
 mange gal
 mania foli
 maniac fou
 manipulation manyen
 manner, way jan
 manners lizay, lizaj

manure fimye
many anpil, yon pakèt, yon pil
map kat
mar v. defigure
marasmus maladi kò chèch, bwa chèch, maras
March mas
marijuana marijàn, mariwana, zèb
mark mak
mark v. make
market, open mache
marriage maryaj, maryay
 common-law ~ plasay, plasaj
 contract a common-law ~ v. plase
married marye, maye
marrow mwèl, mwal
marry v. marye ak
mask (for surgeon or patient)
 mas
mass boul
massage friksyon, masay, masaj
 closed-chest ~ manyen
 lestonmak
massage v. manyen, rale,
 friksyonnen, mase
masseur manyè, mase
masseuse manyèz, masèz
mastectomy wete tete, koupe tete
master mèt
 ~ key kle paspatou
mastitis lafyèv nouris, apse nan tete
mastoid process zo dèyè zòrèy
mastoiditis anflamasyon zo dèyè zòrèy
masturbate v. bat laponyèt
masturbation dyesèlmevwa,
 djesèlmevwa
match (safety) alimèt
material matyè
maternity hospital or ward
 matènite
matter matyè, afè, zafè, keksyon,
 kesyon
mattress matla
 straw ~ payas

mature gran, majè, fòme
maxilla zo machwè anwo
may (permission) mèt
May me
maybe petèt
me, to me mwen, m'
meal manje, repa
mean mechan, michan, makawon
mean v. vle di
meaning sans
means mwayen
measles lawoujòl, woujòl
 German ~ lawoujòl alman, ti lawoujòl, woubewòl
measure mezi
measure v. mezire
measurement mezi
meatus tou pipi, twou pipi
mechanical drill dril
meconium gwodon, gwòdon,
 goudwon, kras nwa
medical medikal
 be under ~ care v. swiv doktè
 have a ~ check-up v. konsilte
 have periodic ~ check-ups v. swiv doktè
 ~ care swenyay doktè
 ~ examination konsiltasyon
 ~ record dosye
 ~ release egzeyat, ekzeyat
 ~ science lamedsin
 ~ treatment tretman, trètman
medicate v. bay renmèd
medication renmèd, remèd,
 medikaman
medicinal renmèd
medicine medikaman, renmèd, remèd
 give or take ~ v. remedye
 ~ dropper konngout, kontgout
 ~ kit bwat fanmasi
 potent ~ metsin chwal
 practice ~ v. fè lamedsin
meeting reyinyon, randevou
melancholia depresyon
melanoma ti bouton kansè sou po
melt v. fonn

member manm
membrane vlen
memory memwa, menmwa
menarche premye règ
mend v. repare
meningitis maladi tèt anfle,
 enfeksyon sèvo, mennenjit,
 menenjit
menopause san ki prale nèt, san pap
 vini ankò, menopòz, menopoz
 begin or reach ~ v. rete, ret,
 antre nan laj
menorrhagia pèdisyon, pèdans
menses règ
 have irregular ~ v. pa regle
 byen
menstrual:
 continual flow of ~ fluids
 pèdisyon, pèdans
 ~ cramps kolik, tranchmann
 vant
 ~ cycle peryòd
 ~ flow règ
menstruate v. wè
 règ/flè/woz/lin/pye, gen règ/mwa,
 regle, fleri
menstruation règ, mwa, mach
 (fann), (la)lin, (ti) woz, flè,
 kwasans, regleman
mental mantal
 ~ breakdown depresyon
 ~ hospital lazil (pou) moun fou
 ~ illness maladi tèt
 ~ retardation reta
mentally retarded ebete, enbete,
 kannaman
mercurochrome mèlkiwokòm
mercury mèki
mess dezòd
 ~ up v. melanje
message mesaj
messenger mesajè, mesaje
messy malpwòp
metal metal
meter (measure) mèt
method mètòd
microbe mikwòb
microscope mikwoskòp
midday midi
middle mitan, mwatye
 ~-aged andezay, andezaj
midjet rasi, nen
midnight minwi, minwit
midriff povant
midwife fanmsay, fanmsaj,
 fanmchay, sajjam, akouchèz
 ~ (with diploma) matwòn
migraine migrèn, migrenn, tèt fè
 mal
mild lejè, dou, pa grav, vyepti
 a ~ case yon vyepti ka
milk lèt
 dried up mother's ~ lèt pase
 ~ of magnesia mayezi
 mother's ~ lèt manman
 powdered ~ lèt an poud, lèt
 sinistre
milligram miligram
milliliter mililit
millimeter milimèt
mind tèt, lide, ide
mine (pronoun) pa mwen
mineral mineral
minister (Protestant) pastè
Ministry of Public Health and
 Population Ministè Sante
 Piblik ak Popilasyon
minor, adolescent ki poko
 granmoun, minè
minor, small piti, ti
minus mwens, mwen
minute (time) minit
miracle mirak
mirror glas, miwa
misbehavior dezòd
miscarriage foskouch, fòskouch,
 movèz (kouch), pèdans
 non-apparent ~ pèdisyon
miscarry v. fè foskouch
misery mizè, lamizè, malsite, tray
misfortune malè, malsite
mishap malè

miss v. manke, rate
miss (title) madmwazèl, matmwazèl
missshapen malfòme, malfèt,
 mafweze, mafwezi, masòkò,
 madoulè
mission lamisyon
missionary misyonè, misyonnè
 ~ post lamisyon
mist seren, bwouya
mistake fòt, fot, mank, erè, èrè
mistaken, be v. twonpe
mister msye, mesye
mistreat v. fè pase mizè
mistress fanm deyò, fanm sou kote
 principal ~ fanm kay
mistrust defyans
mistrustful mefyan
mitte (itch) aka
mix melanj
mix v. mele, melanje, konpoze
mixture melanj, konpoze, posyon
moan v. plenn, plenyen
mobile clinic klinik mobil
moderate sòb
modern nouvo
modest, decent desan
molsten v. mikte, mekte, mouye
molar dan dèyè, dan pilon, dan
 moulen, gwo dan, molè
mold mwezi, mwazi
moldy mwezi, mwazi
mole (on skin) siy, sin, ti bouton
moment (ti) kadè, moman
 a ~ ago talè a, titalè a
 in a ~ (from now) talè, titalè
Monday lendi
money lajan
 ~ (fam.) kòb
mongolism, mongoloid gwo tèt
monitor v. siveye
monkey wrench kle anglèz
mononucleosis (infectious)
 enfeksyon glann ak kò kraz
mons veneris do koko
month mwa
monthly chak mwa
mood imè
moon lalin
mop mòp
more plis, piplis
 ~ (comparative) pi
 ~ or less konsa, plizoumwen(s)
morgue mòg
moribund lagoni, agoni
morning maten
 early ~ bon maten
 every ~ tou lematen
 good ~ bonjou
 in the ~ dimaten
 in the ~(s) lematen, lèmaten
 ~ sickness maladi gwosès
morphine mòfin
mortal mòtèl
mortality rate mòtalite
mortally mòtèlman
mosquito marengwen
 ~ net(ting) moustikè
 small ~ moustik
 tiny ~ bigay
most pifò, plis, piplis
mother manman
 dried up ~'s milk lèt pase
 ~-in-law bèlmè
 nursing ~ nouris
motion mouvman
 be in ~ v. fè mouvman
 ~ sickness mal machin, mal
 kamyon
motor motè
mount v. monte, moute
mountain mòn
mourn v. kenbe rèl
mourner, female plerèz
mourning dèy
 in ~ andèy
 ~ armband bandlèt
 ~ clothes dèy
mouse sourit
mouth bouch
 corner of ~ bò bouch, kwen
 bouch

crack or sore at corner of ~
 bòkyè, bòkè
 ~-to-~ resuscitation
 respirasyon bouch nan bouch
mouthful:
 ~ (drink) gòje
 ~ (food) bouche
mouth wash beny bouch
move:
 ~, flex v. jwe
 ~ in one's sleep v. souke kò
 ~ (oneself) v. fè mouvman
 ~ (s.o.) v. deplase
movement mouvman
Mrs. (title) madan
much anpil, yon pakèt
mucous membrane mikèz
mucus glè, flèm, flenn, larim, rim,
 vlimè
 have ~ stools v. bay glè
 ~ method (contraception)
 kontwòl glè
 ~ stool watè glè
mud labou
 remove ~ v. dekwote
mulatto (female) milatrès
mulatto (male) milat
mulch plit konpòs
mule milèt
multiple sclerosis maladi nè,
 paralezi aparèy nè
multiply v. miltipliye; peple
mumble v. pale nan dan
mumps malmouton
murder v. ansasinen, touye
murky twoub
muscle mis, misk
 ~ twitching kranp nan chè
 pull/strain a ~ v. foule yon
 misk
muscular dystrophy misk k' ap
 mouri nè
must v. fòk, fò, dwe, gen(yen) pou,
 se pou, fèt pou
mustache moustach
mustard plaster anplat, sinapis

mute bèbè
 mutilate v. manje
 my mwen, m'
 myopic myòp
 be ~ v. wè depre

N

nail:
 fingernail zong (men)
 ingrown ~ zong (rantrè) nan
 chè, zong nan vyann, chè nan
 zong, zong enkanè
 ~ bed anba zong
 ~ clippers tayzong
 ~ file lim
 ~ (metal) klou
 ~ root rasin zong
 toenail zong (pye)
naked toutouni, touni
name non
 brand ~ non fabrik, non mak
 Christian ~ non batèm
 generic ~ non kalite
 last ~ siyati
nap kabicha, syès, lasyès
 take a ~ v. kabicha
nape nwakou, dèyè kou
napkin, cloth sèvyèt
 paper ~ napkin
 sanitary ~ twal, twèl, lenj,
 kotèks
narcotic dwòg
narrow jemen, etwat
nasal bone bwa nen
nasal passage(s) anndan nen
nasal ridge do nen
naso-gastric (NG) tube tib ki soti
 nan nen rive jouk nan vant
nasty move
nation peyi
natural nòmàl, natirèl
naturally natirèlman
nature nati
naughty mechan, michan

nausea anvi vonmi, anvi vèse, anvi
 rejete, anvi rechite, anvi rann, kè
 plen, kè fèb, kè tounen, lawouli
 kè, lawouli lesionmak,
 endispozisyon, repiyans, noze
 nauseated dekonpoze
 nauseous, make v. endispoze,
 dekonpoze
 navel lonbrit, lonbrik, bouton vant
 near bò, kote, pre
 nearly (do something) v. manke
 nearsighted (ki) wè depre, myòp
 necessary nesèsè
 It is ~ (that) fòk, fò, se pou
 neck (bwa) kou
 ~ and shoulders gagann
 ~ area kòlèt
 ~ bone nwakou
 stiff ~ kou vire, zekwèl
 necklace chenn, kolye
 necktie kòl, kravat
 need bezwen
 need v. bezwen
 needle zegwi, egwi
 ~ (of syringe) kanil
 negligence neglians
 neighbor vwazen
 female ~ vwazin
 neonate tibebe ki fenk fèt
 nephew neve, nive
 nephritic nefretik
 nephritis maladi ren, nefrit
 nerve nè
 nervous nève
 have a ~ breakdown v. krake
 ~ breakdown depresyon nè
 ~ system aparèy nè
 nervousness nè
 network sistèm
 neuralgia nevalji
 neuritis anflamasyon nè
 neuro- nè
 neurologist doktè nè
 neurosurgeon chirijyen nè
 neurotic flèasezon
 neutral net

never pa janm, janmè
 new nouvo
 newborn tibebe ki fenk fèt
 next adj. pwochè, pwochènn
 next adv. answit
 next to a kote
 nice janti, dou
 nickname non jwèt, ti non
 nicotine nikotin
 niece nyès
 night nwit, lannwit
 at ~ lannwit
 damp ~ air seren
 good ~ bonswa, bonnwit
 ~ blindness avèg nan fènwa,
 pwoblèm pou wè lannwit
 ~ gown chemiz de nwi
 ~-light veyèz
 nightmare kochma
 nightstand tab de nwi
 nipple (bottle) tetin
 nipple (breast) pwent tete, bouton
 tete, pwent tètèt
 inverted ~ tete tonbe
 nitroglycerin gliserin
 no non
 ~ longer, ~ more pa ankò
 nocturnal lannwit
 ~ emision voye nan dòmi
 nodule ti boul
 noise bri, son
 noma java grav nan bouch, noma
 nonmalignant pa grav
 nonsense vye koze
 nonspecific jeneral
 noon midi
 norm règ jeneral
 normal nòmàl
 normally nòmàlman
 nose nen; (see also nen entries in
 Haitian Creole-English section)
 runny ~ nen koule, de ran larim
 tip of ~ pwent nen
 nosebleed nen senyen
 nostril twounen, tounen
 sides or ala of ~s zèl nen

not pa
 ~ at all pa... menm, pa... ditou
 ~ yet poko
 notebook kaye
 nothing anyen
 notice v. remake
 nourish v. nour
 nourishing nourisan
 nourishment manje, lanouriti,
 nouriti
 November novanm
 novice apranti
 now kounye a, koulye a
 from ~ on apatandojodi,
 apatidejodi a
 noxious (an)pwazonnen
 nude toutouni, touni
 numb angoudi, mò, denèfle
 become ~ v. angoudi, mouri
 numb v. mouri
 number nimewo, chif
 numbness angoudisman
 nun masè, sè
 nurse (female) mis, enfimye
 ~'s aide, practical ~, pub-
 lic health ~ oksilyè
 registered ~, trained ~
 enfimye diplome
 scrub ~ enfimye sal doperasyon
 visiting ~ enfimye ki mache
 vizite moun lakay yo
 wet ~ nouris (ki pa manman
 tibebe a)
 nurse (male) enfimye
 nurse, suckle v. (pran) tete
 ~, give suckle v. bay tete
 ~, take care of v. swenyan,
 swanye
 nursing enfimye
 nutrition nitrisyon
 nutritionist nitrisyonis
 nutritious fòtifyan, nourisan
 nymphomaniac konyapis
 nystagmus je lòlòj

O

obedient obeyisan, saj, koutan
 obese gra, gwo
 obey v. obeyi
 object bagay
 obliged to, be v. oblije, bije
 obnoxious nwizib
 observation opsèvasyon
 observe (at childbirth) v.
 temwaye
 observe, notice v. remake
 obstetrician doktè akouchman,
 jinekòlòg
 obstetrics akouchman
 obstruct v. bare, bloke, angòje
 obstruction blokay
 free from ~ v. debonde
 intestinal ~ blokay nan trip
 occasion okazyon
 occipital region dèyè tèt
 occlusion blokay, blokaj
 occupation metye
 occupied okipe
 occur v. rive
 ocean lanmè
 October oktòb
 oculist doktè je
 odor odè, lodè, sant
 oedema see edema
 of course natirèlman
 offend v. blese
 office biwo, kay
 often souvan, dri
 how ~? chak ki lè?
 oil (cooking, lubricating etc.)
 lwil
 ~ of cloves lwil pou dan, lwil
 jwòf
 ointment pomad, ponmad, krèm,
 longan
 OK oke
 I'm ~ M' pa pi mal
 old vye, granmoun
 get or grow ~ v. veyei
 ~ age veyès
 ~ maid vyèy fi

~ man (affectionate title)
 pè
 ~ person granmoun
 very ~ person vye granmoun
 omission oubli
 omit v. sote
 on anwo, sou
 one (pronoun) youn, yonn
 ~-armed moun yon sèl bra
 ~-eyed (je) bdy
 ~-fourth enka
 ~-legged moun yon sèl janm
 ~-third entyè
 oneself (object of verb) tèt li, kò
 li
 only sèlman, annik, nik,
 senpleman
 ooze (out) v. swente, fè sòs
 opaque opak
 open (up) v. louvri, ouvri, lage
 opening ouvèti, pasaj, fant, gòj,
 twou, tou
 operable yo ka opere/wete
 operate (on someone) v. opere, fè
 (yon moun) operasyon, mete kouto
 (sou)
 operating room sal doperasyon
 operating table tab operasyon
 operation operasyon
 operatory area (on body) chan
 ophthalmologist doktè je
 opium opyòm
 opportunity chans
 oppose, counter v. goumen (ak)
 opposite anfas, kontrè
 oppression opresyon
 optic optik
 ~ nerve nè je, nè optik
 optical optik
 optician optisyen
 optometer aparèy pou tcheke je
 optometrist machann linèt, doktè je
 or oubyen, osinon, oswa
 oral oral
 have ~ blisters v. lafyèw pete
 nan bouch
 ~ rehydration solution
 (ORS) sewòm oral, sewòm nan
 bouch, sewòm djare
 ~ surgery chiriji bouch
 orange (color) oranj, jòn abriko
 order lòd, lèzòd
 out of ~ anpàn
 order v. kòmande, konmande,
 koumande
 orderly (hospital) gason, planton
 ordinary kouran, òdinè
 organ (body) ògàn
 organic òganik
 organism mikwòb
 orgasm, reach v. vini, vin
 orifice ouvèti, bouch
 origin rasin, sous
 orphan (female) òfelin
 orphan (male) òfelen
 orphanage òfelina
 orthodontics drese dan
 orthopedic(s) espesyalite zo ak
 misk, òtopedi
 orthopedist doktè zo ak misk,
 òtopedis
 osteomyelitis enfeksyon (nan) zo
 other lòt
 otherwise sansa, si se pa sa
 otitis anflamasyon zòrèy, otit
 otorrhea, have v. zòrèy kouri dlo
 otoscope aparèy pou tcheke zòrèy,
 otoskòp
 ought v. ta dwe
 ounce ons
 our nou, n'
 ours pa nou
 outcome rezilta
 outer deyò
 outhouse latrin, olye, komòd
 out of breath esoufle
 out of control debòde
 out of date pase dat
 outpatient malad ki pa dòmi lopital
 outside deyò
 outsider moun vini
 ovary sak ze, pòch ze, ovè

over sou
 ~ here isit la
 ~ there laba
 overcast (weather) mare
 overcome v. bat
 overdose twòp gwo dòz
 over-exertion simenaj
 overflow tiyon
 overflow v. debòde, debonde
 oversight oubli
 overweight gra
 overwhelmed akable
 overwork simenaj
 ovulation lè ze yon fi soti nan sak
 ze li, ovilasyon
 ovule ze nan sak fi, ovil
 ovum ze yon fi
 owe v. dwe
 own pwòp
 on one's ~ pou kont li
 owner chèmèt-chèmètrès
 oxygen oksijèn
 ~ mask mas oksijèn
 ~ tank oksijèn

P

pacemaker ti aparèy ki regle batman
 kè
 pacifier tetin, sousèt
 pack (of cigarettes) pòch (sigarèt)
 cold ~ ti sak glas
 hot ~ ti sak cho
 package pakèt, koli
 packet (paper, plastic) sache,
 sachè
 packing (of wound) pansman ak
 twal gaz
 pad (gauze dressing) (ti) pansman
 twal gaz; konprès
 heating ~ kousen elektrik
 padlock kadna
 pall bokit
 palm doulè, lapenn, penn, lapèn,
 touman, toumant, manjezon

acute and intermittent
 abdominal ~ vant mòde
 cause ~ v. fè mal
 great ~ moraji
 non-specific ~ or ache foulay
 ~ In... ... fè mal
 ~ pill, ~ rellever kalman
 painful penib
 be ~ v. pike, mòde
 painkiller kalman
 paint (wound, throat etc.) v.
 mete renmèd sou
 pair pè
 pajamas pijama
 palate palèt
 hard ~ palèt di
 soft ~ palèt mou
 pale pal, blèm, blèm
 become ~ v. pali
 ~ and anemic pa gen san
 palliative renmèd kalman
 palm (of hand) plamen, planmen
 palpate v. manyen
 palpation manyen
 palpitations (heart) batman kè
 palsy ti paralezi
 cerebral ~ paralezi serebral
 shaking ~ maladi tranble
 pamphlet bwochi
 pancreas larat, pankreyas
 pancreatitis anflamasyon
 larat/pankreyas
 panties kilòt, pantalèt
 pants kanson, pantalon
 Pap smear/test tè s pou kansè matris
 paper papyè
 paralysis paralezi, paralizi
 paralytic paralitik
 paralyze v. paralize
 paralyzed kokobe, kò mò, demanbre
 partially ~ bò mouri, demi
 mouri
 paramedic oksilyè, ajan lasante,
 travayè lasante, sekouris
 paranoia laperèz, laperè
 paraplegic janm kokobe

parasite (Internal) vèmin, parazit
 (andan), vè
parcel koli
paregoric renmèd kont dyare
parent paran
Parkinson's disease maladi tranble
paroxysm degre pi wo yon maladi
part, section moso, mòso, pòsyon,
 pati
partial yon ti jan
particular espesyal
party, celebration plezi
pass v. pase
 ~ away v. ale nan peyi san
 chapo
 ~ (blood, worms etc.) v.
 bay, ba, ban
 ~ by v. pase
 ~ out, faint v. endispoze, pèdi
 konnesans, tonbe feblès
passage pasaj, koulwa
past pase
paste lakòl
pasteurize v. pasterize
pastor pastè
patch plak
 ~ test tè s alèji
patella zo jenou, boulèt jenou, kakòn
 jenou
patience, lose v. depasyante
patient n. malad
 ~'s gown kanmizòl
patient (n./adj.) pasyan
patient adj. sipòtan
pattern egzanp
paunch pann vant
pause pòz, souf
pause v. poze
pay v. peye
 ~ attention to v. okipe
payment peman
peace lapè, repo
 ~ (of mind) kè poze, trankilite
peaceful pezib
peasant abitan
pectoral muscles pekto(wo)

pediatric pedyatrik
pediatrician doktè timoun, pedyat
pedicure pediki
peel, peel off v. dekale
pellagra maladi chèch
pellet ti grenn
pelvis, pelvic ranch, hanch, (zo)
 basen
pen (writing) plim
pencil kreyon
penetrate v. antre (nan)
penicillin pelisilin, penisilin
penis pijon, pati (sansib), kò gason,
 penis
dorsal vein of ~ ne pijon
glans ~ tèt kòk
penniless razè
people, nation pèp
people, persons moun
per pa
perennial san fen
perfect bon nèt
perforate v. kreve, pete, pèse
perforation twou, tou
perfume odè, lodè
perhaps petèt
pericarditis anflamasyon kè
perineum kouli dèyè
period peryòd
period, menses règ, mwa, kwasans
have one's ~ v. wè règ/
 flè/woz/lin/pye, gen règ/ mwa,
 regle, fleri
periodontist espesyalis jansiv
perish v. peri
peritonitis enfeksyon sak vant,
 peritonit
perlèche bòkyè, bòkè, malbouch
permanent pou tou(t)tan
permission pèmisyon
permit v. kite, pèmèt
persecution pèsekisyon
persist in v. plede
persistent mechan, michan, ki pa
 vie ale, pèsistan
person moun

~ In charge reskonsab,
 responsab
 young ~ jennmoun
 personal pèsonèl, pèsonnèl
 personalty karaktè
 perspiration laswè, swè, swe, sye
 perspire v. swe, sye, transpire
 persuade v. konvenk
 ~ someone v. pran tèt li
 pertussis koklich
 pessary kapòt pou fanm, pwotèj fanm
 pesticide pwazon vèmin
 pestle manch pilon
 petroleum Jelly vazlin
 petticoat jipon
 pharmacist famasyen, fonmasyen
 pharmacy famasi, fanmasi, fonmasi
 pharyngitis gwo malgòj
 pharynx dèyè gòj
 philtrum tèt bouch
 phlebitis anflamasyon yon venn
 phlegm glè, flèm, flenm, lagoum,
 larim, rim, las, vlimè
 bring up ~, cough up ~ v.
 rale flèm
 phobia laperè(z)
 phosphorus fosfò
 physical condition fizik
 physical examination
 konsiltasyon
 physical injury donmajman
 physician doktè, dòk, dòktè, medsen
 physiotherapy egzèsis pou moun ki
 donmaje
 piece moso, mòso, kal
 small ~ tikal
 pigeon-toed pye kwochi
 pile pil
 plies fès soti, tenès, tennès, maladi
 Moyiz, emowoyid
 pill grenn, pilil, tablèt, konprime
 take a ~ v. bwè grenn
 pillow zòrye
 pillowcase sak zòrye, tèt zòrye,
 tèdòrye, tèdòrye, sidòrye
 plimple klòk, klou, bouton

~s ti bouton kwasans
 pin zepeng, epeng
 straight ~ zepeng ti tèt
 pincers pens, tenay, tennay
 pinch v. pichkannen, penche
 pink woz
 pinkeye je drandran, je wouj, maloje,
 malozye, konjonktivit, konjektivit
 pinna fèy zòrèy
 pins and needles (arm, leg etc.),
 have v. mouri
 pint mwatye yon ka
 pinworm vè zepeng, oksiyi
 pipe (for smoking) pip
 pipeline gwo fè tiyo
 pipette (chemistry) pipèt
 piss n./v. pise
 pitcher po, krich
 pitiful minab
 pituitary gland ti glann dèyè tèt ki
 reskonsab fè moun grandi
 pity n. pitye
 place kote, plas
 place v. mete, met
 placebo fo grenn (renmèd)
 placenta mè(t) vant, manman vant,
 delivrans
 plait (of hair) trèz
 plan pwogram
 planned parenthood planin,
 planing
 plantar surface plapye, planpye
 plaque (on tooth) tat, kalkè
 plasma likid ki nan san, plasma
 plaster cast aparèy, anplat, kas
 plastic plastik, jelatin
 ~ sheet enpèmeyab
 plate asyèt
 platelet (blood) plaksan
 play v. jwe
 pleasant agreyab, dous, janti
 please souple, tanpri, silvouplè
 please v. fè plezi, plè
 pleasure plezi
 plenty anpil, kont kò, kont li
 pleura plèv

pleurisy perizi, plerezi
 pliers pens, tenay, tennay, kle
 plug, electric socket plòg
 plug, stopper bouchon
 plug in v. ploge, konekte
 plumber plonbye, bòs plonbye
 plumbing plonbri
 plump grasèt
 plunger (of syringe) piston
 P.M. di swa
 pneumonia nemoni, enfeksyon (nan)
 bwonch
 pocket pòch
 ~ (of pus etc.) sakit
 pocketknife kanif
 pockmark grave vèrèt
 podiatrist doktè pye
 point pwent
 point out v. montre, moutre
 poison pwazon, pwezon
 slow-acting ~ pinga seren
 poison v. (an)pwazonnen
 poisoned anpwazonnen, pwazonnen,
 ranje, kòmande, konmande,
 koumande
 poisoning anpwazonnman
 poisonous (an)pwazonnen
 police lapolis
 policeman jandam, jandanm, lapolis
 polio(myelitis) maladi kokobe,
 polyo
 polish (teeth etc.) v. poli
 polite poli
 pollen poud jòn flè, polenn
 polyneuritis anflamasyon anpil nè
 polyp, nasal chè nan nen
 pomade pomad, ponmad
 poor pòv, malere, ti, pye atè
 pore (of skin) pò
 Port-au-Prince Pòtoprens
 portion pòsyon, pa
 position pozisyon
 position, job djòb, dyòb
 possible posib
 post- apre
 poster afich, postè, foto

postmortem (o)topsi
 postnasal drip rim gòj
 postnatal jis apre akouchman
 post office lapòs
 postoperative apre operasyon
 postpartum apre akouchman
 postpone v. ranvwaye, ranvoye
 posture posti
 pot, cast-iron cooking chodyè
 potable bivab, potab
 potassium potasyòm
 potbelly pann vant
 potlò konpozisyon, posyon
 pouch pòch
 poultice plastè
 pound liv
 poverty lamizè, mizè, malsite
 powder poud
 power fòs
 ~ outage blakawout
 powerful fò
 practical nurse oksilyè
 practice lakoutim
 praise konpliman
 pray v. lapriyè, priye
 prayer lapriyè
 pre- anvan
 preacher (Protestant) pastè
 precaution prekosyon
 precedent egzanp
 precise egzat, ekzat
 prefer v. pito
 pregnancy gwosès, gwòsès, ansent
 ectopic ~ yon gwosès ki pa nan
 matris
 false ~ pèdisyon
 in full ~ an plenn senti
 mask of ~ tach ansent
 term ~ gwosès nòmal
 pregnant ansent, abyenfè, gwovant
 make ~ v. gwòs
 ~ (advanced state) plènsenti
 premature (infant) anvan tèm,
 anvan lè
 premolar dan dèyè, dan pilon
 prenatal care swen gwosès

preoperative anvan operasyon
 preparation konpoze, konpozisyon
 prepare v. pare, prepare
 ~ (medicine) v. konpoze
 prepared pare
 prepuce pokòk, kach, bèk
 presbyopic presbit
 be ~ v. wè delwen
 prescribe v. preskri
 prescription (drug) òdonans,
 lòdonans, preskripsyon
 present v. prezante
 present adj. prezan
 present, gift kado
 press v. peze
 pressing presan
 pressure presyon
 pretend v. fè sanblan
 pretty bèl
 prevent v. enpoze, anpeche, kwape
 prevention prevansyon
 preventive measure(s) prekosyon
 preventive medicine prekosyon
 kont maladi
 previously anvan
 priapism bann san rete
 price pri
 prick v. pike
 prickly sensation pikotman,
 pikòtman
 priest monpè, pè
 unordained or informal ~ pè
 savann
 Voodoo ~ oungan
 priestess (Voodoo) manbo
 private pèsònèl, pèsonnèl
 ~ parts (female) anba, sa
 Bondye ban mwen
 ~ parts (male) pati (sansib)
 privy latrin, komòd
 probable pwobab, pobab
 probably genlè
 probe n. sonn
 dental ~ ekatè
 probe v. sonde
 problem pwoblèm, chay, chaj, ka

(there is) no ~ pa gen pàn
 procedure metòd
 process jan, metòd
 produce v. donnen
 profile pwofil
 profitable itil
 profusely dri
 prognosis chans gerizon
 program pwogram
 progress pwogrè, pogrè
 progress v. fè bèl
 prolapse chit
 prolific pititral
 prolong v. pwolonje
 promise pwomès, pwonmès
 promise v. pwomèt, pwonmèt
 prone, inclined to dispoze
 prone, lying flat kouche sou vant
 proof prèv
 prop up v. apiye
 proper korèk
 prophylactic pwotèj kont maladi
 ~, condom pwotèj (gason)
 prostate pwostat, postat
 prosthesis fo janm, fo dan, (etsetera)
 prostitute jenès, jennès
 prostitution dezòd
 prostrated, exhausted kòkraz(e)
 protect v. menaje, pwoteje
 protection defans, pwoteksyon
 protein poteyin, pwoteyin
 Protestant pwotestan, potestan
 ~ minister pastè
 proud, haughty sekwa
 proud (justifiably) fyè
 prove v. pwouve
 provisions pwovizyon, povizyon,
 rezèv
 provoking agasan
 psoriasis maladi po ak tach wouj
 psychiatrist sikyat
 psychiatry sikatri, sikyatri
 psychoanalysis sikanaliz
 psychologist sikològ
 psychology sikoloji
 psychosis foli

psychosomatic illness maladi
 imajinè
psychotic fou
pterygium chè nan je
ptilosis je griye, je boukannen
ptomaine poisoning manje gate
 nè
puberty fòmasyon, kwasans
 reach ~ v. fòme, fòmen, pouse
 plim
pubescent fòme, fòmen
public area or region ti gazon,
 dozafè, tab
 ~ ~ (of female) toutoun
 ~ hair pwèl, pwal, plim
 ~ louse mòpyon
public health (la)sante piblik
 ~ ~ nurse oksilyè
puffed up boufi, gonfle
puke djapòt, dyapòt
puke v. fè djapòt
pull v. rale, tire
 ~ a muscle v. foule yon misk
 ~ out v. rache
pulmonary poumon
pulsate v. bat
pulse, pulsation batman (venn),
 batman (kè), pou(l)
pump ponp
pump (up) v. ponpe
punctual alè
puncture twou, tou
puncture v. pete, chire
puny malvini, mafweze, mafwezi,
 kata, rabougri
pupil elèv
pupil (of eye) tou je, nwa je, twou
 nwa
pure pi
purgative metsin, pij
 strong ~ lòk
purge v. bay metsin
purify v. pirifye
purify (water etc.) v. distile,
 distiye
purple vyolèt

purpose, on espre
purulent pire
 ~ discharge pyore
pus pij, postim, pi, matyè (jòn)
push v. pouse
 ~ down v. peze
pustule bouton
put v. mete, met
 ~ aside v. mete sou kote
 ~ away v. sere
 ~ closer v. avanse
 ~ in, ~ on v. mete, met
 ~ out, extinguish v. etenn
 ~ together, combine v.
 konbine, konbinen
 ~ to sleep v. andòmi
 ~ up with v. sipòte
putrefaction pouriti
putrid, putrified pouri
pyjamas pijama
pyorrhea jansiv anfle, anflamasyon
 jansiv, san nan dan, piyore, pyore

Q

Q-tip kitip
quack chalatan, doktè pakoti
quadriplegic kokobe tout kote
quadruplet marasa kat
quality kalite, kalte
quantity kantite, lakantite, mezi
quarantine v. mete apa, izole
quarantine n. karantièn
quart (measure, container) ka
quarter ka
quarter (past the hour) eka
quench v. apeze
question keksyon, kesyon
 ask a ~ v. poze yon keksyon
questionnaire keksyonè
quick n. anba zong
quickly vit
quiet n. repo, trankilite
quiet! silans!
 keep ~ v. mouri kò
quiet adj. trankil, kal

quiet v. kalme, trankilize
quietly dousman
quinine kinin
quinsy anjin
quintuplet marasa senk
quilt v. sispann
quite byen, nèt, tou
quiver v. tresayi

R

rabid anraje
rabies laraj, raj
rachitic rabi, rachitik
radiation treatment tretman kansè
radiologist doktè radyografi
radiology radjoloji
radius (bone) radiyis
rag kòt, vye rad, rad chire
rag(s) lòk
rage laraj, ray
ragged kòt, chire
rain lapli
 torrential ~ lavalas
rainy season lepli
raise v. leve, soulve, ose, wose
rally post pòs de rasanbleman
rant v. depale
rape kadejak, vyòl
rape v. fè kadejak sou, vyole
rapid rapid, taptap
rapidly vit, dri
rare ra
rash n. gratèl, bouton, tach ki leve,
 ekzema, ekzema, dat, san grate,
 lota
 diaper ~ chofi kouchèt
 heat ~ chofi
rat rat
rate, rapidly vitès
rather you (ti) jan, manyè, menyè
 ~ than olye
rather, prefer v. pito
ration v. rasyonnen
ravages ravaj, ravay
rave v. depale

raw kri
razor razwa
 ~ blade jilèt, razwa
react v. reyaji
reaction reyaksyon
 allergic ~ alèji
 delayed ~ reyaksyon pi ta
 immune ~ pa gen reyaksyon
 negative ~ reyaksyon negatif
 positive ~ reyaksyon pozitif
read v. li
ready pare
ready, get or be v. pare
real vre
realize v. rive konprann
really byen
rear dèyè, dèryè
reason lakòz, lakoz, rezon
reasonable rezonab
reassure v. rasire
rebandage v. repanse
receipt resi
receive v. resevwa
recent nèt
recently dènyèman, depi de twa jou
recognize v. rekonèt, konnen
recommend v. rekòmande
record, medical dosye
record-keeper (clinic etc.) achivis
recover v. refè, repran, reprann, fè
 mye, retabli
 ~ completely (from
 a sickness) v. gaya
recovery (from illness) gerizon
 beyond ~ ka pèdi
rectum dènye bout gwo trip
 from the ~ pa ba
recuperate v. refè
recuperation gerizon
recurrent ki ale vini
red wouj
 ~-haired tèt lò, tèt wouj
Red Cross Kwa-Wouj
reddish woujat
reduce v. diminye, diminwe
 ~ a fracture v. fè rediksyon

~ (tumor etc.) v. fè vin pi piti
 ~ (weight) v. pèdi pwa, vin pi piti
reduction rediksyon
referral, make a v. voye (yon noun) kay yon espesyalis
refined delika
reflex reflèks
 ~ hammer ti mato
refrigerator frijidè
refusal refi
refuse v. derefize, refize
regain v. repran, reprann
 ~ consciousness v. revini, revni
region zòn
 ~ (of body) zòn (kò)
register rejis
regress v. pèdi fil, fè yon bak, tounen dèyè, regrese
regret v. regrèt, regrete
regret(s) regrè, regre
regular regilye
regularly fidèl, regilyèman
regulations lalwa
rehabilitation reyabilitasyon
rehydration bay dlo (tankou tretman)
reinfection, have a v. refè enfeksyon
reinforce v. ranfòse
reject v. rejete, rechte, rejte, derefize
relapse chit, rechit
 have a ~ v. rechite
relative n. paran
 distant ~ ti fanmi
relative(s) fanmi
relax v. lache kò li, detann, relakse, poze san li
 ~ (muscle etc.) v. lache
relaxant kalman
release v. lage, lache
 ~ or be released from hospital v. egzeyate, ekzeyate
reliable serye, debyen

relief alejman, alèjman, apezman, soulajman
relief, replacement larelèv, relèv
relieve v. soulaje
relieve, replace v. pran larelèv, ranplase
religion relijyon
remain v. rete, ret
remainder rèss
remedial ki bon pou ...
 ~ exercises egzèsis (ki bon pou...)
remedy remèd, remèd
remember v. sonje, chonje
remission yon ti mye
remove v. wete, wet, retire
 ~ (one's) shoes v. dechouse
renal ren
rent v. lwe
 ~ out v. lwe
repair v. ranje, depane
repair (a breakdown) v. leve pàn
repeat v. repete
repeat, give again (dosage etc.) v. rebay
repeatedly dri
repercussions kontrekou
replacement ranplasan
reply repons
reply v. reponn
report rapò
repulsive malouk
require v. mande
required to v. oblije, bije
rescind v. dekòmande
rescue v. sove
resemblance resanblans, sanblans
resemble v. sanble ak
reserves rezèv
reside v. rete, ret
resident, intern (medical) entèn
residual effects tras ki rete
residue rèss
resign oneself v. rezilyen, rezিয়ে, konsòle
resignation rezilyasyon

resist v. redi, goumen, reziste
 resistance rezistans, fyèl
 resistant di, rezistan
 resolute rezoli
 resolution, healing gerizon
 resolve v. rezoud
 respiration respirasyon
 respirator respiratè
 respiratory respiratwa
 acute ~ distress lalwèt tonbe
 ~ arrest pa respire ankò
 ~ rate vitès respirasyon
 ~ system aparèy souf, kannal lè,
 aparèy respirasyon
 respite kalma, apezman, repi, souf,
 kalm, kanpo
 respond, answer v. reponn
 respond, react v. reyaji
 response repons
 responsible (for) reskonsab,
 responsab
 rest kanpo, repo, repi
 rest v. repoze
 rest, remainder rèss
 restless ajite, toumante
 be ~ v. toumante kò li, sakaje
 kò li
 restlessness touman(t)
 restore v. repare
 restroom chanm twalèt
 (gentle)men's ~ twalèt gason
 ladies'/women's ~ twalèt fi
 result konsekans, rezilta
 result, effect rannman
 resuscitate (s.o.) v. leve, fè revini,
 fè revni
 retain v. kenbe
 retarded gaga
 retch v. seye vonmi
 retention (of food, water etc.)
 kenbe
 retina retin
 detached ~ retin dekole
 retrain (muscle etc.) v. egzèse
 (yon misk)

return v. tounen, retounen, repran,
 reprann
 reverse (car) bak
 in ~ pa bak
 put in ~ (car) v. fè bak
 revive (s.o.) v. (fè) revini, (fè)
 revni
 revoke v. dekdmande
 reward v. rekonpanse
 rheumatic fever lafyèv nan zo,
 lafyèv rimatis
 rheumatism maldezo, rimatis,
 womatis, freddi, frechè, gaz nan tout
 kò
 rheumatoid arthritis rimatis
 arthritis, doule nan jwenti
 rhythm (of heartbeat etc.) konpa
 ~ method (family planning)
 kontwòl jou apre règ, metòd
 tanperati
 rib (zo) kòt
 ~ cage kòf lestonmak
 rich rich
 rickets zo rachitik
 ride (free) woulib
 ridiculous ridikil
 right (opposite of left) dwat
 be ~ v. gen rezon
 on the ~ adwat
 ~ away touswit, lapoula
 ~ handed sèvi ak men dwat
 ~ here isit la, la a
 ~ side (of clothing, fabric)
 landrèt, landwat
 righteous dwat
 rigid rèd
 rigor mortis mò rèd
 rim arebò
 ring bag
 ~-finger dwèt bag, (dwèt) anilè
 ring (in ears) v. kònen
 ringing in ears zòrèy sonnen
 ringworm lateng, pyas
 rinse rensè
 rinse v. souke dlo nan bouch, rensè
 rip v. chire, dekoud

ripe mi
 risk ris
 risk v. riske
 risky riskan, riske
 rites, last dènye sakreman
 river larivyè
 road wout
 ~to-health chart (kat) chemen
 lasante
 robe, dressing-gown wòb de
 chanm
 robber vòlè, volè, vòlò
 robust gaya, vanyan, djanm, dyanm,
 byenpòtan
 rock wòch
 roll, list lis
 ~ (bandages, paper etc.)
 woulo
 roll v. woule
 roof tèt kay
 room (of house etc.) chanm, sal
 roomy laj
 root rasin
 perform ~ canal surgery v.
 wete nè/vè nan dan
 rope kòd
 rose woz
 roseola infantum lafyèw timoun ak
 gratèl
 rot pouriti
 rot v. pouri
 rotation woulman
 rotten pike, pouri
 rough brital, pwès
 ~ (throat esp.) graj
 round won
 ~-shouldered do ba
 roundworm gwo vè won, askaris
 rub v. fwote, fote, friksyonnen
 ~ lightly v. basinen
 ~ (with lotion, alcohol etc.)
 v. friksyonnen
 rubber kawòtchou, kawoutchou
 ~ band lastik, elastik
 rubella lawoujòl alman, ti lawoujòl,
 ribeyòl, woubewòl

rugged potorik
 ruin v. depafini, rinen, gache
 rule règ, lwa
 rum, raw (white) kleren
 rumbling (in stomach) bouyi
 rump dèyèkay
 run v. kouri
 ~ away v. chape, sove
 run, flow v. koule
 rundown malangi
 runt rèkè, zege
 rupture frakti, eklatman
 rupture v. pete, eklate

S

sac (of pus etc.) sakit, pòch
 sachet sache, sachè
 sack sak
 sacrament sakreman
 sacrum zo koupyon
 sad tris, chagren, kè grenn, kagou,
 akable
 sadden v. dekonpoze
 sadness kè sere, kè mare
 safe sove, sòf, sof
 ~ and sound sen e sòf
 safety match zalimèt
 safety pin zepeng atache
 large ~ ~ zepeng kouchèt,
 zepeng kwochèt, zepeng kwòk
 small ~ ~ zepenglèt
 saint sen
 saliva dlo bouch, saliv, bav
 dried ~ (at corner of mouth)
 bòkyè, bòkè
 rope ~ gwo filè krache
 ~ ejector sisyon
 spray of ~ postiyon
 salivate v. bouch li kouri dlo
 salivation dlo bouch
 sallow blenm, blèm
 salt sèl
 coarse-grained ~ gwo sèl
 Epsom salts sèl gason
 Glauber's salts sèl fanm

~ water dlo sèl
 salve pomad, ponmad, longan
 same menm
 sample echantiyon, chantiyon
 sanatorlum sana(toryòm)
 sand sab
 sandal sapat, sandal
 sane tèt byen, tèt dwat
 sanitary ijenik, ijyenik, jenik, sanitè
 ~ napkin or pad twal, twèl,
 lenj, kotèks
 sanitation lapwòpte
 sanlty bon sans
 sap v. minen
 sarcoma move timè
 satisfaction plezi
 satisfied (with) kontan (ak)
 satisfy v. fè plezi
 Saturday samdi
 sauce sòs
 saucer soukoup
 save v. sove
 save, put away v. sere, mete sou
 kote
 say v. di
 scab kwout, kout, kal
 scables bouton (grate), gal, lagal
 scald v. chode, boukannen,
 dekwennen, kankannen
 scale (skin) kal
 scale (teeth) v. grate
 ~ off (skin etc.) v. dekalè
 scaler (dental) gratwa
 scales (weight) balans, baskil, pèz
 (hanging)-~ balans ak kwòk
 scalp potèt, (po) kwi tèt, kwann tèt
 ~ infection pyas
 scalpel kouto operasyon, bistouri
 scaly, be v. fann
 scapula zo zepòl, omoplat
 scar mak, tach, grafiyen, grafouyen,
 kouti, balaf, sikatris
 form ~ tissue v. fèmen
 scared kè sote
 be ~ v. pantan
 scarf foula

scarlet fever, scarlatina lafyèv
 eskalatin
 scatter v. grennen
 scent odè, lodè
 schizophrenic eskizofrèn
 school lekòl
 sciatica tay ak janm fè mal
 scissors sizo
 sclera blan je
 sclerosis vin di
 multiple ~ maladi nè, paralezi
 aparèy nè
 scoliosis zo rèdo koubi, eskòlyoz
 scorch v. brile
 scorpion eskòpyon, zekribich
 scour v. dekwote
 scouring powder ajaks
 scrap chiffon
 scrape v. kale
 scraper (dental) gratwa
 scratch n./v. grafiyen, grafouyen,
 gratiyen, grate, kòche
 scrawny krebete, rachitik, kòde
 scream rèl
 scream v. rele
 screen v. triye
 screen (of wire) til
 screening, separating triyaj,
 triyaj
 scrofula zekwèl
 scrotum sak grenn, po grenn, bous,
 pòch
 ~ and testicles kòd grenn
 scrub v. dekwote
 ~ (up) v. pwòpte, fwote, fote
 sea lanmè
 seasickness mal lanmè
 season sezon
 seat, chair chèz
 ~ of latrine kòf latrin
 ~, buttocks dèyè, dèryè
 seated chita
 second dezyèm
 second, moment moman
 secondary akote, segondè
 ~ infection dezyèm enfeksyon

secretary segretè, sekretè
 secrete v. bay sòs, vide, rann, swe
 secretion sòs, pij, dlo blan(ch), swè
 secretly ankachèt
 section pati
 sedate v. bay (yon) kalman
 sedative kalman
 see v. wè
 seed semans
 seedy, poor minab
 seedy (stool) ma
 seem v. sanble, gen lè
 seep (out) v. swente
 seize v. sezi
 seizure kriz, atak, koutsan,
 dekonpozisyon
 seldom raman
 select v. triye
 selection, triage triyaj, triyay
 sell v. vann
 semen dechay, dechaj
 semiconscious, be v. gen mwaye
 konnesans
 seminal vesicles sak dechay
 send v. voye
 ~ away v. ranvwaye, ranvoye,
 voye ale
 ~ (s.o.) for v. voye chache
 senile gaga, ebete, enbete, entatad,
 entete
 sensation sansasyon
 sense sans
 common ~ bonsans
 ~ (of touch etc.) sans
 sensible saj
 sensitive delika, siseptib, sansib
 ~ point venn sansib
 ~ tooth dan sirèt
 separate v. separe
 sepsis enfeksyon nan san
 September septanm, sektanm
 septic arthritis enfeksyon nan
 jwenti
 septicemia enfeksyon nan san,
 septicemi

septum (nasal) pati ki nan mitan de
 twounen yo
 series seri
 serious serye, grav, malouk
 seriously gravman
 seriousness gravte
 serum sewòm, vaksen
 serve v. sèvi
 service sèvis
 setback rechit
 settle v. regle
 seven-year itch lagal
 several plizyè, kèk, kèlke
 severe di, makawon, rèd
 sew v. koud
 sewer (covered) egou, regou
 open ~ rigòl
 sex:
 be having ~ with v. gen rapò,
 amafè (ak), fè bagay
 want ~ v. sou sa
 sexual:
 ~ intercourse kontak, rapò,
 relasyon
 ~ misconduct dezòd
 sexually:
 be ~ active v. gen kontak
 ~ active (male) gason
 ~ aroused cho
 shabby minab, kraze
 shade lonbray, lonbraj
 shadow lonbray, lonbraj
 shake v. souke, sekwe, tranble, ajite
 ~ (about) v. balote
 ~ up v. ajite
 shaken souke, sekwe
 shaky branlan
 shall v. a, va
 shallow pa fon
 shame wont
 shameless sankoutcha, sanmanman
 shampoo chanpou
 shank zo janm, bwa janm
 shape:
 in good ~ an sante
 in (great) ~ anfòm

share pa
 share v. separe
 sharp file
 shave v. raze
 ~ (face) v. fè (la)bab
 shaving brush blewo
 shaving cream krèm (pou) bab
 she li, l'
 sheet (bed) dra
 sheet metal tòl
 shelter lojman
 ~ (for elderly or sick) loispis
 shift (work) larelèv, relèv
 shin zo janm, bwa janm, banbou
 janm
 shingles maladi nè nan po, zona
 shirt chemiz
 shiver frison
 shiver v. tranble, frissonnen
 shock chòk, kou, soukous, sezisman,
 emosyon, endispozisyon
 In ~ anba chòk
 shocked kè kase
 shoe soulye
 shoelace lasèt
 shoot (at) v. tire
 shop magazen
 short kout, ba
 ~ and fat tibout
 be ~ of breath v. rale anlè,
 souf anlè, pèdi souf
 shorten v. rakousi, kousi
 shortness of breath souf kout, souf
 wo, etoufman
 shorts bout pantalon, bout kanson,
 tèt kanson, pantalon kout, chòt
 shot (Injection) piki
 shots vaksinasyon
 should v. ta dwe, fèt pou
 shoulder zepòl, epòl
 ~ blade zo zepòl, omoplat
 shout rèl
 show v. montre, moutre
 ~ up v. parèt
 shower (bath) douch
 shrink v. vin pi piti, (re)tresi

shrunken (face) rale
 shudder frison
 shudder v. frissonnen
 ~ (from fear) v. tresayi
 shut v. fèmen
 shy timid, pèrèz, perèz, fèmen, jennen
 sick malad, ba
 be ~ v. pase maladi, pran kabann
 ~ person malad
 sickening (food) rebitan
 sickle cell anemla anemi falsifòm
 sickly enfim, maladif, kata, malangi
 sickness maladi, mal
 sickroom chanm malad
 side bò, kote
 on the ~ or edge of arebò
 ~ by ~ kòt a kòt
 ~ effect(s) (pwoblèm) sou kote,
 akote, konplikasyon
 ~ (of body) flan, bò kòt
 ~ or edge rebò
 sideburns pafouten, fafouten
 sideways detravè
 slesta syès, lasyès
 sieve paswa
 sift v. koule
 sigh soupi
 sigh v. soupire
 slight, sense of wè, vizyon
 sign remake, renmak, siy, sin,
 endikasyon
 sign (one's name) v. siyen
 signature siyati
 signify v. vle di
 silence silans
 silent san bri
 silliness betiz
 silver nitrate nitrat ajan
 similar parèy, sanblan (ak)
 simple senp
 simply senpleman
 since (because) kòm, konm, piske
 since (temporal) depi
 sinew fil vyann, vlen, triyal
 sing v. chante
 single, alone adj. sèl

single unit or piece (of anything) grenn
 single, unmarried selibatè
 sink lavabo
 sink v. koule
 sinusitis, sinus trouble
 enfeksyon nan tou zo figi moun, sinizit
 sir msye, mesye
 sister sè
 ~in-law bèlsè, bèlsò
 sit:
 ~ down v. chita
 ~ up v. leve chita
 sitting chita
 situation afè, zafè, sitiyasyon, sitirasyon, bagay
 size gwòsè, gwosè, tay
 size (clothing) mezi, nimewo
 skeleton eskèlèt, kakas
 ~like zòkò, zomangay, zòban
 walking ~ zosman
 skillful adwat
 skin po
 rough dry ~ po deng
 ~ irritation san grate, gratèl
 skin v. kòche, kale
 skinny mèg, mègzo, lamègzo, sèk, chèch, sèch, zo, dezose, bagèt
 legede
 ~ person mègrè, lamègrè, mègzo, lamègzo
 skip v. sote
 skirt jip
 skull zotèt, (zo) bwatèt, zo krantèt, zo (kokolo) tèt, kòkòwos (tèt), kalbas tèt
 slack lach
 slacks kanson
 slander v. blanchi
 slash v. dechikete
 slave away v. redi
 sleep dòmi, somèy
 deep ~ gwo somèy

sleep v. dòmi; (see also dòmi entries in Haitian Creole-English section)
 put to ~ (child etc.) v. fè dòmi
 put to ~ (surgery) v. andòmi
 sleep, eye matter kaka je
 sleeping-mat nat
 cheap ~ ~ atèmiyò, soukekouche
 sleeping pill grenn pou dòmi
 sleeping sickness maladi dòmi
 sleepless night nwit blanch
 sleepwalk v. mache nan dòmi
 sleepy, be v. gen dòmi nan je
 sleeve manch
 slew-footed pye kwochi
 slice v. koupe an tranch, tranche
 slick glisan
 slide (for microscope)
 mòsovit, ti vè, lam
 slight adj. mens, lejè
 slim mens
 ~ down v. degrese
 sling, arm bandaj, bandaj
 slip v. trebiche, kase pye
 slip (paper) fich
 slip, petticoat jipon
 slipped disc ti zo nan rèldo ki deplase
 slipper sapat, sandal
 slippery glisan
 silver klis, eklis
 slobber bav
 slobber v. bave
 sloping pandje, pandye
 sloth parès
 slouch v. koube
 slovenly sankoutcha, sangwen
 slow lant, lan
 slow (clock) anreta
 slow down v. ralanti
 slowly dousman, lanteman
 sluggish tèt lou, kò kraze
 sluggishness letèji, letaji
 small piti, ti

smallpox gwo bouton, vèrèt, varyòl,
 lavaryòl, tivewòl, koutpyout,
 tatapyout, alastrim
 smarting pikotman, pikòtman
 smash up v. demantibile
 smear v. badijonnen
 ~ (blood, vaginal etc.)
 fwoti(s)
 smegma kalanbè
 smell sant
 bad ~ odè, lodè
 sickly-sweet ~ santidous
 smell v. santi
 smelly santi
 smile souri
 smile v. souri
 smiling souriyan
 smoke lafimen
 smoke (cigarette, pipe etc.) v.
 fimèn
 smooth lis
 ~ out v. degwosi
 smother v. toufe
 snack soloba, goute
 snarl v. griyen
 sneeze v. estènen, estène
 snooze kabicha, syès, lasyès
 snore v. wonfle
 snoring wonfle
 snot flèm, flenm, rim, larim
 dried ~ kaka nen
 liquid ~ sòs
 snuff tabak an poud
 so si, konsa, kousa
 soak v. tranpe
 soaked antranp
 soap savon
 ~-dish bwat savon
 soap v. savonnen
 sob v. kriye fò
 sober poze
 sober (not a heavy drinker) sòb
 sock (for foot) chosèt
 socket (electric) plòg
 socket (tooth) twou, alveyòl
 sodium sodyòm

soft mou, tann
 soften v. ramoli
 softly dousman
 soil, earth tè
 soil v. souye, sal
 solled, easily salisan, tachan
 solder v. soude
 soldier jandam, jandanm, sòlda
 sole (of foot) plapye, planpye
 Infected ~ pye chik
 sole (of shoe) semèl, senmèl
 solid solid, fèm, dirab
 solution, mixture posyon
 solution, remedy solisyon
 somber sonm
 some kèk, kèke
 something kichòy
 sometimes pafwa
 somewhat yon (ti) jan, manyè,
 menyè
 somnambulism mache nan dòmi
 son (of any age) pitit gason
 ~-in-law bofis, bofi
 song chante
 soon talè, titalè
 soothing kalman
 soporific ki fè dòmi
 sorcerer and healer (Voodoo)
 bòkò
 sore n. plè, blese, blesi, malad,
 chank
 highly malignant open ~ or
 wound java
 Infected ~ maleng, baka
 small ~ bèlen
 ~(s) at corner of mouth
 bòkyè, bòkè, bouch chire, bouch
 manje
 ~(s) on tips of toes (from
 stumbling etc.) zandò
 ~ (which leaves scar) zonyon
 sore adj. malad, sansib, louvri
 ~ throat malgòj
 sore, be v. fè mal
 soreness doulè

sorrow chagren, doulè, lapenn, penn,
 lapèn, regrè, regre
 sorrowful chagren
 sorry, be v. regrèt, regrete
 sort jan, kalite, kalte
 ~ of manyè, menyè
 ~ out v. triye
 sorting triyaj, triyay
 so-so konsa konsa
 sound n. son
 sound v. sonnen
 sound, healthy tèm
 sour anmè, amè
 turn ~ v. tounen
 source sous
 space (between fingers, toes)
 fant
 spaced apart (teeth) dan tchaka, dan
 tyaka
 Spanish panyòl
 spare v. menaje
 spasm kriz
 spasmodic mòde lage
 spastic entatad
 spatula ti palèt
 (dental) cement ~ espatil
 speak v. pale
 special espesyal
 specialist espesyalis
 specimen yon ti kras/gout,
 (e)chantiyon
 ~ cup goblè, gode, po
 speculum aparèy sonn
 spend v. depanse
 ~ (time) v. pase
 sperm dechay, dechaj, jèm, semans
 gason
 spermatozoa grenn dechay
 spermicidal suppository tablèt
 vajinal
 spermicide krèm
 sphincter mis k' ap fèmen yon twou
 anal ~ misk (k' ap fèmen) twou
 dèyè
 urethral ~ misk (k' ap fèmen)
 twou kannal pipi

vaginal ~ misk (k' ap fèmen)
 kannal fi
 spicy pike
 spider arenyen
 spigot tiyo, wòbinèt
 spill over v. debòde
 spinal epinyè
 do a ~ tap v. retire enpe dlo
 nan do pou wè si gen enfèksyon
 nan sèvo
 ~ column baton koumbe
 ~ cord chenn do
 ~ fluid dlo rèldo
 spine zo rèldo, zo chenn do, chini do
 cervical ~ nwakou
 curvature of the ~ koub nan
 zo rèldo
 splinster vyèy fi
 split n.,v. krache
 ~ up v. krache
 spite of, in malgre, magre
 splittoon krachwa
 spleen larat
 ruptured ~ larat li pete
 splint atèl
 splinter klis, klisbwa, eklis, ekla
 split fant, krevas
 split v. fann, pete, anfraje
 spoil v. gate, pouri, defigire
 sponge eponj
 ~ (off) v. benyen ak yon eponj
 spoon kiyè, kouyè
 (dental) ~ excavator eskavatè
 spoonful kiyè plen, kiyere
 sporadic ki rive tanzantan
 spot mak, plak, tak, tach
 spot v. tache
 ~ (between periods) v. make,
 bay ti gout san nan mitan de règ
 spots, see v. fè mimi mimi
 sprain foulay, van
 ~ (ankle and foot)
 antòch, antòs
 sprain v. tòde, tòdye
 sprained foule

~ back senti louvri, ren louvri,
 senti ouvè
 spray v. flite
 spray gun (for insecticide) flit
 spread v. gaye, grennen
 ~ apart v. louvri
 ~ on v. badijonnen
 ~ out v. etann
 ~ rapidly v. mache gaye
 spring (of water) sous
 spry enganm, engam
 spunk nannan
 spurt out v. jayi
 sputum kracha, flèm, flenm
 squat v. akoupi, koupi
 squeeze v. peze, sere
 squint v. twenzi
 squinting je twèt, je tawèt, je louch
 stab v. pike
 ~ wound blesi ponya
 stability, mental lòlòj, lòlòy
 stabilize, remain constant v.
 rete menm jan
 stable adj. ki pa chanje
 staff ekip
 stagnant kòwonpi
 stain tach
 stain v. tache
 stairs eskalye
 stake v. mize
 stale rasi, vante
 stamina rezistans, fòs, fyèl
 stammer v. bege(ye)
 stand v. kanpe
 ~ up v. (leve) kanpe
 stand, frame kad
 standard estanda
 standing kanpe, doubout, debout,
 debou
 stare at v. fikse
 start v. kòmanse, konmanse,
 koumanse
 ~ (doing something) v.
 tonbe
 ~ to v. tanmen, mete, met
 startled kè sote, souke, sekwe

be ~ v. pantan, sote
 starve v. mouri grangou, tonbe faya
 state, condition kondisyon, eta
 state, government leta
 static, quiescent menm jan
 stature wotè
 stay v. rete, ret
 steadily (de) jou an jou
 steady fèm, djanm, dyanm
 steal v. vòlè, volè, vòlò
 steam vapè
 steep apik
 stench sant
 step pa
 ~ by ~ pazapa
 stepbrother bòfrè, bòf
 stepdaughter bèlfi
 stepfather bòpè, bopè
 stepmother bèlmè
 stepsister bèlsè, bèlsò
 stepson bofis, bofi
 sterile:
 ~ man gason ki pa ka fè pitit
 ~ (woman) branrany
 sterile, germ-free esteril
 sterilization esterilizasyon
 sterilize, pasteurize v. pasterize
 sterilize (sanitize; desex) v.
 esterilize
 sterilizer esterilizatè
 gas ~ bwat gaz
 sternum biskèt
 steroid estewoyid
 stethoscope sonn, estetoskòp
 stick baton
 stick (to), cling (to) v. kole
 sticky kole, kolan
 stiff rèd
 stiffen v. redi
 stiffness redisman
 still adv. ankò, toujou
 stillborn fèt tou mouri, mòne
 stimulant eksitan
 stimulate v. chofe, eksite, ankouraje
 sting mòde, pike

sting (bee etc.) v. pike, mòde, bo, bobo
sting or burn v. lanse
stinging pikotman, pikòtman
stink v. santi
 ~ up v. anpeste
stirrups (for pelvic exam) etriye, fè, pye kabann
stitch fil
 projecting end of ~ pwent fil
 ~ (wound etc.) n. kouti, kout zegwi
 ~ up (wound etc.) v. koud
stock, supply valè, estòk
stocking, hose ba
 elastic ~ ba pou gwo venn nan janm
stomach vant, sak manje, gwo sak, pans, gwo pans
 bloating ~ balonnman
 on an empty ~ ajen
 ~ ache vant fè mal, malvant, kolik
 ~ pains, cramps tranchmann vant
 upset ~ kèplen, lafwerad
stone wòch
 kidney ~ wòch/pyè nan ren
 sharpening ~ wòch pou file
stool watè, pou pou, okabine, okabinen
 have a ~ v. pou pou, watè
 have loose ~s v. lach
 have seedy ~s v. watè ma
 have thick ~s v. watè pwès
 have watery ~s v. watè dlo, pou pou dlo
 liquid ~ fwarad
stool (foot) tabourè
stoop v. bese, koubi
stop v. rete, ret, sispann, bare, enpoze, kwape
 ~ functioning (machine) v. pran pàn
stopped up, be v. bouche
stopper bouchon
store magazen
store v. estoke, sere
storehouse depo
stores, provisions rezèv
storm tanpèt
stove recho
 gas ~ fou gaz
strabismus je lanvè
straight dwat, drèt, dirèk
 ~ ahead toudwat
straighten v. drese
strain tansyon
strain (muscle) v. foule
strain, screen v. filtre, koule
strained (breathing) anlè
strainer paswa
straitjacket sèp, ba
 put in a ~ v. mete li nan ba
stranger moun vini
strangle v. toufe, trangle
strangled (e) trangle
strangulation trangleman
strap senti
strapping manbre
straw (for drinking) kalimèt, chalimo
straw mattress payas
streak tras
stream, brook larivyè
stream (perspiration, tears etc.) rigòl
strength (physical) fòs, kouraj, kouraj, fòskouraj, fòsponyèt
strengthen v. fòtifye, ranfòse
streptococcus estrèptokòk
stress tansyon, tèt chaje
stretch v. tire
 ~ (oneself) v. detire
 ~ out v. lonje, alonje, etann
stretcher branka, kad
 wheeled ~ kabann woulèt
striae mak
strict sevè
stricture jennman
strike kou

strike v. frape, bat
string fisèl, ti kòd, fil
strip, band bann, kòdon, kòdwon,
senti
~ (skin, cloth etc.) lèz
stroke atak/kout san nan sèvo,
koutsan, donmaj nan sèvo, chòk
nan tèt, anboli, konjesyon serebral
strong fò, manbre, engam, engam,
rezistan
strong (alcohol) pike
struggle v. redi, lite, debat, bat,
goumen
stubborn, headstrong antete,
entete, volontè
stubborn, resistant pèsistan, rèd,
kolan
student elèv
study v. etidye
stuffed (with food) kore
stumble v. kase pye, trebiche,
tribiche
stump bout
~ (human limb) bout, monyon
~ (tree; human limb) chouk
stun v. toudi, gaga
stunt (one's growth) v. malangi,
siprime
stunted rabi, malvini, rasi, rabougri,
rachòt
become ~ v. malangi
stupid sòt, bèt, ebete, enbete, tèt
kalbas, kannaman
stupidity betiz
stupor gaga
sturdy vanyan
stutter v. bege(ye)
St. Vitus' dance maladi tranble
sty klou (nan je), kis
styptic (ki) rete san
subconscious nan tèt li, nan li
menm
subcutaneous anba po
subject n. koze, matyè
submissiveness reziyasyon
subnormal pi ba pase nòmal
subside (fever, headache etc.) v.
desam, lache, apeze, vin pi piti
subsidence apezman
substitute ranplasan
succeed v. reyisi, resi, mache
success siksè
successive youn apre lòt
succumb v. sikonbe
suck v. souse, sise, tètòt
suckling souse, sise
suckle v. tete, pran tete, rale tete
suction bulb ponp nen
sudden sibit
suddenly sanzatan, toudenkou,
sibitman
suffer v. pase mizè, pase mati,
soufri, sibi, pase traka, kòde yaya
suffering mizè, lamizè, tray, pay,
soufrans
extreme ~ mati
suffocate v. toufe, sifoke, sivoke
suffocating sivokan
suffocation etoufman
sugar sik
suicide:
attempt ~ v. seye fè tèt li mal,
seye touye tèt li
commit ~ v. fè tèt li mal,
touye tèt li
sulfate malèt
sulfa silfa
sulfate silfat
sulfur souf, silfat
sun solèy
sunburn atak solèy, kout solèy
Sunday dimanch
sunrise, before bon maten
sunstroke atak solèy, kout solèy
superficial (not serious) pa grav
superficial (wound) pa fon
superstition vye kwayans,
sipèstisyon, sipètisyon
supine kouche sou do
supper soupe, manje aswè
eat ~ v. soupe
supple soup

suppleness souplès
 supples pwovizyon, povizyon
 supply valè, (la)kantite
 support, hold up v. kenbe, soutni,
 sipòte
 support, take care of v. swen
 support (under woman's hips
 during childbirth) choukèt,
 biyòt
 supportive sipòtan
 supposed to, be v. fèt pou
 suppository sipozitwa, tablèt
 suppurate v. bay sòs, bay pij
 sure sèten, si
 surely siman
 surgeon chirijyen
 ~'s cap bonnè, berè
 surgery operasyon, chiriji
 general ~ operasyon jeneral
 local ~ ti operasyon
 major ~ gwo chiriji
 perform ~ v. opere, fè
 operasyon
 plastic ~ operasyon plastik,
 operasyon kosmetik
 undergo ~ v. opere, fè
 operasyon
 surgical:
 ~ dressing pansman
 ~ instrument tray plato
 ~ ward chiriji
 surprise sezisman, kou souprann
 surprised sezi
 survive v. chape
 susceptible siseptib
 suspenders bretèl
 suspicious mefyan
 suture kout zegwi, fil
 suture v. koud
 swab (cotton) kitip
 swallow gòje
 swallow v. vale
 swarm v. fè bèt
 sweat laswè, swè, swe, sye
 ~ glands glann swe
 sweat v. swe, sye

sweater chanday
 sweep v. bale
 sweet dous
 swell v. anfle, gwosi
 ~ up v. gonfle
 swelling anfleman, anfle,
 anflamasyon, enflamasyon,
 anflet(s)
 reduce ~ v. dezanfle
 ~, bump on head konkonm
 ~, lump boul
 ~, welt louk
 swollen anfle, boufi, gwo, plen, pouf
 be ~ v. fè douk
 ~ eye je bouche
 ~ feet (and legs) efranjit
 sympathetic gen kè sansib
 sympathize v. konpati, gen pitye
 symptom remak, renmak, siy,
 endikasyon, sentòm
 syndrome gwoup siy ki montre gen
 maladi
 syphilis sifilis
 syringe sereng
 syrup siwo
 system sistèm

T

T-shirt (with sleeves) mayo,
 chemizèt ak manch
 table tab
 examining ~ tab kon- siltasyon
 tablespoon gwo kiyè
 tablespoonful, level gwo kiyè san
 tiyon
 tablet konprime, tablèt, grenn
 ~ (of aspirin) kache
 tailbone zo koupyon
 take v. pran, mennen
 ~ advantage of v. pwofite,
 pofite
 ~ apart v. demonte, demoute
 ~ a pill v. bwè grenn
 ~ away v. wete
 ~ back v. repran, reprann

~ care of v. okipe, (pran) swen
 ~ down v. desann, defèt, defè
 ~ notice of v. okipe
 ~ off, ~ out v. wete, wet,
 retire
 ~ over, relieve v. pran larelèv
 ~ (time) v. mete, met
taken okipe
talc talk
talcum tal(k)
 ~ powder poud detal
talk v. pale, koze
tall wo, bèlwotè, gran tay
tampon tanpon
tap, splgot wòbinèt
tap (on) v. tape
tape, cassette kasèt
 adhesive ~ tep, adezif, plastè
 ~ measure mè, santimèt
 ~ (up) v. tepe
tapeworm vè solitè(s), youyou,
 loulou(t), tenya
tarantula krab arenyen, krab banbara
tardy anreta
tarsus jepye, (zo) kakòn pye, chevi
tartar kaka dan, kwout dan
taste gou
taste v. goute
tasty gou
tatters lòk
tattoo n. mak
tattoo v. make
TB tebe
tea te
 herbal ~ tizann, tizàn
teach v. montre, moutre, aprann
team ekip
 mobile ~ klinik mobil
tear(drop) dlo je
tear or lacrimal gland glann kriye
 ~ ~ ~ duct kannal dlo je
tear (up) v. chire, dechire
tearful dlo nan je
tease v. pase nan betiz
teaspoon ti kiyè

teaspoonful, level ti kiyè san
 tiyon
teat (pwent) tete
technician teknisyen, espesyalis
technique teknik
technology teknoloji
teen-ager jennmoun
teeth dan; (see also tooth)
 brush one's ~ v. lave bouch li
 false ~ ratelye
 ~ set far apart dan tchaka, dan
 tyaka
 two ~ growing in same
 position dan doukla, dan marasa
teethe v. fè dan
teething dantisyon
 be ~ v. fè dan
telephone telefòn
telephone v. telefonnen
tell v. di
 ~ jokes, kid around v. bay
 blag
 ~ lies v. manti, mantò
temperament tanperaman
temperature chalè, tanperati
 high ~ lafyèy cho
temper tantrum, have a v. mande
 araje
temple (head) tanp, letanp, etanp
temples (of eyeglasses) manch
 linèt
tempt v. tante
tendency tandans
tender tann, sansib, mou,
 ~ spot venn sansib
tenderness tandrès
tendon fil vyann, triyal, venn
tenesmus tenès, tennès
tennis shoes tenis
tense adj. sou tansyon, konsantre
tension tansyon
tepid tyèd, tchèd, kyèd
terminal adj. tèminal
terminate v. tèmine
terrible terib
test tè, analiz

~ tube epwouvèt, epouvèt
 test v. teste, sonde, seye, eseye
 testicle grenn, testikil
 testify v. temwaye
 testis grenn, testikil
 testosterone matyè ki fè yon gason
 fòmè
 tetanus (maladi) kò rèd, (maladi)
 machwè rèd, (maladi) machwè sere,
 maladi redi, tetanòs, tentanòs
 neonatal ~ tetanòs ki pran
 tibebe
 postpartum ~ malpas
 ~ shot piki tetanòs, piki kont
 maladi kò rèd
 umbillical ~ tetanòs nan lonbrit
 than pase
 thank v. remèsi, remèsye
 ~ God grasa Dye
 ~ you mèsì
 thanks mèsì
 ~ to grasa
 without ~ pou granmèsì
 that pronoun sa
 ~ adj. sa a
 the (singular) a, an, la, lan
 ~ (plural) yo
 theft vòl
 their yo
 theirs pa yo
 them, to them yo
 then lè sa a
 therapeutic ki ka geri ou
 therapy tretman
 physical ~ egzèsis yon pati nan
 kò
 there la, laba
 ~ is/are (pointing out) men
 ~ is/are no nanpwen
 therefore se pou sa
 thermometer tèmomèt
 oral ~ tèmomèt bouch
 rectal ~ tèmomèt twou dèyè
 thermos (bottle) tèmòs
 these sa yo
 they yo

thick pwès, epè
 thief vòlè, volè, vòlò
 thigh kwis
 fatty part of ~ kwann janm
 thighbone zo kwis
 thin mèg, mens, zo
 grow ~ v. megri
 ~skinned siseptib
 thing bagay
 thingumajig bagay
 think v. panse, kwè, krè
 third twazyèm
 one ~ yon tyè
 thirst swaf, swèf
 thirsty swaf, swèf
 this pronoun sa
 ~ adj. sa a
 thorax kòf lestonmak, toraks
 thorn pikan
 thorough ankè, antye
 thoroughly nètale, afon
 those sa yo
 thought panse
 thousand mil
 thread fil
 threadworm vè zepeng, trichin,
 oksiyi
 threatening menasan
 throat gòj, (banbou) gagann, tib
 gagann, gòje, gòjèt
 back of the ~ palèt
 clear one's ~ v. grate gòj li
 opening of the ~ tou gòj,
 twou gòj
 sore ~ gòj fè mal, malgòj
 strep ~ move malgòj
 throb v. lanse
 throbbing batman
 thrombosis boul san, glòb san
 through prep. nan
 throw v. voye, lanse
 ~ away v. (voye) jete
 ~ up v. rann, fè djapòt
 thrush chank lèt, chankalèt
 thumb (gwo) pous, gwo dwèt, dwèt
 pous

thunder loray, loraj
 Thursday jedi
 thus konsa, kousa
 thyroid tiwoyid
 ~ gland glann nan kou
 tibia zo janm, bwa janm, banbou
 janm
 tic tik
 tick (parasite) chik, tik, karapas,
 karapat
 ticket tikè
 tickle v. satouyèt, zatouyèt,
 zigonnen
 tickling satouyèt, zatouyèt
 ticklish sansib
 tie v. mare
 tie, necktie kòl, kravat
 bow ~ wozèt
 tight jis, sere
 tighten v. sere
 tightness in one's chest, feel v.
 santi yon pwa senkant sou
 lestonmak
 tile floor mozayik
 till jous
 time tan, peryòd
 for a long ~ lontan
 from ~ to ~ tanzantan
 time (hour) lè
 at that ~ lè sa a
 at what ~? a ki lè?
 in ~, on ~ alè
 time (instance) fwa
 time-out pòz
 times, at tanzantan
 timid timid, pèrèz, perèz
 tin can fèblan
 tincture of iodine tentidyòd,
 tentidjòd
 tinea pyas
 tingling pikotman, pikòtman
 tinnitus zòrèy sonnen
 have ~ v. gen zòrèy kònen
 tiny bit (a) ti kras
 tip pwent
 tiptoe pwent pye

tire kawòtchou, kawoutchou
 ~ out v. rente, fatigue
 tired bouke, fatigue, akable, kò mòl,
 ize
 tiring fatigan
 tissue (animal, plant) vyann, chè,
 tisi
 to a
 tobacco tabak
 today jodi a
 toddler titit
 toe (dwèt) zòtèy, dwèt pye
 big ~ gwo zòtèy
 little ~ ti zòtèy
 tip of ~ lèt zòtèy, pwent zòtèy
 toenail zong (pye); see nail
 together ansanm
 toilet twalèt, watè, komòd, latrin,
 olye, konfò
 be on the ~ v. sou twòn
 flush ~ watè-klozèt
 ~ paper papye (i)jenik
 ~ seat twòn
 tolerate v. sipòte
 tomb tonm, latonm
 tomorrow denmen, demen
 tongs tenay, tennay, pens, pensèt
 tongue lang
 have a coated or furred ~ v.
 gen fwa li chaje
 string of the ~ filèt, filè
 ~ depressor ti palèt, abèslang
 tonic n. siwo fòtifyan
 tonic adj. fòtifyan
 tonic clonic movements, have
 v. detire
 tonsil chè nan gòj, amigdal, amidal
 tonsillectomy wete chè nan gòj,
 wete amigdal
 tonsillitis chè nan gòj, lalwèt
 tonbe, amigdalit, amigdal, amidal,
 anjim
 too, also tou
 ~ bad! donmaj! domaj!
 ~ many, ~ much twòp, twò
 tool zouti

tooth dan; (see also teeth)
adult ~ dan granmoun
baby ~, deciduous ~ dan timoun, dan lèt
back ~ dan dèyè, dan pilon
broken ~ dan kraze
buck ~ dan griyen
canine ~ dan chen, dan je
dead ~ dan mouri
decayed ~ dan pike, dan gate, dan bonbon
eye ~ dan je, dan chen
false ~ fo dan
front ~ dan devan
gold ~ dan lò
loose ~ dan souke, dan sekwe
lower ~ dan anba
permanent ~ dan granmoun
primary ~ dan timoun, dan lèt
sensitive or sore ~ dan sirèt
short or stunted ~ dan rachòt
sore ~ dan sirèt
stub of ~ chouk dan
stunted ~ dan rachòt
 ~ decay dan pike, dan gate
upper ~ dan anwo
wisdom ~ dan zòrèy, dan sajès
toothache dan fè mal, maldan, malodan, modan
toothbrush bwòs dan, bwòsadan
toothless djòl fobop, djòl flobop
toothpaste kòlgat, patdantifris
toothpick bwadan, kidan
top anwo, anlè
topical espesyal
torment touman(t)
torment v. toumante
torn defèt, defè
torsion kontòsyon
torso tòs
torticollis (maladi) kou rèd
torture mati
torture v. fè pase mizè
toss (about) v. balote
total n. total
 ~ adj. konplèt

totally nètale
touch touche
touch v. touche, manyen, tate
touchy siseptib
tough di, rèd, kòryas, malouk
tourniquet bann pou rete san
toward(s) vè
towel sèvyèt
toxemia entoksikasyon
 ~ of pregnancy pwazon gwosès
toxic (an)pwazonnen
toy jwèt
trace tras
trachea tiyo souf, tigòj, (ti) gòjèt di, tib van poumon
tracheotomy koupe twou nan gòj pou moun ka respire
trachoma trakoma
tract kannal, kanal
traction, place la v. detire (yon janm)
trade metye
training antre-nman
trance posesyon
tranquillizer kalman
transfer v. transfere
transfusion (blood) plis san nan venn, transfizyon (san)
translate v. tradwi
translation tradiksyon
translator entèprèt, tradiktè
transmit v. transmèt
transparent transparan, kiè
transplant (tissue) n. grèf
transplant (tissue) v. grefe
transportation transpò
transvestite (male) gason ki abiye tankou fi
trash fatra
 ~ basket, ~ can poubèl
 ~-bin bwat
trauma chòk
tray kabare
treat:
 ~ kindly v. menaje

~ (medically) v. swenyen,
 swanye, trete
 treatment tretman, swenyay,
 laswenyay
 be under ~ v. swiv tretman
 tree pyebwa
 tremble v. tranble
 trembling latranblad, tranblad,
 tranbleman, tranble
 tremor tranbleman
 trench mouth jansiv anfle/senyen,
 piyore
 triage triyaj, triyay
 trichinosis trichin
 trick v. twonpe
 trim v. taye
 trip v. trebiche, kase pye
 triple trip
 triplet marasa twa
 tropical twopikal
 trouble traka, lapenn, lapèn, tchòbòl,
 deranjman
 be in ~ v. mele
 eye ~, heart ~, etc. pwoblèm
 je, pwoblèm kè, etsetera
 trouble v. twouble
 troublesome anbetan, enbetan
 trousers kanson, pantalon
 track kamyon
 small passenger ~ taptap
 true vre
 trunk mal
 truss senti
 trust konfyans, lakonfyans
 trust v. kwè, krè
 try v. seye, eseye, tante
 ~ out v. teste
 ~ to v. chache, chèche
 tub basen
 tubal ligation ligati (twonp)
 perform a ~ ~ v. mare kòd
 tube tib
 naso-gastric (NG) ~ tib ki
 soti nan nen rive jouk nan vant
 tie the ~s v. mare kòd
 tubercular pwatrinè

tuberculosis, esp. advanced
 active pulmonary ~ maladi
 touse, tebe, maladi poumon,
 maladi pwatrin, move maladi,
 tibèkilo, maladi ti kay, maladi
 pye chèch, maladi kenkenk, maladi
 kenhenk, kahink-kahank, maladi
 fini anwo de pye, maladi san
 fanmi, zepòl kare, konsonmsyon
 place of isolation (room,
 house etc.) for ~ victims
 kay blanch
 suffer from ~ v. pwatrinen
 ~ victim noun touse, pwatrinè
 Tuesday madi
 tumble chit
 tumescence anfleman
 tumor glann, kansè, timè
 breast ~ boul
 fibrous ~ fibwòm
 tunnel vislon, have v. wè tou
 dwat sèlman
 turgid anfle
 turmoll tray
 turn v. vire
 ~ off (light etc.) v. etenn
 ~ on (light etc.) v. louvri,
 ouvri
 ~ on one's left/right side v.
 vire sou kote gòch/dwat
 ~ over v. vire
 turpentine terebantin
 tweezers pensèt, pens
 twin marasa, jimo
 conjoint ~, Slamese ~
 marasa kole
 dissimilar ~, fraternal ~
 marasa ki pa sanble
 identical ~ marasa tèt koupe
 twist v. tòde, tòdye, kòde
 twisted (fingers etc.) makoubi
 twisting kontòsyon
 twitching, involuntary tik
 Tylenol Tilendòl
 type kalite, kalte, jan
 typewriter machin a ekri

typhoid fever (lafyèv) tifoyid
typhus tifis, lafyèv tifo
typical tipik

U

ugly lèd, makawon, malouk
ulcer ilsè
 have stomach ~s v. soufri
 asid
 skin ~ chank, java
ulna kibitis
umbilical:
 ~ binding bann vant, bann
 lonbrit
 ~ cord (kòd) lonbrit, lonbrik,
 mèt trip
 ~ hernia gwo lonbrit, van nan
 lonbrit, èni nan lonbrit
umbilicus lonbrit, lonbrik, nonbrit,
 bouton vant
 protruding ~ gwo lonbrit
unbalanced, become v. dezekilibre
unbuckle v. deboukle
unbutton v. deboutonnen
uncertain riskan
uncle tonton, (mon)nonk
unclean malpwòp
uncomfortable pa alèz
uncomplicated ki pa bay pwoblèm
unconscious endispoze, dekonpoze,
 san konnesans
uncooked kri
uncover v. dekouvri
under anba
underarm anabra, zesèl
underdeveloped (person) malvini,
 rèkè, rabougri
undergo v. sibi
undermine v. minen
underneath anba
undernourished malnouri, malniri,
 malvini
undernourishment, extreme bwa
 chèch
underpants (male's):

boxer shorts kalson
briefs slip
undershirt (without sleeves)
 chemizèt, kanmizòl, kamizòl
undershirt jipon
understand v. konprann, konnen,
 tandè
understanding bonkonprann,
 konpreyansyon
undertaker benyè, kòkmò, kwòkmò,
 antreprenè
underwear kalson, chemizèt
undo v. defèt, defè, lage, dezagrafe
undone (seam) defèt, defè
 become ~ at seams v. dekoud
undress v. dezabiye
undulant fever lafyèv nan san,
 lafyèv malta
uneasy enkyè
unfasten v. dezagrafe, detache
unfavorable kontrè
unfortunate malere
unguent longan, pomad, ponmad,
 krèm
unhappy mekontan
unhealthy malsen
unhook v. dezagrafe
unit inite, linite
unite v. fè yon sèl
United States of America
 Ozetazini, Etazini
unkempt sankoucha
unload v. dechaje
unmarried selibatè
unnecessary inital
unpleasant dezagreyab, move
unplug v. deploge
 ~ (IV tube etc.) v. dekonnekte
unravel v. deplòtonnen
unresponsive dekonpoze
unroll v. dewoule
unscrew v. desere, devise
unsteady branlan, dezekilibre
unstitch v. dekoud, defèt, defè
unstop v. debouche
untie v. lache, lage, desere, detache

until jouk, jous, jiske
 unusual ra
 unwell ba, malad
 unwholesome malsen
 unzip v. dezipe
 up anwo, anlè
 upon anwo
 upper anwo
 upper-arm ponyèt
 ~ ~ circumference ponyèt
 upper part anlè
 upright debout, debou, doubout
 upright, respectable debyen
 upset dekonpoze, fache
 upset v. boulvèse, pote nan tèt
 be ~ v. boulvèse
 ~ (stomach etc.) v.
 endispoze, deranje
 upside down tèt anba
 upstairs anwo
 up there anwo
 up to jouk
 uremia maladi pipi pwazonnen
 ureter tiyo ren
 urethra kannal pipi
 urethral discharge ekoulman
 urgency sèvis prese
 urgent prese, presan, ijan
 urinal piswa, irinwa
 urinalysis tès pipi
 urinary system aparèy pipi
 urinary tract kannal pipi, chemen
 pipi, aparèy pipi
 urinate v. (fè) pipi
 urine pipi
 dark ~ pipi wouj
 dribbling ~ pipi ti tak ti tak
 urologist doktè pwoblèm pipi, doktè
 iwoloji
 urology pwoblèm pipi, iwoloji
 urticaria bousòl, itikè
 us, to us nou, n'
 U.S. cent or penny santim ò
 use v. sèvi ak
 be of ~ v. sèvi
 useful itil

useless initil
 usual kouran, òdinè
 usually dabitid
 uterus sak pitit, lanmè, matris, iteris
 prolapsed ~ lanmè tonbe
 utter a death rattle v. rale
 utterly nètale
 uvula laiwèt

V

vacation vakans
 vaccinate v. bay vaksen, vaksinen,
 vaksine
 vaccinated, be v. pran vaksen
 vaccination vaksinasyon, vaksen
 ~ record kat vaksen
 vaccine vaksen
 BCG ~ Beseje
 vagina nati (yon fi), pati, kannal (fi),
 kanal (fi), vajen
 vaginal vajinal
 have a ~ discharge v. vèsè
 anba, mouye kilòt
 have ~ bleeding v. rann san
 ~ bath (after giving birth)
 dlo pèt
 ~ discharge pèt
 ~ douche douch, lavay bouboun
 ~ Insert sipozitwa
 vaginitis enfeksyon nan pati
 vain, in pou granmèsi
 value valè
 valve soupap
 vapor vapè
 vaporizer vaporizatè
 varicose veins venn gonfle nan
 janm, gwo venn nan janm, varis
 variety melanj
 various plizyè
 vascular system aparèy venn ak atè
 vasectomy vazektomi
 vaseline vazlin
 vell vwal
 vein venn
 jugular ~ gwo venn nan kou

venereal veneryèn
 ~ disease grantchalè,
 grannchalè, grennchalè, maladi nan
 pati
venom venen
ventricle vantrikil
verge on v. tire sou
verification tchèk
verify v. tcheke, fè yon tchèk, sonde
vermifuge vèmfij
vermin vèmin
vertebrae rèldo
vertebral column zo rèldo, zo
 chenn do, kolonn vètebral
vertical toudwat
vertigo tèt vire, toudisman, lawouli
 (tèt), toudlin
very byen, anpil, trè
 (a) ~ little ti kras
vessel (blood) veso, venn
vestige tras
veterinarian; veterinary veterinè
vial poban, anpoul
 small graduated ~ joj
vice, bad habit defo
vicious makawon
victim viktim
vigor vigè
vigorous gaya vivan
Vincent's infection jansiv anfle,
 piyore
violent brital
VIP grannèg, gwonèg, zotobre
virgin tifi, vyèj, vyèy
virginity, lose her v. kreve
virility pisans gason
virus ti jèm (maladi), viris
viscera anndan kò moun
visible vizib
vision limyè, vizyon, wè
 have blurred ~ v. wè twoub
 have double ~ v. wè doub
 have tunnel ~ v. wè tou dwat
 sèlman
visit vizit
visit v. vizite

visiting hours lè vizit
visitor vizitè
visual defect pwoblèm je
vital signs siy lavi
vitamin fòtifyan, vitamin
vittiligo tach blan sou po
vocal cords venn chantrèl, kòd vokal
voice lavwa, vwa
volunteer volontè
 foreign ~ worker kooperan
vomit vonmi, vomi, vomisman,
 vomisman, vèsman, vommiste,
 djapòt, dyapòt
vomit v. vèse, vonmi, vomi, rejete,
 rejte, rechte, rann, ranvèse, fè
 djapòt
 ~ bile v. rekte
 ~ blood v. rann san
 ~ repeatedly v. rann fyèl li,
 vonmi fyèl li
vomiting vommisman, vomisman,
 vèsman, rejetman
Voodoo afè lwa
 practice ~ v. sèvi lwa
 ~ priest oungan
 ~ priestess manbo
 ~ sorcerer bòkò
 ~ spirit lwa
Voodooist sèvitè (lwa)
voracious afre
vulnerable siseptib
vulva bouch vajen, toutoun
 ~ (of a child) fougoun

W

wagon charyo
wall rèl
wall v. kenbe rèl
walst senti, tay, ren
walt v. tann
 ~ for v. tann, espere
walter gason
waiting room sal pou tann, sal
 datant
wake v. leve

~ up v. leve, reveye
 wake (funeral) vèy
 walk v. mache
 ~ backwards v. mache pado
 walking stick baton
 wall mi
 want bezwen
 want v. bezwen, anvi, vle
 ward (hospital) sal
 wardrobe (standing) (l)amwa
 warehouse depo
 warm cho
 get ~ or ~ up v. chofe
 warmth chalè
 warning avètisman
 ~ sign kout klòch
 wart bouton (chen), zanpoud,
 zanpoul, veri
 wash lesiv
 wash v. lave
 ~ up (oneself or s.o. else)
 fè twalèt (li)
 washable netwayab
 washbasin kivèt, lavabo
 washcloth sèvyèt twalèt, ti sèvyèt
 washing lavaj; twalèt
 ~ of public region (woman
 esp.) fè twalèt deba
 washtub benwa
 wasp gèp, djèp, dyèp, gyèp
 waste gaspiyay, gaspiyaj, gaspyay
 waste, garbage fatra
 waste v. gache
 ~ away v. depafini, deperi, peri
 ~ time v. mize
 wastefulness gaspiyay,
 gaspiyaj, gaspyay
 watch v. gade
 ~ over v. gade, gad, veye
 watch (timepiece) mont
 watchful veyatif
 watchman siveyan
 water dlo
 bag of ~s lezo
 drinking ~ dlo pou bwè

~ containing salt (not
 seawater) dlo sèl
 ~ pill grenn ki fè ou pipi anpil
 ~-pipe tiyo
 ~ tank, ~ tower rezèvwà dlo
 water, tear v. fè dlo, kouri dlo
 waterproof enpèmeyab
 watery dlololo
 ~ stool, have a (very) v. ale
 do
 wax lasi
 way jan
 we nou, n'
 weak fèb, ba, delika, demanbre
 become ~ v. febli, tonbe feblès
 very ~ (from hunger) faya
 ~ (child) krebete
 weaken v. febli, afebli, minen
 weakling soufri, pedevi, petevi
 weakness feblès, fèblès, kò lage
 general ~ kò dezole, kò kraz
 wean v. sevre
 weaning sevraj, sevray
 wear (clothes) v. mete sou
 wear down physically (person)
 v. minen, demonte biskèt, ize
 weariness kò dezole, kò kraz, fatig
 weary kò mòl, akable
 weather tan
 wedding maryaj, maryay
 ~-ring bag
 Wednesday mèkredi
 week semèn, senmenn
 weep v. kriye, kenbe rèl
 weigh v. pran pèz, peze
 weight pèz, pwa
 child's ~ and vaccination
 record chemen lasante
 feel a ~ upon or a tightness
 in one's chest v. santi yon
 pwa senkant sou lestonmak
 gain ~ v. pran pwa, gwosi,
 pwofite, pofite
 lose ~ v. megri, deperi, dechouse,
 seche, cheche, kase
 ~ chart chemen lasante

welcome, you're merite, pa gen
pwoblèm, pa gen pàn
well byen
 ~behaved **saj**
 ~preserved **bon ten**
well n. pi
welt plak, louk
wet mouye, imid
wet v. mouye
 have a ~ dream v. voye nan
 dòm
 ~ one's pants v. swente
wet-nurse nouris
what ki
 what? (ki)sa? ki jan?
 ~ a shame! donmaj! domaj!
 ~ else (ki) sa ankò
whatever nenpòt, kenpòt
wheel tach ki leve
wheel wou
wheelchair chèz woulan
wheeze ral
wheeze v. souf anlè, gen ral
wheezing souf anlè, ral
when lè, kon, kou
 when? ki lè? a ki lè?
whenever nenpòt (ki) lè
where kote
 where? (ki) kote? kot? ki bò?
wherever nenpòt (ki) kote
which ki
 ~ direction? ki kote?
 ~ (one)? kilès?
while pandan, lè
whiplash injury chòkanretou
whipworm trichin, trikosefal
whiskers bab
whisper v. pale ba
white (color or person) blan
 ~ of the eye blan je
whitlow pannari, panari
who ki
 who? ki moun?
who(m)ever nenpòt (ki) moun
whole tout, ankè, antye
whom? ki moun?

whooping cough koklich
why poukisa
wide laj, gran
widen v. laji, (a)grandi
widow vèv
widower vèf
width lajè
wife (legal) madanm, madam
 common-law ~ fanm, manman
 pitit
 principal common-law ~
 fanm kay
will volonte, lavolonte
 ~ power kouraj, kouraj,
 volonte, lavolonte
will (future tense indicator) a, va
will, testament testaman
wince v. tresayi
wind van
wind, flatulence gaz, van
window fenèt, fennèt
windpipe kannal souf, tiyo souf,
 tigòj, (ti) gòjèt di
wink v. bat je
wipe (off) v. siye, souye
wire fil
wisdom sajès
 ~ tooth dan sajès, dan zòrèy
wise saj
wish swè
wish v. vle
witch lougawou
witchcraft malfezans
with avèk, ak, avè
withdrawal method or coitus
 Interruptus voye deyò
 practice the ~ ~ v. voye deyò
wither v. deperi
withered hand men chèch
within ladan, ladann
without san
witness (at childbirth etc.)
 temwen
witness v. sèvi temwen
woman nègès, fi, fanm
 elderly ~ lamè

unmarried ~ selibatè
 white ~ blanch
 women medam
 young ~ (ti) kòmè
 womb sak pitit, (manman) vant,
 lanmè, matris
 wood bwa
 wool lenn, lèn
 wooziness soulay, mayilò
 woozy gaga
 word mo
 dirty ~ gwo mo, betiz
 ~of-mouth teledyòl, teledjòl
 work travay
 work v. travay
 ~ (machine) v. mache
 worm vè, vèmin
 have/pass ~s in one's
 stools, vomit ~s v. rann vè,
 pase vè, jete vè
 ~-ridden vere
 worm v. devere
 worn-out kòkraz, kòkrazè, vye, ize
 worried tèt chaje
 worry tèt chaje, traka, sousi, kè sou
 biskèt
 worries kè sote
 worry v. chaje tèt li, enkyete
 worse pi mal
 get ~, make ~, worsen v.
 vin pi mal, anvlimen, degrade,
 anpire, ranpire, desann
 worth valè
 worth, be v. vo
 worthless vye
 worthy debyen
 would v. ta
 wound blesi (grav), blese, malad
 wound v. blese, pike
 wounded (person) blese
 wow! mezanmi! papa!
 wrench kle
 wretched minab
 wring (out) v. tòde, tòdye
 wrinkle pli, min
 wrinkle (face, skin) v. plise

wrist ponyèt
 ~ -watch mont braslè
 write v. ekri
 writhe (in pain) v. tòde, tòdye,
 kòde
 wrong pa sa, antò
 be ~ v. gen tò
 What's ~? Ki sa ou genyen? Sa
 k'genyen?
 ~ side (clothing, fabric)
 lanvè
 wrong, bad mal
 wryneck (maladi) kou rèd

X Y Z

x-ray radyografi, radjografi
 yard lakou
 yawn baye
 yawn v. baye
 yaws pyan, krab
 ~ lesion krab
 year lanne, anne, an
 one ~ ennan
 yearly chak ane
 yeast ledven, lelven
 ~ infection enfeksyon ledven
 yell kri, rèl
 yell v. rele
 yellow jòn
 dark ~-brown tamaren
 ~ fever lafyè v jòn
 yellowjacket gèp panyòl
 yes wi
 yes? (polite reply) plèt il? eti?
 yesterday yè
 yet men, malgre sa
 not ~ poko
 you, to you (singular) ou
 ~, to ~ (plural) nou, n'
 young jenn, jèn
 ~ ladles ti medam
 ~ lady madmwazèl, matmwazèl
 ~ man jennonm, jènjan
 ~ men ti mesye, jènjan
 ~ person jennmoun, pitit

younger, look v. rajeni
youngster jèn timoun
your (singular) ou
 ~ (plural) nou, n'
yours (singular) pa ou
 ~ (plural) pa nou
youth jenès, jennès
zero zewo
zip v. zipe
zipper zip
zone zòn

**GLOSSARY OF FOOD AND DRINK:
HAITIAN CREOLE-ENGLISH**

- abriko, zabriko mammee, tropical
apricot
afiba tripe
akamil baby food
akasan corn-based milky-like gruel
aki akee
akra (usu. malanga) fritter
alen alum
alfalfa alfalfa
alkòl alcohol
anana pineapple
anbègè hamburger
anchwa anchovy
andouyèt, andi, andwi chitterlings
angi eel
angle var. of yam
anzèt anisette liqueur
annanna pineapple
annyetwale star anise
anpan(n)a type of biscuit
aperitif apéritif
arachid peanut
aran herring
aranbarik kipper
aransèl salt herring
aransò smoked herring
arawout arrowroot
ariko green beans
asid vinegar or lime-juice seasoning;
hot spices
asowosi balsam apple
aspèj asparagus
aticho artichoke
atomik juice made from carrots, beets
and coconut
atoutou corn, red beans and pork
avwàn oatmeal; oats
ayo lamb
bakala var. of yam
bako var. of plantain
banana grated plantain soup
bannann plantain
~ graje grated plantain
~ peze plantain slices fried in oil
~ poban less desirable var. of
plantain
~ timalls finger banana (var. of
small sweet banana)
gato ~ banana bread
labouyi ~ plantain gruel
Many other var. of plantain, e.g.,
bako, banmnatè, fran,
kochon, kouyak, kwiyèz,
lougawou, masòk,
mateyenn, miske, mispipl,
polo, pouyak, tchèk
batts var. of mango
bazilik (sweet) basil
bè butter
bèf beef
begamòt tangerine (South)
bekonn bacon
bennzollv bensolive
berejèn eggplant
bèt animal, creature
~ lanmè seafood
~ titèt, ~ volay fowl, poultry
bètrav, bètwouj beet
bif inexpensive cut of beef
biftèk (beef)steak
bikabonat baking soda
bisk bisque
biskwit roll
~ aticho artichoke-shaped roll
~ fou tè popular peasant roll
~ gwomit small square roll
~ rale biscuit
~ sale (salt) cracker
~ sèk, ~ soda (soda) cracker
blanmanje coconut-milk pudding
blan ze egg white
ble wheat
~ bonnit var. of rice
~ jòn bran

kè ~ wheat germ
 blenblen bilimbi (sour fruit
 resembling a pickle)
 bobori thick cassava cake
 bòbòt type of bun
 bonbon cookie; bun, small cake,
 cupcake
 ~ sèl cracker
 bonbonyen verbena
 bouboul soursop mixed with sugar
 and water
 bouden blood sausage
 boujon shoot, tendril
 ~ banbou bamboo shoots
 ~ pwa bean sprouts
 boukannen barbecue
 boukousou var. of large bean
 boul ball, clot
 ~ pen griye crouton
 ~ soup, ~ magi bouillon cube
 boulet meatball
 bouga Bulgar wheat
 bouksenlo jawbreaker (candy)
 bouyon soup, bouillon, broth; stew
 ~ pechè fish soup
 bòy dumpling
 brandl brandy
 breson alcoholic beverage
 breton praline (of corn and syrup)
 brigad var. of alcoholic drink
 briyòch brioche
 briyòl var. of edible plant
 bwadenn rose apple
 bwason, bweson drink, beverage
 bwòchèt shish-kebab
 bwokoll broccoli
 byè beer
 ~ peyl home-made brew
 byennwa muffin
 chadèk shaddock (small sweet var. of
 grapefruit)
 chadwon sea urchin
 chalòt shallot, scallion
 chanmchanm ground roasted corn
 chanpay champagne; fruit cola

chanpoura drink of coffee, sugar,
 milk and rum
 chapechen soursop
 chapon capon
 chat cat; var. of yam
 chateng good quality breadfruit
 chatwouy, chatwouj octopus; squid
 chè pulp (of fruit)
 chevrèt (salt-water) shrimp
 chikore chicory, endive
 chodo caudle, hot spicy sweetened
 milk mixed with raw eggs
 chokola chocolate
 ~ an poud powdered cocoa
 chou cabbage
 ~ allzèn red cabbage
 ~ Briksèl Brussels sprouts
 ~ chinwa Chinese cabbage
 ~ karaylb taro
 ~ moutad var. of edible plant
 ~ palmis palm heart
 ~ peyl collard
 ~ wouj red cabbage
 salad ~ coleslaw
 choufflè cauliflower
 danre foodstuff, produce
 dat date
 de kayèt var. of bean
 desè dessert
 dèyèdo gale-of-wind (used occ. for
 flavoring kleren)
 dlri rice
 ~ ak djondjon rice and
 mushrooms
 ~ ak sòs pwa rice and beans
 ~ glase white rice
 ~ jòn wild rice
 ~ kole (ak pwa) rice and beans
 cooked together
 ~ solèy brown rice
 dlsèl salt
 dlven wine; var. of mango
 djak small roll
 djln gin
 djondjon (small black) mushroom
 dio water; var. of yam

~ dlistile purified water
 ~ dous fresh (unsalty) water
 ~ kann sugar-cane juice
 ~ Killigann Culligan water
 ~ kòk, ~ kokoye coconut milk
 ~ kouran river water;
 undrinkable water
 ~ men unclean or unappetizing
 food; watered-down food
 ~ mineral mineral water
 ~ pwa very thin bean soup
 ~ sòt poisonous booze
 ~ tiyo tap water
 dòb stewing beef
 dollv (Caribbean) wild olive
 dòmldl var. of crab
 donòt doughnut
 doukounou sweet cornmeal pudding;
 thick cassava bread
 doumbrèy dumpling
 dous sweets; candy bar; fudge;
 sweetening, sweetener
 ~ makòs flat fudge-like candy of
 Petit-Goâve
 draje dragée
 echalòt shallot, scallion
 èfòlè custard
 epl, zepl ear (of corn)
 epls spice; seasoning
 ~ dous, ~ te spice for making
 tea
 esans extract, essence (vanilla etc.)
 eskalòp scallop; cutlet; thin steak
 eskanpl scampi
 espadon swordfish
 espageti spaghetti
 estèk steak
 farin flour, meal
 ~ frans wheat flour
 ~ mayl cornflour, cornstarch
 ~ sinistre foreign-donated flour
 fas stuffing, filling
 fèy leaf; herb
 ~ lorye bay leaf
 feyaj green leafy vegetables
 feyèt var. of bread

flg (ml) banana
 ~ bannann banana
 ~ frans fig
 ~ (ml) timalls finger banana,
 small sweet banana
 fil var. of mango
 filè fillet (meat; fish)
 flan custard, flan
 flèsolèy sunflower
 grenn ~ sunflower seed
 floup crush (orange, grape etc.)
 fofllè sirloin steak
 fòksell cornmeal
 foutè var. of bread
 fran var. of plantain
 franbwaz (black) raspberry
 fransik var. of mango
 fresl liver
 freskawo chocolate drink
 fresko snowcone, grated ice with
 flavored syrup
 frèz strawberry
 friddòdòy candy, sweets; junk food
 frikase (vegetable) stew
 fritay fried foods (plantain, meat etc.)
 fwa (dl) liver
 fwi fruit
 JI ~ fruit juice
 fwiddòdòy candy, sweets; junk food
 fwonmaj cheese
 ~ dlo whey
 ~ krèm cream cheese
 ~ lèt cottage cheese
 ~ tilèt curd
 gato cake
 ~ myèl honeycomb
 gaze carbonated
 ginen var. of yam
 glas ice; frosting, icing
 ~ kraze crushed ice
 kare ~ ice-cube
 glasl frosting, icing
 glason ice-cube; small ice-cream cube
 godrin drink made of fermented
 pineapple skins
 gonbo okra; var. of hard bean or pea

gous clove (of garlic)
goute snack
gouyav guava
 pat ~ chewing candy made from
 ground guava
granbonm peppermint; spearmint
gratpetren leftovers; var. of bread
grenad pomegranate
grenadln granadilla (var. of
 passionfruit)
grenadja passionfruit
grenn grain, berry; pit (of fruit);
 kemel; seed
 ~ **flèsolèy** sunflower seed
 ~ **monben** var. of small sweet
 fruit
 ~ **vani** vanilla bean
grès fat(s); grease
griyad, griyay grilled meat
griyo spicy fried pork bits
gwayav guava
gwòg (hard) drink, liquor, booze
gwo manje adult food
gwopo var. of mango
janblan large fresh-water shrimp
janbon ham
janchwa anchovy
jelatin gelatin
jele jelly
jelo Jello
jenjanbrèt gingerbread
jenjanm ginger
jenjerèl ginger ale
ji juice
 ~ **fwl** fruit juice
ji go loin, shank (goat, lamb etc.)
ji jib jujube, Chinese date
ji jiri sesame
jill var. of mango
ji wòf cloves
ji zye gizzard, innards
jòn yellow; var. of yam
 ~ **z e** egg yolk
 soup ~ pumpkin soup
jòndèf, jònbèf var. of fruit
jou(wou)mou pumpkin

kabich large loaf of bread
kabrit goat
kachiman custard-apple
 ~ **kanèl**, ~ **kèbèf** var. of
 sweetsop
 ~ **lachln** cherimoya
kad chinwa Chinese chard (var. of
 beet)
kafe coffee
 ~ **an poud** instant coffee
 ~ **klè** weak coffee
 ~ **olè** coffee with milk or cream
 ma ~ coffee grounds
 poud ~ instant coffee
 seriz ~ coffee bean
kafounji spicy cornmeal dish
kakabèf var. of cookie
kakarat small sugar grains used to
 adorn cake
kakawèt peanut
kakawo cocoa
kakòn var. of mango
kalalou (gonbo) okra, gumbo
kalbasl(k) small edible calabash
kamoml camomile
kanèl cinnamon; var. of mango
kann sugar-cane
 dlo ~ sugar-cane juice
 ~ **kale** stripped sugar cane
 ~ **zannanna** especially sweet
 var. of sugar cane
 ne ~ section of sugar cane
kanna duck
kantaloup cantaloupe
kapsln nasturtium
karamèl caramel
karaylb taro
karèt sea turtle
kari curry
kasav cassava bread
 ~ **dous** sweet cassava
 ~ **wayal** cassava bread spread
 with peanut butter
kastonnad brown-sugar candy
katchòp ketchup
katpoukenz var. of roll

kawòt carrot; var. of mango
kaya var. of vegetable
kayimit star apple
kenèp Spanish lime
kenken finely-ground corn
kib bouillon cube
kibl fried meat and wheat
kich quiche
kleren raw rum
kochon pork; var. of plantain
kòdenn turkey
kòdòk var. of mango
kòdya cordial (liqueur)
kòk cock, rooster; coconut
 ~ **graje** candy made from grated
 coconut
 ~ **ole** ideally ripe coconut
 ~ **panyòl** large coconut
 ~ **rache** coconut cut into thin
 strips
kokonad dish made of coconut,
 butter, dark-brown sugar and
 cinnamon
kokonèt coconut cookie
kokoye coconut
 dlo ~ coconut water
 dous ~ coconut candy
 lèt ~ coconut milk
 mole ~ soft coconut meat
 nannan ~ coconut meat
kòktèl cocktail; any mixed alcoholic
 drink (other than rum)
kola extremely sweet soft drink
kolasonn pick-me-up
kolokent var. of edible gourd
kòn var. of mango
kondpilwen large loaf of bread
kònè(t) cone (for ice-cream)
konfi preserves, crystallized or candied
 fruit; pickled vegetable; home-
 made spiced vinegar
konfitl jam, preserves
kònfleks dry cereal
kong conger eel
kongri cooked with beans (cornmeal,
 rice or millet)

kònichon pickle
konkon var. of bread
konkonm cucumber
 ~ **zonbl** wild cucumber
konparèt coconut bread
konpòt compote
konsèv preserves
konsome bouillon; broth; consommé
konyak brandy, cognac
koryann coriander
kòs twisted roll
kòtlèt (kochon) sparerib; pork chop
koubouyon herbal broth for cooking
 fish; chowder
kouchkouch couscous
koukouloukou gobbler, turkey
koupye purslane
kouyak var. of plantain
kowosòl soursop
krab crab
 ~ **sirik** saltwater crab
 ~ **zoumba** large purplish crab
krèm cream; ice-cream
 fwonmaj ~ cream cheese
 ~ **bat**, ~ **fwete** whipped cream
 ~ **blan ze** meringue
 ~ **(glase)** ice-cream
 ~ **si** sour cream
kreimas eggnog
krèp pancake; crepe
 ~ **kreyòl** pancake dipped in salt
 water and rolled with peanuts and
 watercress
kreson watercress
krevèt (salt-water) shrimp
kreyòl Creole
 soup ~ pumpkin soup
kribich (freshwater) crayfish
kwann pork rind
kwasan croissant
kwis gounouy frog legs
kwiyèz var. of plantain
kwokèt croquette
kwòkwo var. of edible plant
kwout crust
la lard; bacon

labapen breadfruit nut
labich var. of mango
labouyi (avwàn) hot cereal,
 oatmeal
lalo var. of vegetable
lamanjay food (not pejorative)
lamannyè var. of bean
lamanyann booze, liquor
lamveritab, veritab breadfruit
 boulèt ~ breadfruit cakes
lanbi conch
lang tongue
 ~ **bèf** thin crisp cake
langous langouste
lanmidon carbohydrate
lanmilèt omelet
lanmorl cod(fish)
lanni anise; aniseed; dill
 ~ **vèt** fennel
lantly lentil
lapen rabbit
lapsent absinthe
lasibab leftover food
latòtòl corn gruel
lay garlic
legim vegetable
legliz licorice
lèt milk
 fwonmaj ~ cottage cheese
 ~ **an poud**, ~ **famasl** powdered
 milk
 ~ **bèf** cow's milk
 ~ **kabrit** goat's milk
 ~ **kaye** buttermilk; cottage
 cheese
 ~ **kondanse** condensed milk
 ~ **malte** malted milk
 ~ **mayl** corn syrup
 ~ **omojenize** homogenized milk
 ~ **pasterize** pasteurized milk
 ~ **san krèm** skimmed milk
 ~ **sinistre** emergency-relief milk
 (usu. powdered)
 ~ **vapore** evaporated milk
letl lettuce, head of lettuce

levasyon: poud ~ yeast powder;
 baking powder
leven yeast; leavening
lijen var. of edible plant
likè liqueur
likid liquid
lmonad (weak) limeade
lòj barley
lòja treat, delicacy, goody
 siwo ~ special treat; syrup
lorigan oregano; marjoram
lorye laurel
 fèy ~ bay leaf
lougawou var. of plantain; (witch)
lòzèy sorrel
lwil oil
 ~ **fwadmorl** codliver oil
 ~ **koton** cottonseed oil
 ~ **zollv** olive oil
mabl mixed fruit beverage
machmalò marshmallow
magarin margarine
majolèn marjoram
ma kafe coffee grounds
makawonl macaroni; noodle
makiz frozen dessert of sugar,
 crackers, milk, butter etc.
makrèl, makriyo mackerel
malagèt allspice
malanga malanga, taro, dasheen
manba (pike) (spicy) peanut butter
manchèt long narrow loaf of bread
mandarin tangerine
mango mango
 konfitl ~ chutney
 ~ (**madan**) **fransik** largest var.
 of mango in Haiti
 Many var. of mango, e.g., **batis**,
 diven, **fil**, **gwopo**, **jill**,
 kakòn, **kanèl**, **kawòt**, **kòdòk**,
 kòn, **labich**, **miska**, **nimewo**
 onz, **sik**, **won**, **wozall**
mangousa thick meat and bean soup
manje food
 gwo ~ (cooked) adult food

- ~ chèch meal containing only carbohydrates
- ~ chodyè (cooked) adult food
- ~ dòmi leftovers
- mant** mint; mint candy
- mantèg** lard; shortening
- manyòk** manioc
- marigouya** passiflora
- marinad** batter fritter; marinade
- masòk** var. of plantain
- masoko** var. of yam
- matenten** var. of edible plant
- mateyenn** var. of plantain
- matinik** var. of yam
- mawon** chestnut
- mayi** corn, maize
 - kè ~ corn kernel; finely-ground corn
 - ~ boukannen roasted ear of corn
 - ~ griye roasted grains of corn; popcorn
 - ~ moulen cornmeal
 - ~ pèpèt, pèpèt ~ popcorn
 - ~ senma(k) coarsely-ground commeal
- mayilò** stick of candy
- mayizena** var. of hot cereal (esp. for babies)
- mayonèz** mayonnaise
- mazonbèl** var. of root vegetable (similar to yam)
- melas** molasses
- melis** lemon balm
- melojèn** var. of squash
- melon** (honeydew) melon
 - ~ dlo watermelon
 - ~ (frans) (similar to) cantaloupe
- merilan** poor-quality mango
- mi** mulberry
- mich** soft part of bread
- militon** chayote squash
- miska** var. of mango
- miskad** nutmeg
- miske, miskèt** var. of banana
- mispipi** var. of plantain
- moka** inferior type of coffee
- moul** mussel
- moussa** manioc flour for making dumplings
- moutad** mustard
- moutadèl** bologna (sausage)
- mouton** mutton
 - ti ~ lamb
- myèl** bee
 - gato ~ honeycomb
 - siwo ~ honey
- myèt pen** breadcrumb
- nannan** food (baby talk); pulp; innards
- nave** turnip
- nimewo onz** var. of mango
- nouga** nougat
- nwa** nut
 - ~ kajou cashew nut
- nwazèt** hazelnut
- òdèv** hors d'œuvre, appetizer
- ograten** covered with bread crumbs and cheese
- omlèt** omelet
- oranjad** orangeade
- paloud** clam
- pamesan** Parmesan cheese
- pannad** soup of bread, vegetables, spices etc.
- pannenm** var. of edible plant
- panplemous** grapefruit
- papay** papaya
- papita** (usu. plantain) chip
- papye sable** cassava
- pat** dough, batter, paste; pasta
 - ~ brize pie crust
- patat** sweet potato
- pate** paté; meat pie
 - ~ bègè large meat pie
 - ~ mezon brand of commercially-made paté
- patisri** pastry
- pèch** peach
 - ~ mèlba peach melba
- pèdri** quail, partridge
- pen** bread; loaf
 - boul ~ griye crouton
 - mit ~ soft part of bread

- myèt ~ breadcrumb
 ~ bwat flat roll
 ~ depis gingerbread
 ~ griye toast
 ~ mayl cornbread
 ~ nwa wholewheat bread
 ~ patat sweet-potato pudding
 ~ pèdi French toast
 ~ rale unleavened bread
 ~ rezen raisin bread
 ~ won roll
 ti ~ roll
 pendou thick cassava cake
 pentad guinea fowl, guinea hen
 peptazi strong herbal tea
 pèsl parsley
 pètpòt pick-me-up of egg yolk, fruit
 etc.
 pljon pigeon
 plkliz spicy relish
 ~ dous sweet relish
 plman (bouk) hot pepper, red
 pepper, chili pepper, pimento
 ~ dou(s) green pepper, bell
 pepper
 ~ plke hot pepper, chili pepper
 ~ zwazo very small red pepper
 poud ~ chili powder; paprika
 sòs ~ Tabasco
 plmantad hot-pepper sauce
 plre puree
 ~ ponmdetè mashed potatoes
 plse tlg raw rum (familiar)
 plskèt whitebait (var. of small fish)
 pistach peanut
 pltimi millet, sorghum
 pltza pizza
 plwoull sucker, lollipop
 po skin; peel
 poban (less desirable var. of) plantain
 polo var. of plantain
 ponch punch; caudle, warm spiced
 milk with egg and sugar
 ponm apple
 ~ kajou cashew apple
 ~ kanèl sugar-apple
 ~ lyann var. of passionfruit
 ~ malkadi jujube, Chinese date
 sòs ~ applesauce
 ponmdetè potato
 plre ~ mashed potatoes
 ~ fri French-fried potatoes
 ponmkèt muffin; cupcake
 ponpòt compote
 pòpòt bread soup
 poud powder
 ~ kafe, kafe an ~ instant
 coffee
 ~ (e)levasyon baking powder;
 yeast powder
 ~ plman chili powder; paprika
 poudln(g) pudding
 poul chicken
 poule chicken (in supermarket or
 restaurant)
 poulet pullet
 pouyak var. of plantain
 powo leek
 Prestlj Prestige (brand of Haitian
 beer)
 prin plum; prune
 ~ san grenn pitted prune
 pwa bean; pea; pear
 dlo ~ very thin bean soup
 ~ bè butterbean, lima bean
 ~ blan (round) navy bean
 ~ chikann chicory
 ~ chouk lima bean, butterbean
 ~ djangan, ~ enkonl black-
 eyed pea
 ~ foule fava bean
 ~ frans green pea
 ~ je nwa black-eyed pea
 ~ kongo pigeon pea
 ~ nwa black bean
 ~ souch lima bean, butterbean
 ~ tann greenbean, string bean
 ~ valèt (flat) navy bean
 ~ wouj kidney bean; pinto bean
 Among other var. of beans are
 de kayèt, lamannyè, tlkatrin
 pwason fish

~ dlo dous freshwater fish
 ~ fre fresh fish
 ~ kòf shellfish
 ~ lanmè saltwater fish
 ~ sale dried fish
 ~ woz (red) snapper
pwav pepper
 grenn ~ peppercorn
 gwo ~ allspice
radi radish
 ~ fò, ~ plke horseradish
rafrechl cool herbal drink; (any) cool
 refreshing drink
rafrechisman cool drink
ragou stew; casserole
rale unleavened bread
ransyon snack
rapadou brown-sugar candy
rasin root
reglis licorice
rejlm stalk, stem (bananas, plantains)
retay scraps, leftovers
rezen grape
 ~ sèk raisin
ribab rhubarb
riyal var. of yam
sad (woz) (red) snapper
sadln sardine
safran saffron; turmeric
sagou sago, arrowroot flour
sakarln saccharin
sakatay barbecue with spicy sauce
salad salad
salami salami
salèz spicy and salty fried meat
salezon meat or fish preserved in salt
sandwitch sandwich
sanmsanm ground roasted corn
sapotl sapodilla
sèl salt
 gwo ~ rock salt, coarse-grained
 salt
 ~ lanmè sea-salt
selebride strong alcoholic drink of
 Cap-Haïtien
selerl celery

 sèl ~ celery salt
sellpl breadfruit
sereyal cereal
serliz cherry, acerola
 ~ kafe coffee bean
sesln dried salted meat
sèvèl brains
sèvla saveloy, dried spicy pork
 sausage
sibab leftover food
sld cider
sigln var. of yam
sik sugar; var. of mango
 boul ~ sugar cube
 ~ an poud powdered sugar
 ~ jòn, ~ krèm brown sugar
 ~ popilè, ~ wouj, ~ wouj
 dark-brown sugar
sikdòy barley sugar, barley candy
sikri sweets, candy
sirèt hard candy
sirik saltwater crab
sispouvennsenk var. of roll
sitwon lime
 ~ dous lemon
sitwonad limeade
sitwonèl lemon-grass tea, citronella
siv chives
siwèl red mombin, hogplum, loquat
siwo syrup; molasses
 dlo ~ low-quality syrup
 gwo ~ cane syrup; molasses
 ~ kanpèch, ~ lyann savon
 var. of honey
 ~ melas molasses
 ~ myèl honey
sòbè sherbet
soda soda; soda cracker; soda water
soj sage
soja soybean
sòl sole
soloba snack
somon salmon
sòs sauce; dressing; gravy
 ~ piman Tabasco
 ~ pwa bean puree

~ Tmallis spicy sauce
 ~ tomat ketchup
 sosls sausage, frank(furter), wiener,
 hotdog
 gwo ~ salami
 soslson chitterlings (made into
 sausage)
 sotè var. of sweet-water shrimp
 soup soup
 ~ pen thin soup of soaked bread
 and spices
 soupoudre salt pork
 sousèt sucker, lollipop
 sousl marigold
 sowo booze, liquor
 soya soybean
 sòs ~ soy sauce
 tabasko Tabasco
 tablèt peanut brittle-like candy
 tafya booze, liquor
 tako taco
 tamaren tamarind
 tapyoka tapioca
 taso (seasoned and grilled) dried meat;
 beef jerky
 tat pie
 tl ~ tart
 tayo taro, malanga, dasheen
 -fèy ~ malanga leaves
 taza mackerel
 tchaka meat and bean soup
 tchanpan, tchaw unappetizing food;
 junk food
 tchentchen finely-ground corn
 tchèk var. of plantain
 te tea
 ~ glase iced tea
 tebonn T-bone steak
 ten thyme
 tèt bòpè var. of yam
 tètchin China tea
 tèt jiwòf cloves
 tibè small roll
 tibonm peppermint; spearmint
 tiboul roll
 tikatrin var. of bean

tilapya tilapia
 timalls finger banana (var. of banana)
 ti mouton lamb
 ti sale salt pork
 tito candy stick
 tiwon roll
 tizann herbal tea; broth
 tòftòf, tòkmòl passiflora
 toll type of mint candy
 tomat tomato
 sòs ~ ketchup
 tonken var. of banana
 tonmtonm mashed breadfruit etc.,
 meat and seafood with okra sauce
 tonnaffich tuna fish
 tonnik tonic water
 topl var. of water chestnut
 tòtl turtle, tortoise
 tòtòt sucker, lollipop
 toufay grub, eats
 toufe stew
 touloulou small red sea-crab
 tranpe alcoholic drink infused with
 herbs, fruit, roots etc.
 travo "food for work"
 trip tripe; chitterlings
 tripay waste, scraps; tripe; junk food
 tritri small whitebait (fish)
 twapouvennsenk var. of roll
 vani vanilla
 grenn ~ vanilla bean
 vèmsèl vermicelli
 veritab, lamveritab breadfruit
 boulèt ~ breadfruit cakes
 vèvenn vervain
 vlnèg vinegar
 vlv starchy vegetables or grains (rice,
 millet, cornmeal, sweet potato,
 manioc, yam, plantain etc.)
 vo veal
 volay poultry, fowl
 vyann meat; high protein foods; pulp
 (fruit)
 ~ fasi meatloaf
 ~ kochon pork
 ~ moulen hamburger

~ rache ground round
 vyolèt sovaj wild violet
 wafòl waffle
 wayal cassava bread spread with
 peanut butter
 wlskí whiskey
 womaren rosemary
 won var. of mango
 wonm rum
 ~ ponch rum punch
 wonma lobster
 wonyon kidney
 wosbif roastbeef
 wotl roast
 woukou annatto, lipstick bush
 wowoll sesame
 wozall var. of mango
 yanm yam
 Some var. of yam: angle,
 bakala, chat, dlo, ginen,
 jòn, masoko, matink,
 sigin, tèt bòpè
 yawout yogurt
 yesken balsam apple
 yogout yogurt
 yoyo var. of bread
 zaboka, zabèlbòk avocado
 zabriko mammee, tropical apricot
 zangi, angl eel
 zanmann almond
 zannanna, anana, annanna
 pineapple
 ~ pennsik especially sweet and
 juicy var. of pineapple
 ze egg
 blan ~ egg white
 jòn ~ egg yolk
 ~ alakòk soft-boiled egg
 ~ bouyl hard-boiled egg
 ~ brase, ~ bwouye scrambled
 egg
 ~ di hard-boiled egg
 ~ fri fried egg
 ~ lanmè sea urchin
 ~ mole soft-boiled egg
 ~ poche poached egg

zèb herb
 ~ lanmè seaweed
 zèbaklou plant used in cooking and
 tea
 zechalòt, echalòt shallot, scallion
 zepl, epl ear (of corn)
 zepina spinach
 ~ gran fey Swiss chard
 zeps spice; seasoning
 zè(s) peel, twist, liquid in skin (of
 orange, lime etc.)
 zlzye, jlzye, zlzi gizzard, innards
 zo bone
 ~ soup soup bone
 zollv olive
 ~ fasi stuffed olive
 zonyon onion
 zoranj, zorany orange
 konfitl ~ marmalade
 ~ konmen very sweet orange
 ~ lachin very large var. of
 orange
 ~ sl bitter orange
 zwa goose
 zwlt oyster

**GLOSSARY OF FOOD AND DRINK:
ENGLISH-HAITIAN CREOLE**

- absinthe lapsent
acerola seriz
adult food gwo manje
akee aki
alcohol alkòl
alfalfa alfalfa
allspice malagèt, gwo pwav
almond zanmann
alum alen
anchovy anchwa, janchwa
anise lanni
 star ~ annyetwale
aniseed lanni
anissette liqueur anizèt
annatto woukou
apéritif aperitif
appetizer òdèv
apple ponm
 star ~ kayimit
applesauce sòs ponm
apricot (tropical) zabriko
arrowroot arawout
 ~ flour sagou
artichoke aticho
asparagus aspèj
avocado zaboka
baby food akamil
bacon bekonn
baking powder poud (e)levasyon
baking soda bikabonat
balsam apple asowosi, yesken
bamboo shoots boujon banbou
banana fig (mi)
 small sweet ~, finger ~ fig
 (mi) timalis
barbecue boukannen
barley lòj
 ~ sugar, ~ candy sikdòy
basil (sweet) bazilik
batter pat
bay leaf fèy lorye
bean pwa
 ~ puree sòs pwa
 ~ sprouts boujon pwa
beef bèf
 ~ jerky taso
 stewing ~ dòb
beer byè
beet bètrav, bètwouj
bensolve bennzoliv
berry grenn
beverage bwason, bweson
biscuit biskwit rale
bisque bisk
bitter orange zoranj si
black bean pwa nwa
black-eyed pea pwa enkoni, pwa
 djangan, pwa je nwa
bologna moutadèl
bone zo
booze tafya
bouillon bouyon, konsome
 ~ cube kib, boul soup, boul
 magi
brains sèvèl
bran ble jòn
brandy brandi
bread pen
 raisin ~ pen rezen
 unleavened ~ pen rale
 wholewheat ~ pen nwa
breadcrumb myèt pen
breadfruit (lam)veritab
 ~ cake boulèt (lam)veritab
 ~ nut labapen
brioche briyòch
broccoll bwokoli
broth bouyon, konsome; tizann, tizàn
brown-sugar candy rapadou
Brussels sprouts chou Briksèl
bulgar wheat boulga
butter bè
butterbean pwa bè, pwa chouk, pwa
 souch

buttermilk lèt kaye
 cabbage chou
 Chinese ~ chou chinwa
 red ~ chou wouj
 cake gato
 camomile kamomi
 candy sirèt, sikri, tablèt
 ~ bar dous
 hard ~ sirèt
 cane kann
 ~ syrup gwo siwo
 cantaloupe kantaloup, melon frans
 capon chapon
 caramel karamèl
 carbohydrates, starches viv
 carbonated gaze
 carrot kawòt
 cashew apple ponm kajou
 cashew nut nwa kajou
 cassava bread kasav
 sweet cassava kasav dous
 casserole ragou
 cauliflower chouflè
 celery seleri
 ~ salt sèl seleri
 cereal (dry) kònfleks
 hot ~ labouyi (avwàn)
 champagne chanpay
 chayote squash militon
 cheese fwonmaj
 cottage ~ fwonmaj lèt, lèt kaye
 cream ~ fwonmaj krèm
 cherimoya kachiman lachin
 cherry seriz
 chestnut mawon
 chicken poul
 ~ (in supermarket or
 restaurant) poulè
 chicory chikore, pwa chikann
 chill pepper piman pike
 ~ powder poud piman
 Chinese cabbage chou chinwa
 Chinese chard kad chinwa
 Chinese date ponm malkadi, jijib
 chips (usu. plantain) papita
 chitterlings andouyèt, andi, andwi,
 trip
 chives siv
 chocolate chokola
 chowder koubouyon
 chutney konfiti mango
 clder sid
 cinnamon kanèl
 citronella sitwonèl
 clam paloud
 cloves (tèt) jiwòf
 cock, rooster kòk
 cocktail kòktièl
 cocoa kakawo
 powdered ~ chokola an poud
 coconut kokoye
 ~ bread konparèt
 ~ candy dous kokoye
 ~ cookie kokonèt
 ~ meat nannan kokoye
 ~ milk lèt kokoye
 ~ water dlo kokoye
 soft ~ meat mole kokoye
 cod(fish) lanmori
 codliver oil lwil fwadmori
 coffee kafe
 ~ bean seriz kafe
 ~ grounds ma kafe
 ~ with milk or cream kafe
 olè
 instant ~ poud kafe, kafe an
 poud
 weak ~ kafe klè
 cognac konyak
 cola (extremely sweet) kola
 coleslaw salad chou
 collard chou peyi
 compote konpòt, ponpòt
 conch lanbi
 cone (for ice-cream) kònè(t)
 conger eel kong
 consommé konsome
 cookie bonbon
 cordial (liqueur) kòdyal
 coriander koryann
 corn mayi

~ gruel latòltòl
 ~ syrup lèt mayi
 ear of ~ zepi, epi
 finely-ground ~ tchentchen
 ground roasted ~
 chanmchanm, saumsanm
 cornbread pen mayi
 cornflour farin mayi
 cornmeal mayi moulen, fòkseli
 ~ porridge akasan
 cornstarch farin mayi
 cottage cheese fwonmaj lèt, lèt kaye
 cottonseed oll lwil koton
 couscous kouchkouch
 crab krab
 saltwater ~ krab sirik
 cracker bonbon sèl
 crayfish kribich
 cream krèm
 ~ cheese fwonmaj krèm
 sour ~ krèm si
 whipped ~ krèm bat, krèm fwete
 crepe krèp
 croissant kwasan
 croquette kwokèt
 crouton boul pen griye
 crush (orange, grape etc.) floup
 crust kwout
 ple ~ pat brize
 cucumber konkonm
 wild ~ konkonm zonbi
 cupcake ponmkèt
 curd fwonmaj tilèt
 curry kari
 custard èfòlè, flan
 ~-apple kachiman
 cutlet eskalòp
 dasheen tayo
 date dat
 dessert desè
 dill lanni
 dough pat
 doughnut donòt
 dragée draje
 dressing sòs
 drink bwason, bweson

(any) cool refreshing ~
 rafrechi
 (extremely sweet) soft ~
 kola
 hard ~ gwòg
 duck kannna
 dumpling doumbrey, bòy
 eel zangi, angi
 conger ~ kong
 egg ze
 ~ white blan ze
 ~ yolk jòn ze
 fried ~ ze fri
 hard-boiled ~ ze bouyi, ze di
 poached ~ ze poche
 scrambled ~ ze brase, ze
 bwouye
 soft-boiled ~ ze alakòk, ze
 mole
 eggnog kremas
 eggplant berejèn
 endive chikore
 essence, extract esans
 fat(s) grès
 fava bean pwa foule
 fennel lanni vèt
 fig fig Frans
 fillet filè
 filling fas
 finger banana fig (mi) timalis
 fish pwason
 dried ~ pwason sale
 ~ soup bouyon pechè
 fresh ~ pwason fre
 freshwater ~ pwason dlo dous
 saltwater ~ pwason lanmè
 flan flan
 flour farin
 wheat ~ farin Frans
 food manje
 adult ~ gwo manje
 (cooked) adult ~ manje chodyè
 ~ (baby talk) nannan
 ~ containing only
 carbohydrates manje chèch
 " ~ for work" travo

~ (pejorative) toufay
 high protein ~ vyann
 leftover ~ manje dòmi
 See also: Junk food
 foodstuff danre
 fowl bèt tièt, (bèt) volay
 frank(furter) sosis
 French-fried potatoes ponmdetè fri
 French toast pen pèdi
 fried foods fritay
 fritter (plain batter) marinad
 fritter (usu. malanga) akra
 frog legs kwis gounouy
 frosting glas(i)
 fruit fwi
 ~ Julce ji fwi
 fudge dous
 gale-of-wind dèyèdo
 garlic lay
 clove of ~ gous lay
 gelatin jelatin
 gin djin
 ginger jenjanm
 ~ ale jenjerèl
 gingerbread pen depis, jenjanbrèt
 glizzard zizye, jizye, zizi
 goat kabrit
 goose zwa
 granadilla grenadin, grenadja
 grape rezen
 grapefruit panplemous; see
 shaddock
 gravy sòs
 grease grès
 greenbean pwa tann
 green pea pwa frans
 green pepper piman dou(s)
 ground round vyann rache
 guava gouyav, gwayav
 guinea fowl, guinea hen pentad
 gumbo kalalou
 ham janbon
 hamburger anbègè, vyann moulen
 hazelnut nwazèt
 heart of palm chou palmis
 herb zèb
 herring aran
 salt ~ aransèl
 smoked ~ aransò
 high protein foods vyann
 hogplum siwèl
 honey siwo myèl
 honeycomb gato myèl
 honeydew melon melon
 hors d'œuvre òdèv
 horseradish radi fò, radi pike
 hotdog sosis
 ice glas
 crushed ~ glas kraze
 ~ cube kare glas, glason
 ice-cream krèm (glase)
 iced tea te glase
 icing glas(i)
 innards nannan
 jam konfiti
 jawbreaker (candy) boulsenlo
 Jello jelo
 Jelly jele
 Julce ji
 Jujube jijib, ponm malkadi
 Junk food tchanpan, tchaw, tripay,
 friddòy
 ketchup sòs tomat, katchòp
 kidney wonyon
 kidney bean pwa wouj
 kipper aranbarik
 lamb ti mouton, ayo
 langouste langous
 lard mantèg
 laurel lorye
 leaf fèy
 leavening leven
 leek powo
 leftovers manje dòmi, gratpetren,
 lasibab, retay
 lemon sitwon dous
 ~ balm melis
 ~ grass tea sitwonèl
 lentil lantiy
 lettuce leti
 licorice reglis, legliz

lima bean pwa souch, pwa chouk,
 pwa bè
 lime sitwon
 limeade sitwonad
 weak ~ limonad
 lipstick bush woukou
 liqueur likè
 liquid likid
 liquor tafya, gwòg
 liver fwa (di), fresi
 loaf pen
 lobster wonma
 loin jigo
 lollipop sousèt, piwouli, tòtòt
 loquat siwèl
 low-fat ki pa twò gra
 macaroni makawoni
 mackerel taza, makrèl, makriyo
 maize mayi
 malanga tayo
 ~ leaves fèy tayo
 mamme zabriko, abriko
 mango mango
 manioc manyòk
 margarine magarin
 marigold sousi
 marinade marinad
 marjoram majolèn
 marmalade konfiti zoranj
 marshmallow machmalo
 mayonnalse mayonèz
 meat vyann
 dried ~ taso
 fried ~ griyay
 ~ ple pate
 meatball boulèt
 meatloaf vyann fasi
 melon melon
 meringue krèm blan ze
 milk lèt
 condensed ~ lèt kondanse
 cow's ~ lèt bèf
 emergency-relief ~ lèt sinistre
 evaporated ~ lèt vapore
 goat's ~ lèt kabrit
 homogenized ~ lèt omojenize

malted ~ lèt malte
 pasteurized ~ lèt pasterize
 powdered ~ lèt an poud, lèt
 fanasi
 skimmed ~ lèt san krèm
 whole ~ lèt (ak krèm)
 millet pitimi
 mineral water dlo mineral
 mint mant
 ~ candy mant
 molasses siwo melas, gwo siwo
 muffin ponmkèt, byennwa
 mulberry mi
 mushroom (small black) djondjon
 mussel mou
 mustard moutad
 mutton mouton
 nasturtium kapisin
 navy bean:
 (flat) ~ pwa valèt
 (round) ~ pwa blan
 noodle makawoni
 nougat nouga, tablèt
 nut nwa
 nutmeg miskad
 oatmeal labouyi (avwàn)
 oats avwàn
 octopus chatwouy, chatwouj
 oil lwil
 okra kalalou
 olive zoliv
 ~ oil lwil zoliv
 stuffed ~ zoliv fasi
 omelet lanmilèt, omlèt
 onion zonyon
 orange zoranj
 bitter ~ zoranj si
 orangeade oranjad
 oregano lorigan
 oyster zwit
 palm heart chou palmis
 pancake krèp
 papaya papay
 paprika poud pimam
 Parmesan cheese pamesan
 parsley pèsi

partridge pèdri
 passiflora marigouya, tòkmòl, tòfiòf
 passionfruit grenadja, grenadin
 pasta pat
 paste pat
 pastry patisri
 paté pate
 pea pwa
 peach pèch
 ~ melba pèch mèlba
 peanut pistach
 (spicy) ~ butter manba (pike)
 pear pwa
 peel po
 pepper pwav
 green ~, bell ~ piman dou(s)
 hot ~ piman pike
 hot ~ sauce pimantad
 red ~ piman bouk
 (very) small red ~ piman
 zwazo
 peppercorn grenn pwav
 peppermint tibonm, granbonm
 pickle kònichon
 pick-me-up kolasonn
 ~ (of egg yolk, fruit etc.)
 pètpòt
 ple tat
 ~ crust pat brize
 pigeon pijon
 pigeon pea pwa kongo
 pimento piman
 pineapple zannanna
 pinto bean pwa wouj
 pit (of fruit) grenn
 pizza pitza
 plantain bannann
 grated ~ bannann graje
 ~ chip papita
 ~ gruel labouyi bannann
 ~ slices fried in oil bannann
 peze
 plum prin
 pomegranate grenad
 popcorn mayi pèpèt, pèpèt mayi
 pork vyann kochon

(fried) ~ bits griyo
 ~ chop kòtlèt kochon
 salt ~ ti sale, soupoudre
 potato ponmdetè
 French-fried ~ ponmdetè fri
 mashed ~ pire ponmdetè
 ~ chip papita
 poultry bèt titèt, (bèt) volay
 powder poud
 praline tablèt
 preserves konfiti, konsèv, konfi
 produce danre
 prune prin
 pitted ~ prin san grenn
 pudding poudin(g)
 pullet poulèt
 pulp vyann, nannan, chè
 pumpkin jou(wou)mou
 punch ponch
 puree pire
 purslane koupye
 quail pèdri
 quiche kich
 rabbit lapen
 radish radi
 raisin rezen sèk
 raspberry (black) franbwaz
 red cabbage chou alizèn, chou wouj
 red mombin siwèl
 red pepper piman (bouk)
 relish (spicy) pikliz
 sweet ~ pikliz dous
 rhubarb ribab
 rice diri
 brown ~ diri solèy
 ~ and beans diri ak sòs pwa
 ~ and beans cooked together
 diri kole (ak pwa)
 ~ and mushrooms diri ak
 djondjon
 white ~ diri glase
 wild ~ diri jòn
 rind (pork) kwann
 roast woti
 roastbeef wosbif
 roll pen won, ti pen, tiwon

rooster kòk
 root rasin
 rose apple bwadenn
 rosemary womaren
 rum wonm
 raw ~ kleren
 ~ punch wonm ponch
 saccharin sakarin
 saffron safran
 sage soj
 sago sagou
 salad salad
 ~ dressing sòs salad
 ~ oil lwil salad
 salami salami, gwo sosis
 salmon somon
 salt sèl
 rock ~, coarse-grained ~ gwo
 sèl
 sea ~ sèl lanmè
 sandwich sandwich
 sapodilla sapoti
 sardine sadin
 sauce sòs
 sausage sosis
 blood ~ bouden
 saveloy sèvla
 scallion (e)chalòt, zechalòt
 scallop eskalòp
 scampi eskanpi
 scraps retay, tripay
 seafood bèt lanmè
 sea-salt sèl lanmè
 seasoning epis
 sea urchin chadwon, ze lanmè
 seaweed zèb lanmè
 seed grenn
 sesame jijiri, wowoli
 shaddock chadèk
 shallot (e)chalòt, zechalòt
 shank jigo
 shellfish pwason kòf
 sherbet sòbè
 shish-kebab bwòchèt
 shoot, tendril boujon
 shortening mantèg
 shrimp chevrèt, krevèt
 sirloin steak fofilè
 skin po
 snack soloba
 snapper sad (woz), pwason woz
 snowcone fresko
 soda soda; kola
 baking ~ bikabonat
 ~ cracker soda
 ~ water soda
 soft drink (extremely sweet)
 kola
 sole sòl
 sorghum pitimi
 sorrel lòzèy
 soup soup, bouyon
 ~ bone zo soup
 soursop kowosòl
 soybean soya, soja
 soy sauce sòs soya
 spaghetti espageti
 Spanish lime kenèp
 sparerib kòtlèt (kochon)
 spearmint granbonm, tibonm
 spice epis
 spinach zepina
 squid chatwouy, chatwouj
 stalk (bananas, plantains) rejim
 star anise annyetwale
 star apple kayimit
 starchy vegetables viv
 steak estèk
 sirloin ~ fofilè
 T-bone ~ tebonn
 stem (bananas, plantains) rejim
 stew bouyon, toufe, ragou, frikase
 strawberry frèz
 string bean pwa tann
 stuffing fas
 sucker sousèt, piwouli, tòtòt
 sugar sik
 brown ~ sik jòn, sik krèm
 brown ~ candy rapadou
 dark-brown ~ sik wouj, sik
 wouj, sik popilè
 powdered ~ sik an poud

~-apple ponm kanèl
 ~ cane kann
 ~ -cane juice dlo kann
 ~ cube boul sik
 sunflower seed grenn flèsolèy
 sweet basil bazilik
 sweetener, sweetening dous
 sweet potato patat
 ~ pudding pen patat
 sweets dous, sikri
 sweetsop kachiman kanèl, kachiman
 kèbèf
 Swiss chard zepina gran fèy
 swordfish espadon
 syrup siwo
 Tabasco sòs piman, tabasko
 taco tako
 tamarind tamaren
 tangerine mandarin
 tapioca tapyoka
 taro malanga, tayo, (chou) karayib
 tart ti tat
 tea te
 China ~ tèchin
 herbal ~ tizann
 iced ~ te glase
 tendrill, shoot boujon
 thyme ten
 tilapia tilapya
 toast pen griye
 French ~ pen pèdi
 tomato tomat
 tongue lang
 tonic water tonnik
 tortoise tòti
 tripe afiba, trip, tripay
 tuna fish tonnafich
 turkey kòdenm
 turmeric safran
 turnip nave
 turtle tòti
 sea ~ karèt
 twist, peel (of lime or orange
 skin) zè(s)
 vanilla vani
 ~ bean grenn vani

veal vo
 vegetable legim
 verbena bonbonyen
 vermicelli vèmisèl
 vervain vèvenn
 vinegar vinèg
 violet (wild) vyolèt sovaj
 waffle wafòl
 water dlo
 Culligan ~ dlo Kiligann
 mineral ~ dlo mineral
 purified ~ dlo distiye
 tap ~ dlo tiyo
 watercress kreson
 watermelon melon dlo
 wheat ble
 bulgar ~ bouлга
 ~ flour farin frans
 ~ germ kè ble
 whey fwonmaj dlo
 whiskey wiski
 whitebait (var. of small fish)
 piskèt; triti
 wiener sosis
 wine diven
 yam yanm
 yeast leven
 ~ powder poud (e)levasyon
 yogurt yogout, yawout
 yolk jòn ze

DAYS / JOU

Monday - lendi
 Tuesday - madi
 Wednesday - mèkredi
 Thursday - jedi
 Friday - vandredi
 Saturday - samdi
 Sunday - dimanch

MONTHS / MWA

January - Janvyè
 February - fevriye
 March - mas
 April - avrill
 May - me
 June - jen
 July - jiyè
 August - dawou
 September - septanm
 October - oktòb
 November - novanm
 December - desanm

SEASONS / SEZON

dry season - sezon sèk
 rainy season - sezon lapli

COLORS / KOULÈ

black - nwa
 blue - ble
 brown - mawon
 gray - gri
 green - vèt
 orange - oranj
 pink - woz
 purple - vyolèt
 red - wouj
 white - blan
 yellow - jòn

NUMBERS / CHIF

0 - zewo
 1 - en / youn
 2 - de
 3 - twa
 4 - kat
 5 - senk
 6 - sis
 7 - sèt
 8 - wit
 9 - nèf
 10 - dis
 11 - onz
 12 - douz
 13 - trèz
 14 - katòz
 15 - kenz
 16 - sèz
 17 - disèt
 18 - dizwit
 19 - diznèf
 20 - ven
 21 - venteyen
 22 - vennde
 23 - venntwa
 24 - vennkat
 25 - vennsenk
 26 - vennsis
 27 - vennsèt
 28 - ventwit
 29 - ventnèf
 30 - trant
 31 - tranteyen
 32 - trannde
 33 - tranntwa
 34 - tranncat
 35 - trannsenk
 36 - tranncis
 37 - tranncèt
 38 - trantwit
 39 - trantnèf

40 - karant
41 - karanteyen
42 - karannde
43 - karanntwa
44 - karannkat
45 - karannsenk
46 - karannsis
47 - karannsèt
48 - karantwit
49 - karantnèf

50 - senkant
51 - senkanteyen
52 - senkannde
53 - senkanntwa
54 - senkannkat
55 - senkannsenk
56 - senkannsis
57 - senkannsèt
58 - senkantwit
59 - senkantnèf

60 - swasant
61 - swasanteyen
62 - swasannde
63 - swasanntwa
64 - swasannkat
65 - swasannsenk
66 - swasannsis
67 - swasannsèt
68 - swasantwit
69 - swasantnèf

70 - swasanndis
71 - swasantonz
72 - swasanndouz
73 - swasanntrèz
74 - swasannkatòz
75 - swasannkenz
76 - swasannsèz
77 - swasanndisèt
78 - swasann dizwit
79 - swasann diznèf

80 - katreven

81 - katreven-en
82 - katreven-de
83 - katreven-twa
84 - katreven-kat
85 - katreven-senk
86 - katreven-sis
87 - katreven-sèt
88 - katreven-wit
89 - katreven-nèf

90 - katreven-dis
91 - katreven-onz
92 - katreven-douz
93 - katreven-trèz
94 - katreven-katòz
95 - katreven-kenz
96 - katreven-sèz
97 - katreven-disèt
98 - katreven-dizwit
99 - katreven-diznèf

100 - san
101 - san en
150 - san senkant
200 - de san
500 - senk san
1,000 - mil