

Marquette University
e-Publications@Marquette

Chemistry Faculty Research and Publications

Chemistry, Department of

1-1-2002

Molecular Structures of the Metastable Charge-Transfer Complexes of Benzene (and Toluene) With Bromine as the Pre-Reactive Intermediates in Electrophilic Aromatic Bromination

Alexandr V. Vasilyev
University of Houston

Sergey V. Lindeman
Marquette University, sergey.lindeman@marquette.edu

Jay K. Kochi
University of Houston

Accepted version. *New Journal of Chemistry*, Vol. 26, No. 5 (2002): 582-592. DOI. © 2002 The Royal Society of Chemistry and the Centre National de la Recherche Scientifique. Used with permission. Sergey V. Lindeman was affiliated with the University of Houston at the time of publication.

Marquette University

e-Publications@Marquette

Chemistry Faculty Research and Publications/College of Arts and Sciences

This paper is NOT THE PUBLISHED VERSION; but the author's final, peer-reviewed manuscript. The published version may be accessed by following the link in the citation below.

New Journal of Chemistry, Vol. 26 (2002): 582-592. [DOI](#). This article is © Royal Society of Chemistry and permission has been granted for this version to appear in [e-Publications@Marquette](#). Royal Society of Chemistry does not grant permission for this article to be further copied/distributed or hosted elsewhere without the express permission from Royal Society of Chemistry.

Molecular Structures of the Metastable Charge-Transfer Complexes of Benzene (and Toluene) With Bromine as the Pre-Reactive Intermediates in Electrophilic Aromatic Bromination

Alexandr V. Vasilyev

Department of Chemistry, University of Houston, Houston, TX

Sergey V. Lindeman

Department of Chemistry, University of Houston, Houston, TX

Jay K. Kochi

Department of Chemistry, University of Houston, Houston, TX

Abstract

Successful crystallization and X-ray crystallographic analyses of the highly metastable (1:1) complexes of bromine with benzene and toluene establish the unique (localized) structure **B** that differs in notable ways from the long-accepted (delocalized) structure **A**. Furthermore, we demonstrate the (highly structured) charge-transfer complexes $[\text{C}_6\text{H}_6, \text{Br}_2]$ and $[\text{CH}_3\text{C}_6\text{H}_5, \text{Br}_2]$ to be the pre-reactive intermediates that are converted (*via* an overall Br^+ transfer) to the Wheland intermediates in electrophilic aromatic bromination. The role of the dative ion pairs $[\text{C}_6\text{H}_6^{\cdot+} \text{Br}_2^{\cdot-}]$ and $[\text{CH}_3\text{C}_6\text{H}_5^{\cdot+} \text{Br}_2^{\cdot-}]$ in the rate-limiting activation processes is underscored.

More than 52 years ago, Benesi and Hildebrand published their seminal studies describing the unique spectral (UV-vis) changes that accompany the spontaneous complexation of various aromatic hydrocarbons (ArH) with iodine in nonpolar solvents (CCl_4 , C_6H_{14} , *etc.*).¹ Keefer and Andrews (and others) in extending such spectroscopic studies also found the magnitudes of the (thermodynamic) equilibrium constants K_{CT} for the formation of these intermolecular (1:1) complexes



to be uniformly limited, typically with $K_{\text{CT}} < 3 \text{ M}^{-1}$ for the halogens $\text{X}_2 = \text{I}_2, \text{Br}_2,$ and Cl_2 or the interhalogens $\text{XY} = \text{IBr}, \text{ClF},$ *etc.*²

Immediately following the Benesi–Hildebrand report, Mulliken published another landmark paper in 1950,³ in which he assigned these new spectral bands to the unusual electronic (charge-transfer) transition from the ground-state complex $[\text{D}, \text{A}]$ to the dative excited state $[\text{D}^{\cdot+}, \text{A}^{\cdot-}]$, where D is the generic representation of electron donors (such as aromatic hydrocarbons, *etc.*) and A identifies the electron acceptors (such as $\text{X}_2, \text{XY},$ *etc.*) in eqn. (1).

Despite the subsequent explosion in the number and types of papers dealing with the various facets of electron donor/acceptor, or EDA, complexes,^{4,6} reports of their *reactivity* as intermediates in (irreversible) chemical reactions are sparse. In the latter context, there are two reviews^{7,8}—both now more than 25 years old—that unfortunately failed to kindle widespread interest in the *kinetic* (as opposed to static) aspects of these interesting EDA complexes. To make the point, we now focus simply on the benzene/bromine dyad as a prototypical donor/acceptor pair. In this system, the intermolecular (1:1) complex is transient since its diagnostic (charge-transfer) absorption band with energy $h\nu_{\text{CT}}$ slowly disappears as bromobenzene and hydrogen bromide are coproduced. However, these simultaneous chemical events may not be directly coupled, since Colter and Dack⁹ correctly pointed out that the reversible formation of the EDA complex (K_{EDA}) may be an unrelated side process independent of electrophilic bromination (k_{Br}):

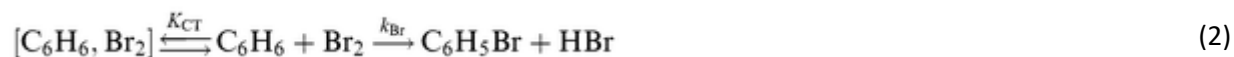

Mechanistically, such a *parallel* process in which the EDA complex is an innocent bystander cannot be kinetically distinguished from the *sequential* process [eqn. (3)], in which it lies squarely on the pathway to electrophilic aromatic bromination:

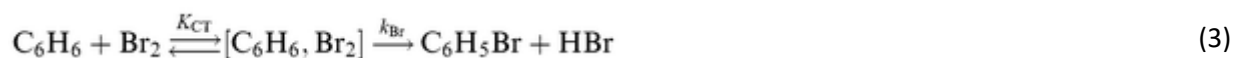

Various spectroscopic (IR, NQR, NMR, *etc.*) techniques have been applied to deduce the structures of $[\text{C}_6\text{H}_6, \text{Br}_2]$ and related complexes,⁹⁻¹¹ but to date the classic X-ray crystallographic determination by Hassel and Strømme in 1958¹² stands alone as the principal structural standard (for the weak binding of bromine to benzene) by which

all others are invariably compared.¹³ Their structure **A** reveals the non-covalently bound dibromine acceptor to lie in an axial orientation relative to the benzene plane. The Br–Br bond (2.28 Å), which has essentially the same length as that found in elemental bromine, lies across an inversion center on (or near) the 6-fold symmetry axis of benzene at an intermolecular bromine–benzene separation of $D = 3.36$ Å that is significantly closer than the van der Waals contact distance of 3.55 Å.¹⁴ As such, structure **A** represents the electronic interaction of a completely *delocalized* benzene donor with the bromine acceptor—much in the way predicted by Mulliken theory.^{3,15} However, our careful perusal of Hassel and Strømme's experimental details raised some serious questions as to the definitiveness of structure **A**.¹⁶ Accordingly, in this paper we re-examine the X-ray crystallography of the benzene/dibromine complex and extend our consideration to the corresponding toluene/dibromine complex for completeness. Furthermore, the availability of the bromine complexes in crystalline form allows us to directly effect the electrophilic bromination of benzene according to eqn. (3), since under these solid-state conditions only nearest neighbors react, and diffusional (second-order) processes are largely precluded.¹⁷

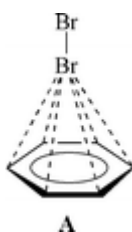

Results

Spectral (UV-vis) changes accompanying the bromine complexation to arene donors Benzene.

When pure benzene was added incrementally in small amounts to a dilute (5 mM) solution of bromine in carbon tetrachloride, the red-brown color changed almost imperceptibly. However, inspection of the UV-vis spectrum readily revealed the progressive growth of a new absorption band at $\lambda_{\text{max}} = 285$ nm [see Fig. 1(A)]. Benesi–Hildebrand treatment of the absorbance data yielded the formation constant $K_{\text{EDA}} = 1.0 \text{ M}^{-1}$, in agreement with the earlier determination.² In the $[\text{C}_6\text{H}_6, \text{Br}_2]$ complex, the “local” band of the bromine moiety was unchanged relative to the absorption of free bromine, as shown by the series of invariant spectra at $\lambda > 350$ nm in Fig. 1(A). The latter is underscored in Fig. 1(B), which was obtained by repeating the foregoing experiments and merely inserting a filter (consisting of the same 5 mM solution of Br_2 in carbon tetrachloride) in the reference beam of the spectrometer. Such spectral features of the $[\text{C}_6\text{H}_6, \text{Br}_2]$ complex are wholly consistent with Mulliken's formulation of weak complexes in which the new UV-vis absorption relates to the electronic transition ($h\nu_{\text{CT}}$) corresponding to:¹⁸



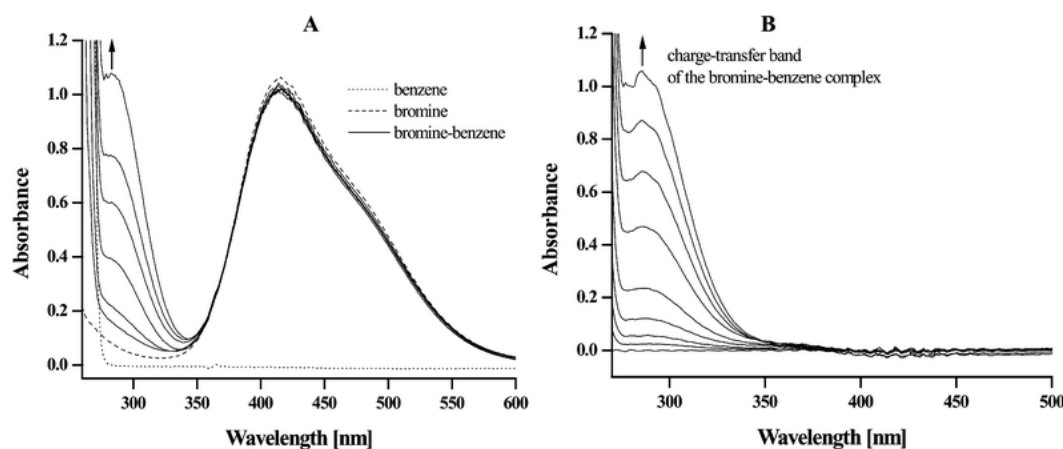

Fig. 1 (A) Spectral (UV-vis) changes attendant upon the incremental addition of benzene aliquots to a dilute solution of 5 mM bromine in carbon tetrachloride at bromine:benzene ratios of 1:2 to 1:40 (bottom to top). For comparison, the spectra of the solutions in CCl_4 :5 mM Br_2 alone (-----) and 0.1 M C_6H_6 alone (.....). (B) Similar to A [except for the insertion of a 5 mM Br_2 in CCl_4 filter (blank solution) in the reference beam of the spectrometer] to isolate the progressive growth of the charge-transfer band ($\lambda_{\text{CT}} = 285 \text{ nm}$).

Toluene.

The spectral changes attendant upon the incremental additions of pure toluene to a 5 mM solution of bromine in carbon tetrachloride are shown in Fig. 2. The red-shift of the charge-transfer absorption band of the toluene/bromine complex to $\lambda_{\text{max}} = 295 \text{ nm}$ follows from the Mulliken correlation of its increased donor strength ($E^{\circ}_{\text{ox}} = 2.25 \text{ V}$) relative to that of benzene ($E^{\circ}_{\text{ox}} = 2.62 \text{ V}$).¹⁹

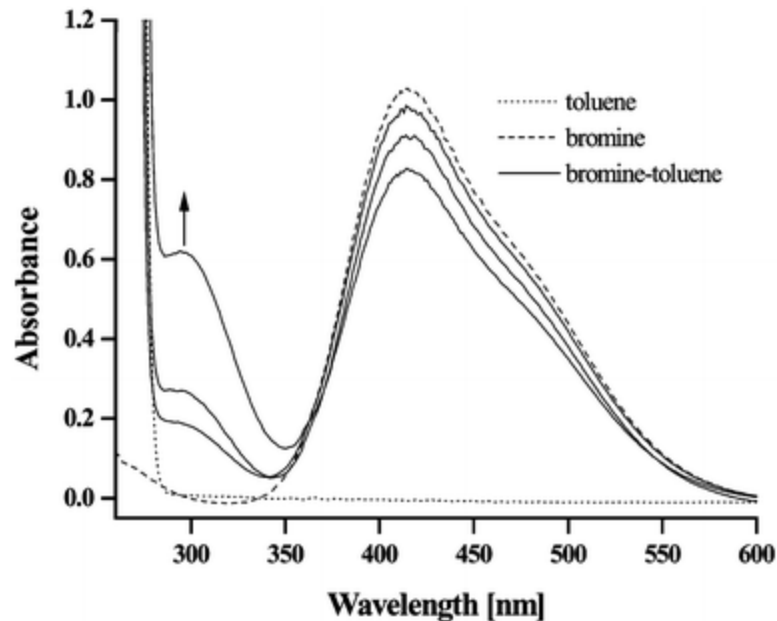

Fig. 2 UV-vis spectral changes upon the addition of toluene in incremental amounts to a dilute solution of 5 mM bromine in carbon tetrachloride at bromine:toluene ratios of 1:5 to 1:20 (bottom to top), showing the growth of the charge-transfer band ($\lambda_{\text{CT}} = 295 \text{ nm}$). For comparison, the spectra of the solutions in CCl_4 :5 mM Br_2 alone (-----) and 0.1 M toluene alone (.....).

Crystallization of the bromine complexes of arenes donors

Benzene.

Owing to the low value of the formation constant K_{EDA} , the benzene/bromine complex was necessarily prepared *in situ* by the low-temperature crystallization of the pure components in a sealed glass capillary.²⁰ For example, the equimolar mixture of benzene and bromine remained liquid at $-30\text{ }^{\circ}\text{C}$, but crystal nucleation was readily initiated by carefully brushing liquid nitrogen over the capillary with a cotton applicator. By a series of local (manual) warmings all but one small crystal was alternately dissolved/melted, and the remaining single crystal was allowed to grow along the capillary axis at $-40\text{ }^{\circ}\text{C}$. The brown color of the crystal was almost indistinguishable from the color of the residual liquid (compare Fig. 1), but its slow growth could be continuously monitored under a microscope using crossed polarizers. Most interestingly, the crystal exhibited a phase change as the temperature was gradually decreased to $-70\text{ }^{\circ}\text{C}$, but only a very slow cooling rate of $\sim 1\text{ }^{\circ}\text{C min}^{-1}$ resulted in the apparent single-crystal-to-single-crystal phase transformation of the $[\text{C}_6\text{H}_6, \text{Br}_2]$ complex.

Toluene.

An equimolar mixture of toluene and bromine was visually indistinguishable from the brown benzene complex. Most notably, a series of carefully controlled studies showed that the toluene complex (visually) bleached within 2–3 h in the temperature range of -40 to $-50\text{ }^{\circ}\text{C}$. In order to successfully grow a single crystal of the toluene/bromine complex, various molar mixtures were examined at lower temperatures. When a 2:1 molar ratio of toluene and bromine was employed, the resulting brown liquid began to crystallize at $-70\text{ }^{\circ}\text{C}$ to produce bright orange crystals. After some manual local warmings, all but one crystal was suppressed in the capillary. The single crystal of the 1:1 complex consisted of a bright orange prism positioned along the capillary axis, and the surrounding liquid (presumably consisting of the excess of toluene) was pale yellow and glassy (clear and isotropic under polarized light) at $-150\text{ }^{\circ}\text{C}$.

X-Ray crystallography of the bromine complexes of benzene and toluene

X-Ray crystallographic analyses of the 1:1 bromine complexes of benzene and toluene were uniformly carried out at $-150\text{ }^{\circ}\text{C}$ to obviate the dynamic disorder observed at higher temperatures. As a result, our structural conclusions about the bromine binding in these complexes differ in substantial ways from those obtained by Hassel and Strømme at higher temperatures (-40 to $-50\text{ }^{\circ}\text{C}$).^{12a}

Bromine binding to benzene.

In striking contrast to the axial (delocalized) structure **A**, we found that bromine does not coordinate to benzene symmetrically. Instead, bromine is positioned over the rim (not the center) of the benzene ring as in structure **B**—being shifted by $\delta = 1.44\text{ \AA}$ from the main (C_6) symmetry axis. In structure **B**, the dibromine molecule is essentially oriented perpendicular to the benzene plane, and tilted by only $\alpha = 5.1\text{ deg}$ off the C_6 axis.

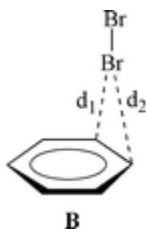

The molecular structure of the $[\text{C}_6\text{H}_6, \text{Br}_2]$ complex in Fig. 3 shows an *asymmetric* coordination of bromine to benzene as given by the shortest pair of $\text{Br}\cdots\text{C}$ distances of $d_1 = 3.18\text{ \AA}$ and $d_2 = 3.36\text{ \AA}$, both of which are substantially shorter than the sum of the van der Waals radii of 3.55 \AA . Otherwise, the intermolecular complex shows little deviation of the $\text{Br}-\text{Br}$ bond of $l = 2.30\text{ \AA}$, which is only slightly longer than that in free bromine ($l =$

2.28 Å). The precision of the bond-length determination in our experiments ($\sigma_{CC} = 0.006 \text{ \AA}$) is insufficient to allow the detection of small polarization effects in the benzene donor since such changes in (multiple) C–C bonds are typically less than 0.005 \AA .²¹

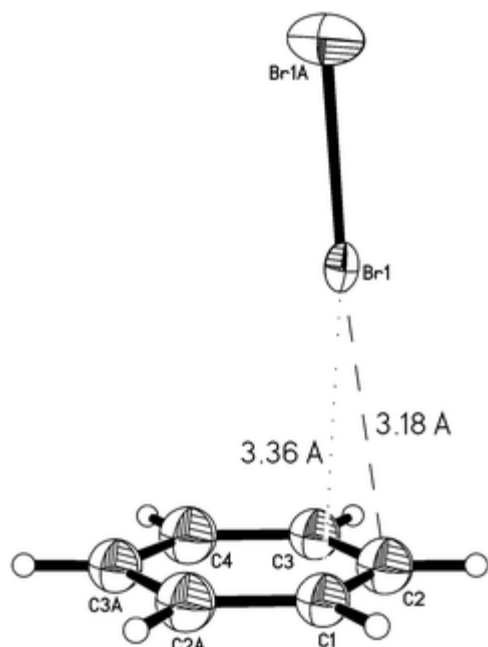

Fig. 3 Molecular diagram showing the localized (over-atom/bond) coordination of Br_2 to benzene. Thermal ellipsoids of non-hydrogen atoms are shown at the 50% probability level.

Bromine binding to toluene.

As in the localized structure **B**, bromine is also positioned over the rim (not above the center) of the toluene ring in the form of non-equivalent dyads, the structural parameters of which are listed in [Table 1](#). The closest approach of bromine occurs at the normal distances $D = 3.01\text{--}3.17 \text{ \AA}$, which are on the average somewhat shorter than that in the benzene complex. In all cases, there is an asymmetric coordination of bromine, as given by the pair of shortest $\text{Br}\cdots\text{C}$ distances d_1 and d_2 in [Table 1](#). More precisely, the coordination of bromine to the aromatic ring can be evaluated as the hapticity (η) for coordination,²² so that $\eta = 1$ when $d_1 = D$ (“over-atom” coordination) and $\eta = 2$ when $d_1 = d_2$ (“over-bond” coordination). For intermediate cases, the hapticity can be estimated as a function of the relative (separation) values: $(d_1^2 - D^2)^{1/2}$ and $(d_2^2 - D^2)^{1/2}$ by using the geometric relationship:

$$\eta = 1 + \frac{2(d_1^2 - D^2)^{1/2}}{[(d_1^2 - D^2)^{1/2} + (d_2^2 - D^2)^{1/2}]} \quad (5)$$

In the toluene complex, the hapticities evaluated in this way vary from 1.70 to 1.86, and thus lie closer to the “over-bond” coordination model. Importantly, the “over-bond” coordinated bromine is shifted toward the *ortho*- and *para*- carbons of toluene [see [Fig. 4](#) and [S2 \(ESI\)](#)].

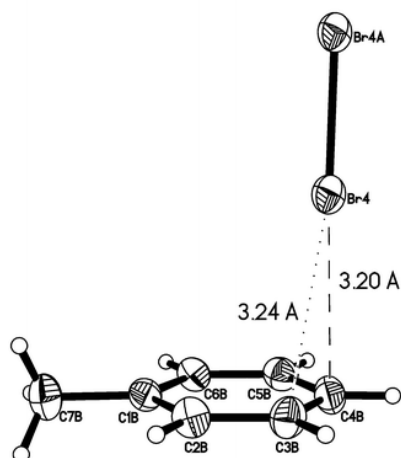
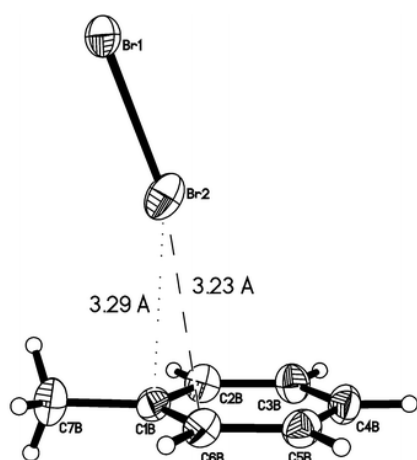

Fig. 4 Localized bonding of bromine to the *ortho*- (top) and *para*- (bottom) centers of toluene in the charge-transfer complex.

Table 1 Principal geometric parameters of the dibromine complexes of benzene and toluene

Interacting molecules	$D^a/\text{Å}$	α^b/de g	$\delta^c/\text{Å}$	$d_1^d/\text{Å}$	$d_2^e/\text{Å}$	η^f	$l^g/\text{Å}$	$l_{av}^h/\text{Å}$
-----------------------	----------------	--------------------	---------------------	------------------	------------------	----------	----------------	---------------------

a Distance of bromine to the mean aromatic plane. *b* Angle between the vector of the Br–Br bond and the normal to the aromatic plane. *c* Deviation of the coordinated Br from the main axis of benzene. *d* The shortest Br...C distance. *e* Second shortest Br...C distance. *f* Hapticity of the coordination. *g* The Br–Br bond length. *h* The average C–C bond length in the aromatic ring.

Benzene complex

Br1A–	3.154(8)	5.1(5)	1.44(1)	3.18(1)	3.36(1)	1.5	2.301(2)	1.39(2)
Br1... (C1...C3A)						2		

Toluene complexes

Br2–	3.009(3)	5.4(2)	1.397(4)	3.053(4)	<i>ortho</i> 3.150(4)	<i>meta</i> 1.7	2.307(1)	1.389(6)
Br1... (C1A...C6A))	<i>o</i>	<i>a</i>	0))

Interacting molecules	$D^a/\text{\AA}$	α^b/de g	$\delta^c/\text{\AA}$	$d_1^d/\text{\AA}$	$d_2^e/\text{\AA}$	η^f	$l^g/\text{\AA}$	$l_{av}^h/\text{\AA}$
Br1– Br2···(C1B...C6B))	3.172(3)	20.7(2)	1.472(4)	3.229(4)	<i>ortho</i> 3.292(4)	<i>ipso</i> 1.8	2.307(1)	1.385(6)
Br3A– Br3···(C1A...C6A))	3.099(3)	4.6(2)	0.936(4)	3.146(4)	<i>para</i> 3.259(4)	<i>meta</i> 1.7	2.291(1)	1.389(6)
Br4A– Br4···(C1B...C6B))	3.133(3)	7.9(2)	1.414(4)	3.196(4)	<i>para</i> 3.241(4)	<i>meta</i> 1.8	2.304(1)	1.385(6)

General structural features of weak arene/Br₂ complexes.

The charge-transfer complex [C₆H₆,Br₂] is presently the weakest EDA complex of dibromine studied in the solid state. Although the intermolecular C···Br separation of $D = 3.18 \text{ \AA}$ is 0.37 \AA closer than the equilibrium van der Waals distance,¹⁴ the contraction is perceptibly less than those previously reported in a series of complexes with slightly polarizable and weakly nucleophilic donors.²³ [For example, the X···Br distance contraction (relative to the corresponding equilibrium van der Waals separations) is 0.55 \AA in the acetone/Br₂ complex (O···Br 2.82 \AA),²⁴ 0.56 \AA in the acetonitrile/Br₂ complex (N···Br 2.84 \AA),²⁵ 0.57 \AA in the [Te₂Cl₁₀]²⁻/Br₂ complex (Cl···Br 3.03 \AA),²⁶ and 0.60 \AA in the [Se₂Br₁₀]²⁻/Br₂ complex (Br···Br 3.10 \AA)^{26,27}]. Moreover, the average C···Br separation of 3.156 \AA in the toluene/Br₂ complex is somewhat shorter than that in the benzene complex, as expected from the better donor strength of toluene.²⁸

The weak C(arene)···Br charge-transfer interaction is reflected in an almost unperturbed geometry of the coordinated dibromine. [The Br–Br bond lengths are actually very sensitive to coordination/polarization effects and readily elongate from 2.284 \AA in the non-coordinated molecule (bond order $n = 1$) to 2.53 \AA in the symmetric [Br₃]⁻ anion²⁹ (bond order $n = 1/2$).] As such, the Br–Br bond lengths of $2.301(2) \text{ \AA}$ in the benzene complex and an average of $2.302(1) \text{ \AA}$ in the toluene complex do not exhibit much elongation during complex formation. For comparison, the Br–Br bond lengths vary within a narrow range (2.28 to 2.33 \AA) in the weakly coordinated acetone, acetonitrile, dioxane and methanol complexes.^{24,25,30,31}

In the *absence of significant polarization*, dibromine can be coordinated equally well from either end (owing to the acceptor σ^* -orbital which is localized on both bromine centers) and this explains why dibromine has often been found *in crystals* to be symmetrically coordinated to a pair of donor molecules (in a bridging manner), especially in complexes with weak donors.^{12bc} [However, it is important to note that in solution, 2:1 complexes of dibromine with benzene (and toluene) are only found at very high Br₂ concentrations.] In the benzene and toluene complexes, dibromine is also positioned symmetrically between the coordinated benzene rings forming infinite (weak) ···Ar···Br–Br···Ar···Br–Br··· chains through the crystal, and there are no specific interactions other than van der Waals contacts between the chains. Although the chains are highly symmetrical in the benzene/dibromine crystals—with 2-fold axes (through the diagonals of the benzene rings and through the centers of the dibromine molecules) across the chains—the chains in the toluene/dibromine crystals are less so. Two of the three dibromines (Br3–Br3A and Br4–Br4A) occupy inversion centers and are thus symmetrically coordinated, but the third dibromine (Br1–Br2) does not show crystallographic symmetry. Indeed, the latter exhibits some signs of larger polarization as a result of a less symmetric coordination (Table 1), and it has the shortest contact, C···Br $3.053(4) \text{ \AA}$, as well as the longest Br–Br bond length, $2.307(1) \text{ \AA}$, in the series.

Interestingly, a similar asymmetric coordination of dibromine is found in the complex with methanol,³⁰ in which the O...Br distance is shorter (2.705 vs. 2.723 Å) and the Br–Br bond length is longer (2.324 vs. 2.303 Å) than those in the closely related (but symmetric) dioxane complex.³¹ This structural effect predicts that *polarization in isolated donor/acceptor dyads (such as those extant in dilute solutions) will be somewhat stronger than that observed in (crystalline) polymeric chains.*

Solid-state (thermal) transformation of arene/Br₂ complexes *via* electrophilic bromination

Benzene/bromine.

Crystals of the EDA complex are surprisingly reactive, especially if one considers that equimolar solutions of benzene and bromine dissolved in carbon tetrachloride remained unchanged at room temperature for prolonged periods if protected from adventitious light. The crystalline 1:1 complex consisting of [C₆H₆,Br₂] melted at –14 °C. Nonetheless, even at –78 °C, the brown crystals slowly evolved hydrogen bromide, and essentially quantitative yields of bromobenzene were found upon workup:



Although the solid-state conversion was deliberately kept low (<0.5%) to minimize disruption of the crystal structure, we consider the electrophilic substitution in eqn. (6) to represent a crystalline (first-order) process. The higher conversion achieved with increasing temperature (Table 2) probably also represented crystalline transformations of the [C₆H₆,Br₂] complex, although there is some ambiguity owing to the phase change observed between –60 and –70 °C (*vide supra*) that may have allowed some (but limited) diffusional separation of benzene from bromine for second-order reactivity. Be that as it may, careful scrutiny revealed the solid-state transformation of [C₆H₆,Br₂] to be singularly uncomplicated by side products.³²

Table 2 Solid-state (thermal) transformation of the benzene/bromine complex *via* electrophilic bromination at different temperatures^a

Bromobenzene yield(%)

<u>T/°C</u>	<u>After 3 h</u>	<u>After 6 h</u>
-------------	------------------	------------------

^a In the dark, without solvent, using 2 mmol each of benzene and bromine.

–78	<0.03	0.08
–60	0.05	0.1
–40	0.1	0.2
–20	1	1.5

Toluene/bromine.

Crystals were derived from an equimolar mixture of pure donor and acceptor. The bright-orange crystals of [PhCH₃,Br₂] slowly evolved hydrogen bromide on standing at –78 °C in the dark. Workup of the reaction mixture after 6 h yielded a roughly 1:2 mixture of *ortho*- and *para*-bromotoluene:

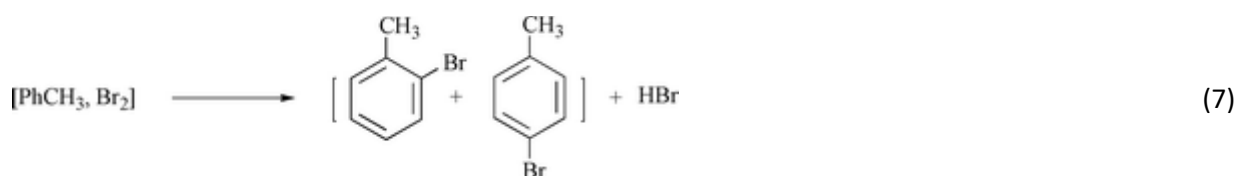

but no benzyl bromide could be detected.³³ The conversion and yields of bromotoluenes obtained at low temperatures are listed in Table 3. It is noteworthy that the molar ratio of the *ortho* and *para* isomers of bromotoluene obtained from the solid-state transformation of the charge-transfer complex was the same as that obtained in carbon tetrachloride solution.

Table 3 Thermal transformation of the neat toluene/bromine complex to bromotoluenes at low temperatures^a

T/°C	Bromotoluene yield ^b (%)	
	<i>ortho</i>	<i>para</i>

^a In the dark, without solvent, using 2 mmol each of toluene and bromine. ^b After 6 h; benzyl bromide <0.05% in all cases.

-78	5.0	13
-70	6.2	15
-65	7.4	22
-60	12	32
-50	16	44

Hexamethylbenzene/bromine.

The complex prepared in a sealed tube from equimolar amounts of hexamethylbenzene and bromine in dichloromethane solution was allowed to stand undisturbed in a cold bath at -40 °C. After more than a week, the mixture deposited a dark red salt with the composition: C₆(CH₃)₆Br⁺Br₃⁻.³⁴ X-Ray crystallographic analysis indicated the formation of a cationic bromoarenum σ -adduct:

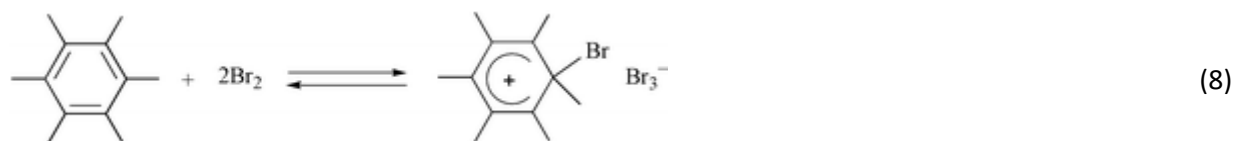

The unit cell consisted of a honeycomb of anionic polybromine networks with cages populated by the cationic σ -complex. Since these cages have a local plane of symmetry the σ -complex structure was sufficiently disordered to afford poor precision. However, the molecular diagram of the well-ordered structure of the same cationic σ -complex obtained as the hexafluoroantimonate salt is illustrated in Fig. 5.³⁵

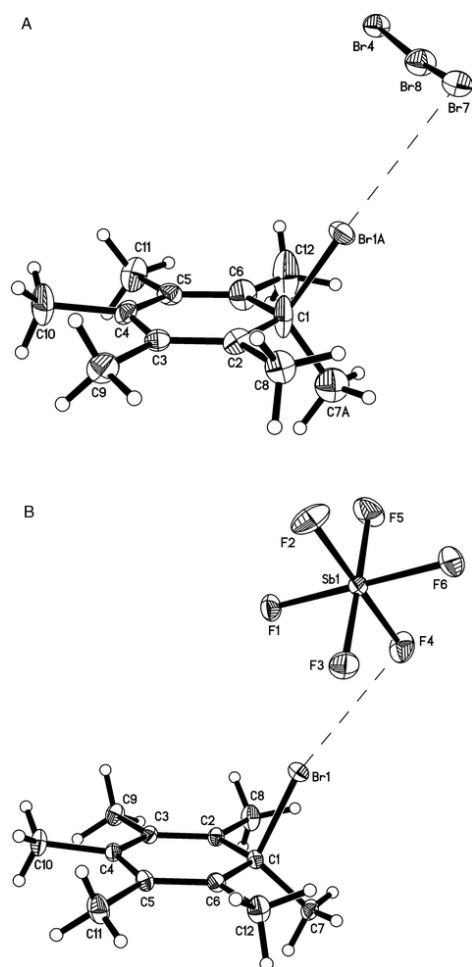

Fig. 5 Molecular structure of the cationic bromohexamethylbenzenium σ -adduct, showing the ion pairing to (A) tribromide anion and (B) to hexafluoroantimonate anion.

Charge-transfer photoreactions of arene/bromine complexes

The spectral characteristics of the UV-vis absorption of the arene/ Br_2 complexes [as described in eqn. (4)] suggested the possibility of their photoactivation by the deliberate irradiation of the charge-transfer band.³⁶ For the benzene complex, the charge-transfer band ($h\nu_{\text{CT}} = 285 \text{ nm}$) occurs in a well-defined (UV) window between $\lambda = 275$ and 350 nm (see Fig. 1), which was well suited for the filter combination we prepared to only allow transmission of light with $280 < \lambda < 350 \text{ nm}$ —hereinafter referred to as $\lambda_{\text{exc}} = 320 \text{ nm}$ (see Experimental).

Benzene.

The specific irradiation ($\lambda_{\text{exc}} = 320 \text{ nm}$) of the charge-transfer absorption band of a crystalline sample of $[\text{C}_6\text{H}_6, \text{Br}_2]$ complex at $-78 \text{ }^\circ\text{C}$ for 6 h led to a 0.10% conversion to bromobenzene that was uncontaminated by other by-products. However, the dark control carried out in a side-by-side experiment led to 0.08% bromobenzene. Moreover, when an equimolar (liquid) mixture of neat benzene and bromine was similarly irradiated at $0 \text{ }^\circ\text{C}$ (6 h), it resulted in a 5% conversion to bromobenzene; at $25 \text{ }^\circ\text{C}$ (6 h) conversion was 12%. However, both of these were close to the bromobenzene conversion rates of 4.5% at $0 \text{ }^\circ\text{C}$ and 11% at $25 \text{ }^\circ\text{C}$ in the dark control for the same period of time (*vide supra*).

Toluene.

An equimolar mixture of neat toluene and dibromine cooled at $-78 \text{ }^\circ\text{C}$ as red-brown crystals was irradiated with $\lambda_{\text{exc}} = 320 \text{ nm}$ for 6 h. Workup of the partially converted reaction mixture resulted in a mixture *ortho*-

and *para*-bromotoluenes in 5% and 14%, respectively. However, the dark control resulted in *ortho*- and *para*-bromotoluenes in 5% and 13% yields, respectively (Table 3). When an equimolar mixture of toluene and bromine was cooled to only $-65\text{ }^{\circ}\text{C}$, it remained as a clear brown liquid. Irradiation at λ_{exc} for 6 h led to a mixture of *ortho*- and *para*-bromotoluenes in 9% and 25% yields, respectively, together with traces (0.1%) of benzyl bromide.³³ When compared to the thermal control (see Table 3), the slightly enhanced yields of *ortho*- and *para*-bromotoluenes were 1.6% and 3.0%. Although such conversions were low, they could be carried out reproducibly (within $\pm 1\%$). Considering the experimental difficulty of carrying out such low-temperature photoirradiations, we consider these experiments to be indicative of the inefficient charge-transfer photoactivation of the $[\text{ArH}, \text{Br}_2]$ complexes for electrophilic bromination of both benzene and toluene:³⁶



the quantum yields of which were estimated to be $<10^{-2}$.

Discussion

The successful crystallization and X-ray crystallographic analyses of the metastable bromine complexes of benzene and toluene bear directly on the mechanism of electrophilic aromatic bromination in several important ways.

First, the molecular structure in Fig. 3 shows the preorganized bromine complex of benzene to have the discrete localized structure **B** in which the binding of bromine occurs at a *specific* carbon center of benzene and not as in the delocalized structure **A** originally proposed by Hassel and Strømme.^{12a,37} Such a highly localized structure is strongly reminiscent of the transition state for electrophilic bromination. Yet it is formed in a rapid pre-equilibrium step (with essentially no energy barrier). The dibromine moiety remains largely intact (with only a slight elongation of the Br–Br bond) in the pre-reactive benzene complex (structure **B**). Moreover, the rather close bromine proximity to the benzene chromophore at an intermolecular distance of $D = 3.15\text{ \AA}$ derives from charge-transfer forces that are sufficient to bind the donor/acceptor pair at a separation $\sim 0.4\text{ \AA}$ closer than that allowed by van der Waals contacts.¹⁸ Such a significant charge-transfer interaction is even more clearly shown in the bromine complexation to toluene. Thus, the molecular structure in Fig. 4 readily shows bromine to gravitate specifically to the electron-rich *ortho* and *para* carbons. It is singularly notable that the dibromine is poised over only those carbon centers in the pre-reactive toluene complex that are expected to lead to the transition state for the preferential *ortho*- and *para*-brominations. In the benzene complex, a pair of dibromines coordinates each benzene ring from opposite sides in the *meta* positions. Otherwise there is no obvious steric reason to favor such a coordination, but the *meta* positions are known to be relatively more electron-rich in arenes with acceptor substituents. Despite the quasi-chain structures of the crystalline $[\text{C}_6\text{H}_6, \text{Br}_2]$ and $[\text{CH}_3\text{C}_6\text{H}_5, \text{Br}_2]$ complexes, there is no doubt that their charge-transfer character derives from discrete intermolecular (1:1) interactions of Br_2 with benzene (and toluene).

Second, the availability of the crystalline charge-transfer complex forms the topochemical basis¹⁷ for the direct (pairwise) interaction of the arene donor and the bromine acceptor in the absence of diffusion. As such, the bromination results in Tables 2 and 3 (showing exceptionally high solid-state reactivity relative to that in solution) prove that electrophilic aromatic bromination of benzene and toluene proceeds *via* the corresponding charge-transfer complex as described in eqn. (3).³⁸ Thus, the complex is not merely an innocent bystander in the bromination process [as suggested in eqn. (2)].

Third, the subsequent steps leading to the electrophilic bromination process are also fairly clear but more difficult to prove unambiguously. Thus, the observation of the bromoarenium σ -adduct ion pair from

hexamethylbenzene and dibromine [eqn. (8)], together with the molecular structures in Fig. 3 and 4, suggests that the bromine attachment coincides with the collapse of the charge-transfer complex:



Such an attachment to the fully-substituted hexamethylbenzene donor is reversible [eqn. (8)].³⁹ However, when the point of attachment occurs at an unsubstituted carbon center (as in benzene or toluene) the subsequent rapid loss of the α -proton renders the interchange effectively irreversible.⁴⁰ Thus, the composite of the molecular structures in Fig. 3 and 5 represents a close-to-ideal transformation adhering to the principle of least motion.^{40d}

Since the transfer of Br^+ in eqn. (10) is most likely to constitute the rate-limiting step, let us consider what the electronic character of the prereactive arene/bromine complex reveals about the activation process for electrophilic bromination. According to Mulliken,³¹⁵ the characteristic new absorption bands in Fig. 1 and 2 derive from the ground-state polarization of the weak $[\text{ArH}, \text{Br}_2]$ complex that leads to charge-transfer upon the absorption of light:⁴¹



Such an electronic (nonadiabatic) transition to the dative state $[\text{ArH}^{\cdot+}, \text{Br}_2^{\cdot-}]$ in eqn. (11) corresponds to the (electron) depopulation of the arene HOMO at the expense of the bromine LUMO, and the resultant destabilization of both the donor and the acceptor moieties.⁴² It is thus particularly noteworthy that such an electronic transition ($h\nu_{\text{CT}}$) has been found to correlate linearly with the activation energy ($\log k_{\text{Br}}$) for electrophilic bromination of a wide series of aromatic donors:¹⁸

$$\log k_{\text{Br}} = \alpha h\nu_{\text{CT}} + \text{constant} \quad (12)$$

Indeed, the direct relationship [expressed by eqn. (12) and illustrated in Fig. 6] indicates that those electronic factors leading to the charge-transfer excited state of the $[\text{ArH}, \text{Br}_2]$ complex and to the transition state $[\text{ArH} \cdots \text{Br}_2]^{\ddagger}$ for electrophilic aromatic substitution are very closely related.⁴³ The *direct* relationship between them is difficult to establish experimentally since the photo-excitation represents a nonadiabatic (vertical) process whereas the thermal activation is adiabatic and accompanied by solvation changes.⁴⁴ Nonetheless, the direct photoexcitation of $[\text{ArH}, \text{Br}_2]$ complexes according to eqn. (9) points to the dative ion-radical pair as the reactive intermediate:



However, its rapid deactivation by back electron transfer (k_{BET}) expectedly leads to an inefficient photoprocess, owing to the highly exergonic driving force for relaxation back to the charge-transfer complex relative to the mesolytic dissociation of $\text{Br}_2^{\cdot-}$, which is relatively slow.^{45,46} We believe that the predominant thermal process for electrophilic aromatic brominations also follows an analogous (adiabatic) pathway,⁴⁷ but the final mechanistic proof must await more definitive (time-resolved spectroscopic) studies^{36,48} on the temporal behavior of the charge-transfer ion pair $[\text{C}_6\text{H}_6^{\cdot+}, \text{Br}_2^{\cdot-}]$.

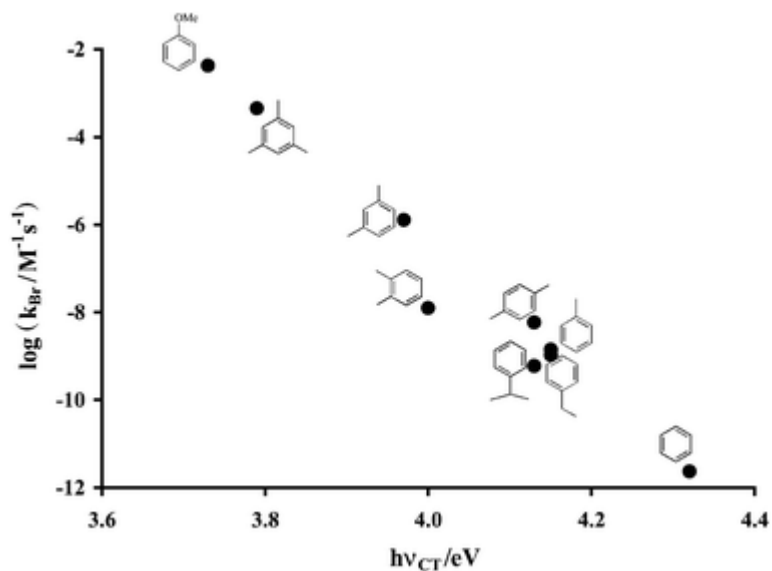

Fig. 6 Linear correlation of the rate ($\log k_{\text{Br}}$) of electrophilic aromatic bromination with the charge-transfer transition energy ($h\nu_{\text{CT}}$) of the bromine complexes with various arene donors (as identified).¹⁸

Conclusions

The metastable (1:1) bromine complexes of benzene (structure **B**) and of toluene are established as the critical pre-reactive intermediates in electrophilic bromination according to mechanistic eqn. (3). Its subsequent (rate-controlling) transformation to the bromoarene σ -adduct (*i.e.*, Wheland intermediate) in eqn. (10) evokes the considerable, if not complete, charge-transfer character established by the correlation in Fig. 6. As such, the dative ion pair $[\text{ArH}^+, \text{Br}_2^-]$ is the best (valence-bond) representation of the rate-limiting transition state.^{43a}

Experimental

Materials

Benzene (EM Science, Merck) and toluene (EM Science, Merck) were purified by repeated shaking with successive portions of cold concentrated H_2SO_4 until the acidic layer was colorless. The aromatic layer was washed with water, aqueous NaHCO_3 , followed by several washings with water, and dried over CaCl_2 . The arene was then refluxed (~ 9 h) and distilled from sodium under an argon atmosphere and stored in Schlenk flasks under argon. Hexamethylbenzene (Aldrich) was purified by recrystallization from absolute ethanol. Bromine (EM Science, Merck) was initially washed by shaking with several portions of H_2SO_4 and it was then refluxed (~ 4 h) over solid KBr and distilled. Predistilled bromine was refluxed (~ 9 h) over P_2O_5 and distilled under an argon atmosphere and stored in flasks equipped with Schlenk adapters under an argon atmosphere. All-glass syringes with Teflon needles or Teflon cannulas (without any steel elements) were used for all operations with bromine. Dichloromethane (EM Science, Merck) and carbon tetrachloride (Aldrich) were repeatedly stirred with H_2SO_4 , until the acidic layer was colorless. After separation, the organic layer was washed with water, aqueous NaHCO_3 , water, and dried over CaCl_2 . The solvent was refluxed (~ 9 h) and distilled from P_2O_5 under an argon atmosphere and it was again refluxed (~ 9 h) and distilled from CaH_2 under an argon atmosphere. Dichloromethane and carbon tetrachloride were stored in Schlenk flasks equipped with Teflon valves fitted with Viton O-rings under an argon atmosphere. Authentic samples of bromobenzene, *ortho*- and *para*-bromotoluene, and benzyl bromide for comparison with the products of photo- and thermo- reactions were from Aldrich.

General

The X-ray crystallographic analyses were carried out with a Siemens–Bruker SMART diffractometer (λ MoK α = 0.71073 Å) equipped with a 1K CCD detector and an LT-2 low-temperature device. Gas chromatography was performed on a Hewlett–Packard 5890A gas chromatograph equipped with a HP 3392 integrator. Gas chromatography-mass spectrometry analyses were carried out on a Hewlett–Packard 5890 gas chromatograph interfaced to a HP 5970 mass spectrometer (EI, 70 eV). ^1H NMR spectra were recorded with a General Electric QE-300 NMR spectrometer. UV-vis absorption spectra were recorded on a Hewlett–Packard 8453 diode-array spectrometer.

The mixtures obtained from the thermal and photo transformations were dissolved in chloroform and the products (bromobenzene, *ortho*- and *para*-bromotoluenes and benzyl bromide) were identified by GC-MS analysis by comparison of their retention parameters and mass-spectral checking patterns with authentic samples, and with the aid of NMR ^1H spectroscopy. Yield of the products was quantified by gas chromatography using the internal standard method.⁴⁹

Measurement of the charge-transfer spectra of $[\text{ArH},\text{Br}_2]$ complexes

In a 1 cm quartz cuvette under an argon atmosphere, the pure arene (benzene or toluene) was incrementally added to a solution of 0.005 M bromine in carbon tetrachloride so that the bromine:arene ratio was increasing from 1:1 to 1:40. The growth of the charge-transfer band was observed at $\lambda_{\text{max}} = 285$ nm for the benzene/bromine complex and at 295 nm for the toluene/bromine complex (see Fig. 1 and 2). In the case of toluene, each spectral measurement was carried out with fresh portions of the bromine solution, owing to the extreme sensitivity of the toluene/bromine mixture under the spectral conditions (to interference from free-radical chain reactions).

In situ Crystallization of the bromine complexes of benzene and toluene

Equimolar amounts of benzene and dibromine were mixed (with the aid of a glass microsyringe attached to a Teflon needle) at +5 °C under an argon atmosphere and kept at 0 °C. Small amounts of the mixture were transferred into glass capillaries ($d = 0.4$ mm) and the contents of the capillaries frozen. The sealed capillary was attached (with wax) to a hollow copper pin, leaving a ~ 7 mm tip exposed. The pin was mounted onto the diffractometer equipped with an LT-2 low temperature device. The capillary was placed at an angle of $\chi = 54^\circ$ under the vertically oriented cooling nozzle, so that the exposed part of the capillary and the pin tip were both positioned well within the laminar flow of nitrogen. The brown color of the crystal was almost indistinguishable from the color of the residual liquid, and its formation and growth were continuously monitored under a polarizing microscope. The initial crystal showed very poor diffraction (similar to the earlier description by Hassel and Strømme¹²). However, as the temperature was gradually decreased through -70 °C, the crystal exhibited a phase transition, but only a slow cooling rate (~ 1 °C min^{-1}) induced a single-crystal-to-single-crystal phase transformation. The resulting bright orange crystal (although cracked and surrounded by smaller satellites) was in a trigonal space group (as opposed to the monoclinic modification studied by Hassel and Strømme¹² at -40 to -50 °C), but it showed a bright high-angle diffraction pattern of regular quality at -150 °C.

The crystallization of the toluene complex was in many details similar to that for the benzene complex. Crystals grown from an equimolar mixture at higher than -70 °C were brown and exhibited extremely poor diffraction—much like the higher-temperature crystalline modification of the benzene/dibromine complex. Below -70 °C, the color of the crystals changed to bright orange and the diffraction intensity increased dramatically (in a manner similar to the transformation observed for the benzene analog). To grow a single crystal of the toluene/dibromine complex, we employed a 2:1 molar ratio of toluene and dibromine. The resulting brown liquid began to crystallize below -70 °C (*i.e.*, below the transformation point of the 1:1 mixture) to produce

bright orange crystals. After some manual local warming, all but one crystal was suppressed in the capillary. The single crystal consisted of a bright orange prism positioned along the capillary axis.

X-Ray crystal structure analysis of the arene/dibromine complexes

The diffraction data were collected at $-150\text{ }^{\circ}\text{C}$. The data were corrected for absorption and other effects using the SADABS program.⁵⁰ The structures were solved using direct methods⁵¹ and refined on F^2 by a least-squares procedure.⁵²

CCDC reference numbers 162148 and 162149. See <http://www.rsc.org/suppdata/nj/b1/b110169m/> for crystallographic data in CIF or other electronic format.

Benzene/dibromine complex.

Formula $\text{C}_6\text{H}_6\text{Br}_2$ ($M = 237.93$); trigonal, space group $P3_22_12$; $a = b = 8.721(2)$, $c = 8.701(2)$ Å, $U = 573.1(2)$ Å³, $Z = 3$; $D_{\text{calc}} = 2.068\text{ g cm}^{-3}$, $\mu(\text{MoK}\alpha) = 105.1\text{ cm}^{-1}$; 7294 reflections were collected over a reciprocal hemisphere ($\theta_{\text{max}} = 29^{\circ}$) of which 605 reflections ($R_{\text{int}} = 0.048$) were symmetrically non-equivalent. Bromine atoms were refined anisotropically, whereas the carbon atoms and the hydrogens (calculated from a riding geometric model) were refined isotropically. The final discrepancy factors were $R_1 = 0.063$ and $wR_2 = 0.178$ for 549 reflections with $I \geq 2\sigma(I)$. The absolute structure was determined with a Flack parameter of $\chi = -0.1(3)$.

Toluene/dibromine complex.

Formula $\text{C}_7\text{H}_8\text{Br}_2$ ($M = 251.95$); triclinic, space group $P-1$; $a = 5.516(1)$, $b = 11.715(2)$, $c = 13.551(3)$ Å, $\alpha = 79.76(1)$, $\beta = 80.89(1)$, $\gamma = 85.56(1)^{\circ}$, $U = 849.8(3)$ Å³, $Z = 4$; $D_{\text{calc}} = 1.969\text{ g cm}^{-3}$, $\mu(\text{MoK}\alpha) = 94.5\text{ cm}^{-1}$; 19 282 reflections were collected over the reciprocal sphere ($\theta_{\text{max}} = 29^{\circ}$) of which 4356 reflections ($R_{\text{int}} = 0.077$) were symmetrically non-equivalent. All non-hydrogen atoms were refined anisotropically; the hydrogens were positioned using a riding and rotating geometric model and refined isotropically. The final discrepancy factors were $R_1 = 0.039$ and $wR_2 = 0.080$ for 3051 reflections with $I \geq 2\sigma(I)$.

Bromohexamethylbenzenium tribromide (σ -complex) as the tris(dibromine) solvate.

Formula $\text{C}_{12}\text{H}_{18}\text{Br}_{10}$ ($M = 961.36$); monoclinic (regular twin), space group $P2_1/c$; $a = 8.7047(4)$, $b = 17.9315(8)$, $c = 15.4610(7)$ Å, $\beta = 90.078(2)^{\circ}$, $U = 2413.3(2)$ Å³, $Z = 4$; $D_{\text{calc}} = 2.646\text{ g cm}^{-3}$, $\mu(\text{MoK}\alpha) = 166.0\text{ cm}^{-1}$; 19 084 reflections were collected over the reciprocal sphere ($\theta_{\text{max}} = 35^{\circ}$) of which 9809 reflections ($R_{\text{int}} = 0.055$) were non-equivalent. All non-hydrogen atoms were refined anisotropically; the hydrogens were positioned using a riding and rotating geometric model and refined isotropically. The final discrepancy factors were $R_1 = 0.071$ and $wR_2 = 0.1568$ for 6223 reflections with $I \geq 2\sigma(I)$.

Bromohexamethylbenzenium hexafluoroantimonate (σ -complex).

Formula $\text{C}_{12}\text{H}_{18}\text{BrF}_6\text{Sb}$ ($M = 477.92$); monoclinic, space group $P2_1/n$; $a = 7.0691(3)$, $b = 11.0782(5)$, $c = 19.5085(9)$ Å, $\beta = 97.180(1)^{\circ}$, $U = 1515.8(1)$ Å³, $Z = 4$; $D_{\text{calc}} = 2.094\text{ g cm}^{-3}$, $\mu(\text{MoK}\alpha) = 45.1\text{ cm}^{-1}$; 18705 reflections were collected over the reciprocal sphere ($\theta_{\text{max}} = 35^{\circ}$) of which 6610 reflections ($R_{\text{int}} = 0.025$) were non-equivalent. All non-hydrogen atoms were refined anisotropically; the hydrogens were positioned using a riding and rotating geometric model and refined isotropically. The final discrepancy factors were $R_1 = 0.025$ and $wR_2 = 0.055$ for 5641 reflections with $I \geq 2\sigma(I)$.

Thermal transformation of the bromine complexes of benzene and toluene

Equimolar mixtures of bromine (0.1 ml, 2 mmol) and arene [benzene (0.17 ml, 2 mmol) or toluene (0.2 ml, 2 mmol)] were prepared in glass tubes and were kept in the dark at different temperatures during 3 or 6 h (see [Tables 2 and 3](#)) in a dry ice–methanol bath. The reaction mixtures were analyzed as described above.

Charge-transfer photoexcitation of bromine complexes of benzene and toluene

Filter for the isolation of UV light for the specific irradiation of the charge-transfer band of arene/bromine complexes.

A medium-pressure mercury lamp (500 W) was used for the photoirradiation. For the isolation of UV light from the medium-pressure mercury lamp in the region of the charge-transfer band of arene/bromine complexes, we used the combination of a colored glass filter UG-5 (Oriel Instruments) and filter solutions consisting of: 1 M solution of CoSO_4 in 5% aqueous H_2SO_4 ; 2 M solution of NiSO_4 and 0.05 M solution of CuSO_4 in 5% aqueous H_2SO_4 ; and 0.05 M solution of Br_2 in CCl_4 in quartz cuvettes. This filter combination had a transmittance from 280 nm to 350 nm with a maximum at 320 nm (for the transmittance characteristics, see the ESI).

Charge-transfer photoirradiation of the benzene/bromine charge-transfer complex as a fluid mixture of neat compounds.

An equimolar mixture of bromine (0.1 ml, 2 mmol) and benzene (0.17 ml, 2 mmol) was prepared in a 1 mm quartz cuvette fitted with a Schlenk adapter under an argon atmosphere at room temperature. The cuvette was placed in a Dewar equipped with quartz windows and it was irradiated with UV light from a medium-pressure mercury lamp at either 0 °C (ice–water bath) or at room temperature (see Results) under an argon atmosphere for 6 h. UV light was focused through an aqueous IR filter and the CT-band isolation filter (see above). As the thermal control, the same mixture was placed in glass tube wrapped with aluminum foil and the tube was kept in the same Dewar (to ensure the same time for the photoreaction). After reaction, the mixtures were analyzed as described above.

Charge-transfer photoirradiation of toluene/bromine charge-transfer complex as a fluid mixture of neat compounds.

Bromine (0.1 ml, 2 mmol) was added to toluene (0.2 ml, 2 mmol) cooled to –78 °C in a 1 mm quartz cuvette fitted with a Schlenk adapter under an argon atmosphere. The mixture was slightly warmed for homogenization and the cuvette was placed in the Dewar with quartz windows (dry ice–methanol bath with temperature –65 °C). The liquid mixture was irradiated with UV light from a medium pressure mercury lamp (see above) at –65 °C under an argon atmosphere for 6 h. The equivalent thermal control was placed in a glass tube wrapped with aluminum foil and the tube was kept in the same Dewar for the same period. After reaction, the mixtures were analyzed as described above.

Procedure for the charge-transfer irradiation of bromine complexes with benzene and toluene in the solid state.

The solid complex, as an equimolar mixture of bromine (0.1 ml, 2 mmol) and arene [benzene (0.17 ml, 2 mmol) or toluene (0.2 ml, 2 mmol)], was irradiated at the CT band for 6 h in a 1 mm quartz cuvette under an argon atmosphere with the apparatus described above, in a Dewar with quartz windows at –78 °C (dry ice–methanol bath). The dark thermal control was carried out in a glass tube wrapped with aluminum foil, which was placed in the same Dewar. After reaction, the mixtures were dissolved in chloroform and the products analyzed by standard GC-MS methods. The Quantum Yields of photoreaction products were measured with the aid of a medium-pressure (500 W) mercury lamp. The intensity of the lamp was determined at $\lambda = 313$ nm with a freshly prepared potassium ferrioxalate actinometer solution,⁵³ under the same conditions as used for the photoreactions of bromine/arene complexes (filters, apparatus).

Acknowledgements

We thank a helpful reviewer for insightful comments/corrections of the manuscript, and the National Scientific Foundation and R. A. Welch Foundation for financial support.

References

- ¹H. A. Benesi and J. J. Hildebrand, *J. Am. Chem. Soc.*, 1949, **71**, 2703 .
- ²(a) R. M. Keefer and L. J. Andrews, *J. Am. Chem. Soc.*, 1950, **72**, 4677 ; (b) For a review see: L. J. Andrews and R. M. Keefer, *Molecular Complexes in Organic Chemistry*, Holden-Day, San Francisco, 1964 .
- ³R. S. Mulliken, *J. Am. Chem. Soc.*, 1950, **72**, 600 .
- ⁴(a) R. Foster, *Organic Charge-Transfer Complexes*, Academic, New York, 1969 ; (b) G. Briegleb, *Elektronen Donor-Acceptor Komplexe*, Springer Verlag, Berlin, 1973 .
- ⁵(a) *Molecular Interactions. From van der Waals to Strongly Bound Complexes*, ed. S. Scheiner, Wiley, New York, 1997 ; (b) P. Hobza and R. Zahradnik, *Intermolecular Complexes*, Elsevier, New York, 1988 ; (c) H. Ratajczak, W. J. Orville-Thomas, *Molecular Interactions*, Wiley, New York, 1980–82, vol. 1–3, EDA complexes are observed variously in the gas phase, rare-gas matrix, solution, or the crystalline solid state .
- ⁶See also: (a) J. Collin and L. D'Or, *J. Chem. Phys.*, 1955, **23**, 397 ; (b) H. B. Friedrich and W. B. Person, *J. Chem. Phys.*, 1966, **44**, 2161 ; (c) G. DeBoer, J. W. Burnet, A. Fujimoto and M. A. Young, *J. Phys. Chem.*, 1996, **100**, 14882 ; (d) P. Y. Cheng, D. Zhong and A. H. Zewail, *J. Chem. Phys.*, 1996, **105**, 6216 ; (e) J. T. Su and A. H. Zewail, *J. Phys. Chem. A*, 1998, **102**, 4082 .
- ⁷E. M. Kosower, *Prog. Phys. Org. Chem.*, 1965, **3**, 81 .
- ⁸A. K. Colter and M. R. J. Dack, in *Molecular Complexes*, ed. R. Foster, Crane, Russak & Co., New York, 1973, vol. 1, ch. 6, p. 301 and 1974, vol. 2, ch. 1, p. 1.
- ⁹(a) F. C. Grozema, R. W. J. Zijlstra, M. Swart and P. T. Van Duijhen, *Int. J. Quantum Chem.*, 1999, **75**, 709 ; (b) A. M. Mebel, H. L. Lin and S. H. Lin, *Int. J. Quantum Chem.*, 1999, **72**, 307 .
- ¹⁰(a) H. Bai and B. S. Ault, *J. Phys. Chem.*, 1990, **94**, 199 ; (b) E. E. Ferguson, *J. Chem. Phys.*, 1956, **25**, 577 ; (c) L. Fredin and B. Nelander, *J. Am. Chem. Soc.*, 1974, **96**, 1672 ; (d) S. A. Cooke, C. M. Evans, J. H. Holloway and A. C. Legon, *J. Chem. Soc., Faraday Trans.*, 1998, **94**, 2295 ; (e) L. Fredin and B. Nelander, *Mol. Phys.*, 1974, **27**, 885 ; (f) W. B. Person, C. F. Cook and H. B. Friedrich, *J. Chem. Phys.*, 1967, **46**, 2521 .
- ¹¹(a) S. S. C. Ammal, S. P. Ananthavel, P. Venuvanalingam and M. S. Hegde, *J. Phys. Chem. A*, 1998, **102**, 532 ; (b) A. Matsuzawa and Y. Osamura, *Bull. Chem. Soc. Jpn.*, 1997, **70**, 1531 However, see: (c) G. Milano, G. Guerra and L. Cavallo, *Eur. J. Inorg. Chem.*, 1998, 1513 ; (d) E. Kochanski and J. Prissette, *Nouv. J. Chem.*, 1980, **4**, 509 ; (e) I. Jano, *Theor. Chim. Acta*, 1985, **66**, 341 ; (f) E. G. Cook and J. C. Shug, *J. Chem. Phys.*, 1970, **53**, 723.
- ¹²(a) O. Hassel and K. O. Strømme, *Acta Chem. Scand.*, 1958, **12**, 1146 See also (b) O. Hassel, *Mol. Phys.*, 1958, **1**, 241 ; (c) O. Hassel and C. Rømming, *Quart. Rev.*, 1962, **16**, 1 ; (d) O. Hassel and K. O. Strømme, *Acta Chem. Scand.*, 1959, **13**, 1781 .
- ¹³It is important to pay tribute (some 40 years later) to the unprecedented (experimental) achievement of Hassel and Strømme in obtaining single crystals of such weak (low-melting) unstable complexes for X-ray crystallographic analysis.
- ¹⁴A. Bondi, *J. Phys. Chem.*, 1964, **68**, 441.
- ¹⁵(a) R. S. Mulliken, *J. Am. Chem. Soc.*, 1952, **74**, 811 ; (b) R. S. Mulliken and W. B. Person, *Molecular Complexes. A Lecture and Reprint Volume*, Wiley, New York, 1969 .

- ¹⁶(a) In this temperature range (from -40 to -50 °C), significant thermal motion caused a weak diffraction pattern and high-angle reflections were absent. [In our repetition of this experiment we also observed only very weak diffraction up to $\theta < 15^\circ$ owing to large thermal motion in the crystal.] As a result of such insufficient diffraction data, Hassel and Strømme^{12a} were unable to definitively assign the space group to either $C2/m$ (centrosymmetric) or $C2$ and Cm (noncentrosymmetric). They arbitrarily chose $C2/m$ and the centrosymmetric structure **A**, although they recognized that some other (unsymmetrical) structures such as **B** (*vide infra*, with 6-fold disorder) were also possible. Nevertheless, in their subsequent papers^{12b-d} Hassel and Strømme put forward structure **A** as the true one (which has been widely accepted by others) despite severe discrepancies in the infrared (spectroscopic) data.¹⁰ Recent theoretical calculations have also cast doubt on the validity of the symmetric structure **A**.^{9,11}; (b) Hassel and Strømme¹² chose a monoclinic space group for the $[C_6H_6, Br_2]$ complex at -40 to -50 °C (*vide supra*), whereas the trigonal modification predominates below -70 °C (*vide infra*). Crystallographically, except for disorder and symmetry patterns, these two modifications differ only by a mere shift of donor/acceptor chains relative to each other.
- ¹⁷For the topochemical control of solid-state reactions, see: (a) M. D. Cohen, G. M. J. Schmidt and F. I. Sonntag, *J. Chem. Soc.*, 1964, 2000 ; (b) G. M. J. Schmidt, *Pure Appl. Chem.*, 1971, **27**, 647 ; (c) T. Y. Fu, Z. Liu, J. R. Scheffer and J. Trotter, *J. Am. Chem. Soc.*, 1993, **115**, 12 202 ; (d) V. Enkelmann, G. Wegner, K. Novak and K. B. Wagener, *J. Am. Chem. Soc.*, 1993, **115**, 10 390 ; (e) H. E. Zimmerman and M. J. Zuraw, *J. Am. Chem. Soc.*, 1989, **111**, 7974 ; (f) J. H. Kim, S. V. Lindeman and J. K. Kochi, *J. Am. Chem. Soc.*, 2001, **123**, 4951 .
- ¹⁸S. Fukuzumi and J. K. Kochi, *J. Am. Chem. Soc.*, 1982, **104**, 7599 .
- ¹⁹S. Fukuzumi and J. K. Kochi, *J. Org. Chem.*, 1981, **46**, 4116 See also [ref. 41](#).
- ²⁰This procedure followed the pioneering work of Hassel and coworkers.¹² For a preliminary communication, see: A. V. Vasilyev, S. V. Lindeman and J. K. Kochi, *Chem. Commun.*, 2001, 909 .
- ²¹For a discussion of this point, see: (a) S. M. Hubig, S. V. Lindeman and J. K. Kochi, *Coord. Chem. Rev.*, 2000, **200–202**, 831 See also (b) P. Le Maguères, S. V. Lindeman and J. K. Kochi, *Organometallics*, 2001, **20**, 115 ; (c) P. Le Maguères, S. V. Lindeman and J. K. Kochi, *J. Chem. Soc., Perkin Trans. 2*, 2001, 1180 (a) The descriptor η is the arene hapticity as defined by F. A. Cotton and G. Wilkinson, *Advanced Inorganic Chemistry*, Wiley, New York, 5th edn., 1988, p. 38 ; (b) In structural comparisons discussed hereinafter, for convenience we make no distinction among the various halogens (Cl_2 , Br_2 or I_2).
- ²³According to Mulliken,^{3,15} the dative contribution from $[Br_2^-, C_6H_6^+]$ plays a role in the noncovalent interaction. As such, for charge-transfer complexes the intermolecular contraction is largely due to the Coulombic and dispersion forces. See also H. O. Hooper, *J. Chem. Phys.*, 1964, **41**, 599 .
- ²⁴O. Hassel and K. O. Strømme, *Acta Chem. Scand.*, 1959, **13**, 275 .
- ²⁵K.-M. Marstokk and K. O. Strømme, *Acta Crystallogr., Sect. B*, 1968, **24**, 713 .
- ²⁶S. Hauge and K. Maroy, *Acta Chem. Scand.*, 1996, **50**, 1095 .
- ²⁷V. Janickis, *Acta Chem. Scand.*, 1999, **53**, 188 .
- ²⁸J. O. Howell, J. M. Goncalves, C. Amatore, L. Klasinc, R. M. Wightman and J. K. Kochi, *J. Am. Chem. Soc.*, 1984, **106**, 3968 .
- ²⁹Cambridge Crystallographic Database, Release Fall 2000.
- ³⁰P. Groth and O. Hassel, *Acta Chem. Scand.*, 1964, **18**, 402 .

- ³¹O. Hassel and J. Hvoslef, *Acta Chem. Scand.*, 1954, **8**, 873 .
- ³²Irradiation of the bromine absorption at $\lambda > 380$ nm leads to homolysis of dibromine, and products of bromine-atom addition to benzene (hexabromocyclohexane, isomeric tribromobenzene, *etc.*) are produced (unpublished results).
- ³³(a) The side-chain bromination of toluene to benzyl bromide was the competing (radical-chain) side reaction that could be controlled by the addition of 2,3-dimethylbutane, as the bromine-atom trap; (b) It is also possible that (some) benzyl bromide was derived from the toluene cation-radical *via* rapid deprotonation to benzyl radical, *etc.*; (c) For the unusual substitution patterns observed in vapor-phase brominations, see: E. C. Kooyman, *Pure Appl. Chem.*, 1963, **7**, 193 .
- ³⁴(a) T. Dhanasekaran, unpublished results. The crystal also contained 3 dibromines as solvates, which are not shown for clarity of the structure in [Fig. 5\(A\)](#); (b) It is important to note the mechanistic equivalency of second-order and third-order kinetics (involving the presence of one and two Br₂ acceptors, respectively, in the rate-limiting transition states) for electrophilic brominations, see: S. Fukuzumi and J. K. Kochi, *Int. J. Chem. Kinet.*, 1983, **15**, 249 .
- ³⁵In [Fig. 5\(A\)](#), the tribromide anion is located from the partially disordered crystal structure of C₆(CH₃)₆Br⁺Br₃⁻ in [ref. 34](#). For the preparation of bromohexamethylbenzenium hexafluoroantimonate, see [ref. 39a](#).
- ³⁶For a related study of electrophilic aromatic substitutions by charge-transfer photoactivation of the charge-transfer complexes, see: (a) J. K. Kochi, *Adv. Phys. Org. Chem.*, 1994, **29**, 185 ; (b) S. M. Hubig and J. K. Kochi, *J. Am. Chem. Soc.*, 2000, **122**, 8279 ; (c) E. K. Kim, T. M. Bockman and J. K. Kochi, *J. Am. Chem. Soc.*, 1993, **115**, 7051 .
- ³⁷(a) If the symmetrical (delocalized) structure **A** actually exists, it must correspond to a single potential energy minimum, and therefore be increasingly populated at lower temperatures, contrary to experiment (*vide infra*). Therefore, the structure **A** observed only at higher temperatures must correspond to the superposition of the (6-fold) disordered structure **B**^{37c}; (b) The fact that there are two crystalline modifications (at -50 and -150 °C corresponding to monoclinic and trigonal space groups)^{16b} does not necessarily point to two separate structures (**A** and **B**) since it is well-known that phase transitions often accompany low-temperature ordering of (disordered) molecular structures. See, for example: H. Cailleau, J.-L. Baudour, J. Meinel, A. Dworkin, F. Moussa and C. M. E. Zeyen, *Faraday Discuss. Chem. Soc.*, 1980, **69**, 7 ; (c) To identify the structural ambiguity, Hassel and Strømme themselves cautiously (and wisely) state:^{12a} “We think that the structure [**A**] derived from our presented material is certainly essentially correct, but hope to be able to supplement the investigation with material obtained at lower temperatures. Such investigations might contribute toward clearing up the question (mentioned above) regarding the potential energy curve of the bromine atom.” Now (40 years later) we herein deliver this low-temperature study that reveals the asymmetric shape of the potential energy curve corresponding to structure **B** that was previously discarded by Hassel and Strømme; (d) See also discussion in [ref. 10f](#); (e) Structure **B** is also favored by high-level theoretical calculations.⁹¹¹
- ³⁸(a) Such a high reactivity of crystalline complexes relative to that in solution occurs despite the somewhat diminished charge-transfer polarization arising from the quasi-chain structure (*vide infra*); (b) This low-temperature observation is tantamount to the classic criterion established

by Kiselev and Miller for the direct involvement of the charge-transfer complex in a chemical transformation. See: V. D. Kiselev and J. G. Miller, *J. Am. Chem. Soc.*, 1975, **97**, 4036 .

³⁹(a) S. M. Hubig and J. K. Kochi, *J. Org. Chem.*, 2000, **65**, 6807 ; (b) Additives such as Lewis acids (that can sequester bromide) will promote the transfer of the bromine cation.

⁴⁰See: (a) P. B. D. de la Mare, *Electrophilic Halogenation*, Cambridge University Press, London, 1976 ; (b) R. O. C. Norman and R. Taylor, *Electrophilic Substitution in Benzenoid Compounds*, Elsevier, New York, 1965 ; (c) L. M. Stock, *Aromatic Substitution Reactions*, Prentice-Hall, Englewood Cliff, NJ, USA, 1968 ; (d) T. H. Lowry and K. S. Richardson, *Mechanism and Theory in Organic Chemistry*, Harper and Row Publishers, New York, 3rd edn., 1987 .

⁴¹According to Mulliken,³¹⁵ $h\nu_{CT}$ corresponds to the electronic excitation from the ground state Ψ_N of the complex to the excited singlet state Ψ_E as described in eqn. (i) and (ii), respectively, where $\psi(DA)$ and $\psi_i(D^+A^-)$ represent the wave functions for the

$$\Psi_N = a\psi(DA) + \sum_i b_i\psi_i(D^+A^-) + \sum_j c_j\psi_j(D^*A) + \sum_k d_k\psi_k(DA^*) \quad (i)$$

and

$$\Psi_E = a^*\psi(DA) + \sum_i b_i^*\psi_i(D^+A^-) + \sum_j c_j^*\psi_j(D^*A) + \sum_k d_k^*\psi_k(DA^*) \quad (ii)$$

no-bond structure and i th zero-order electron transfer singlet state, respectively. $\psi_j(D^*A)$ and $\psi_k(DA^*)$ are the wave functions of the zero-order singlet states corresponding to the j th and k th local excitations within the electron donor and acceptor, respectively. For weak EDA complexes of the type between bromine and arenes, in which the overlap integrals between the donor and acceptor orbitals are small, the transition energy can be expressed (to first order) as

$$h\nu_{CT} = I_D^l - E_A^m + \omega \quad (iii)$$

In eqn. (iii), $h\nu'_{CT}$ corresponds to the transition energy from $\Psi(DA)$ to $\Psi_i(D^+A^-)$, I_D^l is the l th ionization potential of the donor, E_A^m is the m th electron affinity of the acceptor, and ω is the interaction energy between the donor and acceptor moieties in the $\psi_i(D^+A^-)$ state. [For weak complexes of the type described here, the nondiagonal terms in the secular equation derived from eqn. (i) and (ii) are neglected, Ψ_E is given as $\psi_i(D^+A^-)$, $\psi_j(D^*A)$, or $\psi_k(DA^*)$ and the transition energy from $\Psi(DA)$ to $\Psi_i(D^+A^-)$ is given as in eqn. (iii). Thus, any significant deviation from eqn. (iii) owing to the interaction between $\psi(DA)$, $\psi_i(D^+A^-)$, $\psi_j(D^*A)$, and $\psi_k(DA^*)$ in eqn. (i) and (ii) is unlikely for weak complexes. For the nature of Ψ_N in molecular complexes, see: K. Morokuma, *Acc. Chem. Res.*, 1977, 10, 294].

⁴²For a recent review of the enhanced chemical reactivity of donor cation-radicals and acceptor anion-radicals, see: R. Rathore and J. K. Kochi, *Adv. Phys. Org. Chem.*, 2000, **35**, 193 .

⁴³(a) S. Fukuzumi and J. K. Kochi, *J. Am. Chem. Soc.*, 1981, **103**, 7240 ; (b) Thermal electron transfer from electron-rich aromatic donors to Br_2 has been observed by L. Ebersson, M. P. Hartshorn, F. Radner and O. Persson, *Chem. Commun.*, 1996, 215 See also J. K. Kochi, *Tetrahedron Lett.*, 1975, 41 ; (c) See also footnote 34b.

⁴⁴S. Fukuzumi and J. K. Kochi, *Bull. Chem. Soc. Jpn.*, 1983, **56**, 969 .

- ⁴⁵Compare (a) W. A. Chupka, J. Berkowitz and D. Gutman, *J. Chem. Phys.*, 1971, **55**, 2724 ; (b) S. D. Malone and J. F. Endicot, *J. Phys. Chem.*, 1972, **76**, 2223 ; (c) The formation of the cationic σ -complex in eqn. (13) is likely to proceed *via* prior mesolytic cleavage of Br_2^- followed by the very fast collapse of the caged (arene cation radical/bromine atom) pair,⁴⁶ that is:

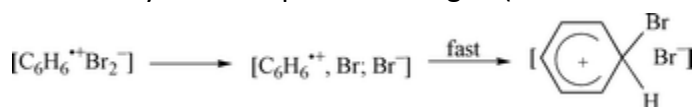

This is followed by the rapid (irreversible) deprotonation of the σ -adduct by the accompanying bromide. The direct collapse of the ion pair to a hypervalent adduct is also possible.

- ⁴⁶The amelioration of such retarding factors, which result in inefficient photoprocesses for $[\text{C}_6\text{H}_6, \text{Br}_2]$, has been shown to lead then to a variety of other (efficient) charge-transfer photoprocesses with other types of donor/acceptor pairs.⁴²
- ⁴⁷For experimental support of such a (thermal) electron-transfer process, see: L. Ebersson, M. P. Hartshorn, F. Radner and O. Persson, *J. Chem. Soc., Perkin Trans. 2*, 1998, 59 .
- ⁴⁸For an example of a rapid rate of such a homolytic (radical-radical) combination, see: E. K. Kim, T. M. Bockman, J. K. Kochi, *J. Am. Chem. Soc.*, 1993, **115**, 3091 in the case of the coupling of $(\text{ArH}^{\cdot+} + \text{NO}_2^-)$ pertinent to the photoactivation of electrophilic aromatic nitration .
- ⁴⁹J. P. Novak, *Quantitative Analysis by Gas Chromatography*, M. Dekker, New York, 2nd edn., 1988 .
- ⁵⁰G. M. Sheldrick, SADABS Bruker–Siemens Area Detector Absorption and Other Corrections, v. 2.03, University of Göttingen, Germany, 2000.
- ⁵¹G. M. Sheldrick, SHELXS 86–Program for Crystal Structure Solutions, University of Göttingen, Germany, 1986.
- ⁵²G. M. Sheldrick, SHELXL 93–Program for Crystal Structure Refinement, University of Göttingen, Germany, 1993 .
- ⁵³J. G. Calvert and J. N. Pitts, *Photochemistry*, Wiley, New York, 1966, pp. 783–786 .

Footnote

† Electronic supplementary information (ESI) available: X-ray crystallographic data for: benzene/bromine charge-transfer complex (Tables S1–S5), toluene/bromine charge-transfer complex (Tables S6–S10), bromohexamethylbenzenium tribromide (σ -complex) as the tris(dibromine) solvate (Tables S11–S15), bromohexamethylbenzenium hexafluoroantimonate (σ -complex) (Tables S16–S20); actual transmittance spectrum of the filter used for the isolation of UV light for the specific irradiation of the charge-transfer band of arene/bromine complexes (Fig. S1); and the detailed structure of the donor/acceptor chains in the crystal structure of the toluene/dibromine charge-transfer complex (Fig. S2). See <http://www.rsc.org/suppdata/nj/b1/b110169m/>