

2002-12-18

Design Guidelines for the use of Curbs and Curb/ Guardrail Combinations Along High-Speed Roadways

Chuck Aldon Plaxico
Worcester Polytechnic Institute

Follow this and additional works at: <https://digitalcommons.wpi.edu/etd-dissertations>

Repository Citation

Plaxico, C. A. (2002). *Design Guidelines for the use of Curbs and Curb/Guardrail Combinations Along High-Speed Roadways*. Retrieved from <https://digitalcommons.wpi.edu/etd-dissertations/466>

This dissertation is brought to you for free and open access by [Digital WPI](#). It has been accepted for inclusion in Doctoral Dissertations (All Dissertations, All Years) by an authorized administrator of Digital WPI. For more information, please contact wpi-etd@wpi.edu.

**DESIGN GUIDELINES FOR THE USE OF CURBS AND CURB/GUARDRAIL
COMBINATIONS ALONG HIGH-SPEED ROADWAYS**

by

Chuck Aldon Plaxico

A Dissertation

Submitted to the Faculty

of the

WORCESTER POLYTECHNIC INSTITUTE

in partial fulfillment of the requirements for the

Degree of Doctor of Philosophy

in

Civil Engineering

by

September 2002

APPROVED:

Dr. Malcolm Ray, Major Advisor
Civil and Environmental Engineering

Dr. Leonard D. Albano, Committee Member
Civil and Environmental Engineering

Dr. Tahar El-Korchi, Committee Member
Civil and Environmental Engineering

Dr. John F. Carney, Committee Member
Provost and Vice President, Academic Affairs

Dr. Joseph R. Rencis, Committee Member
Mechanical Engineering

ABSTRACT

The potential hazard of using curbs on high-speed roadways has been a concern for highway designers for almost half a century. Curbs extend 75-200 mm above the road surface for appreciable distances and are located very near the edge of the traveled way, thus, they constitute a continuous hazard for motorist. Curbs are sometimes used in combination with guardrails or other roadside safety barriers. Full-scale crash testing has demonstrated that inadequate design and placement of these systems can result in vehicles vaulting, underriding or rupturing a strong-post guardrail system though the mechanisms for these failures are not well understood. For these reasons, the use of curbs has generally been discouraged on high-speed roadways. Curbs are often essential, however, because of restricted right-of-way, drainage considerations, access control, delineation and other curb functions. Thus, there is a need for nationally recognized guidelines for the design and use of curbs.

The primary purpose of this study was to develop design guidelines for the use of curbs and curb-barrier combinations on roadways with operating speeds greater than 60 km/hr. The research presented herein identifies common types of curbs that can be used safely and effectively on high-speed roadways and also identifies the proper combination and placement of curbs and barriers that will allow the traffic barriers to safely contain and redirect an impacting vehicle.

Finite element models of curbs and curb-guardrail systems were developed, and the finite element program, LS-DYNA, was used to investigate the event of a vehicle traversing several curb types. Finite element analysis was also used in the analysis of a vehicle impacting a number of curb-guardrail combinations. The results obtained from these analyses were synthesized with the results of previous studies, which involved full-scale crash testing, computer simulation, and other methods. The combined information was then used to develop a set of guidelines for using curbs and curb-barrier combinations on high-speed roadways.

ACKNOWLEDGMENTS

I am indebted to all those who helped make this research possible. I give special thanks to my Advisor, Dr. Malcolm Ray, for his guidance and counsel throughout this research. I have known Dr. Ray for a number of years and have had the opportunity to work with him on numerous research studies in the area of roadside safety. He has been both a mentor and a friend and his tutelage is appreciated.

I would also like to acknowledge the two agencies that funded this research: the National Cooperative Highway Research Program under NCHRP Project 22-17 and the Federal Highway Administration under Project DTFH61-00-X-000114. I would like to extend my gratitude to the members of NCHRP Project 22-17 panel for their extensive comments and advice during this research. I would also like to thank Mr. Martin Hargrave of the Federal Highway Administration who has been instrumental in promoting research in the area of roadside safety and crashworthiness through the Federal Highway Administration's Centers of Excellence program, under which much of this research was sponsored.

Finally, I would like to thank the Texas Transportation Institute and the Midwest Roadside Safety Institute for providing crash test reports and crash test videos which were very helpful in this research.

TABLE OF CONTENTS

ABSTRACT	i
ACKNOWLEDGMENTS	iii
TABLE OF CONTENTS	iv
LIST OF FIGURES	ix
LIST OF TABLES	xxi
LIST OF APPENDICES	xxiv
I. INTRODUCTION	
1.1 Background	1
1.2 Purpose and Applicability	9
1.3 Project Objectives	10
II. LITERATURE REVIEW	
2.1 Introduction	11
2.2 Analysis Methods Applied in the Study of Curb Safety	12
2.2.1 <i>Analytical Methods</i>	12
2.2.2 <i>Vehicle Dynamics Codes</i>	15
2.2.3 <i>Full-Scale Crash Testing</i>	16
2.3 Effect of Curbs on Vehicle Stability	18
2.4 Effect of Curbs Installed in Conjunction with Traffic Barriers	31
2.5 Effects of Curb Trip on Vehicle Stability	41
2.6 Synthesis of Literature Review	53
2.7 Summary	62
III RESEARCH APPROACH	

3.1 Introduction	65
3.2 Computer Simulation Methods	66
3.2.1 <i>Vehicle Dynamics Codes</i>	67
3.2.2 <i>Nonlinear, Dynamic Finite Element Codes</i>	69
3.2.3 <i>Validation of Computer Models</i>	73
3.2.4 <i>Applicability of FEA to Roadside Barrier Impact Studies</i>	74
3.3 Full-Scale Crash Testing	86
3.4 Parametric Analysis Using Computer Simulation	89
3.5 Summary	93

IV. DEVELOPMENT AND VALIDATION OF A FINITE ELEMENT MODEL OF THE MODIFIED G4(1S) GUARDRAIL WITH WOOD BLOCKOUTS

4.1 Introduction	96
4.2 Modeling Methodology	99
4.2.1 <i>W-Beam Rail</i>	100
<u>Geometry Modeling</u>	100
<u>Material Modeling</u>	101
<u>Element Formulation</u>	104
<u>Strain-Rate Effects</u>	105
<u>Application</u>	106
4.2.2 <i>W-Beam Splice Connection</i>	109
4.2.3 <i>Guardrail Posts</i>	121
<u>Mesh Sensitivity Study</u>	125
<u>Element Formulation</u>	126
<u>Through Thickness Integration Points</u>	127
4.2.4 <i>Post and Soil Interaction</i>	128
4.2.5 <i>W-Beam Rail to Post Connections</i>	137
<u>Laboratory Tests</u>	141
<u>Finite Element Model</u>	146
4.2.6 <i>Boundary Conditions Simulating Guardrail Anchor System</i>	150
4.3 Finite Element Model of a Chevrolet 2500 Pickup Truck	155
4.4 Validation of the Modified G4(1S) Guardrail Model	156
4.4.1 <i>Qualitative Validation</i>	159
<u>Full-Scale Crash Test Summary</u>	160
<u>Finite Element Analysis Summary</u>	161

4.4.2	<i>Quantitative Validation</i>	161
	<u>Test Risk Assessment Program (TRAP) Results</u>	173
	<u>NARD, Analysis of Variance and Geer's Parameters</u>	173
4.5	Summary	175
4.6	Conclusions	178
V.	ASSESSMENT OF VEHICLE-TO-CURB IMPACTS USING FEM	
5.1	Introduction	180
5.2	Parametric Study	181
5.3	Data Collected	183
5.3.1	<i>Bumper Trajectory</i>	184
5.3.2	<i>Vehicle Path</i>	185
5.3.3	<i>Acceleration-Time Histories</i>	187
5.3.4	<i>Yaw-, Pitch- and Roll-Time Histories</i>	188
5.3.5	<i>Sequential Snapshots of Impact Event</i>	188
5.3.6	<i>Test Risk Assessment Program Results</i>	189
5.4	Finite Element Model of Curb and Terrain	189
5.4.1	<i>Results of the Friction Tests</i>	191
5.5	Results of Parametric Study	192
5.5.1	Front Bumper Trajectory	193
	<u>Influence of Lateral Offset Distance</u>	193
	<u>Influence of Impact Conditions</u>	197
	<u>Influence of Curb Shape</u>	197
5.5.2	<i>Vehicle Kinematics and TRAP Results</i>	197
	<u>ASI Values</u>	198
	<u>Roll Angles</u>	199
	<u>Roll Rates</u>	199
	<u>Pitch Angles</u>	202
	<u>Pitch Rates</u>	202
	<u>Yaw Angles</u>	202
	<u>Yaw Rates</u>	204
5.6	Additional Modifications to Vehicle Model and Subsequent Results	204
5.7	Summary	214

VI. VEHICLE IMPACT WITH CURB-AND-GUARDRAIL SYSTEMS	
6.1 Introduction	217
6.2 Parametric Study	218
6.3 Data Collected	223
6.3.1 <i>Sequential Snapshots of Impact Event</i>	223
6.3.2 <i>Acceleration-Time Histories</i>	223
6.3.3 <i>Yaw-, Pitch- and Roll-Time Histories</i>	224
6.3.4 <i>Maximum Tensile Force in W-Beam</i>	224
6.3.5 <i>Test Risk Assessment Program (TRAP) Results</i>	227
6.4 Results	227
6.4.1 <i>Sequential Snapshots of the Impact Event</i>	228
<u>Impact Speed of 70 km/hr and Angle of 25 Degrees</u>	232
<u>Impact Speed of 85 km/hr and Angle of 25 Degrees</u>	233
<u>Impact Speed of 100 km/hr and Angle of 25 Degrees</u>	234
6.4.2 <i>Angular Displacement-Time History Data</i>	236
6.4.3 <i>Tensile Force in W-Beam</i>	240
<u>Impact Speed of 70 km/hr and Angle of 25 Degrees</u>	241
<u>Impact Speed of 85 km/hr and Angle of 25 Degrees</u>	246
<u>Impact Speed of 100 km/hr and Angle of 25 Degrees</u>	247
6.4.4 <i>TRAP Results</i>	248
6.5 Summary	251
VII. SYNTHESIS OF ANALYSIS RESULTS	
7.1 Introduction	283
7.2 Vehicle Curb Traversal Tests and Simulation Results	285
7.2.1 <i>Maximum Roll and Pitch Angles</i>	285
7.2.2 <i>Front Bumper Trajectory</i>	286
7.2.3 <i>Non-Tracking Impact</i>	289
7.3 Curb-Guardrail Tests and Simulation Results	290
7.4 Summary	295
VIII. GUIDELINES FOR CURB TYPE SELECTION	
8.1 Introduction	297
8.2 Guidelines for Using Curbs on High-Speed Roadways	297

8.3 Guidelines for Using Curb-Barrier Combinations on High-Speed Roadways	298
8.3.1 <i>Moderate-Speed Roadways (60-80 km/hr)</i>	299
8.3.2 <i>High-Speed Roadways (over 80 km/hr)</i>	299
IX. SUMMARY AND CONCLUSIONS	
9.1 Introduction	303
9.2 Summary of Previous Research Studies	303
9.3 Summary of Current Research	305
9.4 Future Research	308
X. REFERENCES	307

LIST OF FIGURES

Chapter I

Figure 1.1	Typical AASHTO highway curbs	3
Figure 1.2	Curb and strong-post w-beam guardrail on a 90-km/hr two-lane rural roadway in Maine	5
Figure 1.3	Sloping curb installed flush with a strong-post w-beam guardrail on a 90-km/hr two-lane rural roadway in Maine	9

Chapter II

Figure 2.1	Curb performance characteristics of the Trief and Elsholz Curbs ..	12
Figure 2.2	Vehicle used in Olsen <i>et al</i> study	19
Figure 2.3	Possible trajectory of vehicle bumper relative to typical guardrail height	20
Figure 2.4	AASHTO Type I Curb	27
Figure 2.5	Summary of Test Results for MwRSF Test M06C-1	33
Figure 2.6	Sequential video frames from test NEC-1	36
Figure 2.7	Guardrail terminal damage during test NEC-1	37
Figure 2.8	NCHRP Report 350 Test 3-11 impact with modified G4(1S) guardrail with nested 12-guage w-beams and a 102-mm curb under the rail	39
Figure 2.9	Summary of test results of Test NEC-2 from Polivka <i>et al</i>	40
Figure 2.10	Guardrail/curb installation for TTI test 404201-1	42
Figure 2.11	Guardrail damage in test TTI 404201-1	42
Figure 2.12	Posts split vertically during TTI test 404-1 along pre-existing splits in posts	42
Figure 2.13	Summary of test results of TTI test 404201-1 from Bullard and Menges	44
Figure 2.14	Design parameters for curb impacts as defined by AASHTO	58

Chapter III

Figure 3.1	Impacts of a weak-post w-beam guardrail in Test 3-11 conditions (left) and test 3-10 conditions (right)	75
Figure 3.2	Sequential photographs for TTI test 471470-26 and G4(2W) finite element simulation	78
Figure 3.3	Sequential photographs for TTI test 471470-26 and G4(2W) finite element simulation (overhead view).	79
Figure 3.4	Finite Element Simulation of a 2000P vehicle striking a G4(2W) with a 150-mm high AASHTO type “b” mountable curb	81
Figure 3.5	Sequential photographs of finite element simulations comparing the impact performance of the G4(2W) <u>with</u> and <u>without</u> the AASHTO Type b curb	82
Figure 3.6	Effective plastic strains in the back layer of w-beam in a guardrail splice showing the formation of a plastic hinge (front layer of w-beam is transparent).	85
Figure 3.7	Percent of rollover occurrence by vehicle type and crash severity	91

Chapter IV

Figure 4.1	G4(1S) guardrail system	97
Figure 4.2	Close view of G4(1S) guardrail system	97
Figure 4.3	Modified G4(1S) with routed wood blockouts	98
Figure 4.4	TTI test 405421-1 on the modified G4(1S) with wood blockouts	98
Figure 4.5	Finite element model of modified G4(1S) with wood blockouts	101
Figure 4.6	Drawing of the w-beam cross-section	102
Figure 4.7	Cross-section views of the w-beam and finite element mesh for geometrical comparison	103
Figure 4.8	Finite element mesh of w-beam in impact region of model	103

Figure 4.9	The G4(2W) guardrail installation after test 471470-26 and G4(2W) finite element simulation	108
Figure 4.10	Finite element mesh of w-beam in non-impact region of model . . .	109
Figure 4.11	Guardrail splice connection in the modified G4(1S) guardrail	110
Figure 4.12	Components of the finite element model of a weak-post w-beam guardrail splice used in Ray <i>et al</i>	111
Figure 4.13	Force-displacement graphs from uniaxial tension tests of guardrail splice	114
Figure 4.14	a) initial position of splice prior to start of simulation b) position of splice just after start of simulation due to clamping springs	114
Figure 4.15	Force-deflection relationship of splice connection in the longitudinal direction of w-beam	116
Figure 4.16	Schematic representation of longitudinal spring deflection in splice	117
Figure 4.17	Force-deflection relationship of individual springs in splice	118
Figure 4.18	Force-displacement response of simulated splice connection and laboratory test	119
Figure 4.19	Splice model in the impact region of the guardrail (Model)	120
Figure 4.20	Drawing of the w150x13.5 steel guardrail post.	122
Figure 4.21	Finite element model of guardrail post in impact region (fine mesh)	123
Figure 4.22	Finite element model of guardrail post in non-impact region (coarse mesh)	124
Figure 4.23	Schematic of stress-profile through the thickness of a shell element using three- and five-integration points, respectively	128
Figure 4.24	Schematic drawing of soil-springs attached to guardrail post below grade	131

Figure 4.25	Finite element model used for post-soil model validation	133
Figure 4.26	Results of (a) test WISC-1(65) and (b) finite element simulation . .	134
Figure 4.27	Results of (a) test WISC-3(65) and (b) finite element simulation . .	135
Figure 4.28	Results of (a) test WISC-4(65) and (b) finite element simulation . .	136
Figure 4.29	Results of finite element simulation of post-soil tests	137
Figure 4.30	Bolted connection of w-beam-to-post before and after impact	138
Figure 4.31	Test fixture and specimen used in w-beam/bolt connection tests	142
Figure 4.32	Four load case scenarios investigated in laboratory tests	143
Figure 4.33	Force-deflection results from uniaxial load tests on bolted connection	144
Figure 4.34	Deformed w-beam slots after failure of the bolted connection in each of the load cases	145
Figure 4.35	The finite elements mesh of the bolted connection in each of the three finite element models	148
Figure 4.36	Force-deflection results from F.E. model 1, F.E. model 2 and modified F.E. model 3 compared to test data	149
Figure 4.37	Maximum force required to fail bolted connection in tests and simulations	149
Figure 4.38	Finite element model of anchor system	153
Figure 4.39	Deflection of BCT model due to tensile force F in submodel simulations	154
Figure 4.40	Force-deflection response of anchor model	154
Figure 4.41	Finite element model used in preliminary validation of G4(1S) guardrail model	158

Figure 4.42	Sequential overhead views of impact event - TTI test 405421-1 and F.E. analysis	162
Figure 4.43	Sequential frontal views of impact event - TTI test 405421-1 and F.E. analysis	163
Figure 4.43	(CONTINUED) Sequential frontal views of impact event - TTI test 405421-1 and F.E. analysis	164
Figure 4.44	Sequential oblique views of impact event - TTI test 405421-1 and F.E. analysis	165
Figure 4.44	(CONTINUED) Sequential views of impact event - TTI test 405421-1 and F.E. analysis	166
Figure 4.45	Velocity-Time history trace at C.G. of vehicle for TTI test 405421-1 and F.E. analysis	167
Figure 4.46	Roll angle displacement-time history trace at C.G. of vehicle for TTI test 405421-1 and F.E. analysis	167
Figure 4.47	Pitch angle displacement-time history trace at C.G. of vehicle for TTI test 405421-1 and F.E. analysis	168
Figure 4.48	Yaw angle displacement-time history trace at C.G. of vehicle for TTI test 405421-1 and F.E. analysis	168
Figure 4.49	Longitudinal acceleration at C.G. of vehicle for TTI test 405421-1 and F.E. analysis - data filtered with SAE class 60 filter	169
Figure 4.50	Lateral acceleration at C.G. of vehicle for TTI test 405421-1 and F.E. analysis - data filtered with SAE class 60 filter	169
Figure 4.51	Vertical acceleration of C.G. of vehicle for TTI test 405421-1 and F.E. Analysis-data filtered with SAE class 60 filter	170
Figure 4.52	Guardrail damage and anchor movement from TTI test 405421-1 and F.E. analysis	170
Figure 4.53	Vehicle fixed coordinate reference system	171
 Chapter V		
Figure 5.1	Curb types used in curb study	182

Figure 5.2	Front bumper trajectory plot from F.E. simulation of truck model crossing type B curb at 100 km/hr and 15 degrees	184
Figure 5.3	Overhead view showing front bumper trace from F.E. analysis of truck model crossing type B curb at 100km/hr and 15 degrees	186
Figure 5.4	Vehicle fixed coordinate reference system	188
Figure 5.5	Typical view points for sequential snapshots taken from F.E. analyses	188
Figure 5.6	a. Tow-lane roadway detail with curb and gutter section from The Iowa Department of Transportation’s <u>Road Design Details</u> (4) and b. Cross section profile of roadway used in parametric analysis	190
Figure 5.7	Test setup for measuring friction force between tires and asphalt pavement using a Chevrolet 2500 pickup truck.	191
Figure 5.8	Bumper height vs. lateral distance behind curb for C2500 Pickup crossing 150-mm AASHTO type A curb at 70 km/hr	194
Figure 5.9	Bumper height vs. Lateral distance behind curb for C2500 Pickup crossing 150-mm AASHTO type B curb at a) 70km/hr and b) 100km/hr	194
Figure 5.10	Bumper height vs. lateral distance behind curb for C2500 Pickup crossing 150-mm AASHTO type D curb at a) 70 km/hr and b) 100km/hr	194
Figure 5.11	Bumper height vs. lateral distance behind curb for C2500 Pickup crossing 100-mm AASHTO type C curb at a) 70 km/hr and b) 100km/hr	195
Figure 5.12	Bumper height vx. Lateral distance behind curb for C2500 Pickup crossing 100-mm AASHTO type G curb at a) 70 km/hr and b) 100 km/hr	195
Figure 5.13	Bumper height vs. lateral distance behind curb for C2500 Pickup crossing 100-mm NY curb at a) 70km/hr and b) 100km/hr	195
Figure 5.14	Bumper height vs. lateral distance behind curb for C2500 Pickup crossing each curb type at an angle of 5 degrees a) at 70 km/hr and b) at 100km/hr	196

Figure 5.15	Bumper height vs. lateral distance behind curb for C2500 Pickup crossing each curb type at an angle of 15 degrees a) at 70 km/hr and b) at 100km/hr	196
Figure 5.16	Bumper height vs. lateral distance behind curb for C2500 Pickup crossing each curb type at 25 degrees a) at 70km/hr and b) at 100km/hr.	196
Figure 5.17	ASI vs. impact angle for each curb type from finite element analyses	201
Figure 5.18	ASI vs. impact angle for each curb type from finite element analyses	201
Figure 5.19	Maximum roll, pitch and yaw angle displacements of the pickup versus impact angle	205
Figure 5.20	Maximum roll, pitch and yaw rates of the pickup versus impact angle	206
Figure 5.21	Maximum angular displacements and displacement rates with respect to curb and impact speed	207
Figure 5.22	Test device used for measuring shock absorber properties	209
Figure 5.23	Velocity-time history from shock absorber test	209
Figure 5.24	Force-velocity properties (a) obtained from laboratory tests and (b) laboratory tests compared with manufacturer data	211
Figure 5.25	Roll off drop test comparison for finite element simulations and full-scale tests	212
Figure 5.26	Roll off drop test comparison between C2500 pickup model with modified shock absorber properties and full-scale crash tests	213
Figure 5.27	Front bumper trajectory results from original analysis and analysis involving modified shock absorber properties for the case of the C2500R traversing the 150-mm AASHTO type B curb at 70 km/hr.	214

Chapter VI

Figure 6.1	Curb types used in curb study	219
Figure 6.2	Schematic drawing to identify curb and barrier placement along roadway	220
Figure 6.3	Typical view points for sequential snapshots taken from F.E. analyses	224
Figure 6.4	Schematic view of the finite element model identifying the location at which cross-section force data in the w-beam rail was collected	226
Figure 6.5	F.E. simulation of 2000-kg pickup impacting guardrail with AASHTO type C curb underneath rail	231
Figure 6.6	NCHRP Report 350 Tewt 3-11 impact with modified G4(1S) guardrail with nested 12-guage w-beams and a 102-mm curb under the rail	232
Figure 6.7	Initial roll angle of the vehicle at time of impact with guardrail . . .	238
Figure 6.8	Initial pitch angle of the vehicle at time of impact with guardrail . .	238
Figure 6.9	Initial yaw angle of the vehicle at time of impact with guardrail . .	238
Figure 6.10	Maximum roll angle measured at the center of gravity of the pickup truck model during curb-barrier impact	239
Figure 6.11	Maximum pitch angle measured at the center of gravity of the pickup truck model during curb-barrier impact	239
Figure 6.12	Maximum w-beam rail force in impact region of guardrail and at the upstream anchor for the cases involving C2500 impact at 70 km/hr and 25 degrees with curb at 0-m offset . (A) Maximum tensile force in w-beam and (b) Maximum tensile force in w-beam normalized wrt the force in w-beam under NCHRP Report 350 Test 3-11 impact conditions when curb is not present	243
Figure 6.13	Maximum w-beam rail force in impact region of guardrail and at the upstream anchor for the cases involving C2500 impact at 70 km/hr and 25 degrees with curb at 2.5-m offset . (a) Maximum tensile force in w-beam and (b) Maximum tensile force in w-beam	

	normalized wrt the force in w-beam under NCHRP Report 350 Test 3-11 impact conditions when curb is not present.	243
Figure 6.14	Maximum w-beam rail force in impact region of guardrail and at the upstream anchor for the cases involving C2500 impact at 70 km/hr and 25 degrees with curb at 4.0-m offset . (a) Maximum tensile force in w-beam and (b) Maximum tensile force in w-beam normalized wrt the force in w-beam under NCHRP Report 350 Test 3-11 impact conditions when curb is not present.	244
Figure 6.15	Maximum w-beam rail force in impact region of guardrail and at the upstream anchor for the cases involving C2500 impact at 85 km/hr and 25 degrees with curb at 0.0-m offset . (a) Maximum tensile force in w-beam and (b) Maximum tensile force in w-beam normalized wrt the force in w-beam under NCHRP Report 350 Test 3-11 impact conditions when curb is not present.	244
Figure 6.16	Maximum w-beam rail force in impact region of guardrail and at the upstream anchor for the cases involving C2500 impact at 85 km/hr and 25 degrees with curb at 2.5-m offset . (A) Maximum tensile force in w-beam and (b) Maximum tensile force in w-beam normalized wrt the force in w-beam under NCHRP Report 350 Test 3-11 impact conditions when curb is not present.	245
Figure 6.17	Maximum w-beam rail force in impact region of guardrail and at the upstream anchor for the cases involving C2500 impact at 85 km/hr and 25 degrees with curb at 4.0-m offset . (A) Maximum tensile force in w-beam and (b) Maximum tensile force in w-beam normalized wrt the force in w-beam under NCHRP Report 350 Test 3-11 impact conditions when is not present	245
Figure 6.18	Maximum w-beam rail force in impact region of guardrail and at the upstream anchor for the cases involving C2500 impact at 100 km/hr and 25 degrees with curb at 0-m offset . (A) Maximum tensile force in w-beam and (b) Maximum tensile force in w-beam normalized wrt the force in w-beam under NCHRP Report 350 Test 3-11 impact conditions when curb is not present	246
Figure 6.19	Maximum longitudinal ridedown acceleration at the center of gravity of the pickup truck model during curb-barrier impact	248
Figure 6.20	Maximum 50 ms average longitudinal acceleration at the center of gravity of the pickup truck model during curb-barrier impact . .	249

Figure 6.21	Summary of Analysis Results for C2500 impact with modified G4(1S) and 150-mm AASHTO Type B curb at 70 km/hr and 25 degrees with barrier positioned at 0-m offset from curb	254
Figure 6.22	Summary of Analysis Results for C2500 impact with modified G4(1S) and 100-mm AASHTO Type C curb at 70 km/hr and 25 degrees with barrier positioned at 0-m offset with curb	255
Figure 6.23	Summary of Analysis Results for C2500 impact with modified G4(1S) and 150-mm AASHTO Type D curb at 70 km/hr and 25 degrees with barrier positioned at 0-m offset from curb	256
Figure 6.24	Summary of Analysis Results for C2500 impact with modified G4(1S) and 100-mm New York curb at 70 km/hr and 25 degrees with barrier positioned at 0-m offset from curb	257
Figure 6.25	Summary of Analysis Results for C2500 impact with modified G4(1S) and 150-mm AASHTO Type B curb at 85 km/hr and 25 degrees with barrier positioned at 0-m offset from curb	258
Figure 6.26	Summary of Analysis Results for C2500 impact with modified G4(1S) and 100-mm AASHTO Type C curb at 85 km/hr and 25 degrees with barrier positioned at 0-m offset from curb	259
Figure 6.27	Summary of Analysis Results for C2500 impact with modified G4(1S) and 150-mm AASHTO Type B curb at 100 km/hr and 25 degrees with barrier positioned at 0-m offset from curb	260
Figure 6.28	Summary of Analysis Results for C2500 impact with modified G4(1S) and 100-mm AASHTO Type C curb at 100 km/hr and 25 degrees with barrier positioned at 0-m offset from curb	261
Figure 6.29	Summary of Analysis Results for C2500 impact with modified G4(1S) and 150-mm AASHTO Type D curb at 100 km/hr and 25 degrees with barrier positioned at 0-m offset from curb	262
Figure 6.30	Summary of Analysis Results for C2500 impact with modified G4(1S) and 100-mm AASHTO Type G curb at 100 km/hr and 25 degrees with barrier positioned at 0-m offset from curb	263
Figure 6-31	Summary of Analysis Results for C2500 impact with modified G4(1S) abd 100-mm New York curb at 100 km/hr and 25 degrees with barrier positioned at 0-m offset from curb	264

Figure 6.32 Summary of Analysis Results for C2500 impact with modified G4(1S) and 150-mm AASHTO Type B curb at **70 km/hr** and 25 degrees with barrier positioned at **2.5-m offset** from curb 265

Figure 6.33 Summary of Analysis Results for C2500 impact with modified G4(1S) and 100-mm AASHTO Type C curb at **70 km/hr** and 25 degrees with barrier positioned at **2.5-m offset** from curb 266

Figure 6.34 Summary of Analysis Results for C2500 impact with modified G4(1S) and 150-mm AASHTO Type D curb at **70 km/hr** and 25 degrees with barrier positioned at **2.5-m offset** from curb. 267

Figure 6.35 Summary of Analysis Results for C2500 impact with modified G4(1S) and 100-mm AASHTO Type G curb at **70 km/hr** and 25 degrees with barrier positioned at **2.5-m offset** from curb 268

Figure 6.36 Summary of Analysis Results for C2500 impact with modified G4(1S) and 100-mm New York Curb at **70 km/hr** and 25 degrees with barrier positioned at **2.5-m offset** from curb 269

Figure 6.37 Summary of Analysis Results for C2500 impact with modified G4(1S) and 100-mm AASHTO Type B curb at **85 km/hr** and 25 degrees with barrier positioned at **2.5-m offset** from curb 270

Figure 6.38 Summary of Analysis Results for C2500 impact with modified G4(1S) and 100-mm AASHTO Type C curb at **85 km/hr** and 25 degrees with barrier positioned at **2.5-m offset** from curb 271

Figure 6.39 Summary of Analysis Results for C2500 impact with modified G4(1S) and 100-mm AASHTO Type G curb at **100 km/hr** and 25 degrees with barrier positioned at **2.5-m offset** from curb 272

Figure 6.40 Summary of Analysis Results for C2500 impact with modified G4(1S) and 150-mm AASHTO Type B curb at **70 km/hr** and 25 degrees with barrier positioned at **4.0-m offset** from curb 273

Figure 6.41 Summary of Analysis Results for C2500 impact with modified G4(1S) and 100-mm AASHTO Type C curb at **70 km/hr** and 25 degrees with barrier positioned at **4.0-m offset** from curb 274

Figure 6.42 Summary of Analysis Results for C2500 impact with modified G4(1S) and 150-mm AASHTO Type D curb at **70 km/hr** and 25

	degrees with barrier positioned at 4.0-m offset from curb	275
Figure 6.43	Summary of Analysis Results for C2500 impact with modified G4(1S) and 100-mm AASHTO Type G curb at 70 km/hr and 25 degrees with barrier positioned at 4.0-m offset from curb	276
Figure 6.44	Summary of Analysis Results for C2500 impact with modified G4(1S) and 150-mm AASHTO Type B curb at 85 km/hr and 25 degrees with barrier positioned at 4.0-m offset from curb	277
Figure 6.45	Summary of Analysis Results for C2500 impact with modified G4(1S) and 100-mm AASHTO Type C curb at 85 km/hr and 25 degrees with barrier positioned at 4.0-m offset from curb	278
Figure 6.46	Summary of Analysis Results for C2500 impact with modified G4(1S) and 150-mm AASHTO Type B curb at 100 km/hr and 25 degrees with barrier positioned at 4.0-m offset from curb	279
Figure 6.47	Summary of Analysis Results for C2500 impact with modified G4(1S) and 100-mm AASHTO Type C curb at 100 km/hr and 25 degrees with barrier positioned at 4.0-m offset from curb	280
Figure 6.48	Summary of Analysis Results for C2500 impact with modified G4(1S) and 100-mm AASHTO Type G curb at 100 km/hr and 25 degrees with barrier positioned at 4.0-m Offset from curb	281
Figure 6.49	Summary of Analysis Results for C2500 impact with modified G4(1S) and 100-mm New Your curb at 100 km/hr and 25 degrees with barrier positioned at 4.0-m offset from curb	282

Chapter VIII

Figure 8.1	Chart illustrating the design guidelines for the use of curbs along roadways with operating speeds greater than 60 km/hr.	302
------------	-----------------------------------------------------------------------------------------------------------------------------------	-----

LIST OF TABLES

Chapter II

Table 2.1	Summary of full-scale test results from Olsen <i>et al</i>	23
Table 2.2	Summary of HVOSM simulation results from Olsen <i>et al</i>	24
Table 2.3	Test Matrix for Cooperrider Study	45
Table 2.4	Summary of full-scale crash tests of curb-guardrail combinations with curb located behind face of guardrail	59

Chapter III

Table 3.1	Public domain vehicle models available from the National Crash Analysis Center	72
Table 3.2	Summary of major impact events of test 471470-26 and G4(2W) finite element simulation	77

Chapter IV

Table 4.1	LS-DYNA material properties for modeling AASHTO M-180 steel using material type 24	104
Table 4.2	Load curve defining scale factor for stress versus strain-rate	107
Table 4.3	Force-deflection properties of splice connection from Engstrand .	113
Table 4.4	LS-DYNA material properties for modeling AASHTO M-183 steel using material type 24	125
Table 4.5	Analysis time for the model using various element formulations .	127
Table 4.6	Test matrix for bogie impact tests of W150x13.5 posts embedded in soil	132
Table 4.7	Summary of test and simulation results for post-soil study	137
Table 4.8	Summary of post-bolt connection failure from laboratory tests . .	145
Table 4.9	Summary of post-bolt connection failure from tests and simulation	150
Table 4.10	Summary of modifications made to the NCAC C2500R pickup truck by Worcester Polytechnic Institute	157

Table 4.11	TRAP results for TTI test 405421-1 and F.E. analysis	174
Table 4.12	Results of NARD, Analysis of Variance and Geer's Parameters for TTI test 405421-1 and F.E. analysis for the first 0.200 seconds of the impact event	176
Table 4.13	Results of NARD, Analysis of Variance and Geer's Parameters for TTI test 405421-1 and F.E. analysis for the first 0.700 seconds of the impact event	177

Chapter V

Table 5.1	Matrix of simulations regarding vehicle speed and angle of impact for the 2000-kg pickup impacting AASHTO curbs in a tracking manner	183
Table 5.2	Summary of results from TRAP for each analysis in the curb study matrix	200

Chapter VI

Table 6.1	Matrix of simulations regarding offset distance of curb to barrier for modified G4(1S) guardrail system under NCHRP Test 2-11 impact conditions (70 km/hr)	222
Table 6.2	Matrix of simulations regarding offset distance of curb to barrier for modified G4(1S) guardrail system under NCHRP Test 3-11 impact conditions (100 km/hr)	222
Table 6.3	Matrix of simulations regarding offset distance of curb to barrier for modified G4(1S) guardrail system at impact speed of 85 km/hr and angle of 25 degrees	222
Table 6.4	Summary of results from images of sequential snapshot data regarding vehicle override, underride, rollover and redirection	229
Table 6.5	Summary of results from angular displacement-time history data collected at the center of gravity of the vehicle in the analyses	237
Table 6.6	Summary of maximum tensile force values in the w-beam rail within the impact region and at the upstream anchor	242
Table 6.7	Summary of occupant risk factors computed using the computer software TRAP and the results from the finite element analyses of the curb-and-barrier impact study	250

Table 6.8	Summary of curb-barrier impact study regarding success (✓) or failure (✗) of the system based on the results of the finite element analyses	253
Chapter 7		
Table 7.1	Summary of curb tracking results from various studies	288
Table 7.2	Summary of full-scale crash tests of curb-guardrail combinations With curb located behind face of guardrail	291
Chapter 8		
Table 8.1:	Design guidelines for the use of curbs along roadways with operating speeds greater than 60 km/hr.	301

LIST OF APPENDICES

APPENDIX A.	Bumper Trajectory	A.1 - A.18
APPENDIX B.	Vehicle Path	B.1 - B.18
APPENDIX C.	Acceleration-time Histories	C.1 - C.34
APPENDIX D.	Angular Displacements (Roll, Pitch and Yaw)	D.1 - D.18
APPENDIX E.	Angular Displacement Rates	E.1 - E.18
APPENDIX F.	Sequential Views of Impact Event	F.1 - F.134
APPENDIX G.	Test Risk Assessment Program Results	G.1 - G.34
APPENDIX H.	Sequential Views of Curb-barrier Impact	H.1 - H.56
APPENDIX I.	Acceleration-Time Histories From Curb-Barrier Impact ...	I.1 - I.30
APPENDIX J.	Angular Displacement-Time Histories From Curb-Barrier Impact	J.1 - J.16
APPENDIX K.	Cross-Section Forces in W-Beam Rail	K.1 - K.14
APPENDIX L.	Occupant Risk Assessment From Curb-Barrier Impact ...	L.1 - L.30

I. INTRODUCTION

1.1 Background

There has long been concern over the use of curbs on high-speed roadways because of their potential to cause drivers to lose control and crash. Curbs extend 75-200 mm above the road surface for appreciable distances and are located very near the edge of the traveled way; thus, they present a possible hazard for motorists that may encroach on the roadside at any point within the length of the curb. AASHTO highway design policy discourages the use of curbs on high-speed roadways because of their potential to cause drivers to lose control and crash. Curbs can also cause a laterally skidding vehicle to roll over upon striking the curb, a situation referred to as tripping. In some cases, a barrier is placed in combination with a curb, and an inadequate design can result in vehicles vaulting or under-riding the barrier.

While the use of curbs is discouraged on high-speed roadways, they are often required because of restricted right-of-way, drainage considerations, access control, delineation, and other curb functions. Such installations are currently being put in place without a clear understanding of the effects that these combinations will have on the ability of the barrier to safely contain and redirect an errant vehicle. There have been a very limited number of full-scale crash tests on curb-and-barrier combinations and a large percentage of those tests involving the larger class of passenger vehicles such as the 2000-kg pickup truck were unsuccessful. Even the cases involving the 2000-kg pickup truck that satisfied the

requirements of NCHRP Report 350 resulted in excessive damage to the barrier system or extreme trajectories and instability of the vehicle.

Policy on the design and use of cross-sectional highway features, including curbs, is contained in AASHTO's Policy on Geometric Design of Highways and Streets (e.g., the Green Book). (1) The purpose of curbs is to provide drainage, delineate the edge of the pavement, support the pavement edge, provide the edge for a pedestrian walkway, and provide some redirective capacity for low speed impacts. On higher speed roadways, the subject of this study, the primary function of curbs is usually to provide drainage, especially in the area of a bridge approach or other location where the risk of erosion is high.

The Green Book defines two basic types of curbs as shown in Figure 1.1: vertical curbs and sloping curbs. Vertical curbs usually have a vertical or nearly vertical face. Such curbs usually serve several purposes including discouraging vehicles from leaving the road, drainage, walkway edge support, and pavement edge delineation.

Vertical curbs have some ability to redirect errant vehicles since the impacting wheel is steered by the curb in a direction parallel to the traveled way. If the impact velocity is modest, this steering action is all that may be required to prevent the vehicle from leaving the roadway. If the speed and encroachment angle are higher, then the steering action of the curb alone is not sufficient to redirect the vehicle. Since the vehicle center of gravity is

much higher than the top of the curb, a high-speed impact with the curb will introduce a roll moment. This roll moment will in turn introduce an instability into the vehicle trajectory and may even be large enough to cause the vehicle to roll over. Since curbs are often used primarily for drainage purposes, they are often found in conjunction with steep side slopes where a rollover would be even more likely. For these reasons, vertical face curbs are usually restricted to low speed facilities where the steering action of the curb is sufficient for redirection.

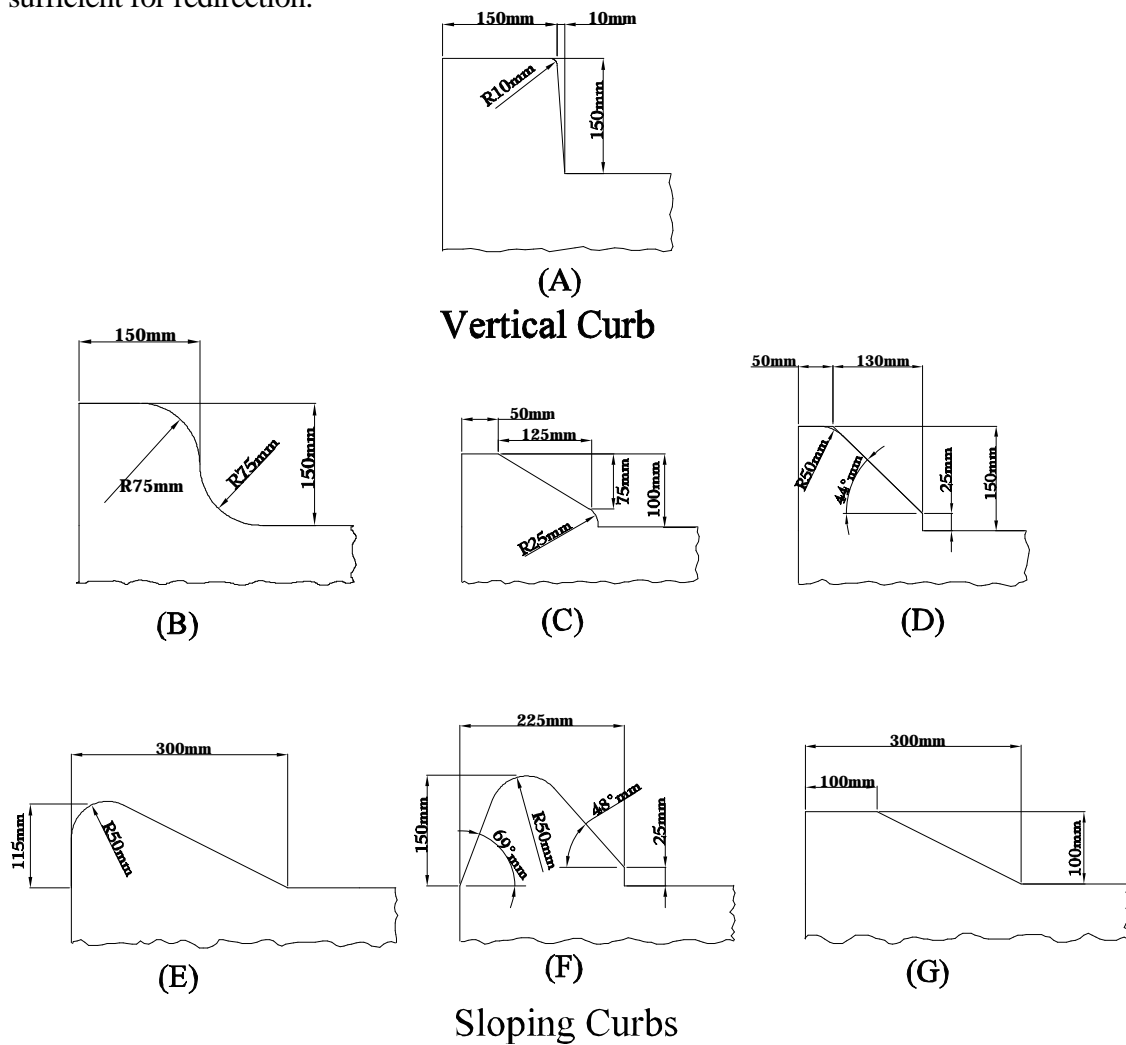

Figure 1.1: Typical AASHTO Highway Curbs (1)

Sloping curbs, as illustrated in Figure 1.1, have a sloped face and are configured such that a vehicle can ride up and over the curb. These curbs are designed so that they do not significantly redirect a vehicle. They are usually used in situations where redirecting a possibly damaged and out-of-control vehicle back into the traffic stream is undesirable. Sloping curbs are often used primarily for drainage purposes but are also used on median islands and along shoulders of higher speed roadways for delineation and other reasons. Sloping curbs provide drainage control while also allowing vehicles access to the roadside in emergency situations.

It is often necessary to use a curb for drainage or other reasons at a particular location that also warrants a traffic barrier. For example, approaches to bridge structures (e.g., overpasses) are often built on fills with steep slopes. An approach guardrail is required both to shield the end of the bridge railing and to shield errant motorists from the steep side slope approaching the structure. If surface water were allowed to drain from the roadway down the steep slope next to the bridge, an erosion problem could develop. A curb is usually required to channel the runoff into a catch basin or some other drainage structure. Both the curb and the traffic barrier are important functional features of the roadside in this situation.

Another similar situation occurs on roadways where a guardrail is needed to shield a steep roadside slope as shown in Figure 1.2. Figure 1.2 shows a 100-mm high sloped face asphalt curb installed just in front of the posts of a G4(1S) W-beam guardrail. The site is

a 90 km/hr rural two-lane roadway in Maine. The curb is placed at this site to provide drainage away from the steep side slope behind the guardrail and thereby prevents erosion. The erosion would likely weaken the edge of the road, erode the soil from around the guardrail posts and cause slope stability problems. The curb is therefore necessary for proper drainage. Likewise, the guardrail is necessary for shielding errant motorists from the steep embankment. In such a



Figure 1.2: Sloping curb installed flush with a strong-post w-beam guardrail on a 90 km/hr two-lane rural roadway in Maine.

situation there are few alternatives but to use a curb and traffic barrier combination.

The Green Book limits its guidance on the use of vertical face curbs and traffic barriers to the following statement (chapter 4, pp 327):

“When using curbs in conjunction with traffic barriers, such as on bridges, consideration should be given to the type and height of barrier. Curbs placed in front of traffic barriers can result in unpredictable impact

trajectories. If a curb is used in conjunction with a traffic barrier, the height of a vertical curb should be limited to 100 mm or it should be of the sloping type, ideally, located flush with or behind the face of the barrier. Curbs should not be used with concrete median barriers. Improperly placed curbs may cause errant vehicles to vault the concrete median barrier or to strike it, causing the vehicle to overturn.” (1)

AASHTO’s policy regarding the use of roadside barriers is contained in the Roadside Design Guide.(2)(3) The use of curbs in conjunction with traffic barriers is addressed in section 5.6.2.1 of the Roadside Design Guide :

“Crash tests have shown that use of any guardrail/curb combination where high-speed, high-angle impacts are likely should be discouraged. Where there are no feasible alternatives, the use of a curb no higher than 100 mm or stiffening of the guardrail to reduce its deflection by bolting a w-beam to the back of the posts or the addition of a rubrail usually proves satisfactory. On lower speed facilities, a vaulting potential still exists, but since the risk of such an occurrence is lessened, a design change may not be cost effective. A case-by-case analysis of each situation considering anticipated speeds and consequences of vehicular penetration should be used.” (2)

The AASHTO policy quoted above is used by most states. For example, the Iowa

Department of Transportation Design Manual states:

“It is not desirable to use guardrail alongside curbs. Every effort should be made to remove fixed objects or relocate them outside the clear zone, instead of using guardrail. If there is no other alternative to using guardrail, it may be used alongside a 4-inch sloped curb, normally with the installation line at the face of the curb. If 6-inch curbs are being used throughout the rest of the project, the curb should be transitioned to a 4-inch sloped curb throughout the guardrail installation.” (4)

At first consideration, combining a curb and a traffic barrier might seem to be a reasonable strategy for redirecting errant vehicles. Curbs, as discussed above, possess some capacity to redirect vehicles, and traffic barriers are designed specifically for that purpose. Combining the two, therefore, might provide cumulative protection to motorists. Unfortunately, the curb’s effect on the trajectory of the vehicle is complicated and can often involve transforming longitudinal kinetic energy into hard-to-control vertical and rotational kinetic energy. Researchers in an early California study called the tendency of the curb to launch the vehicle “dynamic jump.” (5)

Most of the current understanding of vehicle behavior during impact with curbs was developed in full-scale tests performed nearly 40 years ago. (5) More recent testing of bridge railings and guardrail-to-bridge rail transitions have added to this knowledge

somewhat. (6) While the age, variability between tests, and adequacy of the traffic barriers make it difficult to generalize about the results of these tests, it has been generally accepted that when a curb is used in conjunction with a steel post-and-beam traffic barrier, the barrier must be stiffened in some manner to prevent large barrier deflections. In essence, if the barrier deflects too much, the curb can initiate a vertical component of vehicle motion that may launch the vehicle over the barrier. Common methods of stiffening the barrier include nesting two sections of w-beam, adding a w-beam on the back side of the barrier, adding a rub rail and reducing the post spacing. The basic objective is to keep the vehicle from contacting the curb by placing the curb behind the barrier face and limiting the deflection of the barrier.

There are three basic types of longitudinal traffic barriers: rigid barriers, semi-rigid barriers and flexible barriers. The rigid barriers are often shaped, concrete barriers like the F-shape median barrier, the New Jersey barrier, the Ontario tall wall, etc. In essence, these types of barriers can also function as drainage devices so there are probably no common reasons why a curb would be used in conjunction with, a New Jersey barrier, for example.

Semi-rigid barriers include the widely used strong-post w-beam guardrails which usually deflect laterally less than a meter in NCHRP Report 350 Test Level Three crash tests.

These barriers are used in nearly every state and account for the vast majority of the installed inventory of roadside hardware. (7) These types of barriers are also widely used in many states in conjunction with curbs, as illustrated in figure 1.2 and in figure 1.3. The

use of curbs and strong-post W-beam guardrails is a major issue in this research.

The flexible barriers include such systems as the weak-post three-cable guardrail, the weak-post w-beam guardrail, and the weak-post box beam guardrail. These systems are designed to accommodate lateral deflections of as much as three meters. Because these systems allow large lateral deflections, most vehicles would mount the curb while interacting with the barrier. For this reason the author believes that it is relatively unusual for States to use curbs in conjunction with weak-post guardrails. The issue of combining weak-post barriers and curbs relates to how far the barrier should be located behind the curb. For example, if the barrier is located far enough behind the curb, the vehicle can stabilize prior to striking the barrier. An important issue in this research is to determine the lateral encroachment distance that it takes for a vehicle to stabilize after impacting a curb at highway speeds.

1.2 Purpose and Applicability

There is a need for nationally recognized guidelines for the design and use of curbs on various types of high-speed roadways. For example, it may be acceptable to use curbs specifically designed to reduce the risks outlined above. Minimal research has been done on sloping curbs, hence, there is very little information available pertaining to their effect on vehicle tripping or vaulting, especially considering today's mix of vehicle types and sizes. The National Cooperative Highway Research Program (NCHRP) has sponsored Worcester Polytechnic Institute to develop design guidelines for using curbs and curb-

barrier combinations on roadways with operating speeds greater than 60 kph (37 mph) under Project Agreement NCHRP 22-17. The research presented in this dissertation is a large part of that study and will provide very useful information to the NCHRP 22-17 project.

1.3 Project Objectives

The objectives of this research are to identify the common types of curbs that could be used safely and effectively on high-speed roadways, to determine the proper combination and placement of curbs and barriers such that traffic barriers remain effective, and ultimately, to develop design guidelines based on site-specific criteria for installation of curbs and curb-barrier combinations on roadways with operating speeds greater than 60 km/hr.

The first phase of the project involves an in-depth review of published literature in order to identify information pertinent to the design, safety and function of curbs, and curb/barrier combinations on roadways with operating speeds greater than 60 km/hr (37 mi/hr). Computer simulation methods are used in a parametric investigation involving vehicle impact with curbs and curb-barrier combinations to determine which types of curbs are safe to use on high-speed roadways and to determine proper placement of a barrier with respect to curbing such that the barrier remains effective in safely containing and redirecting the impacting vehicle. The results of the study are then synthesized and guidelines for the use of curbs and curb-and-barrier systems are developed.

II. LITERATURE REVIEW

2.1 Introduction

Assessing the safety effectiveness of curbs attracted a considerable amount of attention in the early decades of roadside safety research. Curbs were thought to be a low-cost method of keeping vehicles on the roadway for at least some impact conditions. In 1953 the California Division of Highways performed a series of 149 full-scale tests on 11 different types of curb geometries in order to assess the safety effectiveness of curbs.(5) This test series was followed in 1955 by another series of tests using the four best performing curbs from the first series.(8) The conclusion of the researchers was that barrier curbs should be at least 10 inches high, have undercut faces, and have a relatively smooth surface texture. Other similar but less extensive studies were performed in Canada, Germany and United Kingdom. (9)(10)(11) These early crash tests formed the basis of the AASHTO policy described earlier in Chapter 1. Although the vehicle fleet has changed considerably since the time of these early studies, the current version of the AASHTO Green Book contains substantially the same recommendations as the 1965 Green Book regarding the use of curbs.

The methods that have been employed for analyzing the safety effectiveness of curbs in earlier research included analytical methods, full-scale crash testing, and vehicle dynamics codes. Each of these methods are discussed in the following sections.

Information from selected studies from previous research on curbs and curb-barrier

combinations are also provided, followed by a summary of the literature review.

2.2 Analysis Methods Applied in the Study of Curb Safety

2.2.1 Analytical Methods

Most analytical work regarding vehicle impact into curbs have been concerned with either redirection capabilities of vertical face curbs or their potential to cause rollover. If the impact speed and angle are plotted on a graph and different symbols used to denote redirection and mounting, then a curve like Figure 2.1 can be developed. Figure 2.1 shows the characteristics of two particular experimental curbs, the Trief and Elsholz curbs. (10)(11) The line describes the boundary between redirective behavior and mounting behavior. Combinations of impact speed and angle falling to the left of the curve would result in redirection, and those falling to the right would result in mounting the curb.

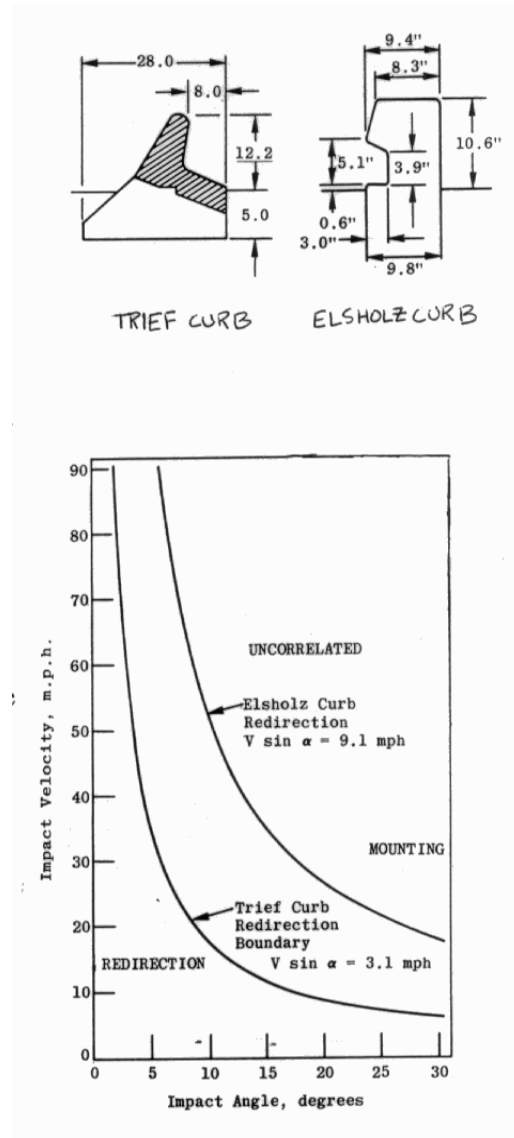

Figure 2.1: Curb performance characteristics of the Trief and Elsholz curbs (10)

The boundary between redirection and mounting can be described by the equation :

$$K = V \sin \alpha$$

where V is the impact velocity and α is the impact angle. In essence, this expression indicates that a given curb will redirect the vehicle when the lateral component of the impact velocity is less than some characteristic value. Dunlap found that the characteristic lateral component of velocity for the Trief curb was 5 km/hr and for the Elsholz curb was 14.6 km/hr; thus, the Elsholz curb was more effective at redirecting vehicles than the Trief curb.(12)

Dunlap attempted to extend this basic methodology by treating the impact speed and angle as a random probabilistic variable along with the vehicle type. If the distribution of encroachment angles and vehicle speeds for a particular roadway is known, the percent of vehicle that would be redirected by each type of curb can be estimated.(12) Dunlap used data from a specific roadway in Michigan for the speed distribution and the Hutchinson-Kennedy encroachment data for the impact angle distribution.(13) For the specific site in Michigan, Dunlap found that the Elsholz curb could be expected to redirect 70 percent of the impacting vehicles and the Trief curb could only be expected to redirect 27 percent. Unfortunately, the curb characteristic lateral component of velocity is also a function of the characteristics of the vehicle that strike the curb and the type of curb. Some vehicles will have geometric, suspension, and handling characteristics more prone to mounting the

curb than other vehicles. A curb's ability to redirect a vehicle depends not only upon the speed and angle of impact, but also upon the dimensions of the curb, the surface material of the curb, if it is wet or dry, and the radius of the impacting tire. The boundary line between mounting and redirection shown in Figure 2.1, therefore, is only valid for a single type of test vehicle impacting a specific type of curb. The dramatic changes in vehicle characteristics over the past decade seriously limit the validity of the findings of these early studies. The vehicles of today are lighter, have higher centers of gravity, and have lower profile tires. In addition, the passenger vehicle population has become much more diverse including pickup trucks, large sport utility vehicles, mini-vans, small sport utilities as well as the traditional passenger car. Some of these vehicle types have proven to be less stable in collisions with traffic barriers than traditional passenger cars. While the testing done over the past 40 years provides some interesting insights, the results must be viewed carefully since the vehicle population of today is much different than it was during the 1960's.

An analytical study on the safety of roadside curbs was conducted by Navin and Thomson at the University of British Columbia.(14) They developed the following empirical relationships to estimate the ability of a dry concrete curb to safely redirect a vehicle based on the findings produced in previous research:

$$h = r \left[\frac{V_r \sin \theta \left(\frac{\mu_N}{\mu_{CD}} \right)}{50} \right]^{\frac{1}{3.5}}$$

where h is the height of the curb required to redirect the impacting vehicle, r is the radius of the tire in millimeters, V_r is the speed at redirection, θ is the impact angle, μ_N is the coefficient of friction of smooth rubber on test surface, and μ_{CD} is the coefficient of friction of smooth rubber on dry concrete. Note that the required height of the curb increases as the radius of the tires increases, the velocity of the vehicle increases, the angle of impact increases, or the friction coefficient increases.

2.2.2 Vehicle Dynamics Codes

The first computer simulation program used for the analysis of vehicle-curb impacts was the Cornell Aeronautical Laboratory Single Vehicle Accident program (CALSSVA).(15) It was used by Wayne State University and the Highway Safety Research Institute (HSRI) at the University of Michigan to determine the redirection capability of various curb configurations.(16) The CALSSVA program, developed by Cornell Aeronautical Laboratory, was only capable of simulating a limited range of impact scenarios due to the simplicity of the program; however, it did serve as a precursor to more advanced computer simulation codes.

The second generation version of CALSSVA was the Highway Vehicle-Object Simulation Model (HVOSM).(17) This program has been used extensively in conjunction with full-scale crash testing to study vehicle dynamics during impact with curbs. A comprehensive review of these studies will be presented in subsequent sections of this chapter.

The vehicle dynamics code VDANL (Vehicle Dynamics Analysis, Non Linear) was developed in the 1980's by the National Highway Traffic Safety Administration (NHTSA) and Systems Technology, Incorporated (STI). It is a comprehensive vehicle dynamics simulation program that runs on a PC in a windows environment. It was designed for the analysis of passenger cars, light trucks, articulated vehicles, and multi-purpose vehicles, and it has been upgraded over the years to expand and improve its capabilities. It now permits analysis of driver-induced maneuvering up through limit performance conditions defined by tire saturation characteristics, as well as driver feedback control features.

VDANL was chosen by the Federal Highway Administration (FHWA) for use in the Interactive Highway Safety Design Model (IHSDM).⁽¹⁸⁾ The IHSDM program is used to assess new roadway designs by using a driver performance model to simulate the vehicle/driver response when traversing the proposed roadway configuration. The Driver Performance Model in IHSDM estimates drivers' speed and path choice along a roadway, and this information is provided as input to VDANL, which estimates vehicle kinematics such as lateral acceleration, friction demand, and rolling moment. The information from VDANL is used to identify conditions that could result in loss of vehicle control (i.e., skidding or rollover).

2.2.3 Full-Scale Crash Testing

Although advancements in computer simulation programs have made it possible to

accurately reproduce and predict complex impact events, full-scale testing is still essential in evaluating the safety performance of curbs and other roadside appurtenances. To evaluate the performance of roadside safety barriers, impact conditions must meet the standard testing procedures accepted by the FHWA. The first procedures document was published by the Highway Research Board in 1962.⁽¹⁹⁾ The later revisions of the procedures were made by the National Cooperative Highway Research Program. The latest revisions of the testing procedures were published in NCHRP Report 350 in 1993.⁽²⁰⁾

From 1981 to 1992 crash tests were conducted according to the test requirements specified in NCHRP Report 230.⁽²¹⁾ The test conditions required for evaluation of guardrail in NCHRP Report 230 involved a 2000-kg sedan impacting the guardrail at a speed of 100 km/hr and an angle of 25 degrees.

The most important change in NCHRP Report 350 was that the large passenger sedan had virtually disappeared from the vehicle population, and new vehicle types such as minivans, sport utility vehicles, and pickup trucks emerged in their place. Since the first testing procedures specified in Highway Research Board Report 482 up until NCHRP Report 350, the large car sedan (i.e., a 2040-kg car) had served as the crash test vehicle representing the fleet of large passenger vehicles. NCHRP Report 350 replaced the large car with a 2000-kg pickup truck. The challenges that the pickup truck introduced to the crash testing procedures were due to its high, more forward center of gravity making it

much more unstable during impacts than its predecessor, the large sedan.

The performance of a curb/guardrail combination are evaluated using test conditions specified in NCHRP Report 350 for evaluating the crashworthiness of the length of need (LON) section of a guardrail. There are currently two tests that are required in Report 350 to evaluate guardrail systems for use along high speed roadways:

- 1) Test 3-11, which involves a 2000P pickup truck (e.g., Chevrolet 2500) impacting the guardrail at a speed of 100 km/hr and an impact angle of 25 degrees, and
- 2) Test 3-10, which involves a 820C (e.g., Honda Civic or Ford Taurus) impacting the guardrail at a speed of 100 km/hr and an impact angle of 20 degrees.

A guardrail system that meets all the strength and safety requirements specified in NCHRP Report 350 is considered acceptable for use on all roadways within the United States.

2.3 Effect of Curbs on Vehicle Stability

Olsen et al.(22)

Olsen and other researchers at Texas Transportation Institute (TTI) conducted a study to investigate how various types of curbs affect vehicle response, such as redirection, trajectory, path, roll, pitch, and accelerations. Their study involved full-scale tests and

simulations of vehicles traversing various types of curbs. Eighteen full-scale tests were conducted on types B and D curbs (see Table 2.1); nine full-scale tests were conducted on each curb type at speeds of 48, 72 and 97 km/hr and



Figure 2.2: Vehicle used in Olsen *et al* study (22)

at 5, 12.5 and 20 degree encroachment angles. The computer program, Highway Vehicle Object Simulation Model (HVOSM), was used to simulate vehicle impact with three different curb types: AASHTO curb types B, D and G ¹. Twelve curb impacts were simulated on each curb type at impact speeds of 48, 72 and 97 km/hr and at 5, 12.5 and 20 degree encroachment angles. A 121-km/hr impact was also simulated at 5, 10 and 15 degrees encroachment angles.

The test vehicle used in their study was a 1963 Ford four-door sedan with heavy-duty suspension. The vehicle's mass was 1905 kg, and the center of gravity of the vehicle was 610 mm above ground. The test vehicle is shown in Figure 2.2. Olsen *et al.* found that AASHTO types B, D and G curbs, which are sloping curbs 150 mm or less in height, provide no redirection for a large passenger vehicle, such as a 1900-kg sedan, traveling at speeds greater than 72 km/hr at encroachment angles greater than 5 degrees. They also

¹ In their study the curbs were referred to as C, E and H curbs which was consistent with the nomenclature of the AASHTO "Blue Book". In the AASHTO "Green Book" these curbs are now referred to as B, D and G, respectively.(13) Nomenclature throughout this document will use the designations defined in the Green Book.

found that type B and D curbs can produce, under certain speed and encroachment angles, vehicle ramping high enough to allow the bumper height to equal or exceed the height of a typical guardrail, as illustrated in Figure 2.3.

Such vehicle trajectories may result in a vehicle snagging on the top of the rail and flipping over. Whether the vehicle penetrates behind the barrier or is redirected is, of course, influenced by other factors including barrier configuration, lateral stiffness properties of the barrier, impact conditions as well as vehicle characteristics, such as bumper shape and vehicle kinematic properties. The trajectory of the vehicle after mounting a curb must allow the vehicle to contact the guardrail, or other roadside device, at the appropriate height.

Olsen *et al.* found that for 150 mm high AASHTO B and D curbs an increase in either speed or impact angle resulted in greater lateral distances to the maximum rise point and

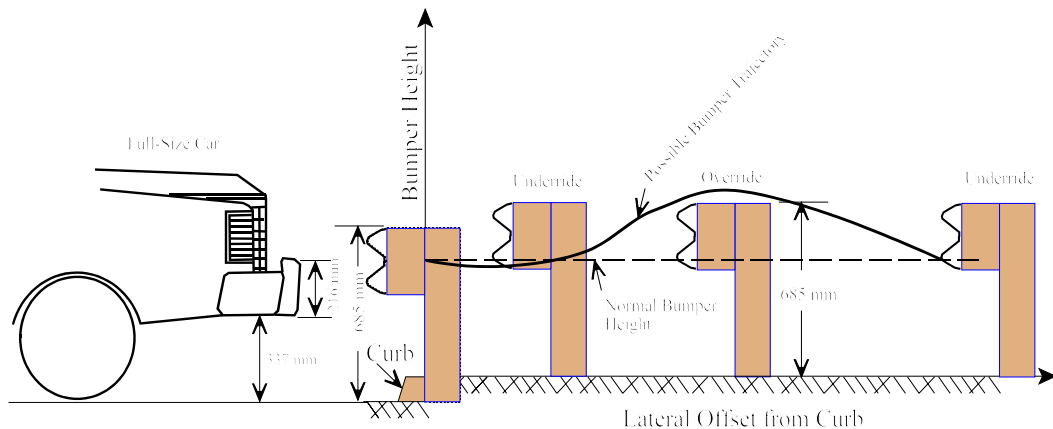

Figure 2.3: Possible trajectory of vehicle bumper relative to typical guardrail height

higher vertical position of the vehicle at the maximum rise point. The encroachment angle had a more notable effect on the maximum rise point and position than did vehicle speed, when vehicle speed was greater than 100 km/hr. The maximum rise height of the bumper, predicted from the simulations, was approximately 737 - 787 mm and occurred in the range of 2.44 - 3.0 m behind 150-mm curbs. The height of a typical w-beam guardrail is 686 mm, as shown in the sketch in Figure 2.3. The maximum rise height during impact with the type G curb was only slightly affected by vehicle speed and encroachment angle. The maximum vertical rise of the vehicle impacting the type G curb was less than 50 mm. Furthermore, the maximum rise height did not increase an appreciable amount for speeds greater than 48 km/hr, indicating that the maximum rise height during impact with the type G curb is relatively independent of vehicle speed and impact angle.

It was concluded that the maximum rise point was dependent on the combination of vehicle roll and pitch caused by striking the curb. When the wheel impacts the curb the loads are distributed to the other three wheels, particularly the other front wheel. If the impacting wheel rises too quickly, then the vertical tire force will be sufficient to “bottom” out the suspension introducing shock loads. In addition, excessive pitch and roll angles are produced when the fully compressed suspension unloads. The effect that curb geometry has on damping the roll angle during wheel impact obviously differs with the height and the steepness of the curb face. The pitch and roll angles produced by simulated collisions with type B and D curbs were as much as twice those produced by

collisions with the type G curb.

Curbs that are 150 mm high and set in front of a 685-mm w-beam guardrail at a 0.61 m lateral offset may result in the vehicle impacting the guardrail at a point below the lower edge of the rail and cause snagging, as shown in Figure 2.3. During impact with the 150-mm curbs, the bumper would dip down slightly and then began to rise as the vehicle crossed the curb. If the angle of impact is such that the bumper is close to the guardrail before the wheel impacts the curb, then the dipping event would cause the bumper to impact the guardrail just below the w-beam rail. Note that the lower edge of the guardrail is 533 mm above the pavement surface due to the 150 mm elevation of the curb; whereas, the lower edge of the rail is only 381 mm above ground level in normal configuration. An initial dipping motion of the bumper was not evident during impact with the type G curb, and the bumper contacted the guardrail on the face of the w-beam in all impact cases.

The simulation study by Olsen *et al.* also demonstrated that the stiffness of the vehicle's suspension had little effect on vehicle trajectory. A summary of full-scale test results performed in Olsen's study is given in Table 2.1 and a summary of their HVOSM simulation results is given in Table 2.2.

Table 2.1. Summary of full-scale test results from Olsen *et al.*(22)

Test Number	Approach Speed (mph)	Encroachment Angle (degrees)	Maximum Bumper Height During Vehicle Trajectory (inches)
Curb Type D			
N-2 ^a	30.4	5.1	24.1
N-3 ^a	45.6	5.0	24.3
N-4	59.3	4.6	23.9
N-5	32	11.6	20.8
N-6	45.3	11.1	23.7
N-7	63.6	12.6	23.5
N-8	32.7	18.5	23.5
N-9	41.8	18.7	21.9
N-10	63.0	17.6	23.3
Curb Type B			
N-11 ^a	34.2	4.9	26.2
N-12	44.7	5.1	24.8
N-13	34.2	11.2	23.8
N-14	43.5	12.8	23.1
N-15	32.1	17.4	22.1
N-16	43.0	18.4	23.5
N-17	66.5	5.1	24.3
N-18	62.2	12.3	21.4
N-19	61.5	18.6	23.0

^a Vehicle redirected

Table 2.2. Summary of HVOSM simulation results from Olsen *et al.*(22)

Curb	Vehicle Speed (mph)	Impact Angle (deg)	Max Roll Angle (deg)	Max Pitch Angle (deg)	Max Bumper Height above Curb (inches)	Lateral Distance to Max Rise Point (ft)	Bumper Height above Curb at 2-ft offset (inches)
Type B (6-in.)	30	20	+8.8	2.9	22	5	12
	45	20	-8.9	3.0	26	8	11
	60	12.5	-13	2.0	27	7	13
	60	20	-8	2.0	29	10	10
	75	10	-15.5	2.0	30	6	13
	75	15	-10.2	1.8	30	10	12
Type D (6-in.)	30	12.5	-9.5	2	21	4	13
	30	20	-8	2.5	21	6	11
	45	12.5	-11	2	23	5	12
	45	20	-8	2.2	25	8	11
	60	5	-11.2	2	23	3	17
	60	12.5	-12	2	25	6	13
	60	20	-9.5	2.5	31	10	11
	75	5	-12	1.5	23	4	16
	75	10	-13	2	25	6	13
	75	15	-11	2	31	9	12
Type G (4-in.)	30	12.5	-5	1	18	5	13
	30	20	-3	1	18	9	12
	45	5	-7	1	20	3	15
	45	20	-4	1	20	10	14
	60	5	-7	1	20	4	15
	60	12.5	-5	1	20	8	13
	60	20	-3	1	20	10	13

Dunlap 1973 (12)(23)

The objective of Dunlap's research was to determine how far in front of the barrier the curb should be placed to achieve the best redirection performance from the curb-traffic barrier system. Dunlap examined all the test data available in the early 1970's and found that the results were difficult to generalize. While there were cases of vehicles vaulting over a guardrail or bridge railing when a curb was used in front of the guardrail, in many cases the guardrail itself had structural problems so it was difficult to assess the contribution of the curb to the failure.

Dunlap performed computer simulations of a variety of curb and barrier combinations using HVOSM to determine the risk of overriding the barrier. Dunlap's analysis indicated that for the six curb and barrier combinations studied, vaulting was not expected to be a problem. This analysis, however, has several serious limitations not least of which is the validity for barrier impact analysis of the HVOSM computer program that was being used at the time. Dunlap's work does, however, illustrate two important points: (1) computer simulation is one possible method for assessing a variety of curb-barrier geometries and (2) the conventional wisdom that curbs should not be used in front of barriers warrants more careful investigation.

Ross and Post (24)

Researchers at Texas Transportation Institute (TTI) conducted a study to evaluate automobile behavior when traversing selected curb configurations and sloped medians

and, also, to evaluate the potential for a vehicle to vault over roadside barriers placed in combination with curbs or sloped medians. HVOSM was used to simulate vehicle impact with 150-mm and 200-mm curbs, modified curbs, and slopes. They also compared the effects of standard curb shapes to various retrofit alternatives, such as, installing wedge-shaped asphalt plugs in front of the curbs and replacement of the curbs with slopes.

It was concluded from the simulation results that traffic barriers should not be placed near curbs due to the probability of vehicles vaulting or underriding the barrier. They also showed that problems with barriers on raised curb-medians or curb-guardrail configurations could be reduced in certain situations by sloping the median or the roadside to the top of the curb.

Holloway et al. (25)

Three types of sloping curbs, commonly used by the Nebraska Department of Roads (NDOR), were investigated for safety performance through a combination of full-scale testing and computer simulation using HVOSM. The curb types investigated included: a 100-mm lip curb (1:3 slope on curb face), a 150-mm lip curb (1:3 slope on curb face) and a 150-mm AASHTO type I curb. The AASHTO type I curb, shown in Figure 2.4, is the curb type most widely used by NDOR. The test matrix in the study included twenty-three full-scale tests: thirteen tests on the 100-mm lip curb, two tests on the 150-mm lip curb, and eight tests on the AASHTO type I curb.

The three curbs tested were found to have little potential for causing a vehicle to lose control during tracking impacts, and, thus, they concluded that the curbs would not pose a significant hazard to vehicles impacting in a tracking mode. Although the 100-mm curb performed better than the 150-mm curbs in all impact conditions, the safety benefit was not

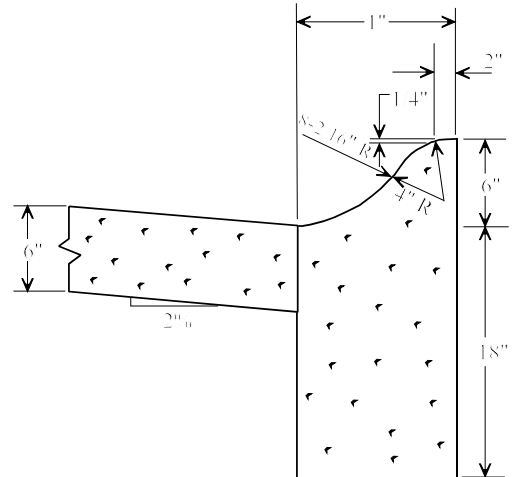

Figure 2.4: AASHTO Type I Curb

considered to be significant. It was also concluded that the performance of w-beam guardrails could be adversely affected when installed behind curbs, and when curb-guardrail combinations are necessary, the curb should be placed behind the face of the guardrail to minimize the potential for vehicle ramping.

The testing area was on a negative grade that may have had some effect on the vehicle kinematics during impact. Tests were conducted using two types of test vehicles: a small car with a mass of 817 kg (1984 Dodge Colt) and a large car with a mass of 2043 kg (1986 Ford LTD). The center of gravity of the test vehicles were 533 mm and 572 mm for the 817-kg and 2043-kg vehicles, respectively.

The impact speeds used in the full-scale tests were 64.4, 72.4, 80.5 and 88.5 km/hr at encroachment angles of 5, 12.5 and 20 degrees. Vehicle decelerations were very low indicating that there is little risk of occupant injury as a direct result of curb impact. The

yaw rate and yaw angle were also very low, indicating that there was minimal redirection of the vehicles as they impacted and mounted the curbs.

Thirteen full-scale tests were conducted on a 100-mm lip curb, and two full-scale tests were conducted on a 150-mm lip curb. For low angle impacts on the 100-mm curbs with the 817-kg vehicle, the maximum roll and pitch angles increased as the impact velocity increased; values ranged from 5.6 to 9.0 degrees and 0.7 to 1.4 degrees for roll and pitch angles, respectively. For the moderate and high angle impact tests, the maximum roll angle increased as the impact speed increased, while the maximum pitch angle decreased with an increase in impact speed. The maximum roll angle in the tests was 9.3 degrees, and the maximum pitch angle was 2.6 degrees. Thus, the pitch and roll angles were considered to be relatively insignificant in terms of producing loss of vehicle control.

It was also concluded in their study that there was only a slight potential for 817-kg vehicle to underride a standard 686-mm w-beam guardrail when the 100-mm lip curb is placed in combination with the guardrail. The greatest potential of the vehicle vaulting over the barrier, would be when the barrier is located in a region 0.76 m to 2.74 m behind the curb.

Similarly, for low angle impacts with the 2043-kg vehicle impacting the 100-mm lip curb, the roll and pitch angle increased as the impact speed increased. The maximum roll and pitch angles were 7.2 degrees and 1.1 degrees, respectively, for the low angle

impacts. The maximum roll and pitch angles for the high angle impacts were 7.2 degrees and 2.0 degrees, respectively. There were only two tests conducted on the 150-mm lip curb. In these two tests a 2043-kg vehicle impacted the curb at an encroachment angle of 20 degrees and at impact speeds of 72.4 and 86.9 km/hr. The maximum roll and pitch angles were 7.8 degrees and 2.6 degrees, respectively. The tests indicated that there was a slight potential for the vehicle to underride a standard w-beam guardrail, if the guardrail was placed within 1.22 m of the curb; however, the tests also indicated that there was very little potential for the vehicle to vault over the barrier.

Tests conducted on the AASHTO type I curb resulted in maximum roll and pitch angles of 9.7 degrees and 3.1 degrees, respectively. Although the angular displacements of the vehicle during impact with this curb were somewhat higher than those produced in impacts with the lip curbs, the potential for loss of control of the vehicle was again considered very low. The driver of the vehicle in the study reported that the suspension system fully compressed and bottomed out against the suspension bumper stops during impact with the 150-mm curbs, and a small jolt was felt. The trajectory of the vehicle during the tests indicated there was a potential for underride of a standard w-beam guardrail, if the barrier is located within 1.22 m of the curb; however, there did not appear to be any significant risk of the vehicles vaulting over such a barrier.

The Highway Vehicle Object Simulation Model (HVOSM) was also used to investigate alternate impact conditions. Simulation models of the twenty-three full-scale tests were

developed, and the results were compared to the full-scale tests to validate their model.

An additional 55 simulations were then performed. Thirty-one simulations were performed to supplement the original twenty-three impact scenarios, including five simulations with the 100-mm lip curb, sixteen simulations with the 150-mm lip curb and ten simulations with the 150-mm type I curb. Another twenty-four simulations were performed to evaluate the effects of curb impact with the curb placed on flat grade.

The simulations with the lip curbs were performed with vehicle velocities of 72.4 and 88.5 km/hr at encroachment angles of 5 and 20 degrees. The results of the simulations with the 100-mm lip curb showed no potential for either underriding or vaulting a w-beam guardrail installed behind the curb. The results of the simulations with the 150-mm lip curb indicated that the small vehicle (817 kg) may underride a w-beam guardrail if the guardrail is placed within 1 m of the curb, and it is likely to vault over a guardrail placed 0.46 to 3.7 m behind the curb. The simulations with the large vehicle (2043 kg) indicated a slight potential for underriding a w-beam guardrail located within 1 m of the curb, and vaulting of the guardrail was likely if the barrier was placed in a region of 0.61 to 3 m behind the curb.

The simulations with the AASHTO type I curb indicated that impact with the curb could cause underride of a w-beam guardrail placed within 0.61 m of the curb. For small car impact, a potential for vaulting existed if the guardrail was placed 0.46 m to 3.0 m behind the curb. For large car impact, a potential for vaulting existed if the guardrail was placed

0.46 m to 3.7 m behind the curb.

The additional twenty-four simulations were performed on all three curb types to investigate the effects of impact with the curbs placed on flat grade. Impact conditions included vehicle speeds of 72.4 and 88.5 km/hr and encroachment angles of 5 and 20 degrees. The results of these simulations showed only minor differences in angular displacements of the vehicle, compared to the simulations with the curb placed on a negative grade (i.e., the test area was on a negative grade).

Non-tracking impacts of vehicles with the three curb types were also investigated using computer simulation; however, no test data was available for validating the results. Impact conditions used in the study included those contained in Appendix G of the NCHRP Report 350 and from accident data analysis studies. All simulations were performed with vehicle speed of 80.5 km/hr and impact angle of 20 degrees. Three initial positions of the vehicle were investigated: 1) 150 degree yaw angle with 50 deg/sec yaw rate, 2) negative 30 degree yaw angle with a negative 25 deg/sec yaw rate and 3) 180 degree yaw angle with 50 deg/sec yaw rate. They found that these curbs may be traversable over a wide range of vehicle orientations and impact conditions, and the curbs pose little threat of vehicle rollovers during impact.

2.4 Effect of Curbs Installed in Conjunction with Guardrails

Holloway et al. (26)

A study was conducted by Holloway and other researchers at Midwest Roadside Safety Facility at the University of Nebraska-Lincoln that involved a full-scale crash test on Missouri's 150-mm vertical curb placed behind the face of a strong post w-beam guardrail (i.e., G4(1S)). Missouri's 150-mm vertical curb is very similar to the AASHTO type B curb, except that the Missouri vertical curb is on a flat grade and has very little rounding on the top and bottom edge of the curb. The impact conditions for the test was in accordance with NCHRP Report 230 specifications; a 2043-kg test vehicle (1985 Ford LTD) impacted the system at 96 km/hr at 25.1 degrees. The center of gravity of the test vehicle was 597 mm above ground. A summary of test M06C-1 is shown in Figure 2.5.

During the test, the right front tire contacted the curb 20 milliseconds after initial contact with the guardrail, and mounted the curb soon after. The maximum roll angle was negative 14 degrees (the roll angle was away from the system). The vehicle exited the rail at 706 milliseconds at a speed of 64 km/hr and an angle of 6.2-degrees. Vehicle decelerations and trajectory were well within the recommended limits of NCHRP Report 230. As a result of the test, they concluded that the system performed satisfactorily and the Missouri Department of Transportation should continue to use the guardrail-curb system where warranted.

Bryden and Phillips (27)

Bryden and Phillips performed twelve full-scale crash tests for the New York Department of Transportation to evaluate the performance of a three-beam bridge-rail system. Two

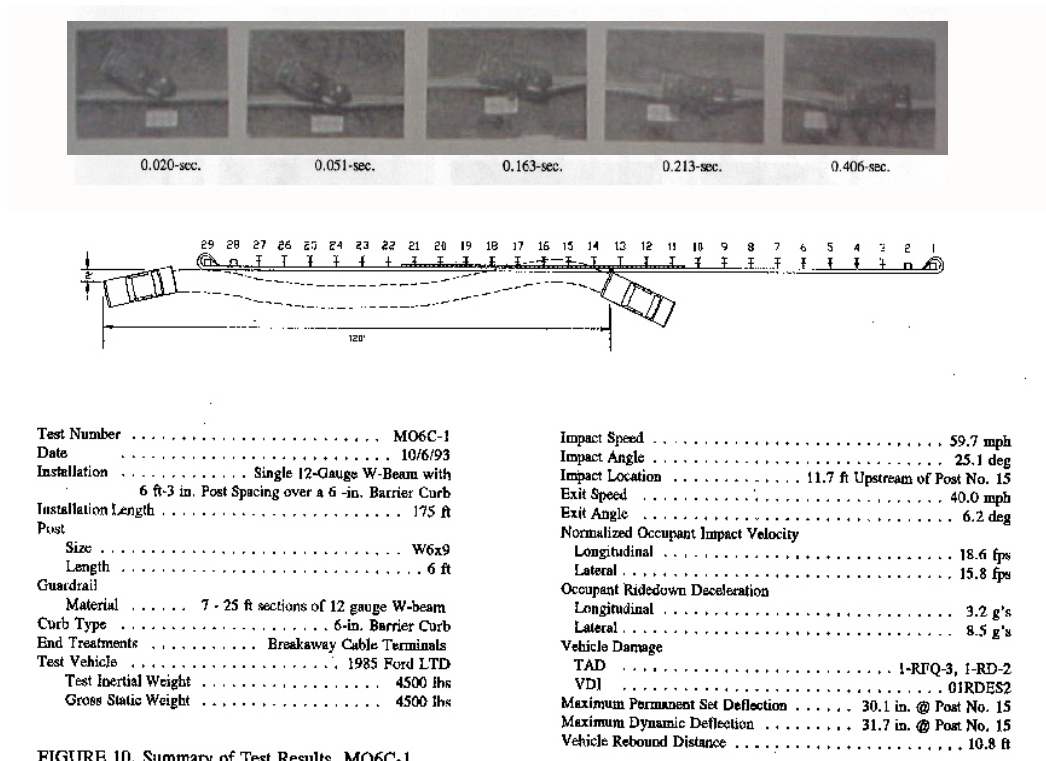

FIGURE 10. Summary of Test Results, MO6C-1

Figure 2.5: Summary of Test Results for MwRSF Test M06C-1 (26)

tests were conducted with a 150-mm curb placed flush with the face of the three-beam rail. The tests involved a 2043-kg Dodge station wagon impacting the system at approximately 100 km/hr at an impact angle of 26 degrees. The vehicle remained stable and was smoothly redirected in both tests.

FHWA Memorandum Feb 28, 1992 (28)

The results of a series of crash tests conducted by ENSCO was reported in an FHWA Memorandum distributed on February 28, 1992. The tests involved various types and

sizes of vehicles impacting w-beam guardrails with curbs placed behind the face of the w-beam rail element. In the cases involving curbs 150 mm high or higher, it was found that the vehicle would vault over the guardrail, if the guardrail deflected enough for the wheels to mount the curb. In crash tests in which the 100-mm AASHTO Type G curb was placed behind the face of the w-beam, the vehicle became airborne when guardrail deflection permitted the wheels to mount the curb; however, the vehicle did not vault the rail. The best alternative for reducing the safety hazards associated with guardrail-curb systems is to stiffen the guardrail. Stiffening the guardrail reduces guardrail deflection and reduces the potential of the vehicle contacting the curb. In tests where the guardrail was sufficiently stiff, the tires of the vehicle did not contact the curb, and the vehicle was redirected in a much more stable manner. Below is a summary of the ENSCO tests:

Test Number 1862-1-88 A 2452-kg pickup truck impacted a G4(1S) guardrail system with a 203 mm high concrete curb (AASHTO type A) installed behind the face of the w-beam. The impact speed was 100 km/hr and the impact angle was 20 degrees. There was significant deflection of the guardrail, and the wheels of the vehicle contacted the curb. The vehicle vaulted over the guardrail.

Test Number 1862-4-89 A 817-kg car impacted a G4(1S) guardrail system with a 150 mm high asphalt dike. The impact speed was 100 km/hr and the impact angle was 20 degrees. The wheels of the vehicle did not contact the curb during the crash event, and the vehicle was smoothly redirected.

Test Number 1862-5-89 A 2043-kg sedan impacted a G4(1S) guardrail system with a 150 mm high asphalt dike. The impact speed was 100 km/hr and the impact angle was 25 degrees. There was significant deflection of the guardrail, and the wheels of the vehicle contacted the curb. The vehicle vaulted over the guardrail.

Test Number 1862-12-90 A 2452-kg sedan impacted a G4(1S) guardrail system with a 100 mm high concrete curb (AASHTO type G). The impact speed was 100 km/hr and the impact angle was 25 degrees. The vehicle became airborne but did not vault the guardrail.

Test Number 1862-13-91 A 2043-kg sedan impacted a G4(1S) guardrail system stiffened with a w-beam bolted to the back of the steel posts. A 150-mm asphalt dike was placed behind the front face of the w-beam. The impact speed was 100 km/hr and the impact angle was 25 degrees. The guardrail system was sufficiently stiff to prevent the wheels of the vehicle from impacting the curb. The vehicle was successfully redirected.

Test Number 1862-14-91 A 2043-kg sedan impacted a G4(1S) guardrail system stiffened with a C6x8.2 hot rolled channel rub rail. A 150-mm asphalt dike was placed behind the face of the w-beam. Again the guardrail system was sufficiently stiff to prevent the wheels of the vehicle from impacting the curb and the vehicle was successfully redirected. The vehicle speed change at redirection, however, was greater than the allowable (24 km/hr) according to NCHRP Report 230; thus the system did not meet all

required safety criteria.

Polivka, et al. (29)

A study was conducted by researchers at the Midwest Roadside Safety Facility at the University of Nebraska-Lincoln to evaluate the effects of an AASHTO type G curb (i.e., 102 mm high and 203 mm wide) placed flush behind the face of a G4(1S) guardrail system. Test NEC-1 was conducted

with impact conditions recommended in NCHRP Report 350 test Level 3, which involves a 2,000-kg pickup truck (1991 GMC 2500) impacting at a speed of 100 km/hr at an impact angle of 25 degrees. (2.12) Sequential

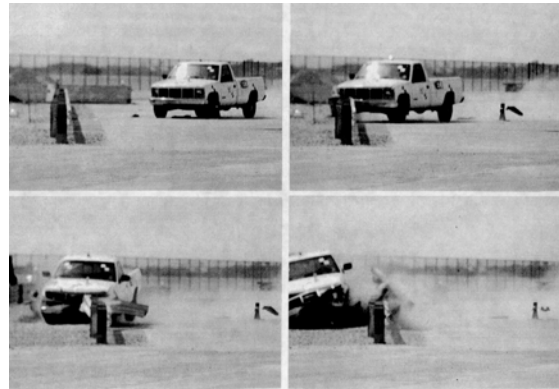

photographs of the crash test are

Figure 2.6: Sequential video frames from test NEC-1. (29)

shown in Figure 2.6. The center of gravity of the test vehicle was 737 mm.

The test installation was a standard 53.34 m long G4(1S) guardrail system anchored on both the upstream and down stream ends of the system by an inline breakaway cable terminal with a strut between the two end posts.

The guardrail ruptured at a splice connection, thus the test was a failure. There was little vertical displacement of the vehicle as it crossed the curb in the full-scale test, and there seemed to be very little potential for underride or vaulting of the barrier. The anchor

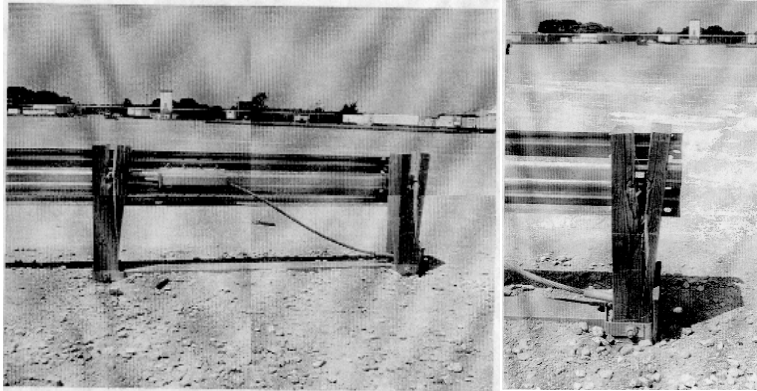

Figure 2.7: Guardrail terminal damage during test NEC-1.
(29)

posts split during the collision, as shown in Figure 2.7, and there was a loss of tension in the w-beam, which resulted in pocketing and rupture of the w-beam rail at a splice connection. The splice failure was attributed to contact and snagging of the post breakout against the w-beam rail splice. The post twisted as it was pushed back in the soil, causing the bottom corner of the breakout to push up against the corner of the w-beam rail splice. This resulted in a tear in the w-beam at the lower downstream bolt location. It was suggested that the guardrail-curb combination could be significantly improved by increasing the capacity of the w-beam rail.

Polivka, et al. (30)

This study involved the second phase of the curb-and-barrier impact investigation conducted by MwRSF, in which the 102-mm AASHTO type G curb was installed in combination with a strong-post guardrail system. Test NEC-2 was conducted with impact conditions recommended in NCHRP Report 350 test Level 3. The test vehicle was a

2000-kg pickup truck (1994 GMC 2500) and the impact speed and angle were 100.3 km/hr and 28.6 degrees, respectively. The center of gravity of the test vehicle was 667 mm.

The test installation was a modified G4(1S) guardrail with routed wood blockouts. In order to reduce the potential for rupture of the rail, two layers of 12-gauge w-beam were nested over a 26.67-m section of the guardrail. This modification was incorporated based on the results of test NEC-1, conducted in the first phase of the study, in which a splice rupture occurred during impact. The total length of the guardrail was 53.34 m, including an inline breakaway cable terminal located at both ends of the system.

The vehicle vaulted during impact and was airborne for much of the impact event. While the vehicle was airborne, it did get over the rail, as shown in Figure 2.8; however, the vehicle remained upright, came down on the front side of the guardrail, and satisfied all safety requirements of NCHRP Report 350. A summary of test NEC-2 is shown in Figure 2.9 which was taken from Polivka *et al.*

Booth et al (31)

During the 1980's, the Federal Highway Administration (FHWA) sponsored the testing of numerous bridge railings, some of which included curbs. In particular, Texas Transportation Institute tested a New Hampshire bridge rail system with a curb protruding in front of the barrier face, and a Colorado Type 5 bridge rail system with a



Figure 2.8: NCHRP Report 350 Test 3-11 impact with modified G4(1S) guardrail with nested 12-gauge w-beams and a 102-mm curb under the rail. (30)

curb flush with the face of the barrier. In both tests, the front impact-side wheel was damaged during impact with the curb, and the wheel wedged between the curb and the bottom rail of the traffic barrier. The performance of both bridge railings was considered unsatisfactory, but it should also be noted that both railings had other poorly designed features that may have contributed to the poor performance.

Bullard and Menges(32)

This study was conducted by researchers at the Texas Transportation Institute (TTI) and involved the evaluation of a 100 mm high asphaltic curb, set out 25 mm from the face of the rail of a G4(2W) strong post guardrail system, as shown in Figure 2.10.

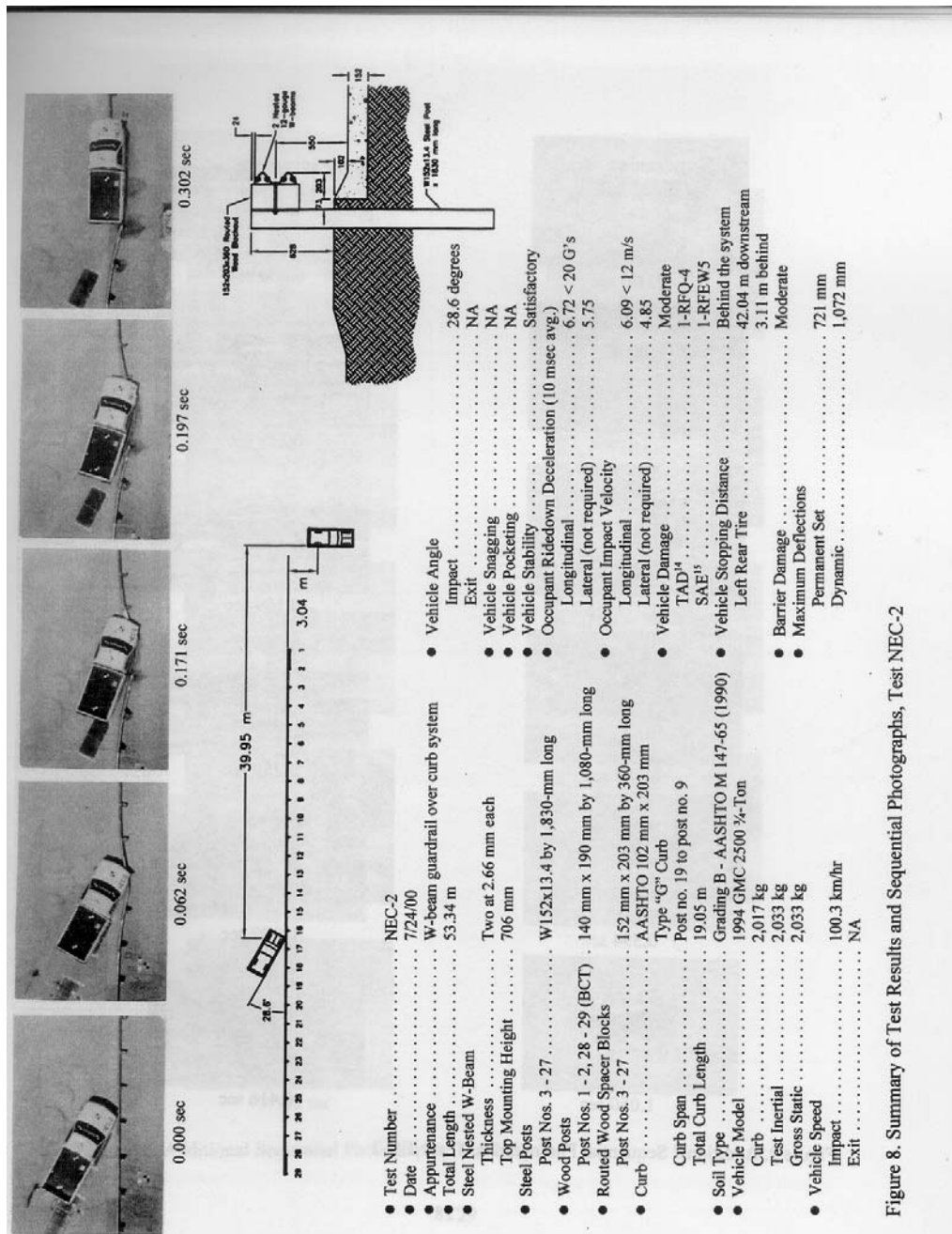

Figure 2.9: Summary of test results of Test NEC-2 from Polivka *et al.* (30)

TTI test 404201-1 was conducted at the Texas Transportation Institute on May 23, 2000 and involved a Chevrolet C2500 pickup impacting the curb-and-barrier system at 101.8 km/hr at an angle of 25.2 degrees (i.e., NCHRP Report 350 Test 3-11).

During the test, there was significant movement of the anchor system as the foundation of the anchor posts moved in excess of 70 mm. The test was successful; however, there was considerable damage to the guardrail system, as shown in Figure 2.11. The extent of damage to the system was much greater than that of previous crash tests on the G4(2W) guardrail system without a curb present.(39) From reviewing the film from the crash test and the test report, it is believed that the excessive damage to the system is due, in part, to the use of poor grade posts in the guardrail installation. Many of the posts split vertically during impact along pre-existing splits passing through the bolt hole location in the posts, as shown in Figure 2.12. A summary of Test 404201-1 is shown in Figure 2.13.

2.5 EFFECTS OF CURB TRIP ON VEHICLE STABILITY

Cooperrider, et al. (33)

Researchers at Failure Analysis Associates, Inc. (FaAA) performed a study to investigate the mechanics of vehicle rollovers. It was their perception that the experimental and analytical methods that were being used at that time (late 1980's) did not accurately represent real world vehicle rollovers. Their investigation involved full-scale tests, in which vehicles were tripped by three different trip mechanisms: sliding into a curb, sliding in soil, and being thrown from a dolly. They also developed a simple analytical



Figure 2.10: Guardrail/curb installation for TTI test 404201-1.(32)



Figure 2.11: Guardrail damage in test TTI 404201-1.
(32)



Figure 2.12: Posts split vertically during TTI test 404201-1 along pre-existing splits in posts. (32)

technique to characterize the mechanics of these different trip modes based on a constant force method.

Eight full-scale tests were conducted using four different vehicle types to examine the rollover mechanics of vehicles tripped by a curb, rolled off a dolly, and tripped by tire-soil interaction. The test matrix and results from the study are presented below in Table 2.3.

For the curb impact tests, a 152-mm square section of steel box tubing, rigidly affixed to the roadway, was used to represent a curb. The vehicles were towed sideways and released just prior to contact with the curb. The friction between the tires and the road surface was reduced by applying soap film to the roadway. In order to more accurately represent the impact conditions of vehicles in real world accidents, where an initial roll of the vehicle would be produced from the tire-ground interaction, a roll angle of 2.5 degrees was built into the test vehicles by extending the left suspension with wood blocks.

Two of the five curb impact tests resulted in rollover. The three vehicles that did not rollover sustained excessive damage to their wheels or axles during impact. Failure or partial failure of these components may result in a reduction of load applied to the vehicle, which reduces the potential for rollover. The tripping force must be applied for sufficient duration to cause rollover. For the vehicles that did roll over, the average

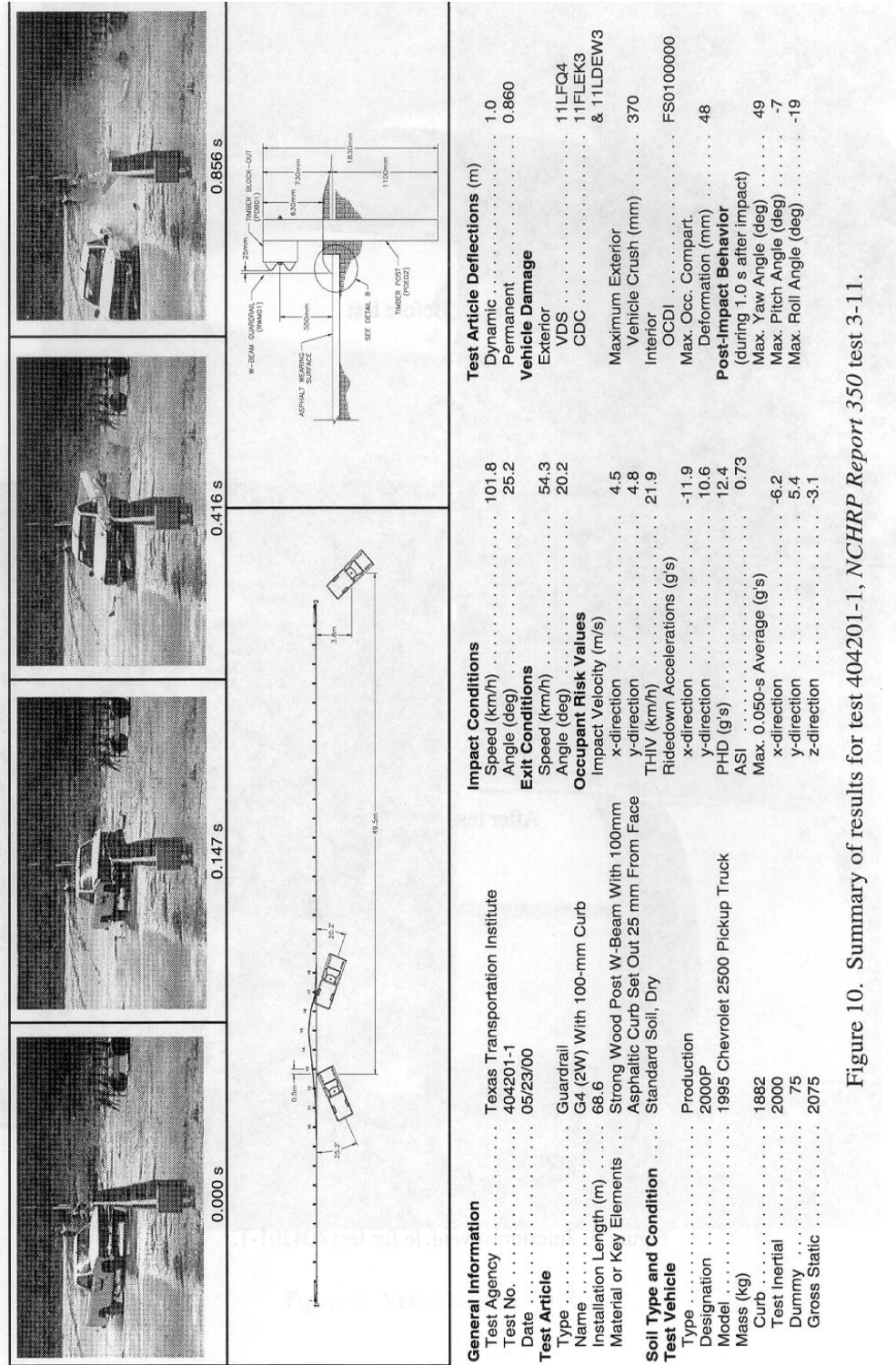

Figure 2.13: Summary of test results of TTI test 404201-1 from Bullard and Menges (32)

Table 2.3: Test Matrix for Cooperrider Study (33)

Test No.	Vehicle Model	Trip Method	Test Speed (km/hr)	Results
1	1981 Dodge Challenger	Curb	48.1	no rollover
2	1981 Dodge Challenger	Curb	47.6	rollover
3	1979 Datsun B210	Curb	47.2	rollover
4	1972 Chevrolet C20 Van	Curb	47.6	no rollover
5	1981 Chevrolet Impala	Curb	48.6	no rollover
6	1981 Dodge Challenger	Dolly	48.6	rollover
7	1981 Dodge Challenger	Soil	54.2	rollover
8	1979 Datsun B210	Soil	43.5	rollover

maximum decelerations at the center of gravity was 12.4 g's, compared to maximum decelerations of 1.62 g's and 1.3 g's in the soil trip tests and dolly tests, respectively.

The curb trip tests resulted in peak angular velocities of 260 degrees/sec and 300 degrees/sec. The peak angular velocities in the soil trip tests were similar with values of 230 degrees/sec and 390 degrees/sec. The peak angular velocity of the vehicle in the dolly test was 460 degrees/sec, which was much higher than the curb tripped and the soil tripped vehicles. The higher roll rate of the dolly-rolled vehicle was attributed to the 48 degree initial roll angle of the dolly when it contacted the ground. This caused a greater moment arm from the point of impact to the center of gravity of the vehicle.

The analytical model developed in the study was based on the assumption that a constant

tripping force acts on the vehicle during the rollover initiation phase. Although the model did not account for the effects of tire and suspension system compliance, the results compared well with the test data.

They found in their study that the kinematics of the tripped vehicle varied significantly, depending on the tripping mechanism (i.e., curb, soil and dolly). Curb impacts produced very high decelerations, usually in excess of 10 g's. Some curb-tripped vehicles, however, did not rollover because critical structural components (e.g., the wheel assembly) failed during impact, providing an alternate path for the unbalanced forces. When components of a vehicle collapse or break during these types of impact, the duration force may not be sufficient to initiate a rollover.

DeLeys and Brinkman 1987 (34)

Computer simulation was used in a study to determine the dynamic response of small and large passenger cars traversing various sideslope, fill-embankment, and ditch configurations. Both tracking and non-tracking departures from the roadway were investigated. A modified version of the Highway Vehicle Object Simulation Model (HVOSM) was used in this research that improved the programs application to rollover situations. The modifications to the program were made by McHenry Consultants, Inc. These modifications included further development of the tire model and the addition of a tire/deformable-soil interaction model to the program.

A literature review and accident data analysis² was performed in their study, and some of the principal findings from that review are listed below:

1. “Embankments, ditches, and culverts are the roadside terrain features cited as being most frequently involved in overturn accidents. However, detailed information on the geometry of the terrain and whether the rollover was caused by vaulting, or by the wheels hitting a small obstacle; or by the wheels digging into soft soil and tripping the vehicle, is generally lacking in accident data files.”
2. “In most (50% to 80%) of the rollover accidents, the vehicles were skidding out of control at a large yaw angle prior to overturning.”
3. “About half of all accidental departures from the roadway occurred at path angles greater than 15 degrees, and the majority of the vehicles were estimated to have been traveling at speeds less than 64 to 80 km/hr.”

Full-scale tests were performed with an instrumented 1979 VW Rabbit automobile to provide data for evaluating the validity of the modified computer program. The tests included spinout of the car on level turf, dragging the car over a sod field, traversals of fill-embankments, and traversals of the front slope of a wide ditch. Motion-resistance force data was collected in these tests and was used for obtaining tire/ground coefficients of friction for typical roadside terrain surfaces, as well as, for validating the computer

² Accident data information came from the accident data recorded in the 1979 - 1981 National Accident Sampling System (NASS).

simulation models.

The “drag” tests were performed by attaching two steel cables to the center of the front and rear wheels on the right side of the vehicle. A load cell was installed on each cable to measure the forces as the vehicle was pulled sideways over the ground surface at speeds of 16 - 24 km/hr. The data from the tests indicated that the average coefficient of friction between the tires of the VW Rabbit and the sodded ground surface were typically about 0.5.

The modified version of HVOSM provided reasonable accuracy of the simulations of the tests on the various roadside terrains. They did point out, however, that “the study did not thoroughly establish the extent to which the model accounts for all of the various real-world conditions that contribute to vehicle rollover.”(34)

Over 200 HVOSM simulations of vehicles traversing various sideslopes, fill-embankments, and ditch configurations were used to determine how much these roadside conditions affect the rollover tendencies of vehicles. In addition to the VW Rabbit model (1093-kg vehicle) that was developed and validated with the full-scale tests, two other vehicles were modeled: one was a relatively light vehicle and the other a much heavier vehicle. The lighter vehicle had a mass of 816 kg and was identical to the VW Rabbit model, except that the mass and moments of inertia were different. The heavier vehicle model had a mass of 2018 kg, representing the larger class of passenger cars, and its

physical characteristics were defined in HVOSM using available data typical for that vehicle type.

The conclusions that the authors made from the study, that pertain to use of HVOSM for predicting the dynamic response of vehicles traversing various types and shapes of terrain, are listed below:

1. “The modified HVOSM has been demonstrated to be capable of predicting the response of vehicles operating on off-road terrains with reasonable accuracy. The development and incorporation of the deformable-soil model in HVOSM is considered an important improvement since it allows simulation for the effects of tire sinkage in soil which has been identified as one of the leading causes of rollover. However, evidence of the validity of the deformable-soil model is clearly still very limited.”
2. “The relatively few simulations that resulted in vehicle rollover in this study point to the dynamic nature of the rollover phenomenon, which is sensitive to the complex interactions of many factors whose effects are not independent. Adequate vehicle parametric data for the severe operating regime associated with the rollover response are generally lacking. Among the most important of these are definitive data for tire properties under the high tire load and large slip and camber angle conditions that prevail in most rollover events.”
3. “Ultimately, the vehicle rollover potential associated with roadside features is

reflected by real-world accident experience. From the literature review performed as part of the study, it is apparent that the existing accident data base lacks the comprehensive and detailed information necessary to define the conditions that lead to rollover for different vehicle types. For example, data contained in accident data files, such as NASS and FARS, usually provide little or no information regarding the geometrics of the accident site (e.g., steepness of slopes, embankment height and roundings), whether the vehicles were tripped by a surface irregularity or as a result of tire ruts in soft soil, where rollovers were initiated with respect to the terrain feature (sideslope, backslope, toe of embankment, etc.), vehicle trajectory, etc.”

Allen et al. 1991 (35)

Researchers at Systems Technology, Inc. (STI) conducted a study to determine the directional and rollover stability of a wide range of vehicles using the computer simulation program VDANL. They showed that rollover stability and directional stability are related to center of gravity location and track width, as well as, the other characteristics that influence these variables under hard maneuvering conditions. Vehicle dynamics and tire ground interaction under such conditions are nonlinear and can be quite complex; therefore, computer simulation is essential in analyzing stability problems.

Forty-one vehicles were used in the study for parameter and field testing. Spinout occurs

when rear tire adhesion limits are exceeded while the front tires still have side force capacity available. Computer simulation results were validated with the field test results, and it was found that in many cases the dynamic behavior of the vehicle was largely dependent upon the tire model and tire-ground interaction. Thus, detailed information about the tire properties and friction coefficients are necessary for valid model development.

One conclusion from their study was that load transfer distribution among the tires should be near to, or greater than, the vehicle weight distribution; although there are several other factors that influence limit performance maneuvering. As the center of gravity of a vehicle is raised and/or track width is narrowed, wheel lift off becomes more likely and balancing load transfer distribution becomes a critical issue. The computer simulation program, VDANL, was validated for both stable and unstable vehicle maneuvering conditions, and was considered to be a practical and effective means of analyzing vehicle stability problems.

Allen et al. 1997 (36)

Researchers at Systems Technology, Inc. and JPC Engineering further improved the Slip Tire Model (STIREMOD) for use in the vehicle dynamics computer simulation program, VDANL. STIREMOD was expanded to include the full-range of operating conditions for both on- and off-road surfaces, including unlevel terrain, changing surface conditions, and tires “plowing” through soil. They discussed in some detail the input parameters for

the model and the means for establishing typical model parameters. The model would be useful for the analysis of vehicle encroachments onto the road shoulders and side slopes. The model could also be used for analyzing vehicle tire interaction with curbs, where the curb would be modeled as an abrupt change in surface shape and surface properties (e.g., asphalt pavement to a concrete curb).

Allen et al. 2000 (37)

Allen and other researchers at Systems Technology, Inc. wrote a paper summarizing the development and application of the vehicle dynamics computer simulation model, VDANL. The subsystem models of VDANL are described (e.g., tires/wheels, brakes, steering, power train, roadway inputs, driver model, steering control and speed control). Discontinuities in the roadway, such as potholes, speed bumps, and curbs, can be modeled in VDANL with additional inputs to the surface profile.

VDANL models the inertial component of the vehicle as a six-degree of freedom sprung mass connected by springs and dampers to the axles, which are supported by pneumatic tires. “Communications services have also been added to VDANL so that it can provide commands for display image generators (Igs), feel and motion systems, sound cuing, and miscellaneous controls and displays.”(37) The program runs in real time on Pentium class computers running Windows 95/98/NT network.

A specialized version of the software was developed for the Federal Highway

Administration as part of the Interactive Highway Safety Design Model (IHSDM), which allows new roadway designs to be assessed using a driver model. Two case studies were presented in their study using VDANL_IHSDM to determine if a truck-climbing lane was necessary for a proposed roadway alignment, and to determine if a loaded tractor-trailer would be able to maintain a specified speed traveling downgrade on the roadway without losing control.

2.6 Synthesis of Literature Review

Both sloping and vertical curbs are regularly used in urban areas along low-speed roadways for drainage purposes, walkway edge support, pavement edge delineation, to discourage vehicles from leaving the roadway, and to provide limited redirection of encroaching vehicles. Vertical curbs have a vertical or nearly vertical face and are recommended for use only on low-speed roads. Sloping curbs have a sloping face and are configured such that a vehicle can ride up and over the curb, in order to reduce the likelihood of causing tire blowout or suspension damage. Sloping curbs are used primarily for drainage purposes, but are also used on median islands and along shoulders of high speed roadways for delineation and other reasons.

Curbs along low-speed roadways are not likely to result in serious injuries and are commonly used in urban areas where speed limits are in the range of 40 - 48 km/hr.

Curbs along high-speed roadways have been discouraged by AASHTO for many years due to the potential hazard caused by high-speed impact with curbs.(1) In the

intermediate range of speed (between 60 - 80 km/hr), however, there are no standards for the use of curbs. Highway engineers must, therefore, determine if a curb is warranted based on individual roadway conditions and location. In urban areas curbs are often considered acceptable; whereas in rural areas curbs are discouraged at intermediate speeds.⁽¹⁾

There have been a limited number of studies performed to determine the effects of impact with curbs on the dynamic stability of vehicles, and on the performance of barriers placed in combination with curbs. The studies have involved full-scale crash testing ⁽²²⁾⁽²⁵⁾⁽²⁶⁾⁽²⁷⁾⁽²⁸⁾⁽²⁹⁾⁽³⁰⁾⁽³¹⁾⁽³²⁾ and computer simulation using the Highway Vehicle Object Simulation Model (HVOSM).⁽²²⁾⁽²³⁾⁽²⁴⁾ A summary of full-scale crash tests involving curb-guardrail combinations are presented in Table 2.4. Although it has been found that sloping curbs do not impede the redirection of a vehicle during tracking impact, they do affect the trajectory of a vehicle. Thus, the curb itself presents very little threat of harm when hit by a vehicle, but, when a vehicle impacts and mounts a curb, the dynamics of the vehicle may cause the vehicle to impact a secondary object in such a manner that will cause the object to not function properly.

A curb located in front of a guardrail may cause an impacting vehicle to strike the guardrail at a point higher or lower than normal. Under certain impact conditions, the curb can cause the vehicle to ramp high enough to vault over the barrier, or, in some cases, under-ride and snag on the barrier.⁽²²⁾⁽²⁵⁾⁽²⁹⁾⁽³⁰⁾⁽³¹⁾ Another example, where a

curb could have adverse effects on the performance of a device, is the placement of a curb in front of a breakaway pole. The breakaway feature at the base of the poles are designed to work when the pole is struck near the base. If a vehicle is airborne when it hits a breakaway pole, the impact point may be well above the base; thus the breakaway feature may not work as it is intended.

In some studies the lateral displacement of the vehicle at maximum rise height has been considered an important factor for determining the potential for vehicle underriding or vaulting a barrier.⁽²²⁾⁽²⁵⁾⁽³⁸⁾ Design parameters defined by AASHTO for curb impacts are shown in Figure 2.14. It was reported that underride and vaulting of a standard strong-post guardrail was possible when the barrier was placed within some critical range behind the curb, usually within 0.76 m for underride and between 0.01 - 3.66 m for vaulting. This data was obtained through measuring vehicle trajectory during impact with curbs.

It has been assumed for many years by design engineers that if the curb is placed behind the face of the w-beam that the guardrail-curb system would perform adequately in safely containing and redirecting an impacting vehicle. Previous crash tests, involving large sedans and pickup trucks impacting various guardrail-curb combinations, have provided researchers with mixed results regarding the performance of such systems.⁽²⁵⁾⁽²⁶⁾⁽²⁸⁾⁽²⁹⁾⁽³⁰⁾⁽³¹⁾⁽³²⁾

In full-scale crash tests performed by ENSCO, it was shown that vaulting is possible even when the curb is located flush with the face of a w-beam guardrail. If guardrail deflections during impact are sufficient to allow the wheel of the vehicle to contact and mount the curb, the vehicle may vault over the barrier.(26) Even though the vehicle contacts the barrier prior to reaching the critical trajectory height that would signify override, the vehicle will continue to rise while it is in contact with the barrier and may result in vaulting during redirection. Crash tests performed at Midwest Roadside Safety Facility (MwRSF), on the other hand, have demonstrated that similar curb/w-beam guardrail combinations do not degrade the performance of the barrier systems.(24)(26)

Some curb types are more likely to cause vaulting of a vehicle than others. The FHWA Memorandum in February 1992 reported that, in the case of curbs 150 mm high or higher, if a guardrail deflects enough for the wheels to mount the curb then the vehicle could vault over the guardrail.(28) It was also reported in the FHWA memorandum that crash tests involving the AASHTO Type G curb (a 100-mm curb height with slanted face) placed behind the face of the w-beam resulted in the vehicle becoming airborne when guardrail deflection permitted the wheels to mount the curb, however, the vehicle did not vault the guardrail. A similar conclusion was found in other studies, which showed that vehicle impact with low profile curbs would result in very little change in trajectory of the vehicle (50-mm maximum), regardless of the vehicle's speed and angle of impact.(22)(25)

A w-beam guardrail is sufficiently stiff enough that the lateral deflections of the barrier are minimal during impact with a small car; thus for curb-guardrail combinations, in which the curb is placed underneath a strong-post w-beam guardrail, there is little chance of vehicle contact with the curb.(25)(28) It has also been found that stiffening the guardrail system by installing a w-beam rail to the back side of the posts, or installing a rub-rail, will enhance the safety performance of a curb-guardrail system.(26) The installation of a rub-rail may provide the most safety benefit, since it both stiffens the system to avoid vehicle-to-curb contact and shields the posts from potential wheel snag.

There have been three tests performed on curb-guardrail systems under NCHRP Report 350 test 3-11 impact conditions: MwRSF tests NEC-1, NEC-2 and TTI test 404201-1.(29)(30)(32) These tests involved 100 mm high curbs placed in combination with strong post guardrails. Both, test NEC-1 and test TTI 404201-1, resulted in significant tensile forces in the w-beam rail and excessive movement of the anchor system. In test NEC-1, the two upstream anchor posts for the G4(1S) guardrail with wood blockouts ruptured causing the vehicle to pocket.(29) This ultimately resulted in rupture of the w-beam rail element, and the vehicle penetrated the guardrail. The poor performance of this system was not directly attributed to the effects of the curb, but rather to a loss of tensile capacity of the guardrail during impact when the anchor system failed.

In TTI test 404201-1, the foundation of the anchor posts of the G4(2W) guardrail moved in excess of 70 mm at the ground line, and there was considerable damage to the

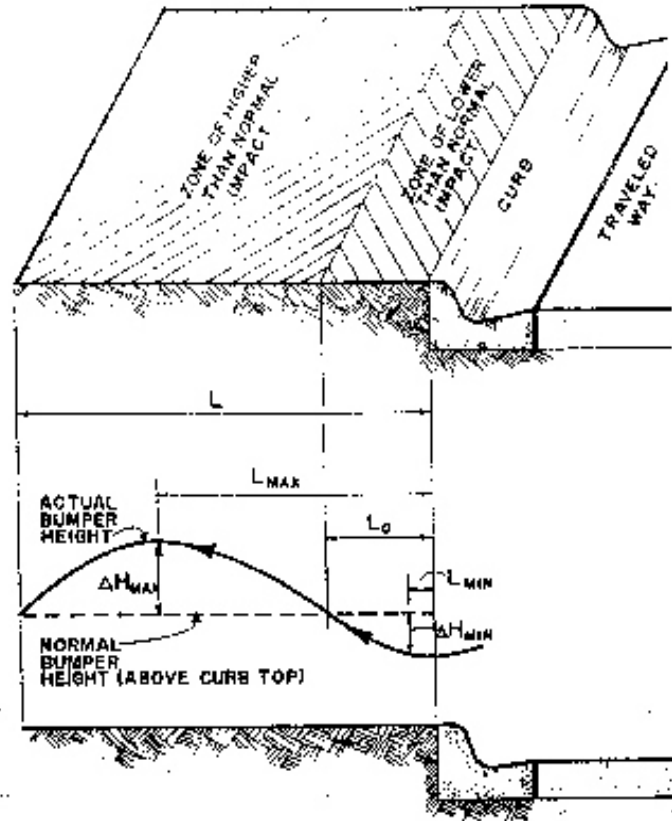

- L = Distance From Top of Curb to the Second Return to Normal Bumper Height
- L_{max} = Distance Measured From Top of Curb to Occurrence of Highest Bumper Height Above Normal
- L_0 = Distance From Top of Curb to the First Return to Normal Bumper Height
- L_{min} = Distance From Top of Curb to the Occurrence of Lowest Bumper Height Below Normal
- ΔH_{min} = Maximum Bumper Height Below Normal Height
- ΔH_{max} = Maximum Bumper Height Above Normal Height

Figure 2.14: Design Parameters for Curb Impacts as Defined by AASHTO (38)

guardrail system; however the system did meet all safety requirements of NCHRP Report 350.(32) Also, the extent of damage to the system in test TTI 404201-1 was much greater than that of previous crash tests on the G4(2W) guardrail system without a curb present.(39)

Table 2.4: Summary of full-scale crash tests of curb-guardrail combinations with curb located behind face of guardrail

Literature Reference	Testing Agency	Test No.	Vehicle Type	Speed and Angle	Curb Type	Guardrail Type	Result	Comment
Holloway <i>et al.</i> (26)	MwRSF	M06C-1	1985 Ford LTD (2041 kg)	96.1 km/hr 25.1 degrees	152-mm vertical curb	G4(1S)	Passed	smoothly redirected
Bryden and Phillips (27)	NYDOT		Dodge Station Wagon (2041 kg)	100 km/hr 26 degrees	152-mm vertical curb	Thrie-Beam Bridge Rail	Passed	smoothly redirected
FHWA Memorandum Feb 1992 (28)	ENSCO	1862-1-88	3/4-ton Pickup Truck (2449 kg)	100 km/hr 20 degrees	203-mm AASHTO A	G4(1S)	Failed	vehicle vaulted over rail
		1862-4-89	Small Car (820 kg)	100 km/hr 20 degrees	152-mm Asphalt Dike	G4(1S)	Passed	smoothly redirected
		1862-5-89	Large Car Sedan (2041 kg)	100 km/hr 25 degrees	152-mm Asphalt Dike	G4(1S)	Failed	vehicle vaulted over rail
		1862-12-90	Large Car Sedan (2449 kg)	100 km/hr 25 degrees	100-mm AASHTO G	G4(1S)	Passed	vehicle was airborne but did not vault
		1862-13-91	Large Car Sedan (2041 kg)	100 km/hr 25 degrees	152-mm Asphalt Dike	G4(1S) stiffened with w-beam	Passed	
		1862-14-91	Large Car Sedan (2041 kg)	100 km/hr 25 degrees	152-mm Asphalt Dike	G4(1S) stiffened with rub rail	Failed	vehicle speed change at redirection was too high
Polivka, <i>et al.</i> (29)	MwRSF	NEC-1	1991 GMC 3/4-ton Pickup (2,000 kg)	103.2 km/hr 24.5 degrees	102-mm AASHTO G	G4(1S)-mod with wood blockout	Failed	Excessive anchor movement / Guardrail ruptured
Polivka <i>et al.</i> (30)	MwRSF	NEC-2	1994 GMC 3/4-ton Pickup (2,000 kg)	100.3 km/hr 28.6 degrees	102-mm AASHTO G	G4(1S)-mod with wood blockout nested w-beam	Passed	vehicle experienced extreme trajectory but did not vault over rail
Bullard and Menges (32)	TTI	404201-1	1995 Chevrolet 3/4-ton Pickup (2000 kg)	101.8 km/hr 25.2 degrees	100-mm CDOT curb	G4(2W)	Passed	Significant guardrail damage and anchor movement

In test NEC-2, the G4(1S) guardrail with wood blockouts was modified and retested.(30) The guardrail was modified by nesting 12-gauge w-beam rails along the length of the system. This test resulted in excessive vertical trajectory of the vehicle during impact, but the vehicle remained upright and successfully met all safety criteria of NCHRP Report 350.

Vehicle tripping on curbs was addressed in a very limited number of studies. The studies that were identified in the literature used a variety of techniques for analysis including analytical methods, computer simulation, full-scale crash testing, and accident data analysis.(25)(33)(34) Vehicle tripping on curbs was addressed in Holloway *et al.* using HVOSM to simulate non-tracking impacts of large passenger sedans.(25) Based on the results of their simulations, they concluded that sloping curbs may not be a significant cause of vehicle rollovers; however, it should be noted that the models used in their study were not validated for non-tracking impacts. It was not reported whether or not friction between the tires and ground surface was included in the simulations. Friction between the tires and ground will affect the initial roll angle and roll rate of the vehicle prior to impact, which may increase the vehicle's tendency to rollover.

DeLeys and Brinkman used crash data analysis and computer simulation to investigate rollover tendencies of vehicles traversing various roadside terrain. They concluded that the data bases lacked the comprehensive and detailed information necessary to define conditions that lead to rollover. A modified version of HVOSM with improved

application for rollover situations was used in their study.(34) Full-scale tests were used to validate the computer models and, subsequently, over 200 simulation were conducted to investigate the rollover tendencies of vehicles traversing various side slopes, fill embankments, and ditch configurations. They did not investigate vehicle-curb interaction; however, the models that were used in their study may have been applicable for such analysis.

Cooperrider *et al.* carried out a series of full-scale crash tests to determine the potential for rollover of various vehicle types tripped by a curb, sliding in soil, and rolled off a dolly.(33) A steel 152-mm square tube section rigidly affixed to the roadway was used to represent a curb in their tests. In five of the eight tests that they conducted, the vehicles rolled over. In the cases where rollover did not occur, the wheel assembly failed during impact with the curb due to the high forces that were developed. The failure of the wheel assembly, consequently, removed the overturning force that was being applied to the vehicle. If the wheel assembly had not failed in those cases, it was possible that all the tests would have resulted in a rollover.

The vehicle dynamics code, VDANL, has been used to study vehicle rollover as a function of unstable maneuvering conditions, and also to investigate vehicle rollover due to impact with various vehicle tripping mechanisms such as curbs, soil, ditches, etc.(35)(36)(37) The results of the computer models developed in those studies were validated with full-scale tests. VDANL was chosen by the Federal Highway

Administration to be incorporated into the Interactive Highway Safety Design Model (IHSDM), which is used to assess new highway designs.

2.7 Summary

While there has been some work performed on the safety effectiveness of curbs and the use of curbs in conjunction with traffic barriers, the literature review shows that there are many limitations such as the age of the tests, the lack of sophistication in early computer models and changing full-scale crash testing guidelines. The literature indicates, however, that curbs should not be used in combination with w-beam guardrail systems on high- speed roadways due to the potential safety hazard of vaulting or underriding the barrier. In cases where design engineers often include curbs along high-speed roadways for drainage reasons or to improve delineation, other methods should be sought to achieve those purposes.

From the literature study it was found that both the large and small cars crossing 150 mm high or smaller curbs in a tracking manner are not likely to result in loss of vehicle control or cause serious injuries. The response of the 2000-kg pickup truck crossing curbs, however, was not known. The large passenger car used in the previous crash testing procedures was replaced in the current testing procedures (NCHRP Report 350) with the 2000-kg pickup truck. The dynamic response of this particular vehicle type crossing over curbs (not in conjunction with a roadside safety barrier) has never been evaluated with either full-scale tests or computer simulation.

Most of the curb impacts that were found in the literature involved vehicles encroaching the curb in a tracking manner. It was concluded in every case that a vehicle encroaching onto a sloping curb in a tracking manner is not likely to cause the driver to lose control of the vehicle or cause the vehicle to become unstable unless a secondary impact occurs. Another aspect of collisions with curbs involves an “out of control” vehicle impacting the curb in a non-tracking position. In these situations, vehicle tripping may be highly probable during impact.

Errant vehicles leave the roadway in a variety of orientations; however, it is assumed that the majority of these vehicles encroach onto the roadside in a semi-controlled tracking manner. In such cases, the left or right front bumper would be the first point of contact with a roadside object in an impact event. The position of the bumper upon impact has, therefore, been a primary concern involving impacts with longitudinal traffic barriers, where it has been assumed that the position of the bumper during impact is a reasonable indicator of vehicle vaulting or underriding the barrier.

A small number of tests have been performed in which a curb was placed behind the face of guardrail barriers. The idea was to locate the curb such that minimal interaction between the vehicle and curb occurred. This worked well with lighter vehicles, such as the 820-kg small car, but did not prevent vehicle-curb interaction with the heavier vehicles, such as the 2000-kg pickup truck, unless the guardrail was retrofit in some manner to strengthen it and minimize guardrail deflection. To circumvent the problem,

one option considered was to use a low profile curb underneath the guardrail. This was expected to minimize the effects that the curb would have on vehicle trajectory when the wheels of the vehicle were able to contact the curb during impact; however, full-scale tests conducted by various organizations provided mixed results. In some cases the crash test was successful, while in others it was not. In cases where the test was a failure, it was not clear whether the failure was induced by vehicle-curb interaction or if it was simply caused by inadequate barrier performance.

APPENDIX J

Angular Displacement-Time Histories From Curb-Barrier Impact Computed at the Center of Gravity of Vehicle

-Finite Element Analysis Results-

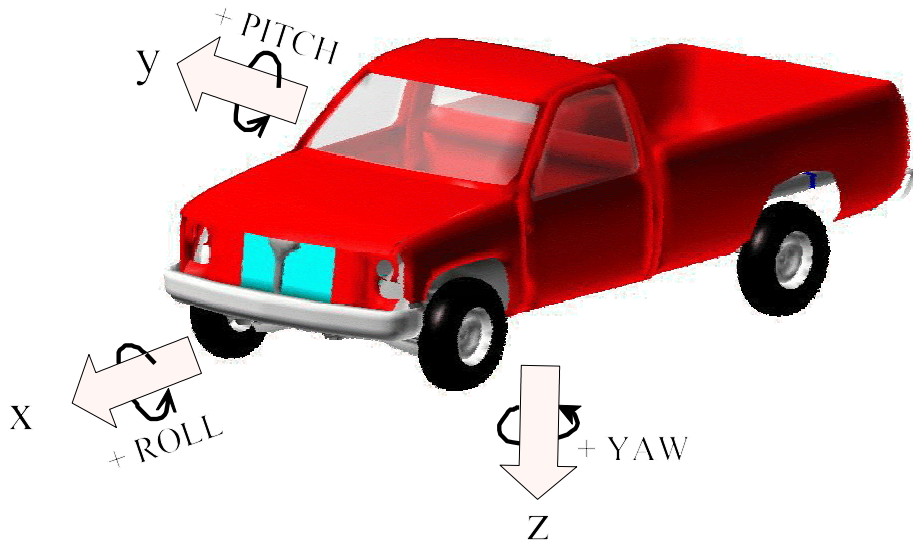

Vehicle fixed coordinate reference system.

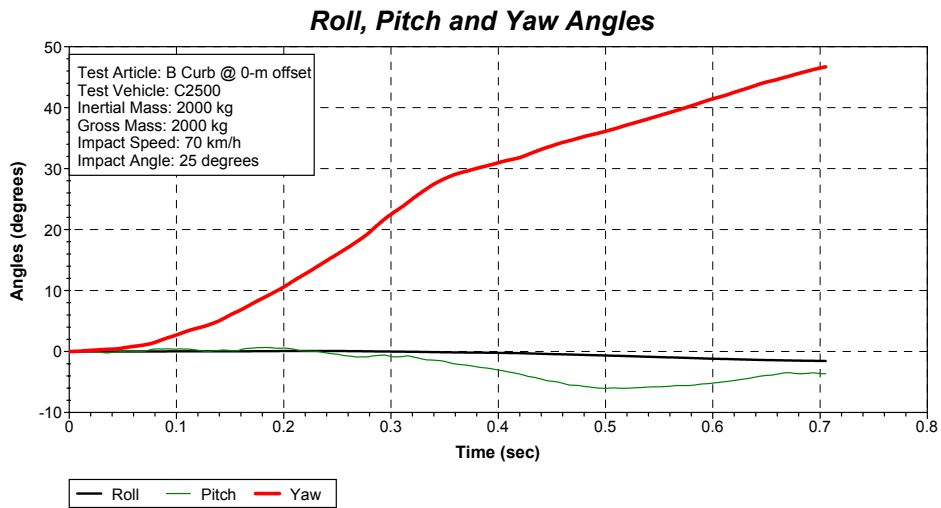

Figure J.1: Angular displacement-time histories at C.G. of pickup truck in local coordinates:
 Curb Type – AASHTO B Curb
 Impact Speed – 70 km/hr
 Offset Distance – 0.0 m.

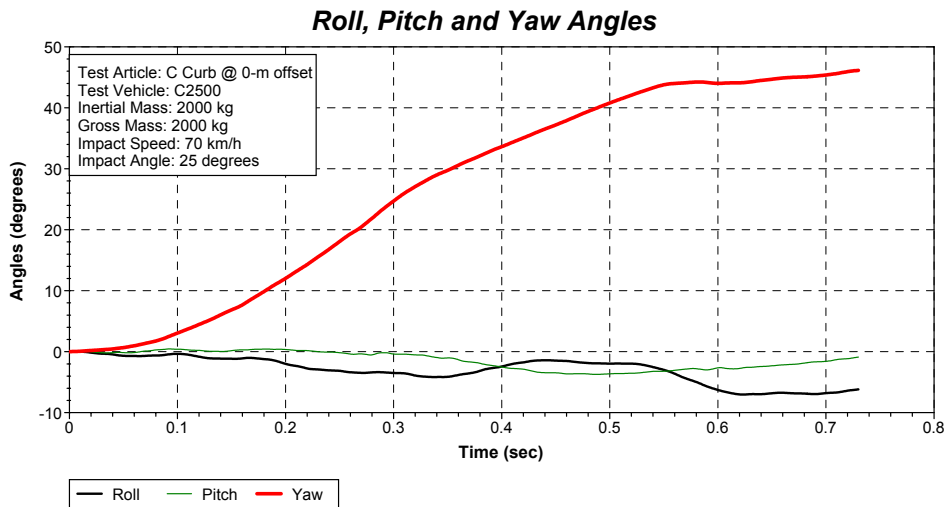

Figure J.2: Angular displacement-time histories at C.G. of pickup truck in local coordinates:
 Curb Type – AASHTO C Curb
 Impact Speed – 70 km/hr
 Offset Distance – 0.0 m.

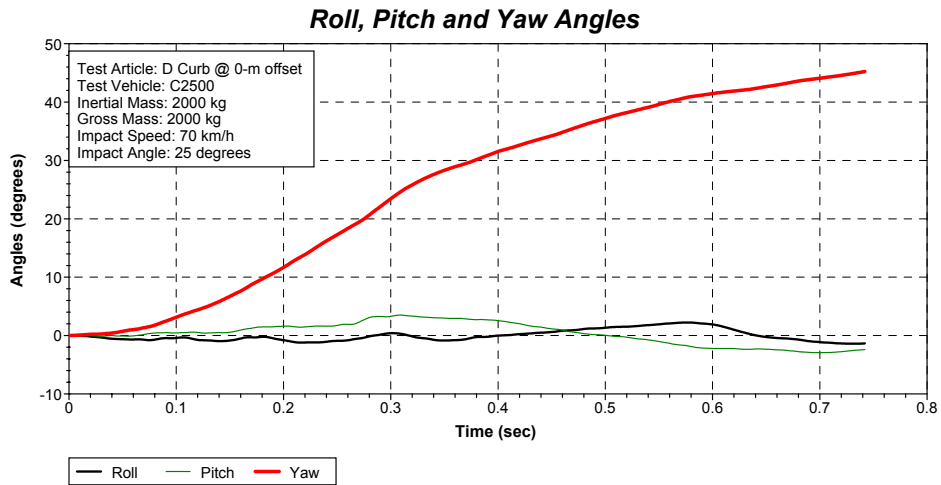

Figure J.3: Angular displacement-time histories at C.G. of pickup truck in local coordinates:
Curb Type – AASHTO D Curb
Impact Speed – 70 km/hr
Offset Distance – 0.0 m.

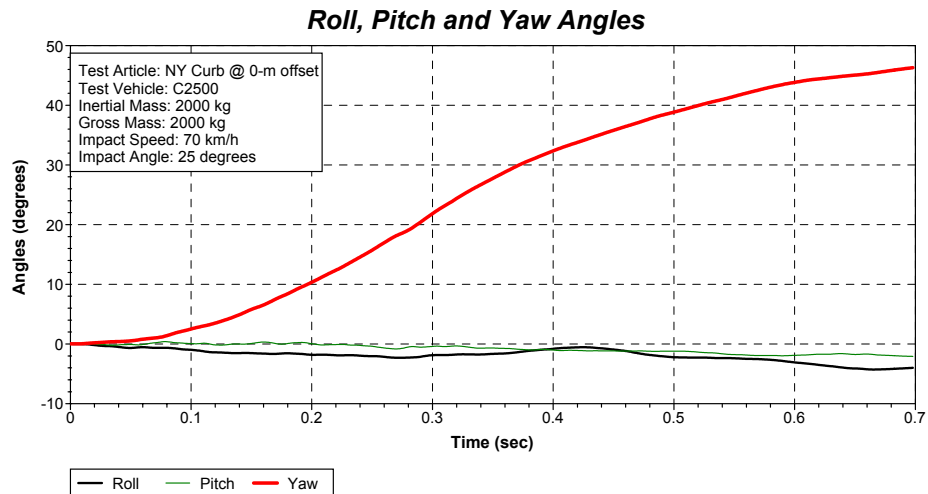

Figure J.4: Angular displacement-time histories at C.G. of pickup truck in local coordinates:
Curb Type – New York Curb (100 mm)
Impact Speed – 70 km/hr
Offset Distance – 0.0 m.

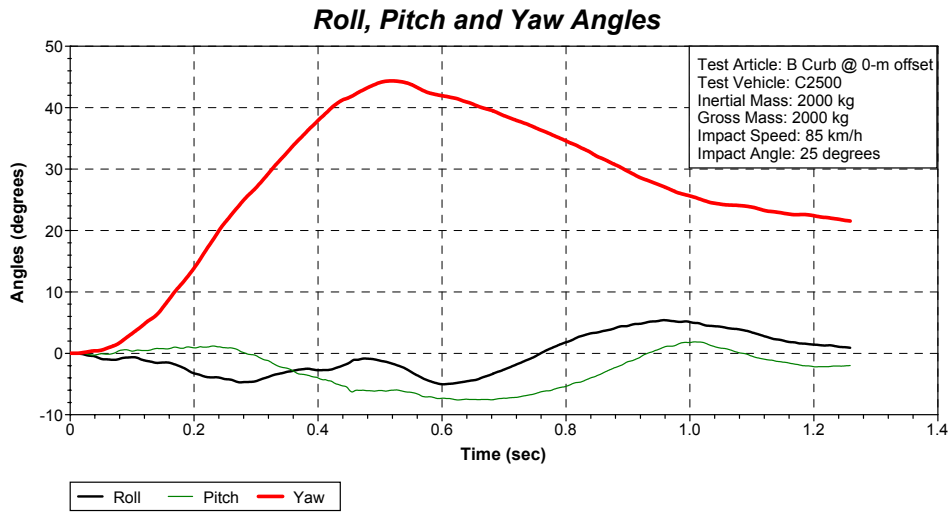

Figure J.5: Angular displacement-time histories at C.G. of pickup truck in local coordinates:
Curb Type – AASHTO B Curb
Impact Speed – 85 km/hr
Offset Distance – 0.0 m.

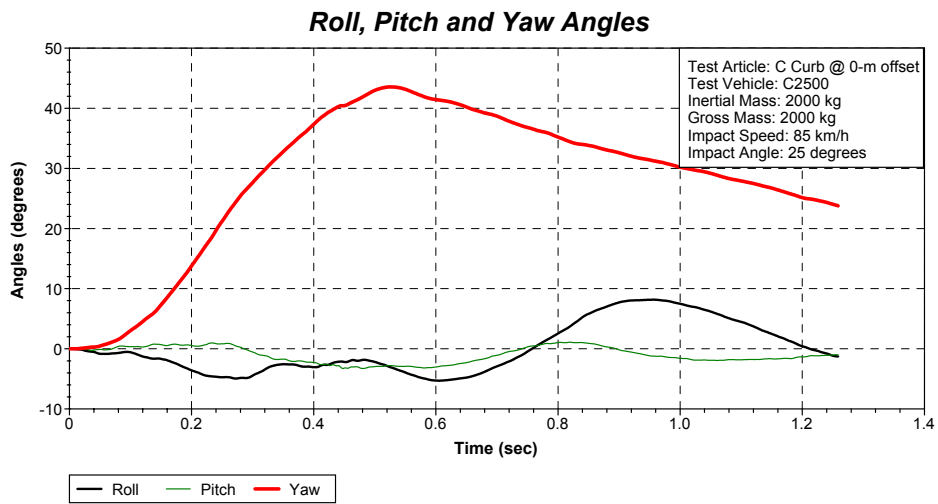

Figure J.6: Angular displacement-time histories at C.G. of pickup truck in local coordinates:
Curb Type – AASHTO C Curb
Impact Speed – 85 km/hr
Offset Distance – 0.0 m.

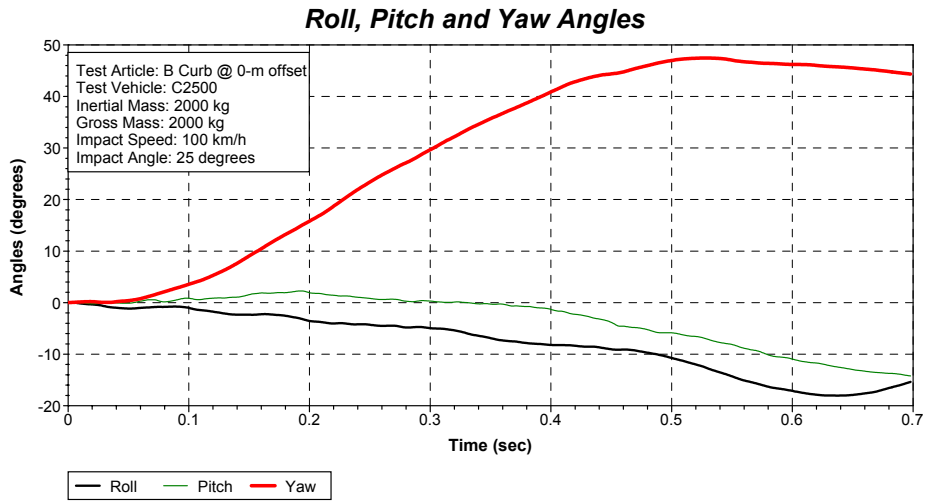

Figure J.7: Angular displacement-time histories at C.G. of pickup truck in local coordinates:
Curb Type – AASHTO B Curb
Impact Speed – 100 km/hr
Offset Distance – 0.0 m.

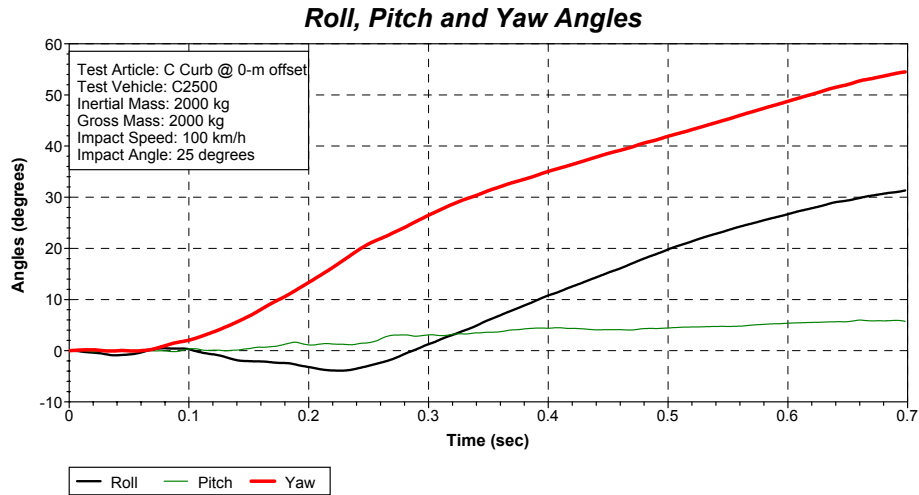

Figure J.8: Angular displacement-time histories at C.G. of pickup truck in local coordinates:
Curb Type – AASHTO C Curb
Impact Speed – 100 km/hr
Offset Distance – 0.0 m.

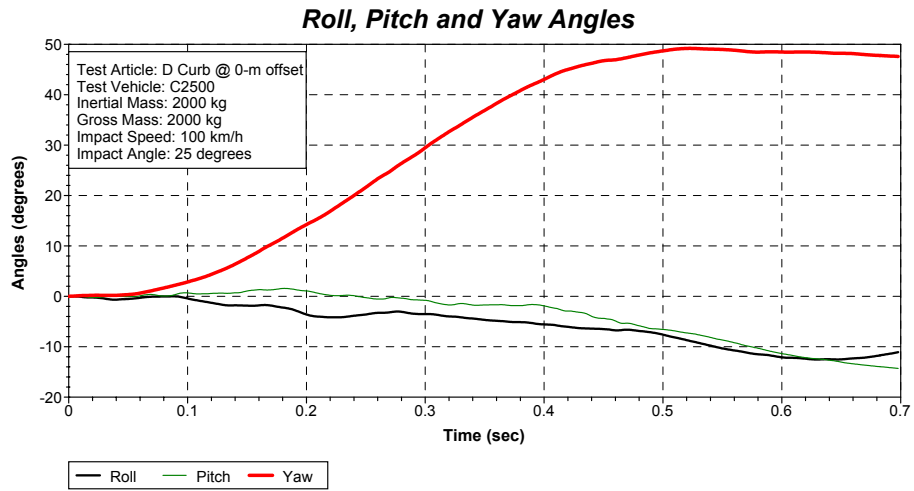

Figure J.9: Angular displacement-time histories at C.G. of pickup truck in local coordinates:
Curb Type – AASHTO D Curb
Impact Speed – 100 km/hr
Offset Distance – 0.0 m.

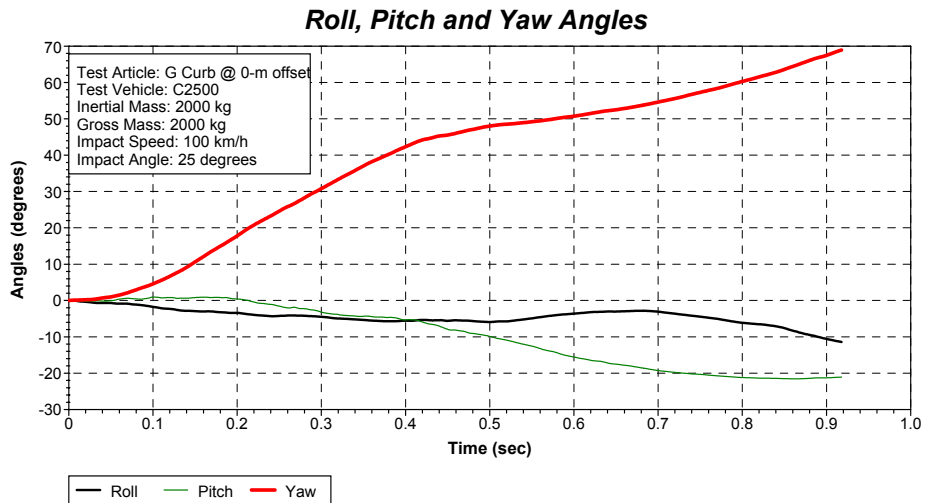

Figure J.10: Angular displacement-time histories at C.G. of pickup truck in local coordinates:
Curb Type – AASHTO G Curb
Impact Speed – 100 km/hr
Offset Distance – 0.0 m.

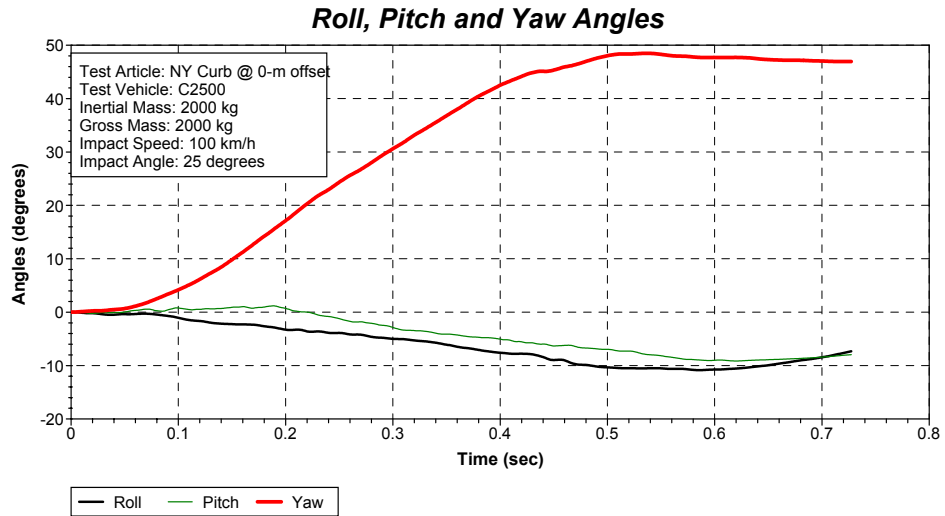

Figure J.11: Angular displacement-time histories at C.G. of pickup truck in local coordinates:
Curb Type – New York Curb (100 mm)
Impact Speed – 100 km/hr
Offset Distance – 0.0 m.

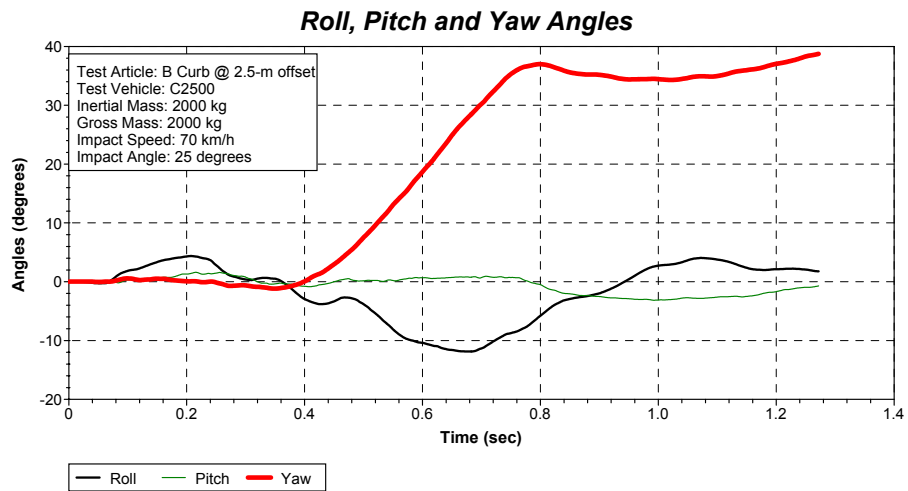

Figure J.12: Angular displacement-time histories at C.G. of pickup truck in local coordinates:
Curb Type – AASHTO B Curb
Impact Speed – 70 km/hr
Offset Distance – 2.5 m.

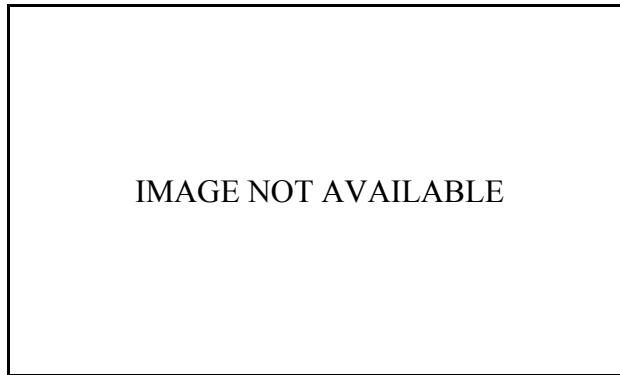

Figure J.13: Angular displacement-time histories at C.G. of pickup truck in local coordinates:
Curb Type – AASHTO C Curb
Impact Speed – 70 km/hr
Offset Distance – 2.5 m.

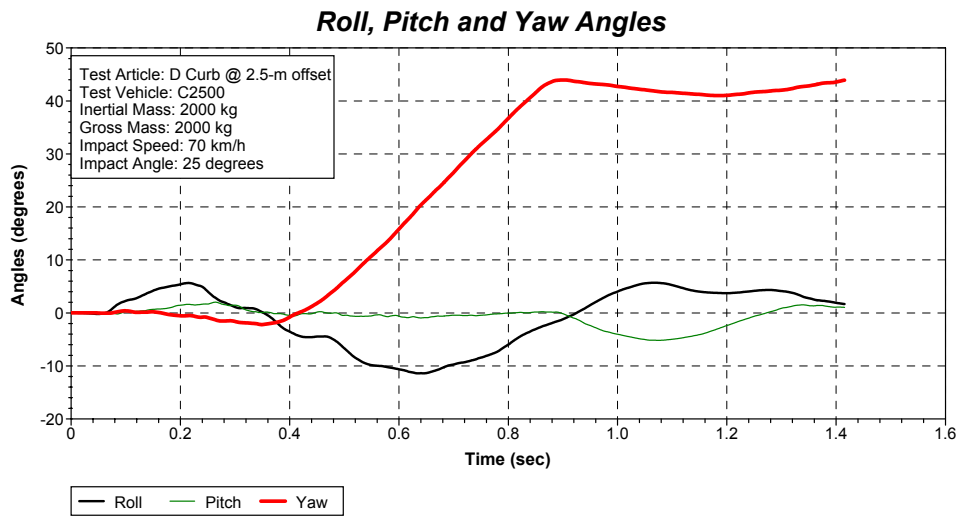

Figure J.14: Angular displacement-time histories at C.G. of pickup truck in local coordinates:
Curb Type – AASHTO D Curb
Impact Speed – 70 km/hr
Offset Distance – 2.5 m.

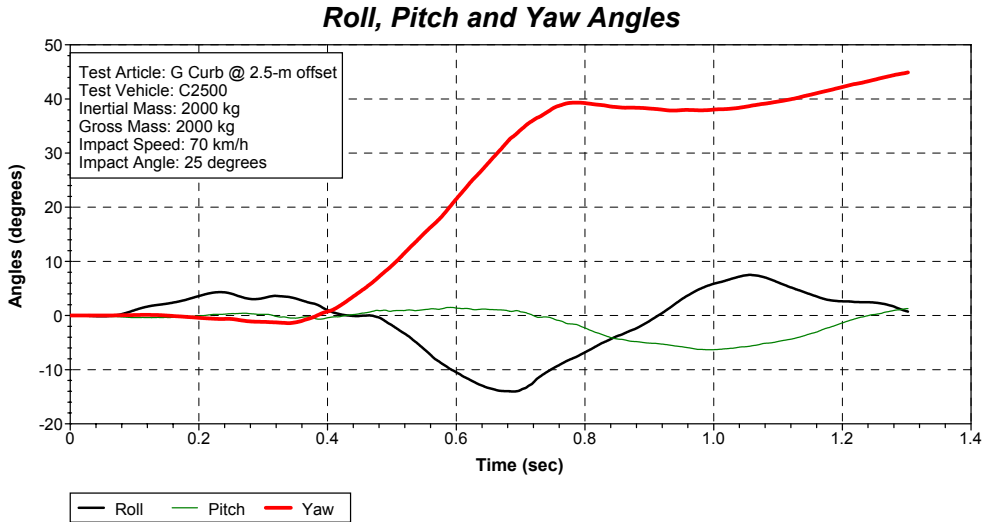

Figure J.15: Angular displacement-time histories at C.G. of pickup truck in local coordinates:
Curb Type – AASHTO G Curb
Impact Speed – 70 km/hr
Offset Distance – 2.5 m.

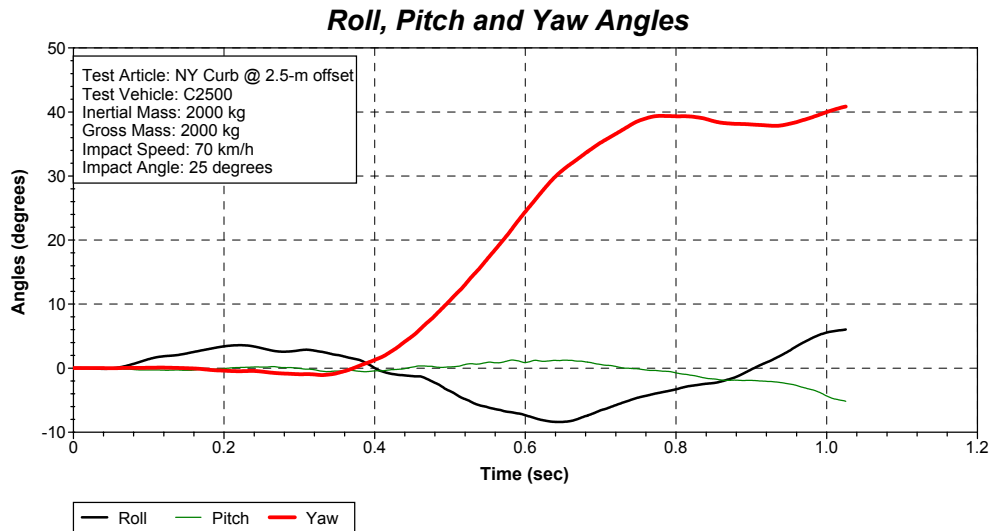

Figure J.16: Angular displacement-time histories at C.G. of pickup truck in local coordinates:
Curb Type – New York Curb (100 mm)
Impact Speed – 70 km/hr
Offset Distance – 2.5 m.

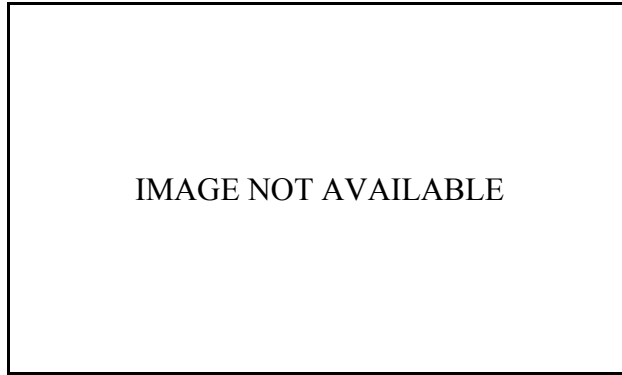

Figure J.17: Angular displacement-time histories at C.G. of pickup truck in local coordinates:
Curb Type – AASHTO B Curb
Impact Speed – 85 km/hr
Offset Distance – 2.5 m.

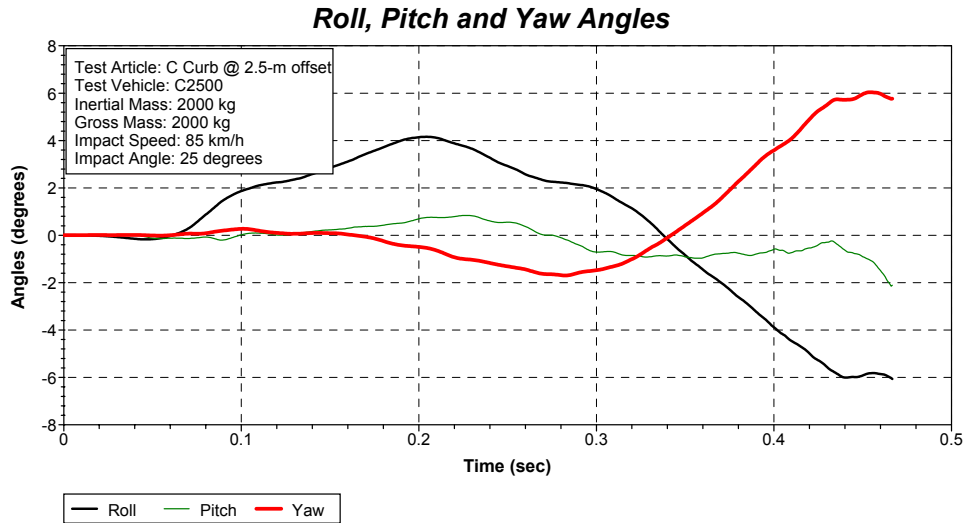

Figure J.18: Angular displacement-time histories at C.G. of pickup truck in local coordinates:
Curb Type – AASHTO C Curb
Impact Speed – 85 km/hr
Offset Distance – 2.5 m.

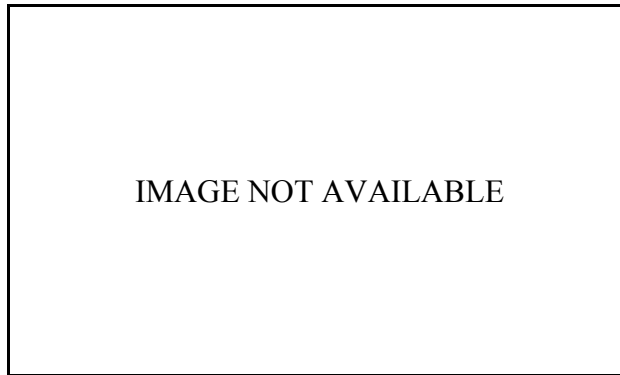

Figure J.19: Angular displacement-time histories at C.G. of pickup truck in local coordinates:
Curb Type – AASHTO G Curb
Impact Speed – 100 km/hr
Offset Distance – 2.5 m.

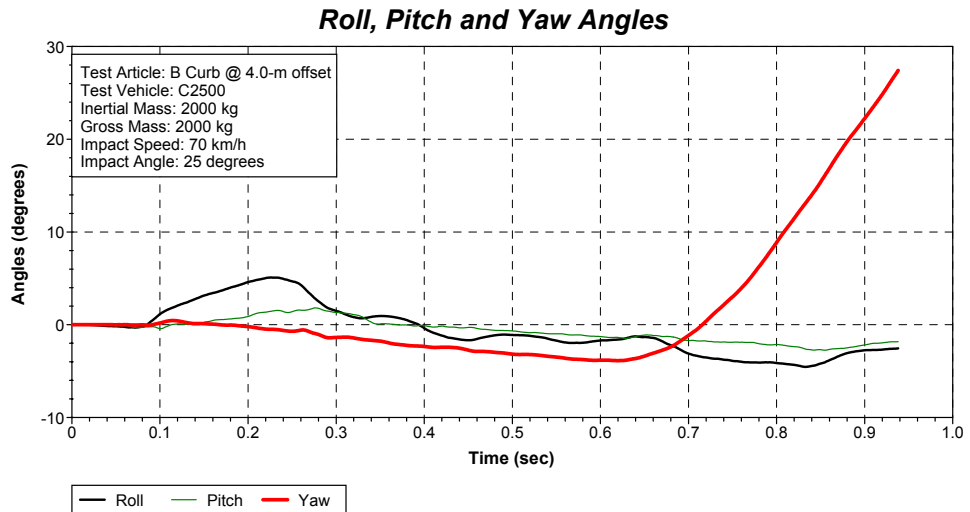

Figure J.20: Angular displacement-time histories at C.G. of pickup truck in local coordinates:
Curb Type – AASHTO B Curb
Impact Speed – 70 km/hr
Offset Distance – 4.0 m.

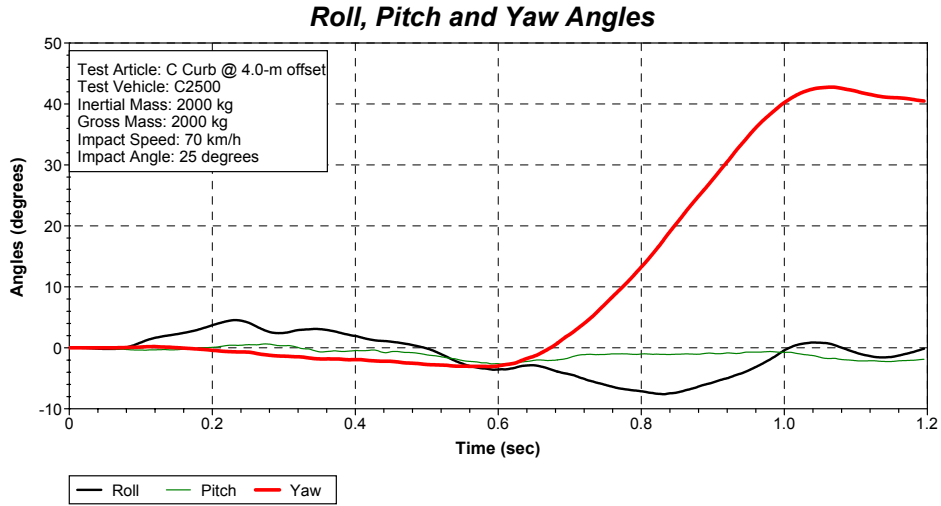

Figure J.21: Angular displacement-time histories at C.G. of pickup truck in local coordinates:
Curb Type – AASHTO C Curb
Impact Speed – 70 km/hr
Offset Distance – 4.0 m.

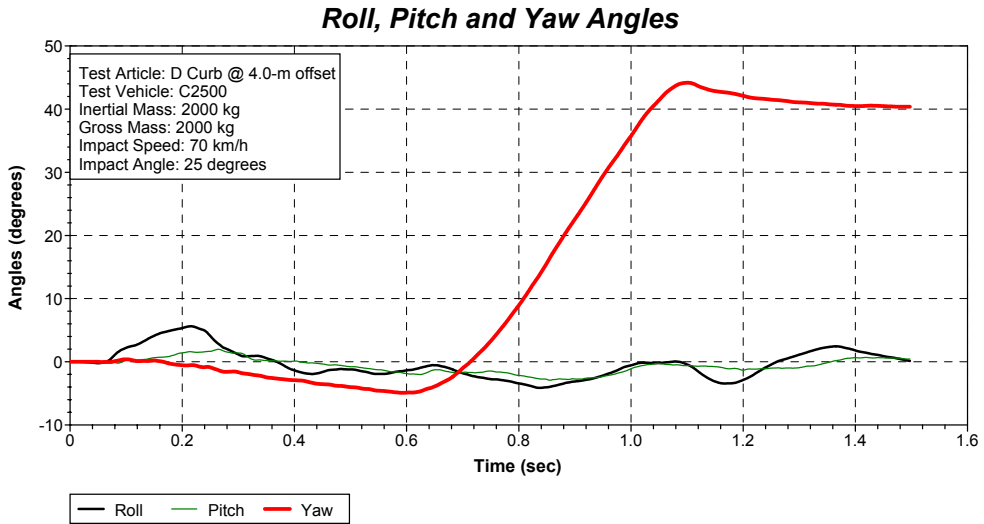

Figure J.22: Angular displacement-time histories at C.G. of pickup truck in local coordinates:
Curb Type – AASHTO D Curb
Impact Speed – 70 km/hr
Offset Distance – 4.0 m.

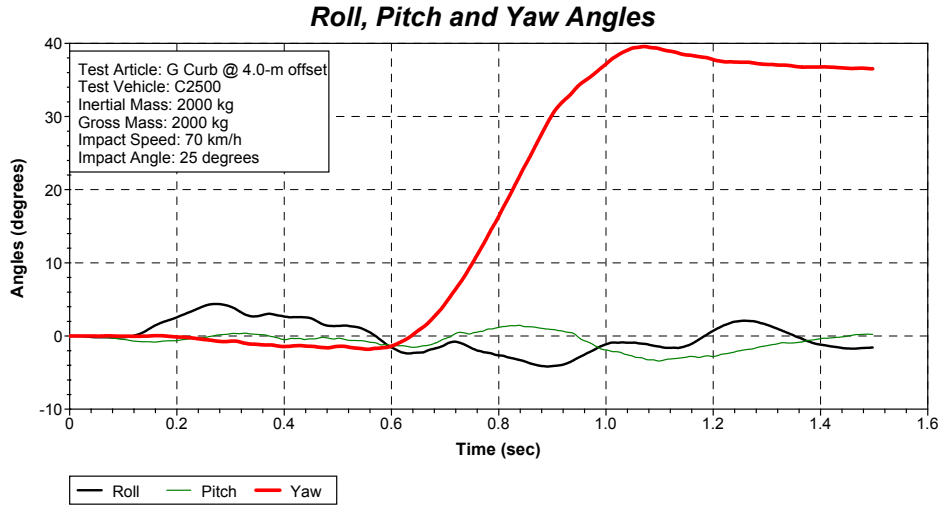

Figure J.23: Angular displacement-time histories at C.G. of pickup truck in local coordinates:
Curb Type – AASHTO G Curb
Impact Speed – 70 km/hr
Offset Distance – 4.0 m.

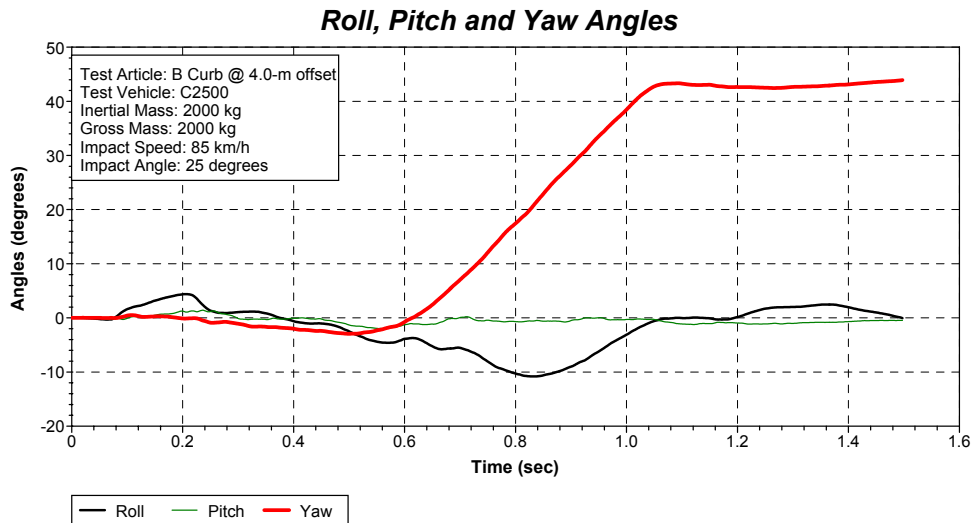

Figure J.24: Angular displacement-time histories at C.G. of pickup truck in local coordinates:
Curb Type – AASHTO B Curb
Impact Speed – 85 km/hr
Offset Distance – 4.0 m.

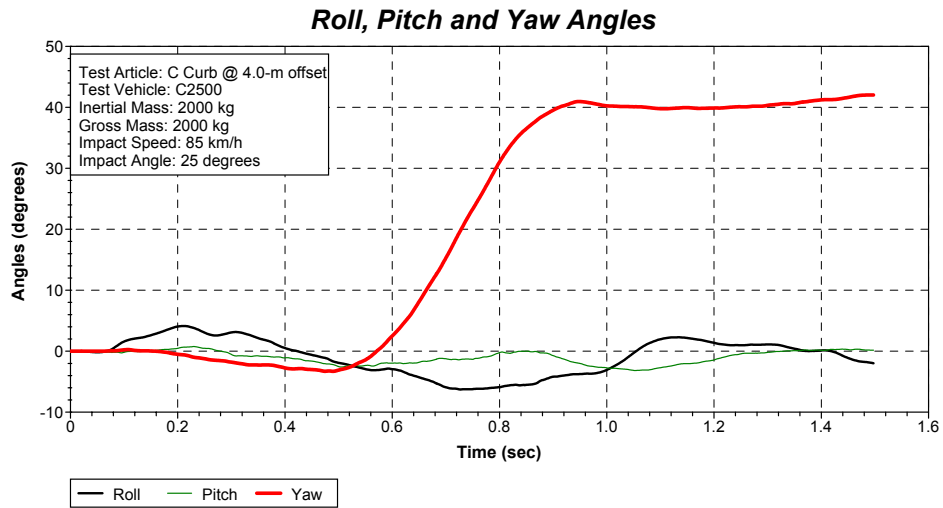

Figure J.25: Angular displacement-time histories at C.G. of pickup truck in local coordinates:
Curb Type – AASHTO C Curb
Impact Speed – 85 km/hr
Offset Distance – 4.0 m.

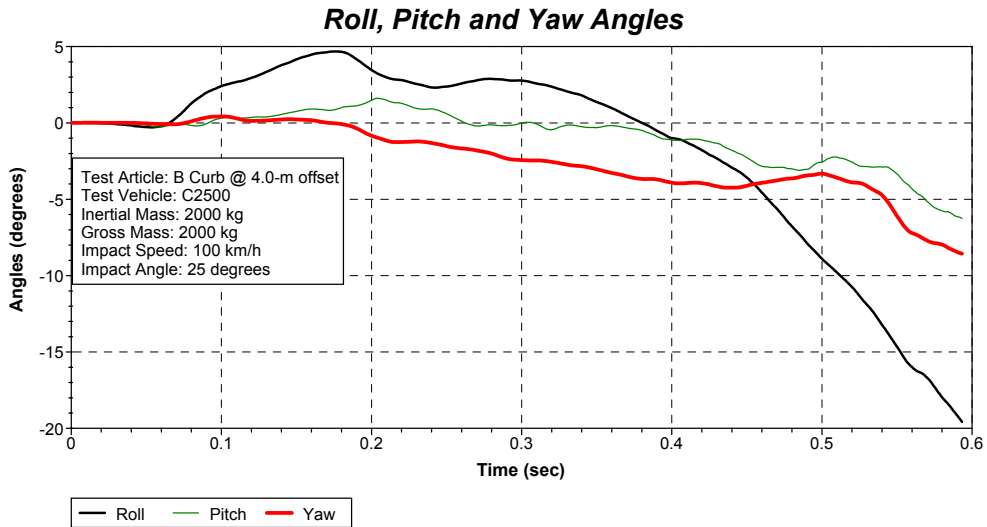

Figure J.26: Angular displacement-time histories at C.G. of pickup truck in local coordinates:
Curb Type – AASHTO B Curb
Impact Speed – 100 km/hr
Offset Distance – 4.0 m.

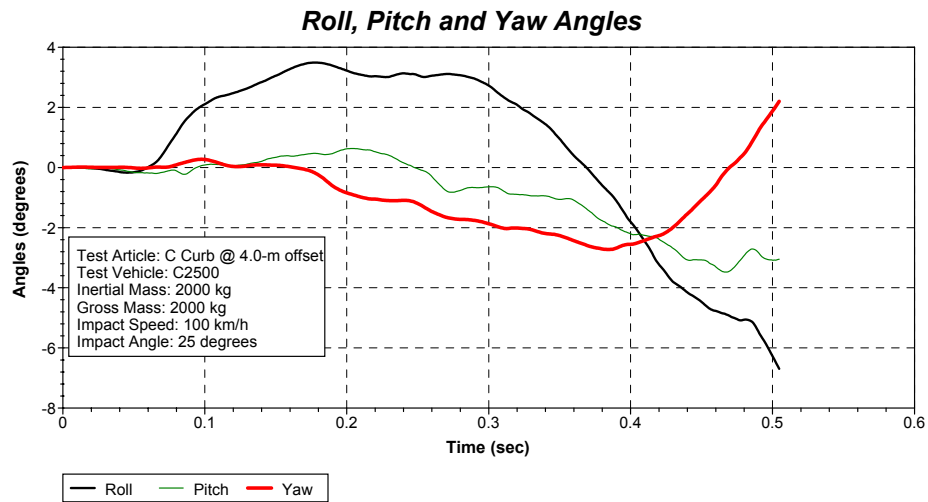

Figure J.27: Angular displacement-time histories at C.G. of pickup truck in local coordinates:
Curb Type – AASHTO C Curb
Impact Speed – 100 km/hr
Offset Distance – 4.0 m.

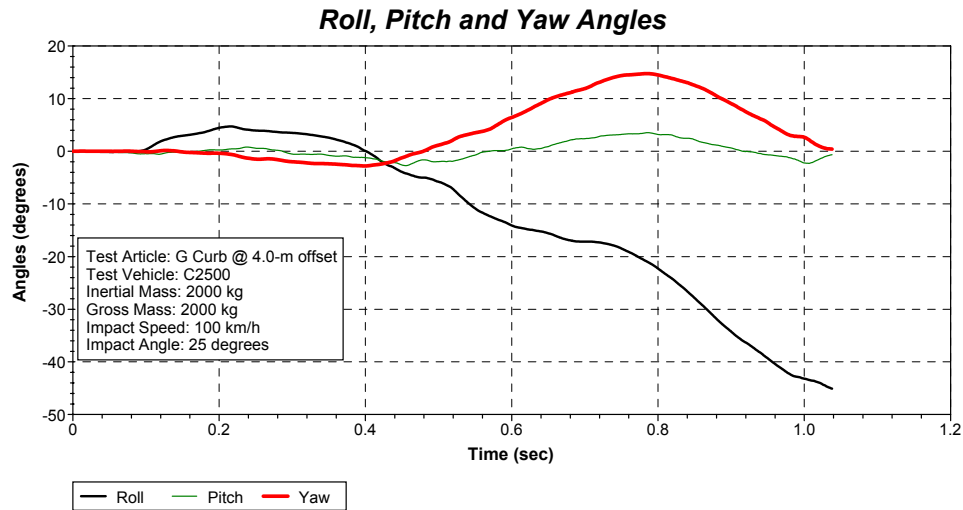

Figure J.28: Angular displacement-time histories at C.G. of pickup truck in local coordinates:
Curb Type – AASHTO G Curb
Impact Speed – 100 km/hr
Offset Distance – 4.0 m.

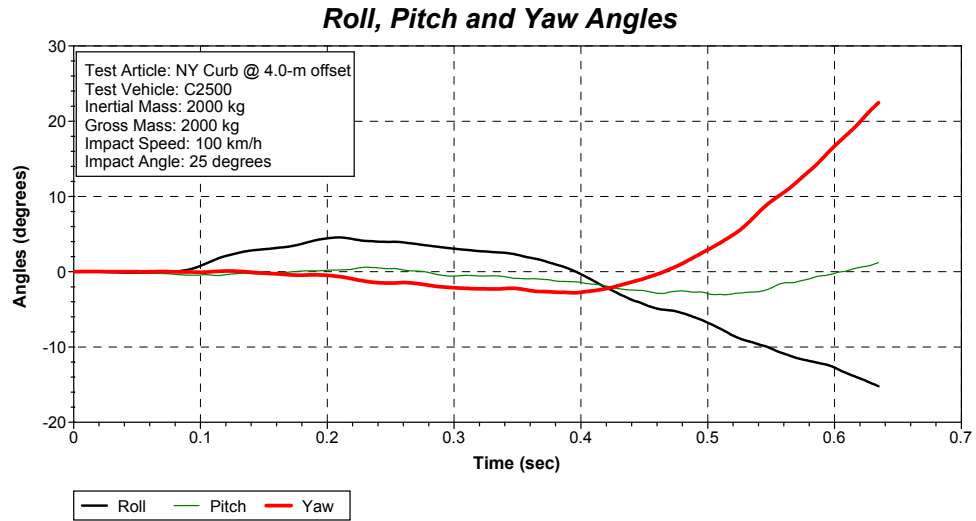

Figure J.29: Angular displacement-time histories at C.G. of pickup truck in local coordinates:

Curb Type	– New York Curb (100 mm)
Impact Speed	– 100 km/hr
Offset Distance	– 4.0 m.

APPENDIX K

Cross-Section Forces in W-Beam Rail

Computed at the nearest splice connection downstream and upstream of the impact point, at the upstream anchor and at a downstream location outside the impact zone (shown schematically below)

-Finite Element Analysis Results-

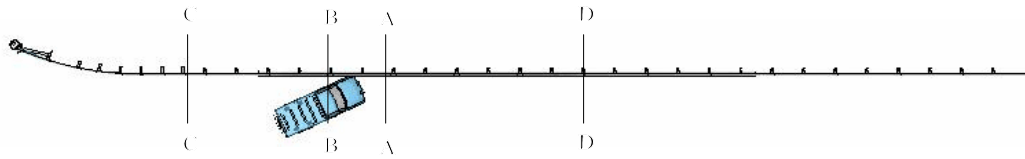

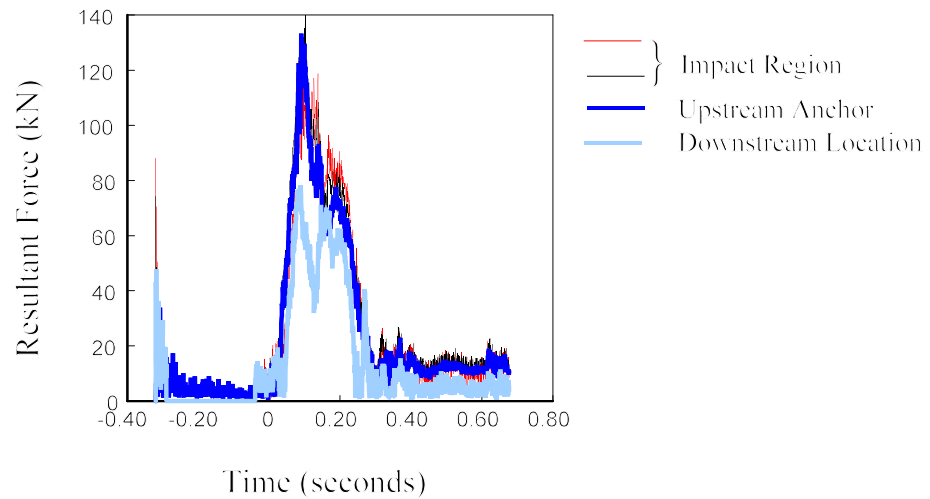

Figure K.1: Cross-section forces in the w-beam rail in the impact region, upstream anchor and at a location downstream of the impact point:
Curb Type – AASHTO B Curb
Impact Speed – 70 km/hr
Offset Distance – 0.0 m.

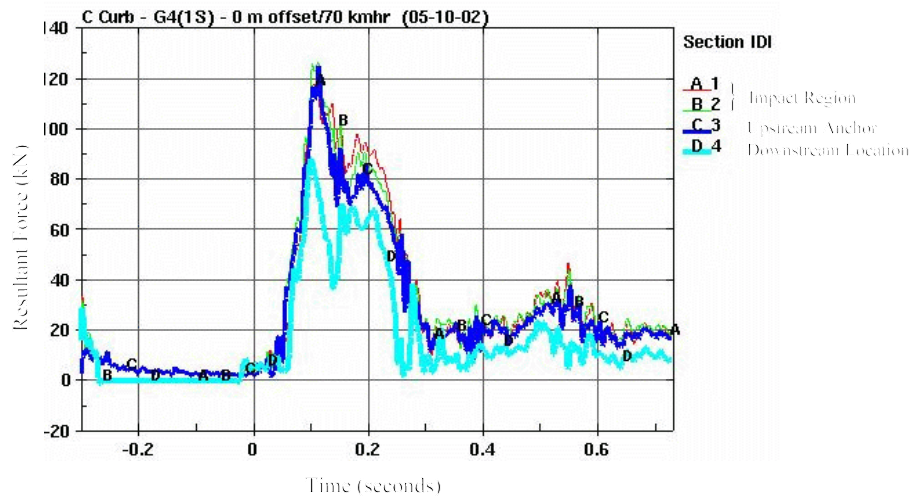

Figure K.2: Cross-section forces in the w-beam rail in the impact region, upstream anchor and at a location downstream of the impact point:
Curb Type – AASHTO C Curb
Impact Speed – 70 km/hr
Offset Distance – 0.0 m.

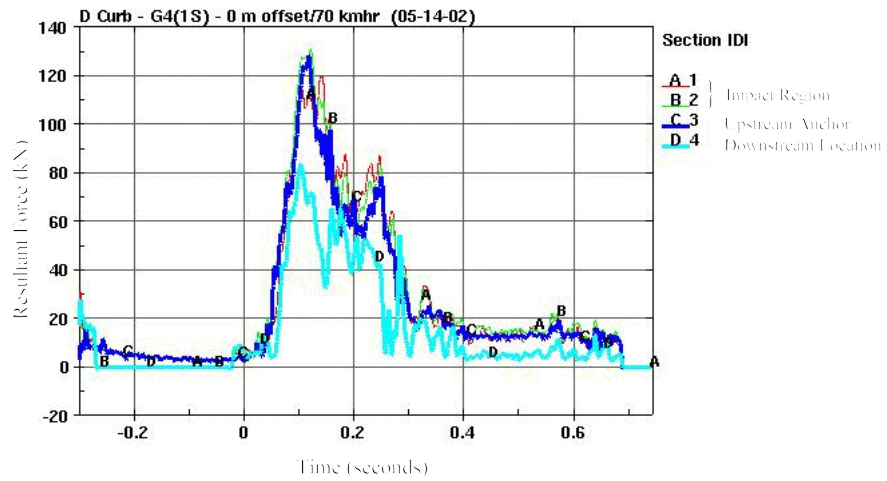

Figure K.3: Cross-section forces in the w-beam rail in the impact region, upstream anchor and at a location downstream of the impact point:

Curb Type – AASHTO D Curb
Impact Speed – 70 km/hr
Offset Distance – 0.0 m.

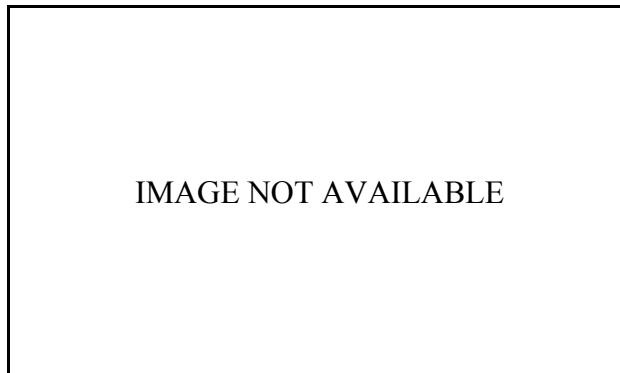

Figure K.4: Cross-section forces in the w-beam rail in the impact region, upstream anchor and at a location downstream of the impact point:

Curb Type – AASHTO G Curb
Impact Speed – 70 km/hr
Offset Distance – 0.0 m.

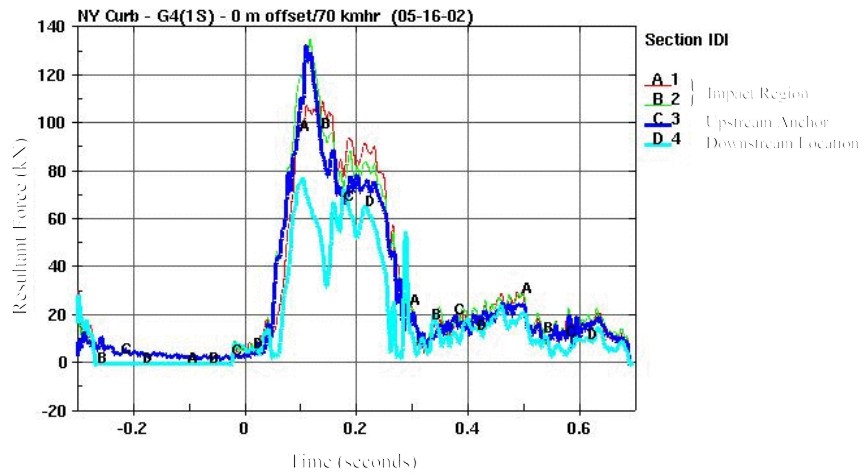

Figure K.5: Cross-section forces in the w-beam rail in the impact region, upstream anchor and at a location downstream of the impact point:
Curb Type – New York Curb (100 mm)
Impact Speed – 70 km/hr
Offset Distance – 0.0 m.

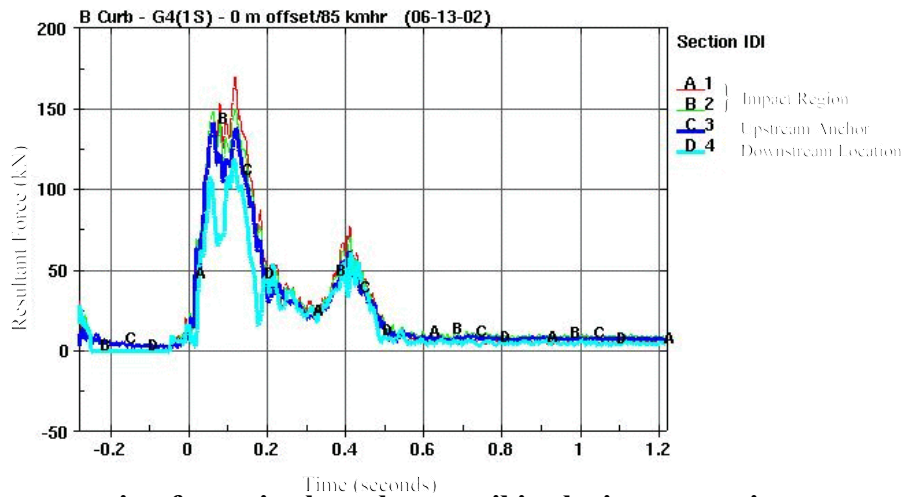

Figure K.6: Cross-section forces in the w-beam rail in the impact region, upstream anchor and at a location downstream of the impact point:
Curb Type – AASHTO B Curb
Impact Speed – 85 km/hr
Offset Distance – 0.0 m.

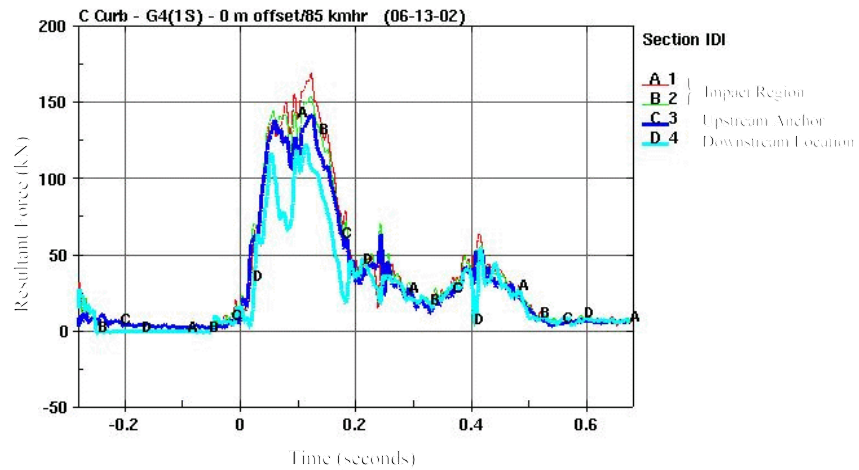

Figure K.7: Cross-section forces in the w-beam rail in the impact region, upstream anchor and at a location downstream of the impact point:

Curb Type – AASHTO C Curb
Impact Speed – 85 km/hr
Offset Distance – 0.0 m.

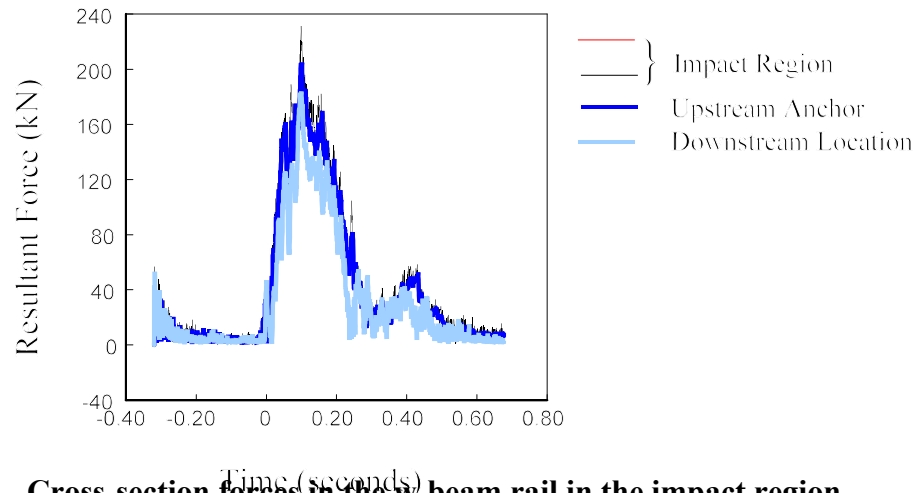

Figure K.8: Cross-section forces in the w-beam rail in the impact region, upstream anchor and at a location downstream of the impact point:

Curb Type – AASHTO B Curb
Impact Speed – 100 km/hr
Offset Distance – 0.0 m.

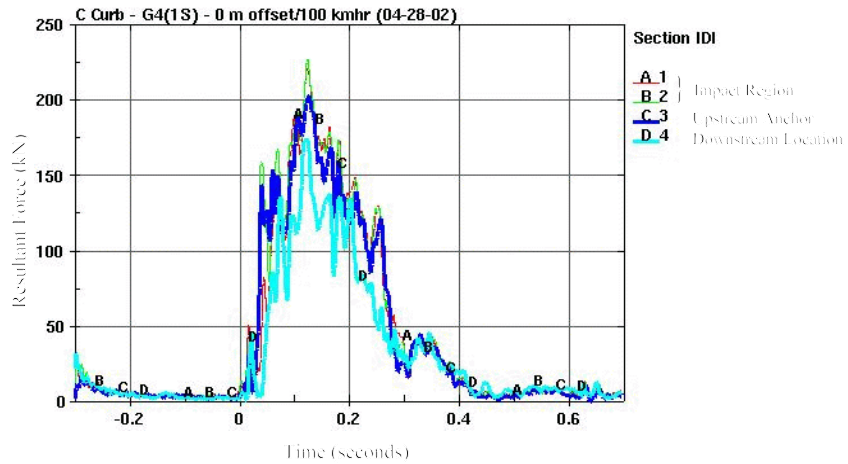

Figure K.9: Cross-section forces in the w-beam rail in the impact region, upstream anchor and at a location downstream of the impact point:

Curb Type – AASHTO C Curb
Impact Speed – 100 km/hr
Offset Distance – 0.0 m.

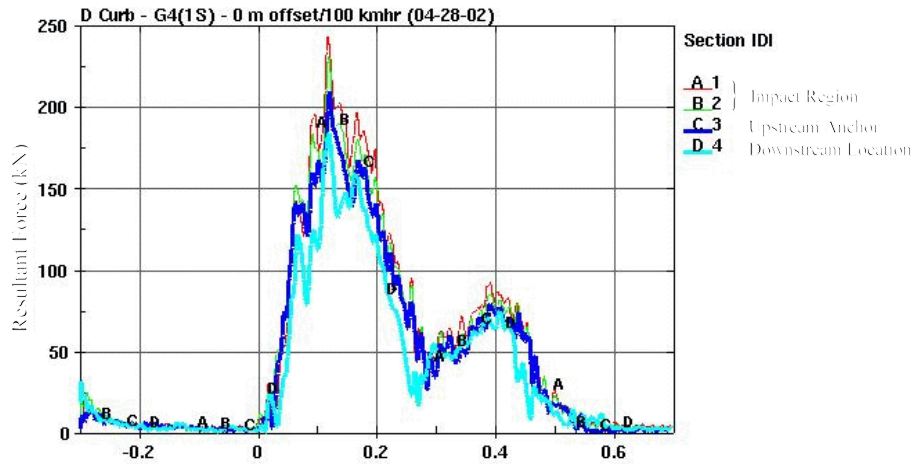

Figure K.10: Cross-section forces in the w-beam rail in the impact region, upstream anchor and at a location downstream of the impact point:

Curb Type – AASHTO D Curb
Impact Speed – 100 km/hr
Offset Distance – 0.0 m.

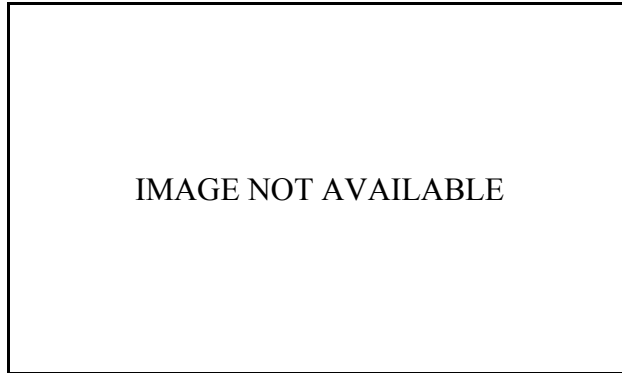

Figure K.11: Cross-section forces in the w-beam rail in the impact region, upstream anchor and at a location downstream of the impact point:

Curb Type – AASHTO G Curb
Impact Speed – 100 km/hr
Offset Distance – 0.0 m.

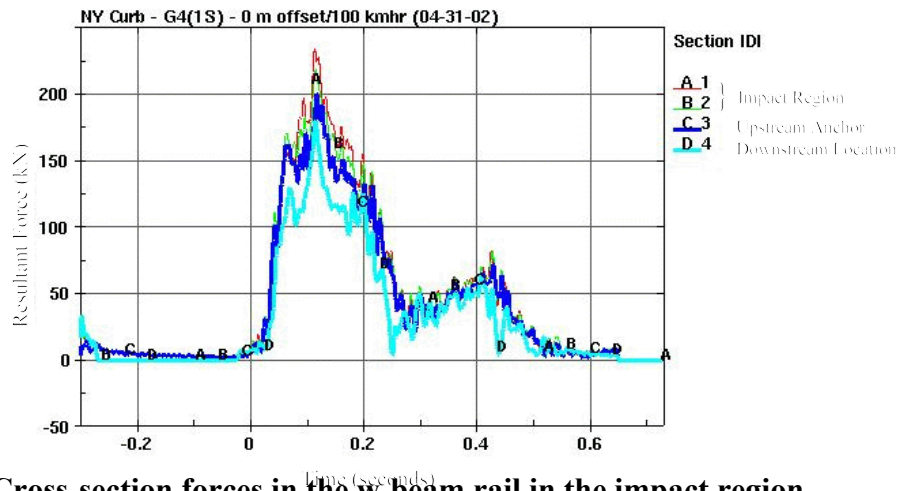

Figure K.12: Cross-section forces in the w-beam rail in the impact region, upstream anchor and at a location downstream of the impact point:

Curb Type – New York Curb (100 mm)
Impact Speed – 100 km/hr
Offset Distance – 0.0 m.

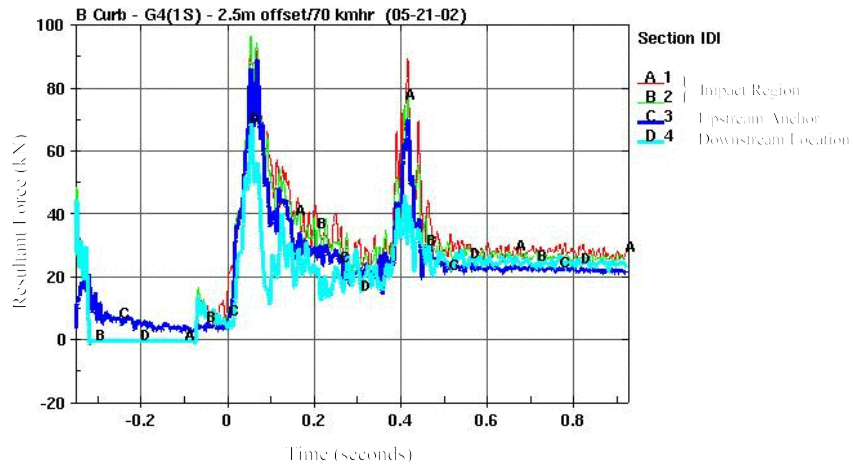

Figure K.13: Cross-section forces in the w-beam rail in the impact region, upstream anchor and at a location downstream of the impact point:

Curb Type – AASHTO B Curb
Impact Speed – 70 km/hr
Offset Distance – 2.5 m.

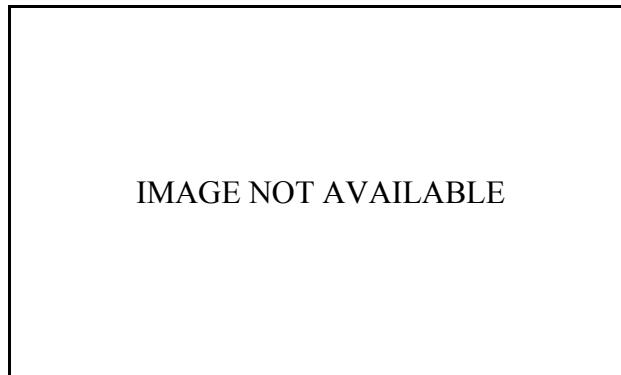

Figure K.14: Cross-section forces in the w-beam rail in the impact region, upstream anchor and at a location downstream of the impact point:

Curb Type – AASHTO C Curb
Impact Speed – 70 km/hr
Offset Distance – 2.5 m.

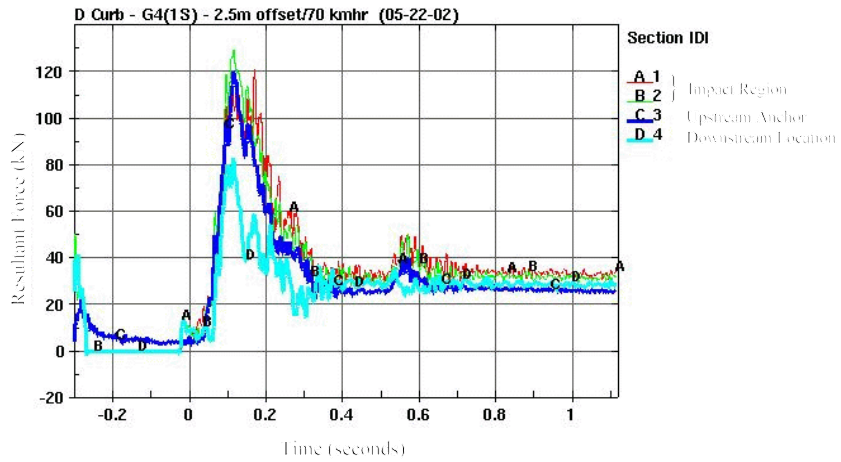

Figure K.15: Cross-section forces in the w-beam rail in the impact region, upstream anchor and at a location downstream of the impact point:

Curb Type – AASHTO D Curb
Impact Speed – 70 km/hr
Offset Distance – 2.5 m.

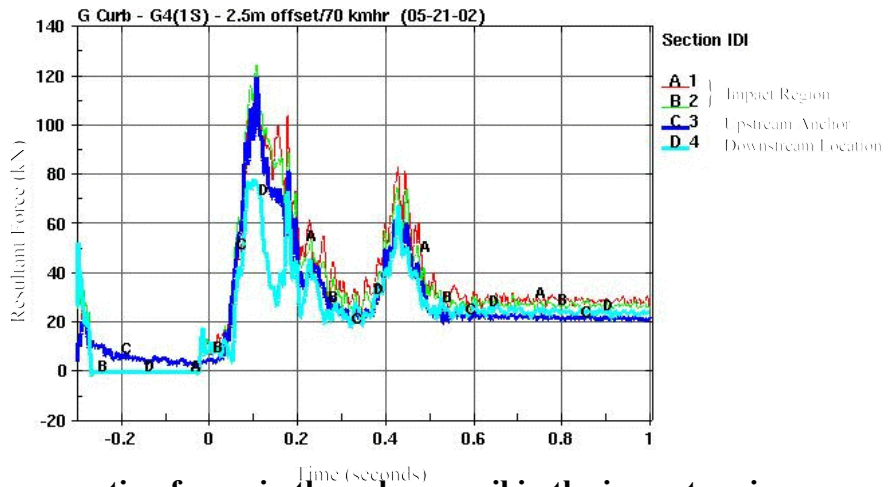

Figure K.16: Cross-section forces in the w-beam rail in the impact region, upstream anchor and at a location downstream of the impact point:

Curb Type – AASHTO G Curb
Impact Speed – 70 km/hr
Offset Distance – 2.5 m.

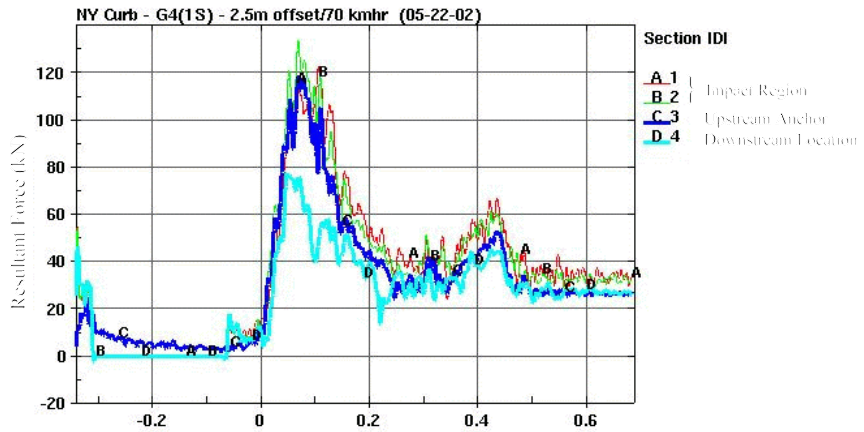

Figure K.17: Cross-section forces in the w-beam rail in the impact region, upstream anchor and at a location downstream of the impact point:

Curb Type – New York Curb (100 mm)
Impact Speed – 70 km/hr
Offset Distance – 2.5 m.

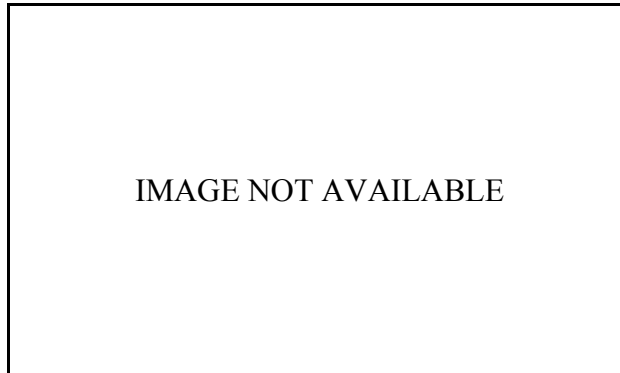

Figure K.18: Cross-section forces in the w-beam rail in the impact region, upstream anchor and at a location downstream of the impact point:

Curb Type – AASHTO B Curb
Impact Speed – 85 km/hr
Offset Distance – 2.5 m.

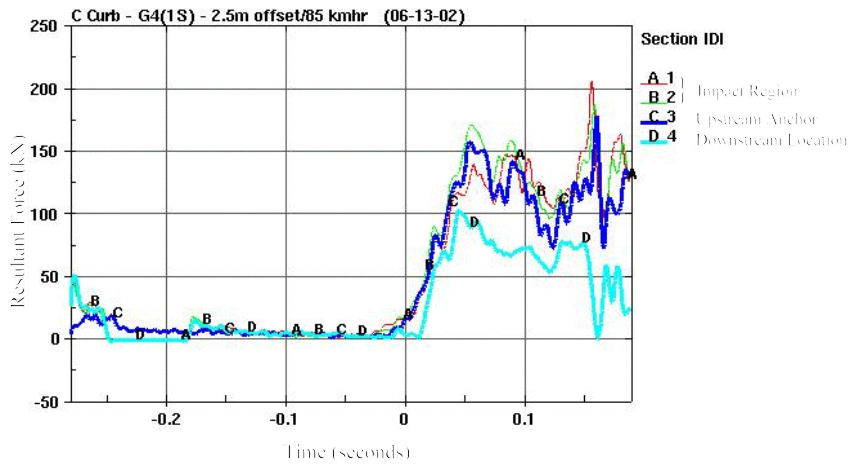

Figure K.19: Cross-section forces in the w-beam rail in the impact region, upstream anchor and at a location downstream of the impact point:

Curb Type – AASHTO C Curb
Impact Speed – 85 km/hr
Offset Distance – 2.5 m.

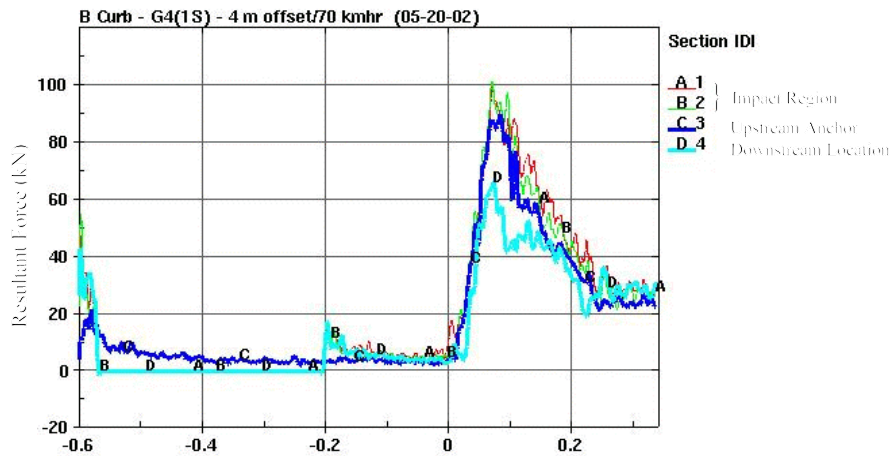

Figure K.20: Cross-section forces in the w-beam rail in the impact region, upstream anchor and at a location downstream of the impact point:

Curb Type – AASHTO B Curb
Impact Speed – 70 km/hr
Offset Distance – 4.0 m.

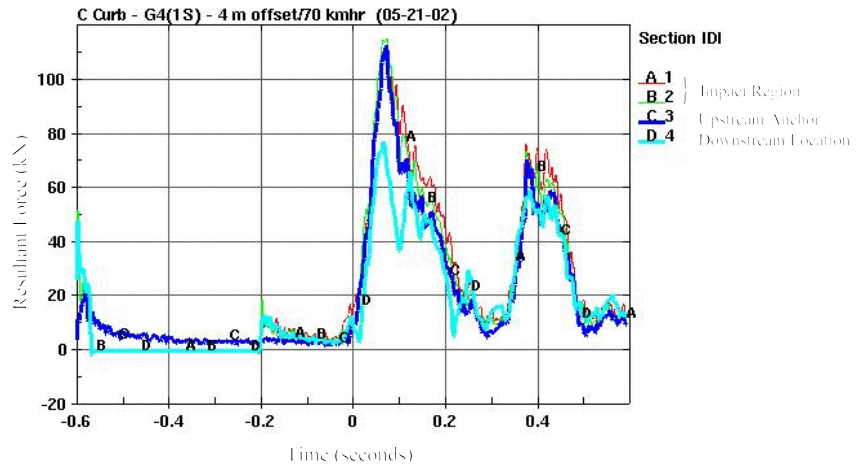

Figure K.21: Cross-section forces in the w-beam rail in the impact region, upstream anchor and at a location downstream of the impact point:

Curb Type – AASHTO C Curb
Impact Speed – 70 km/hr
Offset Distance – 4.0 m.

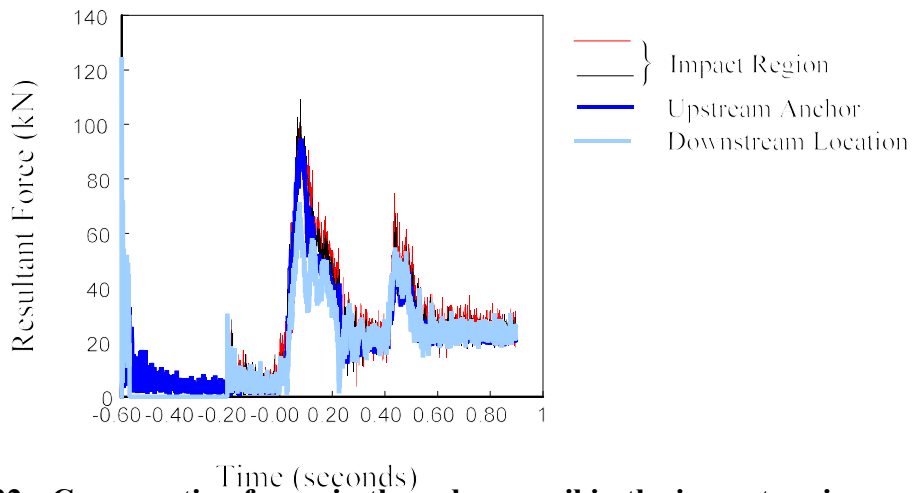

Figure K.22: Cross-section forces in the w-beam rail in the impact region, upstream anchor and at a location downstream of the impact point:

Curb Type – AASHTO D Curb
Impact Speed – 70 km/hr
Offset Distance – 4.0 m.

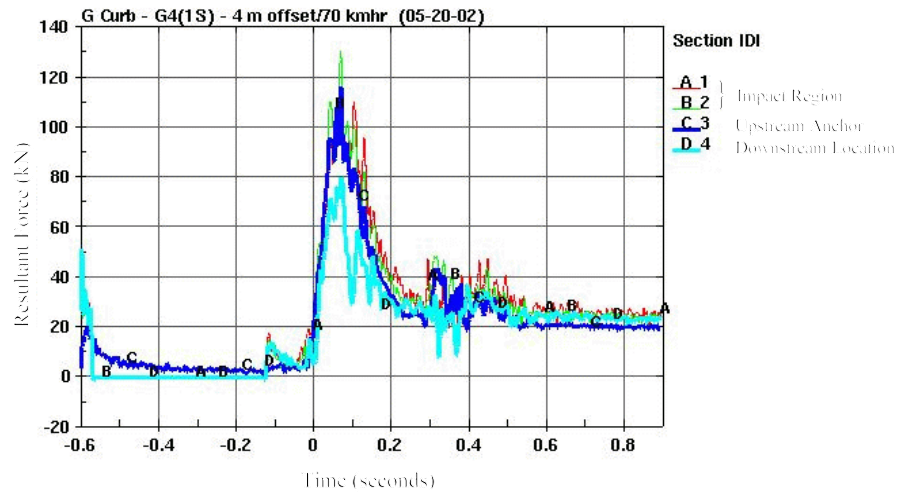

Figure K.23: Cross-section forces in the w-beam rail in the impact region, upstream anchor and at a location downstream of the impact point:

Curb Type – AASHTO G Curb
Impact Speed – 70 km/hr
Offset Distance – 4.0 m.

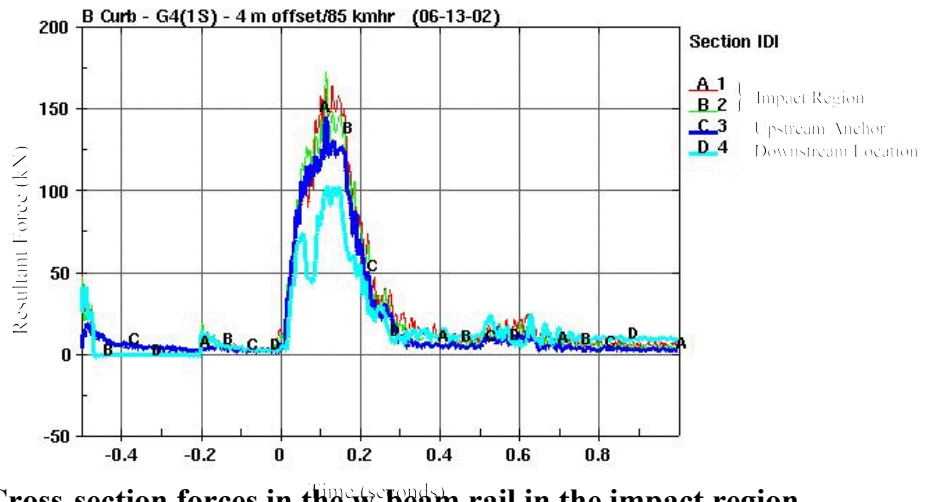

Figure K.24: Cross-section forces in the w-beam rail in the impact region, upstream anchor and at a location downstream of the impact point:

Curb Type – AASHTO B Curb
Impact Speed – 85 km/hr
Offset Distance – 4.0 m.

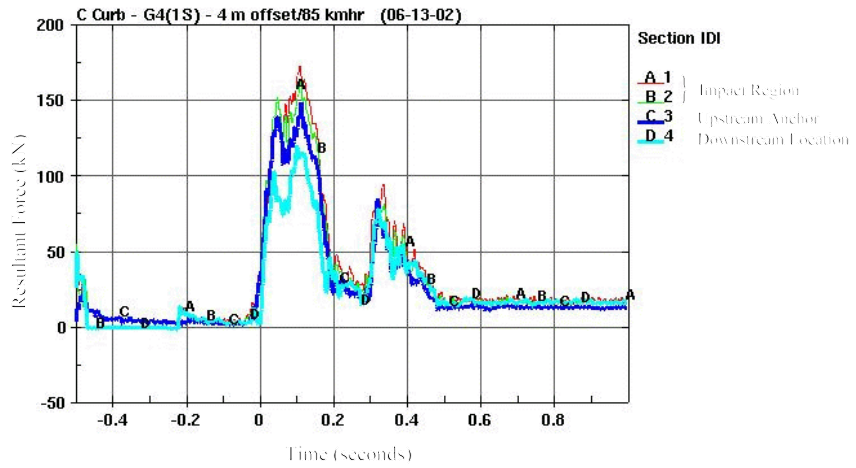

Figure K.25: Cross-section forces in the w-beam rail in the impact region, upstream anchor and at a location downstream of the impact point:

Curb Type – AASHTO C Curb
Impact Speed – 85 km/hr
Offset Distance – 4.0 m.

APPENDIX L

**Occupant Risk Assessment From Curb-Barrier Impact
Summary Report from TRAP**

-Finite Element Analysis Results-

Test Summary Report

General Information

Test Agency: WPI
Test Number: B-0m-70
Test Date: June 2002
Test Article: B Curb @ 0-m offset

Test Vehicle

Description: C2500
Test Inertial Mass: 2000 kg
Gross Static Mass: 2000 kg

Impact Conditions

Speed: 70.0 km/hr
Angle: 25.0 degrees

Occupant Risk Factors

Impact Velocity (m/s) at 0.1487 seconds on left side of interior
x-direction 4.1
y-direction -3.6

THIV (km/hr): 16.3 at 0.1360 seconds on left side of interior
THIV (m/s): 4.5

Ridedown Accelerations (g's)

x-direction -6.0 (0.1597 - 0.1697 seconds)
y-direction 4.7 (0.2490 - 0.2590 seconds)

PHD (g's): 7.2 (0.1710 - 0.1810 seconds)

ASI: 0.47 (0.0067 - 0.0567 seconds)

Max. 50msec Moving Avg. Accelerations (g's)

x-direction -4.6 (0.0070 - 0.0570 seconds)
y-direction 3.3 (0.2130 - 0.2630 seconds)
z-direction 2.0 (0.1210 - 0.1710 seconds)

Max Roll, Pitch, and Yaw Angles (degrees)

Roll -1.9 (0.6060 seconds)
Pitch -6.4 (0.4153 seconds)
Yaw 44.0 (0.6060 seconds)

Figure L.1: Summary Report of Occupant Risk Factors from TRAP:

Curb Type – AASHTO B Curb
Impact Speed – 70 km/hr
Offset Distance – 0.0 m.

Test Summary Report

General Information

Test Agency: WPI
Test Number: C-0m-70
Test Date: June 2002
Test Article: C Curb @ 0-m offset

Test Vehicle

Description: C2500
Test Inertial Mass: 2000 kg
Gross Static Mass: 2000 kg

Impact Conditions

Speed: 70.0 km/hr
Angle: 25.0 degrees

Occupant Risk Factors

Impact Velocity (m/s) at 0.1553 seconds on left side of interior
x-direction 4.2
y-direction -4.2

THIV (km/hr): 20.1 at 0.1500 seconds on left side of interior
THIV (m/s): 5.6

Ridedown Accelerations (g's)
x-direction -6.3 (0.2957 - 0.3057 seconds)
y-direction 7.5 (0.5503 - 0.5603 seconds)

PHD (g's): 9.7 (0.5503 - 0.5603 seconds)

ASI: 0.52 (0.0980 - 0.1480 seconds)

Max. 50msec Moving Avg. Accelerations (g's)

x-direction -4.0 (0.1043 - 0.1543 seconds)
y-direction 3.8 (0.0217 - 0.0717 seconds)
z-direction -1.7 (0.2803 - 0.3303 seconds)

Max Roll, Pitch, and Yaw Angles (degrees)

Roll -7.0 (0.6233 seconds)
Pitch -3.7 (0.4867 seconds)
Yaw 46.1 (0.7300 seconds)

Figure L.2: Summary Report of Occupant Risk Factors from TRAP:

Curb Type – AASHTO C Curb
Impact Speed – 70 km/hr
Offset Distance – 0.0 m.

Test Summary Report

General Information

Test Agency: WPI
Test Number: D-0m-70
Test Date: June 2002
Test Article: D Curb @ 0-m offset

Test Vehicle

Description: C2500
Test Inertial Mass: 2000 kg
Gross Static Mass: 2000 kg

Impact Conditions

Speed: 70.0 km/hr
Angle: 25.0 degrees

Occupant Risk Factors

Impact Velocity (m/s) at 0.1607 seconds on left side of interior
x-direction 4.3
y-direction -4.1

THIV (km/hr): 20.7 at 0.1540 seconds on left side of interior
THIV (m/s): 5.7

Ridedown Accelerations (g's)
x-direction -6.6 (0.2450 - 0.2550 seconds)
y-direction 6.7 (0.3017 - 0.3117 seconds)

PHD (g's): 8.1 (0.2443 - 0.2543 seconds)

ASI: 0.50 (0.0780 - 0.1280 seconds)

Max. 50msec Moving Avg. Accelerations (g's)

x-direction -4.6 (0.1037 - 0.1537 seconds)
y-direction 3.7 (0.0777 - 0.1277 seconds)
z-direction -2.0 (0.0570 - 0.1070 seconds)

Max Roll, Pitch, and Yaw Angles (degrees)

Roll 2.2 (0.5767 seconds)
Pitch 3.5 (0.3087 seconds)
Yaw 45.2 (0.7420 seconds)

Figure L.3: Summary Report of Occupant Risk Factors from TRAP:

Curb Type – AASHTO D Curb
Impact Speed – 70 km/hr
Offset Distance – 0.0 m.

Test Summary Report

General Information

Test Agency: WPI
Test Number: NY-0m-70
Test Date: June 2002
Test Article: NY Curb @ 0-m offset

Test Vehicle

Description: C2500
Test Inertial Mass: 2000 kg
Gross Static Mass: 2000 kg

Impact Conditions

Speed: 70.0 km/hr
Angle: 25.0 degrees

Occupant Risk Factors

Impact Velocity (m/s) at 0.1580 seconds on left side of interior
x-direction 4.7
y-direction -4.2

THIV (km/hr): 21.7 at 0.1527 seconds on left side of interior
THIV (m/s): 6.0

Ridedown Accelerations (g's)
x-direction -5.1 (0.2643 - 0.2743 seconds)
y-direction 5.7 (0.2050 - 0.2150 seconds)

PHD (g's): 7.2 (0.2643 - 0.2743 seconds)

ASI: 0.57 (0.0827 - 0.1327 seconds)

Max. 50msec Moving Avg. Accelerations (g's)

x-direction -4.7 (0.1017 - 0.1517 seconds)
y-direction 4.1 (0.0837 - 0.1337 seconds)
z-direction 1.5 (0.2143 - 0.2643 seconds)

Max Roll, Pitch, and Yaw Angles (degrees)

Roll -4.3 (0.6653 seconds)
Pitch -2.1 (0.6980 seconds)
Yaw 46.3 (0.6980 seconds)

Figure L.4: Summary Report of Occupant Risk Factors from TRAP:
Curb Type – New York Curb (100 mm)
Impact Speed – 70 km/hr
Offset Distance – 0.0 m.

Test Summary Report

General Information

Test Agency: WPI
Test Number: B-0m-85
Test Date: June 2002
Test Article: B Curb @ 0-m offset

Test Vehicle

Description: C2500
Test Inertial Mass: 2000 kg
Gross Static Mass: 2000 kg

Impact Conditions

Speed: 85.0 km/hr
Angle: 25.0 degrees

Occupant Risk Factors

Impact Velocity (m/s) at 0.1533 seconds on left side of interior
x-direction 4.2
y-direction -4.1

THIV (km/hr): 19.7 at 0.1467 seconds on left side of interior
THIV (m/s): 5.5

Ridedown Accelerations (g's)
x-direction 8.1 (0.4403 - 0.4503 seconds)
y-direction 10.6 (0.4330 - 0.4430 seconds)

PHD (g's): 15.9 (0.4363 - 0.4463 seconds)

ASI: 0.67 (0.0807 - 0.1307 seconds)

Max. 50msec Moving Avg. Accelerations (g's)

x-direction -4.2 (0.0803 - 0.1303 seconds)
y-direction 5.7 (0.1443 - 0.1943 seconds)
z-direction 4.2 (0.4503 - 0.5003 seconds)

Max Roll, Pitch, and Yaw Angles (degrees)

Roll 5.4 (0.9580 seconds)
Pitch -7.6 (0.6260 seconds)
Yaw 44.3 (0.5187 seconds)

Figure L.5: Summary Report of Occupant Risk Factors from TRAP:

Curb Type – AASHTO B Curb
Impact Speed – 85 km/hr
Offset Distance – 0.0 m.

Test Summary Report

General Information

Test Agency: WPI
Test Number: C-0m-85
Test Date: June 2002
Test Article: C Curb @ 0-m offset

Test Vehicle

Description: C2500
Test Inertial Mass: 2000 kg
Gross Static Mass: 2000 kg

Impact Conditions

Speed: 85.0 km/hr
Angle: 25.0 degrees

Occupant Risk Factors

Impact Velocity (m/s) at 0.1527 seconds on left side of interior
x-direction 4.1
y-direction -4.3

THIV (km/hr): 19.7 at 0.1467 seconds on left side of interior
THIV (m/s): 5.5

Ridedown Accelerations (g's)

x-direction -12.9 (0.4377 - 0.4477 seconds)
y-direction 12.6 (0.4377 - 0.4477 seconds)

PHD (g's): 32.8 (0.4417 - 0.4517 seconds)

ASI: 0.67 (0.1413 - 0.1913 seconds)

Max. 50msec Moving Avg. Accelerations (g's)

x-direction -4.1 (0.0837 - 0.1337 seconds)
y-direction 5.5 (0.1410 - 0.1910 seconds)
z-direction 2.3 (0.4543 - 0.5043 seconds)

Max Roll, Pitch, and Yaw Angles (degrees)

Roll 8.2 (0.9567 seconds)
Pitch -3.3 (0.4800 seconds)
Yaw 43.5 (0.5247 seconds)

Figure L.6: Summary Report of Occupant Risk Factors from TRAP:

Curb Type – AASHTO C Curb
Impact Speed – 85 km/hr
Offset Distance – 0.0 m.

Test Summary Report

General Information

Test Agency: WPI
Test Number: B-0m-100
Test Date: June 2002
Test Article: B Curb @ 0-m offset

Test Vehicle

Description: C2500
Test Inertial Mass: 2000 kg
Gross Static Mass: 2000 kg

Impact Conditions

Speed: 100.0 km/hr
Angle: 25.0 degrees

Occupant Risk Factors

Impact Velocity (m/s) at 0.1287 seconds on left side of interior
x-direction 5.5
y-direction -5.0

THIV (km/hr): 23.9 at 0.1240 seconds on left side of interior
THIV (m/s): 6.6

Ridedown Accelerations (g's)

x-direction -11.0 (0.4443 - 0.4543 seconds)
y-direction 14.9 (0.4437 - 0.4537 seconds)

PHD (g's): 33.4 (0.4457 - 0.4557 seconds)

ASI: 0.89 (0.1400 - 0.1900 seconds)

Max. 50msec Moving Avg. Accelerations (g's)

x-direction -5.4 (0.0757 - 0.1257 seconds)
y-direction 7.6 (0.1303 - 0.1803 seconds)
z-direction 3.3 (0.4523 - 0.5023 seconds)

Max Roll, Pitch, and Yaw Angles (degrees)

Roll -18.0 (0.6373 seconds)
Pitch -14.2 (0.6980 seconds)
Yaw 47.4 (0.5287 seconds)

Figure L.7: Summary Report of Occupant Risk Factors from TRAP:

Curb Type – AASHTO B Curb
Impact Speed – 100 km/hr
Offset Distance – 0.0 m.

Test Summary Report

General Information

Test Agency: WPI
Test Number: C-0m-100
Test Date: June 2002
Test Article: C Curb @ 0-m offset

Test Vehicle

Description: C2500
Test Inertial Mass: 2000 kg
Gross Static Mass: 2000 kg

Impact Conditions

Speed: 100.0 km/hr
Angle: 25.0 degrees

Occupant Risk Factors

Impact Velocity (m/s) at 0.1427 seconds on left side of interior
x-direction 5.7
y-direction -5.0

THIV (km/hr): 26.1 at 0.1367 seconds on left side of interior
THIV (m/s): 7.2

Ridedown Accelerations (g's)

x-direction 8.7 (0.6477 - 0.6577 seconds)
y-direction 7.4 (0.1530 - 0.1630 seconds)

PHD (g's): 17.5 (0.6863 - 0.6963 seconds)

ASI: 0.76 (0.1167 - 0.1667 seconds)

Max. 50msec Moving Avg. Accelerations (g's)

x-direction -5.3 (0.0337 - 0.0837 seconds)
y-direction 6.0 (0.1150 - 0.1650 seconds)
z-direction -3.9 (0.2523 - 0.3023 seconds)

Max Roll, Pitch, and Yaw Angles (degrees)

Roll 31.3 (0.6980 seconds)
Pitch 6.0 (0.6600 seconds)
Yaw 54.5 (0.6980 seconds)

Figure L.8: Summary Report of Occupant Risk Factors from TRAP:

Curb Type – AASHTO C Curb
Impact Speed – 100 km/hr
Offset Distance – 0.0 m.

Test Summary Report

General Information

Test Agency: WPI
Test Number: D-0m-100
Test Date: June 2002
Test Article: D Curb @ 0-m offset

Test Vehicle

Description: C2500
Test Inertial Mass: 2000 kg
Gross Static Mass: 2000 kg

Impact Conditions

Speed: 100.0 km/hr
Angle: 25.0 degrees

Occupant Risk Factors

Impact Velocity (m/s) at 0.1360 seconds on left side of interior
x-direction 5.9
y-direction -4.8

THIV (km/hr): 24.9 at 0.1307 seconds on left side of interior
THIV (m/s): 6.9

Ridedown Accelerations (g's)

x-direction -14.0 (0.4463 - 0.4563 seconds)
y-direction 15.9 (0.4457 - 0.4557 seconds)

PHD (g's): 29.1 (0.4477 - 0.4577 seconds)

ASI: 0.85 (0.1273 - 0.1773 seconds)

Max. 50msec Moving Avg. Accelerations (g's)

x-direction -5.4 (0.0823 - 0.1323 seconds)
y-direction 7.1 (0.1297 - 0.1797 seconds)
z-direction 3.5 (0.4597 - 0.5097 seconds)

Max Roll, Pitch, and Yaw Angles (degrees)

Roll -12.5 (0.6293 seconds)
Pitch -14.3 (0.6980 seconds)
Yaw 49.2 (0.5227 seconds)

Figure L.9: Summary Report of Occupant Risk Factors from TRAP:

Curb Type – AASHTO D Curb
Impact Speed – 100 km/hr
Offset Distance – 0.0 m.

Test Summary Report

General Information

Test Agency: WPI
Test Number: G-0m-100
Test Date: June 2002
Test Article: G Curb @ 0-m offset

Test Vehicle

Description: C2500
Test Inertial Mass: 2000 kg
Gross Static Mass: 2000 kg

Impact Conditions

Speed: 100.0 km/hr
Angle: 25.0 degrees

Occupant Risk Factors

Impact Velocity (m/s) at 0.1247 seconds on left side of interior
x-direction 4.8
y-direction -5.3

THIV (km/hr): 23.8 at 0.1207 seconds on left side of interior
THIV (m/s): 6.6

Ridedown Accelerations (g's)

x-direction -11.6 (0.4363 - 0.4463 seconds)
y-direction 14.8 (0.4337 - 0.4437 seconds)

PHD (g's): 21.0 (0.4190 - 0.4290 seconds)

ASI: 0.83 (0.1240 - 0.1740 seconds)

Max. 50msec Moving Avg. Accelerations (g's)

x-direction -5.0 (0.0717 - 0.1217 seconds)
y-direction 7.0 (0.1270 - 0.1770 seconds)
z-direction 2.5 (0.4410 - 0.4910 seconds)

Max Roll, Pitch, and Yaw Angles (degrees)

Roll -11.4 (0.9180 seconds)
Pitch -21.6 (0.8607 seconds)
Yaw 68.9 (0.9180 seconds)

Figure L.10: Summary Report of Occupant Risk Factors from TRAP:

Curb Type – AASHTO G Curb
Impact Speed – 100 km/hr
Offset Distance – 0.0 m.

Test Summary Report

General Information

Test Agency: WPI
Test Number: NY-0m-100
Test Date: June 2002
Test Article: NY Curb @ 0-m offset

Test Vehicle

Description: C2500
Test Inertial Mass: 2000 kg
Gross Static Mass: 2000 kg

Impact Conditions

Speed: 100.0 km/hr
Angle: 25.0 degrees

Occupant Risk Factors

Impact Velocity (m/s) at 0.1260 seconds on left side of interior
x-direction 5.0
y-direction -5.2

THIV (km/hr): 23.5 at 0.1213 seconds on left side of interior
THIV (m/s): 6.5

Ridedown Accelerations (g's)

x-direction -8.2 (0.1743 - 0.1843 seconds)
y-direction 13.1 (0.4283 - 0.4383 seconds)

PHD (g's): 16.3 (0.4297 - 0.4397 seconds)

ASI: 0.72 (0.1073 - 0.1573 seconds)

Max. 50msec Moving Avg. Accelerations (g's)

x-direction -5.0 (0.0750 - 0.1250 seconds)
y-direction 5.7 (0.2203 - 0.2703 seconds)
z-direction 2.4 (0.4117 - 0.4617 seconds)

Max Roll, Pitch, and Yaw Angles (degrees)

Roll -10.9 (0.5853 seconds)
Pitch -9.1 (0.6200 seconds)
Yaw 48.5 (0.5360 seconds)

Figure L.11: Summary Report of Occupant Risk Factors from TRAP:

Curb Type – New York Curb (100 mm)
Impact Speed – 100 km/hr
Offset Distance – 0.0 m.

Test Summary Report

General Information

Test Agency: WPI
Test Number: B-2.5m-70
Test Date: June 2002
Test Article: B Curb @ 2.5-m offset

Test Vehicle

Description: C2500
Test Inertial Mass: 2000 kg
Gross Static Mass: 2000 kg

Impact Conditions

Speed: 70.0 km/hr
Angle: 25.0 degrees

Occupant Risk Factors

Impact Velocity (m/s) at 0.4373 seconds on left side of interior
x-direction 3.5
y-direction -2.5

THIV (km/hr): 14.6 at 0.4327 seconds on left side of interior
THIV (m/s): 4.1

Ridedown Accelerations (g's)

x-direction -15.1 (0.5857 - 0.5957 seconds)
y-direction 19.4 (0.5550 - 0.5650 seconds)

PHD (g's): 51.9 (0.5883 - 0.5983 seconds)

ASI: 1.13 (0.5700 - 0.6200 seconds)

Max. 50msec Moving Avg. Accelerations (g's)

x-direction 4.6 (0.7190 - 0.7690 seconds)
y-direction -10.0 (0.5697 - 0.6197 seconds)
z-direction 7.4 (0.4863 - 0.5363 seconds)

Max Roll, Pitch, and Yaw Angles (degrees)

Roll -11.9 (0.6773 seconds)
Pitch -3.2 (0.9927 seconds)
Yaw 38.7 (1.2720 seconds)

Figure L.12: Summary Report of Occupant Risk Factors from TRAP:

Curb Type – AASHTO B Curb
Impact Speed – 70 km/hr
Offset Distance – 2.5 m.

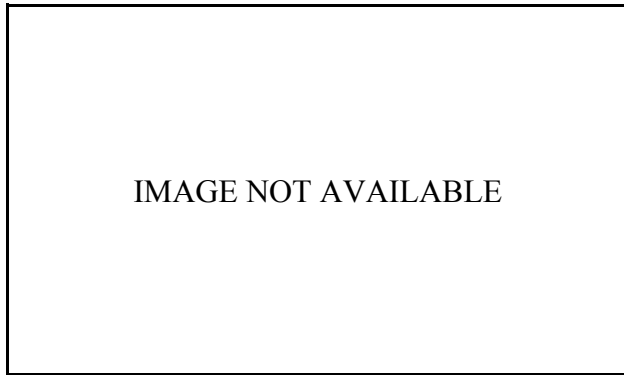

Figure L.13: Summary Report of Occupant Risk Factors from TRAP:

Curb Type	– AASHTO C Curb
Impact Speed	– 70 km/hr
Offset Distance	– 2.5 m.

Test Summary Report

General Information

Test Agency: WPI
Test Number: D-2.5m-70
Test Date: June 2002
Test Article: D Curb @ 2.5-m offset

Test Vehicle

Description: C2500
Test Inertial Mass: 2000 kg
Gross Static Mass: 2000 kg

Impact Conditions

Speed: 70.0 km/hr
Angle: 25.0 degrees

Occupant Risk Factors

Impact Velocity (m/s) at 0.2287 seconds on right side of interior
x-direction -0.1
y-direction 1.6

THIV (km/hr): 6.1 at 0.2293 seconds on right side of interior
THIV (m/s): 1.7

Ridedown Accelerations (g's)

x-direction -12.7 (0.5070 - 0.5170 seconds)
y-direction 17.3 (0.2357 - 0.2457 seconds)

PHD (g's): 34.2 (0.6490 - 0.6590 seconds)

ASI: 0.83 (0.3520 - 0.4020 seconds)

Max. 50msec Moving Avg. Accelerations (g's)

x-direction -5.6 (0.4657 - 0.5157 seconds)
y-direction 5.8 (0.8497 - 0.8997 seconds)
z-direction -7.7 (0.3517 - 0.4017 seconds)

Max Roll, Pitch, and Yaw Angles (degrees)

Roll -11.4 (0.6347 seconds)
Pitch -5.2 (1.0747 seconds)
Yaw 43.9 (0.9020 seconds)

Figure L.14: Summary Report of Occupant Risk Factors from TRAP:

Curb Type – AASHTO D Curb
Impact Speed – 70 km/hr
Offset Distance – 2.5 m.

Test Summary Report

General Information

Test Agency: WPI
Test Number: G-2.5m-70
Test Date: June 2002
Test Article: G Curb @ 2.5-m offset

Test Vehicle

Description: C2500
Test Inertial Mass: 2000 kg
Gross Static Mass: 2000 kg

Impact Conditions

Speed: 70.0 km/hr
Angle: 25.0 degrees

Occupant Risk Factors

Impact Velocity (m/s) at 0.4507 seconds on front of interior
x-direction 6.0
y-direction -2.4

THIV (km/hr): 21.9 at 0.4513 seconds on front of interior
THIV (m/s): 6.1

Ridedown Accelerations (g's)

x-direction -26.6 (0.7197 - 0.7297 seconds)
y-direction 17.2 (0.7143 - 0.7243 seconds)

PHD (g's): 79.6 (0.7103 - 0.7203 seconds)

ASI: 0.89 (1.1880 - 1.2380 seconds)

Max. 50msec Moving Avg. Accelerations (g's)

x-direction -6.6 (0.6063 - 0.6563 seconds)
y-direction 5.2 (0.4997 - 0.5497 seconds)
z-direction -8.2 (1.1877 - 1.2377 seconds)

Max Roll, Pitch, and Yaw Angles (degrees)

Roll -14.1 (0.6880 seconds)
Pitch -6.3 (0.9907 seconds)
Yaw 44.9 (1.3020 seconds)

Figure L.15: Summary Report of Occupant Risk Factors from TRAP:

Curb Type – AASHTO G Curb
Impact Speed – 70 km/hr
Offset Distance – 2.5 m.

Test Summary Report

General Information

Test Agency: WPI
Test Number: NY-2.5m-70
Test Date: June 2002
Test Article: NY Curb @ 2.5-m offset

Test Vehicle

Description: C2500
Test Inertial Mass: 2000 kg
Gross Static Mass: 2000 kg

Impact Conditions

Speed: 70.0 km/hr
Angle: 25.0 degrees

Occupant Risk Factors

Impact Velocity (m/s) at 0.4940 seconds on front of interior
x-direction 5.8
y-direction -4.5

THIV (km/hr): 23.2 at 0.4960 seconds on left side of interior
THIV (m/s): 6.5

Ridedown Accelerations (g's)

x-direction -11.0 (0.5343 - 0.5443 seconds)
y-direction 10.9 (0.5023 - 0.5123 seconds)

PHD (g's): 26.6 (0.5923 - 0.6023 seconds)

ASI: 0.88 (0.3547 - 0.4047 seconds)

Max. 50msec Moving Avg. Accelerations (g's)

x-direction -4.4 (0.4437 - 0.4937 seconds)
y-direction 6.4 (0.3537 - 0.4037 seconds)
z-direction -5.1 (0.3550 - 0.4050 seconds)

Max Roll, Pitch, and Yaw Angles (degrees)

Roll -8.4 (0.6480 seconds)
Pitch -5.2 (1.0253 seconds)
Yaw 40.8 (1.0253 seconds)

Figure L.16: Summary Report of Occupant Risk Factors from TRAP:

Curb Type – New York Curb (100 mm)
Impact Speed – 70 km/hr
Offset Distance – 2.5 m.

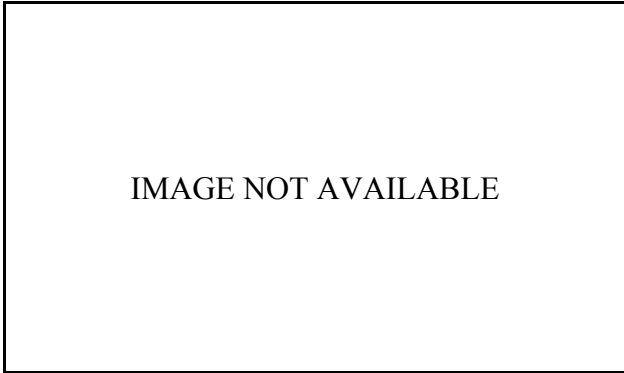

Figure L.17: Summary Report of Occupant Risk Factors from TRAP:

Curb Type	– AASHTO B Curb
Impact Speed	– 85 km/hr
Offset Distance	– 2.5 m.

Test Summary Report

General Information

Test Agency: WPI
Test Number: C-2.5m-85
Test Date: June 2002
Test Article: C Curb @ 2.5-m offset

Test Vehicle

Description: C2500
Test Inertial Mass: 2000 kg
Gross Static Mass: 2000 kg

Impact Conditions

Speed: 85.0 km/hr
Angle: 25.0 degrees

Occupant Risk Factors

Impact Velocity (m/s) at 0.3473 seconds on front of interior
x-direction 6.1
y-direction -3.6

THIV (km/hr): 25.2 at 0.3487 seconds on front of interior
THIV (m/s): 7.0

Ridedown Accelerations (g's)

x-direction -25.2 (0.4317 - 0.4417 seconds)
y-direction -22.0 (0.4463 - 0.4563 seconds)

PHD (g's): 72.8 (0.4570 - 0.4670 seconds)

ASI: 1.68 (0.3947 - 0.4447 seconds)

Max. 50msec Moving Avg. Accelerations (g's)

x-direction -9.2 (0.4170 - 0.4670 seconds)
y-direction 8.5 (0.3963 - 0.4463 seconds)
z-direction -12.5 (0.3983 - 0.4483 seconds)

Max Roll, Pitch, and Yaw Angles (degrees)

Roll -6.1 (0.4667 seconds)
Pitch -2.2 (0.4660 seconds)
Yaw 6.0 (0.4540 seconds)

Figure L.18: Summary Report of Occupant Risk Factors from TRAP:

Curb Type – AASHTO C Curb
Impact Speed – 85 km/hr
Offset Distance – 2.5 m.

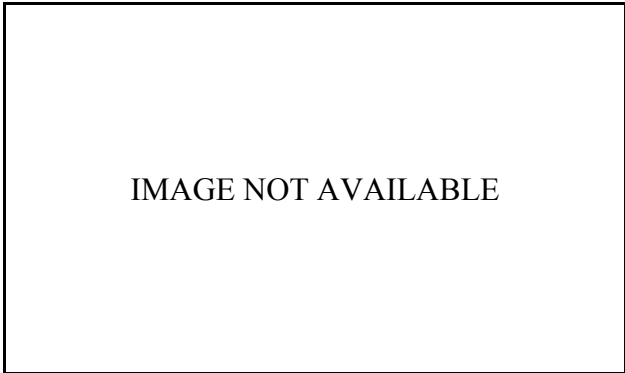

Figure L.19: Summary Report of Occupant Risk Factors from TRAP:

Curb Type	– AASHTO G Curb
Impact Speed	– 100 km/hr
Offset Distance	– 2.5 m.

Test Summary Report

General Information

Test Agency: WPI
Test Number: B-4.0m-70
Test Date: June 2002
Test Article: B Curb @ 4.0-m offset

Test Vehicle

Description: C2500
Test Inertial Mass: 2000 kg
Gross Static Mass: 2000 kg

Impact Conditions

Speed: 70.0 km/hr
Angle: 25.0 degrees

Occupant Risk Factors

Impact Velocity (m/s) at 0.6893 seconds on left side of interior
x-direction 2.0
y-direction -4.5

THIV (km/hr): 18.0 at 0.6907 seconds on left side of interior
THIV (m/s): 5.0

Ridedown Accelerations (g's)

x-direction 13.6 (0.8270 - 0.8370 seconds)
y-direction -19.2 (0.8257 - 0.8357 seconds)

PHD (g's): 41.4 (0.8243 - 0.8343 seconds)

ASI: 1.10 (0.7773 - 0.8273 seconds)

Max. 50msec Moving Avg. Accelerations (g's)

x-direction -6.3 (0.6583 - 0.7083 seconds)
y-direction 8.3 (0.7757 - 0.8257 seconds)
z-direction -6.7 (0.7770 - 0.8270 seconds)

Max Roll, Pitch, and Yaw Angles (degrees)

Roll 5.1 (0.2260 seconds)
Pitch -2.8 (0.8547 seconds)
Yaw 27.4 (0.9380 seconds)

Figure L.20: Summary Report of Occupant Risk Factors from TRAP:

Curb Type – AASHTO B Curb
Impact Speed – 70 km/hr
Offset Distance – 4.0 m.

Test Summary Report

General Information

Test Agency: WPI
Test Number: C-4.0m-70
Test Date: June 2002
Test Article: C Curb @ 4.0-m offset

Test Vehicle

Description: C2500
Test Inertial Mass: 2000 kg
Gross Static Mass: 2000 kg

Impact Conditions

Speed: 70.0 km/hr
Angle: 25.0 degrees

Occupant Risk Factors

Impact Velocity (m/s) at 0.4460 seconds on right side of interior
x-direction 1.6
y-direction 1.4

THIV (km/hr): 8.0 at 0.4400 seconds on right side of interior
THIV (m/s): 2.2

Ridedown Accelerations (g's)

x-direction 14.4 (1.1557 - 1.1657 seconds)
y-direction 13.8 (0.5870 - 0.5970 seconds)

PHD (g's): 38.9 (0.7163 - 0.7263 seconds)

ASI: 0.77 (0.1213 - 0.1713 seconds)

Max. 50msec Moving Avg. Accelerations (g's)

x-direction 6.9 (1.1330 - 1.1830 seconds)
y-direction 6.3 (0.5850 - 0.6350 seconds)
z-direction 6.8 (0.5470 - 0.5970 seconds)

Max Roll, Pitch, and Yaw Angles (degrees)

Roll -7.6 (0.8320 seconds)
Pitch -2.7 (0.6047 seconds)
Yaw 42.7 (1.0667 seconds)

Figure L.21: Summary Report of Occupant Risk Factors from TRAP:

Curb Type – AASHTO C Curb
Impact Speed – 70 km/hr
Offset Distance – 4.0 m.

Test Summary Report

General Information

Test Agency: WPI
Test Number: D-4.0m-70
Test Date: June 2002
Test Article: D Curb @ 4.0-m offset

Test Vehicle

Description: C2500
Test Inertial Mass: 2000 kg
Gross Static Mass: 2000 kg

Impact Conditions

Speed: 70.0 km/hr
Angle: 25.0 degrees

Occupant Risk Factors

Impact Velocity (m/s) at 0.3767 seconds on left side of interior
x-direction 0.3
y-direction -1.6

THIV (km/hr): 6.1 at 0.3813 seconds on left side of interior
THIV (m/s): 1.7

Ridedown Accelerations (g's)

x-direction 13.3 (1.1363 - 1.1463 seconds)
y-direction 14.4 (0.6417 - 0.6517 seconds)

PHD (g's): 49.7 (1.1397 - 1.1497 seconds)

ASI: 0.84 (0.6420 - 0.6920 seconds)

Max. 50msec Moving Avg. Accelerations (g's)

x-direction -3.9 (0.7890 - 0.8390 seconds)
y-direction 7.2 (1.0597 - 1.1097 seconds)
z-direction 5.1 (0.0690 - 0.1190 seconds)

Max Roll, Pitch, and Yaw Angles (degrees)

Roll 5.6 (0.2153 seconds)
Pitch -2.9 (0.8547 seconds)
Yaw 44.2 (1.1013 seconds)

Figure L.22: Summary Report of Occupant Risk Factors from TRAP:

Curb Type – AASHTO D Curb
Impact Speed – 70 km/hr
Offset Distance – 4.0 m.

Test Summary Report

General Information

Test Agency: WPI
Test Number: G-4.0m-70
Test Date: June 2002
Test Article: G Curb @ 4.0-m offset

Test Vehicle

Description: C2500
Test Inertial Mass: 2000 kg
Gross Static Mass: 2000 kg

Impact Conditions

Speed: 70.0 km/hr
Angle: 25.0 degrees

Occupant Risk Factors

Impact Velocity (m/s) at 0.4007 seconds on left side of interior
x-direction 1.1
y-direction -2.6

THIV (km/hr): 10.5 at 0.4027 seconds on left side of interior
THIV (m/s): 2.9

Ridedown Accelerations (g's)

x-direction -21.2 (0.8103 - 0.8203 seconds)
y-direction -16.8 (1.3470 - 1.3570 seconds)

PHD (g's): 39.2 (1.4863 - 1.4963 seconds)

ASI: 0.80 (0.7933 - 0.8433 seconds)

Max. 50msec Moving Avg. Accelerations (g's)

x-direction -8.5 (0.7850 - 0.8350 seconds)
y-direction 5.6 (0.6590 - 0.7090 seconds)
z-direction 6.9 (0.7237 - 0.7737 seconds)

Max Roll, Pitch, and Yaw Angles (degrees)

Roll 4.4 (0.2727 seconds)
Pitch -3.4 (1.0987 seconds)
Yaw 39.6 (1.0707 seconds)

Figure L.23: Summary Report of Occupant Risk Factors from TRAP:

Curb Type – AASHTO G Curb
Impact Speed – 70 km/hr
Offset Distance – 4.0 m.

Test Summary Report

General Information

Test Agency: WPI
Test Number: B-4.0m-85
Test Date: June 2002
Test Article: B Curb @ 4.0-m offset

Test Vehicle

Description: C2500
Test Inertial Mass: 2000 kg
Gross Static Mass: 2000 kg

Impact Conditions

Speed: 85.0 km/hr
Angle: 25.0 degrees

Occupant Risk Factors

Impact Velocity (m/s) at 0.2967 seconds on left side of interior
x-direction 0.1
y-direction -2.6

THIV (km/hr): 9.7 at 0.2973 seconds on left side of interior
THIV (m/s): 2.7

Ridedown Accelerations (g's)

x-direction -31.1 (0.5683 - 0.5783 seconds)
y-direction 29.0 (0.6657 - 0.6757 seconds)

PHD (g's): 68.6 (0.6657 - 0.6757 seconds)

ASI: 1.66 (0.5720 - 0.6220 seconds)

Max. 50msec Moving Avg. Accelerations (g's)

x-direction -14.7 (0.5710 - 0.6210 seconds)
y-direction 10.1 (0.6470 - 0.6970 seconds)
z-direction -9.0 (0.5757 - 0.6257 seconds)

Max Roll, Pitch, and Yaw Angles (degrees)

Roll -10.8 (0.8353 seconds)
Pitch -2.0 (0.5593 seconds)
Yaw 43.9 (1.4973 seconds)

Figure L.24: Summary Report of Occupant Risk Factors from TRAP:

Curb Type – AASHTO B Curb
Impact Speed – 85 km/hr
Offset Distance – 4.0 m.

Test Summary Report

General Information

Test Agency: WPI
Test Number: C-4.0m-85
Test Date: June 2002
Test Article: C Curb @ 4.0-m offset

Test Vehicle

Description: C2500
Test Inertial Mass: 2000 kg
Gross Static Mass: 2000 kg

Impact Conditions

Speed: 85.0 km/hr
Angle: 25.0 degrees

Occupant Risk Factors

Impact Velocity (m/s) at 0.3260 seconds on left side of interior
x-direction 0.7
y-direction -1.7

THIV (km/hr): 5.6 at 0.3307 seconds on left side of interior
THIV (m/s): 1.6

Ridedown Accelerations (g's)

x-direction -20.0 (0.8890 - 0.8990 seconds)
y-direction 16.9 (0.8150 - 0.8250 seconds)

PHD (g's): 50.7 (0.8610 - 0.8710 seconds)

ASI: 0.81 (0.8553 - 0.9053 seconds)

Max. 50msec Moving Avg. Accelerations (g's)

x-direction -6.9 (0.8563 - 0.9063 seconds)
y-direction 5.8 (0.8550 - 0.9050 seconds)
z-direction 6.7 (0.6177 - 0.6677 seconds)

Max Roll, Pitch, and Yaw Angles (degrees)

Roll -6.3 (0.7273 seconds)
Pitch -3.2 (1.0527 seconds)
Yaw 42.0 (1.4973 seconds)

Figure L.25: Summary Report of Occupant Risk Factors from TRAP:

Curb Type – AASHTO C Curb
Impact Speed – 85 km/hr
Offset Distance – 4.0 m.

Test Summary Report

General Information

Test Agency: WPI
Test Number: B-4.0m-100
Test Date: June 2002
Test Article: B Curb @ 4.0-m offset

Test Vehicle

Description: C2500
Test Inertial Mass: 2000 kg
Gross Static Mass: 2000 kg

Impact Conditions

Speed: 100.0 km/hr
Angle: 25.0 degrees

Occupant Risk Factors

Impact Velocity (m/s) at 0.3213 seconds on front of interior
x-direction 3.6
y-direction 0.3

THIV (km/hr): 13.1 at 0.3220 seconds on front of interior
THIV (m/s): 3.6

Ridedown Accelerations (g's)

x-direction -40.0 (0.5437 - 0.5537 seconds)
y-direction -49.9 (0.5570 - 0.5670 seconds)

PHD (g's): 143.3 (0.5650 - 0.5750 seconds)

ASI: 1.79 (0.5040 - 0.5540 seconds)

Max. 50msec Moving Avg. Accelerations (g's)

x-direction -13.1 (0.5037 - 0.5537 seconds)
y-direction 9.6 (0.4330 - 0.4830 seconds)
z-direction -14.6 (0.5417 - 0.5917 seconds)

Max Roll, Pitch, and Yaw Angles (degrees)

Roll -19.6 (0.5933 seconds)
Pitch -6.2 (0.5933 seconds)
Yaw -8.6 (0.5933 seconds)

Figure L.26: Summary Report of Occupant Risk Factors from TRAP:

Curb Type – AASHTO B Curb
Impact Speed – 100 km/hr
Offset Distance – 4.0 m.

Test Summary Report

General Information

Test Agency: WPI
Test Number: C-4.0m-100
Test Date: June 2002
Test Article: C Curb @ 4.0-m offset

Test Vehicle

Description: C2500
Test Inertial Mass: 2000 kg
Gross Static Mass: 2000 kg

Impact Conditions

Speed: 100.0 km/hr
Angle: 25.0 degrees

Occupant Risk Factors

Impact Velocity (m/s) at 0.5007 seconds on left side of interior
x-direction 5.0
y-direction -3.8

THIV (km/hr): 23.7 at 0.4960 seconds on left side of interior
THIV (m/s): 6.6

Ridedown Accelerations (g's)

x-direction -40.0 (0.0190 - 0.0290 seconds)
y-direction -49.9 (0.0323 - 0.0423 seconds)

PHD (g's): 33.5 (0.4957 - 0.5057 seconds)

ASI: 0.87 (0.4420 - 0.4920 seconds)

Max. 50msec Moving Avg. Accelerations (g's)

x-direction -6.5 (0.4157 - 0.4657 seconds)
y-direction 5.8 (0.4417 - 0.4917 seconds)
z-direction -4.2 (0.4423 - 0.4923 seconds)

Max Roll, Pitch, and Yaw Angles (degrees)

Roll -6.7 (0.5047 seconds)
Pitch -3.5 (0.4673 seconds)
Yaw -2.7 (0.3847 seconds)

Figure L.27: Summary Report of Occupant Risk Factors from TRAP:

Curb Type – AASHTO C Curb
Impact Speed – 100 km/hr
Offset Distance – 4.0 m.

Test Summary Report

General Information

Test Agency: WPI
Test Number: G-4.0m-100
Test Date: June 2002
Test Article: G Curb @ 4.0-m offset

Test Vehicle

Description: C2500
Test Inertial Mass: 2000 kg
Gross Static Mass: 2000 kg

Impact Conditions

Speed: 100.0 km/hr
Angle: 25.0 degrees

Occupant Risk Factors

Impact Velocity (m/s) at 0.4667 seconds on front of interior
x-direction 6.3
y-direction -4.9

THIV (km/hr): 28.6 at 0.4680 seconds on front of interior
THIV (m/s): 8.0

Ridedown Accelerations (g's)

x-direction 26.2 (0.6237 - 0.6337 seconds)
y-direction -29.2 (1.0250 - 1.0350 seconds)

PHD (g's): 83.4 (0.9703 - 0.9803 seconds)

ASI: 1.45 (0.9973 - 1.0473 seconds)

Max. 50msec Moving Avg. Accelerations (g's)

x-direction 13.4 (0.6223 - 0.6723 seconds)
y-direction -9.6 (0.9970 - 1.0470 seconds)
z-direction -11.5 (0.9783 - 1.0283 seconds)

Max Roll, Pitch, and Yaw Angles (degrees)

Roll -45.1 (1.0380 seconds)
Pitch 3.5 (0.7860 seconds)
Yaw 14.7 (0.7840 seconds)

Figure L.28: Summary Report of Occupant Risk Factors from TRAP:

Curb Type – AASHTO G Curb
Impact Speed – 100 km/hr
Offset Distance – 4.0 m.

Test Summary Report

General Information

Test Agency: WPI
Test Number: NY-4.0m-100
Test Date: June 2002
Test Article: NY Curb @ 4.0-m offset

Test Vehicle

Description: C2500
Test Inertial Mass: 2000 kg
Gross Static Mass: 2000 kg

Impact Conditions

Speed: 100.0 km/hr
Angle: 25.0 degrees

Occupant Risk Factors

Impact Velocity (m/s) at 0.4920 seconds on front of interior
x-direction 5.3
y-direction -5.6

THIV (km/hr): 24.6 at 0.4927 seconds on front of interior
THIV (m/s): 6.8

Ridedown Accelerations (g's)

x-direction -17.0 (0.5517 - 0.5617 seconds)
y-direction 21.1 (0.5477 - 0.5577 seconds)

PHD (g's): 43.0 (0.6250 - 0.6350 seconds)

ASI: 1.12 (0.4413 - 0.4913 seconds)

Max. 50msec Moving Avg. Accelerations (g's)

x-direction -10.4 (0.5363 - 0.5863 seconds)
y-direction 9.3 (0.4237 - 0.4737 seconds)
z-direction 6.7 (0.4943 - 0.5443 seconds)

Max Roll, Pitch, and Yaw Angles (degrees)

Roll -15.2 (0.6347 seconds)
Pitch -3.1 (0.5140 seconds)
Yaw 22.4 (0.6347 seconds)

Figure L.29: Summary Report of Occupant Risk Factors from TRAP:

Curb Type – New York Curb (100 mm)
Impact Speed – 100 km/hr
Offset Distance – 4.0 m.

VI. VEHICLE IMPACT WITH CURB-AND-GUARDRAIL SYSTEMS

6.1 Introduction

It is often necessary to use a curb at a particular location that also warrants a traffic barrier. Inadequate design of these curb-and-barrier combination systems can result in vehicles vaulting or under-riding the barrier. While the use of curbs is discouraged on high-speed roadways, they are often required because of restricted right-of-way, drainage considerations, access control, delineation and other curb functions. Curb-and-barrier installations are currently being put in place without a clear understanding of the effects that such combinations will have on the ability of the barrier to safely contain and redirect an errant vehicle. There have been a very limited number of full-scale crash tests on curb-and-barrier combinations and a large percentage of those tests involving the larger class of passenger vehicles, such as the 2000-kg pickup truck, were unsuccessful.(28) Even the cases involving the 2000-kg pickup truck that satisfied the requirements of NCHRP Report 350 resulted in excessive damage to the barrier system or extreme trajectories and instability of the vehicle.(29)(30)(32)

This chapter discusses the analysis of various curb-and-barrier systems subjected to impact by a 2000 kg pickup truck (i.e., modified NCAC C2500R pickup truck model) under three different impact conditions:

- 1) 100 km/hr and 25 degrees (i.e., NCHRP Report 350 Test 3-11),
- 2) 85 km/hr and 25 degrees and

3) 70 km/hr and 25 degrees (i.e., NCHRP Report 350 Test 2-11) .

The study includes the modified G4(1S) guardrail installed in combination with five curb types (i.e., AASHTO types B, C, D, G and the 100-mm New York Curb). The analyses are carried out using the finite element program LS-DYNA and are designed to investigate the effects of curb type, curb placement and impact speed on the performance of the barrier system.

6.2 Parametric Study

The modified G4(1S) guardrail model and the modified NCAC C2500R pickup model (refer to Chapter 4) will be used to determine the impact response of guardrail placed in combination with various types of curbs. There are a limited number of analyses that can be conducted due to feasibility and time constraints, however, very useful information can be achieved from the results of selected cases.

The analyses will involve the modified G4(1S) guardrail placed in combination with the most commonly used types of AASHTO curbs and, additionally, the 100-mm New York curb will be included in the study matrix. Each of these curbs are shown in figure 6.1.

The curb types most commonly used by the states are the AASHTO types A, B, C, D and G. Although many states do not use AASHTO curbs, most of them use curbs that are at least similar to one of the AASHTO curb types shown in figure 6.1. The AASHTO type A curb will be excluded from the curb-barrier study due to the results from the curb

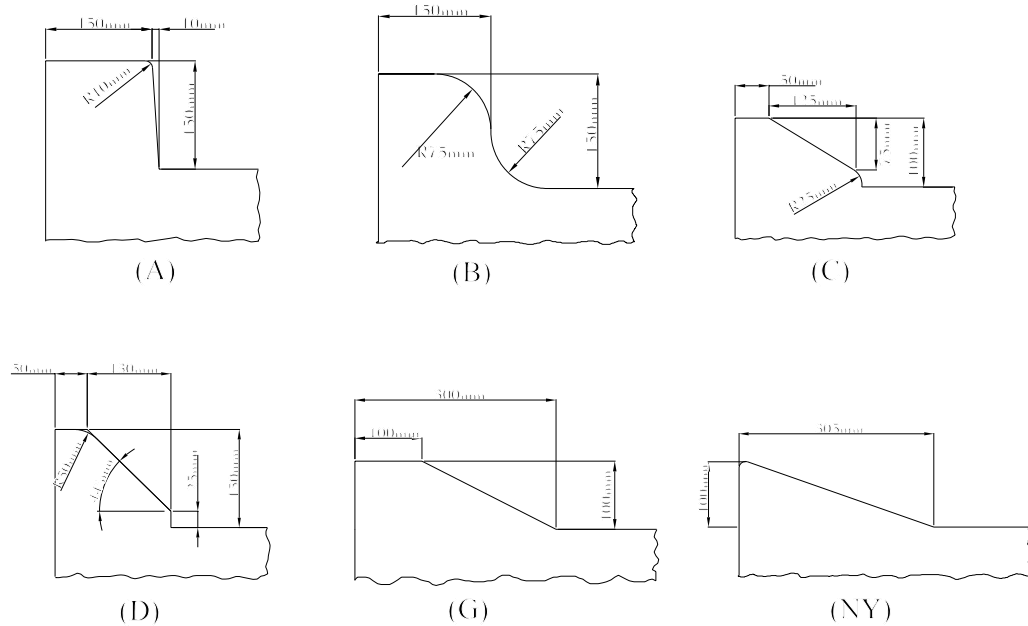

Figure 6.1: Curb types used in curb study.(1)

tracking study in chapter 5 in which the results of the analyses involving the AASHTO type A curb were considered inconclusive.

Three curb placement scenarios will be investigated. One scenario will involve each of the curbs placed behind the face of the barrier with the front of the curb flush with the front of the w-beam where possible. These combinations are consistent with the recommendations of the FHWA memorandum of Feb 28, 1992, and will provide useful information to the states about the performance of these currently advocated curb-barrier combinations.(28) Two other curb-placement scenarios will be investigated to determine the effects of curbs placed in combination with guardrails where the offset distance from curb to barrier is greater than zero, as shown below in figure 6.2. Since offset curb-barrier combinations are more common along low to moderate speed roadways (i.e., < 80 km/hr)

analyses of such combinations will primarily be conducted for NCHRP Test level 2 conditions (i.e., 70-km/hr), although a select number of impacts with certain curb-barrier combinations will be investigated at higher speeds.

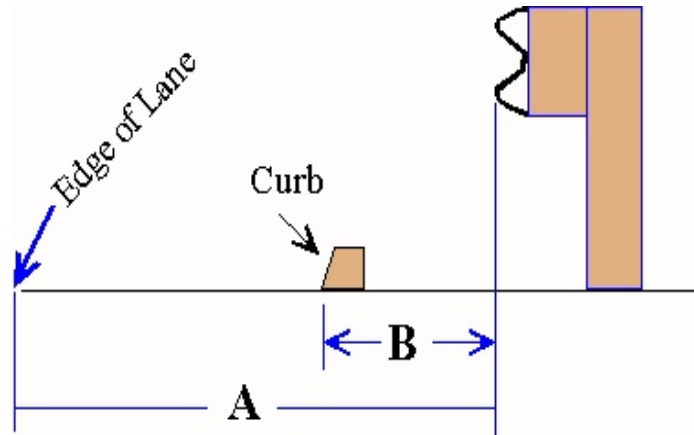

Figure 6.2: Schematic drawing to identify curb and barrier placement along roadway.

The placement of the curbs in

those analyses will be based on the results of the curb-tracking study of Chapter 5 with consideration given to the clear zone distances that are required for typical roadways.

The backfill and the roadway terrain in the computer model simulations will have a zero slope. For design speeds of 70-80 km/hr the Roadside Design Guide states that the clear zone distance ranges from 3.5 m for roadways with an Average Daily Traffic (ADT) count of less than 750 vehicles per day (vpd) to 6.5 m for roadways with ADT greater than 6,000 vpd.(2) For design speeds of 100 km/hr the clear zone distance ranges from 5 m to 8.5 m for roadways with less than 750 ADT to roadways with greater than 6,000 ADT, respectively.

The matrix of simulations shown in Tables 6.1 through 6.3 will be used to investigate the effects of curbs placed in combination with the G4(1S) guardrail. Based on the bumper trajectory plots obtained from the curb traversal study in Chapter 5, a vehicle impact

speed of 70 km/hr and angle of 25 degrees will result in the trajectory of the front bumper continuously increasing from the time of wheel contact with the curb until the front bumper reaches a lateral offset distance of approximately 4 m behind the curb.

Furthermore, the bumper is higher than the top of the guardrail until the vehicle reaches a lateral distance of 5 m behind the curb. Since the median (as in middle value not roadway median) clear zone distance is approximately 5 m it would not be of interest to investigate offset distances of 5 m or greater since the guardrail would not be warranted outside the clear zone area.(2) In these cases offset distances of 2.5 m and 4 m will be investigated under impact conditions consistent with NCHRP Report 350 Test 2-11 (refer to table 6.1).(20)

For the case of the modified C2500R pickup model traversing a curb at 100 km/hr and 25 degrees the bumper trajectory plots from the curb traversal study indicate that the bumper trajectory continuously increases after wheel impact with the curb until the vehicle reaches a lateral distance of approximately 6 m behind the curb. Furthermore, the bumper remains higher than the guardrail for a lateral distance of approximately 8 m with the maximum trajectory occurring at a lateral distance between 4 - 6 m. Computer simulated impacts with curb-barrier systems at an offset distance of 4 m will be investigated under impact conditions consistent with NCHRP Report 350 Test 3-11 (refer to table 6.2). The performance of certain curb-barrier systems will also be investigated at 85 km/hr which will represents the upper speed range for intermediate speed roadways (i.e., 60-80 km/hr) (refer to table 6.3).

Table 6.1: Matrix of simulations regarding offset distance of curb to barrier for modified G4(1S) guardrail system under NCHRP Test 2-11 impact conditions (70 km/hr).

Curb Type	Offset Distance from Barrier to Curb		
	0 m	2.5 m	4 m
B	✓	✓	✓
C	✓	✓	✓
D	✓	✓	✓
G	✓	✓	✓
NY	✓	✓	

Table 6.2: Matrix of simulations regarding offset distance of curb to barrier for modified G4(1S) guardrail system under NCHRP Test 3-11 impact conditions (100 km/hr).

Curb Type	Offset Distance from Barrier to Curb		
	0 m	2.5 m	4 m
B	✓		✓
C	✓		✓
D	✓		
G	✓	✓	✓
NY	✓		✓

Table 6.3: Matrix of simulations regarding offset distance of curb to barrier for modified G4(1S) guardrail system at impact speed of 85 km/hr and angle of 25 degrees.

Curb Type	Offset Distance from Barrier to Curb		
	0 m	2.5 m	4 m
B	✓	✓	✓
C	✓	✓	✓

6.3 Data Collected

The information collected from the analyses is being used to determine the effectiveness of the guardrail to safely contain and redirect the vehicle during impact with the curb-barrier system. The data that were collected are listed below and are included as Appendices to this document. They include:

Appendix 8. Sequential snapshots of the impact event,

Appendix 9. Acceleration-time histories,

Appendix 10. Yaw-, pitch- and roll-time histories,

Appendix 11. W-beam tensile force-time histories, and

Appendix 12. Test Risk Assessment Program Results.

6.3.1 Sequential Snapshots of Impact Event

Sequential snapshots from the analysis are presented in a frontal view and an overhead view. These figures will provide a qualitative means of assessing vehicle stability and trajectory during and after impact, as well as apparent barrier override or underide. Each of these views are illustrated in figure 6.3.

6.3.2 Acceleration-Time Histories

The acceleration-time histories of the vehicle will be collected at the center of gravity of the vehicle in a local coordinate frame that is fixed to the vehicle, as shown in figure 5.4.

These data will be processed such that useful information regarding occupant risk factors can be determined.

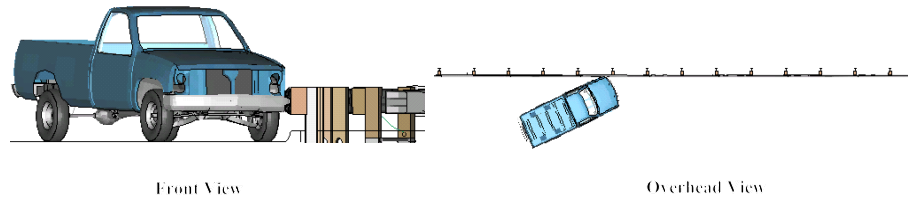

Figure 6.3: Typical view points for sequential snapshots taken from F.E. analyses.

6.3.3 Yaw-, Pitch- and Roll-Time Histories

Vehicular angular displacements (i.e., yaw, pitch and roll) will also be collected at the center of gravity of the vehicle. These data will provide vital quantitative information regarding vehicle stability during and after impact and also provide information regarding occupant risk factors. Another important issue that will be assessed using this data is vehicle yaw-position at time of impact with the guardrail system. For cases in which the guardrail is offset from the curb, the impact of the wheels of the vehicle with the curb may cause the vehicle to yaw such that the vehicle impacts the guardrail at an angle other than 25 degrees which will affect the severity of the impact.

6.3.4 Maximum Tensile Force in W-Beam Rail

An important aspect of guardrail collisions that can not accurately be simulated using the current finite element model is guardrail rupture. In a full-scale crash test that was

conducted at the Midwest Roadside Safety Facility in May of 1998, a guardrail-curb combination was tested under NCHRP Report 350 test 3-11 conditions, which resulted in the guardrail rupturing at a splice connection.(28) Such failure can be assessed with FEA, however, the model used in the current analyses did not incorporate a failure criteria on the w-beam rail elements. This is because accurate simulation of rupture using Lagrangian finite element methods requires a refined mesh (i.e., very small elements) in the fracture region which would result in a very small time-step in order to obtain a stable solution using the explicit time-integration scheme.

Since failure conditions are typically based on failure strain, which is very sensitive to mesh density, it is common practice to exclude failure in the full-scale simulation and rely the results of the full-scale simulation to identify the critical regions in the system (e.g., post and w-beam connections) that may have a potential for failure. Sub-models of these components could then be developed in order to thoroughly assess the performance of those components. This method, however, would severely limit the number of curb-barrier impact scenarios that could be investigated.

Another means of assessing the potential for guardrail rupture is to examine tensile forces in the w-beam during collision. Guardrail rupture is often associated with relatively large displacement of the anchor system which leads to “pocketing”. Pocketing is a term used to describe a situation in which there is large lateral displacement of the rail concurrent with a decrease in guardrail tension downstream of the vehicle which causes the rail

element to form a pocket shape between two adjacent posts, thereby impeding the vehicle's redirection back out of the system. In such cases the rail element will likely rupture either downstream of the vehicle at a post location where there is a high curvature of the rail (e.g., high bending stresses) or at a splice connection just upstream of the vehicle where there is an increase in rail tension.(28) In extreme cases of pocketing the guardrail may experience very low tensile forces or even compression downstream of the vehicle while the upstream sections of rail experience very large tensile forces.

The tensile forces in the rail were collected at four locations along the guardrail, as shown schematically in figure 6.4 and identified below:

- A. the nearest splice connection downstream of the impact point,
- B. the nearest splice connection upstream of the impact point,
- C. the upstream anchor and
- D. at a downstream location outside the impact zone.

The results for each of the curb-guardrail analyses were compared to the results of the

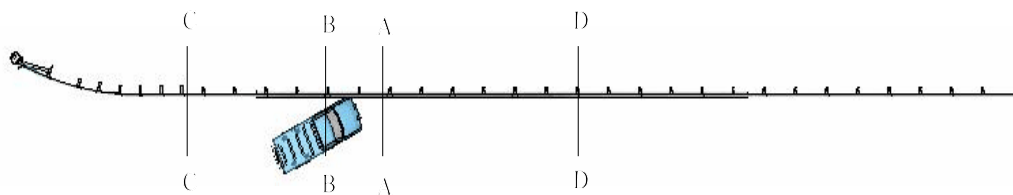

Figure 6.4: Schematic view of the finite element model identifying the locations at which cross-section force data in the w-beam rail was collected.

guardrail analyses without a curb present. Previous results from finite element analysis and crash tests on the modified G4(1S) without a curb imply that the forces in the guardrail under NCHRP Report 350 test 3-11 impact conditions are close to the maximum capacity that the guardrail can withstand without rupture or without causing excessive anchor movement.(56) If the rail forces are significantly higher in the curb-guardrail simulations than they are in the simulations without a curb present, then there may be a potential for rupture in those cases.

6.3.5 Test Risk Assessment Program (TRAP) Results

The acceleration data and displacement-time history data discussed above will be used in the Test Risk Assessment Program (TRAP).(46) NCHRP Report 350 requires that the occupant impact velocity (OIV) in the longitudinal direction should not exceed 12 m/s and the occupant ridedown acceleration (ORA) (i.e., the maximum vehicle acceleration averaged over 10 ms interval after occupant impact) in the longitudinal direction should not exceed 20 G's. Both the NCHRP occupant risk factors and the CEN risk factors will be reported, however, the CEN data are not required by the Federal Highway Administration and will not be considered in the performance evaluation of the curb-barrier systems.

6.4 Results

At the beginning of each analysis the vehicle was aligned to impact post 14 of the guardrail system. This point is 2.4 m upstream of a splice connection. The exact impact

point may vary in some cases where the barrier is offset from the curb depending on the yaw angle of the vehicle after impact with the curb. The results of the finite element analyses are presented in the Appendices of this report. Animations of the impact events are provided on the NCHRP 22-17 project web site at:

http://cee.wpi.edu/Roadsafe/Curbs/Curb-Guardrail_AVIS/ . Summary tables and graphs of the results of the study are presented below.

6.4.1 Sequential Snapshots of the Impact Event

Sequential snapshots of the impact event are shown in Appendix 8. These images provide a qualitative means of evaluating the general behavior of vehicle interaction with the guardrail as well as the important safety issues regarding vehicle kinematics such as barrier override, barrier underride, vehicle overturn, and vehicle redirection. Table 6.4 summarizes the results based upon the images in Appendix 8. It is important to note that vehicle impact into roadside barriers is highly nonlinear which means that small variations in the system may lead to different results. Such variations may include impact conditions, impact location on the barrier, vehicle suspension properties, soil conditions, barrier connections, and barrier component properties to name only a few. Because of the nature of these factors the results of the finite element analyses should only be viewed as a tool for assessing the performance of the system, and are thus only representative of a possible outcome for the conditions specified.

Table 6.4: Summary of results from images of sequential snapshot data regarding vehicle override, underride, rollover and redirection.

Offset Distance	Impact Speed	Curb Type	Over-ride	Under-ride	Roll-over	Redirection Comments	
0.0 m	70 km/hr	B	-	-	-	Stable redirection	
		C	-	-	-	Stable redirection	
		D	-	-	-	Slight bumper trajectory, Stable redirection	
		G	Analysis Not Conducted				
		NY	-	-	-	Stable redirection	
	85 km/hr	B	-	-	-	Slight pitch	
		C	-	-	-	Stable redirection	
	100 km/hr	B	-	-	Possible	Excessive pitch	
		C	Likely	-	Likely	Excessive trajectory	
		D	-	-	Possible	Excessive pitch	
		G	-	-	Possible	Excessive pitch	
		NY	-	-	-	Moderate pitch, stable redirection	
	2.5 m	70 km/hr	B	-	-	-	Moderate roll angle, high yaw rate, bumper gets above rail
C			-	-	-	Moderate roll angle, high yaw rate, slight bumper trajectory	
D			-	-	-	Moderate roll angle, high yaw rate, bumper gets above rail, tierod breaks	
G			-	-	-	Moderate roll angle, high yaw rate, Bumper gets above rail	
NY			-	-	-	Stable redirection, high yaw rate	
85 km/hr		B	Likely	-	-	The analysis terminated prematurely as the bumper started over the rail.	Excessive roll angle, bumper gets over rail
		C	Likely	-	-	The analysis terminated prematurely as the bumper started over the rail.	Excessive roll angle, bumper gets over rail

Table 6.4: (CONTINUED) Summary of results from images of sequential snapshot data regarding vehicle override, underride, rollover and redirection.

Offset Distance	Impact Speed	Curb Type	Over-ride	Under-ride	Roll-over	Redirection Comments	
2.5 m	100 km/hr	G	Likely	-	Likely	Bumper gets over rail, truck rolls over	
4.0 m	70 km/hr	B	-	-	-	Analysis terminated during redirection	
		C	-	-	-	Stable redirection	
		D	-	-	-	Stable redirection	
		G	-	-	-		
		NY	Analysis Not Conducted				
	85 km/hr	B	-	-	-	Stable redirection, high yaw rate	
		C	-	-	-	Stable redirection, high yaw rate	
	100 km/hr	B	Likely	-	-	override	
		C	Likely	-	-	override	
		D	Analysis Not Conducted				
		G	Likely	-	-	override	
		NY	Possible	-	-	Excessive trajectory	
			Analysis terminated prematurely during redirection				

For example, in many cases the trajectory of the vehicle during interaction with the barrier causes the tires to impact higher than normal against the w-beam rail. With the wheels in this position the connection of the w-beam to the post becomes a critical factor. If the connection between the w-beam and post does not fail quickly enough during impact, the posts may pull the w-beam down to a point that allows the wheels of the vehicle to ride up the rail and launch the vehicle, as was the case involving the simulation of the modified C2500R impacting an AASHTO C curb at 100 km/hr and 25 degrees

with the guardrail positioned at 0-m offset from the curb. Figure 6.5 shows the results of the simulation at a specific time during the impact. A more complete illustration of the impact event is provided in

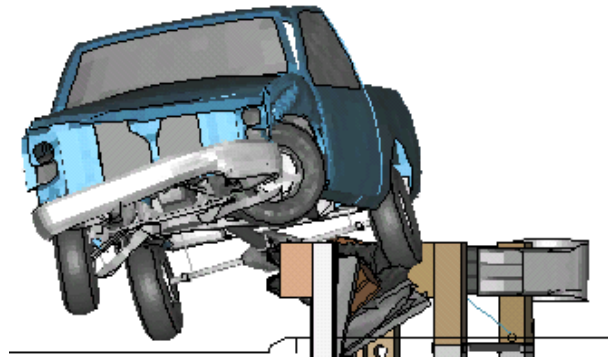

Appendix H.

Figure 6.5: F.E. simulation of 2000-kg pickup impacting guardrail with AASHTO type C curb underneath rail.

A similar event also occurred in a recent crash test performed at the Midwest Roadside Safety Facility in Lincoln, Nebraska which was documented in a test report by Polivka et al.(29) That test involved a modified G4(1S) guardrail with a 102-mm curb placed underneath the rail behind the face of the w-beam under impact conditions corresponding to NCHRP Report 350 Test 3-11. A section of the guardrail in the impact region incorporated two layers of w-beam (e.g., nested w-beams) to reduce the potential for rupture. Consequently, this resulted in four layers of w-beam at the splice connections and required a much higher force to pull the head of the bolt through w-beam slots in the connection of the rail to the posts. As a result of the stronger connection the w-beam rail was pulled down and the vehicle launched into the air, as shown in Figure 6.6 (figure 6.6 was taken from polivka et al (29)). Although the vehicle experienced extreme trajectory during the impact, the vehicle remained upright and came down on the front side of the guardrail and satisfied all requirements of NCHRP Report 350. The repeatability of such an event is questionable due to the instability of the vehicle during impact with the

system, thus slight changes in either the system or impact conditions may lead to drastically different results.

Impact Speed of 70 km/hr and Angle of 25 Degrees - Based on the sequential views of the simulated impact events in which the barrier is positioned at 0-m offset from the curb it appears that for impact speeds of 70 km/hr and impact angle of 25 degrees the vehicle remains very stable throughout the impact event and barrier damage appears to be minimal, regardless of curb type. The scenario with the 150-mm AASHTO type D curb, however, resulted in the bumper getting above the rail during redirection but the potential for override of the barrier appears minimal.



Figure 6.6: NCHRP Report 350 Test 3-11 impact with modified G4(1S) guardrail with nested 12-gauge w-beams and a 102-mm curb under the rail. (29)

For the cases involving the barrier positioned at 2.5-m offset from AASHTO curb types B, C, D and G, the sequential views of the impact events suggests that the vehicle will experience moderate roll angle during impact and a relatively high yaw rate (e.g., the front of vehicle redirects out of the system before the rear of the vehicle contacts the rail). Also, for the cases involving 150-mm curb types the bumper of the vehicle gets above the rail but there is little possibility of override in those cases. The impact scenario involving the 100-mm New York curb resulted in very stable redirection, however, the yaw rate appeared somewhat high in this case as well.

For the cases involving the barrier positioned at 4.0-m offset from the curbs the vehicle remains very stable throughout the impact event and barrier damage appears to be minimal, regardless of the type of curb used in conjunction with the guardrail. However, the vehicle appears to experience a high yaw rate during redirection which may increase risk of occupant injury.

Impact Speed of 85 km/hr and Angle of 25 Degrees - Only two curb types, the 150-mm AASHTO type B and the 100-mm AASHTO type C curbs, were used in the curb-barrier scenarios involving impact speed of 85 km/hr and impact angle of 25 degrees. These cases were analyzed in order to assess the performance of the curb-barrier systems at speeds corresponding to the upper bound of the moderate-speed range (i.e., 60-80 km/hr) and the lower bound of the high-speed range (i.e., > 80 m/hr).

For the cases involving the barrier positioned at 0.0-m offset from the curbs the sequential views of the impact suggests that the vehicle will remain relatively stable during impact. There was a slight pitch of the vehicle when the rear wheels contacted the 150-mm AASHTO type B curb. For the cases with the barrier positioned at 2.5-m offset from the curb the analyses terminated prematurely due to numerical problems in the calculations which were related to contact between the w-beam rail and truck fender. The analyses did continue long enough, however, to conclude that there is a potential for excessive roll of the vehicle during impact and that the bumper is likely to get over the w-beam rail. Furthermore, the momentum of the truck combined with the excessive trajectory of the bumper is sufficient to cause barrier override. For the cases involving the barrier positioned at 4.0-m offset from the curb the sequential views of the impact events suggests that the vehicle will remain stable but it is likely to experience a high yaw rate during redirection.

Impact Speed of 100 km/hr and Angle of 25 Degrees - The sequential views of the impact events involving the barrier positioned at 0.0-m offset from the curbs indicate that rollover of the vehicle is possible for each curb-barrier scenario involving the AASHTO types B, C, D and G curbs due to excessive pitch of the vehicle during redirection. Although the vehicle did not rollover in the simulations, the amount of damage to the front impact side wheel during impact and the position of the front wheels during redirection become a critical factor regarding vehicle stability when the pitch angle of the vehicle is excessive during redirection. In the simulations the wheels remained

undamaged and in straight alignment during redirection. There was one case of barrier override involving the 100-mm AASHTO type C curb. In this analysis a wheel snag against a guardrail blockout early in the impact event caused the tierod to break. The front wheel on the impact side of the vehicle then rotated 90 degrees toward the guardrail. The w-beam rail was pushed down and the vehicle launched over the guardrail.

The impact scenario involving the 100-mm New York curb resulted in minimal trajectory of the vehicle with only moderate pitch and a relatively stable redirection.

Only one curb type, the AASHTO type G curb, was used in the case involving the barrier positioned at 2.5-m offset from the curb. The trajectory of the truck was excessive during impact and, although the trajectory of the front bumper and the momentum of the vehicle appeared sufficient to cause the vehicle to override the barrier, the guardrail redirected the vehicle away from the system where it then proceeded to roll over onto its side. For the cases involving the barrier positioned at 4.0-m offset from the curb the sequential views of the impact events suggest that barrier override is likely regardless of curb type.

Note: the analysis involving the 100-mm New York curb resulted in premature termination due to numerical problems in the calculations which were related to contact between the front tire and the w-beam, however, at the time the analysis was stopped the trajectory and roll angle of the truck was excessive enough to suspect barrier override and/or rollover.

6.4.2 Angular Displacement-Time History Data

The roll, pitch and yaw angle displacement-time history data was collected at the center of gravity of the vehicle during the impact event and are shown graphically in Appendix 10. Table 6.5 gives a summary of the vehicle angular position at the time of impact with the guardrail, the maximum roll and pitch angle of the vehicle during the impact event and the yaw angle of the vehicle as it exits guardrail. Figures 6.7, 6.8 and 6.9 illustrate graphically the initial angular positions of the vehicle at time of impact with guardrail and figures 6.10 and 6.11 show maximum roll angle and maximum pitch angle for each of the curb-barrier impact scenarios, respectively.

Figure 6.7 and 6.8 indicate that when the barrier is offset a distance of 2.5 m from the curb and the truck impacts the system at speeds of 70 km/hr and 85 km/hr the initial roll and pitch angle of the vehicle at time of impact with the guardrail are typically both positive (refer to local coordinate system of figure 5.4) with the exception of the 100-mm New York curb. This results in the position of the front bumper on the impact side of the vehicle being higher than normal at the time of impact and, according to a qualitative analysis of the sequential views of the impact, the bumper was above the rail during impact for each of these cases. The maximum roll angle of the vehicle during impact was relatively higher in those cases as well, as shown in figure 6.10. The graph corresponding to impact speed of 85 km/hr is a little misleading since the vehicle overrode the barrier in those cases and the analysis was terminated before maximum roll was achieved.

Table 6.5: Summary of results from angular displacement-time history data collected at the center of gravity of the vehicle in the analyses.

Offset Distance	Impact Speed	Curb Type	Impact Angle with Guardrail (degrees)			Maximum Angular Displacements During Impact (degrees)		
			Roll	Pitch	Yaw	Roll	Pitch	Yaw
0.0 m	70 km/hr	B	0.0	0.0	-25.0	-1.9	-6.4	21.0
		C	0.0	0.0	-25.0	-7.0	-3.7	21.0
		D	0.0	0.0	-25.0	2.2	3.5	20.2
		G	Analysis not conducted					
		NY	0.0	0.0	-25.0	-4.3	-2.1	21.3
	85 km/hr	B	0.0	0.0	-25.0	5.4	-7.6	19.3
		C	0.0	0.0	-25.0	8.2	-3.3	18.5
	100 km/hr	B	0.0	0.0	-25.0	-18	-14.2	22.4
		C	0.0	0.0	-25.0	31.3	6.0	29.5
		D	0.0	0.0	-25.0	-12.5	-14.3	24.2
		G	0.0	0.0	-25.0	-11.4	-21.6	23.0
		NY	0.0	0.0	-25.0	-10.9	-9.1	23.5
	2.5 m	70 km/hr	B	0.27	0.44	-25.8	-11.9	-3.2
C			Data wasn't recorded due to input error					
D			0.89	1.13	-26.8	-11.4	-5.2	18.9
G			3.48	0.16	-26.2	-14.1	-6.3	19.9
NY			2.87	-0.17	-26.0	-8.4	-5.2	15.8
85 km/hr		B	1.22	1.33	-25.7	-	-	-
		C	2.92	0.55	-26.3	-	-	-
4.0 m	70 km/hr	B	-1.95	-1.14	-28.8	5.1	-2.8	NA
		C	-3.39	-2.48	-28.0	-7.6	-2.7	17.7
		D	-1.80	-1.55	-29.7	5.6	-2.9	19.2
		G	0.49	-0.85	-26.8	4.4	-3.4	14.6
		NY	Analysis not conducted					
	85 km/hr	B	-1.63	-0.81	-27.8	-10.8	-2.0	18.9
		C	-0.82	-1.78	-28.1	-6.3	-3.2	17.0
	100 km/hr	B	0.0	-0.49	-28.7	-19.6	-6.2	NA
		C	-0.06	-1.42	-27.6	-6.7	-3.5	NA
		G	2.21	-0.93	-27.5	-45.1	3.5	NA
		NY	1.84	-0.95	-27.5	-15.2	-3.1	NA

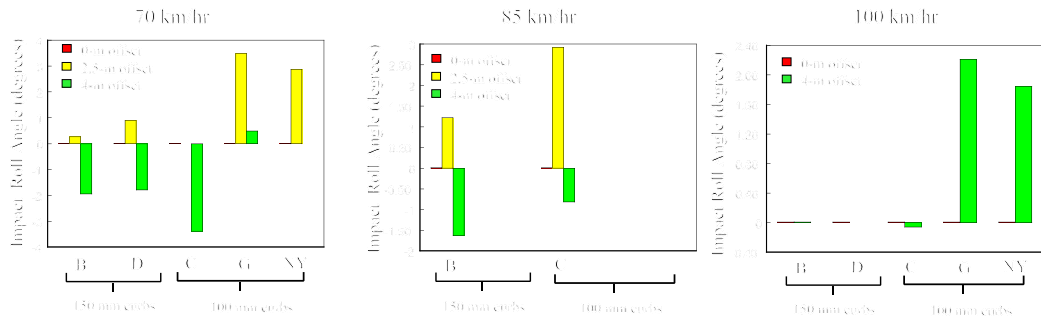

Figure 6.7: Initial roll angle of the vehicle at time of impact with guardrail.

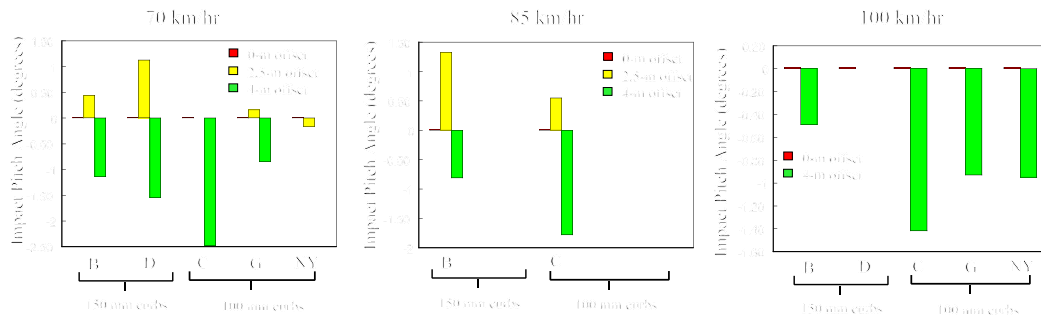

Figure 6.8: Initial pitch angle of the vehicle at time of impact with guardrail.

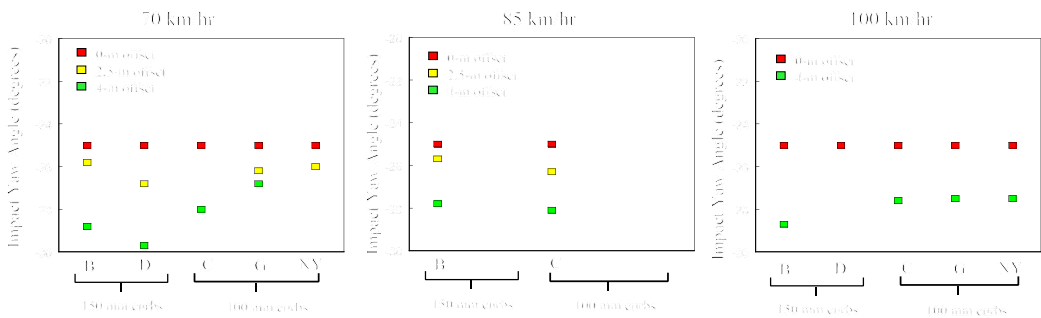

Figure 6.9: Initial yaw angle of the vehicle at time of impact with guardrail.

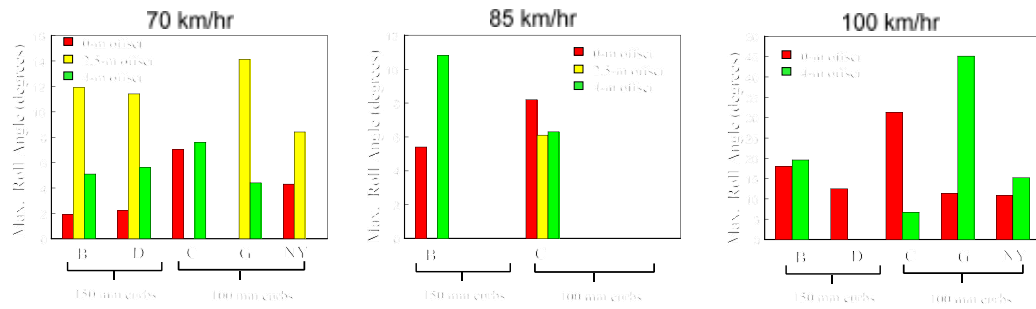

Figure 6.10: Maximum roll angle measured at the center of gravity of the pickup truck model during curb-barrier impact.

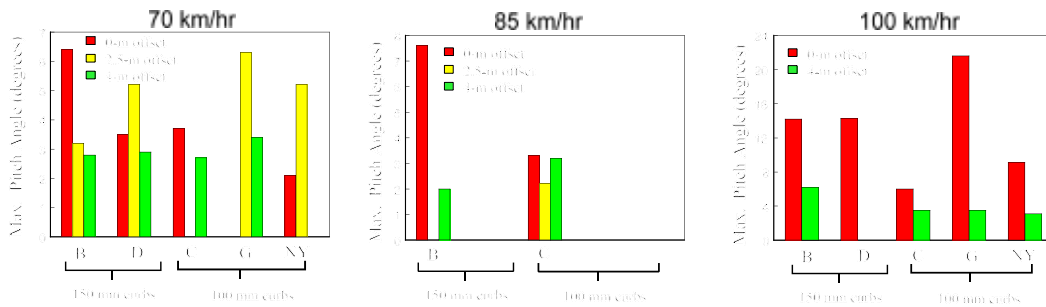

Figure 6.11: Maximum pitch angle measured at the center of gravity of the pickup truck model during curb-barrier impact.

The cases involving the barrier offset a distance of 4.0 m from the curb and impact speeds of 70 km/hr and 85 km/hr, the opposite was typically true, with both the initial roll and pitch angle of the vehicle being negative at time of impact with the guardrail. In those cases the position of the front bumper on the impact side was relatively lower and, according to the sequential views, the bumper stayed below the top of the rail throughout

the impact event. For the scenarios involving impact speeds of 100 km/hr the initial roll angle was typically either zero or positive while the initial pitch angle was typically negative. In those cases the trajectory and momentum of the vehicle dominated and the primary result was vehicle override as illustrated in the sequential views. The graph of maximum roll angle of the vehicle in figure 6.10 is misleading regarding the 4-m offset scenarios since the analysis was terminated prematurely in each of those cases as the vehicle began to override the barrier.

In all cases involving the barrier offset at distances of 2.5 m or 4.0 m from the curb, the curb caused the wheels of the truck to steer toward the guardrail as the vehicle traversed the curb and resulted in the vehicle impacting the guardrail at a steeper than normal angle, as shown in figure 6.9. Consequently, for any given curb-barrier case the impact angle gets steeper as the offset distance increases. A steeper impact angle may increase the severity of the impact by increasing the potential for failure of the barrier and by increasing occupant risk factors.

6.4.3 Tensile Force in W-Beam

The tensile force-time history plots of the w-beam cross-section at two critical locations (e.g., in the impact region of the guardrail and at the upstream anchor) as computed in the finite element analyses are provided in Appendix 11. Table 6.6 provides a summary of the maximum values of tensile force at those locations and the results are also illustrated graphically in figures 6.12 - 6.18. The cases involving the modified C2500R pickup

model impacting the guardrail at 100 km/hr and 25 degrees with an offset distance of 0.0 m from curb to barrier are compared to the results of the modified C2500R pickup model impacting the guardrail under the same impact conditions without a curb present. If the rail forces are significantly higher in the curb-guardrail simulations than they are in the simulations without a curb present then there may be a potential for rupture in those cases.

From the results of the finite element simulation of the guardrail without a curb present under NCHRP Report 350 test 3-11, the maximum force in the guardrail occurs in the impact region and is 209 kN and the maximum anchor force is approximately 179 kN.

Impact Speed of 70 km/hr and Angle of 25 Degrees - The results from the analyses of vehicle impact with the guardrail under Test 2-11 conditions involving each of the different curb types indicate that rupture of the guardrail is not likely to occur regardless of the offset location of the barrier with respect to the curb, as shown in table 6.6 and figures 6.12, 6.13 and 6.14.

For the cases involving the guardrail positioned at 0.0-m offset from the curb the maximum tension in the w-beam rail ranged from 61 to 65 percent and the maximum force at the upstream anchor ranged between 69 and 71 percent of the values computed in the analysis of the guardrail without a curb present under Test 3-11 impact conditions.

For the cases involving the guardrail positioned at 2.5-m offset from the curb the

Table 6.6: Summary of maximum tensile force values in the w-beam rail within the impact region and at the upstream anchor.

Offset Distance	Impact Speed	Curb Type	Maximum Tensile Force in W-Beam Rail					
			Impact Region		Upstream Anchor		Downstream Location	
			(kN)	Force/209	(kN)	Force/179	(kN)	Force/147
0.0 m	70 km/hr	B	127	0.61	-	-	71.2	0.48
		C	127	0.61	124	0.69	87.8	0.60
		D	128	0.61	127	0.71	82.9	0.56
		G	Analysis not conducted					
	NY	135	0.65	131	0.73	76.0	0.52	
	85 km/hr	B	165	0.79	141	0.79	117	0.80
		C	170	0.81	142	0.79	122	0.83
	100 km/hr	B	232	1.11	-	-	182	1.24
		C	226	1.08	202	1.13	175	1.19
		D	243	1.16	210	1.17	183	1.24
		G	223	1.07	-	-	174	1.18
	NY	231	1.11	198	1.11	178	1.21	
2.5 m	70 km/hr	B	95.0	0.45	88.7	0.50	68.6	0.47
		C	Data wasn't recorded due to input error					
		D	128	0.61	120	0.67	82.1	0.56
		G	123	0.59	118	0.66	77.8	0.53
		NY	132	0.63	119	0.66	77.7	0.53
	85 km/hr	B	185	0.89	-	-	91.0	0.62
		C	205	0.98	177	0.99	102	0.69
4.0 m	70 km/hr	B	101	0.48	89.4	0.50	66.1	0.45
		C	114	0.55	113	0.63	76.5	0.52
		D	97.5	0.47	-	-	65.1	0.44
		G	130	0.62	116	0.65	78.8	0.54
		NY	Analysis not conducted					
	85 km/hr	B	171	0.82	143	0.80	103	0.70
		C	171	0.82	148	0.83	120	0.82

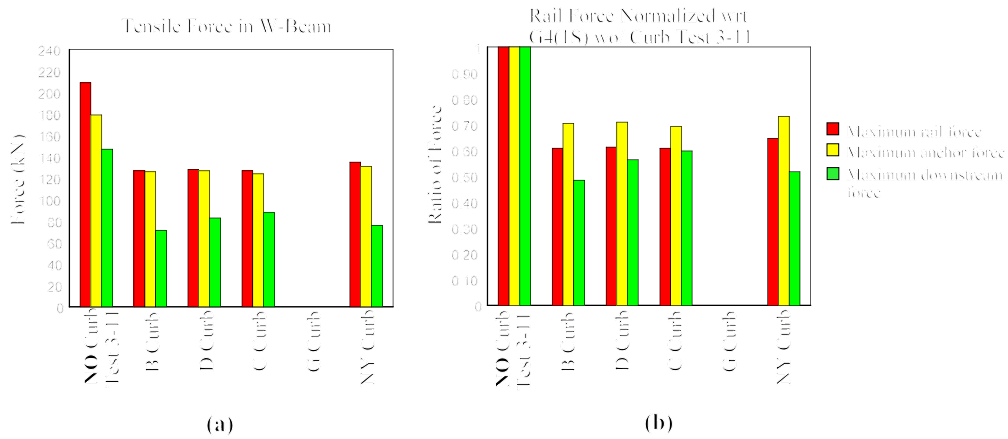

Figure 6.12: Maximum w-beam rail force in impact region of guardrail and at the upstream anchor for the cases involving C2500 impact at **70 km/hr** and 25 degrees with curb at **0-m offset**.(a) Maximum tensile force in w-beam and (b) Maximum tensile force in w-beam normalized wrt the force in w-beam under NCHRP Report 350 Test 3-11 impact conditions when curb is not present.

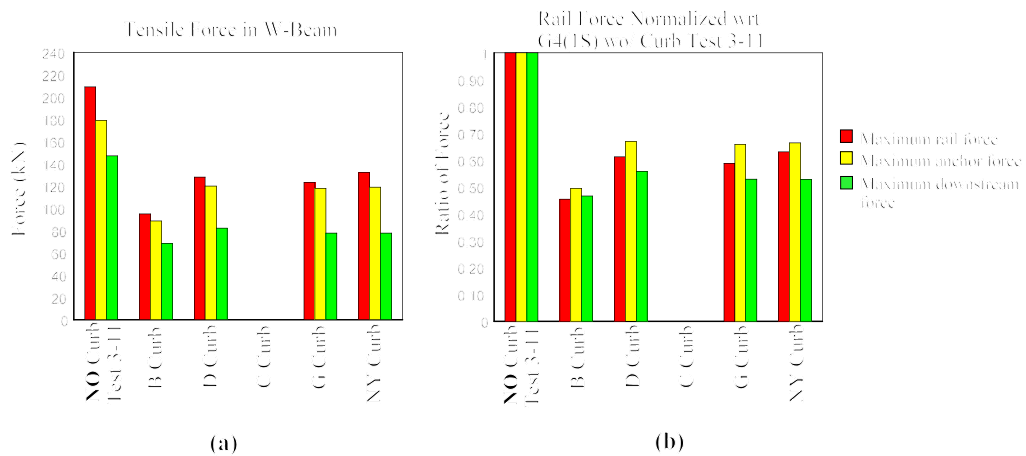

Figure 6.13: Maximum w-beam rail force in impact region of guardrail and at the upstream anchor for the cases involving C2500 impact at **70 km/hr** and 25 degrees with curb at **2.5-m offset**.(a) Maximum tensile force in w-beam and (b) Maximum tensile force in w-beam normalized wrt the force in w-beam under NCHRP Report 350 Test 3-11 impact conditions when curb is not present.

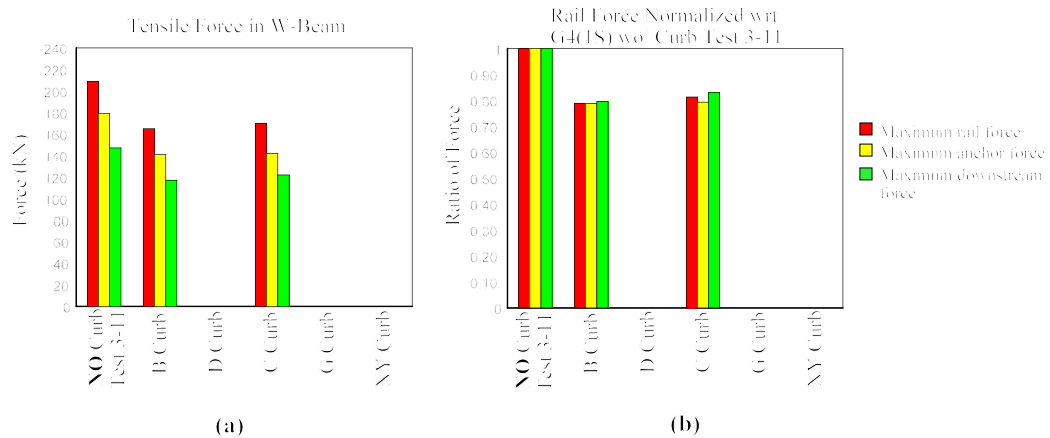

Figure 6.14: Maximum w-beam rail force in impact region of guardrail and at the upstream anchor for the cases involving C2500 impact at **85 km/hr** and 25 degrees with curb at **0.0-m offset**. (a) Maximum tensile force in w-beam and (b) Maximum tensile force in w-beam normalized wrt the force in w-beam under NCHRP Report 350 Test 3-11 impact conditions when curb is not present.

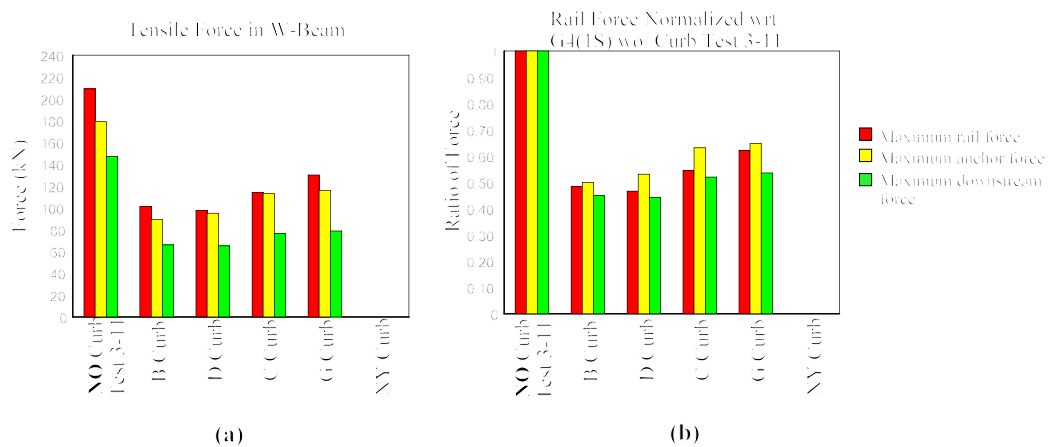

Figure 6.15: Maximum w-beam rail force in impact region of guardrail and at the upstream anchor for the cases involving C2500 impact at **70 km/hr** and 25 degrees with curb at **4.0-m offset**. (a) Maximum tensile force in w-beam and (b) Maximum tensile force in w-beam normalized wrt the force in w-beam under NCHRP Report 350 Test 3-11 impact conditions when curb is not present.

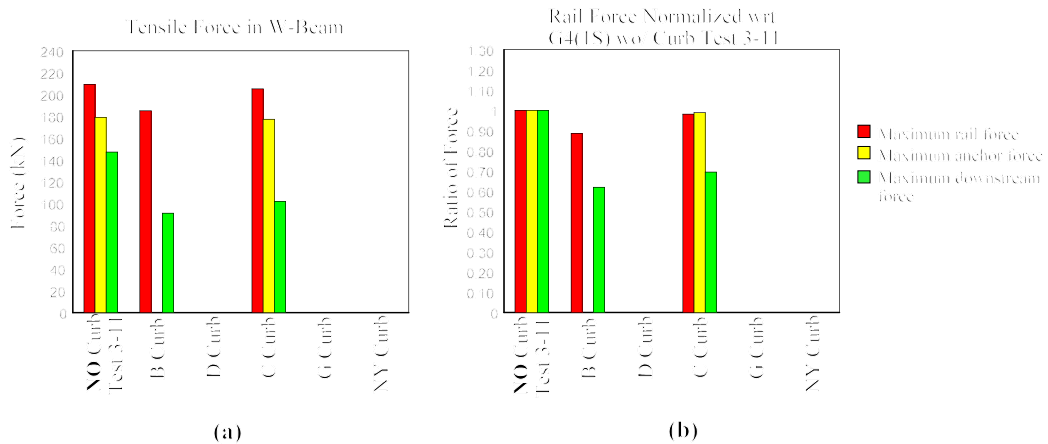

Figure 6.16: Maximum w-beam rail force in impact region of guardrail and at the upstream anchor for the cases involving C2500 impact at **85 km/hr** and 25 degrees with curb at **2.5-m offset**. (a) Maximum tensile force in w-beam and (b) Maximum tensile force in w-beam normalized wrt the force in w-beam under NCHRP Report 350 Test 3-11 impact conditions when curb is not present.

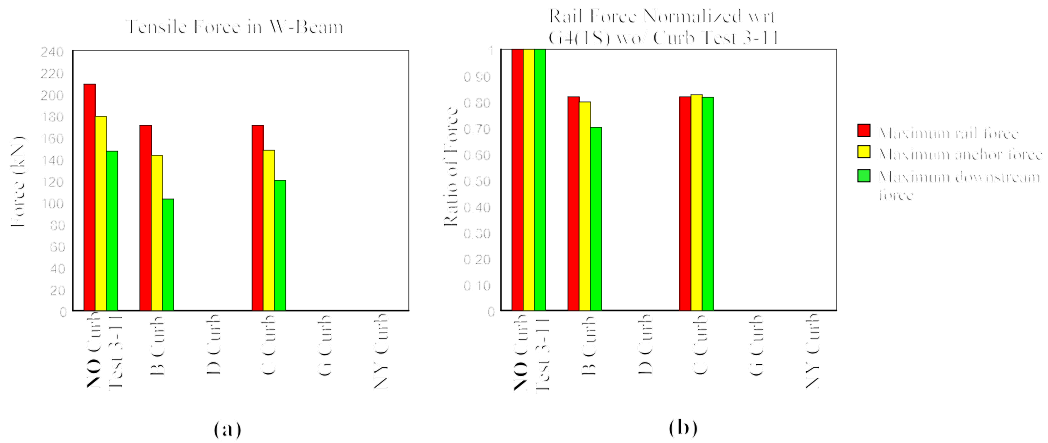

Figure 6.17: Maximum w-beam rail force in impact region of guardrail and at the upstream anchor for the cases involving C2500 impact at **85 km/hr** and 25 degrees with curb at **4.0-m offset**. (a) Maximum tensile force in w-beam and (b) Maximum tensile force in w-beam normalized wrt the force in w-beam under NCHRP Report 350 Test 3-11 impact conditions when curb is not present.

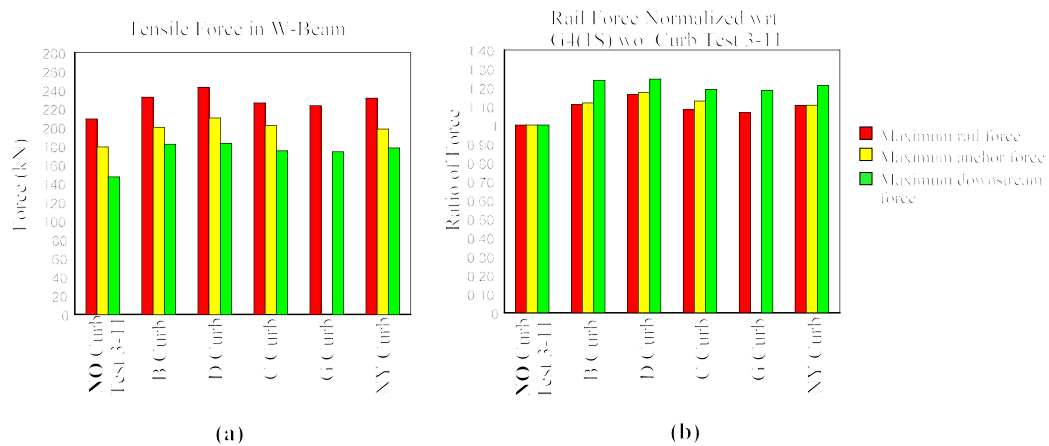

Figure 6.18: Maximum w-beam rail force in impact region of guardrail and at the upstream anchor for the cases involving C2500 impact at **100 km/hr** and 25 degrees with curb at **0-m offset**. (a) Maximum tensile force in w-beam and (b) Maximum tensile force in w-beam normalized wrt the force in w-beam under NCHRP Report 350 Test 3-11 impact conditions when curb is not present.

maximum tension in the w-beam ranged from 45 to 63 percent and the maximum force at the upstream anchor ranged between 50 and 67 percent of the values computed in the analysis of the guardrail without a curb present under Test 3-11 impact conditions. For the cases involving the guardrail positioned at 4.0-m offset from the curb the maximum tension in the w-beam ranged from 48 to 62 percent and the maximum force at the upstream anchor ranged between 50 and 65 percent of the values computed in the analysis of the guardrail without a curb present under Test 3-11 impact conditions.

Impact Speed of 85 km/hr and Angle of 25 Degrees - The results from the analyses of vehicle impact at 85 km/hr at 25 degrees into the guardrail with each of the different curb

types indicate that rupture of the guardrail is not likely to occur for offset distances of 0 m and 4 m, as shown in table 6.6 and figures 6.15, 6.16 and 6.17. In the cases in which the guardrail is placed 2.5 m behind the curb the tension in the rail reaches magnitudes that may be considered critical, however, in those cases there was also bumper override.

For the cases involving the guardrail positioned at 0.0-m offset from the curb the maximum tension in the w-beam rail ranged from 79 to 81 percent and the maximum force at the upstream anchor was 79 percent of the values computed in the analysis of the guardrail without a curb present under Test 3-11 impact conditions. For the cases involving the guardrail positioned at 2.5-m offset from the curb the maximum tension in the w-beam ranged from 89 to 98 percent of the values computed in the analysis of the guardrail without a curb present under Test 3-11 impact conditions. For the cases involving the guardrail positioned at 4.0-m offset from the curb the maximum tension in the w-beam was 82 percent and the maximum force at the upstream anchor ranged between 80 and 83 percent of the values computed in the analysis of the guardrail without a curb present under Test 3-11 impact conditions.

Impact Speed of 100 km/hr and Angle of 25 Degrees - The analyses of vehicle impact with the guardrail under Test 3-11 conditions involving each of the different curb types located at 0-m offset (i.e., under the w-beam rail) resulted in significantly higher forces in the rail and anchor compared to the case of the guardrail without a curb present, as shown in table 6.6 and figure 6.18. In all cases, however, there appears to be a potential for

excessive anchor movement and rail rupture during impact. The maximum rail forces under test 3-11 conditions for curb-barrier offset distances of greater than 0.0 m are not shown since the predominate outcome in all those cases was barrier override.

For the cases involving the guardrail positioned at 0.0-m offset from the curb the maximum tension in the w-beam rail ranged from 107 to 111 percent and the maximum force at the upstream anchor was as high as 117 percent of the values computed in the analysis of the guardrail without a curb present under Test 3-11 impact conditions.

6.4.4 TRAP Results

The results from the TRAP program for each of the curb-and-barrier impact scenarios are provided in Appendix 12. Table 6.7 gives a summary of the TRAP results regarding the OIV, ORA and maximum 50 ms moving average acceleration. Figures 6.19 and 6.20 illustrate graphically a comparison of the longitudinal ORA and maximum 50 ms average longitudinal acceleration for each of the curb-barrier impact scenarios, respectively.

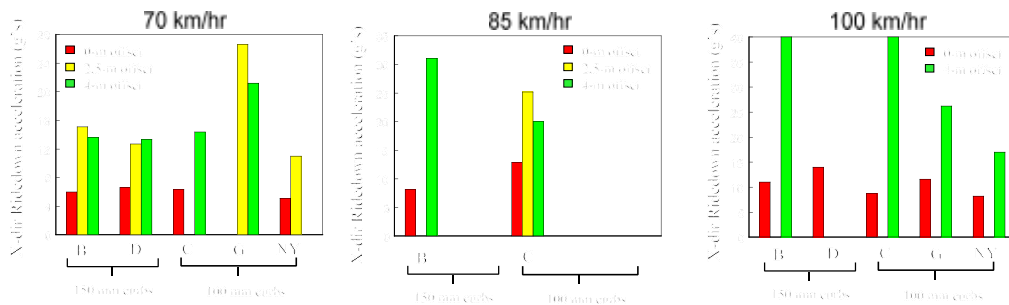

Figure 6.19: Maximum longitudinal ridedown acceleration at the center of gravity of the pickup truck model during curb-barrier impact.

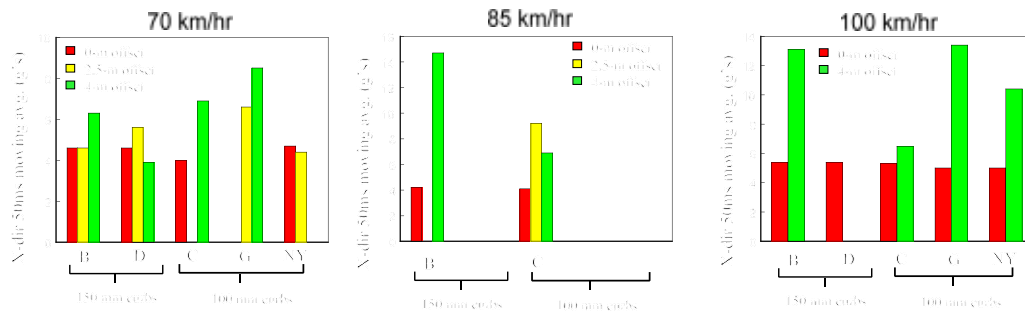

Figure 6.20: Maximum 50 ms average longitudinal acceleration at the center of gravity of the pickup truck model during curb-barrier impact.

The OIV for all cases was below the maximum limit of 12 m/s as required in NCHRP Report 350. For the curb-and-barrier scenarios in which the barrier was offset at 2.5 m and 4.0 m from the curb, the start of the data analysis began at first tire contact with the curb. In some of these cases occupant impact occurred prior to vehicle impact with the barrier (e.g., AASHTO type D curb, 70 km/hr impact speed, 2.5-m offset) which resulted in very low values of occupant impact velocity.

The longitudinal ORA values were below the maximum limit of 20 G's required in NCHRP Report 350 for the cases of 0.0-m offset distance from curb to barrier at all three impact speeds. In the cases for which the offset distance was greater than zero, six of those resulted in longitudinal ORA values exceeding 20 G's. Those cases are listed below:

- ▶ 150-mm AASHTO type B curb, impact speed of 85 km/hr and offset distance of 4.0 m

Table 6.7: Summary of occupant risk factors computed using the computer software TRAP and the results from the finite element analyses of the curb-and-barrier impact study.

Curb Type		Impact Conditions		Occupant Impact Velocity (OIV)		Occupant Ridedown Accelerations (ORA)		Max. 50ms Moving Average (g's)		
		Speed (km/hr)	Offset Distance (m)	x-dir (m/s)	y-dir (m/s)	x-dir (g's)	y-dir (g's)	x-dir (g's)	y-dir (g's)	z-dir (g's)
150 mm Curbs	B	70	0.0	4.1	-3.6	-6.0	4.7	-4.6	3.3	2.0
			2.5	3.5	-2.5	-15.1	19.4	4.6	-10.0	7.4
			4.0	2.0	-4.5	13.6	-19.2	-6.3	8.3	-6.7
		85	0.0	4.2	-4.1	8.1	10.6	-4.2	5.7	4.2
			2.5	-	-	-	-	-	-	-
			4.0	0.1	-2.6	31.1	29.0	-14.7	10.1	-9.0
	100	0.0	5.5	-5.0	-11.0	14.9	-5.4	7.6	3.3	
		2.5	3.6	0.3	-40.0	-49.9	-13.1	9.6	-14.6	
		4.0	3.6	0.3	-40.0	-49.9	-13.1	9.6	-14.6	
	D	70	0.0	4.3	-4.1	-6.6	6.7	-4.6	3.7	-2.0
			2.5	-0.1	1.6	-12.7	17.3	-5.6	5.8	-7.7
			4.0	0.3	-1.6	13.3	14.4	-3.9	7.2	5.1
100		0.0	5.9	-4.8	-14.0	15.9	-5.4	7.1	3.5	
	C	70	0.0	4.2	-4.2	-6.3	7.5	-4.0	3.8	-1.7
			2.5	-	-	-	-	-	-	-
			4.0	1.6	1.4	14.4	13.8	6.9	6.3	6.8
		85	0.0	4.1	-4.3	-12.9	12.6	-4.1	5.5	2.3
			2.5	6.1	-3.6	-25.2	-22.0	-9.2	8.5	-12.5
			4.0	0.7	-1.7	-20.0	16.9	-6.9	5.8	6.7
	100	0.0	5.7	-5.0	8.7	7.4	-5.3	6.0	-3.9	
		2.5	5.0	-3.8	-40.0	-49.9	-6.5	5.8	-4.2	
		4.0	5.0	-3.8	-40.0	-49.9	-6.5	5.8	-4.2	
	G	70	0.0	-	-	-	-	-	-	-
			2.5	6.0	-2.4	-26.6	17.2	-6.6	5.2	-8.2
			4.0	1.1	-2.6	21.2	-16.8	-8.5	5.6	6.9
		100	0.0	4.8	-5.3	-11.6	14.8	-5.0	7.0	2.5
	4.0		6.3	-4.9	26.2	-29.2	13.4	-9.6	-11.5	
	NY	70	0.0	4.7	-4.2	-5.1	5.7	-4.7	4.1	1.5
			2.5	5.8	-4.5	-11.0	10.9	-4.4	6.4	-5.1
			4.0	-	-	-	-	-	-	-
		100	0.0	5.0	-5.2	-8.2	13.1	-5.0	5.7	2.4
2.5			5.3	-5.6	-17.0	21.1	-10.4	9.3	6.7	
4.0			5.3	-5.6	-17.0	21.1	-10.4	9.3	6.7	

- ▶ 100-mm AASHTO type C curb, impact speed of 85 km/hr and offset distance of 2.5 m
- ▶ 100-mm AASHTO type C curb, impact speed of 100 km/hr and offset distance of 4.0 m
- ▶ 100-mm AASHTO type G curb, impact speed of 70 km/hr and offset distance of 2.5 m
- ▶ 100-mm AASHTO type G curb, impact speed of 70 km/hr and offset distance of 4.0 m
- ▶ 100-mm AASHTO type G curb, impact speed of 100 km/hr and offset distance of 4.0 m

6.5 Summary

The finite element program LS-DYNA was used in the analysis of various curb-and-barrier systems subjected to impact by a 2000 kg pickup truck. The study involved the modified G4(1S) guardrail model that was validated in Chapter 4 installed inconjunction with two 150-mm curbs (i.e., AASHTO types B and D) and three 100-mm curbs (i.e., AASHTO types C and G and the 100-mm New York Curb).

The backfill terrain and the roadway terrain in the computer model simulations had a zero slope and the guardrail was positioned at either 0.0 m, 2.5 m or 4.0 m offset from the curbs. Three different impact conditions were considered:

- 1) 100 km/hr and 25 degrees (i.e., NCHRP Report 350 Test 3-11),
- 2) 85 km/hr and 25 degrees and
- 3) 70 km/hr and 25 degrees (i.e., NCHRP Report 350 Test 2-11) .

The data collected in the analyses included sequential snapshots of the impact event, acceleration-time histories, yaw-, pitch- and roll-time histories, w-beam tensile force-time histories and occupant risk information using the Test Risk Assessment Program. Table 6.8 provides a summary of the results of the curb-and-barrier impact study regarding success or failure of the system in each case based on the information obtained from the analyses and figures 6.21 - 6.49 provide a summary of general information regarding each curb-and-barrier impact simulation.

Table 6.8: Summary of curb-barrier impact study regarding success (✓) or failure (✗) of the system based on the results of the finite element analyses.

Impact Speed	Curb Type	Offset Distance from Barrier to Curb		
		0 m	2.5 m	4 m
70 km/hr	B	✓	✓ - high long. ORA - high lateral ORA	✓ - high lateral ORA
	C	✓	✓ ORA?	✓
	D	✓	✓ - high lateral ORA	✓
	G		✗ -excess long. ORA - high lateral ORA	✗ -excess long. ORA - high lateral ORA
	NY	✓	✓	
85 km/hr	B	✓	✗ - override	✗ -excess long. ORA - high lateral ORA
	C	✓	✗ -excess long. ORA - override - high lateral ORA	✓ - high long. ORA - high lateral ORA
100 km/hr	B	✓ - high pitch angle - high rail forces		✗ - override -excess long. ORA - high lateral ORA - high roll angle
	C	✗ - override - rollover -excess long. ORA - high trans. ORA		✗ -excess long. ORA - override - high lateral ORA - high roll angle
	D	✓ - high pitch angle - high rail forces		
	G	✓ - high pitch angle - high rail forces	✗ - rollover - override -excess long. ORA - high lateral ORA	✗ - override -excess long. ORA - high lateral ORA - high roll angle
	NY	✓ - high rail forces		✓ - high trajectory - high roll angle - high long. ORA - high lateral ORA

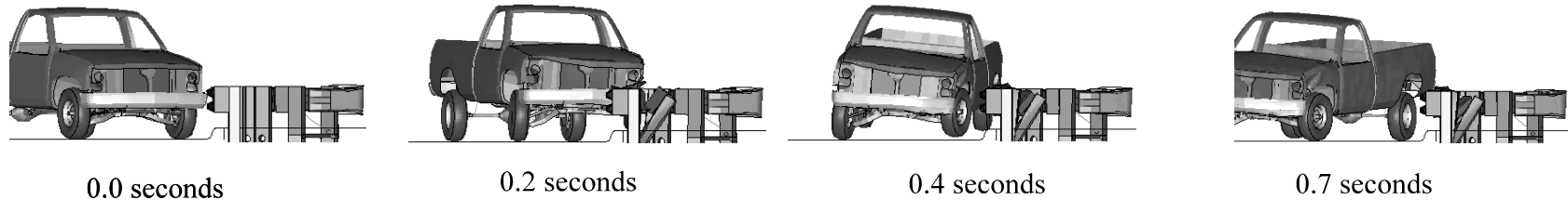

• Guardrail Type	Modified G4(1S) with routed wood blockouts	• Occupant Impact Velocity (m/s)	
• Curb Type	150-mm AASHTO Type B	Longitudinal	4.1 < 12 m/s
• Curb-Barrier Offset	0.0 m	Lateral	-3.6
• Vehicle Model		• Occupant Ridedown Deceleration (g's)	
Type	Modified NCAC C2500	Longitudinal	-6.0 < 20 G's
Mass	2000 kg	Lateral	4.7
• Initial Conditions		• Maximum 50 ms Moving Average Acceleration (g's)	
Speed	70 km/hr	Longitudinal	-4.6
Angle	25 degrees	Lateral	3.3
• Exit Conditions		Vertical	2.0
Speed		• THIV (km/hr)	16.3
Angle	21 degrees	• PHD (g's)	7.2
• Maximum Roll Angle	-1.9 degrees	• ASI	0.47
• Maximum Pitch Angle	-6.4 degrees	• Maximum Force in W-Beam Rail	
• Vehicle Trajectory	Minimal	Impact Region	127 kN
• Vehicle Stability	Satisfactory	Upstream Anchor	-
		Downstream Location	71.2 kN

Figure 6.21: Summary of Analysis Results for C2500 impact with modified G4(1S) and 150-mm AASHTO Type B curb at **70 km/hr** and 25 degrees with barrier positioned at **0-m offset** from curb.

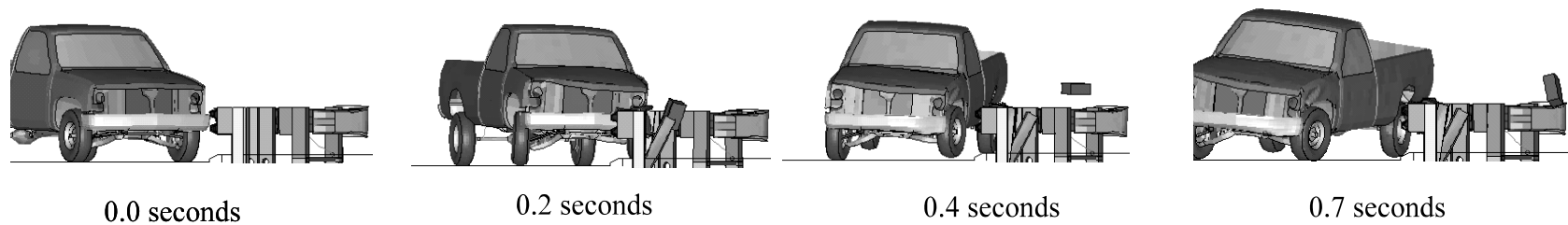

• Guardrail Type	Modified G4(1S) with routed wood blockouts	• Occupant Impact Velocity (m/s)	
• Curb Type	100-mm AASHTO Type C	Longitudinal	4.2 < 12 m/s
• Curb-Barrier Offset	0.0 m	Lateral	-4.2
• Vehicle Model		• Occupant Ridedown Deceleration (g's)	
Type	Modified NCAC C2500	Longitudinal	-6.3 < 20 G's
Mass	2000 kg	Lateral	7.5
• Initial Conditions		• Maximum 50 ms Moving Average Acceleration (g's)	
Speed	70 km/hr	Longitudinal	-4.0
Angle	25 degrees	Lateral	3.8
• Exit Conditions		Vertical	1.7
Speed		• THIV (km/hr)	20.1
Angle	21 degrees	• PHD (g's)	9.7
• Maximum Roll Angle	-7.0 degrees	• ASI	0.52
• Maximum Pitch Angle	-3.7 degrees	• Maximum Force in W-Beam Rail	
• Vehicle Trajectory	Minimal	Impact Region	127 kN
• Vehicle Stability	Satisfactory	Upstream Anchor	124 kN
		Downstream Location	87.8 kN

Figure 6.22: Summary of Analysis Results for C2500 impact with modified G4(1S) and 100-mm AASHTO Type C curb at **70 km/hr** and 25 degrees with barrier positioned at **0-m offset** from curb.

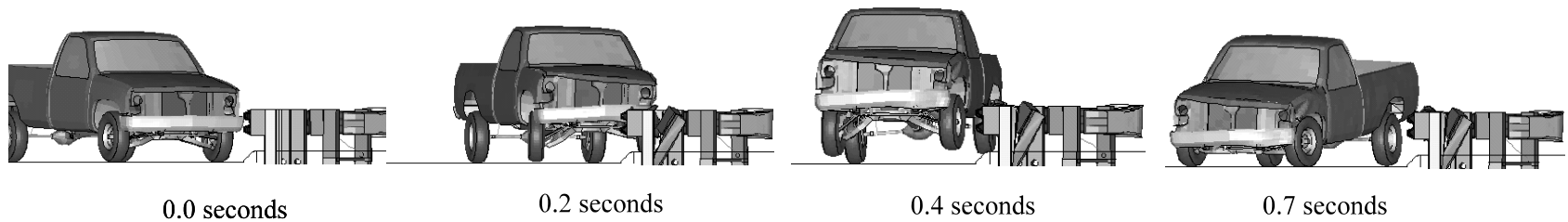

• Guardrail Type	Modified G4(1S) with routed wood blockouts	• Occupant Impact Velocity (m/s)	
• Curb Type	150-mm AASHTO Type D	Longitudinal	4.3 < 12 m/s
• Curb-Barrier Offset	0.0 m	Lateral	-4.1
• Vehicle Model		• Occupant Ridedown Deceleration (g's)	
Type	Modified NCAC C2500	Longitudinal	-6.6 < 20 G's
Mass	2000 kg	Lateral	6.7
• Initial Conditions		• Maximum 50 ms Moving Average Acceleration (g's)	
Speed	70 km/hr	Longitudinal	-4.6
Angle	25 degrees	Lateral	3.7
• Exit Conditions		Vertical	-2.0
Speed		• THIV (km/hr)	20.7
Angle	20.2 degrees	• PHD (g's)	8.1
• Maximum Roll Angle	2.2 degrees	• ASI	0.50
• Maximum Pitch Angle	3.5 degrees	• Maximum Force in W-Beam Rail	
• Vehicle Trajectory	Minimal	Impact Region	128 kN
• Vehicle Stability	Satisfactory	Upstream Anchor	127 kN
		Downstream Location	82.9 kN

Figure 6.23: Summary of Analysis Results for C2500 impact with modified G4(1S) and 150-mm AASHTO Type D curb at **70 km/hr** and 25 degrees with barrier positioned at **0-m offset** from curb.

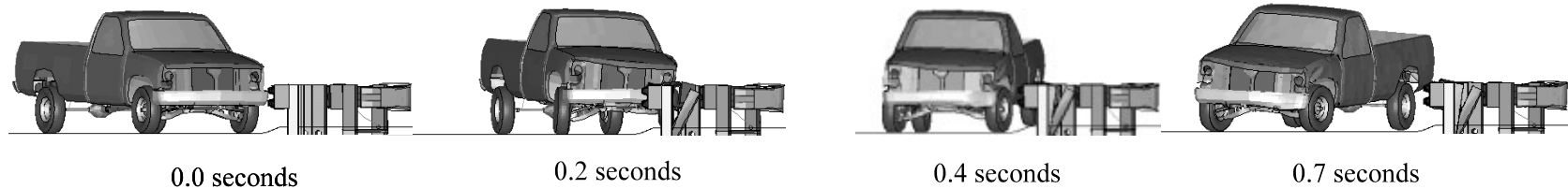

- Guardrail Type Modified G4(1S) with routed wood blockouts
- Curb Type 100-mm New York Curb
- Curb-Barrier Offset 0.0 m
- Vehicle Model
 - Type Modified NCAC C2500
 - Mass 2000 kg
- Initial Conditions
 - Speed 70 km/hr
 - Angle 25 degrees
- Exit Conditions
 - Speed
 - Angle 21.3 degrees
- Maximum Roll Angle -4.3 degrees
- Maximum Pitch Angle -2.1 degrees
- Vehicle Trajectory Minimal
- Vehicle Stability Satisfactory

- Occupant Impact Velocity (m/s)
 - Longitudinal 4.7 < 12 m/s
 - Lateral -4.2
- Occupant Ridedown Deceleration (g's)
 - Longitudinal -5.1 < 20 G's
 - Lateral 5.7
- Maximum 50 ms Moving Average Acceleration (g's)
 - Longitudinal -4.7
 - Lateral 4.1
 - Vertical -1.5
- THIV (km/hr) 21.7
- PHD (g's) 7.2
- ASI 0.57
- Maximum Force in W-Beam Rail
 - Impact Region 135 kN
 - Upstream Anchor 131 kN
 - Downstream Location 76.0 kN

Figure 6.24: Summary of Analysis Results for C2500 impact with modified G4(1S) and 100-mm New York curb at **70 km/hr** and 25 degrees with barrier positioned at **0-m offset** from curb.

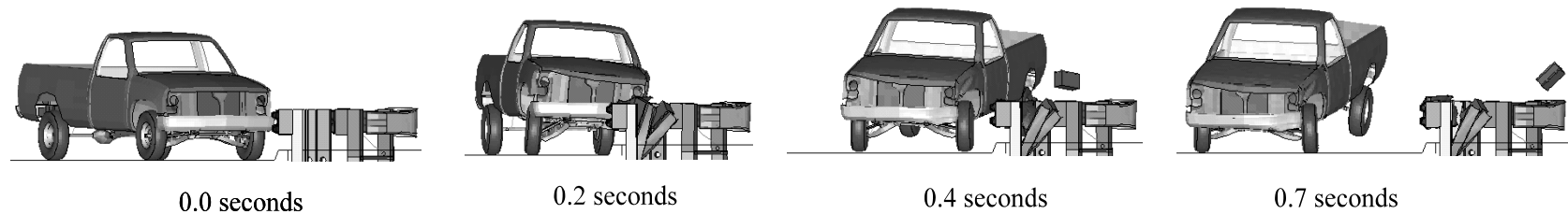

- Guardrail Type Modified G4(1S) with routed wood blockouts
- Curb Type 150-mm AASHTO Type B
- Curb-Barrier Offset 0.0 m
- Vehicle Model
 - Type Modified NCAC C2500
 - Mass 2000 kg
- Initial Conditions
 - Speed 85 km/hr
 - Angle 25 degrees
- Exit Conditions
 - Speed
 - Angle 19.3 degrees
- Maximum Roll Angle 5.4 degrees
- Maximum Pitch Angle -7.6 degrees
- Vehicle Trajectory Moderate
- Vehicle Stability Satisfactory

- Occupant Impact Velocity (m/s)
 - Longitudinal 4.2 < 12 m/s
 - Lateral -4.1
- Occupant Ridedown Deceleration (g's)
 - Longitudinal -8.1 < 20 G's
 - Lateral 10.6
- Maximum 50 ms Moving Average Acceleration (g's)
 - Longitudinal -4.2
 - Lateral 5.7
 - Vertical 4.2
- THIV (km/hr) 19.7
- PHD (g's) 15.9
- ASI 0.67
- Maximum Force in W-Beam Rail
 - Impact Region 165 kN
 - Upstream Anchor 141 kN
 - Downstream Location 117 kN

Figure 6.25: Summary of Analysis Results for C2500 impact with modified G4(1S) and 150-mm AASHTO Type B curb at **85 km/hr** and 25 degrees with barrier positioned at **0-m offset** from curb.

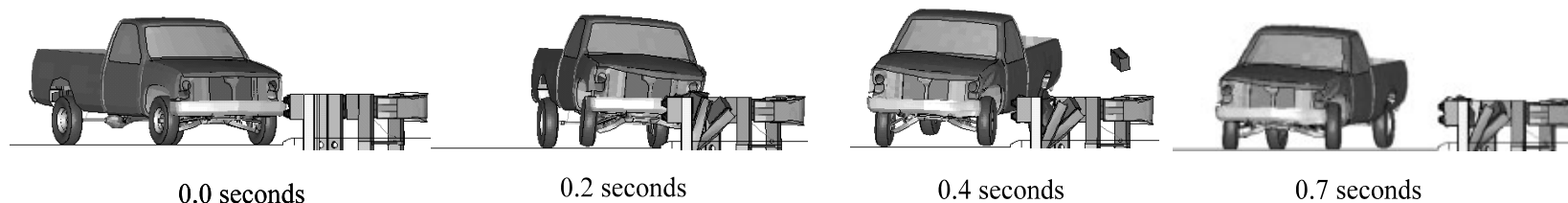

• Guardrail Type	Modified G4(1S) with routed wood blockouts	• Occupant Impact Velocity (m/s)	
• Curb Type	100-mm AASHTO Type C	Longitudinal	4.1 < 12 m/s
• Curb-Barrier Offset	0.0 m	Lateral	-4.3
• Vehicle Model		• Occupant Ridedown Deceleration (g's)	
Type	Modified NCAC C2500	Longitudinal	-12.9 < 20 G's
Mass	2000 kg	Lateral	12.6
• Initial Conditions		• Maximum 50 ms Moving Average Acceleration (g's)	
Speed	85 km/hr	Longitudinal	-4.1
Angle	25 degrees	Lateral	5.5
• Exit Conditions		Vertical	2.3
Speed		• THIV (km/hr)	19.7
Angle	18.5 degrees	• PHD (g's)	32.8
• Maximum Roll Angle	8.2 degrees	• ASI	0.67
• Maximum Pitch Angle	-3.3 degrees	• Maximum Force in W-Beam Rail	
• Vehicle Trajectory	Moderate	Impact Region	170 kN
• Vehicle Stability	Satisfactory	Upstream Anchor	142 kN
		Downstream Location	122 kN

Figure 6.26: Summary of Analysis Results for C2500 impact with modified G4(1S) and 100-mm AASHTO Type C curb at **85 km/hr** and 25 degrees with barrier positioned at **0-m offset** from curb.

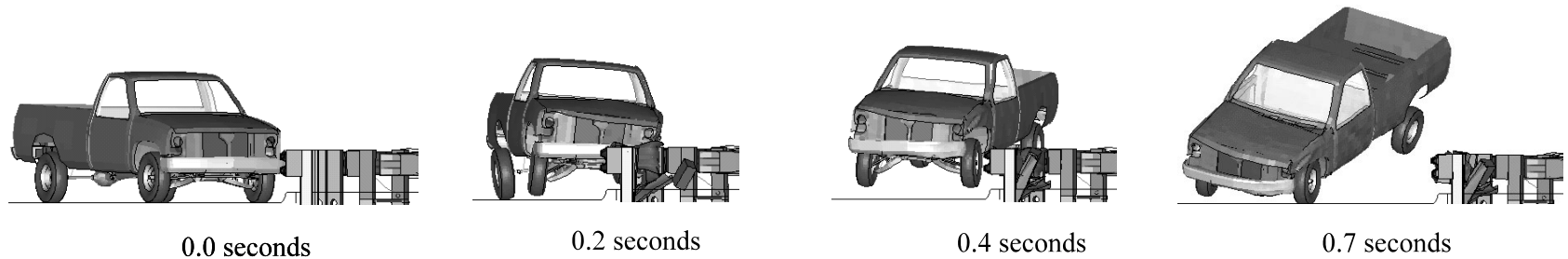

- Guardrail Type Modified G4(1S) with routed wood blockouts
- Curb Type 150-mm AASHTO Type B
- Curb-Barrier Offset 0.0 m
- Vehicle Model
 - Type Modified NCAC C2500
 - Mass 2000 kg
- Initial Conditions
 - Speed 100 km/hr
 - Angle 25 degrees
- Exit Conditions
 - Speed
 - Angle 22.4 degrees
- Maximum Roll Angle -18.0 degrees
- Maximum Pitch Angle -14.2 degrees
- Vehicle Trajectory Significant
- Vehicle Stability Questionable

- Occupant Impact Velocity (m/s)
 - Longitudinal 5.5 < 12 m/s
 - Lateral -5.0
- Occupant Ridedown Deceleration (g's)
 - Longitudinal -11.0 < 20 G's
 - Lateral 14.9
- Maximum 50 ms Moving Average Acceleration (g's)
 - Longitudinal -5.4
 - Lateral 7.6
 - Vertical 3.3
- THIV (km/hr) 23.9
- PHD (g's) 33.4
- ASI 0.89
- Maximum Force in W-Beam Rail
 - Impact Region 232 kN
 - Upstream Anchor
 - Downstream Location 182 kN

Figure 6.27: Summary of Analysis Results for C2500 impact with modified G4(1S) and 150-mm AASHTO Type B curb at 100 km/hr and 25 degrees with barrier positioned at 0-m offset from curb.

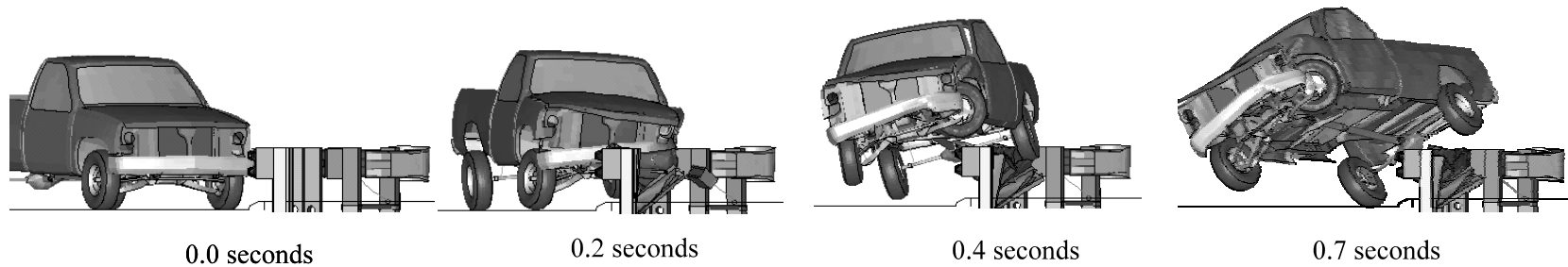

• Guardrail Type	Modified G4(1S) with routed wood blockouts	• Occupant Impact Velocity (m/s)	
• Curb Type	100-mm AASHTO Type C	Longitudinal	5.7 < 12 m/s
• Curb-Barrier Offset	0.0 m	Lateral	-5.0
• Vehicle Model		• Occupant Ridedown Deceleration (g's)	
Type	Modified NCAC C2500	Longitudinal	8.7 < 20 G's
Mass	2000 kg	Lateral	7.4
• Initial Conditions		• Maximum 50 ms Moving Average Acceleration (g's)	
Speed	100 km/hr	Longitudinal	-5.3
Angle	25 degrees	Lateral	6.0
• Exit Conditions		Vertical	-3.9
Speed		• THIV (km/hr)	26.1
Angle	29.5 degrees	• PHD (g's)	17.5
• Maximum Roll Angle	31.3 degrees	• ASI	0.76
• Maximum Pitch Angle	6.0 degrees	• Maximum Force in W-Beam Rail	
• Vehicle Trajectory	Excessive	Impact Region	226 kN
• Vehicle Stability	Unsatisfactory	Upstream Anchor	202 kN
		Downstream Location	175 kN

Figure 6.28: Summary of Analysis Results for C2500 impact with modified G4(1S) and 100-mm AASHTO Type C curb at 100 km/hr and 25 degrees with barrier positioned at 0-m offset from curb.

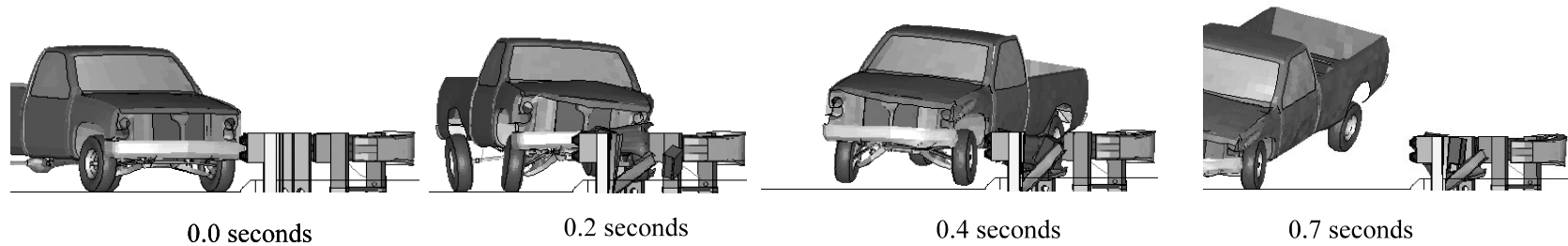

• Guardrail Type	Modified G4(1S) with routed wood blockouts	• Occupant Impact Velocity (m/s)	
• Curb Type	150-mm AASHTO Type D	Longitudinal	5.9 < 12 m/s
• Curb-Barrier Offset	0.0 m	Lateral	-4.8
• Vehicle Model		• Occupant Ridedown Deceleration (g's)	
Type	Modified NCAC C2500	Longitudinal	14.0 < 20 G's
Mass	2000 kg	Lateral	15.9
• Initial Conditions		• Maximum 50 ms Moving Average Acceleration (g's)	
Speed	100 km/hr	Longitudinal	-5.4
Angle	25 degrees	Lateral	7.1
• Exit Conditions		Vertical	-3.5
Speed		• THIV (km/hr)	24.9
Angle	24.2 degrees	• PHD (g's)	29.1
• Maximum Roll Angle	-12.5 degrees	• ASI	0.85
• Maximum Pitch Angle	-14.3 degrees	• Maximum Force in W-Beam Rail	
• Vehicle Trajectory	Moderate	Impact Region	243 kN
• Vehicle Stability	Questionable	Upstream Anchor	210 kN
		Downstream Location	183 kN

Figure 6.29: Summary of Analysis Results for C2500 impact with modified G4(1S) and 150-mm AASHTO Type D curb at 100 km/hr and 25 degrees with barrier positioned at 0-m offset from curb.

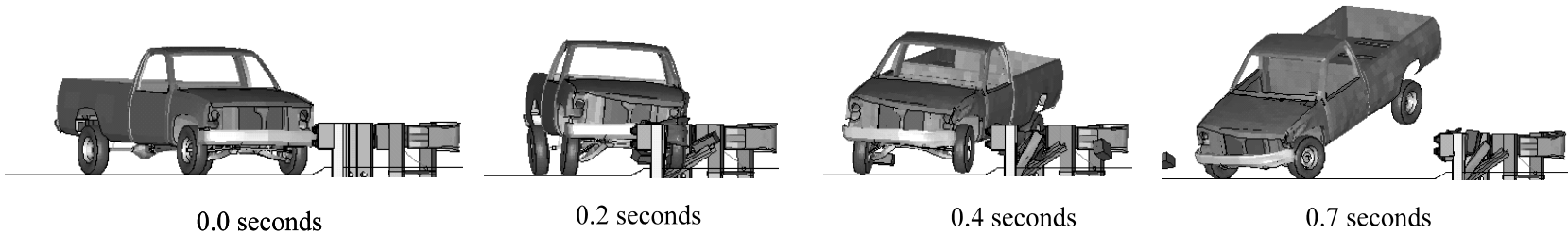

- Guardrail Type Modified G4(1S) with routed wood blockouts
- Curb Type 100-mm AASHTO Type G
- Curb-Barrier Offset 0.0 m
- Vehicle Model
 - Type Modified NCAC C2500
 - Mass 2000 kg
- Initial Conditions
 - Speed 100 km/hr
 - Angle 25 degrees
- Exit Conditions
 - Speed
 - Angle 23.0 degrees
- Maximum Roll Angle -11.4 degrees
- Maximum Pitch Angle -21.6 degrees
- Vehicle Trajectory Moderate
- Vehicle Stability Unsatisfactory

- Occupant Impact Velocity (m/s)
 - Longitudinal 4.8 < 12 m/s
 - Lateral -5.3
- Occupant Ridedown Deceleration (g's)
 - Longitudinal -11.6 < 20 G's
 - Lateral 14.8
- Maximum 50 ms Moving Average Acceleration (g's)
 - Longitudinal -5.0
 - Lateral 7.0
 - Vertical 2.5
- THIV (km/hr) 23.8
- PHD (g's) 21.0
- ASI 0.83
- Maximum Force in W-Beam Rail
 - Impact Region 223 kN
 - Upstream Anchor
 - Downstream Location 174 kN

Figure 6.30: Summary of Analysis Results for C2500 impact with modified G4(1S) and 100-mm AASHTO Type G curb at 100 km/hr and 25 degrees with barrier positioned at 0-m offset from curb.

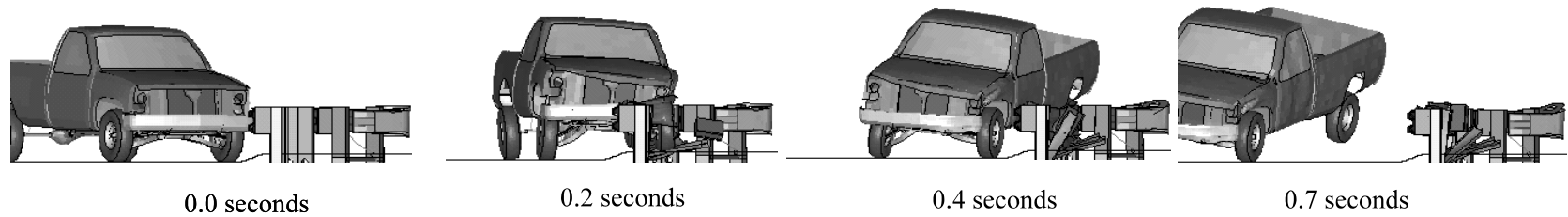

• Guardrail Type	Modified G4(1S) with routed wood blockouts	• Occupant Impact Velocity (m/s)	
• Curb Type	100-mm New York Curb	Longitudinal	5.0 < 12 m/s
• Curb-Barrier Offset	0.0 m	Lateral	-5.2
• Vehicle Model		• Occupant Ridedown Deceleration (g's)	
Type	Modified NCAC C2500	Longitudinal	-8.2 < 20 G's
Mass	2000 kg	Lateral	13.1
• Initial Conditions		• Maximum 50 ms Moving Average Acceleration (g's)	
Speed	100 km/hr	Longitudinal	-5.0
Angle	25 degrees	Lateral	5.7
• Exit Conditions		Vertical	2.4
Speed		• THIV (km/hr)	23.5
Angle	23.5 degrees	• PHD (g's)	16.3
• Maximum Roll Angle	-10.9 degrees	• ASI	0.72
• Maximum Pitch Angle	-9.1 degrees	• Maximum Force in W-Beam Rail	
• Vehicle Trajectory	Minimal	Impact Region	231 kN
• Vehicle Stability	Satisfactory	Upstream Anchor	198 kN
		Downstream Location	178 kN

Figure 6.31: Summary of Analysis Results for C2500 impact with modified G4(1S) and 100-mm New York curb at **100 km/hr** and 25 degrees with barrier positioned at **0-m offset** from curb.

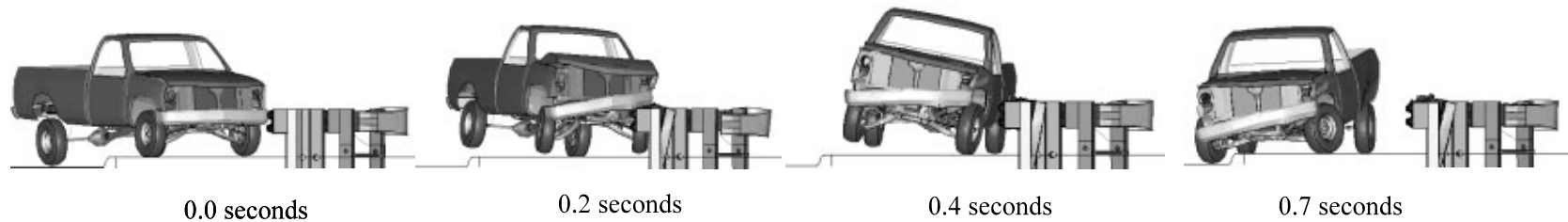

• Guardrail Type	Modified G4(1S) with routed wood blockouts	• Occupant Impact Velocity (m/s)	
• Curb Type	150-mm AASHTO Type B	Longitudinal	3.5 < 12 m/s
• Curb-Barrier Offset	2.5 m	Lateral	-2.5
• Vehicle Model		• Occupant Ridedown Deceleration (g's)	
Type	Modified NCAC C2500	Longitudinal	-15.1 < 20 G's
Mass	2000 kg	Lateral	19.4
• Initial Conditions		• Maximum 50 ms Moving Average Acceleration (g's)	
Speed	100 km/hr	Longitudinal	-4.6
Angle	25 degrees	Lateral	-10.0
• Exit Conditions		Vertical	7.4
Speed		• THIV (km/hr)	14.6
Angle	13.7 degrees	• PHD (g's)	51.9
• Maximum Roll Angle	-11.9 degrees	• ASI	1.13
• Maximum Pitch Angle	-3.2 degrees	• Maximum Force in W-Beam Rail	
• Vehicle Trajectory	Minimal	Impact Region	95.0 kN
• Vehicle Stability	Satisfactory	Upstream Anchor	88.7 kN
		Downstream Location	68.6 kN

Figure 6.32: Summary of Analysis Results for C2500 impact with modified G4(1S) and 150-mm AASHTO Type B curb at **70 km/hr** and 25 degrees with barrier positioned at **2.5-m offset** from curb.

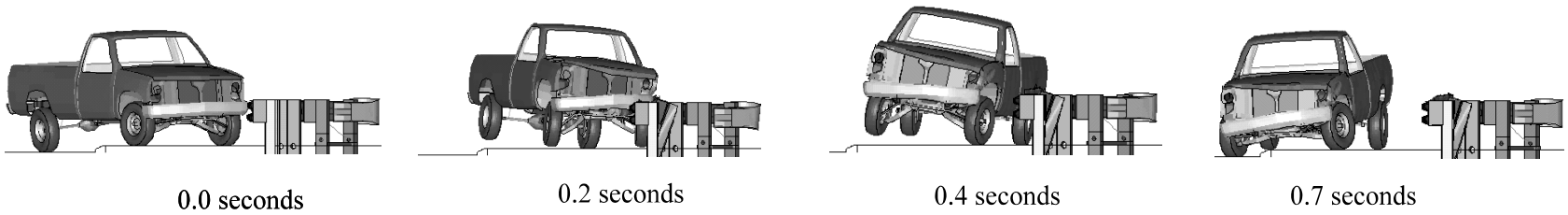

• Guardrail Type	Modified G4(1S) with routed wood blockouts	• Occupant Impact Velocity (m/s)	Longitudinal
• Curb Type	100-mm AASHTO Type C		Lateral
• Curb-Barrier Offset	2.5 m	• Occupant Ridedown Deceleration (g's)	Longitudinal
• Vehicle Model			Lateral
Type	Modified NCAC C2500	• Maximum 50 ms Moving Average Acceleration (g's)	Longitudinal
Mass	2000 kg		Lateral
• Initial Conditions			Vertical
Speed	100 km/hr	• THIV (km/hr)	
Angle	25 degrees	• PHD (g's)	
• Exit Conditions		• ASI	
Speed		• Maximum Force in W-Beam Rail	Impact Region
Angle			Upstream Anchor
• Maximum Roll Angle			Downstream Location
• Maximum Pitch Angle			
• Vehicle Trajectory	Minimal		
• Vehicle Stability	Satisfactory		

Figure 6.33: Summary of Analysis Results for C2500 impact with modified G4(1S) and 100-mm AASHTO Type C curb at **70 km/hr** and 25 degrees with barrier positioned at **2.5-m offset** from curb.

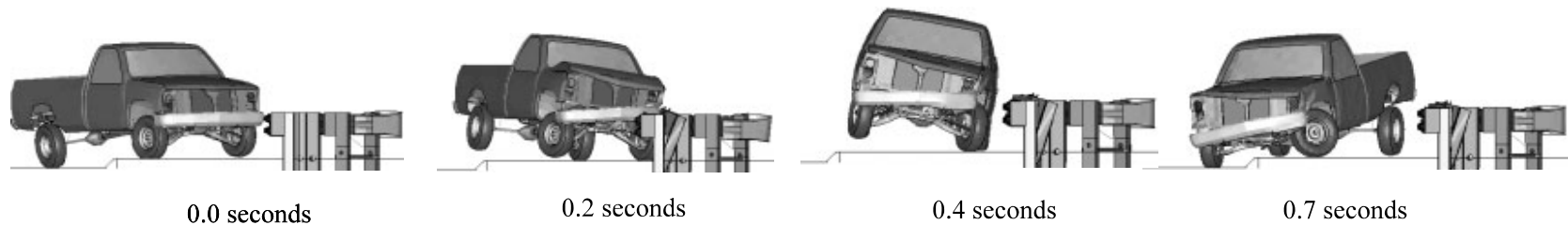

• Guardrail Type	Modified G4(1S) with routed wood blockouts	• Occupant Impact Velocity (m/s)	
• Curb Type	150-mm AASHTO Type D	Longitudinal	-0.1 < 12 m/s
• Curb-Barrier Offset	2.5 m	Lateral	-1.6
• Vehicle Model		• Occupant Ridedown Deceleration (g's)	
Type	Modified NCAC C2500	Longitudinal	-12.7 < 20 G's
Mass	2000 kg	Lateral	17.3
• Initial Conditions		• Maximum 50 ms Moving Average Acceleration (g's)	
Speed	100 km/hr	Longitudinal	-5.6
Angle	25 degrees	Lateral	5.8
• Exit Conditions		Vertical	-7.7
Speed		• THIV (km/hr)	6.1
Angle	18.9 degrees	• PHD (g's)	34.2
• Maximum Roll Angle	-11.4 degrees	• ASI	0.83
• Maximum Pitch Angle	-5.2 degrees	• Maximum Force in W-Beam Rail	
• Vehicle Trajectory	Minimal	Impact Region	128 kN
• Vehicle Stability	Satisfactory	Upstream Anchor	120 kN
		Downstream Location	82.1 kN

Figure 6.34: Summary of Analysis Results for C2500 impact with modified G4(1S) and 150-mm AASHTO Type D curb at **70 km/hr** and 25 degrees with barrier positioned at **2.5-m offset** from curb.

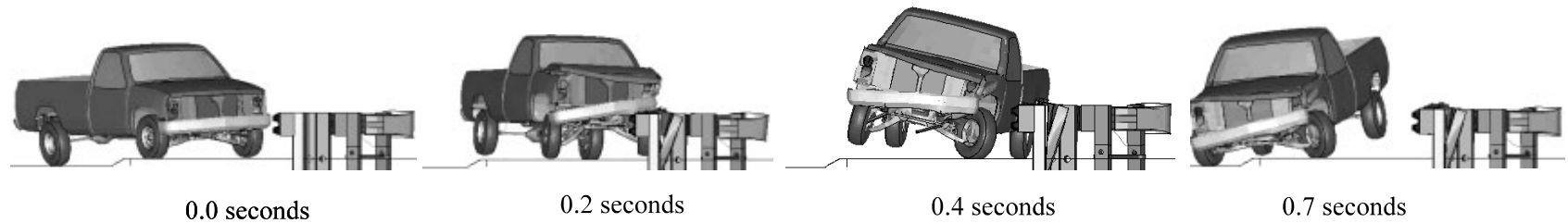

• Guardrail Type	Modified G4(1S) with routed wood blockouts	• Occupant Impact Velocity (m/s)	
• Curb Type	100-mm AASHTO Type G	Longitudinal	6.0 < 12 m/s
• Curb-Barrier Offset	2.5 m	Lateral	-2.4
• Vehicle Model		• Occupant Ridedown Deceleration (g's)	
Type	Modified NCAC C2500	Longitudinal	-26.6 < 20 G's ?
Mass	2000 kg	Lateral	17.2 ?
• Initial Conditions		• Maximum 50 ms Moving Average Acceleration (g's)	
Speed	100 km/hr	Longitudinal	-6.6
Angle	25 degrees	Lateral	5.2
• Exit Conditions		Vertical	-8.2
Speed		• THIV (km/hr)	21.9
Angle	19.9 degrees	• PHD (g's)	79.6
• Maximum Roll Angle	-14.1 degrees	• ASI	0.89
• Maximum Pitch Angle	-6.3 degrees	• Maximum Force in W-Beam Rail	
• Vehicle Trajectory	Moderate	Impact Region	123 kN
• Vehicle Stability	Satisfactory	Upstream Anchor	118 kN
		Downstream Location	77.8 kN

Figure 6.35: Summary of Analysis Results for C2500 impact with modified G4(1S) and 100-mm AASHTO Type G curb at **70 km/hr** and 25 degrees with barrier positioned at **2.5-m offset** from curb.

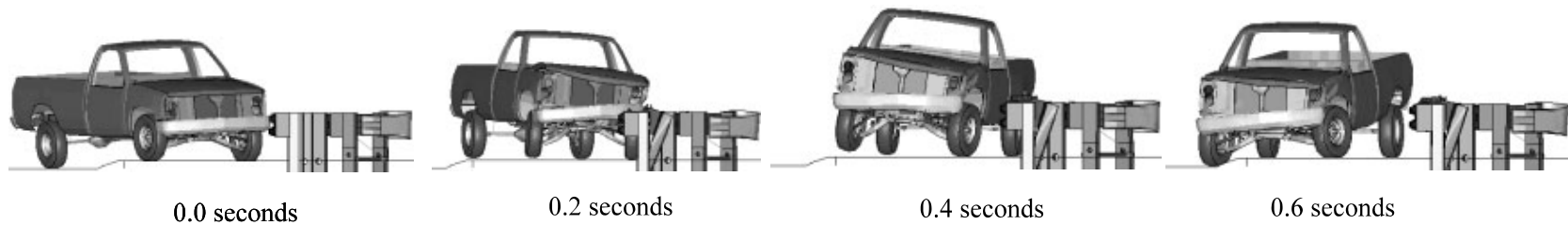

• Guardrail Type	Modified G4(1S) with routed wood blockouts	• Occupant Impact Velocity (m/s)	
• Curb Type	100-mm New York Curb	Longitudinal	5.8 < 12 m/s
• Curb-Barrier Offset	2.5 m	Lateral	-4.5
• Vehicle Model		• Occupant Ridedown Deceleration (g's)	
Type	Modified NCAC C2500	Longitudinal	-11.0 < 20 G's
Mass	2000 kg	Lateral	10.9
• Initial Conditions		• Maximum 50 ms Moving Average Acceleration (g's)	
Speed	100 km/hr	Longitudinal	-4.4
Angle	25 degrees	Lateral	6.4
• Exit Conditions		Vertical	-5.1
Speed		• THIV (km/hr)	23.2
Angle	15.8 degrees	• PHD (g's)	26.6
• Maximum Roll Angle	-8.4 degrees	• ASI	0.88
• Maximum Pitch Angle	-5.2 degrees	• Maximum Force in W-Beam Rail	
• Vehicle Trajectory	Minimal	Impact Region	132 kN
• Vehicle Stability	Satisfactory	Upstream Anchor	119 kN
		Downstream Location	77.7 kN

Figure 6.36: Summary of Analysis Results for C2500 impact with modified G4(1S) and 100-mm New York Curb curb at **70 km/hr** and 25 degrees with barrier positioned at **2.5-m offset** from curb.

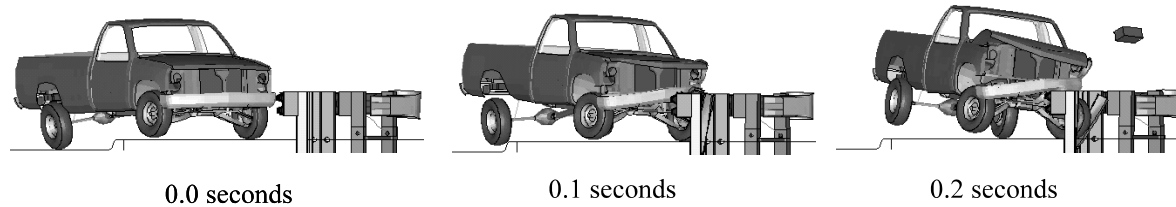

Analysis Terminated Prematurely

• Guardrail Type	Modified G4(1S) with routed wood blockouts	• Occupant Impact Velocity (m/s)	
• Curb Type	100-mm AASHTO Type B	Longitudinal	
• Curb-Barrier Offset	2.5 m	Lateral	
• Vehicle Model		• Occupant Ridedown Deceleration (g's)	
Type	Modified NCAC C2500	Longitudinal	
Mass	2000 kg	Lateral	
• Initial Conditions		• Maximum 50 ms Moving Average Acceleration (g's)	
Speed	85 km/hr	Longitudinal	
Angle	25 degrees	Lateral	
• Exit Conditions		Vertical	
Speed		• THIV (km/hr)	
Angle		• PHD (g's)	
• Maximum Roll Angle		• ASI	
• Maximum Pitch Angle		• Maximum Force in W-Beam Rail	
• Vehicle Trajectory	Excessive	Impact Region	185 kN
• Vehicle Stability	Questionable	Upstream Anchor	
		Downstream Location	91.0 kN

Figure 6.37: Summary of Analysis Results for C2500 impact with modified G4(1S) and 100-mm AASHTO Type B curb at **85 km/hr** and 25 degrees with barrier positioned at **2.5-m offset** from curb.

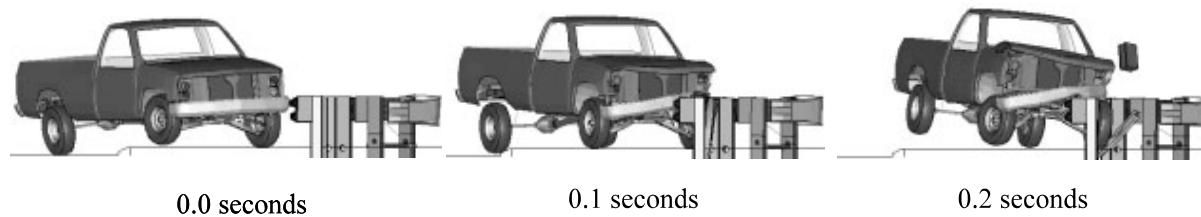

Analysis Terminated Prematurely

• Guardrail Type	Modified G4(1S) with routed wood blockouts	• Occupant Impact Velocity (m/s)	
• Curb Type	100-mm AASHTO Type C	Longitudinal	6.1 < 12 m/s
• Curb-Barrier Offset	2.5 m	Lateral	-3.6
• Vehicle Model		• Occupant Ridedown Deceleration (g's)	
Type	Modified NCAC C2500	Longitudinal	-25.2 < 20 G's
Mass	2000 kg	Lateral	22.0
• Initial Conditions		• Maximum 50 ms Moving Average Acceleration (g's)	
Speed	85 km/hr	Longitudinal	-9.2
Angle	25 degrees	Lateral	8.5
• Exit Conditions		Vertical	-12.5
Speed		• THIV (km/hr)	25.2
Angle	NA	• PHD (g's)	72.8
• Maximum Roll Angle	-6.1 degrees	• ASI	1.68
• Maximum Pitch Angle	-2.2 degrees	• Maximum Force in W-Beam Rail	
• Vehicle Trajectory	Excessive	Impact Region	205 kN
• Vehicle Stability	Questionable	Upstream Anchor	177 kN
		Downstream Location	102 kN

Figure 6.38: Summary of Analysis Results for C2500 impact with modified G4(1S) and 100-mm AASHTO Type C curb at **85 km/hr** and 25 degrees with barrier positioned at **2.5-m offset** from curb.

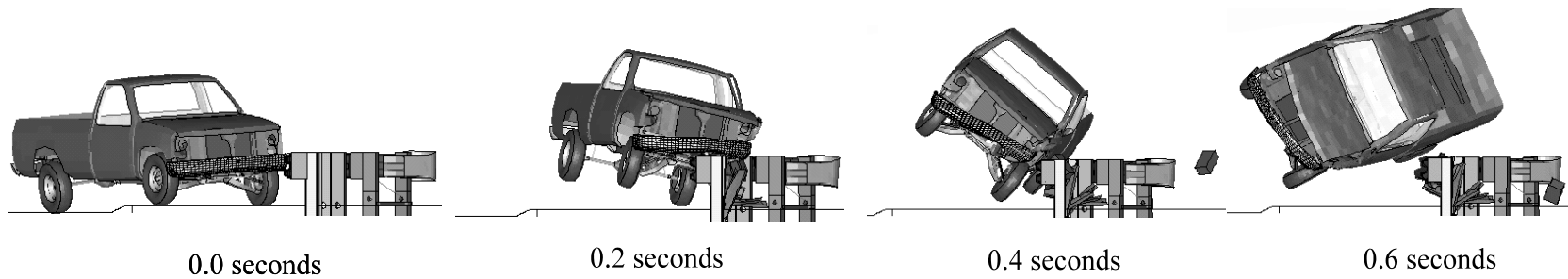

• Guardrail Type	Modified G4(1S) with routed wood blockouts	• Occupant Impact Velocity (m/s)
• Curb Type	100-mm AASHTO Type G	Longitudinal
• Curb-Barrier Offset	2.5 m	Lateral
• Vehicle Model		• Occupant Ridedown Deceleration (g's)
Type	Modified NCAC C2500	Longitudinal
Mass	2000 kg	Lateral
• Initial Conditions		• Maximum 50 ms Moving Average Acceleration (g's)
Speed	100 km/hr	Longitudinal
Angle	25 degrees	Lateral
• Exit Conditions		Vertical
Speed		• THIV (km/hr)
Angle		• PHD (g's)
• Maximum Roll Angle		• ASI
• Maximum Pitch Angle		• Maximum Force in W-Beam Rail
• Vehicle Trajectory	Excessive	Impact Region
• Vehicle Stability	Unsatisfactory	Upstream Anchor
		Downstream Location

Figure 6.39: Summary of Analysis Results for C2500 impact with modified G4(1S) and 100-mm AASHTO Type G curb at 100 km/hr and 25 degrees with barrier positioned at 2.5-m offset from curb.

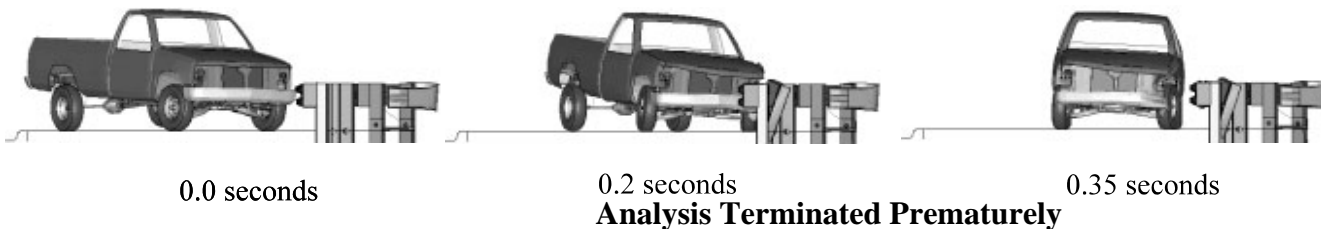

<ul style="list-style-type: none"> • Guardrail Type Modified G4(1S) with routed wood blockouts • Curb Type 150-mm AASHTO Type B • Curb-Barrier Offset 4.0 m • Vehicle Model <ul style="list-style-type: none"> Type Modified NCAC C2500 Mass 2000 kg • Initial Conditions <ul style="list-style-type: none"> Speed 70 km/hr Angle 25 degrees • Exit Conditions <ul style="list-style-type: none"> Speed Angle NA • Maximum Roll Angle -5.1 degrees • Maximum Pitch Angle -2.8 degrees • Vehicle Trajectory Minimal • Vehicle Stability Satisfactory 	<ul style="list-style-type: none"> • Occupant Impact Velocity (m/s) <ul style="list-style-type: none"> Longitudinal 2.0 < 12 m/s Lateral -4.5 • Occupant Ridedown Deceleration (g's) <ul style="list-style-type: none"> Longitudinal 13.6 < 20 G's Lateral -19.2 • Maximum 50 ms Moving Average Acceleration (g's) <ul style="list-style-type: none"> Longitudinal -6.3 Lateral 8.3 Vertical -6.7 • THIV (km/hr) 18.0 • PHD (g's) 41.4 • ASI 1.10 • Maximum Force in W-Beam Rail <ul style="list-style-type: none"> Impact Region 101 kN Upstream Anchor 89.4 kN Downstream Location 66.1 kN
--------------------------------------------------------------------------------------------------------------------------------------------------------------------------------------------------------------------------------------------------------------------------------------------------------------------------------------------------------------------------------------------------------------------------------------------------------------------------------------------------------------------------------------------------------------------------------------------------------------------------------------------------------------------------------------------------------------------------------------------------------------------------------------------------------------	-----------------------------------------------------------------------------------------------------------------------------------------------------------------------------------------------------------------------------------------------------------------------------------------------------------------------------------------------------------------------------------------------------------------------------------------------------------------------------------------------------------------------------------------------------------------------------------------------------------------------------------------------------------------------------------------------------------------------------------------------------------------------------------------------------------------------------------------------------------------------------

Figure 6.40: Summary of Analysis Results for C2500 impact with modified G4(1S) and 150-mm AASHTO Type B curb at **70 km/hr** and 25 degrees with barrier positioned at **4.0-m offset** from curb.

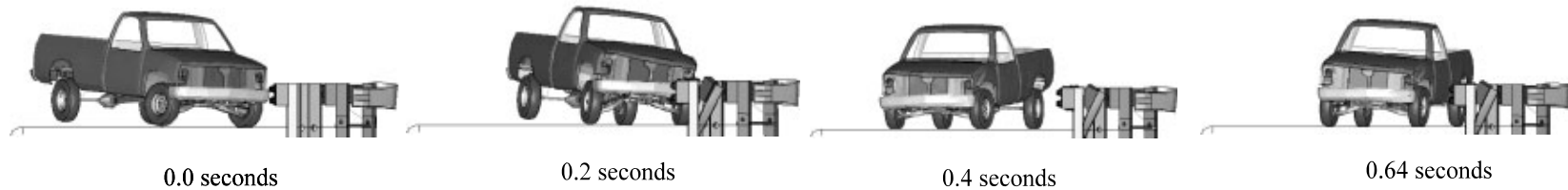

• Guardrail Type	Modified G4(1S) with routed wood blockouts	• Occupant Impact Velocity (m/s)	
• Curb Type	100-mm AASHTO Type C	Longitudinal	1.6 < 12 m/s
• Curb-Barrier Offset	4.0 m	Lateral	1.4
• Vehicle Model		• Occupant Ridedown Deceleration (g's)	
Type	Modified NCAC C2500	Longitudinal	14.4 < 20 G's
Mass	2000 kg	Lateral	13.8
• Initial Conditions		• Maximum 50 ms Moving Average Acceleration (g's)	
Speed	70 km/hr	Longitudinal	6.9
Angle	25 degrees	Lateral	6.3
• Exit Conditions		Vertical	6.8
Speed		• THIV (km/hr)	8.0
Angle	17.7	• PHD (g's)	38.9
• Maximum Roll Angle	-7.6 degrees	• ASI	0.77
• Maximum Pitch Angle	-2.7 degrees	• Maximum Force in W-Beam Rail	
• Vehicle Trajectory	Minimal	Impact Region	114 kN
• Vehicle Stability	Satisfactory	Upstream Anchor	113 kN
		Downstream Location	76.5 kN

Figure 6.41: Summary of Analysis Results for C2500 impact with modified G4(1S) and 100-mm AASHTO Type C curb at 70 km/hr and 25 degrees with barrier positioned at 4.0-m offset from curb.



• Guardrail Type	Modified G4(1S) with routed wood blockouts	• Occupant Impact Velocity (m/s)	
• Curb Type	150-mm AASHTO Type D	Longitudinal	0.3 < 12 m/s
• Curb-Barrier Offset	4.0 m	Lateral	-1.6
• Vehicle Model		• Occupant Ridedown Deceleration (g's)	
Type	Modified NCAC C2500	Longitudinal	13.3 < 20 G's
Mass	2000 kg	Lateral	14.4
• Initial Conditions		• Maximum 50 ms Moving Average Acceleration (g's)	
Speed	70 km/hr	Longitudinal	-3.9
Angle	25 degrees	Lateral	7.2
• Exit Conditions		Vertical	5.1
Speed		• THIV (km/hr)	6.1
Angle	19.2	• PHD (g's)	49.7
• Maximum Roll Angle	5.6 degrees	• ASI	0.84
• Maximum Pitch Angle	-2.9 degrees	• Maximum Force in W-Beam Rail	
• Vehicle Trajectory	Minimal	Impact Region	97.5 kN
• Vehicle Stability	Satisfactory	Upstream Anchor	
		Downstream Location	65.1 kN

Figure 6.42: Summary of Analysis Results for C2500 impact with modified G4(1S) and 150-mm AASHTO Type D curb at 70 km/hr and 25 degrees with barrier positioned at 4.0-m offset from curb.



• Guardrail Type	Modified G4(1S) with routed wood blockouts	• Occupant Impact Velocity (m/s)	
• Curb Type	100-mm AASHTO Type G	Longitudinal	1.1 < 12 m/s
• Curb-Barrier Offset	4.0 m	Lateral	-2.6
• Vehicle Model		• Occupant Ridedown Deceleration (g's)	
Type	Modified NCAC C2500	Longitudinal	21.2 > 20 G's
Mass	2000 kg	Lateral	16.8
• Initial Conditions		• Maximum 50 ms Moving Average Acceleration (g's)	
Speed	70 km/hr	Longitudinal	-8.5
Angle	25 degrees	Lateral	5.6
• Exit Conditions		Vertical	6.9
Speed		• THIV (km/hr)	10.5
Angle	14.6 degrees	• PHD (g's)	39.2
• Maximum Roll Angle	4.4 degrees	• ASI	0.80
• Maximum Pitch Angle	-3.4 degrees	• Maximum Force in W-Beam Rail	
• Vehicle Trajectory	Minimal	Impact Region	130 kN
• Vehicle Stability	Satisfactory	Upstream Anchor	116 kN
		Downstream Location	78.8 kN

Figure 6.43: Summary of Analysis Results for C2500 impact with modified G4(1S) and 100-mm AASHTO Type G curb at 70 km/hr and 25 degrees with barrier positioned at 4.0-m offset from curb.



• Guardrail Type	Modified G4(1S) with routed wood blockouts	• Occupant Impact Velocity (m/s)	
• Curb Type	150-mm AASHTO Type B	Longitudinal	0.1 < 12 m/s
• Curb-Barrier Offset	4.0 m	Lateral	-2.6
• Vehicle Model		• Occupant Ridedown Deceleration (g's)	
Type	Modified NCAC C2500	Longitudinal	-31.1 > 20 G's
Mass	2000 kg	Lateral	29.0
• Initial Conditions		• Maximum 50 ms Moving Average Acceleration (g's)	
Speed	85 km/hr	Longitudinal	-14.7
Angle	25 degrees	Lateral	10.1
• Exit Conditions		Vertical	-9.0
Speed		• THIV (km/hr)	9.7
Angle	18.9 degrees	• PHD (g's)	68.6
• Maximum Roll Angle	-10.8 degrees	• ASI	1.66
• Maximum Pitch Angle	-2.0 degrees	• Maximum Force in W-Beam Rail	
• Vehicle Trajectory	Minimal	Impact Region	171 kN
• Vehicle Stability	Satisfactory	Upstream Anchor	143 kN
		Downstream Location	103 kN

Figure 6.44: Summary of Analysis Results for C2500 impact with modified G4(1S) and 150-mm AASHTO Type B curb at 85 km/hr and 25 degrees with barrier positioned at 4.0-m offset from curb.



• Guardrail Type	Modified G4(1S) with routed wood blockouts	• Occupant Impact Velocity (m/s)	
• Curb Type	100-mm AASHTO Type C	Longitudinal	0.7 < 12 m/s
• Curb-Barrier Offset	4.0 m	Lateral	-1.7
• Vehicle Model		• Occupant Ridedown Deceleration (g's)	
Type	Modified NCAC C2500	Longitudinal	-20.0 = 20 G's
Mass	2000 kg	Lateral	16.9
• Initial Conditions		• Maximum 50 ms Moving Average Acceleration (g's)	
Speed	85 km/hr	Longitudinal	-6.9
Angle	25 degrees	Lateral	5.8
• Exit Conditions		Vertical	6.7
Speed		• THIV (km/hr)	5.6
Angle	17.0 degrees	• PHD (g's)	50.7
• Maximum Roll Angle	-6.3 degrees	• ASI	0.81
• Maximum Pitch Angle	-3.2 degrees	• Maximum Force in W-Beam Rail	
• Vehicle Trajectory	Minimal	Impact Region	171 kN
• Vehicle Stability	Satisfactory	Upstream Anchor	148 kN
		Downstream Location	120 kN

Figure 6.45: Summary of Analysis Results for C2500 impact with modified G4(1S) and 100-mm AASHTO Type C curb at 85 km/hr and 25 degrees with barrier positioned at 4.0-m offset from curb.

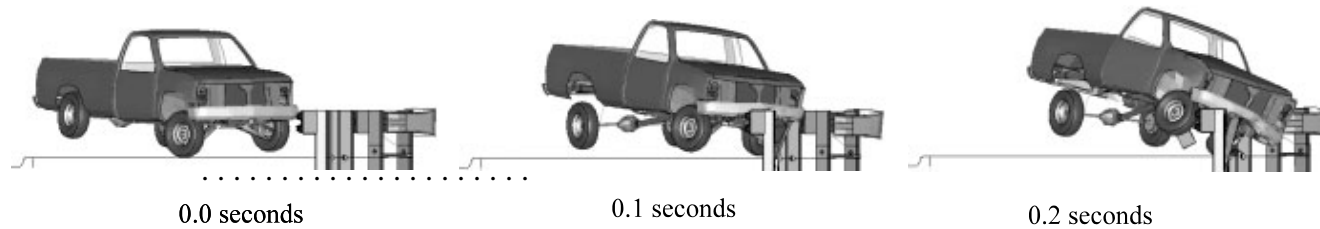

Analysis Stopped After Override

• Guardrail Type	Modified G4(1S) with routed wood blockouts	• Occupant Impact Velocity (m/s)	
• Curb Type	150-mm AASHTO Type B	Longitudinal	3.6 < 12 m/s
• Curb-Barrier Offset	4.0 m	Lateral	0.3
• Vehicle Model		• Occupant Ridedown Deceleration (g's)	
Type	Modified NCAC C2500	Longitudinal	-40.0 > 20 G's
Mass	2000 kg	Lateral	-49.9
• Initial Conditions		• Maximum 50 ms Moving Average Acceleration (g's)	
Speed	100 km/hr	Longitudinal	-13.1
Angle	25 degrees	Lateral	9.6
• Exit Conditions		Vertical	-14.6
Speed		• THIV (km/hr)	13.1
Angle	NA	• PHD (g's)	143.3
• Maximum Roll Angle	-19.6 degrees	• ASI	1.79
• Maximum Pitch Angle	-6.2 degrees	• Maximum Force in W-Beam Rail	
• Vehicle Trajectory	Excessive	Impact Region	
• Vehicle Stability	Unsatisfactory	Upstream Anchor	
		Downstream Location	

Figure 6.46: Summary of Analysis Results for C2500 impact with modified G4(1S) and 150-mm AASHTO Type B curb at 100 km/hr and 25 degrees with barrier positioned at 4.0-m offset from curb.

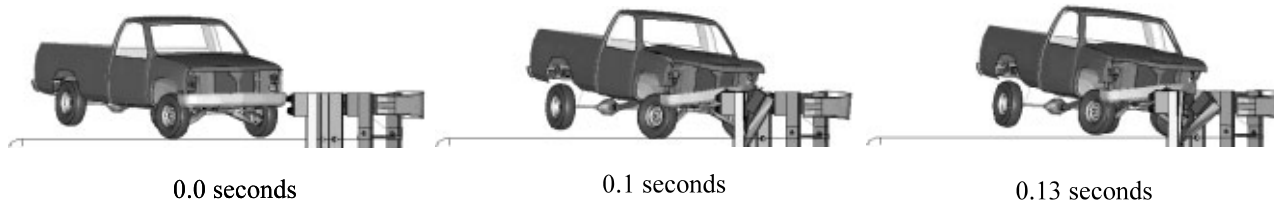

Analysis Terminated Prematurely

• Guardrail Type	Modified G4(1S) with routed wood blockouts	• Occupant Impact Velocity (m/s)	
• Curb Type	100-mm AASHTO Type C	Longitudinal	5.0 < 12 m/s
• Curb-Barrier Offset	4.0 m	Lateral	-3.8
• Vehicle Model		• Occupant Ridedown Deceleration (g's)	
Type	Modified NCAC C2500	Longitudinal	-40.0 > 20 G's
Mass	2000 kg	Lateral	-49.9
• Initial Conditions		• Maximum 50 ms Moving Average Acceleration (g's)	
Speed	100 km/hr	Longitudinal	-6.5
Angle	25 degrees	Lateral	5.8
• Exit Conditions		Vertical	-4.2
Speed		• THIV (km/hr)	23.7
Angle	NA	• PHD (g's)	33.5
• Maximum Roll Angle	-6.7 degrees	• ASI	0.87
• Maximum Pitch Angle	-3.5 degrees	• Maximum Force in W-Beam Rail	
• Vehicle Trajectory	Excessive	Impact Region	
• Vehicle Stability	Unsatisfactory	Upstream Anchor	
		Downstream Location	

Figure 6.47: Summary of Analysis Results for C2500 impact with modified G4(1S) and 100-mm AASHTO Type C curb at 100 km/hr and 25 degrees with barrier positioned at 4.0-m offset from curb.

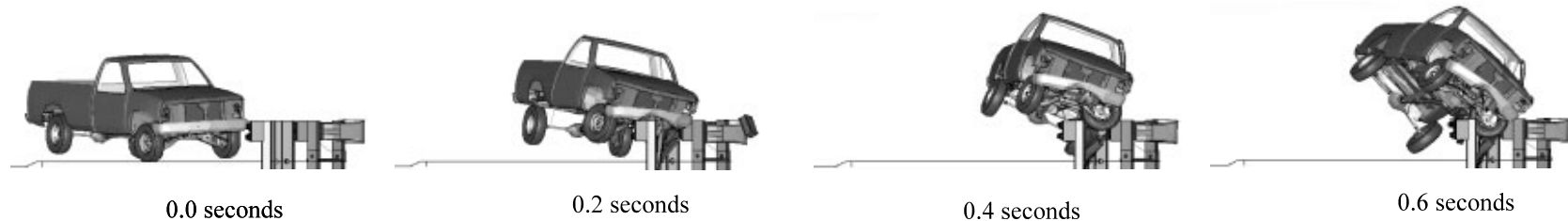

Analysis Stopped After Override

• Guardrail Type	Modified G4(1S) with routed wood blockouts	• Occupant Impact Velocity (m/s)	
• Curb Type	100-mm AASHTO Type G	Longitudinal	6.3 < 12 m/s
• Curb-Barrier Offset	4.0 m	Lateral	-4.9
• Vehicle Model		• Occupant Ridedown Deceleration (g's)	
Type	Modified NCAC C2500	Longitudinal	-26.2 > 20 G's
Mass	2000 kg	Lateral	-29.2
• Initial Conditions		• Maximum 50 ms Moving Average Acceleration (g's)	
Speed	100 km/hr	Longitudinal	13.4
Angle	25 degrees	Lateral	-9.6
• Exit Conditions		Vertical	-11.5
Speed		• THIV (km/hr)	28.6
Angle	NA	• PHD (g's)	83.4
• Maximum Roll Angle	-45.1 degrees	• ASI	1.45
• Maximum Pitch Angle	3.5 degrees	• Maximum Force in W-Beam Rail	
• Vehicle Trajectory	Excessive	Impact Region	
• Vehicle Stability	Unsatisfactory	Upstream Anchor	
		Downstream Location	

Figure 6.48: Summary of Analysis Results for C2500 impact with modified G4(1S) and 100-mm AASHTO Type G curb at 100 km/hr and 25 degrees with barrier positioned at 4.0-m offset from curb.



Analysis Terminated Prematurely

• Guardrail Type	Modified G4(1S) with routed wood blockouts	• Occupant Impact Velocity (m/s)	
• Curb Type	100-mm New York Curb	Longitudinal	5.3 < 12 m/s
• Curb-Barrier Offset	4.0 m	Lateral	-5.6
• Vehicle Model		• Occupant Ridedown Deceleration (g's)	
Type	Modified NCAC C2500	Longitudinal	-17.0 < 20 G's
Mass	2000 kg	Lateral	-21.1
• Initial Conditions		• Maximum 50 ms Moving Average Acceleration (g's)	
Speed	100 km/hr	Longitudinal	-10.4
Angle	25 degrees	Lateral	9.3
• Exit Conditions		Vertical	6.7
Speed		• THIV (km/hr)	24.6
Angle	NA	• PHD (g's)	43.0
• Maximum Roll Angle	-15.2 degrees	• ASI	1.12
• Maximum Pitch Angle	3.1 degrees	• Maximum Force in W-Beam Rail	
• Vehicle Trajectory	Excessive	Impact Region	
• Vehicle Stability	Unsatisfactory	Upstream Anchor	
		Downstream Location	

Figure 6.49: Summary of Analysis Results for C2500 impact with modified G4(1S) and 100-mm New York curb at **100 km/hr** and 25 degrees with barrier positioned at **4.0-m offset** from curb.

VII. SYNTHESIS OF ANALYSIS RESULTS

7.1 Introduction

The analyses of vehicle impact with curbs and curb-barrier combinations conducted in this study were limited to one vehicle type, a 2000-kg pickup truck. Thus, guidelines based solely on the results of those analyses would only be applicable to that one type of vehicle. In order to develop a more general set of guidelines, additional data is needed that will provide more information about the response of a broader range of vehicle types. The literature provides an adequate amount of information on the response of various types of cars traversing curbs and also a limited amount of information from the results of full-scale crash tests regarding both cars and pickup trucks impacting curb-barrier combinations. The information from the current study will be synthesized and combined with the results of prior studies such that general guidelines can be developed for the use and installation of curbs and curb-barrier combinations along high-speed roadways.

There are many factors that influence vehicle behavior when traversing curbs, such as abrupt steering caused by the interaction of the front wheels with the curb, loss of contact between the tires and ground, excessive vehicle accelerations and excessive roll, pitch and yaw rates of the vehicle during impact. Each of these factors may lead to loss of control of the vehicle, however, all the data that have been collected from full-scale tests and computer simulations suggests that total loss of control is unlikely except in extreme cases. A more important issue, however, may be the effects that these factors precipitate when curbs are placed in combination with roadside barriers (e.g., guardrail, crash

cushions, breakaway poles, etc). The trajectory of a vehicle after crossing a curb may be insignificant regarding the potential for losing control of the vehicle, but even a slight increase in bumper height during trajectory may be sufficient to cause the vehicle to impact a roadside safety device at a point higher or lower than normal, which may lead to override or underride of roadside barriers or may adversely affect the breakaway mechanism of roadside hardware devices.

Two of the studies identified in the literature addressed the issue of override and underride indirectly using both full-scale testing and computer simulation: Olsen *et al.* (22) and Holloway *et al.*(25). In those studies the response of various types of cars traversing a number of different curb types was obtained and the information was used to assess vehicle stability and to estimate the potential for barrier override and underride. The types of data that were collected in their studies were roll and pitch displacement-time histories and also relative bumper trajectory-time history of the vehicles when traversing curbs. There were various impact conditions and curb types investigated in those studies, however, all impact conditions were considered equally likely since data are not available to discern the most probable impact conditions of roadside accidents. Only the maximum values of angular displacement and bumper heights during trajectory from the various studies will be considered when synthesizing the data. It should be noted that the maximum encroachment angle of both the Olsen *et al.* study and the Holloway *et al.* study was 20 degrees, whereas the maximum encroachment angle used in the current study was 25 degrees. Furthermore, the vehicle used in the Olsen *et al.* study

was a 1965 Ford four-door sedan and it may be questionable whether or not those results are representative of the current vehicle fleet. The results and conclusions from Olsen's study, however, were similar to those obtained in both the Holloway *et al.* study and the current study.

7.2 Vehicle Curb Traversal Tests and Simulation Results

The vehicle encroachment angle and speed in the various studies ranged from 5 degrees to 25 degrees and 48 km/hr to 120 km/hr, respectively.

7.2.1 Maximum Roll and Pitch Angles

Based on the results of this research and on conclusions made in previous studies the following statements can be made. Maximum roll angles of vehicles crossing curbs decrease as encroachment angles increase, and they are only slightly affected by impact speed. The maximum roll angle also increases as curb height increases, but curb shape has very little influence on roll angle, especially at higher impact speeds. Maximum pitch angle increases as encroachment angle increases, but tends to be independent of vehicle speed. The maximum pitch angle increases slightly as curb height increases, but curb shape has no discernable influence on pitch angle.

Table 7.1 provides a summary of the maximum roll and pitch angles of vehicles crossing various types of curbs for particular vehicle types and for a range of impact conditions.

For the cases involving both small and large cars crossing 150 mm high curbs, the

maximum roll angle ranged from 11.0 to 12.4 degrees, whereas, the pickup truck crossing 150 mm high curbs resulted in a maximum roll angle of 7.6 degrees. The maximum pitch angles in all cases of vehicles crossing 150 mm high curbs were very low and ranged from 1.8 to 3.3 degrees.

For cases involving the small and large cars crossing 100 mm high curbs, the maximum roll angle ranged from 7.0 to 8.1 degrees, and the maximum roll angle of the pickup truck was 6.0 degrees. As with the 150-mm curb cases, the maximum pitch angles of vehicles crossing the 100 mm high curbs were insignificant and ranged from 0.7 to 2.7 degrees.

7.2.2 Front Bumper Trajectory

The trajectory of the front bumper is dependent on curb shape. As curb height increases and as the slope of the curb face increases, the maximum vertical position of the front bumper increases. Curb height, however, has much more influence than does the slope of the curb face. Regarding impact conditions, the maximum vertical component of trajectory of the bumper is nearly independent of encroachment speed, but it increases as impact angle increases.

Table 7.1 provides a summary of lateral offset distances for which bumper trajectory plots indicate a potential for vehicle underride and override of a standard strong-post w-beam guardrail system. Considering the results from all studies, underride is possible for cases involving cars impacting 150-mm curbs placed in conjunction with a w-beam

guardrail when the barrier is offset at distances less than 1.1 m from the curb. The studies also suggests, however, that impact with a 100-mm curb placed in conjunction with a guardrail is not likely to result in underride.

At low encroachment angles (e.g., 5 degrees) onto the 150-mm curbs, the trajectory of the front bumper was such that its vertical position exceeded the height of a standard strong-post w-beam guardrail at offset distances as low as 0.5 m for all vehicle types. As the impact angle increased, so did the lateral distance behind the curb for which the bumper trajectory was sufficient to override a guardrail. For example, computer simulations of the pickup truck traversing curbs at 100 km/hr and 25 degrees indicated that the vertical component of trajectory of the front bumper exceeded the height of a standard guardrail for offset distances as great as 7.0 m. Based on bumper trajectory data of vehicles traversing curbs, override of a strong-post w-beam guardrail is probable for all curb-guardrail cases involving 150-mm curbs when the barrier is placed between 0.5 and 7.0 m behind the curb for the range of impact conditions investigated. The potential for override is less for 100-mm curbs, however, pickup trucks crossing the curbs may vault over a guardrail that is positioned at 0.6 - 7.0 m behind the curb.

The curb traversal studies indicate that the most appropriate placement of curbs with respect to guardrail is to place the curb underneath the guardrail behind the face of the w-beam.

Table 7.1: Summary of curb tracking results from various studies

Curb Height	Vehicle Type	Curb Types	Impact Conditions		Results		Curb-barrier offset dist.	
			Angles (deg)	Speeds (km/hr)	Max Roll (deg)	Max Pitch (deg)	Underride (m)	Override (m)
150 mm	817-kg car ¹	AASHTO I and Lip curb	5, 12.5, 20	72, 80 and 89	12.4	1.8	< 1.1	0.5 - 3.0
	1905-kg sedan ²	AASHTO B and D	5, 10, 12.5, 20	48, 72, 97 and 121	13.0	3.0	< 0.6	0.9 - 3.6
	2043-kg LTD ³	AASHTO I and Lip curb	5, 12.5, 20	72, 80 and 89	11.0	2.0	< 0.9	0.6 - 3.7
	2000-kg pickup	AASHTO A, B and D	5, 15, 25	70 and 100	7.6	3.3	Underride not likely	0.5 - 7.0
100 mm	817-kg car ¹	Lip curb	5, 12.5, 20	72, 80 and 89	8.1	1.6	Underride not likely	Override not likely
	1905-kg sedan ²	AASHTO G	5, 10, 12.5, 20	48, 72, 97 and 121	7.0	1.0	Underride not likely	Override not likely
	2043-kg LTD ³	Lip curb	5, 12.5, 20	72, 80 and 89	7.9	0.7	Underride not likely	Override not likely
	2000-kg pickup	AASHTO C, G and New	5, 15, 25	70 and 100	6.0	2.7	Underride not likely	0.6 - 7.0

¹Holloway *et al.* study (25)

²Olsen *et al.* study (22)

³Holloway *et al.* study (25)

7.2.3 *Non-Tracking Impact*

The analysis of non-tracking impacts was beyond the scope of research in this dissertation, however, there were a few studies identified in the literature review that addressed this issue using analytical methods, computer simulation and full-scale tests.(25)(33)(34). Holloway *et al.* used the HVOSM computer program to simulate non-tracking impacts of both a small car (e.g., 817 kg) and a large car (e.g., 2043 kg) with a 100-mm lip curb, 150-mm lip curb and the AASHTO type I curb.(25) They found that these curbs may be traversable over a wide range of vehicle orientations and impact conditions and that they pose little threat of vehicle rollovers during impact, however, their models were not validated with test results for those types of impact conditions.

Copperrider *et al.* used full-scale tests to investigate the rollover propensity of a wide range of vehicle types tripped by either a 150-mm curb or by soil.(33) Their tests involved towing the vehicles sideways and releasing them just prior to impact with the curb or soil. They found that the duration of contact between the tires and the tripping mechanism (e.g., curb or soil) was the most influential factor affecting vehicle rollover. Although curb impacts resulted in much higher decelerations, the peak angular velocities were very similar in both the curb trip tests and the soil trip tests. Consequently, both are likely to result in vehicle rollover.

Based on the results found in these studies it is difficult to discern whether or not curbs are of any greater hazard than a simple soil and sod roadside. A more direct method of

testing or simulating non-tracking impacts of vehicles with curbs and of vehicles with soil-and-sod needs to be undertaken. Realistic vehicle maneuvers representing more probable impact orientations should also be used in such a test/simulation program.

7.3 Curb-Guardrail Tests and Simulation Results

The conclusions presented in the previous section regarding vehicle override and underride of guardrail barriers were estimated based on the trajectory of the front bumper of vehicles traversing curbs. Another factor that must be considered in such an event is the interaction of the vehicle with the barrier. The results of full-scale crash tests and finite element simulations demonstrate that vehicle impact with curb-guardrail systems will result in more severe impact conditions, and thus poorer performance of the guardrail, than would be the case if a curb were not present. Crash tests and computer analyses have been conducted in which the curb was placed underneath the rail behind the face of the w-beam to minimize the potential for a vehicle to strike the curb. The general outcome in those cases included excessive vertical trajectory of the vehicle and significant damage to the guardrail.

Table 2.5 in the literature review presented a summary of full-scale crash test results of curb-guardrail combinations where curbs were located behind the face of the w-beam of various strong-post guardrail systems. Table 2.5 is repeated here as table 7.2 for convenience. The impact speed in those tests ranged from 96.1 km/hr to 103.2 km/hr and impact angles ranged from 20 degrees to 28.6 degrees. The guardrail safely contained and

Table 7.2: Summary of full-scale crash tests of curb-guardrail combinations with curb located behind face of guardrail

Literature Reference	Testing Agency	Test No.	Vehicle Type	Speed and Angle	Curb Type	Guardrail Type	Result	Comment
Holloway <i>et al.</i> (26)	MwRSF	M06C-1	1985 Ford LTD (2041 kg)	96.1 km/hr 25.1 degrees	152 mm vertical curb	G4(1S)	Passed	smoothly redirected
Bryden and Phillips (27)	NYDOT		Dodge Station Wagon (2041 kg)	100 km/hr 26 degrees	152 mm vertical curb	Thrie-Beam Bridge Rail	Passed	smoothly redirected
FHWA Memorandum Feb 1992 (28)	ENSCO	1862-1-88	3/4-ton Pickup Truck (2449 kg)	100 km/hr 20 degrees	203 mm AASHTO A	G4(1S)	Failed	vehicle vaulted over rail
		1862-4-89	Small Car (820 kg)	100 km/hr 20 degrees	152 mm Asphalt Dike	G4(1S)	Passed	smoothly redirected
		1862-5-89	Large Car Sedan (2041 kg)	100 km/hr 25 degrees	152 mm Asphalt Dike	G4(1S)	Failed	vehicle vaulted over rail
		1862-12-90	Large Car Sedan (2449 kg)	100 km/hr 25 degrees	100 mm AASHTO G	G4(1S)	Passed	vehicle was airborne but did not vault
		1862-13-91	Large Car Sedan (2041 kg)	100 km/hr 25 degrees	152 mm Asphalt Dike	G4(1S) stiffened with w-beam	Passed	
		1862-14-91	Large Car Sedan (2041 kg)	100 km/hr 25 degrees	152 mm Asphalt Dike	G4(1S) stiffened with rub rail	Failed	vehicle speed change at redirection was too high
Polivka, <i>et al.</i> (29)	MwRSF	NEC-1	1991 GMC 3/4-ton Pickup (2,000 kg)	103.2 km/hr 24.5 degrees	102 mm AASHTO G	G4(1S)-mod with wood blockout	Failed	Excessive anchor movement / Guardrail ruptured
Polivka <i>et al.</i> (30)	MwRSF	NEC-2	1994 GMC 3/4-ton Pickup (2,000 kg)	100.3 km/hr 28.6 degrees	102 mm AASHTO G	G4(1S)-mod with wood blockout nested w-beam	Passed	vehicle experienced extreme trajectory but did not vault over rail
Bullard and Menges (32)	TTI	404201-1	1995 Chevrolet 3/4-ton Pickup (2000 kg)	101.8 km/hr 25.2 degrees	100 mm CDOT curb	G4(2W)	Passed	Significant guardrail damage and anchor movement

redirected the vehicle in cases where the wheels of the vehicle did not mount the curb during impact. Those tests were primarily limited to small cars as test vehicles, however, some cases involving large car sedans were also successful when vertical curbs were used or when the guardrail was stiffened. Four full-scale tests were conducted using 3/4-ton pickup trucks. In each of those tests the tires of the vehicle mounted the curb during impact and resulted in either excessive vertical trajectory of the vehicle or significant damage to the guardrail. Two of those tests did not satisfy safety requirements while two other tests were successful. The failure in one case was due to barrier override and in another case guardrail rupture was the cause of failure. The two successful tests were: 1) MwRSF Test NEC-2 which involved a 102-mm curb placed underneath a modified G4(1S) with wood blockouts and stiffened with nested w-beams and 2) TTI test 404201-1 which involved a 100-mm curb placed underneath the G4(2W) guardrail. The repeatability of those tests, however, are questionable due to the excessive vertical trajectory of the vehicle during impact in test NEC-2 and the excessive damage to the guardrail in test 404201-1 (refer to figures 2.8 and 2.11).

The analyses conducted in the current research involved the use of finite element simulation to investigate the response of a 3/4-ton pickup truck impacting curb-barrier systems in which the modified G4(1S) guardrail with wood blockouts was positioned at 0-m, 2.5-m and 4.0-m offset distances from curbs. The curbs used in the study had heights of 100 mm and 150 mm. The backfill area behind the curbs was modeled with rigid elements using a dynamic coefficient of friction of 0.82 between the tires of the

vehicle and the ground surface. It should be noted that the interaction between the tires and ground in these analyses may not accurately represent cases where a backfill material is composed primarily of soft soil. The impact angle was 25 degrees in all simulations and impact speeds of 70 km/hr, 85 km/hr and 100 km/hr were investigated (refer to table 6.8 for summary of results).

The results of the pickup truck impacting the curb-barrier combination at 0-m offset distance (i.e., curbs under the face of the barrier) at speeds of 70 km/hr and 85 km/hr indicate that the vehicle would remain stable throughout the impact event and that barrier damage would be minimal regardless of the type of curb used. The bumper of the pickup was above the rail during redirection in one of the cases involving the 150-mm AASHTO type D curb, but the potential for override of the barrier was considered minimal (refer to the figures in Appendix VIII).

At the higher impact speed of 100 km/hr the analyses provided mixed conclusions. In one case involving the 100 mm high AASHTO type C curb the vehicle vaulted over the guardrail, whereas vaulting was not a serious issue in the other cases. The difference in this particular case was attributed to a wheel snag against a blockout early in the impact event which affected the way the vehicle interacted with the barrier throughout the remainder of the event. Wheel snag is common in impacts with strong-post w-beam guardrails and similar results are possible for cases involving any of the curb types. It was also concluded that vehicle stability may be an issue during redirection due to the

high pitch angles of the vehicle when exiting the system. Furthermore, the tensile forces in the w-beam were high during impact indicating potential for rail rupture at the splice connections, especially for the cases involving the 150-mm curbs. The most promising combination involved the 100-mm New York curb. This combination resulted in safe redirection of the vehicle although the tensile forces in the rail were somewhat high.

The results of the finite element analyses regarding high speed impact indicated that the roll angle and pitch angle of the vehicle after traversing curbs had a significant influence on the kinematics of the vehicle during impact with the guardrail for cases involving offset distances of 2.5 m and 4.0 m. The potential for override was increased when the roll angle of the vehicle was positive (e.g., roll away from the barrier) at the time of impact with the guardrail. When the roll angle of the vehicle was negative (e.g., roll toward the barrier) at the time of impact with the guardrail, rollover became a likely outcome.

At impact speeds of 70 km/hr into curb-guardrail systems at offset distances of 2.5 and 4.0 m there was very little probability of barrier override, however, occupant ride down accelerations during redirection was relatively high and in one case involving the 100-mm AASHTO type G curb the longitudinal occupant ride down accelerations exceeded the maximum value of 20 G's allowed in NCHRP Report 350. At the intermediate speed of 85 km/hr the results from the finite element simulations indicated that there is potential for a pickup truck to override a standard strong-post w-beam guardrail that is located at

2.5-m offset distance from both 150-mm and 100-mm curbs. At an offset distance of 4 m from curb to barrier the guardrail redirected the vehicle at an impact speed of 85 km/hr. The occupant ride down accelerations of the vehicle during redirection was considered high and the analysis involving the AASHTO type B curb resulted in excessive occupant ridedown accelerations (i.e., greater than 20 G's).

7.4 Summary

Regarding high-speed roadways with operating speeds greater than 85 km/hr, the curb-guardrail impact studies indicate that installing curbs in combination with strong-post w-beam guardrails is risky. However, if there are no other alternatives, a low profile curb similar to the 100-mm New York curb should be used and it must be placed underneath the guardrail behind the face of the rail element (e.g., w-beam, thrie-beam, etc.). It may also be necessary to strengthen the rail to prevent rupture due to increased tensile forces in the w-beam during impact with such a system. One method of strengthening the rail that was documented in the literature involved nesting w-beam rail elements, however, it is important to note that this may adversely affect the strength of the rail-to-post connection. Another method documented in the literature involved using thrie-beam guardrail systems installed in conjunction with a curb. This worked well for high speed impact with a large car sedan but it has never been tested with a pickup truck – to the knowledge of the author. Other methods of strengthening the guardrail that have proven successful in full-scale crash tests include attaching a rail element to the back of the posts or installing a rub rail.

Regarding low- to moderate-speed roadways with operating speeds less than 80 km/hr curb-guardrail combinations involving curb heights of 150 mm or less with the curbs placed underneath the guardrail behind the face of the w-beam were considered safe and effective. There is potential for a pickup truck to override a standard strong-post w-beam guardrail that is located at 2.5-m offset distance from both 150-mm and 100-mm curbs for impact speeds of 85 km/hr, however, the guardrail redirected the vehicle at offset distances of 4 m. Also, according to the results of the finite element simulations occupant risk increases due to higher ridedown accelerations when the guardrail is offset from the curb and in many cases the occupant ridedown accelerations exceeded the allowable limit of 20 G's.

VIII. GUIDELINES

8.1 Introduction

The guidelines for the use and installation of curbs and curb-barrier combinations presented in this chapter are based on a synthesis of the research conducted in this study and on information from prior studies documented in the literature review in chapter 2.

8.2 Guidelines for Using Curbs on High-Speed Roadways

The use of curbs on roadways with operating speeds greater than 80 km/hr are discouraged, and alternative means should be considered for providing basic curb functions along the roadside such as drainage control and delineation. Curbs constitute a discontinuity along the roadside that may lead to loss of control of a vehicle under certain impact conditions.

Tracking impacts with curbs are not likely to result in serious injury unless a secondary object is struck behind the curb. When a vehicle leaves the roadway in a non-tracking manner, however, wheel contact with a curb could cause the vehicle to trip and overturn. Even so, based on the results of various studies identified in the literature review, it is difficult to discern whether or not curbs are of any greater hazard than a simple soil-and-sod roadside. Vehicle rollover is believed to occur in only a very small percentage of all curb related accidents, however, the severity of rollovers (e.g., which often result in fatalities) warrants a more in depth analysis of curb design. The analysis of non-tracking impacts with curbs will be addressed in future work in NCHRP Project 22-17.

The following guidelines should be considered tentative until the hazards associated with curbs can be more clearly defined.

For roadways with operating speeds greater than 60 km/hr it is recommended that curb heights should not exceed 100 mm and that the slope of the curb face be 1:3 or flatter so that vehicle accelerations will be minimized while traversing the curb. However, the results of the curb impact study presented in this dissertation, as well as the prior studies identified in the literature review, indicate that curbs with heights 150 mm or less, regardless of the slope of the curb face, pose no significant hazard to encroaching vehicles unless there are secondary objects for the vehicle to encounter in the area behind the curb. The only objects within the clear zone along the roadside should be those that satisfy the safety requirements of NCHRP Report 350. If the secondary object is a guardrail then refer to section 8.3 below to identify proper curb type and placement. When other roadside devices, such as road signs and breakaway poles, are to be used with curbs they should be located as far from traffic as possible. If extensive use of a particular roadside device is to be used with curbing, then computer simulation or full-scale crash testing should be used to ensure that there are no undue hazards associated with such a combination.

8.3 Guidelines for Using Curb-Barrier Combinations on High-Speed Roadways

When curbs are used in conjunction with a roadside safety barrier, the barrier must have adequate strength performance in order to resist excessive lateral dynamic deflections,

thus minimizing the risk of a vehicle mounting the curb during impact. The barrier system should, at a minimum, have the strength performance of a strong-post guardrail system such as the modified G4(1S) with wood blockouts, the G4(2W), a three-beam guardrail system or similar.

8.3.1 Moderate-Speed Roadways (60 - 80 km/hr)

Any type of sloping curb similar to those listed in the AASHTO Green Book (refer to Figure 1.1) with heights equal to or less than 150 mm placed underneath the guardrail behind the face of the rail element can be used safely in combination with strong-post guardrail systems along roadways with operating speeds of 60 to 80 km/hr.

The most desirable location for curb placement is underneath the guardrail behind the face of the rail element, however, along roadways with operating speeds of 70 km/hr or less the barrier may be positioned at a lateral offset distance of 2.5 m or greater behind the curb for curbs with a height of 150 mm or less. When it is necessary to offset a guardrail behind a curb along roadways with operating speeds ranging from 70 km/hr to 80 km/hr, the curb may be placed underneath the guardrail behind the face of the rail element or the barrier must be positioned at a lateral offset distance of 4.0 m or greater behind a curb and the curb height must not exceed 100 mm.

8.3.2 High-Speed Roadways (over 80 km/hr)

The barrier should not be offset from a curb when curb-barrier combinations are used on

roadways with operating speeds greater than 80 km/hr and, further, the use of curbs are discouraged along high-speed roadways with operating speeds greater than 85 km/hr.

When operating speeds are between 80 and 85 km/hr any type of sloping curb similar to those listed in the AASHTO Green Book with heights equal to or less than 150 mm can be used safely with strong-post guardrail systems with the curb placed underneath the guardrail behind the face of the rail element.

When operating speeds are between 85 and 100 km/hr it may be hazardous to install curbs in combination with roadside safety barriers, however, if a curb-barrier system is warranted, the curb should be no higher than 100 mm above the road surface with the curb face having a slope of 1:3 or flatter. It is also recommended that the modified G4(1S) guardrail with wood blockouts not be used unless it is properly modified to increase tensile capacity of the rail element in order to prevent guardrail rupture.

When operating speeds are in excess of 100 km/hr curbs should not be used in combination with roadside safety barriers and other means should be sought to carry out the primary functions of the curb.

A summary of the design guidelines for the use of curb-guardrail combinations along roadways with operating speeds greater than 60 km/hr is presented below in Table 8.1 and in Figure 8.1. The offset distance parameter in Figure 8.1 represents the lateral

distance measured from the face of the curb to the face of the guardrail. An offset distance of zero or less in the figure indicates that the curb face should be positioned at or behind the face of the guardrail barrier.

Table 8.1: Design guidelines for the use of curbs along roadways with operating speeds greater than 60 km/hr.

Operating Speed (km/hr)	Sloped Curb Types	Curb-Barrier Placement
60 - 70	150-mm or smaller	under guardrail behind rail element
	150-mm or smaller	barrier should be offset 2.5 m or greater from curb
70 - 80	150-mm or smaller	under guardrail behind rail element
	100-mm or smaller	barrier should be offset 4 m or greater from curb
80 - 85	150-mm or smaller	under guardrail behind rail element
85 - 90	100-mm or smaller	under guardrail behind rail element
90 - 100	100-mm or smaller with slope of curb face 1:3 or flatter	under guardrail [‡] behind rail element
> 100	Curbs should not be used in combination with safety barriers	

[‡] The G4(1S) guardrail with wood blockouts should not be used unless it is properly modified to increase tensile capacity of the rail element (**REF**)

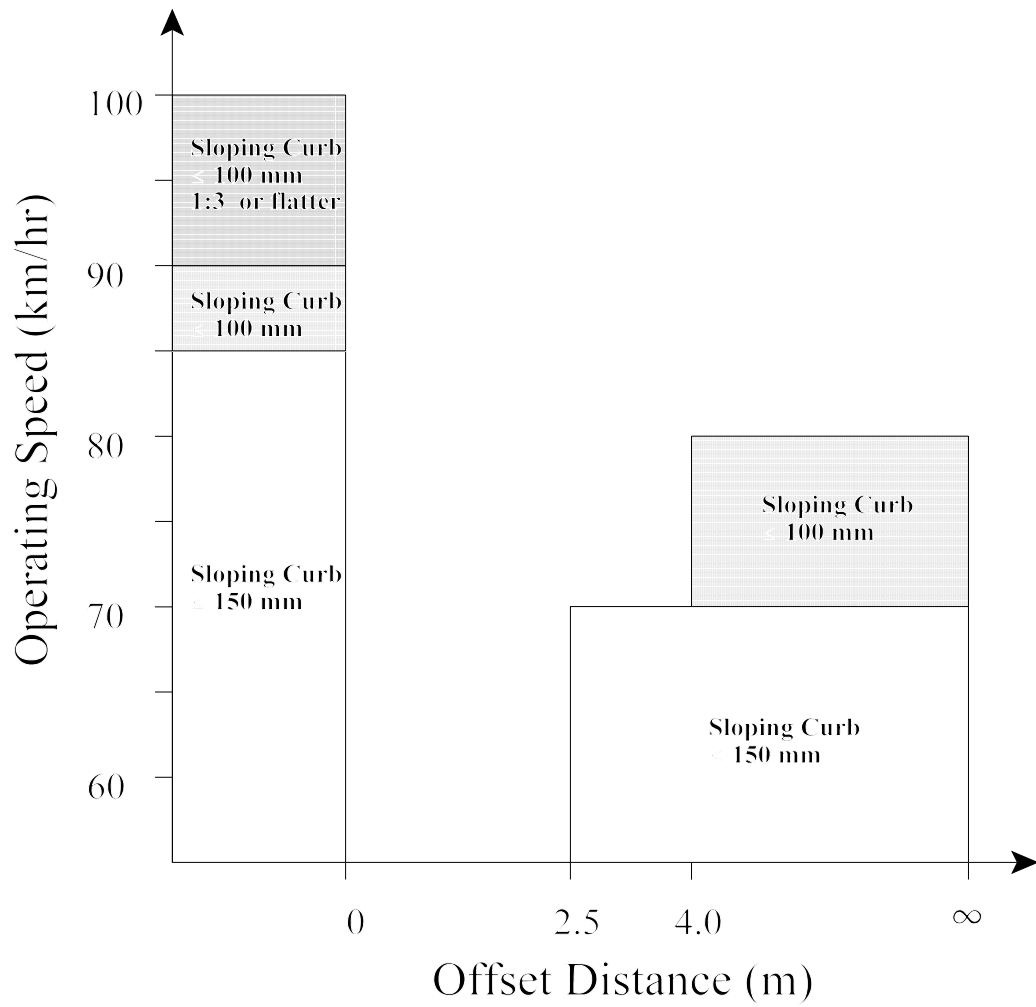

Figure 8.1: Chart illustrating the design guidelines for the use of curbs along roadways with operating speeds greater than 60 km/hr.

IX. SUMMARY AND CONCLUSIONS

9.1 Introduction

The results of the studies identified in the literature and the results of the parametric analyses conducted in this research were synthesized in order to develop a general set of guidelines for the design and installation of curbs and curb-barrier systems along roadways with operating speeds greater than 60 km/hr. The guidelines are based on the results of both computer simulation and full-scale crash tests. The study involved the analysis of vehicles traversing several commonly used curb types under a variety of impact conditions, as well as, the analysis of vehicle impact into various curb-guardrail combinations. The research presented herein identified common types of curbs that could be used safely and effectively on high-speed roadways and also identified the proper combination and placement of curbs and barriers that would allow the traffic barriers to be effective, i.e. safely contain and redirect an impacting vehicle.

9.2 Summary of Previous Research Studies

An in-depth review of published literature was conducted in order to identify information pertinent to the design, safety and function of curbs and curb/barrier combinations. The studies that were found in the literature used a variety of vehicle types including small cars, large cars and pickup trucks. It was found that both the large and small cars crossing curbs less than 150 mm high in a tracking manner are not likely to cause the driver to lose control of the vehicle or cause the vehicle to become unstable, unless a secondary impact occurs. The dynamic response of a pickup truck crossing over curbs, however,

had never been evaluated in previous studies with either full-scale tests or computer simulation and was thus unknown.

Errant vehicles leave the roadway in a variety of orientations, however, it is assumed that the majority of these vehicles encroach onto the roadside in a semi-controlled tracking manner. In such cases, the left or right front bumper would be the first point of contact with a roadside object in an impact event. The position of the bumper upon impact has, therefore, been a primary concern involving impacts with longitudinal traffic barriers, where it has been assumed that the position of the bumper during impact is a reasonable indicator of vehicle vaulting or underriding the barrier.

The conclusions from these earlier tests and analyses were in general agreement that curbs in front of the guardrail could cause vaulting. If curbs were required for drainage purposes the only alternative was to place the curb behind the face of the barrier. This arrangement shields the curb from the impact while allowing the curb to channel runoff water from the roadway. The idea was to locate the curb such that minimal interaction between the vehicle and curb occurred. This worked well with lighter vehicles such as the 820-kg small car, but did not prevent vehicle-curb interaction for the larger cars which have a mass of over 2000 kg, unless the guardrail was retrofit in some manner to strengthen it and minimize guardrail deflection. To circumvent the problem, one option that was considered was to use a low profile curb underneath the guardrail in order to minimize the effects that the curb would have on vehicle trajectory if the wheels of the

vehicle managed to make contact with the curb during impact.

Tests were conducted by various organizations in which a low profile curb was placed behind the face of the guardrail. This design proved successful in tests with the larger cars, while tests involving pickup trucks resulted in success in some cases and failure in others. In cases where the test was a failure, it was not clear whether the failure was induced by vehicle-curb interaction or if it was simply caused by inadequate barrier performance. It was apparent, however, that curb-barrier systems pose a much greater hazard to pickup trucks in high-speed impacts than they do to cars, and also that much more information regarding pickup impact into curb-barrier systems was warranted.

9.3 Summary of Current Research

Finite element analysis was used in this research to conduct a parametric investigation involving a 2000-kg pickup truck impacting various curbs and curb-barrier combinations to determine which types of curbs are safe to use on high-speed roadways and to determine proper placement of a barrier with respect to curbing such that the barrier remains effective in safely containing and redirecting an impacting vehicle. The curb types used in the study included the 150-mm AASHTO type A, the 150-mm AASHTO type B, the 150-mm AASHTO type D, the 100-mm AASHTO type C, the 100-mm AASHTO type G and the 100-mm New York curb. The longitudinal safety barrier used in the study was the modified G4(1S) guardrail with wood blockouts, which is one of the most widely used guardrails in the U.S.

Each component of the guardrail model was validated both quantitatively and qualitatively with laboratory tests, with the exception of the anchor system for which no test data was available. The modified NCAC C2500R (reduced element) pickup truck model (i.e., model with modifications made to the suspension system by WPI) was used to simulate the impact of a 2000-kg pickup truck. The NCAC C2500R model has been widely used in previous studies to analyze vehicle impact into roadside barriers and therefore the model has been generally debugged.

The accuracy of the models' results were quantified prior to being used in this study. The models were first used to simulate a 2000-kg pickup impacting the modified G4(1S) guardrail at 100 km/hr at an angle of 25 degrees. The results were validated by comparing them to results obtained from a full-scale crash test documented in the literature, and it was concluded that the models provide realistic behavior of both the guardrail and vehicle in such an impact event.

The validated models were then used in a parametric analysis to investigate the effects of various curb types in tracking impacts with a 2000-kg pickup truck on the stability and trajectory of the vehicle during simple curb traversals. The parametric analysis involved six curb types (i.e., AASHTO types A, B, C, D and G and the 100-mm New York curb), two impact speeds (i.e., 70 and 100 km/hr) and three impact angles (i.e., 5, 15 and 25 degrees).

The models were also used in a parametric study to investigate the crashworthiness of curb-barrier combinations in tracking impacts with the 2000-kg pickup truck. The parametric analysis involved the modified NCAC C2500R pickup truck model impacting the modified G4(1S) guardrail model at impact speeds of 70, 85 and 100 km/hr, at an impact angle of 25 degrees and at offset distances from curb to barrier of 0, 2.5 and 4 m.

The results of the curb traversal study indicated that the stability of the pickup truck would not be compromised in tracking impacts, however, the trajectory of the front bumper was sufficient to imply a risk of barrier override when a standard strong-post guardrail is placed anywhere from 0.5 m to 7.0 m behind 150 mm high curbs or 0.6 m to 7.0 m behind 100 mm high curbs.

The finite element results of the pickup truck model impacting various curb-guardrail combinations confirmed that the presence of curbs are potentially hazardous. The results of the parametric study were used to identify certain combinations that were more likely to result in acceptable, as well as, unacceptable barrier performance, and a table defining proper curb type and barrier placement was presented. It should be noted that even those cases that were identified as being successful resulted in poorer performance of the guardrail and a higher risk of injury for the occupants of the vehicle than was the case when the curb was not present.

9.4 Future Research

While the foregoing dissertation provided a considerable amount of information regarding the effects of curbs along high-speed roadways there is still a great deal of information needed in order to develop a more complete set of guidelines for the use and installation of curbs. The issue of non-tracking impacts with curbs needs further attention, full-scale tests are needed to confirm computer simulation predictions and an in depth review of crash data bases is needed to develop a more clear understanding of extent of the curb related safety problem in the real world.

Finite element analysis is one method that may be useful in the study of non-tracking impacts with curbs. The lack of detail in the model of the wheel assembly on the vehicle models, however, may greatly affect the accuracy of their results in simulating the response of lateral loading on the wheels (e.g., failure of wheel assembly components) during non-tracking impacts. It is therefore recommended that full-scale testing be used to investigate such an event, however, it is realized that conducting full-scale non-tracking tests under impact conditions representing real life conditions are difficult to achieve without the aid of a live driver.

The advantage of full-scale crash tests is that they are actual physical impact events where there is little ambiguity about the results. The disadvantage is that they are costly, and it is seldom feasible to perform very many tests so the testing results usually do not address a very wide range of conditions. Some full-scale tests should be conducted to

validate the results of the computer simulation analyses. For example, select cases of curb-barrier systems identified in the computer simulation study for which failure or success of the system would be expected, should be crash tested in order to verify the computer predictions. If the full-scale tests confirm that the computer simulation results are accurate then the results of the many computer simulated impacts in the parametric analysis can be considered a reasonable estimate of performance of the various curb-barrier systems and, thus, would strengthen the conclusions made in this dissertation.

Currently, as part of NCHRP project 22-17, researchers at Bellomo-McGee, Inc. are conducting a study of existing crash/geometric databases in order to characterize the extent and severity of safety problems associated with curb and curb-barrier combinations on high-speeds roadways. That study is almost complete and when the final results are available they will be incorporated with the current data which will further aid in the development of the design guidelines being developed by researchers at Worcester Polytechnic Institute for NCHRP Project 22-17.

X. REFERENCES

1. AASHTO, A Policy on Geometric Design of Highways and Streets, American Association of State Highway and Transportation Officials, Washington, D.C. (2001).
2. AASHTO, Roadside Design Guide, American Association of State Highway and Transportation Officials, Washington, D.C. (1996).
3. FHWA, Design Construction and Maintenance of Highway Safety Features and Appurtenances, Federal Highway Administration, Publication No. FHWA-HI-97-026, Washington, D.C. (1997).
4. IA DOT, Design Manual, Iowa Department of Transportation, Ames, IA (1999).
5. Beaton, J.L., and H. Peterson, "A Report on Dynamic Testing of Various Designs of Highway Bridge Curbing – Roadway Barrier Curb Investigation," California Division of Highways (December 1953).
6. Bronstad, M.E., M.H. Ray, J.B. Mayer, Jr., and C.F. McDevitt, "Guardrail-Bridge Rail Transition Evaluations," *Transportation Research Record No. 1133*, Transportation Research Board, Washington, D.C. (1987).
7. Ray, M.H. and R.G. McGinnis, Guardrail and Median Barrier Crashworthiness, *National Cooperative Highway Research Program Synthesis Report No. 244*, Transportation Research Board, Washington, D.C. (1994).
8. Field, R.N. and J.L. Beaton, "Final Report of Full-Scale Dynamic Tests of Bridge Curbs and Rails," California Division of Highways (December 1957).
9. Henault, G.G. and H. Perron, "Research and Development of a Guide Rail System for a High-Speed Elevated Expressway," *Highway Research Record No. 152*, Highway Research Board (1966).
10. Elsholz, J., "Test Concerning the Turn-Away Effect of Curb Stones," *Strasse und Autobahn*, Vol. 19, No. 4 (April 1968).
11. Jehu, V.J., "Safety Fences and Kerbs," *Traffic Engineering and Control*, Vol. 5, No. 9 (January 1964).
12. Dunlap, D.F., "Barrier-Curb Redirection Effectiveness," *Highway Research Record No. 340*, Highway Research Board, Washington, D.C. (1973).

13. Hutchinson, J.W. and T.W. Kennedy, "Safety Considerations In Median Design," Highway Research Record 162 (1966).
14. Navin, F.P.D. and R. Thomson. "Safety and Roadside Curbs," Society of Automotive Engineers, Inc., SAE Paper No. 970964, pp. 365-370 (1997).
15. McHenry, R.R. and N.J. DeLeys, "Determination of Physical Criteria for Roadside Energy Conservation Systems," Report No. VJ-2251-V-1, Cornell Aeronautical Laboratory, Inc. (July 1967).
16. Zobel, E.C., D.F. Dunlap, I.W. Kay, J.J. Blass, P Grote, and K.M. Fram, "Investigation of the Dynamic Impact on Roadside Obstacles – Final Report," College of Engineering, Wayne State University, Detroit, MI (1972).
17. McHenry, R.R. and N.J. DeLeys, "Vehicle Dynamics in Single-Vehicle Accidents – Validation and Extension of a Computer Simulation," Report No. VJ-2251-V-3, Cornell Aeronautical Laboratory, Inc. (December 1968).
18. Paniati, J.F. and J. True, "Interactive Highway Safety Design Model (IHSDM): Designing Highways with Safety in Mind," *Transportation Research Circular No. 453* (February 1996).
19. *Highway Research Circular 482: Proposed Full-Scale Testing Procedures for Guardrails*, Committee on Guardrail and Guide Posts, Highway Research Board, Washington, D.C. (September 1962).
20. Ross, H.E., D.L. Sicking, and H.S. Perrara, "Recommended Procedures for the Safety Performance Evaluation of Highway Appurtenances," *National Cooperative Highway Research Program Report No. 350*, National Academy of Sciences, Washington, D.C (1993).
21. Michie, J.D., "Recommended Procedures for the Safety Performance Evaluation of Highway Appurtenances," *National Cooperative Highway Research Program Report No. 230*, Transportation Research Board, Washington, D.C. (March 1981).
22. Olson, R.M., G.D. Weaver, H.E. Ross, Jr. and E.R. Post, "Effect of Curb Geometry and Location on Vehicle Behavior," *National Cooperative Highway Research Program (NCHRP) Report 150*, Transportation Research Board, Washington, D.C. (1974).
23. Dunlap, D.F., "Curb Vaulting Evaluation," Highway Research Record No. 340, Highway Research Board, Washington, D.C. (1973).

24. Ross, H.E., E.R. Post, "Dynamic Behavior of an Automobile Traversing Selected Curbs and Medians," Research Report 140-6, Texas Transportation Institute, Texas A&M University, College Station, Texas (January 1975).
25. Holloway, J.D., D.L. Sicking and B.T. Rossen, "Performance Evaluation of NDOR Mountable Curbs," *Transportation Report No. TRP-03-37-94* (Final Report), Midwest Roadside Safety Facility, University of Nebraska-Lincoln (June 1994).
26. Holloway, J.C. and B.T. Rosson, "Performance Evaluation of Missouri's 6-inch Barrier Curb Under W-Beam Guardrail," Final Report to the Missouri Highway and Transportation Department, *Transportation Report No. TRP-03-40-94*, Midwest Roadside Safety Facility, University of Nebraska-Lincoln (April 1994).
27. Bryden, J.E. and R.G. Phillips, "Performance of a Thrie-Beam Steel-Post Bridge-Rail System," New York Department of Transportation, Engineering Research & Development Bur, *Transportation Research Record 1024*, pp.18-27 (1985).
28. "Memorandum on Performance of Guardrail/Curb Combinations," February 28, 1992, File Designation HNG-14, Federal Highway Administration (FHWA), Washington, D.C. (1992).
29. Polivka, K.A., R.K. Faller, D.L. Sicking, J.R. Rhode, J.D. Reid and J.C. Holloway, "Guardrail and Guardrail Terminals Installed Over Curbs," *MwRSF Research Report No. TRP-03-83-99*, Midwest Roadside Safety Facility, University of Nebraska-Lincoln (September 23, 1999).
30. Polivka, K.A., R.K. Faller, D.L. Sicking, J.R. Rhode, J.D. Reid and J.C. Holloway, "Guardrail and Guardrail Terminals Installed Over Curbs – Phase II," *MwRSF Research Report No. TRP-03-105-00*, Midwest Roadside Safety Facility, University of Nebraska-Lincoln (November 5, 2001).
31. Buth, E. *et al*, "Safer Bridge Railings," *Report FHWA-RD-82-072*, Federal Highway Administration, Washington, D.C. (1984).
32. Bullard, D.L. and W.L. Menges, "NCHRP Report 350 Test 3-11 on the G4(2W)Strong Post W.-Beam Guardrail with 100 mm High Asphaltic Curb," *Report No. FHWA-RD-00*, Federal Highway Administration, Washington, D.C. (June 2000).
33. Cooperrider, N.K., T.M. Thomas and S.A. Hammoud, "Testing and Analysis of Vehicle Rollover Behavior: Accident Reconstruction: Human, Vehicle and Environmental Factors," *SAE Engineers International Congress & Exposition, SAE SP-90-814*, pp.125-134, Society of Automotive Engineers (1990).

34. Deleys, N.J. and C.P. Brinkman, "Rollover Potential of Vehicles on Embankments, Sideslopes, and Other Roadside Features," *SAE Paper 870234*, Society of Automotive Engineers, Warrendale, PA, pp.149-158 (1987).
35. Allen, R.W., H. Szostak, and T.J. Rosenthal, D.H. Klyde, and K.J. Owens, "Characteristics Influencing Ground Vehicle Lateral/Directional Dynamic Stability," *SAE Paper 910234*, Society of Automotive Engineers, Warrendale, PA pp.23-48 (1991).
36. Allen, R.W., T.J. Rosenthal, and J.P. Chrstos, "A Vehicle Dynamics Tire Model for Both Pavement and Off-Road Conditions," *SAE Paper 970559*, Society of Automotive Engineers, Warrendale, PA (1997).
37. Allen, R.W., T.J. Rosenthal, D.H. Klyde and J.P. Chrstos, "Vehicle and Tire Modeling for Dynamic Analysis and Real-Time Simulation," *SAE Paper 2000-01-1620*, Society of Automotive Engineers, Warrendale, PA, pp.1-22 (2000).
38. "Guide for Selecting, Locating, and Designing Traffic Barriers," American Association of State Highway and Transportation Officials (AASHTO) (1977).
39. Mak, K.K., R.P. Bligh and W.L. Menges, "Crash Testing and Evaluation of Existing Guardrail Systems." Texas Transportation Institute, *Test Report No. 471470-26*, The Texas A&M University, College Station, TX (December 1995).
40. Allen, R.W., H.T. Szostak and T.J. Rosenthal, "Steady State and Transient Analysis of Ground Vehicle Handling," *SAE Paper No. 870495* (February 1987).
41. Ray, M.H., K. Hiranmayee and S. Kirkpatrick, "Performance Validation of Two Side Impact Dummies," *International Journal of Crashworthiness*, Vol. 4 No. 3, Woodhead Publishing Limited, London, UK (1999).
42. LS-DYNA User's Manual Volumes 1 and 2 Version 960, Livermore Software Technology Corporation, Livermore, California (March 2001).
43. Basu, S. and A. Haghighi, "Numerical Analysis of Roadside Design (NARD) Volume III: Validation Procedure Manual," *Report No. FHWA-RD-88-213*, Federal Highway Administration (September 1988).
44. Ray, M.H., "Repeatability of Full-Scale Crash Tests and a Criteria for Validating Simulation Results," *Transportation Research Record 1528*, Transportation Research Board, Washington D.C. (1996).
45. Geers, T.L., "An Objective Error Message for the Comparison of Calculated and Measured Transient Response Histories," *The Shock and Vibration Bulletin* (June 1984).

46. Epperson, B., R. Bligh, and H. Ross, Test Risk Assessment Program (TRAP) Version 2.0: User's Manual, Texas Transportation Institute, College Station, TX (1999).
47. Plaxico, C.A. M.H. Ray, and K. Hiranmayee, "Comparison of the Impact Performance of the G4(1W) and G4(2W) Guardrail Systems Under NCHRP Report 350 Test 3-11 Conditions," *Transportation Research Record, Paper No. 00-0525*, Transportation Research Board, Washington, D.C. (2000).
48. Ray, M.H., "The Use of Finite Element Analysis in Roadside Hardware Design," *International Journal of Crashworthiness*, Vol. 3, No.4, Woodhead Publishing Co., London (1997).
49. Engstrand, K.E., "Improvements to the Weak-Post W-Beam Guardrail," Master's Thesis, Worcester Polytechnic Institute, Worcester, MA (Spring 2000).
50. Ray, M.H., C.A. Plaxico, and K.E. Engstrand, "Performance of W-Beam Splices," *Transportation Research Record 1743, Paper No. 01-2420*, Transportation Research Board, Washington D.C. (2001).
51. Ray, M.H., K.E. Engstrand, C.A. Plaxico, and R.G. McGinnis, "Improvements to the Weak-Post W-Beam Guardrail," *Transportation Research Record 1743, Paper No. 01-2282*, Transportation Research Board, Washington D.C. (2001).
52. Buth, E.C., W.W. Menges, and S.K. Schoeneman, "NCHRP Report 350 Test 3-11 on the Modified PennDOT Type 2 Guide Rail – Test 3," Texas Transportation Institute, Texas A&M University System, College Station, Texas (2000).
53. Buth, E.C., W.L. Menges, and S.K. Schoeneman, "NCHRP Report 350 Test 3-10 on the Modified PennDOT Type 2 Guide Rail – Test 3," Texas Transportation Institute, Texas A&M University System, College Station, Texas (2000).
54. Povlika, K.A., R.K. Faller, D.L. Sicking, J.R. Rhode, J.D. Reid, and J.C. Holloway, "Guardrail and Guardrail Terminals Installed Over Curbs," *MwRSF Research Report No. TRP-03-83-99*, Midwest Roadside Safety Facility, University of Nebraska-Lincoln (September 23, 1999).
55. "Traffic Safety Facts 1996," US Department of Transportation, National Highway Traffic Safety Administration, National Center for Statistics and Analysis (1996).
56. Mak, K.K., R. Bligh, and W. Menges, "Testing of State Roadside Safety Systems," *FHWA Contract DTFH61-89-C-00089, Research Study RF471470*, Texas Transportation Institute, College Station, Texas (1996).

57. Bullard, D., W. Menges, and D. Alberson, "NCHRP Report 350 Compliance Test 3-11 of the Modified G4(1S) Guardrail with Timber Blockouts," *FHWA Contract DTFH61-95-C-00090, Research Project 405421-1*, Texas Transportation Institute, College Station Texas (January 1996).
58. TrueGrid Manual version 2.0.0, XYZ Scientific Applications, Inc. (March 2000).
59. AASHTO-ARTBA-AGC, "A Guide to Standardized Highway Barrier Hardware," American Association of State Highway and Transportation Officials, Washington, D.C. (1995).
60. Wright, A. and M.H. Ray, "Characterizing Roadside hardware Materials for LS-DYNA Simulations," *Report No. FHWA-RD-96-108*, Federal Highway Administration (1996).
61. Hallquist, J.O., "LS-DYNA Theoretical Manual," Livermore Software Technology Corporation, Livermore, CA. (1998).
62. Jones, N., Structural Impact, Cambridge University Press (1989).
63. Calladine, C.R. and R.W. English, "Strain Rate and Inertia Effects in the Collapse of Two Types of Energy-Absorbing Structures," *International Journal of Mechanical Science*, Volume 26, No.11-12, pp. 689-701 (1984).
64. Plaxico, C.A., G.S. Patzner, and M.H. Ray, "Finite Element Modeling of Guardrail Timber Posts and the Post-Soil Interaction," *Transportation Research Record, Paper No. 980791*, Transportation Research Board, Washington, D.C. (1998).
65. Patzner, G.S., C.A. Plaxico, and M.H. Ray, "Effect of Post and Soil Strength on the Performance of the Modified Eccentric Loader Breakaway cable Terminal," *Transportation Research Record, Paper No. 990046*, Transportation Research Board, Washington, D.C. (1999).
66. Tabiei, A. and J. Wu, "Evaluation of a G4 Strong-Post W-Beam Gurardrail for Truck Rollover and Snagging Using Finite Element Simulation," *Research Report*, The University of Cincinnati, Dept. of Aerospace Engineering and Engineering Mechanics, Cincinnati, OH (January 2000).
67. Coon, B.A., J.D. Reid, and J.R. Rhode, "Dynamic Impact Testing of Guardrail Posts Embedded in Soil," *Research Report No. TRP-03-77-98*, Midwest Roadside Safety Facility, University of Nebraska-Lincoln, Lincoln, Nebraska (July 21, 1999).

68. Plaxico, C.A., F.Mozzarelli, and M.H. Ray, "Tests and Simulation of a W-Beam Rail-To-Post Connection," Unpublished Paper, Worcester Polytechnic Institute (2002).
69. Tiso, P., "Improvements to the Suspension of the NCAC C2500 Pickup Truck Finite Element Model," Master's Thesis, Worcester Polytechnic Institute, Worcester, MA (2001).
70. Tiso, P., C.A. Plaxico, and M.H. Ray, "An Improved Truck Model for Roadside Safety Simulations: Part II – Suspension Modeling," *Transportation Research Record* (in press), Transportation Research Board, Washington, D.C. (2002).
71. Bronstad, M.E., L.R. Calcote, K.L. Hancock, and J.B. Mayer, Jr., "Effects of Changes in Effective Rail Height on Barrier Performance," *Federal Highway Administration, Report No. FHWA-RD-86-191*, Washington, D.C. (April 1987).
72. Road Design Details, Iowa Department of Transportation, Project Development Division Ames, Iowa.
73. Consolazio, G.R., J.H. Chung, and K.R. Gurley, "Development of a Low Profile Work Zone Barrier Using Impact Finite Element Simulation," (submitted for review), Transportation Research Board, Washington, D.C. (2002).
74. Giola, A., "Performance of a High-Density Polyethylene Pull-Through Energy Dissipator," Master's Thesis, Worcester Polytechnic Institute, Worcester, MA (2001).

APPENDIX B

Vehicle Path The Path of Each Wheel Marked

-Finite Element Analysis Results-

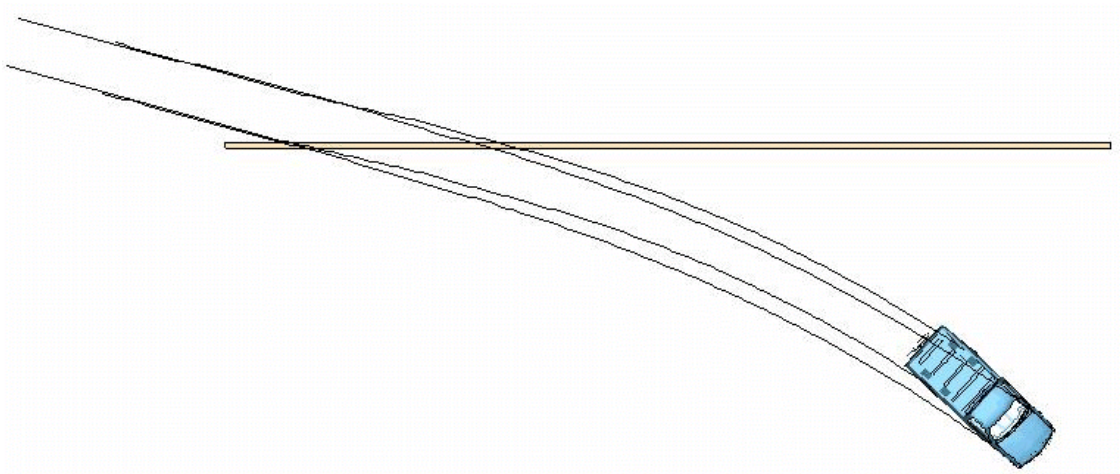

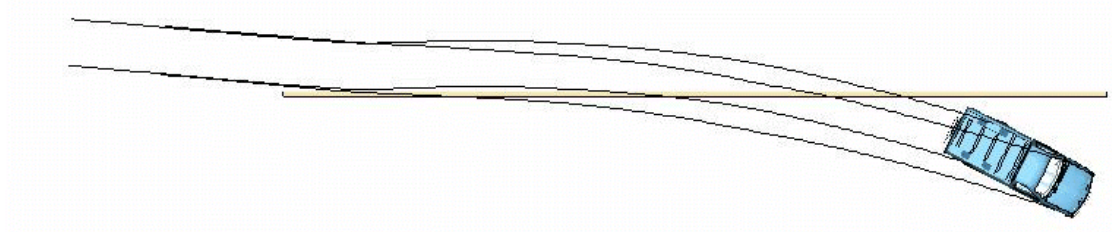

Figure B.1: Overhead view showing vehicle path from F.E. analysis:
Curb Type -- AASHTO A Curb
Impact Speed -- 70 km/hr
Impact Angle -- 5 degrees.

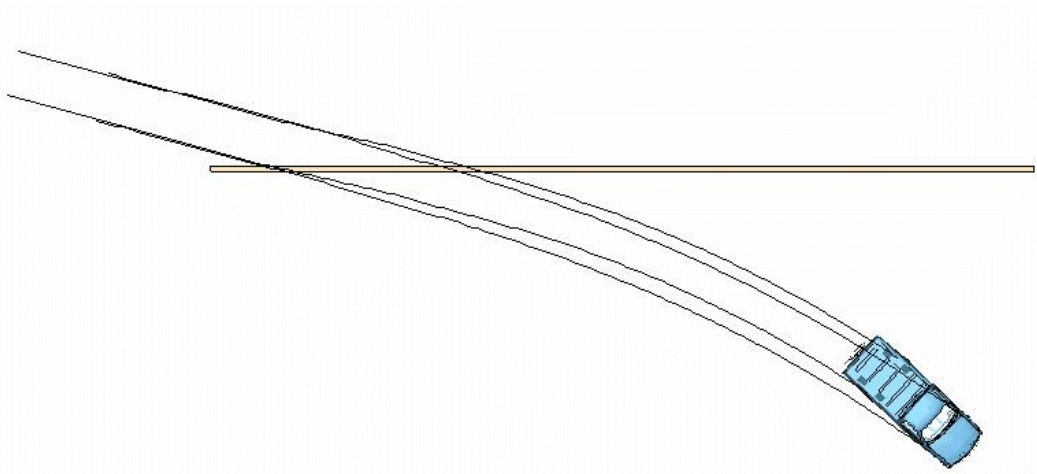

Figure B.2: Overhead view showing vehicle path from F.E. analysis:
Curb Type -- AASHTO A Curb
Impact Speed -- 70 km/hr
Impact Angle -- 15 degrees.

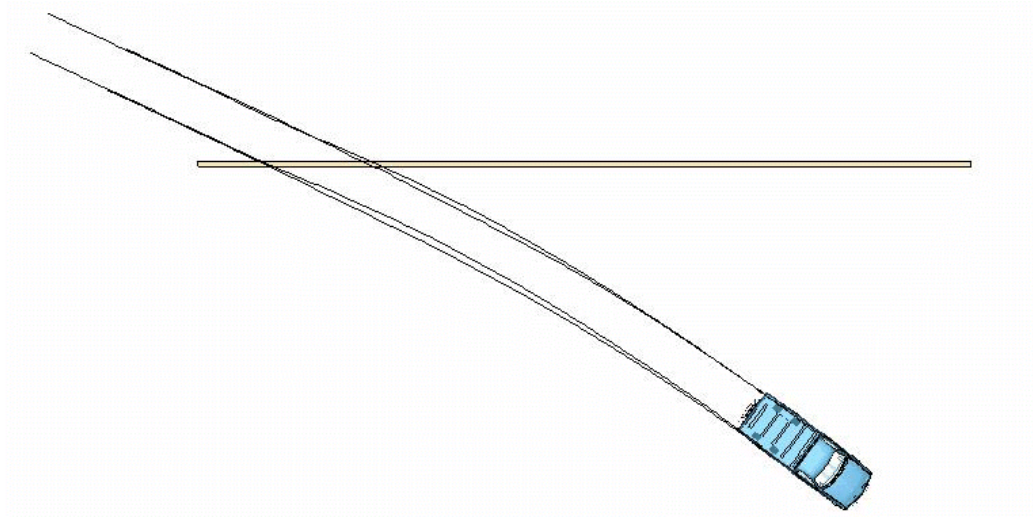

Figure B.3: Overhead view showing vehicle path from F.E. analysis:
Curb Type -- AASHTO A Curb
Impact Speed -- 70 km/hr
Impact Angle -- 25 degrees.

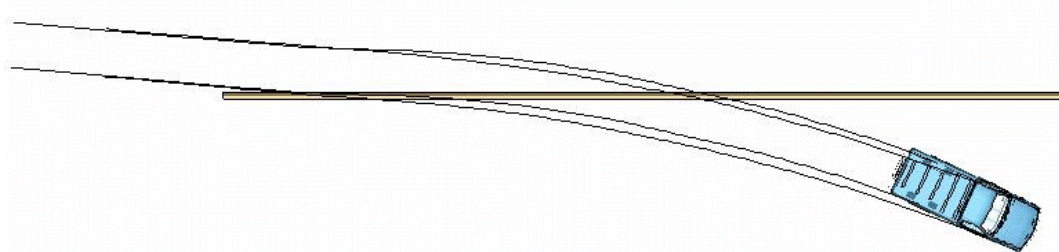

Figure B.4: Overhead view showing vehicle path from F.E. analysis:
Curb Type -- AASHTO B Curb
Impact Speed -- 70 km/hr
Impact Angle -- 5 degrees.

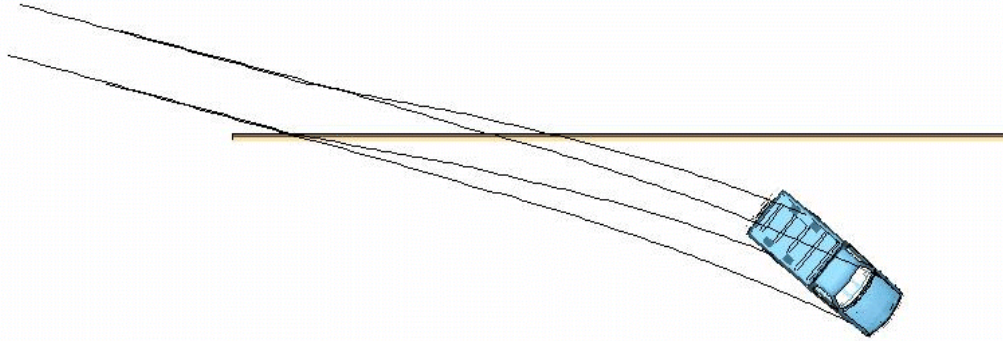

Figure B.5: Overhead view showing vehicle path from F.E. analysis:
Curb Type -- AASHTO B Curb
Impact Speed -- 70 km/hr
Impact Angle -- 15 degrees.

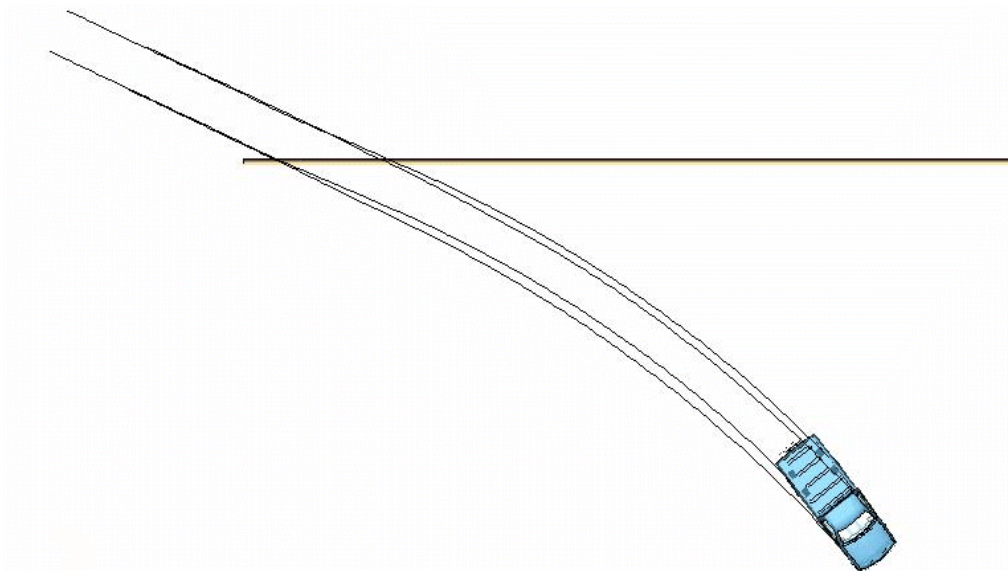

Figure B.6: Overhead view showing vehicle path from F.E. analysis:
Curb Type -- AASHTO B Curb
Impact Speed -- 70 km/hr
Impact Angle -- 25 degrees.

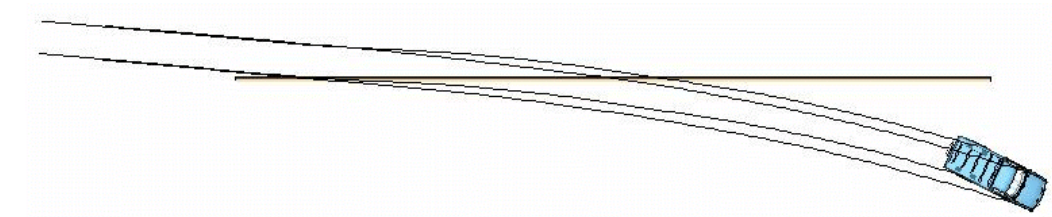

Figure B.7: Overhead view showing vehicle path from F.E. analysis:
Curb Type -- AASHTO B Curb
Impact Speed -- 100 km/hr
Impact Angle -- 5 degrees.

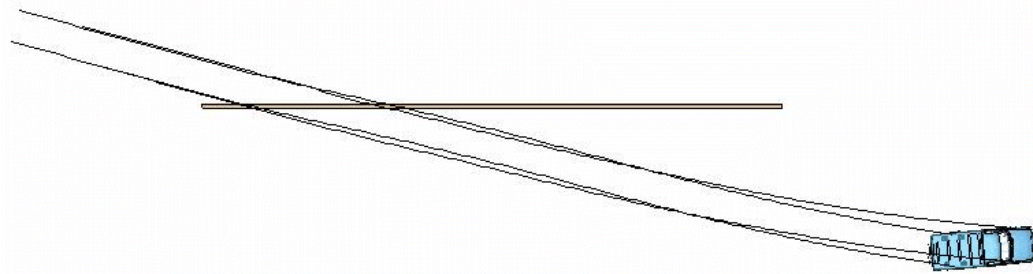

Figure B.8: Overhead view showing vehicle path from F.E. analysis:
Curb Type -- AASHTO B Curb
Impact Speed -- 100 km/hr
Impact Angle -- 15 degrees.

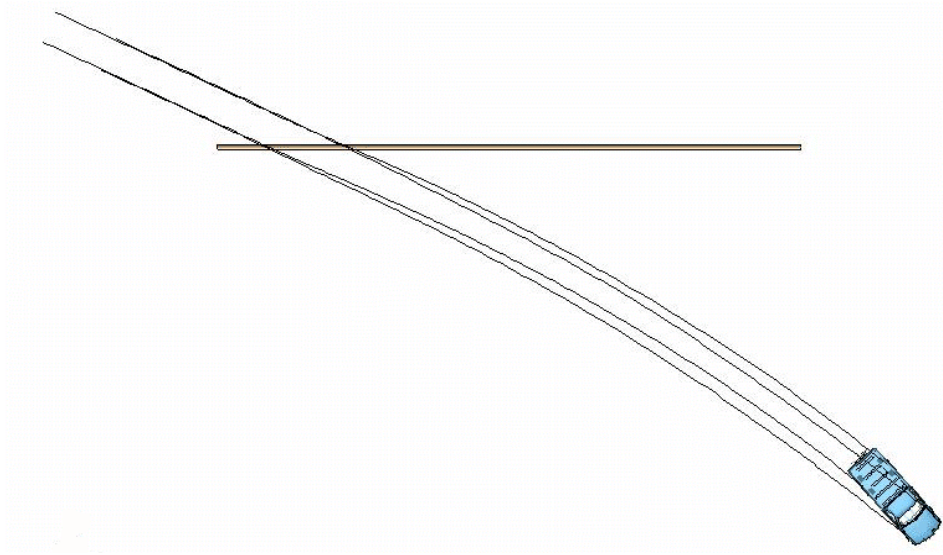

Figure B.9: Overhead view showing vehicle path from F.E. analysis:
Curb Type -- AASHTO B Curb
Impact Speed -- 100 km/hr
Impact Angle -- 25 degrees.

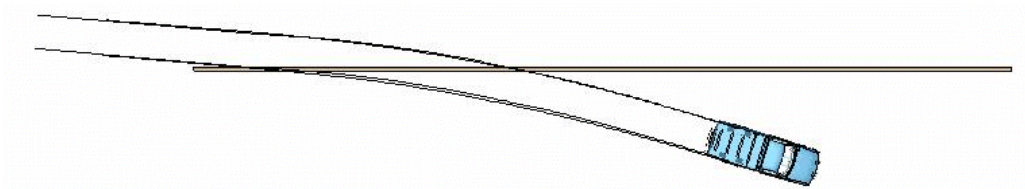

Figure B.10: Overhead view showing vehicle path from F.E. analysis:
Curb Type -- AASHTO C Curb
Impact Speed -- 70 km/hr
Impact Angle -- 5 degrees.

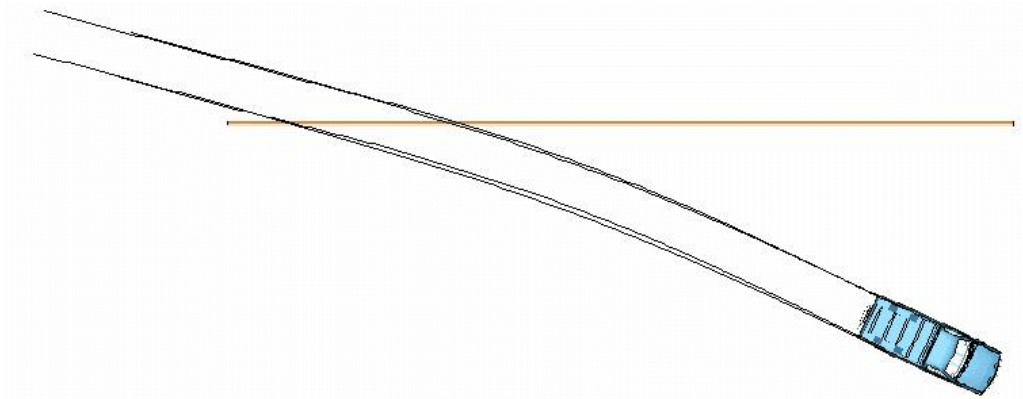

Figure B.11: Overhead view showing vehicle path from F.E. analysis:
Curb Type -- AASHTO C Curb
Impact Speed -- 70 km/hr
Impact Angle -- 15 degrees.

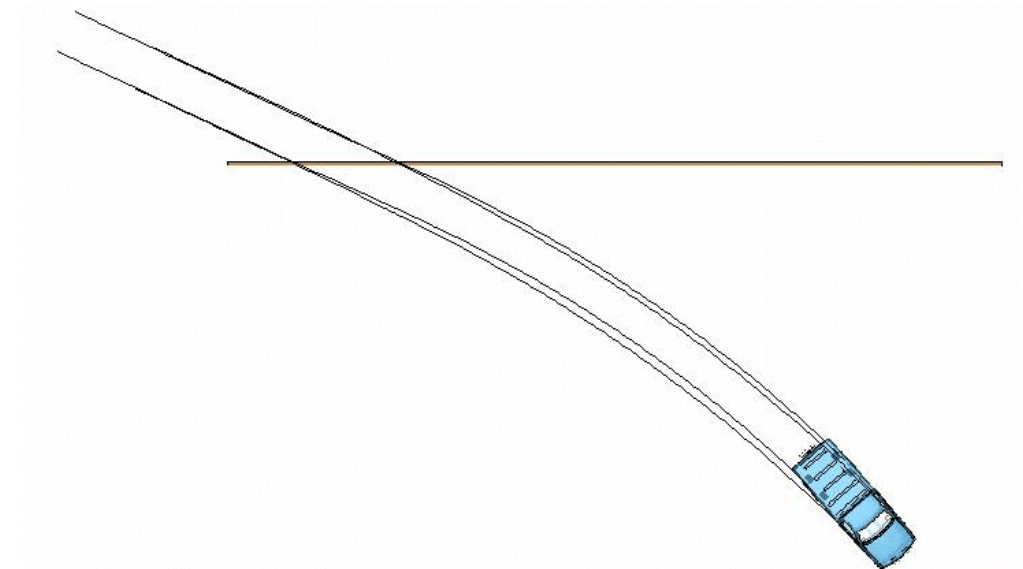

Figure B.12: Overhead view showing vehicle path from F.E. analysis:
Curb Type -- AASHTO C Curb
Impact Speed -- 70 km/hr
Impact Angle -- 25 degrees.

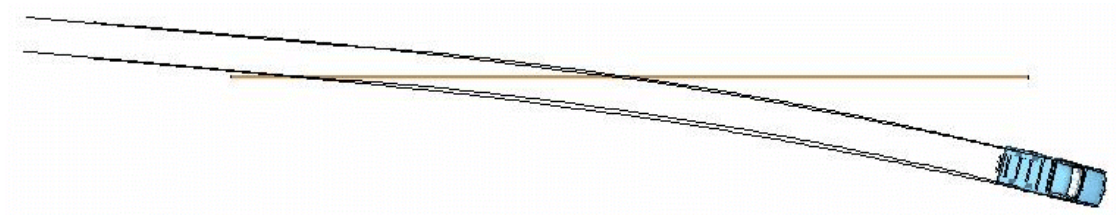

Figure B.13: Overhead view showing vehicle path from F.E. analysis:
Curb Type -- AASHTO C Curb
Impact Speed -- 100 km/hr
Impact Angle -- 5 degrees.

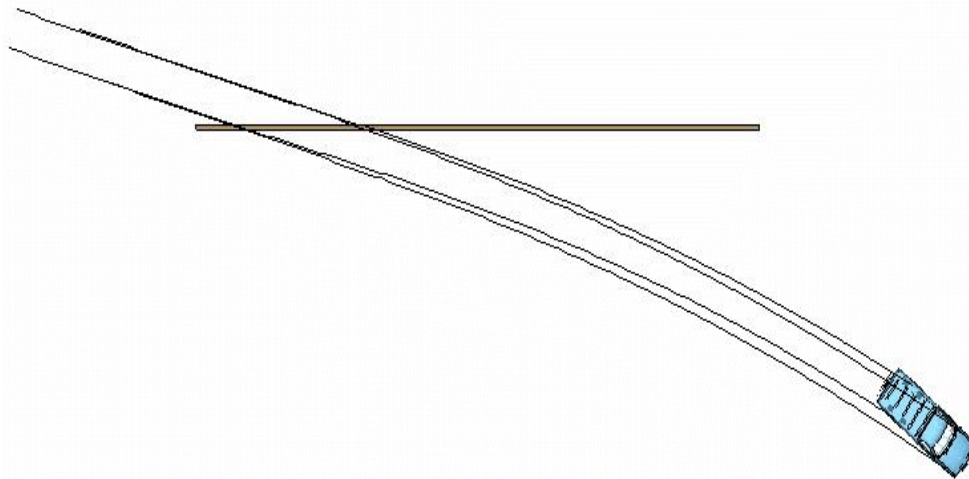

Figure B.14: Overhead view showing vehicle path from F.E. analysis:
Curb Type -- AASHTO C Curb
Impact Speed -- 100 km/hr
Impact Angle -- 15 degrees.

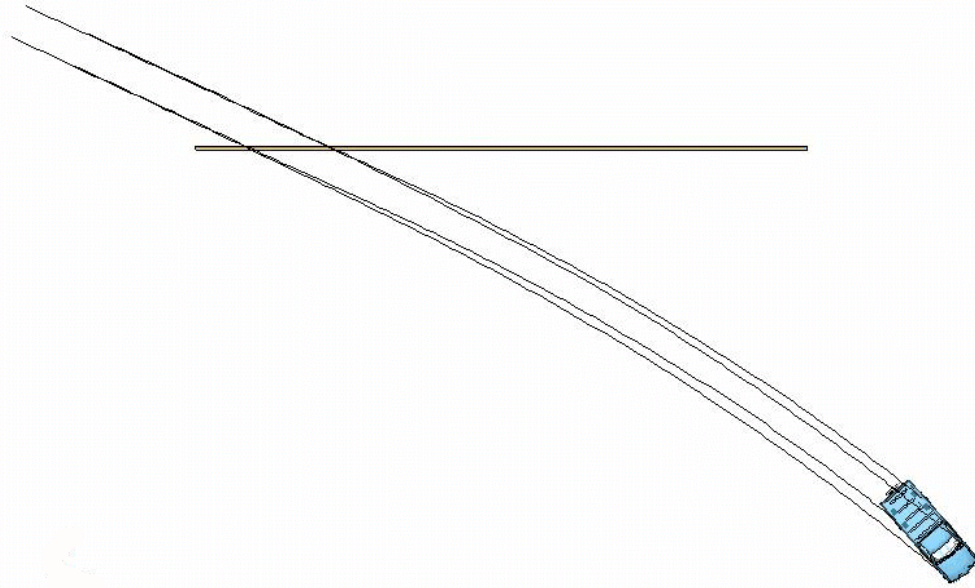

Figure B.15: Overhead view showing vehicle path from F.E. analysis:
Curb Type -- AASHTO C Curb
Impact Speed -- 100 km/hr
Impact Angle -- 25 degrees.

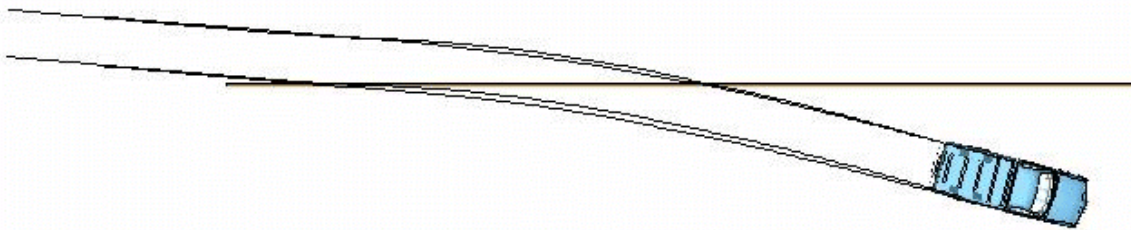

Figure B.16: Overhead view showing vehicle path from F.E. analysis:
Curb Type -- AASHTO D Curb
Impact Speed -- 70 km/hr
Impact Angle -- 5 degrees.

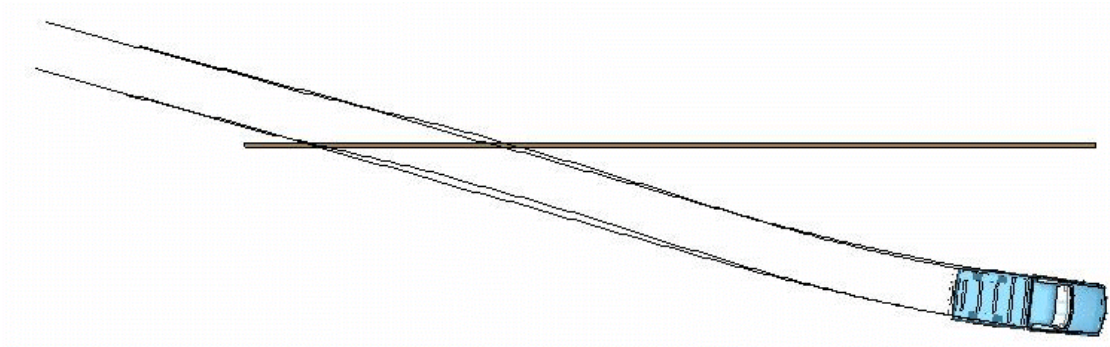

Figure B.17: Overhead view showing vehicle path from F.E. analysis:
 Curb Type -- AASHTO D Curb
 Impact Speed -- 100 km/hr
 Impact Angle -- 15 degrees.

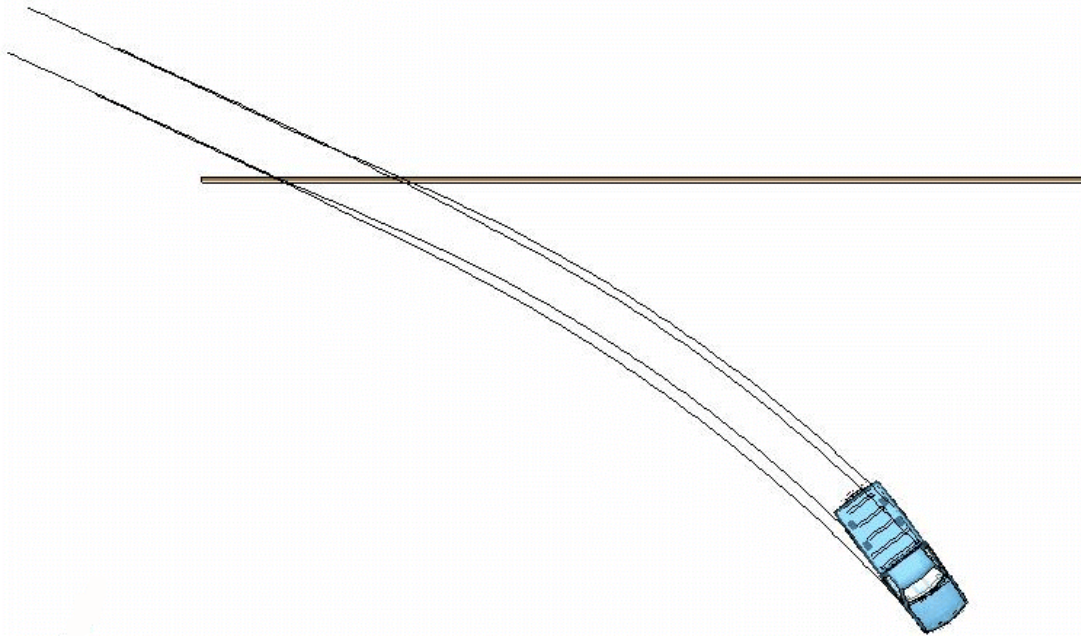

Figure B.18: Overhead view showing vehicle path from F.E. analysis:
 Curb Type -- AASHTO D Curb
 Impact Speed -- 70 km/hr
 Impact Angle -- 25 degrees.

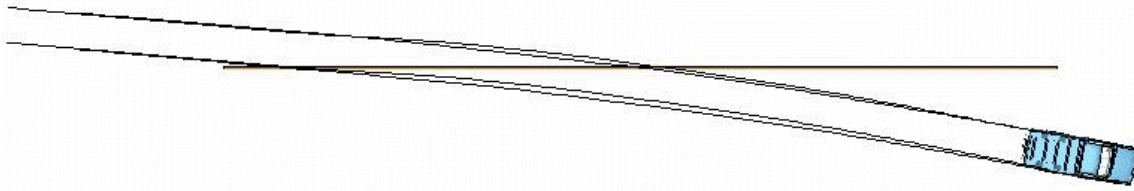

Figure B.19: Overhead view showing vehicle path from F.E. analysis:
Curb Type -- AASHTO D Curb
Impact Speed -- 100 km/hr
Impact Angle -- 5 degrees.

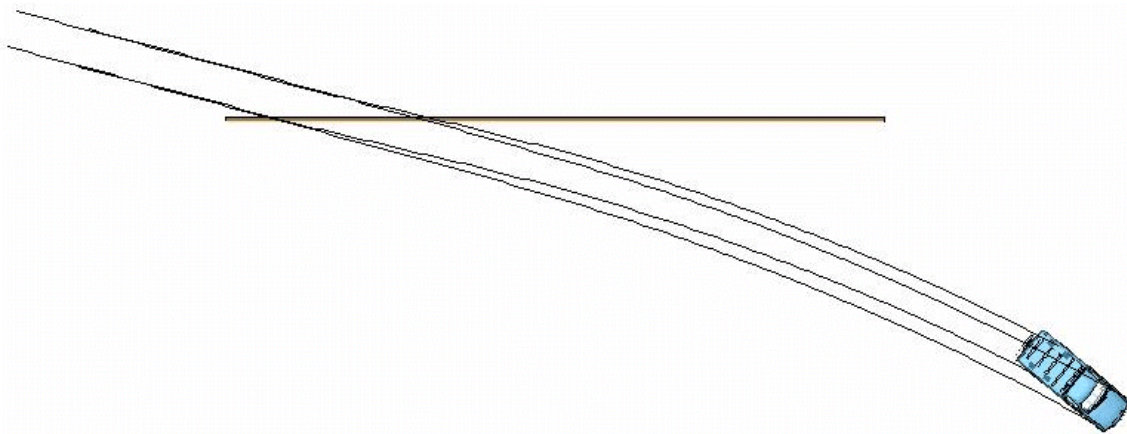

Figure B.20: Overhead view showing vehicle path from F.E. analysis:
Curb Type -- AASHTO D Curb
Impact Speed -- 100 km/hr
Impact Angle -- 15 degrees.

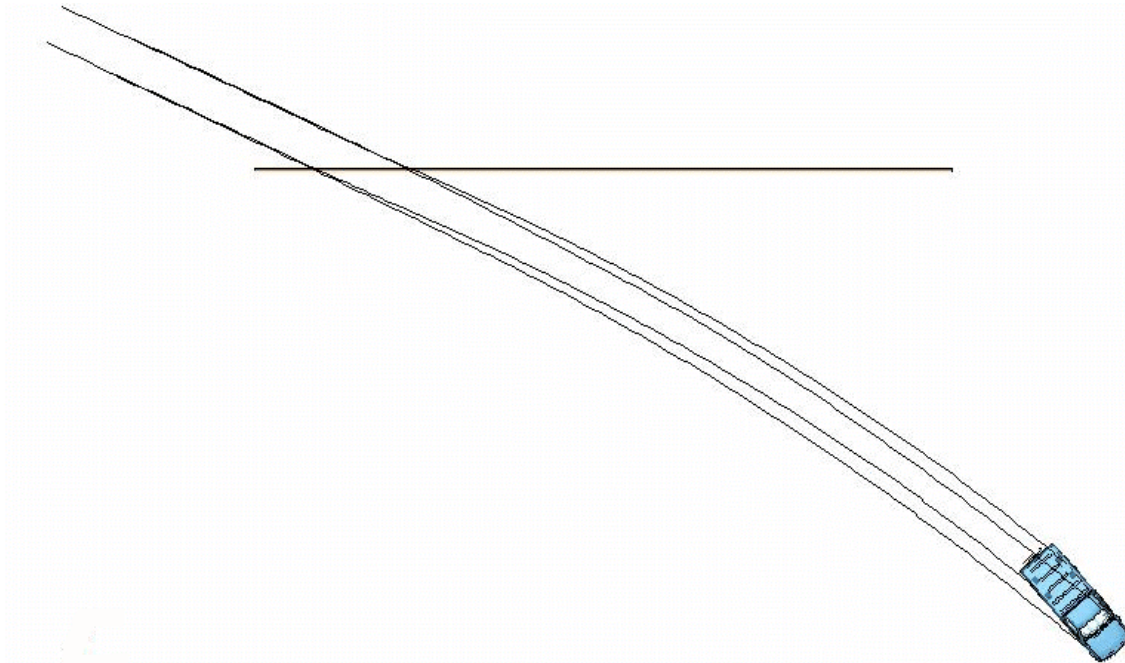

Figure B.21: Overhead view showing vehicle path from F.E. analysis:
Curb Type -- AASHTO D Curb
Impact Speed -- 100 km/hr
Impact Angle -- 25 degrees.

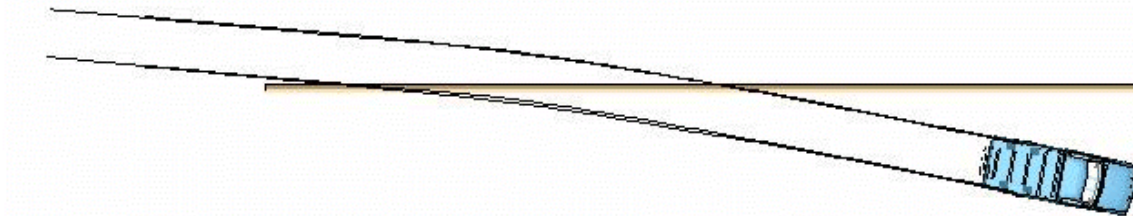

Figure B.22: Overhead view showing vehicle path from F.E. analysis:
Curb Type -- AASHTO G Curb
Impact Speed

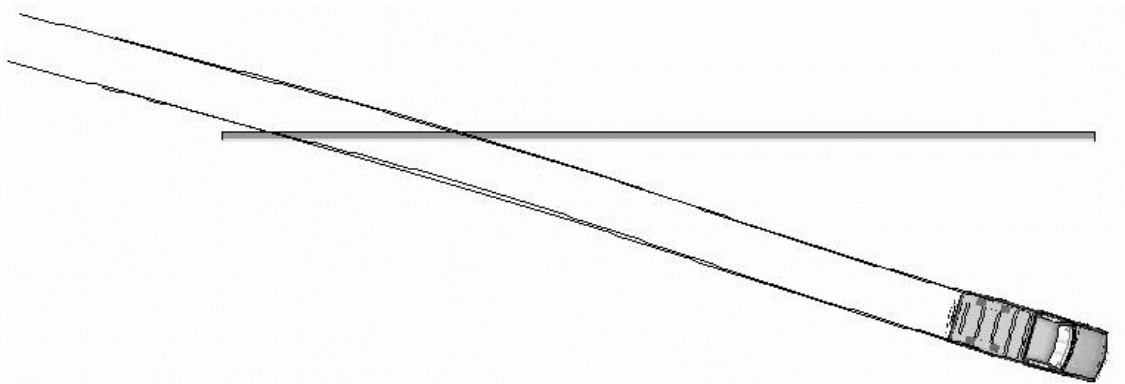

Figure B.23: Overhead view showing vehicle path from F.E. analysis:
Curb Type -- AASHTO G Curb
Impact Speed -- 70 km/hr
Impact Angle -- 15 degrees.

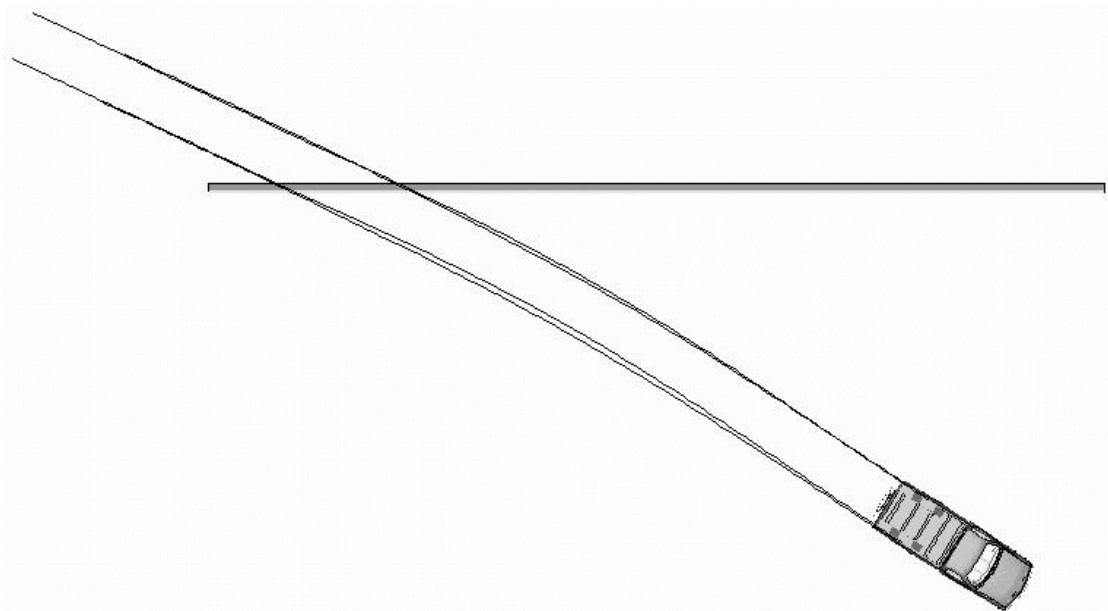

Figure B.24: Overhead view showing vehicle path from F.E. analysis:
Curb Type -- AASHTO G Curb
Impact Speed -- 70 km/hr
Impact Angle -- 25 degrees.

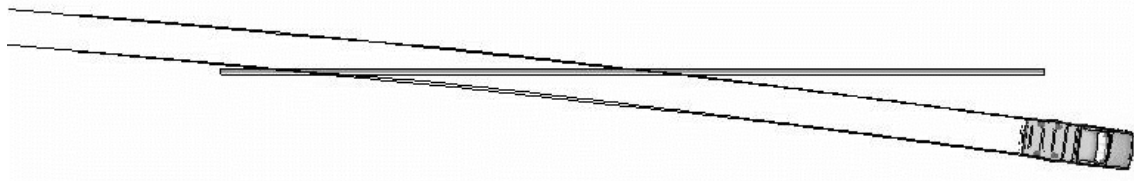

Figure B.25: **Overhead view showing vehicle path from F.E. analysis:**
Curb Type -- AASHTO G Curb
Impact Speed -- 100 km/hr
Impact Angle -- 5 degrees.

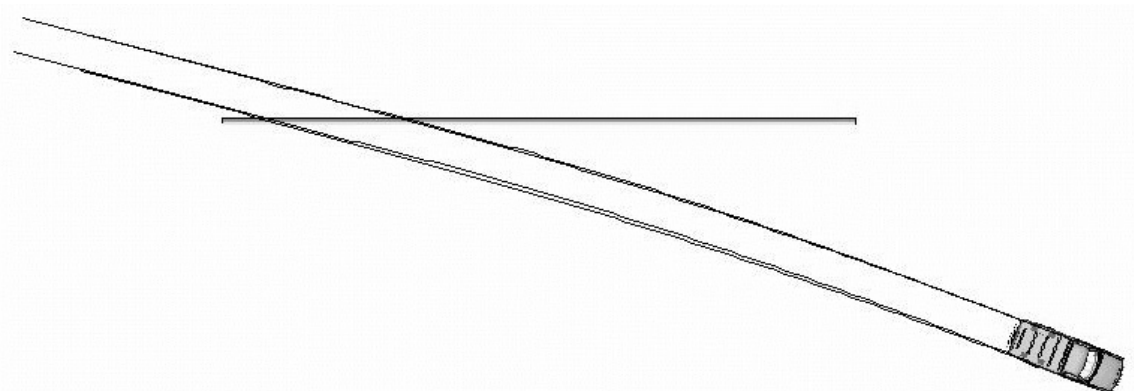

Figure B.26: **Overhead view showing vehicle path from F.E. analysis:**
Curb Type -- AASHTO G Curb
Impact Speed -- 100 km/hr
Impact Angle -- 15 degrees.

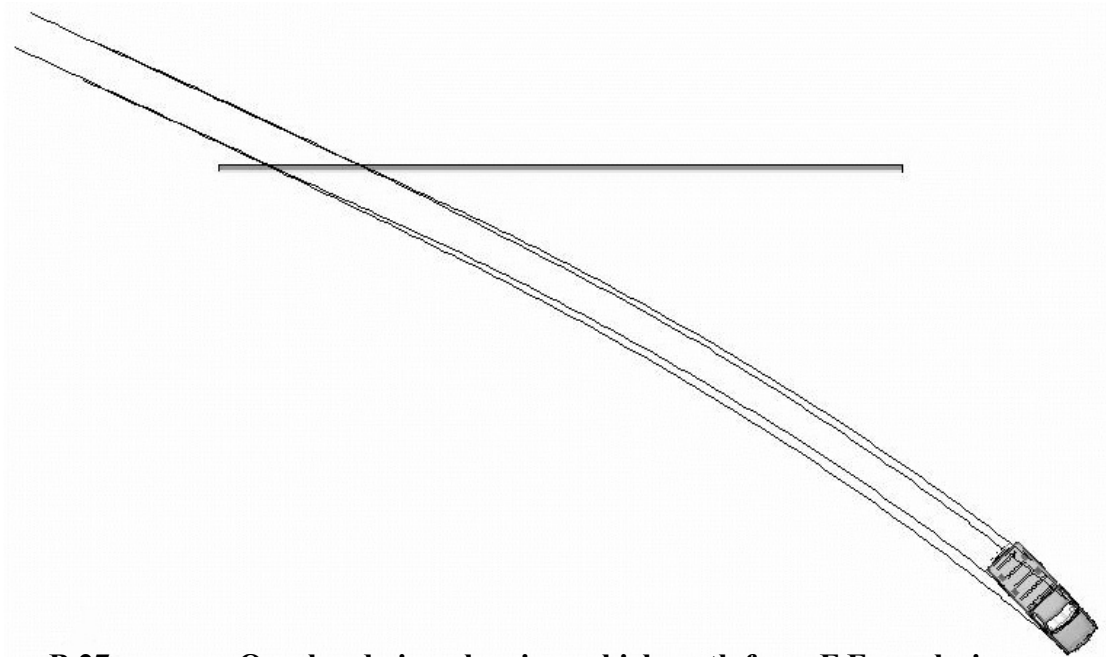

Figure B.27: Overhead view showing vehicle path from F.E. analysis:
Curb Type -- AASHTO G Curb
Impact Speed -- 100 km/hr
Impact Angle -- 25 degrees.

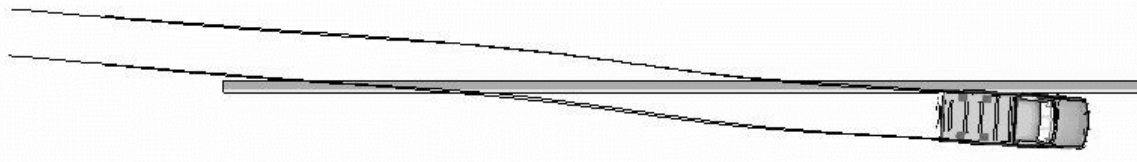

Figure B.28: Overhead view showing vehicle path from F.E. analysis:
Curb Type -- New York Curb (100 mm)
Impact Speed -- 70 km/hr
Impact Angle -- 5 degrees.

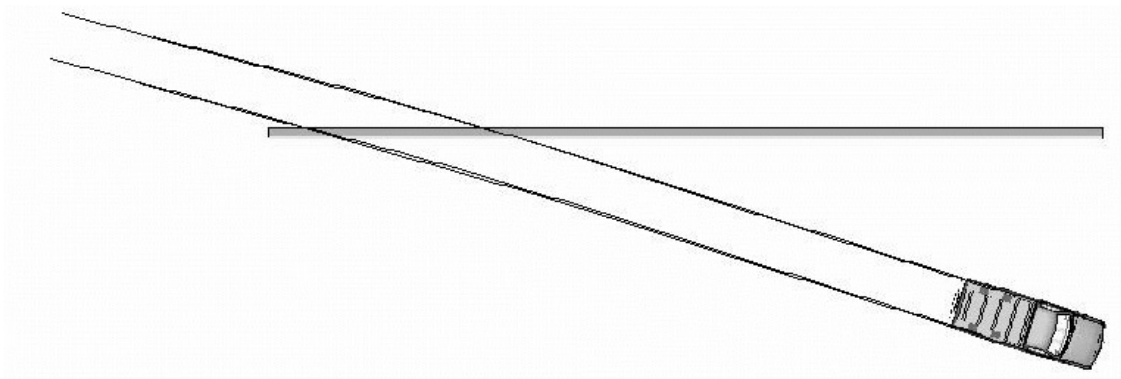

Figure B.29: Overhead view showing vehicle path from F.E. analysis:
Curb Type -- New York Curb (100 mm)
Impact Speed -- 100 km/hr
Impact Angle -- 15 degrees.

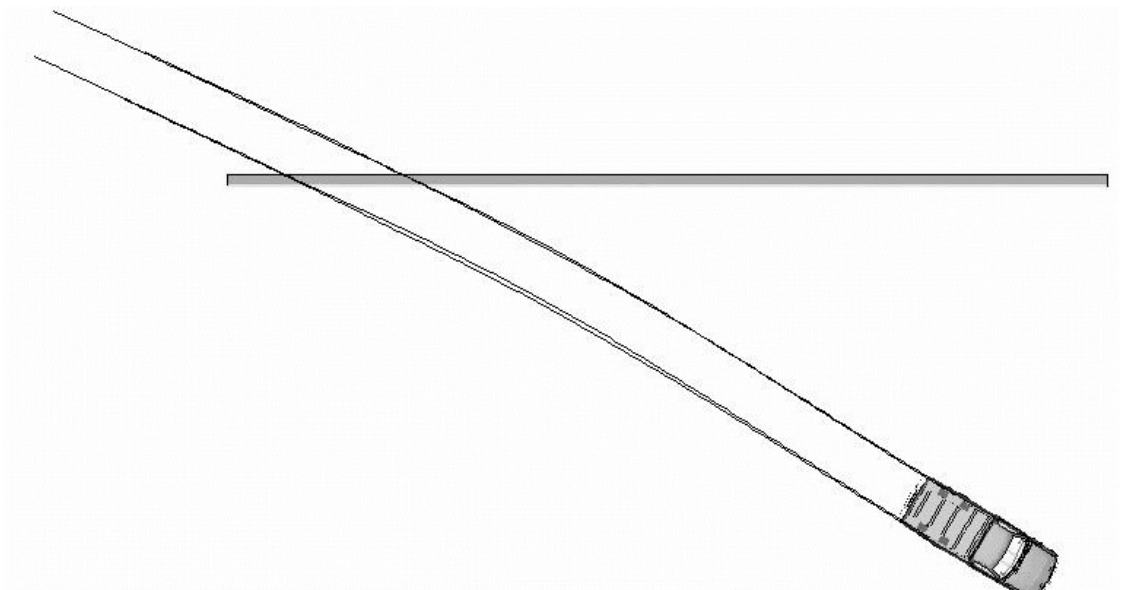

Figure B.30: Overhead view showing vehicle path from F.E. analysis:
Curb Type -- New York Curb (100 mm)
Impact Speed -- 70 km/hr
Impact Angle -- 25 degrees.

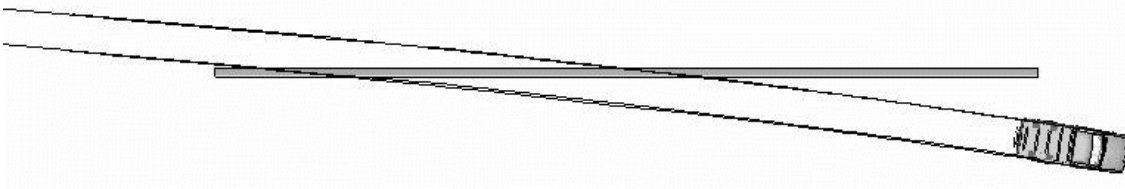

Figure B.31: Overhead view showing vehicle path from F.E. analysis:
Curb Type -- New York Curb (100 mm)
Impact Speed -- 100 km/hr
Impact Angle -- 5 degrees.

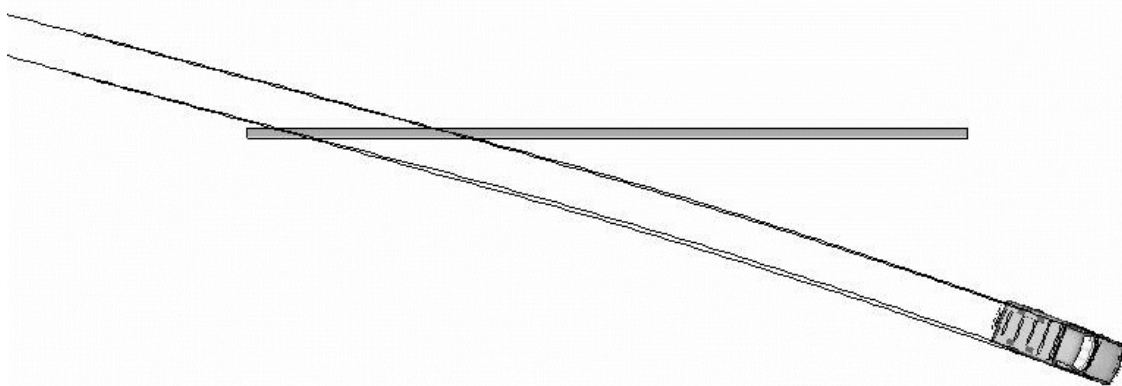

Figure B.32: Overhead view showing vehicle path from F.E. analysis:
Curb Type -- New York Curb (100 mm)
Impact Speed -- 100 km/hr
Impact Angle -- 15 degrees.

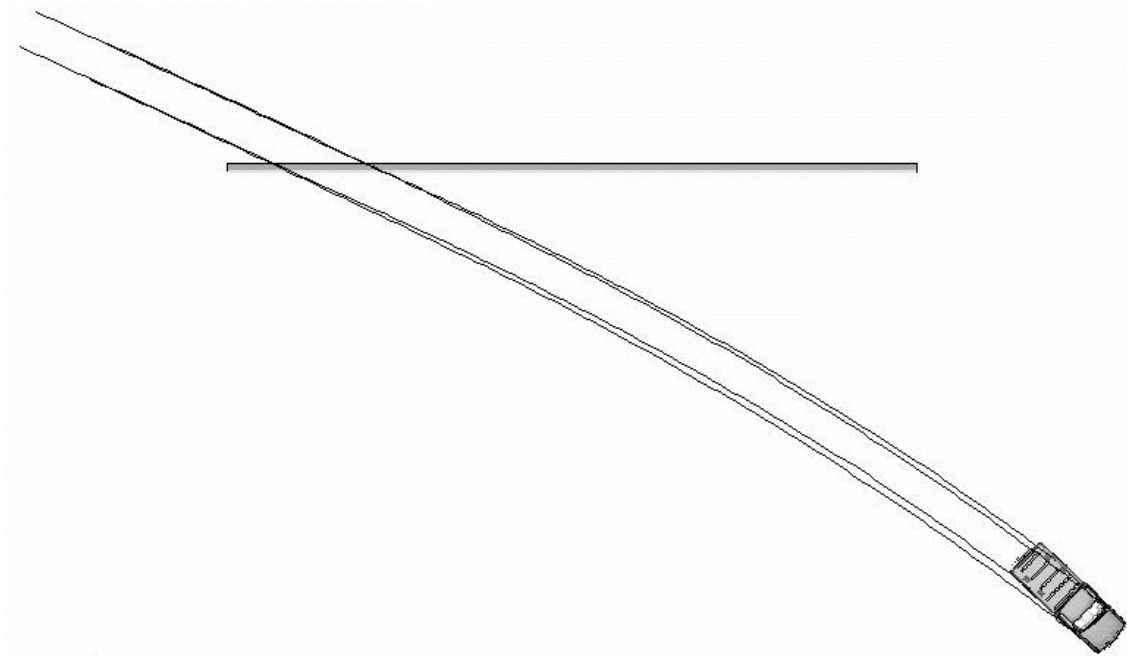

Figure B.33: Overhead view showing vehicle path from F.E. analysis:
Curb Type -- New York Curb (100 mm)
Impact Speed -- 100 km/hr
Impact Angle -- 25 degrees.

APPENDIX C

Acceleration-Time Histories Computed at the Center of Gravity of Vehicle

-Finite Element Analysis Results-

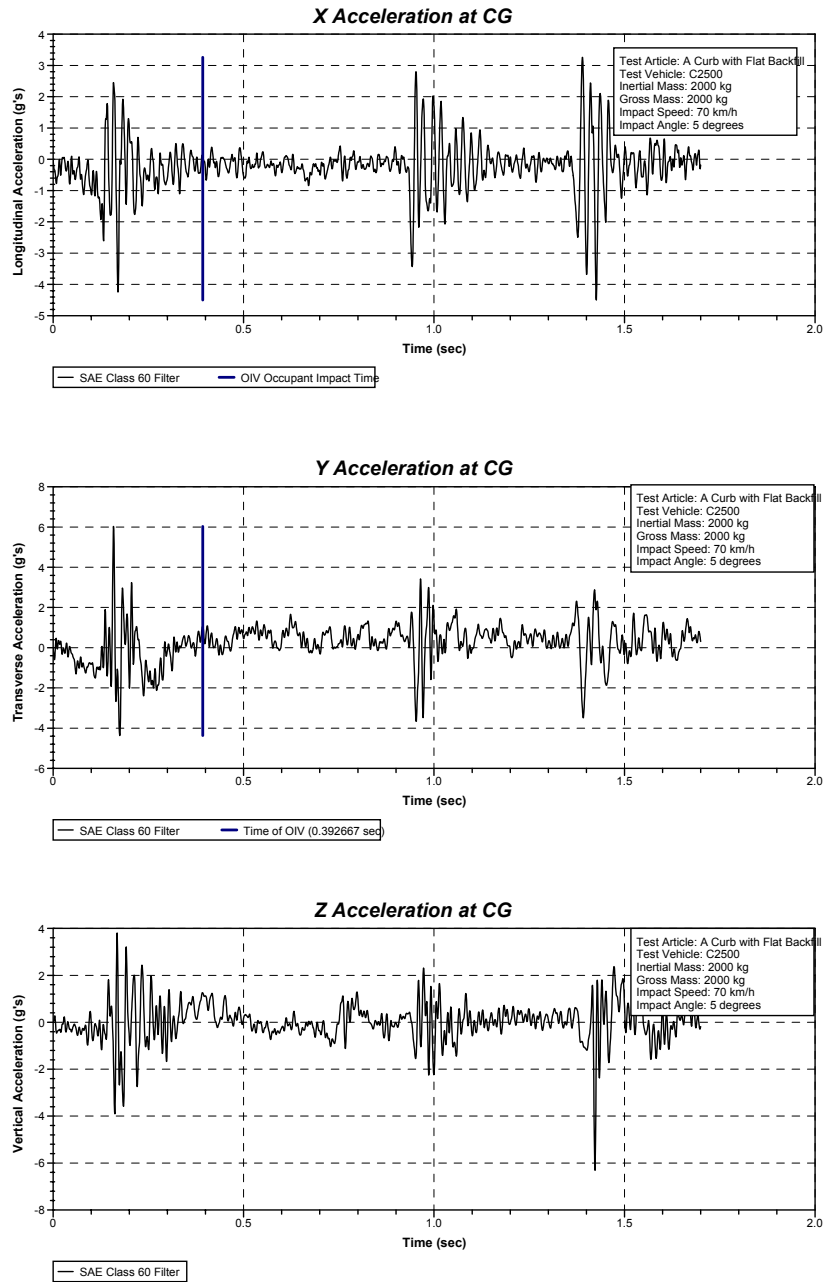

Figure C.1: Acceleration-time histories at C.G. of pickup truck in local coordinates:
Curb Type -- AASHTO A Curb
Impact Speed -- 70 km/hr
Impact Angle -- 5 degrees.

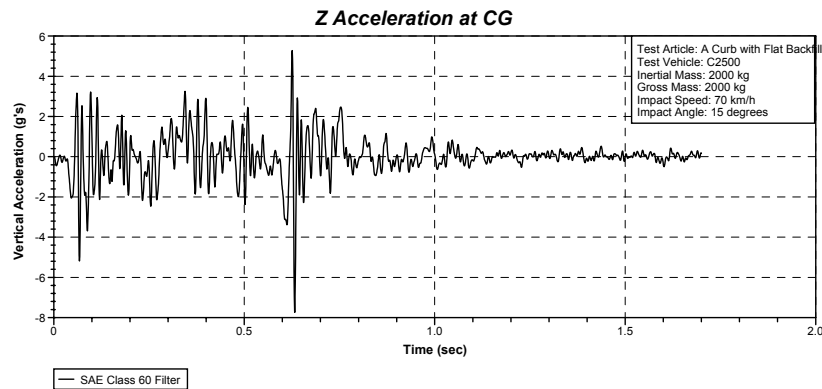
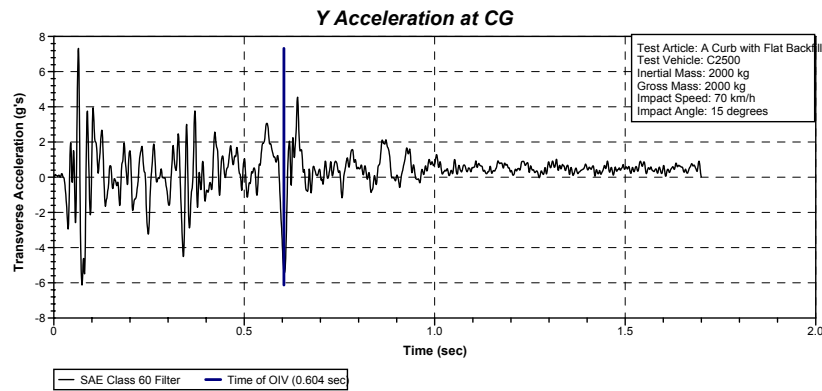
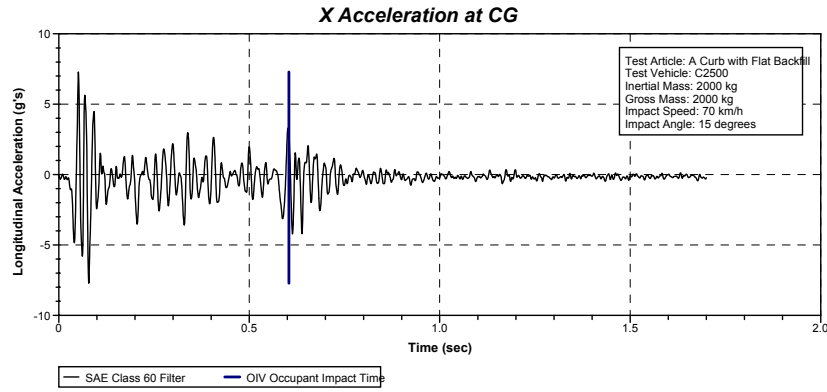

Figure C.2: Acceleration-time histories at C.G. of pickup truck in local coordinates:
Curb Type -- AASHTO A Curb
Impact Speed -- 70 km/hr
Impact Angle -- 15 degrees.

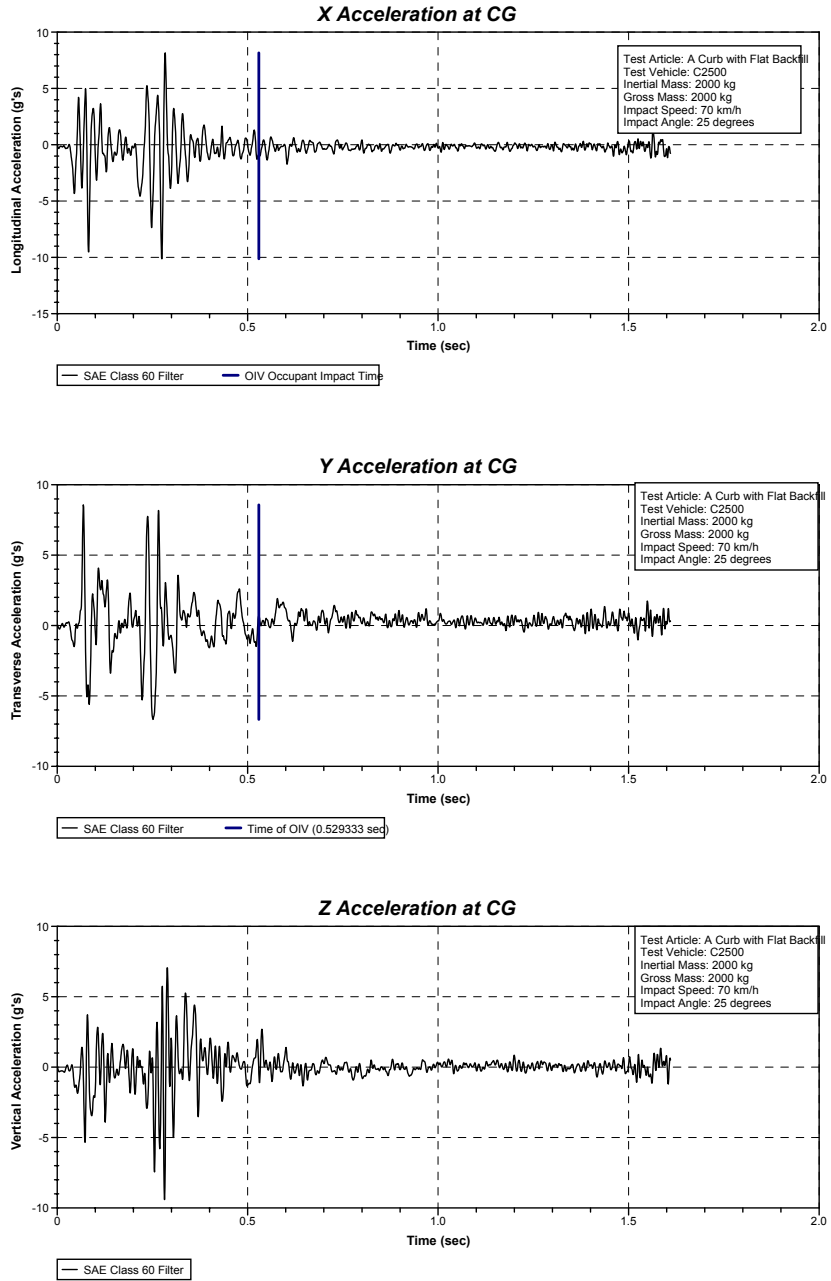

Figure C.3: Acceleration-time histories at C.G. of pickup truck in local coordinates:
Curb Type -- AASHTO A Curb
Impact Speed -- 70 km/hr
Impact Angle -- 25 degrees.

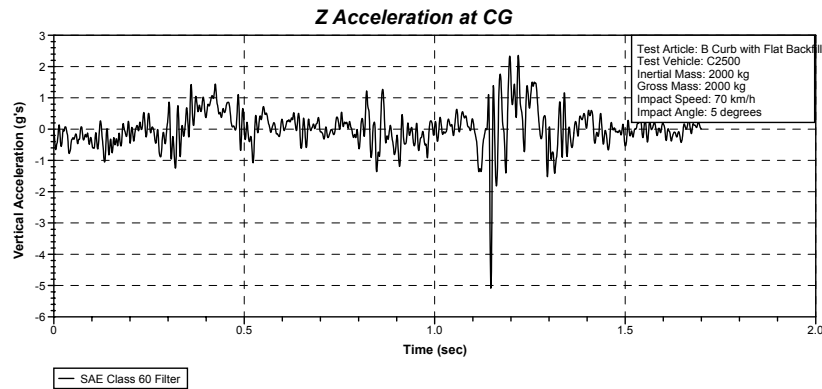
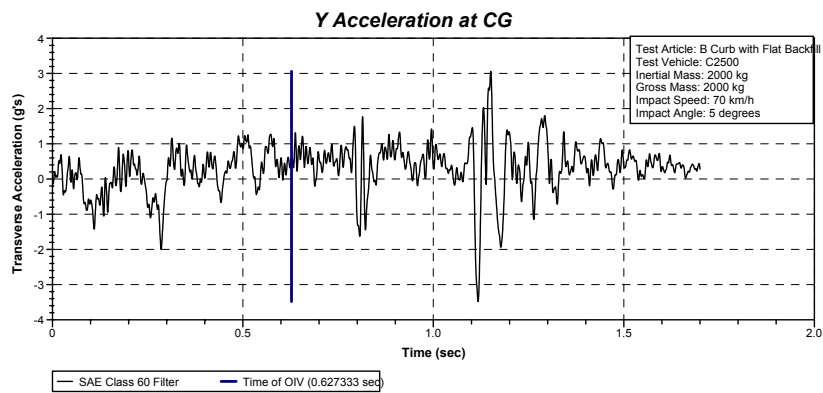
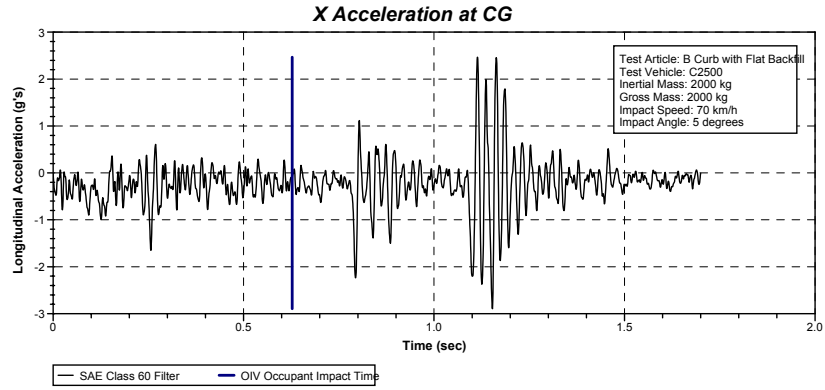

Figure C.4: Acceleration-time histories at C.G. of pickup truck in local coordinates:
 Curb Type -- AASHTO B Curb
 Impact Speed -- 70 km/hr
 Impact Angle -- 5 degrees.

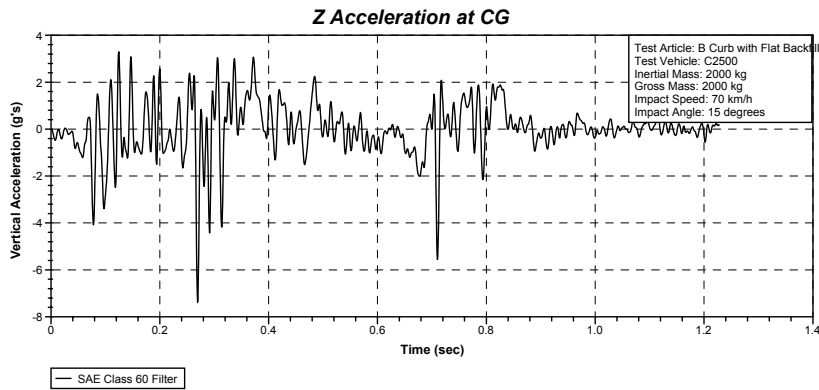
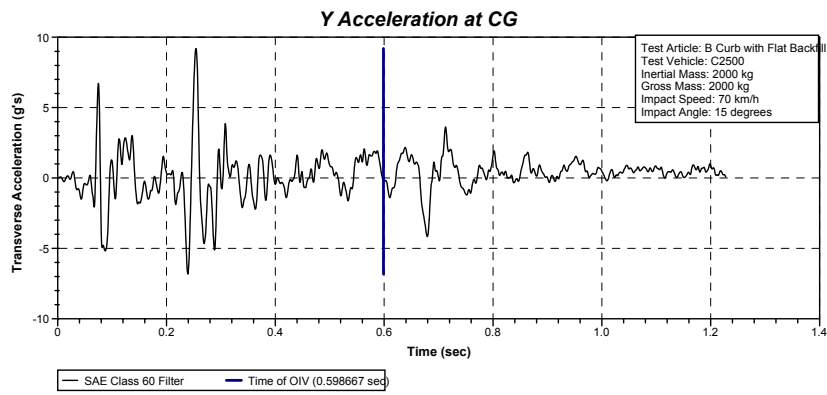
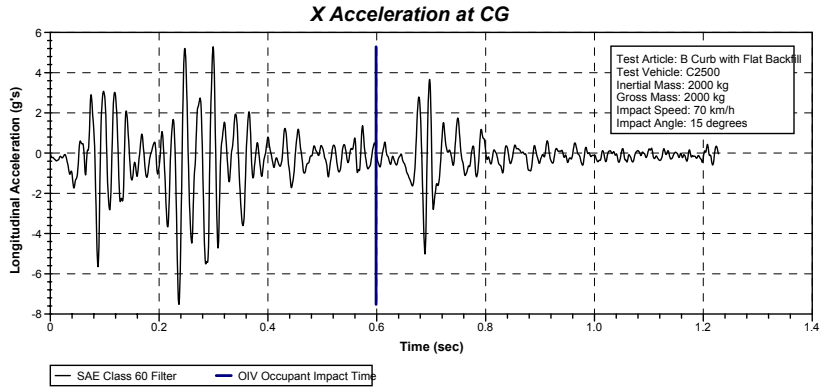

Figure C.5: Acceleration-time histories at C.G. of pickup truck in local coordinates:
Curb Type -- AASHTO B Curb
Impact Speed -- 70 km/hr
Impact Angle -- 15 degrees.

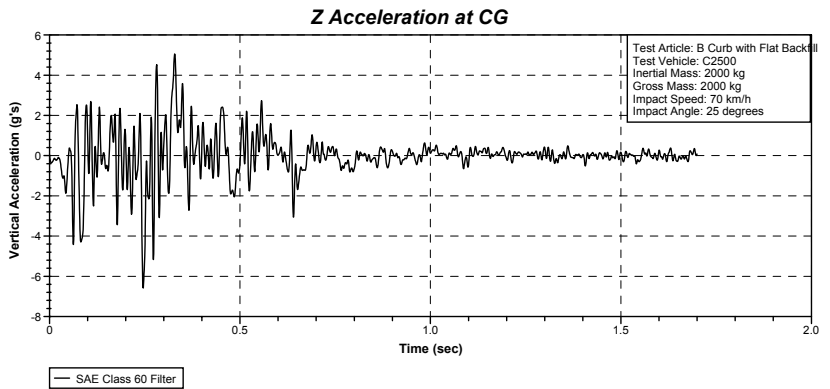
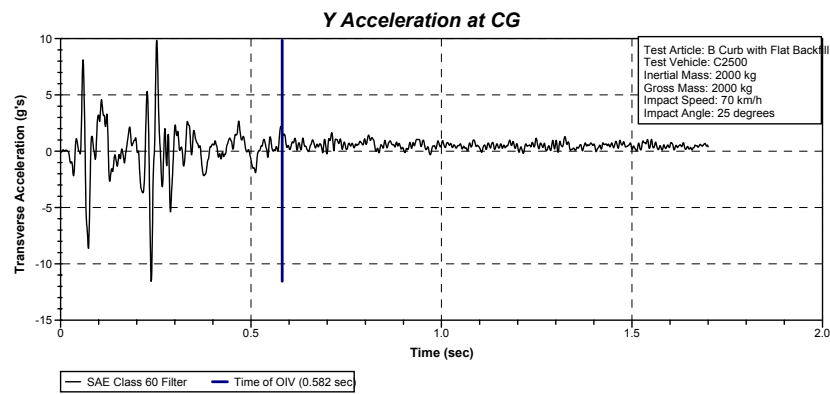
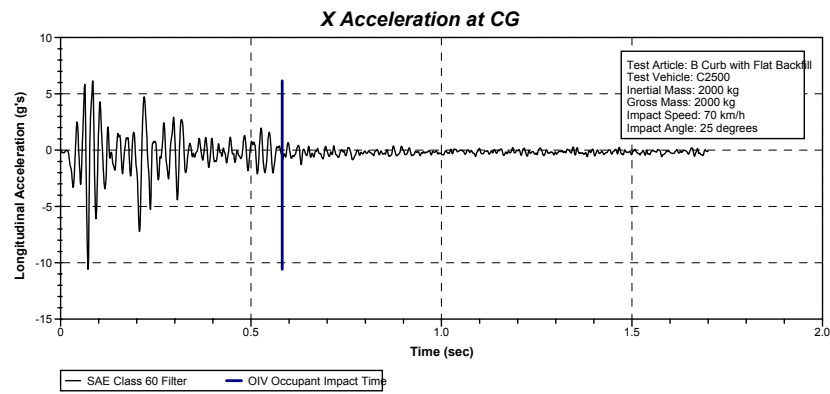

Figure C.6: Acceleration-time histories at C.G. of pickup truck in local coordinates:
Curb Type -- AASHTO B Curb
Impact Speed -- 70 km/hr
Impact Angle -- 25 degrees.

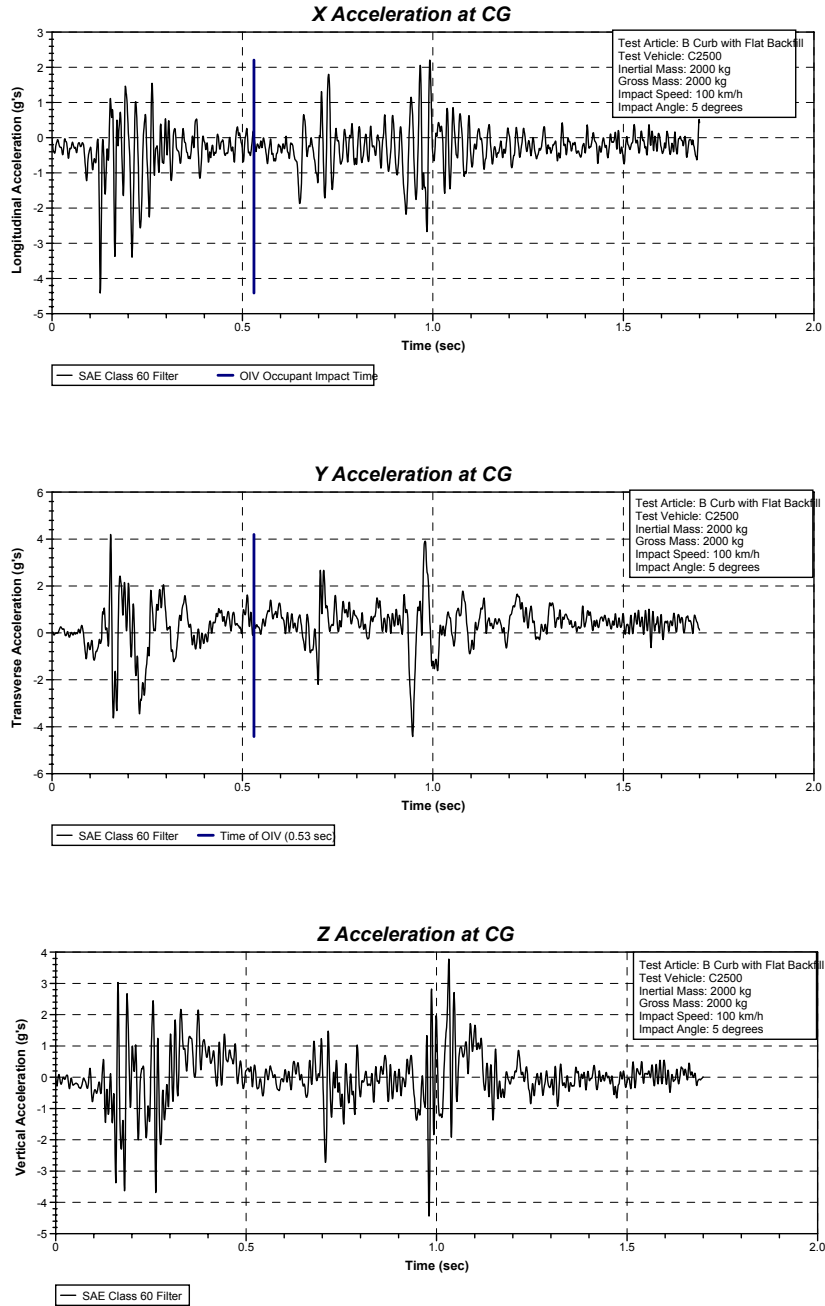

Figure C.7: Acceleration-time histories at C.G. of pickup truck in local coordinates:
Curb Type -- AASHTO B Curb
Impact Speed -- 100 km/hr
Impact Angle -- 5 degrees.

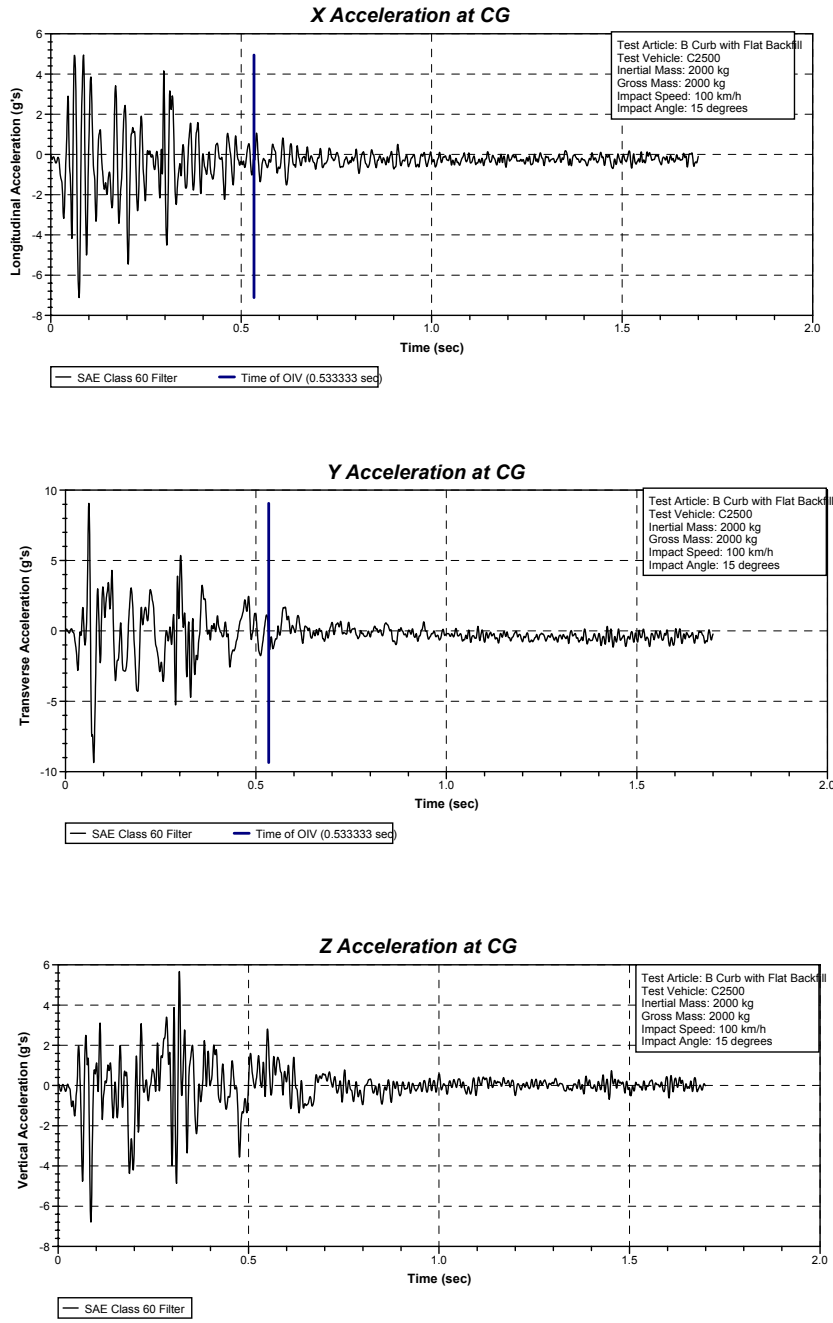

Figure C.8: Acceleration-time histories at C.G. of pickup truck in local coordinates:
Curb Type -- AASHTO B Curb
Impact Speed -- 100 km/hr
Impact Angle -- 15 degrees.

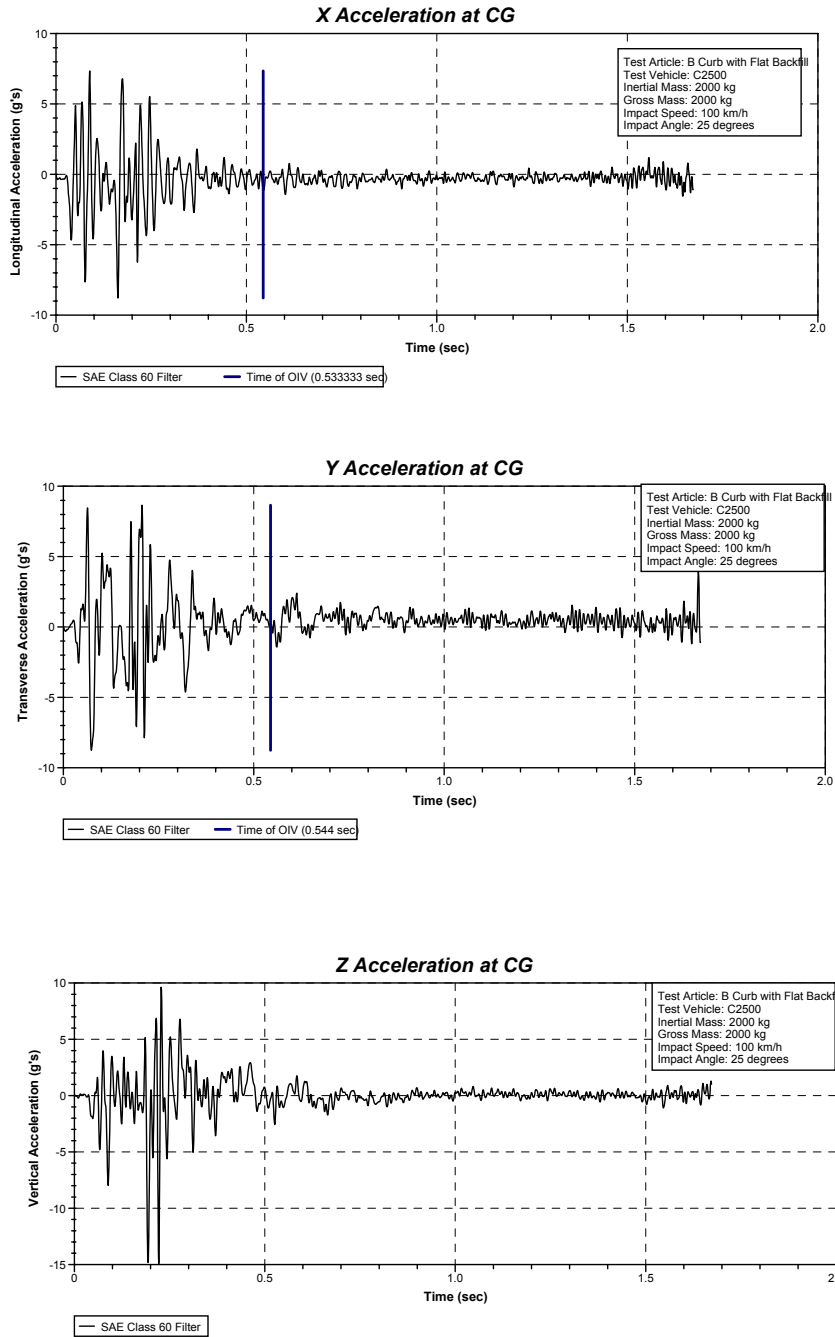

Figure C.9: Acceleration-time histories at C.G. of pickup truck in local coordinates:
Curb Type -- AASHTO B Curb
Impact Speed -- 100 km/hr
Impact Angle -- 25 degrees.

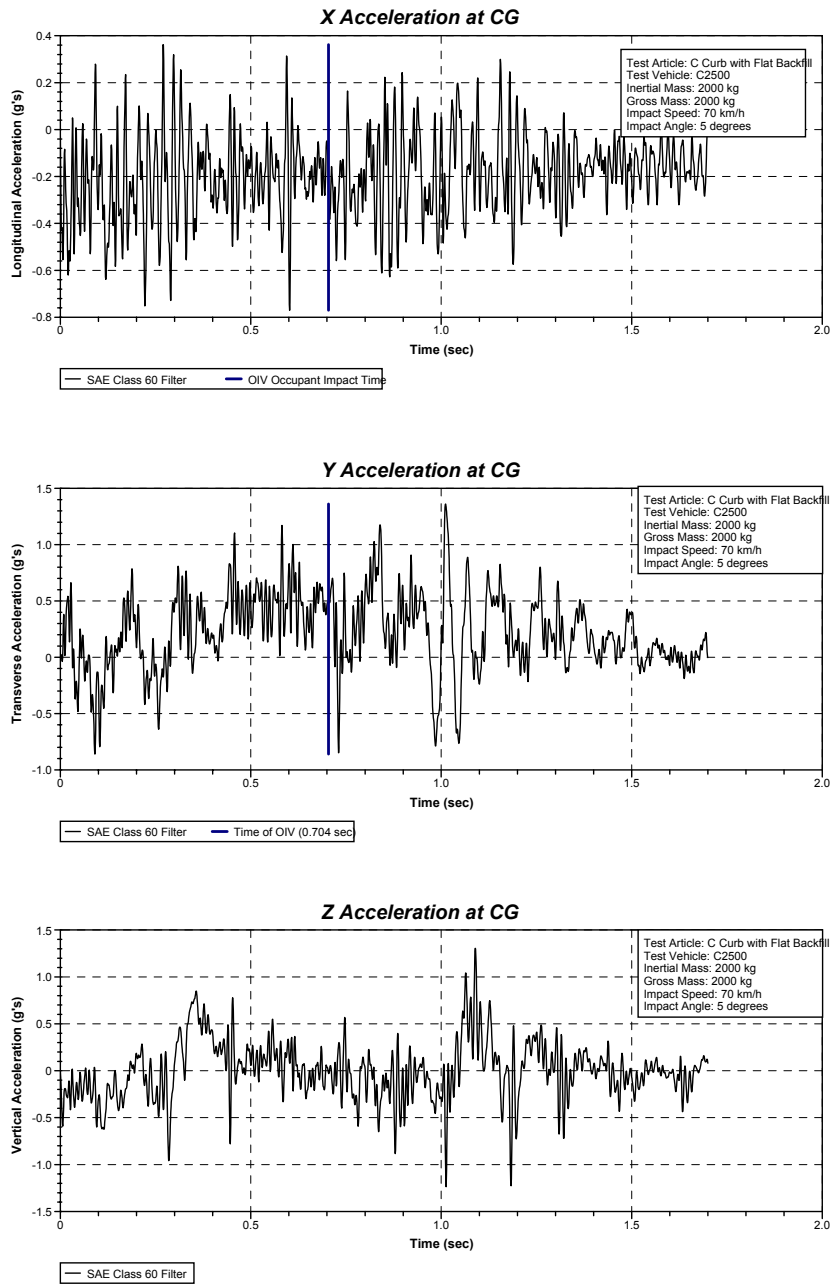

Figure C.10: Acceleration-time histories at C.G. of pickup truck in local coordinates:
Curb Type -- AASHTO C Curb
Impact Speed -- 70 km/hr
Impact Angle -- 5 degrees.

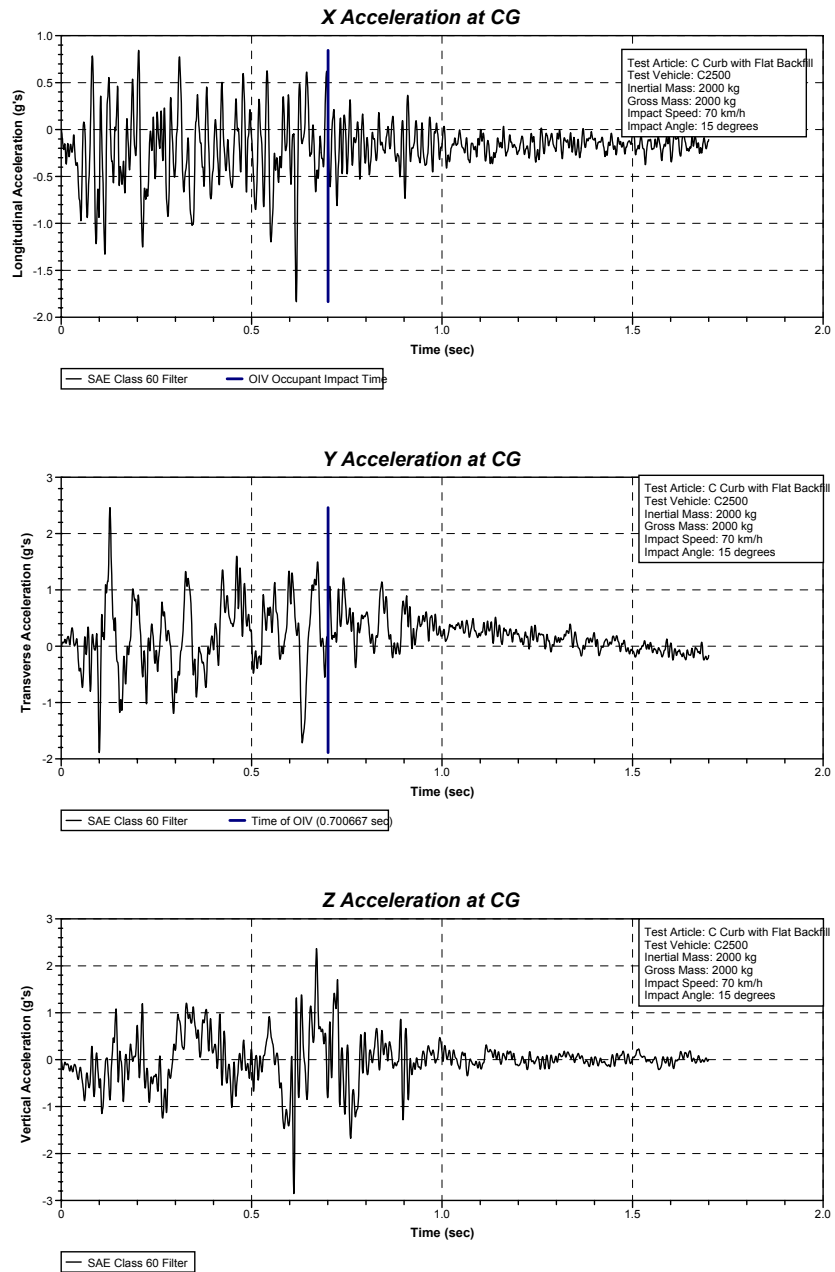

Figure C.11: Acceleration-time histories at C.G. of pickup truck in local coordinates:
Curb Type -- AASHTO C Curb
Impact Speed -- 70 km/hr
Impact Angle -- 15 degrees.

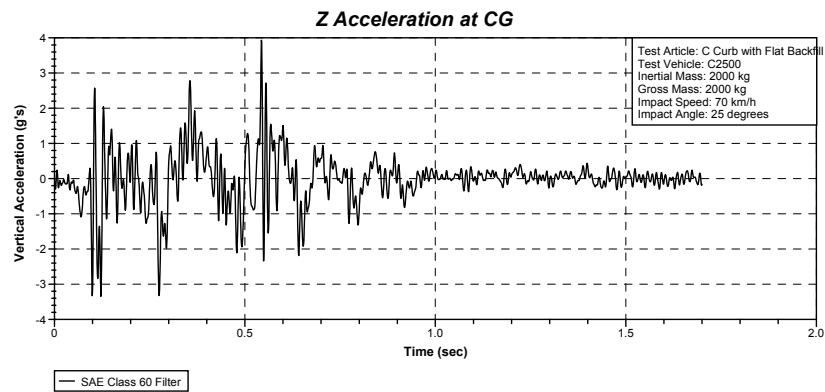
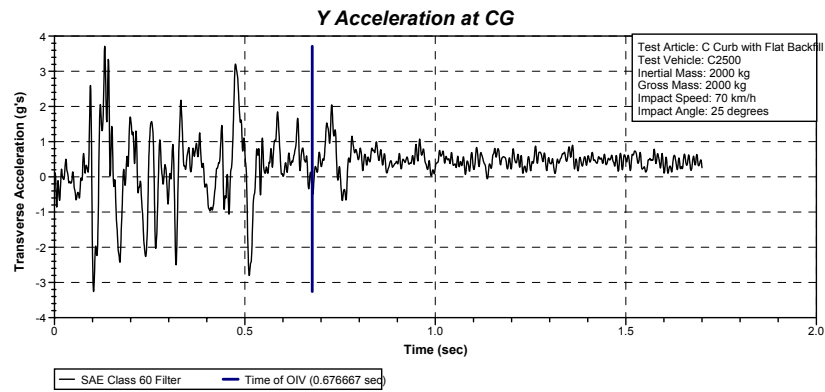
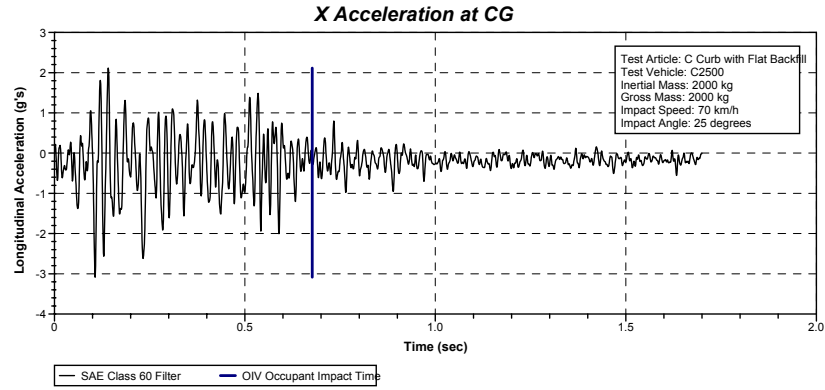

Figure C.12: Acceleration-time histories at C.G. of pickup truck in local coordinates:
Curb Type -- AASHTO C Curb
Impact Speed -- 70 km/hr
Impact Angle -- 25 degrees.

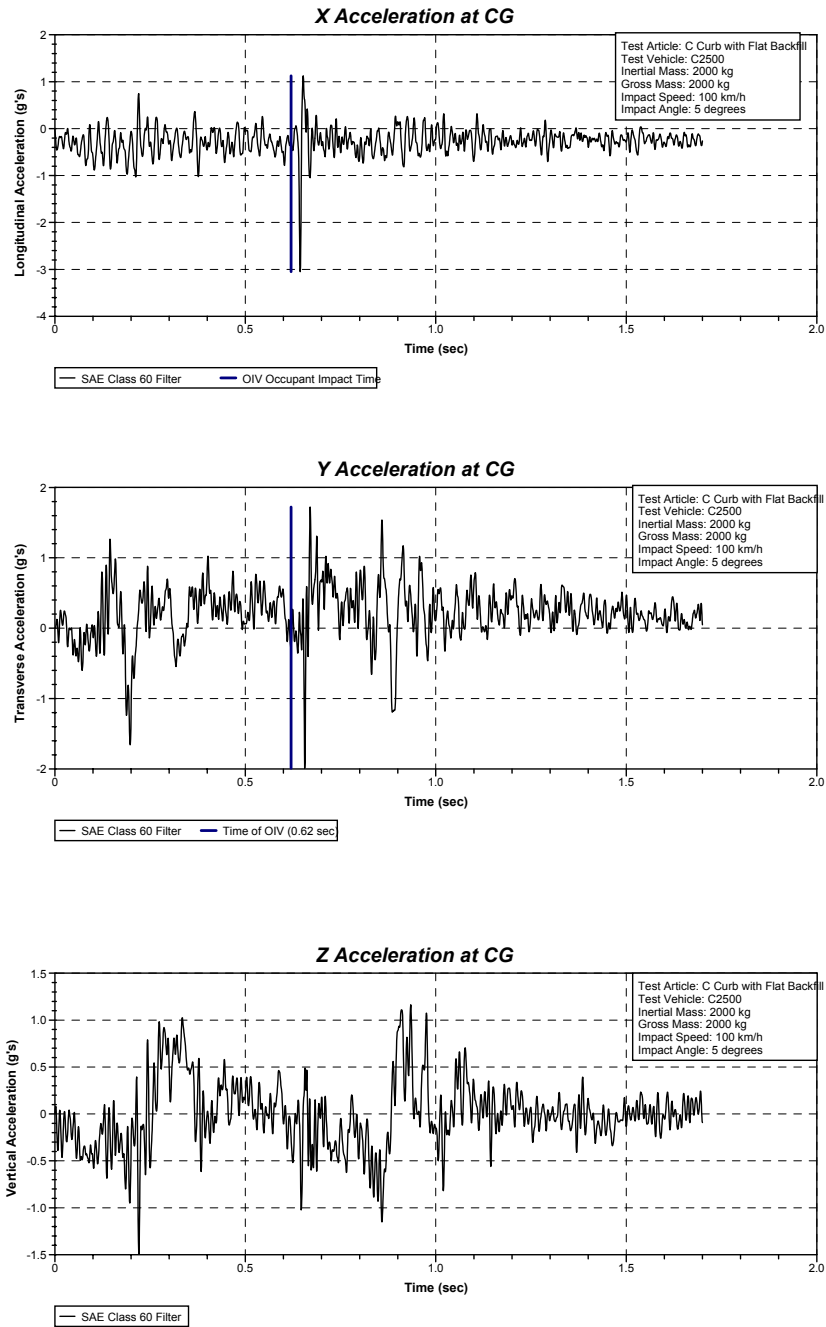

Figure C.13: Acceleration-time histories at C.G. of pickup truck in local coordinates:
Curb Type -- AASHTO C Curb
Impact Speed -- 100 km/hr
Impact Angle -- 5 degrees.

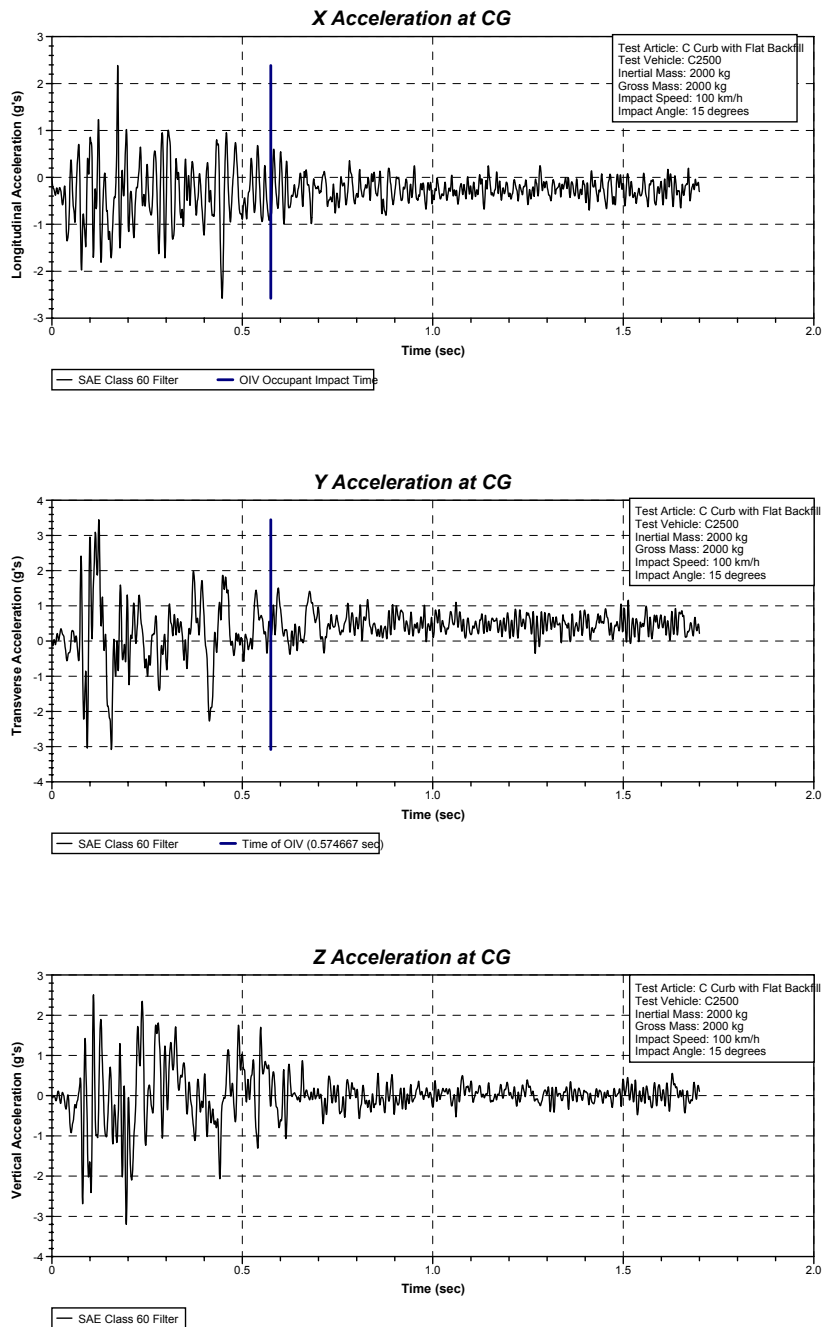

Figure C.14: Acceleration-time histories at C.G. of pickup truck in local coordinates:
Curb Type -- AASHTO C Curb
Impact Speed -- 100 km/hr
Impact Angle -- 15 degrees.

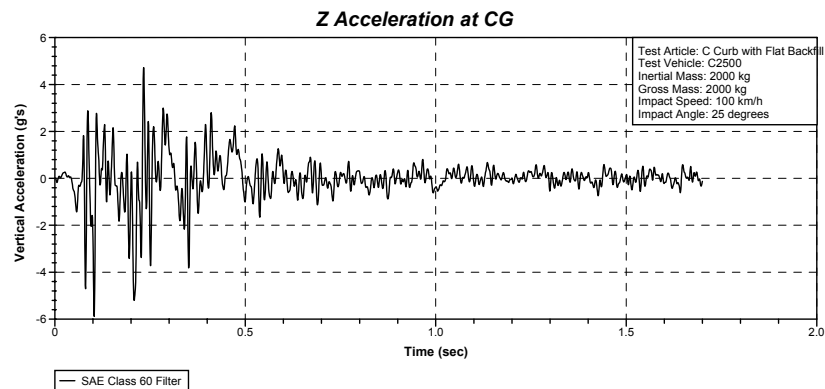
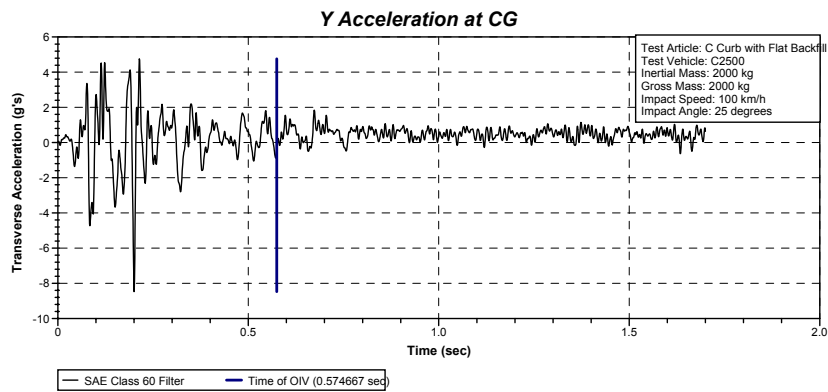
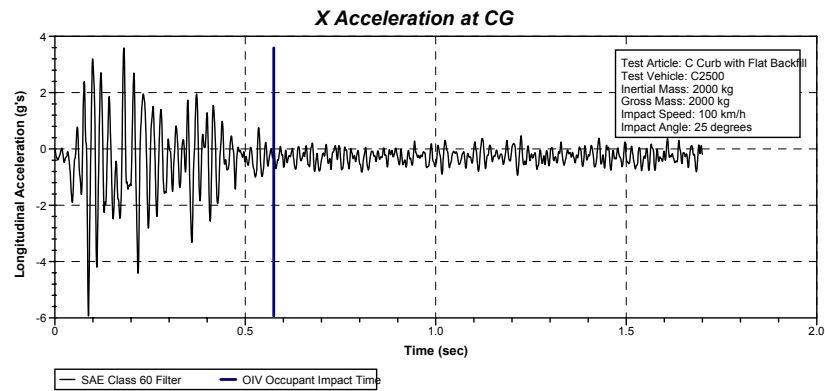

Figure C.15: Acceleration-time histories at C.G. of pickup truck in local coordinates:
Curb Type -- AASHTO C Curb
Impact Speed -- 100 km/hr
Impact Angle -- 25 degrees.

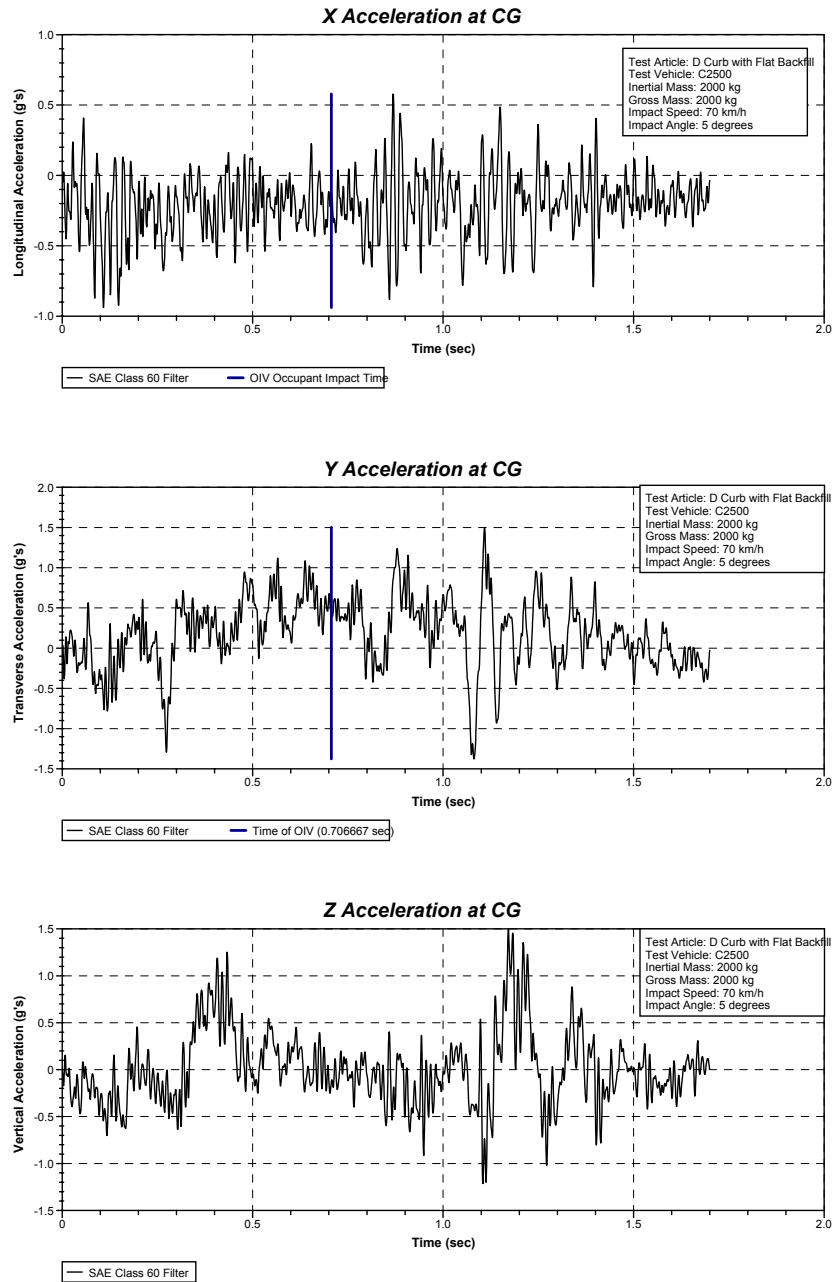

Figure C.16: Acceleration-time histories at C.G. of pickup truck in local coordinates:
Curb Type -- AASHTO D Curb
Impact Speed -- 70 km/hr
Impact Angle -- 5 degrees.

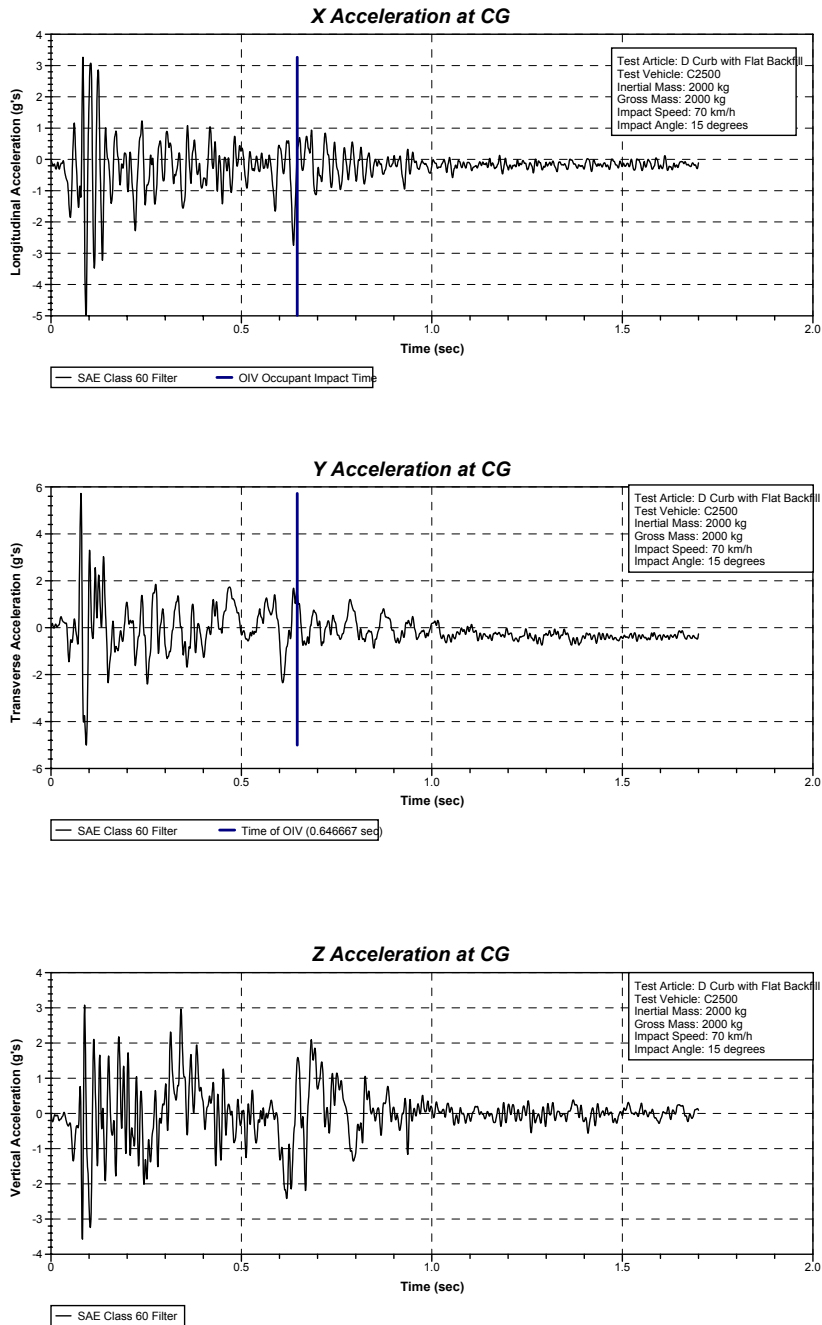

Figure C.17: Acceleration-time histories at C.G. of pickup truck in local coordinates:
Curb Type -- AASHTO D Curb
Impact Speed -- 70 km/hr
Impact Angle -- 15 degrees.

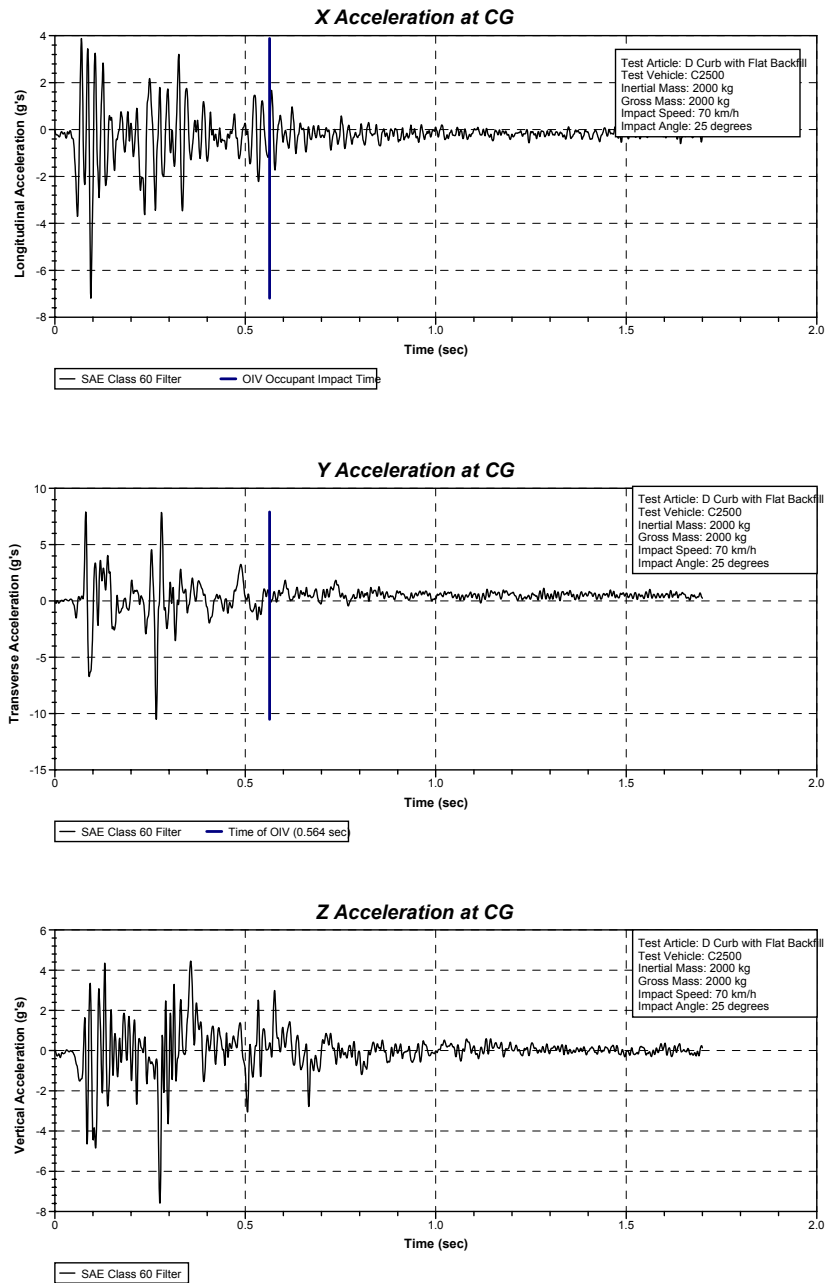

Figure C.18: Acceleration-time histories at C.G. of pickup truck in local coordinates:
Curb Type -- AASHTO D Curb
Impact Speed -- 70 km/hr
Impact Angle -- 25 degrees.

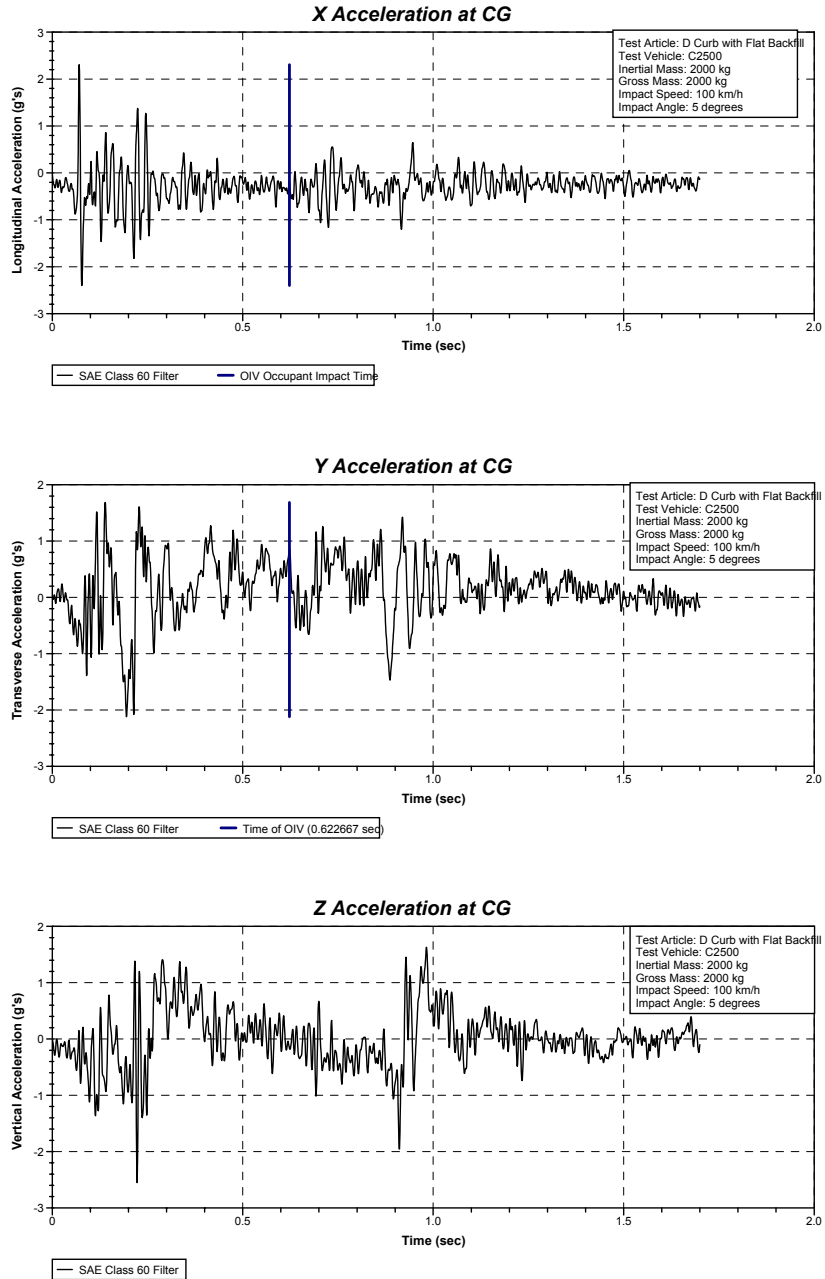

Figure C.19: Acceleration-time histories at C.G. of pickup truck in local coordinates:
Curb Type -- AASHTO D Curb
Impact Speed -- 100 km/hr
Impact Angle -- 5 degrees.

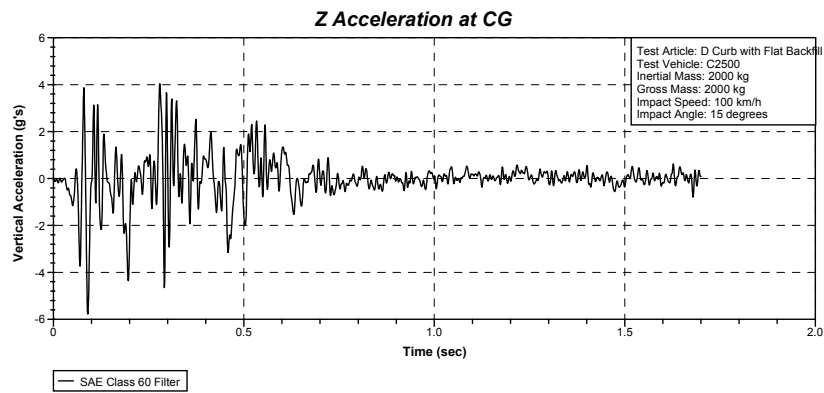
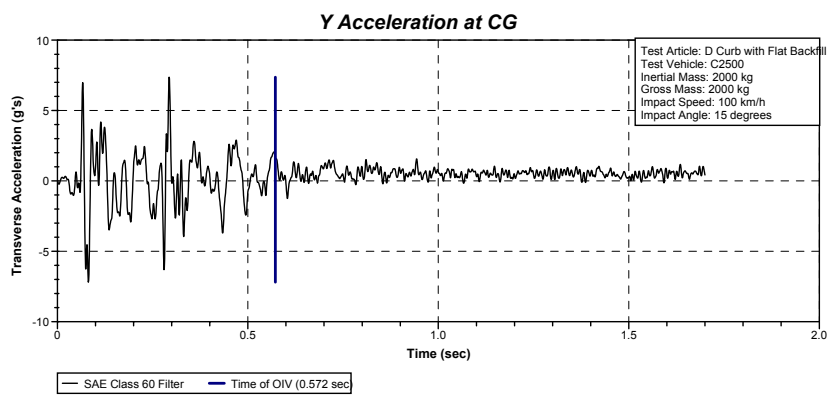
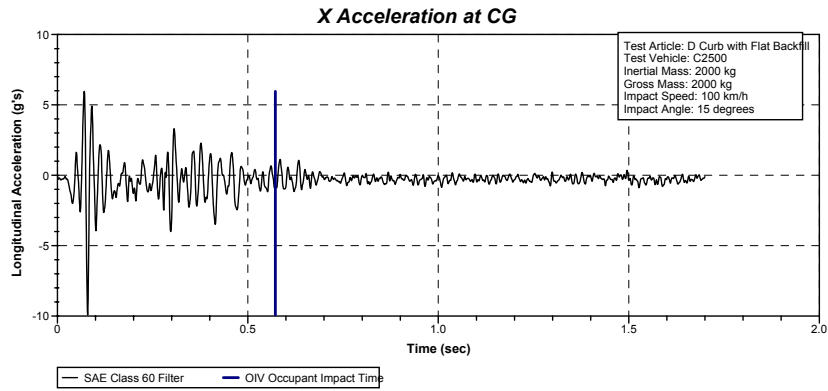

Figure C.20: Acceleration-time histories at C.G. of pickup truck in local coordinates:
Curb Type -- AASHTO D Curb
Impact Speed -- 100 km/hr
Impact Angle -- 15 degrees.

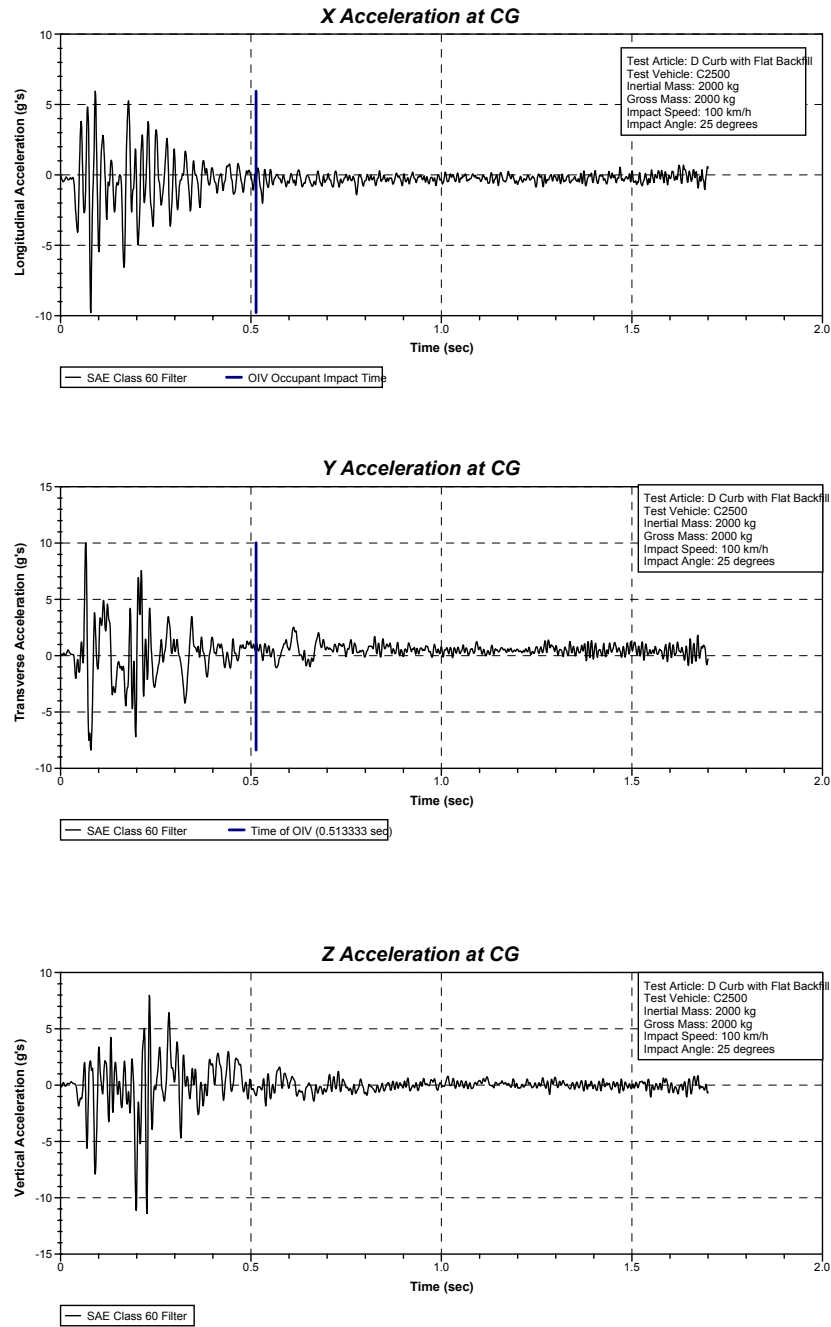

Figure C.21: Acceleration-time histories at C.G. of pickup truck in local coordinates:
Curb Type -- AASHTO D Curb
Impact Speed -- 100 km/hr
Impact Angle -- 25 degrees.

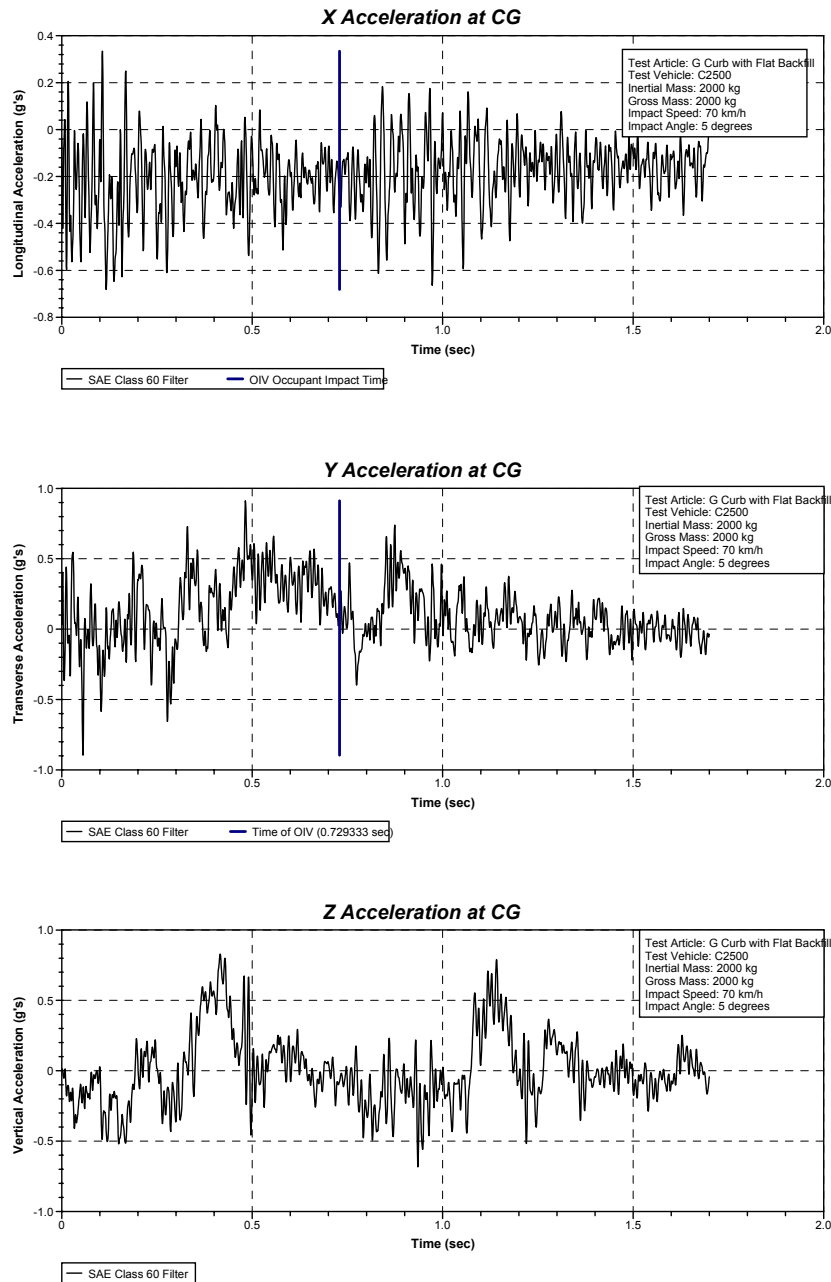

Figure C.22: Acceleration-time histories at C.G. of pickup truck in local coordinates:
Curb Type -- AASHTO G Curb
Impact Speed -- 70 km/hr
Impact Angle -- 5 degrees.

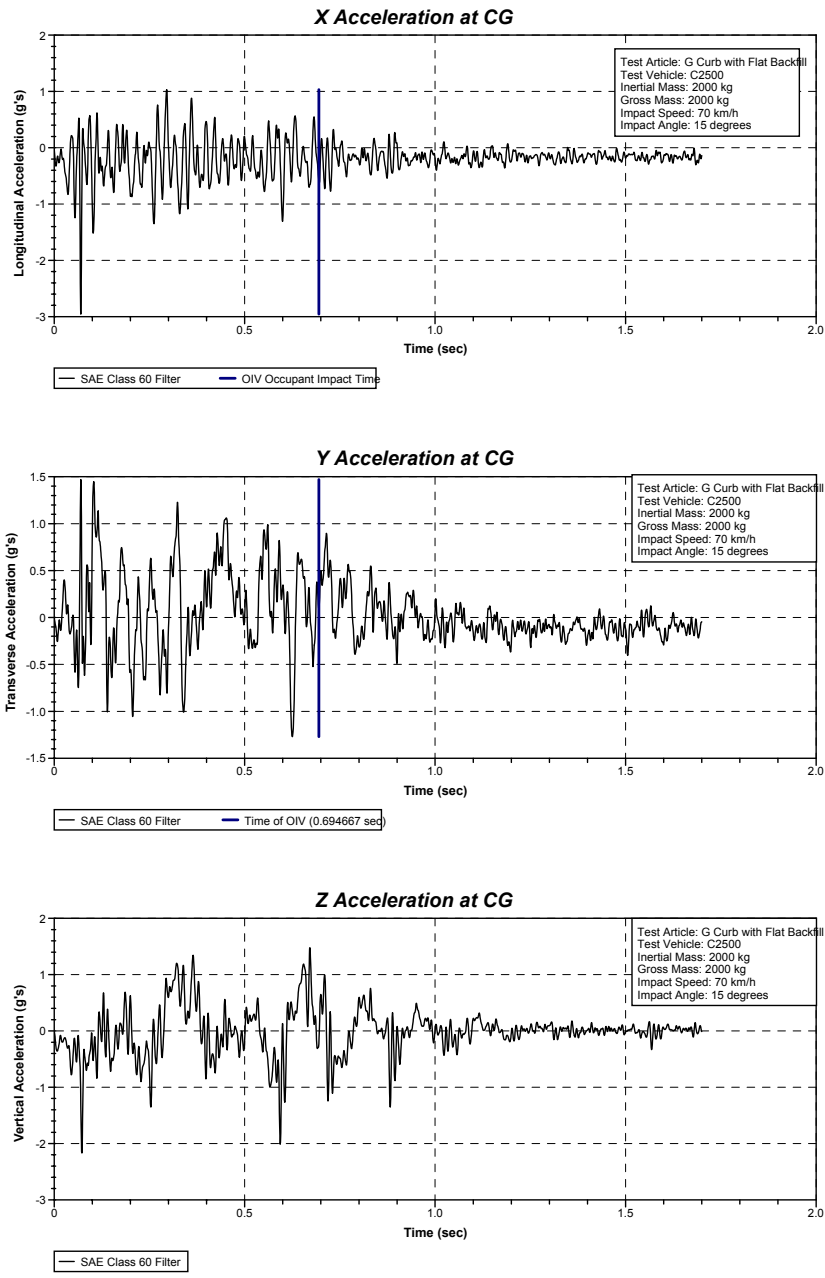

Figure C.23: Acceleration-time histories at C.G. of pickup truck in local coordinates:
Curb Type -- AASHTO G Curb
Impact Speed -- 70 km/hr
Impact Angle -- 15 degrees.

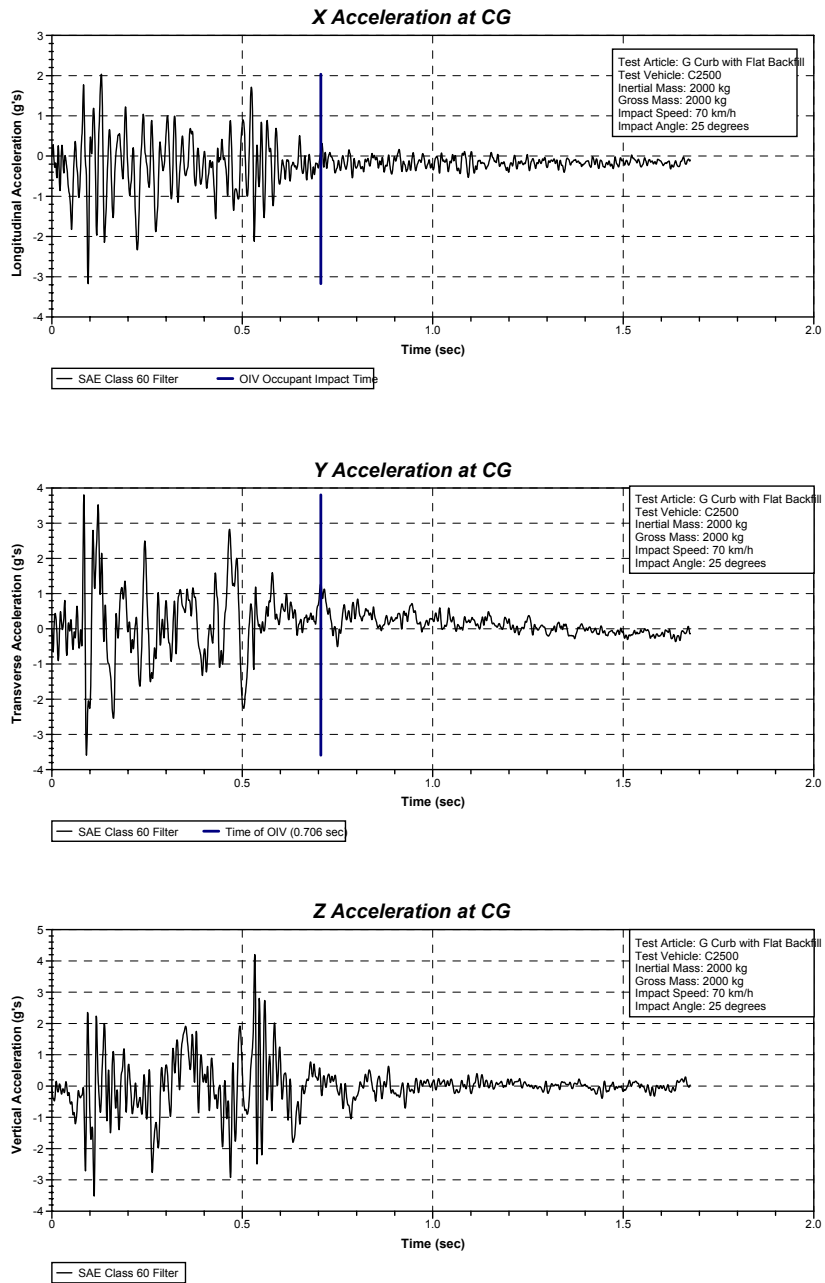

Figure C.24: Acceleration-time histories at C.G. of pickup truck in local coordinates:
Curb Type -- AASHTO G Curb
Impact Speed -- 70 km/hr
Impact Angle -- 25 degrees.

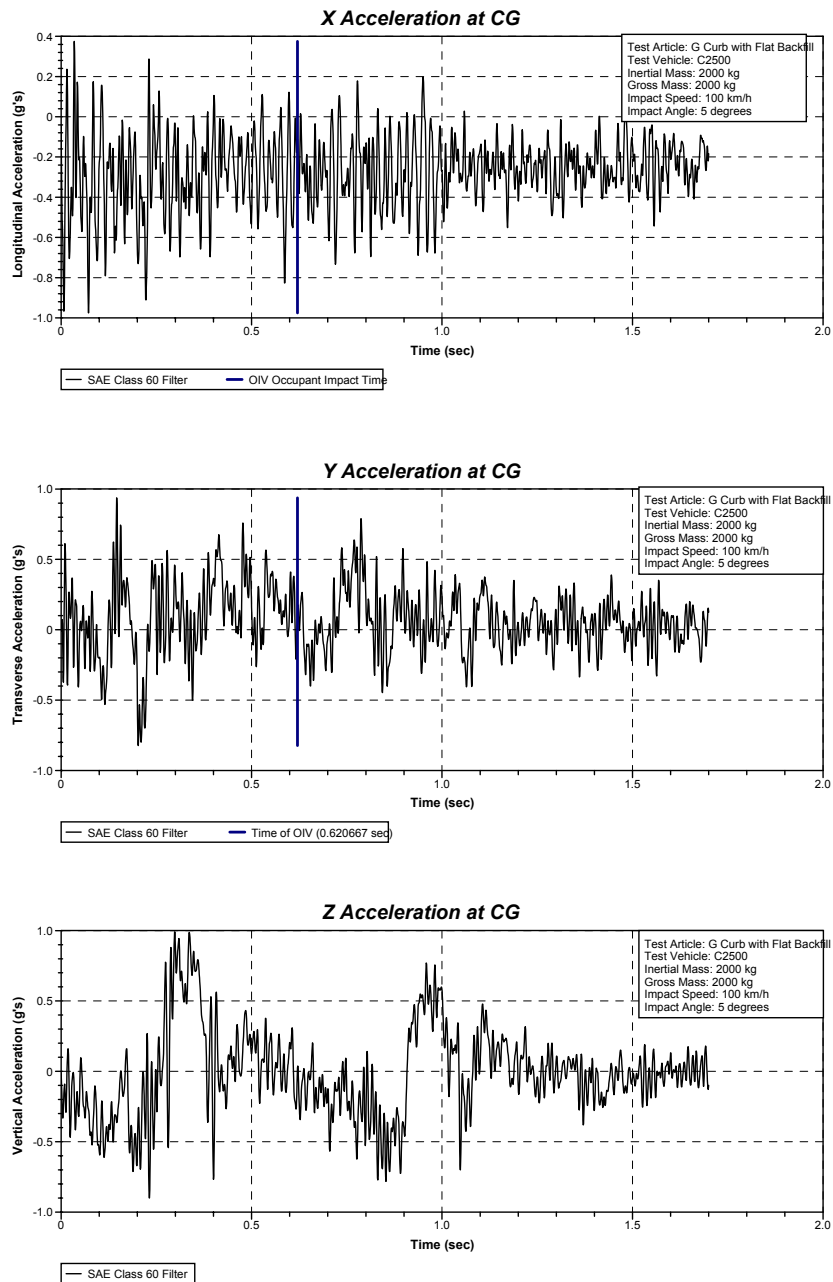

Figure C.25: Acceleration-time histories at C.G. of pickup truck in local coordinates:
Curb Type -- AASHTO G Curb
Impact Speed -- 100 km/hr
Impact Angle -- 5 degrees.

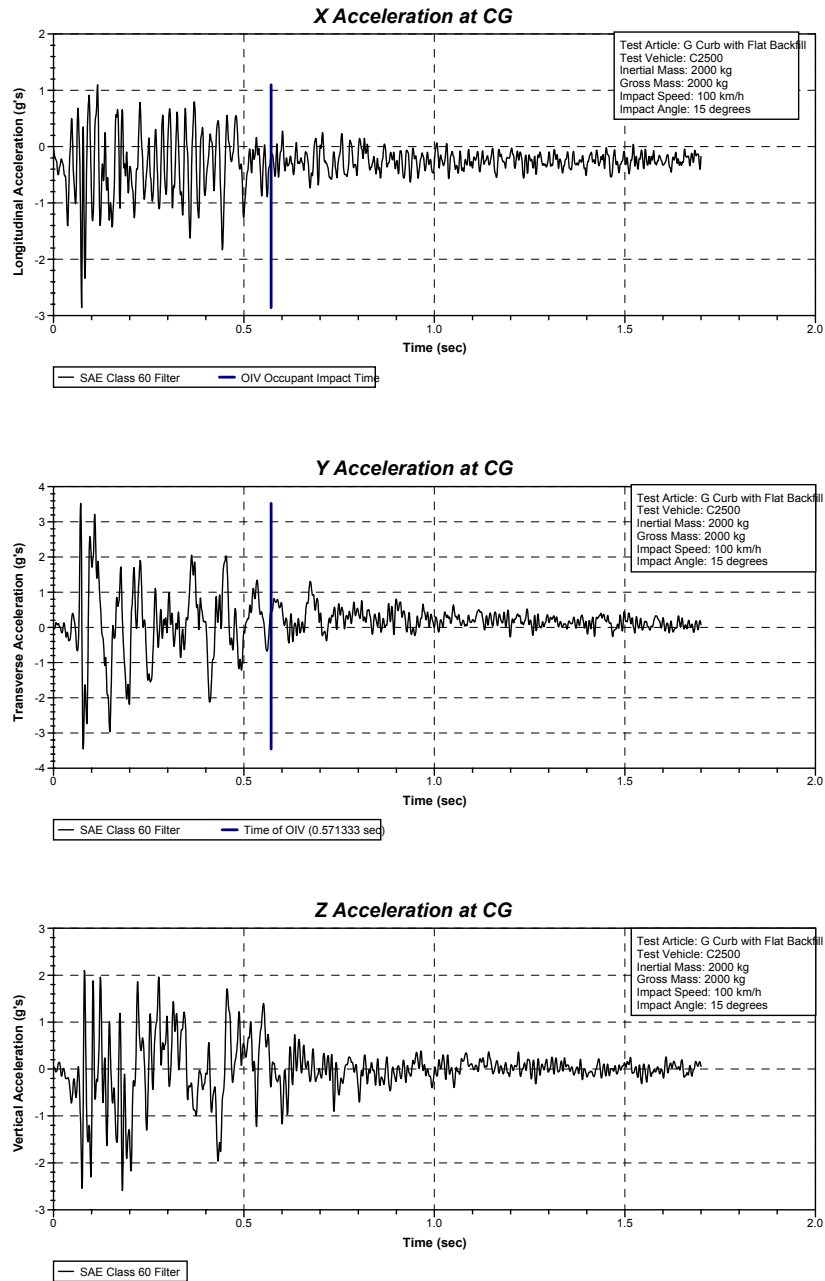

Figure C.26: Acceleration-time histories at C.G. of pickup truck in local coordinates:
Curb Type -- AASHTO G Curb
Impact Speed -- 100 km/hr
Impact Angle -- 15 degrees.

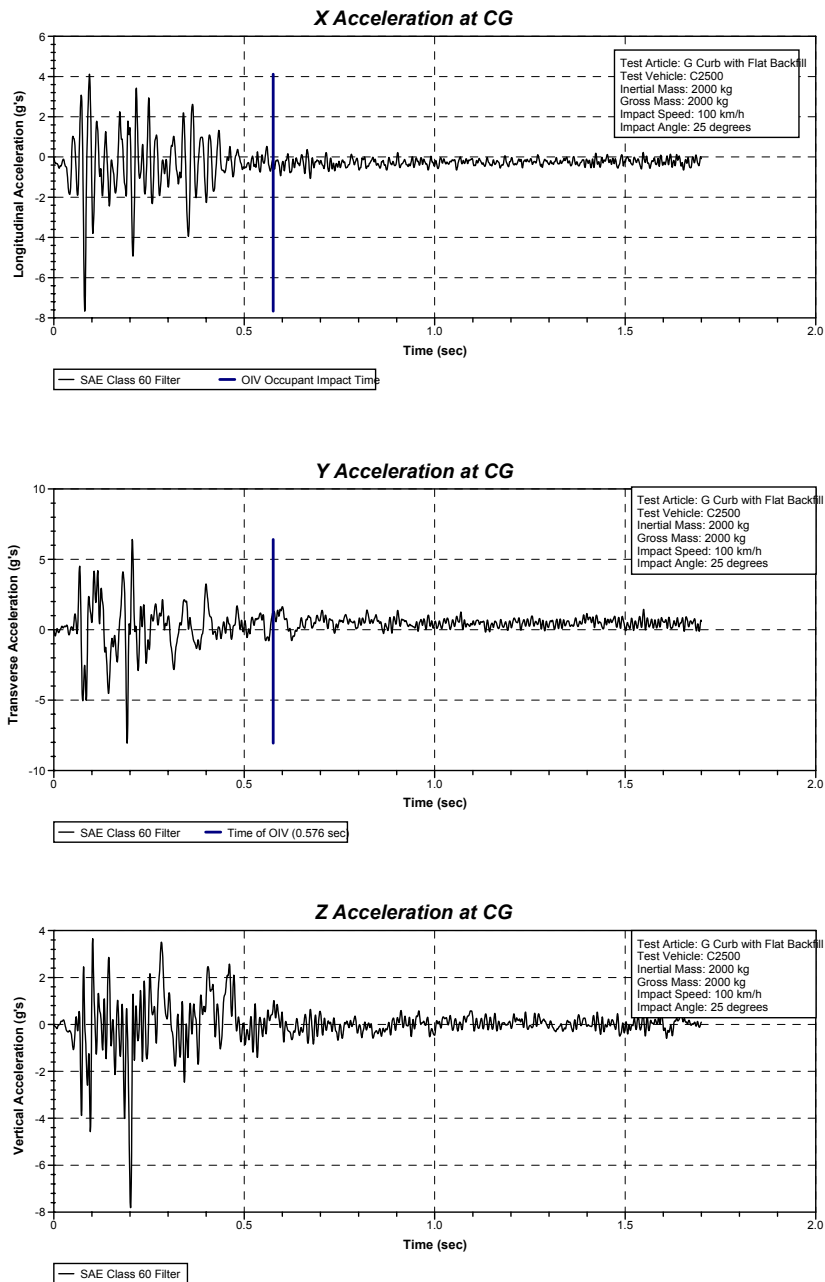

Figure C.27: Acceleration-time histories at C.G. of pickup truck in local coordinates:
Curb Type -- AASHTO G Curb
Impact Speed -- 100 km/hr
Impact Angle -- 25 degrees.

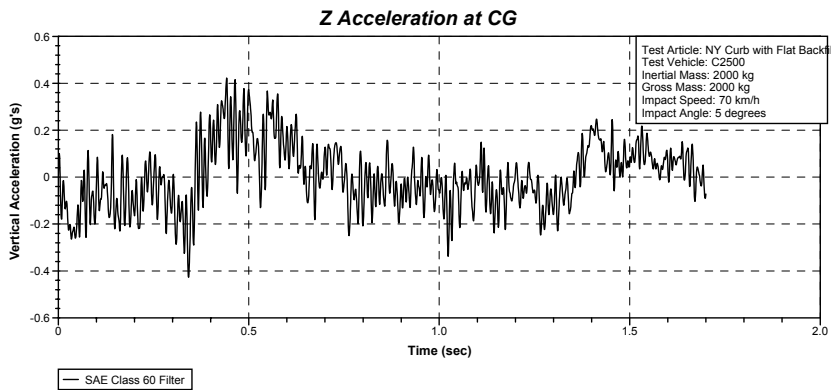
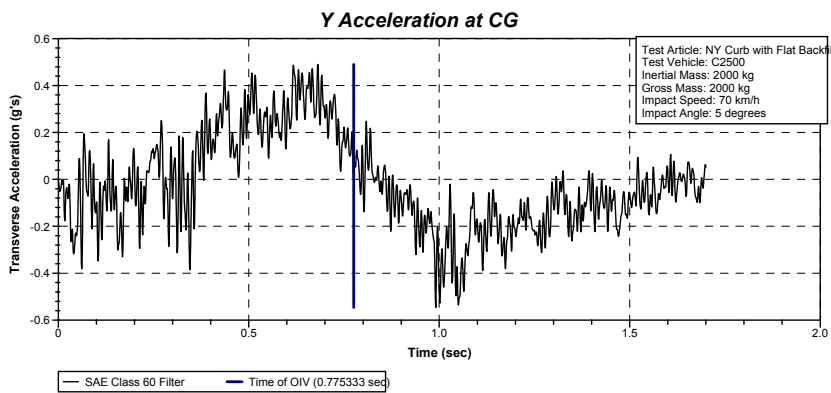
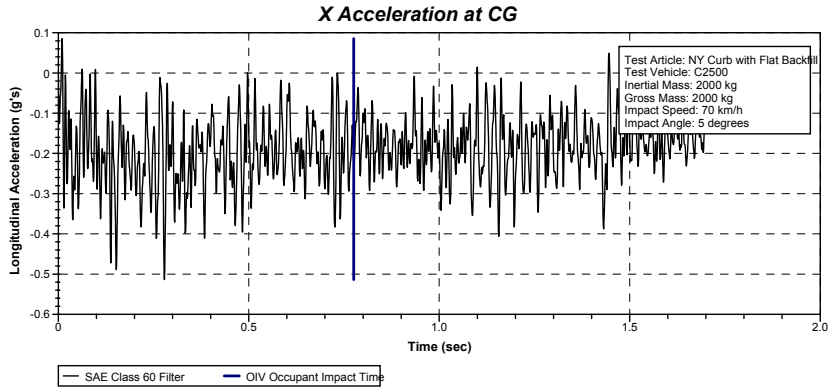

Figure C.28: Acceleration-time histories at C.G. of pickup truck in local coordinates:
Curb Type -- New York Curb (100 mm)
Impact Speed -- 70 km/hr
Impact Angle -- 5 degrees.

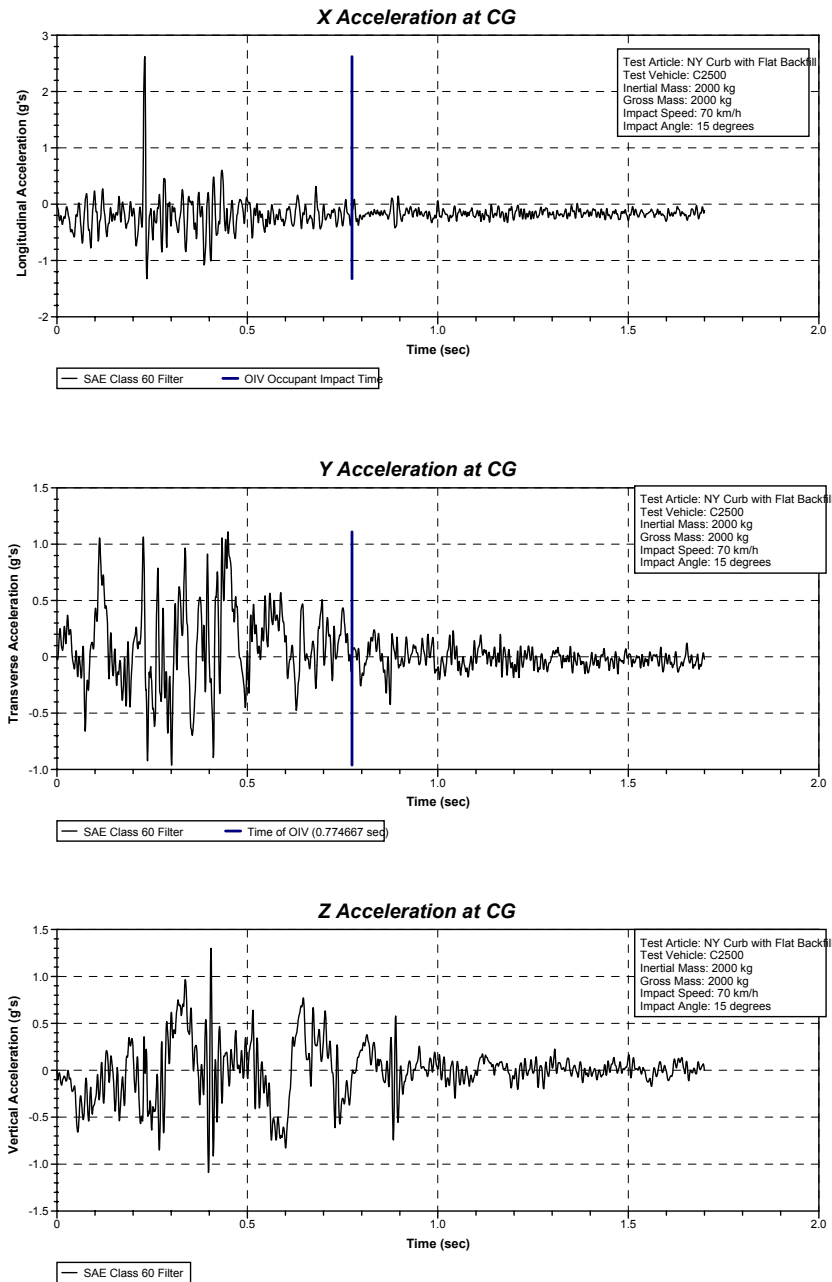

Figure C.29: Acceleration-time histories at C.G. of pickup truck in local coordinates:
Curb Type -- New York Curb (100 mm)
Impact Speed -- 70 km/hr
Impact Angle -- 15 degrees.

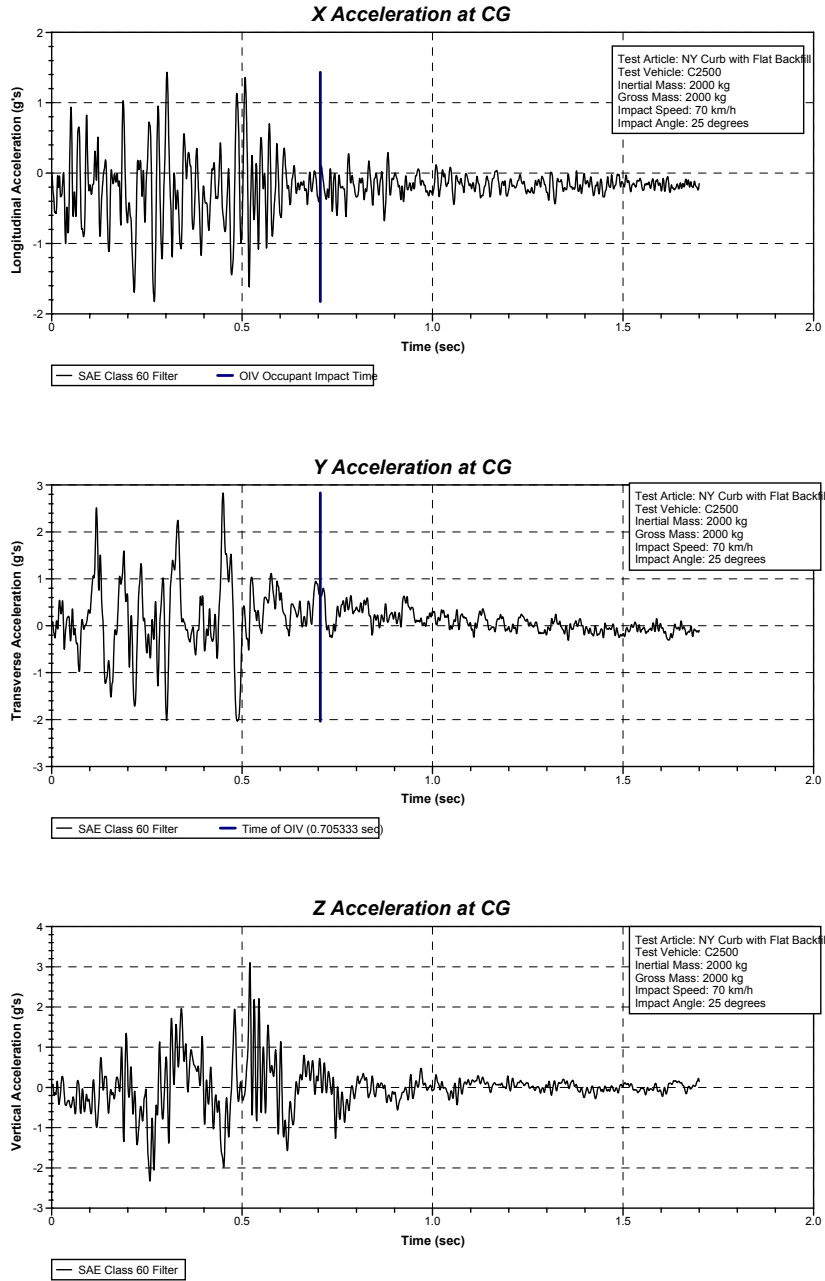

Figure C.30: Acceleration-time histories at C.G. of pickup truck in local coordinates:
Curb Type -- New York Curb (100 mm)
Impact Speed -- 70 km/hr
Impact Angle -- 25 degrees.

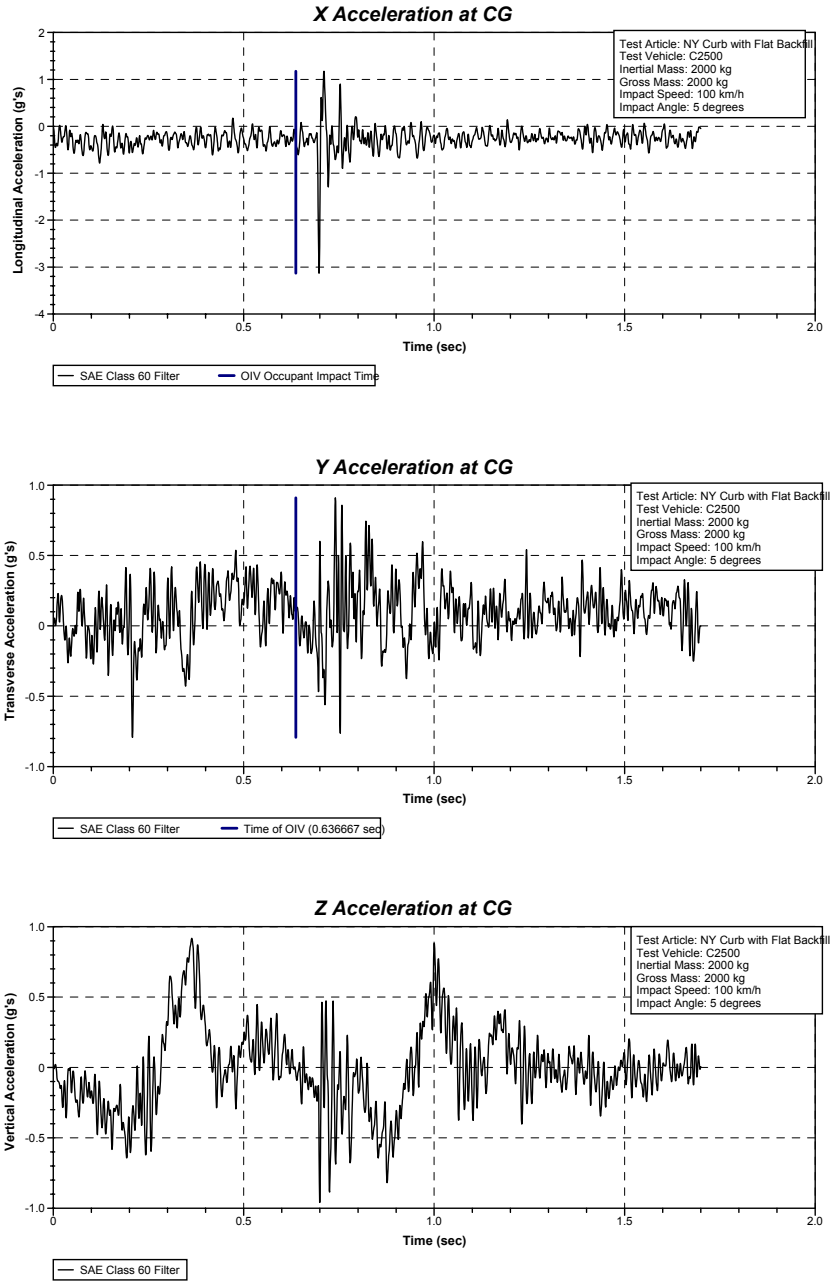

Figure C.31: Acceleration-time histories at C.G. of pickup truck in local coordinates:
Curb Type -- New York Curb (100 mm)
Impact Speed -- 100 km/hr
Impact Angle -- 5 degrees.

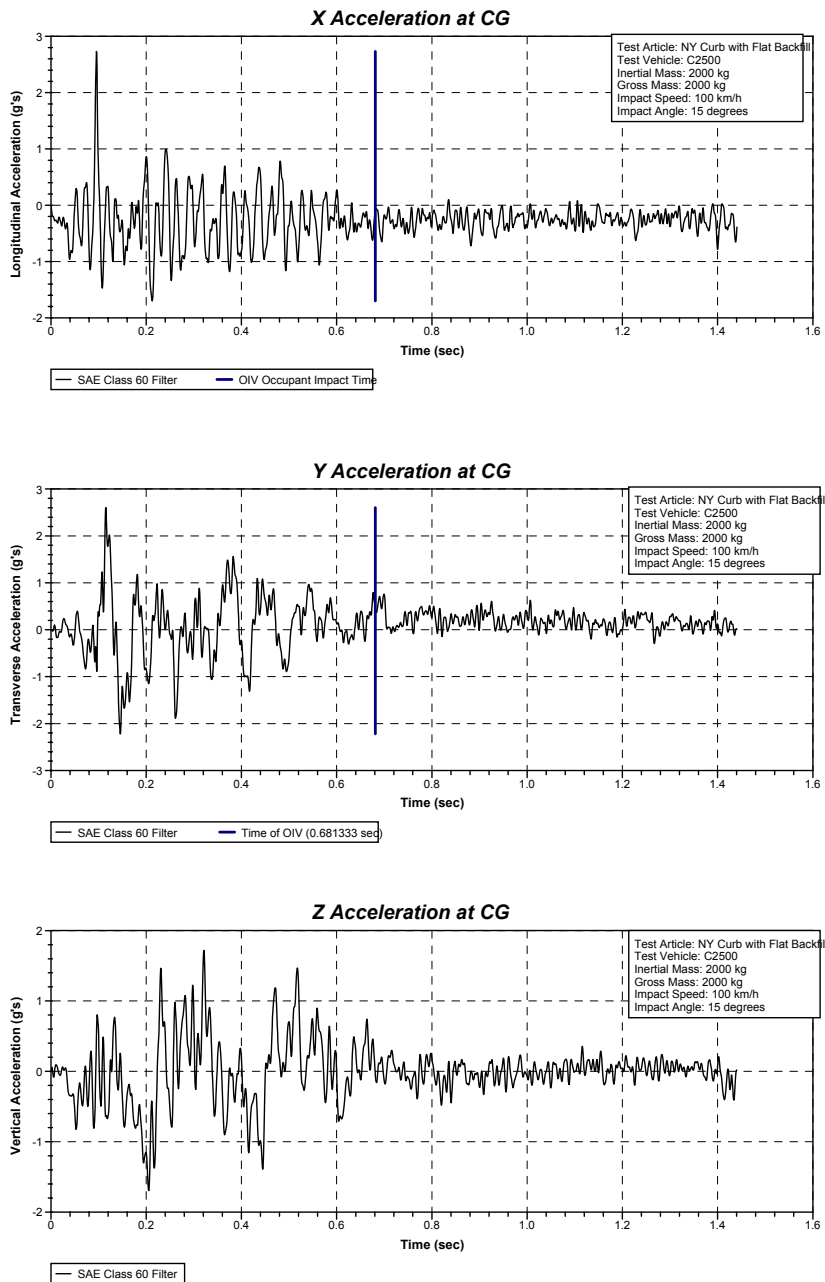

Figure C.32: Acceleration-time histories at C.G. of pickup truck in local coordinates:
Curb Type -- New York Curb (100 mm)
Impact Speed -- 100 km/hr
Impact Angle -- 15 degrees.

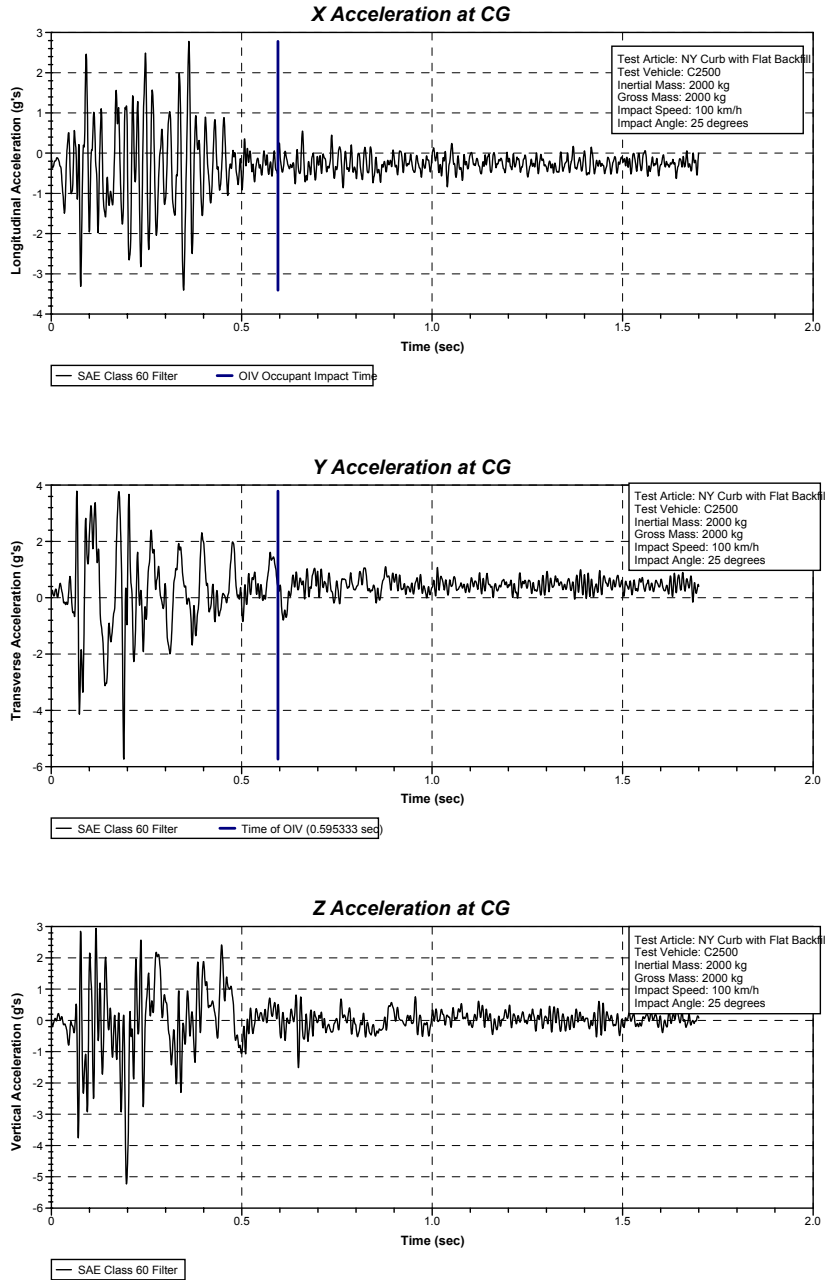
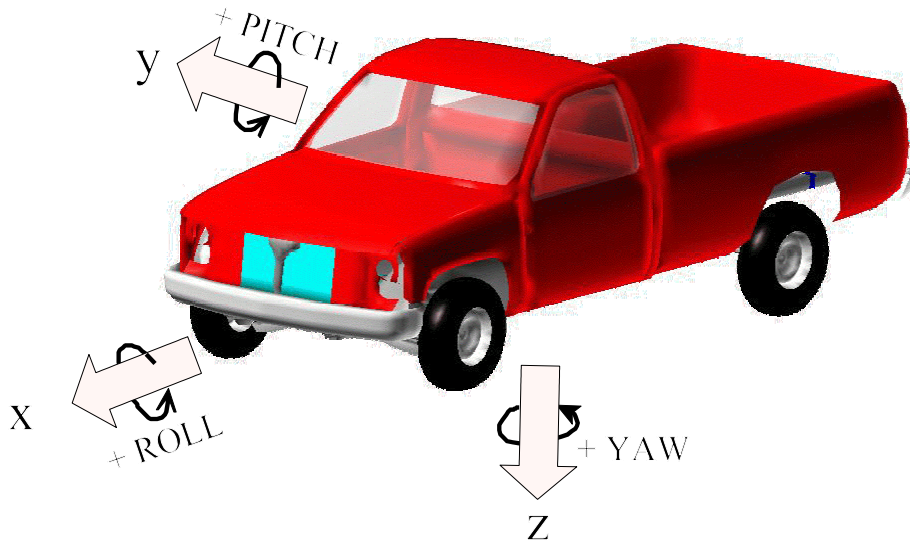

Figure C.33: Acceleration-time histories at C.G. of pickup truck in local coordinates:
Curb Type -- New York Curb (100 mm)
Impact Speed -- 100 km/hr
Impact Angle -- 25 degrees.

APPENDIX D

Angular Displacement-Time Histories Computed at the Center of Gravity of Vehicle

-Finite Element Analysis Results-



Vehicle fixed coordinate reference system.

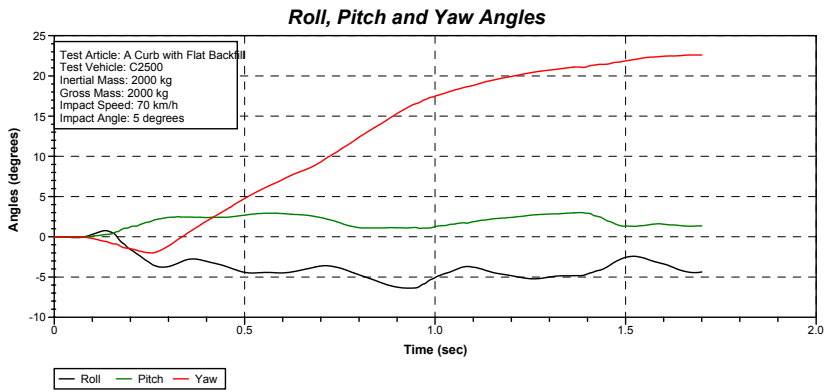

Figure D.1: Angular displacement-time histories at C.G. of pickup truck in local coordinates:
Curb Type -- AASHTO A Curb
Impact Speed -- 70 km/hr
Impact Angle -- 5 degrees.

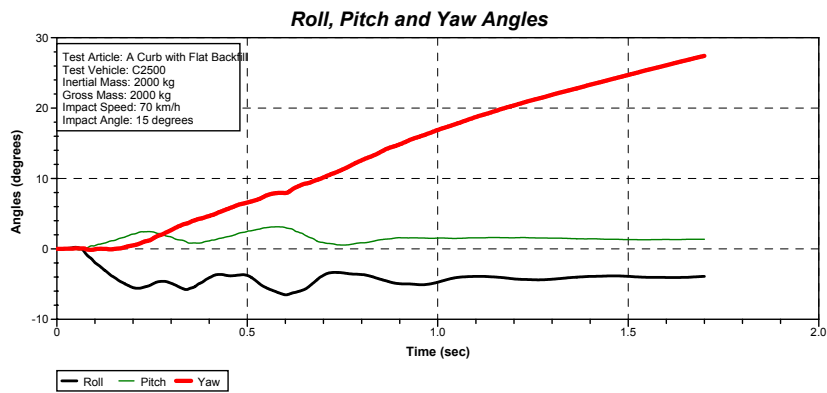

Figure D.2: Angular displacement-time histories at C.G. of pickup truck in local coordinates:
Curb Type -- AASHTO A Curb
Impact Speed -- 70 km/hr
Impact Angle -- 15 degrees.

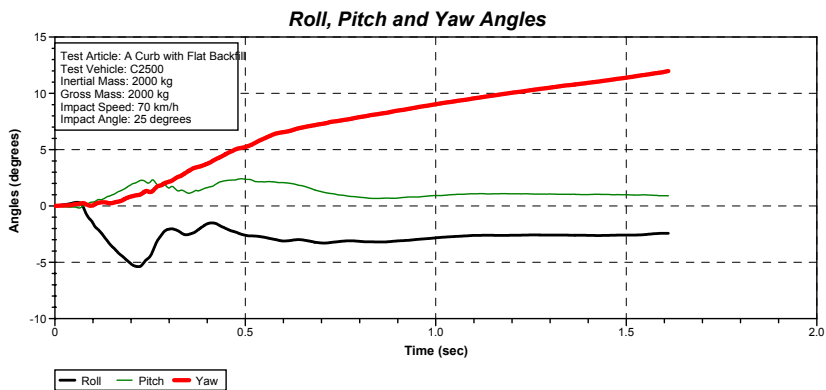

Figure D.3: Angular displacement-time histories at C.G. of pickup truck in local coordinates:
Curb Type -- AASHTO A Curb
Impact Speed -- 70 km/hr
Impact Angle -- 25 degrees.

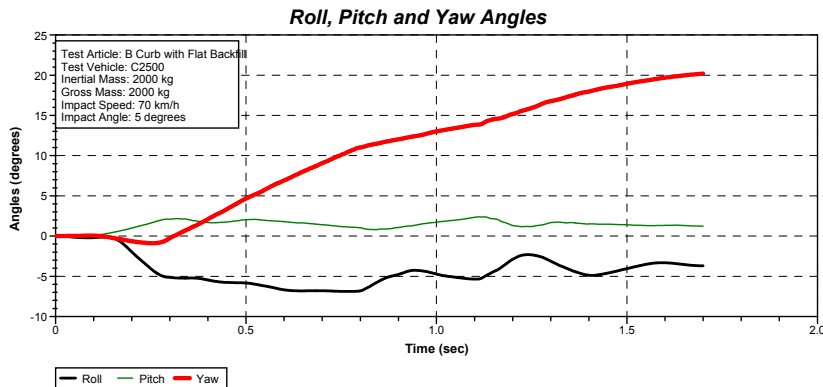

Figure D.4: Angular displacement-time histories at C.G. of pickup truck in local coordinates:
Curb Type -- AASHTO B Curb
Impact Speed -- 70 km/hr
Impact Angle -- 5 degrees.

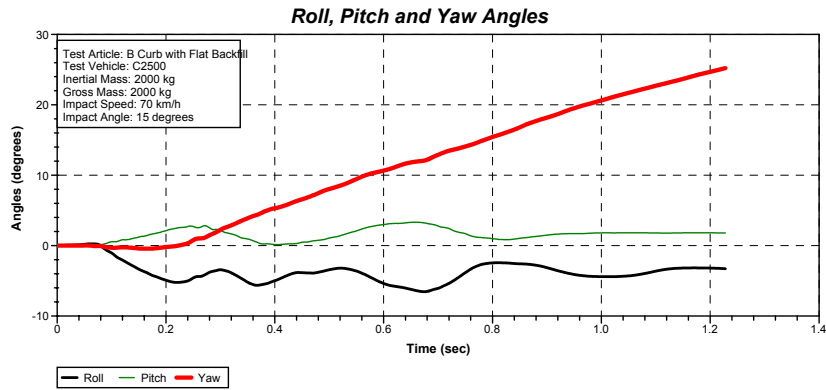

Figure D.5: Angular displacement-time histories at C.G. of pickup truck in local coordinates:
Curb Type -- AASHTO B Curb
Impact Speed -- 70 km/hr
Impact Angle -- 15 degrees.

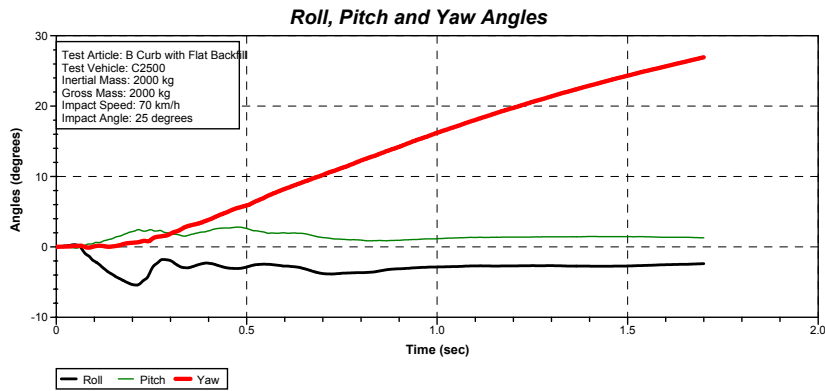

Figure D.6: Angular displacement-time histories at C.G. of pickup truck in local coordinates:
Curb Type -- AASHTO B Curb
Impact Speed -- 70 km/hr
Impact Angle -- 25 degrees.

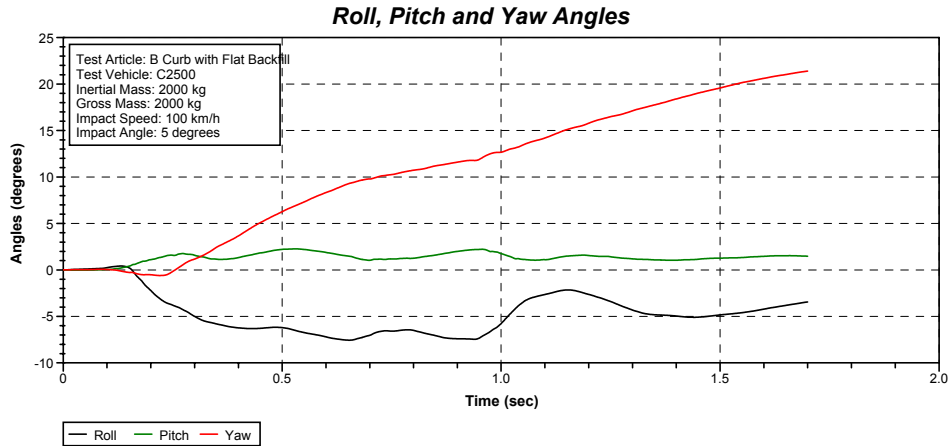

Figure D.7: Angular displacement-time histories at C.G. of pickup truck in local coordinates:
Curb Type -- AASHTO B Curb
Impact Speed -- 100 km/hr
Impact Angle -- 5 degrees.

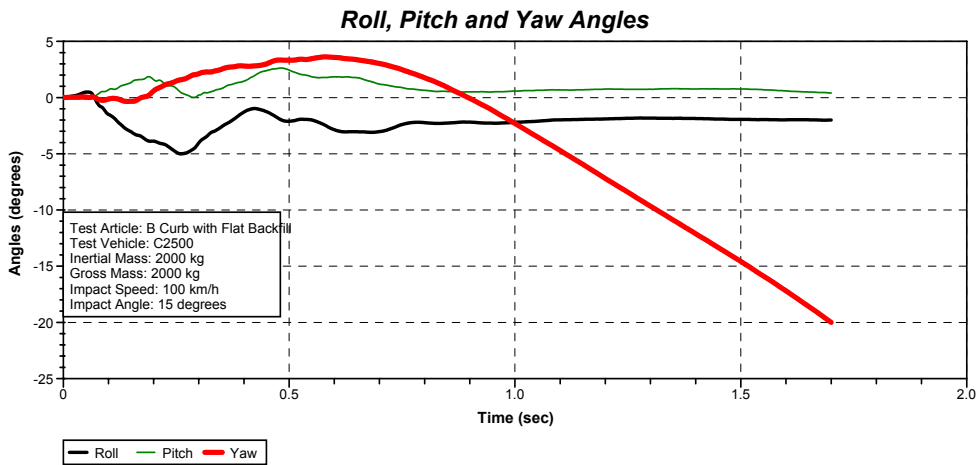

Figure D.8: Angular displacement-time histories at C.G. of pickup truck in local coordinates:
Curb Type -- AASHTO B Curb
Impact Speed -- 100 km/hr
Impact Angle -- 15 degrees.

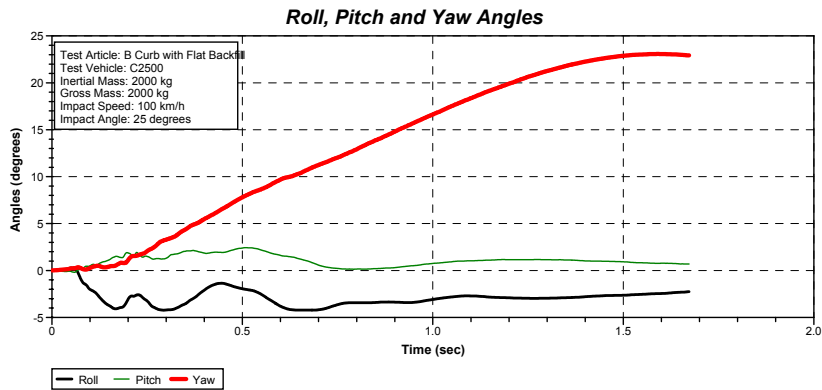

Figure D.9: Angular displacement-time histories at C.G. of pickup truck in local coordinates:
Curb Type -- AASHTO B Curb
Impact Speed -- 100 km/hr
Impact Angle -- 25 degrees.

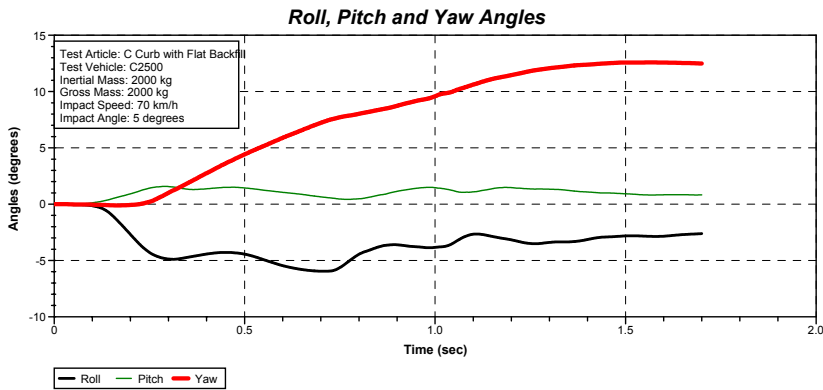

Figure D.10: Angular displacement-time histories at C.G. of pickup truck in local coordinates:
Curb Type -- AASHTO C Curb
Impact Speed -- 70 km/hr
Impact Angle -- 5 degrees.

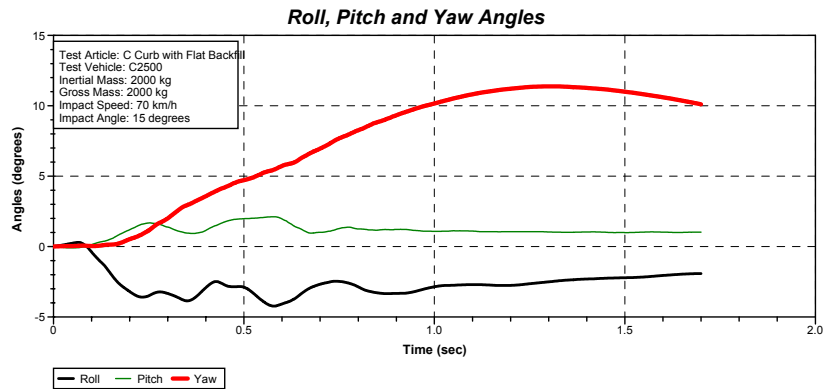

Figure D.11: Angular displacement-time histories at C.G. of pickup truck in local coordinates:
Curb Type -- AASHTO C Curb
Impact Speed -- 70 km/hr
Impact Angle -- 15 degrees.

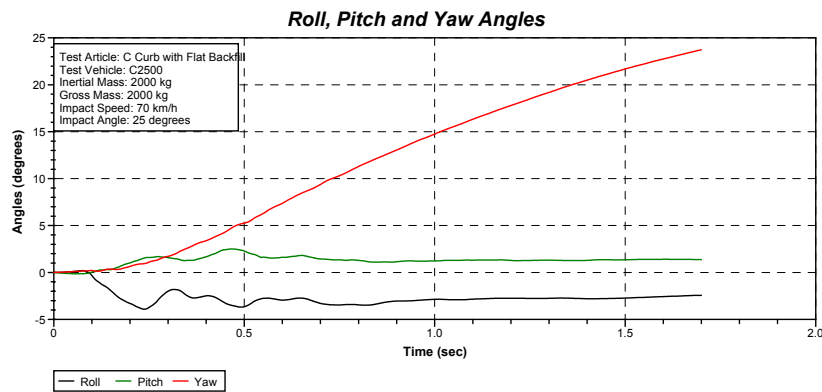

Figure D.12: Angular displacement-time histories at C.G. of pickup truck in local coordinates:
Curb Type -- AASHTO C Curb
Impact Speed -- 70 km/hr
Impact Angle -- 25 degrees.

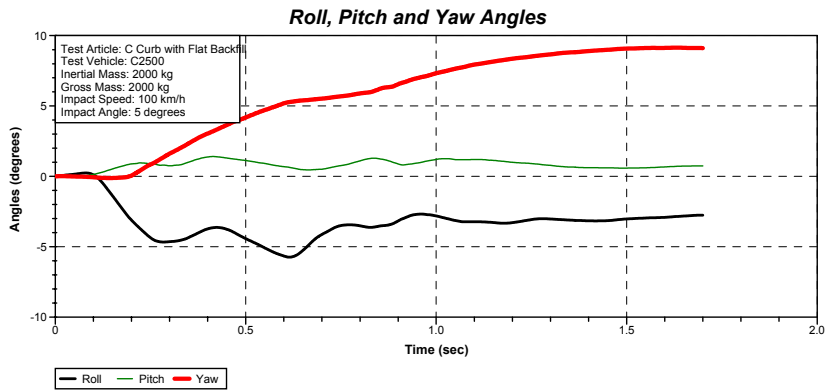

Figure D.13: Angular displacement-time histories at C.G. of pickup truck in local coordinates:
Curb Type -- AASHTO C Curb
Impact Speed -- 100 km/hr
Impact Angle -- 5 degrees.

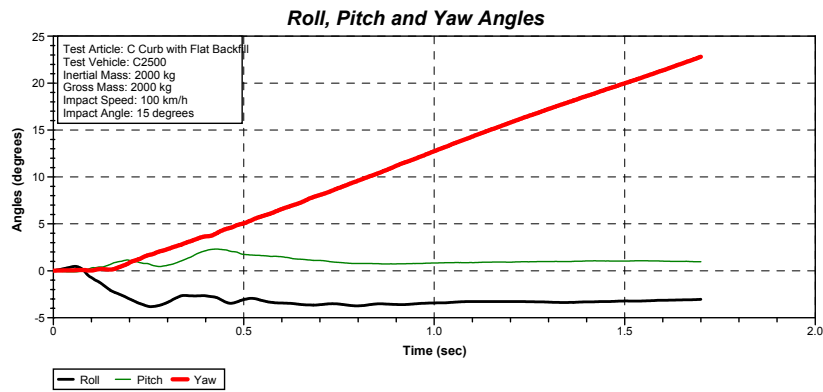

Figure D.14: Angular displacement-time histories at C.G. of pickup truck in local coordinates:
Curb Type -- AASHTO C Curb
Impact Speed -- 100 km/hr
Impact Angle -- 15 degrees.

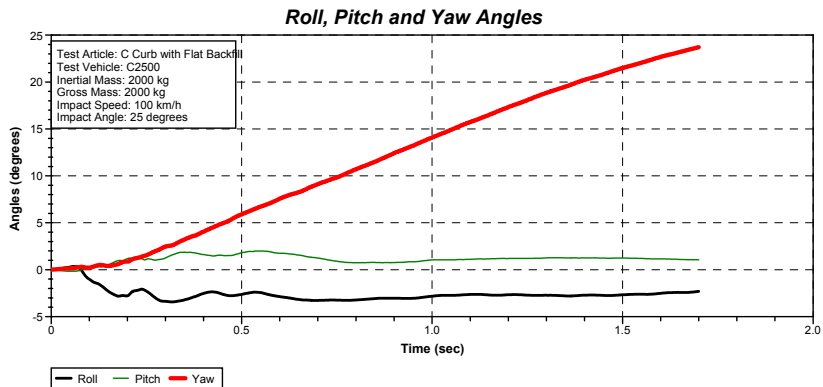

Figure D.15: Angular displacement-time histories at C.G. of pickup truck in local coordinates:
Curb Type -- AASHTO C Curb
Impact Speed -- 100 km/hr
Impact Angle -- 25 degrees.

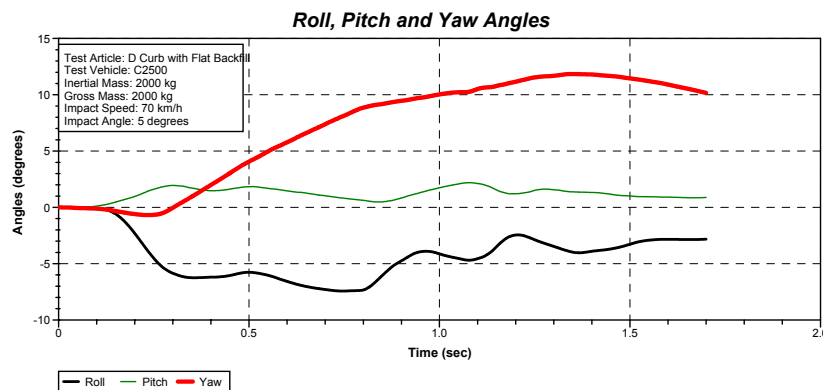

Figure D.16: Angular displacement-time histories at C.G. of pickup truck in local coordinates:
Curb Type -- AASHTO D Curb
Impact Speed -- 70 km/hr
Impact Angle -- 5 degrees.

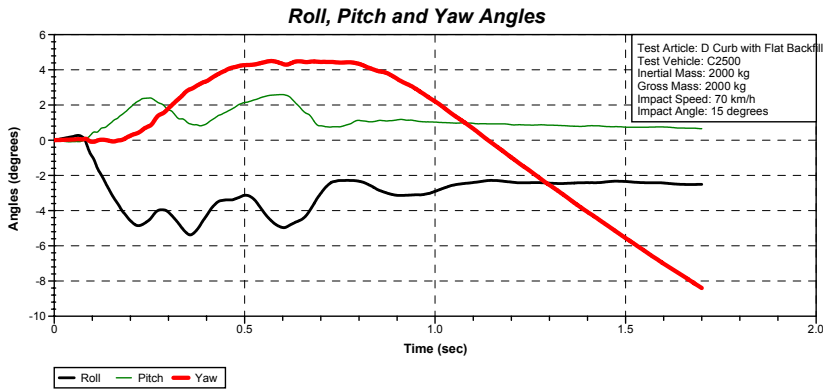

Figure D.17: Angular displacement-time histories at C.G. of pickup truck in local coordinates:
Curb Type -- AASHTO D Curb
Impact Speed -- 100 km/hr
Impact Angle -- 15 degrees.

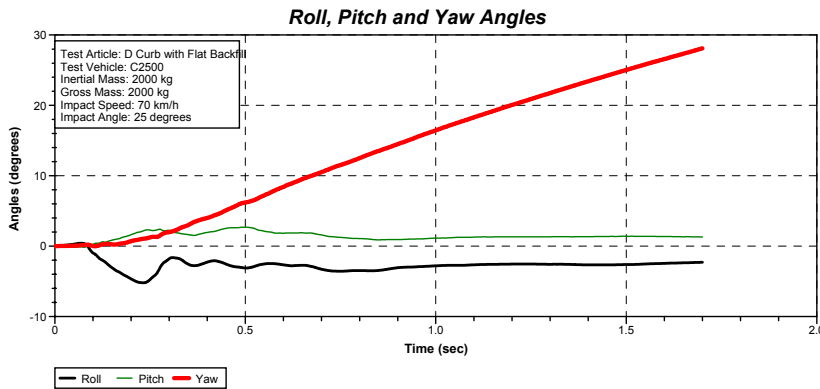

Figure D.18: Angular displacement-time histories at C.G. of pickup truck in local coordinates:
Curb Type -- AASHTO D Curb
Impact Speed -- 70 km/hr
Impact Angle -- 25 degrees.

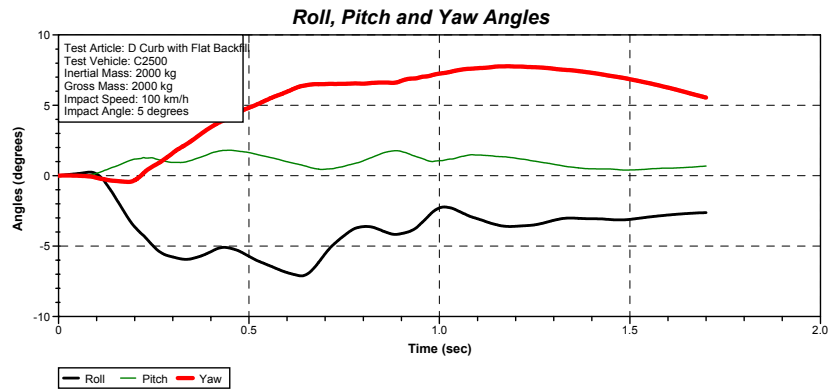

Figure D.19: Angular displacement-time histories at C.G. of pickup truck in local coordinates:
Curb Type -- AASHTO D Curb
Impact Speed -- 100 km/hr
Impact Angle -- 5 degrees.

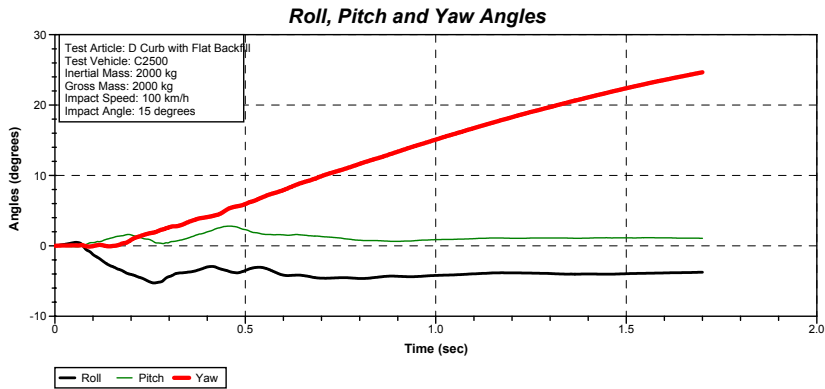

Figure D.20: Angular displacement-time histories at C.G. of pickup truck in local coordinates:
Curb Type -- AASHTO D Curb
Impact Speed -- 100 km/hr
Impact Angle -- 15 degrees.

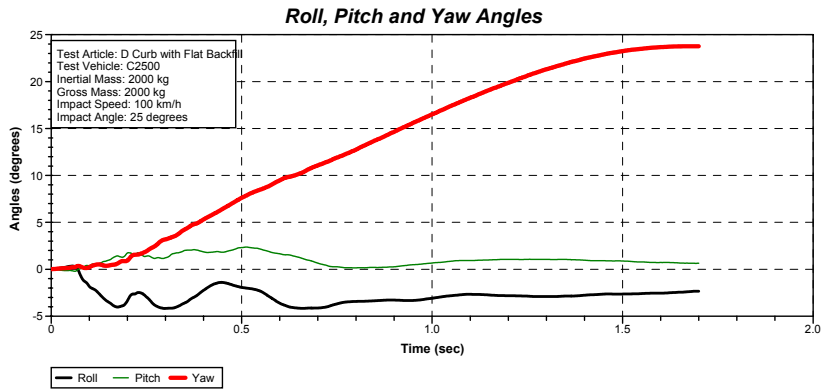

Figure D.21: Angular displacement-time histories at C.G. of pickup truck in local coordinates:
Curb Type -- AASHTO D Curb
Impact Speed -- 100 km/hr
Impact Angle -- 25 degrees.

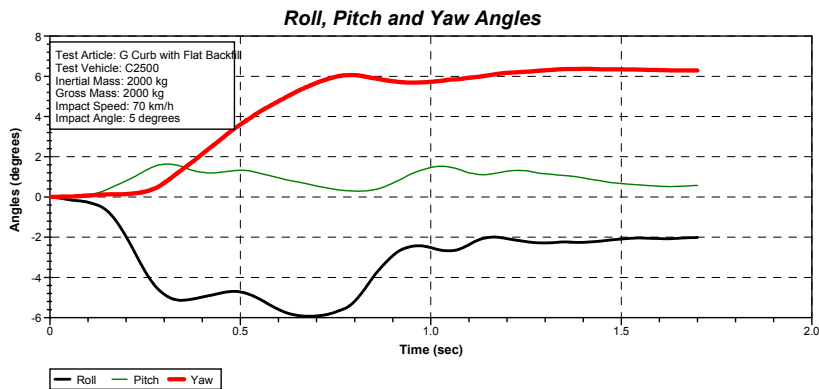

Figure D.22: Angular displacement-time histories at C.G. of pickup truck in local coordinates:
Curb Type -- AASHTO G Curb
Impact Speed -- 70 km/hr
Impact Angle -- 5 degrees.

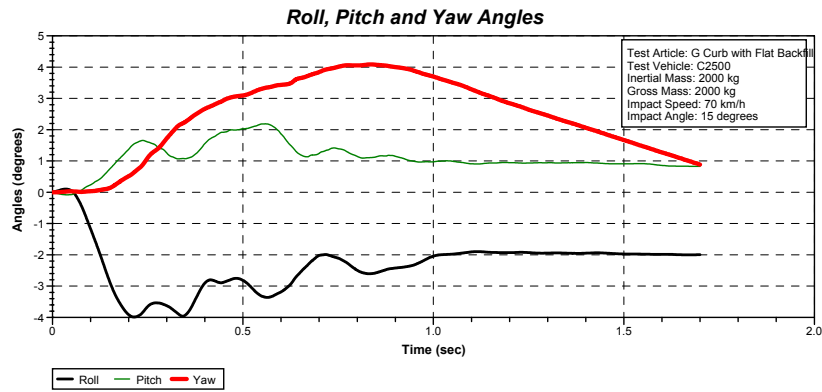

Figure D.23: Angular displacement-time histories at C.G. of pickup truck in local coordinates:
Curb Type -- AASHTO G Curb
Impact Speed -- 70 km/hr
Impact Angle -- 15 degrees.

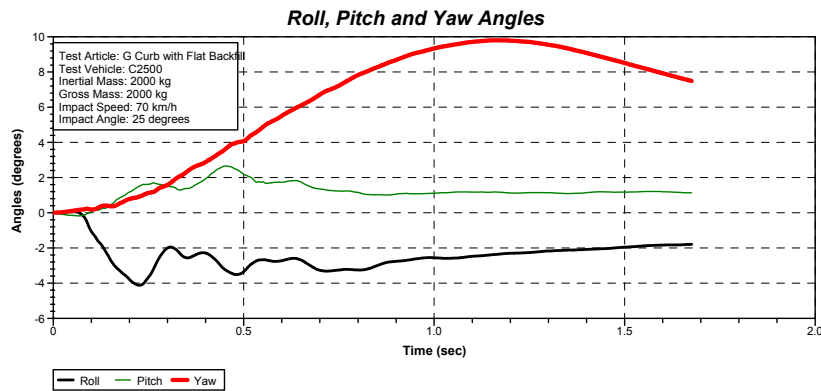

Figure D.24: Angular displacement-time histories at C.G. of pickup truck in local coordinates:
Curb Type -- AASHTO G Curb
Impact Speed -- 70 km/hr
Impact Angle -- 25 degrees.

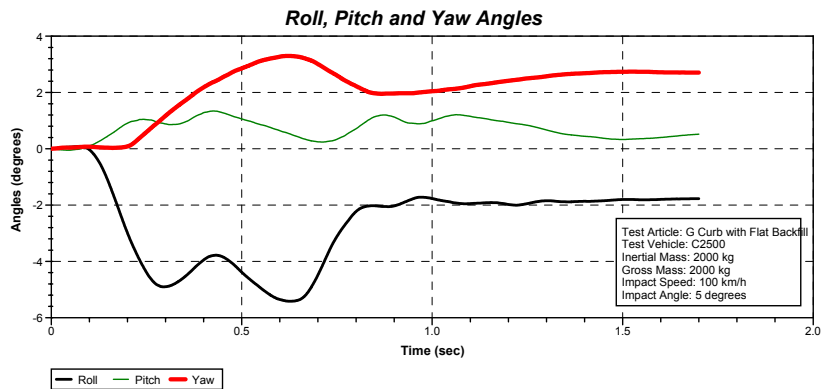

Figure D.25: Angular displacement-time histories at C.G. of pickup truck in local coordinates:
Curb Type -- AASHTO G Curb
Impact Speed -- 100 km/hr
Impact Angle -- 5 degrees.

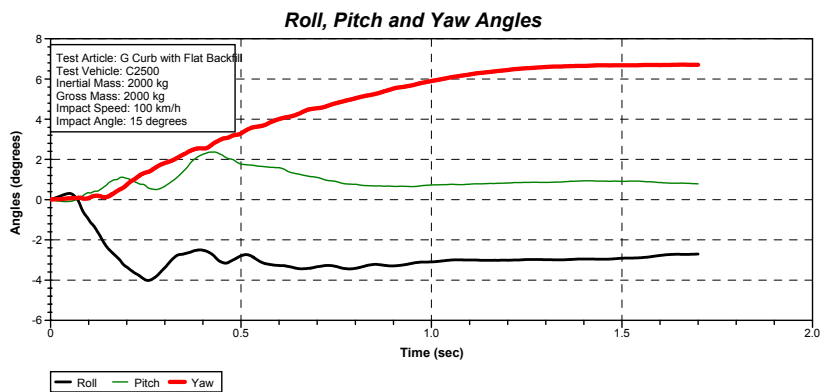

Figure D.26: Angular displacement-time histories at C.G. of pickup truck in local coordinates:
Curb Type -- AASHTO G Curb
Impact Speed -- 100 km/hr
Impact Angle -- 15 degrees.

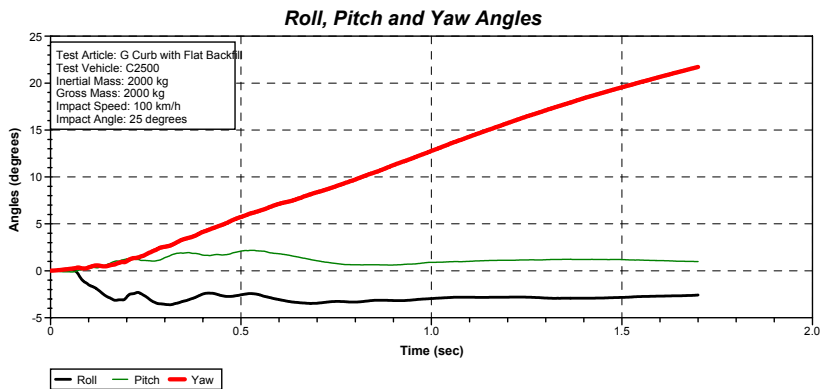

Figure D.27: Angular displacement-time histories at C.G. of pickup truck in local coordinates:
Curb Type -- AASHTO G Curb
Impact Speed -- 100 km/hr
Impact Angle -- 25 degrees.

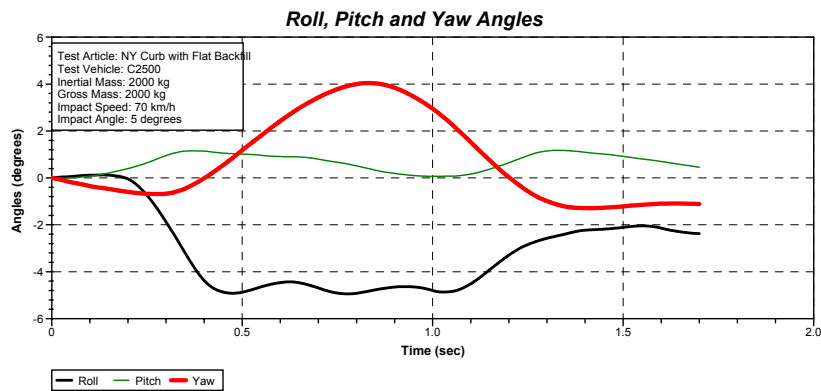

Figure D.28: Angular displacement-time histories at C.G. of pickup truck in local coordinates:
Curb Type -- New York Curb (100 mm)
Impact Speed -- 70 km/hr
Impact Angle -- 5 degrees.

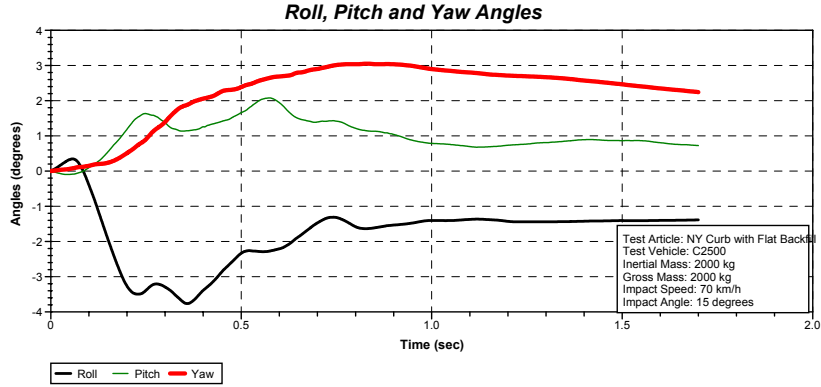

Figure D.29: Angular displacement-time histories at C.G. of pickup truck in local coordinates:
Curb Type -- New York Curb (100 mm)
Impact Speed -- 100 km/hr
Impact Angle -- 15 degrees.

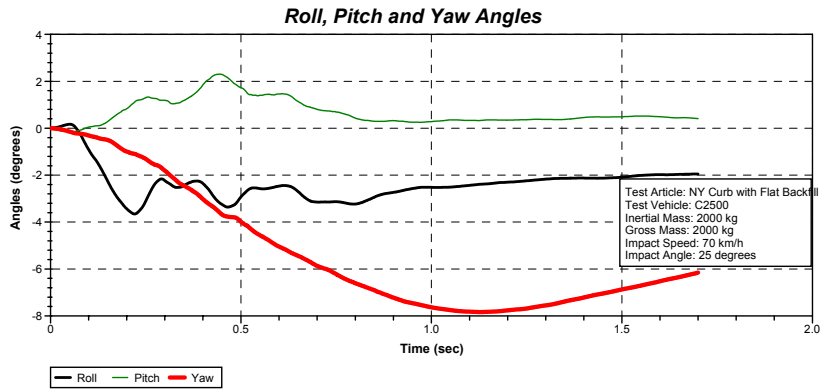

Figure D.30: Angular displacement-time histories at C.G. of pickup truck in local coordinates:
Curb Type -- New York Curb (100 mm)
Impact Speed -- 70 km/hr
Impact Angle -- 25 degrees.

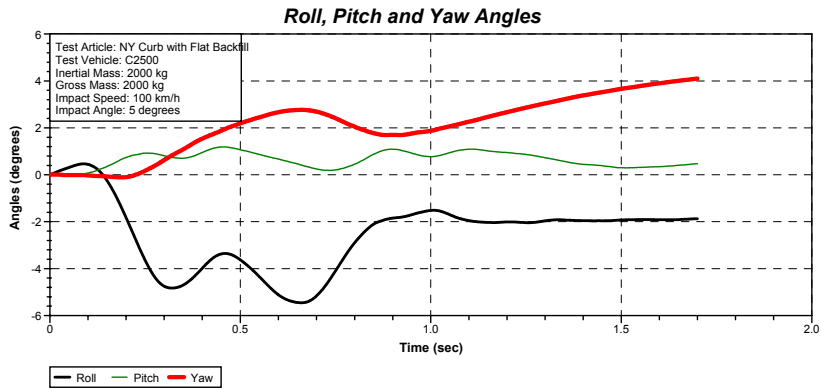

Figure D.31: Angular displacement-time histories at C.G. of pickup truck in local coordinates:
Curb Type -- New York Curb (100 mm)
Impact Speed -- 100 km/hr
Impact Angle -- 5 degrees.

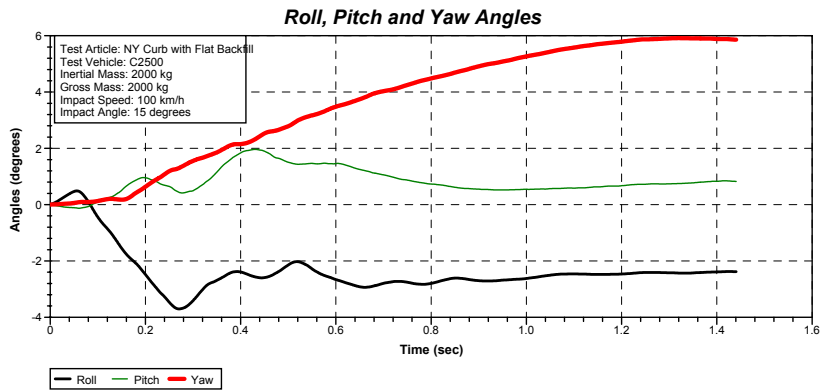

Figure D.32: Angular displacement-time histories at C.G. of pickup truck in local coordinates:
Curb Type -- New York Curb (100 mm)
Impact Speed -- 100 km/hr
Impact Angle -- 15 degrees.

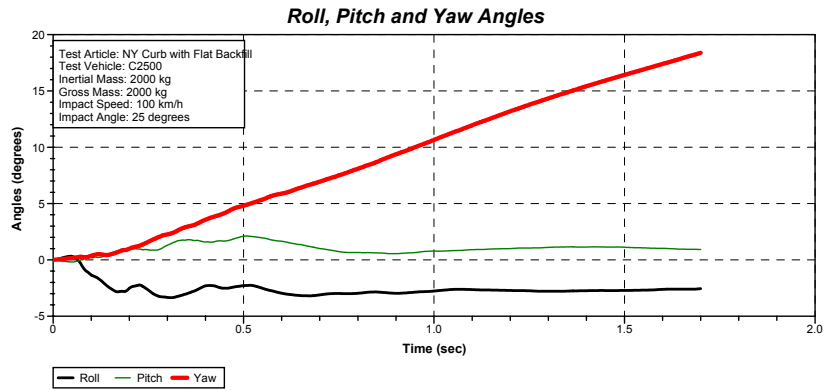
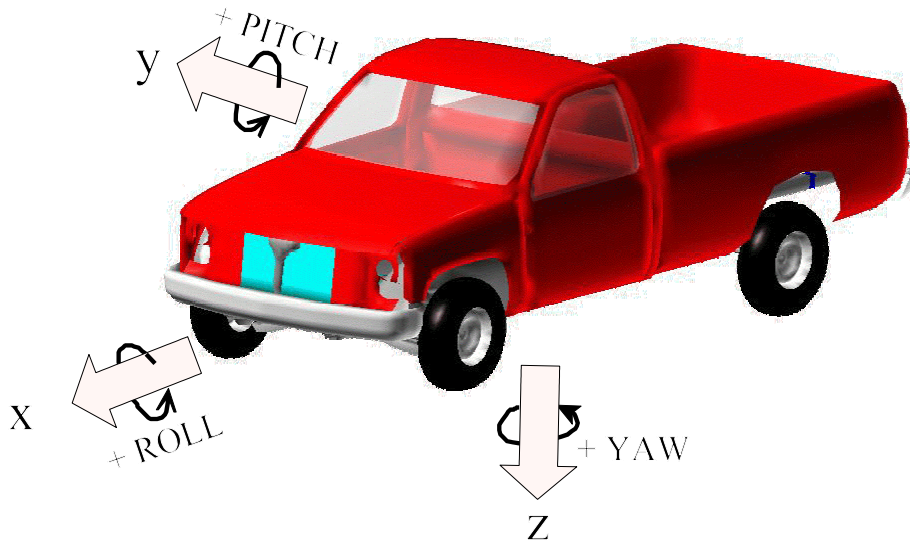

Figure D.33: Angular displacement-time histories at C.G. of pickup truck in local coordinates:
Curb Type -- New York Curb (100 mm)
Impact Speed -- 100 km/hr
Impact Angle -- 25 degrees.

APPENDIX E

Angular Displacement Rate-Time Histories Computed at the Center of Gravity of Vehicle

-Finite Element Analysis Results-



Vehicle fixed coordinate reference system.

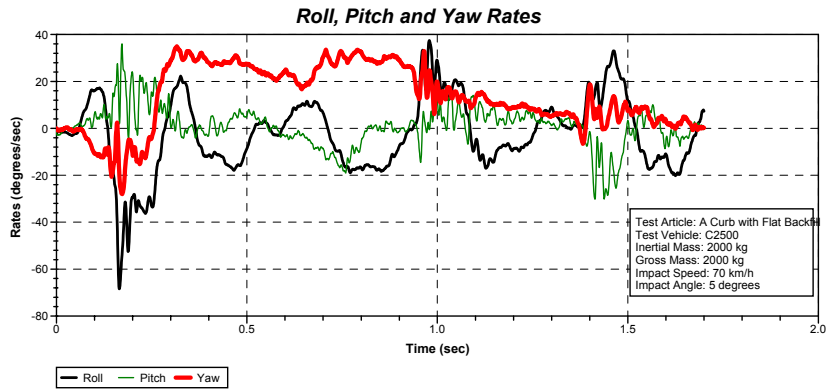

Figure E.1: Angular displacement rate-time histories at C.G. of pickup truck in local coordinates:
Curb Type -- AASHTO A Curb
Impact Speed -- 70 km/hr
Impact Angle -- 5 degrees.

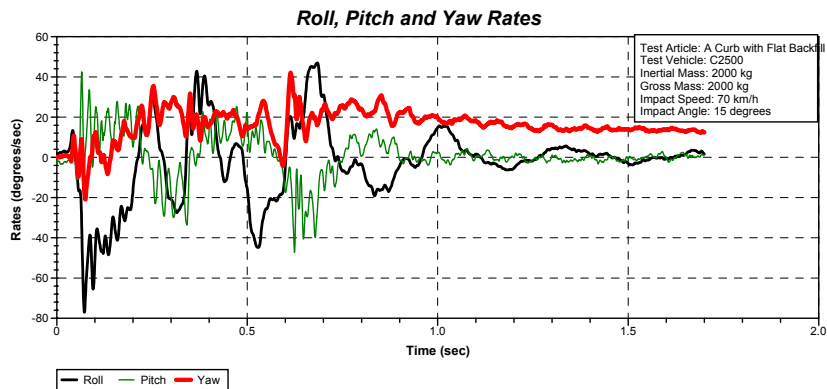

Figure E.2: Angular displacement rate-time histories at C.G. of pickup truck in local coordinates:
Curb Type -- AASHTO A Curb
Impact Speed -- 70 km/hr
Impact Angle -- 15 degrees.

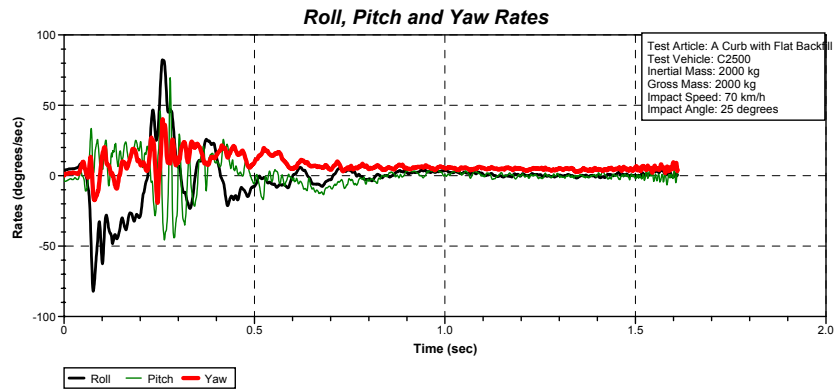

Figure E.3: Angular displacement rate-time histories at C.G. of pickup truck in local coordinates:
Curb Type -- AASHTO A Curb
Impact Speed -- 70 km/hr
Impact Angle -- 25 degrees.

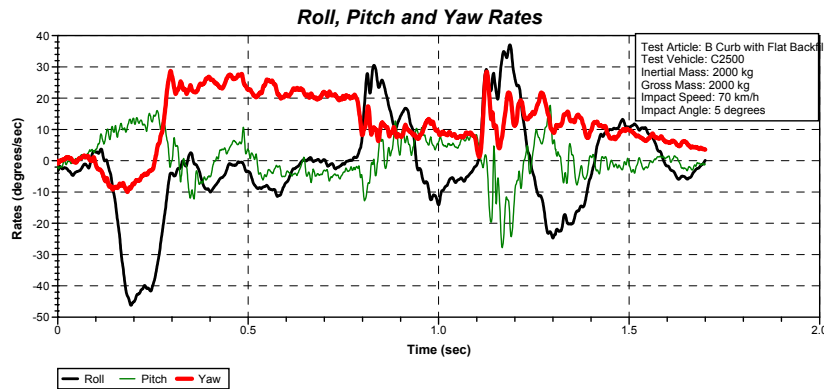

Figure E.4: Angular displacement rate-time histories at C.G. of pickup truck in local coordinates:
Curb Type -- AASHTO B Curb
Impact Speed -- 70 km/hr
Impact Angle -- 5 degrees.

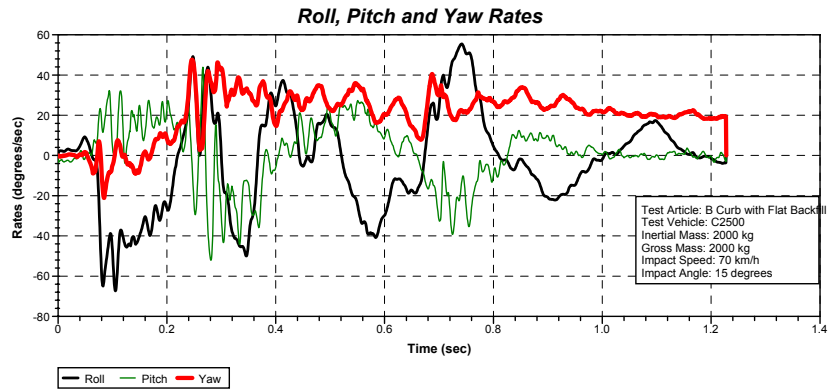

Figure E.5: Angular displacement rate-time histories at C.G. of pickup truck in local coordinates:
Curb Type -- AASHTO B Curb
Impact Speed -- 70 km/hr
Impact Angle -- 15 degrees.

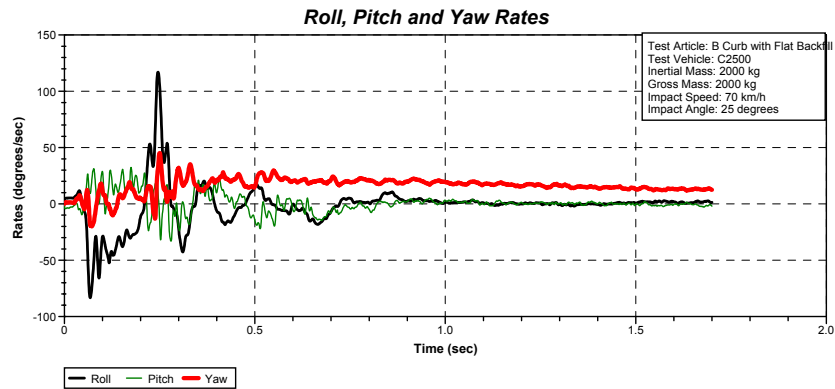

Figure E.6: Angular displacement rate-time histories at C.G. of pickup truck in local coordinates:
Curb Type -- AASHTO B Curb
Impact Speed -- 70 km/hr
Impact Angle -- 25 degrees.

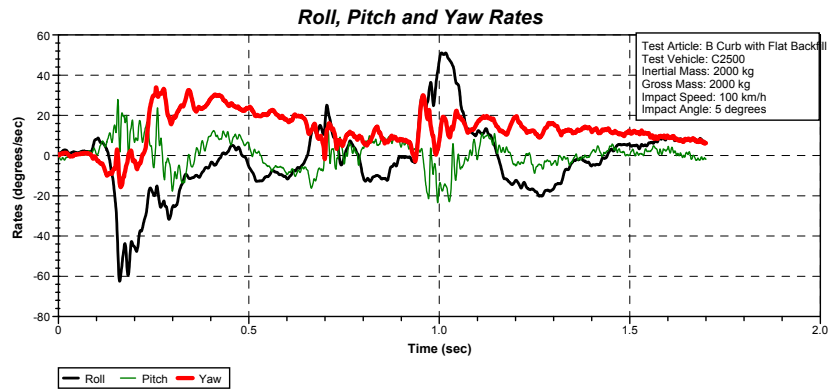

Figure E.7: Angular displacement rate-time histories at C.G. of pickup truck in local coordinates:
Curb Type -- AASHTO B Curb
Impact Speed -- 100 km/hr
Impact Angle -- 5 degrees.

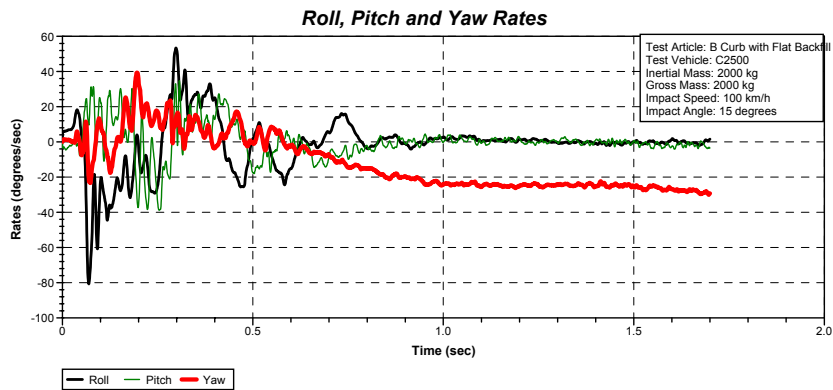

Figure E.8: Angular displacement rate-time histories at C.G. of pickup truck in local coordinates:
Curb Type -- AASHTO B Curb
Impact Speed -- 100 km/hr
Impact Angle -- 15 degrees.

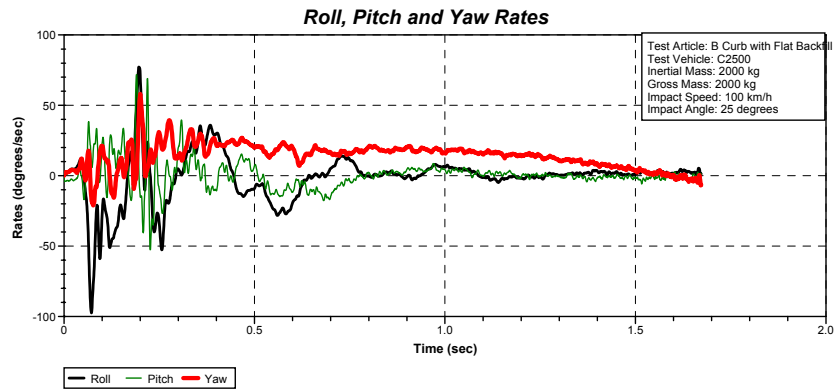

Figure E.9: Angular displacement rate-time histories at C.G. of pickup truck in local coordinates:
Curb Type -- AASHTO B Curb
Impact Speed -- 100 km/hr
Impact Angle -- 25 degrees.

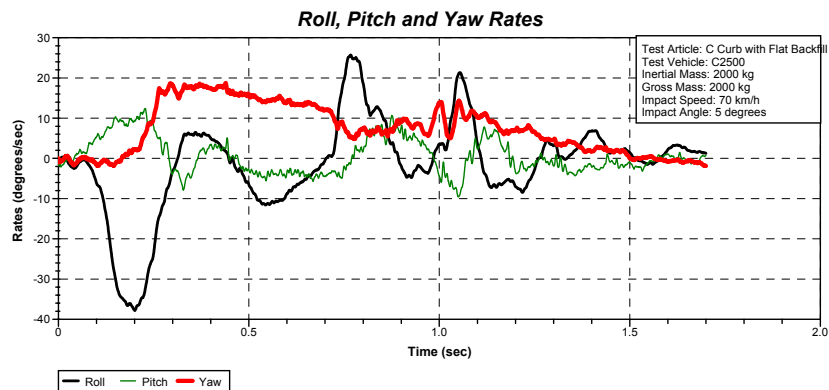

Figure E.10: Angular displacement rate-time histories at C.G. of pickup truck in local coordinates:
Curb Type -- AASHTO C Curb
Impact Speed -- 70 km/hr
Impact Angle -- 5 degrees.

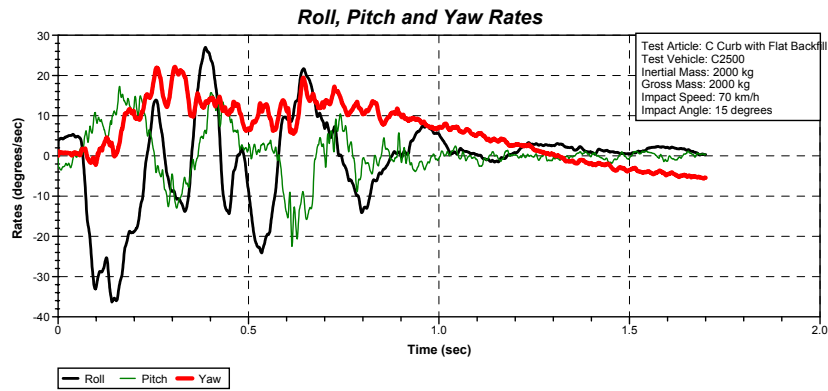

Figure E.11: Angular displacement rate-time histories at C.G. of pickup truck in local coordinates:
Curb Type -- AASHTO C Curb
Impact Speed -- 70 km/hr
Impact Angle -- 15 degrees.

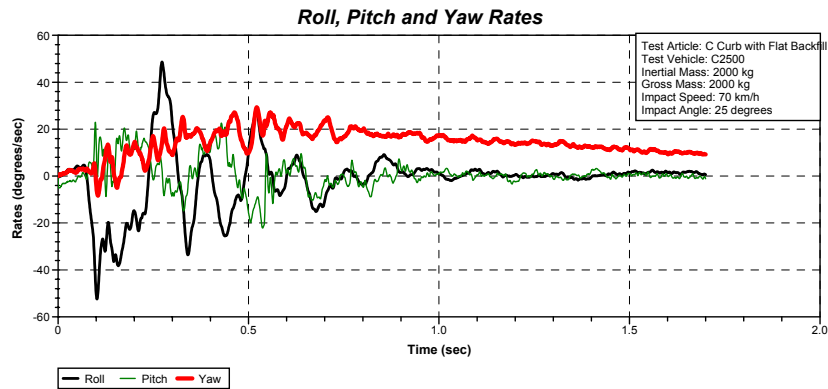

Figure E.12: Angular displacement rate-time histories at C.G. of pickup truck in local coordinates:
Curb Type -- AASHTO C Curb
Impact Speed -- 70 km/hr
Impact Angle -- 25 degrees.

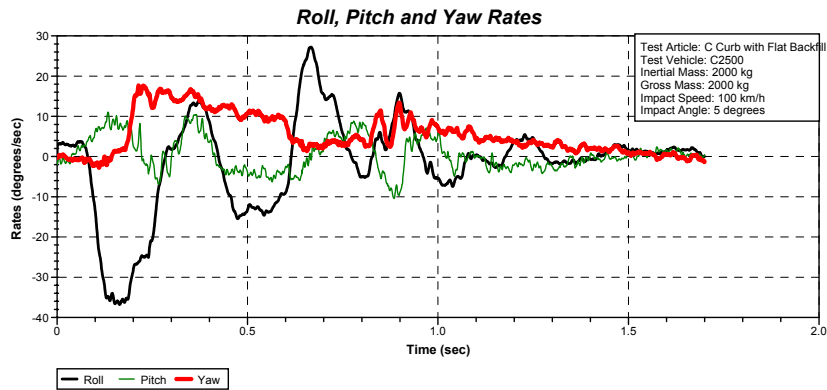

Figure E.13: Angular displacement rate-time histories at C.G. of pickup truck in local coordinates:
Curb Type -- AASHTO C Curb
Impact Speed -- 100 km/hr
Impact Angle -- 5 degrees.

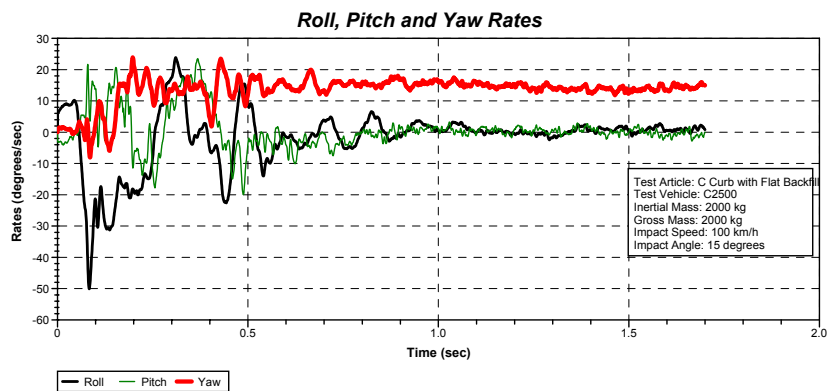

Figure E.14: Angular displacement rate-time histories at C.G. of pickup truck in local coordinates:
Curb Type -- AASHTO C Curb
Impact Speed -- 100 km/hr
Impact Angle -- 15 degrees.

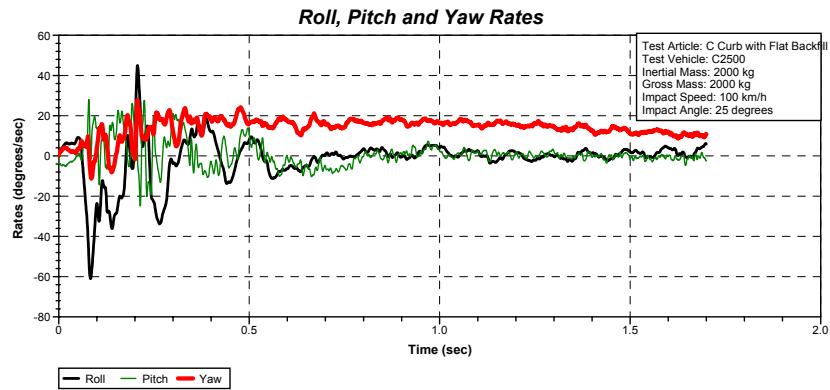

Figure E.15: Angular displacement rate-time histories at C.G. of pickup truck in local coordinates:
Curb Type -- AASHTO C Curb
Impact Speed -- 100 km/hr
Impact Angle -- 25 degrees.

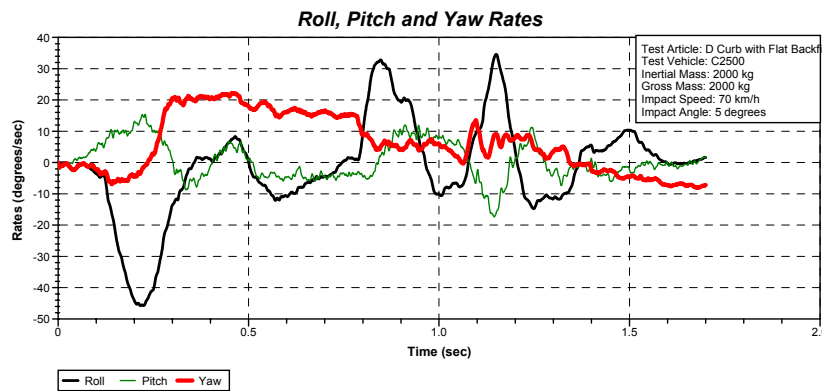

Figure E.16: Angular displacement rate-time histories at C.G. of pickup truck in local coordinates:
Curb Type -- AASHTO D Curb
Impact Speed -- 70 km/hr
Impact Angle -- 5 degrees.

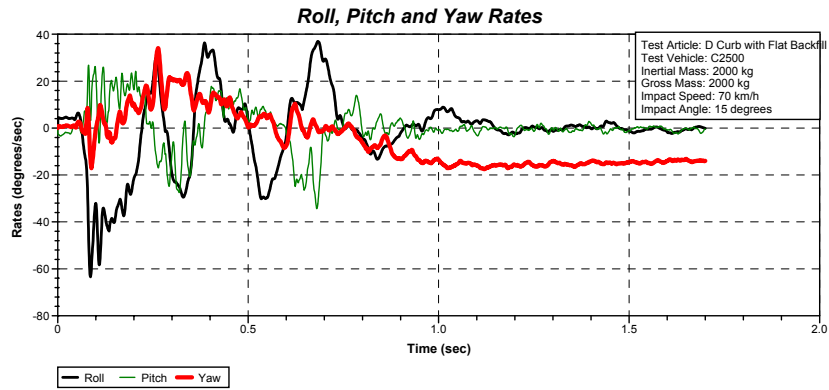

Figure E.17: Angular displacement rate-time histories at C.G. of pickup truck in local coordinates:
Curb Type -- AASHTO D Curb
Impact Speed -- 70 km/hr
Impact Angle -- 15 degrees.

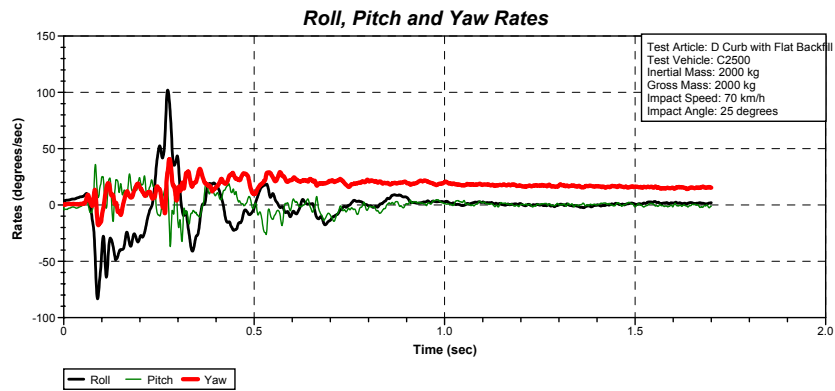

Figure E.18: Angular displacement rate-time histories at C.G. of pickup truck in local coordinates:
Curb Type -- AASHTO D Curb
Impact Speed -- 70 km/hr
Impact Angle -- 25 degrees.

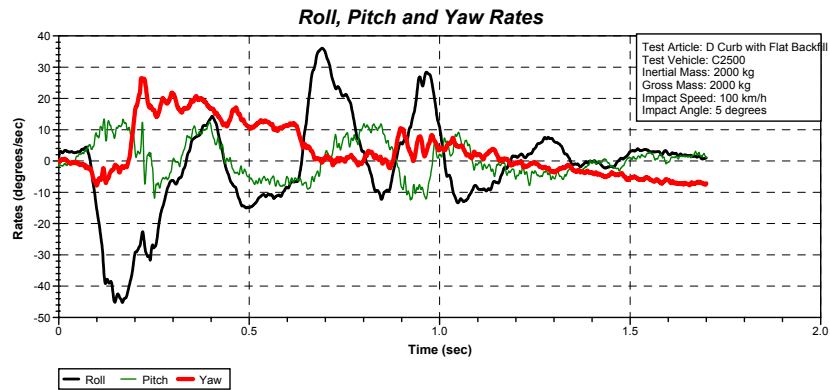

Figure E.19: Angular displacement rate-time histories at C.G. of pickup truck in local coordinates:
Curb Type -- AASHTO D Curb
Impact Speed -- 100 km/hr
Impact Angle -- 5 degrees.

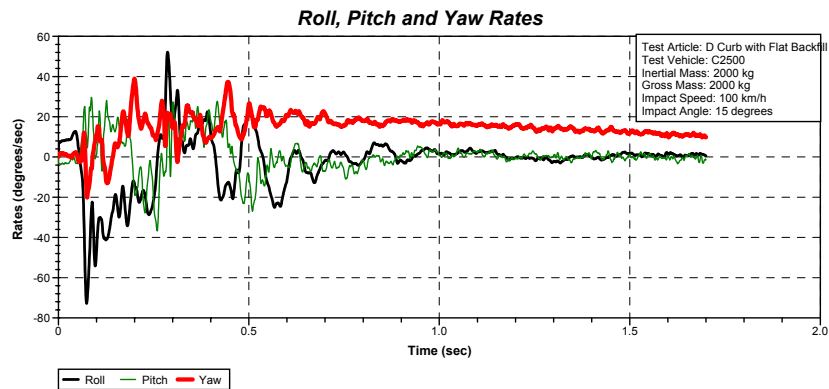

Figure E.20: Angular displacement rate-time histories at C.G. of pickup truck in local coordinates:
Curb Type -- AASHTO D Curb
Impact Speed -- 100 km/hr
Impact Angle -- 15 degrees.

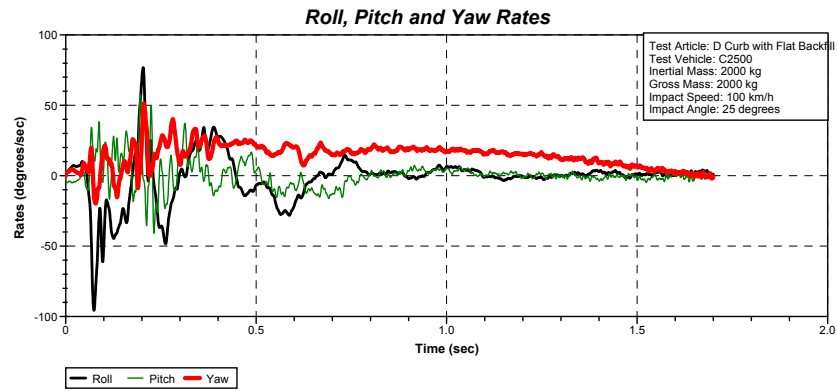

Figure E.21: Angular displacement rate-time histories at C.G. of pickup truck in local coordinates:
Curb Type -- AASHTO D Curb
Impact Speed -- 100 km/hr
Impact Angle -- 25 degrees.

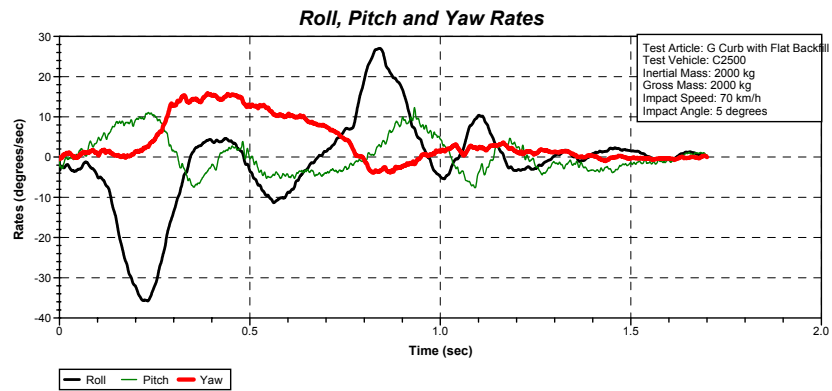

Figure E.22: Angular displacement rate-time histories at C.G. of pickup truck in local coordinates:
Curb Type -- AASHTO G Curb
Impact Speed -- 70 km/hr
Impact Angle -- 5 degrees.

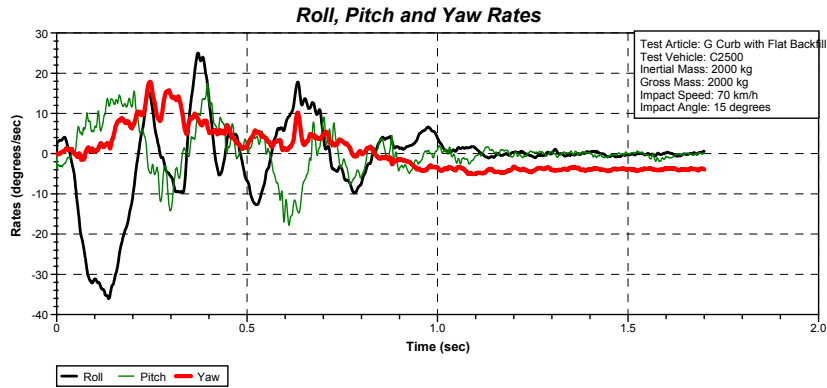

Figure E.23: Angular displacement rate-time histories at C.G. of pickup truck in local coordinates:
Curb Type -- AASHTO G Curb
Impact Speed -- 70 km/hr
Impact Angle -- 15 degrees.

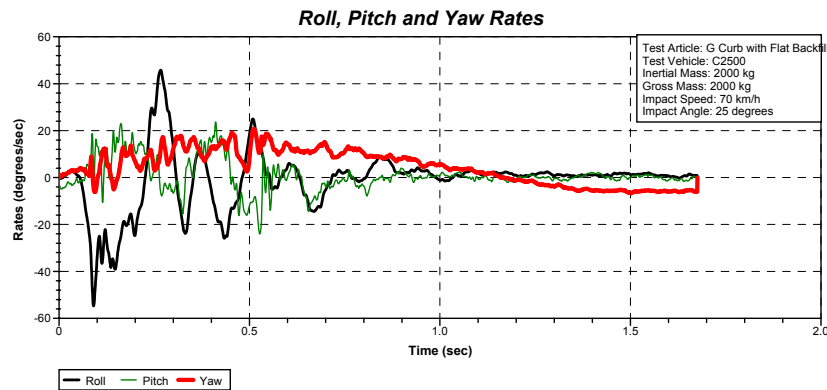

Figure E.24: Angular displacement rate-time histories at C.G. of pickup truck in local coordinates:
Curb Type -- AASHTO G Curb
Impact Speed -- 70 km/hr
Impact Angle -- 25 degrees.

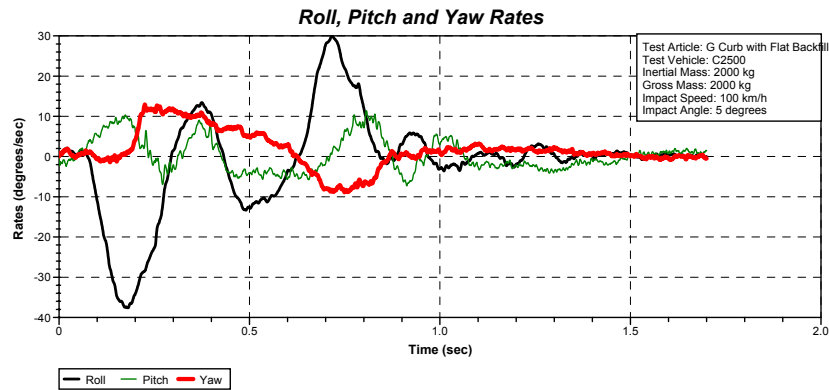

Figure E.25: Angular displacement rate-time histories at C.G. of pickup truck in local coordinates:
Curb Type -- AASHTO G Curb
Impact Speed -- 100 km/hr
Impact Angle -- 5 degrees.

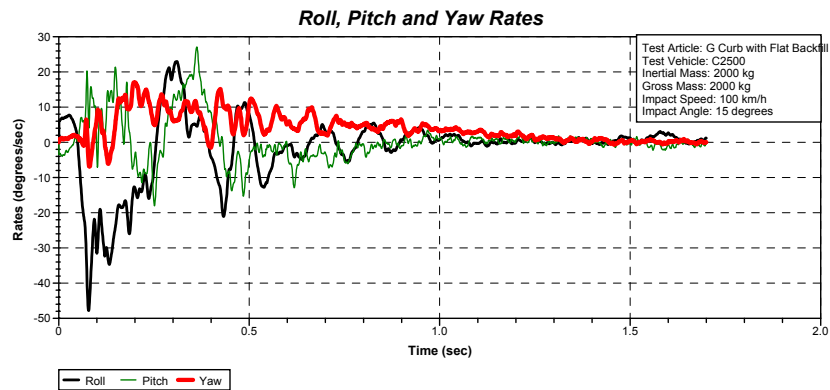

Figure E.26: Angular displacement rate-time histories at C.G. of pickup truck in local coordinates:
Curb Type -- AASHTO G Curb
Impact Speed -- 100 km/hr
Impact Angle -- 15 degrees.

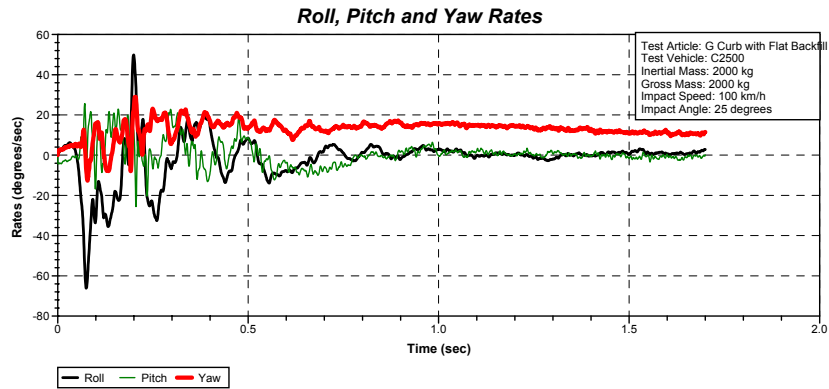

Figure E.27: Angular displacement rate-time histories at C.G. of pickup truck in local coordinates:
Curb Type -- AASHTO G Curb
Impact Speed -- 100 km/hr
Impact Angle -- 25 degrees.

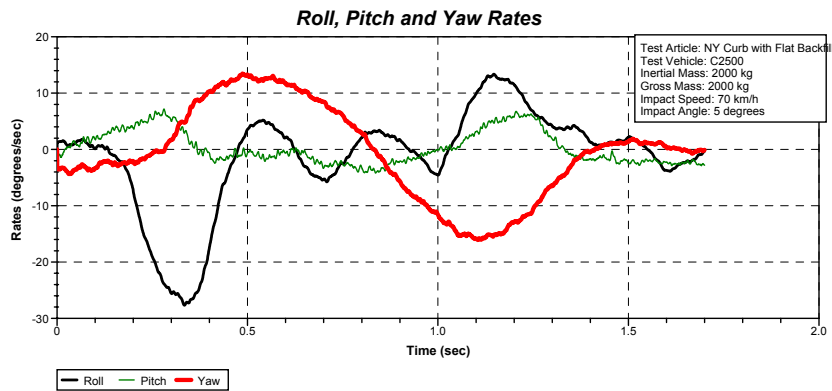

Figure E.28: Angular displacement rate-time histories at C.G. of pickup truck in local coordinates:
Curb Type -- New York Curb (100 mm)
Impact Speed -- 70 km/hr
Impact Angle -- 5 degrees.

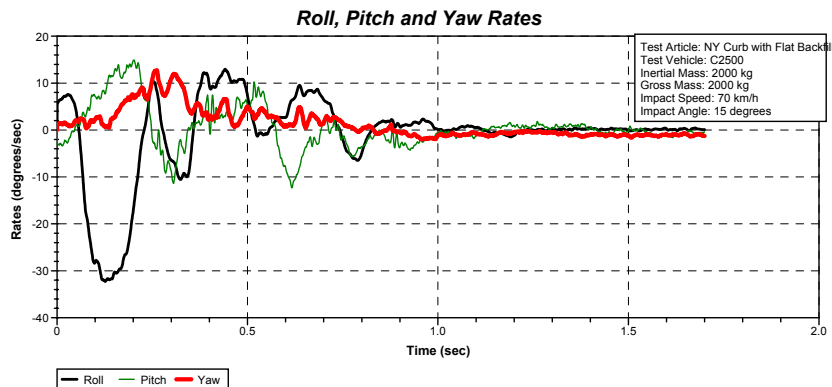

Figure E.29: Angular displacement rate-time histories at C.G. of pickup truck in local coordinates:
Curb Type -- New York Curb (100 mm)
Impact Speed -- 100 km/hr
Impact Angle -- 15 degrees.

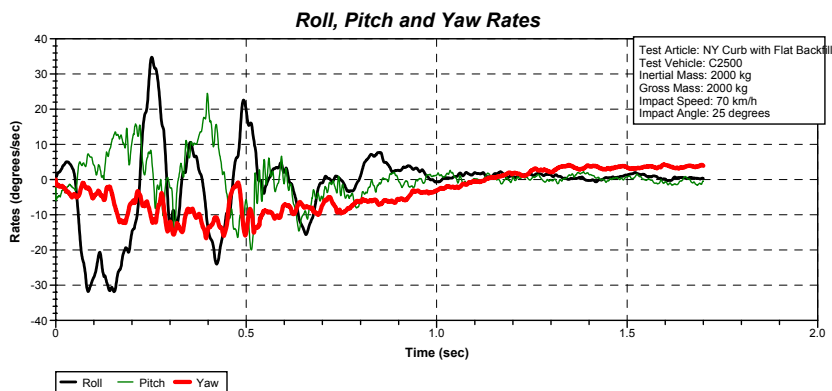

Figure E.30: Angular displacement rate-time histories at C.G. of pickup truck in local coordinates:
Curb Type -- New York Curb (100 mm)
Impact Speed -- 70 km/hr
Impact Angle -- 25 degrees.

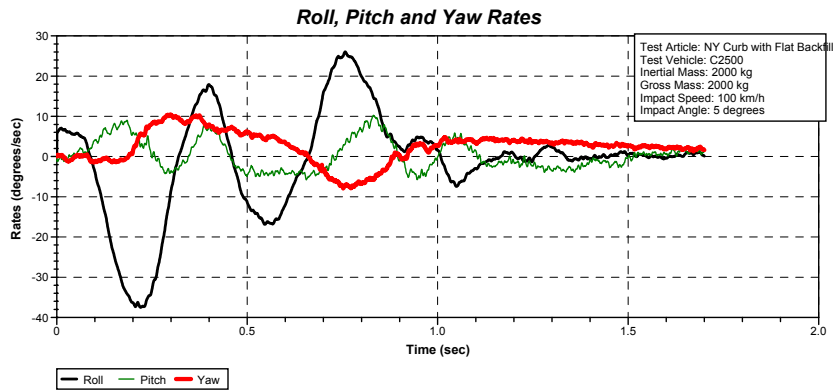

Figure E.31: Angular displacement rate-time histories at C.G. of pickup truck in local coordinates:
Curb Type -- New York Curb (100 mm)
Impact Speed -- 100 km/hr
Impact Angle -- 5 degrees.

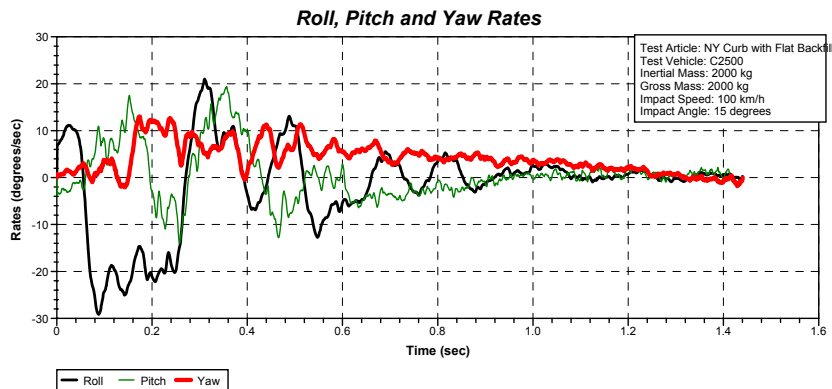

Figure E.32: Angular displacement rate-time histories at C.G. of pickup truck in local coordinates:
Curb Type -- New York Curb (100 mm)
Impact Speed -- 100 km/hr
Impact Angle -- 15 degrees.

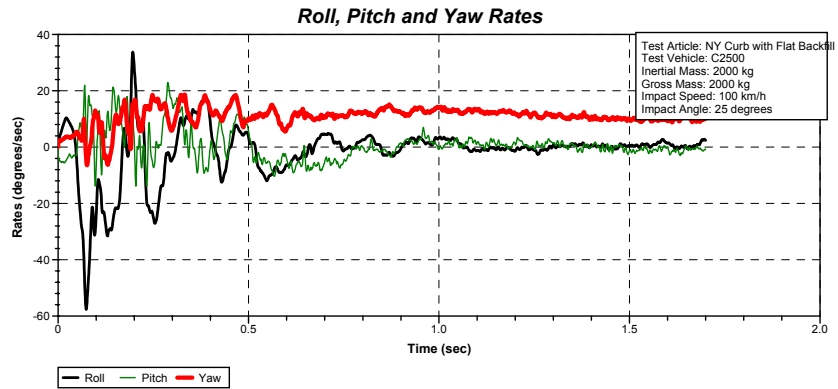

Figure E.33: Angular displacement rate-time histories at C.G. of pickup truck in local coordinates:
Curb Type -- New York Curb (100 mm)
Impact Speed -- 100 km/hr
Impact Angle -- 25 degrees.

APPENDIX G

Occupant Risk Assessment Summary Report from TRAP

-Finite Element Analysis Results-

Test Summary Report

General Information

Test Agency: WPI
Test Number: A-70-05
Test Date: Dec 2001
Test Article: A Curb with Flat Backfill

Test Vehicle

Description: C2500
Test Inertial Mass: 2000 kg
Gross Static Mass: 2000 kg

Impact Conditions

Speed: 70.0 km/hr
Angle: 5.0 degrees

Occupant Risk Factors

Impact Velocity (m/s) at 0.3927 seconds on right side of interior
x-direction 1.4
y-direction 1.3

THIV (km/hr): 6.9 at 0.4053 seconds on right side of interior
THIV (m/s): 1.9

Ridedown Accelerations (g's)

x-direction -2.9 (1.4210 - 1.4310 seconds)
y-direction -2.9 (1.3863 - 1.3963 seconds)

PHD (g's): 4.0 (1.4203 - 1.4303 seconds)

ASI: 0.18 (0.2313 - 0.2813 seconds)

Max. 50msec Moving Avg. Accelerations (g's)

x-direction -1.0 (0.0850 - 0.1350 seconds)
y-direction -1.6 (0.2317 - 0.2817 seconds)
z-direction -1.1 (1.3870 - 1.4370 seconds)

Max Roll, Pitch, and Yaw Angles (degrees)

Roll -6.4 (0.9360 seconds)
Pitch 3.0 (1.3833 seconds)
Yaw 22.6 (1.7000 seconds)

Figure G.1: Summary report of occupant risk factors from TRAP:
Curb Type -- AASHTO A Curb
Impact Speed -- 70 km/hr
Impact Angle -- 5 degrees.

Test Summary Report

General Information

Test Agency: WPI
Test Number: A-70-15
Test Date: Dec 2001
Test Article: A Curb with Flat Backfill

Test Vehicle

Description: C2500
Test Inertial Mass: 2000 kg
Gross Static Mass: 2000 kg

Impact Conditions

Speed: 70.0 km/hr
Angle: 15.0 degrees

Occupant Risk Factors

Impact Velocity (m/s) at 0.6040 seconds on front of interior
x-direction 1.8
y-direction -0.9

THIV (km/hr): 6.4 at 0.6080 seconds on front of interior
THIV (m/s): 1.8

Ridedown Accelerations (g's)
x-direction -2.8 (0.6083 - 0.6183 seconds)
y-direction -3.8 (0.6037 - 0.6137 seconds)

PHD (g's): 4.4 (0.6343 - 0.6443 seconds)

ASI: 0.20 (0.5427 - 0.5927 seconds)

Max. 50msec Moving Avg. Accelerations (g's)

x-direction -1.0 (-0.0050 - 0.0450 seconds)
y-direction 1.7 (0.5390 - 0.5890 seconds)
z-direction -1.4 (0.5870 - 0.6370 seconds)

Max Roll, Pitch, and Yaw Angles (degrees)

Roll -6.5 (0.6013 seconds)
Pitch 3.1 (0.5773 seconds)
Yaw 27.4 (1.7000 seconds)

Figure G.2: Summary report of occupant risk factors from TRAP:
Curb Type -- AASHTO A Curb
Impact Speed -- 70 km/hr
Impact Angle -- 15 degrees.

Test Summary Report

General Information

Test Agency: WPI
Test Number: A-70-25
Test Date: Dec 2001
Test Article: A Curb with Flat Backfill

Test Vehicle

Description: C2500
Test Inertial Mass: 2000 kg
Gross Static Mass: 2000 kg

Impact Conditions

Speed: 70.0 km/hr
Angle: 25.0 degrees

Occupant Risk Factors

Impact Velocity (m/s) at 0.5293 seconds on front of interior
x-direction 1.9
y-direction -0.7

THIV (km/hr): 7.5 at 0.5393 seconds on front of interior
THIV (m/s): 2.1

Ridedown Accelerations (g's)
x-direction -1.1 (0.5977 - 0.6077 seconds)
y-direction 1.6 (0.5850 - 0.5950 seconds)

PHD (g's): 2.5 (1.5970 - 1.6070 seconds)

ASI: 0.22 (0.3147 - 0.3647 seconds)

Max. 50msec Moving Avg. Accelerations (g's)

x-direction -1.5 (0.2043 - 0.2543 seconds)
y-direction 1.7 (0.0877 - 0.1377 seconds)
z-direction -1.8 (0.2343 - 0.2843 seconds)

Max Roll, Pitch, and Yaw Angles (degrees)

Roll -5.4 (0.2200 seconds)
Pitch 2.4 (0.4893 seconds)
Yaw 12.0 (1.6107 seconds)

Figure G.3: Summary report of occupant risk factors from TRAP:
Curb Type -- AASHTO A Curb
Impact Speed -- 70 km/hr
Impact Angle -- 25 degrees.

Test Summary Report

General Information

Test Agency: WPI
Test Number: B-70-05
Test Date: Dec 2001
Test Article: B Curb with Flat Backfill

Test Vehicle

Description: C2500
Test Inertial Mass: 2000 kg
Gross Static Mass: 2000 kg

Impact Conditions

Speed: 70.0 km/hr
Angle: 5.0 degrees

Occupant Risk Factors

Impact Velocity (m/s) at 0.6273 seconds on front of interior
x-direction 1.7
y-direction -0.8

THIV (km/hr): 6.3 at 0.6200 seconds on front of interior
THIV (m/s): 1.8

Ridedown Accelerations (g's)
x-direction -2.2 (1.1470 - 1.1570 seconds)
y-direction -3.1 (1.1110 - 1.1210 seconds)

PHD (g's): 3.6 (1.1103 - 1.1203 seconds)

ASI: 0.11 (1.1927 - 1.2427 seconds)

Max. 50msec Moving Avg. Accelerations (g's)

x-direction -0.7 (1.0577 - 1.1077 seconds)
y-direction 0.9 (0.4737 - 0.5237 seconds)
z-direction 1.0 (1.1930 - 1.2430 seconds)

Max Roll, Pitch, and Yaw Angles (degrees)

Roll -6.9 (0.7647 seconds)
Pitch 2.4 (1.1113 seconds)
Yaw 20.2 (1.7000 seconds)

Figure G.4: Summary report of occupant risk factors from TRAP:
Curb Type -- AASHTO B Curb
Impact Speed -- 70 km/hr
Impact Angle -- 5 degrees.

Test Summary Report

General Information

Test Agency: WPI
Test Number: B-70-15
Test Date: Dec 2001
Test Article: B Curb with Flat Backfill

Test Vehicle

Description: C2500
Test Inertial Mass: 2000 kg
Gross Static Mass: 2000 kg

Impact Conditions

Speed: 70.0 km/hr
Angle: 15.0 degrees

Occupant Risk Factors

Impact Velocity (m/s) at 0.5987 seconds on front of interior
x-direction 1.8
y-direction -0.1

THIV (km/hr): 6.4 at 0.5753 seconds on front of interior
THIV (m/s): 1.8

Ridedown Accelerations (g's)
x-direction -3.1 (0.6823 - 0.6923 seconds)
y-direction -3.6 (0.6730 - 0.6830 seconds)

PHD (g's): 4.2 (0.6730 - 0.6830 seconds)

ASI: 0.19 (0.1947 - 0.2447 seconds)

Max. 50msec Moving Avg. Accelerations (g's)

x-direction -1.5 (0.1930 - 0.2430 seconds)
y-direction 1.5 (0.5443 - 0.5943 seconds)
z-direction 1.4 (0.3337 - 0.3837 seconds)

Max Roll, Pitch, and Yaw Angles (degrees)

Roll -6.6 (0.6740 seconds)
Pitch 3.3 (0.6600 seconds)
Yaw 25.2 (1.2280 seconds)

Figure G.5: Summary report of occupant risk factors from TRAP:
Curb Type -- AASHTO B Curb
Impact Speed -- 70 km/hr
Impact Angle -- 15 degrees.

Test Summary Report

General Information

Test Agency: WPI
Test Number: B-70-25
Test Date: Dec 2001
Test Article: B Curb with Flat Backfill

Test Vehicle

Description: C2500
Test Inertial Mass: 2000 kg
Gross Static Mass: 2000 kg

Impact Conditions

Speed: 70.0 km/hr
Angle: 25.0 degrees

Occupant Risk Factors

Impact Velocity (m/s) at 0.5820 seconds on front of interior
x-direction 1.7
y-direction -0.8

THIV (km/hr): 6.9 at 0.5887 seconds on front of interior
THIV (m/s): 1.9

Ridedown Accelerations (g's)
x-direction -0.7 (0.7637 - 0.7737 seconds)
y-direction 1.4 (0.5817 - 0.5917 seconds)

PHD (g's): 1.6 (0.7097 - 0.7197 seconds)

ASI: 0.25 (0.1987 - 0.2487 seconds)

Max. 50msec Moving Avg. Accelerations (g's)

x-direction -1.3 (0.1617 - 0.2117 seconds)
y-direction -1.9 (0.1983 - 0.2483 seconds)
z-direction 1.9 (0.3023 - 0.3523 seconds)

Max Roll, Pitch, and Yaw Angles (degrees)

Roll -5.4 (0.2100 seconds)
Pitch 2.8 (0.4767 seconds)
Yaw 26.9 (1.7000 seconds)

Figure G.6: Summary report of occupant risk factors from TRAP:
Curb Type -- AASHTO B Curb
Impact Speed -- 70 km/hr
Impact Angle -- 25 degrees.

Test Summary Report

General Information

Test Agency: WPI
Test Number: B-100-05
Test Date: Dec 2001
Test Article: B Curb with Flat Backfill

Test Vehicle

Description: C2500
Test Inertial Mass: 2000 kg
Gross Static Mass: 2000 kg

Impact Conditions

Speed: 100.0 km/hr
Angle: 5.0 degrees

Occupant Risk Factors

Impact Velocity (m/s) at 0.5300 seconds on front of interior
x-direction 2.0
y-direction -0.5

THIV (km/hr): 7.3 at 0.5253 seconds on front of interior
THIV (m/s): 2.0

Ridedown Accelerations (g's)
x-direction -2.0 (0.9763 - 0.9863 seconds)
y-direction -3.6 (0.9403 - 0.9503 seconds)

PHD (g's): 4.0 (0.9757 - 0.9857 seconds)

ASI: 0.19 (0.2067 - 0.2567 seconds)

Max. 50msec Moving Avg. Accelerations (g's)

x-direction -1.0 (0.2070 - 0.2570 seconds)
y-direction -1.5 (0.2070 - 0.2570 seconds)
z-direction -1.1 (0.1343 - 0.1843 seconds)

Max Roll, Pitch, and Yaw Angles (degrees)

Roll -7.6 (0.6533 seconds)
Pitch 2.3 (0.5320 seconds)
Yaw 21.4 (1.7000 seconds)

Figure G.7: Summary report of occupant risk factors from TRAP:
Curb Type -- AASHTO B Curb
Impact Speed -- 100 km/hr
Impact Angle -- 5 degrees.

Test Summary Report

General Information

Test Agency: WPI
Test Number: B-100-15
Test Date: Dec 2001
Test Article: B Curb with Flat Backfill

Test Vehicle

Description: C2500
Test Inertial Mass: 2000 kg
Gross Static Mass: 2000 kg

Impact Conditions

Speed: 100.0 km/hr
Angle: 15.0 degrees

Occupant Risk Factors

Impact Velocity (m/s) at 0.5333 seconds on front of interior
x-direction 2.0
y-direction 0.6

THIV (km/hr): 7.7 at 0.5260 seconds on front of interior
THIV (m/s): 2.1

Ridedown Accelerations (g's)
x-direction -1.2 (0.6150 - 0.6250 seconds)
y-direction 1.7 (0.5697 - 0.5797 seconds)

PHD (g's): 1.7 (0.5697 - 0.5797 seconds)

ASI: 0.22 (0.2420 - 0.2920 seconds)

Max. 50msec Moving Avg. Accelerations (g's)

x-direction -1.2 (0.1157 - 0.1657 seconds)
y-direction -1.6 (0.2417 - 0.2917 seconds)
z-direction -1.4 (0.1650 - 0.2150 seconds)

Max Roll, Pitch, and Yaw Angles (degrees)

Roll -5.0 (0.2607 seconds)
Pitch 2.6 (0.4827 seconds)
Yaw -20.0 (1.7000 seconds)

Figure G.8: Summary report of occupant risk factors from TRAP:
Curb Type -- AASHTO B Curb
Impact Speed -- 100 km/hr
Impact Angle -- 15 degrees.

Test Summary Report

General Information

Test Agency: WPI
Test Number: B-100-25
Test Date: Dec 2001
Test Article: B Curb with Flat Backfill

Test Vehicle

Description: C2500
Test Inertial Mass: 2000 kg
Gross Static Mass: 2000 kg

Impact Conditions

Speed: 100.0 km/hr
Angle: 25.0 degrees

Occupant Risk Factors

Impact Velocity (m/s) at 0.5440 seconds on front of interior
x-direction 2.0
y-direction -0.9

THIV (km/hr): 7.8 at 0.5473 seconds on front of interior
THIV (m/s): 2.2

Ridedown Accelerations (g's)
x-direction -1.2 (1.6417 - 1.6517 seconds)
y-direction 1.9 (0.5963 - 0.6063 seconds)

PHD (g's): 3.3 (1.6630 - 1.6730 seconds)

ASI: 0.29 (0.1753 - 0.2253 seconds)

Max. 50msec Moving Avg. Accelerations (g's)

x-direction -1.9 (0.1170 - 0.1670 seconds)
y-direction 2.0 (0.0817 - 0.1317 seconds)
z-direction -2.8 (0.1750 - 0.2250 seconds)

Max Roll, Pitch, and Yaw Angles (degrees)

Roll -4.2 (0.2933 seconds)
Pitch 2.4 (0.5087 seconds)
Yaw 23.1 (1.5887 seconds)

Figure G.9: Summary report of occupant risk factors from TRAP:
Curb Type -- AASHTO B Curb
Impact Speed -- 100 km/hr
Impact Angle -- 25 degrees.

Test Summary Report

General Information

Test Agency: WPI
 Test Number: C-70-05
 Test Date: Dec 2001
 Test Article: C Curb with Flat Backfill

Test Vehicle

Description: C2500
 Test Inertial Mass: 2000 kg
 Gross Static Mass: 2000 kg

Impact Conditions

Speed: 70.0 km/hr
 Angle: 5.0 degrees

Occupant Risk Factors

Impact Velocity (m/s) at 0.7040 seconds on left side of interior
 x-direction 1.5
 y-direction -1.6

THIV (km/hr): 7.2 at 0.6687 seconds on left side of interior
 THIV (m/s): 2.0

Ridedown Accelerations (g's)
 x-direction -0.6 (0.8623 - 0.8723 seconds)
 y-direction 1.3 (1.0077 - 1.0177 seconds)

PHD (g's): 1.3 (1.0077 - 1.0177 seconds)

ASI: 0.09 (0.7980 - 0.8480 seconds)

Max. 50msec Moving Avg. Accelerations (g's)

x-direction -0.4 (0.1163 - 0.1663 seconds)
 y-direction 0.7 (0.7977 - 0.8477 seconds)
 z-direction 0.6 (1.0550 - 1.1050 seconds)

Max Roll, Pitch, and Yaw Angles (degrees)

Roll -6.0 (0.7027 seconds)
 Pitch 1.6 (0.2900 seconds)
 Yaw 12.6 (1.5633 seconds)

Figure G.10: Summary report of occupant risk factors from TRAP:
 Curb Type -- AASHTO C Curb
 Impact Speed -- 70 km/hr
 Impact Angle -- 5 degrees.

Test Summary Report

General Information

Test Agency: WPI
Test Number: C-70-15
Test Date: Dec 2001
Test Article: C Curb with Flat Backfill

Test Vehicle

Description: C2500
Test Inertial Mass: 2000 kg
Gross Static Mass: 2000 kg

Impact Conditions

Speed: 70.0 km/hr
Angle: 15.0 degrees

Occupant Risk Factors

Impact Velocity (m/s) at 0.7007 seconds on front of interior
x-direction 1.6
y-direction -1.2

THIV (km/hr): 7.0 at 0.6880 seconds on left side of interior

THIV (m/s): 1.9

Ridedown Accelerations (g's)

x-direction -0.5 (0.7197 - 0.7297 seconds)
y-direction 1.0 (0.7377 - 0.7477 seconds)

PHD (g's): 1.1 (0.7370 - 0.7470 seconds)

ASI: 0.11 (0.5653 - 0.6153 seconds)

Max. 50msec Moving Avg. Accelerations (g's)

x-direction -0.4 (0.2070 - 0.2570 seconds)
y-direction 0.8 (0.4210 - 0.4710 seconds)
z-direction -1.0 (0.5643 - 0.6143 seconds)

Max Roll, Pitch, and Yaw Angles (degrees)

Roll -4.2 (0.5787 seconds)
Pitch 2.1 (0.5740 seconds)
Yaw 11.4 (1.3147 seconds)

Figure G.11: Summary report of occupant risk factors from TRAP:
Curb Type -- AASHTO C Curb
Impact Speed -- 70 km/hr
Impact Angle -- 15 degrees.

Test Summary Report

General Information

Test Agency: WPI
Test Number: C-70-25
Test Date: Dec 2001
Test Article: C Curb with Flat Backfill

Test Vehicle

Description: C2500
Test Inertial Mass: 2000 kg
Gross Static Mass: 2000 kg

Impact Conditions

Speed: 70.0 km/hr
Angle: 25.0 degrees

Occupant Risk Factors

Impact Velocity (m/s) at 0.6767 seconds on front of interior
x-direction 1.6
y-direction -1.3

THIV (km/hr): 7.0 at 0.6760 seconds on left side of interior

THIV (m/s): 1.9

Ridedown Accelerations (g's)

x-direction -0.7 (0.8823 - 0.8923 seconds)
y-direction 1.6 (0.7230 - 0.7330 seconds)

PHD (g's): 1.7 (0.7243 - 0.7343 seconds)

ASI: 0.16 (0.4513 - 0.5013 seconds)

Max. 50msec Moving Avg. Accelerations (g's)

x-direction -0.7 (0.1903 - 0.2403 seconds)
y-direction 1.2 (0.4550 - 0.5050 seconds)
z-direction 1.2 (0.3397 - 0.3897 seconds)

Max Roll, Pitch, and Yaw Angles (degrees)

Roll -3.9 (0.2380 seconds)
Pitch 2.5 (0.4667 seconds)
Yaw 23.7 (1.7000 seconds)

Figure G.12: Summary report of occupant risk factors from TRAP:
Curb Type -- AASHTO C Curb
Impact Speed -- 70 km/hr
Impact Angle -- 25 degrees.

Test Summary Report

General Information

Test Agency: WPI
Test Number: C-100-05
Test Date: Dec 2001
Test Article: C Curb with Flat Backfill

Test Vehicle

Description: C2500
Test Inertial Mass: 2000 kg
Gross Static Mass: 2000 kg

Impact Conditions

Speed: 100.0 km/hr
Angle: 5.0 degrees

Occupant Risk Factors

Impact Velocity (m/s) at 0.6200 seconds on front of interior
x-direction 1.9
y-direction -1.0

THIV (km/hr): 7.5 at 0.6240 seconds on front of interior
THIV (m/s): 2.1

Ridedown Accelerations (g's)
x-direction -1.7 (0.6370 - 0.6470 seconds)
y-direction -1.2 (0.8843 - 0.8943 seconds)

PHD (g's): 2.2 (0.6423 - 0.6523 seconds)

ASI: 0.09 (0.6693 - 0.7193 seconds)

Max. 50msec Moving Avg. Accelerations (g's)

x-direction -0.6 (0.5970 - 0.6470 seconds)
y-direction 0.7 (0.6690 - 0.7190 seconds)
z-direction 0.7 (0.8877 - 0.9377 seconds)

Max Roll, Pitch, and Yaw Angles (degrees)

Roll -5.7 (0.6147 seconds)
Pitch 1.4 (0.4147 seconds)
Yaw 9.1 (1.6267 seconds)

Figure G.13: Summary report of occupant risk factors from TRAP:
Curb Type -- AASHTO C Curb
Impact Speed -- 100 km/hr
Impact Angle -- 5 degrees.

Test Summary Report

General Information

Test Agency: WPI
Test Number: C-100-15
Test Date: Dec 2001
Test Article: C Curb with Flat Backfill

Test Vehicle

Description: C2500
Test Inertial Mass: 2000 kg
Gross Static Mass: 2000 kg

Impact Conditions

Speed: 100.0 km/hr
Angle: 15.0 degrees

Occupant Risk Factors

Impact Velocity (m/s) at 0.5747 seconds on front of interior
x-direction 2.0
y-direction -0.9

THIV (km/hr): 7.8 at 0.5813 seconds on front of interior
THIV (m/s): 2.2

Ridedown Accelerations (g's)

x-direction -0.7 (0.8703 - 0.8803 seconds)
y-direction 1.3 (0.6703 - 0.6803 seconds)

PHD (g's): 1.5 (0.6750 - 0.6850 seconds)

ASI: 0.15 (0.0947 - 0.1447 seconds)

Max. 50msec Moving Avg. Accelerations (g's)

x-direction -0.7 (0.1070 - 0.1570 seconds)
y-direction 1.3 (0.0943 - 0.1443 seconds)
z-direction -1.0 (0.1690 - 0.2190 seconds)

Max Roll, Pitch, and Yaw Angles (degrees)

Roll -3.8 (0.2553 seconds)
Pitch 2.3 (0.4287 seconds)
Yaw 22.8 (1.7000 seconds)

Figure G.14: Summary report of occupant risk factors from TRAP:
Curb Type -- AASHTO C Curb
Impact Speed -- 100 km/hr
Impact Angle -- 15 degrees.

Test Summary Report

General Information

Test Agency: WPI
Test Number: C-100-25
Test Date: Dec 2001
Test Article: C Curb with Flat Backfill

Test Vehicle

Description: C2500
Test Inertial Mass: 2000 kg
Gross Static Mass: 2000 kg

Impact Conditions

Speed: 100.0 km/hr
Angle: 25.0 degrees

Occupant Risk Factors

Impact Velocity (m/s) at 0.5747 seconds on front of interior
x-direction 1.9
y-direction -0.9

THIV (km/hr): 7.6 at 0.5813 seconds on front of interior
THIV (m/s): 2.1

Ridedown Accelerations (g's)
x-direction -0.7 (0.7990 - 0.8090 seconds)
y-direction 1.3 (0.6703 - 0.6803 seconds)

PHD (g's): 1.4 (0.6677 - 0.6777 seconds)

ASI: 0.18 (0.1793 - 0.2293 seconds)

Max. 50msec Moving Avg. Accelerations (g's)

x-direction -1.1 (0.1270 - 0.1770 seconds)
y-direction 1.5 (0.0950 - 0.1450 seconds)
z-direction -1.7 (0.1797 - 0.2297 seconds)

Max Roll, Pitch, and Yaw Angles (degrees)

Roll -3.4 (0.3173 seconds)
Pitch 2.0 (0.5393 seconds)
Yaw 23.7 (1.7000 seconds)

Figure G.15: Summary report of occupant risk factors from TRAP:
Curb Type -- AASHTO C Curb
Impact Speed -- 100 km/hr
Impact Angle -- 25 degrees.

Test Summary Report

General Information

Test Agency: WPI
Test Number: D-70-05
Test Date: Dec 2001
Test Article: D Curb with Flat Backfill

Test Vehicle

Description: C2500
Test Inertial Mass: 2000 kg
Gross Static Mass: 2000 kg

Impact Conditions

Speed: 70.0 km/hr
Angle: 5.0 degrees

Occupant Risk Factors

Impact Velocity (m/s) at 0.7067 seconds on front of interior
x-direction 1.6
y-direction -1.4

THIV (km/hr): 7.2 at 0.7080 seconds on front of interior
THIV (m/s): 2.0

Ridedown Accelerations (g's)

x-direction -0.7 (1.0463 - 1.0563 seconds)
y-direction -1.3 (1.0723 - 1.0823 seconds)

PHD (g's): 1.3 (1.1030 - 1.1130 seconds)

ASI: 0.10 (0.8660 - 0.9160 seconds)

Max. 50msec Moving Avg. Accelerations (g's)

x-direction -0.4 (0.1063 - 0.1563 seconds)
y-direction 0.8 (0.8657 - 0.9157 seconds)
z-direction 0.9 (1.1650 - 1.2150 seconds)

Max Roll, Pitch, and Yaw Angles (degrees)

Roll -7.4 (0.7453 seconds)
Pitch 2.2 (1.0800 seconds)
Yaw 11.8 (1.3427 seconds)

Figure G.16: Summary report of occupant risk factors from TRAP:
Curb Type -- AASHTO D Curb
Impact Speed -- 70 km/hr
Impact Angle -- 5 degrees.

Test Summary Report

General Information

Test Agency: WPI
Test Number: D-70-15
Test Date: Dec 2001
Test Article: D Curb with Flat Backfill

Test Vehicle

Description: C2500
Test Inertial Mass: 2000 kg
Gross Static Mass: 2000 kg

Impact Conditions

Speed: 70.0 km/hr
Angle: 15.0 degrees

Occupant Risk Factors

Impact Velocity (m/s) at 0.6467 seconds on front of interior
x-direction 1.8
y-direction -0.2

THIV (km/hr): 6.7 at 0.6440 seconds on front of interior
THIV (m/s): 1.9

Ridedown Accelerations (g's)

x-direction -1.0 (0.6890 - 0.6990 seconds)
y-direction 1.1 (0.7810 - 0.7910 seconds)

PHD (g's): 1.4 (0.6437 - 0.6537 seconds)

ASI: 0.14 (0.5920 - 0.6420 seconds)

Max. 50msec Moving Avg. Accelerations (g's)

x-direction -0.8 (0.0450 - 0.0950 seconds)
y-direction 1.2 (0.0977 - 0.1477 seconds)
z-direction -1.3 (0.5917 - 0.6417 seconds)

Max Roll, Pitch, and Yaw Angles (degrees)

Roll -5.4 (0.3573 seconds)
Pitch 2.6 (0.5980 seconds)
Yaw -8.4 (1.7000 seconds)

Figure G.17: Summary report of occupant risk factors from TRAP:
Curb Type -- AASHTO D Curb
Impact Speed -- 70 km/hr
Impact Angle -- 15 degrees.

Test Summary Report

General Information

Test Agency: WPI
Test Number: D-70-25
Test Date: Dec 2001
Test Article: D Curb with Flat Backfill

Test Vehicle

Description: C2500
Test Inertial Mass: 2000 kg
Gross Static Mass: 2000 kg

Impact Conditions

Speed: 70.0 km/hr
Angle: 25.0 degrees

Occupant Risk Factors

Impact Velocity (m/s) at 0.5640 seconds on front of interior
x-direction 1.9
y-direction -0.7

THIV (km/hr): 6.8 at 0.5727 seconds on front of interior
THIV (m/s): 1.9

Ridedown Accelerations (g's)

x-direction -1.2 (0.5743 - 0.5843 seconds)
y-direction 1.6 (0.7330 - 0.7430 seconds)

PHD (g's): 1.7 (0.7330 - 0.7430 seconds)

ASI: 0.21 (0.0980 - 0.1480 seconds)

Max. 50msec Moving Avg. Accelerations (g's)

x-direction -1.1 (0.0517 - 0.1017 seconds)
y-direction 1.8 (0.1003 - 0.1503 seconds)
z-direction -1.7 (0.2390 - 0.2890 seconds)

Max Roll, Pitch, and Yaw Angles (degrees)

Roll -5.2 (0.2320 seconds)
Pitch 2.7 (0.4933 seconds)
Yaw 28.1 (1.7000 seconds)

Figure G.18: Summary report of occupant risk factors from TRAP:
Curb Type -- AASHTO D Curb
Impact Speed -- 70 km/hr
Impact Angle -- 25 degrees.

Test Summary Report

General Information

Test Agency: WPI
Test Number: D-100-05
Test Date: Dec 2001
Test Article: D Curb with Flat Backfill

Test Vehicle

Description: C2500
Test Inertial Mass: 2000 kg
Gross Static Mass: 2000 kg

Impact Conditions

Speed: 100.0 km/hr
Angle: 5.0 degrees

Occupant Risk Factors

Impact Velocity (m/s) at 0.6227 seconds on front of interior
x-direction 1.9
y-direction -0.8

THIV (km/hr): 7.1 at 0.6173 seconds on front of interior
THIV (m/s): 2.0

Ridedown Accelerations (g's)
x-direction -0.9 (0.6970 - 0.7070 seconds)
y-direction -1.3 (0.8830 - 0.8930 seconds)

PHD (g's): 1.5 (0.9117 - 0.9217 seconds)

ASI: 0.14 (0.1680 - 0.2180 seconds)

Max. 50msec Moving Avg. Accelerations (g's)

x-direction -0.6 (0.1670 - 0.2170 seconds)
y-direction -1.1 (0.1683 - 0.2183 seconds)
z-direction 0.9 (0.9603 - 1.0103 seconds)

Max Roll, Pitch, and Yaw Angles (degrees)

Roll -7.1 (0.6380 seconds)
Pitch 1.8 (0.4520 seconds)
Yaw 7.8 (1.1807 seconds)

Figure G.19: Summary report of occupant risk factors from TRAP:
Curb Type -- AASHTO D Curb
Impact Speed -- 100 km/hr
Impact Angle -- 5 degrees.

Test Summary Report

General Information

Test Agency: WPI
Test Number: D-100-15
Test Date: Dec 2001
Test Article: D Curb with Flat Backfill

Test Vehicle

Description: C2500
Test Inertial Mass: 2000 kg
Gross Static Mass: 2000 kg

Impact Conditions

Speed: 100.0 km/hr
Angle: 15.0 degrees

Occupant Risk Factors

Impact Velocity (m/s) at 0.5720 seconds on front of interior
x-direction 2.0
y-direction -0.3

THIV (km/hr): 7.2 at 0.5680 seconds on front of interior
THIV (m/s): 2.0

Ridedown Accelerations (g's)
x-direction -1.0 (0.5910 - 0.6010 seconds)
y-direction 1.3 (0.7183 - 0.7283 seconds)

PHD (g's): 2.0 (0.5677 - 0.5777 seconds)

ASI: 0.19 (0.0847 - 0.1347 seconds)

Max. 50msec Moving Avg. Accelerations (g's)

x-direction -1.0 (0.0757 - 0.1257 seconds)
y-direction 1.6 (0.0843 - 0.1343 seconds)
z-direction -1.2 (0.1683 - 0.2183 seconds)

Max Roll, Pitch, and Yaw Angles (degrees)

Roll -5.3 (0.2600 seconds)
Pitch 2.8 (0.4587 seconds)
Yaw 24.6 (1.7000 seconds)

Figure G.20: Summary report of occupant risk factors from TRAP:
Curb Type -- AASHTO D Curb
Impact Speed -- 100 km/hr
Impact Angle -- 15 degrees.

Test Summary Report

General Information

Test Agency: WPI
Test Number: D-100-25
Test Date: Dec 2001
Test Article: D Curb with Flat Backfill

Test Vehicle

Description: C2500
Test Inertial Mass: 2000 kg
Gross Static Mass: 2000 kg

Impact Conditions

Speed: 100.0 km/hr
Angle: 25.0 degrees

Occupant Risk Factors

Impact Velocity (m/s) at 0.5133 seconds on front of interior
x-direction 2.0
y-direction -0.7

THIV (km/hr): 7.5 at 0.5173 seconds on front of interior
THIV (m/s): 2.1

Ridedown Accelerations (g's)
x-direction -1.4 (0.5223 - 0.5323 seconds)
y-direction 2.4 (0.6097 - 0.6197 seconds)

PHD (g's): 2.5 (0.6097 - 0.6197 seconds)

ASI: 0.26 (0.1807 - 0.2307 seconds)

Max. 50msec Moving Avg. Accelerations (g's)

x-direction -1.6 (0.1203 - 0.1703 seconds)
y-direction 2.2 (0.0850 - 0.1350 seconds)
z-direction -2.5 (0.1803 - 0.2303 seconds)

Max Roll, Pitch, and Yaw Angles (degrees)

Roll -4.2 (0.2980 seconds)
Pitch 2.4 (0.5120 seconds)
Yaw 23.8 (1.6773 seconds)

Figure G.21: Summary report of occupant risk factors from TRAP:
Curb Type -- AASHTO D Curb
Impact Speed -- 100 km/hr
Impact Angle -- 25 degrees.

Test Summary Report

General Information

Test Agency: WPI
Test Number: G-70-05
Test Date: Dec 2001
Test Article: G Curb with Flat Backfill

Test Vehicle

Description: C2500
Test Inertial Mass: 2000 kg
Gross Static Mass: 2000 kg

Impact Conditions

Speed: 70.0 km/hr
Angle: 5.0 degrees

Occupant Risk Factors

Impact Velocity (m/s) at 0.7293 seconds on front of interior
x-direction 1.6
y-direction -1.2

THIV (km/hr): 7.0 at 0.7367 seconds on front of interior
THIV (m/s): 1.9

Ridedown Accelerations (g's)
x-direction -0.5 (0.8263 - 0.8363 seconds)
y-direction 0.5 (0.8723 - 0.8823 seconds)

PHD (g's): 0.7 (0.8463 - 0.8563 seconds)

ASI: 0.07 (0.3840 - 0.4340 seconds)

Max. 50msec Moving Avg. Accelerations (g's)

x-direction -0.4 (0.1097 - 0.1597 seconds)
y-direction 0.5 (0.4577 - 0.5077 seconds)
z-direction 0.6 (0.3830 - 0.4330 seconds)

Max Roll, Pitch, and Yaw Angles (degrees)

Roll -5.9 (0.6787 seconds)
Pitch 1.6 (0.3107 seconds)
Yaw 6.4 (1.4113 seconds)

Figure G.22: Summary report of occupant risk factors from TRAP:
Curb Type -- AASHTO G Curb
Impact Speed -- 70 km/hr
Impact Angle -- 5 degrees.

Test Summary Report

General Information

Test Agency: WPI
Test Number: G-70-15
Test Date: Dec 2001
Test Article: G Curb with Flat Backfill

Test Vehicle

Description: C2500
Test Inertial Mass: 2000 kg
Gross Static Mass: 2000 kg

Impact Conditions

Speed: 70.0 km/hr
Angle: 15.0 degrees

Occupant Risk Factors

Impact Velocity (m/s) at 0.6947 seconds on front of interior
x-direction 1.6
y-direction -0.8

THIV (km/hr): 6.3 at 0.7007 seconds on front of interior
THIV (m/s): 1.8

Ridedown Accelerations (g's)

x-direction -0.5 (0.7197 - 0.7297 seconds)
y-direction 0.8 (0.7083 - 0.7183 seconds)

PHD (g's): 0.9 (0.7083 - 0.7183 seconds)

ASI: 0.09 (0.2920 - 0.3420 seconds)

Max. 50msec Moving Avg. Accelerations (g's)

x-direction -0.5 (0.0217 - 0.0717 seconds)
y-direction 0.7 (0.4143 - 0.4643 seconds)
z-direction 0.9 (0.2917 - 0.3417 seconds)

Max Roll, Pitch, and Yaw Angles (degrees)

Roll -4.0 (0.2147 seconds)
Pitch 2.2 (0.5587 seconds)
Yaw 4.1 (0.8347 seconds)

Figure G.23: Summary report of occupant risk factors from TRAP:
Curb Type -- AASHTO G Curb
Impact Speed -- 70 km/hr
Impact Angle -- 15 degrees.

Test Summary Report

General Information

Test Agency: WPI
Test Number: G-70-25
Test Date: Dec 2001
Test Article: G Curb with Flat Backfill

Test Vehicle

Description: C2500
Test Inertial Mass: 2000 kg
Gross Static Mass: 2000 kg

Impact Conditions

Speed: 70.0 km/hr
Angle: 25.0 degrees

Occupant Risk Factors

Impact Velocity (m/s) at 0.7060 seconds on front of interior
x-direction 1.6
y-direction -1.2

THIV (km/hr): 6.9 at 0.6993 seconds on left side of interior

THIV (m/s): 1.9

Ridedown Accelerations (g's)

x-direction -0.4 (0.7410 - 0.7510 seconds)
y-direction 1.1 (0.7063 - 0.7163 seconds)

PHD (g's): 1.1 (0.7037 - 0.7137 seconds)

ASI: 0.14 (0.4440 - 0.4940 seconds)

Max. 50msec Moving Avg. Accelerations (g's)

x-direction -0.6 (0.1830 - 0.2330 seconds)
y-direction 1.1 (0.4437 - 0.4937 seconds)
z-direction 1.1 (0.3237 - 0.3737 seconds)

Max Roll, Pitch, and Yaw Angles (degrees)

Roll -4.1 (0.2260 seconds)
Pitch 2.7 (0.4500 seconds)
Yaw 9.8 (1.1580 seconds)

Figure G.24: Summary report of occupant risk factors from TRAP:
Curb Type -- AASHTO G Curb
Impact Speed -- 70 km/hr
Impact Angle -- 25 degrees.

Test Summary Report

General Information

Test Agency: WPI
Test Number: G-100-05
Test Date: Dec 2001
Test Article: G Curb with Flat Backfill

Test Vehicle

Description: C2500
Test Inertial Mass: 2000 kg
Gross Static Mass: 2000 kg

Impact Conditions

Speed: 100.0 km/hr
Angle: 5.0 degrees

Occupant Risk Factors

Impact Velocity (m/s) at 0.6207 seconds on front of interior
x-direction 1.8
y-direction -0.6

THIV (km/hr): 6.8 at 0.6213 seconds on front of interior
THIV (m/s): 1.9

Ridedown Accelerations (g's)
x-direction -0.6 (0.7157 - 0.7257 seconds)
y-direction 0.6 (0.7843 - 0.7943 seconds)

PHD (g's): 0.8 (0.7683 - 0.7783 seconds)

ASI: 0.08 (0.2947 - 0.3447 seconds)

Max. 50msec Moving Avg. Accelerations (g's)

x-direction -0.4 (0.1790 - 0.2290 seconds)
y-direction 0.4 (0.7483 - 0.7983 seconds)
z-direction 0.7 (0.2943 - 0.3443 seconds)

Max Roll, Pitch, and Yaw Angles (degrees)

Roll -5.4 (0.6267 seconds)
Pitch 1.3 (0.4260 seconds)
Yaw 3.3 (0.6247 seconds)

Figure G.25: Summary report of occupant risk factors from TRAP:
Curb Type -- AASHTO G Curb
Impact Speed -- 100 km/hr
Impact Angle -- 5 degrees.

Test Summary Report

General Information

Test Agency: WPI
Test Number: G-100-15
Test Date: Dec 2001
Test Article: G Curb with Flat Backfill

Test Vehicle

Description: C2500
Test Inertial Mass: 2000 kg
Gross Static Mass: 2000 kg

Impact Conditions

Speed: 100.0 km/hr
Angle: 15.0 degrees

Occupant Risk Factors

Impact Velocity (m/s) at 0.5713 seconds on front of interior
x-direction 1.9
y-direction -0.5

THIV (km/hr): 7.1 at 0.5720 seconds on front of interior
THIV (m/s): 2.0

Ridedown Accelerations (g's)

x-direction -0.6 (0.6710 - 0.6810 seconds)
y-direction 1.2 (0.6703 - 0.6803 seconds)

PHD (g's): 1.3 (0.6703 - 0.6803 seconds)

ASI: 0.12 (0.0900 - 0.1400 seconds)

Max. 50msec Moving Avg. Accelerations (g's)

x-direction -0.7 (0.0350 - 0.0850 seconds)
y-direction 1.1 (0.0897 - 0.1397 seconds)
z-direction -1.1 (0.1590 - 0.2090 seconds)

Max Roll, Pitch, and Yaw Angles (degrees)

Roll -4.0 (0.2560 seconds)
Pitch 2.4 (0.4307 seconds)
Yaw 6.7 (1.6547 seconds)

Figure G.26: Summary report of occupant risk factors from TRAP:
Curb Type -- AASHTO G Curb
Impact Speed -- 100 km/hr
Impact Angle -- 15 degrees.

Test Summary Report

General Information

Test Agency: WPI
Test Number: G-100-25
Test Date: Dec 2001
Test Article: G Curb with Flat Backfill

Test Vehicle

Description: C2500
Test Inertial Mass: 2000 kg
Gross Static Mass: 2000 kg

Impact Conditions

Speed: 100.0 km/hr
Angle: 25.0 degrees

Occupant Risk Factors

Impact Velocity (m/s) at 0.5760 seconds on front of interior
x-direction 1.9
y-direction -1.0

THIV (km/hr): 7.6 at 0.5853 seconds on front of interior
THIV (m/s): 2.1

Ridedown Accelerations (g's)
x-direction -0.7 (0.6163 - 0.6263 seconds)
y-direction 1.6 (0.5930 - 0.6030 seconds)

PHD (g's): 1.7 (0.5930 - 0.6030 seconds)

ASI: 0.19 (0.0880 - 0.1380 seconds)

Max. 50msec Moving Avg. Accelerations (g's)

x-direction -1.0 (0.0350 - 0.0850 seconds)
y-direction 1.7 (0.0877 - 0.1377 seconds)
z-direction -1.8 (0.1557 - 0.2057 seconds)

Max Roll, Pitch, and Yaw Angles (degrees)

Roll -3.6 (0.3140 seconds)
Pitch 2.2 (0.5333 seconds)
Yaw 21.7 (1.7000 seconds)

Figure G.27: Summary report of occupant risk factors from TRAP:
Curb Type -- AASHTO G Curb
Impact Speed -- 100 km/hr
Impact Angle -- 25 degrees.

Test Summary Report

General Information

Test Agency: WPI
Test Number: NY-70-05
Test Date: Dec 2001
Test Article: NY Curb with Flat Backfill

Test Vehicle

Description: C2500
Test Inertial Mass: 2000 kg
Gross Static Mass: 2000 kg

Impact Conditions

Speed: 70.0 km/hr
Angle: 5.0 degrees

Occupant Risk Factors

Impact Velocity (m/s) at 0.7753 seconds on front of interior
x-direction 1.5
y-direction -0.8

THIV (km/hr): 6.2 at 0.7753 seconds on front of interior
THIV (m/s): 1.7

Ridedown Accelerations (g's)

x-direction -0.3 (1.4290 - 1.4390 seconds)
y-direction -0.5 (1.0477 - 1.0577 seconds)

PHD (g's): 0.5 (1.0470 - 1.0570 seconds)

ASI: 0.05 (0.6120 - 0.6620 seconds)

Max. 50msec Moving Avg. Accelerations (g's)

x-direction -0.3 (0.3017 - 0.3517 seconds)
y-direction 0.4 (0.6157 - 0.6657 seconds)
z-direction 0.3 (0.4170 - 0.4670 seconds)

Max Roll, Pitch, and Yaw Angles (degrees)

Roll -4.9 (0.7760 seconds)
Pitch 1.2 (1.3327 seconds)
Yaw 4.0 (0.8313 seconds)

Figure G.28: Summary report of occupant risk factors from TRAP:
Curb Type -- New York Curb (100 mm)
Impact Speed -- 70 km/hr
Impact Angle -- 5 degrees.

Test Summary Report

General Information

Test Agency: WPI
Test Number: NY-70-15
Test Date: Dec 2001
Test Article: NY Curb with Flat Backfill

Test Vehicle

Description: C2500
Test Inertial Mass: 2000 kg
Gross Static Mass: 2000 kg

Impact Conditions

Speed: 70.0 km/hr
Angle: 15.0 degrees

Occupant Risk Factors

Impact Velocity (m/s) at 0.7747 seconds on front of interior
x-direction 1.5
y-direction -0.8

THIV (km/hr): 6.1 at 0.7800 seconds on front of interior
THIV (m/s): 1.7

Ridedown Accelerations (g's)

x-direction -0.4 (0.8837 - 0.8937 seconds)
y-direction -0.2 (0.8670 - 0.8770 seconds)

PHD (g's): 0.4 (0.8857 - 0.8957 seconds)

ASI: 0.07 (0.5580 - 0.6080 seconds)

Max. 50msec Moving Avg. Accelerations (g's)

x-direction -0.4 (0.3577 - 0.4077 seconds)
y-direction 0.6 (0.4143 - 0.4643 seconds)
z-direction -0.6 (0.5590 - 0.6090 seconds)

Max Roll, Pitch, and Yaw Angles (degrees)

Roll -3.8 (0.3580 seconds)
Pitch 2.1 (0.5747 seconds)
Yaw 3.0 (0.8300 seconds)

Figure G.29: Summary report of occupant risk factors from TRAP:
Curb Type -- New York Curb (100 mm)
Impact Speed -- 70 km/hr
Impact Angle -- 15 degrees.

Test Summary Report

General Information

Test Agency: WPI
Test Number: NY-70-25
Test Date: Dec 2001
Test Article: NY Curb with Flat Backfill

Test Vehicle

Description: C2500
Test Inertial Mass: 2000 kg
Gross Static Mass: 2000 kg

Impact Conditions

Speed: 70.0 km/hr
Angle: 25.0 degrees

Occupant Risk Factors

Impact Velocity (m/s) at 0.7053 seconds on left side of interior
x-direction 1.5
y-direction -1.3

THIV (km/hr): 7.7 at 0.7173 seconds on front of interior
THIV (m/s): 2.1

Ridedown Accelerations (g's)

x-direction -0.5 (0.8690 - 0.8790 seconds)
y-direction 0.7 (0.7077 - 0.7177 seconds)

PHD (g's): 0.6 (0.9197 - 0.9297 seconds)

ASI: 0.14 (0.4267 - 0.4767 seconds)

Max. 50msec Moving Avg. Accelerations (g's)

x-direction -0.5 (0.1963 - 0.2463 seconds)
y-direction 1.1 (0.4270 - 0.4770 seconds)
z-direction -1.1 (0.2217 - 0.2717 seconds)

Max Roll, Pitch, and Yaw Angles (degrees)

Roll -3.7 (0.2207 seconds)
Pitch 2.3 (0.4447 seconds)
Yaw -7.8 (1.1280 seconds)

Figure G.30: Summary report of occupant risk factors from TRAP:
Curb Type -- New York Curb (100 mm)
Impact Speed -- 70 km/hr
Impact Angle -- 25 degrees.

Test Summary Report

General Information

Test Agency: WPI
Test Number: NY-100-05
Test Date: Dec 2001
Test Article: NY Curb with Flat Backfill

Test Vehicle

Description: C2500
Test Inertial Mass: 2000 kg
Gross Static Mass: 2000 kg

Impact Conditions

Speed: 100.0 km/hr
Angle: 5.0 degrees

Occupant Risk Factors

Impact Velocity (m/s) at 0.6367 seconds on front of interior
x-direction 1.8
y-direction -0.5

THIV (km/hr): 6.8 at 0.6373 seconds on front of interior
THIV (m/s): 1.9

Ridedown Accelerations (g's)

x-direction -1.7 (0.6910 - 0.7010 seconds)
y-direction 0.6 (0.8197 - 0.8297 seconds)

PHD (g's): 2.3 (0.6950 - 0.7050 seconds)

ASI: 0.08 (0.3353 - 0.3853 seconds)

Max. 50msec Moving Avg. Accelerations (g's)

x-direction -0.6 (0.6510 - 0.7010 seconds)
y-direction 0.3 (0.7970 - 0.8470 seconds)
z-direction 0.7 (0.3350 - 0.3850 seconds)

Max Roll, Pitch, and Yaw Angles (degrees)

Roll -5.5 (0.6600 seconds)
Pitch 1.2 (0.4553 seconds)
Yaw 4.1 (1.7000 seconds)

Figure G.31: Summary report of occupant risk factors from TRAP:
Curb Type -- New York Curb (100 mm)
Impact Speed -- 100 km/hr
Impact Angle -- 5 degrees.

Test Summary Report

General Information

Test Agency: WPI
Test Number: NY-100-15
Test Date: Dec 2001
Test Article: NY Curb with Flat Backfill

Test Vehicle

Description: C2500
Test Inertial Mass: 2000 kg
Gross Static Mass: 2000 kg

Impact Conditions

Speed: 100.0 km/hr
Angle: 15.0 degrees

Occupant Risk Factors

Impact Velocity (m/s) at 0.6813 seconds on front of interior
x-direction 1.8
y-direction -0.3

THIV (km/hr): 6.5 at 0.6787 seconds on front of interior
THIV (m/s): 1.8

Ridedown Accelerations (g's)
x-direction -0.6 (0.8783 - 0.8883 seconds)
y-direction 0.6 (0.6923 - 0.7023 seconds)

PHD (g's): 0.8 (0.6883 - 0.6983 seconds)

ASI: 0.10 (0.1713 - 0.2213 seconds)

Max. 50msec Moving Avg. Accelerations (g's)

x-direction -0.5 (0.1223 - 0.1723 seconds)
y-direction -0.8 (0.1297 - 0.1797 seconds)
z-direction -1.0 (0.1710 - 0.2210 seconds)

Max Roll, Pitch, and Yaw Angles (degrees)

Roll -3.7 (0.2707 seconds)
Pitch 2.0 (0.4300 seconds)
Yaw 5.9 (1.3200 seconds)

Figure G.32: Summary report of occupant risk factors from TRAP:
Curb Type -- New York Curb (100 mm)
Impact Speed -- 100 km/hr
Impact Angle -- 15 degrees.

Test Summary Report

General Information

Test Agency: WPI
Test Number: NY-100-25
Test Date: Dec 2001
Test Article: NY Curb with Flat Backfill

Test Vehicle

Description: C2500
Test Inertial Mass: 2000 kg
Gross Static Mass: 2000 kg

Impact Conditions

Speed: 100.0 km/hr
Angle: 25.0 degrees

Occupant Risk Factors

Impact Velocity (m/s) at 0.5953 seconds on front of interior
x-direction 1.9
y-direction -1.3

THIV (km/hr): 7.7 at 0.5820 seconds on left side of interior

THIV (m/s): 2.1

Ridedown Accelerations (g's)

x-direction -0.6 (0.6637 - 0.6737 seconds)
y-direction 1.0 (0.6843 - 0.6943 seconds)

PHD (g's): 1.3 (0.5817 - 0.5917 seconds)

ASI: 0.17 (0.0853 - 0.1353 seconds)

Max. 50msec Moving Avg. Accelerations (g's)

x-direction -0.8 (0.1170 - 0.1670 seconds)
y-direction 1.5 (0.0850 - 0.1350 seconds)
z-direction -1.6 (0.1690 - 0.2190 seconds)

Max Roll, Pitch, and Yaw Angles (degrees)

Roll -3.4 (0.3093 seconds)
Pitch 2.1 (0.5093 seconds)
Yaw 18.4 (1.7000 seconds)

Figure G.33: Summary report of occupant risk factors from TRAP:
Curb Type -- New York Curb (100 mm)
Impact Speed -- 100 km/hr
Impact Angle -- 25 degrees.

APPENDIX H

Sequential Views of Curb-Barrier Impact

-Finite Element Analysis Results-

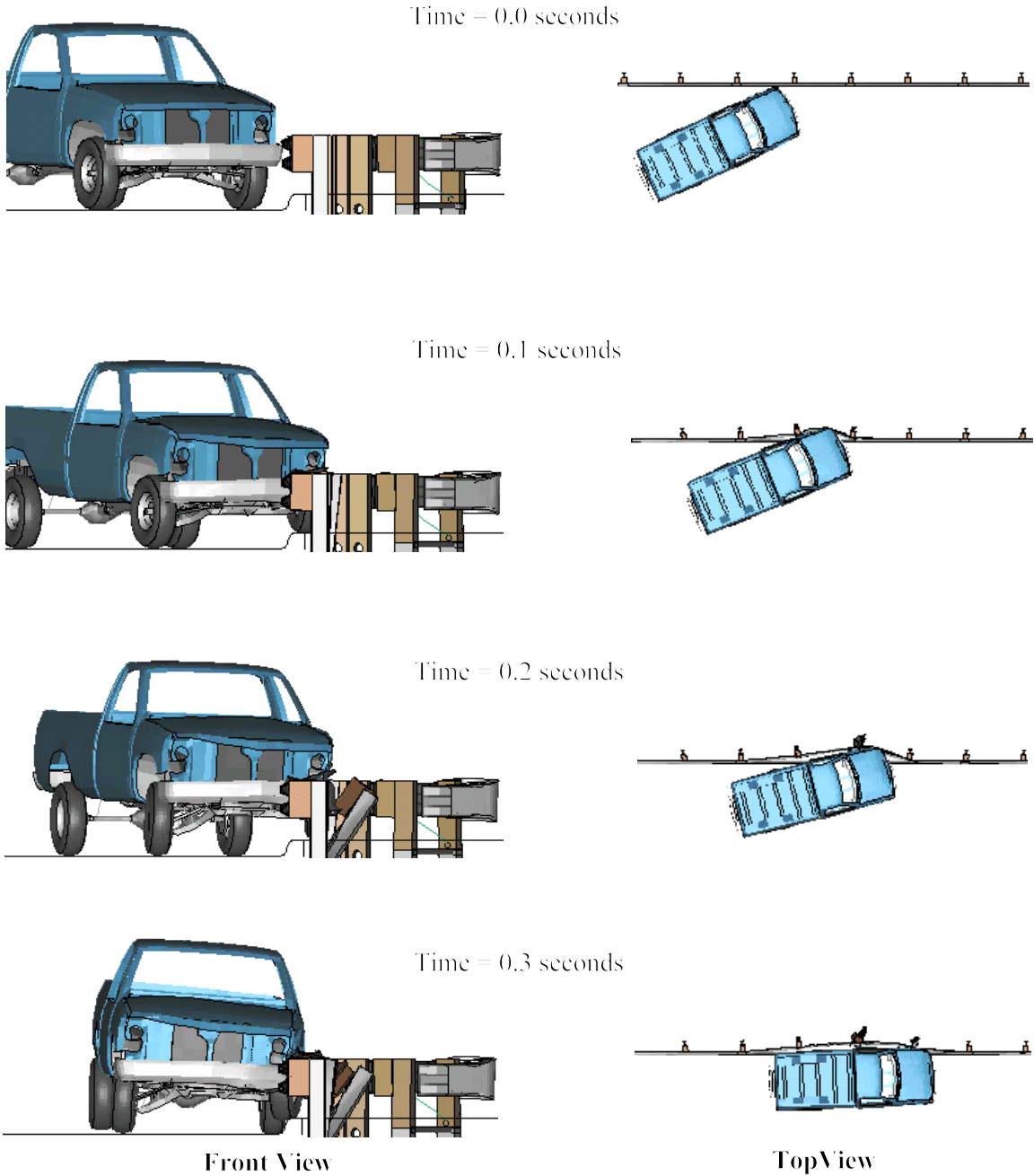

Figure H.1: Sequential views of curb-barrier impact from F.E. analysis - front view and top view

Curb Type -- AASHTO B Curb
Offset Distance -- 0m
Impact Speed -- 70 km/hr
Impact Angle -- 25 degrees.

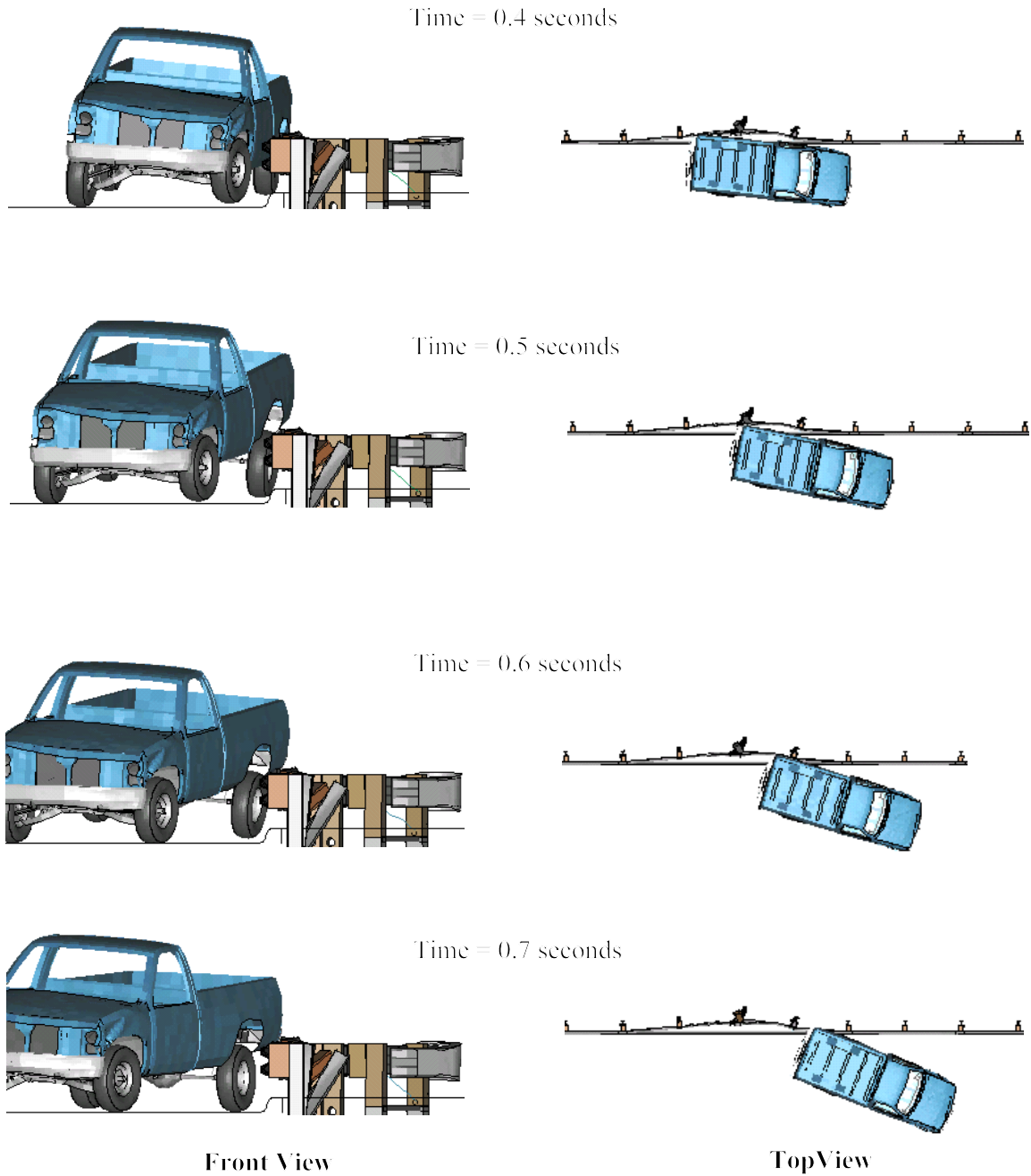
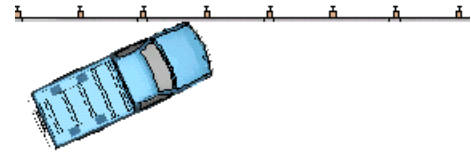
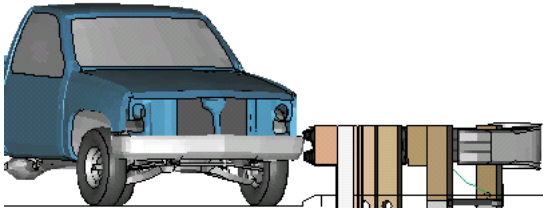
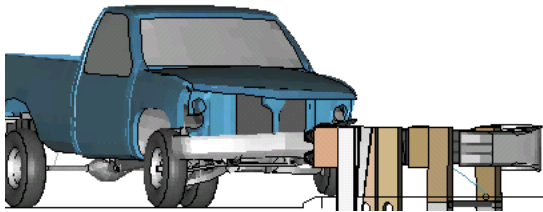

Figure H.1: (CONTINUED) Sequential views of curb-barrier impact from F.E. analysis - front view and top view
Curb Type -- AASHTO B Curb
Offset Distance -- 0m
Impact Speed -- 70 km/hr
Impact Angle -- 25 degrees.

Time = 0.0 seconds



Time = 0.1 seconds



Time = 0.2 seconds

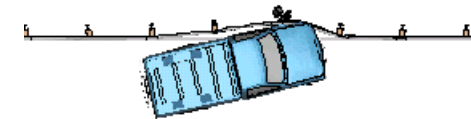
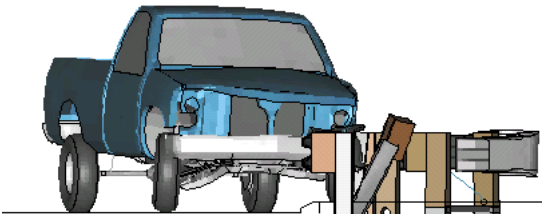

Time = 0.3 seconds

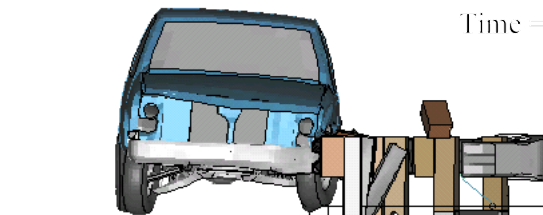

Front View

TopView

Figure H.2:

Sequential views of curb-barrier impact from F.E. analysis - front view and top view

Curb Type -- AASHTO C Curb

Offset Distance -- 0m

Impact Speed -- 70 km/hr

Impact Angle -- 25 degrees.

Time = 0.4 seconds

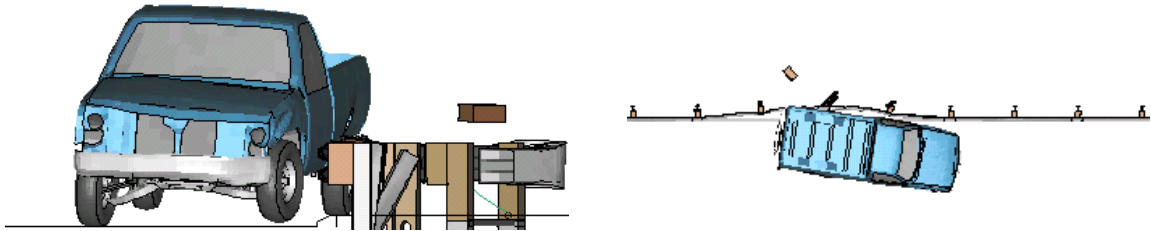

Time = 0.5 seconds

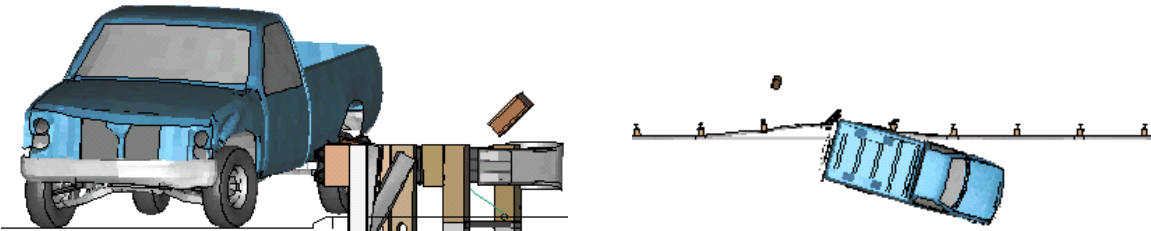

Time = 0.6 seconds

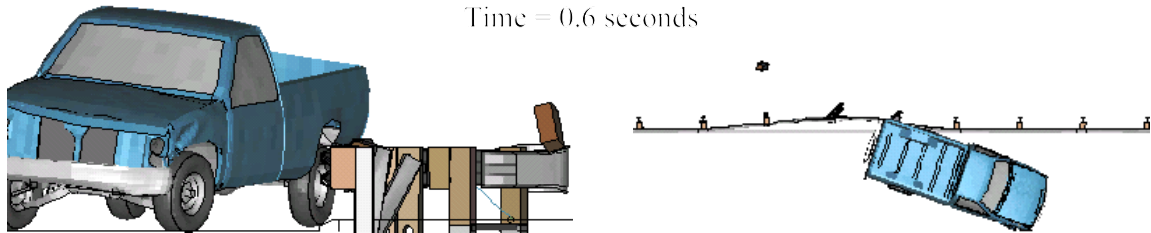

Time = 0.7 seconds

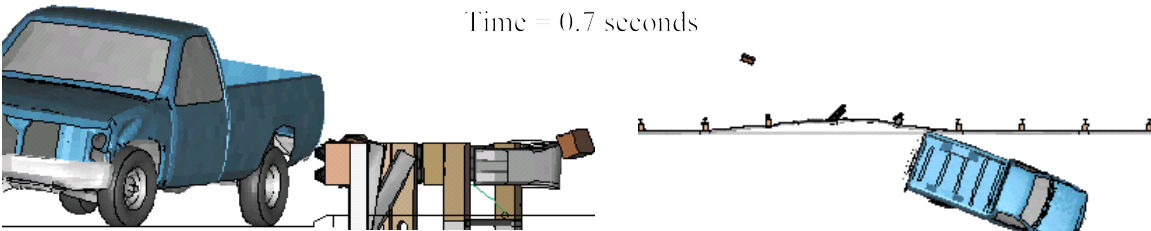

Front View

TopView

Figure H.2:

(CONTINUED) Sequential views of curb-barrier impact from F.E. analysis - front view and top view

Curb Type -- AASHTO C Curb

Offset Distance -- 0m

Impact Speed -- 70 km/hr

Impact Angle -- 25 degrees.

Time = 0.0 seconds

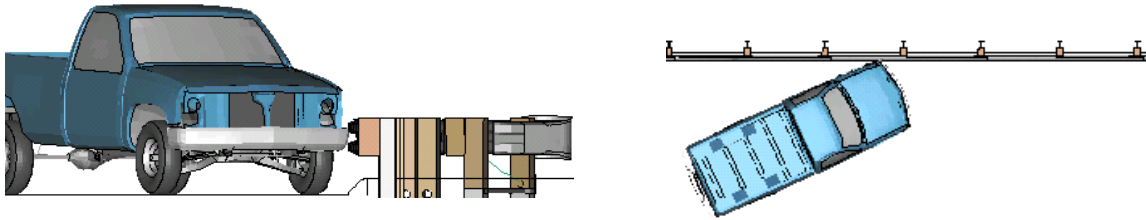

Time = 0.1 seconds

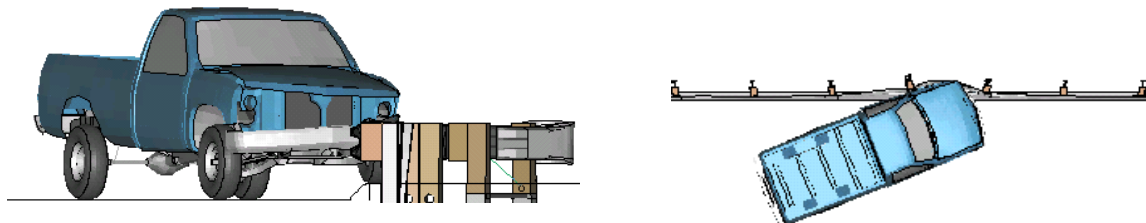

Time = 0.2 seconds

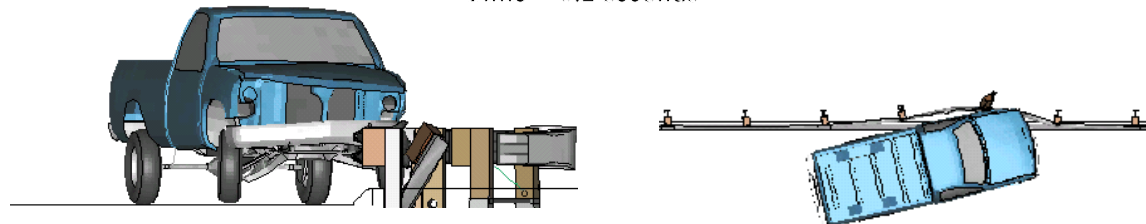

Time = 0.3 seconds

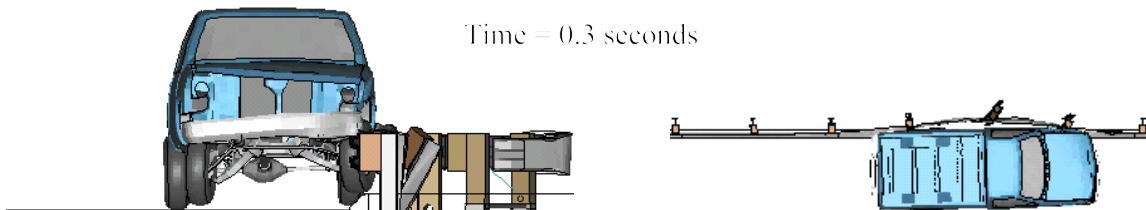

Front View

TopView

Figure H.3: Sequential views of curb-barrier impact from F.E. analysis - front view and top view

Curb Type -- AASHTO D Curb

Offset Distance -- 0m

Impact Speed -- 70 km/hr

Impact Angle -- 25 degrees.

Time = 0.4 seconds

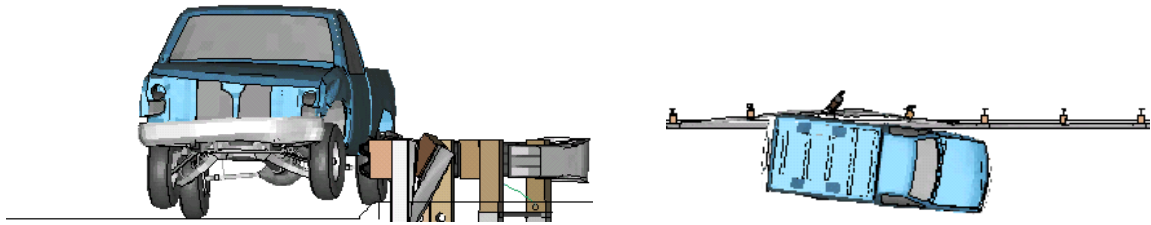

Time = 0.5 seconds



Time = 0.6 seconds

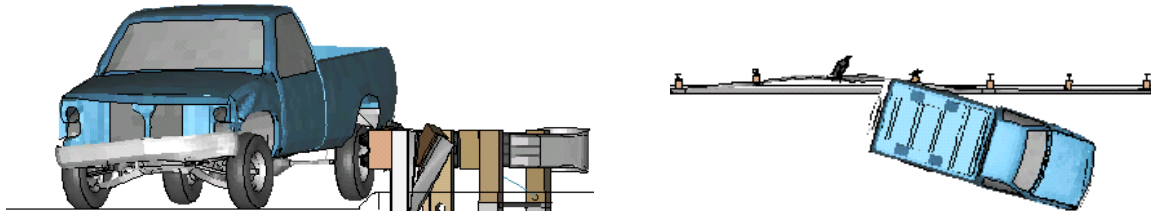

Time = 0.7 seconds

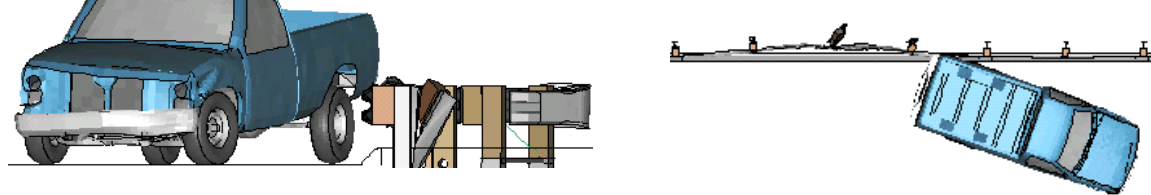

Front View

TopView

Figure H.3: (CONTINUED) Sequential views of curb-barrier impact from F.E. analysis - front view and top view
Curb Type -- AASHTO D Curb
Offset Distance -- 0m
Impact Speed -- 70 km/hr
Impact Angle -- 25 degrees.



Image Not
Available

Figure H.4: Sequential views of curb-barrier impact from F.E. analysis - front view and top view

Curb Type -- AASHTO G Curb

Offset Distance -- 0m

Impact Speed -- 70 km/hr

Impact Angle -- 25 degrees.



Image Not
Available

Figure H.4: (CONTINUED) Sequential views of curb-barrier impact from F.E. analysis - front view and top view
Curb Type -- AASHTO G Curb
Offset Distance -- 0m
Impact Speed -- 70 km/hr
Impact Angle -- 25 degrees.

Time = 0.4 seconds

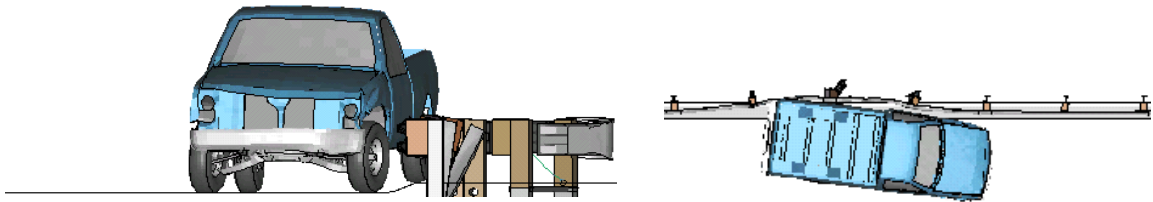

Time = 0.5 seconds

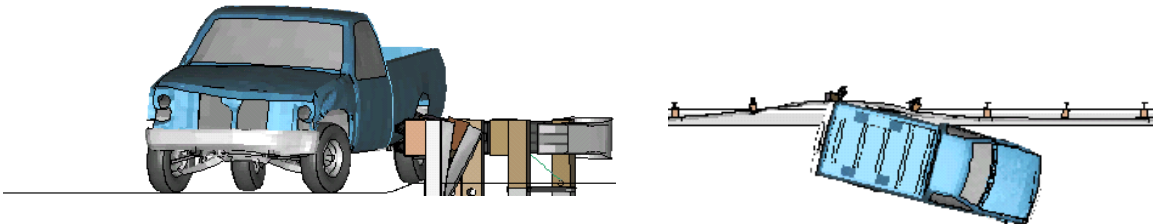

Time = 0.6 seconds

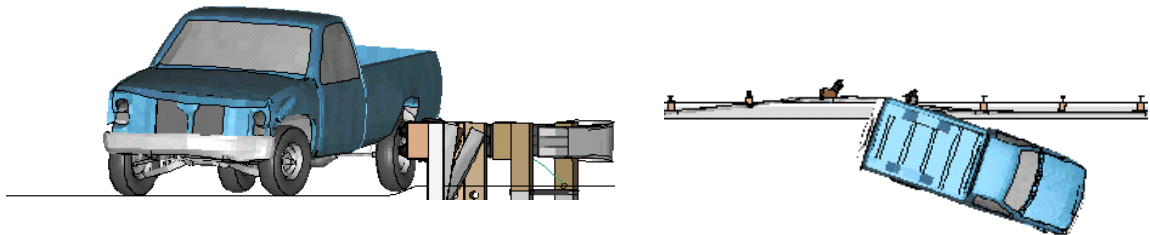

Time = 0.7 seconds

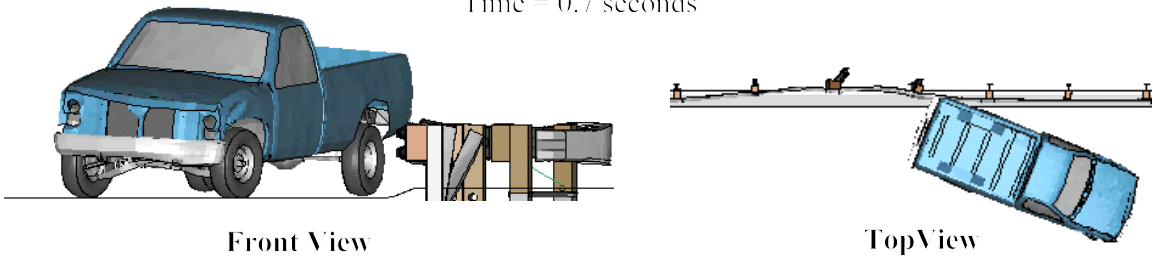

Front View

TopView

Figure H.5: (CONTINUED) Sequential views of curb-barrier impact from F.E. analysis - front view and top view
Curb Type -- New York Curb (100 mm)
Offset Distance -- 0m
Impact Speed -- 70 km/hr
Impact Angle -- 25 degrees.

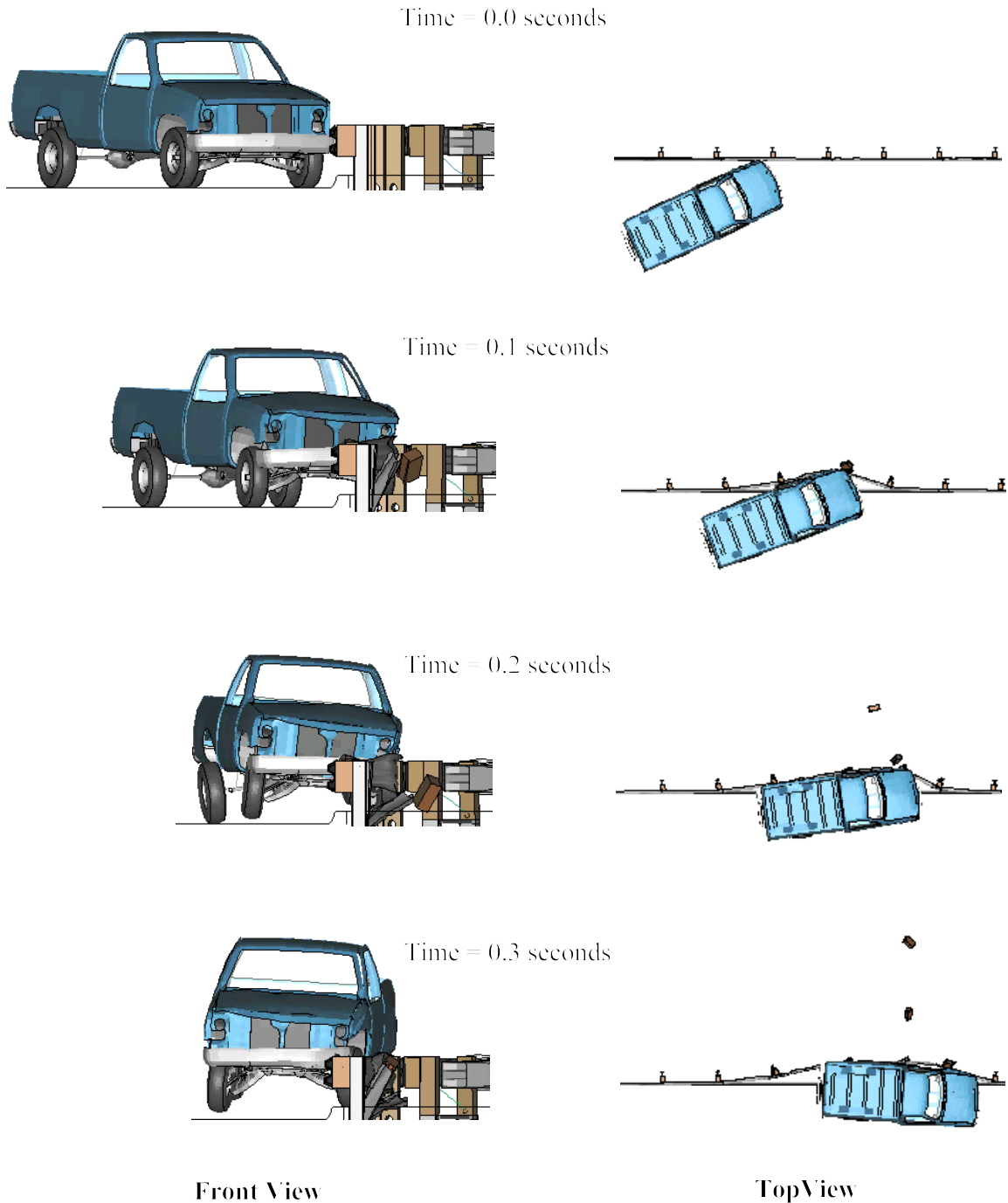

Figure H.6: Sequential views of curb-barrier impact from F.E. analysis - front view and top view

Curb Type -- AASHTO B Curb
Offset Distance -- 0m
Impact Speed -- 100 km/hr
Impact Angle -- 25 degrees.

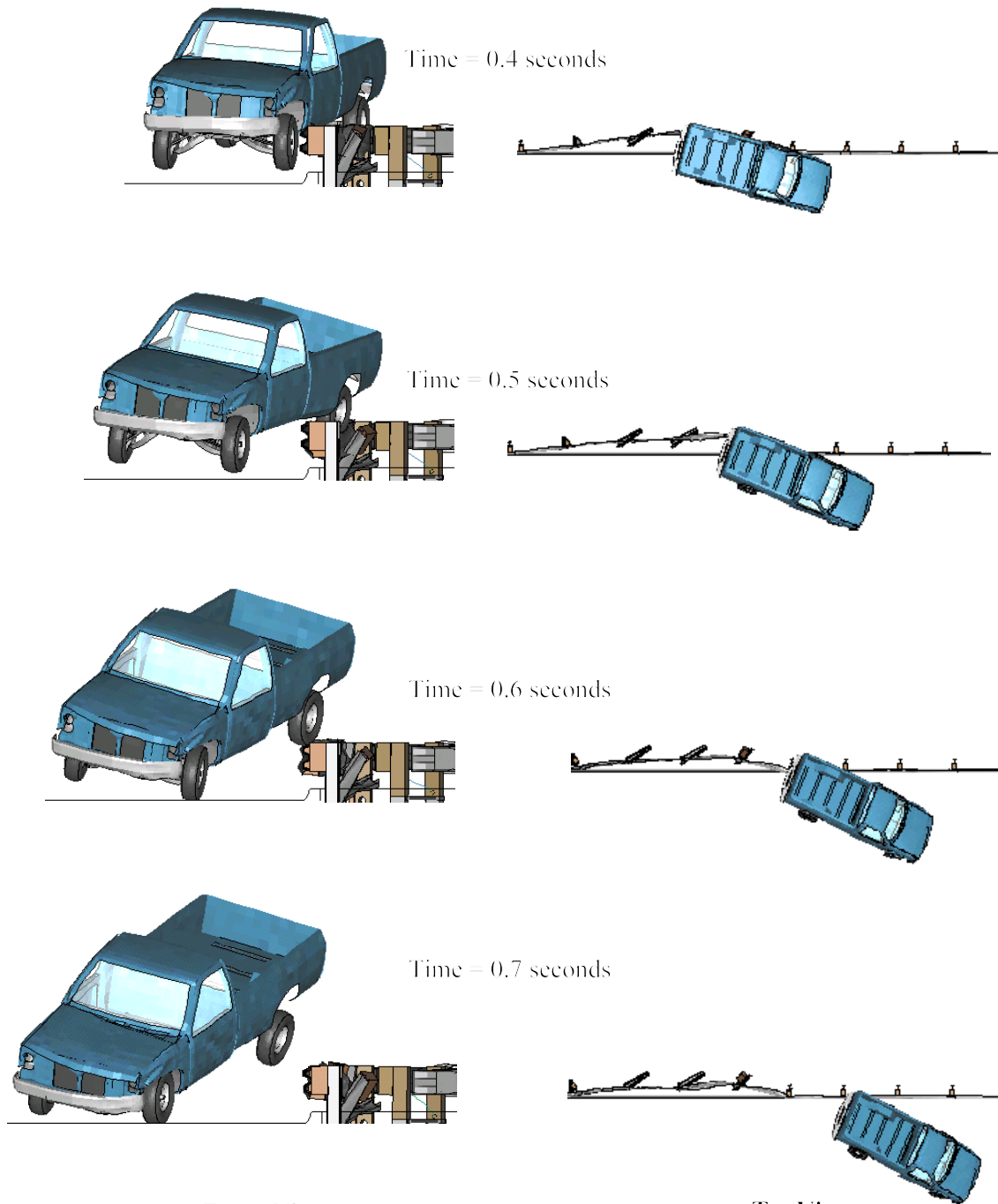

Figure H.6: (CONTINUED) Sequential views of curb-barrier impact from F.E. analysis - front view and top view

Curb Type	-- AASHTO B Curb
Offset Distance	- 0m
Impact Speed	- 100 km/hr
Impact Angle	- 25 degrees.

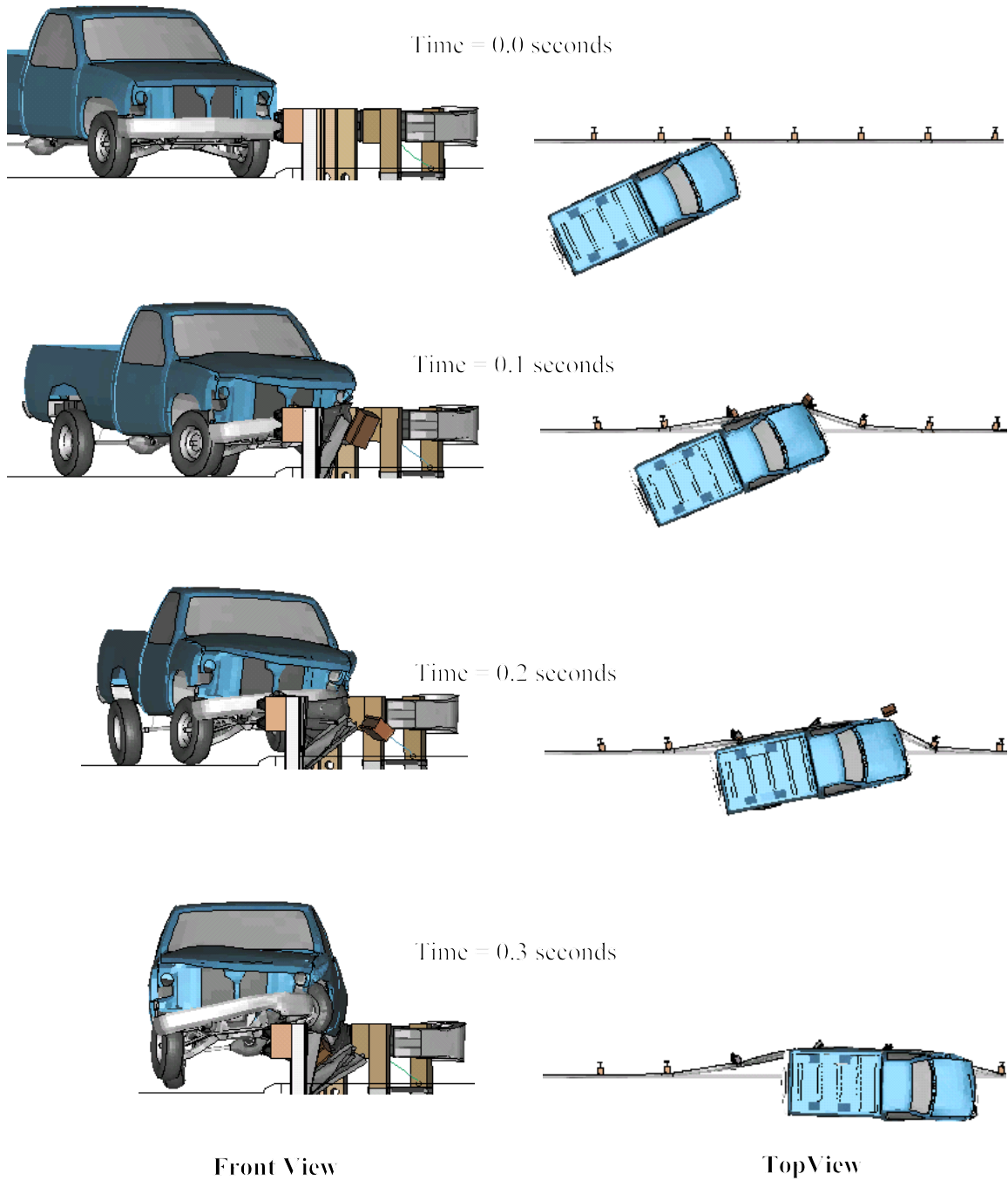

Figure H.7: Sequential views of curb-barrier impact from F.E. analysis - front view and top view

Curb Type -- AASHTO C Curb
Offset Distance -- 0m
Impact Speed -- 100 km/hr
Impact Angle -- 25 degrees.

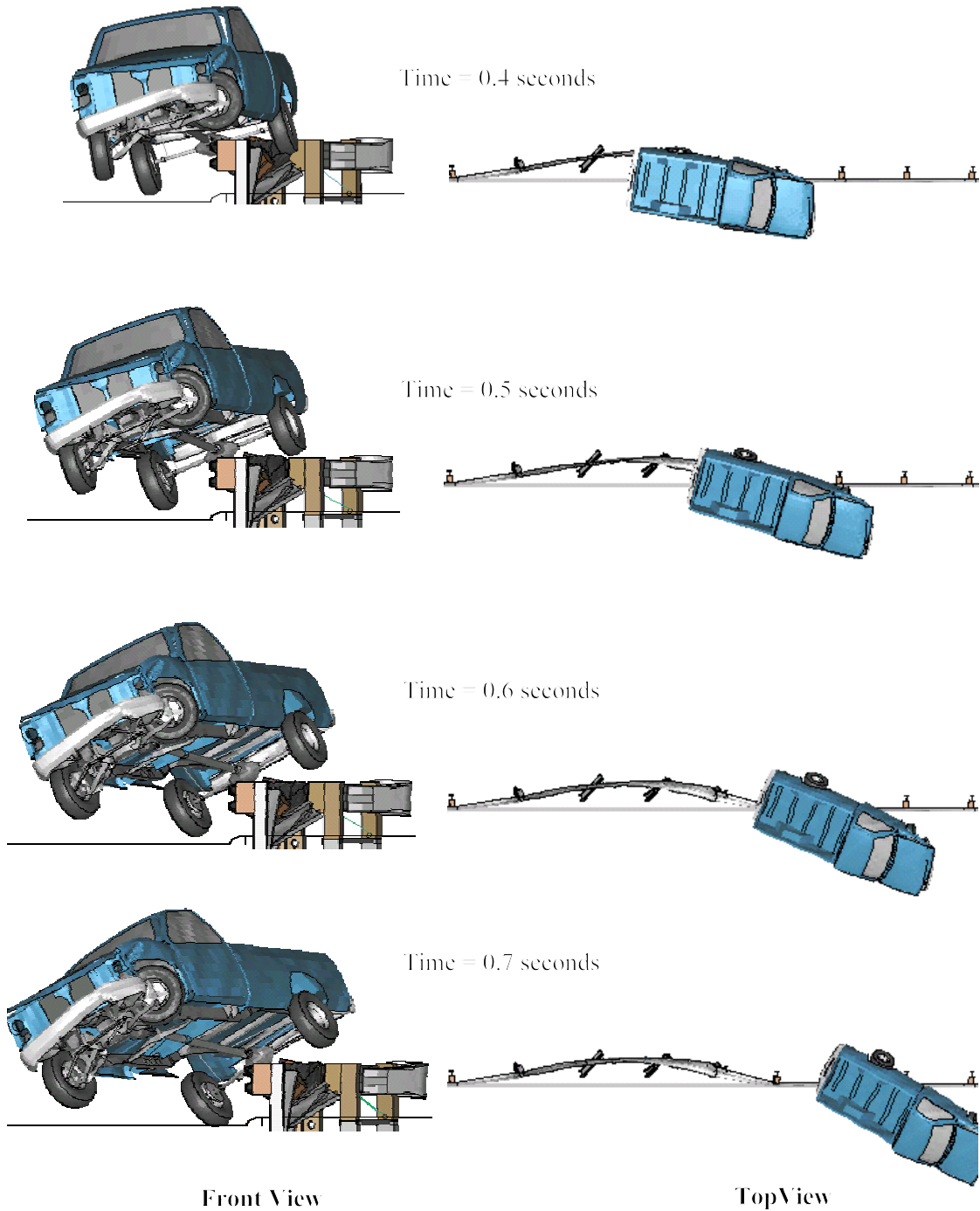
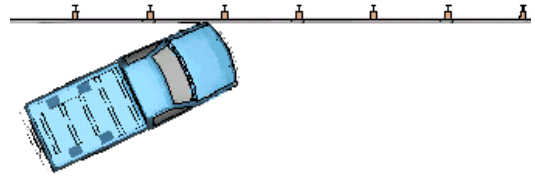
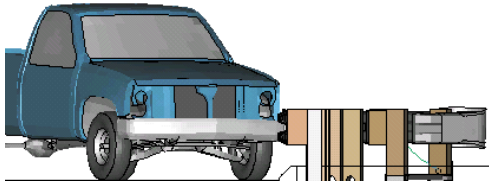

Figure H.7: (CONTINUED) Sequential views of curb-barrier impact from F.E. analysis - front view and top view

Curb Type	-- AASHTO C Curb
Offset Distance	-- 0m
Impact Speed	-- 100 km/hr
Impact Angle	-- 25 degrees.

Time = 0.0 seconds



Time = 0.1 seconds

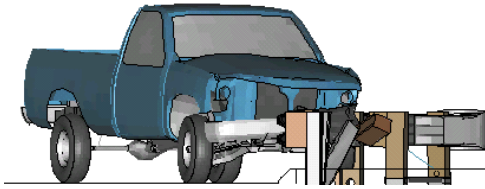

Time = 0.2 seconds

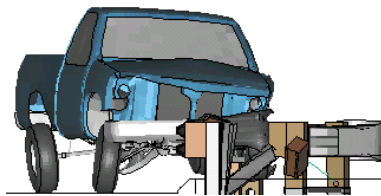

Time = 0.3 seconds

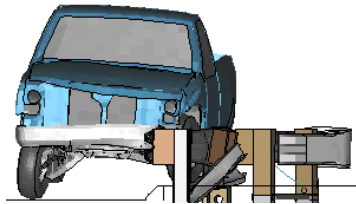

Front View

TopView

Figure H.8:

Sequential views of curb-barrier impact from F.E. analysis - front view and top view

Curb Type -- AASHTO D Curb

Offset Distance -- 0m

Impact Speed -- 100 km/hr

Impact Angle -- 25 degrees.

Time = 0.4 seconds

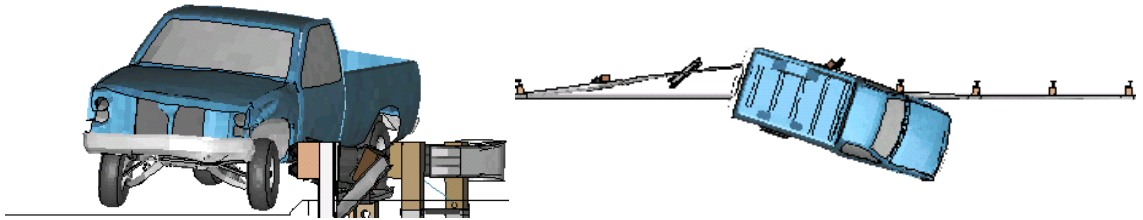

Time = 0.5 seconds

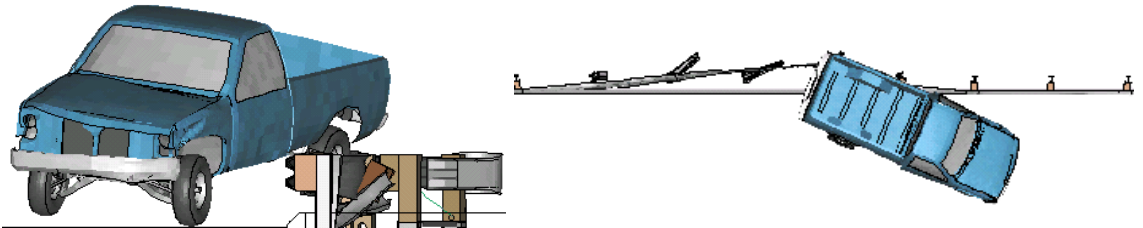

Time = 0.6 seconds

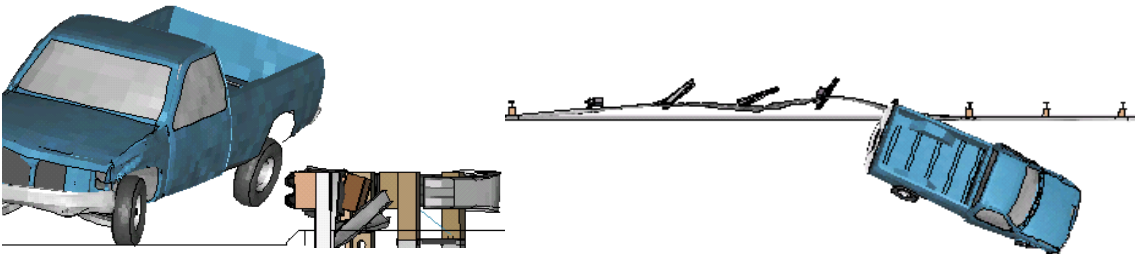

Time = 0.7 seconds

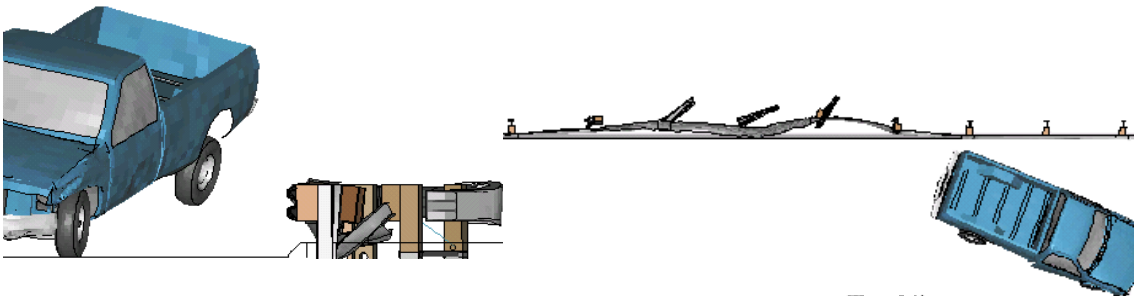

Front View

TopView

Figure H.8: (CONTINUED) Sequential views of curb-barrier impact from F.E. analysis - front view and top view
Curb Type -- AASHTO D Curb
Offset Distance -- 0m
Impact Speed -- 100 km/hr
Impact Angle -- 25 degrees.

Time = 0.0 seconds



Time = 0.1 seconds

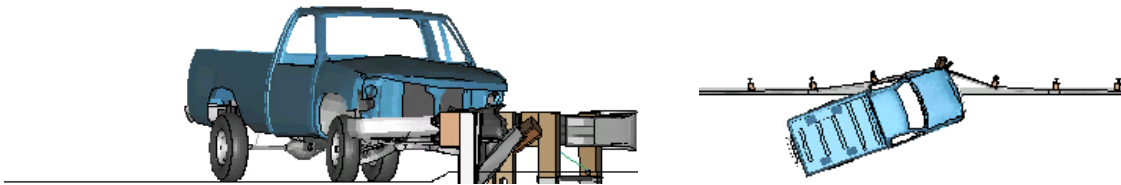

Time = 0.2 seconds

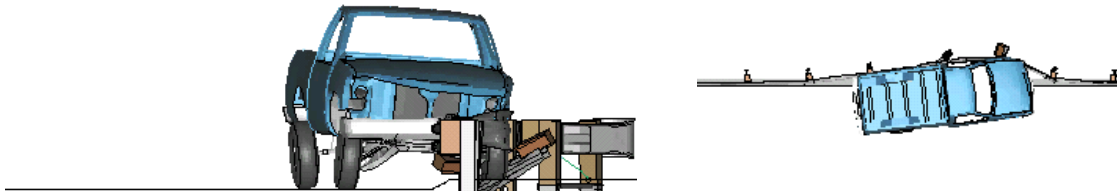

Time = 0.3 seconds



Front View

TopView

Figure H.9: Sequential views of curb-barrier impact from F.E. analysis - front view and top view

Curb Type -- AASHTO G Curb
Offset Distance -- 0m
Impact Speed -- 100 km/hr
Impact Angle -- 25 degrees.

Time = 0.4 seconds

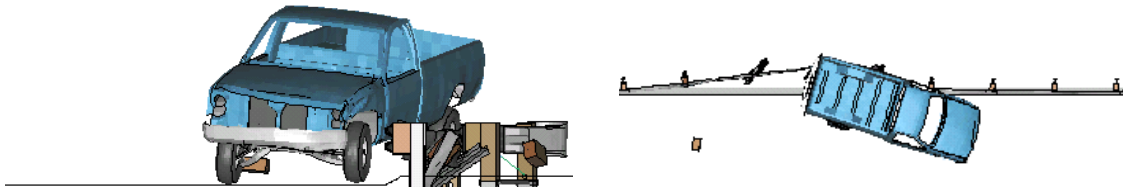

Time = 0.5 seconds

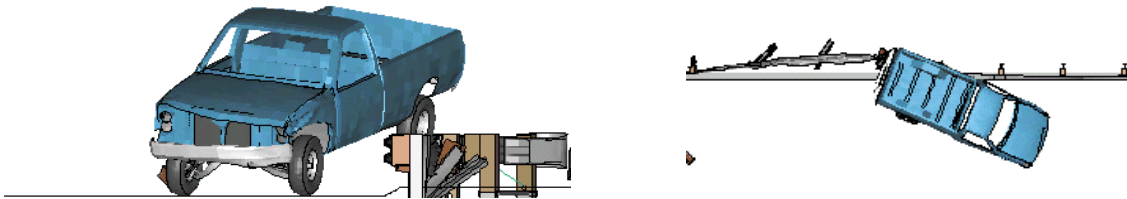

Time = 0.6 seconds

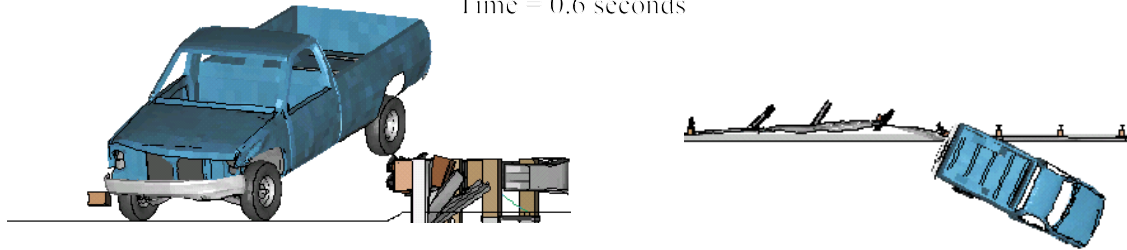

Time = 0.7 seconds



Front View

TopView

Figure H.9: (CONTINUED) Sequential views of curb-barrier impact from F.E. analysis - front view and top view
Curb Type -- AASHTO G Curb
Offset Distance -- 0m
Impact Speed -- 100 km/hr
Impact Angle -- 25 degrees.

Time = 0.0 seconds

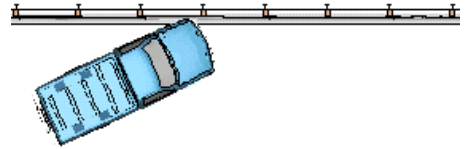
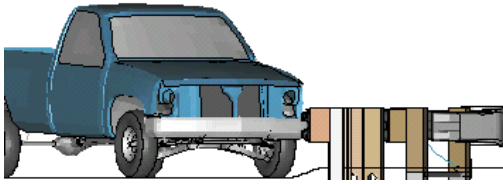

Time = 0.1 seconds



Time = 0.2 seconds

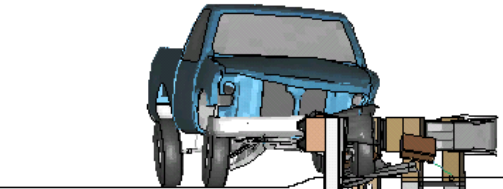

Time = 0.3 seconds

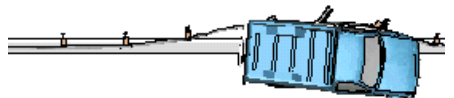

Front View

TopView

Figure H.10: Sequential views of curb-barrier impact from F.E. analysis - front view and top view

Curb Type -- New York Curb (100 mm)

Offset Distance -- 0m

Impact Speed -- 100 km/hr

Impact Angle -- 25 degrees.

Time = 0.4 seconds

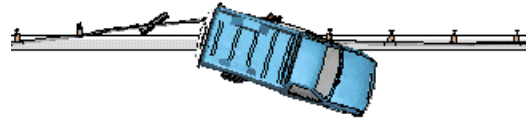
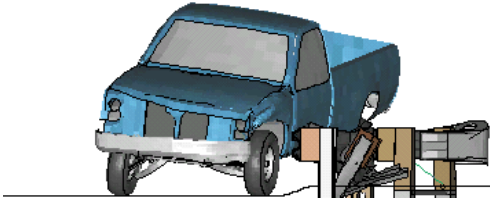

Time = 0.5 seconds

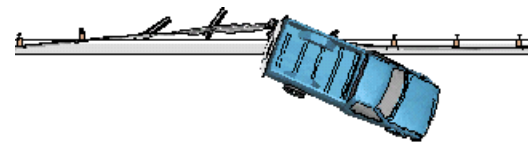
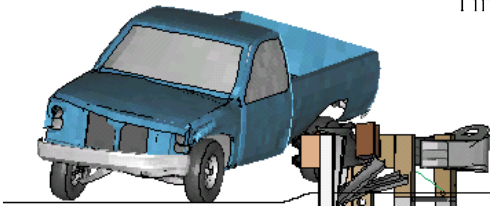

Time = 0.6 seconds

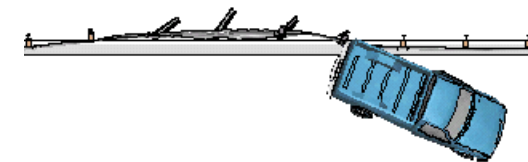
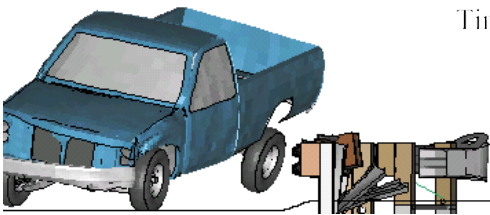

Time = 0.7 seconds

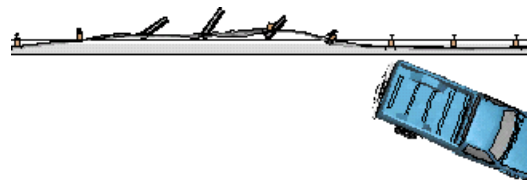
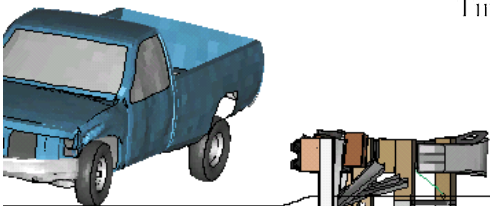

Front View

TopView

Figure H.10: (CONTINUED) Sequential views of curb-barrier impact from

F.E. analysis - front view and top view

Curb Type -- New York Curb (100 mm)

Offset Distance -- 0m

Impact Speed -- 100 km/hr

Impact Angle -- 25 degrees.

Time = 0.4 seconds

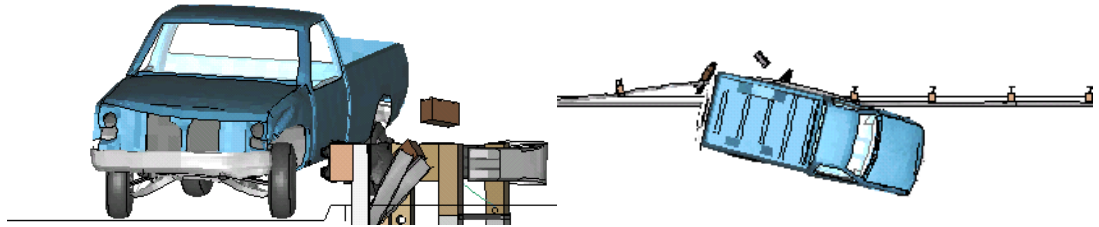

Time = 0.5 seconds

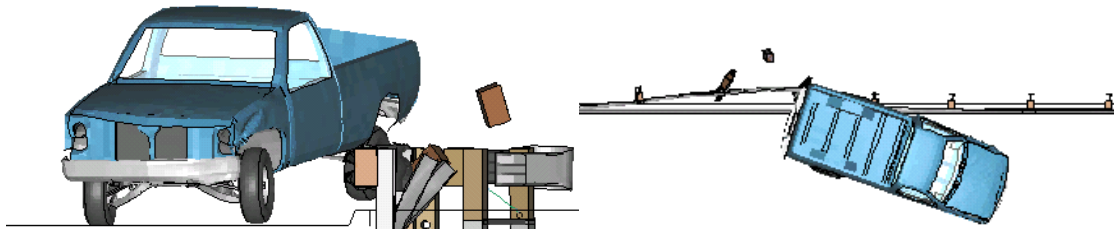

Time = 0.6 seconds

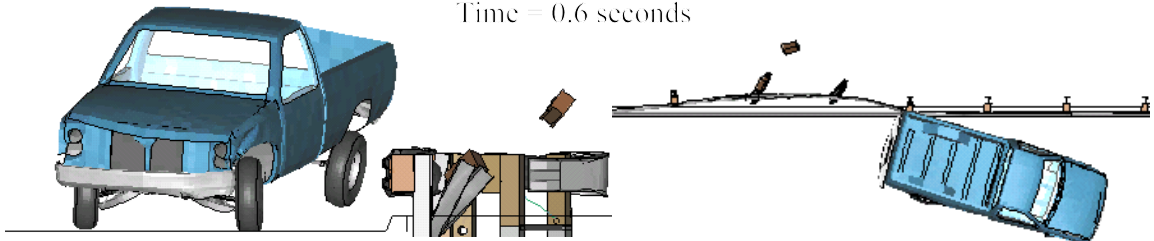

Time = 0.7 seconds

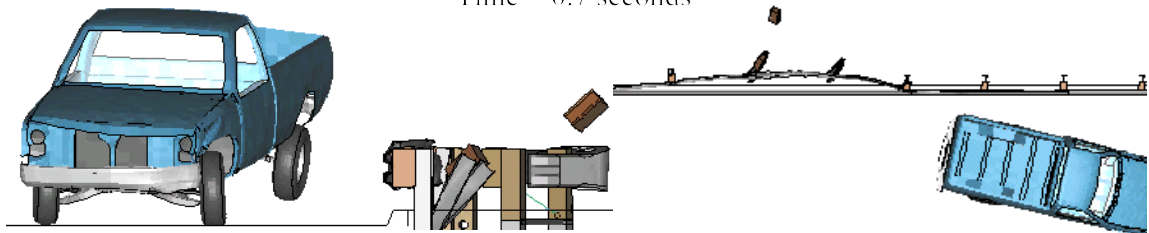

Front View

TopView

Figure H.11: (CONTINUED) Sequential views of curb-barrier impact from F.E. analysis - front view and top view
Curb Type -- AASHTO B Curb
Offset Distance -- 0m
Impact Speed -- 85 km/hr
Impact Angle -- 25 degrees.

Time = 0.0 seconds

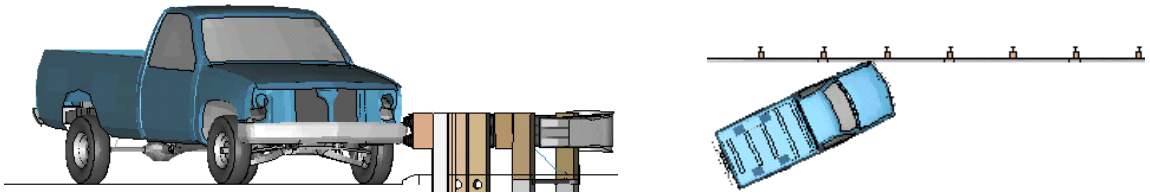

Time = 0.1 seconds

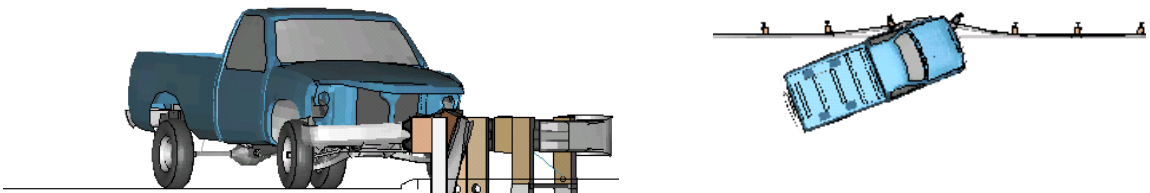

Time = 0.2 seconds

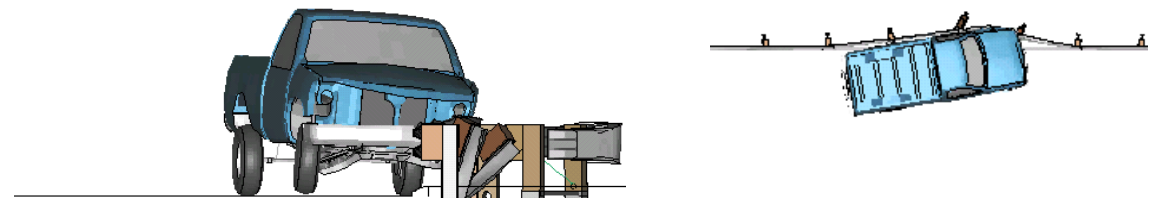

Time = 0.3 seconds

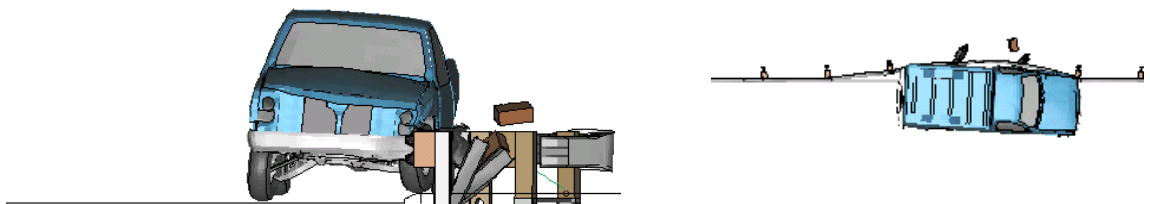

Front View

TopView

Figure H.12: Sequential views of curb-barrier impact from F.E. analysis - front view and top view

Curb Type	-- AASHTO C Curb
Offset Distance	- 0m
Impact Speed	- 85 km/hr
Impact Angle	- 25 degrees.

Time = 0.4 seconds

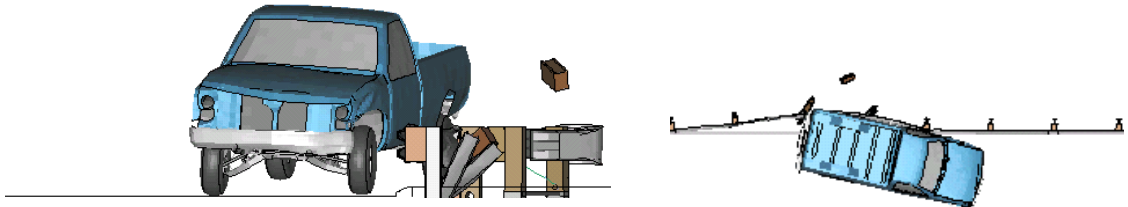

Time = 0.5 seconds

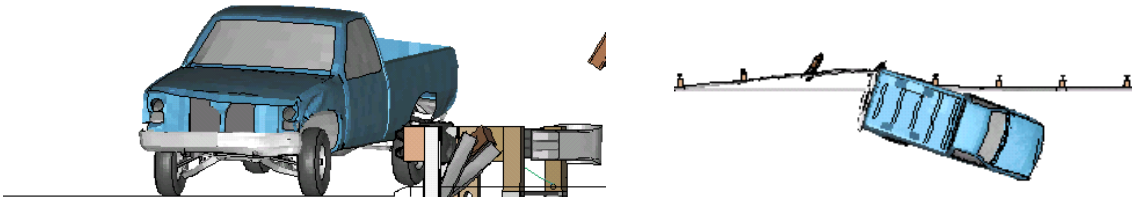

Time = 0.6 seconds

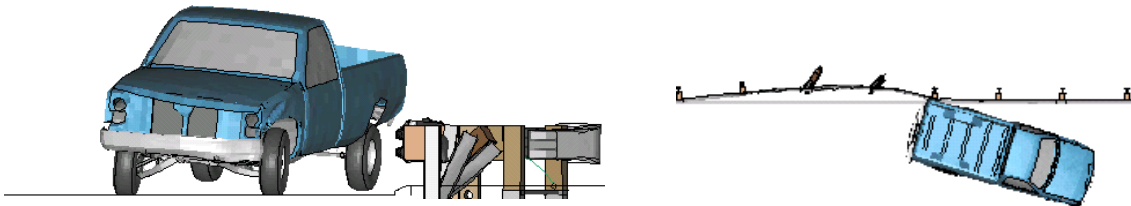

Time = 0.7 seconds

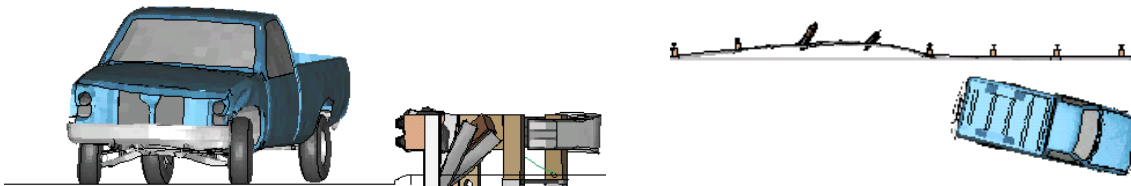

Front View

TopView

Figure H.12: (CONTINUED) Sequential views of curb-barrier impact from

F.E. analysis - front view and top view

Curb Type -- AASHTO C Curb

Offset Distance -- 0m

Impact Speed -- 85 km/hr

Impact Angle -- 25 degrees.

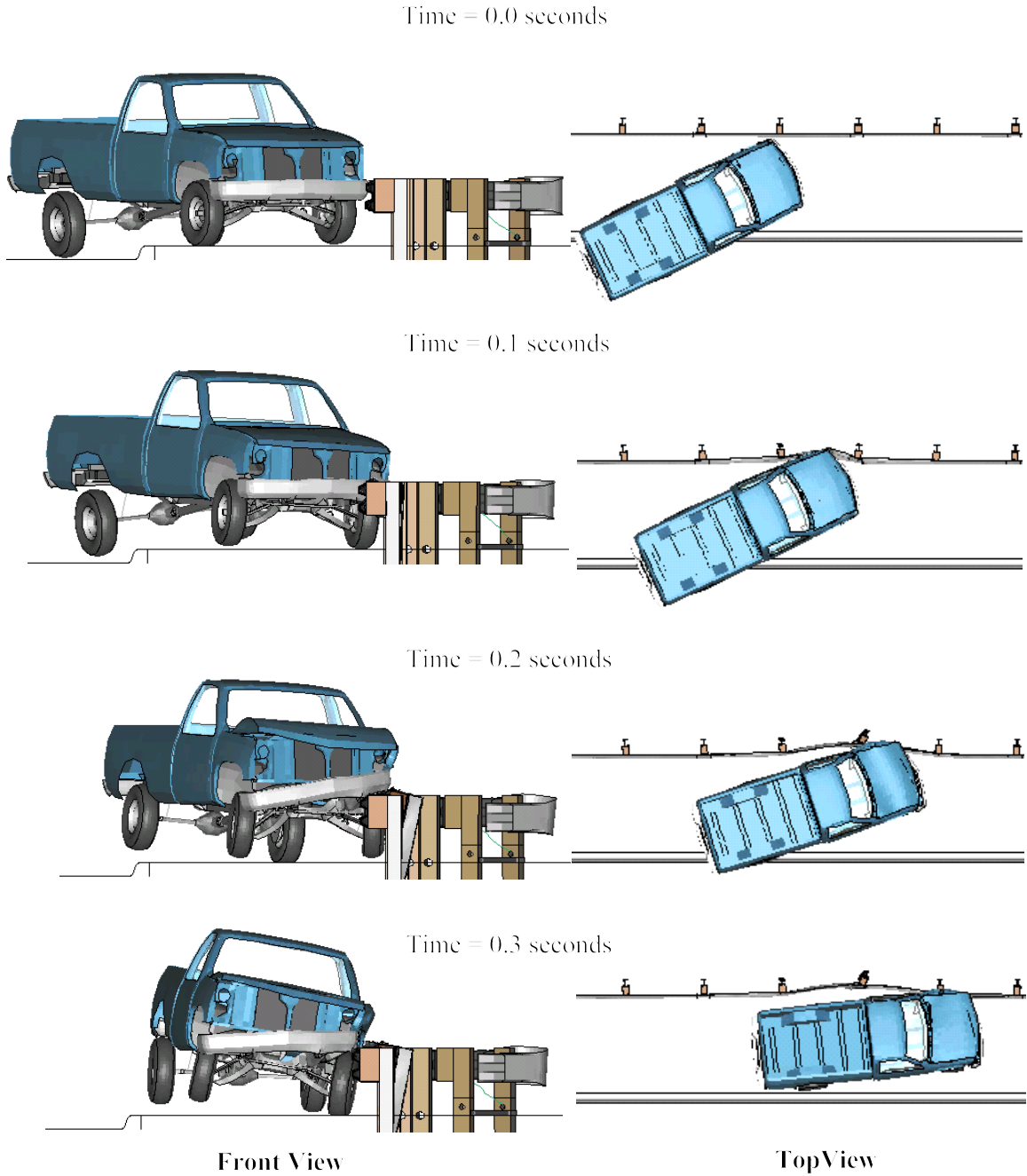

Figure H.13: Sequential views of curb-barrier impact from F.E. analysis - front view and top view

Curb Type	-- AASHTO B Curb
Offset Distance	- 2.5m
Impact Speed	-70 km/hr
Impact Angle	- 25 degrees.

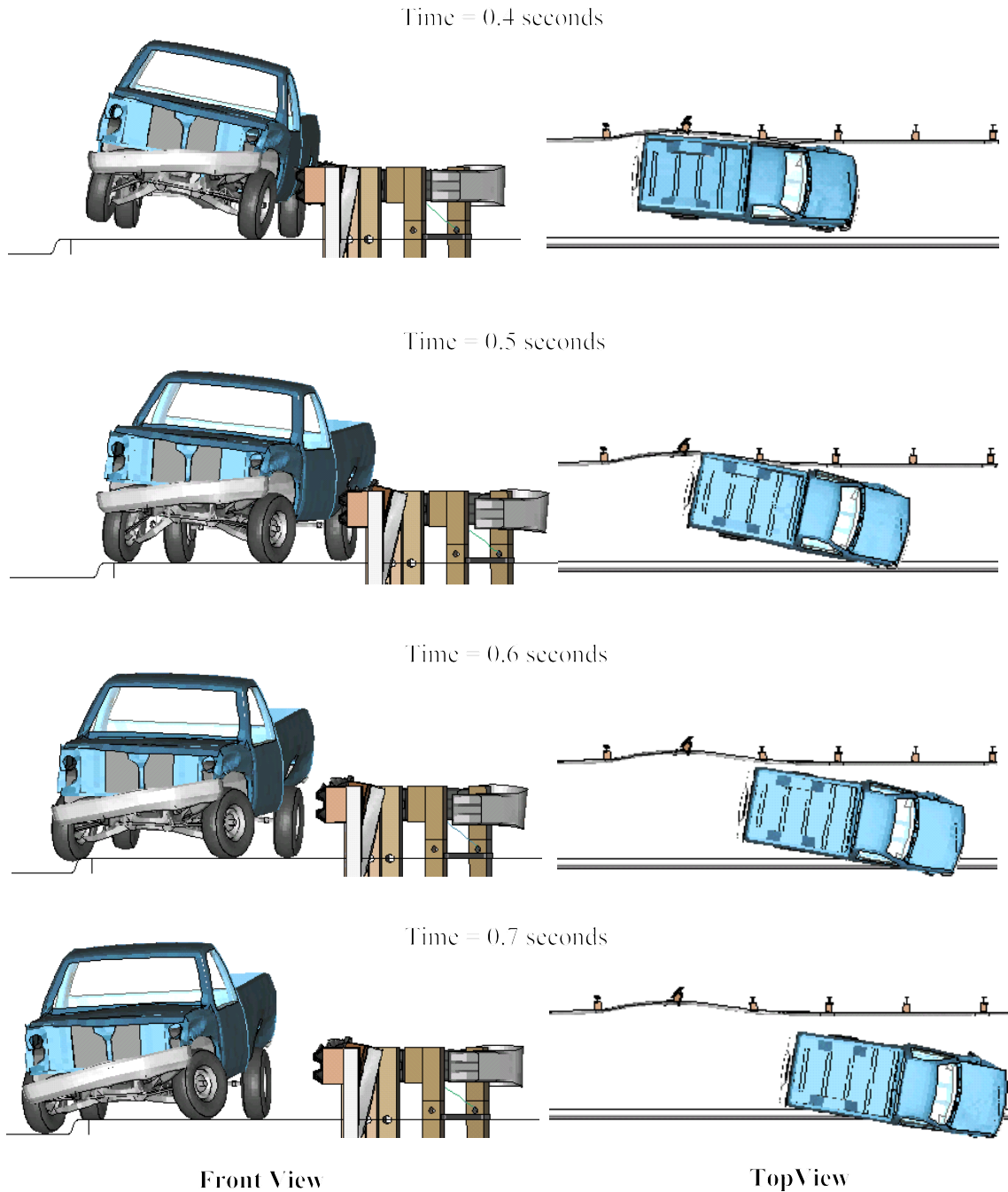

Figure H.13: (CONTINUED) Sequential views of curb-barrier impact from F.E. analysis - front view and top view
Curb Type -- AASHTO B Curb
Offset Distance -- 2.5m
Impact Speed -- 70 km/hr
Impact Angle -- 25 degrees.

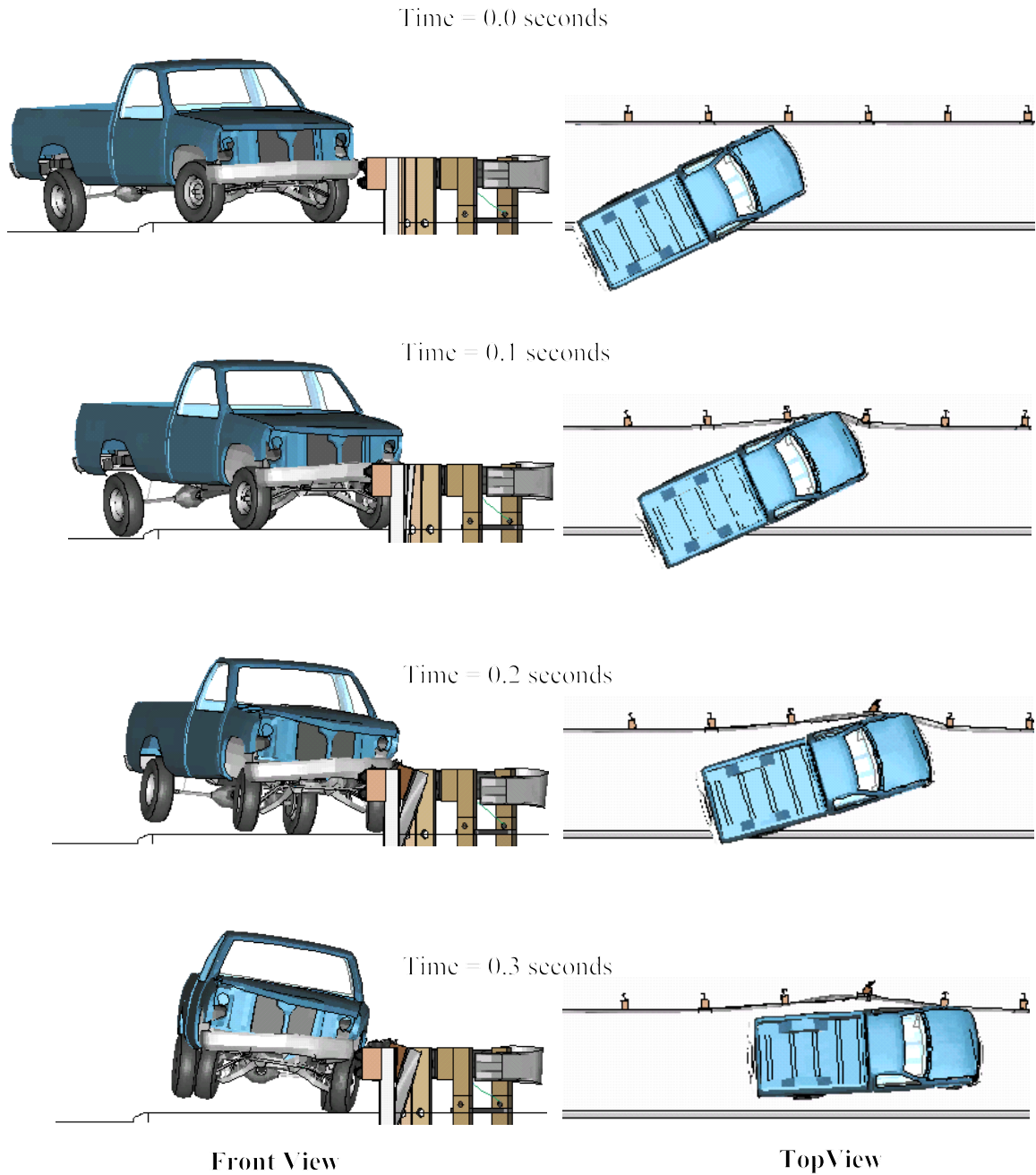
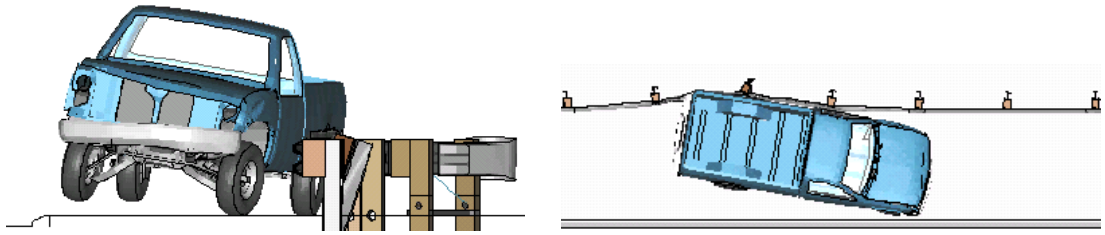

Figure H.14: Sequential views of curb-barrier impact from F.E. analysis - front view and top view

Curb Type -- AASHTO C Curb
Offset Distance -- 2.5m
Impact Speed -- 70 km/hr
Impact Angle -- 25 degrees.

Time = 0.4 seconds



Time = 0.5 seconds

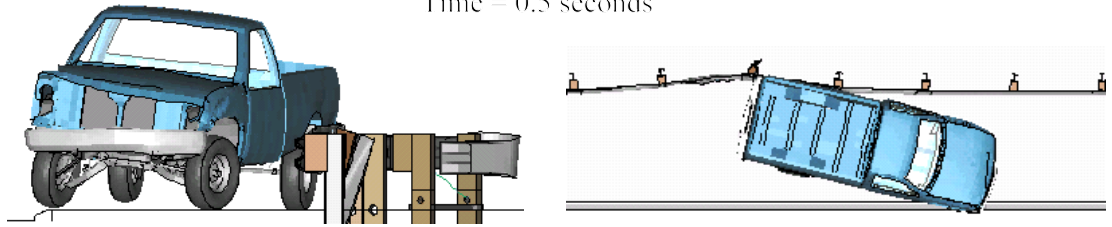

Time = 0.6 seconds

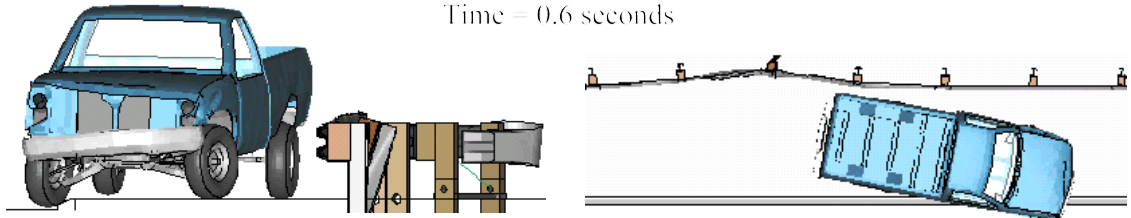

Time = 0.7 seconds

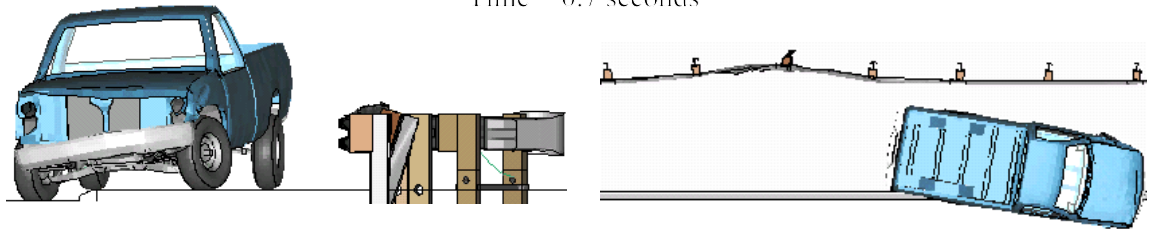

Front View

TopView

Figure H.14: (CONTINUED) Sequential views of curb-barrier impact from F.E. analysis - front view and top view
Curb Type -- AASHTO C Curb
Offset Distance -- 2.5m
Impact Speed -- 70 km/hr
Impact Angle -- 25 degrees.

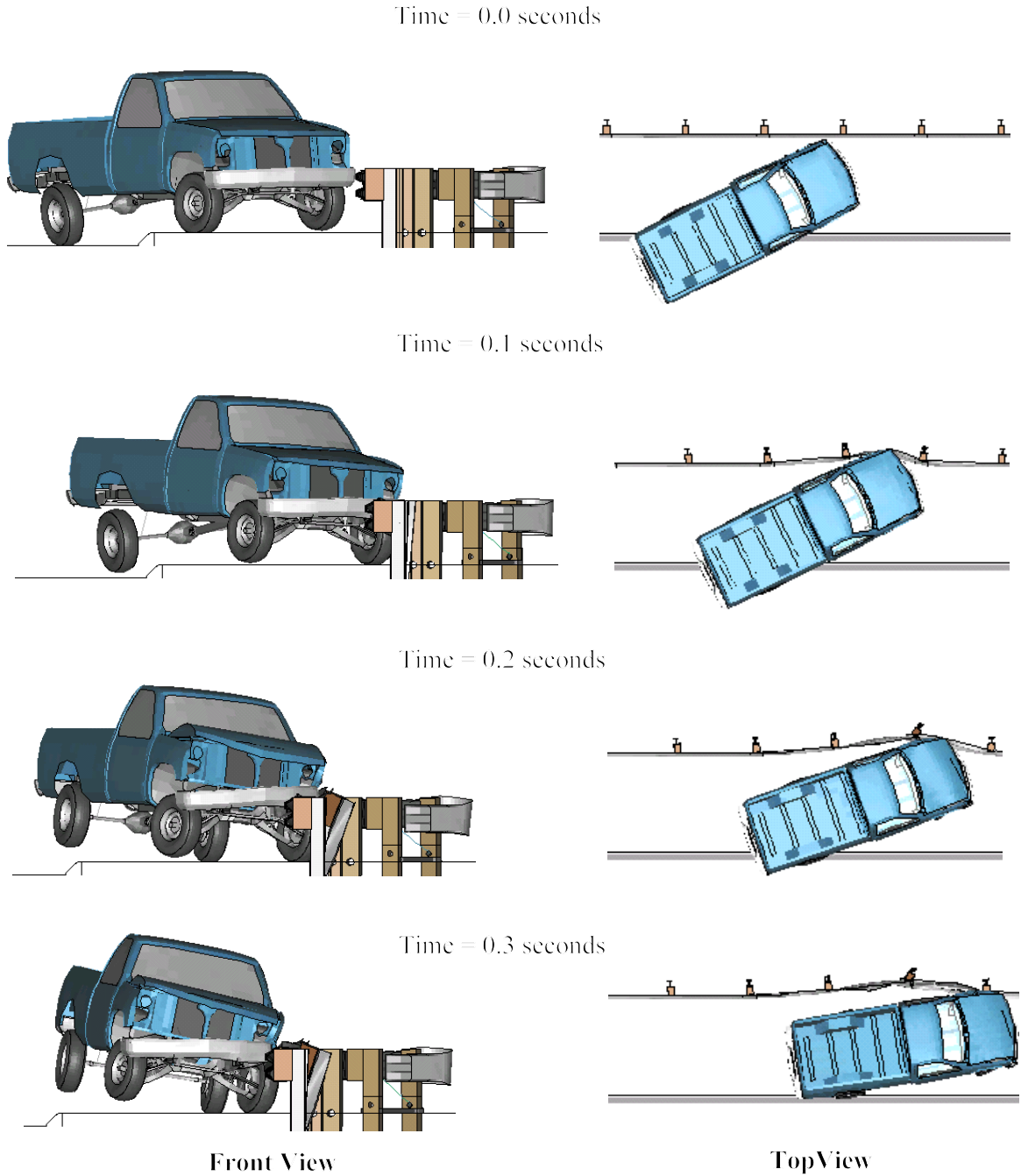

Figure H.15: Sequential views of curb-barrier impact from F.E. analysis - front view and top view

Curb Type -- AASHTO D Curb
Offset Distance -- 2.5m
Impact Speed -- 70 km/hr
Impact Angle -- 25 degrees.

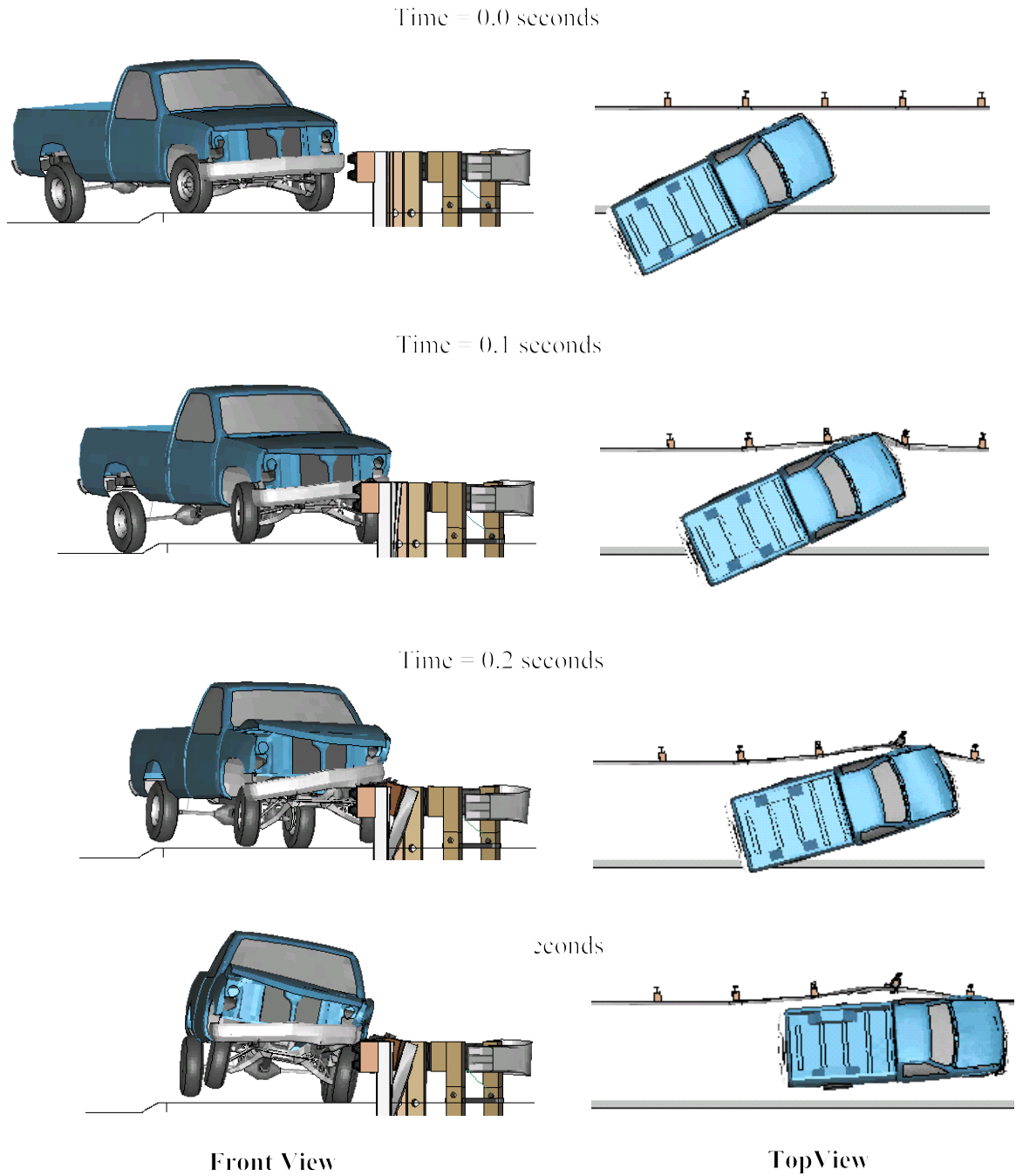

Figure H.16: Sequential views of curb-barrier impact from F.E. analysis - front view and top view

Curb Type -- AASHTO G Curb
Offset Distance -- 2.5m
Impact Speed -- 70 km/hr
Impact Angle -- 25 degrees.

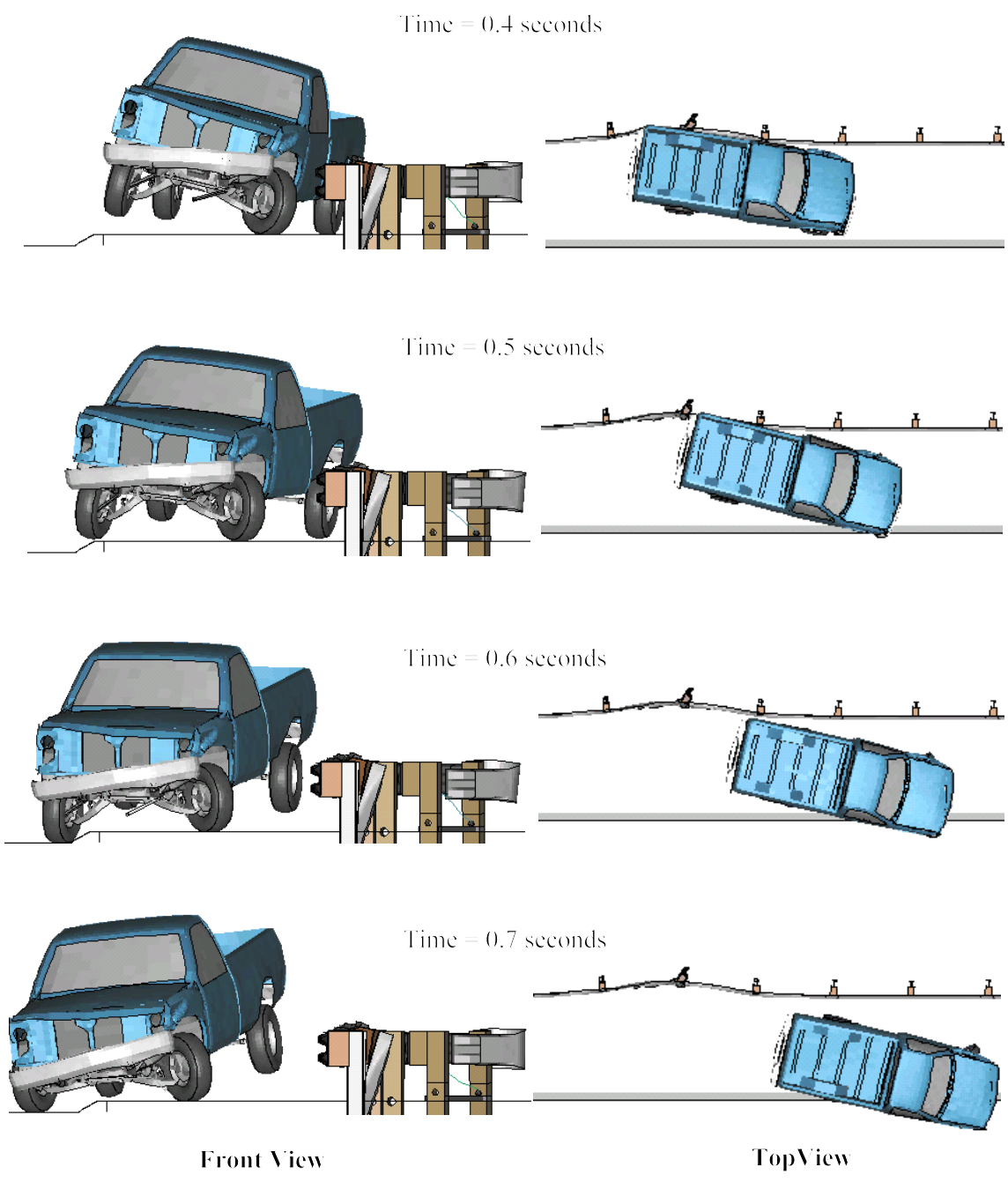

Figure H.16: (CONTINUED) Sequential views of curb-barrier impact from F.E. analysis - front view and top view
Curb Type -- AASHTO G Curb
Offset Distance -- 2.5m
Impact Speed -- 70 km/hr
Impact Angle -- 25 degrees.

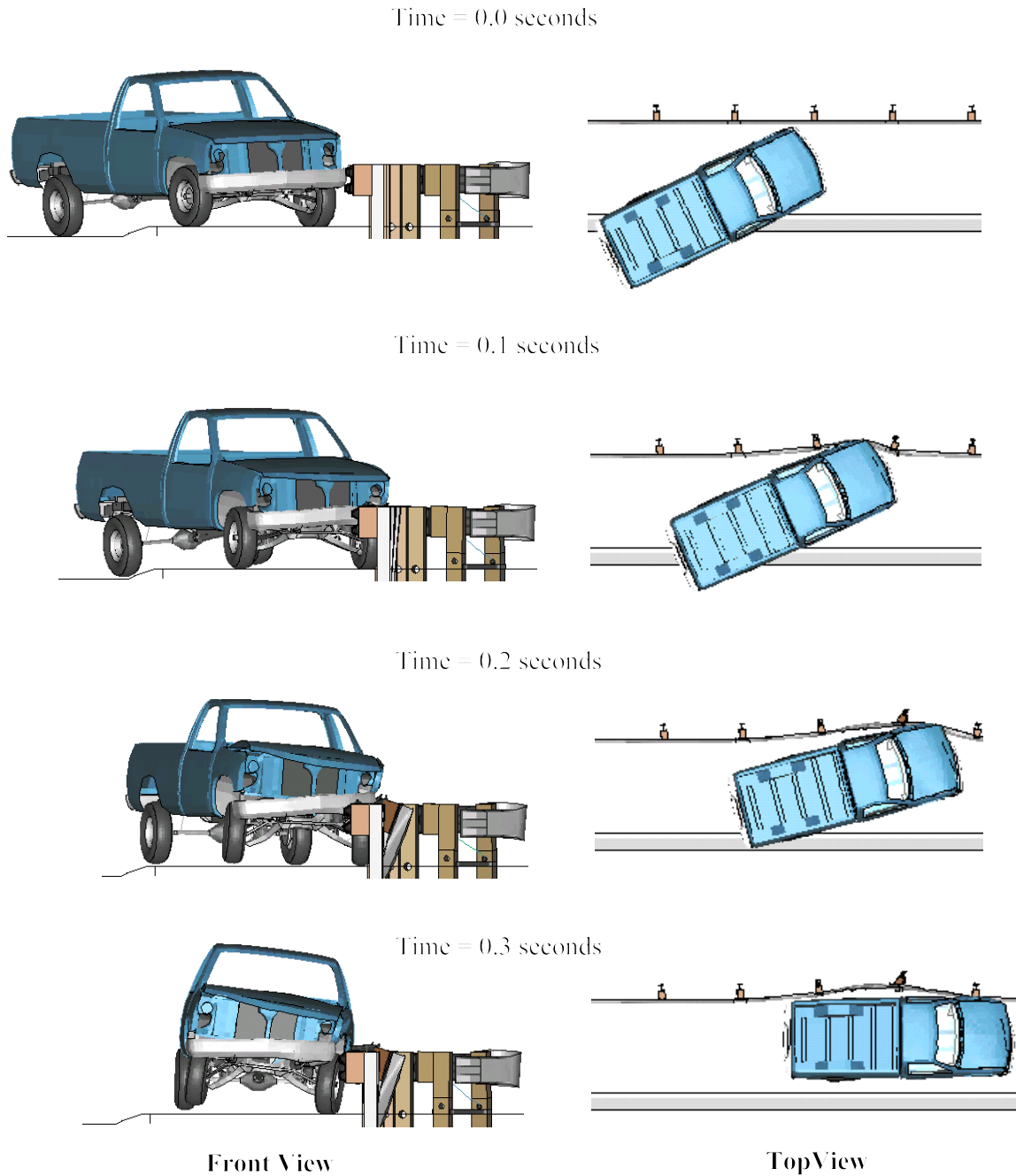
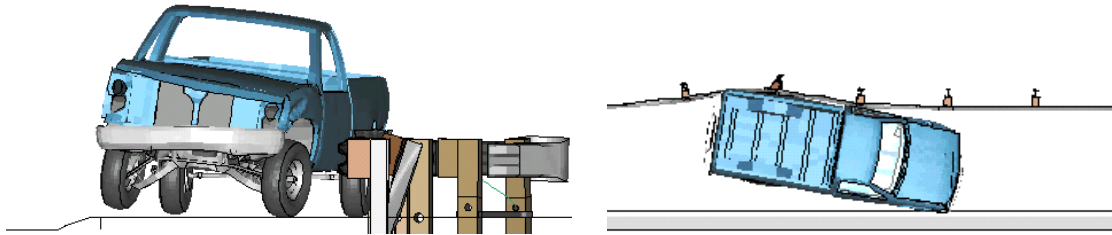

Figure H.17: Sequential views of curb-barrier impact from F.E. analysis - front view and top view

Curb Type	-- New York Curb (100 mm)
Offset Distance	- 2.5m
Impact Speed	-70 km/hr
Impact Angle	- 25 degrees.

Time = 0.4 seconds



Time = 0.5 seconds

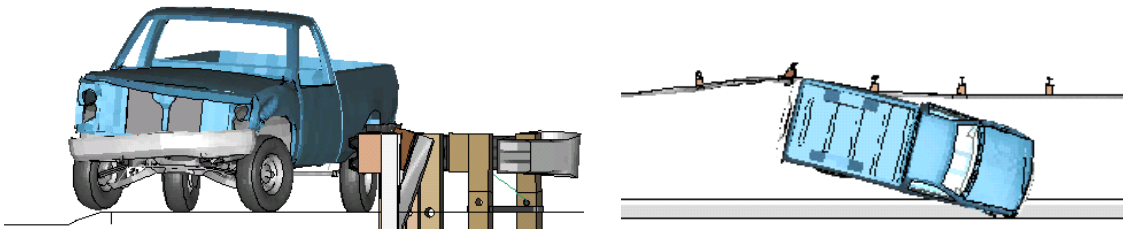

Time = 0.6 seconds

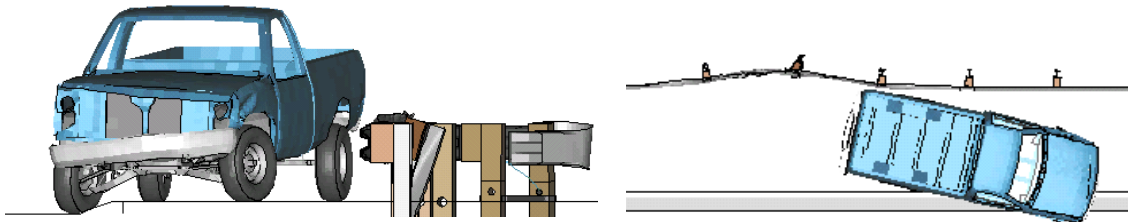

Front View

TopView

Figure H.17: (CONTINUED) Sequential views of curb-barrier impact from F.E. analysis - front view and top view

Curb Type -- New York Curb (100 mm)
Offset Distance -- 2.5m
Impact Speed -- 70 km/hr
Impact Angle -- 25 degrees.

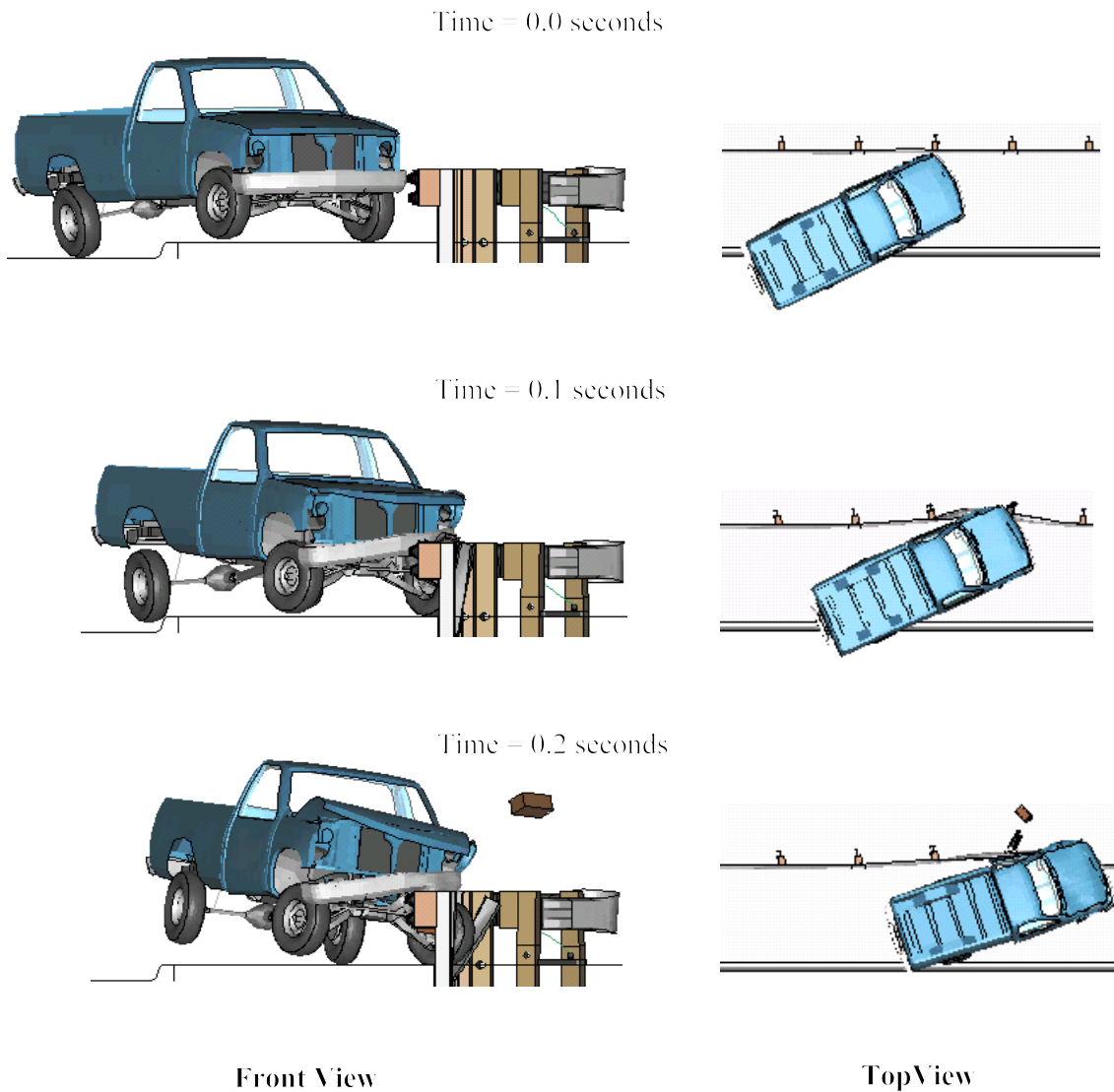
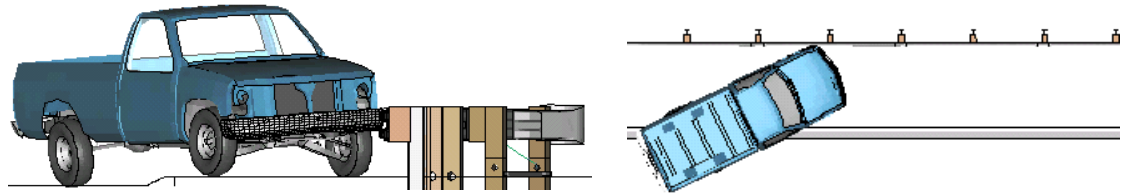

Figure H.18: Sequential views of curb-barrier impact from F.E. analysis - front view and top view

Curb Type	-- AASHTO B Curb
Offset Distance	- 2.5m
Impact Speed	- 85 km/hr
Impact Angle	- 25 degrees.

Time = 0.0 seconds



Time = 0.1 seconds

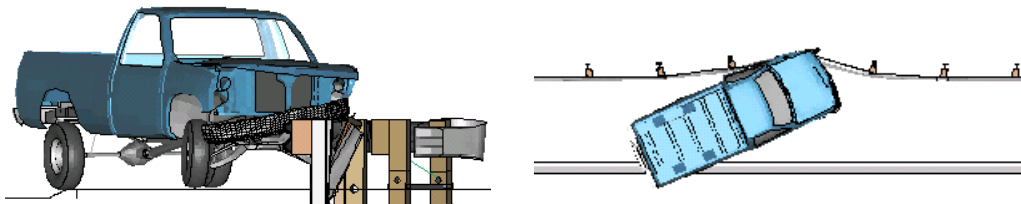

Time = 0.2 seconds

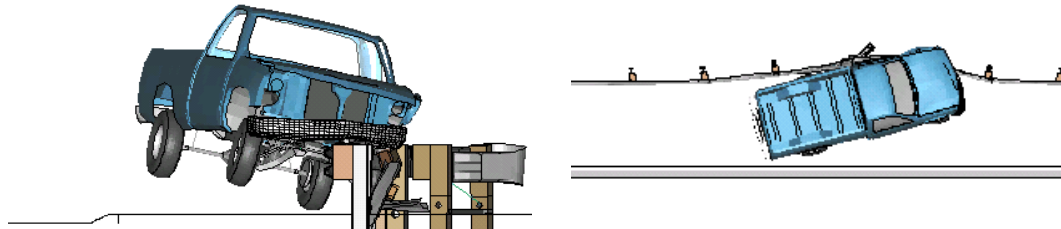

Time = 0.3 seconds

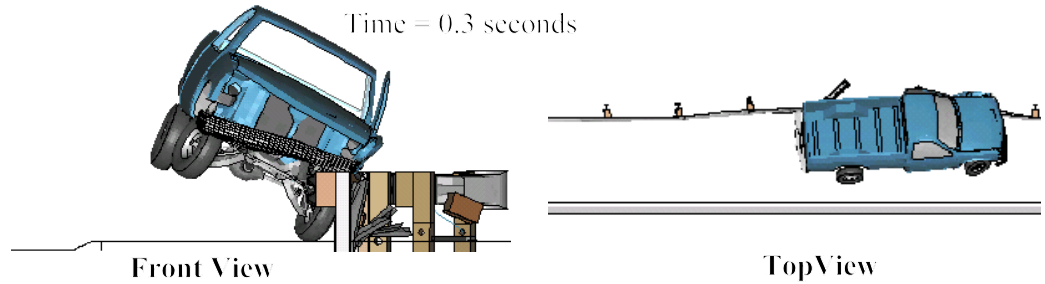

Figure H.20:

Sequential views of curb-barrier impact from F.E. analysis - front view and top view

Curb Type -- AASHTO G Curb

Offset Distance -- 2.5m

Impact Speed -- 100 km/hr

Impact Angle -- 25 degrees.

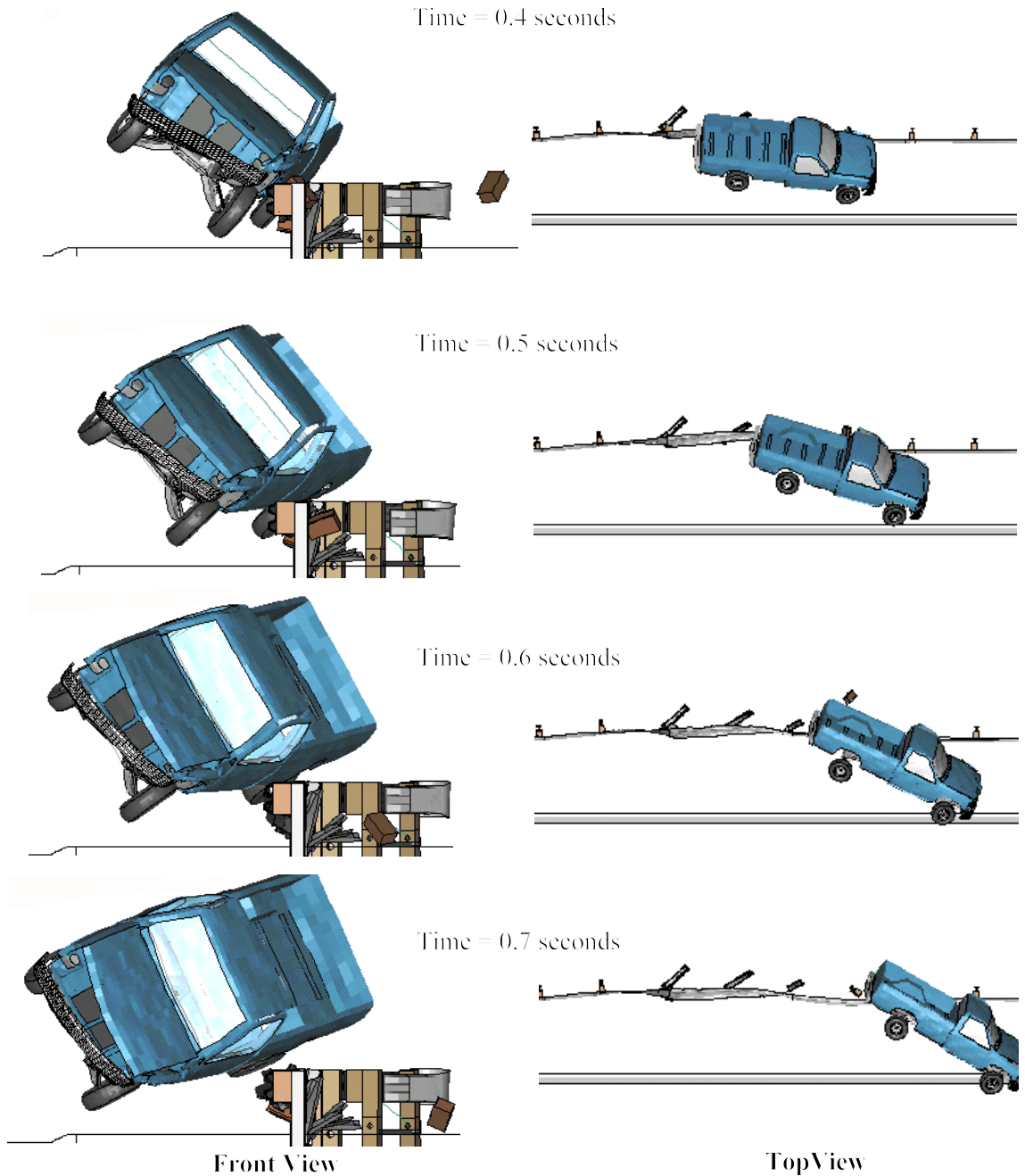

Figure H.20: (CONTINUED) Sequential views of curb-barrier impact from F.E. analysis - front view and top view

Curb Type	-- AASHTO G Curb
Offset Distance	- 2.5m
Impact Speed	- 100 km/hr
Impact Angle	- 25 degrees.

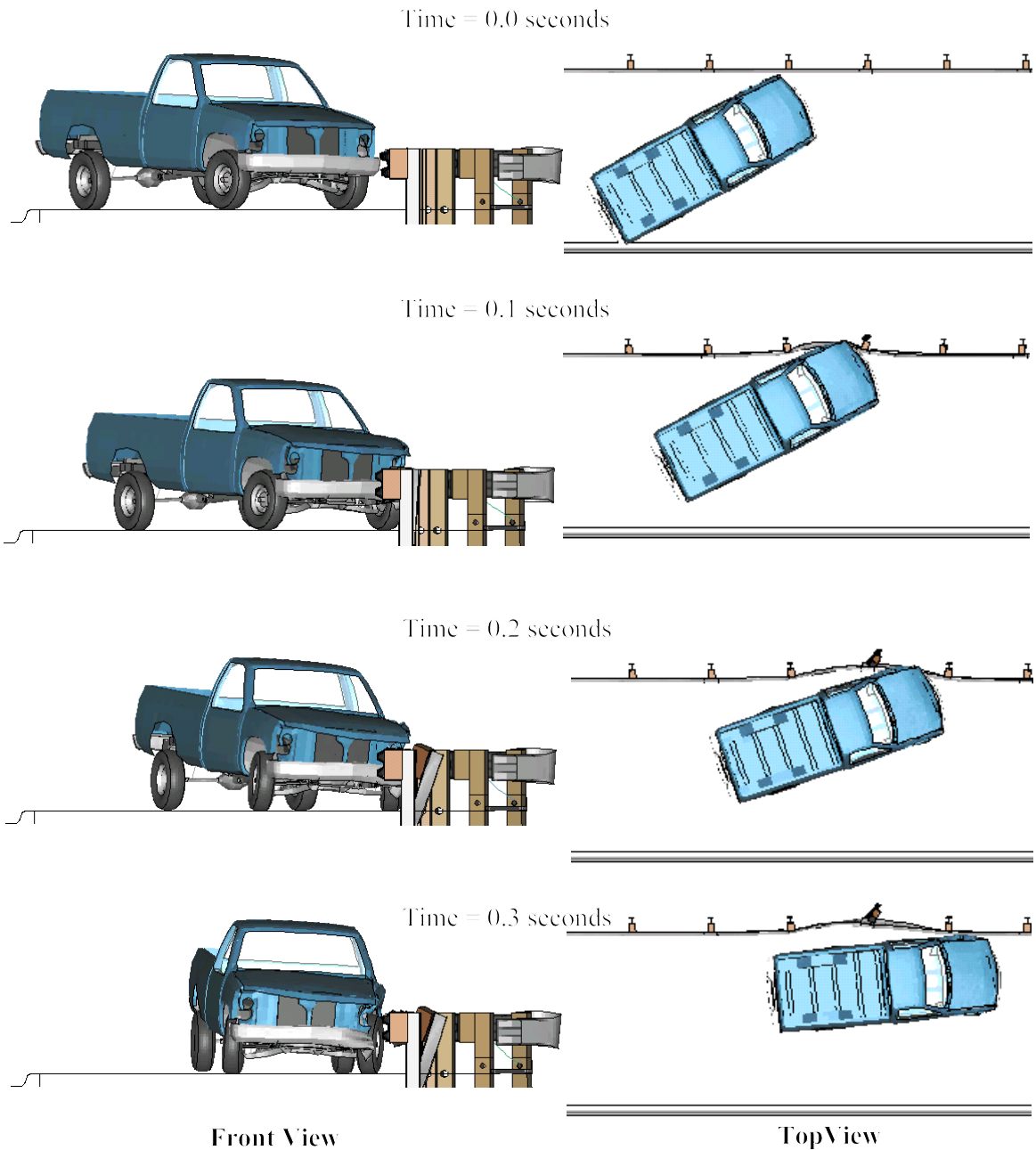

Figure H.21: Sequential views of curb-barrier impact from F.E. analysis - front view and top view

Curb Type -- AASHTO B Curb
Offset Distance -- 4 m
Impact Speed -- 70 km/hr
Impact Angle -- 25 degrees.

Time = 0.35 seconds

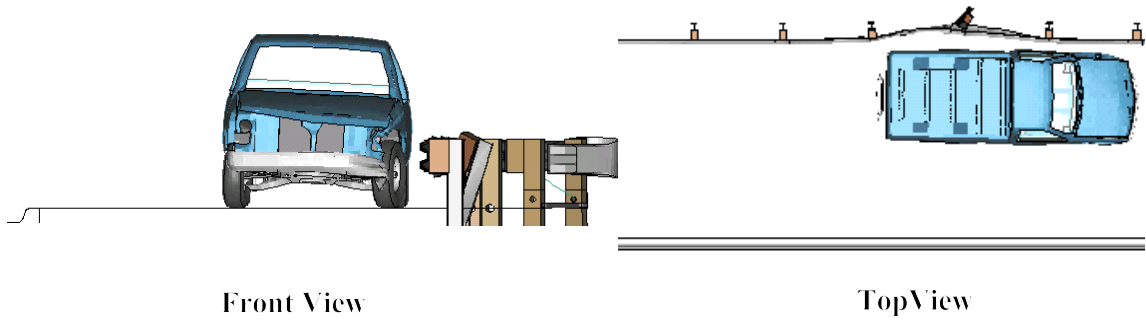

Figure H.21: (CONTINUED) Sequential views of curb-barrier impact from F.E. analysis - front view and top view

Curb Type	-- AASHTO B Curb
Offset Distance	- 4 m
Impact Speed	- 70 km/hr
Impact Angle	- 25 degrees.

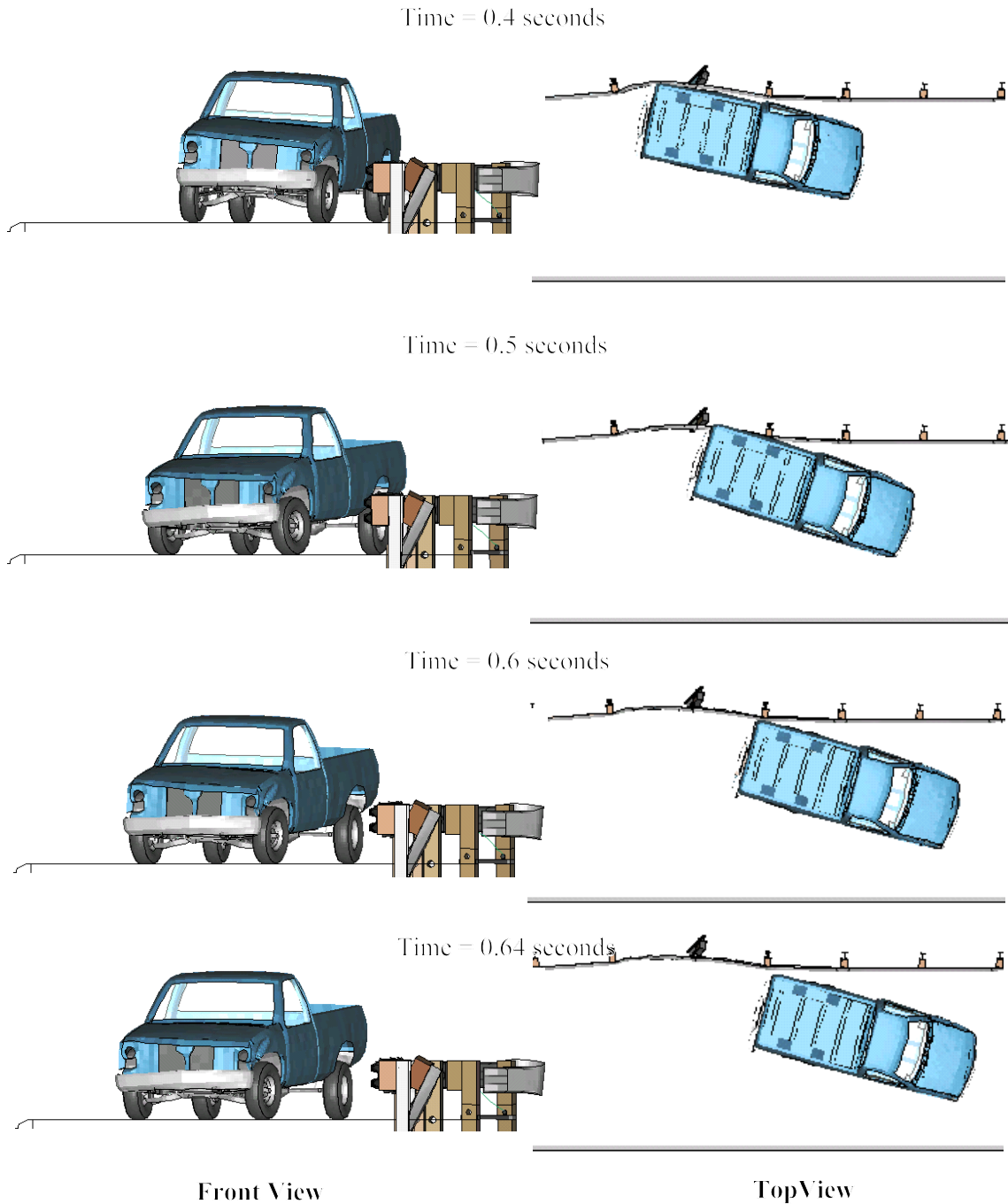

Figure H.22: (CONTINUED) Sequential views of curb-barrier impact from F.E. analysis - front view and top view

Curb Type	-- AASHTO C Curb
Offset Distance	- 4 m
Impact Speed	- 70 km/hr
Impact Angle	- 25 degrees.

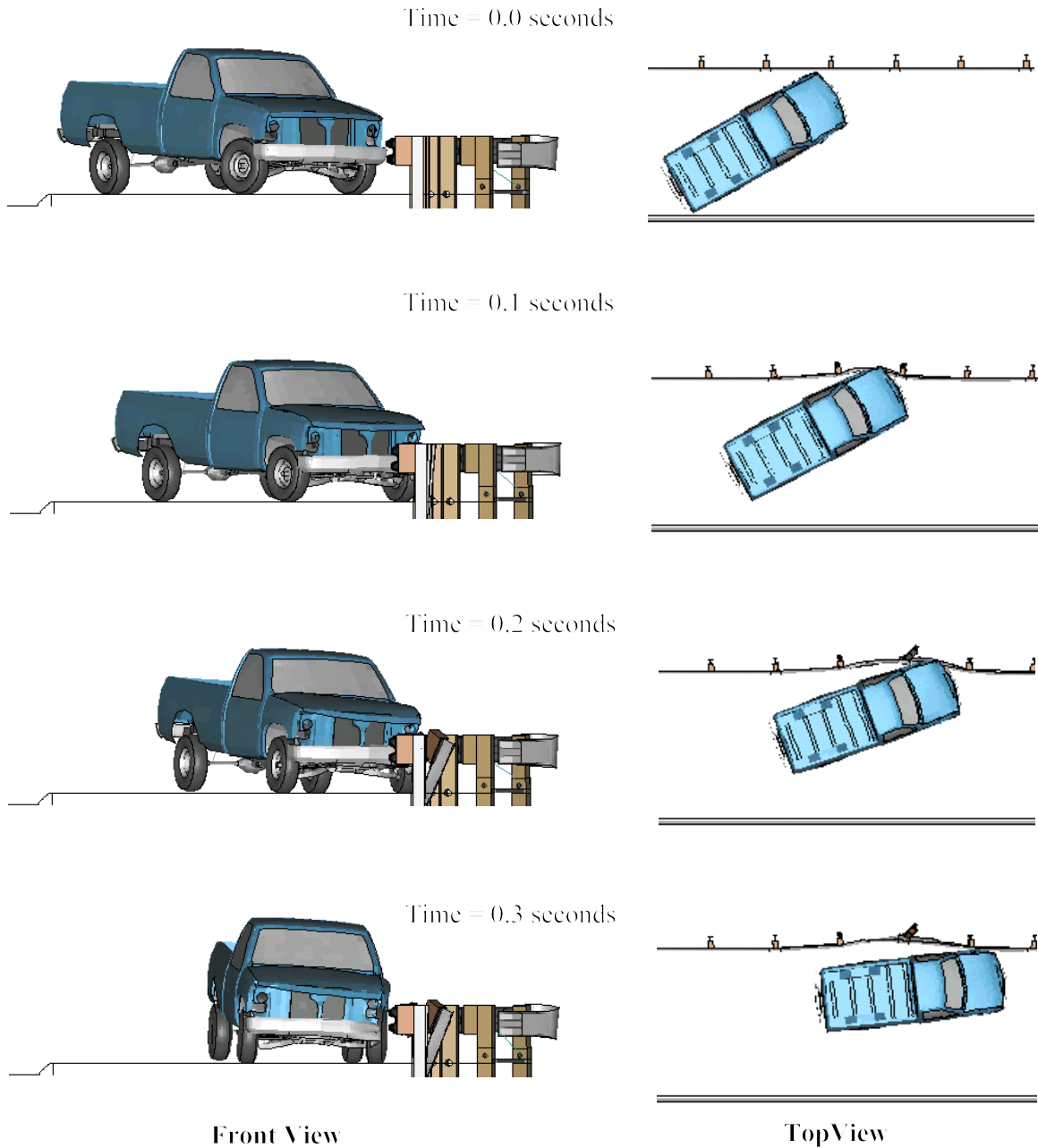

Figure H.23: Sequential views of curb-barrier impact from F.E. analysis - front view and top view

Curb Type -- AASHTO D Curb
Offset Distance -- 4 m
Impact Speed -- 70 km/hr
Impact Angle -- 25 degrees.

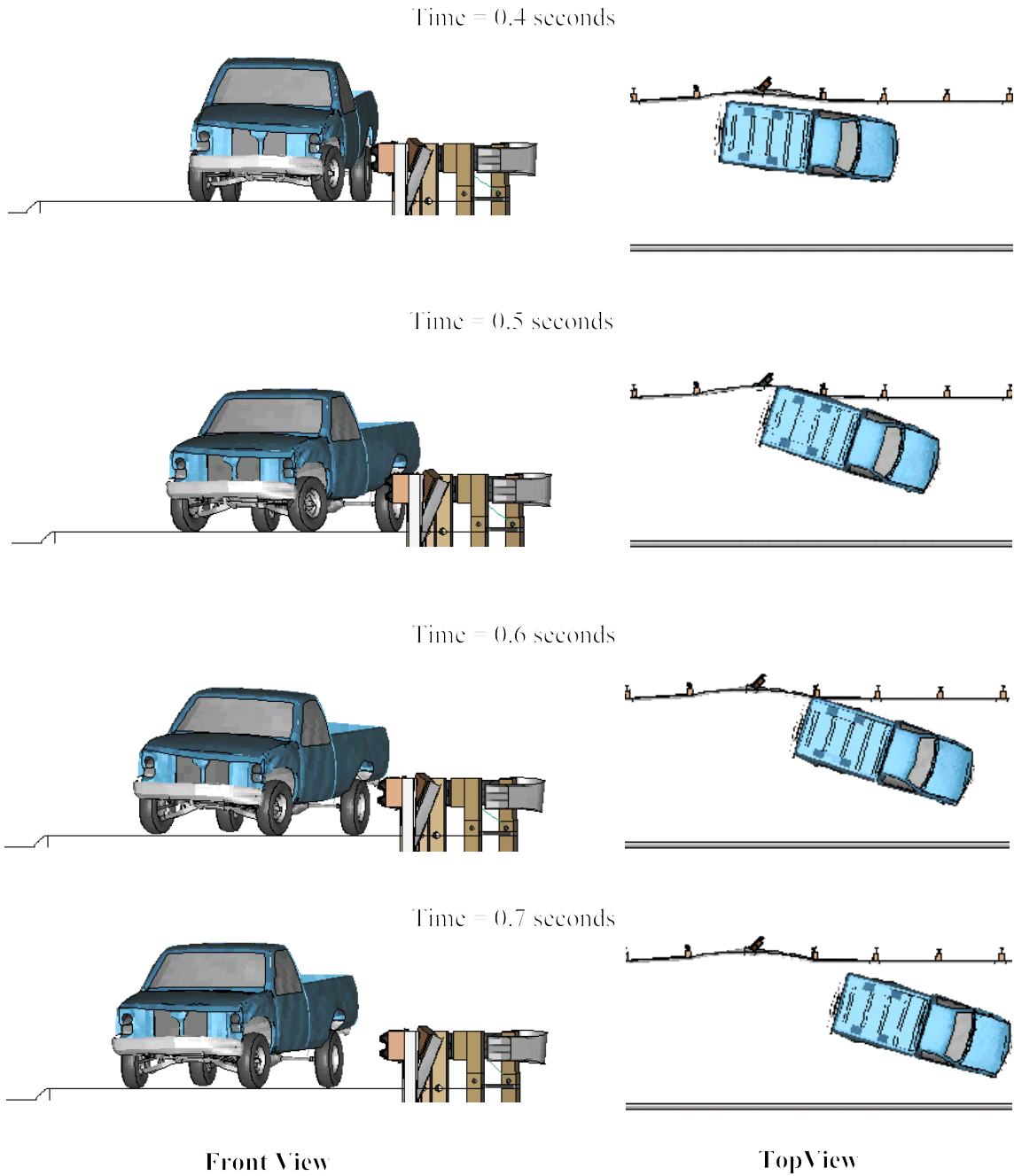

Figure H.23: (CONTINUED) Sequential views of curb-barrier impact from F.E. analysis - front view and top view
Curb Type -- AASHTO D Curb
Offset Distance - 4 m
Impact Speed - 70 km/hr
Impact Angle - 25 degrees.

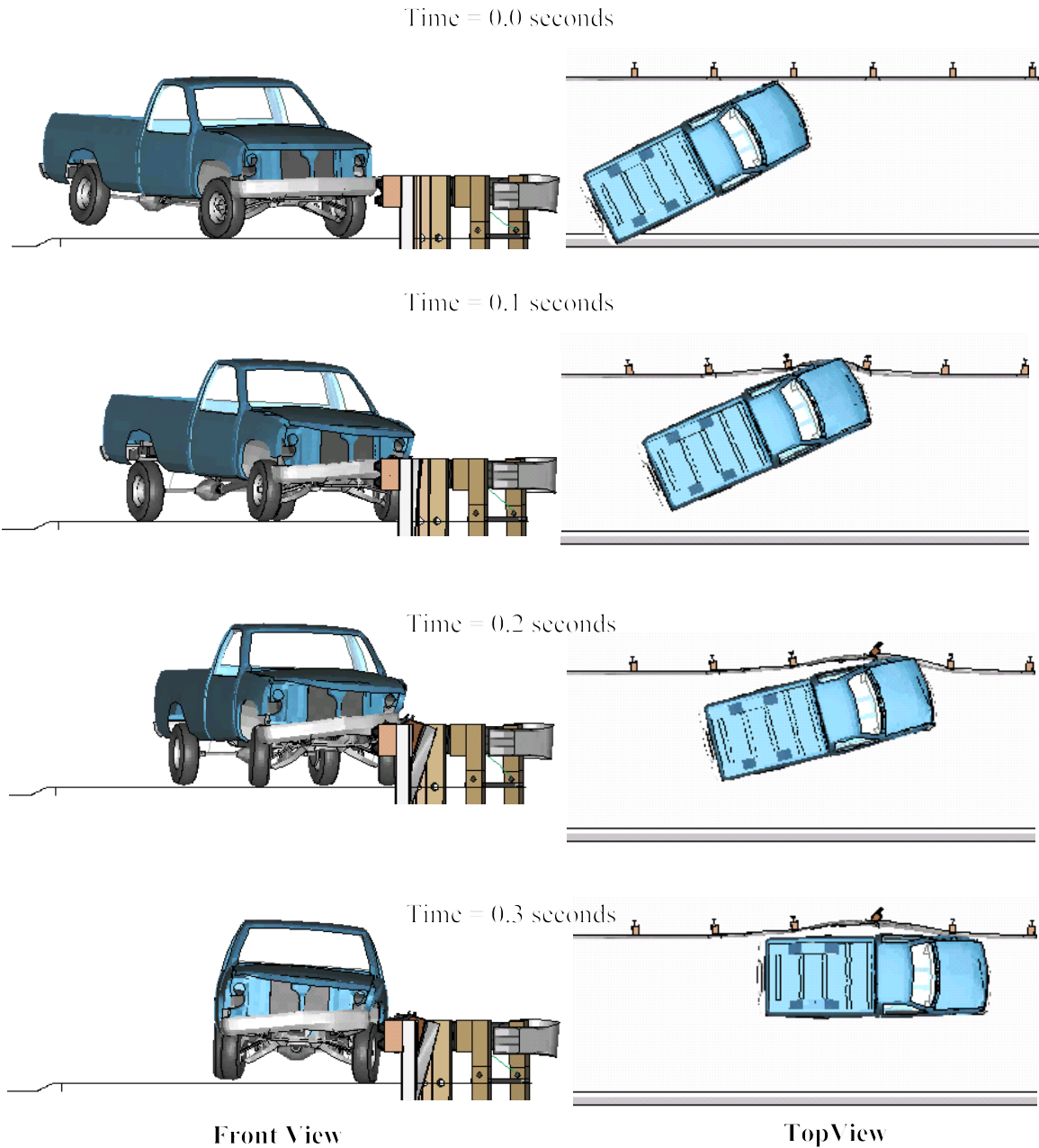

Figure H.24: Sequential views of curb-barrier impact from F.E. analysis - front view and top view

Curb Type -- AASHTO G Curb
Offset Distance -- 4 m
Impact Speed -- 70 km/hr
Impact Angle -- 25 degrees.

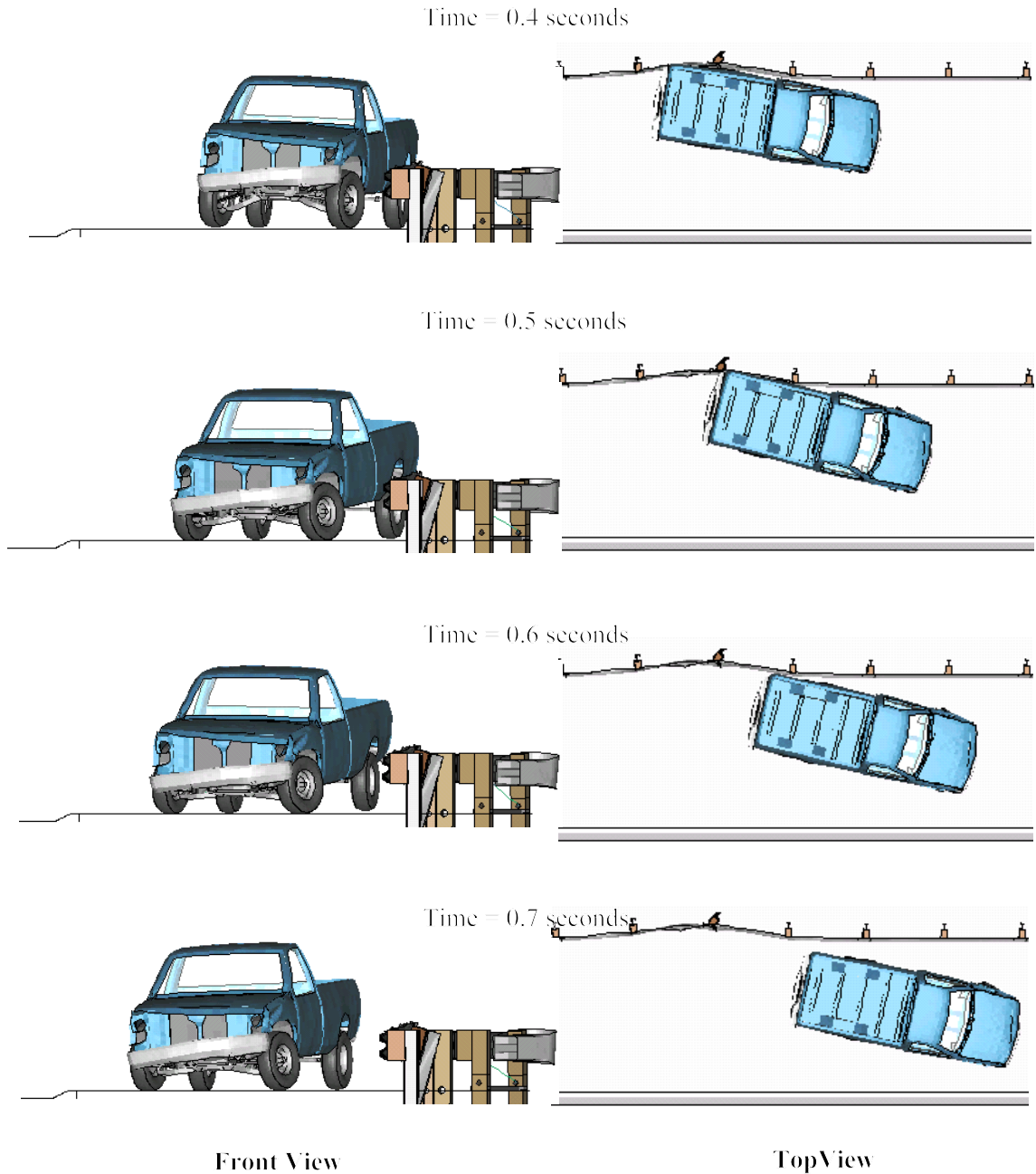

Figure H.24: (CONTINUED) Sequential views of curb-barrier impact from F.E. analysis - front view and top view

Curb Type	-- AASHTO G Curb
Offset Distance	- 4 m
Impact Speed	- 70 km/hr
Impact Angle	- 25 degrees.

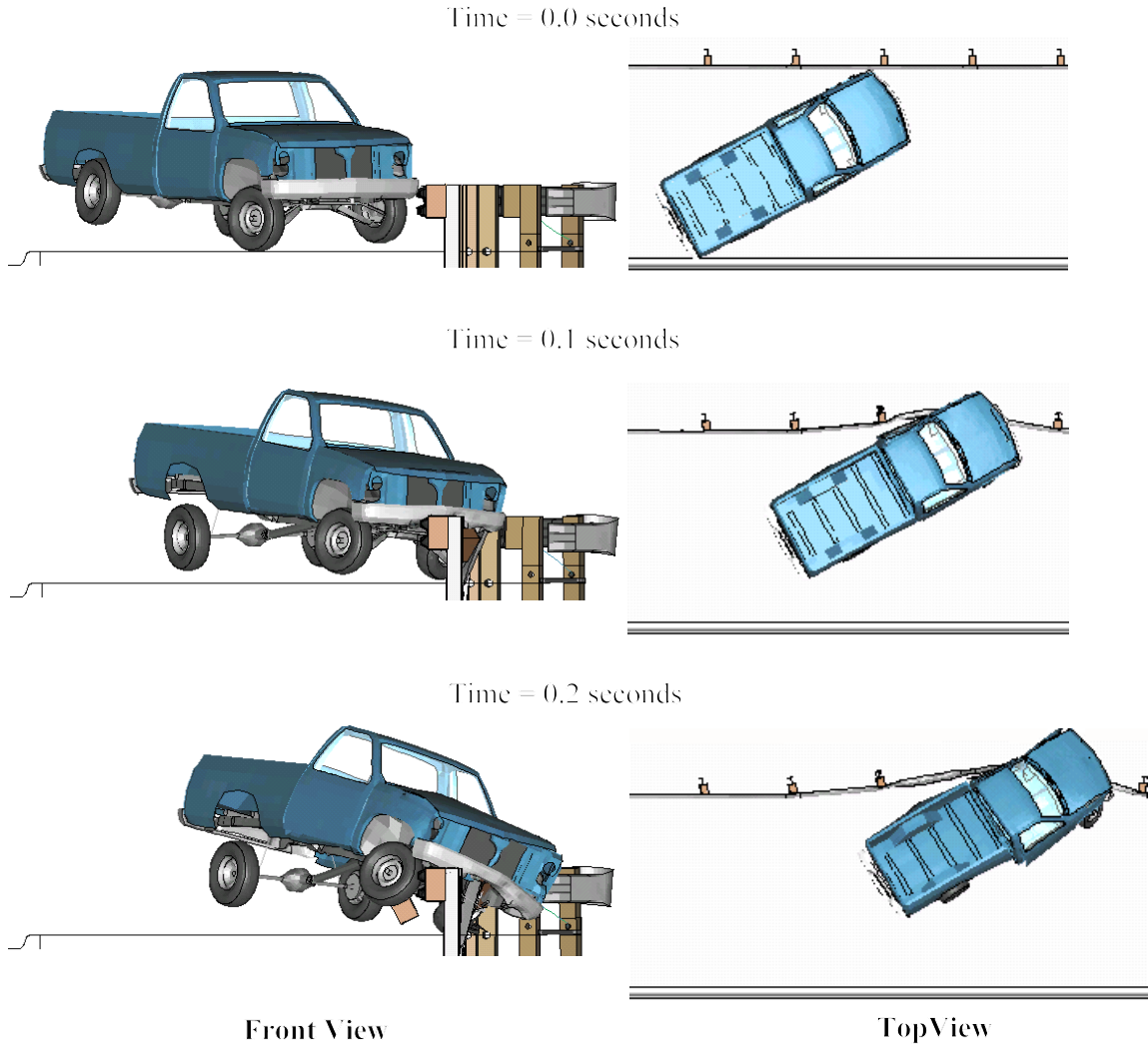

Figure H.25: Sequential views of curb-barrier impact from F.E. analysis - front view and top view

Curb Type	-- AASHTO B Curb
Offset Distance	- 4 m
Impact Speed	- 100 km/hr
Impact Angle	- 25 degrees.

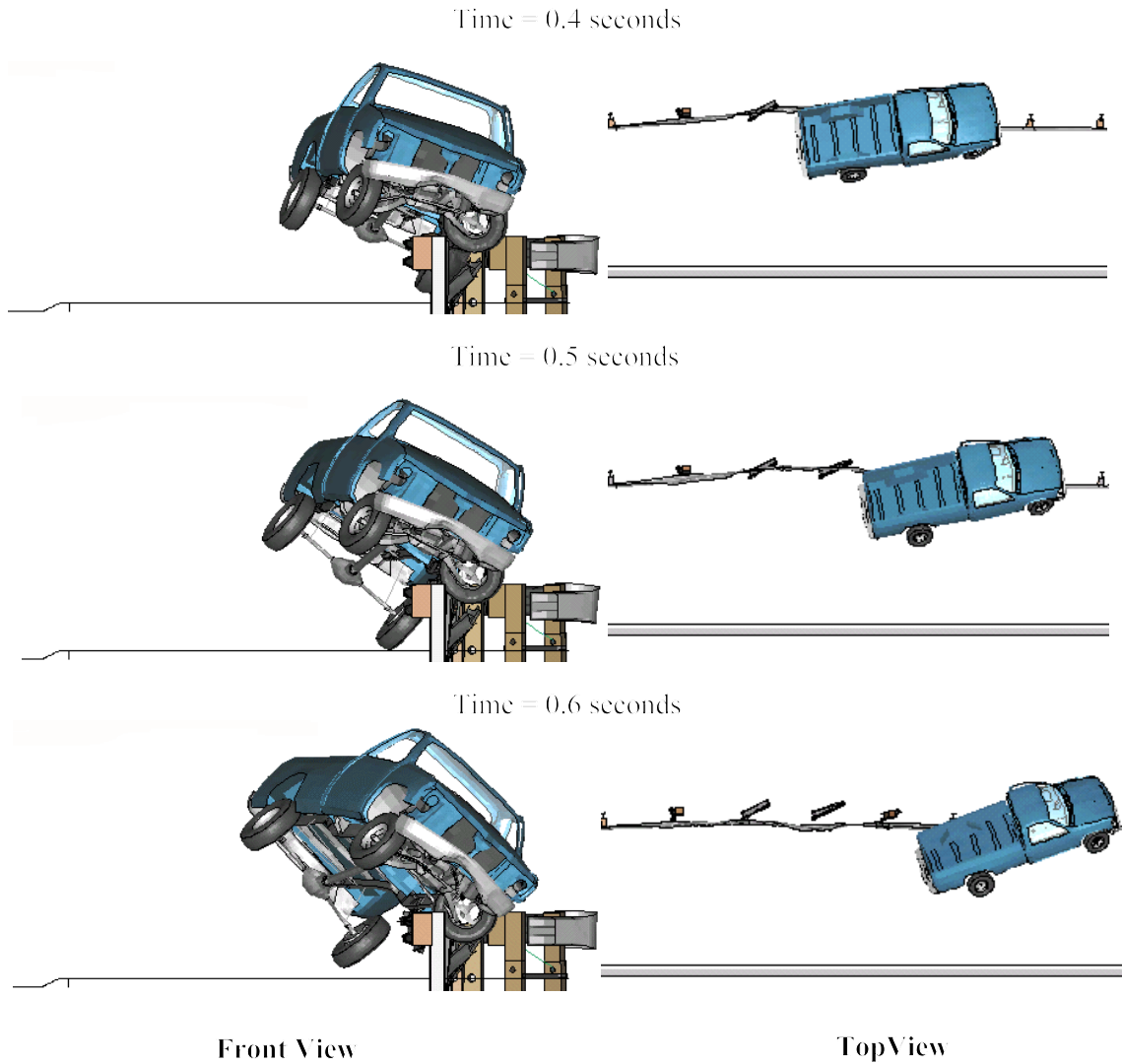

Figure H.27: (CONTINUED) Sequential views of curb-barrier impact from F.E. analysis - front view and top view

Curb Type	-- AASHTO G Curb
Offset Distance	- 4 m
Impact Speed	- 100 km/hr
Impact Angle	- 25 degrees.

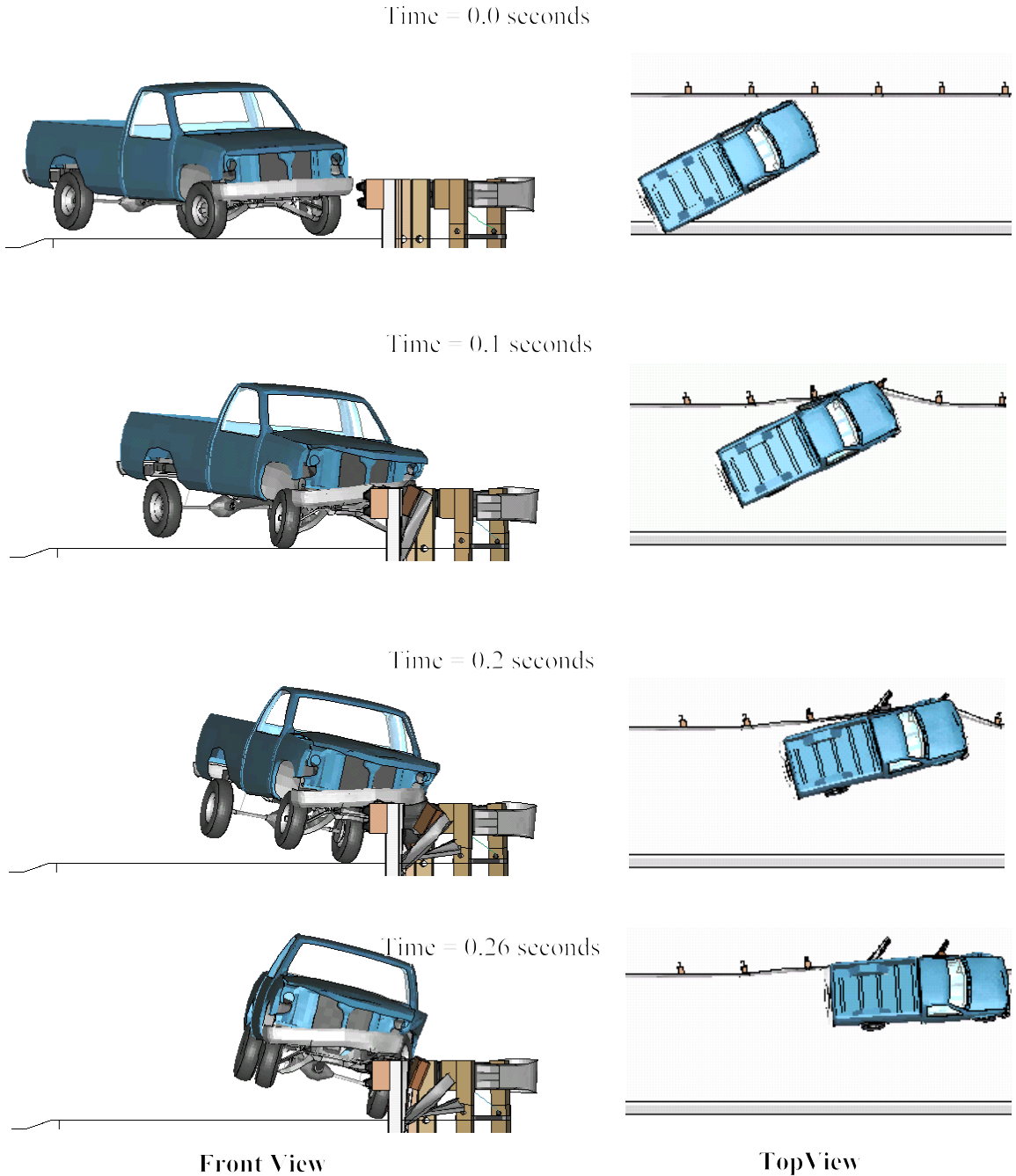

Figure H.28: Sequential views of curb-barrier impact from F.E. analysis - front view and top view

Curb Type	-- New York Curb (100 mm)
Offset Distance	- 4 m
Impact Speed	- 100 km/hr
Impact Angle	- 25 degrees.

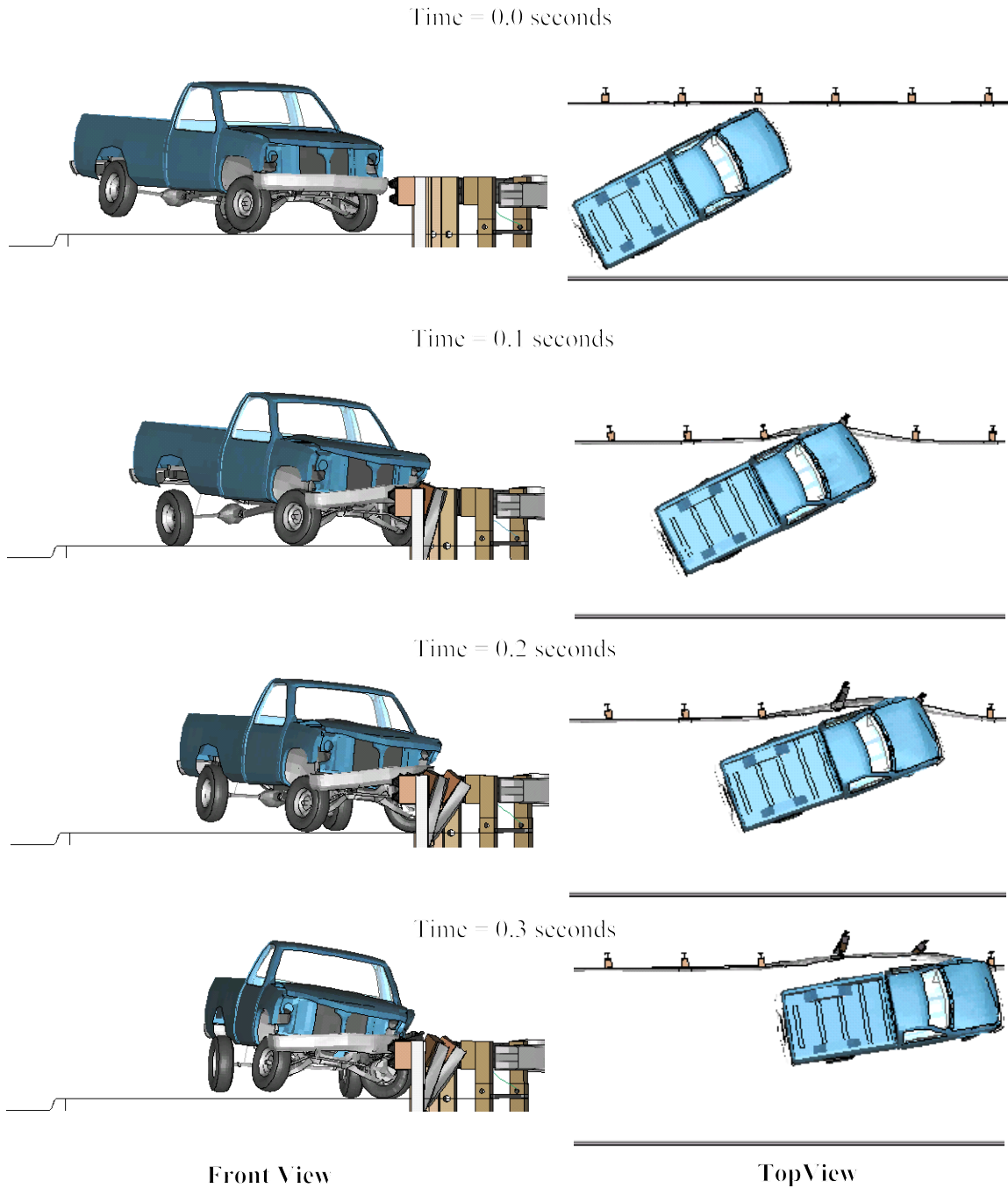

Figure H.29: Sequential views of curb-barrier impact from F.E. analysis - front view and top view

Curb Type	-- AASHTO B Curb
Offset Distance	- 4 m
Impact Speed	- 85 km/hr
Impact Angle	- 25 degrees.

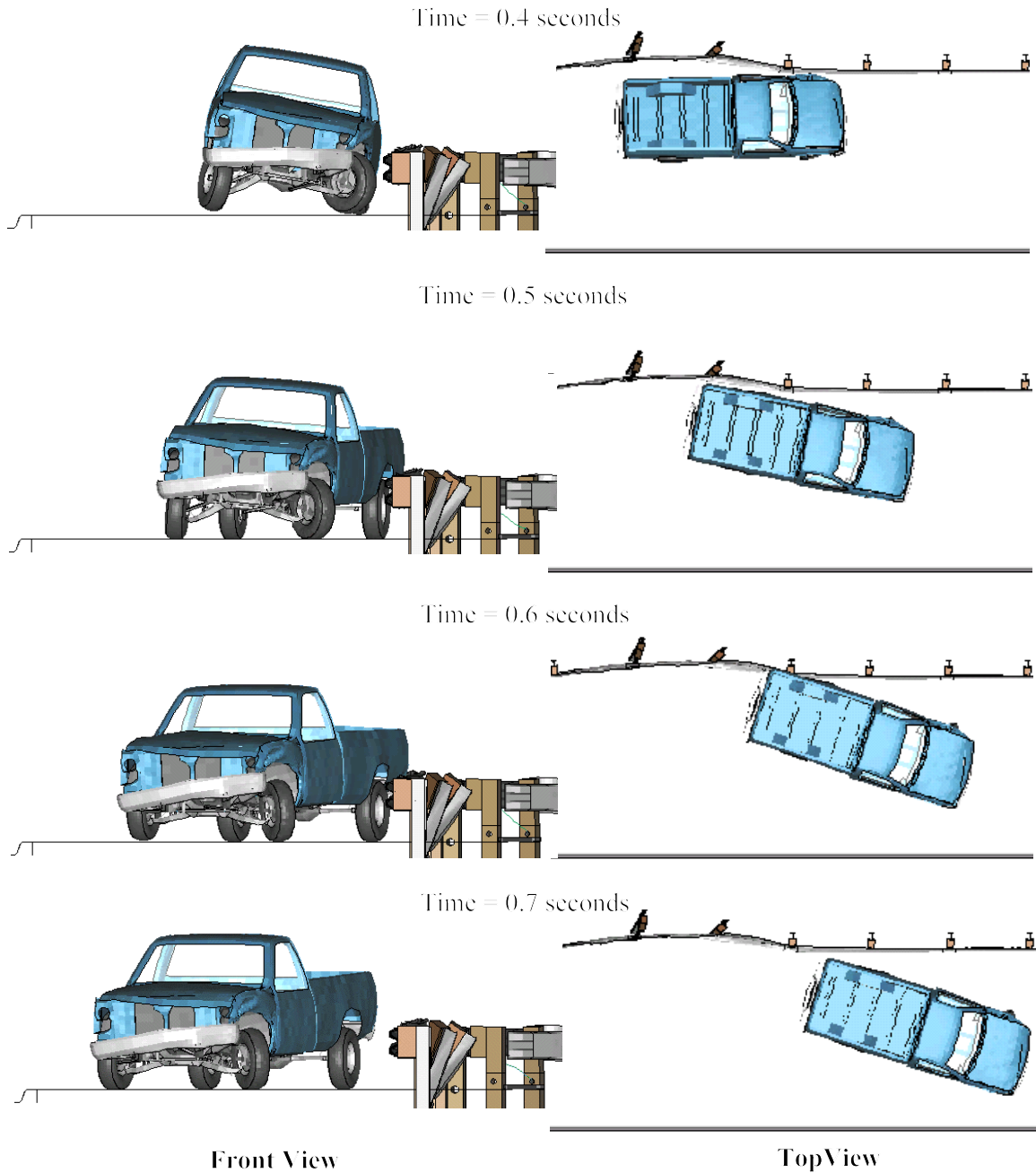

Figure H.29: (CONTINUED) Sequential views of curb-barrier impact from F.E. analysis - front view and top view

Curb Type	-- AASHTO B Curb
Offset Distance	- 4 m
Impact Speed	- 85 km/hr
Impact Angle	- 25 degrees.

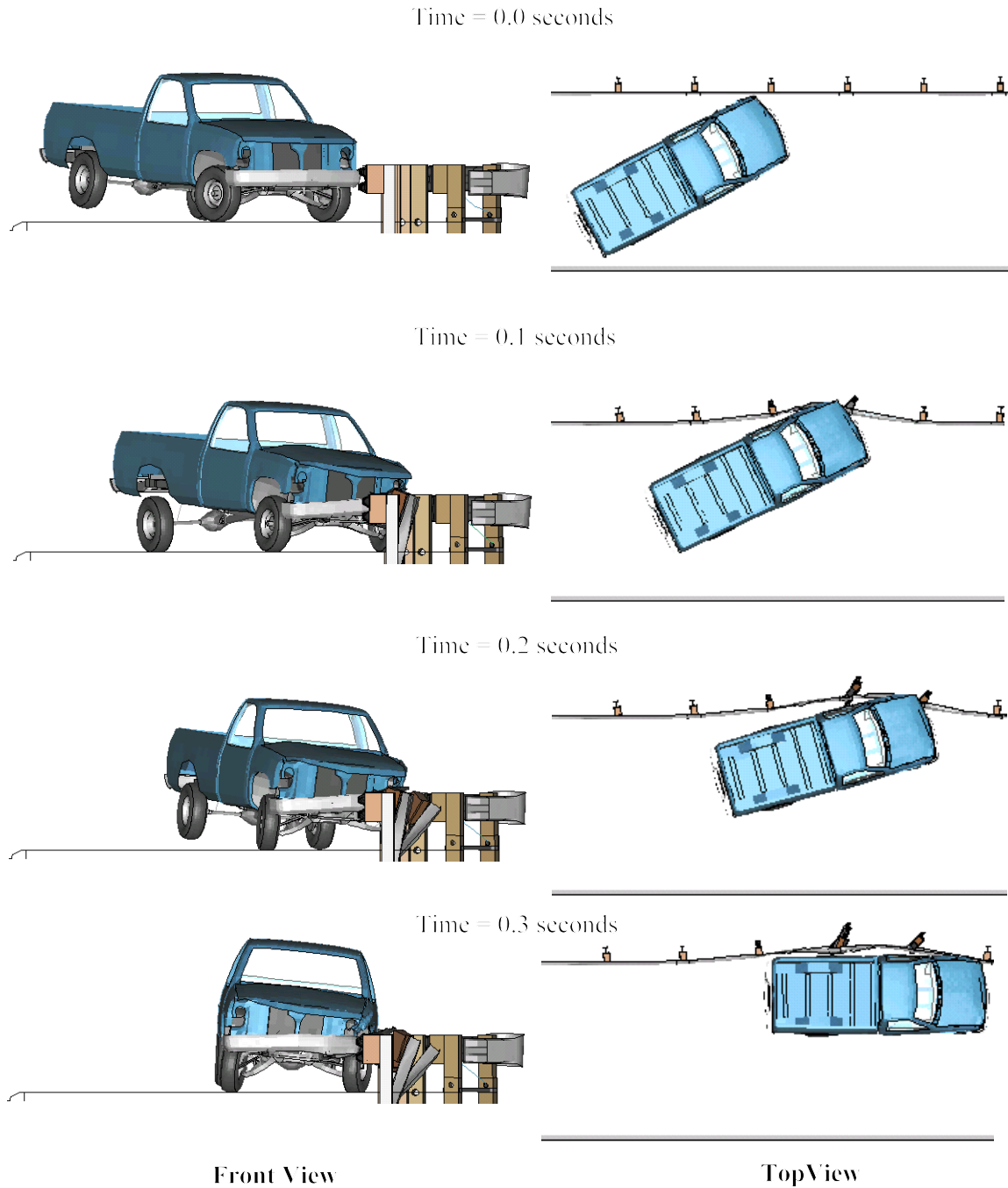

Figure H.30: Sequential views of curb-barrier impact from F.E. analysis - front view and top view

Curb Type -- AASHTO C Curb
Offset Distance -- 4 m
Impact Speed -- 85 km/hr
Impact Angle -- 25 degrees.

APPENDIX I

Acceleration-Time Histories From Curb-Barrier Impact Computed at the Center of Gravity of Vehicle

-Finite Element Analysis Results-

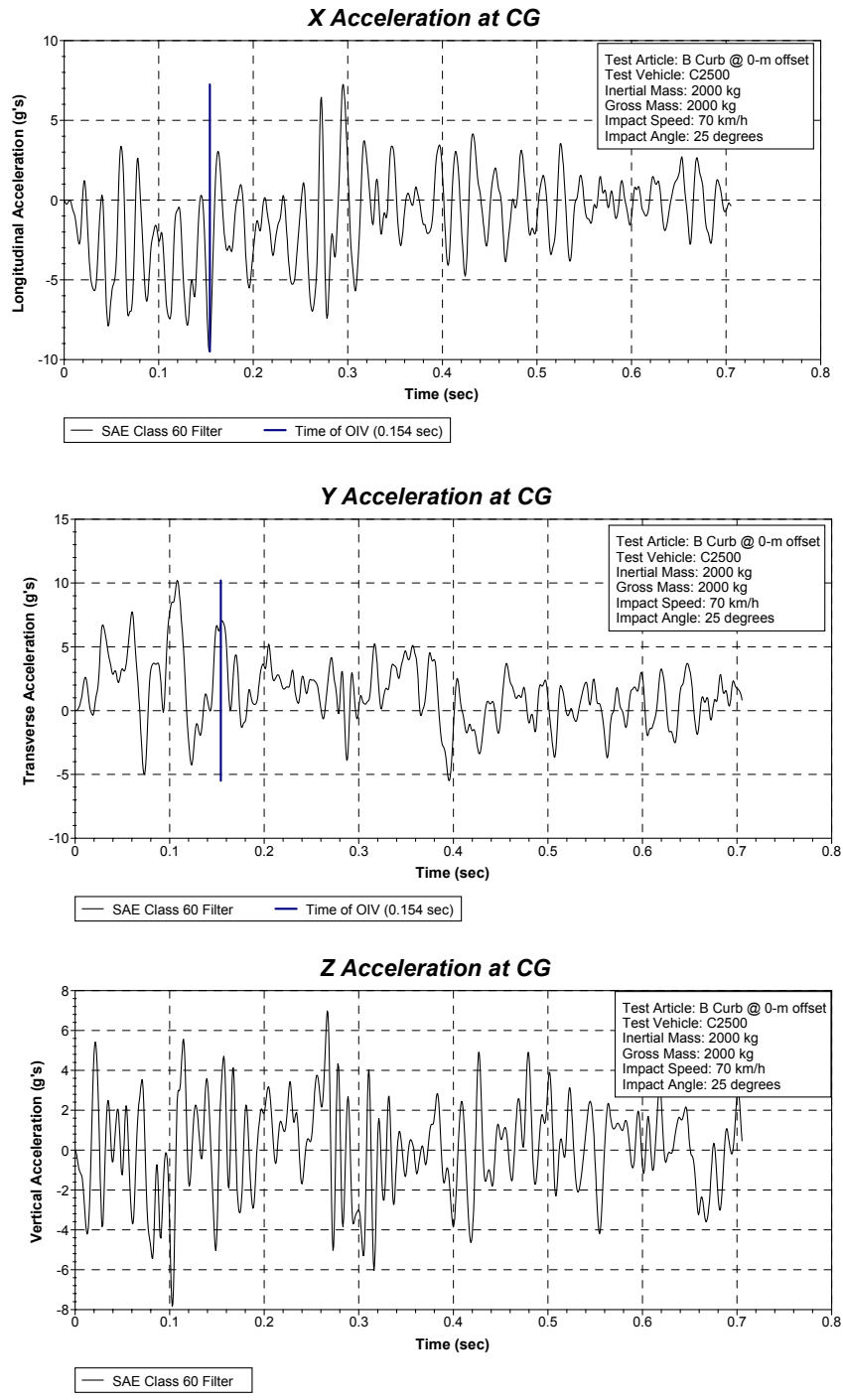

Figure I.1: Acceleration-time histories at C.G. of pickup truck in local coordinates:
Curb Type -- AASHTO B Curb
Impact Speed -- 70 km/hr
Offset Distance -- 0.0 m.

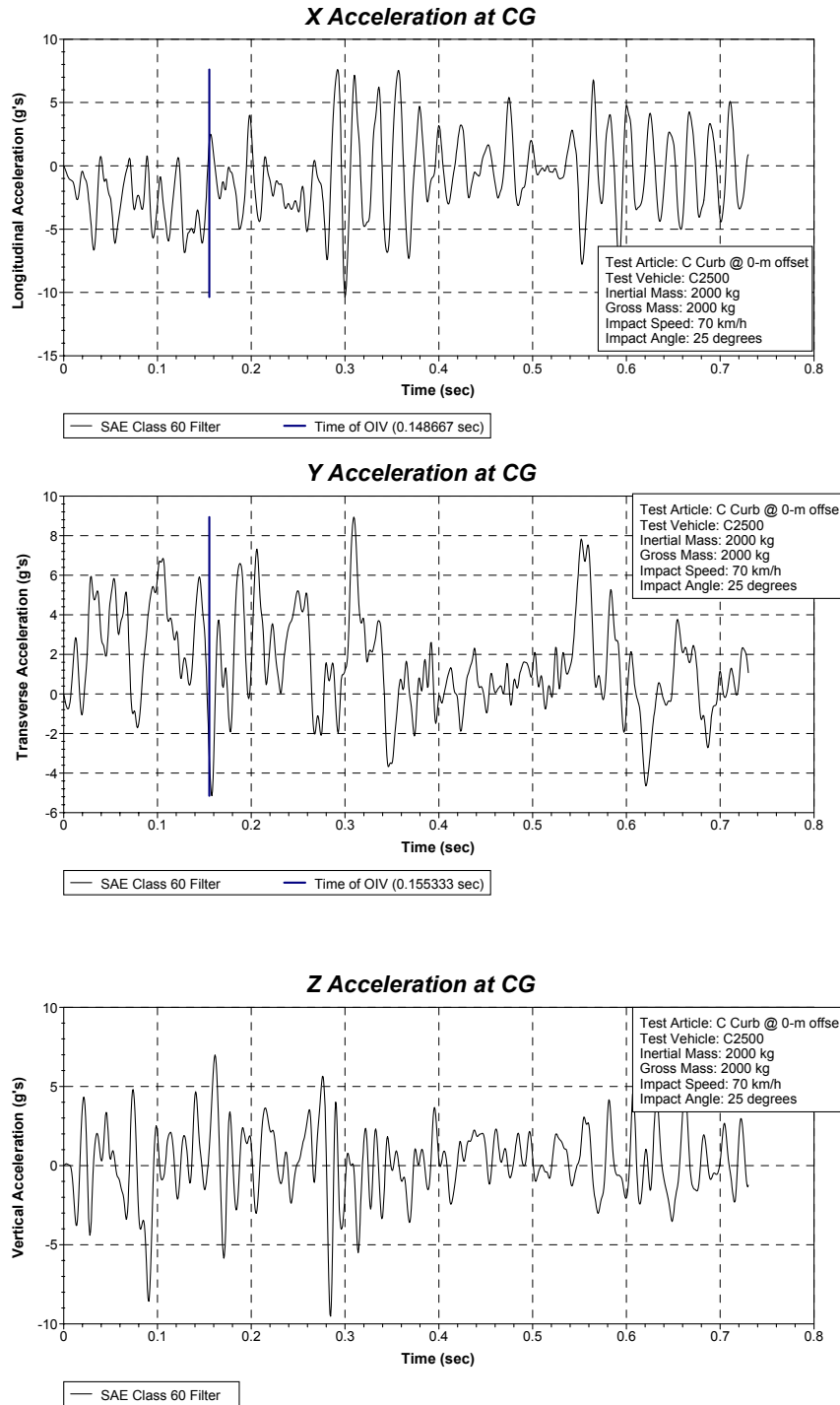

Figure I.2:

Acceleration-time histories at C.G. of pickup truck in local coordinates:

- Curb Type** -- AASHTO C Curb
- Impact Speed** -- 70 km/hr
- Offset Distance** -- 0.0 m.

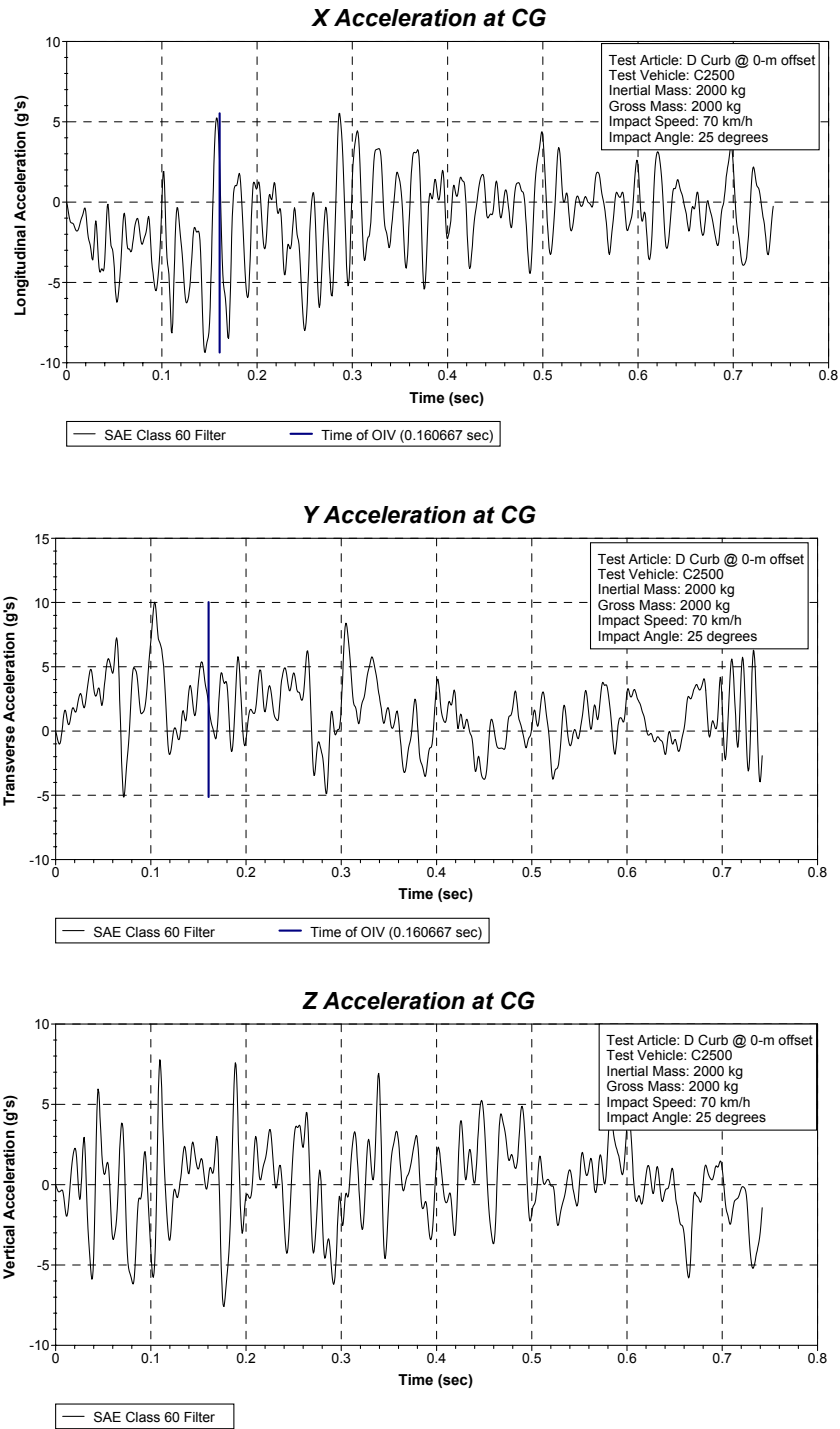

Figure I.3: Acceleration-time histories at C.G. of pickup truck in local coordinates:
Curb Type -- AASHTO D Curb
Impact Speed -- 70 km/hr
Offset Distance -- 0.0 m.

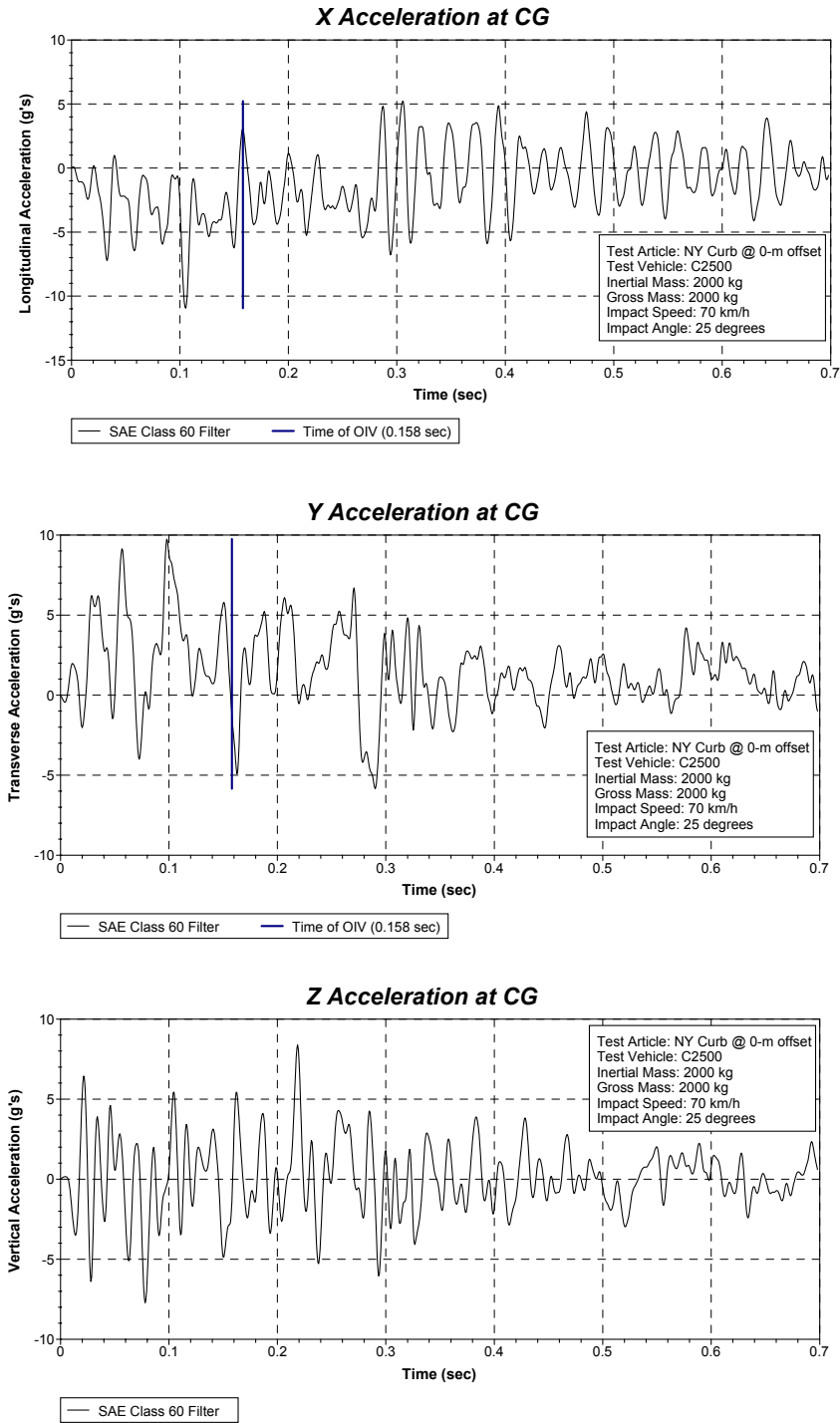

Figure I.4: **Acceleration-time histories at C.G. of pickup truck in local coordinates:**

Curb Type -- **New York Curb (100 mm)**

Impact Speed – **70 km/hr**

Offset Distance – **0.0 m.**

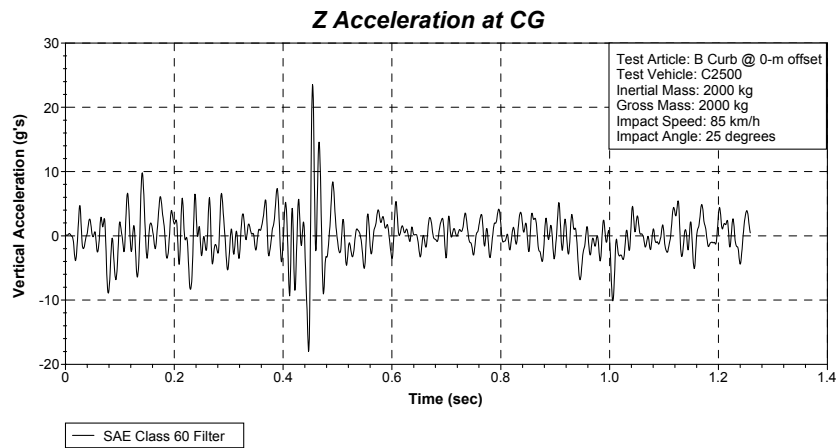
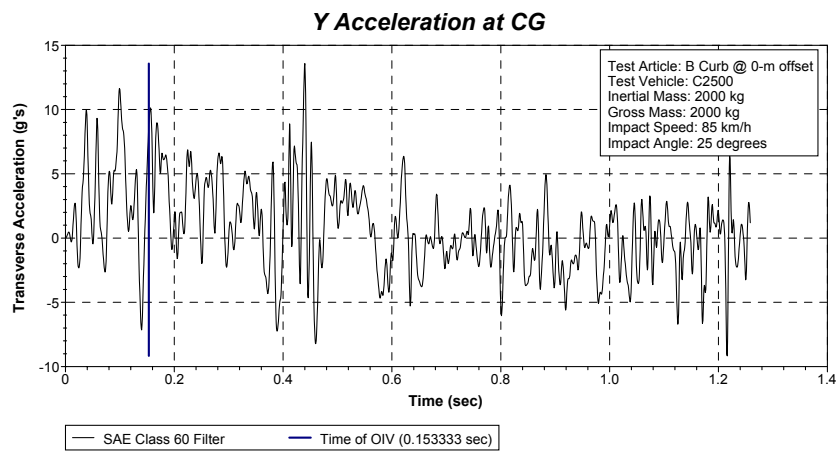
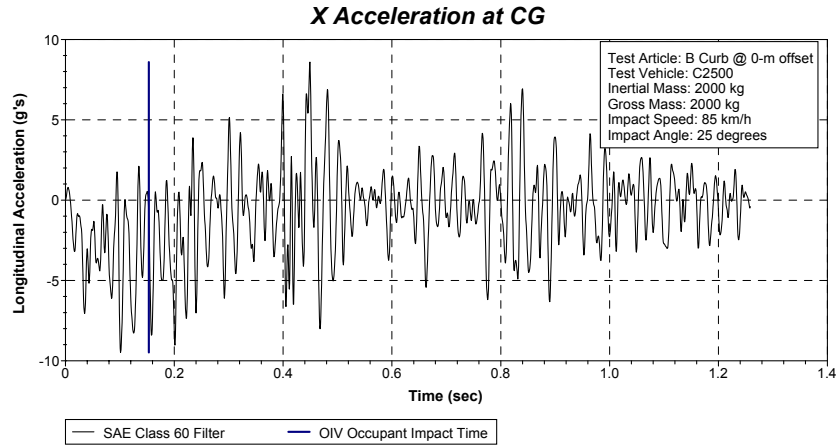

Figure I.5: Acceleration-time histories at C.G. of pickup truck in local coordinates:
Curb Type -- AASHTO B Curb
Impact Speed -- 85 km/hr
Offset Distance -- 0.0 m.

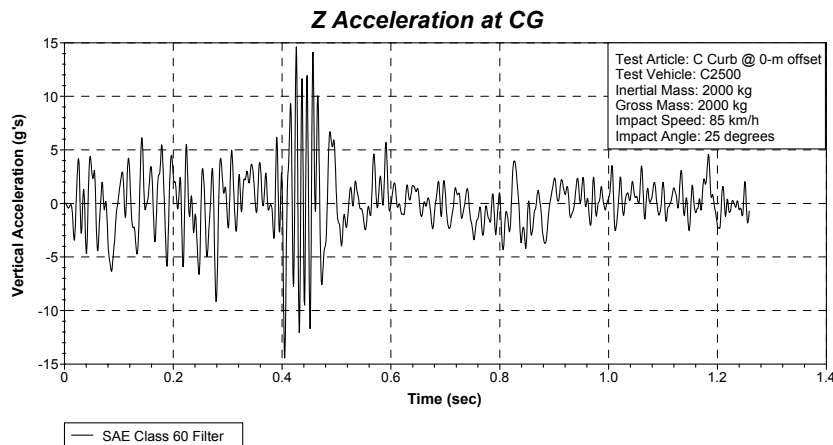
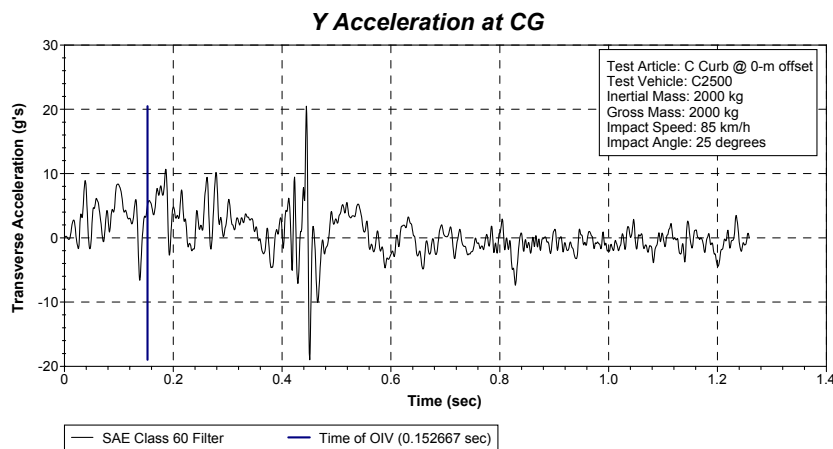
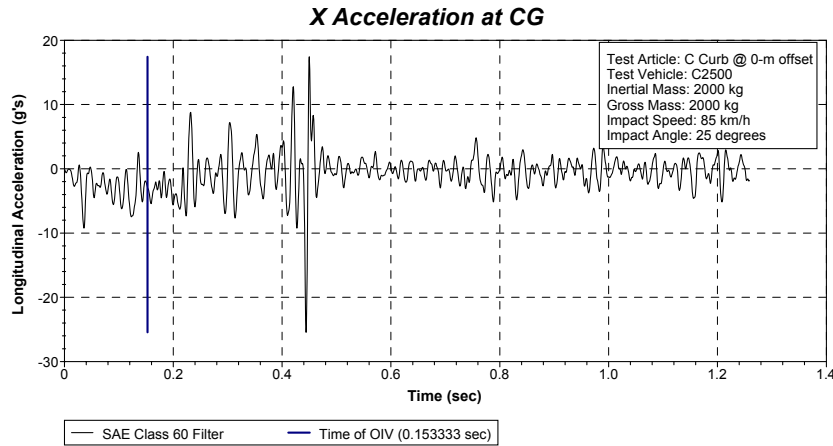

Figure I.6: Acceleration-time histories at C.G. of pickup truck in local coordinates:
Curb Type -- AASHTO C Curb
Impact Speed -- 85 km/hr
Offset Distance -- 0.0 m.

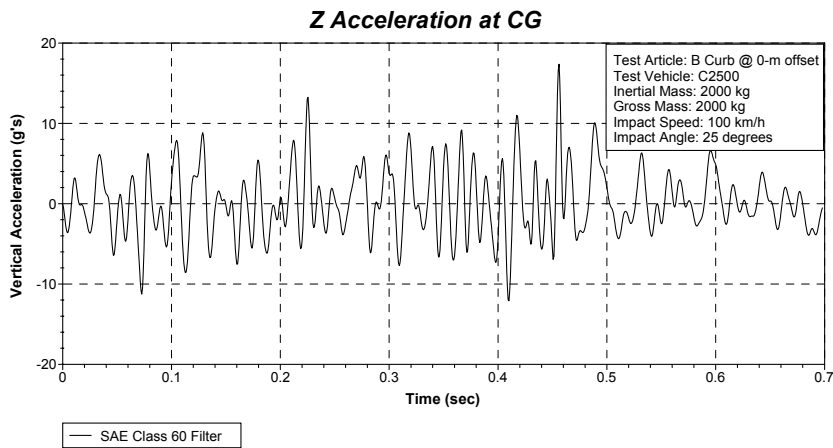
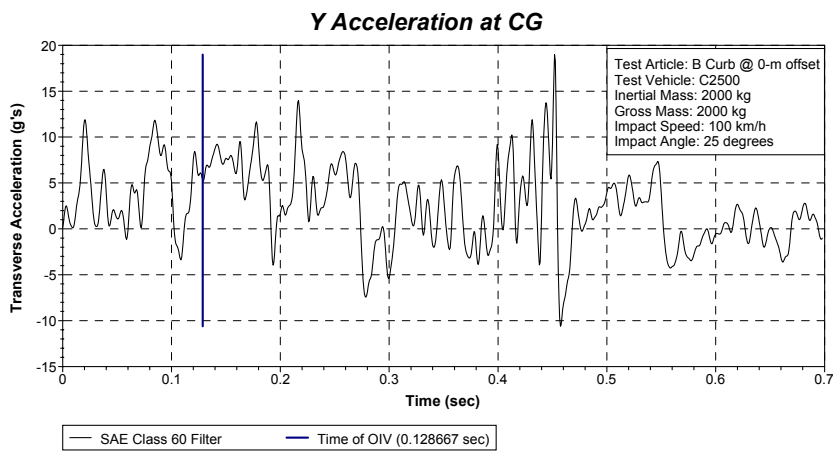
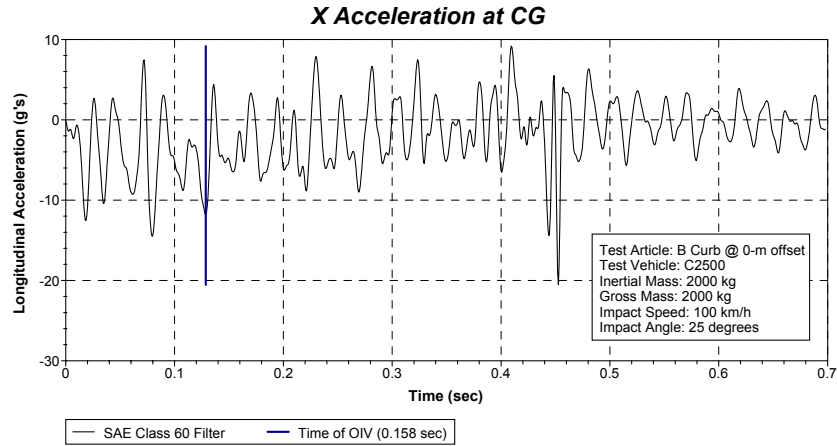

Figure I.7: Acceleration-time histories at C.G. of pickup truck in local coordinates:
Curb Type -- AASHTO B Curb
Impact Speed -- 100 km/hr
Offset Distance -- 0.0 m.

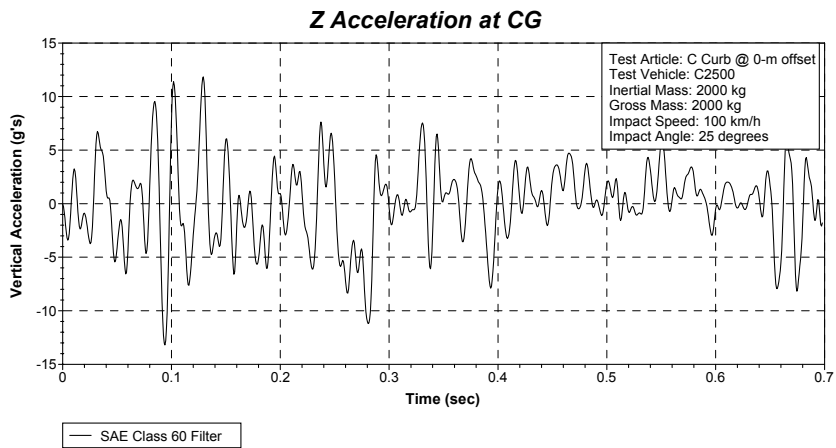
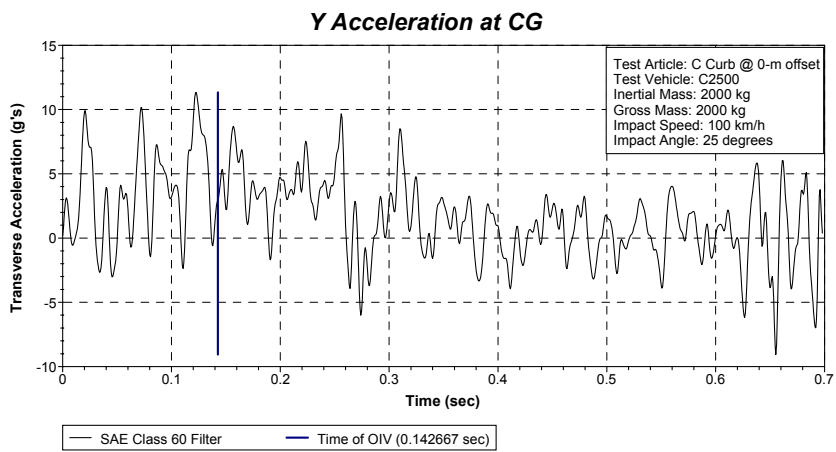
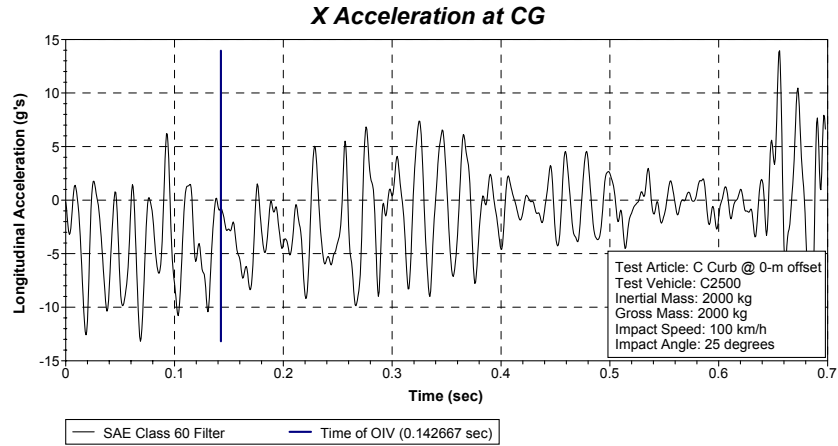

Figure I.8: Acceleration-time histories at C.G. of pickup truck in local coordinates:
Curb Type -- AASHTO C Curb
Impact Speed -- 100 km/hr
Offset Distance -- 0.0 m.

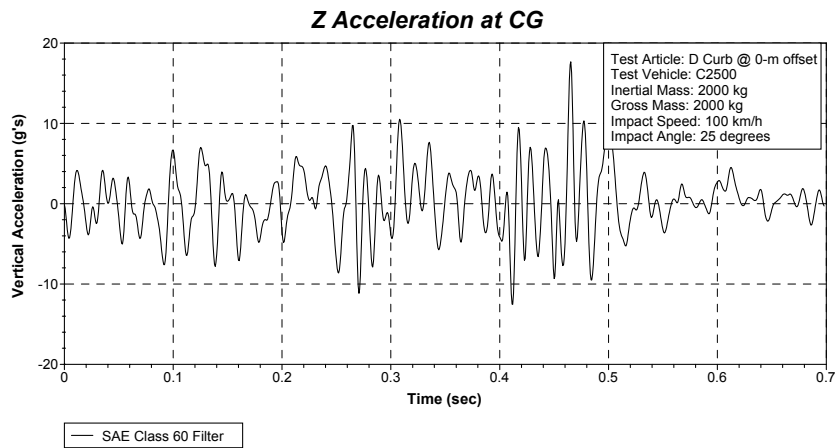
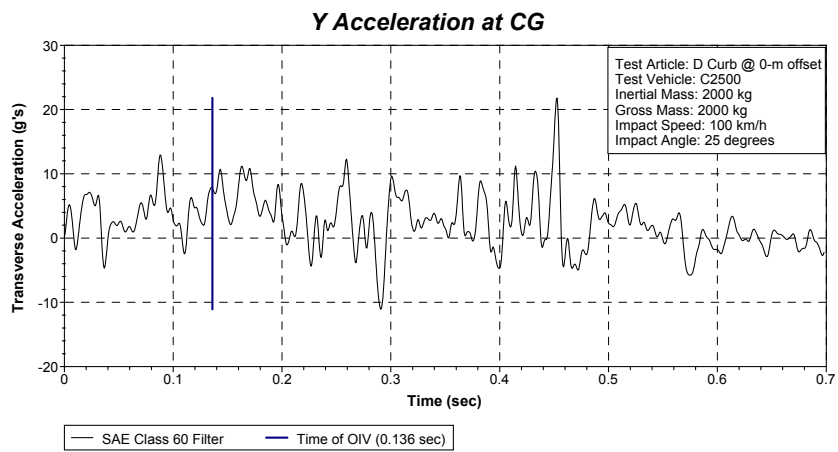
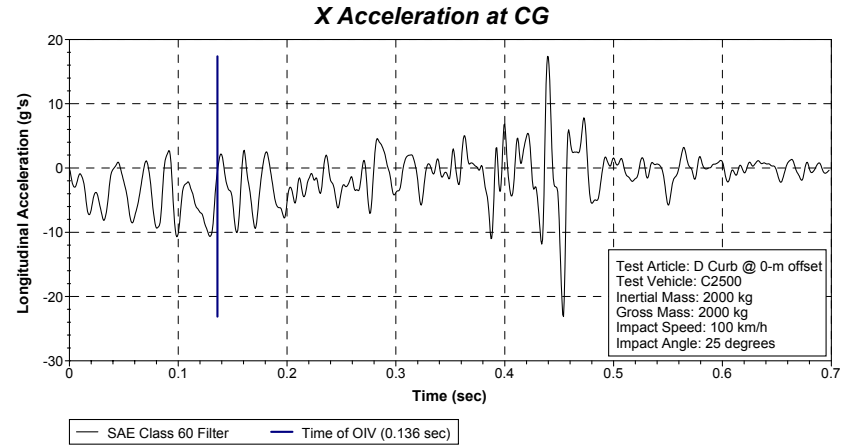

Figure I.9:

Acceleration-time histories at C.G. of pickup truck in local coordinates:

- Curb Type** -- AASHTO D Curb
- Impact Speed** -- 100 km/hr
- Offset Distance** -- 0.0 m.

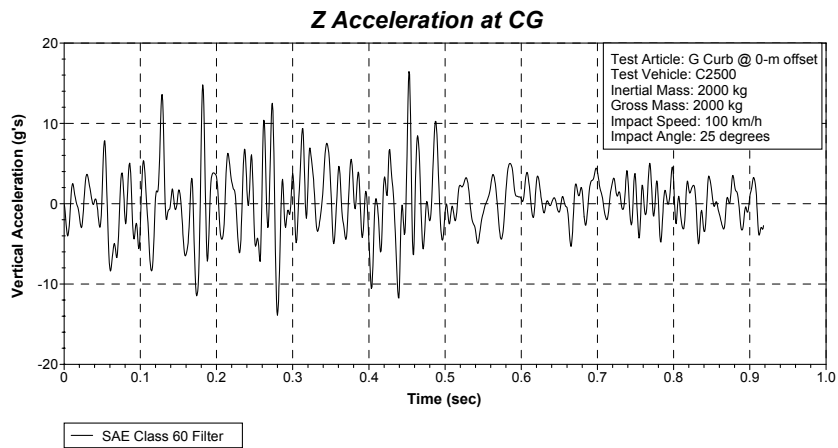
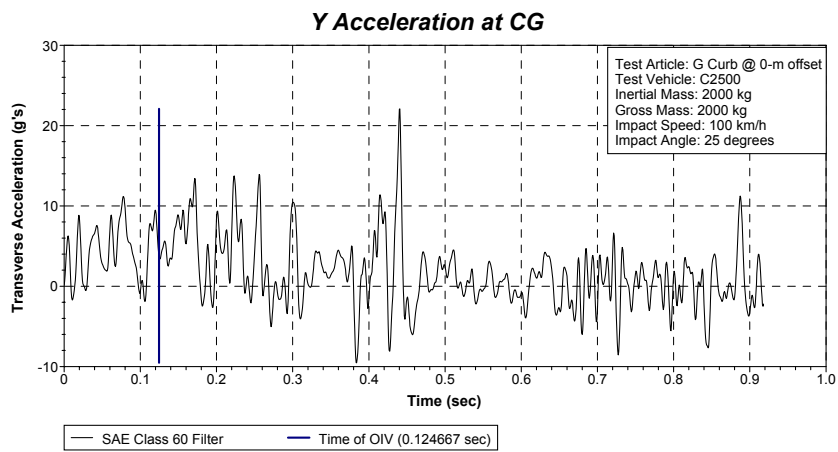
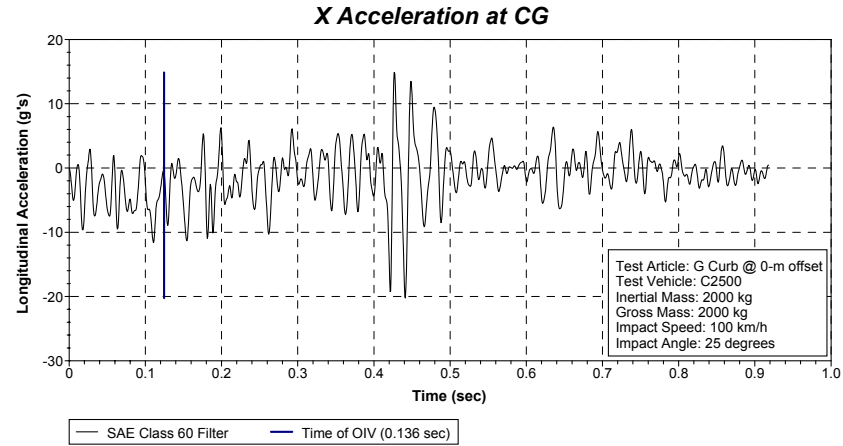

Figure I.10: Acceleration-time histories at C.G. of pickup truck in local coordinates:
Curb Type -- AASHTO G Curb
Impact Speed -- 100 km/hr
Offset Distance -- 0.0 m.

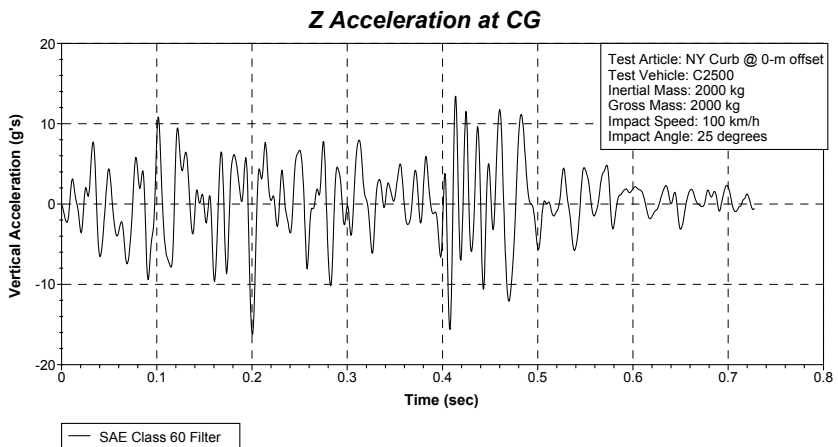
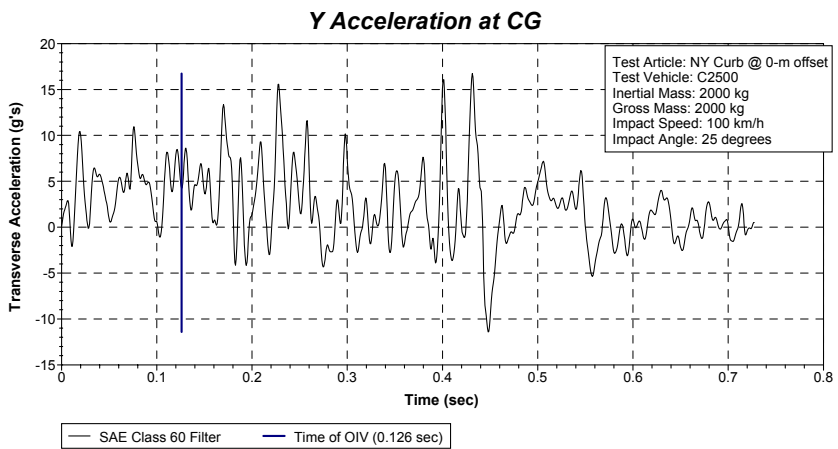
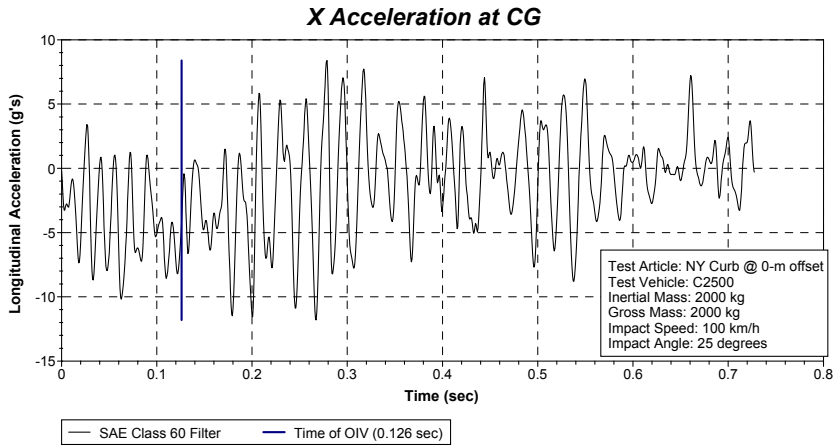

Figure I.11: Acceleration-time histories at C.G. of pickup truck in local coordinates:
Curb Type -- New York Curb (100 mm)
Impact Speed – 100 km/hr
Offset Distance – 0.0 m.

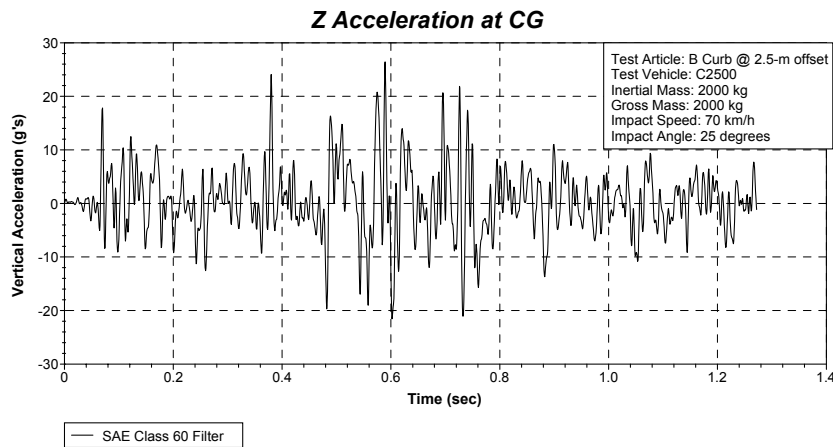
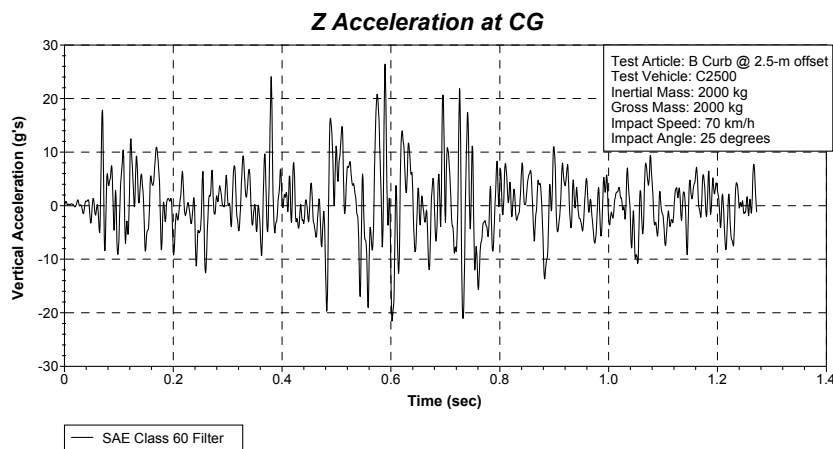
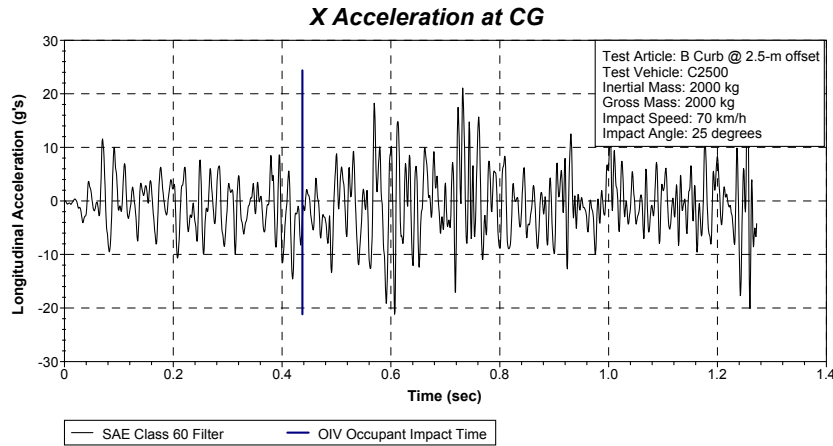

Figure I.12: Acceleration-time histories at C.G. of pickup truck in local coordinates:
Curb Type -- AASHTO B Curb
Impact Speed -- 70 km/hr
Offset Distance -- 2.5 m.

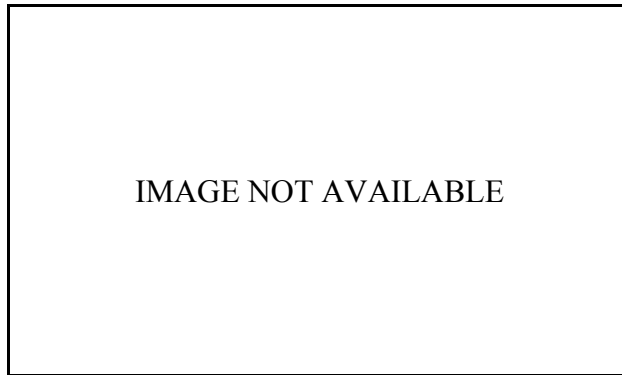

Figure I.13: Acceleration-time histories at C.G. of pickup truck in local coordinates:
Curb Type -- AASHTO C Curb
Impact Speed – 70 km/hr
Offset Distance – 2.5 m.

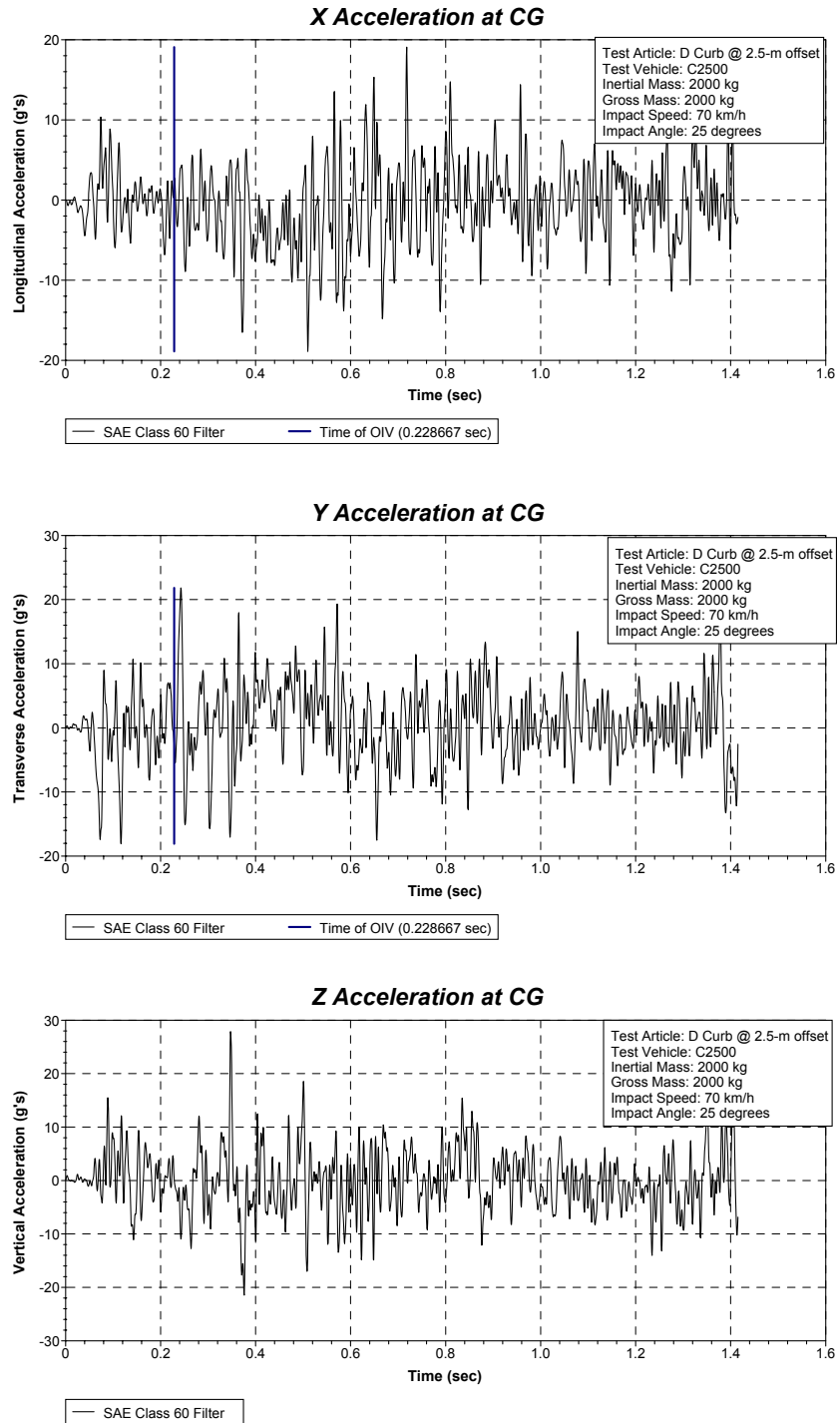

Figure I.14: Acceleration-time histories at C.G. of pickup truck in local coordinates:
Curb Type -- AASHTO D Curb
Impact Speed -- 70 km/hr
Offset Distance -- 2.5 m.

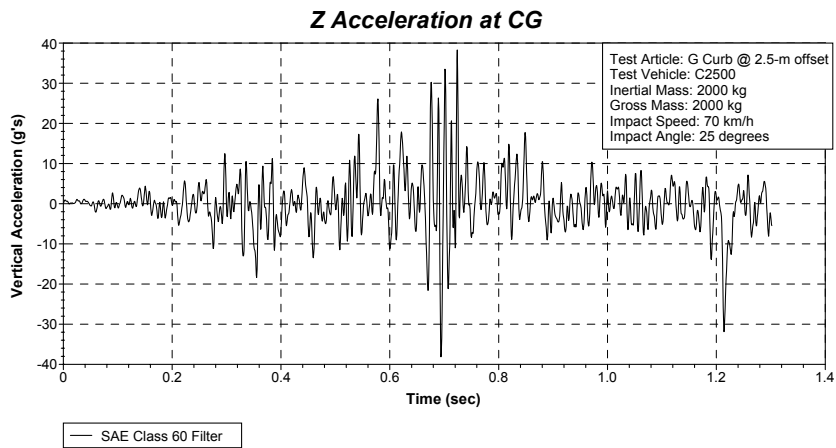
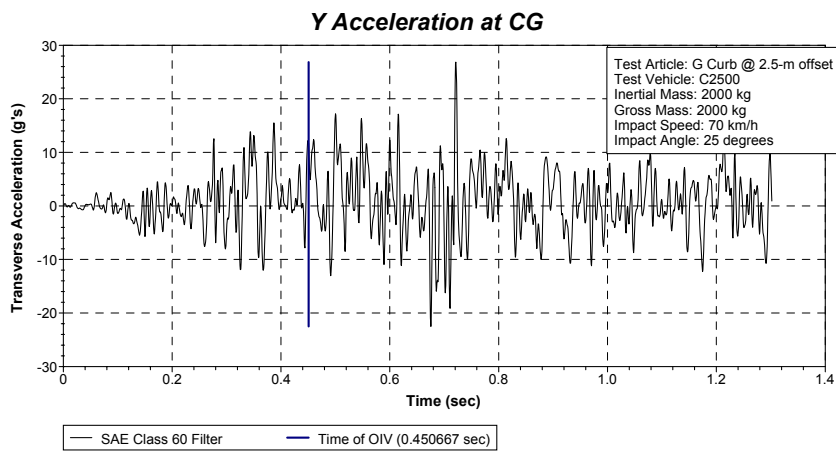
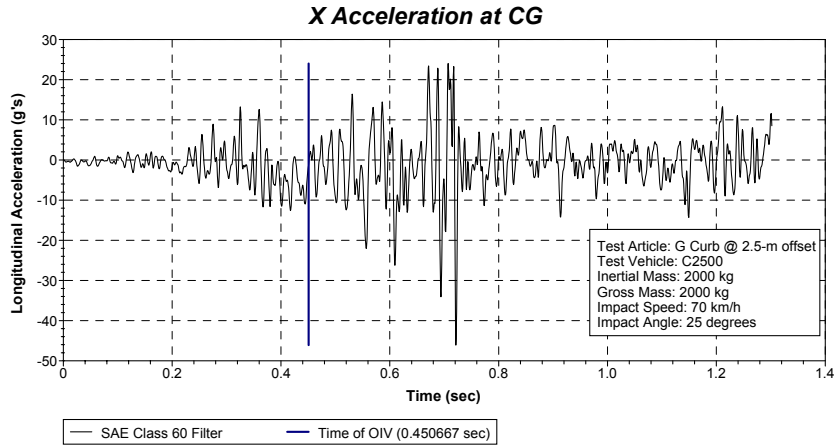

Figure I.15: Acceleration-time histories at C.G. of pickup truck in local coordinates:
Curb Type -- AASHTO G Curb
Impact Speed -- 70 km/hr
Offset Distance -- 2.5 m.

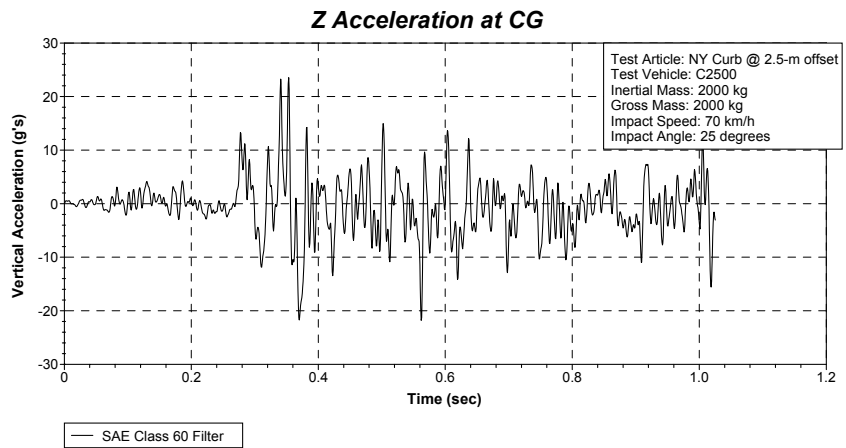
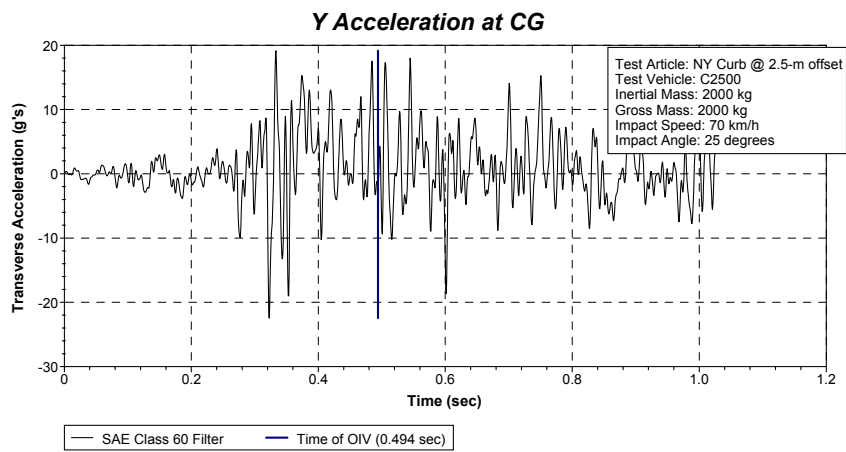
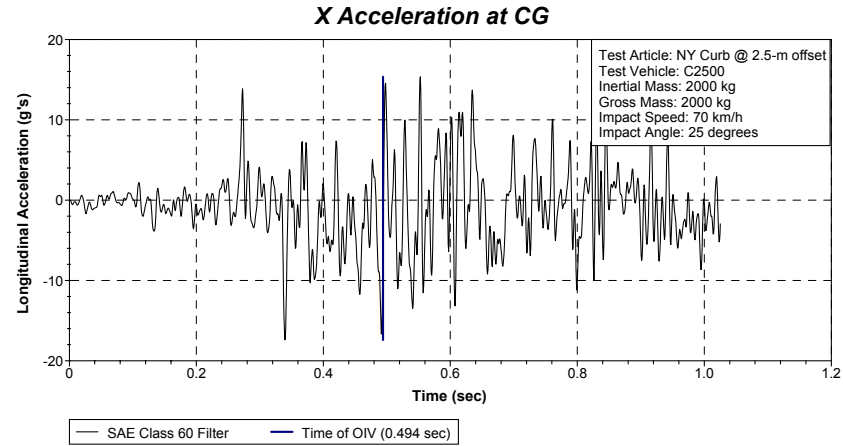

Figure I.16: Acceleration-time histories at C.G. of pickup truck in local coordinates:
Curb Type -- New York Curb (100 mm)
Impact Speed -- 70 km/hr
Offset Distance -- 2.5 m.

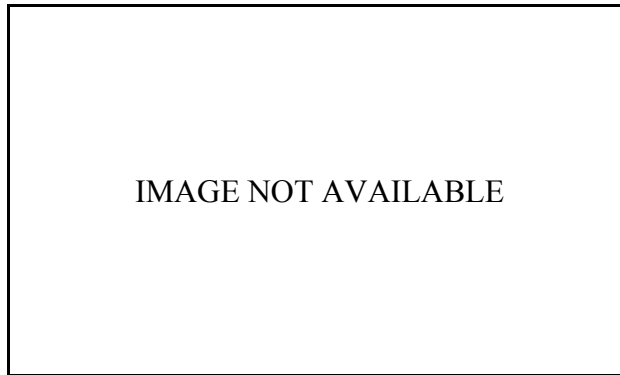

Figure I.17: Acceleration-time histories at C.G. of pickup truck in local coordinates:
Curb Type -- AASHTO B Curb
Impact Speed – 85 km/hr
Offset Distance – 2.5 m.

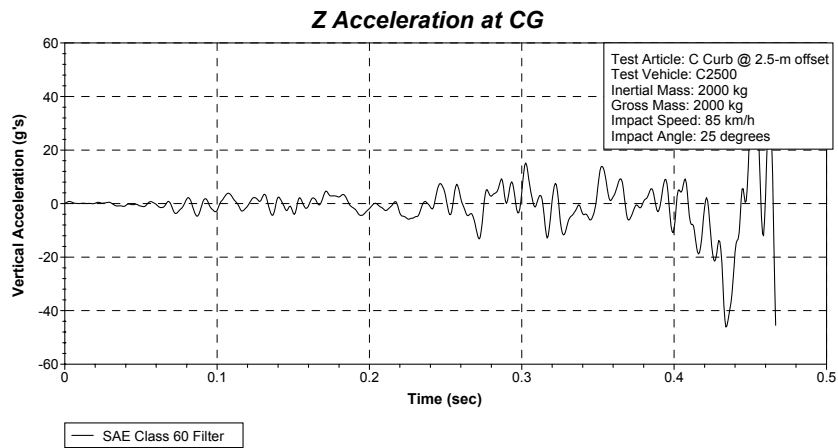
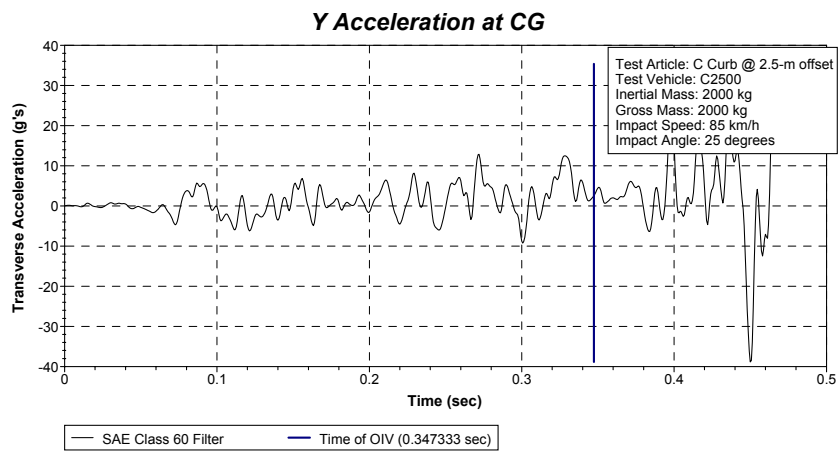
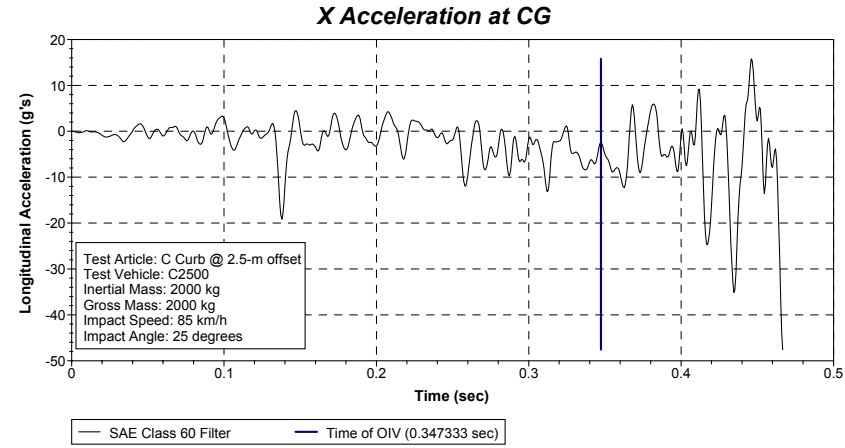

Figure I.18: Acceleration-time histories at C.G. of pickup truck in local coordinates:
Curb Type -- AASHTO C Curb
Impact Speed -- 85 km/hr
Offset Distance -- 2.5 m.

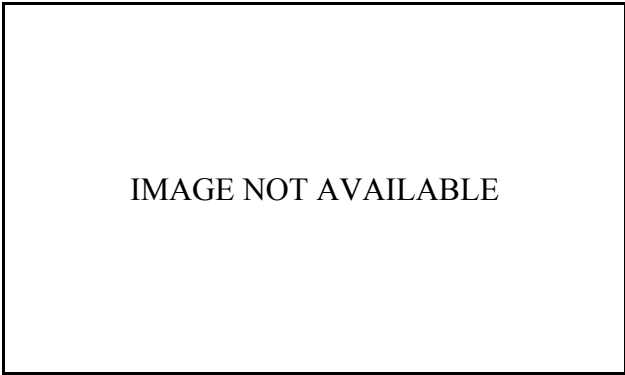

Figure I.19:

Acceleration-time histories at C.G. of pickup truck in local coordinates:

- Curb Type** -- AASHTO G Curb
- Impact Speed** – 100 km/hr
- Offset Distance** – 2.5 m.

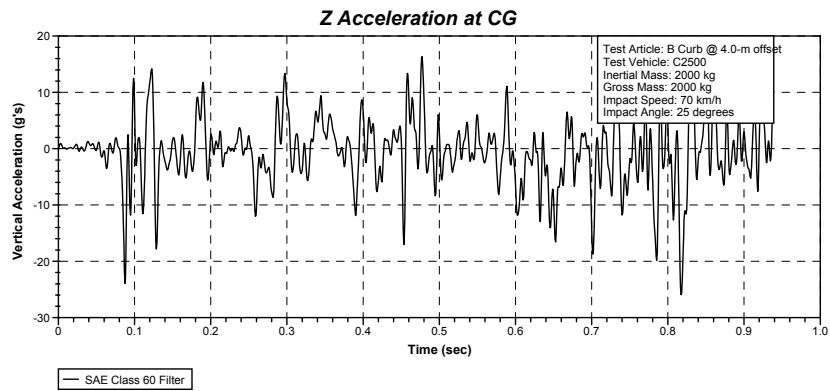
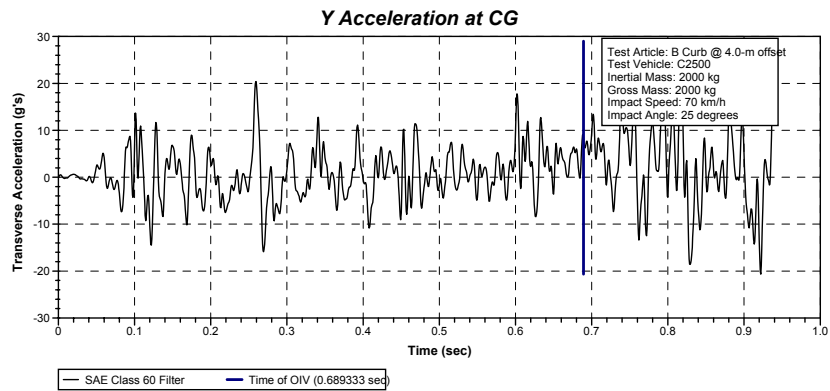
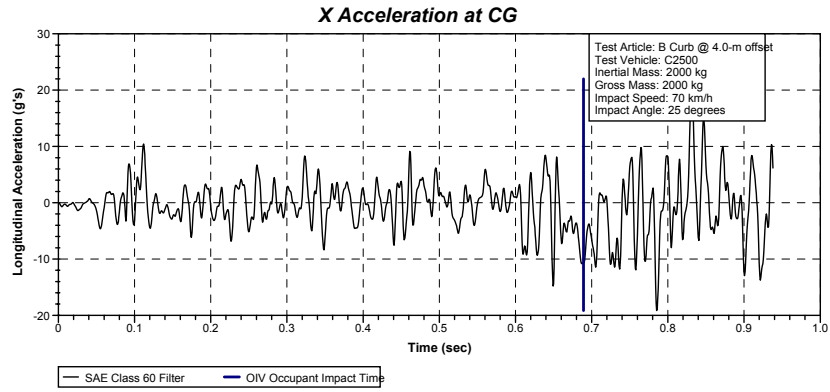

Figure I.20: Acceleration-time histories at C.G. of pickup truck in local coordinates:
Curb Type -- AASHTO B Curb
Impact Speed -- 70 km/hr
Offset Distance -- 4.0 m.

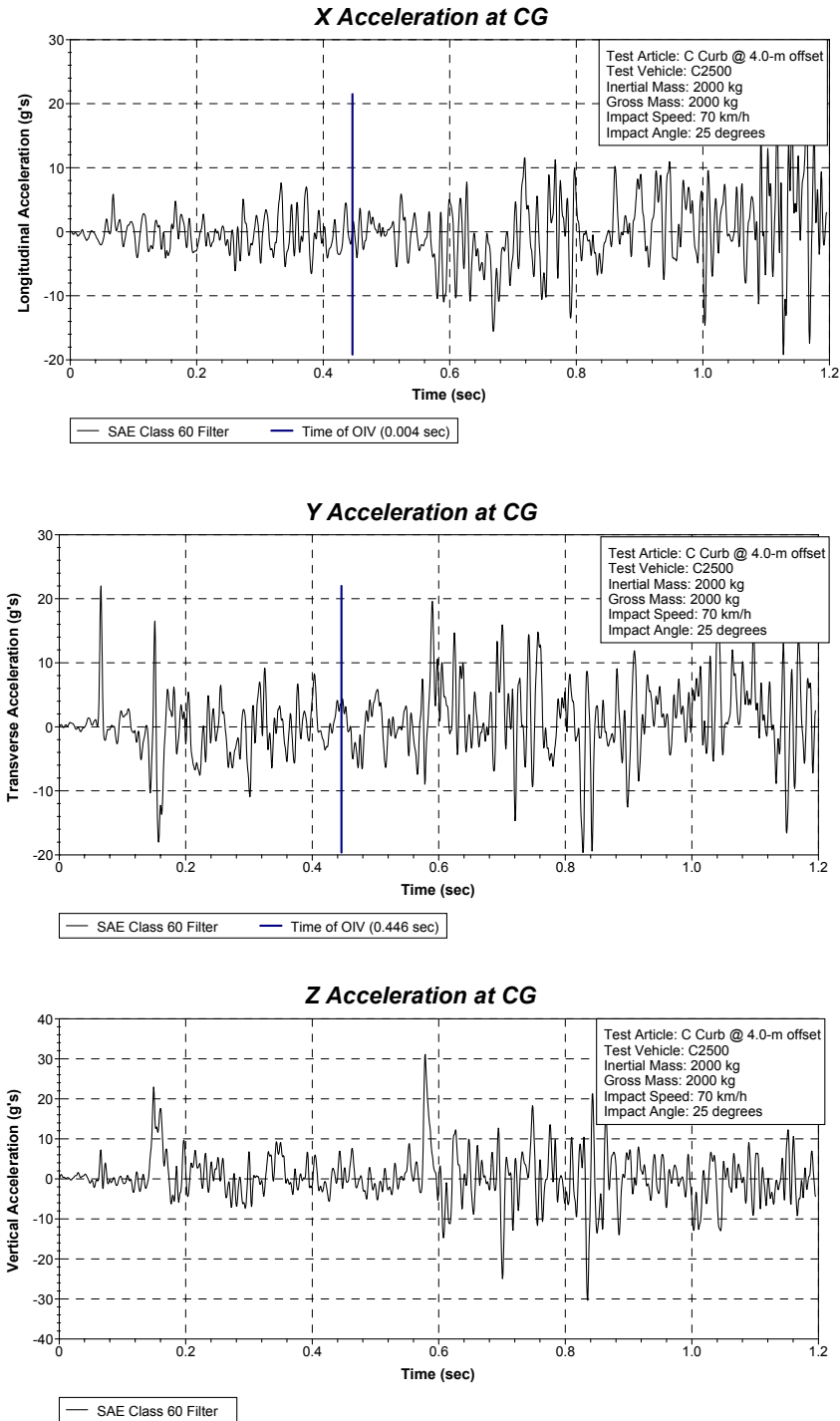

Figure I.21: Acceleration-time histories at C.G. of pickup truck in local coordinates:
Curb Type -- AASHTO C Curb
Impact Speed -- 70 km/hr
Offset Distance -- 4.0 m.

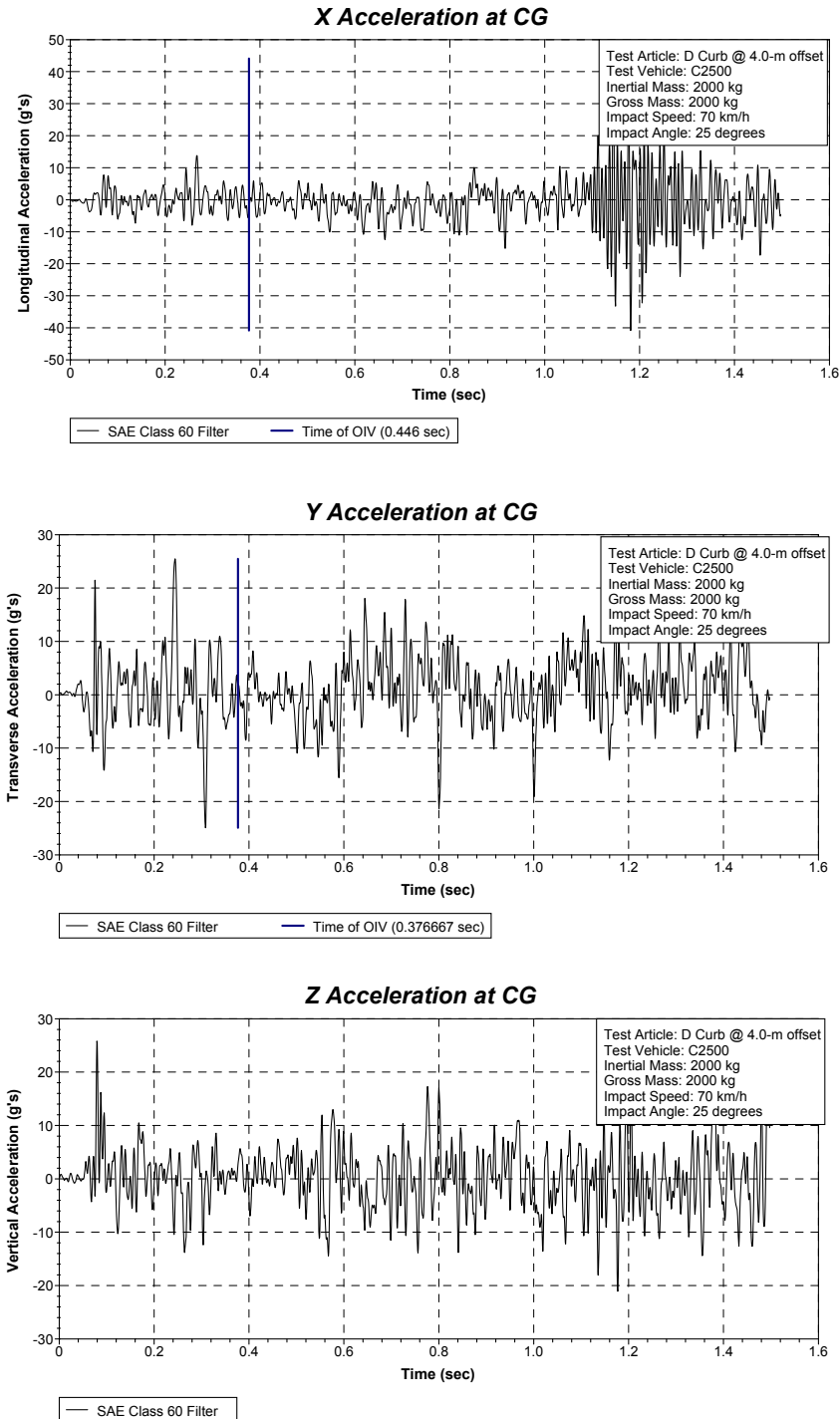

Figure I.22: Acceleration-time histories at C.G. of pickup truck in local coordinates:
Curb Type -- AASHTO D Curb
Impact Speed -- 70 km/hr
Offset Distance -- 4.0 m.

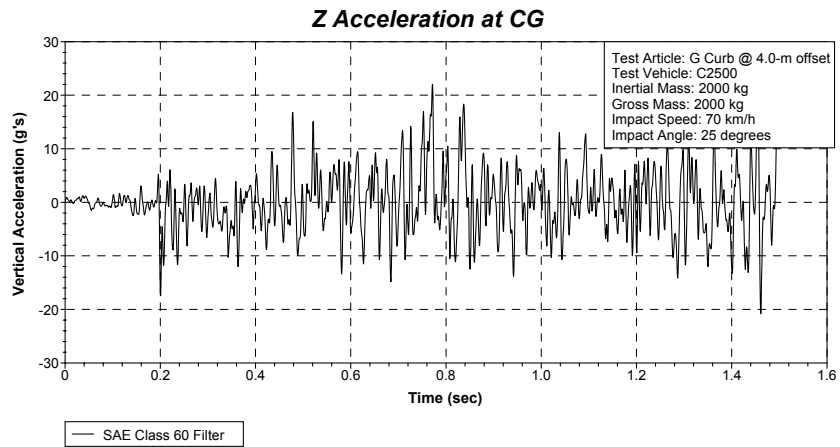
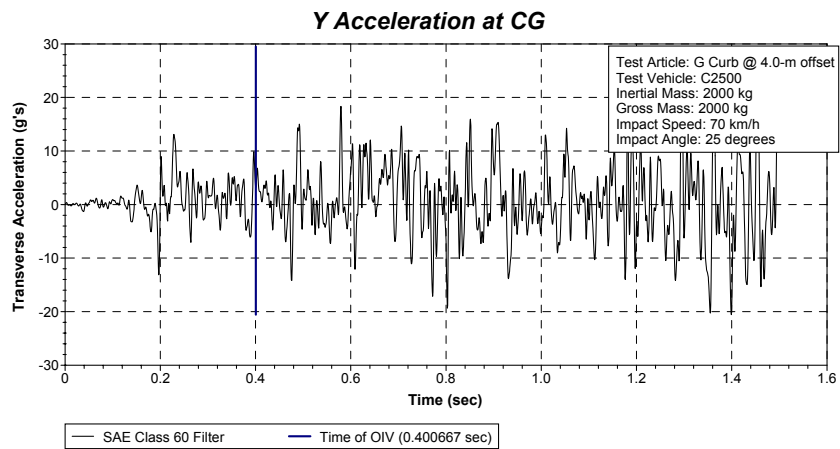
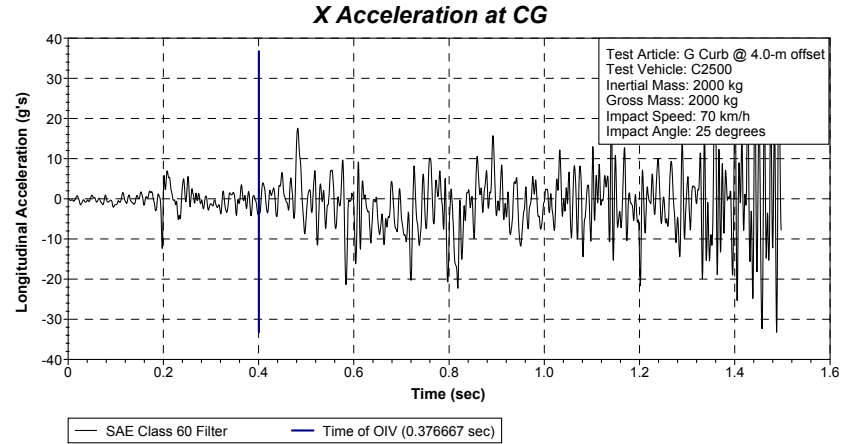

Figure I.23: Acceleration-time histories at C.G. of pickup truck in local coordinates:
Curb Type -- AASHTO G Curb
Impact Speed -- 70 km/hr
Offset Distance -- 4.0 m.

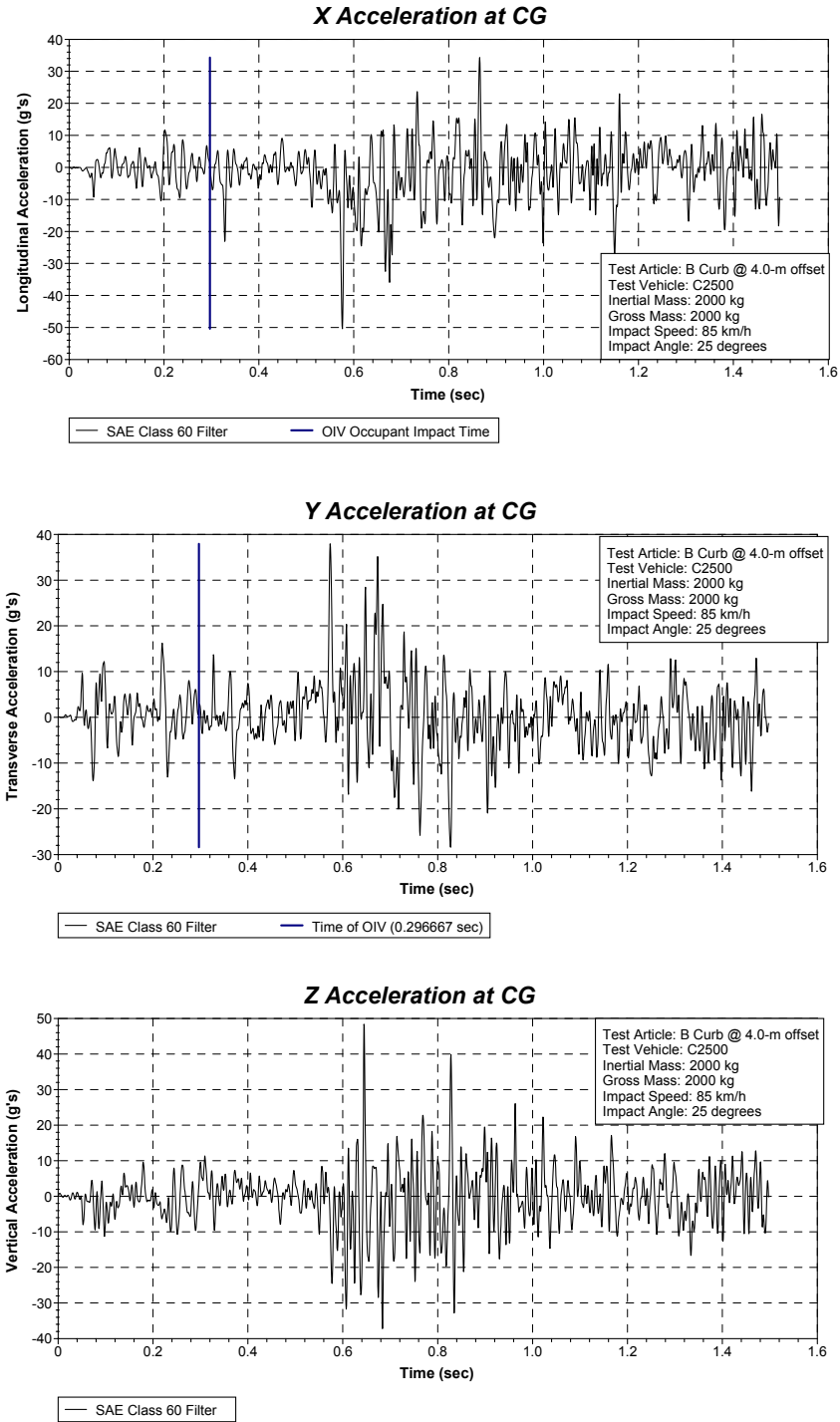

Figure I.24: Acceleration-time histories at C.G. of pickup truck in local coordinates:
Curb Type -- AASHTO B Curb
Impact Speed -- 85 km/hr
Offset Distance -- 4.0 m.

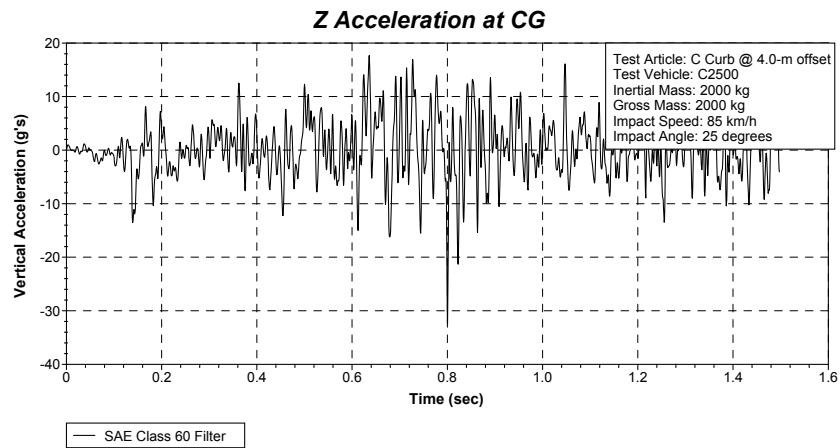
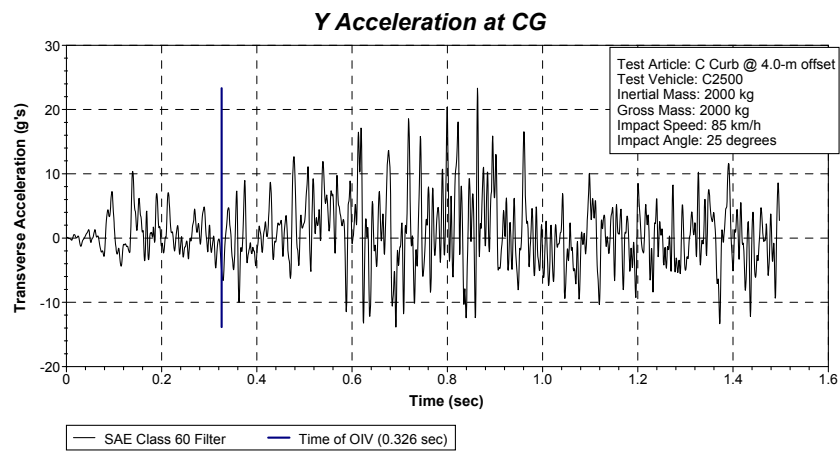
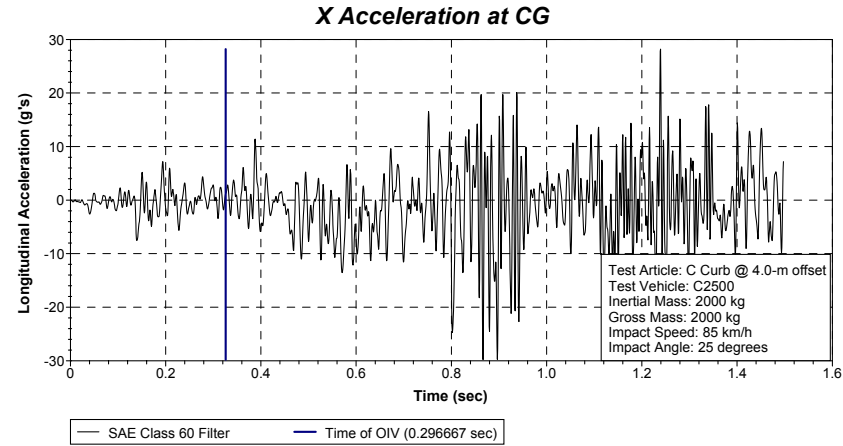

Figure I.25: Acceleration-time histories at C.G. of pickup truck in local coordinates:
Curb Type -- AASHTO C Curb
Impact Speed -- 85 km/hr
Offset Distance -- 4.0 m.

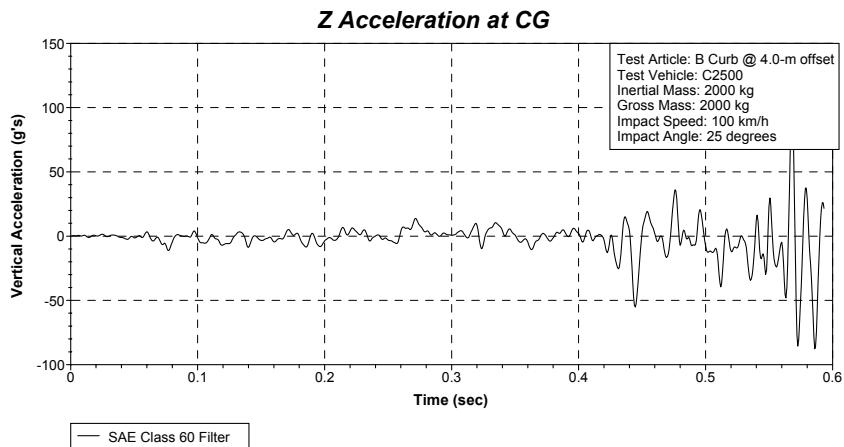
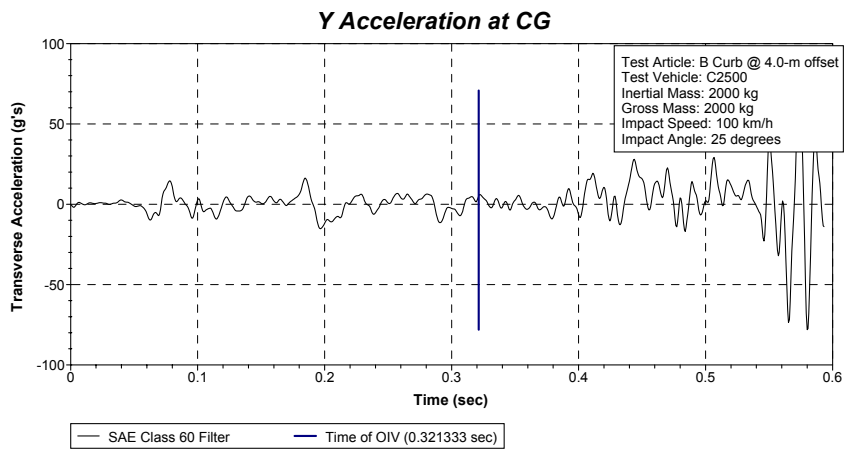
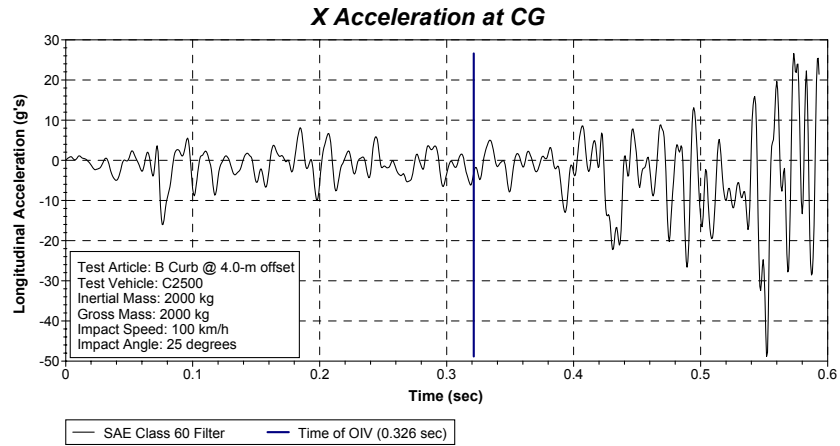

Figure I.26: Acceleration-time histories at C.G. of pickup truck in local coordinates:
Curb Type -- AASHTO B Curb
Impact Speed -- 100 km/hr
Offset Distance -- 4.0 m.

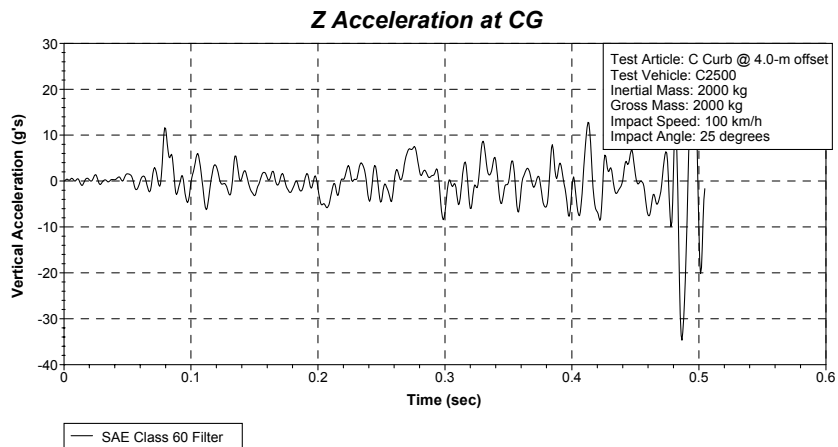
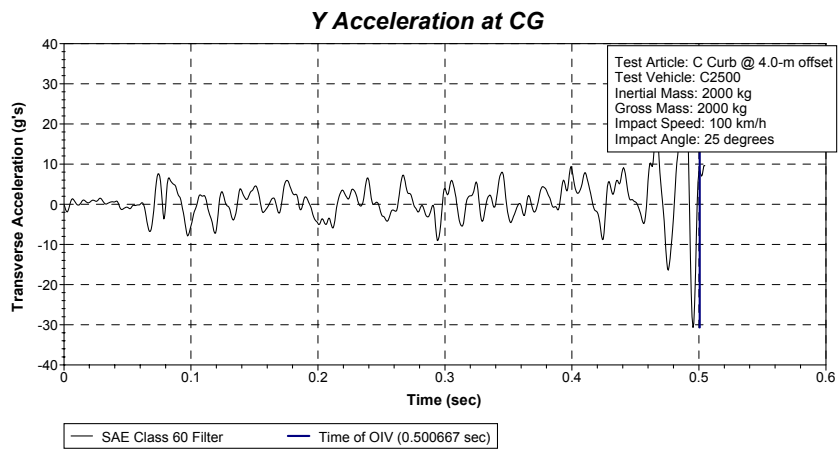
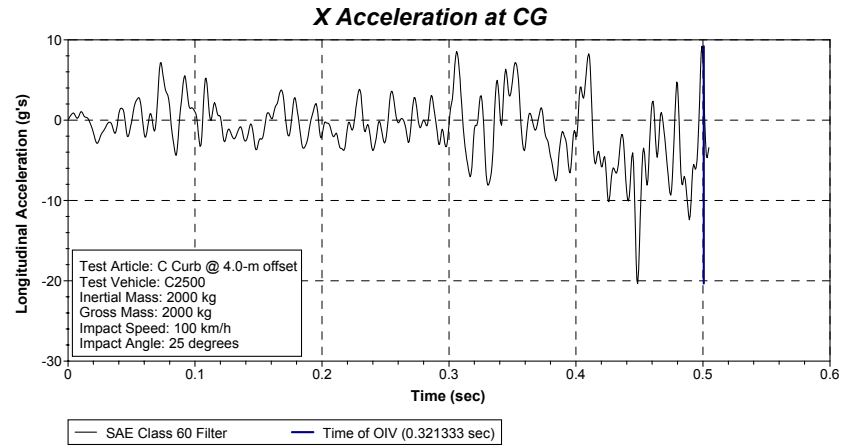

Figure I.27: Acceleration-time histories at C.G. of pickup truck in local coordinates:
Curb Type -- AASHTO C Curb
Impact Speed -- 100 km/hr
Offset Distance -- 4.0 m.

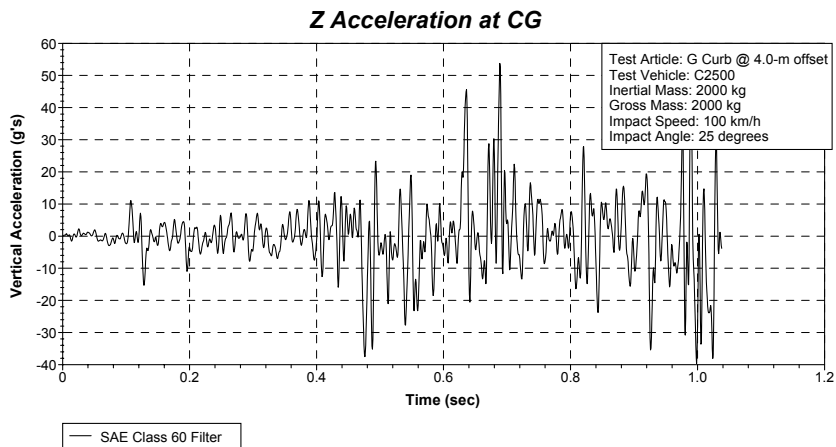
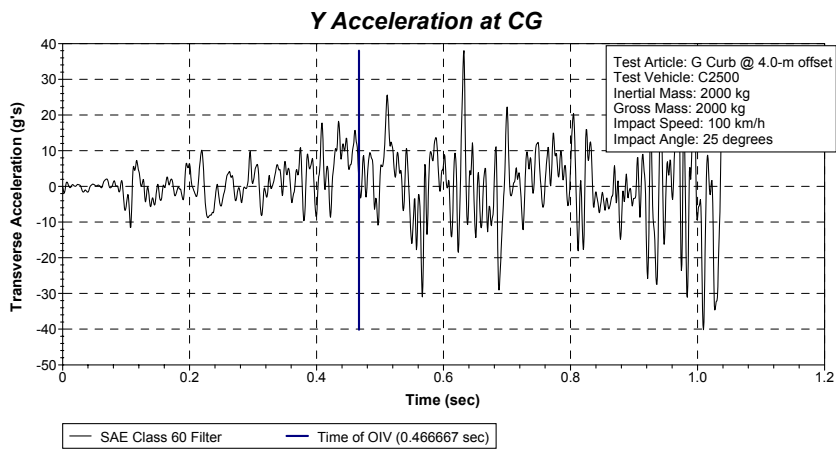
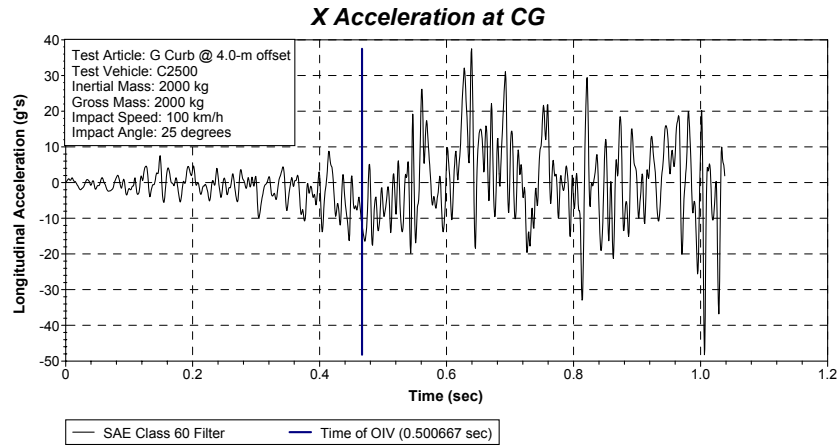

Figure I.28: Acceleration-time histories at C.G. of pickup truck in local coordinates:
Curb Type -- AASHTO G Curb
Impact Speed -- 100 km/hr
Offset Distance -- 4.0 m.

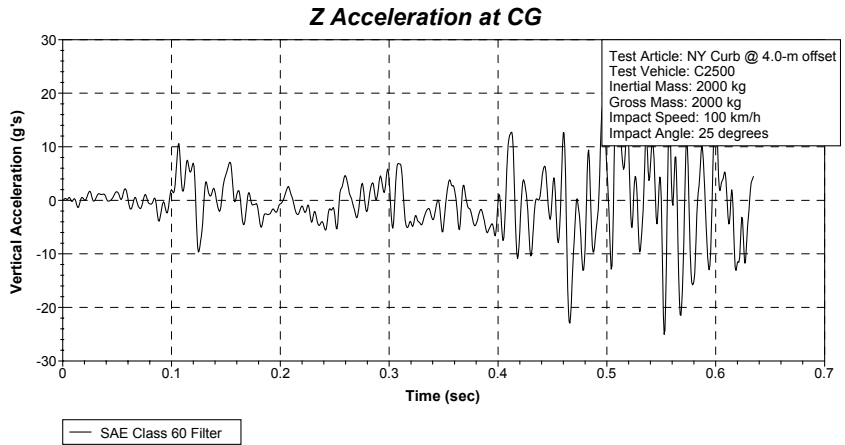
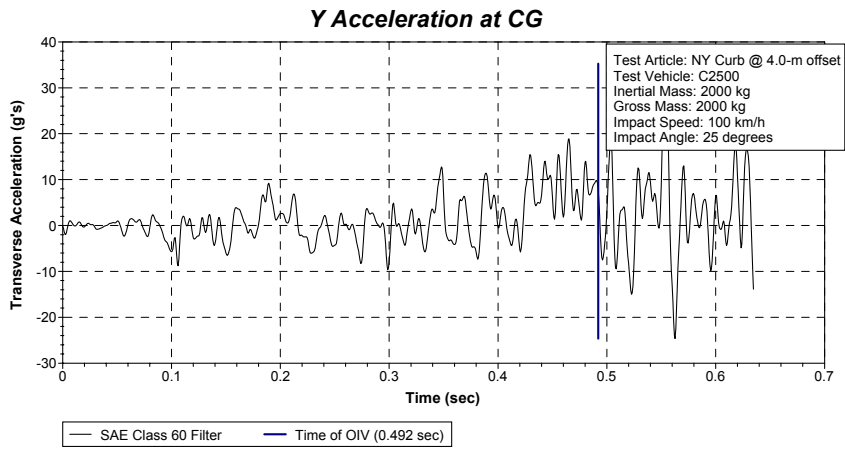
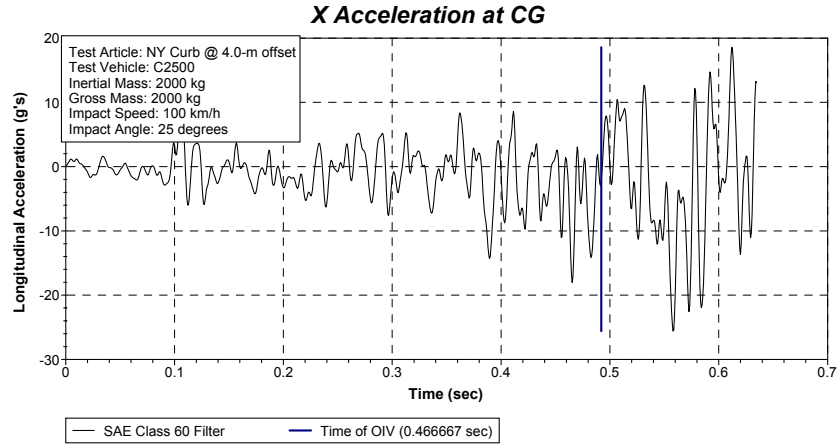

Figure I.29: Acceleration-time histories at C.G. of pickup truck in local coordinates:
Curb Type -- New York Curb (100 mm)
Impact Speed – 100 km/hr
Offset Distance – 4.0 m.