

April 2018

# DYNAMIC CORRECTION OF POSTURAL KYPHOSIS

Connor A. Mastropoll  
*Worcester Polytechnic Institute*

Kirsten M. Herchenroder  
*Worcester Polytechnic Institute*

Maria M Perez Luna  
*Worcester Polytechnic Institute*

Silvio Torres Betancur  
*Worcester Polytechnic Institute*

Follow this and additional works at: <https://digitalcommons.wpi.edu/mqp-all>

---

## Repository Citation

Mastropoll, C. A., Herchenroder, K. M., Luna, M. M., & Betancur, S. T. (2018). *DYNAMIC CORRECTION OF POSTURAL KYPHOSIS*. Retrieved from <https://digitalcommons.wpi.edu/mqp-all/1261>

This Unrestricted is brought to you for free and open access by the Major Qualifying Projects at Digital WPI. It has been accepted for inclusion in Major Qualifying Projects (All Years) by an authorized administrator of Digital WPI. For more information, please contact [digitalwpi@wpi.edu](mailto:digitalwpi@wpi.edu).

# DYNAMIC CORRECTION OF POSTURAL KYPHOSIS

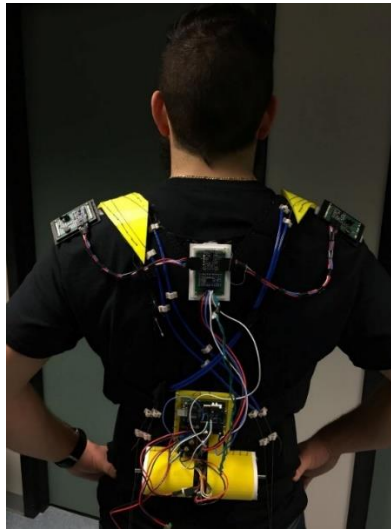

A Major Qualifying Project Report:

Submitted to the Faculty

Of the

WORCESTER POLYTECHNIC INSTITUTE

In partial fulfillment of the requirements for the Degree of Bachelor of Science by

Kirsten M. Herchenroder, Mechanical Engineering

Spenser J. Martin, Biomedical Engineering and Mechanical Engineering

Connor A. Mastropoll, Mechanical Engineering

Maria Manuela Perez Luna, Mechanical Engineering

Silvio Torres Betancur, Biomedical Engineering

Date: 04/26/2018

Prof. Gregory Fischer, Major Advisor

Prof Tiffany Butler, Co-Advisor

Prof. Loris Fichera, Co-Advisor

1. Assistive Device
2. Posture
3. Kyphosis

# Table of Contents

Table of Contents .....	ii
Authorship .....	iv
Acknowledgements.....	v
Abstract.....	vi
List of Figures .....	vii
List of Tables .....	viii
1.0 Introduction .....	1
2.0 Background .....	3
2.1 So, Why is Posture Important? .....	6
2.2 Postural Kyphosis .....	6
2.3 Ways to Correct Postural Kyphosis.....	11
2.4 Monitoring and Creating Movement.....	15
3.0 Project Strategy.....	19
3.1 Design Specifications .....	19
3.2 Initial Client Statement .....	20
3.3 Revised Client Statement.....	20
3.4 Project Approach .....	20
4.0 Design.....	26
4.1 Review of Existing Designs .....	26
4.2 Motion Analysis of the Shoulder Complex .....	28
4.3 Preliminary Designs.....	33
4.4 Modeling .....	36
5.0 Selection of Final Design .....	38
5.1 Decision Matrix Criteria .....	38
5.2 Results from Decision Matrices .....	40
5.3 Materials and Cost .....	40
5.4 CAD Models.....	41
5.5 Manufacturing Process .....	45
5.6 User Safety .....	53

5.7 Standards and Regulations .....	54
6.0 Design Validation .....	55
6.1 Survey.....	55
6.2 Video Analysis Software.....	55
6.3 Software Testing .....	55
7.0 Results and Analysis .....	57
7.1 Video Analysis Software.....	57
7.2 Feedback Survey .....	58
7.3 Final Design .....	59
8.0 Discussion.....	61
8.1 Device Analysis and Review .....	61
8.2 Overall Impact.....	62
9.0 Recommendations and Future Work.....	65
9.1 Long-Term Testing .....	65
9.2 Short-Term Testing .....	65
9.3 Different Size Options .....	65
9.4 User Experience .....	66
10.0 Bibliography .....	67
Appendix .....	72

# Authorship

## **Silvio Torres Betancur**

Worcester Polytechnic Institute  
B.S. Biomedical Engineering 2018

Contributions to report:

Abstract, Introduction, Background, Posture, Revised Client Statement, Project Approach, Study/ Experiments

## **Spenser Martin**

Worcester Polytechnic Institute  
B.S. Biomedical Engineering 2018  
B.S. Mechanical Engineering 2018

Contributions to report:

Abstract, Postural Kyphosis, Initial Client Statement, Revised Client Statement Project Approach, Testing Procedure, Design Validation, Recommendations

## **Kirsten Herchenroder**

Worcester Polytechnic Institute  
B.S. Mechanical Engineering 2018

Contributions to report:

Abstract, Introduction, Ways to Correct Postural Kyphosis, Project Approach, Review of Existing Designs, Modeling, Construction Shoulder Pads, Construction Vest.

## **Connor Mastropoli**

Worcester Polytechnic Institute  
B.S. Mechanical Engineering 2018

Contributions to report:

Ways to Correct Postural Kyphosis, Devices to Use, Project Approach, Feasibility of Designs, Materials and Cost, Coding, Assembly, Recommendations/Future Research

## **Maria Manuela Perez Luna**

Worcester Polytechnic Institute  
B.S. Mechanical Engineering 2018

Contributions to report:

Introduction, Postural Kyphosis, Objectives and Constraints, Preliminary Designs, Motion Analysis of the Shoulder Complex, Design Validation, Discussion User Guide, Recommendations/Future Research.

# Acknowledgements

We would like to thank our advisors Gregory Fischer, Tiffiny Butler, and Loris Fichera as well as Erica Stults and Chris Nycz for all your advisement, technical help, and guidance throughout this project. We would also like to thank the AIM labs, Higgins Shops, and Rapid Prototyping Labs Higgins for permission for the use of equipment, access to facilities.

# Abstract

*Many American adults in today's society spend extended periods of time hunched over a computer or phone. This hunched position weakens the upper posterior muscles that support the shoulder and neck prompting muscle imbalance. Specifically, the lower trapezius and clavicle flexor muscles become too weak while the pectoral and upper trapezius muscles become too tight leading to the condition known as postural kyphosis or, more commonly, rounded shoulders. Our project aimed to design, build, and test a device able to treat and correct postural kyphosis through sensorimotor training. A user guide for the device as well as a supplementary exercise list was produced for the benefit of the user. While the effectiveness of this device was determined through a biomechanic validation processes, we recommend further testing to gather the long-term effects of use.*

# List of Figures

Figure 1: Upper-crossed syndrome (Muscle Imbalance Syndrome, 2014) .....	6
Figure 2: Rounded shoulder acromion test (L. Hodgins et al., 2017) .....	7
Figure 3: Planes used to measure posture angles (Chansirinukor, et al., 2001) .....	8
Figure 4: Upright Sitting Posture (OSHA, n.d.).....	10
Figure 5: Standing Posture (OSHA, n.d.) .....	10
Figure 6: Declined Sitting Posture (OSHA, n.d.).....	10
Figure 7: Reclined Sitting Position (OSHA, n.d.).....	10
Figure 8: Inchworms (Inchworm Stretch, 2015) .....	13
Figure 9: Plank with elbow touch (Plank Exercises, n.d.) .....	13
Figure 10: Ergo Posture Transformer and Back Support (2017).....	14
Figure 11: IEEE posture device (Liao, 2016).....	14
Figure 12: Advancer Technologies EMG sensor .....	15
Figure 13: A hand holding a Flex Sensor.....	16
Figure 14: Design Requirements for a fully functioning device based on design specifications.....	19
Figure 15: ERGO Posture Corrector. (Ergo Posture Transformer and Back Support, 2017.).....	26
Figure 16: Adjustable Posture Corrector Back Support Shoulder Brace Belt .....	27
Figure 17: Anterior and Anterolateral View of the shoulder complex (Woodward, 2000) .....	29
Figure 18: The six lower pair joints (Norton, 2012) .....	30
Figure 19: Kinematic diagram of the shoulder complex.....	31
Figure 20: The extrinsic muscles of the shoulder (The Intrinsic Muscles of the Shoulder, 2017).....	32
Figure 21: The deltoid and teres major (The Intrinsic Muscles of the Shoulder, 2017).....	32
Figure 22: The rotator cuff muscles (The Intrinsic Muscles of the Shoulder, 2017) .....	33
Figure 23: Isometric shoulder muscle forces (Kato, 2015).....	33
Figure 24: Preliminary shoulder pad and motor design .....	34
Figure 25: Preliminary vest with McKibben actuator design.....	34
Figure 26: Preliminary full vest with straps and motor design.....	35
Figure 27: Preliminary Backpack Straps with Motor Design.....	36
Figure 28: Preliminary Fluid Filled Bags Design .....	36
Figure 29: Skanect model of test subject's upper torso .....	42



Figure 30: Creo models of second iteration of shoulder pads .....	42
Figure 31: CAD motor casing and Arduino housing .....	43
Figure 32: CAD motor casing holder .....	43
Figure 33: Kevlar cord .....	43
Figure 34: First spool iteration .....	44
Figure 35: Second spool iteration .....	44
Figure 36: Cord catching component.....	44
Figure 37: Cord guides .....	44
Figure 38: First iteration of shoulder pads with template for hole drilling .....	45
Figure 39: First iteration of shoulder pads after initial modifications.....	45
Figure 40: Second iteration of shoulder pads.....	45
Figure 41: Adafruit IMU (Adafruit Industries, n.d.) .....	46
Figure 42: Initial IMU circuit for testing.....	47
Figure 43: Protoboard containing IMU and vibration motor circuits.....	47
Figure 44: The L298N Dual H bridge DC motor driver for Arduino.....	48
Figure 45: In depth system logic .....	50
Figure 46: Simplified system logic for shoulder position tracking and device actuation .....	51
Figure 47: IMU circuit.....	51
Figure 49: Device’s circuit components.....	52
Figure 49: Vibration Motors Circuit .....	52
Figure 50: Left shoulder pulled back without assistance .....	58
Figure 51: Left shoulder pulled back with assistance .....	58
Figure 52: Right shoulder pulled back without assistance .....	58
Figure 53: Right shoulder pulled back with assistance.....	58
Figure 54: Test Subject wearing device version one .....	59
Figure A1: Side view of the shoulder force test.....	73
Figure A2: Front view of the shoulder force test.....	73

## List of Tables

Table 1: Overall Schedule by half-quarter .....	20
Table 2: Detailed Schedule for A-Term.....	21

Table 3: Detailed Schedule for B-Term .....	21
Table 4: Detailed Schedule for C-Term .....	22
Table 5: Detailed Schedule for D-Term.....	22
Table 6: Goals for A-term.....	24
Table 7: Goals for B-term.....	24
Table 8: Goals for C-term.....	24
Table 9: Goals for D-term.....	25
Table 10: Design idea evaluation decision matrix .....	38
Table 11: Passive vs. active decision matrix .....	39
Table 12: Completed design idea evaluation decision matrix.....	40
Table 13: Materials and cost distribution .....	40
Table 14: Bill of materials .....	60
Table A1: Results from the initial shoulder force pull test separated by teammate .....	73
Table A2: Results from the shoulder pull back test while wearing the vest .....	74

## 1.0 Introduction

Throughout history, human posture has been an important social and physical concern. The way people hold themselves throughout the day has historically affected the way they are treated by each other. Posture requires a conscious effort to maintain because slouching and repetitive movement, especially in the wrong manner, can cause it to deteriorate. Slouching has become normalized due to lack of appropriate ergonomic design and the repetitive activity of overhead movements in activities or daily living and commonly practiced sports.

As technology becomes more prevalent in society, sitting at a computer desk to complete daily tasks has become a typical. While employers are seeing increases in productivity due to tech advancements, employees are experiencing side effects from sitting at desks nearly all day. The side effect that this project is focusing on is called postural kyphosis. This condition can cause pain in the shoulders and neck, but the largest issue is its undesired aesthetic. One of its causes is sitting at a computer desk with rounded shoulders for an extended period, which is typically the posture seen in employees who sit at a desk in front of a computer nearly the entire working day. Although workspaces are required to implement ergonomic workspace environments, it is impossible to monitor each employee's posture to make sure they don't develop any musculoskeletal disorders like postural kyphosis.

Outside of the office, there are many physical activities that can cause postural kyphosis including driving, watching TV, reading, biking, using a computer or laptop, wearing a backpack, sitting at desk, etc. (Huizen, 2017). Furthermore, any form of repetitive overhead arm movement can cause a person's shoulders to curve inwards over time. Such activities include playing tennis, swimming, baseball, softball, and football. The repetitive motions associated with these sports, and many others, induce a muscle imbalance called upper-crossed syndrome. This is a condition where the chest and upper back muscles have an imbalanced strength distribution that causes a person's shoulders to curve inwards towards their chest. Sports are not the only way to develop these muscle imbalances, any sort of exercise or strength training done without proper posture or without appropriate post activity stretching can cause this muscle imbalance issue.

The treatment for postural kyphosis has been widely developed because of its prominence; currently, there are different strategies to correct and treat rounded shoulders. The most common approach is physical therapy. A physical therapist addresses the muscle strength imbalances between shoulder muscles and upper back muscles while teaching the patient corrective exercises for optimal movement and strengthening of these muscles. Another method is sensorimotor training which was specifically developed to treat musculoskeletal syndromes. The main concepts for this type of training are postural control and proprioceptive exercises that guide the body through the restoration of its normal motor programs. Examples of these exercises, like the doorway pec stretch and scapular retraction, can be found in appendix E. Aside from sensorimotor training, some studies have shown that performing various exercises that target posture correction without external help can have positive effects. Additionally, there are various products that use technology to correct shoulder and upper back posture. These focus on specific areas of posture to treat. Although there is a wide variety of treatments, it seems like the use of just one of these approaches is not sufficient to effectively correct postural kyphosis.

The goal of this project was to develop a device that can help desk workers, or anyone who has developed postural kyphosis through repetitive overhead activity, treat their postural kyphosis. This device should be able to be worn by the user in place of physical therapy without any external assistance. There are many different activities that can cause postural kyphosis which makes it likely to redevelop. Because postural kyphosis has many mechanisms for incorrect postural onset, fixing postural kyphosis permanently was established to be outside of this project's scope. The most effective treatment was determined to be the use of a device that simultaneously assists in the correction of postural kyphosis and teaches the user the methods to do so. The final device incorporates sensors to track the user's posture, give feedback to allow the user to correct their posture, and utilizes an actuating mechanism that guides the user into the correct posture.

## 2.0 Background

Posture is the position in which someone holds themselves while sitting or standing. In research done by Peter Stearns and David Yosifon it was found that, in the mid-1700s, posture was considered a physical representation of your class (1998). Proper posture was a sign of good character, proper hygiene, and sexual restraint. Posture itself determined the quality of person one was. Without adequate research, doctors attributed many causes for why someone did not have proper posture. Bad posture was correlated with not being a White European, as it was believed only they were born with straight backs. Other causes ranged from writing too many letters, masturbation, and for women, not exercising enough at an early age.

Lord Chesterfield, a well-known writer at the time, published a book on the code of posture. Since the lower classes could not afford this book, nor had the capability of reading the material, they were not aware of the 'importance' of proper posture. The lower class also completed the most manual labor, worsening their rounded shoulders and further dividing classes as the physical differences became very clear. Correct posture became proper etiquette amongst the middle and upper class. Men wore tight vests and women were expected to wear corsets. Women were held at higher standards as it was seen to have a direct correlation with beauty. (Stearns et al., 1998)

The role of proper posture in society continued well into the 1800s. The dancing style, Waltz, grew in popularity for its emphasis on smooth movements while keeping oneself upright. Chairs for the home were designed to be rigid and most were made without back support to keep one constantly aware of their posture. Schools also implemented backless chairs, or stools, as a way to enforce at an early age. Rocking chairs existed but were heavily frowned upon as a sign of laziness and it was only acceptable for the elderly. (Stearns et al., 1998)

On the turn of the century, furniture began changing the standards of living. Seats and couches with springs, cushions, and backs became more popular among designers. However, using comfortable furniture was still frowned upon. Furniture continued to emphasize comfort rather than one's posture. Sitting pieces allowed turning, twisting, and back support. The early 1900's is known as the "comfort movement" as it made strides against what was considered "old-fashioned pomposity" (Stearns et al., 1998). Around 1910, the concept of living rooms became common in the United States. In 1928, reclining chairs came to be. At the start of World War I, radios were crucial for families in hopes of hearing good news. This created a push towards comfortable seating as radios were placed in living

rooms and news often took long periods. Awareness of war took priority over the need for proper posture, pushing the need for comfort instead. (Stearns et al., 1998)

The new commitment to comfort over the need for proper posture also came with a change in attitude. Dances such as the Shimmy, Swing Dance, the Charleston, and the Jitterbug immensely pushed the limits of the previous rigid, straight-posture movements into more relaxed and smooth movements. The younger generations began defying the older generations through posture. Vaudeville shows, or small unrelated skits put together, also became very popular for the middle and upper-class citizens. The lower class mostly ran these shows, many of whom suffered from hunched backs. As these shows cultivated more and more reputation, the sight of seeing others with deformed backs became more common. This in turn lessened the gap of classes split by old views on posture. (Stearns et al., 1998)

In the 1920s, etiquette manuals were released to try to persuade people back towards proper posture. Although, by the 1950s, sitting erect was no longer expected. Social views were changing and advancing as well as science and the study of how posture affects our lives. Doctors began “Posture Wars”. The middle and lower class were blamed for spinal deformity. A very aggressive front on posture began as scientific publications showed healthy kids playing outside continued by images of badly deformed kids suffering inside, all in attempt to shock people into taking posture seriously. Studies were heavily pushed to try to prove that bad posture was a real problem. German publications at the time cited that over half of all children, and most of young girls, suffered from some kind of posture deformity. (Stearns et al., 1998)

In the second half of the century, doctors continued their effort to better posture by starting at a young age. This led to mandatory physical education throughout school as it was believed that exercise was an effective method against spinal deformity (Stearns et al., 1998). These physical education programs were initiated at prestigious institutions such as Harvard and Simmons College. Professionals at these universities focused on physical training specifically for women. Nationally, the focus on posture shifted to early prevention. Schools, that were once given the guilt for providing an environment detrimental to posture, were selected as the key place to help prevent those very problems. (Stearns et al., 1998)

As the studies progressed, an evident difference between students’ postures during school and during summer vacation further encouraged schools to continue their physical education programs.

Posture once more emerged as a major concern and, with support from institutions, new tests were created. Students were graded based on posture. Competition were encouraged as students gave more effort to come on top in comparison to their classmates. (Stearns et al., 1998)

Posture experts emphasized the necessity of their procedures. This included but was not limited to having students in bathing suits or nude during examinations. Schools recorded nude pictures of students their first and last year to verify progress. Data was freely shared across countless universities to compare results. If a student was seen to have inadequate posture, they would be rejected. Special exercise programs to aid posture became a requirement for first year students at elite universities, especially for women, who were thought to constantly be at a disadvantage. (Stearns et al., 1998)

More serious studies containing factual information on posture and behavioral tendencies began to break down the newly obsolete ways of judging posture itself. From the 1940s to the 1960s, most Victorian views of class distinction, especially connotation to one's character and physical ability, came to an end. Physical education programs all but ceased to exist and became more of an optional recreational activity. Proper posture became something everyone agreed was to be looked out for, but not something required. Standards for posture were too vague as no individual was seen to have the same. (Stearns et al., 1998)

With the societal value of posture gone, experts and doctors dove into medical research. It wasn't until the 1960s that most symptoms and diseases earlier believed to be caused by posture disappeared. The end of the posture era was most significantly displayed as mattress companies began produced new, extra-comfort, orthopedic models. The goal of this new movement was to place the blame for poor posture on the time spent sleeping on a bad mattress. The use of a better, back sustaining bed conjured the thought that it was now up to sleep to help sustain proper posture instead of through each individual's efforts elsewhere. It was the acceptance of this new movement that truly ended national posture sentiments. (Stearns et al., 1998)

Following the 1960s position on posture, schools were no longer considered a major factor. The baby boomers being born into a more easygoing generation of parents aided in concreting this view on posture. Ultimately, doctors and researchers purposely avoided blaming bad posture on their patients as they came in for checkups, as there was a national bitterness towards the previous false accusations against it. The loss of interest in proper posture as a concern, alongside the new generations that

viewed education, physical fitness, character, and sexual standards that all promoted a relaxed poise, ended the era of what posture once stood for. (Stearns et al., 1998)

## 2.1 So, Why is Posture Important?

Posture has been shown to have several effects on body's ability to function at its maximum potential, especially pertaining to oxygen flow. A study examining the position change from standing to laying proved that there was a twenty-five percent less cardiac output throughout the body when laying down (McMichael et al., 1944). Another study focused on the pressure of the pulmonary capillary depending on head tilt; a forward head tilt was heavily cautioned as it elevated levels of pulmonary capillary pressure. This leads to hazardous levels of heart complications (Odeberg et al., 1994). Several other studies have shown concern for the strain on the neck and back muscles produced from bad posture practices while sitting at a desk for more than two hours, which for many of us, is a very realistic world (Blake et al. 2004).

## 2.2 Postural Kyphosis

Kyphosis describes a curve in the spine, primarily in the thoracic spine or upper part of the back, of more than forty degrees. There are three distinct forms of kyphosis. The first being congenital kyphosis, which is a condition people are born with and can only be corrected through surgery. The second is Scheuermann's kyphosis, noticed during adolescence. It is the result of structural deformity in the vertebrae that occurs overtime. This type requires x-rays and, in the worst cases, surgery. The third and most common type is postural kyphosis, it is caused and can be corrected through changes in posture.

Recently, as people are becoming more sedentary, changes in diet, weight, and even posture have occurred. Most people spend the majority of their day sitting down and a lot of that time is spent looking at computer or phone screen. In doing so, overall posture changes. Shoulders move inward to support arms holding phones and hands at keyboards while necks move forward for a better view of the screens. This is especially an issue with adolescents (Straker et al., 2007). Over time, these shoulder

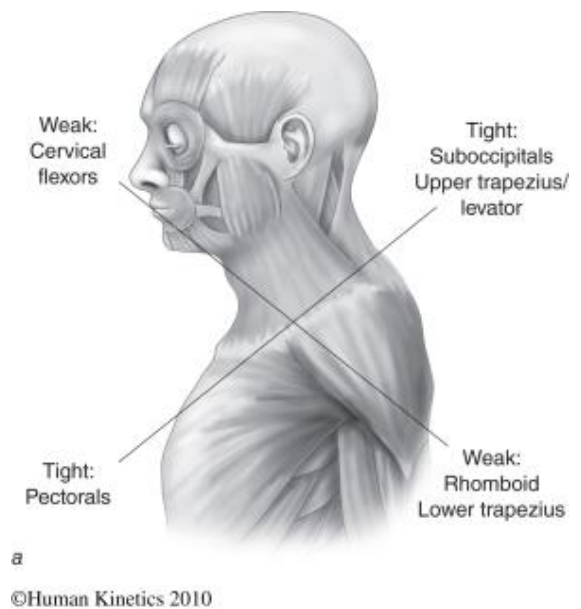

Figure 1: Upper-crossed syndrome (Muscle Imbalance Syndrome, 2014)



and neck muscles become accustomed to this forward-leaning posture, causing it to be a constant state of being.

Upper-crossed syndrome refers to the crossing pattern of certain muscles in the upper body. This crossing pattern is a combination of overactive muscles and underactive muscles. Imagine a side view of a person with an 'X' drawn with the center at the shoulders, as shown in figure 1. The first line of this theoretical cross starts at the upper trapezius muscles and goes across to the pectoral muscles. The other line starts at the cervical flexors and goes to the rhomboid and lower trapezius muscles.

The pectoral muscles and the upper trapezius muscles are tight and short, both on the same line. The second line contains the longer and weaker muscles: the lower trapezius and the cervical flexors. This muscle imbalance is the true cause of postural kyphosis and a forward tilting neck.



*Figure 2: Rounded shoulder acromion test (L. Hodgins et al., 2017)*

### ***2.2.1 Technical Identification of Postural Kyphosis***

A recent study outlined a test to check for rounded shoulders in a participant. The participant lays down, face up with the shoulders and arms at rest in a neutral relaxed position by their side. Next, the distance from the posterior side of the acromion, which is a bony part of the scapula that extends laterally over the shoulder joint, to the table is measured, as shown in figure 2. If the measurement is greater than two and half centimeters, the participant is considered to have postural kyphosis (Coleman et al., 2010).

### ***2.2.2 What Leads to Postural Kyphosis?***

Postural kyphosis is caused by the overexertion of the upper trapezius, levator scapulae, sternocleidomastoid, and pectoralis muscles paired with the underdevelopment of the deep cervical flexors, lower trapezius, and serratus anterior muscles (Muscle Imbalance Syndrome, 2014). The most common cause is poor posture, specifically poor posture for long periods of time. In most cases it stems from sitting or standing with the head forward. This posture comes from various common activities including driving, watching TV, reading, biking, using a computer or laptop, wearing a backpack, sitting at desk, etc. (Huizen, 2017). Upper-crossed syndrome can also be developed through athletics. Athletes that are most likely to develop rounded shoulders are those who play sports that

require more pushing movements compared to pulling movements or sports that require a wide overhead swinging motion such as swimming, volleyball, and baseball, where pitchers are most at risk. The next most common cause can be the result of a past injury of the upper body like a fracture or broken clavicle, shoulder displacement, pectoral tear, and other injuries. This cause is less common and usually caused by improper healing after the injury takes place (Back & Body Medical, n.d.).

### 2.2.3 Who Is Affected by Postural Kyphosis?

Continuous muscle strain can go unnoticed since it occurs while performing other activities such as carrying loads, computer use, driving, and sports. To understand who develops postural kyphosis, one must examine the activities these individuals perform and how it can induce musculoskeletal disorders, affect posture, and eventually lead to postural kyphosis. The three main populations affected by postural kyphosis are as follows:

#### 2.2.3.1 Students

The use of backpacks to carry books in schools has been tested several times to ensure that there are no repercussions in the body due to its load and positioning. However, backpacks have been designed for adults, specifically to distribute the load throughout their spines without causing any strain. It is important to consider that children's spines are significantly different than adult spines. Constant loads on children's shoulders will cause a strain in their muscles.

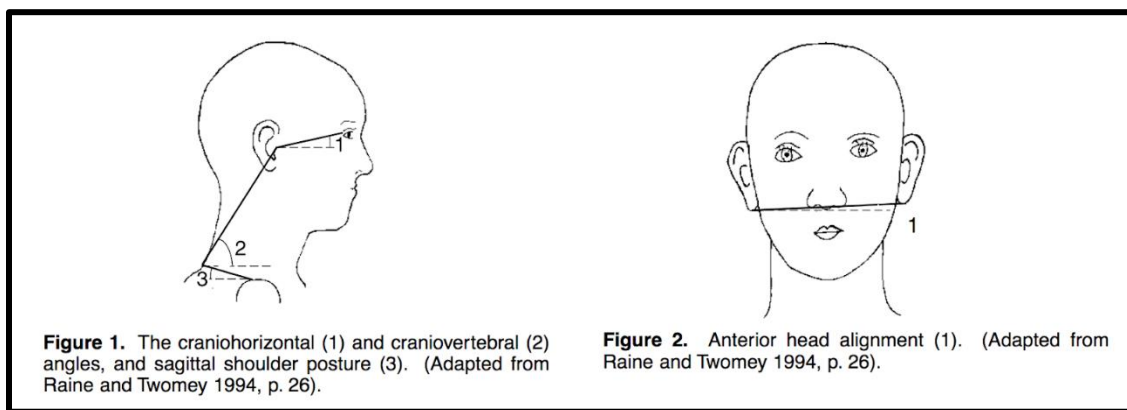

Figure 3: Planes used to measure posture angles (Chansirinukor, et al., 2001)

Various studies have explored the effects of loads on the spine and concluded that the use of backpacks have a negative impact on human posture. A study that was conducted by a group of Australian physiotherapist and orthopedics experts tested how the use of backpacks in different positions with different loads affect cervical and shoulder posture of high school students

(Chansirinukor, Wilson, Grimmer & Dansie, 2001). They observed physical changes by testing different configurations considering the load carried, static and dynamic conditions while carrying the load (i.e. walking or standing), and the subject descriptions prior to the experiment. The results were tracked using cameras; the students had their shoulders exposed and ten different shots were taken at each configuration. This experiment utilized a maximum weight of fifteen percent of each subject's body weight, contrary to the previous maximum between twenty and forty percent. The overall results showed that carrying a smaller backpack load on both shoulders has the most minimal effect on posture. Nevertheless, this load still lowers the craniovertebral angle, shown in figure 3. This is the angle formed by a horizontal line drawn through the spinous process of the seventh cervical (C7) vertebra and the tragus of the ear. The decrease of this angle creates a greater distance between the back and the head, leading to forward head posture. The study concluded that it is important to distribute a maximum load of fifteen percent body weight uniformly along the spine to improve effects of current backpack use although, this will not eliminate posture defects.

#### 2.2.3.2 Office Workers

The Occupational Health and Safety Administration (OSHA) is a national organization that is meant to provide a healthy and safe work environment by enforcing standards to reduce potential hazards in US businesses. One of the areas they focus on is ergonomic hazards. OSHA defines ergonomics as “the design of a job to fit a worker in order to ensure the task is fit for the user and therefore reduce musculoskeletal disorders” (Occupational Safety and Health Administration, 2017). OSHA encourages companies to raise employee awareness of ergonomics and warn them about activities that can cause stress in the muscles such as repetitive motions, load bearing, and sitting while working on a computer all day. Some recommendations by OSHA to create a safe office workspace are to place the top of the computer monitor just below eye level and to use chairs or other practices that ensure the head and neck are in line with the torso with the feet placed flat on the floor. Failing to provide any of these characteristics leads to forward head positioning, neck pain, and strain in muscles due to the lack of lumbar and back support. Figures 4 through 7 are parts of an OSHA diagram providing different strategies for a good office posture (Occupational Safety and Health Administration, 2017).

**Upright Sitting**

*Upright sitting posture.* The user's torso and neck are approximately vertical and in-line, the thighs are approximately horizontal, and the lower legs are vertical.



Figure 1. Upright sitting posture



Figure 2. The user's torso and neck are approximately vertical and in-line, the thighs are approximately horizontal, and the lower legs are vertical.

Figure 4: Upright Sitting Posture (OSHA, n.d.).

**Standing**

*Standing posture.* The user's legs, torso, neck, and head are approximately in-line and vertical. The user may also elevate one foot on a rest while in this posture.

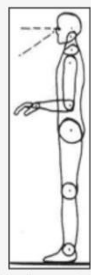

Figure 3. Standing posture



Figure 4. The user's legs, torso, neck, and head are approximately in-line and vertical.

Figure 5: Standing Posture (OSHA, n.d.).

**Declined Sitting**

*Declined sitting posture.* The user's thighs are inclined with the buttocks higher than the knee and the angle between the thighs and the torso is greater than 90 degrees. The torso is vertical or slightly reclined and the legs are vertical.



Figure 5. Declined sitting position



Figure 6. The user's thighs are inclined with the buttocks higher than the knee and the angle between the thighs and the torso is greater than 90 degrees. The torso is vertical or slightly reclined and the legs are vertical.

Figure 6: Declined Sitting Posture (OSHA, n.d.).

**Reclined Sitting**

*Reclined sitting posture.* The user's torso and neck are straight and recline between 105 and 120 degrees from the thighs.



Figure 7. Reclined sitting posture



Figure 8. The user's torso and neck are straight and recline between 105 and 120 degrees from the thighs.

Figure 7: Reclined Sitting Position (OSHA, n.d.).

Although OSHA has some recommendations for better posture ergonomics, it is important to understand that the constant static position induced by sitting in a desk for long periods of time has negative effects on shoulder and spinal posture. A normal office work schedule from nine in the morning to five at night has an average of six hours in front of a computer. This prolonged position combined with work related stress creates a strain on the shoulder muscles, pressure on the spine, and leads to forward head posture.

2.2.3.3 Athletes

Due to the repetitive nature of overhead sports, athletes that often perform this kind of movement are prone to develop muscular imbalances. Overhead sports are those which involve the upper arm and shoulder arching over the athlete's head, like to propel a ball, launch an implement, or

otherwise exert a force with the arms in such a position. Baseball, cricket, handball, javelin throwing, tennis, volleyball, and swimming are some of the most common overhead sports.

One of the best examples of an overhead sport is competitive swimming; it is estimated that the average swimmer swims 1,200 meters per day which is roughly equivalent to 16,000 shoulder rotations (Lynch, 2010). Varsity swimmers are also common victims of shoulder pain known as 'swimmer's shoulder'. This term can include rotator cuff tendonitis, shoulder instability, and shoulder impingement (Lynch, 2010). Rotator cuff tendonitis is inflammation of the tendons located by the rotator cuff due to repetitive motions. Primary shoulder impingement is the obstruction of the rotator cuff tendons and secondary impingement leads to instability and excessive movement of the shoulders due to disruption of ligaments that are static stabilizers. An article in the *Journal of Orthopaedic & Sports Physical Therapy* studies the effect of freestyle varsity swimming on athlete's shoulders (Allegrucci, Whitney, & Irrgang, 1994). From this article, one can conclude that athletes need to focus on strengthening their muscles. The mechanics of the swimming stroke place the shoulder in compromising positions. During mid pull-through, the shoulder is at risk for impingement. During late recovery, the issue of vascular impediment occurs. Additionally, during recovery, mechanical or secondary impingement can occur. Rehabilitation of the swimmer's shoulder must promote equilibrium of the shoulder complex while accounting for the demands of the sport.

Another study published in the *British Journal of Sports Medicine* included varsity swimmers that were subjected to exercise intervention to correct and treat forward head position and rounded shoulders. They would follow their normal athletic routine and follow a routine of exercises intended to strengthen their shoulders. Their Posture, strength, shoulder pain, and shoulder function were monitored throughout this time. Information was collected from the forward head angle, forward head translation, and total scapular distance to estimate posture change before and after the study. After eight weeks, subjects showed positive results which indicated that strengthening of the scapular stabilizers and stretching of the pectoralis minor is the correct treatment for rounded shoulders among varsity swimmers.

### **2.3 Ways to Correct Postural Kyphosis**

Three methods of correcting postural kyphosis include physical therapy, personal exercises, and wearable devices. Therapy for postural kyphosis focuses on the muscle strength imbalances between these muscles. In order to treat patients with Postural Kyphosis, overactive muscles must be loosened

first before focusing on strengthening the weaker muscles (American Physical Therapy Association, n.d.). This strengthening can also be completed alone at a gym or with personal equipment so long as correct technique is implemented. Finally, the imbalance can be corrected by wearing a device that adjusts and holds the shoulders in proper posture, allowing the stretched muscles to relax and the weaker muscles to tighten into place.

### ***2.3.1 Physical Therapy***

Physical Therapy is the treatment of a patient's injury or deformity through physical exercises that reduce or eliminate the need for surgery or medication. Physical therapy aims to either reduce pain levels in patients or improve the present mobility of the patient's injury or deformity. Patients can go see licensed physical therapists who will guide them through the exercises and even give them exercise plans to do on their own time (American Physical Therapy Association, n.d.). The two main methods of physical therapy implemented are postural training and sensorimotor training.

#### ***2.3.1.1 Postural Training***

Postural training, or functional training, focuses on creating optimal body positioning through a variety of means. Some of these means include strengthening and stabilization of the muscles, manual therapy, and modalities. Strengthening certain muscle groups around a joint can aid in stabilizing the joint. It can also recover the joint's full range of motion. Manual therapy focuses on passive movements of joints and soft tissues by using techniques like massaging, myofascial release, mobilization, and passive range of motion facilitated by either a physical therapist or a trained masseuse (Page, 2006). Modalities are physical treatments of disorders, like surgery or electrography which electrically stimulates the muscle to flex (Silva et al., 2015).

#### ***2.3.1.2 Sensorimotor Training***

Developed by Dr. Vladimir Janda, sensorimotor training is a treatment approach to musculoskeletal syndromes in which the goal is to restore normal muscle firing patterns and stabilization through proprioceptive exercises. Proprioceptive exercises are balancing exercises that focus on teaching the body position-control of an injured joint. These exercises utilize exercise tools such as balance boards, foam pads, and elastic bands (Page, 2006). The first stage of this process is called "voluntary control of movement" where the patient has to be aware of their movements while concentrating on correct motion. This requires feedback to the patient on whether or not they are

performing the movements correctly. This rehabilitation idea is basically a “muscle memory” type of program (Gi et al., 2013).

### 2.3.2 Personal Exercises

Instead of relying on a physical therapist to correct muscle imbalances that lead to postural kyphosis, some people choose to do exercises and stretches on their own. A study in the Journal of Strength & Conditioning Research from February 2010 concluded that lengthening muscles in the chest, shoulder, and upper back areas are directly correlated to scapular position. Winged scapula, a condition where the scapulae are noticeably sticking out of the back, are an extreme side effect of rounded shoulders. One of the easiest ways to lengthen muscles is to exercise and stretch them. Another study from the Journal of Physical Therapy Science had students perform exercises and stretches specifically aimed at correcting posture and report on their pain levels before and after the exercise program (DeokJu et al., 2015). This study concluded that pain levels after the program were lower than before the program, especially in the shoulders, middle back, and lower back.

Rounded shoulders have become so prominent that Men’s Health posted an article that provides readers with exercises and stretches that specifically strengthen and lengthen the appropriate muscles associated with rounded shoulders (Federowicz, 2011). Some of their exercises and stretches are inchworms, planks with elbow touches, and fire hydrants.



Figure 8: Inchworms (Inchworm Stretch, 2015)



Figure 9: Plank with elbow touch (Plank Exercises, n.d.)

### 2.3.3 Wearable Devices

Since rounded shoulders have become more prevalent in society, people have found a need to correct this issue by means other than therapy, exercise, or stretching. Devices have been created that aim to correct shoulder and upper back posture, alleviate its symptoms, or even both. One example of such a device is a Korean patent that intends to correct the shoulder, back, and waist posture of teens

and children (Ji Hyun, 2013). It is completely mechanical; it utilizes belts and rigid bars to align and support these areas. Another completely mechanical device is the Ergo Posture, a crowdfunded project that pulls its user’s shoulders back with cords attached to a box resting in the middle of the user’s



Figure 10: Ergo Posture Transformer and Back Support (2017)

shoulder blades (Ergo Posture Transformer and Back Support, 2017). The Ergo Posture Transformer is said to correct posture, provide back support, relieve neck, back, and shoulder strain, and build muscles in these areas by having its users wear the product for at least an hour a day. This device also acts as an exercise device because the cords that hold the shoulders back are flexible.

Completely mechanical devices are not the only upper body, wearable, posture correcting devices out on the market or being tested. There is a device that was in the 2016 Institute of Electrical and Electronics Engineers (IEEE) First International Conference in Washington, DC that was made to correct head and neck posture with “real-time head-and-neck posture monitoring and biofeedback mechanisms” (Liao, 2016). This device collects angle data from an accelerometer and microcontroller that is sent to a cloud for further analysis. When the user’s posture is poor, the device sends back an audible or visible notification to remind the user to return to correct posture. A visual breakdown of how this product functions is shown below in figure 11.

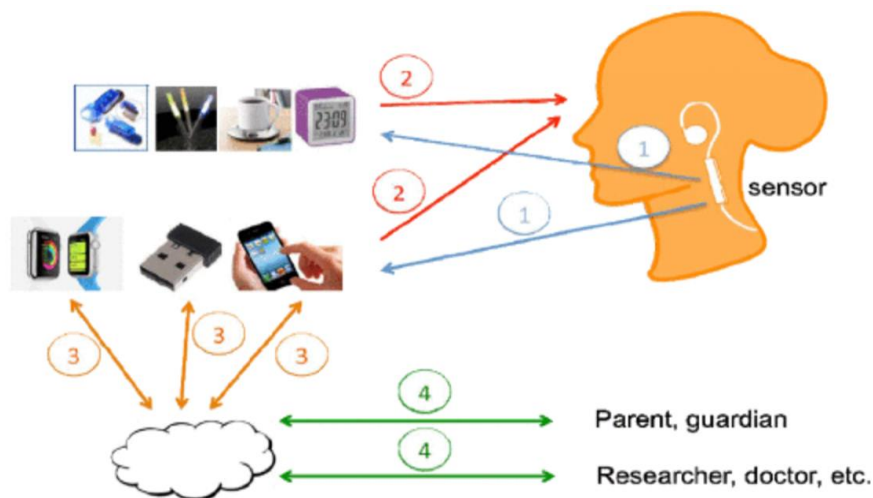

Figure 11: IEEE posture device (Liao, 2016)

A similar device that sends feedback based on incorrect posture is a device that was developed for stroke victims by students at Nanyang Technological University in Singapore in 2013 (Ding et al., 2013). This device also assists patients in correcting their posture by allowing movement one degree of



freedom at a time, starting from the shoulder going down to the forearm. Although this device focuses on its user's arms, it also assists in the correction of upper body posture in general.

Notch is a motion tracking and analysis kit that uses a multitude of IMUs in order to track and record body motion (Notch, 2017). It utilizes typical body sizes for heights and weights and sensor positions to calculate joint angles, accelerations, and velocities. Notch uses the motion tracking information to recreate the body movements and relay that information in a 3D window for examination by the users.

## 2.4 Monitoring and Creating Movement

There are many ways to monitor and create movement. To do so on a wearable device requires small and powerful equipment. Each piece of equipment has a specific task that is categorized as either a sensor, an actuator, or a data processing system. Combining all three of these categories into a single device allows for the creation of a portable and wearable device.

### 2.4.1 Sensors

Sensors are devices that monitor movement and other factors. This could be movement like angles, position, acceleration, or curvature. Other factors include heat and electrical current or voltage. Most devices measure one form of movement, but some devices are a combination of these smaller, more specific devices. The devices that are commonly used in posture correction are EMG sensors, Flex Sensors, and IMUs, all outlined below.



Figure 12: Advancer Technologies EMG sensor

#### 2.4.1.1 EMG Signaling

Electromyography, simply known as EMG, measures the electrical activity of muscles. Invasive EMGs utilize small needles on the sensors that pick up the increase of electrical activity from muscle flexion. The current goes through the needles into an amplifier which increases the visibility of the electrical activity on an oscilloscope (John Hopkins Medicine, n.d.). Noninvasive EMGs attach to the skin and

measure the muscle activity directly under it. There are cheap Arduino-compatible, noninvasive EMGs available for thirty-eight dollars which have mixed reviews (SparkFun Electronics, n.d.). The EMGs

would be used to first benchmark how far back the shoulders need to go, then measure the electrical activity of the muscle in that position. Using that benchmark, the user can start a session and use that benchmark as the goal for how far they're pushing their shoulders back. The long-term goal would be to have the EMG benchmarks have less and less electrical activity as the user progresses, signifying muscles are contracting to a lesser degree to reach correct posture (Holobar et al, n.d.).

#### 2.4.1.2 Flex Sensors

According to SparkFun Electronics, flex sensors are basically elongated strain gauges. Strain gauges work by measuring the electrical resistance that occurs by the bending and stretching of the strain gauge. Flex sensors are longer and are proportional to the angle of deflection. If used, the sensors would be strategically sewn into the vest to measure the flatness of the back and shoulders. The higher the values, the more bent the sensor.

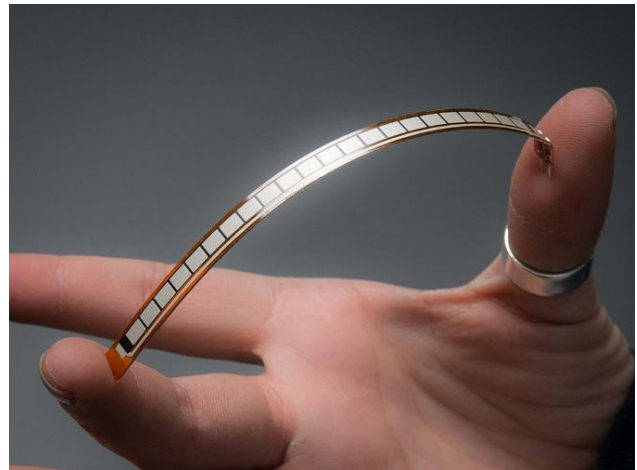

Figure 13: A hand holding a Flex Sensor.

#### 2.4.1.3 Accelerometers, Gyroscopes, and Inertial Measurement Units

Also from SparkFun Electronics, IMUs or inertial measurement units, are the combination of accelerometers and gyroscopes. IMUs give enough information to give exact position information and are widely used in body motion study. Some IMUs can also have a magnetometer that measures the Earth's magnetic field to determine absolute direction.

Accelerometers measure acceleration and can have one axis, two axes, or three axes depending if they measure acceleration in one, two, or three directions. They are typically used as tilt sensors, like in smartphones, or as motion sensors, like the Wii nun chucks. Some specifications that need to be kept in mind while deciding on accelerometers are the range, interface, number of axes needed, and power consumption. Gyroscopes are orientation sensors that measure angular velocity and aren't affected by gravity, allowing the gyroscope to give orientation information. Gyroscopes are similar to accelerometers with either one, two, or three axis options. There are a few considerations to take into account when deciding on which gyroscope to use. The two biggest considerations are the range and number of axes measured. The gyroscope needs to be able to measure the maximum angular

acceleration that is expected but be accurate enough to get enough sensitivity. The number of axes needed greatly changes how expensive the gyroscope will be; the higher the number of axes, the more expensive it will be.

## ***2.4.2 Actuators***

Actuators are devices that create controlled forces and movement in either linear or circular directions. They have many uses and come in a variety of sizes from heavy machinery to microrobotics. Actuators can be powered by a variety of ways including electrically, manually, or by fluids or hydraulics/pneumatics (Thomasnet, n.d.).

### **2.4.2.1 Bowden Cables**

Bowden cables are typically metal cables that can pull and push. They consist of an inner wire typically made of either wound or solid metal, a sheathing to reduce friction in the system, and an outer casing for protection. Bowden cables are usually used in low force situations like car throttles and bicycle brakes but also have many robotics applications. (Hindle Controls, n.d.)

### **2.4.2.2 McKibben linear actuators**

McKibben linear actuators were developed in the 1950's to be used in the humanoid robotics field (De Volder, 2001). These actuators are expandable tubes that pressurize and depressurize to create actuation. The tube is longer when depressurized because when air is pumped into the tube the diameter increases and the total length of the actuator decreases (Tondu, 2014). This simulates a muscle contraction. McKibben linear actuators are useful in high force to weight ratio situations due to the similar force-length properties they share with skeletal muscle (Czernieck, 2002).

### **2.4.2.3 Hydraulics**

Hydraulics are systems of actuators that transfer forces through liquids. A typical simple hydraulic system is a closed system with an actuator on one end forcing liquid through a smaller tube increase pressure. This pressure increase moves a piston on the other side of the system. Hydraulics are typically used in situations that require significant forces, like heavy machinery and car lifts. However, hydraulics has been used in smaller scales like in humanoid robotics. (National Fluid Power Association, n.d.)

### ***2.4.3 Data Processing Systems***

Printed Circuit Boards, otherwise known as PCBs, are circuit management tools that cut down circuit size, organizes the circuits, and increases the reliability and longevity of the circuits. The core material of PCBs is typically fiberglass but some of the flexible ones, like the LilyPad, are made with a material called Kapton. A thin single or double layer of copper foil is included between through-holes to create electrical paths. To prevent short circuiting, a solder mask layer is included over the copper foil layer, also acting as an insulator. PCB's are designed to create specific circuits that are compact and high quality. PCB's can also be sold in mass quantities as circuit templates with rows and columns of through-holes that can be connected by the circuit designer, cutting down costs. This method is tailored for prototyping different circuit designs. (SparkFun Electronics, n.d.)

### 3.0 Project Strategy

The purpose of this project is to design and fabricate a functional prototype of a soft-shell, wearable, assistive device that will facilitate the treatment of Postural Kyphosis through sensorimotor training performed by the user. This device would be used by the user in place of physical therapy without the need of assistance of a second person. The use of this device for three to four times a week for an hour each time, mimicking normal physical therapy sessions, should be effective enough to replace the series of exercises performed in physical therapy. This device will not be disruptive which means it could be worn while performing activities of daily living.

### Design Requirements



Figure 14: Design Requirements for a fully functioning device based on design specifications

### 3.1 Design Specifications

- Device should visibly alleviate effects of postural kyphosis with an hour a day usage
- Device should be able to ‘teach’ the user how to correct their own posture through sensorimotor training techniques
- Device should require active physical effort from the user for optimal results
- Device should be able to be used by one person without requiring assistance including donning and doffing
- Device should be able to exert the required forces to properly strengthen shoulder muscles
- Device should be able to provide the most muscle activation possible
- Device should be able to use sensors to track position of two spots, one on either shoulder, and compare these to the ‘correct’ position for each user

- Device should provide lumbar support to maintain proper spinal posture
- Device should have different settings to adjust for different sized people or levels of postural kyphosis
- Based on the study in Section 3.2.3.1, this device should not be over twenty-five pounds
- Device should be comfortable for user
- Estimated prototype production value less than \$1000 and the product value under \$200

### 3.2 Initial Client Statement

Design a device to correct postural kyphosis, also known as rounded shoulders.

### 3.3 Revised Client Statement

Design a portable, wearable device to facilitate the correction of Postural Kyphosis through sensorimotor training. In an effort to systematically move the user into their optimal posture and alert them when incorrect posture is noted, the device will be both active and passive. In order to avoid muscle atrophy and promote muscle memory, the device will move the user into optimal posture some of the time. It will be designed for the average office worker, who spends up to eight hours a day sitting down in a forward posture.

### 3.4 Project Approach

This project was executed throughout the course of an academic year. The first quarter focused mostly on research about the syndrome and appropriate design concepts that could be useful. The second quarter focused mostly on coming up with different designs and evaluating which one would be the better option. The third quarter focused on prototyping the selected design and going through an iterative process based on feedback provided through some testing. The fourth quarter focused on final testing and design validation to prove the effectiveness of this device.

*Table 1: Overall Schedule by half-quarter*

	A Term	A Term	B Term	B Term	C Term	C Term	D Term	D Term
Research	■	■						
Design		■	■					
Prototyping			■	■				
Finalize Design and Device				■	■	■		
Testing					■	■	■	
Paper and Poster					■	■	■	■

Table 2: Detailed Schedule for A-Term

	Name of Person(s) Responsible	Summer	8/21	8/28	9/4	9/11	9/18	9/25	10/2	10/9
<b>Research</b>	-									
Finalize Project Goal	Kirsten									
What are "rounded shoulders"?	Spenser									
People/Population Effectuated	Manuela									
Physical Therapy	Connor									
Related Projects/Patents/Devices	Kirsten									
Posture effect on people	Silvio									
Related Technical Information	Connor									
Shoulder Testing	Connor, Spenser									
Shoulder Modeling	Connor									
<b>Writing</b>	-									
Objective	Spenser									
Background: Posture	Silvio									
Background: Rounded Shoulders	Spenser, Manuela									
Background: Ways to Correct R.S.	Connor, Kirsten									
Design: Current Devices	Kirsten									
Design: Passive vs Active	Spenser									
Design: Technical Constraints	Connor									
Introduction	Kirsten,									
Client Statement	Spenser, Silvio									
<b>Designing</b>	-									
Design Drawings	Manuela									
Initial Designs Ideas	Spenser, Manuela									
Decision Matrices	Manuela, Spenser									

Table 3: Detailed Schedule for B-Term

	Name of Person(s) Responsible	10/15 (Break)	10/22	10/29	11/5	11/5	11/19	11/26	12/3	12/10
<b>Design</b>	-									
Shoulder Force Testing	Spenser, Connor									
Existing Device Testing	Kirsten, Silvio									
Preliminary Designs Decision Matrix	Manuela									
Buying Parts	Spenser, Connor									
Design Review Meeting	Team									
Shoulder Modeling	Connor									
<b>Paper</b>	-									
Feasibility of Designs	Manuela									
Decision Matrices	Manuela, Spenser									
Advantages vs Disadvantages	Silvio									
Final Design	Kirsten, Manuela									
Manufacturing Process	Connor, Spenser									
Potential Obstacles	Silvio									

Testing Methods	Spenser									
<b>Prototyping</b>	-									
Soldering and PCB Testing	Connor									
Sensors Programming	Connor, Kirsten									
Testing of Actuators	Team Effort									
Installation of Elements on Device	Team Effort									
Testing Sensors and Actuator Response	Team Effort									

Table 4: Detailed Schedule for C-Term

	Name of Person(s) Responsible	Winter Break	1/8	1/15	1/22	1/29	2/5	2/12	2/19	2/26
<b>Prototyping</b>	-									
Coding of Sensors	Connor									
Motor Selection	Kirsten									
Coding of Motors	Kirsten, Connor									
Buying Parts	Team Effort									
Build Prototype	Team effort									
<b>Paper</b>	-									
Review of Earlier Chapters	Team Effort									
Chapter 5	Silvio, Kirsten									
Chapter 6	Manuela, Spenser									
Chapter 7	Spenser, Connor									
Chapter 8	Manuela									
<b>Testing/Validation</b>	-									
Conduct Test (Long or Short Term)	Silvio, Spenser									
Design Validation	Manuela, Kirsten									

Table 5: Detailed Schedule for D-Term

	Name of Person(s) Responsible	Spring Break	3/12	3/19	3/26	4/2	4/9	4/16
<b>Prototyping</b>	-							
Finish First Prototype	Team Effort							
Visual Appeal	Team Effort							
Assemble Second Prototype	Team Effort							
<b>Testing</b>	-							
Analysis with Kinovea	Spenser, Silvio							
Short Term Testing	Silvio							
Design Validation	Spenser, Manuela							
<b>Paper and Poster</b>	-							
Finish Paper	Team Effort							
Finish Poster	Team Effort							



### ***3.4.1 Test Subject***

With design validation in mind, the team decided to use one of their own members as a test subject. This simplified all the testing processes, especially given that all the tests are done on humans. After observations and some testing as described below, it was determined that the entire team has some degree of postural kyphosis. Connor was eliminated as a candidate because his degree of rounded shoulders was not severe enough for the team to justify using him as design validation. Maria was eliminated next for the same reason. Kirsten was then eliminated due to her sports commitment; her coach put an emphasis on shoulder strength and conditioning for the year, so the team did not want an obstructive variable skewing the results. Spenser was not chosen because he designed and facilitated the tests. Finally, there was Silvio, an individual who does a casual overhand sport and spends a good amount of his day at a desk. To the team, Silvio best represented an average person who has rounded shoulders but also did not have any outstanding reasons to not be the test subject.

### ***3.4.2 Preliminary Testing***

A preliminary test was performed to have a better understanding of the physical requirements of changing shoulder posture. This test was a shoulder force test that determined the amount of force required to pull the shoulders back and best way to achieve this movement. This test was performed on each team member by anchoring a force scale to a porch beam, zeroing the scale while the teammate had their shoulders forward, then having them pull their shoulders back to the desired position: flat against a wall behind them. A more detailed procedure including the test equipment as well as the results can be found in Appendix A. From this test, the team was able to determine a general range of force needed for the device: between eight and ten pound-forces. This test helped determine the actuation used for the device.

### ***3.4.3 Goals by Term***

To keep the team on track throughout the year, goals were created for each term. These goals were broken up into standard goals, challenge goals, and reach goals that were determined either at the start of the term or the end of the previous term. Attempts were made to accomplish every goal set forth, but goals were not always met. This was especially true for the reach goals which were only accomplished if time allowed after all other goals were met. The challenge goals were set to be attainable, but still difficult. Most of the time, these were achieved. The standard goals were almost

always met. These goals were used to determine where the team’s timeline status throughout the term. Tables 6 through 9 outline the goals for terms A through D respectively.

*Table 6: Goals for A-term*

<b>Standard Goals</b>	Accomplished (Y/N)	<b>Challenge Goals</b>	Accomplished (Y/N)	<b>Reach Goals</b>	Accomplished (Y/N)
Finish Literature Review Chapter	Y	Have Some Concrete Design Ideas	Y	Start Building Prototype	N
Conduct Preliminary Tests for Shoulder Force	Y	Begin Ordering parts	Y		
Write Client Statement	Y				
Write Most of Introduction	Y				
Start Design Process	Y				

*Table 7: Goals for B-term*

<b>Standard Goals</b>	Accomplished (Y/N)	<b>Challenge Goals</b>	Accomplished (Y/N)	<b>Reach Goals</b>	Accomplished (Y/N)
Continue to Buy Items for Prototype	Y	Finalize Design	Y	Have a Working Final Design	N
Start to Eliminate Design Ideas	Y	Finish Chapters 1-4 of Paper	Y	Start Testing On Final Design	N
Continue Shoulder Force Tests	Y	Conduct Tests on Prototypes	N	Have a Week's Worth of Test Data	N
Keep Updating Paper	Y	Create Schedule and Goals for C term	Y		
Create Schedule for C-Term and D-Term	Y	Build Prototype	N		
Wear Posture Device (Comfort Test)	Y				
Update Schedule	Y				

*Table 8: Goals for C-term*

<b>Standard Goals</b>	Accomplished (Y/N)	<b>Challenge Goals</b>	Accomplished (Y/N)	<b>Reach Goals</b>	Accomplished (Y/N)
Finish Prototype	N	Start Semi-Long-Term Testing	N	Finish MQP Paper	N
Start Short-Term Device Testing	Y	Finish Short-Term Device Testing	N	Finish Semi-Long-Term Device Testing	N
Continue to Develop MQP Paper	Y	Start MQP Poster	Y	Finish MQP Poster	N
Make Schedule for D-Term	Y	Finish Chapter 5 of Paper	Y		

Table 9: Goals for D-term

Standard Goals	Accomplished (Y/N)	Challenge Goals	Accomplished (Y/N)	Reach Goals	Accomplished (Y/N)
Complete MQP Presentation Poster	Y	Present in the NEBEC Conference	Y	Perform Validation Testing on Second Version of Device	N
Complete MQP Paper	Y	Perform Preliminary Testing on Second Iteration of Device	N	Perform Long-Term Testing on First device	N
Finish the second version of the device	Y	Perform Validation Testing on First Version of Device	Y	Establish a Long-Term Test Protocol	Y
Perform Preliminary Testing on First Device	Y	Create Supplementary Exercise List and User Guide	Y		

### 3.4.4 Deliverables

This project had three deliverables:

1. A functioning prototype that visibly alleviates postural kyphosis
2. A user guide that explains the features of the device and walks the user through the donning and doffing, calibration, and training steps of the device
3. A list of supplementary exercises that can correct the effects of postural kyphosis

The first deliverable was the device itself. The team developed a fully functioning prototype that accurately tracked shoulder location and helped the user treat and correct postural kyphosis. This device is intended to be worn by the user in such a way that mimics physical therapy sessions: one to two hours a day for two to three days per week. The device uses sensorimotor training concepts to prompt the user to correct their posture and create a behavioral pattern.

The user guide, found in appendix D, and supplementary exercise list were separate side projects that were eventually put together. The user guide includes directions on how to charge, wear, use, and calibrate the device. The supplementary exercise list, found in appendix E, includes pictures and explanations of six different shoulder posture correcting exercises that can be done outside of the time that the device is being worn. These exercises were provided to hopefully accelerate the process of shoulder posture correction, they are not necessary to operate the device nor correct postural kyphosis but are recommended for optimal results.

## 4.0 Design

### 4.1 Review of Existing Designs

To properly design a Postural Kyphosis correcting device, it is important to investigate existing designs and procedures that have been made to correct upper body posture. Five designs were found to be the most relevant in the design process of this device. Three of these designs are wearable, mechanical posture correcting devices. The other two relied mostly on data feedback to assist the user in correcting their posture. The goal is to build a device that encompasses both mechanical and data feedback methods, creating a product that will hopefully be more effective in less time than any current device.

#### *4.1.1 Existing Devices Utilizing Mechanical Correction*

Postural Kyphosis can be treated mechanically, meaning the muscles are pulled back, and typically held back, by a device so they can adjust to this new, correct positioning and ultimately fix the muscle imbalance. Three mechanical devices were found to be of interest while hypothesizing a design for this project. The first device is the ERGO Posture Corrector, as mentioned previously in section 2.3.3 Wearable Devices (Ergo Posture Transformer and Back Support, 2017). This device is a crowdfunded wearable device that pulls the shoulders back using thick cables attached to a plastic device that allows the cables to be pulled and locked in place. The cables have a pad that wraps around the front of the shoulder, most likely for comfort. ERGO Posture Corrector is marketed towards office workers to use for a minimum of one hour a day to relieve back and neck pain while strengthening posture. There have been no studies posted on the use of this device, only testimonials from apparent users.



Figure 15: ERGO Posture Corrector. (Ergo Posture Transformer and Back Support, 2017.)

The second device is a vest that was found on multiple online stores like Amazon or Walmart that is like a more complex version of the ERGO Posture Corrector. This vest utilizes thick straps that pull back the shoulders by being wrapped around the body and held in place using Velcro. The vest also includes a rigid back support as a base for the straps. Like the ERGO Posture Corrector, this device didn't offer any information done by studies. However, the team ordered this vest to see how it worked in person. Ultimately, this became the base of the final design, which will be described in higher detail later in this report in section 5.5.2.



*Figure 16: Adjustable Posture Corrector Back Support Shoulder Brace Belt*

Finally, three Korean students studied the effects of an experimental rounded shoulder taping using stretchable kinesiology tape (Jin-Tae Han et al., 2015). This taping showed an immediate mechanical response of the shoulders being pulled back. Unfortunately, this is the only result that they found. Additionally, this study was only performed on young male workers whose rounded shoulders aren't nearly as problematic as a person who has suffered from postural kyphosis for many years. They acknowledge that the study needs to be performed further on people more affected by rounded shoulders, and to also include women. Furthermore, they state how the ways that they measured rounded shoulder posture weren't reliable. They measured the changes in pectoralis minor length, the total scapular distance, and the supine measurement of rounded shoulder posture. The supine measurement is important because it is one of the few ways to truly measure rounded shoulders. This is the same measurement mentioned in section 2.2.1 where the distance between the acromion and the surface the subject is laying on is measured. During their study, the Korean students found that this measurement changed after applying the stretchy Kinesiology tape but didn't reach their goal of only an inch between the surface and acromion. They attributed this to the effects of gravity when taping their subjects while they were standing only to perform this measurement while they were laying down. Another factor they considered is the fact that they only applied the kinesiology tape once.

These three mechanical methods of correcting rounded shoulders were the most useful methods found that utilize mechanical methods of pulling the shoulders back. The two wearable

devices helped to visualize what the device should look like and what it should do. The study on kinesiology tape helped to realize what sorts of testing will truly determine how effective the mechanical aspect of the device should be.

#### ***4.1.2 Existing Devices Utilizing Data Feedback***

One of the two devices utilized IMU's and vibrotactile units to measure arm positions and send feedback to the user. This device was made to assist stroke victims regain mobility within their arms and shoulders. While the user had the device on, they would move their arms into ten different positions guided by the vibration motors with help from a person who knew the positions. The IMU's recorded arm position in real time. These recordings were then compared to the loaded data for the ten arm positions and the vibration motors relayed this information to help the user reach the desired position. The study concluded that their device would be very helpful for rehabilitation but required further testing to be used in this setting. (Ding et al., 2013).

The second device measures head and neck angles using an accelerometer to send real time feedback, so the user knew when to correct their posture. This feedback was through auditory, visual, or vibrational signals. The system utilized cloud services connecting the device to an app that interpreted and recorded the data and sent back signals for feedback. Although this device does not correct rounded shoulders, it does aid in the treatment of neck and upper back pain. (Liao, 2016).

Utilizing IMU's or similar devices alongside feedback devices help the user understand their ailment and allows them to take their treatment into their own hands. Having a way to incorporate this into the device is very important. IMU's are great tools that would allow for both posture monitoring and baseline setting; the device can use the IMU's to set an ideal position but also monitor the user to make sure they stay in this position. Adding in vibration motors would create a way for the device to send feedback to the user, giving it a way to keep the user in the desired position.

## **4.2 Motion Analysis of the Shoulder Complex**

To create a design that effectively pulls the shoulders and strengthens the back muscles, it is important to understand the possible range of motion of the shoulders and the forces each set of muscles can exert. This section explains the different muscles and joints of the shoulder area.

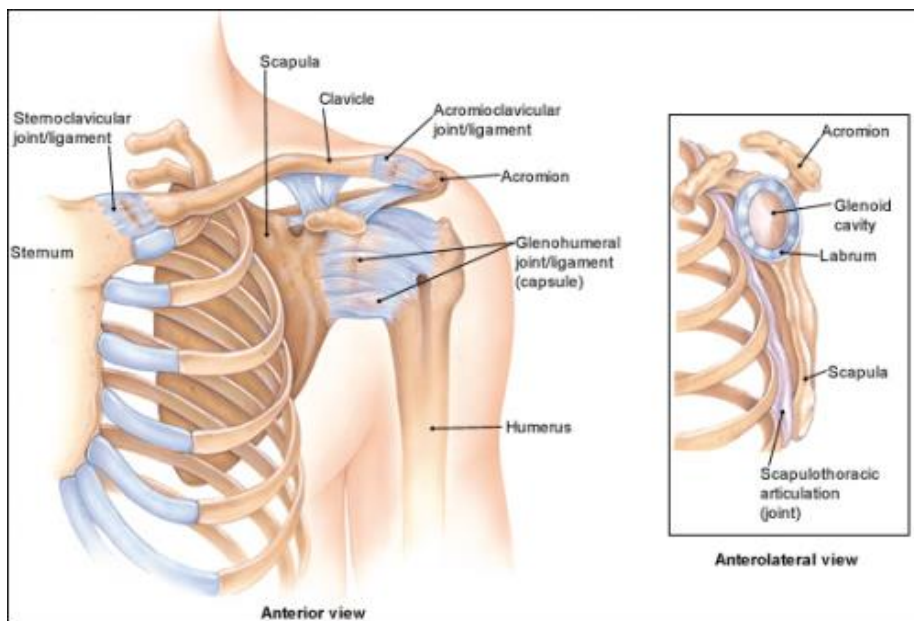

Figure 17: Anterior and Anterolateral View of the shoulder complex (Woodward, 2000)

## 4.2.1 Component Analysis

The shoulder complex is composed of four articulations that are related to the sternum, the clavicle, the ribs, the scapula, and the humerus. These articulations are the glenohumeral joint, the sternoclavicular joint, scapulothoracic joint, and the acromioclavicular joint.

### 4.2.1.1 Glenohumeral Joint

The glenohumeral joint (GJ) is a ball and socket joint where the ball component is the humeral head and the socket component is the glenoid fossa of the scapula. This joint has a shallow socket which adds to flexibility and range of motion to the shoulder joint. The glenoid socket is made deeper by a layer of fibrocartilage called the labrum, which helps stabilizing the joint (Virtual Medical Centre, n.d.). It is important to note that although the GJ a ball and socket, different muscles and ligaments act on it and influence the different motions it can go through. This joint is described as the most mobile joint in the body because it can experience abduction, flexion, extension, internal rotation, external rotation, and horizontal adduction. (Physiopedia, n.d.)

### 4.2.1.2 Sternoclavicular joint

The sternoclavicular joint (SC) forms part of a framework that allows the shoulder blade's outward movement from the body. This joint is categorized as a plane joint which means that it only allows for gliding movement. This gliding joint allows the bones to glide past one another in any direction along the plane of the joint. This joint is also categorized as a synovial joint because it joins two bones with fibrous capsule. This joint has three types of movement: elevation/depression, protraction/retraction, and axial rotation. (Physiopedia, n.d.)

### 4.2.1.3 Scapulothoracic joint

The scapulothoracic joint (ST) refers to the physical relation between the shoulder blade and the thorax. This is not a true anatomic joint as it is not made up of fibrous tissue, synovial joints, or cartilage. The scapula is attached to the lateral end of the clavicle by the acromion process, the clavicle is attached to the sternum through the SC joint, which means that this joint is part of a true closed chain with the AC and SC joints and the thorax. (Physiopedia, n.d.)

### 4.2.1.4 Acromioclavicular joint

The acromioclavicular joint (AC) is formed by the junction of the lateral clavicle and the acromion process of the scapula and is a gliding or plane style synovial joint. The AC Joint attaches the scapula to the clavicle and serves as the main articulation that suspends the upper extremity from the trunk and allows transmission of forces from the upper extremity to the clavicle. The AC joint is responsible for the ST joint's additional range of rotation on the thorax outside the initial plane of the scapula to follow the changing shape of the thorax as arm movement occurs. There are three different motions associated with the AC joint: upward/downward rotation, internal/external rotation, and anterior/posterior tipping. (Physiopedia, n.d.)

## **4.2.2 Kinematic Mechanism Analysis**

Most of the joints that were just mentioned were explained as kinematic joints. Modeling in this way turns the joints into rigid bodies, therefore discounting the effects of muscles, ligaments, and tendons. The different joints can be classified as one of the following: revolute/hinge, prismatic/slider, screw/helical, cylindrical, spherical/ball, or planar. All these joints are shown in figure 18.

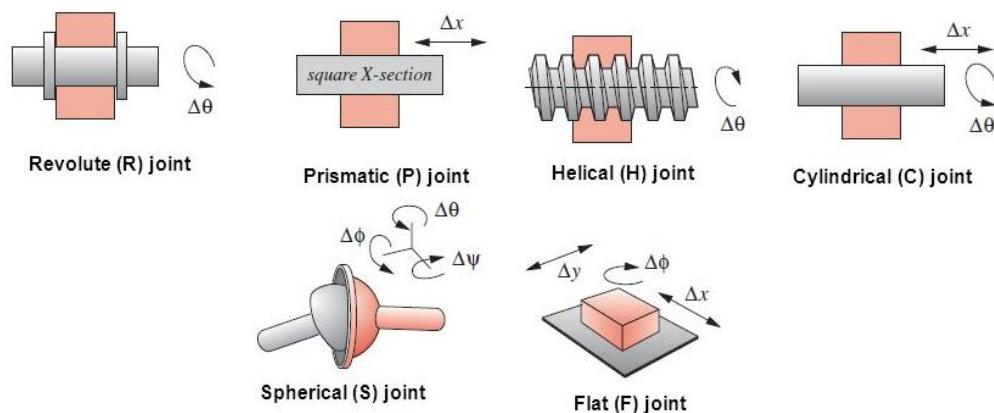

Figure 18: The six lower pair joints (Norton, 2012)



Analyzing the shoulder complex as a mechanism requires assigning each joint a lower joint type that matched its characteristics. The SC, GH, and ST can all be treated as spherical joints with the SC connecting the sternum and the clavicle, the GH connecting the scapula and the humerus, and the ST connecting the thorax and the scapula. The AC can be treated as a prismatic joint between the acromion and the clavicle. To evaluate the movement about the humerus, the wrist was treated as a fixed revolute joint, altogether creating a fully closed mechanism.

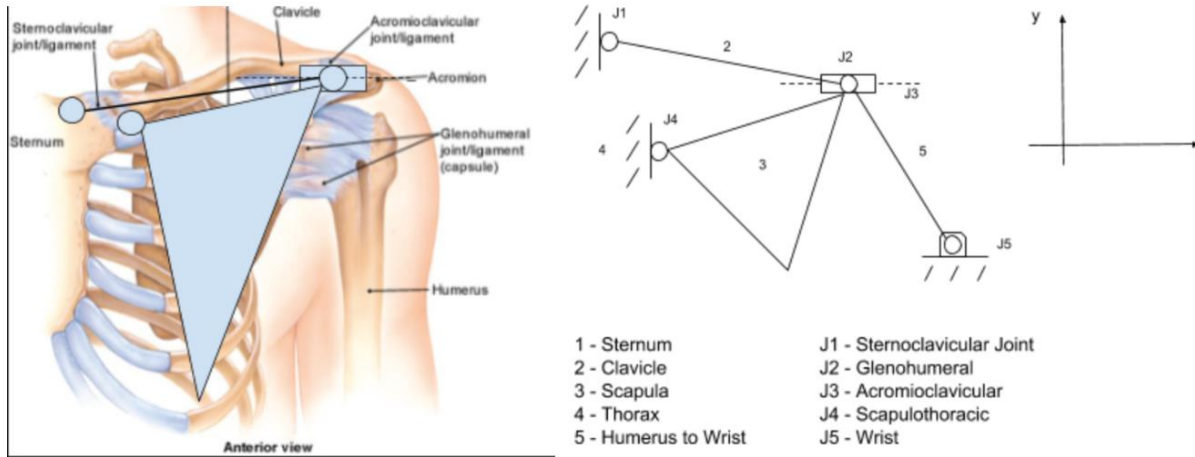

Figure 19: Kinematic diagram of the shoulder complex

The Kutzbach mobility equation for spatial mechanisms can be used to determine the degrees of freedom of a system. It takes into consideration the different kinds of joints and accounts for the degrees of freedom that are associated with each type of joint (Norton, 2012). The Kutzbach equation is as follows:

$$M = 6(L - 1) - 5J_1 - 4J_2 - 3J_3 - 2J_4 - J_5$$

L is equal to the number of existing links in the mechanism and each J represents a different kind of joint where the subscript refers to the number of degrees of freedom associated with that joint. For the shoulder mechanism, L equals four, J<sub>1</sub> equals one for the wrist, J<sub>2</sub> equals one representing the combination of AC and GH, J<sub>3</sub> equals two to represent both SC and ST, and J<sub>4</sub> and J<sub>5</sub> equal zero. From here we obtain:

$$M = 6(4 - 1) - 5(1) - 4(1) - 3(2) - 2(0) - 0$$

$$M = 3$$

Three degrees of freedom means that this mechanism allows three independent angular motions (Norton, 2012). There are six movements in the shoulder complex resulting from the

combined actions of the muscles, ligaments, and joints: abduction, flexion, extension, internal rotation, external rotation, and horizontal adduction.

### 4.2.3 Force Analysis

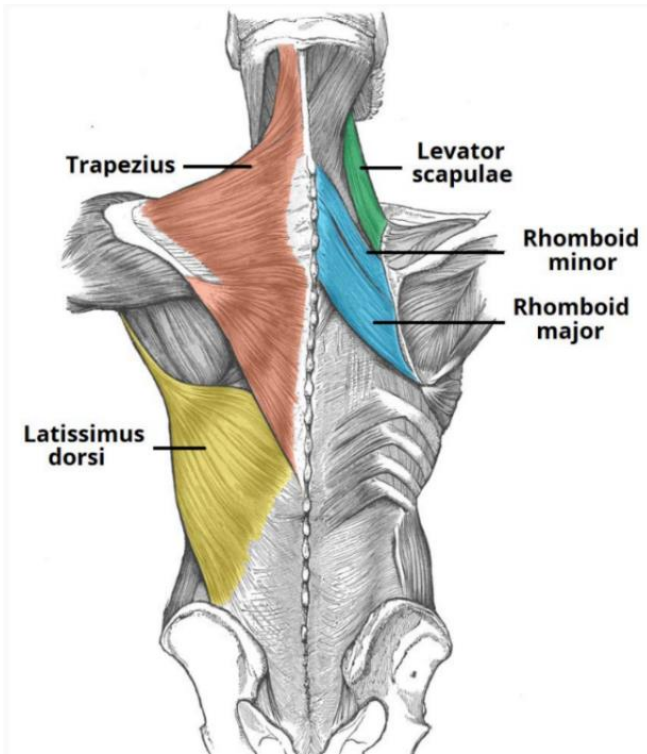

Figure 20: The extrinsic muscles of the shoulder (*The Intrinsic Muscles of the Shoulder, 2017*)

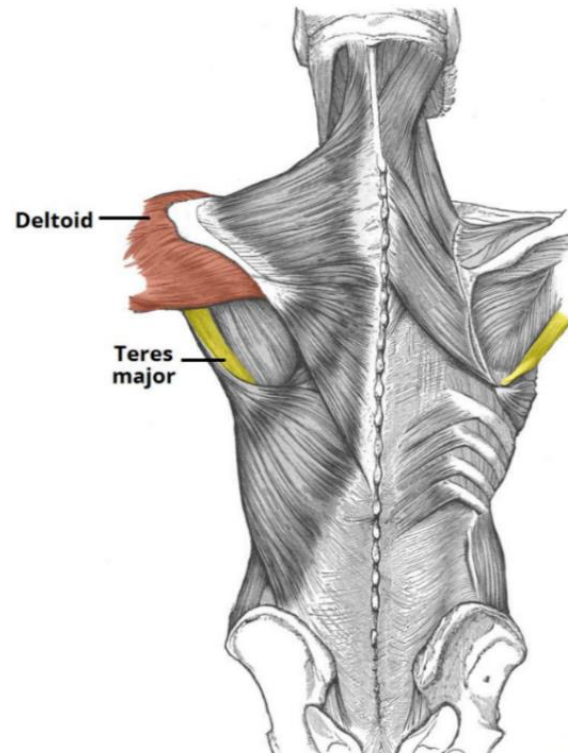

Figure 21: The deltoid and teres major (*The Intrinsic Muscles of the Shoulder, 2017*)

The shoulder complex, being as mobile as it is, relies on muscles to provide stability and actuate the movement. Muscles in the shoulder complex, as shown in figures 20 and 21, can be categorized as extrinsic or intrinsic depending on where they originate. Extrinsic shoulder muscles originate from the torso and attach to the bones of the shoulder. These muscles are the trapezius, latissimus dorsi, levator scapulae, rhomboid major, and rhomboid minor. The intrinsic muscles, also known as the scapulohumeral group, originate from the scapula or clavicle and attach to the humerus. There are six muscles in this group: the deltoid, teres major, and the four rotator cuff muscles: supraspinatus, infraspinatus, subscapularis, and teres minor. The rotator cuff muscles, shown in figure 22, originate from the scapula and attach to the humeral head. Collectively, the resting tone of these muscles pull the humeral head into the glenoid fossa giving the GJ a lot of additional stability.

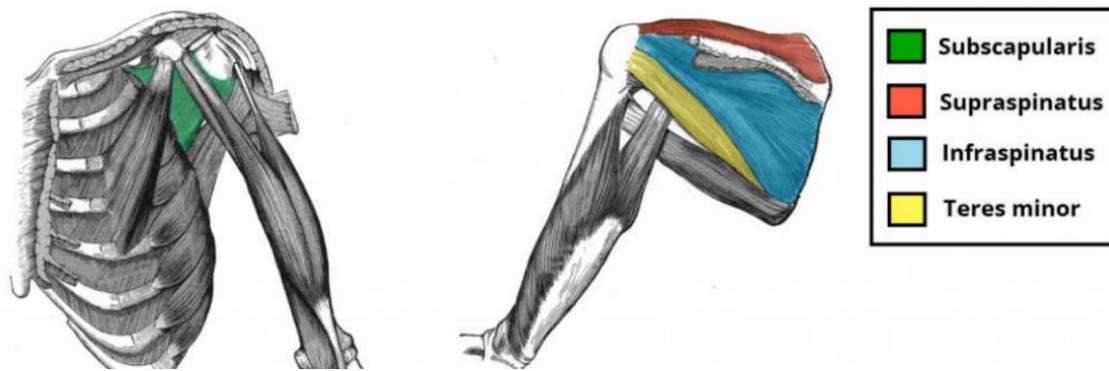

Figure 22: The rotator cuff muscles (*The Intrinsic Muscles of the Shoulder, 2017*)

There are two types of muscle contractions, isotonic and isometric. Isotonic contractions generate force by changing the length of the muscle. Isometric contractions generate force without changing the length of the muscle. A study was created to develop a method to measure the isometric forces of shoulder muscles using a handheld dynamometer with a belt because these types of contractions are the ones used by the body to maintain posture (Katoh, 2015). To obtain a valid range of forces, different standardized positions were tested to measure muscle forces.

Figure 23 shows the average maximum force that the associated group of muscles for each motion can exert. The flexion and extension forces are important values for this project because these are the movements involved with the shoulders being moved forward or backward. The measured value for flexion is 16.15 kilogram-force (kgf) or 35.76 pound-force (lbf). Extension is measured at 14.75 kgf or 32.52 lbf. These values were obtained under specific loadings on the muscle groups to obtain these maximum values. When a person is moving their shoulders forward and backward normally, the forces exerted by their muscles are significantly smaller. Outside of the testing conducted in this study, each network of muscles does not experience much resistance when moving the shoulders forwards and backwards, therefore not requiring its maximum strength level.

Shoulder exertion task	1st time	2nd time
Flexion	16.2 (7.9)	16.1 (7.5)
Extension	14.6 (5.2)	14.9 (4.7)
Abduction	13.9 (5.7)	13.3 (5.5)
External rotation	8.4 (3.4)	7.9 (3.0)
Internal rotation	15.3 (5.8)	15.0 (5.6)
Horizontal extension	11.0 (5.1)	10.7 (4.2)

Values are shown as the mean (SD). Unit: kgf

Figure 23: Isometric shoulder muscle forces (Katoh, 2015)

### 4.3 Preliminary Designs

Upon reviewing the design specifications and existing designs, concepts of potential designs were developed. These designs were later evaluated and compared to help come up with a final design that incorporates the best features accommodating all the design specifications.

### 4.3.1 Shoulder Pads and Motor

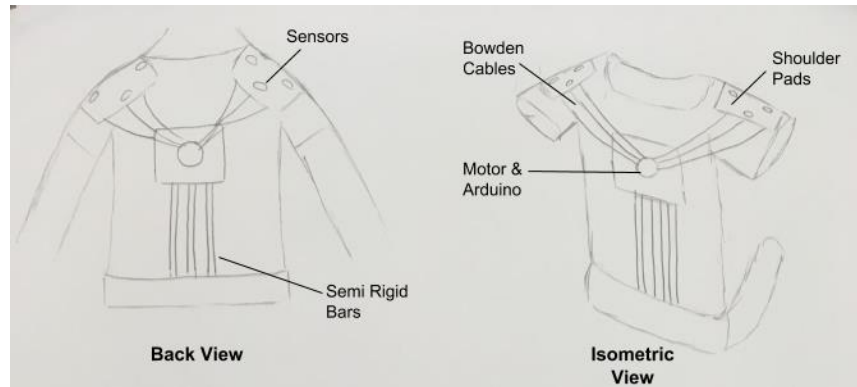

Figure 24: Preliminary shoulder pad and motor design

The first preliminary design, shown in figure 24, incorporates a high torque motor to actuate the movement of the shoulders. This design is different from other existing devices because it uses Bowden cables that are strapped to a shoulder pad to effectively pull the shoulders back and push them forward. The shoulder pads would be semi rigid to allow for different shoulder sizes but also hold the shoulders in place when the Bowden cables are moving them. Sensors would be attached to the shoulder pads to track shoulder position. This information would be processed by an Arduino and an appropriate response would be performed by the motor. Moving the shoulders and shoulder pads backwards and forwards will help this device show the user correct posture. The motor could produce individual responses to address different levels of muscle weakness for each shoulder. Semi rigid bars would be placed at the bottom of the device to provide lumbar support while the shoulders are being adjusted.

### 4.3.2 Vest with McKibben Actuators

The next preliminary design, shown in figure 25, uses McKibben actuators rather than a motor to correct shoulder posture. This design would use pressurized air to pull the shoulders back and push them forward adding a high resistance component to the sensorimotor training. Flex sensors would be placed on the shoulders to track live posture. This information

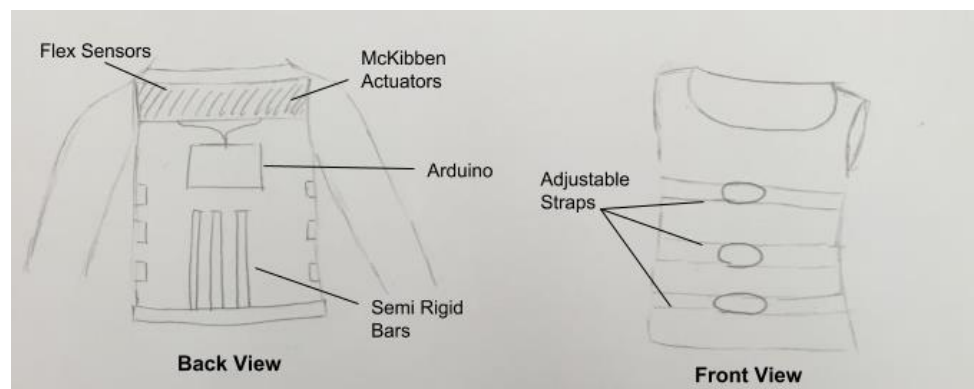
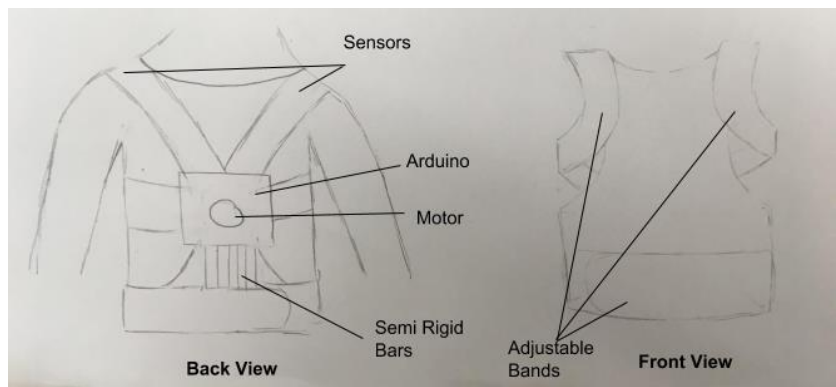

Figure 25: Preliminary vest with McKibben actuator design

would be processed by an Arduino that would send feedback to the pneumatic component to appropriately contract or expand the actuators. Through this contraction or expansion, this device could show the user correct posture. The resistance feature could be useful to strengthen the shoulder muscles while the user performs exercises. This design also has three adjustable straps in the front to account for different torso sizes and provide lumbar support. There are also three semi rigid bars for additional lumbar support.

#### ***4.3.3 Full Vest with Straps and Motor***

Our third preliminary design, as shown in figure 26, involves the use of a vest with straps to move the shoulders into the correct position. This design utilizes sensors around the shoulder area to track shoulder posture and uses a high torque motor to adjust the bands, fixing shoulder position. This design allows for individual adjustments of the straps depending on the severity and strength of each shoulder. Three semi rigid bars are also included in this design to provide lumbar support.



*Figure 26: Preliminary full vest with straps and motor design*

#### ***4.3.4 Soft Robotics***

The fourth preliminary design involves the use of soft robotics and hydraulics. Soft robotic mechanisms are capable of mimicking natural movement patterns, like living organisms, and have been widely used in the medical field. This concept could be used to perfectly adapt to the shape of the shoulders while having control over the specific forces that need to be applied to the shoulders. Sensors would be placed on the shoulders to track current position and provide feedback to a processing system that would then move the shoulders accordingly. Soft robotics are generally actuated by hydraulic inflation of elastomer skins that expand when air or liquid is supplied to them or are cable driven. These skins would be placed around the shoulder area and exert forces to strengthen the shoulders.





Figure 27: Preliminary Backpack Straps with Motor Design

### 4.3.6 Backpack Straps with Motor

As explained in the previous sections, there are various studies that show how backpacks have the potential to affect shoulder posture because of how people interact with them. There are many devices that claim to correct posture that consist of adjustable shoulder straps, like

backpack straps, that keep shoulders in place. This design, shown in figure 27, would have a similar concept and would rely on the use of sensors, a processing system, and motors to pull the shoulders back based on posture feedback from the sensors.

### 4.3.7 Fluid Filled Bags Prototype

The last design has sacs incorporated into a shirt located in the shoulder and back area. One of the biggest concerns when coming up with designs was the ability of the device to exert the force required to move the shoulders and the ability to do it at a slow rate to avoid injuries. This design incorporates the use of fluid filled bags to provide actuation of the shoulder area of the shirt. These sacs can be filled or drained with fluids to move the shoulders back and forward and are capable of exerting great forces at a slow rate. This design would also rely on the use of sensors to track proper shoulder movement and a data processing system to send the correct commands to the pumps.

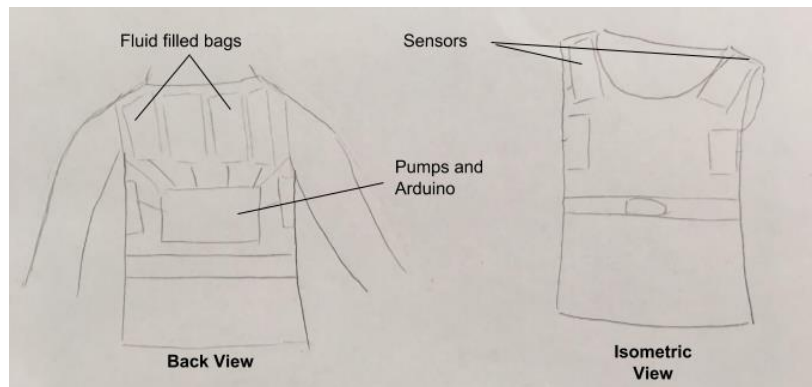

Figure 28: Preliminary Fluid Filled Bags Design

## 4.4 Modeling

Each preliminary design includes either a microcontroller, a motor, shoulder pads or a combination of these three components. The best way to incorporate these into a design is to model them or casings for them using a computer aided design (CAD) software so they can be rapid

prototyped, specifically, 3D printed. The Arduinos and motors would require custom casing that would not only house these components but also streamline them into the design in a way that accounts for the intended use of the design. Meaning, if the user needs to rest up against a chair or a wall, the Arduino or motor would not be affected by this motion both because of its placement and because of its protective custom casing. Shoulder pads would be printed to stabilize the motion of the shoulders while the device corrects their position. These could be custom to the user's shoulders or made to be adjustable like the device.

## 5.0 Selection of Final Design

To fairly select a design that accomplished every goal, the team put together a decision matrix to help eliminate some designs and decide which one to go with. A blank version of this matrix is shown in table 10. This matrix included all the design specifications weighted based on their importance and each design idea. Each team member filled out this table with their opinions.

### 5.1 Decision Matrix Criteria

Table 10: Design idea evaluation decision matrix

Decision Factors	Weight (1-5)	Shoulder pads and motor	Vest with McKibben Actuators	Full Vest with Straps and Motor	Soft Robotics	Backpack Straps with Motor	Fluid Filled Bags Prototype
Adjustable	3						
Training Techniques to Offer	4						
Cost Effective	2						
Comfort	3						
Difficulty to Build	2						
Difficulty to Use	4						
Effectiveness (Lasting of Effects)	5						
	<b>Total</b>						

Each of the six ideas were rated on a scale of one to five for all seven of the different design specifications, listed under decision factors. Each of these decision factors was given a weight between one and five depending its importance for this project. The first decision factor was the adjustability of the device, referring to how easy adjusting the device would be for the user. The second was training techniques to offer, a rating based on the amount and the variety of training techniques that the device would be able to provide. The next decision factor is cost effectiveness which only really considered cost to prototype. With five team members, the budget for this project was more than sufficient for most of these designs so this factor wasn't rated as highly. Fourth was comfort, which refers to how comfortable the device would be for the user to wear. After that is difficulty to build: how difficult it would be for the team to construct that design. The last two factors were difficulty to use and effectiveness of the device. The difficulty to use category was concerned about the user's ability to use the device; the device should be easy to put on and easy to make it function properly. The effectiveness was about how long-term effective the device would be. This rating for this factor was



supposed to be based on a combination of some of the other factors such as training techniques and difficulty to use.

### 5.1.1 Hard-Shell or Soft-Shell

The first design feature discussed was making the device hard-shell or soft-shell. A soft-shell device would allow for more personal customization and could adapt perfectly to each shoulder. The use of a hard-shell or rigid model would allow for better grip and force application on the shoulders, leading to a better movement. The decision was made to make a rigid device that would be custom modeled after the test subject’s shoulders to ensure it matches their shoulder’s natural shape.

### 5.1.2 Passive vs Active

Secondly, a decision was made to make the device either active, passive, or a combination of the two. Each type has both advantages and disadvantages so the choice between the three had to be carefully looked at. This choice was calculated based on a few criteria defined and assigned weights by the team. These criteria were then used in a decision matrix which can be seen below as table 11.

An active version of the device would have motors and the ability to pull the user's shoulders back for them. This would put most of the work on the device and not the user. A passive device would have sensors instead of motors. The sensors would detect where the user’s shoulders are and alert them if they need to correct their posture, but the device itself would not physically move their posture. A device that is both active and passive would have both sensors and motors to use in unison. This would allow for many different types of training, would physically move the muscles, and alert the user when their posture should be adjusted.

Table 11: Passive vs. active decision matrix

Decision Factors	Weight (1-5)	Passive Data	Active Physical	Combination
Cost	2	2	3	1
Difficulty to Build	2	2	3	1
Comfort	3	3	2	2
Difficulty to Use	4	3	5	4
Training Techniques Available	4	2	2	4
Effectiveness	5	1	2	5
	<b>Total</b>	42	56	67

## 5.2 Results from Decision Matrices

After ensuring that each team member fully understood each design idea, each member filled out the design idea decision matrix. Table 12 encompasses the totals of every team member's ratings. The total values in the last row of the table are the design scores, calculated by adding up the numbers in the same column after these numbers are multiplied by the appropriate weight. The design with the highest score is the best design according to the team's opinions. After the decision matrix was filled out by each team member, it was determined that the shoulder pads with motors idea was the best. It had nearly perfect scores for most of the decision factors.

Table 12: Completed design idea evaluation decision matrix

Decision Factors	Weight (1-5)	Shoulder Pads and Motor	Vest with McKibben Actuators	Full Vest with Straps and Motor	Soft Robotics	Backpack Straps with Motor	Fluid Filled Bags Prototype
Adjustable	3	20	14	19	19	24	15
Training Techniques to Offer	4	20	16	18	18	17	13
Cost effective	2	22	16	20	10	21	15
Comfort	3	21	21	23	19	19	18
Difficulty to Build	2	21	16	22	10	21	15
Difficulty to Use	4	22	19	18	17	21	16
Effectiveness (Lasting of Effects)	5	22	20	23	20	17	20
	<b>Total</b>	487	409	469	394	450	375

## 5.3 Materials and Cost

Table 13 outlines most of the materials used for this project. Not every material was bought, some were borrowed or were already owned by the team. These items are listed as having a price of \$0.00. Each material is also listed as either 'device', 'second device', or 'testing'. Items listed as device or second device are items used directly on the device or second device whereas items listed as testing were not put on the device and were only used for tests. In total, the team spent \$437.52 on project materials. A replication of this project could cost between \$300 and \$500.

Table 13: Materials and cost distribution

Expenses	Use	Unit Price	Units	Price
Adafruit 9 DOF IMU Sensor	Device	\$30.19	1	\$30.19
Adafruit 9 DOF IMU Sensor	Device	\$30.49	2	\$60.98
Apoxy Sculpt	Device	\$23.00	1	\$23.00
Arduino Uno	Device	\$24.95	1	\$0.00

Connector Plug Adaptors	Device	\$6.99	1	\$6.99
Kevlar Wire	Device	\$10.00	1	\$10.00
Luggage Scale	Testing	\$10.00	1	\$0.00
Motor 131:1	Device	\$51.87	2	\$103.74
Motor 70:1	Testing	\$39.95	1	\$0.00
Motor Drive Controller	Device	\$6.89	1	\$6.89
Motor Driver 3 pack	Device	\$11.99	1	\$11.99
Multiplexer	Device	\$10.91	2	\$21.82
Paracord	Testing	\$6.00	1	\$0.00
Plastic Mesh	Second Device	\$13.99	1	\$13.99
Prototype PCBs	Device	\$6.48	1	\$6.48
PTFE Teflon tube	Device	\$7.99	1	\$7.99
Shirt	Device	\$15.49	1	\$15.49
Solder	Device	\$11.00	1	\$11.00
Talentcell Battery	Device	\$29.99	1	\$29.99
Vest	Device, Second Device	\$32.99	2	\$65.98
Wires	Device	\$11.00	1	\$11.00
<b>Total:</b>				<b>\$437.52</b>

## 5.4 CAD Models

The final design included multiple 3D printed parts, most notably, the shoulder pads and the motor and Arduino casing. These parts are critical to the design because without the shoulder pads, there wouldn't be a stable way to pull back the shoulders and without the casing, the motors and Arduino could easily slide around out of place or get damaged.

### 5.4.1 Shoulder Pad Models

Modeling the shoulders allowed for a more personalized vest but also helped guarantee that the shoulders would be stabilized while being pulled back. To model the shoulder pads, a 3D scan was taken of the test subject's upper torso. This was done using a program called Skanect, shown in figure 29, which utilizes the spatial capabilities of an Xbox Kinect camera to create a mesh of any 3D object. This mesh file was then edited using the mesh editing software Meshmixer to create two smaller meshes of each shoulder. Now having smaller more manageable files, each shoulder was reconstructed in Creo using layers of splined curves and the swept blend tool. From there, the

shoulders were molded in Creo, creating inverses of the 3D parts. These molds were then cut down into a shoulder pad for each shoulder.

These initial shoulder pads were very large and didn't have any holes to put the Kevlar wire through or to sew the pad onto the vest. To account for this, they were cut down to better fit the vest and had holes

drilled in them, larger ones for the Kevlar wire and smaller ones to sew the pad onto the vest. These modified shoulder pads ended up being a bit small, not sitting very far down the user's back, so a second set was created. For this second set, a new scan was done with the test subject wearing the base vest. After editing the scan in Meshmixer to get a smaller mesh of each shoulder, shoulder pads were created on top of the meshes instead of going through the molding process as was done before, as shown in figure 30. Splines were used in layers again but instead of tracing the whole shoulder, the splines traced the curves of the vest on top of each shoulder. Each of these splines was turned into a misshapen block. Each block was used in another swept blend but this time, the shoulder pads were created. The models were then smoothed out using fillets, had holes added for both the wire and for sewing the pads on the vest, and had a raised 'R' or 'L' so that it was clear which shoulder pad was for which shoulder.



Figure 29: Skanect model of test subject's upper torso

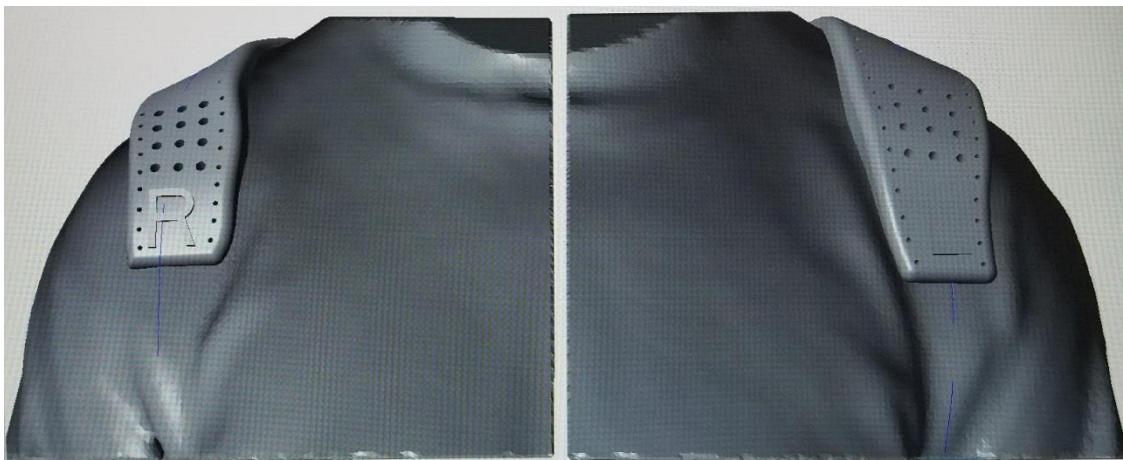

Figure 30: Creo models of second iteration of shoulder pads

### 5.4.2 Motor Casing and Complementary Components

The first motor casing iteration for the vest, shown in figure 31, included two cylinders with a thirty-seven-millimeter inner diameter to house the motors, a recessed area with supports and holes to house the motor driver, and another recessed area with supports and holes to house the Arduino Uno. The total area of the motor casing was cut due to the little space between the motor driver and Arduino. Holes were drilled all around the edge of the motor casing to secure the casing to the vest via sewing.

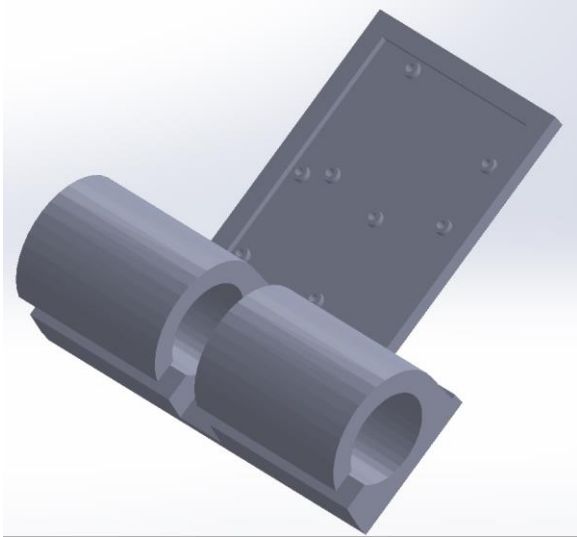

Figure 31: CAD motor casing and Arduino housing

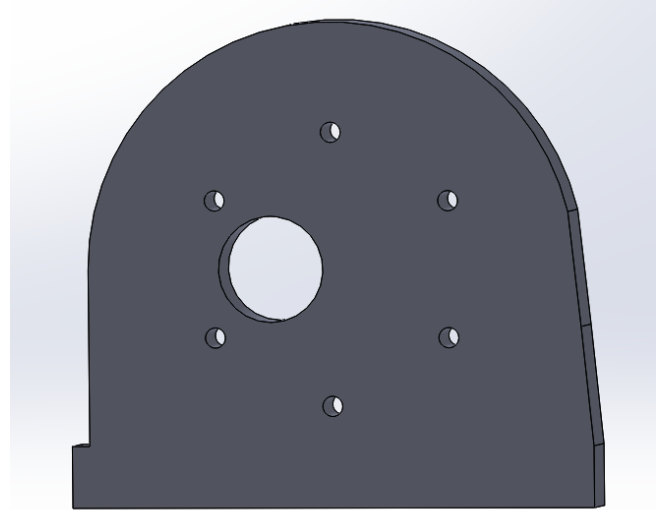

Figure 32: CAD motor casing holder

The motors were secured inside the motor casing using the plastic plates shown in figure 32. These plates have holes that line up with the tapped holes on the output side of the motors. M3 screws secure the motors to the plastic plate and the plastic plates themselves are screwed into the motor casing. The shape of each plate was modeled to exactly match the motor casing side. The second motor casing was extremely similar but had the motors turned upwards at a thirty-degree angle and had a slot added in to house the battery.

Kevlar cord, shown in figure 33, was chosen as the tension cord to transfer the rotational forces from the motors to the shoulder pads because its maximum strength exceeds 80 pounds of force and it has a resistance to fraying (Amazon.com, Inc., n.d.). A spool was designed to contain the Kevlar cord inside a confined space while being wound by the motors. Each spool has two separate channels to keep the Kevlar cords from tangling because each motor pulls two cords. There were



Figure 33: Kevlar cord

two iterations of the spools: a spool designed to be force fitted onto the motor shafts which deformed under torque and eventually spun freely as shown in figure 34 and a spool with a hole and a set screw used to clamp the spool to the motor shaft as shown in figure 35. The last iteration was the best at allowing the spool to collect the Kevlar cord when the motors spun while allowing for easy position adjustments when necessary.

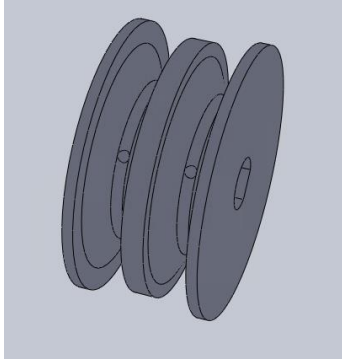

Figure 34: First spool iteration

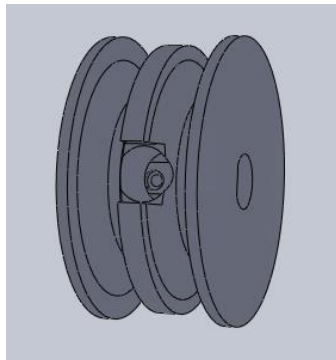

Figure 35: Second spool iteration

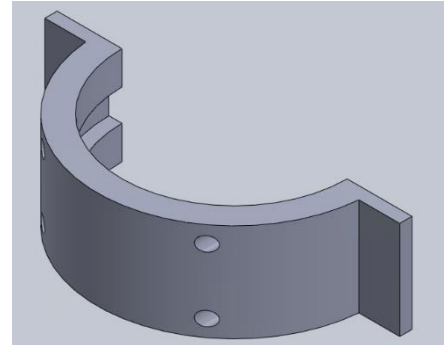

Figure 36: Cord catching component

The largest issue encountered when designing the spools was that the Kevlar cord would bunch up underneath the spool when the motor spun in the opposite direction. The motor would do this to introduce slack, allowing the user to move their shoulders. Occasionally, when the motors spun to pull the shoulders back, the cords would tangle and jump between channels or wrap around the motor shaft. To fix this issue, cord catching components were designed to direct the Kevlar cord to the correct channel while allowing any bunching to happen above the spools. These components were meant to be epoxied together but they were too hard to line up and the edges would catch on the spool, thus spinning with the spool and defeating their purpose. In the second iteration of cord catchers, the holes for the Kevlar cord were widened to eliminate the cord catching on the edges of the hole. The four components were then combined into two wider components that are held together by M3 screws and nuts for a simpler connection. The second iteration of this components is shown in figure 36.



Figure 37: Cord guides

Another precaution taken to keep the Kevlar cord organized and tidy was the creation of small plastic guides that were sewn to the vest. These guides were sewn along the path that the Kevlar cord traveled to get from the shoulder pads to the spools on the motor shafts and are shown in figure 37.



## 5.5 Manufacturing Process

### 5.5.1 Shoulder Pads



*Figure 38: First iteration of shoulder pads with template for hole drilling*

As described in section 5.4.1, the first iteration of shoulder pads had several holes drilled into them after they were 3D printed, the first section shown in figures 38 and 39. A second section of holes was put in as an array positioned towards the front end of the shoulder pads. The team then attached Kevlar cord to these holes to determine the best anchor points for the motor to pull from: the points that pulled the shoulders down and back with the least amount of force. Before attaching the cords to the motor, the cords were pulled manually to test each anchor point. It was determined that the best anchor points were slightly over and in front of the shoulder. This test can be found in Appendix B. Also in this test, a force gauge was used to pull the strings for three trials per shoulder to determine the force required to pull the shoulders back. The results were fairly consistent: the average pull forces were 7.22 pounds of force for the left shoulder and 6.73 pounds for the right shoulder. This data was used in motor selection for the final design and prototype. The second iteration of shoulder pads can be seen in figure 40.



*Figure 39: First iteration of shoulder pads after initial modifications*



*Figure 40: Second iteration of shoulder pads*

### 5.5.2 Vest

The team decided to have an overall vest-like design. Instead of sewing a vest, a preexisting shoulder posture correcting vest was bought to build on top of. This is the same vest that is mentioned in section 4.1.1 which was made by ZSZBACE and sold through amazon by HBpanda, pictured in figure 16. It was designed to statically correct the wearer's posture by holding their shoulders back while keeping their spine straight through the support provided by rigid rods incased in the back. The shoulders are held back with two straps that wrap around the shoulders, going under around the back, then around the torso to be Velcroed together in the front. These straps were modified by cutting them and sewing them so that the straps could no longer be pulled. Once that was done, the vest became a brace which was then used to start building on top of.

### 5.5.3 Electrical Components

#### 5.5.3.1 Motors

Pololu 37D mm metal gearmotors (Pololu item #: 2822) were chosen as actuation devices because the group already possessed a thirty-seven-millimeter diameter motor with a gear ratio of 70:1. After testing, the motor operated at a higher speed than was required and did not have enough power to effectively pull back the user's shoulders. The team tested a 131:1 gear ratio Pololu motor which performed at a slow enough speed to be comfortable for the user and was powerful enough to pull the user's shoulders back into the correct posture.

#### 5.5.3.2 Inertial Measurement Units

IMUs were the sensors of choice for determining shoulder orientations. They typically contain an accelerometer, gyroscope, and magnetometer that work together to extract information to calculate the absolute orientation of the sensor compared to magnetic north. The Adafruit BNO055 absolute orientation sensor shown in figure 41 was chosen due to its ease of use. The sensor was ready to be wired straight out of the packaging and came with an on-board processor. The processor collects all the data from the sensors, performs signal processing, and outputs quaternions through either I2C or SPI serial communication (Adafruit Industries, n.d.). The accuracy and ease of use of these sensors allowed the

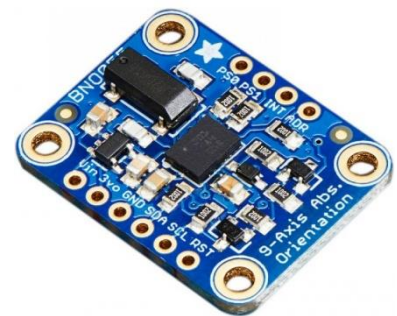

Figure 41: Adafruit IMU (Adafruit Industries, n.d.)



team to start working with them immediately without spending extra time learning signal processing or the math involved in converting all the individual sensor outputs into orientation data. One IMU was placed on each shoulder and one was placed in the middle of the other two. The middle IMU would act as a base for the other two, allowing the shoulder IMUs to have positions relative to it.

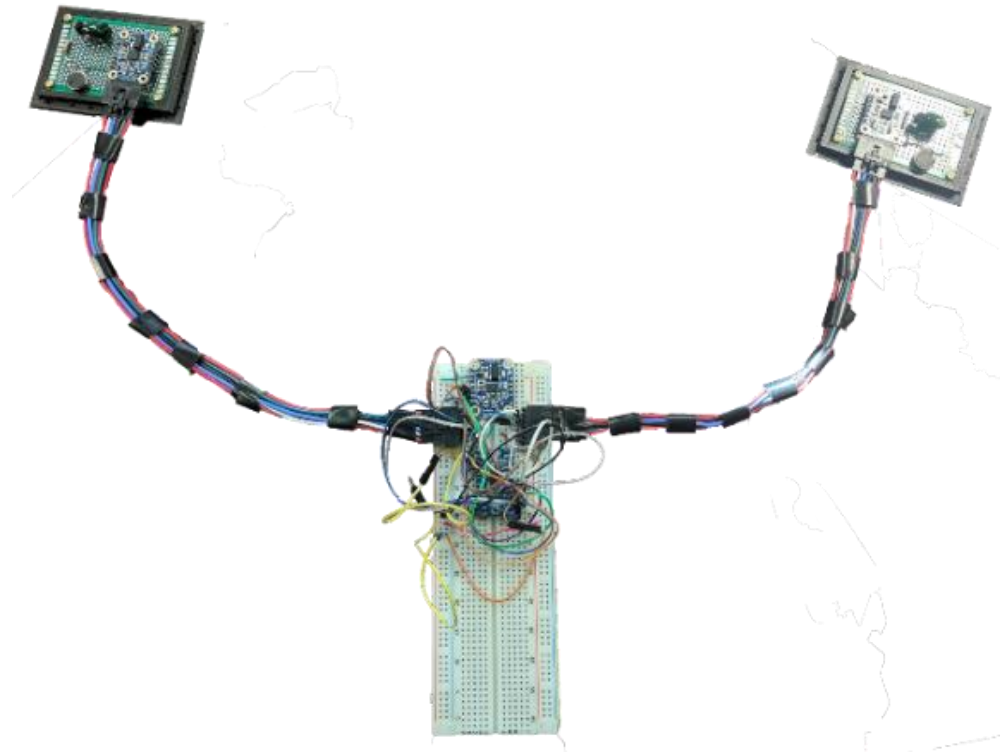

Figure 42: Initial IMU circuit for testing

### 5.5.3.3 Vibration Motors

Vibration motors were installed to provide haptic feedback to alert the user of various scenarios including program start, calibration status, and shoulder positioning. Simple flat coin cellphone vibration motors were chosen due to their small size, flat shape, and low power consumption. These motors can be seen on the protoboard in the top left corner of figure 43.

### 5.5.3.4 Protoboards

Protoboards were used to combine the IMU and the vibration motor circuits on each shoulder, as shown in figure 43. To hold the protoboards in place on the vest, holders were designed

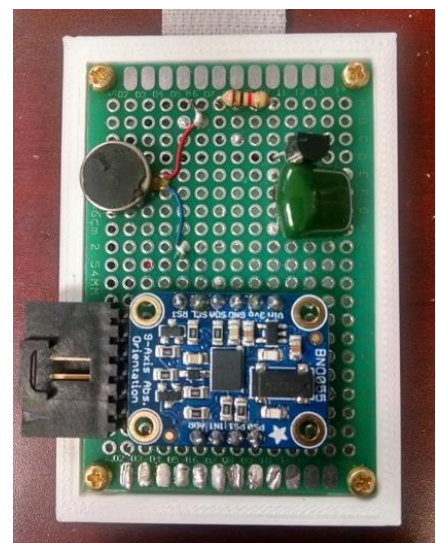

Figure 43: Protoboard containing IMU and vibration motor circuits

and 3D printed. The design was a simple rectangle with a raised siding to protect the protoboard and cylindrical supports within the siding that hold the protoboard in place using four M2 nuts and bolts. The base of the protoboard extended past the siding and holes were drilled through the sides to sew the holder into the vest.

#### 5.5.3.5 Multiplexer

Since the IMUs only had two different addresses and the relative reference setup used three, a multiplexer was needed to create more I2C addresses. The TCA9548A I2C multiplexer was chosen due to its simple pin assembly and eight internal addresses that allowed for a multitude of IMUs to be included. The multiplexer also worked with three-volt and five-volt logic which increases its flexibility (Adafruit Industries, n.d.).

#### 5.5.3.6 Motor Driver

To drive each motor individually, a motor driver was needed that could output twelve volts. The L298N Dual H bridge DC motor driver shown in figure 44 was used because it pulls a maximum of twelve volts and two amps while outputting twelve volts and one amp per motor. The motors themselves can pull up to five amps at twelve volts. The motor driver offers simple direction control and pulse width modulation which allows for complete control over each individual motor. The motor driver also limits the power of the motors, preventing them from injuring the user.

#### 5.5.3.7 Power Source

The device was intended to be portable, so the choice of power supply was limited to a battery. The battery had to have a twelve-volt output and three-amp minimum to power the two motors and the Arduino at the same time. This battery would have to be lightweight and compact to fit on the user's back without adding strain for the user. A Talentcell twelve-volt, 6000 milliamp-hour rechargeable battery was chosen due to its small size of 85 millimeters wide, 145 millimeters long, and 28 millimeters tall. The battery outputs a maximum of three amps and can run at full power for two hours.

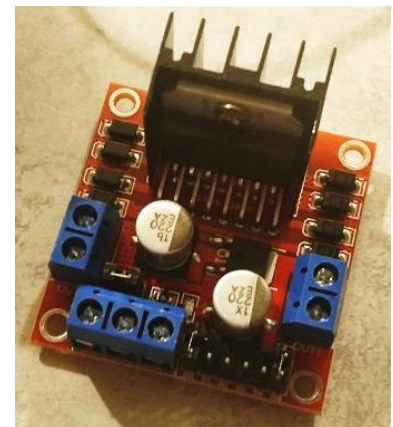

Figure 44: The L298N Dual H bridge DC motor driver for Arduino

#### 5.5.4 Coding

The Arduino language, which is a combination of C and C++ functions, was the electronic platform we used to program the sensors due to its ease of use and ability to transform inputs (i.e. shoulder position tracked by sensors) to an output (i.e. command to move the motors). The code for the device can be divided up into three stages. The first stage is the initialization stage. In this stage, the vest would turn on and run through declaring global variables that will be used throughout the program. The initialization stage then continued by declaring an I2C channel selection function with a channel number as the input. After this, a setup function was created to check whether the IMUs were connected to the correct channels and functioning correctly. This is the point where the user would have all three IMUs touching the same surface, creating a common plane. The program would then start the calibration cycle and the sensors values would all start at 0. The program would not continue until all the IMU's gyroscopes and magnetometers are fully calibrated.

The second stage was the general process of the program. This included compiling data from each sensor and processing it all into relative orientation compared to the middle IMU. This pulls in the quaternion values from each shoulder IMU and compares them to the middle IMU. With the middle IMU as a reference, the shoulder quaternions were multiplied by the conjugate of the quaternion. This calculates the shortest three-dimensional angle from the middle IMU orientation to the shoulder IMU orientations, returning that information as quaternions. These quaternions were then processed into a Tait Bryan angle which is a variation of the Euler angle, commonly used in aviation due to the yaw, or heading, angle being calculated first. Calculating the yaw angle first prevented the value from jumping and proved to be stable and useful for comparing shoulder orientations.

The third stage of the code was monitoring the values of the right and left shoulders individually. When the shoulder angles were greater than the threshold value for more than five minutes, a small vibration would alert the user. If the user does not pull his or her shoulders back within five minutes after the first vibration alert, their shoulders would be pulled back by the motors until they were at the threshold angle. The shoulders would be held there and released after two minutes. This cycle would continue for as long as the user wears the device. Over time the user should start to naturally move their shoulders back more often, which would weaken pectoral muscles and strengthen the upper trapezius muscles therefore correcting the muscle imbalances that cause postural kyphosis.

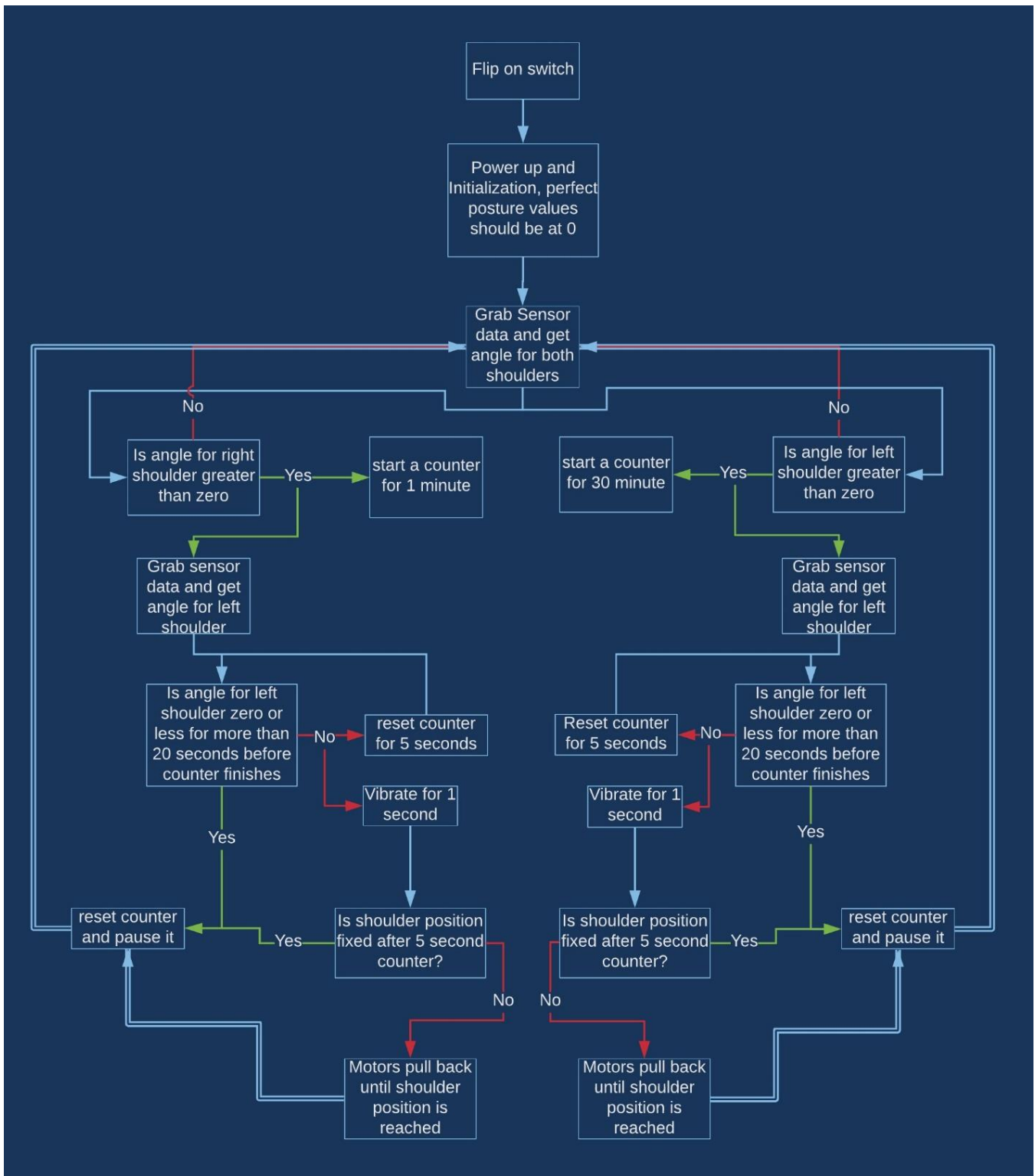

Figure 45: In depth system logic

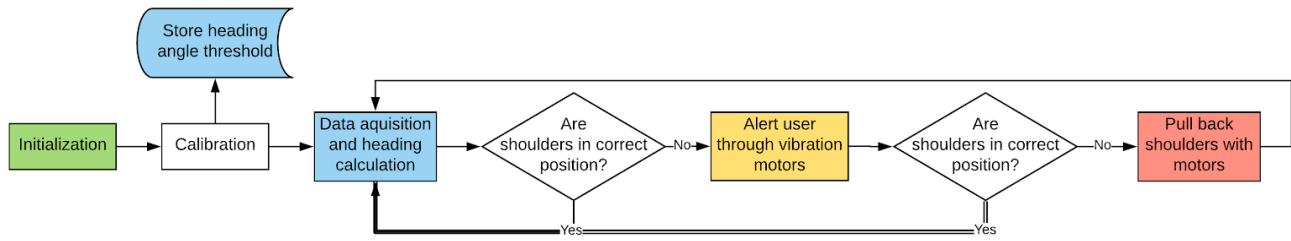

Figure 46: Simplified system logic for shoulder position tracking and device actuation

### 5.5.5 Vest Assembly

First, the shoulder pads were sewed onto the vest using holes placed along the edges. The Kevlar cords were then connected from the shoulder pads down to the motors. To decrease friction Teflon tubes were installed over the Kevlar wires to guide them. The leads were slid over the Teflon tubes to better guide the wire and tubing from the shoulder pads down to the motors. The motors were attached through the motor casing that was sewed onto the vest. This casing housed the motors as well as the Arduino and the motor driver. Finally, all three IMUs were attached with their protoboards, two of them including vibration motors, and everything electric was wired together. A second vest was built in a similar manner however the electrical components remained on the first vest to continue testing. This new vest included the newer shoulder pads and motor casing.

Initially, the leads guiding the Kevlar cords and Teflon tubes were sewed in vertically along the sides of the vest but after several pull tests, they were re sewed to create a crossing pattern i.e. the left shoulder was connected to the right motor and vice versa. After using the angled lead design, friction decreased dramatically. The motors pulled more efficiently and the direction at which the shoulders were pulled back improved. This final design layout can be seen clearly in the Results and Analysis section as figure 55.

### 5.5.6 Circuit Assembly

The Arduino communicates with the multiplexer via I2C serial communication

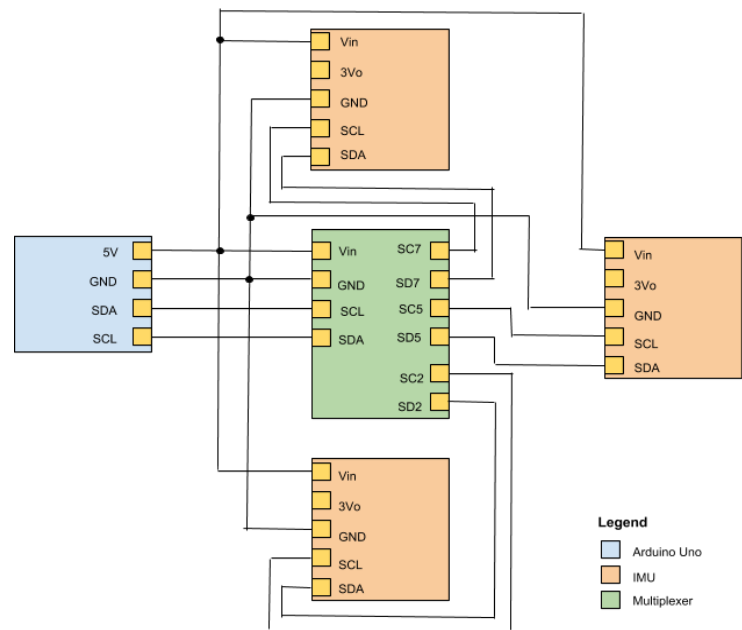

Figure 47: IMU circuit

which relays the individual IMU data back to the Arduino when called upon. For the Arduino to request the IMU data, the multiplexer channel that the IMU is connected to has to be initiated and then the Arduino can request the information. The Arduino receives orientation information from the two outside IMU's that are comparing themselves to the middle reference IMU. If the user has incorrect posture for a certain period, the Arduino pulses the vibration motors on the respective shoulders as haptic feedback. The Arduino then turns the motors on to pull back the user's shoulders if they don't fix it themselves.

The vibration motors are separated into two circuits. Each circuit has a transistor that acts as a switch to either turn the vibration motors on or off depending on whether the circuit is completed with the analog pulse width modulation (PWM) output. The transistor also magnifies the current output from the microcontroller. The vibration motor is in parallel with a capacitor and a diode. The diode protects the microcontroller from voltage spikes that could be caused by the motor. The capacitor also catches and holds the voltage spikes that might be caused by the motor.

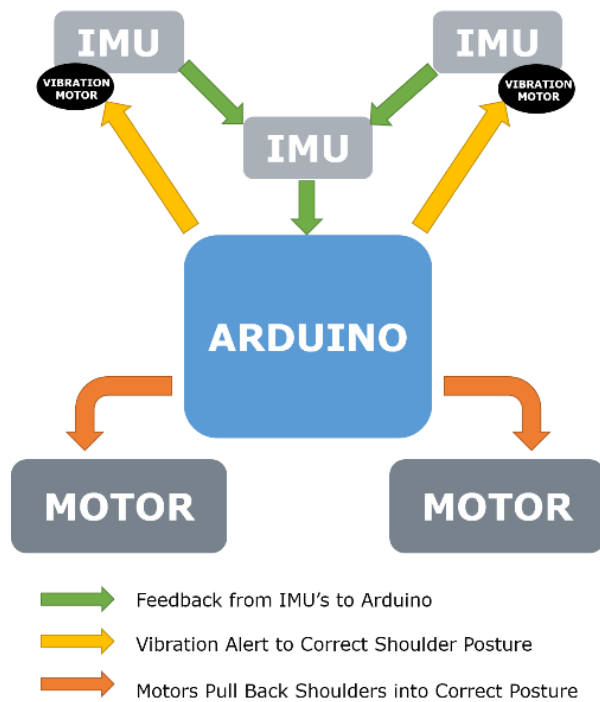

Figure 49: Device's circuit components

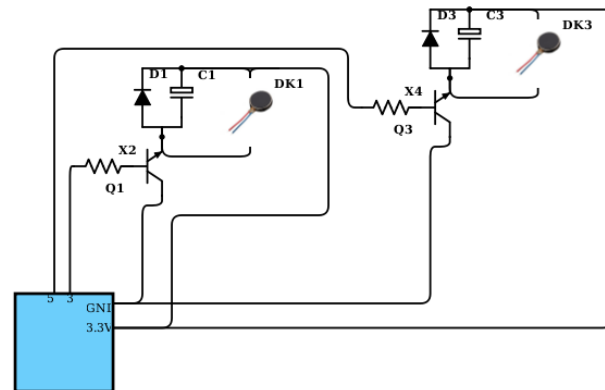

Figure 49: Vibration Motors Circuit

### 5.5.7 Calibration

In order correctly start the calibration process, the user must stay completely still while turning the device on. This will calibrate all three IMU magnetometers. The user must then rotate their shoulders back to calibrate all three IMU gyroscopes. Full calibration of the magnetometers and

gyroscopes will allow the IMUs to output accurate orientation values. Once all the IMUs are correctly calibrated, the vibration motors on the shoulders will turn on to tell the user the device is ready for use. To ensure that the IMU orientation values were correct, the user would rotate their shoulders forward for a few minutes. Having no vibration feedback after a few minutes would mean that the IMU values have a backwards orientation and the values are decreasing as the shoulders move forward when they should be increasing. In this case, the user would have to restart the device and redo calibration.

### ***5.5.8 Manufacturability and Sustainability***

This device could be custom made with a 3D scan of the subject's shoulders or different, set sizes could be produced. This device allows the user to correct his or her postural kyphosis over time. Since it calibrates itself at the beginning each of use, this device can be used whether the kyphosis improves or deteriorates, preventing it from being rendered useless. The motors have an unpredictable lifetime that depends on the type and frequency of use. The battery has an average lifespan of six hours and can be recharged. Because of the frequency of use, it is estimated that this product, as is, can last for up to three months without needing any technical maintenance.

This device can be mass produced because the components are easy to put together. To improve its manufacturability, a similarly shaped vest would be made that would include cloth guides for the wires, reducing the number of parts. To ensure a fully functioning prototype was built, the team opted for 3D scanning the shoulders to make custom shoulder pads. Although this was effective and could seem favorable to customers, this wouldn't be as efficient of a design. Creating set sizes with malleable shoulder pads allows for standardization, would have enough options to fit many body types, and is a smarter design for manufacturing because it would eliminate what would be a lengthy 3D scanning process. However, the effectiveness of custom made shoulder pads versus set sized shoulder pads would be worth evaluating to help decide between these options.

## **5.6 User Safety**

The tests conducted with a luggage scale determined an average range of 6.7lbs-8.9 lbs force necessary to pull back the shoulders, these tests are explained in Appendix A and B. These preliminary forces provided base values that were used to ensure that the motors we selected would be pulling the shoulders with safe forces. All the components of the device were sewed onto the outside of the vest,

therefore having no physical contact with the user. The battery is located within a casing over the vest to avoid any dissipated heat from discomforting the user. All electronics can be taken off easily, so the vest could be hand washed and air dried at the convenience of the user. All 3D printed components would need to be checked weekly for signs of fatigue such as layer separation or discoloration. Components that show signs of fatigue would have to be replaced by a technician to prevent injury to the user.

## **5.7 Standards and Regulations**

Both the Federal Drug Administration (FDA) and International Organization for Standardization (ISO) would have authority over standards for a device like the one produced for this project because it would be classified as a medical device for rehabilitation. However, because the device is only a prototype and was tested using a member of the team, the FDA regulations were not imperative to the project. There are a few ISO standards that had to be investigated and followed because the device was tested on a human and it had sensors used for research (ISO - International Organization for Standardization, 2016). Below is the list of standards that were considered:

- ISO – 21500: Guidance on project management
- ISO – 13485: Medical devices – Quality management systems – Requirement for regulatory purposes
- ISO/IEC – 17025: General requirements for the competence of testing and calibration laboratories
- ISO - 14155: Clinical investigation of medical devices for human subjects - Good clinical practice



## **6.0 Design Validation**

Long-term testing was expected to be done on the device. With the number of different iterations for various parts required to find a functioning design, the team was unable to perform long-term testing. Other methods of design validation were used to make sure the design met all the requirements. All results can be found in Chapter 7.

### **6.1 Survey**

A survey was created to assess the test subject's perception of the device. The aspects that were covered in the survey were: physical effort from the user to use the device, effective sensorimotor training to retain correct posture, requirement of a second person to assist user for donning and doffing, lumbar support provision, and level of comfort while wearing the device. The survey questions can be found in appendix C.

### **6.2 Video Analysis Software**

A video analysis software called Kinovea was used to evaluate the biomechanical movement actuated by the device. This software is commonly used in the athletic training community and by some other medical professionals. Kinovea can track movement as well as obtain data like the distance, speed, and force involved in a movement. It tracks the movement using markers that can be placed anywhere on the body. For this project, Kinovea was used to observe and gather data on the shoulder movement actuated by the device.

### **6.3 Software Testing**

Testing the device software was an iterative process to ensure that all components were working properly. The first test determined the accuracy of the IMU output and confirmed that the math that turned the raw information into Tait Bryan angles was correct. This test utilized a wooden block secured to a table as a reference. Each IMU was then placed on each side of the block, except the bottom, to compare the values at each position to their corresponding Tait Bryan angles assuming that the block faces were all orthogonal to each other. Both IMUs were within four degrees for every test. The next test checked the accuracy of the math used to find the relative orientation of one IMU compared to the reference IMU. For this test, the reference IMU was secured to the top of the wooden block and the relative IMU was placed on the sides of the block to verify already known angles. The

conjugate of the reference IMU was multiplied by the orientation of the relative IMU. This gave the relative IMU's orientation with respect to the reference IMU. The Tait Bryan angles were compared to each relative orientation obtained.

After testing the IMUs, a simple motor test was completed to determine the polarity needed to rotate the motors in the desired direction. An Arduino program was run that rotated the motors in one direction then switched the polarity to switch the direction of the motors. The appropriate polarities for each desired motion were stored in the main code. Next was a motor strength test. The spools and cords were attached to the motors to pull the shoulders using various amperages, all at twelve volts. The amperage used was 0.5 amps, causing the motors to stall without being able to pull the shoulders back. Then the amperage was bumped to 0.75 amps, pulling the shoulders back slightly before stalling out. Finally, one amp of current, the maximum that can be provided by the motor driver, pulled the shoulders back slightly past the threshold value stored by the shoulder IMUs.

The final test was a full system test with all the components combined. The IMUs output expected data and the shoulders were pulled back just past the threshold value when they immediately stopped pulling. This test concluded that the Arduino program was working correctly, and the hardware was working almost without issues. One issue happened a few times with the mounting of the IMU's on the shoulders: the shirt worn underneath would bunch up on the test subject's shoulders rotating the IMU's in the opposite, incorrect direction. Pulling the shirt tighter on the test subject would temporarily fix this issue.

## 7.0 Results and Analysis

### 7.1 Video Analysis Software

Through version 0.8.15 of Kinovea, the team was able to create four videos tracking the motion of the subject's left and right shoulders. Two videos are of the subject pulling back his shoulders on his own and the other two are his shoulders being pulled back by the device. Each video produced a line that tracked the position of the shoulders, a line that showed the shortest distance between the start and end points, and the speed at which the shoulders traveled. The distance was measured using a reference distance of 2.54 centimeters on a tape measure behind the subject and the speed was calculated based off the distance and time traveled. Without the vest, the average speed of pulling the shoulders back was 0.03 meters per second and was 0.025 meters per second with the vest.

Figures 51 and 53 below show that the path the shoulders took without the device were angled upwards and back from the starting position creating a C-like shape. The slight differences between shoulders is most likely due to the subject being right dominant; the right shoulder moved back about one centimeter more than the left and was slightly faster on average. The distance is farther for the dominant shoulder because this shoulder needs more correction, dominant shoulders are more active creating tighter muscles in the overall imbalance. Without the device, the subject seemed to consistently hyper-extend the shoulders backwards, tucking the chin downwards, and expanding the chest, harming the neck muscles. This also occasionally exaggerated the appearance of rounded shoulders. As shown in figures 52 and 54, the assisted shoulder paths are virtually straight and the line indicating the shortest distance between the start and end is directly under this line of motion. Like the motion without the device, the dominant right shoulder moved back farther, but this time by about three centimeters. It was also noticed that the chin is in a more natural position while the shoulders were held back with the device.

The video analysis software proved that, with the help of the device, the user was able to move his shoulders back to a neutral position with a smooth and consistent motion. The speed of shoulder activation showed no significant difference between the user wearing and not wearing the device with values ranging between 0.02 and 0.04 meters per second. Although the speed is similar, the overall movement is very different and although the shoulders move back more without the device, the device creates the more biomechanically normal path without causing any additional movement in the neck flexors.

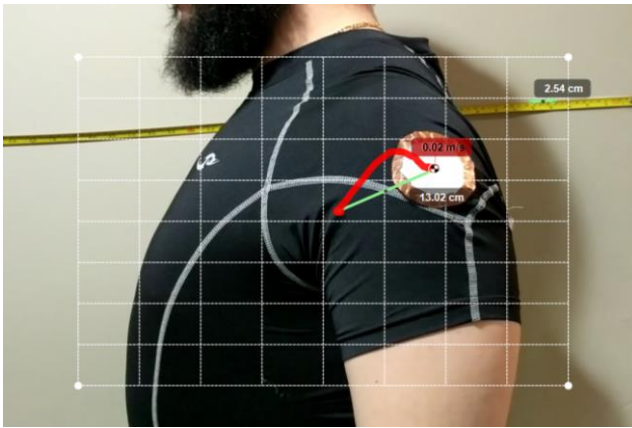

Figure 50: Left shoulder pulled back without assistance

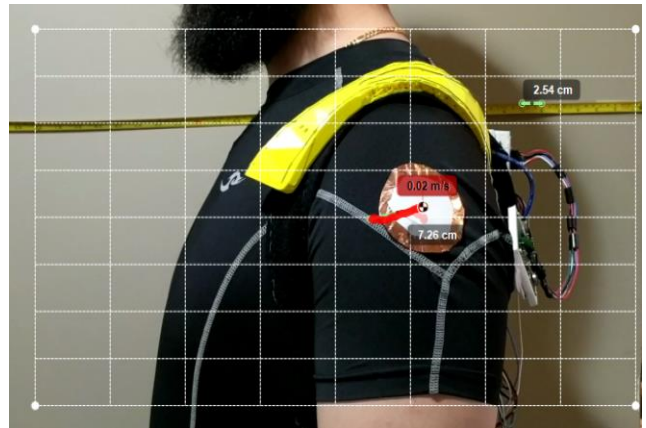

Figure 51: Left shoulder pulled back with assistance

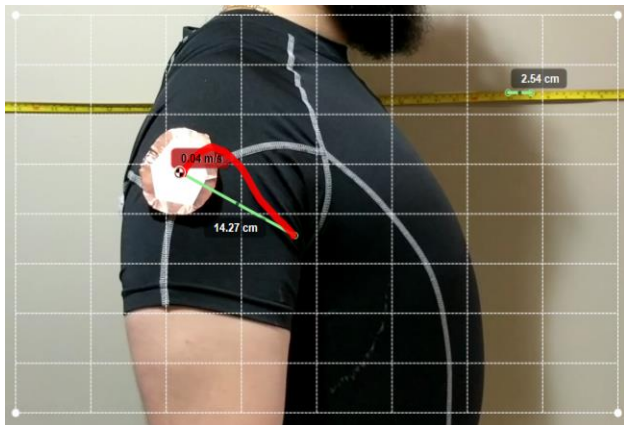

Figure 52: Right shoulder pulled back without assistance

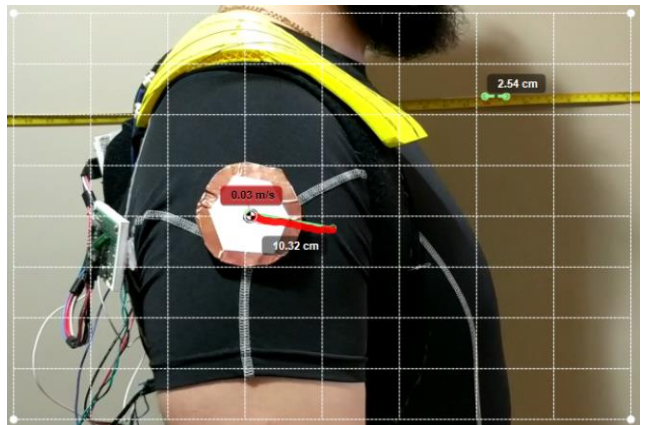

Figure 53: Right shoulder pulled back with assistance

## 7.2 Feedback Survey

A daily survey that meant to be filled out every time the vest is worn can be found in appendix C. One of the answers to this survey can be found following the blank one in the same appendix. This survey was taken at least once by the test subject, Silvio. It was supposed to be taken many times but constructing the device and performing other types of testing got in way and were more of a priority. Silvio's answers were expected because they resulted similarly to how other testing had gone. After his hour-long session in his first survey, Silvio expressed how comfortable the vest was through his answers. He gave helpful feedback about the timing of the vibration versus motor pull back and even noted that he briefly forgot he was wearing the device. Multiple iterations of answers similar or even dissimilar to Silvio's would help determine future steps for the device. Some of these could include adjusting the timers for the vibration motors and rotational motors, adding in padding to make the vest more comfortable, and engineering a way to make the vest easier to put on and take off.

### 7.3 Final Design

The main components in the device were a vest acting as the base, shoulder pads modeled from a 3D scan of the test subject's shoulders for optimal shoulder movement, DC motors to work as actuators, Kevlar wire to transfer the force from the motors to the shoulders, frictionless Teflon tubes to serve as guides for the wires, IMUs to track the position of the shoulder relative to the subject's back, and a processing system that would collect data from the shoulder position and adjust the shoulders accordingly. Two iterations of the device were created during this project. The first version included the initial design concepts and all testing was performed on it. The second iteration of the device was created based on notable design changes that the first version conjured. Some of the changes included new shoulder pads that follow the shape of the vest more accurately and a slot for the battery pack to fit in since the first design did not include a location for it.

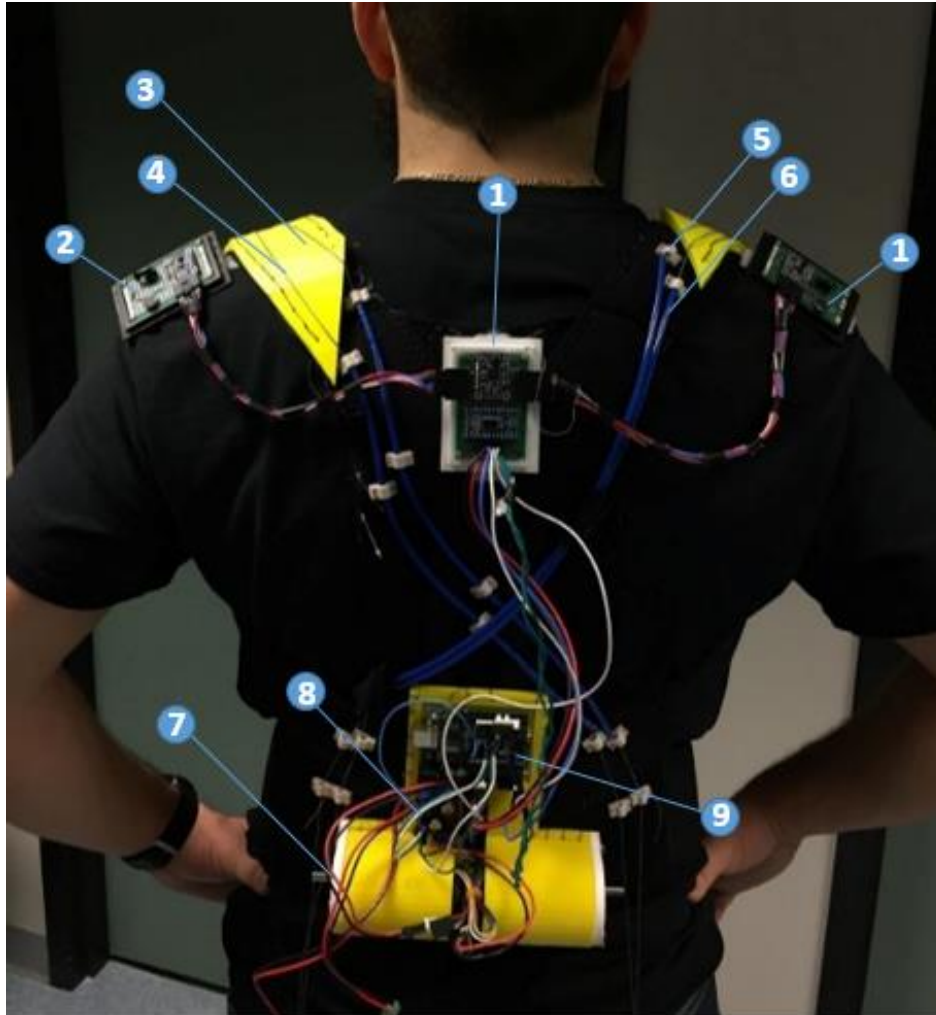

Figure 54: Test Subject wearing device version one

*Table 14: Bill of materials*

<b>Number</b>	<b>Component Name</b>	<b>Quantity</b>
1	Reference IMU	(x1)
2	Shoulder tracking IMU	(x2)
3	Shoulder pads	(x2)
4	Kevlar wire	(x1)
5	3D printed wire guides	(x10)
6	Teflon tube	(x4)
7	DC Motor	(x2)
8	Motor Driver	(x1)
9	Arduino UNO	(x1)

## **8.0 Discussion**

### **8.1 Device Analysis and Review**

Immediate results showed that the device can create a natural shoulder movement with minimal force exerted by the device onto the user. The path of the test subject's shoulders without the device is a C-like shape, showing some hyperextension of the shoulder past the scapular plane which creates unnecessary strain for the shoulders. When assisted, the shoulders are brought back roughly to the edge of the scapular plane which is much easier position for the user to maintain without a great deal of effort. The only similarity between the unassisted and assisted shoulder retraction was the speed at which the shoulders were pulled back; there was no significant difference between the two. It can be concluded that the device pulls the shoulders back comfortably and not forcibly because the device is able to pull the shoulders back at the same speed a person would pull them back on their own.

With a sample size of one and only a few weeks available for testing, long-term testing was not able to be completed. Because of this, the next step for this project would be to conduct longer studies on more subjects. The device itself is customized to a single user, but that could be changed by creating a softer, malleable shoulder pad or by creating new custom shoulder pads using the scanning and printing method outlined in section 5.4.1. Once the device is fitted to the user it is very versatile, able to work with varying degrees of postural kyphosis. The mechanical components are set up in such a way that the device is able to stretch out relatively far from the scapular plane in both directions including any position in between.

Due to the movement the device currently actuates, it can be said that the device can and will facilitate sensorimotor training, but it cannot be confirmed without long-term studies. Sensorimotor training has been proven to be effective in correcting postural and musculoskeletal issues like postural kyphosis. This type of training emphasizes postural control, helps create and strengthen a mind-muscle connection, and allows the user to be more aware of their posture throughout the day. The device implements sensorimotor training by first showing the user where their shoulders should be and then giving reminders to keep the shoulders in that spot. Eventually, the user would no longer need the device maintain proper shoulder posture because they would instinctively do it on their own.

Through the research, prototyping, and testing throughout this project, the team came to the realization that the method posture correction provided by the device could be adapted and used in

different ways. The combination of position tracking and sensorimotor training could be very useful for other types of posture deformities, other muscle imbalances, or even used to monitor athletic movements and techniques in the effort of correcting form and preventing injury.

## **8.2 Overall Impact**

### ***8.2.1 Political Ramifications***

There are various ways that assistive technology devices can be financed because of the impact they can have on people's lives. The National Center on Workforce and Disability (NCWD) explains the three most common ways in which an assistive technology device can be financed: funding from the employer, funding from vocational rehabilitation agencies, or funding from Medicaid or Medicare. In the case that this device is not covered by insurance, this device can be bought by users for an estimated cost between \$300 and \$400, which should be accessible for most people.

#### *8.2.1.1 Employers*

Through the American's Disability Act, employers are required to pay for assistive technology, equipment, and other accommodations, if the request meets the criteria to be considered a reasonable accommodation (NCWD, n.d.). Obtaining this accommodation would be seen as part of the investment needed to ensure a productive employee. This device could fall into this category especially if the job requires the employee to spend prolonged periods of time in front of a computer screen, otherwise hunched over a desk, or holding a steering wheel.

#### *8.2.1.2 Vocational Rehabilitation Agencies*

If an individual requesting this posture correcting device meets the requirements, the device expenses can be covered through their state's vocational rehabilitation agency. These requirements change from state to state but the general requirement is having a disability that interferes with getting or keeping a job (NCWD, n.d.).

#### *8.2.1.3 Medicare or Medicaid*

In most cases, Medicare or Medicaid may pay for a piece of assistive technology equipment for insured individuals if the equipment is deemed medically necessary. The definition of medically necessary is not strictly defined by the providers so in most cases, this judgement is made by the doctors and is controlled by each state. If Medicare or Medicaid won't cover the cost of this device,



private insurance companies may cover the cost of assistive technology or equipment like this device. (NCWD, n.d.).

### ***8.2.2 Society's Tendency to Self-Medicate***

People nowadays live very busy lives and find it hard to make time for healthy habits, let alone medical appointments and physical therapy. Therefore, there has been a surge of mobile apps and fitness trackers that allow users to monitor their health on their own. According to the Food and Drug Administration (FDA), their medical mobile apps can help people manage their own health and wellness, promote healthy living, and gain access to useful information when and where it's needed (U.S. Food & Drug Administration, n.d.). The device for this project provides the user with the tools they need to correct their posture and strengthen their muscles on their own time, whenever they deem convenient. Because of this, it is more likely that the users will prefer this technology and use it as recommended.

### ***8.2.3 Economic Considerations***

When considering any kind of consumer device, it is important to think about its economic impacts. So long as the device is used as recommended, the user should not need to take as many trips to a physical therapist; trips to perform exercises would no longer be necessary, only for necessary checkups. Overall, this could save the user money that would have been spent on copays for each visit. While this may save the user money, it would in turn mean that the therapists would lose this money. The device could also be a cheaper alternative for those who are poorer, do not have insurance, or minimal to no access to physical therapists.

### ***8.2.4 Environmental Considerations***

The manufacturing of this device does not have foreseeable environmental concerns. The only concern could be the battery, but lithium ion battery recycling technology is becoming more commonplace, reducing the environmental impact of disposing the batteries after their lifetime (Boyden et al, 2016). Currently, as mentioned in section 5.5.8, the prototype would last between three and six months due to the sensors that are used. A company called Medtronic has an electronics recycling program that would take care of the fried sensors (Recycle Program, n.d.).

### ***8.2.5 Ethical Considerations***

After considering safety as outlined in section 5.6, standards and regulations as outlined in 5.7, and the other considerations outlined in this overall impact section, this device should be ethically sound because it does not cause any harm to its user, the environment, or anything else.

## **9.0 Recommendations and Future Work**

If anyone were to continue this project, the team has come up with several recommendations and topics of interest future work.

### **9.1 Long-Term Testing**

Long-term studies of a subject using the device need to be conducted to evaluate the effects over time. For this, a test subject would be asked to wear the device three to four times per week for one to two hours per session, mimicking the time that would otherwise be spent with a physical therapist. The purpose of this vest is to be versatile enough to be used during any regular activity as long as the user does not sit back or lay on their backs. All activities able to be completed while wearing device should be accounted for in the long-term testing results. It would also be recommended to have the subject perform the supplementary exercises provided right before or after using the device, adding no more than thirty minutes to the session.

### **9.2 Short-Term Testing**

Daily testing should happen in the form of daily logs. The user would record their natural shoulder position once the vest has been put on using the readouts from the Vest's IMUs. Then, after physical therapy is completed, the user would record their shoulder positions once more to track any immediate changes. After the experiment has been going for a couple of weeks, statistically significant changes in shoulder position may start. The level of comfort and activities completed while wearing the vest should be taken down in the daily logs as well. Another short-term test should be one to determine an average amount of force placed on the shoulders while the device was had the motors pulling them back. It was also used to establish which area of the shoulder was receiving the highest amount of force to validate the positioning of the shoulder pads.

### **9.3 Different Size Options**

One of the biggest points that needs to be developed further is the possibility of providing different size options for this device. This device is intended to be used by people with different lifestyles which could lead to completely different body types. Custom fit vests and shoulder pads were practical for the purposes of this project but realistically, not everyone is going to be willing to pay the extra price for a custom fit device. The different size options can be provided in several ways with one

way being to change the material of the shoulder pads for a more malleable material that is still rigid enough to transfer forces efficiently but also able to adapt to the shape of the user's shoulders. An example material could be Teflon or ultra-high-molecular-weight polyethylene. Another way to provide different sizes would be to create a set of standard sizes, like small, medium, or large, that can have a certain degree of adjustment. Creating different sizes might make the design simpler and easier to manufacture but there might be greater benefits to custom made parts. Additional future work could include testing if a custom-made design allows for better results than a generic size.

#### **9.4 User Experience**

User experience could be bettered with the use of various add-ons or features. Features like including a user interface to control the device, an obvious on/off power switch, modes that control motor pull strength, and a usage timer are highly recommended to be included on future versions of this device. These features would greatly increase user experience by allowing for better device control and would make the device more accessible to more users. Other features that could be included to further improve the user experience and expand accessibility are to incorporate heating pads to soothe muscles, utilize a rechargeable or otherwise eco-friendly power source, and use a sound stimulus either instead of or in conjunction with the vibration motors.

## 10.0 Bibliography

- Allegrucci, M., Whitney, S. L., & Irrgang, J. J. (1994). Clinical implications of secondary impingement of the shoulder in freestyle swimmers. *The Journal of Orthopaedic and Sports Physical Therapy*, 20(6), 307-318. doi:10.2519/jospt.1994.20.6.307
- Adafruit industries. (a). Adafruit BNO055 Absolute Orientation Sensor. Retrieved from <https://learn.adafruit.com/adafruit-bno055-absolute-orientation-sensor/overview>
- Adafruit industries. (b). Adafruit TCA9548A 1-to-8 I2C Multiplexer Breakout. Retrieved from <https://learn.adafruit.com/adafruit-tca9548a-1-to-8-i2c-multiplexer-breakout/overview>
- Amazon.com, Inc..Shomer-Tec SHKTL Kevlar Trip Line. Retrieved from [https://www.amazon.com/dp/B011KNQMFM/ref=tsm\\_1\\_fb\\_lk](https://www.amazon.com/dp/B011KNQMFM/ref=tsm_1_fb_lk)
- American Physical Therapy Association. Manual therapy techniques -&nbsp;guide to physical therapist practice. Retrieved from <http://guidetoptpractice.apta.org/content/1/SEC38.extract>
- American Physical Therapy Association. Who are physical therapists? Retrieved from <http://www.apta.org/AboutPTs/>
- Back & Body Medical. (2012). Upper crossed syndrome causes and treatment options. Retrieved from <https://backandbodyny.com/upper-crossed-syndrome-causes-and-treatment-options/>
- Bertrand Tondu. (2014). Robust and accurate closed-loop control of McKibben artificial muscle contraction with a linear single integral action. *Actuators*, 3(2), 142-161. doi:10.3390/act3020142
- Blake, M. A., Da Silva Dias Fernandes, L., Gervais, D., Hahn, P. F., Harisinghani, M. G., Mueller, P., Saksena, M., Zalis, M. (2004). Importance and effects of altered workplace ergonomics in modern radiology Suites1. *Radiographics*, 24(2), 615. doi:10.1148/rg.242035089
- Boyden, A., Soo, V., & Doolan, M. (2016, July 27). The Environmental Impacts of Recycling Portable Lithium-Ion Batteries. Retrieved from <https://www.sciencedirect.com/science/article/pii/S2212827116300701>
- Bullock, M. P., Foster, N. E., & Wright, C. C. (2005). Shoulder impingement: The effect of sitting posture on shoulder pain and range of motion. *Manual Therapy*, 10(1), 28-37. doi:10.1016/j.math.2004.07.002
- Canales, J. Z., Cordás, T. A., Fiquer, J. T., Cavalcante, A. F., & Moreno, R. A. (2010). Posture and body image in individuals with major depressive disorder: A controlled study. *Revista Brasileira De Psiquiatria (Sao Paulo, Brazil: 1999)*, 32(4), 375-380.

- Chansirinukor, W., Wilson, D., Grimmer, K., & Dansie, B. (2001). *Effects of backpacks on students: Measurement of cervical and shoulder posture* doi://dx.doi.org/10.1016/S0004-9514(14)60302-0
- De Volder, M., Moers, A. J. M., & Reynaerts, D. (2011). Fabrication and control of miniature McKibben actuators. *Sensors and Actuators A: Physical*, 166(1), 111-116. doi:10.1016/j.sna.2011.01.002
- Ding, Z. Q., Luo, Z. Q., Causo, A., Chen, I. M., Yue, K. X., Yeo, S. H., & Ling, K. V. (2013). *Inertia sensor-based guidance system for upperlimb posture correction* doi://doi.org.ezproxy.wpi.edu/10.1016/j.medengphy.2011.09.002
- Ergo Posture Transformer and Back Support. Ergo back support & posture corrector. Retrieved from <https://www.ergobacksupport.com/>
- Federowicz, K. (2011). No pain, real gain: Improve your posture, fix muscle imbalances, and reduce your risk of injury in a month with this routine. *Men's Fitness*, 27, 117. Retrieved from [http://libraries.state.ma.us/login?gwurl=http://go.galegroup.com/ps/i.do?p=ITOF&sw=w&u=mlin\\_c\\_worpoly&v=2.1&it=r&id=GALE%7CA251380025&sid=summon&asid=4f74380b846748dac3292be38d8a4e67](http://libraries.state.ma.us/login?gwurl=http://go.galegroup.com/ps/i.do?p=ITOF&sw=w&u=mlin_c_worpoly&v=2.1&it=r&id=GALE%7CA251380025&sid=summon&asid=4f74380b846748dac3292be38d8a4e67)
- Hindle Controls. Bowden cable. Retrieved from <http://www.controlsandcables.com/products-to-sort/bowden-cable/>
- Hrysmallis, C. (2010). Effectiveness of strengthening and stretching exercises for the postural correction of abducted scapulae: A review. *Journal of Strength and Conditioning Research*, 24(2), 567. Retrieved from <http://www.ncbi.nlm.nih.gov/pubmed/20072041>
- Huizen, J. (2017). Upper crossed syndrome: Causes, symptoms, and exercises. Retrieved from <https://www.medicalnewstoday.com/articles/318897.php>
- Hwang, J. A., Bae, S. H., Do Kim, G., & Kim, K. Y. (2013). The effects of sensorimotor training on anticipatory postural adjustment of the trunk in chronic low back pain patients. *Journal of Physical Therapy Science*, 25(9), 1189-1192. doi:10.1589/jpts.25.1189
- ISO - International Organization for Standardization. (2016, February 25). Retrieved April 24, 2018, from <https://www.iso.org/standard/59752.html>
- Inchworm Stretch. (2015, September 02). Retrieved April 24, 2018, from <https://www.womenshealthmag.com/fitness/inchworm-stretch>
- Ji Hyun, B. (2013). *Youth posture correction device* Retrieved from <https://patents.google.com/patent/KR101296917B1/en>

- Jin-Tae Han, Jung-Hoon Lee & Chul-Han Yoon (2015) The mechanical effect of kinesiology tape on rounded shoulder posture in seated male workers: a single-blinded randomized controlled pilot study, *Physiotherapy Theory and Practice*, 31:2, 120-125, DOI: 10.3109/09593985.2014.960054
- Johns Hopkins Medicine. (a). Before, during and after your EMG test. Retrieved from [http://www.hopkinsmedicine.org/healthlibrary/test\\_procedures/neurological/electromyography\\_emg\\_92,P07656](http://www.hopkinsmedicine.org/healthlibrary/test_procedures/neurological/electromyography_emg_92,P07656)
- Johns Hopkins Medicine. (b). Electromyography (EMG). Retrieved from [http://www.hopkinsmedicine.org/healthlibrary/test\\_procedures/neurological/electromyography\\_emg\\_92,P07656](http://www.hopkinsmedicine.org/healthlibrary/test_procedures/neurological/electromyography_emg_92,P07656)
- Kim, D., Cho, M., Park, Y., & Yang, Y. (2015). Effect of an exercise program for posture correction on musculoskeletal pain. *Journal of Physical Therapy Science*, 27(6), 1791-1794.  
doi:10.1589/jpts.27.1791
- Klute, G. K., Czerniecki, J. M., & Hannaford, B. (2002). Artificial muscles: Actuators for biorobotic systems. *The International Journal of Robotics Research*, 21(4), 295-309.  
doi:10.1177/027836402320556331
- L. Hodgins, Justin & Rubenstein, William & Kovacevic, David & Padaki, Ajay & Jobin, Charles & Ahmad, Christopher. (2017). Pectoralis Minor Contracture in Throwing Shoulders of Asymptomatic Adolescent Baseball Players. *Orthopaedic Journal of Sports Medicine*. 5. 232596711772804.  
10.1177/2325967117728041.
- Leon M. Straker, Peter B. O'Sullivan, Anne Smith, & Mark Perry. (2007). Computer use and habitual spinal posture in australian adolescents. *Public Health Reports (1974-)*, 122(5), 634-643.  
doi:10.1177/003335490712200511
- Liao, D. Y. (June 2016). Design of a secure, biofeedback, head-and-neck posture correction system. Paper presented at the 119-124. doi:10.1109/CHASE.2016.31
- McMichael, J., & Sharpey-Schaefer, E. P. (1944). *Cardiac output in man by direct fick method*
- Muscle Imbalance Syndrome. (2014) Muscle imbalances verified in upper crossed syndrome patients. Retrieved from <http://www.muscleimbalancesyndromes.com/2014/07/14/muscle-imbalances-verified-in-upper-crossed-syndrome-patients/>
- National Fluid Power Association. What is hydraulics? Retrieved from <http://www.nfpa.com/fluidpower/whatishydraulics.aspx>

Norton, R.L (2012) Design of Machinery. New York, NY: McGraw Hill.

Notch. Notch: Smart motion capture for mobile devices. Retrieved from <http://www.wearnotch.com>

National Center on Workforce and Disability. Funding Assistive Technology and Accommodations. Retrieved from [http://www.onestops.info/article.php?article\\_id=22](http://www.onestops.info/article.php?article_id=22)

Occupational Safety and Health Administration. Safety and health topics | ergonomics | occupational safety and health administration. Retrieved from <https://www.osha.gov/SLTC/ergonomics/>

Odeberg, S., Ljungqvist, O., Svenberg, T., Gannedahl, P., Bäckdahl, M., Rosen, A. V., & Sollevi, A. (1994). Haemodynamic effects of pneumoperitoneum and the influence of posture during anaesthesia for laparoscopic surgery. *Acta Anaesthesiologica Scandinavica*, 38(3), 276-283. doi:10.1111/j.1399-6576.1994.tb03889.x

Page, P. (2006). Sensorimotor training: A “global” approach for balance training. *Journal of Bodywork and Movement Therapies*, 10(1), 77-84. doi:10.1016/j.jbmt.2005.04.006

Plank Exercises. (n.d.). Retrieved from <http://sassyfitgirl.com/plankexercises>

Raine, S., & Twomey, L. (1994). Posture of the head, shoulders and thoracic spine in comfortable erect standing. *Australian Journal of Physiotherapy*, 40(1), 25-32. doi:10.1016/S0004-9514(14)60451-7

Recycle Program. (n.d.). Retrieved April 26, 2018, from <http://www.medtronic.com/covidien/en-us/support/sustainability/recycle-program.html>

Silva, A., Mello, M. T. d., Gávea Junior, S. A., Queiroz, S. S. d., Tufik, S., & Mattiello, S. M. (2015). Therapeutic modalities and postural balance of patients with knee osteoarthritis: Systematic review. *Fisioterapia Em Movimento*, 28(3), 605-616. doi:10.1590/0103-5150.028.003.AR01

SparkFun Electronics. (a). Accelerometer, gyro and IMU buying guide. Retrieved from [https://www.sparkfun.com/pages/accel\\_gyro\\_guide](https://www.sparkfun.com/pages/accel_gyro_guide)

SparkFun Electronics. (b). Flex sensor. Retrieved from <https://www.sparkfun.com/datasheets/Sensors/Flex/FlexSensor.pdf>

SparkFun Electronics. (c). MyoWare muscle sensor. Retrieved from <https://www.sparkfun.com/products/13723#reviews>

Sparkfun Electronics. (d). PCB basics. Retrieved from <https://learn.sparkfun.com/tutorials/pcb-basics>

The Intrinsic Muscles of the Shoulder. (2017, December 24). Retrieved Dec 08, 2017, from <http://teachmeanatomy.info/upper-limb/muscles/shoulder/intrinsic/>



Thomasnet. Types of actuators and their applications and uses - A ThomasNet buying guide. Retrieved from <https://www.thomasnet.com/articles/pumps-valves-accessories/types-of-actuators>

Tondu, B. (2014). Robust and accurate closed-loop control of McKibben artificial muscle contraction with a linear single integral action. *Actuators*, 3(2), 142-161. doi:10.3390/act3020142

U.S. Food & Drug Administration. Mobile Medical Applications. Retrieved from <https://www.fda.gov/MedicalDevices/DigitalHealth/MobileMedicalApplications/default.htm#a>

Wong, C. K., Coleman, D., diPersia, V., Song, J., & Wright, D. (2010). The effects of manual treatment on rounded-shoulder posture, and associated muscle strength. *Journal of Bodywork and Movement Therapies*, 14(4), 326-333. doi:10.1016/j.jbmt.2009.05.001

Woodward, T. W., & Best, T. M. (2000, May 15). The Painful Shoulder: Part I. Clinical Evaluation. Retrieved Dec 08, 2017, from <https://www.aafp.org/afp/2000/0515/p3079.html>

Yosifon, D., & Stearns, P. N. (1998). The rise and fall of American posture. *The American Historical Review*, 103(4), 1057-1095. doi:10.2307/2651198

Zazula, D., & Holobar, A. (2005). Non-invasive insight into electrical activity of human muscles. *Computer Methods and Programs in Biomedicine*, 8 Retrieved from <https://lspo.feri.um.si/NeuroTREMOR/Surface%20EMG.pdf>

# Appendix

Appendix A: Preliminary Shoulder Force Test .....	73
Appendix B: Secondary Shoulder Force Test .....	74
Appendix C: User Feedback Survey .....	75
Appendix D: User Guide.....	79
Appendix E: Supplementary Exercises .....	80
Appendix F: Appendix References .....	82

## Appendix A: Preliminary Shoulder Force Test

### Test Objective:

This test was performed in the early stages of the design process to find a range of the forces that would be needed to pull shoulders back into a 'correct' position. The results from this test were used as a basis to understand the actuation equipment that would be needed to perform this action.

### Equipment:

- Handheld luggage scale
- Chair
- Secure Wall Mount
- Parachute cord (paracord)

### Procedure:

1. Set up wall mount so that the luggage scale is secured to an anchor point
2. Have subject sit in chair with back flat against a wall
3. Create straps from paracord to put around subject's shoulders
4. Have subject bring shoulders forward as to imitate postural kyphosis, but keeping back straight and flat on the wall
5. Reduce slack in paracord and zero the force gauge
6. Have subject pull shoulders back to also be flat against the wall behind them
7. Read force gauge and record data
8. Repeat steps 1-7 for at least three trials with at least three test subjects



Figure A1: Side view of the shoulder force test

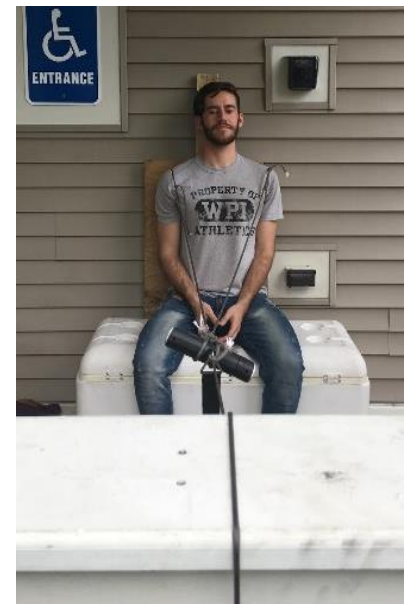

Figure A2: Front view of the shoulder force test

### Results:

Table A1: Results from the initial shoulder force pull test separated by teammate

Subject	Trial 1 (lbf)	Trial 2 (lbf)	Trial 3 (lbf)	Trial 4 (lbf)	Trial 5 (lbf)	Average (lbf)
Connor	9.88	8.97	9.55	9.41	10.58	9.678
Manuela	7.16	6.99	7.05	6.94	6.53	6.934
Silvio	9.63	7.67	10.71	11.61	11.02	10.128
Spenser	9.04	9.46	9.39	9.92	8.93	9.348
Kirsten	9.28	7.85	8.53	8.18	8.42	8.452
<b>Total Average</b>						<b>8.908</b>

## Appendix B: Secondary Shoulder Force Test

### Test Objective:

This test was done as soon as the shoulder pads had the necessary holes and were installed on the device for two purposes:

1. Figure out where the Kevlar cords should be anchored on the shoulder pads to give the best pull direction
2. Gain a more accurate estimate of how much force will be required

### Equipment:

- Vest with shoulder pads
- Force gauge
- Kevlar string
- Washers
- Sewing needle

### Procedure:

1. Fasten cords to each set of holes that were drilled into device using a sewing needle and washers
2. Using adjacent sets of cords, begin to manually pull them parallel to the subject's back
3. Observe how the shoulders were pulled, taking photos and videos if available
4. Repeat this test for all three sets of holes and cords
5. Based on observations, pictures, and videos, determine the best anchor points
6. Remove cords from all other holes
7. For one shoulder at a time, secure the loose end of the cords to the force gauge
8. Pull the shoulders back as far as possible from the attached force gauge and record the force
9. Repeat this test for three sets, pulling the shoulder three times per set

### Results:

*Table A2: Results from the shoulder pull back test while wearing the vest*

Shoulder Pulling	Left Shoulder (lbf)	Right Shoulder (lbf)
Trial 1.1	7.4	6.7
Trial 1.2	6.3	7.3
Trial 1.3	7.8	6.9
Trial 2.1	7.2	5.4
Trial 2.2	7.6	5.1
Trial 2.3	6.1	7.5
Trial 3.1	8.2	7.2
Trial 3.2	6.7	7.7
Trial 3.3	7.7	6.8
Average	7.222	6.733

# Appendix C: User Feedback Survey

## Briefing Statement

The purpose of this survey is to gather information regarding the overall effectiveness of this postural kyphosis correcting device. Please answer each question to the best of your ability every day that the device is worn, immediately after your session. Keep in mind that the device is only supposed to be worn two to three days a week for one to two hours.

## Survey Questions

1. How long did you wear the device for this session? \_\_\_\_\_

a. If this length is not within the one to two hour recommended time, why was this session cut short or lengthened?

---

---

2. Please rate the amount of time spent wearing the device. Consider how invasive the device was to your daily schedule.

1	2	3	4	5
(needed less time)		(time was perfect)		(needed more time)

3. If you experienced the vest alerting you to pull back your shoulders and then had the vest pull them back, please rate the time interval between these two situations.

1	2	3	4	5	N/A
(too long)		(perfect)		(too short)	

a. Do you feel like the device brought you to a 'correct' posture?

1	2	3	4	5	N/A
(posture feels worsened)		(no change)		(posture feels bettered)	

b. How useful was the vibration notification before motor actuation?

1	2	3	4	5
(not useful)		(somewhat useful)		(very useful)

c. Please rate the level of comfort you experienced when the device pulled your shoulders into correct position based upon the speed at which they were pulled back.

1	2	3	4	5
(too fast)		(movement was natural)		(too slow)

4. How many times did you consciously pull back your shoulders while wearing the device? \_\_\_\_\_

5. Please rate how difficult it was to put the vest on.

1	2	3	4	5
(very difficult)		(neutral)		(very easy)

6. Please rate how difficult it was to take the vest off.

1	2	3	4	5
(very difficult)		(neutral)		(very easy)

7. How sore are your muscles after wearing this device?

1	2	3	4	5
(very)		(a little)		(totally fine)

8. Please rate how comfortable was wearing the device this session.

1	2	3	4	5
(very uncomfortable)		(comfortable)		(very comfortable)

Comments:

---

---

---

---

---

---

---

Name: \_\_\_\_\_

Signature: \_\_\_\_\_ Date: \_\_\_\_\_

# User Feedback Survey

## Briefing Statement

The purpose of this survey is to gather information regarding the overall effectiveness of this postural kyphosis correcting device. Please answer each question to the best of your ability every day that the device is worn, immediately after your session. Keep in mind that the device is only supposed to be worn two to three days a week for one to two hours.

## Survey Questions

9. How long did you wear the device for this session? 1 hour

a. If this length is not within the one to two hour recommended time, why was this session cut short or lengthened?

N/A

---

---

10. Please rate the amount of time spent wearing the device. Consider how invasive the device was to your daily schedule.

1 (needed less time)      2      3 (time was perfect)      4      5 (needed more time)

11. If you experienced the vest alerting you to pull back your shoulders and then had the vest pull them back, please rate the time interval between these two situations.

1 (too long)      2      3 (perfect)      4      5 (too short)      N/A

a. Do you feel like the device brought you to a 'correct' posture?

1 (posture feels worsened)      2      3 (no change)      4      5 (posture feels bettered)      N/A

b. How useful was the vibration notification before motor actuation?

1 (not useful)      2      3 (somewhat useful)      4      5 (very useful)

c. Please rate the level of comfort you experienced when the device pulled your shoulders into correct position based upon the speed at which they were pulled back.

1	2	3	4	5
(too fast)		(movement was natural)		(too slow)

12. How many times did you consciously pull back your shoulders while wearing the device? several

13. Please rate how difficult it was to put the vest on.

1	2	3	4	5
(very difficult)		(neutral)		(very easy)

14. Please rate how difficult it was to take the vest off.

1	2	3	4	5
(very difficult)		(neutral)		(very easy)

15. How sore are your muscles after wearing this device?

1	2	3	4	5
(very)		(a little)		(totally fine)

16. Please rate how comfortable was wearing the device this session.

1	2	3	4	5
(very uncomfortable)		(comfortable)		(very comfortable)

Comments:

I had a very pleasant experience using the device. I could have used the device longer, but I did not want to overdue my first session. The vibrating reminder was really helpful as I forgot I was wearing the vest after some time. I was running into the situation where I pulled my shoulders back but was still pulled back further by the device as I kept thinking I was in proper posture but actually was not. The vibration reminder was great, although it felt like too long of a wait. It was difficult to hold my shoulders at a correct posture which made me unconsciously bring them back to an improper posture making the device have to pull me back every time. I can see and feel the difference when my shoulders are pulled back. It was a very comfortable speed for my shoulders to be moved back. It was not startling, nor did it take too long to make things annoying. I did not feel sore at all the day I used the device nor the days afterwards. The vest material is very soft and having the shoulder pads molded to my own shoulders made me forget I was wearing it at all.

Name: Silvio Torres Betancur

Signature: Silvio Torres Betancur Date: 4/18/18



# Appendix D: User Guide

## Physical Therapy. On your Back



MQPosture

### QUICKSTART GUIDE

## MQPosture Features

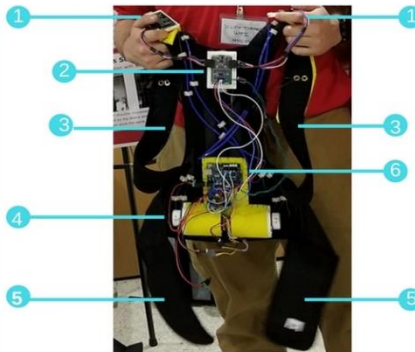

### COMPONENTS

1. Sensors and vibration motors	(x2)
2. Processing System	(x1)
3. Arm Straps	(x2)
4. Motor	(x2)
5. Lower Straps	(x2)
6. Battery	(x2)

### BENEFITS

- ✓ Portable and easy to use
- ✓ Can be used while completing other activities
- ✓ Allows you to continue your daily activities
- ✓ Recreates natural shoulder movement

## Getting started

### Turning Power On

1. Remove cover to expose battery
2. Make sure power source is properly charged and connected. If not, insert battery
3. Turn on device

## Put on Device

### Put the vest on

1. Put arms through arm straps
2. Adjust the lower straps on the waist area until tightened comfortably

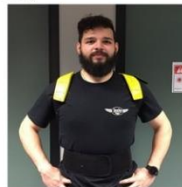

## Personalized Set Up

### Device Calibration

1. Rotate shoulders back and forward
2. Repeat this movement until there is a vibration signaling that the sensors were calibrated correctly
3. The motors will start and show you the correct position at which you should move your shoulders

## Exercising your Shoulders

### Device is ready to use

1. Continue daily activities
2. Remember to move shoulders as indicated previously by the device  
**Note:** If you forget to move the shoulders for 5 minutes, the device will do it for you!
3. Once the exercise period has ended, take off and turn off the device at any time.

## Recommended Use

### Use this device as you would do physical therapy

1. The recommended frequency of use is two (2) to three (3) times a week for one (1) to (2) hours at a time
2. Device may be taken off at any time during your training

## MQPosture Benefits

### Train your mind AND your muscles

1. MQPosture combines active tracking of your shoulder position with sensorimotor training
2. Postural kyphosis is often a recurring issue, MQPosture can help you consciously correct your posture



## Appendix E: Supplementary Exercises

### SUPPLEMENTAL GUIDE

#### Wondering what you can do to maximize results?

Here is a list of exercises you can perform in conjunction with using MQPosture as recommended by the manufacturer and your physical therapist.

**Note:** These exercises are not required but will be helpful in your training. It is recommended that these exercises are done on the days when the device is not in use but can be on the same day if necessary

#### How do they work?

These exercises help to hit all of the muscles involved in postural kyphosis in a higher degree than solely using the MQPosture device. It should take you about 30 minutes to complete all of these exercises.

### Doorway Pec Stretch

#### Walk to a doorway and center yourself

1. Bring your elbows up to shoulder height and place your forearm in door frame
2. Take a step forward and push yourself through the doorway stretching your pectoral muscles. Hold this stretch between 30 and 45 seconds
3. Take a small break, then repeat this stretch 3 to 5 times



### Cervical Retraction

#### Sit or stand up straight

1. Look straight ahead and focus on something in front of you
2. Bring your chin back toward your neck. You should feel this stretch in the back of your neck
3. Hold this position for 5 to 10 seconds and repeat 10 times

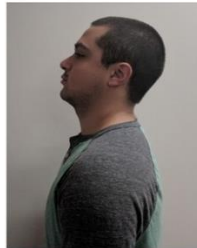
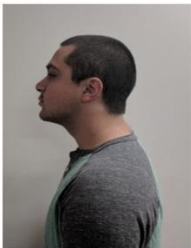

### Upper Trapezius Stretch

#### Find a bench or chair without a back

1. Hold on to the bench with a clenched hand, keeping the other hand relaxed
2. Bring your ear towards the shoulder of the clenched hand. Hold this position for 15 seconds
3. Switch sides and bring your ear towards the the shoulder of the relaxed hand. Hold for 15 seconds



## Seated Posture Correction

### Find a chair and sit upright

1. Imagine a plank of wood behind you going from the bottom of the chair to the top of your head
2. Try to get your body in contact with this imaginary plank as much as possible

**Note:** You should be bringing your shoulders back, your back should be straight, and your head should be pulled back

3. Hold this pose for 10 seconds and repeat 3 times



## Scapular Retraction (Pronated Arms)

### Lay on a flat surface with your stomach to the ground

1. Bring your arms up as if you were making a V shape with your arms and head. Keep your palms on the floor
2. Lift your arms up off the ground and at the same time pull your shoulder blades inwards as if you are squeezing an object between them. Hold this for 5 to 10 seconds, then relax. Repeat this 5 times

**Note:** Avoid shrugging shoulders.

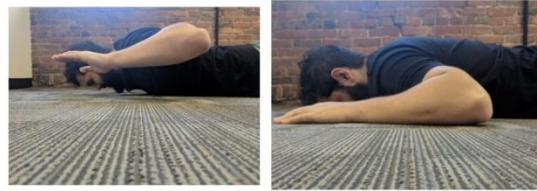

## Scapular Retraction (Arms Overhead)

### Lay on a flat surface with your stomach to the ground

1. Bring your arms up in front of you, keeping them stretched above your head
2. While lying on the ground, bring your arms up and with your shoulder blades inwards as if you were squeezing an object with your shoulders
3. Hold this position for 5 to 10 seconds and repeat 5 times

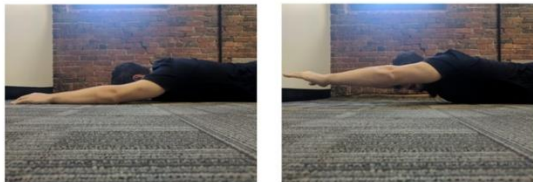

## Other Helpful Tips

### Be mindful of your posture

1. Repeat these exercises often for improved results.
2. Avoid spending long periods of time in front of a screen. If this is not possible, make sure to incorporate 15 minute breaks to walk around, relax the muscles and stimulate blood flow.
3. Avoid carrying heavy loads on your back.
4. Stretch often. Make sure to stretch at least once a day.

**Note:** If you experience major discomfort while completing these exercises stop immediately and notify your doctor or physical therapist.

## **Appendix F: Appendix References**

Exercises to prevent and fix rounded shoulders | Shine365 from marshfield clinic. (2016). Retrieved from <http://shine365.marshfieldclinic.org/bone-joint/prevent-and-fix-rounded-shoulders/>

Miller, K. (2016, Upper crossed syndrome.&nbsp;identifying and applying movement strategies for improved posture.

Upper crossed syndrome: The personal trainer's guide. (2014). Retrieved from <https://www.theptdc.com/2014/07/upper-crossed-syndrome/>