

April 2011

Perfusion Bioreactor for the Development of Tissue-Engineered Blood Vessels

Faith K. Gilmore

Worcester Polytechnic Institute

Janese Marie Cerulli

Worcester Polytechnic Institute

Jared Matthew Franklin

Worcester Polytechnic Institute

Mustapha Fadi Zailah

Worcester Polytechnic Institute

Follow this and additional works at: <https://digitalcommons.wpi.edu/mqp-all>

Repository Citation

Gilmore, F. K., Cerulli, J. M., Franklin, J. M., & Zailah, M. F. (2011). *Perfusion Bioreactor for the Development of Tissue-Engineered Blood Vessels*. Retrieved from <https://digitalcommons.wpi.edu/mqp-all/2909>

This Unrestricted is brought to you for free and open access by the Major Qualifying Projects at Digital WPI. It has been accepted for inclusion in Major Qualifying Projects (All Years) by an authorized administrator of Digital WPI. For more information, please contact digitalwpi@wpi.edu.

Perfusion Bioreactor for the Development of Tissue-Engineered Blood Vessels

A Major Qualifying Project Report:
Submitted to the Faculty
Of the
WORCESTER POLYTECHNIC INSTITUTE
In partial fulfillment of the requirements for the
Degree of Bachelor of Science
By

Janese Cerulli

Jared Franklin

Faith Gilmore

Mustapha Zailah

Date: April 21, 2011

Approved:

Prof. Marsha Rolle, Major Advisor

Table of Contents

Authorship	6
Acknowledgements.....	7
Abstract.....	8
Table of Figures	9
Table of Tables	11
Chapter 1: Introduction	12
Chapter 2: Literature Review	14
2.1 Vascular Physiology	14
2.1.1 Physiological Parameters	14
2.1.2 Blood Vessels.....	16
2.1.3 Diseases and Current Treatments.....	16
2.2 Current Tissue Engineering Methods	17
2.2.1 Scaffolds	17
2.2.2 Cell Sheet Method.....	18
2.3 Cell Culture Method Used in Professor Rolle's Lab	18
2.4 Our Project.....	19
2.5 Bioreactors	20
2.5.1 Cell Culture Media.....	20
2.5.2 Perfusion in Bioreactors.....	20
2.5.3 Anchoring Methods.....	20
2.5.4 Gas Exchange.....	20
2.5.5 Specific Designs.....	21
Chapter 3: Project Strategy	26
3.1 Initial Client Statement	26
3.2 Objectives	26

3.3 Constraints	28
3.4 Functions.....	28
3.5 Specifications.....	29
3.5 Revised Client Statement	30
Chapter 4: Design Alternatives.....	31
4.1 Design Components.....	31
4.1.1 Nourish Tissue/ Media Flow.....	31
4.1.2 Anchor Tissue	32
4.1.3 Media Container.....	33
4.1.4 Emptying the Media.....	34
4.1.5 Gas Exchange.....	34
4.2 Design Alternatives.....	35
4.2.1 Open Cartridge Design.....	35
4.2.2 Lunchbox Design	37
Chapter 5: Design Verification	41
5.1 Magnetic Track Lunchbox Design Initial Prototype.....	41
5.2 Magnetic Track Lunchbox Design Acrylic Prototype	44
Chapter 6: Final Design and Verification	52
6.1 Verification	52
6.2 Final Design.....	53
6.3 Manufacturing of the Final Design	56
6.4 Final Design Testing.....	58
6.4.1 Laminar Flow Testing.....	58
6.4.2 Sterility Assessment.....	59
6.4.3 Leakage Tests.....	61
6.4.4 Volume Test.....	61

6.4.4 Histological Analysis	62
6.5 Final Design Testing Results	65
6.5.1 Laminar Flow Test Results	65
6.5.2 Sterility assessment Results	67
6.5.3 Leakage Test Results	72
6.5.4 Volume Test Results	73
6.5.5 Histological Analysis Results	73
6.6 Discussion	80
6.6.1 Laminar Flow Testing	80
6.6.2 Sterility Assessing	81
6.6.3 Leakage Testing	83
6.6.4 Volume Testing	83
6.6.5 Histological Analysis	83
Chapter 7: Potential Influences and Concerns of the Final Design	85
7.1 Economical Influence	85
7.2 Health and Safety Concerns	85
7.3 Environmental Influence	85
7.4 Societal Influence	86
7.5 Ethical Concerns	86
7.6 Sustainability of the Device	86
7.7 Manufacturability of the Device	86
Chapter 8: Conclusions and Recommendations	88
8.1 Future Recommendations	88
8.1.1 Mounting Method and Interchangeability	88
8.1.2 Chamber Alterations	88
8.1.3 Lid Alterations	89

8.1.4 Multiple chambers.....	90
8.1.5 Endothelialization	90
References.....	92
APPENDIX A: Testing Protocols.....	96
APPENDIX B: Final Design CAD Drawings.....	101
APPENDIX C: Fixed Future Final Design CAD Drawings	106

Authorship

All group members contributed equally to the progress of both the project and this report.

Acknowledgements

Our group would like to thank the following people for their contributions to our project. We would like to acknowledge and thank Marsha Rolle and Zoe Reidinger for their feedback on our designs and providing insight on the progression of our project, as without them our project would not be where it is today. We would like to thank Neil Whitehouse and Michael Fagan for their assistance in the machine shop while fabricating our bioreactor. We would also like to thank Sakthikumar Ambady for helping us with cell culture techniques and assisting us in the MQP lab. We would also like to thank Lisa Wall for assisting us with autoclaving and helping us find materials for our project.

Abstract

The purpose of this project was to design a perfusion bioreactor to nourish the lumen of a 1 cm long 1.19mm inner diameter tissue tube comprised of rat smooth muscle cells in order to eliminate luminal cell necrosis. The bioreactor maintained laminar flow through the lumen of the tube and a wall shear stress of 5-10 dynes/cm². After two prototypes were made, a final design was produced and tested. This design incorporated a chamber which could be connected to a flow loop along with a lid that could slide into the top of the chamber. The lid was unique in that it had a hanging assembly for mounting the tissue tube, which was adjustable because one arm of the assembly moves along a magnetic track. Various proof-of-concept tests were performed to display the basic functionality of the device, including its ability to perfuse media through the lumen of a tissue tube and anchor a tissue tube in place. More tests were performed to observe specific qualities of the bioreactor, such as its ability to avoid contamination and generate laminar luminal flow. The final test performed involved mounting a 19-day old tissue tube inside the bioreactor and running the bioreactor for 3 days inside an incubator. Tissue tubes from the same batch were left growing in static culture on silicone mandrels, and tissue tubes cultured statically for 19 days served as additional control tissues for histology. This way, the size and morphology of tissue tube cultured in the bioreactor could be compared to tissue tubes prior to incubation and also to tissue tubes which were not mounted in the bioreactor. It was ultimately concluded that the bioreactor successfully minimized cell necrosis near the luminal surface, as there was a lack of fragmented nuclei in the bioreactor-cultured sample compared to the statically-cultured sample.

Table of Figures

Figure 1: Schematic of a laminar flow profile	15
Figure 2: The layers of a blood vessel	16
Figure 3: Schematic from Doshi (2009) of the hanging drop cell seeding method.	19
Figure 4: Growth cassette developed by Webb <i>et al.</i> (2007).....	21
Figure 5: Bioreactor made by Zhang <i>et al.</i> (2009).....	23
Figure 6: Top View Bioreactor Schematic of the design by Lovett <i>et al.</i> (2007).....	24
Figure 7: The vessel culture chamber of De Maria <i>et al.</i> 's (2007) design.	25
Figure 8: The “one media chamber” design.....	33
Figure 9:The “single media reservoir” design	34
Figure 10: Open Cartridge Design 1	36
Figure 11: Open Cartridge Design 2	36
Figure 12: Open Cartridge Design 3	36
Figure 13: Original Lunchbox Design	37
Figure 14: Lunchbox Design with sliding Luer connection.....	38
Figure 15: The first iteration of the sliding track design.....	39
Figure 16: Pin and hole track system that was considered for adjustability of the movable arm.	39
Figure 17: The magnetic track design.....	40
Figure 18: The initial Tupperware® prototype.....	42
Figure 19: Fisher Scientific Variable-Speed Pump Low Flow	43
Figure 20: The acrylic prototype components	44
Figure 21: Acrylic prototype chamber top view	45
Figure 22: Acrylic prototype lid.....	46
Figure 23: Fisher Scientific Variable-Speed Pump Medium Flow	48
Figure 24: Leak around threading of the stationary arm.....	49
Figure 25: No leaking was observed around sutured tubing.....	50
Figure 26: Laminar flow testing with particles	50
Figure 27: Final design chamber.....	54
Figure 28: Lid of the final design.....	55
Figure 29: Arc cutout of the lid that enables gas exchange	55
Figure 30: Silicone tube mounted onto the syringe tips using medical sutures	56
Figure 31: Sterility assessment set-up in sterile hood.....	60

Figure 32: Pump and bioreactor set up in the incubator.	60
Figure 33: Connection of flow loop while the lid is being tested.	61
Figure 34: The steps of setting up the bioreactor with a tissue tube	63
Figure 35: No leaking was observed when tissue tube was attached.....	64
Figure 36: Perfusion of red dye into the bioreactor for laminar flow testing.....	65
Figure 37: Flow patterns that resembled laminar flow and turbulent flow	66
Figure 38: Laminar flow shown by upstream injection of food coloring	67
Figure 39: The cell media evaporated during sterility assessment 1.....	68
Figure 40: The leakage observed in the tray occurred after 1 day in the incubator.	69
Figure 41: Minor leak after two days	70
Figure 42: The cell media after two days in the incubator shows no turbidity for sterility assessment 2 ..	71
Figure 43: After 24 hours in the second assessment, the cell media had turned orange and was turbid. ...	72
Figure 44: Media sample of Sterility assessment 3 as seen under microscope.....	72
Figure 45: At 72 hours, no media was flowing through the system and a puddle of media was found.....	73
Figure 46: The tissue tube mounted at day 19 (A) and the tissue tube after 3 days of dynamic culture.....	73
Figure 47: Cross section of 19-day tissue (H&E staining at 4x magnification).	74
Figure 48: Cross section of 22-day statically grown tube (H&E staining at 4x magnification)	75
Figure 49: Cross section of the 22-day bioreactor tissue (H&E staining at 4x magnification)	75
Figure 50: Close-up of 19-day statically grown tissue wall (20x magnification).....	76
Figure 51: Close-up of 22-day bioreactor tissue tube wall (20x magnification)	76
Figure 52: Close up of 22-day statically grown tissue tube wall (20x magnification)	77
Figure 53: The rat artery acted as the control to show high levels of actin	78
Figure 54: An example of a negative control.....	78
Figure 55: Hoechst and smooth muscle alpha actin stained 19-day sample	79
Figure 56: Hoechst and smooth muscle alpha actin stained 22-day dynamic (bioreactor) sample.....	79
Figure 57: Hoechst and smooth muscle alpha actin stained 22-day static sample.....	80
Figure 58: Magnet after it was removed from the movable arm.....	82
Figure 59: Top picture: Arc cutout on the lid around the inlet Luer connector.	90

Table of Tables

Table 1: The summary of the results from our Pairwise Comparison Chart. High numbers correspond to objectives with the most importance.....	27
Table2: Velocity, flow rate, and Reynolds number for wall shear stresses between 5 and 10 dynes/cm ² ..	29
Table 3: Morphological chart depicting the functions and means to fulfill those functions. Each mean is ranked by feasibility; 1 being the most feasible.....	31
Table 4: Results of the Low Flow pump flow rate test.....	44
Table5: Flow rates of 0.4-85 mL/min peristaltic pump.	47

Chapter 1: Introduction

Tissue engineered blood vessels could be one of the next great developments in modern medicine. However, tissue engineering as a science is still in its developing stages and there are a variety of ways to grow tissue tubes to mimic blood vessels. For example, Professor Marsha Rolle's laboratory team produces tissue tubes by culturing rat smooth muscle cells on silicone tubing mandrels. Unfortunately, a problem has been noted with this method. The inside of the tubes contact silicone tubing mandrels, therefore the inner cell layers do not receive the same access to nutrients as the outer layers when they are submerged in cell culture medium. Because of this, there is non-uniform growth in the tube; the outer layers grow faster than the inner layers. If the tubes grow thick enough, the inner layers suffer cell death due to a lack of nutrients.

A means of solving this problem would be to pump media through the inside of the tube, called the lumen, in order to both nourish the cells and keep the tissue tube open after the mandrel is removed. This would require the use of a perfusion bioreactor. Bioreactors are devices which house tissue, nourish it, and promote its growth in a simulated physiological environment. A perfusion bioreactor accommodates hollow regions within a specific tissue structure, such as the pores of bone tissue or the lumen of a blood vessel, by flowing media through these regions.

Due to the qualities of the tissue tubes in question, a custom perfusion bioreactor needed to be made. The tubes are very fragile and small, 1 cm in length and 1.19 mm in diameter. Such a small size makes it challenging to mount the tubes into available bioreactors. Flow through the lumen needed to be very slow due to this size, so as to not put unnecessary stress on the tubes. In addition, fluid flow needed to be laminar, meaning that the flow would move through the tube in a straight path without turbulence, also to prevent excessive stress on the tube walls.

Our group's project progressed as follows. First, we focused on gaining a better understanding of the physiological parameters of blood vessels as well as the unique features of the tissue tubes we would be working with. We then decided on a list of constraints as well as objectives we needed to meet. Second, we researched existing perfusion bioreactors and decided which ideas and features could be borrowed from these designs and incorporated into our own. Third, we focused on coming up with original ideas to deal with the unique problems we faced to create an easy to use, leak-free perfusion bioreactor that was as effective, if not more, than existing means. Finally, we produced and tested a prototype to determine whether or not it satisfied all constraints, while taking into consideration how well it met objectives. From here, minor alterations were made and the final product was assembled.

The paper summarizes the literature we reviewed on physiological parameters of blood vessels, as well as existing bioreactors. Next, we discuss our progression through the design process, outlining design alternatives and the reasons specific choices were made. The last sections deal with tests of our prototype and final design along with the final conclusions our group has made regarding the outcome of our project.

Chapter 2: Literature Review

The following chapter will introduce the reader to the problem our project is trying to overcome. Vascular physiology, tissue engineering, bioreactors, and the current methods being used in the field will be discussed.

2.1 Vascular Physiology

An understanding of normal physiology is necessary to design an environment which mimics the conditions inside a natural blood vessel. Physiological parameters in normal individuals will be discussed as well as the diseases affecting blood vessels and current treatment. It is important to understand how the body works in a physiological state when trying to recreate those parameters in a bioreactor.

2.1.1 Physiological Parameters

Normal blood pressure is about 120/80 mm Hg. Blood flow through a vessel depends upon the viscosity of blood (η), the pressure gradient ($P_i - P_o$), and the radius of the vessel (r), all of which can vary depending upon the location of the vessel. Flow (Q) can be determined by the following equation:

$$Q = \frac{\pi(P_i - P_o)r^4}{8\eta l}$$

The viscosity of blood depends on the diameter of the tube it is flowing through, shear rate or velocity, hematocrit, and temperature (Khurana, 2006). Viscosity decreases as the flow rate increases due to shear thinning (Koeppen & Stanton, 2010). The viscosity of blood at 37°C is 2.8-3 centipose (mPa/s) (Khurana, 2006) which converts to 7.5×10^{-6} mmHg/second. The relative viscosity of blood (when compared to water at 5.2×10^{-6} mmHg/second) can vary between about 2 and 4.6 when tube diameter is smaller than 500 μ m (D'Ancona, Ricci, & Bergsland, 2001).

The velocity of blood running through a blood vessel can be calculated by $v=Q/A$, where v is velocity, Q is flow rate, and A is cross sectional area. Typical resting blood flow rates are about 68 mL/min in the carotid artery and can increase to about 300 mL/min during exercise (Carnagey *et al.*, 2003).

Flow of a fluid can be described as either laminar or turbulent. In laminar flow, shown in Figure 1, particles at the center of the vessel have the highest velocity while those against the walls have almost no velocity. Laminar flow occurs when particles travel parallel to the vessel walls (Noble, 2005). Laminar fluid flow reduces friction between layers of cells in the blood and the blood cells and platelets travel at the center of the vessel (Hannon, Pooler, & Mattson Porth, 2009). Higher energy and pressure is needed to propel turbulent flow (Hannon, Pooler, & Mattson Porth, 2009). Turbulence occurs at critical velocity

(Noble, 2005) and can be caused by increased velocity, change in diameter, or a change in blood viscosity (Hannon, Pooler, & Mattson Porth, 2009). Turbulence is characterized by random flow of particles caused by the breaking up of the fluid layers (Bell & Rhoades, 2008). Turbulent flow can damage the endothelial lining of blood vessels, leading to atherosclerotic plaques (Noble, 2005) which can cause blood clots (Hannon, Pooler, & Mattson Porth, 2009). A Reynolds number under 2100 corresponds to laminar flow (Munson *et al.*, 2009). The Reynolds number can be calculated for each flow rate with the following equation, where ρ is density of the fluid, V is the mean velocity, r is tube radius, and μ is the viscosity of the fluid:

$$Re = \frac{\rho V (2r)}{\mu}$$



Figure 1: Schematic of a laminar flow profile. Particles flow parallel to the vessel walls and those in the center of the vessel have a higher velocity.

Blood vessels are exposed to a hemodynamic force called shear stress. Shear stress plays a critical role in the function of blood vessels. Shear stress protects vessels from atherosclerosis by increasing the production of prostacyclin, a substance that increases vasodilation and decreases platelet aggregation (Waksman, Serruys, & Schaar, 2007). It also does this by releasing tissue plasminogen activator and nitric oxide. Thus, vessels with low shear stress are more likely to have atherosclerosis and intimal lesions. High shear stress can cause damage to vascular smooth muscle cells because the nitric oxide levels can become too high and activate Fas which initiates apoptosis (Waksman, Serruys, & Schaar, 2007). Shear stress can also alter endothelial cell alignment as well as their proliferation and migration (Ascher & Haimovici, 2004). The average range of shear stress in normal blood vessels has been found to be between 10 and 15 dynes/cm² (Aird, 2007). Shear stress can be calculated by the following equation:

$$\tau = \frac{4\eta Q}{\pi r^3}$$

Where η is the viscosity of the fluid, Q is the flow rate, and r is the radius of the tube (Reneman, 2006).

2.1.2 Blood Vessels

The primary function of blood vessels is to carry oxygenated blood from the heart to the rest of the body as well as return the deoxygenated blood to the heart. Three major types of blood vessels exist: arteries, veins, and capillaries. The main function of arteries is to carry blood from the heart and deliver oxygen to the body cells. Veins return the oxygen-deprived blood to the lungs via the heart so that the blood can be re-oxygenated and reused. Capillary beds supply blood to organs and tissues. Arteries and veins are cylindrical in shape and have multiple layers, as seen in Figure 2. The blood containing space in the center of the vessel is referred to as the lumen. The innermost layer, the *tunica intima*, is a layer of connective tissue lined with endothelial cells that produces substances to regulate vasoactivity, blood clotting, inflammation, and vascular growth. The middle layer, or the *tunica media*, is composed of smooth muscle cells and elastin. The cellular agents found in this layer cause vasoconstriction and vasodilation, the muscular movements that affect blood flow. The final layer, the *tunica adventitia*, structurally supports the vessel with collagen fibers and by anchoring the vessels to other structures (Marieb & Hoehn, 2006).

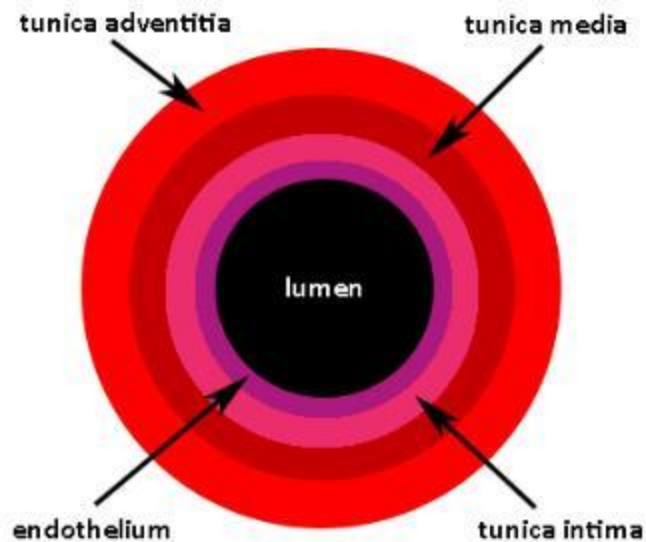

Figure 2: The layers of a blood vessel. Blood vessel is shown transversely.

2.1.3 Diseases and Current Treatments

Cardiovascular disease is the leading cause of death in the United States (Roger et al., 2011). Tissue engineering holds promise for new advances in the treatment of cardiovascular disease. For example, coronary bypass surgery currently uses the saphenous vein in the leg, mammary artery in the chest, or the radial artery in the arm to bypass the blockage (Bhimji, 2010). Tissue engineered blood

vessels could make coronary bypass surgery simpler (Mitchell and Niklason, 2003) by removing the step of retrieving an autologous graft or skipping the process of finding a donor. The primary disadvantage to using transplanted arteries is the extraction process. The patient must undergo surgery to extract the artery as well as the bypass surgery, increasing the chance of complications. Luckily, advancements in tissue-engineered blood vessels could be the key to increasing the success rate of this procedure by making artery extraction unnecessary (L'Heureux *et al.*, 2007).

2.2 Current Tissue Engineering Methods

The following sections discuss different methods for engineering vascular tissues.

2.2.1 Scaffolds

In order to develop tissue engineered blood vessels, there needs to be a structure for seeding cells. Scaffolds provide support and promote cell adhesion and proliferation. There are many natural and synthetic materials used to make scaffolds which can be permanent or biodegradable (Baguneid *et al.*, 2006).

Synthetic scaffolds can be made from various non-biodegradable polymers such as polyester urethane, polyurethane, Dacron, and poly(carbonate–urea)urethane (Baguneid *et al.*, 2006). The non-biodegradable polymers can be coated with collagen to mimic the extracellular matrix to allow endothelial cells and smooth muscle cells to grow on the surface (Baguneid *et al.*, 2006). Furthermore, bio-degradable polymers can be used in blood vessel scaffolds. PGA and polyhydroxyalkanoate (PHA) are most widely used for this application because smooth muscle cells can be seeded onto these bio-degradable scaffolds and over time take the place of the polymer molecules to create a 3D tissue construct (Baguneid *et al.*, 2006). PCL is also used in this application in PCL-PLA scaffolds (Shin'oka, 2004).

Examples of materials used as natural scaffolds include collagen (Baguneid *et al.*, 2006), silk (Lovett *et al.*, 2007), fibrin, and hyaluronan (Burdick, 2010). Collagen is a good candidate because it is abundant in the body and present in the extracellular matrix (Baguneid *et al.*, 2006). Collagen also promotes cell adhesion, growth, and differentiation and is commonly used in scaffolds for these properties as well as its structural properties (Burdick, 2010). Fibrin is made from fibrinogen and thrombin which are found in blood plasma. Fibrin is involved with blood clotting, inflammation, and wound healing and promotes angiogenesis, cell adhesion, and cell proliferation (Burdick, 2010). Hyaluronan (HA) is a major component of the extracellular matrix and plays a role in cell proliferation, adhesion, motility, and morphogenesis. Scaffolds made from HA are very biocompatible and flexible (Burdick, 2010).

Decellularized tissue can also be used as scaffolds. These structures consist of the extracellular matrix (ECM) of the original source. These scaffolds can be derived from sources in the body such as human umbilical cord veins and small intestine submucosa or from xenografts like a porcine aorta which can then be seeded with human cells (Baguneid *et al.*, 2006). Decellularized tissue is often used as scaffolds because they promote stem cell differentiation due to biochemical cues from the ECM and because they provide the geometry of the structure being engineered (Burdick, 2010).

2.2.2 Cell Sheet Method

L'Heureux *et al.* (1998) developed a new way to grow tissue engineered blood vessels. This method is referred to as the “Cell Sheet Method” and involves culturing smooth muscle cells with fibroblasts in a tissue culture flask. After thirty days, the cells formed sheets which were then removed from the flask and rolled around a mandrel. Cell adhesion resulted in the formation of a tubular structure. This method proved to be a breakthrough in tissue engineering because the tissue tube did not require a synthetic scaffold like previous tissue engineered blood vessels.

2.3 Cell Culture Method Used in Professor Rolle's Lab

There are many different ways tissue engineered blood vessels can be made. For our project, we will be working with tissue engineered blood vessels that are grown using a similar method that Kshama Doshi (2009) developed in Professor Marsha Rolle's lab. This method is similar to the scaffold method because a silicone mandrel is used to assist in the growth and shape of the tissue tubes. However, the final result is a tube made predominantly from cells and cell-derived matrix, without exogenous scaffolds.

First, a silicone mandrel is prepared. The silicone mandrel's purpose is to provide a support structure for cell seeding and growth. The cells grow and adhere around the mandrel resulting in a tubular structure. Doshi (2009) used collagen-coated silicone mandrels in her experiments to facilitate cell adhesion, whereas plasma-etched silicone mandrels were used in subsequent experiments and for our project. The cell seeding process requires the construction of a cell seeding ring, which is made of polydimethylsiloxane (Doshi, 2009). The cell seeding ring has two grooves in it so the mandrel can fit into it and be glued in place. Next, the smooth muscle cells are pipetted into the middle of the cell seeding ring. The culture dishes are then inverted and placed in an incubator at body temperature (37°C) for thirty minutes (Doshi, 2009). This procedure is referred to as that hanging drop method (Figure 3). After the thirty minutes have passed, the samples are rinsed twice with buffer solution to remove any unattached cells. Next each well is filled with 6 mL of fresh cell culture media. The cells continue to grow

in culture for approximately twenty to twenty-eight days. The silicone mandrel is then removed using forceps.

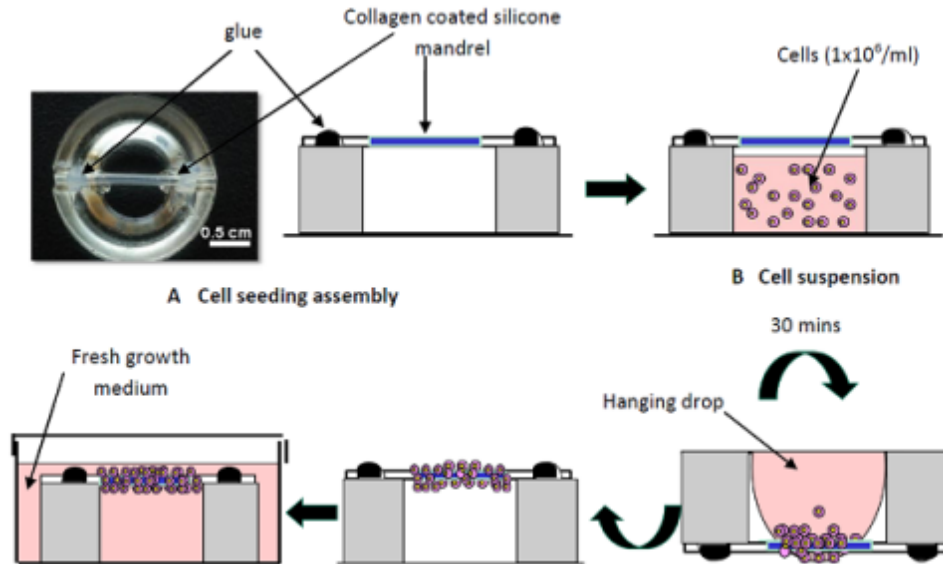

Figure 3: Schematic from Doshi (2009) of the hanging drop cell seeding method. A: Top view photograph and side view schematic of the final cell seeding assembly. B: RASM C cell suspension pipetted into the center of the seeding assembly. In the last step, the seeding assembly is flipped upside-down

After evaluating the tissue growth, Doshi noticed that cells at the inner layer of the tube that was closest to the mandrel appeared necrotic. The cell density on the inside was far less than that of the outside, which had been in direct contact with the media (Doshi, 2009). It was concluded that the inner layer was poorly nourished due to its positioning beneath the other layers and adjacent to the silicone mandrel, which prevented exposure to the media.

2.4 Our Project

Our MQP was developed to produce a perfusion bioreactor which could grow the tissue tubes while preventing necrosis of the inner cells by the lumen. Our group will be removing the silicone mandrel between the twentieth and twenty-eighth day of culture. By introducing flow through the lumen of the tissue tube during cultivation, necrosis should be prevented while keeping the tube from collapsing shut.

2.5 Bioreactors

Bioreactors are devices used to cultivate tissues and simulate an *in vivo* environment. Most bioreactors are designed with a specific tissue type in mind, so that exact physiological environment for the singular tissue type can be fabricated. In the case of this project, vascular tissue is the focus.

2.5.1 Cell Culture Media

Bioreactors typically contain cell culture medium, an aqueous solution containing nutrients required for cell growth. In addition to serum, the media often contains a pH buffer, antibiotics, amino acids, and glucose.

2.5.2 Perfusion in Bioreactors

In this project, perfusion must be maintained through the lumen of the artery. The most common means of doing this is to use a pumping system to directly flow media through the lumen. There are several creative methods of producing perfusion in existing bioreactors. For instance, gravity and fluid dynamics along with some applied force on the bioreactor module can create flow and mixing of the media (Baguneid *et al.*, 2006). The most common choices of pumping mechanisms are syringe pumps and peristaltic pumps. Williams and Wick (2005) created a design which used a pair of syringe pumps to provide perfusion while a peristaltic pump produced external flow to circulate the media for the outer cell layers.

2.5.3 Anchoring Methods

With the presence of fluid flow around and within a tissue, a method of anchoring the tissue in place becomes a necessity. Ultimately the goal of anchoring the tissue is to secure it within the chamber while making as little physical contact with the tissue as possible. If too much surface area is covered by an anchoring structure, the cells in that area may not receive proper nutrition and oxygenation. Zhang *et al.* (2009) anchored their cell tube with O-rings at each end. Williams and Wick (2005) anchored their cell tubes by simply mounting both ends onto parallel syringe needles and suturing.

2.5.4 Gas Exchange

Providing the cells of tissue engineered blood vessels with the proper nutrients is important and can be achieved by flowing media through and around the constructs. However, the cells need to receive oxygen and expel CO₂. Gas exchange occurs naturally in the body in the pulmonary capillary beds (Koeppen & Stanton, 2010). When air comes into contact with media, oxygen can diffuse into the media and CO₂ can diffuse out. Gas exchange can be achieved by peroxide-cured silicone tubing (Zhang *et al.*,

2009), a gas exchange unit (Iwasaki *et al.*, 2008), or leaving an opening (with a semipermeable membrane or filter) so gas can diffuse in and out (Webb *et al.*, 2007).

2.5.5 Specific Designs

Webb *et al.* (2007) designed a bioreactor for small-diameter tissue engineered blood vessels. The bioreactor consisted of a media reservoir, a peristaltic pump, a compliance chamber, a growth cassette, tubing, and a series of components to regulate the pressure in the media reservoirs. Air pressure was controlled (and maintained at a constant level) by a gas regulator and compressed air tank and valves were controlled via LabVIEW. The compliance chamber was put in place to reduce the pulsatile fluid flow from the pump so that only the pressure from the pump was being used (this was mainly for mechanical conditioning). The transparent growth cassette (Figure 4) was needed to measure vessel growth by LED micrometer, but also provided a housing unit for the vessel and could be removed easily from the circuit. The growth cassette provided a water-tight chamber made from rubber gaskets, thumb screws, and an aluminum frame. Vessels were secured in the cassette by male Luer connectors. Additional Luer connectors were put in the growth cassette to allow for gas exchange between the media and the air inside the incubator and were also used as inlets and outlets for media change.

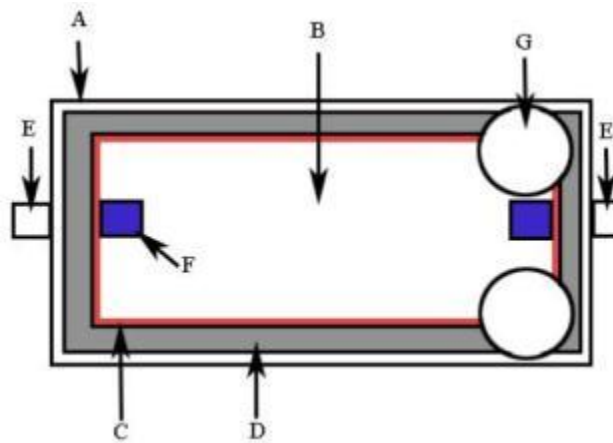

Figure 4: Growth cassette developed by Webb *et al.* (2007) which includes the cassette body (A), plexiglass faceplate (B), rubber gasket (C), aluminum frame (D), flow inlet/outlets via Luer connectors (E), Luer connector for scaffold attachment (F), and an air filter for gas exchange attached to a Luer connector (G).

The construction of the cassette provided a leak-free system and a clear viewing window of the sample; however, the assembly appears to be tedious to assemble due to the frames and screws. It may take time to break down and reassemble the cassette each time the tissue samples were inserted or

removed. The cassette is compact and a convenient way to move the tissue sample. It is also very adaptable because the cassette can be attached to a wide range of pumps or other machines.

Gas exchange through the Luer connectors and filters is a good alternative to the semipermeable silicone tubing. An additional attachment may be needed so that the tube does not slip off or leak, a feature that was not mentioned in the paper. It was not mentioned how the tube attached to the Luer connectors.

Neumann, Nicholson, and Sanders (2003) created a perfusion bioreactor for tissue engineered blood vessels by seeding vascular smooth muscle cells onto nylon fibers. These vessels were very small in size at about 100 microns in diameter and not designed as vascular grafts. Shrink tubing was used in order to hold the nylon fibers in place. The culture chamber was made from polycarbonate sheets and grooves were made to insert the shrink tubing and nylon. The whole bioreactor was put into a cell-suspended culture medium in order for the cells to adhere onto the nylon. After culture, the vessel chamber was filled with agar and the nylon fibers were gently pulled out of the bioreactor. The bioreactor outlet was connected to a peristaltic pump set to pump media through at 2 mL/hour. Gas exchange was achieved by an aerated culture flask used as a media reservoir. This feature compromises portability and also requires a volume of 25 mL of media.

This bioreactor was successful in creating very small blood vessels but the nylon/shrink tubing of the bioreactor must be replaced after each procedure. The materials are inexpensive and it has been shown that the nylon lines come out easily without disrupting the tissue tubes. With the use of shrink tubing, the need to find a way to attach the tissue tubes to the perfusion system is eliminated. The tissue is not being pinched or punctured in any way and the whole length of the tube is receiving nutrients. By filling the chamber with agar, the vessels were physically protected and received nutrients. It is unclear whether or not this method is advantageous with regards to nutrient delivery, but it clearly stabilizes the small tubes.

Zhang et al. (2009) developed a bioreactor that could grow and condition artificial silk-based vascular grafts. The bioreactor had both an external and internal closed perfusion loop through the lumen and the outside the tissue respectively, as seen in Figure 5. The polycarbonate perfusion chamber was transparent for observation. The chamber was watertight to prevent media loss and contamination. Each end of the graft was secured with a pair of O-rings. Pulsatile flow was conducted by a peristaltic pump. Gas exchange was achieved through peroxide-cured silicone tubing.

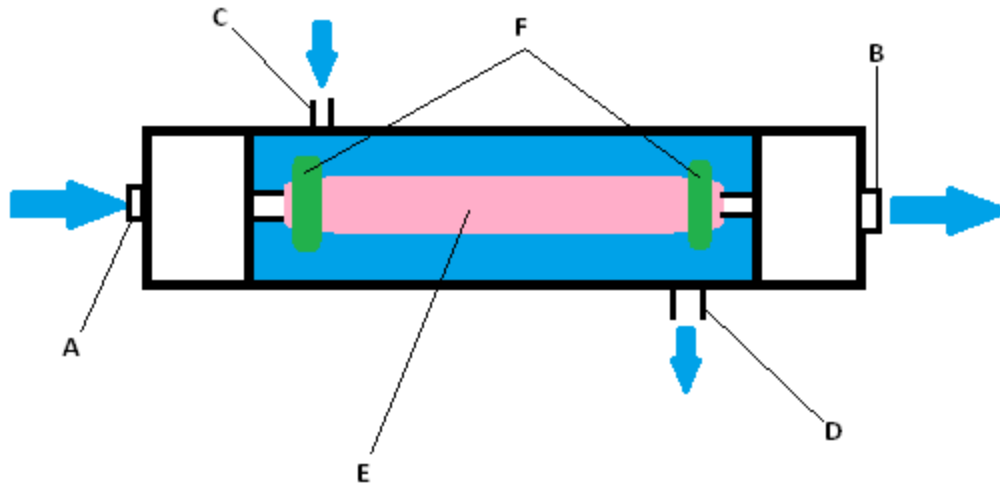

Figure 5: Bioreactor made by Zhang *et al.* (2009). Labeled are (A) luminal inlet, (B) luminal outlet, (C) external media inlet, (D) external media outlet, (E) silk-based vascular graft, and (F) the O-rings which hold the graft in place.

Williams and Wick (2005) created a bioreactor to co-culture smooth muscle cells and endothelial cells to simulate the structure of blood vessels. This design has two methods of pumping, one for luminal flow and one for external flow. Luminal flow is produced by dual syringe pumps, which the tissue tube is sutured between. Meanwhile, in a perpendicular direction, a peristaltic pump flows media externally. It is unclear how the media was kept oxygenated.

The simplistic design of the chamber allows for repeating units, meaning several tissue tubes can be grown at the same time by a single peristaltic pump, although it would still necessitate additional syringe pumps since the chambers cannot share luminal flow. To improve the design, a multichannel peristaltic pump could be incorporated to pump media both lumenally and externally in order to cut costs.

Lovett *et al.* (2007) created a bioreactor that could culture tissue microtubes. The main structure of the bioreactor is composed of a 25mm × 60 mm × 5mm PDMS block, a glass cover slip bonded together using vacuum gas plasma, and a glass cover top attached using label tape. Three 10mm × 15mm × 5mm wells exist within the PDMS block to form the bioreactor space. Perfusion of fluid through the lumen of the tubes is achieved by running stainless steel needles through each bioreactor. The microtubes span the length of the steel needles in the bioreactor. An external syringe pump was used to provide the pressure to perfuse the bioreactor with media.

The reactor's small size allows it to be portable. One disadvantage is that media in the well is stagnant. Another disadvantage is that the small volume of each individual well may require media to be changed frequently. Figure 6 illustrates the design of the bioreactor.

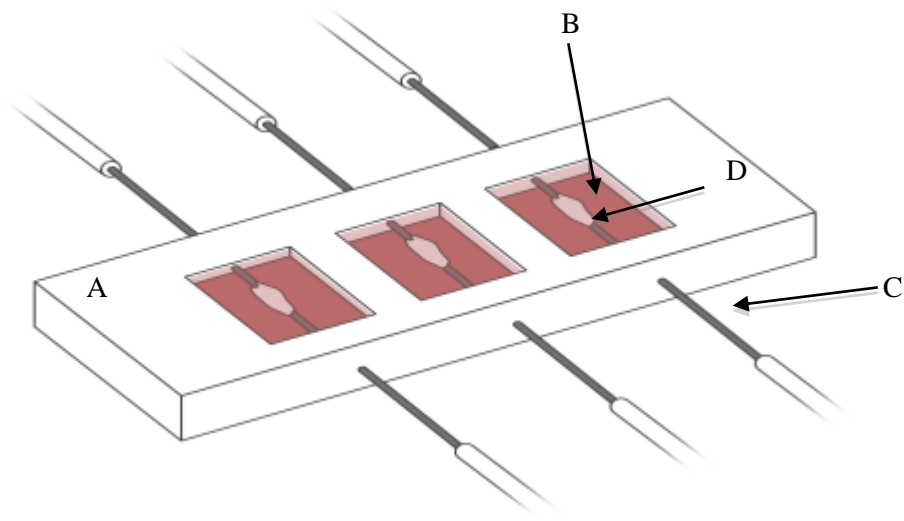

Figure 6: Top View Bioreactor Schematic of the design by Lovett *et al.* (2007). Labeled are the PDMS block (A), the media-filled wells (B), steel needles for perfusion (C), and the tissue tube mounted on the needles (D).

Another example of a bioreactor that has produced viable vessel cultures is that of De Maria *et al.* (2007). The main components of the bioreactor system were a vessel culture chamber, a peristaltic pump, and a mixing chamber. The vessel culture chamber is PDMS casted with a top and a bottom portion, as displayed in Figure 7. Silicone tubes connected to the perfusion system are inserted through the top portion and sealed. The bottom portion creates a larger volume for the chamber and locks with the top to create an airtight seal. A peristaltic pump allowed perfusion of media through the silicone tubes. Laminar flow of the system was validated by calculating the Reynolds number of the system. The mixing chamber acts as a media reservoir and also contains feedback sensors for the temperature, pH, oxygen and CO₂ levels, and flow of the media.

The advantages of using this system are that the bioreactor uses little media and is made of low-cost PDMS and aluminum. Although the volume and dimensions of the device were not specified, the size of the chamber accommodated vessels that were 1cm long and .2cm wide. Based on the size of the tube and the scale used in Figure 7, the volume of media necessary to submerge the tissue appears minimal. Sensors also give information about the media that can be used to alter the system to emulate different physiological conditions.

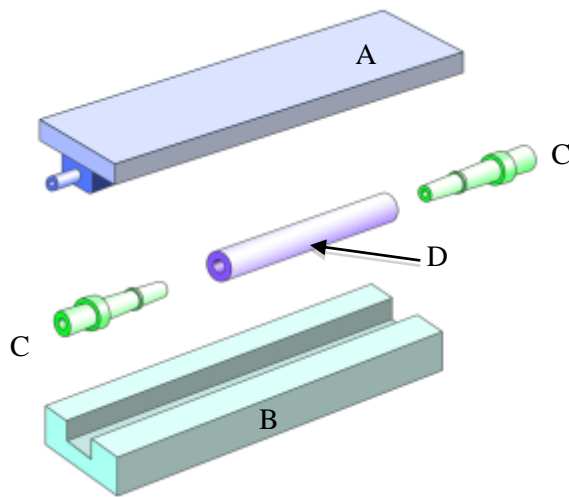

Figure 7: The vessel culture chamber of De Maria *et al.*'s (2007) design. The top of the chamber (A) and the bottom of the chamber (B) assemble together and the inlet connectors (C) allow for perfusion through the tissue tube (D).

These bioreactors all have design aspects that allow successful tissue tube nourishment. A major distinction between the types of perfusion bioreactors is the number of flow loops, which is generally either one or two. The design by Williams and Wick uses two flow loops to nourish both the lumen and the exterior of the tubes. De Maria *et al.* and Lovett *et al.* perfuse media through the lumen of the tubes while having the rest of the tissue remain in static culture. Ideally we would like to produce a bioreactor that could dynamically culture the exterior of a tissue tube along with the inside, but at the same time our budget would make having two pumps difficult.

Familiarizing ourselves with these bioreactors, along with various tissue engineering methods, helped us formulate a good idea of what our bioreactor should do and what features it should have. Based on the objectives of our project, our design needed to be able to house a tissue tube and perfuse cell media through its lumen while providing gas exchange. Ideally the device would be as safe as possible for the tissue tube while being simple to use and inexpensive.

Chapter 3: Project Strategy

After meeting with Professor Rolle and Zoe Reidinger, our clients, we were able to acquire a better understanding of the goals of our project. We then underwent extensive background research to familiarize ourselves with bioreactors. Other areas of research included physiological parameters of blood vessels, cardiovascular physiology and problems, and alternate tissue engineering methods to grow arteries. To help us determine which direction our project was heading, we had to determine the objectives, constraints, and functions of our perfusion bioreactor. We used several design tools such as client interviews to clarify the objectives, constraints, and functions, a pairwise comparison chart, and a morphological chart.

3.1 Initial Client Statement

Our initial client statement given by Professor Rolle was, "The goal of this project is to create a cartridge to house a tissue engineered blood vessel that securely anchors the tissue sample without damage or leaking, and can be connected to both a luminal flow system and an external medium flow loop to provide continuous nutrient supply to the tissue and apply physiological shear stresses at the inner surface of the vessel. Ideally, the cartridge should be inexpensive and easy to manufacture, such that multiple cartridges can be used in a single experiment to culture batches of tissue engineered blood vessels. Finally, the cartridge should be interchangeable with the mechanical conditioning cartridge under development by another MQP team and members of the Rolle Laboratory."

3.2 Objectives

In order to better understand the task at hand, we had to determine the wants of the client. We made a list of objectives that our client wanted to be present in the design and they are ranked by importance based on the summary chart of our pairwise comparison chart seen in Table 1.

- Easy to sterilize and clean
- Control flow of media
- Maintain laminar flow
- Durable
- Easy to make
- Easy to use
- Portable
- Interchangeable cartridge

- Inexpensive
- Adjustable (able to fit different sized tissue tubes)

The perfusion bioreactor is in direct contact with living cells; therefore, all of the components must be easy to sterilize and clean. The tissue tubes being used in this project are not made using scaffolds. Without a physical object, or constant fluid perfusion, holding the lumen open, the tissues are prone to collapse and ingrowth. The perfusion bioreactor should be able to withstand everyday use. The device should be easy to manufacture and assemble with regards to the availability of parts. Our design should be easy to use so that few instructions are needed to operate it. The fewer components the device has, the cheaper and more durable it will be. The interchangeable cartridge should fit in our perfusion bioreactor as well as the mechanical conditioning device and be easily portable. The parts should be relatively cheap so they can be replaced. Lastly, the device could potentially be able to accommodate multiple sample sizes. In order to organize and rank these objectives, we constructed a pairwise comparison chart and the summary is shown in Table 1.

Table 1: The summary of the results from our Pairwise Comparison Chart. High numbers correspond to objectives with the most importance.

Rank	Goal	Total
1	Ease of Sterilization	9
2	Control Flow of Media	8
3	Maintain Laminar Flow	7
4	Durable	5.5
5	Easy To Make	4.5
6	Easy to Use	4
7	Portable	4
8	Interchangeable	2
9	Adjustable	1
10	Inexpensive	1

The results of our pairwise comparison chart showed that the clients find ease of sterility the most important. While sterility is a constraint, our goal is to make sterilization as easy as possible by reducing the steps that are required. The clients wanted to be able to control the flow of the media and for the device to maintain laminar flow. Other important factors turned out to be durability, easy to manufacture,

portability, and easy to use. The clients did not feel that price was as important an issue. Other objectives given the least priority were making the device adjustable for different size tubes or interchangeable with other devices.

3.3 Constraints

Our group has several constraints to meet. If our project does not meet a constraint, the project as a whole will be a failure. These constraints include:

- Device Must Maintain Sterility During Cultivation
- Time (the A-D term deadline)
- Budget of \$524
- No Leaking
- Size (must fit in the incubator)
- Mechanically Safe for Tissue Tube (no ripping)
- Safety for User

Our group is working with living tissue so the materials we use to construct the perfusion bioreactor must be able to be kept sterile. The project must be completed before Project Presentation Day on April 21, 2011. Our team budget consists of \$524. The perfusion bioreactor cannot leak media. The perfusion bioreactor must fit in an allotted incubator which is approximately nine inches high. In order for our device to be successful, it must be safe physically and biologically for the tissue tube. Most importantly, the device must be safe for its users. There should not be any sharp edges or dangerous components that are exposed.

3.4 Functions

Once we established the objectives and constraints, we had to determine what functions our perfusion bioreactor actually had to perform. We concluded that our perfusion bioreactor had to:

- Supply Media Through the Lumen in Order to Nourish the Tissue Tube
- Anchor the Tissue Tube
- Fill Cell-Holding Chamber with Media
- Empty Used Media
- Permit Gas Exchange

The primary function that is mentioned in the client statement is pumping media through the lumen of the tissue. According to Zoe Reidinger, the tissue tube has to be fed from the inside to reduce

the cell death that was observed after culturing tissue tubes on silicone mandrels for 14 days. Our device also has to anchor the tissue while the media is being pumped through the lumen. Lastly, our perfusion bioreactor must enable gas exchange to maintain oxygenation and buffering of the cell culture medium.

3.5 Specifications

The tissue tube sample we used was 1cm in length and had an inner diameter of 1.19mm. Based upon the information Zoe gave us, the tissue tubes required 6mL of media exchanged every four days. Our perfusion bioreactor contained enough media for a three day period which is a minimum of 4.5mL. This number was calculated by assuming a linear relationship.

Wall shear stress is a tangential stress applied to vessel walls when blood is flowing through the vessel and has been found to affect cell function, shape, and gene expression in blood vessels (Reneman, 2006). Typically in a human blood vessel shear stress ranges between 10 and 15 dynes/cm² (Aird, 2007), however, our client requested a range of 5-10 dynes/cm². By putting the minimum and maximum shear stress values (5 and 10 dynes/cm²) into the wall shear stress equation found in section 2.1.1, we were able to calculate the appropriate range of flow rates of 7.16 to 14.3 mL per minute.

We needed to know if the appropriate flow rates were laminar in order to abide by our laminar flow constraint. The data in Table2 shows the velocity, flow rate, and Reynolds numbers (Re) within the required shear stress range. In order to meet our specification, we used a flow rate between 4.4 and 8.8mL/min. As seen below, all of the flow rates in this range are laminar because $Re < 2100$.

Table2: Velocity, flow rate, and Reynolds number for wall shear stresses between 5 and 10 dynes/cm².

Pump Flow Rate (mL/min)	Fluid Velocity (cm/s)	Calculated Wall Shear Stress (dynes/cm²)	Calculated Reynolds No. (Re)
7.16	10.7	5.00	183
8.00	12.0	5.59	204
9.00	13.5	6.29	230
10.0	15.0	6.98	255
11.0	16.5	7.68	281
12.0	18.0	8.38	306
13.0	19.5	9.08	332
14.0	21.0	9.78	357

14.3	21.5	10.0	365
------	------	------	-----

In order to reduce the amount of media required to fill our bioreactor, we tried to make it as small as possible while still performing the needed functions. The dimensions of the lid are 5 inches by 2.5 inches with a thickness of 0.5 inches. The chamber is 4 inches by 1.65 inches with a height of 0.88 inches. The chamber can hold 26 mL of cell media. To recapitulate our specifications:

- Tube dimensions: 1 cm long, 1.19 mm inner diameter
- Bioreactor chamber dimensions: 4" x 1.65" x 0.88"
- Media reservoir volume: 26 mL
- Pump flow rate: 8.33 mL/min
- Calculated shear stress: 5.65 dynes/cm²
- Calculated Re: 185

3.5 Revised Client Statement

After clarifying our objectives, constraints, and functions, we were able to develop a revised client statement that focused on the main goals of the project. The goal of our project is to construct a bioreactor that will simulate an *in vivo* environment for tissue-engineered blood vessels. The bioreactor will deliver nutrients to the lumen of the engineered blood vessel via laminar flow and provide nourishment for the cells at the outer edge of the vessel. It will contain enough media to sustain the tissue tube for three days. The bioreactor must not leak or cause the tissue to tear. The overall design should also be easy and inexpensive to make and intuitive to use.

Chapter 4: Design Alternatives

After defining our functions, we developed a morphological chart (seen in Table 3) to examine the different combinations of means to meet the functions. Each function and mean is discussed in the sections below. We ranked the morphological chart based on our prioritized objectives and feasibility.

Table 3: Morphological chart depicting the functions and means to fulfill those functions. Each mean is ranked by feasibility; 1 being the most feasible.

Functions	Means						
Nourish Tissue/Media Flow	3.) rocking	4.) vertical flip	2.) fish tank pump	1.) peristaltic pump	5.) intake manifold/ventilator
Anchor Tissue	2.) suture	3.) Silicone washer	5.) zip tie	4.) elastic bands	6.) drawstring	7.) socket	1.) Lunchbox Handle
Media Container	1.) one media chamber	2.) media reservoir & chamber	3.) Double media reservoir
Emptying Media	2.) sloped bottom to collector	3.) plug	1.) valve	4.) vacuum
Gas exchange	2.) peroxide-cured coil tubing	1.) filters	3.) oxygenator

4.1 Design Components

This section discusses the means considered to fulfill each function. Their advantages and disadvantages are explained.

4.1.1 Nourish Tissue/ Media Flow

As previously mentioned, the perfusion bioreactor must provide media flow through the lumen of the tissue tube to prevent cell death and keep the lumen open. The peristaltic pump is widely used in perfusion bioreactors. Peristaltic pumps can power single or multiple flow loops and can be adjusted to an appropriate speed. One of the original ideas we had when deciding on a pumping mechanism was a fish tank pump. This variety of pump uses a small water wheel to propel fluids. Generally fish tank pumps are very cheap, but their flow rates are non-adjustable.

There are means of perfusion other than pumps. The rocking method involves a media chamber rocking back and forth to mix the media. This method is generally used when the sample is a 2D scaffold rather than a 3D construct. In addition, the rocking method is not suitable for our project because it would likely result in turbulent flow. Turbulent flow could cause damage to the cells and the

structure of the tube. The vertical flip method was one of our original ideas which involves attaching the tissue tube in a vertical manner in which flipping the media chamber up-side down would allow gravity to move the media through the lumen. As this method is similar to the rocking method, it would not be suitable for our project because it would cause turbulent flow.

The intake manifold ventilator uses moving air to apply a pressure to the media which then propels the media through the tissue tube. This method is very complex and involves many parts.

4.1.2 Anchor Tissue

The tissue sample has to be held in place while it is being fed. Our group brainstormed different ways in which we could attach the sample to blunt-end syringes, needles, or tubes. Suturing is a common method used in the Rolle Lab when anchoring the tissue tube is necessary, such as during burst pressure testing. Thus, suturing could also be used to anchor the sample onto the blunt-end syringes of our perfusion bioreactor. The disadvantage to this would be that it is tedious and can potentially damage the tissue sample.

Some alternatives to suturing include using small rubber washers, elastic bands, zip ties, or drawstrings. The washers would be circular and flexible and could be placed over the ends of the tissue tube to anchor it to the ends of tubing or syringe needles. The elastic bands are very similar to the washer. They would be placed over the ends of the tissue tube to anchor it onto some other structure. The potential disadvantage of using elastic bands is that they might break or damage the tissue. Zip ties would work like the sutures, but would simply be more user friendly. However, it is uncertain how easy it would be to remove the zip tie once it is tied down, and it is likely that more tissue would be destroyed because zip ties are wider than sutures.

The drawstring method was an original idea which consisted of a suture inside of a sleeve that could rest within the bioreactor even when it was not in use, unlike an ordinary non-reusable suture. It would eliminate the initial looping of the suture, but would still require the step of tying, and due to the small scale of the components, the drawstring would be difficult to manufacture and use. The socket method involved two rings each with three flexible protrusions that would grip the tissue tube at either end. However, due to the small size of the components the socket would be difficult to manufacture. Also, because the tissue tubes are so flimsy, it is likely that the tube would arch down in the center and slide off the sockets.

4.1.3 Media Container

The perfusion bioreactor must hold a certain amount of media at any given time. All of our designs require the tissue sample to be submerged in a container of media as well as receive media through the lumen. We decided that there can be one media chamber, a media reservoir, or two media reservoirs. These are discussed below.

The “one media chamber” design does not incorporate a reservoir. The media in the container would be pumped through a tube that can feed the lumen of the tissue. From there the media would simply empty into the chamber to nourish the exterior of the tube and eventually be reintroduced to the flow loop through an outlet port. One media chamber would make our device more portable because there would be fewer components. Therefore, media may be used more efficiently because there would be no mixing of used media and fresh media. Instead the media would be circulated until it is used up and then it could be swapped out with fresh media.

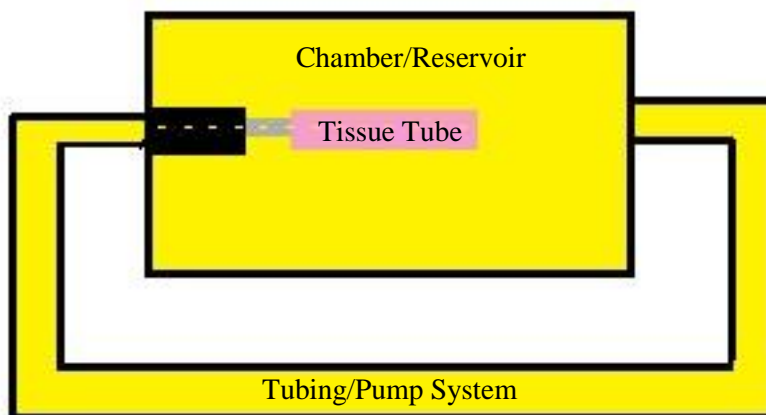

Figure 8: The “one media chamber” design consists of a chamber that acts as the media reservoir as well as the area where the tissue sample is submerged. The same media is circulated through the lumen as well as around the outside of the tissue tube, indicated by the single color of the media.

The “single media reservoir” design is a common feature among bioreactor designs. There would still have to be a separate container of media that the sample is submerged in. The advantages are that the media chamber could constantly be receiving fresh media. The disadvantages to this method is that it will use more media than the “one media chamber” design and there are more components so it is less portable, less durable, and more expensive.

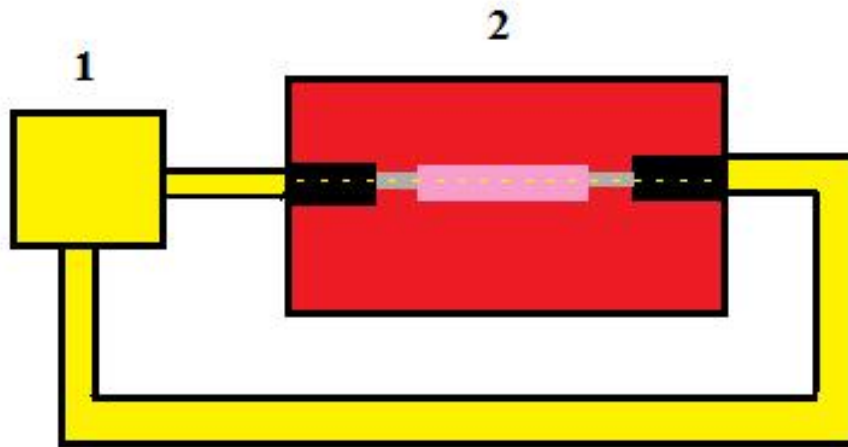

Figure 9: The “single media reservoir” design consists of a media reservoir that contains the media that perfuses through the lumen (1, and yellow dotted line) and a second media reservoir where the tissue tube sample is submerged (2). The two media reservoirs do not mix as indicated in the two separate colors.

The double media reservoir consists of two separate but linked reservoirs. The gas exchange takes place in the first reservoir, which then passes its media into a second reservoir.

4.1.4 Emptying the Media

Ideally, the media in our bioreactor will be changed every three days, if not longer. The tissue tubes require about 6mL of media every four days and we anticipate that our design will incorporate more volume than 6mL. Thus, we expect that we can exceed our goal of changing media every 3 days. Our group brainstormed methods of emptying the media from the media container with this information in mind.

A valve at the bottom of the media container could be opened to drain the media and closed to retain the media. A plug would be very similar to the valve but might be more durable. However, the plug must produce a leak-proof seal. If the bottom of the media container was sloped, the media could easily be drained through the valve or plug.

In the lab there are aspirators that can remove excess liquid from tissue culture dishes. Aspirating media is an easy and efficient way to remove media when it is time to be replaced since it is readily available in the lab.

4.1.5 Gas Exchange

The media must have gas exchange to provide the cells with oxygen while disposing of their excess carbon dioxide. Gas exchange is also needed for the CO₂-mediated buffering of the culture

medium. A hole could be made in the media chamber or reservoir which allows air to come into contact with the media. Also, a gap between components on the device could allow enough air flow between the inside and outside of the chamber without being too large to compromise the sterility of the environment. A filter could be used in order to prevent contamination if the gap or hole is large.

Many bioreactors use a peroxide-cured coil of silicone tubing to produce gas exchange as it is air-permeable. However, this would add to the overall volume of media being used because media would be flowing through the tube at all times. It is used in a coiled form to maximize the surface area for gas exchange while limiting the space it takes up.

An oxygenator is a medical device used to carry out gas exchange in a patient who cannot use his or her lungs to do so. This device is likely too large and expensive for our design.

4.2 Design Alternatives

The following section describes the full designs that were considered for prototypes. The designs incorporate features from the above sections to attempt to accomplish our objectives and operate within our constraints.

4.2.1 Open Cartridge Design

The open cartridge design consisted of a subset of ideas which incorporated an inlet of a syringe needle coming from the wall and a stationary arm to hold the tissue tube in place. The name “Open Cartridge” came from the idea that the end of the tissue tube is open to the chamber and not connected to a separate flow loop. The general idea behind this design is that the medium flows through the tissue tube and empties into the chamber. Three different configurations were conceptualized. These include an arm with a syringe needle in the middle of the bottom face of the chamber (Figure 10), arms holding a syringe needle coming from the outlet face of the chamber (Figure 11), and a support arm with a circular trough for the end of the tissue in the middle of the bottom face of the chamber (Figure 12). The open cartridge designs are simple and would be easy to manufacture with readily available materials.

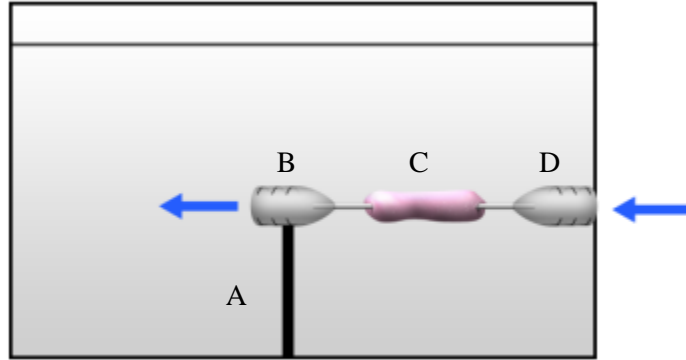

Figure 10: Open Cartridge Design 1 consists of a plastic arm (A) attached to the bottom face of the chamber. A syringe needle (B) is used to support the end of the tissue tube (C) while another syringe needle supports the other end at the inlet (D).

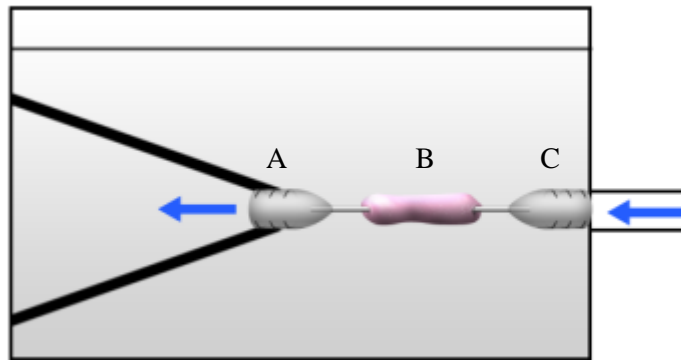

Figure 11: Open Cartridge Design 2 consists of plastic supports connected to a syringe needle (A) to hold the end of the tissue tube (B) while a syringe needle on the inlet (C) holds the other end.

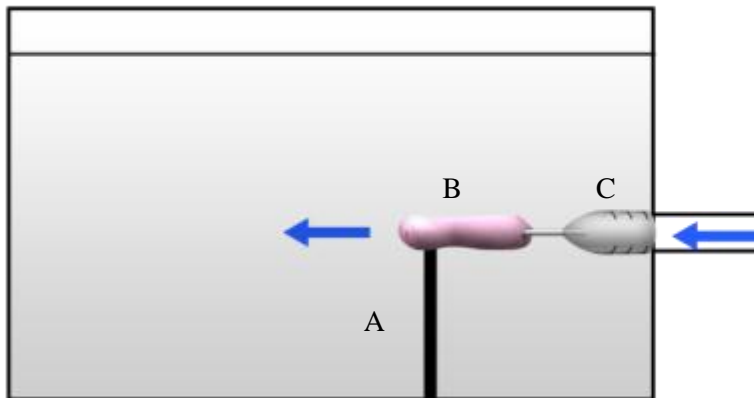

Figure 12: Open Cartridge Design 3 consists of a plastic arm with a round support (A) underneath the tissue tube (B). The syringe needle at the inlet (C) holds the tissue open.

Additionally, there are limitations to the open cartridge designs. The supports are stationary so putting the tissue tube on the needles could be difficult. Also, design 3 does not provide enough support for the tissue tube and may cause it to collapse since there is nothing holding the lumen open.

4.2.2 Lunchbox Design

Our first iteration of the lunchbox design, seen below in Figure 13, incorporated a tissue tube-holding mechanism attached to the lid of the chamber. The lid had a handle on top for easy opening and transportation. This design is called the Lunchbox Design because of the original idea of having a handle on top. Posts with ring-shaped supports for the tissue tube extended down from the lid. Posts with ring-shaped supports for the tissue tube extended down from the lid.

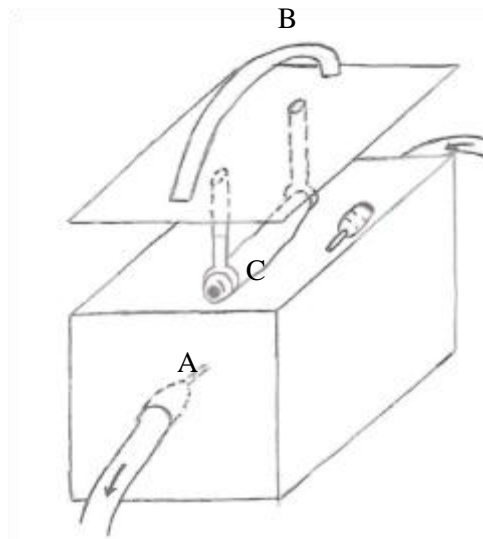

Figure 13: Original Lunchbox Design with syringe needles embedded in the walls (A), a handle on the top of the lid (B), and ring-shaped posts to hold the tissue (C).

This design would not have worked because the rings would not provide enough support for the tissue tube and would eventually collapse. Also, there was no way to move either of the arms to attach the tissue.

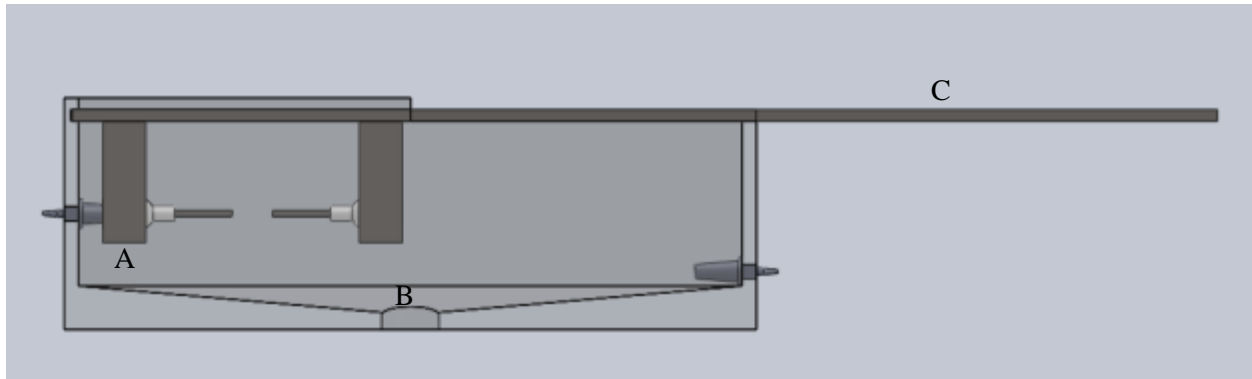

Figure 14: Lunchbox Design with sliding Luer connection (A), sloped bottom for draining media (B), and sliding lid with long handle (C).

The next iteration included a sliding lid with a handle on the side, so that the top of the lid was flat as seen in C in Figure 14. By making the top flat, the user can flip it upright on the lab bench to prepare the sample. The lid slid into a ridge on the chamber to stay in place and to ensure a direct connection between the Luer connector and syringe needle at the inlet of the chamber. This design still incorporated two stationary arms but now included syringe needles to support the tissue tube. Luer connections between the inlet in the wall and the syringe needle in the arm created the flow loop after the lid was slid into place. The main idea behind this design was to allow the user to set up the tissue tube outside of the chamber and to easily attach the sample to the flow loop. The bottom of the chamber was sloped towards a plug for easy drainage.

Unfortunately, this design was not practical. The stationary arms did not allow the tissue tube to be mounted easily. Also, the sloped bottom was not needed because media can be aspirated out, or the pump could be run in reverse. The long handle was also unnecessary because it made the chamber significantly larger. The chamber needed to be about twice as long as the span of the mounting arms to accommodate for the sliding motion. The arms needed to be submerged into the chamber before the lid was slid into its closed position. The sloped bottom and long handle would also require unnecessary machining.

4.2.2.1 Sliding Track Lunchbox Design

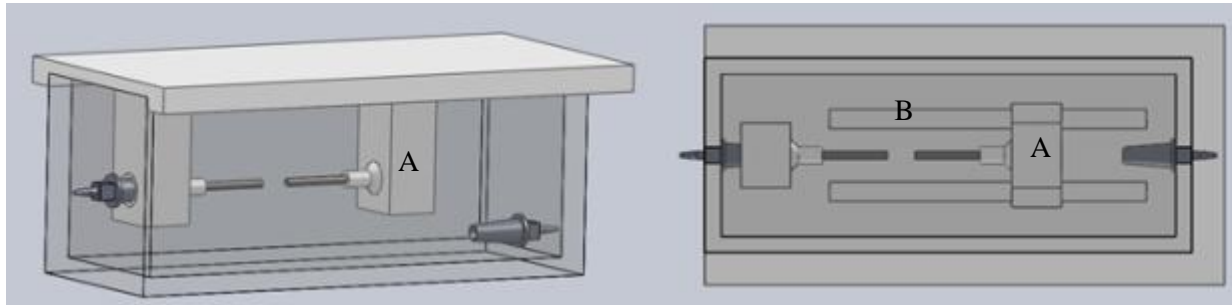

Figure 15: The first iteration of the sliding track design. A sliding T-shaped arm (A) moved along tracks (B) in order to adjust the positioning of one of the syringe needles.

We altered the previous design to remove the side handle because it takes up space and increases the volume of the chamber significantly. As a result, this design has much smaller dimensions. The chamber has a height and width of 1.5” and a length of 3.75”. The lid is 4” x 2”. The main concern with all of the previous designs was movement of the arms for insertion of the tissue tube. We designed a sliding track in order for the user to easily attach the tissue to each of the syringe needles. This design was not used; however, because the arm was not easily secured in one place. Originally it was thought that a pin-and-hole system (Figure 16) could be used on the moveable arm but this proved to be difficult to manufacture. Also, with a pin-and-hole system only exact fixation points could be chosen. Thus if the tissue varied slightly, the exact mounting position would not be attainable.



Figure 16: Pin and hole track system that was considered for adjustability of the movable arm.

4.2.3.2 Magnetic Track Lunchbox Design

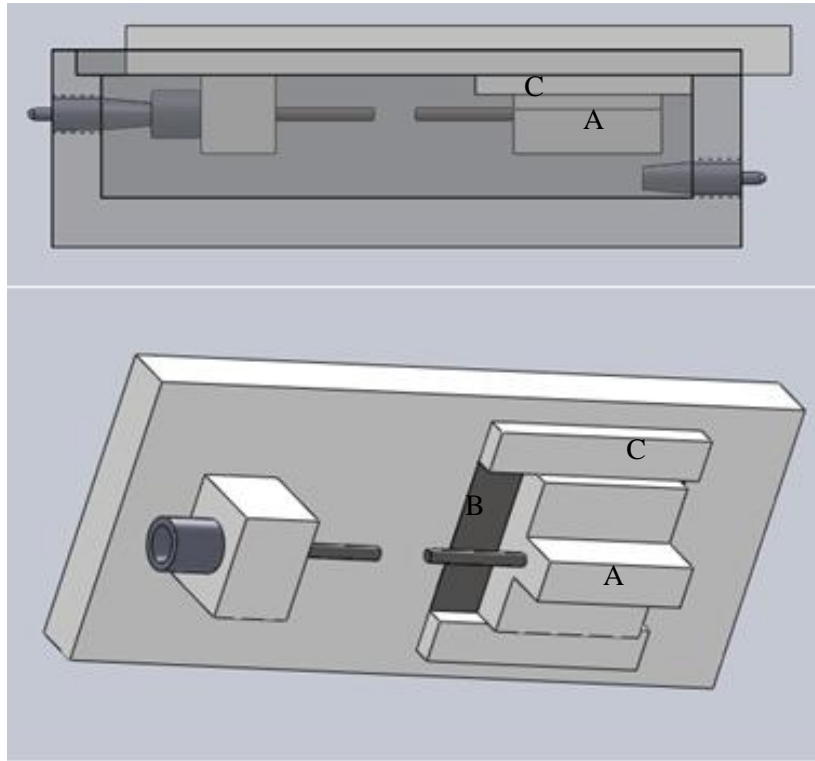

Figure 17: The magnetic track design includes a moveable arm with an embedded magnet (A). The lid had an embedded steel plate (B) with ridges along the side for guidance (C).

The idea of a magnetic track was considered as an alternative to the pin-and-hole system. There were several distinct advantages of the magnetic track over the pin-and-hole system. First, this would eliminate the small parts required for the pin-and-hole system. Additionally, the lid consists of a permanently attached magnetic surface and an arm with an attached magnet. This would improve durability and lessen the amount of work required by the user. Secondly, the pin-and-hole system only accommodates certain arm positions, while the magnetic track allows the user to customize the distance between the arms. To provide stability and guidance for the moveable arm, ridges could be put on either side of the magnetic surface to hold the arm in place. This ensures that the syringe needles line up the same every time.

From our conceptual designs, we decided to move forward with the magnetic track design because it provided the user an easy way to manipulate the device for tissue tube attachment and adjustment. It is unique in that the tissue tube is hanging down and being submerged within the chamber. This design also incorporated the sliding lid mechanism which allows easy connection of the flow loop.

Chapter 5: Design Verification

This section describes the two prototypes and testing methods used to evaluate the designs. The results are also discussed. The protocols for all tests can be found in APPENDIX A: Testing Protocols.

5.1 Magnetic Track Lunchbox Design Initial Prototype

The first prototype was constructed out of Tupperware®, a magnet, wood, welded steel, aluminum, two 16 gauge syringe needles, two Luer connectors, 1/16" silicone tubing, and the peristaltic pump. Images of this prototype can be seen in Figure 18. The Tupperware® was used as a bioreactor chamber. We cut two holes on either side of the Tupperware® and glued the two Luer connectors in place. We constructed the lid out of wood and glued the 2" steel piece to it. The steel was used as the magnetic track for the moveable arm. Both arms were made out of aluminum and holes were drilled to accommodate the syringe needles. The magnet was attached to the one arm by epoxy. The inlet Luer connector in the Tupperware® connects to the Luer connector in the stationary arm of the lid to complete the flow loop. This loop is completed by a sliding lock motion. Essentially, when the syringe tip is pushed against the male Luer connector, the friction between the two holds the lid tight to the chamber and establishes a flow loop. We used Prince® Tubettini pasta to simulate the tissue tube.

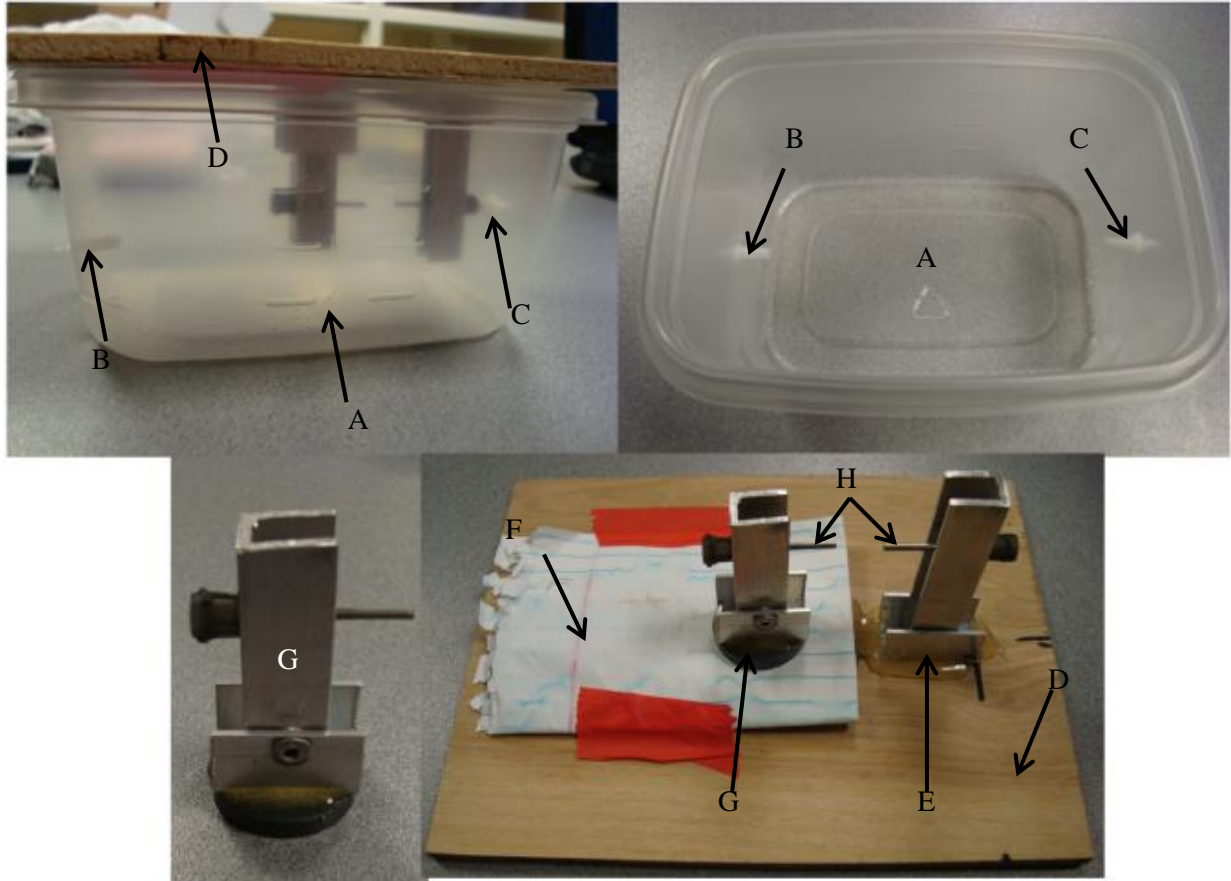

Figure 18: The initial prototype consisted of a Tupperware® container (A) with outlet (B) and inlet (C) Luers, a wooden board (D) acting as the lid with a stationary aluminum arm (E) and steel track (hidden by the paper labeled by F), and a magnetic aluminum movable arm (G). Both arms have aligned syringe needles (H). The paper was used to even out the height of the movable arm.

Once the prototype was built we could start the proof of concept testing. We tested the prototype’s ability to create a full flow loop, the pump’s flow rate, and the ease of anchoring the Tubettini to the device. Before any of these tests could be performed, we had to make sure that our prototype did not leak. We filled the Tupperware® container with water and did not observe any leakage around the glued Luer connectors.

Next, we attached the Tubettini pasta onto the syringe needles. We tried to suture the Tubettini to the syringe needles but the pasta started to rip. We removed the ripped pasta and attached another piece without anchoring it to the syringe needles in order to proceed with testing.

We placed the lid onto the Tupperware® and proceeded to pump the water through the pump and through the pasta. At first, we did not observe any flow going through the pasta so we removed the lid and examined the syringe needles. The syringe needles were clogged with pasta residue that collected

inside the needles while the pasta was being attached. We moved the piece of pasta to one needle and unclogged the syringe needles.

To ensure that it was unclogged, we pipetted water through each syringe needle. The water flowed effortlessly through the syringe needles. Then we positioned the pasta back in place over both syringe needles and proceeded to pipette water through. The water flowed through the syringe needle and the pasta and out the other syringe needle. There was no leakage where the syringe needle attaches to the pasta.

The next test performed was measuring the flow rate of water through the prototype in order to determine what setting of the pump we needed to use. The pump we used to test the flow rate was the Fisher Scientific Variable-Speed Pump Low Flow (model number 13-876-1) that ranged from 0.003-8.20mL/min and can be seen in Figure 19. The dials on the pump do not specify the flow rate so they needed to be calculated. In order to calculate the flow rate, we filled the silicone tubing and chamber with water and ran the pump on the different speed settings. The water emptied into a graduated cylinder. We measured how much water was in the graduated cylinder after three minutes.



Figure 19: Fisher Scientific Variable-Speed Pump Low Flow was used to pump fluid through the bioreactor. Flow rates ranged from 0.003-8.20mL/min.

The pump settings were recorded and the total volume was divided by three minutes in order to obtain units of milliliters per minute. We chose to set the speed to “Fast” and the dial setting to 7 and 10.

The fastest setting was dial 10, at 6.3mL/min. At seven, the flow rate was 4mL/min. We chose to use the pump at 6.3mL/min because this rate fell within the acceptable wall shear stress range of 4.4-8.8mL/min, which is different than the necessary 7.16-14.3mL/min because we had made errors in our calculations at the time of this experiment. The results of this test can be found in Table 4.

Table 4: Results of the Low Flow pump flow rate test.

Test	Setting	Volume (mL) after 3 min	Flow Rate (mL/min)
1	10 Fast	19	6.3
2	7 Fast	12	4

5.2 Magnetic Track Lunchbox Design Acrylic Prototype

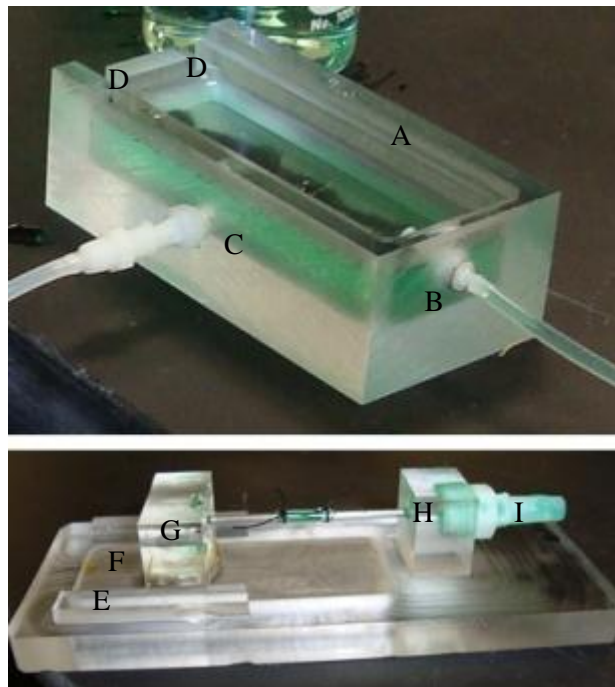

Figure 20: The components of the acrylic prototype chamber consist of a cut out for the placement of the lid (A), inlet female Luer connector (B), outlet male Luer connector (C), and two rectangular gaps for the track ridges to slide on (D). The components of the acrylic prototype lid consist of ridges for guidance of the moveable arm (E), an embedded steel track (F), a moveable arm (G), a stationary arm (H), and a male Luer connector for the wall connection (I).

The acrylic prototype optimizes size while taking advantage of quality materials and precision machining. The acrylic design is comprised of three separate but connectable parts, all made out of acrylic with a few smaller stock parts required for functionality. The three main components are the chamber, the lid, and the moveable arm. All of the components described in this section can be seen in Figure 20.

The chamber was designed to have an open top, a threaded hole in the front wall, and a threaded hole on one of the sidewalls. The chamber was milled down to the correct conformation using a milling machine. The chamber is 3.5 inches long, 1.0 inch tall, and 1.65 inches wide. The wall thickness of the chamber is 0.25 inches, and thus its depth is 0.75 inches. The back wall's height is 0.88 inches, and the three other walls are 1 inch tall, resulting from an indent that goes .12 inches into each wall. Two standard ¼-28 ANSI Inch threaded holes were drilled into two of the chamber walls. Both holes are threaded with ¼-28 ANSI Inch screw threading. The front hole has a diameter of .21 inches and the side hole has a diameter of .16 inches.

A female threaded barbed Luer connector was used for the inlet, labeled B in Figure 20, with the female Luer connection facing into the chamber and the barb on the outside. The outlet, labeled C in Figure 20, was moved from the side to the front wall because the Luer extends into the chamber and would cause the chamber to be longer than necessary. The top edge of the chamber had three sides carved out to create an edge that the lid could slide into that can be labeled A in Figure 20 and highlighted in yellow in Figure 21. Slots were etched into the top of the rear edge of the chamber. These slots, labeled D in Figure 20 and labeled with arrows in Figure 21, were created so that the ridges on the lid would not collide with the rear wall when the lid is sliding on or off.

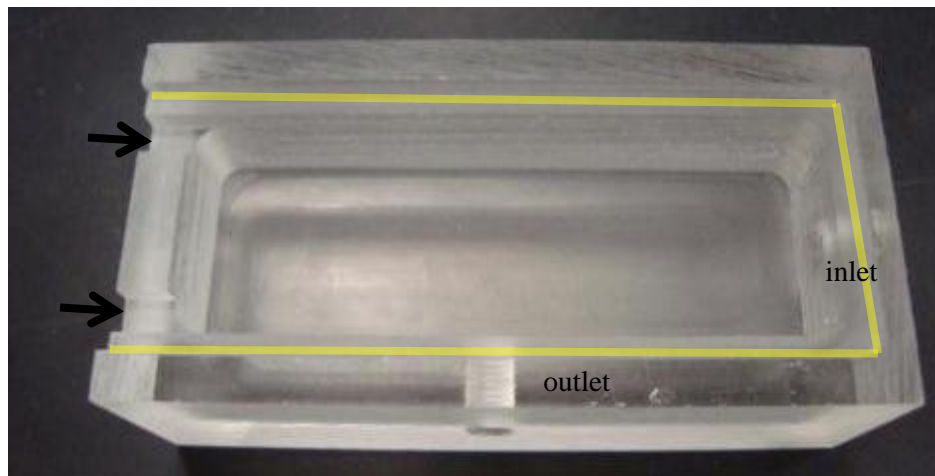

Figure 21: Acrylic prototype chamber with edges for lid (highlighted in yellow) and slots for ridges on lid (labeled with arrows).

The second major component is the lid, which features a stationary arm for mounting as well as a track for a moveable arm to slide across. The stationary arm can be seen in C of Figure 22. The lid is 3.375 inches long in order to fit over the indent of the front chamber wall as well as the surface of the back wall. It is 1.40 inches wide and .25 inches thick. This stationary arm's frontal face is positioned .38 inches from the frontal face of the lid and it is also .38 inches long. Its width is .5 inches. The

stationary arm was fitted with a 1/4-28 ANSI Inch threaded hole so that a threaded male Luer could be screwed into place. The male Luer connector was positioned to connect with the female Luer of the chamber. A .05 inch diameter unthreaded hole was drilled through the rest of the arm. An 18-gauge needle was tapped into this hole until about a half inch of needle was exposed.

The lid was also milled to have two 1.1 inch ridges protruding out of the bottom of the lid. These ridges seen in A of Figure 22, which are each .2 inches thick and .1 inches tall, have their back ends positioned .93 inches from the back edge of the lid and are spaced apart .75 inches. These ridges fit into the slots of the chamber when the lid is sliding on. The lid was also milled with a rectangular depression on the exterior so that a steel bar could be pressed in. This depression measures 2.0 inches in length, .75 inches in width, and .19 inches in depth. A piece of steel was cut so that it could fit into the hole. The fit was sufficient that no adhesive was needed to keep the steel in place. The steel serves as the magnetic track and is separated from the cartridge by the remaining layer of acrylic.

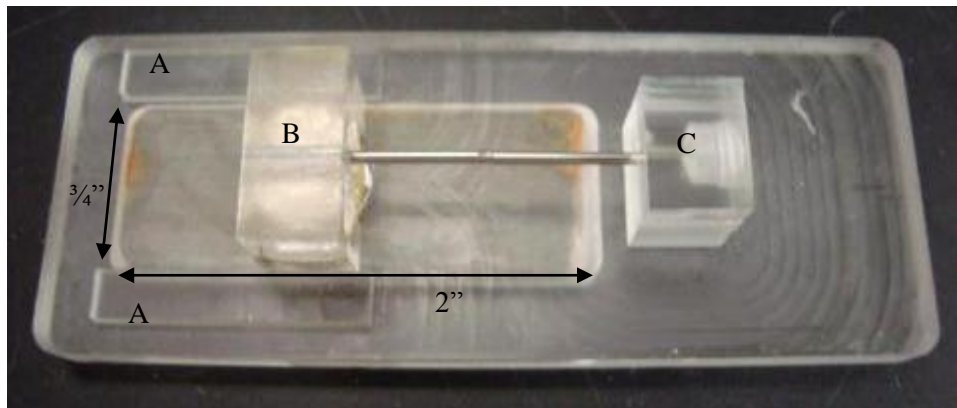

Figure 22: Acrylic prototype lid consisting of ridges (A) for the moveable arm (B) and a stationary arm (C). Arrows indicate the dimensions of the depression for the steel piece.

The movable arm, seen in B of Figure 22, was created using a small acrylic block, an 18-gauge needle and a neodymium magnet. The acrylic block was milled to be .375 inches long, .75 inches wide, and .50 inches in height. A hole .05 inches in diameter was drilled through the movable arm to match the hole previously created in the stationary arm. The 18-gauge needle was lined with superglue and placed inside of the movable arm so that a similar amount of needle was exposed. When lined up with the needle of the stationary arm, a tissue tube can be sutured and stabilized. The movable arm was also created with a circular cutout in the base in order for it to house a disk-shaped neodymium magnet. The magnet is .5 inches in diameter and .13 inches thick, so the hole was made to accommodate that size. Epoxy was used to attach the magnet to the movable arm. The attraction between the magnet of the movable arm and the steel embedded in the lid provides enough force for the movable arm to adhere to the lid.

The first test performed on the acrylic prototype was to measure the volume the bioreactor could hold. This was done by filling the chamber with water, adding the lid, and removing any excess. The water had to be raised above the syringe tips because the tissue tube would have to be completely submerged in media when the device was in use. Next, the water was poured into a graduated cylinder for measuring. This simple test was repeated two times and we determined the average volume of the bioreactor to be 25mL.

Our second test involved calculating and comparing various flow rates of the pump. The pump used was Fisher Scientific Variable-Speed Pump -Medium Flow (part number 13-876-2) that has flow rates of 0.4mL/min-85mL/min pump, shown in Figure 23. This pump was used instead of the previously mentioned Low Flow pump because the Low Flow pump's maximum flow rate was only 8.2mL/min. According to our calculations, we needed a flow between 7.16 and 14.3 mL/min. We used one of the pieces of tubing that came with the Fisher Scientific pump (3/16") inside the rotating mechanism of the peristaltic pump. We tested the flow rates by attaching the inlet of the pump to tubing in a beaker of water and the outlet to an empty graduated cylinder. The pump was run at various settings for 3 minutes. At the end of three minutes the total volume was divided by three in order to obtain a flow rate value in mL/minute. The results of this test can be seen below in Table5.

Table5: Flow rates of 0.4-85 mL/min peristaltic pump.

Pump Setting	Flow Rate (mL/min)	Velocity (cm/sec)	Wall Shear Stress₂ (dynes/cm)	Reynolds Number
2 (slow)	5.33	7.99	3.62	119
1 (fast)	8.00	12.0	5.43	178
1 (fast)	8.33	12.5	5.65	185

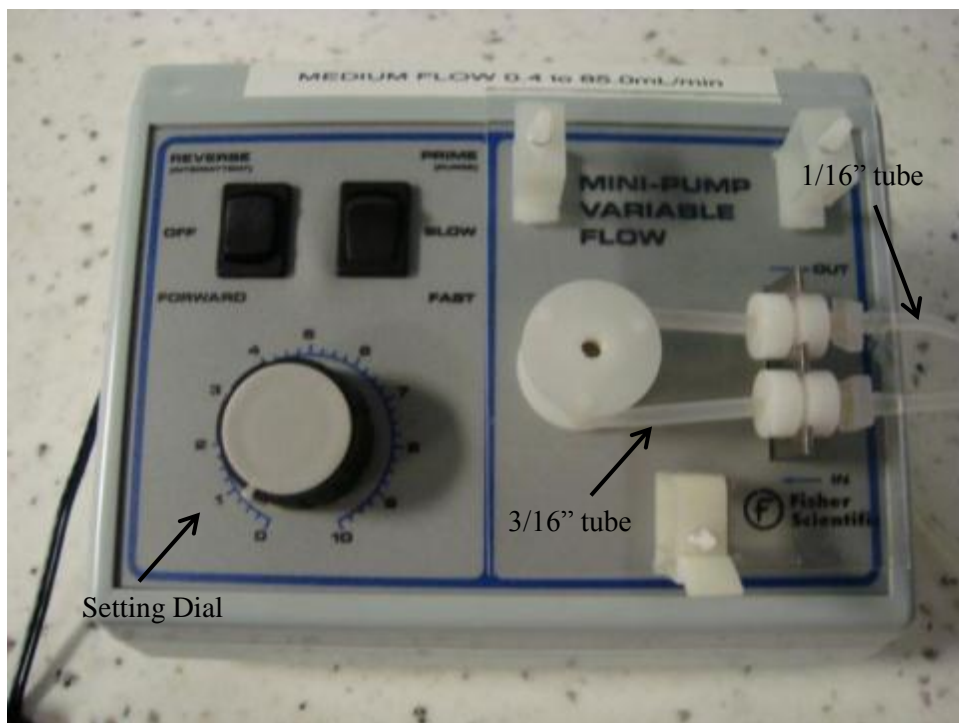

Figure 23: Fisher Scientific peristaltic pump with flow rates ranging between 0.4-85.0mL/min.

We then checked for leaking through the arms of the lid since having no leakage is one of our constraints. This was done by pipetting colored water through the Luer connector on the stationary arm while the lid was laid flat on the bench top. Water moved all the way through the syringe needle. Unfortunately, we saw some leaking from the threading of the Luer connector on the stationary arm. An image of the leak can be seen circled below in Figure 24. There was no leaking on the opposite side of the stationary arm where the syringe needle was tapped in.

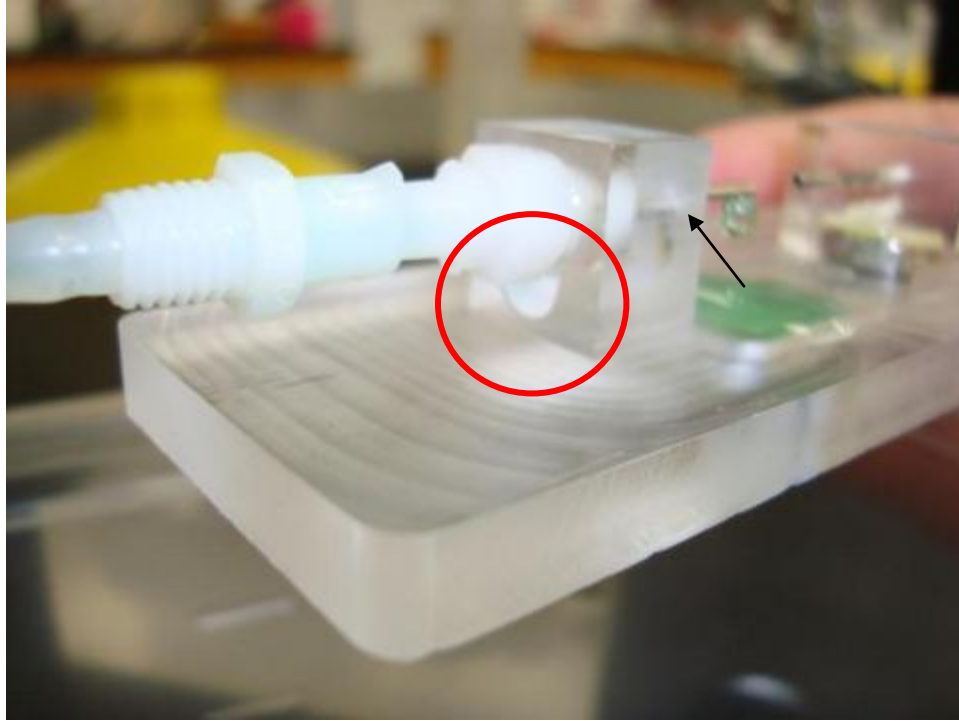

Figure 24: Leak around threading of the stationary arm (circle). No leaking was observed at the stationary arm-syringe needle interface (arrow).

The whole flow loop was tested for leaking by suturing a 1.47mm inner diameter clear silicone tube resembling the tissue tube onto the syringe needles. Since our prototype chamber is not translucent, we did this test with the lid alone on the bench top. A female Luer was attached to the male Luer of the stationary arm. The 1/16" tubing was attached from this female Luer to the pump. The pump inlet tubing was set in a beaker filled with water. The pump was turned on in order to release any air bubbles. No leaking was observed from either syringe needle, or from the sutured tubing. All the water successfully emptied through the end of the other syringe needle. The leak-free sutured tube is shown below in Figure 25. As mentioned before, there was leaking at the threading of the Luer connector in the stationary arm. The leaking was fixed by applying Teflon tape to the threading of the Luer connector.

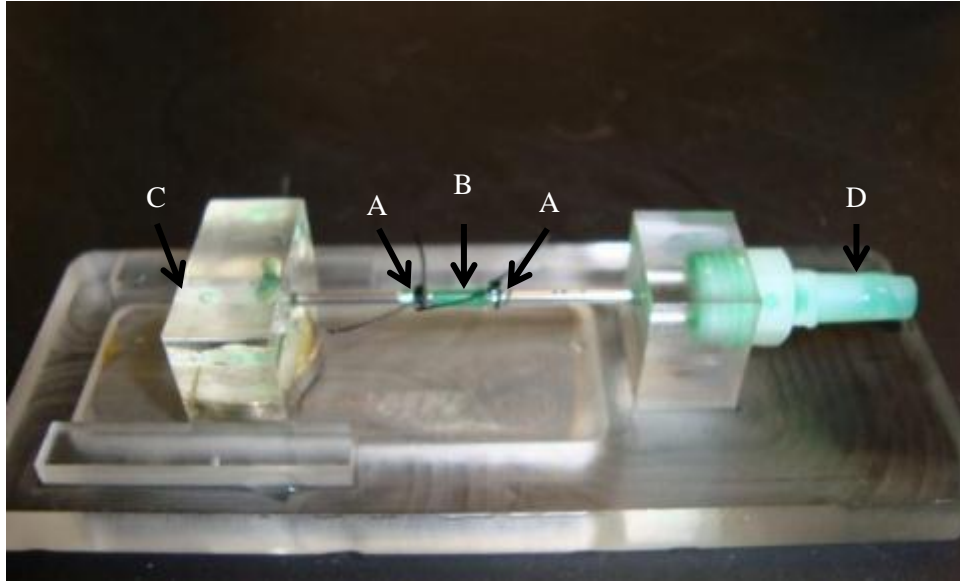

Figure 25: No leaking was observed around sutured tubing. In this image the sutures (A) and the silicone tubing (B) are shown. The inlet (D) and outlet (C) are also visible.

Finally, the bioreactor was tested to see if flow was laminar through the region where the tissue tube would be attached. As mentioned in the previous paragraph, 1.47mm inner diameter clear silicone tubing was sutured on the ends of the syringe needles to simulate the tissue tube while providing a transparent material. Next, a beaker was filled with water and green sugar particles. Using the peristaltic pump, this solution was flowed through the clear silicone tube. The motion of the particles was recorded using a camcorder and later reviewed for analysis. The full protocol can be found in Appendix A. There appeared to be turbulent flow based on the movement of the particles. Some particles seemed to move straight across the tube while others swirled and flowed in circles. However, it was later realized that the particles were not of uniform size and could be affecting the flow. This test was deemed inconclusive. Figure 26 shows the different sized particles flowing through the silicone tube.

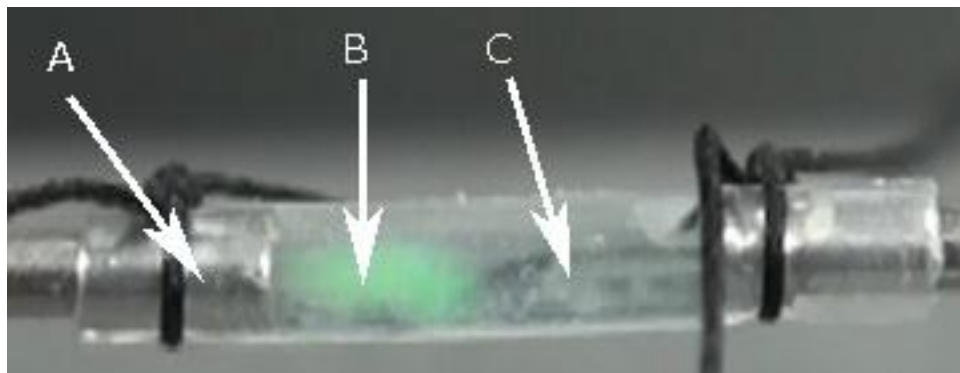

Figure 26: Silicone tubing (ID 1.47mm) was sutured to the syringe needles (A). Both large (B) and small (C) particles are seen flowing through the tubing.

After testing, we found that this prototype meets some of our design objectives. Attaching and suturing silicone tubes to the device were simple processes due to the mobility of one of the arms. The attraction of the magnet on the movable arm to the steel created enough force to hold the silicone tube without shifting. This force was well balanced and the movable arm easily slid along the track. The movable arm was also easily removed when slid to the end of the steel track. Without hindering the functionality of the chambers, we significantly downsized the dimensions to reduce the amount of media. Another positive feature of the design is that the Luer connectors are all replaceable since no permanent bonds were used to attach them to their respective locations.

Despite the general improvements made to this prototype over the previous prototype, several flaws were still noted. When the lid is slid over the chamber to make the Luer wall connection, the device is sealed. However, sometimes this connection is made too tight and needs to be forcefully removed. The motion of forcefully opening the lid may inadvertently cause the movable arm to collide with the wall of the chamber. The collision would be detrimental to any tissue tube mounted, as the movable arm's position is affected when it hits the chamber wall.

Another flaw in the acrylic design is that the two 18-gauge needles, which secure the tissue tube, do not line up perfectly. Since the placement of the holes for the needles were precisely measured (to the thousandth of an inch), we speculate that the reason for the misalignment is because the layer of epoxy used to attach the magnet to the movable arm was not accounted for.

The slots built into the side of the design were deemed to allow too much contact with the outside environment. Large gaps in the exterior of the device can compromise the sterility of the design.

Testing the perfusion capabilities of the acrylic prototype enabled us to find a leak where the male Luer connector meets the stationary arm. The flaw could potentially be attributed to imperfections of the threading. The acrylic may also be cracked at some point, since the 18-gauge needle was tapped into the hole drilled through it.

In conclusion, our acrylic prototype showed that our design concept was feasible. By testing the acrylic prototype we were able to identify the flaws of the design. Creating a final prototype allowed us to improve upon this concept. We decided to take this design to the next step and create it out of a material able to undergo autoclaving in order to be able to test with biological samples.

Chapter 6: Final Design and Verification

The following chapter describes the components and features of the final design of the device. Manufacturing of the device, including parts used, measurements, and the procedure for making device is also included in the chapter. Testing of the device and the corresponding results are also in this chapter.

6.1 Verification

Several changes had to be made from our acrylic prototype to produce a suitable perfusion bioreactor. First, the material had to be changed. Acrylic melts in autoclaves, so we needed to find a material that could resist the temperature and pressure of an autoclave. Polycarbonate was suggested to us for use by our consultants Neil Whitehouse and Michael Fagan. We purchased polycarbonate to create our final device after careful research and consideration of its properties.

Next, we had to alter the lid design so that it was better suited for aseptic techniques. Referring to Table 1, our Pairwise Comparison Chart Results, it is evident that the most important objective to be met was “ease of sterilization.” Sterility was also a constraint. The acrylic prototype’s lid slid into the chamber and was held in place by thin walls. Our clients wanted a lid design which would hang over the edges of the chamber rather than fitting within it. The idea was based on the properties of a Petri dish; the overhanging lid would provide additional protection from contamination on the surfaces of the chamber while still promoting gas exchange and featuring the easy-to-use sliding mechanism. In addition to the new lid design, the chamber would have slots cut out for the ridges of the lid to fit in. We realized that the acrylic prototype’s slots had too much clearance; there was open space even when the lid was connected. This increased the likelihood of contamination. The final step was to cover over the magnet and piece of steel with some form of polymer to prevent rusting in or around the chamber. Rust could cause the media inside the chamber to become cytotoxic.

A few matters of efficiency and poor planning had to be addressed during the manufacturing process. The moveable arm was made smaller as there was excessive material used in the acrylic moveable arm. Due to the shape of a drilling tool used to drill a hole in the stationary arm, a region had to be bored out of the lid in front of the stationary arm. This hollowed out area, shown in Figure 28 (A), was embraced as a new means of gas exchange.

Based on these changes, the device would now meet the criteria for our sterilization constraints and objectives. Laminar flow was tested multiple times and ultimately our conclusion was that the tests indicated little to no turbulence. Polycarbonate is highly durable, and although the device was not tested under stresses to see if cracking or bending occurred, we can say from handling the device that it does not seem to be at all fragile. In general, the device was fairly easy to make. As with any new device, there

were some mistakes made during the initial manufacturing process. Our suggestions for avoiding these mistakes are outlined in the Future Recommendations section. Our device is quite easy to use; the only part of using it which should offer any trouble is mounting the tissue tubes. However, considering the method of tube mounting we employ (suturing) is consistent with current practice in the Rolle Lab, and is being used to perform burst pressure testing. Other than the mounting process, our device only requires a bare minimum of upper body strength to attach and detach the lid. Because of its size, the bioreactor is quite portable, and we met our “adjustable” objective by engineering a lid with arms that could be adjusted for holding variable length tissue tubes. Our device was fairly inexpensive, as we were able to stay within our budget while making two prototypes and the final device.

6.2 Final Design

The final design uses aspects of the acrylic prototype, but with some major changes to improve functionality. The main components of the final design were made with polycarbonate instead of acrylic. All of the dimensions of the final design can be found in APPENDIX B: Final Design CAD Drawings.

The chamber of the device is represented by Figure 27. The chamber has suitable space to hold media, as well as two threaded holes for the inlet and outlet Luer connectors. The inlet Luer connector is Part No. PBR-007 and is represented by A of Figure 27. This part consists of a barb, followed by a threaded segment, and finally a female Luer component. The female Luer component protrudes from the inner wall of the chamber. The outlet Luer connector is Part No. PBR-006 and is represented by B of Figure 27. The outlet Luer consists of a threaded segment and a male Luer connection segment. The male connection can connect to any standard female Luer with a barbed end, such as Part No. PBR-007. The chamber also has two slots that accommodate for the ridges of the magnetic track and allow the lid to slide. These slots are located at the top of the side opposite the inlet Luer, and are represented by C in Figure 27.



Figure 27: Final design chamber showing female inlet Luer (A), male outlet Luer (B), and slots for ridges on lid (C).

Modifications were made to the lid to help prevent contamination. The lid of the final design is represented by Figure 28. The length and width of the lid was extended so that the lid could fully cover the cartridge. As seen in Figure 29, the lid overhangs the cartridge to protect the chamber's surfaces from potential contamination. A small steel plate is embedded within a depression located on the top of the lid. Silastic® Medical Adhesive, a silicone sealant, was used to cover over the steel. Another feature of the final design lid is the arc cutout located above the inlet Luer. This opening allows gas exchange between the chamber and the incubator. The arc cutout can be seen in Figure 29.

The movable arm, represented by B of Figure 28, was modified from that of the acrylic design so that the neodymium magnet could be embedded deeper into it. The movable arm of the final design is also wider than that of the acrylic design so that it can hold the entire magnet within it. Silastic® Medical Adhesive was used to seal the neodymium magnet in the movable arm. An 18-gauge syringe needle, Part No. PBR-005, goes through most of the movable arm. The male Luer connector, Part No. PBR-006 and represented by C of Figure 28, allows media to be perfused through the stationary arm. Another 18-gauge syringe needle goes through the stationary arm. As seen in Figure 30, a tube can be mounted on the 18-gauge syringe needles.

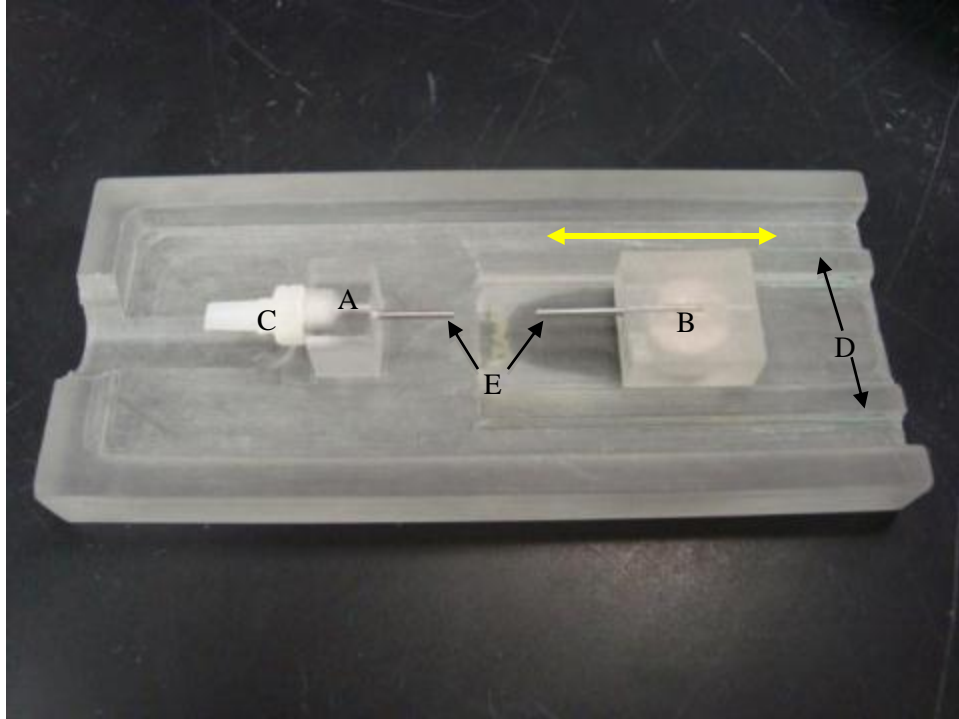

Figure 28: Lid of the final design, which includes the stationary arm (A), the movable arm (B), male Luer connector (C), the ridges for the magnetic track (D), and 18-gauge syringe tips (E). The movable arm's movement is illustrated by the yellow arrow.

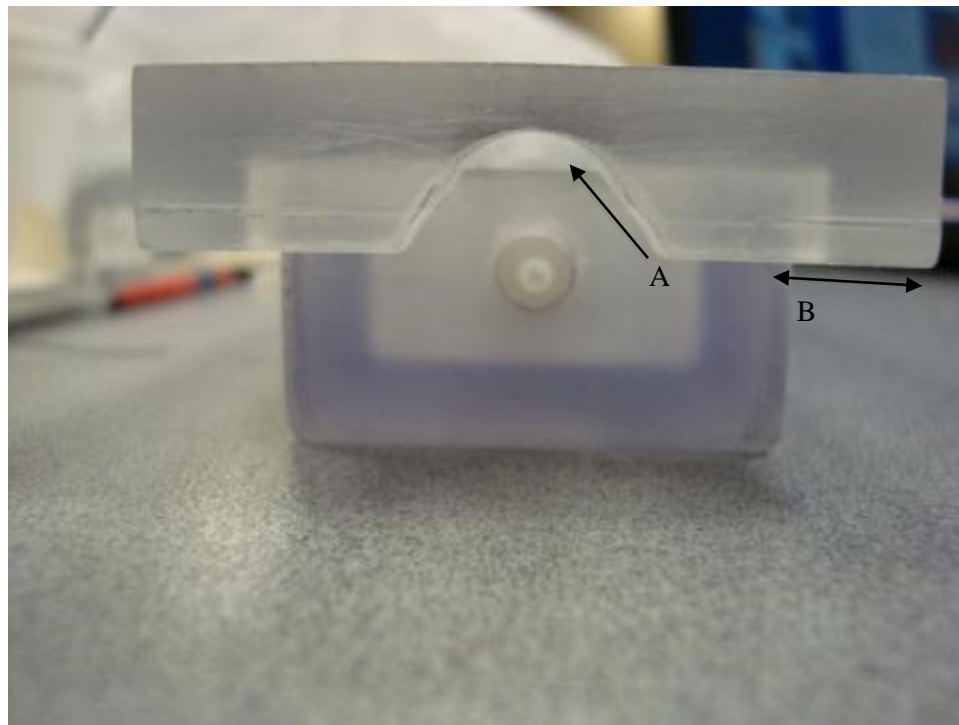

Figure 29: Arc cutout of the lid that enables gas exchange (A). The overhang of the lid can also be clearly seen here (B).

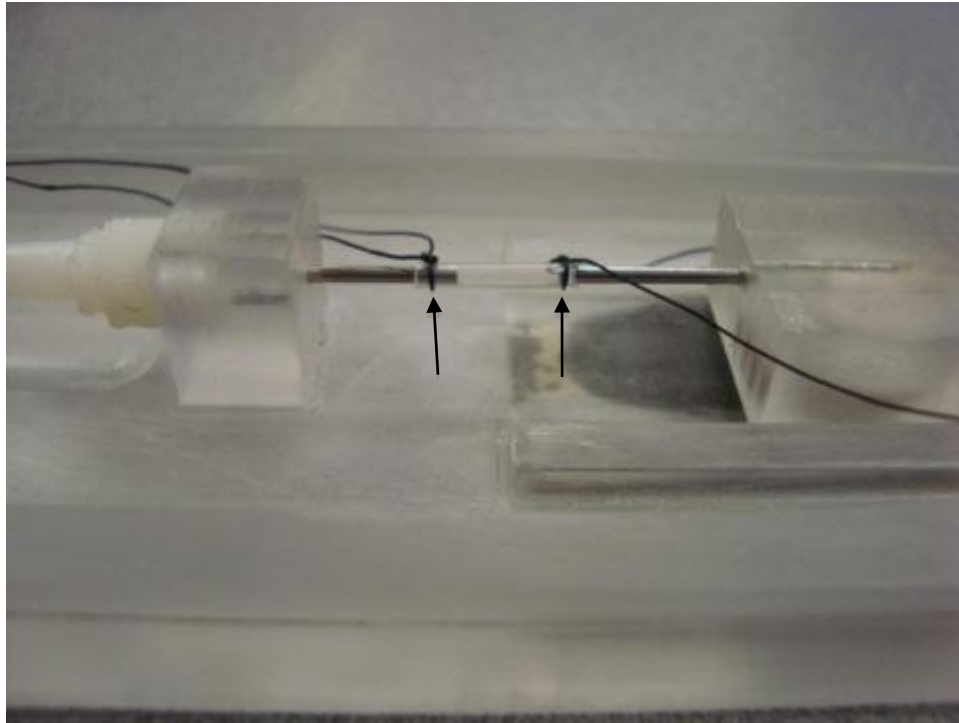

Figure 30: Silicone tube mounted onto the syringe tips using medical sutures (arrows).

6.3 Manufacturing of the Final Design

The chamber of the final design, as seen in Figure 27, was created by first milling an opening into a polycarbonate brick. A HAAS Toolroom Mill, model T-1, was used for all milling done to the chamber. The chamber was milled to be 3.5” long, 1.0” tall, and 1.65” wide. The opening was milled so that the thickness of the walls of the chamber on all sides is .25”. Two slots were milled at the top of one of the 1.75” edges to accommodate for the ridges of the magnetic track on the lid. They are each 0.2” wide and 0.1” deep. These slots are labeled as C in Figure 27.

After the milling, two threaded holes with measurements of ¼-28 ANSI Inch were drilled into the device. This was so that inlet and outlet Luers could be inserted. The hole for the inlet Luer, located at A of Figure 27, was drilled on the 1.0” by 1.75” face, 0.32” below the top of the cartridge. The female inlet Luer, Part No. PBR-007, was inserted so that the barb was on the outside of the chamber. The hole for the outlet Luer, located at B of Figure 27, was drilled on the 3.5” by 1.0” face, at the bottom of the chamber. The outlet Luer, Part No. PBR-006, was inserted with the male Luer facing away from the chamber. The threading of both Luers was lined with Teflon tape to prevent leaking. Refer to the Appendix B: Final Design CAD Drawings for the CAD representation of the chamber.

The first step in manufacturing the lid of the final design was using the HAAS Toolroom Mill on another polycarbonate brick. The lid was milled to be 5.0" long, 2.15" wide, and .50" tall. A rectangular depression 1.50" long, .75" wide, and .22" deep was milled into the top of the lid. The mill also created the block for the stationary arm, represented by B of Figure 28. The last feature created by the mill was the ridges used to guide the movable arm on the magnetic track. Each ridge measures 2.5" in length, .20" in width, and .1" in height. The ridges are labeled as D of Figure 28.

The next step in manufacturing the device was to ensure that the lid and chamber fit together properly. The edges of the cartridge needed to be curved so that it could fit with the lid, since the mill cuts rounded edges. The edges were curved by using wet sand paper while rotating the device. The mill also left residue and uneven surfaces on the polycarbonate lid, and the slots for the magnetic track on the chamber were not cut through all of the way. A scalpel, sanding paper, various files, and a sanding belt were used to polish the surfaces and remove the excess polycarbonate. The sanding belt used was Hammond of Kalamazoo's Model PD-10.

Once the lid and the cartridge were sanded down, a piece of steel was cut for the magnetic track. The steel was cut using the blade saw on DoAll's Model No. DBW-12B Butt Welder. The steel was inserted into the depression in the lid and was sealed in with epoxy. After the steel was placed into the lid, the movable arm needed to be made. A small piece of polycarbonate was cut and milled using DoAll's Model No. GPM 2CCV. The resulting brick measured .75" in width, .75" in length, and .52" in height. Refer to the APPENDIX B: Final Design CAD Drawings for the CAD representation of the movable arm block. A hole was milled out of the brick so that the neodymium magnet can be embedded. Epoxy was used to embed the neodymium magnet. Acquired from K&J Magnetics, the magnet itself is an N-52 grade neodymium disk magnet measuring .5" in diameter and .125" in height. This hole measured .519" in diameter and .12" in depth.

Model No. GPM 2CCV was also used to drill a hole through the brick. This hole was made so that the 18-gauge blunt needle could fit into the movable arm. The device as a whole needed two 18-gauge needles. These needles were obtained by cutting the needle portion off of blunt end syringe tips. The lengths of the resulting 18-gauge needles varied slightly, but were always less than 1.0". The first 18-gauge needle was fitted into the movable arm. A small amount of super glue was used to secure the needle inside of the hole. At this point manufacturing of the movable arm was complete, but the epoxy needed to be left to dry. The complete movable arm is represented by B of Figure 28.

The next step in manufacturing device was to drill the 1/4-28ANSI Inch threaded hole into the stationary arm. A .05" hole for fitting the 18-gauge needle into the stationary arm was also necessary. The DoAll Model No. GPM 2CCV machine was used for both tasks. However, the portion of the lid

above the inlet Luer was preventing the drill from accessing the stationary arm. An arc shape was cut out of the lid so that the drill could reach the arm. Figure 29 portrays the arc cutout. The hole for the 18-gauge needle was created by drilling through the bottom of the ¼-28 ANSI Inch hole and out the other side of the stationary arm. To complete the stationary arm, the second 18-gauge needle was lined with superglue and inserted into the .05” hole. The male Luer connector, Part No. PBR-006, was lined with Teflon tape and threaded into the ¼-28 ANSI hole. The complete stationary arm is represented by A of Figure 28.

At this point the final design was fully constructed. However, after testing the device, it became clear that a few modifications needed to be made. The female inlet Luer did not line up with the male Luer connector of the stationary arm. The top of the chamber was sanded down until the two lined up and a connection could readily be made. The two 18-gauge needles were not level with each other. To fix this, the bottom of the movable arm was sanded down until the two were level. Also, the epoxy did not retain its shape when autoclaved. The magnet in the movable arm and the steel piece in the crevice of the lid were removed so that they could be sealed in with another substance. Silastic® Medical Adhesive was chosen to replace the epoxy. After these modifications were made, the manufacturing of the device was complete. A CAD representation of the exploded view of the device in its entirety can be found in APPENDIX B: Final Design CAD Drawings.

6.4 Final Design Testing

In order to determine if the changes we made to our design fixed the previous problems with our prototypes and met the objectives of our project, we conducted a series of tests. The protocols for the testing of the final design can be found in APPENDIX A: Testing Protocols.

6.4.1 Laminar Flow Testing

Laminar flow was tested in three different ways with our final design. All three tests used food coloring as dye. The first laminar flow test involved flowing clear water through 1.47mm inner diameter silicone tubing sutured onto the syringe needles and then introducing colored water. This was performed with the lid upright on the workbench and was recorded with a camcorder for further analysis. The flow loop was primed with clear water, the pump was stopped, and food coloring was injected via pipette into the end of the 1/16” pump tubing. Once the food coloring was in the system, the pump was turned back on and the dye flowed through the sutured tubing.

The next laminar flow test involved injecting food coloring into the 1.47mm inner diameter silicone tubing as the clear water ran through the system. First, blue food coloring was put into a syringe

and a 30-gauge needle was attached. Then, with the lid on the tabletop, the flow loop was primed with clear water. Once the sutured tubing was full of water and free of any bubbles, the needle was used to pierce the tubing and food coloring was injected into the stream of flowing water. This was recorded with a camcorder for later analysis.

The third and final laminar flow test was performed by injecting the food coloring upstream from the bioreactor. The bioreactor, pump, tubing, and needle with food coloring were set up as previously described in laminar flow test 2. The flow loop was primed with water. The 30-gauge needle was used to inject food coloring into 1/16" silicone tubing that connected from the pump outlet to the lid inlet just before the inlet Luer. As with the previous tests, the camcorder was used to record and analyze the data.

6.4.2 Sterility Assessment

Before the bioreactor can house living tissue, we must ensure that it is a sterile environment. We performed three sterility assessments. First we autoclaved the bioreactor and tubing for fifteen minutes. We then proceeded to open the autoclave bags in the sterile hood and set everything up inside the hood. The bottle of media was wiped down with 70% ethanol and placed in the hood. Next we connected the tubing to the inlet and outlet Luer connectors in the chamber and pipetted 26mL of DMEM media into the chamber. Then the lid was carefully placed on the chamber and locked in place. Lastly, we carried the bioreactor to the incubator. The bioreactor was placed in the incubator for 48 hours. The media was poured into a cell culture flask and observed under the microscope for potential contamination. We used Trypan Blue to stain the media to easily identify any microorganisms or particulates.

The second sterility assessment we ran followed the same autoclave procedure, except that we also autoclaved sutures and 1/16" silicone tubing. We opened everything in the sterile hood and wiped the pump, a beaker, a plastic tray, and the bottle of DMEM media with 70% ethanol. This time we placed the chamber into a plastic tray for easier transportation and to collect any potential spills. This setup can be seen in Figure 31. Next we ran the pump with a beaker full of media as a source and the bioreactor chamber as a destination to prime the tubing and fill the chamber. Once the tubing and chamber were filled with media we sutured a 1.47mm inner diameter silicone tube with a length of 1cm onto the syringe tips. The lid was carefully placed on the chamber and locked in place. The water pan in the incubator was filled about halfway with distilled water then the bioreactor and pump were placed in the incubator for 48 hours as seen in Figure 32. We checked to make sure everything was still running at the 24 hour mark. The media was poured into a cell culture flask and observed under the microscope for potential contamination.

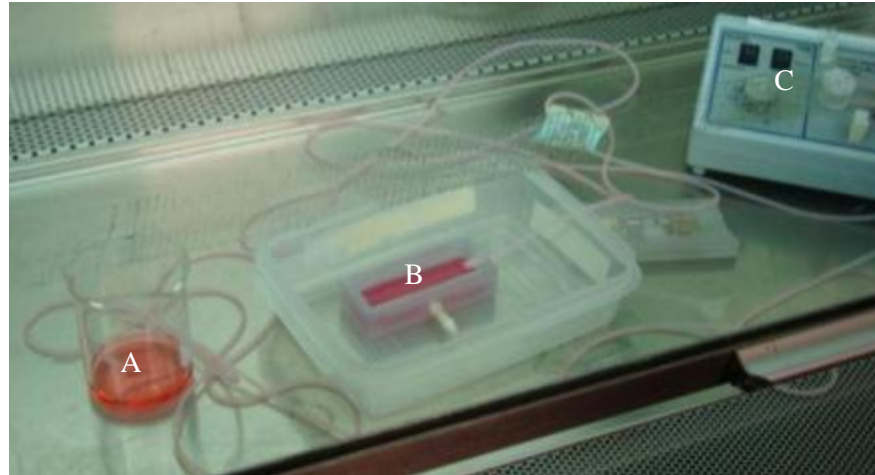

Figure 31: (A) Beaker containing media, (B) bioreactor chamber in plastic tray, and (C) pump being set up under a sterile fume hood.

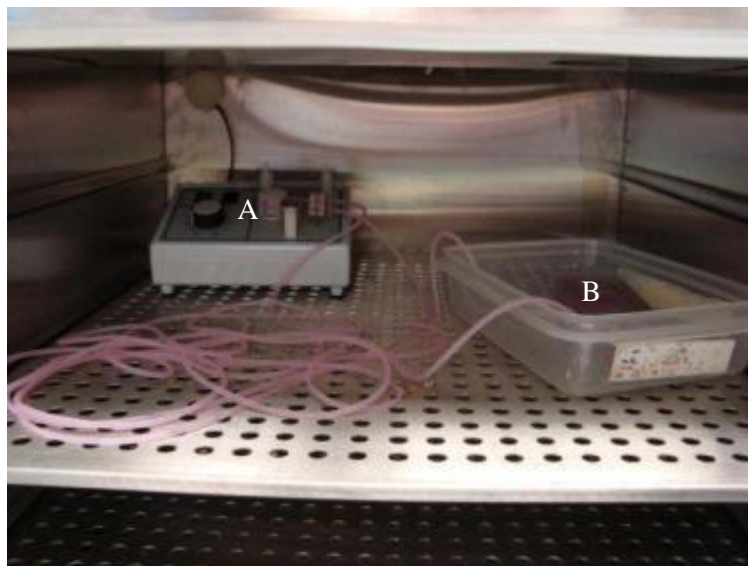

Figure 32:(A) Pump and (B) bioreactor set up in the incubator.

The last sterility assessment we conducted followed the same autoclave procedure as the second test. We opened everything in the sterile hood. This time we added 3mL of fetal bovine serum to the 27mL of media in order to create a 10% FBS media solution. Because our tissue tube samples were not ready we wanted to test a living sample, rather than the silicone tubing. Rat carotid arteries were obtained from the Physiology and Engineering Lab and IACUC-approved procedures were followed when sacrificing the animals. Rat carotid arteries were chosen because they are similar in size and fragility to the tissue tubes. We attempted to mount the rat carotid arteries on the syringe needles but were unable to do so due to the lumens of the arteries being too large to fit snugly on the syringe

needles. We resorted to using the 1cm long piece of 1.47mm inner diameter silicone tube. We wiped the tube and the syringe tips with 70% ethanol before suturing it to the syringe tips. After filling the tubing and chamber with the media solution, the lid and chamber were connected. We placed the pump and the plastic tray with the bioreactor in the incubator for 24 hours. We checked to make sure everything was still running at the 24 hour mark. Then the media was poured into a cell culture flask and observed under the microscope for potential contamination.

6.4.3 Leakage Tests

We performed two leakage tests. The first leakage test was to ensure that there was no leaking around any of the Luer connectors. We filled the chamber with water and observed. The second leakage test we performed was to ensure that there was no leaking at the tissue-syringe interface as seen in Figure 25. This test was conducted without the chamber because the walls of the chamber make it difficult to observe leaking. We attached a female Luer connector to the stationary arm Luer connector. We then connected the pump with the inlet Luer connector using 1/16" tubing. Next we sutured a 1cm piece of 1.47mm inner diameter silicone tube to the syringe tips in order to simulate the tissue tube. This setup can be seen in Figure 33.

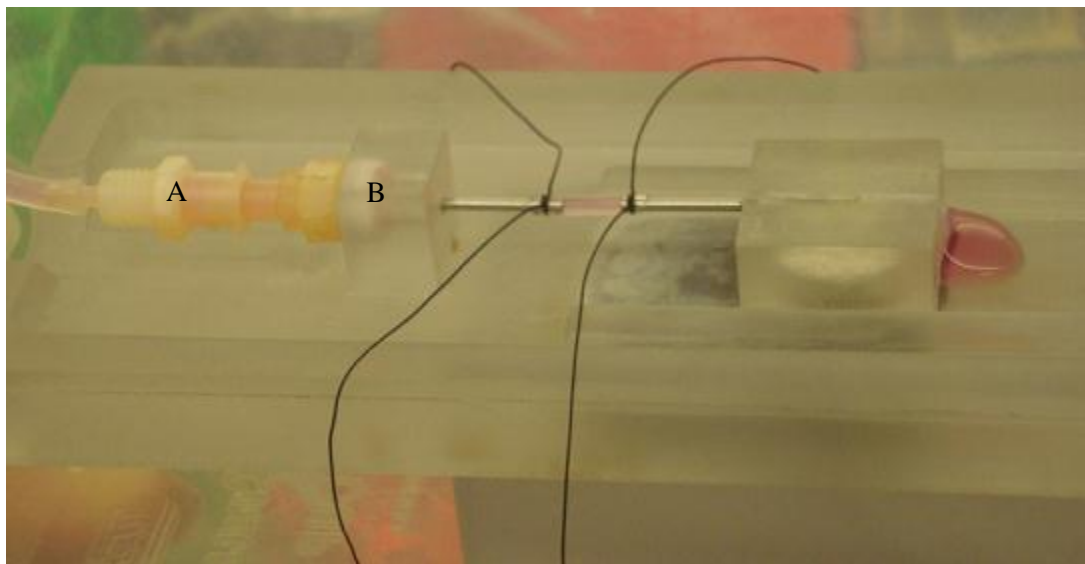

Figure 33: Female Luer connector (A) attached to the stationary arm (B) to complete flow loop when lid is being tested.

6.4.4 Volume Test

In order to measure how much media the bioreactor would hold, we filled the chamber with water. The objective was to hold enough media for three days. We filled the chamber with water so

that it was above the inlet Luer connector but not spilling out the back ridge slots. Then we locked the lid in place and observed if any water spilled out of the slots.

6.4.4 Histological Analysis

Once our bioreactor passed the sterility tests, we were ready to test real tissue tubes in our bioreactor. First, we autoclaved the bioreactor, tubing, and sutures. We opened everything in the sterile hood and wiped the pump, a beaker, a plastic tray, the centrifuge tube of fetal bovine serum, and the bottle of DMEM media down with 70% ethanol. Two batches of cell media were made. Each batch consisted of 10mL fetal bovine serum, 50mL of DMEM, and 500 μ L of Pen-Strep.

The tissue tube samples used had been grown in static culture for 19 days. Along with Zoe Reidinger, we attempted to mount multiple tubes to the bioreactor but they either ripped or had deformities. Our third attempt of mounting a tissue tube onto the syringe needles was successful, however. To attach the tissue to the bioreactor, the tissue was slid off of the silicone mandrel onto the syringe needle of the movable arm. Then, the needles of the movable arm and stationary arm were aligned and the tissue tube was partially slid onto the stationary arm needle. The movable arm was adjusted so that the tissue tube was suspended between both syringe needles. Once the tissue is in place, it is sutured onto the syringe needles. Finally, the chamber is filled and the tubing is primed with media by running the pump. This procedure is depicted in Figure 34, below.

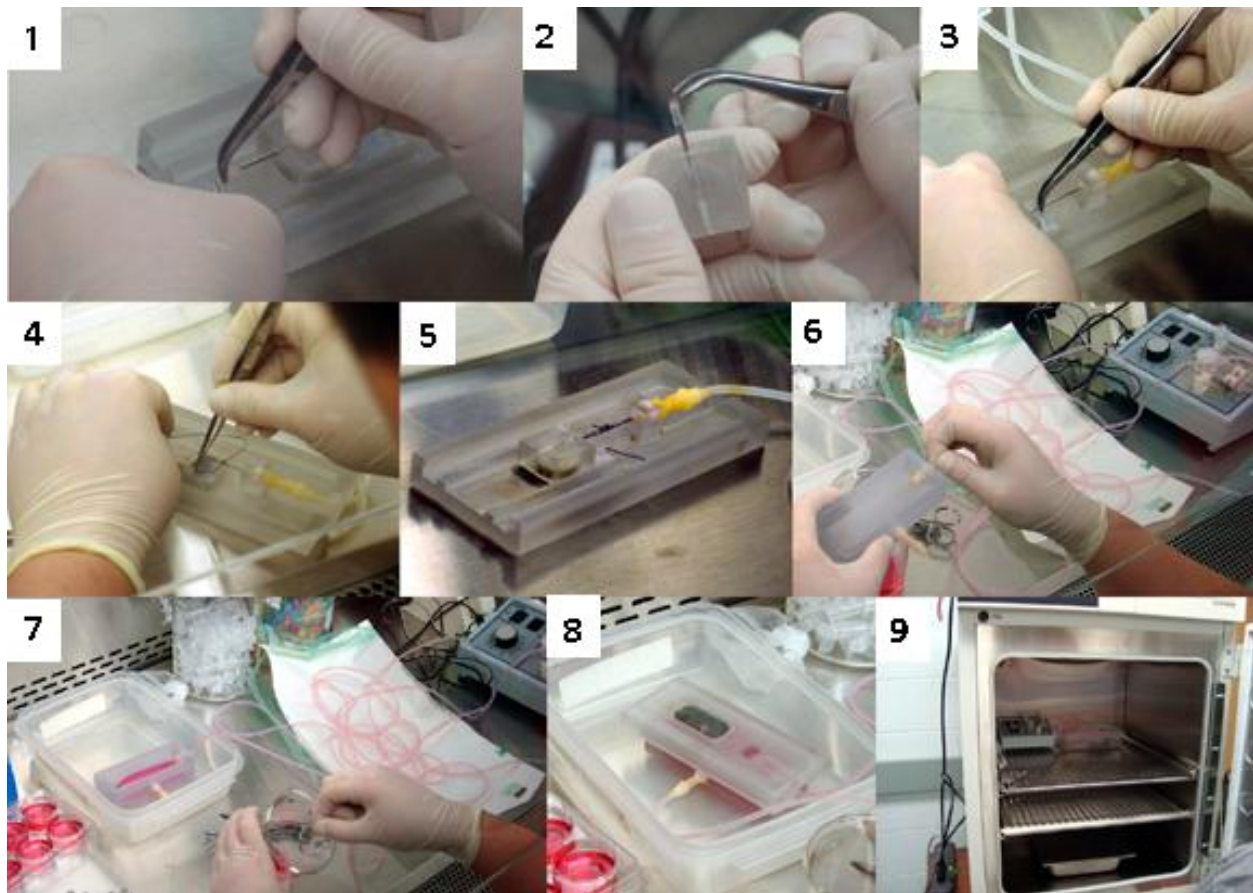

Figure 34: 1&2) Tissue tube is slid off of the silicone mandrel and onto the syringe needle of the movable arm. 3) Syringe needles of both arms are aligned and the tissue tube is moved between both. 4&5) Movable arm is moved back so that the tissue is suspended between both arms and the ends are sutured onto the syringe needles. 6) The pump outlet is connected to the chamber inlet. 7) The chamber is filled with media by running the pump to move media from beaker. 8) Inlet of pump is attached to the outlet of the chamber and the lid is connected. 9) Pump and bioreactor are placed in the incubator for 3 days. All of these steps were performed with the help of Zoe Reidinger.

In order to assure that no leaking was present at the tissue-syringe interface and the Luer-tubing interface, we connected barbed female Luer to the male Luer in the stationary arm and flowed media through to check for leaks as seen in Figure 35. Then we locked the lid onto the chamber. We added distilled water into the tray in the incubator before placing the pump and bioreactor in the incubator. We ran the system for three days checking once every twenty-four hours. Then we removed the bioreactor and the pump at the three-day mark.

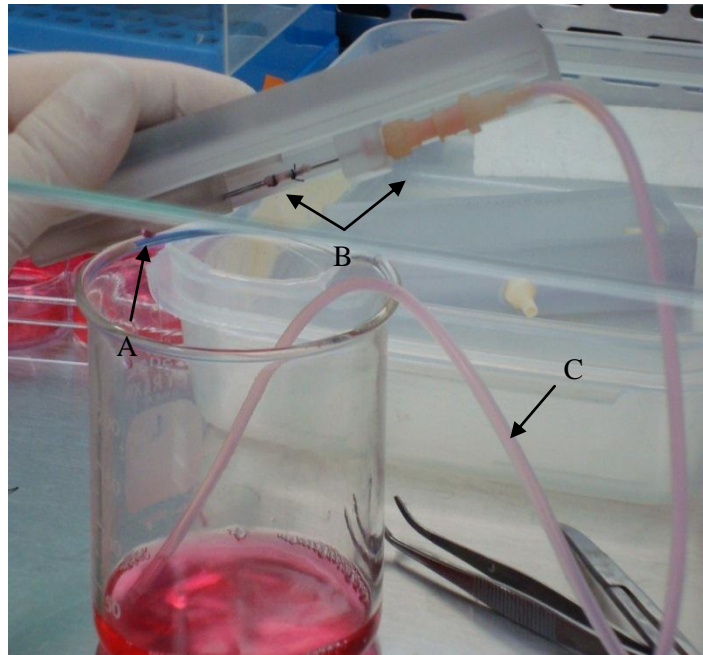

Figure 35: Media flows all the way through the tissue tube and comes out the end of the movable arm (A). No leaking is observed at the tissue-syringe interface or the Luer-tubing interface (B). Media flows from a beaker through the tubing and into the arms of the lid, priming the tubes in the process (C).

We preserved one 19-day-old tissue tube by treating it with 10% neutral-buffered formalin (NBF) for 45 minutes. This sample was stored using 70% ethanol. This tissue tube served as the starting point for the tubes grown in the bioreactor and static culture. We cultured three tissue tubes statically (on the silicone mandrels) for the same amount of time as the dynamic bioreactor culturing. At the 24 and 48 hour marks, the tissue tubes in static culture were fed with 6mL of the media described earlier and after 72 hours, the tissues were harvested along with the bioreactor tissue tube. Histological analysis was performed by Zoe Reidinger, which included preserving the tissues in the same manner as the 19-day tissue tube, then embedding the samples in paraffin, slicing the samples, mounting them onto microscope slides, and staining with H&E, Hoechst stain, and smooth muscle alpha actin stain.

All samples were preserved with 10% neutral-buffered formalin and stored in 70% ethanol, just like the nineteen-day old tissue tube. Samples were removed from the ethanol and run through a series of chemicals which replaced the water in the samples with wax. The preserved tissue tubes were embedded in paraffin and cut transversely into 5 μm sections and mounted on microscope slides. Some of the slices from each sample were stained with H&E so that the cell morphology and nuclei could be viewed under a microscope.

The preserved samples were viewed under a Leica microscope. Three tissue tube samples were viewed: the tissue tube incubated in the bioreactor, one of the 22-day statically grown tissue tubes, and the 19-day statically grown tissue tube. Using a built-in camera and the Leica image acquisition software

to control image parameters such as exposure, pictures were taken of each sample at 4X, 10X, and 20X magnification. H&E stained slides were viewed under bright field microscopy while the smooth muscle alpha actin and Hoechst stains were viewed under fluorescent microscopy. The Hoechst and smooth muscle alpha actin stained samples were merged using ImageJ software.

6.5 Final Design Testing Results

6.5.1 Laminar Flow Test Results

When the colored water was introduced into the tubing during the first laminar flow test, layers of the food coloring and clear water could be seen, as shown in Figure 36. These layers of color continued to be visible until the food coloring ran out.

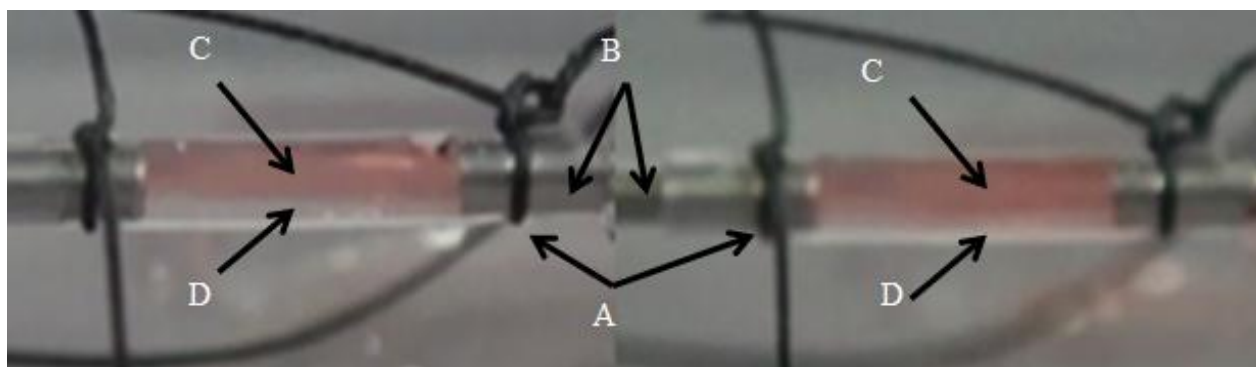

Figure 36: The silicone tubing is sutured (A) to the syringe needles (B). The red food coloring makes a visible, distinct layer (C) above the clear water (D).

The second laminar flow test attempted to show flow patterns by injecting dye into a flowing stream of water. This test provided a variety of results. Some flow patterns appeared to be more laminar, as seen in Figure 37A, while others appeared to be more turbulent, as seen in Figure 37B. The images in Figure 37A demonstrate straight paths of dye and little mixing. Figure 37B shows mixing and swirling of the dye. The dye is also seen flowing backward. While this test showed the possibility of both laminar and turbulent flow, there were several variables which may have affected the flow and will be presented in the discussion chapter.

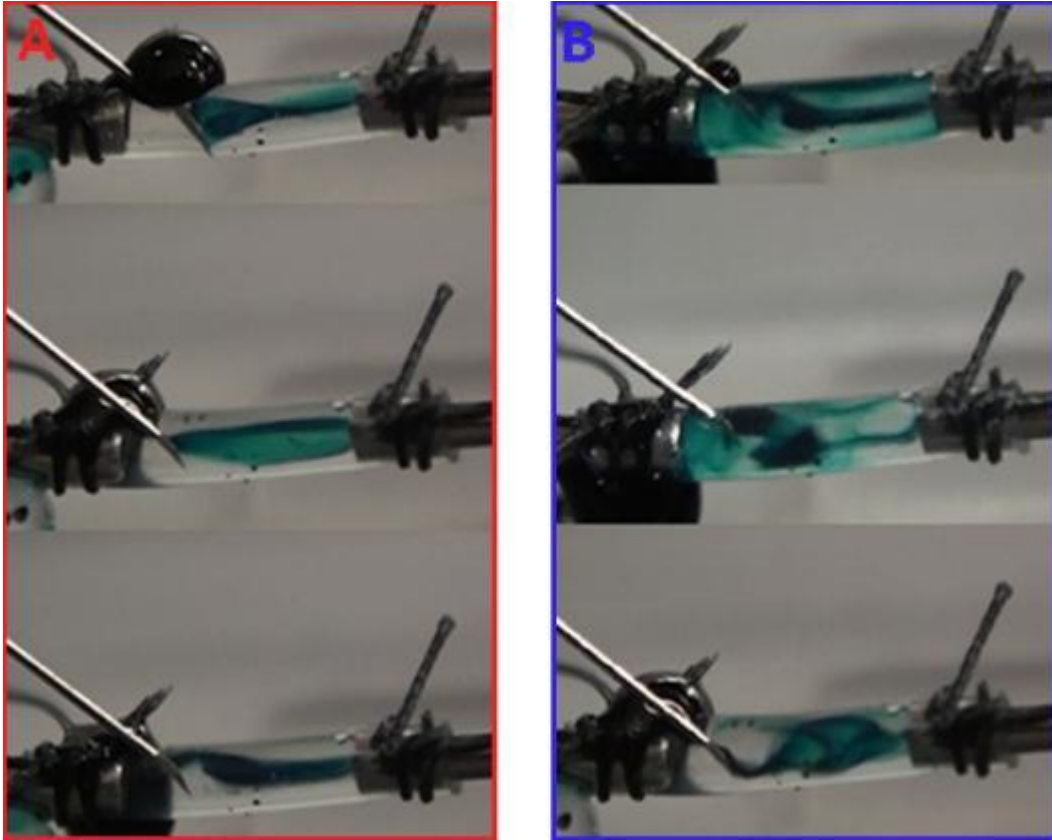

Figure 37: Flow patterns that resembled laminar flow (A) and turbulent flow (B).

A third laminar flow test was performed in order to eliminate the effect of the needle's presence on the flow of the water. Dye was injected upstream of the Luer connectors. No turbulent flow was observed. Figure 38 shows flow profiles for the laminar flow testing.

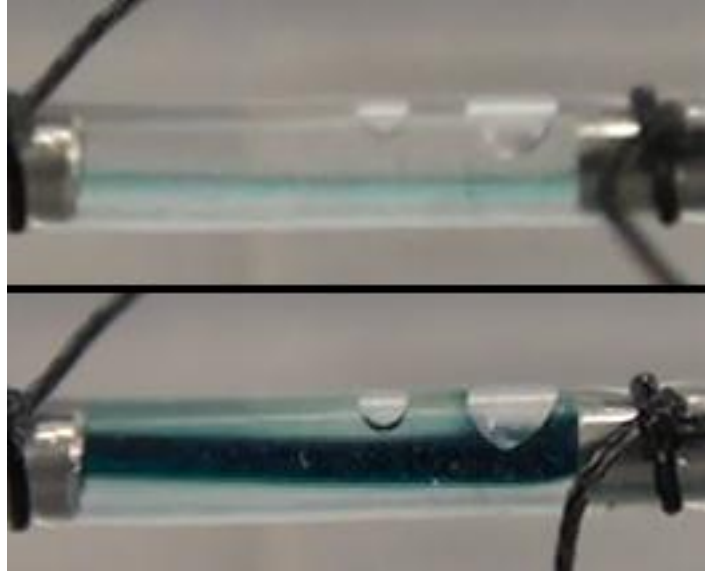

Figure 38: Laminar flow shown by upstream injection of food coloring. This image shows a thin stream (A) as well as a thick stream (B) showing no signs of turbulent flow.

6.5.2 Sterility assessment Results

Sterility assessments were performed in order to determine if our device could run in an incubator for a certain period of time and remain sterile. Evaporation was observed after the first sterility assessment as seen in Figure 39. The cell media evaporated leaving the inlet Luer exposed to air. The outlet Luer was also not fully submerged. The evaporation was most likely caused by a lack of water in the incubator which may have affected the humidity. A second test needed to be run with the proper humidity in the incubator.

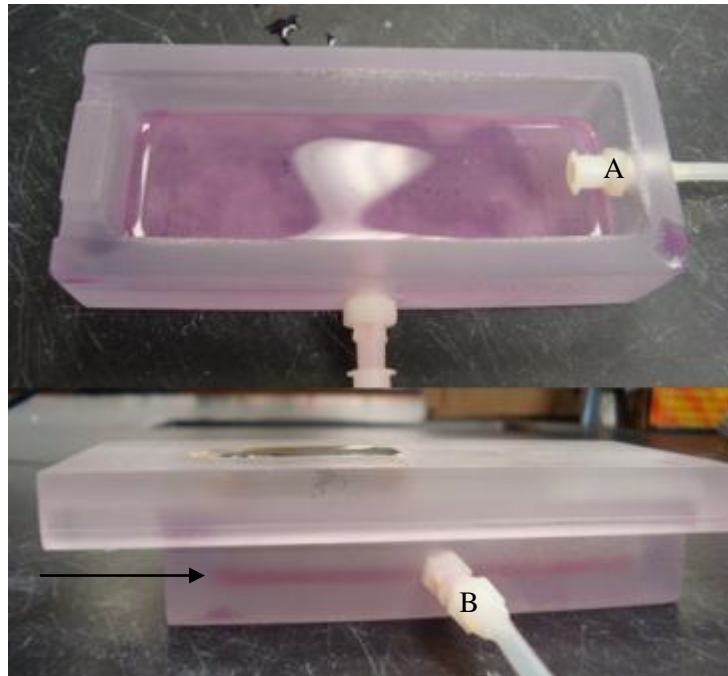

Figure 39: The cell media evaporated which did not allow the cell media to contact the inlet Luer (A). The cell media just barely reached the outlet Luer (B). The level of media is indicated by an arrow in the side-view.

No turbidity was seen in the media after the first sterility assessment. However, some small particles were observed. The contents of the bioreactor were emptied into a tissue culture flask and examined under a microscope with Trypan Blue stain. Everything in the flask stained blue, which indicated that no living organisms were in the media. It was concluded that the particles may have been plastic shavings from when the chamber was being sanded.

A second sterility assessment was performed after distilled water was poured into the water pan of the incubator. After the first day, there was a small amount of leakage in the tray around the bioreactor, seen in Figure 40. When this was observed, it was discovered that somehow the pump had been activated incorrectly and was running in reverse. No media was replaced or added to the bioreactor chamber. The leak was cleaned up and the pump was set to run forward for another day.

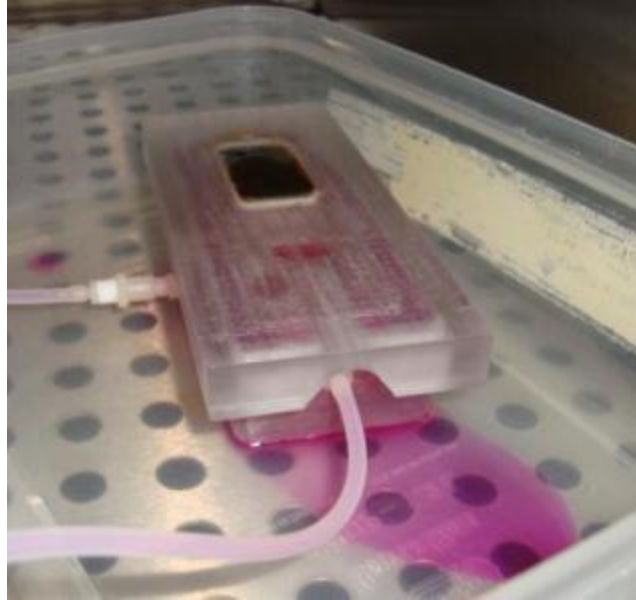

Figure 40: The leakage observed in the tray occurred after 1 day in the incubator.

When the bioreactor was removed on the second day, minor leakage was observed but could have been residue underneath the chamber from the previous day's leakage. Figure 41 shows the level of media present in the chamber after two days and after the leakage on day one. The media level was at the center of the inlet Luer. There may have been a small amount of evaporation, but the loss of media is mainly due to the leakage on day one. It was also observed that the media remained the same in color, indicating there was no major contamination present.



Figure 41: After two days in the incubator and a minor leak, the remaining media in the bioreactor filled the chamber to about the middle of the inlet Luer (A).

Finally, after two days in the incubator, the media was removed from the bioreactor and put into a tissue culture flask for further examination. No turbidity was observed in the media, indicating a lack of contaminants as seen in Figure 42. The contents of the flask were viewed under a microscope and a few particles were seen. None of the particles were moving or appeared to be bacteria. It was concluded that no contaminants were found.



Figure 42: The cell media after two days in the incubator is shown. No turbidity was observed and the color remained unchanged.

A third sterility assessment was performed with fetal bovine serum in our media. The rat carotid arteries were unable to be mounted on the syringe tips. We then had to resort to suturing the 1cm piece of 1.47 mm inner diameter silicone tubing onto the syringe tips. At the 24hour mark the media had changed to an orange color and turbidity was observed, as seen in Figure 43. This was indicative of contamination and we confirmed this by observing the media under a microscope, as seen in Figure 44.



Figure 43: After 24 hours, the cell media had turned orange and was turbid.



Figure 44: Media sample of Sterility assessment 3 as seen under microscope. The media appeared to contain bacteria.

6.5.3 Leakage Test Results

During the first leakage test, we noticed leaking between the inlet Luer connector and the stationary arm Luer connector. The second leakage test we performed focused on leaking that would occur between the tissue tube and the blunt-end needles. To do this, we sutured a 1.47mm inner diameter silicone tube onto the needles and ran water through the flow loop. Either due to our relative inexperience with suturing or because of the tube's resilience and thickness, there was almost always leaking from this area occurring when we had the pump turned on. We resolved the leaking problems, as discussed later in the discussion section.

6.5.4 Volume Test Results

The amount of water that the chamber could contain without spilling out the back ridge slots when the lid was locked in place was found to be 26mL.

6.5.5 Histological Analysis Results

At the 24 and 48 hour marks, we checked on the bioreactor and the fixed tissue tube. The media in the wells of the static cultures had turned slightly orange but was not turbid or cloudy. The media in the bioreactor was pink and flowing through the system correctly. Each day more distilled water was added to the incubator to maintain humidity. Unfortunately, at the 72 hour mark we noticed that there was very little media in the tubing and the bioreactor while the pump was still running.

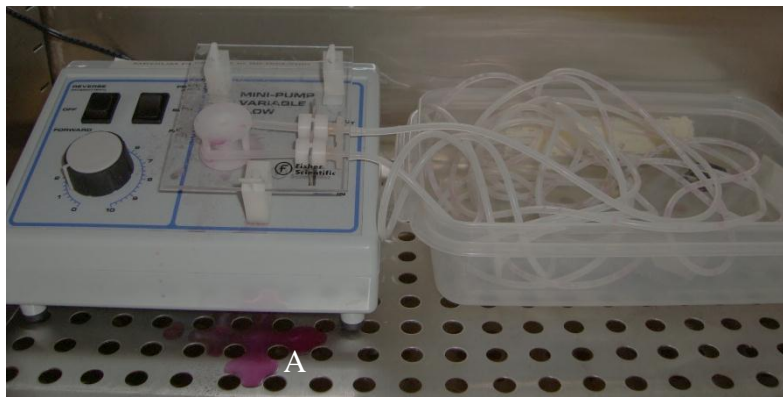

Figure 45: At 72 hours, no media was flowing through the system and a puddle of media was found (A).

When the bioreactor sample was taken out of the incubator, the tissue appeared more opaque and thicker than when it was first mounted to the bioreactor. The physical difference after 3 days in dynamic culture can be seen in Figure 46.

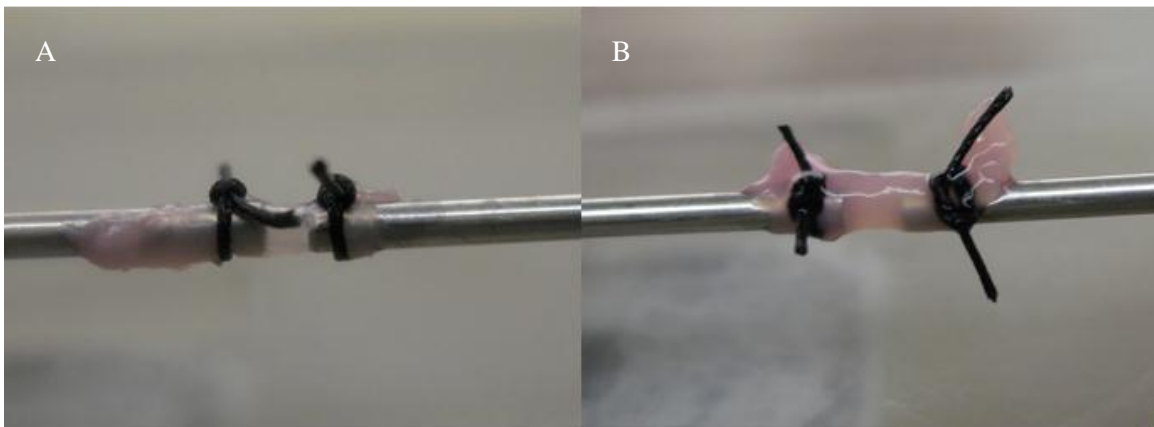

Figure 46: The tissue tube mounted at day 19 (A) and the tissue tube after 3 days of dynamic culture (B).

H&E staining enabled us to compare the 19-day old statically cultured tissue tube (Figure 47) the 22-day statically cultured tissue tube (Figure 48) to the 22-day bioreactor cultured tissue tube (Figure 49).

This stain showed a significant increase in wall thickness of both 22-day tissue tubes. Formation of two layers can clearly be seen in both 22-day samples, whereas the cellular structure appears more uniform in the 19-day tissue tube.

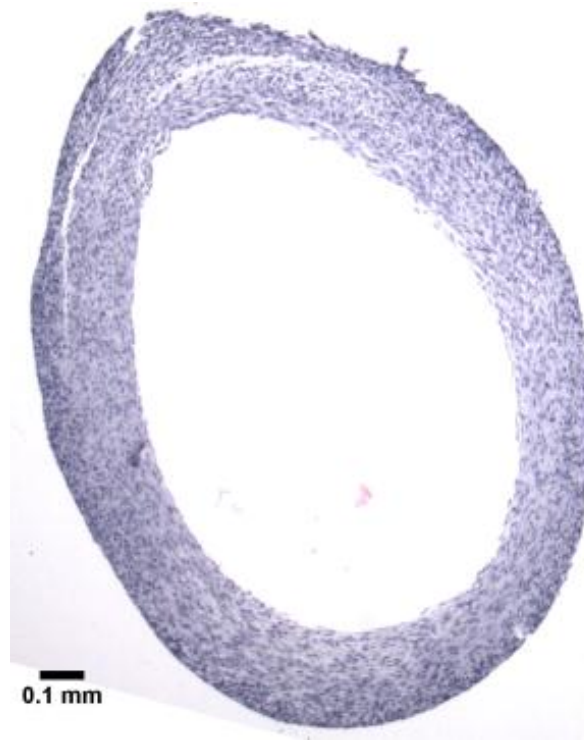

Figure 47: Cross section of 19-day tissue (H&E staining at 4x magnification).

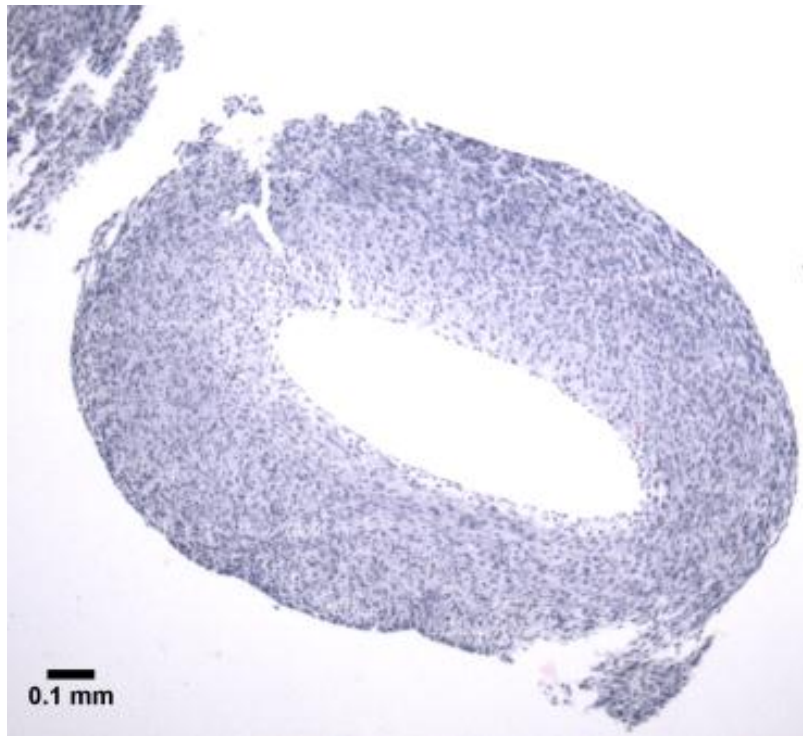

Figure 48: Cross section of 22-day statically grown tube (H&E staining at 4x magnification)

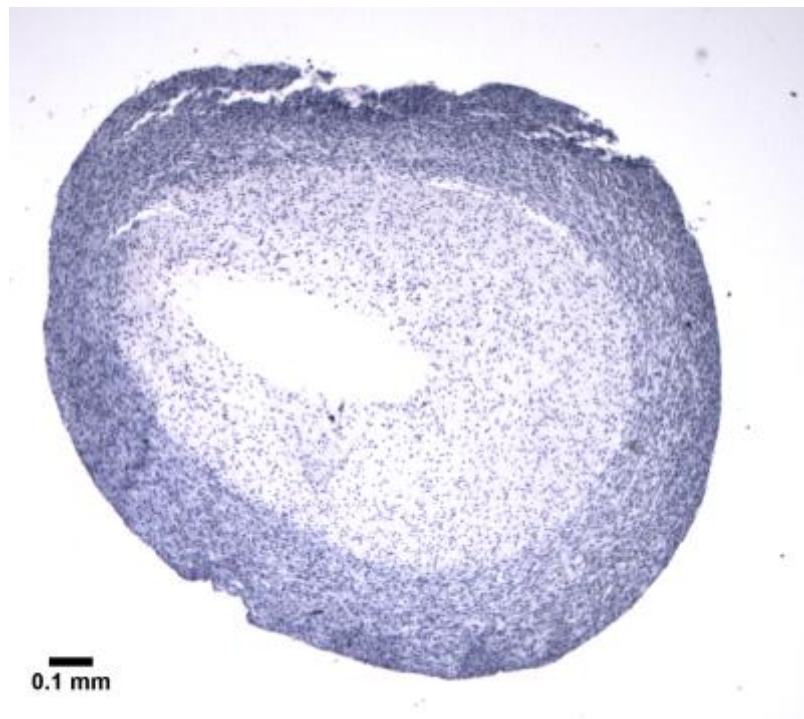

Figure 49: Cross section of the 22-day bioreactor tissue (H&E staining at 4x magnification). Distinct inner and outer layers can be seen.

Significant amounts of fragmented nuclei were visible in the 22-day statically grown sample (Figure 52). No fragmented nuclei were visible in either the 19-day tissue tube (Figure 50) or the 22-day bioreactor tissue tube (Figure 51). Both 22-day tissue tubes exhibited different cell densities. However, the 22-day bioreactor tissue tube has a much more noticeable contrast in cell density than the statically cultured tissue tube. The darker regions of the images represent a higher cell density.

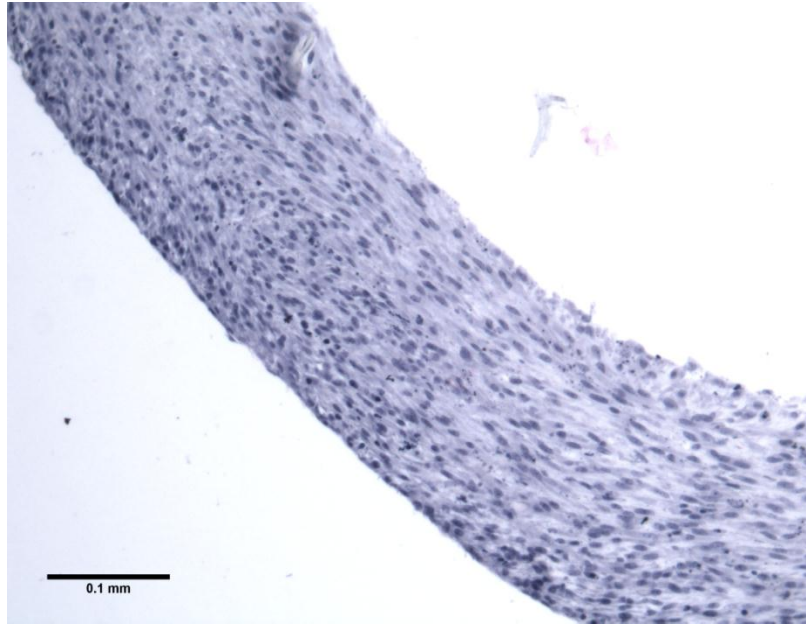

Figure 50: Close-up of 19-day statically grown tissue wall (20x magnification).

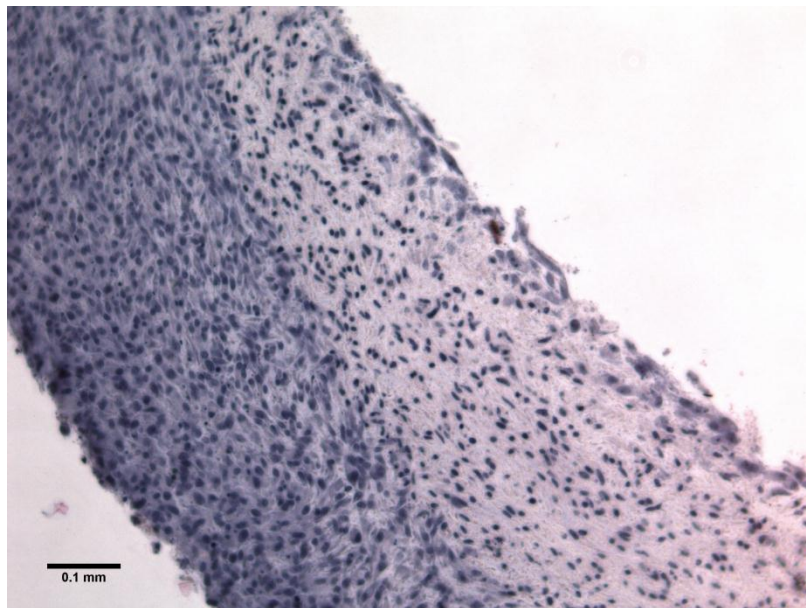

Figure 51: Close-up of 22-day bioreactor tissue tube wall (20x magnification). Details of the two layers can be seen. No fragmented nuclei are present.

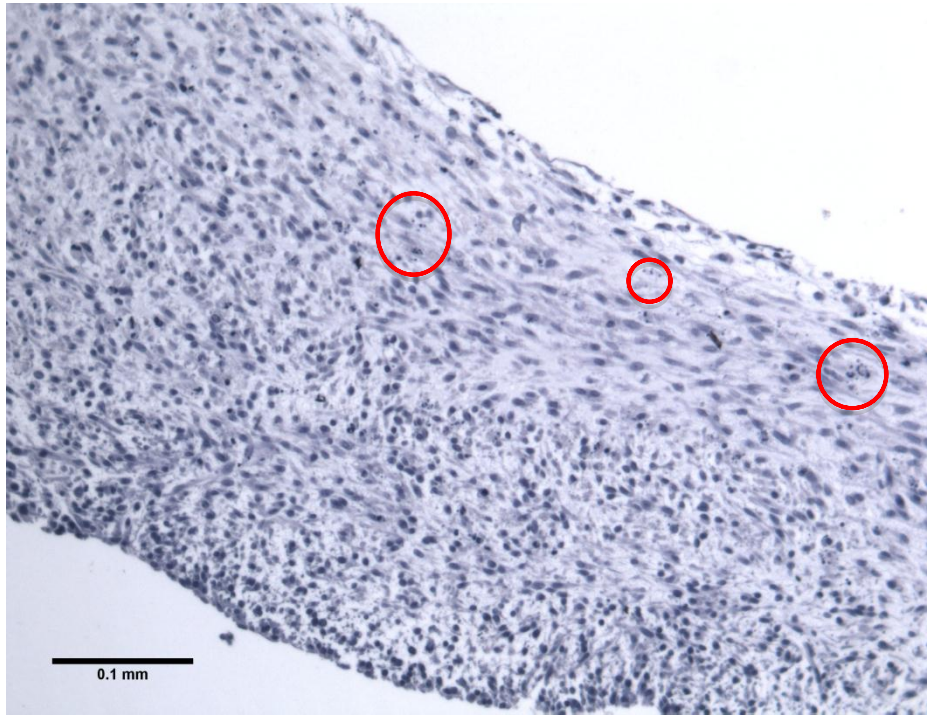

Figure 52: Close up of 22-day statically grown tissue tube wall (20x magnification). Distinct layers can be noted by change in cellular density. Fragmented nuclei can also be observed. Examples of fragmented nuclei are circled.

The Hoechst and smooth muscle alpha actin stains show the nuclei in blue and the actin in green. A high presence of alpha actin suggests that a sample has a contractile phenotype, while a sample with low actin shows a synthetic phenotype. In order to visualize a known contractile phenotype, a rat aorta was stained as the control (Figure 53). Negative controls of each sample were also taken to take factors such as auto-fluorescence into consideration (Figure 54).

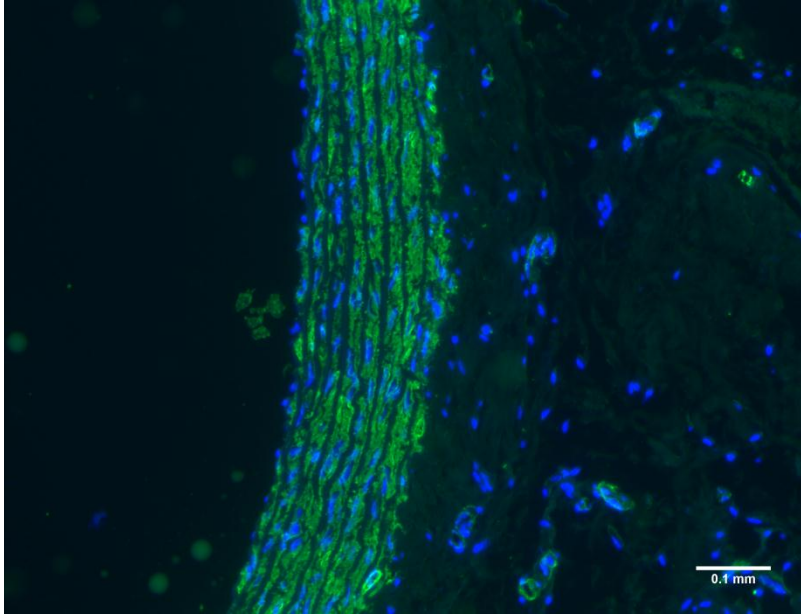

Figure 53: The rat artery acted as the control to show high levels of actin (green). Nuclei are also seen (blue) at 20x magnification.

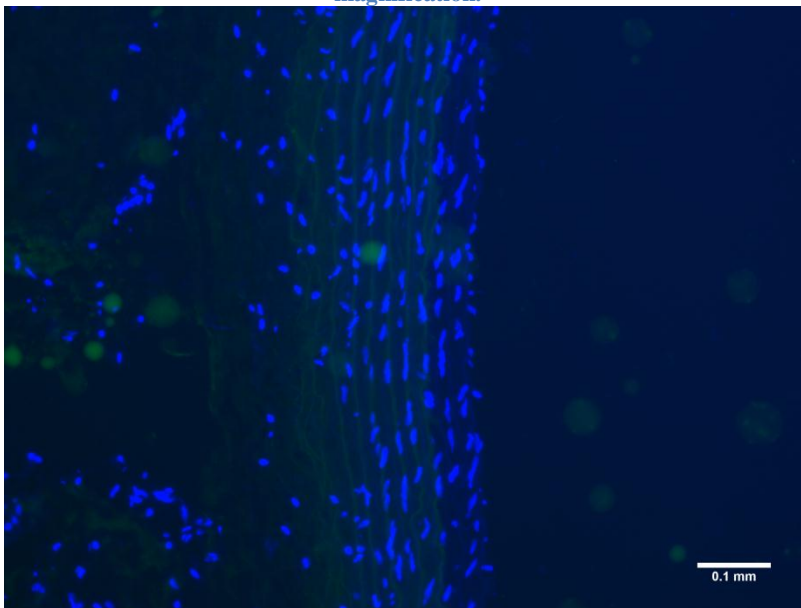

Figure 54: An example of a negative control. The signals are not as strong in the negative control of the rat artery.

The Hoechst stain, like the H&E stain, revealed that the 22-day statically cultured sample was the only sample to exhibit a significant amount of fragmented nuclei, as seen in Figure 57. Both the 19-day sample and the 22-day bioreactor sample lacked fragmented nuclei, as seen in Figure 55 and Figure 56, respectively. The smooth muscle alpha actin stain revealed that very low levels of actin were present in all three samples. The bioreactor sample showed the least actin, as seen in Figure 56. Both static cultures (day 19 and 22) exhibited similar levels of actin.

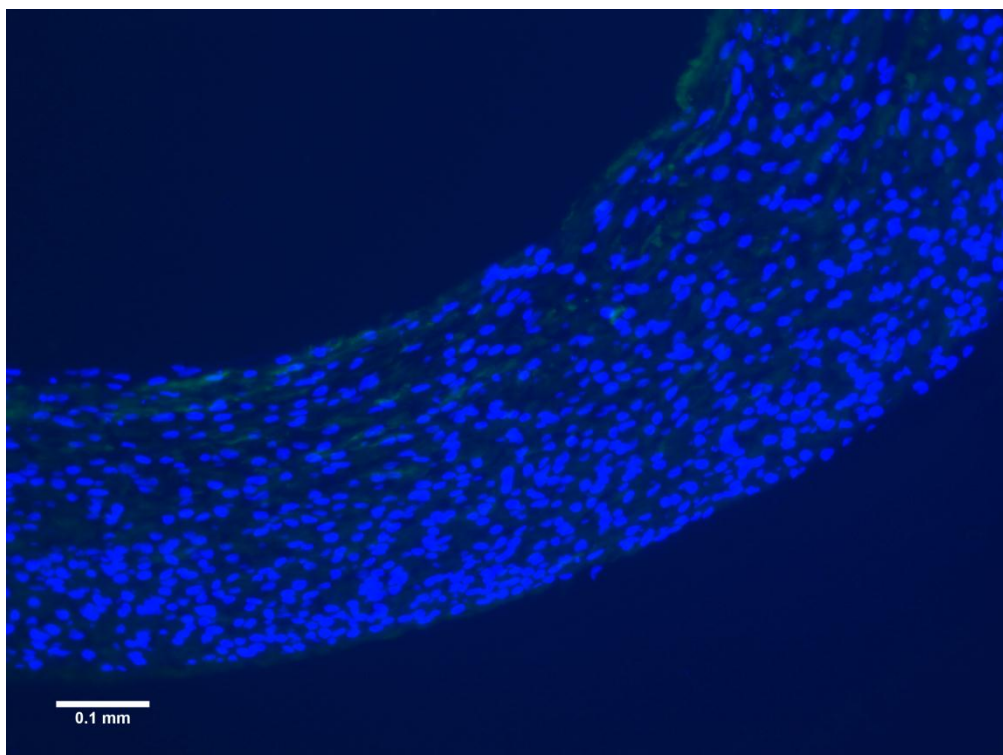

Figure 55: Hoechst and smooth muscle alpha actin stained 19-day sample. Little actin is present (green). No fragmented nuclei observed.

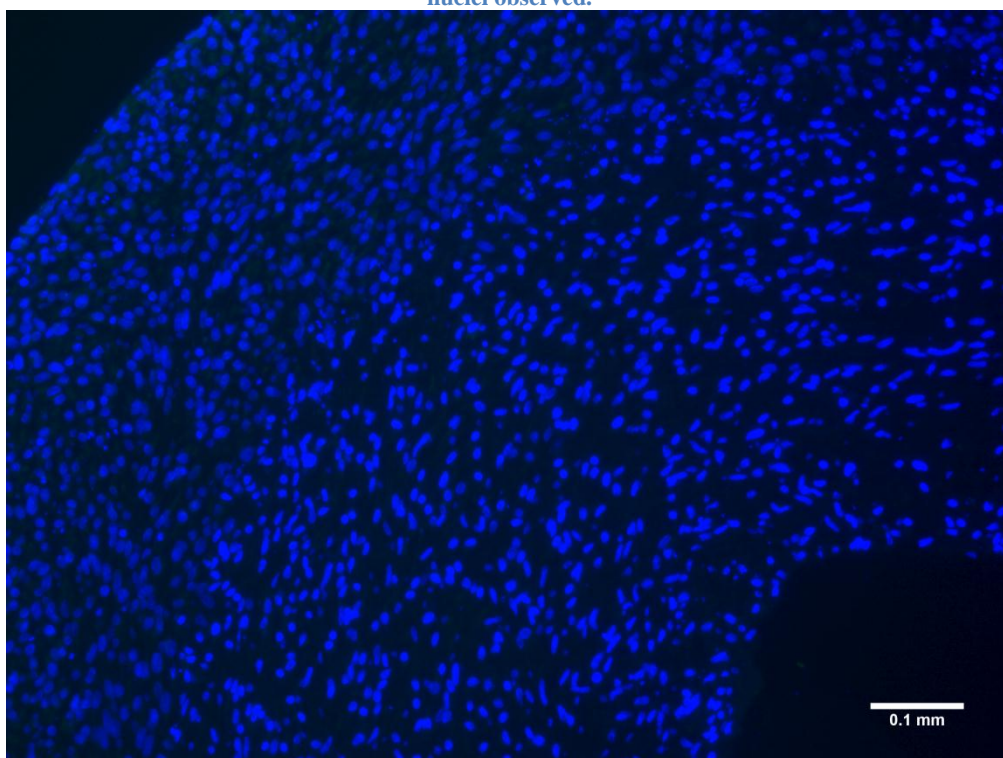

Figure 56: Hoechst and smooth muscle alpha actin stained 22-day dynamic (bioreactor) sample. Little to no actin is present. No fragmented nuclei were observed.

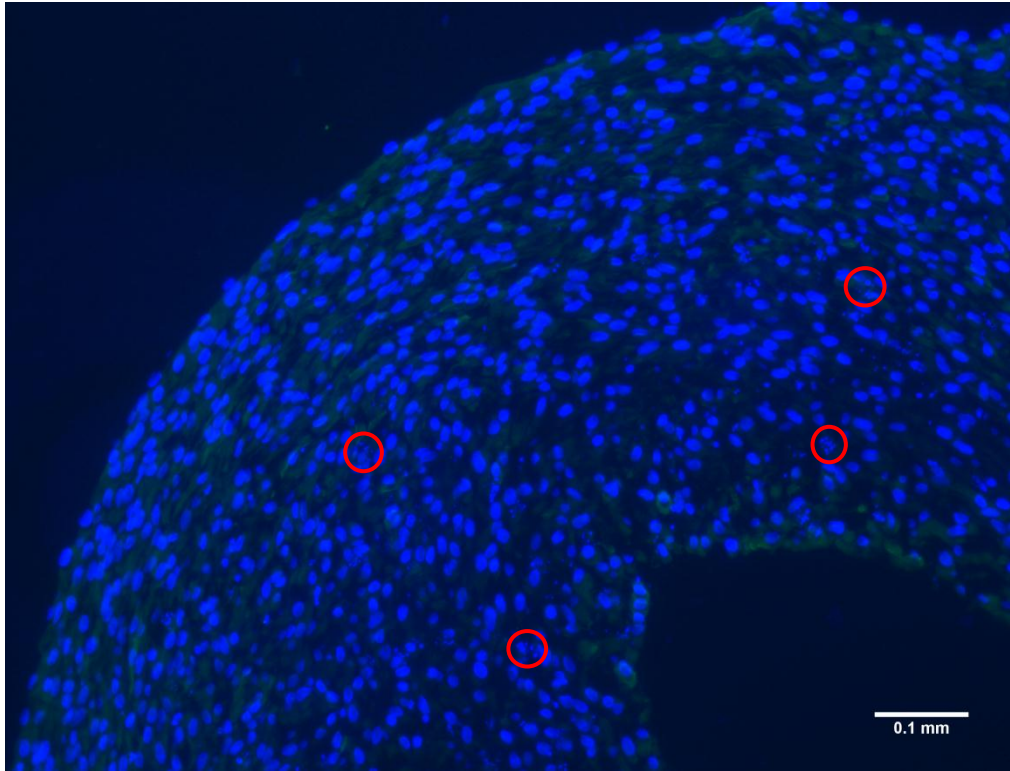

Figure 57: Hoechst and smooth muscle alpha actin stained 22-day static sample. Little actin is present. A few examples of fragmented nuclei are outlined in red.

6.6 Discussion

6.6.1 Laminar Flow Testing

At first glance, the first laminar flow test was believed to show that laminar flow was present, based on the distinct layers of fluid observed. However, the dye may be floating on top of the water due to the difference in density. We also hypothesized that the layers may have formed because the lower portion of fluid in the tube is not moving. If the lower region is not moving, then the clear water would be stagnant and the food coloring would flow on top of it. Thus, the next laminar flow test was required.

The second laminar flow test was performed due to discrepancies in the previous test. The idea behind this test was to see if a stream of dye was disrupted when introduced into the flow of the bioreactor. The test showed turbulent flow but there were some factors that could have contributed to these results. The injection of the dye was done by hand, and therefore it was difficult to keep the needle steady and at a constant height as well as keep constant flow of the dye by pushing down the plunger of the syringe. Additionally, the peristaltic pump creates a pulsatile flow, which may contribute to the dye swirling backwards. The flow may have also been affected by the presence of the needle in the stream of water. It is likely that the needle caused turbulence by blocking and redirecting water flow. In conclusion,

while turbulent flow was observed, this test is inconclusive due to factors that could not be controlled. However, our calculations show that the flow in our device should be laminar because the Reynolds Number is well below 2100, as seen in Table 2.

A third laminar flow test was performed to address the limitations of the second test, namely the disruption of fluid flow by the needle. Although the food coloring was injected from a distance away from the sutured tubing where it was being observed, the fluid layers were not disturbed and mixing did not occur. The stream of food coloring remains independent of the clear water, which indicates laminar flow.

6.6.2 Sterility Assessing

In the first sterility assessment we observed several particles. By using the Trypan Blue stain, we were able to conclude that the particles were not alive and were probably just dust and polycarbonate shavings from the sanding process. When we removed the bioreactor from the incubator, nearly all the media had disappeared as seen in Figure 39. We hypothesized two possible reasons why so much media was lost. Either the incubator was poorly saturated with water vapor and evaporation occurred, or there was leakage at some area of the chamber. After emptying all the media out into a cell culture flask we filled the chamber with water, ran the pump, and noticed leaking from the outlet Luer connector. During the leakage tests previously conducted we did not notice any leaking at the outlet Luer. This is probably because prior to this test we had unscrewed the outlet Luer connector several times, weakening the Teflon tape. We added a new piece of Teflon tape to the outlet Luer connector and made sure it would not leak for the next tests. This test was not a good representation of the real incubation setup because the pump was not used during the incubation.

The second sterility assessment was performed to address the problems discovered in the first test. This time the pump was included and a silicone tube was used to simulate the tissue tube. This test ran smoothly and no contamination was observed. After 24 hours, we checked on the bioreactor and realized we had accidentally set the pump to run in reverse. The pump direction should not have had any effect on the sterility of the bioreactor. We also noticed a small puddle of media under the bioreactor. Because we made sure the water pan was filled and that the chamber did not leak, we concluded that the media spill was from condensation which may have dripped down the side of the chamber.

After the second sterility assessment we realized two problems that had occurred due to the autoclave process. The first problem we noticed was that the magnet was rusting. Also, the steel piece embedded in the lid protruding out of the lid. The magnet used in our bioreactor was nickel plated. Nickel plating is supposed to prevent the magnet from rusting, but it appeared the plating had begun to

chip away, resulting in rust as seen in Figure 58. An orange ring-shaped stain had developed on the magnetic track where the magnetic arm usually rested. This stain was likely due to the rust of the magnet or from melting epoxy. With regards to the steel, the epoxy used to keep it in place, which was the same used on the magnet, had melted and re-solidified, allowing the steel to move slightly each time it was autoclaved. We reattached the original steel and a new magnet in their respective spots with medical silicone glue. We decided to use silicone glue because it can withstand the high temperatures of the autoclave.



Figure 58: Magnet after it was removed from the movable arm. The nickel appears to be chipped causing it to rust.

Unfortunately, the bioreactor did not pass the third sterility assessment. It was the first time we had used fetal bovine serum that provides a nutrient rich environment that promotes proliferation of cells and microorganisms. In the previous two sterility assessments we used only DMEM, which decreases the risk of contamination because there are far less nutrients for bacteria to consume. Upon observing the bioreactor at the 24hour mark, we noticed the media had changed to a turbid orange color as seen in Figure 43. This was indicative of contamination. We observed the media under the microscope to confirm that it was contaminated as seen in Figure 44.

There are several factors that were out of our control and we believe these caused the contamination. The rat arteries were most likely not extracted within a sterile hood and could have been contaminated. Additionally, when we received the rat arteries they had not been washed with antibiotics. Even though we did not successfully mount the rat arteries in the bioreactor, the arteries came in contact with the components of the bioreactor during set up. We do not think our bioreactor is unsafe for living tissue but believe the rat arteries were not sterile and were responsible for the contamination.

6.6.3 Leakage Testing

To eliminate leaking around the Luer connectors, we wrapped Teflon tape around the screw threads of the Luers. After screwing them in, we filled the chamber back up to make sure the Teflon tape sealed the threading. No leaking was observed. If for some reason we have to remove or adjust the Luer connectors, there is a potential they may leak again if Teflon tape is not reapplied.

After a few attempts, we were able to successfully suture 1.47mm inner diameter silicone tubing onto the syringe tips and run the pump without any leaking at the tube-syringe interface.

6.6.4 Volume Testing

The bioreactor chamber has been redesigned to use the least amount of media required to keep a tube healthy for a three day period. The chamber is just big enough to accommodate the locking lid mechanism without requiring too much media. The chamber can hold 26mL, which is a sufficient amount of media for three days considering a tissue tube typically uses 6mL per day.

6.6.5 Histological Analysis

While feeding the static culture tissue tubes, the media was slightly orange, but was neither cloudy nor turbid. This was due to the cells using up the nutrients and was a sign for us to replenish the media. After 72 hours, we removed the bioreactor and pump and observed that the majority of the media was gone from the system. There was a pink stain on the pump as well as on the shelf in the incubator, as seen in Figure 45. This led us to believe that the tubing around the rotating portion of the pump had split. We removed the tubing and noticed it was really thin and flat. Upon cleaning the tubing with water and bleach, we realized that our assumption was correct and that there was a hole in that portion of the tubing. Because we checked the bioreactor at the forty-eight hour mark we can safely say that the system was running correctly for at least forty-eight hours.

Histological results revealed a lack of fragmented nuclei in our 22-day bioreactor tissue tube, which indicates that our bioreactor was successful in preventing cell death in the inner layers of the tissue tube. Fragmented nuclei were only observed in the 22-day statically cultured tissue tube due to the lack of nutrients diffusing into the inner layers of the tissue. A lack of fragmented nuclei in the 19-day tissue tube indicates that the thickness at 19 days is sufficient for nutrient diffusion into the inner layers, while the thickness at day 22 is not.

The histology also showed unexpected cell growth patterns. As seen in Figure 51, there are two regions of different contrast levels in the 22-day bioreactor sample, signifying two distinct layers. The difference in contrast level and the number of visible nuclei between the two layers signify that the outer

layer has greater cell density. The inner layer of lower cell density was unexpected ingrowth. A possibility is that the ingrowth was caused by the lack of perfusion after the tubing broke. The tubing broke sometime between 48 and 72 hours, but it is unclear how long the tissue tube went without perfusion. Another possibility is that the wall shear stress caused by the perfusion of the media was too low, so cells started growing on the lumen.

Finally, actin levels showed that all samples were in the synthetic, not contractile, phenotype. The rat aorta control (Figure 53) demonstrates the high level of actin (high contrast, bright green) found in contractile smooth muscle cells. Both of the static samples contain very low levels of actin and our bioreactor sample seemed to contain no actin at all. The cells in all the samples were also very proliferative, which is another trait of synthetic smooth muscle cells. The presence of serum and other nutrients in the cell media may have contributed to the synthetic phenotype.

Chapter 7: Potential Influences and Concerns of the Final Design

7.1 Economical Influence

During our experimentation significant cell growth was noted after three days. Therefore, our bioreactor offers a fast and efficient way to nourish and grow tissue tubes. Due to the lack of contamination and necrosis observed in the tissue tubes, tissue samples are not wasted and therefore money is saved. The bioreactor also does not require a great deal of power to run and it does not waste cell media. The use of our bioreactor can benefit researchers that are currently growing tissue tubes. Based on the material cost spent making our final design was low, and we stayed well below our budget limit. Use of our device could facilitate growth and usage of tissue in experiments, saving researchers time. If properly used, our device reduces the possibility of damaging tissue samples, which could potentially have a positive economic impact on research done with tissue tubes because fewer tissue tubes would be wasted. By being able to perfuse liquid through the lumen of tissue tubes, lining the lumen with endothelial cells could be possible and is the next step in developing tissue engineered blood vessels to be commercialized.

7.2 Health and Safety Concerns

Our device is meant to be used with live tissue and cell-culture media. Any safety or health concerns involved with tissue culture should be applied to using our device. To maintain sterility of all items involved, a biosafety cabinet needs to be used when mounting tissue tubes in the bioreactor. The biosafety cabinets emit UV light to disinfect the work area while not in use, which can be dangerous to the user and to the tissue if the cabinet is used incorrectly. Proper precautions should also be taken if any sharp objects, such as pipettes and needles, are used. As with all live cultures, the possibility of bacterial or fungal contamination exists. One's health could potentially be affected if exposed to such contamination. To reduce the risk of human exposure, laboratory standards and aseptic technique should be adhered to.

7.3 Environmental Influence

Byproducts of the device will not significantly affect the environment. No toxic fumes, pollutants, or chemicals are produced when the device is used. However, certain items involved with the device need to be disposed of. Used gloves and disposable lab instruments will contribute to the overall waste produced. Polycarbonate waste is a byproduct of the manufacturing process. Also, procedures involved with disposal of biological waste will affect the environment. The incubators, fume hoods, and the

peristaltic pump all get their power from electrical outlets. Overall, there is no particularly hazardous waste produced from the manufacture or use of our bioreactor. The device does not produce much waste and does not require an exorbitant amount of energy to run.

7.4 Societal Influence

At this point in time, our device does not have a great impact on society because it is used for experimental research. However, the use of our bioreactor would provide an alternate means for growing tissue tube samples. Successful experiments that solve problems in the medical field may use our design to grow tissue. In that case, our design would contribute to the success of the experiment and whatever result is produced.

7.5 Ethical Concerns

Currently the smooth muscle cells used to create the tissue tubes are extracted from rat specimen. The ethical concern with use of animal cells is that the means of extraction generally requires the animal to experience some pain and be euthanized. However, the potential improvement in the ease of the surgical procedure and the quality of life of the patients should be weighed against this. To ensure proper animal treatment, IACUC approved procedures were followed when handling and euthanizing the rats.

7.6 Sustainability of the Device

A considerable amount of electrical energy is consumed during the manufacturing and use of the device. The device was manufactured using a HAAS Toolroom Mill, which needs to run for over an hour to mill the device. Another consideration to the sustainability of the device includes the energy required to incubate the tissue. Electrical energy and carbon dioxide are required for the incubator. A peristaltic pump needs to run consistently for the length of time that the tissue is being nourished, which in our trials was three full days. All components of the device, as well as tubing and instruments, must be autoclaved prior to use.

7.7 Manufacturability of the Device

Manufacturing the device using the machines, materials, and procedures listed is long and tedious. The error involved with the HAAS Toolroom Mill is such that the device needs to be touched upon manually. The device required extensive sanding and trimming so that the lid slid properly over the chamber. The need for manual revisits means that manufacturing the device using current methods is time-consuming. Some components of the device, such as the movable arm, were manually created and

therefore subject to human error. Reproducing our device using the same procedures and machines would be inefficient. Making a few changes to our CAD files, particularly making the fit between the lid and the chamber less tight, could make the manufacturing process less difficult.

Chapter 8: Conclusions and Recommendations

Due to the prevalence of cardiovascular disease in America, researchers have been investigating ways to grow tissue engineered blood vessels to try to improve current treatment. In order to fabricate tissue engineered blood vessels, the physiological environment must be simulated. This simulation was accomplished by our bioreactor. Our group designed and produced a perfusion bioreactor to nourish tissue tubes internally and externally in hopes of advancing the scientific community's pursuit of tissue engineered blood vessels by improving current tissue tube cultivation methods. To test the functionality of the bioreactor, it was run for a three day period with a live tissue tube mounted inside. After the experiment, we compared tissue tubes that were grown in static culture to the tissue tube that was grown in our bioreactor. Through histology, it was found that while a great deal of fragmented nuclei, indicating cell death, were found in the statically grown tube, the tube extracted from our bioreactor showed no definitive signs of necrosis. Therefore, our design met all required constraints while fulfilling all our objectives with a unique and user-friendly design.

8.1 Future Recommendations

8.1.1 Mounting Method and Interchangeability

Although we successfully met the project objectives, there are many things we would have liked to incorporate or change about our design. One of our objectives was to make the bioreactor adjustable to accommodate different length tissue tubes. In order to expand upon the adjustability of our device, we suggest making the syringe needles interchangeable. By changing the needles, tubes of different diameters would be able to be housed in the bioreactor. Also, it would allow for easy detachment of the tissue from the bioreactor while remaining on the syringe needles. Currently, 18 gauge hypodermic tubing was tapped and glued into the arms. Syringe needles with a threading would be an ideal solution because they can be changed. To make the syringe needles interchangeable, threaded Luer locks could be incorporated into both the stationary arm and movable arm. The lid and chamber would need to be lengthened to accommodate for both the Luer locks and the length of the syringe needles.

8.1.2 Chamber Alterations

There are several changes we would recommend regarding the chamber. One of the main problems with the chamber is that it is difficult to see through. It would be beneficial to the user if they could observe the tissue tubes while they are growing without having to take apart the device. We would suggest using a more translucent material which could be autoclaved. Another alteration we would

suggest is to position the chamber's inlet Luer deeper and make both arms longer so that ultimately the tissue tube is suspended deeper within the chamber. By making this alteration, the risk of spilling media out of the grooves would be reduced.

Due to a miscalculation of the distance between the stationary arm Luer connector and the inlet Luer connector, the stationary arm Luer connector had to be sanded down to fit inside the inlet Luer connector. Although this did not interfere with the functionality of the design, it would be better if the user did not have to alter the Luer connector length before use. We would suggest making the chamber a quarter inch longer to ensure that the Luer connector will fit correctly. APPENDIX C: Fixed Future Final Design CAD Drawings presents the Final CAD with this change taken into consideration. Along with extending the chamber length, we would recommend reducing the chamber thickness. When the device components were finished, it was discovered that there was a great deal of friction when trying to remove the lid from the chamber. We had to sand the lid and chamber down so it did not take as much force to attach and detach the lid from the chamber. By altering the thickness, there will be less friction between the lid and chamber.

8.1.3 Lid Alterations

During the machining process, it was brought to our attention that the drill bit needed to drill the threaded hole for the Luer connector in the stationary arm could not clear the underside of the lid. Thus, part of the lid had to be bored out in order for the drill bit to make a straight hole through the stationary arm. The indent is shown in Figure 59. This actually worked to our advantage and supplies sufficient gas exchange. The earlier suggestion of making the lid deeper would solve the problem as long as the arms were extended as well. However, we suggest a similar shape, albeit smaller, be cut into the lid regardless to promote gas exchange.

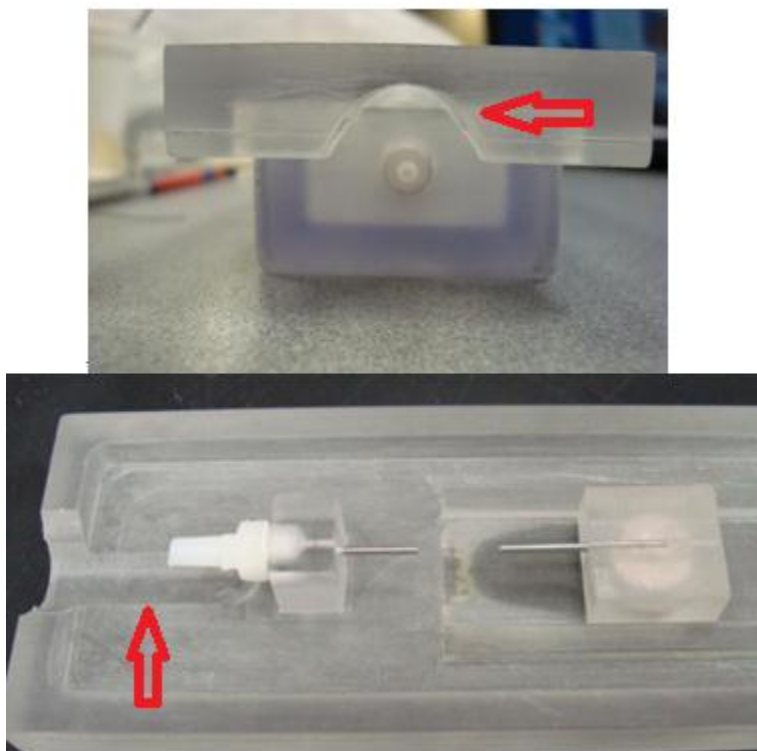

**Figure 59: Top picture: Arc cutout on the lid around the inlet Luer connector.
Bottom Picture: Arc depression in the lid.**

Our device has been autoclaved several times since we changed the epoxy to the silicone glue. Unfortunately, we noticed that the steel piece is starting to rust. So far, the magnet seems unchanged but repeated exposure during the autoclave process might affect the silicone glue even more. Perhaps another epoxy such as Loctite® M-121HP would work better. Another alteration we would suggest is making the steel piece a half an inch longer so the movable arm can move back even further allowing more room between syringe tips.

8.1.4 Multiple chambers

If we had had more time and funds for our project, we would have undoubtedly produced a multiple chamber design for the cultivation of multiple tissue tubes. This could also be achieved by simply using multiple bioreactors hooked up to a multichannel peristaltic pump.

8.1.5 Endothelialization

Although it was not in the scope of our project, we would suggest using our bioreactor to endothelialize the tissue tubes. The bioreactor's flow is laminar and should work well in this application.

By lining the tissue tubes with endothelial cells, the tissue tube will be one step closer to mimicking an artery.

References

- Aird, W. C. (2007). In Aird W. C. (Ed.), *Endothelial biomedicine* Cambridge University Press.
- Ascher, E., & Haimovici, H. (2004). In Ascher E., Haimovici H. (Eds.), *Haimovici's vascular surgery, volume 151* (5th ed.) Wiley-Blackwell.
- Baguneid, M., Seifalian, A., Salacinski, H., Murray, D., Hamilton, G., & Walker, M. (2006). Tissue engineering of blood vessels. *British Journal of Surgery*, 93(3), 282-290.
- Bhimji, S. (2010). *Heart bypass surgery*.
<http://www.nlm.nih.gov/medlineplus/ency/article/002946.htm>
- Botchwey, E. A., Dupree, M. A., Pollack, S. R., Levine, E. M., & Laurencin, C. T. (2003). Tissue engineered bone: Measurement of nutrient transport in three-dimensional matrices. *Journal of Biomedical Materials Research Part A*, 67A(1), 357-367.
doi:10.1002/jbm.a.10111
- Burdick, J. A. (2010). In Burdick J. A., Mauck R. L. (Eds.), *Biomaterials for tissue engineering applications: A review of the past and future trends* Springer.
- D'Ancona, G., Ricci, M., & Bergsland, J. (2001). In D'Ancona G., Ricci M. and Bergsland J. (Eds.), *Intraoperative graft patency verification in cardiac and vascular surgery* Wiley-Blackwell.
- De Maria, C., Vozzi, G., Domenici, C., & Ahluwalia, A. (2007). A novel vascular bioreactor for remodelling and testing mechanical properties of blood vessels. *Industrial Electronics*, 4(7), 2805-2809.
- DiMuzio, P., & Tulenko, T. (2007). Tissue engineering applications to vascular bypass graft development: The use of adipose-derived stem cells. *Journal of Vascular Surgery*, 45(6, Supplement 1), A99-A103. doi: 10.1016/j.jvs.2007.02.046

- Doshi, Kshama. (2009). *Direct cell seeding on a collagen-coated silicone mandrels to generate cell-derived tissue tubes* (Master's Thesis). Worcester Polytechnic Institute, Worcester Ma.
- Hannon, R. A., Pooler, C., & Mattson Porth, C. (2009). In Lippincott Williams & Wilkins (Ed.), *Porth pathophysiology: Concepts of altered health states*
- Jaasma, M. J., Plunkett, N. A., & O'Brien, F. J. (2008). Design and validation of a dynamic flow perfusion bioreactor for use with compliant tissue engineering scaffolds. *Journal of Biotechnology*, 133(4), 490-496. doi: 10.1016/j.jbiotec.2007.11.010
- Khurana, I. (2006). *Textbook of medical physiology* Elsevier India.
- Koeppen, B. M., & Stanton, B. A. (2010). In Koeppen B. M., Stanton B. A. (Eds.), *Berne & levy physiology: Sixth edition* (6th ed.). Philadelphia, PA: Mosby Elsevier.
- L'heureux, N., Paquet, S., Labbe, R., Germain, L., & Auger, F. A. (1998). A completely biological tissue-engineered human blood vessel. *The FASEB Journal*, 12(1), 47.
- L'Heureux, N., Dusserre, N., Marini, A., Garrido, S., de la Fuente, L., & McAllister, T. (2007). Technology insight: The evolution of tissue-engineered vascular grafts—from research to clinical practice. *Nature Clinical Practice Cardiovascular Medicine*, 4, 389-395.
- Lovett, M., Cannizzaro, C., Daheron, L., Messmer, B., Vunjak-Novakovic, G., & Kaplan, D. L. (2007). Silk fibroin microtubes for blood vessel engineering. *Biomaterials*, 28(35), 5271-5279. doi: 10.1016/j.biomaterials.2007.08.008
- Lovett, M., Rockwood, D., Baryshyan, A., & Kaplan, D. L. (2010). Simple modular bioreactors for tissue engineering: A system for characterization of oxygen gradients, human mesenchymal stem cell differentiation, and prevascularization. *Tissue Engineering Part C: Methods*, doi:10.1089/ten.tec.2010.0241
- Lovett, M., Rockwood, D., Baryshyan, A., & Kaplan, D. L. (2010). Simple modular bioreactors for tissue engineering: A system for characterization of oxygen gradients, human

mesenchymal stem cell differentiation, and prevascularization. *Tissue Engineering Part C: Methods*, 16(6), 1565-1573. doi:10.1089/ten.tec.2010.0241

Marieb, E. N., & Hoehn, K. (2006). *Human anatomy & physiology* (7th ed.). San Francisco: Benjamin Cummings.

Mitchell, S. L., & Niklason, L. E. (2003). Requirements for growing tissue-engineered vascular grafts. *Cardiovascular Pathology*, 12(2), 59-64. doi: 10.1016/S1054-8807(02)00183-7

Munson, B. R., Young, D. F., Okiishi, T., & Huebsch, W. W. (2009). In Welter J., Sapira L. and Dumas S. (Eds.), *Fundamentals of fluid mechanics* (6th ed.). River Street, Hoboken, NJ: John Wiley & Sons, Inc.

Neumann, T., Nicholson, B. S., & Sanders, J. E. (2003). Tissue engineering of perfused microvessels. *Microvascular Research*, 66(1), 59-67.

Noble, A. (2005). *The cardiovascular system*. Edinburgh: Elsevier/Churchill Livingstone.

Reneman, R. S., Arts, T., & Hoeks, A. P. G. (2006). Wall shear stress—an important determinant of endothelial cell function and structure—in the arterial system in vivo. *Journal of Vascular Research*, 43(3), 251-269. doi:10.1159/000091648

Rhoades, R., & Bell, D. R. (2008). *Medical physiology: Principles for clinical medicine* (3rd ed.). Philadelphia: Lippincott Williams & Wilkins.

Roger, V. L., Go, A. S., Lloyd-Jones, D. M., Adams, R. J., Berry, J. D., Brown, T. M., et al. (2011). Heart disease and stroke statistics—2011 update: A report from the American Heart Association. *Circulation*, 123(4), e18-209. doi:10.1161/CIR.0b013e3182009701

Shin'oka, T. (2004). Mid-term clinical results of tissue-engineered vascular autografts seeded with autologous bone marrow cells. *Yonsei Medical Journal*, 45(Suppl), 73-74.

- Waksman, R., Serruys, P. W., & Schaar, J. (2007). In Waksman R., Serruys P. W. and Schaar J. (Eds.), *The vulnerable plaque* (2nd ed.) CRC Press.
- Webb, A. R., Macrie, B. D., Ray, A. S., Russo, J. E., Siegel, A. M., Glucksberg, M. R., et al. (2007). In vitro characterization of a compliant biodegradable scaffold with a novel bioreactor system. *Ann Biomed Eng*, 35(8), 1357-1367.
- Williams, C., & Wick, T. M. (2005). Endothelial cell–smooth muscle cell co-culture in a perfusion bioreactor system. *Annals of Biomedical Engineering*, 33(7), 920-928.
- Yu, P., Lee, T. S., Zeng, Y., & Low, H. T. (2009). Fluid dynamics and oxygen transport in a micro-bioreactor with a tissue engineering scaffold. *International Journal of Heat and Mass Transfer*, 52(1-2), 316-327. doi: 10.1016/j.ijheatmasstransfer.2008.06.021
- Zhang, X., Wang, X., Keshav, V., Wang, X., Johanas, J. T., Leisk, G. G., et al. (2009). Dynamic culture conditions to generate silk-based tissue-engineered vascular grafts. *Biomaterials*, 30(19), 3213-3223. doi: 10.1016/j.biomaterials.2009.02.002

APPENDIX A: Testing Protocols

Total Chamber Volume Test

1. Block the inlet and outlet by attaching silicone tubing and tying it off.
2. Fill the chamber with water until it reaches the two cut outs for the track lips.
3. Place the lid on the chamber so that any excess squeezes out and make sure water is covering the syringe needles.
4. Remove the lid and empty the chamber contents into a graduated cylinder for measuring.

Flow Rate Test Protocol

1. Insert the 3/16" tubing that came with the Fischer Science pump into the peristaltic pump (0.4-85 mL/min) and attach to 1/16" tubing.
2. Connect 1/16" tubing to the barb of the outlet of the bioreactor chamber.
3. Plug the inlet so that it is sealed.
4. Put the end of the 1/16" tubing into a graduated cylinder.
5. Fill the chamber with water and run the pump so that the water is flowing from the chamber to the graduated cylinder.
6. Once the fluid starts to drip into the cylinder, begin timing for 3 minutes.
7. After 3 minutes, stop the pump and measure the volume. Divide the volume by three to get a flow rate of mL/minute.
8. Repeat for various pump settings.

Closed Flow Loop Testing Protocol (Suture Leakage)

1. Suture tubing or tissue tube into place on syringe needles.
2. Fill chamber with dyed water/media.
3. Attach lid to the chamber and the tubing to the appropriate inlets/outlets.
4. Begin the pump and allow all air bubbles to be released.
5. Turn off the pump and remove the lid.
6. The colored liquid should still remain in the tube. Dry off any excess to check for leaking.

Stationary Arm Leakage Testing Protocol

1. Remove the lid from the bioreactor and lay it flat on the bench top.
2. Prepare stained water by mixing water and food coloring in a glass.
3. Pipette the colored water through the Luer on the stationary arm until water comes out of syringe needle.
4. If colored water is found at any other point except the end of the syringe needle, there is leakage.

Laminar Flow Test (Acrylic Prototype) Protocol

1. Lay the bioreactor lid on the bench top.
2. Suture 1.47mm ID silicone tubing onto syringe needles.
3. Set up high resolution video recorder about 1 inch away from the silicone tubing.
4. Attach female Luer to the male Luer on stationary arm.
5. Attach tubing from the barb of the female Luer, which was just attached, to the “out” port of the pump.
6. Fill beaker with water and add particles (colored sugar bits).
7. Put the end of another piece of tubing into the clear water and attach the other end to the “in” port of the pump.
8. Start the video recorder.
9. Run the pump on 2 (slow).
10. Observe movement patterns of particles flowing through the clear tubing to determine if turbulence is present.

Laminar Flow Test 1 Protocol

1. Lay the bioreactor lid on the bench top.
2. Suture 1.47mm ID silicone tubing onto syringe needles.
3. Set up high resolution camcorder about 1 inch away from the silicone tubing.
4. Attach female Luer to the male Luer on stationary arm.
5. Attach tubing from the barb of the female Luer, which was just attached, to the “out” port of the pump.
6. Fill beaker with water.
7. Put the end of another piece of tubing into the clear water and attach the other end to the “in” port of the pump.
8. Run the pump on 1 (fast) to fill tubing with clear water.
9. Put colored water, dyed with food coloring, into a pipette and pick the tubing out of the water.
10. Insert the pipette into the tube and squeeze the colored water into the tubing.
11. Run the pump again and use the camcorder to capture the colored water passing through the sutured tubing.
12. Observe how the water and food coloring react in the clear tubing. Look for straight lines and layers.

Laminar Flow Test 2 Protocol

1. Lay the bioreactor lid on the bench top.

2. Suture 1.47mm ID silicone tubing onto syringe needles.
3. Set up high resolution camcorder about 1 inch away from the silicone tubing.
4. Put several drops of food coloring into syringe and attach 30 gauge needle.
5. Attach female Luer to the male Luer on stationary arm.
6. Attach tubing from the barb of the female Luer, which was just attached, to the “out” port of the pump.
7. Fill beaker with water.
8. Put the end of another piece of tubing into the clear water and attach the other end to the “in” port of the pump.
9. Turn on the camcorder to record.
10. Run the pump on 1 (fast) to fill tubing with clear water.
11. Use the needle to poke through the sutured silicone tubing near the inlet blunt end syringe needle and inject the food coloring slowly.
12. Observe how the water and food coloring react in the clear tubing. Look for straight lines and layers.

Laminar Flow Test 3 Protocol

1. Lay the bioreactor lid on the bench top.
2. Suture 1.47mm ID silicone tubing onto syringe needles.
3. Set up high resolution camcorder about 1 inch away from the silicone tubing.
4. Put several drops of food coloring into syringe and attach 30 gauge needle.
5. Attach female Luer to the male Luer on stationary arm.
6. Attach tubing from the barb of the female Luer, which was just attached, to the “out” port of the pump.
7. Fill beaker with water.
8. Put the end of another piece of tubing into the clear water and attach the other end to the “in” port of the pump.
9. Turn on the camcorder to record.
10. Run the pump on 1 (fast) to fill tubing with clear water.
11. Use the needle to poke through the silicone tubing connecting the pump to the inlet Luer of the lid near the inlet Luer. Inject the food coloring slowly.
12. Observe how the water and food coloring react in the clear tubing. Look for straight lines and layers.

Sterility assessment 1 Protocol

1. Autoclave bioreactor for 20 minutes in autoclavable disposable bag.
2. Remove from autoclave and place into clean laminar flow hood.
3. Open the bag in the hood and remove the sterile bioreactor. Remove the lid.
4. Using a pipette, put 26mL of DMEM (cell media without antibiotics) into chamber of bioreactor.
5. Replace lid and put the bioreactor in the incubator for 2 nights.

Sterility assessment 2 Protocol

1. Autoclave bioreactor and silicone tubing for 20 minutes in autoclavable disposable bag(s).
2. Remove bag(s) from autoclave and place into clean laminar flow hood.
3. Open the bag(s) in the hood and remove the sterile bioreactor and tubing. Remove the lid of the bioreactor and set aside.
4. Wipe the surfaces of the peristaltic pump with 70% ethanol and place in hood.
5. Attach 1/16" silicone tubing to the pump. Attach the pump outlet to the inlet of the chamber and put the tubing from the pump inlet into a clean beaker.
6. Using a pipette, dispense about 26mL of DMEM into the beaker from step 5.
7. Run the pump forward until the chamber and tubing are filled with media. Dispense more media into the beaker if necessary. When full, lock lid in place.
8. Move bioreactor and peristaltic pump into an incubator on a tray to contain any spills. Thread the power cord for the pump through the port in the back of the incubator and plug into power strip.
9. Run pump forward on the 1 Fast setting for ~48 hours.

Sterility assessment 3 Protocol

1. Autoclave bioreactor and silicone tubing for 20 minutes in autoclavable disposable bag(s).
2. Remove bag(s) from autoclave and place into clean laminar flow hood.
3. Open the bag(s) in the hood and remove the sterile bioreactor and tubing. Remove the lid of the bioreactor and set aside.
4. Wipe the surfaces of the peristaltic pump with 70% ethanol and place in hood.
5. Attach 1/16" silicone tubing to the pump. Attach the pump outlet to the inlet of the chamber and put the tubing from the pump inlet into a clean beaker.
6. Using a pipette, dispense 27mL of DMEM and 3mL of FBS into the beaker from step 5.
7. Run the pump forward until the chamber and tubing are filled with media. When full, lock lid in place.
8. Move bioreactor and peristaltic pump into an incubator on a tray to contain any spills. Thread the power cord for the pump through the port in the back of the incubator and plug into power strip.
9. Run pump forward on the 1 Fast setting for ~48 hours.

Connection Leakage Test Protocol

1. Suture silicone tubing to the syringe needle on the stationary arm.
2. Snake the silicone tubing through the outlet Luer of the chamber.
3. Attach silicone tubing from peristaltic pump inlet to a container of water.
4. Attach silicone tubing from peristaltic pump outlet to the inlet of the stationary arm.
5. Connect the lid and chamber and run the pump. If water flows out of the tubing, the connection between the chamber and the lid has been made. If water accumulates in the chamber, the Luers are not connected.

APPENDIX B: Final Design CAD Drawings

ITEM NO.	PART NUMBER	DESCRIPTION	QTY.
1	PBR-001	CHAMBER	1
2	PBR-002	LID	1
3	PBR-003	STEEL TRACK	1
4	PBR-004	MOVABLE ARM	1
5	PBR-005	18G SYRINGE NEEDLE	2
6	PBR-006	MALE LUER CONNECTOR	2
7	PBR-007	FEMALE LUER CONNECTOR	1
8	PBR-008	MAGNET	1

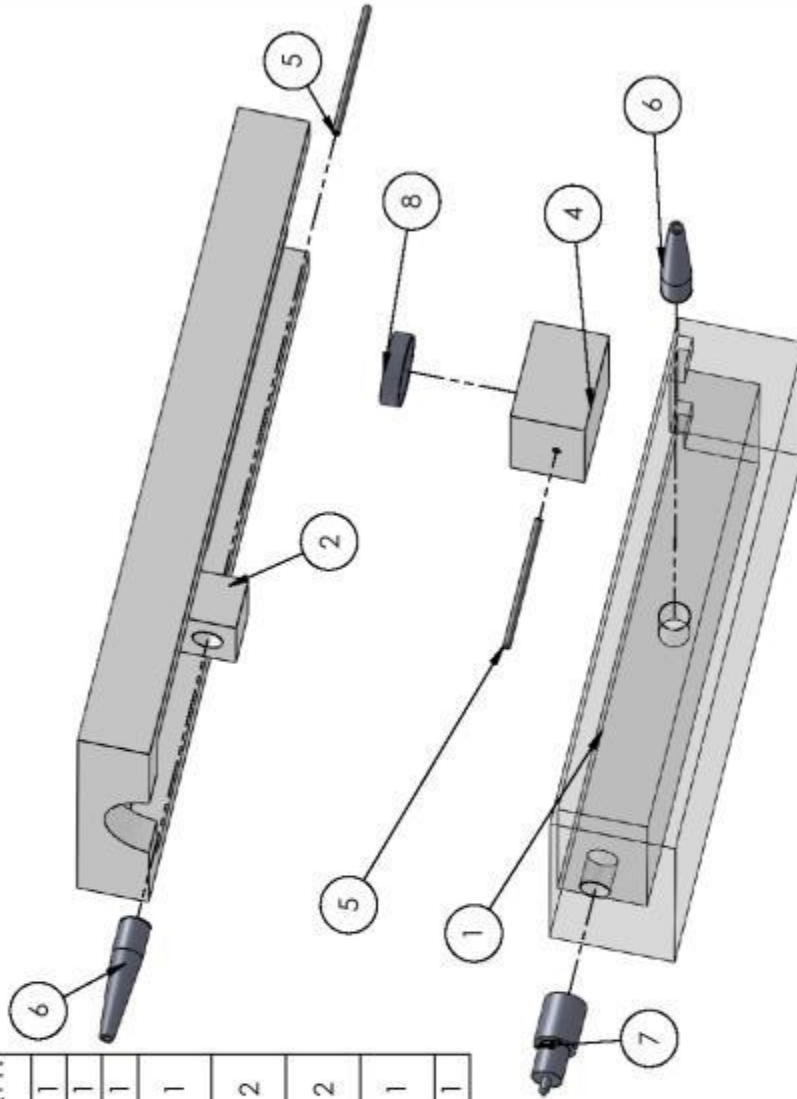

UNLESS OTHERWISE SPECIFIED:		NAME	DATE
DIMENSIONS ARE IN INCHES		FKG	2/20/11
TOLERANCES:		DRAWN	CHECKED
FRACTIONS $\frac{1}{8}$ CH $\frac{1}{16}$ BEND $\frac{1}{8}$		ENG APPR.	MFG APPR.
DECIMALS $\frac{1}{10}$ CH $\frac{1}{20}$ BEND $\frac{1}{10}$		Q.A.	COMMENTS:
THREE PLACE DECIMAL $\frac{1}{1000}$		HIDDEN GEOMETRIC TOLERANCING PER:	
NEXT ASSY		MATERIAL:	
USED ON:		FINISH:	
APPLICATION:		DO NOT SCALE DRAWING	

5

4

3

2

1

WORCESTER POLY-TECHNIC INSTITUTE

TITLE:

EXPLODED VIEW

SIZE DWG. NO. **A** REV

SCALE: 1:1 WEIGHT: SHEET 1 OF 1

PROPRIETARY AND CONFIDENTIAL
 THE INFORMATION CONTAINED IN THIS DRAWING IS THE PROPERTY OF WORCESTER POLY-TECHNIC INSTITUTE. ANY REPRODUCTION IN PART OR AS A WHOLE WITHOUT THE WRITTEN PERMISSION OF WORCESTER POLY-TECHNIC INSTITUTE IS PROHIBITED.

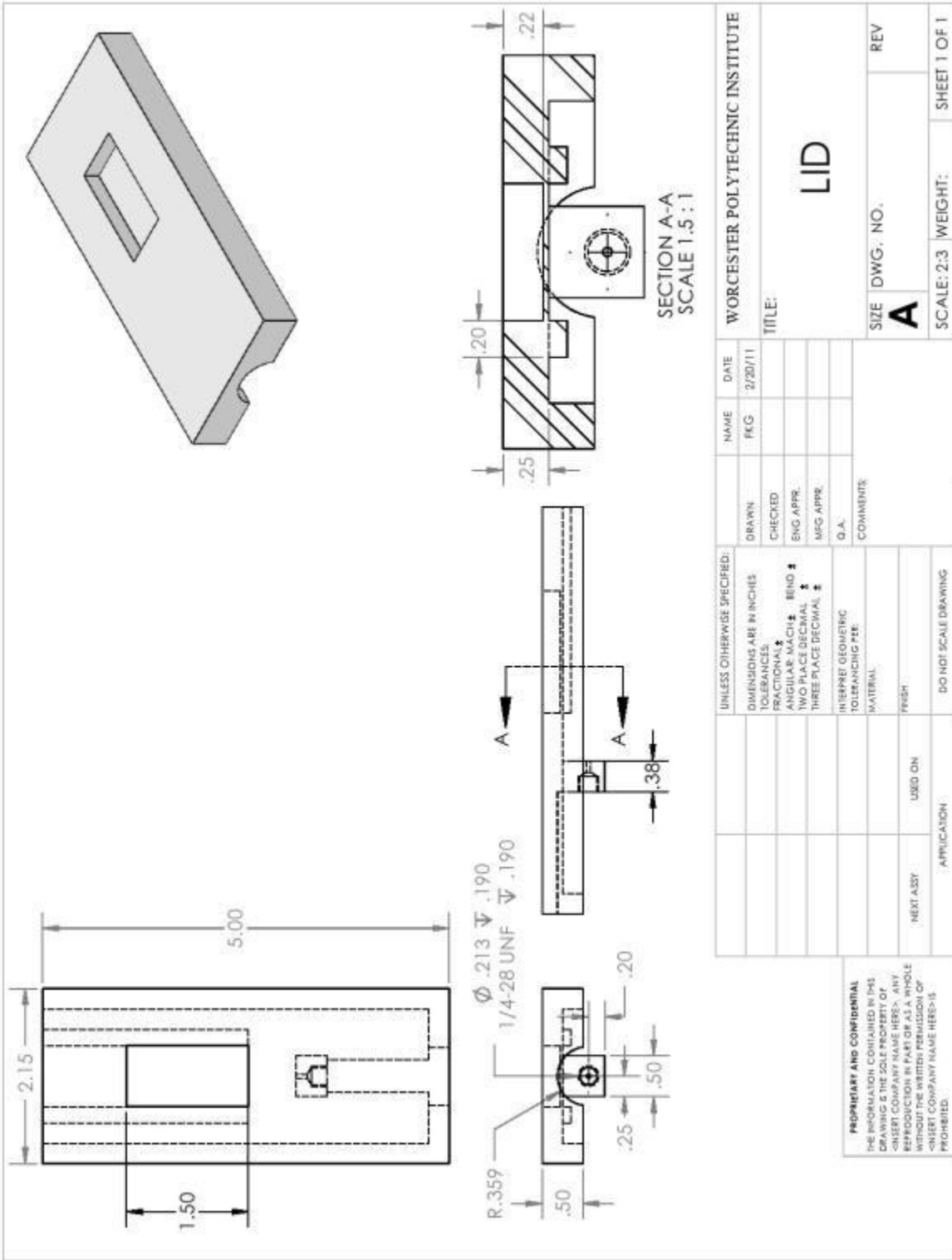

UNLESS OTHERWISE SPECIFIED: DIMENSIONS ARE IN INCHES TOLERANCES: FRACTIONS \pm CHS - BEND \pm DECIMALS \pm CHS - BEND \pm TWO PLACE DECIMAL \pm THREE PLACE DECIMAL \pm		DRAWN	CHECKED	ENG APPR.	MFG APPR.	Q.A.	COMMENTS
MATERIAL		FINISH					DO NOT SCALE DRAWING
NEXT ASY		USED ON					APPLICATION
5		4					3
6		2					1
PROPRIETARY AND CONFIDENTIAL THE INFORMATION CONTAINED IN THIS DRAWING IS THE PROPERTY OF WORCESTER POLYTECHNIC INSTITUTE. ANY REPRODUCTION IN PART OR AS A WHOLE WITHOUT THE WRITTEN PERMISSION OF WORCESTER POLYTECHNIC INSTITUTE IS PROHIBITED.							SCALE: 2:3 WEIGHT: SHEET 1 OF 1
WORCESTER POLYTECHNIC INSTITUTE TITLE: LID SIZE DWG. NO. A REV							NAME DATE FKG 2/20/11

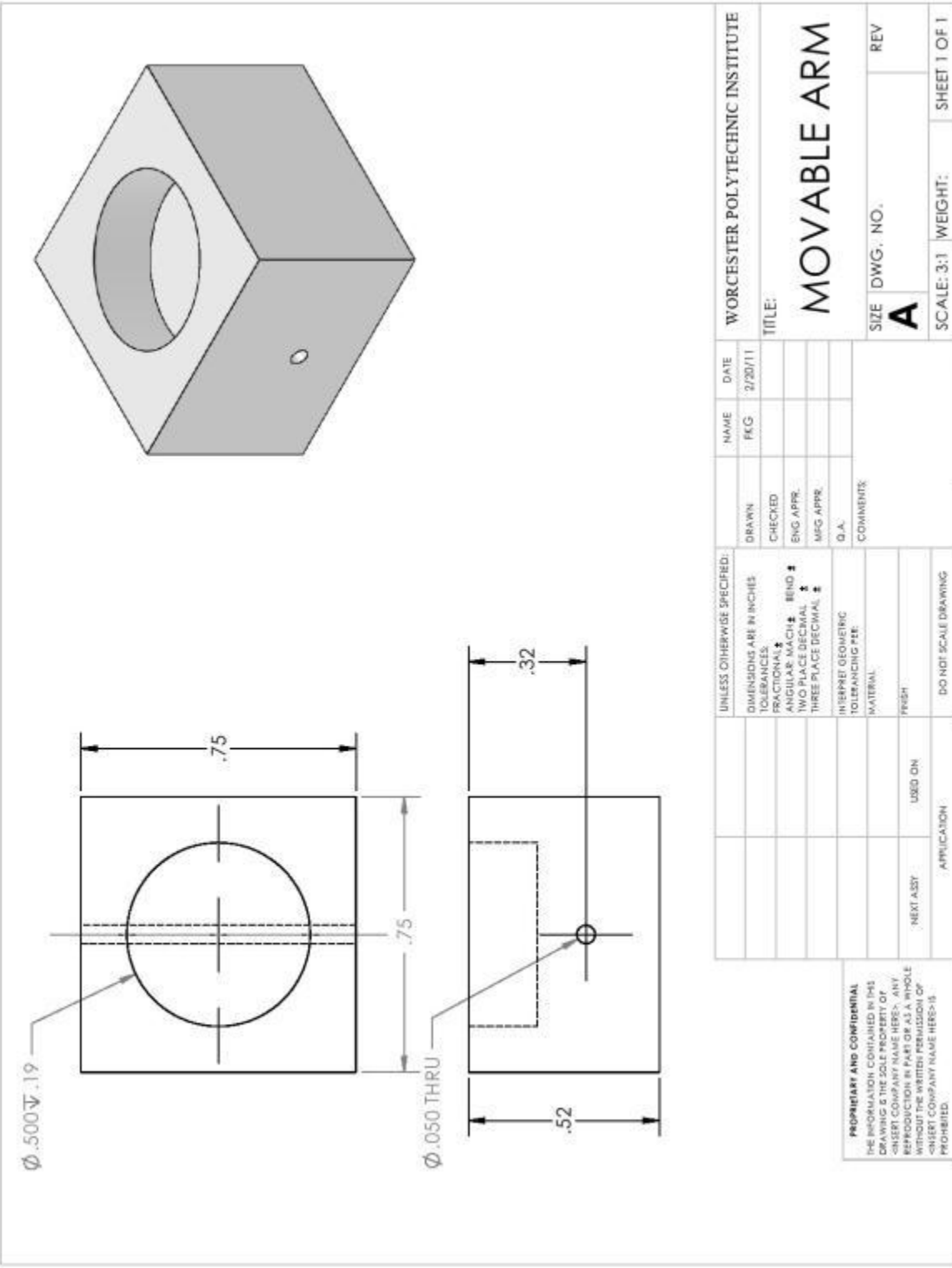

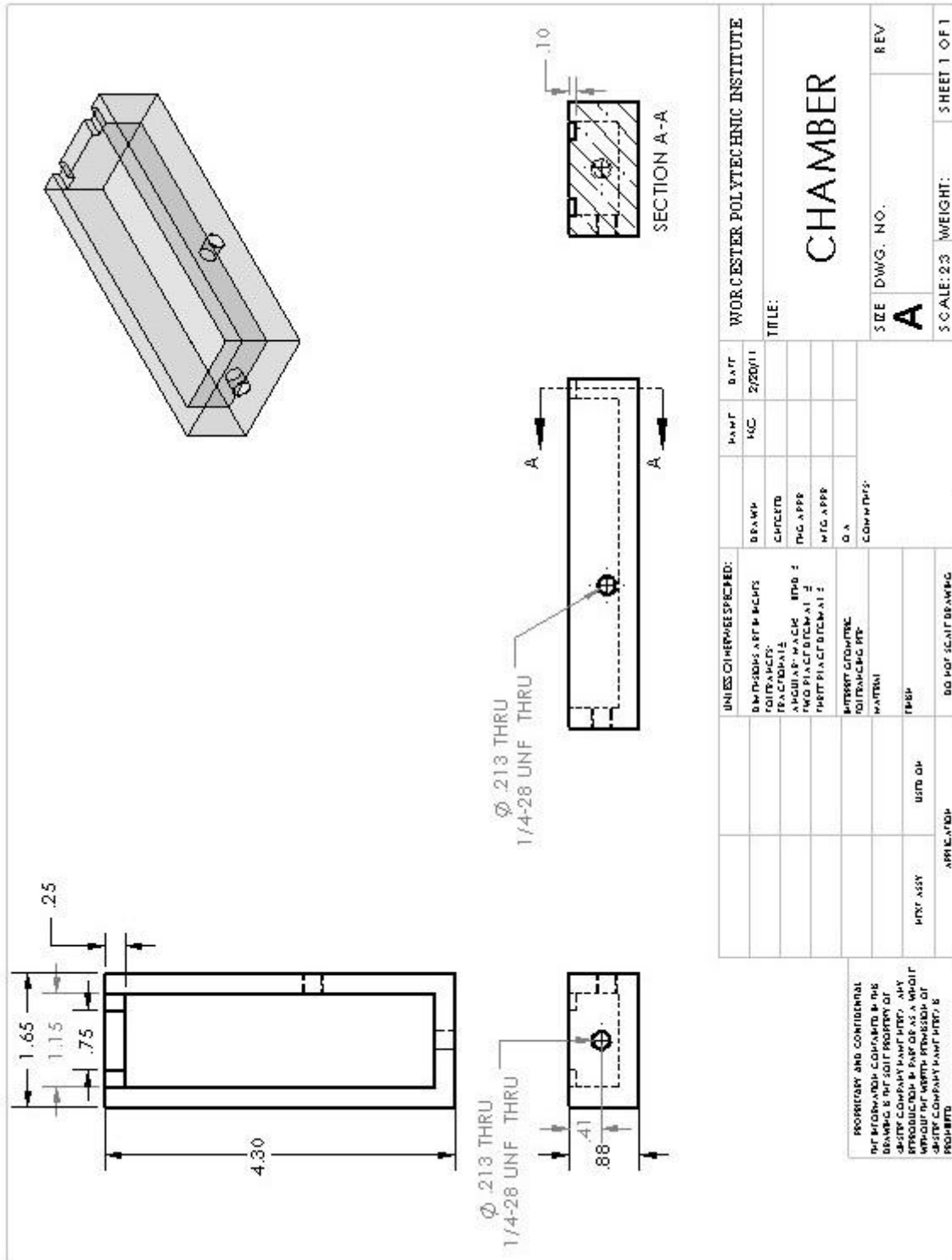

PROPRIETARY AND CONFIDENTIAL
 ALL INFORMATION CONTAINED IN THIS
 DRAWING IS THE SOLE PROPERTY OF
 JACOBS COMPANY PART FIRST. ANY
 REPRODUCTION OR USE OF AS A WHOLE
 WITHOUT THE EXPRESS PERMISSION OF
 JACOBS COMPANY PART FIRST IS
 PROHIBITED.

UNLESS OTHERWISE SPECIFIED:		DESIGN	DATE
DIMENSIONS ARE IN INCHES	SCALE	2/20/11	
TOLERANCES:	DATE		
FRACTIONS: 1/16	FIG. APPR		
DECIMALS: 0.0005	FIG. APPR		
ANGLES: 30 MIN	DATE		
SPRINGS: PER PART DRAWING	DATE		
WELDING: PER PART DRAWING	DATE		
FINISH: PER PART DRAWING	DATE		
DO NOT SCALE DRAWING	DATE		

WORCESTER POLYTECHNIC INSTITUTE
 TITLE:
CHAMBER
 SIZE DWG. NO. **A** REV
 SCALE: 2:3 WEIGHT: SHEET 1 OF 1

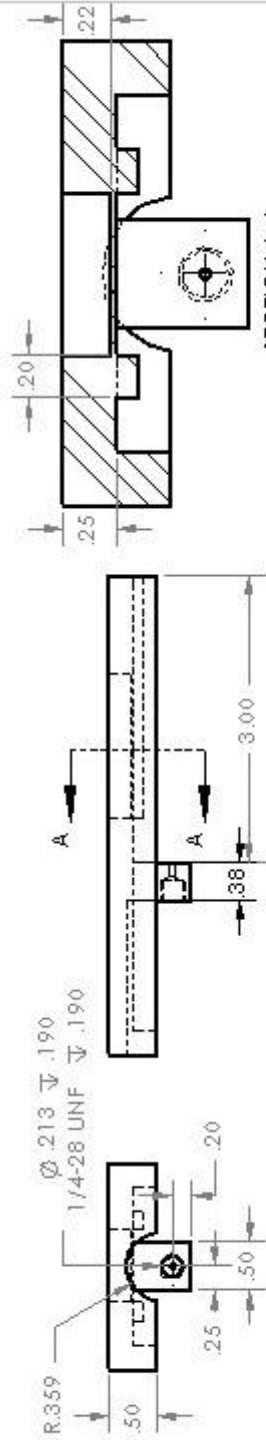
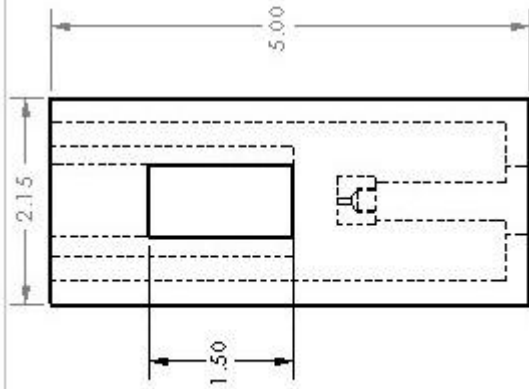
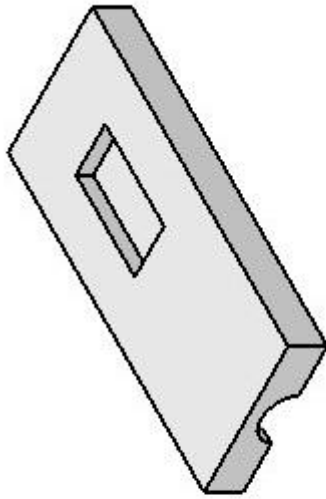

SECTION A-A
SCALE: 1.5:1

WORCESTER POLYTECHNIC INSTITUTE

TITLE:

LID

SIZE DWG. NO. REV

A

SCALE: 2:3 WEIGHT: SHEET 1 OF 1

UNLESS OTHERWISE SPECIFIED:	DATE	BY	REV
DIMENSIONS ARE IN INCHES			
TOLERANCES:			
FINISHES:			
APPROX. MACH. FINISH			
TEXT PLACEMENT			
UNLESS OTHERWISE SPECIFIED:			
MATERIAL			
FINISH			
LIST OF PARTS			
APPLICATION			
DO NOT SCALE DRAWING			

PROPRIETARY AND CONFIDENTIAL
THIS DRAWING COMPARTS IS THE
PROPERTY OF WORCESTER POLYTECHNIC
INSTITUTE. ANY REPRODUCTION OR
DISSEMINATION OF THIS DRAWING
WITHOUT THE WRITTEN PERMISSION OF
WORCESTER POLYTECHNIC IS
PROHIBITED.

