

March 2008

# A Sustainable Science Laboratory Program for Rural Thailand

Emily J. Briskey  
*Worcester Polytechnic Institute*

Jessica A. LaGoy  
*Worcester Polytechnic Institute*

McGhee Orme-Johnson  
*Worcester Polytechnic Institute*

Nathan Bagdis Largesse  
*Worcester Polytechnic Institute*

Nicholas D. Amendolare  
*Worcester Polytechnic Institute*

Follow this and additional works at: <https://digitalcommons.wpi.edu/iqp-all>

---

## Repository Citation

Briskey, E. J., LaGoy, J. A., Orme-Johnson, M., Largesse, N. B., & Amendolare, N. D. (2008). *A Sustainable Science Laboratory Program for Rural Thailand*. Retrieved from <https://digitalcommons.wpi.edu/iqp-all/600>

This Unrestricted is brought to you for free and open access by the Interactive Qualifying Projects at Digital WPI. It has been accepted for inclusion in Interactive Qualifying Projects (All Years) by an authorized administrator of Digital WPI. For more information, please contact [digitalwpi@wpi.edu](mailto:digitalwpi@wpi.edu).

# A Sustainable Laboratory Program for the Advancement of Secondary Science Education in Rural Thailand



by  
Nicholas Amendolare  
Emily Briskey  
Jessica LaGoy  
Nathan Largesse  
McGhee Orme-Johnson



This report represents the work of one or more WPI undergraduate students submitted to the faculty as evidence of completion of a degree requirement. WPI routinely publishes these reports on its web site without editorial or peer review.

# A Sustainable Laboratory Program for the Advancement of Secondary Science Education in Rural Thailand

An Interactive Qualifying Project  
submitted to the faculty of  
WORCESTER POLYTECHNIC INSTITUTE  
in partial fulfillment of the requirements for the  
Degree of Bachelor of Science

by  
Nicholas Amendolare  
Emily Briskey  
Jessica LaGoy  
Nathan Largesse  
McGhee Orme-Johnson

Date:  
February 28<sup>th</sup>, 2008

Report submitted to:  
The Office of H.R.H. Princess Maha Chakri Sirindhorn's Projects,  
Professors Chrysanthe Demetry, Thomas Robertson and Richard Vaz  
Worcester Polytechnic Institute

## **ABSTRACT**

In rural Thailand, students had less educational opportunities than their urban counterparts. The goal of our project, sponsored by the Office of H.R.H. Princess Maha Chakri Sirindhorn's Projects, was to develop an engaging, educationally valuable, sustainable laboratory program for lower-secondary school students in Sakon Nakhon. The goal was achieved in three stages: initial program development, program testing, and program refinement. The result was a science laboratory program that contained the developed experiments as well as supplementary materials for teachers.



## **ACKNOWLEDGEMENTS**

Our team would first like to thank our sponsor, the Office of Her Royal Highness Princess Maha Chakri Sirindhorn's Projects, and our liaisons, Khun Nantaporn, Khun Aphisit, Khun Panarat, and Khun Tara, for providing us with the opportunity to work on such an important, rewarding project.

We would also like to thank Aacaan Ing-On, Aacaan Ning, Aacaan Noi, Aacaan Pie, Doctor B., Mr. A., and the rest of the staff at the Kusuman Wittayakhom School for being such kind hosts and helping our team in so many ways.

We would like to thank our liaisons from Chulalongkorn University, Aacaan Siripastr and Aacaan Supawan, for advising our project and providing us with such valuable advice.

Finally, we would like to thank our advisors from Worcester Polytechnic Institute, Professor Demetry, Professor Robertson, and Professor Vaz, for helping us in every stage of our project, through planning, research, field work, and the drafting of the final report and Program Manual

## **EXECUTIVE SUMMARY**

In a time where roughly 45% of the world's population lives below the poverty line (The World Bank, 2007), poverty is an internationally recognized crisis. Northeast Thailand is an isolated region where roughly 90% of the population works in the agriculture industry (Cherdchuchai and Otsuka 2006) and poverty is a serious issue. Its many struggles include environmental complications such as drought and soil erosion (Tsubo et. al, 2007). In such an agrarian society, environmental degradation can severely impact the economy. Researchers have proposed science education, as a means of improving science literacy, as one possible solution to the poverty crisis. With an improvement to science literacy and education, individuals would be better able to understand their environment, and thus how to utilize it sustainably (De la Rosa, 2007). Additionally, "Science education imparts a method of inquiry and a systematic way of processing knowledge in the physical world" (Thulstrup, 1999). This indicates that in order for people to understand the world around them, they need a good science education.

The science education system in Northeast Thailand faces many challenges. Funding for schools and qualified teachers are both in short supply and the general population has had a limited education. Forty-five percent of inhabitants ages 6-24 do not attend school (UNESCAP, 2000). Schools struggle to provide learning materials for students, and classes tend to be teacher-centered, stressing rote memorization of facts. Also, students' exposure to hands-on, laboratory activities is limited. Activities tend to be very simple and do not emphasize independent thinking or creativity (HRHPP, 2008). Research suggests that engaging laboratory activities that relate to students' lives can significantly enhance student learning (Bybee, 2005).

Our team was commissioned by the Office of Her Royal Highness Princess Maha Chakri Sirindhorn's Projects to develop an engaging, educationally valuable, sustainable science laboratory program with the goal of increasing science literacy in rural Thailand. The program included science laboratory activities that related directly to local issues and students' daily lives and used only inexpensive, locally available materials. After designing and testing the program, our team created a manual that detailed each activity, complete with teacher instructions and student worksheets. We hope that through the work of Princess Sirindhorn's Office the science laboratory program can be adopted throughout rural Thailand, improving science literacy among local students and, ultimately, the region as a whole.

### **Development and Testing**

Based on our research and the recommendations of our sponsor, our team developed three criteria for a successful laboratory activity. Activities should be:

**Educationally Valuable:** Each activity should teach valuable scientific lessons that are relevant to students' daily lives.

**Sustainable & Replicable:** Each activity should fit within the scope of the national curriculum and use only inexpensive, locally available materials.

**Fun and Engaging:** Each activity should allow students to take part in hands-on learning that is both enjoyable and thought-provoking.

We first used these criteria to assist in designing the science activities to be included in the program, and then to assess the success of each activity. Following are our four designed activities.

**Two Methods of Water Purification:** Students learned about two methods of water purification: boiling and filtering. The students used both methods to purify each of three different types of water: pond water, tap water, and distilled water. Students learned that filtering was effective in removing large particles from water, making the water look clean, but did not remove microorganisms. Boiling, however, did kill microorganisms, making water safe to drink, even if it looks dirty.

**Exploring Agriculture:** Students planted seeds of a local plant in soil and observed how various fertilizers and pollutants affected plant growth. They learned about the negative effects of two pollutants, acid rain (indicated by lime juice) and dish soap, and the positive effects of two fertilizers, manure and industrial fertilizer.

**Storing Food Safely:** Students stored both meat and fruit in three different locations: a cool, dry place, a warm, dry place, and a warm, moist place. After observing the resulting growth of bacteria and other microorganisms, students learned that moisture and warmth promoted the growth of bacteria, making food unsafe to eat.

**Tragedy of the Commons:** Students played a simulated fishing game that taught them about sustainability and resource management. Groups of students used communication, education, and teamwork to develop sustainable fishing strategies. This exercise was connected to real-world problems such as deforestation and pollution.

These activities were tested at the Kusuman Wittayakhom School in northeast Thailand. The school is comprised of 1,035 students and 41 teachers. We began testing the program by teaching the activities to seventh grade science teachers. These teachers, with little to no assistance from team members, then conducted each activity in their seventh grade classes. After testing, activities were refined based on both our team's observations and teacher feedback received during the testing process. The refined activities were then compiled in a Program Manual that included teacher instructions, student worksheets, and supplementary materials.

## Results and Findings

After the testing process, our team evaluated the success of each activity based on our established criteria. In general, through our team's observations and discussions with teachers, we found that the activities met each of the established criteria to varying degrees.

### Criterion #1: Activities Should Be Educationally Valuable

Throughout the testing process, our team observed students learning actively, answering discussion questions from teachers, and thoughtfully forming hypotheses and conclusions. Because of our status as foreign observers, our team used feedback from teachers in addition to our own observations to evaluate the educational value of the activities. Teachers expressed enthusiasm about the topics of the activities, saying that they were pleased by the relevance of the activities and the inclusion of the scientific method. *Exploring Agriculture* taught students lessons in biology and earth science that were particularly practical because of the agrarian nature of the community. In *Two Methods of Water Purification* and *Storing Food Safely*, students were able to observe the growth of microorganisms, and learned how their decisions could affect whether food and water were safe to consume. After testing *Tragedy of the Commons*, teachers commented that they thought the activity taught a very educationally valuable lesson on sustainability and resource management. Teachers were excited to explain how the concepts related to environmental issues like overfishing, over-forestry, and pollution.

### Criterion #2: Activities Should Be Sustainable and Replicable

In order to assure that the activities were sustainable for the Kusuman Wittayakhom School and able to be transferred to other rural schools, the activities were designed to require only inexpensive, locally available materials. Required materials included: plastic containers, soil and fertilizers, fruit and meat, and candy. Additionally, the activities covered topics that were within the scope of the national curriculum, so that they could be easily integrated into schools' existing science programs.

### Criterion #3: Activities Should Be Fun and Engaging

Throughout testing, our team observed students smiling, laughing, actively using laboratory materials, discussing the activity enthusiastically, and forming hypotheses and conclusions. Students also demonstrated care in conducting the activities correctly and showed exceptional focus. Teachers expressed that students enjoyed each of the activities to varying degrees. *Two Methods of Water Purification* and *Storing Food Safely* appeared to be the least interesting to the students, perhaps due to the ordinary nature of the materials involved. In *Exploring Agriculture* students enjoyed working with their hands and a variety of different materials, and in *Tragedy of the Commons* students enjoyed competing in a classroom game that taught an interesting lesson.

In addition to observing whether the activities met our criteria, our team made some observations about student behavior and communication with teachers. Through these observations, our team was able to extract key findings that guided the development of the program and ultimately the Program Manual:

**Students appeared to be engaged by hands-on activities.** This finding confirmed our background research relating to teaching methods that used hands-on activities. We observed students smiling, working in teams, and participating in focused discussion. The science teachers of the Kusuman Wittayakhom School agreed that the activities stimulated interest in the students.

**Students were often hesitant to seek help when struggling with an activity.** During both lecture and lab-work, we observed that students infrequently raised their hands or asked for help, even when struggling. Students often used a trial-and-error approach instead.

**Some students did not participate in activities when groups were too large.** While most students participated actively in activities, some students did not. Researchers agree that group-size must be considered carefully when designing a classroom activity; students need to have enough work to keep them engaged while also not being overwhelmed.

**Students benefited from guidance while reaching higher-level conclusions.** It was initially suggested by the science teachers that activity questions should guide students to draw conclusions. We observed that while students were usually not capable of reaching higher-level conclusions on their own, they did not struggle when given questions that provided direction to the proper conclusion.

**Visual aids were an effective way to overcome the language barrier.** Throughout the teacher training process, we found that the use of pictures and diagrams helped to clarify important concepts. Visual aids were also provided for students during most classroom activities.

**Teachers often viewed science as factual rather than experimental.** When an activity did not produce the hypothesized results, teachers often became uncomfortable. Our research suggests that Eastern cultures often view science as a body of knowledge, rather than as a process. As a result, teachers did not understand how lessons could be learned even from unexpected results. We believe that this misconception was clarified to some degree through the use and understanding of the program.

**Teachers were often hesitant to change or add to existing plans or ideas.** Teachers resisted writing conclusions questions for each of the activities, were hesitant to take the lead in creating posters for the science open house, and were unsure of how to use extra class-time after completing the activities. We feel that there may be several factors that contributed to this hesitance, such as feelings of intimidation by or fear of disappointing the team members.

**Our assumptions about teachers' scientific backgrounds were incorrect.** Our team found that many of the teachers at the Kusuman Wittayakhom School did not have the knowledge and skills that we had anticipated. This was specifically evident when using some laboratory equipment such as microscopes.

While our results and evaluations of the program are valid, we recognize that there are limitations to our project. We had limited time for observation. The language barrier also limited our ability to understand how much the students were learning. Despite these limitations, we believe our project was successful in that it met all our criteria and has the potential to be sustained and replicated.

## **The Program Manual**

A Program Manual was constructed in an effort to assure sustainability and replicability. Its contents include the aforementioned science laboratory activities, along with supplementary science materials. It was designed to serve as a stand-alone training guide for teachers such that it contained all of the information a teacher would need to implement the program at any school in rural Thailand.

More specifically, the Program Manual includes teacher instructions and student worksheets for each activity. Student worksheets are framed around the scientific method. They ask students to make hypotheses, fill in data tables, and draw conclusions based on their results. Teacher instructions explain how to prepare for each activity, how to obtain required materials inexpensively, and how to conduct each activity with a class.

Supplementary materials include a description of the scientific method, a guide to using microscopes, and pictures of how common microorganisms look when viewed through a microscope. Instructions for teachers who wish to adapt or create new laboratory activities are also included, along with methods for finding up-to-date scientific information using the internet and other means. These supplementary materials were included to allow teachers of almost any background to be able to implement the program.

Utilization of the Program Manual can act as a training tool for teachers to learn how to construct and conduct hands-on activities. The science teachers that we worked with at the Kusuman Wittayakhom School displayed greater understanding of, and comfort with, experimental science after teacher training and conducting the activities in their classrooms. It is our hope that the Program Manual could act not only as a guide for the implementation of the Program, but also as a tool to instruct teachers on the true nature of experimental science.

While we believe the Program Manual is comprehensive enough to serve as an independent teacher training tool in other rural Thai schools, we must acknowledge a level of

uncertainty as to the sustainability and replicability of the program. Our team designed the manual after extensive literary research and fieldwork; however, there are limitations to our findings. Such limitations include that we tested the program in only one school, our fieldwork was limited to four weeks, and our presence could have had an effect on teacher and student behavior.

## **Recommendations for Program Expansion**

The development and testing of the program and the creation of the Program Manual were only the first phase in a larger educational process. Our team has two recommendations for our sponsor and other groups who wish to expand the program and help achieve the goal of improving science literacy in rural Thailand.

**We recommend that the manual be translated into Thai and distributed to other rural Thai schools.** Following the translation of the program from English into Thai, we recommend that the manual be distributed to other rural schools in Northeast Thailand. First the manual could be distributed only to schools that are similar to Kusuman Wittayakhom School in size, available staff and standardized test scores. If initial distribution is successful, the manual could then be distributed more widely. We also recommend some actions be taken to actively promote the use of the manual. Active distribution would require that personnel visit schools to explain the purpose of the program, demonstrate its use, and field any questions that teachers or administrators might have. Teachers from Kusuman Wittayakhom School could perhaps serve as tutors to teachers in other nearby schools as well, in light of their firsthand experience with the activities.

**We recommend a future visit to the Kusuman Wittayakhom School to evaluate the sustainability of the program.** Representatives from our sponsor or future teams from Worcester Polytechnic Institute (WPI) could evaluate the sustainability of the program by answering a number of questions. Are the activities still being used? Have the activities been modified? Have any new activities been created? How could the program be further improved? Through answering each of these questions, valuable lessons could be learned pertaining to the program, the Program Manual, and other similar programs that may be developed in the future. Further refinements could be made to the program to assure that it is having the desired impact, or perhaps assess what went wrong.

One of our team's hopes is that our project will have a lasting impact on rural Thailand. The activities were designed such that they would be suitable not only for the Kusuman Wittayakhom School, but for any school in rural Thailand. The Program Manual was created so that teachers at any rural school could implement this science laboratory program easily for little cost. With help from our sponsor, we hope that other schools in rural Thailand will be able to implement the program, sustain it, and eventually improve science literacy in their communities.

## **AUTHORSHIP PAGE**

Nicholas Amendolare, Emily Briskey, Jessica LaGoy, Nathan Largesse, and McGhee Orme-Johnson all shared responsibilities for the planning, outlining, and final editing all of major sections. The following is a breakdown of individual writing and editing responsibilities, by chapter. Authors wrote drafts of chapters or made major revisions, editors were responsible for revising content, grammar, and voice.

Abstract:	Author – McGhee Orme-Johnson
Executive Summary:	Authors – Nathan Largesse and McGhee Orme-Johnson Editor – Nicholas Amendolare
Introduction:	Author – Nicholas Amendolare Editor – McGhee Orme-Johnson
Background:	Authors – Nicholas Amendolare, Emily Briskey, Nathan Largesse, and McGhee Orme-Johnson Editor – Jessica LaGoy
Methodology:	Authors – Nicholas Amendolare and McGhee Orme-Johnson Editors – Emily Briskey and Nathan Largesse
Findings:	Authors – Nicholas Amendolare and Nathan Largesse Editor – Emily Briskey
Conclusions:	Author – McGhee Orme-Johnson Editor – Nicholas Amendolare
Recommendations:	Author – Nathan Largesse Editor – Emily Briskey
Program Manual:	Authors – Emily Briskey and Jessica LaGoy Editors – Nathan Largesse and McGhee Orme-Johnson



## TABLE OF CONTENTS

ABSTRACT.....	i
ACKNOWLEDGEMENTS.....	ii
EXECUTIVE SUMMARY.....	iii
AUTHORSHIP PAGE.....	x
INTRODUCTION.....	1
BACKGROUND.....	3
Causes of Rural Poverty.....	3
Education as a Solution to Rural Poverty.....	4
Economy, Environment, and Education in Northeast Thailand.....	6
Education in Northeast Thailand.....	7
Kusuman Wittayakhom School, Sakon Nakhon Province.....	9
Chapter Summary.....	10
METHODOLOGY.....	11
Initial Program Development.....	11
Testing and Refinement.....	12
Assuring Sustainability.....	14
RESULTS AND ANALYSIS.....	15
Development, Testing, and Refinement.....	15
Two Methods of Water Purification.....	15
Exploring Agriculture.....	16
Storing Food Safely.....	16
Tragedy of the Commons.....	17
Evaluation of the Activities Based On Our Criteria.....	17
Criterion #1: Activities Should Be Educationally Valuable.....	18
Criterion #2: Activities Should Be Sustainable and Replicable.....	19
Criterion #3: Activities Should Be Fun and Engaging.....	20
Findings: Teachers Instructing Students.....	21
Findings: Teacher Training.....	22
Assessing the Program’s Impact.....	24
Plan for Sustaining and Transferring the Program.....	25
SUMMARY AND CONCLUSIONS.....	27
Development, Testing, and Refinement.....	27
The Program Manual.....	30
RECOMMENDATIONS.....	32
Recommendations for Expanding Program Implementation.....	32
Recommendations for Further Development of the Program.....	32
Recommendations for Other Students Working in Rural Thailand.....	33
Looking Forward.....	34

REFERENCES .....	35
APPENDIX A: ACTIVITY BOOKS BIBLIOGRAPHY.....	39
APPENDIX B: TEAM OBSERVATIONS DURING CLASSES .....	40
Observation of Classroom 1.21.08 .....	40
Observation of Classroom 1.22.08 .....	40
Observation of Classroom 1.23.08 .....	40
Observation of Classroom 1.24.08 .....	41
APPENDIX C: TEAM OBSERVATIONS DURING TEACHER TRAINING.....	43
Teaching Teachers Agriculture Activity 1.24.08.....	43
Teaching Teachers Water Purification Activity and TOC Activity 1.30.08-1.31.08 .....	44
APPENDIX D: TEAM OBSERVATIONS, ACTIVITIES WITH STUDENTS .....	45
Teachers Leading Food Safety Activity (Session 1) 1.28.08 .....	45
Teachers Leading Food Safety Activity (Session 2) 1.28.08 .....	46
Teachers Leading Agriculture Activity (Session 1) 1.29.08 .....	48
Teachers Leading Agriculture Activity (Session 2) 1.29.08 .....	49
Teachers Leading Water Purification Activity (Session 1) 1.31.08 .....	51
Teachers Leading Water Purification Activity (Session 2) 1.31.08 .....	52
Teachers Leading TOC Activity (Session 1) 2.6.08.....	53
Teachers Leading TOC Activity (Session 2) 2.6.08.....	55
APPENDIX E: TEACHER RESPONSES TO DISTRICT OFFICE SURVEY .....	57
APPENDIX F: PROGRAM MANUAL .....	61

## INTRODUCTION

In September, 2000, at the United Nations' Millennium Summit, eight Millennium Development Goals were formed. These goals, set to be achieved by 2015, addressed worldwide social issues deemed to be of utmost importance. The first goal of the eight was to eliminate extreme poverty and hunger (United Nations, 2000) Poverty is by nature self-perpetuating; those who are affected by it are often unable to escape it (Corcoran et. al, 1985). Rural areas can be particularly vulnerable to poverty as they are typically agrarian and can often be economically isolated. Improving education has been proposed as one possible solution to the poverty crisis. However, in poor regions the resources required to reform the education system are often unavailable.

Northeast Thailand is one region where poverty is a serious issue. It is an isolated agricultural region where roughly 90% of the population works in the agriculture sector (Cherdchuchai and Otsuka 2006). Thailand's economy collapsed in 1997, and since then the northeast, in particular, has struggled economically. Its struggles have been complicated by environmental issues such as drought and soil erosion (Tsubo et. al, 2007). The region's education system struggles to find qualified teachers and sufficient funding for schools, and overall the general population has had a limited education. In Sakon Nakhon, a province in Northeast Thailand, adults (age 15 and over) have attained, on average, only 6.4 years of education (UNESCO, 2005)

The Office of H.R.H. Princess Maha Chakri Sirindhorn's Projects has been working for almost thirty years to improve education in rural schools throughout Thailand. These projects have aimed to improve student nutrition, the quality and availability of education, provide scholarships, and promote environmental awareness, among other goals. According to Princess Sirindhorn's Office, however, the schools in Northeast Thailand still face several specific challenges. Funding for sufficient teaching materials is often unavailable due to budgetary constraints. Teachers are in short supply and are sometimes under qualified. Additionally, Thailand's national curriculum is very rigid, leaving little room for teachers to be inventive or incorporate local indigenous knowledge in their teachings.

Thailand's national curriculum standardizes lecture topics, laboratory activities, and student textbooks. Due to a lack of resources and the preference for traditional East-Asian teaching styles that emphasize rote memorization over hands-on learning, the science laboratory program is very limited (Takemura, 1993). Labs and activities tend to be very simple and do not emphasize independent thinking or creativity (HRHPP, 2008). Research has shown that engaging laboratory activities that directly relate to students' lives can significantly enhance student learning (Bybee, 2005). As a result, Princess Sirindhorn's Office has proposed expanding the laboratory program as a way to improve the region's science literacy.

Our team was commissioned by Princess Sirindhorn's Office to design an engaging, educationally valuable, sustainable science laboratory program at a school in the Kusuman District, Sakon Nakhon, Thailand. This program was to include activities that relate directly to local issues and students' lives and use only inexpensive, locally available materials. After designing and testing these science activities with students and teachers our team created the Program Manual, which detailed each activity and included teacher instructions and student worksheets. We hope that through the work of Princess Sirindhorn's Office our science laboratory program can be adapted and implemented throughout Northeast Thailand, improving science literacy among local students and ultimately in the region as a whole.

## **BACKGROUND**

In a time where roughly 45% of the world's population lives below the poverty line, poverty is an internationally recognized crisis (The World Bank, 2007). Due to its self-perpetuating nature, those who are impoverished often have a very difficult time escaping it. This is particularly true in rural areas. In this chapter, we will discuss rural poverty and introduce science education as one possible solution. We will then introduce the site of our field work, the Sakon Nakhon province in Northeast Thailand, describe the existing education system, and explain what has been done so far to improve education.

### **Causes of Rural Poverty**

Rural poverty is particularly difficult to overcome as the affected areas often do not have access to the resources needed for development.

“The causes of rural poverty are complex and multidimensional. They involve, among other things, culture, climate, gender, markets, and public policy. Likewise, the rural poor are quite diverse both in the problems they face and the possible solutions to these problems” (Khan, 2000).

There is almost always more than one reason for poverty in a region; the causes are typically numerous and interconnected. Some common causes include destructive agricultural practices, an unstable government, and a lack of education. In many rural areas, agriculture plays an immensely important role in the economy. Therefore, the failure of local agriculture can have devastating effects (Rosenzweig, 1988). When survival is an everyday concern, and education is in short supply, agricultural shortcuts are often taken (Cornell, 2007). These shortcuts can help farmers significantly in the short term, but are often very destructive in the long term. One such practice is slash-and-burn agriculture, in which fire is used to quickly and easily clear land for gardens and pastures. This type of agriculture can be ecologically friendly on a small scale when fields are left to lie fallow, so that nutrients can return to the soil. But, in poor, rural areas this often is not the case. In just a few years, soil can become greatly depleted and eroded due to slash-and-burn agricultural practices. This can eventually lead to damaged ecosystems, continually poor crop yields, and prolonged poverty for farmers (Cornell, 2007).

Economic issues, and more specifically a lack of economic development, can also contribute to rural poverty. Involvement in the global economy can be an excellent way for a nation to overcome poverty. Involvement, in the forms of resource procurement, production, and manual labor, all contribute to economic development.

“The pace and level of [global] integration is empirically associated with economic growth, and there are good theoretical reasons to expect integration and growth to be mutually enhancing” (Brahmbhatt & Dadush, 1996).

Remote areas are often marginalized from the global economy. Because they are isolated, many rural areas have a labor force that is too large, and struggle to attract new industries. As a result, they are unable to become involved in the global market.

A lack of education can also contribute to rural poverty. According to the United Nations Educational, Scientific and Cultural Organization, “The role of education in poverty eradication, in close co-operation with other social sectors, is crucial,” (UNESCO, 2001). However, rural areas often have less access to educational resources. Quality schools, established curriculums, and qualified teachers are often difficult to find in poor, rural communities. Additionally, education is not typically valued by rural families. Parents who have never been educated themselves often do not encourage their children to go to school, or they have their children stay at home to help with manual labor. This pattern is cyclical. As a result, communities remain uneducated and community members are not able to obtain higher level jobs. This situation increases the likelihood of destructive economic, environmental, or agricultural decisions (Khan, 2000).

## **Education as a Solution to Rural Poverty**

Improving education in rural areas is challenging, but when solid education programs are backed by sufficient resources the results can be astounding. In 2000, China universalized a nine-year compulsory education program for school-aged children. The program was extensive, implemented in areas throughout urban and rural China, and was backed by significant resources of the Chinese government. Since implementation, children in rural areas have edged closer to the educational level of their peers in urban areas. Moreover, economic growth in rural areas has increased (Zhang, 2006). Researchers agree that improving the education systems in rural areas can be a very effective strategy for overcoming poverty.

In 1997, in the Indian state Madhya Pradesh, the local government implemented a program that legally guarantees “to provide a school within 90 days of any written request from a village-elected council” (Narayan & Glinskaya, 2007). Upon written request, the government will provide the materials and labor necessary to build a local school. With help from local villagers and local teachers, villages across the state have been able to expand their education systems. Schools provided through this program (nearly 27,000 in the first three years) have provided millions of children with access to various educational opportunities that, in all likelihood, they would not have had otherwise. Over 90% of the students enrolled in these

schools are from highly disadvantaged social groups such as lower castes and villages (Narayan & Glinskaya, 2007).

So far, the program has been a success, and the economy of Madhya Pradesh has benefitted as a result. Test scores have improved throughout the region, and economic growth is expanding rapidly. This program was recognized in 1998 as the best International Innovation by the Commonwealth Association for Public Administration and Management (CAPAM) (DARPG, 2007). At this point, the state stands poised for even further advancement into the global economy because of the strong educational background of its people.

Science literacy can be loosely defined as a group's knowledge of basic scientific facts, theories, and methods. Researchers agree that, perhaps more than education in any other subject, science education is critical to alleviating rural poverty due to its broad applications. "Science education imparts a method of inquiry and a systematic way of processing knowledge in the physical world" (Thulstrup, 2007). Some researchers believe that one of the inherent differences between a developed and a developing nation is the technological and scientific infrastructure of a country, which is defined by the quality of its educational system (Bilsel and Oral, 1995). The rural poor often lack basic science literacy, and because of this sometimes make decisions that are damaging to themselves and the community. With an improvement to science literacy, rural people would be able to understand their environment better, and thus how to utilize it sustainably (De la Rosa, 2007). Such knowledge could lead to more effective agricultural practices, and ultimately a better future for rural, agrarian communities.

An important component of science education that is often overlooked is a hands-on laboratory component. Science laboratory activities are typically expensive and therefore not widely used in rural areas. Fortunately, effective and affordable solutions are available. Even in the rural areas where poverty is rampant, recent developments are making affordable education available. Thulstrup, who studied the worth of laboratories in developing countries in 1999, observed the following:

"It has been demonstrated in both developing and industrialized countries that low-cost teaching strategies are feasible as well as effective... The use of standardize sets of hands-on teaching materials for science (science kits) is widespread in the developing world. One of the best known kit-based science education projects in the developing world took effect in Zimbabwe in the early 1980s, shortly after independence, in order to satisfy the needs for hands-on opportunities during a period when the educational system was expanding rapidly."

Zimbabwe was able to improve its science education system by creating the Zim-Sci kit. These kits, which were produced with inexpensive, locally available materials, were made for primary and lower secondary schools. At the cost of just \$30 USD per student, students participated in

hands-on, science laboratory activities throughout their nine years of compulsory education. By avoiding importing from industrialized countries, it was possible to avoid many cost issues while simultaneously helping the local economy and making science feel more familiar, and somewhat less intimidating to students and the community (Thulstrup, 1999).

According to Thulstrup, using labs for secondary education in developing nations is not only feasible, but worth the effort and the cost. By adapting programs from other countries as guidelines, developing countries can tailor programs to their own cultures and economic statuses, so that students can experience learning that has meaning in their lives. Researchers agree that in order for students to achieve the highest level of understanding, science activities and curricula should be relevant to students' daily lives.

“It therefore seems essential that an important goal of science education in a developing non-Western country such as Zimbabwe ought to be the understanding and the critical integration of Western science relative to locally held worldviews” (Shumba, 1999).

To improve science literacy in rural areas, science education programs must include a hands-on laboratory component, be relevant to the lives of students, and be locally feasible.

## **Economy, Environment, and Education in Northeast Thailand**

One country that could benefit from an improvement in science education is Thailand, specifically the northeastern region, which is largely rural, agrarian, and impoverished. Northeast Thailand is the poorest region of the country and has been described as largely “infertile” (U.S. Department of State, n.d.). There are many environmental and economic conditions that inhibit development in the region. Northeast Thailand makes up about one third of Thailand's total population, making its poverty a substantial problem for the country as a whole. As the area is primarily agrarian, environmental strains can lead to economic strains, which can often lead to economic stagnation and poverty. There is also an issue of insufficient education in the region, which contributes to poverty (HRHPP, 2007).

Environmental strains result from both the human impact on the land and natural weather conditions. As the population of the region has grown, so too has its demand for energy. Logging has increased dramatically, which has diminished the forest and caused “severe soil erosion in upland areas and the increased silting of rivers with the associated problem of flooding in lowland areas” (Parnwell, 1988). Additionally, farmers in the region must often contend with a natural environment that is harsh and dry. Northeast Thailand is an area known for experiencing frequent and extensive droughts. “Erratic distribution of rainfall, shallower water reservoir, low water holding capacity of soil and erosion sediment are major causes of drought” (Mongkolsawat et. al, n.d.). Additionally, only 6% of the Northeast's farms utilize irrigation, leaving over 70% of



the farms to rely heavily on rain (Rigg, 1985) (Mongkolsawat et. al, n.d.). For farmers in the northeast, it is almost impossible to plant crops with confidence they will endure in the harsh environment as farmers are left at the mercy of the region's inconsistent weather (Ng, 1970). Droughts also severely impact domestic use of drinking water, which can be detrimental environmentally, economically and socially (Mongkolsawat et. al, n.d.).

While environmental problems can ultimately strain the economy, other factors also have also contributed to the perpetuation of poverty in Northeast Thailand. In 1997, the collapse of the Thailand economy had a devastating effect on the poor. The collapse caused hundreds of thousands of urban Thais to lose their jobs, sending many back to the rural areas from where they came. This migration resulted in a regional labor surplus. When the economy began recovering the Thai industry saw economic growth, but agricultural regions did not. As a direct result, the poverty rate has seen a decline in urban settings, but not in rural ones (Warr, 2002).

The education system in Northeast Thailand is also struggling. In Sakon Nakhon, a province in Northeast Thailand, adults (age 15 and over) have attained, on average, only 6.4 years of education. Nearly half of the province's population, ages 6-24, is not attending school (UNESCO, 2005). This statistic, however, does not seem to be a reflection of the wishes of the general population. Many rural Thai people would prefer office work to manual labor and an agricultural lifestyle (Jongudomkarn, 2006). In Thai culture, farming is considered one of the lowest economic statuses. Some rural Thais recognize that education is an important first step toward advancing one's career. In Jongudomkarn and Camfield's study, a man commented:

“The most regrettable thing in my life was having to stop studying after I finished secondary school. I wish I could have finished high school so that I could apply to study in a police academy. I want to be a policeman. It is a good job. People pay respect to policemen,” (Jongudomkarn, 2006).

Agriculture is also a less reliable source of income than either office or industry work, which are typically more stable in nature (Zhang & Minxia, 2006). However, without adequate education, rural Thais may not have the opportunity to pursue other livelihoods.

## **Education in Northeast Thailand**

Establishing, improving, or simply maintaining an effective education program can be a challenge in any area. Rural, northeast Thailand is no exception. Throughout the region, schools struggle to provide a quality educational experience for students. Thailand instituted a national curriculum, in 1997, for secondary schools across the country (SEAMEO, 2006). However, many rural schools, especially those in poverty-stricken areas, have struggled with adopting the national curriculum. A lack of funding for rural schools and a lack of qualified teachers are two issues at the root of this struggle.

The national curriculum standardized education material for every secondary-school subject. It is a six year program made up of two levels. Level #1 focuses on intellect, ethics, and basic skills with the goal of exposing students to various topics. Some students in Thailand end their education after level #1 and enter the work-force. Level #2 expands the scope of the curriculum to cover language, science, math, social studies, and character development (SEAMEO, 2006). The government produces standardized textbooks for each subject at both levels. The books include lessons, activities, and assignments. Teachers are allowed some leeway in tailoring their classes to fit local needs, and schools are allowed to buy other government-approved textbooks from private suppliers.

Schools require funding to pay for their many expenses. In Thailand, the majority of these funds come from the national government. Since 1994, the government has also provided additional aid for struggling education programs across the country. However, that aid is divided among a number of beneficiaries. Small rural schools make up 34% of the schools in Thailand and, for many of them, government funding is not enough. Funds are required to provide equipment for students and to hire an effective teaching staff. Expensive materials like microscopes and other science equipment are often available in limited quantities or are in a state of disrepair.

Qualified teachers are also in short supply at many rural schools. Rural communities usually produce very few college-educated teachers. As a result, teachers for rural schools must be imported from other parts of the country. This presents a number of problems. First, rural locations can discourage newcomers because they are isolated from mainstream culture (Boharamik, 2004). Second, impoverished rural communities are often unable to pay teachers from other parts of the country. Lastly, when imported teachers are found, they often do not understand the local culture, local lifestyles, and the common livelihoods of the area in which they are teaching. Because of all of this, many rural schools are under-staffed with under-qualified teachers (HRHPP, 2008).

Rural schools often need help to acquire necessary resources because of the many challenges that face rural education. In northeast Thailand, this help comes primarily from The Office of Her Royal Highness Princess Maha Chakri Sirindhorn's Projects (our project's sponsor) and non-government organizations (NGO's). Princess Sirindhorn's Office, a government organization, has been making efforts to help disadvantaged students, including those in rural schools, for more than 25 years. One of the Office's most recent projects has been School-Net. The goal of School-Net was to provide free internet access to every school across the country of Thailand, regardless of environment or distance (Bangkok Post, 2007). Another project, Food for School Lunch, addressed the problem of undernourished students that many rural schools were facing. Each of these projects was highly successful (HRHPP, 2008). NGO's often provide assistance to rural schools as well. Organizations like the Anglo-Thai Foundation provide education help directly to students and the Mueang Volunteers provide resources for

teacher training (About Thailand, n.d.). While many efforts have been made to improve the state of rural schools, many schools still struggle to provide quality education for students.

### **Kusuman Wittayakhom School, Sakon Nakhon Province**

Our team worked at the Kusuman Wittayakhom School, in Kusuman, Sakon Nakhon. This school was chosen by our sponsor to be the site of the program's testing. Kusuman is a small district in the province of Sakon Nakhon about 40 km from Sakon Nakhon city. Many of the residents are of "So" heritage, an ethnic group that migrated to the region from Laos roughly 150 years ago and has its own customs and language. The area is largely agricultural. Most families own livestock or small plots of farmland. A large portion of the land in this area has been deforested; very little of the natural rainforest remains as most of the land has been cleared for farming and grazing. Rainfall in the region is sporadic, but mostly occurs during the rainy season that spans from May to October. The cool season occurs from October to February and the hot season lasts from February until May. The region's soil is typically sandy and dry, making agriculture difficult.

Citizens in Kusuman, like in most of Sakon Nakhon, are generally impoverished. The per-capita, yearly income in Kusuman was projected at \$1,320 USD for 2008, roughly one third of that of the average Thai citizen (Bank of Thailand, 2007). Due to this factor, the education system in Kusuman faces many challenges. Many families live very far from school and cannot afford to provide transportation for their children. Some families cannot afford the uniforms and shoes that their children need for school. Other students stay at home because their help is needed on the family farm.

The Kusuman Wittayakhom School has 1,035 students, ranging from Grade 7 to Grade 12, and 41 teachers. We primarily worked with students in Grade 7, which is divided into six different groups of students. The groups are formed based on students' academic aptitude and ordered sequentially: Group #1 has the most "intelligent" students while Group #6 has the least "intelligent" students. In general, the students do not speak very much English, though English is a component of their curriculum. The school's faculty members are generally college educated, most of them having attended a local college in the region, and speak varying amounts of English. There were three 7th-grade science teachers whom we did most of our work with at the school: Aacaan Ing-On, Aacaan Ning, and Aacaan Noi.

The school has facilities that include chemistry, biology, and physics laboratories, complete with basic science supplies like beakers and microscopes. Class sizes typically vary between 30 and 40 students. The school follows the national science curriculum and uses nationally standardized textbooks. These textbooks contain pre-designated lecture topics for teachers and some simple science activities for students. During our team's initial observation of

classes at the school we observed that classes tend to stress rote memorization. This tendency was consistent with typical Eastern classrooms, which are teacher-centered and stress rote memorization (Gallagher, 2000). We also observed that students would often answer their teacher's questions in unison; students who were unsure of the answers were usually silent. Also, recitation of facts seemed to be emphasized over independent, creative thinking and students seemed to have knowledge of facts and vocabulary, rather than knowledge of scientific concepts or processes. We observed that the hand-on activities from the national textbook did get students engaged on some level, but it was usually difficult to determine exactly how much the students were learning. During interviews with our team, teachers reported that student apathy, restrictive curriculum, and a lack of modern, working laboratory equipment were some of their biggest obstacles.

## **Chapter Summary**

Poverty is an internationally recognized crisis, and science education is just one of many proposed solutions. In countries like Zimbabwe, science education has been shown as an effective way to empower local communities and ultimately to alleviate poverty. In impoverished, agrarian regions, like Sakon Nakhon, the local people lack basic knowledge of science. With the help of our team and our sponsor, we hope that we will ultimately improve science literacy in Sakon Nakhon, and that the lives of local people will be better as a result.

## METHODOLOGY

The goal of our project was to increase science literacy in rural Thailand through the development of an engaging, educationally valuable, sustainable science laboratory program. Our team set three objectives that we would complete in order to accomplish our goal:

1. ***Initial Program Development:*** Develop a sustainable, engaging science laboratory program for seventh grade students for testing in rural Thailand.
2. ***Testing and Refinement:*** Test the program with teachers and students at our host school, record observations, and refine the program to maximize effectiveness.
3. ***Assure Sustainability and Replicability:*** Create a Program Manual, including descriptions of activities, teacher instructions, student worksheets, and supplementary materials, for distribution to other rural, Thai schools.

In this chapter we will discuss and justify the methods used to complete each of our objectives.

### Initial Program Development

Before developing the program, our team determined that having a comprehensive knowledge of existing curriculum and the local economy and environment would be beneficial. Our team researched curriculum standards in Thailand by looking on the internet and speaking with our Thai advisors, Aacaan Siripastr and Aacaan Supuwan, as well as speaking with staff at Chulalongkorn University's Demonstration School. Once we found the national curriculum standards for seventh, eighth and ninth graders, we had a better understanding of students' relative grade levels and the scientific material that those students were learning. Research into the local economy and environment proved to be useful, as we discovered that the area we were working in was largely agrarian and poverty-stricken. Using this information, we sought to create activities that were relevant to students' lives.

Based on our research, our team developed three criteria that an effective science laboratory activity should meet. In order to best achieve our goal of increasing the science literacy of students in the region, each of these three criteria would need to be met by each of the activities:

**Educationally Valuable:** Each activity should teach valuable scientific lessons that are relevant to students' daily lives.

**Sustainable & Replicable:** Each activity should fit within the scope of the national curriculum and use only inexpensive, locally available materials.

**Fun and Engaging:** Each activity should allow students to take part in hands-on learning that is both enjoyable and thought-provoking.

Knowledge of the region's economy and environment helped us to focus the activities on topics that would have relevance to the students' lives. Before arriving in Sakon Nakhon, our team researched a number of activities that met these criteria. This research created a large collection of activities to pull ideas from for the project. By purchasing and reviewing several books containing activities that required only household materials (See Appendix A for specific book information) our team was able to brainstorm ideas for inexpensive activities that would be locally relevant.

Upon meeting with officials from Princess Sirindhorn's Office, especially important topics were suggested to our team. The officials explained to our team that the Office wanted the activities to cover three specific areas that they felt were the most relevant to the region. These three areas were agriculture, food safety and the local environment. The officials said they preferred a focus on one or more of these areas. Agriculture directly reflected the economy of Sakon Nakhon. Food safety is important to a region in which most food is produced and prepared locally, and often in the presence of the children. The local environment simply describes the setting in which the students live.

Using the information received from the officials, our knowledge of Sakon Nakhon, and our three criteria, our team developed four activities. Each of the activities was thought to teach a valuable scientific lesson that would be relevant to students' daily lives, use only inexpensive, locally available materials, and be fun and engaging for students.

## **Testing and Refinement**

Our second objective was to test each activity with teachers and students over the course of four weeks and then refine the program to increase effectiveness. Before testing, though, our team conducted on-site research to achieve a better understanding of the faculty, the students, and the Kusuman Wittayakhom School. Our team informally interviewed five teachers from the science department at the school. This helped our team to identify the curriculum and academic level of the students in the school, as well as the relevance of the proposed activities. By better understanding our host school, we were able to tailor the program more specifically to the school and the region. Our team chose to speak primarily with science teachers, as they were the most knowledgeable about matters that concerned the project. The language barrier significantly limited the effectiveness of our communication; our team was not fluent in Thai, and the teachers were not fluent in English. This obstacle was overcome through the use of translators and the use of visual aids.

To learn more about our host school, our team visited science classes to observe both students and teachers. We determined the specific classes we observed based on teachers'

interest in the program, convenience, and the teachers' English skills. The observation method was a useful method of research because it is a somewhat objective means of understanding the nature of science classes. Our team observed four science classes, sitting in the back of the classroom to minimize distraction, and taking notes in several categories. Those categories included: how often students asked questions, how often the teachers asked the students questions, whether the teacher used visual aids, whether the students took notes, how much textbooks were used, and how engaged students seemed (see Appendix B for our detailed observations). There were a few drawbacks to the observation method. Observation was time consuming and there was the possibility that our own personal biases would influence our discoveries. Also, our presence may have been distracting to the students and teachers to the extent that the results did not accurately portray a normal class. Although these had potential to skew our results, we believe that it was safe to draw some general conclusions from our data.

Our team held training sessions where we taught teachers how to perform and teach each of our laboratory activities. The goal was to give teachers enough experience with each activity to allow them to complete the activities with their classes. On the morning of each training day our team would give the teachers a worksheet on the activity that they were to be trained in that day. In the afternoon, the teachers would be given two hours to complete the activities, following the activity procedure, with assistance from one or two team members. The remaining team members observed (see Appendix C for observations). Once the activity was completed, our team discussed the activity with the teachers. Our team asked questions concerning the appropriateness, relevance, and feasibility of the activity. As with interviewing, our team had to consider that personal biases could affect their answers, along with the nuances of Thai culture. For example, the concept of "saving face" could deter a teacher from criticizing the activities. This training method was effective, yet time consuming. Each training session required that team members prepare materials and instructions, observe the session, and debrief the teachers. Also, some of the activities' results were not evident for several weeks, delaying activity analysis with teachers."

Upon completion of the preliminary testing with the teachers, the teachers taught each of the activities to their classes. Each activity was taught to two different classes. During the activity our team members were divided into three groups: primary assistants, secondary assistants and observers. Two primary assistants helped the teacher run the lab, while the secondary assistants walked around the classroom to help the students if needed. Assistance was minimized, as the activities were designed to be taught by a single teacher. However, at times our team members stepped in to make sure that the activity would run smoothly and be completed correctly. One observer sat out of the way, recording observations in predetermined categories (see Appendix D for detailed observations). The categories included:

- Did students ask the teacher questions?
- Did the teacher ask the students questions?

- Were the students engaged?
- Did the teacher help the students?
- Did our team members help the students?
- Did the team members help the teachers?
- Did the students make mistakes?
- Did the teacher make mistakes?

During the refinement phase, our team made use of these observations to modify our activity and thereby increase their effectiveness. The activities were also modified so that they would easily fit within the scope of the national curriculum. One concern was that modifying our activity based on observations that were specific to our host school would affect whether the program be easily replicable at other rural schools. Our team kept this concern in mind throughout the refinement process.

## **Assuring Sustainability**

In order to assure that the program would be sustainable and replicable our team created the Program Manual. The manual was to be a stand-alone training tool. It was designed to include all of the information that a teacher would need to implement the program in any rural, Thai school. To accomplish this, our team determined that the manual must not only contain the laboratory activities themselves but also any supplementary information that a teacher may need to implement or expand upon the program. The manual was to be translated into Thai and distributed to other rural schools by Princess Sirindhorn's Office.

To introduce the program to the community and transfer some ownership of the program to local teachers, our team held an open house to which students, teachers, parents, and local community members were invited. Through research, we had determined that transferring ownership of the program was an important part of ensuring the program's sustainability. An open house was a simple way to accomplish this. During the open house, students displayed what they had learned in class with posters, and there were fun science activities for everyone's participation. Some of the activities were interactive and gave the participants a hands-on experience, while others were competitive and had prizes for the winners. There were also scientific demonstrations that explained some basic science concepts.

Through our methods of both preliminary research and on-site interviews and observations, our team sought a better understanding of our host school and the local community. Throughout our project's three phases: initial program development, testing and refinement, and assuring sustainability and replicability, our team used this understanding to increase the effectiveness of the program. Our team was able to complete each of our objectives, throughout our project's three phases. Our results and findings, and their respective limitations will be discussed in subsequent chapters.



## RESULTS AND ANALYSIS

In this chapter we will discuss the development, testing, and refinement of our science laboratory program, review the lessons learned through the testing process, and give an overview of our efforts to assure sustainability through the creation of a Program Manual. In general, we believe the program was successful, as the activities met the aforementioned criteria. However, we recognize that this evaluation has limitations. We were only able to assess the short-term success or failure of the program. Long-term success, meaning sustainability and replicability, as well as long-term effectiveness, can only be gauged in the future. Despite the limitations of our evaluations, and because the program was developed through sound research, our team is confident that the program could have a lasting, positive impact on rural Thailand.

### Development, Testing, and Refinement

Based on our research and the recommendations of our sponsor, the Office of Her Royal Highness Princess Maha Chakri Sirindhorn's Projects, our team developed a prototype science laboratory program before beginning field work. The program included four science laboratory activities that were designed to satisfy the criteria for a successful activity outlined in our Methodology. The four activities were: *Two Methods of Water Purification*, *Exploring Agriculture*, *Storing Food Safely*, and *Tragedy of the Commons*. Our team designed the first three activities. The fourth activity was adapted from a common American science activity (Environmental Literacy Council, 2007). A fifth activity, *An Ecology Treasure Hunt*, was eliminated before testing due to time constraints and difficulties we experienced when communicating the activity to teachers. The activities will be described in further detail in the following chapter. Procedures, teacher instructions and student worksheets can be found in Appendix F.

#### *Two Methods of Water Purification*

In this activity students learned about two methods of water purification: boiling and filtering. The students used both methods to purify each of three different types of water: pond water, tap water, and distilled water. Also included was a control of each water variety that remained unpurified. Students were asked to hypothesize which water samples were safe to drink. Following detailed procedures, students gathered filtered and boiled samples of each type of water and added a sterile amplifier (sugar) to promote the growth of organisms. After the samples were prepared, students monitored the growth of organisms in



each sample with microscopes. Students learned that filtering was effective in removing large particles from water, but did not remove microorganisms. Students also learned that boiling effectively killed microorganisms, but left behind particles that made the water look discolored. The purpose of this activity was to make students conscious of the cleanliness of the water they consume. It also served to instruct students on methods of sterilizing unclean water.

### Exploring Agriculture

During this activity, students learned about the effects of fertilizers and pollutants on plant growth. Students tested the effects of industrial fertilizer (20-20-0 fertilizer) and natural fertilizer (manure) as well as two different pollutants (acidic lime juice to simulate acid rain and common dish soap). Following detailed procedures, students planted fast-growing seeds (mung bean seeds) in planting trays. Each fertilizer and pollutant was added to a different group of seeds. A control group, without any additives, was also created. Students were asked to determine which plants they thought would grow to be the healthiest. Over the course of several weeks, students monitored the growth of each group of plants. The goal of this activity was to reinforce the scientific method while teaching the students about the effects of their actions on the environment.



### Storing Food Safely

Students learned about different methods of food storage in this activity. Following detailed procedures, students stored both meat and fruit in three different locations: a cool and dry place, a warm and moist place, and a warm and dry place. Students recorded their initial observations of the meat and fruit (appearance, smell, texture etc.) using microscopes and their naked eye. They were asked to hypothesize which method of food storage they believed would keep meat and fruit freshest. Observation was continued over the next three days as the food spoiled. Students learned that moisture and warmth promoted the growth of bacteria, fungus, and other organisms. Students also learned that fruit and meat both spoiled at different rates and with different consequences. The purpose of this activity was to make students aware that proper food storage is necessary in preventing the growth of organisms that may cause them harm.



### Tragedy of the Commons

In 1968, Garrett Hardin coined the phrase “Tragedy of the Commons,” which explains the human tendency to value one’s immediate needs over long-term needs and the welfare of a community. He used the analogy of New England commons areas (public areas for grazing livestock) explaining that over-grazing could result from this “Tragedy of the Commons” mentality. In this activity, students played a game that taught them firsthand about this tendency and some methods that can be used to overcome it. Students divided into groups; each group was the owner of a small community pond that was stocked with pretend fish (candy). Students took turns fishing each day, with the knowledge that fish are needed to survive (students must eat two fish every night in order to survive until the next morning). Most groups struggled to survive, usually fishing their ponds to extinction, unaware of exactly how overfishing could affect the reproduction of the fish. Eventually, elements of communication, education, and teamwork, three strategies for overcoming the “Tragedy of the Commons” mentality, were introduced and students worked towards a sustainable living strategy. The purpose of this activity was to provide students with the tools to interact sustainably with the environment and their community.



While the content of each activity consisted of topics of local importance, our purpose in all of the activities was also to teach students how to think critically, hypothesize, and be creative when analyzing problems. By following the scientific method, the students were asked to propose their “best guess” as to what might occur given a list of conditions. Students were introduced to the concepts that no hypothesis is necessarily wrong, and that it is acceptable for the results to be unexpected, as that is the nature of experimental science. This emphasis was intended to teach students not only the specific lessons in each activity, but the overarching concepts of experimentation and the scientific method.

### **Evaluation of the Activities Based On Our Criteria**

After testing the activities with both students and teachers, our team evaluated the success of each activity using the criteria outlined in our Methodology. The three criteria stated that each activity should be: educationally valuable, sustainable and replicable, and fun and engaging. In general, through our team’s observations and discussions with teachers, we found that the activities met each of the established criteria to varying degrees.

### Criterion #1: Activities Should Be Educationally Valuable

In order for a science laboratory activity to be educationally valuable, it must teach worthwhile scientific lessons to students. These lessons could include facts, analytical skills, the scientific method, and more. As described in our background, when teaching science in rural areas, researchers agree that lessons should be relevant to students' daily lives to facilitate better understanding and to make science seem less foreign. The Sakon Nakhon Province is the poorest province of Thailand and is predominantly agrarian. *Storing Food Safely* and *Two Methods of Water Purification* apply to basic health concerns. We believed that these concerns would be very applicable to this region, as we observed that not all families have access to clean water and proper means of food storage. *Exploring Agriculture* and *Tragedy of the Commons* discussed how human interactions with the environment can affect not only an individual's livelihood, but also that of the community. Therefore, the educational value of these activities is determined by the ability of the lessons to be applied to everyday life. Our team observed students learning actively, answering discussion questions from teachers, and thoughtfully forming hypotheses and conclusions. Due to our status as foreign observers, however, our team had to rely on feedback from teachers to help in evaluating the educational value of the activities. During testing and after testing, teachers expressed enthusiasm about the topics of the activities, saying that they were pleased by the relevance of the activities and the inclusion of the scientific method. In a written evaluation, teachers expressed that they were pleased with the practical and applicable lessons their students were learning. Also in their written evaluation, teachers rated the knowledge and practical skills that the activities provided as "Good<sup>1</sup>".

*Exploring Agriculture* taught students lessons in biology and earth science. Students were able to form educated hypotheses about the effects of the fertilizers and pollutants. Teachers were particularly enthusiastic about the practical application of this activity, telling us that most students' parents were farmers, and that the students help farm at home as well. *Two Methods of Water Purification* taught students about how bacteria and other organisms grow in water. Students observed organisms using microscopes, and learned about the effects of boiling and filtering. By the end of the activity, students were able to draw correct conclusions about which samples of water would be safe for drinking and which would not. In *Storing Food Safely*, students were also able to observe the growth of microorganisms with microscopes, this time on pieces of meat and fruit. During this activity, both students and teachers were surprised to learn that some small amount of bacteria was presented even on refrigerated pieces of meat. After witnessing their surprise, one of our team members responded, "That's why we cook meat before we eat it!" After testing *Tragedy of the Commons*, teachers commented that they thought the activity taught a very educationally valuable lesson on sustainability and resource management. Teachers were able to explain how the concepts related to environmental issues like overfishing, over-forestry, and pollution.

---

<sup>1</sup> The written evaluation, found in Appendix E, applies to our research team as well as another five person research team that was developing English activities in the Kusuman District



Criterion #2: Activities Should Be Sustainable and Replicable

An important part of our team’s goal was to design a science laboratory program that would be sustainable in a location once introduced and could be easily transferrable to other rural schools. In order to assure that the activities were sustainable and replicable, we developed activities that required only inexpensive, locally available materials. Materials required for each activity included: plastic containers, soil and fertilizers, fruit and meat, and candy. For a comprehensive list of materials and estimated costs for a class of about 40 students, see Table 1 below. More expensive equipment like microscopes and hot-plates were always optional in activity procedures and low-cost alternatives for all materials were included wherever possible.



*Table 1 - Approximate Cost of Each Activity*

	Materials Required	Estimated Cost (does not include equipment)
<i>Two Methods of Water Purification</i>	45 small containers, pond water, tap water, distilled water, sugar, 15 pieces of filtration paper, 3 funnels, hot plate, 3 glass beakers, tongs	160 Baht (approx. \$4.85USD) Small containers can be made from used water bottles, clean cloth can be used as filtration paper, funnels can be fashioned from used water bottles, and pots and a stove top can replace a hot plate, glass beakers and tongs.
<i>Exploring Agriculture</i>	Plant trays, seeds, dish soap, lime juice, industrial fertilizer, natural fertilizer, tap water, soil	240 Baht (approx. \$7.25 USD) Plant trays can be made from used water bottles, manure can be used as natural fertilizer, and outside soil can be used for this activity.
<i>Storing Food Safely</i>	5 pieces of raw meat, 5 pieces of fruit, 30 sealable plastic bags, 5 magnifying glasses	200 Baht (approx. \$6.05 USD)
<i>Tragedy of the Commons</i>	9 ponds, 180 pieces of small candy	50 Baht (approx. \$1.50 USD) Ponds can be made entirely from household materials.

Additionally, the activities dealt with topics that were part of the national curriculum, so that the program could be integrated easily as part of schools’ existing science programs. The activities were designed to fit within two specific sections of the national curriculum: *Living Things and Their Environment* and *Life and Its Basic Functions*. When asked about whether the

activities could be integrated into the existing science education program at our host schools, teachers responded that they believed it could be done easily.

### Criterion #3: Activities Should Be Fun and Engaging

Researchers agree that students learn more when they are actively engaged by educational activities (Thulstrup, 1999). Therefore, making fun, exciting activities for students was a vital part of our mission. Generally, all four of the activities proved interesting and thought-provoking for the students. Our team observed students smiling, laughing, actively using laboratory materials, discussing the activity enthusiastically, and forming hypotheses and conclusions. Students also demonstrated care in conducting the activities correctly and were focused. Teachers expressed that students were active in their learning during activity periods and, in a written evaluation, rated student involvement in the activities as “excellent”<sup>2</sup>. Through our observations with support from teachers, we believe the activities were very effective in stimulating interest in the students.

While levels of engagement were moderate to high for all activities, of the four activities *Two Methods of Water Purification* appeared to be the least interesting to the students. We speculate that this was due to the ordinary nature of the materials involved. *Storing Food Safely* was also less stimulating when compared to the other three activities, as students struggled in their first experience using microscopes. Both *Exploring Agriculture* and *Tragedy of the Commons* interested students. *Exploring Agriculture* engaged the students on a number of levels. Students enjoyed having a constructive project of their own and working with their hands. In *Tragedy of the Commons*, students enjoyed competing in a classroom game and remained interested in its lesson.

### Limitations of Our Evaluations

It was extremely difficult for our group to draw conclusions about the effectiveness of the activities for a few reasons. First, due to the language barrier, it was difficult to determine how much and exactly what the students were learning. This impediment made it difficult to assess educational value in particular. To overcome the language barrier, our group relied on discussions with the teachers. However, in light of cultural differences and perhaps their desire to “tell us what we want to hear” our team could not be sure how honest the teachers were being with us. Our group used our own observations, in addition to feedback from teachers, to draw conclusions.

Another limitation was that our host school owned microscopes, which were used in *Two Methods of Water Purification* and *Storing Food Safely*. When these two activities are transferred to other schools, they can be conducted without the use of microscopes, however, we are unsure how the lack of this equipment will affect the level of student engagement and

---

<sup>2</sup> The written evaluation, found in Appendix E, applies to our research team as well as another five person research team that was developing English activities in the Kusuman District

learning. In spite of these limitations, our team is confident that the activities were fun and engaging, educationally valuable, and sustainable and replicable. Admittedly, the precise degree to which each of these criteria was met is unknown.

## Findings: Teachers Instructing Students

Teachers conducted the four activities with their respective classes with some help from other science teachers at the Kusuman Wittayakhom School. WPI students observed and assisted to varying degrees, depending on the difficulty of the activity. Through working with the teachers and observation during the activities, we made a number of findings. These findings affected our refinement of the activities, as well as the content we chose to include in the Program Manual.

**Students appeared to be engaged by hands-on activities.** In general, students looked very focused and enthusiastic during the activities. This finding was confirmed by our background research relating to teaching methods that used hands-on activities. We observed students smiling, working in teams, and participating in focused discussion. The science teachers of the Kusuman Wittayakhom School agreed that the activities stimulated interest in the students. In a written evaluation of the program, teachers described the “active learning” in the activities as “excellent”<sup>3</sup>.

**Students responded positively to visual learning aids.** In our worksheets, beginning with *Storing Food Safely*, we provided space for the students to draw pictures of important qualitative data from the lab. In addition to this, we provided illustrations as supplements to lab procedures in *Two Methods of Water Purification* and *Tragedy of the Commons*. Although we cannot comment on advanced understanding, we observed that including visual aids as part of procedures and data collection methods helped clarify objectives and goals for students. To facilitate better understanding, the student worksheets in our Program Manual contained numerous prompts for student illustrations. Diagrams and pictures were also included in procedures wherever possible.

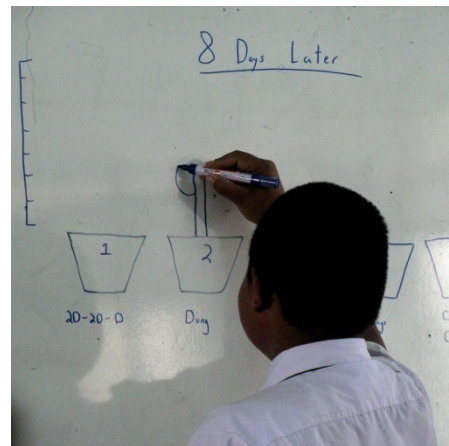

**Students were often hesitant to seek help when struggling with an activity.** During both lecture and lab-work, we observed that students infrequently raised their hands or asked for help. When learning how to use microscopes during *Storing Food Safely*, the most common strategy was trial and error; students rarely sought out instructions from teachers. This trend was evident throughout the rest of the activities as well. Accordingly, we did our best to anticipate

<sup>3</sup> The written evaluation, found in Appendix E, applies to our research team as well as another five person research team that was developing English activities in the Kusuman District

student difficulties and questions, and include preemptive solutions in our instructions to teachers. Also, in the Program Manual, we addressed potential difficulties that might be encountered in each of our four activities. We included a discussion on the importance of monitoring student lab groups for struggles and failures in the manual.

**Some students did not participate in activities when groups were too large.** As discussed in our background, researchers agree that group-size must be considered carefully when designing a classroom activity; students need to have enough work to keep them engaged while also not being overwhelmed. We observed during *Two Methods of Water Purification* that work in each group was mostly completed by one to three students, leaving the remaining three to five students with nothing to do. Although several of these idle students carefully watched or found ways to help, some students simply sat patiently until the lab period had finished. In our teacher training program, we have suggested that groups be as small as possible, based on available materials and the number of instructors. We have also designed a method for dividing lab procedures among individual group members to help focus students and give them individual responsibilities.

**Students benefited from guidance while reaching higher level conclusions.** Student worksheets were initially designed with open-ended conclusion sections. Before activities with students began, teachers requested that we add more specific questions to this section in an effort to guide the students to the proper lessons to be learned. Our observations support the teachers' belief that such structure would benefit the students, as students often struggled to answer open-ended questions. We provided questions for all four activities, and after each activity was completed, the teacher called on students individually to describe their answers to the guide the conclusions of the class.

## Findings: Teacher Training

Working with the teachers at the Kusuman Wittayakhom School, we had to overcome a number of challenges during the teacher training process. Throughout our efforts, a number of findings were made that guided the training process. These findings influenced not only the creation of the program, but also our creation of the Program Manual, a tool that will be used to train teachers in the future.

**Teachers often viewed science as factual rather than experimental.** When an activity did not proceed as planned, teachers often became uncomfortable. *Exploring Agriculture* produced some surprising results during the first trial with students. The orange juice that was initially used as an acidic pollutant contained a significant amount of sugar. As a result, the plants contaminated with this “pollutant” actually grew taller than the control group. This surprising result, understandably, made the teachers uneasy. However, when we tried to make clear to them that surprising results are often part of the scientific process, they were confused. Our research suggests that Eastern cultures often view science as a body of knowledge, rather



than as a process. This view may have been a contributing factor to the teachers' discomfort. Research by Bybee in 2005 implied that it is important that students understand the experimental nature of science work in addition to the body of knowledge that surrounds it. The Program Manual provides a description the scientific method as well as additional insight into the nature of experimental science to promote this lesson.

**Teachers were often hesitant to change, add to, or enhance existing plans or ideas.** In many instances, when our group encouraged teachers to assume creative roles, teachers were hesitant. They were hesitant to help write conclusions questions for each of the activities, hesitant to take the lead in creating posters for the science open house, and were unsure of how to use extra class-time after completing the activities. There are several factors that probably contributed to this hesitance. The teachers may have been intimidated by our position as American university students, and been hesitant to make suggestions for fear of sounding unintelligent. Cultural differences, like inexperience with producing creative works, may have played a role as well. We accounted for this tendency when creating the Program Manual, making sure to not rely too heavily on teachers' creativity. We have also included some material that could guide teachers toward enhancing existing activities or creating their own, if they wish.

**Visual aids were an effective way to overcome the language barrier.** Throughout our training of the teachers, we found that using pictures and diagrams helped clarify important concepts. Beginning with an illustrative breakdown of the procedure of *Storing Food Safely*, we found that pictures could demonstrate procedures quickly and clearly. We continued to use illustrations in the remaining teacher training sessions and in classroom sessions with students. Pictures were used extensively during *Tragedy of the Commons* to help explain some of the more complicated rules of the game. Because visual aids were so effective, our team used them extensively in our Program Manual.

**Our assumptions about teachers' scientific backgrounds were not always accurate.** Our team found that many of the teachers at the Kusuman Wittayakhom School did not have the scientific knowledge or skills that we expected. During *Storing Food Safely*, teachers struggled to use microscopes and were unsure what bacteria looked like. During *Exploring Agriculture*, teachers were unsure why sugar promoted plant growth and dish soap did not. After we found that our initial assumptions were incorrect, we were able to adjust the program accordingly, to include more detailed explanations of the activities and more guidance to teachers. The Program Manual was also adjusted; a microscope guide was included for both teachers and students as well pictures of what bacteria and other microorganisms look like when viewed through a microscope.

### Limitations of Our Findings

Several limitations affect the validity of our observations and the findings they helped produce. First, most of our interactions with teachers and students involved only those at the Kusuman Wittayakhom School. Therefore, we are unsure whether our findings can be applied to other rural Thai schools. We believe that our conclusions are still valid, however, as our

assumption that the Kusuman Wittayakhom School is representative of other rural schools was reinforced by Princess Sirindhorn's Office.

Time was another factor that affected the quality and reliability of our observations and findings. One must consider that our teacher-training took place during five, two-hour sessions over a two week period. Also, our time observing teachers leading the activities with their classes was limited to eight, 100-minute sessions over a two-week period. Although we can assume teachers and students do not change dramatically from week to week, our team does recognize that it is dangerous to draw conclusions based on such a brief period of observation.

Lastly, our presence could have had an effect on teacher and student behavior. Teachers may have acted unnaturally in an attempt to please our team. Also, students may have been affected by our presence. Students may have been distracted by us, or more apt to pay attention because of the presence of extra authority figures. Even with all of these limitations taken into account, however, our team is confident that our findings are valid due to the evidence from our research, from the teachers, and from our own observations.

## **Assessing the Program's Impact**

When we arrived at the Kusuman Wittayakhom School, we found that the seventh grade science class already conducted the National Curriculum's laboratory activities. According to our sponsor, the existing science laboratory program was inadequate because the activities were not relevant to students' lives and were not grounded in the scientific method. Team members observed one such activity, and found a lack of specific process. The students did not hypothesize before beginning the activity and were not given a procedure to follow. Students recorded observations, but were not asked to draw conclusions or analyze results. Additionally, the activity's topic, chromatography, was never related to real-world applications.

The program's activities were designed to follow the scientific method. Our goal was to increase science literacy through encouraging creative thinking and analysis and providing an understanding of the nature of experimental science. While it is very difficult to conclude if the students gained this insight, we are confident that they have at least been introduced to it. It is our hope that, through the sustainment of the program, the students will gain a basic understanding of the scientific method.

By the end of our work at the Kusuman Wittayakhom School, we observed several key changes in the teachers that, we believe, were indicative of the program's impact. During our initial training with teachers, they were overtly hesitant to lead the activities. After the first activity, *Two Methods of Water Purification*, was finished early, teachers did not know how to fill the rest of the class period. In this instance, a group member led the students in a class hypothesis exercise. This same problem arose during the *Exploring Agriculture* activity. Throughout our four weeks of field work, our team recognized that teachers were becoming

more comfortable with adapting activities and initiating unstructured activity discussion. After the *Tragedy of the Commons* procedure had been completed, one teacher independently initiated a concluding discussion with the students that connecting the activity's lesson to real-world environmental issues. Before the Science Open House, team members assembled several demonstrations to engage the public. During the Open House, the teachers, unasked, assumed the responsibilities of leading the demonstrations as well as providing explanations. These observations are by no means proof that the program will have long-term success. We acknowledge that evaluating the program's success is impossible at these early stages of its implementation, however, we firmly believe that, with our sponsor's help, it has the potential to have a lasting impact on science education in rural schools throughout Thailand.

## **Plan for Sustaining and Transferring the Program**

In addition to developing the science laboratory program, our team devised a plan for transferring the program to other rural schools while sustaining the program at existing schools. To accomplish this, our team created a Program Manual (see Appendix F) that included four science laboratory activities with both teacher and student instructions, as well as supplementary materials to aid teachers in implementing the program. The manual, written in English to be later translated into Thai, was designed to be entirely self-sufficient, containing all of the information that teachers would need to implement the program at any rural Thai school. The manual includes four components: an Introduction, teacher instructions for each activity, student worksheets for each activity, and Supplementary Materials section.

### *Introduction:*

The manual begins with a discussion of the sponsor, the Office of Her Royal Highness Princess Maha Chakri Sirindhorn's Projects, followed by important notes about the program and a brief introduction to the program's authors. Finally, details about the Kusuman Wittayakhom School are also mentioned to provide the reader with context. The purpose of this section is to prepare the reader for the coming sections.

### *Student Worksheets:*

Student worksheets for each of the four activities contain everything that the students need to know about each activity. An introduction is provided for each activity that briefly describes what areas of knowledge and life the activity deals with, what the activity entails, and what is to be learned. A hypothesis section contains questions or diagrams that extract from students their "best guess" on what the activity's results will be. Materials and Procedure sections describe the specific experimental aspects of the activity to the students. Data tables or picture boxes are then provided for quantitative and qualitative data. Finally, each worksheet ends with a conclusion section that has questions specific to the lab that guide students toward

the lesson that is to be learned. The student worksheets provide students with information about the activity in addition to interactive components to keep students focused.

### *Teacher Instructions:*

The manual also contains teacher instructions for each of the four activities. The instructions include all of the content in the student worksheets with additional information for teachers. The additional material includes instructions on activity preparation and a more expansive introduction that is to be read or explained to the students. The materials section gives instructions on where to find required materials and low-cost alternatives to materials. Discussion questions for the class are also included to prepare students for answering their written conclusion questions. There are also suggestions for visual aids, diagrams and illustrations, which can be used to help explanations. Finally, expected results for each activity, common problems that teachers may encounter, and instructions on how to connect each activity to the real world are included. Instructions are very detailed, so as to accommodate teachers with varying degrees of science literacy and expertise.

### *Supplementary Materials:*

The supplementary materials provided in the manual include much of the information that team members communicated to teachers at the Kusuman Wittayakhom School in written form as well as other helpful materials. A description of the scientific method, a guide to using microscopes and a guide to identifying microorganisms provide important background knowledge that the activities may require. Instructions on how to adapt and develop one's own science laboratory activities are included, in addition to instructions on how to obtain up-to-date scientific knowledge using the internet and other resources. These instructions were added to the manual with the hope that teachers will expand upon their use of hands-on activities after successfully completing the four activities included in the program. Finally, the manual has recommendations for how to implement the science laboratory program, including teaching strategies, difficulties teachers may encounter during activities, and ways to involve students' families and the local community in the science program.

### *The Role of the Program Manual:*

When our team left Sakon Nakhon, our hope was that our project would have a lasting impact on the area. We designed the Program Manual to accomplish exactly that. The activities were refined so that they would be suitable not only for the Kusuman Wittayakhom School, but for any school in the region. We hope that other schools in the area will be able to successfully implement the program, sustain it, and, as a result, improve science literacy in their communities.

## SUMMARY AND CONCLUSIONS

The goal of our project was to increase science literacy in rural Thailand through the development of an engaging, educationally valuable, and sustainable science laboratory program. In this chapter, we will give a brief review of our projects results. First we will discuss how the program was developed, tested and refined, key findings that guided the development of the program, and our strategy for enabling sustainability and replicability through the creation of a Program Manual. In general, we found the program to be successful, as it was fun and engaging for students, educationally valuable, and easily sustainable and replicable.

### Development, Testing, and Refinement

Based on our research and the recommendations of our sponsor, our team developed three criteria for a successful laboratory activity. Activities should be:

**Educationally Valuable:** Each activity should teach valuable scientific lessons that are relevant to students' daily lives.

**Sustainable & Replicable:** Each activity should fit within the scope of the national curriculum and use only inexpensive, locally available materials.

**Fun and Engaging:** Each activity should allow students to take part in hands-on learning that is both enjoyable and thought-provoking.

We used these criteria first to assist in designing the science activities to be included in the program and later to evaluate the success of each of the four activities. Our four activities are described briefly below.

#### Two Methods of Water Purification

In this activity, students learned about two methods of water purification: boiling and filtering. The students used both methods to purify each of three different types of water: pond water, tap water, and distilled water. Students learned that filtering was effective in removing large particles from water, but did not remove microorganisms, whereas boiling did kill the microorganisms.

#### Exploring Agriculture

Students planted seeds in soil and observed how various fertilizers and pollutants affected plant growth. They learned about the negative effects of two pollutants, lime juice and dish soap, and the positive effects of two fertilizers, manure and industrial fertilizer.

### Storing Food Safely

Students stored both meat and fruit in three different locations: a cool, dry place, a warm, dry place, and a warm, moist place. After observing the resulting growth of bacteria and other microorganisms students learned that moisture and warmth promoted the growth of bacteria.

### Tragedy of the Commons

Students played a simulated fishing game in groups of four or five that taught them about sustainability and resource management. The groups used communication, education, and teamwork to develop sustainable fishing strategies.

Each of the activities was tested with science teachers and their 7<sup>th</sup> grade classes at the Kusuman Wittayakhom School in rural Thailand. After testing, activities were refined based on our team's observations. The refined activities were then compiled in a Program Manual that included teacher instructions, student worksheets, and supplementary materials.

## **Results and Findings**

After the testing process, our team evaluated the success of each activity based on our established criteria. In general, through our team's observations and discussions with teachers, we found that the activities met each of the established criteria to varying degrees.

### Criterion #1: Activities Should Be Educationally Valuable

Throughout the testing process, our team observed students learning actively, answering discussion questions from teachers, and thoughtfully forming thoughtful hypotheses and conclusions. However, because of our status as foreign observers our team used feedback from teachers, in addition to our observations, to evaluate the educational value of the activities. Teachers expressed enthusiasm about the topics of the activities, saying that they were pleased by the relevance of the activities and the inclusion of the scientific method. *Exploring Agriculture* taught students lessons in biology and earth science that were particularly practical because of the agrarian nature of the community. In *Two Methods of Water Purification* and *Storing Food Safely* students were able to observe the growth of microorganisms, and learned how their decisions could affect whether food and water were safe to consume. After testing *Tragedy of the Commons*, teachers commented that they thought the activity taught a very educationally valuable lesson on sustainability and resource management. Teachers were excited to explain how the concepts related to environmental issues like overfishing, over-forestry, and pollution.

### Criterion #2: Activities Should Be Sustainable and Replicable

In order to assure that the activities were sustainable for our school and able to be transferred to other rural schools, the activities were designed to require only inexpensive, locally available materials. Required materials included: plastic containers, soil and fertilizer, fruit and meat, and candy. Also, the activities covered topics within the scope of the national curriculum so that they could be easily integrated into schools' existing science programs.

### Criterion #3: Activities Should Be Fun and Engaging

Throughout testing, our team observed students smiling, laughing, actively using laboratory materials, discussing the activity enthusiastically, and forming hypotheses and conclusions. Students also demonstrated care in conducting the activities correctly and showed exceptional focus. Teachers expressed that students enjoyed each of the activities to varying degrees. *Two Methods of Water Purification* and *Storing Food Safely* appeared to be the least interesting to the students, perhaps due to the ordinary nature of the materials involved. In *Exploring Agriculture* students enjoyed working with their hands on a creative project, and in *Tragedy of the Commons* students enjoyed competing in a classroom game and that taught an interesting lesson.

In addition to observing whether the activities met our criteria, our team made some observations about student behavior and communication with teachers. Through these observations, our team was able to extract key findings that guided the development of the program and ultimately the Program Manual.

**Students appeared to be engaged by hands-on activities.** This finding confirmed our background research relating to teaching methods that used hands-on activities. We observed students smiling, working in teams, and participating in focused discussion. The science teachers of the Kusuman Wittayakhom School agreed that the activities stimulated interest in the students.

**Students were often hesitant to seek help when struggling with an activity.** During both lecture and lab-work, we observed that students infrequently raised their hands or asked for help, even when struggling. Students often used a trial-and-error approach instead.

**Some students did not participate in activities when groups were too large.** While most students participated actively in activities, some students did not. Researchers agree that group-size must be considered carefully when designing a classroom activity; students need to have enough work to keep them engaged while also not being overwhelmed.

**Students benefited from guidance while reaching higher-level conclusions.** Initially suggested by the teachers, we observed that students did not struggle with making conclusions

when provided with guiding conclusion-questions. Students were usually not capable of reaching higher-level conclusions on their own.

**Visual aids were an effective way to overcome the language barrier.** Throughout our training of the teachers, we found that the use of pictures and diagrams helped clarify important concepts. Visual aids were also provided for students during some classroom activities.

**Teachers often viewed science as factual rather than experimental.** When an activity did not proceed as planned, teachers often became uncomfortable. Our research suggests that Eastern cultures often view science as a body of knowledge, rather than as a process. As a result, teachers did not understand how lessons could be learned even from unexpected results.

**Teachers were often hesitant to change or add to existing plans or ideas.** Teachers resisted writing conclusions questions for each of the activities, were hesitant to take the lead in creating posters for the science open house, and were unsure of how to use extra class-time after completing the activities. There are several factors that probably contributed to this hesitance.

**Our assumptions about teachers' scientific backgrounds were incorrect.** Our team found that many of the teachers at the Kusuman Wittayakhom School did not have the knowledge and skills that we expected. This was specifically evident when using laboratory equipment.

## **The Program Manual**

Through research, our team determined that in order for the program to have a widespread, lasting impact on the region, it needed to be easily sustainable and replicable. To accomplish this, we packaged the program in the Program Manual, a comprehensive manual containing all of the information a teacher would need to implement the program, including teacher instructions, student works sheets, and supplementary materials.

Student worksheets contained everything a student would need to know about each activity: an introduction that briefly explains the activity's topic, a hypothesis section that allowed students to make their "best guess" about results, materials and procedures for the students to read and follow, data tables for the students to fill in, and detailed conclusions questions that guided students toward the lesson of the activity. The teacher instructions contained all the components of the student worksheets, along with some additional components. The teachers' materials section offered instructions on how to obtain required materials inexpensively. The teachers' section also included class discussion questions that teachers could use to help students reach appropriate conclusions, as well visual aids that could be used during activities. The section also detailed the expected results of each activity, potential problems that could arise in the classroom and some solutions, and instructions on how to connect each activity's lesson to real-world issues.



In addition to student worksheets and the teacher instructions, our team chose to include supplementary materials that would be useful for teachers who were implementing the program. Among these was a description of the scientific method, a guide to using microscopes, and photographs of bacteria and other microorganisms viewed through a microscope. Instructions for teachers who wish to create or adapt their own laboratory activities were included as well. Finally, the manual contains recommendations on how implement the program, including teaching strategies and ways to involve students' families and the local community.

## RECOMMENDATIONS

The development, testing, and completion of the program were only part of the first phase in a much larger process. To accomplish the goal of improving science literacy throughout rural Thailand, our team has a few recommendations. Our first set of recommendations deals with steps that should be taken to implement the program in other schools in rural Thailand. Our second set of recommendations concerns the expansion or further development of the program. The last set of recommendations is for other students working in rural Thailand.

### Recommendations for Expanding Program Implementation

Our team has two recommendations for our sponsor regarding steps that should be taken to implement the program throughout rural Thailand:

**We recommend that the manual be translated from English to Thai.** We believe that this translation will make the manual much easier to understand as many rural science teachers have limited experience with the English language. Additionally, translation will provide an added level of comfort for both students and teachers whose native language is Thai.

**We recommend that the Program Manual be distributed to other rural Thai schools.** This distribution could be done in two stages. First, the manual would be distributed to schools similar to the Kusuman Wittayakhom School, in respect to size, available staff, and standardized test scores. Because our program was developed at one specific school, similar schools would be most likely to adopt our program successfully. If these schools do adopt our program, distribution could then be expanded to include other, less similar rural schools. Additionally, some endorsement or instruction from Princess Sirindhorn's Office could encourage rural schools to make serious efforts toward implementing the program. A peer tutoring program could also be developed to further aid program expansion. The teachers that our team worked with at the Kusuman Wittayakhom School would be excellent candidates due to their intimate knowledge of the program and its activities.

### Recommendations for Further Development of the Program

Our team has three additional recommendations for our sponsor, future WPI teams, or other groups who wish to develop the program further:

**We recommend a future visit to the Kusuman Wittayakhom School to evaluate the program's successful sustainment.** Representatives from Princess Sirindhorn's Office or a

future WPI team should revisit the Kusuman Wittayakhom School one or more years later to assess the sustainment of the program and answer some of the following questions: Are the activities still being used? Have the activities been modified? Have any new activities been implemented? Has the science literacy of students increased? These questions could be answered easily through future observation at the Kusuman Wittayakhom School along with assessment of changes in students' standardized test scores. Answering these questions and refining the program appropriately could help further assure sustainability.

**We recommend that the program's replicability and effectiveness be evaluated at other rural schools.** The Program Manual was designed to be a stand-alone tool that would contain all of the information teachers would need to implement the program at any school in rural Thailand. However, teachers at the Kusuman Wittayakhom School already had intimate knowledge of the activities before receiving the manual. To evaluate whether the manual is truly effective as a stand-alone tool one would need to test the manual with teachers at other rural schools. After testing, the manual could be refined based on feedback from these teachers. Additionally, pre- and post-tests could be given to students and teachers to assess the educational value of the program. Students' tests would be given before and after the students completed each activity and would measure how much the students learned about the topics in each activity. Teachers' tests would be given at the beginning and end of each academic year to assess the extent to which teachers had incorporated hands-on teaching methods into their lessons.

**We recommend that teachers be trained to adapt or develop new laboratory activities on their own.** Training teachers to develop new, relevant science laboratory activities for their students could vastly improve science education in rural Thailand. Doing so would expand hands-on science laboratory education well beyond the four activities that our team developed. Students would be exposed to a wide variety of laboratory activities that could be tailored to their local communities. One way to accomplish this would be to utilize the supplementary materials provided in the Program Manual and expand it. By creating templates for laboratory activities and including open-ended laboratory activities, teachers could build the confidence and skills necessary to adapt or develop their own laboratory activities.

## **Recommendations for Other Students Working in Rural Thailand**

During our time at the Kusuman Wittayakhom School, our team learned several lessons regarding preliminary communication, working with teachers and students, and gathering data. Through our successes and failures, our team had several realizations about things that we wished we had done differently. Based on these realizations, our team has three specific recommendations for other students who will be working to improve education in rural Thailand.

**Before beginning field work, we recommend that students communicate extensively with both their project sponsor and host school.** Clarifying objectives with all parties involved

and giving each party adequate time to prepare will be greatly appreciated. Communicating should also allow students to develop a detailed plan of action that will allow them to work efficiently and effectively after arrival in the field.

**We recommend that students should develop a close relationship with teachers and students.** Not only will this lead to a more enjoyable, positive working experience but it will also allow students to work more effectively. Getting to know teachers and students requires time, and the sooner students can accomplish this, the more teachers will be inclined to participate and provide input. We recommend that students be sure that that they are approachable and that teachers are comfortable expressing doubt, worry, or uncertainty. Having open lines of communication will pay great dividends throughout work.

**We recommend that students gather qualitative and quantitative data throughout field work.** Although data collection can be a challenge when faced with a number of other seemingly more pressing needs, it is vital. It is impossible to collect data about a project's success after fieldwork has been completed, and data is very important for supporting project conclusions and recommendations. We recommend that students make use of observation, interviewing, and surveying to gather as much data as possible during fieldwork.

## **Looking Forward**

Our goal was to improve science literacy in rural Thailand through the development of a hands-on science laboratory program. Our team worked for five months to produce a program that contained educationally valuable, sustainable, engaging activities for students. During our time at the Kusuman Wittayakhom School, our team observed very real results. It may take a decade for the effect of our work to be visible in national test scores. In fact, the results might never be visible. But this would not mean that our project failed. We saw children standing in front of their classmates, smiling widely as they shared their experiment results. We saw teachers standing proudly as they connected simple classroom activities to real-world environmental issues. For us, this was enough. Our team would like to thank our sponsor, the Office of Her Royal Highness Princess Maha Chakri Sirindhorn's Projects, for providing us with an unforgettable project experience. We will carry memories of Kusuman with us forever.

## REFERENCES

- About Thailand. (n.d.). Retrieved February 6, 2008, from About Thailand:  
<http://www.aboutthailand.info/social.asp>
- Asian Development Bank. (2005). Poverty in the Phillipines: Income, Assets and Access.
- Bangkok Post*. (2007). Retrieved February 2, 2008, from [www.bangkokpost.com](http://www.bangkokpost.com)
- Bank of Thailand*. (2007). Retrieved February 6, 2008, from  
[http://www.bot.or.th/bothomepage/dataBank/RegionEcon/n\\_east/econne/text/english/structure\\_ea.htm](http://www.bot.or.th/bothomepage/dataBank/RegionEcon/n_east/econne/text/english/structure_ea.htm)
- Bartle, P. (n.d.). *Factors of Poverty: The Big Five*. Retrieved November 5, 2007, from Seattle Community Network: <http://www.scn.org/cmp/modules/emp-pov.htm>
- Bilsel, A., & Oral, O. (1995). Role of Education, Science and Technology in Developing Countries. *Frontiers in Education Conference* .
- Boharamik, D. A. (2004, August). Education Cooperation in Asia. (T. a. Asia, Interviewer)
- Brahmbhatt, M., & Dadush, U. (1996, September). Disparities in Global Integration. *Finance & Development* .
- Bybee, R. W. (2005). *Science Curriculum Reform in the United States*. Retrieved February 6, 2008, from National Academy of Sciences: <http://www.nas.edu/rise/backg3a.htm>
- Cherdchuchai, Supattra and Otsuka, Keijiyo.(2006) *Rural Income Dynamics and Poverty Reduction in Thai Villages from 1987 to 2004*. *Agricultural Economics*, vol. 35, Issue s3, pages 409-423
- Corcoran, Duncan, Gurin, Gurin. (1985) *Myth and Reality: The Causes and Persistence of Poverty*, *Journal of Policy Analysis and Management*. Association for Public Policy Analysis and Management. Published by [John Wiley & Sons](http://www.johnwiley.com)
- Cornell, J. (2007, January 31). *Slash and Burn*. Retrieved February 4, 2008, from Encyclopedia of Earth: [http://www.eoearth.org/article/Slash\\_and\\_burn](http://www.eoearth.org/article/Slash_and_burn)
- DARPG. (2007, August 23). *About Us*. Retrieved November 5, 2007, from Department of Administrative Reforms and Public Grievances of India: <http://darpg.nic.in/arpg-website/aboutus/internationalexchangeoperation.asp>
- De la Rosa, C. (2000). *Improving Science Literacy and Conservation in Developing Countries*. Retrieved February 6, 2008, from American Institute of Biological Sciences: [www.actionbioscience.org/newfrontiers/delarosa.html](http://www.actionbioscience.org/newfrontiers/delarosa.html)

Gallagher, J. (2000). Journal article by James J. Gallagher; *School Science and Mathematics*, vol. 100, 2000. *School Science and Mathematics*, 100.

Grusky, D. B. (2005). *Poverty and Inequality : Essays by Amartya Sen, Martha C. Nussbaum, François Bourguignon, William J. Wilson, Douglas S. Massey, and Martha A. Fineman* . Stanford University Press.

Her Royal Highness Princess Maha Chakri Sirindhorn. (2004). *Education of The Disadvantaged. Education of The Disadvantaged: A Lecture* . Bangkok, Thailand: UNESCO Asia and Pacific Bureau for Education.

Jongudomkarn, D. (2006). Exploring the Quality of Life of People in Northeastern and Southern Thailand. *Social Indicators Research* , 489-529.

Khan, M.H., 2000. Rural poverty in developing countries. *Finance and Development* 37 (4), 26–29.

Mitsuru Tsubo, Shu Fukai, Jayampathi Basnayake, To Phuc Tuong, Bas Bouman and Dome Harnpichitvitaya (2007) . “Effects of Soil Clay Content on Water Balance and Productivity in Rainfed Lowland Rice Ecosystem in Northeast Thailand”. *Plant Production Science*, Vol. 10, pp.232-241.

Mongkolsawat et. al, T. P. (n.d.). *An Evaluation of Drought Risk Area in Northeast Thailand using Remotely Sensed Data and GIS*. Retrieved February 6, 2008, from GISdevelopment.net: <http://www.gisdevelopment.net/aars/acrs/2000/ts5/env004pf.htm>

Muyeed, A. (1982). Some Reflections on Education for Rural Development. *International Review of Education* .

(n.d.). Retrieved November 5, 2007, from Fundaschool: <http://www.fundaschool.org/faq.html#quality>

Narayan, D., & Glinskaya, E. (2007). *Ending Poverty in South Asia: Ideas That Work*. Washington, D.C.: The World Bank.

Ng, R. C. (1970). Some Land-Use Problems of North-east Thailand. *Modern Asian Studies* , 23-42.

Office of H.R.H. Princess Maha Chakri Sirindhorn. (2008). Personal Communication, January 11, 2008.

Parnwell, M. J. (1988). Rural Poverty, Development and the Environment: The Case of Northeast Thailand. *Journal of Biogeography* , 199-208.

Perry, G. E. (2006). *Poverty Reduction and Growth: Virtuous and Vicious Cycles*. Washington, D.C.: The World Bank.

Rosenzweig, M. R. (1988). Risk, Implicit Contracts and the Family in Rural Areas of Low-Income Countries. *The Economic Journal* , Vol. 98 (393), 1148-1170.

SEAMEO. (2006, September 1). *Thailand*. Retrieved February 6, 2008, from SEAMEO - Southeast Asia Ministers of Education:  
[http://www.seameo.org/index.php?option=com\\_content&task=view&id=68&Itemid=91](http://www.seameo.org/index.php?option=com_content&task=view&id=68&Itemid=91)

Shah, A. (2007, September 23). *Causes of Poverty*. Retrieved November 5, 2007, from Global Issues: <http://www.globalissues.org/TradeRelated/Poverty.asp>

Shumba, O. (1999). Relationship between secondary science teachers' orientation to traditional culture and beliefs concerning science instructional ideology. *Journal of Research in Science Teaching*, 36(3), 333Y354: <http://www3.interscience.wiley.com/cgi-bin/fulltext/55000083/PDFSTART>

Takemura, S., & Shimizu, K. (1993). Goals and strategies for science teaching as perceived by elementary school teachers in japan and the united states. *Peabody Journal of Education*, 68(4, Japanese Teacher Education, Part 2), 23-33. <http://links.jstor.org/sici?sici=0161-956X%28199322%2968%3A4%3C23%3AGASFST%3E2.0.CO%3B2-O>

The Office of Her Royal Highness Princess Maha Chakri Sirindhorn's Projects. (2003). Her Royal Highness Princess Maha Chakri Sirindhorn's Development Work In Remote Areas. Bangkok, Thailand: The Office of Her Royal Highness Princess Maha Chakri Sirindhorn's Projects.

The World Bank. (2007). *Poverty - Overview*. Retrieved November 5, 2007, from The World Bank Web site:  
<http://web.worldbank.org/WBSITE/EXTERNAL/TOPICS/EXTPOVERTY/0,,contentMDK:20153855~menuPK:373757~pagePK:148956~piPK:216618~theSitePK:336992,00.html>

Thulstrup, E. W. (1999). *School Laboratories in Developing Countries: Are They Worth the Effort and Expense?* Retrieved from  
<http://ieeexplore.ieee.org/Xplore/login.jsp?url=/iel2/3500/10344/00483223.pdf>

United Nations. (2000, September 8). *55/2. United Nations Millenium Declaration*. Retrieved November 5, 2007, from United Nations Millenium Declarations Web site:  
<http://www.un.org/millennium/declaration/ares552e.htm>

U.S. Department of State. (n.d.). *Thailand Economy*. Retrieved February 6, 2008, from Factover.com; <http://www.state.gov>:  
[http://www.factover.com/economy/Thailand\\_economy.html](http://www.factover.com/economy/Thailand_economy.html)

UNESCO. (2001). *International Workshop on Education and Poverty Eradication Kampala, Uganda, 30 July to 3 August 2001*. Retrieved November 5, 2007, from UNESCO News Web site: <http://www.unesco.org/education/poverty/news.shtml>

UNESCO. (2005). *Northeast Thailand*. Retrieved February 6, 2008, from United Nations Economic and Social Commission for Asia and the Pacific: <http://intranet.unescap.org/esid/psis/population/database/thailanddata/northeast/SakonNakhon.html>

UNESCAP, (2000). Sakon Nakhon. Retrieved February 1, 2008, from UNESCP website: <http://intranet.unescap.org/esid/psis/population/database/thailanddata/northeast/SakonNakhon.htm>

Warr, P. G. (2002). Poverty, Inequality, and Economic Growth: The Case of Thailand. *Journal of Asian and African Studies* , 113.

Zhang, T., & Minxia, Z. (2006). Universalizing Nine-Year Compulsory Education for Poverty Reduction in Rural China. *International Review of Education* , 261.



## **APPENDIX A: ACTIVITY BOOKS BIBLIOGRAPHY**

Churchill, R. E., Loeshnig, L. V., & Madell, M. (1997). *365 Simple Science Experiments With Everyday Materials*. Sterling Publishing Company, Inc.

Churchill, R. E., Loeshnig, L. V., & Madell, M. (1997). *730 Easy Science Experiments: With Everyday Materials*. Tess Press.

Vancleave, J. P. (1991). *Janice Vancleave's Earth Science for Every Kid: 101 Easy Experiments That Really Work*. John Wiley & Sons, Inc.

Vancleave, J. P. (1989). *Janice Vancleave's Biology for Every Kid: 101 Easy Experiments That Really Work*. John Wiley & Sons, Inc.

## **APPENDIX B: TEAM OBSERVATIONS DURING CLASSES**

### **Observation of Classroom 1.21.08**

Science Class Grade 7, taught by Aacaan Ing-On, 33 students

- Students always answer in unison; no individual responses
- Students are engaged in activity about chromatography
- Activity is from textbook
- Students seem talkative, but it doesn't seem to bother the teacher

### **Observation of Classroom 1.22.08**

Science Class Grade 7, taught by Aacaan Ing-On, 34 students

- Worksheet has no pictures
- Students recite answers
- Students take lot of notes
- Students much less talkative than in lab the day before
- The lesson seemed too advanced for the grade level (specific heat was the topic?)
- Kelvin scale on the board was incorrect. Unsure if this was due to teacher writing error, teacher knowledge error, textbook error, or other.

### **Observation of Classroom 1.23.08**

Science Class Grade 7, taught by Aacaan Ing-On

Do students ask questions?

- No questions asked by students.

Does the teacher ask questions?

- The teacher asked 22 questions throughout the class, all questions were directed to the class as a whole to answer.

Does the teacher use visual stimulus?

- The teacher showed the students all of the materials, and demonstrated procedure. Also, the teacher used the whiteboard.

How engaged are the students?

- The students pay attention to the lecturing, and all actively participate in the experiment.

- Generally students looked bored or distracted

Do the students follow along in a text?

- No

Do the students take notes?

- 3 students take notes during lecture. Almost to all of the students record experiment observations and take notes on the lab.

After ten minutes of lecture, the students get the materials for activity. Each table (5-7 students) forms one group.

The teacher compared two groups' results in front of the class. One was obviously wrong.

Students are given time to write in their notebooks, they then turn them in to the teacher.

One student stands in front of the class (chosen by the teacher) and reads from her notebook. Many of the students are talking while she reads. Five students in total go to the front of the class and read. Note: The students are reading their observations after all of the notebooks have been collected (possibly to avoid students changing information in their notebooks?)

### **Observation of Classroom 1.24.08**

Science Class Grade 7, taught by Aacaan Pai, 36 students

Does the teacher ask questions?

- The teacher asked 7 questions throughout the class, questions are directed to the whole class, small groups of students answer together

Does the teacher use visual stimulus?

- Yes. The teacher has a large, colorful poster board with pictures and charts
- Note: Another teacher, Bah, told us during this observation that Pai had prepared this lesson knowing that we would be observing it. This could have impacted her use of visual stimulus.

Do the students follow along in a text?

- About half of the students follow along in textbook

After short lecture, students break into groups and write their thoughts on global warming. One member of each group reads these in front of the class.

Students frequently talk amongst themselves during lecture.

Teacher said that the students in this class have problems (unclear as to whether she is referring to the class as a whole or some students in the class). They have lower I.Q.'s as well as behavioral problems. Many of them live with their grandparents. The teacher said that activities are hard to do because there is not enough equipment and it is often broken. She said that she sometimes tries to take the children to use the internet – the students can start up the computers, but cannot do any more with it (“cannot even shut it down.”). Most students are too poor to own a computer. The teachers said that one of her students just walks into class and sleeps. She said that he typically cannot answer her questions, but when he does he is very proud.

During the course of the individual students reading group thoughts in front of the class, three times a student raised his/her hand and asked a question to the student reading.

The atmosphere is causal; there is conversation between students and between the teacher and students, quite a bit of laughing.

## **APPENDIX C: TEAM OBSERVATIONS DURING TEACHER TRAINING**

### Teaching Teachers Water Purification Activity 1.22.08

- when team members ask “what?”, the teachers often don’t realize that we didn’t understand, and will continue talking
- pictures are very effective
- written handouts for individuals work well
- teachers take quite a bit of time to discuss amongst themselves
- not sure what it means when the teachers are silent – unhappy, confused, bored?
- Teachers asked lots of questions
- Filtering and Boiling took a significant amount of time
- Next time, need to remember: beakers for boiling water, tongs
- Maybe have kids do worksheet during lab?
- Pictures = Good
- Grid = Excellent
- Get really dirty water
- Maybe next time just have teachers do lab, we help?

From discussion with teachers:

- acid rain is not a problem here (there is a very small amount, and minimally impacts the environment or economy)
- there are not any significant pollutants
- the soil here is rocky
- the teachers would like us to use a lot of pictures and make the experiments fun

### **Teaching Teachers Agriculture Activity 1.24.08**

- The teachers are not intimidated by trying. They are engaged.
- There was a tremendous improvement in understanding today because we gave the teacher the experiment to read ahead of time.
- Aacaan Ing-On is actually doing the experiment, everyone else is watching and participating in a supportive role.
- Teachers are comfortable asking questions to the team members and offering alternate suggestions.
- The teachers are much more engaged and interested, I think because all of the materials are set out and labeled already.

- Teachers suggested to us that we moisturize the water, soak the seeds for 24 hours ahead of time, sift the soil, and buy better seeds that will grow faster. Aacaan Ling offered to buy these seeds for us.
- The teachers request that we write in the exact volume of water that needs to be added to the plants every day, as well as a conclusion worksheet component.
- Teachers suggest that we use lemon juice rather than orange juice.
- Aacaan Pai would like to do this experiment with her class in week 3, and plant each seed outside for that experiment.
- Teachers asked many questions
- Mostly Ing-On conducting the activity, other teacher are just watching
- More exact weights?
- Soap → 1 spoonful
- Idea: Have students make predictions about what will happen

### **Teaching Teachers Water Purification Activity and TOC<sup>4</sup> Activity 1.30.08-1.31.08**

- The teachers did not receive the write-up ahead of time (but have seen the water purification experiment done last week).
- The teachers seem a little bored
- Teachers are having a difficult time understanding the conclusion questions.
- The TOC experiment went well, it was a lot of fun for both teachers and team members
- All the teachers worked together
- For manual – if funnels not available, used cut up plastic bottle
- Water purification does not seem to be the most interesting lab to the teachers
- Boiling water – let kids do it?
- Teachers talk a lot amongst themselves
- Teachers will boil water for all the kids
- For TOC, teachers understand most of the activity, but are having trouble understanding the reproduction part
- I think they were unsure what to talk about once given communication – they didn't seem to make a strategy
- Some of the teachers seem initially confused
- Still confused about how reproduction works
- Teachers will tell students to be honest, not to restock pond
- They seemed to understand the “just take two” strategy by the end of the activity, hopefully students will understand it too

---

<sup>4</sup>“TOC” represents the Tragedy of the Commons activity

## **APPENDIX D: TEAM OBSERVATIONS, ACTIVITIES WITH STUDENTS**

### **Teachers Leading Food Safety Activity (Session 1) 1.28.08**

#### Students Questions:

- Student don't seek help, they just keep trying new methods (using microscopes).

#### Teacher Questions:

- All questions asked to whole class and students answer in unison. Teacher helps with those answers that the class struggles with.

#### Teacher Repeating Instruction:

- Everything that the teacher explained about the microscopes before the start of the lab has to be repeated a number of times DURING the lab to each group individually.

#### Teacher Helping Groups:

- When activities are in English, activity instructions require extra time.
- Teacher holds a basic demonstration before lab on how to use microscope.
- Aacaan Ing-On "helped" one group by basically doing it for them.
- Teachers return to groups that need help after WPI students have helped and visa versa.

#### WPI Helping Groups:

- Team members help distribute food samples
- Nick, McGhee and Jess help groups with microscopes because teachers cannot keep up.
- Team members help students to make and focus the slides. Try to show the kids how to do it.

#### WPI Helping Teachers:

- Team members set up the all of the activity materials before lab period
- Team members help explain parts of the handout (English) to teachers
- Team members identified a microscope that wasn't working. Later, it would be found it only needed adjustment.
- Team members help with cleanup and transition to next period

#### Group Mistakes:

- Teachers need LOTS of guidance with microscopes
- Students drew wrong pictures in wrong windows on handout (which is in English) – for example, students drew pictures of meat in the windows designated for samples under the microscope.
- Students are learning about microscopes by trial and error instead of correct procedures.

#### Teacher Mistakes:

- Misunderstood pictures on handout and explained it incorrectly to students. This was corrected later in the lab period.

#### Comments:

- Almost all science teachers present
- 6 groups, 6 teachers
- One student looked at a handout through a microscope
- Aacaan Sassy took pictures of lab and students, as opposed to helping groups
- Range of skill levels and confidence among students and groups
- Kids love the microscopes once they ARE focused
- Teacher drew pictures on the board to help explain to students
- No smiles from students during 15 minute introduction lecture to lab
- Teacher went through ENTIRE handout during introduction before lab even started.
- As soon as intro finish, kids can touch materials, they are smiling and chatting
- This was the first time students had used microscopes
- Typically, any worksheets the students use are in Thai, not English
- Some students seemed really excited
- Teachers think they would like to start giving students handout night before

### **Teachers Leading Food Safety Activity (Session 2) 1.28.08**

#### Students Questions:

- Students still don't ask for help, they utilize the trial and error method

#### Teacher Questions:

- All questions directed to class as a whole, answered by class as a whole

#### Teacher Helping Groups:



- 2 Teachers participate during introduction to lab
- Shortage of teachers when giving out supplies to groups
- Teachers leave groups before the problem is resolved. Maybe giving hints? Doesn't seem effective. Students still struggle.
- Eventually teachers just focus microscopes for kids

#### Student Engagement:

- Students immediately smile when lab actually starts.
- This class is much more focused and scientific with microscope use. Their attempts to figure it out are a lot more methodological.

#### WPI Helping Groups:

- Nick helped the center group, and then Jess helped the same group. Both of these were before a teacher could try themselves. Context: groups were being neglected because shortage of teachers.

#### WPI Helping Teachers:

- Emily helped distribute materials at start of lab

#### Group Mistakes:

- Students and teachers still experiencing a lot of problems with microscopes!
- Students ARE drawing pictures in the CORRECT windows this time.
- Problems with microscopes have to do with setup mostly.

#### Comments:

- 6 Groups, 4 teachers
- 6 students per group
- More use of visuals during introduction by teachers
- Some students take notes onto their handout during introduction lecture
- Much more hands-on demonstration on correct microscope use during INTRO than in last class
- The misadjusted microscope (that was a source of problems in the first class) was not replaced in between lab periods
- Students are not so much learning how to use microscopes as simply being introduced to microscopes.
- Kids need less help with the handout
- Kids love the microscopes once they are focused

- Glass slide was dropped when bags taken out of basket – perhaps find a safer place to transport slides.
- Aacaan Sassy explained to students how to set up microscope
- Maybe we should include a microscope diagram in the manual
- Aacaan Pai able to troubleshoot microscope problems, but teachers without microscope knowledge cannot help
- Some students will sit back unless told to participate
- Some students are copying each other

For the afternoon session, 3 groups use apples, 3 groups use watermelon. We brought one bag of each fruit to the experiment, and told the teacher that the students could choose what fruit they wanted. The teacher was not comfortable with the idea, and told each group what fruit to use.

Aacaan Ing-On showed the class two of the boxes from the morning's experiment as part of the experiment explanation

The lab was completed in an hour.

## **Teachers Leading Agriculture Activity (Session 1) 1.29.08**

Teacher Questions:

- A lot of teacher interaction with students during INTRO to lab. More than last 2 labs periods.

Teacher Helping Groups:

- Much less teacher assistance needed now that no microscopes are used
- Teachers actually standing idle, waiting for students to have difficulty

Student Engagement:

- 90% of them happy and interested

WPI Helping Groups:

- Absolutely no need

WPI Helping Teachers:

- WPI ERROR – we used wet dirt and left watering in the instructions

Group Mistakes:

- Groups were given a number of spoons, one for each pollutant/fertilizer. Immediately students grab ALL the spoons and use for scooping dirt.

- Amount of soil in each cup is very inconsistent

Teacher Mistakes:

- Using old version of worksheet. Incorrect amounts of pollutants/fertilizers. Also, watering instructions inconsistency error.
- Some students clearly excluded from their groups. These students remain idle while rest of group conducts lab.

Comments:

- 10 groups of 3-4
- Aacaan Sassy taught
- Very short (10 min) intro
- 1 Thai handout per group
- Dirty spoons contaminate all pollutants/fertilizers
- 1 in 8 kids being idle during activity
- Students are VERY NEAT and clean messes as they happen
- Add paper towels to materials
- Almost too easy for 1 student to do the entire lab
- WPI ERROR – we forgot to bring trays to reduce mess
- All groups finished entire lab within 5 minutes of one another
- 3 or 4 teachers conducting the activity, they are constantly in and out of the room
- Students seem to never ask questions
- Aacaan Pai said that the students do this (referring to the experiment procedures) at home and that they enjoy it.
- Very little teacher aid is needed.

## **Teachers Leading Agriculture Activity (Session 2) 1.29.08**

Students Questions:

- No need, students understand it all

Teacher Questions:

- Teacher called individual students (two) to the white board to explain responses on handout

Teacher Helping Groups:

- Teachers mostly just observing and occasionally offering groups hints or information

#### Student Engagement:

- Students are excited!

#### WPI Helping Groups:

- Nick made hypothesis diagram on the board and had kids come up and try to generate hypotheses

#### WPI Helping Teachers:

- Entire lab finished in one 50 minute time block, WPI team helps to fill rest of class time

#### Group Mistakes:

- FIX: students use hands for dirt, not spoons. Much better. A little messier
- In general, activity is messier than this morning. Teacher may not have emphasized cleanliness as much.
- Many groups contaminated the orange juice with dirt!!!

#### Teacher Mistakes:

- Exact measurements not followed by students, and therefore not enforced by teachers.

#### Comments:

- Fixed watering instruction inconsistencies and no longer need trays
- One Thai worksheet per group, every student receives a handout in English
- Slightly longer and more complete intro lecture than session #1. About 15 minutes
- Two groups per table. Sometimes groups work together. Definitely talk between one another.
- Only 2 science teachers present consistently
- Teacher comments to Jess that the students are comfortable with this because it is familiar from home
- Groups look at other groups to see how they're doing it
- Hands very messy. Maybe suggest hand washing after dirt step
- Aacaan Sassy conducted this activity mostly on her own
- Aacaan Sassy use one table (center table) as example for rest of class

- Students communicate well together
- Girls seem more in control, boys just dive into activity
- Common dynamic – one person reads, everyone else does/observes
- Change 3cm to 1.5 cm
- Labs went very quickly – try to do it in one period
- Aacaan Sassy had students draw what they think will happen
- Student predicts orange juice will make it grow the best

## **Teachers Leading Water Purification Activity (Session 1) 1.31.08**

### Teacher Questions:

- The only question asked by teachers during intro to class is “OK?” And then the students started.
- After lab, Aacaan Sassy ask debrief questions to class
- Used show of hands to show trends in the class

### Student Engagement:

- Students loved looking at the pond water
- Students show TEAMWORK! One student hold filter, one student pour
- Students are impatient with the filters
- Students smell pond water
- Whole class has fun when a student is called to the front

### WPI Helping Groups:

- Team members help with collecting and distributing boiled water

### WPI Helping Teachers:

- Team members set up hypothesis diagram on the board for teacher
- Team members provide ideas of what to do to fill class time

### Group Mistakes:

- GOOD: most mistake caught because so many kids in each group
- Aacaan Sassy catches most mistakes before they happen

### Teacher Mistakes:

- Hot plate was off for about 10 minutes.
- Activity started late
- Teachers had difficulty filling last 20 min of class

Comments:

- Aacaan Pai led this activity
- Procedure and placemat were translated into Thai
- Short introduction lecture, 8 minutes
- No visuals in intro
- Jess helped clarify how to make filter into funnel
- Only Aacaan Pai and Aacaan Sassy are present for this activity
- Difficult to include all students in the lab
- Entire lab only takes about 15 to 20 minutes
- Students work together on data tables
- 36 students
- During hypothesis activity, one girl figured out the cleaning effect of boiling. Class impressed

### **Teachers Leading Water Purification Activity (Session 2) 1.31.08**

Teacher Questions:

- Teachers ask for hypothesis input from students

Teacher Helping Groups:

- Team members guide teachers in the right direction, very minimal though
- Team members catch a couple mistakes before they happen
- Team members boiled water for groups

Student Engagement:

- Even students who aren't directly participating are interacting. They are watching, interested.

Comments:

- Show how to fold filters during introduction this time
- The worksheets and placemats are in Thai again.
- There is a 5 minute introduction.
- Students point and use pictures on tables. Visuals obviously help clarify procedures.
- One group actually discussed the lab before beginning.
- Aacaan Pai taught. She is a little more serious, but still fun
- Pretty quiet and well behaved class

- Pace of this session is slower than last, there are not hands everywhere and in all directions
- SUGGESTION: add shaking up the pond water before pouring it to procedures
- Entire lab complete in 25 minutes
- Boiling water was explained/clarified to class, as well as why students can't do it themselves
- More talking from teachers in this session than last
- General comment: No raised hands. Ever.
- Teachers put hypothesis on board again. Aacaan Pai pointed out that one student was wrong and made him think about it and revise his decision in front of the whole class.

### **Teachers Leading TOC<sup>5</sup> Activity (Session 1) 2.6.08**

#### Teacher Questions:

- After game, students answer questions in front of entire class. Students were picked by teacher.

#### Teacher Helping Groups:

- Teachers are only giving instructions. NO ENFORCING of rules.

#### Student Engagement:

- LOVE IT!
- Definitely use visuals to remind students of rules
- Even by the end of the game, students are still focused and interested.

#### WPI Helping Groups:

- All four students help out. Direct kids during “daytime” fishing. Keep them from cheating or making mistakes.

#### WPI Helping Teachers:

- 3 WPI help during nighttime candy re-fills. Nick works directly with Aacaan Ing in conducting the game.

#### Group Mistakes:

- Two kids fish in the same pond.

---

<sup>5</sup> Tragedy of the Commons

- Order numbers are put back on the wrong tables. This is fixed quickly
- When their pond is empty, the kids reach for another group's pond. Fixed pretty quickly.

#### Teacher Mistakes:

- Teachers gave out handouts to students before lab. Don't know how much details were on the handouts (could ruin game).
- In the case of two groups, too much candy was in the ponds. This was because a student was taken out of the group, but the candy was not removed.
- Difficult to count the correct candy refill amount, and so many groups seem sustainable, though their practices are not.

#### Comments:

- Students used pictures, but the pictures were only in black and white
- Even during non-talking round, students talk when they pick numbers
- During talk round, Ing reminds them, but they still hardly speak
- No problem keeping kids from looking inside the ponds
- Groups messy, not in lines, but they seem to know where they belong
- During nighttime, all students sit on floor and turn to face wall
- Ing leads this activity by herself, other teachers present but remain in a supportive role.
- Kids help mix the numbers (randomize numbers) by end of game
- Lots of LAUGHING and FUN!
- Could almost adapt this activity to make it a group-vs-group game
- Kids are better at following rules in Game 2
- Ing give mini-lecture between games 2 and 3
- Sometimes groups don't work together. Smaller groups within groups stick together, pairs. Therefore the group lasts longer, but still dies
- There is small talk after activity, then students fill out worksheet
- GAME 1 – 1<sup>st</sup> dead in round 2. End of round 3, 3 tables are dead. 2 tables survive 4 rounds because started with extra candy. 1 other table survived because they fished in other ponds.
- GAME 2 – End of round 2 some ponds have too much candy for each to have taken two. Cheating involved. 1<sup>st</sup> table dies in round 3, all group members die simultaneously. 3 tables survive to round 5.
- GAME 3 – Still cheating. 1<sup>st</sup> dead in round 4. End in round 6, no tables died.



## Teachers Leading TOC Activity (Session 2) 2.6.08

### Teacher Questions:

- Teachers used questions to class to clarify rules during intro
- Teacher describes purpose for game after game is finished

### Teacher Helping Groups:

- Again, teacher offers only instruction, no enforcement

### Student Engagement

- Lots of smiles
- Look at visuals. Play and re-arrange pictures.

### WPI Helping Groups:

- Team members offered a little daytime guidance, less than last time necessary

### WPI Helping Teachers:

- Nick help Ing again
- Jess and McGhee help with nighttime refills
- Definite system for nighttime refills is created - good teamwork

### Group Mistakes:

- Students still talk while choosing numbers
- Talking between groups at the ponds
- Some students stockpile fish and then share them back at their groups
- Groups talk about strategies with one another

### Teacher Mistakes:

- Teacher may be not collecting enough from kids?
- Could try harder to prevent cheating maybe?

### Comments:

- Aacaan Ing preface lab by telling me this is a talkative class
- More student participation during intro
- Many teachers present, only Aacaan Ing leads the class
- Aacaan Ja is in the back of all the groups. As soon as she gets into the classroom, they all straighten up and shut up. Maybe one teacher in back in addition to the leader is a good way of keeping order in the game.

- One selfish girl ruined the game for her group for both games 1 and 2
- Handouts were translated into Thai.
- Finished by 11:20, quicker than last first session
- In general, game needs 1 teacher and 3 helpers.
- This class was not well-behaved during nighttime. Not sitting in straight lines. After game 1, they straighten up.
- IMPORTANT: Students from session 1 may have told the solution to students in session 2 during 20 minute break
- More discussion and strategy than last session.
- Even with talking, some students still secretive with group members.
- GAME 1: Round 1, 9 candy in a body, indicating cheating again. Round 3, first table and first student dead. 3 tables survive
- GAME 2: First dead round 3. First table round 4. 4 tables survive
- GAME 3: First dead round 4. Talking at ponds, probably just small talk. 1 table still dies by end.
- AFTER: questions to entire class. Aacaan Ing singled out the table that died every game. Students work in groups on questions.

## APPENDIX E: TEACHER RESPONSES TO DISTRICT OFFICE SURVEY

Questionnaire to evaluate the satisfaction and opinion to the procedure

Of Science Team and English Team

21 January – 15 February 2008

At Kusumal Wittayakhom School and Ban Phone Phang School

Sakonnakhon Province, Thailand

.....

Explanation: 1. This questionnaire has 2 parts:

Part 1 Teacher's satisfaction to the procedure of Science Team and English Team

Part 2 Teacher's opinion to the model of instructions

2. number of the teachers who answer questionnaires 14.

Male 4 Female 10

3. 4.51 – 5.00 excellence

3.51 – 4.50 good

2.51 – 3.50 fair

1.51 – 2.50 little

1.50 → less

number	activity	Level of satisfaction	
<b>Part 1: Teacher's satisfaction to the procedure of Science Team and English Team</b>			
1	Topic of activities (teaching) suitable	4.26	Good
2	Prepare materials for learning activity (materials for laboratory and instructional materials)	4.35	Good
3	Prepare worksheet, text, explanations	4.35	Good
4	Have a plan and well prepare	4.71	Excellence

5	Well Design activity	4.35	Good
6	Inform teachers knowing the plan	4.28	Good
7	Learning activities are attractive	4.35	Good
8	Have non formal meeting for sharing and learning together	4.21	Good
9	Work with teachers as teamwork	4.52	Excellence
10	Motivate teachers eager to learn	4.28	Good
11	Clear method or procedure and clear explanation	4.35	Good
12	Learning Activities are suitable with time	4.35	Good
13	Give an opportunity to teachers and Thai students to share their ideas	4.28	Good
14	Respect the views and opinions of others	4.42	Good
15	Caring and interesting teachers	4.42	Good
16	Using suitable instrument in measuring and evaluation	4.14	Good
17	Monitoring teaching all the time	4.28	Good
<b>Part 2: Teacher's opinion to the model of instructions (training)</b>			
18	Learning activities make the children (Thai students) need to learn and help each other	4.57	Excellence
19	students learn with happiness	4.35	Good
20	Learning activities make the students more knowledge and practical skills (from experiment, conversation, listening, Reading, etc.)	4.35	Good
21	Students have good attitude toward Science and English subject	4.07	Good
22	Students are active in learning because of	4.64	Excellence

	attractive activities		
23	Students have responsibility to do their work	4.40	Good
24	Students have good interaction with the Teachers and WPI team	4.28	Good
25	Students can use their knowledge and skills and experiences in daily life	4.30	Good

---

As the result above. The highest score is

WPI team have a plan and well prepare

The lowest score is

Students have good attitude toward Science and English subject

### **Comment and suggest.**

1. Problem in communication, if WPI Team speak in long sentences, we don't understand
2. Teachers feel worry because they think they may not do well
3. Problem about pronunciation, listening and speaking
4. Teachers and Thai students are not good in English
5. Problem in communication, so we want to make sure of understanding before teaching in the classroom
6. Problem of translating English into Thai so some activity take much time to understand
7. There is a gap between WPI team and teachers and Thai students because WPI team spend much time in the office room and look busy so we are afraid to connect or talk may be it will interrupt. We want WPI team have more talking, playing or other thing closely
8. Energizer ought to teach morality to the students not only funny
9. Want WPI team have project to push up the Educational Quality Next year in Mathematics and Science

### **Our Impression**

1. Lesson plan about greeting, about me
2. Song
3. New teaching, game
4. Communication: working with others
5. Students learn with language owner so they can pronounce correctly
6. WPI team response and high intend on their duty
- 7.

8. It's very good project, WPI team ought to workshop in Kusumal every Year
9. Your task make teachers creative thinking
10. WPI team have good relationship that very kind to us and not hesitate to participate in Morning Assembly Activity "English Minute" and Sound Lab. Good attitude to us
11. Appreciate on WPI teamwork
12. WPI team make the students active to learn
13. WPI team have good relationship, can adjust to school, community and the environment which are different from your home in many way
14. As you see, Year 7's achievement is under national standard, so we need help from WPI team so much
15. Learning activities can use and apply in daily life
16. Experience about basic conversation
17. The students are very active to learn with WPI team

.....

Praptsorn Kosulwat report  
Teacher Supervisor  
The office of Sakonnakhon Educational Service Area 1  
Thailand 47000  
Praptsorn\_Kosulwat@yahoo.com

**APPENDIX F: PROGRAM MANUAL**

# Teaching Interactive Science In Northeast Thailand

*Strategies for Improvement in Lower Secondary Education*



*The Office of Her Royal Highness  
Princess Maha Chakri Sirindhorn*

~

*Chulalongkorn University*

~

*Worcester Polytechnic Institute*

Amendolare  
Briskey  
LaGoy  
Largesse  
Orme-Johnson



# INTRODUCTION

---

This program manual was created as part of a project done by five undergraduate students from Worcester Polytechnic Institute, Worcester, MA, USA, at the request of The Office of Her Royal Highness Princess Maha Chakri Sirindhorn's Projects.

The manual focuses on the use and development of inexpensive science laboratories and hands-on activities designed to help increase scientific literacy among lower secondary students. Science is an important subject for students as it teaches about the world around them. We hope that this program will provide you with a sense of empowerment by giving you the tools necessary to take your science class into your own hands, and tailor it to the goals and needs of you and your students. This manual contains several experiments that we have already tested and refined. The experiments cover the topics of food safety, agriculture and sustainability, which were topics deemed important by the Princess' Office. There is also information on how to develop or adapt experiments on your own. Worksheets are provided for both you and your students and step-by-step instructions to guide you through the process. Throughout the manual you will also see that we have made suggestions as to how to substitute household materials for certain laboratory equipment and included some key information on topics that we found many students struggled with or were not previously exposed to such as the Scientific Method and the use of microscopes.

We worked on the development of this program at the Kusuman Wittayakom School in Sakon Nakhon Province, Thailand. We lived in Kusuman for four weeks working at the school daily. We tested the experiments with both the teachers and the students. During this time, we had the opportunity to interact with teachers and students on both a professional and social level. Their hospitality and cooperation enabled us to successfully complete our mission. We refined the experiments, decided on the program content, and gathered information about the current state of science education in Thailand's rural areas. We feel that this program will be a valuable tool in your classroom for both you and your students as you explore the exciting world of hands-on science.

# TABLE OF CONTENTS

---

---

INTRODUCTION .....	2
TABLE OF CONTENTS.....	3
GUIDE TO TEACHER WORKSHEETS .....	5
Activity #1: Two Methods of Water Purification – Teacher Instructions .....	7
Activity #1: Two Methods of Water Purification – Student Worksheet .....	16
Activity #2: Exploring Agriculture – Teacher Instructions .....	22
Activity #2: Exploring Agriculture – Student Worksheet .....	30
Activity #3: Storing Food Safely – Teacher Instructions .....	34
Activity #3: Storing Food Safely – Student Worksheet.....	42
Activity #4: Tragedy of the Commons – Teacher Instructions.....	47
Activity #4: Tragedy of the Commons – Student Worksheet.....	58
Supplementary Material.....	61
WHAT IS SCIENCE?.....	62
The Scientific Method.....	62
Looking At the Steps in Detail.....	64
What If Your Results Do Not Turn Out As Expected? .....	65
ADAPTING AND CREATING EXPERIMENTS FOR YOUR CLASS .....	66
Picking an Experiment Topic.....	66
Formulating the Experiment .....	68
Table 1: Experimental Procedure Questions.....	70
Table 2: Comparison of Materials List.....	71
PREPARING AN EXPERIMENT FOR CLASS.....	72
ADDITIONAL SCIENCE RESOURCES – WHERE TO LOOK .....	74
Tables 3: Science Web Sites .....	78

USING MICROSCOPES.....	79
How to Prepare a Microscope Slide.....	83
Exercise 1: Determining Diameter of Field.....	85
Exercise 2: Observing a Specimen .....	85
Application Questions.....	86
Questions for Consideration: .....	86
 BUILDING ENTHUSIASM ABOUT SCIENCE .....	 88
 EXPERIMENT CREATION WORKSHEET .....	 89
 Appendix A – Additional Pictures for Activity #1 .....	 93
Appendix B – References .....	94

## GUIDE TO TEACHER WORKSHEETS

---

Each of the four activities in the next section contains a set of *Teacher Worksheets* and a set of *Student Worksheets*. The *Student Worksheets* are intended to be given out to the students during the activity. The *Teacher Worksheets* are intended to be a guide for the teacher to learn about the experiment. The *Teacher Worksheets* also help explain how to present the activity to a class. Before conducting each activity with students, you should go through these worksheets independently. The following is a description of each section that you will see in the *Teacher Worksheets* provided for the four activities in this manual. (*Some categories are not in every activity*)

**Grade Level(s):** Gives the appropriate educational level for the activity.

**Purpose:** This section is designed to give you a brief overview of what the students should learn through doing the activity.

**Background:** This section contains information to help you better understand the subject of the activity before teaching it to the class. Some of this information is also repeated in the *Teacher Introduction* section.

**Teacher Introduction:** This section contains an overview of the type of information that you will want to pass on to the students before beginning the activity. You can adapt this information as needed and feel free to add to it and/or use it to draw a connection to the curriculum and everyday life.

**Preparation Considerations:** This section talks about topics that you will have to think about before doing the activity as well as potential issues that can come up during the activity.

**Hypothesis:** This section contains a suggested hypothesis for the experiment under ideal conditions. The answers given by students for this can vary.

**Materials:** This section is a list of the materials needed for the activity. This version of the materials list has very specific details about the materials required for the activity as well as instructions on how to substitute for these materials if necessary. If any special preparation of materials is required this will also be mentioned here.

**Procedure:** This section contains a copy of the procedure that is included in the *Student Worksheets* along with any notes or hints that might be helpful for you.

**Teacher Conclusions:** This section contains information to help you guide the students to conclusions after they complete the activity. Using for this information, you should develop discussion with the class connecting the activity with both the curriculum and the students' lives.

**Conclusions:** This section contains a copy of the questions seen on the *Student Worksheets* with recommended answers filled in. These answers will help you evaluate students' answers when grading. Keep in mind that student answers will vary and the information in this section is just intended to be a guide.

**Charts and Tables:** Some of the charts and tables present in the *Teacher Worksheets* are filled in with information to assist you in guiding the students as they work on the experiment. Others are left blank because they are for observations that can vary each time the experiment is done.

## **Activity #1: Two Methods of Water Purification**

### *Teacher Worksheet*

Grade Level(s)      Grades 7-9

#### Purpose

This lab should teach students about the contaminants that make water unsafe to drink and how water can be made safe to drink through purification.

#### Background

Water purification is the process of removing contaminants from water. These contaminants can be in the form of visible particles, such as sand or organic materials (fauna, animal feces, etc.) or living organisms, such as bacteria, algae, parasites, or fungi, etc. There are many methods of water purification. This activity will focus on boiling and filtering. The first method of purification that you will test is filtering. This removes large particles from the water, but has no effect on substances that are dissolved in the water, such as phosphorous, nitrates and heavy metal ions or various small living organisms, such as bacteria, fungi or parasites. The second method of purification that you will test is boiling. Boiling removes nothing from the water, but it kills any living organisms. But, because boiling does not leave behind any residual disinfectant, water that has been boiled and stored for a length of time may acquire new trace amounts of living organisms.

#### Teacher Introduction

There are many methods of water purification. This activity will focus on boiling and filtering. You will begin with three different types of water (pond water, tap water, and distilled water) and you will test two methods of purification (filtering and boiling). Pond water is full of bacteria, parasites and other living organisms, as well as visible particles, such as plant life and animal feces. The quality of tap water varies greatly from one location to another. Typically, tap water will not contain any visible particles, but may contain living organisms. Distilled water is purified industrially and is free of visible particles as well as salt and other minerals and living organisms.

Sugar is a sterile amplifier. This means that sugar acts as food and makes bacteria grow. Because bacteria are so small, we need to add sugar so that we can notice the growth of bacteria. The addition of sugar to each water sample will encourage more visible results.

Preparation Considerations

If your laboratory is not equipped with such materials as beakers, glass funnels, filter paper, hot plate and tongs, preparation is necessary to gather and/or create alternative materials. Each group will need a sample of boiled pond, tap and distilled water. It is suggested that the teacher boil enough of each type of water for the entire class.

CAUTION





*Make it clear to students that they should not drink any of their water samples. This experiment requires the boiling of water samples. Use caution near students with hot plates and boiling water.*

Hypothesis

**Place a check mark (√) in each box that represents water that you believe is safe to drink.**

**Place an (+) in each box that represents water that looks clean.**

*While there is no wrong hypothesis, the following represents typical experiment results.*

	Unpurified	Filtered 	Boiled 
Pond Water 		+	√
Tap Water 	This is dependent on the quality of local tap water.	This is dependent on the quality of local tap water.	√
Distilled Water 	√ +	√ +	√ +

## Materials

### **Nine Small Containers with Lids**

(approximately 200-300mL) These containers can be purchased at a local store or made inexpensively by cutting the top  $\frac{3}{4}$  off of a plastic water bottle and using plastic wrap as a cover.

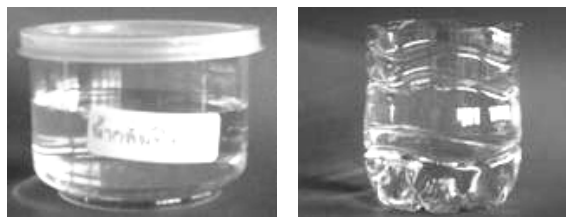

### **Pond Water, Tap Water, Distilled Water**

About 500mL of each type of water is needed per group. If pond water is not available, water from a river, lake or ocean can be used as an alternative, though results will vary. Distilled water is free from salts and other minerals and gases, and cannot be replaced by drinking bottled water without affecting results.

### **Sterile Amplifier (Sugar)**

Everyday cooking sugar can be used for this experiment. Alternatives include 1 teaspoon of beef broth or  $\frac{1}{4}$  teaspoon of yeast in the place of  $\frac{1}{2}$  teaspoon sugar.

### **Three Pieces of Filtration Paper**

These filter papers can be of any size equal to or greater than 7 cm in diameter.

*Inexpensive Suggestions:* Coffee filters or pieces of cheese cloth of the same size can be used in place of scientific filter papers.

### **Three Funnels**

These funnels can be glass funnels purchased from science supply stores, designed specifically for chemistry experiments, or funnels can be made inexpensively by cutting off the bottom  $\frac{3}{4}$  of a plastic water bottle and unscrewing the lid.

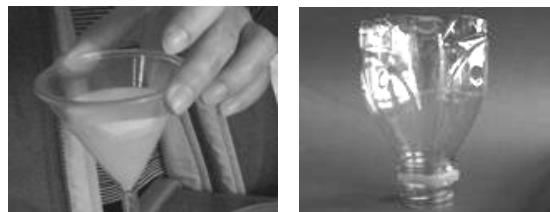

### **Hot Plate (for boiling water), Three Glass Beakers, Tongs**

These three types of materials are used to boil three different samples of water.

Three pots and a stovetop can be used to boil the water in place of these materials.

### **Plate for Cooling Beakers**

This is simply an area in which you can place beakers of boiling water to cool.

### **Grid Worksheet\***

See next page for a copy of the grid worksheet. This grid will serve as a guide for students to organize water samples.

*\*Pictures can help students to better understand the grid worksheet. See Appendix A.*



<p><b>Container #1</b></p> <p><u>Pond Water</u> <i>Unpurified</i></p>	<p><b>Container #4</b></p> <p><u>Pond Water</u> <i>Filtered</i></p>	<p><b>Container #7</b></p> <p><u>Pond Water</u> <i>Boiled</i></p>
<p><b>Container #2</b></p> <p><u>Tap Water</u> <i>Unpurified</i></p>	<p><b>Container #5</b></p> <p><u>Tap Water</u> <i>Filtered</i></p>	<p><b>Container #8</b></p> <p><u>Tap Water</u> <i>Boiled</i></p>
<p><b>Container #3</b></p> <p><u>Bottled Water</u> <i>Unpurified</i></p>	<p><b>Container #6</b></p> <p><u>Bottled Water</u> <i>Filtered</i></p>	<p><b>Container #9</b></p> <p><u>Bottled Water</u> <i>Boiled</i></p>

## Procedure

1. Begin the experiment with 9 small containers.

2. Obtain samples of each water type.

*Make it clear to students that they should not drink any of their water samples.*

- Pour 150mL of pond water into container #1. Label the container and place it on the grid.
- Pour 150mL of tap water into container #2. Label the container and place it on the grid.
- Pour 150mL of distilled water into container #3. Label the container and place it on the grid.

3. Fold 3 pieces of filtration paper into cones. Insert papers into 3 funnels.

*The following is the process of folding filter paper to use in a funnel*

*I. Fold the filter down the middle to create a semicircle.*

*II. Fold the semicircle down the middle to create a cone.*

*III. Hold three of the four parts of the filter paper in one hand, and use your other hand to pull away the fourth part of the filter paper, creating a cone.*

*IV. Place the cone into the funnel*

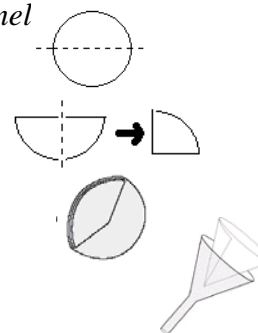

4. Obtain filtered samples of each water type.

- Put the first funnel into jar #4. Pour 150mL of pond water into the funnel. Wait for water to filter. Label the container and place it on the grid.
- Put the second funnel into jar #5. Pour 150mL of tap water into the funnel. Wait for the water to filter. Label the container and place it on the grid.
- Put the third funnel into jar #6. Pour 150mL of distilled water into the funnel. Wait for the water to filter. Label the container and place it on the grid.

5. Obtain 3 glass beakers.

6. Obtain boiled samples of each water type.

a. Turn on hot plate.

*This experiment requires the boiling of water samples. Use caution near students with hot plates and boiling water.*

b. Fill 1<sup>st</sup> beaker with pond water. Place on hot plate.

c. Fill 2<sup>nd</sup> beaker with tap water. Place on hot plate.

d. Fill 3<sup>rd</sup> beaker with distilled water. Place on hot plate.

e. Bring water to a boil. Let water boil for 3 minutes. Use tongs to move each beaker onto cooling plate. Wait at least 5 minutes for water to cool.

f. After water is cool, pour 150mL of each type of water from the 3 beakers into 3 separate containers. Pour the boiled pond water into container #7, boiled tap water into container #8 and boiled distilled water into container #9. Label each container and place them on the grid.

7. Add ½ teaspoon of sugar to each of the 9 containers on the grid. Put lids on each container. Observe each of the 9 containers and record your observations in the data table. If a

microscope is available, use the microscope to observe the microscopic organisms of each pond, tap and distilled water. Place containers in the sun and leave them there for one week.

8. Observe each container after one week. Record your observations in the data table. Notice which containers show organism growth and which do not. If a microscope is available, use the microscope to observe the microscopic organisms in each sample.



### Expected Data Results

	Unpurified	Filtered	Boiled
Pond Water (Initial, After 1 Week)	Visible particles, discoloration, living organisms visible with microscope	Few visible particles, living organisms visible with microscope	Visible particles, discoloration, no living organisms present
	More particles and discoloration, increased organisms visible with microscope	Few visible particles, increased living organisms visible with microscope	Visible particles, discoloration, minimal detectable living organisms present
Tap Water (Initial, After 1 Week)	Varies	Few visible particles, presence of living organisms may vary	Variable particles, no living organisms present
	Varies	Few visible particles, presence of living organisms may vary	Variable particles, minimal living organisms present
Boiled Water (Initial, After 1 Week)	No particles or organisms	No particles or organisms	No particles or organisms
	No particles or organisms	No particles or organisms	No particles or organisms

Chart to Record Observations

	Water Type	Observations (color, presence of particles)
Before 1 Week of Growth	#1 Pond Water - Unpurified	
	#2 Tap Water - Unpurified	
	#3 Distilled Water - Unpurified	
	#4 Pond Water - Filtered	
	#5 Tap Water - Filtered	
	#6 Distilled Water - Filtered	
	#7 Pond Water - Boiled	
#8 Tap Water - Boiled		
#9 Distilled Water - Boiled		
After 1 Week of Growth	#1 Pond Water - Unpurified	
	#2 Tap Water - Unpurified	
	#3 Distilled Water - Unpurified	
	#4 Pond Water - Filtered	
	#5 Tap Water - Filtered	
	#6 Distilled Water - Filtered	
	#7 Pond Water - Boiled	
#8 Tap Water - Boiled		
#9 Distilled Water - Boiled		



Teacher Conclusions

- Pond water began with substantial amounts of visible particles and living organisms.
- Tap water began with no visible particles and possible trace amounts of living organisms.
- Distilled water began with no visible particles or living organisms.
- Filtering samples of water removes all visible particles, but has no effect on the presence of living organisms.
- Boiling samples of water kills all living organisms, but does not remove anything from the water.
- The sugar, which is a food for bacteria, acted as an indicator of living organisms.

This lab should serve to teach students to be aware of the cleanliness of the water that they drink. They should recognize that boiling is the most effective means of making water safe to drink because it kills living organisms. Ponds, lakes and rivers often contain disease-causing living organisms (such as Giardia Lamblia and Cryptosporidium), so students should take care to avoid drinking this water without filtering and then boiling it for three minutes.

Conclusions

*Please answer each of the following questions. If you have difficulty, ask your teacher for help.*

1. Which of the 9 samples showed the most significant growth of organisms after one week? Why do you think this was so?

*Students' answers will vary based on results*

---

---

---

---

---

2. You added sugar to each of the 9 samples. Why did the sugar promote organism growth in some samples, but not in others?

*The sugar acted only as food for bacteria. If there was no bacteria present when the sugar was added, the sugar would have no impact.*

---

---

---

3. The pond water that was boiled is still discolored, but it may actually be safer to drink than the filtered pond water. Why do you think this is so? Are there any other pollutants that might be in pond water that boiling would not have affected that could still make the water bad for you?

The living organisms, as well as contaminants dissolved in the water are what will make humans sick. While boiling water may kill living organisms, though, there is no guarantee that the water is safe for humans, as it may contain chemicals and ores such as phosphorous, nitrate and heavy metal ions, which can make humans sick.

---

4. Imagine you are stranded in the middle of a forest. You have no safe water to drink. The only nearby water is in a small pond. You have filtration papers and a pot that you can use to boil water over your fire. What would be the best way to make the water safe to drink?

The best way to make the water safe to drink would be to filter the water, and then to boil it. Filtering the water would remove any visible particles, such as plant products, sand or feces. Boiling the water would kill any living organisms such as bacteria, parasites and viruses that filtering would not remove.

---

Images found on hypothesis grid taken from:

Pond and Tap Water: [http://www.clipartguide.com/\\_search\\_terms/pond.html](http://www.clipartguide.com/_search_terms/pond.html)

Boiled Water:

<http://www.fotosearch.com/results.asp?keyword=beaker&category=7&searchtype=sss>

Water Bottle: [http://www.fotosearch.com/clip-art/water-bottle\\_2.html](http://www.fotosearch.com/clip-art/water-bottle_2.html)

Filter Paper Folding Instruction Images:

<http://www.freyscientific.com/premierScience/errata/PMPage123.pdf>

Name: \_\_\_\_\_

Date: \_\_\_\_\_

## **Activity #1: Two Methods of Water Purification**

### *Student Worksheet*

#### Background





There are many methods of water purification. This activity will focus on boiling and filtering. You will begin with three different types of water - pond water, tap water, and distilled water. You will test two methods of purification - filtering and boiling. The first method of purification that you will test is filtering. This removes large particles from the water. The second method of purification that you will test is boiling. Boiling removes nothing from the water, but it kills any living organisms.

#### Problem

Not all water is safe for humans to drink. Pond water is full of bacteria, parasites, plants, and other organisms. Tap water varies from one location to another. Distilled water is purified industrially and is clean. This experiment will explore two different methods of water purification and their effects on three different types of water.

Hypothesis

*Place a check mark (✓) in each box that represents water that you believe is safe to drink.  
Place an (+) in each box that represents water that looks clean.*

	Unpurified	Filtered 	Boiled 
Pond Water 			
Tap Water 			
Distilled Water 			



## Materials

- 9 small containers with lids (approximately 200-300mL)
- Pond water
- Tap water
- Distilled water
- Sugar
- 3 filtration papers
- Hot plate (for boiling water)
- 3 funnels
- 3 glass beakers
- Tongs
- Plate for cooling beakers
- Grid worksheet

## Procedure

1. Begin the experiment with 9 small containers.
2. Obtain samples of each water type.
  - a. Pour 150mL of pond water into container #1. Label the container and place it on the grid.
  - b. Pour 150mL of tap water into container #2. Label the container and place it on the grid.
  - c. Pour 150mL of distilled water into container #3. Label the container and place it on the grid.
3. Fold 3 pieces of filtration paper into cones. Insert papers into 3 funnels.

*The following is the process of folding filter paper to use in a funnel:*

  - I. *Fold the filter down the middle to create a semicircle.*
  - II. *Fold the semicircle down the middle to create a cone.*
  - III. *Hold three of the four parts of the filter paper in one hand, and use your other hand to pull away the fourth part of the filter paper, creating a cone.*
  - IV. *Place the cone into the funnel*
4. Obtain filtered samples of each water type.
  - a. Put the first funnel into jar #4. Pour 150mL of pond water into the funnel. Wait for water to filter. Label the container and place it on the grid.
  - b. Put the second funnel into jar #5. Pour 150mL of tap water into the funnel. Wait for the water to filter. Label the container and place it on the grid.
  - c. Put the third funnel into jar #6. Pour 150mL of distilled water into the funnel. Wait for the water to filter. Label the container and place it on the grid.
5. Obtain 3 glass beakers.

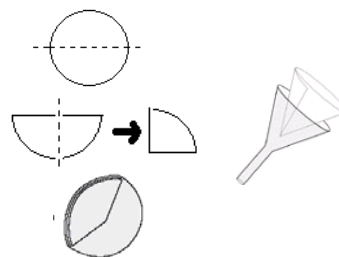

6. Obtain boiled samples of each water type.
  - a. Turn on hot plate.
  - b. Fill 1<sup>st</sup> beaker with pond water. Place on hot plate.
  - c. Fill 2<sup>nd</sup> beaker with tap water. Place on hot plate.
  - d. Fill 3<sup>rd</sup> beaker with distilled water. Place on hot plate.
  - e. Bring water to a boil. Let water boil for 3 minutes. Use tongs to move each beaker onto cooling plate. Wait 5 minutes for water to cool.
  - f. After water is cool, pour 150mL of each type of water from the 3 beakers into 3 separate containers. Pour the boiled pond water into container #7, boiled tap water into container #8 and boiled distilled water into container #9. Label each container and place them on the grid.
7. Add ½ teaspoon of sugar to each of the 9 containers on the grid. Put lids on each container. Observe each of the 9 containers and record your observations in the data table. If a microscope is available, use the microscope to observe the microscopic organisms of each pond, tap and distilled water. Place containers in the sun and leave them there for one week.
8. Observe each container after one week. Record your observations in the data table. Notice which containers show organism growth and which do not. If a microscope is available, use the microscope to observe the microscopic organisms in each sample.

Observations

	Water Type	Observations (color, presence of particles)
Before 1 Week of Growth	#1 Pond Water - Unpurified	
	#2 Tap Water - Unpurified	
	#3 Distilled Water - Unpurified	
	#4 Pond Water - Filtered	
	#5 Tap Water - Filtered	
	#6 Distilled Water - Filtered	
	#7 Pond Water - Boiled	
	#8 Tap Water - Boiled	
After 1 Week of Growth	#1 Pond Water - Unpurified	
	#2 Tap Water - Unpurified	
	#3 Distilled Water - Unpurified	
	#4 Pond Water - Filtered	
	#5 Tap Water - Filtered	
	#6 Distilled Water - Filtered	
	#7 Pond Water - Boiled	
	#8 Tap Water - Boiled	
#9 Distilled Water - Boiled		

Conclusions

*Please answer each of the following questions. If you have difficulty, ask your teacher for help.*

1. Which of the 9 samples showed the most significant growth of organisms after one week? Why do you think this was so?

---



---



---



---



---

2. You added sugar to each of the 9 samples. Why did the sugar promote organism growth in some samples, but not in others?

---

---

---

---

---

3. The pond water that was boiled is still discolored, but it may actually be safer to drink than the filtered pond water. Why do you think this is so? Are there any other pollutants that might be in pond water that boiling would not have affected that could still make the water bad for you?

---

---

---

---

---

4. Imagine you are stranded in the middle of a forest. You have no safe water to drink. The only nearby water is in a small pond. You have filtration papers and a pot that you can use to boil water over your fire. What would be the best way to make the water safe to drink?

---

---

---

---

---

## **Activity #2: Exploring Agriculture**

### *Teacher Worksheet*

Grade Level            Grades 7-8

#### Purpose

This lab should teach students about the effect of both fertilizers and common pollutants on plant growth, and make students aware of how their behavior can have an influence on the environment.

#### Background

Agriculture is a major industry in many rural provinces, including Sakon Nakhon. Often, humans are unaware that their behavior influences the soil and the ability of the plants to grow. Polluted water from human activities can contribute to decreased water quality, which, in turn, hinders the growth of agriculture. Thailand's Government has stated that "Pollution problems have been accumulating due to carelessness, irresponsible human acts and inefficient control..." Knowledge of the effects of human behavior can help to encourage responsible use of community land.

#### Teacher Introduction

In this activity students will learn about the effects of fertilizers and pollutants on plant growth. Dish Soap (Pollutant #1) is a common household item that can hurt plant growth. Frequently dirty dishwater containing dish soap is dumped outside. Because of soap's low pH level, it can have a negative effect of plant life. Lime juice (Pollutant #2) makes the soil acidic, just like acid rain. It can also hurt plant growth. Industrial fertilizer, like 20-20-0 fertilizer (Fertilizer #1) is used to help plant growth. Natural fertilizers like manure (Fertilizer #2) can also help plant growth. A control group will also be tested, where the seeds will grow in only normal soil.

## Hypothesis

*In the space below, sketch what you think the plants will look like after one week.*

*While there is no wrong hypothesis, the following represents typical experiment results.*

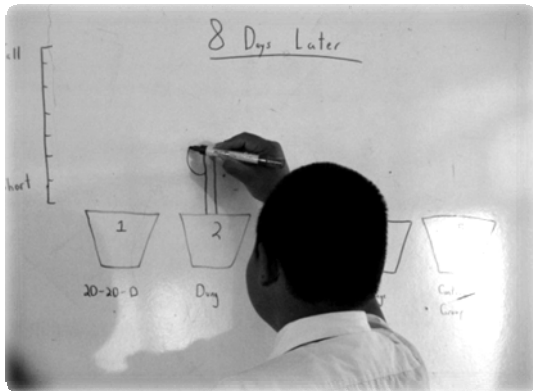
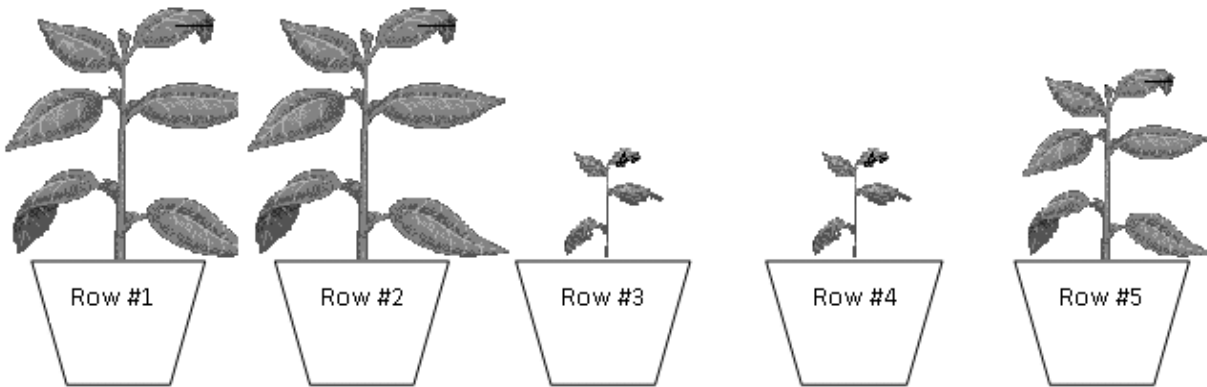

*Image of plant found in Hypothesis adapted from:*

*[http://www.phschool.com/science/biology\\_place/biocoach/images/plants/plant.gif](http://www.phschool.com/science/biology_place/biocoach/images/plants/plant.gif)*

## Preparation and Materials

### **Plant trays**

Must be at least five circles long and five circles wide. These trays can be purchased at local gardening and agricultural stores.

*Inexpensive Suggestion:* Plant trays can be replaced by any small containers, or can be made by using the bottom ¼ of plastic water bottles.

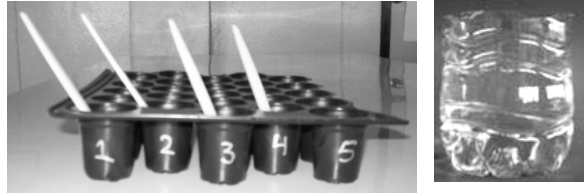

Alternatively, each row could be condensed to one large pot, in which would be planted five seeds. If this method is used, each group receives five large planting pots. Pot # 1 would represent Row #1, and would contain five seeds and the same amount of 20-20-0 fertilizer (¼ tsp crushed), Pot # 2 would represent Row #2, and would contain five seeds and 1 tsp of manure, etc.

### **Black Gram (Mung Bean) seeds (soaked in water overnight)**

Any type of local, fast-growing seed may be used for this experiment. Regardless of what type of seed is used, the seeds will grow fastest if they are soaked in water for 24 hours before the experiment.

### **Pollutant #1: Solution 25% Dish Soap, 75% Water**

Any type of dish soap may be used for this experiment, however different brands of soap may require slightly different proportions, as the concentration of active ingredients varies. If dish soap is not available, laundry detergent may also be used in similar proportions.

### **Pollutant #2: Lime Juice**

Lime juice was selected because of its acidity. It is an acidic juice that does not contain large amounts of sugar (like orange juice). Diluted vinegar is an appropriate substitute as it is acidic and does not contain large amounts of sugar.

### **Fertilizer #1: Industrial Fertilizer (20-20-0 or other), crushed into powder**

Any industrial fertilizer may be used for this experiment. The best type is 10-10-10 fertilizer, and 20-20-0 also works well.

### **Fertilizer #2: Natural Fertilizer (Manure/Dung)**

Any rich, natural fertilizer may be used for this experiment. Manure (dung) and compost make very good fertilizers.

## One teaspoon

## Tap water

## Moist soil

This soil should be local soil and not potting soil. Potting soil is not representative of the soil used by farmers, and will diminish the effects of the fertilizer. If the local soil is rocky, you may have to sift the soil prior to the experiment. The soil should be moistened before beginning.

## Optional Material

## Litmus Paper



## Procedure

1. Fill each circle of plant tray with soil. Fill each circle 90% full.
2. Insert a single seed into each circle. Seeds should be buried about 3cm deep. Pack soil lightly.
3. Add  $\frac{1}{2}$  gram (just a few grains) of industrial fertilizer to each circle in row #1.
4. Add 1 teaspoon of manure to each circle in row #2.
5. Add 1 teaspoon of dish soap solution to each circle in row #3.  
*Optional addition to experiment: Have students use litmus paper to test the pH level of the soil after adding dish soap. Record data.*
6. Add 1 teaspoon of lime juice to each circle in row #4.  
*Optional addition to experiment: Have students use litmus paper to test the pH level of the soil after adding lime juice. Record data.*
7. Leave row #5 untouched. Row #5 is the control group.
8. Leave the plant trays outside or near a sunny window. The plants should be watered every day (approximately 15 ml) so that the soil is kept moist. On very hot, sunny days it may be necessary to water plants more than once each day to keep the soil moist.
9. Over the next week, you will keep a record of the growth of each row of plants. In the data table below, record the height of each plant and write down any observations.



### Potential Difficulties

- If the industrial fertilizer is too strong, or too much is used, it will act as a pollutant and can suffer from fertilizer burn. If this occurs, use less fertilizer.
- If the lime juice has too much sugar, the sugar will act as a fertilizer. If this occurs, lime juice can be replaced by diluted vinegar.
- Manure has a tendency to float to the top when the plants are watered. If this occurs, try mixing the manure into the soil.
- Make sure that each potting circle is not filled to the top. If there is no space on top, pollutants may spill over to other circles when the plants are watered.
- Since seeds contain nutrients naturally, it may be difficult to observe the effects of the fertilizers over the first week. If plants are allowed to grow for a few weeks, the seeds' natural nutrients will run out, and the effects of the fertilizers' additional nutrients will be more visible

### Expected Results

- Row #1: This row contained industrial fertilizer. These plants should be tall, strong and look healthy.
- Row #2: This row contained natural fertilizer. These plants should look very similar to those in Row #1; they should be tall, strong and look healthy.
- Row #3: This row contained dish soap. Dish soap is a pollutant, so these plants should grow, but should be weak, discolored, and short. Overall, these plants should not be healthy.
- Row #4: This row contained lime juice. Lime juice is a pollutant as well, so these plants should look similar to those in Row #3; they should be unhealthy.
- Row #5: This row is the control group. These plants should grow well and look healthy, but should not to be as tall or healthy as those in Rows #1 and #2.



Data Table: Observations Over 8 Days

	Soil Type	Height (cm)	Observations (health, color, strength etc.)
Day #1	Row #1: Industrial Fertilizer		
	Row #2: Natural Fertilizer		
	Row #3: Dish Soap		
	Row #4: Lime Juice		
	Row #5: Control Group		
Day #2	Row #1: Industrial Fertilizer		
	Row #2: Natural Fertilizer		
	Row #3: Dish Soap		
	Row #4: Lime Juice		
	Row #5: Control Group		
Day #3	Row #1: Industrial Fertilizer		
	Row #2: Natural Fertilizer		
	Row #3: Dish Soap		
	Row #4: Lime Juice		
	Row #5: Control Group		
Day #4	Row #1: Industrial Fertilizer		
	Row #2: Natural Fertilizer		
	Row #3: Dish Soap		
	Row #4: Lime Juice		
	Row #5: Control Group		
Day #5	Row #1: Industrial Fertilizer		
	Row #2: Natural Fertilizer		
	Row #3: Dish Soap		
	Row #4: Lime Juice		
	Row #5: Control Group		
Day #6	Row #1: Industrial Fertilizer		
	Row #2: Natural Fertilizer		
	Row #3: Dish Soap		
	Row #4: Lime Juice		
	Row #5: Control Group		
Day #7	Row #1: Industrial Fertilizer		
	Row #2: Natural Fertilizer		
	Row #3: Dish Soap		
	Row #4: Lime Juice		
	Row #5: Control Group		

Day #8	Row #1: Industrial Fertilizer		
	Row #2: Natural Fertilizer		
	Row #3: Dish Soap		
	Row #4: Lime Juice		
	Row #5: Control Group		

Teacher Conclusions

The plants in Rows #1 and #2 hopefully grew to be the tallest and healthiest. This is because fertilizer, whether industrial or natural, provides extra nutrients to seeds. Those plants in Row #3, which contained dish soap, did not grow as well as either the fertilized plants or the control group. This experiment displayed that dumping dirty dishwater onto the ground is harmful to plants. Finally, the plants in Row #4 also did not grow as well as those plants in the control group. This is because lime juice is very acidic, that is, it has a very high pH level. Acidic lime juice had a negative effect on plant growth just like acid rain often does in the real world.

Conclusions

*Please answer each of the following questions. If you have difficulty, ask your teacher for help.*

1. How tall are the plants that were fertilized (in row #1 and row #2)? How healthy do these plants look? If the fertilizer were added only to the soil, why did they have any effect on the plants?

*Answers based on students' observations.*

*When fertilizer is added to soil, it is dissolved in the soil, and the nutrients are then absorbed by the roots of the plants. This is how plants absorb fertilizer's nutrients.*

---



---

2. How tall are the plants that were contaminated with pollutants (in row #3 and row #4)? How healthy do these plants look?

*Answers based on students' observations.*

---



---



---

3. How did the natural fertilizer compare to the industrial fertilizer? Which fertilizer worked best, and why do you think this was?

*Answers based on students' observations.*

---

---

---

---

4. Did all the plants in a single row grow to the same height? For example, all of the plants in row #1 received the same amount of soil, water, and fertilizer. Why aren't they all the same height?

All of the plants in a single row did not grow to be the same height because there are several variables affecting plant growth. Examples are the health and size of the seeds and amount of direct sunlight. Additionally, there could be human error in the amount of fertilizer or water that was added. The variation in growth is the reason for a large number of samples

5. Draw a picture of an average plant from each row in the space below.

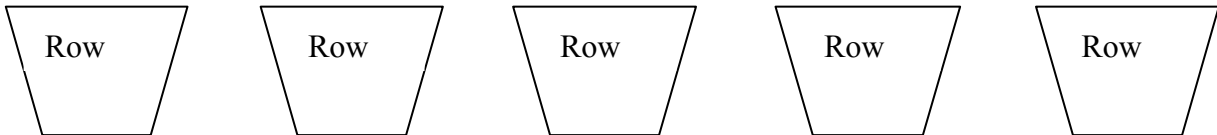

Name: \_\_\_\_\_

Date: \_\_\_\_\_

## **Activity #2: Exploring Agriculture**

### *Student Worksheet*

#### Background

Agriculture is a major industry in many rural provinces, including Sakon Nakhon. Oftentimes, humans are unaware that their behavior impacts the soil and the ability of the plants to grow. Knowledge of the effects of human behavior can help to encourage responsible use of community land.

#### Problem

In this activity you will learn about the effects of fertilizers and pollutants on plant growth. Dish Soap (Pollutant #1) is a common household item that can hurt plant growth. Frequently dirty dishwater containing dish soap is dumped outside. Because of soap's low pH level, it can have a negative effect of plant life. Lime juice (Pollutant #2) makes the soil acidic, just like acid rain. It can also hurt plant growth. Industrial fertilizer, like 20-20-0 fertilizer (Fertilizer #1) is used to help plant growth. Natural fertilizers like manure (Fertilizer #2) can also help plant growth, and are an environmentally sustainable alternative. A control group will also be tested, where the seeds will grow in only normal soil.

#### Hypothesis

*In the space below, sketch what you think the plants will look like after one week.*

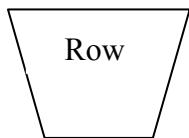

Industrial Fertilizer

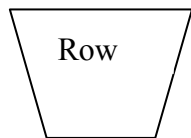

Natural Fertilizer

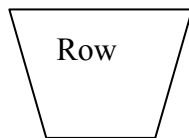

Dish Soap

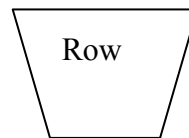

Lime Juice

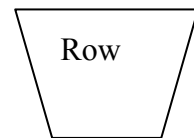

Control

## Materials

- Plant trays (at least 5 circles long and five circles wide)
- Black Gram (Mung Bean) seeds (soaked in water overnight)
- Pollutant #1: Solution 25% Dish Soap, 75% Water
- Pollutant #2: Lime Juice
- Fertilizer #1: Industrial Fertilizer (20-20-0 or other), crushed into powder
- Fertilizer #2: Natural Fertilizer (Manure/Dung)
- One teaspoon
- Tap water
- Moist soil

## Procedure

1. Fill each circle of plant tray with soil. Fill each circle 90% full.
2. Insert a single seed into each circle. Seeds should be buried about 3cm deep. Pack soil lightly.
3. Add ½ gram (just a few grains) of industrial fertilizer to each circle in row #1.
4. Add 1 teaspoon of manure to each circle in row #2.
5. Add 1 teaspoon of dish soap solution to each circle in row #3.
6. Add 1 teaspoon of lime juice to each circle in row #4.
7. Leave row #5 untouched. Row #5 is the control group.
8. Leave the plant trays outside or near a sunny window. The plants should be watered every day (approximately 15 ml) so that the soil is kept moist. On very hot, sunny days it may be necessary to water plants more than once each day to keep the soil moist.
9. Over the next week, you will keep a record of the growth of each row of plants. In the data table below, record the height of each plant and write down any observations.

## Data Table: Observations Over 8 Days

	Soil Type	Height (cm)	Observations (health, color, strength etc.)
Day #1	Row #1: Industrial Fertilizer		
	Row #2: Natural Fertilizer		
	Row #3: Dish Soap		
	Row #4: Lime Juice		
	Row #5: Control Group		

Day #2	Row #1: Industrial Fertilizer		
	Row #2: Natural Fertilizer		
	Row #3: Dish Soap		
	Row #4: Lime Juice		
	Row #5: Control Group		
Day #3	Row #1: Industrial Fertilizer		
	Row #2: Natural Fertilizer		
	Row #3: Dish Soap		
	Row #4: Lime Juice		
	Row #5: Control Group		
Day #4	Row #1: Industrial Fertilizer		
	Row #2: Natural Fertilizer		
	Row #3: Dish Soap		
	Row #4: Lime Juice		
	Row #5: Control Group		
Day #5	Row #1: Industrial Fertilizer		
	Row #2: Natural Fertilizer		
	Row #3: Dish Soap		
	Row #4: Lime Juice		
	Row #5: Control Group		
Day #6	Row #1: Industrial Fertilizer		
	Row #2: Natural Fertilizer		
	Row #3: Dish Soap		
	Row #4: Lime Juice		
	Row #5: Control Group		
Day #7	Row #1: Industrial Fertilizer		
	Row #2: Natural Fertilizer		
	Row #3: Dish Soap		
	Row #4: Lime Juice		
	Row #5: Control Group		
Day #8	Row #1: Industrial Fertilizer		
	Row #2: Natural Fertilizer		
	Row #3: Dish Soap		
	Row #4: Lime Juice		
	Row #5: Control Group		

Conclusions

*Please answer each of the following questions. If you have difficulty, ask your teacher for help.*

1. How tall are the plants that were fertilized (in row #1 and row #2)? How healthy do these plants look? If the fertilizer were added only to the soil, why did they have any effect on the plants?

---

---

---

---

2. How tall are the plants that were contaminated with pollutants (in row #3 and row #4)? How healthy do these plants look?

---

---

---

---

3. How did the natural fertilizer compare to the industrial fertilizer? Which fertilizer worked best, and why do you think this was?

---

---

---

---

4. Did all the plants in a single row grow to the same height? For example, all of the plants in row #1 received the same amount of soil, water, and fertilizer. Why aren't they all the same height?

---

---

---

---

5. Draw a picture of an average plant from each row in the space below.

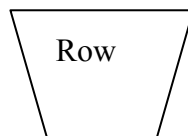
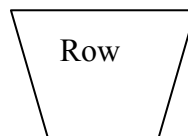
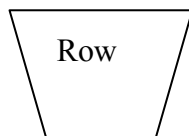
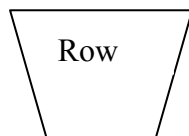
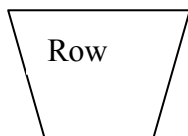



## Activity #3: Storing Food Safely

### *Teacher Worksheet*

Grade Level            Grades 7-9

#### Purpose

This lab should teach students about proper methods of storing food, as well as the potential consequences of improper food storage.

#### Background

Improper storage of food is a common cause of illness and disease. Food naturally contains varying amounts of bacteria and other living organisms. Proper food storage methods can reduce the extent to which these organisms reproduce, which will reduce the risk of illness caused by spoiled food. Information about salmonella specifically can be found at the end of this teacher worksheet.

#### Teacher Introduction

There are many methods of safe food storage. This activity explores the safety of three different methods of storing meat and fruit: storing food in a dry, cool place, drying food in the sun, and storing food in the sun under moist conditions. The students should learn about the implications of these different conditions and be able to apply these findings to their daily lives.

#### Hypothesis

*Which method of storage do you think will keep the food freshest? Which food do you think will spoil the fastest, the meat or fruit?*

*Storage in a cool, dark place should keep the food the freshest. The meat will spoil faster than the fruit.*

---

---

---

### Preparation and Materials

Before the experiment begins, the teacher will need to prepare cut pieces of meat and fruit to be used as samples for the experiment. Use extreme caution when handling raw meat.



#### **3 Pieces of raw meat**

Any type of meat can be used for this experiment, however chicken is typically the cheapest and yields good results.

#### **3 Pieces of fruit**

Any type of fruit can be used for this experiment. It is best to choose a locally available fruit that is known to spoil rather quickly. Fruits that have high water content (watermelon, for example) will grow mold quicker and will yield how more dramatic results.

#### **6 Sealable plastic bags**

The experiment calls for clear plastic bags (approximately 100 mL) that either self-seal or can be tied with a rubber band to seal. Alternatively, foam food storage containers can be used. This experiment is meant to be relevant to students' lives, so it is suggested that the experiment uses materials that are currently used in everyday food storage.

#### **Pipette**

A scientific pipette could be used for this experiment. Alternatively, any sort of dropper can be used.

#### **Magnifying Glass**

#### **Optional Materials:**

#### **Microscope and 6 microscope slides with slide covers**

## Procedure

1. Collect three pieces of meat and three pieces of fruit.  
*Use extreme caution when handling raw meat. It is advised that only teachers handle the meat.*
2. Place one section of meat in a sealed bag and one piece of fruit in another sealed bag and store both bags in a cool, dry place.  
*A refrigerator is the perfect atmosphere for this sample.*
3. Place the second section of meat in a sealed bag and the second section of fruit in a sealed bag and store both bags in the sun under dry conditions.
4. Place the last piece of meat in a bag and add ten drops of tap water. Seal the bag and place it in the sun. Do the same for the last piece of fruit.
5. Record your observations immediately in the table below. Look at a cross-section of each piece of fruit and meat using a magnifying glass (or a microscope if available) and record what you see.
6. Over the following three days, observe and record any changes in appearance, smell and the presence of bacteria and fungus.
7. After three days, look at a cross-section of each piece of meat and fruit using a magnifying glass (or a microscope if available) and record what you see.  
*The teacher may want to prepare a cross-section of each piece of meat and fruit for the students to observe with magnifying glasses (or microscopes), as this would reduce student contact with raw meat and spoiled food.*

## Potential Difficulties

The samples of meat, specifically, may emit a very strong, terrible smell after three days. It is advisable that students observe their individual samples without opening the bag. Any students or teachers working with the samples directly may want to wear a mask.

## Expected Data Results

- Meat and fruit in a cool, dry place: These samples should maintain freshness and exhibit very little change. There will be some bacteria present the meat sample, as bacteria are present on any raw meat.
- Meat and fruit in a hot, dry place: The meat should be spoiled, and a very large amount of bacteria should be present. This will also result in a pungent odor. The results of the fruit will vary greatly depending on the type of fruit used. It should exhibit at least minimal evidence of mold and change in appearance.
- Meat and fruit in a hot, moist place: The results of these samples should be very similar to those of the hot, dry samples. The meat should be spoiled, and a very large amount of bacteria should be present. It should also emit a pungent odor. The results of the fruit will vary greatly depending on the type of fruit used. It should exhibit at substantial evidence of mold and change in appearance.

Observations

Initial Observation				
	Specimen	Describe Appearance (Color, presence of organism growth)	Smell	Picture of Sample
Stored Dry, Cool	Meat			
	Fruit			
Stored Dry, Hot	Meat			
	Fruit			
Stored Moist, Hot	Meat			
	Fruit			

Look at a sample of a piece of meat and fruit using a magnifying glass (or a microscope if available) and record what you see below:

*In the circles below, students should draw what they see when they look at each sample using a magnifying glass or microscope.*

Meat

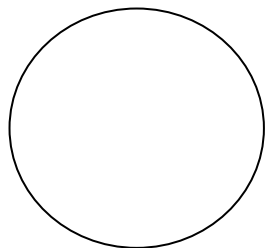

Fruit

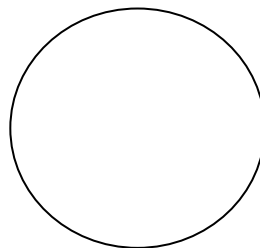



*In the data chart below, students should observe each sample, without taking it out of the plastic bag, and observe the following characteristics. In the “Describe Appearance” section, students should record any change in color, presence of mold, fungus etc, or any shriveling or otherwise morphing of the sample’s appearance. Students can open the bags to observe the smell, but should be warned against contact with any of the contents of the bag. In the “Picture of Sample” section, students should draw a picture of the entire sample.*

After 1 Day				
	Specimen	Describe Appearance (Color, presence of organism growth)	Smell	Picture of Sample
Stored Dry, Cool	Meat			
	Fruit			
Stored Dry, Hot	Meat			
	Fruit			
Stored Moist, Hot	Meat			
	Fruit			

After 2 Days				
	Specimen	Describe Appearance (Color, presence of organism growth)	Smell	Picture of Sample
Stored Dry, Cool	Meat			
	Fruit			
Stored Dry, Hot	Meat			
	Fruit			
Stored Moist, Hot	Meat			
	Fruit			

After 3 Days				
	Specimen	Describe Appearance (Color, presence of organism growth)	Smell	Picture of Sample
Stored Dry, Cool	Meat			
	Fruit			
Stored Dry, Hot	Meat			
	Fruit			
Stored Moist, Hot	Meat			
	Fruit			

After three days, look at a sample of each piece of meat and fruit using a magnifying glass (or a microscope if available) and record what you see below:

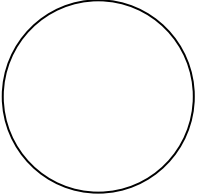
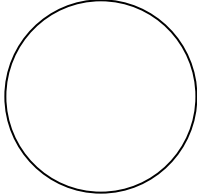
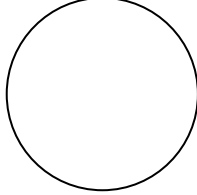
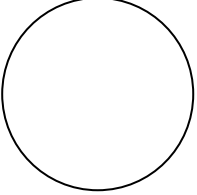
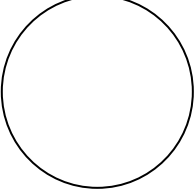
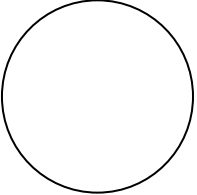
Meat Dry Cool	Fruit Dry Cool	Meat Dry Hot	Fruit Dry Hot	Meat Moist Hot	Fruit Moist Hot
					

The following is an example of student observations:

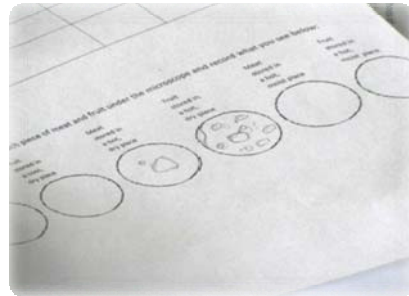

### Teacher Conclusions

This experiment should demonstrate to students that care is to be taken when handling food. Three important components of food safety are storing foods in the right place, at the right temperature and for the right length of time. Students should have concluded that while different foods, meat and fruit in this experiment, require different conditions to stay fresh, storing foods out of the sun and in the refrigerator is necessary to keep perishable foods fresh. Students should also have observed that some food should be eaten shortly after purchasing to avoid spoiling. The following URL contains a chart that lists the conditions and length at which foods can be safely stored: <http://www.ext.colostate.edu/PUBS/foodnut/09310.html>

### Conclusions

*Please answer each of the following questions. If you have difficulty, ask your teacher for help.*

1. Which meat sample changed the most over the course of three days?

Answers will be based on students' observations. The meat that was stored under hot, moist conditions should have exhibited the most change.

2. Which fruit sample changed the most over the course of three days?

Answers will be based on students' observations. The fruit that was stored under hot, moist conditions should have exhibited the most change.

---

3. What can you learn from these changes?

Students can learn that bacteria grow more rapidly on food that is left in the sunlight, and that moist conditions also accelerate bacteria growth.

---

4. What do you think is the safest method of storing food? Why?

The safest method of storing food is to seal it and store it in a dry, cool place, like a refrigerator. Also, students should have observed that bacteria grows even on meat that is stored properly, which is why it is important to cook meat thoroughly before eating it.

---

### **Staying Healthy Through Proper Food Storage and Handling**

An example of an illness that can be spread through improper food handling is *salmonella*. This is an illness caused by bacteria that exists in some raw foods such as beef, poultry and eggs, as well as animal feces. People infected with salmonella suffer from diarrhea, fever and cramps. This can start within 12 hours to 3 days after infection and last up to a week. For young children, the elderly, and those with compromised immune systems, the sickness can be more severe and last even longer. Illnesses such as this are why it is *especially* important that we are all careful about how we handle, store, and cook our food.

Ways to avoid catching and spreading illnesses such as this include

- Always wash your hands thoroughly, with soap, before and after handling any type of food – *especially raw meat!!!*
- Wash your hands after handling live animals or their feces
- Store food in a cool, dry place
- Cook your meat thoroughly and wash or cook your vegetables and fruits as well
- Be sure to *immediately and thoroughly* wash all containers, utensils and surfaces that come into contact with raw meat or eggs
- When cooking, do not put cooked meat back on to a plate or surface that has had raw meat on it – *this could lead to recontamination!*



Name: \_\_\_\_\_

Date: \_\_\_\_\_

### **Activity #3: Storing Food Safely**

#### *Student Worksheet*

#### Background

There are many methods of safe food storage. This activity explores the safety of three different methods of storing meat and fruit: storing food in a dry, cool place, drying food in the sun, and storing food in the sun under moist conditions. The students will learn about the implications of these different conditions and be able to apply these findings to their daily lives.

#### Problem

All foods contain at least a small amount of bacteria and other living organisms. These living organisms, if put under conditions in which they reproduce, cause food to spoil and can cause humans to become sick. Proper food storage can reduce the rate at which these living organisms reproduce.

#### Hypothesis

*Which method of storage do you think will keep the food freshest? Which food do you think will spoil the fastest, the meat or fruit?*

---

---

---

---

#### Materials

- 3 pieces of raw meat
- 3 pieces of fruit
- 6 sealable plastic bags
- Pipette
- Magnifying Glass
- Microscope (optional)
- 6 microscope slides (optional)

Procedure

1. Collect three pieces of meat and three pieces of fruit.
2. Place one section of meat in a sealed bag and one piece of fruit in another sealed bag and store both bags in a cool, dry place.
3. Place the second section of meat in a sealed bag and the second section of fruit in a sealed bag and store both bags in the sun under dry conditions.
4. Place the last piece of meat in a bag and add ten drops of tap water. Seal the bag and place it in the sun. Do the same for the last piece of fruit.
5. Record your observations immediately in the table below. Look at a cross-section of each piece of fruit and meat using a magnifying glass (or a microscope if available) and record what you see.
6. Over the following three days, observe and record any changes in appearance, smell and the presence of bacteria and fungus.
7. After three days, look at a cross-section of each piece of meat and fruit using a magnifying glass (or a microscope if available) and record what you see.

Observations

Initial Observations				
	Specimen	Describe Appearance (Color, presence of organism growth)	Smell	Picture of Sample
Stored Dry, Cool	Meat			
	Fruit			
Stored Dry, Hot	Meat			
	Fruit			
Stored Moist, Hot	Meat			
	Fruit			

Look at a sample of a piece of meat and fruit using a magnifying glass (or a microscope if available) and record what you see below:

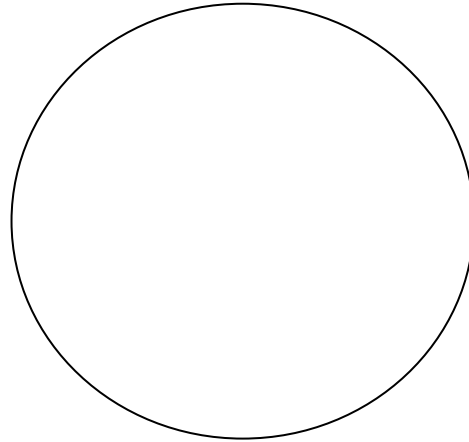
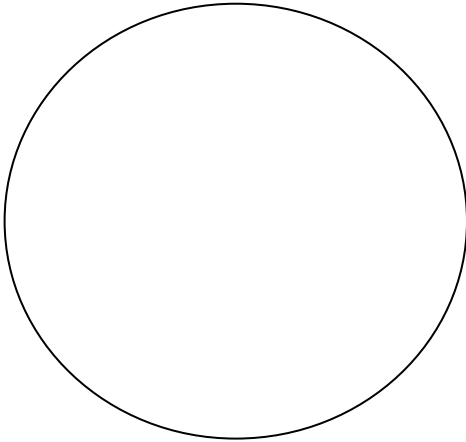

After 1 Day				
	Specimen	Describe Appearance (Color, presence of organism growth)	Smell	Picture of Sample
Stored Dry, Cool	Meat			
	Fruit			
Stored Dry, Hot	Meat			
	Fruit			
Stored Moist, Hot	Meat			
	Fruit			

After 2 Days				
	Specimen	Describe Appearance (Color, presence of organism growth)	Smell	Picture of Sample
Stored Dry, Cool	Meat			
	Fruit			
Stored Dry, Hot	Meat			
	Fruit			
Stored Moist, Hot	Meat			
	Fruit			

After 3 Days				
	Specimen	Describe Appearance (Color, presence of organism growth)	Smell	Picture of Sample
Stored Dry, Cool	Meat			
	Fruit			
Stored Dry, Hot	Meat			
	Fruit			
Stored Moist, Hot	Meat			
	Fruit			

After three days, look at a sample of each piece of meat and fruit using a magnifying glass (or a microscope if available) and record what you see below:

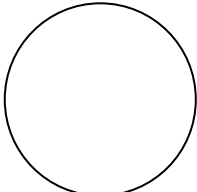
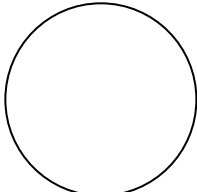
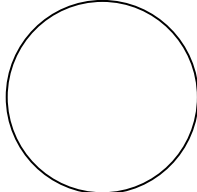
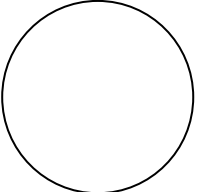
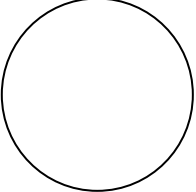
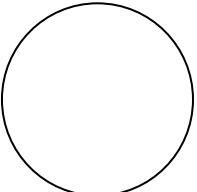
Meat Dry Cool	Fruit Dry Cool	Meat Dry Hot	Fruit Dry Hot	Meat Moist Hot	Fruit Moist Hot
					

Conclusions

*Please answer each of the following questions. If you have difficulty, ask your teacher for help.*

1. Which meat changed the most over the course of three days?

---

---

---

---

2. Which fruit changed the most over the course of three days?

---

---

---

---

3. What can you learn from these changes?

---

---

---

---

4. What do you think is the safest method of storing food? Why?

---

---

---

---

## **Activity #4: Tragedy of the Commons**

### *Teacher Worksheet*

Grade Level            Grades 9-12

#### Purpose

The purpose of this activity is to teach students the importance of environmental sustainability, as well as three tools – communication, education and teamwork – required to attain sustainability.

#### Background

In 1968, Garrett Hardin coined the phrase “Tragedy of the Commons” to explain the human tendency to value one’s immediate needs over long-term needs and the welfare of a community. He used the analogy of New England commons (public areas for grazing livestock) explaining that over-grazing resulted from the “Tragedy of the Commons” mentality. He explained that a small increase in the use of a resource (in this case, the common grass area) provides great benefit for one individual (the owner of the livestock) in the short term, while in the long term it will hurt both the individual and the group (the common grass area will die). The “Tragedy of the Commons” has been used to explain numerous environmental problems from overfishing, to deforestation, to littering. In this activity students will learn about the “Tragedy of the Commons” mentality. They will see firsthand the results of this human tendency and learn about two ways to overcome this tendency: communication and education.

#### Preparation and Materials

This lab requires the construction of a number of “ponds” for students to fish in, which will take some time. Each group should be made up of four or five students, so the number of ponds will be the number of students in the class divided by four or five. These can be constructed by students, which would require less time.

#### **Fish**

Fish can be represented by any small items. Individually wrapped pieces of small candy work well. The number of fish you will need will be the number of students times approximately 5 (only 4 fish per student are necessary, however extras may be needed) .

#### **A bag of numbers for each group**

Each group will need numbered pieces of paper from which to choose the order in which they will “fish”.

## A pond

These ponds can be constructed in a variety of different ways, and can use a variety of different materials. The guidelines of the pond are as follows:

- The ponds can be 20-30 cm tall and approximately 0.1m<sup>2</sup> in width and length.
- The pond must be enclosed except for one hole on the top for students to “fish” through. The students must be able to feel the entire bottom of the box while “fishing”.

Ponds can be easily created by converting a cardboard board. Directions for fashioning a pond using this method are as follows:

- Cut the top cardboard flaps off of the box.
- Tape a strip of cardboard over the top of the box through the middle.
- Tape construction paper or poster board over the top of the box.
- Cut a hole (approximately 5cm in diameter) in one half of the top.
- In the other half of the top of the box, tape the paper such that it can cover the box or be lifted, allowing the teacher to see the contents of the box.

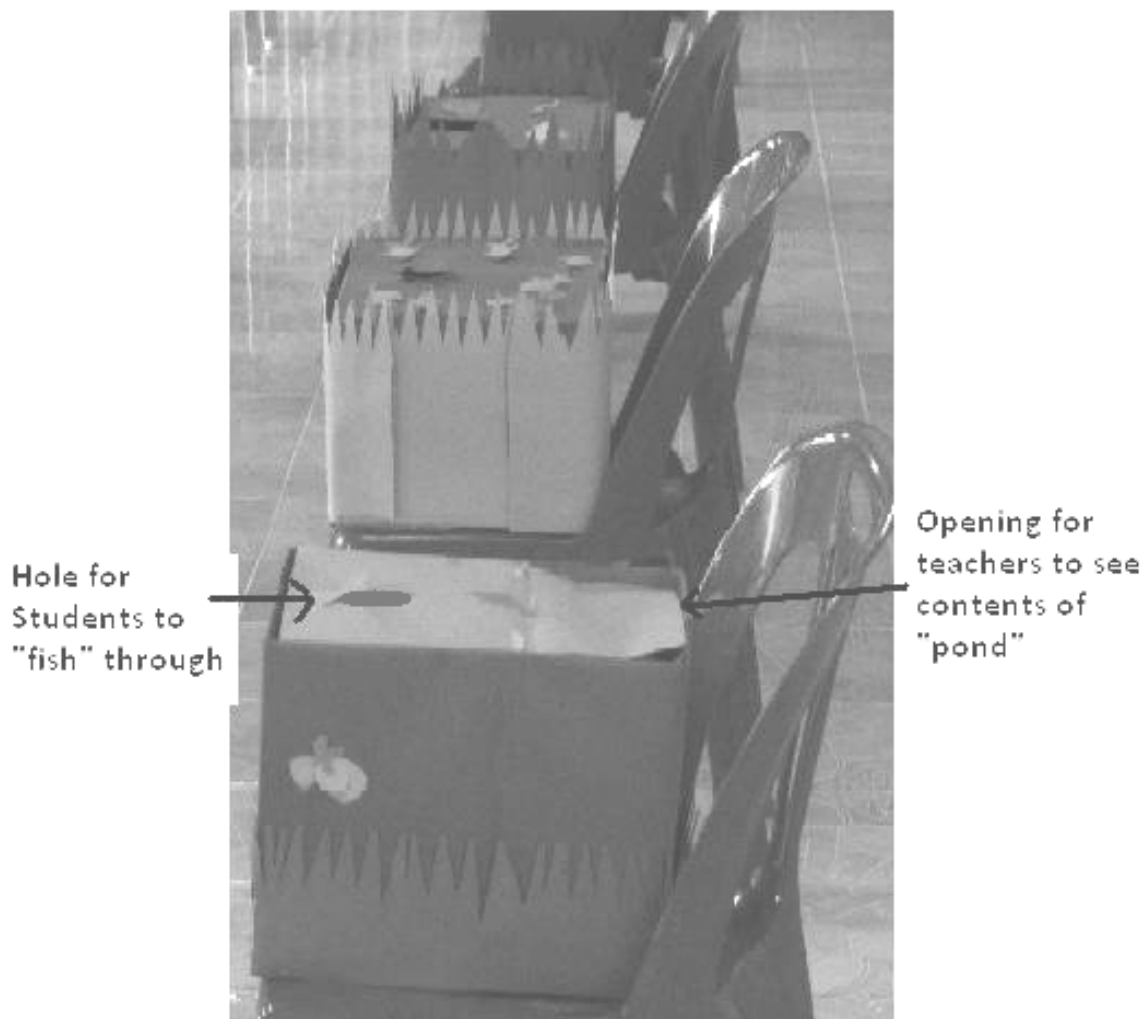

## Summary of Activity Rules

### **Rules for Every Round:**

- Every day the students must go fishing.
- Students pick numbers out of bags to decide who goes fishing first.
- Students must eat two fish every night to survive.
- Students can take as many fish as they want.
- Looking inside the pond is not allowed. Students must reach into the pond without looking.

### **Additional Rules for Round #1:**

- Students are not allowed to communicate with each other.
- Students are not told how the fish reproduce.

### **Additional Rules for Round #2:**

- Students are allowed to communicate with each other.
- Students are not told how the fish reproduce.

### **Additional Rules for Round #1:**

- Students are allowed to communicate with each other.
- Students are told how the fish reproduce (every night each fish has one baby).



### Teacher Procedure

The following procedures have been adapted to allow one teacher and one or two aides to lead this game with a whole class of students.

1. Arrange classroom like the figure below. The classroom must have one “sleeping area”, one “pond area”, one gateway, and one “graveyard”.

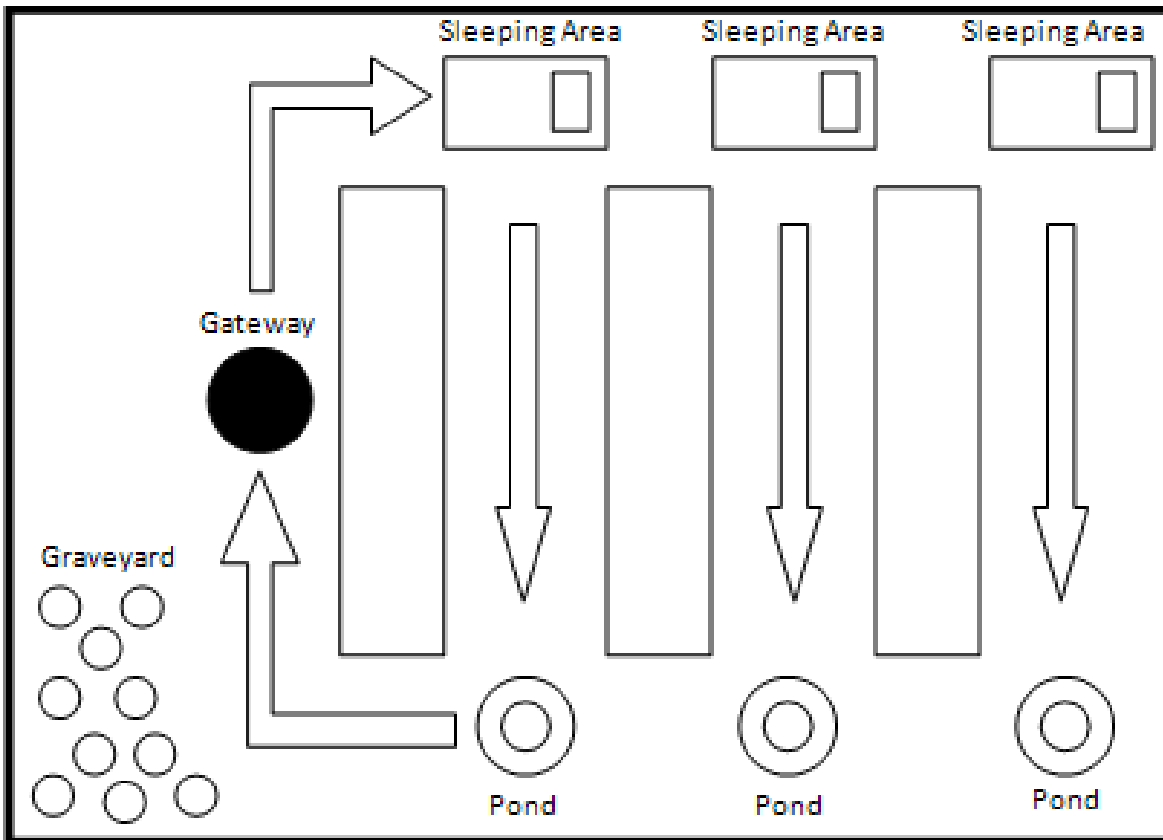

2. Divide students into groups of 4-5. Each group will need its own pond.
3. There will be three rounds, each round consisting of several days. In Round #1 communication (talking amongst students) will not be allowed and students will not be given information about how the fish reproduce.
4. Each round begins with the teacher stocking each pond full of fish. There should be four fish per student in each pond (i.e. 16 fish for a pond with four students). The teacher must then read students the instructions for Round #1 (see next section).
5. Students will begin each day by waking up from the “sleeping area” and drawing a number from their group’s bag. The bag should contain a number for each student (for example, a group of four students would have the numbers 1, 2, 3, and 4 written on separate slips of paper and placed in the bag). The student who drew #1 from the bag will go fishing first; the student who drew #2 will go second, and so on.

- Each student will walk from the “sleeping area” to the “pond area” and take as many fish as they want.



- After students go fishing for the day each student must walk through the “gateway”. The student must eat (or give back) two fish in order to be allowed through to the “sleeping area”. Students who do not have two fish must go to the “graveyard”.
- Students who survive the night must then go to sleep (close their eyes) while the teacher restocks each pond (for every fish that remains, the teacher must add one more fish to the pond).



9. The next day the students will wake up, draw numbers from their bag, and go fishing again. The round will continue for several days, until all the students die or until the students demonstrate a sustainable fishing strategy. After Round #1 ends, the teacher should read the instructions for Round #2 and begin that round in the same way.
10. After all three rounds have been completed, give Student Worksheets to students. Have students answer the questions on the worksheet.



## Verbal Instructions

### **Round #1: No Communication or Education**

Read the Instructions below to the students:

*“The classroom has been divided into four areas: a “sleeping area”, a “pond area”, a “gateway”, and a “graveyard”. Every day each of you will wake up in the “sleeping area” and then go to the “pond area” to go fishing. Each member of your group will pick a number from your group’s bag. The member who selects #1 will go first, #2 will go second, and so on. You can take as many fish as you want when it is your turn, but you will need two to survive until the next day. Any extra fish that you take you can save for later days. After fishing you will walk to the “gateway”. In order to survive the night and return to the sleeping area you must eat two fish. If you do not have two fish to eat, you will die of starvation and you must go to the “graveyard”. At night, just as in nature, the fish will reproduce and the next day you will wake up and go fishing again. While you are fishing you will not be allowed to look inside the pond. No talking to other participants or any other form of communicating is allowed. The goal of the game is for you to survive as long as possible.”*

### **Round #2: Communication, but No Education**

Read the Instructions below to the students:

*“This is the second round of our game. Every day will follow the same format as Round #1. This time, though, you will be allowed to communicate with your group members and devise a strategy for fishing if you want. Remember, the goal of the game is for you to survive as long as possible!”*

### **Round #3: Communication and Education!**

Read the Instructions below to the students:

*“This is the third round of our game. Every day will follow the same format as Round #1. This time you will still be allowed to communicate with your group members and devise a strategy for fishing. You will also be given some information on how the fish reproduce. Listen closely, students: every night each fish that is left in the pond has one baby. If there are only 4 fish left in the pond, the fish will have only 4 babies, and there will only be a total of 8 fish the next day. If there are 8 fish left after one day, there will be 16 the next day. Use this information to help you accomplish your goal. And remember, your goal is to survive as long as possible!”*

## Visual Aids

The following diagrams can be used to visually explain the rules of the game. These can be placed on the students tables to remind them.

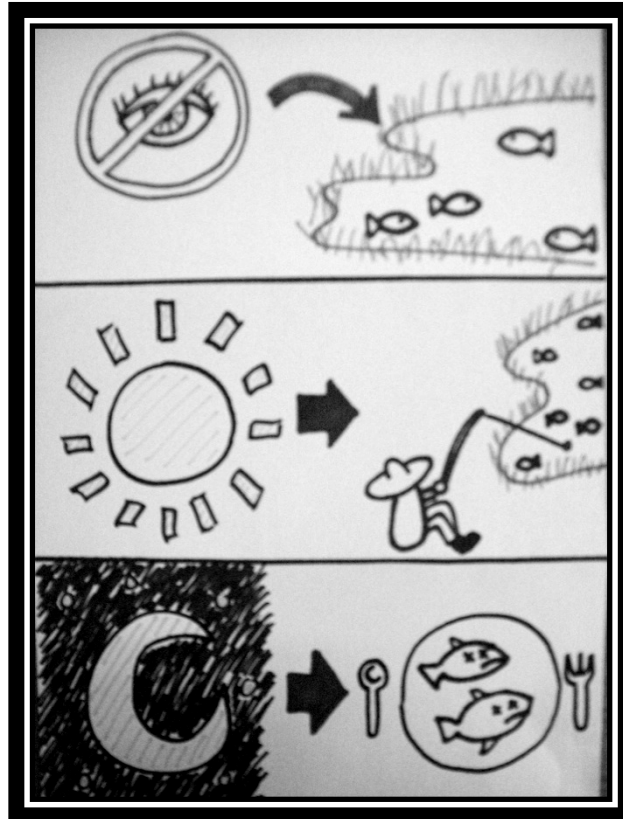

**Initial Rules**

**Round #1**  
**No Communication**

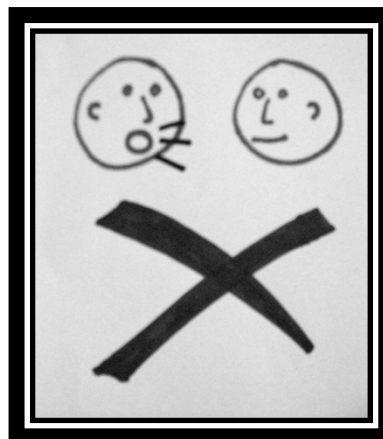

**Round #2**  
**Communication**  
**Allowed**

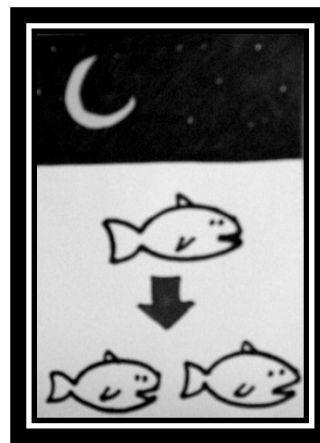
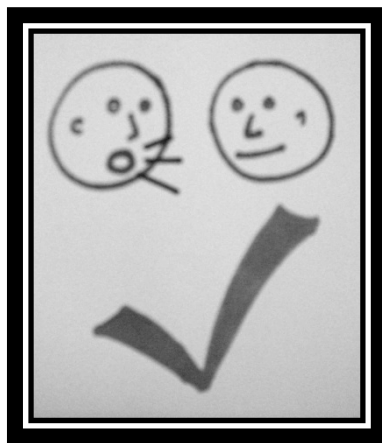
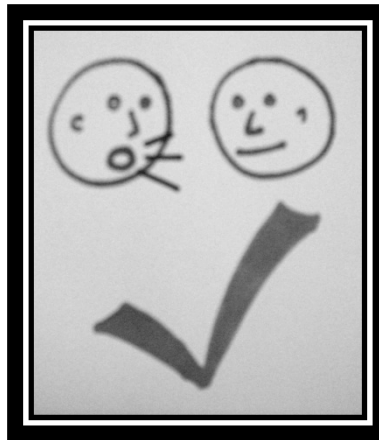

**Round #3**  
**Communication Allowed**

**Number of fish in ponds double**

Expected Results

- Round #1: Most groups of students will overfish, and the entire group will die in the first few days as a result.
- Round #2: Most groups of students will devise a strategy. Because the students do not yet know how the fish reproduce, most strategies will probably result in overfishing and the death of the group. Communication should allow the groups to survive more days than they did in Round #1, and some groups' strategies may be sustainable.
- Round #3: Upon receiving education and being allowed to communicate, most groups of students should devise a sustainable fishing strategy.

Teacher Conclusion

This experiment should teach students that their individual actions can have a significant impact on their community. Students should recognize that the Tragedy of the Commons mentality is apparent in many different areas of life – for example, deforestation profits the individual selling the lumber. The behavior is not sustainable, however, and both that individual and the community suffer in the long run when the forests have all been lumbered.

There are three tools to overcome the Tragedy of the Commons mentality. First, communication helps community members to identify and publicize the problem, as well as work together to find a solution. Education allows communities to devise realizable solutions. Finally, teamwork assures that individuals work together to place the welfare of the whole community over that of the individual.

Conclusion

*Please answer each of the following questions. If you have difficulty, ask your teacher for help.*

1. What happened in Round #1? How long did you survive?

*Answers will be based on students' observations.*  
\_\_\_\_\_  
\_\_\_\_\_  
\_\_\_\_\_

2. What happened in Round #2? Did your group make a strategy? What was it? How long did you survive?

*Answers will be based on students' observations.*  
\_\_\_\_\_  
\_\_\_\_\_  
\_\_\_\_\_

3. What happened in Round #3? Did the information about the fish help you? How long did you survive?

*Answers will be based on students' observations.*  
\_\_\_\_\_  
\_\_\_\_\_  
\_\_\_\_\_

4. In this activity you used communication, education, and teamwork as strategies for developing sustainability. How could each of these strategies be used in the real world to overcome an issue like global warming?

*In the real world, communication would be used to spread the word that a problem exists, education would be used to find the best solution for the problem, and teamwork and communication would be used to work on the solution together.*

---

5. Relate this activity to something in the real world. In this activity we used “overfishing” as an example of the Tragedy of the Commons mentality. What are some other examples of how this mentality exists in the real world (littering, overgrazing, etc.)?

*Examples of other real world applications of the Tragedy of the Commons mentality can be seen in over-irrigation, deforestation, habitat destruction, and excessive energy use.*

---



Name: \_\_\_\_\_

Date: \_\_\_\_\_

## **Activity #4: Tragedy of the Commons**

### *Student Worksheet*

#### Background

In 1968, Garrett Hardin coined the phrase “Tragedy of the Commons” to explain the human tendency to value ones immediate needs over long-term needs and the welfare of a community. He used the analogy of New England commons (public areas for grazing livestock) explaining that over-grazing resulted from the “Tragedy of the Commons” mentality. He explained that a small increase in the use of a resource (in this case, the common grass area) provides great benefit for one individual (the owner of the livestock) in the short term, while in the long term it will hurt both the individual and the group (the common grass area will die). The “Tragedy of the Commons” has been used to explain numerous environmental problems from overfishing, to deforestation, to littering. In this activity student will learn about the “Tragedy of the Commons” mentality. They will see firsthand the results of this human tendency and learn about two ways to overcome this tendency: communication and education.

#### Materials

- “Fish”
- A “pond”
- A bag of numbers for each group

#### Procedure

Each group of students shares a community pond. Every day you will go fishing in the pond. You are required to eat two fish to survive the night. You can take as many fish as you want and you can eat them during the night or save them for later days. At night, just as in nature, the fish reproduce. Every day, you will draw numbers to determine the order of who goes fishing first, second, third, and forth. You are not allowed to look into the pond that you are fishing in.

#### **Round #1: No Communication or Education**

In the first round, you and the other fishermen are not allowed to talk or otherwise communicate. You do not know how the fish reproduce.

**Round #2: Communication without Education**

In the second round, you and the other fishermen are allowed to communicate. It is encouraged that you devise a strategy for fishing that will benefit all members equally. You do not know how the fish reproduce.

**Round #3: Communication and Education!**

In the third round, you and the other fishermen are allowed to communicate. You will be given details on exactly how the fish reproduce. Using this new information, you are encouraged to meet with your group and devise a strategy for sustainable fishing that equally benefits all members.

Conclusion

*Please answer each of the following questions. If you have difficulty, ask your teacher for help.*

1. What happened in Round #1? How long did you survive?

---

---

---

---

---

2. What happened in Round #2? Did your group make a strategy? What was it? How long did you survive?

---

---

---

---

---

3. What happened in Round #3? Did the information about the fish help you? How long did you survive?

---

---

---

---

---

4. In this activity you used communication, education, and teamwork as strategies for developing sustainability. How could each of these strategies be used in the real world to overcome an issue like global warming?

---

---

---

---

---

5. Relate this activity to something in the real world. In this activity we used “overfishing” as an example of the Tragedy of the Commons mentality. What are some other examples of how this mentality exists in the real world (littering, overgrazing, etc.)?

---

---

---

---

---

# **Supplementary Material**

## WHAT IS SCIENCE?

---

Science is the study of how the natural world works. Through observation and experimentation, scientists study natural processes and phenomena. Science is important because it helps us to better interact with the world around us, and to increase our understanding of how we affect our environment and how it affects us. Scientific discoveries also make valuable contributions to society such as improved quality of life and increased economic development. At the same time, many people in the world enjoy science simply because it satisfies their curiosity of knowing how things work, both naturally and mechanically.

### *The Scientific Method*

---

When doing experimental science it is very important that your work be as done in a particular way to ensure credibility. To accomplish this, early scientists developed what is known as the *scientific method*. This method also ensures results are both reliable and replicable.

The scientific method includes six steps:

- Asking a question
- Doing background research
- Constructing a hypothesis
- Following experimental procedure (testing your hypothesis)
- Drawing conclusions
- Reporting results

Figure 1: How the Six Steps of the Scientific Method Connect.

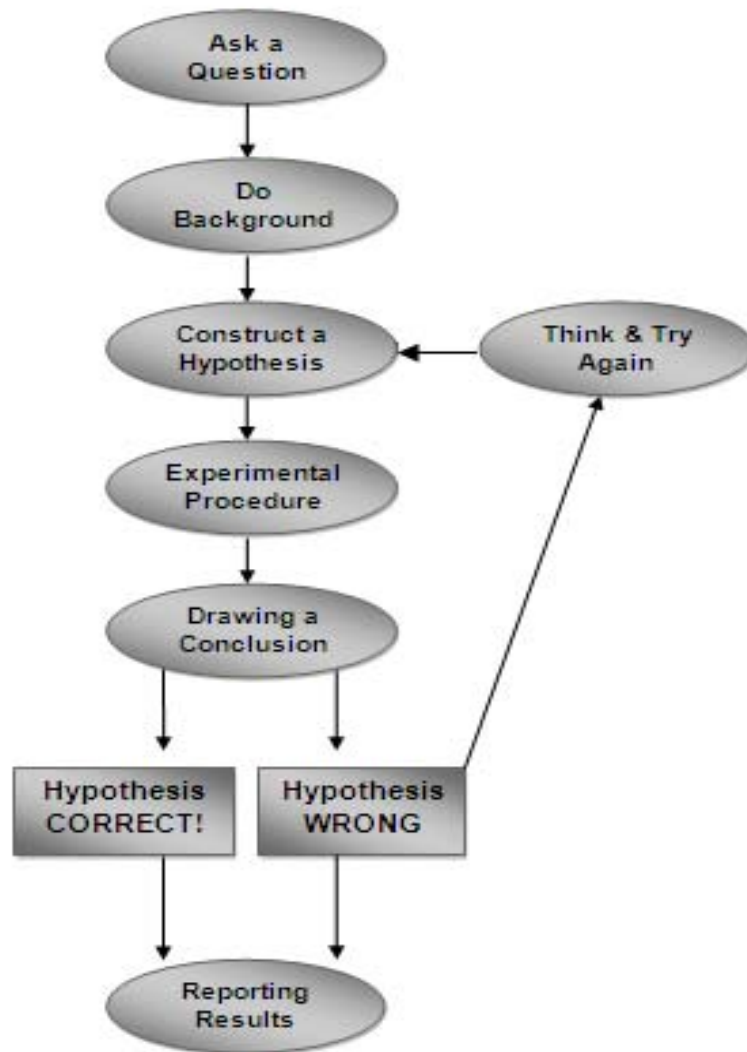

## ***Looking At the Steps in Detail***

---

Many students aren't necessarily aware of what these steps mean even if they have done them many times. They may have just been following the steps without knowing why they are important. The following is a more detailed explanation of each.

**Asking a Question:** It is important to first identify the *How, What, When, Who, Which, Why, or Where* of your experiment. In order for you to arrive at an answer to this question, it is important that the question refers to something that you can measure, often with some type of a number.

**Doing Background Research:** In order to answer your questions you may have to use the process of trial and error, however, you can often find a great deal of information concerning research that has already been done to answer your questions or similar ones.

**Hypothesis:** A hypothesis is an educated guess about how things work:

"If \_\_\_\_\_ [*I do this*] \_\_\_\_\_, then \_\_\_\_\_ [*this*] \_\_\_\_\_ will happen."

Scientists try to state their hypothesis clearly and make sure that it predicts something measurable. It is important that the hypothesis help to answer your initial question. When trying to come up with a hypothesis it is helpful to keep in mind the known or expected behavior of both **independent** and **dependent variables**\*.

**Experimental Procedure:** To see if your hypothesis is correct and find the answer to your question you need to conduct an experiment. You will need to be sure to only change one variable at a time and keep all other conditions equal to one another. Many experiments involve a **control** (something that never has any factors changed) in order to have something to compare their results to. For example, if you wanted to see how much taller a plant will grow with a certain type of fertilizer, you should also have a plant that does not get any fertilizer on it so that you can compare the heights and see how much of a measurable difference there is between the heights of the plants. It is also very important to repeat these procedures a few times to make sure that your original results were not an accident and that your procedure produces the same results each time. With the case of the plants you could just grow several "control" plants and several fertilizer plants at the same time; with another type of experiment you may just have to repeat the process.

**\*Independent Variable:** *the item or process in the experiment that will be changed; there should only be one independent variable in an experiment in order to be able to properly identify the cause of your results*

**\*Dependent Variables:** *the items or process that will be measured or observed during the experiment.*

**Drawing Conclusions:** Once you have finished your experiment and collected the measurements, compare your results and analyze them to see if your hypothesis was correct. A

data table or graph is often a very good way to help yourself and others better understand your results.

**Reporting Results:** The final step is to clearly record the information you have obtained and put it in a form that clearly communicates the results to others. This is common of professional scientists and students of all levels and there are many ways to accomplish this. Sometimes writing about what you found is the easiest way and maybe including your data tables to support your explanations. When possible, pictures and diagrams are *very* helpful tools for this.

### ***What If Your Results Do Not Turn Out As Expected?***

---

Aside from simply illustrating the scientific method, Figure 1 also shows us a very important fact for every scientist to keep in mind: ***Sometimes a hypothesis is incorrect!*** Even the best scientists sometimes get things wrong, especially if they are doing experiments with things they are not very familiar with. An incorrect hypothesis, or wrong answer in general, is not something that you should let discourage you. Getting things wrong is an important part of learning. If your hypothesis turns out to be incorrect or the experiment just does not work, reexamine your thinking and try again. Were there problems with your background research, your hypothesis, or your procedure? Was there a problem with your equipment? Did you account for *all* of the variables? Because of the many factors can affect an experiment, it is very common to get unexpected results. Even if your hypothesis is correct, it is still sometimes a good idea to test it again in a different way, especially if you are doing a new experiment that does not have a lot of background information that relates to it. Additionally, if you begin to think you may have done something wrong or recorded information incorrectly, it is important to go back and repeat the steps to ensure that things turn out correctly. These types of methods will help make your results reliable as well.



## ADAPTING AND CREATING EXPERIMENTS FOR YOUR CLASS

---

Although this manual does contain several very practical experiments for you to do with your classes, you might find that you would like to have more experiments to do with your students. This section is intended to help you either adapt an existing experiment to do with your class or to create an experiment of your own. At first this task may seem overwhelming, but it becomes very manageable once broken down into smaller pieces as shown below. Additionally, there are many sources that you can go to for ideas and help (these are discussed later).

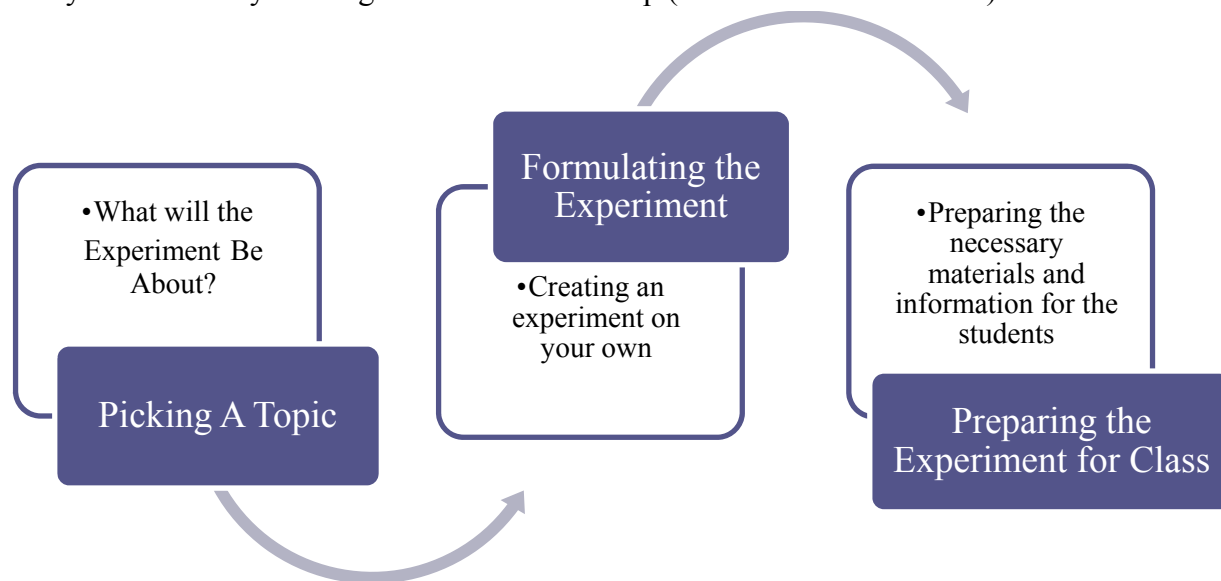

### *Picking an Experiment Topic*

---

Whether you are adapting and existing experiment of creating your own, the first thing that you will have to determine is, “*What will this experiment be about?*” To start with, you will have to ask yourself some key questions to make sure that your experiment is appropriate, feasible, and accomplishes your individual goals. Whether you are going to take an experiment you find and use it in its original form or find a concept and adapt it in to an experiment of your own, the following questions can be useful for evaluating how well it meets the necessary criteria:

1. What is the particular area of science or specific topic that I want this experiment to address? (*Biology? Physics? Maybe an individual topic such as electrical current or agriculture? Does it need to mirror a particular aspect of the curriculum for the class?*)
2. What levels of ability will this experiment to be intended for? (*What grade level are the students? Are they especially good at science or do they struggle with it?*)

3. How much time do I want this experiment to take? (*Will there need to be visible results by the end of one class period or can the experiment continue through several classes or perhaps a week?*)
4. What is the lesson that I want the students to learn? (*Will the focus be more on gaining a better understanding of the overall process of doing a laboratory activity or am I trying to communicate specific scientific ideas?*)
5. What materials are currently available? Can I obtain additional materials if necessary? **(Keep in mind that, especially if you want to use recycled materials or have students bring something in, it could take awhile to gather everything needed and you will have to plan for this)**
6. Has someone else already done an experiment like this? (*It is often easier to adapt existing ideas than it is to create your own*)
7. What background information will I need to research? (*Do I already know enough about the topic to conduct the experiment and address any particular questions or problems that the students might have?*)

Additionally, the following is a list of questions that we used to develop and evaluate the four experiments in this manual:

- Overall, is the experiment of good educational value to the students?
- Does the experiment engage the students? (*Will they find it interesting and perhaps even fun?*)
- Will this experiment encourage them to think independently and not just follow directions?

Not every experiment can address every single one of these questions, but they provide a good starting point for thinking about, and developing or picking out, an experiment that is well suited to your class.

Perhaps in answering these questions and going to the library, another teacher, friend, or the internet, you have already found a great experiment. If this is the case then you can skip on to the section, *Preparing the Experiment for Class*. If not, you will now need to go through the process of formulating the details of the experiment covered in the following section.

## ***Formulating the Experiment***

---

**Step 1:** The first thing you will need to do is to identify your control and the independent and dependent variables. This will allow you to have a clear picture of what the experiment involves before you start. You may also want to consider pointing out these variables to the students or asking students to identify the variables on their own when they conduct the lab. A good idea is to simply list the variables or put them into a table. Remember that, if your experiment is being conducted correctly, there will only be one independent variable (the one that the scientist changes). If you find that you have more than one independent variable you will have to eliminate all but one to make the experiment valid.

**Step 2:** Since you have already answered the *Who? Where? How? Why?* questions when you decided what the experiment would be about, the next step is to make your hypothesis. Because you are creating this experiment for students, you may already know the outcome. However, by indentifying your variables and creating your own hypothesis statement you will have a more structured means of evaluating the hypotheses that your students develop. Perhaps you want to make a list of important terms that you are looking for from students in their hypothesis statements to evaluate their thinking and effort. There is never really a “wrong” hypothesis, as long as the students are clearly and logically justifying their reasons for stating it. Often, students can learn just as much, if not more, by being proved wrong because they have been exposed to something new and/or shown an alternative to their current way of thinking.

**Step 3:** The next step is to create a procedure for the experiment. This should be a set of very detailed, step-by-step instructions that are clear and easy to follow. The procedure should be detailed enough that someone who has not done the experiment before can duplicate it exactly without your help. Keep in mind that amounts should be given in specific quantities. It is also important to include information about the control and the independent variable of your experiment. Remember, you should test only one variable at a time. This is also the place to mention if the experiment will be done somewhere other than a typical classroom, i.e. outside or in a different type of room. Answering the questions in *Table 1* is a good way to see if your experimental procedure is good. You should be able to answer “*Yes*” to every question

**Step 4:** Now you should have a concrete idea of what materials you used and in what quantities. This information is what you will use to create your materials list. The materials list should include everything that you need to conduct one setup of the experiment. It is *very* important that the quantities of items be given very specific numbers. Remember to list any tools or measuring devices used such as beakers, hot plates, scissors, rulers, etc., so that there are no surprises during the experiment. *Table 2* provides a good list of examples for evaluating your materials list.

**Step 5:** The next step is to redo the experiment a few times to make sure that the procedure and materials yield consistent results. Compare the experiments to your hypothesis as well as to each other. You might encounter some unexpected results. You can adjust anything necessary in your hypothesis, procedure, and materials list to account for these results and think about why they might have happened. It can also be helpful to ask another teacher or willing person to do the experiment with you once to get their suggestions.

**Step 6:** After doing the actual experiment you will need to create your own “conclusion” and think of how you want the students to develop conclusions when they do the experiment. Consider:

- How did the results of your experiment compare to your hypothesis? Was your hypothesis correct?
- If your hypothesis was incorrect, why do you think this was the case? (Was something done incorrectly during the experiment? Were the controls hard to maintain? Were you perhaps not sure what to expect for results? Etc.)
- What did you learn from all of this?
- How do these results apply to something outside of the classroom? (In your everyday life or perhaps the world in general)
- Do you have any recommendations for someone else doing this type of experiment?
- Are there any questions you had that have not been answered?

*Experiment Creation Worksheet* in the back of the manual gives a blank form that you can use to help yourself get through the process of experiment development and adaptation. This worksheet is designed for teacher use.

***Table 1: Experimental Procedure Questions***

---

<b>What Makes a Good Experimental Procedure?</b>	<b>For a Good Experimental Procedure, You Should Answer "YES" to Every Question</b>
Have you included a description and size for all experimental and control groups?	Yes / No
Have you included a step-by-step list of all procedures?	Yes / No
Have you described how to change independent variable and how to measure that change?	Yes / No
Have you explained how to measure the resulting change in the dependent variable or variables?	Yes / No
Have you explained how the controlled variables will be maintained at a constant value?	Yes / No
Have you specified how many times you intend to repeat the experiment (should be at least three times), and is that number of repetitions sufficient to give you reliable data?	Yes / No
The ultimate test: Can another individual duplicate the experiment based on the experimental procedure you have written?	Yes / No
If you are doing an engineering or programming project, have you completed several preliminary designs?	Yes / No

*Table 1: Taken from:*

*[http://www.sciencebuddies.org/science-fair-projects/project\\_experimental\\_procedure.shtml](http://www.sciencebuddies.org/science-fair-projects/project_experimental_procedure.shtml)*

*Copyright © 2002-2008 Kenneth Lafferty Hess Family Charitable Foundation. All rights reserved.*

***Table 2: Comparison of Materials List***

---

<b>GOOD Materials List</b>	<b>BAD Materials List</b>
500 ml of distilled water	A Bottle of Water
25 mung bean seeds	Seeds
2 C alkaline batteries	A Few Batteries
3 sets of clean microscope slides and covers	Microscope equipment
6 pieces of string, each 50cm long	6 pieces of string
100 mL flask	Flask
Safety glasses and rubber gloves for each group member	Safety equipment
10g of baking soda	Small amount of baking soda

*Table 2: Comparison of an example of the proper way to create a materials list and a list that is insufficient. The “Good” list is very detailed and helpful to someone who has not done the experiment before, allowing for exact replication. The “Bad” list leaves a lot to be guessed and therefore an increased chance of errors.*

## **PREPARING AN EXPERIMENT FOR CLASS**

---

Whether you have created or adapted your experiment, there are certain things that you will need to do to prepare it for your class. The following is an outline of tasks and consideration necessary to make the experiment more engaging and ensure its success.

### **Test the Experiment**

This corresponds to *Step 5 of Formulating the Experiment*. You should do the experiment two or three times so that you are able to anticipate student problems and questions and to make sure that it works as expected. As mentioned previously, it can also be helpful to ask another teacher or willing person to do the experiment and give you some suggestions.

### **Perform Any Necessary Modifications**

After testing, you will probably have to modify the experiment. Modifications could be based on difficulty levels for students who are more advanced in science or students who struggle in science. You may also need to modify the amounts or types of materials being used. Perhaps you would like to do a chemistry experiment on a smaller scale to make it less dangerous or to save materials (if the ratio of one chemical to another stays consistent you should get the same results). Perhaps you would like to have the steps of the experiment assigned to individual students or groups to increase class participation. This is the point in the preparation process to address all of these issues.

### **Create an Introduction**

When students get ready to do a science activity of any sort, it is helpful to have an introduction to the topic the experiment deals with, connections to the curriculum text, and the relevance and/or purpose of the experiment. This introduction can be presented to the students verbally, in written form, or both. This would also be a good time to discuss any materials or procedures the students might find unfamiliar. The more prepared a student is for an experiment, the better they will be able to complete it successfully.

### **Creating the Conclusion Questions**

If you have not already created your own conclusions for the experiment, please read *Step 6 of Formulating the Experiment*, then come back to this paragraph. Once you have answered the questions presented in *Step 6* you will be better able to determine if your students will be able to arrive at such conclusions on their own. If you think that

your students will not quite be ready to think independently enough to draw these conclusions, you should create some questions to help guide the students. These questions should be similar to those that you answered yourself but focused more directly on the particular experiment you are working with. For instance, you can ask them what specific changes they saw or measured and possibly provide them with a data table to fill in or place to draw pictures of what they observed. The questions you provide should guide the students towards answers that will highlight what they should be learning and its connection to everyday life. If you think that your students are more advanced in this type of independent thinking, you can provide fewer questions, ask them to draw their own conclusions, create their own data table, etc.

### **Creation of Visual Aids**

Visual aids, such as diagrams, posters, models, graphs, drawings, demonstrations or photographs are all very useful tools in helping to communicate with a broad audience of people. Even when everyone speaks the same language, in general, people tend to have diverse learning styles. This is the time in the development process where you will want to think about any visual aids you could create or find that might relate to the experiment. Including visual aids will help to make the lab more interactive for some and easier to understand for others. Including visual aids can be a highly successful learning tool. These aids can provide clarification on details that may be difficult to explain verbally to people who are unfamiliar with the topic you are discussing.

### **Physical Experiment Preparation**

Finally, prior to starting the actual class during which you will conduct the experiment, you need to physically gather materials and decide how many students will work together in a group. Smaller groups usually allow more participation from each student; however, this is not always possible due to space and materials available. If the groups need to be larger, it might be helpful to think about how you could assign each student a designated task within the group. This can help encourage participation from those students who might have otherwise observed passively. It is also important to keep in mind that ***if a material item can be spilled, broken, or ruined in some way (cut to the wrong size for example) it probably will, at least once.*** Therefore it is highly recommended to take this into consideration when gathering materials and try to have extra items available when possible!

Congratulations! Now that you have everything together you are officially ready to conduct a well-organized, successful science experiment with your class!!



## **ADDITIONAL SCIENCE RESOURCES – WHERE TO LOOK**

---

In order to find an experiment to use or modify, or to do additional research about a science related topic in general, it is important that you know *how* and *where* to look. This section will give you some information about places where you and your students can find much of the information that you will need to expand your current library of scientific experiments, literature, and news.

**The Internet:** One of the easiest places to find lots of helpful information is the internet. You can find experiment ideas, lesson plans, worksheets, “*How To*” guides, get answers to science questions, and more online. The next section, *Finding Science Materials One the Internet*, goes through some important details on how to search the internet, what to look for, and a table of selected websites that have a lot of good information to help you teach.

**Science Journals:** Nearly all college and public libraries will have some selection of scientific journals available for your use or, at the very least, be able to get them for you. These journals are essentially a large magazine filled with information on the latest scientific news, usually in a specific area such as Medicine, Science Teaching, Environmental Science, General/Popular Science, etc. Many of these journals can also be found online; some free, some requiring a subscription. You should always check to see if there is a teacher discount available if you plan to order a subscription yourself. You may want to consider subscribing your school to a few and having them housed in the school library if there is room in the budget or multiple teachers want to chip in.

**Books:** There are many books, other than textbooks, available for teachers and students that have a huge selection of science activities, information and experiments for all levels. The books referenced to help develop some of the experiments used in this guide were:

- Biology for Every Kid by Janice VanCleave
- Earth Science for Every Kid by Janice VanCleave
- 730 Easy Science Experiments: With Everyday Materials by Churchill, Mandell and Loesching

These and other such books are commonly found at most larger book stores, but you can often buy a used copy for a *very* low price if you shop online through a used book retailer or look in a used book store.

**People:** Another valuable source of information to keep in mind is other people. You might be surprised by the suggestions and information you get from other science teachers, coworkers, and friends. Even if they do not teach science, these people might remember a really interesting experiment they have seen or done in the past, or know someone to refer you to.

### **Finding Science Information on the Internet**

This section briefly explains details on how to find information through the use of a search engine. The section also describes what kinds of information to look for, and some good resources that we can direct you to as a start.

- **Where to Start**

When searching the internet the first thing you need to know is where to look. You can either use a single search engine or a website that searches multiple search engines at once. There are also certain websites that have answers on a lot of different topics and can link to information within their page and perform a search at the same time.

Some popular search engines are:

- [www.google.com](http://www.google.com)
- [www.dogpile.com](http://www.dogpile.com) (searches multiple search engines at the same time)
- [www.search.com](http://www.search.com) (works like Dogpile; includes results from Google, MSN, AltaVista, etc.)

There are also websites such as *AOL.com* and *MSN.com* that allow you to search the web from their homepage. The place that you search from is a matter of preference, however, you will find that one search engine often provides you with different results from the others. Because of this, it is helpful to use a combination of several search engines if you are not finding what you need right away.

- **What to Look For**

The information you will be looking for will typically be designed for primary and secondary science teachers and students. *There is no need to spend money to get this type of information.* The only thing that might cost money is a subscription to a scientific journal, but often these can also be obtained without cost to you personally. *If a website asks for payment, move on.* The same information will almost certainly be found somewhere else for free. It is also not necessary to buy fancy science kits. The purpose of this manual is to help you create inexpensive science labs from everyday materials and there is more than enough information online to do this.

The following is a list of example words and phrases to use when searching the internet to try to find experiments.

- experiments
- science
- “lesson plans”
- “children’s science”
- “science on a shoestring”
- “science experiment ideas”
- “science fair ideas”
- “science lab ideas”
- “middle school science”
- “high school science”
- “science projects”
- “middle school science resources”
- “science teacher information”
- “free ...”

\*(for example, “*free science lesson plans*” will yield different results than “*science lesson plans*”, but both could produce results that you find useful)

Keep in mind that these are just examples and that rearranging and combining these words and phrases and adding new ones will give you even more results and resources to choose from.

### **Tips for Searching**

In order to use a search engine more effectively there are a few things that you should know.

1. The same words in a different order can produce very different results
2. Using quotation marks ( “...” ) around your words (“*science projects*” instead of *science projects*) will give you results where the words *science* and *projects* are connected instead of just both present on the page
3. Changing the words you use to search for something will produce *very* different results. For example, *science lesson plans* and *high school science lessons* give very distinct results. If you are not getting what you need try changing how you ask.

4. Using a minus sign ( - ) in front of a search term will exclude results that contain that word (typically used when two words are commonly associated but you do not want one of them present). An example would be searching for *fish -ocean*. This would exclude any websites relating to fish that mentioned the ocean. You could also use this for a string of terms: *fish -ocean -pet*
5. Using a plus sign ( + ) in front of a search term will only yield results that contain that term. If you searched for *fish +ocean* you would only get results containing both terms. This can also be used in a string: *fish +ocean +Asia*.

### Tables 3: Science Web Sites

Here are links to some helpful websites related to finding experiments and help with classroom science in general, as well as a brief description of each the contents of each page.

Table 3: Web Sources for Free Science Worksheets, Lessons, Experiment Ideas, etc.	<u>Web Address</u>	<u>Contents</u>
	<a href="http://www.sciencenetlinks.com/">http://www.sciencenetlinks.com/</a>	Material for science educators working with students from grades K-12. Includes lesson plans, teacher and student worksheets, links to and reviews for other science web pages and updates on current scientific research and discoveries.
	<a href="http://education.jlab.org/">http://education.jlab.org/</a>	Includes teacher resources such as hands-on activity guides, worksheets and ideas. There is also a big section for students that includes homework help, lesson supplements and a variety of games and puzzles.
	<a href="http://www.homeschoolingonahoestring.com/science.html">http://www.homeschoolingonahoestring.com/science.html</a>	Information and lesson ideas for all fields of science for students grade K-12. Links to other sources as well.
	<a href="http://scienceclub.org/scifair.html">http://scienceclub.org/scifair.html</a>	Various science fair ideas. Separated by difficulty level ranging from beginners to high school and adult.
	<a href="http://www.exploratorium.edu/snacks/index.html">http://www.exploratorium.edu/snacks/index.html</a>	Link within a science museums website that contains "How To" guides on creating miniature versions of some of the museums most popular exhibits. Can be searched by activity type of supplies required.
	<a href="http://www.all-science-fair-projects.com/">http://www.all-science-fair-projects.com/</a>	Over 500 experiment and project ideas for all subjects and grade levels. Has easy to use search tool on main page. Results appear very low on page so you will have to scroll to the bottom to view them.
	<a href="http://www.juliantrubin.com/schooldirectory/environmentresources.html">http://www.juliantrubin.com/schooldirectory/environmentresources.html</a>	Resources for K-12 Environmental Science materials. Includes activities, information, world issues in environmental science and project ideas.
	<a href="http://library.unesco-iiiba.org/English/SECONDARY_SCIENCE_SERIES/index_pages/science_lessons_by_topic.htm">http://library.unesco-iiiba.org/English/SECONDARY_SCIENCE_SERIES/index_pages/science_lessons_by_topic.htm</a>	Lesson plans from the Zimbabwe Science Program. Focus on interactive science that is relevant to people living in rural areas. Instructions are very clear and adaptable. Materials needed for experiments are typically <i>very</i> inexpensive and readily available or adaptable.

## USING MICROSCOPES

---

This section gives information about the use and care of microscopes and how to introduce them to your class. There are also pictures of various specimens (as seen through a microscope), as well a laboratory experiment designed to help teach students how to use microscopes effectively.

- **Using Microscopes With Your Class**

- If microscopes are available to your students, you should realize that the students may not understand how to use them properly. Improper use of the microscope can damage it very quickly. Therefore, before allowing your students to use microscopes, you should first pass on the information contained within *Worksheet B* and run through an instructional session with them (the beginners' lesson contained on *Worksheet C*). This will protect your equipment and ensure that the students get the most from their use of it.

- **What Am I Looking For?**

- Even if you know how to use a microscope you may not know what you are looking for with it. There are many different things that you can view with a microscope including bacteria, parasites, samples of plant and animal tissue. In most situations you will know what you put under the microscope and viewing it will just require adjusting the lens until your specimen comes into focus. However, in some circumstances, such as when you are looking for bacteria or parasites in a sample specimen that you have collected (water, feces, food, etc.) you might not know what to look for even if you are able to focus the microscope. To help give a better idea of what these things look like, pictures of some examples of bacteria and parasites have been included at the end of this section. Not all bacteria and parasites look the same, but these pictures should help to give you the general idea.

**Pictures**



Roundworm



Pinworm



Whipworm



Dwarf Tapeworm



Intestinal Fluke



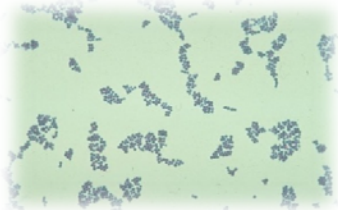

Amoeba Parasite

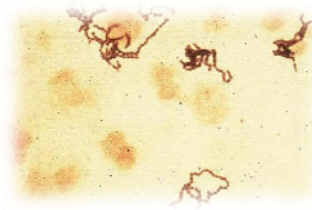

cocci bacteria

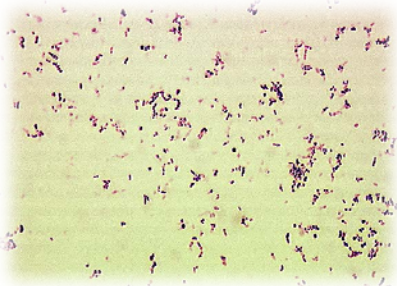
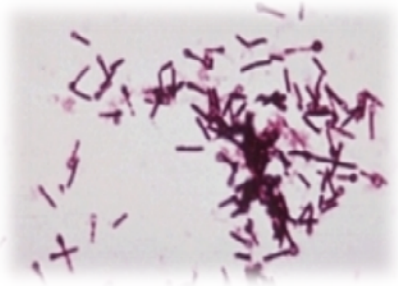
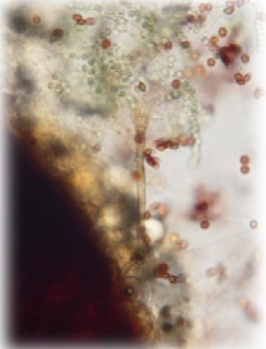

A different form of cocci bacteria

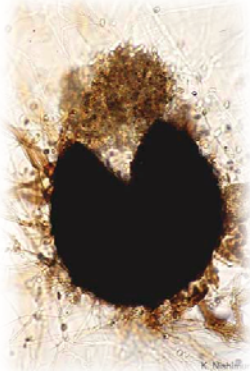
 <p data-bbox="365 577 618 611">rod shaped bacteria</p>	 <p data-bbox="998 577 1252 611">rod shaped bacteria</p>
 <p data-bbox="305 1010 686 1043">Aspergillus nidulans - fungus</p>	 <p data-bbox="951 1010 1304 1043">Bipolaris specifera - fungus</p>
 <p data-bbox="326 1444 665 1478">Curvularia lunata - fungus</p>	 <p data-bbox="919 1444 1339 1478">Pseudallescheria boydii - fungus</p>

*Pictures taken from:*

[www.thelifetree.com](http://www.thelifetree.com)

<http://www.geocities.com/capecanaveral/3504/gallery.htm>

<http://www.pf.chiba-u.ac.jp/english/egallery-index.htm#A>



## **Microscope Instruction:**

---

### **Parts of the Microscope:**

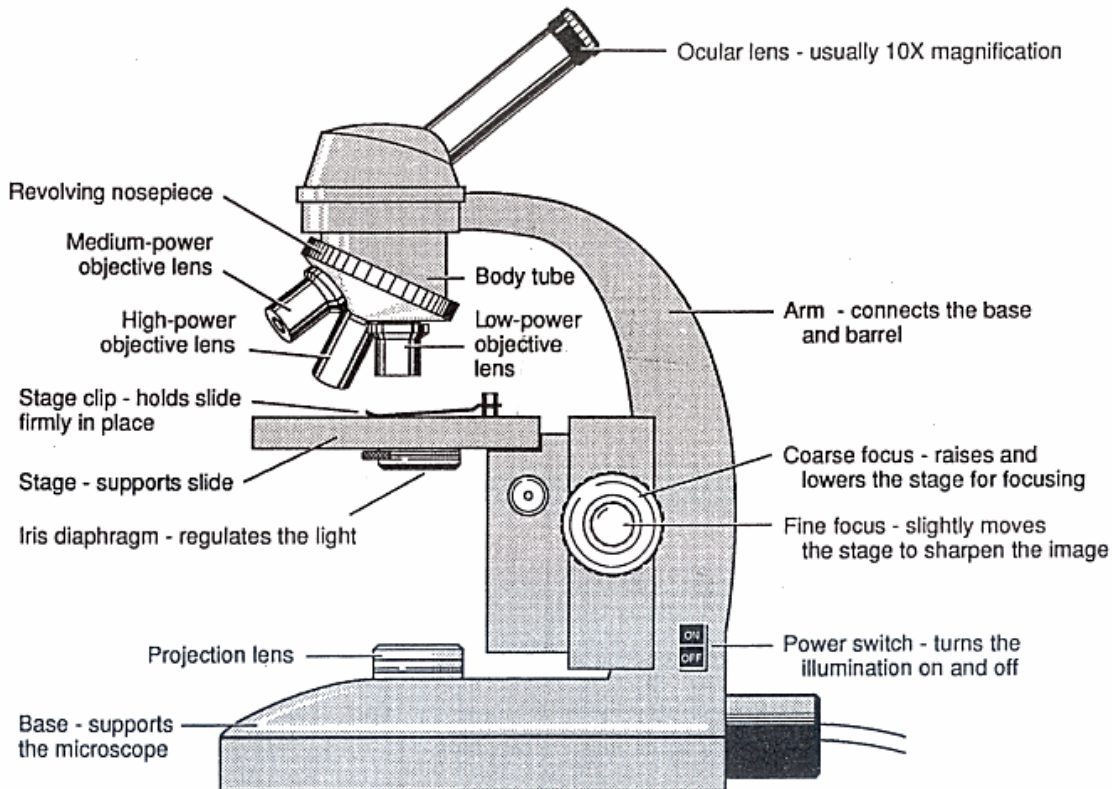

### **Proper Care and Use Instructions:**

1. Always carry the microscope with two hands. One hand on the arm of the microscope, while the other supports the base. Always carry the microscope upright so that the lens does not fall out.
2. Use only lens paper to clean the lenses. Coarse paper will scratch the lens. Never touch the lenses with your fingers.
3. Never allow the lens to touch the cover slip of a slide. This can break the slip cover and/or the lens of the microscope.
4. Never attempt to repair your microscope yourself. Always notify the teacher.
5. Before returning your microscope to storage, remove the slide from the stage and rotate the nosepiece so the low power objective is in place. The low power objective is the shortest and so is least likely to be damaged. Slides left on the stage may damage the lens.
6. When preparing a microscope slide always be sure to make the specimen as thin as possible so that light can transmit through it to help you view.

## ***How to Prepare a Microscope Slide***

---

The following is taken directly from

<http://www.usoe.k12.ut.us/curr/science/sciber00/7th/cells/sciber/slidepre.htm>

and explains how to prepare microscope slides. Two different methods are given as well as explanations on when to use which method. There is also information on how to use stains if they are available to you and which chemicals work for this.

**Slide** - rectangular piece of glass or plastic on which you place the specimen.

**Coverslip** - thin, square piece of glass or plastic which you place over the specimen on the slide.

A. **Dry Mount** - requires no water (slide, object, coverslip); usually used for inanimate objects that don't require water to live.

1. Place slide on a flat surface.
2. Lay specimen on top of slide (use as thin of a specimen as possible - 1 cell layer thick is best).
3. Place coverslip slowly on top of specimen as flat as possible.

B. **Wet Mount** - requires water (slide, water, object, coverslip); used to prepare slides that hold living organisms (mobile or not).

1. Place slide on a flat surface.
2. Place a drop of water on the slide. Add the specimen to the drop of water (at times, you may want to have the specimen already on the slide before adding the water).
3. Hold the coverslip by its sides and lay its bottom edge on the slide close to the specimen. Holding the coverslip at a 45o angle helps.
4. Slowly lower the coverslip so that it spreads the water out. If you get air bubbles (looking like little black doughnuts), gently press on the coverslip to move them to the edge. If there are dry areas under the coverslip, add a little more water at the edge of the coverslip. Too much water can be dabbed off with a piece of paper towel.
5. Moving organisms can be slowed down with commercially prepared solutions, such as Protoslo. A few strands from a cottonball added to the water also can help trap and slow down organisms.

C. **Staining Specimens** - Lugol's iodine, methylene blue, or crystal violet may be added to specimens in order to increase contrast. The stain can be directly added to the water when first preparing the slide or it can be added later after first viewing the specimen without the stain. Add a drop of the stain along one edge of the coverslip. Placing a piece of paper towel along the opposite edge of the coverslip will help draw the stain under the coverslip.

**CAUTION:** *The above dyes will stain skin and clothing. They are also harmful if ingested.*

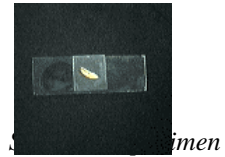
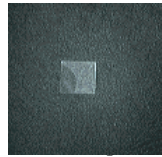
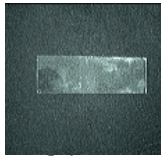

*These exercises will walk you through how to use a light microscope. The information contained here can be found in its original form at <http://kvhs.nbed.nb.ca/gallant/biology/biology.html>*

### ***Exercise 1: Determining Diameter of Field***

1. Rotate the nosepiece to low-power magnification. Place a clear plastic ruler on the microscope stage and focus on the millimeter divisions along the edge of the ruler.
  - a) Measure and record the diameter of the field of view by counting the number of millimeter divisions. Estimate to the nearest 0.5 mm.
  - b) Convert millimeters to micrometers ( $\mu\text{m}$ ). (1 mm = 1000  $\mu\text{m}$ .)
2. The field of view for both medium and high-power magnification can be determined indirectly by calculating the ratio quotient of the high-power objective lens to the low-power objective lens. Calculate the ratio quotient for each lens.
  - c) Ratio quotient =  $\frac{\text{magnification of desired lens}}{\text{magnification of low power lens}}$
3. Calculate the diameter of the field of view for both the medium and high-power objectives (use micrometers).
  - d) Desired lens diameter =  $\frac{\text{low-power field diameter}}{\text{ratio quotient}}$

### ***Exercise 2: Observing a Specimen***

1. Locate and cut out a lower case letter “e” from the newspaper and prepare a slide by placing the letter on the slide, adding a drop of water and then placing the cover on top.
2. Adjust the nosepiece so the low power objective lens is in place and clip the slide in place.
3. Using the coarse adjustment knob and by moving the slide as required, locate the “e” under low power. View the stage from the side so you can be careful not to allow the lens to touch the slide. It is easier on your eyes if you keep both eyes open while looking through the ocular lens (this takes some practice).
  - e) Describe the orientation of the “e” as seen through the microscope.
  - f) If the slide is moved to the right, in which direction does the “e” appear to move?
  - g) What does the appearance of the “e” through the microscope tell you about the resolving power of the instrument?

4. With the specimen centered in the field of view and in focus, rotate the nosepiece so that the medium power objective lens is in place. Bring the specimen into focus using the fine adjustment knob.
  - h) How does the size of the “e” seem to change?
  
5. With the specimen centered in the field of view and in focus, rotate the nosepiece so that the high power objective lens is in place. Bring the specimen into focus using the fine adjustment knob.
  - i) Do you see more or less of the letter?
  - j) Under which magnification is the image brought closer to the eye?
  - k) Which magnification would be most suited for scanning several objects?
  - l) Which magnification provides the widest angle for viewing?
  
6. Cut a 1 cm square out of a newspaper picture and prepare a wet mount.
  - m) Describe the picture under low, medium, and high power.

### ***Application Questions***

1. A student switches from the low- to the high-power objective lens of a microscope. The object being viewed disappears, even after careful focusing. Indicate why the object cannot be seen, and suggest a technique that would help eliminate this problem.
  
2. An oil immersion lens is often used to view very tiny objects. If an oil immersion lens has a magnification of 100x, calculate its field of view.
  
3. A correcting lens can be placed into the microscope to make objects appear in their normal (non-reversed) position. Suggest reasons why this would be useful.
  
4. Why is it important to measure the size of microscopic objects?

### ***Questions for Consideration:***

(If you did not get the information to answer the questions from this activity, you should use an outside source such as a textbook or the internet to look up the correct answer)

1. When centering an object under the microscope you move it from left to right, which way does it appear to move? When you move it away from you, how does it appear to move?
  
2. Why is it easier to locate objects under low rather than high power?
  
3. Why is it a good idea to centre a specimen in the field of view before switching to a higher power?

4. If you were trying to estimate the diameter of a very small specimen, which magnification would you use?
5. Explain why microscopes are stored with the low power lens in position?
6. Why should the coarse adjustment focus not be used with a medium or high power lens?
7. A thicker lens is often necessary for greater magnification, but results in a loss of resolving power. Explain why resolving power decreases as the thickness of the lens increases.
8. What is the proper way to carry a microscope?
9. How do you determine total magnification?
10. What is the total magnification of the specimen when you are looking through each of the objective lenses on your microscope?
11. Why is the built in pointer a useful feature of the microscope?
12. Why are micrometers rather than millimeters used for microscopic measurements?
13. Why is the field of view brighter under low power?

## **BUILDING ENTHUSIASM ABOUT SCIENCE**

---

As a teacher, you have probably already discovered that finding good material or creating a lesson is part of the process. Encountering apathy in the classroom is not uncommon, and if the students do not want to learn it is very difficult to teach them. However, if you can create a sense of enthusiasm within your classroom and towards the subject of science in general, it can be a lot easier to get the lessons across. There are many ways to build towards this type of enthusiasm. Below are some examples.

- Incorporate demonstrations and hands-on activities (in addition to regular labs)
- Have friendly competitions between students (or lab groups) that revolve around science related games, assignments, labs or activities
- Host a science fair. It can be optional, mandatory or maybe for extra credit. Award a prize to students who excel. Again, extra credit is always good if funding is not available for physical prizes. You can find many helpful ideas for this online (see the list of websites in Table 3 for some good places to look)
- Send experiments home with students. If the students create something or draw pictures of what they do in science class, you can send these home with them for their families to see
- Have students find science related things at home and bring these materials in to talk about them to the class. You might be surprised by what they find and it will help create a real connection for them between science and their lives

# EXPERIMENT CREATION WORKSHEET

---

## Answer the Following Questions to Help Identify What Experiment You Will Use or Create

### *For use with the Experiment Creation Worksheet*

1. What is the particular area of science or specific topic that I want this experiment to address? (*Biology? Physics? Maybe an individual topic such as electrical current or agriculture? Does it need to mirror a particular aspect of the curriculum for the class?*)
2. What levels of ability will this experiment to be intended for? (*What grade level are the students? Are they especially good at science or do they struggle with it? etc.*)
3. How much time do I want this experiment to take? (*Will there need to be visible results by the end of one class or can it continue on through several classes or perhaps a week?*)
4. What is the lesson that I want the students to learn? (*Will the focus be more on gaining a better understanding of the overall process of doing a laboratory activity or am I trying to communicate specific scientific ideas?*)
5. What materials are currently available? Can I obtain additional materials if necessary? (*Keep in mind that, especially if you want to use recycled materials or have students bring something in, that it could take awhile to gather everything needed and you will have to plan for this in scheduling*)
6. Has someone else already done an experiment like this? (*It is often easier to adapt existing ideas than it is to create your own.*)
7. What background information will I need to research for this? (*Do I already know enough about the topic to conduct the experiment and address any particular questions or problems that the students might have?*)



**Experiment Creation Worksheet**

***Title*** \_\_\_\_\_

***Brief Description of Topic*** \_\_\_\_\_  
\_\_\_\_\_  
\_\_\_\_\_

***Describe Control*** \_\_\_\_\_  
\_\_\_\_\_

***Describe Independent Variable*** \_\_\_\_\_  
***(there should only be 1)*** \_\_\_\_\_  
\_\_\_\_\_

***List and Briefly Describe All Dependent Variables***  
\_\_\_\_\_  
\_\_\_\_\_  
\_\_\_\_\_  
\_\_\_\_\_  
\_\_\_\_\_  
\_\_\_\_\_  
\_\_\_\_\_

*(Use back of paper if additional room needed)*

***Hypothesis*** (if I \_\_\_\_\_ (do this) \_\_\_\_\_, then \_\_\_\_\_ (this) \_\_\_\_\_, will happen)  
\_\_\_\_\_  
\_\_\_\_\_  
\_\_\_\_\_  
\_\_\_\_\_  
\_\_\_\_\_  
\_\_\_\_\_

***What Background Information Do I Need to Gather?***  
\_\_\_\_\_  
\_\_\_\_\_  
\_\_\_\_\_  
\_\_\_\_\_  
\_\_\_\_\_  
\_\_\_\_\_



## **Experiment Creation Worksheet**

### ***What Conclusions Can You Draw? (Keep in mind the following questions)***

- How did the results of your experiment compare to your hypothesis? Was your hypothesis correct? \_\_\_\_\_  
\_\_\_\_\_

- If your hypothesis was incorrect, why do you think this was the case? (Was something done incorrectly during the experiment? Were the controls hard to maintain? Were you perhaps not sure what to expect for results? Etc.)  
\_\_\_\_\_  
\_\_\_\_\_  
\_\_\_\_\_

- What did you learn from all of this?  
\_\_\_\_\_  
\_\_\_\_\_  
\_\_\_\_\_

- How do these results apply to something outside of the classroom? (In your everyday life or perhaps the world in general)  
\_\_\_\_\_  
\_\_\_\_\_  
\_\_\_\_\_

- Do you have any recommendations for someone else doing this type of experiment?  
\_\_\_\_\_  
\_\_\_\_\_  
\_\_\_\_\_

- Are there any questions you had that have not been answered?  
\_\_\_\_\_  
\_\_\_\_\_  
\_\_\_\_\_

### ***General Conclusions***

\_\_\_\_\_  
\_\_\_\_\_  
\_\_\_\_\_

## Appendix A – Additional Pictures for Activity #1

---

The following picture portrays a visual added to the grid worksheet used in *Two Methods of Water Purification*.

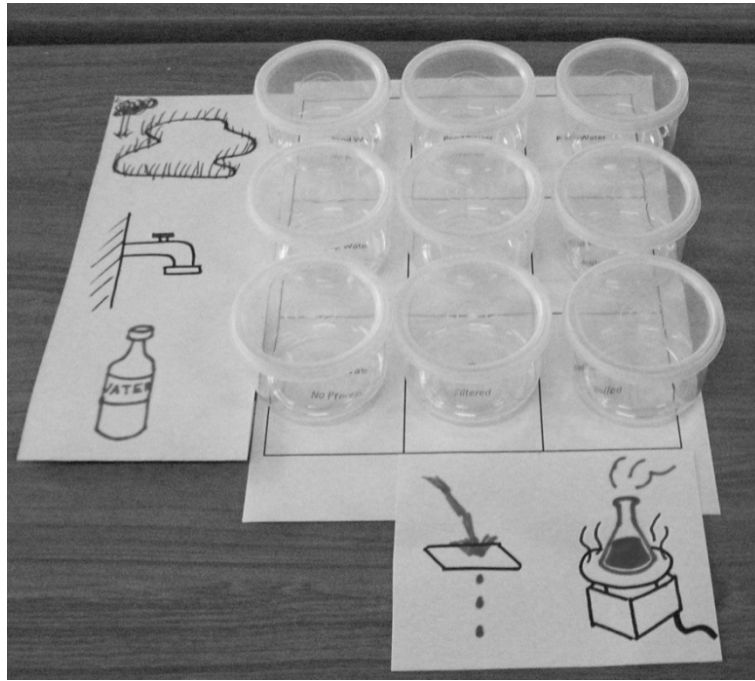

The following picture portrays a scientific funnel and an inexpensive alternative funnel (made from the top of a plastic water bottle):



## Appendix B – References

---

- Boswell, W. (2008). *Web Search 101*. Retrieved February 20, 2008, from About.com: <http://websearch.about.com>
- Dym, C. L., & Little, P. (2004). *Engineering Design: A Project-Based Introduction*. John Wiley & Sons, Inc.
- Fancher, L. (2004, September 13). *The Great "SM"*. Retrieved February 14, 2008, from College of DuPage: <http://www.cod.edu/people/faculty/fancher/SciMeth.htm>
- foodlink. (n.d.). *Food Storage Fact File*. Retrieved February 2008, from foodlink: <http://www.foodlink.org.uk/factfile3.pdf>
- Gallant, T. (2007, June 19). *Gallant's Biology Stuff*. Retrieved February 15, 2008, from Kennebecasis Valley High School: <http://kvhs.nbed.nb.ca/gallant/biology/biology.html>
- Kenneth Lafferty Hess Family Charitable Foundation. (2007-2008). *Resources*. Retrieved February 13, 2008, from Science Buddies: [www.sciencebuddies.org](http://www.sciencebuddies.org)
- Office of Natural Resource and Environmental Policy and Planning . (2005). *State of Environment Executive Summary*. Retrieved February 2008, from ONEP Website: [http://www.onep.go.th/eng/soe/soe2001\\_1.asp](http://www.onep.go.th/eng/soe/soe2001_1.asp)
- Rigg, J. D. (1985). *The Role of Environment in Limiting the Adoption of New Rice Technology in Northeast Thailand*. London: Geography Department, School of Oriental and African Studies.
- State of Water Environmental Issues. (n.d.). *State of Water: Thailand*. Retrieved February 2008, from WEPA: <http://www.wepa-db.net/policies/state/thailand/thailand.htm>
- US Department of Health. (2006, November 4). *Salmonella, General Information*. Retrieved February 25, 2008, from CDC Bacterial, Mycotic Diseases: [http://www.cdc.gov/ncidod/dbmd/diseaseinfo/salmonellosis\\_g.htm](http://www.cdc.gov/ncidod/dbmd/diseaseinfo/salmonellosis_g.htm)
- Wolf, F. (2004, June). *Introduction to the Scientific Method*. Retrieved February 13, 2008, from University of Rochester: [http://teacher.pas.rochester.edu/phy\\_labs/AppendixE/AppendixE.html](http://teacher.pas.rochester.edu/phy_labs/AppendixE/AppendixE.html)

# ThaiScience Cultural Essay Compilation

## **Contents**

Nicholas Amendolare – “The Farang” .....	2
McGhee Orme-Johnson .....	4
Jessica LaGoy – “Elevator Encounters” .....	6
Nathan Largesse.....	8
Emily Briskey .....	10

## Nicholas Amendolare – “The Farang”

When you’re walking through a crowd and someone says your name, you hear it. Even if there are a dozen other conversations happening around you, you’ll always hear your name. It sticks out. Certain words, like your name, are hooked up to some mental alarm. Swear words are the same way. You’ll always catch it when someone near you says a swear word. Naturally, when I was learning to speak Thai, I hooked other words up to this same mental alarm. “Farang” was the very first one.

A farang is a white foreigner. The word comes from the Thai word for the country of France, as the French were the first white foreigners to occupy Southeast Asia. Naturally, when more white people came to Thailand, Thai people couldn’t tell the difference, and so they referred to all white as Frenchmen, or “farang”. So, whenever someone said the word “farang” in Thailand, it triggered my mental alarm. Upon hearing the word, it always became a game of fill in the blank. I was never sure exactly what was said, but I usually assumed that it was not a kind remark. After all, I come from the United States, where foreigners are almost never welcomed. I imagined that “farang” was simply the Thai equivalent of the word “chink”. As such, it always caught my ear, and I was always wary of it.

During my third week in Sakon Nakhon, I was going for an afternoon run through the local village. I ran past many houses on this route, and I would usually see parents working in the yard and children playing. I was running past a friendly, neighborhood game of Tahkraw when the word “farang” jumped out at me. It was a boy who said it, one of the high school students that I knew well from school. At that point, I was puzzled. The boy said his remark with a smile. He obviously recognized me. And he said it rather loudly. I couldn’t understand. If I were to make a remark to my friends about some foreigner, I wouldn’t have said it loudly, or with a smile, or about a person I knew and liked. And then it dawned on me. Perhaps the word “farang” didn’t have a negative connotation after all. Maybe it used to. Maybe, when the French were colonizing the area the word did carry some distain with it. But, I realized that this was not the case any longer.

The word really just means “foreigner”. I carried my American prejudices with me when I made my assumptions about its meaning. Coming from a country where foreigners are almost always looked down upon, I could not imagine living in place where foreigners might be accepted, or even looked up to. I heard the word “farang” many times after that, and it always carried new meaning for me. One evening, I played soccer with some of the local students outside of the school. It was a three-on-three match on a small pitch, with various players substituting frequently. A crowd of girls and younger students gathered to watch us play, and I couldn’t help but hear them refer to me as “the farang”. I was never quite sure exactly what was said, but it was always said positively, almost lovingly, and I imagined that the conversation went something like this.

*“Oh, the farang’s playing soccer, is he? I didn’t know that farang knew how to play soccer.”*

*“Yeah, he’s been playing since before dinner.”*

*"Is he any good?"*

*"Yeah, he's ok. He's fast. Doesn't have good ball-skills, though."*

*"Oh, look! The farang just scored a goal... and now he's doing the airplane celebration."*

*"Silly farang."*

I will always remember being "the farang" for an evening. I played pretty well, in fact, and I did score a goal (and an airplane celebration afterwards). More importantly, though, my revelation about how Thais perceived foreigners has changed the way I view American culture. No, I don't hate America. I love America. But, I don't love all of it. We're a diverse country, a creative country, and a good country, in my opinion. But all this talk of how we Americans should be "tolerant" of foreigners needs to stop. Tolerance? How about acceptance? When I go back I will view foreigners from a different perspective. They aren't a group of people that crosses our borders to steal jobs and hurt the country. They come because they love their families and because they want a better life, just like all of us. And they're probably scared of this new country they're in, just like I was when I first came to Thailand. Besides, if you look back far enough, we're all immigrants. And we're all people, too. We all want to be happy, just like everyone else.



## McGhee Orme-Johnson

When visiting another culture, often there can be miscommunications that can lead to confusion and possibly offending people. One such situation happened to me a short time ago. While I was at the Princess' Projects Office, I was standing in line waiting for food. As I picked up one of the plates, I noticed it had a pattern around the edge that I thought was very pretty. I turned to Emily who was behind me and pointed to the edge of the plate and told her it was a nice pattern. One of the women who worked at the office saw me do this and took the plate away from me and handed me another one.

After a moment, it became clear that the woman thought I was saying the plate was dirty. I tried to explain that I meant it was pretty, and Emily tried to help by saying "may may, suay," which means "no no, beautiful." However, the woman misheard and thought Emily said "may suay," which means "not beautiful" and the woman interpreted that as Emily saying that she was not beautiful. Finally a man came over who spoke better English and I was able to explain the situation, but I think the woman was still very confused because she put the plate at the bottom of the stack.

This cultural misunderstanding appeared as very strange for me, mostly due to the fact that I could not explain myself to the woman. I was simply trying to say it was beautiful, and I did not understand why the woman would ever think I would point out a dirty plate. The way I was raised, it was considered very rude to do something like that. So for most of the situation I was just very confused as to what was going on, and then I was so embarrassed when I finally realized what had happened.

For the woman, this must have also appeared very confusing and embarrassing. I do not know how etiquette works exactly in this country, but I imagine it is considered rude here to point out that a plate is dirty. As such, when the woman saw me pointing to the plate, she must have assumed the worst and been very embarrassed. Then when she thought Emily was saying she was not pretty, I would think she was embarrassed again. She was also clearly confused the entire time, as she took the plate back at the end of it all anyway.

As I spent more time in Thailand, I noticed a trend that may have added to the confusion of this incident. It seemed that Thai people reserve the word "suay" for people. For example, while I was working at the Kusuman Wittayakom School, I tried to tell one of the teachers that her shirt was pretty. She sort of understood what I was saying, but then said, "I am suay too, yes?" This indicated to me that maybe I was using the word "suay" wrong. It also just may be that in this culture objects are not ever described as beautiful or not beautiful. While I have not been able to clarify this with a Thai person, I have spoken to my fellow students here, and my observation is not a unique one. Therefore I believe this observation is at least partially valid.

The first important thing I learned from this incident was that words are not necessarily used the same way in one culture as they are in another. Since my observation, I have not used the word "suay" to describe something as beautiful. The other important thing I learned from this experience was

to speak slowly and listen clearly to what is being said. As the woman and I could not understand each other most of the time it probably would have helped if we had both spoken slower to each other. It is also clear that embarrassment is something that goes across cultures and saving face is not something that is unique to Thai people.

## Jessica LaGoy – “Elevator Encounters”

About a month ago, at some ridiculously early hour of the morning, I arrived at the Bangkok Airport welcomed by a sign that read “*Long Live the King*” along the side of the breezeway next to my plane. This was, like many other things I have since seen here in Thailand, something I would have never encountered back home in the U.S. For the most part, however, most of the differences I have experienced here in Thailand have not been too surprising or confusing to me. I mostly credit this to cultural background research done in my classes last semester and my past experiences with people from different cultures. Unlike the majority of situations experienced here in Bangkok, the conversations that I recently had with a female Thai student in the elevator at Sutsiknives (our dormitory here in Bangkok) does stick out in particular.

About a week and a half ago I encountered a friendly young lady in the elevator and began a conversation as we made our way up to our floors. When we arrived at her stop I invited her to come hang out with later me because I was going to watch a movie on my floor. She was very glad for the invitation but had to decline and said that she was busy at the moment but perhaps we could hang out later....but it would have to be downstairs in the common area or on her floor. Of course I looked slightly confused at this response, so she went on to explain how *Thai female students are not allowed up on the 7<sup>th</sup> and 8<sup>th</sup> floors because there are American men there*. I told her it was no big deal and we could hopefully find time to hang out when she was done with her work. The more I thought about the situation, however, the more odd it seemed to me. Especially since I had previously been told that our dorm is only for international students and female Thai *graduate* students.

Reflecting upon the situation a little more closely I would have to say that I can, in a large part, understand where these regulations are coming from. Even though WPI has a good relationship with our host school here, we are still not completely trusted in certain ways because we are foreign. This is not to say that we have done anything wrong, just that we do not necessarily follow or understand the codes of conduct that are part of Thai culture. It does make sense in that respect because we Americans are typically not as conservative as a culture and tend to behave differently from what would be expected of a proper Thai person. Americans tend to be much more open to things like public displays of affection, open expression of anger, correcting people in public, etc. I also know that in Thai culture people are considered “children” and taken care of much longer than in my own culture; even as an adult the people of this culture care very much about what their families and elders think. They generally seem to do their best to keep these people happy, even if they disagree with what is wanted from them. It seems that due to this, elders feel much more responsibility and a stronger need to look out for people below them in a much closer way than we, as Americans, would typically expect a stranger to look out for our children/family. It seems very likely that this responsibility could cause the feeling of need for stronger regulations – to make sure that you are doing all you can to care for this other person’s child while they are away from their family’s home.

This is odd to me, however, because in my culture this is a point in your life when you would be totally free to do as you please because you are an adult. Someone this age would probably not live in a dorm

in America, let alone be under such restrictions; however these Thai students find it perfectly normal and accept it. I have a very hard time imagining myself or the typical American college student being accepting of such a restriction back home. I, as well as quite a few women I know, have shared living environments with men through most of the college experience and would feel rather awkward not being allowed to socialize in mixed company freely.

## Nathan Largesse

After spending about three weeks in Thailand, I'd had many memorable interactions with Thai people. Some of these had been positive and even nourishing to the soul. Others, however, had been frustrating, stressful, or even disrespectful. My four days spent in a luxurious Thai hospital was rather bland in the way of new experiences. Pleasantly uneventful, the nurses and doctors did their best to speak English and keep daily life comfortably dull. One event did test my patience, as there was not only an inability to communicate, but also culturally inflicted abrasion. Because I was connected to an IV, I required help from nurses to detach from the pump-machine so I could shower with the water-proof plastic solution bag elevated. This particular morning, my solution bag was just about empty at daily shower hour. I knew that this meant there was less pressure from the water in the bag holding blood in my body, and as I predicted, as soon as the pump was removed and the nurse left, my blood flowed upwards towards the bag. I called the nurse back and an ineffective game of charades ensued. She agreed that something was wrong with the upwards blood flow but was unsure how to solve this problem and sought another nurse for assistance. The miscommunication occurred when I tried to explain my solution to this problem and she did not understand it. In fact, she may very well have misunderstood it for a rather foolish solution. This only frustrated me further.

My solution to the problem was to replace the nearly empty IV bag with a full one. This would provide more opposition to my blood pressure, therefore keeping my blood from flowing up the IV tube. I knew this solution required a little work on the part of the nurse, and also potentially the potential waste of the 5% of water left in the existing solution bag, however it would have solved the problem. Even acknowledging the drawbacks to my suggestion, I wanted the nurse to at least recognize this suggestion as a solution to our shared problem. The fact that I was unable to communicate such a simple concept, and also that she was somewhat reluctant to listen, frustrated me to no end. It also bothered me that I imagined this was a common problem and that a solution should be readily available. I then had to stop, breathe, and remind myself that I have been in a hospital for four days, people all over the world aren't perfect at their job, and that a little blood really isn't a big deal.

After I had finished my shower and was once again receiving water through my left hand, I rethought the situation. I believe that she saw the problem of IV backflow much differently than I did. Where I saw this as simply *a* problem, she saw it as *her* problem. I believe that it is for this reason that she did not put very much effort into understanding me, and instead focused her efforts on generating her own solution. I believe that her feeling of responsibility for the problem has nothing to do with being Thai and instead has to do with simply her role as the nurse. The language barrier clearly is a cultural factor, however, and could be avoided in some other environments. In respect to language difficulties, I believe that she in fact misunderstood my proposed solution. Instead of hearing what I was trying to say, she believed that I was requesting a new bag because this bag "was broken". These were her words, not mine. Contributing to this conclusion could have been her idea of westerners being well to do, used to quick service, or even spoiled. Perhaps her "westerner" simply throws something away when it isn't working properly and obtains a new one. Although this may seem like a strong judgment

coming from someone who has spent so little time in Thailand, having witnessed this event in particular, it is my judgment that she was utilizing some form of prejudice, for better or worse. Her solution to the problem was very predictable. Like so many of us, we often approach a problem with a certain number of skills and known facts. Often we will use a tedious, long-way-around, or algorithmic approach simply because we know it will achieve our goal even if it is not the best way. Instead of understating the problem better, the nurse simply re-attached the IV to the pump where she knew backflow would not occur. This resulted in clearing up the backflow, however I had to shower with one hand up against the door and my body turned for the duration of the shower. This method of problem solving I have not seen to be especially Thai, and I in fact have seen myself use it numerous times. In fact, I have found this method is most desirable when one has already made a mistake and they are trying to avoid any other possible errors. This could directly relate to saving face. Having spent much longer in Thailand now, and observing personally that Thai people do not necessarily like to try new things or generate new solutions, this method of fool-proof problem solving makes even more sense. For her to try my solution, she would have to break away from procedure, what she was taught. This would provide results that she could not predict for sure. When working with the teachers at Kusuman Wittayakhom school, I noticed they were uncomfortable with most situations in which the end product was a mystery. Although this tendency for caution exists in all people, I believe it is partially a cultural trait in Thais.

Finally, I have thought about the differences in a situation such as this in the United States and as it was currently witnessed in Thailand. I believe an American nurse would be reluctant to accept help from a patient for the sake of pride, a “don’t tell me how to do my job” attitude. This attitude puts the nurse in charge and even superior to the patient. In Thailand, the nurse is reluctant to accept help because of “saving face”. This attitude is very submissive, as it directly recognizes a mistake was made on the part of the nurse. For the nurse to accept help from the patient would be embarrassing to the nurse, especially if another nurse is present. I think this difference between dominant and submissive attitudes in a similar situation represents two different cultural attitudes towards service industries. Where those serving others in Thailand have no problem with their position and readily tend to the needs of the client, servers in the United States are more conscious of their position and often make a point of establishing themselves as equals with their client.

I believe this incident was indicative of clashes in terms of both culture and role. At the root of the problem was the language barrier which prevented my potentially superior solution from being communicated. Equally as important, however, was the conflict of nurse and patient dynamics. The nurse’s attitude towards accepting help from a patient may have very well effected how hard she tried to understand me. In the united states however, it is very possible that the conflict and result would have been very similar, however for somewhat different reasons.

## Emily Briskey

The first day that my group arrived in Kusuman was a long, stressful one. We had spent the entirety of the previous day driving up to Sakon Nakhon. The day we arrived, we first went to the Kusuman District Office, where we gave a presentation and tried to speak with our school's teachers. Interactions with our new hosts were limited and stressful because of the language barrier and each side's anxiety over the coming weeks. Afterwards, we visited our host school, the Kusuman Wittayakom School. We were eventually taken to the house where we were to live for the next four weeks. Desperately needing a rest, we were grateful that we had the afternoon to ourselves to unpack, familiarize ourselves with our new abode, and relax. Although we did not have any obligations and, by all means, were free to unpack or look around, I found that the afternoon was not as relaxing as I had imagined. The teachers and staff made periodic trips to the house to drop off household items like fans, a refrigerator, microwave, etc. They frequently came in and inspected the house.

Later that night, we attended the rice festival at our host school. We were exhausted, but we thoroughly enjoyed ourselves and had the opportunity to meet the school community. We left the festival before it had ended so that we could make that long awaited jump into bed and finally get some sleep. After all, we had work the following morning, and we were told that we were expected to be at the school by eight. We went home and promptly got ready for bed. Nate and I were the last people to get ready. As I was crawling into bed around eleven thirty, I heard voices from the common room. At this point, all of my group members were in our pajamas, and three members were already in bed. I was desperately wanting sleep but anxious to not offend, so I decided to go out and see who was visiting. In our common room were two teachers and at least four students from our host school. There was no obvious point to this unannounced, late-night visit. The teachers inspected the house a bit, and the students mostly spoke in hushed tones to each other and played with Nick's guitar. I was feeling very awkward and somewhat imposed upon by this midnight intrusion. After poking around for almost a half hour, the whole group finally left, and we were free to sleep.

The next morning, at six forty-five, I awoke to the cleaning lady yelling "Sawadee Kha" through the door and unlocking it to bring in breakfast. She set up the table, inspected the washing machine and brought in some household supplies. I reluctantly got up and greeted her and began preparing for the day.

The group ate breakfast in almost complete silence. We were all feeling the effects of inadequate sleep and an intimidating new environment. We were aiming to leave the house about five minutes before we were due at the school, which would give up ample time to arrive by eight. Around seven forty-five, two students showed up at our door. They just knocked, came in when invited, and stood next to the doorway, waiting to escort us to school.

At this point, I realized that we had not been left at our house uninterrupted for more than one, six and a half hour stretch. I remember thinking to myself, "This is absolutely ridiculous." I had a legitimate fear that our lives were going to be micromanaged by our hosts for the next four weeks. I understood that the teachers were concerned for our comfort and well-being, but it seemed excessive. And I could not

understand how the teachers didn't recognize how imposing their frequent visits were rapidly becoming. Did they not understand that we were more than capable of waking ourselves up in the morning, or finding our way to the school, which was about a quarter mile away? While I appreciated the good intentions, I could not comprehend how our hosts rationalized this micromanaging behavior as acceptable.

At this point, I remembered a caveat that we had received from Aacaan Pat. She told us that Thais typically are not as independent as Americans. They live with their families until they are married. Even then, they remain closely tied with their parents. Aacaan Pat told us that even if she, as a professor and adult, went home and asked for anything, whether it be to move home or ask for money, her parents would comply. And in Thai culture, that is perfectly acceptable. She had warned us that our hosts would not know or understand that we all lived in our own apartments and were very independent.

Understanding the Thais' perspective of the situation, I realized that, though I knew along that our hosts' intentions were good, I had not appreciated the extent of their graciousness. Their agenda was not just to make sure that we were comfortable and that we woke up or arrived to school on time. Rather, this behavior was their way of caring for us as if we were their own children. This epiphany helped me tremendously in dealing with the frustrations of limited independence. More importantly, though, it helped me to grasp the extent to which the Thai people can truly be remarkable.