

May 2017

Renewable Energy SMART Lessons: An Educational Approach to a Sustainable Future in Namibia

Emily M. DiRuzza
Worcester Polytechnic Institute

Jessica Grabinsky
Worcester Polytechnic Institute

Katherine Pelissari
Worcester Polytechnic Institute

Timothy Edward Consedine
Worcester Polytechnic Institute

Follow this and additional works at: <https://digitalcommons.wpi.edu/iqp-all>

Repository Citation

DiRuzza, E. M., Grabinsky, J., Pelissari, K., & Consedine, T. E. (2017). *Renewable Energy SMART Lessons: An Educational Approach to a Sustainable Future in Namibia*. Retrieved from <https://digitalcommons.wpi.edu/iqp-all/2480>

This Unrestricted is brought to you for free and open access by the Interactive Qualifying Projects at Digital WPI. It has been accepted for inclusion in Interactive Qualifying Projects (All Years) by an authorized administrator of Digital WPI. For more information, please contact digitalwpi@wpi.edu.

Renewable Energy SMART Lessons: Promoting A Sustainable Future in Namibia



Timothy Consedine

Emily DiRuzza

Jessica Grabinsky

Katherine Pelissari



Renewable Energy SMART Lessons: Promoting A Sustainable Future in Namibia

An Interactive Qualifying Project submitted to the faculty of
Worcester Polytechnic Institute in partial fulfillment of the requirements
for the degrees of Bachelor of Science and Bachelor of Arts



Submitted by:

Timothy Consedine

Emily DiRuzza

Jessica Grabinsky

Katherine Pelissari

Proposal Submitted To:

Mr. Corris Kaapehi, EduVentures Trust

Project Advisors:

Professor Robert Kinicki

Professor Sarah Wodin-Schwartz

May 2017

This report represents work of WPI undergraduate learners submitted to the faculty as evidence of a degree requirement. WPI routinely publishes these reports on its web site without editorial or peer review. For more information about the projects program at WPI, see <http://www.wpi.edu/Academics/Projects>.

Abstract

This project assisted EduVentures Trust in developing four renewable energy SMART modules to expand sustainability awareness throughout Namibia. The team created the modules based on background research, local high school observations, rural school pre-visit surveys, and stakeholder interviews. After implementing the modules in the Ombombo mobile classroom, this project evaluated module effectiveness using pre-tests and post-tests, a learner evaluation, and module observations during field tests at Okondjatu Combined School. Results showed significant knowledge retention by the learners from the renewable energy modules. The evaluations revealed that the learners enjoyed the lessons and planned to continue their renewable energy education after the completion of the program.

Executive Summary

Introduction and Background

“The Windhoek learner has so many resources: labs, computers, and electricity. But the learner in the rural area has nothing and we need to address that” (Ministry of Mines and Energy Official, Personal Communication). A great divide exists between rural and urban education, although the government of Namibia emphasizes “Education for All” in its national initiative, *Vision 2030* (National Planning Commission, 2004). It is vital that the children of Namibia all have the same access to knowledge and resources because the ethical stances they form in their youth will influence their future contributions to Namibian society. To bridge the educational gap between rural and urban schools and spread environmental education throughout the nation, EduVentures Trust (EduVentures) delivers lessons to rural high school learners (the colloquial term for students) throughout the country in their solar-powered Ombombo mobile classroom. Their programs incorporate experiential teaching techniques, games and activities, and interactive SMART Technology to maximize learner retention and provide a hands-on approach to teach environmental topics (EduVentures Trust, 2008). EduVentures focuses on environmental education because Namibia is currently facing detrimental effects of climate change.

Climate change is causing national temperatures to rise, which makes Namibia’s land more arid than it already is. Rising temperatures lead to unpredictable weather patterns, which can cause drought or severe flooding. These consequences are harming key economic sectors within Namibia and in turn hurting the livelihoods of its citizens. This has become a serious problem in Namibia, as over 70% of the population rely on sustainable agriculture either directly or indirectly as a source of income (Chioreso & Munyayi, *Think Namibia: Climate Smart Agriculture*, 2015). Namibia plans to battle the harmful effects of climate change by transitioning to renewable energy resources. Specifically, Namibia is a great candidate for solar energy, wind energy, and a Namibian form of a biomass called Bush-to-Energy.

Methodology

This project’s goal was to spread renewable energy awareness by educating Namibian youth. Also, this project works to bridge the gap between rural and urban education systems by creating lessons for the Ombombo mobile classroom. The project team worked alongside EduVentures to develop four interactive SMART modules: *An Introduction to Renewable Energy*, *Wind Energy*, *Solar Energy* and *Bush-to-Energy*. The designer of each module incorporated interactive games and activities to maintain learner engagement and maximize the learners’ experiences during the program.

The team developed four renewable energy SMART modules incorporating extensive research on education and renewable energy, as well as data from stakeholder interviews, Windhoek classroom observations, and rural school pre-visit surveys. Each module followed the Association of Supervision and Curriculum Development’s Eight Phases of Curriculum Development, incorporated experiential learning techniques and followed a learner-centered teaching approach (Cunningham, 2009). The stakeholder interviews with government officials, teachers, and informed young adults provided information on current Namibian energy initiatives, successful teaching techniques, and possible challenges with high school

learners. The classroom observations provided valuable information about the relationship between teaching styles and learner engagement. Finally, the pre-visit surveys allowed the researchers to gauge how much information rural learners already knew about renewable energy. The pre-visit surveys included both low-level questions, such as ‘What is renewable energy?’, and high-level questions, such as ‘Why is renewable energy important to Namibia?’. The background research conducted in Namibia, helped develop modules that suited the Namibian learner.

The module designers presented the initial drafts to the EduVentures staff for feedback. After making the requested edits to the modules, each module designer worked alongside the EduVentures educators to practice the module and explain the intended delivery of each slide. Before departing for the week-long field test, the entire project team and EduVentures staff collaborated to finalize the modules.

EduVentures tested each module in the Ombombo Mobile classroom at Okondjatu Combined School. The project team assessed the effectiveness of the new renewable energy modules using a learner pre-test and post-test, four module observations, and a learner evaluation. The pre-test and post-test were compared to determine the learners’ abilities to answer different levels of questions and their abilities to connect the information presented throughout the modules to problems in their villages and country.

The four module observations provided information about learner engagement throughout each lesson. Finally, the learner evaluations allowed the participants to provide feedback on their experience and whether they intended to continue their renewable energy education after the program. After the field test, the team and EduVentures worked together to modify the modules based on the successes and challenges of the field test.

Results

The project gained a variety of information from the stakeholder interviews, classroom observations, and pre-visit surveys. The stakeholder interviews stressed the importance of including interactive games throughout the lessons. The classroom observations indicated that a teacher who asked questions and actively interacted with their classroom had higher learner engagement rates. Lastly, the pre-visit survey depicted the levels of renewable energy knowledge in rural learners. The pre-visit survey showed that 93% of the learners could define the term renewable energy, but only 31% of the learners could explain its importance to Namibia.

Each module included a variety of slide structures and content, including: lecture material, interactive SMART activities, group discussions, and competitive games. Lecture slides focused on delivering important information to the learners. The interactive activities included sorting games, matching games, and fill-in-the-blank vocabulary activities. The modules also incorporated group work throughout each lesson, as data from the pre-visit surveys indicated a higher learner-performance during group work activities. Finally, the Wind Energy and Bush-to-Energy modules incorporated competitive games subsequent to the completion of each module. These games served as a summary activity for the two modules. The designers of these two modules chose to develop longer games to review the content of the lessons in a fun and competitive way. Figure 0.1 depicts the four different types of lesson slides discussed above.

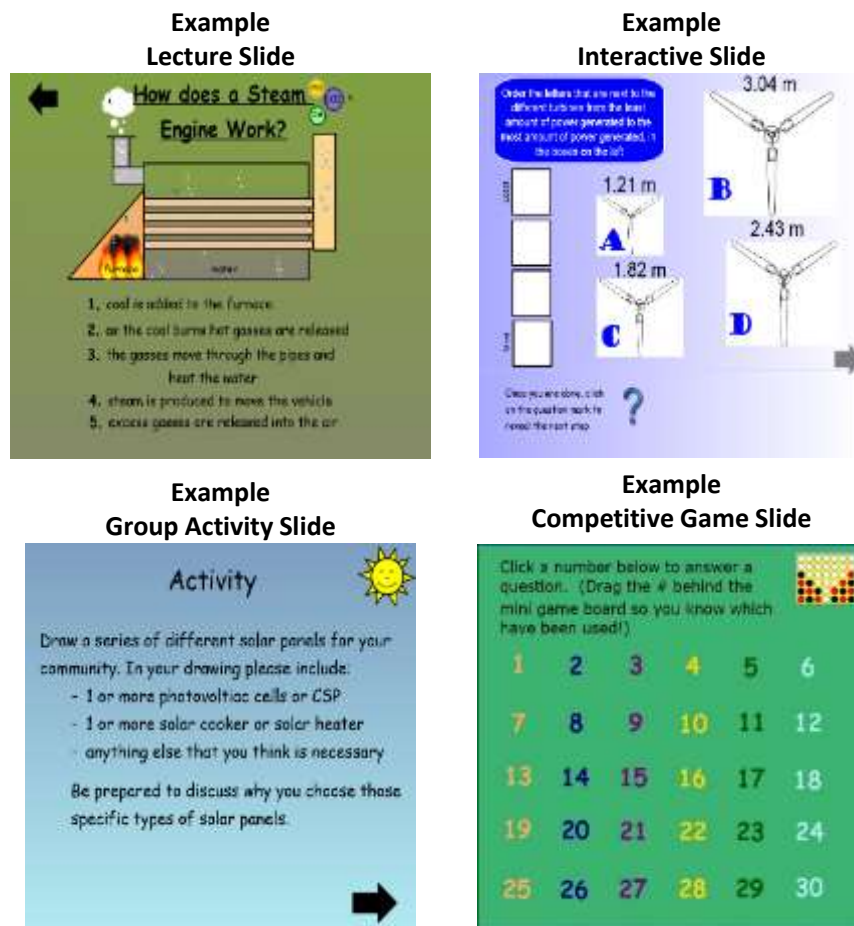

Figure 0.1: Different types of slides from the four renewable energy modules

While piloting the modules at Okondjatu Combined School, the team members discovered that the longer the module was, the more likely learner engagement would decrease. The length of each lesson varied, but module delivery times ranged from three hours to sixty minutes. The observers found that learner engagement dropped after about 90 minutes.

The questions listed on the pre-tests and the post-tests were identical, but the order of the questions was altered between the two. The questions varied in difficulty, with concrete questions being the easiest, guiding questions are intermediate, and the essential questions the most challenging. The pre-tests and post-tests contained four concrete, three guiding, and two essential questions. All of the questions asked on the pre-tests and post-tests stemmed from content presented in the modules. Figure 0.2 below provides the results from these tests. The learners performed better across all types of questions, indicating that the four SMART modules increased learner knowledge on renewable energy topics and provided the scaffolding to connect basic knowledge to real-world problems. Learners not only recollected factual information about renewable energy, but they developed a deeper understanding of its importance in Namibia.

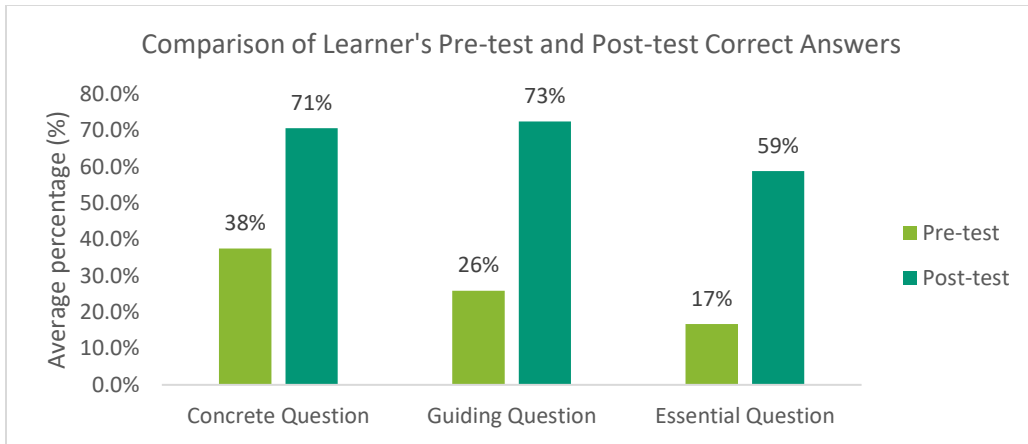

Figure 0.2: Comparison of learner's pre-test and post-test correct answers

Analysis of the responses to the learner evaluation demonstrated that learners had a positive experience throughout the week-long field test. The evaluation had the learners read a statement and rank the same statement from 1-5; if they ranked the statement a 1, they strongly disagreed, if they ranked it a 5, they strongly agreed. This project intentionally omitted 3 to avoid receiving neutral responses. Table 0.1 shows the list of statements from the evaluation and Figure 0.3 depicts the average score of each question.

Table 0.1: Statements from learner evaluation

Question Number	Question
1	The information throughout the entire program was easy to understand.
2	I think the games and activities in the lessons were fun.
3	The lessons were more fun than my classes at school.
4	I would want to participate in another EduVentures program.
5	I feel like I know much more about renewable energy now than before I started this program.
6	If my school started an environmental club, I would join it.
7	I plan to learn more about renewable energy after the end of this program.
8	What I learned in the program will change the way I think about energy generation.

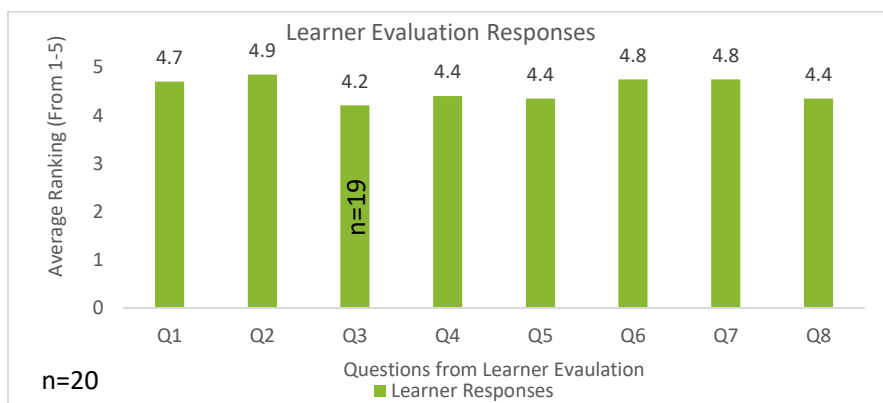

Figure 0.3: Learner Evaluation Responses

The learner evaluation showed that the learners had overall positive experience participating in EduVentures' program. The most notable results are questions 2, 6, and 7. Question 2 asked "I think the games and activities were fun" and had a value of 4.9 out of 5. Questions 6 and 7 stated "If my school started an environmental club, I would join" and "I plan to learn more about renewable energy after the end of the program"; both of these questions scored a 4.8 out of 5. These results indicate that the learners enjoyed the modules, learned more about renewable energy, and planned to continue their renewable energy education after the program.

Finally, the team sat down with the EduVentures educators who taught all four modules to discuss areas for improvement in the modules. The *Introduction to Renewable Energy module* underwent several changes to decrease the length and clarify any confusing points. The most notable change was the order of the slides within the module. The EduVentures educators believed that it was more important to stress the current problems in Namibia and the importance of renewable energy in Namibia. The other three modules underwent minor changes, such as simplifying English and removing activities that required learners to write on the board. The project team gave the finalized modules to the EduVentures staff at the end of the project.

Conclusion

Once the researchers finished the week-long field test, the results from both the pre-test and post-test, as well as the learner evaluations, confirmed the program's success. In the post-test, the learners performed significantly better on questions of all difficulty levels. These results indicated that the learners developed a deeper understanding of the information presented in the modules. The learner evaluation showed an overall positive response to the modules, with many of the learners stating that they want to participate in another program and plan to continue their renewable energy education.

Developing four renewable energy SMART lessons for EduVentures Trust, was the first step in Hanns Seidel Foundation Namibia's new project: Promoting Renewable Energies in Namibia (PREN). This three-year project aims to raise awareness about renewable energy in Namibia. However, after speaking with Dr. Clemens von Doderer, the Head of Namibia's Hanns Seidel Foundation, the success of this project team's field test inspired the Hanns Seidel to expand their renewable energy awareness program and partnership with EduVentures an additional three to five years. Additionally, the Hanns Seidel Foundation plans to increase the project's funding so they can provide rural schools with renewable energy technologies (Doderer, 2017).

Field testing the modules showed significant impact on the learners who participated in EduVentures' program. The lessons inspired the learners to continue learning about renewable energy, pursue engineering fields when they graduate from high school, and strive to one day bring renewable energy technologies to their villages. It is with great pride that the project team left EduVentures and the Hanns Seidel Foundation Namibia with successful renewable energy SMART lessons to bridge the gap between rural and urban education systems and inspire youth to join Namibia's sustainability movement.

Bibliography

Chioreso, E., & Munyayi, R. (2015). Think Namibia: Climate Smart Agriculture. *Think Namibia*. Hanns Seidel Foundation Namibia. Retrieved February 2017

EduVentures Trust. (2008). *About*. Retrieved February 2017, from EduVenture: http://eduventures-africa.org/1_about.htm

National Planning Commission. (2004). *Vision 2030*. Government of the Republic of Namibia. Retrieved February 2017

Acknowledgements

This project would not have been possible without the assistance of the any individuals throughout the team's journey. Most importantly, we would like to thank Worcester Polytechnic Institute's IGSD and the site director, Creighton Peet, for making this experience possible.

We are so thankful that we were able to contribute in the expansion of EduVentures Trust's program. Their mission and work was truly inspiring to the team and we would like to thank our sponsors, Corris Kaapehi, Maria Johannes, Sophia Nuuyuni, and Benson Muramba. Working alongside the EduVentures employees was a true pleasure and we will miss them as we return to the United States. Their unwavering support, communication, and positive attitudes inspired the team every day.

We would also like to thank the project advisors: Professor Robert Kinicki and Professor Sarah Wodin-Schwartz. Their input, advice, and flexibility helped the team make this project as impactful as possible. The team cannot put into words how influential they were in this project's success.

It is with great thanks that the team acknowledge the many individuals who impacted the lesson modules. The eight rural high school teachers, the Ministry of Mines and Energy Officials, and the two informed young adults. Also, the team would like to thank Gustav Kandjii High School and Okamatapati Combined School for allowing the team members to conduct pre-visits, Jan Möhr Secondary School for allowing the team to conduct classroom observations, and finally, Okondjatu Combined School for serving as the school to pilot the modules.

It will be difficult to forget the learners that the team came into contact with. Their excitement about learning and their cooperation and patience throughout the field test of the modules ensured the success of this project. The team is confident that each and every learner will make a difference in their communities and their nation.

We would like to thank Professor Scott Jiusto and Research Librarian, Lori Steckervetz, for their assistance throughout the prep-term. Their help put the team on the right track for our time here in Namibia.

Finally, the team would like to thank our friends and family for their support and guidance through this life-changing journey. Although the team will miss Namibia, we are excited to return home to our loved ones.

It is impossible to mention all the individuals who contributed to the success of this project. Each and every individual who came into the team's lives during this project influenced the way that we look at the world.

Table of Contents

Abstract.....	i
Executive Summary.....	ii
Introduction and Background	ii
Methodology.....	ii
Results	iii
Conclusion	vi
Bibliography.....	vii
Acknowledgements	viii
Table of Contents.....	ix
Table of Figures.....	xiv
Table of Tables.....	xvi
1 Introduction.....	1
2 Background.....	3
2.1 Education in Namibia	3
2.2 Sponsor and Partnerships	5
2.2.1 EduVentures Trust	5
2.2.2 Hanns Seidel Foundation	7
2.3 Effective Environmental Education Techniques.....	7
2.3.1 Environmental Education Challenges	8
2.3.2 Elements of Successful Environmental Education Programs.....	8
2.3.3 Environmental Education Case Studies	9
2.3.4 Experiential Learning and Effective Teaching Techniques.....	13
2.3.5 Curriculum Reform and Theory	14
2.3.6 Curriculum Development.....	15
2.4 Climate Change and Renewable Energy Initiatives.....	16
2.4.1 The Industrial Revolution and its Impact on Climate Change.....	16
2.4.2 Climate Change in Namibia.....	17
2.4.3 Socio-Economic Impacts of Climate Change.....	19
2.4.4 Vision 2030	20
2.5 Renewable Energy Topics	22
2.5.1 Wind Energy.....	22

2.5.2	Solar Energy	27
2.5.3	Bush-to-Energy	29
3	Methodology	35
3.1	Stakeholder Interviews	37
3.2	Classroom Observations.....	41
3.3	School Pre-Visits.....	44
3.4	Module Development	44
3.4.1	Implementation of Background Research in Module Outlines	45
3.4.2	Initial Module Development in SMART Notebook.....	46
3.4.3	Preliminary Modifications of Modules	46
3.5	Implementation and Module Modification	47
3.5.1	Pre-Testing and Post-Testing	48
3.5.2	Module Observation Form.....	49
3.5.3	Learner Evaluation	50
3.5.4	Module Modification	51
3.5.5	Curriculum Development for the Ministry of Education	52
4	Results and Analysis.....	53
4.1	Stakeholder Interviews	53
4.1.1	Urban and Rural Teachers	53
4.1.2	Teacher Interview Issues	56
4.1.3	Informed Young Adults and Government Officials.....	56
4.2	Classroom Observations.....	58
4.2.1	Grade 10 Geography	59
4.2.2	Grade 11 Biology.....	61
4.2.3	Grade 11 Geography.....	63
4.2.4	Classroom Observation Issues	66
4.3	Pre-Visit Surveys.....	66
4.3.1	Pre-visit Survey Issues.....	71
4.4	Module Development	71
4.4.1	Initial Module Outlines	71
4.4.2	Initial Module Development.....	72
4.4.3	EduVentures Review	74

4.5	Module Observations.....	76
4.5.1	<i>Introduction to Renewable Energy Module</i>	76
4.5.2	<i>Wind Energy Module</i>	77
4.5.3	<i>Solar Energy Module</i>	78
4.5.4	<i>Bush-to-Energy Module</i>	79
4.5.5	Module Observation Issues	80
4.6	Pre-Tests and Post-Tests	80
4.6.1	Pre-test and Post-Test Issues.....	81
4.7	Learner Evaluations.....	82
4.7.1	Learner Evaluation Issues	83
4.8	Module Modification after the Pilot Test.....	84
4.8.1	Introduction to Renewable Energy Modifications.....	84
4.8.2	Wind Energy Modifications.....	85
4.8.3	Solar Energy Modifications	86
4.8.4	Bush-to-Energy Modifications	87
4.9	Summary of Field-Test Results.....	88
5	Recommendations and Future Work.....	89
5.1	Recommendations	89
5.2	Future Work	90
6	Conclusion.....	92
	Bibliography.....	93
	Appendix A: High School Teacher Interview Plan.....	102
	Appendix B: Namibian Government Official Interview Plan.....	104
	Appendix C: Informed Young Adults Interview Plan.....	106
	Appendix D: High School Teacher Interview Plan: Frank G Mungunda.....	107
	Appendix E: High School Teacher Interview Plan: Kelvin Naholo	109
	Appendix F: High School Teacher Interview Plan: Ebenezer Muwngua	111
	Appendix G: High School Teacher Interview Plan: Joshua Nauripo Kambueza	113
	Appendix H: High School Teacher Interview Plan: Okondjatu Combined School Teacher 1	115
	Appendix I: High School Teacher Interview Plan: Nanguai Kahikummu.....	117
	Appendix J: High School Teacher Interview Plan: Vindina Muje	119
	Appendix K: High School Teacher Interview Plan: Esilon N. Kaangundue	121

Appendix L: Namibian Government Official Interview Plan: Ministry of Mines and Energy	123
Appendix M: Informed Young Adults Interview Plan: Kornelia Lipinage	126
Appendix N: Informed Young Adults Interview Plan: Hannah Pohlmann	127
Appendix O: Teacher Observation Form	128
Appendix P: Learner Engagement Observation Form	130
Appendix Q: Jan Möhr High School Period 1: Learner and Teacher Observation Forms	131
Appendix R: Jan Möhr High School Period 3: Learner and Teacher Observation Forms	134
Appendix S: Jan Möhr High School Period 4: Learner and Teacher Observation Forms	137
Appendix T: Rural School Pre-Visit Survey	140
Appendix U: Rural School Pre-Visit Survey Responses: Gustav Kandjii High School Responses	141
Appendix V: Rural School Pre-Visit Survey Responses: Okondjatu Secondary School Responses	146
Appendix W: Rural School Pre-Visit Survey Responses: Okamatapati Secondary School Responses	151
Appendix X: Course Outline Provided by EduVentures	156
Appendix Y: Outline of Module 1: Introduction to Renewable Energy	157
Appendix Z: Outline of Module 2: Solar Energy	162
Appendix AA: Outline of Module 3: Wind Energy	166
Appendix BB: Outline of Module 4: Bush-to-Energy	174
Appendix CC: Module 1: Introduction to Renewable Energy	182
Appendix DD: Module 2: Solar Energy	188
Appendix EE: Module 3: Wind Energy	225
Appendix FF: Module 4: Bush-to-Energy	295
Appendix GG: Module 1: Introduction to Renewable Energy Teacher Guide	308
Appendix HH: Module 2: Solar Energy Teacher Guide	320
Appendix II: Module 3: Wind Energy Teacher Guide	334
Appendix JJ: Module 4: Bush-to-Energy Teacher Guide	369
Appendix KK: EduVentures Excursion Program Schedule	404
Appendix LL: Pre-Test: Distributed before the Program	406
Appendix MM: Pre-Test: Distributed before the Program: Responses	407
Appendix NN: Module Observation Form	417
Appendix OO: Module Learner Engagement Observation Form: Module 1 Introduction to Renewable Energy 418	
Appendix PP: Module Learner Engagement Observation Form: Module 2 Solar Energy	423

Appendix QQ: Module Learner Engagement Observation Form: Module 3 Wind Energy.....	427
Appendix RR: Module Learner Engagement Observation Form: Module 4 Bush-to-Energy.....	430
Appendix SS: Post-Test: Distributed after the Program.....	433
Appendix TT: Post-Test: Distributed after the Program: Responses	434
Appendix UU: Program Evaluation	444
Appendix VV: Program Evaluation: Responses.....	445
Appendix WW: Final Draft of Introduction to Renewable Energy Module	465
Appendix XX: Final Draft of Wind Energy Module.....	477
Appendix YY: Final Draft of Solar Energy Module.....	508
Appendix ZZ: Final Draft of Bush-to-Energy Module	546
Appendix AAA: Final Introduction to Renewable Energy Teacher’s Guide	565
Appendix BBB: Ministry of Education Curriculum	575
Appendix CCC: Presentation to the Ministry of Education.....	588

Table of Figures

- Figure 2.1: Structure of Namibian education system (Modified from Chin, n.d.) 4
- Figure 2.2: Ombombo mobile classroom 6
- Figure 2.3: Inside the Ombombo mobile classroom 6
- Figure 2.4: Percentage of students enrolled in wildlife and environmental clubs (Modified from Kioko, 2010) 12
- Figure 2.5: The Kolb Cycle (Modified from Kolb, 2014) 13
- Figure 2.6: How steam engines work –fire-tube boiler (Brain, 2000) 17
- Figure 2.7: EEP thermal biofuel boiler (Namibia EEP - Africa, 2015) 20
- Figure 2.8: Interlinking issues that threaten Namibia's potential for sustainable development (Modified from National Planning Commission, Sustainable Resource Base, 2004) 21
- Figure 2.9: Comparison of vertical (right) and horizontal (left) wind turbines (Eco Energy, n.d.) 23
- Figure 2.10: Map of Namibia (Rieck, 2013) 26
- Figure 2.11: The "Wind Tree" (Parke, 2015) 27
- Figure 2.12: Main types of solar panels **Error! Bookmark not defined.**
- Figure 2.13: Map of the extent of encroacher bush in Namibia (Ministry of Agriculture, 2016). 29
- Figure 2.14: Aerial views of (a) selective bush clearing and (b) bush elimination (Ministry of Agriculture, 2016) 31
- Figure 2.15: Possible locations for the implementation of Bush-to-Energy plants (Modified from SA Places, 2016) 32
- Figure 2.16: Comparison of greenhouse gas emissions for different power resources (Vattenfall, 2016) 33
- Figure 3.1: Flowchart of project 35
- Figure 3.2: Flowchart of methods for module development 36
- Figure 3.3: Flowchart of methods for module modification 36
- Figure 3.4: List of all stakeholders. Interviewed stakeholders shown in teal. 38
- Figure 3.5: Objectives of interviews and each correlating stakeholder group 39
- Figure 3.6: Example of filled out teacher observation form at the ten-minute mark 42
- Figure 3.7: Process for module development 45
- Figure 3.8: Title slide of Introduction to Renewable Energy Module and its assigned directions 47
- Figure 3.9: The staircase to inquiry 48
- Figure 3.10: An example of a partially completed learner evaluation 51
- Figure 4.1: Learner engagement in Grade 10 Geography 61
- Figure 4.2: Learner engagement in Grade 11 Biology 63
- Figure 4.3: Learner engagement in Grade 11 Geography 65

Figure 4.4: Map of pre-visit schools in comparison to Windhoek 67

Figure 4.5: Learners who answered Q1. a) and Q1. b) Correctly (n=29) 68

Figure 4.6: Learners who answered low-level questions and high-level questions correctly (n=29) 69

Figure 4.7: Comparison by each question of learners answering in groups vs. answering alone 70

Figure 4.8: Impacts of group work on learner performance 70

Figure 4.9: Lecture slide from Introduction to Renewable Energy Module 72

Figure 4.10: Wind Energy Module turbine activity 73

Figure 4.11: Solar Energy Module drawing activity 73

Figure 4.12: Wind Energy Module Jeopardy activity 74

Figure 4.13: Bush-to-Energy Module Connect Four activity 74

Figure 4.14: Learner behavior in module 1: Introduction to Renewable Energy versus time (n=20) 76

Figure 4.15: Learner behavior in module 2: Wind Energy versus time (n=19) 77

Figure 4.16: Learner behavior in module 3: Solar Energy versus time (n=17) 78

Figure 4.17: Learner behavior in module 4: Bush-to-Energy versus time (n=18) 79

Figure 4.18: Comparison of learner's pre-test and post-test correct answers 81

Figure 4.19: Learner evaluation responses 83

Figure 4.20: Emerging technologies slide from the Solar Energy Module 86

Table of Tables

- Table 2.1: Learner's ability to determine the nature of energy sources (Modified from Zyadin, Puhakka, et. al., 2012) 9*
- Table 2.2: Results of area, gender, and school type variables of the learners' ability to determine the nature of energy sources (Modified from Zyadin, Puhakka, et. al., 2012) 10*
- Table 2.3: Learners' level of renewable energy knowledge: summary descriptive statistics (Modified from Zyadin, Puhakka, et. al., 2012) 10*
- Table 2.4: Youth's Perceptions of the Value of Protected Areas (Modified from Kioko, 2010) 11*
- Table 2.5: Relationship between level of schooling and stated reasons for wildlife conservation (Modified from Kioko, 2010) 12*
- Table 2.6: Eight phases of curriculum development (Modified from Cunningham, 2009) 15*
- Table 2.7: Climate-smart practices useful in smallholder agricultural production (Modified from Chioreso & Munyayi, Think Namibia: Climate Smart Agriculture, 2015) 19*
- Table 2.8: Components of a horizontal axis wind turbine (Modified from BWE Bundesverband WindEnergie, n.d.) 23*
- Table 2.9: Components of a vertical axis wind turbine (Modified from Atta, n.d.) 24*
- Table 2.10: Relation between size of turbine and power produced (Modified from Meyers B. , Wind Turbines: How Much Power Can You Expect, 2013) 25*
- Table 3.1: Gantt schedule of the projects timeline in Namibia 37*
- Table 3.2: Interview guidelines (Modified from Ferguson, 2002) 39*
- Table 3.3: Summarized sponsor outline of modules 45*
- Table 3.4: List of questions of pre-test and post-test 49*
- Table 3.5: Learner evaluation questions 51*
- Table 4.1: Teacher responses and their corresponding objective 54*
- Table 4.2: Government Official responses and their corresponding objective 57*
- Table 4.3: Informed young adult responses and their corresponding objective 58*
- Table 4.4: Teacher and learner activities observed during classroom observations 59*
- Table 4.5: Summary of teacher and learner observation forms for Grade 10 Geography 60*
- Table 4.6: Summary of teacher and learner observations for Grade 11 Biology 62*
- Table 4.7: Summary of teacher and learner observations for Grade 11 Geography 64*
- Table 4.8: Breakdown of pre-visit survey question type 68*
- Table 4.9: Module One suggestions from EduVentures educators 85*
- Table 4.10: Module Two suggestions from EduVentures educators 85*
- Table 4.11: Module Three suggestions from EduVentures educators 87*
- Table 4.12: Module Four suggestions from EduVentures educators 87*

1 Introduction

While the government of Namibia emphasizes “Education for All” in its national initiative *Vision 2030*, a great divide exists between rural and urban education. The apartheid regime enhanced this educational divide because the South African government only allocated funding to urban schools with white learners. Although this regime no longer exists in the country, rural schools never received enough government support to counteract this imbalance (Chin, n.d.). Today, even after 27 years of independence, rural schools throughout Namibia lack the resources and technology readily available to urban learners, causing rural learners to have outdated resources and limited exposure to modern technologies. It is vital that the children of Namibia have equal access to knowledge and resources, because the ethical stances that they form in their childhood will influence their future contributions to Namibian society.

To progress as a nation, education for all citizens must increase significantly, especially for those in rural areas. Now that Namibia is facing severe consequences of climate change, uniting the country through education is essential. Climate change is negatively effecting key economic sectors within Namibia. Farmers are facing increased temperatures, unpredictable rainfall, and a reduced carrying capacity of their livestock and crop fields. This has become a serious problem in Namibia, as over 70% of the population relies on agriculture as a source of income. Namibia plans to battle the harmful effects of climate change by transitioning to renewable energy resources (Chioreso & Munyayi, 2015). To ensure success of their sustainability movement, the government plans to improve the quality of school children’s environmental education.

To bridge the educational gap between rural and urban schools and spread environmental education throughout the nation, EduVentures Trust (EduVentures) delivers lessons to rural high school learners throughout the country in their solar-powered Ombombo mobile classroom. Their programs incorporate experiential teaching techniques, games and activities, and interactive SMART Technology to maximize learner retention and provide a hands-on approach to teach theoretical environmental topics.

The purpose of this project was to assist EduVentures Trust in expanding their program by developing four renewable energy modules for use in the Ombombo mobile classroom. The modules developed were: *An Introduction to Renewable Energy*, *Wind Energy*, *Solar Energy*, and *Bush-to-Energy*. This project used preliminary data collected from classroom observations, relevant stakeholder interviews, and pre-visit surveys to develop an understanding of Namibian culture. The lesson designers then used this information to develop the four modules, with each team member responsible for one. After completing the first draft, each team member presented their module to the EduVentures staff and gathered feedback for needed adjustments. Then, each team member spent time with the EduVentures educators to explain how to teach each slide in the module. After the module development phase completed, the team conducted a five-day field test of the modules at Okondjatu Combined School. This study gathered data to gauge the success of the modules through pre-testing and post-testing of the learners, module observation forms, and a learner

evaluation. In collaboration with EduVentures, the project team used the field results to modify the modules accordingly.

The success of this project depended on the fusion of successful environmental education techniques and the current needs of Namibian learners. Many of the rural learners knew very little about renewable energy technologies. Scores from the pre-visit surveys and the pre-tests indicated that the learners lacked the scaffolding to connect basic principles to real-world problems. At the conclusion of the pilot test, the learners scored 3.5 times higher on questions that required the learners to connect content presented in the lessons to real-world problems. In addition, the learner evaluations indicates that the learners enjoyed the program and intended to continue their renewable energy education after the program concluded.

EduVentures utilization of these modules has the potential to impact rural communities around the country by bridging the gap in the Namibian education system, and assisting the government in its efforts to transition towards a sustainable future. By educating the nation on sustainability efforts, Namibia has the potential to create informed citizens, consumers, and employees. Educating the future of the nation will hopefully ensure that Namibia works towards the promotion of sustainable living and the mitigation of the effects of climate change.

2 Background

This chapter discusses effective teaching techniques and curriculum building, the effects of climate change in Namibia, and the renewable energy technologies that Namibia can implement to counteract these effects. The intent of conducting research in these fields was for the project team to understand the common practices and gaps in the Namibian education system, how to properly create interactive and engaging lesson plans and to develop an in-depth understanding of the technologies incorporated in each lesson module. This chapter examines:

- The Namibian Education System
- The Goals of EduVentures Trust
- Effective Environmental Education Techniques
- Experiential Learning and Curriculum Building
- Climate Change and Renewable Energy Initiatives in Namibia
- Renewable Energy Topics

2.1 Education in Namibia

After gaining independence in 1990, Namibia's Ministry of Education overcame many obstacles. The prior apartheid rule enforced by South Africa on the citizens of Namibia, led to inequalities in the education between the various ethnic groups. The colonial education system did not satisfy the needs or goals of the newly independent Namibian people, as the content, teaching methods, and assessments were archaic (Chin, n.d.). To satisfy these new standards, the Ministry of Education undertook a comprehensive reform process to increase access, equity, quality and lifelong learning (UNESCO, 2004). In response to many issues including: education, social reform, and environmental degradation, the Namibian government created a national development agenda – Vision 2030. In regards to education, Vision 2030's plan is to create, "a fully integrated, unified and flexible education and training system, that prepares Namibian learners to take advantage of a rapidly changing environment and contributes to the economic, moral, cultural, and social development of the citizens throughout their lives" (National Planning Commission, Section 4.3.3, 2004).

The Ministry of Education implemented several changes after Namibia gained independence. They introduced a new curriculum in all grade levels, increased effort to improve teacher qualifications, and improved scholastic infrastructure (National Planning Commission, Section 4.3.3, 2004). The new design follows a tiered learning process, with three main levels of learning each split into two sublevels (see Figure 2.1).

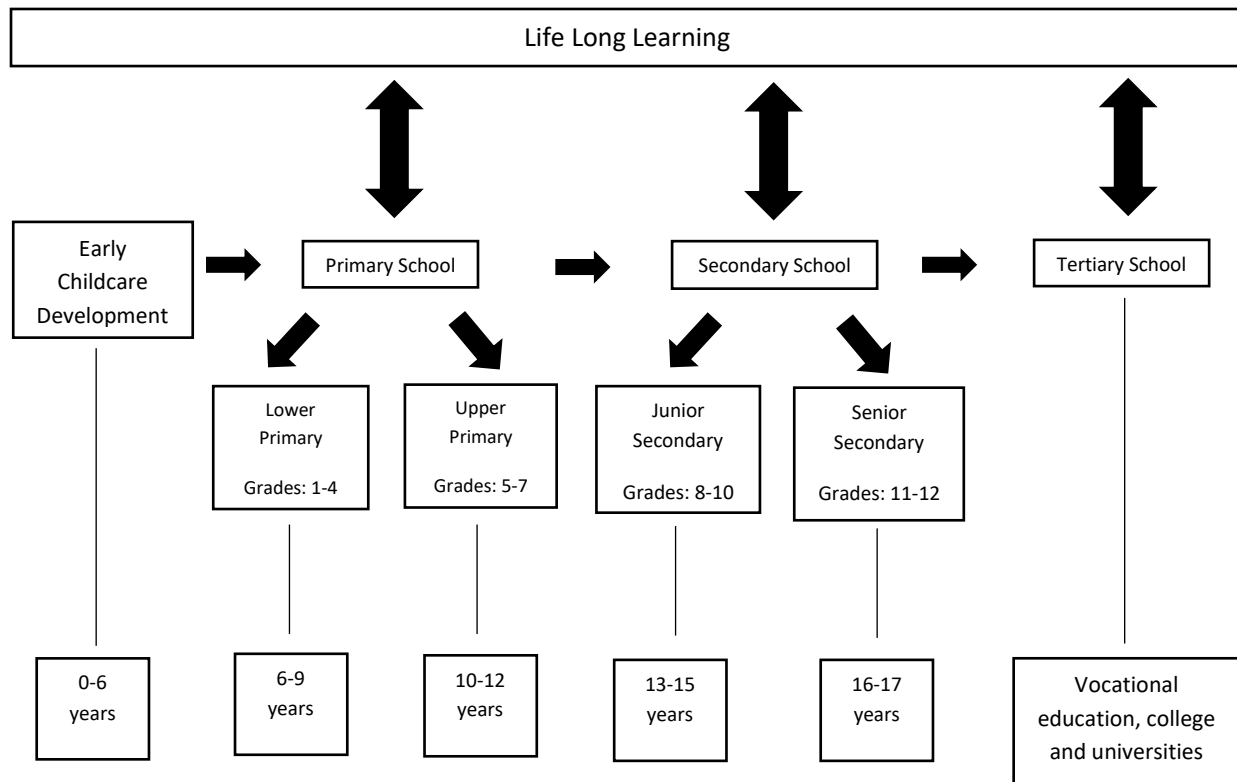

Figure 1.1: Structure of Namibian education system (Modified from Chin, n.d.)

Primary education lasts seven years, divided into lower primary and upper primary levels. A ‘learner’ (the Namibian term for a student) begins grade one at the age of six, and completes their lower primary education in grade four, where they proceed to upper primary education, that contains grades five through seven (Ministry of Education, 2010-2011). Once the learners complete their primary education, they move on to secondary education, which is split into junior secondary and senior secondary school. Junior secondary school comprises of grades eight to ten. At the end of tenth grade, learners take an external examination to obtain the Junior Secondary Certificate (JSC) (Ministry of Education, 2010-2011). This phase marks the end of required formal education in Namibia. Learners may continue to senior secondary level of education, from grades ten to twelve. Learners must take an additional competency examination, the National Senior Secondary Certificate examination at either the Ordinary level (NSSCO) or the Higher Level (NSSCH). Upon the completion of these examinations, learners receive certificates of recognition of completion of their elementary education and may proceed to university-level education (Ministry of Education, 2010-2011). Learners must apply to university should they decide to continue their education at a higher level. Once enrolled at a university, the “learner” becomes a “student”, and they complete their degree in a specific topic (Ministry of Education, 2010-2011).

While all schools in Namibia follow this tiered learning system, there are inequalities between urban and rural school systems. Most rural schools lack qualified staff because young educators prefer to teach in urban districts. Urban schooling also tends to have better managerial approaches, as they have the funds to send their principals and head staff to management workshops. Rural schools have poor managerial systems due to minimal government funding (The Namibian, 2007). South African governance developed most of the urban schools while Namibia was a colony. Urban schools have access to the Internet and other modern

technologies, which provide significantly better access to information centers (The Namibian, 2007). Another problem in most rural schools is a lack of access to information and little exposure to modern civilization. To overcome this educational divide in Namibia, the Ministry of Education has outlined the following steps:

- Reintroduction of incentives, such as reduced taxes for teachers, must occur to attract younger professionals to rural school districts
- Budget allocations for schools must consider the physical state of the schools, as well as the location of the school districts
- The government should provide Internet access and subsidize computers for schools nationwide
- Regional offices must organize school tours (known as field trips), as some schools do not have the necessary funds
- The government should make it mandatory for all school administrators to undergo training to learn proper management skills.

If the Ministry of Education can implement these steps, rural learners have the potential to obtain a comparable education to urban learners (The Namibian, 2007). The government of Namibia has several plans drafted to implement these changes in the future in the educational reform section of Vision 2030, as mentioned above (National Planning Commission, Section 4.3.3, 2004).

2.2 Sponsor and Partnerships

The project sponsor is EduVentures Trust (EduVentures), a nonprofit organization that works in conjunction with the National Museum of Namibia. EduVentures is currently receiving funding from the Hanns Seidel Foundation, a German non-profit organization that supports the efforts of the Namibian government by contributing to a politically, socially, environmentally, and economically stable Namibian future.

2.2.1 EduVentures Trust

The mission of EduVentures Trust is to “provide environmental experiences for mainly disadvantaged Namibian youth whilst simultaneously contributing to the continued expansion of Namibian scientific knowledge and deepening the collective understanding of its natural and cultural heritage” (EduVentures Trust, 2008). According to the Merriam-Webster dictionary, “disadvantaged” refers to those who do not have access to some of the necessities of life such as proper housing, educational opportunities, and adequate medical care. EduVentures educates disadvantaged Namibian youth, grades eight to twelve, on a variety of educational subjects, such as biodiversity, heritage and renewable energy. They also provide several learning opportunities, such as web-expeditions, hands-on expeditions, fieldwork, individual projects, museum activities, and lessons in their Ombombo mobile classroom (shown in Figures 2.2 and 2.3). The main objective of the Ombombo mobile classroom is to supplement the theoretical components of the Namibian school curriculum using practical hands-on learning methods.



Figure 1.2: Ombombo mobile classroom



Figure 1.3: Inside the Ombombo mobile classroom

The Ombombo mobile classroom's technology located in the back of the truck runs on solar power and the EduVentures staff equipped the classroom with SMART Technology. The classroom travels throughout the country to rural Namibian schools bringing different educational lessons on various environmental and science topics. Interested schools must go through an application process to be eligible for consideration for a possible visit from the mobile classroom. If the EduVentures staff believes that the school is a good candidate, the staff will conduct a pre-visit. During this visit, the staff presents the program to the learners at the rural school and if the learners want to participate in the program, they must write an essay explaining their interest in the program. The school's contact teacher then selects around 20-25 learners for the program, and sends the learners' applications to EduVentures. If the school is a good fit for the program, the Ombombo mobile classroom will go to that school and conduct the week-long program with the selected learners.

The first two days of the program focus on teaching EduVentures' lesson modules to the selected learners. EduVentures' modules contain: games, activities, group work, discussion, lectures, and several other

teaching techniques. The third day of the program is a field test where the learners embark on a hike or expedition to reinforce the information taught in the lesson modules. For example, learners could look in the surrounding area for types of species introduced in the biodiversity module. The EduVentures employees on the fourth day then teach the learners about creating and running an environmental club at their school. The purpose of these environmental clubs is to continue the participant's environmental education and spread their newfound environmental awareness throughout their community. Finally, on the fifth day, the learners practice their presentation skills by presenting to their schools about their new knowledge gained during the program. The learners decide the format of their presentation, but traditionally EduVentures encourages the use of computers to convey their information.

EduVentures strives to bridge the gap between rural and urban learner exposure by providing fun, educational programs that cover a variety of topics in their mobile classroom. One of the long-term goals of EduVentures is to inspire children from rural areas to pursue further education or careers in environmental science and STEM fields and to expose them to the technology that is normally not available to them.

2.2.2 Hanns Seidel Foundation

The Hanns Seidel Foundation is a German non-profit organization that operates in over 50 countries across the world. This organization is currently finishing their environmental awareness and climate change project, known as "ThinkNamibia", which operated from March 2015 to March 2017. This project's objectives were to:

- Increase knowledge and skills on environmental issues
- Promote knowledge transfer in the environmental sector
- Promote social entrepreneurship in the environmental sector
- Support journalistic work in the environmental sector.

The Hanns Seidel Foundation partnered with the Desert Research Foundation of Namibia to achieve these objectives and support the guiding principles of the National Climate Change Policy (NCCP). They also partnered with EduVentures Trust to impart this knowledge through lesson modules in their mobile classroom. The success of this project inspired them to establish another project which they hope to be just as successful. The WPI team's project with EduVentures will launch their new three-year project which aims to educate the population on renewable energy potential in Namibia. As such, the Hanns Seidel Foundation will act as the primary source of funding for EduVentures' renewable energy project.

2.3 Effective Environmental Education Techniques

Education is crucial to the success of Namibia because it has the potential to produce skilled workers, enhance livelihoods, and unite the nation (Zyadin, Puhakka, et. al., 2012). The US EPA defines environmental education as, "a process that allows individuals to explore environmental issues, engage in problem-solving, and take action to improve the environment. Consequently, people develop a deeper understanding of environmental issues and have the skills to make informed and responsible decisions" (US EPA, n.d.). Environmental education is successful when the lesson includes receiving, participating, and learning by doing (Corris, 2017). However, there are several factors to consider when developing environmental lessons.

2.3.1 Environmental Education Challenges

Educational case studies in rural villages around the world found that the main challenge facing researchers was the learners' minimal background in renewable energy (Kioko, 2010). Although Africa is a good fit for several different types of renewable energy, the resources to support energy generation in the desired countries are minimal. At the 2007 European Conference on local energy, South Africa was seen as the ideal candidate for renewable energy initiatives, however, several issues arose at the conference, such as: lack of trained teachers in the subject area, strict school curricula, and lack of cooperation between private energy advisors and educational leaders (Sebitosi & Pillay, 2008). The lack of sufficient experts in renewable energy throughout the globe is one of the reasons behind the poor expansion of renewable energy. The concept of renewable energy is a hard topic for some individuals to grasp, especially children. To expand the renewable energy sector, Namibia needs knowledgeable individuals. In education, the instructions must be clear, engaging, and inspiring.

Currently, Namibia's curriculum does not support the expansion of renewable energy knowledge because the education system is unable to provide resources to the targeted age groups thus they lack the proper understanding to further explore the topics. According to a study in Kenya, the prime age for renewable energy education is middle school to high school students (Kioko, 2010). This is because the students have a higher likelihood of looking at preservation of the environment in a positive manner when compared to primary school students (Kioko, 2010). However, the Namibian curriculum only provides environmental education in grades one to four (Ministry of Education, Arts, and Culture, 2017). If the country wants to inspire the youth to pursue careers in the energy fields, it is important for learners to gain the knowledge when they are closer to the end of their education (Minnis, 2006).

2.3.2 Elements of Successful Environmental Education Programs

One of the most important components in environmental education is the purpose of the lesson. According to Athman, in *Elements of Effective Environmental Education Programs*, there are five main purposes in any environmental education program – awareness, knowledge, attitude, skills, and participation. Awareness familiarizes the learners with the problem and its impact on the society, economy and environment. Knowledge provides the learners with a basic understanding of the subject and the background material. Once the learners understand the material, they can create their own opinions and attitudes about the future of the environment. Skills help learners identify and solve problems that may arise around them. Finally, participation encourages the learners to actively take part in their communities and to inform others of the problems surrounding them (Athman & Monroe, 2001). Similar themes are found in *Renewable Education: A Global Status Review*; the review concludes that the following themes are key to a successful environmental education:

- Develop student awareness about the causes of energy related problems (climate change, economy, etc.)
- Inform the learners about the sources of energy – renewable and nonrenewable. Then teach the learners about outcomes – economic stimulation, environmental impacts, socio-cultural effects, and governmental impact – of renewable energy:

- Motivate the learners to pursue efforts in the renewable energy fields by stressing the various challenges the country is currently facing and the potential positive impact of harnessing renewable energy sources
- Work with the learners to develop values and attitudes about renewable energy implementation in the future (Kandpal & Broman, 2014).

The information above highlights key themes of awareness, attitudes, and knowledge. If teachers incorporate these themes into lesson plans, learners will be more likely to succeed later in life (Kandpal & Broman, 2014).

2.3.3 Environmental Education Case Studies

The energy sector in Jordan nearly mimics the situation in Namibia. Jordan currently imports 90% of its total energy from Saudi Arabia, Iraq, and Egypt (Zyadin, Puhakka, et. al., 2012). Jordan hopes to combat this problem by educating their youth to create informed, future consumers. This case study, conducted in 2012, focused on 617 learners and their current education levels and outlooks on renewable energy. The first aspect investigated by the researchers was the ability of the learners to determine the nature of energy sources, by deciding whether a resource is renewable or nonrenewable. Table 2.1 shows the responses of the learners.

Table 1.1: Learner's ability to determine the nature of energy sources (Modified from Zyadin, Puhakka, et. al., 2012)

Item	Response Percentage (N=67)		
	Yes (%)	No (%)	Missing (%)
<i>Renewable</i>			
Solar	96	3	1
Wind	94	5	1
Geothermal	75	22	3
<i>Non-renewable</i>			
Fossil Fuel	15	83	2
Coal	18	80	2
Oil Shale	25	74	1
Nuclear	23	74	3
N. Gas	35	63	2

The misconceptions in these learners' responses are in regards to the more abstract forms of energy: natural gas, nuclear, and geothermal. To investigate the factors behind the learners' answers, the study provided the following table dividing the responses based on living area, gender, and school type (see Table 2.2).

Table 1.2: Results of area, gender, and school type variables of the learners' ability to determine the nature of energy sources (Modified from Zyadin, Puhakka, et. al., 2012)

	Responses						
	Area (%)		Gender (%)		School Type (%)		
	Urban	Rural	Male	Female	Urban	Rural	Private
Renewable (Yes)							
Solar	99	94	97	98	96	94	99
Wind	96	93	93	97	97	93	95
Geothermal	81	70	78	76	80	72	82
Nonrenewable (No)							
Fossil Fuel	87	81	81	90	89	81	84
Coal	83	79	77	87	84	79	82
Oil Shale	75	75	73	76	75	75	74
Nuclear	78	75	71	81	81	75	71
N. Gas	64	67	62	67	64	67	63

The study stated: “While identification of non-renewable sources generally showed no significant variation by residence, there was some significant indication of better urban awareness of the nature of fossil fuels” (Zyadin, Puhakka, et. al., 2012). The study expands further by testing learners on the purposes or functions of the different energy sources, Table 2.3 displays the results of these tests.

Table 1.3: Learners' level of renewable energy knowledge: summary descriptive statistics (Modified from Zyadin, Puhakka, et. al., 2012)

Knowledge Item	SA (%)	SDA (%)	DtK (%)	Mode
1. Sunshine is utilized to produce electricity	76	13	11	Agree
2. Wind turbines are utilized to produce electricity	7	9	21	Agree
3. Geothermal energy is the earth's internal heat	56	13	31	Agree
4. Bioenergy is the energy produced from plant biomass	42	10	48	Don't Know
5. Biodiesel is fuel produced from plant oils	28	21	51	Don't Know
6. Bioethanol is fuel produced from fermenting biomass	28	10	61	Don't Know
a. SA: Sum of strongly agree and agree b. SDA: Sum of strongly disagree and disagree c. DtK: Don't Know				

Learners were most knowledgeable about wind and solar energy, meanwhile 50% of the learners responded with “I Don’t Know” for biomass related forms of energy. The final test surveyed the opinions of the learners on renewable energy related to the country’s future. Learners in the urban schools were more likely to favor the transition to renewable energy resources than rural learners. This case study provides insight to the background of the rural Namibian learners and the outlooks that they might have on implementation of renewable energy (Zyadin, Puhakka, et. al., 2012).

A 2010 study, conducted in Kenya, tested many learners’ outlooks on preservation of the surrounding land (Kioko, 2010). The Kenya Wildlife Service is working to increase the level of awareness in conservation topics through educational programs. The survey showed that 87.5% of the learners favored conservation tactics. The reasoning behind why the learners supported conservation of their surrounding environments varied; the responses included tourism, recreation, species preservation, and wildlife containment, as shown in Table 2.4.

Table 1.4: Youth’s Perceptions of the Value of Protected Areas (Modified from Kioko, 2010)

Perceived Value of Protected Areas	Percentage of Respondents
Tourism/Foreign Exchange	35.0
Wildlife Containment	12.6
Recreation/Aesthetics	11.8
Species Preservation/Conservation	11.8
Employment	7.7
School Fees/Bursaries	3.6
Animal/Wildlife Products	3.1
Education	2.5
Helps in Infrastructural Development	1.5
Religious Importance	1.2
Cultural Value	0.6

The study also investigated the relationship between level of schooling and student conservation attitudes. The researchers distributed a questionnaire to the students asking whether they were in favor of wildlife conservation, and if they answered yes, the students had to provide a reason for why they believed in conservation. The results concluded that the older the student, the higher the chance that their outlook on preservation was positive. The primary school students were not able to comprehend the presented material, meanwhile the secondary school students responded much better to the concept of conservation. Table 2.5 shows the percentage of students who support wildlife conservation, and their stated reasoning behind implementation of conservation tactics.

Table 1.5: Relationship between level of schooling and stated reasons for wildlife conservation (Modified from Kioko, 2010)

Level of School	Tourism/ Foreign Exchange	Recreation/ Aesthetics	Species Preservation/ Conservation	Wildlife Containment
Primary Lower	11.8%	4.9%	16.0%	37.5%
Primary Upper	48.0%	16.7%	9.3%	4.7%
Secondary	61.5%	8.1%	10.1%	2.7%
P-Value	0.0001	0.0001	0.0001	0.0001
Chi-Value	244.00	60.00	70.00	92.00

The third segment of the study collected data based on involvement in wildlife and environmental clubs. It demonstrated that secondary school students were more likely to involve themselves with environmental clubs than primary school learners, as shown in Figure 2.4.

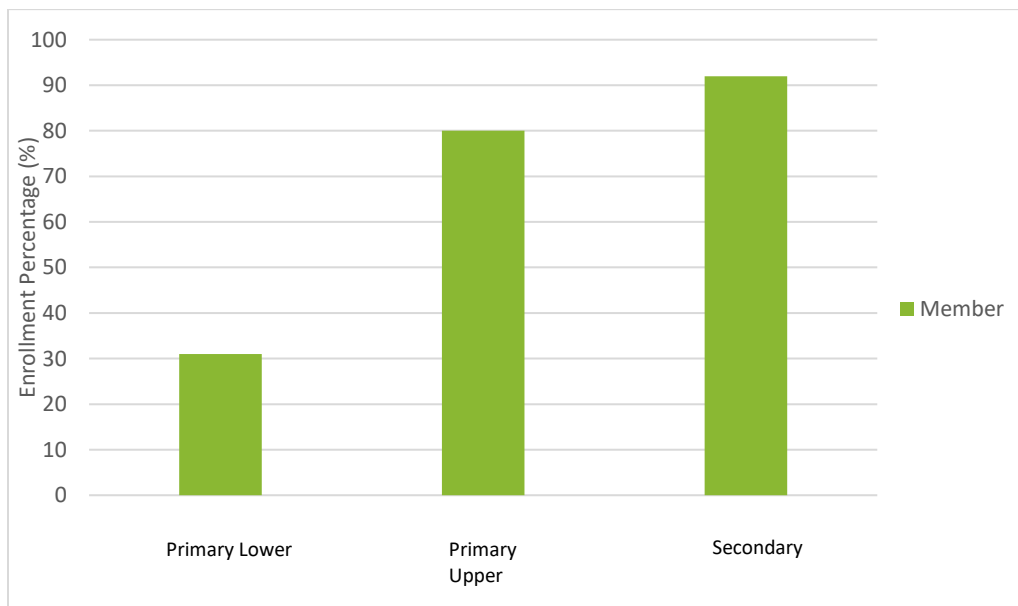

Figure 1.4: Percentage of students enrolled in wildlife and environmental clubs (Modified from Kioko, 2010)

Once involved with one of the clubs, the students showed a higher participation in local conservation activities. In fact, 65% of the contributors to local conservation activities were participants in wildlife clubs. Not only do these clubs increase community involvement, they also inspire members to continue their environmental learning and engage others in the conversation of surrounding environments (Kioko, 2010). This study demonstrated the effectiveness of choosing the proper age groups in environmental education and the importance of environmental club involvement after the program concludes.

2.3.4 Experiential Learning and Effective Teaching Techniques

David Kolb, a theorist specializing in education, defines experiential learning as, “learning in which the learner is directly in touch with the realities being studied” (Kolb, 2014). The emphasis is on direct sense experience and in-context action as the primary source of learning, analysis, and academic knowledge. Classrooms that implement experiential learning employ alternative educational techniques such as guided inquiry, hands-on experiments, and embedded activities that explore problem-based studies to increase learner engagement in the classroom (University of Texas at Austin, 2016-2017).

In his book, *Experiential Learning: Experience as the Source of Learning and Development*, David Kolb identifies four stages of this experience-focused learning style (see Figure 2.5).

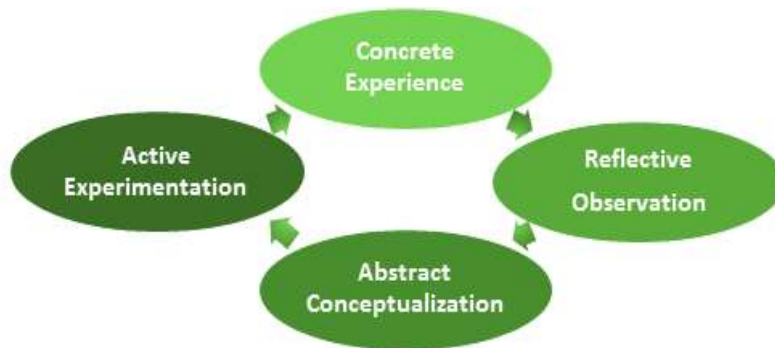

Figure 1.5: The Kolb Cycle (Modified from Kolb, 2014)

The *concrete experience* stage begins the cycle, where the teacher assigns tasks that require learners to actively participate. Kolb believes that one cannot learn simply by watching or reading about something; to learn effectively the individual or team must do something. The activities utilized to help in this stage include ice breakers, team games, problem solving activities, and debates (Kolb, 2014). After a period of time, the class enters the second stage, known as *reflective observation*. Now the class takes a step back from the tasks they are performing to review what they experienced. The expectation for this stage is that communication channels are open for the class. The class will ask an array of questions and give feedback on the lesson (Kolb, 2014). The class performs *abstract conceptualization* of their task after they reflect on their experience. During this stage, the class should interpret events that occurred and provide theories about why the events happened, based on previous knowledge, and what they discovered during the concrete experience stage (Kolb, 2014). The final stage of the learning cycle, *active experimentation*, is when the learner considers ways to utilize their new knowledge in real-world applications.

Experiential learning has great potential as an educational tool. John Dewey believed that learners develop a greater appreciation for nature and the environment if they experience the lessons first-hand (Saylan & Blumstein, 2011). Advantages of experiential technology in environmental education include an increased interest in nature, participatory learning, flexibility, and technological integration (Dunham, Hawkes, Lyles, & Misera, 2015). Researchers at Comité de Valorisation de la Rivière Beauport (CSVB) agree with Dewey. They believe that experiential learning as a part of environmental education restores the relationship with natural and industrial environments. This subsequently allows learners to develop an awareness of what is transpiring in their surroundings (Par Group de recherche Littoral et vie, n.d.). The environment of the classroom is important to consider when developing lesson plans. For example,

attempting to educate a class about marine life to learners who have never come in contact with the ocean is ineffective and harder than teaching them about their surrounding environment (Dunham, Hawkes, Lyles, & Misera, 2015). Ensuring that learners can ascertain by partaking in their surroundings increases engagement and interest in the lessons because learners have a role in their own education. Participatory learning is especially effective in rural communities, as rural learners tend to have a stronger connection to their local communities due to their isolation from surrounding communities (Dunham, Hawkes, Lyles, & Misera, 2015). Experiential learning similarly allows for increased flexibility in each learner's learning style and permits a more adaptable curriculum for the school and the teachers. This is beneficial for environmental education, as it can take place in a variety of locations. Environmentalist and artist Young Imm Kang Song commented that, "One of the most fundamental problems with environmental education is the detached, unemotional way in which it is taught," (Song, 2008). Teachers use experiential learning techniques to counteract this problem by developing engaging environmental education lesson plans to inspire moral responsibility in learners.

When teachers implement experiential learning techniques into their curriculum, they are using a learner-centered teaching approach. Learner-centered teaching methods shift the focus of activity from the teacher to the learners by implementing active learning, cooperative learning, and inductive teaching and learning (Felder, 2017). Active learning involves solving problems and asking questions, participating in discussions or debates, and formulating questions and ideas on their own (Felder, 2017). Cooperative learning involves working together in teams to solve problems, allowing them to develop positive interdependence and individual accountability (Felder, 2017). Inductive teaching involves presenting the class with challenges and teaching the course material in the context of addressing those challenges. Learner-centered methods combine these three concepts to create a teaching model which is more successful than traditional teacher-centered approach with regards to retention rates and learner-engagement (Felder, 2017).

2.3.5 Curriculum Reform and Theory

Children growing up in a variety of environments face different challenges and require individualized attention for their needs (Gaido, 2005). Dewey compares rural children and urban children to explain the importance of learning from experiences and the need for exposure to different activities in an educational setting. Children who grow up in an urban environment, exposed to industry, lose out on many opportunities to develop skills such as sewing, spinning, and caring for animals. While rural children develop these skills to help the family around the house (Gaido, 2005). Today, education reform continues with the addition of technology and computers. In Namibia, urban schools have SMART boards and computers, while rural schools fall short of obtaining new technology. SMART technology provides new hands-on capabilities and experiences to learners, so rural and urban schools should both have access to it.

SMART Technology utilizes interactive whiteboards, interactive flat panels, projectors, streaming devices, and software to enhance the learner's' experience in the classroom (Filigree Consulting, 2016). A report filed in 2016 by Filigree Consulting, sponsored by SMART Technology, analyzed the benefits of integrating SMART Technology into the classroom. They found that varied technologies in the classroom positively impacts the learner's success (Filigree Consulting, 2016). They also determined that group activities significantly benefited the learner. Classroom settings that frequently conduct group activities observe a 23% increase in active engagement, due to learner engagement in the lesson and participation in the discussion (Filigree Consulting, 2016). The report stressed that increasing the frequency of SMART technology will

increase learner successes. SMART Technology allows learners to create content rather than consume content (Filigree Consulting, 2016).

John Dewey introduced a curriculum theory that suggests that education can share qualities of democracy; these qualities include a free form of education available to all from kindergarten through college, the learners are responsible for carrying out their education, and teachers are present for learner guidance (Gaido, 2005). From Dewey’s theory, successful curriculums also depend on what to teach and how to teach, not just the teacher’s ability to develop lesson plans (Hansen, 1995). Instead of drilling learners mechanically, Dewey insisted that “education should give every child the chance to grow up spontaneously, harmoniously and all-sidedly” (Gaido, 2005). For instance, if children take up weaving, they may later inquire about the cotton process or the history of spinning because their education included hands-on learning (Gaido, 2005) In the context of Namibia, children introduced to renewable energy in the form of a pinwheel demonstrations, may later inquire about the science behind how a wind turbine works. More generally, if learners in rural areas of Namibia experience environmental education through interactive activities, they may later inquire about the complex science and economic factors behind environmental problems in their country. When developing a curriculum, it is important that teachers plan out experiential learning and hands-on activities.

A curriculum refers to the entire content of a subject or topic that encompasses everything that the school teaches, not just the separate subjects or a syllabus. A curriculum should include all experiences of the learners during their educational studies (Kelly, 2009). Experiences outside of a formal curriculum, include informal curriculum or extracurricular activities and different skills and trainings. Many educational settings regard extracurricular activities as integral for the total curriculum, yet separate them from the formal curriculum (Kelly, 2009). John Dewey and new educators stress the importance of experiences learned from the experiential world of the child (Deng, 2015). Dewey’s theory “gets rid of the prejudicial notion that there is some gap in kind between the child’s experience and the various subject-matter that make up the course of study”. This supports the new educators’ argument that a child’s experiences are crucial to growth and development (Deng, 2015).

2.3.6 Curriculum Development

According to Kelly, a curriculum should include four dimensions - intentions of the planners, procedures for implementing those intentions, the actual experiences of the learners because of the teaching, and the ‘hidden’ learning by-product (Kelly, 2009). The Association of Supervision and Curriculum Development (ASCD) created a template that uses eight phases to build a curriculum (Cunningham, 2009). Table 2.6 below outlines important aspects of a lesson plan.

Table 1.6: Eight phases of curriculum development (Modified from Cunningham, 2009)

Phase Number	Purpose
Phase 1: Introduction	Sets the goal/purpose of the lesson
Phase 2: Foundation	Checks what the learners already know
Phase 3: Brain Activation	Prompts the learners
Phase 4: Body of New Information	Teaches the bulk of the lesson plans
Phase 5: Clarification	Engages the learners via interactive activities
Phase 6: Practice and Review	Allows learners to work in small groups on demos or practice activities
Phase 7: Independent Practice	Prepare for future learning by completing homework tasks
Phase 8: Closure	Summarizes the lesson and how it fits into the greater picture

Although eight phases are overwhelming for a lesson plan, the time allotted to each phase is not equal. Phases one through four include the introduction and main topics for the class. Phases five through seven are central to reinforcing the learners' understanding of the lessons. Phase seven is particularly important because the learners will work independently on an activity both inside and outside the classroom (Cunningham, 2009).

One of the challenges of developing a curriculum is determining strategies that work best for all the learners. Since learners remember differently, there is no way to develop a lesson that suits everyone's ability to learn. Mr. Pelissari, a sixth-grade history teacher from Connecticut, said "When I first started [teaching], it was more of a lecture style or read [from] the text. Now there is a lot more group work [in the lessons] rather than working out of the book." Group work and full class discussions help engage the learners and their interests in the subjects. Another way to engage the learners and their interest in the subjects is through incorporating relatable content in the lesson plan. Mr. Pelissari also suggested that learners stay focused on the material when the lesson plan is broken down in fifteen to twenty minute sections (Pelissari, 2017).

Instructors develop curriculums with units and objectives. In each unit, there is an overall question that the teacher hopes the learner will be able to answer and understand. This overall question is known as an essential question. Essential questions prompt discussions about the unit topics (McTighe & Wiggins, 2013). An essential question strives to develop and deepen a learners's understanding of key ideas in the curriculum (McTighe & Wiggins, 2013). These types of questions are important because they drive learners to apply the knowledge in real world settings. Essential questions explore bigger topics and ideas while stimulating the connections between facts and abstract ideas (McTighe & Wiggins, 2013). However, before a learner is able to discuss and answer an essential question they need to answer rhetorical and guiding questions. Rhetorical questions lead the learners to remember specific information from the lesson (McTighe & Wiggins, 2013). They are important because they reinforce new, factual material. Guiding questions are slightly more challenging than rhetorical questions because they are more broad. Although not completely open-ended, guiding questions direct learners towards a definite answer through factual information and inference (McTighe & Wiggins, 2013).

2.4 Climate Change and Renewable Energy Initiatives

Namibia is one of the few countries in the world with the potential to become entirely powered by renewable energy (Munyayi, Iлека, & Chiguvare, 2015). Specifically, Namibia is an ideal candidate for the implementation of wind energy, solar energy, and Bush-to-Energy initiatives. With the significant effects of climate change that the country battles daily, Namibia is working to prepare its citizens to transition to renewable energy.

2.4.1 The Industrial Revolution and its Impact on Climate Change

The industrial revolution, the "process of change from an agrarian and handicraft economy to one dominated by industry and machine manufacturing", began in the 18th century and lasted till the 20th century (Encyclopedia Britannica, 2017). During this time, Britain underwent changes in basic materials, energy sources, production, transportation, communication, and social organization. Before this major

change, rural communities revolved around farming and individual production of goods (History.com Staff, 2009).

People had more access to a variety of goods and as a result the standard of living increased (History.com Staff, 2009). Although some economic classes benefited from the new technological, others such as the poor and working class continued to live with challenges. Living conditions in urban areas became unsanitary and overcrowded as people moved to the cities from rural areas (History.com Staff, 2009). Working conditions were dangerous and wages were inadequate. A major issue during the industrial revolution was that children were often times used for the most dangerous jobs.

Britain also had an abundant supply of coal and iron ore deposits. Metal workers used these raw materials in a cheaper and easier production of cast iron and steel, as well as powering new steam engine ships and locomotives, which Thomas Newcomen developed in 1712 (History.com Staff, 2009). Steam engines work by applying high-pressure steam to a series of interval valves and pistons (Brain, 2000). The furnace produces high-pressure steam in a boiler (Brain, 2000). The most common steam engine in the 1800s used a fire-tube boiler (see Figure 2.6).

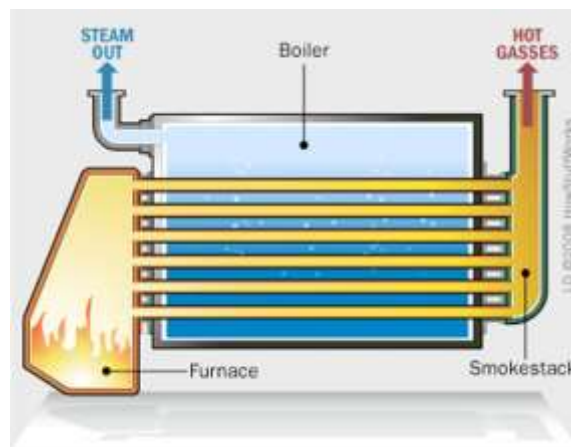

Figure 1.6: How steam engines work –fire-tube boiler (Brain, 2000)

Coal or wood burned in the furnace and releases hot gases. These hot gases then run through the pipes to heat the water and produce steam (Brain, 2000). The machine then releases excess hot gases into the air. Today these gases released are known as greenhouse gases. Machines emit these gases after the burning of fossil fuels. Fossil fuels include hydrocarbons such as coal, fuel, oil, and natural gas which form from the remains of dead plants and animals buried in geologic deposits. As industrial development progressed, industries around the world used fossil fuels as their main source of energy and power production. Fossil fuels are nonrenewable energy sources because once the world depletes them, they will not regenerate for millions of years. Renewable energy sources, however, replenish after a short period of time and consumers can use them in the near future.

2.4.2 Climate Change in Namibia

According to Namibia's House of Democracy, climate change is, "a change over long periods of time of temperature, precipitation, atmospheric pressure, and wind patterns on a global scale," (Lubinda, 2015). The natural causes of climate change include: the earth's orbit around the sun, the intensity of the sun's rays,

circulation of the ocean and atmosphere, and volcanic activity. Human contributions to climate change include burning fossil fuels, cutting down forests, and developing land. As the ozone layer of the earth disappears, surface temperatures rise, precipitation patterns change, and drought and flooding occurrences increase (Jackson, 2017).

Although Namibia is a small contributor of greenhouse gas emissions, the nation experiences massive climate change effects (Lubinda, 2015). According to the Climate Research Unit, the global temperature increased 1°C in the latter half of the twentieth century, meanwhile Namibia's average temperature increase was 1.2°C. These temperature increases have the potential to affect water availability, agriculture, coastlines, tourism, and the national economy (Renkhoff, 2014). Namibian communities whose livelihoods depend on natural resources, such as subsistent agriculturalists feel the effects of these changes. Land degradation, caused by severe drought and flash flooding, jeopardizes agriculture, and since 70% of Namibia's population is part of an agricultural community, the government believes it is urgent to act and prepare the country for the anticipated future consequences of climate change (Lubinda, 2015).

Namibia is currently preparing for climate change using two different tactics: mitigation and adaptation. Mitigation is the act of reducing or preventing the emissions of greenhouse gases, while adaptation is the tactic of anticipating the adverse effects of climate change and preparing accordingly. The main opportunities for Namibia to mitigate climate change is by investing in renewable – clean energies (Renkhoff, 2014). The main interests of the government are solar, wind, and biomass implementation projects. In regards to adaptation, Namibia is monitoring many of the potential climate change effects in water availability, agriculture, sea – level changes, and tourism. The main technique for battling climate change with the adaption approach is to educate the population on the importance of reducing greenhouse gas emissions.

Namibia currently imports 80% of its energy from surrounding countries, but has the potential to become a country completely powered by renewable energy (Munyayi, Iлека, & Chiguvare, 2015). The Namibian government recognizes this potential and, through the Ministry of Environment and Tourism (MET), implemented several policies that address different strategies to adapt to climate change and established four within the past decade:

- 2001- Established the National Climate Change Committee (NCCC), which functions as a federal advisory committee on climate change (Benyamin & Nantanga, n.d.)
- 2011- Developed the National Climate Change Policy (NCCP), which outlined a comprehensive framework on climate risk management in accordance with Namibia's development agenda (Ministry of Environment & Tourism, 2011)
- 2012- Implemented the Disaster and Risk Management Act, which established institutions for risk management to plan for disasters such as flooding and drought (Lubinda, 2015)
- 2014- Created the National Climate Change Strategy and Action Plan (NCCSAP) from the NCCP, which exemplifies the goals of their organization by creating effective, efficient and practical guiding principles that are responsive to climate change (Lubinda, 2015).

These policies laid the groundwork for nationwide change. If Namibia can maintain the traction that these initial changes created, the country will continue to work towards transitioning to renewable energy technologies.

2.4.3 Socio-Economic Impacts of Climate Change

As mentioned above, sustainable agriculture supports approximately 70% of Namibia’s population (Chioreso & Munyayi, Think Namibia: Climate Smart Agriculture, 2015). As such, agriculture plays a vital role in Namibia’s economy. Land degradation leaves less than one-third of Namibia’s land available for agricultural purposes (Chioreso & Begbie-Clench, Think Namibia: Land Degradation, 2015). Since most of the population lives entirely off the land, and many suffer in poverty, this lack of usable land has become an increasingly problematic issue in Namibia (Chioreso & Begbie-Clench, Think Namibia: Land Degradation, 2015).

The government has already begun to counteract this issue. One governmental plan integrates Climate Smart Agriculture (CSA) into the economy. CSA contains three main pillars of sustainable development: economic, social, and environmental impacts. CSA in Namibia aims to: sustainably increase agricultural productivity and income, adapt and build resilience to climate change, and reduce greenhouse gas emissions. Table 2.7 depicts the government’s plans to integrate CSA into Namibia’s current agriculture sector to improve current practices and the economy (Chioreso & Munyayi, Think Namibia: Climate Smart Agriculture, 2015).

Table 1.7: Climate-smart practices useful in smallholder agricultural production (Modified from Chioreso & Munyayi, Think Namibia: Climate Smart Agriculture, 2015)

Crop Management	Livestock Management	Solid and Waste Management	Agro Forestry
<ul style="list-style-type: none"> • Intercropping with legumes • Crop Rotations • New Crop Varieties • Improved Storage and Processing Techniques • Greater Crop Diversity 	<ul style="list-style-type: none"> • Improved Feeding Strategies • Rotations Grazing • Fodder Crops • Grassland Restoration and Conservation • Manure Treatment • Improved Livestock Health • Animal Husbandry Improvements 	<ul style="list-style-type: none"> • Conservation Agriculture • Contour Planting • Terraces and Bunds • Planting Pits • Water Storage • Dams, Pits, Ridges • Improved Irrigation 	<ul style="list-style-type: none"> • Boundary Trees and Hedgerows • Nitrogen-Fixing Trees on Farms • Multi-Purpose Trees • Improved Fallow with Fertilizer Shrubs • Woodlots • Fruit Orchards

Along with these initiatives, the Namibian government introduced several energy saving measures, such as installing solar water heaters in all government buildings, introducing independent power producer concepts, supporting the development of energy from bush encroachment, solar-diesel hybrid mini-grid systems, and wind power generation (Namibia - EEP Africa, 2015). The Namibian cabinet decided to aim for nation-wide self-sufficiency in electricity generation and to reduce dependency on foreign products in 2008. The Energy and Environment Partnership (EEP) of Southern and East Africa has been working in conjunction with the Namibian cabinet to implement renewable energy throughout the nation, and currently has four projects in development in Namibia:

1. Fish-based biodiesel
2. A feasibility study for the potential of anaerobic bio-digesters to produce renewable energy
3. Invader (encroachment) Bush-to-Energy
4. Innovative Technologies for Underserved Populations.

These are EEP's current projects in Namibia. In the past, the EEP completed several successful projects that promote renewable energy in the country, such as the Biofuel boiler depicted in Figure 2.7 below (Namibia - EEP Africa, 2015).



Figure 1.7: EEP thermal biofuel boiler (Namibia EEP - Africa, 2015)

While neither the EEP's initiatives nor the CSA's program will provide immediate solutions, both projects are working to promote environmental awareness and sustainable development in Namibia, which will cause positive long-term effects. If citizens continue to implement climate-smart agriculture and the EEP manages to implement environmentally friendly changes throughout the nation, the effects of climate change will hopefully become less severe. This will lead to an increase in useable land, which could promote job growth and improve the economy.

2.4.4 Vision 2030

As discussed in Section 2.1, the National Planning Commission (NPC) of Namibia created Vision 2030 to clearly define the developmental programs and strategies to improve the lives of Namibian citizens. While Vision 2030 covers a diverse range of topics, chapter five targets the issues of developing a sustainable resource base (National Planning Commission, Preface, 2004).

Chapter five of Vision 2030 discusses the potential of sustainable development, the current environmental issues in Namibia, and the actions the country can take to overcome these unwelcome trends. The six significant components that the NPC believes threaten sustainable development are:

- Maintaining people's rights, responsibilities, and authority over land and resources
- Achieving sustainability in the land and agricultural sectors, and the need for diversified livelihoods
- Promoting sustainability of the forestry sector
- Sustaining the coastal and marine fisheries and ecosystems
- Optimizing Namibia's comparative advantage in the wildlife and tourism section of the government
- Harvesting the earth's bountiful minerals with minimal impacts.

Figure 2.8 depicts the interconnections between these six components and how they directly affect one another and the climate (National Planning Commission, Sustainable Resource Base, 2004).

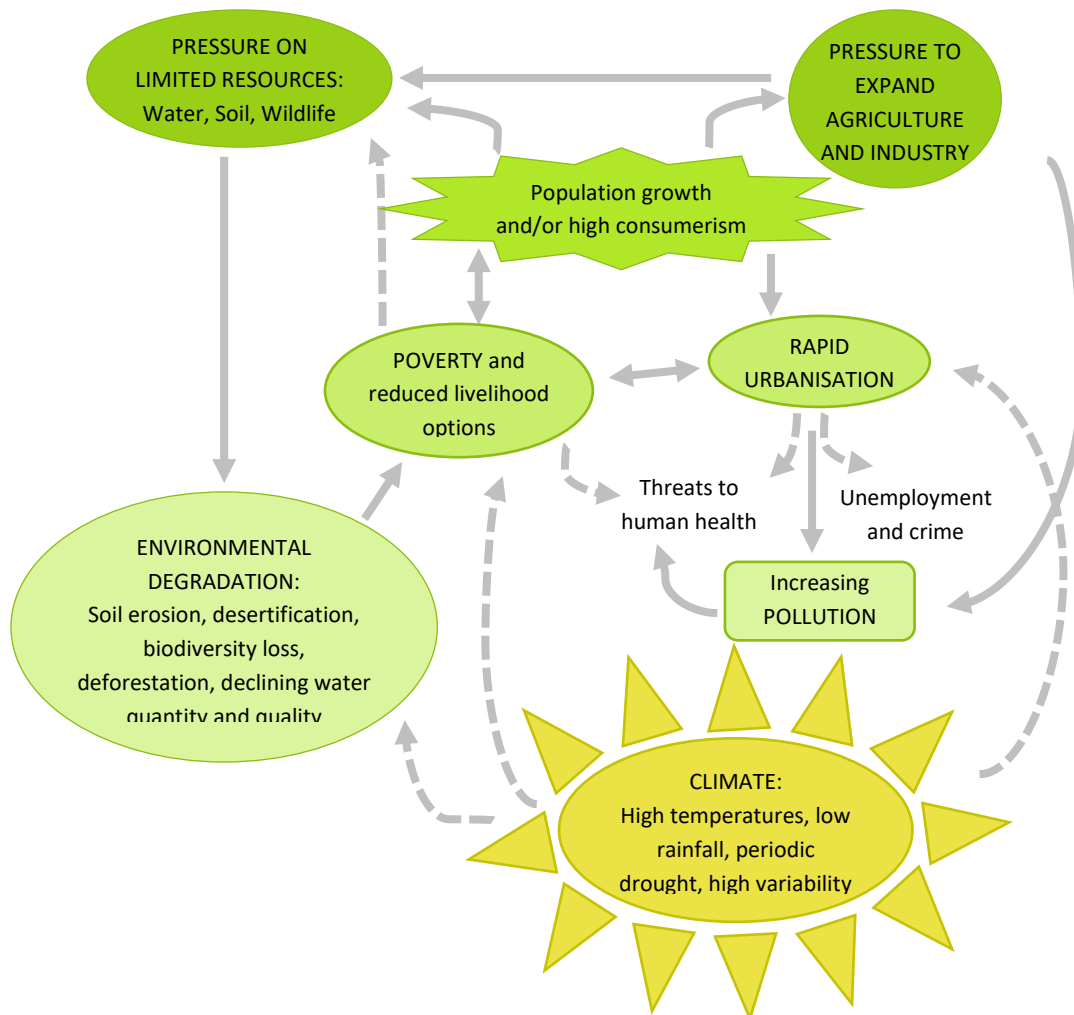

Figure 1.8: Interlinking issues that threaten Namibia's potential for sustainable development (Modified from National Planning Commission, Sustainable Resource Base, 2004)

Surface water scarcity, minimal availability for livestock grazing, and low livestock-carrying capacity limits cultivation and commodity farming development. Soil erosion, bush encroachment, and soil salinization continue to cause economic loss and escalating poverty. Thousands of families utilize land as their only form of livelihood. While 94% of rural Namibian households identify agriculture as their main source of income, the lack of available land has adverse effects on farmers' incomes (National Planning Commission, 2004).

Forests provide life-sustaining environmental services by expelling oxygen and absorbing carbon dioxide. Forests also act as stabilizing units for ecosystems and are sources of economically valuable products. These ecosystems improve the livelihoods of most Namibian citizens through the supply of fuel and construction materials, as well as food, medicine, and grazing space for livestock. They also support a wealth of biodiversity and game. Unfortunately, unsustainable deforestation of natural woodland and forest areas occurs throughout the country, and is most severe in areas with high population density, especially in northern Namibia (National Planning Commission, 2004).

Consequences of deforestation include rainfall runoff and soil erosion, as well as decreasing soil fertility, changes in Namibia's water cycle, a loss of biodiversity, and increased rates of global warming. Namibia's ecosystems play a vital role in maintaining environmental health. They promote soil stabilization and climate control, and hold Namibia's limited supply of hardwood timber resources. Namibia will suffer economic downfalls in the form of limited supply of hardwood and biodiversity reduction if deforestation continues to occur (National Planning Commission, 2004).

The government's plan for increasing biodiversity is another major component of Vision 2030. Namibia is home to many species of plants and animals which inhabit the country's different biomes. Even though only a few are directly useful to humans, all species are of ecological importance. Natural ecosystems provide vital genetic material, and indirect benefits including air, water, and productive soils.

As ecosystems lose complexity, pests and disease become more prevalent and disruption of essential ecological functions occur. Disturbances in ecosystems also increase vulnerability to drought, floods, and climate change. Biodiversity deprivation threatens food supplies, sources of wood and medicines, and the sustainment of rural communities. Without biodiversity, the environment and economy will begin to decline. Accordingly, the government implemented a conservation program to prevent biodiversity loss. Conservancies offer opportunities for communities to generate revenue and employment, and promote the protection and sustainment of wildlife (National Planning Commission, Sustainable Resource Base, 2004).

2.5 Renewable Energy Topics

Currently, Namibia imports most its energy from the surrounding countries, with the majority of the imports being fossil fuels. Namibia has an opportunity to achieve independence from these countries with the implementation of renewable energy. The Namibian government is investigating in the use of solar energy, wind energy, and a specific biomass process called "Bush-to-Energy". A plant species called 'encroacher bush' covers Namibia. With the utilization of Bush-to-Energy, the country can produce energy from burning the encroacher bush as a source of biomass.

2.5.1 Wind Energy

Wind energy is a renewable energy that utilizes wind to generate electricity with a turbine. A healthier atmosphere, environment, and planet can exist if the world adopts wind energy (Wind 101: the basics of wind energy, n.d.). Wind energy is a clean energy source because it does not produce emissions that affect the ozone layer or increase health issues among the population (Office of Energy Efficiency & Renewable Energy, n.d.) The Wind Vision Report concludes that the implementation of wind energy can reduce greenhouse gas emissions by 14%, thus preventing \$400 billion spent in repairing global damage by 2050 (Office of Energy Efficiency & Renewable Energy, n.d.). Wind energy is also a great candidate for many countries throughout the globe because it does not use water in its energy production process. This is essential for water-deprived countries such as Namibia (Office of Energy Efficiency & Renewable Energy, n.d.).

Although wind energy has many potential benefits, there are also several limitations to consider when installing wind turbines. The energy generation is entirely dependent on wind qualities and frequencies. Wind energy is not a consistently reliable source as it depends entirely on wind, which is

naturally intermittent (Wind 101: the basics of wind energy, n.d.). This would not be an issue if manufacturers were able to equip wind turbines with storage systems, however this is not currently possible with the available technologies. Depending on a variety of factors such as species, type of ecosystems, and locations of the facilities, wind turbines can disrupt surrounding ecosystems by generating noise, disrupting soil, and eroding land (Jaber, 2013). After installation of these turbines, certain species relocate due to destroyed or altered ecosystems, and in extreme cases, the food pyramid of an ecosystem may shift due to the blades of the turbines killing a large number of aerial animals.

The two primary types of turbines are horizontal and vertical axis turbines (Wind Energy and Wind Power, n.d.). The designs and sizes of the horizontal and vertical turbines vary depending on the installation area and types of wind utilized. Figure 2.9 shows a comparison between the two physiques of the wind turbines. Horizontal axis turbines typically consist of three large blades with a large pole attached to the three blades. The vertical axis turbine has blades on the top and bottom with a rotor connecting both ends (Meyers, Types of Wind Turbines, 2013).

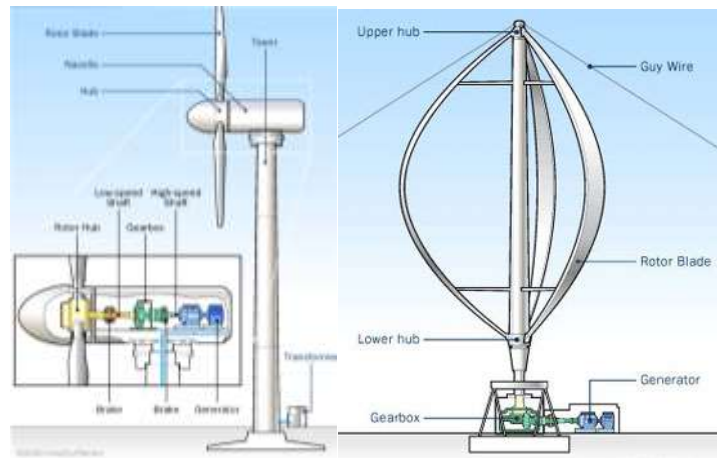

Figure 1.9: Comparison of vertical (right) and horizontal (left) wind turbines (Eco Energy, n.d.)

Horizontal and vertical axis turbines function very differently and therefore have their own components, and sets of advantages and disadvantages. First, a horizontal axis wind turbine, or a HAWT, consists of the components listed in Table 2.8.

Table 1.8: Components of a horizontal axis wind turbine (Modified from BWE Bundesverband WindEnergie, n.d.)

Part of Turbine	Purpose
Tower & Foundation	The tower and foundation anchor the wind turbine to the ground
Hub	The hub converts the energy in the wind into rotary mechanical movement
Rotor Blades	The rotor blades take energy out of the wind and delivers it to the hub through rotation
Nacelle	The nacelle holds all the turbine machinery
Gearbox	The gearbox takes the low rotational speed from the shaft and increases it to an rpm that the generator can process
Generator	The generator converts mechanical energy from the rotation of the gearbox into electrical energy
Brakes	The brakes keep the speed of rotation of the turbine between its upper and lower limits to avoid damage to the turbine (How Wind Energy Works, n.d.)

There are many benefits of the designs of HAWTs. First, they maximize power output by acting perpendicularly to the wind. The tower lifts the turbines off the ground which allows access to stronger winds. According to Centurion Energy, for every 10 meters up from ground-level, wind speed can increase by 20% and thus increase power production by 34% (Meyers, Wind Turbines: How Much Power Can You Expect, 2013). Horizontal axis turbines are more efficient than the vertical axis turbines, and therefore HAWTs mostly dominate the wind industry.

However, constructing the massive HAWTs is extremely expensive because of the weight of the components. The initial installation of the turbine is costly, but the overall maintenance needed is fairly small. Although the large tower allows for more energy production, it is much more difficult to perform maintenance and the height off the ground makes the turbine more visible to surrounding people. One major drawback is that many citizens think that HAWTs are an eyesore because they look extremely unnatural in comparison to their surrounding environments (Wind Energy and Wind Power, n.d.). In some cases, wind turbines may even be dangerous to surrounding communities because some turbines undergo fatigue, break, and the debris may potentially injure surrounding people (Meyers, Wind Turbines: How Much Power Can You Expect, 2013). Therefore, when installing a wind turbine, one must look for:

1. Flatland where wind is not obstructed by forests
2. Windy areas of the country
3. Land that is far from neighbors or homes
4. At least one acre of land.

As long as the selected installation location follows these guidelines, wind turbines are fairly safe (LandCentury, 2017).

Vertical axis wind turbines, or VAWTs, are much smaller and located closer to the ground. The components of these turbines are listed in Table 2.9.

Table 1.9: Components of a vertical axis wind turbine (Modified from Atta, n.d.)

Part of Turbine	Purpose
Guide Wire	The guide wire keeps the shaft in a fixed position
Hub	The hub is the center of the rotor, and it is where the rotor blades attach together
Rotor Blades	The rotor blades take energy out of the wind and delivers it to the hub through rotation
Shaft	The shaft is the center of the turbine and the blades turn the shaft
Nacelle	The nacelle holds all the turbine machinery
Gearbox	The gearbox takes the low rotational speed from the shaft and increases it to an rpm that the generator can process
Generator	The generator converts of mechanical energy from the rotation of the gearbox to electrical energy
Brakes	The brakes keep the speed of rotation of the turbine between its upper and lower limits to avoid damage to the turbine (How Wind Energy Works, n.d.)

VAWT designs ensure that the turbines are always facing the wind. This is an advantage but also a disadvantage because they create more drag than HAWTs (Meyers, Types of Wind Turbines, 2013). Although VAWTs lack the ability to use the high magnitudes of wind that HAWTs receive, maintenance is much easier

on VAWTs because they are on or near the ground. The close proximity to the ground also ensures that the turbines are less visible to the surrounding communities.

The overall goal of the turbines is to maximize the power output and therefore to do this HAWTs are more frequently installed than VAWTs. Not only are VAWTs inferior in design (because of the increased drag), but they are also inferior in the exposed wind speeds (because of their proximity to the ground) (Meyers, Wind Turbines: How Much Power Can You Expect, 2013).

Wind power is sensitive because the electricity generated by turbines must reach the correct voltage and frequency to enter the power grid. Specifically, in Namibia, some areas have higher wind speeds than others and this will cause energy fluctuations. The different regions of the country might benefit from different sizes of turbines. The size of the turbine relates directly to the amount of power generated; Table 2.10 shows the amount of power produced in Watts in relation to blade size.

Table 1.10: Relation between size of turbine and power produced (Modified from Meyers B. , Wind Turbines: How Much Power Can You Expect, 2013)

Wind Speed	5 mph	10 mph	20 mph	35 mph
1.21 m Blade Dia	0.9 Watts	6.8 Watts	54.5 Watts	292.2 Watts
1.82 m Blade Dia	1.9 Watts	15.3 Watts	122.7 Watts	657.4 Watts
2.43 m Blade Dia	3.5 Watts	27.7 Watts	221.7 Watts	1188.3 Watts
3.04 m Blade Dia	5.5 Watts	43.7 Watts	349.9 Watts	1875.2 Watts

Although the 3.04 m turbines produce the most power, smaller plots of land cannot support these massive turbines, so it is important that the industry maintains a variety of sizes. The type of design also affects the amount of energy that the turbines can produce, since only certain wind speeds will maximize its efficiency.

Wind energy is cost-effective compared to energy produced by gas, oil, or petroleum (Wind 101: the basics of wind energy, n.d.). According to The Economics of Wind Energy, the turbine, foundation, and connection to the power grid amount to around 75% of the total upfront costs of wind energy (The European Wind Energy Association, 2009). Typically, natural gas plants' "continued" costs (operations, maintenance, and fuel) are between 40%-70%, while wind energy's operation, maintenance, and installation costs are less than 60% of the "continued" total costs for onshore turbines (The European Wind Energy Association, 2009). The offshore turbines are 50% more expensive than onshore turbines; however, this cost difference is offset by the energy output that each offshore turbine produces. The offshore turbines produce approximately four thousand full load hours per year while the onshore wind turbines supply around two thousand full load hours per year.

Wind energy is extremely cost-effective compared to energy produced by gas, oil, or petroleum (Wind 101: the basics of wind energy, n.d.). This type of alternative energy also has the possibility of creating

many jobs throughout the world in design, manufacturing, installation, electrical, maintenance, and many others (Wind 101: the basics of wind energy, n.d.). Namibia desperately needs job growth due to the unemployment rate that was 26.8% in 2011 and 29.6% in 2013 (Namibia Unemployment Rate, n.d.; Unemployment rate - Namibia Data Portal, n.d.). With such a large amount of the population unemployed, integrating wind energy allows Namibians to learn new, valuable skills and potentially lower the unemployment rate.

Namibia is a great candidate for wind energy because it has 1572.33 km of open coastline (Smith, Wind energy could fill Namibia's electricity gap, 2011). The government of Namibia is working to implement wind farms along the coast in Lüderitz and Walvis Bay, as shown in Figure 2.10.



Figure 1.10: Map of Namibia (Rieck, 2013)

The government of Namibia just granted a license to a Namibian-Korean collaboration on a forty-four MW project near Lüderitz, and NamPower is currently discussing the approval of a sixty MW project near Walvis Bay (Dodd, 2013).

The future of wind turbines focuses on the designs and storage capabilities. Engineers throughout the globe are now designing smaller wind turbines that generate energy from breezes. Figure 2.11 depicts a prototype of a smaller wind turbine, known as “Abre a vent” or “Wind Tree” that is in testing in France (Parke, 2015). These micro turbines take on the shape of leaves, giving the appearance of a tree, and produce around 3.1 kW of energy (Johansson, 2016). These wind trees can produce energy for direct integration into the power grid or to power a single, family home (Wind Energy and Wind Power, n.d.).



Figure 1.11: The "Wind Tree" (Parke, 2015)

However, the future of wind technology lies with improving the efficiency and physical aesthetic of wind turbines. To further improve wind technology, engineers must design storage capabilities to provide a stable influx of energy. Overall, the implementation of wind energy in Namibia has the potential to create jobs, lessen the emission of greenhouse gases, and improve the national economy.

2.5.2 Solar Energy

Solar energy is a renewable resource that utilizes the sun's rays for a variety of functions such as producing electricity, cooking food, and heating water. Figure 2.12 depicts some of the available technologies. Solar technologies can be classified by two subtypes: "passive" and "active". "Active" solar systems convert the sun's light into electricity using mechanical or electrical devices. While "passive" solar systems convert the sun's light without the use of mechanical or electrical devices, with heating as their primary use (Matthews, 2016).

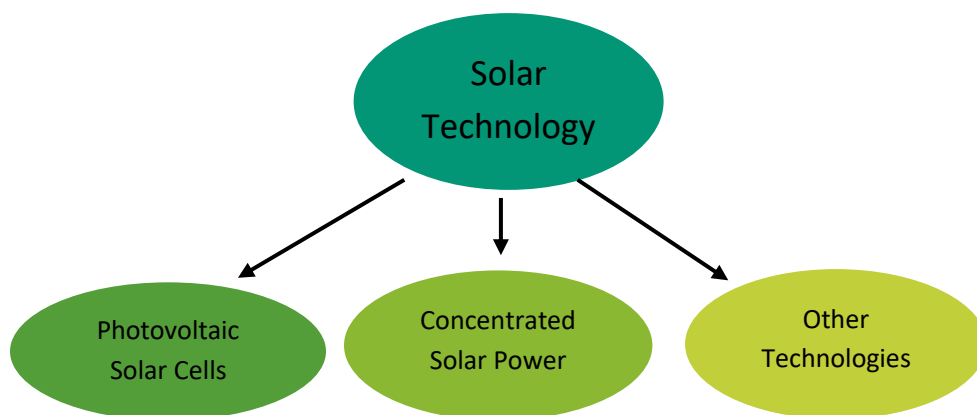

Figure 1.12: Main types of solar panels

Photovoltaic (PV) solar cells are one of the most common types of solar technology. PV solar panel arrays absorb sunlight over larger areas to generate electricity. Within the PV solar cells, silicon operates by absorbing light from the sun to generate an electric field through the movement of electrons (Dhar, 2013). Photovoltaic solar cells generally operate by absorbing light through the semi conductive material of the cells, silicon. Manufacturers add phosphorus to the top layer of the silicon and boron to the bottom layer.

This creates a resulting negative charge to the top layer because of the phosphorus adding electrons; while the bottom layer creates a positive charge as the boron metal reduces the number of electrons. The manufacturers also add a metal conductive pattern on both sides of the solar cell. The PV cells have both p-silicon and n-silicon; they are next to each other within each cell. The p-silicon (silicon that contains electron holes) and n-silicon (silicon that contains excess electrons) create the p-n junction, which is a boundary that electrons have difficulty crossing. This results in a generation of a constant electric field (Parry-Hill, Sutter, & Davidson, 2015). When the UV light hits the silicon, it transfers energy to the loose electrons, freeing them from the silicon atom. The electric field pushes the electrons across the p-n junction, where the electrons move into the n-silicon, which creates a charge imbalance. Due to the charge imbalance, the electrons travel on a path, or circuit, provided by metal traces connecting the p- and n-type silicon layers. While flowing through this circuit, the electrons can provide power to a variety of electronic devices such as battery packs or electric lights. The electric current flows through the circuit because this path requires less energy for the electron to return from the n-type to the p-type silicon than for the electron to travel back across the p-n junction. (Dhar, 2013).

Another technology that collects energy from the sun is called concentrated solar power (CSP). CSP uses mirrors to heat a liquid, turn a turbine, then produces electricity (Amatya, et al., 2015). CSP technology appears in a variety designs such as the solar tower, parabolic trough, linear Fresnel, and the sterling dishes (Amatya, et al., 2015). The mirrors in this technology allow the panels to follow the sun throughout the day, to collect the most sunlight possible. The power tower in CSP technology also contains a form of thermal storage, which allows it to store the energy generated throughout the day (Concentrating Solar Power (CSP) Technologies, n.d.).

There are also several other technologies on the market utilizing solar power. Solar water heaters collect energy from the sun to provide hot water to homes or other buildings. Solar cookers and solar ovens are another passive solar technology. They function by concentrating sunlight in a specific area designed for cooking. There are several different types of cookers such as the parabolic solar cooker and the box cooker (Solar Cookers: Varieties and Styles, 2015).

Solar energy has several advantages during the day as it will absorb the sun's energy to create electricity (Amatya, et al., 2015). In countries where it is sunny for most the year, such as Namibia, solar energy is a great renewable energy resource. In 2015, the solar energy industry experienced a 20% job growth and the industry predicts this to continue in the upcoming years. In 2015, the solar industry created 65% of the new jobs offered throughout the globe. Implementing this technology can stimulate the economy and significantly reduce unemployment. Along with economic opportunities, the use of solar energy also builds an environmentally friendly future (Harvey, 2016). PV solar panels require very little maintenance which includes cleaning dust and dirt buildup (Solar Panel Maintenance, n.d.)

One of the major disadvantages of using solar energy as a primary source of electricity is that it is inefficient (Osman, 2015). The silicon wafers currently used in solar panels are poor light absorbers, with an efficiency of only 10%. Additionally, solar power is expensive in terms of installation, manufacturing, and the little maintenance it requires. Installation and price of solar panels are one-time payments, but maintenance is a continuous expense throughout a panels' lifetime. Similar to wind energy, most solar panels do not have a storage system (Osman, 2015). Without a storage system, solar powered machinery can only operate on a sunny day. To implement a solar farm, the requirements include a generally low population density and a

large amount of flat land. The regions in Namibia best suited for solar farms are Kuenene, Karas, Erongo Hardap, Omaheke, and Otjozondjupa (LandCentury, 2017).

A priority for current PV technologies is to reduce production costs, improve efficiencies, and create more capable storage systems (Amatya, et al., 2015). One method to improve the current PV technology is to implement solar tracking. This is when solar panels follow the sun throughout the day to collect as much sunlight as possible. Solar collectors are another possible improvement to increase the efficiency of the current photovoltaic cells. This technology involves flat plates that optimize collection and storage of solar energy (U.S. Department of Energy, 2012). Lastly, hybrid power uses solar energy in conjunction with another form of energy generation such as wind power or hydropower.

2.5.3 Bush-to-Energy

Bush-to-Energy is a form of biomass energy which uses wood chips, made of harvested encroacher bush in place of coal and oil, as a source of energy. As Lars Josefsson said, “[Bush-to-Energy] essentially acts as a renewable type of fossil fuel, combining the flexibility and controllability of coal with the sustainability of wind and solar...bioenergy is an ideal source of baseload of electricity, especially for Namibia which is endowed with such vast resources of biomass in its encroacher bush,” (Josefsson, 2016). Encroacher bush is a group of plant species that dominate land and reduce available water and nutritional resources. This encroacher bush currently covers over 45 million hectares (111 million acres) of Namibia’s land area, which approximates to over 55% of the country. The brown squares represent the encroacher bush in Figure 2.13 (Ministry of Agriculture, 2016). This is a significant portion of Namibia’s land, and all indicators show that the amount of bush is continuously spreading (Ministry of Agriculture, 2016).

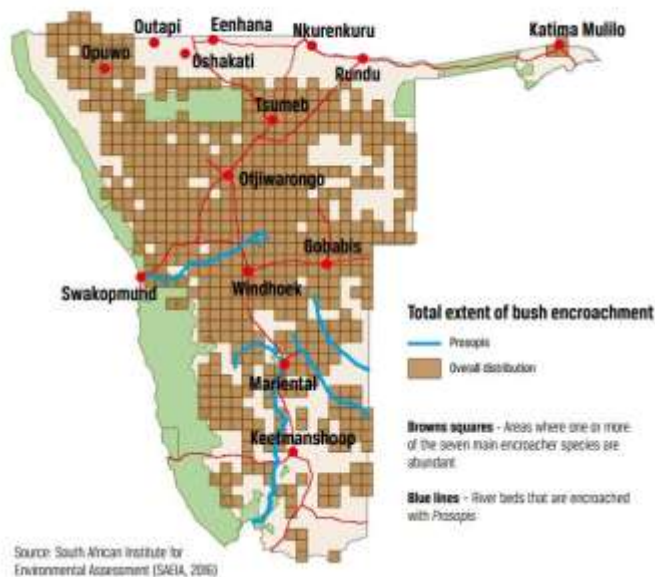

Figure 1.13: Map of the extent of encroacher bush in Namibia (Ministry of Agriculture, 2016).

Encroacher bush has become a serious problem in Namibia. These invader plants reduce water and nutrient retention in soil, which makes it difficult for other plants and essential grasses to grow. This limits the amount of sellable produce that farmers can provide for user consumption. This also affects the growth

of grass that livestock graze, which in turn, reduces the carrying capacity of livestock (GmbH, 2015). The lack of vegetation and livestock affect many citizens' quality of life, as well as Namibia's economy (Lubinda, 2015). Encroacher bush also reduces the biodiversity of many ecosystems, as the plants and animals cannot sustain themselves, and they die off from malnourishment. The culmination of these issues leads to a need to eliminate a significant portion of this encroacher bush so that Namibia's economy can improve.

The best way to manage the amount of bush encroachment in Namibia is through harvesting. Harvesting encroacher bush not only provides control over the rate at which the bush is growing, it can also promote job growth, improve biodiversity, and lessen Namibia's dependency on surrounding countries for energy resources. In 2016, the Ministry of Agriculture established a set of guidelines called the, "Forestry and Environmental Authorisations Process for Bush Harvesting Projects," which outlines the procedures for conducting a harvesting project. The overriding theme in this policy's framework is promoting the sustainable use of Namibia's rangeland and combating bush encroachment for the restoration and recovery of livestock productivity (Ministry of Agriculture, 2016). The Ministry believes that while harvesting bush is important, harvesting projects must occur in a manner that does not cause additional harm to Namibia's environment (Ministry of Agriculture, 2016). To ensure maintenance of the environment and relevant ecosystems, the intended project manager must obtain a number of permits and environmental clearances prior to any type of bush clearing. After harvesting the bush, the harvesters must obtain permits for transport and exports. Normally, this is a very lengthy and expensive process. For bush harvesting, the Ministry of Agriculture streamlined these processes to avoid heavy fees and time delays to encourage bush harvesting and promote environmental sustainability (Ministry of Agriculture, 2016).

The Ministry of Agriculture also provided the public with a set of "good" and "poor" practices so that, should smaller projects which do not require a permit occur, the individual still harvests the bush in an environmentally friendly way (Ministry of Agriculture, 2016). "Good" practices include: selective harvesting, manual application of arborcides, harvesting in phases, and not harvesting protected plant species (Ministry of Agriculture, 2016). Selective thinning or harvesting refers to intentionally leaving a portion of bush untouched. This allows for the maintenance of habitats and biodiversity in the plant life of the area. If Namibia eliminates all bush through a bush harvesting project, not only will additional land degradation occur, but it will destroy habitats for the various species in the area. Figure 2.14 depicts the differences in the types of harvesting.

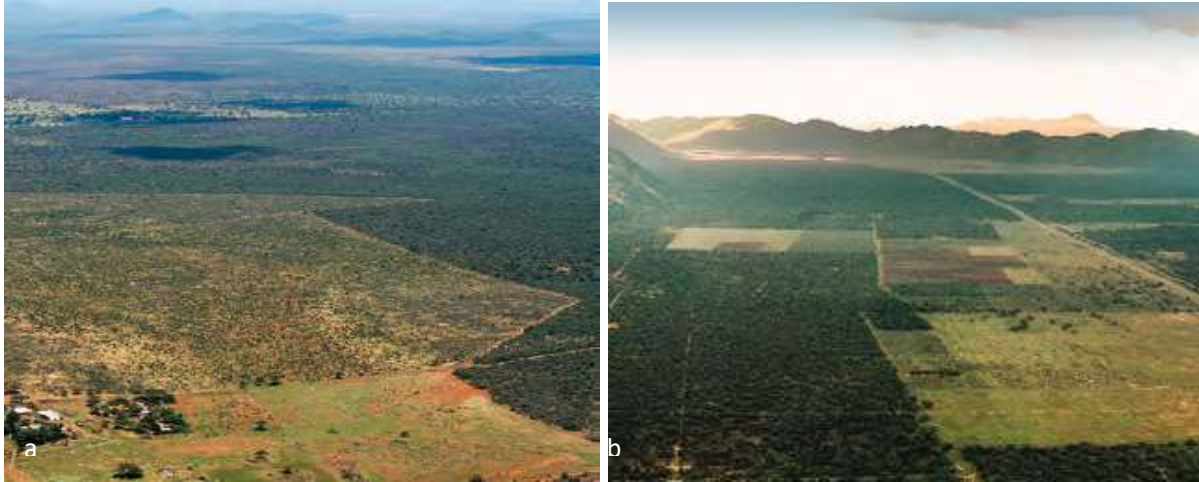

Figure 1.14: Aerial views of (a) selective bush clearing and (b) bush elimination (Ministry of Agriculture, 2016)

After the completion of harvesting projects, power plants can convert the encroacher bush into useable energy. Once project managers harvest the bush, machinists in processing centers process the bush and convert it into wood chips. Delivery trucks then transfer these wood chips to a bunker stored underneath a water tank. When power plants need to produce energy, workers burn the bush to heat water in a boiler to create steam. The steam travels into a turbine and forces the blades to spin, creating power. The power travels to a generator and creates a magnetic field. The generated magnetic fields create electricity, which is then distributed to the public (eSchoolToday, 2010). This is the most standardized technique for converting bush into useable energy.

While there are currently no Bush-to-Energy plants established in Namibia, NamPower conducted a prefeasibility study to evaluate where such a power plant would best function in the country (NamPower, 2012). They determined with their study that three areas in the north; Tsumeb, Outjo, and Otjiwarongo. Indicated by the orange dots in Figure 2.15, the prefeasibility study determined that these three locations were the best possible locations for the implementation of this technology. NamPower selected these northern areas because of the high density of encroacher bush in these regions (NamPower, 2012).

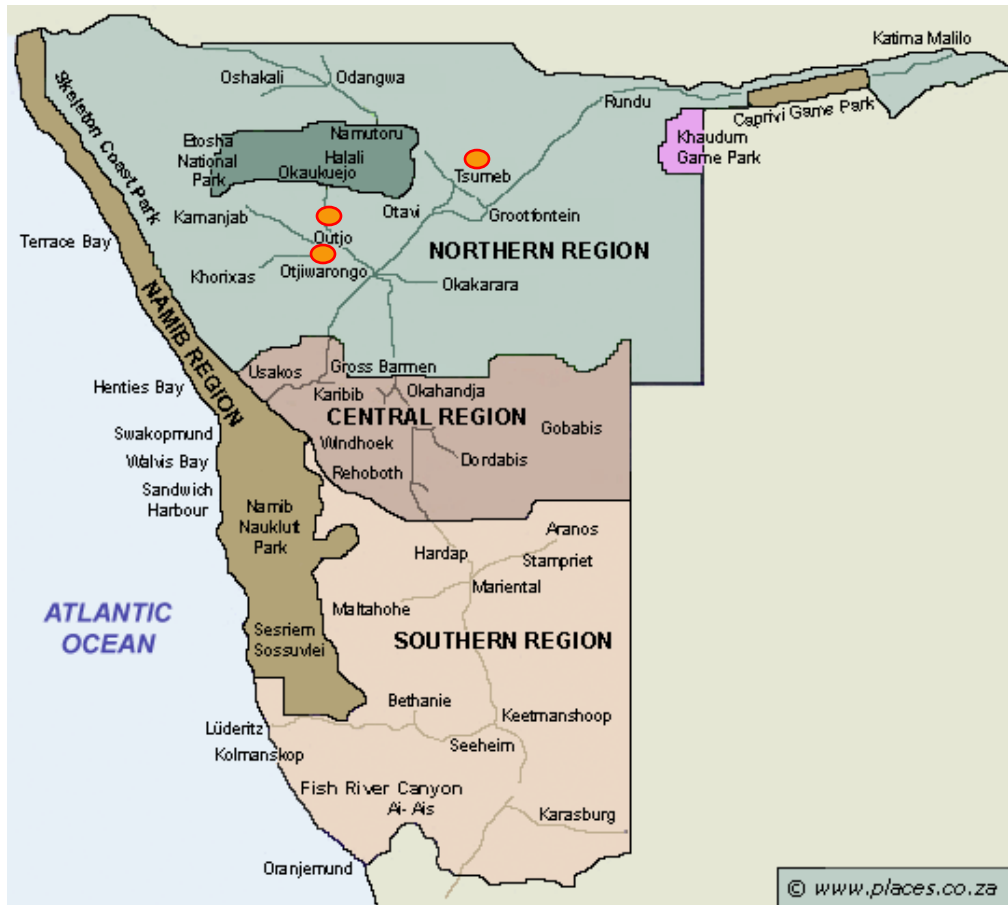

Figure 1.15: Possible locations for the implementation of Bush-to-Energy plants (Modified from SA Places, 2016)

There are several advantages of implementing Bush-to-Energy in Namibia. The amount of encroacher bush that covers Namibia has the potential to be a massive renewable energy resource. Assuming a zero percent growth rate, there would be a sufficient amount of bush to supply ten 20 Megawatt (MW) power plants for 114 years (NamPower, 2012). These ten power plants could power over 240,000 houses. As encroacher bush will continue to grow for years to come, the amount of power that Bush-to-Energy could possibly supply is much higher than this estimate. With the amount of encroacher bush that continues to cover Namibia, Bush-to-Energy has a sustainable energy potential of 25,000 GWh per year of 500 MW to 1000 MW electric generating capacity, which would realistically cover 80% of Namibia’s national demand (DRFN, 2012).

By reducing the amount of energy imports per annum, Namibia could increase national funds as, according to former Ministry of Trade and Industry representative Ben Amathlia, Namibia is, “spending close to N\$3 billion annually to buy electricity from outside countries,” (GmbH, 2015). Bush-to-Energy technology could also allow Namibia to become energy exporters. According to a study performed by the Ministry of Agriculture, Bush-to-Energy could generate anywhere between N\$25-112 billion in national funds (Ministry of Agriculture, 2016). In addition to reducing foreign imports and increasing national funds, Bush-to-Energy can provide a variety of jobs for unemployed Namibians. According to the Desert Research Foundation of Namibia, Namibia could create up to 30,000 jobs with the establishment of Bush-to-Energy plants (DRFN, 2012).

Bush-to-Energy is also ideal for establishing decentralized power supplies. A 5 MW capacity plant could source a 20-km radius, and a 10MW capacity plant could source a fifty-km radius. This amount of independent energy would allow for alternative ownership of power in the energy sectors. The national grid of energy has feed-in tariffs, where citizens must pay to add energy sources into the grid. Decentralized Bush-to-Energy plants would allow for the establishment of mini-grids, which would reduce local dependency on government resources and decrease the cost of energy in rural communities. This would also motivate local democracies to participate in Bush-to-Energy models, promote alternative local government models, and encourage development of self-sufficient communities (GmbH, 2015).

The use of this form of renewable energy also allows for the ecosystem to grow, as more desirable plants will grow in the bush's place and animals will migrate to the restored areas (Ben-Shahar, 1992). This will, in turn, increase the carrying capacity of the livestock and the amount of sellable goods for farmers (Ben-Shahar, 1992). Removing enough bush from the land will also increase the biodiversity of the area, as the infested habitats would now be able flourish (Ministry of Agriculture, 2016).

Another benefit of Bush-to-Energy technology is the reduction of greenhouse gas emissions. While the burning of this biomass does produce greenhouse gas emissions, the amount of these emissions is significantly smaller than the current fossil fuel greenhouse gas output for the same amount of energy production. Figure 2.16 displays the 2:100 ratio of greenhouse gas emission for the two types of energy. This means that the burning of wood chips in Bush-to-Energy emits only 2% of CO₂ that the burning of fossil fuels such as coal and oil does (Vattenfall, 2016). This percentage indicates that, with the implementation of Bush-to-Energy, Namibia can decrease their overall CO₂ emissions and counteract the effects of climate change.

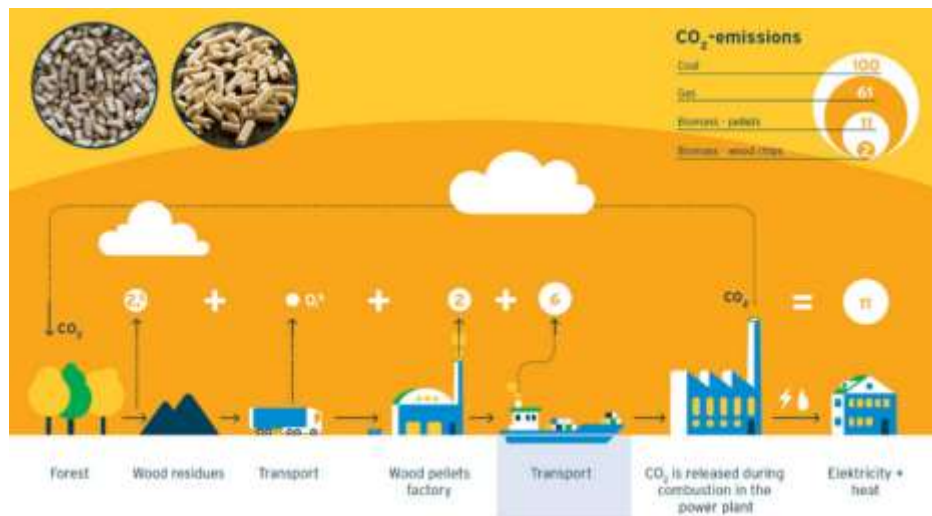

Figure 1.16: Comparison of greenhouse gas emissions for different power resources (Vattenfall, 2016)

While Bush-to-Energy has several advantages, this technology is not without its disadvantages. The laborers must harvest the bush properly and then perform the proper aftercare of the land (Ministry of Agriculture, 2016). If these steps do not occur, adverse effects could hurt the pre-existing ecosystems, thus affecting both plants and animals, creating an additional decrease in biodiversity (How Biopower Works, 2015).

This form of renewable energy is also more expensive than other available energy resources, including other renewable energies and fossil fuels (Ministry of Agriculture, 2016). Bush harvesters and machinists must receive training on establishing proper processing centers, and establishing Bush-to-Energy plants can be very costly (Ministry of Agriculture, 2016). Another reason is that individuals must purchase permits and receive approval before any harvesting projects can occur (Ministry of Agriculture, 2016). On top of having to pay for all of the fees and permits involved in harvesting encroacher bush and establishing the power plants, the owners must budget for the salaries for all of the workers involved. All of these expenses add up, causing Bush-to-Energy to be much more of an initial investment than other available sources of energy.

Another serious issue with Bush-to-Energy is the removal of carbon sinks. Carbon sinks are naturally occurring, and refer to the process of plants removing carbon dioxide from the atmosphere to use in photosynthesis (FERN, 2009). If Namibia removes a significant portion of the encroacher bush, there will be fewer plants absorbing the carbon dioxide from the atmosphere. As a result, higher concentrations of carbon dioxide will rise to the ozone layers, and the effects of climate change could increase.

Although these issues exist, Bush-to-Energy remains a good renewable energy candidate for Namibia. The future of Bush-to-Energy lies in promoting and upscaling the process of harvesting and harnessing the energy of encroacher bush. Industries will need to be competitive and reliable in their supplies of bush wood chips. Harvesting bush will also have to increase drastically to guarantee a constant supply of bush. For the Bush-to-Energy industry to successfully upscale, future harvesters and processors must cooperate to ensure successful operation (GmbH, 2015). Bush-to-Energy will allow new groups to enter the market. Farmers have an opportunity to harvest their encroacher bush and sell it to a variety of plants to companies as well. These companies can utilize these plants as sources of biomass to produce the desired energy product (Gustafson, n.d.). If all of these changes take place, Namibia can work to move closer to their overall goals of decreasing foreign imports and promoting a sustainable future.

3 Methodology

This project aimed to assist EduVentures Trust in developing interactive SMART lesson modules to further educate rural high school learners on renewable energy topics for implementation in the Ombombo mobile classroom. The project team developed four interactive SMART modules on renewable energy topics for use in the mobile classroom. The four modules were:

1. Introduction to Renewable Energy
2. Wind Energy
3. Solar Energy
4. Bush-to-Energy

Figure 3.1 shows the overall breakdown of the project.

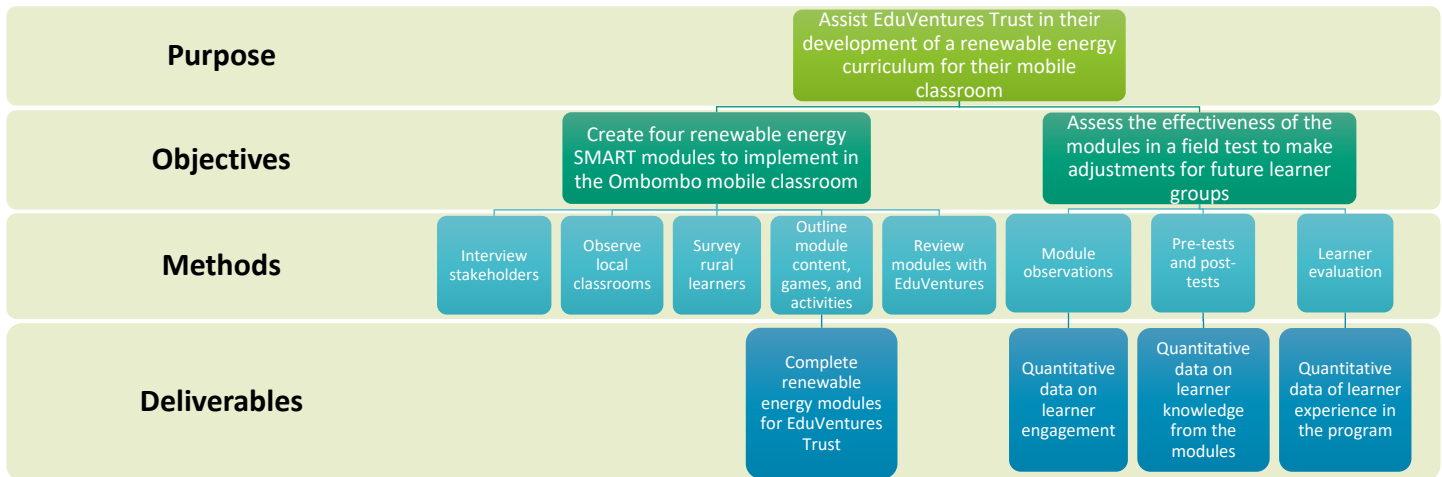

Figure 3.1: Flowchart of project

To develop successful modules, the team needed to gain insight on the Namibian culture and background on the project. The first step was to conduct several interviews with stakeholders to gather background information on renewable energy in Namibia and Namibian education systems. Simultaneously, the project team observed local Namibian classrooms to understand the differences between American teaching styles and Namibian teaching styles. The next step was to travel with the EduVentures staff to conduct three rural school pre-visits to gauge the learners’ existing knowledge on renewable energy and interview several rural teachers. After gathering background research, the team analyzed the data collected and developed the modules incorporating the knowledge gained through the preliminary methods. Before departing on the pilot test, each designer presented their module to the EduVentures staff and worked alongside the EduVentures educators to practice teaching the modules. The subsequent phase of this research included pilot testing the four modules in the mobile classroom and gathering data using a pre-test, a post-test, module observations, and a learner evaluation. After the completion of the pilot testing, the EduVentures staff and the team collaborated to make final edits to the modules.

The main deliverables of this project were four SMART modules on renewable energy topics. Methods for developing the modules are shown in Figure 3.2. The trends and themes seen in the preliminary data affected the development of the modules.

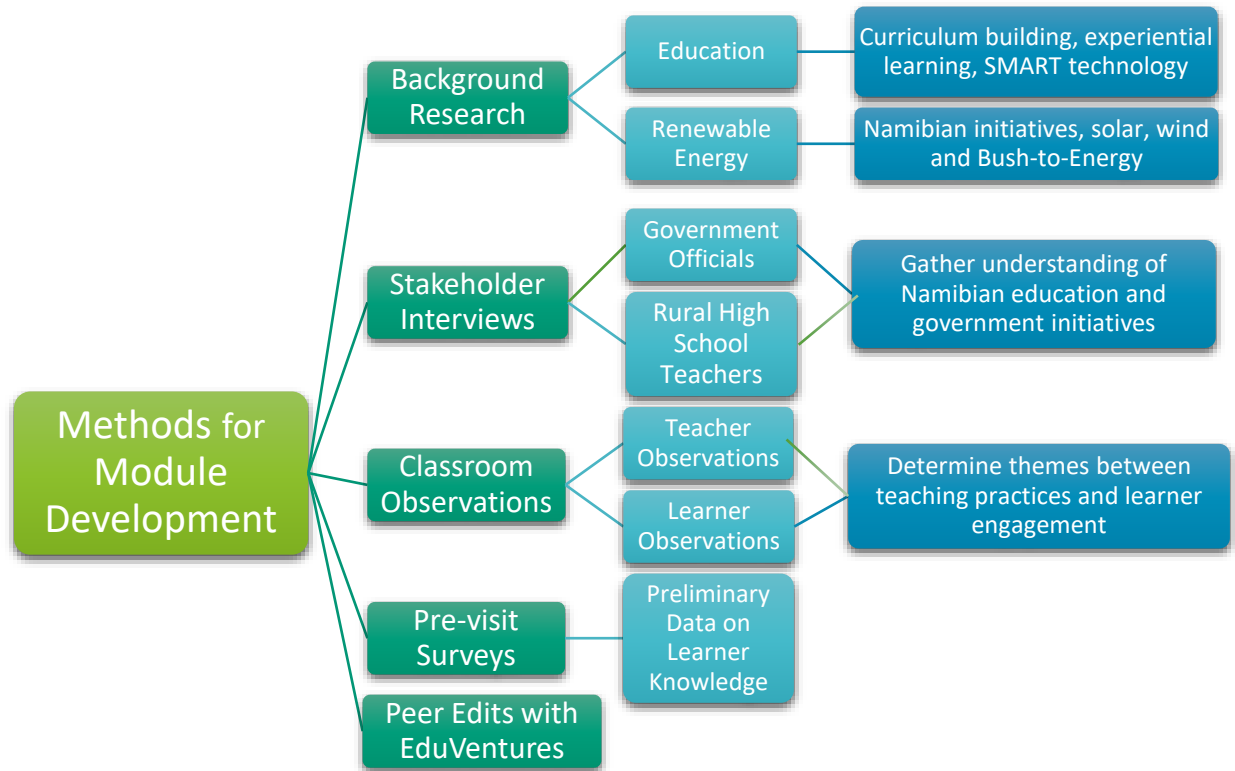

Figure 3.2: Flowchart of methods for module development

The data collected from pilot testing affected the modification of the modules (see Figure 3.3). The next research step was to collect data to make any necessary adjustments and modifications to the modules. The goal of the field test was to gauge the effectiveness of the modules and make any changes based on the collected data. Prior to departing from Namibia, the project team modified the modules based on the successes and pitfalls of the field test in order to provide EduVentures with modules that would leave the biggest impact on the learners who will participate in future EduVentures programs.

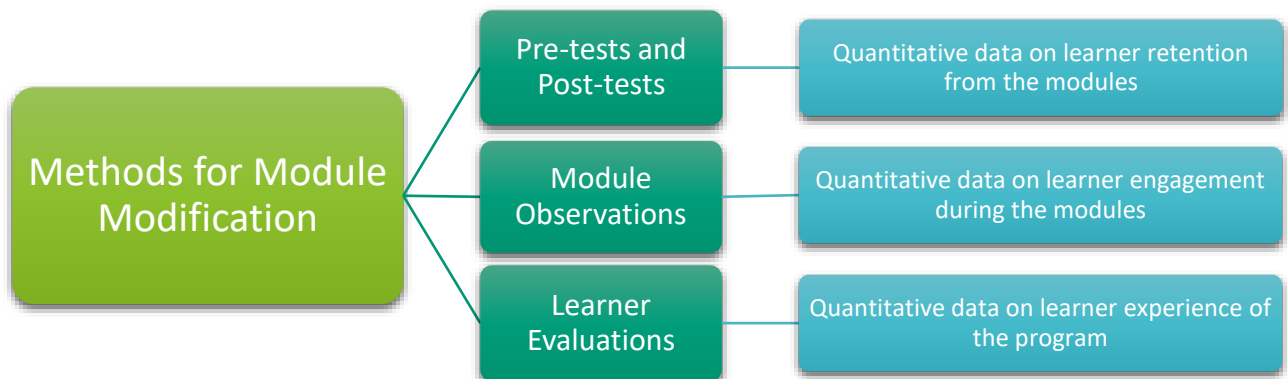

Figure 3.3: Flowchart of methods for module modification

This project began in the United States from January 12th, 2017 to March 3rd, 2017 and continued in Namibia from March 13th, 2017 to May 5th, 2017. The majority of the time spent in the United States focused on researching solar energy, wind energy, Bush-to-Energy, and successful education tactics. The team submitted their first draft of their project proposal to EduVentures and the project advisors on March 3rd, 2017 before departing to Namibia. Table 3.1 gives the Gantt schedule for the project in Namibia.

Table 3.1: Gantt schedule of the projects timeline in Namibia

Task	March 14 -17	March 20-24	March 27-31	April 3-7	April 10-14	April 17- 21	April 24- 28	May 1-5
Introduction and Museum Tour								
Continued Background Research								
Conduct Interviews								
Classroom Observation								
Analyze Gathered Information								
Conduct Rural School Pre-Visits								
Create Lesson Plans and Activities								
Finalize Field test of Modules								
School Visits and Implementation								
Analyze Gathered Information								
Final Edits to Modules								
Ministry of Education Presentation								
Final Presentation								
Final Report								

3.1 Stakeholder Interviews

The possible stakeholders affected by this project fall into four categories: residents, companies, community, and government. Figure 3.4 depicts the final list of stakeholders, with the relevant stakeholders that this study interviewed highlighted by the teal boxes outlined in black.

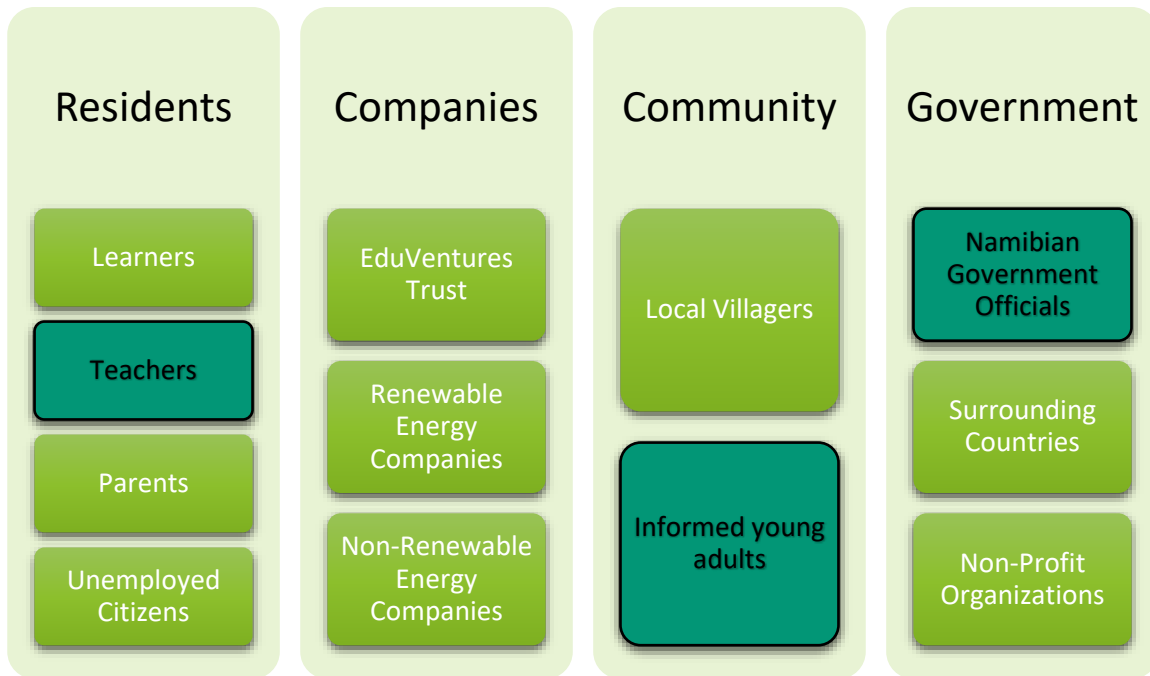

Figure 3.4: List of all stakeholders. Interviewed stakeholders shown in teal.

The stakeholders highlighted in teal (local high school teachers, informed young adults, and Namibian government officials) were the stakeholders most accessible and relevant to interview for the project. Although every group listed in the figure could provide insight to the project, the time constraints limited the number of interviews conducted. Therefore, the final stakeholders selected were local high school teachers because they provided insight for building a successful curriculum, as well as different teaching practices best suited for Namibian classrooms. The demographics of the teachers varied in levels of experience, subjects taught, and teaching settings (rural or urban). The Hanns Seidel Foundation recommended interviewing ‘informed young adults’. Informed young adults were young Namibian residents who attended environmental focus groups at the House of Democracy. These adults exemplify the type of citizens that the EduVentures’ program hopes to create. They provided information about their background and what inspired them to pursue a degree or career in environmental topics. Lastly, the team selected Namibian government officials because they helped explain future or current renewable energy initiatives in the country. In total, this study included interviews with one Namibian government organization, two informed young adults, and eight high school teachers. The objectives of the interviews were to understand more about the learner experience in the classroom, to further develop an understanding of Namibia’s renewable energy goals and initiatives, and to learn about successful teaching methods, curriculum building, and the integration of interactive activities (see Figure 3.5).

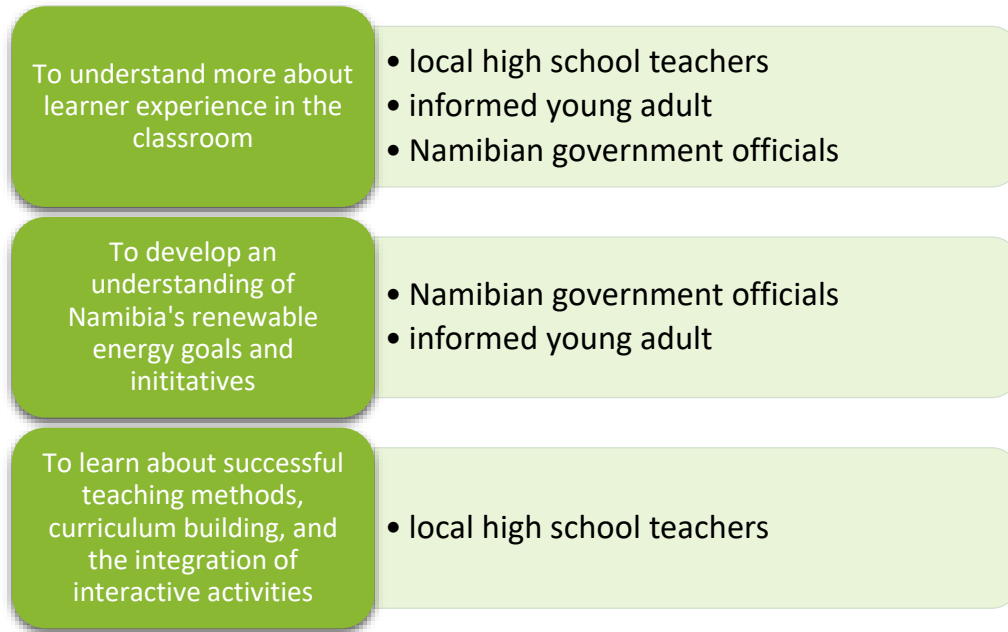

Figure 3.5: Objectives of interviews and each correlating stakeholder group

This project conducted semi-structured interviews based on Linda Ferguson’s guidelines outlined in Table 3.2. By choosing these guidelines, the team hoped to create a comfortable, and respectful setting in every interview.

Table 3.2: Interview guidelines (Modified from Ferguson, 2002)

1	<i>Approach visitors in a relaxed way with an expectation of cooperation</i>
2	<i>Speak with a well projected, clear, and easily understood voice</i>
3	<i>Listen and understand others</i>
4	<i>Recognize nonverbal communication</i>
5	<i>Maintain a professional and friendly attitude</i>
6	<i>Show only polite interest with responses</i>
7	<i>Probe for opinions, attitudes, and emotions in a non-directive manner</i>
8	<i>Record all responses and information obtained</i>
9	<i>End by leaving the respondent feeling positive about the interview experience</i>

The general interview process followed these steps: 1) the interviewer read the project's goals and confidentiality statement to the interviewee. The informed consent statement articulates the following:

“We are students from Worcester Polytechnic Institute working with EduVentures to develop interactive lessons on renewable energy for their mobile classroom.

We wish to interview you to hear your opinions on Namibian education and renewable energy so that we can assist EduVentures in their mission to teach rural learners more about renewable energy. We will not ask for your name or other personal information and will refer to you as [Teacher/Government Official/Informed young adult] X. If you wish to provide your name, please let us know. Any information you share with us about the questions may be accessible to the public on the internet in our final report.

Your participation in this interview is completely voluntary and any information you share with us is greatly appreciated. However, if at any time, you are uncomfortable and wish to stop the interview, let us know and we will stop immediately. Do you have any questions?"

2) If the interviewee gave consent to continue, the interviewer proceeded with the interview; 3) An additional team member, which the team called the transcriber, recorded the responses in the stakeholder-specific interview plan (located in Appendices A through C); 4) At the conclusion of the interview, the interviewer asked permission to include the participant's name in the report.

The interviews conducted with the informed young adults and six of the eight high school teachers were one-on-one interviews. For the other two teacher interviews, two team members were present where one acted as the interviewer and the other was the transcriber. During the interview with the Ministry of Mines and Energy Officials, all four team members served as both interviewers and transcribers. The team compiled the notes at the conclusion of the interview.

After the completion of the interview process, the next step was to analyze the data to find statements that supported the objectives listed in Figure 3.5. Each interview plan contained specific questions that provided valuable information when analyzing the interviews. The questions selected provided direct information for one of the three interview objectives.

To achieve objective one 'understand learner experience in the classroom', the interviewer asked the teachers: *"What is the biggest challenge when working with high school learners?"*, and the informed young adults: *"What is your favorite part of science classes?"*.

To develop an understanding of Namibia's renewable energy initiatives, the interviewer asked the teachers: *"What do learners already know about energy from your school's curriculum?"*, and the government officials: *"What is your opinion on educating Namibian youth in Renewable Energy Topics such as wind energy, solar energy, and Bush-to-Energy?"*, as well as: *"Do you think that it is possible for Namibia to stop depending on foreign countries for energy?"*, and *"How helpful will the government be in adding renewable energy topics into school curriculums?"* The interviewer also asked the informed young adults: *"What do you think other learners should know about environmental awareness and climate change?"*.

Finally, to learn about successful teaching methods, curriculum building, and the integration of interactive activities, the interviewer asked the teachers: *"How do you make your lessons interactive and engaging for the learners?"* and *"In your opinion, what do you think we should add to our lesson modules in order to make them as effective as possible?"*.

3.2 Classroom Observations

EduVentures Staff contacted Jan Möhr Secondary School to conduct classroom observations. The purpose of the classroom observations was to gain insight into teaching techniques and standard classroom practices in Namibia. Jan Möhr Secondary School was most likely to allow this investigation to observe science classes because they did not follow the same examination schedule as the other local high schools. Other high schools already proceeded into examinations and holidays upon the team's arrival in Namibia. Due to time constraints, this study included visits to two geography classes (one Grade 10 and one Grade 11) and one biology class (one Grade 11). The purpose of the classroom observations was to better understand the difference between Namibian and United States high school settings. The data collected helped the team adapt the renewable energy lesson plans towards a traditional Namibian high school curriculum. Approximately 35-43 learners were present in each class. Two team members observed each classroom, so it was less intimidating for the teachers and learners. These two members recorded all observations by hand on hard copies of the observation forms. After finishing the observations, the team members returned to the EduVentures office and converted these forms to electronic copies.

Design:

This project used two observation forms for the observations – a teacher observation form and a learner engagement observation form. One team member was responsible for recording teacher observations, while the other team member was responsible for recording learner engagement observations.

The teacher observation form, presented in Appendix O, had three focus areas: type of activity, teacher actions, and materials used. The two observers evaluated the focus areas in relation to the lesson timeline. The 'type of activity' area focused on the different teaching styles the teacher used in the classroom (ex. lecture, group work, etc.). The 'teacher actions' area focused on teacher interactions with the classroom (ex. asking questions, answering questions, etc.). Finally, the 'materials used' area focused on the different teaching materials the teacher used throughout the lesson (ex. White board, black board, etc.). Questions at the end of the observation form recorded the observer's opinions on the clarity of the teacher's lesson and their clarity of speech. The observer who focused on the teacher actions recorded observations every five minutes of the lesson and checked off the appropriate boxes in each focus area. For example, if the teacher was lecturing with a blackboard and not asking any questions ten minutes into the lesson, the observer would mark the time in the lesson, and check off each of the three observations in the appropriate categories. Figure 3.6 provides the proposed example.

		Type of Activity (please check the appropriate activity)												
		Start	5 min	10 min	15 min	20 min	25 min	30 min	35 min	40 min	45 min	50 min	55 min	60 min
At 5-minute mark	Lecture			X										
	Non-technology based activity													
	Technology based activity													
	Groupwork													
	Other (please specify)													

		Teacher Actions (please check the time when the teacher performed the action)												
		Start	5 min	10 min	15 min	20 min	25 min	30 min	35 min	40 min	45 min	50 min	55 min	60 min
During 5-minute time-period	When was the purpose of the lesson stated?	X												
	When did the teacher ask questions throughout the lesson?													
	When did the teacher answer questions throughout the lesson?													

		Materials Used (check materials after every five minutes)												
		Start	5 min	10 min	15 min	20 min	25 min	30 min	35 min	40 min	45 min	50 min	55 min	60 min
During 5-minute time-period	Black board			X										
	White Board													
	SMART Board													
	Projector													
	Computer													
	Poster													
	Other (please list)													

Figure 3.6: Example of filled out teacher observation form at the ten-minute mark

This research team designed the teacher observation form so it aligned with the learner engagement observation form; therefore, one could draw conclusions between the spikes of learner engagement and the type of teaching styles and materials utilized. The team framed the questions and observation points from a classroom observation form developed by Susan Murphy (Murphy, 2013). The questions on the form reflected the overall themes listed below:

- *Organization* of the observed lesson would provide information on the amount of time dedicated to different parts of the lessons (such as lecturing, group work, activities, etc.).
- *Instructional Style* facilitated looking for effective teaching methods and to observe different types of lecture styles.
- *Clarity* observed how well the teacher presented the objectives of the lesson and the quality of any explanations the teacher provided when asked a question.
- *Presentation of Material* evaluated the equipment that the teacher used in throughout their lessons (such as a projector, a white board, computers, etc.).

The observation form mainly focused on the teacher's role in learner success based on the belief that collecting this data would assist in deciding the organization of the modules, the equipment to utilize, and the amount of time to dedicate to each part of the lesson.

The second observation form focused on learner engagement. This project used a form similar to the EduVentures 2015 WPI Project Team (Dunham, Hawks, Lyles, Misera, 2015). The observation form, shown in Appendix P, re-evaluated the classroom after every five minutes. At every five-minute mark, the team member marked how many of the learners were:

- Sitting up and listening
- Maintaining eye contact with the teacher
- Taking Notes
- Talking in side conversations
- Expressing confusion or anger

During the five-minute time frame, in-between the previously mentioned observations, the team member counted how many learners were:

- Asking questions
- Answering questions from the teacher
- Participating in group work
- Leaving to go to the bathroom
- Volunteering to participate in activities.

After collaboration with the sponsor, the team believed that these aspects would not only provide quantitative data, but also correlate the timeline of the lesson with loss of learner interest. The two observations forms provided simultaneous information of learner engagement and teacher instruction style.

Assessment:

After completing the observations, the observers compiled the data to determine when learners were most and least engaged in the lessons. For each activity, the observers took the total number of learners that were performing that activity and divided it by the total number of learners in the class (n , sample size). Then the team members converted the data to percentages and plotted it versus time. The timelines needed to be consistent across both forms so that the observers could analyze any correlation between the teacher and learner observations. For example, if the observer noted that twenty-four out of the twenty-five learners were sitting up and listening, the analysts could then consult the teacher evaluation form to see what activity or materials that the teacher was utilizing to maintain such a high percentage of learner engagement.

Conclusions drawn from this assessment enabled the team to develop lesson plans that resemble lessons taught in urban areas of Namibia and develop lesson plans with the intent to stimulate and engage the learners by presenting material in ways that work well in Namibian classrooms.

3.3 School Pre-Visits

Two team members traveled with the EduVentures employees to three rural secondary schools in Otjinene, Okondjatu, and Okamatapati, to gauge which was the best school to pilot the modules. The EduVentures employees presented details about the program to the potential schools. If the learners wanted to participate in the program, the potential learners for the program wrote a short application essay to the EduVentures staff. The teachers at the local schools and the EduVentures employees then selected the strongest candidates for the program. The chosen school would serve to field test all four modules developed for this study.

Design:

During these school pre-visits, the team interacted with the learners in the form of a pre-visit survey (Appendix T). The survey contained nine questions and the questions gauged the learners' pre-existing knowledge about the renewable energy topics. The responses to this survey provided this investigation with a better understanding of how technical the modules should be. The team members analyzed the responses to discover which questions the learners answered correctly and which questions the learners found difficult.

Assessment:

The team assessed the pre-visit surveys using a grading method of correct and incorrect questions. Since the pre-visit survey's purpose was to see what the learners knew about renewable energy, the graders of the survey marked blank answers incorrect. The team also compared the questions based on difficulty to determine if there were any trends. Some questions contained two parts: a lower level initial component and a high-level follow up question. For example, the first part of the first question asked: 'What is renewable energy?', and the second part asked, 'Why is it important to Namibia?'. The analyst separated lower and higher-level questions and quantified the learners' performances. The team also analyzed every question to check which topics the learners scored poorly on, so the modules could address which topics were difficult for the learners.

3.4 Module Development

The deliverables of this project were four interactive, SMART lesson modules. These modules balanced important content about renewable energy and interactive activities. This project developed the modules after assessing the current Namibian education system through interviews, classroom observations, and rural school pre-visit surveys. The development of each module followed the process shown in Figure 3.7.

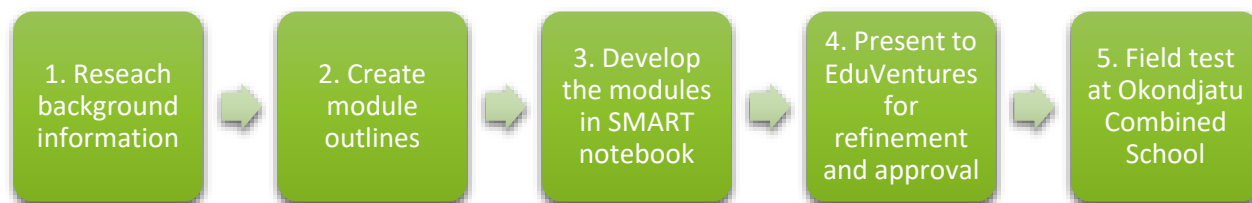

Figure 3.7: Process for module development

The team aimed to complete the modules by the fifth week, allowing two weeks to implement and modify the modules for future use.

3.4.1 Implementation of Background Research in Module Outlines

The team used their extensive research on education and renewable energy to develop outlines of the four modules – *An Introduction to Renewable Energy*, *Solar Energy*, *Wind Energy*, and *Bush-to-Energy*. The developed outlines expanded on the original outline provided by the EduVentures staff, shown in Table 3.3 (modified from the sponsor outline in Appendix X). The EduVentures staff asked that the modules stay within 60-90 minutes.

Table 3.3: Summarized sponsor outline of modules

Introduction to Renewable Energy	<ul style="list-style-type: none"> ● What is renewable energy? ● History of renewable energy ● Climate change ● Namibian need for renewable energy ● Types of renewable energy
Wind Energy	<ul style="list-style-type: none"> ● What is it? ● Why should Namibia use it? ● Operation and Maintenance ● Where could it be used in Namibia? ● Advantages and disadvantages
Solar Energy	
Bush-to-Energy	

Each outline incorporated successful elements of an environmental lesson, including Athman’s five purposes and Kolb’s cycle of experiential learning. Section 2.3.2 explains Athman’s five purposes – awareness, knowledge, attitude, skills, and participation, which the team used to help create the initial outlines. The introduction of each module provided the learner with *awareness* by highlighting the energy generation problems throughout Namibia. All four modules aimed to teach the learners background information, or *knowledge*, on each renewable energy technology and their potential impacts in Namibia. At the conclusion of each module, the idea is for the educator to work with the learners to help develop an ethic responsibility, or *attitude*, for the future of their nation. The educator then encourages learner critical thinking to help the learners gain *skills* on how to address renewable energy related problems. Finally, the team provided the educator with resources and contacts to share with the learners if they want to continue their education in the renewable energy fields and *participate* in Namibia’s sustainability movement. (Athman, 2001).

Section 2.3.4 explains the Kolb Cycle of experiential learning and the importance developing learner-centered modules, instead of teacher-centered modules. Learner-centered teaching methods focus on developing an interactive curriculum to ensure that learners are retaining information and participating in the class. This was important for the team to consider when developing the lessons, as the focus of these modules was to maintain learner engagement through interactive activities.

The Eight Phases of Curriculum Development, discussed in Section 2.3.6, acted as a guide for the project while creating the outlines for each module. The outlines included a purpose, several objectives, an introduction activity, lecture material, practice and review activities, and a summary. Each outline incorporated detailed information about the renewable energy technologies taken specifically from the background research in Section 2.4. The designers then gave each of the outlines to the EduVentures staff for review. After EduVentures provided feedback, the team made adjustments to the outlines before developing the modules in SMART Notebook.

3.4.2 Initial Module Development in SMART Notebook

Each member of the team downloaded SMART Notebook to develop the SMART modules. SMART Notebook is an interactive presentation developer, similar to PowerPoint, which works in conjunction with SMART Board technology. Each designer worked on one module and learned how to use SMART Notebook and its interactive features. This project incorporated SMART activities and games into the modules to help solidify the learners' understanding of the lecture material. The interactive capabilities of SMART technology enabled the researchers to utilize experiential learning techniques in the modules.

After the team completed each module, the designers of each lesson presented the modules in the Ombombo mobile classroom to the EduVentures Staff. For the duration of the day, each module designer presented the content and activities in their modules. After each module, the EduVentures staff provided comments and suggestions to the module designer. Each designer used the comments and suggestions from EduVentures to improve the modules.

3.4.3 Preliminary Modifications of Modules

After the first module modifications, the team developed teacher's guides located in Appendices GG to JJ. These guides accompany the module outlines and SMART Notebook modules, and help prepare the EduVentures' educators to teach the modules in the Ombombo mobile classroom. One column of the teacher guide is an image of the slide and the other column is a detailed description of the educator's actions on each of the slides. For example, on the title slide of the Introduction to Renewable Energy Module, shown in Figure 3.8, the teacher's guide prompts the educator to ask the learners what they see in the image to get the learners thinking about different types of non-renewable and renewable energy. Each guide provides instructions for all of the activities and talking points for the lecture slides.

Slide 1		<p>Ask learners if they know what renewable energy is? What can they see in the picture?</p> <p>What do they know about climate change?</p>
---------	-----------------------------------------------------------------------------------	---------------------------------------------------------------------------------------------------------------------------------------------

Figure 3.8: Title slide of Introduction to Renewable Energy Module and its assigned directions

The module designers gave the teacher guides to the EduVentures educators before practicing the modules in the Ombombo mobile classroom. The module designers once again received feedback on the usability and relevancy of the lessons and made final modifications. Once these final modifications were made based on the EduVentures' educators input, the lessons were ready for pilot testing.

3.5 Implementation and Module Modification

Of the three schools the EduVentures staff presented to in the pre-visits, Okondjatu Combined School (CS) was the best candidate to pilot the modules. This is because Okondjatu CS had been contacting EduVentures for over a year, expressing their interest in the program. After developing the modules and selecting the school, the next step was to implement the program in the Ombombo mobile classroom. The team departed with EduVentures to test the modules during the seventh week in Namibia. The EduVentures educators taught all four modules to a pilot group of learners from Okondjatu Combined School. The field test followed the schedule shown in Appendix KK. Day One, the EduVentures staff taught the *Introduction to Renewable Energy* and *Wind Energy Modules* to the 20 learners in the program. On day Two they taught the *Solar Energy* and *Bush-to-Energy Modules*. Day Three, consisted of the learners going out into the village and learning about bush encroachment and beginning work on projects. The assigned project was a debate between the classroom to argue for or against allowing bush encroachment to continue in Namibia. The team for bush encroachment used arguments such as bushes act as carbon sinks, they provide food and shelter for animals, and they prevent soil erosion. The team against bush encroachment argued that bushes reduce biodiversity, they are a good source for renewable energy, and you can use bushes as animal feed. On the fourth day, the project team and the EduVentures staff assisted the learners with their projects. Finally, the learners debated in front of the administration of Okondjatu Combined School on Day Five. Although this project's work focused on Days One and Two, the project team assisted the EduVentures staff in completing the rest of the five-day program.

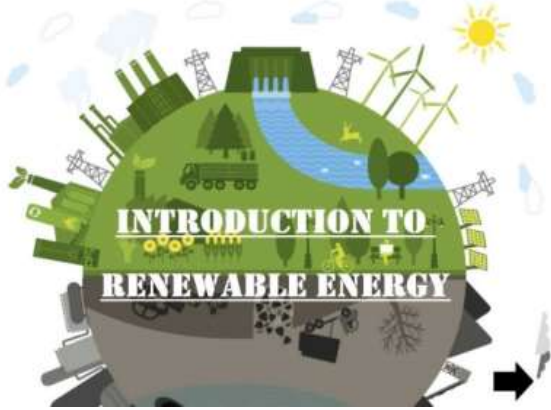
3.5.1 Pre-Testing and Post-Testing

To collect data on learner retention rates, the educators distributed a pre-test at the beginning of the first module and a post-test at the end of the fourth module (see Appendices LL and SS). These anonymous tests depicted the learner's growth throughout the program. The educators asked each learner to put their name on the top. The team assigned each learner a number based on the name at the top of the pre-test, then wrote their name and assigned number on the post-test. The purpose of this was to ensure that only the learners who took the pre-test would take post-test. To save anonymity, the researchers did not include any names in this report, simply the assigned numbers. The questions on the pre-test and post-test were the same, however the questions were in a different order. The investigators collected all of the tests and corrected each test marking the answers correct or incorrect. The use of this test allowed the study to observe trends in learner retention of the material presented and the ability of the learners to apply their new knowledge to real world situations.

The questions created were an assortment of rhetorical, guiding and essential questions to test the range of thinking form the learner. Section 2.3.6 provides the definitions of these questions. For simplicity, the team will refer to rhetorical questions as concrete questions throughout the rest of this report. This is because the definition provided by McTighe and Wiggins differs from the more commonly known definition of a rhetorical question. One of the project team members created the Staircase to Inquiry, shown in Figure 3.9, from information in *Essential Questions: Opening Doors to Student Understanding* ((McTighe & Wiggins, 2013).



Figure 3.9: The staircase to inquiry

The bottom stair is concrete questions. Learners were more likely to answer concrete questions because that information is easily accessible. These questions demonstrate a learner's ability to recollect specific information but shows no further inquiry into the topic (McTighe & Wiggins, 2013). Although these questions show no further inquiry, they do show what the learners already know about renewable energy. Concrete questions are the most basic questions, but provide good insight into the educational foundation or background of the learner. The middle stair is guiding questions. Guiding questions challenge the learners to come to an answer by recalling some information and also making inferences (McTighe & Wiggins, 2013). The middle stair is important for the teacher to get the learners thinking more about the bigger picture. The top stair is essential questions. Essential questions stimulate inquiry and ongoing thinking about a certain topic (McTighe & Wiggins, 2013). The hope of the modules is to get learners thinking more about renewable energy and climate change in Namibia. The team used the Staircase to Inquiry to modify the four modules

accordingly, based on conclusions drawn from the the pre-visit data. The wind module, for example, included several different levels of questions to stimulate learner inquiry:

1. Concrete Question: What is wind energy?
2. Guiding Question: How does wind energy work?
3. Essential Question: Why should Namibia use wind energy?

In the pre-test and post-test, there are four concrete questions, three guiding questions, and two essential questions. Table 3.4 shows the questions in the pre-tests and post-tests. The type of question is denoted in the colors listed above in Figure 3.9, light green is concrete, green is guiding, and teal is essential.

Table 3.4: List of questions of pre-test and post-test

Pre-Test Question #	Question	Post-Test Question #
1	What is renewable energy?	9
2	How do encroacher bushes affect the environment?	2
3	What is wind energy?	3
4	Why is solar energy good to use in villages?	8
5	What is solar energy?	4
6	What is encroachment bush?	6
7	Why are wind turbines best for coastal regions?	5
8	Why is renewable energy important to Namibia?	7
9	How can you help battle the effects of climate change?	1

The researchers assessed these tests in the same way as the pre-visit surveys but included side-by-side comparisons of the pre-tests and post-tests. The team then analyzed the tests based on the learners’ performances on the three types of questions, the classroom’s performance on each question, and overall improvement.

3.5.2 Module Observation Form

The team decided to use an adjusted observation form during field test evaluation, as shown in Appendix NN. The new form targeted learner engagement attitudes and behaviors only, while the previous classroom observations recorded both teaching styles and learner engagement. For the field test of the modules at Okondjatu Combined School, the module observers looked for similar behaviors in the form: asking questions, talking in side conversations, etc. However, the designer of the observation form also included learner interaction with the SMART Board. It is important that a variety of learners are utilizing the technology and actively participating in the lessons. Two team members were each responsible for counting the behaviors for half of the learners in the mobile classroom, both of which were not the designer of the module. These two members sat at the front of the mobile classroom on either side of the SMART board. While the modules observations occurred, the other two team members were analyzing data. The investigators used these module observations to gain insight on the level of engagement throughout the entirety of the lesson.

Design

The module observation form was a modification of the version of the learner observation form mentioned above in Section 3.2., seen in Appendix O. This form tallied the number of learners performing various positive (shown in blue) and negative behaviors (shown in red) throughout the entirety of the module. The observer, at each five-minute mark throughout the lesson, counted the number of learners performing the following behaviors:

- Sitting up and listening
- Maintaining eye contact with the teacher
- Smiling
- Expressing confusion or anger
- Talking in side conversations

During the five-minute time periods, the team members observing the classroom counted the number of learners exhibiting the following behaviors:

- Asking questions
- Answering questions
- Coming up to the SMART board to participate
- Looking out the window
- Not fully participating in group work

The module observations provided information regarding learner engagement throughout the lesson. The observation form allowed for the identification of successful activities in each module.

Assessment

Throughout the lesson, the team members counted the number of learners performing each action. However, because each team member was responsible for half of the class; after the observation concluded the investigators entered the data into excel sheets individually as well as coalesced their observations together to have data representing the entire classroom. The next step was to compile the number of learners performing positive behaviors and then negative behaviors. Then the team divided each compilation by the number of learners present to obtain percentages of learners performing positive and negative learner behaviors. To display the percentage of learners performing each action over time, the research group graphed learner behaviors over the module time period. This study then looked at learner engagement and matched it with specific sections of the modules. For example, if 96% of the class was sitting up and listening, the team referred to the lesson and check to see what part of the module was causing such a high engagement rate.

3.5.3 Learner Evaluation

In order to gather information on the learner experience throughout EduVentures' program, the team developed a learner evaluation form located in Appendix UU). The learners ranked a variety of statements (Questions 1-8), on a scale of one to five, and answered questions based on their experiences during the modules (Questions 9-10). Table 3.5 shows the questions from the learner evaluation.

Table 3.5: Learner evaluation questions

Question #	Question
1	The information throughout the entire program was easy to understand.
2	I think the games and activities in the lessons were fun.
3	The lessons were more fun than my classes at school.
4	I would want to participate in another EduVentures program
5	I feel like I know much more about renewable energy now than before I started this program.
6	If my school started an environmental club, I would join it.
7	I plan to learn more about renewable energy after the end of this program.
8	What I learned in the program will change the way I think about energy generation.
9	What was the most interesting topic to learn about?
10	What was the least interesting topic to learn about?

For each statement, the learners ranked their responses from strongly disagree (1) to strongly agree (5). The learners were not able to answer with the number three, which would be the neutral or no opinion category. As the team wished to know what the learners liked and disliked, the neutral option was intentionally left out so the learners had to state whether they liked or disliked something, and the extent to which they felt this way. Figure 3.10 shows an example of the learner evaluation. From this survey, the researchers hoped to better understand which aspects of the program the learners liked and which aspects they think should change. The researcher group used this information to modify the lesson modules after the conclusion of the program.

Please circle a number based on your opinions of the program.
 1= strongly disagree, 2 = disagree, 4 = agree, 5 = strongly agree.

1. The information throughout the entire program was easy to understand

Strongly Disagree 1 2 4 5 Strongly Agree

Figure 3.10: An example of a partially completed learner evaluation

3.5.4 Module Modification

The team used the information obtained from module observations, pre-tests and post-tests, and learner evaluations to determine modifications to the modules. From each form of data collection, the team members evaluated the important positive and negative aspects and used these to change the modules accordingly.

From module observations, the investigators identified when the learners were most engaged in the class and the times at which they were most distracted. When anything other than lecturing occurred, the observer noted what activity was occurring, whether it was group work, a SMART activity or some other form of teaching. Any additional comments made about both the successful and unsuccessful aspects of each lesson were taken into consideration. The researchers then correlated this information with learner

engagement to determine which activities worked and which did not. The team also used this information to gauge how long the lessons should be to maintain learner engagement.

From the pre-tests and post-tests, the team evaluated the knowledge the learners gained from the four modules. As discussed in Section 3.5.1, the questions remained the same in both tests, but the order in which the questions appear on the form changed. This was so that the learners did not memorize the order of the form. If there was one subject which the learners were still not performing well on, the module designers took this into consideration and modified the module related to those questions accordingly.

From the learner evaluation, the team was able to gauge learners likes and dislikes throughout the program. From their rankings, the analysts calculated an average for each question and used this information to modify their modules accordingly.

At the conclusion of the second day of the program, the team had the information needed to make the necessary module modifications and, due to time constraints, began the modification process while the EduVentures' Program was still ongoing. This was so that the designers could deliver four final, modified versions of the Renewable Energy modules to EduVentures prior to their departure from Namibia.

3.5.5 Curriculum Development for the Ministry of Education

Upon the completion of the modifications to the modules, the team developed an in-depth summary of each lesson in the form of a complete curriculum for the EduVentures' program, shown in Appendix BBB. The designers based their curriculum off the 2015 WPI EduVentures team, by placing relevant information about each module into it. This curriculum will provide the Ministry of Education with a summary of the information discussed in each of the four modules. This was so that the Ministry of Education could ensure the information EduVentures' educators presented to the learners throughout the five-day program was relevant to the topics of the renewable energy program. By filling out this curriculum for the EduVentures staff, the team believes that this is the only information that is required for approval by the Ministry of Education.

The team also provided EduVentures with their final presentation (see Appendix CCC), so that they could present the results of the field test to the Ministry of Education. The team anticipated that the EduVentures staff would present to the Ministry of Education after their departure from Namibia, and that EduVentures would deliver the detailed, written curriculum to Ministry members in attendance. By gaining approval from the Ministry of Education for this new curriculum, EduVentures will be able to bring these modules throughout Namibia. This will allow EduVentures continue their work of bridging the gap between rural and urban education and spreading Renewable Energy awareness throughout Namibia.

4 Results and Analysis

This study had two main objectives: to develop four interactive SMART modules and assess the effectiveness of the modules during a field test at Okondjatu Combined School. The data collected prior to the implementation of the modules included classroom observations, stakeholder interviews, and the school pre-visit surveys. During the pilot testing of the modules, the team collected information from module observations, pre-tests and post-tests, and a learner evaluation. This collected information enabled the team to analyze the effectiveness of the lessons and then modify the modules in particular areas, if necessary. This chapter will discuss how these preliminary data collection methods influenced the development of the modules and how the pilot testing data collection influenced the final modifications of the modules.

4.1 Stakeholder Interviews

4.1.1 Urban and Rural Teachers

During the fourth week in Namibia, the team conducted teacher interviews in both urban and rural schools. The purpose of the teacher interviews was to further understand learner experience in the Namibian classroom and to learn about successful teaching methods, curriculum building, and the integration of interactive activities. All completed interviews are found in Appendices D through K.

Local Windhoek High School:

Two team members visited Jan Möhr secondary school on 5 April, 2017, and interviewed two physical science teachers, Mr. Frank G. Mungunda and Mr. Kelvin Naholo. Mr. Mungunda's interview took place in his classroom during a free period. This created a calm and quiet, one-on-one environment for the interview. On the other hand, Mr. Naholo's interview took place on a bench outside the main office in between class periods. As a result, this interview environment was noisy and somewhat distracting, and the interviewer rushed to conduct the interview.

Pre-visit Rural High Schools:

Two team members visited three rural high schools with EduVentures on 5 April 2017 and 6 April 2017. The first school was Gustav Kandjii High School. While at this high school, the two team members interviewed an English teacher, Mr. Joshua Nguripo Kambueza, and an accounting teacher, Mr. Ebenezer Muungua. Both interviews took place outside in the early evening by the school's main office. The second school visited was Okondjatu Combined School. One team member interviewed a teacher who taught science, who asked to remain anonymous, and a grade eight through ten science teacher, Mr. Nanguai Kahikumunu. The same team member conducted both interviews inside a large dining hall, while the other team member was setting up the pre-visit presentation with the EduVentures staff. The last school visited was Okamatapati Combined School and the interviews conducted were with a life science and agriculture teacher, Mr. Eslon K. Kaangundue, and an English teacher, Mr. Vindina Muje. One team member interviewed Mr. Muje during the EduVentures' presentation, while the other team member interviewed Mr. Kaangundue after the presentation, upon his request. As a reminder, the designer of the teacher interview plan created questions to align with the original objectives of the teacher interviews. These objectives were to understand more about learner experience in the classroom, gauge the learners' renewable energy background, and

discover successful teaching methods, curriculum building, and the integration of interactive activities. Table 4.1 highlights four different sets of questions and answers from the teacher interview plans that relate to the original objectives, and shows the data gathered from each teacher.

Table 4.1: Teacher responses and their corresponding objective

Objective 1: What is the biggest challenge when working with high school learners?		
High School Name	Teacher Name	Responses
Jan Möhr Secondary School	Mr. Frank G. Mungunda	Resources and materials are a challenge. It is sometimes even a struggle to get ink and paper.
	Kelvin Naholo	Puberty. It causes so much peer pressure.
Gustav Kandjii High School	Joshua Nguripo Kambueza	Pregnancy is a big challenge. Learners are more grown up so they act mature, but they do not act mature academically
	Mr. Ebenezer Muungua	Discipline. A big number of learners are prone to get involved in bad activities. Puberty is also a challenge.
Okondjatu Combined School	Nanguoi Kahikumunu	Their behavior; misbehaving; sexual activities. [Learners] are concentrating on other activities. There were 13 pregnancies last year.
	Anonymous	There are many [learners] in the class which makes it hard to control.
Okamatapati Combined School	Mr. Eslon K. Kaangundue,	Challenges include learner attitude, puberty, willingness to learn and attention seekers.
	Vindina Muje	In rural areas, there are not a lot of materials so there is limited access to the materials that can be used.
Objective 2: What do learners already know about renewable energy from your school's curriculum?		
High School Name	Teacher Name	Responses
Jan Möhr Secondary School	Mr. Mungunda	They have a general idea, but in terms of benefits and to really understand, they don't really know them. To really sit down and see the impact requires understanding.
	Mr. Naholo	[Learners] know a lot when it comes to renewable energy. They know a lot about solar energy.
Gustav Kandjii High School	Mr. Kambueza	[The learners] know about oil, coal. They practice by making fire.
	Mr. Muungua	[Learners know about] wind energy, solar energy, Bush-to-Energy and methane which is a natural gas (biomass).
Okondjatu Combined School	Mr. Kahikumunu	Teach [the learners] and have clear information. They know several [renewable energies].
	Anonymous	[Learners] know nothing.
Okamatapati Combined School	Mr. Kaangundue	They know about solar and wind. Solar [energy] in schools. Learn from government.
	Mr. Muje	The grammar part. Use what the learners will use outside. They know solar energy
Objective 3: How do you make lessons interactive and engaging for the learners?		
High School Name	Teacher Name	Responses
Jan Möhr Secondary School	Mr. Mungunda	It's a challenge without a SMART board. Here you have to talk to them through examples. You have to constantly verbally engage [the learners].
	Mr. Naholo	No response

Gustav Kandjii High School	Mr. Kambueza	Put [the learners] in groups. Then teach the language and ask them to prepare. The next day they do a role play
	Mr. Muungua	No response.
Okondjatu Combined School	Mr. Kahikumunu	Learner-centered lessons. I give them activities and demonstrations.
	Anonymous	No response.
Okamatapati Combined School	Mr. Kaangundue	Involve learners in an activity. Let the learners do the most in the lesson. Ask [the learners] what they know.
	Mr. Muje	Making the lesson learner centered and asking [the learners] questions.
Objective 3: In your opinion, what do you think we should add to our lesson modules in order to make them as effective as possible?		
High School Name	Teacher Name	Responses
Jan Möhr Secondary School	Mr. Mungunda	Visuals work nicely and your PowerPoint should be really interactive. Try to make [the PowerPoint] more practical to that community, so [the learners] can relate more.
	Mr. Naholo	More practical work that will enable them to discover.
Gustav Kandjii High School	Mr. Kambueza	Add more pamphlets, reading material, and a variety of learning materials.
	Mr. Muungua	You should have demonstrations, have fun, and renewable energy
Okondjatu Combined School	Mr. Kahikumunu	To expose [the learners] to different renewable energies and places where they can be used.
	Anonymous	Include more visuals.
Okamatapati Combined School	Mr. Kaangundue	Lessons should be practical and follow guidelines.
	Mr. Muje	Renewable energy [lessons] should be practical and [include] demonstrations.

To understand the possible challenges, the selected question was, “*What is the biggest challenge when working with high school learners?*”. From the teacher interviews, this project discovered that most of the biggest challenges are out of the teacher’s control. For example, several teachers mentioned puberty, pregnancy, and peer pressure. Although these responses do not directly affect the development of the modules, knowing that learners can be difficult at times is beneficial for the EduVentures educators. If a learner is difficult, rather than the educator getting upset and reprimanding the learner, they could attempt to be patient and work with the learner to address the issue. This would help build respect between the learner and the educator, which in turn would improve the classroom environment.

To discover how to maintain learner engagement and effective teaching practices, the interviewers asked: “*How do you make lessons interactive and engaging for the learners?*”. The interviews provided valuable information about the importance of learner-centered lessons. Five out of the eight teachers spoke of interactive activities or learner-centered lessons. Learner-centered lessons allow the learner to direct the discussions in class and the teacher acts as a facilitator more than a lecturer. Based on these findings, the designer of each module included several discussions and learner centered activities throughout the lesson.

To understand the learners’ background in renewable energy the team asked, “*What do learners already know about renewable energy from your school’s curriculum?*” and found that renewable energy is in most of the schools’ curriculum. Learners should already have a basic understanding of solar and wind energy

based on the responses from the teachers. Only two out of the eight teachers did not answer the question in regards to the learners' knowledge on renewable energy. Instead, these teachers talked about non-renewable energy such as oil and coal, or simply stated that the learners knew nothing about renewable energy.

The question, *"In your opinion, what do you think we should add to our lesson modules in order to make them as effective as possible?"*, yielded suggestions to add more visuals, demonstrations, and practical elements to the modules. These suggestions supported the project's background research on experiential learning and hands-on activities.

4.1.2 Teacher Interview Issues

Although these teacher interviews yielded many positive results and suggestions, they yielded unexpected results. While the original intention was to have two team members present at all interviews, time restrictions led to only two of the interviews conducted in this manner. Only one team member was present for the other six interviews. This meant that the same person was responsible for asking the teacher questions and writing down their responses. This set-up had the potential for a team member to miss information or incorrectly hear or record a response.

Another issue with the teacher interviews was the different levels of transcribing. When the transcribers transferred the interviews into the computer, it was sometimes difficult to read the responses. Each team member utilized a different type of short hand writing and needed to explain their note taking to ensure that the recorded responses were accurate. If the same team member wrote down all the responses, then the chance of any discrepancies decreased. Additionally, the interview location may have impacted the teacher's responses. Four of the rural high school teacher interviews took place outside, with both the interviewer and interviewee standing. Conducting the interviews outside limited the ability to hear responses and could increase the number of distractions for both the interviewer and interviewee. Two interviews took place inside a large dining hall. This setting had fewer distractions as both participants in the interview could focus on the questions and each other. At the Jan Möhr secondary school interviews, team members conducted one of the interviews over a 20-minute time period in a quiet classroom, while the other was in a busy lobby area in between class periods, providing a much more hectic interviewing environment. The teacher in the classroom had time to think about the questions and allowed the transcriber to write down detailed answers. The interview conducted in the hallway felt rushed and frantic, which led the transcriber to write down quicker summaries of answers and it is possible that the interviewer could have misinterpreted or not heard some of the answers correctly.

4.1.3 Informed Young Adults and Government Officials

Each stakeholder group provided a variety of information to influence module development. The informed young adults provided insight about why they were interested in sustainability and the teaching practices they enjoyed the most. While the interviews with the government officials provided information about current and future renewable energy initiatives in Namibia. All completed interviews are located in Appendices L through N.

Government officials:

The interview with the Ministry of Mines and Energy (MME) took place on the morning of 22 March 2017 and involved a circle discussion with the project team and five employees from the department. All four

project team members were present for the interview and took notes. The team asked all five employees every question listed in Appendix B, but in some cases only one or two officials answered a specific question. When asked why they choose a career in the energy field, the officials gave a variety of responses such as: energy being their passion, they needed a career change, they had an interest in renewable energy, and that energy is the “technology of the future”. One governmental official stated that, “Energy is very interesting and can make a lasting impact. We all need energy because it is the heartbeat of the whole universe. I chose to work in the energy sector because I want to make an impact on someone’s life”. It was also pertinent to gather information on why these officials believed that it was important to educate the youth on renewable energy topics. One employee believed that “the learners are the future” and thus education will encourage a sustainable future for Namibia. Another employee commented that the modules should connect the information in the modules to real applications.

When asked if it was possible to become completely energy independent from other nations by using renewable energy resources, one of the government officials said that yes, it is possible. However, Namibia is not striving for energy independence because they want to maintain foreign relations. Instead of becoming independent, the officials said that Namibia hopes to one day become an energy exporter. Table 4.2 below shows the responses from the stakeholders and which question aligns with the interview objectives discussed in Section 3.1.

Table 4.2: Government Official responses and their corresponding objective

Objective 2: What is your opinion on educating Namibian youth in renewable energy topics such as wind energy, solar energy, and Bush-to-Energy?	
Ministry Mines and Energy Official 1	They are the future, the new generation, we have to live in a sustainable environment. In that case, we need to focus on solar, wind and biomass.
Ministry Mines and Energy Official 5	Solar energy is more accessible to them, should focus on that for the youth.
Objective 2: Do you think that it is possible for Namibia to stop depending on foreign countries for energy?	
Ministry Mines and Energy Official 1	It’s possible, we don’t necessarily need to depend on them, but we do need to honor our agreements with other countries. Should those ever fall out though, and if we have everything in place, we could be self-sustaining, it’s definitely possible
Ministry Mines and Energy Official 5	It’s possible but our policy is that we should have a mix of energy, we need to have the dependency on exporting and importing from other countries to maintain relationships. The long-term goal in Namibia is to become an energy exportation country, so maintaining those relationships is key.
Objective 2: How helpful will the government be in adding renewable energy topics into school curriculums?	
Ministry Mines and Energy Official 3	[Renewable energy education] needs to be boosted in rural areas for sure. A learner in Windhoek has so many resources, labs and computers and electricity, in rural schools there is none of that, so they definitely need to learn about this.
Ministry Mines and Energy Official 4	The best approach is to engage learners in what they usually do. You need to integrate it into what they normally do, so that they can understand how it can be applied to their lives
Ministry Mines and Energy Official 5	Currently it only exists in higher education, such as sustainability studies at NUST, UNam. There are also vocational centers for renewable energy studies, but we haven’t done anything in lower education yet.

Informed Young Adults:

The interviews with the informed young adults took place after an Environmental Awareness Forum on the Sustainable Development Goals (SDGs) on 31 March 2017 at the House of Democracy. The interview

plan for the informed young adults is in Appendix C. Each interview had one team member acting as both the interviewer and the transcriber. The first interview was with Hannah Pohlmann, a German volunteer who recently completed university. She informed the interviewer that she obtained most of her information regarding environmental awareness and renewable energy topics from the Internet, in the form of blogs and forums. The interviewer asked Ms. Pohlmann why she was personally interested in environmental awareness; she stated “It is important, because if we don’t know, the future generations will die.” With this statement, she gave her belief that the youth should inform themselves on environmental topics such as renewable energy, as they will one day inherit the planet as their own and they will make decisions regarding the future of the environment. Ms. Pohlmann also realized that her family farm is not the most sustainable, but wants to make changes.

Another team member interviewed Kornelia Lipinage, an informed young adult who has both a Master’s Degree in Water Resource Management and a Bachelor’s Degree in Environmental Science. In comparison to Ms. Pohlmann, Ms. Lipinage learned most of her information on these topics from her undergraduate studies at the University of Namibia. Ms. Lipinage said, “I think Namibia needs to constantly prepare for what is coming next. Battling climate change and educating the population will create environmental awareness throughout the nation.”

The team asked the informed young adults, ‘What is your favorite part of science classes?’ to align with the goals of objective one, and ‘what do you think other learners should know about environmental awareness and climate change?’ to align with interview objective two. Table 4.3 shows their responses below.

Table 4.3: Informed young adults’ responses and their corresponding objective

Objective 1: What is your favorite part of science classes?	
Informed young adults’ name	Response
Hannah Pohlmann	Biology
Kornelia Lipinage	Going out into the field and performing hands on learning.
Objective 2: What do you think other learners should know about environmental awareness and climate change?	
Informed young adults’ name	Response
Hannah Pohlmann	Plastic Bags, how they should package their goods better and recycle more.
Kornelia Lipinage	I think you need to start environmental education from primary school. It’s hard to learn conservational practices when you’re older, if you teach the youth, they will grow up around the idea. I think it is also good to have science books or posters in the village’s local languages, and make sure that you are targeting the parents as well as the learners. If a parent doesn’t believe in climate change, it will be very hard for the learner to begin to live sustainably.

4.2 Classroom Observations

This project conducted three classroom observations on the morning of 5 April 2017 at Jan Möhr Secondary School, located in Windhoek, Namibia. The same two team members were present for all three classroom observations in a Grade 10 Geography class, Grade 11 Biology class, and a Grade 11 Geography

class. The completed classroom observation forms are located in Appendices Q through S. Each class lasted for 25 minutes. The two team members gathered both quantitative and qualitative data from the teacher and learner observations and used these observations to make connections between teaching techniques and learner engagement throughout each lesson.

When analyzing the data obtained from classroom observations, the team split the actions observed on the learner observation form into two categories: Positive Learner Behavior and Negative Learner Behavior. There were three main categories for teacher observations. Table 4.4 depicts the breakdown of the teacher observation form into three principal categories: type of activity performed, teacher actions, and materials used. Prior to performing observations, the designer of the observation form believed that participating in group work, expressing confusion or anger, leaving to go to the bathroom, and texting would reflect learner engagement throughout the lesson. However, not one of the learners throughout all four classes performed any of these actions. Consequently, the analysts ignored all four of these actions on the learner classroom engagement form. The faded words in Table 4.4 indicate the learner actions the team ignored when analyzing the classroom observation forms. After analyzing observation forms from each class, the team made connections between teaching methods and learner engagement by correlating different learner and teacher actions occurring at each time interval and additional observations team members made in each lesson.

Table 4.4: Teacher and learner activities observed during classroom observations

Learner Observations	
Positive Learner Behaviors	Negative Learner Behaviors
Sitting up and listening	Expressing confusion or anger
Maintaining eye contact with teacher	Talking in side conversations
Taking notes	Leaving to go to the bathroom
Asking questions	Texting
Answering teacher questions	
Participating in group work	
Teacher Observations	
Type of activity performed	
Teacher actions	
Materials Used	

4.2.1 Grade 10 Geography

In the first class the sample size was 43 learners. The observers sat in the back-left corner of the room and noted that the classroom seemed small for the observed class size. Table 4.5 summarizes the relevant teacher and learner observations for this class. The teacher utilized a chalkboard to write down important information, and structured the class using a lecture style. The class spoke English throughout the entirety of the lesson. The teacher began the lesson by stating the purpose, which was to discuss climate change and renewable energy. For the majority of the class, the teacher walked around the room asking the learners questions, elaborating on correct answers to cover the material, and clarifying answers that were not correct. This teacher also used examples that were relevant to the learners so that they could connect to the material. The learners had a relatively high engagement rate throughout this class. The observers witnessed that this class included several learner volunteers to answer questions and participate. Throughout

the lesson, approximately 30 learners were sitting up and paying attention and maintaining eye contact with the teacher, and a range of ten to twenty learners were asking questions, which are all positive learning behaviors. Only a small number, about three to six learners, were exhibiting negative learning behaviors throughout the lesson.

Table 4.5: Summary of teacher and learner observation forms for Grade 10 Geography

Grade 10 Geography (n=43)		Start-0	5 min	10 min	15 min	20 min
Teacher Observations						
Type of Activity Performed						
Lecture		X	X	X	X	X
Non-technology based activity						
Technology based activity						
Group-work						
Other (please specify)	X Review	X Review	X Review	X Review	X Review	X Review
Teacher Actions						
When was the purpose of the lesson stated?		X				
When did the teacher ask questions throughout the lesson?		X	X	X	X	X
When did the teacher answer questions throughout the lesson?						X
Material Used						
Chalk board		X	X	X		X
White board						
SMART board						
Projector						
Computer						
Posters						
Other (please specify)					X None	X Map
Learner Engagement Observations						
At 5-minute mark						
Positive Learner Behavior	Sitting up and listening	35	32	33	34	25
	Maintaining eye contact with the teacher	32	32	33	32	20
	Taking notes	0	3	0	2	0
Negative Learner Behavior	Talking in side conversations	3	5	0	2	0
During 5-minute time frame						
Positive Learner Behavior	Asking questions	0	0	1	0	0
	Answering questions from the teacher/volunteering	13	10	10	20	3
Additional Observations						
<p>Very interactive; teacher moved around a lot between desks and board, holding conversations with learners rather than just lecturing.</p> <p>Uses relevant examples to learners.</p> <p>Talked about renewable energy; learners had some knowledge of it.</p> <p>Asked questions throughout the lesson, to gauge their knowledge of the material.</p>						

Figure 4.1 depicts the different average percentages of learners exhibiting positive and negative behaviors at and during each five-minute period. At the beginning of the lesson, 47% of the learners were exhibiting positive learner behaviors and 7% were exhibiting negative learner behaviors. Throughout the lesson, the team observed relatively consistent positive learner behavior until the 15-minute mark. Negative

learner behavior increased slightly to 12% at the five-minute mark before decreasing to 0% at the ten-minute mark and remaining relatively low for the rest of the lesson. Both positive learner behavior and negative learner behavior decreased significantly during the 15-20-minute time frame. This is in part due to the teacher using this time to allow the learners to ask questions, and in the last five minutes of the class the teacher let the learners talk amongst themselves before they had to leave for class.

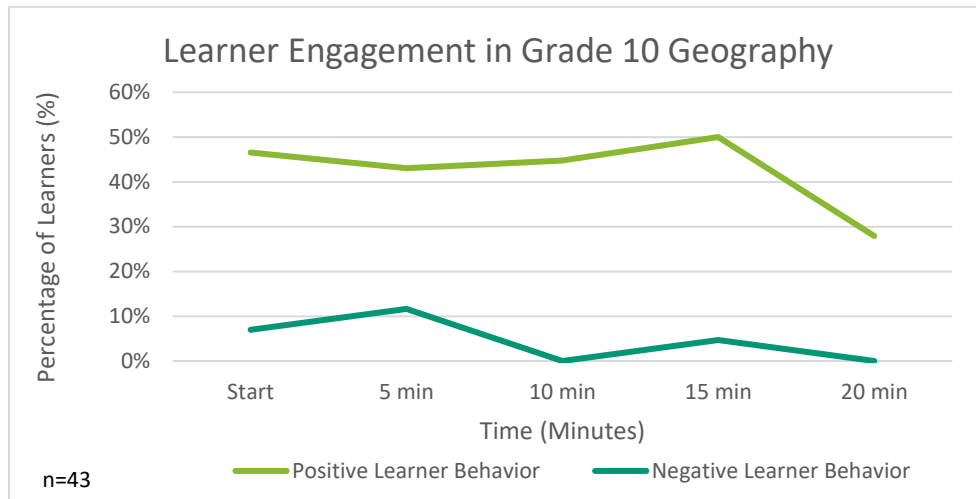

Figure 4.1: Learner engagement in Grade 10 Geography

From these observations, the observers made several connections. It seemed as if learners were motivated to try and answer questions when the teacher was actively interacting with the class. The teacher used the entire lesson to ask the learners about what they remembered from previous lessons, and this caused the learners to actively try to participate throughout the lesson. This stressed that developing lessons which allow the teacher to ask the learners questions and actively interact encourages the learners to pay attention and participate.

4.2.2 Grade 11 Biology

In the second class observed, the sample size was 42 learners. The observers sat in the front left corner of the room, and noted that rather than having individual desks, the learners sat very close together at tables of three to four learners. There were no windows and the lights were off so that the teacher could use the projector, making the room very dark. While this did not affect the team's ability to observe the lesson, as the front of the room had more light, it is possible that learners in the middle and back of the class could have had a difficult time writing notes and seeing the board. Table 4.6 summarizes the relevant teacher and learner observations for this class. The teacher utilized a SMART board, projector and computer throughout the lesson. However, rather than utilizing the interactive capabilities of the SMART board, the teacher used it to project the lesson onto the screen. The teacher structured the class using a lecture style, focusing on review topics the class learned previously. The teacher's mannerisms were very sharp and their tone of voice was assertive. The teacher spoke a combination of English and Afrikaans throughout the lesson and remained at the front of the room the entire time, using hand gestures when speaking. A majority of the learners were sitting up and listening, with 30-39 learners exhibiting this behavior throughout the lesson. In this class, the number of learners that were maintaining eye contact with the teacher was slightly lower, with only 20-30 learners exhibiting this throughout the lesson. The learners asked few questions, and the number

of learners who answered the teacher’s questions varied greatly throughout the duration of the lesson. Negative learning behaviors were higher in this class when compared to the other two classes, with a range of two to ten side conversations occurring throughout the entire lesson.

Table 4.6: Summary of teacher and learner observations for Grade 11 Biology

Grade 11 Biology (n= 42)		Start	5 min	10 min	15 min	20 min
Teacher Observations						
Type of Activity Performed						
Lecture		X	X	X	X	X
Non-technology based activity						
Technology based activity						
Group-work						
Other (please specify)		X Review	X Review	X Review	X Review	X Review
Teacher Actions						
When was the purpose of the lesson stated?						
When did the teacher ask questions throughout the lesson?		X	X	X		X
When did the teacher answer questions throughout the lesson?			X	X	X	
Material Used						
Chalk board						
White board						
SMART board		X	X	X	X	X
Projector		X	X	X	X	X
Computer		X	X	X	X	X
Posters						
Other (please specify)						
Learner Engagement Observations						
At 5-minute mark						
Positive Learner Behavior	Sitting up and listening	34	39	34	32	30
	Maintaining eye contact with the teacher	20	31	26	30	25
	Taking notes	5	0	3	0	0
Negative Learner Behavior	Talking in side conversations	3	2	10	3	5
During 5-minute time frame						
Positive Learner Behavior	Asking questions	2	1	4	0	2
	Answering questions from the teacher/volunteering	8	1	20	0	6
Additional Observations						
Very assertive and harsh tone of voice. Made occasional jokes with the material presented. Sometimes spoke in Afrikaans. Used SMART board mostly for visuals. Has posters around the room. Explained exam questions. Used hands to explain a concept.						

Figure 4.2 depicts the different average percentages of learners exhibiting positive and negative behaviors at and during each five-minute period. While positive learner behaviors remained relatively consistent throughout the lesson, fluctuating between 36% and 43%, the amount of negative learner behaviors varied greatly. At the beginning of the class, negative learner behaviors were relatively low, with only 7% of the learners exhibiting these actions. However, at the ten-minute mark, the number of learners exhibiting negative learner behaviors increased to more than three times that amount, with 24% of the class

acting in a negative fashion. For the remainder of the lesson the negative learner behavior decreased significantly and fluctuated between 7% and 11% for the last 15-minutes of the class.

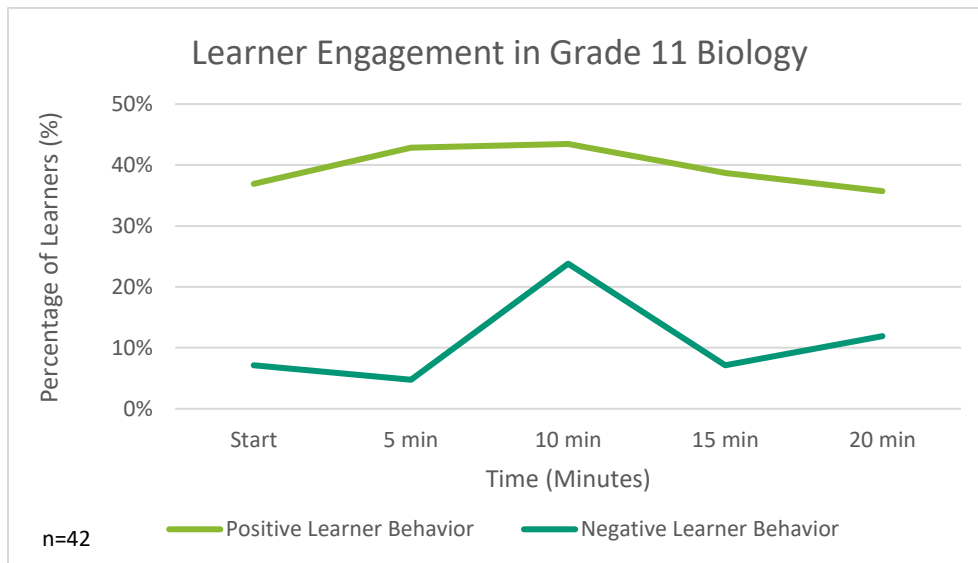

Figure 4.2: Learner engagement in Grade 11 Biology

Learner engagement was lower in this class than in the other two. The observers attributed this to the teaching style that the teacher implemented in this class. Throughout this lesson, the learners were sitting up and paying attention, but the observers noticed that the learners were much less focused throughout this lesson. The team members observed that in this class, learners engaged in side conversations almost immediately after the teacher paused. This could be attributed to the lecture-based teaching style. While the teacher did ask questions throughout the lesson, the number of questions asked was significantly fewer than the first class. After the teacher asked the question, they continued on with the lecture rather than attempting to engage in a discussion. This style of teaching was minimally interactive because there were only occasional moments when the teacher was actively attempting to engage with the learners. The module designers used this information and tried to avoid having blocks of time dedicated to straight lecture material in their modules.

4.2.3 Grade 11 Geography

In the third class, the sample size was 35 learners, making this the smallest sample size of the three classroom observations. The observers sat in the back-right corner and noted that the classroom was much bigger than the other two. This class had half of the windows painted black and a green chalkboard wrapped around the entirety of the room. Table 4.7 summarizes the relevant teacher and learner observations for this class. The teacher used a whiteboard, projector, computer and SMART board throughout the lesson. Again, rather than utilizing the interactive possibilities of the SMART board, the teacher used it to project lesson material. The team members also noted that this teacher seemed to be introducing new material to the learners. This could account for the high number of learners taking notes and paying attention in this lesson, as in the other lessons they were reviewing material they learned in previous lessons. This teacher had a stern voice that often times came across as strict and harsh. The teacher spoke English throughout the lesson, although the observers noted that the teacher was not speaking clearly, as it was hard to understand

what he was saying in the back of the room. The teacher used a lecture style and paced in front of the room throughout the lesson. While the learners answered questions throughout the lesson, the observers noticed that the teacher often interrupted them when they tried to answer. At times the teacher even answered his own questions without giving the learners a chance to participate. A majority of the learners were both sitting up and listening and maintaining eye contact with the teacher. This class also had the most learners taking notes. This indicates that there were relatively high positive learner behaviors in this classroom. No learners asked questions and only a few volunteered to answer questions at the beginning of the lesson. While there were few side conversations, they continued throughout the duration of the lessons, so the team consistently observed negative learner behavior.

Table 4.7: Summary of teacher and learner observations for Grade 11 Geography

Grade 11 Geography (n= 35)		Start	5 min	10 min	15 min	20 min
Teacher Observations						
Type of Activity Performed						
Lecture		X	X	X	X	X
Non-technology based activity						
Technology based activity						
Group-work						
Other (please specify)						
Teacher Actions						
When was the purpose of the lesson stated?		X				
When did the teacher ask questions throughout the lesson?		X	X	X	X	X
When did the teacher answer questions throughout the lesson?						
Material Used						
Chalk board						
White board			X	X	X	
SMART board				X	X	X
Projector				X	X	X
Computer				X	X	X
Posters						
Other (please specify)		X None				
Learner Engagement Observations						
At 5-minute mark						
Positive Learner Behavior	Sitting up and listening	33	33	33	32	34
	Maintaining eye contact with the teacher	30	27	32	32	32
	Taking notes	0	12	25	34	33
Negative Learner Behavior	Talking in side conversations	1	2	4	2	3
During 5-minute time frame						
Positive Learner Behavior	Asking questions	0	0	0	0	0
	Answering questions from the teacher/volunteering	2	3	4	0	0
Additional Observations						
<p>Has SMART board, uses it as a projector. Interrupted learners when they tried to answer. Half the windows are painted black. No posters around the room. Writing was small and hard to read from the back of the room. Lots of noise from open windows.</p>						

This information showed that while the learners all appeared to be exhibiting high amounts of positive behaviors, there were consistent negative learner behaviors throughout the lesson. Figure 4.3 depicts the different average percentages of learners exhibiting positive and negative behaviors at and during each five-minute period. Positive learner behaviors were relatively high throughout the duration of this lesson, beginning at 46% and increasing to over 72% by the end of the lesson. Meanwhile, negative learner behaviors remained relatively low, with exhibitions of negative learner behaviors occurring between 9% and 11% for the entirety of the lesson. While this is low compared to the amount of positive behaviors observed for this class, the analysts noticed that the average negative behaviors were slightly higher overall compared to the Grade 10 Geography lesson.

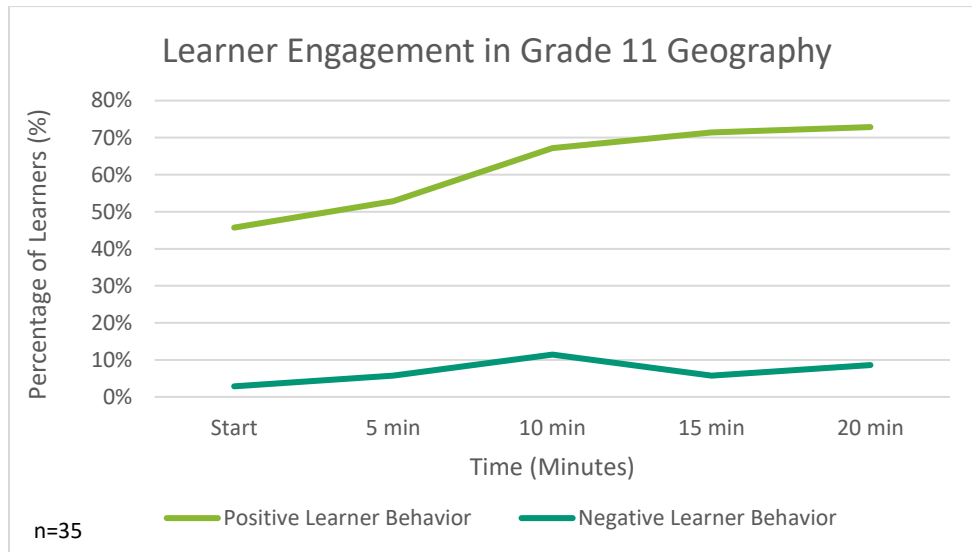

Figure 4.3: Learner engagement in Grade 11 Geography

During this lesson, the learners were sitting up and listening and most appeared to be taking notes. This class also had the highest rates of positive learner behavior from the data collected through the observation forms. However, the observers made additional observations that there was very little learner engagement. While the learners seemed to be sitting up and taking notes, the observers were not able to completely confirm that the learners were paying attention, as the observers were sitting in the back of the classroom. In fact, no learners asked questions and very few volunteered to answer a question. They were the quietest class observed. This again could be due to the teacher presenting new material, so the learners were paying more attention so that they could learn the new material before exams. Considering these factors, the analysts believed that this class was minimally engaged in the lesson and that the learners had minimal interest in the material. This teaching style, talking at the class and not to them, resulted in minimal interest and little learner engagement. The designer of each module took this into consideration and made sure that the amount of time the teacher spent lecturing was minimal. The project team also encouraged the EduVentures educators to interact with the learners even when lecturing, to make sure that the learners felt involved and connected to the lesson.

While it was not possible to identify concrete trends across all three classroom observations, this study gained a great deal of information by connecting ideas between teaching techniques and learner engagement. It was impossible to include every learner behavior on the learner engagement form; therefore,

the observers wrote down additional observations that did not fit into a category on the form. The observers witnessed learner excitement in interactive classroom settings and learner disengagement in lecture-based classrooms. The team used this information to develop their renewable energy lessons in a manner that enabled the teacher to actively engage with the class.

4.2.4 Classroom Observation Issues

The team encountered several issues that may have affected these observations. The most important challenge to consider is the time period of the observed classes. These observations took place during a review period for examinations. As such, it was possible that the learners were paying more attention to the teacher to prepare for their exams. This could skew learner engagement rates to be higher than normal. Due to the school being in a review and examination period, the classes were shorter, which also could affect the learner engagement rates, as they did not have to remain engaged for longer than 25-minutes.

Another issue the team encountered was that the observers sat in the classroom at the discretion of the teacher. Each teacher seated the observers in the area of the classroom where they would best fit. As such, the team members sat in the back of the classroom for both geography classes and in the front of the classroom for the biology class. This affected the observations, as in the biology class the observers were able to watch the learner's faces to gauge whether they were paying attention or not. The observation of the class also may have distracted the learners or simply caused them to behave differently than they normally would in class.

There were also discrepancies in observation style. In the Grade 11 Geography class, the observers switched roles, so the observer who previously focused on learner engagement concentrated on teacher observations, and vice versa. This may have skewed the data, as the observers could have gauged different actions and observations differently. When analyzing the observation forms and making connections, the project's analysis tried to account for all of these issues.

4.3 Pre-Visit Surveys

Two team members visited three rural high schools to introduce the EduVentures program and gauge learner knowledge on renewable energy topics. The pre-visits provided the team with valuable information to further the development of the modules. The three schools visited were: Gustav Kandjii High School in Otjinene, Okondjatu Combined School, and Okamatapati Combined School (see Figure 4.4).

The two team members discovered while on this field test that rural schools throughout Namibia resemble 'boarding schools' in the United States. Learners stay in 'youth hostels' on the school premises and only return home on holidays and school breaks. When the EduVentures staff presented the program, the learners were extremely excited about the Ombombo mobile classroom. At each of the rural schools, one team member randomly selected ten learners to take the pre-visit survey and the learners were competing with each other to take one of the surveys. At the first and third school, learners worked in small groups and at the second school learners worked alone.

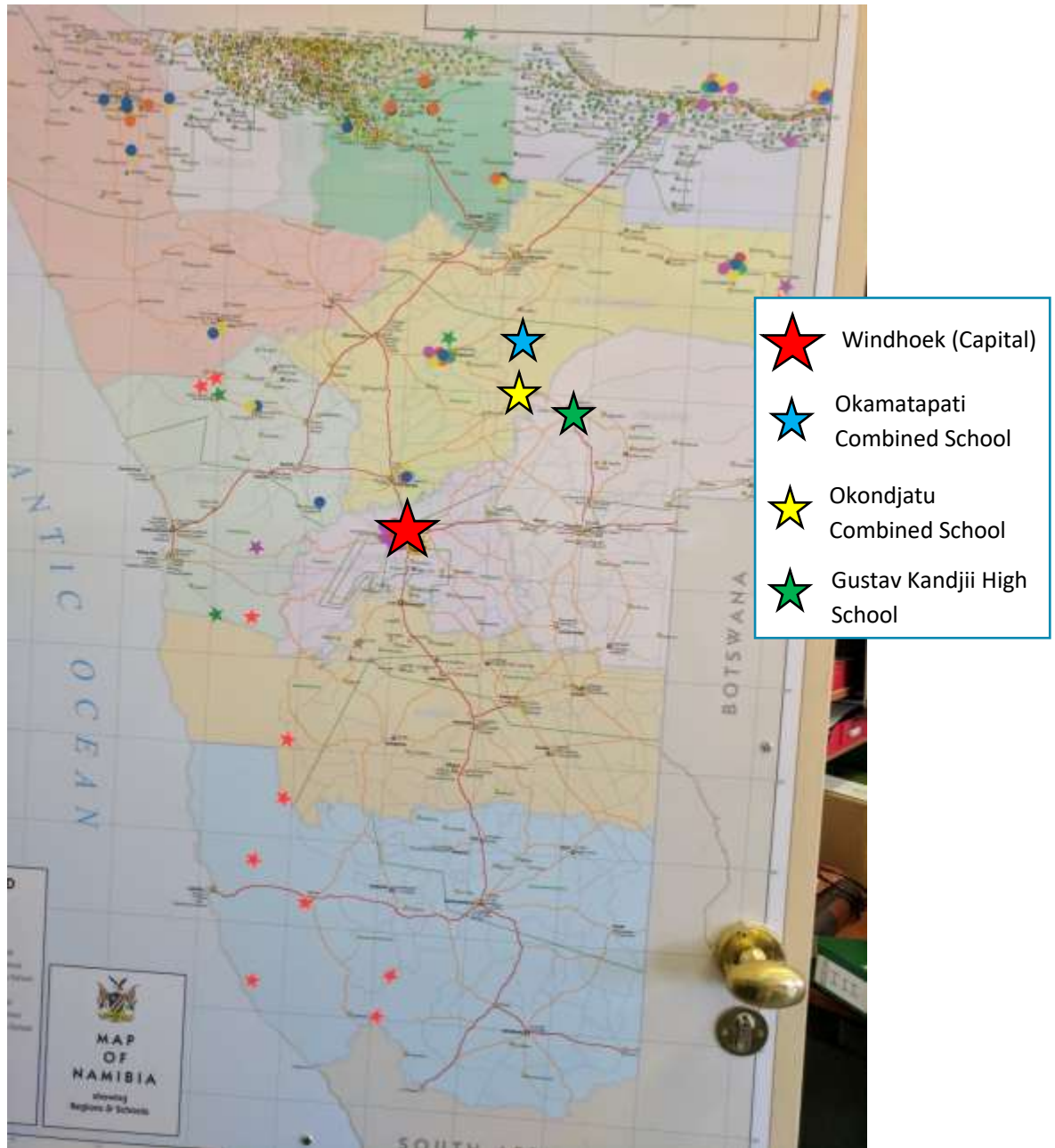

Figure 4.4: Map of pre-visit schools in comparison to Windhoek

After collecting the surveys (located in Appendices U through W), the analysts recorded the number of correct answers and incorrect answers. Since the survey's purpose was to gauge whether the learners knew the answer or did not know the answer, the analysts marked any question left blank as incorrect. The team analyzed trends between schools, questions, and between the learners who worked in groups versus the learners who worked alone.

Most of the questions on the survey had a low-level thinking question, which focused on basic knowledge of a topic, and a higher-level thinking question, which required more critical thinking because of its open-ended nature. Table 4.8 shows the different questions based on level of thinking and the reference

code. Questions 4, 6, and 7 did not fall into either category. The rest of this section refers to questions simply using the reference codes found below.

Table 4.8: Breakdown of pre-visit survey question type

Low-level thinking Questions		Higher-level thinking Questions	
Reference code	Question	Reference code	Question
Q1. a)	What is renewable energy?	Q1. b)	Why is it important to Namibia?
Q2. a)	What is solar energy?	Q2. b)	How does it work?
Q3. a)	What is an encroachment bush?	Q3. b)	How can Namibia use it for power generation?
Q5. a)	What is wind energy?	Q5. b)	How does it work?
Q9.	Define the industrial revolution?	Q8.	What can you do to help in Namibia's transition to renewable energy?

Figure 4.5 illustrates the percentage of learners who answered Q1. a) 'What is renewable energy?' correctly compared to Q1. b) 'Why is it important to Namibia?'. Almost all learners, 93%, correctly defined renewable energy. However, when prompted to answer the second part of the question, only 31% of all learners could explain the importance of renewable energy in Namibia.

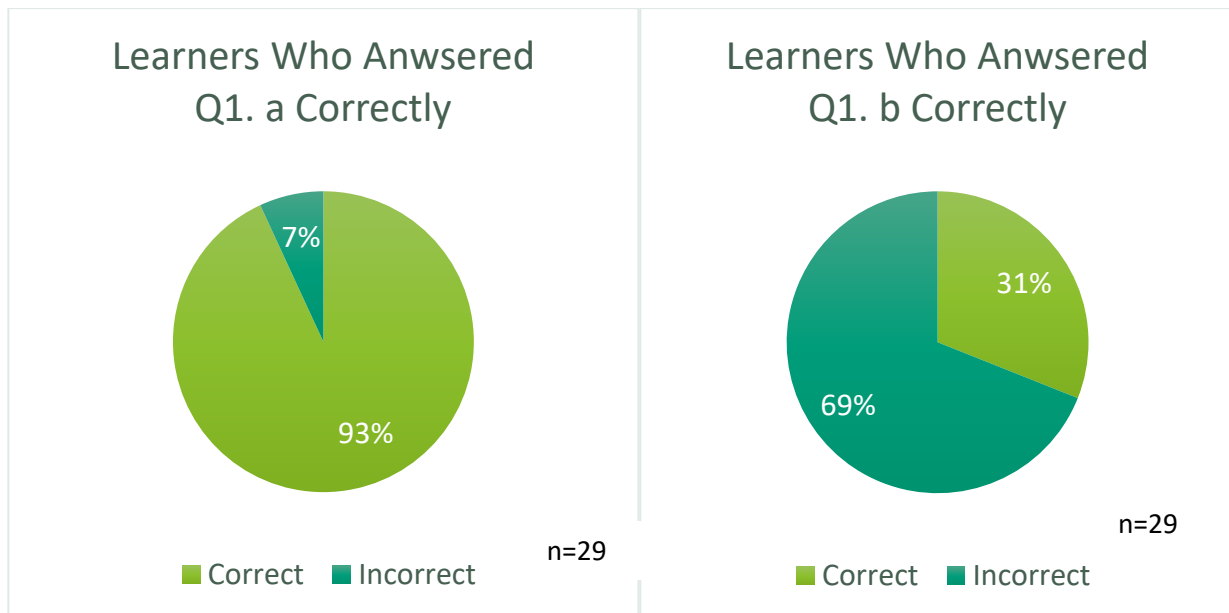

Figure 4.5: Learners who answered Q1. a) and Q1. b) Correctly (n=29)

Figure 4.6 shows the combined scores of lower-level thinking questions and higher-level thinking questions. The survey contained five lower-level questions and five higher-level questions. The percentage of correct answers on the lower-level questions was more than twice as high as the percentage of correct answers for the higher-level thinking questions that required critical thinking. This led the team to believe that the learners knew concrete, factual answers but lacked the scaffolding to make connections to real-world applications.

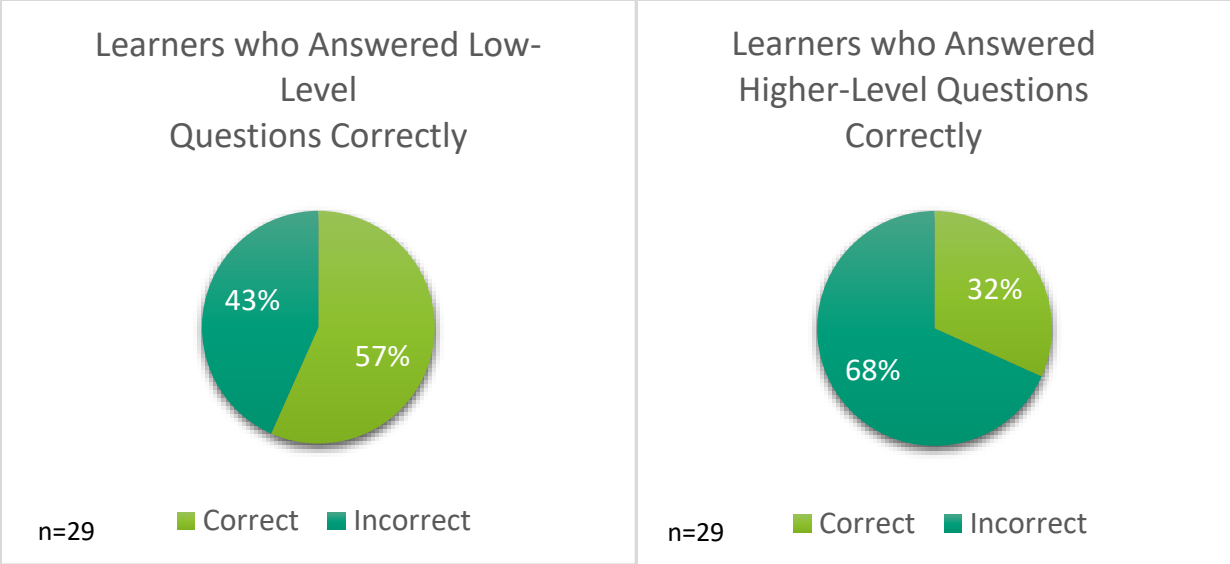

Figure 4.6: Learners who answered low-level questions and high-level questions correctly (n=29)

As mentioned earlier, learners from schools one and three filled out the survey in groups, while learners from the second school filled out the survey individually. Although the team anticipated that working together in a group would yield higher scores, the data in Figure 4.7 supports this assumption with quantitative data. Learners who answered the survey in groups shared ideas with each other and eventually arrived at the correct answer to the questions. In Figure 4.8, the analysts noticed that the learners that worked in groups scored three times higher on their pre-visit surveys than the learners that worked individually. Therefore, the more learners that work together on an assignment, the more knowledge, ideas and brainstorming techniques are available to solve the provided problem. Although the team already planned to incorporate some group work into the modules, this data inspired the designers of each module to make almost every activity within the lessons require teamwork. The analysts omitted question seven in these results because it asked the learners to list as many renewable energy technologies as possible. Therefore, it was difficult to deem this question either correct or incorrect.

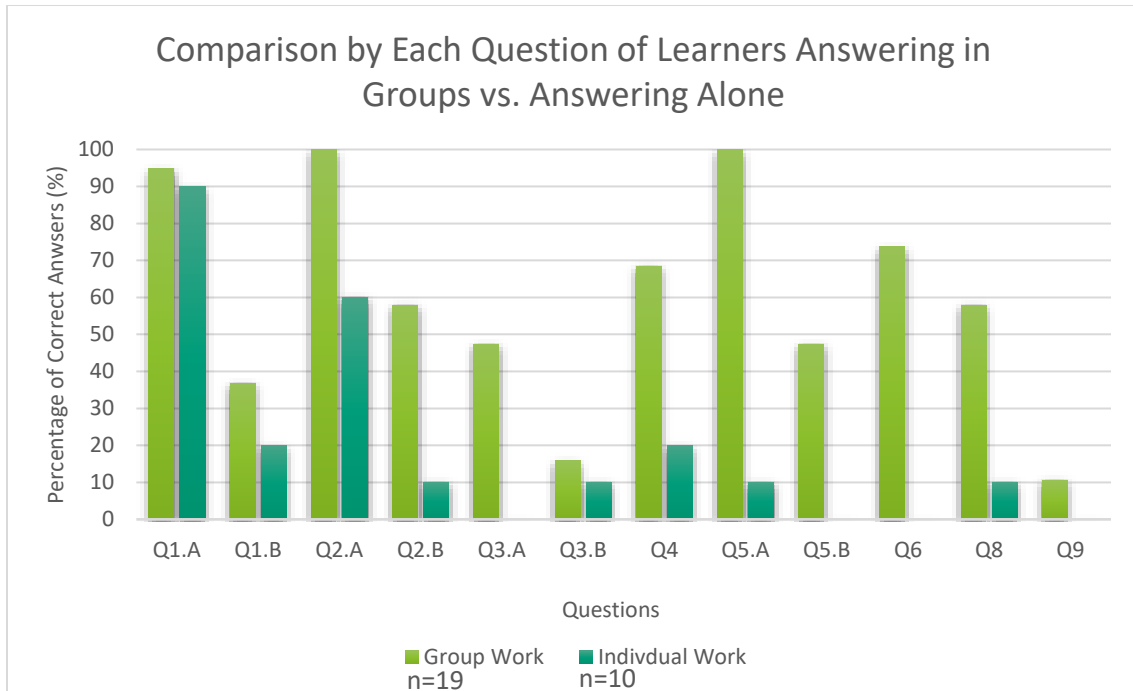

Figure 4.7: Comparison by each question of learners answering in groups vs. answering alone

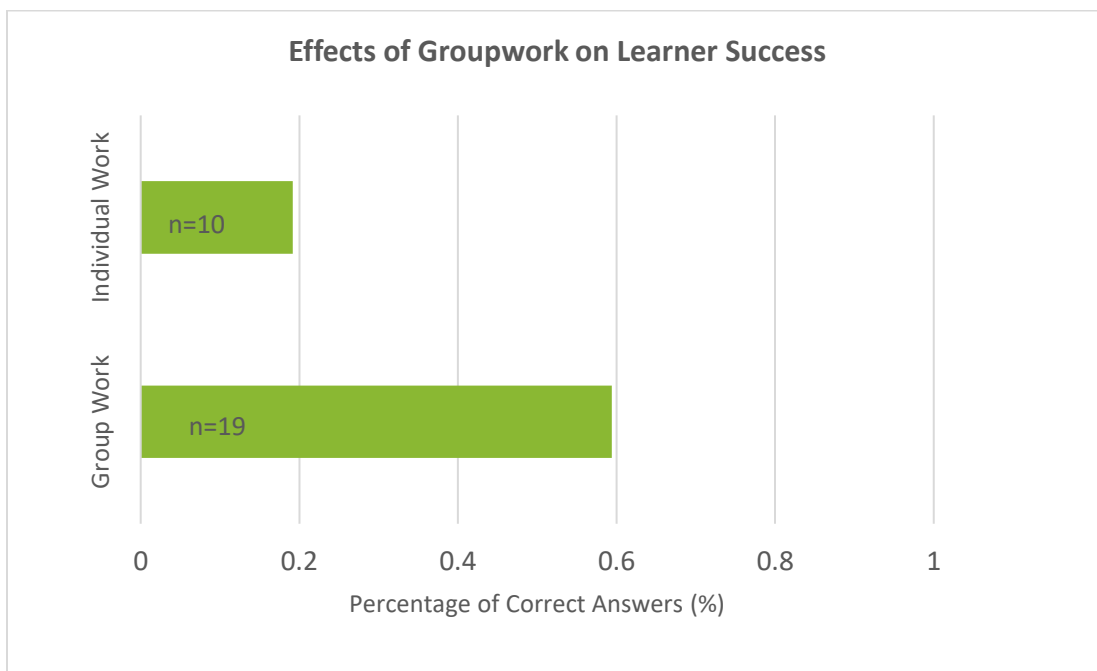

Figure 4.8: Impacts of group work on learner performance

The pre-visit surveys provided valuable information on learner background and the effects of teamwork. The team discovered how in-depth the modules needs to be based on the learners' scores on the pre-visit survey. The learners were more successful in answering the low-level questions, but struggled with

the high-level questions. The results made the designers of each module create the lessons to include both low-level and high-level questions. This is extremely important because the project team wanted the learners to be able to link their concrete knowledge on renewable energy gained from the lessons to problems in their communities and country. The modules include several activities in which the learners must work together to solve real-world problems using the knowledge presented during the lesson. Furthermore, to maximize the learners' experiences with EduVentures Trust, the module designers incorporated many group activities in all four modules.

4.3.1 Pre-visit Survey Issues

There were several unavoidable issues throughout the pre-visits. The team members did not originally intend to have two schools fill out the surveys in groups, but the learners were fighting each other to get a chance to fill out the survey. To avoid further conflict between learners, the two members decided to diffuse the situation by letting the learners fill out the form in groups. In addition, the structure of the questions may have influenced the way that the learners responded. For example, most learners responded to the first question in every box, yet left the second question unanswered. It is possible that the results could shift based on whether every question had its own box; learners may have been more likely to attempt to answer every question if they all had their own boxes. Additionally, at the first school, Gustav Kandjii High School, one learner that received a survey did not fill out a single question and simply returned the survey to the facilitators. The team assumed that the learner was either not interested in taking the survey, or his/her understanding of renewable energy was extremely low. This is why the sample size is 29 learners and not 30 learners. Finally, the quality of education provided at each school could severely impact the gathered results.

4.4 Module Development

The deliverables of this project were four interactive SMART lesson modules. These modules balanced important content about renewable energy and interactive activities. This project developed modules after assessing the current Namibian education system through interviews, classroom observations, and rural school pre-visit surveys.

4.4.1 Initial Module Outlines

Prior to the development of the four modules, each team member first developed a detailed outline for each of the modules and gave them to EduVentures for review (see Appendices Y through BB). During this initial review period, the EduVentures staff provided feedback to modify the outlines to cater them more to the Namibian learner. One of the most important critiques to address was the complexity of the English. The staff at EduVentures believed that the English in the initial outlines was too complicated for the learners to understand. They stressed the importance of simplifying all of the English to eliminate any language barriers throughout the lessons. EduVentures also believed that each lesson had to include more technical descriptions of how each technology works. While the outlines initially included one or two activities in each lesson, EduVentures believed that incorporating more interactive activities would maintain learner engagement in the modules.

After receiving this feedback from EduVentures, team members implemented the necessary changes to each outline and resubmitted to the EduVentures staff for approval. Once EduVentures approved the edited outlines, it was time to develop the modules in SMART Notebook.

4.4.2 Initial Module Development

Upon the completion of preliminary data collection, the team added additional activities to the lessons, limited the amount of text on each slide, ensured that the lessons gave the learners a sense of control over their education, and simplified the English vocabulary in the lesson to reduce the language barriers. The completed initial modules are found in Appendices CC through FF.

Each lesson had a variety of slide structures and content. The slides included lecture material, interactive SMART activities, group discussions, and competitive games. This report defines a 'lecture slide' as a non-interactive slide that focuses solely on delivering important information to learners. Figure 4.9 depicted an example of a lecture slide from the *Introduction to Renewable Energy* module. Since the teacher interviews indicated that learners do not enjoy lecture-heavy lessons, the team worked to minimize the amount of lecture slides in the modules. However, when the lesson required a lecture slide, it usually contained an accompanying diagram or visual to keep learners engaged.

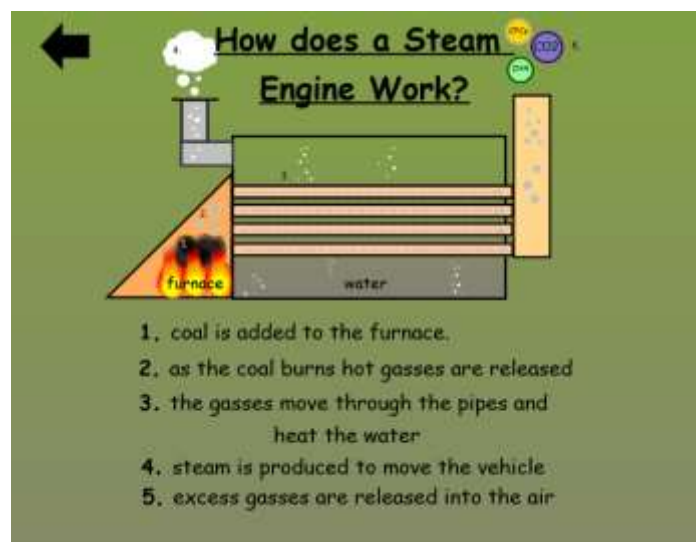

Figure 4.9: Lecture slide from *Introduction to Renewable Energy Module*

All four lessons included interactive activities. The team incorporated as many interactive SMART activities as possible, as several stakeholders highlighted the importance of activities because they maintain learner engagement throughout the lesson. These activities included sorting games, matching games, and fill-in-the-blank vocabulary activities. Figure 4.10 shows an example of one of the interactive activities, a game in the *Wind Energy Module* which tasked the learners to rank the power outputs of different sized turbines. All of the activities worked to reinforce information presented in each lesson and allowed the learners to actively participate in class.

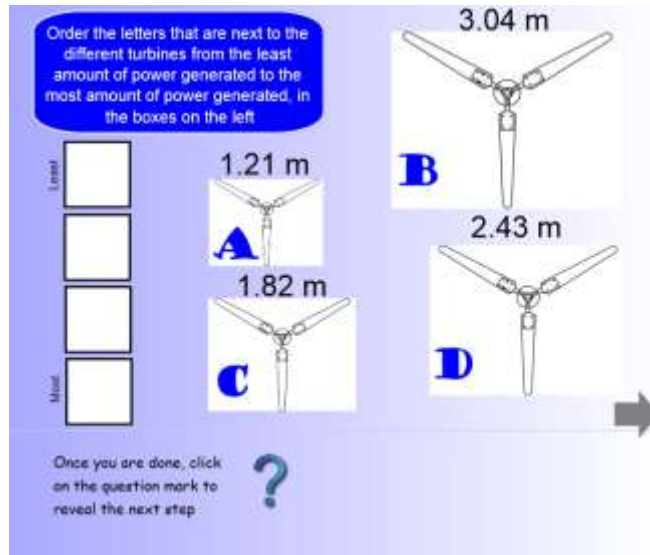

Figure 4.10: *Wind Energy Module* turbine activity

Each module also incorporated group work throughout the lesson. From the pre-visit surveys, the designers found that the learners had higher performance rates when they worked in groups, as they could discuss their ideas and work together to solve a problem. Figure 4.11 represents one of the group activities used in the *Solar Energy Module*. The educator asks the learners to draw a series of solar panels that they could use in their communities. In addition, each learner-group needs to develop arguments about why the technologies they selected would be good candidates for their village. This allowed learners to utilize their critical thinking and creative skills to produce a sound argument.

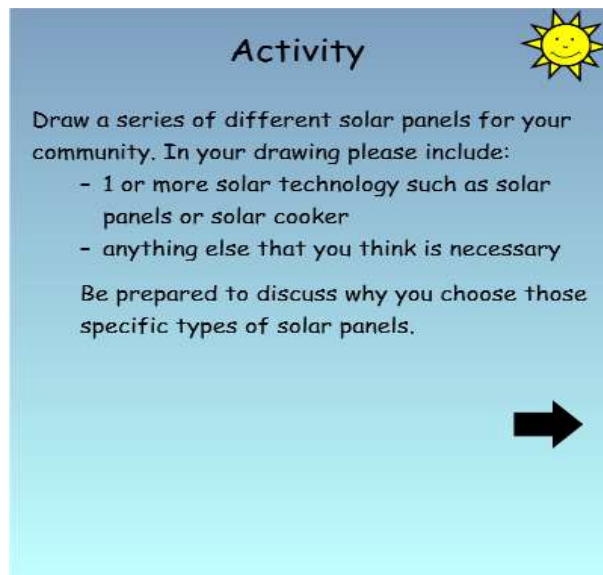

Figure 4.11: *Solar Energy Module* drawing activity

Finally, the team incorporated two competitive games at the end of the *Wind Energy* and *Bush-to-Energy Modules*. These games served as a summary activity for the two modules. The two games were Jeopardy and Connect Four, shown in Figures 4.12 and 4.13. These games were longer than the activities inside the modules and summarized all of the information throughout the lesson.

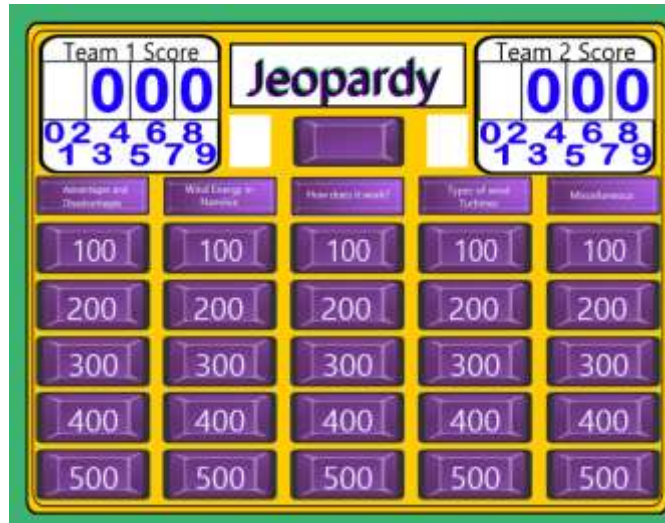

Figure 4.12: *Wind Energy Module* Jeopardy activity



Figure 4.13: *Bush-to-Energy Module* Connect Four activity

Although the modules include several other activities, games, and content, the sample slides shown represent important highlights from the four modules. Once the project group developed the initial drafts of the four modules, all the module designers met with EduVentures to conduct a thorough review of each module.

4.4.3 EduVentures Review

The team spent a full day in the Ombombo mobile classroom presenting each of the modules to EduVentures staff to gather feedback on their initial lessons. All four designers needed to simplify the English of the descriptions and operations of each technology. The project team removed a significant portion of the text from the lecture slides, as EduVentures believed they were too busy for the learners to follow. EduVentures recommended adding more pictures to all of the lecture slides as well to keep the learners engaged. Each designer had specific issues to address within their module.

Introduction to Renewable Energy Module

For the *Introduction to Renewable Energy Module*, EduVentures asked for the designer to incorporate pictures specific to Namibia. They believed that the generic pictures from around the world would not allow the learners to connect to the topics discussed. The EduVentures staff also recommended elaborating on the importance of renewable energy to Namibia. Another change the designer made was in regards to the one scenarios slide. The EduVentures staff believed that the scenarios were too broad and, rather than having two scenarios focused on solar energy, each scenario should address the three technologies discussed in the other lessons. The module designer took all of this information into account and made the necessary changes before proceeding with the project.

Wind Energy Module

The one change specific to this module was the issue with the SMART lab activity. SMART Notebook has a tool to build activities, which the module designer used to create their sorting review activity. When the team presented this module to EduVentures, they found that the newest version of SMART Notebook was not installed in the mobile classroom, therefore the SMART lab activity did not work. To account for this, the module designer manually developed the sorting activity and removed the SMART lab activity.

Solar Energy Module

The *Solar Energy Module* required several modifications. EduVentures wanted more pictures specific to Namibia. They also requested that the module designer simplify the explanation of how a solar panel works, as they found the slides difficult to follow. In addition, the EduVentures staff also wanted the module designer to include information about the how the mobile classroom operates through solar power. The solar panels on the bus convert UV light into energy, the energy then passes through an inverter, and then the battery stores the produced energy for future use. EduVentures asked for more information on solar farms incorporated into the curriculum.

Bush-to-Energy Module

For the *Bush-to-Energy Module*, most of the changes involved correcting the information on the lecture slides. EduVentures wanted the designer to make the types of encroacher bush discussed more relevant to the learners, as different species are more common in specific regions of Namibia. They also wished for the designer to add a slide about invader species, to allow the learners to develop a more in-depth background of what exactly encroacher bush is. In addition, EduVentures believed it was important to include the removal of carbon sinks as a major disadvantage of Bush-to-Energy. The slide discussing how one can convert encroacher bush into energy was also too busy. Aesthetically, the slides were too bright when projected on the SMART board, and everyone present found the text difficult to read. To mitigate this problem, the module designer changed the color of the slide to a darker green.

The team presented the modules once again after developing a detailed teacher's guide for the EduVentures educators (located in Appendices GG through JJ). This second practice of the modules enabled the designers to address any overlooked issues and to elaborate on any instructions or talking points the educators found confusing. Once the project team and the EduVentures staff discussed all four modules, the lessons were ready for the pilot test. The first drafts of all four modules are in Appendices CC-FF.

4.5 Module Observations

During the pilot-test of the four modules, two observers sat in the front of classroom on either side of the SMART board. The observations took place in the Ombombo Mobile classroom at Okondjatu Combined School in Okondjatu, Namibia. The rest of this section will summarize the findings from the four module observations conducted in the first two days of the program (see Appendices OO through RR).

4.5.1 Introduction to Renewable Energy Module

Twenty learners attended the *Introduction to Renewable Energy Module* on the morning of 24 April 2017. The EduVentures educator taught this lesson over a 175-minute period with a five-minute break at the seventy-minute interval.

Figure 4.14 depicts the average percentage of learners who exhibited positive and negative behaviors at and during each 5-minute interval. This graph also shows no consistency in the positive or the negative learner behavior seen in the lesson. However, there was a higher percentage of positive learner actions in comparison to the negative learner actions in the lesson. At the start of the lesson 45% of the learners displayed a positive learning behavior while at the end of the lesson only 20% displayed these same behaviors. As for the negative learning behavior, 9% of the learners began the lesson with this type of action. Finally, towards the 175-minute time interval 0% of the learners displayed any kind of negative behavior.

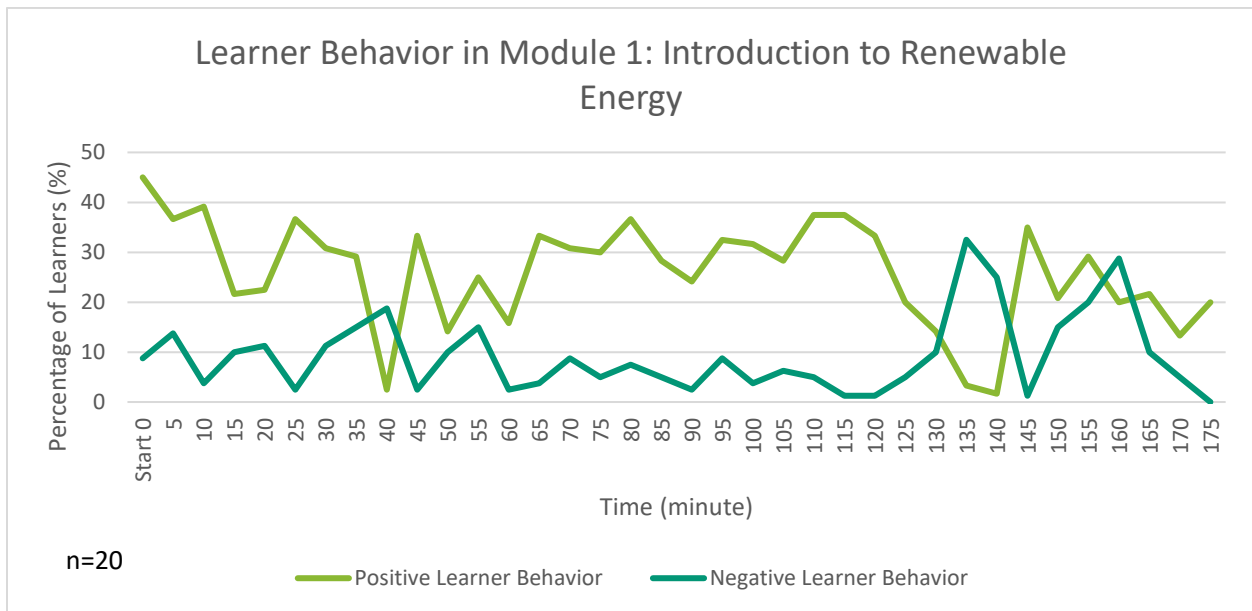

Figure 4.14: Learner behavior in module 1: *Introduction to Renewable Energy* versus time (n=20)

In this lesson, the learners took notes in small notebooks provided by EduVentures. The learners asked very few questions throughout the lesson, even at times when the team members observed that they were confused with the presented material. In the first 70-minutes of the lesson, the learners were engaged in the material and the activities presented to them. The one exception to this was the video on the Industrial Revolution, where the English in the video was too fast for the learners. 70 minutes into the lesson, the class took a five-minute break, in which the team members paused their observations. After the break, the

learners' engagement improved for 25 minutes but then decreased. An activity in which learners needed to work in groups to find a solution to a provided scenario took place between the 120-minute and 145-minute mark. The observation form did not include mechanisms to effectively measure this type of group work, therefore positive learner behavior decreased on the graph even though the learners were heavily engaged in the activity. The main observation found was that the length of the lesson was too long for the learners to remain focused for its entirety.

4.5.2 Wind Energy Module

Nineteen learners attended the *Wind Energy Module* in the afternoon of 24 April 2017. The EduVentures educator taught this lesson over a sixty-five-minute time period. In this module, the teacher told the learners not to take notes, but simply listen to the module and engage with her.

Figure 4.15 depicts the percentages of learners who exhibited positive and negative behaviors at and during each 5-minute interval. Both positive and negative learner behaviors were relatively constant throughout the lesson. However, the positive learner behavior in this module was significantly higher than the negative behavior. At the beginning of the lesson, 40% of the learners exhibited a positive behavior and 3% of the learners showed negative behaviors. Towards the end of the lesson, the positive learner behavior was 37%, which is only slightly less than the beginning of the lesson. At the end the class of the negative behavior was 7%, which was slightly higher than the beginning of the lesson.

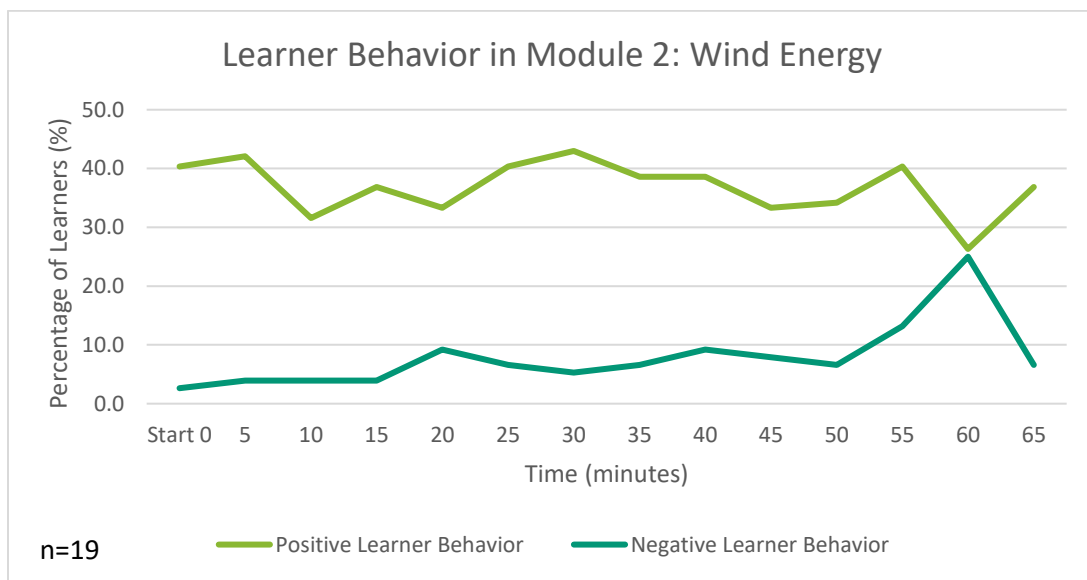

Figure 4.15: Learner behavior in module 2: *Wind Energy* versus time (n=19)

The learners did not ask many questions throughout this lesson. The team observed that the class as a whole was more tired and distracted than in the first module. Many of the learners were yawning throughout the introduction of the lecture material. For several of the activities, the teacher used candy as a motivator which sparked learner participation. At the 60-minute mark, the learners were coming up and writing their ideas on the SMART Board. As some learners were doing this, other learners started talking in side conversations and losing attentiveness. The length of this module was the approximate amount of time

aimed for when designing the modules, which allowed for a constant learner engagement in comparison to the first module.

4.5.3 Solar Energy Module

Seventeen learners attended the *Solar Energy Module* on the morning of the 25 April 2017. The EduVentures educator taught this lesson over a 120-minute period. The EduVentures educator did not schedule a break during the module. Additionally, the educator asked the learners to not take notes during the lesson, simply listen and engage in the content presented.

Figure 4.16 shows the percentages of learners who exhibited positive and negative behaviors at and during each 5-minute interval. From the figure, there is no consistent trend in positive or negative behavior throughout the module. However, the percentage of learners who exhibited positive behavior at the beginning was higher than at the end, with a difference of 14%. The most noticeable feature of the figure starts at the 25-minute mark, when the positive behavior drops from 25% to 3%. Between the 25 and 45-minute mark, the learners were engaged in a group activity which required them to draw their village equipped with solar technologies. The class split into four groups and worked on drawing solar energy technologies in their communities. Although the team was not able to record this as positive behavior on the form, the learners were engaged and cooperating during the activity. Positive learner behavior increased between 50 and 55 minutes as the learners presented their drawings to the rest of the class. After the group activity, the positive behavior increased slowly again until reaching a maximum at 100 minutes, before decreasing again during the last 25 minutes of the module. During these last 25 minutes, negative behavior increased to 10%.

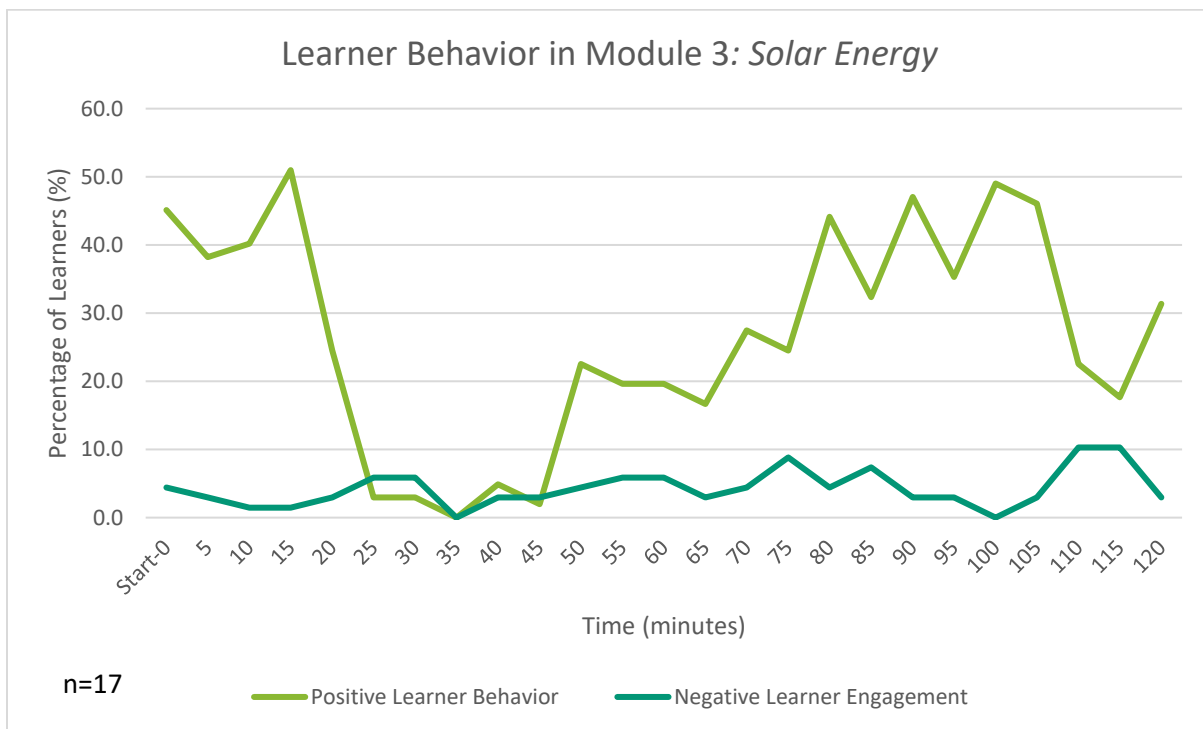

Figure 4.16: Learner behavior in module 3: *Solar Energy* versus time (n=17)

Under additional comments, the two team members observing noted that learners lost engagement in the lesson at the 70-minute mark when the teacher introduced the operation of solar panels. The learners appeared uninterested in the module and their eyes kept wandering around the classroom. Although the learners showed this lack of engagement, they still exhibited positive learner behaviors, such as sitting up and listening, and keeping eye contact with the teacher. Although module three was not as long as module one, it was still longer than the 60-90-minute target length, which resulted in a decrease in learner engagement towards the end of the module.

4.5.4 *Bush-to-Energy Module*

Eighteen learners attended the *Bush-to-Energy Module* in the afternoon of 25 April 2017. The EduVentures educator taught this lesson over a 55-minute period. There was no break during the module. This educator allowed the learners to take notes during the lesson.

Figure 4.17 shows the positive and negative learner behaviors over the 55-minute lesson period. The figure shows an outlier at 30 minutes. During this time, the teacher asked the learners many questions, which prompted the learners to sit up and answer questions. The average positive behavior exhibited in the fourth module was 34%.

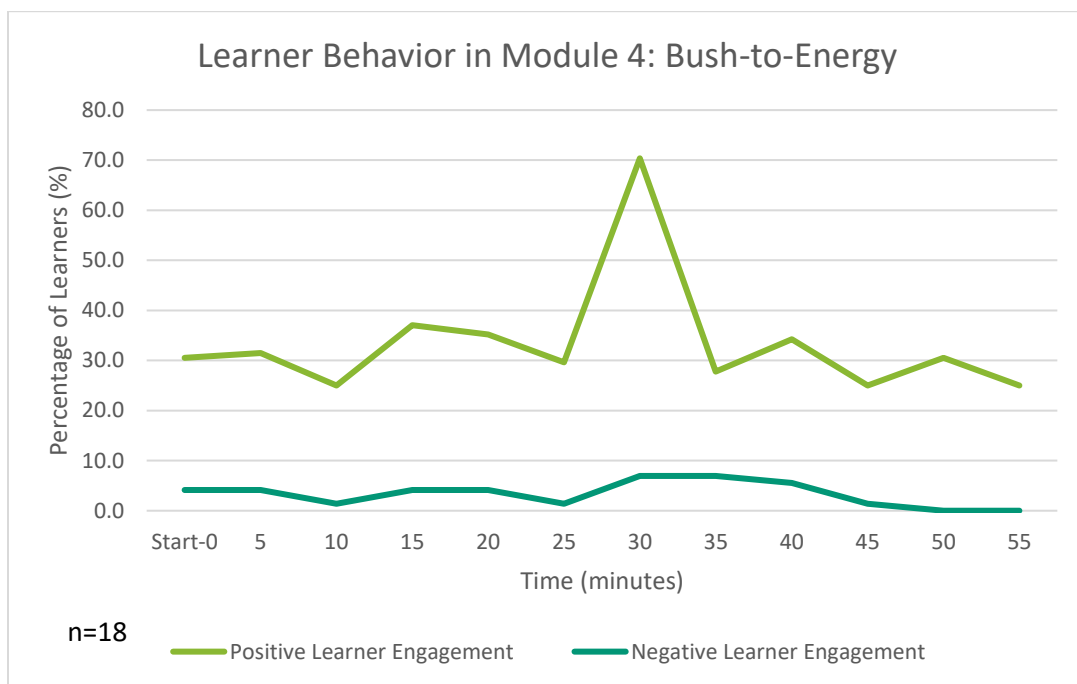

Figure 4.17: Learner behavior in module 4: *Bush-to-Energy* versus time (n=18)

The two team members observing the fourth module, recorded that the learners appeared more tired than in the *Solar Energy Module* taught that morning. The EduVentures staff taught this module right after lunch. Most of the learners put their heads on their desks and seemed unfocused and fidgety. When the educator asked questions, it was difficult to engage the learners and have them answer questions. There were a lot of side-conversations during the module review activity, which started at the 50-minute mark and continued to the end of the lesson.

4.5.5 Module Observation Issues

The biggest limitation of the observation form was the lack of behaviors listed. The recorded observations do not fully characterize the behaviors of the learners because the designer of the form did not anticipate the need to include some of the negative behaviors that the observers witnessed throughout the modules. Therefore, since some negative behaviors were not present on the form, at times the data reflects that the learners were more engaged than they actually were. The opposite is also true, when learners were exhibiting positive behaviors, such as group work, there was nowhere to record it. Therefore, the recording methods on the observation forms were flawed. Also, each team member recorded behaviors in different ways. This related to the limitation of the observation form because some team members included learner behaviors on the form that were similar to a category listed, whereas other team members only recorded exactly what was on the observation form. For example, one team member counted wandering eyes throughout the room as 'looking out the window', meanwhile other team members did not.

There were times when the interactive aspects of the lesson were not working because of challenges with the SMART Technology. This may have resulted in learner engagement decreasing because the learners were disappointed that they could not interact with the board.

Learner understanding and the language barrier was also a challenge during the observations. Many times throughout the modules the learners would talk in their native language with the EduVentures educator. Consequently, the team members were not able to understand some student-teacher conversations. The learners tended to speak in their native language when they did not understand the lesson material. Furthermore, the learners may have been frustrated during the lesson, which would decrease their engagement and interest in the lesson.

Each of the two EduVentures employees taught modules differently. One educator instructed the learners to not take notes during modules two and three, meanwhile the other educator allowed the learners to take notes. The educator who asked learners to refrain from taking notes prompted many questions and actively wanted the learners to participate in the lesson. The other educator moved more quickly through modules one and four. The learners did not answer as many questions or interact as frequently with the SMART board.

Learner engagement also heavily depended on the time of day that the EduVentures educators delivered the modules. The modules taught in the morning showed that the learners appeared more engaged in the lesson, whereas modules taught after lunch showed more learners looking tired and unfocused during the first half of each lesson.

4.6 Pre-Tests and Post-Tests

To gather quantitative data on the impact of the modules, the project team distributed pre-tests and post-tests to each of the learners during the field test (see Appendices MM and TTA). The pre-tests and post-tests were identical, except for the order of the questions. One EduVentures staff member informed the participants while taking the pre-test that there would be an identical survey at the end, which was not what the team planned. The purpose of these tests was to check learner retention, therefore, the analysts only focused on identifying correct or incorrect answers. If a learner answered a question incorrectly or left it

blank, the analyst evaluating the tests deemed the response incorrect. One learner filled out both the pre-test and post-test in a mix between English and Otjiherero, so neither the project team nor the EduVentures staff could read the responses. Therefore, the results below exclude this set of responses.

The team compared the pre-test scores with the post-test scores. The data in Figure 4.18 shows the average percentage of learners who answered correctly for each question type. The questions on the test and their levels of difficulty are in Table 3.4. Learners scored three and a half times better on essential questions after attending all four lesson modules and answering the post-test. The results excited the project team, as the learners were able to answer the essential question: ‘Why is renewable energy important to Namibia?’ after partaking in the program. This indicates that the learners understood and applied the information to answer the essential questions.

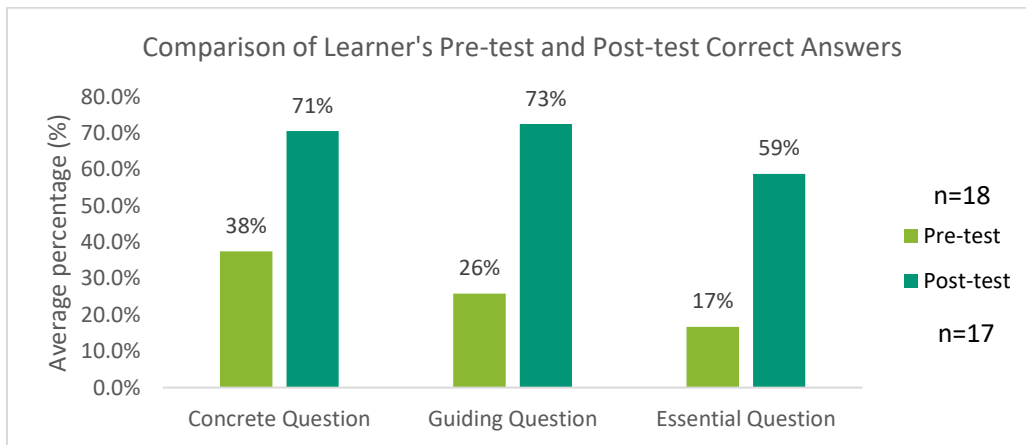

Figure 4.18: Comparison of learner's pre-test and post-test correct answers

The results of the pre-tests and post-tests showed that the modules improved the learners' knowledge on renewable energy topics.

4.6.1 Pre-test and Post-Test Issues

The first issue to arise during the field test was that an EduVentures staff member notified the learners at the beginning of the program that there would be a test after the four lessons. This was in contradiction to what the project group discussed with EduVentures prior to departing on the field test. While the team did not observe any of the learners studying throughout the piloting of the modules, it is possible that this information affected the extent to which the learners paid attention throughout the four lessons. As such, it is possible that this action skewed the results of the post-test results.

One variable of the pre-tests and post-tests was the different sample sizes. At the beginning of the program one learner was missing, so only 19 learners took the pre-test. At the end of the program, two learners were missing. The analysts omitted one learner's responses from the results because they wrote in a combination of English and Otjiherero. It was too difficult to decipher what the learner wrote, even with the help of an EduVentures employee. The learner may have understood the information taught, but the team had no way of determining their score on the pre-test or the post-test. In addition, the sample sizes differed from module to module, so it was difficult to know which learners attended all four modules. Learners who

missed a module would not know key material presented during the lesson, and therefore would not perform as well on the post-test.

Another issue with the survey was the difference in teaching styles of the EduVentures educators. One educator taught modules one and four and went quickly through the modules. The other educator taught modules two and three and told the learners not to take notes, but simply listen to her and engage in the lesson. These different teaching techniques probably affected the learners' retentions from the information in each module. As a result, some learners may have scored better or worse on the post-tests. The team did not analyze the learners' answers by module because the questions for each module on the tests varied in number and in difficulty.

4.7 Learner Evaluations

At the conclusion of the second day of EduVentures' program, one team member distributed the learner evaluation to 20 learners (Appendix VV). The evaluation asked each learner to rank from one to five (excluding three) their answer for each of the ten statements, listed in Table 3.5. A ranking of one represented strongly disagree, two represented agree, four meant agree, and five signified strongly agree. The designer of the learner evaluation decided to not include three on the evaluations because three is a neutral response. By only providing 1, 2, 4, 5 as options the learners needed to provide either a 'like' or 'dislike' as a response. All of the evaluations remained anonymous. Once the team recorded all of the learner's responses, the analysts developed an average ranking for each question out of five. Figure 4.19 shows the average scores for each question. This data indicated a highly positive response from the learners, with all of the average rankings occurring in the 4 to 5 out of 5 range. The question with the lowest ranking was Question 3, which was, *"The lessons were more fun than my classes at school."* One learner left this question blank. The analysts decided to omit his answer and change the sample size for Question 3 to 19 instead of 20. The most promising results to note are the highest averages on Question 2, 6 and 7. Question 2 was *"I think the games and activities in the lessons were fun."* The second highest scoring questions with an average of 4.8 out of 5 were Questions 6 and 7, which asked *"If my school started an environmental club, I would join it,"* and, *"I plan to learn more about renewable energy after the end of this program."* This indicates that the learners enjoyed the interactive aspects of the modules and that the program inspired them to continue their education in these topics after the conclusion of the program.

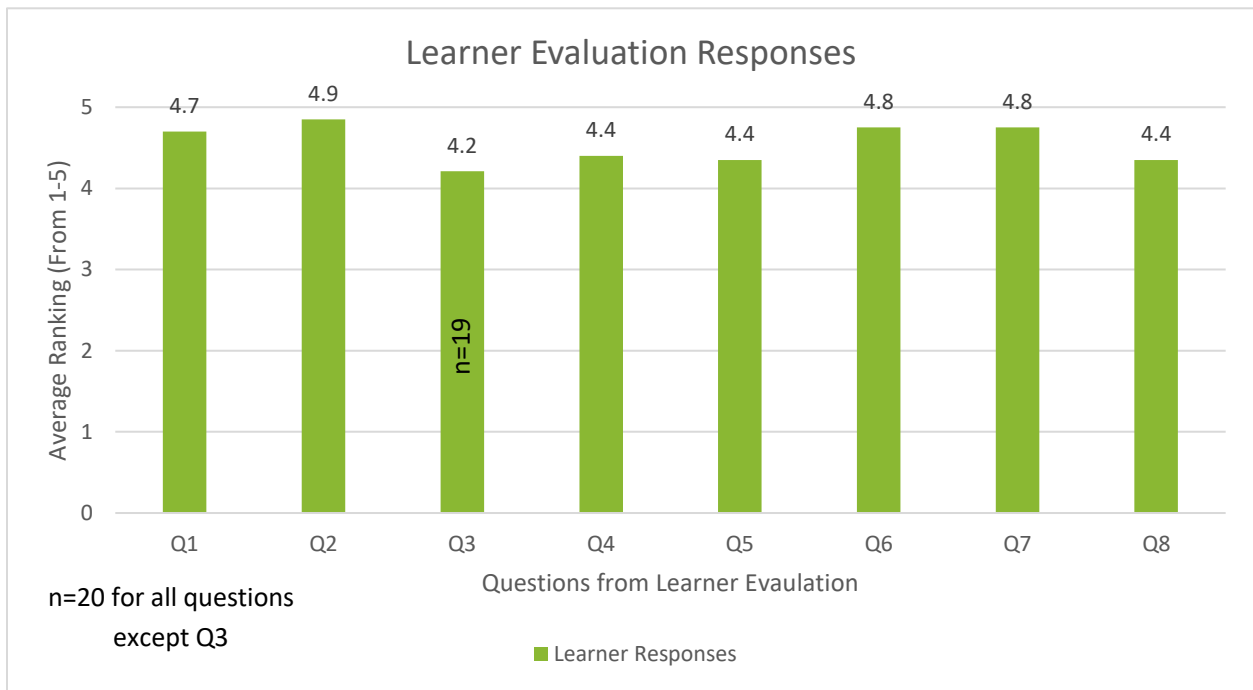

Figure 4.19: Learner evaluation responses

The learner evaluation originally included two additional questions which asked the learners to select which lesson module was their ‘most’ favorite and which was their ‘least’ favorite. However, many of the learners did not understand the words, “most” and “least”, nor the direction to only select one module. Many selected multiple modules, or picked the same module for both their most and least favorite lesson. Due to these inconsistencies, this report does not include these results.

The last part of the learner evaluation was the additional comments section. After the facilitators explained to the learners what this was, many learners left positive and useful remarks, which helped during the modification of the modules. Many of the comments emphasized how much the learners enjoyed the modules and that they want EduVentures to return to their school for another program. One learner commented, “I really liked this program and I enjoyed it very much, and I will love to be [taught] more about energy.” Other comments expressed how the learners appreciated how much the EduVentures staff and project team helped them. One learner commented, “I will like to say thanks to everyone who [taught] us about their program.... THIS PROGRAM IS VERY INTERESTING!” The overwhelmingly positive feedback the learners expressed on this evaluation satisfied the project team, who used this information to modify the lesson plans accordingly.

4.7.1 Learner Evaluation Issues

Several aspects of this evaluation could have influenced the learners’ responses. The most important bias to note is the language barrier between the project team and the learners. Many of the phrases on the evaluation form were difficult for the learners to understand, and several learners had to call a team member over to further explain the question. The most influential language issues were that the learners did not understand *strongly disagree* and *strongly agree* on the ranking portion of the form and did not understand

what the form meant by least favorite module. This could have skewed their answers, as it is possible that the facilitators' verbal explanations of the form did not help them fully understand the question. Another possible bias is that not all learners attended all four modules. For unknown reasons, some learners only attended a select number of the lessons. This could have skewed the learner's responses on how they enjoyed the program.

4.8 Module Modification after the Pilot Test

After the pilot test, the designer of each lesson made edits to their module (see Appendices WW through ZZ). Each module had its successes and pitfalls throughout the program, so the team members collaborated to make suggestions and edits to all of the modules. The team compiled a list of improvements for each module after the program; and then presented the list to the EduVentures staff and asked for any further input. Once the staff completed the list was sufficient, the designers made the adjustments to the modules.

4.8.1 Introduction to Renewable Energy Modifications

The *Introduction to Renewable Energy Module* was the longest module, therefore the designer made several modifications to decrease the length. The first modification was the first group activity. The observers found that the learners took longer to brainstorm different technologies in their community than anticipated. To reduce this time, the EduVentures educator will now assign one technology to each of four self-created (?) groups. The learners will then brainstorm the effects of the technology on their community. After brainstorming for ten minutes, each group will share their ideas with the class for another five minutes.

The module designer also deleted three slides on different renewable energies: nuclear, biogas, and geothermal. These renewable energies are the least relevant to Namibia, so they do not have to be in the module. Since the module designer removed three of the different types of renewable energy, the fill-in-the-blank activity changed as well. The observers found that it took a long time for the learners to come up to the SMART board and write down answers, so the team deleted some slides that asked the learners to write a response. Instead the teacher will ask the learners verbally and have volunteers answer the question orally.

The second modification was removing the industrial revolution video. Learners were unable to follow the video because the English was too complex and the speaker spoke too fast. The designer replaced the video with key bullet points to help discuss the positive and negative effects of the industrial revolution.

Lastly, the designer changed one scenario in the last activity. The second scenario confused the learners because they did not understand how flooding relates to building a wind turbine. The new scenario explains that Tauno will not be able to pay for electricity because of crop failures, so he wants to build a wind turbine. Hopefully the learners will have an easier time understanding this scenario.

After the field test, the module designers made edits to their modules. The following week, each designer presented their changes to the EduVentures staff and asked for their input. They provided the suggestions listed in Table 4.9. The educators believed that the content in the first module was sufficient but they suggested that the designer re-order the slides to explain the importance of renewable energy in a clearer way. The adjusted *Introduction to Renewable Energy Module* is in Appendix WW. Since the order of

the module changed drastically, the designer also created a new teacher’s guide, which is shown in Appendix AAA.

Table 4.9: Module One suggestions from EduVentures educators

Introduction to Renewable Energy – Educator 1	
<i>What didn't go well</i>	<i>Modifications/Suggestions/Comments</i>
Good content but wrong flow.	<ul style="list-style-type: none"> - Start with fossil fuels and how greenhouse gases contribute to climate change, then move into renewable energy. - Emphasize the importance of renewable energy to Namibia; move the slides to the beginning, before explaining the types of renewable energies. - Namibia needs renewable energy because importing energy is expensive. - Move the renewable and non-renewable energy sorting activity to after the explanations of the renewable energies.
Edits already made by Designer before meeting: <ul style="list-style-type: none"> - Changed industrial revolution video to a slide with bullets. - Changed the technology activity to only have 4 technologies choices. - Fixed the scenario that confused the learners. - Removed writing on the board and replaced with oral discussion. 	

4.8.2 Wind Energy Modifications

Overall, this module was a success. The main weakness of the module was the time at which the EduVentures staff taught the module. Since they taught it right after lunch time, the learners were tired and disengaged. However, in regards to changes in the slides of the lesson, the educators found the writing slides, where the learners come up to the board and write their answers, took too long and therefore, needed to change. The EduVentures staff requested that the question appear on the slide and then the educator can simply facilitate a discussion with the learners. The educator who taught the wind energy module accidentally skipped the last activity in the lesson, which was the activity where the learners had to brainstorm activities that they could do in their community to battle climate change. As such, this paper cannot conclude whether that activity was successful or not. Therefore, the designer is going to leave the activity in the lesson. EduVentures employees can remove it if it is not successful in the next implementation of the renewable energy modules. The adjusted wind energy module is shown in Appendix XX.

The EduVentures educators did not have any modifications for the wind energy module besides the modifications already made by the designer of the module. Table 4.10 shows the points talked about with the EduVentures educators.

Table 4.10: Module Two suggestions from EduVentures educators

Wind Energy – Educator 2	
<i>What didn't go well</i>	<i>Modification/Suggestions/Comments</i>
Slides that required the learners to write on the board	- Nothing
Edits already made by Designer <ul style="list-style-type: none"> - Removed the slides that required the learners to write on the board. Replaced the slides with a question that required the educator to facilitate a discussion. 	

4.8.3 Solar Energy Modifications

Overall, this module was a success. However, there were several changes that the designer made to the solar module after its field test in the Ombombo mobile classroom. The first modification pertains to the emerging technologies slide in the lecture, shown in Figure 4.20 below.

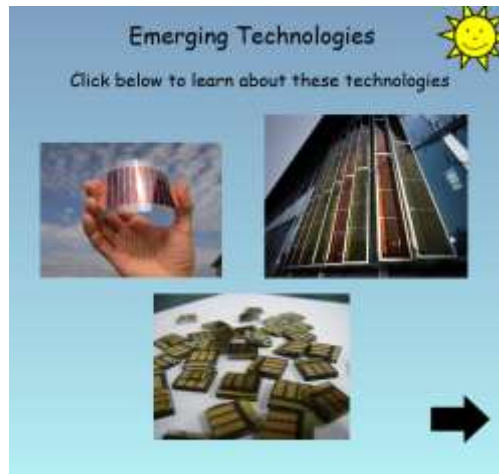

Figure 4.20: Emerging technologies slide from the *Solar Energy Module*

The learners did not grasp the different technologies when presented with the information. As a result, the project team, along with the EduVentures staff, thought it was best to delete this slide all together in order for the learners to stay engaged. The solar operation portion of the lecture also needed modifications. These modifications, however, are more directed towards adding further explanations into slides with the diagrams showing how solar operation works. For example, in the first portion of this process the designer of the module used the term 'UV light', but did not explain that reason why UV light has the ability to remove electrons from the silicon atoms in solar panels. These changes will allow future learners to understand the process, as well as make the lesson easier for the educator to teach. Additionally, the team member edited the drawing activity to make it simpler and make the module shorter. The last modification was the deletion of all writing activities on the board. The modified solar module is shown in Appendix YY.

The EduVentures employees suggested that the designer of the module find a way to further simplify the solar panel operation, and to move the drawing activity to the end of the module due to the amount of time the activity required. They believed it would be best at the end of the module because it would not break up the lesson into two halves. In addition to, the SMART Technology malfunctioned on the slide in which the learners needed to select the regions which were good candidates for solar farms. Therefore, the designer needed to lock the names of the regions with their matching pictures. Table 4.11 shows the breakdown of the discussion.

Table 4.11: Module Three suggestions from EduVentures educators

Solar Energy – Educator 2	
<i>What didn't go well</i>	<i>Modification/Suggestions/Comments</i>
Operation and storage was too complex.	<ul style="list-style-type: none"> - Find an easier way to explain energy operation and storage. - Drawing activity should come at the end. - Lock the names of the regions in the solar farm activity
Edits already made by Designer <ul style="list-style-type: none"> - Made drawing activity simpler: only draw one type of solar technology. - Removed the slides that required writing on the board. - Added more descriptions and details to operation and storage. - Deleted emerging technology slide. - Added more definitions of “passive” and “active”. 	

4.8.4 Bush-to-Energy Modifications

Throughout this module this module, the team members conducting observations found that the educator performed some of the interactive activities intended for learner volunteers. This led to all interactive elements occurring at the end of the lesson, rather than throughout. Moreover, this led to a lower observed learner engagement. To account for this, the designer made modifications to the module. The slides that the educator performed themselves instead of calling for a learner-volunteer now have instructions on the slide to ask for a volunteer. The team member also moved the review activity slides, including the “good vs. bad harvesting practices” and “advantages and disadvantages of Bush-to-Energy” into the lesson so that the learners could perform these activities right after they acquired the material. This should split up the lecture portions of the lesson and allow for the learners to actively participate throughout the duration of the module. There were also instances of a language barrier in which the learners did not understand some of the English used in the module, which caused the module designer to further simplify the English.

When meeting with the EduVentures educators, the designer of the module suggested replacing the terms ‘indigenous’ and ‘alien’ with ‘native’ and ‘not-native’, as this was the most visible language barrier issues. The educators disagreed and said that the learners should learn the terms ‘indigenous’ and ‘alien’. As such, they instructed the designer to incorporate the definitions of indigenous and alien on the invasive species slide. The educators also suggested to remove the fossil fuel slide from the presentation because it confused the learners. Table 4.12 shows the description of the conversation between the project team and the EduVentures staff. The modified Bush-to-Energy module is depicted in Appendix ZZ.

Table 4.12: Module Four suggestions from EduVentures educators

Bush-to-Energy – Educator 1	
<i>What didn't go well</i>	<i>Modification/Suggestions/Comments</i>
Some confusion with flow	<ul style="list-style-type: none"> - The participants should learn the terms ‘indigenous’ and ‘alien’- add to invasive species slide - Remove fossil fuel from Bush-to-Energy definition - Remove fossil fuel slide - Explain encroacher bush first then explain what invasive is
Edits already made by Designer <ul style="list-style-type: none"> - Changed definition of encroacher bush - Moved sorting activities within the module to break up the lecture 	

4.9 Summary of Field-Test Results

The pre-tests and post-tests yielded positive improvements in learner retention and understanding across all questions on the test. Specifically, the results show the biggest improvement in answering the guiding questions. The average percentage of learners who answered guiding questions correctly increased by 47%. Learners began to think deeper about the information while still using the factual information from the lessons. The assessment of the modules also yielded positive results from the learner evaluation. The learners' responses on each question were a rating of four or higher (on a 1-5 scale), which demonstrates that the learners had an overall positive experience from the modules. In addition, the classroom observations reveal that the modules should be around 60 to 90 minutes. After 90 minutes, learner became tired, unfocused and disengaged from the lessons. Although this was not evident in the quantitative data because of the flawed observation form, all observers witnessed that the learners were disengaged and restless during the longer lessons. The loss of learner engagement may stem from several different causes: whether the learners received breaks, whether the educator allowed the learners to take notes, and the functionality of the SMART Technology. Additionally, the language barriers in the learner evaluation made it difficult to gather reliable data. Even after all of these obstacles, the results confirmed that the learners knew more about renewable energy topics after participating in the modules and that they enjoyed their experiences in the Ombombo mobile classroom.

5 Recommendations and Future Work

5.1 Recommendations

Although this report depicts the field test at Okondjatu Combined School as a success, the team believes that the program still has room for improvements. As such, the project group developed these recommendations to help guide EduVentures towards a more successful program in the future:

- 1. EduVentures' educators should practice teaching each of the modules to other staff, as well as the module designer prior to the start of the program.** Although the designer of each module spent time teaching the educators how to execute the lesson, future educators teaching the modules should perform a full rehearsal of the module without the designer's assistance. If possible, the designer of the module should be present but should simply listen to the educator's approach to the lesson. This will allow the educator to ask the designer any questions about the module or clarify anything about the structure of the activities in the module. If the designer cannot be there, the educators should still teach the modules to other EduVentures staff. The educator would also be able to determine the timing of each lesson. If the educators realize that they are spending too long on one topic during the practice, they can adjust their teaching styles for the actual program. Practicing the modules will allow for a smoother and more efficient delivery of the modules and should increase learner engagement for all of the lessons.
- 2. EduVentures should create and implement more competitive games into their program.** The competitive games engaged the learners and inspired them to work together to recall the module content. Encouraging the learners to work together in teams to compete against their peers was a fun technique of solidifying learner retention of the information from the lessons. The EduVentures employees and the project team noted that these games were highly successful and future teams should create similar games and activities for future modules.
- 3. EduVentures should use motivators such as candy and other prizes throughout the lessons to maintain learner engagement.** When conducting classroom observations, the team found that the learners were much more engaged and interested in the information presented when they received a prize for participating. This increased the competitive spirit of the learners and made them more willing to participate. However, only one team member brought candy to distribute throughout their lesson as a motivator. If EduVentures supplies prizes for all of the lessons presented in future excursions, the project team believes that the learners will remain more engaged and interested in every module.
- 4. EduVentures should periodically update the modules as technology advances in the future.** The goal of the modules is to educate rural learners on renewable energy. However due to the fact that the technologies are not static and are constantly changing, EduVentures will have to constantly update them. This is to ensure that the learners receive the most recent information in these topics.

5.2 Future Work

The team has several recommendations for any future project teams that work on projects with EduVentures.

Conduct classroom observations, interview stakeholders, and go on the pre-visits to the rural schools.

These methods of data collection provided this study with information that was vital to the success of the project. Classroom observations and teacher interviews allowed the researchers to gather information on the Namibian school system, so that the designers of each module could cater the lessons to a Namibian learner. Stakeholder interviews provided recommendations to the team about information to include in the modules and corrected any misconceptions the team had about renewable energy in Namibia. Teacher interviews provided expert advice on how to build a curriculum and successful teaching techniques. Surveys that the team distributed during the pre-visits provided information on the level of pre-existing knowledge the learners had on renewable energy topics. The project would not have been as successful without these methods. Therefore, this project team encourages that future teams working with EduVentures Trust consider these methods when collecting preliminary data.

Collaborate with EduVentures to schedule all important events during the preparatory term.

EduVentures had difficulty scheduling classroom observations because many schools were on holiday or in the middle of examinations. The best time to conduct classroom observations and pre-visits was the first or second week on site. However, due to a slow start, the team was not able to visit any schools until the fourth week. Due to time constraints, the project group was only able to conduct a minimal amount of stakeholder interviews. If future teams can schedule both classroom observations, pre-visits, and stakeholder interviews with EduVentures during the preparatory term, it is possible that they will be able to collect more preliminary data. Additionally, if future project teams schedule the classroom observations ahead of time, it is possible that they could observe more classrooms, and even visit multiple schools. This would allow for a higher sample size and they would then be able to confidently identify common trends. Conducting additional stakeholder interviews would allow for a more consistent sample size for all stakeholder categories and obtain additional information. By conducting the pre-visits earlier in the term, the module designers could have gained valuable information about learner background in renewable energy topics, which was influential to the development process. In addition, by going earlier in the term, the team could have potentially conducted rural classroom observations rather than urban classroom observations. After the completion of the pre-visits, the schools spent around two weeks preparing their applications for EduVentures- this forced the field test of the modules into the second to last week of the project. The team highly recommends to shift the entire schedule forward at least one or two weeks, so that the field test does not occur so close to the end of the term.

Outline the modules in the preparatory term.

The module designers wished that the opportunity arose to complete the outlines of the modules prior to arrival to Namibia. If the project group started or even completed the first draft of the module outlines in the preparatory term, there would have been more time to conduct interviews, classroom observations, and develop the modules alongside the EduVentures employees.

Understand that the extent to which the language barrier exists and address this in all aspects of your project.

Throughout this study, there were several instances in which the researchers faced difficulties in regards to the language barrier between the team and the rural learners. Understanding that a language barrier exists, and working to address this issue in all aspects of future projects is an important step to success. A possible future project could be designing and creating an industrial revolution video, similar to the Biodiversity video developed by the 2016 WPI Project Team. The video should contain similar information to the current video, but include slower and simplified English.

Work together to peer-edit each other's modules.

Each team member was responsible for all of the materials for one module. Although this was time efficient, the module designers believed that the modules would have been more uniform if the team peer-edited the modules more often throughout the development process. After working on only one module for the entirety of the project, the designers had minimal knowledge on the modules that were not their own. By peer-editing or rotating the authorship of the modules, the team believes the modules would have been even more successful.

Understand the technological limitations you will face when completing an international project

Technological standards vary greatly across the world. Internet availability may be limited, which could hinder the abilities of future teams to efficiently complete their tasks. It is important to anticipate any and all possible obstacles in regards to access to technological and Internet resources while in country, and to prepare for any setbacks that may arise during the preparatory term. Be sure to download any software that you may need to complete your project, such as SMART Notebook or a Video editing software, prior to your departure. It is also important to remember to be patient and work around this limitation to ensure the success of a project.

6 Conclusion

This project has the potential to make a significant impact on Namibia. The success of this project led the Hanns Seidel foundation to consider extending their Renewable Energy Awareness program from three years to eight. They also decided to increase the amount of funds dedicated to this project, to provide high performing schools who participate in EduVentures' program with some of the technologies taught in the lesson modules (Doderer, 2017). This means that, not only will EduVentures be able to educate additional learners on renewable energy topics, they will also be able to contribute to Namibia's transition to renewable energy through the implementation of these technologies in rural communities. Education is essential for national development, but the quality of education offered to rural learners is significantly lower than urban learners. To progress as a nation, education for all citizens must increase significantly but especially for those in rural areas. Now that the nation is facing severe consequences from climate change, uniting the country through education is essential. This project assisted Namibia in its transition to renewable energy resources by focusing on the future consumers, employees, and stakeholders of their nation, the youth. These renewable energy modules will expose rural high school learners throughout the nation to the problems of climate change and how renewable energy can help mitigate these effects. In the post-test, the learners performed significantly better on all types of questions. These results indicated that the learners developed a deeper understanding of the information presented in the modules. This growth between the pre-tests and the post-tests, along with high remarks from the learner evaluation, demonstrated that the modules were a success. After field testing in Okondjatu, the team finalized the modules for future use in villages throughout Namibia, and provided the EduVentures staff with a complete renewable energy curriculum and project presentation for a proposal to the Ministry of Education.

Bibliography

- A Few Small Incidents Can Take Out As Many Days As A Major Failure. (2008). ISET. Retrieved from <http://offlinehbpl.hbpl.co.uk/NewsAttachments/OPW/data2.gif>
- Amatya, R., Brushett, F., Campanella, A., Maurano, A., Kavlak, G., Macko, J., . . . Tuller, H. (2015). *The Future of SOLar Energy*. MIT, Cambridge, MA. Retrieved January 29, 2017, from <http://energy.mit.edu/wp-content/uploads/2015/05/MITEI-The-Future-of-Solar-Energy.pdf>
- Athman, J., & Monroe, M. (2001). *Elements of Effective Environmental Education Programs*. Recreational Boating & Fishing Foundation. ERIC. Retrieved January 22, 2017, from <https://eric.ed.gov/?id=ED463936>
- Atta, T. (n.d.). *Vertical Axis Wind Turbine Parts*. Retrieved March 23, 2017, from Green-Mechanic: <http://www.green-mechanic.com/2013/03/vertical-axis-wind-turbine-parts.html>
- Ben-Shahar, R. (1992). The Effects of Bush Clearance on African Ungulates in a Semi-Arid Nature Reserve. *Ecological Applications*, 2(1), 95-101. doi:10.2307/1941892
- Benyamin, L. T., & Nantanga, L. I. (n.d.). *The Namibia National Climate Change Committee (NCCC) evaluation and the possibility of establishing the Regional Climate Change Committees (RCCCs)*. Africa Adaption Project Namibia (AAP NAM). Namibia: Ministry of Environment and Tourism (MET). Retrieved March 2017
- Biraimah, K. L. (2016). Moving beyond a destructive past to a decolonised and inclusive future: The role of ubuntu-style education in providing culturally relevant pedagogy for Namibia. *International Review of Education*, 62(1), 45-62. doi:10.1007/s11159-016-9541-1
- Brain, M. (2000, April 1). *How Steam Engines Work*. Retrieved March 2017, from HowStuffWork.com: <http://science.howstuffworks.com/transport/engines-equipment/steam.htm>
- BWE Bundesverband WindEnergie. (n.d.). *The Structure of a Modern Wind Turbine – An Overview*. Retrieved March 23, 2017, from www.wind-energie.de
- Carr, K. E. (2017, February). Photons: What is a Photon? - Physics of Light. *QUATR.US*. Retrieved March 2017, from <http://quatr.us/physics/light/photon.htm>
- Chin, L. (n.d.). *Education in Namibia*. Retrieved March 2017, from The Knowledge of Namibia: <http://knownamibia.weebly.com/education.html>
- Chioreso, E., & Begbie-Clench, B. (2015). Think Namibia: Land Degradation. *Think Namibia*. Hanns Seidal Foundation of Namibia. Retrieved February 2017
- Chioreso, E., & Munyayi, R. (2015). Think Namibia: Climate Smart Agriculture. *Think Namibia*. Hanns Seidal Foundation Namibia. Retrieved February 2017
- Concentrating Solar Power (CSP) Technologies*. (n.d.). Retrieved February 5, 2017, from Solar Energy Programmatic EIS: <http://solareis.anl.gov/guide/solar/csp/>

- Corris, K. (2017). Ombombo Mobile Classroom: sustainability biodiversity heritage. Okondjatu. Retrieved April 2017
- Cunningham, G. (2009). *Chapter 7: Lesson Plans and Unit Plans: The Basis for Instruction*. Retrieved March 2017, from ASCD: <http://www.ascd.org/publications/books/109051/chapters/Lesson-Plans-and-Unit-Plans@-The-Basis-for-Instruction.aspx>
- Deng, Z. (2015). Bringing curriculum theory and didactics together: a Deweyan perspective. *Pedagogy, Culture & Society*, 24(1), 75-99. doi:10.1080/14681366.2015.1083465
- Dhar, M. (2013, December 16). *How Do Solar Panels Work?* Retrieved from Live Science: <http://www.livescience.com/41995-how-do-solar-panels-work.html>
- Dodd, J. (2013, August 13). *Namibia pushed to install wind power*. Retrieved March 23, 2017, from Wind Power Monthly: <http://www.windpowermonthly.com/article/1194848/namibia-pushed-install-wind-power>
- Doderer, C. v. (2017, May 3). Discussion about the future of the Hanns Seidel Foundation's renewable energy project. (E. D. Timothy Consedine, Interviewer)
- DRFN. (2012). *Bush Encroachment in Namibia*. Desert Research Foundation Namibia. Retrieved April 2017
- Dunham, E., Hawkes, B., Lyles, C., & Misera, A. (2015). *Sustainable Movement: Developing A Mobile Environmental Education Curriculum for Rural Schools in Namibia*. Worcester Polytechnic Institute, Worcester, Massachusetts. Retrieved April 2017
- EduVentures Trust. (2008). *About*. Retrieved February 2017, from EduVenture: http://eduventures-africa.org/1_about.htm
- Ejikeme, A. (2011). *Culture and Customs of Namibia* (126-140 ed.). ABC-CLIO. Retrieved May 1, 2017
- Encyclopedia Britannica (Ed.). (2017, March 09). *Industrial Revolution*. Retrieved March 23, 2017, from Encyclopedia Britannica.
- Energy.gov. (2017). *Advntages and Challengedes of Wind Energy*. Retrieved from Energy.gov: <https://energy.gov/eere/wind/advantages-and-challenges-wind-energy>
- Energy.gov. (2017). *Fossil*. Retrieved April 2017, from Energy.gov: <https://energy.gov/science-innovation/energy-sources/fossil>
- EPA. (n.d.). *Glossary of Climate Change Terms*. Retrieved from EPA: <https://www3.epa.gov/climatechange/glossary.html>
- Erixon Arreman, I., Erison, P.-O., & Rehn, K.-G. (2016). Postcolonial teacher education reform in Namibia: Travelling of policies and ideas. *European Education Research Journal*, 15(2), 236-259. doi:10.1177/1474904115612794
- eSchoolToday. (2010). *Renweable Energy Sources*. Retrieved April 2017, from Energy: An Ideal Revision Lesson For All Young People: <http://www.eschooltoday.com/energy/renewable-energy/biomass-energy.html>

- Felby, C., & Bentsen, N. (2011). Biomass for energy in the European Union - a review of bioenergy resource assessments. *Biotechnology for Biofuels*. Retrieved February 2017, from <https://biotechnologyforbiofuels.biomedcentral.com/articles/10.1186/1754-6834-5-25>
- Felder, R. (2017, February 22). *Learner-Centered Teaching*. Retrieved April 2017, from Learner-Centered Teaching: <http://www4.ncsu.edu/unity/lockers/users/f/felder/public/Student-Centered.html>
- Ferguson, L. (2002). *Evaluation and Visitor Research Special Interest Group*. EVRSIG Publications Committee. Retrieved March 2017
- Ferrouhki, R., Khalid, A., Renner, M., & Lopez-Pena, A. (2016). *Renewable Energy and Jobs Annual Review 2016*. IRENA. Retrieved April 2017
- Filigree Consulting. (2016). *TEACHING, TECHNOLOGY, AND LEARNING: Understanding the Interconnection*. Filigree Consulting. Retrieved February 18, 2017
- Gaido, D. (Ed.). (2005). John Dewey's Theories of Education. *International Socialist Review*, 21(1, Winter 1960). Retrieved February 4, 2017
- Gaspar, F., Deac, T., Tutunaru, L. V., & Moldovnu, D. (2016). Experimental Study on the Sun Tracking Ability of a Spherical Solar Collector. *Energy Procedia*, 85, 220-227. doi:10.1016/j.egypro.2015.12.227
- Gill, P., Stewart, K., Treasure, E., & Chdwick. (2008). Methods of data collection in qualitative research: interviews and focus groups. *British Dental Journal*, 204(6), 291-295. doi:10.1038/bdj.2008.192
- GmbH, D. G. (Producer), & German Cooperation Deusch Zusammenarbeit (Director). (2015). *GIZ: De-bushing Namibia* [Motion Picture]. Federal Ministry for Economic Cooperation and Development. Retrieved February 2017
- Gustafson, C. (n.d.). *New Energy Economics: Future Biomass Markets*. Retrieved January 22, 2017, from North Dakota State University News: <https://www.ag.ndsu.edu/news/columns/biofuels-economics/new-energy-economics-future-biomass-markets/>
- Hansen, R. E. (1995). Five Principles for Guiding Curriculum Development Practice: The Case of Technological Teacher Education. *Journal of Industrial Teacher Education*, 32(2). Retrieved February 4, 2017
- Harvey, C. (2016, January 15). Thus technology be the future of solar energy. *The Washington Post*. Retrieved January 22, 2017
- History.com Staff. (2009). *Industrial Revolution*. Retrieved March 23, 2017, from history.com: <http://www.history.com/topics/industrial-revolution>
- How Biopower Works*. (2015, November 12). Retrieved February 2017, from Union for Concerned Scientists for a Safe and Healthy World: http://www.ucsusa.org/clean_energy/our-energy-choices/renewable-energy/how-biomass-energy-works.html#.WIVykPkrJPa
- How Wind Energy Works*. (n.d.). Retrieved January 21, 2017, from Union of Concerned Scientists: <http://www.ucsusa.org/clean-energy/renewable-energy/how-wind-energy-works>

- INSABA. (n.d.). *Development of RE in the South Africa and Namibia*. Intelligent Energy Europe. Integrated Southern Africa Business Advisory. Retrieved January 29, 2017, from https://ec.europa.eu/energy/intelligent/projects/sites/iee-projects/files/projects/documents/insaba_development_of_re_in_the_region.pdf
- Jaber, S. (2013). Environmental Impacts of Wind Energy. *Journal of Clean Energy Technologies*, 1(3). Retrieved February 2017
- Jackson, R. (2017, February 16). *Global Climate Change: Effects*. Retrieved March 2017, from Climate Change: Vital Signs of the Planet: <https://climate.nasa.gov/effects>
- Johansson, A. (2016). Plastic Wind Trees Are Bringing Sustainable Power To Homes. Retrieved January 22, 2017, from PSFK: <http://www.psfk.com/2016/08/plastic-wind-trees-are-bringing-sustainable-power-to-residential-homes.html>
- Jong, W. d., & Ommen, J. R. (2014). *Biomass as a Sustainable Energy Source for the Future: Fundamentals of Conversion Processes*. John Wiley & Sons. Retrieved February 3, 2017
- Josefsson, L. G. (2016, January 26). Bioelectricity is the Future of Namibia. *The Namibian*. Retrieved March 2017
- Kamupingene, T. (2002). *Education for All: National Plan of Action*. Government of the Republic of Namibia. Retrieved February 2017, from <http://planipolis.iiep.unesco.org/upload/Namibia/Namibia%20EFA%20NPA.pdf>
- Kandpal, T. C., & Broman, L. (2014). Renewable energy education: A global status review. *Renewable and Sustainable Energy Reviews*, 300-324. doi:10.1016/j.rser.2014.02.039
- Katjavivi, P. H. (2016). *Educational Transformation in Namibia*. Forum of the Commonwealth Council on Education. Retrieved March 2017, from http://www.parliament.na/phocadownload/media/2016/speech_at_commonwealth_16.pdf
- Kelly, A. V. (2009). *The Curriculum* (6th ed. ed.). Retrieved January 2017
- Kioko, J. (2010). Youth's Knowledge, Attitudes and Practices in Wildlife and Environmental Conservation in Maasailand, Kenya. *Southern African Journal of Environmental Education*. Retrieved January 22, 2017
- Kolb, D. (2014). *Experiential Learning: Experience as the Source of Learning and Development* (2nd ed. ed.). Pearson FT Press. Retrieved January 22, 2017
- LandCentury. (2017). *What Type of Land Do You Need for Solar and Wind Energy Solutions?* Retrieved from LandCentury: <https://www.landcentury.com/articles-news/what-type-of-land-do-you-need-for-solar-and-wind-energy-solutions/>
- Lubinda, M. (2015). Think Namibia: Climate Change. Hanns Seidel I Foundation Namibia. Retrieved March 2017
- Maehlum, M. (2013, May 3). *How Electricity is Generated from Biomass*. Retrieved January 22, 2017, from EnergyInitiative: <http://energyinformative.org/how-electricity-is-generated-from-biomass/>

- Matthews, K. (2016, June 2). *Difference Between Active and Passive Solar System*. Retrieved May 4, 2017, from Conserce Energy Future: <http://www.conserve-energy-future.com/difference-between-active-and-passive-solar-systems.php>
- McTighe, J., & Wiggins, G. (2013). *Essential Questions: Opening Doors to Student Understanding*. ASCD. Retrieved April 2017, from <http://www.ascd.org/publications/books/109004/chapters/What-Makes-a-Question-Essential%C2%A2.aspx>
- Meyers, B. (2013, December 9). *Types of Wind Turbines*. Retrieved February 2017, from Centurion Energy: <http://centurionenergy.net/types-of-wind-turbines>
- Meyers, B. (2013, March 4). *Wind Turbines: How Much Power Can You Expect*. Retrieved February 2017, from Centurion Energy: <http://centurionenergy.net/wind-energy-advantages>
- Milborrow, D. (2010, June 10). *Breaking down the cost of wind turbine maintenance*. Retrieved from Wind Power Monthly: <http://www.windpowermonthly.com/article/1010136/breaking-down-cost-wind-turbine-maintenance>
- Milborrow, D. (2010, June 15). *Breaking down the cost of wind turbine maintenance*. *Wind Power Monthly*. Retrieved March 23, 2017, from <http://www.windpowermonthly.com/article/1010136/breaking-down-cost-wind-turbine-maintenance>
- Ministry of Agriculture. (2016). *Forestry and Environmental Authorisations Process for Bush Harvesting*. Retrieved April 2017
- Ministry of Education. (2010-2011). World Data on Education- Namibia. *UNESCO-IBE(7)*, 6-10. Retrieved March 2017
- Ministry of Education, Arts, and Culture. (2017). *Ministry of Education - Namibia*. Retrieved April 2017, from [moe.gov.na](http://www.moe.gov.na): <http://www.moe.gov.na/>
- Ministry of Environment & Tourism. (2011). *National Policy on Climate Change for Namibia*. Republic of Namibia. Retrieved April 2017
- Minnis, J. R. (2006). Nonformal Education and Informal Economies in Sub-Saharan Africa: Finding the Right Match. *Adult Education Quarterly*, 56(2), 119-133. doi:10.1177/0741713605283
- Munyayi, R., Iлека, H., & Chiguvare, Z. (2015). *Think Namibia: Renewable Energy*. Hanns Seidel Foundation Namibia. Retrieved February 2017
- Murphy, S. (2013). Classroom Observation Form. Retrieved February 27, 2017, from <https://www.slideshare.net/SusanMurphyLCC/classroom-observation-form-27312652>
- Namibia - EEP Africa*. (2015). Retrieved January 22, 2017, from Energy and Environment Partnership/Southern and East Africa: <http://eepafrica.org/projects/namibia/>
- Namibia Unemployment Rate*. (n.d.). Retrieved January 22, 2017, from <http://www.tradingeconomics.com/namibia/unemployment-rate>

- Namibian Education System. (2012). Retrieved February 2017, from Classbase:
<http://www.classbase.com/countries/Namibia/Education-System>
- NamPower. (2012). *PREFEASIBILITY STUDY FOR BIOMASS POWER PLANT, NAMIBIA*. Retrieved March 2017
- National Planning Commission. (2004). *Vision 2030*. Government of the Republic of Namibia. Retrieved February 2017
- National Renewable Energy Laboratory. (n.d.). *Biomass Energy Basics*. Retrieved January 22, 2017, from National Renewable Energy Laboratory: <https://www.nrel.gov/workingwithus/re-biomass.html>
- Office of Energy Efficiency & Renewable Energy. (n.d.). *Advantages and Challenges of Wind Energy*. Retrieved March 23, 2017, from Energy.gov: <https://energy.gov/eere/wind/advantages-and-challenges-wind-energy>
- Osman, N. (2015, May 19). *Top 7 Disadvantages of Solar Energy*. Retrieved January 22, 2017, from Understandsolar: <https://understandsolar.com/advantages-vs-disadvantages-solar-power/>
- Oxford English Dictionary. (n.d.). Definition of arid in English. Oxford English Dictionary. Retrieved February 2017
- Par Group de recherche Littoral et vie. (n.d.). Experiential Learning in Environmental Education. *Université de Moncton, NB*. Retrieved February 2017
- Parke, P. (2015, January 12). *The 'Wind Tree' that could heat your home*. Retrieved January 21, 2017, from CNN: <http://www.cnn.com/2015/01/21/tech/wind-tree-arbre-a-vent/index.html>
- Parry-Hill, M. J., Sutter, R. T., & Davidson, M. W. (2015). *Solar Cell Operation*. Retrieved May 1, 2017, from Molecular Expressions: <http://micro.magnet.fsu.edu/primer/java/solarcell/>
- Pelissari, A. (2017, January 29). Interview with a Middle School History Teacher. (K. Pelissari, Interviewer) Retrieved January 2017
- physics.org. (2017). *How do solar cells work?* Retrieved February 2017, from physics.org.
- REEEP. (2015, October 11). *REEEP - Namibia (2014)*. Retrieved January 22, 2017, from REEEP: <https://www.reeep.org/namibia-2014>
- ReGenerate. (2017). *What is Biogas?* Retrieved April 2017, from ReGenerate: <http://www.regeneratebiogas.com/what-is-biogas/>
- Reinhard, K., Pogrzeba, A., Townsend, R., & Pop, C. A. (2016). A comparative study of cooperative education and workintegrated learning in Germany, South Africa, and Namibia. *Asia-Pacific Journal of Cooperative Education*, 249-263. Retrieved February 2017
- Renkhoff, N. A. (Ed.). (2014). *Powering Namibia Into the Future: Towards Sustainable Energy Production*. Friedrich Ebert Stiftung. Retrieved April 2017
- Rieck, J. (2013, May 22). Map of Namibia. Retrieved April 2017, from <http://jriek.blogspot.com/2013/05/pray-for-benguella-baptist-church-in.html>

- Rosenberg, R. H. (2008). Diversifying America's energy future: the future of renewable wind power. *Virginia Environmental Law Journal*, 1045-5183. Retrieved February 2017
- SA Places. (2016). *Map of Namibia*. Retrieved April 30, 2017, from SA Places: <http://www.places.co.za/html/map-of-namibia.html>
- Saylan, C., & Blumstein, D. (2011). *The Failure of Environmental Education (And How We Can Fix It)*. University of California Press. Retrieved January 22, 2017
- Science Daily. (n.d.). *Renewable Energy*. Retrieved March 2017, from Science Daily: https://www.sciencedaily.com/terms/renewable_energy.htm
- Sebitosi, A. B., & Pillay, P. (2008). <http://scholarship.law.wm.edu/cgi/viewcontent.cgi?article=1084&context=facpubs>. *Energy Policy*, 3312--3316. doi:10.1016/j.enpol.2008.05.013
- Shaftel, H. (Ed.). (2017, March 16). *A blanket around the Earth*. Retrieved March 17, 2017, from <https://climate.nasa.gov/causes/>
- Shaftel, H. (Ed.). (2017, February 23). *Climate change evidence: How do we know?* Retrieved March 17, 2017, from <https://climate.nasa.gov/evidence/>
- Shwarts, M. (2016, October 20). New perovskite solar cell design could outperform existing commercial technologies, Stanford and Oxford scientists report. *Stanford News*. Retrieved March 2017, from <http://news.stanford.edu/2016/10/20/perovskite-solar-cell-design-shows-promise/>
- Smith, J.-M. (2011, November 15). Wind energy could fill Namibia's electricity gap. *The Namibian*, p. Front Page. Retrieved March 17, 2017, from <http://www.namibian.com.na/index.php?id=88177&page=archive-read>
- Smith, J.-M. (2011, November 2011). Wind energy could fill Namibia's electricity gap. *The Namibian*, p. 1. Retrieved March 23, 2017
- Solar Cookers: Varieties and Styles*. (2015). Retrieved May 1, 2017, from Solar Cooker at CantinaWest: <http://www.solarcooker-at-cantinawest.com/solarcookers-types.html>
- Solar Energy*. (n.d.). Retrieved January 22, 2017, from SEIA: <http://www.seia.org/about/solar-energy>
- Solar Panel Maintenance*. (n.d.). Retrieved March 23, 2017, from The Solar Company: <https://www.thesolarco.com/solar-energy/solar-panels/solar-panel-maintenance/>
- Song, Y. I. (2008). Exploring Connections Between Environmental Education and Ecological Public Art. *Childhood Education*, 85(1). Retrieved March 2017
- Steve. (2013, October 25). Map1: Vulnerability. Retrieved from <https://blographyvarndeancollege.wordpress.com/2013/10/25/climate-change-in-africa/>
- The European Wind Energy Association. (2009). *The Economics of Wind Energy*. Sussex, United Kingdom. Retrieved February 2017

The Future of Biomass Energy. (2005). *Energy Technology Innovation Policy Seminar Series*. Retrieved February 2017, from <http://www.belfercenter.org/event/future-biomass-energy>

The Namibian. (2007, March). On The Rural/Urban Schools Divide. *The Namibian*. Retrieved March 2017

The Solar Foundation. (2016). *National Solar Job Census*. Retrieved February 5, 2017, from The Solar Foundation: <http://www.thesolarfoundation.org/national/>

Typesetter. (2016, August 12). Converting Bush to Clean Energy. *Namibia Economist*. Retrieved March 2017, from <https://economist.com.na/18798/environment/convertng-bush-to-clean-energy/>

U.S. Department of Energy. (2012). *Sunshot Vision Study: A Comprehensive Analysis of the Potential for U.S. Solar Electricity Generation*. Technical Report, National Renewable Energy Laboratory, United States. doi:10.2172/1043097

U.S. Department of Energy FEMP. (2016, September 15). *BIOMASS FOR ELECTRICITY GENERATION*. Retrieved March 2017, from WBDG: <https://www.wbdg.org/resources/biomass-electricity-generation>

Unemployment rate - Namibia Data Portal. (n.d.). Retrieved January 22, 2017, from Namibia Data Portal: <http://namibia.opendataforafrica.org//blizore/unemployment-rate?Region=Namibia>

UNESCO. (2004). *National Report on the Development of Education in Namibia*. Ministry of Education: Sports and Culture. Retrieved March 2017

University of Texas at Austin. (2016-2017). *Experiential Learning Defined*. Retrieved February 2017, from University of Texas at Austin Faculty Innovation Center: <https://facultyinnovate.utexas.edu/teaching/strategies/overview/experiential-learning>

US EPA. (n.d.). *What is Environmental Education?* Retrieved February 12, 2017, from EPA: United States Environmental Protection Agency: <https://www.epa.gov/education/what-environmental-education>

(2015). *Utilisation of Namibian Encroacher Bush*. Development Consultants of Southern Africa (DECOSA) CC. Retrieved January 29, 2017, from [http://www.the-eis.com/data/literature/Biomass%20Value%20Chain%20Opportunities_Complete%20\(2015\)-2.pdf](http://www.the-eis.com/data/literature/Biomass%20Value%20Chain%20Opportunities_Complete%20(2015)-2.pdf)

Vattenfall. (2016, August 24). *Biomass plant - how it works*. Retrieved April 29, 2017, from Vattenfall: <http://corporate.vattenfall.com/about-energy/renewable-energy-sources/biomass/how-it-works/>

What Type of Land Do You Need for Solar and Wind Energy? (n.d.). Retrieved March 23, 2017, from Land Century: <https://www.landcentury.com/articles-news/what-type-of-land-do-you-need-for-solar-and-wind-energy-solutions/>

WhatisNuclear. (2016). *Learn about nuclear energy*. Retrieved March 2017, from <https://whatisnuclear.com/>

Wind 101: the basics of wind energy. (n.d.). Retrieved February 2017, from American Wind Energy Associations: <http://www.awea.org/wind-energy-101>

Wind Energy and Wind Power. (n.d.). Retrieved February 2017, from Wind energy Development Programmatic EIS: <http://windeis.anl.gov/guide/basics/>

Zyadin, A., Puhakka, A., Ahponen, P., Cronberg, T., & Pelkonen, P. (2012). School students' knowledge, perceptions, and attitudes toward renewable energy in Jordan. *Renewable Energy*, 45, 78-85. doi:10.1016/j.renene.2012.02.002

Appendix A: High School Teacher Interview Plan

Stakeholder Category: Local (Windhoek) Teachers
Interviewer name:
Transcriber:
Interviewee name (if permission was granted):
Date & Time of Interview:
Location:
Project Description and Goal: Hello, we are students from WPI working with EduVentures to develop interactive lessons on renewable energy for their mobile classroom. We would like to interview you on information regarding educational techniques and curriculum building.
Confidentiality Statement: We are students from Worcester Polytechnic Institute working with EduVentures to develop interactive lessons on renewable energy for their mobile classroom. We wish to interview you to hear your opinions on Namibian education and renewable energy so that we can assist EduVentures in their mission to teach rural learners more about renewable energy. We will not ask for your name or other personal information and will refer to you as [Teacher/Official/Informed Young Adult] X. Any information you share with us about the questions may be accessible to the public on the internet in our final report. If you wish to provide your name, please let us know. Your participation in this interview is completely voluntary and any information you share with us is greatly appreciated. However, if at any time, you are uncomfortable and wish to stop the interview, let us know and we will stop immediately. Do you have any questions? At this time, we will begin the interview.
Q: What inspired you to be a teacher? What is your favorite part about your job? A:
Q: How long have you been a teacher? What type of environments have you taught in? (public or private? Urban vs rural?) If so, please elaborate on the difference between the teaching experiences. A:
Q: What is the biggest challenge when working with high school learners? A:
Q: What is important to include in a science lesson for high school learners? A:
Q: Over the years, has your style of teaching changed? If so why? A:
Q: Typically, when are the learners most focused during the lessons? Why? When are the learners least focused during the lesson? Why? A:
Q: How do you make lessons interactive and engaging for the learners? A:
Q: What do learners already know about renewable energy from your school's curriculum? A:

Q: Do learners usually benefit from renewable energy lessons?

A:

Q: In your opinion, what do you think we should be add to our lesson modules in order to make them as effective as possible?

A:

Q: Have you heard of *Vision 2030*? Has *Vision 2030* changed how you create a lesson plan? If yes, how so?

A:

Q: Do we have permission to use your name in our final report?

A:

Additional Comments:

Final Remarks: Thank you for taking the time to meet with us and share your opinions. If you have any questions or comments about the interview or the information we have collected, you can contact us at nam17-eduvent@wpi.edu. If this method of communication does not work, please contact EduVentures Trust, and they will forward your questions or comments to us.

Appendix B: Namibian Government Official Interview Plan

Stakeholder Category: Government Officials
Interviewer:
Transcriber:
Interviewee Name/Position (if permission was granted):
Date & Time of Interview:
Location:
Project Description and Goal: Hello, we are students from WPI working with EduVentures to develop interactive lessons on renewable energy for their mobile classroom. We would like to interview you on information regarding renewable energy education and initiatives.
Confidentiality Statement: We are students from Worcester Polytechnic Institute working with EduVentures to develop interactive lessons on renewable energy for their mobile classroom. We wish to interview you to hear your opinions on Namibian education and renewable energy so that we can assist EduVentures in their mission to teach rural learners more about renewable energy. We will not ask for your name or other personal information and will refer to you as [Teacher/Official/ Informed Young Adult] X. Any information you share with us about the questions may be accessible to the public on the internet in our final report. If you wish to provide your name, please let us know. Your participation in this interview is completely voluntary and any information you share with us is greatly appreciated. However, if at any time, you are uncomfortable and wish to stop the interview, let us know and we will stop immediately. Do you have any questions? At this time, we will begin the interview.
Q: What is your position within the government and what department do you work under? How long have you been working in your department? A:
Q: What made you want to pursue a career in Namibia's Energy Department? How has your department changed during your employment? Please explain. A:
Q: What do you believe to be the biggest threat to Namibia's environment? A:
Q: What is your opinion on educating Namibian youth in Renewable Energy Topics such as wind energy, solar energy, and Bush-to-Energy? A:
Q: Do you have any ideas for improving the guidelines of processing harvested bush? If so, what are they? A:
Q: Do you think that it is possible for Namibia to stop depending on foreign countries for energy? How many years do you think that would take? Why? A:
Q: How does the government plan on helping the government in adding renewable energy topics into all school systems? A:
Q: How likely do you think it will be possible for the public schools to implement a required course on renewable energy with the government's help?

A:
Q: Do we have permission to use your name in our final report?
A:
Additional Comments:
Final Remarks: Thank you for taking the time to meet with us and share your opinions. If you have any questions or comments about the interview or the information we have collected, you can contact us at nam17-eduvent@wpi.edu . If this method of communication does not work, please contact EduVentures Trust, and they will forward your questions or comments to us.

Appendix C: Informed Young Adults Interview Plan

Interviewer:
Transcriber:
Interviewee name and Position (if allowable):
Date:
Time:
Location:
Project Description and Goal: Hello, we are students from WPI working with EduVentures to develop interactive lessons on renewable energy for their mobile classroom. We would like to interview you on information regarding your interests in sustainability and your environmental education background.
Confidentiality Statement: We are students from Worcester Polytechnic Institute working with EduVentures to develop interactive lessons on renewable energy for their mobile classroom. We wish to interview you to hear your opinions on Namibian education and renewable energy so that we can assist EduVentures in their mission to teach rural learners more about renewable energy. We will not ask for your name or other personal information and will refer to you as [Teacher/Official/ Informed Young Adult] X. Any information you share with us about the questions may be accessible to the public on the internet in our final report. If you wish to provide your name, please let us know. Your participation in this interview is completely voluntary and any information you share with us is greatly appreciated. However, if at any time, you are uncomfortable and wish to stop the interview, let us know and we will stop immediately. Do you have any questions? At this time, we will begin the interview.
Q. What grade are you in? A.
Q. How did you learn about environmental topics? A.
Q. If you learned it in school, what was the most memorable thing? A.
Q. How was the information taught to you? A.
Q. Why are you interested in environmental awareness and climate change? A.
Q. How did you learn about this program at the House of Democracy? A.
Q. Is this the first program you went to? A.
Q. If not, how many times have you come? A.
Q. What do you enjoy about the programs? A.
Q. What do you think other learners should know about environmental awareness and climate change? A.
Q. What is your favorite part of science classes? A.
Additional Comments:
Final Remarks: Thank you for taking the time to meet with us and share your opinions. If you have any questions or comments about the interview or the information we have collected, you can contact us at nam17-eduvent@wpi.edu . If this method of communication does not work, please contact EduVentures Trust, and they will forward your questions or comments to us.

Appendix D: High School Teacher Interview Plan: Frank G Mungunda

Stakeholder Category: Local (Windhoek) Teachers
Interviewer name: Tim
Transcriber: Emily
Interviewee name (if permission was granted): Frank G. Mungunda
Date & Time of Interview: 8:08 AM April 5 th , 2017
Location: Jan Mohr Secondary School
Project Description and Goal: Hello, we are students from WPI working with EduVentures to develop interactive lessons on renewable energy for their mobile classroom. We would like to interview you on information regarding educational techniques and curriculum building.
Confidentiality Statement: We are students from Worcester Polytechnic Institute working with EduVentures to develop interactive lessons on renewable energy for their mobile classroom. We wish to interview you to hear your opinions on Namibian education and renewable energy so that we can assist EduVentures in their mission to teach rural learners more about renewable energy. We will not ask for your name or other personal information and will refer to you as [Teacher/Official/ Informed Young Adult] X. Any information you share with us about the questions may be accessible to the public on the internet in our final report. If you wish to provide your name, please let us know. Your participation in this interview is completely voluntary and any information you share with us is greatly appreciated. However, if at any time, you are uncomfortable and wish to stop the interview, let us know and we will stop immediately. Do you have any questions? At this time, we will begin the interview.
Q: What inspired you to be a teacher? What is your favorite part about your job? A: To be honest, I majored in chemistry and minored in geology but jobs are hard to find. Started in 2014. Impact you can make in someone's life
Q: How long have you been a teacher? What type of environments have you taught in? (public or private? Urban vs rural?) If so, please elaborate on the difference between the teaching experiences. A: 3 years, been in a government setting, teaching in holiday. Schools grade 10 + 12 learners. Wife is also a teacher and both are private tutors and help university students.
Q: What is the biggest challenge when working with high school learners? A: resources and materials. Last year, semi-private (parents really support schools). Struggle to even get ink and paper. Mindset of the learners
Q: What is important to include in a science lesson for high school learners? A: Social, bio, life and physical science should do more interlinking curriculums. More practical, 90% is bored.
Q: Over the years, has your style of teaching changed? If so why? A: n/a
Q: Typically, when are the learners most focused during the lessons? Why? When are the learners least focused during the lesson? Why? A: In the morning before break, still has a lot of energy. After the break, tired.
Q: How do you make lessons interactive and engaging for the learners? A: It's a challenge without SMART board, here you have to talk to them through examples, you have to verbally engage them.

<p>Q: What do learners already know about renewable energy from your school's curriculum?</p> <p>A: They have a general idea, but in terms of benefits to really understand, they don't really know that. To really sit down and see impact requires understanding.</p>
<p>Q: Do learners usually benefit from renewable energy lessons?</p> <p>A: see above</p>
<p>Q: In your opinion, what do you think we should be add to our lesson modules in order to make them as effective as possible?</p> <p>A: visuals work nicely and your PowerPoint should be really interactive, try to make it more practical to that community, can relate more.</p>
<p>Q: Have you heard of <i>Vision 2030</i>? Has <i>Vision 2030</i> changed how you create a lesson plan? If yes, how so?</p> <p>A: yes, heard about it, to certain extent has affected, Personally, want to be practical for Vision 2030, need to be innovative on how you can apply it in the future.</p>
<p>Q: Do we have permission to use your name in our final report?</p> <p>A: yes</p>
<p>Additional Comments: Make sure you understand the culture, background and language of the region you will be traveling to.</p>
<p>Final Remarks: Thank you for taking the time to meet with us and share your opinions. If you have any questions or comments about the interview or the information we have collected, you can contact us at nam17-eduvent@wpi.edu. If this method of communication does not work, please contact EduVentures Trust, and they will forward your questions or comments to us.</p>

Appendix E: High School Teacher Interview Plan: Kelvin Naholo

Stakeholder Category: Local (Windhoek) Teachers
Interviewer name: Tim
Transcriber: Emily
Interviewee name (if permission was granted): Kelvin Naholo
Date & Time of Interview: 10:43 AM 5 April, 2017
Location: Jan Mohr Secondary School
Project Description and Goal: Hello, we are students from WPI working with EduVentures to develop interactive lessons on renewable energy for their mobile classroom. We would like to interview you on information regarding educational techniques and curriculum building.
Confidentiality Statement: We are students from Worcester Polytechnic Institute working with EduVentures to develop interactive lessons on renewable energy for their mobile classroom. We wish to interview you to hear your opinions on Namibian education and renewable energy so that we can assist EduVentures in their mission to teach rural learners more about renewable energy. We will not ask for your name or other personal information and will refer to you as [Teacher/Official/ Informed Young Adult] X. Any information you share with us about the questions may be accessible to the public on the internet in our final report. If you wish to provide your name, please let us know. Your participation in this interview is completely voluntary and any information you share with us is greatly appreciated. However, if at any time, you are uncomfortable and wish to stop the interview, let us know and we will stop immediately. Do you have any questions? At this time, we will begin the interview.
Q: What inspired you to be a teacher? What is your favorite part about your job? A: Teaching
Q: How long have you been a teacher? What type of environments have you taught in? (public or private? Urban vs rural?) If so, please elaborate on the difference between the teaching experiences. A: Public for eight years
Q: What is the biggest challenge when working with high school learners? A: puberty causes so much peer pressure
Q: What is important to include in a science lesson for high school learners? A: need to include matter and make sure they understand it
Q: Over the years, has your style of teaching changed? If so why? A: n/a
Q: Typically, when are the learners most focused during the lessons? Why? When are the learners least focused during the lesson? Why? A: Activities on the board, questions, demos, and videos. When there's little engagement
Q: How do you make lessons interactive and engaging for the learners? A: see above
Q: What do learners already know about renewable energy from your school's curriculum? A: know a lot when it comes to RE; know about solar mostly

Q: Do learners usually benefit from renewable energy lessons?
A: yes they would

Q: In your opinion, what do you think we should be add to our lesson modules in order to make them as effective as possible?
A: More practical work that will enable them to discover

Q: Have you heard of *Vision 2030*? Has *Vision 2030* changed how you create a lesson plan? If yes, how so?
A: Heard about, but a lot things have already failed

Q: Do we have permission to use your name in our final report?
A: yes

Additional Comments: n/a

Final Remarks: Thank you for taking the time to meet with us and share your opinions. If you have any questions or comments about the interview or the information we have collected, you can contact us at nam17-eduvent@wpi.edu. If this method of communication does not work, please contact EduVentures Trust, and they will forward your questions or comments to us.

Appendix F: High School Teacher Interview Plan: Enbenezer Muwngua

Stakeholder Category: Local (Windhoek) Teachers
Interviewer name: Jessica Grabinsky
Transcriber: Jessica Grabinsky
Interviewee name (if permission was granted): Enbenezer Muwngua Accounting Teacher
Date & Time of Interview: 05/04/2017 5:00 PM
Location: Gustav Kandjii High School
Project Description and Goal: Hello, we are students from WPI working with EduVentures to develop interactive lessons on renewable energy for their mobile classroom. We would like to interview you on information regarding educational techniques and curriculum building.
Confidentiality Statement: We are students from Worcester Polytechnic Institute working with EduVentures to develop interactive lessons on renewable energy for their mobile classroom. We wish to interview you to hear your opinions on Namibian education and renewable energy so that we can assist EduVentures in their mission to teach rural learners more about renewable energy. We will not ask for your name or other personal information and will refer to you as [Teacher/Official/ Informed Young Adult] X. Any information you share with us about the questions may be accessible to the public on the internet in our final report. If you wish to provide your name, please let us know. Your participation in this interview is completely voluntary and any information you share with us is greatly appreciated. However, if at any time, you are uncomfortable and wish to stop the interview, let us know and we will stop immediately. Do you have any questions? At this time, we will begin the interview.
Q: What inspired you to be a teacher? What is your favorite part about your job? A: To pass knowledge to the next generation. When they are successful.
Q: How long have you been a teacher? What type of environments have you taught in? (public or private? Urban vs rural?) If so, please elaborate on the difference between the teaching experiences. A: 17 years, public (North for 13 years)
Q: What is the biggest challenge when working with high school learners? A: discipline, big number of learners prone to get involved in bad activities (puberty, 16 is a challenge)
Q: What is important to include in a science lesson for high school learners? A: Using technology (SMART board), videos, internet. (They are all exposed to)
Q: Over the years, has your style of teaching changed? If so why? A: n/a
Q: Typically, when are the learners most focused during the lessons? Why? When are the learners least focused during the lesson? Why? A: Morning, they are not tired
Q: How do you make lessons interactive and engaging for the learners? A: n/a
Q: What do learners already know about renewable energy from your school's curriculum? A: Wind energy, solar energy, Bush-to-Energy, methane (biomass)

Q: Do learners usually benefit from renewable energy lessons?

A: They like them, promoting; diversify, move away from normal electricity

Q: In your opinion, what do you think we should be add to our lesson modules in order to make them as effective as possible?

A: Demonstrations, have fun, renewable energy

Q: Have you heard of *Vision 2030*? Has *Vision 2030* changed how you create a lesson plan? If yes, how so?

A: yes, we have to position ourselves to responsive. He likes it.

Q: Do we have permission to use your name in our final report?

A: yes.

Additional Comments: Very grateful
se environment resources sustainably to benefit the next generation

Final Remarks: Thank you for taking the time to meet with us and share your opinions. If you have any questions or comments about the interview or the information we have collected, you can contact us at nam17-eduvent@wpi.edu. If this method of communication does not work, please contact EduVentures Trust, and they will forward your questions or comments to us.

Appendix G: High School Teacher Interview Plan: Joshua Nauripo Kambueza

Stakeholder Category: Local (Windhoek) Teachers
Interviewer name: Katie Pelissari
Transcriber: Katie Pelissari
Interviewee name (if permission was granted): Joshua Nauripo Kambueza
Date & Time of Interview: 5/4/2017
Location: Gustav Kandjii High School
Project Description and Goal: Hello, we are students from WPI working with EduVentures to develop interactive lessons on renewable energy for their mobile classroom. We would like to interview you on information regarding educational techniques and curriculum building.
Confidentiality Statement: We are students from Worcester Polytechnic Institute working with EduVentures to develop interactive lessons on renewable energy for their mobile classroom. We wish to interview you to hear your opinions on Namibian education and renewable energy so that we can assist EduVentures in their mission to teach rural learners more about renewable energy. We will not ask for your name or other personal information and will refer to you as [Teacher/Official/ Informed Young Adult] X. Any information you share with us about the questions may be accessible to the public on the internet in our final report. If you wish to provide your name, please let us know. Your participation in this interview is completely voluntary and any information you share with us is greatly appreciated. However, if at any time, you are uncomfortable and wish to stop the interview, let us know and we will stop immediately. Do you have any questions? At this time, we will begin the interview.
Q: What inspired you to be a teacher? What is your favorite part about your job? A: Motivated by school teacher. When you share info with learners
Q: How long have you been a teacher? What type of environments have you taught in? (public or private? Urban vs rural?) If so, please elaborate on the difference between the teaching experiences. A: 11 years/ public – started in 2001 at Gustav. Started in Botswana, grew up in Herero in Cultural.
Q: What is the biggest challenge when working with high school learners? A: Pregnancy, learners are grown up so act mature but not academically
Q: What is important to include in a science lesson for high school learners? A: Experiments, demonstrate what is being told
Q: Over the years, has your style of teaching changed? If so why? A: n/a
Q: Typically, when are the learners most focused during the lessons? Why? When are the learners least focused during the lesson? Why? A: Learners centered teaching. "Feel they own the lesson". Teacher centered
Q: How do you make lessons interactive and engaging for the learners? A: Put in group. Teach language, ask to prepare them next day do the roll play.
Q: What do learners already know about renewable energy from your school's curriculum? A: oil, coal, practice by making fire

Q: Do learners usually benefit from renewable energy lessons?
A: yes, because they practice and send out and are exposed outside the class

Q: In your opinion, what do you think we should be add to our lesson modules in order to make them as effective as possible?
A: Add more pamphlets, add reading materials, variety of learning materials

Q: Have you heard of *Vision 2030*? Has *Vision 2030* changed how you create a lesson plan? If yes, how so?
A: yes; "anthem of the nation". Indeed, in most cases using current articles from newspaper; talking about daily news about development.

Q: Do we have permission to use your name in our final report?
A: yes

Additional Comments: English teacher

Final Remarks: Thank you for taking the time to meet with us and share your opinions. If you have any questions or comments about the interview or the information we have collected, you can contact us at nam17-eduvent@wpi.edu. If this method of communication does not work, please contact EduVentures Trust, and they will forward your questions or comments to us.

Appendix H: High School Teacher Interview Plan: Okondjatu Combined School Teacher 1

Stakeholder Category: Local (Windhoek) Teachers
Interviewer name: Jess Grabinsky
Transcriber: Jess Grabinsky
Interviewee name (if permission was granted): n/a
Date & Time of Interview: April 6 th , 2017
Location: Okondjatu Combined School
Project Description and Goal: Hello, we are students from WPI working with EduVentures to develop interactive lessons on renewable energy for their mobile classroom. We would like to interview you on information regarding educational techniques and curriculum building.
Confidentiality Statement: We are students from Worcester Polytechnic Institute working with EduVentures to develop interactive lessons on renewable energy for their mobile classroom. We wish to interview you to hear your opinions on Namibian education and renewable energy so that we can assist EduVentures in their mission to teach rural learners more about renewable energy. We will not ask for your name or other personal information and will refer to you as [Teacher/Official/ Informed Young Adult] X. Any information you share with us about the questions may be accessible to the public on the internet in our final report. If you wish to provide your name, please let us know. Your participation in this interview is completely voluntary and any information you share with us is greatly appreciated. However, if at any time, you are uncomfortable and wish to stop the interview, let us know and we will stop immediately. Do you have any questions? At this time, we will begin the interview.
Q: What inspired you to be a teacher? What is your favorite part about your job? A: My parents, they were teachers. Some Holidays
Q: How long have you been a teacher? What type of environments have you taught in? (public or private? Urban vs rural?) If so, please elaborate on the difference between the teaching experiences. A: 3 years, stayed in Okondjatu
Q: What is the biggest challenge when working with high school learners? A: There are many in the class, hard to get control.
Q: What is important to include in a science lesson for high school learners? A: Local teaching aids, use resources available.
Q: Over the years, has your style of teaching changed? If so why? A: n/a
Q: Typically, when are the learners most focused during the lessons? Why? When are the learners least focused during the lesson? Why? A: The morning after break it's hard. More confused with teaching aids
Q: How do you make lessons interactive and engaging for the learners? A: n/a
Q: What do learners already know about renewable energy from your school's curriculum? A: Nothing.

Q: Do learners usually benefit from renewable energy lessons?
A: n/a

Q: In your opinion, what do you think we should be add to our lesson modules in order to make them as effective as possible?
A: More visuals.

Q: Have you heard of *Vision 2030*? Has *Vision 2030* changed how you create a lesson plan? If yes, how so?
A: Yes, I like it but has not changed his lesson

Q: Do we have permission to use your name in our final report?
A: No, do not include.

Additional Comments: Mathematics (5-6); Natural Science (5-6)

Final Remarks: Thank you for taking the time to meet with us and share your opinions. If you have any questions or comments about the interview or the information we have collected, you can contact us at nam17-eduvent@wpi.edu. If this method of communication does not work, please contact EduVentures Trust, and they will forward your questions or comments to us.

Appendix I: High School Teacher Interview Plan: Nanguei Kahikummmnu

Stakeholder Category: Local (Windhoek) Teachers
Interviewer name: Katie Pelissari
Transcriber: Katie Pelissari
Interviewee name (if permission was granted): Nanguei Kahikummmnu
Date & Time of Interview: 6/4/2017
Location: Okondjatu
Project Description and Goal: Hello, we are students from WPI working with EduVentures to develop interactive lessons on renewable energy for their mobile classroom. We would like to interview you on information regarding educational techniques and curriculum building.
Confidentiality Statement: We are students from Worcester Polytechnic Institute working with EduVentures to develop interactive lessons on renewable energy for their mobile classroom. We wish to interview you to hear your opinions on Namibian education and renewable energy so that we can assist EduVentures in their mission to teach rural learners more about renewable energy. We will not ask for your name or other personal information and will refer to you as [Teacher/Official/ Informed Young Adult] X. Any information you share with us about the questions may be accessible to the public on the internet in our final report. If you wish to provide your name, please let us know. Your participation in this interview is completely voluntary and any information you share with us is greatly appreciated. However, if at any time, you are uncomfortable and wish to stop the interview, let us know and we will stop immediately. Do you have any questions? At this time, we will begin the interview.
Q: What inspired you to be a teacher? What is your favorite part about your job? A: Your nation, need to bring input to my nation. Like children.
Q: How long have you been a teacher? What type of environments have you taught in? (public or private? Urban vs rural?) If so, please elaborate on the difference between the teaching experiences. A: 10 years, Zimbabwe, Windhoek, Okondjatu. Urban has advantages, more equipped. Rural now performing better. Not only the resources provided but your ability to teach.
Q: What is the biggest challenge when working with high school learners? A: Their behavior, misbehaving. Sexual activities concentrated on others. 13 pregnancy cases last year.
Q: What is important to include in a science lesson for high school learners? A: Models, it helps a lot to get to the main concepts.
Q: Over the years, has your style of teaching changed? If so why? A: n/a
Q: Typically, when are the learners most focused during the lessons? Why? When are the learners least focused during the lesson? Why? A: They are most engaged at the beginning. Least at the end.
Q: How do you make lessons interactive and engaging for the learners? A: Learner centered. Giving them activities, demonstrations by us.

<p>Q: What do learners already know about renewable energy from your school's curriculum? A: Teach them, clear information, know several.</p>
<p>Q: Do learners usually benefit from renewable energy lessons? A: They do.</p>
<p>Q: In your opinion, what do you think we should be add to our lesson modules in order to make them as effective as possible? A: To expose them to different renewable energies and places where they can be used.</p>
<p>Q: Have you heard of <i>Vision 2030</i>? Has <i>Vision 2030</i> changed how you create a lesson plan? If yes, how so? A: Our curriculum is always changing. He likes it.</p>
<p>Q: Do we have permission to use your name in our final report? A: Yes</p>
<p>Additional Comments: teaches grades 8-10</p>
<p>Final Remarks: Thank you for taking the time to meet with us and share your opinions. If you have any questions or comments about the interview or the information we have collected, you can contact us at nam17-eduvent@wpi.edu. If this method of communication does not work, please contact EduVentures Trust, and they will forward your questions or comments to us.</p>

Appendix J: High School Teacher Interview Plan: Vindina Muje

Stakeholder Category: Local (Windhoek) Teachers
Interviewer name: Jess Grabinsky
Transcriber: Jess Grabinsky
Interviewee name (if permission was granted): Vindina Muje
Date & Time of Interview: 6/4/2017
Location: Okamatapati Combined School
Project Description and Goal: Hello, we are students from WPI working with EduVentures to develop interactive lessons on renewable energy for their mobile classroom. We would like to interview you on information regarding educational techniques and curriculum building.
Confidentiality Statement: We are students from Worcester Polytechnic Institute working with EduVentures to develop interactive lessons on renewable energy for their mobile classroom. We wish to interview you to hear your opinions on Namibian education and renewable energy so that we can assist EduVentures in their mission to teach rural learners more about renewable energy. We will not ask for your name or other personal information and will refer to you as [Informed Young Adult /Teacher/Official] 1. Any information you share with us about the questions may be accessible to the public on the internet in our final report. If you wish to provide your name, please let us know. Your participation in this interview is completely voluntary and any information you share with us is greatly appreciated. However, if at any time, you are uncomfortable and wish to stop the interview, let us know and we will stop immediately. Do you have any questions? At this time, we will begin the interview.
Q: What inspired you to be a teacher? What is your favorite part about your job? A: Help the learners to make them become responsible citizens of this country. Build the culture.
Q: How long have you been a teacher? What type of environments have you taught in? (public or private? Urban vs rural?) If so, please elaborate on the difference between the teaching experiences. A: 30 years, Okamatapati
Q: What is the biggest challenge when working with high school learners? A: Rural areas, the materials to be used, not a lot of materials. Limited access.
Q: What is important to include in a science lesson for high school learners? A: The grammar part, use what the learners will use outside.
Q: Over the years, has your style of teaching changed? If so why? A: n/a
Q: Typically, when are the learners most focused during the lessons? Why? When are the learners least focused during the lesson? Why? A: n/a
Q: How do you make lessons interactive and engaging for the learners? A: make the lessons centered, asking questions
Q: What do learners already know about renewable energy from your school's curriculum? A: They know about it; every subject has environmental issues.

Q: Do learners usually benefit from renewable energy lessons?
A: Yes

Q: In your opinion, what do you think we should be add to our lesson modules in order to make them as effective as possible?
A: Renewable Energy should be practical, demonstrations

Q: Have you heard of *Vision 2030*? Has *Vision 2030* changed how you create a lesson plan? If yes, how so?
A: Yes, everything is adapted. Step by step.

Q: Do we have permission to use your name in our final report?
A: Yes

Additional Comments: English 7,9,10

Final Remarks: Thank you for taking the time to meet with us and share your opinions. If you have any questions or comments about the interview or the information we have collected, you can contact us at nam17-eduvent@wpi.edu. If this method of communication does not work, please contact EduVentures Trust, and they will forward your questions or comments to us.

Appendix K: High School Teacher Interview Plan: Eslon N. Kaangundue

Stakeholder Category: Local (Windhoek) Teachers
Interviewer name: Katie Pelissari
Transcriber: Katie Pelissari
Interviewee name (if permission was granted): Eslon N. Kaangundue
Date & Time of Interview: 6/4/2017
Location: Okamatapati Combined School
Project Description and Goal: Hello, we are students from WPI working with EduVentures to develop interactive lessons on renewable energy for their mobile classroom. We would like to interview you on information regarding educational techniques and curriculum building.
Confidentiality Statement: We are students from Worcester Polytechnic Institute working with EduVentures to develop interactive lessons on renewable energy for their mobile classroom. We wish to interview you to hear your opinions on Namibian education and renewable energy so that we can assist EduVentures in their mission to teach rural learners more about renewable energy. We will not ask for your name or other personal information and will refer to you as [Teacher/Official/ Informed Young Adult] X. Any information you share with us about the questions may be accessible to the public on the internet in our final report. If you wish to provide your name, please let us know. Your participation in this interview is completely voluntary and any information you share with us is greatly appreciated. However, if at any time, you are uncomfortable and wish to stop the interview, let us know and we will stop immediately. Do you have any questions? At this time, we will begin the interview.
Q: What inspired you to be a teacher? What is your favorite part about your job? A: Love working with people. Enjoy critical thinking and thinking of new ideas.
Q: How long have you been a teacher? What type of environments have you taught in? (public or private? Urban vs rural?) If so, please elaborate on the difference between the teaching experiences. A: Started teaching in 1999. 18 years in urban. 1 year in rural. Different resources. Urban are well equipped competence of learners. Low here, speak different. Exposure is problem in rural
Q: What is the biggest challenge when working with high school learners? A: Attitude, teenage/puberty, willingness. Seek attention, but fun.
Q: What is important to include in a science lesson for high school learners? A: Climate ecology. Live in environment but not aware. Conserve, Sustain, preserve
Q: Over the years, has your style of teaching changed? If so why? A: n/a
Q: Typically, when are the learners most focused during the lessons? Why? When are the learners least focused during the lesson? Why? A: Mostly, early hours of the day. When the lesson is practical/hands on. After break (11 AM). When its theoretical topic/lesson.
Q: How do you make lessons interactive and engaging for the learners? A: Involve learner's activity. Let the learners do the most in the lesson. Ask what they know.

<p>Q: What do learners already know about renewable energy from your school's curriculum? A: They know solar and wind. Solar in schools, loans from the government.</p>
<p>Q: Do learners usually benefit from renewable energy lessons? A: Not really</p>
<p>Q: In your opinion, what do you think we should be add to our lesson modules in order to make them as effective as possible? A: Lessons should be practical, guidelines.</p>
<p>Q: Have you heard of <i>Vision 2030</i>? Has <i>Vision 2030</i> changed how you create a lesson plan? If yes, how so? A: Yes. By 2030, we want to see the differences moved to learner centered facilitator.</p>
<p>Q: Do we have permission to use your name in our final report? A: Yes</p>
<p>Additional Comments: Life Science, Agriculture</p>
<p>Final Remarks: Thank you for taking the time to meet with us and share your opinions. If you have any questions or comments about the interview or the information we have collected, you can contact us at nam17-eduvent@wpi.edu. If this method of communication does not work, please contact EduVentures Trust, and they will forward your questions or comments to us.</p>

Appendix L: Namibian Government Official Interview Plan: Ministry of Mines and Energy

Stakeholder Category: Government Officials
Interviewer: All
Transcriber: All
Interviewee Name/Position: 5 employees of the Ministry of Mines and Energy
Date and Time of Interview: 22 March, 2017 at 9:30 AM Location: Ministry of Mines and Education, 6 th floor boardroom
Project Description and Goal: Hello, we are students from WPI working with EduVentures to develop interactive lessons on renewable energy for their mobile classroom. We would like to interview you on information regarding renewable energy education and initiatives.
Confidentiality Statement: We are students from Worcester Polytechnic Institute working with EduVentures to develop interactive lessons on renewable energy for their mobile classroom. We wish to interview you to hear your opinions on Namibian education and renewable energy so that we can assist EduVentures in their mission to teach rural learners more about renewable energy. We will not ask for your name or other personal information and will refer to you as [Teacher/Official/ Informed Young Adult] X. Any information you share with us about the questions may be accessible to the public on the internet in our final report. If you wish to provide your name, please let us know. Your participation in this interview is completely voluntary and any information you share with us is greatly appreciated. However, if at any time, you are uncomfortable and wish to stop the interview, let us know and we will stop immediately. Do you have any questions? At this time, we will begin the interview.
Q: How long have you been working in your department? A: Range of 2-9 years
Q: What made you want to pursue a career in Namibia's Energy Department? A: GO1: Went to school for electrical engineering, likes energy from the electrical side. No other options really for electrical engineers in Namibia GO2: Energy is a very interesting topic, feels very happy when working on energy projects GO3: Was looking for a career change, originally an environmental biologist and teacher, thought that the opportunity for something new in the energy field would suit them best GO4: Mechanical Engineering by trade, favorite subject was thermofluids, believes energy can make an impact, "energy is the heartbeat of the universe", likes helping people, and energy is one of the careers that can combine all of those things GO5: Likes energy, especially renewable energy, is actually a researcher for renewable energy. Believes that renewable energy is the technology for the future, and is a big impact in the country.
Q: What do you believe to be the biggest threat to Namibia's environment? A: GO1: greenhouse gases is the obvious answer GO2: N/A GO3: Namibia is a very dry climate, water is one of the resources that we have to find ways of making sure there is some left for now and for the future. In addition to that, since Namibia isn't really a big contributor, mitigation is a top priority we want to see renewable energy take a bigger mix in energy resources. Lots of projects right now in the policies and administration , as well as at other institutions, so that the development is sustained GO4: N/A GO5: N/A Q: Do you have any ideas for improving the guidelines of processing harvested bush? If so, what are they? GO1: N/A GO2: N/A GO3: N/A GO4: N/A GO5: Ministry of agriculture is much more relevant for this topic. They came up with a set of guidelines and put them in a booklet, which will partially help with the process of harvesting bush. There was a 5-year de-bushing program that looked at the outtake of bush in regards to agriculture and sustainability of the bush. They are looking to continue the program for longer

<p>Q: What is your opinion on educating Namibian youth in Renewable Energy topics such as wind energy, solar energy, and Bush-to-Energy?</p> <p>A: GO1: they are the future, the new generation, we have to live in a sustainable environment. In that case, we need to focus on solar, wind and biomass. GO2: N/A GO3: N/A GO4: N/A GO5: Solar energy is more accessible to them, should focus on that for the youth.</p>
<p>Q: Do you think that it is possible for Namibia to stop depending on foreign countries for energy?</p> <p>A: GO1: It's possible, we don't necessarily need to depend on them, but we do need to honor our agreements with other countries. Should those ever fall out though, and if we have everything in place, we could be self-sustaining, it's definitely possible GO2: N/A GO3: N/A GO4: N/A GO5: it's possible but our policy is that we should have a mix of energy, we need to have the dependency on exporting and importing from other countries to maintain relationships. The long-term goal in Namibia is to become an energy exportation country, so maintaining those relationships is key.</p>
<p>Q: How helpful will the government be in adding renewable energy topics into school curriculums?</p> <p>A: GO1: N/A GO2: N/A GO3: Schools have science fairs. I think, but I'm not sure, it might be exposed more even in primary schools using science and science projects. Tertiary schools have science weeks where primary schools can come in and learn about science. Exposure is more there (in tertiary schools) these days, with the topic being sustainable development. Not just at the higher level anymore though, it's being cascaded down into lower levels. It needs to be boosted in rural areas for sure. A learner in Windhoek has so many resources, labs and computers and electricity, in rural schools there is none of that, so they definitely need to learn about this GO4: The best approach is to engage learners in what they usually do. You need to integrate it into what they normally do, so that they can understand how it can be applied to their lives GO5: currently it only exists in higher education, such as sustainability studies at NUST, UNam. There are also Vocational centers for renewable energy studies, but we haven't done anything in lower education yet.</p>
<p>Q: Do you have any suggestions for what we should include in our lessons that would be important for Namibia's renewable energy future?</p> <p>A: GO1: For the mobile classroom, I'd expect the children to see the solar panels and know how they work GO2: when I was in school, we were showed a solar cooker once, had a huge effect on me and that technology was very interesting to me GO3: Kids at early levels need to see the links to see how we use renewable energy to address climate change, kids can relate to cooking technologies and might find that interesting GO4: N/A GO5: Efficient cooking technologies such as solar cookers and ovens, wood efficient cook stoves as well, look up NaDEET, they have posters on these technologies</p>
<p>Q: Is there any renewable energy that is more important than the others?</p> <p>A: GO1: N/A GO2: N/A GO3: None are more important, but the issues currently being addressed are more focused in solar energy. Wind is more to the coast, and biomass is more concentrated in the northern part of the country, whereas solar is more widespread and has a bigger base. But none is more important than the other GO4: N/A GO5: PV (solar) is the most cost effective</p>

Q: Do we have permission to use your names in our final report?

A: No, government officials is fine

Additional Comments

Do you have any questions for us?

GO5: So, the bus is currently focused around Windhoek?

A: No, it travels throughout Namibia to rural communities, depending on their funding. For our projects' purposes, and because of time constraints, we will be closer to Windhoek for the first trial of these lesson modules, but in the future these modules will be used in farther, more rural communities.

GO1: Will you be discussing the cost of these energies?

A: Yes, each module will have a section about the advantages and disadvantages of these technologies, and cost effectiveness will be included in this category for all of the technologies

Final Remarks: Thank you for taking the time to meet with us and share your opinions. If you have any questions or comments about the interview or the information we have collected, you can contact us at nam17-eduvent@wpi.edu. If this method of communication does not work, please contact EduVentures Trust, and they will forward your questions or comments to us.

Appendix M: Informed Young Adults Interview Plan: Kornelia Lipinage

Interviewer: Jessica Grabinsky
Transcriber: Jessica Grabinsky
Interviewee name: Kornelia Lipinage
Date: 31-03-2017
Time: 4:00 PM
Location: House of Democracy
Project Description and Goal: Hello, we are students from WPI working with EduVentures to develop interactive lessons on renewable energy for their mobile classroom. We would like to interview you on information regarding your interests in sustainability and your environmental education background.
Confidentiality Statement: We are students from Worcester Polytechnic Institute working with EduVentures to develop interactive lessons on renewable energy for their mobile classroom. We wish to interview you to hear your opinions on Namibian education and renewable energy so that we can assist EduVentures in their mission to teach rural learners more about renewable energy. We will not ask for your name or other personal information and will refer to you as [Teacher/Official/ Informed Young Adult] X. Any information you share with us about the questions may be accessible to the public on the internet in our final report. If you wish to provide your name, please let us know. Your participation in this interview is completely voluntary and any information you share with us is greatly appreciated. However, if at any time, you are uncomfortable and wish to stop the interview, let us know and we will stop immediately. Do you have any questions? At this time, we will begin the interview.
Q. What grade are you in? A. I have a Master's Degree in water resource management from University of Namibia, my Bachelor's Degree is in environmental science
Q. How did you learn about environmental topics? A. I learned about the environment and sustainability during my undergrad years earning my Bachelor's Degree.
Q. If you learned it in school, what was the most memorable thing? A. I love nature. I grew up in Northern Namibia so the environment and nature was very prevalent. If the nature is ruined in the country, then so many aspects of the country are affected. For example, tourism.
Q. How was the information taught to you? A. Lectures in science classes, there were very minimal interactive activities. I loved science experiments, but I didn't have any until I reached university.
Q. Why are you interested in environmental awareness and climate change? A. Namibia is a very arid country, so we are "vulnerable to a lot of things". "Water is very limited". One day you could have flooding, and the next day you could have drought. Nothing is ever guaranteed with the weather here, so I think Namibia needs to constantly prepare for what is coming next. Battling climate change and educating the population will create environmental awareness throughout the nation
Q. How did you learn about this program at the House of Democracy? A. Facebook
Q. Is this the first program you went to? A. Yes
Q. If not, how many times have you come? A.
Q. What do you enjoy about the programs? A. Yes, I thought it was very good. It brought together different youth to talk about the future of the nation. SDGs (Sustainable Development Goals) do not focus just on the environment though, we need to integrate all the goals to work towards a good future.
Q. What do you think other learners should know about environmental awareness and climate change? A. I think you need to start environmental education from primary school. It's hard to learn conservational practices when you're older, if you teach the youth, they will grow up around the idea. I think it is also good to have science books or posters in the village's local languages, and make sure that you are targeting the parents as well as the learners. If a parent doesn't believe in climate change, it will be very hard for the learner to begin to live sustainably.
Q. What is your favorite part of science classes? A. Going out into the field and performing hands on learning.
Final Remarks: Thank you for taking the time to meet with us and share your opinions. If you have any questions or comments about the interview or the information we have collected, you can contact us at nam17-eduvent@wpi.edu . If this method of communication does not work, please contact EduVentures Trust, and they will forward your questions or comments to us.

Appendix N: Informed Young Adults Interview Plan: Hannah Pohlmann

Interviewer: Emily DiRuzza
Transcriber: Emily DiRuzza
Interviewee name and Position (if allowable): Hanna Pohlmann
Date: 31 March 2017
Time: 4:11 PM
Location: House of Democracy
Project Description and Goal: Hello, we are students from WPI working with EduVentures to develop interactive lessons on renewable energy for their mobile classroom. We would like to interview you on information regarding past projects at EduVentures and your opinions regarding them.
Confidentiality Statement: We are students from Worcester Polytechnic Institute working with EduVentures to develop interactive lessons on renewable energy for their mobile classroom. We wish to interview you to hear your opinions on Namibian education and renewable energy so that we can assist EduVentures in their mission to teach rural learners more about renewable energy. We will not ask for your name or other personal information and will refer to you as [Teacher/Official/ Informed Young Adult] X. Any information you share with us about the questions may be accessible to the public on the internet in our final report. If you wish to provide your name, please let us know. Your participation in this interview is completely voluntary and any information you share with us is greatly appreciated. However, if at any time, you are uncomfortable and wish to stop the interview, let us know and we will stop immediately. Do you have any questions? At this time, we will begin the interview.
Q. What grade are you in? A. Volunteer from Germany, just finished University
Q. How did you learn about environmental topics? A. Mostly the internet, especially blogs and forums. There's a German Platform and Forum on environmental topics that I read frequently, it's where I get most of my information from
Q. If you learned it in school, what was the most memorable thing? ** Edited question*** Based off of the information you know, what's the most memorable thing you can think of regarding renewable energy and sustainable development? A. I am from a farm, and what we are doing isn't at all sustainable. I thought it was growing up, but after I learned about environmental protection and sustainability topics, I realized that it's not, not at all. I want to change it, but I can't.
Q. How was the information taught to you? A. In the forum
Q. Why are you interested in environmental awareness and climate change? A. I think it's really important, because when we don't know, our future generation will die.
Q. How did you learn about this program at the House of Democracy? A. I found out about it on Facebook. Before coming to Namibia, I did a lot of research about environmental NGOs here, and I followed a few of them on Facebook. One of them was this program, and I was in Windhoek this weekend so I wanted to stop in.
Q. Is this the first program you went to? A. Yes
Q. If not, how many times have you come? A. N/A
Q. What do you enjoy about the programs? A. I like that we worked more together, that different people came together to hear different opinions on the same topic. In a forum, you can read a lot of information, but to actually hear it was great.
Q. What do you think other learners should know about environmental awareness and climate change? A. Plastic Bags, how they should package their goods better and recycle more
Q. What is your favorite part of science classes? A. Biology
Final Remarks: Thank you for taking the time to meet with us and share your opinions. If you have any questions or comments about the interview or the information we have collected, you can contact us at nam17-eduvent@wpi.edu . If this method of communication does not work, please contact EduVentures Trust, and they will forward your questions or comments to us.

Appendix O: Teacher Observation Form

Observer:

Date:

Subject/Grade Level:

School Name:

At 5-minute mark	Lecture																
	Non-technology based activity																
	Technology based activity																
	Group work																
	Other (please specify)																
	Teacher Actions (please check the time when the teacher performed the action)	Start	5 min	10 min	15 min	20 min	25 min	30 min	35 min	40 min	45 min	50 min	55 min	60 min			
During 5-minute time-period	When was the purpose of the lesson stated?																
	When did the teacher ask questions throughout the lesson?																
	When did the teacher answer questions throughout the lesson?																
	Materials Used (check materials after every five minutes)	Start	5 min	10 min	15 min	20 min	25 min	30 min	35 min	40 min	45 min	50 min	55 min	60 min			
During 5-minute time-period	Black board																
	Chalk Board																
	SMART Board																
	Projector																
	Computer																
	Poster																

	Other (please list)													
--	------------------------	--	--	--	--	--	--	--	--	--	--	--	--	--

Other Questions:

1. Did the teacher use English or Afrikaans?
 - a. English
 - b. Afrikaans
2. On a scale of 1-5 how well did the teacher answer the questions? (Quality of answers)

1 2 3 4 5
3. On a scale of 1-5 how clear was the teacher speaking?

1 2 3 4 5

Additional Comments:

Appendix P: Learner Engagement Observation Form

This team used this form to observe **Jan Möhr high school** science classrooms and the renewable energy modules in the Ombombo mobile classroom. The project team counted the number of learners performing each activity throughout the lessons. Every five minutes, a team member counted the number of learners exhibiting the behavior (the first five rows of the observation form). Also, during the five-minute time period, observer counted the number of learners exhibiting the behavior (the last five rows of the observation form).

Learner Engagement Form

Observer _____ Date _____ Subject _____ School _____

At 5-minute mark	Positive Learner Behavior	Sitting up and listening													
		Maintaining eye contact with the teacher													
		Taking notes													
	Negative Learner Behavior	Expressing confusion or anger													
		Talking in side conversations													
During 5-minute time frame	Positive Learner Behavior	Asking questions													
		Answering questions from the teacher													
		Participating in group work													
	Negative Learner Behavior	Leaving to go to the bathroom													
		Texting													

Appendix Q: Jan Möhr High School Period 1: Learner and Teacher Observation Forms

Learner Engagement Form

Emily 4/5/2017 Grade 10: Geography Jon Mohr Secondary School
 Observer Date Subject School

Total learners: 43

At 5-minute mark	Positive Learner Behavior	Sitting up and listening	35	32	33	34	25
		Maintaining eye contact with the teacher	32	32	33	32	20
		Taking notes	0	3	0	2	0
	Negative Learner Behavior	Expressing confusion or anger	0	0	0	0	0
		Talking in side conversations	3	5	0	2	0
During 5-minute time frame	Positive Learner Behavior	Asking questions	0	0	1	0	0
		Answering questions from the teacher/ volunteering to participate	13	10	10	20	3
		Participating in group work	n/a	n/a	n/a	n/a	n/a
	Negative Learner Behavior	Leaving to go to the bathroom	0	0	0	0	0
		Texting	n/a	n/a	n/a	n/a	n/a

Teacher Observation Form

Tim
Observer

4/5/2017
Date

Grade 10: Geography
Subject/Grade Level

Jon Mohr Secondary School
School

At 5-minute mark	Lecture	X	X	X	X	X
	Non-technology based activity					
	Technology based activity					
	Group work					
	Other (please specify) Review	X	X	X	X	X

During 5-minute time-period	When was the purpose of the lesson stated?	X				
	When did the teacher ask questions throughout the lesson?	X	X	X	X	
	When did the teacher answer questions throughout the lesson?					X

During 5-minute time-period	Black board	X	X	X		X
	White Board					
	SMART Board					
	Projector					
	Computer					
	Poster					

	Other (please list)				None X	Map X
--	------------------------	--	--	--	-----------	----------

Other Questions:

4. Did the teacher use English or Afrikaans?
 - a. **English**
 - b. Afrikaans
5. On a scale of 1-5 how well did the teacher answer the questions? (Quality of answers)

1 2 3 4 **5**
6. On a scale of 1-5 how clear was the teacher speaking?

1 2 3 **4** 5

Additional Comments:

- **Very interactive; teacher moved around a lot between desks and board**
- **Uses relevant examples to learners**
- **Talked about RE; learners had some knowledge of it**
- **Asked questions throughout the lesson, in order to gauge their knowledge of the material**

Appendix R: Jan Möhr High School Period 3: Learner and Teacher Observation Forms

Learner Engagement Form

Emily

5/5/2017

Grade 11: Biology

Jon Mohr Secondary School

Observer

Date

Subject

School

Total learners: 42

At 5-minute mark	Positive Learner Behavior	Sitting up and listening	34	39	34	32	30
		Maintaining eye contact with the teacher	20	31	26	30	25
		Taking notes	5	0	3	0	0
	Negative Learner Behavior	Expressing confusion or anger	0	0	0	0	0
		Talking in side conversations	3	2	10	3	5
During 5-minute time frame	Positive Learner Behavior	Asking questions	2	1	4	0	2
		Answering questions from the teacher/ volunteering	8	1	20	0	6
		Participating in group work	n/a	n/a	n/a	n/a	n/a
	Negative Learner Behavior	Leaving to go to the bathroom	0	0	0	0	0
		Texting	n/a	n/a	n/a	n/a	n/a

Teacher Observation Form

Tim
Observer

4/5/2017
Date

Grade 11: Biology
Subject/Grade Level

Jon Mohr Secondary School
School

At 5-minute mark	Lecture	X	X	X	X	X
	Non-technology based activity					
	Technology based activity					
	Group work					
	Other (please specify)					

During 5-minute time-period	When was the purpose of the lesson stated?				
	When did the teacher ask questions throughout the lesson?	X	X	X	X
	When did the teacher answer questions throughout the lesson?		X	X	X

During 5-minute time-period	Black board					
	White Board					
	SMART Board	X	X	X	X	X
	Projector	X	X	X	X	X
	Computer	X	X	X	X	X
	Poster					
	Other (please list)					

Other Questions:

7. Did the teacher use English or Afrikaans?
 - a. **English**
 - b. Afrikaans
8. On a scale of 1-5 how well did the teacher answer the questions? (Quality of answers)

1 2 3 4 5
9. On a scale of 1-5 how clear was the teacher speaking?

1 2 3 4 5

Additional Comments:

- **Very assertive**
- **Sometimes spoke in Afrikaans**
- **Has posters around the room**
- **Made jokes with the material presented**
- **Used SMART board mostly for visuals**
- **Explained exam questions**
- **Used hands to explain a concept**

Appendix S: Jan Möhr High School Period 4: Learner and Teacher Observation Forms

Learner Engagement Form

Tim **4/5/2017**

Grade 11: Geography

Jon Mohr Secondary School

Observer

Date

Subject

School

Total Learners: 35

At 5-minute mark	Positive Learner Behavior	Sitting up and listening	33	33	33	32	34
		Maintaining eye contact with the teacher	30	27	32	32	32
		Taking notes	0	12	25	34	33
	Negative Learner Behavior	Expressing confusion or anger	0	0	1	0	0
		Talking in side conversations	1	2	4	2	3
During 5-minute time frame	Positive Learner Behavior	Asking questions	0	0	0	0	0
		Answering questions from the teacher	2	3	4	0	0
		Participating in group work	n/a	n/a	n/a	n/a	n/a
	Negative Learner Behavior	Leaving to go to the bathroom	0	0	0	0	0
		Texting	n/a	n/a	n/a	n/a	n/a

Teacher Observation Form

Emily

4/5/2017

Grade 11: Geography

Jon Mohr Secondary School

Observer

Date

Subject/Grade Level

School

At 5-minute mark	Lecture	X	X	X	X	X
	Non-technology based activity					
	Technology based activity					
	Group work					
	Other (please specify)					

During 5-minute time-period	When was the purpose of the lesson stated?	X				
	When did the teacher ask questions throughout the lesson?	X	X	X	X	X
	When did the teacher answer questions throughout the lesson?					

During 5-minute time-period	Black board					
	White Board		X	X	X	
	SMART Board			X	X	X
	Projector			X	X	X
	Computer			X	X	X
	Poster					
	Other (please list)	None X				

Other Questions:

10. Did the teacher use English or Afrikaans?

a. **English**

b. Afrikaans

11. On a scale of 1-5 how well did the teacher answer the questions? (Quality of answers)

1 2 3 4 5

n/a the teacher answered their own questions; the learners did not ask questions

12. On a scale of 1-5 how clear was the teacher speaking?

1 2 3 4 5

Additional Comments:

- **Has SMART board, uses it as a projector**
- **Half the windows are painted black**
- **No posters around the room**
- **Interrupted learners when they tried to answer**
- **Writing was small and hard to read from the back of the room**
- **Lots of noise from open windows**

Appendix T: Rural School Pre-Visit Survey

For Official Use Only: Learner Number:

You will not be graded on your answers to this survey. The purpose of this work sheet is for the EduVentures staff to see how much you already know about renewable energy. If you are not sure about the answer to a question, you can guess or simply leave the box blank.	
1.	What is renewable energy? Why is it important to Namibia? 1A. 1B.
2.	What is solar energy? How does it work? 2A. 2B.
3.	What is an encroachment bush? How can Namibia use it for power generation? 3A. 3B.
4.	Name some of the benefits of using renewable energy technology. 4.
5.	What is wind energy? How does it work? 5A. 5B.
6.	Name one consequence if Namibia does not transition to renewable energy 6.
7.	Name as many types of renewable energy sources as you can. 7.
8.	What can you do to help in Namibia's transition to renewable energy? 8.
9.	Define the Industrial Revolution. 9.

[] * indicates that the word was illegible and the team guessed what the word was

Appendix U: Rural School Pre-Visit Survey Responses: Gustav Kandjii High School Responses

The project team transcribed the responses exactly from what the learner wrote on the form. If the team was not able to read the word, they denoted it with [] *. Inside the brackets was the team's guess of what the word was.

For Official Use Only: Learner Number: School 1 Learner 1

You will not be graded on your answers to this survey. The purpose of this work sheet is for the EduVentures staff to see how much you already know about renewable energy. If you are not sure about the answer to a question, you can guess or simply leave the box blank.	
1.	What is renewable energy? Why is it important to Namibia? 1A. Energy that can be restored in a short period of time 1B.
2.	What is solar energy? How does it work? 2A. Energy conducted from the sun 2B.
3.	What is an encroachment bush? How can Namibia use it for power generation? 3A. 3B.
4.	Name some of the benefits of using renewable energy technology. 4. For cooking with at the village
5.	What is wind energy? How does it work? 5A. is that energy that comes from the wind 5B.
6.	Name one consequence if Namibia does not transition to renewable energy 6. it will not have something that will comes from resources
7.	Name as many types of renewable energy sources as you can. 7. solar energy, wind energy
8.	What can you do to help in Namibia's transition to renewable energy? 8. you need to work with people
9.	Define the Industrial Revolution. 9. is when something or at area is [dirty]*

For Official Use Only: Learner Number: School 1 Learner 2

You will not be graded on your answers to this survey. The purpose of this work sheet is for the EduVentures staff to see how much you already know about renewable energy. If you are not sure about the answer to a question, you can guess or simply leave the box blank.	
1.	What is renewable energy? Why is it important to Namibia? 1A. Renewable energy is energy that can be restore [one]* from their in the start 1B.
2.	What is solar energy? How does it work? 2A. is energy from the sun 2B.
3.	What is an encroachment bush? How can Namibia use it for power generation? 3A. 3B.
4.	Name some of the benefits of using renewable energy technology. 4. For cooking and getting water from
5.	What is wind energy? How does it work? 5A. it work when there is too much wind 5B. wind energy is the energy that come from wind
6.	Name one consequence if Namibia does not transition to renewable energy 6. there will be less of water
7.	Name as many types of renewable energy sources as you can. 7. wind energy, solar energy, bush energy
8.	What can you do to help in Namibia's transition to renewable energy? 8. by giving them one
9.	Define the Industrial Revolution. 9.

For Official Use Only: Learner Number: School 1 Learner 3

You will not be graded on your answers to this survey. The purpose of this work sheet is for the EduVentures staff to see how much you already know about renewable energy. If you are not sure about the answer to a question, you can guess or simply leave the box blank.	
1.	What is renewable energy? Why is it important to Namibia? 1A. is energy that can be used again and again 1B. because reliable energy is expensive
2.	What is solar energy? How does it work? 2A. is energy absorbed from the sun 2B. heat is absorbed in a solar panel and stored to a batter
3.	What is an encroachment bush? How can Namibia use it for power generation? 3A. this when the natural grass is invaded by unwanted bushes. 3B. By replacing the bushes with solar panels
4.	Name some of the benefits of using renewable energy technology. 4. They cheaper than non-renewable energy; they can be reused, they are environmentally friendly
5.	What is wind energy? How does it work? 5A. This is energy gained from moving air (wind) 5B.
6.	Name one consequence if Namibia does not transition to renewable energy 6. all the fossil fuels, natural gas and coil will be used up. Energy will be scarce/not enough
7.	Name as many types of renewable energy sources as you can. 7. geothermal, solar, wind, tides, biomass, and hydroelectric energy
8.	What can you do to help in Namibia's transition to renewable energy? 8. by joining the Ombombo class mobile group
9.	Define the Industrial Revolution. 9. it is a change in a country from a primary sector to a secondary or tertiary sector

For Official Use Only: Learner Number: School 1 Learner 4

You will not be graded on your answers to this survey. The purpose of this work sheet is for the EduVentures staff to see how much you already know about renewable energy. If you are not sure about the answer to a question, you can guess or simply leave the box blank.	
1.	What is renewable energy? Why is it important to Namibia? 1A. is the energy that can be used over and over 1B. it is important to Namibia because it can be used over and over
2.	What is solar energy? How does it work? 2A. is the energy we got from the sun 2B. when the sun heats the solar panel it works
3.	What is an encroachment bush? How can Namibia use it for power generation? 3A. 3B.
4.	Name some of the benefits of using renewable energy technology. 4.
5.	What is wind energy? How does it work? 5A. is the energy we got from the air 5B. it works when the wind is blowing the wind bump will tern and brig water
6.	Name one consequence if Namibia does not transition to renewable energy 6. water
7.	Name as many types of renewable energy sources as you can. 7. water, sunlight
8.	What can you do to help in Namibia's transition to renewable energy? 8. by saving water
9.	Define the Industrial Revolution. 9.

For Official Use Only: Learner Number: School 1 Learner 5

You will not be graded on your answers to this survey. The purpose of this work sheet is for the EduVentures staff to see how much you already know about renewable energy. If you are not sure about the answer to a question, you can guess or simply leave the box blank.	
1.	What is renewable energy? Why is it important to Namibia? 1A. is the energy that can be renewed or used again and again. 1B. it is cheap to get
2.	What is solar energy? How does it work? 2A. it refers to the energy that comes from the direct sunrays 2B. it works through solar panels
3.	What is an encroachment bush? How can Namibia use it for power generation? 3A. refers to the cutting down of other trees and the environment is only left with bushes 3B. they can use it by cutting the trees down
4.	Name some of the benefits of using renewable energy technology. 4. it is cheap to get/not expensive; it saves resources
5.	What is wind energy? How does it work? 5A. is the energy that come from/generated by the wind 5B.
6.	Name one consequence if Namibia does not transition to renewable energy 6. more resources will be used up
7.	Name as many types of renewable energy sources as you can. 7. wind energy, geothermal energy, tital energy, hydro energy, solar energy
8.	What can you do to help in Namibia's transition to renewable energy? 8. I will join the Ombombo mobile classroom and learn more about transition to renewable energy
9.	Define the Industrial Revolution. 9. it is the change between the 18 th and 19 th century were by people uses machines and equipment instead of labour

For Official Use Only: Learner Number: School 1 Learner 6

You will not be graded on your answers to this survey. The purpose of this work sheet is for the EduVentures staff to see how much you already know about renewable energy. If you are not sure about the answer to a question, you can guess or simply leave the box blank.	
1.	What is renewable energy? Why is it important to Namibia? 1A. is the energy that can be reused 1B. It is important for you to use it in future
2.	What is solar energy? How does it work? 2A. is the energy that can be used by using the sunlight 2B.
3.	What is an encroachment bush? How can Namibia use it for power generation? 3A. is an open bush area that was covered with grass 3B.
4.	Name some of the benefits of using renewable energy technology. 4. It is cheap; resources wont be scares
5.	What is wind energy? How does it work? 5A. is the energy come from the wind 5B. the wind blows into the instrument to let it work
6.	Name one consequence if Namibia does not transition to renewable energy 6. it can be very expensive like if you bought energy from other country
7.	Name as many types of renewable energy sources as you can. 7. wind energy, bush energy, solar energy
8.	What can you do to help in Namibia's transition to renewable energy? 8. to educate people, we need people to design renewable energy that are friendly to the environment
9.	Define the Industrial Revolution. 9.

For Official Use Only: Learner Number: School 1 Learner 7

This learner handed in the survey blank

You will not be graded on your answers to this survey. The purpose of this work sheet is for the EduVentures staff to see how much you already know about renewable energy. If you are not sure about the answer to a question, you can guess or simply leave the box blank.	
1.	What is renewable energy? Why is it important to Namibia? 1A. 1B.
2.	What is solar energy? How does it work? 2A. 2B.
3.	What is an encroachment bush? How can Namibia use it for power generation? 3A. 3B.
4.	Name some of the benefits of using renewable energy technology. 4.
5.	What is wind energy? How does it work? 5A. 5B.
6.	Name one consequence if Namibia does not transition to renewable energy 6.
7.	Name as many types of renewable energy sources as you can. 7.
8.	What can you do to help in Namibia's transition to renewable energy? 8.
9.	Define the Industrial Revolution. 9.

For Official Use Only: Learner Number: School 1 Learner 8

You will not be graded on your answers to this survey. The purpose of this work sheet is for the EduVentures staff to see how much you already know about renewable energy. If you are not sure about the answer to a question, you can guess or simply leave the box blank.	
1.	What is renewable energy? Why is it important to Namibia? 1A. is energy that can be renewed or replaced once it is used up 1B. it is important because it does not cause any harm to the environment or its resources
2.	What is solar energy? How does it work? 2A. is energy that comes from the sun 2B. the solar panels absorb the heat and then transform it into energy
3.	What is an encroachment bush? How can Namibia use it for power generation? 3A. is a bush that grows at an area previously covered by grass. 3B. Namibia can chop it down, burn it and use it for coal stations
4.	Name some of the benefits of using renewable energy technology. 4. Does not cause pollution; this type of energy can't be used up
5.	What is wind energy? How does it work? 5A. is energy that comes from the wind. 5B. it is transformed into energy by wind turboid/wind vanes
6.	Name one consequence if Namibia does not transition to renewable energy 6. Namibia will experience climate change which comes with a lot of bad things
7.	Name as many types of renewable energy sources as you can. 7. wind, sun, water, bushes, heat
8.	What can you do to help in Namibia's transition to renewable energy? 8. make Namibians aware of the benefits of using renewable energy
9.	Define the Industrial Revolution. 9. Is the gradual change in term of stages in the industry of a country

For Official Use Only: Learner Number: School 1 Learner 9

You will not be graded on your answers to this survey. The purpose of this work sheet is for the EduVentures staff to see how much you already know about renewable energy. If you are not sure about the answer to a question, you can guess or simply leave the box blank.	
1.	What is renewable energy? Why is it important to Namibia? 1A. is energy that can be replaced 1B. its important because Namibia can benefit more on it. It develops Namibian environment
2.	What is solar energy? How does it work? 2A. is the energy from the sun 2B. you put the solar panel directly to the sun rays and then connect the wires together and then the circuit
3.	What is an encroachment bush? How can Namibia use it for power generation? 3A. it when the natural grass is invited by un-wanted bushes 3B.
4.	Name some of the benefits of using renewable energy technology. 4. It is cheap
5.	What is wind energy? How does it work? 5A. is the energy from the wind. 5B. When the wind blows it turns the speed of the vane. And then the vane gives power
6.	Name one consequence if Namibia does not transition to renewable energy 6. it can be very expensive
7.	Name as many types of renewable energy sources as you can. 7. water, sunlight, bushes, heat
8.	What can you do to help in Namibia's transition to renewable energy? 8. by creating solar panels, so that people can use it especially the one's in villages and farms.
9.	Define the Industrial Revolution. 9. is the amount of electricity that is in urban area or rural area

For Official Use Only: Learner Number: School 1 Learner 10

You will not be graded on your answers to this survey. The purpose of this work sheet is for the EduVentures staff to see how much you already know about renewable energy. If you are not sure about the answer to a question, you can guess or simply leave the box blank.	
1.	What is renewable energy? Why is it important to Namibia? 1A. is the type of energy that can be used 1B. it is important to Namibia because Namibia is not having enough electricity to supply to the whole nation
2.	What is solar energy? How does it work? 2A. is the energy that is directly produce from the sun 2B. a solar system is put in a clear area where the sun can heat it and its actually conducted to batteries and this batteries are charged and energy is produced
3.	What is an encroachment bush? How can Namibia use it for power generation? 3A. is when the land is covered with species and the grass is not given space to grow. 3B. People can cut down this trees and burn them and use the coal as power generation
4.	Name some of the benefits of using renewable energy technology. 4. It is cheap; not enough skills are needed
5.	What is wind energy? How does it work? 5A. is the energy produce through wind 5B.
6.	Name one consequence if Namibia does not transition to renewable energy 6. there will be a shortage of electricity since a lot of people staying in rural area are the type of energy they mostly use
7.	Name as many types of renewable energy sources as you can. 7. wind energy, solar energy, biomass
8.	What can you do to help in Namibia's transition to renewable energy? 8. need skill people who learn to produce this type of system and to cut down unneeded species and make coal to produce power generation
9.	Define the Industrial Revolution. 9.

Appendix V: Rural School Pre-Visit Survey Responses: Okondjatu Secondary School Responses

The project team transcribed the responses exactly from what the learner wrote on the form. If the team was not able to read the word, they denoted it with []. Inside the brackets was the team's guess of what the word was.

For Official Use Only: Learner Number: School 2 Learner 1

You will not be graded on your answers to this survey. The purpose of this work sheet is for the EduVentures staff to see how much you already know about renewable energy. If you are not sure about the answer to a question, you can guess or simply leave the box blank.	
1.	What is renewable energy? Why is it important to Namibia? 1A. energy that can be used again. E.g. solar energy, wind 1B.
2.	What is solar energy? How does it work? 2A. is the energy that workers from the sun 2B.
3.	What is an encroachment bush? How can Namibia use it for power generation? 3A. things that do to cut the trees and using to the wood 3B.
4.	Name some of the benefits of using renewable energy technology. 4. by burning tree and grass
5.	What is wind energy? How does it work? 5A. to some of renewable the burning in houses 5B.
6.	Name one consequence if Namibia does not transition to renewable energy 6.
7.	Name as many types of renewable energy sources as you can. 7. hydropower, solar energy, wind energy
8.	What can you do to help in Namibia's transition to renewable energy? 8.
9.	Define the Industrial Revolution. 9.

For Official Use Only: Learner Number: School 2 Learner 2

You will not be graded on your answers to this survey. The purpose of this work sheet is for the EduVentures staff to see how much you already know about renewable energy. If you are not sure about the answer to a question, you can guess or simply leave the box blank.	
1.	What is renewable energy? Why is it important to Namibia? 1A. is the energy that you can use over again 1B.
2.	What is solar energy? How does it work? 2A. is the energy that we get from the sun. 2B. You actually put where the sun is and it get charged
3.	What is an encroachment bush? How can Namibia use it for power generation? 3A. is to cut down trees than it get dry from that we put on fire 3B.
4.	Name some of the benefits of using renewable energy technology. 4.
5.	What is wind energy? How does it work? 5A. 5B.
6.	Name one consequence if Namibia does not transition to renewable energy 6.
7.	Name as many types of renewable energy sources as you can. 7. solar energy, bush energy, hydrogen energy, wind energy
8.	What can you do to help in Namibia's transition to renewable energy? 8.
9.	Define the Industrial Revolution. 9.

For Official Use Only: Learner Number: School 2 Learner 3

You will not be graded on your answers to this survey. The purpose of this work sheet is for the EduVentures staff to see how much you already know about renewable energy. If you are not sure about the answer to a question, you can guess or simply leave the box blank.	
1.	What is renewable energy? Why is it important to Namibia? 1A. is the energy that you can use [again]* 1B.
2.	What is solar energy? How does it work? 2A.it work much already [wan the world]* 2B.
3.	What is an encroachment bush? How can Namibia use it for power generation? 3A. 3B.
4.	Name some of the benefits of using renewable energy technology. 4.
5.	What is wind energy? How does it work? 5A. 5B.
6.	Name one consequence if Namibia does not transition to renewable energy 6.
7.	Name as many types of renewable energy sources as you can. 7.
8.	What can you do to help in Namibia's transition to renewable energy? 8. I wall bee of mbombo people
9.	Define the Industrial Revolution. 9.

For Official Use Only: Learner Number: School 2 Learner 4

You will not be graded on your answers to this survey. The purpose of this work sheet is for the EduVentures staff to see how much you already know about renewable energy. If you are not sure about the answer to a question, you can guess or simply leave the box blank.	
1.	What is renewable energy? Why is it important to Namibia? 1A. is an energy that you can renew again 1B. For us to provide more
2.	What is solar energy? How does it work? 2A. is the energy that come from the sun. 2B. by shining ahead us
3.	What is an encroachment bush? How can Namibia use it for power generation? 3A. thing that are used to cut trees and use as wood for fire 3B.
4.	Name some of the benefits of using renewable energy technology. 4. you get more knowledge and more idears
5.	What is wind energy? How does it work? 5A. 5B.
6.	Name one consequence if Namibia does not transition to renewable energy 6. They will loss their level
7.	Name as many types of renewable energy sources as you can. 7. wind energy, sun energy, sound energy, hydropower energy
8.	What can you do to help in Namibia's transition to renewable energy? 8. I would like to tell them how important of transition this energy
9.	Define the Industrial Revolution. 9.

For Official Use Only: Learner Number: School 2 Learner 5

You will not be graded on your answers to this survey. The purpose of this work sheet is for the EduVentures staff to see how much you already know about renewable energy. If you are not sure about the answer to a question, you can guess or simply leave the box blank.	
1.	What is renewable energy? Why is it important to Namibia? 1A. is the energy once that you can use again 1B.
2.	What is solar energy? How does it work? 2A. is a ability to do work 2B.
3.	What is an encroachment bush? How can Namibia use it for power generation? 3A. 3B.
4.	Name some of the benefits of using renewable energy technology. 4. solar energy
5.	What is wind energy? How does it work? 5A. is they wind that can be supported the energy 5B.
6.	Name one consequence if Namibia does not transition to renewable energy 6.
7.	Name as many types of renewable energy sources as you can. 7. wind energy, solar energy
8.	What can you do to help in Namibia's transition to renewable energy? 8. they will can help with the [any]* energy
9.	Define the Industrial Revolution. 9.

For Official Use Only: Learner Number: School 2 Learner 6

You will not be graded on your answers to this survey. The purpose of this work sheet is for the EduVentures staff to see how much you already know about renewable energy. If you are not sure about the answer to a question, you can guess or simply leave the box blank.	
1.	What is renewable energy? Why is it important to Namibia? 1A. energy that can be replace or use over 1B. to help one
2.	What is solar energy? How does it work? 2A. you get it from one sun 2B. it works by one power of energy
3.	What is an encroachment bush? How can Namibia use it for power generation? 3A. 3B.
4.	Name some of the benefits of using renewable energy technology. 4. to save electricity, to save car when you are [using]* water
5.	What is wind energy? How does it work? 5A. By blowing wind when are you pumping water 5B.
6.	Name one consequence if Namibia does not transition to renewable energy 6.
7.	Name as many types of renewable energy sources as you can. 7. solar, wind, and bush
8.	What can you do to help in Namibia's transition to renewable energy? 8.
9.	Define the Industrial Revolution. 9.

For Official Use Only: Learner Number: School 2 Learner 7

You will not be graded on your answers to this survey. The purpose of this work sheet is for the EduVentures staff to see how much you already know about renewable energy. If you are not sure about the answer to a question, you can guess or simply leave the box blank.	
1.	What is renewable energy? Why is it important to Namibia? 1A. renewable energy is the energy that can be reuse again 1B. renewable energy is important because they can have light
2.	What is solar energy? How does it work? 2A. is the energy that is in the houses for people to cook on it 2B. it works when you put your solar outside the house for it to get some heat so that it can work
3.	What is an encroachment bush? How can Namibia use it for power generation? 3A. 3B.
4.	Name some of the benefits of using renewable energy technology. 4.
5.	What is wind energy? How does it work? 5A. wind energy is energy that can be used for water. 5B. It can work for wind blowing it and it works
6.	Name one consequence if Namibia does not transition to renewable energy 6.
7.	Name as many types of renewable energy sources as you can. 7. solar, wind, bush (that's all I know)
8.	What can you do to help in Namibia's transition to renewable energy? 8. you can help by giving them solar energy or you can just give electricity so they cannot waste
9.	Define the Industrial Revolution. 9.

For Official Use Only: Learner Number: School 2 Learner 8

You will not be graded on your answers to this survey. The purpose of this work sheet is for the EduVentures staff to see how much you already know about renewable energy. If you are not sure about the answer to a question, you can guess or simply leave the box blank.	
1.	What is renewable energy? Why is it important to Namibia? 1A. is the energy that you can use again 1B.
2.	What is solar energy? How does it work? 2A. is the energy that use sun. 2B. it works with sun to charge its battery
3.	What is an encroachment bush? How can Namibia use it for power generation? 3A. it can be burned and used for coals 3B.
4.	Name some of the benefits of using renewable energy technology. 4.
5.	What is wind energy? How does it work? 5A. wind energy is the energy that you can use even for your water bore wholes 5B. it works with win
6.	Name one consequence if Namibia does not transition to renewable energy 6.
7.	Name as many types of renewable energy sources as you can. 7. wind energy, solar energy, manure energy, sound energy
8.	What can you do to help in Namibia's transition to renewable energy? 8. I would like to tell that how important is renewable energy
9.	Define the Industrial Revolution. 9.

For Official Use Only: Learner Number: School 2 Learner 9

You will not be graded on your answers to this survey. The purpose of this work sheet is for the EduVentures staff to see how much you already know about renewable energy. If you are not sure about the answer to a question, you can guess or simply leave the box blank.	
1.	What is renewable energy? Why is it important to Namibia? 1A. energy that can be replace or use over 1B. to help environment
2.	What is solar energy? How does it work? 2A. you get it from the sun and it works by the power of the energy 2B. they got from the sun
3.	What is an encroachment bush? How can Namibia use it for power generation? 3A.is cutting down trees and using them for wood 3B.
4.	Name some of the benefits of using renewable energy technology. 4. to save electricity, to reduce fire burning in houses
5.	What is wind energy? How does it work? 5A.by the wind blowing 5B. it help to wind [bumb]* to help us with water
6.	Name one consequence if Namibia does not transition to renewable energy 6.
7.	Name as many types of renewable energy sources as you can. 7. solar, wind, bush
8.	What can you do to help in Namibia's transition to renewable energy? 8.
9.	Define the Industrial Revolution. 9.

For Official Use Only: Learner Number: School 2 Learner 10

You will not be graded on your answers to this survey. The purpose of this work sheet is for the EduVentures staff to see how much you already know about renewable energy. If you are not sure about the answer to a question, you can guess or simply leave the box blank.	
1.	What is renewable energy? Why is it important to Namibia? 1A. is energy that it can be used again 1B.
2.	What is solar energy? How does it work? 2A. is energy that receives energy from the sun 2B.
3.	What is an encroachment bush? How can Namibia use it for power generation? 3A. cutting down trees and using for fire wood 3B.
4.	Name some of the benefits of using renewable energy technology. 4. to save the electricities
5.	What is wind energy? How does it work? 5A. it work with wind, like wind mill to get water 5B.
6.	Name one consequence if Namibia does not transition to renewable energy 6.
7.	Name as many types of renewable energy sources as you can. 7. Hydropower, solar energy, bush energy, wind energy
8.	What can you do to help in Namibia's transition to renewable energy? 8.
9.	Define the Industrial Revolution. 9.

Appendix W: Rural School Pre-Visit Survey Responses: Okamatapati Secondary School Responses

The project team transcribed the responses exactly from what the learner wrote on the form. If the team was not able to read the word, they denoted it with [] *. Inside the brackets was the team's guess of what the word was.

For Official Use Only: Learner Number: School 3 Learner 1

You will not be graded on your answers to this survey. The purpose of this work sheet is for the EduVentures staff to see how much you already know about renewable energy. If you are not sure about the answer to a question, you can guess or simply leave the box blank.	
1.	What is renewable energy? Why is it important to Namibia? 1A. a renewable energy are energy that can be replaced if they are finished 1B. the importance of renewable resource is that is can be reused once they are finished
2.	What is solar energy? How does it work? 2A. a solar energy is a energy that comes from the sun 2B. the importance of solar energy is that even though you don't have electricity you can still use it
3.	What is an encroachment bush? How can Namibia use it for power generation? 3A. is a lot of bushes in one area 3B.
4.	Name some of the benefits of using renewable energy technology. 4. it can be used once again, it never get finished
5.	What is wind energy? How does it work? 5A. wind energy are energy that comes from the wind, mostly when the wind it's blowing 5B.
6.	Name one consequence if Namibia does not transition to renewable energy 6. people will not breath normally because their will not be enough energy for them to survive
7.	Name as many types of renewable energy sources as you can. 7. solar energy, wind energy, bush energy
8.	What can you do to help in Namibia's transition to renewable energy? 8. I will provide Namibia with a nature club group
9.	Define the Industrial Revolution. 9. is when something is used again and again

For Official Use Only: Learner Number: School 3 Learner 2

You will not be graded on your answers to this survey. The purpose of this work sheet is for the EduVentures staff to see how much you already know about renewable energy. If you are not sure about the answer to a question, you can guess or simply leave the box blank.	
1.	What is renewable energy? Why is it important to Namibia? 1A. is the source or energy that can be replace 1B. because it can be used twice
2.	What is solar energy? How does it work? 2A. solar energy is energy that come from the sun 2B. solar panel attrack the sunlight and create energy
3.	What is an encroachment bush? How can Namibia use it for power generation? 3A. is trees that are at once place and not needed 3B. it can be [short]* cut down and become sources of energy
4.	Name some of the benefits of using renewable energy technology. 4. it can be used again and again
5.	What is wind energy? How does it work? 5A. is energy that comes from the wind 5B. it turn when the wind is blowing and create energy
6.	Name one consequence if Namibia does not transition to renewable energy 6. air pollution can caused
7.	Name as many types of renewable energy sources as you can. 7. solar, wind
8.	What can you do to help in Namibia's transition to renewable energy? 8. nature club
9.	Define the Industrial Revolution. 9. is when something is used again

For Official Use Only: Learner Number: School 3 Learner 3

You will not be graded on your answers to this survey. The purpose of this work sheet is for the EduVentures staff to see how much you already know about renewable energy. If you are not sure about the answer to a question, you can guess or simply leave the box blank.	
1.	What is renewable energy? Why is it important to Namibia? 1A. are replaceable materials 1B.
2.	What is solar energy? How does it work? 2A. energy from the sun because the can't afford electricity 2B.
3.	What is an encroachment bush? How can Namibia use it for power generation? 3A. is the overloading of the bushes in an area. 3B. is when the land is overcrowded by bushes
4.	Name some of the benefits of using renewable energy technology. 4. it can be used once again; it never get finished
5.	What is wind energy? How does it work? 5A. is the energy from the wind 5B. to help operate wind wheel
6.	Name one consequence if Namibia does not transition to renewable energy 6. they will suffer from electricity
7.	Name as many types of renewable energy sources as you can. 7. solar, wind, bush
8.	What can you do to help in Namibia's transition to renewable energy? 8. save water, provided them with coals
9.	Define the Industrial Revolution. 9. is the early revolution that took place between the british and black americans

For Official Use Only: Learner Number: School 3 Learner 4

You will not be graded on your answers to this survey. The purpose of this work sheet is for the EduVentures staff to see how much you already know about renewable energy. If you are not sure about the answer to a question, you can guess or simply leave the box blank.	
1.	What is renewable energy? Why is it important to Namibia? 1A. is the energy that can be recycled or used again 1B.
2.	What is solar energy? How does it work? 2A. is something that works from the sun, is there is no sun not work 2B.
3.	What is an encroachment bush? How can Namibia use it for power generation? 3A. is the increase of shurb layer in the environment than grass 3B. by cutting down trees and make coals
4.	Name some of the benefits of using renewable energy technology. 4. because energy can be used for many years
5.	What is wind energy? How does it work? 5A. is the energy that works with wind 5B. it can be used to operate a windmill
6.	Name one consequence if Namibia does not transition to renewable energy 6. energy will be expensive in Namibia
7.	Name as many types of renewable energy sources as you can. 7. solar, wind, bush, therminal, neuclear energy
8.	What can you do to help in Namibia's transition to renewable energy? 8. by providing more solar panel
9.	Define the Industrial Revolution. 9. is the early revolution that place between the british and black americans

For Official Use Only: Learner Number: School 3 Learner 5

You will not be graded on your answers to this survey. The purpose of this work sheet is for the EduVentures staff to see how much you already know about renewable energy. If you are not sure about the answer to a question, you can guess or simply leave the box blank.	
1.	What is renewable energy? Why is it important to Namibia? 1A. energy that can be recycle 1B. because you can use it as much as you want
2.	What is solar energy? How does it work? 2A. energy from the sun 2B.
3.	What is an encroachment bush? How can Namibia use it for power generation? 3A. by cutting down trees and use in coals 3B. it is an area where there is a lot of trees
4.	Name some of the benefits of using renewable energy technology. 4. its cheap, you can use it as much as you want and its not expensive
5.	What is wind energy? How does it work? 5A.energy that we get from the wind by using a windmill 5B.
6.	Name one consequence if Namibia does not transition to renewable energy 6. energy that will be expensive
7.	Name as many types of renewable energy sources as you can. 7. solar, wind, bush
8.	What can you do to help in Namibia's transition to renewable energy? 8. by providing more solar panels, and windmill
9.	Define the Industrial Revolution. 9. the early revolution that took place between british and black americans

For Official Use Only: Learner Number: School 3 Learner 6

You will not be graded on your answers to this survey. The purpose of this work sheet is for the EduVentures staff to see how much you already know about renewable energy. If you are not sure about the answer to a question, you can guess or simply leave the box blank.	
1.	What is renewable energy? Why is it important to Namibia? 1A. is energy that can be used again that does not finish 1B. because it is saver and wants its finish it can be brought back
2.	What is solar energy? How does it work? 2A. is energy from the sun 2B. the sun heats to the solar panels and it transfers electricity
3.	What is an encroachment bush? How can Namibia use it for power generation? 3A. 3B.
4.	Name some of the benefits of using renewable energy technology. 4. it is cheap because it is natural; it can be renewed wants its done
5.	What is wind energy? How does it work? 5A. is wind from the wind 5B. the wind turbns the wind pump which is given energy to pump water into the dams
6.	Name one consequence if Namibia does not transition to renewable energy 6. they will use more money on non-renewable energy; wants the non-renewable energy are finished they wont be anymore
7.	Name as many types of renewable energy sources as you can. 7. bush energy, solar, wind
8.	What can you do to help in Namibia's transition to renewable energy? 8. consume, give them ideas, help the communities through environmental adventures
9.	Define the Industrial Revolution. 9. is a revolution which deals with resources in the industry

For Official Use Only: Learner Number: School 3 Learner 7

You will not be graded on your answers to this survey. The purpose of this work sheet is for the EduVentures staff to see how much you already know about renewable energy. If you are not sure about the answer to a question, you can guess or simply leave the box blank.	
1.	What is renewable energy? Why is it important to Namibia? 1A. is an energy that can be renewed or reused 1B. because we can use it again and again
2.	What is solar energy? How does it work? 2A. is energy that come or produced by the sun 2B. the heat is trapped in solar panels and coverted into electricity
3.	What is an encroachment bush? How can Namibia use it for power generation? 3A. is an area were there is a lot of bushes 3B. Namibia can use this for the production of coals
4.	Name some of the benefits of using renewable energy technology. 4. it is cheap; it can be used in rural area where there is no electricity
5.	What is wind energy? How does it work? 5A. is energy that is produced by wind 5B. it blows to turn the windmill
6.	Name one consequence if Namibia does not transition to renewable energy 6. we will have problem with electricity
7.	Name as many types of renewable energy sources as you can. 7. solar energy, wind energy, water energy
8.	What can you do to help in Namibia's transition to renewable energy? 8. provide more solar panels and wind-mill; by having more electrical engineers in Namibia
9.	Define the Industrial Revolution. 9. is the process where by industrialization change from year to year or generation to generation

For Official Use Only: Learner Number: School 3 Learner 8

You will not be graded on your answers to this survey. The purpose of this work sheet is for the EduVentures staff to see how much you already know about renewable energy. If you are not sure about the answer to a question, you can guess or simply leave the box blank.	
1.	What is renewable energy? Why is it important to Namibia? 1A. are energy that can be used for many times 1B.
2.	What is solar energy? How does it work? 2A. is the energy that comes from the sun 2B. the solar panel used to trapped the sun rays from the sun
3.	What is an encroachment bush? How can Namibia use it for power generation? 3A. is the overloating of bushes in the area 3B. is when the area is over crowded by bush
4.	Name some of the benefits of using renewable energy technology. 4. it can be used for many period of times
5.	What is wind energy? How does it work? 5A. is the energy that come's from the wind 5B. it can helps a wind mill to operate
6.	Name one consequence if Namibia does not transition to renewable energy 6. we will have problems of electricity
7.	Name as many types of renewable energy sources as you can. 7. solar, wind, thermal
8.	What can you do to help in Namibia's transition to renewable energy? 8. by providing resources that can be renewed. Providing more solar panels and wind mills
9.	Define the Industrial Revolution. 9. is early revolution that took place between the british government and the black americans

For Official Use Only: Learner Number: School 3 Learner 9

You will not be graded on your answers to this survey. The purpose of this work sheet is for the EduVentures staff to see how much you already know about renewable energy. If you are not sure about the answer to a question, you can guess or simply leave the box blank.	
1.	What is renewable energy? Why is it important to Namibia? 1A. is the energy that can be renew 1B. is because it cheap and you cannot buy it again
2.	What is solar energy? How does it work? 2A. is the energy that came from the sun 2B. the solar panel attract the sunlight and connect it to electricity
3.	What is an encroachment bush? How can Namibia use it for power generation? 3A. is the place that have more bushes 3B. thereby cutting tree and convert to coal
4.	Name some of the benefits of using renewable energy technology. 4. they are cheap; provide employment
5.	What is wind energy? How does it work? 5A. is a energy that come from wind. 5B. the wind blows it turn wind pump and produce electricity
6.	Name one consequence if Namibia does not transition to renewable energy 6. it will spend lots of money on buying instrument or machinery need to produce electricity
7.	Name as many types of renewable energy sources as you can. 7. wind, water, solar
8.	What can you do to help in Namibia's transition to renewable energy? 8. save water, privent harmful effect on environment
9.	Define the Industrial Revolution. 9. is a early revolution take place between a british government and black people

For Official Use Only: Learner Number: School 3 Learner 10

You will not be graded on your answers to this survey. The purpose of this work sheet is for the EduVentures staff to see how much you already know about renewable energy. If you are not sure about the answer to a question, you can guess or simply leave the box blank.	
1.	What is renewable energy? Why is it important to Namibia? 1A.is an energy that can be used again or renewed again 1B. it is very important to the Namibian nation because it is very cheap
2.	What is solar energy? How does it work? 2A. is an energy can comes from solar panels 2B. it works from the sun
3.	What is an encroachment bush? How can Namibia use it for power generation? 3A.is the overloading bushes in the area where there is some of grasses and it can be used with coal 3B.
4.	Name some of the benefits of using renewable energy technology. 4. save money
5.	What is wind energy? How does it work? 5A.is a energy that is supplied by wind and it works when the wind is blowing 5B.
6.	Name one consequence if Namibia does not transition to renewable energy 6. it will use more money
7.	Name as many types of renewable energy sources as you can. 7. wind, solar, water
8.	What can you do to help in Namibia's transition to renewable energy? 8. provide it with coals, save water
9.	Define the Industrial Revolution. 9. is the process of building new things

Appendix X: Course Outline Provided by EduVentures

Table of Content for SMART lesson on renewable energy in Namibia

SMART Lesson 1: Renewable energy in Namibia

- What is renewable energy
- Discovery of fossil fuel (The Industrial revolution)
- The link to Climate change
- The path to renewable energy

The need for renewable energy – A case study from Namibian

- Combine social, environmental and economic aspects which calls for a need to use renewable energy in Namibia
- Group activities on how to solve community problem

Renewable energy sources

- Mention all renewable energy sources worldwide
- Biogas, sun, wind, nuclear, geothermal, wave, Bush-to-Energy
- What are the opportunities for renewable energy in Namibia
 - Solar
 - Wind
 - Bush-to-Energy

SMART lesson 2: Solar

- What is solar power
- Why solar power in Namibia
- Solar power operation and maintenance
- Where in Namibia
- Advantages and disadvantages of Solar power
- Activities and games

SMART lesson 3: Wind

- What is wind power
- Why wind power in Namibia
- Wind power operation and maintenance
- Where in Namibia
- Advantages and disadvantages of wind power
- Activities and games

SMART lesson 4: Bush-to-Energy

- What is Bush-to-Energy
- Why Bush-to-Energy power in Namibia
- Bush-to-Energy power operation and maintenance
- Where in Namibia
- Advantages and disadvantages of Bush-to-Energy power
- Activities and games

Appendix Y: Outline of Module 1: Introduction to Renewable Energy

- I. **Purpose** – Introduce the topic of renewable energy to the learners and why it is important to them and their country
- II. **Objective:**
 - a. Define renewable energy
 - b. Explain what climate change is and the causes of it
 - c. Discuss social, environmental and economic problems and solutions
 - d. Explain what you can do to help
- III. **Activity** – Teacher begins on the first slide and asks the learners several questions.
 - a. What do you see in the picture?
 - b. What is renewable energy?
 - c. What do you think non-renewable energy is?
 - d. Who has heard of climate change?
- IV. **SMART Activity** – get the learners to come to the board and sort the different pictures of energy. The two categories of energy are non-renewable and renewable

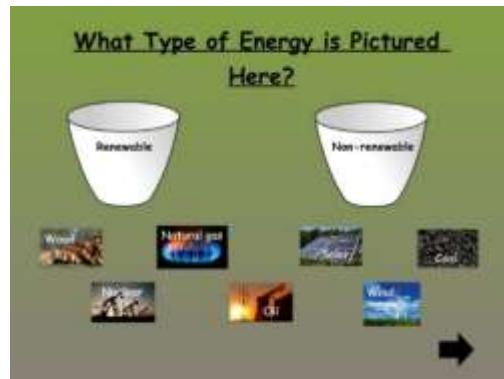

- V. **Lecture**
 - a. Non-renewable energy
 - i. Definition: energy sources that cannot be used again after they run out
 - ii. Comes from fossil fuels which takes thousands of years to form
 - iii. Ask → What are fossil fuels? Where do they come from?
 1. Definition: include hydrocarbons such as coal, fuel oil, and natural gas which have formed from the remains of dead plants and animals buried in geologic deposits
 2. Largely used in industrial development
 3. They were discovered and widely used during the Industrial Revolution
 - b. The Industrial Revolution
 - i. Pre-18th century Great Britain
 1. Life was difficult. Lots of poverty, malnourishment and disease
 2. Rural communities that revolved around farming and individual production
 - ii. 18th century Great Britain
 1. Birthplace of the industrial revolution because of iron and coal
 2. Manufacturing switched from using hand tools and basic machines in homes to powered, special purpose machinery, factories and mass production.
 3. Introduced iron and textile industries, and the steam engine which improved transportation, communication and banking.
 4. Life greatly improved as more products became available to people
 - iii. Definition of Industrial Revolution: process of change from an agrarian and handicraft economy to one dominated by industry and machine manufacturing
 - iv. How does a steam engine work?
 1. Coal is added to a furnace
 2. As the coal burns hot gases are released
 3. The gases move through the pipes and heat water

4. Steam is produced which moves the vehicle through a series of pistons
 5. Excess gases are released into the air
- c. Activity
- i. Description: after learning about some of the new technologies and inventions of the industrial revolution, think about some inventions or technologies you have in your community.
 - ii. Directions: in groups of 2-3 learners brainstorm different inventions or technologies. The inventions or technologies may either be harmful or helpful in your community.
 - iii. Please consider:
 1. Impacts of the inventions or technologies on the environment (good or bad)
 2. If you have direct access to the invention or technology
 3. How did you think of the invention or technology?
 - iv. SMART Discussion: learners will share what they brainstormed and write on the SMART board for a brief discussion
- d. Fossil fuels
- i. They release greenhouse gases when they are burned which is very bad
 - ii. The atmosphere naturally contains carbon dioxide, water vapor, chlorofluorocarbons, methane, and nitrous oxide
 - iii. For thousands of years the earth's climate has changed naturally because of events such as volcanic eruptions and solar energy bursts.
 - iv. Since the Industrial Revolution, the amount of these in the atmosphere have increased
 - v. Scientific consensus is that humans are causing rapid Climate Change across the globe
 - vi. Greenhouse gasses trap heat which raises the surface temperature of earth and causes Climate Change.
 - vii. Climate change
 1. Consequently, regions may see higher precipitation while others experience drought and plants may adapt to higher concentrations of carbon dioxide while others may experience crop failures.
 2. Industrial activities have increased carbon dioxide levels from 280 parts per million to 400 ppm in just the last 150 years
- e. What can Namibia do?
- i. Transition to renewable energy
 1. Definition of Renewable Energy: an energy source that is replenished very quickly because of natural processes
 2. Renewable energy replenishes on a daily basis compared to non-renewable energy which takes years
 3. There are many different types of renewable energy
 4. Solar
 - a. Power generated using solar panels which absorb photons and knock off electrons.
 - i. Photons - tiny particles of light with no mass
 - ii. Electrons - a tiny piece of electricity, negatively charged
 - b. Different kinds of applications
 - i. Solar cookers
 - ii. Solar water heater
 - iii. Solar powered lamp that also is a phone charger
 5. Wind
 - a. Power generated using turbines that convert wind to electricity.
 - b. Good places to build turbines are along the coast
 6. Wave and tidal
 - a. Wave and Tidal - power generated from waves and tides when it passes through special buoys, turbines and other technologies. More predictable than wind energy. Electricity is produced without any pollutant emissions or greenhouse gasses, but full environmental impacts are scarce.
 - b. 3 types in the modules as examples
 - i. Vertical Axis Tidal Turbine (VATT)
 - ii. Point Absorbers
 - iii. Attenuators
 7. Biomass

- a. Generates electricity by burning biological material. A specific biomass to Namibia is known as Bush-to-Energy. This process utilizes the abundant, invasive encroacher bushes and burns them to produce electricity.
- f. SMART Activity - What options are best for Namibia?
 - i. Learners can come up and write their answers on the board
 - ii. The teacher can then briefly discuss the best options: solar, wind, and Bush-to-Energy



- g. SMART Activity - Why is renewable energy important to Namibia?
 - i. Ask the learners first before revealing the answers
 - ii. Answers:
 1. Provides electricity to more places
 - a. Communities do not have to be dependent on NamPower for electricity because they can have their own source of energy from solar panels, wind turbines, or Bush-to-Energy
 2. Reduces Namibia's carbon footprint
 - a. A carbon footprint is the amount of CO₂ a place releases into the atmosphere. Renewable energy will help reduce the amount of CO₂ Namibia emits. As a result, the air in Namibia will be cleaner and safer for its people. This means a healthier environment for people and animals.
 3. Improve economy, promote entrepreneurship and create jobs
 - a. This is important because Namibia is reliant on other countries for energy. Namibia hopes to eventually export energy. Renewable energy has the potential to raise the confidence of Namibian people and create jobs for many. Also, as Namibia grows and industrializes, entrepreneurs need ways to establish green businesses to help mitigate the effects of Climate Change
 4. Improve agriculture and food availability
 - a. Important because some places have limited access to food. The unpredictable changes in the climate have left farmers struggling to provide enough crops
 5. Improve water availability
 - a. Namibia is a dry arid country that suffers from a lack of water. If Climate changes continues to get worse water will become even more scarce and unavailable to people and animals. Namibia also relies on hydro power and if the rivers run dry they won't be able to use this type of renewable energy
 6. Supports Vision 2030
 - a. Supporting sustainable development in Namibia and mitigating Climate Change effects in the country. Improving education across urban and rural areas and incorporating environmental education
- h. What can you do?
 - i. Explain to the learners actions that they can do that helps mitigate Climate Change and supports Namibia's sustainable development goals
 - ii. Organize cleanup projects around your school or village
 - iii. Build solar cookers instead of using wood stoves
 - iv. Tell other about what you learned
 - v. These are all important because they are small actions, but if many do them then the impacts become greater
 - vi. Ask the learners if they can think of anything else that they can do
 - vii. If they give an answer that is "use more solar power" explain why that isn't good enough and how they can actually achieve that goal.
- i. SMART Activity

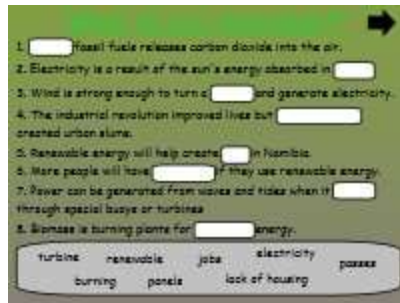

- i. Fill in the blank activity to test the learners on how much they remember about renewable energy
- ii. Answers:

1. The sun is energy and when absorbed in panels creates electricity.
2. Electricity is a result of the sun's energy absorbed in panels.
3. Wind is strong enough to turn a turbine that creates electricity.
4. The Industrial Revolution improved lives but lack of housing created urban slums.
5. Renewable Energy will help create jobs in Namibia.
6. More people will have electricity if they use renewable energy.
7. Power can be generated from waves and tides when it passes through special buoys or turbines.
8. Biomass is burning of plants for renewable energy.

VI. Final Activity

- a. Description: after learning about the importance of renewable energy, it is time to share your opinions and give advice to others.
- b. Directions: divide yourselves into 3 groups. Each group will get a scenario. The scenario will explain a problem a Namibian is facing. They are looking for suggestions about what to do.
- c. Please consider: Social, Environmental and Economic Aspects of Renewable Energy (Teacher information only – may be talked about during discussion)
 - i. Improving livelihood of families
 - ii. Supports agriculture by decreasing the effects of Climate Change
 - iii. Increase the number of jobs
 - iv. Bush-to-Energy releases carbon dioxide and other greenhouse gasses in the process
 - v. Promote sustainable development
 - vi. Namibia spends most of the money from exports on imported energy. Transitioning to renewable energy makes use of an indigenous asset. "Power stations built on solar and wind also have a much higher "local content" if compared with gas-, coal- or nuclear stations. That means not only the power station but also its operation yields huge benefits in terms of important factors like money outflow and job creation"
 - vii. An increase in solar panels will occur when it becomes cheaper to produce than to buy which keeps money outflow for imports available in Namibia
- d. Scenarios:
 - i. Group 1 (Solar): A community to the east of Windhoek has heard about solar energy but is not sure about taking advantage of the government loan program because it is expensive. What can you tell them about the benefits of renewable energy? Why is solar energy a good fit for the community?
 1. Discussion points: Solar energy will be cheaper in the long run because you do not need to be on the NamPower electrical grid; Since Namibia is sunny a majority of year and the community is not near the coast, solar energy has the greatest potential; solar energy does not harm the environment.
 - ii. Group 2 (Wind): Tauno is a farmer in the northern region of Namibia and has lost much of his crops because flooding. He thinks it is a good idea to construct a turbine on his property to supply electricity. Why is this a bad idea?
 1. Discussion points: He does not live in a windy area so the power generated will be unreliable; he is endangering the birds in the area; a better alternative for him would be to install solar panels
 - iii. Group 3 (Biomass): Penda and his family want to increase their property for farming. They decide to cut down and burn encroacher bush. What are positive and negatives impacts of Penda's actions?
 1. Positive discussion points: more land for farming means they will have more food to sell; since encroacher bush is an invasive species there will be more area for grass to grow

2. Negative discussion points: burning the bush releases CO₂ which is increasing Namibia's carbon emission; destroying all the encroacher bush is very harmful to the environment and ecological systems.

e. Discussion: The teacher will facilitate the discussion between the learners. It will be good if some learners disagree.

VII. Summary

- a. Renewable Energy is important not only for Namibia but also the world. Resources like fossil fuels are disappearing and cannot be renewed as quickly as wind or solar resources. It's important to work together to help create a future with the same opportunities and resources as we currently have. Namibia is setting a good example for other developing nations to invest in alternative energy and resources to minimize their carbon footprint.

Appendix Z: Outline of Module 2: Solar Energy

SMART Lesson 2: Solar Energy

- I. Purpose - To educate the learners on all aspects of solar energy as to allow them to form their own opinion on it as a source of energy for Namibia
- II. Objectives:
 - a. Be able to give a definition of solar power
 - b. Explain how solar panels convert light energy into electricity and how to store said energy
 - c. Give some of the advantages and disadvantages to this form of renewable energy
 - d. Explain why it can be used in Namibia specifically
 - e. Explain where in Namibia it can be implemented and why it should be implemented there to begin with
- II. Lecture
 - a. *What is Solar power*
 - i. Brief definition of solar energy:
 1. Solar and energy will be defined separately and then combined for the definition below.
 - a. Solar: about the sun
 - b. Energy: power created from other resources to produce heat or light
 - c. Solar energy: any energy that is generated in conjunction with sunlight/UV rays
 - b. *Types of Solar Panels*
 - i. Discussion Question: the teacher will ask the learners "how many different types of solar technology do you think there are? Any Examples?"
 - ii. The learners will brainstorm together and then come back to the teacher with answers
 - iii. "Active" vs "passive" solar panels
 1. Active: use mechanical/electrical energy to convert solar energy into electricity
 2. Passive: converts solar energy without use of mechanical/electrical energy
 3. Solar panels are primarily composed of photovoltaic cells
 - a. Composed mainly of silicon
 4. Photovoltaic cells can have solar tracking technology, solar collecting, hybrid power, solar heater
 - a. Solar tracking: the solar panels follow the sun as a way to collect the most sunlight
 - b. Solar collectors: flat plates that are able to collect more sunlight and store this converted energy
 - c. Hybrid power: to use solar energy in conjunction with another energy source, either renewable or fossil fuel based
 - d. Side with other PV applications will be presented. Examples are a calculator, flashlight, and cell phone charger
 5. Many types of concentrated solar panels: linear Fresnel, solar tower, parabolic troughs, sterling dishes, and solar cookers
 - a. Utilizes concentrated sunlight and a generator
 - b. Needs a large amount of land for use
 6. Ongoing Projects:
 - i. Solar panel loan program through the government
 - ii. Solar PV Park in Omburu
 - iii. 10 MW PV park in Gobabis
 - iv. 35 MW PV plant in Mariental
 - v. Feasibility of 250 GW CSP project
 - vi. Tsumkwe solar diesel hybrid system
 - c. *Operation*
 - i. General operation: the solar cells will absorb the UV light from the sun by the silicon. Once the light hits the silicon atoms it transfers energy to the loose electrons, knocking them off. These electrons then "jump" between the different types of silicon in the cell, causing an electric field and subsequently an electric current to be generated.
 - ii. Summary of Operation: This is hard the material so the teacher will take any questions and clarify any confusion of the operation of solar panels at this point
 - d. *Storage*:
 - i. Some of the energy created from solar panels is sent to an inverter, where it converts the energy made into usable energy. This usable energy is then sent into the existing electrical grid for use. Another part of the energy made is sent to the batteries to charge them during the day so they may use solar energy at night.

e. **Vocabulary Activity:**

- i. Five learners will be chosen and one at a time to drag a vocab word into its corresponding blank. If stays there, then it is correct; if it bounces back then it is incorrect and they will have another chance to pick the right blank.

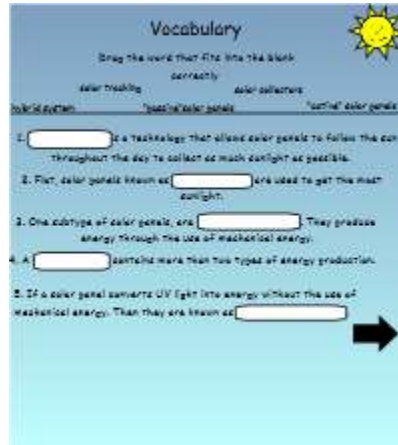

f. **Future**

- i. Click on the sun to reveal the information below
- ii. Priority is to reduce the production cost of the material used
- iii. Overall purpose of research in this field is to make more affordable solar cells available to the public

g. **Why solar power in Namibia**

- i. Approximately 300 sunny days gives optimal use of this technology
- ii. Job growth opportunity
 1. allows to decrease the unemployment rate
- iii. Economic opportunity
 1. If allowed to produce their own energy, more money will go into the Namibian economy

h. **Discussion Question:**

- i. The teacher will ask the class "what kind of improvements do you think that can be made to solar technology as of right now?"
- ii. The class will break up into small groups and think of answers together and then tell the teacher what they came up with.

i. **Why in Namibia:**

- i. Activity: some of the learners and verbally state some ideas on why they think solar energy can be implemented in Namibia specifically.
- ii. The teacher will then click on three photos to reveal why Namibia should implement this technology.
 1. Around 300 sunny days per year
 2. Job growth opportunity
 - a. Ability to learn new skills
 3. Economic Opportunity
 - a. More money stays in Namibia then is exported to other countries

j. **Discussion Question:**

- i. The teacher will ask "what is maintenance? Why is it important?"
- ii. The learners will answer these questions in groups and then tell the teacher what they came up with.

k. **Maintenance**

- i. Maintenance will first be defined as a way to tell the learners what it is in case they do not know
- ii. General Maintenance: there is very little maintenance involved with this technology due to the fact the lack moving parts unlike other forms of renewable energy. However, they need to be inspected a few times a year for dirt and other material that may build up over time. These materials will be cleaned out when present.

l. **Where in Namibia**

- i. Solar farms need to be implemented in areas that are flat, with relatively low population and not close to the cities
- ii. For individual panels, they can be implemented anywhere there is sun
- iii. Activity: Learners will sort what regions are best for solar farms, by dragging them into a box. If they bounce back then they do not satisfy the requirements for implementing solar farms.

- III. Summary: the learners will come to the board one and at a time and say something new that they have learned. If the learners have any last-minute questions about solar energy then they will be answered here.

Appendix AA: Outline of Module 3: Wind Energy

SMART Lesson 3: Wind Energy

I. Purpose - Introduce the topic of wind energy to the learners and explain the applications of wind energy in Namibia

II. Objectives:

- a. Identify the parts of a turbine
- b. Specify the advantages and disadvantages of wind energy
- c. Explain the process of creating energy from wind
- d. Identify the importance of wind energy in Namibia

III. Activity – teacher begins by showing a wind turbine prototype in the front of the classroom and ask the learners

- a. What is wind energy?
- b. How does it work?

This helps the teacher gauge what the learners already know about the technology, and then after the learners finish guessing, the teacher explains the basics of what wind energy is and how it works.

IV. SMART Activity

- a. Several turbine sizes on screen

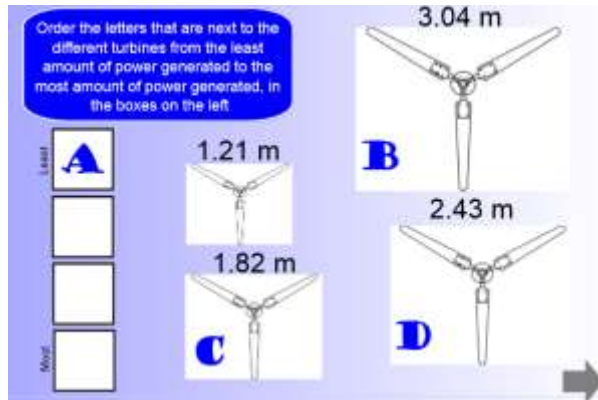

- b. The teacher will ask the learners to rank the power outputs of the turbines from lowest to highest
- c. If the learner drags the correct letter into the box, the letter will remain in the box. If the learner drags the incorrect turbine, then the letter will bounce back to the picture.
- d. After the activity is completed, the learners will divide into groups of five and brainstorm why different shapes and sizes of turbines will create different energy outputs. The teams will then share their brainstormed ideas to the class.

V. Lecture

- a. *What causes wind??*

- i. Wind is air in motion; it is produced by the uneven heating of the Earth's surface by the sun.

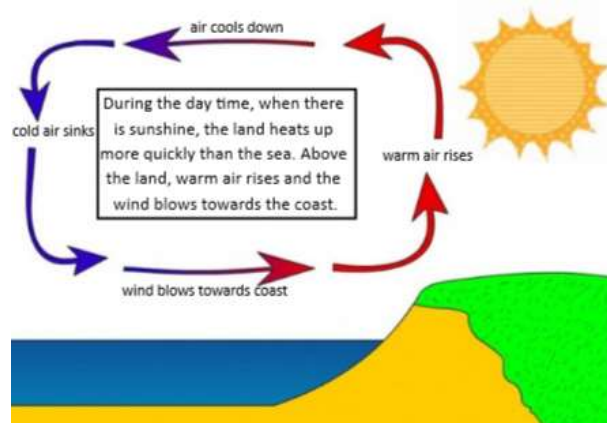

- b. *Advantages and Disadvantages*

- i. The teacher will proceed to a slide with an option to select either the advantages or disadvantages of wind turbines.
- ii. After selecting the slide, the following important information is highlighted by the teacher
 1. Advantages
 - a. **It is a clean fuel source:** Wind energy doesn't pollute the air like power plants that rely on combustion of fossil fuels, such as coal or natural gas.

- b. **It does not use water, unlike other electricity sources.** Water is becoming a scarce resource all over the country. Wind power uses zero water in its energy generation
- c. **It is cost-effective: It is one of the lowest-cost renewable energy technologies available**
- d. **It is a domestic source of energy; the nation's wind supply is abundant.**
- e. **It creates jobs:** It can create jobs in manufacturing, installation, maintenance, and supporting services

2. Disadvantages

- a. Wind energy cannot be the sole provider of the electricity for the whole country because **it is not always windy. Also, the current technology is not able to store energy.**
- b. **The cost is not currently equal to fossil fuel energy production.** In order for wind energy to take over, it must be equal or cheaper than fossil fuels
- c. **Good wind sites are often located in remote locations, far from cities where the electricity is needed.** Transmission lines must be built to bring the electricity from the wind farm to the city.
- d. **Turbines might cause noise and look unnatural.**
- e. Though wind turbines harm wildlife less than some conventional sources of electricity, **turbine blades could damage local wildlife.** Birds and bats are at an especially high risk because they can collide with the blades

c. *Types of Turbines*

i. Horizontal Axis Turbines (HAWT)

- 1. Description: typically consist of three large blades with a large pole attached to the three blades

ii. Picture/Video of Horizontal Axis Turbine



- 1. Parts of a Wind Turbine and Function: The slide will show the following picture. By clicking the question mark under the machine component, the lesson will switch to a slide explaining the purpose of that component

Wind Turbine Diagram

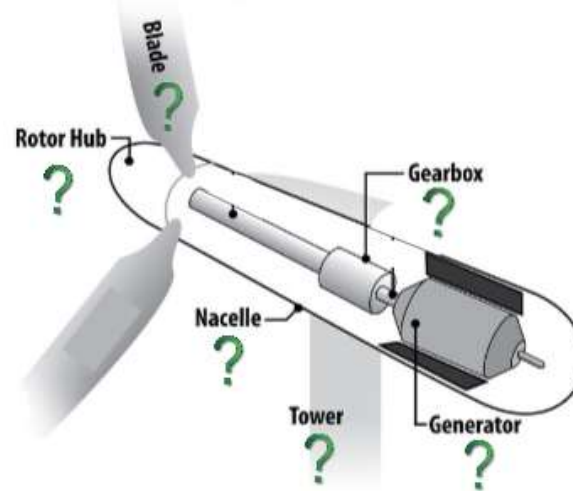

- a. Tower and Foundation: anchors the wind turbine to the ground
 - b. Hub: Brings the rotation of the blades to the gearbox
 - c. Rotor blades: the wind turns the rotor blades
 - d. Nacelle: holds all the turbine machinery (gearbox, brakes, generator)
 - e. Gearbox: converts the speed of rotation from the hub to a faster rotation speed
 - f. Generator: once at the proper rotation speed, the generator converts the blade rotation into energy
- iii. HAWT Advantages and Disadvantages: The teacher will proceed to a slide with an option to select either the advantages or disadvantages of horizontal axis wind turbines. After selecting the slide, teacher highlights the following important information:
1. HAWT Advantages:
 - a. **The tall tower allows access to stronger winds.**
 - b. **The turbines act perpendicular to the wind** so they produce power constantly when the blades are spinning.
 2. HAWT Disadvantages: There are pictures on the screen and the learners must use the pictures as hints to guess the disadvantages of HAWTs. The teacher or learner can click on the picture to reveal the disadvantage.
 - a. Tower Construction is expensive since the components are very heavy (blades, gearbox, generator)
 - b. Sight of wind turbines: unnatural, eyesore
 - c. Turbines can undergo fatigue, break, and potentially injure surrounding people or systems
 - d. Disruption of ecosystems and they kill bats and birds
 3. REVIEW!
 - a. The learners can perform a fill in the blank activity to review the information presented
- iv. Vertical Axis Turbines (VAWT)
1. Definition: a type of wind turbine which has two or three blades and in which the main rotor shaft runs vertically
 2. Picture/Video of Vertical Axis Turbine



3. Parts of a Wind Turbine and Function: The slide will show the following picture. By clicking the question mark under the machine component, the lesson will switch to a slide explaining the purpose of that component

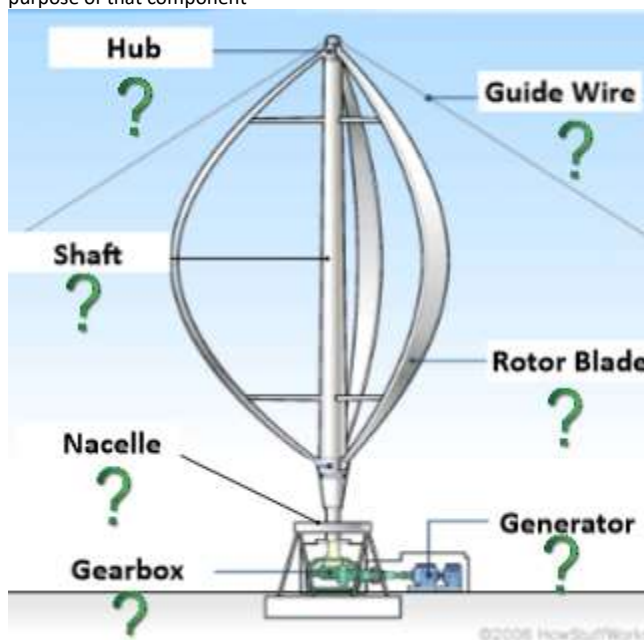

- a. Guide Wire: keeps the turbine in position
 - b. Hub: center of the rotor; where the rotor blades are attached
 - c. Rotor Blades: the wind turns the rotor blades
 - d. Shaft: the part that gets turned by the blades; the center of the turbine
 - e. Nacelle: holds all the turbine's machinery
 - f. Gearbox: converts the speed of rotation from the blades to a faster rotation speed
 - g. Generator: once at the proper speed, the generator converts the wind to energy
- v. VAWT Advantages and Disadvantages: The teacher will proceed to a slide with an option to select either the advantages or disadvantages of wind turbines. After selecting the slide, the following important information is highlighted by the teacher:
1. VAWT Advantages:

- a. **Can spin with wind from all directions**
 - b. **Close to the ground**
 - i. **Easy maintenance**
 - ii. **Less visible to surrounding communities**
 - 2. VAWT Disadvantages:
 - a. **Less efficient than HAWTs because they produce more drag**
 - b. **Locations lower to the ground only have access to smaller wind speeds**
 - c. **They need a ‘push’ in order to start rotating**
 - 3. Review
 - a. The learners can participate in a fill in the blank activity to review what they learned.
- d. *Why Wind Power in Namibia?*
 - i. The teacher will ask the learners their best guesses as to why Namibia should use wind power.
 - ii. After this is completed, the next screen has many Namibian maps, and the teacher or learner can click on the maps to reveal the reasons why Namibia should use wind energy. They include: job growth, large coasts, clean environment, and stopping climate change. The following slides explained the four reasons.
 - 1. Job growth needed in Namibia
 - a. Wind power creates jobs in design, manufacturing, installation, electrical, maintenance, and many others.
 - b. Wind Energy → Creates jobs → Lowers Unemployment → Happier Namibia
 - 2. Clean Environment
 - a. If wildlife or environments are damaged, Namibia can lose: food to eat, clean water, wildlife, tourism, clean air to breathe
 - 3. Large Coasts: A large map of Namibia appears with three numbers next to it. When the teacher clicks on the numbers it reveals information about Namibia’s coastlines.
 - a. 1572.2 km of coastlines
 - b. Ongoing Project in Walvis Bay: 60 MW project near Walvis Bay (status: under discussion with NamPower)
 - c. Ongoing Project in Luderitz: 44 MW project near Luderitz (status: license granted)
 - 4. Stop Climate Change
 - a. The teacher will click the numbers to reveal the effects of Climate Change in Namibia
 - i. Amount of Rainfall
 - ii. Global Temperatures
 - iii. Extreme Weather: drought and floods
 - iv. Farming and Namibia’s economy
 - 5. REVIEW
 - a. The teacher will split the classroom into groups of five and have them brainstorm the different stakeholders in Namibia in regards to wind energy. The prompt reads: “Split into groups of five and think of all the people or things affected by Namibia choosing to install wind turbines”
 - b. The teams will then come up to the board and write their list of stakeholders
 - c. The teacher will then ask each group to select their most important stakeholder, and brainstorm why their selected group will care about renewable energy.
 - d. The provided example is: The Namibian Government. They care about renewable energy because of profits, reduced unemployment rates, happier citizens, and a healthier environment.
 - 6. Community Review
 - a. The teacher will split the classroom into groups of five and have the teams brainstorm different activities to do in their community to save the Earth and stop Climate Change.
 - b. The team will write all of their ideas on a piece of paper, and the team with the most (practical) ideas at the end of the five-minute time period, will receive a piece of candy!
- VI. Activity – Teacher will answer any last questions then move onto a game of Jeopardy
- VII. Jeopardy Activity; Categories will include:
 - a. Advantages and Disadvantages
 - i. 100 Points
 - 1. Name one advantage and disadvantage of wind energy
See above Advantages and Disadvantages sections
 - ii. 200 Points
 - 1. True or **False**: Wind energy is beneficial because it uses a cheap resource: water
 - iii. 300 Points
 - 1. **True** or False: Wind Energy is one of the cheapest renewable energy options
 - iv. 400 Points
 - 1. Name two species of animals that could be negatively affected by wind turbines
Birds and Bats
 - v. 500 Points
 - 1. Explain how the introduction of wind turbines will help Namibia’s future

Open ended; ensure that the answer goes along with above information

- b. Wind Energy in Namibia
- i. 100 Points
 - 1. What can happen if Namibia uses wind energy?
 - a. **Reduce Unemployment Rate**
 - b. It will pollute the air
 - c. Citizens will lose their jobs
 - ii. 200 Points
 - 1. Approximately how many km of coastline are there in Namibia?
 - a. 3000 km
 - b. **1570 km**
 - c. 970 km
 - d. 2230 km
 - iii. 300 Points
 - 1. Name two things that Namibia can lose if they do not implement wind energy or any other renewable energies.
 - a. **Food to eat, clean water, wildlife, tourism, clean air to breath**
 - iv. 400 Points
 - 1. Pick two out of the following list that are consequences of Climate Change
 - a. **Change in Rainfall**
 - b. Increased land for farming
 - c. **Increase in Temperatures**
 - d. Better economy
 - e. **Drought and Flooding**
 - v. 500 Points
 - 1. Name the two Namibian cities that are considering installing wind turbines
Walvis Bay and Lüderitz
- c. How does it work?
- i. 100 Points
 - True** or False: Wind is produced by the uneven heating of the Earth's surface by the sun.
 - ii. 200 Points
 - 1. Please in your own words define wind energy.
 - a. **Wind energy is a renewable energy that uses wind to generate electricity with a turbine**
 - iii. 300 Points
 - 1. True or **False**: the smaller the turbine, the more electricity it produces.
 - iv. 400 Points
 - 1. What is the best environment to put wind turbines?
 - a. **Near the coast**
 - b. In the desert
 - c. In the city
 - d. In the forest
 - v. 500 Points
 - 1. Place the seven steps in the proper order for how wind turbines work.
 - a. The blades of windmills are spun
 - b. The spinning of the blades also spin generators to create electricity
 - c. Local transformers reduce the voltage so you now have electricity to use
 - d. Wind blows
 - e. A transformer increases the voltage created from the generator to send the electricity over distribution lines.
- 4,1,2,5,3**
- d. Types of Wind Turbines
- i. 100 Points
 - 1. Name the two types of wind turbines
Horizontal and vertical axis turbines
 - ii. 200 Points
 - 1. **True** or False: Horizontal Axis Turbines are more efficient than Vertical Axis turbines
 - iii. 300 Points
 - 1. Name one advantage and one disadvantage of HAWTs
 - Advantages:**
 - i. **The tall towers let the turbine get stronger winds**
 - ii. **The wind hits the turbine horizontally; which gets the most energy**
 - iii. **Most efficient type of turbine**
 - Disadvantages**
 - i. **Very expensive; the tall towers require heavy construction**

- ii. Turbines look very unnatural in comparison with the surrounding landscape
 - iii. They disrupt ecosystems because the turbines are noisy; the blades also kill many bats and birds
 - iv. Can break under fatigue and the broken parts can injure surrounding people
- iv. 400 Points
1. Name one advantage and one disadvantage of VAWTs

Advantages:

 - a. Can spin with wind from all directions
 - b. Close to the ground
 - i. Easy maintenance
 - ii. Less visible to surrounding communities

Disadvantages

 - i. Produces less power than HAWTs
 - ii. Small wind speeds since closer to the ground
 - iii. They also need a 'push' in order to start rotating

v. 500 Points

1. Name the different parts to the location on the turbine

Generator

Tower

Rotor Blades

Gearbox

Nacelle

Hub

Wind Turbine Diagram

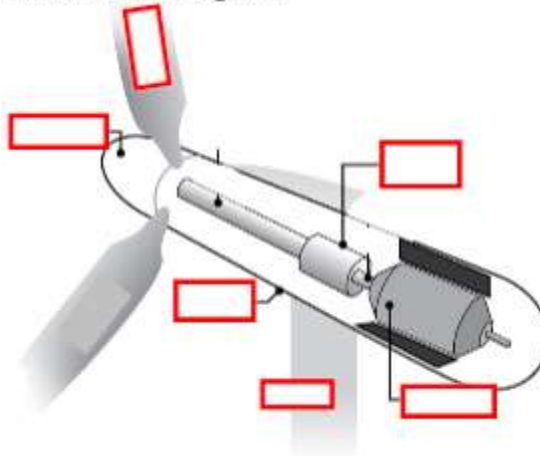

Answer:

Wind Turbine Diagram

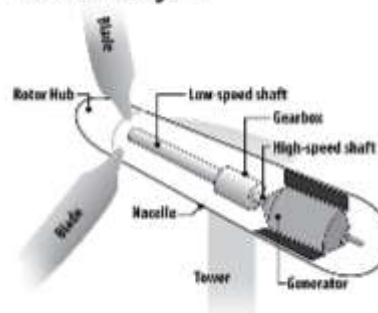

e. Miscellaneous

i. 100 Points

1. **True** or False: Bigger turbines create more energy

ii. 200 Points

1. True or **False**: HAWTs cannot be seen by surrounding communities because they are located close to the ground

- iii. 300 Points
 - 1. True or **False**: Wind Energy can completely power Namibia if implemented throughout the country
 - iv. 400 Points
 - 1. What is not a cause of wind?
 - a. **Satellites in space**
 - b. Uneven heating of the atmosphere
 - c. Different pressures on the Earth's surface
 - d. Earth's different types of environments (ex: water vs land)
 - v. 500 Points
 - 1. What is the purpose of the gearbox?
converts the speed of rotation from the hub to the proper rotation speed
- VIII. Summary – open discussion where the teachers prompts the learners with questions
- a. What did you find the most interesting about wind energy?
 - b. Do you think Namibia should implement this technology? Why or why not?
 - c. What aspect of wind energy would you like to learn more about? Was anything unclear?

Appendix BB: Outline of Module 4: Bush-to-Energy

SMART Lesson 4: *Bush-to-Energy*

- I. Purpose: define Bush-to-Energy technology, its advantages and disadvantages, and Namibia's potential for this power
- II. Objectives: By the end of the lesson the learners should be able to:
 - a. Define encroacher bush and understand why it's a problem in Namibia
 - b. Understand the different ways this bush can be converted into goods and energy
 - c. Recognize the advantages and disadvantages of this type of energy.
 - d. Be able to identify where this would be of use in Namibia.
- III. Lecture:
 - a. Title Page:
 - i. Discuss the purpose of the lesson and the objectives
 - ii. Introductory activity: Class discussion, ask learners what they think Bush-to-Energy is.
 - b. What is Bush-to-Energy?
 - i. Slide 1- Definition: Bush-to-Energy works as a renewable replacement for fossil fuels, using wood chips made from encroacher bush to create power and energy.
 - ii. Slide 2- Invasive Species:
 1. Definition: a type of plant that is not native to an area
 2. Spread all over the land and use up important nutrients
 3. Can harm habitats and the environment
 - c. Why in Namibia?
 - i. Slide 3- Encroacher bush activity:
 1. Activity: Discuss with class what they think encroacher bush might be, based off of the definition of an invasive species
 - ii. Slide 4- Encroacher bush definition:
 1. Activity: Have a learner come up and move the magnifying glass over the screen until they find the definition.
 2. Read definition aloud and make sure the learners understand it
 - iii. Slide 5- Types of Encroacher Bush:
 1. 19 types total, four main types:
 - a. *Prosopis*, located in all of Namibia, only encroacher bush that was brought from another country, brought from the US decades ago, has become naturalized
 - b. *Swarthaak*, located in central Namibia, native to Namibia but grows aggressively fast and is hard to manage
 - c. *Silver Cluster-leaf*, located in the eastern band of Namibia, also a native plant, also grows aggressively fast
 - d. *Mopane*, located in Northwestern Namibia, also native, also an aggressively fast grower.
 - iv. (Slides 6-11) Why is it a problem in Namibia?
 1. Slide 6: Main page, provides images and titles of each of the three main issues with encroacher bush: *Desertification, Bush Encroachment, Economy*
 2. Slide 7- Desertification:
 - a. Click near the mini bush to reveal each fact
 - i. Definition: occurs when soil does not have enough water, the land dries up and nothing can grow.
 - ii. If plants can't grow, farmers can't grow sellable products, won't be able to sustain farms and family
 - iii. Also, no plants mean no grass for animals to eat, so animals are malnourished and the carrying capacity of livestock on farms decreases
 3. Slide 8- Bush encroachment activity:
 - a. Volunteer learner should come up to the board and click the map until all of the bush pops up.
 - b. Note: 8 groups-of-bush should appear on the board by the time the learner completes the activity
 4. Slide 9- Bush Encroachment information:
 - a. Click near little bush to reveal each fact
 - i. Encroacher bush covers 55% of Namibia's land and is still growing rapidly
 - ii. The more bush there is, the less underground water and nutrient reserves there are to sustain important vegetation and grasses
 - iii. Causes severe desertification

5. Slide 10-Economy:
 - a. Click near mini bush to reveal the facts
 - i. If farmers can't produce enough sellable produce or livestock, they cannot sustain their farms
 - ii. If they can't make enough money to sustain farms, they cannot afford to pay employees, and many will lose their jobs.
 - iii. Since over 70% of Namibian citizens are farmers, this would cause a dramatic loss of income for a significant portion of Namibia's population, and the economy would suffer greatly
 6. Slide 11- Activity:
 - a. How do you think you could fix the problem of encroacher bush?
 - b. Get together in groups of four and brainstorm how you could solve the problem of encroacher bush in your community
 - c. This activity should take about 10 minutes of brainstorming, 5 minutes of class discussion about what each team came up with.
- v. Slide 12- How to fix the problem of encroacher bush:
1. Best way to address the problem of Encroacher bush is to harvest it
 2. Click on each bush before talking about the method of harvesting
 - a. Manual labor- the bush can be cut down using saws and clippers by hand, but this is labor intensive and requires a large number of people to work
 - b. Mechanical labor- utilize large harvesting machines which will require skilled workers that know how to use them. This will be faster than manual labor but requires additional skills and training
 - c. Chemical harvesting- manually go through the bushes and spray arborcides on the bush. Faster than manually chopping them down, but slower than mechanical labor. This can also affect plants that weren't intended to be killed and thus, decrease biodiversity.
- vi. Slide 13- Important things to remember when harvesting bush:
1. Read this slide out to the class, ask if they have any questions:
 2. While it is good to harvest this encroacher bush, you need to be mindful of the surrounding environment. If you aren't careful, you could end up doing even more damage. Some side effects of improper de-bushing include:
 - a. Reduction of Biodiversity- if you unintentionally kill protected plants, the plant biodiversity will decrease.
 - b. Increased Land Desertification- if too much bush is removed and the land isn't tended to afterwards, soil erosion could increase, which would also increase desertification
 - c. Habitat destruction- killing off too much bush could ruin habitats and animals will suffer as well.
- vii. Slide 14- Bad Practices of Harvesting:
1. *Clearing near rivers:* if the bush near the rivers is cleared, the soil will erode into the river, which ruins the river and increases desertification. Rivers also act as wildlife corridors, connecting wildlife populations together. If the bush is removed, the rivers could dry out and be destroyed, removing these wildlife corridors as well as important water resources.
 2. *Aerial spraying of arborcides:* If you spray arborcides, which are chemicals that target plants to kill them, from a plane, a large area of land will be effected. While this is quicker and less labor intensive, you would kill a large area of plant life, destroying the biodiversity in that area, and in turn destroying those habitats.
 3. *Elimination of all bush:* While it may seem like the simple solution to simply destroy all of the encroacher bush all at once, this would actually have even worse effects on the biodiversity. All of that plant life which had been consuming CO₂ would all of a sudden be gone, and so CO₂ emissions would increase drastically. Destroying all encroacher bush at once would also ruin habitats, as trees and coverage that animals had from these bushes are taken away overnight, and now they have no protection, and in some cases, no home.
- viii. Slide 15-Good practices of Harvesting bush:
1. *Applying arborcides by hand:* While this requires more time and more laborers, applying arborcides by hand is a much more environmentally friendly way to harvest bush. This allows citizens to intentionally kill a specific amount and type of bush, so that plant biodiversity remains intact and habitats are not seriously affected.
 2. *Harvesting in Phases:* While it may make sense to clear all of the bush at once and be done with it, this can actually harm ecosystems more, as mentioned before. By harvesting an area of bush in

phases, you can still eliminate bush while maintaining these ecosystems. Harvesting in phases refers to only harvesting one section of land at a time, waiting a few weeks or months before harvesting the next section of land. This takes much longer than simply cutting it all down at once, but it is much better for the environment.

3. *Selective Harvesting*- While removing bush is important, not all bushes should be removed. Some animals depend on these bushes for homes and protection, and if you remove all of the bush, they will no longer have a place to live or a way to protect themselves from prey. By harvesting a select portion of the bush, you allow for these habitats to remain safe while decreasing the amount of bush that encroaches your land.

d. *Operation and Maintenance*

i. Slide 16- Important vocabulary:

1. Read off slide, as you talk about each vocab word hit the bush to see the definition.
 - a. *Turbine*- a machine that uses the power of spinning blades to make power
 - b. *Generator*- any device for converting mechanical energy into electrical energy by using magnetic fields
 - c. *Magnetic fields*- an electrically charged area around a magnet caused by the moving of particles

ii. Slides 17-22- Converting Harvested bush into renewable energy:

1. Six steps, click the arrow to see the next step
 - a. Bush is harvested and sent to a processor where it is converted into wood chips
 - b. Once the bush is processed, it is transported and stored in a bunker underneath a water tank
 - c. The wood chips are then burned, which boils the water in the tank above, creating steam
 - d. The steam acts as a force to move the blades in the turbines
 - e. The moving of the turbines cause the coils and magnets in the generators to create a magnetic field
 - f. The magnetic fields produce electricity, which is stored and distributed to homes around Namibia

e. *Where in Namibia?*

i. Slide 23- Where in Namibia will this technology be useful?

1. While encroacher bush covers most of Namibia, it is most densely populated in the Northern Region of Namibia (Click on map)
2. In a prefeasibility study that was conducted, it was determined that the best possible locations for the future establishment of Bush-to-Energy power plants are Otjiwarango, Outjo, and Tsumeb (Click on each word as you list it off).

f. *Advantages*

i. Slide 24-List of main advantages:

1. Reduce Foreign imports, improve the economy, decentralized power supply, and decrease CO₂ emissions.
2. Click on each picture to go to the page that discusses that advantage

ii. Slide 25-Reduce Energy Imports

1. 80% of Namibia's energy is currently imported from other countries
2. If Namibia used all of the bush that currently exists, and it does not continue to grow, Bush-to-Energy could completely satisfy Namibia's energy need
3. This amount of bush also has the potential to power ten 20MW plants for 100 years, and a total of over 240,000 households per year could utilize this technology
4. While it's important to reduce imports from other countries, Namibia isn't looking to completely disconnect from surrounding countries. They will still import some energy, in order to maintain foreign relations, but the amount in which they will have to import will be reduced if Bush-to-Energy is implemented
5. Namibia is also hoping to become an energy exporter, and establishing Bush-to-Energy plants could make that possible

iii. Slide 26- Improve the Economy

1. Using Bush-to-Energy would decrease national spending, as Namibia would have to spend less money on importing energy from other countries.

2. New job opportunities would also become available, as there would have to be workers and laborers to harvest the bush, machinists to process the bush and workers at the plant to work the machines. Many people would also have to be hired to build the plants. Implementing Bush-to-Energy in Namibia has the potential to create over 30,000 new jobs.
 3. If Namibia begins to export energy as they hope to, they have the potential to gain anywhere from N\$25-112 billion per year from Bush-to-Energy
 4. All of these factors would significantly improve Namibia's economy and the lives of its citizens
- iv. Slide 27-Decentralized Power Supply
1. Decentralized power- distributing widely owned resources over smaller areas of the country
 2. Allows local communities to create their own power grids
 - a. Decrease local dependency on government, as each rural community would be able to provide their own electricity supply
 - b. More cost effective for rural communities- if they don't have to pay the tariffs and high electrical costs associated with government power supply, then they will be saving money
- v. Slide 28-Decrease CO₂ Emissions
1. If Bush-to-Energy is implemented in Namibia, dependency on nonrenewable energy supplies such as coal and oil will be reduced.
 2. This is good because the CO₂ emissions from Bush-to-Energy are significantly lower than those that fossil fuels create. If you compare them to each other, Bush-to-Energy emits only 2% the amount of CO₂ that fossil fuels do
 3. This means that, over time, the overall CO₂ emissions of Namibia will decrease, which will lessen the effects of Climate Change
- vi. Slide 29-Disadvantages of Bush-to-Energy
1. Carbon Sinks, Expensive, Takes a lot of time, Potential environmental harm
 2. Click on each picture to go to the page that discusses that disadvantage
- vii. Slide 30-Carbon Sinks
1. Definition of Carbon sink- when plants remove large amounts of CO₂ from the atmosphere to use in photosynthesis
 2. Carbon sinks are good for the environment, as they remove harmful CO₂ emissions from the atmosphere
 3. If you harvest too much encroacher bush at one time, you could remove a significant part of Namibia's carbon sinks, and CO₂ emissions could increase once more
- viii. Slide 31-Expensive
1. While Bush-to-Energy has great potential in Namibia, it is more expensive than both fossil fuels and other forms of renewable energy, which makes the government resistant to implementing this technology.
 2. This is because there are several costs involved in establishing Bush-to-Energy in Namibia:
 - a. Training of bush harvesters and machinists would have to occur to ensure that they are not harvesting protected species and that the way in which they are harvesting is good for the environment and follows regulation.
 - b. Actually, building and establishing a power plant involves several stakeholders and workers, all of whom must be paid. This can become quite expensive
 - c. There are several fees associated with harvesting bush as there are many permits which must be purchased and approved before a harvesting project can take place.
 - d. Once power plants are established salaries for all of the workers in the plant, as well as for the laborers harvesting the bush, must be paid for
 3. All of these factors add up and make Bush-to-Energy quite expensive
- ix. Slide 32- Takes a lot of time
1. There are several aspects which require a significant amount of time when implementing Bush-to-Energy.
 - a. Permits for harvesting must be approved, and while the government has tried to streamline this process for bush harvesting projects, it still takes quite a bit of time
 - b. Laborers and machinists must also be trained on how to properly perform their jobs, which can take weeks
 - c. It also takes a significant amount of time to build a Bush-to-Energy plant, hire workers, and be established for a long enough time to produce a profit.

2. All of these aspects add up, and show that implementing Bush-to-Energy would take a lot of time. This is a problem because the more time it takes to establish a successful plant, the more money that has to be invested
- x. Slide 33-Potential environmental harm
 1. As previously talked about, if the land is not taken care of properly when the bush is harvested, environmental harm could occur. Improper harvesting techniques and aftercare of the land could lead to an increase in desertification, soil erosion and a decrease in the land's water retention. All of these have the potential to affect farmers, who make up 70% of the population, so this could seriously affect Namibia
- xii. Slide 34- What can YOU do to create awareness on Bush-to-Energy?
 1. Tell your parents and community- make sure that your parents and community members understand the full potential of this technology in Namibia. If they are more aware of how it could help them, they might be more willing to work together to implement this technology.
 2. Especially make sure to encourage and inform farmers about Bush-to-Energy. If they knew that they could clear the encroacher bush off of their land and sell it to a Bush-to-Energy power plant, then they would be much more likely to harvest the bush on their land.
 3. Make sure that they are properly harvesting their bush, though. You still want to maintain the environment, so make sure that they know the proper practices to harvest the bush in a sustainable way.
 4. Finally, work with your classmates to promote awareness in your communities and brainstorm activities that you could to encourage Bush-to-Energy implementation in your community
- xiii. Slide 35- Review activity: Harvesting Bush
 1. Learners will be able to come to the board and drag a word or phrase into either the "Good practices" or "Bad Practices" baskets. If the answer is incorrect and does not belong in the basket that the learner chose, the answer will bounce back to its original place. If it is the right answer, the basket will accept it and the answer will disappear from the board.
- xiii. Slide 36- Review activity: Advantages and Disadvantages
 1. Learners will be able to come to the board and drag a word or phrase into either the "Advantages" or "Disadvantages" baskets. If the answer is incorrect and does not belong in the basket that the learner chose, the answer will bounce back to its original place. If it is the right answer, the basket will accept it and the answer will disappear from the board.

IV. Review Activity: Connect Four

- a. Questions (Answers represented with **bold**):
 - i. What is Encroacher Bush?
 1. plants in their natural habitats
 2. **plants that take over an area**
 3. plants that came from other countries
 4. plants that are placed in pots in people's homes
 - ii. How much land does encroacher bush cover in Namibia?
 1. 100%
 2. 40%
 3. **55%**
 4. 25%
 - iii. What type of bush is located all over Namibia?
 1. **Prosopis**
 2. Swarthaak
 3. Sicklebush
 4. Thornbush
 - iv. What is the most common bush species in Northwestern Namibia?
 1. Blackthorn
 2. Aloe
 3. **Mopane**
 4. Sicklebush
 - v. What is the most common bush type in Eastern Namibia?
 1. Swarthaak
 2. Whitethorn
 3. Prosopis

4. **Silver Cluster-leaf**
- vi. What is one problem that encroacher bush creates?
 1. **severely limits the water supply**
 2. there are too many plants
 3. plant species live together peacefully
 4. encroacher bush is not good to eat
- vii. What is another problem with encroacher bush?
 1. **decreases the biodiversity in Namibia**
 2. increases the overall temperature
 3. makes Namibia's landscape beautiful
 4. provides water to surrounding plants
- viii. What is one thing you SHOULD do when harvesting bush?
 1. clear all of the bush
 2. **clear a select number of bush**
 3. burn a patch of bush
 4. use arborcides to clear the bush
- ix. What is one thing you should NOT do when harvesting bush?
 1. get a permit
 2. **use aerial arborcides**
 3. manually clear select amounts of bush
 4. leave some species alone
- x. What is a good practice for harvesting bush?
 1. eliminating all encroacher bush
 2. using aerial arborcides
 3. clearing the bush near rivers
 4. **selectively clearing sections of bush**
- xi. What is a bad practice for harvesting bush?
 1. harvesting in several phases
 2. getting animals to eat the bush
 3. **harvesting all at once**
 4. manually applying arborcides
- xii. What is desertification?
 1. when you eat too much dessert and don't feel well after
 2. **when the land does not have enough water and nothing can grow**
 3. when your throat feels very dry
 4. the act of growing used to the weather in the desert
- xiii. What region of Namibia is being considered for Bush-to-Energy plant implementation?
 1. west
 2. east
 3. **north**
 4. south
- xiv. What type of bush harvesting requires workers to use hand tools?
 1. **manual labor**
 2. mechanical harvesting
 3. chemical harvesting
- xv. What is Bush-to-Energy?
 1. the energy plants get from the sun
 2. **uses wood chips from bush to create power and energy**
 3. using bush as a food source to boost energy levels
- xvi. What is one advantage of Bush-to-Energy?
 1. increasing greenhouse gases
 2. makes the plants more appealing
 3. **creates a lot of new jobs**
 4. uses up less of the sun's energy
- xvii. What is another advantage of Bush-to-Energy?
 1. environmental harm

2. fewer jobs available
 3. there will be less water for the plants
 4. **increase biodiversity and available land**
- xxviii. What is a disadvantage of Bush-to-Energy?
1. **environmental harm**
 2. reducing dependency on foreign countries
 3. more jobs
 4. environmental protection
- xix. What is a disadvantage of Bush-to-Energy?
1. **can be expensive**
 2. creates new jobs
 3. reduces the beauty of Namibia's land
 4. increases biodiversity
- xx. How is Bush-to-Energy good for the economy?
1. fewer jobs
 2. increased foreign imports
 3. **increase in national funds**
 4. environmental harm
- xxi. What is another disadvantage of Bush-to-Energy?
1. allowing for decentralized power supply
 2. a long-term decrease in CO₂ emissions
 3. **removal of many carbon sinks**
 4. creation of new jobs
- xxii. What is something you can do to increase awareness of Bush-to-Energy?
1. **talk to your parents and community members**
 2. carry a bush around with you
 3. try to harvest bush yourself
 4. there's nothing you can do
- xxiii. What is an invasive plant species?
1. an indigenous plant that you eat often
 2. a type of plant that lives in harmony with other species
 3. **a type of plant that takes over a habitat**
 4. an alien plant that you don't like to eat
- xxiv. What does steam do to help convert Bush-to-Energy?
1. boils the leaves so that you can eat the bush
 2. moves the magnets around in the generator
 3. **pushes the blades in the turbines to make them move**
 4. steam does not help in the process of converting Bush-to-Energy
- xxv. What is a turbine?
1. a machine that uses magnets to create electricity
 2. a machine that turns milk to make ice cream
 3. **a machine that uses the power of spinning blades to create electricity**
 4. a machine that uses the sun to create energy
- xxvi. What is a magnetic field?
1. **an electrically charged area around a magnet that is caused by the moving of particles**
 2. a field that is full of magnets
 3. an area surrounding a magnet that is infested with encroacher bush
 4. when two magnets cannot be put together, even by extreme force
- xxvii. What causes the turbines to spin in a Bush-to-Energy power plant?
1. the encroacher bush being poured into the processor
 2. **steam power that pushes the blades**
 3. electricity
 4. solar panels charge the turbine and cause it to spin
- xxviii. Why is time an issue when trying to implement Bush-to-Energy?
1. taking too much time on a project means less time for you to enjoy your day
 2. **the more time that a project takes, the more money it costs, which could effect the economy**

3. wasting time makes you lazy
 4. time is not an issue
- xxix. What can you do to increase awareness of Bush-to-Energy?
1. encourage your community to eliminate all of the bush
 2. you should not try to increase awareness, this technology would not be useful to Namibia
 3. **tell the farmers in your hometown about how they can use the bush on their farm in Bush-to-Energy**
 4. tell the farmers in your town that they should hire a plane to spray arborcides to get rid of the bush

Appendix CC: Module 1: Introduction to Renewable Energy

1. 

2. 

3. 

4. 

5. 

6. 

How does a Steam Engine Work?

1. coal is added to the furnace.
2. as the coal burns hot gasses are released
3. the gasses move through the pipes and heat the water
4. steam is produced to move the vehicle
5. excess gasses are released into the air

7.

Changing Lifestyles: Positive and Negative

Industrial Revolution

8.

Activity: After learning about some of the new technologies and inventions of the industrial revolution, think about some inventions or technologies you have.

Directions: In groups of 2-3 learners brainstorm different inventions or technologies. The inventions or technologies may either be helpful or harmful in your community.

Please consider:

- impacts of the invention or technology on the environment (good or bad)
- if you have direct access to the invention or technology
- how did you think of the invention or technology

9.

Good ✓	✗ Bad

10.

Why are fossil fuels bad?

coal, oil, and natural gas release greenhouse gases when they are burned

CO₂ H₂O CFCs CH₄ NO_x

11.

What can Namibia do?

12.

Renewable Energy

- Energy sources that can be used again and again

Biogas Wind Biomass Geothermal
Solar Nuclear Wave and Tidal

13.

Biogas

14.

Solar

- sun's rays are absorbed in the solar panels
- In the sun's rays are tiny particles of light called photons
- the photons knock off tiny pieces of electricity called electrons
- the energy gets converted into usable energy in an inverter
- Excess electricity is stored for later

15.

Solar Application

16.

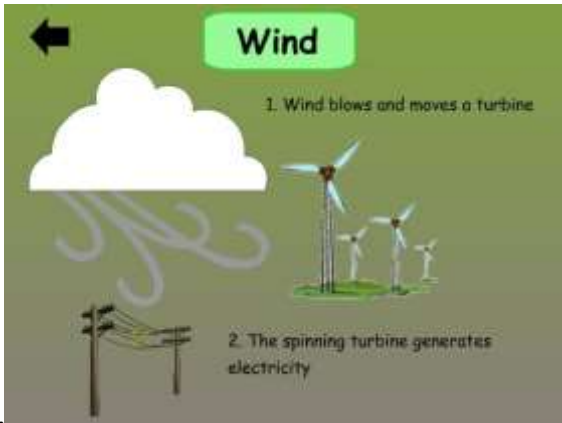

17.

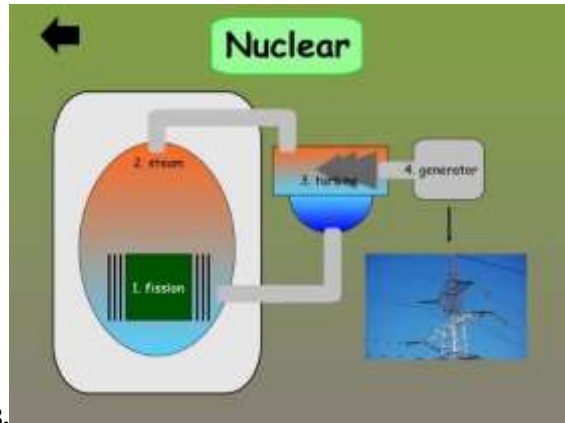

18.

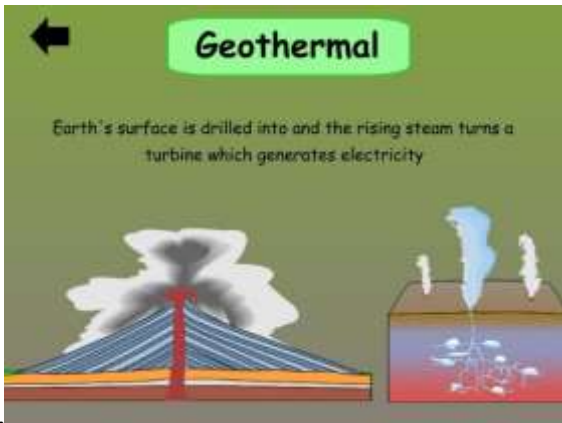

19.

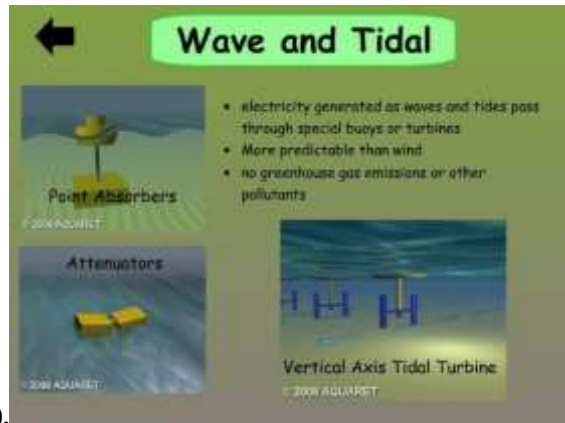

20.

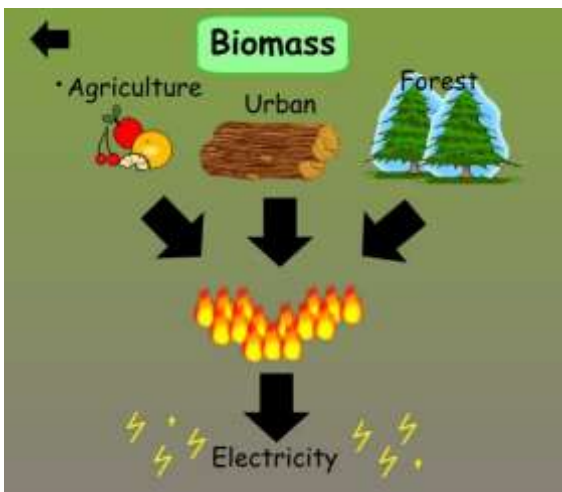

21.

What options are best for Namibia?

Come up to the board and write your answer!

22.

Why is Renewable Energy important?

A grid of images related to renewable energy and sustainability, including a map of Namibia, a pile of coins, a person in traditional dress, a person working in a field, a landscape with solar panels, and the Sustainable Development Goals logo.

23.

What can you do?

- organize clean up project around your school or village
- build solar cookers instead of using wood stoves
- tell others about what you learned

24.

What is a renewable energy source?

- When **bacteria** breaks down organic matter, **biogas** is created.
- electricity** is a result of the sun's energy absorbed in panels.
- Wind is strong enough to turn a **turbine** and generate electricity.
- Nearly **carbon free** energy can be produced when atoms split in a **nuclear** reactor.
- Geothermal sources use **steam** and **hot water** to turn turbines and generate electricity.
- Power can be generated from **waves** and tides when it **passes** through special buoys or turbines.
- biomass** is burning plants for **renewable** energy.

25.

Activity: After learning about the important of renewable energy, it is time to share your opinions and give advice to others.

Directions: Divide yourselves into 3 groups. Each group will get a decision a fellow Namibian is facing in there life. Please provide them some helpful advice.

Please consider:

- environmental impacts
- economic impacts
- social impacts

26.

Scenario 1: A community to the east of Windhoek has heard about solar energy but is not sure about taking advantage of the government loan program because it is expensive. What can you tell them about the benefits of renewable energy?

Scenario 2: Tauno is a farmer in the northern region of Namibia and has lost much of his crops because flooding. He thinks it is a good idea to construct a turbine on his property to supply electricity. Why is this a bad idea?

Scenario 3: Penda and his family want to increase their property for farming. They decide to cut down and burn the encroachment bush. What are positive and negatives impacts of Penda's actions?

27.

What advice do you have?

28.

Renewable Energy is important not only for Namibia but also the world. Resources like fossil fuels are disappearing and cannot be renewed as quickly as wind or solar resources.

Namibia is setting a good example for other developing nations to invest in alternative energy and resources to minimize their carbon footprint.

It is important to work together to help create a future with the same opportunities and resources as we currently have.

29.

Appendix DD: Module 2: Solar Energy

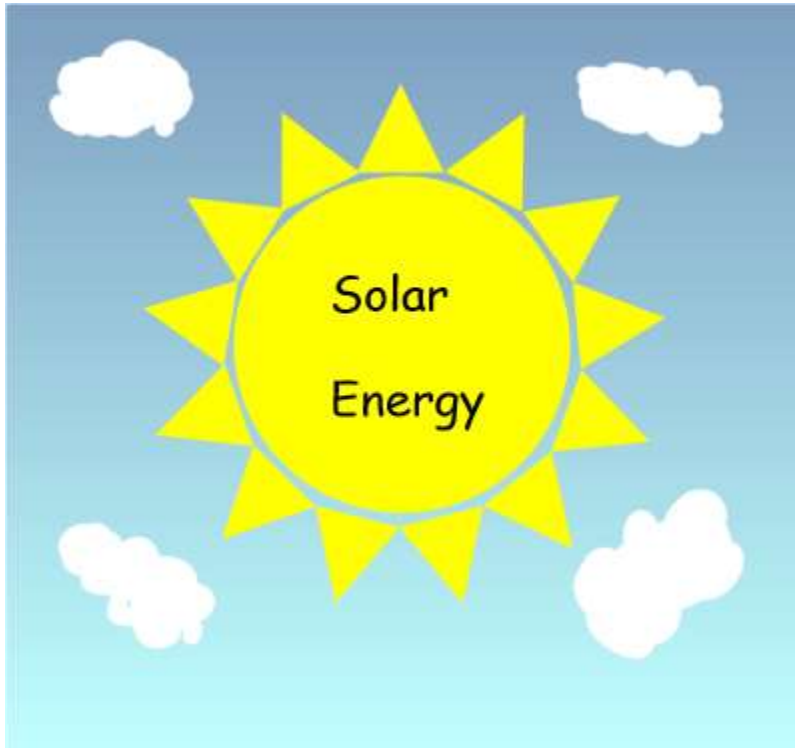

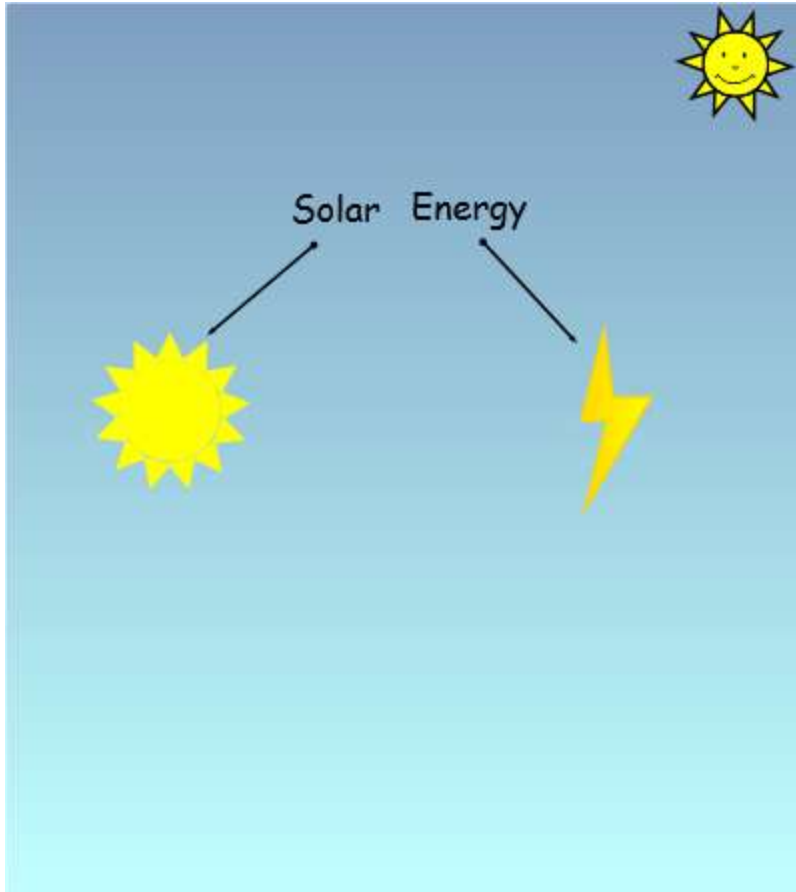

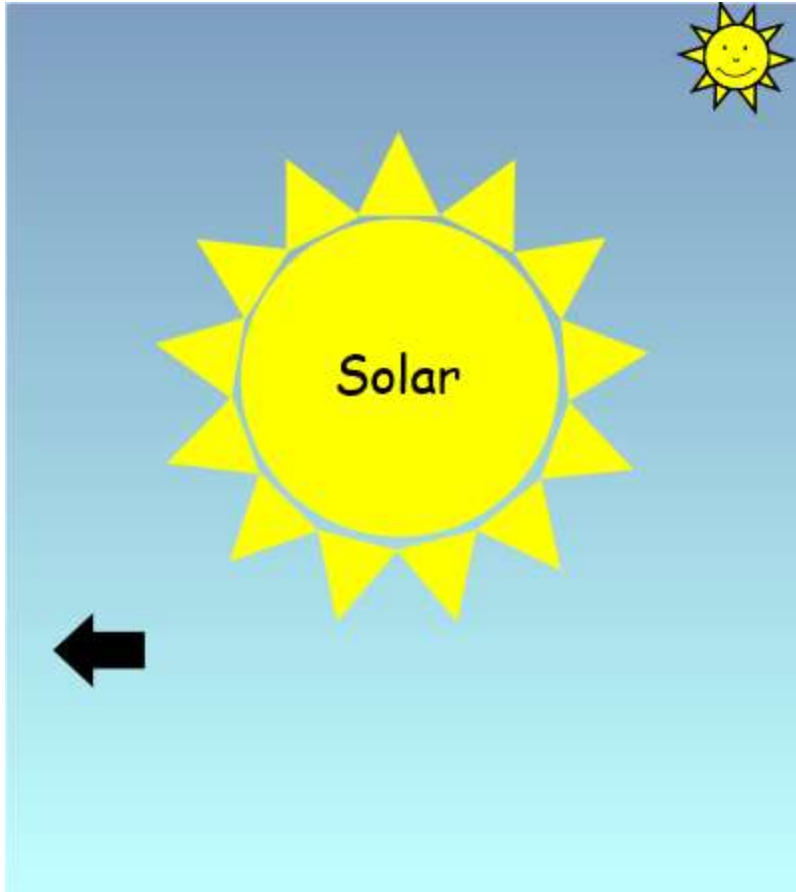





Solar Energy



Power made from UV light from the sun





How many types of solar technology do you think there is? Any examples?





Solar Panels

"Passive"

"Active"

Photovoltaic
Solar Cells

CSP

Photovoltaic Solar Cells



- Found in homes, businesses, or solar farms
- One of the main types of solar technology
- Primarily composed of silicon
- Can contain a variety of technologies such as:
 - > Solar tracking
 - > Solar collecting
 - > Hybrid system
 - > Solar heater



Concentrated Solar Power (CSP)



- Utilizes focused sunlight through the use of mirrors and a generator
- Requires a large area of land for solar farms
- Several types such as:
 - Parabolic Trough
 - Sterling Dish
 - Linear Fresnel
 - Solar Tower
 - Solar Cooker



Vocabulary



Drag the word that fits into the blank correctly

solar tracking

solar collectors

hybrid system

"passive" solar panels

"active" solar panels

1. is a technology that allows solar panels to follow the sun throughout the day to collect as much sunlight as possible.
2. Flat, solar panels known as are used to get the most sunlight.
3. One subtype of solar panels, are . They produce energy through the use of mechanical energy.
4. A contains more than two types of energy production.
5. If a solar panel converts UV light into energy without the use of mechanical energy. Then they are known as



Ongoing Projects



- Solar panel loan program through the government
- Solar PV Park in Omburu
- 10 MW PV park in Gobabis
- 35 MW PV plant in Mariental
- Feasibility of 250 GW CSP project



Activity



Draw a series of different solar panels for your community. In your drawing please include:

- 1 or more photovoltaic cells or CSP
- 1 or more solar cooker or solar heater
- anything else that you think is necessary

Be prepared to discuss why you choose those specific types of solar panels.



Operation of Solar Panels



1. The solar cells absorb UV light through the silicon material.
2. This process allows the light to hit the silicon atoms and transfers energy to loose electrons, knocking them.
3. The loose electrons then "jump" to different types of silicon.
4. This causes an electric field to be generated and then an electric current.

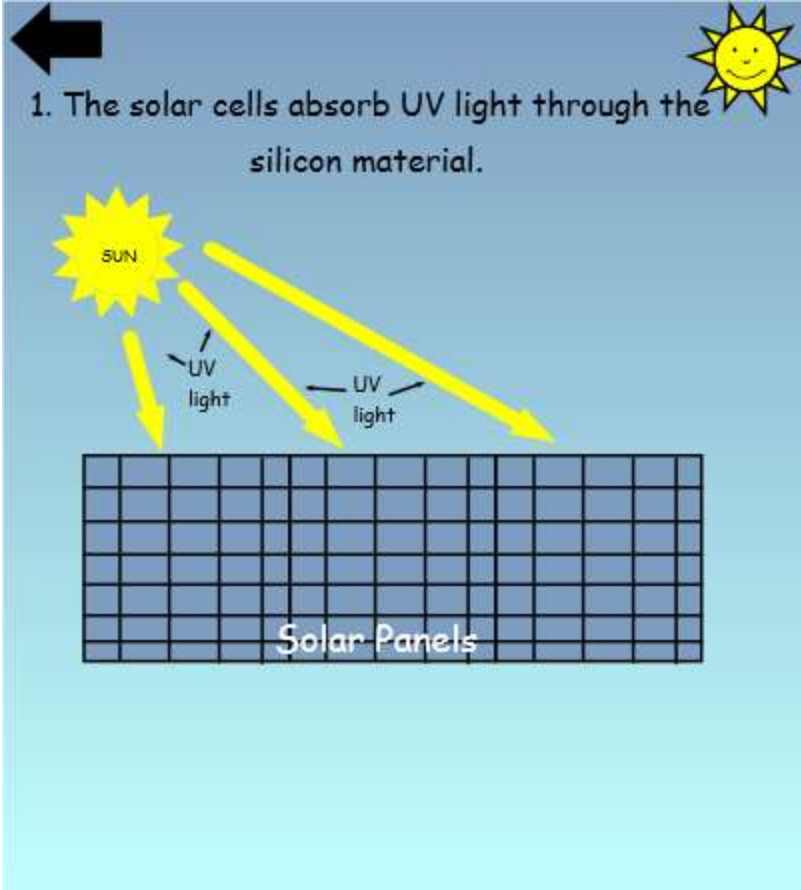

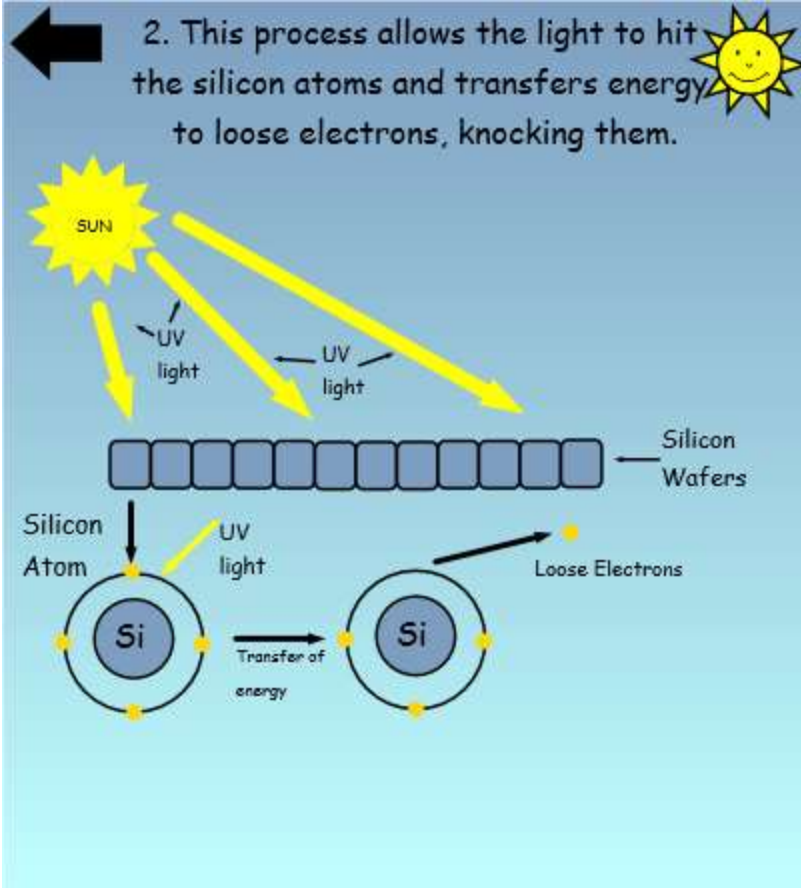



3. The loose electrons then "jump" to different types of silicon.

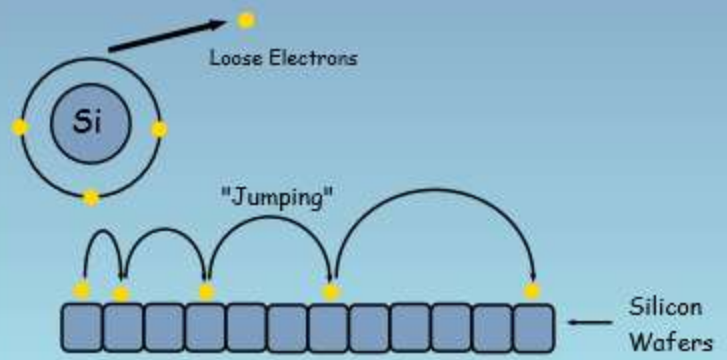

4. This causes an electric field to be generated and then an electric current.

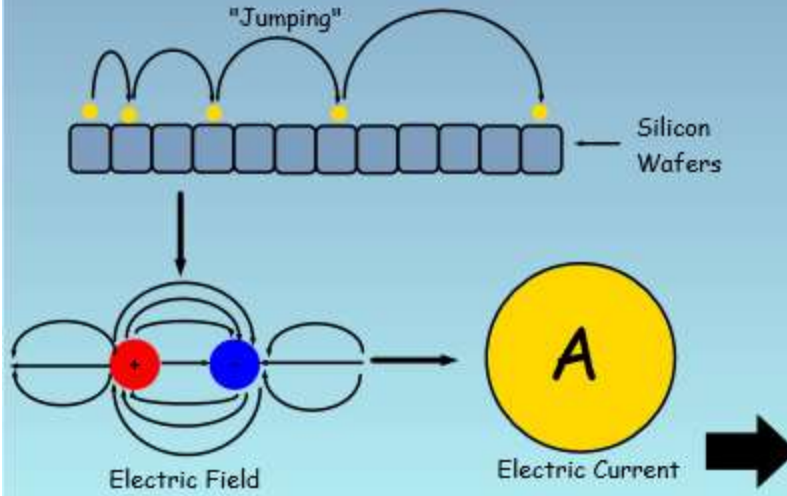



Operation of Solar Panels is a hard
topic to cover for everyone.

Please ask any questions about it here
if you're confused!



Solar Energy Storage



1. Some of the energy created from solar panels is sent to an inverter, where it converts the energy made into usable energy.
2. This energy is then sent into the existing electrical grid for use.
3. Another part of the energy made is sent to the batteries to charge them during the day so they may use solar energy at night.

1. Some of the energy created from solar panels is sent to an inverter, where it converts the energy made into usable energy.

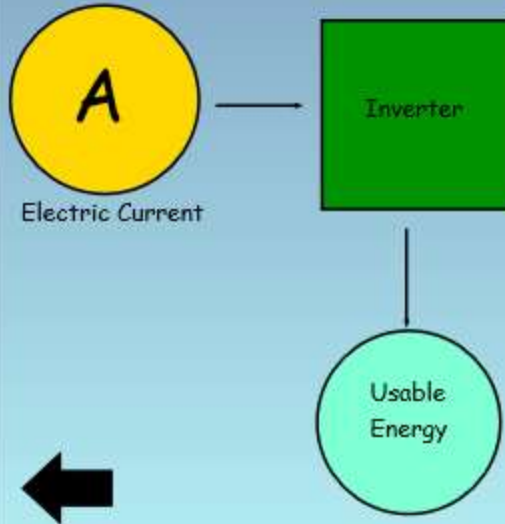

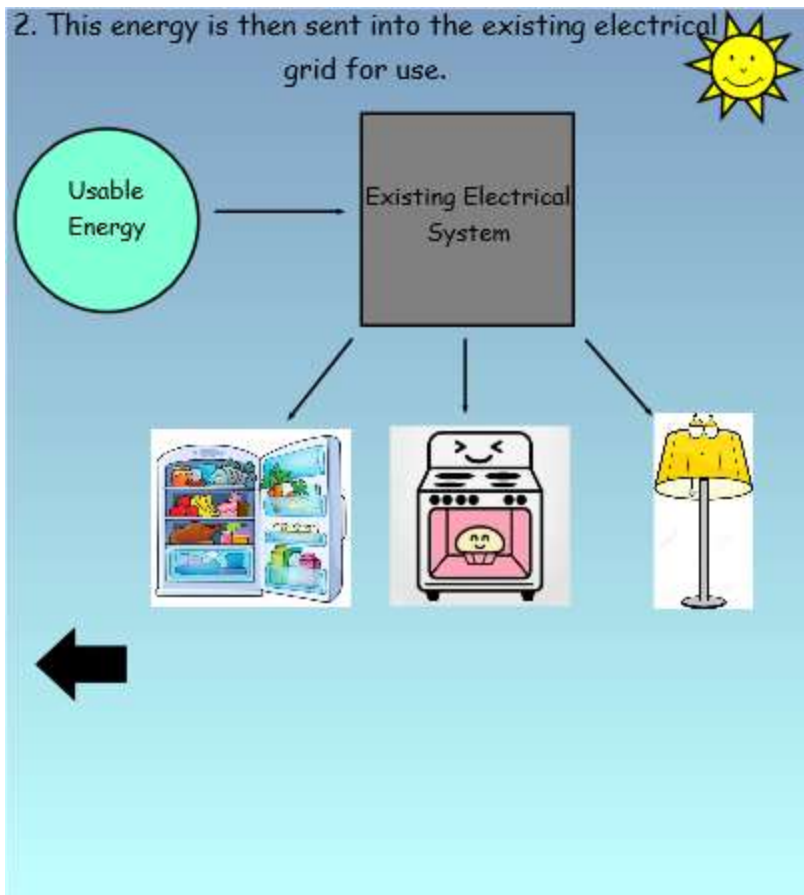

3. Some of the energy made is sent to the batteries to charge them during the day so they may use solar energy at night.

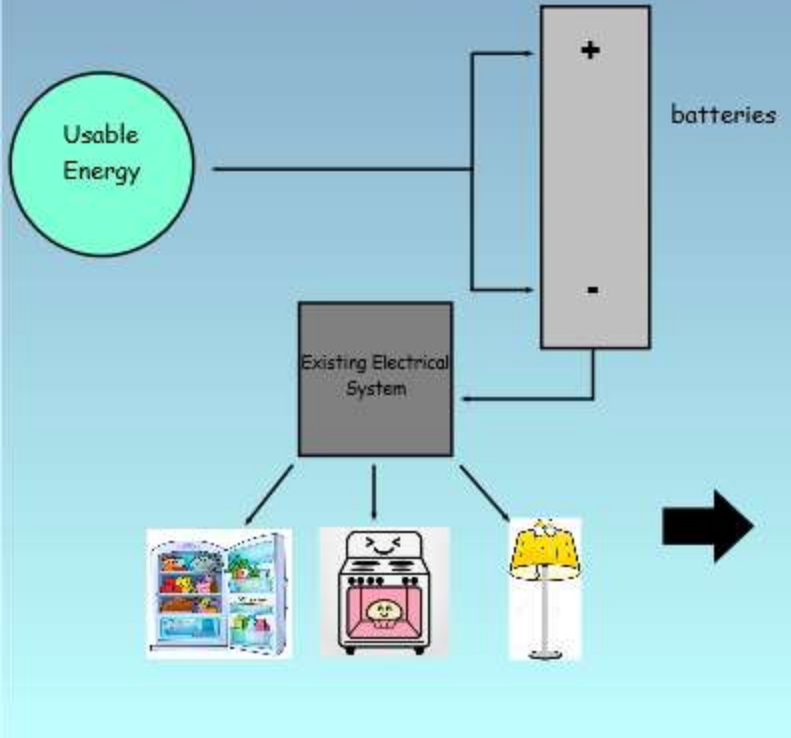



What is maintenance? Why
is it important?





Maintenance



Emerging Technologies



Click below to learn about these technologies



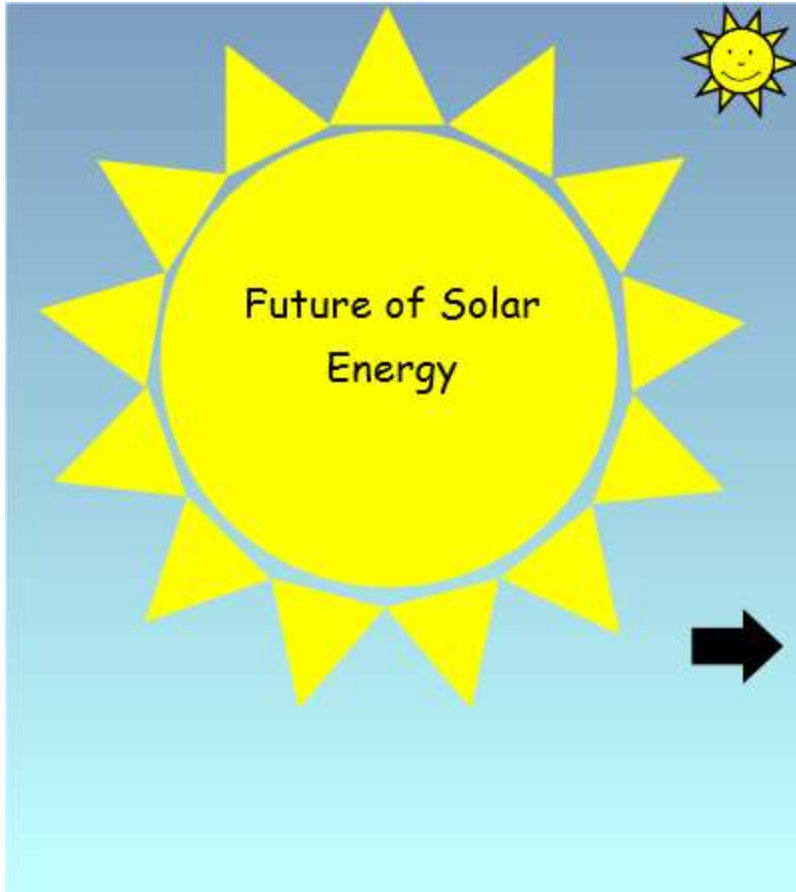



What kind of improvements do
you think that can be made to
solar technology as of right
now?



Brainstorm some Advantages of Solar Energy and list them below



Advantages of Solar Energy



1. Limitless opportunity during the day
 - « around 300 sunny days a year
2. Job Growth
 - « 20% job growth in this field since 2015
3. Reduces unemployment
4. Builds an Environmentally Friendly Future
 - « Globally reduce green house gas emission
5. Little Maintenance Required



Brainstorm some Disadvantages
and list them below



Disadvantages of Solar Energy



1. Inefficient
 - « silicon has an efficiency of around 10%
2. Expensive
3. No storage system in the current cells
4. Can only generate energy for 12 hours a day



Why in Namibia



Come up to the board and list some reasons below!!!!



Why in Namibia?



Where in Namibia?



- For individuals, solar panels can be used anywhere
- Typically need flat land with a smaller population for solar farms



Where in Namibia?

Guess some of the regions that can use solar farms



Drag Photos Here



Summary



Discuss what you have learned today in small groups and write them below.



Appendix EE: Module 3: Wind Energy

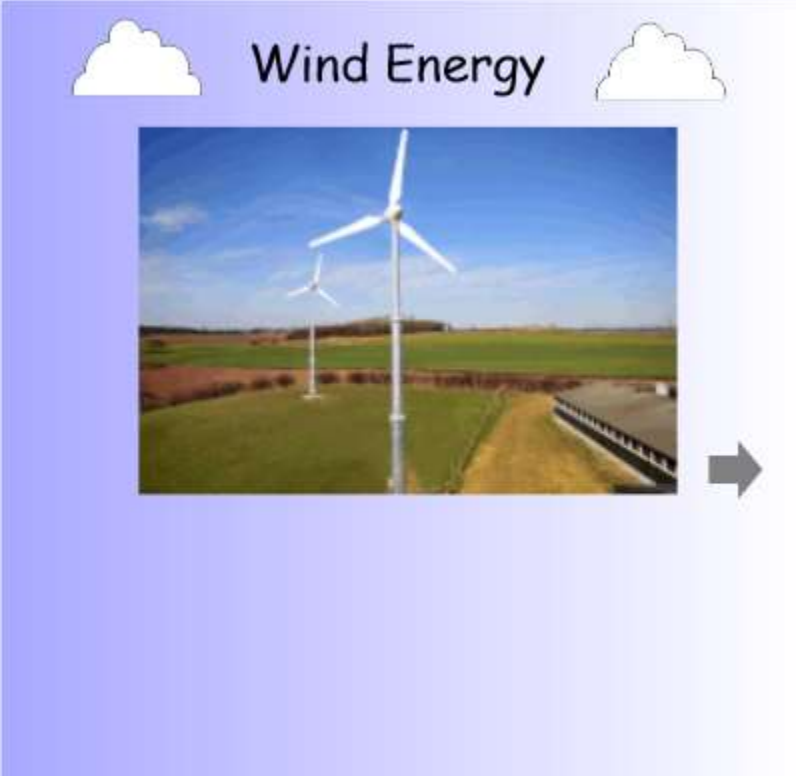



What is wind energy?

Please come up to the board and write your best guess



What is wind energy?

Please come up to the board and write your best guess

Wind energy is a renewable energy that
uses wind to generate electricity
with a turbine





How does it work?

Please come up to the board and write your best guess



How does it work?



1. Wind blows...	2. across tall windmills...	3. to turn the blades of huge turbines...	4. which spin generators to create electricity.	5. A transformer increases the voltage to send electricity over...	6. distribution lines. The local transformer reduce the voltage...	7. for you to use.
---------------------	--------------------------------	----------------------------------------------------	-------------------------------------------------------------	--------------------------------------------------------------------------------------	-----------------------------------------------------------------------------------	-----------------------



Order the letters that are next to the different turbines from the least amount of power generated to the most amount of power generated, in the boxes on the left

Least

Most

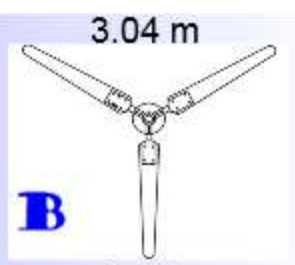

Once you are done, click on the question mark to reveal the next step



What causes wind?

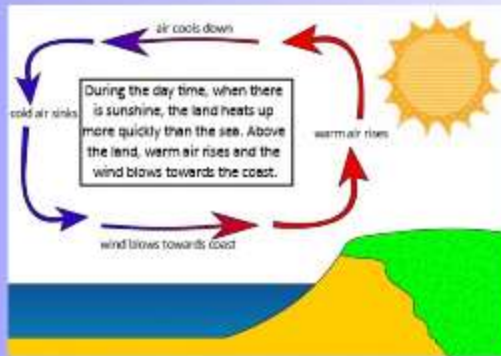

Wind is air in motion. It is produced by the uneven heating of the earth's surface by the sun.

Near coastlines are much windier than inland because of the different temperatures of the land and water



Advantages and Disadvantages





Click on the diamonds to learn the advantages or disadvantages of wind energy

Advantages

Disadvantages



Advantages

-  Clean fuel source; no pollution
-  Does not use water for cooling
-  One of the cheapest renewable energies
-  Domestic energy; produced in country
-  Creates jobs

 Back

Disadvantages

1 Not always windy; not able to store energy

2 More expensive than fossil fuels

3 Windy sites are usually far from cities

4 Noisy and looks unnatural

5 Effect surrounding wildlife



Types of Turbines

Horizontal Axis Wind Turbine



Vertical Axis Wind Turbine



Parts of a HAWT

Click on the question mark to reveal the part's purpose.

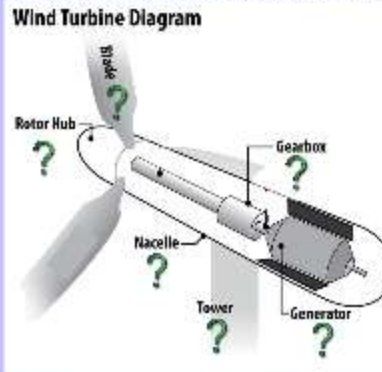

Rotor Blade

click the picture to reveal the definition



Gearbox

click the picture to reveal the definition



Nacelle

click the picture to reveal the definition



Generator

click the picture to reveal the definition



← Back

Rotor Hub

click the picture to reveal the definition



Back

Tower

click the picture to reveal the definition



HAWT Advantages and Disadvantages

Click on the boxes to find out!

Advantages

Disadvantages



😊 Advantages 😊

- The tall tower lets the turbine get stronger winds
- The wind hits the turbine horizontally; which gets the most energy



Disadvantages



Please use the pictures as hints, raise your hand and guess the disadvantages. Click on the picture to reveal the answer

Back



HAWT Review



Drag the words at the bottom into the correct phrases

The wind rotates the .

The converts the speed of rotation from the blades to a faster rotation speed so it can be converted into electricity.

The holds the turbine's machinery.

Once at the proper rotation speed, the converts the blade rotation into energy.

The brings the rotation of the blades created by the wind to the gearbox.

The anchors the wind turbine to the ground.

HAWTs can hurt surrounding .

ecosystems rotor-hub gearbox generator
tower nacelle rotor-blades

Parts of a VAWT

Click on the question mark to reveal the part's purpose.

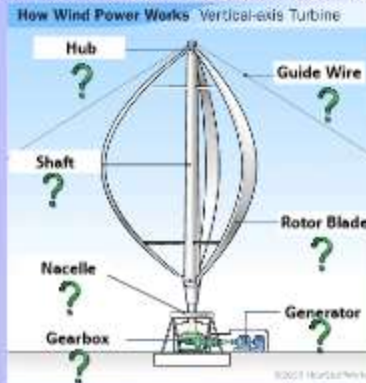

Guide Wire

keeps the
turbine in
position



Hub

center of the rotor; where the blades are attached



Rotor Blades

the wind turns the
rotor blades to
produce electricity



Back

Shaft

The part that is turned by the blades; the center of the turbine



Nacelle

Holds all the
turbine's
machinery



Gearbox

converts the
speed of rotation
from the blades
to a faster
rotation speed



Generator

once at the proper rotation speed, the generator converts the wind to energy



Back

VAWT Advantages and Disadvantages

Click on the boxes to find out!

Advantages

Disadvantages



😊 Advantages 😊

- Can spin with wind from all directions
- Close to the ground
 - > Easy maintenance
 - > Less visible to surrounding communities

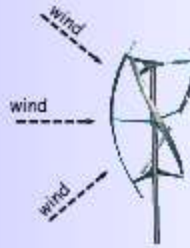

☹️ Disadvantages ☹️

- Produces less power than HAWTs
- Small wind speeds since closer to the ground
- They also need a 'push' in order to start rotating



Back

VAWT Review



Drag the words at the bottom into the correct phrases

The keeps the turbine in position.

The is where the blades attach to the shaft; there are two of these.

The wind turns the to produce electricity.

Once at the proper speed, the converts the blade rotation to energy.

The holds all the turbine's machinery.

The is the part that is turned by the blades and the center of the turbine.

The converts the speed of rotation from the blades to a faster rotation speed

Generator

Gearbox

Rotor blades

Hub

Nacelle

Shaft

Guide wire



Why should Namibia use Wind Energy?

Please come up to the board and write your best guess



Why should Namibia use Wind Energy?

Click on the Namibias to reveal the answers

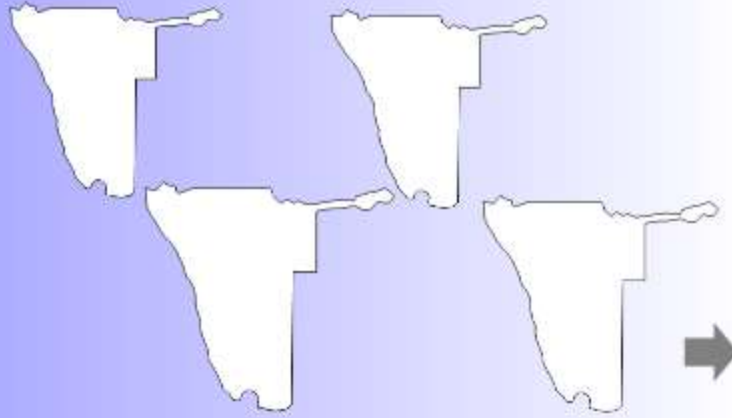



Why should Namibia use Wind Energy?

Job Growth

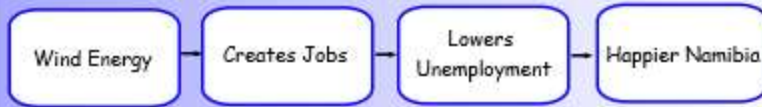



Why should Namibia use Wind Energy?

Clean Environment



If wildlife or environments are damaged Namibia can lose:

- food to eat
- clean water
- wildlife
- tourism
- clean air to breathe



Why should Namibia use Wind Energy?

Large Coasts

Click on the numbers to reveal facts

- 1
- 2
- 3

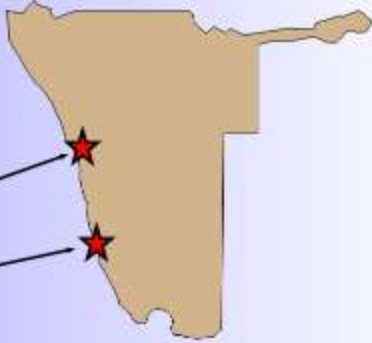

A map of Namibia is shown in a light brown color. Two red stars are placed on the western coast. Two black arrows point from the stars to the input boxes for numbers 2 and 3. A large grey arrow points to the right from the bottom right of the map area.



Why should Namibia use Wind Energy?

Stop Climate Change



Click on the numbers to see what climate change effects

- 1
- 2
- 3
- 4





ACTIVITY: Who does installing wind energy affect?

Split into groups of five and think of all the people or things affected by Namibia choosing to install wind turbines



Who does installing wind energy affect?



Please come up to the board and write some of your team's ideas

Namibian Government





Representing the stakeholders

Let's pick five from the previous page and brainstorm why each of the selected groups will care about renewable energy

1. *Namibian Government*
 - *Profits*
 - *Reduce unemployment*
 - *Happier citizens*
 - *Healthier environment*



What can you do as a community to help combat climate change and help save the environment?

Get into groups of five. Think of all the ways you could help save the Earth and stop climate change from inside your community. Use only the resources you already have in your community. For example, if you cannot do this project tomorrow, then it does not count. An example of a good answer would be: to start an environmental club at my school. A bad answer would be: put up wind turbines everywhere. Any questions?



The team with the most answers on their sheet of paper at the end of the 5-minute time period receives a prize!

Team 1 Score **000** **Jeopardy** Team 2 Score **000**

0 2 4 6 8
1 3 5 7 9

0 2 4 6 8
1 3 5 7 9

American and European...	Wind Energy in Numbers	How does it work?	Type of wind Turbines	Miscellaneous
100	100	100	100	100
200	200	200	200	200
300	300	300	300	300
400	400	400	400	400
500	500	500	500	500

Advantages and
Disadvantages - 100

Name one advantage
and disadvantage of
wind energy.

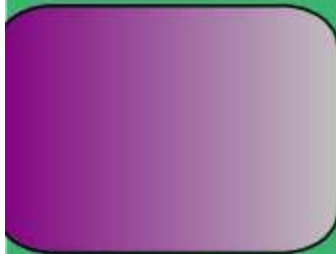

Jeopardy Board

Advantages and
Disadvantages - 200

True or False: Wind
energy is beneficial
because it uses a
cheap resource:
water



Jeopardy Board

Advantages and
Disadvantages - 300

True or False: Wind
Energy is one of the
cheapest renewable
energy options



Jeopardy Board

Advantages and
Disadvantages - 400

Name two species of
animals that could be
negatively affected
by wind turbines



Jeopardy Board

Advantages and
Disadvantages - 500

Explain how the
introduction of wind
turbines will help
Namibia's future.



Jeopardy Board

Wind Energy in
Namibia - 100

What can happen if Namibia uses wind energy?

(Pick one)

1. Reduced Unemployment Rate
2. It will pollute the air
3. Citizens will lose their jobs



Jeopardy Board

Wind Energy in
Namibia - 200

Approximately how many km of
coastline are there in Namibia?

1. 3000 km
2. 1570 km
3. 970 km
4. 2230 km



Jeopardy Board

Wind Energy in
Namibia - 300

Name two things that
Namibia can lose if they do
not start using wind energy
or any other renewable
energy sources



Jeopardy Board

Wind Energy in
Namibia - 400

Pick three out of the following list that are
consequences of climate change

1. Change in Rainfall
2. Increased Land for Farming
3. Increased Temperatures
4. Better economy
5. Drought and Flooding



Jeopardy Board

Wind Energy in
Namibia - 500

Name the two
Namibian cities that
are considering
installing wind
turbines.



Jeopardy Board

How does it work? -
100

True or False: Wind
is produced by the
uneven heating of
the Earth's surface
by the sun



Jeopardy Board

How does it work? -
200

Please define wind energy in
your own words



Jeopardy Board

How does it work? -
300

True or False: the smaller the
turbine, the more electricity it
produces



Jeopardy Board

How does it work? -
400

Where is the best place to put a turbine?

1. In the desert
2. In the city
3. Near the coast
4. In the forest



Jeopardy Board

How does it work? -
500

Place the five steps in the proper order for how wind turbines work

1. The blades of windmills are spun
2. The spinning of the blades also spin generators to create electricity
3. Local transformers reduce the voltage so the electricity can now be used by the community
4. Wind blows
5. A transformer increases the voltage created from the generator to send the electricity over distribution lines



Jeopardy Board

Types of Wind
Turbine - 100

Name the two types
of wind turbines.



Jeopardy Board

Types of Wind
Turbines - 200

True or False: Horizontal
Axis Turbines are more
efficient than Vertical Axis
turbines



Jeopardy Board

Types of Wind
Turbines - 300

Name one advantage
and one disadvantage
of HAWTs.



Jeopardy Board

Types of Wind
Turbines - 400

Name one advantage
and one disadvantage
of VAWTs.



Jeopardy Board

Types of Wind Turbines - 500

Name the different parts of the turbines to the correct place on the picture

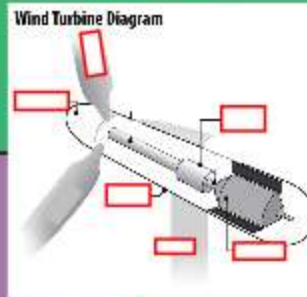

1. Generator
2. Tower
3. Rotor Blades
4. Gearbox
5. Nacelle
6. Hub

Jeopardy Board

Miscellaneous - 100

True or False: Bigger
turbines create more
energy.



Jeopardy Board

Miscellaneous - 200

True or False:
HAWTs cannot be
seen by surrounding
communities because
they are located
closer to the ground



Jeopardy Board

Miscellaneous - 300

True or False: Wind Energy
can completely power Namibia
if implemented throughout
the country.



Jeopardy Board

Miscellaneous - 400

What is not a cause of wind?

1. Satellites in space
2. Uneven heating of the atmosphere
3. Different pressures on the Earth's surface
4. Earth's different types of landscapes (ex: water vs land)



Jeopardy Board

Miscellaneous- 500

What is the purpose
of the gearbox?



Jeopardy Board

Appendix FF: Module 4: Bush-to-Energy



What is an invasive plant species?

- Definition- a type of plant that takes over a habitat
- Invasive plants tend to spread all over the land and use up important nutrients
- This can harm the environment

➔

What is Bush-to-Energy?

Bush-to-energy works as a renewable replacement for fossil fuels, using wood chips made from encroacher bush to create power and energy

➔

Encroacher Bush

Now that you know what an invasive plant is, what do you think encroacher bush is?

➔

Fossil Fuels

Do you remember what fossil fuels are?

Fossil fuels are compounds made of plant and animal remains that are burned to create energy, like coal and oil.

When they are burned, fossil fuels release greenhouse gases.

These gases harm the earth's atmosphere, and are the main cause of global warming and climate change.



➔

Types of Encroacher Bush

- There are 17 types of plants that are considered to be encroacher bush.
- Of these plants, four types are the most common forms of encroacher bush:



➔

Why is Encroacher Bush a problem in Namibia?





Desertification
Bush Encroachment
Income

How to fix the problem of Encroacher Bush

The best way to fix the problem of Encroacher bush is to harvest it.

There are many ways to harvest bush:





manual labor
mechanical
chemical

Desertification

Desertification occurs when the soil does not have enough water in it. The land dries up and nothing can grow.



If plants can not grow, farmers can not grow crops to sell, and don't have enough money to take care of their family.



Animals also suffer, as the plants they eat can not grow, and they do not have enough food to be happy and healthy.



Important Things to Remember when Harvesting Bush

While it is good to harvest this encroacher bush, you need to be mindful of the surrounding environment. If you aren't careful, you could end up doing even more damage.

Some side effects of improper de-bushing include:

- Reduction of Biodiversity
- Increased Land Desertification
- Habitat destruction

Bush Encroachment

Encroacher bush covers over **55%** of Namibia's land, and is still growing rapidly.

The more the bush grows, the less land there is available for farmers to sustain their livestock and grow crops.

An increase in the amount of bush also reduces the amount of water in the soil, increasing desertification.

As the country is already arid and water is scarce, this bush also decreases our water tables.

Important Things to Remember when Harvesting Bush

Some **bad practices** for harvesting bush include:

Clearing Near Rivers



Aerial Spraying of Herbicides



Elimination of all Bush



Impact on the Economy

- No crops → cannot sell enough goods to maintain farms
- Cannot maintain farms → Job Loss
- Over 70% Population Affected → Economic downfall





Important Things to Remember when Harvesting Bush

Some **good practices** for harvesting bush include:

Applying Herbicides by Hand



Harvesting in phases



Selective harvesting



Important Vocabulary

Once the encroacher bush has been properly harvested, it can be processed and used as an energy resource.
Before we talk about how to convert this bush to energy, it's important to know about some key technologies

Turbine

Magnetic Field

Generator

Converting Harvested Bush into Useable Energy

4. The steam acts as a force to move the blades in the turbines

Converting Harvested Bush into Useable Energy

1. Bush is harvested and sent to a processor where it is converted into wood chips

Converting Harvested Bush into Useable Energy

5. The moving of the turbines cause the coils and magnets in the generators to create a magnetic field

Converting Harvested Bush into Useable Energy

2. Once the bush is processed, it is transported and stored in a bunker underneath a water tank

Converting Harvested Bush into Useable Energy

6. The magnetic fields produce electricity, which is stored and distributed to homes around Namibia

Converting Harvested Bush into Useable Energy

3. The wood chips are then burned, which boils the water in the tank above, creating steam

Where in Namibia will this technology be useful?

Advantages of Bush-to-Energy

- Reduce Energy Imports
- Improve the economy
- Decentralized Power Supply
- Decrease CO2 emissions

Decrease CO2 Emissions

- Decrease dependency on nonrenewable energy supplies
- Bush-to-Energy would produce 2% the amount of CO2 that nonrenewable energy emits
- Bush-to-Energy implementation → long-time decrease in CO2 emissions

Reduce Energy Imports

- 80% of Namibia's electricity is currently imported from other countries
 - Bush-to-energy could completely satisfy this need every year
- Potential to power ten 20MW plants for 100 years
 - Total of over 240,000 households per year
- Maintain foreign relations
- Namibia to become an energy exporter

Disadvantages of Bush-to-Energy

- Carbon Sinks
- Expensive
- Take a lot of time
- Potential environmental harm

Improve the Economy

- Decrease National Spending
- Job Opportunity
 - Over 30,000 new jobs created
- Energy Exporter
 - Could possibly gain N\$25-112 billion per year

Carbon Sinks

- Definition: Plants remove CO2 from the atmosphere to use in photosynthesis
- Carbon Sinks are good for the environment
- Harvesting encroacher bush affects these carbon sinks

Decentralized Power Supply

- Decentralized power-distributing widely owned resources over smaller areas of the country
- Allows local communities to create own power grids
 - Decrease local dependency on government
 - More cost effective for rural communities

Expensive

- More expensive than fossil fuels (coal & oil) and other renewable energies (wind & solar)
- Costs of Bush-to-Energy include
 - Training bush harvesters and mechanics
 - Establishing processing centers and power plants
 - Paying fees associated with harvesting permits
 - Paying salaries of all workers, both in the field and at the power plants

Takes a lot of Time

- Several factors of bush-to-energy which take time:
 - Approval of Permits
 - Properly training laborers and machinists
 - Building and establishing a successful bush-to-energy plant
- More time → less money



Potential Environmental Harm

- Improper Harvesting leads to environmental harm
 - increased desertification 
 - soil erosion 
 - decreased water retention 
- Improperly cared for land impacts farmers the most

What can YOU do to create awareness on Bush-to-Energy?

- Tell your parents and community 
- Encourage farmers to learn more about bush-to-energy 
- Make sure people are properly harvesting bush and taking care of the land 
- Work with your classmates to promote awareness in your communities 

REVIEW ACTIVITY

The group will be split into teams of 2

The first team will pick a number from the question board. If they get the correct answer, then they can place a game piece on the board, starting from the bottom. If they don't get the correct answer, they do not get to put a game piece on the board.

After the first team tries to answer their question, the second team gets a chance.

This continues until one team gets four game pieces in a row of their team's color.

Good luck!

Connect 4

Click here for questions

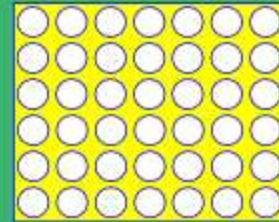

Click a number below to answer a question. (Drag the # behind the mini game board so you know which have been used!)



1	2	3	4	5	6
7	8	9	10	11	12
13	14	15	16	17	18
19	20	21	22	23	24
25	26	27	28	29	30

1



What is Encroacher Bush?

- plants in their natural habitats
- plants that take over an area
- plants that come from other countries
- plants that are placed in pots in people's homes

1



answer:

- plants that take over an area

2



How much land does encroacher bush cover in Namibia?

- a. 100%
- b. 40%
- c. 55%
- d. 25%

2



answer:

c. 55%

3



What type of bush is located all over Namibia?

- a. Prosopis
- b. Swarthoak
- c. Sicklebush
- d. Thornbush

3



answer:

a. Prosopis

4



What is the most common bush species in Northwestern Namibia?

- a. Blackthorn
- b. Aloe
- c. Mopane
- d. Sicklebush

4



answer:

c. Mopane

5



What is the most common bush type in Eastern Namibia?

- a. Swarthoak
- b. Whitethorn
- c. Prosopis
- d. Silver Cluster-leaf

5



answer:

d. Silver Cluster-leaf

6



What is one problem that Encroacher Bush creates?

- a. severely limits the water supply
- b. there are too many plants
- c. plant species live together peacefully
- d. Encroacher Bush is not good to eat

8



What is one thing you SHOULD do when harvesting bush?

- a. clear all of the bush
- b. Clear a select number of bush
- c. Burn a patch of bush
- d. Use aerial arborcides to clear the bush

6



answer:

- a. severely limits the water supply

8



answer:

- b. Clear a select number of Bush

7



What is another problem with encroacher bush?

- a. decreases the biodiversity in Namibia
- b. increases the overall temperature
- c. makes Namibia's Landscape beautiful
- d. provides water to surrounding plants

9



What is one thing you should NOT do when harvesting bush?

- a. get a permit
- b. use aerial arborcides
- c. manually clear select amounts of bush
- d. leave some species alone

7



answer:

- a. decreases bio-diversity in Namibia

9



answer:

- b. use aerial arborcides

10 

What is a good practice for harvesting bush?

- a. eliminating all encroacher bush
- b. using aerial arborcides
- c. clearing the bush near rivers
- d. selectively clearing sections of bush

10 

answer:

d. selectively clearing sections of bush

11 

What is a bad practice for harvesting bush?

- a. harvesting in several phases
- b. getting animals to eat the bush
- c. harvesting all at once
- d. manually applying arborcides

11 

answer:

c. harvesting all at once

12 

What is desertification?

- a. When you eat too much dessert and don't feel well after
- b. When the land does not have enough water and nothing can grow
- c. When your throat feels very dry
- d. The act of growing used to the weather in the desert

12 

answer:

b. When the land does not have enough water and nothing can grow

13 

What region of Namibia is being considered for bush-energy plant implementation?

- a. West
- b. East
- c. North
- d. South

13 

answer:

c. North

14



What type of bush harvesting requires workers to use hand tools?

- a. Manual Labor
- b. Mechanical Harvesting
- c. Chemical Harvesting

16



What is one advantage of bush-energy?

- a. increasing greenhouse gases
- b. makes the plants more appealing
- c. creates a lot of new jobs
- d. uses up less of the sun's energy

14



answer:

- a. Manual Labor

16



answer:

- c. creates a lot of new jobs

15



What is bush-to-energy?

- a. the energy plants get from the sun
- b. the process of harvesting bush and using it as a renewable replacement for fossil fuels
- c. Using bush as a food source to boost energy levels

17



What is another advantage of bush-to-energy?

- a. environmental harm
- b. fewer jobs available
- c. there will be less water for the plants
- d. increase biodiversity and available land

15



answer:

- b. the process of harvesting bush and using it as a renewable replacement for fossil fuels

17



answer:

- d. increase biodiversity and available land

18



What is a disadvantage of bush-to-energy?

- a. environmental harm
- b. reducing dependency on foreign countries
- c. more jobs
- d. environmental protection

18



answer:

- b. reducing dependency on foreign countries

19



What is a disadvantage of bush-to-energy?

- a. can be expensive
- b. creates new jobs
- c. reduces the beauty of Namibia's land
- d. increases biodiversity

19



answer:

- a. can be expensive

20



How is bush-to-energy good for the economy?

- a. fewer jobs
- b. increased foreign imports
- c. increase in national funds
- d. environmental harm

20



answer:

- c. increase in national funds

21



What is another disadvantage of Bush-to-Energy?

- a. Allowing for decentralized power supply
- b. A long-term decrease in CO2 emissions
- c. removal of many carbon sinks
- d. creation of new jobs

21



answer:

- c. removal of many carbon sinks

22



What is something you can do to increase awareness of Bush-to-Energy?

- a. Talk to your parents and community members
- b. Carry a bush around with you
- c. Try to harvest bush yourself
- d. There's nothing you can do

24



What does steam do to help convert bush to energy?

- a. boils the leaves so that you can eat the bush
- b. moves the magnets around in the generator
- c. pushes the blades in the turbines to make them move
- d. steam does not help in the process of converting bush to energy

22



answer:

- a. Talk to your parents and community members

24



answer:

- c. pushes the blades in the turbines to make them move

23



What is an invasive plant species?

- a. A indigenous plant that you eat often
- b. A type of plant that lives in harmony with other species
- c. A type of plant that takes over a habitat
- d. An alien plant that you don't like to eat

25



What is a turbine?

- a. a machine that uses magnets to create electricity
- b. a machine that turns milk to make ice cream
- c. a machine that uses the power of spinning blades to create electricity
- d. a machine that uses the sun to create energy

23



answer:

- c. A type of plant that takes over a habitat

25



answer:

- c. a machine that uses the power of spinning blades to create electricity

26



What is a magnetic field?

- a. an electrically charged area around a magnet that is caused by the moving of particles
- b. a field that is full of magnets
- c. an area surrounding a magnet that is infested with encroacher bush
- d. When two magnets cannot be put together, even by extreme force.

28



What is a benefit of decentralized power?

- a. decentralized power is actually bad for the environment and shouldn't be used
- b. decentralized power can be established anywhere, not just in the center of town
- c. decentralized power has no benefits
- d. decentralized power allows local communities to spend less on government supplied electricity

26



answer:

- a. an electrically charged area around a magnet that is caused by the moving of particles

28



answer:

- d. decentralized power allows local communities to spend less on government supplied electricity

27



What causes the turbines to spin in a bush-to-energy power plant?

- a. The encroacher bush being poured into the processor
- b. Steam power that pushes the blades
- c. Electricity
- d. Solar panels charge the turbine and cause it to spin

29



Why is time an issue when trying to implement bush to energy?

- a. Taking too much time on a project means less time for you to enjoy your day
- b. The more time that a project takes, the more money it costs, which could effect the economy
- c. Wasting time makes you lazy
- d. Time is not an issue

27



answer:

- b. Steam power that pushes the blades

29



answer:

- b. The more time that a project takes, the more money it costs, which could effect the economy

30



What can you do to increase awareness of bush-to-energy?

- a. Encourage your community to eliminate all of the bush
- b. You should not try to increase awareness, this technology would not be useful to Namibia
- c. Tell the farmers in your hometown about how they can use the bush on their farm in bush-to-energy
- d. Tell the farmers in your town that they should hire a plane to spray herbicides to get rid of the bush

30



answer:

- c. Tell the farmers in your hometown about how they can use the bush on their farm in bush-to-energy

Appendix GG: Module 1: Introduction to Renewable Energy Teacher Guide

Slide 1

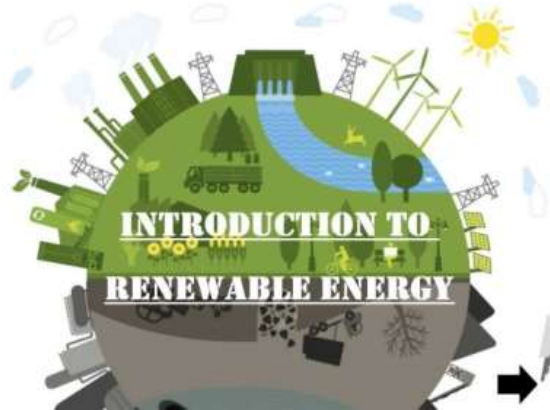

Ask learners if they know what renewable energy is? What can they see in the picture?

What do they know about climate change?

Slide 2

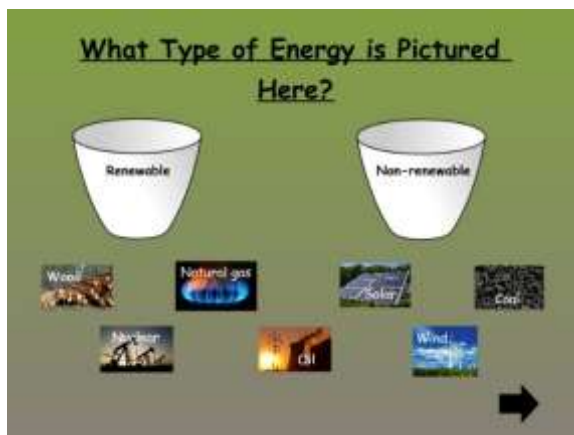

Have the learners come up to the board and sort the pictures

Slide 3

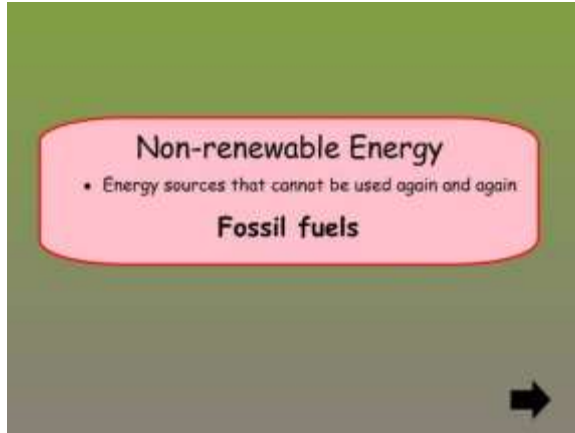

The first type of energy is non-renewable. Explain definitions. The source of non-renewable energy is fossil fuel.

Slide 4

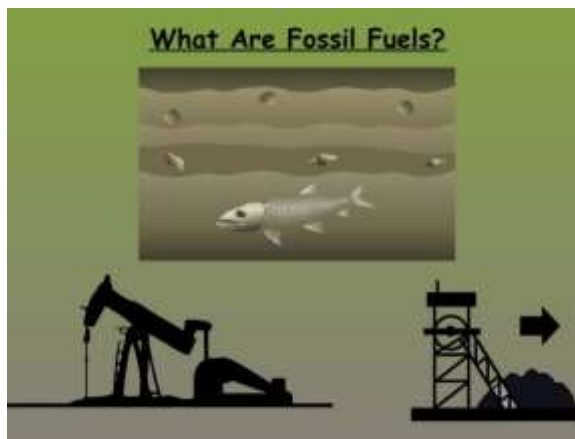

Ask the learners if they know what fossil fuels are? Where do they come from?

Then reveal the answer under the fossil

Link fossil fuels to the industrial revolution and development

Slide 5

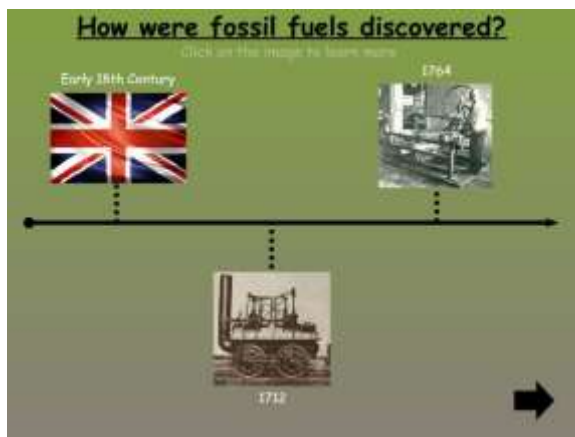

Click on each part of the time line to learn more about what it means. A learner can come up to the board if they want.

Industrial Revolution was mostly in Europe and America but all developing nations go through some kind of industrial Revolution.

Slide 6

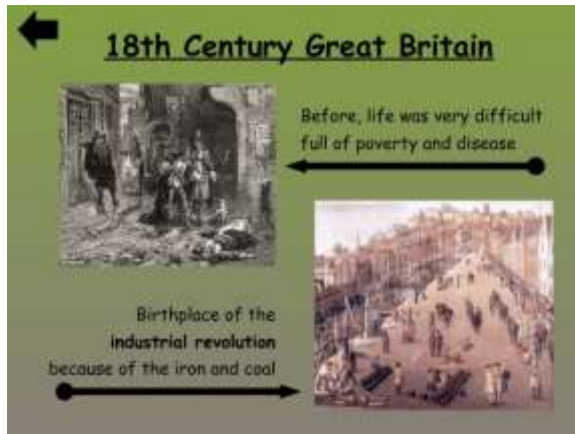

First image.

Reveal definition of the Industrial Revolution under the bottom picture.

Explain where it happened, why and how. Ask learners what they think this meant for society.

The arrow takes you back to the timeline

Slide 7

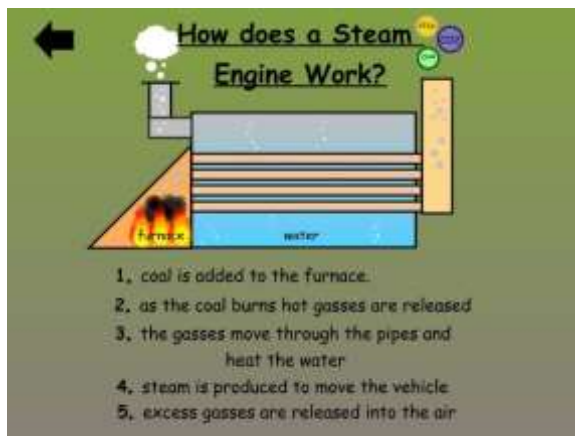

Here is a diagram of how a steam engine works. Teacher or learner can click each number to reveal the process. Steam engines were invented during the industrial revolution. They improved transportation.

Slide 8



Video to help summarize the industrial revolution.

Right arrow continues forward.

Before the video starts remind the learners to think about what was invented, why it was invented and some of the good and bad things that came from the industrial revolution.

Discussion at the end.

Slide 9

Activity: After learning about some of the new technologies and inventions of the industrial revolution, think about some inventions or technologies you have.

Directions: In groups of 2-3 learners brainstorm different inventions or technologies. The inventions or technologies may either be helpful or harmful in your community.

Please consider:

- impacts of the invention or technology on the environment (good or bad)
- if you have direct access to the invention or technology
- how did you think of the invention or technology



Activity! Break up learners into groups of 2-3 and ask them to brainstorm local technologies and inventions that help and hurt their community and environment.

Should take 20 minutes max.

Have the learners share afterward.

Responses can be written on the board.

Slide 10



Learners can come up to the board and share what they discussed. Short discussion with everyone.

Slide 11

Why are fossil fuels bad?

coal, oil, and natural gas release greenhouse gases when they are burned

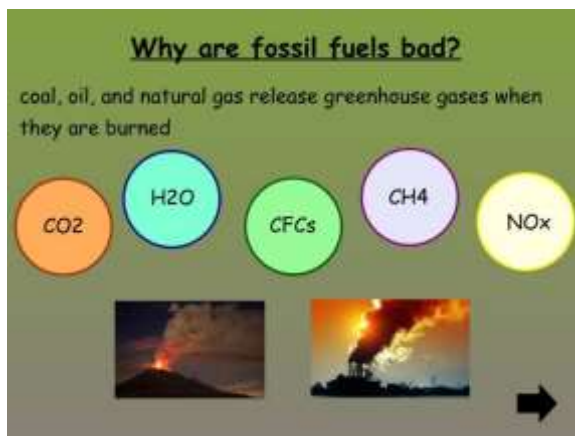

Fossil fuels release greenhouse gases when they are burned.

Each gas reveals a consequence

Reveal Carbon Dioxide – Each of these is a gas. They are all found naturally in the atmosphere

Reveal Water Vapor – For thousands of years the earth's climate has changed naturally because of events such as volcanic eruptions and solar energy bursts.

Reveal Chlorofluorocarbons – The gases trap heat in the atmosphere

Reveal Methane – Since the Industrial Revolution the amount of these in the atmosphere have increased by a lot

Reveal Nitrous oxide – Scientific consensus is that humans are causing rapid climate change across the globe.

Greenhouse gases trap heat which raises the surface temperature of earth and causes Climate Change.

Slide 12



Ask the learners if they have any ideas for what Namibia can do to decrease greenhouse gases and Climate Change? Tap the flag to reveal the answer

Slide 13

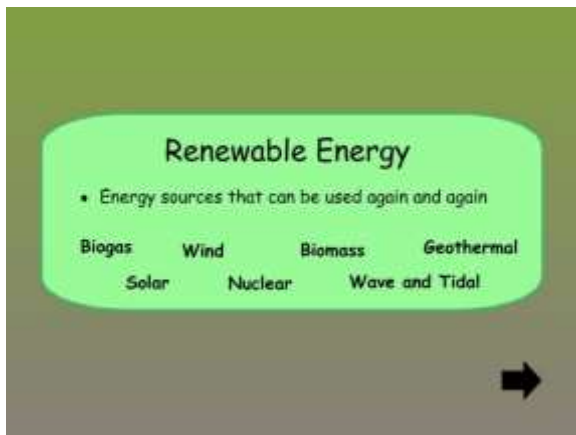

Renewable energy home page.

Explain the definition of renewable energy.

Teacher or learner can click on each type of energy to learn more about it.

Ask the learners which one they want to learn more about first

Slide 14

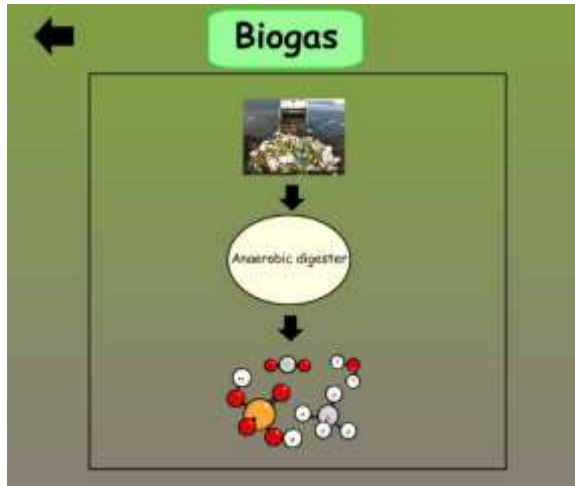

The general process is:

Food waste → digester → gases → further processing → natural gas or electricity

Specific is:

Biogas is the breakdown of organic matter in the absence of oxygen through heating in a digester, which releases gases such as methane, and carbon dioxide. These gases are known as biogas and can be used for electricity, heating, cooling, or piped into the natural gas grid.

Teacher will click through and explain the process in detail

Slide 15

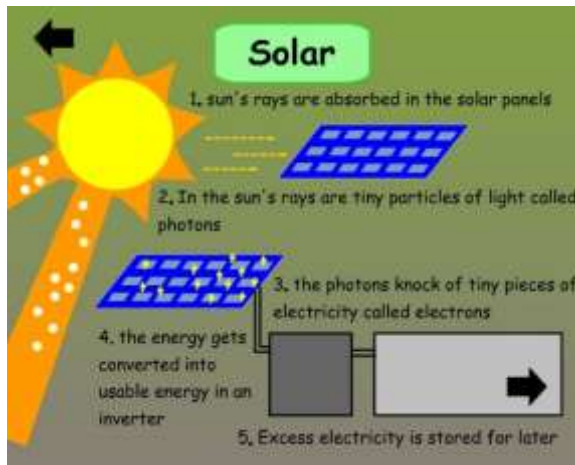

Solar energy converts solar energy to electricity.

Each number can be clicked and revealed.

Photons, electrons.

Slide 16



All pictures can be clicked to reveal four different applications of solar energy.

Solar cookers

Solar water heaters, electricity,

power lamps and chargers

Ask the learners what is the best thing they can do given the choice of these applications?

Answer: build a solar cooker, buy a solar powered lamp

Slide 17

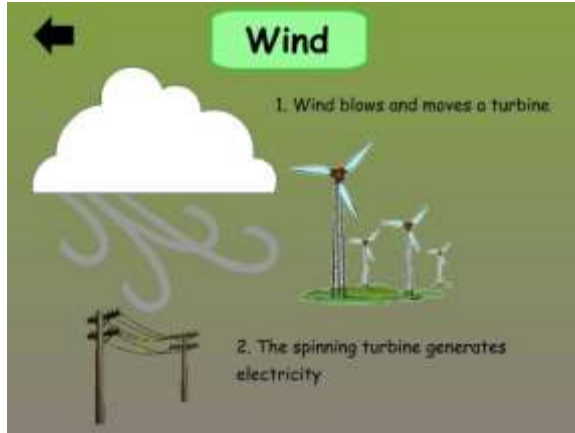

Wind energy uses wind to turn a turbine and generate electricity. Click the cloud and click the turbine to spin.

Good places for wind energy are coastal areas.

Slide 18

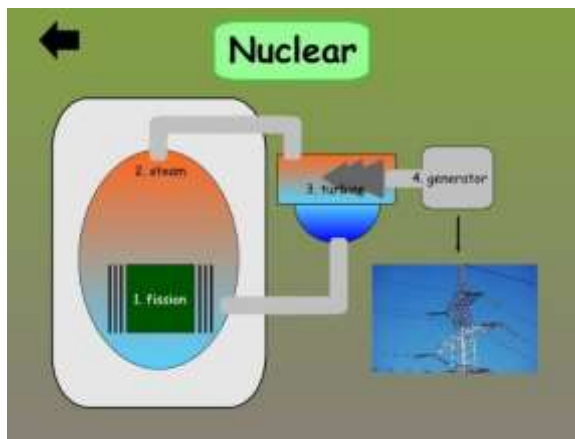

Explain the process.

The fission in the reaction of atoms splitting a part. That heats the water and makes steam. The steam turns a turbine.

Click the turbine. Electricity is generated.

When a large atom splits in two, it creates a large amount of energy and also sets off the same reaction in nearby atoms. This reaction takes place in a nuclear reactor and converts the energy into electricity. Downside to nuclear is the radiation. Able to produce energy nearly carbon free

Slide 19

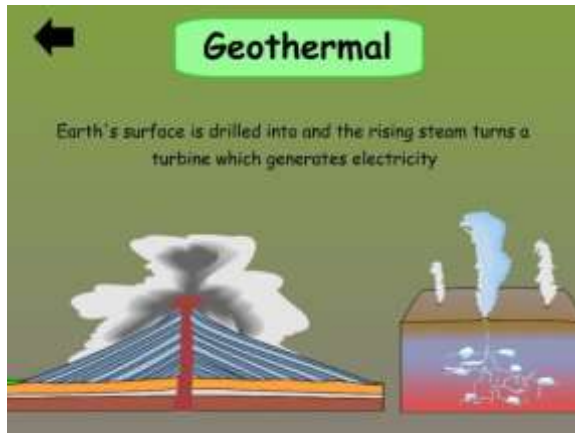

Explain where it comes from and how to get it.

2 forms of geothermal: core of the earth and ground source heat, which is solar energy absorbed in the first few feet of the earth. Sources of geothermal energy are volcanoes, hot springs, and geysers. To generate electricity, wells are drilled into the surface and the steam and hot water turn turbines.

Slide 20

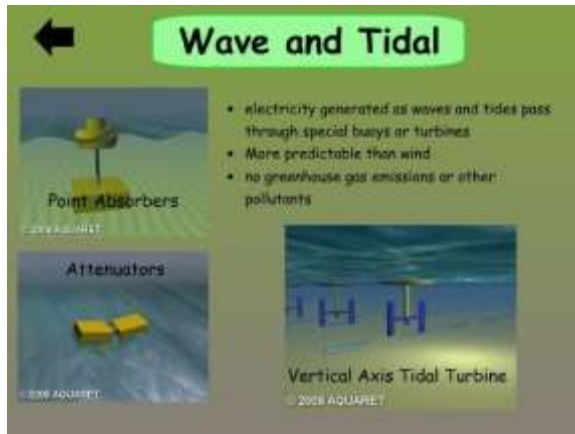

Wave and Tidal

- electricity generated as waves and tides pass through special buoys or turbines
- More predictable than wind
- no greenhouse gas emissions or other pollutants

Point Absorbers

Attenuators

Vertical Axis Tidal Turbine

© 2009 AQUARET

It is power generated from waves and tides when it passes through special buoys, turbines and other technologies. More predictable than wind energy. Electricity is produced without any pollutant emissions or greenhouse gases, but full environmental impacts are scarce.

Each of the images move and can be explained.

Slide 21

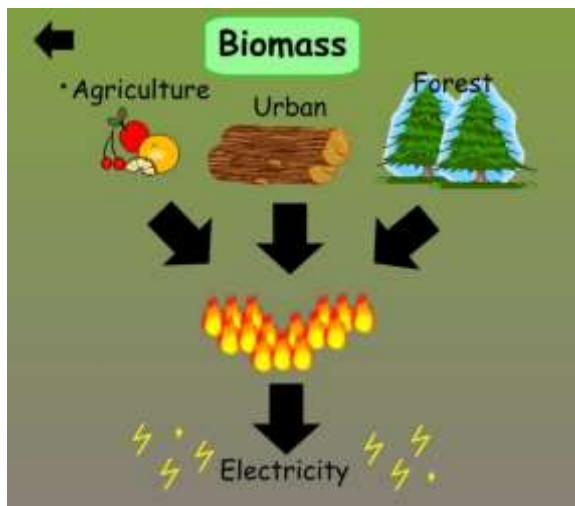

Biomass

Agriculture Urban Forest

Electricity

Very simple explanation as it will be further explained in another module.

It generates electricity by burning biological material. A specific biomass to Namibia is known as Bush-to-Energy. This process utilizes the abundant, invasive encroacher bushes and burns them to produce electricity.

Scraps of biological material → combustion → electricity

Slide 22



What options are best for Namibia?

Come up to the board and write your answer!

Learners can come up and write their answers on the board.



Ask the learners why renewable energy is important, then reveal the answers behind the flags and explain why. How does it relate to the learner?

Answers -

Provides electricity to more places

Reduces Namibia's carbon footprint - a carbon footprint is the amount of CO₂ a place releases into the atmosphere.

Renewable energy will help reduce the amount of CO₂ Namibia emits. As a result, the air in Namibia will be cleaner and safer for its people. This means a healthier environment for people and animals.

Improve economy, promote entrepreneurships and create jobs – this is important because Namibia is reliant on other countries for energy. Namibia hopes to eventually export energy. Renewable energy has the potential to raise the confidence of Namibian people and create jobs for many. Also, as Namibia grows and industrializes, entrepreneurs need ways to establish green businesses to help mitigate effects of Climate Change.

Improve agriculture and food availability – important because some places have limited access food. The unpredictable changes in the climate have left farmers struggling to provide enough crops

Improve water availability – Namibia is a dry arid country that suffers from a lack of water. If Climate Changes continues to get worse, water will become even more scarce and unavailable to people and animals. Namibia also relies on hydro power and if the rivers run dry, they won't be able to use this type of renewable energy

Supports Vision 2030 – supporting sustainable development in Namibia and mitigating Climate Change effects in the country. Improving education across urban and rural areas and incorporating environmental education

Slide 24

What can you do?

- organize clean up project around your school or village
- build solar cookers instead of using wood stoves
- tell others about what you learned



Go through the slide then ask learners if they can think of anything else that they can do.

Explain the importance of each

If they give an answer that is “use more solar power” explain why that isn’t good enough and how they can actually achieve that goal.

Slide 25

- When **bacteria** breaks down organic matter, **biogas** is created.
- electricity** is a result of the sun’s energy absorbed in panels.
- Wind is strong enough to turn a **turbine** and generate electricity.
- Nearly **carbon free** energy can be produced when atoms split in a **nuclear** reactor.
- Geothermal sources use **steam** and **hot water** to turn turbines and generate electricity.
- Power can be generated from **waves** and tides when it **passes** through special buoys or turbines.
- biomass** is burning plants for **renewable** energy.

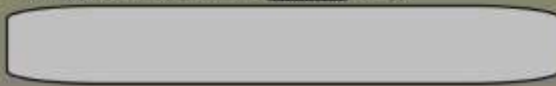

Let as many learners as you can come up to the board and try filling in the sentences.

Remember to reset this slide.

Slide 26

Activity: After learning about the important of renewable energy, it is time to share your opinions and give advice to others.

Directions: Divide yourselves into 3 groups. Each group will get a decision a fellow Namibian is facing in there life. Please provide them some helpful advice.

Please consider:

- environmental impacts
- economic impacts
- social impacts



Activity

Slide 27

Scenario 1: A community to the east of Windhoek has heard about solar energy but is not sure about taking advantage of the government loan program because it is expensive. What can you tell them about the benefits of renewable energy?

Scenario 2: Tauno is a farmer in the northern region of Namibia and has lost much of his crops because flooding. He thinks it is a good idea to construct a turbine on his property to supply electricity. Why is this a bad idea?

Scenario 3: Penda and his family want to increase their property for farming. They decide to cut down and burn the encroachment bush. What are positive and negatives impacts of Penda's actions?

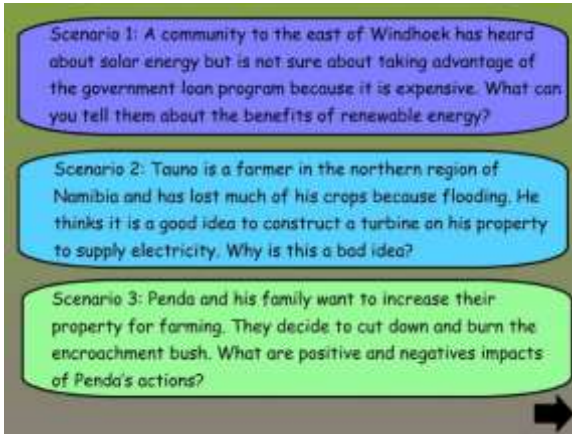

Scenarios

Slide 28

What advice do you have?



Responses for discussion.

Possible discussion point per scenario:

Slide 29

Renewable Energy is important not only for Namibia but also the world. Resources like fossil fuels are disappearing and cannot be renewed as quickly as wind or solar resources.

Namibia is setting a good example for other developing nations to invest in alternative energy and resources to minimize their carbon footprint.

It is important to work together to help create a future with the same opportunities and resources as we currently have.

Go through each point to help summarize the lesson.

Ask the learners if they have any questions.

Reveal section on left first. Then right section.

Appendix HH: Module 2: Solar Energy Teacher Guide

Slide 1

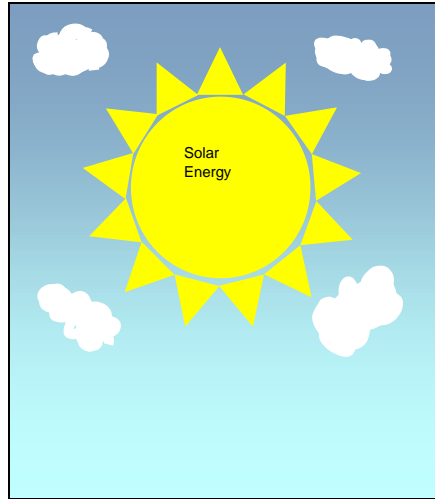

Introduce purpose and objectives of the lesson. Also gauge the amount of knowledge by asking questions such as “what is solar energy” and “what does solar energy use.

Objectives:

- Be able to give a definition of solar power
- Explain how solar panels convert light energy into electricity and how to store energy
- Give some of the advantages and disadvantages to this form of renewable energy
- Explain why it can be used in Namibia specifically
- Explain where in Namibia it can be implemented and why it should be implemented there to begin with

Slide 2

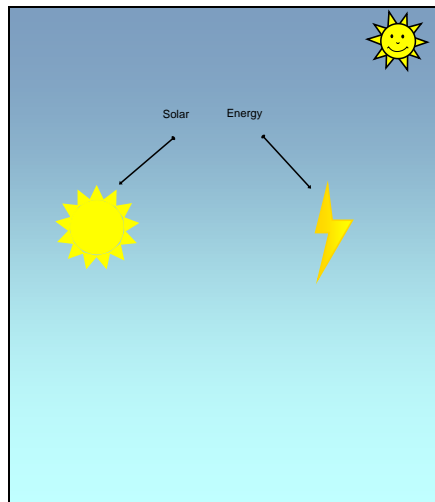

Ask learners what they think the definition of solar is and what the definition of energy is. Then click on each word on this slide.

Slide 3

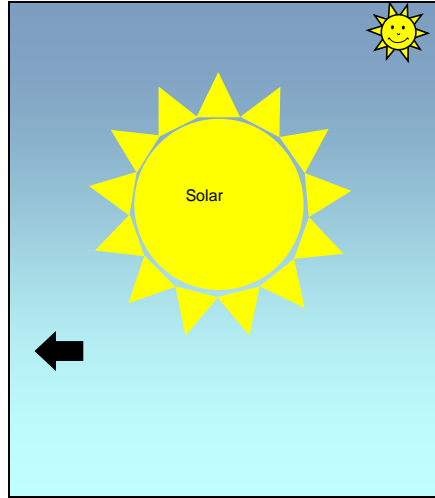

Have one learner come up to the board and reveal the definition of solar.

Slide 4

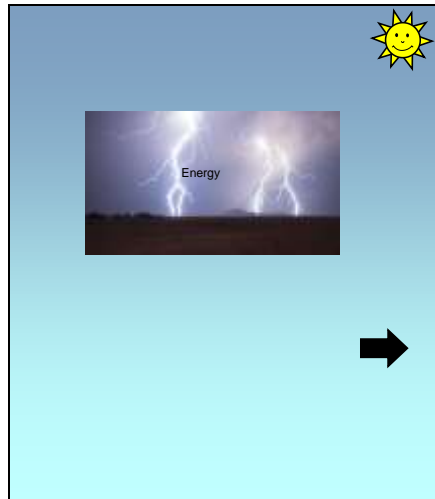

Have one learner reveal the answer by clicking on the picture above.

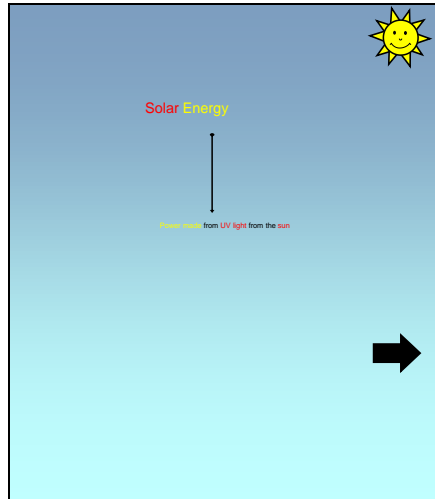

Slide 5



Read the combined definition of solar energy.

Slide 6

How many types of solar technology do you think there is? Any examples?



Have the learners break up into small groups to discuss these questions, then bring the group back to discuss what they came up with. Some examples: solar panels, solar cookers, CSP, solar water heaters

Slide 7

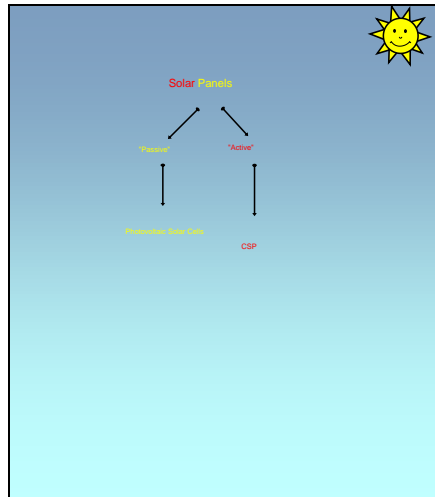





Explain the different types of solar panels here and how each follow under each category. “passive”: does not require the help of mechanical energy, “active”: does

Slide 8

Photovoltaic Solar Cells



Found in homes, businesses, or solar farms
One of the main types of solar technology
Primarily composed of silicon
Amount of energy produced varies
Can contain a variety of technologies such as:
Solar Tracker
Solar Collector
Hybrid System
Solar Heater



Read the information off the slide.

Slide 9



Solar Tracker: when solar panels follow the sun throughout the day
 Solar Collector: flat solar panels that try to collect as much sun throughout the day
 Hybrid System: when two energy creation systems are used together



Read the information off the slide.

Slide 10

Other PV Technologies 











Show that these everyday items use PV solar cells

Slide 11

Concentrated Solar Power (CSP) 

Utilizes focused sunlight through the use of mirrors and a generator
 Requires a large area of land for solar farms
 Several types such as:
 Parabolic Trough
 Stirling Dish
 Linear Fresnel
 Solar Tower
 Solar Cooker







Read the information off the slide.

Slide 12

Vocabulary
Drag the word that fits into the blank, correctly



solar tracking solar collectors "active" solar panels

1. _____ technology that allows solar panels to follow the sun throughout the day to collect as much sunlight as possible.

2. Flat, solar panels known as _____ get the most sunlight.

3. One subtype of solar panels, are "active" solar panels, _____ use of mechanical energy.

4. _____ hybrid system contains more than two types of energy production.

5. If a solar panel converts UV light into energy without the use of mechanical energy, then they are known as "passive" solar panels.



Have learners come to the board one at a time and drag the words to the blanks. If it bounces back, have them try again.

Slide 13

Ongoing Projects





Solar panel loan program through the government
Solar PV Park in Omburu
10 MW PV park in Gobabis
35 MW PV plant in Mariental
Feasibility of 250 GW CSP project
Tsumkwe solar diesel hybrid system





Read the information off the slide.

Slide 14

Activity



Draw a series of different solar panels for your community. In your drawing please include:

- 1 or more photovoltaic cells or CSP
- 1 or more solar cooker or solar heater
- anything else that you think is necessary

Be prepared to discuss why you choose those specific types of solar panels.



Have the learners perform this activity and then have them discuss with the rest of the class.



Slide 15

Operation of Solar Panels 

1. The solar cells absorb UV light through the silicon material.
2. This process allows the light to hit the silicon atoms and transfers energy to loose electrons, knocking them.
3. The loose electrons then "jump" to different types of silicon.
4. This causes an electric field to be generated and then an electric current.

One at a time, reveal a step in the operation of solar panels. Then go to the corresponding slide with that information.

Slide 16



1. The solar cells absorb UV light through the silicon material.

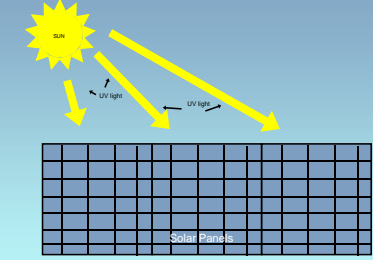

The diagram shows a sun in the top left corner emitting several yellow arrows labeled 'UV light' that point towards a grid of squares labeled 'Solar Panels' at the bottom.

Press the animations and explain the given step

Slide 17

2. This process allows the light to hit the silicon atoms and transfers energy to loose electrons, knocking them.

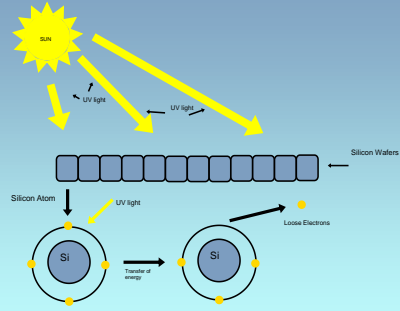

The diagram illustrates the atomic level process. At the top, a sun emits 'UV light' rays towards a row of 'Silicon Atoms' (represented as small blue rectangles). Below this, a detailed view shows a 'Silicon Atom' with a central nucleus labeled 'Si' and two concentric electron shells. An arrow labeled 'Transfer of energy' points to a second silicon atom where one electron has been ejected, labeled as a 'Loose Electron'.

Press the animations and explain the given step

Slide 18

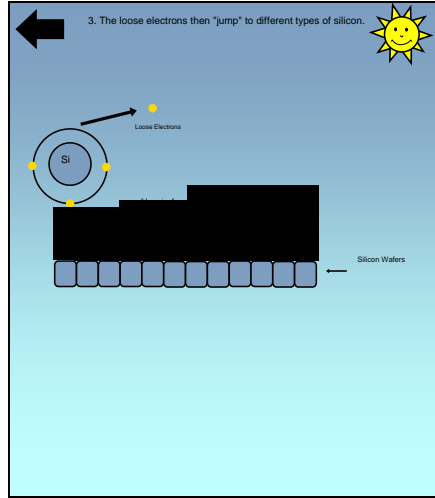

Press the animations and explain the given step

Slide 19

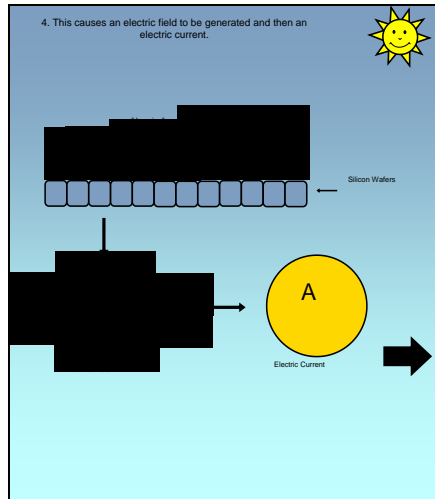

Press the animations and explain the given step

Slide 20

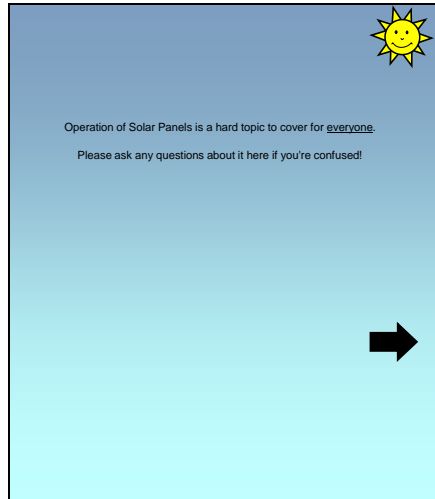

Answer questions about operation here if needed.

Slide 21

Solar Energy Storage 

1. Some of the energy created from solar panels is sent to an inverter, where it converts the energy made into usable energy.
2. This energy is then sent into the existing electrical grid for use.
3. Another part of the energy made is sent to the batteries to charge them during the day so they may use solar energy at night.

One at a time, reveal a step in the process of storage of solar panels and then go to the corresponding slide with that information.

Slide 22

1. Some of the energy created from solar panels is sent to an inverter, where it converts the energy made into usable energy. 

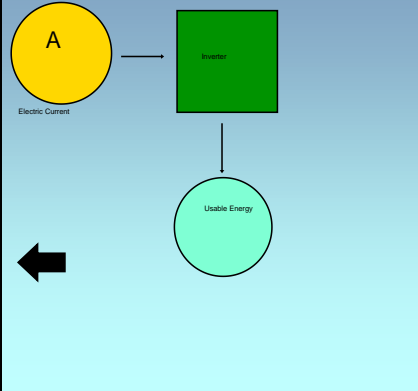

```
graph TD; A((A  
Electric Current)) --> Inverter[Inverter]; Inverter --> UE((Usable Energy)); UE --> Left[←];
```

Press the animations and explain the given step

Slide 23

2. This energy is then sent into the existing electrical grid for use. 

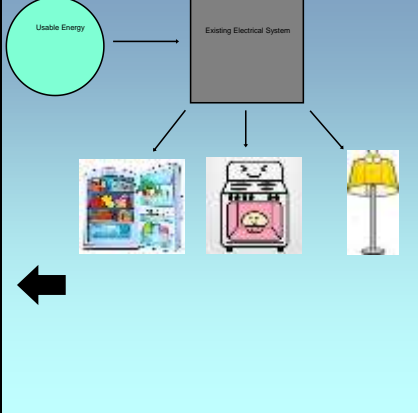

```
graph TD; UE((Usable Energy)) --> EES[Existing Electrical System]; EES --> Ref[Refrigerator]; EES --> WM[Washing Machine]; EES --> Lamp[Lamp]; UE --> Left[←];
```

Press the animations and explain the given step

Slide 24

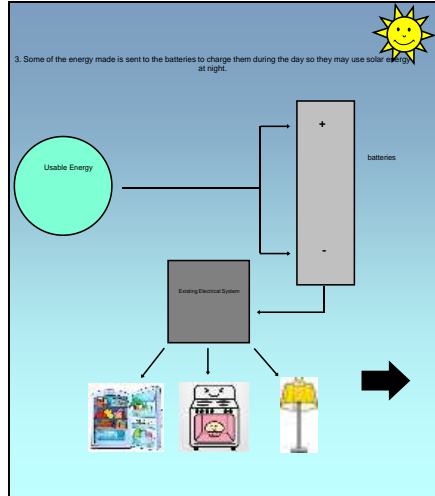

Press the animations and explain the given step

Slide 25

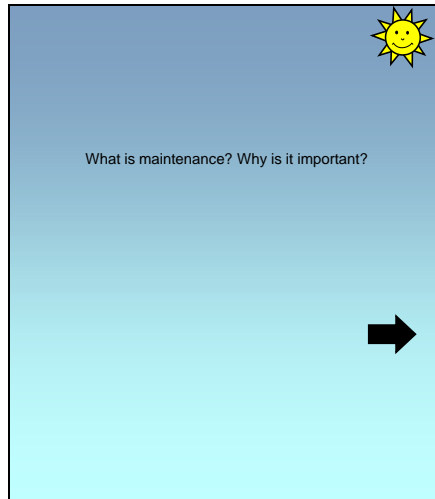

Have the learners break up into small groups to discuss this question, then bring the group back to discuss what they came up with.

Slide 26

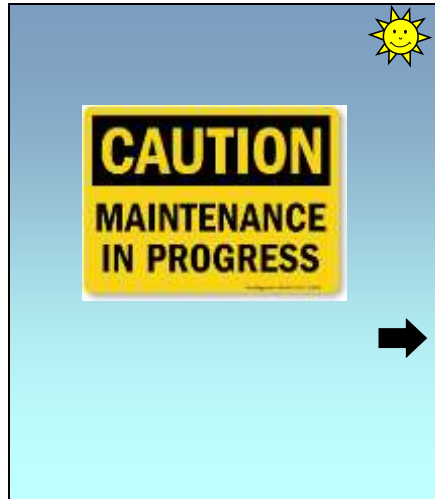

Click on the photo to reveal the definition of maintenance and state the importance of maintaining solar panels

Slide 27



Click to reveal the maintenance of solar panels and read information from the slides.

Slide 28

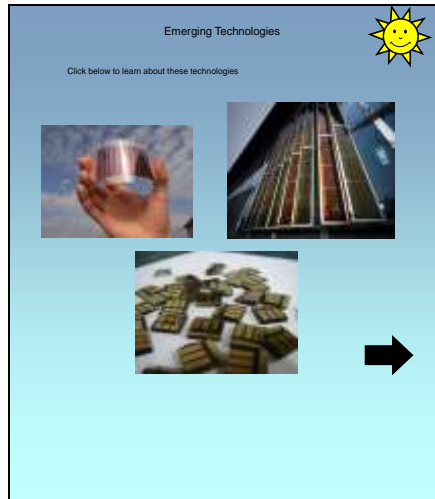

Hit each picture to reveal each of the emerging technologies. Once each of them are revealed, explain the difference between these and current technologies.

Slide 29

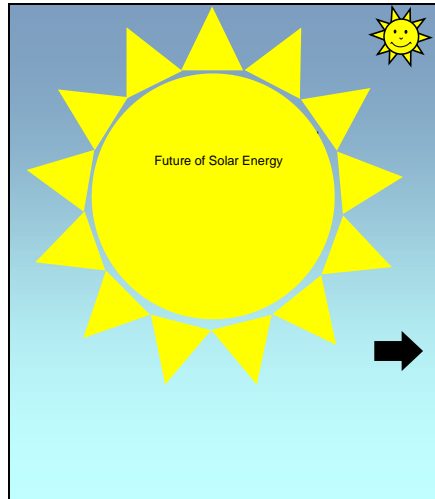

Have the learner brainstorm what the future of solar is and then reveal it by hitting the sun. Read information from the slide.

Slide 30

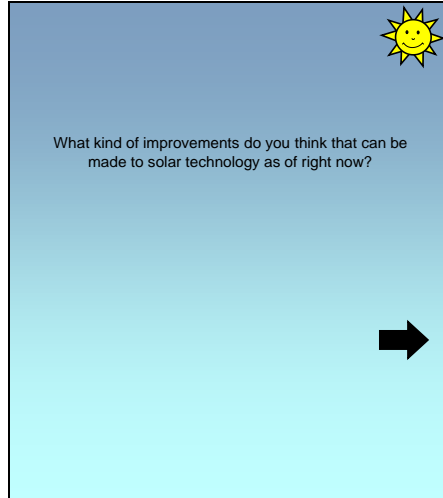

What kind of improvements do you think that can be made to solar technology as of right now?

Have the learners break up into small groups to discuss this question, then bring the group back to discuss what they came up with.

Slide 31

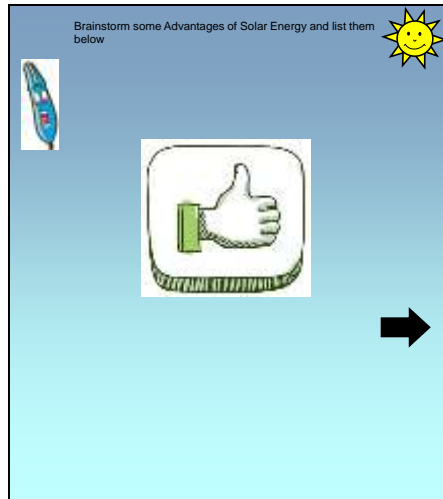

Brainstorm some Advantages of Solar Energy and list them below

Have learners come to the board and write their ideas below. For more space, click the picture and it will disappear.

Slide 32

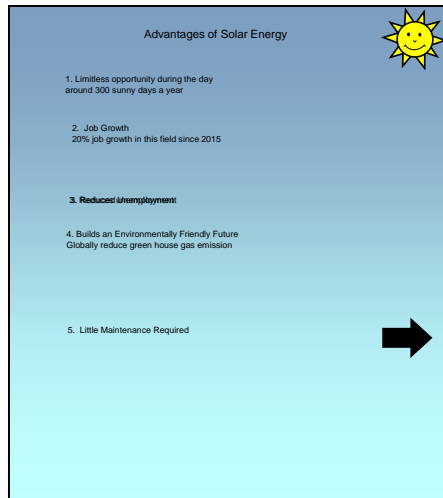

Advantages of Solar Energy

1. Limitless opportunity during the day
around 300 sunny days a year
2. Job Growth
20% job growth in this field since 2015
3. Reduced unemployment
4. Builds an Environmentally Friendly Future
Globally reduce green house gas emission
5. Little Maintenance Required

Read each of the advantages on the slide, click to reveal each.

Slide 33

Brainstorm some Disadvantages and list them below



Have learners come to the board and write their ideas below. For more space, click the picture and it will disappear.

Slide 34

Disadvantages of Solar Energy



1. Inefficient
silicon has an efficiency of around 10%
2. Expensive
3. No storage system in the current cells
4. Can only generate energy for 12 hours a day





Read each of the disadvantages on the slide, click to reveal each.

Slide 35

Why in Namibia

Come up to the board and list some reasons below!!!



Have learners come up to the board and write why they think solar can be used in Namibia

Slide 39

Summary 

 Discuss what you have learned today in small groups and write them below

[Large empty area for writing]

Have the learners discuss what they have learned and then they can come up to the board to write what they have learned. The teacher can answer any last-minute questions here as well.

Appendix II: Module 3: Wind Energy Teacher Guide

Slide 1

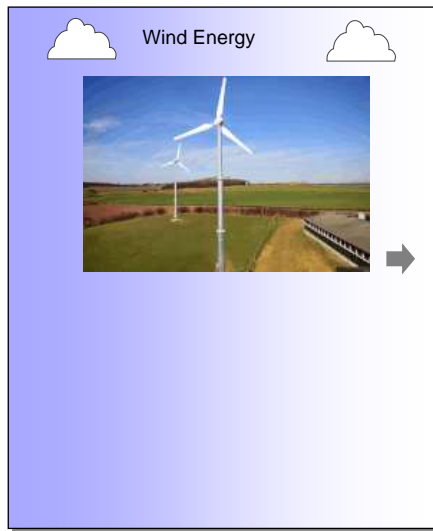

Introduce wind energy and state the purpose of the lesson: introduce the topic of wind energy to the learners and explain the applications of wind energy. Objectives:

- Identify the parts of a turbine
- Specify the advantages and disadvantages of wind energy
- Explain the process of creating energy from wind
- Identify the importance of wind energy in Namibia

Slide 2

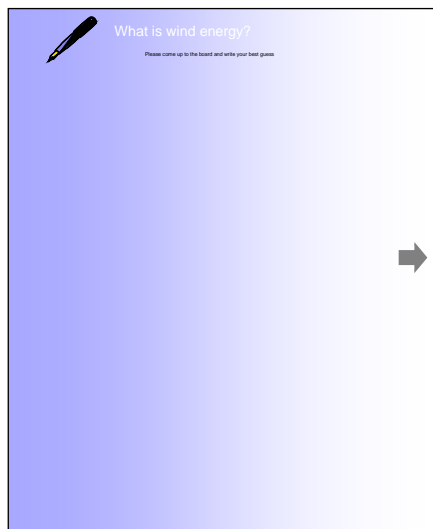

Ask the learners what they think wind energy is. Have the learners raise their hands to answer the question.

Slide 3

What is wind energy?

Please come up to the board and write your best guess

Wind energy is a renewable energy that uses wind to generate electricity with a turbine



Slide 4



How does it work?

Please come up to the board and write your best guess



Ask the learners how wind energy works. Have the learners raise their hands to answer the question.

Slide 5

How does it work?



1. Wind blows...
2. across tall turbines...
3. to turn the blades of the turbines...
4. which spin generators to create electricity...
5. A transformer increases the voltage to send electricity over...
6. Distribution lines take the local transformers reduce the voltage...
7. for you to use.

Explain the process of creating wind energy using the diagram as a reference

Slide 6

Order the letters that are next to the different turbines from the least amount of power generated to the most amount of power generated, in the boxes on the left.

USER

A

1.21 m

1.82 m

C

3.04 m

B

2.43 m

D

Once you are done, click on the question mark to reveal the next step ?

Have the learners come up to the board and drag the different letters, next to the turbines, into the boxes on the left. They should be ordered from the least amount of power produced to the most power produced. After they complete the activity, click on the question mark to reveal an activity for the learners

Slide 7

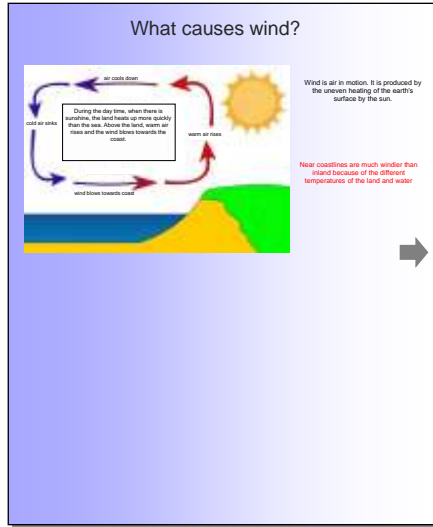

Use the diagram to explain how wind is created. Stress that wind energy is best used near the shore

Slide 8

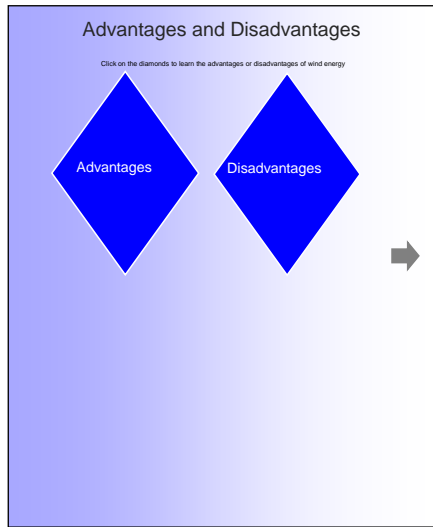

Click on either of the diamonds to reveal the advantages and disadvantages of wind energy

Slide 9

😊 Advantages 😊	
1	Clean fuel source; no pollution
2	Does not use water for cooling
3	One of the cheapest renewable energies
4	Domestic energy; produced in country
5	Creates jobs 

Slide 10

😞 Disadvantages 😞	
1	Not always windy; not able to store energy
2	More expensive than fossil fuels
3	Windy sites are usually far from cities
4	Noisy and looks unnatural
5	Effect surrounding wildlife 

Slide 11



Click under the words to reveal the pictures below

Slide 12

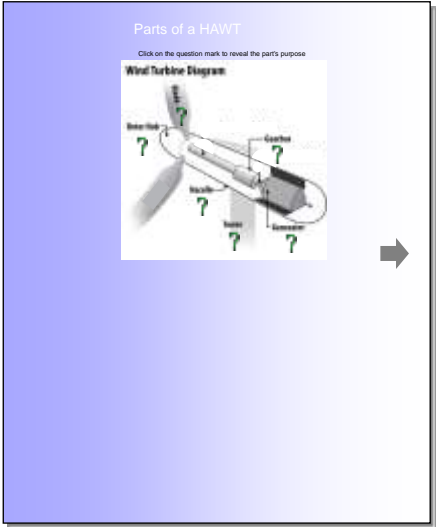

Click on the question marks under the labeled part and it will bring you to the next page to reveal the purpose of the part

Slide 13

Rotor Blade

click the picture to reveal the definition



Back

Slide 14

Gearbox

click the picture to reveal the definition



Back

Slide 15

Nacelle

click the picture to reveal the definition



Back

Slide 16

Generator

click the picture to reveal the definition



Back

Slide 17

Rotor Hub

click the picture to reveal the definition



Back

Slide 18

Tower

click the picture to reveal the definition



Back

Slide 19

HAWT Advantages and Disadvantages

Click on the boxes to find out!

Advantages

Disadvantages

Click on the boxes to reveal the advantages and disadvantages of HAWTs

Slide 20

😊 Advantages 😊

The tall tower lets the turbine get stronger winds
The wind hits the turbine horizontally; which gets the most energy



Back

Slide 21



Have the learners use the pictures as hints. They should try and guess the disadvantages based on the picture. If they guess the advantages correctly, click on the picture to reveal the answer. The answers are:

- Money picture: very expensive; the tall towers need heavy construction
- Turbines in field: turbines look unnatural in the surrounding landscape
- Broken turbine: strong winds can break the turbine and the broken parts can hurt people below
- Bird: they hurt ecosystems because the turbines are noisy; the blades also kill many bats and birds

Slide 22

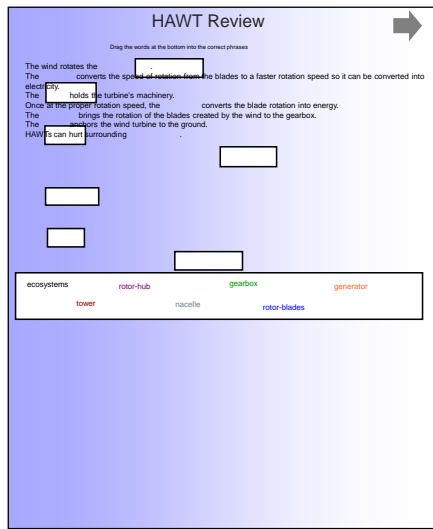

Have the learners come up to the board and drag the correct word into the blank space in the proper sentence

Slide 23

Parts of a VAWT

Click on the question mark to reveal the part's purpose

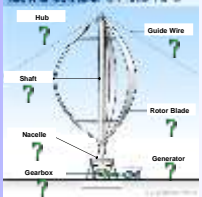

Hub

Guide Wire

Shaft

Rotor Blade

Nacelle

Gearbox

Generator

➔

Repeat steps previously used for HAWTs

Slide 24

Guide Wire

keeps the turbine in position



Back

Slide 25

Hub

center of the rotor; where the blades are attached



Back

The slide features a light blue gradient background. At the top center, the word "Hub" is written in black. Below it, the text "center of the rotor; where the blades are attached" is displayed. To the right is a photograph of a wind turbine hub assembly with three blades. Two red dashed arrows point to the top and bottom connection points, labeled "Upper Hub" and "Lower Hub" respectively. On the left side, there is a dark grey arrow pointing left with the word "Back" written inside it.

Slide 26

Rotor Blades

the wind turns the rotor blades to produce electricity



Back

The slide features a light blue gradient background. At the top center, the words "Rotor Blades" are written in black. Below it, the text "the wind turns the rotor blades to produce electricity" is displayed. To the right is a photograph of a wind turbine rotor with three blades against a clear blue sky. On the left side, there is a dark grey arrow pointing left with the word "Back" written inside it.

Slide 27

Shaft

The part that is turned by the blades; the center of the turbine



Back

Slide 28

Nacelle

Holds all the turbine's machinery



Back

Slide 29

Gearbox

converts the speed of rotation from the blades to a faster rotation speed



Back

Slide 30

Generator

once at the proper rotation speed, the generator converts the wind to energy



Back

Slide 31

VAWT Advantages and Disadvantages

Click on the boxes to find out

Advantages

Disadvantages

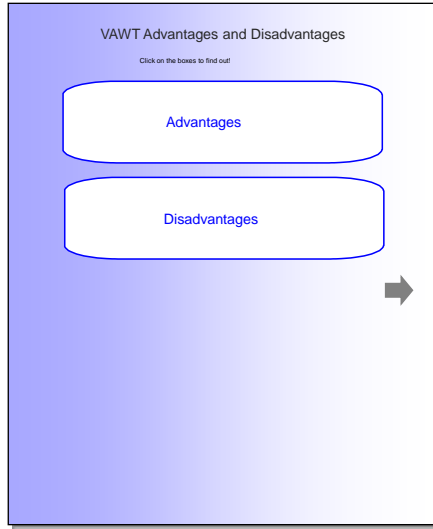

Click on the boxes to reveal the advantages and disadvantages of VAWTS

Slide 32

😊 Advantages 😊

- Can spin with wind from all directions
- Close to the ground
- Easy maintenance
- Less visible to surrounding communities



Back

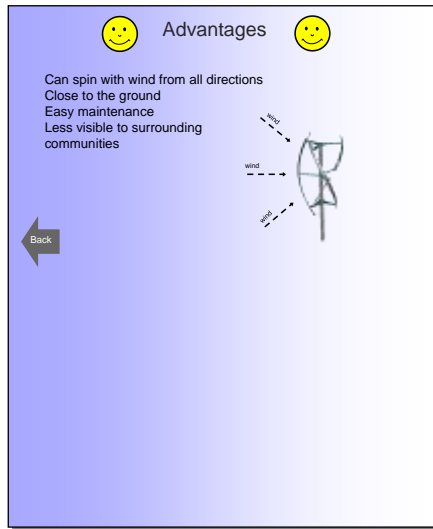

Slide 33

☹ Disadvantages ☹

Produces less power than HAWTs
Small wind speeds since closer to the ground
They also need a 'push' in order to start rotating



Back

Slide 34

VAWT Review

Drag the words at the bottom into the correct phrases

The is the turbine in position.
The are the blades attach to the shaft; there are two of these.
The are blades to produce electricity.
Once the generator converts the blade rotation to energy.
The nacelle holds all the blades and the center of the turbine.
The shaft is the part from the blades to a faster rotation speed.
The gearbox converts the from the blades to a faster rotation speed.

Generator	Gearbox	Rotor blades	Hub
Nacelle	Shaft	Guide wire	

Have the learners drag the appropriate word into the blanks

Slide 35

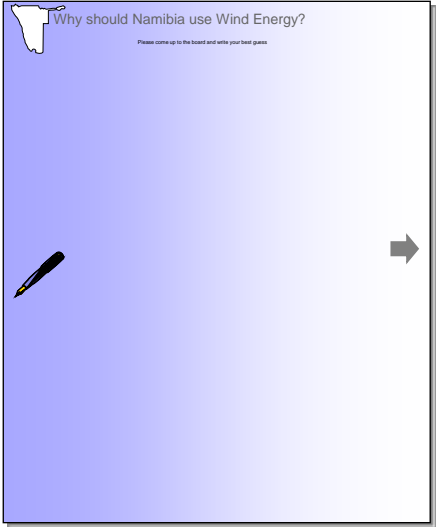

Ask the learners why they think Namibia should use wind energy. Have the learners raise their hands to answer the question.

Slide 36

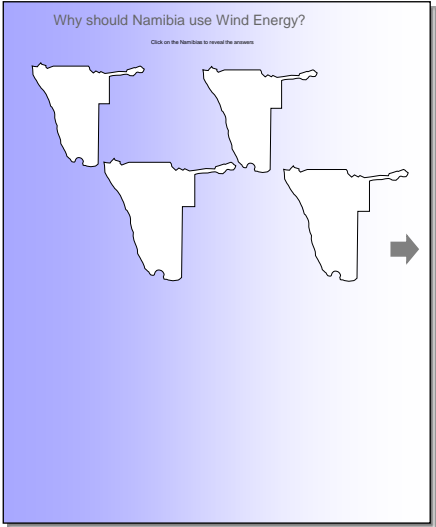



Click on the Namibias to reveal different reasons why Namibia should use wind energy

Slide 37

Why should Namibia use Wind Energy?

Job Growth

Wind Energy → Creates Jobs → Lowers Unemployment → Happier Namibia



Click in the middle of the boxes from left to right to reveal the process of wind energy helping job growth

Slide 38

Why should Namibia use Wind Energy?

Clean Environment



If wildlife or environments are damaged Namibia can lose:
food to eat
clean water
wildlife
tourism
clean air to breathe



Slide 39

Why should Namibia use Wind Energy?

Large Coasts

Click on the numbers to reveal facts

1

2

3

Click on the triangles to reveal facts about Namibia's coastlines. The project in Lüderitz was approved by NAMPower, meanwhile the project in Walvis Bay is still under discussion

Slide 40

Why should Namibia use Wind Energy?

Stop Climate Change

Click on the numbers to see what climate change effects

1

2

3

4

Click on the triangles to reveal effects of Climate Change

Slide 41

ACTIVITY: Who does installing wind energy affect?

Split into groups of five and think of all the people or things affected by Namibia choosing to install wind turbines

→

The slide features a background of stylized human figures in shades of orange and red. The text is contained within white rounded rectangles. A white arrow points to the right.

Have the learners break into groups of five and have them brainstorm a list of all people or things that are effected by the installation of wind energy. Ex: birds, the Namibian government, etc.

Slide 42

Who does installing wind energy affect?

Please come up to the board and write some of your team's ideas

Namibian Government

→

The slide has a light blue gradient background. It includes a pen icon, a title, an instruction, and a list item. A grey arrow points to the right.

Have the learners come up and write their lists on the board. Then have each team pick one from their list that they think is the most important. Have them brainstorm why each of the selected groups will care about renewable energy

Slide 43

Representing the stakeholders

Let's pick five from the previous page and transform why each of the selected groups will care about renewable energy.

1. Namibian Government
Profits
Reduce unemployment
Happier citizens
Healthier environment



The learners can then come up to the board and write their reasons

Slide 44

What can you do as a community to help combat climate change and help save the environment?

Get into groups of five. Think of all the ways you could help save the Earth and stop climate change from inside your community. Use only the resources you already have in your community. For example, if you cannot do this project tomorrow, then it does not count. An example of a good answer would be: to start an environmental club at my school. A bad answer would be: put up wind turbines everywhere. Any questions?



The team with the most answers on their sheet of paper at the end of the 5-minute time period receives a prize!



Have the learners break into teams of five. Start a five-minute timer, and have them brainstorm ways to battle Climate Change from inside their communities. All the answers should be practical. At the end, go over the lists and count how many ideas (that were practical) that each team thought of. The team with the most answers gets candy.

Slide 45

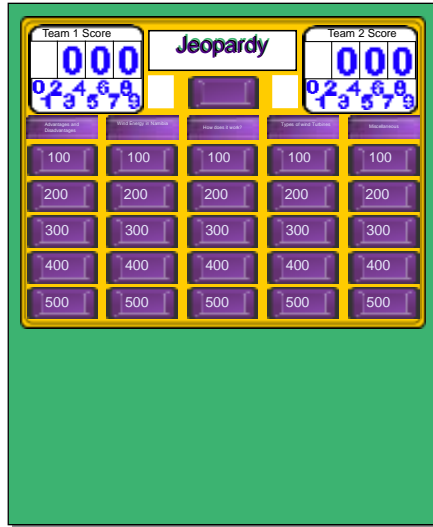

Split the classroom into two teams. Then pick one team to pick a question on the board. The questions get harder as the point values go up. Click on the question the team wanted, and it will bring you to a new page with the question on it. The team will have one minute to answer the questions correctly. If correct, click on the purple box to reveal the answer. If incorrect, the other team gets a chance to steal the points. If the team steals the points, they then get to choose the next category. After returning to the home screen, drag the point values into the score board at the top.

Slide 46

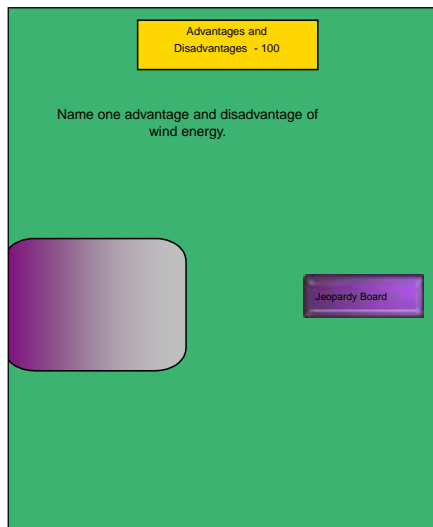

Advantages:

- Clean fuel source; no pollution
- Does not use water for cooling
- One of the cheapest renewable energies
- Domestic Energy; can be produced in Namibia
- Creates Jobs
- Any other answer that the teacher deems correct

Disadvantages:

- Not always windy; cannot power all of Namibia
- More expensive than fossil fuels
- Windy sites are usually far from cities
- Noisy
- Effect surrounding wildlife

Slide 47

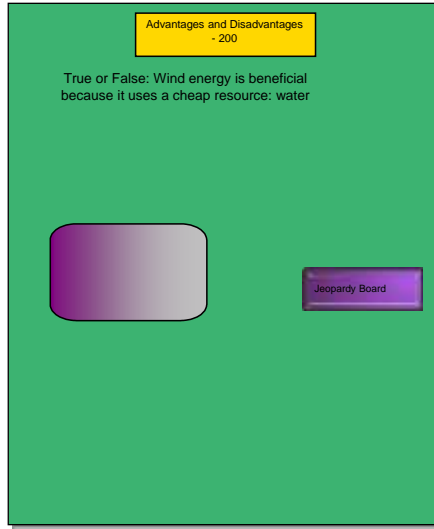

Advantages and Disadvantages - 200

True or False: Wind energy is beneficial because it uses a cheap resource: water

Jeopardy Board

A green rectangular slide with a yellow title box at the top containing the text "Advantages and Disadvantages - 200". Below the title is a question: "True or False: Wind energy is beneficial because it uses a cheap resource: water". At the bottom left is a purple-to-white gradient rounded rectangle, and at the bottom right is a purple box labeled "Jeopardy Board".

FALSE

Slide 48

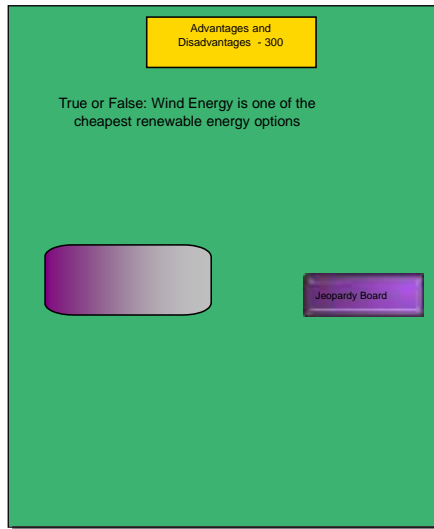

Advantages and Disadvantages - 300

True or False: Wind Energy is one of the cheapest renewable energy options

Jeopardy Board

A green rectangular slide with a yellow title box at the top containing the text "Advantages and Disadvantages - 300". Below the title is a question: "True or False: Wind Energy is one of the cheapest renewable energy options". At the bottom left is a purple-to-white gradient rounded rectangle, and at the bottom right is a purple box labeled "Jeopardy Board".

TRUE

Slide 49

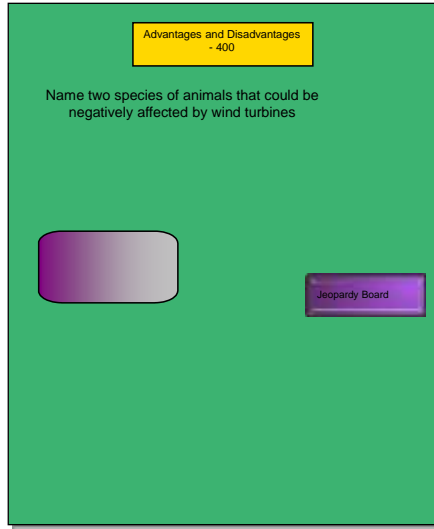

Advantages and Disadvantages
- 400

Name two species of animals that could be negatively affected by wind turbines

Jeopardy Board

A green rectangular slide with a yellow title box at the top containing the text 'Advantages and Disadvantages - 400'. Below the title is the question 'Name two species of animals that could be negatively affected by wind turbines'. At the bottom left is a purple-to-white gradient rounded rectangle, and at the bottom right is a purple box labeled 'Jeopardy Board'.

Birds and bats

Slide 50

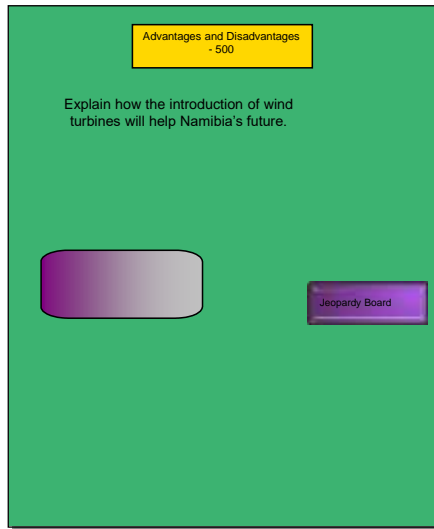

Advantages and Disadvantages
- 500

Explain how the introduction of wind turbines will help Namibia's future.

Jeopardy Board

A green rectangular slide with a yellow title box at the top containing the text 'Advantages and Disadvantages - 500'. Below the title is the question 'Explain how the introduction of wind turbines will help Namibia's future.'. At the bottom left is a purple-to-white gradient rounded rectangle, and at the bottom right is a purple box labeled 'Jeopardy Board'.

Teacher can decide if the provided definition is correct or not

Slide 51

Wind Energy in Namibia - 100

What can happen if Namibia uses wind energy? (Pick one)

- Reduced Unemployment Rate
- It will pollute the air
- Citizens will lose their jobs

Jeopardy Board

#1 Reduced unemployment rate

Slide 52

Wind Energy in Namibia - 200

Approximately how many km of coastline are there in Namibia?

- 3000 km
- 1570 km
- 970 km
- 2230 km

Jeopardy Board

1570 km

Slide 53

Wind Energy in Namibia - 300

Name two things that Namibia can lose if they do not start using wind energy or any other renewable energy sources

Jeopardy Board

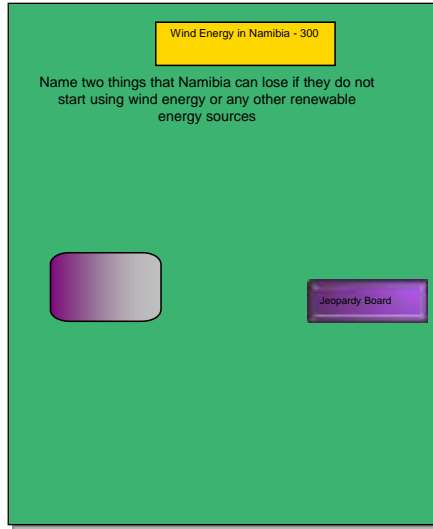

Food to eat, clean water, wildlife, tourism, clean air to breathe

Slide 54

Wind Energy in Namibia - 400

Pick two out of the following list that are consequences of climate change

1. Change in Rainfall
2. Increased Land for Farming
3. Increased Temperatures
4. Better economy
5. Drought and Flooding

Jeopardy Board

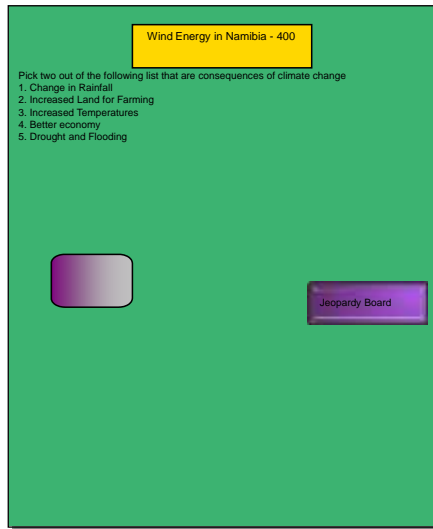

#1, #3, #5

Slide 55

Wind Energy in Namibia - 500

Name the two Namibian cities that are considering installing wind turbines.

Jeopardy Board

Walvis Bay and Lüderitz

Slide 56

How does it work? - 100

True or False: Wind is produced by the uneven heating of the Earth's surface by the sun

Jeopardy Board

True

Slide 57

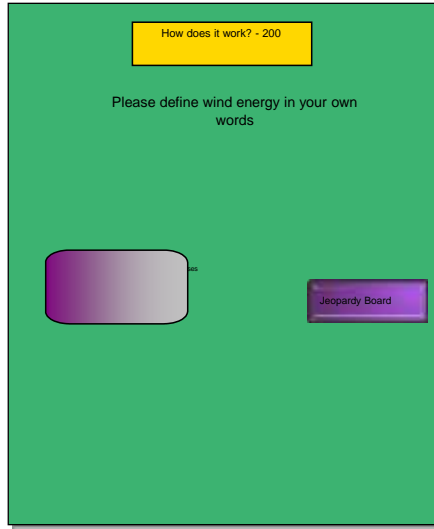

How does it work? - 200

Please define wind energy in your own words

Jeopardy Board

A green rectangular slide with a yellow question box at the top, a text prompt in the center, a purple rounded rectangle on the left, and a purple 'Jeopardy Board' label on the right.

Wind energy is a renewable energy that uses wind to generate electricity with a turbine. *Teacher can decide if the provided definition is correct or not*

Slide 58

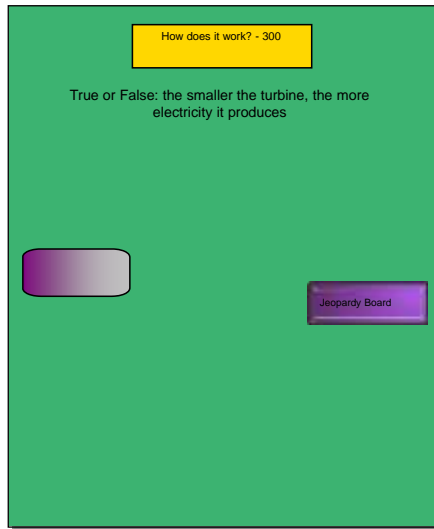

How does it work? - 300

True or False: the smaller the turbine, the more electricity it produces

Jeopardy Board

A green rectangular slide with a yellow question box at the top, a text prompt in the center, a purple rounded rectangle on the left, and a purple 'Jeopardy Board' label on the right.

False

Slide 59

How does it work? - 400

Where is the best place to put a turbine?

1. In the desert
2. In the city
3. Near the coast
4. In the forest

#3 Near the coast

Jeopardy Board

#3

Slide 60

How does it work? - 500

Place the five steps in the proper order for how wind turbines work

1. The blades of windmills are spun
2. The spinning of the blades also spin generators to create electricity
3. Local transformers reduce the voltage so the electricity can now be used by the community
4. Wind blows
5. A transformer increases the voltage created from the generator to send the electricity over distribution lines

4, 1, 2, 5, 3

Jeopardy Board

4,1,2,5,3

Slide 61

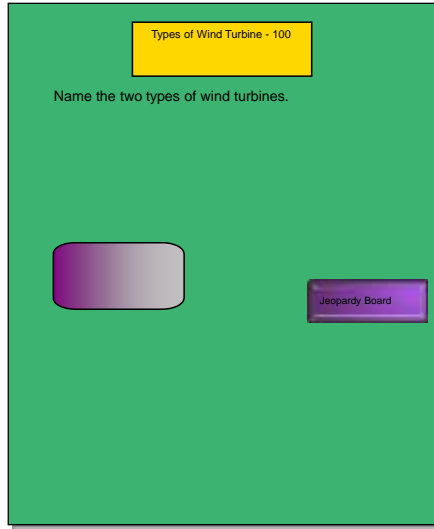

Types of Wind Turbine - 100

Name the two types of wind turbines.

Jeopardy Board

A green rectangular slide with a yellow title box at the top containing the text "Types of Wind Turbine - 100". Below the title is the question "Name the two types of wind turbines." In the lower-left area, there is a purple rounded rectangle representing a blank answer space. In the lower-right area, there is a purple box labeled "Jeopardy Board".

Horizontal and vertical axis turbines

Slide 62

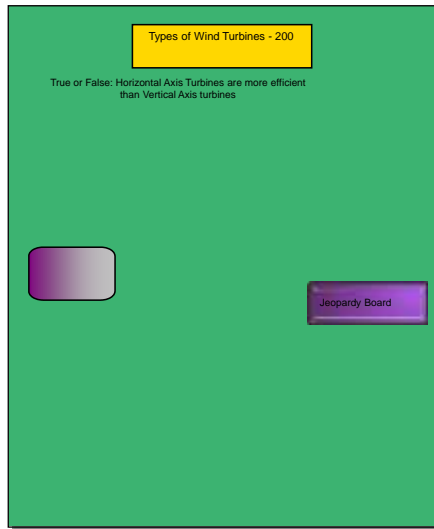

Types of Wind Turbines - 200

True or False: Horizontal Axis Turbines are more efficient than Vertical Axis turbines

Jeopardy Board

A green rectangular slide with a yellow title box at the top containing the text "Types of Wind Turbines - 200". Below the title is the question "True or False: Horizontal Axis Turbines are more efficient than Vertical Axis turbines". In the lower-left area, there is a purple rounded rectangle representing a blank answer space. In the lower-right area, there is a purple box labeled "Jeopardy Board".

True

Slide 63

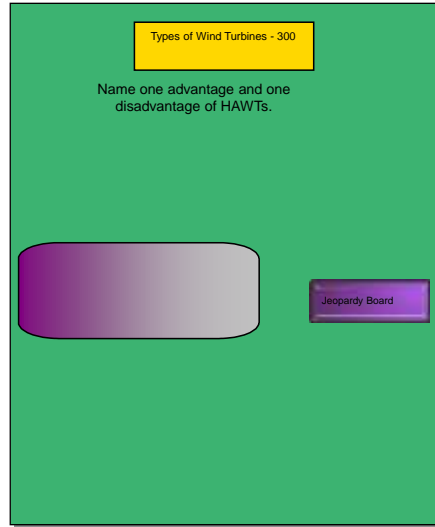

Types of Wind Turbines - 300

Name one advantage and one disadvantage of HAWTs.

Jeopardy Board

A Jeopardy Board slide with a green background. At the top, a yellow box contains the text 'Types of Wind Turbines - 300'. Below it, the text 'Name one advantage and one disadvantage of HAWTs.' is displayed. In the center, there is a large, rounded rectangular area with a purple-to-white gradient. To the right of this area is a purple box labeled 'Jeopardy Board'.

Advantages:

- The tall tower lets the turbine get stronger winds
- The wind hits the turbine horizontally; which gets the most energy
- Most efficient type of wind turbine

Disadvantages:

- Very expensive; the tall towers require heavy construction
- Turbines look very unnatural in comparison with the surrounding landscape
- They disrupt ecosystems because the turbines are noisy; the blades also kill many bats and birds
- Can break under fatigue and the broken parts can injure surrounding people

Slide 64

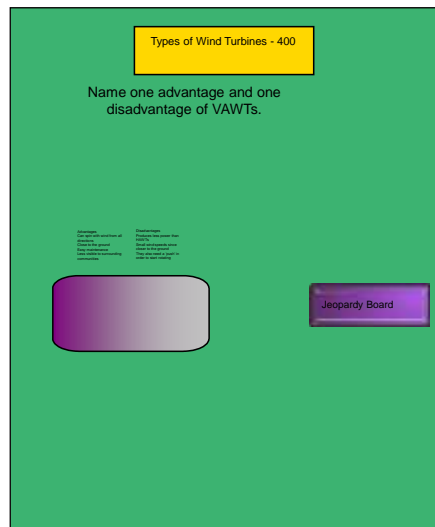

Types of Wind Turbines - 400

Name one advantage and one disadvantage of VAWTs.

Jeopardy Board

A Jeopardy Board slide with a green background. At the top, a yellow box contains the text 'Types of Wind Turbines - 400'. Below it, the text 'Name one advantage and one disadvantage of VAWTs.' is displayed. In the center, there is a large, rounded rectangular area with a purple-to-white gradient. To the right of this area is a purple box labeled 'Jeopardy Board'.

Advantages

- Can spin with wind from all directions
- Close to the ground
- Easy maintenance
- Less visible to surrounding communities

Disadvantages

- Produces less power than HAWTs
- Small wind speeds since closer to the ground
- They also need a 'push' in order to start rotating

Slide 65

Types of Wind Turbines - 500

Name the different parts of the turbines to the correct place on the picture

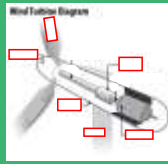

Generator
Rotor
Rotor blades
Gearbox
Nacelle
Hub

Jeopardy Board

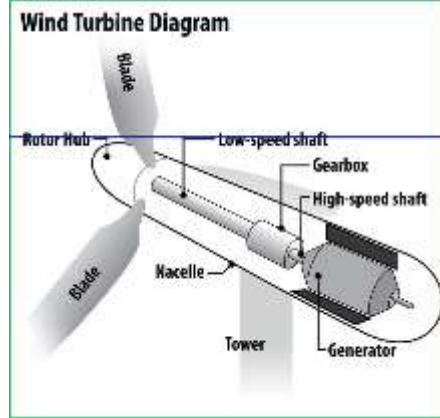

Slide 66

Miscellaneous - 100

True or False: Bigger turbines create more energy.

Jeopardy Board

True

Slide 67

Miscellaneous - 200

True or False: HAWTs cannot be seen by surrounding communities because they are located closer to the ground

Jeopardy Board

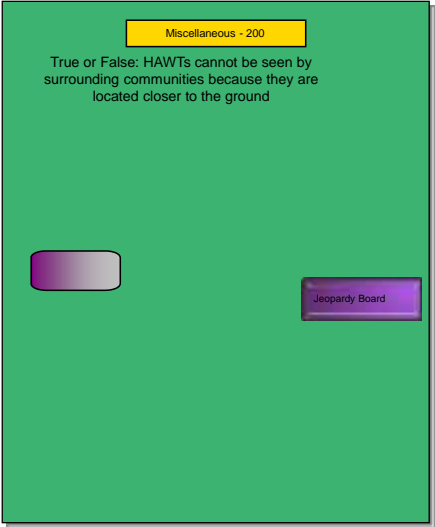
A green rectangular slide with a yellow title box at the top containing the text "Miscellaneous - 200". Below the title is a true or false question: "True or False: HAWTs cannot be seen by surrounding communities because they are located closer to the ground". On the left side, there is a purple rounded rectangular button. On the right side, there is a purple rectangular button labeled "Jeopardy Board".

False

Slide 68

Miscellaneous - 300

True or False: Wind Energy can completely power Namibia if implemented throughout the country.

Jeopardy Board

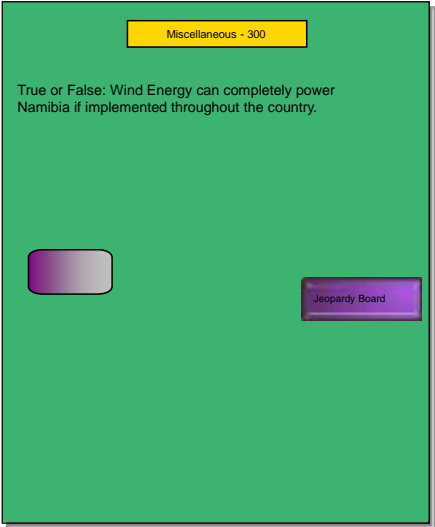
A green rectangular slide with a yellow title box at the top containing the text "Miscellaneous - 300". Below the title is a true or false question: "True or False: Wind Energy can completely power Namibia if implemented throughout the country.". On the left side, there is a purple rounded rectangular button. On the right side, there is a purple rectangular button labeled "Jeopardy Board".

False

Slide 69

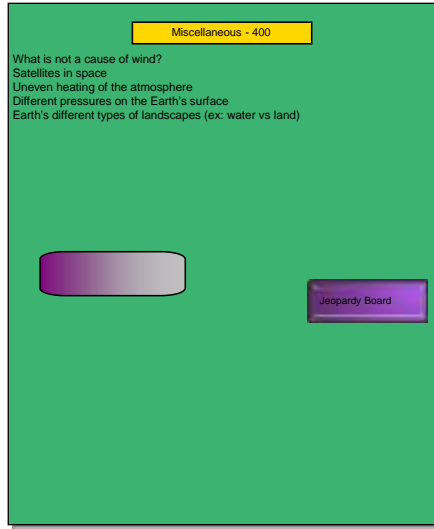

Miscellaneous - 400

What is not a cause of wind?
Satellites in space
Uneven heating of the atmosphere
Different pressures on the Earth's surface
Earth's different types of landscapes (ex: water vs land)

Jeopardy Board

Satellites in space

Slide 70

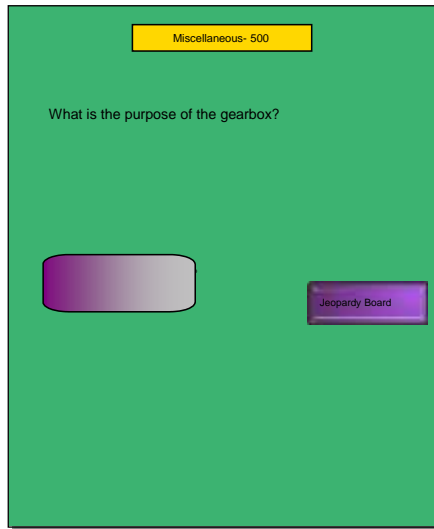

Miscellaneous- 500

What is the purpose of the gearbox?

Jeopardy Board

It converts the speed of rotation from the hub to the proper rotation speed

Appendix JJ: Module 4: Bush-to-Energy Teacher Guide

Slide 1

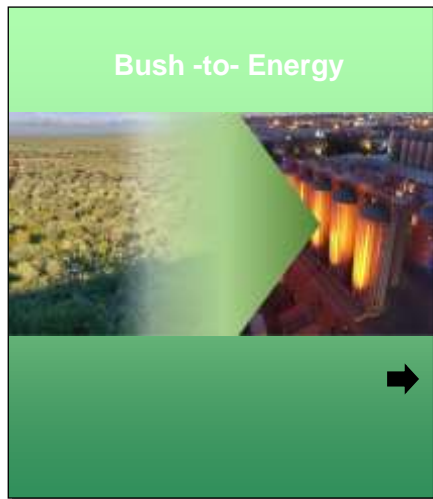

Introduce purpose of the lesson: In this lesson, the learners will learn about what bush-to-energy is, how it works, its advantages and disadvantages, and how Namibia can best use this technology.

Activity: Ask learners if they can say what bush-to-energy is.

Slide 2

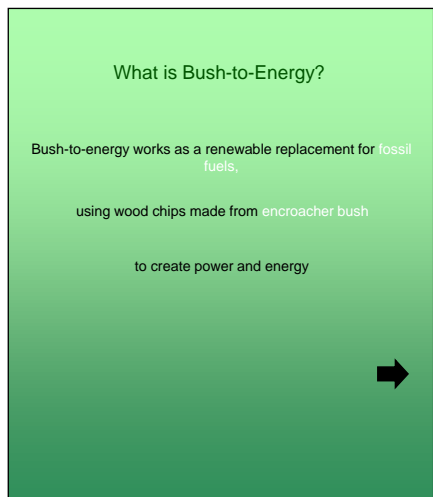

Read the definition of Bush-to-Energy to the class

Slide 3



Activity: Before hitting the definitions, ask the learners if they can remember what fossil fuels are from the intro to renewable energy.

Once you have discussed briefly, tap close to the small bush on the screen. After you are done with each bullet, tap near the next bush

Slide 4

What is an invasive plant species?

Definition- a type of plant that is not native to an area

Invasive plants tend to spread all over the land and use up important nutrients

This can harm both local habitats and the environment



Read through this slide and at the end ask if they have any questions. If they do, elaborate more on invasive species.

Extra talking points: an example of invasive species is prosopis; it was brought to Namibia from the US and it took over the land. Invasive species are usually from foreign countries, but if a plant came from a different region of a country, that can also count

Slide 5

Encroacher Bush

Now that you know what an invasive plant is, what do you think encroacher bush is?



Activity: Discuss with the class what they think encroacher bush might be, based off of the information they learned about invasive species. This should take 5-10 minutes.

Slide 6

Encroacher Bush

What do you think encroacher bush is?

Move the magnifying glass to find the definition!

Encroacher bush is a group of native and foreign invasive plants which take up a significant portion of Namibia's available land and use a lot of important resources

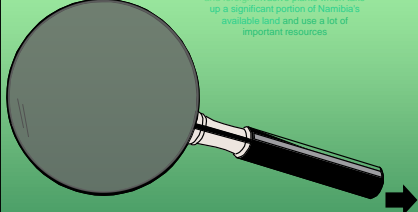





Activity: Ask for a volunteer to come up to the board and drag the magnifying glass until they find the definition.

Slide 7

Types of Encroacher Bush

There are 19 types of plants that are considered to be encroacher bush

Of these plants, four types are the most common forms of encroacher bush:



Prosopis (All species) Location: All of Namibia Native Plant		Swarthaak (Acacia melloripha) Location: Southern Namibia Native Plant	
Silver Cluster-Leaf (Euclea undulata) Location: Central Namibia Native Plant		Mopane (Colophospermum mopane) Location: Northern Namibia Native Plant	

➔

Read the information on the slide. As you talk about each of the four main types of encroacher bush, click above the little bush for the information about that type to appear. In order the types of bush are: Prosopis, swarthaak, silver cluster-leaf, and mopane.

Slide 8

Why is Encroacher Bush a problem in Namibia?

 Desertification	 Bush Encroachment	 Economy
------------------------------------------------------------------------------------------------------	--------------------------------------------------------------------------------------------------------	----------------------------------------------------------------------------------------------

⬅ ➔

To talk about each problem, click on the picture above each subject.

Slide 9

Desertification

Desertification occurs when the soil does not have enough water in it. The land dries up and nothing can grow.



If plants can not grow, farmers can not grow crops to sell, and won't have enough money to take care of their family



Animals also suffer, as the plants they eat can not grow, and they do not have enough food to be happy and healthy



⬅

Discussion points: desertification: not enough water retention in land, soil dries out and nothing can grow

No plants: no vegetation for farmers to sell

No water in soil: grass can't grow → animals cannot eat
→ carrying capacity of livestock is reduced

Slide 10

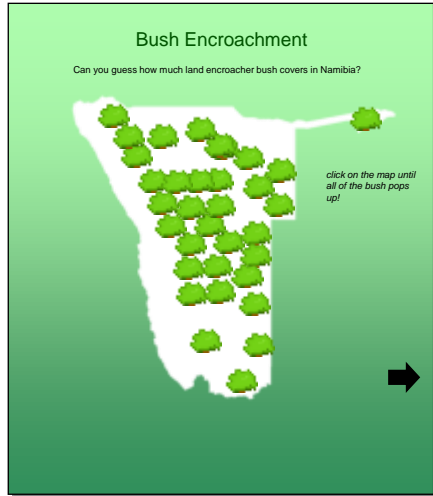

Activity: A volunteer can come up to the board and click on the map until all of the bush appears. There should be 8 groups of bushes that show up.

Slide 11

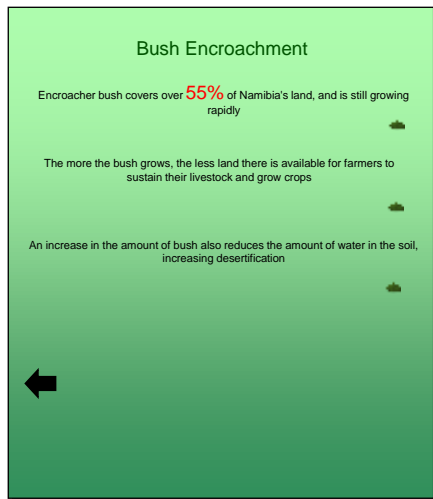

Read through each fact, clicking just above each bush as you finish the previous fact. If they have any questions, answer them here. When you are done with this slide, hit the arrow to go back to the "Problem" Page

Slide 12



Click near mini bush to reveal the facts

If farmers can't produce enough sellable produce or livestock, they cannot sustain their farms

→ cannot afford to pay employees, and many will lose their jobs.

Since over 70% of Namibian citizens are farmers, → economy would suffer greatly

Slide 13

ACTIVITY
How do **YOU** think you can fix the problem of encroacher bush?

Get together in groups of four and think about how you could solve the problem in your community.



Have learners get in groups of 3 or 4 and brainstorm the possible ways in which they could address the problem of encroacher bush. After, have the learners discuss their answers with the class. Should take 5-10 minutes

Slide 14

How to fix the problem of Encroacher Bush

The best way to fix the problem of Encroacher bush is to harvest it.

There are many ways to harvest bush:



manual labor mechanical chemical



Best way to address encroacher bush is to harvest. There are three harvesting types:

1. Manual labor: harvesting by hand, lots of time and labor intensive, requires lots of people
2. Mechanical: less works, but need more training, is much faster than manual
3. Chemical: manually go through bushes and spray specific bush. Can harm environment

Slide 15

Important Things to Remember when Harvesting Bush

While it is good to harvest this encroacher bush, you need to be mindful of the surrounding environment. If you aren't careful, you could end up doing even more damage.

Some side effects of improper de-bushing include:

- Reduction of Biodiversity
- Increased Land Desertification
- Habitat destruction



Read off slide

Slide 16

Important Things to Remember when Harvesting Bush

Some **bad practices** for harvesting bush include:

Clearing Near Rivers

Aerial Spraying of Arboricides

Elimination of all Bush



→

Clearing near rivers: soil will erode into river causing the river to dry out, destruction of wildlife corridors

Aerial spraying of arboricides: affects too much land, can also harm animals and protected plants

Elimination of all bush: bad for biodiversity and carbon sinks, could ruin habitats

Slide 17

Important Things to Remember when Harvesting Bush

Some **good practices** for harvesting bush include:

Applying Arboricides by Hand

Harvesting in Phases

Selective harvesting

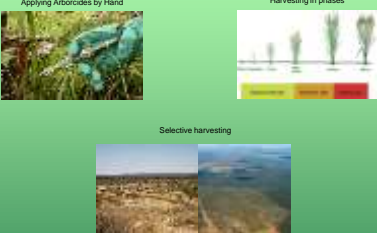

→

Applying arboricides by hand: allows for intentional selection of which bush is killed, harvesting in an environmentally friendly way

Harvesting in Phases: Don't remove your bush all at once, as that could cause harm to land, instead select smaller areas over different periods of time to clear

Selective harvesting: Harvesting only part of bush allows for habitat maintenance

Slide 18

Important Vocabulary

Once the encroacher bush has been properly harvested, it can be processed and used as an energy resource.

Before we talk about how to convert this bush to energy, it's important to know about some key technologies

Turbine

Magnetic Field

Generator

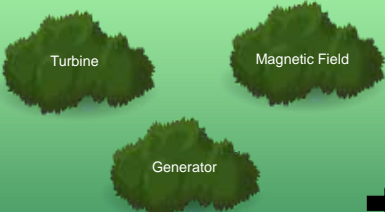

→

Click on each bush to reveal the definition. Read definition off of slide

Slide 19

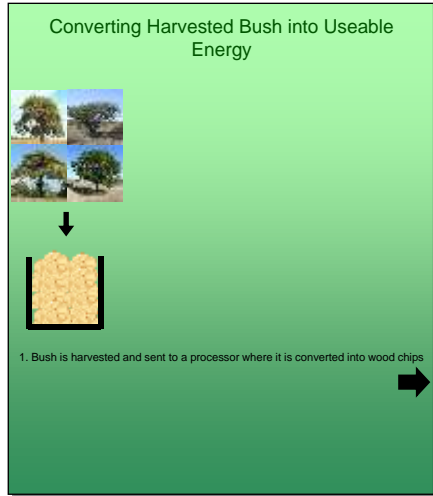

Step by step guide for how bush is converted into electricity. Read each step at the bottom of the board. When you want to see next step, click the arrow on the right side of the board

Slide 20

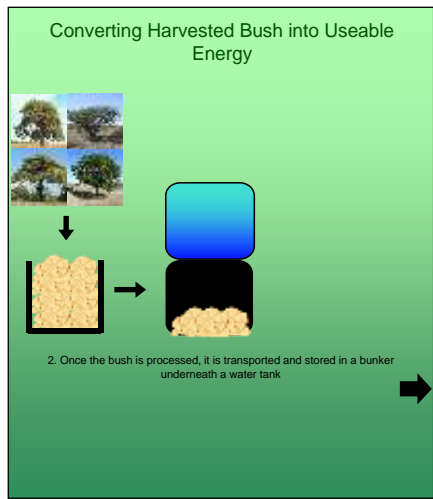

Slide 21

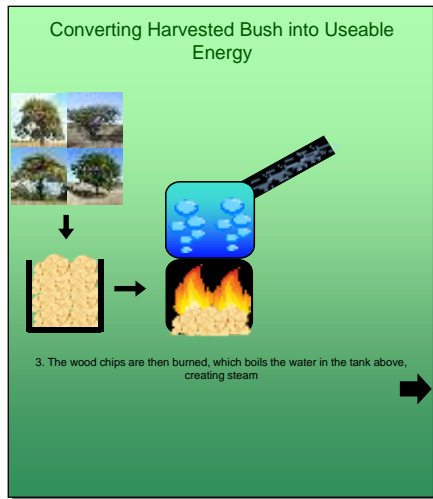

Slide 22

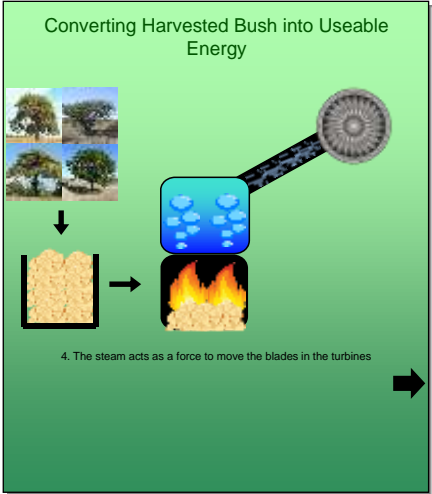

Slide 23

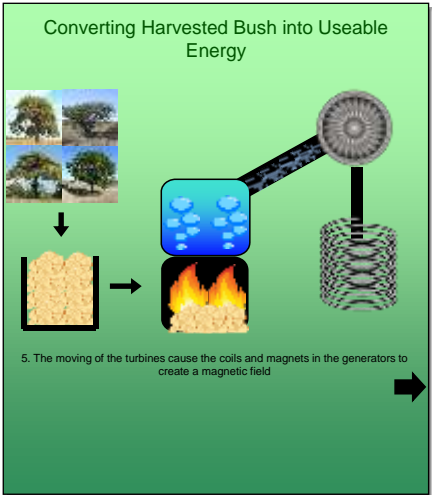

Slide 24

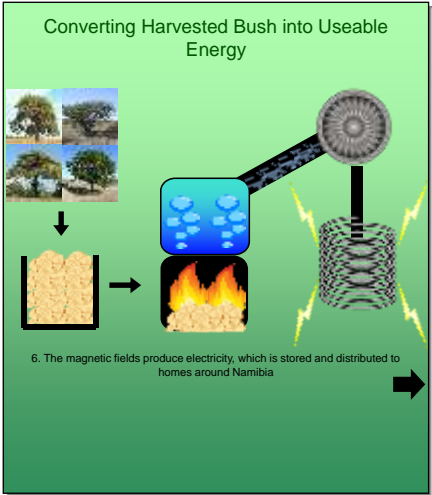

Slide 25

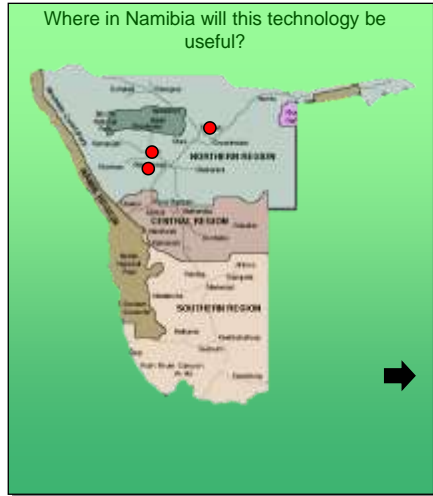

Slide 26



Click on each picture to discuss an advantage

Slide 27



Currently import 80% of the national energy. Bush-to-energy could completely satisfy this need. Bush-to-energy, using the current amount available could actually power all of Namibia for up to 100 years

But Namibia wants to maintain foreign relations, this allows for less dependency on other countries

Could become an energy exporter

Slide 28

Improve the Economy

Decrease National Spending

Job Opportunity

>> Over 30,000 new jobs created

Energy Exporter

>> Could possibly gain N\$25-112 billion per year



←

Bush-to-Energy → decrease national spending → spend less money on importing energy from other countries.

New job opportunities would also become available → workers and laborers to harvest the bush, machinists to process the bush and workers at the plant to work the machines → potential to create over 30,000 new jobs.

If Namibia begins to export energy as they hope to, they have the potential to gain anywhere from N\$25-112 billion per year from Bush-to-Energy.

Slide 29

Decentralized Power Supply

Decentralized power- distributing widely owned resources over smaller areas of the country

Allows local communities to create own power grids

>> Decrease local dependency on government

>> More cost effective for rural communities

←

Decentralized power- distributing widely owned resources over smaller areas of the country

Allows local communities to create own power grids

→ Decrease local dependency on government, as each rural community would be able to provide their own electricity supply

→ More cost effective for rural communities- if they don't have to pay the tariffs and high electrical costs associated with government power supply, then they will be saving money

Slide 30

Decrease CO2 Emissions

Decrease dependency on nonrenewable energy supplies

Bush-to-Energy would produce 2% the amount of CO2 that nonrenewable energy emits

Overall, decrease in CO2 emissions would occur

←





If Bush-to-Energy is implemented in Namibia, dependency on nonrenewable energy supplies such as coal and oil will be reduced.

This is good because the CO₂ emissions from Bush-to-Energy are significantly lower than those that fossil fuels create. If you compare them to each other, Bush-to-Energy emits only 2% the amount of CO₂ that fossil fuels do

This means that, over time, the overall CO₂ emissions of Namibia will decrease, which will lessen the effects of Climate Change

Slide 31

Disadvantages of Bush-to-Energy

<p>Carbon Sinks</p> 	<p>Expensive</p> 
<p>Takes a lot of time</p> 	<p>Potential environmental harm</p> 



Click on different disadvantages of Bush-to-Energy



Slide 32

Carbon Sinks

Definition: Plants remove CO₂ from the atmosphere to use in photosynthesis

Carbon Sinks are good for the environment

Harvesting encroacher bush effects these carbon sinks



Definition of Carbon sink- when plants remove large amounts of CO₂ from the atmosphere to use in photosynthesis

Carbon sinks are good for the environment, as they remove harmful CO₂ emissions from the atmosphere

If you harvest too much encroacher bush at one time, you could remove a significant part of Namibia's carbon sinks, and CO₂ emissions could increase once more

Slide 33

Expensive

More expensive than fossil fuels (coal & oil) and other renewable energies (wind& solar)

Costs of Bush-to-Energy include:

- >> Training bush harvesters and machinists
- >> Establishing processing centers and power plants
- >> Paying fees associated with harvesting permits
- >> Paying Salaries of all workers, both in the field and at the power plants



more expensive than both fossil fuels and other forms of renewable energy, which makes the government resistant to implementing this technology.

several costs involved in establishing Bush-to-Energy in Namibia:

- Training of bush harvesters → need to pay them for work
- Building and establishing a power plant involves several stakeholders and workers, all of whom must be paid. This can become quite expensive
- several fees associated with harvesting bush → many permits which must be purchased
- Once power plants are established, salaries for all of the workers in the plant, as well as for the laborers harvesting the bush, must be paid for

Slide 34

Takes a lot of Time

Several factors of bush-to-energy which take time:

- >> Approval of Permits
- >> Properly training laborers and machinists
- >> Building and establishing a successful bush-to-energy plant

More time -> less money



There are several aspects which require a significant amount of time when implementing Bush-to-Energy.

- Permits for harvesting must be approved, and while the government has tried to steam-line this process for bush harvesting projects, it still takes quite a bit of time
- Laborers and machinists must also be trained on how to properly perform their jobs, which can take weeks
- It also takes a significant amount of time to build a Bush-to-Energy plant, hire workers, and be established for a long enough time to produce a profit.

Slide 35

Potential Environmental Harm

Improper Harvesting leads to environmental harm

- >> increased desertification
- >> soil erosion
- >> decreased water retention



Improperly cared for land impacts farmers the most





As previously talked about, if the land is not taken care of properly when the bush is harvested, environmental harm could occur. Improper harvesting techniques and aftercare of the land could lead to an increase in desertification, soil erosion and a decrease in the land's water retention. All of these have the potential to affect farmers, who make up 70% of the population, so this could seriously affect Namibia

Slide 36

What can YOU do with Bush-to-Energy?

- Tell your parents and community
- Encourage farmers to learn more about bush-to-energy
- Make sure people are properly harvesting bush and taking care of the land
- Work with your classmates to promote awareness in your communities

- Tell your parents and community- make sure understand the full potential of this technology in Namibia. more aware
- more willing to work together to implement this technology.
- Especially make sure to encourage and inform farmers about Bush-to-Energy. If they knew that they could clear the encroacher bush off of their land and sell it to a bush-to-energy power plant, then they would be much more likely to harvest the bush on their land.
- Make sure that they are properly harvesting their bush, though. You still want to maintain the environment, so make sure that they know the proper practices to harvest the bush in a sustainable way.
- Finally, work with your classmates to promote awareness in your communities and brainstorm activities that you could to encourage Bush-to-Energy implementation in your community

Slide 37

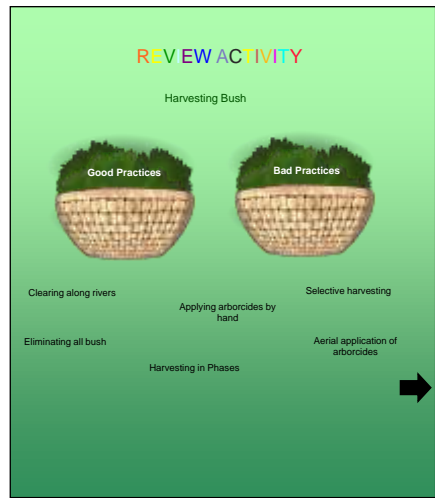

Review activity: Have learners click on each word or phrase and drag it to either the good practices or bad practices basket. If it's right, the basket will accept it, if it's wrong, the basket will reject it and it will bounce back to its original place.

Good practices: Applying arborcides by hand, selective harvesting, harvesting in phases

Bad practices: clearing along rivers, aerial application of arborcides, eliminating all bush

Slide 38

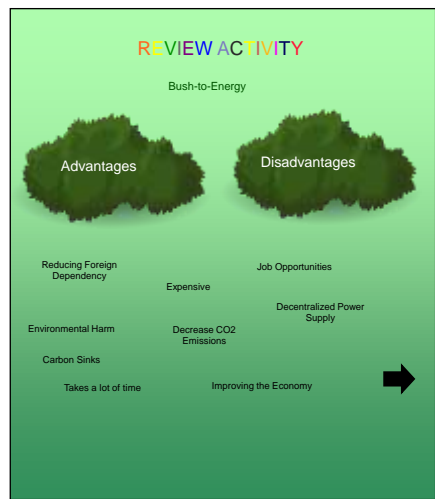

Review activity: Have learners click on each word or phrase and drag it to either the advantages or disadvantages bush. If it's right, the basket will accept it, if it's wrong, the basket will reject it and it will bounce back to its original place

Advantages: reducing foreign dependency, decrease CO₂ emissions, job opportunities, improving economy, decentralized power supply

Disadvantages: expensive, carbon sinks, lots of time

Slide 39

REVIEW ACTIVITY

The group will be split into teams of 2

The first team will pick a number from the question board. If they get the correct answer, then they can place a game piece on the board, starting from the bottom. If they don't get the correct answer, they do not get to put a game piece on the board.

After the first team tries to answer their question, the second team gets a chance.

This continues until one team gets four game pieces in a row of their teams color. Good luck!

Instructions (After reading these go to Bush-to-Energy Connect 4 SMART Notebook file):

This is a game that will test learner knowledge on Bush-to-Energy as a whole. The class will split into two teams, the red and the black team. There will be a 'questions slide' in which the first team can pick a number, and that number when clicked will lead to a question. If the team gets the question right, they get to place a game piece of their team's color on the board. The pieces must be placed in the lowest row possible, but can be placed in any column. After that, the other team will go. If they get the answer right, they get to place a game piece of their team's color on the board. If a team does not get a question right, they do not get to place a game piece on the board. The first team to have four game pieces in a row, either horizontally, vertically, or diagonally wins the game.

Slide 1

Connect 4

Click here for questions

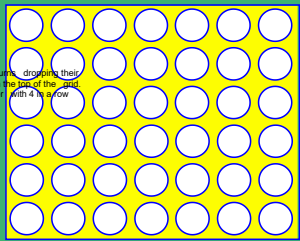

Players take turns dropping their marker from the top of the grid. The first player with 4 in a row wins.

This is the game board. Learners can place a game piece of their team's color in the lowest available spot in a row if they get an answer right. If they get four in a row either horizontally, vertically, or diagonally, they win!

Slide 2

Click a number below to answer a question. (Drag the # behind the mini game board so you know which have been used!)

1	2	3	4	5	6
7	8	9	10	11	12
13	14	15	16	17	18
19	20	21	22	23	24
25	26	27	28	29	30

Learners can click on a number to go to that question.
Once they have answered that question, the number can be dragged behind the miniature game board so that it's no longer an option

****From now on, I will just be putting the answer for each question on the question slide****

Slide 3

1

What is Encroacher Bush?

- a. plants in their natural habitats
- b. plants that take over an area
- c. plants that came from other countries
- d. plants that are placed in pots in people's homes

b. plants that take over an area

Slide 4

1

answer:
b. plants that take over an area

Slide 5

2



How much land does encroacher bush cover in Namibia?

- a. 100%
- b. 40%
- c. 55%
- d. 25%

c. 55%

Slide 6

2



answer:

- c. 55%

Slide 7

3



What type of bush is located all over Namibia?

- a. Prosopis
- b. Swarthaak
- c. Sicklebush
- d. Thornbush

a. Prosopis

Slide 8

A green rectangular slide with a small icon in the top-left corner and a grid of colored dots in the top-right corner. The text in the center reads: "answer: a. Prosopis".

answer:
a. Prosopis

Slide 9

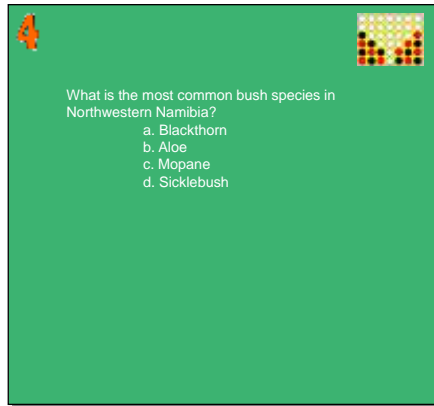
A green rectangular slide with a small icon in the top-left corner and a grid of colored dots in the top-right corner. The text in the center reads: "What is the most common bush species in Northwestern Namibia? a. Blackthorn b. Aloe c. Mopane d. Sicklebush".

What is the most common bush species in
Northwestern Namibia?
a. Blackthorn
b. Aloe
c. Mopane
d. Sicklebush

c. Mopane

Slide 10

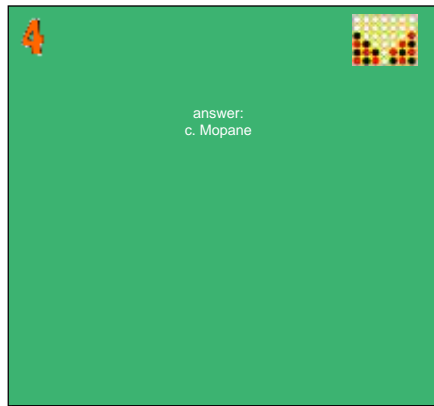
A green rectangular slide with a small icon in the top-left corner and a grid of colored dots in the top-right corner. The text in the center reads: "answer: c. Mopane".

answer:
c. Mopane

Slide 11

5



What is the most common bush type in Eastern Namibia?

- a. Swarthaak
- b. Whitethorn
- c. Prosopis
- d. Silver Cluster-leaf

d. silver-clusterleaf

Slide 12

5



answer:
d. Silver Cluster-leaf

Slide 13

6



What is one problem that Encroacher Bush creates?

- a. severely limits the water supply
- b. there are too many plants
- c. plant species live together peacefully
- d. Encroacher Bush is not good to eat

a. Severely limits water supply

Slide 14

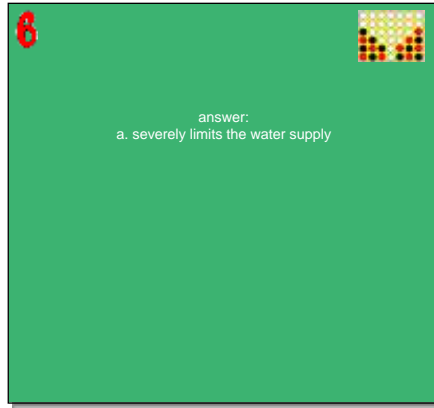
A green rectangular slide with a red number '6' in the top left corner and a small grid of colored dots in the top right corner. The text in the center reads: "answer:
a. severely limits the water supply".

6

answer:
a. severely limits the water supply

Slide 15

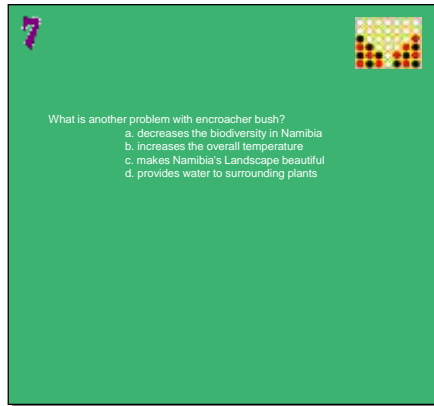
A green rectangular slide with a purple number '7' in the top left corner and a small grid of colored dots in the top right corner. The text in the center reads: "What is another problem with encroacher bush?
a. decreases the biodiversity in Namibia
b. increases the overall temperature
c. makes Namibia's Landscape beautiful
d. provides water to surrounding plants".

7

What is another problem with encroacher bush?
a. decreases the biodiversity in Namibia
b. increases the overall temperature
c. makes Namibia's Landscape beautiful
d. provides water to surrounding plants

- a. Decrease the biodiversity in Namibia

Slide 16

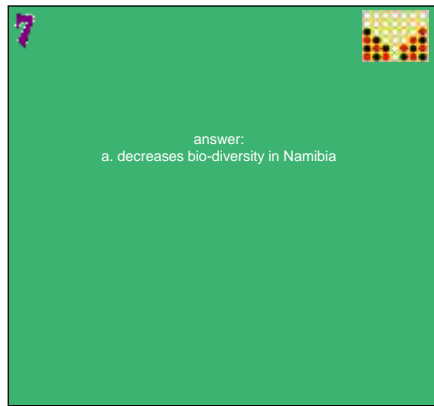
A green rectangular slide with a purple number '7' in the top left corner and a small grid of colored dots in the top right corner. The text in the center reads: "answer:
a. decreases bio-diversity in Namibia".

7

answer:
a. decreases bio-diversity in Namibia

Slide 17

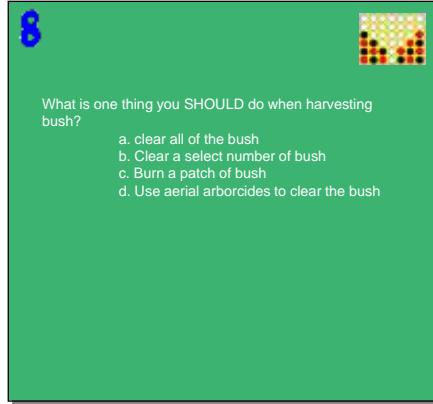
A green rectangular slide with a blue number '8' in the top left corner and a small grid of colored dots in the top right corner. The text on the slide asks for a 'SHOULD' action when harvesting a bush and lists four options: a. clear all of the bush, b. Clear a select number of bush, c. Burn a patch of bush, and d. Use aerial arborcides to clear the bush.

8

What is one thing you SHOULD do when harvesting bush?

- a. clear all of the bush
- b. Clear a select number of bush
- c. Burn a patch of bush
- d. Use aerial arborcides to clear the bush

b. Clear a select number of bush

Slide 18

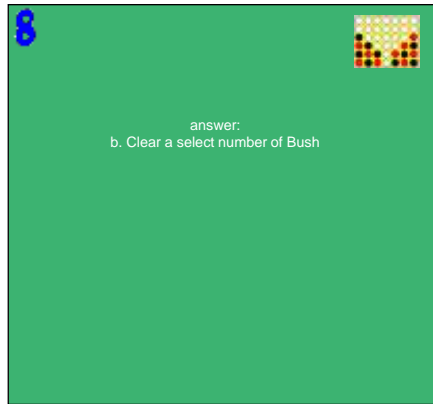
A green rectangular slide with a blue number '8' in the top left corner and a small grid of colored dots in the top right corner. The text on the slide provides the answer to the question on Slide 17: 'answer: b. Clear a select number of Bush'.

8

answer:
b. Clear a select number of Bush

Slide 19

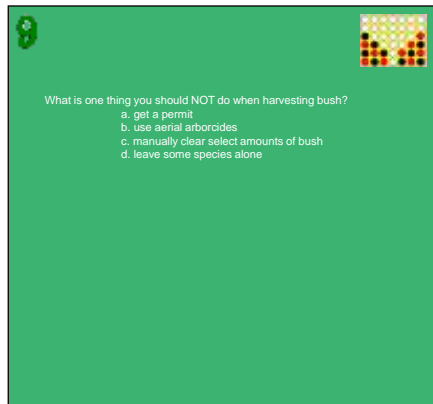
A green rectangular slide with a blue number '9' in the top left corner and a small grid of colored dots in the top right corner. The text on the slide asks for a 'NOT' action when harvesting a bush and lists four options: a. get a permit, b. use aerial arborcides, c. manually clear select amounts of bush, and d. leave some species alone.

9

What is one thing you should NOT do when harvesting bush?

- a. get a permit
- b. use aerial arborcides
- c. manually clear select amounts of bush
- d. leave some species alone

b.use aerial arborcides

Slide 20

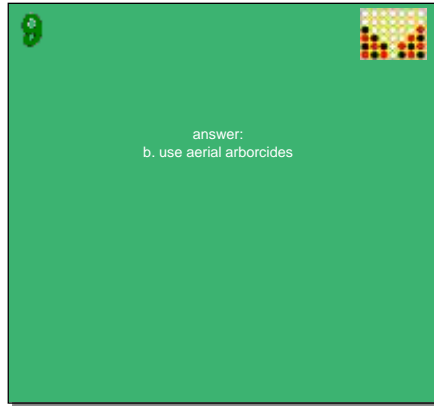

answer:
b. use aerial arborcides

Slide 21

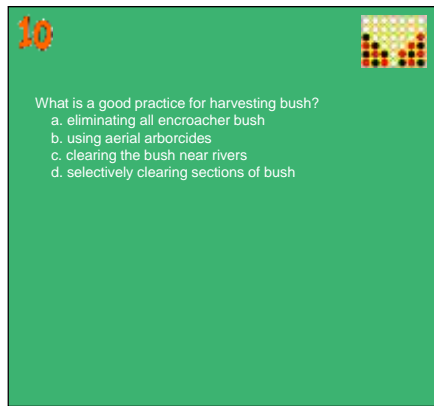

10

What is a good practice for harvesting bush?

- a. eliminating all encroacher bush
- b. using aerial arborcides
- c. clearing the bush near rivers
- d. selectively clearing sections of bush

d. Selectively clearing sections of bush

Slide 22

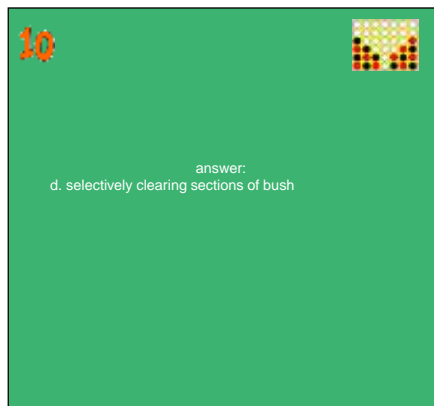

10

answer:
d. selectively clearing sections of bush

Slide 23

11



What is a bad practice for harvesting bush?

- a. harvesting in several phases
- b. getting animals to eat the bush
- c. harvesting all at once
- d. manually applying arborcides

c.harvesting all at once

Slide 24

11



answer:
c. harvesting all at once

Slide 25

12



What is desertification?

- a. When you eat too much dessert and don't feel well after
- b. When the land does not have enough water and nothing can grow
- c. When your throat feels very dry
- d. The act of growing used to the weather in the desert

b.When the land does not have enough water and nothing can grow

Slide 26

12



answer:
b. When the land does not have enough water and nothing can grow

Slide 27

13



What region of Namibia is being considered for bush-energy plant implementation?
a. West
b. East
c. North
d. South

c. North

Slide 28

13



answer:
c. North

Slide 29

14



What type of bush harvesting requires workers to use hand tools?

- a. Manual Labor
- b. Mechanical Harvesting
- c. Chemical Harvesting

a. Manual Labor

Slide 30

14



answer:

- a. Manual Labor

Slide 31

15



What is bush-to-energy?

- a. the energy plants get from the sun
- b. the process of harvesting bush and using it as a renewable replacement for fossil fuels
- c. Using bush as a food source to boost energy levels

b.the process of harvesting bush and using it as a renewable replacement for fossil fuels

Slide 32

15



answer:
b. the process of harvesting bush and using it as a renewable replacement for fossil fuels

Slide 33

16



What is one advantage of bush-energy?
a. increasing greenhouse gases
b. makes the plants more appealing
c. creates a lot of new jobs
d. uses up less of the sun's energy

c. creates a lot of new jobs

Slide 34

16



answer:
c. creates a lot of new jobs

Slide 35

17

What is another advantage of bush-to-energy?

- a. environmental harm
- b. fewer jobs available
- c. there will be less water for the plants
- d. increase biodiversity and available land



d.increase biodiversity and available land

Slide 36

17

answer:

d. increase biodiversity and available land



Slide 37

18

What is a disadvantage of bush-to-energy?

- a. environmental harm
- b. reducing dependency on foreign countries
- c. more jobs
- d. environmental protection



a.environmental harm

Slide 38

18



answer:
b. reducing dependency on foreign countries

Slide 39

19



What is a disadvantage of bush-to-energy?
a. can be expensive
b. creates new jobs
c. reduces the beauty of Namibia's land
d. increases biodiversity

a.can be expensive

Slide 40

19



answer:
a. can be expensive

Slide 41

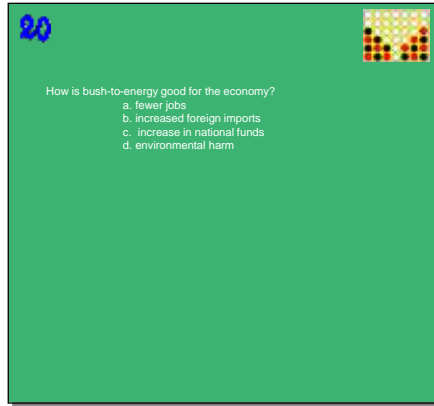
A green slide with a blue '20' in the top left and a decorative grid of colored dots in the top right. The text asks how bush-to-energy is good for the economy and lists four options.

20

How is bush-to-energy good for the economy?

- a. fewer jobs
- b. increased foreign imports
- c. increase in national funds
- d. environmental harm

c.increase in national funds

Slide 42

A green slide with a blue '20' in the top left and a decorative grid of colored dots in the top right. The text indicates the answer to the previous slide's question.

20

answer:

c. increase in national funds

Slide 43

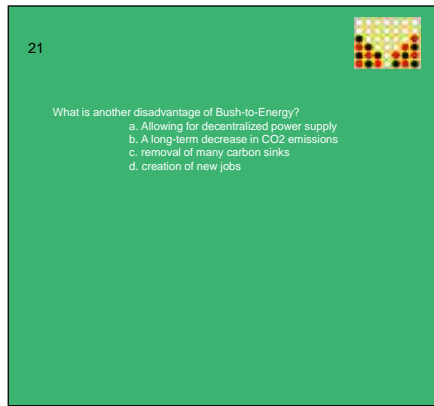
A green slide with the number '21' in the top left and a decorative grid of colored dots in the top right. The text asks for another disadvantage of Bush-to-Energy and lists four options.

21

What is another disadvantage of Bush-to-Energy?

- a. Allowing for decentralized power supply
- b. A long-term decrease in CO2 emissions
- c. removal of many carbon sinks
- d. creation of new jobs

c.removal of many carbon sinks

Slide 44

21



answer:
c. removal of many carbon sinks

Slide 45

22



What is something you can do to increase awareness of Bush-to-Energy?

- a. Talk to your parents and community members
- b. Carry a bush around with you
- c. Try to harvest bush yourself
- d. There's nothing you can do

a. Talk to your parents and community members

Slide 46

22



answer:
a. Talk to your parents and community members

Slide 47

23



What is an invasive plant species?

- a. A indigenous plant that you eat often
- b. A type of plant that lives in harmony with other species
- c. A type of plant that takes over a habitat
- d. An alien plant that you don't like to eat

c.A type of plant that takes over a habitat

Slide 48

23



answer:
c. A type of plant that takes over a habitat

Slide 49

24



What does steam do to help convert bush to energy?

- a. boils the leaves so that you can eat the bush
- b. moves the magnets around in the generator
- c. pushes the blades in the turbines to make them move
- d. steam does not help in the process of converting bush to energy

c.pushes the blades in the turbines to make them move

Slide 50

24



answer:
c. pushes the blades in the turbines to make them move

Slide 51

25



What is a turbine?

- a. a machine that uses magnets to create electricity
- b. a machine that turns milk to make ice cream
- c. a machine that uses the power of spinning blades to create electricity
- d. a machine that uses the sun to create energy

c.a machine that uses the power of spinning blades to create electricity

Slide 52

25



answer:
c. a machine that uses the power of spinning blades to create electricity

Slide 53

26



What is a magnetic field?

- a. an electrically charged area around a magnet that is caused by the moving of particles
- b. a field that is full of magnets
- c. an area surrounding a magnet that is infested with encroacher bush
- d. When two magnets cannot be put together, even by extreme force

a. an electrically charged area around a magnet that is caused by the moving of particles

Slide 54

26



answer:

- a. an electrically charged area around a magnet that is caused by the moving of particles

Slide 55

27



What causes the turbines to spin in a bush-to-energy power plant?

- a. The encroacher bush being poured into the processor
- b. Steam power that pushes the blades
- c. Electricity
- d. Solar panels charge the turbine and cause it to spin

b. Steam power that pushes the blades

Slide 56

27



answer:
b. Steam power that pushes the blades

Slide 57

28



What is a benefit of decentralized power?
a. decentralized power is actually bad for the environment and shouldn't be used
b. decentralized power can be established anywhere, not just in the center of town
c. decentralized power has no benefits
d. decentralized power allows local communities to spend less on government supplied electricity

d. decentralized power allows local communities to spend less on government supplied electricity

Slide 58

28



answer:
d. decentralized power allows local communities to spend less on government supplied electricity

Slide 59

29 

Why is time an issue when trying to implement bush to energy?

- a. Taking too much time on a project means less time for you to enjoy your day
- b. The more time that a project takes, the more money it costs, which could effect the economy
- c. Wasting time makes you lazy
- d. Time is not an issue

b.The more time that a project takes, the more money it costs, which could effect the economy

Slide 60

29 

answer:

- b. The more time that a project takes, the more money it costs, which could effect the economy

Slide 61

30 

What can you do to increase awareness of bush-to-energy?

- a. Encourage your community to eliminate all of the bush
- b. You should not try to increase awareness, this technology would not be useful to Namibia
- c. Tell the farmers in your hometown about how they can use the bush on their farm in bush-to-energy
- d. Tell the farmers in your town that they should hire a plane to spray arborcides to get rid of the bush

c.Tell the farmers in your hometown about how they can use the bush on their farm in bush-to-energy

30



answer:

- c. Tell the farmers in your hometown about how they can use the bush on their farm in bush-to-energy

Appendix KK: EduVentures Excursion Program Schedule

Daily activities

Day	Time	Topic	Timing
	07H00 – 08H00	BREAKFAST	
1a)	09H00 – 13H00		
	a).	Introduction and pre – questionnaire	30 min
	b).	Interactive teaching – Smart lesson	1 hour
	c).	Activity – Discussion on Climate Change, energy and sustainability.	1 hour
		LUNCH	
1b)	14H00 – 16H00	Wind energy	
		Interactive teaching – Smart lesson	1hour
		Activity – Jeopardy game	1 hour
		DINNER	
1c)	19H00 – 21H00	Movie on renewable energy world wide	1 hour 30 min
		Discussion and feedback	30 min
	07H00 – 08H00	BREAKFAST	
2a)	09H00 – 13H00		
	a).	Solar energy	
	b).	Interactive teaching – Smart lesson	1 hour
	c).	Activity – Enviro TV: The possibility for Solar energy in Okondjatu.	2 hour 30 min
		LUNCH	
2b)	14H00 – 21H00	Bush-to-Energy	
		Interactive teaching – Smart lesson	1 hour
		Activity – Connect four	1 hour 30 min
		DINNER	
	19H00 – 21H00	Movie on energy and climate change world wide	1 hour 30 min
		Discussion and feedback	30 min
	07H00 – 08H00	BREAKFAST	
3a)	09H00 – 13H00		
		Field excursion- accompanied by an expert - Discussion	3 hour
	a).	Bush encroachment	30 min

	b).	Field trap up/discussion	1 hour
	c).	Introduction to projects	
		LUNCH	
3b)	14H00 – 21H00	Projects	
	a).	Projects - debate (Non-Renewable vs Renewable energy)	
	b).	Researching and designing	3 hours
		DINNER	
	19H00 – 21H00	Movie night – Action movie	
	07H00 – 08H00	BREAKFAST	
4a)	09H00 – 13H00	How to create and maintain Enviro Clubs	
	a).	Presentation	1 hour
	b).	Committee selection	1 hour
	c).	Club activities	1 hour
		LUNCH	
4b)	14H00 – 21H00	Project continuation	
	a).	Continue with research and preparations	2 hours 30 min
	b).	Practice for project presentation	1 hour
		DINNER	
	19H00 – 21H00	Movie night – Action movie	
	07H00 – 08H00	BREAKFAST	
5)	08H00 – 11H00	Project presentation – Debating event	1 hour
	a).	Thanks giving ceremony	1 hour
	b).	Handover of certificates	
	c).	Post questionnaires and group photo	45 min
	d).	Closing remarks	
		Lunch pack and departure	

Appendix LL: Pre-Test: Distributed before the Program

For Official Use Only: Learner number:
You will not be graded on your answers to this survey. This work sheet is for the EduVentures staff to gauge how much you learned about renewable energy from the modules. If you are not sure about the answer to a question, you can guess or just leave the box blank.
1. What is renewable energy?
2. How do encroacher bushes affect the environment?
3. What is wind energy?
4. Why is solar energy good to use in villages?
5. What is solar energy?
6. What is encroachment bush?
7. Why are wind turbines best for coastal regions?
8. Why is renewable energy important to Namibia?
9. How can you help battle the effects of climate change?

Appendix MM: Pre-Test: Distributed before the Program: Responses

The project team transcribed the responses exactly from what the learner wrote on the form. If the team was not able to read the word, they denoted it with []. Inside the brackets was the team's guess of what the word was.

For Official Use Only: Learner number: 1	
You will not be graded on your answers to this survey. This work sheet is for the EduVentures staff to gauge how much you learned about renewable energy from the modules. If you are not sure about the answer to a question, you can guess or just leave the box blank.	
1. What is renewable energy?	It is when the sunlight that is heating to the solar energy
2. How do encroacher bushes affect the environment?	It' affect us to encroacher to the environment and do know about the insect in the bush
3. What is wind energy?	It's a pole that gave us energy when the wind it's blowing
4. Why is solar energy good to use in villages?	Because it gives us light to us and some of the villages they don't not have solar energy
5. What is solar energy?	It is an energy that gives us light and they get it to the sun
6. What is encroachment bush?	<i>No answer</i>
7. Why are wind turbines best for coastal regions?	<i>No answer</i>
8. Why is renewable energy important to Namibia?	Because Namibian people need to renewable energy
9. How can you help battle the effects of climate change?	<i>No answer</i>

For Official Use Only: Learner number: 2	
You will not be graded on your answers to this survey. This work sheet is for the EduVentures staff to gauge how much you learned about renewable energy from the modules. If you are not sure about the answer to a question, you can guess or just leave the box blank.	
1. What is renewable energy?	It is the thank that you can use
2. How do encroacher bushes affect the environment?	Dry paper's
3. What is wind energy?	<i>No answer</i>
4. Why is solar energy good to use in villages?	Solar energy is good for using of cooking
5. What is solar energy?	Is the energy that give light to use
6. What is encroachment bush?	<i>No answer</i>
7. Why are wind turbines best for coastal regions?	<i>No answer</i>
8. Why is renewable energy important to Namibia?	Because is help people to use it all the world
9. How can you help battle the effects of climate change?	<i>No answer</i>

For Official Use Only: Learner number: 3 *This learner barely wrote in English* (the team did not count his/her answers)
You will not be graded on your answers to this survey. This work sheet is for the EduVentures staff to gauge how much you learned about renewable energy from the modules. If you are not sure about the answer to a question, you can guess or just leave the box blank.
1. What is renewable energy? Wer enegy that ones you used it can be [renewed]*
2. How do encroacher bushes affect the environment? No answer
3. What is wind energy? Thes singa was eat only no a suga
4. Why is solar energy good to use in villages? This work sheet is for the
5. What is solar energy? Welan have be naviaha biangi the wod
6. What is encroachment bush? Is the shengi was air wad is nat the people
7. Why are wind turbines best for coastal regions? Tem
8. Why is renewable energy important to Namibia? Becose the leana wili not see
9. How can you help battle the effects of climate change? Becosethe nady wa change

For Official Use Only: Learner number: 4
You will not be graded on your answers to this survey. This work sheet is for the EduVentures staff to gauge how much you learned about renewable energy from the modules. If you are not sure about the answer to a question, you can guess or just leave the box blank.
1. What is renewable energy? Is the energy that you re-do it again
2. How do encroacher bushes affect the environment? So that goats and hoeps must eat them
3. What is wind energy? Because some time it help people with water
4. Why is solar energy good to use in villages? Is good because in some villages there is not electrical and people are using solar energy
5. What is solar energy? Because it help us with electrical
6. What is encroachment bush? Are the shortes trees
7. Why are wind turbines best for coastal regions? No answer
8. Why is renewable energy important to Namibia? Because it help us with many things
9. How can you help battle the effects of climate change? We cannot help them because they are eating our crops

For Official Use Only: Learner number: 5
You will not be graded on your answers to this survey. This work sheet is for the EduVentures staff to gauge how much you learned about renewable energy from the modules. If you are not sure about the answer to a question, you can guess or just leave the box blank.
1. What is renewable energy? Is the energy that can be replaced
2. How do encroacher bushes affect the environment? Trees must not be eated
3. What is wind energy? Is the energy that we get from wind
4. Why is solar energy good to use in villages? Because if the is no electricity solar will help
5. What is solar energy? Is the energy that we get from the sun
6. What is encroachment bush? Is the cutting down of trees
7. Why are wind turbines best for coastal regions? Because it helps with the energy
8. Why is renewable energy important to Namibia? Because we can replace it
9. How can you help battle the effects of climate change? We must look at the weather

For Official Use Only: Learner number: 6
You will not be graded on your answers to this survey. This work sheet is for the EduVentures staff to gauge how much you learned about renewable energy from the modules. If you are not sure about the answer to a question, you can guess or just leave the box blank.
1. What is renewable energy? Is that renewable energy is some of guess
2. How do encroacher bushes affect the environment? Because it can have not many diseases
3. What is wind energy? Is the energy work at with wind energy
4. Why is solar energy good to use in villages? Because is a good energy to use in villages
5. What is solar energy? Is a formed of energy
6. What is encroachment bush? Is a solar ener bush
7. Why are wind turbines best for coastal regions? Because the are turbines
8. Why is renewable energy important to Namibia? Because it can help us with may things
9. How can you help battle the effects of climate change? Is the atmosphere that take longe afert day

For Official Use Only: Learner number: 7
You will not be graded on your answers to this survey. This work sheet is for the EduVentures staff to gauge how much you learned about renewable energy from the modules. If you are not sure about the answer to a question, you can guess or just leave the box blank.
1. What is renewable energy? Is where by making electricitys
2. How do encroacher bushes affect the environment? No answer
3. What is wind energy? Something blows things
4. Why is solar energy good to use in villages? Because it can assist to charge your phones
5. What is solar energy? Is a pan where we used in the villages
6. What is encroachment bush? No answer
7. Why are wind turbines best for coastal regions? No answer
8. Why is renewable energy important to Namibia? Because it helps us
9. How can you help battle the effects of climate change? No answer

For Official Use Only: Learner number: 8
You will not be graded on your answers to this survey. This work sheet is for the EduVentures staff to gauge how much you learned about renewable energy from the modules. If you are not sure about the answer to a question, you can guess or just leave the box blank.
1. What is renewable energy? Renewable energy is the energy that renew again. For example, solar energy and water energy
2. How do encroacher bushes affect the environment? When people cutting trees in the environment it will affect
3. What is wind energy? Is the energy that come from the wind when it blows in the air
4. Why is solar energy good to use in villages? Because is the most solar in the villages that used with solar sun energy to used
5. What is solar energy? Is the energy that come from the sun
6. What is encroachment bush? No answer
7. Why are wind turbines best for coastal regions? No answer
8. Why is renewable energy important to Namibia? Because it helps some people that are not using electricity which is nam electricity to be used a renewable energy
9. How can you help battle the effects of climate change? Help them to beat the safety place

For Official Use Only: Learner number: 9
You will not be graded on your answers to this survey. This work sheet is for the EduVentures staff to gauge how much you learned about renewable energy from the modules. If you are not sure about the answer to a question, you can guess or just leave the box blank.
1. What is renewable energy? Is the energy from the sunlight
2. How do encroacher bushes affect the environment? By make the environment clean
3. What is wind energy? Is a wind that speed from renewable energy
4. Why is solar energy good to use in villages? We can only not west our wood can put in solar
5. What is solar energy? Is the energy that came from the sun
6. What is encroachment bush? Is the bush that is effect the environment
7. Why are wind turbines best for coastal regions? Because it is control use to breath and to take
8. Why is renewable energy important to Namibia? Carbon dioxide out or oxygen; because we have energy that is control use
9. How can you help battle the effects of climate change? Is the change from the climate of global warming

For Official Use Only: Learner number: 10
You will not be graded on your answers to this survey. This work sheet is for the EduVentures staff to gauge how much you learned about renewable energy from the modules. If you are not sure about the answer to a question, you can guess or just leave the box blank.
1. What is renewable energy? Is the energy that can be renewed or used again
2. How do encroacher bushes affect the environment? They affect the environment by when a person steps on the encroacher he/she will start or will have blood on his/her feet and it will be very painful
3. What is wind energy? Is the energy that blows dity stuff away. Examples: papers, act
4. Why is solar energy good to use in villages? Because we need it for cooking inside the house when the rain comes and there are snow or something, so solar energy will help you very much in a lot of things
5. What is solar energy? Is the energy that restore more energy to television and more
6. What is encroachment bush? Are bushes that have encroach and when somebody step on it he will have blood
7. Why are wind turbines best for coastal regions? No answer
8. Why is renewable energy important to Namibia? Because we need it for every where we go, and it provide the economy
9. How can you help battle the effects of climate change? No answer

For Official Use Only: Learner number: 11
You will not be graded on your answers to this survey. This work sheet is for the EduVentures staff to gauge how much you learned about renewable energy from the modules. If you are not sure about the answer to a question, you can guess or just leave the box blank.
1. What is renewable energy? Is when you have a solar energy
2. How do encroacher bushes affect the environment? Because in village we don use toleint
3. What is wind energy? Is the thing like wind direction
4. Why is solar energy good to use in villages? Because most people in their home they have solar energy to charge the phones
5. What is solar energy? Is the thing that give us electricity
6. What is encroachment bush? Because there no toleint
7. Why are wind turbines best for coastal regions? Because they like the regions
8. Why is renewable energy important to Namibia? Because we don have time cooking outside
9. How can you help battle the effects of climate change? Is when you change climate to climate changes

For Official Use Only: Learner number: 12
You will not be graded on your answers to this survey. This work sheet is for the EduVentures staff to gauge how much you learned about renewable energy from the modules. If you are not sure about the answer to a question, you can guess or just leave the box blank.
1. What is renewable energy? Is the energy that bring benefit in our country
2. How do encroacher bushes affect the environment? It affet the mix trees in the same place
3. What is wind energy? [Is the ear that you can not see and lock it is the energy that work with wind]*
4. Why is solar energy good to use in villages? Is the thing that we used it for sun with out sun it cannot work
5. What is solar energy? Is the things that used for sun so that it can make electricity
6. What is encroachment bush? Is the trees that are in the velleg that are tongethe
7. Why are wind turbines best for coastal regions? Because it make the coastal regions to be clean
8. Why is renewable energy important to Namibia? Because it will help all the Namibians
9. How can you help battle the effects of climate change? I will help it with what it want because I cannot live it like that

For Official Use Only: Learner number: 13	
You will not be graded on your answers to this survey. This work sheet is for the EduVentures staff to gauge how much you learned about renewable energy from the modules. If you are not sure about the answer to a question, you can guess or just leave the box blank.	
1.	What is renewable energy? No answer
2.	How do encroacher bushes affect the environment? No answer
3.	What is wind energy? Its gets air to us
4.	Why is solar energy good to use in villages? Because the villages are not have electricity
5.	What is solar energy? Is the thing that are give energy to other like light
6.	What is encroachment bush? No answer
7.	Why are wind turbines best for coastal regions? No answer
8.	Why is renewable energy important to Namibia? No answer
9.	How can you help battle the effects of climate change? No answer

For Official Use Only: Learner number: 14	
You will not be graded on your answers to this survey. This work sheet is for the EduVentures staff to gauge how much you learned about renewable energy from the modules. If you are not sure about the answer to a question, you can guess or just leave the box blank.	
1.	What is renewable energy? Is when you can do anything in the energy
2.	How do encroacher bushes affect the environment? Is it when the environment study of people
3.	What is wind energy? Is the energy that can hight
4.	Why is solar energy good to use in villages? No answer
5.	What is solar energy? Solar energy is when the sunlight on the solar together
6.	What is encroachment bush? Is the energy that is [onto]* the bush
7.	Why are wind turbines best for coastal regions? Is it the regions that you see in Namibia
8.	Why is renewable energy important to Namibia? Is when you see the energy that you want for your energy
9.	How can you help battle the effects of climate change? Is when the sun change to climate or to change to the weather

For Official Use Only: Learner number: 15
You will not be graded on your answers to this survey. This work sheet is for the EduVentures staff to gauge how much you learned about renewable energy from the modules. If you are not sure about the answer to a question, you can guess or just leave the box blank.
1. What is renewable energy? Is the energy that can be replace
2. How do encroacher bushes affect the environment? No answer
3. What is wind energy? Is the energy that we get from the wind
4. Why is solar energy good to use in villages? Because in the villages people they does not have a electricity
5. What is solar energy? Is the energy that we get from the sun
6. What is encroachment bush? No answer
7. Why are wind turbines best for coastal regions? No answer
8. Why is renewable energy important to Namibia? The renewable energy is important because it can be replaced the new energy
9. How can you help battle the effects of climate change? No answer

For Official Use Only: Learner number: 16
You will not be graded on your answers to this survey. This work sheet is for the EduVentures staff to gauge how much you learned about renewable energy from the modules. If you are not sure about the answer to a question, you can guess or just leave the box blank.
1. What is renewable energy? Is the energy that we can use but it will be renew again
2. How do encroacher bushes affect the environment? We can encroacher the bushes by cutting them down
3. What is wind energy? Is the energy that use wind for example the one that is pumping water
4. Why is solar energy good to use in villages? Because in villages the is no electricity and it is good to use in villages because you will not buy electricity
5. What is solar energy? Is the energy that people use from the sun
6. What is encroachment bush? Is the bushes around the environment
7. Why are wind turbines best for coastal regions? No answer
8. Why is renewable energy important to Namibia? It is good for Namibia because it will be renew again
9. How can you help battle the effects of climate change? No answer

For Official Use Only: Learner number: 17	
You will not be graded on your answers to this survey. This work sheet is for the EduVentures staff to gauge how much you learned about renewable energy from the modules. If you are not sure about the answer to a question, you can guess or just leave the box blank.	
1.	What is renewable energy? Is energy that we can use over and over
2.	How do encroacher bushes affect the environment? Bad
3.	What is wind energy? Is the energy we get from the wind
4.	Why is solar energy good to use in villages? Because it in villages there is no electricity
5.	What is solar energy? Is the energy that we got from the solar when it is heated by the sun
6.	What is encroachment bush? Bushes that grow over the larger area and they are poisoners trees
7.	Why are wind turbines best for coastal regions? Because there is a lot of wind that side
8.	Why is renewable energy important to Namibia? Because it is used over and over
9.	How can you help battle the effects of climate change? No answer

For Official Use Only: Learner number: 18	
You will not be graded on your answers to this survey. This work sheet is for the EduVentures staff to gauge how much you learned about renewable energy from the modules. If you are not sure about the answer to a question, you can guess or just leave the box blank.	
1.	What is renewable energy? Is think that can be rew back againt, like water
2.	How do encroacher bushes affect the environment? Because it can have not many diseases
3.	What is wind energy? Is the energy that works with wind to pump energy
4.	Why is solar energy good to use in villages? Electricity
5.	What is solar energy? Is energy that produce electricity someway
6.	What is encroachment bush? Is the bushes that people butting dirty thing
7.	Why are wind turbines best for coastal regions? Is can produces energy and electricity
8.	Why is renewable energy important to Namibia? Because it think can renew back wil help Namibia
9.	How can you help battle the effects of climate change? We can stop those factory that exhausted smoking. So that they can not damage the climate

For Official Use Only: Learner number: 19

You will not be graded on your answers to this survey. This work sheet is for the EduVentures staff to gauge how much you learned about renewable energy from the modules. If you are not sure about the answer to a question, you can guess or just leave the box blank.

1. What is renewable energy?

Are energy that ones you used up it can be renewed

2. How do encroacher bushes affect the environment?

It burn the field and also moves animals to move away

3. What is wind energy?

Are energy that we get from air or wind

4. Why is solar energy good to use in villages?

Because it were the sun heat and so that you can safe electricity

5. What is solar energy?

Is the energy that we get from the sun

6. What is encroachment bush?

Is the burning and cutting bushes

7. Why are wind turbines best for coastal regions?

Because the wind blows good there

8. Why is renewable energy important to Namibia?

Because Namibia has no power station and it need renewable energy

9. How can you help battle the effects of climate change?

No answer

Appendix NN: Module Observation Form

Module Learner Engagement Observation Form

Observer _____ Date _____ Module _____

		Observer	Date	Module																		
At 5-minute mark	Positive Behavior	Sitting up and listening																				
		Keeping eye contact with the teacher																				
		Smiling																				
	Negative Behavior	Expressing confusion or anger																				
		Talking in side conversations																				
During 5-minute time frame	Positive Behavior	Asking questions																				
		Answering questions from the teacher																				
		Coming up to the SMART Board to participate																				
	Negative Behavior	Looking out the window																				
		Not fully contributing to group work																				

Additional Comments:

Appendix OO: Module Learner Engagement Observation Form: Module 1 Introduction to Renewable Energy

Emily DiRuzza 4/24/2017 Introduction to Renewable Energy

At 5-minute mark	Positive behavior	How many learners are?	Start-0	5	10	15	20	25
		sitting up and listening	11	10	11	7	8	9
		keeping eye contact with the teacher	11	10	11	0	0	9
		smiling	0	0	0	0	0	0
	Negative behavior	expressing confusion or anger	0	0	0	0	0	0
		talking in side conversations	0	0	0	0	3	0
During 5-minute mark	Positive behavior	asking questions	0	0	0	0	0	0
		answering questions from the teacher	9	5	0	0	0	6
		coming up to the SMART board to participate	0	0	2	0	0	0
	Negative behavior	looking out the window	4	5	0	6	2	0
		not fully contributing to group work	0	0	0	0	0	0
At 5-minute mark	Positive behavior	How many learners are?	30	35	40	45	50	55
		sitting up and listening	11	10	0	11	3	7
		keeping eye contact with the teacher	11	8	0	11	0	7
		smiling	0	0	0	0	0	0
	Negative behavior	expressing confusion or anger	0	0	0	0	0	0
		talking in side conversations	0	6	11	0	3	3
During 5-minute mark	Positive behavior	asking questions	1	1	0	0	0	0
		answering questions from the teacher	1	0	0	0	1	2
		coming up to the SMART board to participate	0	0	0	0	1	2
	Negative behavior	looking out the window	7	0	0	1	3	5
		not fully contributing to group work	0	4	0	0	0	0
At 5-minute mark	Positive behavior	How many learners are?	60	65	70	75	80	85
		sitting up and listening	3	11	10	9	10	9
		keeping eye contact with the teacher	0	9	10	9	10	9
		smiling	0	0	0	0	0	0
	Negative behavior	expressing confusion or anger	0	0	0	0	0	0
		talking in side conversations	0	0	0	2	1	0
During 5-minute mark	Positive behavior	asking questions	0	0	0	0	0	0
		answering questions from the teacher	1	0	0	2	4	2

		coming up to the SMART board to participate	1	0	0	0	0	0
	Negative behavior	looking out the window	3	4	5	2	4	2
		not fully contributing to group work	0	0	0	0	0	0
At 5-minute mark	Positive behavior	How many learners are?	90	95	100	105	110	115
		sitting up and listening	8	9	11	11	11	10
		keeping eye contact with the teacher	7	9	7	5	10	10
		smiling	0	2	0	0	1	1
	Negative behavior	expressing confusion or anger	0	1	0	4	5	0
		talking in side conversations	2	0	0	0	0	0
During 5-minute mark	Positive behavior	asking questions	0	0	0	0	0	0
		answering questions from the teacher	1	0	2	2	3	4
		coming up to the SMART board to participate	0	0	0	0	3	4
	Negative behavior	looking out the window	2	7	3	3	1	2
		not fully contributing to group work	0	0	0	0	0	0
At 5-minute mark	Positive behavior	How many learners are?	120	125	130	135	140	145
		sitting up and listening	11	10	8	0	0	15
		keeping eye contact with the teacher	11	7	6	0	0	15
		smiling	0	0	0	0	0	6
	Negative behavior	expressing confusion or anger	0	0	3	6	0	0
		talking in side conversations	0	0	0	10	15	0
During 5-minute mark	Positive behavior	asking questions	0	0	2	0	0	1
		answering questions from the teacher	1	0	1	2	0	0
		coming up to the SMART board to participate	1	0	0	0	0	0
	Negative behavior	looking out the window	1	3	0	4	0	1
		not fully contributing to group work	0	0	3	5	2	0
At 5-minute mark	Positive behavior	How many learners are?	150	155	160	165	170	175
		sitting up and listening	15	15	3	4	7	11
		keeping eye contact with the teacher	0	0	0	2	7	11
		smiling	3	7	3	0	0	0
	Negative behavior	expressing confusion or anger	0	0	0	0	0	0
		talking in side conversations	7	10	15	3	0	0
During 5-minute mark	Positive behavior	asking questions	0	0	0	0	0	0
		answering questions from the teacher	1	2	4	2	2	2
		coming up to the SMART board to participate	1	1	2	1	0	0

	Negative behavior	looking out the window	3	4	5	5	4	0
		not fully contributing to group work	0	0	0	0	0	0

Tim Consedine

4/24/2017

Introduction to Renewable Energy

At 5-minute Interval	Positive behavior	How many learners are?	Start-0	5	10	15	20	25
		sitting up and listening	10	10	10	10	10	9
		keeping eye contact with the teacher	8	8	9	10	10	8
		smiling	1	1	2	0	0	0
	Negative behavior	expressing confusion or anger	1	0	0	1	0	1
		talking in side conversations	0	2	3	0	4	0
During 5-minute Interval	Positive behavior	asking questions	0	0	1	0	0	0
		answering questions from the teacher	7	3	1	0	0	6
		coming up to the SMART board to participate	0	0	3	0	0	0
	Negative behavior	looking out the window	3	5	0	2	2	1
		not fully contributing to group work	0	0	0	0	0	0
At 5-minute Interval	Positive behavior	How many learners are?	30	35	40	45	50	55
		sitting up and listening	9	9	0	10	8	7
		keeping eye contact with the teacher	8	10	0	8	5	7
		smiling	0	0	3	0	0	0
	Negative behavior	expressing confusion or anger	3	1	2	0	1	2
		talking in side conversations	0	2	3	2	3	2
During 5-minute Interval	Positive behavior	asking questions	0	0	0	0	0	0
		answering questions from the teacher	0	0	0	1	1	1
		coming up to the SMART board to participate	0	0	0	1	1	1
	Negative behavior	looking out the window	0	0	0	0	0	2
		not fully contributing to group work	0	1	0	0	0	0
At 5-minute Interval	Positive behavior	How many learners are?	60	65	70	75	80	85
		sitting up and listening	9	10	8	9	10	8
		keeping eye contact with the teacher	4	8	8	9	10	7
		smiling	0	0	0	0	0	0
	Negative behavior	expressing confusion or anger	0	0	0	2	3	3
		talking in side conversations	0	0	2	0	0	0
During 5-minute Interval	Positive behavior	asking questions	0	0	0	0	0	0
		answering questions from the teacher	4	4	3	1	3	2
		coming up to the SMART board to participate	0	0	0	0	0	0
	Negative behavior	looking out the window	0	0	1	0	0	0
		not fully contributing to group work	0	0	0	0	0	0
At 5-minute Interval	Positive behavior	How many learners are?	90	95	100	105	110	115
		sitting up and listening	9	7	10	9	10	10
		keeping eye contact with the teacher	6	10	8	8	9	9

During 5-minute Interval	Negative behavior	smiling	0	0	0	0	1	0
		expressing confusion or anger	0	0	0	0	0	0
		talking in side conversations	0	0	0	0	0	0
	Positive behavior	asking questions	1	1	0	0	0	0
		answering questions from the teacher	0	4	3	0	0	0
		coming up to the SMART board to participate	0	0	0	2	2	2
Negative behavior	looking out the window	0	1	1	0	0	0	
	not fully contributing to group work	0	0	0	0	0	0	
At 5-minute Interval	Positive behavior	How many learners are?	120	125	130	135	140	145
		sitting up and listening	10	4	0	0	0	5
		keeping eye contact with the teacher	7	3	0	0	0	0
		smiling	0	0	0	0	0	0
	Negative behavior	expressing confusion or anger	0	0	0	0	0	0
		talking in side conversations	0	0	1	0	0	0
During 5-minute Interval	Positive behavior	asking questions	1	0	0	0	0	0
		answering questions from the teacher	2	0	0	0	0	0
		coming up to the SMART board to participate	0	0	0	2	2	0
	Negative behavior	looking out the window	1	0	0	1	2	0
		not fully contributing to group work	0	1	1	0	1	0
		How many learners are?	150	155	160	165	170	175
At 5-minute Interval	Positive behavior	sitting up and listening	5	4	4	5		
		keeping eye contact with the teacher	0	5	5	5		
		smiling	0	0	0	0		
		How many learners are?	150	155	160	165	170	175
	Negative behavior	expressing confusion or anger	0	0	0	0		
		talking in side conversations	1	2	1	0		
During 5-minute Interval	Positive behavior	asking questions	0	0	0	3		
		answering questions from the teacher	0	1	2	0		
		coming up to the SMART board to participate	0	0	1	4		
	Negative behavior	looking out the window	1	0	2	0		
		not fully contributing to group work	0	0	0	0		
		How many learners are?	150	155	160	165	170	175

Additional Comments:

- First sorting didn't work, fix what's accepted and not
- Lots of kids taking notes, should've had that on observation form
- Indicates all taking notes, still positive behavior but not ones on form
- At 22 min sound from movie wasn't working; fixed at 24 min
- Doing group activity
- Maria went very fast through each technology
- Group activity took too long
Need to explain each tech to Maria better
- Link to solar goes to wrong place
- Matching was already filled in

- Text isn't locked, words moved when they tried to drag
- Some were able to remember answers that appeared on the board
- Everyone had a hard time understanding the scenarios, had to be explained 2-3 times
- Very hard to write out answers on board
- Needed more space to write answers

Appendix PP: Module Learner Engagement Observation Form: Module 2 Solar Energy

Katie Pelissari 4/25/2017

Solar Energy

At 5-minute Interval	Positive behavior	How many learners are?	Start-0	5	10	15	20	25
		sitting up and listening	7	5	5	8	8	0
		keeping eye contact with the teacher	8	3	8	7	0	0
		smiling	2	1	0	0	2	0
	Negative behavior	expressing confusion or anger	0	0	0	0	0	0
		talking in side conversations	0	0	0	0	0	0
During 5-minute Interval	Positive behavior	asking questions	0	0	1	0	2	1
		answering questions from the teacher	6	10	1	5	0	0
		coming up to the SMART board to participate	0	0	2	1	0	0
	Negative behavior	looking out the window	2	2	0	0	1	0
		not fully contributing to group work	0	0	0	0	0	3
At 5-minute Interval	Positive behavior	How many learners are?	30	35	40	45	50	55
		sitting up and listening	0	0	0	0	0	0
		keeping eye contact with the teacher	0	0	0	0	0	0
		smiling	0	0	1	0	0	0
	Negative behavior	expressing confusion or anger	0	0	0	0	0	0
		talking in side conversations	0	0	1	0	0	2
During 5-minute Interval	Positive behavior	asking questions	1	0	0	1	0	0
		answering questions from the teacher	0	0	1	0	3	2
		coming up to the SMART board to participate	0	0	0	0	0	0
	Negative behavior	looking out the window	1	0	0	0	1	2
		not fully contributing to group work	2	0	1	2	0	0
At 5-minute Interval	Positive behavior	How many learners are?	60	65	70	75	80	85
		sitting up and listening	5	4	3	3	4	3
		keeping eye contact with the teacher	6	5	1	2	2	3
		smiling	1	0	0	0	0	0
	Negative behavior	expressing confusion or anger	0	0	0	0	0	0
		talking in side conversations	0	0	0	0	0	0
During 5-minute Interval	Positive behavior	asking questions	0	0	0	0	0	1
		answering questions from the teacher	2	0	3	1	9	4
		coming up to the SMART board to participate	0	0	0	0	0	0
	Negative behavior	looking out the window	4	2	3	3	2	2
		not fully contributing to group work	0	0	0	0	0	0
At 5-minute Interval	Positive behavior	How many learners are?	90	95	100	105	110	115
		sitting up and listening	4	6	7	8	5	5
		keeping eye contact with the teacher	3	6	7	8	4	0

		smiling	0	0	0	0	0	0
	Negative behavior	expressing confusion or anger	0	0	0	0	0	0
		talking in side conversations	0	0	0	0	0	0
During 5-minute Interval	Positive behavior	asking questions	0	0	0	0	0	0
		answering questions from the teacher	12	7	2	8	3	2
		coming up to the SMART board to participate	0	0	6	0	0	0
	Negative behavior	looking out the window	1	0	0	2	0	1
		not fully contributing to group work	0	0	0	0	0	0

Additional Comments:

- Not supposed to be writing (Sophie)
- Some learners yawning
- At 12 mins the fill in the blank activity and the learners are very excited because of sweets
- At 17 minutes, some side conversations present due to the activity
- Activity took too long
- Lots of talking during presentation
- Speed up 2nd process animations
- Learners were fidgety
- Learners lost engagement at 70 minutes

Jessica Grabinsky

4/25/2017

Solar Energy

At 5-minute interval	Positive behavior	How many learners are?	Start-0	5	10	15	20	25
		sitting up and listening	9	9	9	9	9	0
		keeping eye contact with the teacher	9	9	9	9	0	0
		smiling	0	0	0	3	2	2
At 5-minute interval	Negative behavior	expressing confusion or anger	0	0	1	0	0	0
		talking in side conversations	0	0	0	0	0	0
During 5-minute interval	Positive behavior	asking questions	0	0	0	1	2	0
		answering questions from the teacher	5	2	2	9	0	0
		coming up to the SMART board to participate	0	0	4	0	0	0
	Negative behavior	looking out the window	1	0	0	1	0	0
		not fully contributing to group work	0	0	0	0	1	1
At 5-minute interval	Positive behavior	How many learners are?	30	35	40	45	50	55
		sitting up and listening	0	0	0	0	9	9
		keeping eye contact with the teacher	0	0	0	0	9	9
		smiling	2	0	2	1	0	0

	Negative behavior	expressing confusion or anger	1	0	0	0	0	0
	Negative behavior	talking in side conversations	0	0	0	0	0	0
During 5-minute interval	Positive behavior	asking questions	0	0	1	0	0	0
		answering questions from the teacher	0	0	0	0	2	0
		coming up to the SMART board to participate	0	0	0	0	0	0
	Negative behavior	looking out the window	0	0	0	0	0	0
	Negative behavior	not fully contributing to group work	0	0	0	0	2	0
At 5-minute interval	Positive behavior	How many learners are?	60	65	70	75	80	85
		sitting up and listening	3	0	9	8	10	10
		keeping eye contact with the teacher	3	0	9	8	10	8
		smiling	0	0	0	0	0	0
	Negative behavior	expressing confusion or anger	0	0	0	3	0	0
	Negative behavior	talking in side conversations	0	0	0	0	0	0
During 5-minute interval	Positive behavior	asking questions	0	0	0	1	0	0
		answering questions from the teacher	0	4	3	2	10	4
		coming up to the SMART board to participate	0	4	0	0	0	0
	Negative behavior	looking out the window	0	0	0	0	1	3
		not fully contributing to group work	0	0	0	0	0	0
At 5-minute interval	Positive behavior	How many learners are?	90	95	100	105	110	115
		sitting up and listening	10	8	9	9	5	5
		keeping eye contact with the teacher	10	7	9	9	5	5
		smiling	0	0	0	0	0	0
	Negative behavior	expressing confusion or anger	0	0	0	0	0	1
		talking in side conversations	0	2	0	0	2	2
During 5-minute interval	Positive behavior	asking questions	0	0	0	0	0	0
		answering questions from the teacher	9	2	5	5	1	1
		coming up to the SMART board to participate	0	0	5	0	0	0
	Negative behavior	looking out the window	1	0	0	0	5	3
		not fully contributing to group work	0	0	0	0	0	0
At 5-minute interval	Positive behavior	How many learners are?	120	125	130	135	140	145
		sitting up and listening	9	9				
		keeping eye contact with the teacher	8	9				
		smiling	0	5				
	Negative behavior	expressing confusion or anger	0	0				
		talking in side conversations	0	0				
During 5-minute interval	Positive behavior	asking questions	0	0				
		answering questions from the teacher	5	5				
		coming up to the SMART board to participate	0	0				
	Negative behavior	looking out the window	1	0				
		not fully contributing to group work	0	0				
At 5-minute interval	Positive behavior	How many learners are?	150	155	160	165		
		sitting up and listening						

		keeping eye contact with the teacher						
		smiling						
During 5-minute interval	Negative behavior	expressing confusion or anger						
		talking in side conversations						
	Positive behavior	asking questions						
		answering questions from the teacher						
		coming up to the SMART board to participate						
	Negative behavior	looking out the window						
not fully contributing to group work								

Additional Comments:

- Too in depth with the technologies
- More candy
- More time for drawing activity
- Hard time with passive vs active
- Operation too in depth
- Lock screen on regions
- Need more short activities (opinion)

Appendix QQ: Module Learner Engagement Observation Form: Module 3 Wind Energy

Emily DiRuzza

4/24/2017

Wind Energy

At 5-minute Interval	Positive behavior	How many learners are?	Start 0	5	10	15	20	25
		sitting up and listening	9	9	9	9	9	7
		keeping eye contact with the teacher	9	9	5	7	9	7
		smiling	0	0	0	1	0	0
	Negative behavior	expressing confusion or anger	0	0	0	0	2	3
During 5-minute Interval	Positive behavior	asking questions	0	0	0	0	0	0
		answering questions from the teacher	5	4	3	4	1	7
		coming up to the SMART board to participate	0	2	0	0	0	0
	Negative behavior	looking out the window	1	0	3	1	5	1
		not fully contributing to group work	0	0	0	0	0	0
At 5-minute Interval	Positive behavior	How many learners are?	30	35	40	45	50	55
		sitting up and listening	9	9	9	9	10	10
		keeping eye contact with the teacher	9	9	7	9	10	8
		smiling	1	0	0	0	0	0
	Negative behavior	expressing confusion or anger	1	1	0	0	2	3
During 5-minute Interval	Positive behavior	asking questions	0	0	0	1	0	11
		answering questions from the teacher	4	3	2	0	0	0
		coming up to the SMART board to participate	4	0	2	0	0	0
	Negative behavior	looking out the window	3	4	1	5	0	2
		not fully contributing to group work	0	0	0	0	0	0
At 5-minute Interval	Positive behavior	How many learners are?	60	65	70	75	80	85
		sitting up and listening	10	10				
		keeping eye contact with the teacher	0	10				
		smiling	0	3				
	Negative behavior	expressing confusion or anger	0	0				
During 5-minute Interval	Positive behavior	asking questions	0	0				
		answering questions from the teacher	1	1				
		coming up to the SMART board to participate	1	1				
	Negative behavior	looking out the window	4	0				
		not fully contributing to group work	2	0				
At 5-minute Interval	Positive behavior	How many learners are?	90					
		sitting up and listening						
		keeping eye contact with the teacher						

During 5-minute Interval	Negative behavior	smiling						
		expressing confusion or anger						
		talking in side conversations						
	Positive behavior	asking questions						
		answering questions from the teacher						
		coming up to the SMART board to participate						
	Negative behavior	looking out the window						
		not fully contributing to group work						

Additional Comments:

- Sophia told them not to take notes
- Overall class is more distracted and tired
- See lot of yawning/fidgeting
- Didn't do second activity
- Shaft didn't bounce back on matching
- Fade job growth slide slightly
- Candy was a good motivator

Tim Consedine

4/24/2017

Wind Energy

At 5-minute Interval	Positive behavior	How many learners are?	Start 0	5	10	15	20	25
		sitting up and listening	9	9	9	9	9	9
		keeping eye contact with the teacher	9	9	6	8	9	9
		smiling	0	0	0	0	0	0
Negative behavior	expressing confusion or anger	1	1	0	1	0	0	
	talking in side conversations	0	0	0	0	0	0	
During 5-minute Interval	Positive behavior	asking questions	0	0	0	0	0	0
		answering questions from the teacher	5	3	4	4	1	7
		coming up to the SMART board to participate	0	3	0	0	0	0
	Negative behavior	looking out the window	0	2	0	1	0	1
not fully contributing to group work		0	0	0	0	0	0	
At 5-minute Interval	Positive behavior	How many learners are?	30	35	40	45	50	55
		sitting up and listening	9	9	9	7	7	8
		keeping eye contact with the teacher	9	9	8	7	7	8
		smiling	0	0	0	0	0	0
	Negative behavior	expressing confusion or anger	0	0	1	0	0	0
		talking in side conversations	0	0	4	0	2	3
During 5-minute Interval	Positive behavior	asking questions	0	0	0	0	1	1
		answering questions from the teacher	0	5	1	5	4	0
		coming up to the SMART board to participate	4	0	6	0	0	0

	Negative behavior	looking out the window	0	0	1	1	1	0
		not fully contributing to group work	0	0	0	0	0	0
At 5-minute Interval	Positive behavior	How many learners are?	60	65	70	75	80	85
		sitting up and listening	9	7				
		keeping eye contact with the teacher	9	7				
		smiling	0	0				
	Negative behavior	expressing confusion or anger	0	0				
		talking in side conversations	3	2				
During 5-minute Interval	Positive behavior	asking questions	0	0				
		answering questions from the teacher	0	2				
		coming up to the SMART board to participate	0	1				
	Negative behavior	looking out the window	0	0				
		not fully contributing to group work	0	0				
At 5-minute Interval	Positive behavior	How many learners are?	90					
		sitting up and listening						
		keeping eye contact with the teacher						
		smiling						
	Negative behavior	expressing confusion or anger						
		talking in side conversations						
During 5-minute Interval	Positive behavior	asking questions						
		answering questions from the teacher						
		coming up to the SMART board to participate						
	Negative behavior	looking out the window						
		not fully contributing to group work						

Additional Comments:

- n/a

Appendix RR: Module Learner Engagement Observation Form: Module 4 Bush-to-Energy

Katie Pelissari

4/25/2017

Bush-to-Energy

At 5-minute interval	Positive behavior	How many learners are?	Start-0	5	10	15	20	25
		sitting up and listening	6	6	11	10	9	8
		keeping eye contact with the teacher	11	9	5	11	11	6
		smiling	0	0	0	0	0	0
	Negative behavior	expressing confusion or anger	0	0	0	0	0	0
		talking in side conversations	0	0	0	0	0	0
During 5-minute interval	Positive behavior	asking questions	0	0	0	0	0	0
		answering questions from the teacher	0	3	1	3	1	3
		coming up to the SMART board to participate	0	0	0	0	0	0
	Negative behavior	looking out the window	3	0	1	1	1	0
		not fully contributing to group work	0	0	0	0	0	0
At 5-minute interval	Positive behavior	How many learners are?	30	35	40	45	50	55
		sitting up and listening	2	8	8	2	3	3
		keeping eye contact with the teacher	4	5	11	6	10	2
		smiling	1	0	0	0	0	0
	Negative behavior	expressing confusion or anger	0	1	0	0	0	0
			talking in side conversations	0	1	0	0	0
During 5-minute interval	Positive behavior	asking questions	1	0	0	0	0	0
		answering questions from the teacher	5	1	0	1	2	0
		coming up to the SMART board to participate	0	0	0	0	0	3
	Negative behavior	looking out the window	0	1	1	1	0	0
			not fully contributing to group work	0	0	0	0	0
At 5-minute interval	Positive behavior	How many learners are?	60					
		sitting up and listening	3					
		keeping eye contact with the teacher	1					
		smiling	0					
	Negative behavior	expressing confusion or anger	0					
			talking in side conversations	0				
During 5-minute interval	Positive behavior	asking questions	0					
		answering questions from the teacher	2					
		coming up to the SMART board to participate	5					
	Negative behavior	looking out the window	0					
			not fully contributing to group work	0				

Additional Comments:

- Can't see all faces
- Learners taking notes
- Encroacher bush definition is too complex
- Speed up land desertification animations
- No response when Maria asks questions
- Whole lesson was lecture style
- Learners not focused
- Learners talked a lot during activity
- Learner asked what foreign means

Jess Grabinsky

4/25/2017

Bush-to-Energy

At 5-minute interval	Positive behavior	How many learners are?	Start-0	5	10	15	20	25
		sitting up and listening	7	7	5	7	7	6
		keeping eye contact with the teacher	7	7	5	7	7	6
		smiling	0	0	0	0	0	0
	Negative behavior	expressing confusion or anger	0	0	0	0	0	0
		talking in side conversations	0	0	0	0	0	0
During 5-minute interval	Positive behavior	asking questions	0	0	0	0	0	0
		answering questions from the teacher	2	2	0	2	3	3
		coming up to the SMART board to participate	0	0	0	0	0	0
	Negative behavior	looking out the window	0	3	0	2	2	1
		not fully contributing to group work	0	0	0	0	0	0
At 5-minute interval	Positive behavior	How many learners are?	30	35	40	45	50	55
		sitting up and listening	5	7	7	7	7	7
		keeping eye contact with the teacher	57	7	7	7	7	7
		smiling	0	0	0	0	0	0
	Negative behavior	expressing confusion or anger	0	0	1	0	0	0
		talking in side conversations	2	0	0	0	0	0
During 5-minute interval	Positive behavior	asking questions	0	1	0	0	1	3
		answering questions from the teacher	1	1	1	3	2	2
		coming up to the SMART board to participate	0	0	3	1	1	0
	Negative behavior	looking out the window	3	2	2	0	0	0
			not fully contributing to group work	0	0	0	0	0

Additional Comments:

- Don't know "indigenous" or "alien"
- Contradict herself on prosopis
- Need more activities throughout the lesson, lots of yawing

- Learners putting head on their desks
- More SMART activities

Appendix SS: Post-Test: Distributed after the Program

For Official Use Only: Learner number:
You will not be graded on your answers to this survey. This work sheet is for the EduVentures staff to gauge how much you learned about renewable energy from the modules. If you are not sure about the answer to a question, you can guess or simply leave the box blank.
1. How can you help battle the effects of climate change?
2. How do encroacher bushes affect the environment?
3. What is wind energy?
4. What is solar energy?
5. Why are wind turbines best for coastal regions?
6. What is encroachment bush?
7. Why is renewable energy important to Namibia?
8. Why is solar energy good to use in villages?
9. What is renewable energy?

Appendix TT: Post-Test: Distributed after the Program: Responses

The project team transcribed the responses exactly from what the learner wrote on the form. If the team was not able to read the word, they denoted it with [] *. Inside the brackets was the team's guess of what the word was.

For Official Use Only: Learner number: 1	
You will not be graded on your answers to this survey. This work sheet is for the EduVentures staff to gauge how much you learned about renewable energy from the modules. If you are not sure about the answer to a question, you can guess or simply leave the box blank.	
1.	How can you help battle the effects of climate change? No answer
2.	How do encroacher bushes affect the environment? Creative job; no crops
3.	What is wind energy? Is when the wind is blowing a turbines their prodict energy
4.	What is solar energy? is when the solar panel are getting through the sunlight
5.	Why are wind turbines best for coastal regions? In walvis bay and luderitz
6.	What is encroachment bush? Is when the bus occiup the environment
7.	Why is renewable energy important to Namibia? Creative jobs; clean environment
8.	Why is solar energy good to use in villages? Because mostly in the villages they are not electricity so that there need solary energy to help them form lighting house
9.	What is renewable energy? It is something that never not stop it just climate climate change

For Official Use Only: Learner number: 2	
You will not be graded on your answers to this survey. This work sheet is for the EduVentures staff to gauge how much you learned about renewable energy from the modules. If you are not sure about the answer to a question, you can guess or simply leave the box blank.	
1.	How can you help battle the effects of climate change? The thank in the world star to change
2.	How do encroacher bushes affect the environment? Be cut down bushes
3.	What is wind energy? It is something that give us energy to do something
4.	What is solar energy? It is the energy that we get from the sun
5.	Why are wind turbines best for coastal regions? Because it create job of people; it is to expires
6.	What is encroachment bush? No answer
7.	Why is renewable energy important to Namibia? Because they can not speed lot of money to buy electricity from south africa
8.	Why is solar energy good to use in villages? To pam water; to cook with it; to change phone
9.	What is renewable energy? It is the energy that can be used

For Official Use Only: Learner number: 3	
You will not be graded on your answers to this survey. This work sheet is for the EduVentures staff to gauge how much you learned about renewable energy from the modules. If you are not sure about the answer to a question, you can guess or simply leave the box blank.	
1.	How can you help battle the effects of climate change? Heving a chaozi of matera mbero or caods
2.	How do encroacher bushes affect the environment? In the location was leca apepa or sorowing in kating
3.	What is wind energy? Plan was energy was a tee wala anigsa you
4.	What is solar energy? Energy was change climate apel and banana
5.	Why are wind turbines best for coastal regions? The wiblo nasa number of the sollidy
6.	What is encroachment bush? Encroachmen bush is the change of cata
7.	Why is renewable energy important to Namibia? Be renewable energy ipoortortant twar
8.	Why is solar energy good to use in villages? Change environment turbines coastel of matel
9.	What is renewable energy? The ca mairatte was hout withes

For Official Use Only: Learner number: 4	
You will not be graded on your answers to this survey. This work sheet is for the EduVentures staff to gauge how much you learned about renewable energy from the modules. If you are not sure about the answer to a question, you can guess or simply leave the box blank.	
1.	How can you help battle the effects of climate change? No answer
2.	How do encroacher bushes affect the environment? The make the environment diety
3.	What is wind energy? Is the energy that we get from wind when it blows
4.	What is solar energy? Is the energy that we get from the sun
5.	Why are wind turbines best for coastal regions? Because it help them to pumb water and they are very tall
6.	What is encroachment bush? Is bush that are grow together and there is no space
7.	Why is renewable energy important to Namibia? It is important because we are not senting money to buy electricy from other country
8.	Why is solar energy good to use in villages? It helps us with light and cooking
9.	What is renewable energy? Is energy that we can use it again and again

For Official Use Only: Learner number: 5	
You will not be graded on your answers to this survey. This work sheet is for the EduVentures staff to gauge how much you learned about renewable energy from the modules. If you are not sure about the answer to a question, you can guess or simply leave the box blank.	
1.	How can you help battle the effects of climate change? Not making air pollution
2.	How do encroacher bushes affect the environment? Climate change
3.	What is wind energy? Is the energy that we get from the wind
4.	What is solar energy? Is the energy that we get from the sun
5.	Why are wind turbines best for coastal regions? Because the coastal area has more wind
6.	What is encroachment bush? Is a place where enough space for planting
7.	Why is renewable energy important to Namibia? So that the government cannot by electricity from other country
8.	Why is solar energy good to use in villages? Is generated the more electricity to peoples
9.	What is renewable energy? Is the energy that can be replace

For Official Use Only: Learner number: 6	
You will not be graded on your answers to this survey. This work sheet is for the EduVentures staff to gauge how much you learned about renewable energy from the modules. If you are not sure about the answer to a question, you can guess or simply leave the box blank.	
1.	How can you help battle the effects of climate change? By air pollution; patrol and oil
2.	How do encroacher bushes affect the environment? By patrol; by oil
3.	What is wind energy? Is the energy that we get from the sun
4.	What is solar energy? Is the energy that can be replace again and again
5.	Why are wind turbines best for coastal regions? Because they get more wind to work wall
6.	What is encroachment bush? Is the bush that can be use to do Bush-to-Energy
7.	Why is renewable energy important to Namibia? Because we cannot use alot of money to go and paid elect to south African
8.	Why is solar energy good to use in villages? It we can use solar energy for cooking and anther
9.	What is renewable energy? Is the energy that can be replace again and again

For Official Use Only: Learner number: 7
You will not be graded on your answers to this survey. This work sheet is for the EduVentures staff to gauge how much you learned about renewable energy from the modules. If you are not sure about the answer to a question, you can guess or simply leave the box blank.
1. How can you help battle the effects of climate change?
2. How do encroacher bushes affect the environment?
3. What is wind energy?
4. What is solar energy?
5. Why are wind turbines best for coastal regions?
6. What is encroachment bush?
7. Why is renewable energy important to Namibia?
8. Why is solar energy good to use in villages?
9. What is renewable energy?

For Official Use Only: Learner number: 8
You will not be graded on your answers to this survey. This work sheet is for the EduVentures staff to gauge how much you learned about renewable energy from the modules. If you are not sure about the answer to a question, you can guess or simply leave the box blank.
1. How can you help battle the effects of climate change? No answer
2. How do encroacher bushes affect the environment? With their thorne and too more they are
3. What is wind energy? Is the energy that we get from the sun
4. What is solar energy? Is the energy that we get from the sun
5. Why are wind turbines best for coastal regions? Because there is most wind in the coastal regions
6. What is encroachment bush? No answer
7. Why is renewable energy important to Namibia? Because in some villages there is no electricity ans so that we can not waste our government money
8. Why is solar energy good to use in villages? Because in some vilages the rain is not rainy there just sun rasy
9. What is renewable energy? Is the energy that renew again for example sun energy and wind energy

For Official Use Only: Learner number: 9	
You will not be graded on your answers to this survey. This work sheet is for the EduVentures staff to gauge how much you learned about renewable energy from the modules. If you are not sure about the answer to a question, you can guess or simply leave the box blank.	
1.	How can you help battle the effects of climate change? By not lighting the light that is not be light on that time
2.	How do encroacher bushes affect the environment? By not cutting all bushes
3.	What is wind energy? Is the energy from the wind
4.	What is solar energy? Is the energy from the sun
5.	Why are wind turbines best for coastal regions? Is to control a turbines wind to move in the air
6.	What is encroachment bush? Is energy that is Bush-to-Energy
7.	Why is renewable energy important to Namibia? Because you can breathe through the renewed energy
8.	Why is solar energy good to use in villages? For watching movies
9.	What is renewable energy? Is energy that is make again and again

For Official Use Only: Learner number: 10	
You will not be graded on your answers to this survey. This work sheet is for the EduVentures staff to gauge how much you learned about renewable energy from the modules. If you are not sure about the answer to a question, you can guess or simply leave the box blank.	
1.	How can you help battle the effects of climate change? Take them away; and let the air get green
2.	How do encroacher bushes affect the environment? They have big roots, so the other trees wont have space
3.	What is wind energy? is the energy that we get from wind turbines act
4.	What is solar energy? Is the energy that we get from the sun
5.	Why are wind turbines best for coastal regions? Because there is a lot of wind and it can produce electricity faster as the wind is blowing or turning the turbines
6.	What is encroachment bush? Are bush that grow together at many places where there is no other trees because their roots are big
7.	Why is renewable energy important to Namibia? It creates jobs; reduces poverty; produce electricity to many places
8.	Why is solar energy good to use in villages? Because people cook with it if they rain is raining; because people we can wach tv and change cellphones and more
9.	What is renewable energy? Is the energy that can be used again and again

For Official Use Only: Learner number: 11	
You will not be graded on your answers to this survey. This work sheet is for the EduVentures staff to gauge how much you learned about renewable energy from the modules. If you are not sure about the answer to a question, you can guess or simply leave the box blank.	
1.	How can you help battle the effects of climate change? To clean up environment
2.	How do encroacher bushes affect the environment? Creates jobs
3.	What is wind energy? Is the thing come from soil
4.	What is solar energy? No answer
5.	Why are wind turbines best for coastal regions? Luderitz
6.	What is encroachment bush? Is the thing like tree
7.	Why is renewable energy important to Namibia? Because they can turn
8.	Why is solar energy good to use in villages? Because we don't have electricity at villages
9.	What is renewable energy? No answer

For Official Use Only: Learner number: 12	
You will not be graded on your answers to this survey. This work sheet is for the EduVentures staff to gauge how much you learned about renewable energy from the modules. If you are not sure about the answer to a question, you can guess or simply leave the box blank.	
1.	How can you help battle the effects of climate change? I will tell my parent to help the environment
2.	How do encroacher bushes affect the environment? It affect with drouth
3.	What is wind energy? Is electricity that we get from the wind when the wind blow and turn the wind and produce electricity
4.	What is solar energy? Is the energy that we get from the panel when the sun heat the solar it produce electricity
5.	Why are wind turbines best for coastal regions? Because there is a good space and it produce electricity
6.	What is encroachment bush? Are trees that are in the same place where you can not work between it
7.	Why is renewable energy important to Namibia? Because it bring or produce jobs in our country
8.	Why is solar energy good to use in villages? Because it will help you to charge you phone and be used it for light
9.	What is renewable energy? Is the energy that you can used again

For Official Use Only: Learner number: 13	
You will not be graded on your answers to this survey. This work sheet is for the EduVentures staff to gauge how much you learned about renewable energy from the modules. If you are not sure about the answer to a question, you can guess or simply leave the box blank.	
1.	How can you help battle the effects of climate change? No answer
2.	How do encroacher bushes affect the environment? Government speed more money
3.	What is wind energy? Is the energy that use for turbines and the turbines produce electricity
4.	What is solar energy? Is the energy that we get from the sun
5.	Why are wind turbines best for coastal regions? Because the coastal region are have more wind
6.	What is encroachment bush? No answer
7.	Why is renewable energy important to Namibia? No answer
8.	Why is solar energy good to use in villages? Because in villages we are not have electricity that's why are use solar energy
9.	What is renewable energy? Is the energy that you can use again

For Official Use Only: Learner number: 14	
You will not be graded on your answers to this survey. This work sheet is for the EduVentures staff to gauge how much you learned about renewable energy from the modules. If you are not sure about the answer to a question, you can guess or simply leave the box blank.	
1.	How can you help battle the effects of climate change? No answer
2.	How do encroacher bushes affect the environment? Is when you calt down tree
3.	What is wind energy? Wind is when you yours to the atmosphere
4.	What is solar energy? Is the solar that you can make to the sun
5.	Why are wind turbines best for coastal regions? It is when you make for the sun
6.	What is encroachment bush? Is when you calt all tree the will never get the energy
7.	Why is renewable energy important to Namibia? No answer
8.	Why is solar energy good to use in villages? To cook the food; to see the television
9.	What is renewable energy? Is the energy that light the solar

For Official Use Only: Learner number: 15	
You will not be graded on your answers to this survey. This work sheet is for the EduVentures staff to gauge how much you learned about renewable energy from the modules. If you are not sure about the answer to a question, you can guess or simply leave the box blank.	
1.	How can you help battle the effects of climate change? No answer
2.	How do encroacher bushes affect the environment? The encroacher bushes affect the environment over 55%
3.	What is wind energy? Is energy that are renewable
4.	What is solar energy? Is the energy that we get from the sun and heats the solar panels
5.	Why are wind turbines best for coastal regions? Because they does not have a sun and it is the most windy energy
6.	What is encroachment bush? Are the group of indigenous bush in our country
7.	Why is renewable energy important to Namibia? Because you can use it when there is no electricity
8.	Why is solar energy good to use in villages? Because mostly in many villages there is no electricity
9.	What is renewable energy? Is energy that can be used again and again

For Official Use Only: Learner number: 16	
You will not be graded on your answers to this survey. This work sheet is for the EduVentures staff to gauge how much you learned about renewable energy from the modules. If you are not sure about the answer to a question, you can guess or simply leave the box blank.	
1.	How can you help battle the effects of climate change? By not polluting the air we must keep the air clean
2.	How do encroacher bushes affect the environment? It affect the wild animal because the is no grass
3.	What is wind energy? Is the energy that we get from wind and heat the turbines produce electric current
4.	What is solar energy? Is the energy that we get from the sun
5.	Why are wind turbines best for coastal regions? Because at the coastal is very windy
6.	What is encroachment bush? Is the place where the is a lot of bush that they grow in a large place
7.	Why is renewable energy important to Namibia? So that they can not buy electricity from south Africa
8.	Why is solar energy good to use in villages? So that they can use it for lighting and tv and radio
9.	What is renewable energy? Is the energy that we can use it again and again after using it

For Official Use Only: Learner number: 17	
You will not be graded on your answers to this survey. This work sheet is for the EduVentures staff to gauge how much you learned about renewable energy from the modules. If you are not sure about the answer to a question, you can guess or simply leave the box blank.	
1.	How can you help battle the effects of climate change? Do not leaf the lights on for a hole night
2.	How do encroacher bushes affect the environment? It course less of water under the ground for other plant use for the to stay alive
3.	What is wind energy? Is the energy we got from the wind turbines when it turned by wind
4.	What is solar energy? Is the energy we get from solar panels when they heated by the sun
5.	Why are wind turbines best for coastal regions? Because at coastal is very too much windy
6.	What is encroachment bush? They are bush that occupy a lot of space
7.	Why is renewable energy important to Namibia? They have no green gases and they are very cheap
8.	Why is solar energy good to use in villages? Course it provide electricity
9.	What is renewable energy? Is energies that can be used over and over

For Official Use Only: Learner number: 18	
You will not be graded on your answers to this survey. This work sheet is for the EduVentures staff to gauge how much you learned about renewable energy from the modules. If you are not sure about the answer to a question, you can guess or simply leave the box blank.	
1.	How can you help battle the effects of climate change? We must stop using fossil fuel will damage the ozone layer then we died and no food
2.	How do encroacher bushes affect the environment? If you cutting trees you will effect the wildlife
3.	What is wind energy? Is the wind that blows in the turbine produces in the gear box
4.	What is solar energy? Is the energy that we get on the sun then produces electricity in the batter
5.	Why are wind turbines best for coastal regions? Because is to windy the electricity will more in the town
6.	What is encroachment bush? Is when you are cutting down; no water then is drought
7.	Why is renewable energy important to Namibia? Because will spent a lot of money; create job
8.	Why is solar energy good to use in villages? Will produces electricity to more house using it to like tv, radio, change cellphone
9.	What is renewable energy? Is the energy that can be use again and again

For Official Use Only: Learner number: 19	
You will not be graded on your answers to this survey. This work sheet is for the EduVentures staff to gauge how much you learned about renewable energy from the modules. If you are not sure about the answer to a question, you can guess or simply leave the box blank.	
1.	How can you help battle the effects of climate change? We must use renewable; we must stop burning fossil fuels; we must use transport that does not pollute the air
2.	How do encroacher bushes affect the environment? It cause soil erosion; it cause the grass not to grow
3.	What is wind energy? Is the type of energy that we get from the wind then its blowing and it turns the turbine and the gear box and generate electricity
4.	What is solar energy? Is the energy that we get from the UV of the sun
5.	Why are wind turbines best for coastal regions? Because there is windy that side and it will work well
6.	What is encroachment bush? Is when bush occupied in a large space
7.	Why is renewable energy important to Namibia? Because the Namibian government will save a lot of money because it not buying electricity to south Africa because Namibia want to have a clean invironment
8.	Why is solar energy good to use in villages? Because may be a problem that south Africa want to cut off the electricity
9.	What is renewable energy? Are energy there ones you used up they can be renewed

Appendix UU: Program Evaluation

Please circle a number based on your opinions of the program.

1= strongly disagree, 2 = disagree, 4 = agree, 5 = strongly agree.

1. The information throughout the entire program was easy to understand
Strongly Disagree 1 2 4 5 Strongly Agree
2. I think the games and activities in the lessons were fun
Strongly Disagree 1 2 4 5 Strongly Agree
3. The lessons were more fun than my classes at school
Strongly Disagree 1 2 4 5 Strongly Agree
4. I would want to participate in another EduVentures program
Strongly Disagree 1 2 4 5 Strongly Agree
5. I feel like I know much more about renewable energy now than before I started this program
Strongly Disagree 1 2 4 5 Strongly Agree
6. If my school started an environmental club, I would join it.
Strongly Disagree 1 2 4 5 Strongly Agree
7. I plan to learn more about renewable energy after the end of this program
Strongly Disagree 1 2 4 5 Strongly Agree
8. What I learned in the program will change the way I think about energy generation
Strongly Disagree 1 2 4 5 Strongly Agree

Please put a check mark next to the lesson that you liked the most and the least.

9. What was the most interesting topic to learn about?
 Introduction to Renewable Energy
 Wind Energy
 Solar Energy
 Bush-to-Energy
10. What was the least interesting topic to learn about?
 Introduction to Renewable Energy
 Wind Energy
 Solar Energy
 Bush-to-Energy

Additional Comments:

Appendix VV: Program Evaluation: Responses

The numbers in red and the Xs are the answers that the learners selected for the learner evaluations. There were 20 program evaluations collected.

Please circle a number based on your opinions of the program.

1= strongly disagree, 2 = disagree, 4 = agree, 5 = strongly agree.

1. The information throughout the entire program was easy to understand
Strongly Disagree 1 2 4 5 Strongly Agree
2. I think the games and activities in the lessons were fun
Strongly Disagree 1 2 4 5 Strongly Agree
3. The lessons were more fun than my classes at school
Strongly Disagree 1 2 4 5 Strongly Agree
4. I would want to participate in another EduVentures program
Strongly Disagree 1 2 4 5 Strongly Agree
5. I feel like I know much more about renewable energy now than before I started this program
Strongly Disagree 1 2 4 5 Strongly Agree
6. If my school started an environmental club, I would join it.
Strongly Disagree 1 2 4 5 Strongly Agree
7. I plan to learn more about renewable energy after the end of this program
Strongly Disagree 1 2 4 5 Strongly Agree
8. What I learned in the program will change the way I think about energy generation
Strongly Disagree 1 2 4 5 Strongly Agree

Please put a check mark next to the lesson that you liked the most and the least.

9. What was the most interesting topic to learn about?
 Introduction to Renewable Energy
 Wind Energy
 Solar Energy
 Bush-to-Energy
10. What was the least interesting topic to learn about?
 Introduction to Renewable Energy
 Wind Energy
 Solar Energy
 Bush-to-Energy

Additional Comments:

I have learned more about renewable energy resources and how to save the environment.

Please circle a number based on your opinions of the program.

1= strongly disagree, 2 = disagree, 4 = agree, 5 = strongly agree.

1. The information throughout the entire program was easy to understand
Strongly Disagree 1 2 4 5 Strongly Agree
2. I think the games and activities in the lessons were fun
Strongly Disagree 1 2 4 5 Strongly Agree
3. The lessons were more fun than my classes at school
Strongly Disagree 1 2 4 5 Strongly Agree
4. I would want to participate in another EduVentures program
Strongly Disagree 1 2 4 5 Strongly Agree
5. I feel like I know much more about renewable energy now than before I started this program
Strongly Disagree 1 2 4 5 Strongly Agree
6. If my school started an environmental club, I would join it.
Strongly Disagree 1 2 4 5 Strongly Agree
7. I plan to learn more about renewable energy after the end of this program
Strongly Disagree 1 2 4 5 Strongly Agree
8. What I learned in the program will change the way I think about energy generation
Strongly Disagree 1 2 4 5 Strongly Agree

Please put a check mark next to the lesson that you liked the most and the least.

9. What was the most interesting topic to learn about?
 Introduction to Renewable Energy
 Wind Energy
 Solar Energy
 Bush-to-Energy
10. What was the least interesting topic to learn about?
 Introduction to Renewable Energy
 Wind Energy
 Solar Energy
 Bush-to-Energy

Additional Comments:

Please circle a number based on your opinions of the program.

1= strongly disagree, 2 = disagree, 4 = agree, 5 = strongly agree.

1. The information throughout the entire program was easy to understand
Strongly Disagree 1 2 4 5 Strongly Agree
2. I think the games and activities in the lessons were fun
Strongly Disagree 1 2 4 5 Strongly Agree
3. The lessons were more fun than my classes at school
Strongly Disagree 1 2 4 5 Strongly Agree
4. I would want to participate in another EduVentures program
Strongly Disagree 1 2 4 5 Strongly Agree
5. I feel like I know much more about renewable energy now than before I started this program
Strongly Disagree 1 2 4 5 Strongly Agree
6. If my school started an environmental club, I would join it.
Strongly Disagree 1 2 4 5 Strongly Agree
7. I plan to learn more about renewable energy after the end of this program
Strongly Disagree 1 2 4 5 Strongly Agree
8. What I learned in the program will change the way I think about energy generation
Strongly Disagree 1 2 4 5 Strongly Agree

Please put a check mark next to the lesson that you liked the most and the least.

9. What was the most interesting topic to learn about?
 Introduction to Renewable Energy
 Wind Energy
 Solar Energy
 Bush-to-Energy
10. What was the least interesting topic to learn about?
 Introduction to Renewable Energy
 Wind Energy
 Solar Energy
 Bush-to-Energy

Additional Comments:

Please circle a number based on your opinions of the program.

1= strongly disagree, 2 = disagree, 4 = agree, 5 = strongly agree.

1. The information throughout the entire program was easy to understand
Strongly Disagree 1 2 4 5 Strongly Agree
2. I think the games and activities in the lessons were fun
Strongly Disagree 1 2 4 5 Strongly Agree
3. The lessons were more fun than my classes at school
Strongly Disagree 1 2 4 5 Strongly Agree
4. I would want to participate in another EduVentures program
Strongly Disagree 1 2 4 5 Strongly Agree
5. I feel like I know much more about renewable energy now than before I started this program
Strongly Disagree 1 2 4 5 Strongly Agree
6. If my school started an environmental club, I would join it.
Strongly Disagree 1 2 4 5 Strongly Agree
7. I plan to learn more about renewable energy after the end of this program
Strongly Disagree 1 2 4 5 Strongly Agree
8. What I learned in the program will change the way I think about energy generation
Strongly Disagree 1 2 4 5 Strongly Agree

Please put a check mark next to the lesson that you liked the most and the least.

9. What was the most interesting topic to learn about?
 Introduction to Renewable Energy
 Wind Energy
 Solar Energy
 Bush-to-Energy
10. What was the least interesting topic to learn about?
 Introduction to Renewable Energy
 Wind Energy
 Solar Energy
 Bush-to-Energy

Additional Comments:

Please circle a number based on your opinions of the program.

1= strongly disagree, 2 = disagree, 4 = agree, 5 = strongly agree.

1. The information throughout the entire program was easy to understand
Strongly Disagree 1 2 4 5 Strongly Agree
2. I think the games and activities in the lessons were fun
Strongly Disagree 1 2 4 5 Strongly Agree
3. The lessons were more fun than my classes at school
Strongly Disagree 1 2 4 5 Strongly Agree
4. I would want to participate in another EduVentures program
Strongly Disagree 1 2 4 5 Strongly Agree
5. I feel like I know much more about renewable energy now than before I started this program
Strongly Disagree 1 2 4 5 Strongly Agree
6. If my school started an environmental club, I would join it.
Strongly Disagree 1 2 4 5 Strongly Agree
7. I plan to learn more about renewable energy after the end of this program
Strongly Disagree 1 2 4 5 Strongly Agree
8. What I learned in the program will change the way I think about energy generation
Strongly Disagree 1 2 4 5 Strongly Agree

Please put a check mark next to the lesson that you liked the most and the least.

9. What was the most interesting topic to learn about?
 Introduction to Renewable Energy
 Wind Energy
 Solar Energy
 Bush-to-Energy
10. What was the least interesting topic to learn about?
 Introduction to Renewable Energy
 Wind Energy
 Solar Energy
 Bush-to-Energy

Additional Comments:

I like it so much and have more fun, learn to it.

Please circle a number based on your opinions of the program.

1= strongly disagree, 2 = disagree, 4 = agree, 5 = strongly agree.

1. The information throughout the entire program was easy to understand
Strongly Disagree 1 2 4 5 Strongly Agree
2. I think the games and activities in the lessons were fun
Strongly Disagree 1 2 4 5 Strongly Agree
3. The lessons were more fun than my classes at school
Strongly Disagree 1 2 4 5 Strongly Agree
4. I would want to participate in another EduVentures program
Strongly Disagree 1 2 4 5 Strongly Agree
5. I feel like I know much more about renewable energy now than before I started this program
Strongly Disagree 1 2 4 5 Strongly Agree
6. If my school started an environmental club, I would join it.
Strongly Disagree 1 2 4 5 Strongly Agree
7. I plan to learn more about renewable energy after the end of this program
Strongly Disagree 1 2 4 5 Strongly Agree
8. What I learned in the program will change the way I think about energy generation
Strongly Disagree 1 2 4 5 Strongly Agree

Please put a check mark next to the lesson that you liked the most and the least.

9. What was the most interesting topic to learn about?
 Introduction to Renewable Energy
 Wind Energy
 Solar Energy
 Bush-to-Energy
10. What was the least interesting topic to learn about?
 Introduction to Renewable Energy
 Wind Energy
 Solar Energy
 Bush-to-Energy

Additional Comments:

I will like to say thanks to everyone who teach us about their program and advice other learners that. Please guys let's do best for our best teachers that we are having. THE PROGRAM IS VERY INTERESTING!

Please circle a number based on your opinions of the program.

1= strongly disagree, 2 = disagree, 4 = agree, 5 = strongly agree.

1. The information throughout the entire program was easy to understand
Strongly Disagree 1 2 4 5 Strongly Agree
2. I think the games and activities in the lessons were fun
Strongly Disagree 1 2 4 5 Strongly Agree
3. The lessons were more fun than my classes at school
Strongly Disagree 1 2 4 5 Strongly Agree
4. I would want to participate in another EduVentures program
Strongly Disagree 1 2 4 5 Strongly Agree
5. I feel like I know much more about renewable energy now than before I started this program
Strongly Disagree 1 2 4 5 Strongly Agree
6. If my school started an environmental club, I would join it.
Strongly Disagree 1 2 4 5 Strongly Agree
7. I plan to learn more about renewable energy after the end of this program
Strongly Disagree 1 2 4 5 Strongly Agree
8. What I learned in the program will change the way I think about energy generation
Strongly Disagree 1 2 4 5 Strongly Agree

Please put a check mark next to the lesson that you liked the most and the least.

9. What was the most interesting topic to learn about?
 Introduction to Renewable Energy
 Wind Energy
 Solar Energy
 Bush-to-Energy
10. What was the least interesting topic to learn about?
 Introduction to Renewable Energy
 Wind Energy
 Solar Energy
 Bush-to-Energy

Additional Comments:

I really liked this program, enjoyed it very much and I will love to be teached more about energy

Please circle a number based on your opinions of the program.

1= strongly disagree, 2 = disagree, 4 = agree, 5 = strongly agree.

1. The information throughout the entire program was easy to understand
Strongly Disagree 1 2 4 5 Strongly Agree
2. I think the games and activities in the lessons were fun
Strongly Disagree 1 2 4 5 Strongly Agree
3. The lessons were more fun than my classes at school
Strongly Disagree 1 2 4 5 Strongly Agree
4. I would want to participate in another EduVentures program
Strongly Disagree 1 2 4 5 Strongly Agree
5. I feel like I know much more about renewable energy now than before I started this program
Strongly Disagree 1 2 4 5 Strongly Agree
6. If my school started an environmental club, I would join it.
Strongly Disagree 1 2 4 5 Strongly Agree
7. I plan to learn more about renewable energy after the end of this program
Strongly Disagree 1 2 4 5 Strongly Agree
8. What I learned in the program will change the way I think about energy generation
Strongly Disagree 1 2 4 5 Strongly Agree

Please put a check mark next to the lesson that you liked the most and the least.

9. What was the most interesting topic to learn about?
 Introduction to Renewable Energy
 Wind Energy
 Solar Energy
 Bush-to-Energy
10. What was the least interesting topic to learn about?
 Introduction to Renewable Energy
 Wind Energy
 Solar Energy
 Bush-to-Energy

Additional Comments:

Please circle a number based on your opinions of the program.

1= strongly disagree, 2 = disagree, 4 = agree, 5 = strongly agree.

1. The information throughout the entire program was easy to understand
Strongly Disagree 1 2 4 5 Strongly Agree
2. I think the games and activities in the lessons were fun
Strongly Disagree 1 2 4 5 Strongly Agree
3. The lessons were more fun than my classes at school
Strongly Disagree 1 2 4 5 Strongly Agree
4. I would want to participate in another EduVentures program
Strongly Disagree 1 2 4 5 Strongly Agree
5. I feel like I know much more about renewable energy now than before I started this program
Strongly Disagree 1 2 4 5 Strongly Agree
6. If my school started an environmental club, I would join it.
Strongly Disagree 1 2 4 5 Strongly Agree
7. I plan to learn more about renewable energy after the end of this program
Strongly Disagree 1 2 4 5 Strongly Agree
8. What I learned in the program will change the way I think about energy generation
Strongly Disagree 1 2 4 5 Strongly Agree

Please put a check mark next to the lesson that you liked the most and the least.

9. What was the most interesting topic to learn about?
 Introduction to Renewable Energy
 Wind Energy
 Solar Energy
 Bush-to-Energy
10. What was the least interesting topic to learn about?
 Introduction to Renewable Energy
 Wind Energy
 Solar Energy
 Bush-to-Energy

Additional Comments:

Please circle a number based on your opinions of the program.

1= strongly disagree, 2 = disagree, 4 = agree, 5 = strongly agree.

1. The information throughout the entire program was easy to understand
Strongly Disagree 1 2 4 5 Strongly Agree
2. I think the games and activities in the lessons were fun
Strongly Disagree 1 2 4 5 Strongly Agree
3. The lessons were more fun than my classes at school
Strongly Disagree 1 2 4 5 Strongly Agree
4. I would want to participate in another EduVentures program
Strongly Disagree 1 2 4 5 Strongly Agree
5. I feel like I know much more about renewable energy now than before I started this program
Strongly Disagree 1 2 4 5 Strongly Agree
6. If my school started an environmental club, I would join it.
Strongly Disagree 1 2 4 5 Strongly Agree
7. I plan to learn more about renewable energy after the end of this program
Strongly Disagree 1 2 4 5 Strongly Agree
8. What I learned in the program will change the way I think about energy generation
Strongly Disagree 1 2 4 5 Strongly Agree

Please put a check mark next to the lesson that you liked the most and the least.

9. What was the most interesting topic to learn about?
 Introduction to Renewable Energy
 Wind Energy
 Solar Energy
 Bush-to-Energy
10. What was the least interesting topic to learn about?
 Introduction to Renewable Energy
 Wind Energy
 Solar Energy
 Bush-to-Energy

Additional Comments:

The class was good because we were having fun with white people. The class or cl program was good and fun.

Please circle a number based on your opinions of the program.

1= strongly disagree, 2 = disagree, 4 = agree, 5 = strongly agree.

1. The information throughout the entire program was easy to understand
Strongly Disagree 1 2 4 5 Strongly Agree
2. I think the games and activities in the lessons were fun
Strongly Disagree 1 2 4 5 Strongly Agree
3. The lessons were more fun than my classes at school
Strongly Disagree 1 2 4 5 Strongly Agree
4. I would want to participate in another EduVentures program
Strongly Disagree 1 2 4 5 Strongly Agree
5. I feel like I know much more about renewable energy now than before I started this program
Strongly Disagree 1 2 4 5 Strongly Agree
6. If my school started an environmental club, I would join it.
Strongly Disagree 1 2 4 5 Strongly Agree
7. I plan to learn more about renewable energy after the end of this program
Strongly Disagree 1 2 4 5 Strongly Agree
8. What I learned in the program will change the way I think about energy generation
Strongly Disagree 1 2 4 5 Strongly Agree

Please put a check mark next to the lesson that you liked the most and the least.

9. What was the most interesting topic to learn about?
 Introduction to Renewable Energy
 Wind Energy
 Solar Energy
 Bush-to-Energy
10. What was the least interesting topic to learn about?
 Introduction to Renewable Energy
 Wind Energy
 Solar Energy
 Bush-to-Energy

Additional Comments:

I said renewable energies to me is least because I herd it before bu I never herd about Bush-to-Energy

Please circle a number based on your opinions of the program.

1= strongly disagree, 2 = disagree, 4 = agree, 5 = strongly agree.

1. The information throughout the entire program was easy to understand
Strongly Disagree 1 2 4 5 Strongly Agree
2. I think the games and activities in the lessons were fun
Strongly Disagree 1 2 4 5 Strongly Agree
3. The lessons were more fun than my classes at school
Strongly Disagree 1 2 4 5 Strongly Agree
4. I would want to participate in another EduVentures program
Strongly Disagree 1 2 4 5 Strongly Agree
5. I feel like I know much more about renewable energy now than before I started this program
Strongly Disagree 1 2 4 5 Strongly Agree
6. If my school started an environmental club, I would join it.
Strongly Disagree 1 2 4 5 Strongly Agree
7. I plan to learn more about renewable energy after the end of this program
Strongly Disagree 1 2 4 5 Strongly Agree
8. What I learned in the program will change the way I think about energy generation
Strongly Disagree 1 2 4 5 Strongly Agree

Please put a check mark next to the lesson that you liked the most and the least.

9. What was the most interesting topic to learn about?
 Introduction to Renewable Energy
 Wind Energy
 Solar Energy
 Bush-to-Energy
10. What was the least interesting topic to learn about?
 Introduction to Renewable Energy
 Wind Energy
 Solar Energy
 Bush-to-Energy

Additional Comments:

Please circle a number based on your opinions of the program.

1= strongly disagree, 2 = disagree, 4 = agree, 5 = strongly agree.

1. The information throughout the entire program was easy to understand
Strongly Disagree 1 2 4 5 Strongly Agree
2. I think the games and activities in the lessons were fun
Strongly Disagree 1 2 4 5 Strongly Agree
3. The lessons were more fun than my classes at school
Strongly Disagree 1 2 4 5 Strongly Agree
4. I would want to participate in another EduVentures program
Strongly Disagree 1 2 4 5 Strongly Agree
5. I feel like I know much more about renewable energy now than before I started this program
Strongly Disagree 1 2 4 5 Strongly Agree
6. If my school started an environmental club, I would join it.
Strongly Disagree 1 2 4 5 Strongly Agree
7. I plan to learn more about renewable energy after the end of this program
Strongly Disagree 1 2 4 5 Strongly Agree
8. What I learned in the program will change the way I think about energy generation
Strongly Disagree 1 2 4 5 Strongly Agree

Please put a check mark next to the lesson that you liked the most and the least.

9. What was the most interesting topic to learn about?
 Introduction to Renewable Energy
 Wind Energy
 Solar Energy
 Bush-to-Energy
10. What was the least interesting topic to learn about?
 Introduction to Renewable Energy
 Wind Energy
 Solar Energy
 Bush-to-Energy

Additional Comments:

I will like this group to come again I will participate in the group

Please circle a number based on your opinions of the program.

1= strongly disagree, 2 = disagree, 4 = agree, 5 = strongly agree.

1. The information throughout the entire program was easy to understand
Strongly Disagree 1 2 4 5 Strongly Agree
2. I think the games and activities in the lessons were fun
Strongly Disagree 1 2 4 5 Strongly Agree
3. The lessons were more fun than my classes at school
Strongly Disagree 1 2 4 5 Strongly Agree
4. I would want to participate in another EduVentures program
Strongly Disagree 1 2 4 5 Strongly Agree
5. I feel like I know much more about renewable energy now than before I started this program
Strongly Disagree 1 2 4 5 Strongly Agree
6. If my school started an environmental club, I would join it.
Strongly Disagree 1 2 4 5 Strongly Agree
7. I plan to learn more about renewable energy after the end of this program
Strongly Disagree 1 2 4 5 Strongly Agree
8. What I learned in the program will change the way I think about energy generation
Strongly Disagree 1 2 4 5 Strongly Agree

Please put a check mark next to the lesson that you liked the most and the least.

9. What was the most interesting topic to learn about?
 Introduction to Renewable Energy
 Wind Energy
 Solar Energy
 Bush-to-Energy
10. What was the least interesting topic to learn about?
 Introduction to Renewable Energy
 Wind Energy
 Solar Energy
 Bush-to-Energy

Additional Comments:

Please circle a number based on your opinions of the program.

1= strongly disagree, 2 = disagree, 4 = agree, 5 = strongly agree.

1. The information throughout the entire program was easy to understand
Strongly Disagree 1 2 4 5 Strongly Agree
2. I think the games and activities in the lessons were fun
Strongly Disagree 1 2 4 5 Strongly Agree
3. The lessons were more fun than my classes at school
Strongly Disagree 1 2 4 5 Strongly Agree
4. I would want to participate in another EduVentures program
Strongly Disagree 1 2 4 5 Strongly Agree
5. I feel like I know much more about renewable energy now than before I started this program
Strongly Disagree 1 2 4 5 Strongly Agree
6. If my school started an environmental club, I would join it.
Strongly Disagree 1 2 4 5 Strongly Agree
7. I plan to learn more about renewable energy after the end of this program
Strongly Disagree 1 2 4 5 Strongly Agree
8. What I learned in the program will change the way I think about energy generation
Strongly Disagree 1 2 4 5 Strongly Agree

Please put a check mark next to the lesson that you liked the most and the least.

9. What was the most interesting topic to learn about?
 Introduction to Renewable Energy
 Wind Energy
 Solar Energy
 Bush-to-Energy
10. What was the least interesting topic to learn about?
 Introduction to Renewable Energy
 Wind Energy
 Solar Energy
 Bush-to-Energy

Additional Comments:

Please circle a number based on your opinions of the program.

1= strongly disagree, 2 = disagree, 4 = agree, 5 = strongly agree.

1. The information throughout the entire program was easy to understand
Strongly Disagree 1 2 4 5 Strongly Agree
2. I think the games and activities in the lessons were fun
Strongly Disagree 1 2 4 5 Strongly Agree
3. The lessons were more fun than my classes at school
Strongly Disagree 1 2 4 5 Strongly Agree
4. I would want to participate in another EduVentures program
Strongly Disagree 1 2 4 5 Strongly Agree
5. I feel like I know much more about renewable energy now than before I started this program
Strongly Disagree 1 2 4 5 Strongly Agree
6. If my school started an environmental club, I would join it.
Strongly Disagree 1 2 4 5 Strongly Agree
7. I plan to learn more about renewable energy after the end of this program
Strongly Disagree 1 2 4 5 Strongly Agree
8. What I learned in the program will change the way I think about energy generation
Strongly Disagree 1 2 4 5 Strongly Agree

Please put a check mark next to the lesson that you liked the most and the least.

9. What was the most interesting topic to learn about?
 Introduction to Renewable Energy
 Wind Energy
 Solar Energy
 Bush-to-Energy
10. What was the least interesting topic to learn about?
 Introduction to Renewable Energy
 Wind Energy
 Solar Energy
 Bush-to-Energy

Additional Comments:

Please circle a number based on your opinions of the program.

1= strongly disagree, 2 = disagree, 4 = agree, 5 = strongly agree.

1. The information throughout the entire program was easy to understand
Strongly Disagree 1 2 4 5 Strongly Agree
2. I think the games and activities in the lessons were fun
Strongly Disagree 1 2 4 5 Strongly Agree
3. The lessons were more fun than my classes at school
Strongly Disagree 1 2 4 5 Strongly Agree
4. I would want to participate in another EduVentures program
Strongly Disagree 1 2 4 5 Strongly Agree
5. I feel like I know much more about renewable energy now than before I started this program
Strongly Disagree 1 2 4 5 Strongly Agree
6. If my school started an environmental club, I would join it.
Strongly Disagree 1 2 4 5 Strongly Agree
7. I plan to learn more about renewable energy after the end of this program
Strongly Disagree 1 2 4 5 Strongly Agree
8. What I learned in the program will change the way I think about energy generation
Strongly Disagree 1 2 4 5 Strongly Agree

Please put a check mark next to the lesson that you liked the most and the least.

9. What was the most interesting topic to learn about?
 Introduction to Renewable Energy
 Wind Energy
 Solar Energy
 Bush-to-Energy
10. What was the least interesting topic to learn about?
 Introduction to Renewable Energy
 Wind Energy
 Solar Energy
 Bush-to-Energy

Additional Comments:

This was it was fun to me.

I really like it if it come again a will be number one and it was really nice we were learn more thing the that we don't now and we were have fun together

Please circle a number based on your opinions of the program.

1= strongly disagree, 2 = disagree, 4 = agree, 5 = strongly agree.

1. The information throughout the entire program was easy to understand
Strongly Disagree 1 2 4 5 Strongly Agree
2. I think the games and activities in the lessons were fun
Strongly Disagree 1 2 4 5 Strongly Agree
3. The lessons were more fun than my classes at school
Strongly Disagree 1 2 4 5 Strongly Agree
4. I would want to participate in another EduVentures program
Strongly Disagree 1 2 4 5 Strongly Agree
5. I feel like I know much more about renewable energy now than before I started this program
Strongly Disagree 1 2 4 5 Strongly Agree
6. If my school started an environmental club, I would join it.
Strongly Disagree 1 2 4 5 Strongly Agree
7. I plan to learn more about renewable energy after the end of this program
Strongly Disagree 1 2 4 5 Strongly Agree
8. What I learned in the program will change the way I think about energy generation
Strongly Disagree 1 2 4 5 Strongly Agree

Please put a check mark next to the lesson that you liked the most and the least.

9. What was the most interesting topic to learn about?
 Introduction to Renewable Energy
 Wind Energy
 Solar Energy
 Bush-to-Energy
10. What was the least interesting topic to learn about?
 Introduction to Renewable Energy
 Wind Energy
 Solar Energy
 Bush-to-Energy

Additional Comments:

I will learn more about solar energy and others

I we like to think for all you tachus

Please circle a number based on your opinions of the program.

1= strongly disagree, 2 = disagree, 4 = agree, 5 = strongly agree.

1. The information throughout the entire program was easy to understand
Strongly Disagree 1 2 4 5 Strongly Agree
2. I think the games and activities in the lessons were fun
Strongly Disagree 1 2 4 5 Strongly Agree
3. The lessons were more fun than my classes at school
Strongly Disagree 1 2 4 5 Strongly Agree
4. I would want to participate in another EduVentures program
Strongly Disagree 1 2 4 5 Strongly Agree
5. I feel like I know much more about renewable energy now than before I started this program
Strongly Disagree 1 2 4 5 Strongly Agree
6. If my school started an environmental club, I would join it.
Strongly Disagree 1 2 4 5 Strongly Agree
7. I plan to learn more about renewable energy after the end of this program
Strongly Disagree 1 2 4 5 Strongly Agree
8. What I learned in the program will change the way I think about energy generation
Strongly Disagree 1 2 4 5 Strongly Agree

Please put a check mark next to the lesson that you liked the most and the least.

9. What was the most interesting topic to learn about?
 Introduction to Renewable Energy
 Wind Energy
 Solar Energy
 Bush-to-Energy
10. What was the least interesting topic to learn about?
 Introduction to Renewable Energy
 Wind Energy
 Solar Energy
 Bush-to-Energy

Additional Comments:

Is the energy that can do for solar othe bush

Please circle a number based on your opinions of the program.

1= strongly disagree, 2 = disagree, 4 = agree, 5 = strongly agree.

1. The information throughout the entire program was easy to understand
Strongly Disagree 1 2 4 5 Strongly Agree
2. I think the games and activities in the lessons were fun
Strongly Disagree 1 2 4 5 Strongly Agree
3. The lessons were more fun than my classes at school
Strongly Disagree 1 2 4 5 Strongly Agree
4. I would want to participate in another EduVentures program
Strongly Disagree 1 2 4 5 Strongly Agree
5. I feel like I know much more about renewable energy now than before I started this program
Strongly Disagree 1 2 4 5 Strongly Agree
6. If my school started an environmental club, I would join it.
Strongly Disagree 1 2 4 5 Strongly Agree
7. I plan to learn more about renewable energy after the end of this program
Strongly Disagree 1 2 4 5 Strongly Agree
8. What I learned in the program will change the way I think about energy generation
Strongly Disagree 1 2 4 5 Strongly Agree

Please put a check mark next to the lesson that you liked the most and the least.

9. What was the most interesting topic to learn about?
 Introduction to Renewable Energy
 Wind Energy
 Solar Energy
 Bush-to-Energy
10. What was the least interesting topic to learn about?
 Introduction to Renewable Energy
 Wind Energy
 Solar Energy
 Bush-to-Energy

Additional Comments:

A was redyngne ne ada stedeng

I wada to red

Appendix WW: Final Draft of Introduction to Renewable Energy Module

****see accompanying SMART Notebook file for higher resolution****



How were fossil fuels discovered?

Click on the image to learn more

Early 18th Century



1764



1712



18th Century Great Britain



Before, life was very difficult
full of poverty and disease



Birthplace of the
industrial revolution
because of the iron and coal





How does a Steam Engine Work?

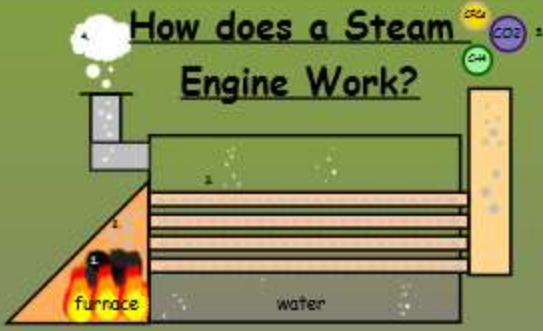

1. coal is added to the furnace.
2. as the coal burns hot gasses are released
3. the gasses move through the pipes and heat the water
4. steam is produced to move the vehicle
5. excess gasses are released into the air



Changing Lifestyles: Positive and Negative



- New ways to get nature's energy
- Water, steam, and coal powered trains, ships, and automobiles
- Factories built for specialty work
- Fuel, clothing, and food more affordable
- Pollution turned cities black
- Lack of housing caused the first urban slums
- Abuse of workers
- New Technological Revolution today
- Connect with others around the globe



Activity: After learning about some of the new technologies and inventions of the industrial revolution, think about some inventions or technologies you have.

Directions: In 4 groups discuss the good and bad things of technology. Think about how the technology is helpful or harmful in your community.

Each group will get one technology:

- cell phone
- television
- car
- computer



You will have 10 minutes to discuss and 5 minutes to share

Why are fossil fuels bad?

coal, oil, and natural gas release greenhouse gases when they are burned



The Problems

Effects of Climate Change
in Namibia

land degradation



Extreme
temperatures



flash flooding
in the North

Reliance on Foreign Countries
for Energy



Why is Renewable Energy important?





What can Namibia do?

Renewable Energy

- Energy sources that can be used again and again

Solar **Wind** **Biomass** **Wave and Tidal**



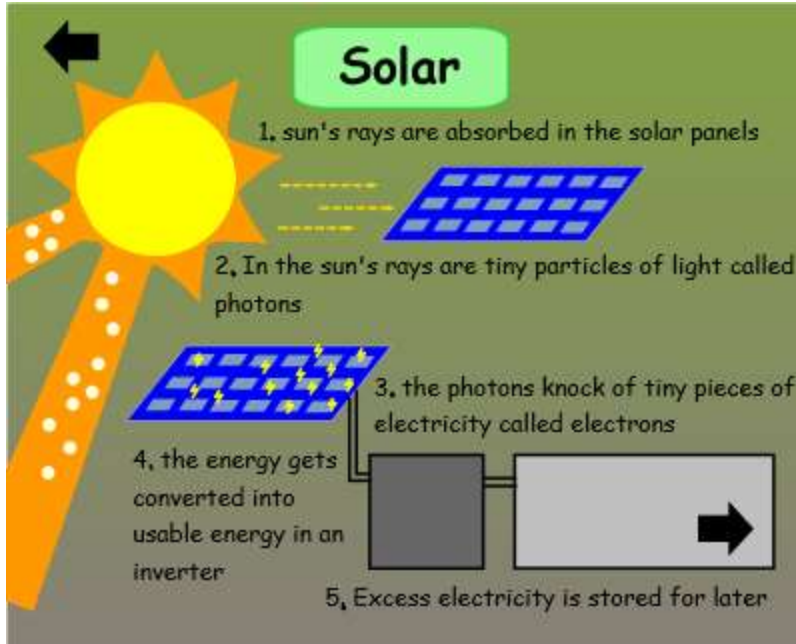



Wind



1. Wind blows and moves a turbine



2. The spinning turbine generates electricity



Wave and Tidal



- electricity generated as waves and tides pass through special buoys or turbines
- More predictable than wind
- no greenhouse gas emissions or other pollutants



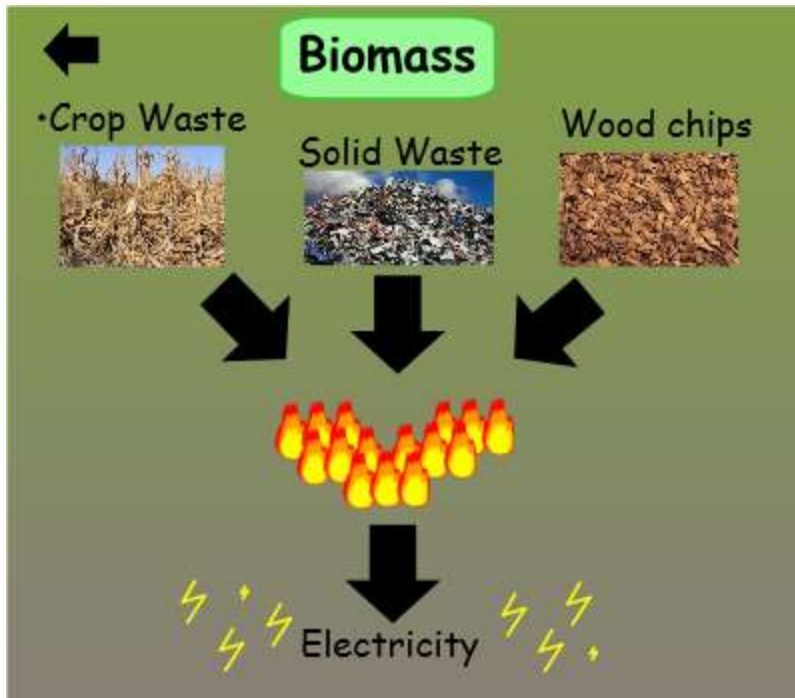

What Type of Energy is Pictured Here?

Renewable Non-renewable

Wood Natural gas Solar Coal

Nuclear Oil Wind

→

This section is a classification activity. It features two white bowls at the top, one labeled 'Renewable' and one labeled 'Non-renewable'. Below the bowls are seven small images representing different energy sources: 'Wood', 'Natural gas', 'Solar', 'Coal', 'Nuclear', 'Oil', and 'Wind'. A large black arrow at the bottom right points to the right, indicating the direction for the activity.



What can you do?

- organize clean up project around your school or village
- build solar cookers instead of using wood stoves
- tell others about what you learned



A black arrow points to the right at the bottom right corner.

What do you remember?



1. fossil fuels releases carbon dioxide into the air.
2. Electricity is a result of the sun's energy absorbed in
3. Wind is strong enough to turn a and generate electricity.
4. The industrial revolution improved lives but created urban slums.
5. Renewable energy will help create in Namibia.
6. More people will have if they use renewable energy.
7. Power can be generated from waves and tides when it through special buoys or turbines
8. Biomass is burning plants for energy.

turbine renewable jobs electricity passes
burning panels lack of housing

Activity: After learning about the important of renewable energy, it is time to share your opinions and give advice to others.

Directions: Divide yourselves into 3 groups. Each group will get a decision a fellow Namibian is facing in their life. Please provide them some helpful advice.

Please consider:

- environmental impacts
- economic impacts
- social impacts



Scenario 1: A community to the east of Windhoek has heard about solar energy but is not sure about taking advantage of the government loan program because it is expensive. What can you tell them about the benefits of renewable energy?

Scenario 2: Tauno is a farmer in the northern region of Namibia and has lost much of his crops and won't have money for electricity. He thinks it is a good idea to construct a turbine on his property to supply electricity. What do you think of Tauno's idea?

Scenario 3: Penda and his family want to increase their property for farming. They decide to cut down and burn the encroachment bush. What are positive and negative impacts of Penda's actions?

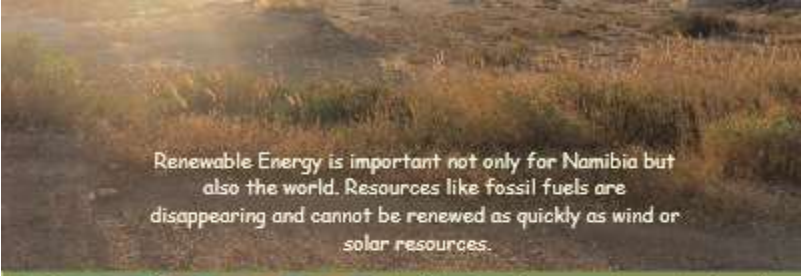

Renewable Energy is important not only for Namibia but also the world. Resources like fossil fuels are disappearing and cannot be renewed as quickly as wind or solar resources.



It is important to work together to help create a future with the same opportunities and resources as we currently have.

Namibia is setting a good example for other developing nations to invest in alternative energy and resources to minimize their carbon footprint.



Appendix XX: Final Draft of Wind Energy Module

****see accompanying SMART Notebook file for higher resolution****

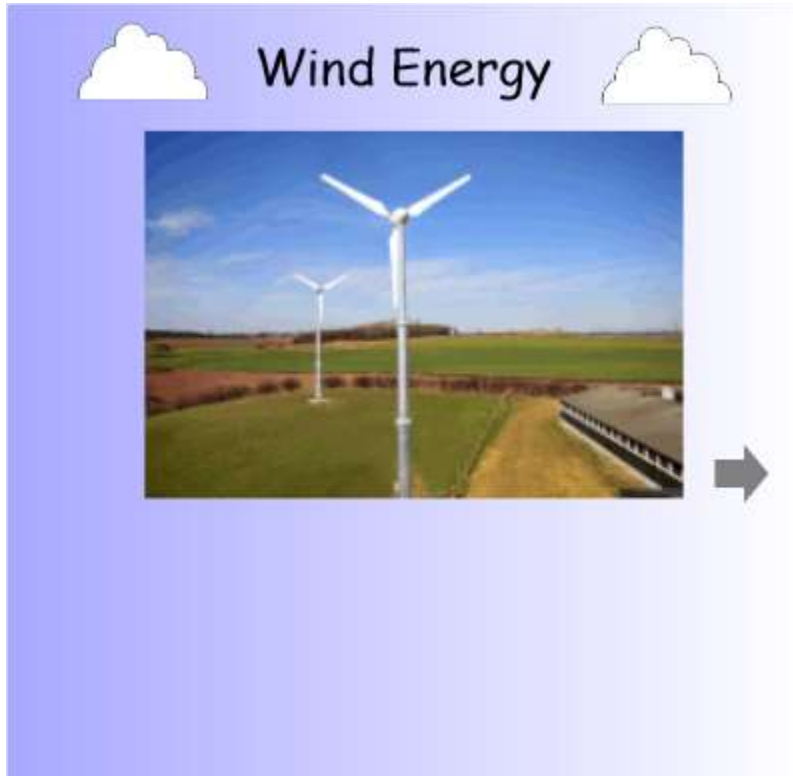

What is wind energy?

Please raise your hand and give your best guess!



What is wind energy?

Wind energy is a renewable energy that uses wind to generate electricity with a turbine



How does it work?

Please come up to the board and write your best guess



How does it work?



Order the letters that are next to the different turbines from the least amount of power generated to the most amount of power generated, in the boxes on the left

Least

Most

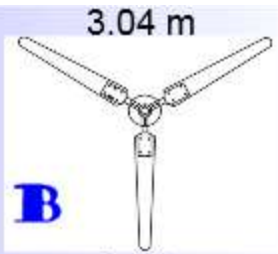

Once you are done, click on the question mark to reveal the next step



What causes wind?

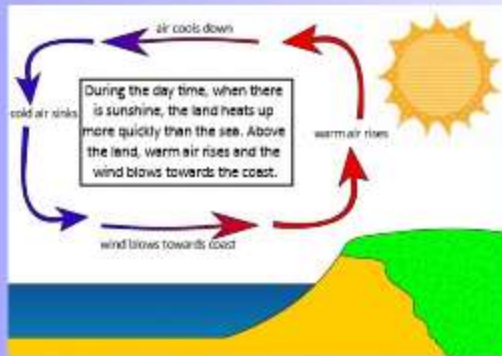

Wind is air in motion. It is produced by the uneven heating of the earth's surface by the sun.

Near coastlines are much windier than inland because of the different temperatures of the land and water







Advantages and Disadvantages

Click on the diamonds to learn the advantages or disadvantages of wind energy



Advantages

-  Clean fuel source; no pollution
-  Does not use water for cooling
-  One of the cheapest renewable energies
-  Domestic energy; produced in country
-  Creates jobs

 Back

Disadvantages

1 Not always windy; not able to store energy

2 More expensive than fossil fuels

3 Windy sites are usually far from cities

4 Noisy and looks unnatural

5 Effect surrounding wildlife

 Back

Types of Turbines

Horizontal Axis Wind Turbine



Vertical Axis Wind Turbine



Parts of a HAWT

Click on the question mark to reveal the part's purpose.

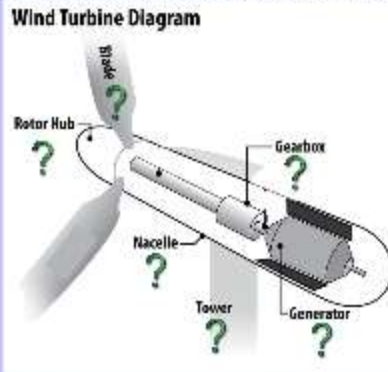

Rotor Blade

click the picture to reveal the definition



Back

Gearbox

click the picture to reveal the definition



Back

Nacelle

click the picture to reveal the definition



Generator

click the picture to reveal the definition



Rotor Hub

click the picture to reveal the definition



Back

Tower

click the picture to reveal the definition



Back

HAWT Advantages and Disadvantages

Click on the boxes to find out!

Advantages

Disadvantages



😊 Advantages 😊

- The tall tower lets the turbine get stronger winds
- The wind hits the turbine horizontally; which gets the most energy



Back

Disadvantages



Please use the pictures as hints, raise your hand and guess the disadvantages. Click on the picture to reveal the answer

Back



HAWT Review

Drag the words at the bottom into the correct phrases

The wind rotates the .

The converts the speed of rotation from the blades to a faster rotation speed so it can be converted into electricity.

The holds the turbine's machinery.

Once at the proper rotation speed, the converts the blade rotation into energy.

The brings the rotation of the blades created by the wind to the gearbox.

The anchors the wind turbine to the ground.

HAWTs can hurt surrounding .

ecosystems rotor-hub gearbox generator
tower nacelle rotor-blades

Parts of a VAWT

Click on the question mark to reveal the part's purpose.



Guide Wire

keeps the turbine in position



Back

Hub

center of the rotor; where the blades are attached



Rotor Blades

the wind turns the blades



Back

Shaft

The part that is turned by the blades; the center of the turbine



Back

Nacelle

Holds all the turbine's machinery

Back



Gearbox

converts the speed of rotation from the blades to a faster rotation speed

Back



Generator

once at the proper rotation speed, the generator converts the wind to energy



Back

VAWT Advantages and Disadvantages

Click on the boxes to find out!

Advantages

Disadvantages



😊 Advantages 😊

- Can spin with wind from all directions
- Close to the ground
 - > Easy maintenance
 - > Less visible to surrounding communities

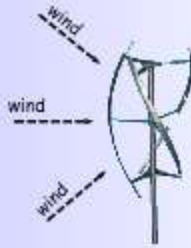

Back

☹️ Disadvantages ☹️

- Produces less power than HAWTs
- Small wind speeds since closer to the ground
- They also need a 'push' in order to start rotating



Back

VAWT Review



Drag the words at the bottom into the correct phrases

The keeps the turbine in position.

The is where the blades attach to the shaft; there are two of these.

The wind turns the .

Once at the proper speed, the converts the blade rotation to energy.

The holds all the turbine's machinery.

The is the part that is turned by the blades and the center of the turbine.

The converts the speed of rotation from the blades to a faster rotation speed

Generator	Gearbox	Rotor blades	Hub
Nacelle	Shaft	Guide wire	



Why should Namibia use Wind Energy?

Please raise your hand and give your best guess!



Why should Namibia use Wind Energy?

Click on the Namibias to reveal the answers

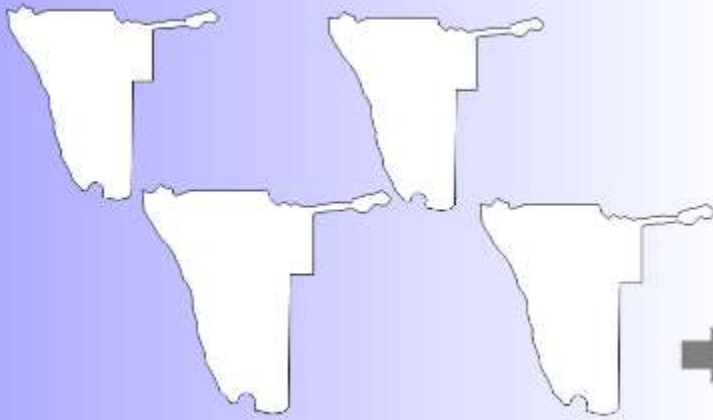



Why should Namibia use Wind Energy?

Job Growth

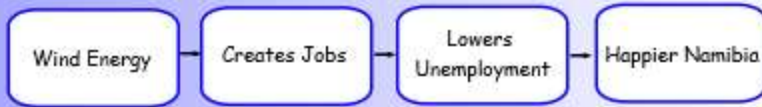



Why should Namibia use Wind Energy?

Clean Environment



If wildlife or environments are damaged Namibia can lose:

- food to eat
- clean water
- wildlife
- tourism
- clean air to breathe





Why should Namibia use Wind Energy?

Large Coasts

Click on the numbers to reveal facts

1

2

3

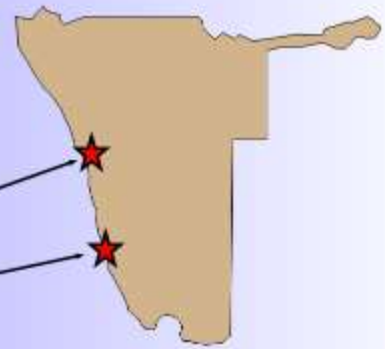



Why should Namibia use Wind Energy?

Stop Climate Change



Click on the numbers to see what climate change effects

- 1
- 2
- 3
- 4



ACTIVITY: Who does installing wind energy affect?

Split into groups of five and think of all the people or things affected by Namibia choosing to install wind turbines



Who does installing wind energy affect?



Please come up to the board and write some of your team's ideas

Namibian Government





Representing the stakeholders

Let's pick five from the previous page and brainstorm why each of the selected groups will care about renewable energy

1. *Namibian Government*
 - *Profits*
 - *Reduce unemployment*
 - *Happier citizens*
 - *Healthier environment*



What can you do as a community to help combat climate change and help save the environment?

Get into groups of five. Think of all the ways you could help save the Earth and stop climate change from inside your community. Use only the resources you already have in your community. For example, if you cannot do this project tomorrow, then it does not count. Any questions?



The team with the most answers on their sheet of paper at the end of the 5-minute time period receives a prize!

Appendix YY: Final Draft of Solar Energy Module

****see accompanying SMART Notebook file for higher resolution****

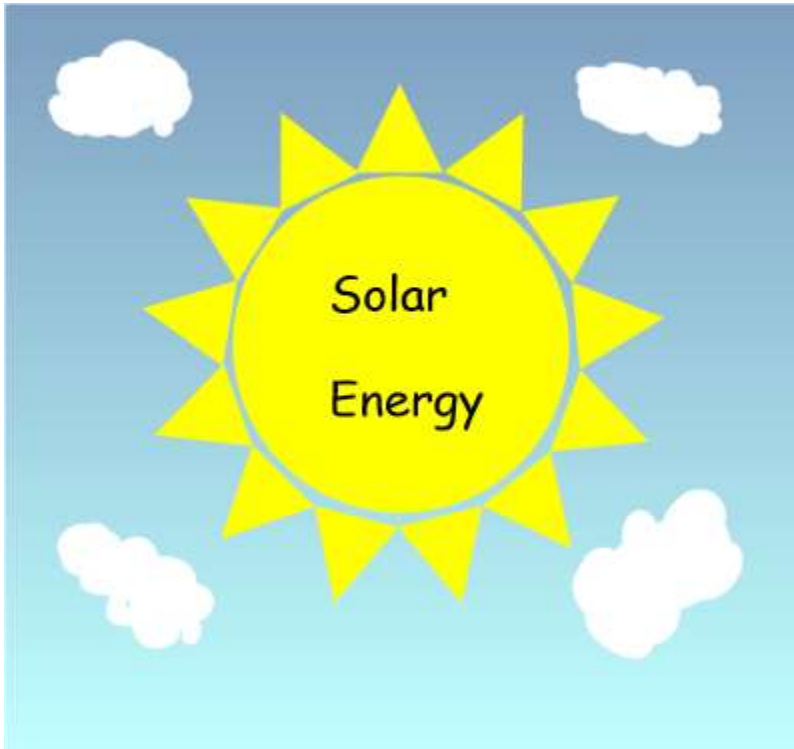

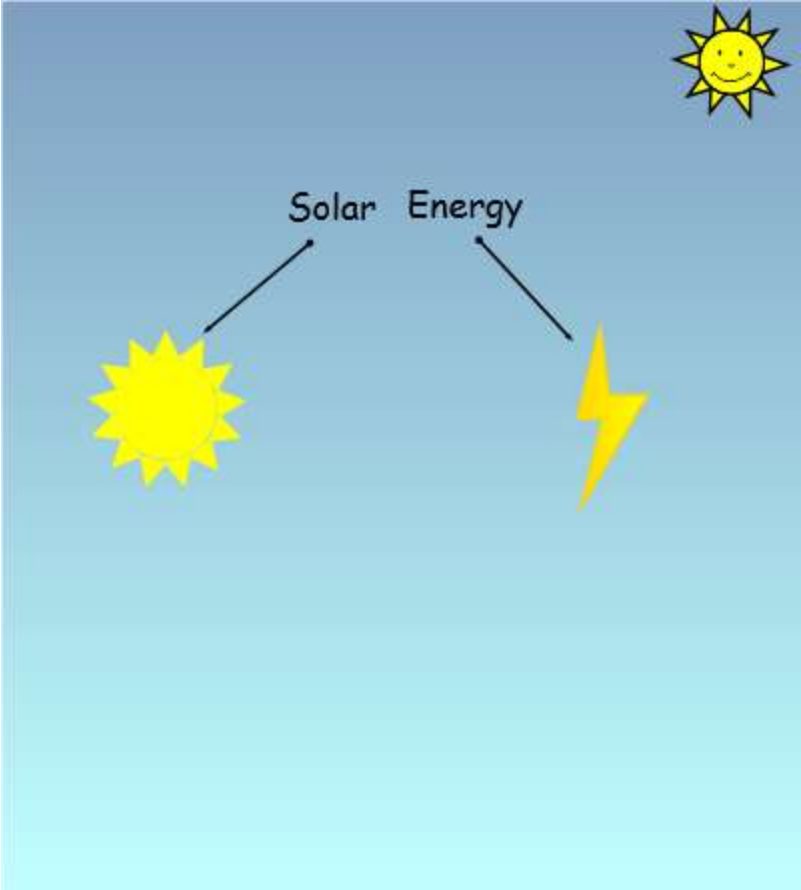

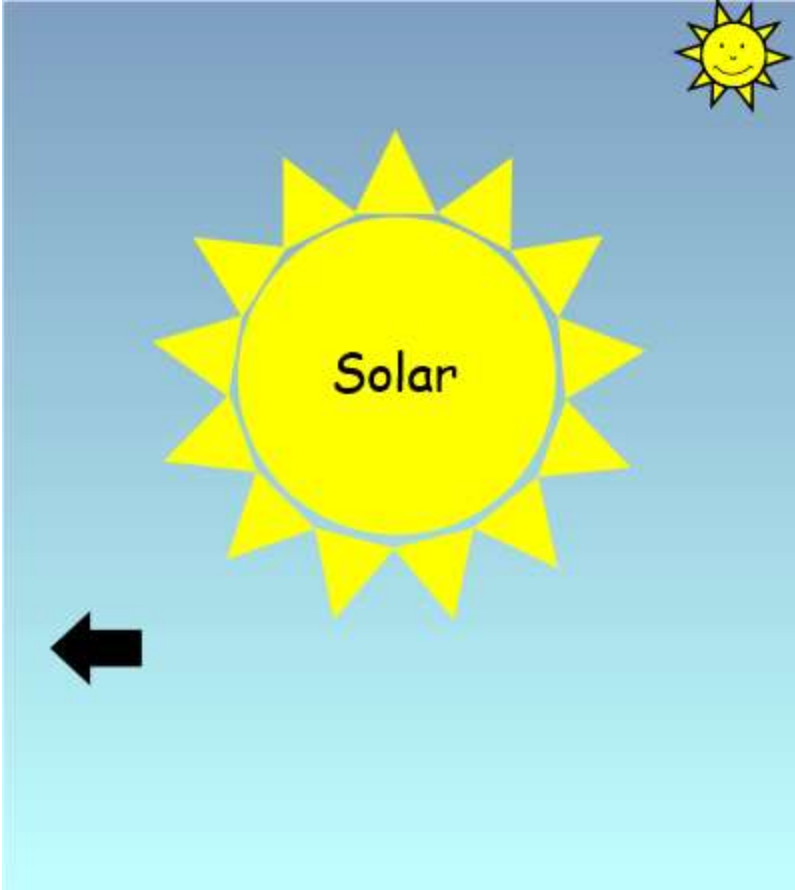





Solar Energy



Power made from UV light from the sun





How many types of solar technology do you think there is? Any examples?





Solar Panels

"Passive"

"Active"

Photovoltaic
Solar Cells

CSP

Photovoltaic Solar Cells



- Found in homes, businesses, or solar farms
- One of the main types of solar technology
- Primarily composed of silicon
- Amount of energy produced varies
- Can contain a variety of technologies such as:
 - > Solar Tracker
 - > Solar Collector
 - > Hybrid System
 - > Solar Heater





"Active" Solar System: requires the help of mechanical or electrical energy

"Passive" Solar System: does not require the help of mechanical or electrical energy

Solar Tracker: when solar panels follow the sun throughout the day

Solar Collector: flat solar panels that try to collect as much sun throughout the day

Hybrid System: when two energy creation systems are used together



Other PV Technologies



Concentrated Solar Power (CSP)



- Utilizes focused sunlight through the use of mirrors and a generator
- Requires a large area of land for solar farms
- Several types such as:

- Parabolic Trough
- Sterling Dish
- Linear Fresnel
- Solar Tower
- Solar Cooker



Vocabulary



Drag the word that fits into the blank
correctly

solar tracking

solar collectors

hybrid system

"passive" solar panels

"active" solar panels

1. is a technology that allows solar panels to follow the sun throughout the day to collect as much sunlight as possible.
2. Flat, solar panels known as are used to get the most sunlight.
3. One subtype of solar panels, are . They produce energy through the use of mechanical energy.
4. A contains more than two types of energy production.
5. If a solar panel converts UV light into energy without the use of mechanical energy. Then they are known as



Ongoing Projects



- Solar panel loan program through the government
- Solar PV Park in Omburu
- 10 MW PV park in Gobabis
- 35 MW PV plant in Mariental
- Feasibility of 250 GW CSP project
- Tsumkwe solar diesel hybrid system



Operation of Solar Panels



1. The solar cells absorb UV light (photons) through the silicon material.
2. This process allows the light to hit the silicon atoms and transfers energy to the loose electrons, knocking them off.
3. The loose electrons then "jump" to other silicon atoms because of the electron's negative charge.
4. This causes an electric field to be generated and then an electric current.



1. The solar cells absorb UV light (photons) through the silicon material.

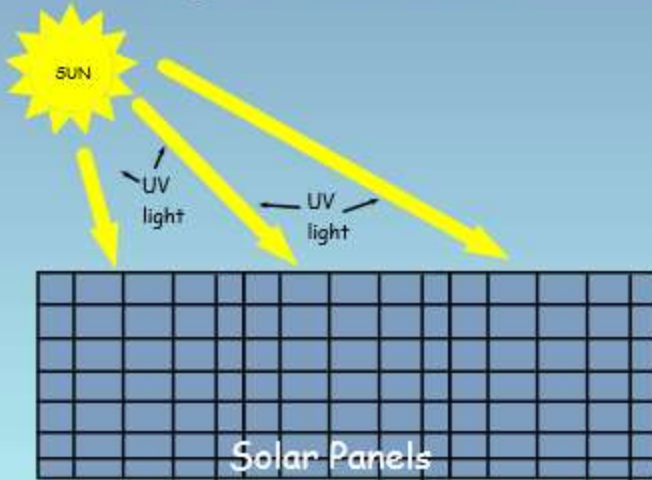

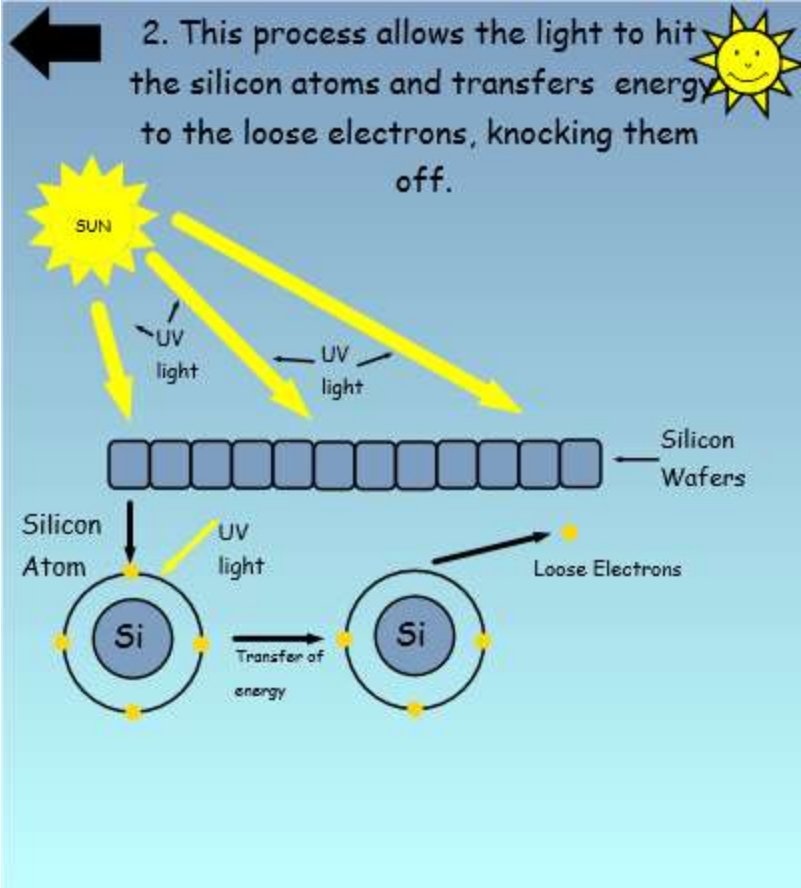



3. The loose electrons then "jump" to different types of silicon because of the electron's negative charge.

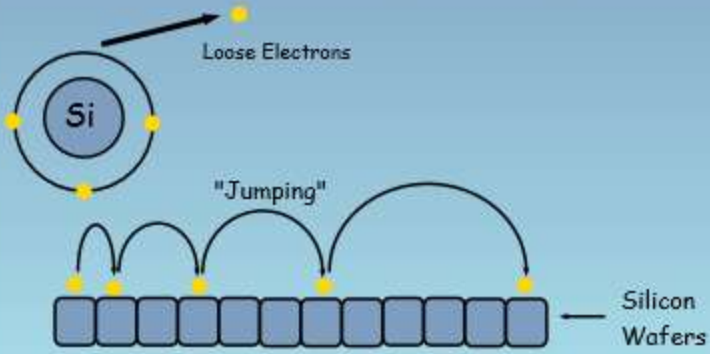

4. This causes an electric field to be generated and then an electric current.

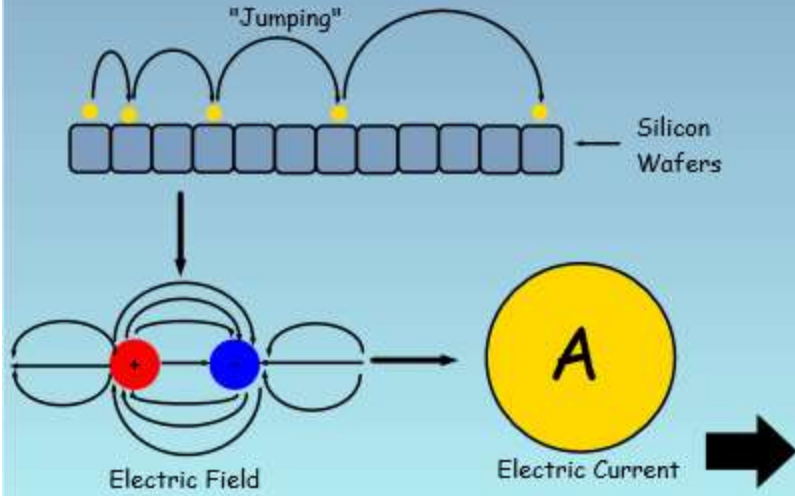



Operation of Solar Panels is a hard
topic to cover for everyone.

Please ask any questions about it here
if you're confused!



Solar Energy Storage



1. Some of the energy created from solar panels is sent to an inverter, where it converts the energy made into usable energy.
2. This energy is then sent into the existing electrical grid for use.
3. Another part of the energy made is sent to the batteries to charge them during the day so they may use solar energy at night.

1. Some of the energy created from solar panels is sent to an inverter, where it converts the energy made into usable energy.

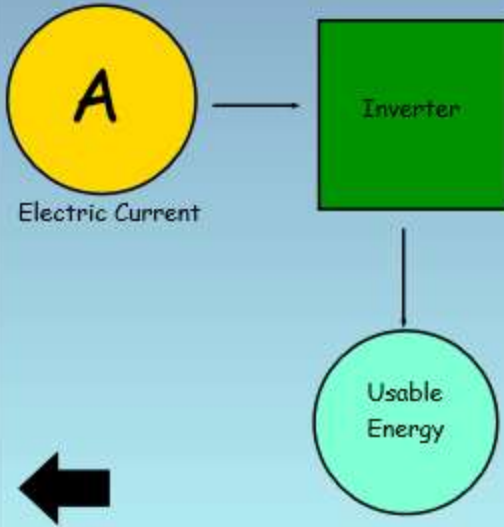

2. This energy is then sent into the existing electrical grid for use.

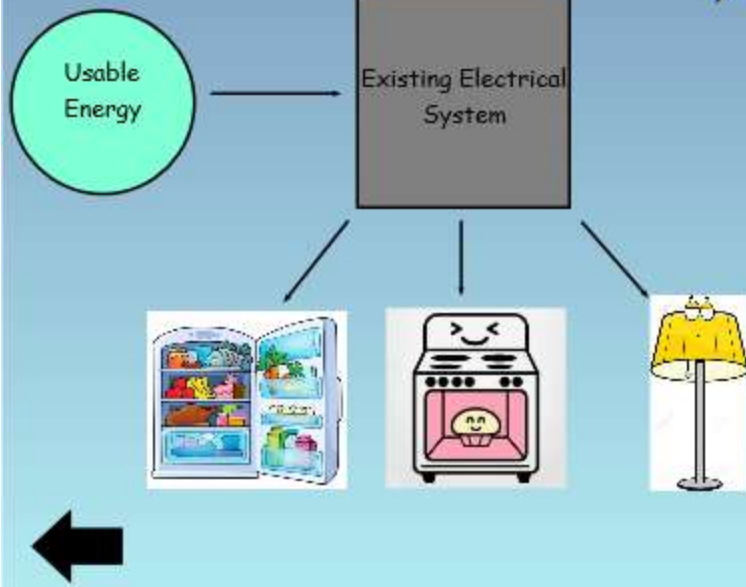



3. Some of the energy made is sent to the batteries to charge them during the day so they may use solar energy at night.

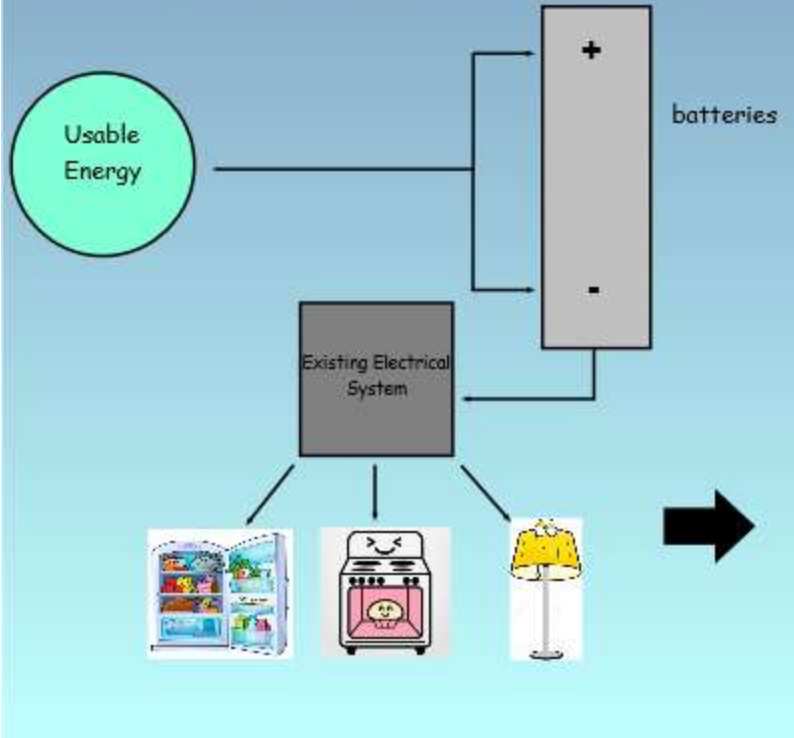



What is maintenance? Why
is it important?





Maintenance



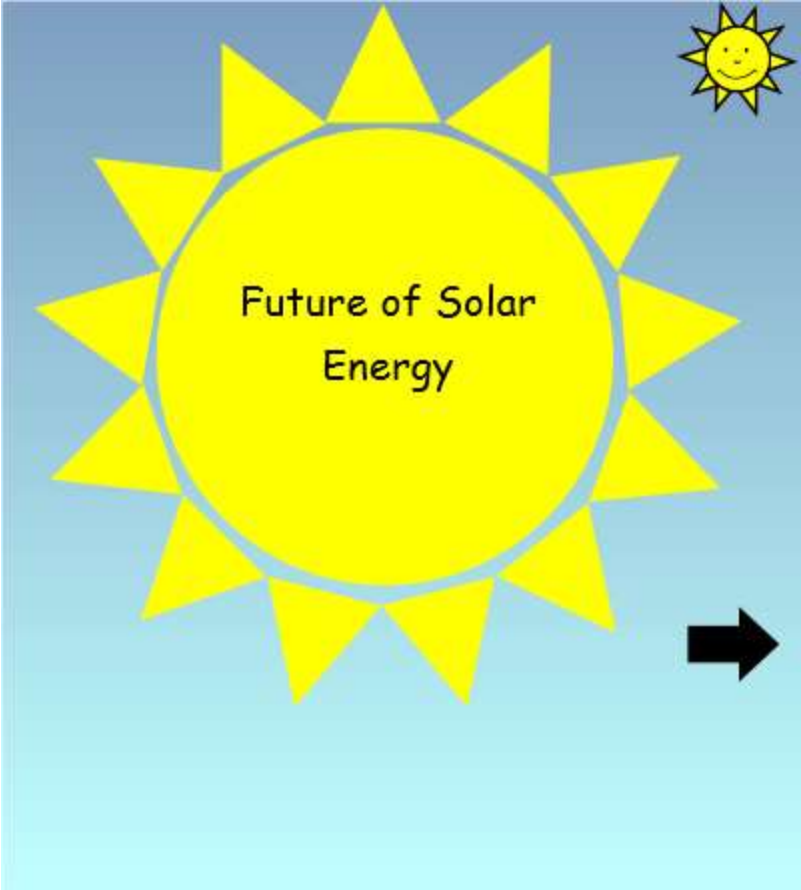



What kind of improvements do you think that can be made to solar technology as of right now?



Brainstorm some Advantages of
Solar Energy and state them to the
class



Advantages of Solar Energy



1. Limitless opportunity during the day
 - « around 300 sunny days a year
2. Job Growth
 - « 20% job growth in this field since 2015
3. Reduces unemployment
4. Builds an Environmentally Friendly Future
 - « Globally reduce green house gas emission
5. Little Maintenance Required



Brainstorm some Disadvantages
and sat them to the rest of the
class



Disadvantages of Solar Energy



1. Inefficient
 - « silicon has an efficiency of around 10%
2. Expensive
3. No storage system in the current cells
4. Can only generate energy for 12 hours a day



Why in Namibia



Break up into groups and brainstorm. When you are done share with the rest of the class.



Why in Namibia?



Where in Namibia?



- For individuals, solar panels can be used anywhere
- Typically need flat land with a smaller population for solar farms and plants



Where in Namibia?

Guess some of the regions that can use solar farms



Drag Photos Here



Activity



Draw a series of different solar panels for your community. In your drawing please include:

- 1 or more solar technology such as solar panels or solar cooker
- anything else that you think is necessary

Be prepared to discuss why you choose those specific types of solar panels.



Summary

Discuss what you have learned today in small groups and share with the rest of the class



Appendix ZZ: Final Draft of Bush-to-Energy Module

see accompanying SMART Notebook file for higher resolution

Bush -to- Energy

What is Bush-to-Energy?

Bush-to-energy
uses wood chips made from
encroacher bush
to create power and energy

Encroacher Bush

What do you think encroacher bush is?

Have a volunteer move the magnifying glass to find the definition!



What is an invasive plant species?

- Definition- a type of plant that takes over a habitat
- Invasive plants tend to spread all over the land and use up important nutrients, which can harm the environment
- There are two different types of plants that can be invasive:



Types of Encroacher Bush

- There are 19 types of plants that are considered to be encroacher bush
- Of these plants, four types are the most common forms of encroacher bush:

Prozopsis
(all species)
Location: All of Namibia
Alien plant



Swarthoek
(*Acacia mellifera*)
Location: Central Namibia
Indigenous Plant



Silver Cluster-Leaf
(*Terminalia sericea*)
Location: Eastern Namibia
Indigenous Plant



Mopane
(*Colophospermum mopane*)
Location: Northwestern Namibia
Indigenous Plant



Why is Encroacher Bush a problem in Namibia?



Desertification



Bush Encroachment



Economy



Desertification

Desertification occurs when the soil does not have enough water in it. The land dries up and nothing can grow.



If plants can not grow, farmers can not grow crops to sell, and won't have enough money to take care of their family



Animals also suffer, as the plants they eat can not grow, and they do not have enough food to be happy and healthy



Bush Encroachment

Can you guess how much land encroacher bush covers in Namibia?



Have a volunteer click on the map until all of the bush pops up!

Bush Encroachment

Encroacher bush covers over **55%** of Namibia's land, and is still growing rapidly

The more the bush grows, the less land there is available for farmers to sustain their livestock and grow crops

An increase in the amount of bush also reduces the amount of water in the soil, increasing desertification

As the country is already arid and water is scarce, this bush also decreases our water tables



Impact on the Economy

- No crops-> cannot sell enough goods to maintain farms



- Cannot maintain farms
» Job Loss



- Over 70% Population Effected
» Economic downfall



ACTIVITY:

How do **YOU** think you can fix the problem of encroacher bush?

Get together in groups of four and think about how you could solve the problem in your community.



How to fix the problem of Encroacher Bush

The best way to fix the problem of Encroacher bush is to Harvest it.

There are many ways to harvest bush:



manual labor



mechanical



chemical



Important Things to Remember when Harvesting Bush

While it is good to harvest this encroacher bush, you need to be mindful of the surrounding environment. If you aren't careful, you could end up doing even more damage.

Some side effects of improper de-bushing include:

- Reduction of Biodiversity
- Increased Land Desertification
- Habitat destruction



Important Things to Remember when Harvesting Bush

Some **bad practices** for harvesting bush include:

Clearing Near Rivers



Aerial Spraying of Arboricides



Elimination of all Bush



Important Things to Remember when Harvesting Bush

Some **good practices** for harvesting bush include:

Applying Arboricides by Hand



Harvesting in phases

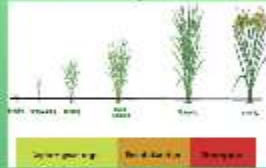

Selective harvesting



REVIEW ACTIVITY

Harvesting Bush



Clearing along rivers

Applying arborcides
by hand

Selective harvesting

Eliminating all bush

Harvesting in Phases

Aerial application
of arborcides



Important Vocabulary

Once the encroacher bush has been properly harvested, it can be processed and used as an energy resource.

Before we talk about how to convert this bush to energy, it's important to know about some key technologies



Converting Harvested Bush into Useable Energy



1. Bush is harvested and sent to a processor where it is converted into wood chips



Converting Harvested Bush into Useable Energy

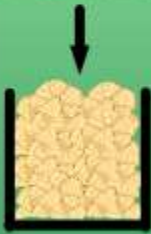

2. Once the bush is processed, it is transported and stored in a bunker underneath a water tank



Converting Harvested Bush into Useable Energy

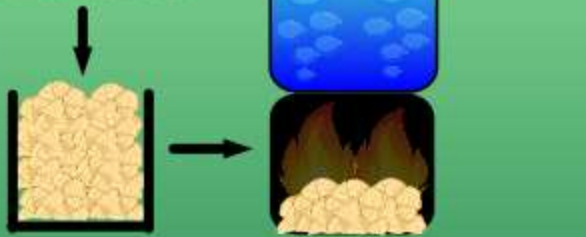

3. The wood chips are then burned, which boils the water in the tank above, creating steam



Converting Harvested Bush into Useable Energy



4. The steam acts as a force to move the blades in the turbines



Converting Harvested Bush into Useable Energy

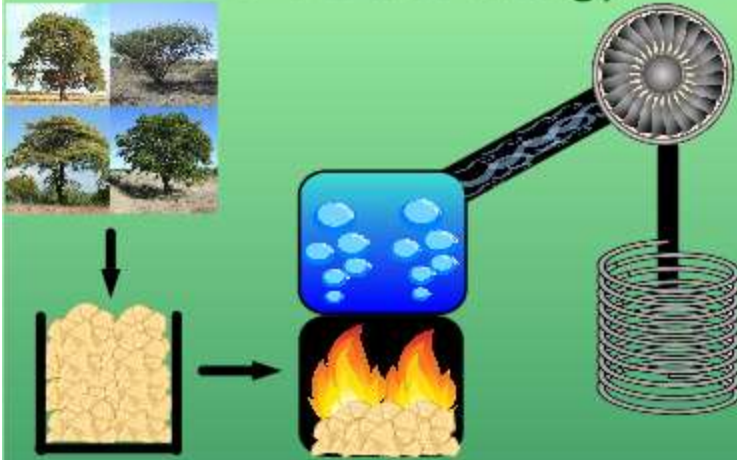

5. The moving of the turbines cause the coils and magnets in the generators to create a magnetic field →

Converting Harvested Bush into Useable Energy

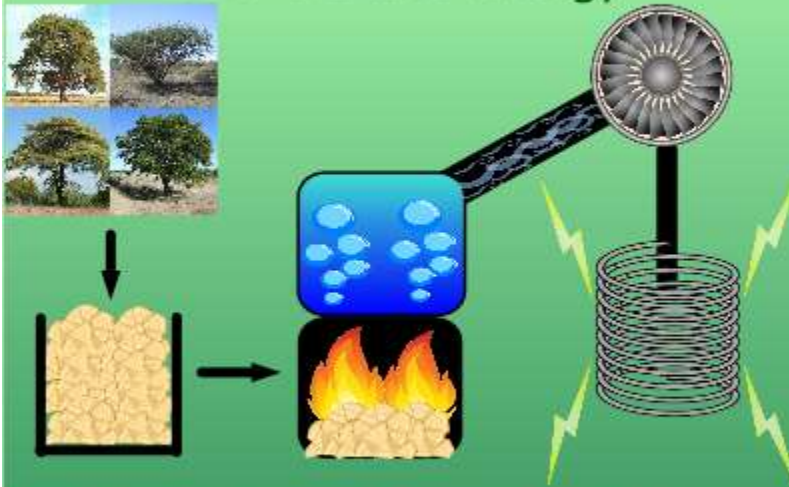

6. The magnetic fields produce electricity, which is stored and distributed to homes around Namibia →

Where in Namibia will this technology be useful?

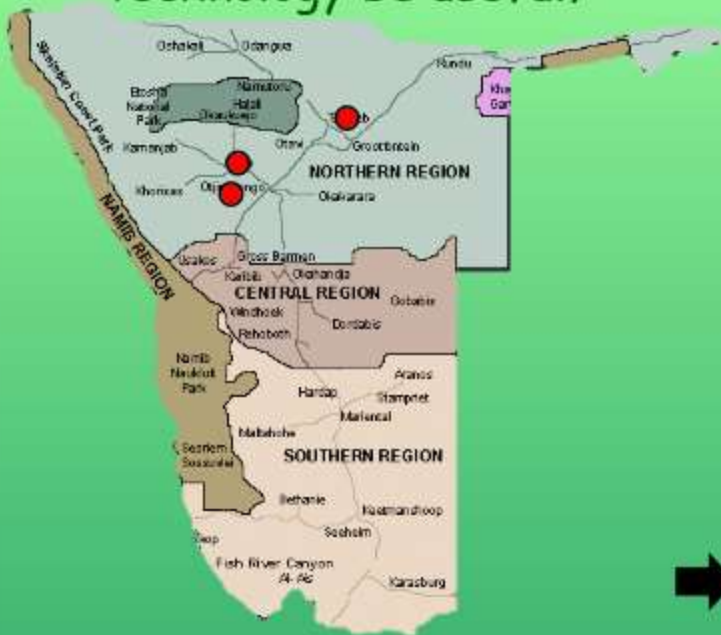

Advantages of Bush-to-Energy

Reduce Energy Imports



Improve the economy



Decentralized Power Supply



Decrease CO₂ emissions



Reduce Energy Imports

- 80% of Namibia's electricity is currently imported from other countries
 - » Bush-to-energy could completely satisfy this need every year
- Potential to power ten 20MW plants for 100 years
 - » Total of over 240,000 households per year
- Maintain foreign relations
- Namibia to become an energy exporter



Improve the Economy

- Decrease National Spending
- Job Opportunity
 - » Over 30,000 new jobs created
- Energy Exporter
 - » Could possibly gain N\$25-112 billion per year



Decentralized Power Supply

- Decentralized power-distributing widely owned resources over smaller areas of the country
- Allows local communities to create own power grids
 - >> Decrease local dependency on government
 - >> More cost effective for rural communities

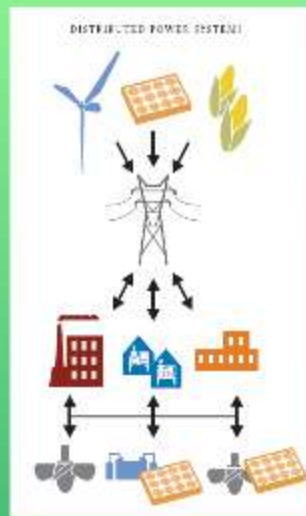

Decrease CO₂ Emissions

- Decrease dependency on nonrenewable energy supplies
- Bush-to-Energy would produce 2% the amount of CO₂ that nonrenewable energy emits
- Bush-to-Energy implementation -> long-time decrease in CO₂ emissions

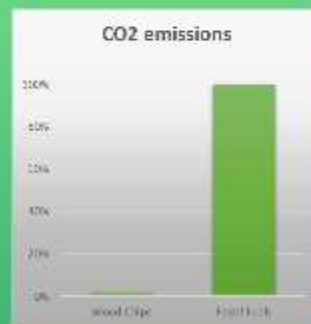

Disadvantages of Bush-to-Energy

Carbon Sinks



Expensive



Takes a lot of time



Potential environmental harm



Carbon Sinks

- Definition: Plants remove CO_2 from the atmosphere to use in photosynthesis
- Carbon Sinks are good for the environment
- Harvesting encroacher bush effects these carbon sinks



Expensive

- More expensive than fossil fuels (coal & oil) and other renewable energies (wind & solar)
- Costs of Bush-to-Energy include:
 - » Training bush harvesters and machinists
 - » Establishing processing centers and power plants
 - » Paying fees associated with harvesting permits
 - » Paying Salaries of all workers, both in the field and at the power plants



Takes a lot of Time

- Several factors of bush-to-energy which take time:
 - » Approval of Permits
 - » Properly training laborers and machinists
 - » Building and establishing a successful bush-to-energy plant
- More time -> less money



Potential Environmental Harm

- Improper Harvesting leads to environmental harm

>> increased desertification



>> soil erosion



>> decreased water retention



- Improperly cared for land impacts farmers the most



REVIEW ACTIVITY

Bush-to-Energy



Reducing Foreign
Dependency

Expensive

Job Opportunities

Environmental Harm

Decrease CO2
Emissions

Decentralized Power
Supply

Carbon Sinks

Takes a lot of time

Improving the Economy



What can YOU do to create awareness on Bush-to-Energy?

- Tell your parents and community
- Encourage farmers to learn more about bush-to-energy
- Make sure people are properly harvesting bush and taking care of the land
- Work with your classmates to promote awareness in your communities



REVIEW ACTIVITY

The group will be split into teams of 2

The first team will pick a number from the question board. If they get the correct answer, then they can place a game piece on the board, starting from the bottom. If they don't get the correct answer, they do not get to put a game piece on the board.

After the first team tries to answer their question, the second team gets a chance.

This continues until one team gets four game pieces in a row of their teams color.

Good luck!

Appendix AAA: Final Introduction to Renewable Energy Teacher's Guide

Slide 1

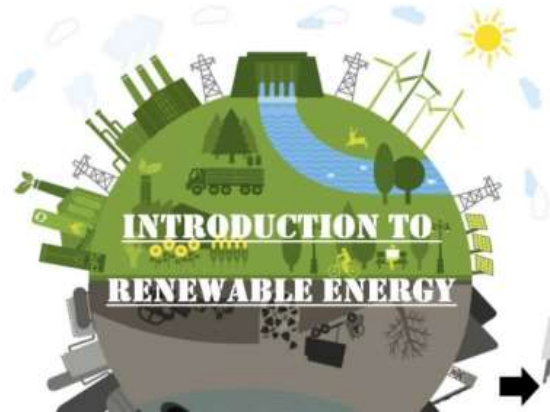

Ask students if they know what renewable energy is? What can they see in the picture? What do they know about climate change?

Slide 2

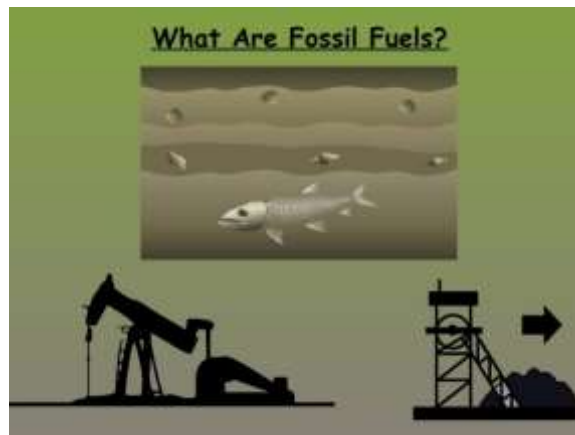

Ask the students if they know what fossil fuels are? Where do they come from? Then reveal the answer under the fossil Link fossil fuels to the industrial revolution and development

Slide 3

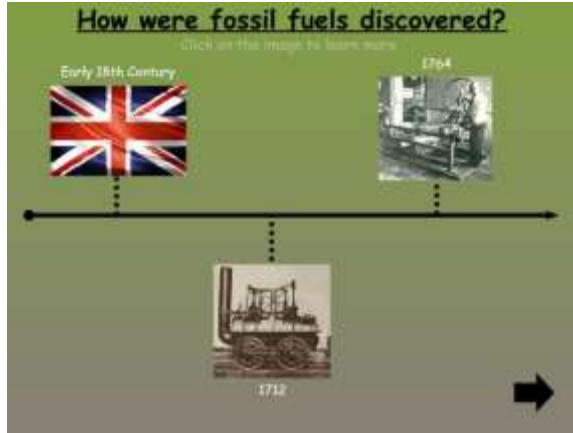

Click on each part of the time line to learn more about what it means. A student can come up to the board if they want. Industrial revolution was mostly in Europe and America but all developing nations go through some kind of industrial revolution.

Slide 4

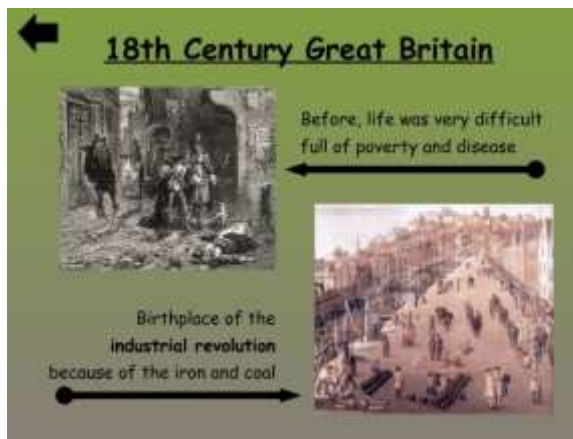

First image. Reveal Definition of industrial revolution under bottom picture. Explain where it happened, why and how. Ask learners what they think this meant for society. The arrow takes you back to the timeline

Slide 5

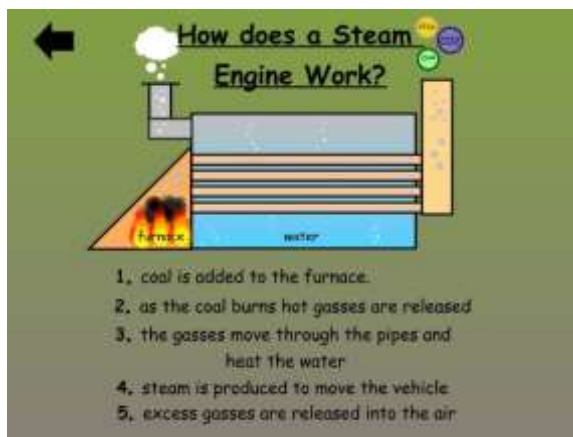

Here is a diagram of how a steam engine works. Teacher or student can click each number to reveal the process. Steam engines were invented during the industrial revolution. They improved transportation.

Slide 6

← Changing Lifestyles: Positive and Negative

- New ways to get nature's energy
- Water, steam, and coal powered trains, ships, and automobiles
- Factories built for specialty work
- Fuel, clothing, and food more affordable

- Pollution turned cities toxic
- Lack of housing caused the first urban slums
- Areas of conflict
- New Technological Revolution today
- Connect with others around the globe

→

Go over the positive and negative effects of the industrial revolution. Then touch on the current technological revolution. Green is positive; Red is negative
Right arrow continues forward.

Slide 7

Activity! After learning about some of the new technologies and inventions of the industrial revolution, think about some inventions or technologies you have.

Directions: In 4 groups discuss the good and bad things of technology. Think about how the technology is helpful or harmful in your community.

Each group will get one technology!

- cell phone
- television
- car
- computer

You will have 10 minutes to discuss and 5 minutes to share.

→

Activity! Break up learners into 4 groups and assign each group a technology. Let each group brainstorm how the technology effects their community for 10 minutes. Then share with the group for 5 minutes.

Slide 8

Why are fossil fuels bad?

coal, oil, and natural gas release greenhouse gases when they are burned

→

Fossil fuels release greenhouse gases when they are burned. Each gas reveals a consequence
Reveal Carbon Dioxide – Each of these is a gas. They are all found naturally in the atmosphere
Reveal Water Vapor – For thousands of years the earth's climate has changed naturally because of events such as volcanic eruptions and solar energy bursts.
Reveal Chlorofluorocarbons – The gases trap heat in the atmosphere
Reveal Methane – Since the industrial revolution the amount of these in the atmosphere have increased by a lot
Reveal Nitrous oxide – Scientific consensus is that humans are

causing rapid climate change across the globe
 Greenhouse gasses trap heat which raises the surface temperature of earth and causes climate change.

Slide 9

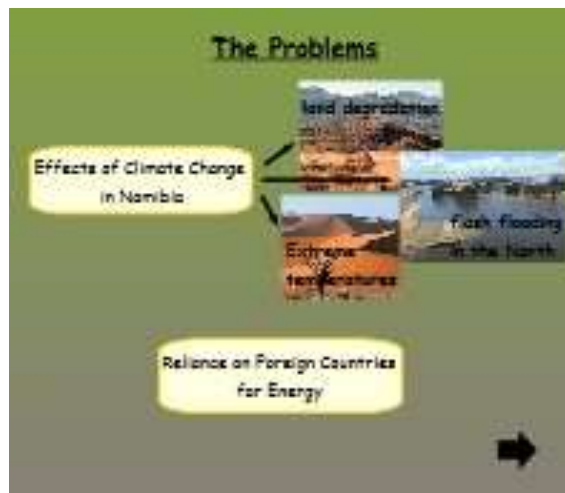

Explain the problem Namibia currently faces in regards to Climate Change and energy. Reveal the three photos one at a time.

Slide 10

Why is Renewable Energy important?

10 images with question marks:

- Map of Namibia
- Solar panels
- Woman in traditional dress
- Person working in a field
- Landscape with trees
- Sustainable Development Goals logo

Ask the learners why renewable energy is important, then reveal the answers behind the flags and explain why. How does it relate to the learner?

Answers -

- Provides electricity to more places
- Reduces Namibia's carbon footprint - a carbon footprint is the amount of CO₂ a place releases into the atmosphere. Renewable energy will help reduce the amount of CO₂ Namibia emits. As a result the air in Namibia will be cleaner and safer for its people. This means a healthier environment for people and animals.
- Improve economy, promote entrepreneurs and create jobs – this is important because

Namibia is reliant on other countries for energy. Namibia hopes to eventually export energy. RE has the potential to raise the confidence of Namibian people and create jobs for many. Also, as Namibia grows and industrializes, entrepreneurs need ways to establish green businesses to help mitigate effects of climate change. Improve agriculture and food availability – important because some places have limited access food. The unpredictable changes in the climate have left farmers struggling to provide enough crops. Improve water availability – Namibia is a dry arid country that suffers from a lack of water. If Climate changes continues to get worse water will become even more scarce and unavailable to people and animals. Namibia also relies on hydro power and if the rivers run dry they won't be able to use this type of renewable energy. Supports Vision 2030 – supporting sustainable development in Namibia and mitigating climate change effects in the country. Improving education across urban and rural areas and incorporating environmental education.

Slide 11



Ask the learners if they have any ideas for what Namibia can do to decrease greenhouse gases and climate change? Tap the flag to reveal the answer

Slide 12

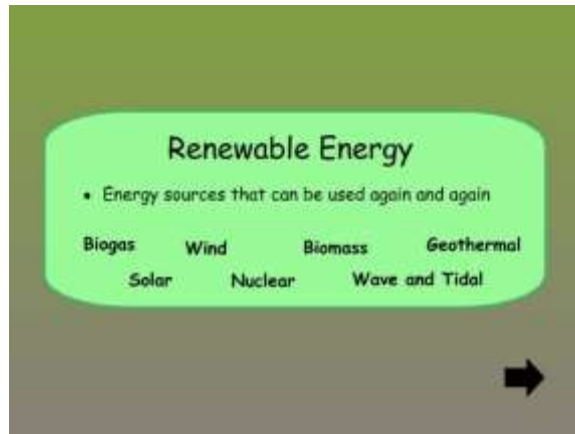

Renewable energy home page. Explain the definition of renewable energy. Teacher or learner can click on each type of energy to learn more about it. Can ask the learners which one they want to learn more about first

Slide 13

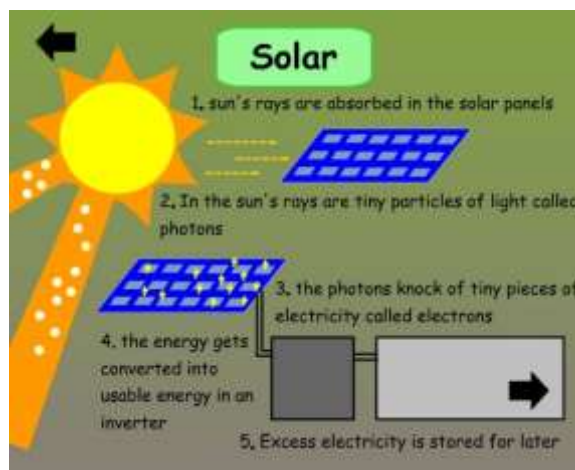

Solar energy converts solar energy to electricity. Each number can be clicked and revealed. Photons, electrons.

Slide 14



All pictures can be clicked to reveal four different application of solar energy. Solar cookers, Solar water heaters, Electricity, Power lamps and chargers. Ask the learners what is the best thing they can do given the choice of these application? Answer: build a solar cooker, buy a solar powered lamp

Slide 15

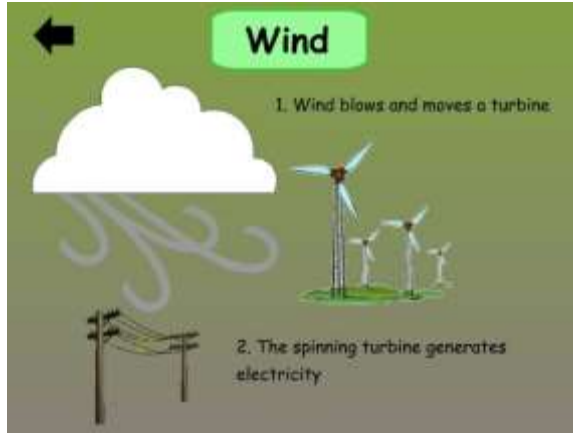

Wind energy uses wind to turn a turbine and generate electricity. Click the cloud and click the turbine to spin. Good places for wind energy are coastal areas.

Slide 16

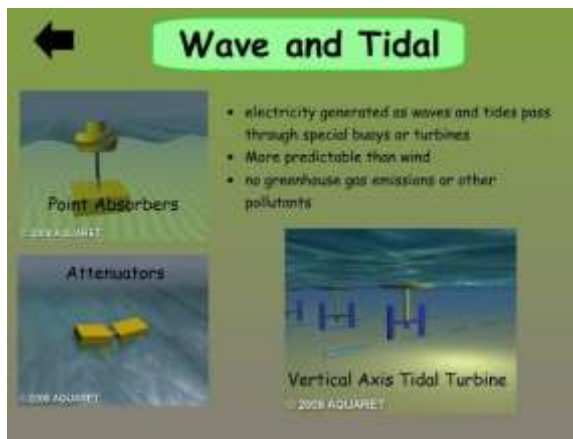

It is power generated from waves and tides when it passes through special buoys, turbines and other technologies. More predictable than wind energy. Electricity is produced without any pollutant emissions or greenhouse gases, but full environmental impacts are scarce. Each of the images move and can be explained.

Slide 17

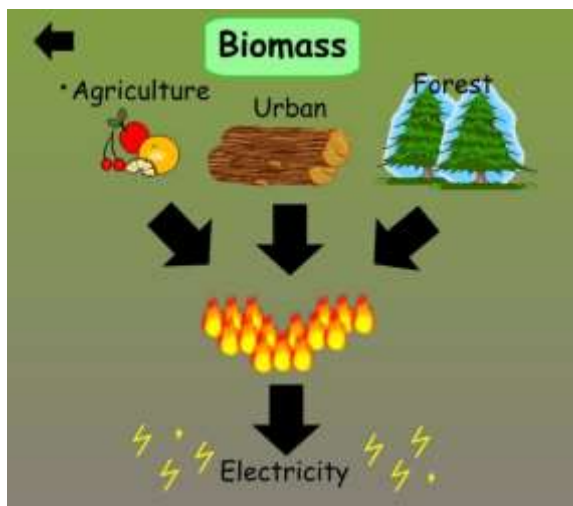

Very simple explanation as it will be further explained in another module. It generates electricity by burning biological material. A specific biomass to Namibia is known as Bush-to-Energy. This process utilizes the abundant, invasive encroacher bushes and burns them to produce electricity. Scraps of biological material → combustion → electricity

Slide 18



Sorting Activity. Let learners come up to the board and sort the types of renewable energy.

Slide 19



Ask the learners What are the best options for Namibia. Short Discussion.

Slide 20



Go through the slide then ask learners if they can think of anything else that they can do. Explain the importance of each. If they give an answer that is "use more solar power" explain why that isn't good enough and how they can actually achieve that goal.

Slide 21

1. When **bacteria** breaks down organic matter, **biogas** is created.
2. **Electricity** is a result of the sun's energy absorbed in panels.
3. Wind is strong enough to turn a **turbine** and generate electricity.
4. Nearly **carbon free** energy can be produced when atoms split in a **nuclear** reactor.
5. Geothermal sources use **steam** and **hot water** to turn turbines and generate electricity.
6. Power can be generated from **waves** and tides when it **passes** through special buoys or turbines.
7. **Biomass** is burning plants for **renewable** energy.

Let as many learners as you can come up to the board and try filling in the sentences. Remember to reset this slide.

Slide 22

Activity: After learning about the important of renewable energy, it is time to share your opinions and give advice to others.

Directions: Divide yourselves into 3 groups. Each group will get a decision a fellow Namibian is facing in there life. Please provide them some helpful advice.

Please consider:

- environmental impacts
- economic impacts
- social impacts

Activity

Slide 23

Scenario 1: A community to the east of Windhoek has heard about solar energy but is not sure about taking advantage of the government loan program because it is expensive. What can you tell them about the benefits of renewable energy?

Scenario 2: Tauno is a farmer in the northern region of Namibia and has lost much of his crops and won't have money for electricity. He thinks it is a good idea to construct a turbine on his property to supply electricity. What do you think of Tauno's idea?

Scenario 3: Penda and his family want to increase their property for farming. They decide to cut down and burn the encroachment bush. What are positive and negative impacts of Penda's actions?

Scenarios

Slide 24



Renewable Energy is important not only for Namibia but also the world. Resources like fossil fuels are disappearing and cannot be renewed as quickly as wind or solar resources.

Namibia is setting a good example for other developing nations to invest in alternative energy and resources to minimize their carbon footprint.

It is important to work together to help create a future with the same opportunities and resources as we currently have.

Go through each point to help summarize the lesson.
Ask the students if they have any questions.
Reveal section on left first. Then right section.

Appendix BBB: Ministry of Education Curriculum

Curriculum for the EduMobile Project



National philosophy

“To arrange for the provision of an accessible and equitable, qualitative and democratic national education service; to provide for the establishment of the National Advisory Council on Education, National Examination Assessment and Certification Board, Regional Education Forums, School Boards and Education Development Fund; to provide for the establishment of schools and hostels; to provide for the establishment of Teaching Services and the Teaching Services Committee; and to provide for incidental matters.” (Education Act, No. 16 of 2001).

National Education Philosophy

“We, in partnership with our stakeholders, are committed to providing all Namibian residents with equitable access to quality education programmes to develop the abilities of individuals to acquire the knowledge, understanding, skills, values and attitudes required throughout their lifetimes.”

(Mission of the Ministry of Education).

Introduction

Namibia's aspiration of becoming an industrialized society relies largely on science and technology. Providing quality science education to Namibians from an early age is a vital prerequisite for developing Namibia as a knowledge based society and becoming a competitive player in the global market.

The Ministry of Education undertook a comprehensive reform process to increase access, equity, quality and lifelong learning (UNESCO, 2004). In response to many issues including education, social reform, and environmental degradation, the Namibian government created a national development agenda called *Vision 2030*. In regards to education, *Vision 2030*'s plan is to create, "a fully integrated, unified and flexible education and training system, that prepares Namibian learners to take advantage of a rapidly changing environment and contributes to the economic, moral, cultural, and social development of the citizens throughout their lives" (National Planning Commission, Section 4.3.3, 2004).

The Ministry of Education implemented several changes already, with new curricula introduced in all grade levels, an increased effort to improve teacher qualifications, and improvements to scholastic infrastructure (National Planning Commission, Section 4.3.3, 2004).

There are drastic differences between urban and rural school systems. Most rural schools lack qualified staff because most young educators prefer to teach in urban districts. Urban schooling also tends to have better managerial approaches, as they have the funds to send their principals and head staff to management workshops. Rural schools have poor managerial systems due to minimal government funding (The Namibian, 2007). Most the rural schools are also ill-equipped with necessary school supplies and technology.

The HARAMBEE PLAN FOR PROSPERITY [HPP] has been developed to complement the National Development Plans and Vision 2030. The HPP is a focused and targeted approach to achieve high impact in defined priority areas. In line with this the HPP focuses on poverty alleviation amongst the youth by putting more focus on vocational education.

One of the agreed upon features of planning is that it must be flexible. While our Vision remains unchanged, we remain agile in our approach to achieving those targets. The Namibian education system specifically faces a lack of resources, informed teachers, and a diverse population. To develop as a nation towards complete independence, education must be one of the highest priorities (Kandpal, Broman, 2014).

Programme Description

Namibia is one of the few countries in the world with the potential to become entirely powered by renewable energy (Munyayi, Iлека & Chiguvare, 2015). Specifically, Namibia is an ideal candidate for the implementation of wind energy, solar energy, and Bush-to-Energy initiatives. With the significant effects of climate change that the country battles daily, preparing Namibian citizens to transition to renewable energy for power will have several positive effects nationwide. This transition would not only enable the country to better counteract the effects of climate change, it would also reduce their dependence on foreign goods and promote job growth throughout Namibia (Munyayi, Iлека & Chiguvare, 2015).

Namibia's total electricity demand is currently estimated in the region of 600 MW per annum. Due to the envisaged growth trajectory, this demand is expected to grow at about 5 percent per annum. Total generation capacity delivers approximately 400MW, thereby rendering a deficit of about 200MW. It is,

however, important to note that much of the generating capacity [332 MW] is linked to hydro supply from Ruacana that is dependent on the seasonal flow.

Namibia imports a significant amount of electricity from neighbouring countries, with the bulk coming from Eskom in South Africa, through the use of fossil fuels. Eskom however has its own challenges in providing electricity. To the extent that South Africa in the year intermittently experienced load shedding in most parts of the country. According to the Harambe Goal and Outcome, the desired goal with regards to electricity supply will be an increase in local electricity from 400 MW to 600 MW, provision of electricity to all schools and health facilities by 2020 as well as an increase in rural electrification rate from 34 percent in 2015 to 50 percent by 2020.

Namibia has an opportunity to achieve independence from these countries with the implementation of renewable energy. The Namibian government is investigating the use of solar energy, wind energy, and a Namibia-specific biomass process called "Bush-to-Energy". Namibia is covered in an invasive plant species known as encroacher bush, and with the utilization of Bush-to-Energy, the country can produce energy from burning the encroacher bush as a source of biomass. EduVentures plans to use all three of this energy forms in their renewable energy program. These lessons are a method for the government to educate its population in these unfamiliar topics and prepare them for the upcoming future.

Climate change and renewable energy in Namibia

The natural causes of climate change include: earth's orbit around the sun, intensity of the sun's rays, circulation of the ocean and the atmosphere, and volcanic activity. Human contributions to climate change include burning fossil fuels, cutting down forests, and developing land. As the ozone disappears, surface temperatures rise, precipitation patterns change, and drought and flooding occurrences increase (Jackson, 2017).

Although Namibia is a small contributor of greenhouse gas emissions, the nation experiences massive climate change effects (Lubinda, 2015). Changing precipitation patterns, delay Namibian farming seasons and changing seasonal temperatures result in increased occurrences of drought and flash floods. Namibian communities whose livelihoods depend on natural resources, such as subsistent agriculturalists, undoubtedly feel the effects of these changes. Land degradation, jeopardizes agriculture, and since 70% of Namibia's population is part of an agricultural community, the government believes it is urgent to act and prepare the country for the anticipated future consequences of climate change (Lubinda, 2015).

Namibia currently imports 80% of its energy from surrounding countries, but has the potential to become a country completely powered by renewable energy (Munyayi, Ileka & Chiguvare, 2015). The Namibian government recognizes this potential and, through the Ministry of Environment and Tourism (MET), implemented several policies that address different strategies to adapt to climate change and established four within the past decade:

2001- Established the National Climate Change Committee (NCCC), which functions as a federal advisory committee on climate change (Benyamin & Nantanga, n. d.)

2011- Developed the National Climate Change Policy, which outlined a comprehensive framework on climate risk management in accordance with Namibia's development agenda (Ministry of Environment & Tourism, 2011)

2012- Implemented the Disaster and Risk Management Act, which established institutions for risk management to plan for disasters such as flooding and drought (Republic of Namibia, 2012)

2014- NCCP created the National Climate Change Strategy and Action Plan (NCCSAP), which exemplifies the goals of their organization.

EduVentures has years of experience working with and educating learners on natural resource and environmental issues. Based on this experience, we have proposed a mobile EduVentures project, referred to as the Ombombo Mobile. This project has broadened our services to target *Namibia's rural schools (Grade 8-12) and communities*, which previously had no access to experience-based education due to lack of facilities and isolation of these areas. The aim of this project is to compliment Namibia's National Curriculum for Basic Education with hands-on experiential learning of theoretical topics that are covered in the curriculum. The target group of the project are secondary school (Grade 8-12) learners in rural areas. Global significant biodiversity loss, inefficient use of non-renewable resources, excessive water consumption and unsustainable use of natural resources will form the core of the education programme.

The programme aims to increase environmental competency of the participating schools and/or groups by stimulating the learners' passion for the environment. This goal will be achieved by: enabling participants to make informed decisions concerning use of natural resources and biodiversity conservation by exposing them to biodiversity and biodiversity issues and by encouraging personal development; fostering a sense of ownership towards Namibia's natural heritage and an appreciation of those who derive livelihoods from the Namibian environment; and to cultivate responsible and engaged citizens who are able to drive the process of sustainable development in Namibia.

Mobile environmental education using a specially equipped vehicle allows for moving the classroom into open space and bringing the classroom to the learners, especially in Namibia's rural areas. The vehicle will be equipped with a computer and science laboratory designed to cover a variety of relevant environmental topics. Under professional guidance, groups will be able to participate in a variety of practical and fun activities to help them understand environmental issues, renewable and non-renewable concerns specific to Namibia.

In addition, the establishment of environmental clubs will be actively encouraged at all participating schools. The aim of these clubs is to leave behind the legacy of this interactive learning experience. The clubs will be run by the learners themselves with the help of interested and committed teachers at each school. EduVentures will provide some financial support for the first year of operation and continued technical support to the clubs. All environmental clubs will be invited to participate in an annual country-wide competition to present their club activities and progress. This will help with monitoring and evaluation of this project.

The programme has implemented the topics of Biodiversity, Climate change, Sustainability and heritage to 32 schools in central and North to North Eastern Namibia. Close to 4000 learners participated in this programme

The entire programme will cover four major topics, namely Introduction to Renewable Energy in Namibia, Solar Energy in Namibia, Wind Energy in Namibia and Bush-to-Energy in Namibia. Depending on local issues of concern and interest, two of these topics will be covered at each visited school. Educational modules,

presentations, picture series and games have already been developed to cover these four topics. In addition, existing environmental education materials and resources, e.g. Fact sheets produced by Think Namibia through the Hans Seidel Foundation (HSF), Namib Desert Environmental Education Trust (NaDEET) booklet series, Africa Adaptation Project (AAP NAM) booklets and posters, and other materials produced by Gobabeb Research and Training Centre and the Desert Research Foundation of Namibia (DRFN) will be used and reprinted if necessary.

Table 1: Daily activities during the five day programme with 1 a), b), and c), as options available depending on the topic to be taught at school.

Day	Time	Topic	Timing
1	14H00 – 17H00	Renewable energy in Namibia	
	a).	Introduction and pre - questionnaire	30 min
	b).	Interactive teaching – Smart lesson	1 hour
	c).	Activity -	1 hour 30 min
	18H00 – 21H00		3 hours
		Movie on renewable energy world wide	
		Discussion and feedback	
2 a).	14H00 – 17H00		
	a).	Solar energy	
	b).	Interactive teaching – Smart lesson	1 hour 30 min
	c).	Activity – Ombombo Mobile Classroom	1 hour
	18H00 – 21H00	Movie and discussion	3
2 b).	14H00 – 17H00		
	a).	Bush-to-Energy	30 min
	b).	Interactive teaching – Smart lesson	1 hour 30 min
	c).	Bush game	1 hour
	18H00 – 21H00		
	a).	Movie and discussion	1 hour 30 min
	b).		1 hour 30 min
2 c).	14H00 – 17H00		
	a).	Wind energy	1 hour 30 min
	b).	Interactive teaching – Smart lesson	1 hour
	c).	Wind activity	30 min
	18H00 – 21H00	Movie and discussion	3 hours
3	14H00 – 17H00		
	a).	Field visit	1 hour 30 min
	b).	Accompanied by an expert - Discussion	
	c).		1 hour 30 min

	18H00 – 21H00		1 hour
	a).	Discussions on the field visit	1 hour
	b).	Create an energy farm for your region/ village	1 hour
	c).	Introduce the idea of a club	
4	14H00 – 17H00	How to create and maintain Enviro Clubs	
	a).	Presentation	1 hour
	b).	Committee selection	1 hour
	c).	Club activities	1 hour
	18H00 – 21H00		
	a).	Project continuation	20 min
	b).	Researching and designing	10 min
	c)		2 hours 30 min
5	14H00 – 17H00	Continue with research and prepare materials	
	a).	Prepare posters and presentation materials	3 hours
	b)	Post questionnaires and group photo	
	18H00 – 21H00		
	a).	Project presentation	1 hour 30 min
	b)	Handover of certificates	

Content description

Table 1: Introduction to Renewable Energy Curriculum

Unit	Content description	Unit description	Learning outcomes – learners should be able to:
1. Non-renewable Energy	1.1 What is non-renewable energy? 1.2 Fossil fuels 1.3 Effects of fossil fuels	Brief overview of non-renewable energy and the formation of its sources. Link between fossil fuels, greenhouse gases and climate change.	<i>Know</i> what non-renewable energy is <i>Know</i> where non-renewable energy comes from <i>Explain</i> how fossil fuels takes years to form and cannot be reused
2. The Industrial Revolution	2.1 Where it started and what it is? 2.2 Discovery of iron and coal 2.3 Uses of new fuels	Go through highlights of the industrial revolution and explain the impacts on society.	<i>Know</i> where the industrial revolution took place <i>Know</i> what the industrial revolution is <i>List</i> positive and negative outcomes <i>Explain</i> the process of how a steam engine works
3. Renewable Energy	3.1 What is renewable energy? 3.2 Types of renewable energy	Discussion of what renewable energy is and the many different types of sources.	<i>Know</i> what renewable energy is <i>Explain</i> the process of different types of renewable energy

			<i>Consider</i> the best options for Namibia
4. Renewable Energy in Namibia	4.1 Why is it important? 4.2 What can you do? 4.3 Problems and solutions	Explain, in detail, the importance of renewable energy and the long-term effects of transitioning to renewable energy in Namibia. Explain that there are little acts learners can do to help support mitigating climate change in Namibia through example scenarios.	<i>Discuss</i> the importance of renewable energy <i>Identify</i> activities and actions that can be done on a small scale <i>Brainstorm</i> possible solutions to hypothetical and real problems
PRACTICAL ACTIVITIES			
ACTIVITY 1	What Type of Energy is Pictured Here? (sorting)		There are seven different images labeled with different types of energy. This activity gets the learners up and interacting with the SMART board. It lets the learners think about which type of energy falls under the two categories of non-renewable and renewable energy. Learners can come up one at a time to the board to try sorting.
ACTIVITY 2	Brainstorming inventions and technologies		After learning about some of the new technologies and inventions of the industrial revolution, think about some inventions or technologies you have in your community. In groups of 2-3 learners, brainstorm different inventions or technologies. The inventions or technologies may either be harmful or helpful in your community. Points to consider should be 1) Impacts of the inventions or technologies on the environment (good or bad); 2) If you have direct access to the invention or technology; and 3) How did you think of the invention or technology. After brainstorming for 15-20 minutes, learners will share what they brainstormed and write on the SMART board for a brief discussion
ACTIVITY 3	What do you remember? (fill in the blank)		There are seven different statements about the different types of renewable energy with missing words. Learners will be able to come up to the board and drag words from the word bank to the correct spaces. The activity tests the learners on how much they remember about renewable energy from the lesson.
ACTIVITY 4	Hypothetical scenario problem solving		After learning about the importance of renewable energy, it is time to

		share your opinions and give advice to others. Divide yourselves into 3 groups. Each group will get a scenario. The scenario will explain a problem a Namibian is facing. They are looking for suggestions about what to do. Please consider: Social, Environmental and Economic Aspects of Renewable Energy. At the end, learners will write their suggestions on the board to share with everyone else. The teacher will facilitate the discussion between the learners. It will be good if some learners disagree.
--	--	-----------------------------------------------------------------------------------------------------------------------------------------------------------------------------------------------------------------------------------------------------------------------------------------------------------------------------------------------------------------------------------------------------------------------------------------------------------------------------------------------------------------------

Table 2: Solar Energy Curriculum

Unit	Content description	Unit description	Learning outcomes – learners should be able to:
1. Introduce Solar Energy	1.1 What is solar and energy 1.2 How does it work? 1.3 How does it store energy? 1.4 Maintenance of solar panels	Understand the basic concepts of solar energy and how it works, how it stores energy	<i>Know</i> what solar energy is <i>Describe</i> how solar energy works <i>Describe</i> how it stores energy <i>Describe</i> the maintenance of solar panels
2. Types of Solar Panels	2.1 Photovoltaic Solar Panels 2.2 Concentrated Solar Panels 2.3 Future Work and Emerging Technologies	Discuss what they are made of, where they can be used (i.e. home), the types of the technologies that belong to each subtype. Also, defining what kind of solar panels are under each subtype. Lastly, discuss what can be improved from the current technology and what is in the current research for solar panels.	<i>List</i> the different types of solar panels <i>Describe</i> where each can be implemented <i>Define and List</i> the different technologies that each can use <i>Describe</i> new, emerging technologies within this field.
3. Advantages and Disadvantages	3.1 Advantages 3.2 Disadvantages	Present the advantages and disadvantages for solar energy to the learners. Each will be explained why they fall under each category.	<i>List</i> both the advantages and disadvantages <i>Explain</i> why solar energy can be both beneficial and harmful <i>Understand</i> why both the advantages and disadvantages exist for this technology
4. Solar Energy in Namibia	4.1 Why in Namibia 4.2 Where in Namibia	Discuss the reasons why Namibia should use solar energy as a source of energy with the learners. Discuss where solar panels	<i>Argue</i> why Namibia should use this technology <i>Understand</i> where individuals and solar plants can use this technology

		can be implemented for both the individual and for solar plants/farms.	<i>Explain</i> how Namibia can be positively affected by the use of solar technology
PRACTICAL ACTIVITIES			
ACTIVITY 1	Vocabulary Fill in the Blank		The learners will go to the board one at a time and drag different vocab word to the blank spaces. The vocab words will be terms presented throughout part of the lesson. If it is wrong, the word will bounce away from the blank space. If the learner drags the correct word, then the word will disappear. This will be done until all the words have been matched with their corresponding definition.
ACTIVITY 2	Community Drawing		The learners will have to draw a picture of their community where they include various solar technologies. They have to include at least 1 PV solar cell or CSP solar cell, 1 solar cooker or heater, and anything else they think is important. They will then have to discuss where they choose those aspects in their drawings and why they choose where they drew them.
ACTIVITY 3	Brainstorming Advantages and Disadvantages		Learners will come up to the board one at a time and write down their ideas of the advantages and disadvantages of solar energy. These will then be compared to the reasons presented to them to see if any match.
ACTIVITY 4	Brainstorming "Why in Namibia"		The learners will again come up to the board if they want to and write down any ideas on why they think solar energy can be used in Namibia. These answers will be compared to the responses presented by the teacher.
ACTIVITY 5	"Where in Namibia" Sorting		Learners will go up to the board and drag which areas they think can use solar farms to a box. If the answer is incorrect, it will bounce away and if it is correct it will disappear. They will continue to do this until all the correct regions

Table 3: Wind Energy Curriculum

Unit	Content description	Unit description	Learning outcomes – learners should be able to:
------	---------------------	------------------	-------------------------------------------------

1. Introduce Wind Energy	1.1 What is wind energy 1.2 How does it work? 1.3 How is wind created?	Understand the basic concepts of wind energy and how it works	<i>Know</i> what wind energy is <i>Describe</i> how wind energy works <i>Explain</i> the causes of wind
2. Advantages and Disadvantages of Wind Energy	2.1 Advantages 2.2 Disadvantages	Discuss the important factors to consider when installing wind energy. For example, although wind energy does not produce any greenhouse gas emissions, the blades of the turbines can kill birds and bats.	<i>Explain</i> how wind energy is beneficial to Namibia <i>Consider</i> possible consequences of wind energy <i>Compare</i> the good aspects of wind energy to the bad aspects and be able to argue either for or against wind energy
3. Types of Wind Turbines	3.1 Horizontal Axis Turbines 3.2 Vertical Axis Turbines	Discuss the different designs and parts of each type of turbine. Also, teach the learners what each part does in the turbine assembly. Each turbine has its own list of advantages and disadvantages to consider	<i>List</i> the different types of turbines <i>Identify</i> the different parts of the turbines and identify their purpose in the assembly <i>Consider</i> the advantages and disadvantages of each type of turbine <i>Compare</i> the two impacts of the turbines and which would be best suited for use in Namibia
4. Wind Energy in Namibia	4.1 Why should Namibia use Wind Energy 4.1.1 Job Growth 4.1.2 Clean Environments 4.1.3 Large Coastlines 4.1.4 Stop Climate Change	Realize the impact that renewable energy implementation can have in Namibia. The lesson will show the potential benefits of using wind energy, and also warn the learners about the consequences of continuing to use fossil fuels.	<i>Enhance</i> the previous topics presented by explaining wind energy's impact on Namibia <i>Understand</i> how their communities and their country will be affected if Namibia continues to live unsustainably. <i>Argue</i> in favour of introduction of wind energy in Namibia
PRACTICAL ACTIVITIES			
ACTIVITY 1	Stakeholder Brainstorming	Identify and describe all of the people or things that can be affected by Namibia choosing to install wind turbines. The learners will split into groups and brainstorm the wind energy stakeholders, and discuss with the class their importance and how they are affected	

ACTIVITY 2	Combating Climate Change in Your Community	The learners will get into groups of five. They will be tasked to think of all the ways they could help save the Earth and stop climate change from inside their community. They must only use the resources they already have in their community. For example, if they could not do this project tomorrow, then it does not count. The team with the most brainstormed answers at the end of the 5-minute time period wins the activity.
ACTIVITY 3	Wind Energy Jeopardy	Test the learners on the content presented throughout the lesson. This activity includes 25 questions ranging in difficulty. The learners will split into two groups and compete against each other to earn points by answering questions correctly. The team with the most points at the end of the activity will win.

Table 4. Bush-to-Energy Curriculum

Unit	Content Description	Unit Description	Learning Outcomes- learners should be able to:
1. Introduce Bush-to-Energy	1.1 What is Bush-to-Energy? 1.2 Review of Fossil Fuels 1.3 Encroacher bush a) Invasive species b) Encroacher bush definition c) Types of encroacher bush	Understand the term Bush-to-Energy and the basic components of this technology, specifically what encroacher bush is	<i>Know</i> what Bush-to-Energy is <i>Describe</i> how it is different from fossil fuels
2. Potential for Bush-to-Energy in Namibia	2.1 Problems with encroacher bush a) Desertification b) Bush encroachment c) Economy 2.2 Harvesting Bush a) Types of harvesting b) Good Practices c) Bad Practices	Understand why encroacher bush is a problem in Namibia and how this bush can be properly harvested to be used in energy production.	<i>Explain</i> what encroacher bush is <i>List</i> the main types of encroacher bush and good and bad practices of harvesting <i>Understand</i> why encroacher bush is a problem that needs to be addressed
3. Power Operation and Maintenance	3.1 Converting Bush into Energy a) Important vocabulary b) Step-by-Step process	Review descriptions of technologies that are used in the conversion of Bush-to-Energy. Learn how the harvested encroacher bush can be converted into electricity	<i>Know</i> what Bush-to-Energy is <i>List</i> the steps of converting Bush-to-Electricity <i>Describe</i> how Bush-to-Energy works
4. Where in Namibia?	4.1 Possible locations for Power plants and implementation	Discuss the regions of Namibia where Bush-to-	<i>Describe</i> where this can be implemented

		Energy power plants would be of most use	<i>Understand</i> why this region is the best fit for this technology
5. Advantages and Disadvantages	5.1 Advantages a) Reduce Imports b) Improve the economy c) Decentralized Power supply d) Decrease CO ₂ emissions 5.2 Disadvantages a) Carbon Sinks b) Expensive c) Takes a lot of time d) Potential Environmental Harm	Realize the impact that Bush-to-Energy can have in Namibia. Discuss the advantages and disadvantages for Bush-to-Energy, so that the learners will know the benefits of this technology and be able to acknowledge the limitations	<i>Understand</i> the advantages and disadvantages of Bush-to-Energy and how this technology can impact Namibia <i>Develop</i> an ethical stance for this type of technology
PRACTICAL ACTIVITIES			
ACTIVITY 1	Encroacher bush brainstorming		Learners will discuss with class what they think encroacher bush is. Once they have discussed with the class, a learner can come up to the board and drag the magnifying glass across the board to find the definition
ACTIVITY 2	Interactive map		A learner can volunteer to come up to the board and click on the map of Namibia to find all of the areas of Namibia where Encroacher bush exists.
ACTIVITY 3	Solving the problem of encroacher bush		The class will split into groups of four or five and discuss with their classmates how they could solve the problem of encroacher bush. This should take 5-10 minutes, and they should brainstorm different ways to address this issue.
ACTIVITY 4	Review Sorting Activity- Good vs. Bad Practices		This will occur at the end of the module as a review of good and bad practices to remember when harvesting bush. If an answer does not belong to one of the categories, it will not be accepted and will bounce back. For example, eliminating all of the bush is a bad practice, so if a learner dragged that answer to the good practice basket, then the answer would not be accepted and would bounce back to its original location.
ACTIVITY 5	Review Sorting Activity- Advantages vs. Disadvantages		This will occur at the end of the module as a review of the advantages and disadvantages of harvesting bush. If an answer does not belong to one of the categories, it will not be accepted and will bounce back. For example, reducing imports is an advantage, so if a learner dragged that answer to the disadvantages bush, then the answer

		would not be accepted and would bounce back to its original location.
ACTIVITY 6	Bush-to-Energy Connect 4	This is a game that will test learner knowledge on Bush-to-Energy as a whole. The class will split into two teams, the red and the black team. There will be a 'questions slide' in which the first team can pick a number, and that number, when clicked, will lead to a question. If the team gets the question right, they get to place a game piece in their team's color on the board. The pieces must be placed in the lowest row possible, but can be placed in any column. After that, the other team will go. If they get the answer right, they get to place a game piece of their team's color on the board. If a team does not get a question right they do not get to place a game piece on the board. The first team to have four game pieces in a row, either horizontally, vertically, or diagonally wins the game.

References

Jackson, R. (2017). Global climate change: Effects. Retrieved from <https://climate.nasa.gov/effects>

Kandpal, T. C., & Broman, L. (2014). Renewable energy education: A global status review. *Renewable and Sustainable Energy Reviews, 34*, 300-324. doi:10.1016/j.rser.2014.02.039

Munyayi, R., Ileka, H., & Chiguvare, Z. (2015). *Think Namibia: Renewable energy*. House of Democracy: Hanns Seidel Foundation Namibia.

Namibian, T. (2007). On the rural/urban schools divide. Retrieved from <http://www.namibian.com.na/index.php?page=archive-read&id=35400>

National Planning Commission. (2004). *Vision 2030*. Government of the Republic of Namibia.

UNESCO. (2004). *National report on the development of education in Namibia*.

Appendix CCC: Presentation to the Ministry of Education



Climate Change in Namibia



Climate Change in Namibia



Climate Change in Namibia



Climate Change in Namibia



Climate Change in Namibia



Renewable Energy as a Solution

"We all need energy because it is the heartbeat of the whole universe."

- Namibian Ministry of Mines and Energy Official

Renewable Energy as a Solution



Wind Energy
• 1572 km of Coastline



Solar Energy
• Over 300 Sunny Days a Year



Bush-to-Energy
• Bush Infests 55% of Namibia's Land

Mission Statement

This project aims to assist **EduVentures Trust** in developing **four interactive SMART lesson modules** to further educate rural high school learners on **renewable energy** topics for implementation in the **Ombombo Mobile Classroom**.

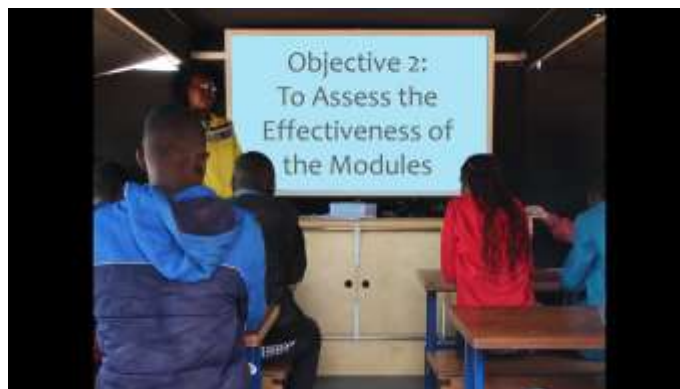
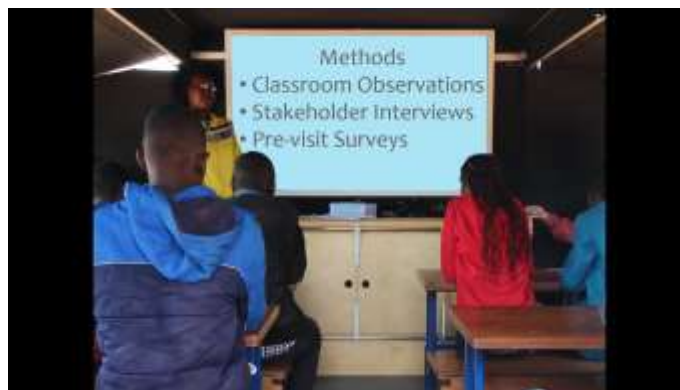



Classroom Observations

Team Member Conducting Classroom Observations

1 2 3 4 5 6 7 8 9 10 11 12

Classroom Observations

- Engaging Teacher
- Questions throughout the Lesson
- Less Lecture, More Activities

Team Member Conducting Classroom Observations

1 2 3 4 5 6 7 8 9 10 11 12

Stakeholder Interviews

Team Member Interviewing a Teacher at Ghazijeta Combined School

1 2 3 4 5 6 7 8 9 10 11 12

Stakeholder Interviews



Team Member Interviewing a Teacher at Okavango Combined School

- Learner-centered Approach
- Demonstrations and Interactive Activities
- Renewable Energy in Namibia

Pre-Visit Surveys



Pre-Visit Surveys



Pre-Visit Surveys



Team Taking the Pre-visit Survey at Okavango Combined School

8

Pre-Visit Surveys



- Minimal Learner Knowledge
 - Low Level Question-93%
 - High-Level Question-3%
- Staircase to Inquiry

Learners Taking the Pre-visit Survey at Obwaleni Combined School

8

Pre-Visit Surveys



- Concrete Question: "What is renewable energy?"
- Guiding Question: "Why is wind energy best in coastal regions?"
- Essential Question: "Why is renewable energy important in Namibia?"

9

Module Development



10

Program Results



Module Observations



Team Members Observing the Solar Energy Module

- Length of the Lesson
- SMART Board Challenges
- Successful Interactive Activities



Pre-tests and Post-tests



Learners at Okavango Combined School Taking a Pre-Test During the Pilot Test of the Module



Pre-tests and Post-tests

Comparison of Learner's Pre-test and Post-test Correct Answers

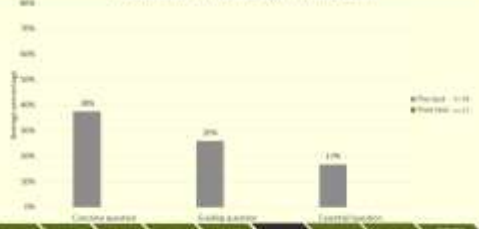

Pre-tests and Post-tests

Comparison of Learner's Pre-test and Post-test Correct Answers

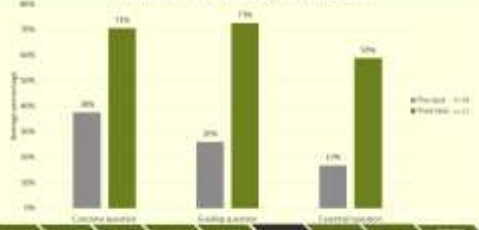

23

Learner Evaluation



Learners taking the Learner Evaluation



23

Learner Evaluation

Learner Evaluation Responses



Question	Average Rating
Q1	4.5
Q2	4.8
Q3	4.2
Q4	4.4
Q5	4.6
Q6	4.8
Q7	4.8
Q8	4.6

Questions from learner Evaluation

Learner Responses



23

Learner Evaluation

Learner Evaluation Responses



Question	Average Rating
Q1	4.5
Q2	4.8
Q3	4.2
Q4	4.4
Q5	4.6
Q6	4.8
Q7	4.8
Q8	4.6

Questions from learner Evaluation

Learner Responses



23

Learner Evaluation

Learner Evaluation Responses



Question	Average Rating
Q1	4.5
Q2	4.8
Q3	4.2
Q4	4.4
Q5	4.6
Q6	4.8
Q7	4.8
Q8	4.6

Questions from learner Evaluation

Learner Responses



14

Pilot Testing the Modules



14

EduVentures Renewable Energy Program
5 Days in Okondjatu, Namibia



15

Modifications and Recommendations



16

Module Modifications



- Shorten Lessons
- Simplify English
- Change Activities

Photo: Members Making Cells for the Modules



Recommendations



The Deliverable Module Classroom in front of Ghana's Entrepreneurial School

- Use Motivators
- Gain Familiarity with the Modules
- Update the Modules Periodically



Reflection



Acknowledgements

EduVentures Trust	Worcester Polytechnic Institute	Other Institutions
Conor Kasegha	Professor Gregorin Peet	Ghana's Entrepreneurial School
Sandra Ninsami	Professor Robert Katsiki	Quincy Smith High School
Walia Johnson	Professor Sarah Wiedt-Schwartz	Shawmutapob Combined School
Seyoum Muremia	Professor Scott Davis	The Future Social Foundation
Tunde Okunfolu	Sam Appokoraye	San Mateo Secondary School

Questions?



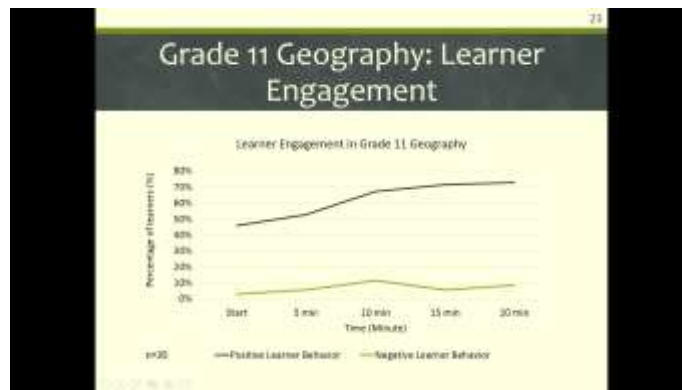
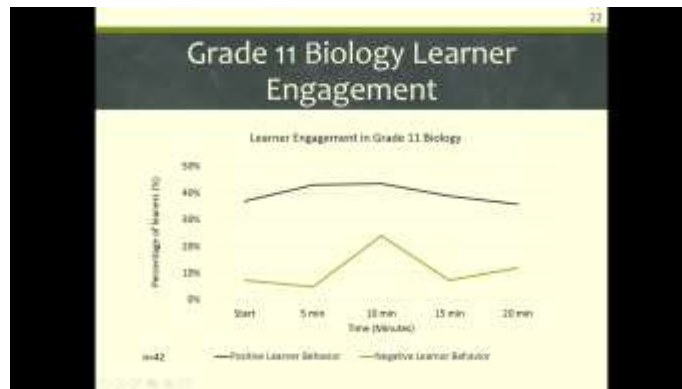
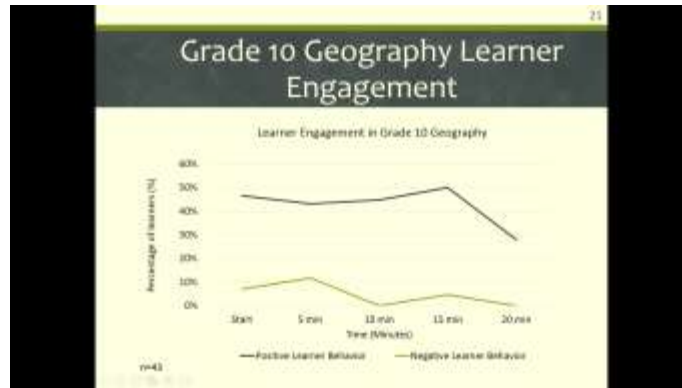

Pre-Visit Survey: Higher level Questions vs Lower level Questions

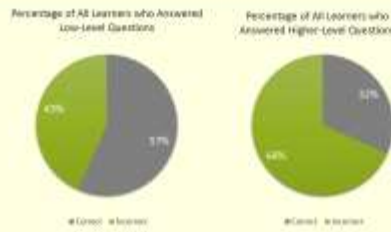

Pre-Visit Survey: Group Work vs Individual Work



Pre-Visit Survey: Overall Comparison of Group Work and Individual Work

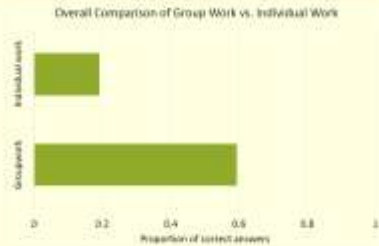

Introduction to Renewable Energy: Learner Engagement



Wind Energy: Learner Engagement

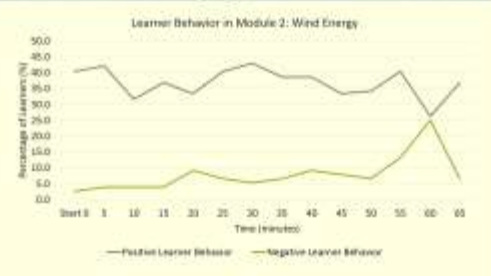

Solar Energy: Learner Engagement

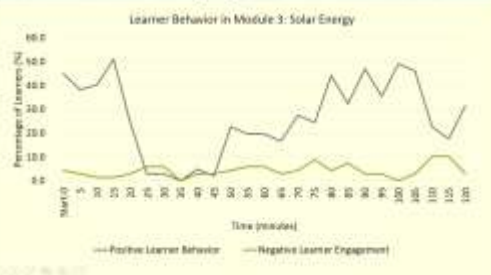

Bush-to-Energy: Learner Engagement

