

**Viktor Milardić**

**Ivica Pavić**

[viktor.milardic@fer.hr](mailto:viktor.milardic@fer.hr)

[ivica.pavic@fer.hr](mailto:ivica.pavic@fer.hr)

**University of Zagreb Faculty of Electrical Engineering  
and Computing**

## **ANALYSIS OF SURGE ARRESTERS FAILURES IN THE INSTALLATION OF BROADCASTING TRANSMITTER**

### **SUMMARY**

In the operation of the broadcasting transmitter, during a lightning storm, comes to frequent surge arrester failures in the switchgear of the broadcasting transmitter and along the 10 kV supply cable (surge arresters in the cable section boxes). Analysis of lightning strokes to the broadcasting transmitter is given in the paper. EMTP simulation of surge arresters loading was conducted. The energy overload of surge arresters is due to lightning flash with more than one lightning strokes or more lightning flashes in short time. Recommendations were also given for improvement of existing surge protection and reduction the number of surge arresters failures.

**Key words:** broadcasting transmitter, lightning stroke, overheating, surge arrester failure

## 1. INTRODUCTION

Broadcasting transmitters like all other tall objects (tall buildings, wind turbines) are exposed to frequent lightning strokes [1]. The average annual number of lightning strokes in such facilities can be hundreds of times [2]. Every lightning stroke in the facility may result in some damage. Lightning protection systems and surge protection seeks the probability of damages reduced to an acceptable value. Analysis of lightning strokes in the broadcasting transmitter (BT), analysis of surge arresters (SAs) failures in the switchgear of BT and along the route of the 10 kV supply cable and recommendations for improving the existing surge protection is given in this paper.

## 2. LIGHTNING STROKES IN THE BT

### 2.1. The BT

In the operation of the BT, located at 1762 m above sea level, Figure 1, during a lightning storm, comes to frequent SA failures in the switchgear of BT, Figure 2 and along the 10 kV supply cable (SAs in the cable section boxes). BT is power supplied from 35/10 kV transformer substation using 10 kV cable line length 8.455 km. The cable is sectioned by four cable boxes (CB1, CB2, CB3 and CB6), Figure 3. In every CB are installed 2 disconnectors and 3 SA (one in phase). The SAs in CBs are  $U_C=14$  kV, line discharge class 4.

SA failures have occurred in the switchgear of BT and in the cable boxes CB6 and CB3.



Figure 1. BT on Biokovo maintain 1762 m above sea level



Figure 2. Overloaded SA

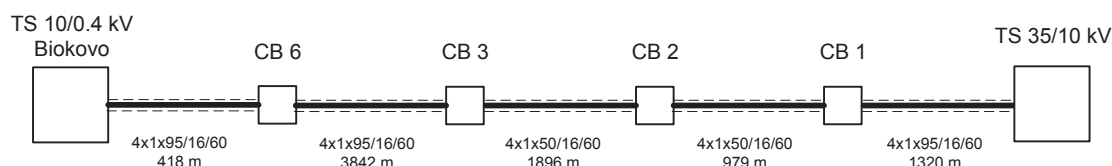

Figure 3. Schematic diagram of the 10 kV cable line

## 2.2. Statistical analysis of lightning flashes

In the Lightning Location System (LLS) [2], data were collected on lightning strokes at location of the BT. LLS data were collected over a period of six years, from 14th January 2009 to 5th January 2015. Lightning strokes were collected inside 2 km radius around the BT using LLS. LLS was collected a total of 3939 lightning strokes, with an average flash multiplicity of 1.63 gives the 2417 lightning flashes. The analysis of data on lightning strokes provided the following summary results, Table I.

Table I. Lightning flashes at location of BT [2]

Area [km <sup>2</sup> ]	Number of lightning strokes to ground	Average flash multiplicity	Number of lightning flashes to ground	Lightning flash density [1/km <sup>2</sup> year]
12.56	3939	1.63	2416	32.05

If we compare lightning flash density at the location of the BT 32.05 [1/ km<sup>2</sup>year], with the map of mean lightning flash density it is clear that the BT is many times more exposed to lightning flashes. On maps of mean lightning flash density the highest values are up to 4 [1/km<sup>2</sup>year] in Italy [3] to 6 [1/ km<sup>2</sup>year] in Spain [4] and to 4.84 [1/km<sup>2</sup>year] in Germany [5]. It should be additionally noted that the lightning flash density has been calculated for the circle radius of 2 km (12.56 km<sup>2</sup> area) around the BT. If we take the minor radius, e.g. 1 km, we will receive even greater lightning flash density, because lightning flashes are concentrated in the BT.

The analysis of the distribution of the peak values of the lightning current (3939 lightning strokes) gets the cumulative distribution shown in Figure 4.

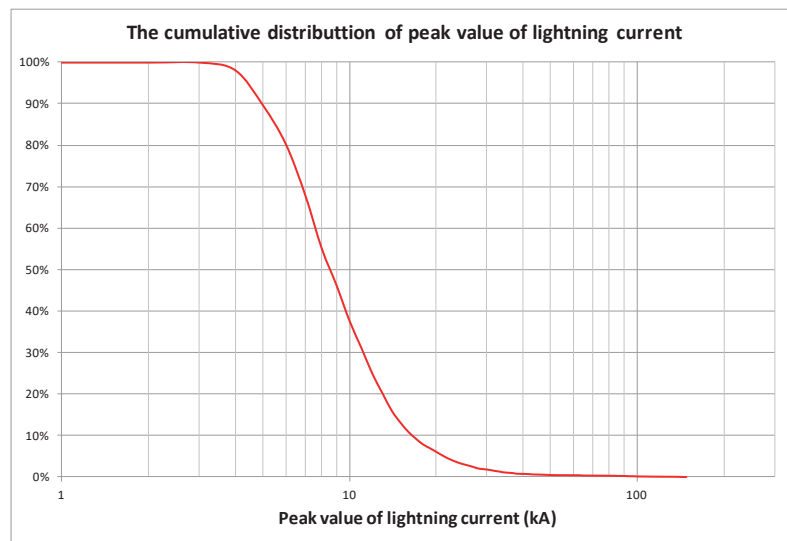

Figure 4. The cumulative distribution of peak value of lightning current (3939 lightning strokes) [2]

From Figure 4 can be read that 37.6% of all lightning strokes have a peak value greater than 10 kA. Less than 10% of lightning strokes have a peak value greater than 17 kA, and the peak value of lightning strokes greater than 37 kA, is less than 1%. The maximum peak value of lightning strokes (148.9 kA) was measured on 19<sup>th</sup> December 2011. This statistical analysis shows that the peak value of lightning strokes significantly deviating from those stated in Table A.1 in the IEC 62305-1 [6].

As previously stated, the BT like all other tall objects is exposed to frequent lightning strokes. As an example, lightning strokes from 4 PM 22<sup>nd</sup> November 2013 to 4 PM 23<sup>rd</sup> November 2013 and concentration of lightning strokes in the BT are shown in Figure 5. Lightning strokes inside 2 km radius around the BT in time between 23:26:24 and 24:00:00, 22<sup>nd</sup> November 2013 are in Table II. From Table II, we can see:

- a) There are not lightning strokes with high peak value of current;
- b) There are a large number of lightning strokes in a very short time interval.

Table II. Lightning strokes inside 2 km radius around BT in time between 23:26:24 and 24:00:00, 22<sup>nd</sup> November 2013 [2]

TIME (UTC)	CURRENT
22/11/2013/ 23:26:24,6370000	-7,3
22/11/2013/ 23:26:24,6760000	-19,2
22/11/2013/ 23:26:24,8530000	-15,8
22/11/2013/ 23:26:24,8880000	-13,2
22/11/2013/ 23:26:24,8960000	-9,8
22/11/2013/ 23:26:24,9200000	-6,2
22/11/2013/ 23:26:24,9750000	-5,5
22/11/2013/ 23:26:24,9970000	-10,1
22/11/2013/ 23:26:25,0500000	-17,6
22/11/2013/ 23:26:25,1010000	-4,8
22/11/2013/ 23:26:25,1450000	-15,1
22/11/2013/ 23:29:34,3230000	-9,3
22/11/2013/ 23:29:34,3610000	-7,7
22/11/2013/ 23:29:34,4050000	-10,7
22/11/2013/ 23:29:34,5020000	9,3
22/11/2013/ 23:30:57,0220000	4,1
22/11/2013/ 23:30:57,0320000	-9,6
22/11/2013/ 23:32:23,5520000	-3,9
22/11/2013/ 23:32:23,6190000	-5,7
22/11/2013/ 23:32:23,6340000	-14,9
22/11/2013/ 23:32:23,6430000	-6,8
22/11/2013/ 23:32:23,6500000	-9,5
22/11/2013/ 23:50:14,2110000	-9,9
22/11/2013/ 23:50:14,2520000	-9,2
22/11/2013/ 23:50:14,2660000	-4,5
22/11/2013/ 23:50:14,2810000	-4,5
22/11/2013/ 23:51:12,7370000	-4,2
22/11/2013/ 23:51:12,7690000	-4,5
22/11/2013/ 23:51:12,7810000	-3,9
22/11/2013/ 23:51:12,7930000	-4,5
22/11/2013/ 23:51:12,8090000	-9,2
22/11/2013/ 23:51:12,8330000	-4,1
22/11/2013/ 23:51:12,8560000	-5,0
22/11/2013/ 23:51:12,9170000	-9,0
22/11/2013/ 23:51:12,9200000	-9,7
22/11/2013/ 23:51:12,9420000	-8,4
22/11/2013/ 23:51:12,9670000	-9,6
22/11/2013/ 23:51:12,9850000	-7,9
22/11/2013/ 23:51:13,0250000	-21,9
22/11/2013/ 23:51:13,2310000	-4,4
22/11/2013/ 23:55:27,9280000	-10,4
22/11/2013/ 23:55:27,9450000	-4,7
22/11/2013/ 23:55:27,9630000	-4,7
22/11/2013/ 23:59:28,0590000	-8,2

Figure 6 shows the concentration of lightning strokes for a longer period of time. The different colors in Figure 6 indicate the range of peak value of lightning currents obtained from Linet LLS:

- ✕  $I \leq 3 \text{ kA}$
- ✕  $3 \text{ kA} < I \leq 5 \text{ kA}$
- ✕  $5 \text{ kA} < I \leq 10 \text{ kA}$
- ✕  $10 \text{ kA} < I \leq 16 \text{ kA}$
- ✕  $I > 16 \text{ kA}$

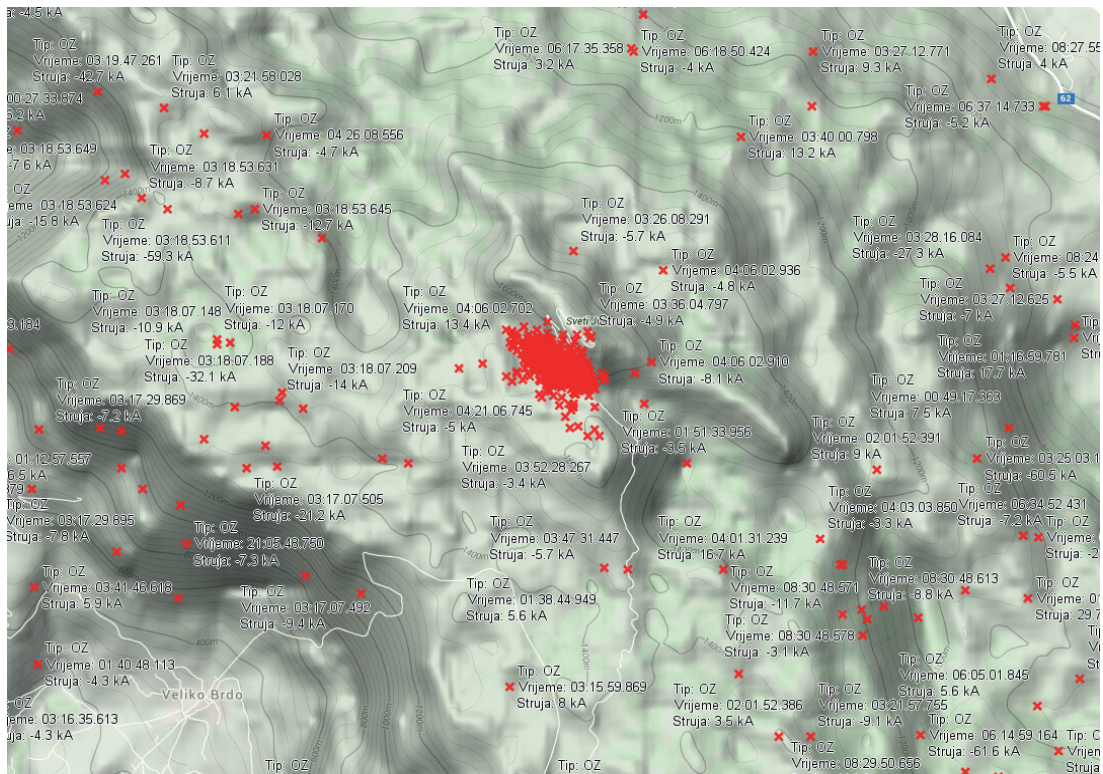

Figure 5. Concentration of lightning strokes in the BT, from 4 PM 22<sup>nd</sup> to 4 PM 23<sup>rd</sup> November 2013 [2]

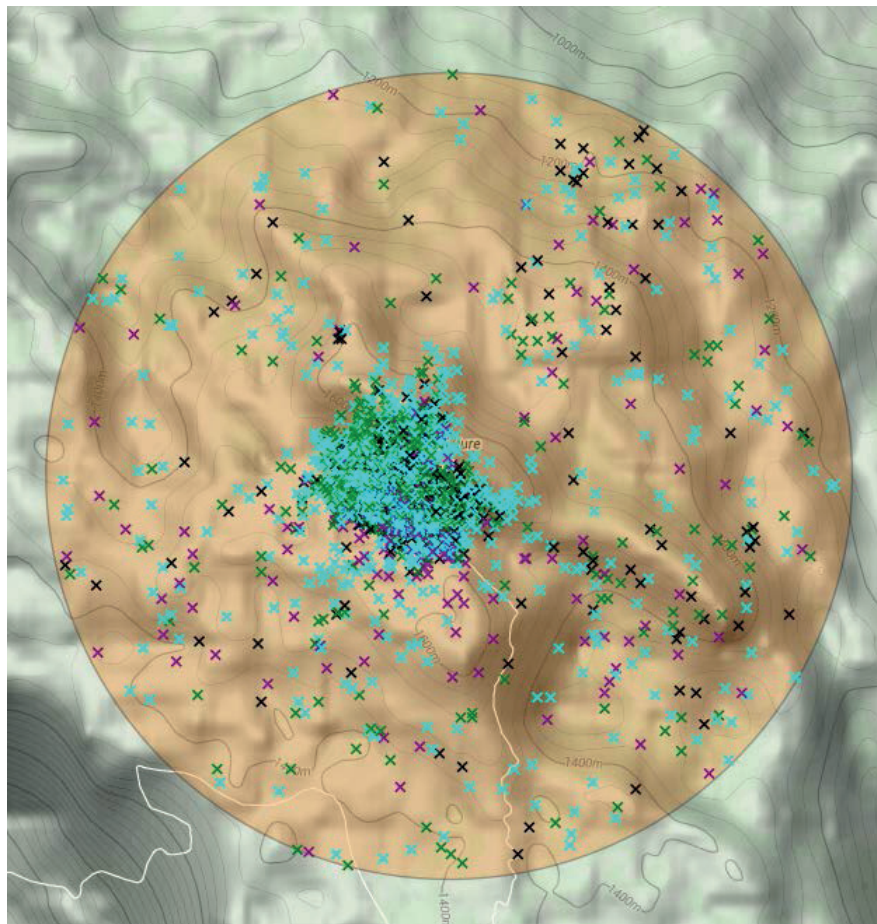

Figure 6. Concentration of lightning strokes in the BT from 14<sup>th</sup> January 2009 to 5<sup>th</sup> January 2015 [2]

Analysis of lightning strokes by months is following. Lightning strokes were collected inside 2 km radius around the BT using LLS [2]. Figure 7 shows the average monthly number of lightning flashes calculated using an average multiplicity 1.63. Lightning strokes were collected in the period January 2009 until January 2015. It can be concluded that the greatest number of lightning flashes in the BT were in October, November, December and May, Figure 7. Accordingly, the largest number of SAs failures was in those months.

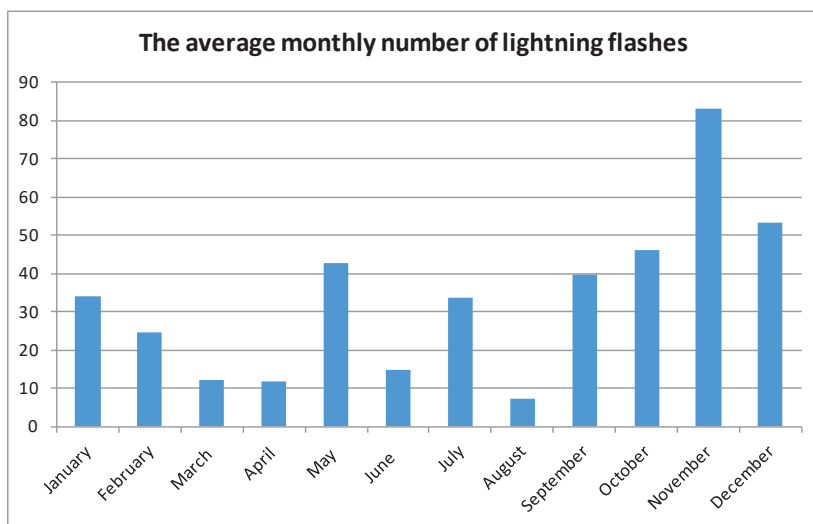

Figure 7. The average monthly number of lightning flashes

The average yearly number of lightning flashes inside 2 km radius around the BT is shown on Figure 8. It is clear that the number of lightning flashes varies considerably from year to year, and that 2013 was an extreme year by lightning flashes at the location of the BT.

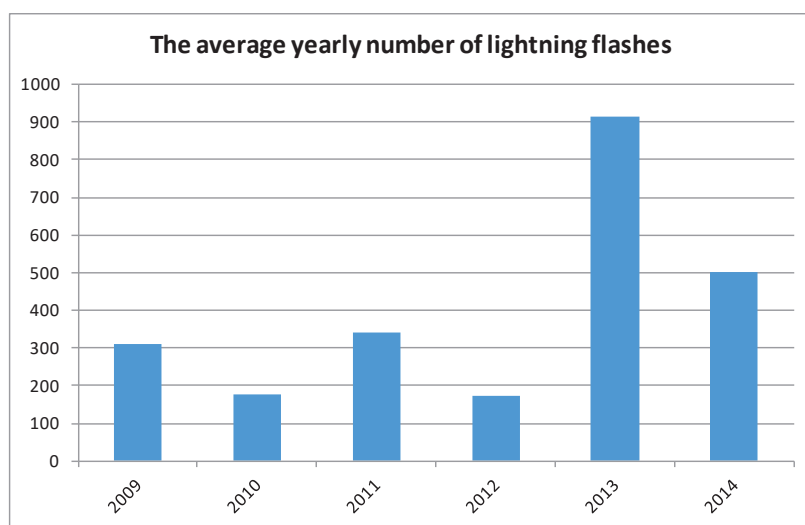

Figure 8. The average yearly number of lightning flashes

### 3. SAs FAILURES IN THE INSTALLATION OF BT

#### 3.1. Theoretical analysis

When lightning strikes BT, the lightning current flows through the earth electrode of BT and increase its potential to the reference earth. The occurrence of high transient potential of the earth electrode creates the transient voltage between the earth electrode and the phase conductors of 10 kV cables. Installed SAs limit the transient voltage conducting a part of lightning current from the earth electrode of BT to the phase conductors of 10 kV cables. In this way, the main insulation of 10 kV cables is protected. SA is heated by passing current through it. Thermal energy absorption capability is defined as the maximum level of energy injected into the SA at which it can still cool back down to its normal operating temperature. Figure 9 explains the problem of the thermal stability of SA. The electrical power loss resulting from the continuously applied power-frequency voltage is temperature-dependent. It rises over proportionally as the temperature increases. On the other hand, because of its design, the SA can only dissipate a certain limited amount of heat into the surroundings. Indeed, this heat-flow value also rises with the temperature, however, not nearly as much as the electrical power loss does. Both power curves have two common points of intersection. The left one is stable operating point. At this point exactly as much heat is dissipated to the outside, as is produced in the MO resistors i.e. a thermal balance prevails. A discharge operation disturbs this balance. The energy which is introduced increases the temperature of MO resistors rapidly, and the operating point moves to the right on the power loss curve, as is shown with an arrow in Figure 9. As long as the right point of intersection of the curves is not reached, the heat generated by electrical power loss can easily be dissipated, and the SA can return to the stable operating point. If, however, the right point of intersection is reached or exceeded, then cooling is no longer possible. The SA then becomes thermally unstable and heats up until it self-destructs. This point of intersection, therefore, represents the thermal stability limit. The thermal energy absorption capability is specified in such a way that the related temperature increase bring the SA to a temperature which exhibits an adequate safety margin to the thermal stability limit. The actual thermal stability limit depends on the overall design of SA and has a value of typically between 170 °C and 200 °C. Generally speaking, SA with molded polymeric housing dissipates the heat of the MO resistors better into the surrounding (comparing to porcelain-housed SA) and therefore its thermal stability limit is at slightly higher temperatures. On the other hand, the characteristics of MO materials (electrical losses and their temperature dependence) have an impact.



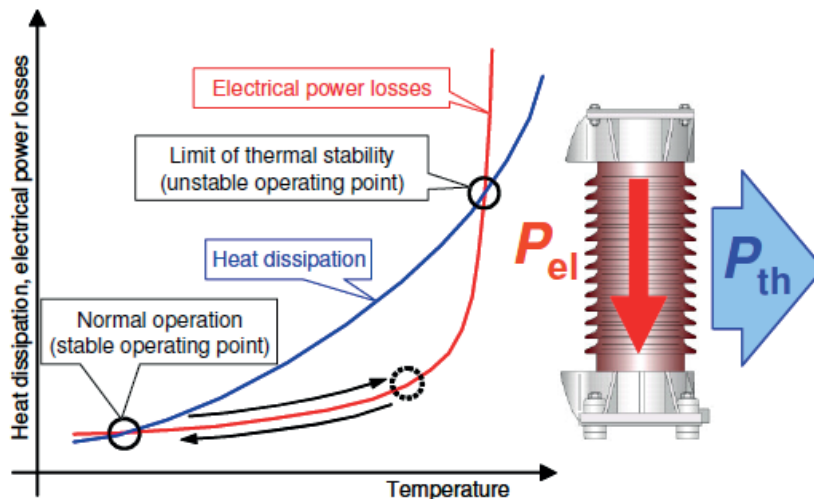

Figure 9. Explanation of the thermal stability of SA [7]

Failure of the SAs occurs by heating above the thermal stability limit. Therefore, if the SA is heated above the thermal stability limit, it leads to the thermal destruction of the SA and ultimately to earth fault (line-to-earth fault). Thermal destruction of SAs in the switchgear of BT occurs as a result of large number of lightning strokes in a very short time interval, table II. Every lightning stroke increases the temperature of MO resistors. There is not enough time for cooling of MO resistors between the lightning strokes or to return to a stable operating point. It leads to overheating and thermal destruction of the SA.

### 3.2. EMTP-ATP analyze

ATPDraw [8] simple model, shown in Figure 10, is formed for simulation of lightning stroke in the BT. Lightning stroke is simulated as the injected current. SAs of continuous operating voltage  $U_C = 14$  kV and  $U_C = 12$  kV, line discharge class 4, are modeled with their protective characteristics, Table III. SA can absorb about 186 kJ ( $U_C = 14$  kV) and about 160 kJ ( $U_C = 12$  kV). The connections of SAs to the earth electrodes are modeled as  $R=1$  m $\Omega$  and  $L=1$   $\mu$ H (or  $L=2$   $\mu$ H in dependence of their length). MV cables are modeled using JMarti model and electrical and geometrical parameters of the cable. Earth electrode resistances of the BT and of the CBs are not known. They had been measured but the sheath and the armor of the cables had not been disconnected. Because of that, resistances of certain earth electrode are not known. The assumption is that the earth electrode resistances of each one CB is 10  $\Omega$  and the earth electrode resistances of the BT is considered as parameter: 5  $\Omega$ , 10  $\Omega$  and 20  $\Omega$ . The earth electrode resistance of the BT is not necessary to modeled as nonlinear [9] according to equation (1) because the limiting current to initiate sufficient soli ionization, equation (2), in given case are: 159.16 kA ( $R=20$   $\Omega$ ), 636.6 kA ( $R=10$   $\Omega$ ) i 2546.5 kA ( $R=5$   $\Omega$ ).

$$R_i = \frac{R_0}{\sqrt{1 + \frac{I}{I_g}}} \quad (1)$$

$$I_g = \frac{\rho \cdot E_0}{2 \cdot \pi \cdot R_0^2} \quad (2)$$

In accordance to Figure 4 lightning strokes with so large peak value of current are unlikely.

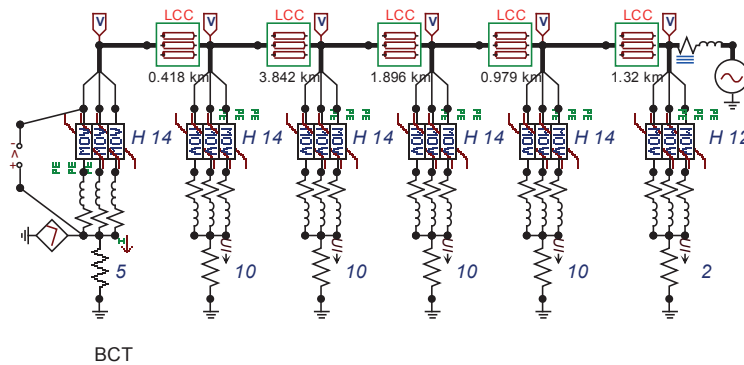

Figure 10. ATPDraw model

The lightning current 200 kA, 10/350  $\mu$ s is simulated according to [6] and the absorbed energy of SAs in all three phases are calculated. Obtained values are in Table IV (for SAs in BT), Table V (for SAs in CB6) and Table VI (for SAs in CB3). SA with  $U_C = 14$  kV, line discharge class 4, can absorb about 186 kJ, as previously was told. It is clear that energy-overload of all three SAs (in the switchgear of BT) will occur for any value of earth electrode resistance in the range (5-20)  $\Omega$ . Energy-overload of all three SAs (in CB6) will occur for value of earth electrode resistance in range just above 5  $\Omega$ . Such case of failure of all three SAs in the switchgear of BT has not been occurred.

Table III. Protective characteristics of SAs:  $U_C = 14$  kV AND  $U_C = 12$  kV, Line discharge Class 4

SAs with $U_C$	14 kV	12 kV
I (A)	U (kV)	U (kV)
0.001	19.8	16.97
0.01	22.5	19.28
0.1	25.2	21.58
1	27.9	23.89
10	30.6	26.19
100	33.3	28.50
1000	36.0	30.80
2000	37.1	31.80
5000	38.9	33.40
10000	40.6	34.80
20000	44.3	38.00
40000	49.6	42.50

Table IV. Absorbed energy of SAs in the Switchgear of BT (Lightning stroke 200 kA, 10/350)

Earth electrode resistance of BT ( $\Omega$ )	Absorbed energy of SA in phase A (kJ)	Absorbed energy of SA in phase B (kJ)	Absorbed energy of SA in phase C (kJ)
20	920	939	941
10	755	780	787
5	534	562	572

Table V. Absorbed energy of SAs in CB6 (Lightning stroke 200 kA, 10/350)

Earth electrode resistance of BT ( $\Omega$ )	Absorbed energy of SA in phase A (kJ)	Absorbed energy of SA in phase B (kJ)	Absorbed energy of SA in phase C (kJ)
20	303	323	334
10	238	254	262
5	161	169	175

Table VI. Absorbed energy of SAs in CB3 (Lightning stroke 200 kA, 10/350)

Earth electrode resistance of BT ( $\Omega$ )	Absorbed energy of SA in phase A (kJ)	Absorbed energy of SA in phase B (kJ)	Absorbed energy of SA in phase C (kJ)
20	117.1	118.2	117.7
10	94.3	91.6	89.8
5	65.6	60.6	58.7

Lightning current 37 kA, 10/350  $\mu$ s is simulated next, because less than 1% of peak value of lightning strokes are greater than 37 kA according to Figure 4. The absorbed energy of SAs in the switchgear of BT are calculated, Table VII. Different values of absorbed energy in phases occur due to different values of the power-frequency voltage at the time of stroke. From Table VII it is clear that the energy overload of SAs in case of one lightning stroke is unlikely. Therefore, the energy overload of SAs is due to lightning flash with more than one lightning stroke or more lightning flashes in short time.

Table VII. Absorbed energy of SAs in all three phases (Lightning stroke 37 kA, 10/350)

Earth electrode resistance of BT ( $\Omega$ )	Absorbed energy of SA in phase A (kJ)	Absorbed energy of SA in phase B (kJ)	Absorbed energy of SA in phase C (kJ)
20	114.0	127.0	130.7
10	80.0	94.0	98.0
5	39.3	53.0	56.7

There are 44 lightning strokes in less than 34 minutes, Table II. Every lightning stroke causes the current through the SAs and increases the temperature of MO resistors. There is not enough time for cooling of MO resistors between the lightning strokes or to return to a stable operating point. Such events can cause the overload of one or more SAs.

### 3.3. Recommendations

What can be done to avoid failures of SAs or minimize the number of failures?

Solutions are as follows:

1. Reduction of earth electrode resistance of the BT, what increases the part of the lightning current flowing through the earth electrode and decreases the part of the lightning current flowing through the SAs. This solution requires considerable financial costs. It includes the rehabilitation of the earth electrode of the BT, replacement of existing and laying new earth rods in adequately prepared channels.

2. Increase the thermal energy absorption capability of SAs (several SAs of the same type in parallel). One set of 3 SAs are installed directly at the power

transformer and the second set of 3 SAs at the point of arrival of 10 kV cable to the BT. These SAs are approximately in parallel, in phases. For this application SAs must be selected and tested in the factory accordingly to verify equal current distribution among them. For example, if the protective characteristics of parallel connected SAs differ only 1% one SA will absorb 64.45 kJ and other one 68.77 kJ (in one scenario of lightning stroke). Therefore, the protective characteristics of SA must be different under 1% in order to ensure equal current distribution in two parallel connected SAs.

3. Increase the cooling of SA (avoid squeezed closed spaces as places for installation).

In the described case, recommendations 2 and 3 are implemented. In the further monitoring of the BT operation will be decided whether to reduce the earth electrode resistance.

#### 4. CONCLUSION

Recommendations for improvement of existing surge protection of the switchgear of BT and reduction the number of SAs failures are:

- Reduction of earth electrode resistance of the BT;
- Increase the thermal energy absorption capability of SAs (two SAs of the same type in parallel pro phases);
- Increase the cooling of SAs;
- Further monitoring of the surge protection of the switchgear of BT and the 10 kV supply cable.

#### 5. REFERENCES

- [1] IEC 61400-24 ed. 1.0 (2010), Wind turbines - Part 24: Lightning protection
- [2] Lightning Location System <http://lls.zvne.fer.hr/lls/>
- [3] CEI 81-3 : "Valori medi del numero dei fulmini a terra per anno e per chilometro quadrato dei Comuni d'Italia, in ordine alfabetico." Maggio 1999.
- [4] [www.arqui.com/ayuda/Tekton3D/Modulos/Capitulos/SU8/Datos/MapaDensImpac.htm](http://www.arqui.com/ayuda/Tekton3D/Modulos/Capitulos/SU8/Datos/MapaDensImpac.htm)
- [5] DEHN: Lightning Protection Guide, 2nd updated edition, 2007.
- [6] IEC 62305-1 ed. 2.0. (2010-12) Protection against lightning – Part 1: General principles
- [7] V. Hinrichsen: MO Energy Handling Capability, V1.1., 10.3.2009.
- [8] ATPDraw, Windows version 5.6p6, NTNU/SINTEF, Norway.
- [9] IEEE Working Group: A Simplified method for estimating lightning performance of transmission Lines, *IEEE Transactions on Power Apparatus and Systems*, vol. 104, no. 4, July 1985.