ISSN 0554-6397
Prethodno priopćenje
(Preliminary communication)

Saša Sladić

E-mail: sladics@riteh.hr

Damir Kolić

E-mail: damir.kolic@riteh.hr

University of Rijeka, Faculty of Engineering, Vukovarska 58, 51000 Rijeka, Croatia

Marko Šuljić

E-mail: onjevoliabrodove@gmail.com

University of Rijeka, Faculty of Maritime Studies, Studentska 2, 51000 Rijeka, Croatia

Bidirectional DC/DC Power Converter for Hybrid Yacht Propulsion System

Abstract

Typical application of bidirectional DC/DC power converter exists in hybrid cars. Recently, a similar approach has been applied in hybrid propelled ships as well. In this paper, a novel low power bidirectional DC/DC power converter of standard Buck/Boost topology has been designed in order to explore possibilities of the high power design in maritime applications. In order to discover critical points of a design, thermal imaging has been investigated. The results clearly indicate that the proposed solution is more cost effective than a typical standard bidirectional DC/DC power converter. Likewise, the improvement in maneuvering of the propelled vessel system with two and more electric drives has been investigated and compared to a classical diesel, single engine propulsion system.

Keywords: bidirectional DC/DC power converter, ship propulsion, ship maneuvering

1. Introduction

After the extensive use for residential applications [1], [2], [3] and for applications in hybrid cars (e.g. Toyota Prius) [4]. DC/DC power converters have been used in different vehicles [5], [6], [7], [8], [9], [10], [11], [12] airplanes, locomotives [13] and finally ships [14] of different sizes; from radio controlled models of ships to yachts and larger ships. In each case the addition of electrical propulsion improve the maneuverability of propelled system.

The purpose of this approach is to increase maneuverability [15] of the ship while in harbor by adding additional electric motors, rationalization of consumption and environmental issues. Bidirectional DC/DC power converters are power converters

which could control a power flow between different DC sources including fuel cells, batteries, supercapacitors and solar cells. The possibility of bidirectional power flow exists due to of batteries and supercapacitors. These components could be charged and discharged numerous times, especially supercapacitors which practically have an unlimited cycle life [17]. Additional power from this type of storage could be used for reinforcement of ship propulsion or to decrease consumption of ship generators during maneuvering. For example, instead two generators for supply of ship propulsion only one could be used. However during electrical transients produced by maneuvering or starting a movement or arbitrary acceleration, energy from supercapacitors or batteries via bidirectional power converters could be used. During the steady state, fuel cells or internal combustion engines (ICE) are most appropriate because of their high energy density. In this paper a new solution in the frame of Buck – Boost topology has been investigated. Low power model of a power converter has been built in order to investigate possibilities for a design of a power converter for larger applications in the range of few kilowatts up to 30 kW as a target for a yacht propelled system (e.g. small passenger boat [18]). In this paper, a classic topology was modified by the repositioning of power switches. This approach enables use of the more cost effective drivers for switching transistors which could be important on higher powers when the power converter cost effectiveness is more important than on low powers.

Generally, microgrids are under rapid change under the several trends [16]. DC sources like solar cells and fuel cells appears more frequently because of energy independency from the external world. Police departments, post offices and similar institutions tend to be independent from external AC networks by internal DC sources, usually with fuel cells, solar modules, internal combustion engine aggregates etc. On other hand, the ship is microgrid as well, with intensive power consumption [17], [19]. It could be expected that DC microgrids will get additional attention in future.

2. Bidirectional Buck – Boost power converter

Bidirectional Buck – Boost power converter (Figure 1) enables energy flow from a supercapacitor bank when the transistor S_2 is switching (gating signal g_2 is present). In that situation AC machine has been fed both from DC link (batteries and electrolytic capacitor) and from supercapacitors which could stand, only low voltages (typically 2,7 V). Without additional current (i_L) from supercapacitor bank batteries could not supply peak values of load current. Unfortunately, supercapacitors could supply load only for a few seconds or minutes, so after the transient (ship maneuvering) finishes, supercapacitors demand charging by the action of switch S_1 (gating signal g_1 is present).

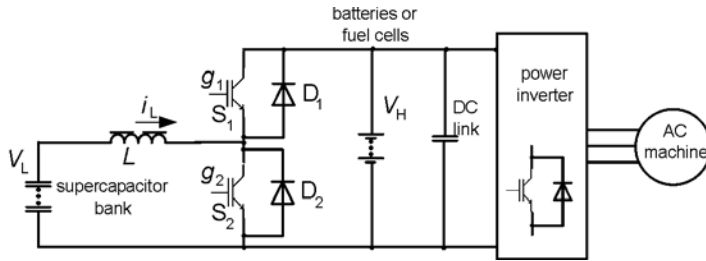

Fig. 1 Commercial solution of bidirectional DC/DC power converter used in Toyota Prius 2009 [4]

This topology (Figure 1) has been used in many modern articles in order to connect different power sources and to get high energy, high power supply for different applications. In spite of the fact that some level of modification is possible [3], [5] the standard topology is still used most frequently [6], [7], [12]... Maybe the most appropriate example for that is commercial Toyota Prius from 2009 [4].

Figure 2 shows that DC link enables the connection of other DC/DC power converters to same microgrid (or DC buses).

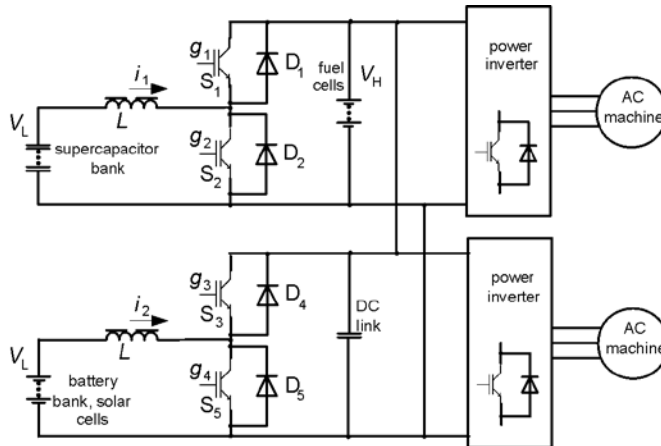

Figure 2. Connection of multiple electric drives to the same DC microgrid

The connection of multiple electric machines to a DC link does not require synchronization of power generators as in an AC electric network. Generally, ship propulsion systems demand larger power than that of hybrid cars. This problem could be solved by using numerous sources which could participate in total power. According to Figure 2, DC link represents a more flexible solution for linking different power sources especially fuel cells and solar cells. For example, the use of two or more generators which supply electric power requires synchronization; DC link use, does not require a procedure of this kind.

In opposition to many commercial solutions (including Toyota Prius), the proposed solution has both transistors at lower potential. However, their potential is changing during the operation but it has no influence on converter waveforms.

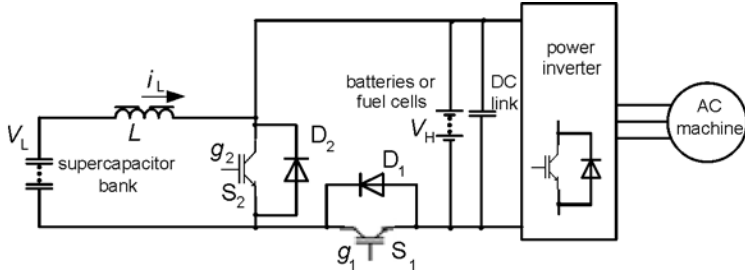

Fig. 3. Proposed solution with cost effective transistor drivers

It could be noted that the proposed solution operates in the same way as the Boost power converter. However, in simulated results, the oscillation of inductance current does not appear since in practical results oscillations represent an unavoidable part of waveforms (Fig. 4).

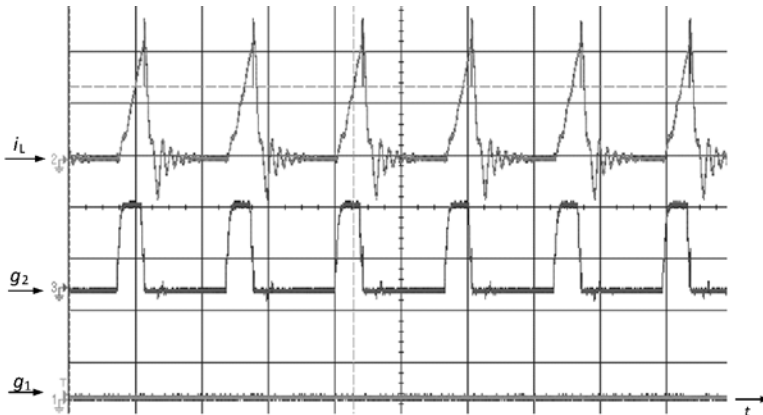

Figure 4. Measured waveforms during the Boost action of bidirectional DC/DC power converter (10 V/div., 5 A/div., 20µs/div.)

Ringing in the inductance current waveform could be noticed during Boost operation (Fig. 4) as well during the Buck operation (Fig. 5) of the bidirectional DC/DC power converter. During the Buck operation, a transistor S_1 is switching (signal g_1 is present) and during the Boost operation, transistor S_2 is switching (signal g_2 is present).

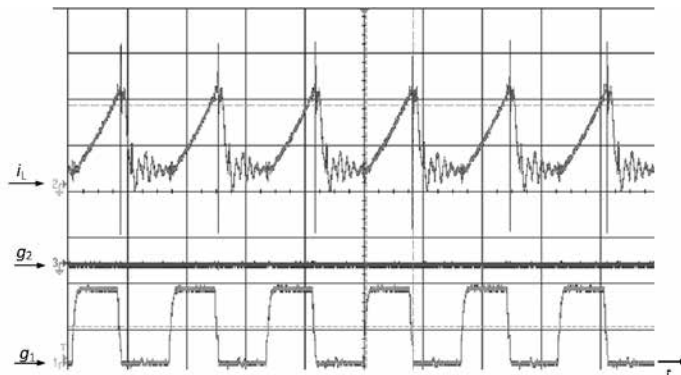

Figure 5. Measured waveforms during the Buck action of bidirectional DC/DC power converter (10 V/div., 5 A/div., 20 μ s/div.)

Waveforms are obtained at low power with input voltage $V_L = 7\text{V}$, and output (higher voltage) $V_H = 15\text{V}$. In spite of the fact that power converter involves two different converters (Buck and Boost) which operate independently only one inductance (L) has been used for both converters. Figure 6. shows current i_L but also the potential change on transistor S_2 during the reconfiguring from Boost to Buck mode operation.

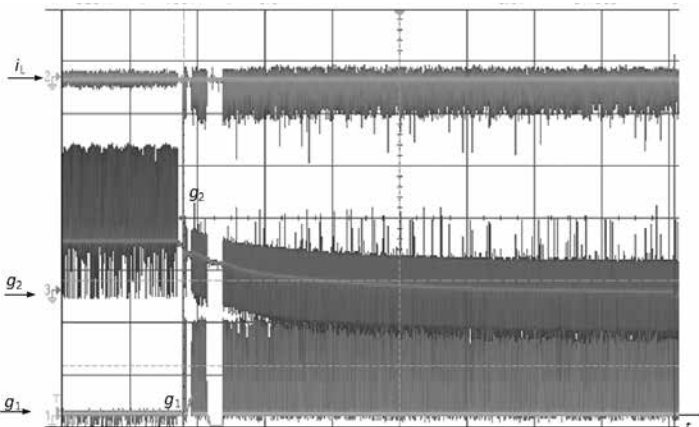

Figure 6. Measured waveforms during the Boost and after that Buck action of bidirectional DC/DC power converter (10 V/div., 10 A/div., 100ms/div.)

With the proposed topology, it is possible to turn on and turn off both transistors. However, the reference point has to be switched from the emitter of one transistor to the emitter of the other transistor. With the used level shifter (CD40109BE) a commercial solution cannot operate and more advanced transistor drivers has to be used (IR2113). Furthermore, that driver has other limitations and it is more appropriate for the same

topology in inverter applications which means the proposed topology could be the only cost effective solution in many cases when the bidirectional DC/DC power converter has to be implemented. However, operation on lower powers (obtained results) does not mean this solution is acceptable for higher power especially because current oscillations appear both for Buck and Boost operation modes which could result in electromagnetic interference and switching problems at higher powers.

3. EMI and thermal considerations

It has been shown that current oscillation has been present in the proposed DC/DC converter. This is not a surprise, since coils (inductors) bring a parasitical capacitance in the converter causing the ringing in the converter. Figure 7a shows the testing prototype and the figure 7b shows its thermal image. It is obvious that power transistors have the highest temperature and represent the most sensitive part of the design.

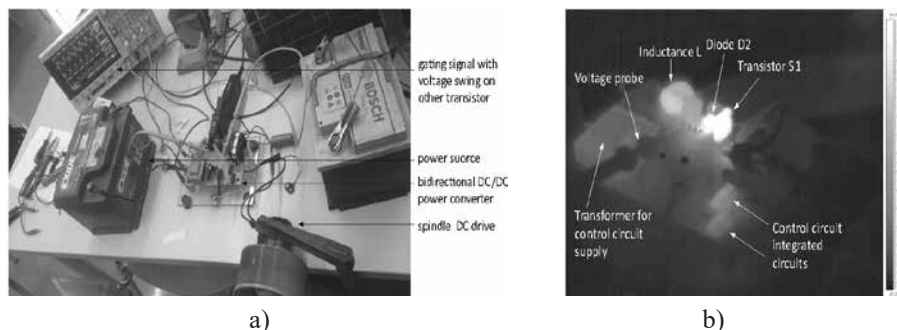

Figure 7. Power converter laboratory model application with spindle DC drive a) with its thermal image during Buck operation mode b)

Other components like a coil (reactor) are not under such thermal stress. In order to mitigate this effect, transistors have to be equipped with heat sinks or even more sophisticated cooling systems (e.g. water cooling systems).

4. DC microgrids for improved maneuvering

In order to show compatibility between the application of the DC microgrid along with numerous DC/DC power converters [16] and the improvements of maneuvering demands in harbors [15], an additional investigation was taken. Additional electric power systems based on batteries and/or supercapacitors could be used in order to supply additional power during maneuvering in order to achieve precise positioning of a ship (Figure 8).

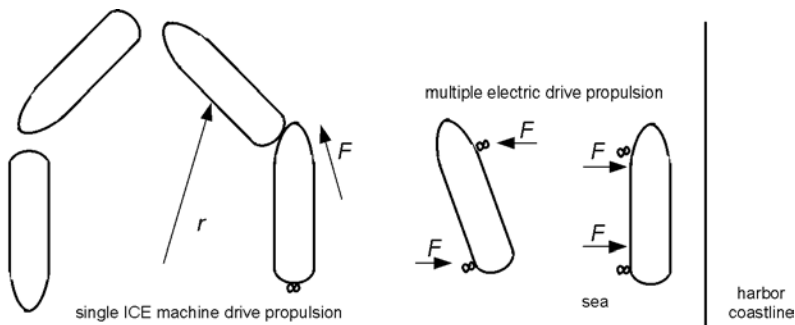

Figure 8. Typical yacht maneuvering with single drive and with multiple drive propulsion systems

Similar results could be obtained using the flywheel instead of supercapacitors, however capacitors has larger specific power and could faster releases their energy.

Generally, electric ship propulsion has advantages because of possibility of positioning of electric drives along the vessel. However, implementation of bidirectional power converters could involve additional power including maneuvering and in start/stop sessions and improve the dynamic performance of ships (Figure 9).



Figure 9. Application of additional electric drives during the ship precise maneuvering

Supercapacitors do not bring additional energy into the system but they bring additional power compensating the propelled system inertia. Their current use is limited because they are still less cost effective than solutions which involve connection to AC ship supply (Fig. 9). However, supercapacitors in different forms represent the emerging technology which is expected to penetrate in different applications where the energy storage is needed or even in cases where additional power is needed during the limited time (e.g. car cranking or yacht maneuvering).

5. Conclusions

Bidirectional DC/DC converter is a crucial part of a ship microgrid and hybrid system because it enables adding of numerous DC power sources (e.g. fuel cells, solar cells...) to a ship propulsion system. In this way, diesel generator power could be combined with fuel cell power or with energy stored in supercapacitor banks in order to achieve power burst during maneuvering or to get high acceleration when needed. In this paper a new solution for transistor driver were applied in order to achieve cost effective solution of bidirectional power converter. Such approach enables same results in the sense of waveforms as classic solution but more cost effective. Besides, special attention was given to component positioning in electronic system (printed circuit board) in order to decrease electromagnetic interference (EMI) different positions for inductance were tested. Furthermore, a flexibility of DC bus is connected with an increased number of electric drives and with improved maneuverability as compatible targets. Further work will involve a case study with the bidirectional power converter of larger scale.

Acknowledgements

In this way authors would like to thank to colleagues from Laboratory of Thermodynamics, Faculty of Engineering Rijeka, prof. Bernard Franković, Ph.D. former head of the Laboratory for Thermodynamics and to his colleague Paolo Blecich, Ph.D. who helped us by additional equipment to improve our research.

References

1. CHAO K. H.; TSENG, M. C.; HUANG C. H., LIU, Y. G., HUANG, L. C.: “*Design and Implementation of Bidirectional DC-DC Converter for Stand-Alone Photovoltaic Systems*”, International Journal of Computer, Consumer and Control (IJ3C), vol. 2, no. 3, 2013.
2. CPHAM, C., KEREKES, T., TEODORESCU, R.: “*High Efficient Bidirectional Battery Converter for Residential PV Systems*”, in Proceeding of the 3rd IEEE International Symposium on Power Electronics for Distributed Generation Systems, IEEE Press, pp. 890-894. PEDG 2012.
3. SLADIĆ, SAŠA; DOŠEN, TOMISLAV; DANČULOVIĆ, LUKA: “*Bidirectional Power Converter for Photovoltaic Applications: Design Considerations*”, Energy and the Environment 2016, pp. 239-246. Opatija, Croatia, October 2016.
4. NAMM, KWANG HEE: “*AC Motor Control and Electric Vehicle Applications*”, CRC Press 2010.
5. CICCARELLI, F.; LAURIA, D.: “*Sliding-mode Control of Bidirectional dc-dc Converter for Supercapacitor Energy Storage Applications*” International Symposium on Power Electronics, Electrical Drives, Automation and Motion, SPEEDAM 2010.
6. PANY, PREMANANDA; SINGH, R.K.; TRIPATHI, R.K.: “*Bidirectional DC-DC converter fed drive for electric vehicle system*”, International Journal of Engineering, Science and Technology, vol. 3, no. 3, pp. 101-110, 2011.
7. WU, Z. W., ZHANG, Z. L., YIN, C. L., ZHAO, Z.: “*Design of a Soft Switching Bidirectional DC-DC Power Converter for Ultracapacitor-Battery Interfaces*”, International Journal of Automotive Technology, vol 13, no.2, pp. 325-336, 2012.

8. SAGERT, C., SAWODNY, O.: “*Modeling of the electrical DC-link in fuel cell vehicles for DC-DC converter control design*”, 15. Internationales Stuttgarter Symposium, Springer Fachmedien Wiesbaden 2015.
9. BHAJANA, V. V. S. K.; DRABEK, P.: “*A New Non-isolated ZCS Bidirectional Buck-Boost DC-DC Converter for Energy Storage Applications in Electric Vehicles*”, Arab J. Sci. Eng. 2015.
10. WU, Z.; ZHANG, J.; ZHANG, X.; YIN, C.: “*Peak Current Control Strategy with Extended-State Tracking Compensator for DC-DC in Hybrid Energy Storage System*”, Shangai Jiaotong University and Springer-Verlag Berlin Heidelberg 2013.
11. KARTHIKEYAN, P., CHIDAMBARANATHAN V. S.: “*Bidirectional Buck-Boost Converter-Fed Drive*”, Artificial Intelligence and Evolutionary Computations in Engineering Systems, Advances in Intelligent Systems and Computing, Springer India 2016.
12. CIANCETTA, F.; OMETTO, A.; ROTONDALE, N.: “*Analysis of PEM Fuel Cell – Supercapacitor – battery pack system during standard cycle*” International Symposium on Power Electronics, Electrical Drives, Automation and Motion, SPEEDAM 2010.
13. ZINOV’EV, G. S., LOPATKIN, N. N., VAIS, H.: “*High-Voltage DC-DC Converter for New-Generation Electric Locomotives*”, Russian Electrical Engineering, vol. 80, no. 12., 2009.
14. ZAHEDI, BIJAN: “*Shipboard DC Hybrid Power Systems*” Ph.D. Thesis, NTNU, Trondheim, October 2014.
15. LI, YE; LANDSBURG, A. C.; BARR, R.A; CALISAL, S. M.: “*Improving ship maneuverability standards as a means for increasing ship controllability and safety*”, Oceans, Proceedings of MTS/IEEE, 2005.
16. LUCIA, OSCAR, CVETKOVIĆ, IGOR; SARNAGO, HECTOR; BOROYEVICH, DUSHAN; MATTAVELLI, PAOLO: “*Design of Home Appliances for a DC-Based Nanogrid System: An Induction Range Study Case*”, IEEE Journal of Eerging and Selected Topics in Power Electronics, vol. 1, no.4. December 2013.
17. JAJASINGHE, SHANTHA, GAMINI; MEEGAHAPOLA, LASANTHA, FERNANDO, NUWANTHA; JIN ZHEMING, GUERRERO, JOSEP, M.: “*Review of Ship Microgrids: System Architectures, Storage Technologies and Power Quality Aspects*”, Inventions, MDPI, 2017.
18. POSTIGLIONE, C. S., COLLIER, D. A. F., DÚPCZAK, B. S., HELDWEIN, M. L., PERIN, A. J.: “*Propulsion system for an all electric passenger boat employing permanent magnet synchronous motors and modern power electronics*”, Electrical Systems for Aircraft, Railway and Ship Propulsion (ESARS) conference, Bologna, Italy, 2012.
19. CHUNG, IL-YOP; LIU, WENXIN; ANDRUS, MIKE; SCHODER, KARL; LENG, SIYU; CARTES, DAVID, A.; STEURER, MICHA: “*Integration of a bi-directional dc-dc converter model into a large-scale system simulation of shipboard MVDC power system*”, Electric Ship Technologies Symposium, IEEE, ESTS 2009.

Saša Sladić, Damir Kolić, Marko Šuljić

Bidirekcijski istosmjerni učinski pretvarač za hibridne brodove

Sažetak

Bidirekcijski istosmjerni učinski pretvarač se tipično koristi kod hibridnih automobila. Ipak, o nedavno su sve učestalije njegove primjene u području propulzije/poriva brodova. U cilju izrade pretvarača većih snaga, izrađen je model manje snage. Kritične točke djelovanja pretvarača su istražene primjenom termovizijske kamere. Rezultati potvrđuju da je predloženi bidirekcijski pretvarač cjenovno pristupačniji od klasičnog. Istodobno su istražene mogućnosti poboljšanja manevriranja plovila s dieselskim jenomotornim pogonom s onim koji ima više pogonskih električnih strojeva.

Ključne riječi: bidirekcijski istosmjerni učinski pretvarač, poriv broda, manevriranje broda