

On the Estimation and Reduction of the Frequency of the Loss of Offsite Power Event

Hrvoje Grganić

Nuclear Power Plant Krško
Vrbina 12, 8270 Krško, Slovenia
hrvoje.grganic@nek.si

Zdenko Šimić

Faculty of Electrical Engineering at University of Zagreb, Department of Energy and Power Systems
Unska 3, 10000 Zagreb, Croatia
zdenko.simic@fer.hr

ABSTRACT

Loss of offsite power (LOOP) contributes significantly to the estimated core damage frequency (CDF) for the majority of nuclear power plants (NPPs). Based on experience from some near-miss events around the world and especially in Japan from Fukushima Daiichi accident and several other NPPs it was proven the how important power supply is for nuclear safety. Therefore comprehensive description of the LOOP initiating event is given in this paper. Specific experience of the NPP Krško (NEK) related operation is also presented with comparison to the U.S. NPPs' approaches and experience. Statistical data are given to explain main characteristics (frequency and duration) of the LOOP event. Important historical trends are also identified.

LOOP event frequency is often calculated using generic data because of statistical data base. Thereat, many important factors that influence LOOP are neglected, such as the specific power network configuration, load profiles, climate conditions, and ageing of the equipment. Several different approaches that take these factors into consideration are therefore presented and discussed. Familiarity with the actual state of the NPP, power network and weather conditions helps in the proper planning process of the test and maintenance (T&M) activities and reducing of the risk. This is significant for better online risk estimate.

Due to the Fukushima accident, it is necessary to review the safety of the NPPs from new different angles. This paper also shortly reviews planned modifications in NEK that will increase the electric power supply availability (i.e., reduce LOOP event frequency). Other, worldwide solutions that can help to avoid or mitigate LOOP effects are briefly presented.

1 INTRODUCTION

Not very different from the other, nuclear industry strives to minimize the probability of the accidents, and to limit the consequences if they happen. In the other words, the goal is to increase safety, i.e. to reduce the risk:

$$\text{risk} = \text{probability} \times \text{consequence} \quad (1)$$

NPPs are generating electricity most of the time. When not, NPPs need electricity from the grid for different reasons, such as operation of various equipment, maintenance work and most importantly, to power safety systems. Once the chain reaction in the reactor is stopped, decay heat is still generated. Hence, the reactor cooling has to be provided to avoid the meltdown. That cannot be achieved without the electricity provided to the reactor cooling system and the heat sink.

It is important for all NPPs to have permanent and reliable electrical power sources. That raises the level of safety in the power plant during different modes of operation. Electrical power systems can be either offsite or onsite. Offsite power sources are used if available. If not, onsite power sources are used instead. It is necessary to consider the possibility that offsite power sources can be lost. That event is well known in literature as the Loss of offsite power.

LOOP as the initiating event contributes significantly to core damage frequency (CDF). This is shown in figure below [1].

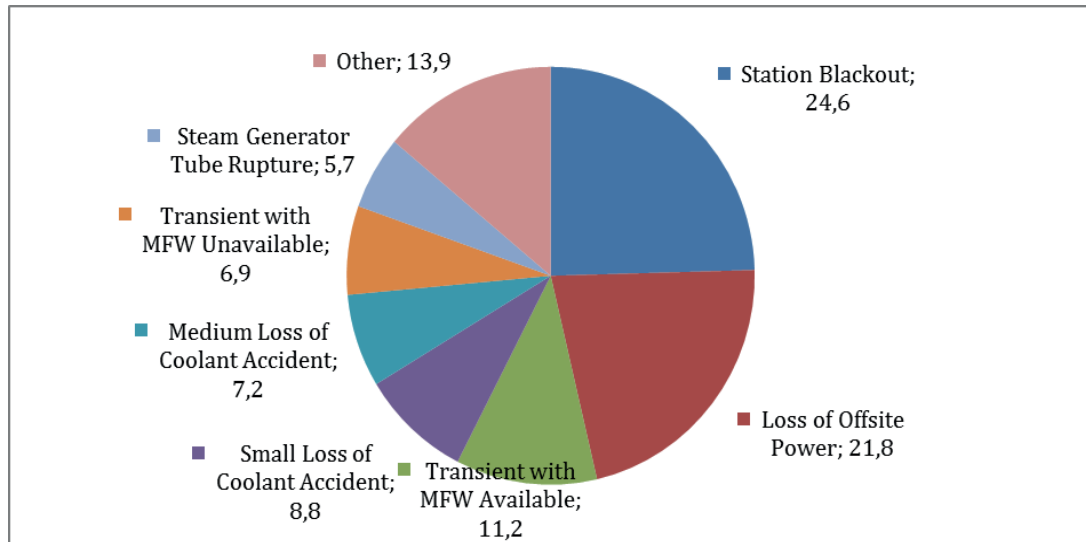

Figure 1: The main contributors to CDF

Hence, it is important to understand the LOOP event, its causes, possible consequences and methods to reduce the risk.

2 NEK ELECTRICAL SYSTEM

2.1 Design basis

It is important already in the design phase to choose appropriate location for the NPP. That means, among the other things, to consider the electric grid to which the NPP will connect. Some of the key parameters are [2]:

- Off-peak electricity has to be high enough so that NPP can work in the baseload mode. That can be assured by locating the NPP near the centers of the electricity demand,
- reserve generating capacity has to be large enough to ensure grid stability during the planned outages, and
- sudden disconnect of the NPP should not cause the instability of the power network. The larger the power network, the more stable it is. The UCTE is an example of such a network. Nuclear site which is in the accordance with those three requests reduces the LOOP risk.

2.2 NEK electrical system description

The main generator is connected to the 400 kV bus via generator load breaker (BBC), two main step-up transformers GT1 and GT2 and substation breaker. NEK is connected to the offsite power sources via:

- Double 400 kV transmission line towards Zagreb
- Single 400 kV transmission line towards Maribor
- Single 110 kV transmission line towards Brestanica

During the normal operation, main generator supplies electrical network over main transformers GT1 and GT2. It also supplies onsite power supply over unit the transformers T1 and T2 to two Class 1E (MD1 and MD2) 6,3 kV busses and two Non 1E (M1 and M2) 6,3 kV busses. Class 1E busses are also powered from their respective 3,5 MW diesel generators. The maximum operation duration of the DGs is 7 days.

Alternatively, if that power supply is not available, all four busses that provide onsite power supply can be energized from station auxiliary transformer T3, which is connected to the 110 kV RTP Krško (underground cable) and directly to combined gas-steam power plant Brestanica. Direct connection can be established over the Q92 switch which bypasses the 110 kV switchyard RTP Krško. Brestanica is equipped with three gas powered units of 23 MVA (23 MW) capable of the blackstart in the event of a breakdown of the 110 kV system and to provide electrical power to NEK station auxiliary transformer in 20 minutes. It is an obligation of the system operator to establish electrical power to NEK.

All self-supply safety systems are Class 1E. Safety systems are connected to the one of the following voltage levels:

- 6,3 kV AC, busses MD1 and MD2
- 400 V AC distribution system, 4 busses (LD11, LD12, LD21, LD22) and 17 Motor Control Centers (MCCD) connected to them
- 125 and 220 V DC distribution systems
- 118 V AC distribution system

NEK simplified electrical network scheme is shown on the Figure 2. Newly added diesel generator DG3 enhances Krško Emergency Power Supply. It can be used as an alternate AC source and as the source to MD1 and MD2, i.e. as the replacement for DG1 and DG2.

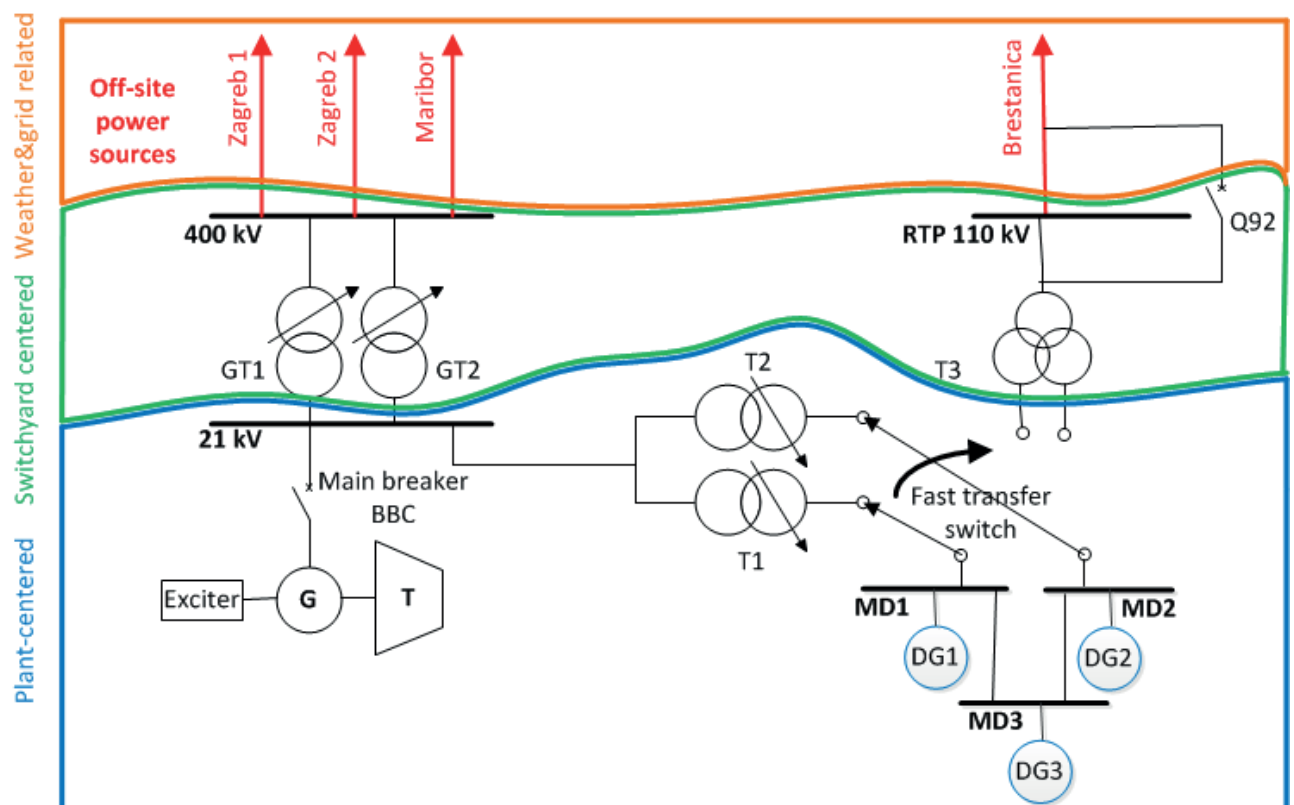

Figure 2 NEK simplified electrical power scheme

Loss of AC power includes loss of both offsite and onsite AC power. Offsite power can be lost because of the failure of either connection to the grid or grid itself [3]. The first possibility refers to the switchyard related events, as comprehensively studied in the next chapter. Onsite AC power, i.e. DGs can be lost either due to T&M activities or their fail.

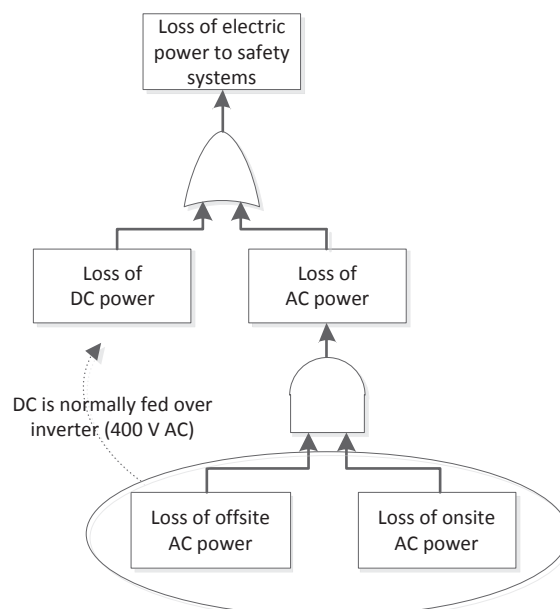

Figure 3 Simplified fault tree on electric power

3 LOOP ANALYSIS

LOOP events can be caused by different events. It is easier to understand and analyze it if those events are grouped in categories.

LOOP causes are commonly divided into four categories [4]:

- Plant centered
- Switchyard centered
- Grid related
- Weather related

Classification of the LOOP causes is not unique. Depending on the NPP characteristics, different classification can be made.

Before the deeper analysis, it is necessary to describe all four categories [4]. Plant centered events are typically caused by human errors, hardware failures, design deficiencies and localized weather-induced faults. They occur inside the power plant, up to main and station power transformer high voltage terminals (GT1&2 and T3 for NEK). From that point, up to the output bus bar in the switchyard is the zone where switchyard centered events occur. The most common causes are failures in the equipment, possibly human induced. These two types of LOOP are under the NPP personnel control. Grid related LOOP events are those whose initial failure occurs outside the power plant, in the transmission power grid. They are mainly the responsibility of the transmission grid personnel. Weather related events are caused by severe weather, in which the weather was widespread. That condition excludes the lightning strikes from this category. A separate category of the extreme weather can be also found in some literature. In this paper both severe and extreme weather are merged to one category.

The latest available study, NUREG/CR-6890 [4], that covers time period 1986 - 2004 and 103 NPP across the USA has distinguished two characteristic LOOP parameters:

- LOOP frequency
- LOOP duration

The CDF risk is larger for the larger values of the LOOP frequency. Longer LOOP duration also increases the CDF risk. In the example of NEK, if one offsite power source is unavailable, it has to be restored within 72 hours. Otherwise, power plant has to be taken to Hot stand-by and afterwards to Cold shutdown mode.

The NUREG/CR-6890 study results are presented below. Plant centered causes are analyzed together with the switchyard centered.

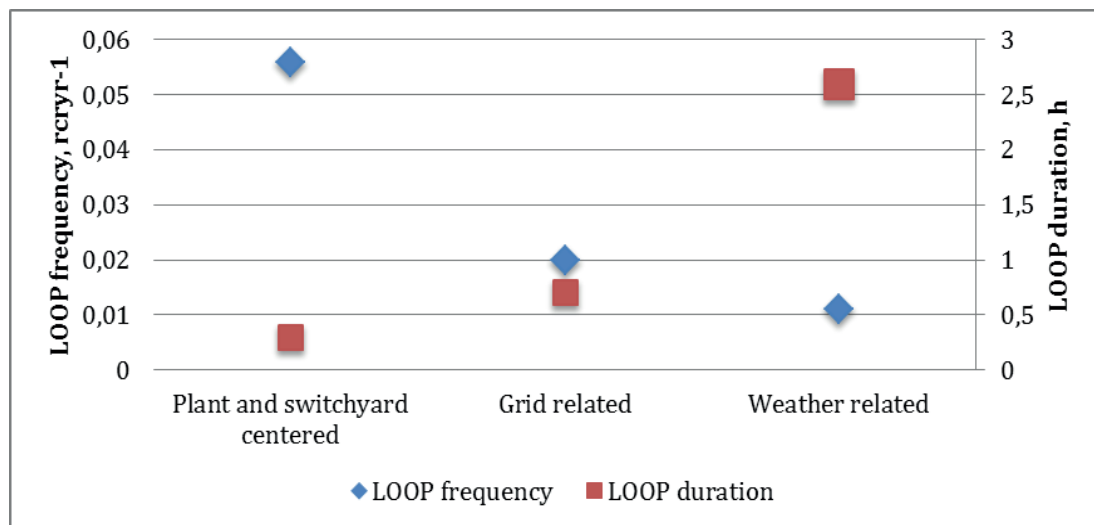
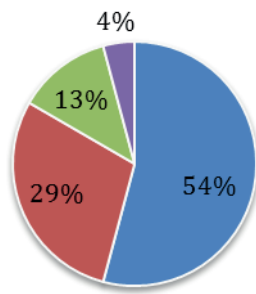

Figure 4: LOOP frequency and duration according to NUREG/CR-6890 [4]

It can be seen that plant centered causes are the most common, but with the shortest duration. Vice versa, weather related causes are the most infrequent, but with the longest duration. Due to severe weather, the power network can be seriously damaged, and hence the long time for its restoration is needed. This result does not reveal another important difference. Basically, LOOP can happen in two different NPP states:

- LOOP during the operation (reactor is critical)
- LOOP during the shutdown

More likely event is LOOP during shutdown, with mean frequency $1,96 \times 10^{-1}$, i.e. once per 5 years, compared to mean frequency during critical operation of $3,59 \times 10^{-2}$, i.e. once per 28 years. That result is not surprising. During the shutdown, typically outage, numerous maintenance work takes place, and not all of the equipment is operable. Below shown results point out that grid related LOOP events dominate during the critical operation, and switchyard related events dominate during the shutdown. This difference between the critical operation and the shutdown state roughly indicates main risks to which attention should be paid.



■ Grid related ■ Switchyard centered
 ■ Weather related ■ Plant centered

Figure 5: LOOP causes according to NUREG/CR-6890 during critical operation

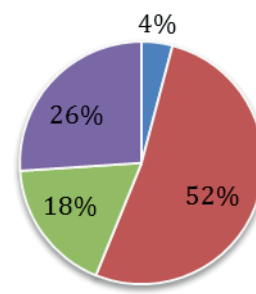

■ Grid related ■ Switchyard centered
 ■ Weather related ■ Plant centered

Figure 6: LOOP causes according to NUREG/CR-6890 during shutdown

The most common duration of the offsite power sources unavailability, either 110 or 400 kV, was less than 1 hour. The complete data is shown on the histogram below.

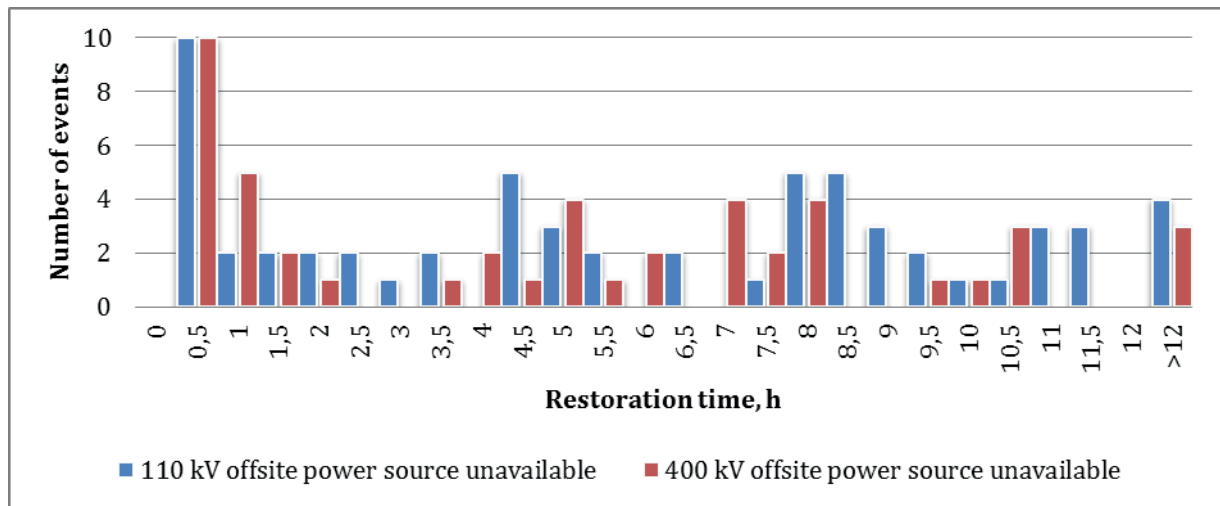

Figure 7: Duration of loss of one offsite power source events histogram for NEK

3.1 Mathematical background

In order to calculate the LOOP frequency, it is necessary to know the distribution of the events. All four types of LOOP events have Poisson distribution. But, it is not needed to know frequency for every of the four types of LOOP events to calculate the overall frequency, because the sum of the Poisson independent variables is again a Poisson variable. It is enough to know the overall frequency. Proof is given in [5]. Hence, the only needed information is frequency of all LOOP events, regardless their type. This simplifies the LOOP frequency analysis. Under stable conditions and given a failure rate λ , the number of LOOP incidents during a time period t , denoted by X , can be reasonably assumed to have a Poisson distribution:

$$P(x \text{ incidents in time } t \mid \text{given } \lambda) = \frac{e^{-\lambda t} (\lambda t)^x}{x!} \quad (2)$$

Assumption of a Poisson distribution is reasonable. That is confirmed in the NUREG/CR-6890 for the time period 1997 - 2004 [4]. Also, it predicted one LOOP for NEK in the 30 years with the highest probability of 0,328. The only LOOP event in NEK occurred in 1986.

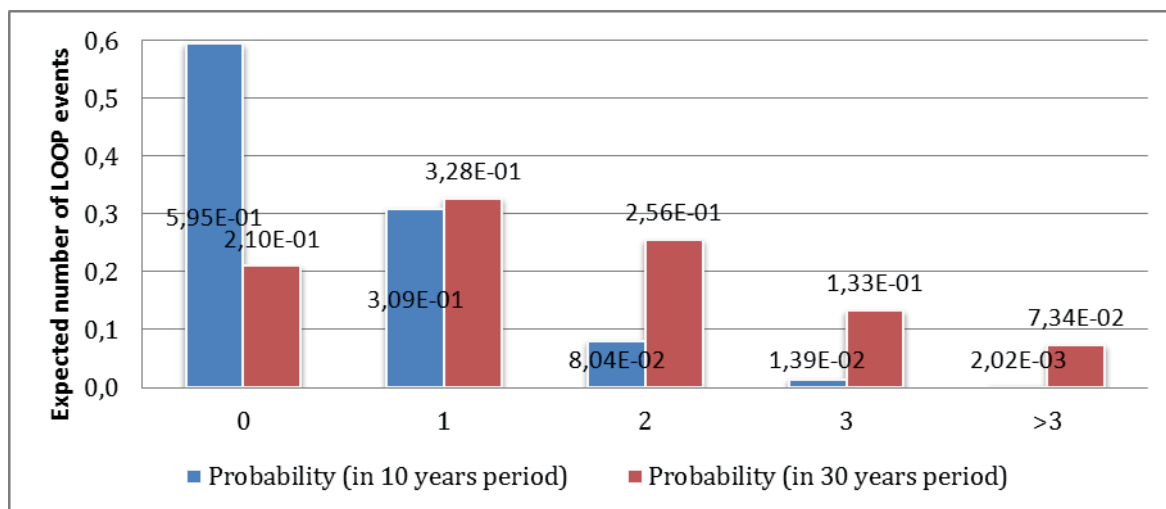

Figure 8: Probabilities of N LOOP events for NEK

4 NEK LOOP FREQUENCY CALCULATION

The last calculation of the LOOP frequency for NEK was made in year 2000, based on plant experience up to the end of 1999. The downside of this calculation is that NEK On-Line Maintenance (OLM) program was initiated at the end of the 1997. Hence, only a short period of time is observed. More accurate results are expected within the new Technical Report. The value of LOOP frequency is currently estimated as:

$$IEV - LSP = \frac{(T - T_{110kV})\lambda_{LSP} + T_{110kV}\lambda_{110kV}}{T} \quad (3)$$

- T total number of plant operating hours
- T_{110kV} total number of operating hours while 110 kV power source is unavailable
- λ_{LSP} baseline LOOP frequency, i.e. when it is known that 110 kV power source is not unavailable due to OLM. This is the value, which was used as an estimator of “IEV-LSP” before the NEK OLM was introduced. Here presumed value is 0,05 rcryr⁻¹ [1].
- λ_{110kV} estimation of conditional LOOP frequency while the 110 kV power source is unavailable due to preventive OLM. Presumed value is 0,25 rcryr⁻¹ [1].

This equation is a rough approximation. Baseline Loss of offsite frequency λ_{LSP} is taken from the NUREG-1784 [6]. In that report value of 0,05 LOOPS/rcryr is stated as the value that was valid before the deregulation (1985 – 1986). After the deregulation the LOOP frequency is estimated to be 0,014, i.e. much smaller.

One of the fundamental steps in carrying out a probabilistic analysis is choosing the failure rates of components. In principle, specific plant data should be used, that is obtained by the operating experience of the plant itself [7]. Whenever plant specific data are not available generic data from different generic databases are used.

The 110 kV unavailability represents unavailability of 110 kV power source, or unavailability of station auxiliary transformer T3.

Data about unavailability of the 110 kV power source be found in NEK OLM Risk Evaluation Weekly Reports, while OLM activities are performed at NEK on weekly base [8].

Table 1 Input data for IEV-LSP calculation

Year	NEK total operating time, h	NEK operating time (110 kV source unavailable), h
1998	7913	70,3
1999	7479	89,3
Total	15392	159,6

Taking into the account data from above, NEK LOOP frequency is $IEV-LSP=0,052 \text{ rcryr}^{-1}$.

Comparison with the other known results is given below. If the results are expressed in the other way, for NEK it is expected to have one LOOP every 19 years, Surry NPP every 13 years, while NUREG results is one LOOP per approximate 28 years.

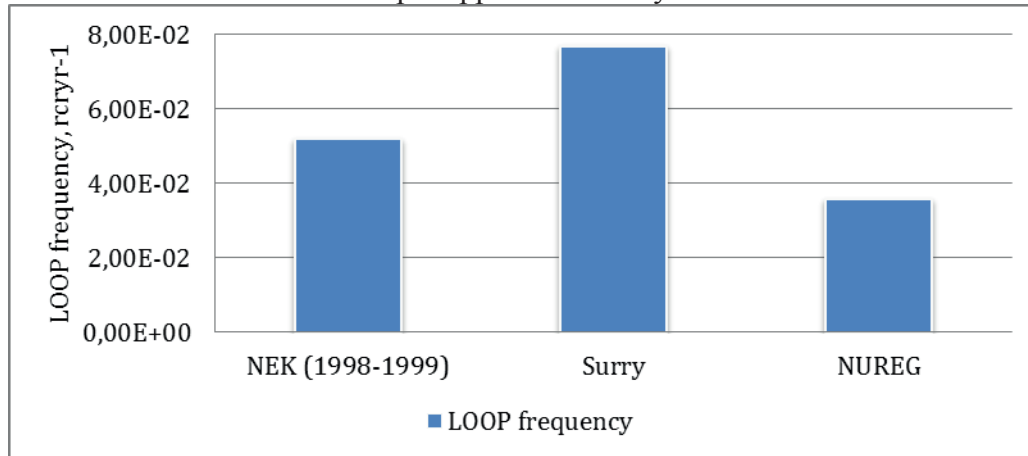

Figure 9: Comparison of LOOP frequencies

LOOP frequency calculation can be improved. Instead of using the generic data, it is recommended to find power plants with the similar offsite power configuration and to study their experience. Furthermore, known data for NEK should be used. Weather data for the Krško area is available and extensive. Also, grid reliability evaluations should be performed.

Some literature as NUMARC 87-00 [9] proposes empirical formulas for calculating LOOP frequencies. Mentioned source gives estimated LOOP frequency due to severe weather. The inputs for their equation are the annual expectations of snowfall, tornadoes above given severity, storms with the wind velocities between 75 and 124 mph, and storms with significant salt spray.

DGs in NEK are even more reliable than the offsite grid. The probability that one diesel generator will fail is 3,3%, and probability for the failure of both is 0,21%, compared to the LOOP frequency of 5,21%.

5 INFLUENCE OF THE POWER NETWORK ON LOOP FREQUENCY

As already mentioned in the Chapter 5, LOOP events can be plant centered, switchyard centered, grid related and weather related. This chapter provides a deeper analysis of the grid and weather related LOOP events.

Electric power grid reliability strongly influences the operation of a NPP, and vice versa. Typical grid problems that impact NPP are [10]:

- load rejection, loss of external load
- degraded voltage frequency
- NPP trip causing grid collapse and hence the LOOP to NPP
- LOOP due to external grid disturbance

Reliability of the power system includes its redundancy, diversity and lack of the choke points. Most of the disturbances are related to the environment, e.g. lightning, wind or birds. Other possible causes are the faults of the technical equipment, human errors and other, less important. The most common technical faults are related to overhead lines. Significantly less frequently are

faults of the transformers, breaker and disconnector faults, cable, protection, control equipment faults and other [11]. Power system component failures are affected by maintenance practice, design useful life and operation environment and conditions. The Croatian power system is already aged (220 and 400 kV network are approx. 50 and 35 years old, respectively). It is reasonable to assume that aging failures of the components will become a dominant factor of system unreliability [12].

Weather conditions affect both frequency and duration of the faults in the power network. Prediction of the duration helps in the planning of the recovery efforts. Paper [13] compares statistical methods for modeling power outage durations during hurricanes. It is interesting because it ranks influences of the different factors on the power restoration time.

Generally, in heavily loaded power networks happens more faults and they are less reliable. Important information is power flow through the particular power lines. The reinforcement of the existing grid would contribute to the decreased LOOP frequency. With a new 400 kV power line between Krško and Beričevo LOOP frequency is expected to be reduced for approximately 50%. Number of lines (single or double) does not change the result significantly. This transmission line is already under construction. It is expected to be finished in the late 2013.

Proper communication protocols between TSO and NPP operators keep NPP personnel better informed about the possible threats. Also, it gives them more time to react. This is especially desirable during times of high grid load and stress, which is usually easy to predict [14].

Calculation of the LOOP frequency for NEK assuming the different grid layouts is described in the paper [15].

6 FUKUSHIMA EVENT CONSEQUENCES AND LESSONS

A short overview of the Fukushima Daiichi event, mostly from the perspective of the Unit 1, and with the accent on electrical power supply is given below.

On March 11, 2011, three out of six units at the Fukushima Daiichi site automatically shut down due to the earthquake which caused LOOP. The cause of that LOOP was the damaged transformer station about 10 kilometers from the plant. Design basis acceleration in the horizontal direction, measured at the Fukushima Daiichi site, was exceeded. The probability for that was in the range 10^{-4} to 10^{-6} rcr_{yr}⁻¹ [16]. The emergency DGs started as expected. Exceptionally, DG in Unit 4 was out of service due to maintenance.

The earthquake caused seven tsunamis, which have hit the site more than 24 hours after. Flooding of the electrical switchgear and some of the diesel rooms caused the Loss of all AC power for units 1 - 5. After that, portable electric generators have been delivered to the site, despite the problems with the transportation and installation. The explosion caused by the buildup of hydrogen damaged the mobile generator that had been installed to power the standby liquid control pumps. All DC power on Units 1 and 2 was lost. Although installed batteries have the capacity to power the system for 8 hours, they were flooded, and DC distribution system was damaged. Without the AC power and the ultimate heat sink, core cooling was not possible. Offsite power to the Units 1 and 2 was restored 9 days after the earthquake.

That scenario could have been avoided with simple measures. Here are mentioned those related to the electrical power supply. The first one is sufficiently high location of DG. That is a standard in neighboring countries as South Korea. Secondly, portable electric generators were not immediately available. Also, secure, and earthquake resistant cable that connects NPP with the offsite source would have to mitigate the consequences. That solution is applied on the similar NPP in Taiwan. Finally, at Fukushima Daini Nuclear Power Station, units 1 - 4 are connected by two 550kV transmission lines and two 66 kV transmission lines; in addition, power can be shared among units [17].

Due to the Fukushima accident, comprehensive review of the safety in NPPs is requested (so-called Stress tests). Slovenian Nuclear Safety Administration (SNSA) requested from NEK to

perform Special Safety Review, which is completely in line with the specifications of European Stress Tests. NEK has sent full scope Stress Test Final Report to SNSA in the December 2011 [18].

Several natural phenomena can cause LOOP. Earthquakes affect the ceramic insulators in the switchyard. Flooding can affect either the switchyard or the wider grid. Strong winds usually cause damage to the wider grid. Extremely low temperatures lead to the icing of the cables and thus to the grid failure. Some of these phenomena are not applicable to the NEK. Despite that, it is important to carry out a high quality and detailed PSA and to study the possible influence.

The CDF for events initiated by LOOP is reduced by installation of the third emergency DG. This modification is finished in 2012 outage. The third emergency DG is located in a separate building. It is connected to the separate safety bus (MD3) which can be connected to the one of the existing busses, either MD1 or MD2. Both DG and MD3 are seismic qualified. Also it is possible to connect smaller, mobile DG to the MD3. The similar safety measure can be found in the other countries' Stress test reports also. Besides the new diesel generator, other improvements in NEK are also proposed, such as already mentioned power line Krško - Beričevo.

7 CONCLUSION

The principle requirement for the NPP operation is ensuring safety.

It is important to understand the LOOP event, its causes, possible consequences and methods to reduce the risk, since it is one of the main contributors to the CDF. LOOP risk can be significantly decreased already during the site location selection.

Proper planning of the DG T&M contributes to the increased safety. Fine weather conditions decrease the LOOP frequency. It is desirable to postpone the T&M otherwise. Same as for weather, power grid also influences LOOP frequency. TSO's online monitoring and the proper communication between NPP and TSO have the potential to reduce the LOOP risk. The latest grid state and weather data are prerequisite needed to prevent LOOP events.

Fukushima event already caused instantaneous improvements in the safety of the NPPs. Stress tests identify the possible weak points by observing the plant response in the extreme situations.

Comprehensive operational experience of the U.S. NPPs and well documented event history are applicable to NEK. It is useful to compare NEK to similar U.S. NPPs as the starting point in the LOOP analysis.

Sensitivity studies indicated that emergency diesel reliability strongly reduces Station Blackout CDF [4]. The risk for NEK is significantly reduced by the installation of the third DG which is installed in the outage '12 and new power line that will connect Krško and Beričevo.

REFERENCES

- [1] M. Kaštelan, I. Vrbanić, I. Košutić, "Post-modernization NEK PSA Baseline Model Update and IAEA IPSART Mission Comments Implementation", NEK ESD-TR-20/00, 2000
- [2] International Atomic Energy Agency, "Interfacing Nuclear Power Plants with the Electric Grid: the Need for Reliability and Complexity", 2009
- [3] Z. Šimić, V. Mikuličić, I. Vuković, "Use of Probabilistic Safety Assessment for Infrastructure Risk Modeling", 2007
- [4] Nuclear Regulatory Commission, "Reevaluation of Station Blackout Risk at NPPs, Analysis of LOOP Events: 1986-2004", NUREG/CR-6890, 2005
- [5] R. Johnson, "Probability and Statistics for Engineers, Sums of Independent Random Variables", 2007

- [6] Nuclear Regulatory Commission, “Operating Experience Assessment - Effects of Grid Events on Nuclear Power Plant Performance”, NUREG/CR-1784, 2003
- [7] G. Petrangeli, “Nuclear Safety”, Elsevier, 2006
- [8] I. Vrbanić, I. Košutić, “NEK PSA Parameters Update”, NEK ESD-TR-20/99, 1999
- [9] Nuclear Management and Resources Council, Inc, “Guidelines and Technical Bases for NUMARC Initiatives Addressing Station Blackout at Light Water Reactors”, NUMARC 87-00, 2001
- [10] J. H. Bickel, “Grid Stability and Safety Issues Associated With Nuclear Power Plants”, 2001
- [11] G. H. Kjølle, “What do fault statistics tell us regarding causes resulting in power outages”, 2011
- [12] X. Kaigui, L. Wenyuan, “Analytical model for unavailability due to aging failures in power systems”, 2008
- [13] R. Nateghi, S. D. Guikema, S. M. Quirking, “Comparison and Validation of Statistical Methods for Predicting Power Outage Durations in the Event of Hurricanes”, 2011
- [14] Nuclear Regulatory Commission, “Operational Readiness Of Offsite Power And Impact On Plant Risk”, TI 2515/165, 2006
- [15] A. Volkanovski, “Impact of offsite power system reliability on nuclear power plant safety”, 2008
- [16] Institute of Nuclear Power Operations, “Special Report on the Nuclear Accident at the Fukushima Daiichi Nuclear Power Station”, INPO 11-005, 2011
- [17] Tokyo Electric Power Company, “Security of offsite power supply of Fukushima Daini Nuclear Power Station”, 2011
- [18] Slovenian Nuclear Safety Administration, “Slovenian National Report on Nuclear Stress Tests, Final Report”, 2011