

EVALUATION OF ENERGY STRESS ON LINE ARRESTERS

I. UGLEŠIĆ, V. MILARDIĆ, B. FILIPOVIĆ-GRČIĆ

**Faculty of Electrical Engineering and Computing
University of Zagreb
(Croatia)**

A. TOKIĆ

**Faculty of Electrical Engineering
University of Tuzla
(Bosnia and Herzegovina)**

SUMMARY

Line Surge Arresters (LSAs) are efficient means for the improvement of the lightning performance of transmission lines. Determination of optimal LSA number, location and rating is important for the improvement of the reliability and availability of a transmission system. In selection of the LSA special attention should be paid to their energy stress which depends on complex interactions between the arrester locations, grounding, shielding and the local lightning environment. LSAs experience higher energy stress compared to station arresters, because the incoming surge to a station is limited by insulator flashover on the transmission line and impulse corona.

In this paper calculations of energy stresses were carried out for a double-circuit 220 kV line with a single shielding wire. Parametric studies were conducted in which arrester discharge energy was a function of: time to half value of stroke current, number of towers with arresters, footing resistance, span length and angle of power frequency voltage. Arrester energy stress is analyzed in case of stroke to tower and shielding failure. From conducted analysis it can be concluded that energy stress on LSAs is lower for shorter span lengths. Tower footing resistance has only minor effect on the discharge energy. Arrester discharge energy strongly depends on time to half of the stroke current, number of towers with installed arresters and angle of power frequency voltage.

KEYWORDS

Line surge arrester, modelling, energy stress calculations, double-circuit line, parametric analysis, ATP-EMTP simulations

ivo.uglesic@fer.hr

1. INTRODUCTION

Short circuits on transmission lines need to be avoided, not only to ensure continuous electricity supply for consumers but also to prevent stresses and damage they can cause to power system elements. Interruptions provoked by lightning are usually the most frequent cause of transmission line outages. One way for improving the lightning performance of transmission lines is LSA installation on critical places on transmission line corridor (high tower footing resistance and high lightning stroke density). LSAs are already employed by numerous electrical utilities around the world. In this paper calculations of energy stresses were carried out for a double-circuit 220 kV line with a single shielding wire. Parametric studies were conducted in which arrester discharge energy was a function of: time to half value of stroke current, number of towers with arresters, footing resistance, span length and angle of power frequency voltage.

2. MODELLING PROCEDURE FOR CALCULATING LSA ENERGY STRESS

The lightning stroke hitting a tower or a phase conductor can be replaced by a surge current generator and a resistor (Norton generator). The peak current magnitude and the tail time are important when observing the line arrester energy stresses, while the influence of the rise time is hardly noticeable in such a case. In contrast the current wave front is an important parameter with regard to insulator flashover. The slope ramp model was used in simulations for arrester discharge energy analysis. Tower surge impedances [1] were calculated using equation (1). Each tower was divided in four parts. First part is from tower top to upper arm, second one from upper arm to middle arm, third part from middle arm to lower arm and the last part from lower arm to ground. On this way it was possible to calculate transient voltages of tower arms.

$$Z = 60 \cdot \left\{ \ln \left(\frac{H}{R} \right) - 1 \right\} \quad (R \ll H) \quad (1)$$

where:

H – tower height [m],

R – tower equivalent radius (determined by equivalently replacing the tower with a cylinder) [m].

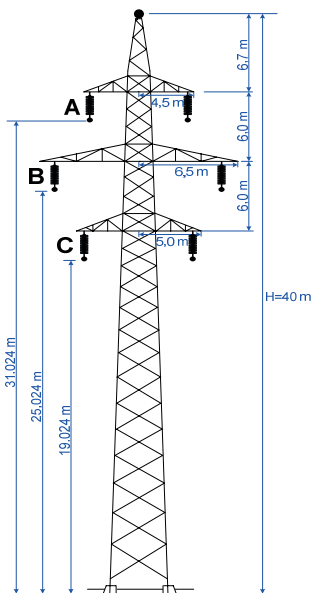

Figure 1. – 220 kV tower

Table 1. Line conductor data

	Resistance	Radius
Shield wires	0.28 Ω/km	1.33 cm
Phase conductors	0.08 Ω/km	0.69 cm

Figure 1 shows a double-circuit 220 kV tower used in simulations with line conductor data in Table 1. The transmission line, earth wire and conductors were represented by 6 untransposed frequency-

dependent spans at each side of the point of impact. Each line span has been simulated with the “Jmart” model of ATP-EMTP. A line termination was added at each side. Figure 2 depicts the model used for simulation of LSA energy stress on a double-circuit 220 kV line. All simulations were conducted with parameters from Figure 2. When the influence of single parameter on arrester energy was analysed, one parameter was varied while the other parameters remained the same.

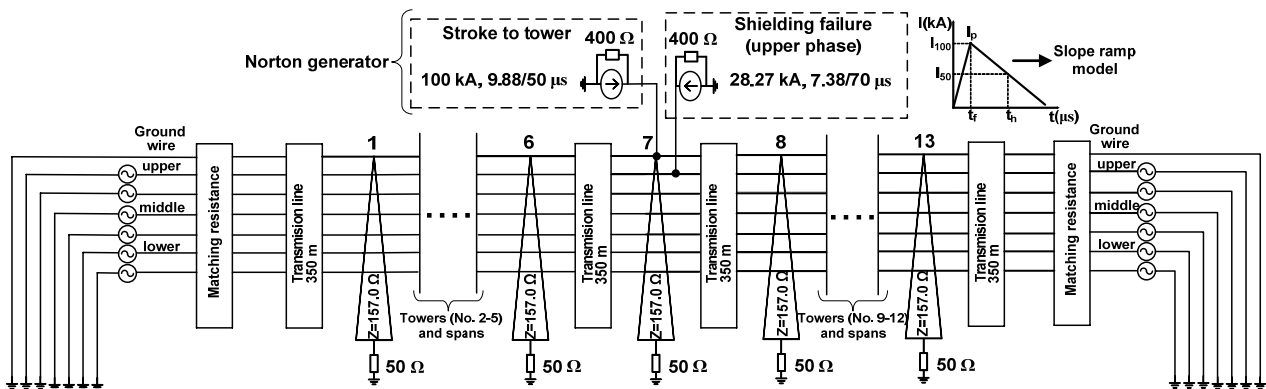

Figure 2. – Model of 220 kV double-circuit line

Tower footing resistances were modelled taking into account ionization [2]. The ionization model according to equation (2) takes into account the soil ionization that is caused by the lightning currents:

$$R_i = \frac{R_o}{\sqrt{1 + \left(\frac{I}{I_g}\right)^2}} \quad (2)$$

where:

R_o - footing resistance at low current and low frequency, i.e. 50 or 60 Hz [Ω],

I - stroke current through the resistance [kA],

I_g - limiting current to initiate sufficient soil ionization [kA].

The tower footing resistance remains $R_i=R_o$ if $I < I_g$ and varies according to the given equation if $I > I_g$. The limiting current [4] is given by:

$$I_g = \frac{\rho \cdot E_0}{2 \cdot \pi \cdot R_o^2} \quad (3)$$

where:

ρ - soil resistivity [Ωm],

E_0 - soil ionization gradient, recommended value: 400 [kV/m].

In the ATP-EMTP calculation the tower grounding was represented as non-linear resistors using Models and TACS-controlled time-dependent resistor. The model of gapless type line surge arrester includes non-linear and dynamic behaviour of the arrester. The non-linear behaviour was represented by the U-I characteristic depicted in Figure 3. while the frequency-dependent arrester model takes into account its dynamic behaviour. A frequency-dependent arrester model is depicted in Figure 4. Model parameters were identified using a formula that does not require any iterative correction and that makes use only of the data reported on manufacturers' datasheets [3].

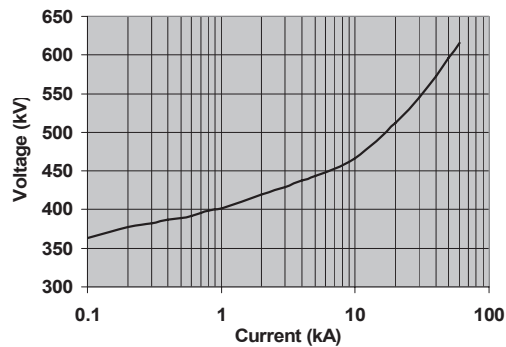

Figure 3. U-I characteristic of surge arrester for 220 kV line ($U_r=198$ kV)

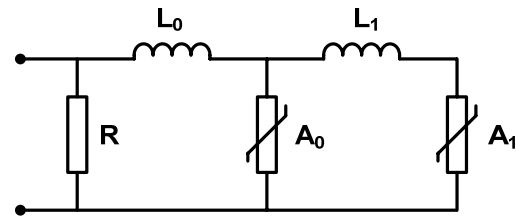

Figure 4. Frequency-dependent arrester model

Surge arrester electrical data is shown in Table 2.

Table 2. Electrical data for line surge arrester

Rated voltage [kV _{rms}]	Line discharge class	Lightning discharge capability [kJ]	Maximum residual voltage with current wave 8/20 μ s [kV]			
			5 kA	10 kA	20 kA	40 kA
198	3	1544.4	443	466	512	573

Circuit without LSAs was modelled with flashover volt-time characteristic using Models and TACS-controlled switch in an ATP-EMTP calculation.

3. CONDUCTED SIMULATIONS

Arrester energy stress was analyzed in case of stroke to tower and shielding failure. In all conducted simulations three arresters were installed on one circuit of a double-circuit line.

3.1. Arrester energy analysis in case of stroke to tower

Although lightning currents can have very high magnitudes in case of stroke to tower, only a part of the total current flows through arrester in a short time period. Therefore the energy stress of arrester remains low.

In all conducted simulations following data was used:

- lightning current 100 kA, 9.88/50 μ s strikes the tower No. 7 (Figure 2),
- soil resistivity $\rho=1000$ Ω m,
- footing resistance $R=50$ Ω ,
- span length 350 m,
- angle of power frequency voltage in phase A is 0°.

Figure 5 shows the energy discharged by arresters at the three phases of the struck tower as a function of the number of towers with arresters. The energies taken by the arresters at struck tower increase when arresters are installed in adjacent towers. This phenomenon occurs because the currents through arresters at the adjacent towers are of opposite polarity to the currents through arresters at the struck tower, they flow back to the point of impact, and result in an increase of energy [4].

Figure 6 shows the effect of the tower footing resistance on energy discharged by arresters in all phases at the struck tower when arresters were installed in one circuit of all towers. The tower grounding resistance was varied from 20 Ω to 110 Ω . Arrester energy in phase C changed from 20 kJ ($R=20$ Ω) to 55 kJ ($R=110$ Ω).

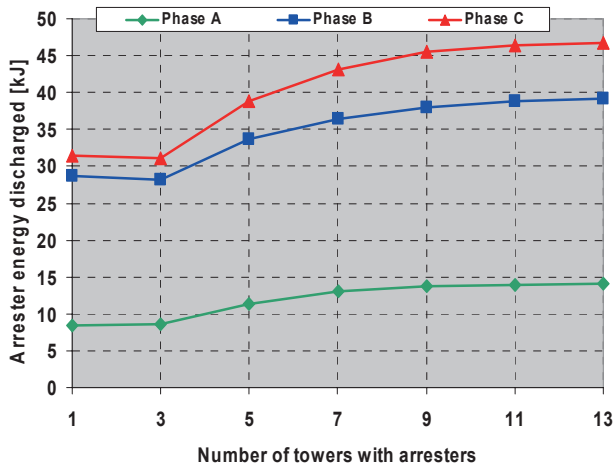

Figure 5. Influence of number of towers with arresters on discharge energy

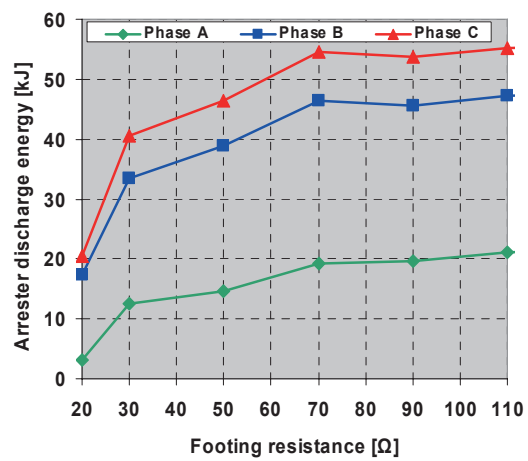

Figure 6. Influence of footing resistance on discharge energy

Figure 7 shows the effect of span length on the energy discharged by the arresters at the struck tower when arresters were installed in one circuit of all towers. The longer spans produce higher inductances of the transmission line, which tends to increase the current time constants and hence, the energy discharge levels.

Arrester energy value depends on the angle of power frequency voltage [5]. Figure 8 shows the effect of power frequency voltage angle on arrester energy in all phases at struck tower when arresters were installed in one circuit of all towers. Power frequency voltage source is represented with a cosine function. For power frequency voltage angle of 180° , arrester in phase A takes a highest discharge energy of 37 kJ (highest voltage difference on arrester). Because of difference in coupling factors arrester in phase C had the highest discharge energy of all phases (54 kJ for power frequency voltage angle of 60° in phase A).

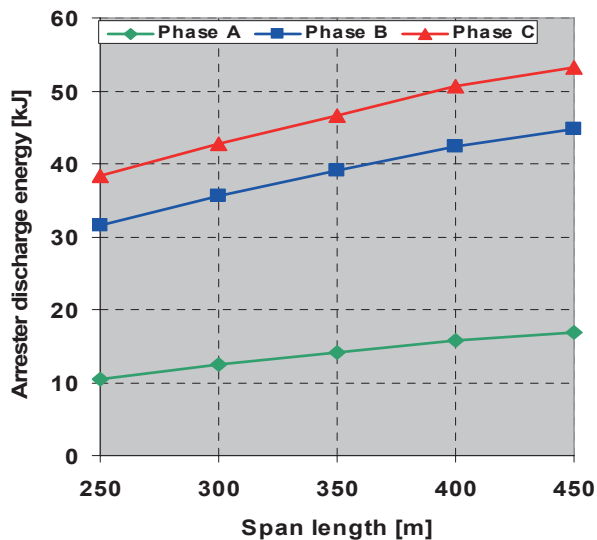

Figure 7. Influence of span length on discharge energy

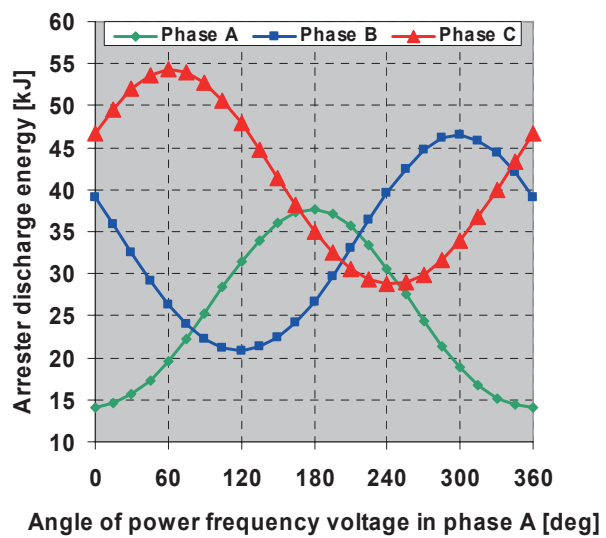

Figure 8. Arrester energy as function of the power frequency voltage angle

3.2. Arrester energy analysis in case of shielding failure

A shielding failure event or a stroke to the conductor is essentially a single-phase event. Although the probability of a shielding failure is very low, the energy stress is much higher when the return stroke hits a phase conductor than when the impact is produced at a shield wire. Lightning currents are of smaller amplitudes, but they are directly striking the phase conductor and stressing the LSAs and in this case overload (failure or damage) can occur. A previous study of the lightning performance of the double-circuit 220 kV line showed that shield wires prevent return stroke with a peak current magnitude greater than 28.27 kA. Therefore a lightning stroke (28.27 kA, 7.38/70 μ s) to phase A

conductor at tower No. 7 was analyzed (Figure 2). In all conducted simulations the same data was used as in case of stroke to tower.

In case of shielding failure in phase A (Figure 9) the energy reached maximum when arresters are installed only in a single tower. This energy rapidly decreased as additional arresters were installed in adjacent towers. For time to half of $70 \mu\text{s}$ the energy stress of arrester was 739 kJ. For time to half of $200 \mu\text{s}$ the energy stress of arrester was 2219 kJ, which exceeded arrester's rated discharge capability of 1544.4 kJ. Conducted analysis showed that (for simulated stroke current amplitude of 28.27 kA and time to front of $7.38 \mu\text{s}$) arrester will be endanger for time to half values higher than $140 \mu\text{s}$.

The primary reason for the decrease in energy as additional arresters were added on adjacent towers is that the time to half value of the arrester current decreased (Figure 10). When arresters were installed on single tower, time to half value of current through the arrester in phase A was approximately equal to that of the stroke current. With additional arresters installed on adjacent towers time to half value of arrester current rapidly decreased.

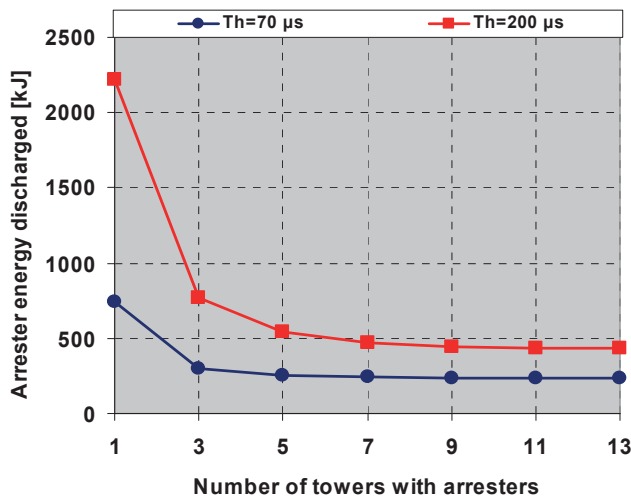

Figure 9. Influence of number of towers with arresters on discharge energy

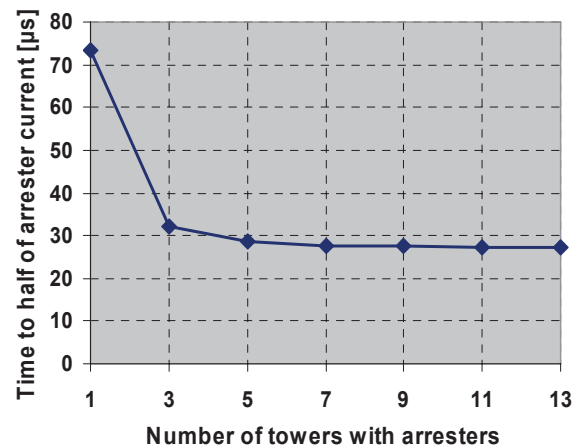

Figure 10. Influence of number of towers with arresters on time to half of arrester current

Arrester discharge energy strongly depends on time to half of the stroke current. Figure 11 shows the effect of the time to half value of the stroke current for 3 and 13 towers with arresters. For the case of three towers with arresters, the energy appears to be linearly dependent, but for 13 towers with arresters, the energy increased more moderately. The rise time of the return stroke has a small influence.

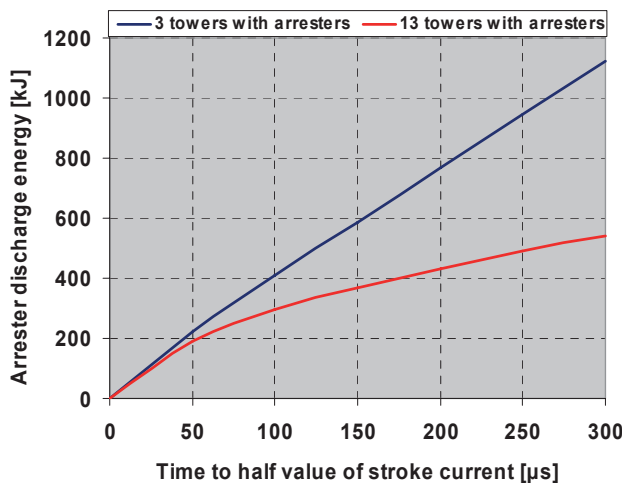

Figure 11. Influence of time to half of stroke current on arrester discharge energy

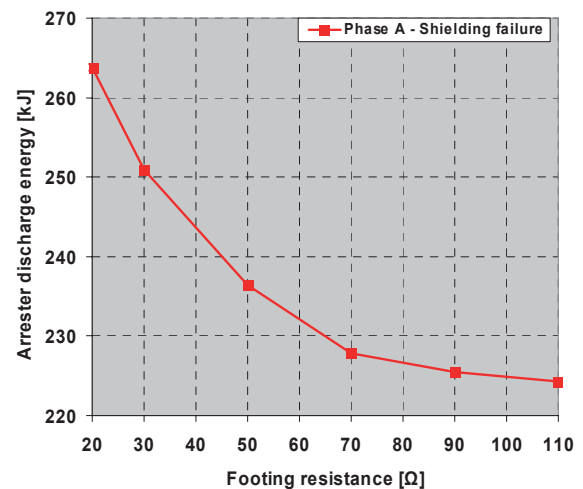

Figure 12. Influence of footing resistance on discharge energy

Figure 12 shows the effect of the tower footing resistance on energy discharged by arrester. The tower grounding resistance was varied from 20 Ω to 110 Ω . The effect of the footing resistance on the discharge energy was minor - arrester discharge energy changed from 264 kJ ($R=20 \Omega$) to 224 kJ ($R=110 \Omega$). Thus the shielding failure event produced more arrester energy than the stroke to a tower. Figure 13 shows the effect of span length on energy discharged by arresters at the struck tower. Energy in phase A changed from 203.12 kJ (span length=250 m) to 262.09 kJ (span length=450 m). The longer spans produce higher inductances of transmission line, which tends to increase the energy discharge levels.

Figure 14. shows the effect of power frequency voltage angle on the arrester energy in phase A. For power frequency voltage angle of 0° in phase A, arrester energy reached 739.64 kJ when arresters were installed on a single tower and 236.36 kJ when arresters were installed on 13 towers.

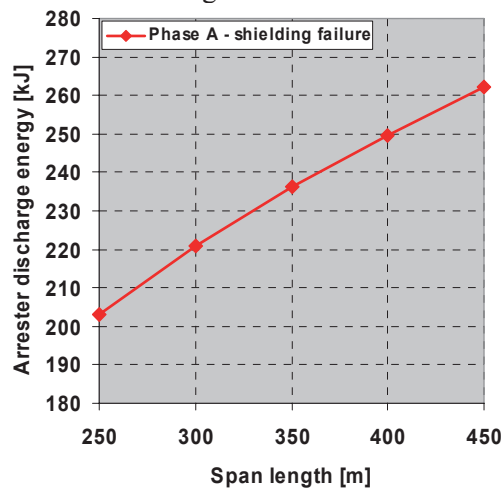

Figure 13. Influence of span length on discharge energy

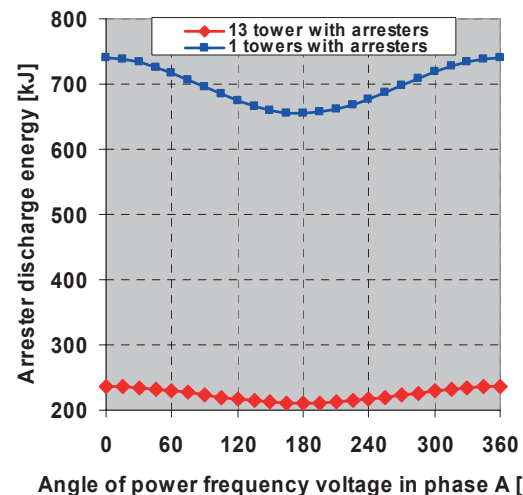

Figure 14. Arrester energy as function of the power frequency voltage angle

For power frequency voltage angle of 0°, arrester in phase A had a highest discharge energy (highest voltage difference on arrester). Arrester energy value depends on the angle of power frequency voltage. The influence of power frequency voltage is more evident when the stroke hits a tower, but the energy discharged in those cases is rather low and very rarely will exceed the maximum absorption capability of arresters installed in a shielded transmission line.

4. CONCLUSIONS

Calculations of energy stresses were carried out for a double-circuit 220 kV line with the single shielding wire. Modelling procedure for arrester energy calculation was described. Developed ATP model provides a good tool for calculating the arrester energy duties. Case study was performed to show how arrester energy behaves under different conditions. From conducted analysis it can be concluded:

- LSAs energies and currents are acceptable for almost all cases except direct strokes to phase conductors with time to half longer than 140 μs (for simulated stroke 28.27 kA, $t_f=7.38 \mu\text{s}$),
- Energy stress on LSAs is lower for shorter span lengths.
- The tower footing resistance has only minor effect on the discharge energy (in case of stroke to tower, increase of tower footing resistance resulted with increase in discharge energy; in case of shielding failure, increase of tower footing resistance resulted with decrease in discharge energy).
- Arrester discharge energy strongly depends on time to half of the stroke current, number of towers with installed arresters and angle of power frequency voltage.
- The influence of power frequency voltage is more evident when the stroke hits a tower, but the energy discharged in those cases is rather low and very rarely will exceed the maximum absorption capability of arresters installed in a shielded transmission line.
- The rise time of the return stroke has a small influence on discharge energy.

The demonstrated principle can be applied in different situations for selection of LSA when concerning energy stress.

5. BIBLIOGRAPHY

- [1] IEC 60071-4: “Insulation co-ordination – Part 4: Computational guide to insulation co-ordination and modelling of electrical networks”, 2004.
- [2] IEEE Working Group: “A Simplified method for estimating lightning performance of transmission Lines”, *IEEE Transactions on Power Apparatus and Systems*, vol: PAS – 104, no. 4, July 1985.
- [3] P. Pinceti and M. Giannetoni, “A simplified model for zinc oxide surge arrester”, *IEEE Transactions on Power Delivery*, vol. 14, no. 2, pp. 545–550, April 1999.
- [4] Hileman R. A., “Insulation coordination for power systems”, Power Engineering Book, Marcel Dekker, Inc., 1999.
- [5] Martinez J. A. and Castro-Aranda F., “Modeling Overhead Transmission Lines for Line Arrester Studies”, *IEEE Power Engineering Society General Meeting*, vol. 1, pp. 1125-1130, June 2004.