

Mohammad Shabani, Abbas Saberi Noghbi, Mohsen Farshad

A new optimization formulation for determining the optimum reach setting of distance relay zones by probabilistic modeling of uncertainties

DOI 10.7305/automatika.2017.12.1560
UDK [681.5.015.23:519.766.4]:621.316.925.45

Original scientific paper

In this paper, by probabilistic modeling of uncertainties, the problem of determining the reach setting of distance relay zones is presented as a new optimization problem. For this purpose, uncertainties are modeled based on their probability density functions. Then, by using the Monte-Carlo process, the impedance seen by the distance relay is obtained. In this paper, probabilistic sensitivity and selectivity indices are defined for each zone of the distance relay. Therefore, the problem of determining the optimum reach setting of distance relay for each zone is converted to an optimization problem with the objective of maximizing of the probabilities indices of sensitivity and selectivity. The objective function and the constraints of the optimization problem are defined based on the protection philosophy of each of the three different zones of the distance relay. Considering the fact that the optimization problem is nonlinear and non-convex, the particle swarm optimization (PSO) is used to solve this problem. The proposed optimization problem is applied on a 9-bus network, and the reach settings of distance relays are calculated and compared with those of the conventional approach. Also, uncertainties are prioritized based on the amount of their impact on the probabilistic indices of sensitivity and selectivity.

Key words: Distance relay, Probabilistic setting, Selectivity, Sensitivity

Nova formulacija optimizacijskog problema za određivanje optimalnog dosega zona udaljenih releja uz stohastičko modeliranje neodređenosti. U ovom radu je problem određivanja dosega zona udaljenih releja uz stohastičko modeliranje neodređenosti predstavljen kao novi optimizacijski problem. S tim u vezi, neodređenosti su modelirane na osnovu njihovih funkcija gustoće vjerojatnosti. Potom je korištenjem Monte-Carlo procesa dobivena impedancija koju vidi udaljeni relej. U ovom radu su definirani indeksi stohastičke osjetljivosti i selektivnosti za svaku zonu udaljenog releja. Problem određivanja optimalnog dosega udaljenog releja za svaku zonu je transformiran u optimizacijski problem s kriterijem maksimiziranja stohastičkih indeksa osjetljivosti i selektivnosti. Kriterijska funkcija i ograničenja optimizacijskog problema definirani su na osnovu strategije zaštite svake od tri različite zone udaljenog releja. Uzimajući u obzir da je dobiveni optimizacijski problem nelinearan i nekonveksan, za dobivanje rješenja je u radu korištena optimizacija rojem čestica. Predloženi optimizacijski problem primijenjen je na mrežu s 9 sabirnica, pri čemu je izračunati doseg udaljenih releja uspoređen s konvencionalnim pristupom. Također, prioritet neodređenosti određen je na osnovu njihovog utjecaja na stohastičke indekse osjetljivosti i selektivnosti.

Ključne riječi: udaljeni relej, stohastičko okruženje, selektivnost, osjetljivost

1 INTRODUCTION

Distance relay has widely been used as a fast and selective protection in power systems. This relay is used as the primary and back up protection in transmission and sub-transmission lines.

Distance relay detects the fault location by measuring the impedance seen from where it is installed, and comparing it to the relay setting. Thus, the reach setting of the distance relay must be determined in a way that the relay operates for an internal fault of the protection zone (sensitivity),

and it does not operate for an external fault of protection zone (selectivity). Therefore, the error in the impedance measured by the relay may result in mal-operation of this relay. Uncertainties that can cause errors in measuring the impedance include: fault location, fault type, fault resistance, the errors of measuring equipment, and change in network topology [1-3].

Different methods have been proposed for setting distance relays that take the uncertainties into account. In [4], an adaptive approach has been presented for distance pro-

tection of transmission lines in presence of wind farms. In the proposed adaptive approach, considering the amount of generation and impedance of the wind farm as well as the amount of the network load, the reach setting of the distance relay has been determined instantaneously.

In general, in one hand, adaptive approach has high costs and the other hand, it is not very easy to consider some uncertainties such as fault resistance and errors in measuring equipment. Therefore, non-adaptive schemes have been proposed in some papers.

In conventional approaches of setting the distance relay, usually a safety margin (about 10 to 30 percent) is considered in order to include uncertainties. For example, the zone-1 setting of distance relay in conventional approaches is considered to be 80 percent of the line impedance [5]. Considering the fact that the safety margin can be changed for different networks with different measuring devices, in [6-7], probabilistic methods have been proposed for determining the setting of distance relay.

In [6], probabilistic setting of a distance relay with quadrilateral characteristics, taking the uncertainties affecting its operation into account, has been presented. In this paper, the reach setting of the distance relay has been determined in a way that the probabilities of sensitivity and selectivity are maximized.

In [7], uncertainties such as measuring errors, fault location, and fault resistance, have been identified as the effective factors on distance relay. Then, the amount of variations in the probabilities of sensitivity and selectivity for variations in the reach setting of distance relay has been obtained.

In this paper, by probabilistic modeling of uncertainties, the problem of determining the reach setting of distance relay is presented as an optimization problem. The uncertainties affecting the performance of the distance relay such as fault location, fault type, fault resistance, the errors in measuring equipment, and change in operation conditions are modeled considering their probability density functions. Then, the probabilistic indices of sensitivity and selectivity are defined for each zone of the distance relay. After that, the problem of determining optimum setting of distance relay for each zone is defined as an optimization problem with the objective of maximizing the probability of sensitivity and with the constraint of perfect selectivity. By combining the Monte-Carlo approach with the PSO algorithm, and with probability density function of each uncertainty being known, the optimization problem is solved for each zone and the optimum settings of the different zones of the distance relay are determined. Then, the proposed setting is compared with that of the conventional approach. The capability of the new formulation presented in solving the problem of setting the distance relay is shown by applying it on a 9-bus network.

2 UNCERTAINTIES AFFECTING THE PERFORMANCE OF DISTANCE RELAY

Whether distance relays should operate or not is determined based on a comparison between the impedance measured by the relay and its reach setting impedance. Therefore, some uncertainties can cause the measured impedance to change and consequently result in maloperation of the relay. In this paper, the following uncertainties are considered:

Fault conditions: variations in fault location and fault type (three phase, phase to phase, phase to phase to ground and single phase to ground) [8] in the network will cause the impedance measured by the relay to change. Therefore, it can affect the relay performance. In this paper, uncertainties of fault location are modelled by a uniform distribution function. The occurrence probability of each type fault is considered in a discrete form.

The fault resistance includes the electrical arc resistance, the resistance of towers and ground, and it affects the impedance measured by the relay and its performance as well. Since the values of fault resistance are always positive, the Weibull distribution function can be used to model it [9]. The mathematical formulation of the Weibull distribution function is presented in (1).

$$y = ABx^{B-1}e^{-Ax^B} \quad (1)$$

Variations in operation conditions: variation in load of power systems causes the change of current carries through the lines and affects the pre-fault bus voltages. The variations of load in power system are usually represented by the load duration curve. For the sake of simplification, the load duration curve is presented in three load levels (low, medium, and high load).

The errors of measuring equipment: The existence of any kind of fault in measuring transformers results in error in calculation of the impedance seen by the relay. The accuracy class of current and voltage transformers are given in IEC 60044-1 and IEC 60044-5 standards, respectively.

3 DEFINING THE PROBABILISTIC INDICES OF SENSITIVITY AND SELECTIVITY

The three zones of distance relay need to be set in a way that the relay operates correctly for an internal fault of the protection zone (sensitivity), and it does not operate for an external fault of the protection zone (selectivity). Considering these definitions, the probabilistic index of sensitivity of protection zones of a distance relay can be defined as (2):

$$P_s = \frac{Z_s}{Z_t} \quad (2)$$

In the above equation, Z_t represents the total number of internal faults of the protection zone of the relay, and Z_s denotes the number of these faults which have measured impedance lower than the reach setting of the protection zone. In zone 1, Z_s represents the number faults that have occurred in the main line (the line on which the relay is located) and the impedance measured by the relay is seen within the zone 1 of the relay. The aim of zone 2 is to operate for faults that occur in the rest of the main line (the part which is not protected by zone 1), therefore, similar to zone 1, Z_s represents the number of faults that have occurred on the main line and their impedances are seen within zone 2 of the distance relay. Since zone 3 must completely protect the relays of the next lines, in zone3, Z_s represents the number of faults that have occurred in the adjacent next lines and the impedance measured by the relay is lower than the reach setting of the zone 3. The probabilistic index of selectivity of protection zones of a distance relay is defined as (3):

$$P_c = \frac{Z_c}{Z'_t} \quad (3)$$

In the above equation, Z'_t represents the total number of external faults of the protection zone of the relay, and Z_c represents the number these Z'_t faults for which the impedance measured by the relay is higher than the reach setting of that protection zone. In zone 1, Z_c is the number of faults that have occurred in the adjacent lines of the relay (the lines after the main line) for which the impedance seen by the relay is out of the first protection zone. In zone 2, Z_c represents the number of external faults of the first protection zones of the relays of the adjacent lines for which the impedance seen by the relay is higher than reach setting of the zone 2 of the main line relay. Also, in zone 3, Z_c is the number of external faults of zone 2 of the adjacent lines' relays for which the impedance seen by the relay is higher than the reach setting of zone 3 of the relay of the main line.

4 NEW FORMULATION PROPOSED FOR SOLVING THE PROBLEM

In distance relays with quadrilateral characteristics, it is possible to independently set the relay on R and X axes. Thus, this characteristic makes it possible to effectively take the arc resistance or fault resistance into account. In this paper, distance relays with quadrilateral characteristics are used.

The optimum setting of each zone of distance relay must be determined in a way that the perfect sensitivity and selectivity are achieved for that zone. Since in some zones of distance relay, it is not possible to achieve perfect sensitivity and perfect selectivity simultaneously, therefore under such conditions, achieving perfect selectivity is of higher priority and the sensitivity will be maximized.

4.1 The formulation proposed for zone 1

In general, loss of selectivity results in remove of a larger part from the network during a fault. Therefore, the optimization problem of (4) is presented for determining the optimum setting of zone 1 of the distance relay.

$$\begin{aligned} \max P_s \\ \text{Subject to : } P_c = 1 \end{aligned} \quad (4)$$

In this equation, the aim is to maximum of the sensitivity index of zone 1 of the distance relay, and the selectivity index must be considered as a constraint in the problem so that the perfect selectivity is achieved.

4.2 The formulation proposed for zone 2

If the reach setting impedance of zone 2 is higher than the maximum impedance seen for faults in the main line, and is lower than the minimum impedance seen for external faults of zone 1 of the relays of the next lines, the perfect sensitivity and selectivity will be achieved. Therefore, it is clear that there is an interval of settings for zone 2 of distance relay where the probabilities of sensitivity and selectivity are equal to one. Thus, in this paper, the problem of (5) is proposed for determining the optimum setting of zone 2 of distance relay.

$$\begin{aligned} \max X_r \\ \text{Subject to : } \begin{cases} P_s = 1 \\ P_c = 1 \end{cases} \end{aligned} \quad (5)$$

In this formulation, the probabilities of sensitivity and selectivity are considered as a constraint. In equation (5), the aim is to obtain the highest setting that has the perfect sensitivity and selectivity. Considering the fact that the higher is the value of setting reactance of relay (X_r), the larger will be the length of the next lines that is completely covered by zone 2 of the distance relay. Therefore, in this formulation, the objective function is considered as maximizing X_r .

Under certain condition, when the impedance of adjacent lines is lower than that of the main line, there will be no such setting for which the probabilistic indices of sensitivity and selectivity are simultaneously equal to one. Under these conditions, the optimization problem represented by (6) is proposed for determining the optimum setting of this zone.

$$\begin{aligned} \max P_s \\ \text{Subject to : } P_c = 1 \end{aligned} \quad (6)$$

Considering that the selectivity is more important than sensitivity for zone 2, similar to zone 1, the selectivity is defined as a constraint and the sensitivity index is maximized as well.

4.3 The formulation proposed for zone 3

The third protection zone of the relay as a backup protection must be completely cover all of the next lines. Therefore, in this zone, considering the higher importance of sensitivity compared to selectivity, the optimization problem of (7) is proposed for determining the optimum setting of zone 3 of the distance relay.

$$\begin{aligned} & \max P_c \\ & \text{Subject to : } \quad P_s = 1 \\ & \quad R_{r3} < R_L \text{ or } X_{r3} < X_L \end{aligned} \quad (7)$$

In above equation, R_L and X_L are the real and imaginary parts of the load impedance, respectively. In this formulation, in addition to selectivity constraint, in order to prevent the relay from operating for the load impedance, the constraint of operation of zone 3 of the distance relay under load conditions is added as well.

5 THE PROPOSED ALGORITHM FOR SOLVING THE PROBLEM

The proposed algorithm for solving the problem of setting the distance relay is presented in two parts as shown in Fig. 1.

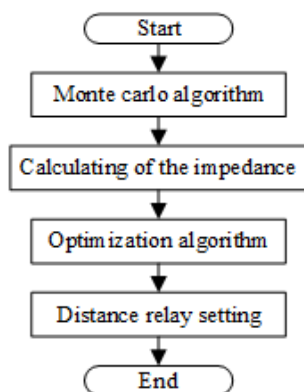

Fig. 1. The algorithm proposed for solving the problem

First, using the Monte-Carlo process and by taking all the uncertainties and their probability density functions into account, the impedance seen by the relay is calculated and saved. In the next stage, the proposed optimization problem for each zone of the distance relay is solved by using the PSO algorithm, and the optimum settings of the different zones of the distance relay are obtained.

5.1 Calculating of the impedance seen by the relay

In Figure 2, the Monte-Carlo algorithm proposed for calculating and saving the impedance measured by the relay, by considering of the uncertainties, is shown.

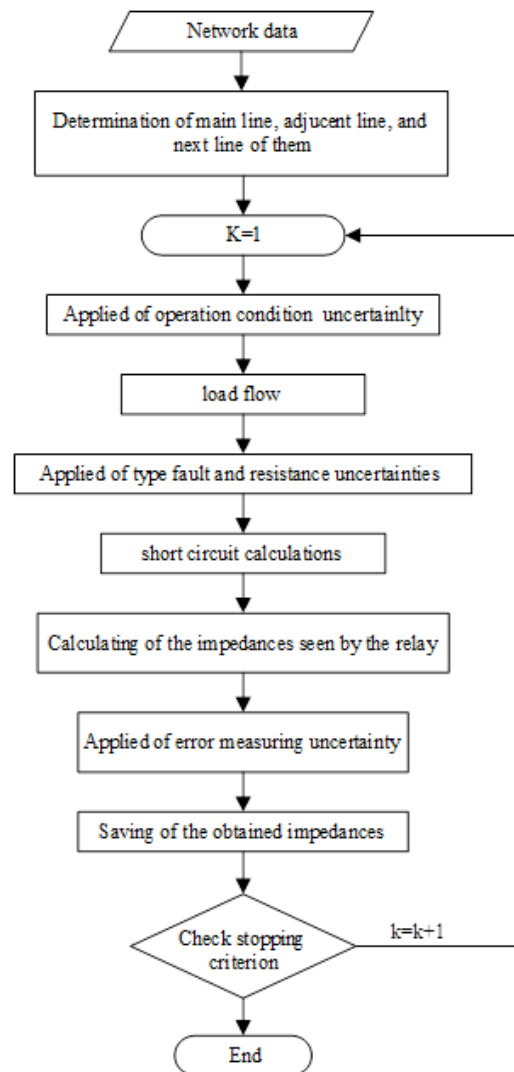

Fig. 2. The Monte-Carlo algorithm for calculating and saving the impedances measured by the relay

In the beginning of the algorithm, the network data including the line data, bus data, and the probability distribution functions corresponding to uncertainties, are entered. Then, a relay is selected and the main line, the adjacent lines and the next lines are determined for that relay and the Monte-Carlo process is started.

As the Monte-Carlo process begins, the uncertainty of variation in operation conditions is applied. For this purpose, considering the load duration curve, a load level is randomly selected. Due to the dependency of the amount of generation of generator units to the amount of existing load in the network, once the selected load level is calculated and becomes known, the amount of generation of each unit is also modified. Then the load flow is performed to calculate the pre-fault bus voltages. In order to model the uncertainty of fault location, first, one of the lines related to the relay (the main line or the adjacent lines) is selected. Then, the location of fault is determined randomly with a uniform distribution. Next, considering the occurrence probability of different types of faults, a symmetric three-phase fault, phase to phase fault, phase to phase to ground fault, or a single phase to ground fault is randomly selected. The uncertainty of fault resistance is randomly selected by taking its proposed density function into account as well.

When the fault location, fault type and the fault resistance being known, the short circuit calculations are performed, and the voltage of the point where the relay is installed and the current flowing through the relay are obtained, and the impedance seen by the relay is calculated.

At the final stage of the Monte-Carlo iterative process, the error of measuring equipment is randomly generated, considering their probability density functions, and the impedances measured by the relay are calculated as (8). Then, the obtained impedance is saved.

$$Z_{ap} = \frac{V_R(1 + \varepsilon_v)}{I_R(1 + \varepsilon_i)} \quad (8)$$

In the above equation, Z_{ap} is the impedance measured by the relay, and V_R and I_R are the voltage of the relay location and the current flowing through the relay, respectively. Also, ε_v and ε_i are the errors of voltage and current transformers, respectively. The abovementioned steps are repeated until a complete probability density function is obtained for the impedance seen by the relay. The impedances obtained for the faults in the main line, the adjacent lines, and the lines after them are saved in separate variables. In the next section, these impedances are used as the input of the optimization algorithm in order to determine the optimum settings of different zones of the distance relay.

5.2 The PSO algorithm

In the previous section, the problem of determining the optimum settings of the different zones of distance relay was converted into several optimization problems. Intelligent algorithms can be used to solve these nonlinear and constrained problems. In this paper, considering the continuous nature of the problem, the PSO algorithm is used [10]. The PSO algorithm for determining the optimum setting of the relay is shown in Fig. 3.

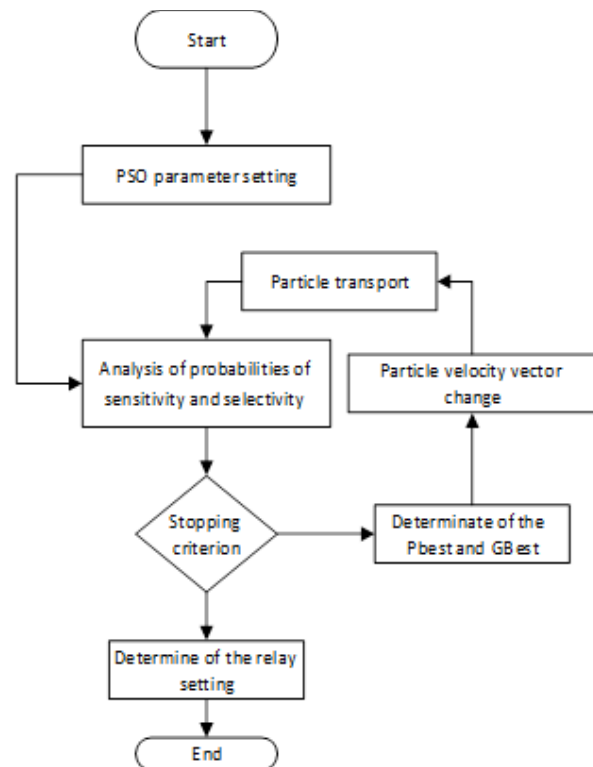

Fig. 3. The PSO algorithm

In the algorithm presented, each candidate particle is a solution of the problem. The position of each particle is determined in a way that its data contains the setting of one zone of the distance relay. By determining the position of each particle, the objective function is evaluated and if this value is higher than the value calculated for the previous particle, the position of the particle is saved as its best position. Within the search space, the best position experienced by a particle is represented by PBest and the best position of the group of particles is represented by GBest. These steps are repeated until all particles are converted into an optimum particle.

The decision variables in the optimization problems for each of the three zones of the distance relay are the settings of its different zones. Since quadrilateral characteristics is considered for the distance relay, the resistance (R_r) and



Fig. 4. The structure of a particle

characteristic reactance (X_r) setting of relay are shown in Fig. 4 as PSO strings.

It should be mentioned that the objective function for each zone of the distance relay will be different as shown by (4)-(7).

5.3 Prioritizing uncertainties

In this section, uncertainties are prioritized according to the amount of their impact on the sensitivity and selectivity of distance relays. For this purpose, first the optimization problems presented for each protection zone are solved without considering the uncertainties, and the optimum settings of the distance relays are obtained. The results obtained in this case are considered as the base case. Then, by considering one of the uncertainty in Monte-Carlo algorithm, the indices of probabilities of sensitivity and selectivity are calculated. It is obvious that if including an uncertainty causes more change in indices of probabilities of sensitivity and selectivity compared to the base case, that uncertainty has more impact on these indices.

6 NUMERICAL RESULTS

In order to perform the proposed approach, the 9-bus WECC network shown in Fig. 5 is considered. This network consists of 3 generators, 6 transmission lines, and 3 loads with a total of 315 MW and 114 MVar. The network voltage is 345 kV and its frequency is 60 Hz. Also, this network includes 12 distance relays with quadrilateral characteristics. The other features of this network are given in [11].

In this section, the optimum settings of three zones of the distance relay R_1 are determined. It is clear that the other relays of the network can be set in a similar way. Since the setting of this relay is dependent on the relays of other lines as well, the relays of the next lines are represented by R_2 and R_3 . Also, the main line, the adjacent line of the relay R_1 , and the line after them are represented by L_1 , L_2 , and L_3 , respectively.

In the proposed Monte-Carlo algorithm, the probabilities of a three phase fault, phase to phase fault, phase to phase to ground fault, and single phase to ground fault are considered to be equal to 5%, 15%, 10%, and 70%, respectively [12]. The range of variation of fault resistance for phase-to ground faults is considered to be within the interval of 0 to 50 Ohms, and for three phase and phase to phase faults is considered to be within the interval of 0

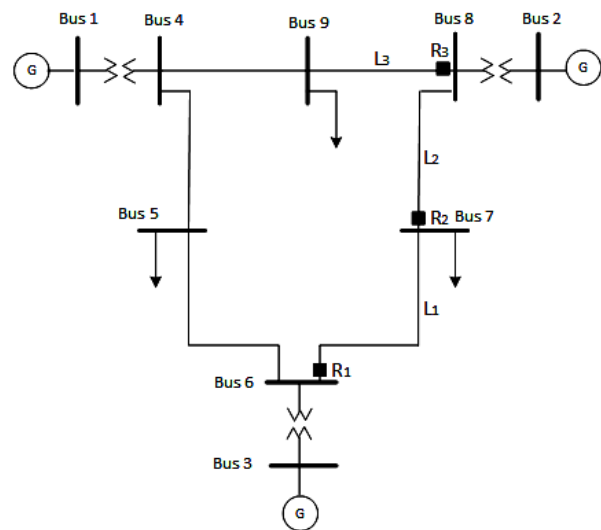

Fig. 5. WECC-9 bus test system

to 10 Ohms [6]. Thus, to model the three phase fault and phase to phase fault, the parameters of Weibull distribution function are considered as $A = 1.6$ and $B = 2$, and for phase to ground faults are considered as $A = 32$ and $B = 2.3$.

Each relay of the above network (Fig. 5) has a current transformer with 5P10 class of accuracy and a voltage transformer with 3P class of accuracy. Therefore, to model the uncertainty of errors of the measuring equipment, a normal distribution function with a standard deviation of $\sigma = 0.016$ and an average of $\mu = 0$ is proposed, and for the voltage transformer a normal distribution function with a standard deviation of $\sigma = 0.01$ and an average of $\mu = 0$ is proposed.

To model the load, three load levels are selected which are shown in Table 1 together with their corresponding probabilities.

Table 1. Modeling the load variations

The ratio of the load level to the maximum of the network load	Probability of the load level
0.440	0.114
0.783	0.730
1	0.156

6.1 Impedances saved by the relay

In the beginning, the Monte-Carlo algorithm proposed in Section 5.1 is performed and the impedances measured by the relay R_1 for faults in the main line (L_1), the adjacent line (L_2), and the line after it (L_3) are saved. The number

of iteration of the Monte-Carlo process is considered to be equal to 20000.

Figures 6, 7, and 8, show the impedances measured by the relay R_1 for faults in the main line (L_1), the adjacent line (L_2), and the line after it (L_3) (as points) and in per unit, respectively. The horizontal axis represents the real part of impedance, and the vertical axis represents its imaginary part.

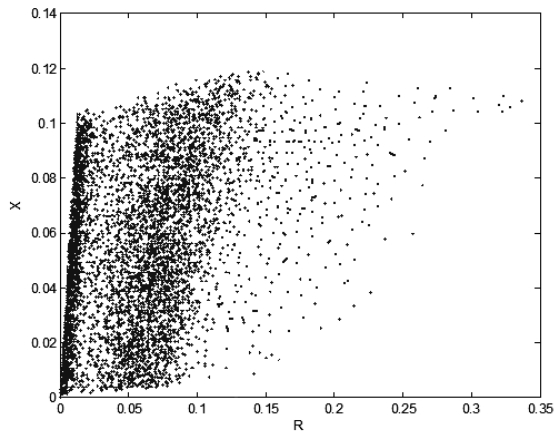

Fig. 6. The impedances seen by the relay R_1 for faults in the L_1 by considering of the uncertainties

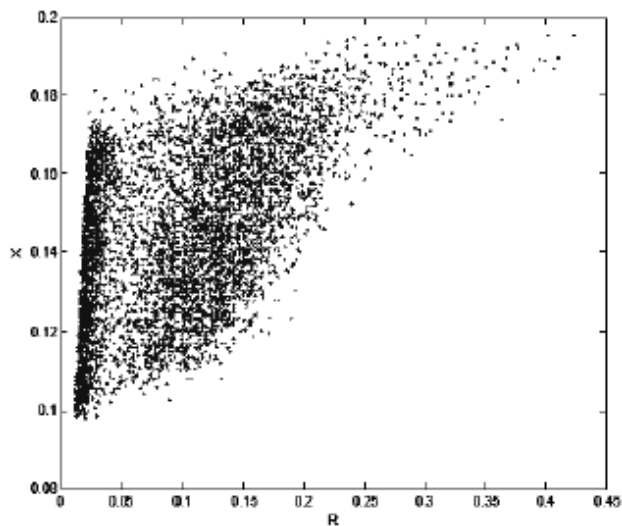

Fig. 7. The impedances seen by the relay R_1 for faults in the L_2 by considering of the uncertainties

6.2 Determining of the optimum settings of the different zones

Once the impedances measured by the relay R_1 are saved, the PSO algorithm is performed for each one of the

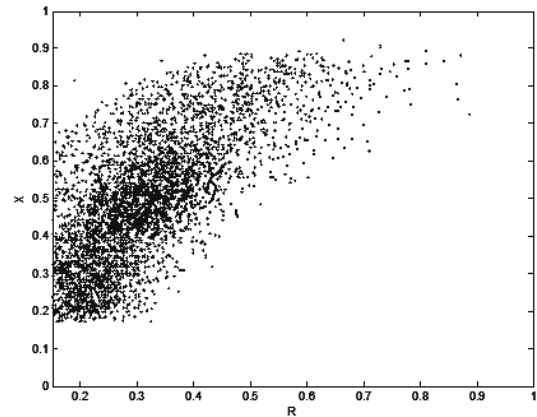

Fig. 8. The impedances seen by the relay R_1 for faults in the L_3 by considering of the uncertainties

three zones of the distance relay. The number of iterations considered for this optimization algorithm is 1000, and the initial population is 200, the weight coefficient (w) is equal to 0.98 and the learning coefficients C_1 and C_2 are considered to be equal to 2.

Zone 1 By applying the PSO algorithm to the problem of optimizing zone 1 of the distance relay, its optimum points are obtained. The optimum setting for zone 1 of the Relay R_1 is $R_r = 0.286$ pu and $X_r = 0.0985$ pu. As shown in Fig. 9, none of the impedances which have occurred in the adjacent line, L_2 , has not been seen in zone 1 of the relay R_1 .

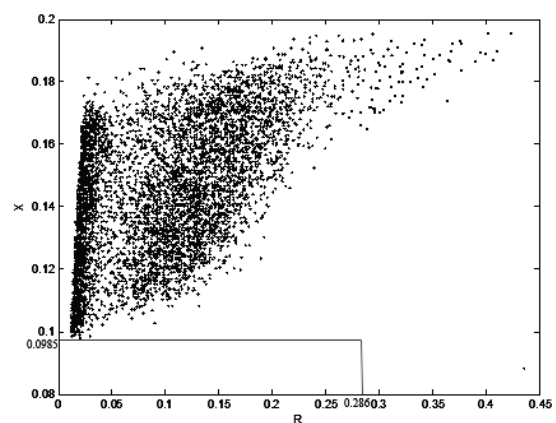

Fig. 9. The impedances seen by relay R_1 for faults in L_2 together with zone 1 setting of relay R_1

By this setting, the probability of selectivity is one and the probability of sensitivity is equal to 0.9379.

Also, as shown in Fig. 10, most of the impedances occurred in the main line (93.79%) are seen by the relay R_1 .

Since the optimum zone 1 settings of relays R_2 and R_3 are required for setting the next zones of Relay R_1 , the optimization algorithm is also applied to these relays. Their optimum zone 1 setting and the probabilities of selectivity and sensitivity are presented in Table 2.

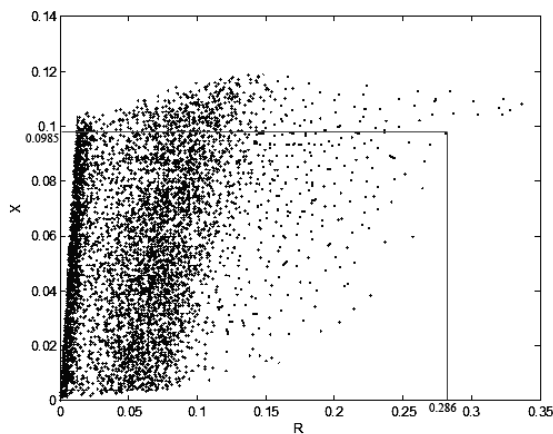

Fig. 10. The impedances seen by relay R_1 for faults in L_1 together with zone 1 setting of relay R_1

Table 2. The zone 1 settings of the relays of the next lines

P_c	P_s	X_r (pu)	R_r (pu)	
1	0.9661	0.0688	0.2890	R_2
1	0.9440	0.1508	0.3060	R_3

Zone 2 The impedances seen by the relay R_1 for internal faults in line L_1 and for external faults outside the zone 1 of the relay R_2 are calculated by the Monte-Carlo process and are presented in Fig. 11.

The optimization problem proposed for determining the optimum setting of zone 2 is solved for the relay R_1 by means of the PSO algorithm. The optimum setting for zone 2 of the relay R_1 is obtained as $R_r = 0.340$ and $X_r = 0.1498$. These setting are shown as a quadrilateral characteristic in Fig. 11. According to this figure, for the setting proposed for zone 2, all the faults that have occurred in the main line are covered by zone 2 of relay R_1 (the probability of sensitivity is one). Also, the external faults outside the zone 1 of the relay R_2 are seen outside the zone 2 characteristics of the relay R_1 (the probability of selectivity is one). Furthermore, the setting presented in

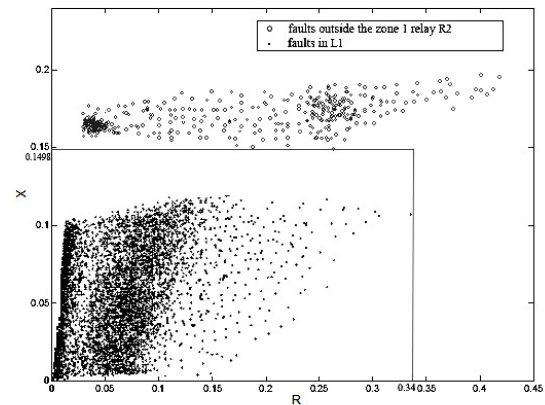

Fig. 11. The impedances seen by the relay R_1 for faults in L_1 and for external faults outside the zone 1 of the relay R_2 together with zone 2 setting of the relay R_1

Fig. 11 is the highest setting for which the probabilities of sensitivity and selectivity are one.

In a similar way, by solving the optimization problem, the optimum setting of zone 2 of the relay R_2 is obtained as $R_r = 0.3826$ and $X_r = 0.1241$ per unit.

Zone 3 By solving the proposed problem by means of the PSO algorithm, the optimum settings of zone 3 of the distance relay R_1 are obtained as $R_r = 0.4270$ and $X_r = 0.1987$. For this solution, the probability of selectivity is 0.9945 and the probability of sensitivity is one. In other words, for the proposed setting, all faults that have occurred in the adjacent line, L_2 , are completely covered. Also, the number of faults that have occurred in line L_3 and outside zone 2 of relay R_2 which are seen by relay R_1 is minimized. It should be noted that the load impedance is $Z_L = 0.549 + 0.09j$ which is outside zone 3 of relay R_1 .

6.3 Prioritizing uncertainties

In order to prioritize the uncertainties, first the zone 1 setting of relay R_1 is calculated without considering the uncertainties, and its probabilities of sensitivity and selectivity are considered as the base case. Three phase fault type is considered for the base case, and the fault resistance is considered to be equal to zero. The errors of CT and PT are zero and the load variation is neglected. The uncertainty of fault location is considered in the base case and all other cases. Under such conditions, the zone 1 setting of relay R_1 is $R_r = 0.0119$ and $X_r = 0.1008$ and the probabilities of sensitivity and selectivity are both equal to one. Then, each uncertainty is taken into account separately, and again, the probabilistic indices of sensitivity and selectivity for zone 1 are calculated.

The amount of impact of each uncertainty on the index of probability of sensitivity of zone 1 of relay R_1 is shown in Fig. 12. As it can be seen in this figure, the uncertainty of fault resistance has had the highest impact on the sensitivity probabilistic index of zone 1. The errors of current and voltage transformers which, compared to the base case, have the second rank in the index of probability of sensitivity. Also, the uncertainty of variation of operation conditions is in the next rank.

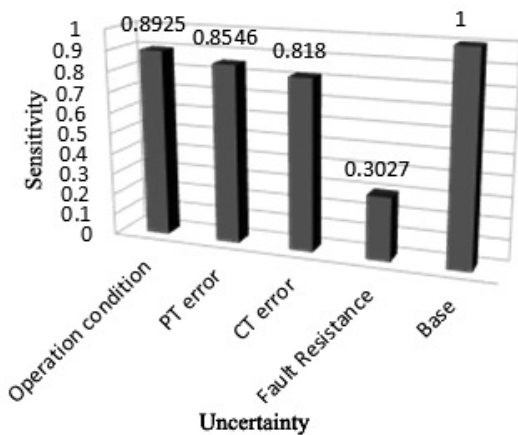

Fig. 12. The probability of sensitivity of relay R_1 by considering uncertainties

The variation of probability of selectivity of zone 1 of relay R_1 , by taking all uncertainties into account is shown in Fig. 13. The results show that the error of current and voltage transformers create the highest deviation in the probabilistic index of selectivity of zone 1 compared to the base case. Also, the impact of uncertainties of variations in operation conditions on the selectivity of zone 1 is very low.

6.4 Comparing the results of the proposed approach with those of the conventional approach

In this section, similar to conventional approach, the zone 1 settings of the relays R_1 , R_2 , and R_3 are considered to be 85% of the impedance of the main line. For sake of comparison, the setting of the relays using the conventional and proposed method are shown in table 3.

According to the above Table, considering uncertainties, the proposed approach has selected larger impedance. The index of probability of sensitivity in the proposed approach has higher than the conventional approach. Also, no selectivity with relays of the next lines has occurred, and the probability of selectivity is the same for both methods.

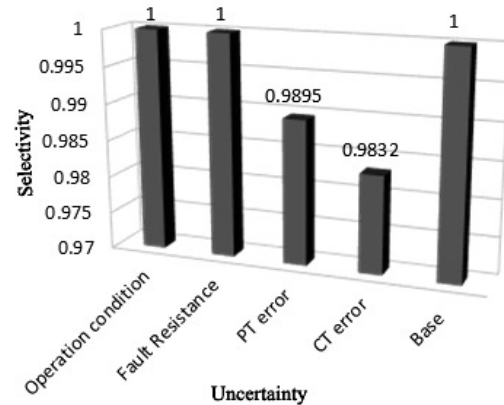

Fig. 13. The probability of selectivity of relay R_1 by considering uncertainties

Table 3. Comparison between the proposed approach with the conventional approach

Proposed approach			Conventional approach			Relay
P_{C1}	P_{S1}	setting	P_{C1}	P_{S1}	Setting	
1	0.9379	$0.2860 + 0.0985j$	1	0.2988	$0.01011 + 0.08568j$	R_1
1	0.9661	$0.2890 + 0.0688j$	1	0.3011	$0.00720 + 0.06120j$	R_2
1	0.9440	$0.2760 + 0.0696j$	1	0.2849	$0.02720 + 0.13685j$	R_3

7 CONCLUSION

In this paper, a new formulation of the problem of determining the optimum settings of distance relay, considering the uncertainties was presented. The fault location, fault type, fault resistance, errors of measuring equipment, and variations of operation conditions, were probabilistically modeled as uncertainties affecting the distance relay. Then, the probabilities of sensitivity and selectivity were defined and the Monte-Carlo simulation was used to calculate these indices. After that, an optimization problem was defined for each zone of the distance relay in order to determine the optimum settings of that zone. For zones 1 and zone 2 of the distance relay, considering the protection philosophy of these zones, the objective function was considered as maximizing the probability of sensitivity, and the constraint of the problem was considered as achieving perfect selectivity. For zone 3, the objective function was considered as maximizing the probability of selectivity and the constraint of the problem was considered as achieving perfect sensitivity. The proposed approach was applied to one of the relays of the 9-bus network. By solving the optimization problem for each zone, the optimum settings are obtained in a way that maximum sensitivity and selectivity are created for that zone. A comparison between the

results of the proposed approach with those of the conventional method showed that the settings of the proposed approach have resulted in perfect selectivity and maximum sensitivity.

Also, uncertainties were prioritized based on the amount of their impact on the sensitivity and selectivity of the distance relay. It became clear that the fault resistance, followed by the error of CT, have the highest impact on the selectivity and sensitivity of the distance relay.

REFERENCES

- [1] T. Rodolakis and D. Crevier, "Effect of Loads, Shunts and System Uncertainties on Short Circuit Relays Settings", *IEEE Transactions on Power Apparatus and Systems*, vol. 12, pp. 4701-4709, 1981.
- [2] T. S. Sidhu, D. S. Baltazar, R. M. Palomino, and M. S. Sachdev, "A new approach for calculating zone-2 setting of distance relays and its use in an adaptive protection system", *IEEE Transactions on Power Delivery*, vol. 19, pp. 70-77, 2004.
- [3] M. Taghizadeh, J. Sadeh, M. Bashir, and E. Kamyab, "Effect of single phase to ground fault with arc resistance on the performance of distance relay", *10th International Conference on Environment and Electrical Engineering (EEEIC)*, pp. 1-5, 2011.
- [4] R. K. Dubey, S. R. Samantaray, and B. K. Panigrahi, "Adaptive distance relaying scheme for transmission network connecting wind farms", *Electric Power Components and Systems*, vol. 42, pp. 1181-1193, 2014.
- [5] G. Ziegler, *Numerical distance protection: principles and applications*: John Wiley & Sons, 2011.
- [6] E. Sorrentino and V. De Andrade, "Optimal-probabilistic method to compute the reach settings of distance relays", *IEEE Transactions on Power Delivery*, vol. 26, pp. 1522-1529, 2011.
- [7] W.-H. Zhang, S.-J. Lee, and M.-S. Choi, "A Probabilistic Approach to the Protection Capability Evaluation of Distance Relay in Transmission Systems", *Journal of Electrical Engineering & Technology*, vol. 5, pp. 407-414, 2010.
- [8] N. Tleis, *Power systems modelling and fault analysis: theory and practice*: Newnes, 2007.
- [9] J. Barnard and A. Pahwa, "Determination of the impacts of high impedance faults on protection of power distribution systems using a probabilistic model", *Electric power systems research*, vol. 28, pp. 11-18, 1993.
- [10] G. Venter and J. Sobieszczanski-Sobieski, "Particle swarm optimization", *AIAA journal*, vol. 41, pp. 1583-1589, 2003.
- [11] P. W. Sauer and M. A. Pai, *Power System Dynamics and Stability*: Prentice Hall, 1998.
- [12] T. Gonen, *Electrical Power Transmission System Engineering: Analysis and Design*: CRC Press, 2011.



Mohammad Shabani was born in Arak, Iran in 1991. He received his B.E degree in Electrical Engineering from the Islamic Azad University of Khomein in 2013. He received his M.S. degree in Electrical and Computer Engineering from University of Birjand in 2015. His research interests include protection and control of power system.



Abbas Saberi Noghahi was born in Gonabad, Iran, in 1977. He received the B.Sc. degree in electrical engineering from Abbaspour University, Tehran, Iran, in 1999, the M.Sc. degree in electrical engineering from K. N. Toosi University of Technology, Tehran, Iran, in 2001, and the Ph.D. degree in electrical engineering from the Ferdowsi University of Mashhad, Mashhad, Iran, in 2010. Now, he is an Assistant Professor at Department of Power Engineering, Computer and Electrical Engineering Faculty, University of Birjand, Birjand, Iran. His research interests are power system protection, distribution system planning and optimization methods.



Mohsen Farshad was born in Birjand, Iran, in 1967. He received the B.S. degree in electrical engineering from Sharif University of Technology, Tehran, Iran, in 1990 and the M.S. degree in electrical engineering from the University of Tehran, Tehran, Iran, in 1994. He received the Ph.D. degree from the Department of Electrical and Computer Engineering, University of Tehran in 2006. Now, he is an associate professor at Department of power Engineering, computer and electrical engineering faculty, university of birjand, Birjand, South Khorasan, Iran. His teaching and research interests are soft computing (including intelligent optimization algorithms, neural networks and fuzzy logic), modeling and control of electric drives (particularly Switched Reluctance machine), systems identification and control, modelling and control of vehicular traffic.

AUTHORS' ADDRESSES

Mohammad Shabani, M.Sc.

Assist. Prof. Abbas Saberi Noghahi, PhD

Assoc. Prof. Mohsen Farshad, PhD

Department of power Engineering,

Faculty of Electrical and Computer Engineering,

University of Birjand,

Birjand, P.O. 97175-615, Iran

email: shabani2718@gmail.com, a.saberi@birjand.ac.ir,

mfarshad@birjand.ac.ir

Received: 2015-11-18

Accepted: 2017-01-09