



EUDEM2

**The EU in Humanitarian Demining-
State of the Art on HD Technologies, Products,
Services and Practices in Europe**

IST-2000-29220

EUDEM2 Technology Survey

Metal Detectors for Humanitarian Demining: a Patent Search and Analysis

Cédric Gaudin, CH-1315 La Sarraz, Switzerland

Tel. +41 76 57 76139, Cedric.Gaudin@a3.epfl.ch

Christian Sigrist, SLF, CH-7260 Davos Dorf, ch.sigrist@gmx.ch

Claudio Bruschini, Ecole Polytechnique Fédérale de Lausanne
EPFL-I&C-LAP, Bâtiment IN-F, CH-1015 Lausanne, Switzerland

Tel. +41 21 69 33911, Fax 35263, Claudio.Bruschini@epfl.ch

November 2003, v2.0

<http://www.eudem.info/>



Project funded by the European Community and
OFES (Swiss Federal Office for Education and
Science) under the "Information Society
Technologies" Programme (1998-2002)

Vrije Universiteit Brussel
VUB, B

Swiss Federal Institute of
Technology – Lausanne
EPFL, CH

Gdansk University of
Technology
GUT, PL

Table of Contents

1. Introduction.....	2
Improvements with respect to v1	2
2. A Brief Introduction to Metal Detectors	3
3. General Patent Information and Structure.....	5
3.1 The Front Page	6
3.2 The Main Parts of a Patent	6
4. Classification of the Collected Patents.....	7
4.1 Classification after the Topic.....	7
4.2 Categorisation after the Importance	7
4.3 Patent Listing Order	8
4.4 Patent Listing Criteria	8
5. Overview of the Collected Patents	10
6. Description of Reference and Important Patents	34
7. Conclusions	44
8. References	45
8.1 Documents.....	45
8.2 Websites	45
Patent Offices	45
Patent Servers.....	45
Others.....	46
9. Acknowledgements.....	47
A. Annex	48
A.1 European Patent System (source: EPA/EPO/OEB 2002).....	48
A.2 Patent Co-operation Treaty (PCT) (source: WIPO web site)	48
A.3 Patent Numbering Systems.....	50

Disclaimer

The following references to or inclusion of specific patents are not all-inclusive and do not represent endorsement of specific systems, techniques or manufacturers.

1. Introduction

Detection and clearance are still being very often carried out in Humanitarian Demining using manual methods as the primary procedure. When operating in this way the detection phase still relies heavily on metal detectors, whereby each alarm needs to be carefully checked until it has been fully understood and/or its source removed. This is normally done visually, and by prodding and/or excavating the ground. Metal detectors are still to the best of our knowledge, apart from dogs, the only detectors really being used in the field, and are probably going to remain in use for some time.

Metal detectors cannot unfortunately differentiate a mine or UXO (Unexploded Ordnance) from metallic debris. In most battlefields, but not only there, the soil is contaminated by large quantities of shrapnel, metal scraps, cartridge cases, etc., leading to between 100 and 1,000 false alarms for each real mine. Each alarm means a waste of time and induces a loss of concentration. Note that when manual methods follow other procedures, such as mechanical clearance, constraints on the need to check each alarm are often somewhat relaxed.

When looking at the actors dealing with metal detectors we are confronted on the one hand with a relatively small market in which mostly SMEs operate, on the other with a scientific community which is not always aware of the practical problems linked to the actual production of equipment and its operation under field conditions (e.g. the importance of ground signals). Manufacturers do not tend to participate to scientific conferences and workshops, and rely mostly on patents, of which the scientific community is not always aware, to protect their intellectual property.

This work, carried out within the framework of the European IST EUDEM2 survey activity (<http://www.eudem.info/>), does therefore aim at bridging the previously mentioned gap. It focuses on the metal detector technology and details a corresponding patent search and analysis. To increase cross-fertilization opportunities interesting patents in fields other than humanitarian demining (e.g. security applications or Non-Destructive Testing) have also been integrated whenever possible and appropriate.

Improvements with respect to v1

The second revision (2003) of this report represents a major improvement with respect to the previous releases:

1. A large number of patents (nearly 200) have been added. About 20 of them are directly related to Metal Detectors (for demining applications) and have been added to the overview in Chapter 5.
2. All patent related information has been collected in a database system in order to facilitate data entry, data extraction, report generation and searching.
3. At end of this report, the annex A presents improved general information about the European patents system and the Patent Co-operation Treaty (PCT) as well as the patent numbering systems.

All patents are available online (<http://www.eudem.vub.ac.be/> → Search: “patent”) as PDF files linked from the main document. A CD-ROM version, which also contains all patents, is available from [Karin de Bruyn](#)

2. A Brief Introduction to Metal Detectors

Electromagnetic induction devices, which are the ones often referred to when speaking of “metal detectors”, are active, low frequency inductive systems. They are usually composed of a search head, containing one or more coils carrying a time-varying electric current. The latter generates a corresponding time-varying magnetic field that “propagates” towards the metallic target (and in other directions as well). This primary (or incident) field reacts with the electric and/or magnetic properties of the target, usually the soil itself or a solid structure, and any metallic object contained in it. The target responds to it by modifying the primary field or, as a more accurate description, by generating a secondary (or scattered) magnetic field. This effect links back into the receiver coil(s) in the search head, where it induces an electrical voltage which is detected and converted, for example, into an audio signal.

The secondary field depends, both temporally and spatially, on a large number of parameters: the problem’s geometry (object distance and orientation), the object’s properties (shape, size, conductivity and permeability), the temporal and spatial distribution of the primary field and, last but absolutely not least, the presence of any background signal (in particular the ground itself in the case of buried objects!). Note that at the frequency range of interest we are basically insensitive to the target’s dielectric properties. Target characterization is very difficult in the general case, but there are a number of situations where some (limited) statements on its nature can be issued.

The secondary field is due to eddy currents, which are induced by the primary field in nearby conductive objects. Low conductivity metals, such as some alloys and stainless steel, are in general more difficult to detect, whereas the detector’s response is magnified for ferromagnetic objects due to the high value of their relative permeability μ_r (induced magnetization). Magnetic effects can play a substantial role, in particular for ferromagnetic objects at the lower frequency range.

Eddy currents are due to time-varying magnetic fields and are basically governed by the law of induction (Faraday’s Law). They circulate mostly on the surface of the metallic target (“skin effect”), which explains why metal detectors are mostly surface area detectors. As a rule of thumb, larger objects will generate more eddy currents, but an object with twice the surface will not be found twice as deep; indeed, the field decreases very rapidly with distance.

Metal detectors can be schematically subdivided in Frequency Domain (FD), or Continuous Wave (CW), and Time Domain (TD) systems.

Frequency Domain instruments make use of a discrete number of sinusoidal signals, very often just one. Single coil and separate transmit/receive circuits are possible. Information on the target’s nature is contained in the amplitude and phase of the received signal, or equivalently in the real and imaginary part of the probe’s complex impedance, as the detector approaches the target. Their measurement in background conditions can be used to reject part of the background signal itself, especially in areas in which the detector’s performance would otherwise be seriously degraded¹, such as sea beaches (salt water is conductive) or strongly mineralized regions (containing for example bauxite, laterite, magnetite or magmatite), which can be conductive or iron rich, as found in parts of Cambodia, Mozambique and Angola. Generally speaking, background rejection is more difficult in non-homogeneous areas.

Frequency Domain systems have often been the choice for mine detection because they seem to work well especially for very small and close objects, except where ground conditions are severe and request the use of pulsed systems. The possibility of using an

¹ We are talking here about buried objects.

array of frequency domain detectors is somewhat complicated by interference effects between neighbouring systems.

Most modern Frequency Domain metal detectors do in fact use separate transmit/receive circuits and operate in the VLF region of the spectrum, typically between a few kHz and a few tens of kHz (say 1-50 kHz). For this type of detectors the coils are often arranged to have as low a mutual inductance as possible when no object is present (i.e. minimize direct coupling if we talk of transmitted and received field), in order to enhance the contrast between the situation with presence and with absence of signal. They are therefore usually referred to as *Induction Balance* systems. In such a setup the position of the coils can therefore be critical, for example in presence of large temperature gradients and/or of mechanical stress (coil flexing) which can influence the coil coupling.

Time Domain, or “**Pulse Induction**”, instruments work by passing pulses of current through a coil (typical repetition rate of the order of 1 kHz), taking care to minimise the current switch-off time (a few μsec). Eddy currents are thus induced in nearby conductive objects; the exponential decay of the corresponding secondary magnetic field, which is slower than the primary one, is observed with time. A Time Domain metal detector measures in other words how quickly the momentarily generated magnetic field breaks down, which happens to be slower in presence of metal.

The eddy current decay time constant itself, some tens (short) to hundred μsec , depends (predominantly) on the target’s conductivity, permeability and size. Low conductivity background and nuisance items, such as sea water and thin foils for example, have a very short decay time. A pulse detector, which is tuned to sample only a specific portion of the received signal, can therefore be “easily” made insensitive to them by an appropriate choice of the delay (some tens of μsec) between switch-off and sample. A similar argument applies to purely magnetic but non-conductive targets, which are magnetised by the transmit pulse but demagnetise just as promptly after switch-off. On the other hand it was true until a few years ago that overall sensitivity is probably reduced too in comparison with Frequency Domain detectors, and there can be problems in finding low conductivity metallic object such as those made of stainless steel.

Given that the transmit and receive phase are temporally separated – the received waveform is (usually!) sampled during the time in which the transmitter is off – pulse detectors can use one and the same coil for transmitting and receiving; the decoupling of the two phases also allows to work with high power, and therefore in practice to go deeper (increased sensitivity due to higher field strength). Power consumption might obviously become an issue, and the presence of a large inductance (due for example to a large number of turns and/or a large area of the transmitter coil) can cause switch-off problems.

Pulse systems are often the detector of choice when it comes to working in salt water or strongly mineralised soils; they are however increasingly challenging CW systems, and not only where conditions are severe.

Time Domain systems are inherently broadband and sample therefore a larger portion of the VLF electromagnetic spectrum. This information is however often not used directly, for example when the received signal is sampled only in a few points, or when its integral over a time window is used.

3. General Patent Information and Structure

A patent is a form of personal property that provides the owner with the exclusive right to make, use commercially and sell the invention described in the claims of the patent. This right is limited in time and in space. A patent is valid for up to 20 years from the date of filing and the protection is limited to a country or set of countries. Patents and published patent applications are public documents and not protected by copyright. Patents provide a useful source of information about innovative developments in all areas of technology. The main objective of a patent is to encourage innovation and the sharing of technical knowledge. The patent system plays a major role in the transfer of technology.

The exclusive right to exploit an invention commercially makes it easier for research laboratories and companies to finance research and development. Patents can indeed provide a short term protection and a cost-effective way to transfer research work to industrial applications. On the other hand, patents strengthen a company's market position when used as an exclusive right. Companies often use patent portfolios to resolve conflicts and thus avoid long and costly lawsuits. They also use patents to attract investors or as marketing tools.

An invention must fulfill several conditions to be patentable:

- It must be new and never made public anywhere in the world before the date of the patent application (except in the US).
- It must involve an inventive step.
- It must be capable of industrial application.
- It must not be excluded. The exclusion depends on national legislation. For example, at present algorithms or mathematical methods can not be patented in a number of European countries.

Patents can be very helpful as starting point for a new invention or a further development; this is particularly true when there is otherwise a lack of information, as in the case of metal detectors. The technical know-how is often explained in detail including diagrams, flowcharts and other useful graphical information; the description of the state of the art of the technology is also often quite useful. On the other hand patents are not scientific publications as commonly found in research papers for example; the reader has therefore to read quite often between the lines and cope with the typical jargon used in these documents.

The form of a patent looks similar in all states. The important parts like author names, dates, abstracts, etc. can easily be found in all kind of patents. Most of the patents listed in this report are of US origin and therefore we will focus on these to briefly describe their different parts.

3.1 The Front Page

On the front page of a US patent a lot of useful information is presented; it is particularly helpful when searching for other similar patents. On the left side of every line there is an index in brackets. The title is equivalent to [54] for example. The same indices can also be found in patents of most other states. Very useful may be the cited references [56] where the numbers of other patents dealing with a similar topic are listed. A search after the classification numbers [51], [52] and [58] can also lead to good results.

The classification number consists of two numbers separated by a slash: the first indicates the main class, the second the subclass. For our search only one main class was relevant: class 324 standing for ELECTRICITY: MEASURING AND TESTING. The most frequently used subclasses are:

- 233 MAGNETIC: With means to create magnetic field to test material; With phase sensitive element
- 225 MAGNETIC: With compensation for test variable

- 326 OF GEOPHYSICAL SURFACE OR SUBSURFACE IN SITU; For small object detection or location
- 327 OF GEOPHYSICAL SURFACE OR SUBSURFACE IN SITU; For small object detection or location; Using oscillator coupled search head
- 328 OF GEOPHYSICAL SURFACE OR SUBSURFACE IN SITU; For small object detection or location; Using oscillator coupled search head; Of the beat frequency type
- 329 OF GEOPHYSICAL SURFACE OR SUBSURFACE IN SITU; For small object detection or location; Using movable transmitter and receiver

The meaning of other US classification numbers and the international classification numbers [51] are detailed at, respectively:

<http://www.uspto.gov/go/classification/>

http://classifications.wipo.int/fulltext/new_ipc/ipc7/eindex.htm.

Where an application is performed on the basis of a foreign patent, this is marked by the index [30]. In general the number of the original patent and the date when it was accepted by the foreign state are reported.

3.2 The Main Parts of a Patent

The whole document can be divided in three main parts: the description, the image section and the claims. The description gives a detailed view of the invention. In the text explanatory images are described which can be seen in the image section, whereas the inventor's claims are defined and numbered in the claims section.

On many websites (see section 8) patents can be downloaded in PDF form for free but only one page at the time. On the websites of the patent offices the complete documents can usually be ordered for a fee either in PDF or in paper form.

4. Classification of the Collected Patents

In order to offer the best possible overview of the existing patents and to help the reader in locating the most relevant ones we decided to classify them in several different classes according to their main topic, and to afterwards categorise them in order of importance.

4.1 Classification after the Topic

As discussed above the classification presented in this report is an internal one. The classification should help the user to find a searched patent of a special topic as fast as possible. A clear classification of every patent was sometimes not possible, because some patents fulfilled the criteria of more than one category. As an example in most of the patents focusing on the discrimination of objects various aspects related to the background rejection are also mentioned. In those cases the patent is classified after its main idea.

The patents are divided in four main classes, as shown in Figure 1. The *Induction Balance*² class contains all patents describing frequency domain sensors working according to the induction balance principle. The time domain sensors are in the *Pulse Induction* class. The *Miscellaneous* class contains all patents that concentrate on special hard- or software features. All other metal detector patents more loosely related to our main topic have been archived in the *Others* class. *Induction Balance* and *Pulse Induction* are mainly subdivided in a *Discrimination* class and a *Background Rejection* class. The *Discrimination* classes concentrate on systems able to distinguish between different types, sizes or shapes of targets, whereas the *Background Rejection* classes contain various techniques to subtract the unwanted ground signal, originating from the fact that the searched target is buried in the soil, from the total received signal.

Note: The second revision (2003) of this report has seen the addition, without pretending to be exhaustive, of a large number of patents which might also be of interest to the reader, although outside the main focus of this work: patents related to magnetometers and magnetic field measurements have been grouped in class 4.2, whereas those dealing with a number of geophysical investigation methods have been collected in class 4.3. In both cases only minimal comments have been provided.

4.2 Categorisation after the Importance

Furthermore the patents are divided in three categories according to their importance. Those that seem to represent the most important ones are marked bold with a star in front of the patent number. We call these patents *Reference Patents*. In this first category fall the patents with an absolutely new invention in the given field. The second category – the *Important Patents* – is also marked bold. These are also interesting patents because they include good explanatory text or illustrative drawings, etc. The third category includes all the other patents we found on a given topic and is not highlighted.

The patents in the first and second category, i.e. the most important ones, are summarized so as to help the reader focus on their new and/or most important parts.

² Induction Balance is usually synonymous with Very Low Frequency (frequency domain) transmit/receive systems, a convention we decided to follow.

4.3 Patent Listing Order

In this report patents are listed by inverse chronological date of publication.

The *Full Listing* features the possibility of sorting the entries by clicking on the column head (e.g. Number, Inventor, Assignee, etc.).

4.4 Patent Listing Criteria

In the Number column only one patent is listed, the equivalent ones (if any) being available under "details".

In the case of equivalent patents we have tried to privilege, whenever possible, European ones when these have been issued first (i.e. are the oldest ones), and when they are available in one of the European Patent Office's official languages (English, French, and German).

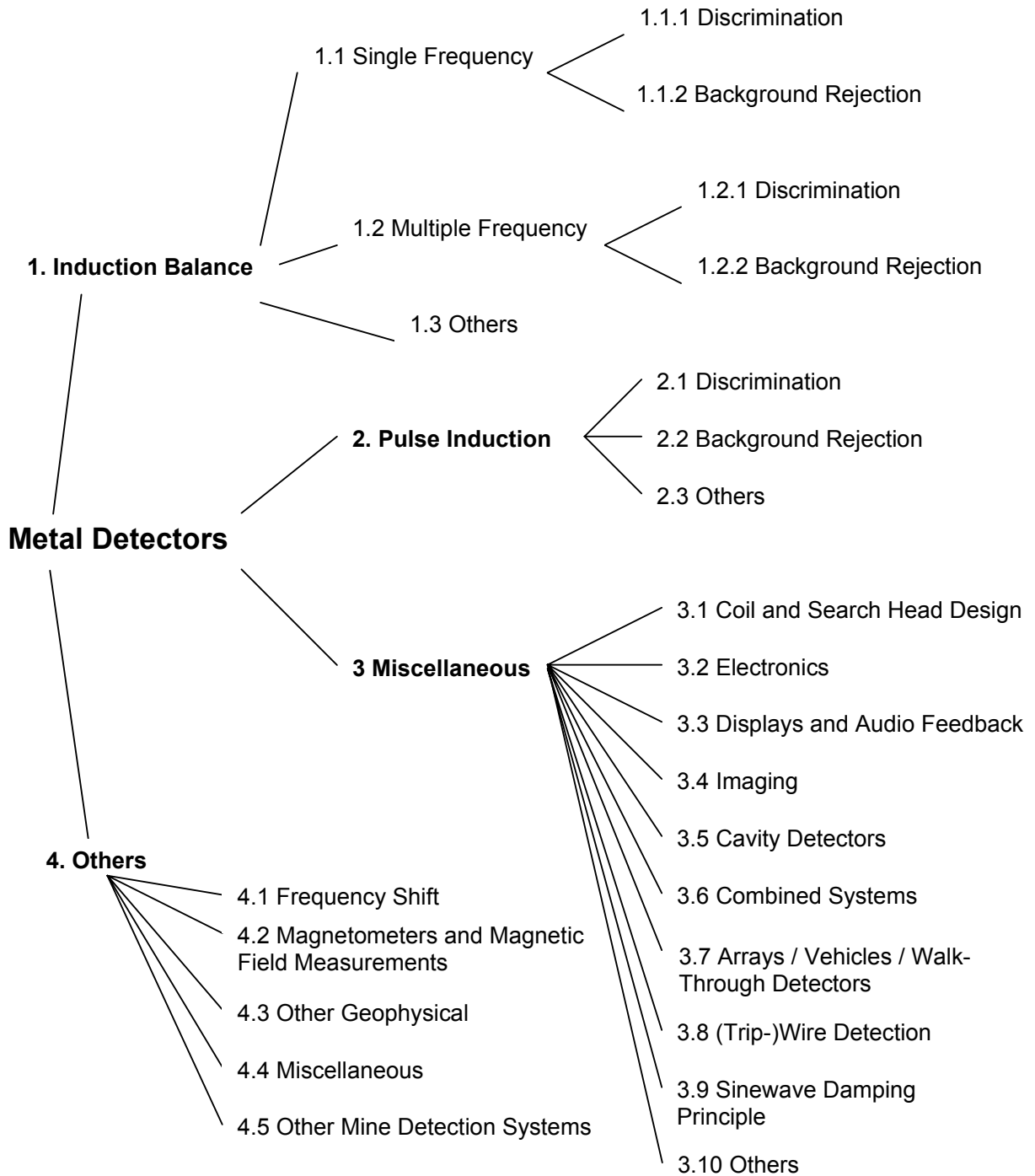

Figure 1: Schematic view of the patent classes and subclasses used in this work

5. Overview of the Collected Patents

***XY123,456 Reference Patent**
XY123,456 Important Patent
 XY123,456 Other Patent

"Date of Patent" indicates when the patent or patent application with the corresponding number in the first column was published by the patent office.

1. Induction Balance

1.1 Single Frequency

1.1.1 Discrimination

Number	Inventor	Assignee	Date of Patent	Title / [Basic Idea]	Remarks	Field of Applic.
<u>US6,172,504</u>	Earle	White's Electronics	Jan 09, 2001	Metal detector target identification using flash phase analysis [Phase windows corresponding to the different targets.]		Treasure Hunting
<u>US5,786,696</u>	Weaver et al	Garrett	Jul 28, 1998	Metal detector for identifying target electrical characteristics, depth and size, [Fourier transform on signal, energy of freq. band is used for identification. Two rx coils to calculate object depth.]	Lots of diagrams and flowcharts. Good explanation of motion detection and ground signals.	Treasure Hunting
<u>US4,868,910</u>	Maulding	White's Electronics	Sep 19, 1989	Metal detector with microprocessor control and analysis [Microprocessor based operation. Covers also automatic ground exclusion balancing.]	Extensive information on target identification strategy	Treasure hunting

<u>US4,507,612</u>	Payne	Teknetics Inc	Mar 26, 1985	Metal detector system for identifying targets in analysis [Phase windows corresponding to the different targets.]	Several interesting concepts; huge docum. not easily readable! Good summary of developm. until the early '80s.	Treasure Hunting
<u>*US4,486,713</u>	Gifford	Gifford	Dec 04, 1984	Metal detector apparatus utilizing controlled phase response to reject ground effects and to discriminate between different types of metals [Variable rotation angle of sample axis, variable, scale factor.]	Basis of discrimination and motion based differentiation (filtering) well described; explanatory drawings.	Treasure Hunting
<u>DE32 28 447</u>	Vallon et al	Vallon	Feb 02, 1984	Measurement method for detecting metallic objects, and metal detector for carrying out the method [The TX circuit is actually excited by impulses at a pulse repetition frequency which is much smaller than the resonating frequency.]		
<u>US4,024,468</u>	Hirschi	White's Electronics	May 17, 1977	Induction balance metal detector with inverse discrimination [Inverse discrimination: signals below a threshold are amplified.]		
<u>US4,016,486</u>	Pecori	US Army	Apr 05, 1977	Land mine detector with pulse slope, width and amplitude determination channels [Slope, pulse width and amplitude check. AND connected]		Mine Detection

1.1.1.2 Background Rejection

<u>Number</u>	<u>Inventor</u>	<u>Assignee</u>	<u>Date of Patent</u>	<u>Title / [Basic Idea]</u>	<u>Remarks</u>	<u>Field of Applic.</u>
<u>US5,729,143</u>	Tavernetti et al	Zircon Corp.	Mar 17, 1998	Metal detector with nulling of imbalance [Microprocessor based active core balancing; uses a nulling (bucking) signal. Should help in reducing coil tolerances and therefore manufacturing costs.]		
<u>WO91/04502</u>	Thompson	Bayliss	Apr 04, 1991	Induced field mineral value detector [Balanced search head; detection signal peak discriminator.]		Mineral Value Detection
<u>US4,783,630</u>	Shoemaker	White's Electronics	Nov 08, 1988	Metal detector with circuits for automatically screening out the effects of offset and mineralized ground [Automatic ground exclusion balance (GEB)]		Treasure Hunting
<u>US4,628,265</u>	Johnson et al	FRL Inc.	Dec 09, 1986	Metal detector and classifier with automatic compensation for soil magnetic minerals and sensor misalignment [Automatic compensation of mineralised soil and misalignment of coils.]		Treasure Hunting
<u>US4,514,692</u>	Johnson et al	FRL Inc.	Apr 30, 1985	Metal detector and discriminator using differentiation for background signal suppression [Double differentiation is employed to eliminate signals from the ground.]		Treasure Hunting

1.2 Multiple Frequency

<u>Number</u>	<u>Inventor</u>	<u>Assignee</u>	<u>Date of Patent</u>	<u>Title / [Basic Idea]</u>	<u>Remarks</u>	<u>Field of Applic.</u>
<u>US6,501,276</u>	Bosnar	Bosnar	Dec 31, 2002	Frequency domain geophysical mapping instruments [TX generates current pulse waveforms formed by half-sinusoidal output segments. The pulse lengths can vary for ex. according to a PRBS.]		Geophysics
<u>US3,686,564</u>	Mallick Jr et al	Westinghouse Electric Corp.	Aug 22, 1972	Multiple frequency magnetic field technique for differentiating between classes of metal objects [Use and detection of more than one frequency.]	one of the first patents on multiple frequency detectors.	Security

1.2.1 Discrimination

<u>Number</u>	<u>Inventor</u>	<u>Assignee</u>	<u>Date of Patent</u>	<u>Title / [Basic Idea]</u>	<u>Remarks</u>	<u>Field of Applic.</u>
<u>US6,104,193</u>	Bell	AETC Inc	Aug 15, 2002	System and method for detecting low metal content buried mines [Exploits the presence of minimum-metal mine components made of dissimilar metals, and the corresponding phase response properties.]		(Plastic) Mine Detection
<u>*US5,963,035</u>	Won	Geophex Ltd.	Oct 05, 1999	Electromagnetic induction spectroscopy for identifying hidden objects. [Use of low frequency broadband spectrum to obtain a spectral "fingerprint" (Electromag. Induction Spectroscopy).]		
<u>*DE196 48 834</u>	Patzwaldt	Förster	May 28, 1998	Method for the operation and for the evaluation of signals from an eddy current probe and device for performing the method [Combination of differential signals to realise a better discrimination. Simple target model (loop), ferromagnetic objects also considered.]		Mine Detection
<u>US5,654,638</u>	Shoemaker	White's Electronics	Aug 05, 1997	Plural frequency method and system for identifying metal objects in a background environment	See US5,642,050 also	

<u>*US5,642,050</u>	Shoemaker	White's Electronics	Jun 24, 1997	Plural frequency method and system for identifying metal objects in a background environment using a target model [Discrimination by the ratio of L/R and skin factor]	Good summary of single freq. systems and major drawbacks. Good description of calibration procedure.	Treasure Hunting
<u>DE44 36 078</u>	Eschner et al	Domier GmbH	Apr 11, 1996	Sensor system for detecting, locating and identifying metal objects [Use of the gradient technology. System was known as ODIS (Ordnance Detection and Identification System). 2D probe data converted to an "image" of the objects (object map).]	WO96/11414 Arrangement of an array is presented (see also DE44 23 623). Emphasis on the sensor.	UXO detection
<u>US4,975,646</u>	Llamas Llamas et al.	Llamas Llamas et al.	Dec 04, 1990	Detector system for recognizing a magnetic material [Frequency synthesizer based. Frequency beat detection (magnetic material hysteresis).]		
<u>US4,263,551</u>	Gregory et al	Georgetown University	Apr 21, 1981	Method and apparatus for identifying conductive objects by monitoring the true resistive component of impedance change in a coil system caused by the object [Characteristic diagram when plotting resistive component / frequency against frequency. Also signatures from complex objects.]	Does not consider ground influence.	Security
<u>US3,950,695</u>	Barringer	Barringer	Apr 13, 1976	Geophysical Prospecting method utilizing correlation of received waveforms with stored reference waveforms	Use of a frequency modulated signal	Geophysical (Airborne Prospecting)
<u>US3,852,659</u>	Barringer	Barringer	Dec 03, 1974	Geophysical prospecting method and apparatus utilizing correlation of received waveforms with stored reference waveforms		Geophysical (Airborne Prospecting)

1.2.2 Background Rejection

<u>Number</u>	<u>Inventor</u>	<u>Assignee</u>	<u>Date of Patent</u>	<u>Title / [Basic Idea]</u>	<u>Remarks</u>	<u>Field of Applic.</u>
<u>US5,994,897</u>	King	Thermo Sentron Inc	Nov 30, 1999	Frequency optimizing metal detector		Food Industry
<u>US4,942,360</u>	Candy	Candy	Jul 17, 1990	A method and apparatus of discrimination detection using multiple frequencies to determine a recognisable profile of an undesirable substance [2-3 frequencies, use of difference signals]	Good description of background (ground phase angle ~ frequency independent). Descr. of "ground balance" proc.	
<u>US4,868,504</u>	Johnson et al	FRL Inc.	Sep 19, 1989	Apparatus and method for locating metal objects and minerals in the ground with return of energy from transmitter coil to power supply [Power return to lower power consumption.]	See the suggested use of frequency differencing and combination methods.	
<u>WO87/04801</u>	Candy	Minelab	Aug 13, 1987	Metal detection in conducting media using a two frequency signal		Mine Detection
<u>US4,544,892</u>	Kaufman et al	Geonics	Oct 01, 1985	Signal processing apparatus for frequency domain geophysical electromagnetic surveying system		Geophysical
<u>US4,506,225</u>	Loveless et al	Barringer	Mar 19, 1985	Method for remote measurement of anomalous complex variations of a predetermined electrical parameter in a target zone		Geophysical (Airborne Prospecting)
<u>US4,303,885</u>	Davis et al	Electric Power Research Institute	Dec 01, 1981	Digitally controlled multifrequency eddy current test apparatus and method	Quite well described and illustrated	Non-Destructive Testing
<u>GB2 004 069</u>	Poole	Plessey Co. Ltd	Mar 21, 1979	Improvements in or relating to metal detectors	2 frequency system	

1.3 Others

<u>Number</u>	<u>Inventor</u>	<u>Assignee</u>	<u>Date of Patent</u>	<u>Title / [Basic Idea]</u>	<u>Remarks</u>	<u>Field of Applic.</u>
<u>US5,523,690</u>	Rowan	White's Electronics	Jun 04, 1996	Metal detector with display.	White's patent detailing VDI, includes assembly code. (see US5,596,277). (Original Geotech comment)	
<u>US5,506,506</u>	Candy	Halcro Nominees Pty Ltd	Apr 09, 1996	Metal detector for detecting and discriminating between ferrous and non-ferrous targets in ground	Combines synchronous demodulators with PI, calls it multi-frequency. Compare with US5,576,624. (Original Geotech comment)	
<u>US4,894,618</u>	Candy	Minelab	Jan 16, 1990	Metal detector using cross-correlation between components of received signals	Good explanatory text. (Original Geotech comment)	
<u>US4,709,213</u>	Podhrasky	Garrett	Nov 24, 1987	Metal detector having digital signal processing		
<u>US4,700,139</u>	Podhrasky	Garrett	Oct 13, 1987	Metal detector circuit having selectable exclusion range for unwanted objects	Pretty good explanation of I&Q signal processing. (Original Geotech comment)	
<u>US4,677,384</u>	Payne	Teknetics Inc	Jun 30, 1987	Target-identifying metal detector		

<u>US4,488,115</u>	Podhrasky	Garrett	Dec 11, 1984	Low battery voltage indicator circuit for a metal detector	See also US4,423,377. (Original Geotech comment)	
<u>US4,470,015</u>	Hirschi et al	Teknetics Inc	Sep 04, 1984	Metal detector system with undesirable target and mineralized ground discrimination	Teknetics, lots of diagrams and waveforms. (Original Geotech comment)	
<u>US4,423,377</u>	Podhrasky	Garrett	Dec 27, 1983	Compact metal detector of the balanced induction type	Handheld with integrated double-D coil. See also US4,488,115. (Original Geotech comment)	
<u>US4,348,639</u>	Karbowski	Triple Dee Electronics	Sep 07, 1982	Transmitter-receiver loop buried metal object locator with switch controlled reference voltage	Discovery Electronics' two-box detector. (Original Geotech comment)	
<u>US4,344,034</u>	Randolph Jr.	Gardiner	Aug 10, 1982	Selective/ground neutralizing metal detector	Patent for phase discriminator. (Original Geotech comment)	
<u>US4,325,027</u>	Dykstra et al	Compass Electronics Corp.	Apr 13, 1982	Metal detector for locating objects with full sensitivity in the presence of distributed mineral material		
<u>US4,303,879</u>	Podhrasky	Garrett	Dec 01, 1981	Metal detector circuit with mode selection and automatic tuning		
<u>US4,300,097</u>	Turner	Techna Inc	Nov 10, 1981	Induction balance metal detector with ferrous and non-ferrous metal identification	Techna, now First Texas Mfg. (Bounty Hunter). (Original Geotech comment)	
<u>US4,249,128</u>	Karbowski	White's Electronics	Feb 03, 1981	Wide pulse gated metal detector with improved noise rejection		

<u>US4,128,803</u>	Payne	PNI Inc.	Dec 05, 1978	Metal detector system with ground effect rejection	PNI (the old Bounty Hunter), probably the Red Baron series (RB3/5/7). (Original Geotech comment)	
<u>US4,099,116</u>	Tyndall	Tyndall	Jul 04, 1978	Metal detector with phase related circuit selective discrimination	Nautilus, feedback method for ground balance and discrimination. (Original Geotech comment)	
<u>US4,096,432</u>	Spencer	Arado Electronics	Jun 20, 1978	Metal detectors for discriminatory detection of buried metal objects	Basic phase response IB. (Original Geotech comment)	
<u>US4,053,828</u>	Ambler et al	Xonics Inc	Oct 11, 1977	Metal detector with first and second nested rectangular coils	Not too practical for a handheld. (Original Geotech comment)	
<u>US4,030,026</u>	Payne	White's Electronics	Jun 14, 1977	Sampling metal detector	The basis of most of their early-80's analog detectors. (Original Geotech comment)	
<u>US3,872,380</u>	Gardiner	Gardiner	Mar 18, 1975	Metal detector distinguishing between different metals by using a bias circuit actuated by the phase shifts caused by the metals	Basic phase response IB (Original Geotech comment)	
<u>US3,848,182</u>	Gerner et al	Magnetic Analysis Corp.	Nov 12, 1974	Apparatus for limiting phase-angle response range, particularly in eddy current testing apparatus		
<u>US3,826,973</u>	Pflaum	Benson	Jul 30, 1974	Electromagnetic gradiometer		
<u>US3,471,772</u>	Smith	Singer	Oct 07, 1969	Instrument for measuring the range and approximate size of buried or hidden metal objects		

US3,471,773	Penland	Electronic Sensing Prod.	Oct 07, 1969	Metal detecting device with inductively coupled coaxial transmitter and receiver coils		
US3,405,354	Callan et al	Magnetic Analysis Corp.	Oct 08, 1968	Apparatus for limiting phase-angle response range, particularly in eddy current testing apparatus.	Uses synchronous demodulation to determine target phase, see US3,848,182. (Original Geotech comment)	

2. Pulse Induction

<u>Number</u>	<u>Inventor</u>	<u>Assignee</u>	<u>Date of Patent</u>	<u>Title / [Basic Idea]</u>	<u>Remarks</u>	<u>Field of Applic.</u>
<u>US3,315,155</u>	Colani	Colani	Apr 18, 1967	Method and apparatus for investigating a generally homogeneous medium as to regions of anomalous electrical conductivity	(See also DE16 98 481) One of the earliest presentations of a pulsed system.	

2.1 Discrimination

<u>Number</u>	<u>Inventor</u>	<u>Assignee</u>	<u>Date of Patent</u>	<u>Title / [Basic Idea]</u>	<u>Remarks</u>	<u>Field of Applic.</u>
<u>DE197 31 560</u>	Laukemper et al	TZN	Feb 18, 1999	Localisation and identification method of buried mine, bomb, etc. [Integral of the received pulse signal is used to discriminate objects.]		UXO / mine detection
<u>US5,552,705</u>	Keller	Keller	Sep 03, 1996	Non-obtrusive weapon detection system and method for discriminating between a concealed weapon and other metal objects [Decay curve time constant analysis.]		Security
<u>US5,537,041</u>	Candy	BHC Consulting Pty Ltd	Jul 16, 1996	Discriminating time domain conducting metal detector utilizing multi-period rectangular transmitted pulses [Combining received signals of different periods]	Interesting analysis of the properties of magnetic soils.	
<u>DE43 39 419</u>	Keller	Vallon	May 24, 1995	Arrangement and method for detecting metal objects [Pulsed system with two oval coils, with very low mutual inductance (can work like independent detectors).]		

<u>US5,414,411</u>	Lahr	White's Electronics	May 09, 1995	Pulse induction metal detector [Better stability of the pulsed system, less noise]	
<u>US5,047,718</u>	Aittoniemi et al	Outokumpu Oy	Sep 10, 1991	Improving the discrimination of an impulse technique metal detector by correlating responses inside and outside of a cut-off peak area [Correlation of the responses is compared, more reliability in discrimination]	original patent Finnish

2.2 Background Rejection

Number	Inventor	Assignee	Date of Patent	Title / [Basic Idea]	Remarks	Field of Applic.
<u>US6,326,791</u>	Bosnar	Geonics	Dec 04, 2001	Discrimination of metallic targets in magnetically susceptible soil [Ground has a linear (log-log-plot) response.]		
<u>AT404 408</u>	Eder	Schiebel	Nov 25, 1998	Process and device for testing a medium		
<u>US5,654,637</u>	McNeill	Geonics	Aug 05, 1997	Method for detecting buried high conductivity objects including scaling of voltages for eliminating noise of a particular depth [Receivers at two horizontal coaxial planes; response ratio used to est. object depth, or responses scaled and summed to eliminate the response from a particular depth (layer).]		UXO detection
<u>US5,576,624</u>	Candy	BHC Consulting Pty Ltd	Nov 19, 1996	Pulse induction time domain metal detector [Uses combination of the signal detected during non-transmission to eliminate signal from the ground.]		

<u>DE195 06 339</u>	Ebinger et al	Ebinger	Aug 29, 1996	Method and arrangement for electromagnetic object detection		
<u>US4,837,514</u>	Spies	Spies	Jun 06, 1989	Method of reducing noise in electromagnetic geophysical exploration data		Geophysical
<u>GB2 071 327</u>	Corbyn	Corbyn	Sep 16, 1981	Improvements in electromagnetic induction systems for geophysical exploration and conductor location		
<u>US4,110,679</u>	Payne	White's Electronics	Sep 29, 1978	Ferrous/non-ferrous metal detector using sampling		

2.3 Others

Number	Inventor	Assignee	Date of Patent	Title / [Basic Idea]	Remarks	Field of Applic.
<u>US6,326,790</u>	Ott et al	Ott et al	Dec 04, 2001	Ground piercing metal detector having range, bearing, and metal-type discrimination		
<u>US5,025,218</u>	Ramstedt	US Navy	Jun 18, 1991	Pulsed field system for detecting the presence of a target in a subsurface environment [Operating in the Extremely Low Frequency (ELF) range, 1-100 Hz]		Sea Mine Detection
<u>US4,894,619</u>	Leinonen et al	Outokumpu Oy	Jan 16, 1990	Impulse induced eddy current type detector using plural measuring sequences in detecting metal objects	original Finnish patent	
<u>US4,605,898</u>	Aittoniemi et al	Outokumpu Oy	Sep 12, 1986	Pulse field metal detector with spaced, dual coil transmitter and receiver system	original Finnish patent	

3. Miscellaneous

3.1 Coil and Search Head Design

<u>Number</u>	<u>Inventor</u>	<u>Assignee</u>	<u>Date of Patent</u>	<u>Title / [Basic Idea]</u>	<u>Remarks</u>	<u>Field of Applic.</u>
<u>US6,437,573</u>	Golder et al	Hilti	Aug 20, 2002	Inductive detection sensor head for buried ferrous and non-ferrous electrically conducting objects		Rebar Detection
<u>US5,969,528</u>	Weaver	Garrett	Oct 19, 1999	Dual field metal detector [Generation of a narrow or a wide detection field by coil arrangement]		
<u>US5,863,445</u>	Geisel et al	Control Screening LLC	Jan 26, 1999	Etched coil unibody digital detector	Handheld wand. (Original Geotech comment)	
<u>US5,557,206</u>	Won	Geophex Ltd	Sep 17, 1996	Apparatus and method for detecting a weak induced magnetic field by means of two concentric transmitter loops [Use of magnetic cavity effect. Detailed magnetic field calculation.]	Using magnetic cavity effect	
<u>DE44 17 931</u>	Rohrbeck	IUT GmbH	Aug 17, 1995	Metal detector for indicating buried object presence and direction		
<u>US4,890,064</u>	Candy	Minelab	Dec 26, 1989	Metal detector sensing head with reduced eddy current coils	equiv. WO87/03380	
<u>US4,862,316</u>	Smith et al	White's Electronics	Aug 29, 1989	Static charge dissipating housing for metal detector search loop assembly	White's Concentric Loop. (Original Geotech comment)	
<u>DE37 07 210</u>	Auslaender et al	Förster	Sep 07, 1988	Phase shift compensation for metal detection apparatus [Means to suppress an unwanted phase shift of the transmitter frequency.]	equiv. US4,881,036	

<u>DE37 05 308</u>	Auslaender et al	Förster	Sep 01, 1988	Apparatus for the detection of metal objects located within a poor electrically conductive environment [Means of determining exactly the difference between reference and received signal]	equiv. US4,926,127
<u>DE36 19 308</u>	Ebinger	Ebinger	Dec 03, 1987	Sensor for a metal detector	
<u>US4,345,208</u>	Wilson	Wilson	Aug 17, 1982	Anti-falsing and zero nulling search head for a metal detector	Daytona search coil. (Original Geotech comment)
<u>US4,293,816</u>	Johnson	White's Electronics	Oct 06, 1981	Balanced search loop for metal detector	White's Concentric Loop. (Original Geotech comment)
<u>US4,255,711</u>	Thompson	Compass Electronics Corp.	Mar 10, 1981	Coil arrangement for search head of a metal detector	Compass, concentric IB. (Original Geotech comment)
<u>US3,882,374</u>	McDaniel	US Army	May 06, 1975	Transmitting-receiving coil configuration	Induction Balance. (Original Geotech comment)

3.2 Electronics

<u>Number</u>	<u>Inventor</u>	<u>Assignee</u>	<u>Date of Patent</u>	<u>Title / [Basic Idea]</u>	<u>Remarks</u>	<u>Field of Applic.</u>
<u>US5,691,640</u>	King	Ramsey	Nov 25, 1997	Forced balance metal detector [Microprocessor to get electrical balance of the head and determine the characteristics of a product (food check)]		Non-destructive Testing
<u>US4,334,192</u>	Podhrasky	Garrett	Jun 08, 1982	Metal detector circuit having automatic tuning with multiple rates [Plurality of operation modes, selected by the user.]	Huge reference list. Probably their Master Hunter VLF. (Original Geotech comment)	
<u>US4,334,191</u>	Podhrasky	Garrett	Jun 08, 1982	Metal detector circuit having momentary disabled output		

3.3 Displays and Audio Feedback

<u>Number</u>	<u>Inventor</u>	<u>Assignee</u>	<u>Date of Patent</u>	<u>Title / [Basic Idea]</u>	<u>Remarks</u>	<u>Field of Applic.</u>
<u>US5,596,277</u>	Rowan	White's Electronics	Jan 21, 1997	Method and apparatus for displaying signal information from a detector [Phase angle and counts exceeding threshold or amplitude are displayed.]	Compare with US5,523,690	Treasure Hunting
<u>US5,148,151</u>	Podhrasky	Garrett	Sep 15, 1992	Metal detector having target characterization and search classification [VDI display to identify a target.]		Treasure Hunting

<u>US4,486,712</u>	Weber	Weber	Dec 04, 1984	Frequency dependent pulsed modulated metallic object detector		
<u>US4,309,658</u>	Leff	Leff	Jan 05, 1982	Portable, buried object detection system with improved signal processing and presentation		Hidden Objects Detection
<u>US4,213,093</u>	Pecori	US Army	Jul 15, 1980	Portable buried object detection system with error reducing signal processing		Hidden Objects Detection
<u>US4,196,391</u>	Weber	Weber	Apr.01, 1980	Metal locator with stereotonic indication of translateral position		

3.4 Imaging

Number	Inventor	Assignee	Date of Patent	Title / [Basic Idea]	Remarks	Field of Applic.
<u>US6,124,712</u>	Chaiken	University of California	Sep 26, 2000	Apparatus and method for imaging metallic objects using an array of Giant Magnetoresistive sensors		UXO detection
<u>US6,084,412</u>	Guo et al	Johns Hopkins University	Jun 04, 2000	Imaging objects in a dissipative medium by nearfield electromagnetic holography		
<u>US5,557,277</u>	Tricoles et al	GDE Systems Inc	Sep 17, 1996	Method for locating leakage of substances from subterranean structures		Environmental Analysis
<u>DE41 03 216</u>	Kousek et al	Hilti	Aug 06, 1992	Apparatus for determining location of an element of magnetizable material in a construction structure [A monitor shows the location of a hidden metallic object, typically rebars in concrete.]	equiv. US5,296,807	Non-Destructive Testing
<u>US4,476,434</u>	Collins et al	US Energy	Oct 09, 1984	Non-destructive testing method and apparatus utilising phase multiplication holography		Non-Destructive Testing

3.5 Cavity Detectors

<u>Number</u>	<u>Inventor</u>	<u>Assignee</u>	<u>Date of Patent</u>	<u>Title / [Basic Idea]</u>	<u>Remarks</u>	<u>Field of Applic.</u>
<u>*DE196 48 833</u>	Förster	Förster	May 28, 1998	Method and device for locating and identifying search objects concealed in the ground particularly plastic mines [Detection of metallic part followed by searching ground for cavity, using one and the same multifrequency system.]	equiv. US6,097,190	Mine Detection
<u>US4,719,426</u>	Weiss	Scopemoor Ltd	Jan 12, 1988	Method for magnetically detecting a localized disturbance of the ground [A buried object appears to cause a disturbance of the local value of earth's magnetic field. The horizontal and/or vertical gradients of this magnetic disturbance are detected.]		Mine Detection
<u>US4,393,350</u>	Hansen et al	US Navy	Jul 12, 1983	Method for rapidly detecting subterranean tunnels by detecting a non-null value of a resultant horizontal magnetic field component		Tunnel/Void Detection
<u>US4,290,020</u>	Hansen et al	US Navy	Sep 15, 1981	Method and apparatus for detecting subterranean anomalies by generating two parallel magnetic fields		Tunnel/Void Detection
<u>US4,079,309</u>	Seeley	US Navy	Mar 14, 1978	Method for determining changes in earth resistivity by measuring phase difference between magnetic field components		Tunnel Detection

3.6 Combined Systems

<u>Number</u>	<u>Inventor</u>	<u>Assignee</u>	<u>Date of Patent</u>	<u>Title / [Basic Idea]</u>	<u>Remarks</u>	<u>Field of Applic.</u>
<u>US6,064,209</u>	Banerjee	Xtech Explosive Decontamination	May 16, 2000	Apparatus and process for clearance of unexploded ordnance [Firstly, use a high power electromagnetic signal to trigger UXO, secondly use a lower power TD metal detector having the same frequency and pulse duration.]		UXO Detection
<u>WO98/30921</u>	Goldfine et al	Jentek	Jul 16, 1998	Magnetometer and dielectrometer detection of subsurface objects ["Meandering Winding Magnetometer" and dielectric sensor]		UXO (metallic) mine detection
<u>US5,680,048</u>	Wollny	Net Results	Oct 21, 1997	Mine detecting device having a housing containing metal detector coils and an antenna [Portable metal detector combined with ground penetrating radar.]		Mine Detection
<u>US5,307,272</u>	Butler et al	US Energy	Apr 26, 1994	Minefield reconnaissance and detector system [Vehicle combines metal detector with ground penetrating radar.]		Mine Detection

3.7 Arrays / Vehicles / Walk-Through Detectors

<u>Number</u>	<u>Inventor</u>	<u>Assignee</u>	<u>Date of Patent</u>	<u>Title / [Basic Idea]</u>	<u>Remarks</u>	<u>Field of Applic.</u>
<u>US6,525,539</u>	Birken et al	Witten Technologies Inc.	Feb 25, 2003	Apparatus and method for locating subsurface objects in conductive soils by induction measurements		Pipe Detection

Metal Detectors for Humanitarian Demining: a Patent Search and Analysis, v2.0

<u>US6,342,835</u>	Nelson-White	Nelson-White	Jan 29, 2002	Sensor panel and a detection apparatus incorporating the same. [Plurality of receive elements arranged in a matrix and use of a cancellation circuit.]		Security
<u>US6,133,829</u>	Johnstone et al	FRL Inc.	Oct 17, 2000	Walk-through metal detector system and method [Disturbance in earth's magnetic field are measured.]		Security
<u>DE195 18 342</u>	Ebinger	Ebinger	Nov 21, 1996	Method and probe arrangement for the electromagnetic detection of metal objects	Equiv. US5,770,944	
<u>DE44 23 661</u>	Auslaender et al	Förster	Jan 11, 1996	Coil system for inductive object detector [Array of receiver coils for a fast search with a high local resolution.]		
<u>DE44 23 623</u>	Eschner et al	Förster	Jan 11, 1996	Process for detecting metallic items including a search path defined by a linear movement with a superimposed rotational movement along a curved close path [System was known as ODIS (Ordnance Detection and Identification System). 2D probe data converted to an "image" of the objects (object map).]	Equiv. US5,719,500 See also DE44 36 078. Emphasis on the process.	UXO detection
<u>DE42 42 541</u>	Aulenbacher et al	TZN	Jun 30, 1994	Arrangement for locating below-ground ammunition [Remote control vehicle for ground search.]	Equiv. US5,452,639	UXO detection
<u>US5,198,768</u>	Keren	Eiscint	Mar 30, 1993	Quadrature surface coil array		Nuclear Magnetic Res. (NMR)
<u>US4,912,414</u>	Lesky et al	Lesky et al	Mar 27, 1990	Induction-type metal detector with increased scanning area capability [Array of receiver coils, also for underwater use.]		
<u>US4,021,725</u>	Kirkland	US Navy	May 03, 1977	Mobile mine detection system having plural color display		Mine Detection

3.8 (Trip-)Wire Detection

<u>Number</u>	<u>Inventor</u>	<u>Assignee</u>	<u>Date of Patent</u>	<u>Title / [Basic Idea]</u>	<u>Remarks</u>	<u>Field of Applic.</u>
<u>DE196 42 748</u>	Ebinger	Ebinger	Apr 23, 1998	Method and apparatus for detection of metallic objects		UXO / mine detection
<u>US4,990,852</u>	Kirkland	US Navy	Feb 05, 1991	Automatic classifier for electric wire detector		Mine Detection

3.9 Sinewave Damping Principle

<u>Number</u>	<u>Inventor</u>	<u>Assignee</u>	<u>Date of Patent</u>	<u>Title / [Basic Idea]</u>	<u>Remarks</u>	<u>Field of Applic.</u>
<u>DE198 58 713</u>	Ebinger	Ebinger	Jun 21, 2000	Buried metal object detection method uses lower operating frequencies for suppressing detection of small metal objects and compensation of operating frequency for suppressing ground interference		
<u>DE196 26 363</u>	Guennewig et al	Ebinger	Jan 08, 1998	Metal detector and process for operating a metal detector		
<u>DE42 12 363</u>	Ebinger	Ebinger	Oct 14, 1993	Metal detector		
<u>US4,323,847</u>	Karbowski	Triple Dee Electronics	Apr 06, 1982	Oscillator type metal detector with switch controlled fixed biasing [The Q of the search coil decreases in proximity to a metal object. The resulting decrease in oscillation amplitude is measured.]		Treasure Hunting

3.10 Others

<u>Number</u>	<u>Inventor</u>	<u>Assignee</u>	<u>Date of Patent</u>	<u>Title / [Basic Idea]</u>	<u>Remarks</u>	<u>Field of Applic.</u>
<u>US5,696,490</u>	Maloney	Maloney	Dec 09, 1997	FM (VHF) infrared wireless digital metal detector	Places the control box near the coil and uses IR to transfer info to the meter, pretty useless. (Original Geotech comment)	
<u>EPO 532 604</u>	Stanley et al	University of New England, Australia	Mar 24, 1996	Method and apparatus for simultaneously collecting spatially and temporally varying magnetic survey data [Use of a single transducer designed to simultaneously measure several electromagnetic properties of the ground, and 2 frequencies. Good explanations.]	equiv. WO91/19210	
<u>DE43 18 563</u>	Vallon	Vallon	Dec 08, 1994	Telescopic support tube for a metal detector (metal detecting device)		
<u>US5,247,257</u>	Chullick	Chullick	Sep 21, 1993	Electronic metal detector return signal phase changer	A nail and two coils, weird. I don't know what to make of this one. (Original Geotech comment)	Underground Object Detection
<u>EPO 535 139</u>	Salsman et al	The Charles Machine Works	Apr 07, 1993	System for locating concealed underground objects using digital filtering [Digital filtering.]		
<u>US4,529,937</u>	Cornelius	Cornelius	Jul 16, 1985	Metal detector with spring loaded hinged support [Spring-loaded hinge support.]		

<u>DE30 35 094</u>	Ebinger	Ebinger	Mar 25, 1982	Vorrichtung zum Orten von Metallteilen	
------------------------------------	---------	---------	-----------------	--	--

Notes:

- All others patents are available in the *Full Listing*.
- All the “Original Geotech comment” are provided as *is*. For details please refer directly to the Geotech Website (see also §8.2).

6. Description of Reference and Important Patents

Number: [US 5,786,696](#)

Title: Metal Detector for Identifying Target Electrical Characteristics, Depth and Size

Date: July 28, 1998

Author: Weaver et al.

Assignee: Garrett

Abstract: FD system (single frequency). A threshold (triggering) processing operation is performed to determine whether a valid target signal is present in the data. The in-phase and quadrature components are processed using Fourier transforms to select a frequency band which includes the energy for the target signal (basically a bandpass operation). The energy in this frequency band is then utilized for target identification, basically taking the ratio of quadrature to in-phase components in this frequency band (similarly to what usually done for the phase calculation).

Target depth: determined using 2 receive coils and comparing their quadrature components.

Target size: determined using a look-up table which takes into account the target depth, signal amplitude and target ID.

[Note: the in-phase and quadrature components are interchanged with respect to other patents and articles.]

Number: [US 4,486,713](#)

Title: Metal Detector Apparatus Utilizing Controlled Phase Response to Reject Ground Effects and to Discriminate between Different Types of Metals

Date: Dec. 4, 1984

Author: Gifford

Assignee:

Abstract: Metal detector with a variable sampling axis and a variable scale factor allowing an operation with reduced ground effects while discriminating between various types of metal. The resistive axis R and the reactive axis X (see figure 2) can be rotated with a variable angle. Every signal of a metallic object can then be expressed as relation of the two new axis A and B according to its phase angle. With a simple condition of the form: $|B| > |x \cdot A|$ where x is the variable scale factor, the signals can be divided in desirable and undesirable signals according to their phase angle.

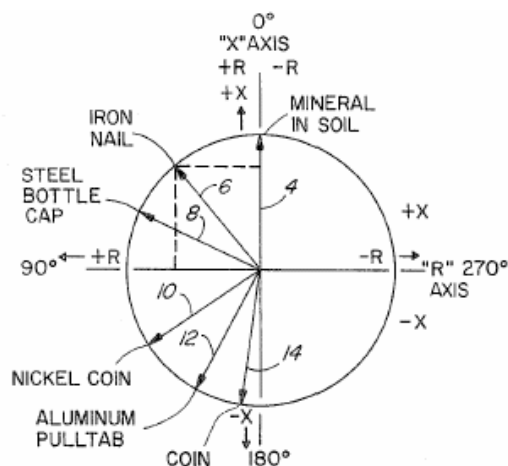

FIG. 2

Number: [US 6,172,504](#)
Title: Metal Detector Target Identification Using Flash Phase Analysis
Date: Jan. 9, 2001
Author: Earle
Assignee: White's
Abstract: The phase of a received signal is analysed simultaneously in several phase windows. A parallel output is provided which indicates whether the signal of the target falls in one of the phase windows. A signal falling in a special phase window is characteristic for a certain type of material. A faster discrimination is guaranteed than with a conventional serial phase check.

Number: [US 4,783,630](#)
Title: Metal Detector With Circuits for Automatically Screening Out the Effects of Offset and Mineralized Ground
Date: Nov. 8, 1988
Author: Shoemaker
Assignee: White's
Abstract: The system provides an automatic ground exclusion balance (GEB). It can be used in a static or in a continuous mode. In the static mode the influence of the ground is measured and excluded before the sensor is used whereas in the continuous mode the ground exclusion is readjusted during the use. The instrument's control logic circuit automatically makes the necessary changes in the loop circuit parameters to accomplish ground effect elimination.

Number: [US 3,686,564](#)
Title: Multiple Frequency Magnetic Field Technique for Differentiating Between Classes of Metal Objects
Date: Aug. 22, 1972
Author: Mallick, Jr. et al.
Assignee: Westinghouse
Abstract: Security applications. Uses the response at two well separated frequencies (their in-phase and quadrature components) for object classification. Some emphasis is put on permeable objects (e.g. guns).
Of particular interest: suggests the use of a magnetization direction having components of the primary field along the object's principal axes (fixed geometry or rotating magnetic field) and one discrimination system for each axis!

Number: [US 5,963,035](#)
 Title: Electromagnetic induction spectroscopy for identifying hidden objects.
 Date: Oct. 5, 1999
 Author: Won
 Assignee: Geophex Ltd.
 Abstract: Multi-frequency inductive target characterization and identification.

A time-varying multi-frequency primary electromagnetic field is generated, e.g. in the range 0.1-300 kHz. The strength of the induced (secondary) field, typically in-phase and quadrature components, is plotted as a spectrogram (over a low frequency broadband spectrum) as a function of frequency and spatial relationship between the target and the detector. From this spectrogram, indications may be extracted as to the nature of the target (location, size, shape, material composition), preferably by comparing it against a library of reference spectrograms.

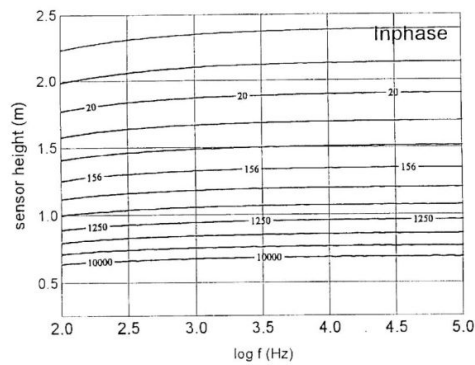

Fig. 1A

A number of articles on this topic (Electromagnetic Induction Spectroscopy, or EMIS) have also appeared in the *IEEE Transactions on Geoscience and Remote Sensing*. The basic idea is that different objects will exhibit different electromagnetic responses across a low frequency broadband spectrum ("spectral signature"), a fact which is normally not exploited by ordinary frequency domain metal detectors, which mostly work only at one or at a few discrete frequencies.

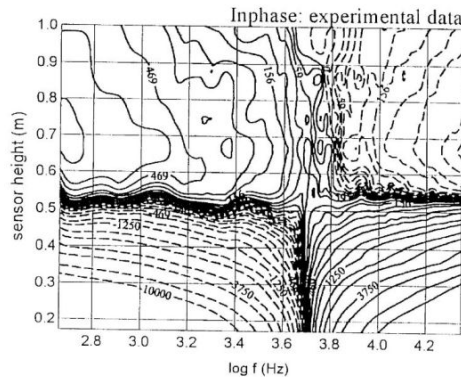

Fig. 2A

One of the challenges is here represented by target orientation effects, in particular for ferromagnetic objects, and by the contribution from the soil (the soil's signal), in particular in heavily mineralised areas, or for small or deep targets.

Number: [DE 196 48 834](#) (equal to [US 6,005,392](#))
Title: Method for the Operation and for the Evaluation of Signals from an Eddy Current Probe and Device for Performing the Method
Date: May 28, 1998
Author: Patzwaldt
Assignee: Förster
Abstract: Multifrequency; background reduction, metal identification. A better object discrimination is guaranteed by a combination of differential signals. At least two different frequencies are used. The received a.c. voltage is broken down into corresponding frequency components and the real and imaginary parts of every component are formed. Then a differential signal is formed out of the real/imaginary parts of the different frequency components. This leads to a background free signal. At least two differential signals are combined in a non-linear way (e.g. via quotients) to a combination signal offering more information for object discrimination based on a simple target model (loop). Ferromagnetic objects can also be taken into account by adding another (two) low frequency component(s) and adapting the model. Constant target L,R and background signal (at least the imaginary component) are assumed. The eddy current probe can be used as a ground probe, i.e. to deliver only the signal from the ground itself.

Number: [US 5,642,050](#)
Title: Plural Frequency Method and System for Identifying Metal Objects in a Background Environment Using a Target Model
Date: Jun. 27, 1997
Author: Shoemaker
Assignee: White's
Abstract: At least two frequencies are used. The metal detector generates background excluded components from the signal components measured in phase detectors. A signal processor then computes the ratio between resistance and inductance and the skin constant of a given target; this amounts to an extension of a simple target model (loop), actually a hybrid model looking like a combination of a sphere and a loop (simple circuit) model. The background is excluded by subtracting signal components measured at two different frequencies or by the use of filters. A background which changes with frequency can apparently also be coped with.

Number: [US 4,263,551](#)

Title: Method and Apparatus for Identifying Conductive Objects by Monitoring the True Resistive Component of Impedance Change in a Coil System Caused by the Object

Date: Apr. 21, 1981

Author: Gregory et al.

Assignee: Georgetown University

Abstract: Security applications. The resistive component of the received signal is measured for different frequencies (stepped frequency like, ~30 frequencies in the 0.1-10 kHz band). The measurement points are plotted in a diagram with the resistive component divided by the frequency against the frequency (see figure 4). The diagram is characteristic for a kind of metal and an approximate cross section. Furthermore for a given cross section and metal type there exists a frequency at which the resistive component reaches a maximum. Different cross sections lead to different maximum frequencies. This peak frequency is proportional to the sample's resistivity divided by its cross-sectional area. Actual signals for complex objects (e.g. revolvers, see figure 10) are also discussed, as well as phase accuracy and system stability issues. Object orientation effects do however not seem to be addressed.

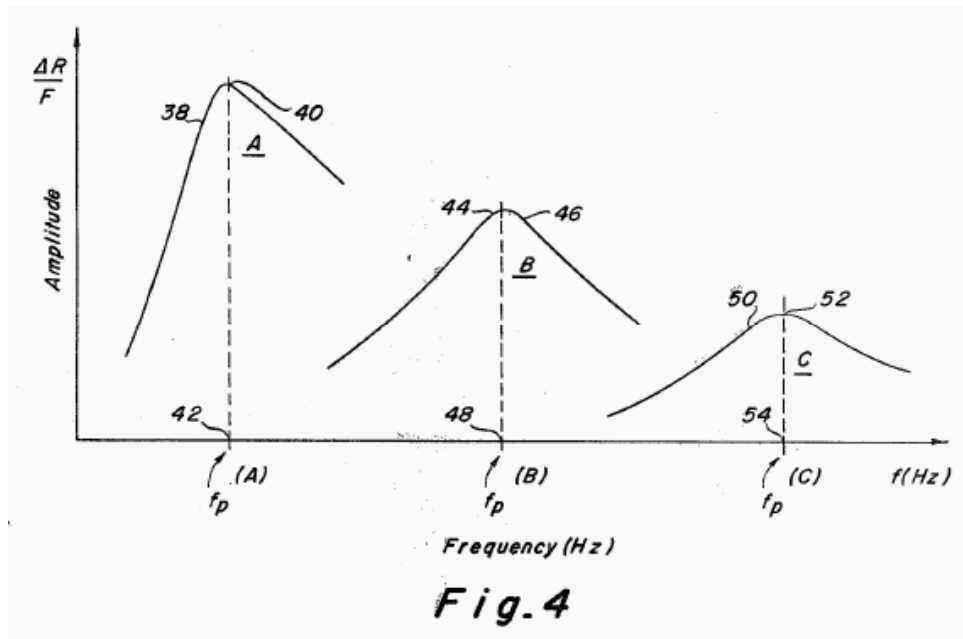

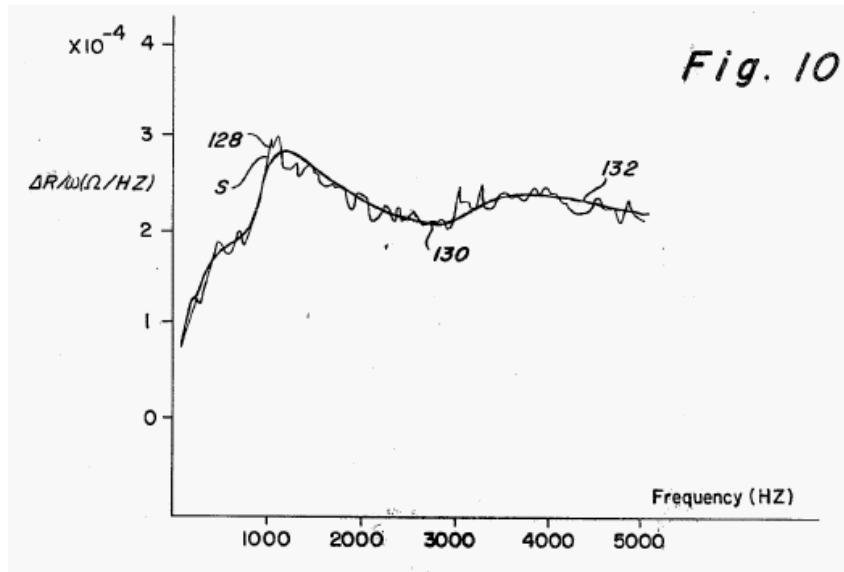

Number: [US 4,942,360](#)

Title: A Method and Apparatus of Discrimination Detection Using Multiple Frequencies to Determine a Recognizable Profile of an Undesirable Substance

Date: Jul 17, 1990

Author: Candy

Assignee:

Abstract: At least two or in preference three frequencies are used to interrogate a target. Resistive and reactive components of the received signals are distinguished. Then a difference signal is build in such a way as to exclude the background effect. "Magnetic viscosity" effects ("superparamagnetic" ground) are probably also addressed.

Number: [DE 197 31 560](#)

Title: Localisation and identification method of buried mine, bomb, etc.

Date: Feb. 18, 1999

Author: Laukemper et al.

Assignee: TZN

Abstract: The discrimination of the received signal is based on its fade out. The received signal (see figure 3) is integrated over a given time interval (T_3-T_2). The integral value S_2 , normalised by the peak value S_1 ($S_3 = S_2/S_1$), results in a value which is characteristic for the material and the shape of a buried object.

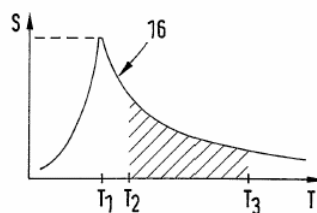

Number: [US 5,537,041](#)

Title: Discriminating Time Domain Conducting Metal Detector Utilizing Multi-Period Rectangular Transmitted Pulses

Date: July 16, 1996

Author: Candy

Assignee: BHC Consulting

Abstract: Uses a multi-period rectangular transmit waveform (different pulse periods) and combines the components received during different periods, using a ground model to eliminate the ground signal (in particular for magnetic soils).
Magnetic soils: describes their response in terms of an instantaneous and a historical component, the latter due to "magnetic viscosity" effects ("superparamagnetic" ground). Their ratio is apparently constant up to 100 kHz.

Number: [DE 43 39 419](#)

Title: Arrangement and method for detecting metal objects

Date: May 24, 1995

Author: Keller

Assignee: Vallon

Abstract: (Pulse) System with two oval, coplanar partially overlapping coils with very low mutual inductance; it can therefore be used to measure short time constants as well. The two coils can work like two independent detectors, whose received signals allow absolute as well as differential measurements.

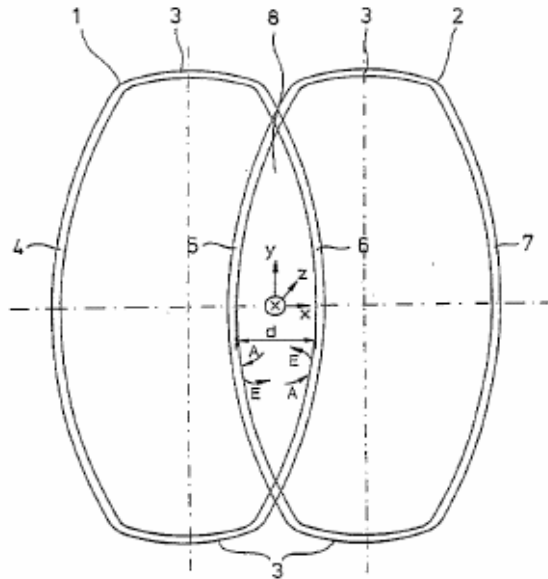

Number: [US 6,326,791](#)

Title: Discrimination of Metallic Targets in Magnetically Susceptible Soil

Date: Dec. 4, 2001

Author: Bosnar

Assignee: Geonics Lim.

Abstract: Pulse systems. The received signal is plotted in a double logarithmic diagram (see figure 2). In such a diagram the background signal (due to magnetically susceptible soil, $V = kt^{-x}$, with $x \sim 1.3$ usually?!) is linear. Thus the received signal is tested at three different times (t_1 , t_2 , t_3) and the corresponding amplitude values are compared. If they do not lie on a single line then an alarm signal is produced.

Alternatively, the response is measured at a late or very late time, when the ground signal is much larger than the target signal; the soil response is then subtracted from the total response to obtain the target signal alone.

[Note: the reason for the $x=1.3$ value is unclear.]

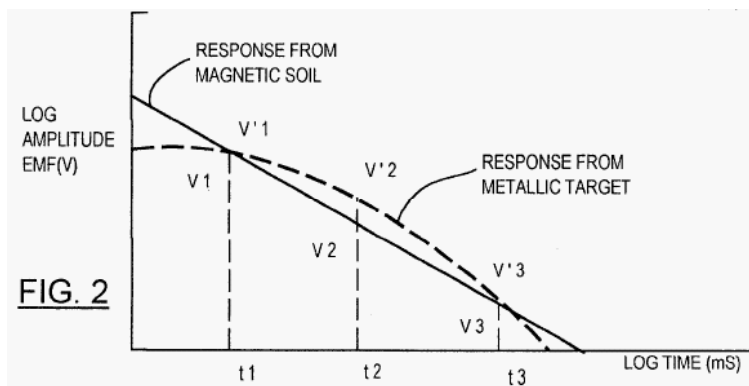

Number: [DE 196 48 833](#) (equal to [US 6,097,190](#))
 Title: Method and Device for Locating and Identifying Search Objects Concealed in the Ground, Particularly Plastic Mines
 Date: May 28, 1998
 Author: Förster
 Assignee: Förster
 Abstract: Multifrequency system; MD and ground probe (uses the ground signal normally suppressed) are identical.
 Metal detector designed to detect minimum metal and plastic mines. First the position of the metallic part is located. Then a search area around this part is investigated for the presence of ground material. For this purpose an eddy current probe with at least three frequencies is used. The ground conductivity or permeability can be increased by impregnating it with a liquid. Thus it can be searched for metallic parts in combination with a "cavity", a lack of ground material. The results can be combined in a display (see figure below) where (64) represents the signal from the metal detector and (62) the detected absence of ground material, which is wider than (65) in this example.

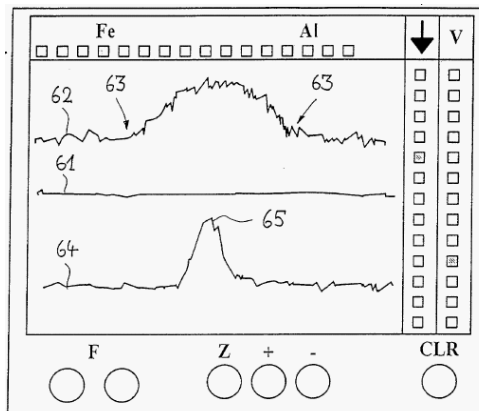

Number: [US 4,719,426](#)
 Title: Method for magnetically detecting a localized disturbance of the ground
 Date: Jan 12, 1988
 Author: Weiss
 Assignee: Scopemoor Ltd.
 Abstract: Passive, motion based inductive magnetic field gradient measurement.

The proposed system builds on the disturbance of the local value of the earth's magnetic field due to both the disruption of the soil and the material of buried objects (including non-metallic targets such as plastic encased mines, water or gas pipes, etc.). The horizontal and/or vertical gradients of such a magnetic disturbance are detected. The sign of the horizontal magnetic gradient encountered when traversing an area of ground containing a buried object will give an indication as to whether the buried object is magnetically susceptible or not.

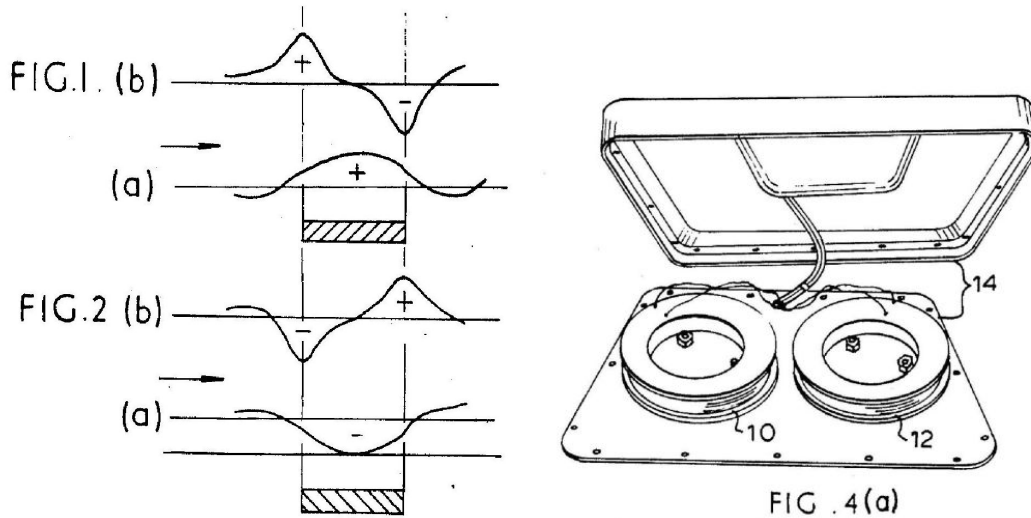

According to the inventor it is believed that once the [top] soil is disturbed, the earth's magnetic field becomes locally distorted and non-uniform at the disturbance. Also, it would appear that the lack of uniformity in the magnetic field due to the disturbance persists for at least several months and possibly for substantially longer.

In simple form, the proposed detector consists of two coils spaced apart in a common plane and electrically connected in series opposition to a detector circuit. Movement of the detector in a horizontal plane just above the surface of the ground will cause the coils to cut lines of the earth's magnetic field which at most places on the surface of the earth are inclined to the horizontal. The apparatus is arranged such that where the ground is undisturbed and the magnetic field is uniform, the detector circuit produces no output. At the point in the scanning movement when one coil is moving over undisturbed ground and the other coil enters an area of magnetic disturbance, the output from the coils is unbalanced and this can produce a signal such that the boundary of the disturbance is indicated.

7. Conclusions

We can briefly summarize the most important aspects of this work as well as what we learned as follows:

- The previously described and listed patents, although not exhaustive, represent a good information source on the working principles of most modern metal detectors for humanitarian demining and similar applications.
- The importance of the ground signal has been confirmed; a large number of techniques employed to counteract its effects are indeed reported.
- As already hinted at in section 3, one has often to read between the lines and cope with the technical and legal jargon. The intimate principles on which some patents are based on can indeed be quite hard to understand, and reading them quite time consuming. It therefore helps quite a lot to have a good prior knowledge of the topics discussed.
- Nearly all the references are to other patents
- Internet based patent servers have become quite powerful, accessible and useful tools.

Finally, one should always keep in mind that patents are not synonymous with products (and vice versa, a product or system has not necessarily been patented), and that they do obviously not represent a guarantee that the corresponding system or idea will really be useful in practice.

8. References

8.1 Documents

- [1] **Bruschini, C.:** *A Multidisciplinary Analysis of Frequency Domain Metal Detectors for Humanitarian Demining*, PhD thesis, Vrije Universiteit Brussel (VUB), September 2002. Available from <http://www.eudem.info/> (Publications -> Thesis).
- [2] **Bruschini, C.; Sahli H.:** *Phase angle based EMI object discrimination and analysis of data from a commercial differential two frequency system*, Proc. SPIE proceedings, Vol. 4038, paper [4038-156] (2000) Available from <http://diwww.epfl.ch/lami/detec/>
- [3] **Bruschini, C.:** *Metal Detectors in Civil Engineering and Humanitarian De-mining: Overview and Tests of a Commercial Visualising System*, INSIGHT, Non-Destructive Testing and Condition Monitoring, Vol. 42, pp. 89-97 (2000) Available from <http://diwww.epfl.ch/lami/detec/>
- [4] **Carin, L.:** *Special Issue on Landmine and UXO Detection*, IEEE Transactions on Geoscience and Remote Sensing, Vol. 39 No 6 (June 2001)
- [5] **Daniels, D.; Cespedes E.:** *Special Issue UXO and Mine Detection*, Subsurface Sensing Technologies and Applications (SSTA), Vol. 2 Issue 3 (July 2001)
- [6] **Rocker, G.:** *Systeme zur Detektion und Ortung von Gegenständen und Personen (Systems for Detecting and Locating Objects and Persons)*, (in German), Erfinderaktivitäten, Deutsches Patent- und Markenamt (German Patent Office), 10 pp (1999) <http://www.dpma.de/veroeffentlichungen/jahresbericht98/ea/seite2.html>
- [7] **Rowan, M.; Lahr W.:** *How Metal Detectors Work*, White's Electronics, (19??) Available from <http://www.treasurenet.com/misc/howmetaldetectorswork.html>
- [8] **Szyngiera, P.:** *A Method of Metal Object Identification by Electromagnetic Means*, in Proc. MINE'99 (Mine Identification Novelties Euroconference), Florence, Italy, pp. 155-160 (1999). Available from <http://demining.jrc.it/aris/events/mine99/index.htm>
- [9] **Guelle, D.; Smith, A.; Lewis, A.; Bloodworth, T.:** *Metal Detector Handbook for Humanitarian Demining*, Publication EUR 20837, ISBN 92-894-6236-1, European Communities, 2003. Available from <http://hsu.jrc.it>

8.2 Websites

Patent Offices

Federal Institute for Intellectual Property (Swiss Patent Office): <http://www.ige.ch/>

European Patent Office: <http://www.european-patent-office.org/>

US Patent Office: <http://www.uspto.gov>

WIPO (World Intellectual Property Organization): <http://www.wipo.org/>

Patent Servers

Espacenet: Patents of all countries can be found. Various search criteria can be used: <http://ep.espacenet.com/>

The Swiss version of Espacenet: <http://www.espacenet.ch>

Search site of the US Patent Office: Only US patents can be found; all mentioned reference patents are linked: <http://www.uspto.gov/patft/index.html>

The Delphion intellectual property homepage: Free search is only possible to a limited extend. All mentioned reference patents are linked: <http://www.delphion.com/>

Others

Geotech: The homepage for all treasure hunters:
<http://www.thunting.com/geotech/index.shtml>

Geotech's excellent patent list on metal detectors (click on *Patents* in the left column):

<http://www.thunting.com/cgi-bin/geotech/pages/common/index.pl?page=metdet&file=patents.dat>

9. Acknowledgements

First of all we would like to thank Carl Moreland from the Geotech homepage. His list of patents has been an excellent starting point for our search.

Peter Choi from EPPRA (France), Jim Lewellen from the Fisher Research Laboratory (US), and Piotr Szyngiera (Silesian Polytechnical University, Poland) gave us some most valuable hints on existing patents, in particular the Geotech homepage courtesy of Piotr.

We are also grateful to the staff at the Swiss Federal Institute of Intellectual Property, which promptly answered all our questions about patent rights in a very friendly way.

We would also like to thank Russell Gasser, the Institute Dr. Förster and John Daspit for their helpful hints.

Finally, we would like to thank in particular Piotr Szyngiera (Silesian Polytechnical University, Poland) for his list of patents, which has represented one of our main starting points for this third version, together with the previous release.

This work has been supported by the Swiss Federal Office for Education and Science within the framework of the EC IST EUDEM2 project (<http://www.eudem.vub.ac.be>).

A. Annex

We briefly present in the following document, as a complement to Ch. 3, the European Patent System and the Patent Co-operation Treaty (PCT), as well as their numbering systems.

A.1 European Patent System (source: EPA/EPO/OEB 2002)

The European Patent Organization was set up on the basis of the European Patent Convention (EPC), which was signed in Munich in 1973. The EPC entered into force for Belgium, France, Germany, Luxembourg, the Netherlands, Switzerland and the United Kingdom in 1977. The first European patent applications were received by the European Patent Office on 1 June 1978. Twenty-five years on, the European Patent Organization boasts 27 member states. The office receives over 150'000 patent applications per year.

A European patent can be obtained by filing a single application in one of the official languages (English, French or German) in a unitary procedure, and is valid in as many of the contracting states as the applicant cares to designate.

The main advantages of the European Patent are:

- Single application filing in one of three languages (English, German, French).
- Examination is done at European level.
- Protection limited to all contracting states that the applicant has designated.
- Same rights as a national patent granted in any of these states.

Nevertheless, the applicant needs to translate the patent in one of the national languages for each designated state.

A.2 Patent Co-operation Treaty (PCT) (source: WIPO web site)

The Patent Co-operation Treaty (PCT) was concluded in 1970, amended in 1979 and modified in 1984. It is open to States party to the Paris Convention for the Protection of Industrial Property (1883). The Treaty makes it possible to seek patent protection for an invention simultaneously in each of a large number of countries by filing an „international patent” application. Such an application may be filed by anyone who is a national or resident of a contracting state. It may generally be filed with the national patent office of the contracting state, with the European Patent Office or with the International Bureau. The Treaty regulates in detail the formal requirements that any international application must comply with.

Among all the contracting states, the applicant indicates those in which he wishes his international application to have effect (designated states). The international application in each designated state is the same as if a national patent application had been filed with the national patent office of that state. The main advantage of the PCT procedure is that the applicant files only one request. The International Bureau of WIPO can carry out a preliminary examination; it does however not deliver patents.

A PCT application is composed of two main phases:

1. International phase divided in four steps:
 - a. The initial application, usually in the applicant's country in their national language.
 - b. At 12 months starting from the date of the first application, the applicant must file an international patent application under the PCT, again in the national language.
 - c. At 18 months, the international patent application is published, in one of seven official languages (English, French, German, Japanese, Russian, Spanish or Chinese).
 - d. Optional international preliminary examination.
2. At 20 months the applicant can continue in each foreign country designated in the international application (step 1.c). This phase is called Regional. The applicant must provide a translation (where necessary) of the application into the official language of the foreign country's national office and pay the usual fees. The 20 months period can be extended by a further 10 months after which the applicant chooses to ask for an „international preliminary examination report“.

A.3 Patent Numbering Systems

Patent Numbering Systems are quite different from country to country, and have sometimes changed many times for historical or political reasons (e.g. after the fall of the Berlin Wall).

Patent numbers can be followed by a code (e.g. A2, B1), called “kind code”, whose significance depends on the patent office conventions. In general, they represent the state of a patent application or label a related document (e.g. A3 is a search result in a PCT application). All numbering systems tend to converge towards a unified system.

The following table provides some examples of “kind codes”.

Patent office	Kind code	Type of publication
European Patent Organization (EPO)	A1	Patent application (with search report)
	A2	Patent application (without search report)
	A3	Patent application search report
	B1	Patent
	B2	Revised Patent
World Intellectual Property Organization (WIPO)	A1	PCT international application (with search report)
	A2	PCT international application (without search report)
	A3	PCT international application search report
	B1	Publication of amended claims
	C1	Modified first page
	C2	Corrected document

A more complete list of kind codes can be found at the following addresses:

- <http://www.european-patent-office.org/inpadoc/faq/kindcode.htm>
- <http://www.delphion.com/help/kindcodes>
- <http://www.cas.org/EO/patkind.html>