



Behaviour of ^{137}Cs in a raised bog in central Sweden

Pilar Román Galán



Supervisors: Dr Klas Rosén
Prof Karl-Johan Johanson

Examiner: Prof Ingvar Nilsson

MSc thesis

Sveriges lantbruksuniversitet
Institutionen för markvetenskap
Avdelningen för markkemi och jordmånslära
Examens- och seminariearbeten Nr 78

Uppsala 2006

ISSN 1102-1381

ISRN SLU-MLE-EXS--78--SE

Abstract

Vertical migration of ^{137}Cs and ^{137}Cs activity concentrations in plants growing on a raised bog in Central Sweden were investigated. Raised bogs are among the most nutrient poor ecosystems. Blocks of soil (peat) and samples of plants were collected from two sites on the bog, the open bog site where no trees were growing and the low pine site with slowly growing Scots pine. The peat at both sites was composed of living Sphagnum mosses in the upper 5 cm layer and dead and more or less decomposed Sphagnum material in deeper layers. Samples were also collected from a forest on mineral soil close to the bog. The soil blocks from the bog were cut in 2 cm layers down to a depth of about 40 cm. The ^{137}Cs activity concentrations ($\text{Bq kg}^{-1} \text{ dw}$) in plant samples and the ^{137}Cs activity per m^{-2} in each peat layer were determined and the migration centers and the migration rates were calculated.

In 2005, the migration center at the open bog site was 13.42 cm and the migration rate was 0.70 cm y^{-1} , at the low pine site the migration center was 15.53 cm and the migration rate 0.81 cm y^{-1} . The corresponding values in the forest soil were 7.47 cm and 0.39 cm y^{-1} . At the open bog site about 35 % of the total ^{137}Cs activity in the soil profile was found in the upper 5 cm (living part). The corresponding percentage at the low pine site was 20 % and 50% at the forest site. The results from 2005 were compared with results from 1989. In 1989, the migration center was 5.0 cm and the migration rate was 1.67 cm y^{-1} at the open bog site. Obviously, the migration rate was higher in 1989 compared to 2005.

In 2005, the highest ^{137}Cs activity concentrations in plants collected from the open bog site were found in heather – about $20\,000 \text{ Bq kg}^{-1}$. The corresponding value in heather collected from the low pine site was about $10\,000 \text{ Bq kg}^{-1}$ and at the forest site $5\,000 \text{ Bq kg}^{-1}$. A much lower level, 418 Bq kg^{-1} , was found in crowberry growing at the forest site. In 1989, the ^{137}Cs activity concentration in heather growing at the open bog site was $44\,000 \text{ Bq kg}^{-1}$. The ^{137}Cs activity concentrations thus seem to have decreased by about 50 % from 1989 to 2005.

Table of contents

1 Introduction	5
1.1 Radioecology	5
1.1.1 Historical aspects	5
1.1.2 Natural occurred radionuclides	5
1.1.3 Radionuclides from accidents.	6
<i>1.1.3.1 Radionuclides from Kyshtym.</i>	7
<i>1.1.3.2 Radionuclides from Windscale</i>	7
<i>1.1.3.3 Radionuclides from Chernobyl</i>	7
1.2 Released and spread of Radionuclides in Sweden	9
1.2.1. Deposition map	10
1.3 Specific features of Radiocaesium	10
1.4 ¹³⁷Cs in the environment	11
1.4.1 Bioavailability	12
1.4.2 In Mineral soils	12
1.4.3 In Organic soils	14
1.4.4 In Plants	14
1.4.5 In Fungi	14
1.5 The raised bog as an ecosystem	15
1.6 Radiocaesium pathways from forest to man	16
1.7 Radiation dose	17
1.8 γ-ray Detector	17
1.9 Aim of study	17
2 Material and methods	18
2.1 Study Area	18
2.2 Soil, plants and water sampling	20
2.2.1 Soil sampling	20
2.2.2 Plants sampling	20
2.2.3 Water sampling	21
2.3 Soil, plant and water treatment	21
2.3.1 Soil treatment	21
2.3.2 Plants treatment	22
2.3.3 Water treatment	22
2.4 Radiometry	22
2.4.1 Detector characteristics	22
2.5 Data treatment	23
2.5.1 Calculations	23
<i>2.5.1.1 Data transformation</i>	23
<i>2.5.1.2 Relative nuclide distribution</i>	23
<i>2.5.1.3 Migration depth and rate</i>	23
<i>2.5.1.4 Soil to plant transfer</i>	23

3 Results	24
3.1 Soil	24
3.1.1 Open bog	24
3.1.1.1 <i>Water table –open bog- result</i>	24
3.1.2 Low pine	24
3.1.2.1 <i>Water table –Low pine- results</i>	24
3.1.3 Forest	24
3.1.4 Comparison soil results	25
3.2 Plant	25
3.2.1 Open bog	26
3.2.2 Low pine	26
3.2.3 Forest	26
3.2.3 Comparison plant	26
3.3 Transfer factor: Soil to Plant	26
4 Discussion	27
4.1 Deposition and distribution of ¹³⁷Cs	27
4.1.1 Comparison ¹³⁷ Cs distribution in study sites	27
4.1.2 Comparison with earlier data	29
4.2 Uptake and transfer of ¹³⁷Cs from soil to plants	31
4.2.1 Comparison with earlier data	32
5 Conclusions	33
Acknowledgements	33
References	34
Appendix	37

1 Introduction

1.1 Radioecology

Radioecology or “radiation ecology” can be considered as a field of research which encompasses the relationships between ionizing radiation or radioactive substances and the environment, i.e. plant and animal populations, communities, ecosystems, biomes, or even the whole biosphere (Stricht & Kirchmann. 2001). Radiobiology, in contrast, deals with radiation and levels of biological organization from the molecule to the organism. The primary subdivisions of radiation ecology include (Whicker & Schultz, 1982):

- Radionuclide movement within ecological systems and accumulation within specific ecosystem components such as soil, air, water and biota.
- Ionizing radiation effects on individual species, populations, communities, and ecosystems.
- Use of radionuclides and ionizing radiation in studies of structure and function of ecosystems and their components.

Behaviour of radionuclides in the environment is governed by a complex set of natural processes and circumstances. Nearly every component of an ecological system will have some influence upon the fate of radioactive materials introduced into that system.

1.1.1 Historical aspects

One can distinguish three main stages in the history of radioecology:

From the end of the 19th century to the end of the Second World War (1945): Research was carried out on migration of radionuclides in the environment. A prominent finding was the discovery that some radionuclides are accumulated by living organisms (microorganisms, plants, animals).

During the 1950s and 1960s the research was related to fall-out from nuclear weapons. The most relevant progress in radiation protection during this period was the establishment of permissible doses of radiation in terms of ultimate effects on mankind.

End of 1960s until now (2005): Studies of radio-ecological problems linked to the expansion of civilian nuclear power primarily in industrial countries.

1.1.2 Naturally occurring radionuclides

Radionuclides are found naturally in air, water, soil and rocks. They are even found in human beings (for example, ^{40}K) because we are products of our environment. Every day, we inhale and ingest radionuclides from air, food and water. Radionuclides are common in bedrock, soil, freshwaters and oceans, as well as in building materials and houses. There is no place on earth where you can not find natural radionuclides.

Natural radionuclides are divided into “cosmogenic radionuclides” and “primordial radionuclides”:

- The cosmogenic radionuclides are produced through nuclear reactions between cosmic rays and nuclei in the atmosphere, soil, and water. They may have long half-lives, but the majority of them have shorter half-lives than the primordial nuclides.

Table 1. Some cosmogenic radionuclides (U.S. Environmental Protection Agency)

Nuclide	Symbol	Half-life	Source
Carbon 14	^{14}C	5730 yr	Cosmic-ray interactions, $^{14}\text{N}(\text{n,p})^{14}\text{C}$;
Tritium 3	^3H	12.3 yr	Cosmic-ray interactions with N and O; spallation from cosmic-rays, $^6\text{Li}(\text{n},\alpha)^3\text{H}$
Beryllium 7	^7Be	53.28 days	Cosmic-ray interactions with N and O;

Some cosmogenic radionuclides are: ^{10}Be , ^{26}Al , ^{36}Cl , ^{80}Kr , ^{14}C , ^{32}Si , ^{39}Ar , ^{22}Na , ^{35}S , ^{37}Ar , ^{33}P , ^{32}P , ^{38}Mg , ^{24}Na , ^{38}S , ^{31}Si , ^{18}F , ^{39}Cl , ^{38}Cl , $^{34\text{m}}\text{Cl}$.

- The primordial radionuclides were formed when planet Earth was formed and account for the major part of what we call background radiation.

They are typically long-lived, with half-lives often in the order of hundreds of millions of years. Radionuclides that have existed for more than billions of years are not measurable. Some other primordial radionuclides are ^{50}V , ^{87}Rb , ^{113}Cd , ^{115}In , ^{123}Te , ^{138}La , ^{142}Ce , ^{144}Nd , ^{147}Sm , ^{152}Gd , ^{174}Hf , ^{176}Lu , ^{187}Re , ^{190}Pt , ^{192}Pt , ^{209}Bi .

Table 2. Some basic information on common primordial radionuclides and their daughters (U.S. Environmental Protection Agency)

Nuclide	Symbol	Half-life
Uranium 235	^{235}U	7.04×10^8 yr
Uranium 238	^{238}U	4.47×10^9 yr
Thorium 232	^{232}Th	1.41×10^{10} yr
Radium 226	^{226}Ra	1.60×10^3 yr
Radon 222	^{222}Rn	3.82 days
Potassium 40	^{40}K	1.28×10^9 yr

The increased release of man-made radioactive substances into the environment during the second half of the 20th century has resulted in a global extra (above background) irradiation to all living organisms and exposure from ionizing radiation has been recognized as one of the key radioecological factors on our planet. Within the last decades many areas have received increasing amounts of radionuclides originating from the discharge of radioactive wastes into the environment. The wastes have been disposed to the atmosphere and aquatic environment from nuclear industry and nuclear power engineering enterprises.

1.1.3 Radionuclides from accidents

Of special concern during the last decades of the 20th century were some accidents at nuclear power plants, which led to radioactive contamination of rather large areas. Some of these areas became unsuitable for farming or human residence.

1.1.3.1 Radionuclides from Kyshtym

The Kyshtym accident was an explosion that occurred on 29 September 1957 near Chelyabinsk in the Ural mountain. Until June 1989 there had been no formal admission by the Soviet authorities that the accident had actually occurred.

The explosion occurred because of design defects of the storage reservoir, which led to radiation overheating of a tank followed by an explosion of nitrate and acetate salts which were stored in the tank. The explosion caused about 7.4×10^{17} Bq of radionuclides to be ejected. Of this amount, 90% fell in the vicinity of the tank, whereas the remaining activity (7.4×10^{16} Bq) formed a radioactive cloud which had a height of about one kilometre. The radionuclides were scattered by wind over a significant distance and led to radioactive contamination of the northern part of the Chelyabinsk region and the southern part of the Sverdlovsk region. Maps of the territories contaminated with ^{90}Sr and ^{137}Cs were drawn up in accordance with data from investigations conducted in 1993 by the Chelyabinsk Regional Center on Hydrometeorology and Environmental Monitoring (Egorov, 2000).

1.1.3.2 Radionuclides from Windscale

On October 10, 1957, the graphite core of a nuclear reactor at Windscale, (United Kingdom), caught fire releasing substantial amounts of radioactive contamination into the surrounding area. The event, known as the Windscale fire, was considered the world's worst nuclear accident until it was dwarfed by the Chernobyl accident in 1986.

The fire itself released an estimated 700 TBq of radioactive material into the nearby countryside. Of particular concern was the radioactive isotope ^{131}I , which has a half-life of only 8 days and is taken up by the human body and stored in the thyroid gland. No one was evacuated from the surrounding area, but there was a concern that milk might have been dangerously contaminated. For about a month, milk from about 500 km² of the nearby countryside was destroyed by dumping it into local rivers, (Coughtrey, 1989).

1.1.3.3 Radionuclides from Chernobyl

On April 26 in 1986 the nuclear power plant in Chernobyl in Ukraine was subject to a core meltdown in one of its reactors as a consequence of a control experiment which went wrong (IAEA, 1991). Two explosions blew off the roof of the reactor building, exposing the core. As a consequence, large amounts of fuel particles containing transuranic elements and fission products such as ^{131}I , ^{137}Cs and ^{90}Sr were released from the reactor core, including essentially all radioactive noble gases.

Table 3. Core inventory and total release from the Chernobyl power plant reactor unit 4 (Rosén, 1996). Decay corrected to 6 May 1986

Radionuclide	Half life ^{a)}	Core inventory	% of core inventory released
Krypton 85	10,8 y	$3,3 \times 10^{16}$	100
Xenon 133	5,3 d	$1,7 \times 10^{18}$	100
Iodine 131	8,1 d	$1,3 \times 10^{17}$	50-60
Caesium 134	2,1 y	$1,9 \times 10^{17}$	33
Caesium 137	30,6 y	$2,9 \times 10^{18}$	33
Ruthenium 103	39,5 d	$4,1 \times 10^{18}$	3,5
Ruthenium 106	368 d	2×10^{18}	3,5
Zirconium 95	65,5 d	$4,4 \times 10^{18}$	3,5
Cerium 141	12,8 d	$2,9 \times 10^{18}$	4-6
Cerium 144	284 d	$3,3 \times 10^{18}$	3,5
Strontium 89	53 d	2×10^{18}	4-6
Strontium 90	28 y	2×10^{17}	4-6
Plutonium 238	$3,6 \times 10^4$ y	1×10^{15}	3,5
Plutonium 239	$8,9 \times 10^6$ y	$8,5 \times 10^{15}$	3,5
Plutonium 240	$2,4 \times 10^6$ y	$1,7 \times 10^{15}$	3,5

^{a)}d = day, y = year

Radionuclides associated with large particles were deposited near the site and smaller particles were carried upwards by the heat of the explosions to more than 1 km altitude, and then drifted away with the prevailing winds towards the Nordic countries. Continuing release over a ten-day-period, changing meteorological conditions and wind directions at different altitudes resulted in a very complex dispersion pattern. The released radioactive plume moved west- and southward contaminating nearly all parts of Europe (Fig. 1 & 2).



Figures 1 & 2: Areas affected by radiation due to Chernobyl accident (RADNET & Humus project).

1.2 Release and spreading of radionuclides in Sweden

In the Nordic countries, two radiocaesium isotopes, ^{137}Cs and ^{134}Cs , have been studied, because they appeared to be the most important contributors to human exposure after the Chernobyl accident, and because they are relatively simple to monitor (the fact that ^{137}Cs emits energetic photons makes it simple to measure).

Large areas in central and northern Sweden were heavily contaminated with radiocaesium carried by rain (fig. 3). The deposition of ^{137}Cs in these regions, was estimated to be within a range up to 80 kBq/m^2 (Rosén, 1999). Wet deposition into forest ecosystems resulted in an interception of nearly 100% in the tree canopies. During the first year after the fallout, radiocaesium was relocated from canopy to ground.

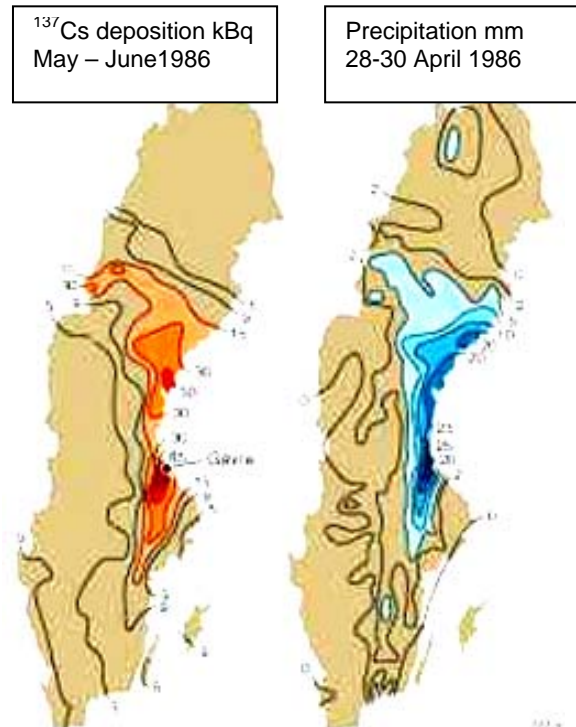

Figure 3. Comparison between deposition and precipitation in Sweden, (Persson et al, 1987; Spring 1986 (RADNET)).

Most of the contaminated areas are covered by forest. In some contaminated areas the level of radiocaesium in the meat of game animals was quite high and in several cases the level was above the established intervention level for meat and other types of food.

1.2.1. Deposition map

Outside the former USSR, radioactive material was first detected in Sweden on April 28, 1986, two days after the accident. It was mainly deposited as wet-deposition (figure 3), i.e. it was washed out with rain or snow from the radioactive plume. In figure 4 the deposition of ^{137}Cs in Sweden is shown. It mainly occurred in the middle and northern part of the country, with the highest deposition in the Gävle municipality where a ground deposition of more than 200 kBq/m^2 was found. Deposition of ^{137}Cs before the Chernobyl accident emanated from atmospheric testing of nuclear bombs during the 1950s and 1960s. This fallout was estimated in 1985 and found to be between 1.2 and 1.9 kBq/m^2 (Bergman 1991, Nylen & Ericsson 1989).

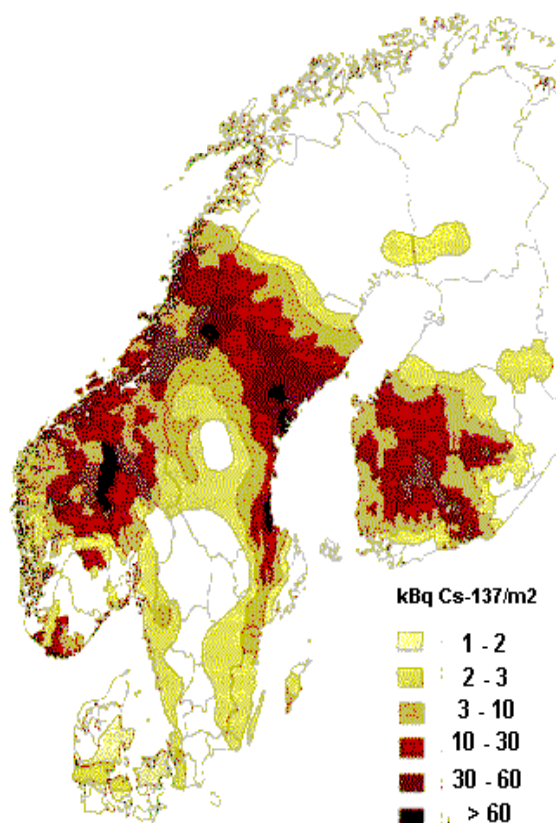

Figure 4. Deposition of ^{137}Cs in Nordic countries due to Chernobyl accident. (Ed. Dahlgaard, 1994).

1.3 Specific features of Radiocaesium

Caesium is one of the alkali metals, which include Li, Na, K, Rb and Cs. In nature Cs is distributed in small quantities, and is usually associated with other alkaline elements such as K and Rb. The known minerals containing stable caesium (^{133}Cs) are pollucite (Cs_2O), and carnotite.

Among the alkali elements, Cs is strongly bound to clay minerals due to its small hydrated radius, and also strongly accumulated by plant species.

^{137}Cs was discovered in the late 1930s by Glenn T. Seaborg and Margaret Melhase. It is formed when uranium and plutonium absorb neutrons and undergo fission reactions. ^{137}Cs undergoes radioactive decay with the emission of beta particles and relatively strong gamma radiation (Fig.5). ^{137}Cs is a relatively long-lived radionuclide (the half-life is 30 years).

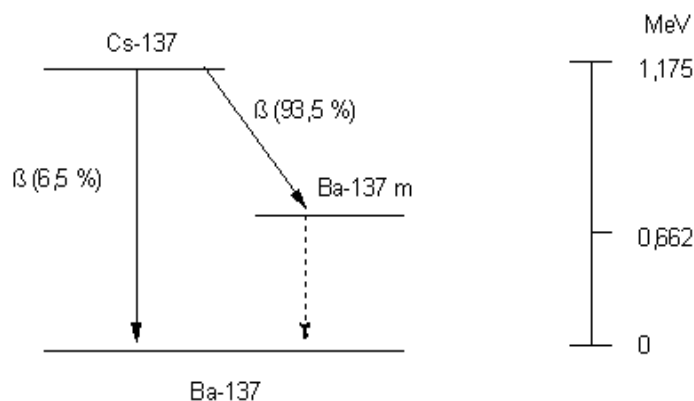

Figure 5. Decay scheme of the nuclide. (Lederer et al., 1967).

^{137}Cs disintegrates with a probability of 6.5% directly and with a probability of 93.5% indirectly via the metastable $^{137\text{m}}\text{Ba}$ into stable ^{137}Ba . During indirect decay, beta rays with a maximum energy of 0.513 MeV are released. The meta-stable ^{137}Ba then disintegrates with a physical half-life of 2.55 minutes emitting gamma rays (0.662 MeV). The activity of ^{137}Cs is deduced from the gamma rays.

Like all ionizing radiation, exposure to radiation from ^{137}Cs results in an increased risk of cancer. Everyone is exposed to very small amounts of ^{137}Cs in soil and water as a result of atmospheric fallout. Exposure to waste materials from contaminated sites, or from nuclear accidents may increase the risk of obtaining cancer. Intake of about 75.000 Bq of ^{137}Cs will result in a radiation dose of 1 mSv.

Because of the similarity to K, Cs is likely to be found in biological systems. This makes the cleanup of ^{137}Cs rather difficult. People may ingest ^{137}Cs with food and water, or may inhale it with dust. If ^{137}Cs enters the body, it is distributed fairly uniformly throughout the soft tissues, resulting in exposure of those tissues.

1.4 ^{137}Cs in the environment

The uptake of ^{137}Cs into plant tissues from contaminated soils often represents a significant pathway of radiation exposure to man following either direct consumption of fruits or grain, or indirectly, by consumption of products from animals (game animals, cattle, etc) which feed on contaminated plant material. The pathways leading to crop contamination and the behaviour of the ^{137}Cs are complex and are affected not only by the physical and chemical properties of the radionuclide but also by factors which include soil type, cropping system (including soil management), climate, season and, where relevant, the biological half life within animal bodies.

The Chernobyl accident provoked a major rethinking in the world of radioecology, including an awareness of the many potential food-web pathways to humans other than those which included agricultural crops. Wild games, berries and mushrooms are supplementary food sources for many of the inhabitants of the contaminated regions. Because of the pronounced filtering characteristics of trees, the atmospheric deposition is often higher in forests than in agricultural areas. The specific pathways in forests often result in an enhanced retention of contaminating radionuclides. The high organic matter

content and stability of the forest floor in coniferous forests increases the soil-to-plant transfer of radionuclides. The transfer of radionuclides to game animals, which live in forest area could pose an unacceptable exposure for some individuals who are strongly dependent on game animals as a food source.

The main pathways for potential human exposure via water may be either direct through contamination of drinking water, or indirect from the use of contaminated water for irrigation. Consumption of contaminated fish is still another pathway.

The present project concerns ^{137}Cs migration at the Harbo forest, specifically in a raised bog within the forest area. The bog vegetation is dominated by Sphagnum mosses. Due to the morphology of these mosses that does not vary much with the seasons, ^{137}Cs accumulation can occur throughout the whole year. Mosses usually have a considerable longevity and lack roots, which makes them suitable to be used as long-term integrators and bioindicators of atmospheric dry and wet deposition. The lack of a thick cuticle promotes the migration of heavy metals and radionuclides to the free cation exchange sites located on the cell walls, (Ah-Peng, 2004).

1.4.1 Bioavailability

The availability of radionuclides for biological uptake is of vital importance for their transfer through the food-webs to humans. To decide concerning proper countermeasures to be used, the short- and long-term bioavailability of the radionuclides should be known. A good method for availability assessment is *in situ* extraction of radionuclides in soil using strong adsorbents (i.e. zeolites). One disadvantage of this method is that one only obtains information concerning the available pool of nuclides, while the so called non-available pool is interesting for long-term predictions of food-chain transfers (Forsberg , 2000).

To obtain information on less available pools of nuclides, chemical extractions are applied. Regarding mineral soils, (Riise et al. 1990) suggested ammonium acetate, ($\text{CH}_3\text{COONH}_4$) as an extractant of the exchangeable Cs^+ fraction. For organic soils, Rigol et al. (1999) suggested the use of $\text{CH}_3\text{COONH}_4$, $\text{Na}_4\text{P}_2\text{O}_7$, NaOH (in a N_2 atmosphere) and H_2O_2 in a sequential extraction.

After fallout, ^{137}Cs becomes strongly bound to the soil matrix. Approximately 40% could be bound in an acid-digestible form. The easily exchangeable fraction of Cs^+ in mineral soils is generally in the range of 10-30% (Rigol et al., 1999), but in soils with high organic matter content it may be higher. Bioavailability also increases with depth because the fixation of ^{137}Cs to the soil matrix has not yet been completed at greater depths (Andersson & Roed, 1994).

1.4.2 In mineral soils

The main difference between semi-natural acid organic soils and agricultural soils is that the potassium pool is likely to be much higher in agricultural soils, especially in those soils which receive mineral fertilizers. This difference will have implications for the behaviour of ^{137}Cs .

Physical migration of radionuclides in soils can lead to a contamination of sub-surface waters which in its turn can lead to human and animal exposure if the water is used for

irrigation or drinking purposes. As radionuclide migration rates along this pathway are usually slow, this is only likely to be a problem in the following cases:

- Prolonged migration of long-lived radionuclides.
- Short migration distances (i.e. shallow water tables).

In podsolised forest soils, Cs^+ tends to remain concentrated near the soil surface for many years after a deposition. At least 80% of ^{137}Cs activity remains in the upper 15 cm of the soil. In bogs we may assume that ^{137}Cs migrates faster since the clay content as well as the content of the fungal mycelium are both very low. The rate at which a radionuclide migrates downwards through a contaminated soil is important for several reasons:

- A high migration rate reduces the direct gamma radiation exposure of organisms present on the surface of the soil.
- The relative proximity of the radionuclide to the root system affects the migration: The deeper within the soil a radionuclide migrates the lower is the density of roots and mycelium available for absorbing radioactive ions from the soil. Consequently, the radionuclides incorporated into plant tissues will be lower under these circumstances.

The most important physical-chemical interaction of radiocaesium within soils and sediments is the specific fixation to clay minerals. Clay minerals are leaf-like structures composed of layered negatively charged platelets. In 2:1 clay minerals cations are taken up between the layers to neutralize negative charges. Cs^+ and K^+ ions fit well into these interlayers due to their ionic radii and high polarity. They thus become fixated. The clay minerals illite and vermiculate are important in this respect. Attachment of Cs^+ ions (fig.6) may occur.

- on the flat, so called planar, surfaces on the top and bottom of the “staked plate” structures which make up the clay mineral.
- on the weathered “frayed edge” sites at the edges of these structures.

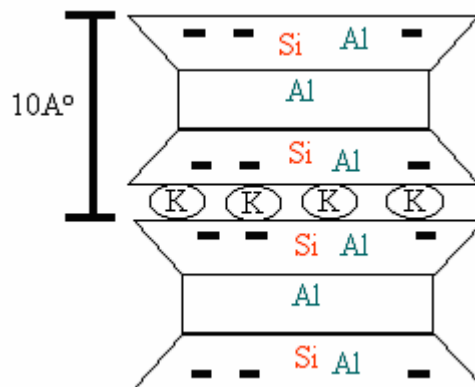

Figure 6. Structure of a 2:1 clay mineral, where the Cs^+ can exchange for K^+ ions.

Additionally, slow but almost irreversible penetration into the “interlayer spaces” between the plate-like components of the mineral can take place, during which the potassium interlayer ions are exchanged for Cs^+ ions. It is this process which leads to long-term fixation of radiocaesium in soils, rendering Cs physically immobile and biologically unavailable.

1.4.3 In organic soils

The organic peat soils of forest and upland areas in Europe have been of major interest after the Chernobyl accident. These soils have relatively low potassium content, and a negligible content of clay minerals. There may also be a high NH_4^+ concentration in the soil solution. The combination of these characteristics increases the Cs^+ availability in organic soils.

1.4.4 In plant-

Cs^+ is strongly accumulated by a number of plant species, but has not been found to replace K^+ completely. The plant uptake depends, among other things, on the availability of Cs^+ in soil (see 1.4.2 and 1.4.3) and the activity of symbiotic fungi (see 1.4.5). Plants may take up radionuclides through their leaves or through their roots. Leaf uptake is most important soon after depositions on vegetation surfaces. Under these circumstances, plant interception and subsequent uptake may amount to several per cent of the total deposition. Root uptake is also important, since about 50% of this uptake can be expected to be translocated to the shoots. About 10% of the above-ground activity can be expected to be found in the edible parts of cereals and vegetables (Coughtrey & Thorne, 1983).

1.4.5 In fungi

In forest ecosystems, the roots of most vascular plants are colonized by symbiotic fungi forming mycorrhizae. Mycorrhizal symbiosis plays a key role in the cycling of essential elements as well as pollutants, such as heavy metals and radionuclides in the forest ecosystem. Fungi are likely to be responsible for the long-term retention of radiocaesium in organic horizons of forest soils. Many studies report that a major fraction of the released radiocaesium from Chernobyl is still found in the organic horizons of forest soils two decades after deposition (Nylén, 1996, Nikolova et al., 2000).

The horizontal transport of radiocaesium in forest soil can also be mediated by the fungal mycelia which are responsible for the spatial redistribution of radionuclides (Nikolova et al., 2000).

The long-term retention of radionuclides in organic layers of forest soil is attributed to fungal and microbiological activity (Linkov & Schell, 1999). The fungus-mediated translocation of ^{137}Cs into fresh litter is supposed to be one reason for the persistence of radiocaesium in the organic horizons in the forest soil. The downward migration of radiocaesium is rather slow and partially compensated by an upward translocation in fungal mycelia and roots. In the mineral horizons beneath the organic horizons, the retention of radiocaesium is supposed to be outweighing the potential fungus-mediated upward transport. The mineral horizons thus act as a sink for radiocaesium (Rühm et al. 1996).

The uptake of radionuclides in forests is a phenomenon that is expected to depend on the following factors (Fawaris & Johanson, 1995):

- Climatic conditions, soil moisture regime, cation exchange capacity and soil acidity.
- Type of plant cover and time elapsed since contamination occurred.
- Soil structure, thickness of humus layer, organic matter content and dry bulk density.
- Amounts and types of exchangeable cations and soil minerals.
- Soil microflora (including fungi) and microfauna.
- Activity and concentration of radionuclides in soil as well as their chemical speciation.

1.5 The raised bog as an ecosystem

Bogs are peat deposits found on all continents except Antarctica, and are most common at northern latitudes where retreating glaciers left moist, depressed land with poor drainage. Precipitation is the only source of water (the so called ombrotrophic system). If fed by water originating from mineral soil, the peat deposits are called fens.

Climate and topography determine the bog type. Waterlogging first lowers the oxygen level, which slows down the decay rate of plant remains. Plant litter settles and becomes peat. Swamps and some marshes also produce peat. However, the accumulation of peat is most pronounced in bogs, where exudates from Sphagnum mosses contribute to the water acidity. Sphagnum peat is used as a fuel (due to its high carbon content), or as a garden compost (it retains moisture). It has been historically used as bandage material because of its acidity and antibacterial properties. Also bogs help to maintain reliable supplies of water to rivers. In this study, we worked on a raised bog (Fig.7).

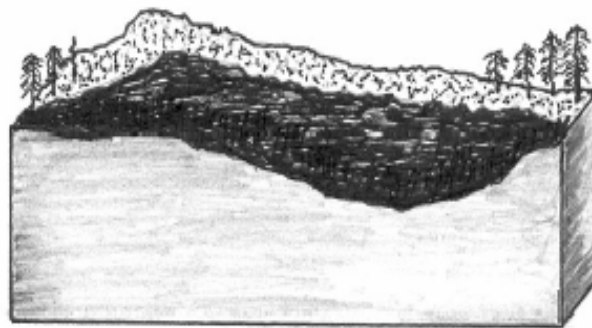

Figure 7. Raised bog (Irish Peatland Conservation Council, 1996).

Raised bogs have a surface raised in the middle, like a dome. The surface of a raised bog is a mixture of pools, mossy hummocks and flat lawns, and is colonised by plants and animals adapted to the acidic conditions and low levels of nutrients found there. This favours the growth of plants such as Heather, Cottongrasses and, most importantly, Sphagnum mosses. These plants die to form peat that is markedly different from fen peat and often very deep.

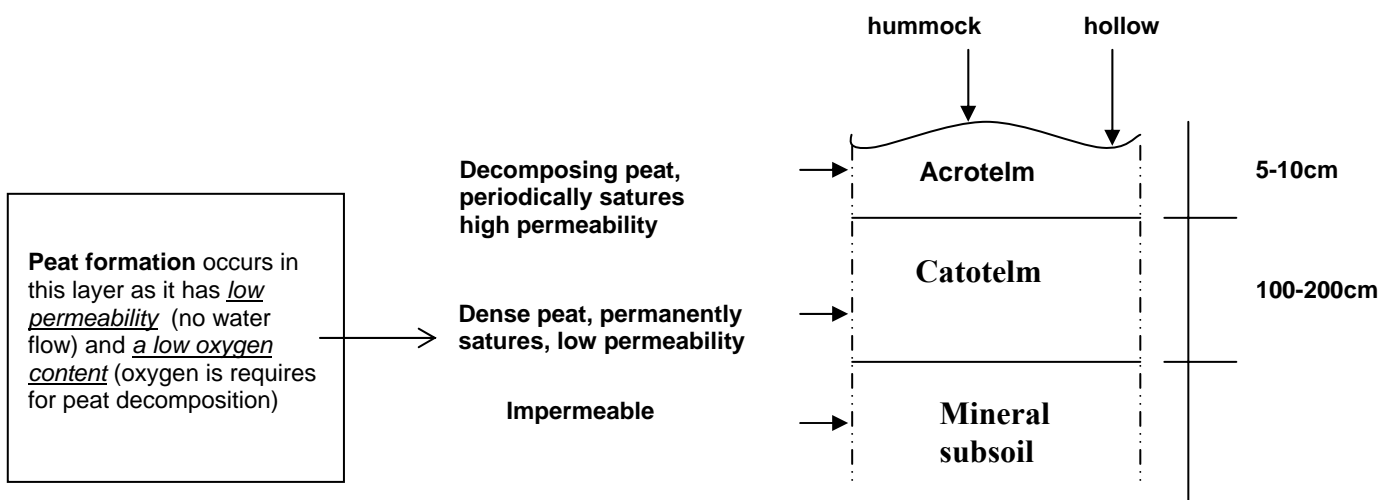

Figure 8. Raised bog layers (Irish Peatland Conservation Council, 1996).

A bog consists of two layers: the upper, thin layer, known as the acrotelm, is only some 10 cm deep, and consists of upright shoots of Sphagnum mosses, largely still alive and colourful (red, yellow and ochre). Water can move rapidly through this layer (Fig. 8).

Below this layer is a much thicker bulk of peat, known as the catotelm, where individual plant stems have collapsed under the weight of the mosses above them to produce an amorphous, chocolate-coloured mass of Sphagnum fragments. Water movement through the amorphous peat is typically very slow. This is where most of the rainwater is stored. From here the water slowly seeps down through the bog over several weeks or even months.

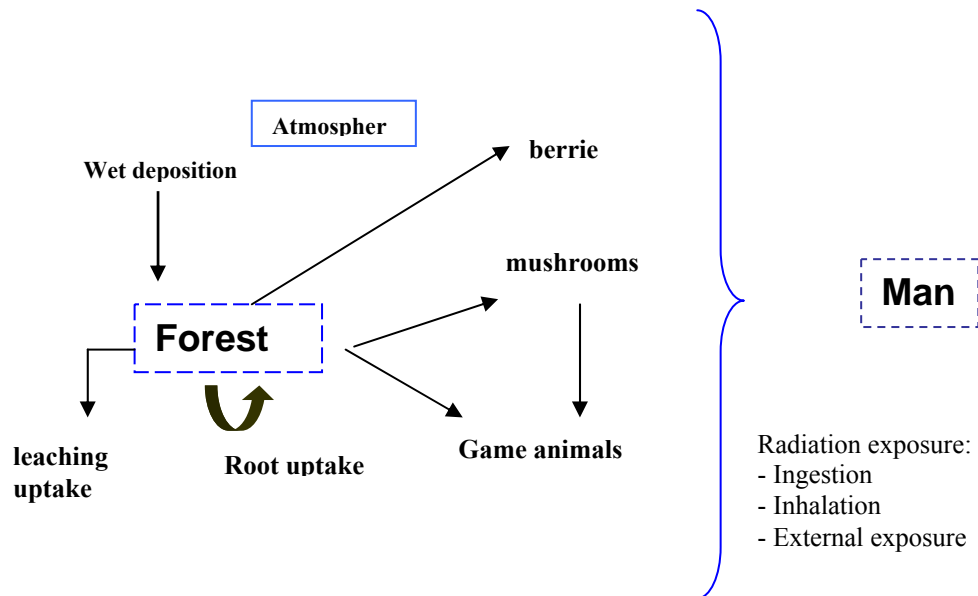

Figure 9. ¹³⁷Cs pathways from forest to man.

Because the surface of a bog typically consists of low hummocks and ridges, as well as scattered hollows or pools, the stable water table produces intense competition for living space between species. Therefore, several zones of characteristic vegetation have evolved each depending on their proximity to the water table (Irish Peatland Conservation Council 1996)

1.6 Radiocaesium pathways from forest to man

The exposure pathways that have to be considered when evaluating radiation exposure to people in general, are ingestion of contaminated plant and animal food products and water, as well as inhalation of radionuclides and external exposure (Fig. 9). Most of the knowledge existing today about radiocaesium pathways from forest ecosystems to man was obtained during the investigations of radiocaesium behaviour in forests contaminated by the releases during the Kyshtym and Chernobyl accidents. At the time of the atomic bomb tests the lichen-reindeer-man food chain was studied as well as pathways from crops and lakes to man. Shortly after the Chernobyl accident it became clear that contaminated forests could cause a significant dose to man. Thus an interest developed concerning uptake of radiocaesium into wild berries, game animals and edible mushrooms. The latter are highly effective to take up caesium from the soil.

1.7 Radiation doses

Exposure to ionizing radiation is expressed in terms of absorbed dose, which is the amount of energy imparted to matter per unit mass. The absorbed dose is a fundamental concept in measuring and quantifying the effects of exposure to radiation and the unit is the gray ($1\text{Gy}= 1\text{Joule kg}^{-1}$).

Equivalent dose is a concept that considers the absorbed dose and the relative effectiveness of the type of ionizing radiation in damaging biological systems, using a radiation-weighted factor; w_R ($\text{Sv}=\text{Gy}\cdot w_R$). The unit of equivalent dose is the Sv (sievert).

In quantifying the effects of radiation on humans, other concepts are also used. The concept of effective dose is used to quantify effects of heterogenous irradiation of the body. It involves estimates of a tissue-specific weighting factor based on the susceptibility of that tissue to radiation-induced cancer. The equivalent dose multiplied by the specific tissue weighting factor is the effective dose. The unit of effective dose is also the Sv (sievert).

The activity of a radioactive source is measured in becquerels (Bq) and one disintegration per second correspond to 1 Bq.

1.8 γ -ray Detector

Today, practically all γ -ray spectroscopy experiments employ high-resolution germanium detectors. The germanium detector is a large reverse-biased p-n junction diode. At the junction between the p-type and n-type material, the migration of electrons from the n-type material and from the holes of the p-type material gives rise to a region of net zero charge. This region is known as the depletion region. The net positive charge on one side of the junction, and the net negative charge on the other, creates an electric field gradient across the depletion region. Any γ -rays interacting with the germanium will produce electron-hole pairs in the depletion region, which then will be swept to the edges of the detector because of the electric field gradient, and an electric current will be created. Since the depletion region is the active part of the Ge detector, the active volume is required to be as large as possible. If a reverse-bias is applied, the width of the depletion region can be increased. The width is proportional to $(V/N)^{1/2}$. Here, V is the bias voltage applied and N is the impurity concentration of the germanium. Germanium of natural purity can only maintain a depletion region of a few millimeters before electrical breakdown occurs. Therefore at a given bias voltage the only way to increase the width of the depletion region is to reduce the impurity concentration, (ORTEC, 1986).

1.9 Aim of study

This study deals with the deposition, migration and behaviour of radiocaesium in a Swedish raised bog ecosystem. The work was conducted to obtain a better understanding of ^{137}Cs behaviour in an open raised bog, a raised bog with small pine trees and a coniferous forest near the raised bog by:

- Determining the vertical distribution of ^{137}Cs and its seasonal variation.
- Determining the uptake by plants.
- Comparing the plant uptake and ^{137}Cs migration in the open bog area, the bog area with low pine and the coniferous forest.

2 Material and methods

2.1 Study area

The study area was a raised bog (Pålsjömossen) located within a forest in the Heby municipality situated about 35 km NW of Uppsala. The geographic position is shown in Fig. 10. The latitude is $59^{\circ} 60' 60''$ N, and the longitude $15^{\circ} 73' 60''$ E (x is the place where were working).

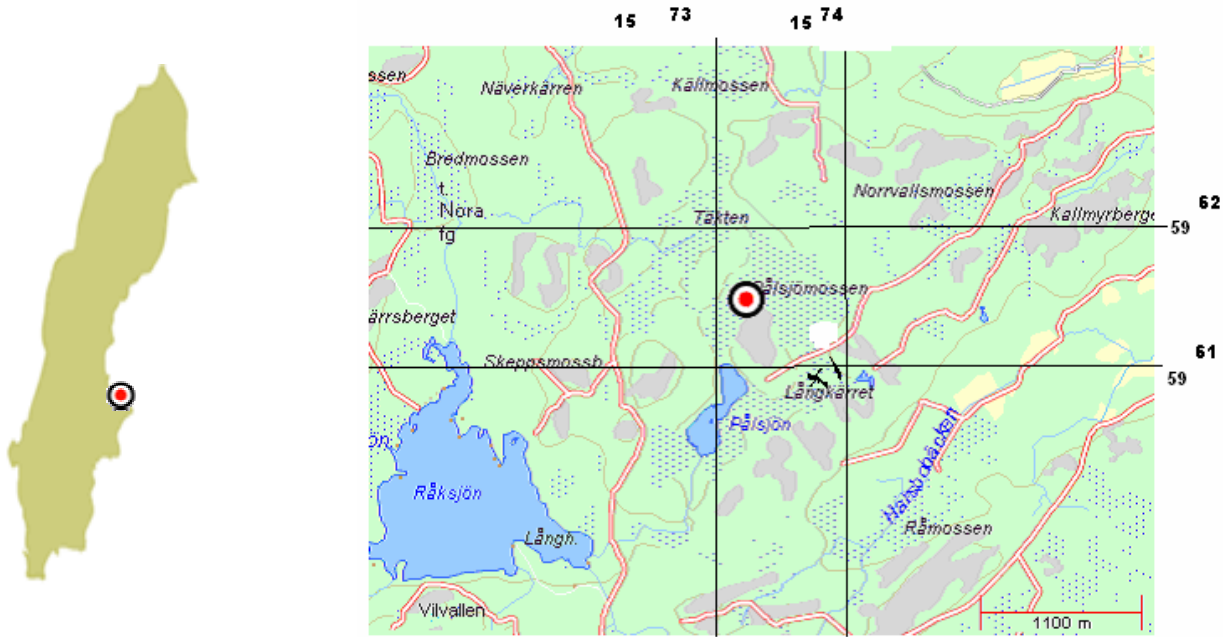

Figure 10. Map of the study zone.

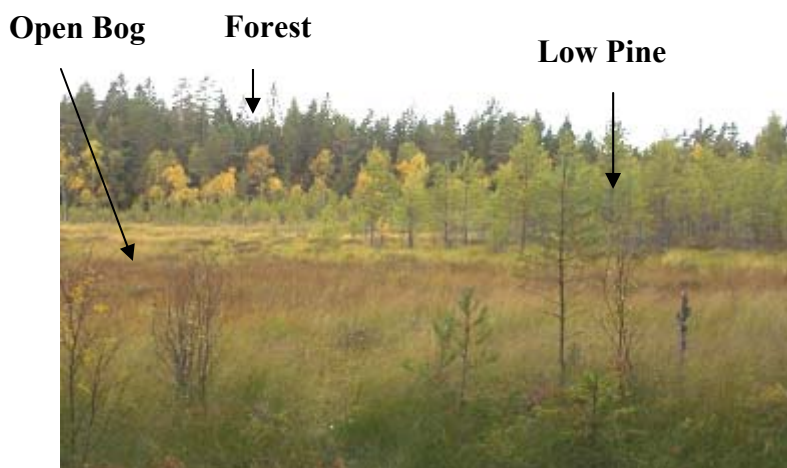

Figure 11. The study site, raised bog (Open area and Low pine) and the surrounding forest.

The forest vegetation consisted mainly of the conifers Scots pine (*Pinus sylvestris*) and Norway spruce (*Picea abies*), with some intermixture of deciduous trees such as birch (*Betula spp.*).

In the forest understorey, bilberry (*Vaccinium myrtillus*) lingonberry (*Vaccinium vitis-idaea*) and heather (*Calluna vulgaris*) were rather common. Large portions of forest floor, including the rocky outcrops, were covered by a carpet of lichens and mosses.

The forest floor consisted of a shallow surface layer (3-10 cm) which mainly originated from partially decomposed tree litter and other plant debris which had accumulated on top of the mineral substratum which to a great extent consisted of large stones and, in some locations, of solid rocks.

Within the forest area there were some raised bogs. Pålsjömossen was the main study area in this work. The bog was divided into two different parts, an open bog area and a low-pine area (Fig. 11). The open bog area had a typical structure with hummocks and hollows (Fig. 2). The vegetation consisted mostly of *Sphagnum* mosses and a sparse cover of low-growing vascular plants. The hollows were dominated by *Sphagnum* species belonging to the *Cuspidata* section (*S. balticum*, *S. tenellum*) and Hare's-tail cottongrass (*Eriophorum vaginatum*) dominated the cover of vascular plants. Ridges and hummocks were covered by more densely growing *Sphagnum* species (*S. fuscum*, *S. rubellum*), low Ericaceae species such as heather (*Calluna vulgaris*) and crowberry (*Empetrum nigrum*). On the hummocks there was also a minor cover of bog rosemary (*Andromeda polifolia*), cloudberry (*Rubus chamaemorus*), sundew (*Drosera rotundifolia*) and cranberry (*Vaccinium oxycoccus*). In the drier part of the open bog area single Scots pine trees about 1.5 m high were found. In the low pine area, slowly growing Scots pine was rather frequent and in the field layer crowberry, cloudberry (*Rubus chamaemorus*), heather and Labrador tea (*Ledum palustre*) were common.

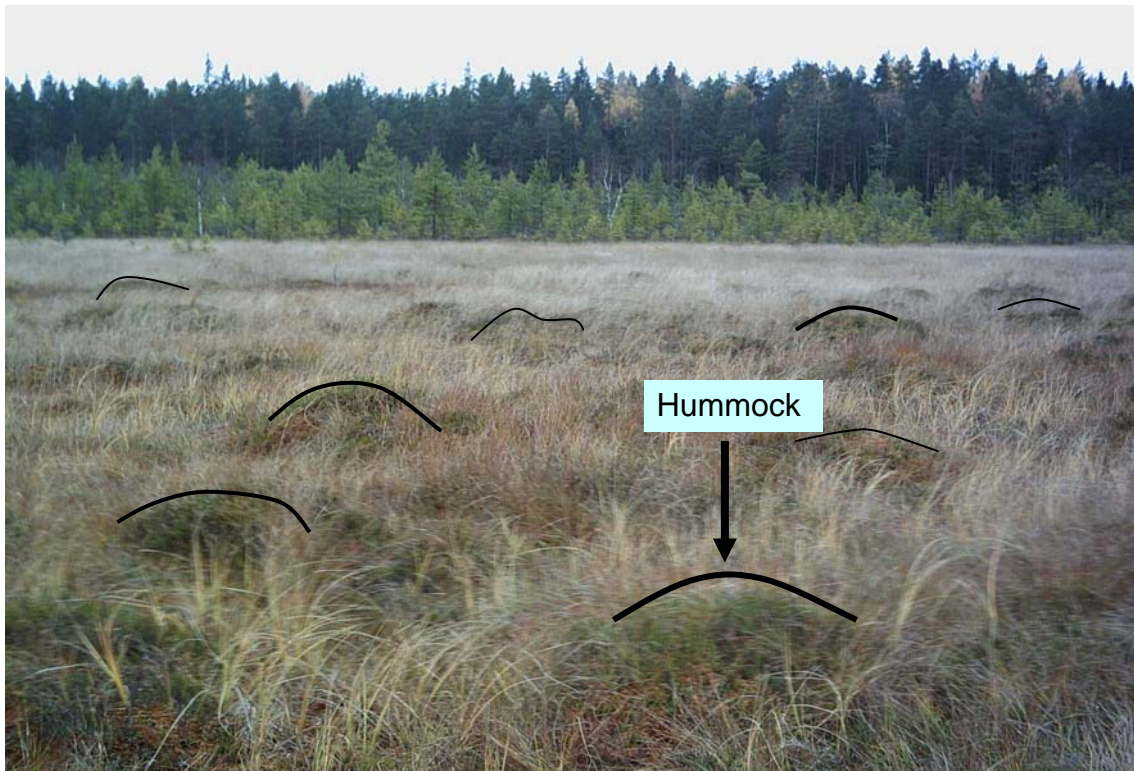

Figure 12. The structure of hummocks is shown.

2.2 Soil, plant and water sampling

From each of the three ecosystems described above, soil and plant samples were collected between October 2004 and September 2005.

2.2.1 Soil sampling

November 4th 2004 was the first sampling date. Seven peat profiles located in hollows on the open bog were sampled, using a cylindrical steel borer with a diameter of 5.8 cm and a length of 10 cm. These samples were used for estimating the ground deposition. In winter (January 25th 2005), samples were collected from two peat profiles on the open bog, using another method. The samples were obtained by digging with a spade and cutting with a saw a 10x10 cm² area to a depth between 30 and 45 cm. This method was then used in both the spring and summer samplings. In spring (11th May 2005) four profiles were collected, two in the open bog site and two in the low pine site. Each profile was 28-33 cm deep. Due to ice melting the ground water table was high and it was impossible to dig deeper.

The last sampling took place in summer (25th July 2005) when three profiles, one in the open bog, one in the low pine and one in the forest site, were collected. In the low pine and open bog sites, the depth was around 40 cm, while the profile collected in the forest site was 18 cm deep due to the proximity of the bedrock.

2.2.2 Plant sampling

The first plant sampling was in October 2004 when 48 plant samples were collected from the different areas of the study. The next sampling date was in spring (11st May 2005) when 9 plant samples were collected from the open bog and low pine site. In summer (25th July 2005), 19 plant samples were collected from the raised bog and forest sites, and the last plant sampling took place in autumn (21st September 2005) when 29 plant species were collected (see table 4).

The sampling of the plants was mainly focused on the green parts (shoots from the current year), except for the sundew specimen where the whole plant was collected and the cottongrass in which brown parts and roots were collected as well. Mushrooms are not plants in a botanical sense but they will still be considered here since they were treated in the laboratory in the same way as the plants. Some mushroom specimens were collected in the autumn, spring and summer in the three areas, in order to compare the ¹³⁷Cs uptake for each season and area.

Table 4. The collected plant species

Area	Common name	Scientific name
Open bog	Bog rosemary	<i>Andromeda polifolia</i>
	Bogbean	<i>Menyanthes trifoliata</i>
	Sedge	<i>Carex rostrata</i>
	Crowberry	<i>Empetrum nigrum</i>
	Cranberry	<i>Vaccinium oxycoccus</i>
	Heather	<i>Calluna vulgaris</i>
	Hare's-tail cottongrass	<i>Eriophorum vaginatum</i>
	Sphagnum mosses	<i>Sphagnum spp.</i>
	Sundew	<i>Drosera rotundifolia</i>
	Scot pine	<i>Pinus sylvestris</i>
Low pine	Blueberry	<i>Vaccinium myrtillus</i>
	Cloudberry	<i>Rubus chamaeromus</i>
	Crowberry	<i>Empetrum nigrum</i>
	Heather	<i>Calluna vulgaris</i>
	Hare's-tail cottongrass	<i>Eriophorum vaginatum</i>
	Labrador tea	<i>Ledum palustre</i>
	Lingonberry	<i>Vaccinium vitis-idaea</i>
	Sphagnum mosses	<i>Sphagnum spp.</i>
	Scot pine	<i>Pinus sylvestris</i>
Forest area	Blueberry	<i>Vaccinium myrtillus</i>
	Crowberry	<i>Empetrum nigrum</i>
	Heather	<i>Calluna vulgaris</i>
	Lingonberry	<i>Vaccinium vitis-idaea</i>

2.2.3 Water sampling

Samples of ground water from the open bog and low pine sites were collected in airtight glass bottles. The water samples were obtained as grab samples from the holes left in the bog after digging.

2.3 Soil, plant and water treatment

All samples were kept in a refrigerator at a temperature of 8 degrees before starting the laboratory treatments.

2.3.1 Soil treatment

All profiles were sectioned by means of a measuring scale and a sharp knife while the samples were still wet. The thickness of the sections was 2 cm. Each section was kept in a paper bag, weighed and dried at 105⁰C in a hot air oven until the samples felt dry by touch, (after approximately 24 hours). All sections were reweighed and dried samples were milled to a grain size of 2 mm (except for the stony forest soil samples), to produce a homogeneous and well-mixed material. Plastic vials were filled with soil material for ¹³⁷Cs measurements by gamma spectroscopy.

2.3.2 Plant treatment

Plant samples (including mushrooms) were dried at 105⁰C in a hot air oven during 24 hours and then milled weighed and transferred to plastic vials for determination of plant ¹³⁷Cs activity concentrations.

2.3.3 Water treatment

Water aliquots were transferred into duplicate polyethylene vials. The first vial contained unfiltered water, and the second vial contained water filtered through a piece of cotton.

2.4 Radiometry

Activity concentrations (Bq kg⁻¹ dry matter) of ¹³⁷Cs in soil, plants, mushrooms and water samples were determined at the Department of Soil Sciences, SLU (Uppsala) using a high resolution gamma spectroscopy system consisting of three hyper pure Ge-detectors (HPGe) (Fig. 13). The time needed to reach sufficiently low statistical errors (maximum ± 5%); usually ranged from 30 minutes to several hours. Only small samples with very low activities, as the water samples with a ¹³⁷Cs activity concentration of 1 Bq kg⁻¹, needed longer measurements (maximum 12 hours)



Figure 13. HPGe detector.

2.4.1 Detector characteristics

The energy required to create an electron-hole pair in Ge is approximately 3 eV thus an incident γ -ray, with energy of several hundred keV, produces a large number of such pairs, leading to good resolution and low statistical fluctuations. HPGe detectors are operated at temperatures of around 77 K, in order to reduce “noise” from electrons which may be thermally excited across the small band gap in Ge (0.67 eV) at room temperature. The low temperature is achieved through thermal contact of the Ge crystal with a Dewar vessel containing liquid nitrogen, using a copper rod, known as a cold finger (table 2).

Table 5. The characteristics of the used detectors (ORTEC, 1986)

Model	Crystal diameter	Resolution(FWHM)at 1,33MeV, ⁶⁰ Co	Relative(efficiency)at 1,33MeV, ⁶⁰ Co
GMX-13200	47,0 mm	1,87 keV	14,2%
GEM-20200	51,5 mm	1,70 keV	20,5%
GEM-33210	60,9 mm	1,94 keV	31,3%

2.5 Data treatment

All estimates of ¹³⁷Cs activity should be related to a fixed date because ¹³⁷Cs decay has been taking place during the years that have elapsed since the analysis of the previously collected samples. However, as the half life of ¹³⁷Cs is 30 years, the deviation due to the time gap can be considered as small compared to other measurement errors.

2.5.1 Data transformations

Data from the detectors (expressed as Bq kg⁻¹), were converted to Bq m⁻², which facilitated the interpretation of ¹³⁷Cs deposition to the areas of interest. For a given soil section, Bq m⁻² was obtained as the ¹³⁷Cs activity concentration in the soil section (Bq kg⁻¹) times the soil dry weight per unit surface area (kg m⁻²). Percentage activity distribution was calculated as the activity distribution in each soil section divided by the total nuclide activity in the soil profile x 100.

2.5.2 Relative nuclide distribution

In order to establish deposition-independent values for comparison of depth distribution between soils, a relative nuclide distribution was calculated as follows:

$$q_i = \frac{A_i}{A_{\text{tot}}}$$

q_i : nuclide fraction in the layer of interest
 A_i : activity content in the layer (Bq m⁻²)
 A_{tot} : total activity content (Bq m⁻²) in the soil profile

2.5.3 Migration depth and rate

The migration rate was defined according to Arapis et al. (1997) using the following expression:

$$\sum (X - X_i) q_i = 0$$

X_i : depth (cm) from the surface to the center of soil layer I
 q_i : nuclide fraction in the same soil layer

The migration rate is then obtained as the value of X (cm) divided by the time (years) since deposition.

2.5.4 Soil to plant transfer

The transfer factor per unit surface of soil, TF_g (m² kg⁻¹) is obtained as

$$TF_g = \frac{\text{Activity concentration in vegetation Bq}_{\text{plant}} \text{ kg}^{-1} \text{ dw}}{\text{Ground deposition Bq}_{\text{soil}} \text{ m}^{-2}}$$

3 Results

3.1 Soil

3.1.1 Open bog

In 2005, the mean deposition of ^{137}Cs at the open bog site was $22\,583 \pm 1\,426 \text{ Bq m}^{-2}$ (Table 6). About 30% of ^{137}Cs activity was retained within the upper 4 cm and 51% within the upper 10 cm (Table A1 in appendix). Below a depth of 30 cm, 8 % of the total ^{137}Cs activity was found in the studied soil profiles (Fig. 14). This means that downward migration of ^{137}Cs to deeper layers is a very slow process and the ^{137}Cs activity will remain within the upper layer of the bog, i.e. the acrotelm (Figure 8) for many years. The migration centre value was 13.4 cm and the migration rate was 0.7 cm/year (Table 6).

3.1.1.1 Water table - open bog

The ^{137}Cs activity concentration in the ground water in the open bog was 3.4 Bq l^{-1} in the unfiltered sample and 1.8 Bq l^{-1} in the sample which was filtered. The unfiltered water showed a higher activity due to particles suspended in the water.

3.1.2 Low pine

In 2005, the mean ground deposition of ^{137}Cs was $29\,657 \pm 583 \text{ Bq m}^{-2}$ (Table 6) at the low pine site. About 16 % of ^{137}Cs was retained within the upper 4 cm and 36% within the upper 10 cm (Table A3 in appendix). Below a depth of 30 cm 7 % of the total ^{137}Cs activity was found in the studied soil profiles (Fig. 15). The migration centre value was 15.53 cm and the migration rate was 0.81 cm/yr (Table 6).

3.1.2.1 Water table – low pine

The ^{137}Cs activity concentration in the ground water at the low pine site was 2.8 Bq l^{-1} in the unfiltered sample and 0.0 Bq l^{-1} in the sample which was filtered. The results show thus a negligible activity concentration of ^{137}Cs in the ground water (Table A4? in appendix).

3.1.3 Forest

In 2005, the mean deposition of ^{137}Cs was $17\,936 \text{ Bq m}^{-2}$ (Table 6) to a depth of 18 cm. Due to the dense and stony character of the forest soil, it was not possible to reach below 18 cm. However, we may assume that ^{137}Cs had migrated to greater depths. About 50% of the ^{137}Cs found within the depth interval 0-18 cm was retained within the upper 6 cm and 71 % within 10 cm. (Table A5 in appendix). The migration centre was about 7.47 cm and the migration rate was 0.39 cm yr^{-1} (Table 6).

3.1.4 Soil comparison

The migration of ^{137}Cs decreased in the order: low pine > open bog > forest. This result was expected since it is generally assumed that the mobility of ^{137}Cs is higher in organic than in mineral soils.

Table 6. Ground deposition, migration centre and migration rate for the study areas

	<i>Open bog</i>	<i>Low pine</i>	<i>Forest</i>
Ground deposition (Bq m⁻²)	22 583	29 657	17 936
Migration centre (cm)	13,42	15,53	7,47
Migration rate (cm/yr)	0,70	0,81	0,39

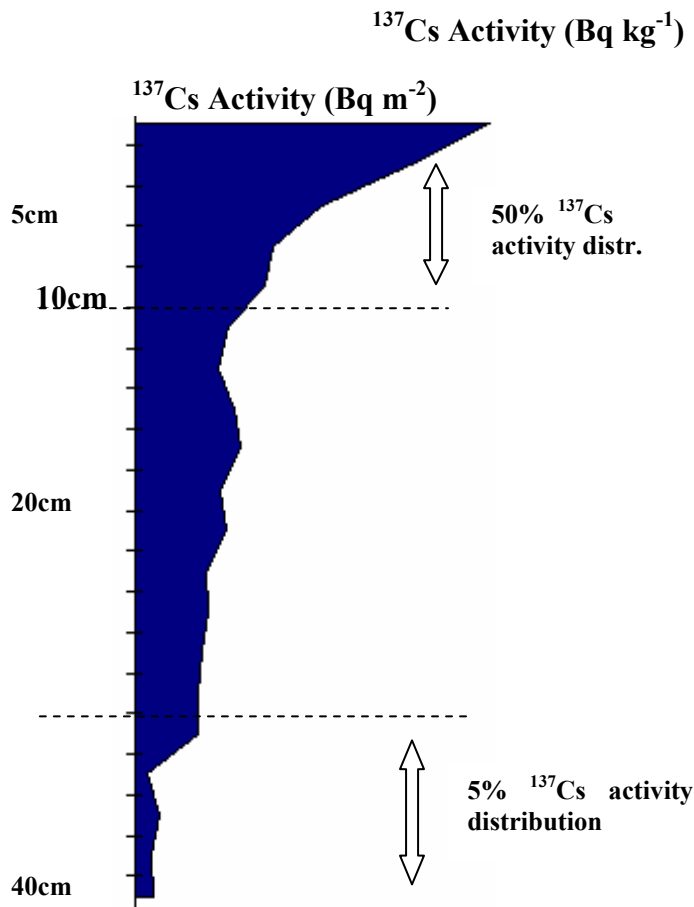

Figure 14. ¹³⁷Cs distribution by depth at the Open bog site.

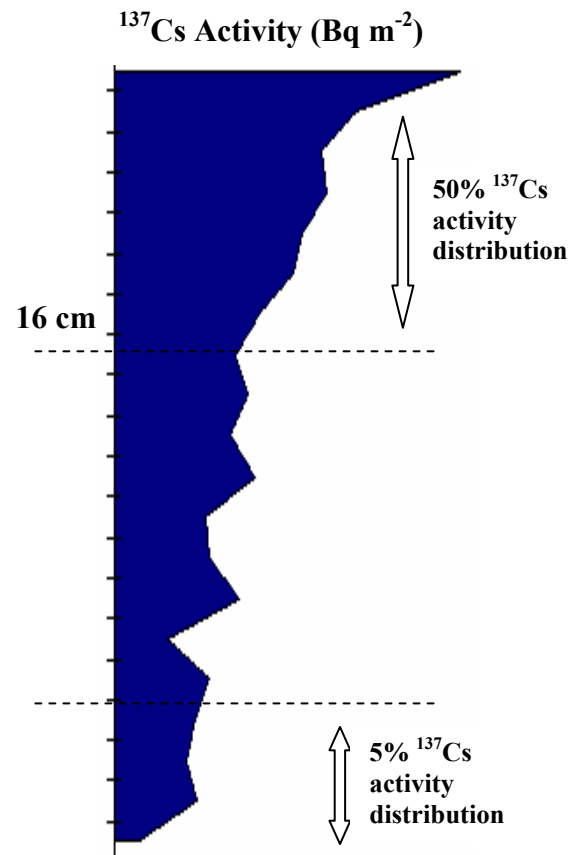

Figure 15. ¹³⁷Cs distribution by depth at the Low pine site.

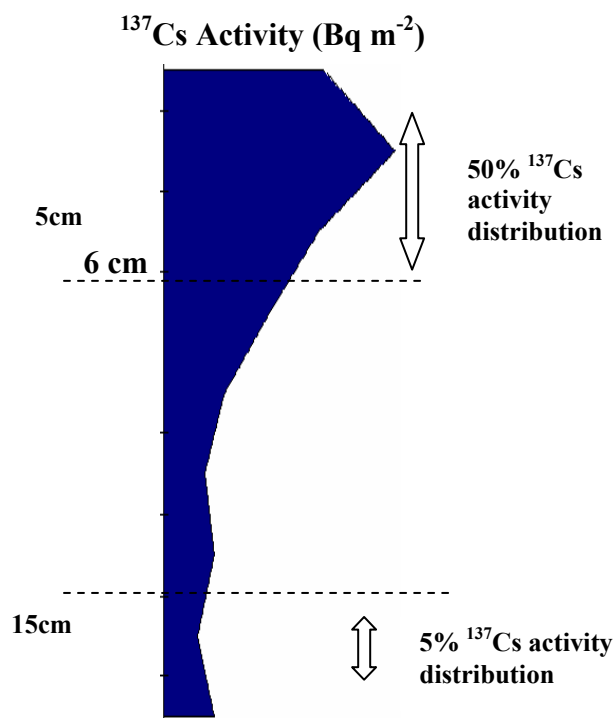

Figure 16. ^{137}Cs distribution in depth in forest.

The results showed a similar distribution of ^{137}Cs at the open bog site and low pine sites (Figure 14 & 15). Samples from the two sites showed a high ^{137}Cs activity at the surface followed by a sharp drop a few centimetres below the surface.

3.2. Plant

3.2.1 Open bog

The highest ^{137}Cs activity concentration in plants growing at the open bog site was found in heather and was about $20\,000\text{ Bq kg}^{-1}\text{ d.w.}$ All other plant species at the open bog site showed much lower activity concentrations. For example, the ^{137}Cs activity concentration in sundew was $4\,200\text{ Bq kg}^{-1}\text{ d.w.}$ and in crowberry $3\,400\text{ Bq kg}^{-1}\text{ d.w.}$ (Table A6 in the appendix). The ^{137}Cs activity concentration in the Sphagnum mosses was about $1\,300\text{ Bq kg}^{-1}\text{ d.w.}$ (Table A10 in appendix).

3.2.2 Low pine

In 2005, the highest ^{137}Cs activity concentration in plants growing at the low pine site was found in heather and was about $12\,000\text{ Bq kg}^{-1}\text{ d.w.}$ All other plant species found at this site showed much lower activity concentrations. For example, cloudberry had $6\,000\text{ Bq kg}^{-1}\text{ d.w.}$ and Labrador tea $3\,800\text{ Bq kg}^{-1}\text{ d.w.}$ The ^{137}Cs activity concentration in the Sphagnum mosses at this site was about $1\,800\text{ Bq kg}^{-1}\text{ d.w.}$ (Table A7 in appendix). The few mushrooms found showed much higher ^{137}Cs activity concentrations than the vascular plants, with a mean value of $113\,460\text{ Bq kg}^{-1}\text{ d.w.}$

3.2.3 Forest

At the forest site the ^{137}Cs activity concentration in plants ranged from 5000 Bq/kg d.w, for heather to 418 Bq kg⁻¹ d.w for crowberry. Mushrooms showed a ^{137}Cs activity concentration of 22 000 Bq kg⁻¹ d.w. (Table A8 in appendix).

3.3 Transfer factors soil-to-plant

The TF_g values varied greatly between species but also between the different sites and ranged from 0.02 m² kg⁻¹ d.w.(crowberry in forest) to 3.83 m² kg⁻¹ d.w in mushrooms (Table A9 in appendix). Heather had a high transfer factor decreasing in the order: open bog > low pine > forest. In most plants, the transfer factors decreased in this order.

The plant species with the lowest transfer factors were bog rosemary, Scots pine, blueberry and bogbean.

4 Discussion

4.1 Deposition and distribution of ^{137}Cs

^{137}Cs distribution in the soil was studied in order to obtain a better knowledge of ^{137}Cs behaviour. Previous data from the three sites were compared with the data obtained in the present study. The results agreed very well with those from the previous studies carried out on forest soils and Sphagnum species (Fawaris & Johanson, 1995, Nylén 1996).

However, several problems have to be considered in field studies, such as the possibility of large seasonal variations in climatic and hydrological conditions. These factors, as well as the heterogeneity of the ^{137}Cs deposition led to a high variability among the samples.

4.1.1 Comparison of ^{137}Cs distribution at the study sites

The fallout in this area was coming as wet deposition in 1986. In the early phase there were some spatial differences in the interception of radionuclides. At the open bog, the radionuclides were intercepted directly on the Sphagnum material. At the low pine site quite a large fraction of the activity was intercepted in the canopy of Scots pine and during the first year after the Chernobyl accident ^{137}Cs was relocated from the canopy to the Sphagnum layer. Now (2005) we would not expect any differences in the distribution ^{137}Cs due to the two ways of interception.

Still 20 years after the deposition of ^{137}Cs , 50% of the activity at the open bog site was found in the upper 10 cm of the peat profile. The corresponding migration rate was 0.70 cm y^{-1} . The highest migration rate, 0.81 cm y^{-1} was found at the low pine site. The migration rate of ^{137}Cs was higher at the bog site than in the forest, where the rate was as low as 0.38 cm y^{-1} . Low migration rates, particularly in arable soils, are usually explained by the fixation of ^{137}Cs to clay minerals which act as a sink for the Cs^+ ion (see 1.4.3). In bogs the clay content is negligible, which means that there is a limited possibility for ^{137}Cs to be fixated. Therefore, other processes seem to be involved in the retardation of the downward migration of ^{137}Cs . The net vertical migration depends on the balance between downward and upward migration. In forest soils upward migration seems to be performed by the fungal mycelium (Melin & Wallberg, 1991; Fawaris & Johansson, 1995; Nylén, 1996; Forsberg & Strandmark, 2000; Vinichuk, 2004; Brückmann & Wolters, 1994; Wirth et al., 1994; Rafferty et al., 1997). In a raised bog, there is a rather small amount of fungal mycelium. Therefore it is reasonable to assume that fungal mycelium as well as clay only marginally will affect the migration rate of ^{137}Cs in the raised bog ecosystem. Sphagnum species might be a potential vector of ^{137}Cs . There seems to be a rather low ^{137}Cs activity (less than $2\,000 \text{ Bq kg}^{-1} \text{ d.w.}$) in living Sphagnum mosses. This level is several orders of magnitude lower than the level observed in fungal mycelium in forests. The present study was carried out 19 years after the fallout from Chernobyl. This means that the thickness of the Sphagnum peat had increased with about 3 cm since the fallout assuming that Sphagnum mosses grow with a rate of 1 to 2 mm per year. However, in this post-Chernobyl part of the Sphagnum cover we found the highest ^{137}Cs activity concentrations.

At the low pine site, there was a field layer dominated by Labrador tea, heather and crowberry. Roots of these plants are often located rather deep in the Sphagnum mat and will probably have no effect on the vertical migration of ^{137}Cs in the upper layers of Sphagnum.

In the forest there is a large amount of fungal mycelium in the organic rich upper part (O horizon) which seems to be an efficient system for upward migration of ^{137}Cs in the profile. Figure 17 indicates that the relative ^{137}Cs activity per section was higher in the upper part of the forest soil compared to the upper part of the two peat soils. It was observed that 25% of the total ^{137}Cs activity in forest soil samples was found at 4-6 cm depth, whereas in the raised bog between 10 - 15% of the total activity was found at the same depth.

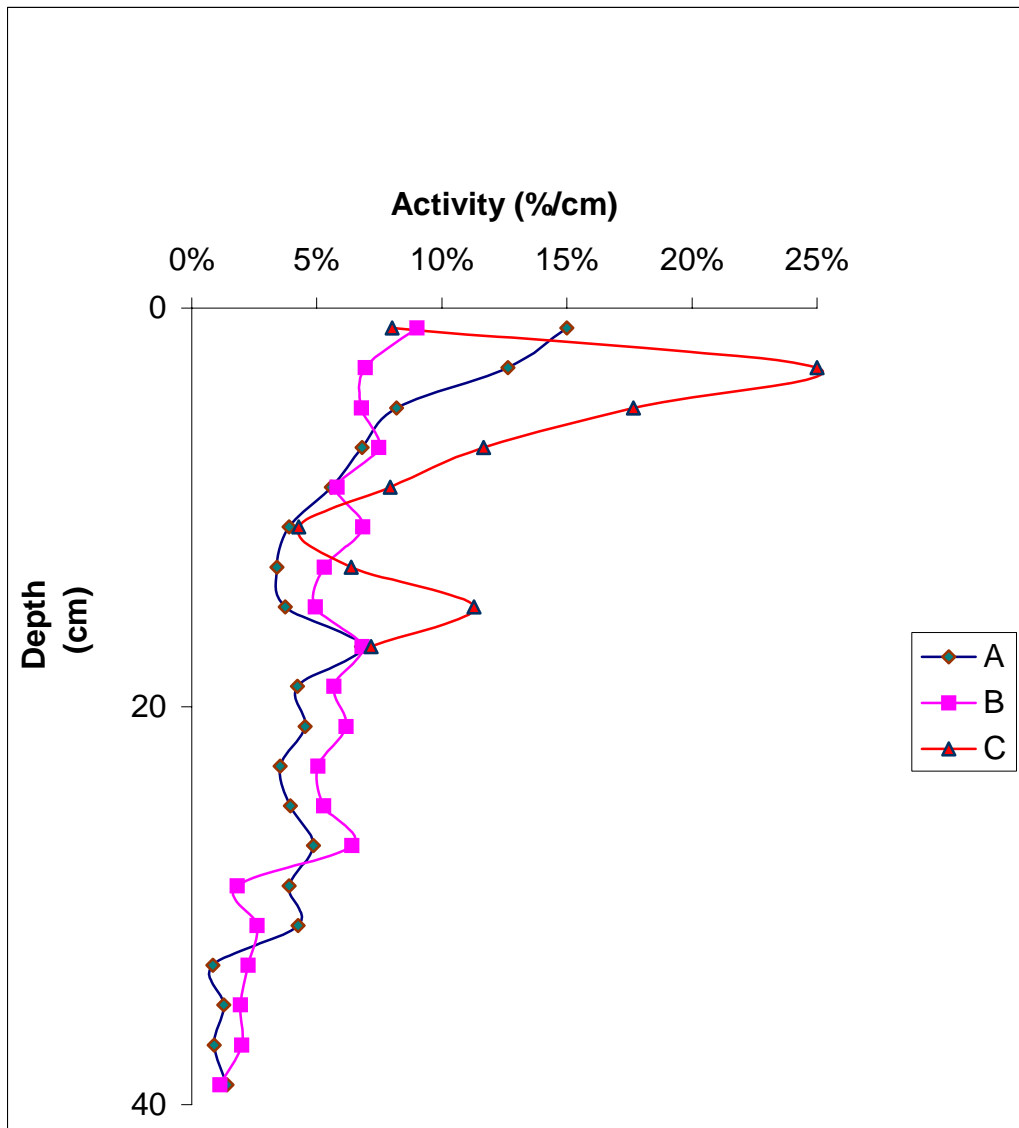

Figure 17. ^{137}Cs activity percentage per section in Open bog (A), Low pine (B) and Forest soils (C).

As mentioned above, two main peat layers are found in a bog (Fig. 8): an upper layer containing living material (0-5cm) and a layer beneath containing dead and decomposing material. The fact that living material was found in the upper 5 cm suggests that most of the ^{137}Cs was retained in the living part of the Sphagnum, even many years after the fallout. This suggestion makes sense since Sphagnum species have the following characteristics:

- They have a layer of dead *hyaline* cells, which serves to retain water, in amounts up to 20 times their dry weight of water.

- The branches of Sphagnum are *pendulous*, which means that they act like wicks, which soak water upwards.

4.1.2 Comparison with earlier investigations

In 1989, the same sites were investigated by Johansson. In the present report the migration rate has been calculated based on the data collected by him. In 1989, the migration centre in the open bog was at 5 cm depth and the migration rate was 1.67 cm yr^{-1} , whereas the current results from 2005 show a migration centre of 13.42 cm and that the migration rate had decreased to 0.7 cm yr^{-1} .

These findings are in accordance with those of other workers, who have shown that, the initial migration rate is rather fast immediately after a fallout event, but that the rate then decreases (Kirchner & Baumgartner, 1992; Rosén et al. 1999). Previous data from the Harbo forest were published by Fawaris & Johansson, (1995), who demonstrated that more than 85% of the total ^{137}Cs activity ($27 \pm 8.5 \text{ kBq m}^{-2}$) was confined to the upper 5 cm. In our study, 10 years later (2005), this percentage had decreased to 50 % of 18 kBq m^{-2} .

The results above show a greater loss of ^{137}Cs activity from the peat area than from the forest area. This result agrees well with the assumption that peat bogs constitute the main source of loss of ^{137}Cs from catchments in the boreal zone, at least over a five year period after deposition- (Nylen & Grip 1989; Bergman et al. 1991).

In order to compare the percentage of ^{137}Cs per section in Johanson's data set from 1989 and in the current one, new graphs (Fig. 18 & 19) were constructed. A clear difference in vertical distribution of the ^{137}Cs activity between the years was observed. Figure 18 shows the ^{137}Cs distribution 3 years after the fallout. In 1989, nearly 90% of the total ^{137}Cs activity was found within the upper 10 cm. At the bottom of the profile, only 1% of the total ^{137}Cs activity was found. The ^{137}Cs distribution 19 years after the fallout shows that 74 % of the ^{137}Cs activity was found within the upper 10 cm, and a corresponding increase of ^{137}Cs activity was found in deeper layers.

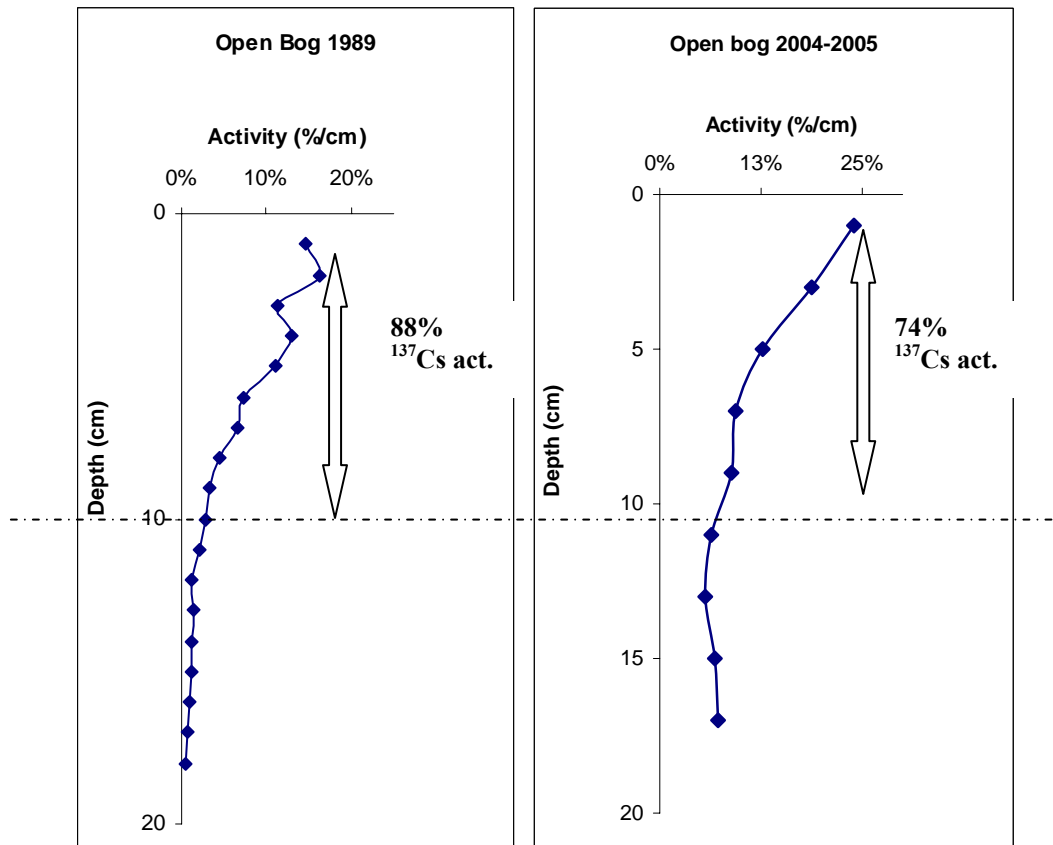

Figure 18. Percentage of ^{137}Cs activity per cm in 1989.

Figure 19. Percentage of ^{137}Cs activity per cm in the years 2004-2005.

4.2 Uptake and transfer of ^{137}Cs from soil-to-plant

Different plant species have specific ^{137}Cs uptake characteristics and this phenomenon has been extensively studied (Rosén, 1991). The ^{137}Cs activity concentrations in plants which grow in the study area are presented in Tables 6, 7 and 8 in the appendix. The range was from $418 \text{ Bq kg}^{-1} \text{ d.w.}$ (crowberry in forest) to $19\,878 \text{ Bq kg}^{-1} \text{ d.w.}$ (heather in open bog). Our data are in good agreement with previous studies (Fawaris & Johanson, 1995; Vinichuk et al. 2004), which showed a high ^{137}Cs activity concentration in heather and in some other ericoid plants and lower values for most other plants. Heather has an ericoid mycorrhiza which may explain the very high ^{137}Cs levels.

Differences in ^{137}Cs activity concentrations found in mushrooms growing at different locations were probably due to different species of mushrooms being collected. According to many previous studies (Fawaris & Johanson, 1995; McGee et al. 2000; Vinichuk et al. et al. 2004) mushrooms generally have very high ^{137}Cs activity concentrations.

The activity concentration of ^{137}Cs found in plants collected on the raised bog seems to be much higher than in plants collected in the forest close to the raised bog (Johanson, 1994; Fawaris and Johanson, 1994; Mc Gee et al., 2000). This may be explained as follows:

- Sphagnum is known to release acidic compounds, which make the ^{137}Cs more water soluble, i.e. there is an increase in the ^{137}Cs bioavailability.
- Radioactive nuclides often migrate with percolating water, which increases the plant availability (JHP, 2005).

The ^{137}Cs activity concentration of heather was thus 20 000 Bq kg⁻¹ at the open bog site, about 12 000 Bq kg⁻¹ at the low pine site and 5 000 Bq kg⁻¹ at the forest site. The reasons for these differences in ^{137}Cs activity concentration are probably rather complicated but the nutrient status seems to be an important factor.

4.2.1 Comparison with previous investigations

From 1989 to 2005 heather had decreased its ^{137}Cs activity concentration by about 50%. In 1989, heather had a value of 44 000 Bq kg⁻¹ at the open bog site and in the current study (2005) the ^{137}Cs activity concentration was 23 000 Bq kg⁻¹. At the low pine site the value was 22 000 Bq kg⁻¹ in 1989 and had decreased to 12 000 Bq kg⁻¹ in 2005. Sundew had decreased even more, in 1989, the ^{137}Cs activity concentration at the open bog was 24 800 Bq kg⁻¹ and in 2005 it had decreased to 4 000 Bq kg⁻¹. Sundew is a very small plant with roots in the upper cm of the peat which may explain the high activity in the first years after the fallout. In 1989, Sphagnum mosses in the open bog had a ^{137}Cs activity concentration of 10 000 Bq kg⁻¹ and in 2005 the value was 1 300 Bq kg⁻¹.

At the low pine site, Scots pine had decreased its ^{137}Cs activity concentration by about 4 times from 1989 to 2005 (from 3 000 Bq kg⁻¹ to 750 Bq kg⁻¹) and heather had decreased its activity concentration during the same period from 22 000 Bq kg⁻¹ to 12 000 Bq kg⁻¹.

In the forest, data were collected during 1986-1989 (Fawaris & Johanson, 1994). Concerning blueberry and lingonberry, the following activity concentrations were measured (Table 7).

Table 7. ^{137}Cs activity concentration (Bq kg⁻¹d.w.) in plants various years after the fallout at the forest site

	1986-1989	1989	2004-2005
Blueberry	4662	1577	587
Lingonberry	7960	1570	861

The transfer factors calculated from our data collected in 2005 compared with data from (1986-1989) presented by Fawaris & Johanson, (1994) showed a decrease in transfer factor with time. This is in good agreement with Krouglov et al. (1998) who suggested that ^{137}Cs became less and less plant available with the time after a deposition.

Table 8. Transfer factors for some dominating plants in the forest

	1986-1989	2004-2005
Heather	0,46	0,28
Blueberry	0,18	0,03

^{137}Cs activity concentrations in plants for each location in the study area and for different years were calculated and the results are shown in the Table A10 and A11 in the appendix.

5 Conclusions [^]

A raised bog is characterized by a slow decomposition rate and subsequent accumulation of organic matter in which the bioavailability of ^{137}Cs tends to be relatively high. A raised bog is a very nutrient poor ecosystem since it is fed almost entirely by rainfall. Therefore all the plants that the bog supports assimilate compounds and elements that come with the rain. In this study it was found that

- ^{137}Cs migrated faster in the raised bog than in the forest. The migration rate was 0.70 cm y^{-1} at the open bog site, 0.81 cm y^{-1} at the low pine site and 0.39 cm y^{-1} at the forest site close to the bog. About 35% of the ^{137}Cs activity in the peat profile was found in the upper 5 cm at the open bog site. The corresponding percentage at the low pine site was 20% and at the forest site 50%.
- At the open bog site heather was the plant species which accumulated the highest ^{137}Cs activity and also had the highest transfer factor. The activity concentration was $20000 \text{ Bq kg}^{-1} \text{ d.w.}$ and the transfer factor was $0.68 \text{ m}^2 \text{ kg}^{-1}$. The corresponding values at the low pine site were $12\ 000 \text{ Bq kg}^{-1}$ and $0.41 \text{ m}^2 \text{ kg}^{-1}$, and at the forest site $5\ 000 \text{ Bq kg}^{-1}$ and $0.28 \text{ m}^2 \text{ kg}^{-1}$.
- In 1989, the ^{137}Cs activity concentration in heather which was growing at the open bog site was $49\ 000 \text{ Bq kg}^{-1}$, $22\ 000 \text{ Bq kg}^{-1}$ at the low pine site, and $12\ 000 \text{ Bq kg}^{-1}$ at the forest site.
- The raised bog seemed to be the ecosystem that transferred the highest ^{137}Cs activity from soil to plant.

Acknowledgements [^]

I wish to express my most sincere gratitude to all persons who helped me during my work and particularly to:

My supervisors: Dr. Klas Rosén, the person who gave me the opportunity to work in this project. For his guidance and friendship. Professor Karl J. Johanson, my deepest gratitude to him. His support, his critical review, his tremendous help made the writing of this project possible.

Dolores Curt, my supervisor in Spain, for her help from the distance.

Tord Johnsson and Johanna, for their help collecting samples and especially to Johanna, who always make a friendly atmosphere.

Staff from department of Radioecology and Soil Science for all the help I received, especially to Gerd Johansson and Anne Olsson.

Stina Lena-Hellgren, my friend and the person who made possible my studies here.

My helpful friends here in Sweden: Susana, Iria, Ali, Cris, Dani...who always help me and all these persons who support me in the distance: Pablo, Marta and Isra.

My mother, Pilar Galán, for her continuous encouragement.

References

- Arapis, G., Petrayev, E., Shagalova, E., Zhukova, O., Sokolik, G & Ivanova, T. 1997. Effective Migration of ^{137}Cs and ^{90}Sr as a function of the type of soils in Belarus. *Journal Environmental Radioactivity*, 34, 171,185.
- Bergman, R., Nylén, T., Palo, T. & Lindström, K. 1991. The behaviour of radioactive Caesium in a boreal ecosystem. FOA report C 40066-4,3, October 1991.
- Brückmann, A. & Wolgters, V. 1994. Microbial immobilisation and recycling of ^{137}Cs in the organic layers of forest ecosystems: relationship to environmental conditions, humification and invertebrate activity. *The Science of the Total Environment*. 157, 249-256.
- Coughtrey, P.J. & Thorne, M.C. 1983. Radionuclide Distribution and Transport in Terrestrial and Aquatic Ecosystems. Volume 1. A.A. Balkema, Rotterdam, 496p.
- Coughtrey, P.J., Kirton, J.A. & Mitchell, N.G. 1989. Environmental distribution of radionuclides in West Cumbria following the Windscale and Chernobyl accidents. In: Environmental Impact of Radionuclides Released during Three Major Nuclear Accidents: Kyshtym, Windscale, Chernobyl. EUR-13574.
- Dahlgaard, H. (Ed) 1994: The transfer of radionuclides through Nordic ecosystems to Man. Elsevier Science publishers. Amsterdam. p 9.
- Egorov, N.N., Novikov, V.M., Parker, F.L. & Popov, V.K. 2000. The radiation legacy of the Soviet Nuclear Complex" Editors. IIASA-EARTHSCAN, London: Earthscan Publications Ltd. 2000, 236 pp.
- Fawaris, B.H. & Johanson, K.J. 1994. Radiocaesium in soil and plants in a forest in central Sweden. *The Science of the Total Environment*. 154, 133-138.
- Fawaris, B.H. & Johanson, K.J. 1995. Fractionation of caesium (^{137}Cs) in coniferous forest soil in central Sweden. *Science of the Total Environment* 170:221-228.
- Forsberg, S. 2000. Behaviour of ^{137}Cs and ^{90}Sr in agricultural soils: influence of ageing and soil type on availability, migration and plant uptake. Sveriges Lantbruksuniversitet. Uppsala. Acta Universitatis Agriculturae Sueciae. Agraria 212.
- IAEA, 1991. International Chernobyl Project. Technical Report. Assessment of radiological consequences and evaluation of protective measures. Report by International Advisory Committee. IAEA. Austria. Vienna.
- Johanson, K.J. 1994. Radiocaesium in game animals in the Nordic countries. In: Nordic radioecology. The transfer of radionuclides through Nordic Ecosystems to man. Ed. H. Dahlgaard. Elsevier Science Publishers. 62, pp 287-301. Amsterdam.
- Kirchner, G., & Boumgartner, D. (1992). Migration rates of radionuclides deposited after the Chernobyl accident in various north German soils. *Analyst*, 117, 475-479.
- Krouglov et al., 1998. Chemical fraction of ^{90}Sr , ^{106}Ru , ^{137}Cs and ^{144}Ca in Chernobyl-contaminated soils: an evolution in the course of time. *Journal of Environmental Radioactivity*. 47
- Lederer, M., Hollander, J.M. & Perlmann, I. 1967. Table of isotopes. Wiley and Sons. New York.

- Linkov, I & Schell, W.R. 1999. Contaminated forest: Recent development in risk identification and future perspective. Amsterdam, Kluwer pp430.
- McGee, E.J., Synnott, H.J., Johanson, K.J., Fawaris, B.H., Nielsen, S.P., Horrill, A.D., Kennedy, V.H., Barbayiannis, N., Veresoglou, D.S., Dawson, D.E., Colgan, P.A. & McGarry, A.T. 2000. Chernobyl fallout in a Swedish spruce forest ecosystem. *Journal of Environmental Radioactivity*. 48 (1):59-78.
- Melin, J. & Wallberg, L. 1991. Distribution and retention of Cesium in Swedish boreal forest ecosystems. In: The Chernobyl fallout in Sweden. Ed: L. Moberg. The Swedish Radiation Protection Institute. pp. 467-489.
- Nykolova, I., Johanson, K.J. & Clegg, S. 2000. The accumulation of ^{137}Cs in the biological compartments of forest soils. *Journal of Environmental Radioactivity*. 47, 319-326.
- Nylen, T & Ericsson, A. 1989. Uptake and retention of ^{137}Cs in Scots Pine. The radioecology of natural and artificial radionuclides. Congress 10-14 September, 1989. Ed: W.Feldt. pp 227-231.
- Nylen, T & Grip, H. 1989. Transport of cesium-137 in a forest catchment. In the radioecology of natural and artificial radionuclides. Ed: W.Feldt. pp 221-226.
- Nylén, T. 1996. Uptake, turnover and transport of radiocaesium in boreal forest ecosystems. Dissertation, 1996. Swedish University of Agricultural Science. Umeå.
- ORTEC, 1986. EG&G. Solid- State Photon Detector. Operators Manual.
- Persson, C., Rodhe, H. & De-Geer, L.E. 1987. The Chernobyl accident, a meteorological analysis of how radionuclides reached and where deposited in Sweden. *Ambio*. 16:20-31.
- Rafferty, B., Dawson, D. & Kliashtorin, A. 1997. Decomposition in two pine forest: the mobilization of ^{137}Cs and K from forestlitter. *Soil biology chemistry Biochemistry*. 29 (11/12), 1673-1681.
- Riise, G., Björnstad, H.E., Lien, H.N., Oughton, D.H. & Salbu, B. 1990. A study of radionuclide association with soil components using a sequential extraction procedure. *J. Radioanal. Nucl. Chem*. 142, 531-538.
- Rigol A., Roig, M., Vidal, M & Rauret, G. 1999. Sequential extraction for the study of radiocesium and radiostrontium dynamics in mineral and organic soils from western Europe and Chernobyl areas. *Environmental Science and Technology*, 33, 887-895.
- Rosén, K. 1991. Effects of potassium fertilization on caesium transfer to grass, barley and vegetables after Chernobyl. The Chernobyl fallout in Sweden. Results from a research programme on environmental radiology (Ed. L. Moberg). The Swedish Radiation Protection Institute, Stockholm, 305-322.
- Rosén, K. 1996. Field studies on the behaviour of radiocaesium in agricultural environments after the Chernobyl accident. Ph D Thesis. Report SLU-REK-78, Department of Radioecology, Swedish university of agricultural Sciences, Uppsala.
- Rosén, K., Öborn, I. & Lönsjö, H. 1999. Migration of radiocaesium in Swedish soil profiles after the Chernobyl accident, 1987-1995. *Journal of Environmental Radioactivity*. 46(1):45-66.
- Vinichuk M.M., Johanson K.J., Taylor, A. 2004. ^{137}Cs in the fungal compartments of Swedish forest soils. *Science of the Total Environment*. 323, 243-251.
- Whicker W.F. & Schultz V. 1982. Radioecology: *Nuclear energy and the Environment*. Volume 1. CRC, Press. Boca raton, Florida. 212pp.

Wirth, E., Hiersch, L., Kammerer, G., Krajewska, G. & Krestel, R. 1994. Transfer equations for ^{137}Cs for coniferous forest understorey plant species. *The Science of the Total Environment*. 157, 163-207.

Schimmach, W., Bunze, K. & Sellen, E. 1989. Initial rates of migration of radionuclides from the Chernobyl fallout in undisturbed soils. *Geoderma*, 44, 211-218.

Stricht E. & Kirchmann, R. 2001. Radioecology: Radioactivity & Ecosystems. Fortemps, Liège, Belgium. 602pp.

Internet references:

JHP, 2005. Wormwood Forest: A natural History of Chernobyl. pp51-52. The national Academies Press: <http://www.nap.edu/openbook/0309094305/html/51.html>

Kyshtym accident: http://www.kiaa.ru/gis_radleg/kyshtym.htm

Irish Peatland Conservation Council. 1996: <http://www.ipcc.ie/>

RADNET: <http://www.davistownmuseum.org/cbm/Rad01a.html>

HUMUS PROJECT : <http://www.progettohumus.it/enindex.php>

U.S. Environmental Protection Agency: www.epa.gov

Appendix

Table A1. ^{137}Cs activity (\pm SD) and cumulative distribution by depth, Open bog

	^{137}Cs Activity Bq m⁻²	^{137}Cs cumulative values Bq m⁻²	%
0-2	3672 (1463)	3 672	16%
2-4	3025 (1208)	6 697	30%
4-6	1959 (355)	8 656	38%
6-8	1626 (1182)	10 282	46%
8-10	1336 (527)	11 618	51%
10-12	931 (336)	12 549	56%
12-14	812 (77)	13 361	59%
14-16	893 (507)	14 254	63%
16-18	1623 (1129)	15 877	70%
18-20	1013 (60)	16 890	75%
20-22	1083 (142)	17 973	80%
22-24	848 (55)	18 821	83%
24-26	627 (554)	19 448	86%
26-28	776 (674)	20 224	90%
28-30	622 (624)	20 846	92%
30-32	678 (795)	21 524	95%
32-34	201 (116)	21 725	96%
34-36	309 (178)	22 034	98%
36-38	212 (123)	22 246	99%
38-40	337 (195)	22 583	
	22 583 (1426)		

Table A2. Water content (% of fresh weight) and dry bulk density of samples, Open bog

Depth (cm)	Water content %	Bulk density g/cm³
0-2	93%	0.06
2-4	92%	0.06
4-6	93%	0.05
6-8	93%	0.06
8-10	92%	0.07
10-12	93%	0.05
12-14	91%	0.07
14-16	92%	0.07
16-18	91%	0.07
18-20	90%	0.09
20-22	88%	0.12
22-24	91%	0.09

Table A3. ^{137}Cs activity ($\pm\text{SD}$) and cumulative distribution by depth, Low pine

	^{137}Cs Activity Bq m⁻²	^{137}Cs cumulative values Bq m⁻²	%
0-2	2619 (1037)	2 619	9
2-4	2056 (535)	4 675	16
4-6	2011 (182)	6 686	23
6-8	2216 (775)	8 903	30
8-10	1725 (216)	10 627	36
10-12	2028 (1374)	12 656	43
12-14	1569 (871)	14 224	48
14-16	1464 (1538)	15 688	53
16-18	2016 (1084)	17 704	60
18-20	1687 (1200)	19 391	65
20-22	1827 (1134)	21 218	72
22-24	1496 (1366)	22 714	77
24-26	1564 (1309)	24 279	82
26-28	1895 (1468)	26 174	88
28-30	538 (113)	26 712	90
30-32	777 (418)	27 489	93
32-34	665 (656)	28 154	95
34-36	576 (378)	28 730	97
36-38	590 (534)	29 320	99
38-40	337 (0)	29 658	
	29 657 (583)		

Table A4. Water content (% of fresh weight) and dry bulk density, Low pine

Depth (cm)	Water content %	Bulk density g/cm³
0-2	89%	0.11
2-4	95%	0.04
4-6	94%	0.05
6-8	96%	0.04
8-10	93%	0.05
10-12	93%	0.03
12-14	91%	0.06
14-16	92%	0.06
16-18	92%	0.06
18-20	91%	0.07
20-22	92%	0.04
22-24	95%	0.04
24-26	95%	0.05
26-28	95%	0.03

Table A5. ¹³⁷Cs activity (±SD) and cumulative distribution by depth in Forest

Depth cm	¹³⁷ Cs Activity Bqm ⁻²	¹³⁷ Cs cumulative Bq m ⁻²	%
0-2	1 452	1 452	8%
2-4	4 579	6 031	34%
4-6	3 168	9 199	51%
6-8	2 092	11 291	63%
8-10	1 423	12 714	71%
10-12	768	13 482	75%
12-14	1 143	14 625	82%
14-16	2 025	16 650	93%
16-18	1 286	17 936	100%
Σ	17 936		

Table A6. ¹³⁷Cs activity concentration (Bq/kg d.w.) in plants, Open bog. Blanks denote not sampled

	Autumn 2004	Spring 2005	Summer 2005	Autumn 2005	Mean
<i>Andrómeda t.</i>		964	1 579	2 197	1 580
<i>Calluna v.</i>	22 139		14 065	23 432	19 878
<i>Carex r.</i>			2 906		2 906
<i>Drosera r.</i>			4 283		4 283
<i>Empetrum n.</i>			6 041	780	3 410
<i>Eriophorum v.</i>	4 144	779	2 829	3 748	2 875
<i>Menyanthes t.</i>			1 890	2 258	2 074
<i>Vaccinium o.</i>		2 156	3 154	3 486	2 932
<i>Pinus s.</i>	1 014	4 420 ^b	1 790		2 408

^bShoots

Table A7. ¹³⁷Cs activity conc. (Bq/kg d.w.) in plants, Low pine. Blanks denote not sample

	Autumn 2004	Spring 2005	Summer 2005	Autumn 2005	Mean
<i>Calluna v.</i>	9 544	14 289		13 071 ^a	12 301
<i>Empetrum n.</i>		900		1 284	1 092
<i>Eriophorum v.</i>	1 044		3 472	1 784	2 100
<i>Ledum p.</i>	4 457		3 908	3 090	3 818
<i>Mushroom</i>	255 117		41 245	44 018	113 460
<i>Pinus s.</i>	595		955	703	751
<i>Rubus ch.</i>			6 017		6 017
<i>Sphagnum spp.</i>	2 497			1 208	1 852
<i>Vaccinium m.</i>				850 (3 573 ^b)	850

^aFlowering ^bShoots

Table A8. ¹³⁷Cs activity concentration (Bq/kg d.w.) in plants, Forest. Blanks denote not sampled

	Autumn 2004	Spring 2005	Summer 2005	Autumn 2005	Mean
<i>Calluna v.</i>	3618		6423	4954 ^a	5000
<i>Empetrum n.</i>				418	418
<i>Mushrooms</i>				22077	22077
<i>Vaccinium m.</i>				587	587
<i>Vaccinium v.</i>	1200			861 (153 ^c)	1030

^aFlowering ^cFruit

Table A9. Transfer factors at the different sites

	TFg m ² /kg d.w.		
	Open bog	Low Pine	Forest
<i>Andromeda p</i>	0,07		
<i>Calluna v.</i>	0,68	0,41	0,28
<i>Carex r.</i>	0,13		
<i>Drosera r.</i>	0,19		
<i>Empetrum n.</i>	0,15	0,04	0,02
<i>Eriophorum v.</i>	0,13	0,07	
<i>Menyanthes t.</i>	0,09		
<i>Vaccinium o.</i>	0,13		
<i>Pinus s.</i>	0,08	0,03	
<i>Rubus ch.</i>		0,20	
<i>Vaccinium m.</i>		0,03	0,03
<i>Ledum p.</i>		0,13	
Mushroom		3,83	1,23

Table A10. ¹³⁷Cs activity concentration (Bq/kg d.w.) in plants, 3 and 19 years after fallout

		1989-1993	2004-2005
Open bog	<i>Calluna v.</i>	44 231	23 432
	<i>Rubus ch.</i>	9 262	4 055
	<i>Pinus s.</i>	2 075	1 790
	<i>Drosera r.</i>	24 865	4 283
	<i>Sphagnum spp.</i>	10 033	1 327
	<i>Menyanthes t</i>	2 950	1 890
	<i>Andromeda p.</i>	5 524	1 579
Low pine	<i>Ledum p.</i>	8 809	3 818
	<i>Empetrum n.</i>	5 718	1 092
	<i>Vaccinium o.</i>	2 946	2 118
	<i>Rubus ch.</i>	5 345	6 017
	<i>Pinus s.</i>	2 993	751
	<i>Calluna v.</i>	22 313	12 301

Table A11. ^{137}Cs activity concentration (Bq/kg d.w.) in plants, 3, 7 and 19 years after fallout

		1986-1989**	1989-1993*	2004-2005
Forest	<i>Pinus s.</i>	3 500		
	<i>Vaccinium m.</i>	4 662	1 577	587
	<i>Vaccinium vitis-i.</i>	7 960	1 570	861
	<i>Calluna v.</i>	12 269	12 256	6 423

* Samples collected by Johanson 1994 in the study area

** Samples extracted from the old data bank of the Department of Radioecology, Fawaris & Johanson , 1995.