

**Influence of fungi on N and C dynamics  
during organic matter decomposition  
in boreal forests**

Preetisri Baskaran  
*Faculty of Forest Sciences*  
*Department of Ecology*

Doctoral Thesis  
Swedish University of Agricultural Sciences  
Uppsala 2017

Acta Universitatis Agriculturae Sueciae

2017:61

ISSN 1652-6880  
ISBN (print version) 978-91-7760-012-1  
ISBN (electronic version) 978-91-7760-013-8  
© 2017 Preetisri Baskaran, Uppsala  
Print: SLU Service/Repro, Uppsala 2017

Cover: Illustration of the N and C processes in the boreal forest ecosystem

(Design: Max Hantke)

# Influence of fungi on N and C dynamics during organic matter decomposition in boreal forests

## Abstract

Soils in terrestrial ecosystems store more carbon (C) than plants and the atmosphere combined, and ecosystems' C dynamics are strongly dependent of nitrogen (N) availability. Moreover, plant production in boreal ecosystems is often limited by low N availability, and N retention in soils is a major constraint on N recirculation to plants. Soil fungi strongly influence C and N interactions in boreal ecosystems. However, a better knowledge of their role in the C and N interactions and balances is required. In this work we address this question with modelling and experimental approaches and explore impacts of fungi on C and N balances during soil organic matter decomposition in boreal ecosystems. We developed a biogeochemical model of C and N flows between plants, soil organic matter (SOM), saprotrophs, ectomycorrhizal (ECM) fungi, and inorganic N stores to predict the effects of ECM fungi decomposition on plant production and soil C sequestration. Model-based qualitative investigations on plant-mycorrhizal symbiosis were performed to improve our understanding of the mutualistic-parasitic continuum of ECM fungi's relationships with plants. Under controlled laboratory conditions microcosms were set up with saprotrophic fungi (*Gymnopus androsaceus* and *Chalara longipes*) to explore saprotrophic fungi's influence on soil N retention and changes in microbial carbon use efficiency (CUE) during decomposition. The model-based analysis indicated that under low-N conditions, increased ECM decomposition promotes plant growth but decreases soil C storage. Further, the model analysis indicated that the mutualistic-parasitic continuum between plant and the mycorrhiza depended on the rates of C allocation from the plant to ECM fungi. The experimental observation showed that both *G. androsaceus* and *C. longipes* incorporated N into the non-hydrolysable fraction, but with a relatively higher N incorporation in the latter. Overall, this thesis highlights that soil C storage in boreal forests is regulated by the relationship between plant and ECM fungi and this relationship depends on the partitioning of decomposition between saprotrophs and ECM fungi. This work shows that differences in decomposing strategies between two saprotrophic fungi play an important role in N retention during litter decomposition. In addition, we propose that better methods to evaluate CUE could improve predictions of C and N dynamics in ecosystem models. Taken together, I suggest that enhanced knowledge about the functional properties of soil fungi and incorporating different fungal traits into ecosystem models could significantly improve predictions of ecosystem responses to environmental changes.

Keywords: Boreal forest, ecosystem models, plant productivity, ECM fungi decomposition, N retention, CUE

Author's address: Preetisri Baskaran, SLU, Department of Ecology, Box 7044, 75007 Uppsala, Sweden.

# Dedication

To my Grandfather.



Picture by Shreya Soundar

*'Science never solves a problem without creating ten more' – George Bernard Shaw*

# Contents

<b>List of Publications</b>	<b>8</b>
<b>Abbreviations</b>	<b>10</b>
<b>1 Background</b>	<b>11</b>
1.1 The boreal forest ecosystem	11
1.2 N limitation in boreal forests	12
1.3 Soil layers	13
1.4 Soil fungi	14
1.4.1 Saprotrophs – the litter decomposers	14
1.4.2 Mycorrhizal fungi	16
1.5 Degradative enzymes and litter components	17
1.6 Nutrient dynamics in boreal forest ecosystems	19
1.7 Ecosystem models	22
1.8 Carbon use efficiency in ecosystem models	26
<b>2 Aim</b>	<b>28</b>
<b>3 Material and methods</b>	<b>30</b>
3.1 Modelling studies	30
3.1.1 Ectomycorrhizal symbiosis in ecosystem models	30
3.1.2 Transfer of Plant C to mycorrhizal fungi	33
3.1.3 Transfer of mycorrhizal N to plants	33
3.2 Experimental studies	34
3.2.1 Components in the litter decomposition experiment	34
3.2.2 N retention in organic matter (Paper III)	35
3.2.3 Effects of C and N addition on fungal CUE (Paper IV)	36
3.3 Chemical analysis	36
3.4 Calculations and statistical analysis	37
<b>4 Results and Discussion</b>	<b>39</b>
4.1 Influence of mycorrhizal symbiosis on plant nutrition (Papers I and II)	39
4.2 Influence of mycorrhizal symbiosis on soil C sequestration (Paper I)	44
4.3 N retention during saprotrophic litter decomposition (Paper III)	45
4.4 Carbon use efficiency (Paper IV)	49
4.5 Implications of experimental results for future model development	51

<b>5</b>	<b>Highlights</b>	<b>53</b>
<b>6</b>	<b>Conclusion</b>	<b>55</b>
<b>7</b>	<b>Challenges and future prospects</b>	<b>56</b>
7.1	Modelling	56
7.2	Experimental investigations	56
<b>8</b>	<b>References</b>	<b>58</b>
<b>9</b>	<b>Acknowledgements</b>	<b>69</b>
<b>10</b>	<b>Popular Science</b>	<b>71</b>

# List of Publications

This thesis is based on the work contained in the following papers, referred to by Roman numerals in the text:

- I Baskaran, P.**, Hyvönen, R., Berglund, L., Clemmensen, K.E., Ågren, G.I., Lindahl, B.D. and Manzoni, S. (2016). Modelling the influence of ectomycorrhizal decomposition on plant nutrition and soil carbon sequestration in boreal forest ecosystems. *New Phytologist*, 213:1452-1465.
  
- II Ågren, G.I., Hyvönen, R. and Baskaran, P.** Mycorrhiza, friend or foe? (manuscript)
  
- III Baskaran, P., Ekblad, A., Soucemarianadin, L., Hyvönen, R., Schleucher, J. and Lindahl, B.D.** N stabilisation during decomposition of boreal forest litter (manuscript).
  
- IV Baskaran, P., Ekblad, A., Lindahl, B.D. and Herrmann, A.** A reductionist approach to evaluate carbon use efficiency of a litter-decomposing fungus after glucose and nitrogen additions (manuscript).

Papers I is reproduced with the permission of the publisher.



The contribution of PB to the papers/manuscripts included in this thesis was as follows:

- I** Main author. Performed major part of the work. Participated substantially in planning, analysis, and writing in collaboration with co-authors RH, LB, KEC, GÅ, BDL and SM.
- II** Co-author. Developed ideas and hypothesis in collaboration with main author GÅ and co-author RH. GÅ performed major part of the work, analysis, and writing in collaboration RH and PB.
- III** Main author. Performed major part of the work. Participated substantially in planning and analysis with AE, LS, JS and BDL. Writing of the manuscript in collaboration with co-authors AE, LS, RH, JS, and BDL.
- IV** Main author. Developed ideas and hypothesis in collaboration with AH, AE and BDL. Planned and performed major part of the work, analysed the data, and wrote the manuscript in collaboration with AE, BDL and AH.

# Abbreviations

C	– Carbon
CUE	– Carbon use efficiency
ECM	– Ectomycorrhiza
N	– Nitrogen
NPP	– Net primary production
SOM	– Soil organic matter

# 1 Background

## 1.1 The boreal forest ecosystem

Boreal forests comprise one of the largest biomes on earth, covering large areas in countries including Sweden, Norway, Finland, Russia, the USA and most parts of Canada at latitudes between 50 and 65° degrees in the northern hemisphere. They cover ca. 11% of the earth's land surface and hold ca. 16% of the total carbon sequestered in soils (Bonan & Shugart, 1989). Northern forest ecosystems have been identified as global carbon (C) sinks, and forest soils contain more organic C than the plants (Schlesinger & Andrews, 2000). The vegetation is dominated by coniferous trees of genera including pine and spruce that produce lignified litter rich in polyphenolic substances (Aerts, 1995). The resulting combination of highly recalcitrant litter and cold climate retards decomposition processes in such ecosystems (Myneni et al., 2001). This can lead to accumulations of soil organic matter (SOM), with nutrients such as N being immobilized and locked up in the soil (Northup et al., 1995). The resulting accumulation of nutrients in organic soil pools restricts recirculation to plants, constraining ecosystem production by low nitrogen (N) availability (Tamm, 1991). Substantial information about these processes has been acquired, as summarized below. However, due to the importance of nutrient dynamics in the soils of such ecosystems, better understanding of the interactions between N and C during decomposition is highly desirable.



**Fig. 1-** Boreal forest in Sweden.

## 1.2 N limitation in boreal forests

Ecosystem production in northern forests is generally limited by low N availability. More specifically, N retention in SOM plays an important role in constraining net primary production (NPP) of the ecosystems (Wardle et al., 2004). The below-ground soil organic matter decomposition and the N cycle are associated with each other in a complex manner (Neff et al., 2002), with fungal mycelial dynamics and community composition regulating soil organic matter decomposition (Clemmensen et al., 2013; Clemmensen et al., 2015). Therefore, N availability strongly affects organic matter dynamics (Janssens et al., 2010) and it is essential to understand the mechanisms that drive N dynamics in forest SOM.

### 1.3 Soil layers

An important property of the typically podzolic boreal soils is vertical stratification into several distinct organic layers (or “horizons”). This is due to the harsh conditions (including low pH and temperatures) for soil animals such as earthworms, and consequently weak mixing of the soil profile. The topmost layer is the litter or L layer, which consists of recently shed litter together with mosses and partly decomposed litter. As decomposition progresses, the litter in this layer is transformed into a well decomposed layer of fragmented litter called the F layer, which is usually interwoven with a dense fungal mycelial network. The L- and F-layers can reach depths up to 5 cm and the mean ages of these layers are 3-10 years. The humus (H-) layer lies just below the F-layer, consists of organic matter with little to no traces of mineral particles, and is situated just above the mineral layers. The H-layer can reach depths of 20 cm and is approximately 16-45 years old (Lindahl et al., 2007). Below the H-layer are the eluviation (A), illuvial (B) and C horizons (mineral horizons). A and B are mineral soil horizons mixed with traces of humus and the C horizon mostly contains unweathered soil material (Ågren & Andersson, 2011). Thus, we would suggest that in boreal forest soils biochemical processes rather than physical processes represent the main bottleneck along the decomposition pathway. In this work we have focused on N and C processes of L-, F- and H- layers, since the biotic interactions between the organic matter and soil fungi are most likely to occur in these soil layers. Furthermore, for model simplicity, no mineral horizons were accounted for in our biogeochemical model.

## 1.4 Soil fungi

In boreal forests, soil fungi are major drivers of decomposition and nutrient cycling. The most important fungal phyla are diverse basidiomycetes and ascomycetes that play important roles as decomposers in biogeochemical transformations and interactions between the soil horizons.

### 1.4.1 Saprotrophs – the litter decomposers

The saprotrophic community of litter decomposers has been observed to be restricted to the upper litter layer (O'Brien et al., 2005; Lindahl et al., 2007). Before reaching the forest floor, the newly shed litter is colonized by endophytic fungi, such as *Lophodermium pinastri*, which is frequently found in pine litter. Once it reaches the forest floor, the endophytic community that resides in recently shed litter is outcompeted by basidiomycetes, which are commonly regarded as efficient colonizers of litter (Osono, 2007), and effective degraders of lignin through the production and secretion of a suite of oxidative enzymes. Basidiomycetes' nutrient foraging capacities are also boosted by the formation of long chords of rhizomorphic mycelia, which enable transport of nutrients and water over substantial distances between different soil horizons (Boddy, 1999; Lindahl & Olsson, 2004). *Gymnopus androsaceus* (also known as *Marasmius androsaceus*) is a common white-rot basidiomycete litter fungus, and commonly known as the 'horse hair fungus' due to its visible rhizomorphs.



**Fig. 2-**Sporocarps of *Gymnopus androsaceus* on the forest floor (photo: Karina Clemmensen)

In addition to basidiomycetes, needle litter in boreal forests is colonized by ascomycetes. In Scots pine needles, species of Leotiomyces primarily dominate the fungal ascomycete community (Lindahl *et al.*, 2007). Ascomycetes are generally known to have much lower degrading capacity than basidiomycetes, as they lack synthesizing lignin-degrading oxidative enzymes. However, they are reportedly more tolerant of environmental stresses, such as low nutrient availability, and harsh physical environments (Koukol *et al.*, 2004). Some ascomycetes also have dark pigments called melanins in their cell walls (Wheeler, 1983; Koukol *et al.*, 2004), which provide protection from harsh abiotic conditions and fungivores (Ekblad *et al.*, 2013), thereby prolonging mycelial persistence. The basidiomycete *Gymnopus androsaceus* and the ascomycete *Chalara longipes* have been used as study organisms in paper II and III, as the two fungal species are

common colonizer of litter in boreal forests and represent different functional strategies.

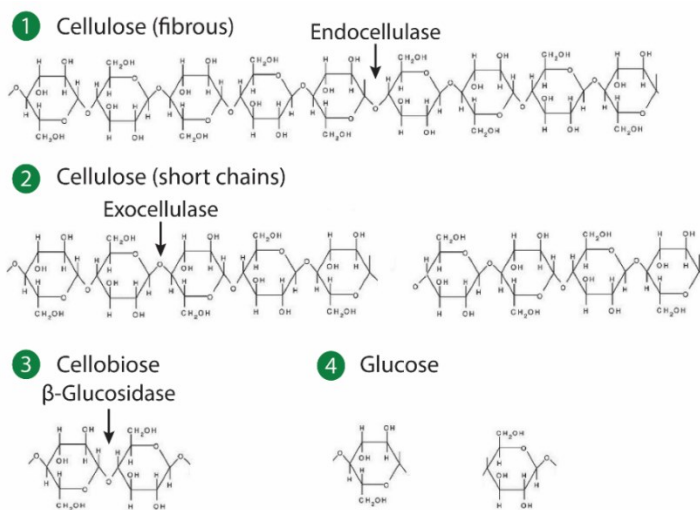
#### 1.4.2 Mycorrhizal fungi

Mycorrhizal fungi form symbiotic associations with higher plants through which they obtain photoassimilated C, and in return provide the plants with nutrients (Smith & Read, 2010). There are three types of mycorrhizal fungi: ectomycorrhizal and ericoid (which respectively form extracellular and intracellular connections with their host plants) and arbuscular (which penetrate cortical cells of roots and form specialized structures called arbuscules and vesicles). Many of the most abundant mycorrhizal fungi in mature or old boreal forest are ectomycorrhizal (ECM) fungi (Lindahl et al., 2007), which can produce the extracellular enzymes required to decompose complex organic matter, thereby mobilizing N (Bödeker et al., 2009). These extracellular enzymes mediate the decomposition of recalcitrant organic matter in boreal forests (Sinsabaugh, 2010) and it has been suggested that the presence of ECM fungi, which are basidiomycetes, could lead to reductions in SOM (Clemmensen et al., 2015). In contrast, the presence of ericoid mycorrhizal fungi may putatively result in SOM accumulation (Clemmensen et al., 2015). Important properties of the latter (stress-tolerant root-associated ascomycetes) include the ability to produce melanized cell walls and the lack of ligninolytic capacity (Lindahl & Clemmensen, 2016), both of which promote accumulation of organic matter and thus limit nutrient cycling in the ecosystem.



## 1.5 Degradative enzymes and litter components

The vegetation in boreal forests is mainly dominated by pine and spruce trees, which produce needle litter containing organic compounds rich in cellulose, hemicellulose and lignin. Overall, the litter contains high amounts of polyphenolic substances and low amounts of N (Aerts, 1995). The enzymatic activities of fungi in such ecosystems play major roles in the decomposition and chemical transformation of plant litter into humus (Berg & McLaugherty, 2008). During early stages of decomposition, labile litter components such as cellulose and hemicellulose are degraded, relatively quickly, primarily by hydrolytic enzymes (Baldrian & Valášková, 2008), such as  $\beta$ -glucosidases, cellobiohydrolases, endocellulases and xylanases. About 40% of the plant litter consists of cellulose (Berg & McLaugherty, 2008), which is formed from long chains of D-glucose and is decomposed into monomers and oligomers by fungal hydrolytic enzymes. Initially cellulose is transformed into cellobiose through reactions catalyzed by two kinds of hydrolytic enzymes, cellobiohydrolases and glucosidases, then cellobiose is further transformed into glucose by  $\beta$ -glucosidases. Hemicelluloses are linear or branched polymers containing several kinds of sugar units and constitute about 15% of the plant litter (Berg & McLaugherty, 2008). Xylanase enzymes degrade hemicellulose by randomly cleaving  $\beta$ -1, 4-glycosidic bonds.



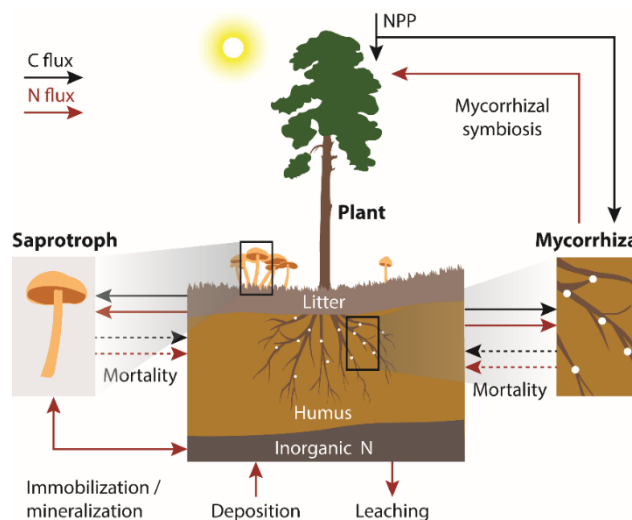
**Fig. 3-** Enzymatic steps involved in the breakdown of cellulose into glucose.

The second most abundant component of the plant litter after cellulose is lignin (Kögel-Knabner, 2002). Lignin is an aromatic polymer with a complex chemical structure consisting of phenolic rings, which are linked in C-C and ether bonds. It is a major component of so-called ‘Klason lignin’, the residual fraction following acid hydrolysis (Berg et al., 1982), although this non-hydrolysable fraction also contains tannins (Preston et al., 1997), and may include fungal remains such as chitin and melanin. Decomposition of lignin requires potent oxidative enzymes such as peroxidases, laccases and enzymes that generate hydrogen peroxide (Steffen et al., 2000; Valášková et al., 2007; Baldrian & Valášková, 2008; Sinsabaugh, 2010). These oxidative enzymes are mainly synthesized by litter-degrading basidiomycetes and some white rot wood decomposers (Courty et al., 2007). A large fraction of the cellulose in plant material is protected by lignin, suggesting that oxidative enzymes are required for efficient cellulose exploitation and extensive litter decomposition (Boddy & Jones, 2008; Boberg et al., 2010). Oxidative enzymes such as cellobiohydrogenases have high redox potential and degrade both cellulose and lignin simultaneously. Overall, the synthesis of

fungal extracellular enzymes requires large amounts of C and N resource and their production is believed to be tightly regulated to minimize the nutrient losses (Sinsabaugh, 2005)

## 1.6 Nutrient dynamics in boreal forest ecosystems

The interactions involved in the N and C cycles in boreal forest ecosystems can be generally summarized as follows. The C derived from plant photosynthesis is combined with N taken up by roots and allocated to roots, shoots, leaves and twigs, which are eventually shed as litter. The freshly fallen pine litter is degraded by saprotrophic fungi, which return most of the C to the atmosphere through respiration and immobilize some N, leaving the remaining C and N to be incorporated in complex humus compounds. The N may be subsequently mobilized by mycorrhizal fungi and transported to plants in exchange for C provided via the plant roots (Smith and Read 2010).



**Fig. 4-** Overview of the N and C dynamics in the boreal forest ecosystem (NPP, Net Primary Production).

Saprotrophs synthesizing hydrolytic enzymes compete successfully for resources in relatively fresh litter. However, due to the generally low N availability in conifer litter, the litter-feeding fungi may have problems meeting their N requirements (Parton *et al.*, 2007). Accordingly, adding external N can increase the N concentration in the needle litter, leading to higher litter decomposition rates (Boberg *et al.*, 2008). Moreover, the general idea that microbial growth is primarily constrained by the availability of simple sugars, is not applicable to boreal forest litter, although microbial growth increases respiration, because adding glucose does not necessarily increase fungal growth (Boberg *et al.*, 2008). Generally, microbial-mediated litter decomposition results in CO<sub>2</sub> loss through respiration, accompanied by mineralization of N (Parton *et al.*, 2007).

In boreal forests, saprotrophic fungi tend to be limited by N (Boberg *et al.*, 2014). C is often available in excess, and N is maintained in organic forms, either reallocated to growing mycelial biomass or accumulating as dead mycelium (Boberg *et al.*, 2014). During the decomposition process, the saprotrophs take up C and N, but only a fraction of the acquired C is incorporated in their biomass due to losses through respiration (Ågren & Bosatta, 1996). The rate of N uptake from SOM by the saprotrophs is proportional to the N:C ratio of the SOM and the assimilation rate of C. Excess N in SOM that the saprotrophs cannot take up (because the N:C ratio is above the threshold at which C limits uptake) will be mineralized and join the N pool in the soil. As CO<sub>2</sub> is respired and N is incorporated into the microbial biomass, saprotrophic litter decomposition leads to humus having a higher N:C ratio than fresh litter.

In boreal forests, plants are highly dependent on mycorrhizal fungi to acquire N from organic sources, due to the combined effects of N retention in fungal mycelium and retention of N stores in the humus (Read, 1991; Bending & Read, 1996; Näsholm *et al.*, 1998; Lindahl *et al.*, 2002). The plants' capacity

to assimilate organic N to a large extent depends on their association with mycorrhizal fungi. Further, it has been hypothesized that mycorrhizal fungi are primarily adapted to mobilize N, and therefore utilize SOM as a C source less efficiently than free-living saprotrophs (Lindahl & Tunlid, 2015). This view is supported by demonstrations, involving  $^{14}\text{C}$  dating, that the C in proteins of ectomycorrhizal sporocarps was young (Hobbie *et al.*, 2013). The cited authors suggested that structural carbohydrates were synthesized from recently assimilated C, indicating that the ECM fungi had a biotrophic strategy (acquiring C symbiotically from the associated plants) rather than a saprotrophic strategy. Moreover, in another field study using  $^{14}\text{C}$ -labelled leaf litter material in temperate deciduous forests, Treseder *et al.* (2006) found that ectomycorrhizal fungi did not assimilate C from litter. However, to what degree mycorrhizal C and N acquisitions from organic matter are coupled remains an open question.

C allocation to ECM fungi can be advantageous to plants, enabling development of a ‘mutualistic’ interaction, providing that the plants can acquire N from the fungi. However, above a certain limit, C costs may exceed the benefits for the plant, resulting in a ‘parasitic’ relationship (Colpaert *et al.*, 1996). An optimal level of C investment in ECM fungi that maximizes plant growth has been identified by monitoring C allocation to ECM fungi and its impact on plant growth (Pringle, 2016). Other relevant studies have shown that plants associated with ECM fungi may allocate 15–30 % of current photosynthate to their fungal symbionts (Leake *et al.*, 2001; Högberg *et al.*, 2008). Generally, plants appear to allocate more C to ECM fungi in N-limited forests, thereby extending a complementary nutrient acquisition pathway. Corrêa *et al.* (2012) suggested that C allocation to the ECM fungi occurs as a result of excess C production by the plants, and that plant growth may be constrained by N limitation rather than by C allocation to ECM fungi. In contrast, some other studies have suggested that despite a significant input

of C from trees to ECM fungi (Finlay & Söderström, 1992; Simard *et al.*, 1997), the trees remain N-limited due to high N retention by mycorrhizal fungi (Colpaert *et al.*, 1996, Näsholm *et al.*, 2013). However, this negative effect of ECM fungi on plant growth (if present) is likely to depend on the composition of the mycorrhizal fungal community. Clemmensen *et al.* (2015) found that the relative abundance of certain groups of ECM fungi species was negatively related to below-ground accumulation of C and N, but positively related to ecosystem productivity. This was probably linked to the ability of these fungi to decompose complex organic matter, returning a fraction of the mobilized N to their plant hosts. In contrast to the plant-ECM fungi symbiosis theory, some studies have also suggested that ECM fungi can live separately from their host plants and compete with saprotrophs to gain C from plant litter (Courty *et al.*, 2010).

The discrepancies in some of these suggestions show that we still have limited understanding of the temporal and spatial interactions between saprotrophic and mycorrhizal fungi involved in the recirculation of C and N from plant litter and SOM (Lindahl *et al.* 2007). In field settings, it is difficult to experimentally test the overall importance of these interactions, but modelling provides opportunities to explore the complex interactions and feedback mechanisms in idealized, theoretical systems, as described in the following section.

## 1.7 Ecosystem models

Process-based ecosystem models have varying degrees of uncertainty, which depend on how well they address critical ecosystem processes (Randerson *et al.*, 2009). Traditionally, it has been challenging to incorporate below-ground soil processes in large-scale models, hence there are ca. 40% variation in their predictions of global soil C stocks (Todd-Brown *et al.*, 2014), depending on the parameter settings. This level of uncertainty in ecosystem

models is a concern as soil stores more C than the atmosphere and vegetation. Thus, it is clearly important to identify ways to improve their accuracy. In order to achieve this, a better knowledge of below-ground nutrient dynamics is required.

Microbial ecology has received increasing attention in the recent development of ecosystem models (e.g. McGuire & Treseder, 2010; Treseder *et al.*, 2012; Todd-Brown *et al.*, 2014). Notably, some recently published models explicitly consider microbial mechanisms, describing decomposition as a product of microbial and extracellular enzyme activities (Schimel & Weintraub, 2003; Wieder *et al.*, 2013; Table 1). Not all models explicitly include these activities (Table 1), but recent large-scale models that include more microbial details provide better predictions of soil C dynamics (e.g. Allison *et al.*, 2010; Allison, 2012; Wieder *et al.*, 2013). Thus, incorporation of microbial activities seem to be important for further improvement of the models.

As already outlined, mycorrhizal symbiosis plays highly important roles in soil C and N sequestration and cycling. However, scarcity of data about allocation rates of C and N between the symbiotic partners severely hinders implementation of mycorrhizal interactions in models. Partly for this reason, very few models currently include them explicitly (Table 1). Moreover, in some models, mycorrhizal symbiosis is included explicitly by considering the C and N flows between plants and mycorrhizal fungi, accounting for mycorrhizal mobilization of organic N (Meyer *et al.*, 2010; Orwin *et al.*, 2011), while in others mycorrhizal N uptake is considered but not any explicit mycorrhizal stores (Kirschbaum & Paul, 2002).'

In addition, most models accounting for ECM fungi incorporate first order kinetics models of decomposition, but neglect the presence and activity of microbial biomass in the decomposition process. Thus, adding microbial biomass explicitly to account for decay kinetics on plant-ECM fungi

symbioses and their roles in C and N dynamics should significantly improve ecosystem models (Deckmyn *et al.*, 2014). Therefore, in the work underlying this thesis, a model was developed to explore ecosystem production and C sequestration, including ECM decomposition as a potential driver of both SOM decomposition and N mobilization.

Ecosystem models are essential for understanding the processes and controls involved in nutrient dynamics. Quantitative models are used to predict sizes of various ecosystem pools and estimate rates of nutrient transformations, while relatively simple qualitative models are used to explore the mechanistic processes and controls. Quantitative models of SOM and nutrient dynamics are attempts to describe soil processes rather than accurate mathematical expressions, whereas simulations of important ecosystem components are incorporated in qualitative models in attempts to elucidate links between them. In the work, we have attempted to develop both quantitative and qualitative models to improve understanding of the role and significance of mycorrhizal symbiosis in terrestrial ecosystem processes. The quantitative and qualitative models are described in the following chapters and, in more detail, in two appended papers, respectively designated Papers I and II.



Model	Decomposition rate kinetics	Litter/ SOM separation	Explicit microbial pool	Explicit mycorrhizal symbiosis	Nutrient elements	Reference
CENTURY	First order	Yes	No	No	N	(Parton, 1996)
Q- model	First order	No	No	No	N	(Agren & Bosatta, 1998)
Roth C	First order	Yes	No	No	-	(Jenkinson <i>et al.</i> , 1987)
MyScaN	Michaelis-Menten First order	Yes	Yes	Yes	N	(Orwin <i>et al.</i> , 2011)
MYCOFON	Michaelis-Menten First order	Yes	Yes	Yes	N	(Meyer <i>et al.</i> , 2010)
NCSOIL	First Order	Yes	No	No	N	(Molina <i>et al.</i> , 1983)
Soil food web model	Michaelis-Menten First order	Yes	Yes	Yes	N	(Hunt <i>et al.</i> , 1987)
Mycorrhizal symbiosis model		-	-	Yes	N	(Franklin <i>et al.</i> , 2012)
Modified CENTURY Model	First order	Yes	No	Yes (mycorrhizal N uptake)	N	(Kirschbaum & Paul, 2002)

**Table 1** – Summary of attributes of ecosystem models

## 1.8 Carbon use efficiency in ecosystem models

In organic matter decomposition, soil microorganisms partition C between biomass growth and respiration, and the ratio of amounts used in these processes is referred to as carbon use efficiency (CUE), usually defined as the proportion of total assimilated C that is allocated to growth (Manzoni *et al.*, 2012). CUE is an important microbial parameter for understanding soil C dynamics during organic matter decomposition, but it is often assumed to be a constant in terrestrial ecosystem models (Ågren & Bosatta, 1996; Parton *et al.*, 1987). Moreover, although CUE has known sensitivity to various environmental factors, including temperature and nutrient availability (Bradford & Crowther, 2013; Tucker *et al.*, 2013), greater understanding of the mechanisms involved is essential for improving soil organic carbon (SOC) projections in ecosystem models.

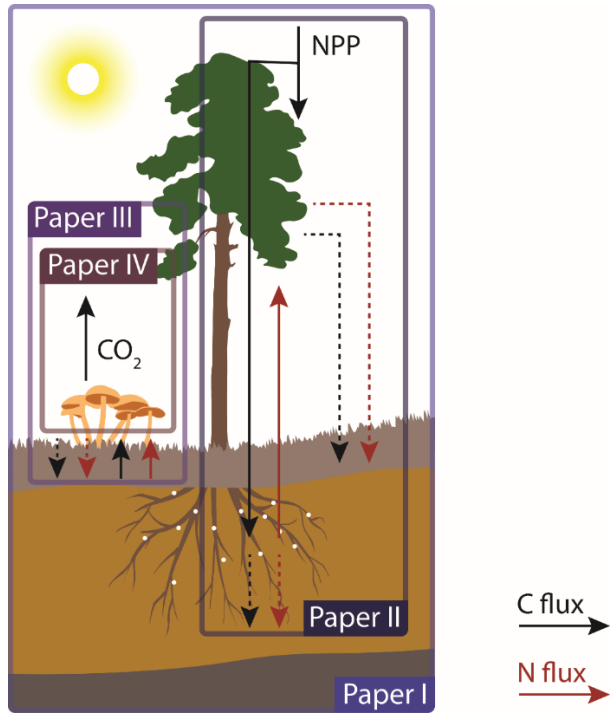
A traditional, biomass-based approach to evaluate CUE is to account for respiration and incorporation of C into microbial biomass (Herron *et al.*, 2009), often by monitoring isotopically labeled C in the microbial biomass and respired CO<sub>2</sub>. Recently, microbial energetics approaches, such as use of calorespirometric ratios, have been applied to evaluate microbial substrate use efficiencies in soil systems (Hansen *et al.*, 2004; Herrmann *et al.*, 2014). Calorespirometric ratios are calculated from metabolic heat releases (Q) in relation to CO<sub>2</sub> produced (mJ µg CO<sub>2</sub>- C). Isothermal calorimetry is used for determining these ratios, by measuring heat effluxes (Q) from substrate-induced samples to quantify the net balance of all catabolic and anabolic reactions, and provide complementary information to CO<sub>2</sub> production during microbial metabolism (Herrmann *et al.*, 2014).

When organic matter is decomposed, changes in calorespirometric ratio indicate variation in CUE (Hansen *et al.*, 2004). For example, a decrease in calorespirometric ratio may indicate an increase in CUE, as the reduction in heat dissipation per unit CO<sub>2</sub> reflects lower loss of energy from the system through decomposition (Herrmann & Bölscher, 2015; Barros *et al.*, 2016). The applicability of calorespirometric ratios has been tested (Barros *et al.*, 2016; Herrmann & Bölscher, 2015), but it has not yet been investigated in the context of pure organic matter systems where fungi explicitly act as decomposers. Thus, in the work underlying this thesis, we compared the traditional biomass-based and calorespirometric approaches to evaluate CUE.

## 2 Aim

The overall aim (as schematically illustrated in Figure 5) was to improve understanding of the interactions between N and C dynamics in the boreal forest ecosystem, particularly fungal control of nutrient dynamics. The key objectives were to:

- Improve mechanistic understanding of plant-ECM mycorrhizal symbiosis along a mutualistic–parasitic continuum (Papers I & II)
- Elucidate effects of the capacity of ECM fungi to decompose organic matter on plant growth and C sequestration (Paper I)
- Improve understanding of N retention in organic matter during litter decomposition in boreal forests (Paper III)
- Identify better proxies for the evaluation of microbial CUE (Paper IV)



**Fig. 5-** Schematic illustration of the processes addressed in the appended papers (NPP, Net Primary Production).

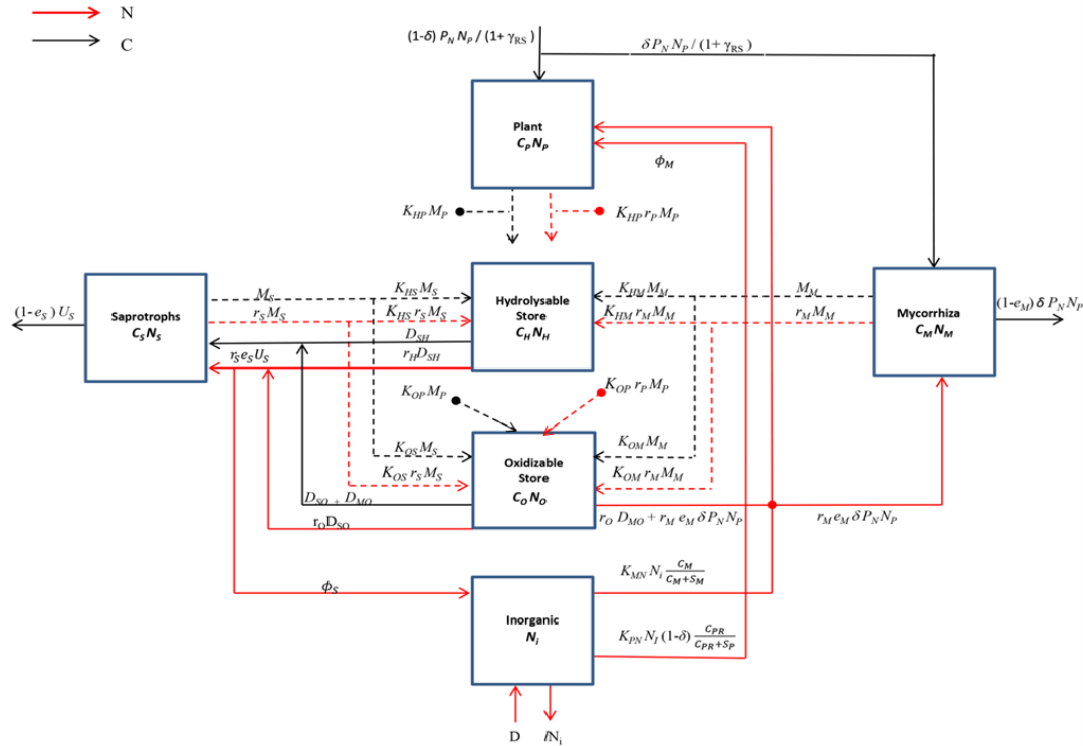
## 3 Material and methods

### 3.1 Modelling studies

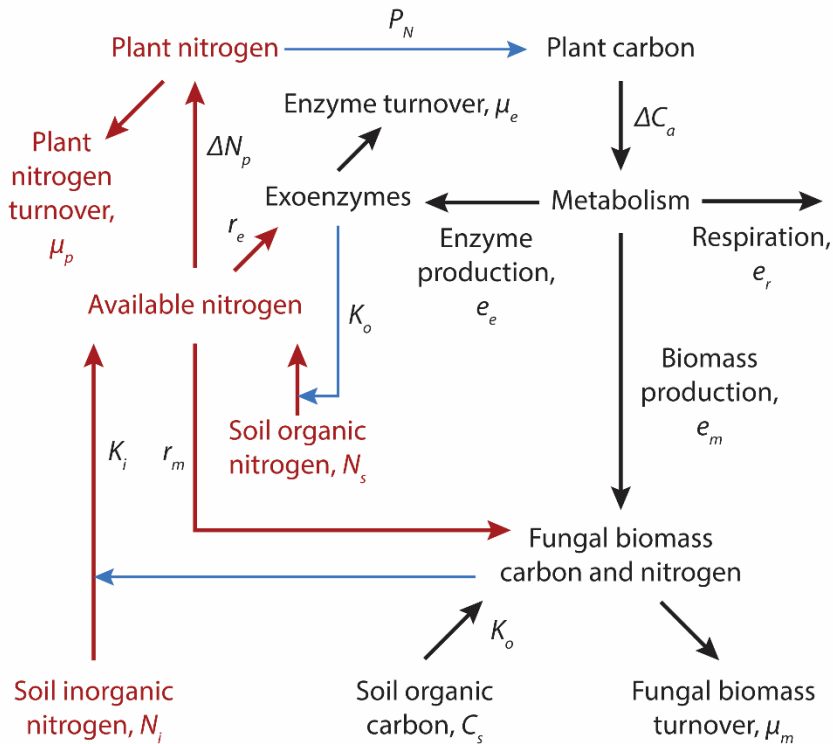
#### 3.1.1 Ectomycorrhizal symbiosis in ecosystem models

We developed ecosystem models to explore the mechanisms involved in the effects of mycorrhizal fungi on ecosystem C and N balances. In Paper I we formulated a model of N and C flows that includes the following stores: plant biomass; two SOM stores, hydrolysable soil organic matter ( $SOM_H$ ) and non-hydrolysable (hereafter oxidizable) soil organic matter ( $SOM_O$ ); two microbial stores, saprotrophs and ECM fungi; and the inorganic N store  $N_i$ . The differential equations used to describe these C and N stores and flows among them are illustrated in Fig. 6a (Baskaran *et al.*, 2016). The model simulates changes on an annual time scale, and the N and C stores represent yearly averages. To capture the long-term behavior of the ecosystem, we considered the steady state solution of the system of N and C equations. Analytical and numerical solutions were obtained using Wolfram Mathematica version 10.

In Paper II, we qualitatively focused on transitions between symbiosis and parasitism in plant-ECM fungi relationships and formulated a simplified conceptual model excluding the stores (Fig. 6b). This model mainly addresses the delivery of nitrogen (N) by a mycorrhizal fungus to a plant. The simulations were implemented in Mathcad 14.0. All changes in biomasses are expressed in units of C relative to 1 unit of C transferred from the plant to the fungus.



**Fig. 6a-** Diagram of the stores and flows of C and N in the model (Baskaran et al., 2016). Black lines, C flows; red lines, N flows; dashed lines, microbial and plant mortality. See Table 1 in Paper I for explanation of symbols



**Fig 6b** - Diagram of the model in Paper II. Black arrows show carbon flows, red arrows nitrogen flows, and blue arrows show important controls. Symbols next to arrows show the key parameters controlling a flux. Arrows ending in nothing indicate losses that are not considered in the model.



### 3.1.2 Transfer of Plant C to mycorrhizal fungi

A key part of the conceptual framework of the models presented in Paper I and II is that an N-limited plant allocates a certain amount of C to the ECM fungi, and in return receives an amount of N. In both models, the mutualist-parasitic nature of the ECM fungus strongly depends on the amount of C that the plants allocate to the fungus and N availability, which in turn govern the capacity of the fungus to decompose and assimilate organic N.

In the model presented in Paper I, ECM fungi respire a fraction of the assimilated C and the rest is incorporated into mycelial biomass, but for simplicity the enzyme activities are treated as being at equilibrium relative to the corresponding microbial biomass. Further, we chose to base the model on the conventional view of soil C cycling in mycorrhizal systems, with ECM fungi strictly obtaining C solely from their photosymbionts (Smith & Read 2010).

In the model presented in Paper II, the plant C utilized by the ECM fungi is allocated to three pathways: (i) respiration, (ii) new biomass, and (iii) exoenzyme synthesis. Moreover, the fungal biomass uses part of the C acquired from the plant to assimilate C from SOM by the action of degradative enzymes.

### 3.1.3 Transfer of mycorrhizal N to plants

In the models presented in both Paper I and II, the N has two sources, organic and inorganic N pools in SOM. In the model presented in Paper I, ECM fungi obtain organic N via degradation of the organic (SOM) store at a rate  $r_o D_{MO}$ , where  $D_{MO}$  is the rate of decomposition of the oxidizable pool of SOM ( $C_o$ ) mediated by ECM fungal enzymes ( $k_{MO} C_M C_o$ ).  $D_{MO}$  depends on the size of ECM fungal biomass ( $C_M$ ) and the size of the  $C_o$  store, capturing the link between C allocation by plants that promotes ECM fungal growth and ECM decomposition, while the inorganic N uptake by ECM follows a Michaelis-

Menten equation (Eq. 22 in Paper I). Overall, the N demand of ECM fungi is set by the rate of C received from the plant multiplied by the ECM fungal N:C ratio and the N exceeding fungal requirements is transferred to plants according to the flux  $\Phi_M$ . As in the approach applied in Paper I, in the model formulated in Paper II, the SOM is decomposed to obtain organic N, but we also considered the N consumed in enzyme production ( $r_e$ , N:C of enzymes). In paper I and II, we calculated the fraction of the total N uptake by the mycorrhizal fungus that is transferred to the plant. The inorganic N taken up by the fungus was withdrawn from uptake by the plant. We calculated this N withdrawn from plant uptake as the fraction of inorganic N uptake to total N uptake incorporated in the extra fungal growth.

## 3.2 Experimental studies

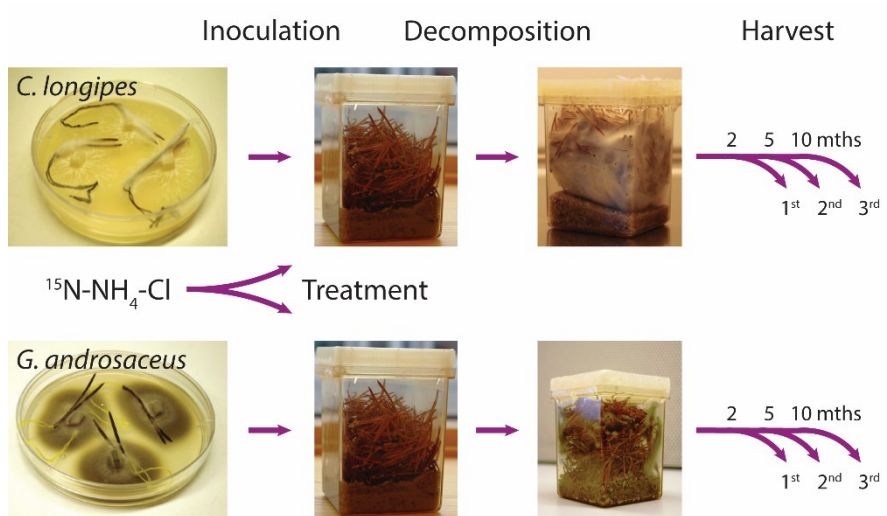
### 3.2.1 Components in the litter decomposition experiment

Two species of litter-decomposing basidiomycetous fungi, *Gymnopus androsaceus* (Paper III and IV) and *Chalara longipes* (Paper III) were used in our experiments. The two fungal species have different ecological and decomposition strategies and are common colonizers of litter in pine forests (Boberg *et al.*, 2010). *Gymnopus androsaceus* is a white-rot fungus, which has a well-developed capacity to degrade lignin (Boberg *et al.*, 2010). *Chalara longipes* is a stress-tolerant, soft-rot fungus with melanized cell walls (Koukol *et al.*, 2004).

Brown abscised Scots pine needles were used as substrate in both experimental studies. The needles were collected on sheets in a 25-year-old pine stand situated in Jädraås, central Sweden, in the autumn of 2002 as described in Boberg *et al.* (2014).

### 3.2.2 N retention in organic matter (Paper III)

To understand the mechanisms involved in N redistribution among total and non-hydrolysable pools during decomposition of needle litter, pine needle litter was inoculated with *Gymnopus androsaceus* or the ascomycete *Chalara longipes* in axenic laboratory microcosms (Fig. 7). To trace the N redistribution, a  $^{15}\text{N}$ -labelled  $\text{NH}_4\text{Cl}$  solution (enriched to 1 atom% excess), was then added and the microcosms were incubated for 10 months. The incubation conditions and other experimental details are described in Paper III.



**Fig. 7**– Illustration of the experimental design.

### 3.2.3 Effects of C and N addition on fungal CUE (Paper IV)

To evaluate changes in CUE, axenic microcosms were established by placing pine needles on N-free agar medium in petri dishes (24 replicates). The microcosms were inoculated with *Gymnopus androsaceus* and pre-incubated at 20°C for 56 days. Needle litter from each microcosm was then split into two equal portions. One of the two resulting sets of 24 sub-samples was used for calorimetric measurements and 20 of the other set for respiration measurements (after using four for pre-testing). Both sets of sub-samples were amended with 1 ml of the following solutions per gram of needle litter: double deionized water (control), 8 µmol (NH<sub>4</sub>)<sub>2</sub>SO<sub>4</sub> (designated nitrogen), 210 µmol D-glucose (designated glucose) or 8µmol (NH<sub>4</sub>)<sub>2</sub>SO<sub>4</sub> + 210 µmol D-glucose (glucose + nitrogen). For respiration measurements, the glucose was labelled with 99 atom % <sup>13</sup>C (Laradon, Solna, Sweden) to enable estimation of the added <sup>13</sup>C-glucose (<sup>13</sup>CO<sub>2</sub>), and to quantify the <sup>13</sup>C incorporated into the biomass.

### 3.3 Chemical analysis

In Paper III, the harvested needle litter was treated with concentrated hydrochloric acid to separate the hydrolysable from the non-hydrolysable fraction. The litter's C, N, <sup>15</sup>N and <sup>13</sup>C contents were determined using an elemental analyzer coupled to an IsoPrime isotope-ratio mass spectrometer (GV Instruments, Manchester, UK) (Paper III and IV). Solid-state <sup>13</sup>C-CPMAS NMR was performed to determine the chemical composition of the decomposed needle litter and non-hydrolysable fractions in Paper III. In Paper IV, heat production was measured continuously over 24 h after substrate addition, using a TAM Air isothermal calorimeter (TA Instruments, Sollentuna, Sweden) with the thermostat set to 20 °C. Respiration rates were also measured (over 10-minute periods 2, 5, 10 and 24 h after substrate

addition) in Paper IV using a Picarro cavity-ringdown G2101-i laser absorption spectrometer (Picarro, Inc., Santa Clara, CA, USA).

### 3.4 Calculations and statistical analysis

In Paper III, the microbial CUE was estimated using a traditional biomass-based approach and the equation proposed by Herron *et al.* (2009):

$$\text{CUE} = \frac{{}^{13}\text{C excess [biomass]}}{{}^{13}\text{C [CO}_2\text{]} + {}^{13}\text{C excess [biomass]}} \quad (1)$$

Where  ${}^{13}\text{C [CO}_2\text{]}$  ( $\mu\text{mol}$ ) denotes the loss of  ${}^{13}\text{C}$  through  $\text{CO}_2$  respiration and  ${}^{13}\text{C [biomass]}$  ( $\mu\text{mol}$ ) denotes the amount of  ${}^{13}\text{C}$  incorporated into the needle litter.

${}^{13}\text{C excess [biomass]}$  is calculated using equation (2)

$${}^{13}\text{C excess [biomass]} = \left( \frac{{}^{13}\text{C}}{\text{C}_A} - \frac{{}^{13}\text{C}}{\text{C}_B} \right) \times \text{Needle litter}_C \quad (2)$$

Where  $\frac{{}^{13}\text{C}}{\text{C}_A}$  denotes the isotope fraction of  ${}^{13}\text{C}$  in the needle litter after  ${}^{13}\text{C}$  glucose addition.  $\frac{{}^{13}\text{C}}{\text{C}_B}$  denotes the isotope fraction of  ${}^{13}\text{C}$  in the original needle litter.  $\text{Needle litter}_C$  denotes the total C content in the needle litter ( $\mu\text{mol}$ ).

The calorespirometric ratio  $\gamma$  ( $\text{J } \mu\text{mol}^{-1} \text{CO}_2$ ) calculated and applied in Paper III is the ratio of heat production to  $\text{CO}_2$  production (Hansen *et al.* 2004):

$$\gamma = \frac{R_Q}{R_{\text{CO}_2}} \quad (3)$$

Here,  $R_Q$  and  $R_{\text{CO}_2}$  are the heat generated ( $\text{J g}^{-1}$  needle litter) and  $\text{CO}_2$  production ( $\mu\text{mol CO}_2 \text{g}^{-1}$  needle litter), respectively, after substrate addition

In Paper III, two-way ANOVA followed by Tukey's HSD test was applied to assess the main and interaction effects of time and species on <sup>15</sup>N tracer redistribution, N content, C:N ratio and chemical composition changes in the needle litter. We also applied two-way ANOVA followed by Tukey's HSD to assess the main and interaction effects of glucose and ammonium treatments on heat production, respiration and calorespirometric ratios in Paper IV. Further, the differences in CUE associated with two treatments (addition of glucose or glucose + ammonium) were analyzed using one-way ANOVA in Paper IV. All ANOVA tests were done using the multcomp package in R (R Core Team, 2014). In Paper IV, due to the uneven number of replicates for heat and respiration measurements, the standard deviations for calorespirometric ratios were calculated using bootstrapping with 200 replications (R Core Team 2014). Principal Components Analysis (PCA) was also applied, in Paper III, to explore changes in the chemical composition of non-hydrolysable fractions of the needle litter using CANOCO version 5.

## 4 Results and Discussion

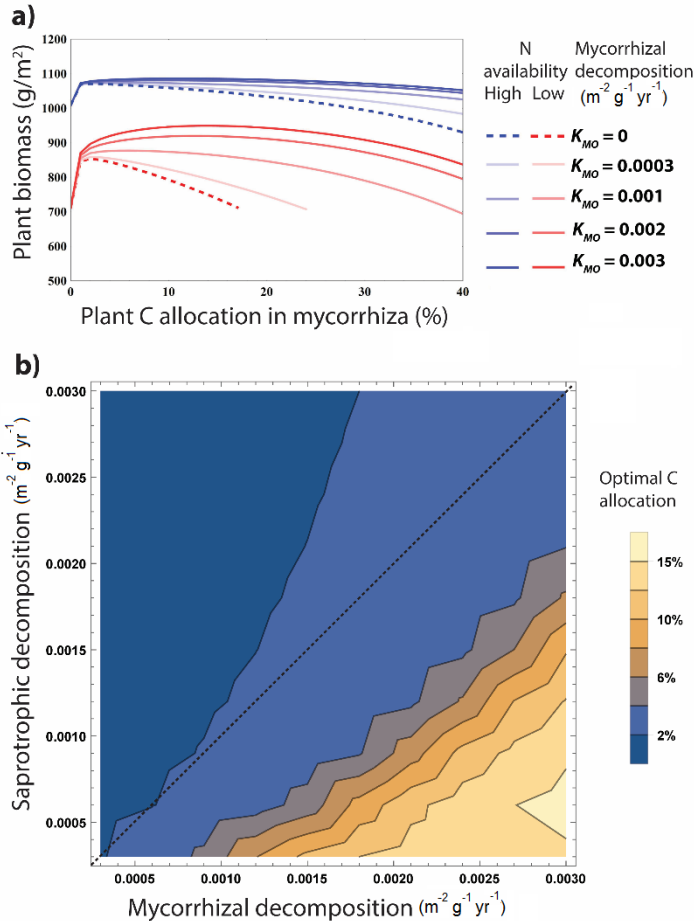
### 4.1 Influence of mycorrhizal symbiosis on plant nutrition (Papers I and II)

Numerous studies, some more than a century old, have observed mutualistic relationships between plants and mycorrhizal fungi, for example Frank (1885), Wang & Qiu (2006) and references in the latter. However, the symbiotic relationship with mycorrhiza might not always be balanced in terms of costs and benefits for the plants. In Paper I, we found that the optimum plant C allocation to ECM fungi depends on the capacity of the fungi to decompose SOM. At high levels of ECM decomposition ( $>0.001 \text{ m}^2 \text{ g}^{-1} \text{ y}^{-1}$ ), the plant biomass peaked at certain C allocation levels (4-15%) (Fig. 8a), and declined at higher C allocation levels (Paper I). Our model predicted that the proportion of C allocated to ECM fungi up to 15% would be advantageous for plants for their organic N acquisition. In line with our predictions, other studies have shown that C allocation levels up to 15% of NPP to ECM fungi is beneficial for plants, despite immobilization of the N required to meet needs of the fungi (Alberton et al., 2007). However, at rates of C allocation exceeding 15% NPP, N provided by the ECM fungi cannot compensate for C losses from the plants, leading to reductions in plant biomass and productivity. Näsholm *et al.* (2013) also proposed that increasing C allocation to ECM fungi may aggravate plant N limitation, but mainly due to high rates of N immobilization in ECM mycelium rather than the cost of photoassimilate allocation. Overall, our model predicts that the degree to which ECM fungi are mutualistic or parasitic for plants depends to a large degree on the ECM's decomposition capacity.

According to our model predictions, allocation of between 4 and 15% of the C plants photosynthetically fix to ECM fungi has mutualistic results when a large fraction of recalcitrant organic matter is decomposed by ECM fungi

rather than by saprotrophs (Fig. 8b). Assuming, as widely accepted, that ECM fungi with decomposer capacity evolved from saprotrophic ancestors (Kohler *et al.*, 2015), such partitioning of decomposition between the two fungal groups could be questioned. However, ECM fungi may be more strongly involved in recalcitrant matter decomposition than saprotrophs due to factors such as differences in CUE and rates of mycelial mortality affecting the biomass of the two fungal groups, together with the higher inherent capacity of ECM taxa to produce oxidative enzymes. Several authors have estimated that ECM fungal biomass accounts for ~50% of total fungal biomass in boreal forest soils (Bååth *et al.*, 2004; Clemmensen *et al.*, 2013), which is a much higher proportion than our model predictions of ~13%. The differences between the two fungal biomasses could be explained by differences in mortality rates between functional guilds, with ectomycorrhizal mycelia accumulating higher biomass and having higher litter-degrading activities than saprotrophs.

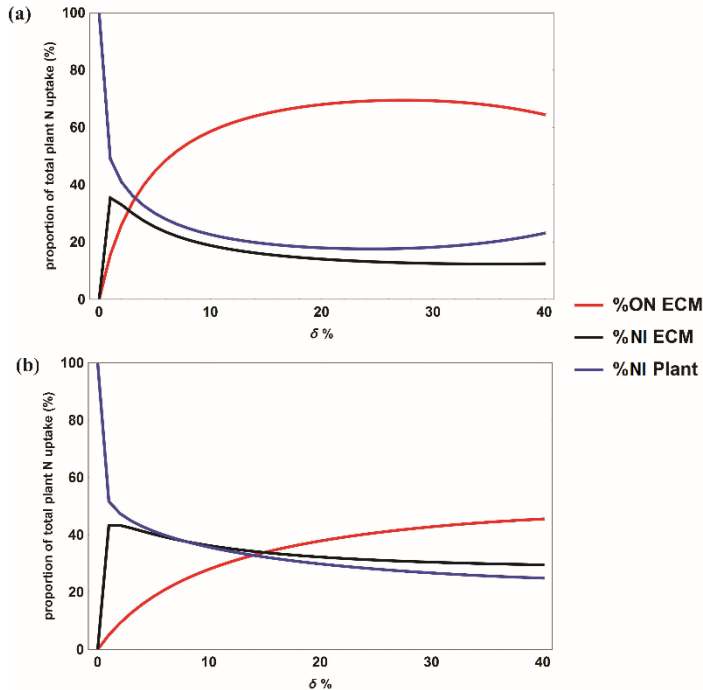




**Fig. 8-** (a) Plant biomass ( $\text{g/m}^2$ ) as a function of plant C allocated to mycorrhiza (%) at indicated ECM decomposition ( $K_{MO}$ ) with high (blue:  $3 \text{ m}^2 \text{ g}^{-1} \text{ yr}^{-1}$ ) or low (red:  $0.7 \text{ m}^2 \text{ g}^{-1} \text{ yr}^{-1}$ ) external N inputs. (b) Contour plot showing the optimal C allocation to ECM fungi as a function of saprotrophic and ECM decomposition (expressed in  $\text{m}^2 \text{ g}^{-1} \text{ yr}^{-1}$ ).

Our model results presented in Papers I strongly indicate that N availability affects the proportion of plant C allocated to ECM fungi. Previous studies have suggested that this proportion decreases as nutrient availability increases (Johnson & Wedin, 1997; Treseder, 2004). At high N availability,

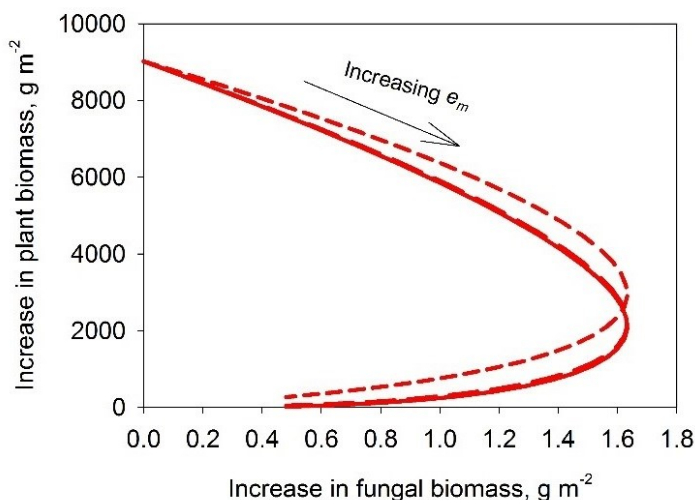
our model (Paper I) predicts that plants depend more on inorganic forms of N and the increase in uptake of inorganic N by plant roots induces reductions in uptake of organic N by ECM fungi (Fig. 9).



**Fig. 9** – Proportions of indicated sources of plant N uptake as a function of the proportion of plant C allocated to ECM fungi ( $\delta$ ) at (a) low external N input (0.6 g N m<sup>-2</sup>) and (b) high external N input (3 g N m<sup>-2</sup>). Proportions of N acquired by plants through direct inorganic N uptake by their roots (NI Plant), inorganic N uptake via ECM fungi (NI ECM) and organic N uptake via ECM fungi (ON ECM) are shown by the black, blue and red lines, respectively.

Further, the results in paper II suggest that mycorrhizal association is most beneficial to the plant at high N availability and when mycorrhiza has the

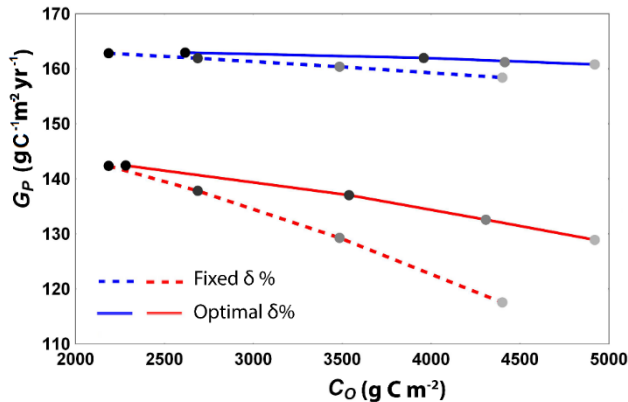
ability to use SOM as a C source. By making the enzymes more efficient (i.e. by increasing the parameter  $K_o$ , enzymatic rate of SOM degradation– see Table 1, Paper II), it is beneficial to both plant and mycorrhiza (Fig.10 – the curves will be displaced to the right and upwards). Moreover, the plants would benefit when preferentially combining with mycorrhizal fungi having saprotrophic capabilities. In paper II, the important conclusion is that the benefit of the mycorrhizal association to the plant seems to be the increased uptake of inorganic N. In addition, we suggest that the ability of the plant to control C transfer to mycorrhizal fungi needs attention in the future.



**Fig.10-** Relation between plant and fungal biomasses as a function of increasing mycorrhizal allocation to biomass production ( $e_m$ ) for three different levels of inorganic N ( $N_i$ ) (Low N= 0.1 g N /m<sup>2</sup>, Medium N = 1 g N /m<sup>2</sup>, and High N = 10 g N /m<sup>2</sup>).

## 4.2 Influence of mycorrhizal symbiosis on soil C sequestration (Paper I)

Our model results suggest that under N-limited conditions, plants' productivity depends on the organic N acquisition enabled by ECM decomposition of the recalcitrant, oxidizable SOM pool. At low N inputs, higher levels of ECM decomposition were positively related to plant productivity and negatively related to SOM storage ( $C_O$ ), under both optimal C allocation and fixed C allocation rates (Fig. 11). Thus, SOM storage and plant productivity were negatively correlated along a gradient of increasing ECM decomposition.



**Fig. 11**– Relationship between plant productivity ( $G_P$ ) and oxidizable soil C store ( $C_O$ ), at optimal C allocation and fixed C allocation rates at four levels of ECM decomposition ( $\text{m}^2 \text{g}^{-1} \text{y}^{-1}$ ) (indicated by increases in darkness of the circles) with low ( $0.7 \text{ g N m}^{-2} \text{y}^{-1}$ , red) and high ( $3 \text{ g N m}^{-2} \text{y}^{-1}$ , blue) external N inputs.

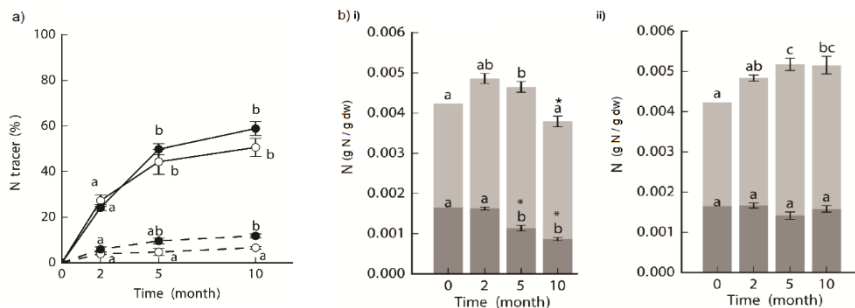
Clemmensen et al. (2015) suggested that efficient N mobilization and low C sequestration were linked to relatively high abundance of ECM fungi, and that soil C accumulation to a large extent depends on the fungal community composition. The model presented in Paper I does not explicitly include the

fungal community composition, but varying the ECM mediated decomposition of  $C_o$  at four levels strongly affected the negative relationship between soil C accumulation and plant productivity. Thus, although the community composition was not explicitly defined in our model, the variation in ECM decomposition affected our results (Fig. 11), highlighting the importance of explicitly incorporating fungal community composition in future ecosystem models.

### 4.3 N retention during saprotrophic litter decomposition (Paper III)

The mechanisms of N retention by saprotrophs during litter decomposition were investigated using a controlled laboratory setup in Paper III. The rate of decomposition was higher in microcosms with the basidiomycete white-rot fungus *G. androsaceus*, but the rate of incorporation of  $^{15}\text{N}$  in the non-hydrolysable fraction was higher in microcosms with the ascomycete soft-rot fungus *C. longipes*. After 10 months, 6% and 11% of the  $^{15}\text{N}$  tracer was recovered from the non-hydrolysable fraction of the needle litter in systems inoculated with *G. androsaceus* and *C. longipes*, respectively (Fig. 12a).

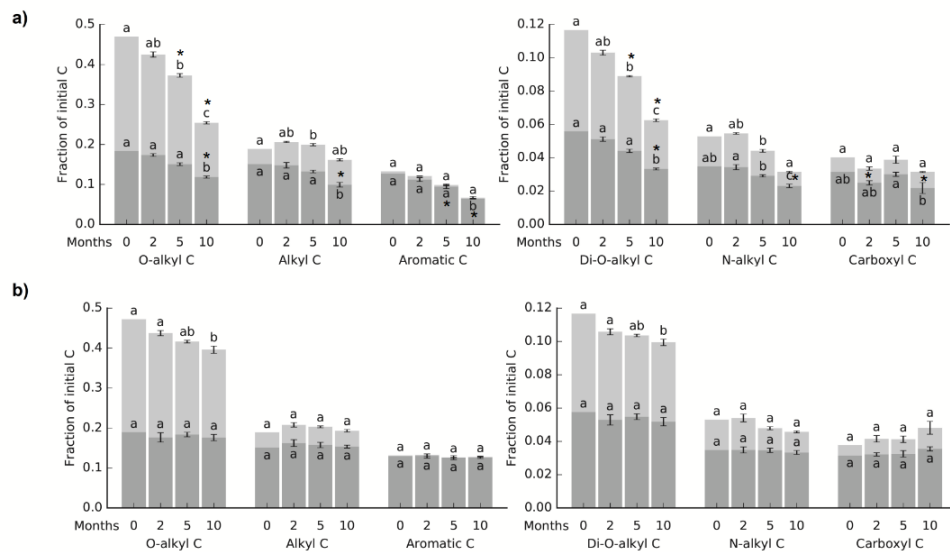
Although a relatively higher incorporation of  $^{15}\text{N}$  with *C. longipes* was observed, there was no evident increase in the total non-hydrolysable N pool (Fig. 12b) or aromatic C pool with time (Fig. 13b). We assume that this could be due to larger background of plant N and lignin, where synthesis of fungal melanins or other non-hydrolysable, N-containing compounds or complexes may have been too low for significant visibility. Supporting this idea, Clemmensen et al. (2015) also postulated that melanin may have led to the larger proportion of fungal necromass preserved in long-term humus stores dominated by root-associated ascomycetes in their late-successional stage boreal forests.



**Fig. 12- (a)** Proportion of added  $^{15}\text{N}$  tracer (% recovered from supplementary  $^{15}\text{N}\text{-NH}_4\text{Cl}$ ) in the total (solid lines) and non-hydrolysable fraction (broken lines) of *Pinus sylvestris* needle litter colonized by the fungi *Gymnopus androsaceus* (open symbols) and *Chalara longipes* (closed symbols) at indicated times after inoculation. **(b)** Nitrogen content (g/dry weight of needle litter) in hydrolysable (light grey) and non-hydrolysable (dark grey) fractions of *Pinus sylvestris* needle litter colonized by the fungi (i) *Gymnopus androsaceus* and (ii) *Chalara longipes* at indicated times after inoculation. Presented data are means  $\pm$  SE ( $n = 4$ ). Significant changes over time are indicated by different letters (Note: at time 0 the needle litter was uncolonized and no  $^{15}\text{N}\text{-NH}_4\text{Cl}$  had been added)

Although the rate of  $^{15}\text{N}$  incorporation was higher with *C. longipes* than with *G. androsaceus*, our results indicate that both fungi synthesized stable N compounds in the non-hydrolysable pool (Fig. 12a). The relatively low net accumulation of  $^{15}\text{N}$  in the non-hydrolysable pool in the systems with *G. androsaceus* after 5 months could have been due to the fungus mining for organic N during decomposition (Fig. 12b (i)). Moreover, the weaker incorporation of the N tracer in the non-hydrolysable fraction with *G. androsaceus* (Fig. 12 a) was accompanied by greater reductions in this fraction's N contents (Fig. 12 b (i)). A possible explanation for this is that *G.*

*androsaceus*, which has strong lignin-degrading capacity, preferentially mined organic N rather than assimilating the readily available supplementary N, and therefore incorporated less N tracer than *C. longipes*. Our results show that aromatic C contents significantly decreased in the needles inoculated with *G. androsaceus* ( $P < 0.001$ ) (Fig. 12a), in accordance with its ability to produce manganese peroxidase (MnP) enzymes. MnP enzymes have putative involvement in the degradation of humic compounds (Steffen et al., 2000), their activities are frequently detected in litter and soils, and used as indicators of decomposition of recalcitrant organic matter (Sinsabaugh *et al.*, 2005). Overall, the observations show that litter quality and differences in decomposing ability between the two fungi significantly affected N dynamics and retention during decomposition of the organic matter in our simple microcosms. Therefore, mechanisms of N retention in forest soils may be better understood by taking into account the community composition of litter-degrading fungi, notably the relative abundance of white-rot basidiomycetes and soft-rot ascomycetes (Sterkenburg *et al.*, 2015).



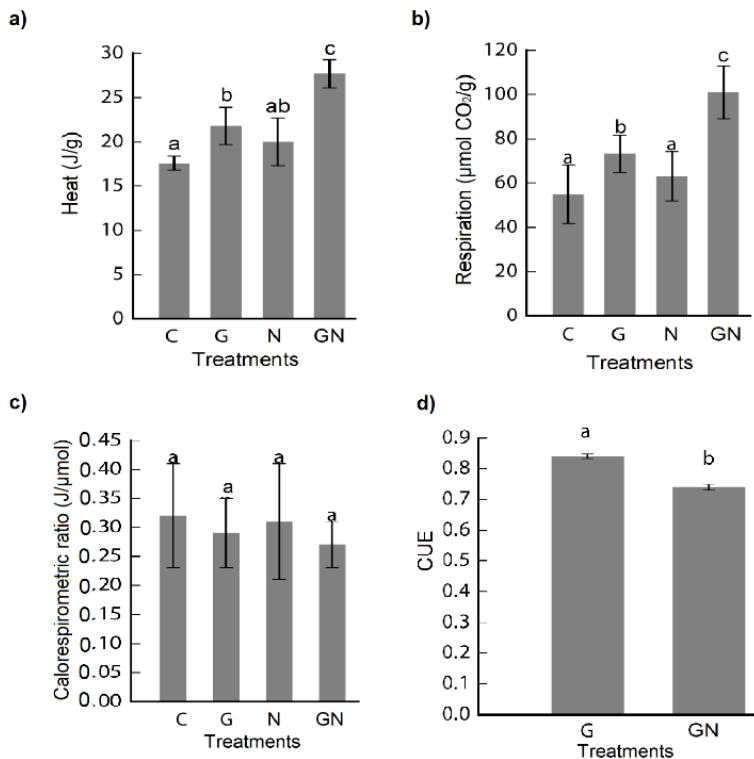
**Fig 13-** Chemical composition of *Pinus sylvestris* needle litter during decomposition by the fungi a) *Gymnopus androsaceus* and b) *Chalara longipes* at indicated times after inoculation. Data presented are remaining proportions of the C pool in indicated chemical fractions (means  $\pm$  SE, n = 4) according to  $^{13}\text{C}$  NMR. Non-hydrolysable fractions are indicated by dark shading. Significant differences in the abundance of the C pools at different time points are indicated by different letters, with upper letters and SE referring to the hydrolysable fraction, and lower letters and SE referring to the non-hydrolysable fraction. Asterisks indicate significant differences between species.



#### 4.4 Carbon use efficiency (Paper IV)

Using the traditional biomass-based approach, the observed CUE was high in the microcosms subjected to both the glucose and glucose + nitrogen treatments in Paper IV (0.85 and 0.75, respectively; Fig. 14d). Such high efficiencies have also been observed in previous studies and criticized as experimental artefacts due to the combination of storage compound synthesis and short incubation times (Lundberg *et al.*, 2001; Nguyen & Guckert, 2001; Blagodatskaya *et al.*, 2014). Further, the lower CUE under the glucose + nitrogen treatment could have been a result of faster metabolism of storage compounds in the presence of a readily available source of N. Thus, the differences in CUE obtained using the traditional biomass-based approach with short incubation times (Fig. 14d), may have been at least partly due to artefactual induction of changes in storage compound metabolism.

The CO<sub>2</sub> and heat production responded in similar ways to the two treatments (Fig. 14a and b). Thus, we did not observe any between-treatment differences in calorespirometric ratios of microcosms subjected to the treatments applied in the microbial energetics approach (Fig. 14c). This may have been because too little glucose was added in relation to the turnover-rate of litter carbohydrates (Berg & McLaugherty, 2008) to generate detectable between-treatment differences, and too little N in the supplementary (NH<sub>4</sub>)<sub>2</sub>SO<sub>4</sub>, which amounted to about 5% of the total N (0.005 g g<sup>-1</sup> dry weight) in the freshly fallen needle litter. Overall, small amounts of nutrients were added in this study, partly to avoid microbial growth and partly to ensure that the C:N ratio in the glucose + nitrogen treatment (12) was lower than the C:N ratio of the fungi (ca. 15) (Boberg *et al.*, 2014).



**Fig. 14-** Measurements of (a) heat release (J/g), (b) respiration rate ( $\mu\text{mol CO}_2/\text{g}$ ), (c) calorespirometric ratio ( $\text{J}/\mu\text{mol}$ ) and (d) CUE of samples of *Pinus sylvestris* needle litter colonized by the fungi *Gymnopus androsaceus* amended with: milli-Q water (C), glucose (G), ammonium sulfate (N), or ammonium sulfate + glucose (GN). Presented data are means ( $n = 6$  for heat release and  $n = 5$  for respiration rate) and standard deviations (whiskers). Significant between-treatment differences are indicated by different letters.

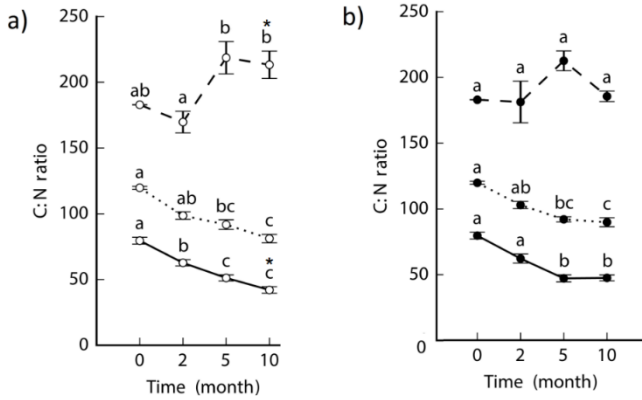
In Paper IV, heat dissipation and respired  $\text{CO}_2$  were determined from separate samples. The measurement of calorespirometric ratios could have been more precise if it had been possible to measure heat and respiration

from the same samples. This has been attempted in earlier studies, but the incubation time applied in those studies was limited to 5 hours due to CO<sub>2</sub> accumulation in the restricted head space of the vials (Campbell *et al.*, 2003; Herrmann and Bölscher., 2015). Concurrent measurement of heat and respiration was not feasible in our experiment due to the requirement of 24 hours incubation. Clearly, further development of methods to measure calorespirometric ratios could be highly beneficial for evaluating microbial CUE.

#### 4.5 Implications of experimental results for future model development

In the model presented in Paper I and many other ecosystem models (Table.1), N immobilization during microbial decomposition depends on the difference in C:N ratio between the substrate and the decomposer community. Further, with increasing decomposition, the C:N ratios are measured to decrease causing an increase in recalcitrance of organic pools (Berg & McLaugherty, 2008). In Paper III, the C:N ratio observed in the non-hydrolysable fraction was high (150-240; Fig. 16) and increased further during decomposition by the white rot fungus *G. androsaceus* (Fig. 15a).

The hydrolysable pool had a much lower C:N ratio, indicating that C and N availabilities may differ within a single substrate. If litter contains a high proportion of high C:N compounds with low metabolic utility, fungi may experience C limitation at much higher C:N ratios than normally considered. In addition to this, when the fungal biomass incorporates N into this more stable high C:N pool, retention of N may progress. We suggest such information about litter quality may improve predictive power of ecosystem models, when applied to forest ecosystems in which fungi dominate the decomposer community.



**Fig. 15** - C:N ratios of the total material (dotted line), hydrolysable fraction (solid line) and non-hydrolysable fraction (dashed line) of *Pinus sylvestris* needle litter colonized by the fungi (a) *Gymnopus androsaceus* and (b) *Chalara longipes* at indicated times after inoculation. Presented results are means  $\pm$  SE (n = 4). Significant differences between time points are indicated by different letters and asterisks indicate significant differences between species.

## 5 Highlights

Lack of knowledge about the identity and functional properties of soil fungi, and their interactions with plants in regulation of C sequestration, has hampered development of ecosystem models. In Paper I, we explicitly investigated the impact of ECM fungal traits on ecosystem C cycling, focusing on fungal traits that mediate decomposition of organic matter, thereby allowing ECM fungi to access organic nutrients. The model results demonstrate the complexity of plant-ECM fungi symbiosis, showing that certain allocation of C to ECM fungi may maximize plant productivity under a given N availability (Papers I and II). The model presented in Paper I also provides a tool for studying long-term ecosystem productivity, where mycorrhizal decomposition acts as a potential driver of both SOM decomposition and N mobilization. Overall, the model contributes to increasing indications that explicit incorporation of below-ground microbial community traits in ecosystem models could radically improve our understanding of ecosystem C and N dynamics. In the development of ecosystem models, including community composition dynamics (Clemmensen *et al.*, 2013; Clemmensen *et al.*, 2015) and associated changes in process parameters may enhance our understanding of organic matter dynamics, because fungal community composition strongly affects N dynamics and retention in SOM. More specifically, consideration of the relative abundance of white-rot basidiomycetes and stress-tolerant litter ascomycetes (Sterkenburg *et al.*, 2015) is essential to understand C and N dynamics in ecosystems. Clearly, care should be taken when extrapolating results from laboratory microcosms (Paper III) with only two species of litter-decomposing fungi, to field systems involving many species. Nevertheless, our study demonstrates that litter quality and differences in the decomposing abilities of fungal taxa can strongly influence N dynamics and

retention during organic matter decomposition. Our findings from a highly controlled laboratory experiment (Paper III) suggest that the fungal communities in natural ecosystems may play major roles in the dynamic interactions between N retention and C sequestration.

## 6 Conclusion

Boreal forests receive substantial attention as globally significant sinks for C, but there are major gaps in our knowledge of highly relevant C-N interactions. This thesis highlights the importance of effects of ECM fungi decomposition on C and N dynamics, which strongly influence soil C sequestration and plant nutrition. In the underlying work, we observed differences in decomposing strategies between two litter-degrading saprotrophic fungi, which strongly influenced N retention and dynamics during litter decomposition under controlled laboratory conditions. Taken together, the results of the studies show that deeper knowledge of the fungal communities and incorporation of different fungal traits into ecosystem models improve our mechanistic understanding of C and N cycling in boreal forest ecosystems.

## 7 Challenges and future prospects

### 7.1 Modelling

One of the biggest uncertainties in model development is to assess realistic parameter values. This difficulty is partly due to lack of a perfect correspondence between modeled and measured pools and parameters – a problematic issue in ecosystem modeling. Our modelling exercise (Paper I and Paper II) is more about identifying sensitivities and directions of responses rather than simulating the real situation. A major limitation of the modelling presented in Paper I was the lack of partitioning of fungal communities. Another limitation was that we did not account explicitly for competition for nutrients between mycorrhizal fungi and saprotrophs, which is connected to the so-called Gadgil effect (Gadgil & Gadgil, 1975), although the indirect competition mediated by the SOM pool size and contrasting N and C acquisition strategies of ECM fungi and saprotrophs was captured by the model. The current model can be improved in the future in numerous ways, but I suggest that two steps are particularly important. One is to incorporate fungal community composition with varying decomposition strategies to improve simulations of their responses and effects on SOM dynamics. The other is to include competition for N between saprotrophs and ECM fungi, by introducing variation in the microbial CUE linked to variations in nutrient availability.

### 7.2 Experimental investigations

The generality of results obtained in Studies III and IV should be tested in experiments with more species and litter types under controlled laboratory conditions with different N availabilities to improve conclusions about the functional significance of the litter fungi on ecosystem levels. Further, the knowledge obtained from laboratory studies should be applied in field



investigations. For example, it would be interesting to investigate N retention mechanisms in ecosystems with typical variations in environmental factors such as N availability, temperature etc. Overall, better understanding of the factors and mechanisms that influence the interactions and activities of saprotrophs involved in litter decomposition could substantially improve future interpretation of N and C dynamics in boreal forest ecosystems.

## 8 References

- Aerts R. 1995.** The advantages of being evergreen. *Trends in ecology & evolution* **10**: 402-407.
- Ågren GI, Bosatta E. 1996.** Quality: a bridge between theory and experiment in soil organic matter studies. *Oikos* **76**: 522-528.
- Ågren GI, Bosatta E. 1998.** *Theoretical ecosystem ecology: understanding element cycles*: Cambridge University Press.
- Ågren GI, Andersson FO. 2011.** *Terrestrial ecosystem ecology: principles and applications*: Cambridge University Press.
- Alberton O, Kuyper TW, Gorissen A. 2007.** Competition for nitrogen between *Pinus sylvestris* and ectomycorrhizal fungi generates potential for negative feedback under elevated CO<sub>2</sub>. *Plant and Soil* **296**: 159-172.
- Allison S. 2012.** A trait-based approach for modelling microbial litter decomposition. *Ecology letters* **15**: 1058-1070.
- Allison SD, Wallenstein MD, Bradford MA. 2010.** Soil-carbon response to warming dependent on microbial physiology. *Nature Geoscience* **3**: 336-340.
- Baldrian P, Valášková V. 2008.** Degradation of cellulose by basidiomycetous fungi. *FEMS microbiology reviews* **32**: 501-521.
- Barros N, Hansen L, Piñeiro V, Pérez-Cruzado C, Villanueva M, Proupín J, Rodríguez-Añón J. 2016.** Factors influencing the calorespirometric ratios of soil microbial metabolism. *Soil Biology and Biochemistry* **92**: 221-229.
- Baskaran, P, Hyvönen, R, Berglund, S. L, Clemmensen, K. E, Ågren, G. I., Lindahl, B. D, Manzoni, S. 2017.** Modelling the influence of ectomycorrhizal decomposition on plant nutrition and soil carbon sequestration in boreal forest ecosystems. *New Phytologist*, **213**(3), 1452-1465.

- Behera B, Wagner G. 1974.** Microbial growth rate in glucose-amended soil. *Soil Science Society of America Journal* **38**: 591-594.
- Bending GD, Read DJ. 1996.** Nitrogen mobilization from protein-polyphenol complex by ericoid and ectomycorrhizal fungi. *Soil Biology and Biochemistry* **28**: 1603-1612.
- Berg B, McClaugherty C. 2008.** Plant litter. *Decomposition, humus formation, carbon sequestration. 2nd Ed Springer.*
- Berg B, Wessén B, Ekbohm G. 1982.** Nitrogen level and decomposition in Scots pine needle litter. *Oikos* **38**: 291-296.
- Blagodatskaya E, Blagodatsky S, Anderson T-H, Kuzyakov Y. 2014.** Microbial growth and carbon use efficiency in the rhizosphere and root-free soil. *PLoS ONE* **9**(4): e93282.
- Boberg J, Finlay RD, Stenlid J, Näsholm T, Lindahl BD. 2008.** Glucose and ammonium additions affect needle decomposition and carbon allocation by the litter degrading fungus *Mycena epipterygia*. *Soil Biology and Biochemistry* **40**: 995-999.
- Boberg JB, Finlay RD, Stenlid J, Ekblad A, Lindahl BD. 2014.** Nitrogen and carbon reallocation in fungal mycelia during decomposition of boreal forest litter. *PLoS ONE* **9**(3): e92897.
- Boberg JB, Finlay RD, Stenlid J, Lindahl BD. 2010.** Fungal C translocation restricts N-mineralization in heterogeneous environments. *Functional Ecology* **24**: 454-459.
- Boddy L. 1999.** Saprotrophic cord-forming fungi: meeting the challenge of heterogeneous environments. *Mycologia* **91**: 13-32.
- Boddy L, Jones TH 2008.** Interactions between basidiomycota and invertebrates. *British Mycological Society Symposia Series*: Elsevier. 155-179.

**Bonan GB, Shugart HH. 1989.** Environmental factors and ecological processes in boreal forests. *Annual review of ecology and systematics* **20**: 1-28.

**Bradford MA, Crowther TW. 2013.** Carbon use efficiency and storage in terrestrial ecosystems. *New Phytologist* **199**: 7-9.

**Bååth E, Nilsson LO, Göransson H, Wallander H. 2004.** Can the extent of degradation of soil fungal mycelium during soil incubation be used to estimate ectomycorrhizal biomass in soil? *Soil Biology and Biochemistry* **36**: 2105-2109.

**Bödeker IT, Nygren CM, Taylor AF, Olson Å, Lindahl BD. 2009.** Class II peroxidase-encoding genes are present in a phylogenetically wide range of ectomycorrhizal fungi. *The ISME Journal* **3**: 1387-1395.

**Campbell CD, Chapman SJ, Cameron CM, Davidson MS, Potts JM. 2003.** A rapid microtiter plate method to measure carbon dioxide evolved from carbon substrate amendments so as to determine the physiological profiles of soil microbial communities by using whole soil. *Applied and environmental microbiology* **69**(6): 3593-3599.

**Clemmensen K, Bahr A, Ovaskainen O, Dahlberg A, Ekblad A, Wallander H, Stenlid J, Finlay R, Wardle D, Lindahl B. 2013.** Roots and associated fungi drive long-term carbon sequestration in boreal forest. *Science* **339**: 1615-1618.

**Clemmensen KE, Finlay RD, Dahlberg A, Stenlid J, Wardle DA, Lindahl BD. 2015.** Carbon sequestration is related to mycorrhizal fungal community shifts during long-term succession in boreal forests. *New Phytologist* **205**: 1525-1536.

**Colpaert JV, Van Laere A, Van Assche JA. 1996.** Carbon and nitrogen allocation in ectomycorrhizal and non-mycorrhizal *Pinus sylvestris* L. seedlings. *Tree Physiology* **16**: 787-793.

- Corrêa A, Gurevitch J, Martins-Loução M, Cruz C. 2012.** C allocation to the fungus is not a cost to the plant in ectomycorrhizae. *Oikos* **121**: 449-463.
- Courty P-E, Bréda N, Garbaye J. 2007.** Relation between oak tree phenology and the secretion of organic matter degrading enzymes by *Lactarius quietus* ectomycorrhizas before and during bud break. *Soil Biology and Biochemistry* **39**: 1655-1663.
- Courty P-E, Buée M, Diedhiou AG, Frey-Klett P, Le Tacon F, Rineau F, Turpault M-P, Uroz S, Garbaye J. 2010.** The role of ectomycorrhizal communities in forest ecosystem processes: new perspectives and emerging concepts. *Soil Biology and Biochemistry* **42**: 679-698.
- Deckmyn G, Meyer A, Smits M, Ekblad A, Grebenc T, Komarov A, Kraigher H. 2014.** Simulating ectomycorrhizal fungi and their role in carbon and nitrogen cycling in forest ecosystems. *Canadian Journal of Forest Research* **44**: 535-553.
- Ekblad A, Wallander H, Godbold D, Cruz C, Johnson D, Baldrian P, Björk R, Epron D, Kieliszewska-Rokicka B, Kjoller R. 2013.** The production and turnover of extramatrical mycelium of ectomycorrhizal fungi in forest soils: role in carbon cycling. *Plant and Soil* **366**: 1-27.
- Finlay RD, Söderström B. 1992.** Mycorrhiza and carbon flow to the soil. In: **Allen M**, ed. *Mycorrhiza functioning*. London, UK: Chapman & Hall, 134 – 160
- Frank B. 1885.** Ueber die auf Wurzelsymbiose beruhende Ernährung gewisser Baume durch unterirdische Pilze. *Ber. dt. Bot. Ges.***3**: 128-145.\*\*
- Franklin O, Johansson J, Dewar RC, Dieckmann U, McMurtrie RE, Brännström Å, Dybzinski R. 2012.** Modeling carbon allocation in trees: a search for principles. *Tree Physiology* **32**: 648-666.
- Gadgil RL, Gadgil PD. 1975.** Suppression of litter decomposition by mycorrhizal roots of *Pinus radiata*. *New Zealand Journal of Forest Science* **5**: 35–41.

- Hansen LD, Macfarlane C, McKinnon N, Smith BN, Criddle RS. 2004.** Use of calorimetric ratios, heat per CO<sub>2</sub> and heat per O<sub>2</sub>, to quantify metabolic paths and energetics of growing cells. *Thermochimica Acta* **422**: 55-61.
- Herrmann AM, Bölscher T. 2015.** Simultaneous screening of microbial energetics and CO<sub>2</sub> respiration in soil samples from different ecosystems. *Soil Biology and Biochemistry* **83**: 88-92.
- Herrmann AM, Coucheny E, Nunan N. 2014.** Isothermal microcalorimetry provides new insight into terrestrial carbon cycling. *Environmental science & technology* **48**: 4344-4352.
- Herron, P. M., Stark, J. M., Holt, C., Hooker, T., Cardon, Z. G. 2009.** Microbial growth efficiencies across a soil moisture gradient assessed using <sup>13</sup>C-acetic acid vapor and <sup>15</sup>N-ammonia gas. *Soil Biology and Biochemistry*, **41**(6): 1262-1269.
- Hobbie EA, Ouimette AP, Schuur EA, Kierstead D, Trappe JM, Bendiksen K, Ohenoja E. 2013.** Radiocarbon evidence for the mining of organic nitrogen from soil by mycorrhizal fungi. *Biogeochemistry* **114**: 381-389.
- Hunt H, Coleman D, Ingham E, Ingham R, Elliott E, Moore J, Rose S, Reid C, Morley C. 1987.** The detrital food web in a shortgrass prairie. *Biology and Fertility of Soils* **3**: 57-68.
- Högberg P, Högberg M, Göttlicher S, Betson N, Keel S, Metcalfe D, Campbell C, Schindlbacher A, Hurry V, Lundmark T. 2008.** High temporal resolution tracing of photosynthate carbon from the tree canopy to forest soil microorganisms. *New Phytologist* **177**: 220-228.
- Janssens I, Dieleman W, Luysaert S, Subke J-A, Reichstein M, Ceulemans R, Ciais P, Dolman AJ, Grace J, Matteucci G. 2010.** Reduction of forest soil respiration in response to nitrogen deposition. *Nature Geoscience* **3**: 315-322.

- Jenkinson D, Hart P, Rayner J, Parry L. 1987.** Modelling the turnover of organic matter in long-term experiments at Rothamsted. *INTECOL Bulletin* **15**: 1-8.
- Johnson NC, Wedin DA. 1997.** Soil carbon, nutrients, and mycorrhizae during conversion of dry tropical forest to grassland. *Ecological Applications* **7**: 171-182.
- Kirschbaum MU, Paul KI. 2002.** Modelling C and N dynamics in forest soils with a modified version of the CENTURY model. *Soil Biology and Biochemistry* **34**: 341-354.
- Kögel-Knabner I. 2002.** The macromolecular organic composition of plant and microbial residues as inputs to soil organic matter. *Soil Biology and Biochemistry* **34**: 139-162.
- Kohler A, Kuo A, Nagy LG, Morin E, Barry KW, Buscot F, Canbäck B, Choi C, Cichocki N, Clum A. 2015.** Convergent losses of decay mechanisms and rapid turnover of symbiosis genes in mycorrhizal mutualists. *Nature genetics* **47**: 410-415.
- Koukol O, Gryndler M, Novak F, Vosatka M. 2004.** Effect of *Chalara longipes* on decomposition of humic acids from *Picea abies* needle litter. *Folia microbiologica* **49**: 574-578.
- Leake J, Donnelly D, Saunders E, Boddy L, Read D. 2001.** Rates and quantities of carbon flux to ectomycorrhizal mycelium following <sup>14</sup>C pulse labeling of *Pinus sylvestris* seedlings: effects of litter patches and interaction with a wood-decomposer fungus. *Tree Physiology* **21**: 71-82.
- Lindahl BD, Clemmensen KE. 2016.** Fungal ecology in boreal forest ecosystems. *Molecular Mycorrhizal Symbiosis*: 387-404.
- Lindahl BD, Ihrmark K, Boberg J, Trumbore SE, Högberg P, Stenlid J, Finlay RD. 2007.** Spatial separation of litter decomposition and mycorrhizal nitrogen uptake in a boreal forest. *New Phytologist* **173**: 611-620.

- Lindahl BD, Olsson S. 2004.** Fungal translocation—creating and responding to environmental heterogeneity. *Mycologist* **18**: 79-88.
- Lindahl BD, Tunlid A. 2015.** Ectomycorrhizal fungi—potential organic matter decomposers, yet not saprotrophs. *New Phytologist* **205**: 1443-1447.
- Lindahl BO, Taylor AF, Finlay RD. 2002.** Defining nutritional constraints on carbon cycling in boreal forests—towards a **less phytocentric perspective**. *Plant and Soil* **242**: 123-135.
- Lundberg P, Ekblad A, Nilsson M. 2001.** <sup>13</sup>C NMR spectroscopy studies of forest soil microbial activity: glucose uptake and fatty acid biosynthesis. *Soil Biology and Biochemistry* **33**: 621-632.
- Manzoni S, Taylor P, Richter A, Porporato A, Ågren GI. 2012.** Environmental and stoichiometric controls on microbial carbon-use efficiency in soils. *New Phytologist* **196**: 79-91.
- McGuire KL, Treseder KK. 2010.** Microbial communities and their relevance for ecosystem models: decomposition as a case study. *Soil Biology and Biochemistry* **42**: 529-535.
- Meyer A, Grote R, Polle A, Butterbach-Bahl K. 2010.** Simulating mycorrhiza contribution to forest C-and N cycling—the MYCOFON model. *Plant and Soil* **327**: 493-517.
- Molina J, Clapp C, Shaffer M, Chichester F, Larson W. 1983.** NCSOIL, a model of nitrogen and carbon transformations in soil: description, calibration, and behavior. *Soil Science Society of America Journal* **47**: 85-91.
- Myneni R, Dong J, Tucker C, Kaufmann R, Kauppi P, Liski J, Zhou L, Alexeyev V, Hughes M. 2001.** A large carbon sink in the woody biomass of northern forests. *Proceedings of the National Academy of Sciences* **98**: 14784-14789.



- Neff JC, Townsend AR, Gleixner G, Lehman SJ, Turnbull J, Bowman WD. 2002.** Variable effects of nitrogen additions on the stability and turnover of soil carbon. *Nature* **419**: 915-917.
- Nguyen C, Guckert A. 2001.** Short-term utilisation of  $^{14}\text{C}$ -[U] glucose by soil microorganisms in relation to carbon availability. *Soil Biology and Biochemistry* **33**: 53-60.
- Northup RR, Yu Z, Dahlgren RA, Vogt KA. 1995.** Polyphenol control of nitrogen release from pine litter. *Nature* **377**: 227.
- Näsholm T, Ekblad A, Nordin A, Giesler R, Högberg M, Högberg P. 1998.** Boreal forest plants take up organic nitrogen. *Nature* **392**: 914-916.
- Näsholm T, Högberg P, Franklin O, Metcalfe D, Keel SG, Campbell C, Hurry V, Linder S, Högberg MN. 2013.** Are ectomycorrhizal fungi alleviating or aggravating nitrogen limitation of tree growth in boreal forests? *New Phytologist* **198**: 214-221.
- O'Brien HE, Parrent JL, Jackson JA, Moncalvo J-M, Vilgalys R. 2005.** Fungal community analysis by large-scale sequencing of environmental samples. *Applied and environmental microbiology* **71**: 5544-5550.
- Orwin KH, Kirschbaum MU, St John MG, Dickie IA. 2011.** Organic nutrient uptake by mycorrhizal fungi enhances ecosystem carbon storage: a model-based assessment. *Ecology letters* **14**: 493-502.
- Osono T. 2007.** Ecology of ligninolytic fungi associated with leaf litter decomposition. *Ecological Research* **22**: 955-974.
- Parton, W. J, David S. Schimel, C. V. Cole, D. S. Ojima. 1987.** Analysis of factors controlling soil organic matter levels in Great Plains grasslands. *Soil Science Society of America Journal* **51**(5): 1173-1179.
- Parton W 1996.** The CENTURY model. *Evaluation of soil organic matter models*: Springer, 283-291.
- Parton W, Silver WL, Burke IC, Grassens L, Harmon ME, Currie WS, King JY, Adair EC, Brandt LA, Hart SC. 2007.** Global-scale similarities

in nitrogen release patterns during long-term decomposition. *Science* **315**: 361-364.

**Preston CM, Trofymow J, Niu J, Sayer BG. 1997.** <sup>13</sup>C nuclear magnetic resonance spectroscopy with cross-polarization and magic-angle spinning investigation of the proximate-analysis fractions used to assess litter quality in decomposition studies. *Canadian Journal of Botany* **75**: 1601-1613.

**Pringle EG. 2016.** Integrating plant carbon dynamics with mutualism ecology. *New Phytologist* **210**: 71-75.

**Randerson JT, Hoffman FM, Thornton PE, Mahowald NM, Lindsay K, LEE YH, Nevison CD, Doney SC, Bonan G, Stöckli R. 2009.** Systematic assessment of terrestrial biogeochemistry in coupled climate-carbon models. *Global Change Biology* **15**: 2462-2484.

**R Core Team. 2014.** Vienna: R Foundation for Statistical Computing. Available at <http://www.R-project.org/>

**Read DJ. 1991.** Mycorrhizas in ecosystems. *Experientia* **47**: 376-391.

**Schimel JP, Weintraub MN. 2003.** The implications of exoenzyme activity on microbial carbon and nitrogen limitation in soil: a theoretical model. *Soil Biology and Biochemistry* **35**: 549-563.

**Schlesinger WH, Andrews JA. 2000.** Soil respiration and the global carbon cycle. *Biogeochemistry* **48**: 7-20.

**Simard SW, Perry DA, Jones MD, Myrold DD, Durall DM, Molina R. 1997.** Net transfer of carbon between ectomycorrhizal tree species in the field. *Nature* **388**: 579-582.

**Sinsabaugh RL. 2010.** Phenol oxidase, peroxidase and organic matter dynamics of soil. *Soil Biology and Biochemistry* **42**: 391-404.

**Sinsabaugh RL, Gallo ME, Lauber C, Waldrop MP, Zak DR. 2005.** Extracellular enzyme activities and soil organic matter dynamics for northern hardwood forests receiving simulated nitrogen deposition. *Biogeochemistry* **75**: 201-215.

- Smith SE, Read DJ. 2010.** *Mycorrhizal symbiosis*: Academic press.
- Steffen K, Hofrichter M, Hatakka A. 2000.** Mineralisation of <sup>14</sup>C-labelled synthetic lignin and ligninolytic enzyme activities of litter-decomposing basidiomycetous fungi. *Applied Microbiology and Biotechnology* **54**: 819-825.
- Sterkenburg E, Bahr A, Brandström Durling M, Clemmensen KE, Lindahl BD. 2015.** Changes in fungal communities along a boreal forest soil fertility gradient. *New Phytologist* **207**: 1145-1158.
- Sterner RW, Elser JJ. 2002.** *Ecological stoichiometry: the biology of elements from molecules to the biosphere*: Princeton University Press.
- Tamm, C.O. 1991.** Nitrogen in **terrestrial ecosystems**-questions of productivity, **vegetational changes**, and ecosystem stability. *Berlin: Springer-Verlag. Ecological Studies*: **81**
- Todd-Brown K, Randerson J, Hopkins F, Arora V, Hajima T, Jones C, Shevliakova E, Tjiputra J, Volodin E, Wu T. 2014.** Changes in soil organic carbon storage predicted by Earth system models during the 21st century. *Biogeosciences* **11**: 2341-2356.
- Treseder KK. 2004.** A meta-analysis of mycorrhizal responses to nitrogen, phosphorus, and atmospheric CO<sub>2</sub> in field studies. *New Phytologist* **164**: 347-355.
- Treseder KK, Balsler TC, Bradford MA, Brodie EL, Dubinsky EA, Eviner VT, Hofmockel KS, Lennon JT, Levine UY, MacGregor BJ. 2012.** Integrating microbial ecology into ecosystem models: challenges and priorities. *Biogeochemistry* **109**: 7-18.
- Treseder KK, Torn MS, Masiello CA. 2006.** An ecosystem-scale radiocarbon tracer to test use of litter carbon by ectomycorrhizal fungi. *Soil Biology and Biochemistry* **38**: 1077-1082.

- Tucker CL, Bell J, Pendall E, Ogle K. 2013.** Does declining carbon-use efficiency explain thermal acclimation of soil respiration with warming? *Global Change Biology* **19**: 252-263.
- Valášková V, Šnajdr J, Bittner B, Cajthaml T, Merhautová V, Hofrichter M, Baldrian P. 2007.** Production of lignocellulose-degrading enzymes and degradation of leaf litter by saprotrophic basidiomycetes isolated from a *Quercus petraea* forest. *Soil Biology and Biochemistry* **39**: 2651-2660.
- Wang B, Qiu Y-L. 2006.** Phylogenetic distribution and evolution of mycorrhizas in land plants. *Mycorrhiza* **16**: 299-363.
- Wardle DA, Bardgett RD, Klironomos JN, Setälä H, Van Der Putten WH, Wall DH. 2004.** Ecological linkages between aboveground and belowground biota. *Science* **304**: 1629-1633.
- Wheeler MH. 1983.** Comparisons of fungal melanin biosynthesis in ascomycetous, imperfect and basidiomycetous fungi. *Transactions of the British Mycological Society* **81**: 29-36.
- Wieder WR, Bonan GB, Allison SD. 2013.** Global soil carbon projections are improved by modelling microbial processes. *Nature Climate Change* **3**: 909-912.

## 9 Acknowledgements

I am thankful for the support of many people who were involved during this half-a-decade long journey.

First of all, I would like to thank my supervisors, who were supportive and helpful during my time as a PhD. **Stefano Manzoni**, thank you for your confidence, patience, and scientific guidance. It has been an educating and inspiring experience to collaborate with you and I am grateful for the lively email communication that we had during the development of the modelling work. **Björn Lindahl**, I would like to thank you for valuable scientific inputs to this work - I have learnt a lot about soil ecology from you. **Karina Clemmensen**, thank you for being my mentor, you always had your doors open, which was helpful for me in difficult situations. **Göran Ågren**, thank you for extending our collaboration on the modelling work and for your availability even when the deadlines were tight. **Anke Herrmann**, thank you for guidance on the carbon use efficiency work, constructive feedbacks, and direct way of communication. **Helena Bylund**, thank you very much for taking over the responsibility of supervising me just half a year before my defense date. I admired your well-organized and positive way of supervising me. You have been incredibly helpful during these months. I would also like to thank **Astrid Taylor**, **Erik Öckinger** and **Thomas Kätterer**, who were essential in the process of my work.

I would like to acknowledge my valuable collaborators near and far. **Alf Ekblad**, **Laura Soucemarianadin**, **Jürgen Schleucher**, and **Tryggve Persson** thank you for your inputs and constructive feedback on the manuscripts and the work. I would also like to thank **Katta**, **Johanna**, **Andreas** and **Julia** for helping out with my queries while working in the lab at the mycology department.

I would like to thank my friends for the precious memories. **Pernilla**, thank you for being a wonderful friend at all times - I wish that we never part 😊. **Laura** and **Francesca** – thank you for being there for me and in all goofy moments 😊. **Sadhna** - Thank you for your advices when needed during this journey. **Eve** – I owe special thanks to you, for your very supportive times. I would also like to thank **Marta, Fama, Friderike, Raj, Jörg, Martin, Jonas, David, Åsa, Nanthan & Diana, Benedikt, Dävide** and **Prakash** for all the cheerful times in Uppsala!

**Hantke** family, thank you for your good wishes and encouragement.

**Max**, thank you for being very supportive and indulgent. I'm glad that I met you! 😊

Finally, I would like to thank my family living in the far. **Rajaram Thatha, Prabha Avva, Ayya, Amma, Gomu akka, Soundar, Uma akka, Praveen, Shreya, Anirudh, Aaditya** – I'm fortunate to have such a loving big family! Without all your wonderful support none of this would have been possible

♥.

## 10 Popular Science

Boreal forests stretch across large areas of the northern hemisphere and cover up to 30% of all woodland on Earth. In Fennoscandia's boreal forests, pine and spruce trees provide valuable resources for timber and biofuel production. Pine and spruce trees shed litter and 25% of the litter mass is attributed to lignin, a slowly decomposing (group of) chemical compound. The production of lignin-rich litter in combination with cold climate retards the decomposition process. Soil organic matter accumulates and locks up essential plant nutrients such as nitrogen. This process has major implications on nutrient availability, which impacts plant growth. Globally, NASA estimates that nutrient-limitation reduces plant growth on Earth by 16-28% on average. The accumulation of soil organic matter in boreal forests affects not only plant growth but also the CO<sub>2</sub> balance of the atmosphere and the global climate.

Soil organic matter in boreal forests accumulates slowly and the long term processes involved are therefore challenging to study. To handle this problem, mathematical ecosystem models have been developed that attempt to capture processes in soil organic matter dynamics. Despite the known importance of decomposer fungi as nutrient regulators, most ecosystem models do not include them explicitly. The main reason for this is the lack of knowledge about their identity and functional properties.

In this work, we developed ecosystem models that explicitly include the two decomposer fungal communities of free-living saprotrophs (Paper I) and symbiotic mycorrhiza (Paper I and Paper II). Our model predicts that at low nitrogen availability, increasing ectomycorrhizal mediated decomposition of soil organic matter promotes plant growth and reduces soil organic matter sequestration (Paper I). However, when the plant provides large amounts of carbohydrates to the symbiotic mycorrhiza, our model predicts that

mycorrhiza can turn into a parasite for the plant (Paper I & II). We find that the interplay between plant growth and soil organic matter storage is highly dependent on the partitioning of decomposition between the fungal communities (Paper I). We conclude that a better understanding of interactions between communities and species of soil fungi is a key for improving model predictions. For this reason, we performed laboratory scale studies with one (Paper IV) or two (Paper III) saprotrophic species to characterize the role of these fungi in retaining nitrogen in organic matter (Paper III). We found that differences in decomposing strategies between the two species of saprotrophic fungus, strongly influence the nitrogen retention mechanisms in the decomposing litter. Further, we identified the need and the potential of new methods to measure important parameters, such as carbon-use efficiency (Paper IV), for better predictions of nutrient dynamics in ecosystem system models.

Taken together, this work highlights the importance of soil fungi in the nutrient dynamics of boreal forest ecosystems. It demonstrates that incorporating the influence of different fungal traits on organic matter decomposition in ecosystem models can improve model predictions of global soil carbon budgets.