

Connecting sensors to LTE

Suresh Krishnan

A Thesis

in

The Department

of

Electrical and Computer Engineering

Presented in Partial Fulfillment of the Requirements  
for the Degree of Master of Applied Science at  
Concordia University  
Montréal, Québec, Canada

March 2012

© Suresh Krishnan, 2012

# CONCORDIA UNIVERSITY

## School of Graduate Studies

This is to certify that the thesis prepared

By: Suresh Krishnan

Entitled: Connecting sensors to LTE

and submitted in partial fulfillment of the requirements for the degree of

### **Master of Applied Science (Electrical and Computer Engineering)**

Complies with the regulations of the University and meets the accepted standard with respect to originality and quality.

Signed by the final examining committee:

\_\_\_\_\_ Dr. R. Paknys, Chair

\_\_\_\_\_ Dr. C. Assi, Examiner

\_\_\_\_\_ Dr. M. Mehmet Ali, Examiner

\_\_\_\_\_ Dr. F. Khendek, Supervisor

Approved by

\_\_\_\_\_  
Dr. W. Lynch  
Chair, Department of Electrical and Computer Engineering

\_\_\_\_\_ 20 \_\_\_\_\_

\_\_\_\_\_  
Dr. R. Drew  
Dean, Faculty of Engineering and Computer Science

## **ABSTRACT**

Connecting sensors to LTE

Suresh Krishnan

The number of sensors that will be connected to the internet is expected to grow exponentially in the near future. As sensors are starting to get used for more and more applications, a large number of them will be placed in locations where wireless networks, such as Long Term Evolution (LTE), are the only available method of connectivity. Examples of such locations include remote areas (e.g. for Smartgrid and agricultural applications), and inhospitable environments (e.g. for industrial applications). Unfortunately, these wireless networks have not been designed for low power constrained devices, like battery operated sensors, and the procedures for attaching and staying connected to such networks would consume significant amounts of energy. Due to this increased power consumption the battery life on these devices would be too low to be useful. In addition to this due to the always-connected nature of the devices, the wireless network will quickly run out of resources when large numbers of sensors get connected. The resources include radio spectrum (that is extremely limited and prohibitively expensive) and signaling capacity on the network nodes. This thesis describes a new connection paradigm for connecting sensors to LTE networks along with the necessary wireless signaling changes that will allow for a battery life of the sensor to be at least 10 fold than that using the current mechanisms. This will enable the sensors to be placed in more applications where battery replacement cycles are very long and the battery replacement costs are very expensive. The new signaling mechanism will also conserve scarce resources

in the wireless network so that the wireless network can scale to handle 10 fold more connections than today's wireless networks.

## ACKNOWLEDGEMENTS

I would like to thank my supervisor Dr. Ferhat Khendek for supporting and expertly guiding me throughout the process. He helped me structure my thoughts and was always available to review my work and provide suggestions for improvements.

I would like to thank my colleagues at Ericsson: Laurent Marchand, Denis Monette, Maria Toeroe, Meral Shirazipour, and Stephane Ouellette who have been very helpful and supportive. I would like to thank Gyorgy Miklos for helping me out with the MATLAB model for the UE power consumption. The message sequence charts in this thesis were generated using the MSC generator tool [15].

This work would not have been possible without my family. I would like to thank my parents for inspiring me to work on this thesis and talking me through when I was disheartened. I would like to thank my wife and daughter for their support during my period of study and for the constant encouragement they gave me.

# Table of Contents

TABLE OF CONTENTS .....	VI
LIST OF FIGURES .....	IX
LIST OF TABLES .....	X
ACRONYMS AND ABBREVIATIONS .....	XI
CHAPTER 1 INTRODUCTION .....	1
1.1 RESEARCH DOMAIN .....	1
1.2 MOTIVATION AND PROBLEM STATEMENT .....	2
1.3 CONTRIBUTIONS OF THIS THESIS .....	3
1.4 ORGANIZATION OF THIS THESIS .....	4
CHAPTER 2 BACKGROUND INFORMATION ON LTE AND WIRELESS SENSOR NETWORKS .....	6
2.1 LTE .....	6
2.1.1 <i>The Need for LTE</i> .....	6
2.1.2 <i>Reference network architecture</i> .....	8
2.1.3 <i>LTE Radio Access Network</i> .....	9
2.1.4 <i>LTE Radio Technologies</i> .....	9
2.1.4.1 Orthogonal Frequency-Division Multiple Access (OFDMA) .....	9
2.1.4.2 Single Carrier - Frequency Division Multiple Access (SC-FDMA) .....	10
2.1.5 <i>The Evolved Packet Core (EPC)</i> .....	11
2.1.5.1 Mobility Management Entity (MME) .....	12
2.1.5.2 The Serving Gateway (S-GW) .....	12
2.1.5.3 Packet Data Network Gateway (P-GW) .....	12
2.1.5.4 The Policy and Charging Rules Function (PCRF) .....	13
2.1.6 <i>LTE attach signaling</i> .....	13
2.2 WIRELESS SENSOR NETWORKS .....	16
2.2.1 <i>Characteristics of wireless sensors</i> .....	17
2.2.2 <i>Applications of wireless sensor networks</i> .....	18
2.2.2.1 Military and Battlefield applications .....	19
2.2.2.2 Environmental applications .....	19
2.2.2.3 Industrial applications .....	19
2.2.2.4 Smart Grid .....	20
2.2.2.5 Home automation .....	20
2.3 THE NEED FOR CONNECTING WSNS TO LTE .....	20
2.4 APPLICABILITY AND TARGETED TOPOLOGIES .....	21

CHAPTER 3 A NOVEL AND OPTIMIZED SIGNALING SCHEME FOR PERIODICALLY TRANSMITTING SENSORS .....	22
3.1 ANALYSIS OF POWER CONSUMPTION OF UE .....	22
3.1.1 <i>Active mode power consumption</i> .....	24
3.1.2 <i>Idle mode power consumption</i> .....	24
3.2 POWER CONSUMPTION OF LTE UE WITH SMALL SIZE DATA PACKETS .....	25
3.3 ISSUES WITH CURRENT SIGNALING SCHEME .....	27
3.4 PROPOSED SIGNALING SCHEME .....	27
3.4 BENEFITS OF THE LTE_PTP SIGNALING SCHEME .....	30
CHAPTER 4 SIMULATIONS, TEST SETUP AND RESULTS.....	32
4.1 MECHANISM USED FOR SIMULATION .....	32
4.2 MODEL PARAMETERS FOR CURRENT LTE UES .....	32
4.3 TESTS TO BE PERFORMED .....	33
4.3.1 <i>Baseline power consumption and battery life</i> .....	34
4.3.2 <i>Variations in packet sizes and reporting intervals</i> .....	34
4.3.3 <i>Measuring improvements due to LTE_PTP</i> .....	35
4.3.4 <i>Battery capacity</i> .....	35
4.4 CONVENTIONS USED .....	36
4.5 BASELINE POWER CONSUMPTION OF AN UNMODIFIED LTE UE .....	37
4.6 BASELINE BATTERY LIFE OF AN UNMODIFIED LTE UE .....	39
4.7 BASELINE IMPROVEMENTS OF LTE_PTP SIGNALING .....	41
4.8 MEASUREMENTS FOR 256 BYTE PACKETS .....	46
4.9 MEASUREMENTS FOR 1024 BYTE PACKETS .....	48
4.10 EFFECT OF VARYING CONDITIONS ON THE GAINS .....	50
4.10.1 <i>Effect of varying packet sizes on the gains</i> .....	50
4.10.2 <i>Effect of varying distance on the gains</i> .....	51
4.11 OBSERVATIONS.....	58
CHAPTER 5 .....	59
CONCLUSION AND FUTURE WORK.....	59
RESEARCH CONTRIBUTIONS .....	59
FUTURE WORK .....	60
REFERENCES .....	61
APPENDIX A: TERMINAL POWER CONSUMPTION MODEL .....	66
A.1 CLOCKS .....	67
A.1.1 <i>Coarse clock</i> .....	67
A.1.2 <i>Fine clock</i> .....	67
A.2 DUPLEX FILTER .....	67

A.3 RECEIVER CHAIN .....	67
<i>A.3.1 Low-noise amplifier and receive mixer</i> .....	67
<i>A.3.2 Filter and analog-to-digital converter</i> .....	68
<i>A.3.3 Receiver baseband</i> .....	68
A.4 TRANSMITTER CHAIN .....	69
<i>A.4.1 Power amplifier</i> .....	69
<i>A.4.2 Transmitter mixer</i> .....	69
<i>A.4.3 Digital-to-analog converter</i> .....	69
<i>A.4.4 Transmitter baseband</i> .....	70



## List of Figures

Figure 1: LTE/EPC Reference Architecture [3].....	8
Figure 2: LTE attach signaling.....	15
Figure 3: Wireless Sensor Network Architecture [24].....	17
Figure 4: LTE connected wireless sensor topology .....	21
Figure 5: Power consumption of typical LTE UE - 64 byte packets .....	25
Figure 6: LTE_PTP initial attach signaling.....	28
Figure 7: LTE_PTP periodic data transmission .....	29
Figure 8: Baseline power consumption.....	37
Figure 9: Baseline battery life.....	39
Figure 10: Comparison of baseline power consumption .....	41
Figure 11: Comparison of baseline battery life.....	43
Figure 12: Decrease in baseline power consumption .....	44
Figure 13: Increase in baseline battery life.....	45
Figure 14: Power consumption comparison for 256 byte packets.....	46
Figure 15: Battery life comparison for 256 byte packets.....	47
Figure 16: Power consumption comparison for 1024 byte packets.....	48
Figure 17: Battery life comparison for 1024 byte packets.....	49
Figure 18: Change in power consumption gains by packet size .....	50
Figure 19: Change in battery life gains by packet size .....	51
Figure 20: LTE UE increase in power consumption with distance.....	53
Figure 21: LTE_PTP UE increase in power consumption with distance.....	54
Figure 22: Change in power consumption gains by distance .....	55
Figure 23: LTE UE decrease in battery life with distance .....	55
Figure 24: LTE UE decrease in battery life with distance .....	56
Figure 25: Change in battery life gains by distance.....	57
Figure 26: Structure of terminal power consumption model .....	66

## List of Tables

Table 1: Performance requirements for LTE.....	7
Table 2: Typical power consumption values for LTE UE.....	26
Table 3: Model parameters for state-of-the-art LTE Release 8 terminals.....	33
Table 4: Baseline power consumption .....	38
Table 5: Baseline battery life .....	40
Table 6: Comparison of baseline power consumption.....	42
Table 7: Comparison of baseline battery life .....	43
Table 8: Decrease in power consumption for 256 byte packets.....	46
Table 9: Increase in battery life for 256 byte packets .....	47
Table 10: Decrease in power consumption for 1024 byte packets.....	48
Table 11: Increase in battery life for 1024 byte packets .....	49
Table 12: Distance of sensor from base station .....	52

## Acronyms and Abbreviations

3GPP	3rd Generation Partnership Project
EPC	Evolved Packet Core
E-UTRAN	Evolved Universal Terrestrial Radio Access Network
FMC	Fixed Mobile Convergence
HSS	Home Subscriber Server
IP	Internet Protocol
LTE	Long term evolution
M2M	Machine to Machine
MME	Mobility Management Entity
NAS	Non-Access Stratum
OFDM	Orthogonal Frequency-Division Multiplexing
OFDMA	Orthogonal Frequency-Division Multiple Access
PAPR	Peak-to-average-power ratio
PCEF	Policy and Charging Enforcement Functions
PCRF	Policy and Charging Rules Function
PDN	Packet Data Network
P-GW	PDN Gateway
PS	Packet Switched
QoS	Quality of Service
RAN	Radio Access Network
RNC	Radio Network Controller
SC-FDMA	Single Carrier - Frequency Division Multiple Access
S-GW	Serving Gateway
UE	User equipment
WSN	Wireless Sensor Network

# Chapter 1

## Introduction

### 1.1 Research domain

Long Term Evolution (LTE) [14] is a fourth generation wireless network that provides high speed data connectivity to mobile terminals. It provides peak downlink data rates upto 300Mbps and uplink data rates upto 75Mbps. The high data rates provided by LTE allow for the connection of large number of devices to wireless networks and hence enable several forms of machine-to-machine (M2M) [1][17] communications that were previously impossible due to bandwidth constraints. Compared to earlier generation wireless technologies (2G/3G), LTE also provides a much more efficient use of expensive spectrum that enables its use for connecting a large number of devices.

The LTE specifications [19] also introduce a flat network architecture called the Evolved Packet Core (EPC) [3] based on the Internet Protocol (IP) [20][21]. The EPC network is optimized for packet data transmission. It provides high Quality of Service (QoS) guarantees and mobility support for the user equipment (UE). It also provides very low transmission latencies of around 10ms. Earlier generation wireless technologies suffered from much higher latencies that made them unpractical for latency sensitive applications. The low latency characteristics allow the use of LTE in applications that require very quick response times.

A sensor [2] is a device that is used for measuring a physical quantity in analog form and producing a digital output. Commonly used sensors include temperature sensors, light sensors, chemical sensors, fire/smoke sensors etc. With extensive advances in solid state sensor technologies over the past few years, the prices of sensors have dropped considerably. This has made it feasible for sensors to be deployed in cost-sensitive applications such as smart home automation and environmental monitoring.

A wireless sensor network (WSN) [12] consists of sensors that are geographically distributed and able to communicate using some form of, usually short range, wireless technology. Wireless sensor networks have traditionally been used in mission critical applications such as military applications and battlefield monitoring [22], and have now become popular for use in healthcare applications [23]. Recently, improvements in wireless technologies have allowed such sensors to consume decreasingly smaller amounts of energy thus enabling their use for battery powered applications.

## **1.2 Motivation and problem statement**

As sensors are starting to get used for more and more applications, a large number of them will be placed in locations where wireless networks, such as LTE, are the only available method of connectivity. Examples of such locations include remote areas (e.g. for Smartgrid and agricultural applications), and inhospitable environments (e.g. for industrial applications).

Unfortunately, these wireless networks have not been designed for low power constrained devices, like battery operated sensors. The procedures for attaching and staying connected to such networks would consume significant amounts of energy and would ensure that the battery life on these devices would be too low to be useful.

In addition to this due to the always-connected nature of the devices, the wireless network will quickly run out of resources when large numbers of sensors get connected. The resources include radio spectrum (that is extremely limited and prohibitively expensive) and signaling capacity on the network nodes.

### **1.3 Contributions of this thesis**

The contributions of this thesis are as follows:

- We analyze the power consumption of an LTE connected sensor both while actively transmitting data and in idle mode. We enumerate the major sources of power consumption and identify the potential sources power savings that can be achieved without sacrificing any functionality.
- We analyze the signaling performed by wireless sensors to attach to LTE networks and send their periodic transmissions. We also identify the overhead (in terms of network capacity used and energy consumed on the sensor) and we propose a new signaling scheme called LTE Periodic Transmission Profile (LTE\_PTP) in order to minimize the attach signaling for periodically transmitting sensors.

- We analyze the proposed signaling scheme by simulating it with a mathematical model of power consumption of an LTE UE. We compare the results of our simulation with those obtained with unmodified LTE UEs in order to quantify the gains that could be achieved using the proposed scheme.

## **1.4 Organization of this Thesis**

The rest of this thesis is organized as follows:

Chapter 2 provides the necessary background information into the research domains. It provides an introduction to LTE/EPC networks including information about the radio network, the core network and the signaling schemes. It also describes wireless sensor networks and their applications. In particular, it describes the use of wireless sensor networks in scenarios where the sensors are powered by batteries and LTE is the only form of wireless communication that is feasible.

Chapter 3 provides a complete description of the proposed signaling scheme (LTE\_PTP) that can be used to optimize energy usage in LTE connected sensors. It details the steps that led to the creation of this scheme, including analyzing the power consumption of an unmodified LTE UE and identifying areas of potential improvement.

Chapter 4 describes the various simulations that we performed and the various parameters that have been varied across the simulations. It describes the basic differences between the proposed scheme and the existing LTE signaling scheme and proposes a set of tests to measure the effectiveness of the proposed scheme in a variety of circumstances. It presents the simulation results comparing the proposed signaling

scheme to the unmodified LTE signaling scheme. It quantifies the battery life gains that can be achieved as a function of transmission frequency and proves that the scheme can provide a 10 fold increase in battery life with very minor changes to LTE attach signaling.

Finally, Chapter 5 presents the contributions and conclusions from this thesis and discusses potential areas for future work.



# **Chapter 2**

## **Background Information on LTE and wireless sensor networks**

This chapter provides the relevant background information about Long term evolution (LTE) [14] radio technology and Radio Access Network (RAN) [9], the associated packet core network called Evolved Packet Core (EPC) [3] and about wireless sensor networks [12].

### **2.1 LTE**

#### **2.1.1 The Need for LTE**

In 2005 3GPP decided to develop a new framework for the evolution of its radio technologies in order to provide

- Low latency
- High data transfer rates
- Efficient support for packet-switched (PS) services
- Support for higher transmission bandwidth (>5MHz)

In addition the new technology would have to satisfy some very stringent performance requirements [5] in the areas of data rate, spectral efficiency, coverage, mobility support and backward compatibility with legacy 3GPP radio technologies as well as competing radio and fixed access technologies.

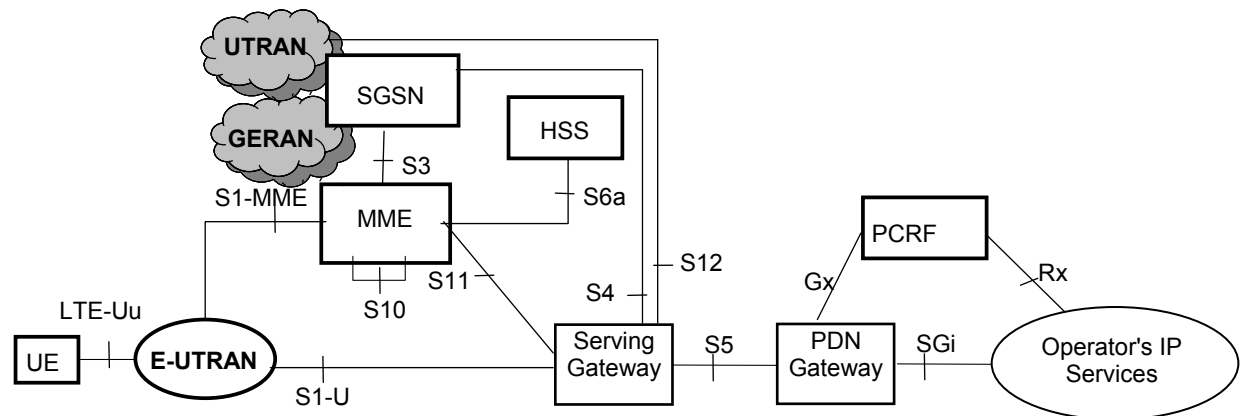
The performance requirements are detailed in the table below

High peak data rates	<b>100 Mbps (Downlink)</b> <b>50 Mbps (Uplink)</b>
High speed mobility support	Support UE speeds of between <b>0-350kmph</b>
Increase cell edge bitrates while maintaining current base station locations	Support mobility targets for nodes upto <b>30km</b> away with minor degradation in data rates and spectral efficiency
Significantly improved spectrum efficiency (Bits of information / Hz of transmission bandwidth)	<b>2-4</b> times higher than that of Release 6
Extremely low RAN latency	<b>&lt; 10ms</b>
Support for larger and smaller channel sizes	Support <b>5/10/15/20MHz</b> channels Support <b>1.25/1.6/2.5MHz</b> channels
Reduced control plane latency	Idle->Active delay <b>&lt; 100ms</b>
Support for inter-working with existing 3G systems and non-3GPP specified systems	

**Table 1: Performance requirements for LTE**

## 2.1.2 Reference network architecture

The LTE specifications also introduce an Internet Protocol (IP) based flat network architecture called the Evolved Packet Core (EPC) [3]. The architecture reference model in the non-roaming case is shown below:



**Figure 1: LTE/EPC Reference Architecture [3]**

One of the most important goals of defining this new core network is to reduce the number of nodes in the data plane. In this case, the only core network nodes in the data plane are the Serving Gateway (S-GW) and the Packet Data Network (PDN) Gateway. The functionality of these two nodes could even be combined, at least in the non-roaming case, resulting in just one node on the data plane. The complete LTE/EPC network is also referred to by the name Evolved Packet System (EPS). It consists of two major components

- LTE Radio Access Network
- Evolved Packet Core Network

### **2.1.3 LTE Radio Access Network**

The Radio Access Network for LTE is a flat IP based network. It is composed entirely of a single type of node called the eNodeB. The eNodeB is simply an LTE base station. Having only one kind of node greatly simplifies the network and minimizes the management complexity. Governing nodes in the RAN such as the Radio Network Controller (RNC) have been removed and any necessary functionality has been folded either into the eNodeB or the EPC nodes.

### **2.1.4 LTE Radio Technologies**

The LTE Radio link between the UE and the eNodeB uses two different radio technologies. One technology is used for sending uplink data and another for downlink data. Even though this makes the radio a bit more complex, this decision was made because each of the technologies provides some significant advantages that the other does not. The technology used for downlink transmission is called Orthogonal Frequency-Division Multiple Access (OFDMA) and the technology used for uplink transmission is called Single Carrier - Frequency Division Multiple Access (SC-FDMA).

#### **2.1.4.1 Orthogonal Frequency-Division Multiple Access (OFDMA)**

The LTE downlink radio technology called OFDMA is simply a multiuser version of Orthogonal Frequency-Division Multiplexing (OFDM). OFDM [9] is a multiplexing technique that works by dividing the available spectrum resources into a large number (usually hundreds) of smaller narrow-band subcarriers. The carrier is divided in a way that the sub-carriers are orthogonal to each other. Because of this OFDM can eliminate

the need for non-overlapping sub-carriers in order to avoid interference. The eNodeB basically splits the high data rate downlink stream into a large number of low data rate narrow-band streams and puts each of them on a different sub-carrier. The UE receives the multiple narrowband streams over different sub-carriers and multiplexes them to form the original high data rate stream,

OFDMA has the following advantages that make it well suited for use as the preferred technology for use in the LTE downlink:

- It is capable of providing high data rates
- It has high spectral efficiency
- It allows multiple users to use the radio link simultaneously.
- It uses lower maximum transmission power for low data rate users
- It can easily be deployed across various frequency bands with very small changes to the air interface.
- It provides very good frequency diversity since it spreads out the carriers throughout the available spectrum.

#### **2.1.4.2 Single Carrier - Frequency Division Multiple Access (SC-FDMA)**

The LTE uplink radio technology is based on a technique called Single Carrier - Frequency Division Multiple Access (SC-FDMA) [10] which is also based on OFDM. The main characteristic of SC-FDMA is that it only uses a single carrier as opposed to OFDMA that uses multiple carriers. Even though OFDMA provides very good

characteristics described earlier, it consumes a lot of power in doing so. In mobile terminals that are powered by batteries, this amount of power consumption during transmission would severely reduce the battery life of the UE. SC-FDMA avoids the high power consumption by using only a single carrier and hence benefiting from a low Peak-to-average-power ratio (PAPR).

### **2.1.5 The Evolved Packet Core (EPC)**

In addition to the new and improved technology the LTE networks were also designed to be connected to a completely new packet core network called the Evolved Packet Core (EPC). The main goals for defining the Evolved Packet Core network were as follows

- Improve performance over previously defined 3GPP packet core network
- Minimize the number of user plane nodes
- Allow the integration of other access technologies (fixed, CDMA etc.) in order to create a truly converged network
- Provide network based mobility support
- Allow optimized handovers from previous generation 3GPP radio technologies as well as selected non-3GPP radio technologies [8]

The evolved packet core network consists of 4 main different types of nodes. Two data-plane nodes called the Serving Gateway (S-GW) and PDN Gateway (P-GW) and two control plane nodes called the Mobility Management Entity (MME) and the Policy and Charging Rules Function (PCRF).

### **2.1.5.1 Mobility Management Entity (MME)**

The MME is a control plane entity in the EPC and it performs several core functions. It is responsible for gateway selection and it selects an appropriate S-GW during the initial attach procedure as well as during handovers [3]. The MME performs a crucial role in the authentication of the UE and acts as an interface between the UE and the security entity called the Home Subscriber Server (HSS) that holds the subscriber information. This is performed using a mechanism called Non-Access Stratum (NAS) signaling [4]. The MME is also responsible for tracking the UE (i.e. locate it) and for paging it to wake it up from idle mode.

### **2.1.5.2 The Serving Gateway (S-GW)**

The S-GW is the node that acts as the interface between the LTE radio access network (E-UTRAN) and the packet core network (EPC). The S-GW also acts as a localized mobility anchor when the UE is moving between two eNodeBs that are attached to it. The S-GW also acts as a kind of proxy receiver for the UE when it is in idle mode. The S-GW will terminate the downlink path for data when the UE is idle and starts paging the UE in order to get it to activate itself. The S-GW is also used for lawful intercept purposes where traffic from a specific user needs to be replicated and sent to law enforcement agencies.

### **2.1.5.3 Packet Data Network Gateway (P-GW)**

The P-GW is the node that acts as the interface between the 3GPP network and a set of external packet data networks (PDNs) [3]. The PDNs can include corporate

networks, operator service networks and the Internet. The P-GW is the entity that acts as the IP point of presence for the UE. I.e. The address that is provided to the UE is logically attached to the P-GW. For this reason, the P-GW is also the first hop router for the UE as well as the default gateway for all traffic. Due to its role as the IP point of presence the P-GW also acts as the mobility anchor for the UE in order for it to maintain its IP address even when it moves through several base stations and S-GWs.

The P-GW plays a crucial role in Fixed Mobile Convergence (FMC) as it is responsible for acting as an anchor and entry point for traffic originating from non-3GPP accesses [8].

#### **2.1.5.4 The Policy and Charging Rules Function (PCRF)**

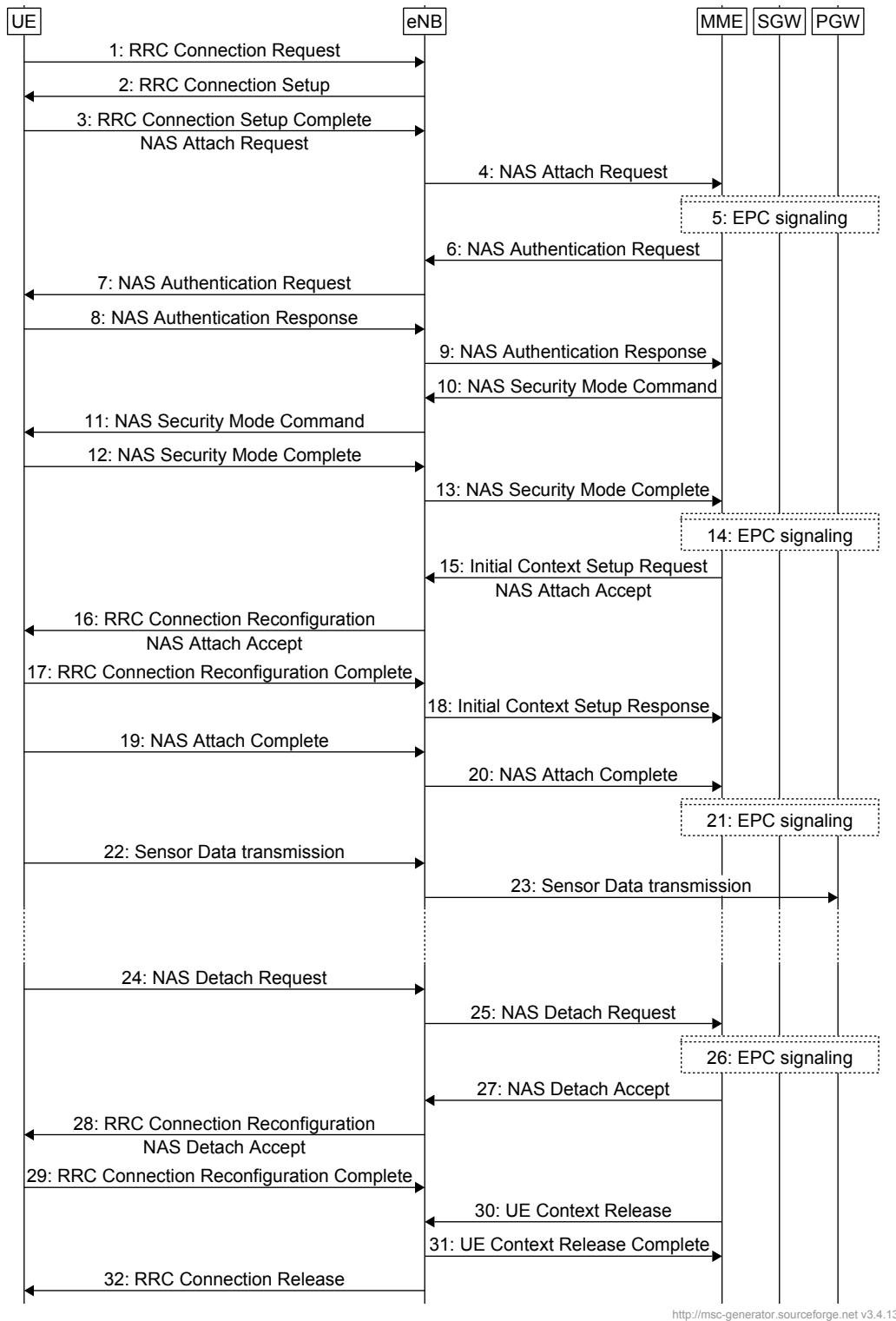
The PCRF is the node in the EPC that is tasked with initiating policy control decisions and determining the use of flow-based charging for traffic [3]. It is responsible for controlling the enforcement points called Policy and Charging Enforcement Functions (PCEF) that are distributed into several points in the network. E.g. The P-GW includes a PCEF function. In the typical use case, an Application Function (AF), typically located within the LTE operator's network, sends the service information to the PCRF. The PCRF uses this information to specify the handling of the service specific flow on one or more PCEFs.

#### **2.1.6 LTE attach signaling**

When a UE wants to connect to the LTE network in order to transmit or receive data it needs to perform a series of signaling steps in order to establish the connectivity



to the RAN as well as the core network. This set of signaling steps that the UE is required to perform is called “attach signaling”. The attach signaling for LTE UEs is performed over several different layers and between a large number of functional entities [3][4][8][11].



**Figure 2: LTE attach signaling**

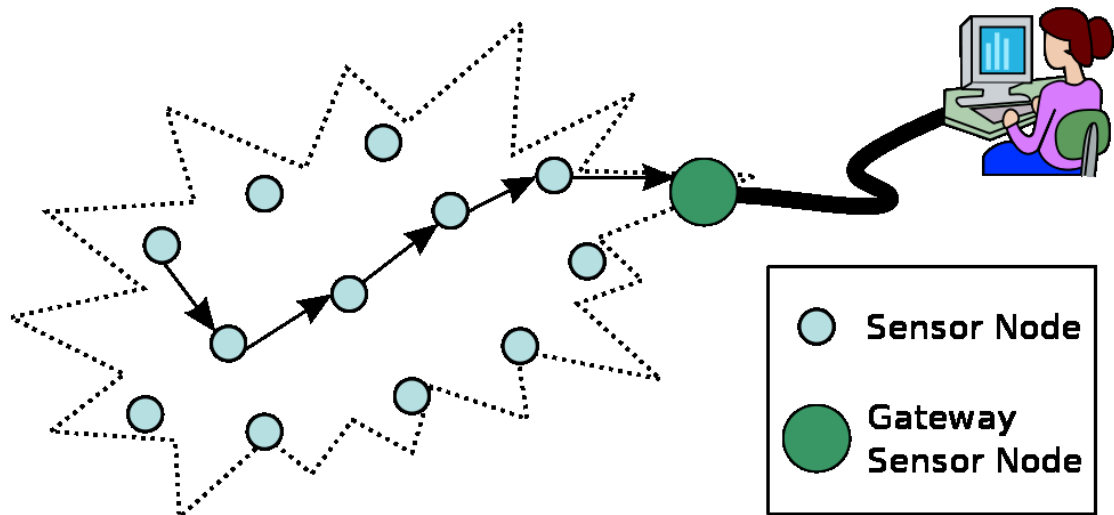
LTE networks were defined with mobility and quality of service (QoS) as the most important requirements. In order to fulfil these requirements, attachment to an LTE/EPC

network involves several rounds of signaling over the radio link and associated signaling over the core network in order to get anchored with a suitably located mobility anchor point within the EPC network. The attach procedure can be roughly classified into are three separate classes of signaling. The Radio Resource Control (RRC) signaling for management of the radio resources [11]; The NAS signaling for invoking procedures regarding the control of mobility, security and bearer management [4]; and finally the EPC signaling [3][8] to initiate state and services in the packet core nodes.

## **2.2 Wireless Sensor Networks**

A sensor is a device that is used for measuring a physical quantity in analog form and producing a digital output [2]. A wireless sensor is a specific kind of sensor that can transmit the aforementioned digital output over a wireless link. The wireless links can be short reach or long reach, infrastructure based or ad-hoc, meshed or multi-hop. Wireless Sensor Networks (WSNs) consist of a set of wireless sensors that are geographically distributed [12].

Commonly used WSNs of today often communicate using ad-hoc and multi-hop wireless technologies to communicate among themselves as well as communicate to the outside world through a gateway or a sink [12]. Sensors communicate among themselves using some form of low power radio links that operate some form of energy aware routing protocol. Any communications that the wireless sensor network has with the outside world is directed through some form of sensor network gateway that sits at the border between the WSN and an external network. A typical representation of a wireless sensor network is shown below [12].



**Figure 3: Wireless Sensor Network Architecture [24]**

A gateway node is usually needed because the wireless sensors cannot typically communicate over long distances and hence need a node that talks some form of low power short range radio towards the sensors and some form of fixed access or wide area wireless technology towards the network that utilizes the data provided by the sensors. Additionally, since most WSNs currently use proprietary protocols, the gateway will usually talk the proprietary protocol on one side and standard internet protocols on the other side.

### **2.2.1 Characteristics of wireless sensors**

Wireless sensors are built with simplicity and power efficiency in mind and can be generally characterized by the presence heavily constraints on common computing and communication resources. E.g. A typical wireless sensor would have

- Computing resource: **Low powered Microcontroller**
- Memory: **10s of Kilobytes of RAM 100s of Kilobytes of ROM/Flash**

- Communication technology: **Low power, low bit-rate, short range wireless technology such as IEEE 802.15.4**
- Energy source: **Low capacity Battery 9.36 KJ / 2.6Wh**

We can see that the resources on a typical wireless sensor are more than an order of magnitude lower than a typical smartphone. This is what makes it challenging to connect the wireless sensors to wireless wide area networks such as LTE. The wireless technologies that are commonly used for wireless sensor networks are

- **Zigbee / IEEE 802.15.4**: New low-rate wireless personal area network technology. Becoming popular in home automation applications
- **ISA100** : A wireless system that was developed for the needs of process control and industrial automation systems
- **WirelessHART**: It is a self-organizing and self-healing mesh network designed for industrial wireless sensing applications.

### **2.2.2 Applications of wireless sensor networks**

In the past few years, there have been significant advances in wireless technologies that allow for their use in constrained sensor nodes. Due to the decreasing cost of manufacturing sensors, they can now be used in cost conscious applications as well. Some of the major application areas towards which WSNs are targeted are listed below:

- Military and Battlefield applications [22]
- Environmental applications [25]

- Industrial applications [26]
- Smart Grid [28]
- Home automation [27]

### **2.2.2.1 Military and Battlefield applications**

Military applications were the main driver for the development of wireless sensor networks [12]. WSNs were originally targeted towards performing battlefield surveillance. But due to the advances in WSN technology, they are being used in more and more applications. The major new fields of application are monitoring of equipment and ammunition, damage assessment, targeting systems, perimeter surveillance etc. [22].

### **2.2.2.2 Environmental applications**

As the concerns surrounding the environment mount, WSNs are increasingly being used for environmental monitoring. They are used to monitor critical resources such as ground water levels, presence of pollutants in soil/water, detection of natural disasters such as forest fires, volcano eruptions, tsunamis etc. [25][29].

### **2.2.2.3 Industrial applications**

Industrial applications have always used sensors in several applications such as equipment health monitoring. These sensors were usually wired and this limited their areas of use. Due to their wireless communication interface, WSNs are being used in areas where wiring was not possible. E.g. inside rotating machinery, inside hazardous environments, monitoring industrial effluent/waste levels etc. [26].

#### **2.2.2.4 Smart Grid**

The ever increasing demand for energy and the limited availability of energy sources has led to a drive to increase energy efficiency. A Smart Grid is an electrical grid that uses information and communication technologies to increase its security, reliability and the efficiency. WSNs are targeted towards several smart grid applications including, substation automation, subscriber demand-response, distribution network monitoring, renewable energy source monitoring etc. [28].

#### **2.2.2.5 Home automation**

The availability of low cost wireless sensors has enabled their use in home automation applications [27]. Common applications include climate control, security etc. For example, wireless temperature sensors are used to monitor temperature levels inside home to decide whether to turn on air conditioning/heating. Wireless sensors are also being used in home security applications. E.g. Infrared sensors that are used for intrusion detection and triggering an alarm towards a security firm. The wireless sensors used for home automation predominantly use low-rate low power radio technologies such as Zigbee/802.15.4.

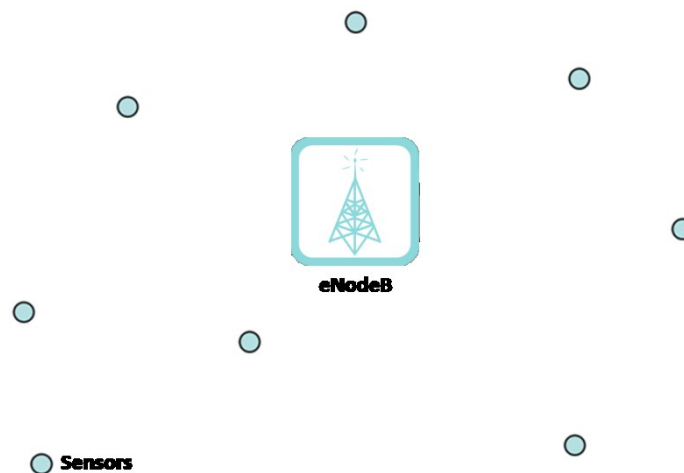
### **2.3 The need for connecting WSNs to LTE**

As sensors are starting to get used for more and more applications, a large number of them will be placed in locations where wide area wireless networks, such as LTE, are the only available method of connectivity. If we examine the list of applications of WSNs it is apparent that a large majority of WSN applications will fall under these environments (Applications **2.2.2.1-2.2.2.4** potentially fall under this classification).

Examples of such locations include remote areas (e.g. for Smart grid and agricultural applications), and inhospitable environments (e.g. for industrial applications). As LTE could be the only available technology for sensors to communicate, it is necessary to study how wireless sensors can be connected to LTE in an efficient manner.

## 2.4 Applicability and targeted topologies

As described in Section 2.3 the scenarios targeted by this thesis for direct connection of wireless sensors to LTE involve topologies where sensors are not in close proximity to each other, unlike the classical wireless sensor topology shown in Figure 3. Hence, the regular short range multi-hop wireless technologies used in classical sensor networks will not be usable in such scenarios.



**Figure 4: LTE connected wireless sensor topology**

The new signaling scheme described in this thesis is optimized for periodically transmitting sensors, and will not provide any active mode performance gains for asynchronously transmitting sensors as the signaling overhead will continue to exist for such sensors. However, they will still obtain some performance gains by using the scheme due to the reduction in idle mode power consumption.



# Chapter 3

## A novel and optimized signaling scheme for periodically transmitting sensors

This chapter defines a new signaling scheme for attaching and transmitting data to LTE networks that is optimized for the need of sensors that transmit small amounts of data periodically and do not receive any data. In order to define such a scheme, this section analyzes the power consumption in an LTE UE and identifies the components that are potentially unnecessary and proposes mechanisms for eliminating them. Several power consumption models have been developed for wireless sensors that use classical short range radios with multi-hop topologies [32][33] but no such model is publically available for sensors directly connected to Wireless Wide Area Networks. Hence, this thesis uses a proprietary power consumption model for an UE [7] that was developed inside Ericsson. This model has been summarized in Appendix A as it is not externally available.

### 3.1 Analysis of power consumption of UE

Using the power consumption model of a typical LTE UE that is defined in [7], the power consumed by a LTE connected sensor can be calculated. The total power consumption of the UE can be calculated as the sum of idle mode power consumption ( $p_{idle}$ ) and the transmit power consumption ( $p_{tx}$ ).

$$P_{total} = P_{idle} + P_{tx}$$

In order to reduce the total power consumption of the UE, we need to first identify what are the sources of power consumption. We can do this by analyzing the UE power consumption model and correlating the various components to the operation of the UE. In particular, we can categorize the components of the model that contribute to the idle power consumption and those that contribute to active power consumption during transmissions.

### **3.1.1 Active mode power consumption**

By analyzing the power consumption model of a typical LTE UE that is defined in [7] and by studying the power parameters obtained from measurement of real LTE UEs we can come to the conclusion that the receiver chain and the transmitter chain are the most power hungry parts of an LTE UE. Since the sensor communicates primarily in the uplink direction, the receiver chain is used much less than the transmitter chain. If we analyze the transmission chain, we can find out that the power consumed is directly related to the amount of time that the sensor uses to transmit data. At a given data rate, the amount of time the transmission chain stays active is directly proportional to the number of bytes that need to be transmitted.

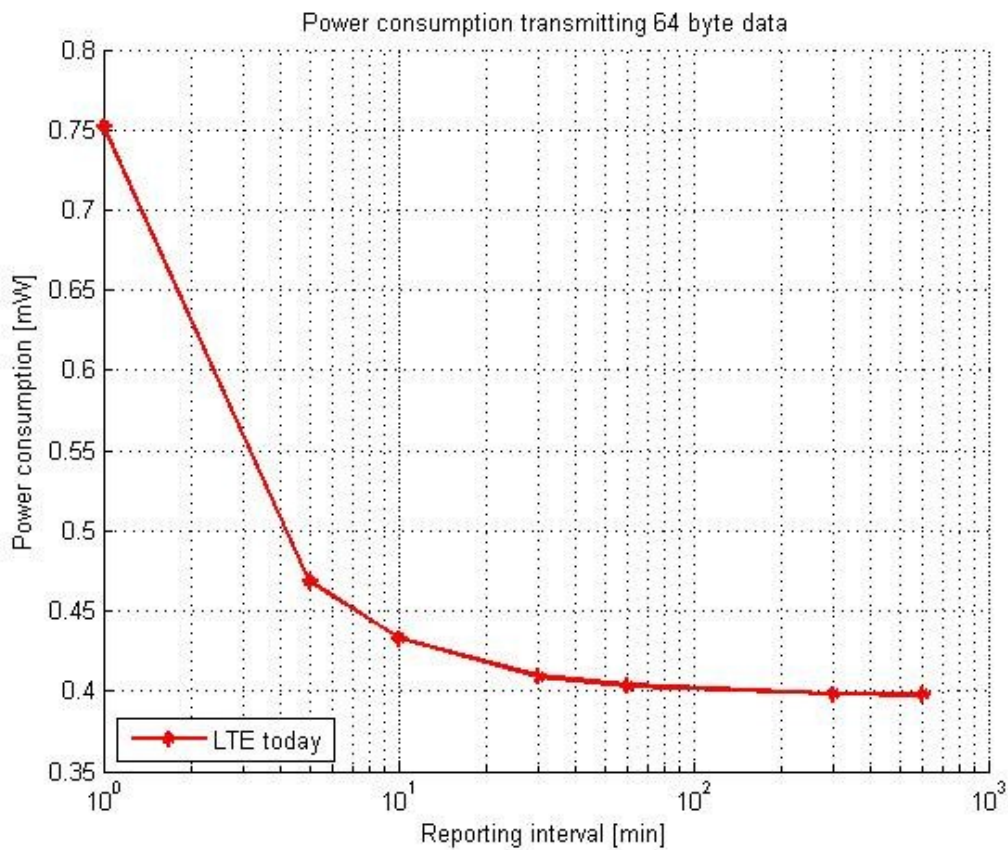
### **3.1.2 Idle mode power consumption**

In idle mode the UE has to perform some tasks in order to stay connected to the LTE network. One of the main tasks of the LTE UE is to constantly monitor the paging channel in a periodic fashion. This has to be done in order to see if the network wants the UE to wake and move into active mode. E.g. the network pages an UE in idle mode for receiving an incoming data transmission. The amount of power consumed by the UE in idle mode is fairly constant and is not related to the amount of data it transmits. The only variable that changes the idle mode power consumption is the length of the paging cycle. In order to minimize the idle mode power consumption, we need to use the

longest paging cycle possible. For the purpose of calculating the power consumption, we use the maximum length specified for the paging cycle by LTE of 2.56 seconds.

### 3.2 Power consumption of LTE UE with small size data packets

In order to obtain the baseline figures for power consumption, we can instantiate the power model for various packet sizes and various intervals between periodic retransmissions (Reporting interval). As a base scenario, we assume a packet size of 64 bytes and plot the power used by the terminal as a function of the reporting interval.



**Figure 5: Power consumption of typical LTE UE - 64 byte packets**

As expected, we can see that the power consumption decreases with an increase in reporting interval. This is because with higher reporting intervals, the sensor spends

more time in idle mode and less time in transmit mode. As the idle mode power consumption is lower than that of active transmit mode power consumption, higher percentage of idle time leads to lower power consumption. Typical power consumption values from this figure are shown in the table below

<b>Reporting interval (mins)</b>	<b>Power consumption (mW)</b>
1	0.752563
5	0.4684326
10	0.4329163
30	0.409238767
60	0.403319383
300	0.398583877
600	0.397991938

**Table 2: Typical power consumption values for LTE UE**

As we can see, even very large increases in reporting interval do not lead to a significant reduction of power consumption of the UE. A 600 fold increase in reporting time only leads to a twofold reduction (barely) in power consumption. Even worse, the reduction in power gradually reduces and, at about 300 minutes almost vanishes completely. Even if the reporting interval increases past this, there will not be any visible reduction in power consumption.

In terms of battery life, these numbers correspond to a battery life of about 140 days with a 1 minute reporting interval and a 270 day battery life with a 600 minute reporting interval. As with the power consumption figures, the increase in battery life becomes negligible at around 300 minute reporting intervals.

### **3.3 Issues with current signaling scheme**

Given the measured results of power consumption and battery life, it becomes apparent that the current LTE signaling scheme described in 2.1.6 LTE attach signaling cannot satisfy the lifetime requirements for wireless sensors even with small size data packets and extremely large reporting intervals. This problem has been described in [16] and there are efforts that are underway to provide some enhancements for M2M communications in future 3GPP radio technologies such as LTE-Advanced [17][18].

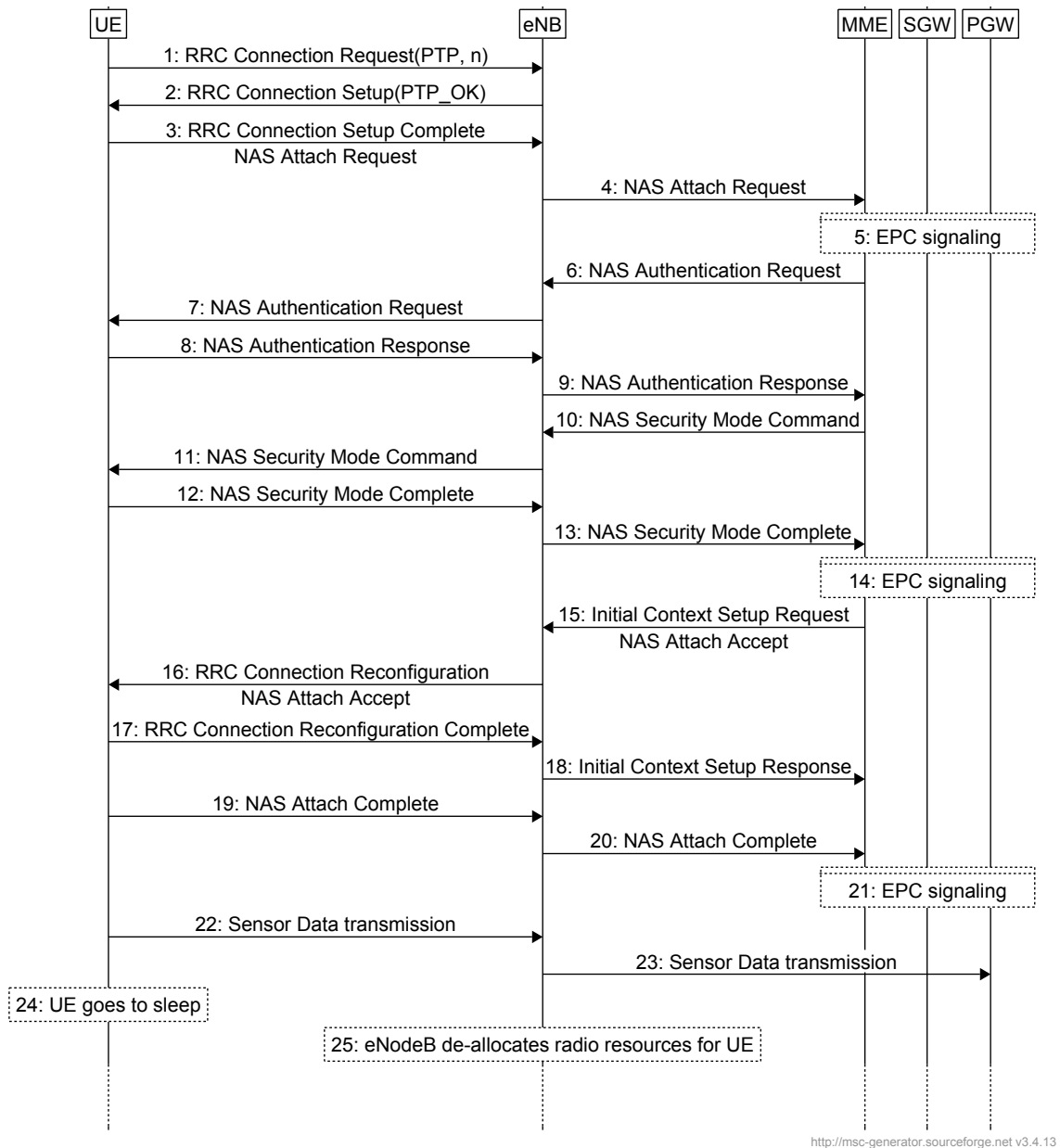
There are two major sources of power drain that are not necessary for wireless sensors.

- The idle mode power consumption for paging is wasteful in the case of periodically transmitting sensors as they never receive downlink data.
- The active mode power consumption for sending a large number of attach signaling messages every time the sensor transmits periodically is also extremely wasteful

### **3.4 Proposed signaling scheme**

In the proposed signaling scheme, the LTE connected sensor informs the network that it wishes to be connected only intermittently to the network. This proposed signaling scheme will be called Periodic Transmission Profile (PTP).

The sensor informs the eNodeB that it wishes to use PTP. This request is piggybacked into an existing signaling message (Message 3. RRC connection request). In this request, the sensor also includes the frequency at which it expects to transmit data. E.g. If the sensor wakes up every hour to transmit data, it would include 3600 seconds as the transmission period.



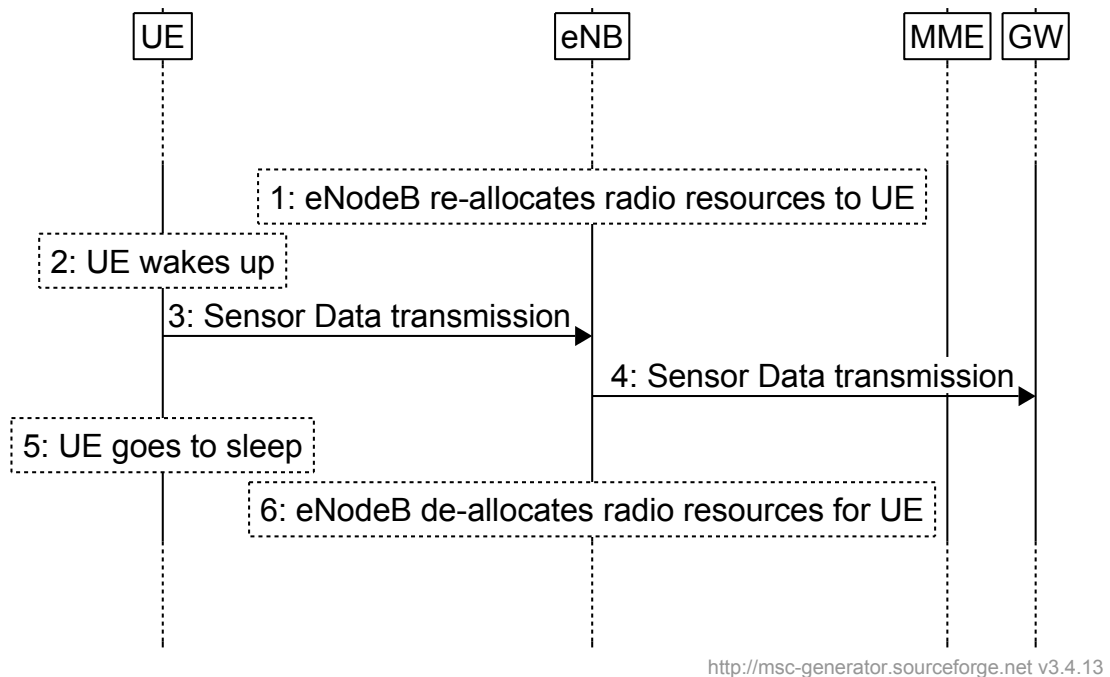
<http://msc-generator.sourceforge.net v3.4.13>

**Figure 6: LTE\_PTP initial attach signaling**

If the eNodeB also supports the Periodic Transmission Profile, it will respond with a PTP\_OK flag in the RRC Connection Request message (Message 4). If it does not recognize PTP, it will not include this flag in message 4 and the sensor will realize that PTP is not supported by the network. If the network supports PTP, the UE and all the networks will perform the steps necessary for the attach procedure. The rest of the steps in the attach procedure are identical to those in a current LTE network. After

transmitting the data it needs to transmit (Step 22), the sensor will go back into sleep. The LTE network will keep all the core network resources reserved for the sensor, but will free all the radio resources that were allocated for the sensor.

For all future periodic transmissions, the UE will no longer perform the complete attach procedure. It will simply wake up, transmit the required data and go back to sleep right after. In order to make sure that the radio resources are available for the UE to transmit, the eNodeB re-allocates the resources to the UE slightly before the UE is scheduled to wake up and it de-allocates the resources after the UE has completed its scheduled data transmission. This is very effective because the frequency of transmissions is known up front and the sensor data is sent only in the uplink direction.



**Figure 7: LTE\_PTP periodic data transmission**



### 3.4 Benefits of the LTE\_PTP signaling scheme

The LTE\_PTP signaling scheme was specifically optimized to minimize the power consumption for LTE connected sensors that transmit periodically. It achieves its goals by identifying and eliminating the two major sources of energy waste identified in 3.3 Issues with current signaling scheme. The techniques used to reduce the power consumption are twofold.

The LTE\_PTP scheme reduces the idle power consumption by allowing the UE to go to sleep without needing to be available for paging by the network. This will not cause any issues for sensors as they do not usually receive data.

The LTE\_PTP scheme reduces the transmission (active mode) power consumption by reducing the number of bytes transmitted in order to send a specific amount of data. Given a typical sensor data transmission of a relatively low size (say 64 bytes), the associated attach signaling can more than **double** the active power transmission per reporting period. The LTE\_PTP scheme completely eliminates this overhead by keeping the periodic retransmission state in the eNodeB without any further signaling from the sensor.

The combination of these two optimizations should result in much lower power consumption for LTE connected sensors than with the unmodified LTE signaling scheme. The specific gains that can be achieved are highly variable and dependent on the data size and reporting intervals. In the following sections we will prove that the LTE\_PTP

scheme can provide the necessary 10 fold increase in battery life for reasonable values of packet size and reporting interval.

Additionally, since the LTE UE does not stay connected to the eNodeB when it goes to sleep, it does not occupy any radio resources. The eNodeB is thus free to use the radio resources to serve other UEs during the time the sensor is known to sleep. This allows for more efficient use of the expensive and highly restricted wireless spectrum and allows for the LTE network to potentially accommodate 10 fold the number of sensors than is possible today.

# **Chapter 4**

## **Simulations, Test Setup and Results**

This chapter describes the various simulations that have been performed and the various parameters that will be varied across the simulations. It describes the basic parameters for simulating both the LTE\_PTP scheme and the existing LTE signaling scheme and proposes a set of tests to measure the effectiveness of the proposed scheme in a variety of circumstances.

### **4.1 Mechanism used for simulation**

The thesis uses a set of MATLAB programs in order to simulate the expected power consumption of an LTE connected sensor. The MATLAB programs are used to perform a programmatic instantiation of the UE power consumption model defined in [7]. In order to obtain realistic results, the program uses the parameters measured from commercially available UEs. These measured model parameters are listed in 4.2 Model Parameters for current LTE UEs.

### **4.2 Model Parameters for current LTE UEs**

For calculating the actual power usage of the UE, we need to obtain the values for the parameters in Table 3 to plug into the model. The following parameters have been obtained by measuring power consumption on a commercially available LTE terminal that uses 3GPP Release 8 mechanisms [3][11] to attach to a network.

<b>Parameters</b>	<b>Values</b>
$p_{\text{application}}$	3.2 mW
$p_{\text{coarse}}$	0.015 mW
$p_{\text{fine}}$	10 mW
$p_{\text{RX,frontend}}$	72 mW
$k_{\text{RX,analog}}$	14 mW/MHz
$p_{\text{RX,baseband,0}}$	25 mW
$k_{\text{RX,baseband}}$	7 mW/Mbps
$p_{\text{TX,PA}}$	$72 + 17.5 P_{\text{TX}}^{0.784}$ mW
$p_{\text{TX,mixer}}$	80 mW
$k_{\text{TX,DAC}}$	16 mW/MHz
$p_{\text{TX,baseband,0}}$	11 mW
$k_{\text{TX,baseband}}$	1 mW/Mbps
$L_{\text{duplex}}$	2 dB

**Table 3: Model parameters for state-of-the-art LTE Release 8 terminals**

### 4.3 Tests to be performed

We perform a set of power consumption tests in order to verify whether the LTE\_PTP scheme produces any significant gains over the current LTE signaling schemes. In order to accurately simulate the performance under widely varying conditions, we need to instantiate the UE power consumption model under each of these conditions. As we determined by the analysis of the UE power consumption, the two major factors that have the greatest impact on the total power consumption of the UE are

- Reporting interval
- Packet size

Therefore we vary these two conditions while keeping the rest of the model intact.

### **4.3.1 Baseline power consumption and battery life**

In order to obtain the baseline figures for power consumption and battery life, we pick a reference packet sizes and measure power consumption over various intervals between periodic retransmissions (Reporting interval). As a base scenario, we will use a packet size of 64 bytes and plot the power used by an unmodified LTE terminal.

### **4.3.2 Variations in packet sizes and reporting intervals**

Since we are interested in observing the power consumption behavior of sensors under different conditions, it is helpful to use greatly different values of the key variables (packet sizes and reporting intervals) to see whether our assumptions still hold true under extreme circumstances. We use the following reporting intervals

- a) 1 minute
- b) 5 minutes
- c) 10 minutes
- d) 30 minutes
- e) 60 minutes
- f) 300 minutes
- g) 600 minutes

We will be using the following packet sizes

- a) 64 bytes
- b) 256 bytes
- c) 1024 bytes

### 4.3.3 Measuring improvements due to LTE\_PTP

In order to obtain the measurements for the improvements in power consumption and battery life, we instantiate the UE power consumption model with the same values for packet size (64 bytes) and reporting interval(1-600 minutes) that we used for the baseline measurement in unmodified LTE UEs.

Then we can plot the power consumption and battery life values obtained for LTE\_PTP UEs against those measured for unmodified LTE UEs for identical reporting intervals. We can calculate the gains due to LTE\_PTP as follows:

The gain in power consumption  $G_{pow}$  can be calculated as follows

$$G_{pow} = P_{lte} / P_{ptp}$$

Where  $P_{ptp}$  is the power consumption of the LTE\_PTP UE and  $P_{lte}$  is the power consumption of the unmodified LTE UE

Similarly, the gain in battery life  $G_{bat}$  can be calculated as follows

$$G_{bat} = BL_{ptp} / BL_{lte}$$

Where  $BL_{ptp}$  is the battery life of the LTE\_PTP UE and  $BL_{lte}$  is the battery life of the unmodified LTE UE.

### 4.3.4 Battery capacity

We also need to select a standard battery capacity in order to calculate the expected battery lifetime. For the purposes of this thesis we assumed that the sensor was powered by a standard alkaline AA battery with a capacity of 2.6 Wh (9.36KJ). With the improvements in battery technology it is possible that the battery capacity might increase dramatically. On the contrary, due to space constraints in the sensor it may

reduce dramatically as well. In either case, the battery lifetimes are only indicative, and we believe that the magnitude of gains due to the signaling scheme will stay constant for any value of battery capacity.

#### **4.4 Conventions used**

The results are presented both in a graphical form as well as in a tabular form. The graphs are presented on a logarithmic scale on the x axis (reporting interval) since the reporting interval spans a large and sparse range (1-600 minutes).

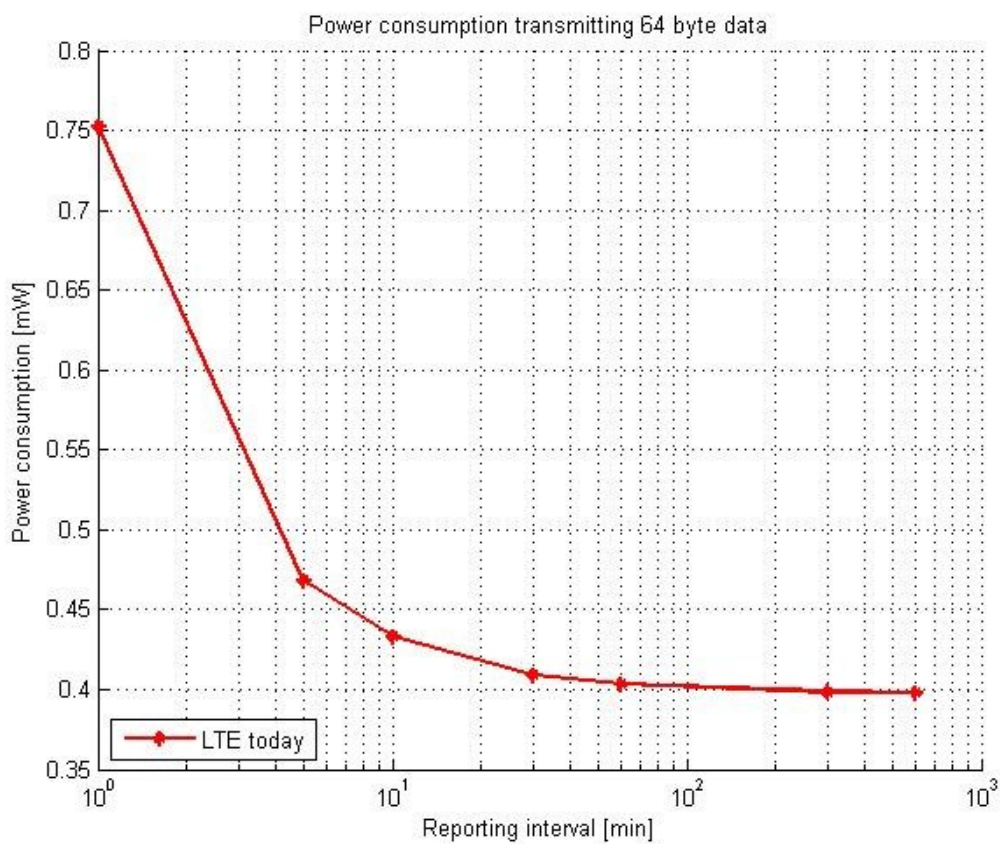
The results of power consumption and battery life for unmodified LTE UEs are always presented with a red colored solid line. The results of power consumption and battery life for modified LTE\_PTP UEs are always presented with a blue colored solid line.

When the power consumption results are being presented in a tabular form, the reporting interval is listed in units of minutes and the power consumption values are presented in units of milliwatts (mW). Similarly for the battery life results, the table lists the expected battery life in units of years for different reporting intervals.

Performance gains using the LTE\_PTP scheme are calculated as described in Section 4.3.3 Measuring improvements due to LTE\_PTP and graphed using a bar chart with different colored bars for each of the tested packet sizes. The results for different reporting intervals are presented in the same chart.

## 4.5 Baseline power consumption of an unmodified LTE UE

In order to obtain the baseline figures for power consumption, we can instantiate the power model for a 64 byte packet size and various intervals between periodic retransmissions as specified in Section 4.3.2 Variations in packet sizes and reporting intervals. We then plot the power used by the terminal as a function of the reporting interval.



**Figure 8: Baseline power consumption**

As expected, we can see that the power consumption decreases with an increase in reporting interval. This is because with higher reporting intervals, the sensor spends more time in idle mode and less time in transmit mode. As the idle mode power



consumption is lower than that of active transmit mode power consumption, higher percentage of idle time leads to lower power consumption. Typical power consumption values from this figure are listed in the table below

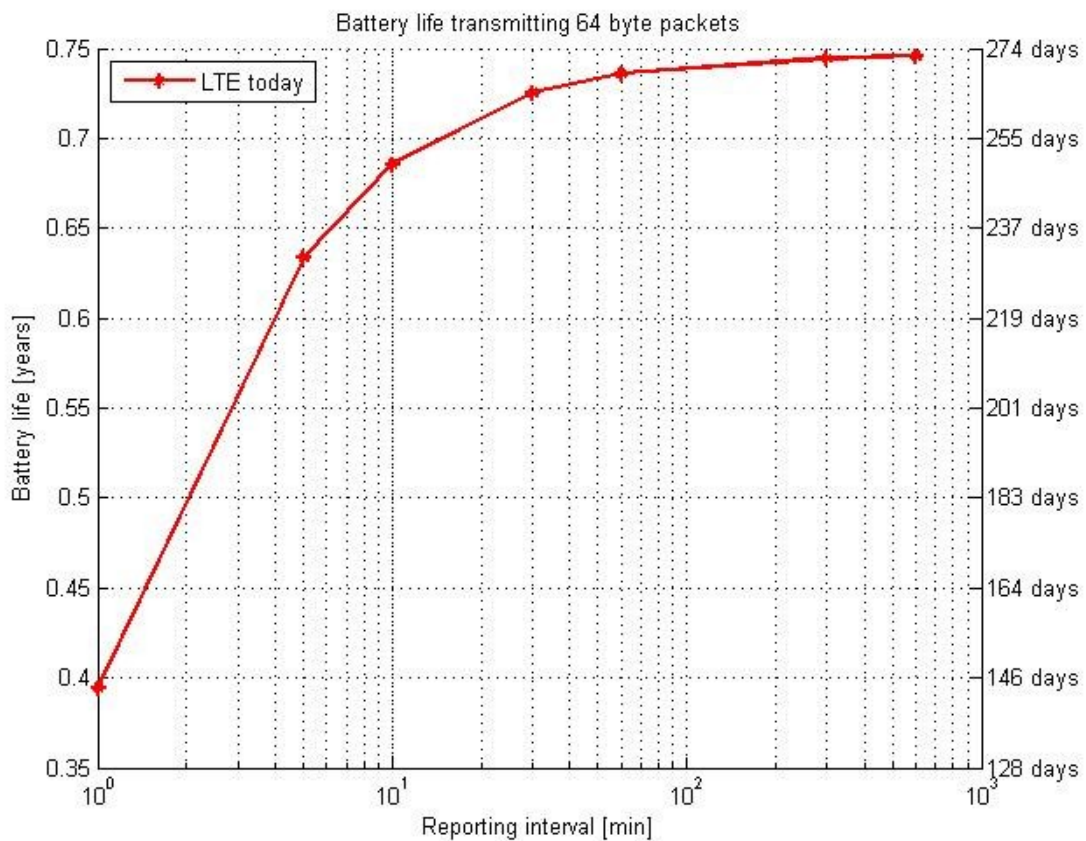
<b>Reporting interval (mins)</b>	<b>Power consumption (mW)</b>
1	0.752563
5	0.4684326
10	0.4329163
30	0.409238767
60	0.403319383
300	0.398583877
600	0.397991938

**Table 4: Baseline power consumption**

As we can see, even very large increases in reporting interval do not lead to a significant reduction of power consumption of the UE. A 600 fold increase in reporting time only leads to a twofold reduction in power consumption. Even worse, the reduction in power gradually reduces and, at about 300 minutes almost vanishes completely. Even if the reporting interval increases past this, there will not be any visible reduction in power consumption.

## 4.6 Baseline battery life of an unmodified LTE UE

In order to obtain the baseline figures for battery life, we can instantiate the power model for a 64 byte packet size and various intervals between periodic retransmissions as specified in Section 4.3.2 Variations in packet sizes and reporting intervals. We then plot the expected battery life of the terminal as a function of the reporting interval.



**Figure 9: Baseline battery life**

As expected, we can see that the battery life of the sensor increases with an increase in reporting interval. This is because with higher reporting intervals, the sensor spends more time in idle mode and less time in transmit mode. As the idle mode power consumption is lower than that of active transmit mode power consumption, higher

percentage of idle time leads to lower power consumption and hence a higher battery life.

Typical battery life values from this figure are listed in the table below.

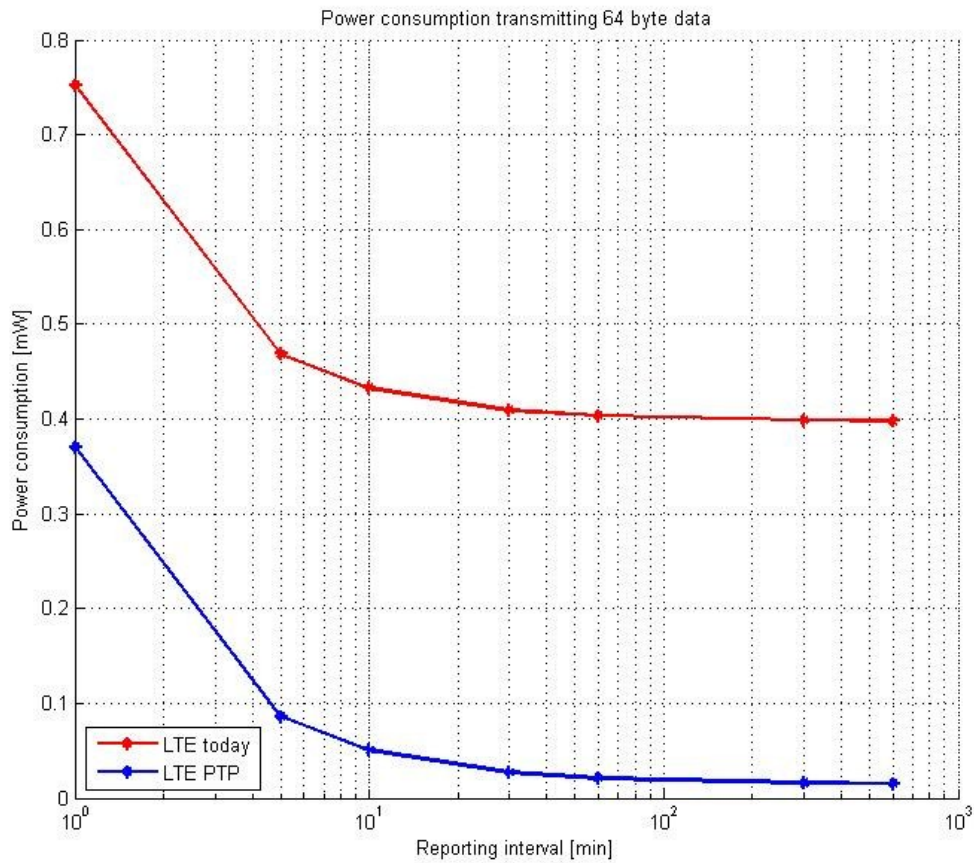
<b>Reporting interval (mins)</b>	<b>Battery life (years)</b>
1	0.39439044
5	0.633610156
10	0.685591309
30	0.725257911
60	0.735902278
300	0.744645407
600	0.745752927

**Table 5: Baseline battery life**

As we can see, even very large increases in reporting interval do not lead to a significant increase in the battery life of the UE. A 300 fold increase in reporting time only leads to a twofold increase in battery life. Even worse, just like in the power consumption case, the increase in battery life gradually reduces and, at about 300 minutes almost vanishes completely. Even if the reporting interval increases past this, there will not be any visible increase in battery life.

## 4.7 Baseline improvements of LTE\_PTP signaling

After obtaining the results of calculating the power consumption and battery life for both the typical LTE UEs and modified UEs that follow the LTE\_PTP signaling scheme we can compare the characteristics of both the schemes and evaluate if we have succeeded in obtaining the original target we have set for ourselves (10 fold increase in battery life). First we compare the power consumptions between the typical LTE and LTE\_PTP UEs.



**Figure 10: Comparison of baseline power consumption**

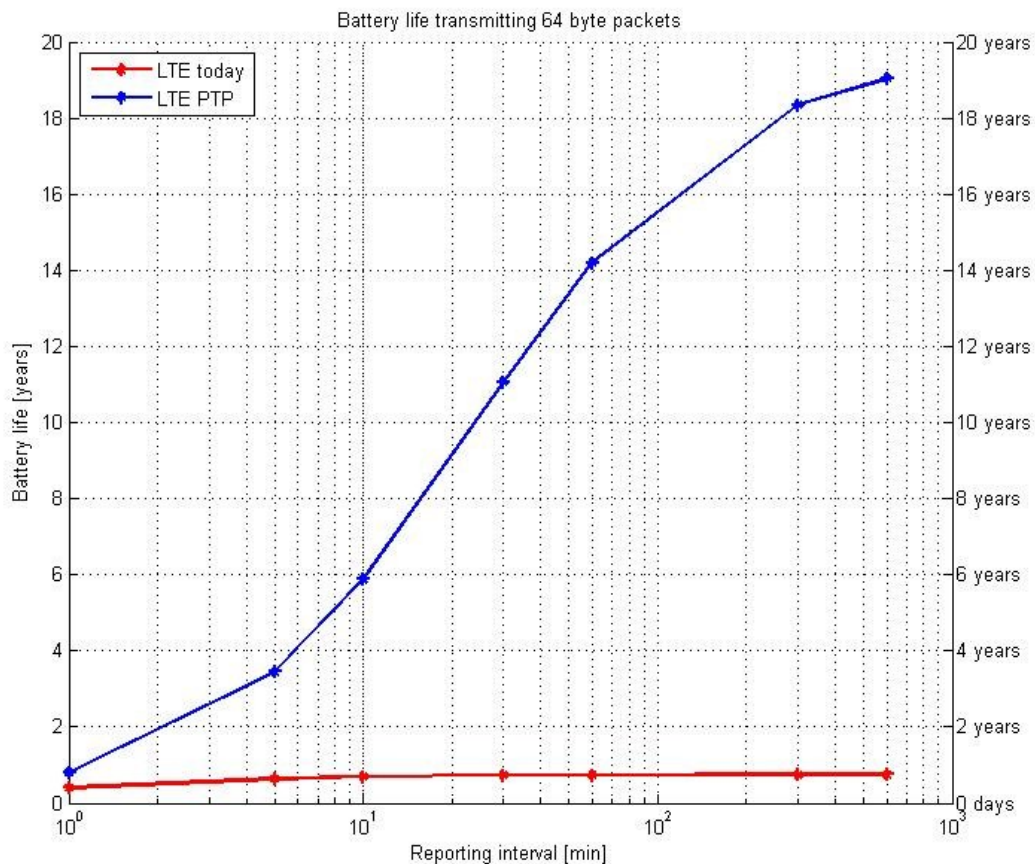
Using the results of the power consumption calculations we can create a table to measure the decrease in power consumption as a consequence of using the improved LTE\_PTP signaling.

Reporting interval (mins)	LTE Power consumption (mW)	LTE_PTP Power consumption (mW)	Decrease in Power Consumption
1	0.752563	0.370163	2.033058409
5	0.4684326	0.0860326	5.444826727
10	0.4329163	0.0505163	8.569833893
30	0.409238767	0.026838767	15.24804667
60	0.403319383	0.020919383	19.27969754
300	0.398583877	0.016183877	24.6284549
600	0.397991938	0.015591938	25.52549464

**Table 6: Comparison of baseline power consumption**

It is clear from the comparison above that the LTE\_PTP scheme provides very significant decreases in power consumption as compared to a regular LTE UE. It can be noted that, for reporting intervals slightly larger than 10 minutes, the LTE\_PTP scheme provides at least a 10 fold decrease in power consumption. Based on this calculation, we can confirm that the LTE\_PTP scheme does achieve its target of a 10 fold improvement in power consumption over a regular LTE terminal.

Then we also compare the baseline battery lives of typical LTE and LTE\_PTP UEs.



**Figure 11: Comparison of baseline battery life**

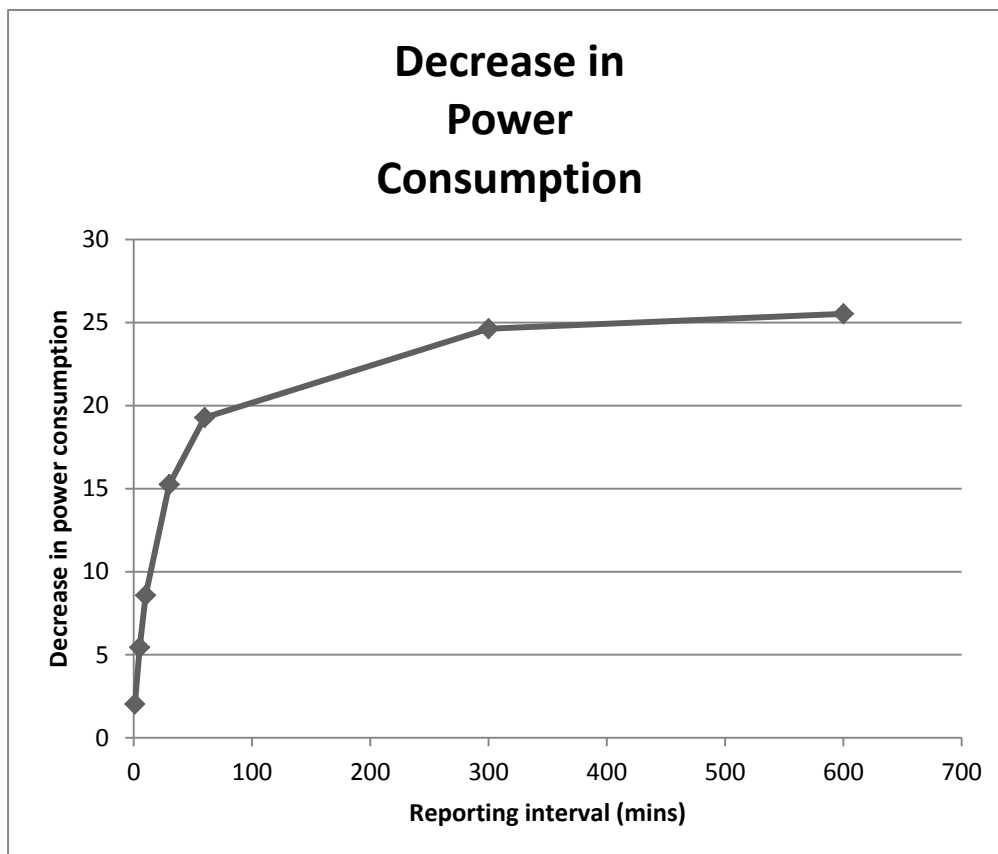
Using the results of the power consumption calculations we can create a table to measure the increase in battery life as a consequence of using the improved LTE\_PTP signaling.

Reporting interval (mins)	LTE Battery life (years)	LTE_PTP Battery life (years)	Increase in Battery Life
1	0.39439044	0.801818801	2.033058409
5	0.633610156	3.449897514	5.444826727
10	0.685591309	5.87540364	8.569833893
30	0.725257911	11.05876647	15.24804667
60	0.735902278	14.18797334	19.27969754
300	0.744645407	18.33946582	24.6284549
600	0.745752927	19.03571234	25.52549464

**Table 7: Comparison of baseline battery life**

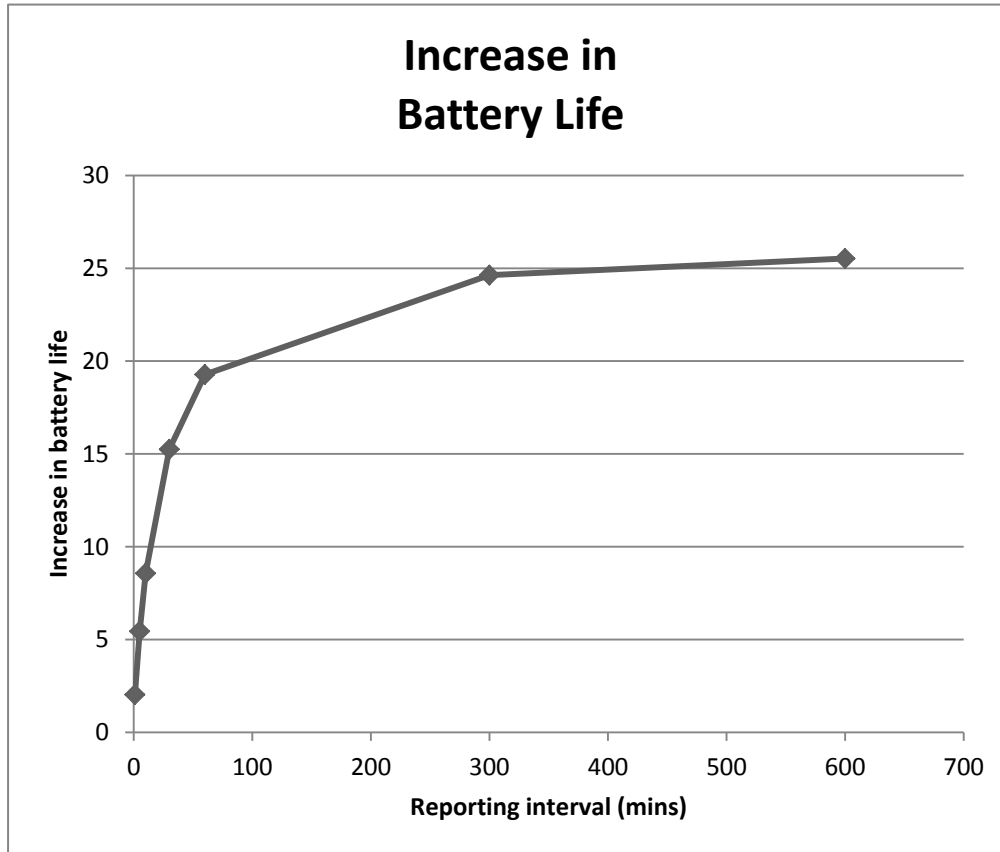
Again, as in the power consumption case, it is clear from the comparison above that the LTE\_PTP scheme provides very significant increase in battery life as compared to a regular LTE UE. It can be noted that, for reporting intervals slightly larger than 10 minutes, the LTE\_PTP scheme provides at least a 10 fold increase in battery life. Based on this calculation, we can confirm that the LTE\_PTP scheme does achieve its target of a 10 fold improvement in battery life over a regular LTE terminal.

Since we have already measured the power consumption and battery life under the baseline conditions, we can plot the decrease in baseline power consumption as a function of the reporting interval.



**Figure 12: Decrease in baseline power consumption**

Next we can plot the increase in baseline battery life as a function of the reporting interval.



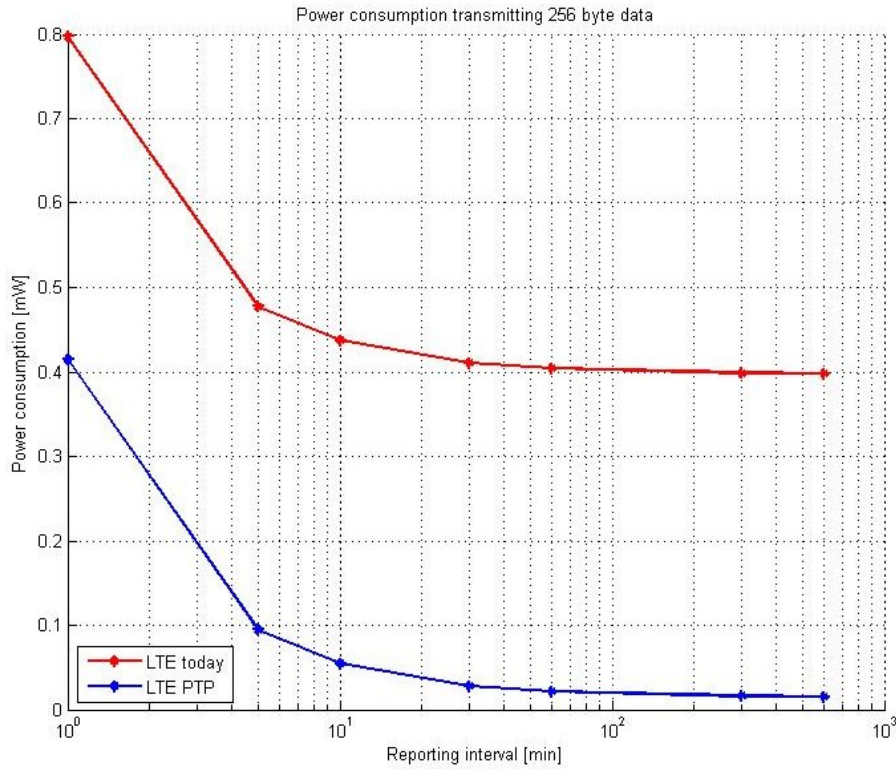
**Figure 13: Increase in baseline battery life**

As we see from the above figures the gains in power consumption and battery life seem to be significant and meet our target of a 10 fold improvement. In order to see if the gains still hold true for larger packets, we rerun the power model for larger sized packets and evaluate the results obtained to see if they provide similar improvements.



## 4.8 Measurements for 256 byte packets

First we compare the power consumptions between the typical LTE and LTE\_PTP UEs using 256 byte data packets



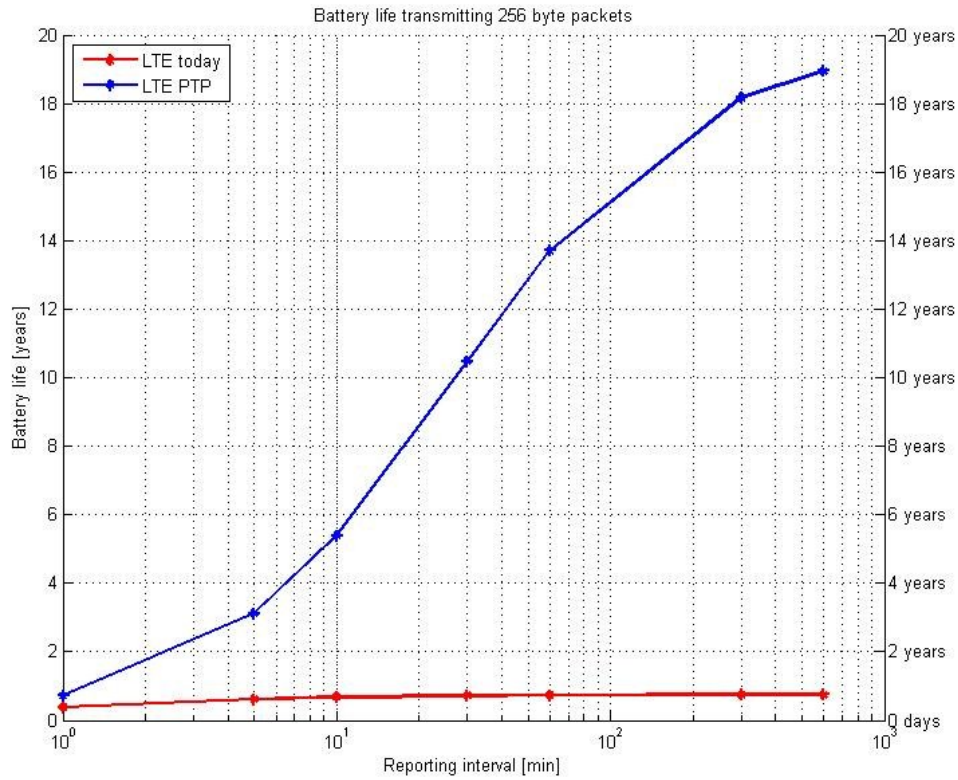
**Figure 14: Power consumption comparison for 256 byte packets**

Using these values we can measure the decrease in power consumption for 256 byte packets.

Reporting interval (mins)	LTE Power consumption (mW)	LTE_PTP Power consumption (mW)	Decrease in Power Consumption
1	0.797077103	0.414677103	1.922163287
5	0.477335421	0.094935421	5.028001329
10	0.43736771	0.05496771	7.956811521
30	0.41072257	0.02832257	14.50159957
60	0.404061285	0.021661285	18.65361562
300	0.398732257	0.016332257	24.41378781
600	0.398066129	0.015666129	25.40934912

**Table 8: Decrease in power consumption for 256 byte packets**

Then we compare the expected battery lives between the typical LTE and LTE\_PTP UEs using 256 byte data packets



**Figure 15: Battery life comparison for 256 byte packets**

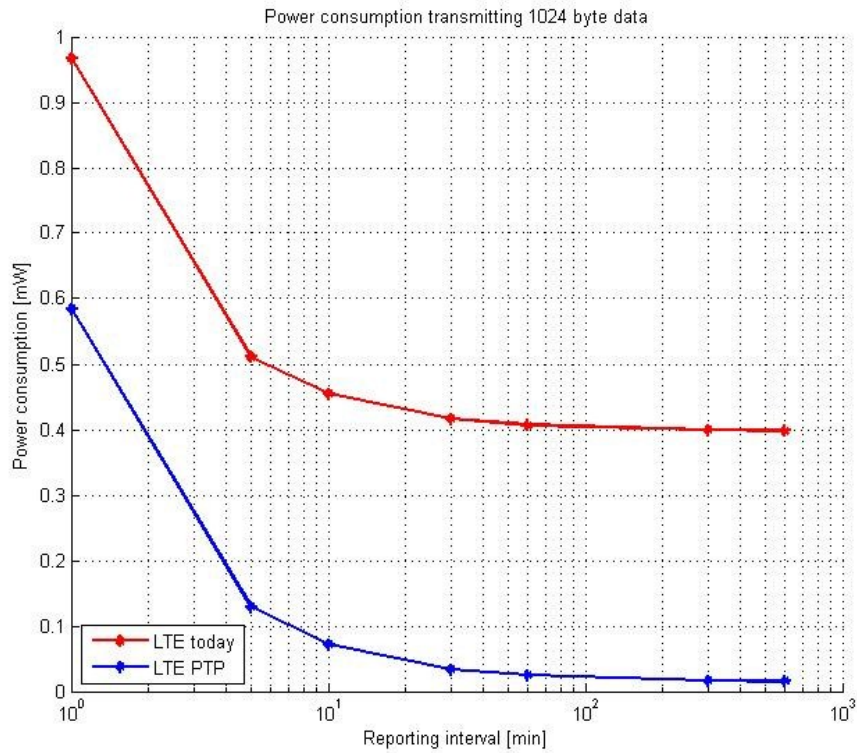
Using these values we can measure the increase in battery life for 256 byte packets.

Reporting interval (mins)	LTE Battery life (years)	LTE_PTP Battery life (years)	Increase in Battery Life
1	0.372365047	0.715746423	1.922163287
5	0.621792644	3.126374238	5.028001329
10	0.678613546	5.399600085	7.956811521
30	0.722637796	10.47940395	14.50159957
60	0.734551079	13.70203348	18.65361562
300	0.744368302	18.17284977	24.41378781
600	0.745613936	18.94556481	25.40934912

**Table 9: Increase in battery life for 256 byte packets**

## 4.9 Measurements for 1024 byte packets

First we compare the power consumptions between the typical LTE and LTE\_PTP UEs using 1024 byte data packets



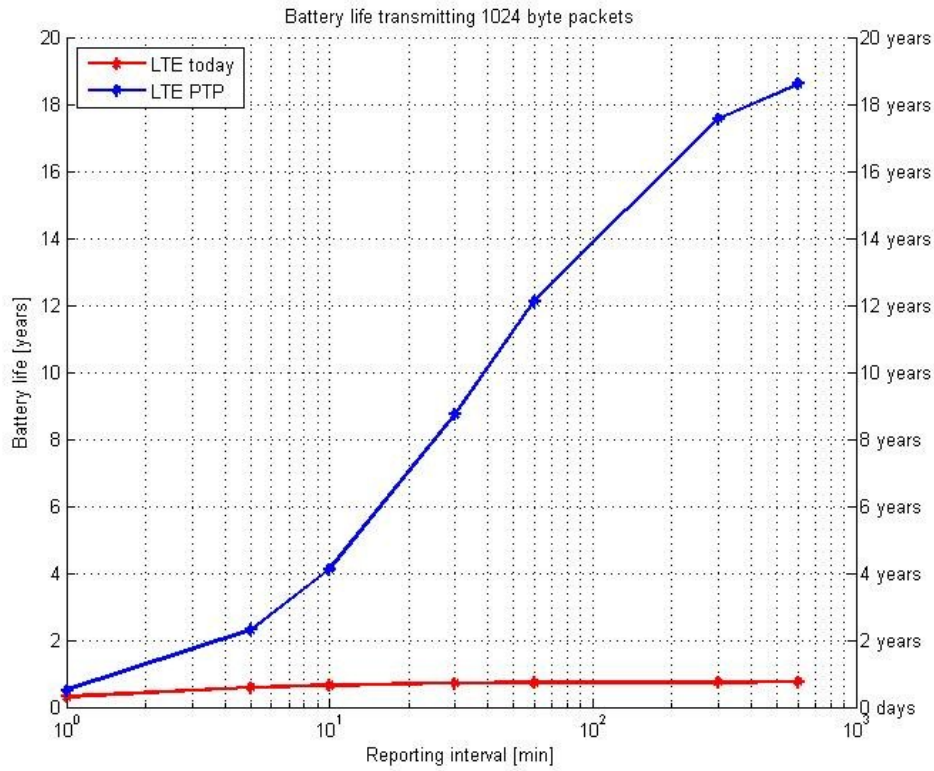
**Figure 16: Power consumption comparison for 1024 byte packets**

Using these values we can measure the decrease in power consumption for 1024 byte packets.

Reporting interval (mins)	LTE Power consumption (mW)	LTE_PTP Power consumption (mW)	Decrease in Power Consumption
1	0.96713545	0.58473545	1.653970954
5	0.51134709	0.12894709	3.965557422
10	0.454373545	0.071973545	6.313063291
30	0.416391182	0.033991182	12.24997664
60	0.406895591	0.024495591	16.61097271
300	0.399299118	0.016899118	23.62839967
600	0.398349559	0.015949559	24.9755844

**Table 10: Decrease in power consumption for 1024 byte packets**

Then we compare the expected battery lives between the typical LTE and LTE\_PTP UEs using 1024 byte data packets



**Figure 17: Battery life comparison for 1024 byte packets**

Using these values we can measure the increase in battery life for 1024 byte packets.

Reporting interval (mins)	LTE Battery life (years)	LTE_PTP Battery life (years)	Increase in Battery Life
1	0.306889436	0.507586213	1.653970954
5	0.580434814	2.301747584	3.965557422
10	0.653215083	4.123788162	6.313063291
30	0.712800045	8.731783902	12.24997664
60	0.729434429	12.11661539	16.61097271
300	0.743311566	17.56326277	23.62839967
600	0.745083423	18.60889391	24.9755844

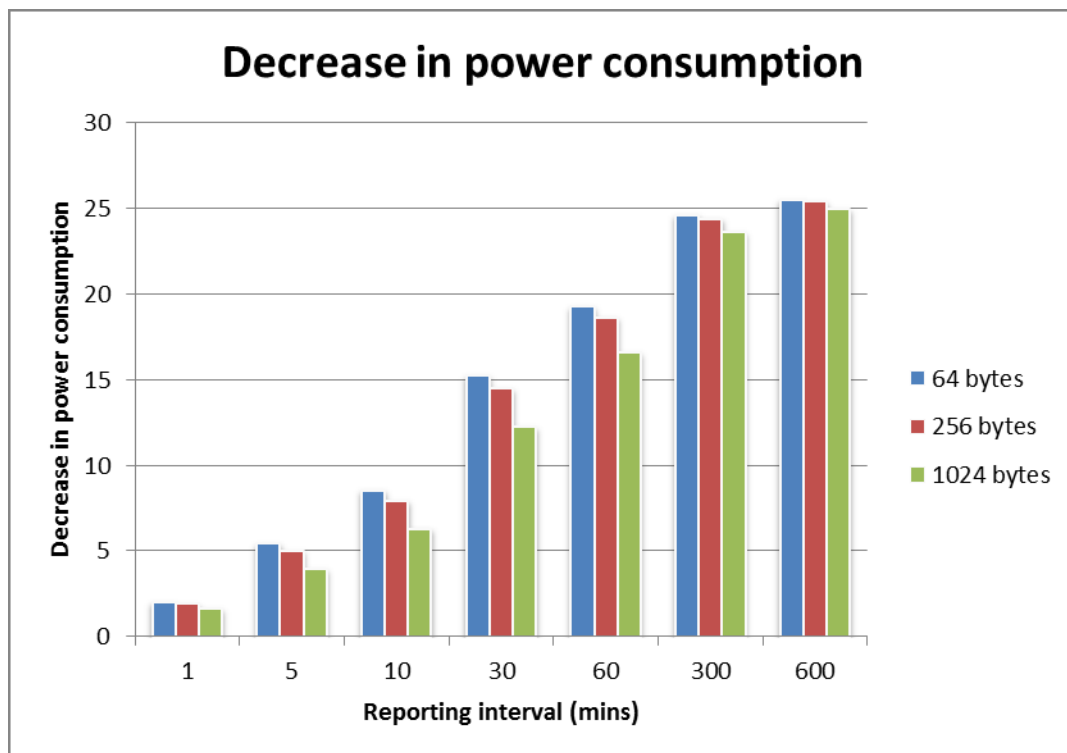
**Table 11: Increase in battery life for 1024 byte packets**

## 4.10 Effect of varying conditions on the gains

In order to verify whether the scheme works well under varying conditions, we need to repeat the power consumption tests by changing the packet sizes as well as locating the sensors at varying distances from the LTE base station (eNodeB).

### 4.10.1 Effect of varying packet sizes on the gains

When we observe the results of the tests with various packet sizes, we can notice some subtle changes in the performance gains that are obtained due to the introduction of the LTE\_PTP signaling scheme. Here are the comparisons.

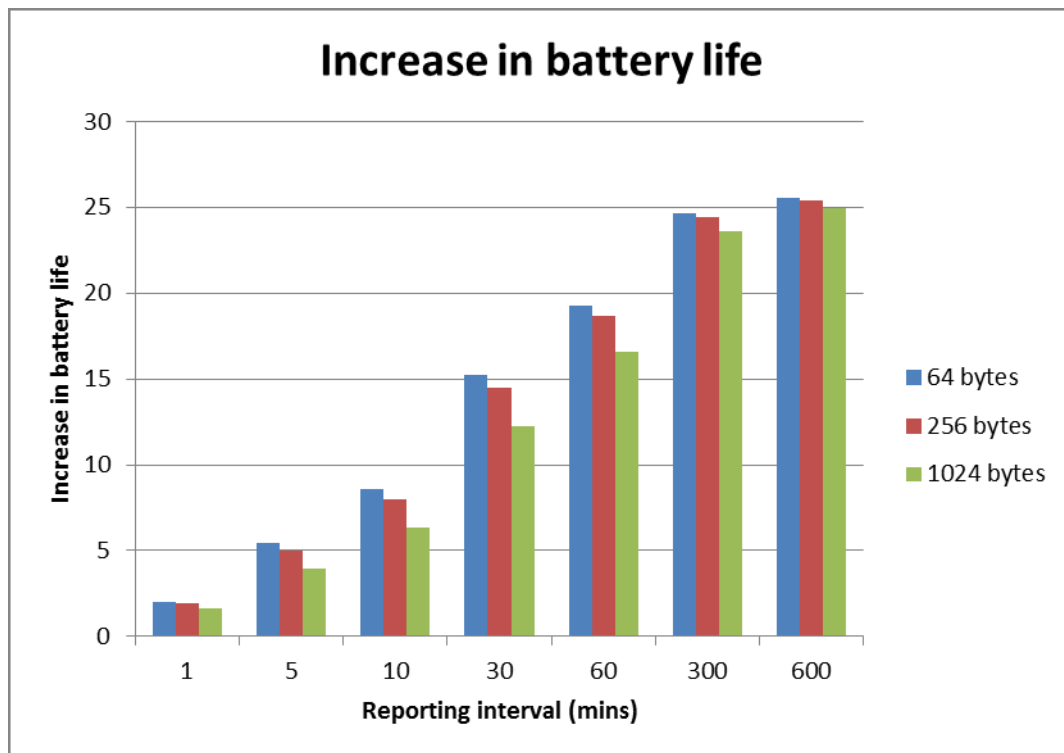


**Figure 18: Change in power consumption gains by packet size**

When we compare the power consumption decreases across packet sizes, we can notice a slight reduction in the gains while using the LTE\_PTP scheme. The reduction in gains is more pronounced with low reporting intervals and almost vanishes at high reporting intervals. This is to be expected because the performance gains of LTE\_PTP due to

reduced signaling overhead become less prominent as the actual data packet size increases. The changes become insignificant at high reporting intervals because of the significant reduction in idle mode power consumption.

We can do a similar comparison for measuring the battery life increases across packet size changes.



**Figure 19: Change in battery life gains by packet size**

Here again, we can notice a slight reduction in the gains while using the LTE\_PTP scheme for the same reasons specified as for the power consumption gains.

#### 4.10.2 Effect of varying distance on the gains

Similarly, we vary the distance between the sensor and the base station in order to determine the effect of the distance on the performance gains. In order to perform this simulation we use a set of 50 sensors that are located at random distances from the base station. The distances between the 50 sensors and the base station were derived by

running a pseudo-random number generator in MATLAB in order to come up with a distance between 1km and 20km (to simulate realistically the typical useful range of an LTE connected sensor). The random distances that were generated for the 50 sensors and used in the calculation are shown in Table 12 below.

16480	18210	3413	18354	13015
2853	6291	11391	19193	19333
3995	19441	19186	10222	16205
3696	9013	18399	16052	19230
13459	1679	17133	18746	13896
15397	15120	8452	13454	4253
14415	1605	6262	1877	2846
16646	14202	7025	19054	1654
9336	8250	15545	16109	4551
10306	9466	13280	14478	15339

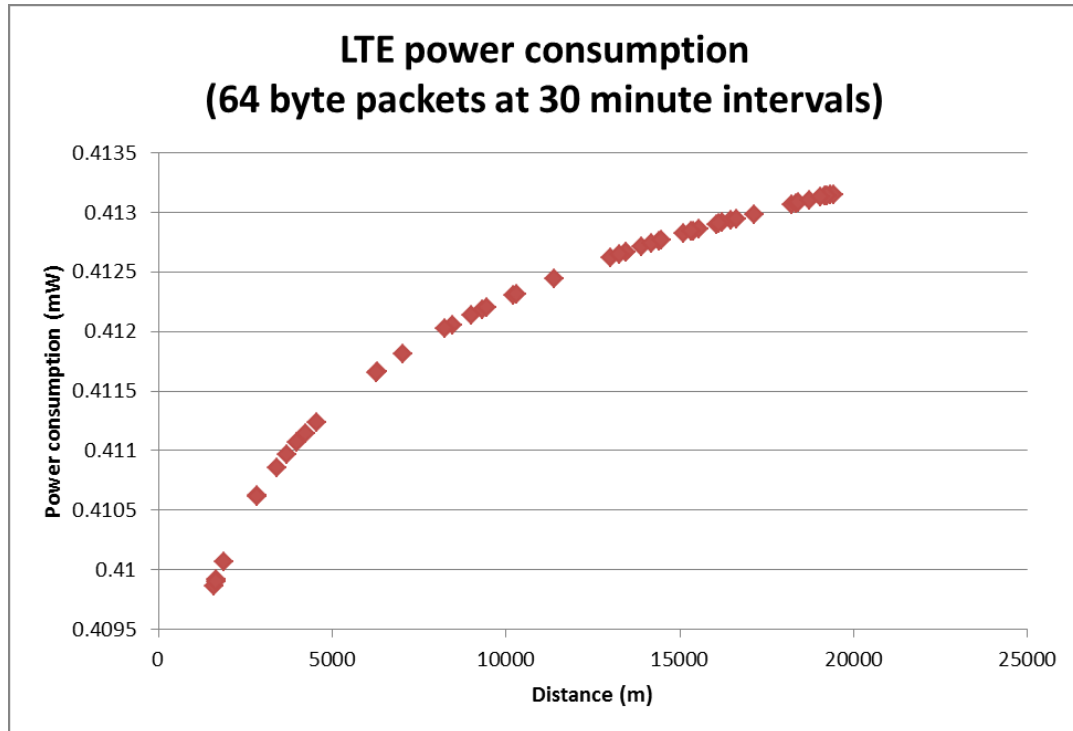
**Table 12: Distance of sensor from base station**

The variation of the (uplink) transmit power of an LTE UE as a function of distance is mainly determined by the path loss (PL) as described in Section 5.1 of [31]. The spatial channel model for MIMO simulations for LTE [30] describes a formula for the calculation of path loss as a factor of distance. For a suburban scenario, with the eNodeB placed at a height of 32m and the sensor placed at a height of 1.5m and a carrier frequency of 1900MHz, the path loss is calculated as

$$PL = 31.5 + 35\log_{10}(d)$$

where  $d$  is the distance between the sensor and the eNodeB. After introducing the path loss as a factor into the simulations we can quantify the effect of distance on the improvements. For the purpose of these simulations we fix the packet size to be 64 bytes and the reporting interval to be 30 minutes (1800s).

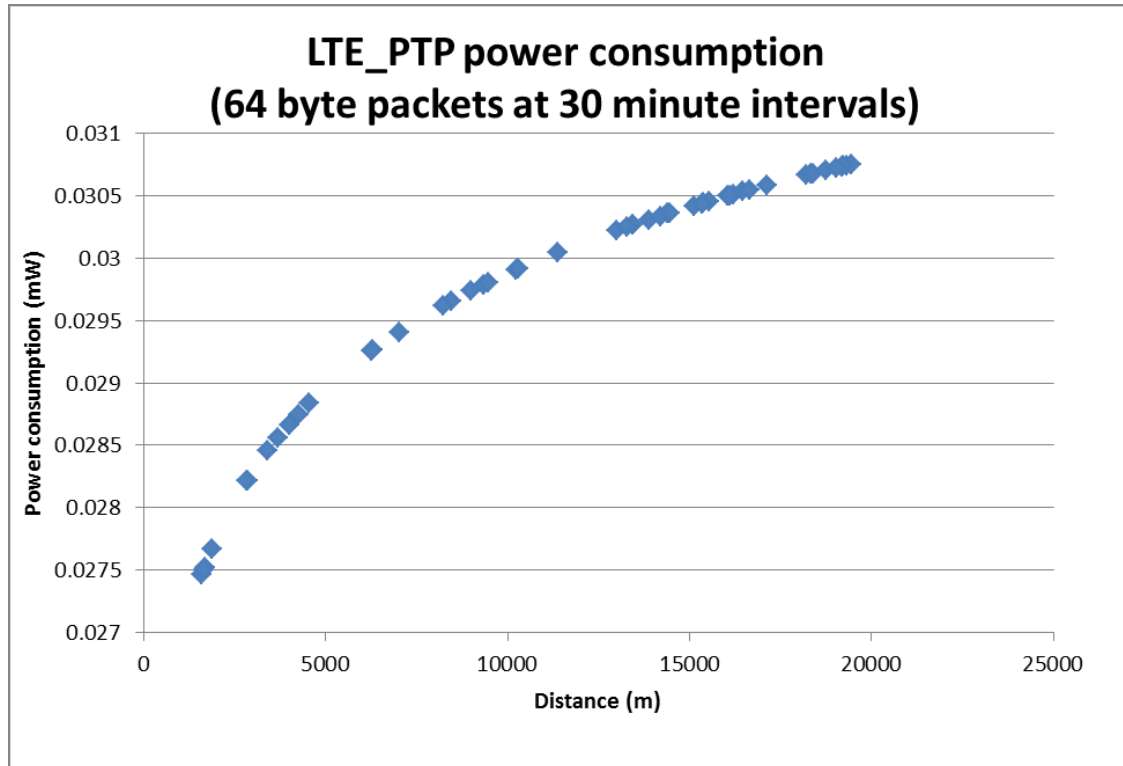
The effect of distance on the power consumption of an unmodified LTE UE is shown in Figure 20 below. As expected, due to the increase of path loss, the power consumption of the UE increases with distance.



**Figure 20: LTE UE increase in power consumption with distance**

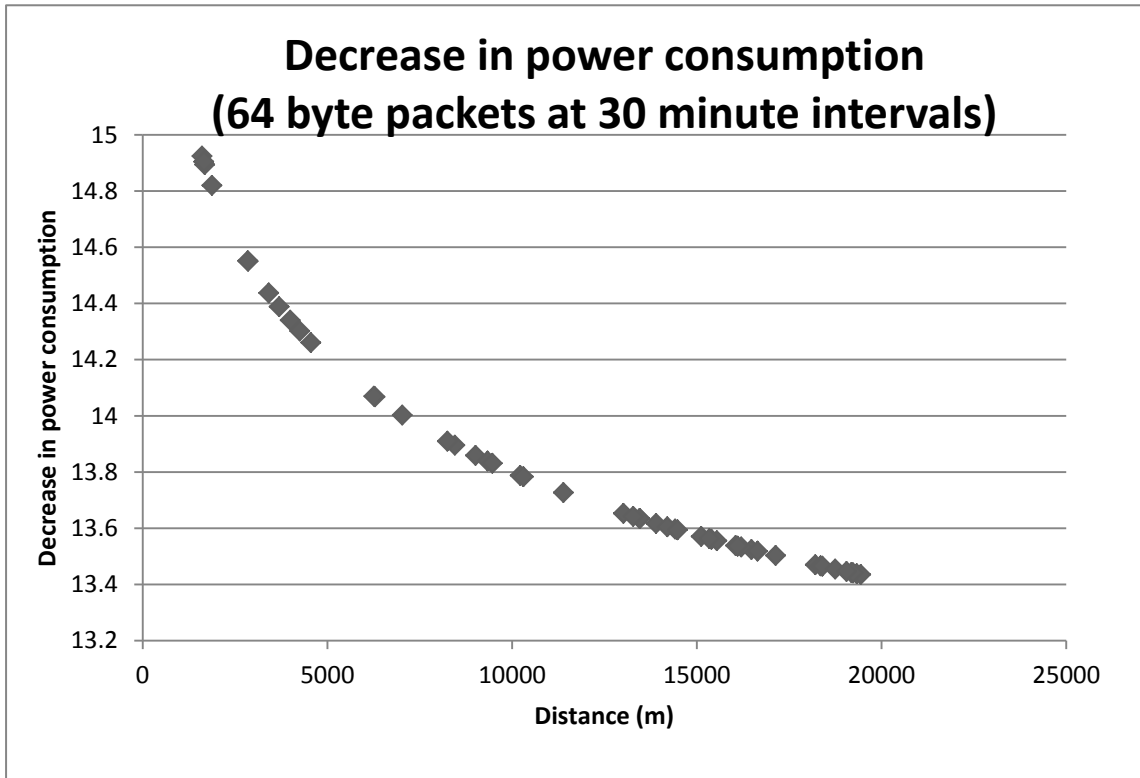


Similarly, the effect of distance on the power consumption of a LTE\_PTP UE is shown in Figure 21 below. As in the case of the unmodified LTE UE, due to the increase of path loss, the power consumption of the UE increases with distance.



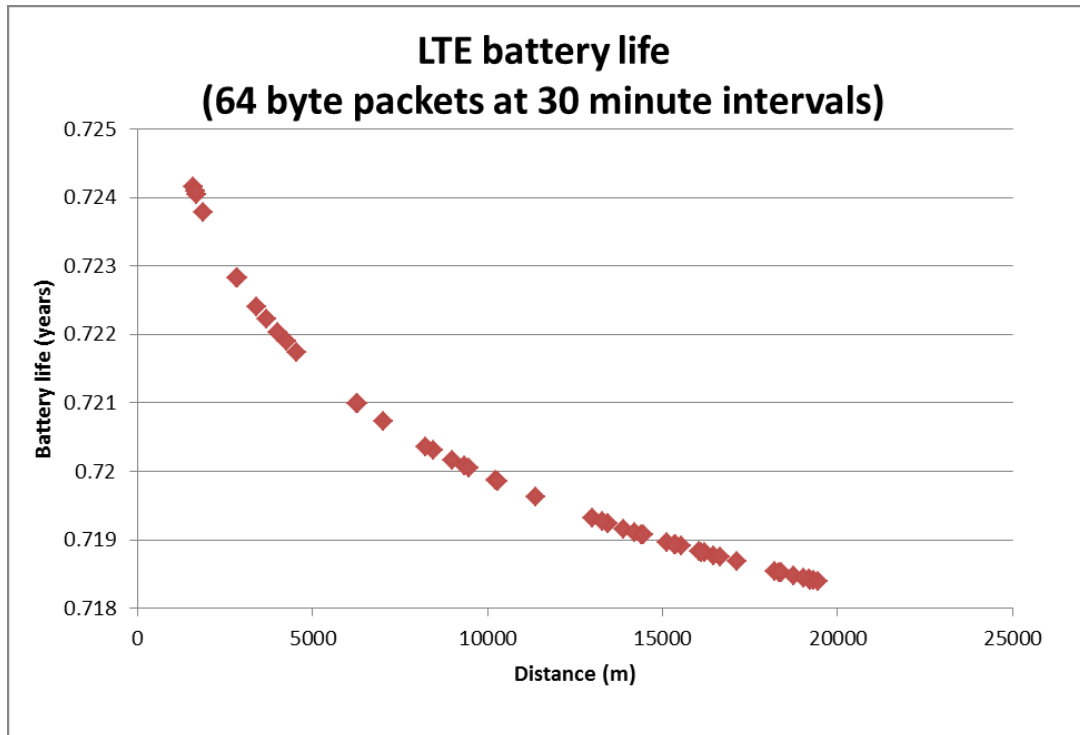
**Figure 21: LTE\_PTP UE increase in power consumption with distance**

We can also plot the magnitude of the decrease in power consumption due to the new signaling scheme as a function of distance as shown in Figure 22 below.

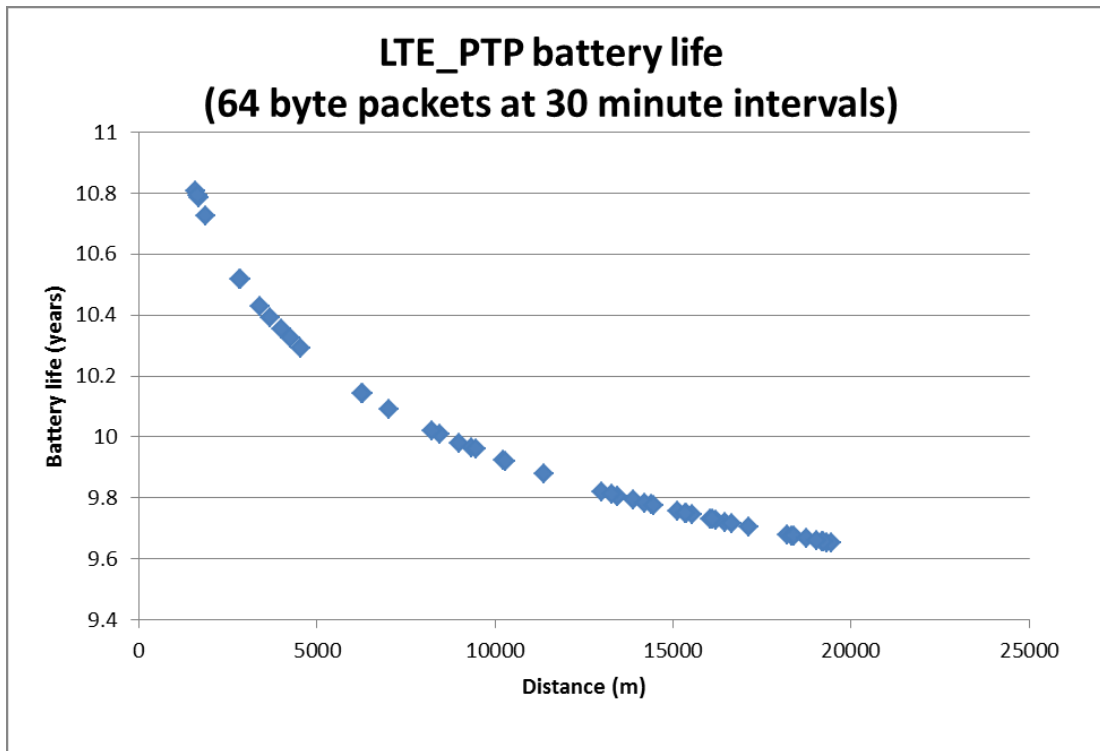


**Figure 22: Change in power consumption gains by distance**

The path loss also results in a decrease in battery lives of both the unmodified LTE UEs and the LTE\_PTP UEs as shown in Figures 23 and 24 below.

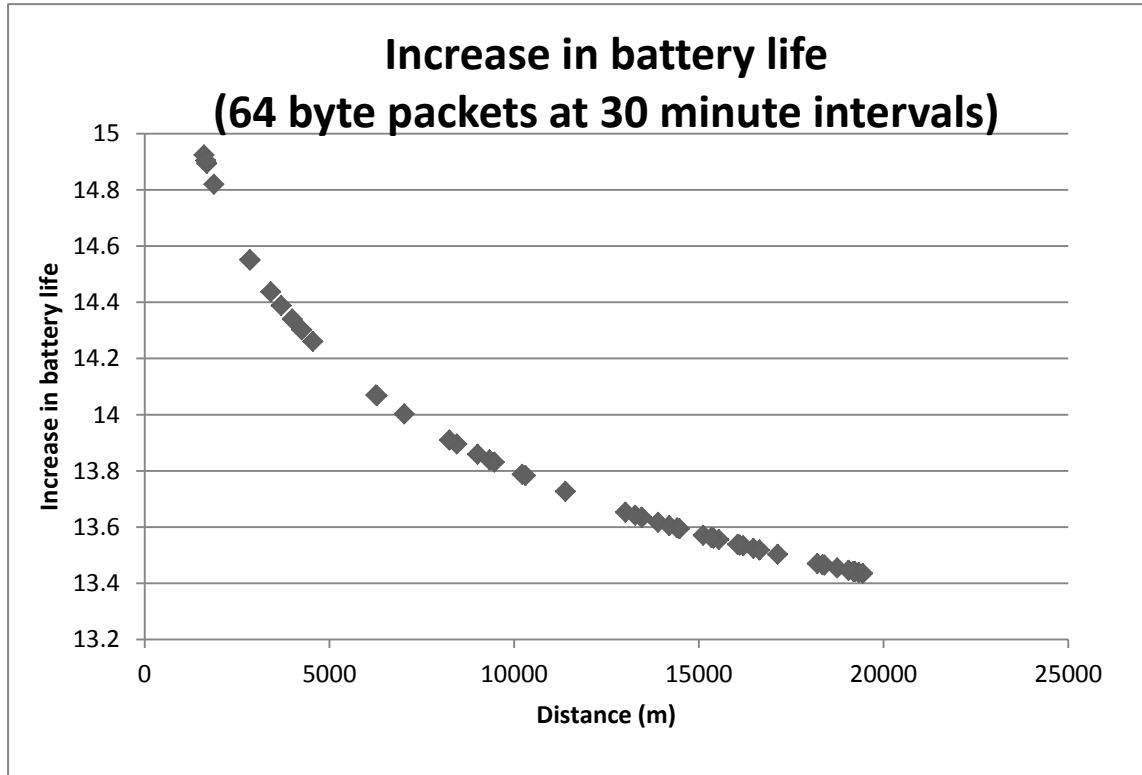


**Figure 23: LTE UE decrease in battery life with distance**



**Figure 24: LTE UE decrease in battery life with distance**

We can also plot the magnitude of the increase in battery life due to the new signaling scheme as a function of distance as shown in Figure 25 below.



**Figure 25: Change in battery life gains by distance**

Due to the increased path loss, there is a slight increase in the active mode power consumption of the UE with increasing distance. Meanwhile, the idle mode power consumption of the UE with both the unmodified LTE scheme as well as the LTE\_PTP scheme remains constant with distance. Due to this, the magnitude of battery life gains due to LTE\_PTP slightly decrease with increasing distance. At a distance of 20km, there is a roughly 10% drop in the magnitude of gains from 15x (at ~1km) to 13.5x (at ~20km). Still the magnitude of gains stays above 10x for reasonable values of packet size and reporting interval.

## **4.11 Observations**

From the above results we can conclude that the new signaling scheme described in this thesis provides a 10 fold increase in battery life under baseline comparisons for reasonable values of reporting interval. We can also conclude that, even under varying conditions with larger packet sizes as well as widely varying distances (1-20km), the performance gains obtained by the new scheme are still significant and above the tenfold improvement threshold. Hence, we find that the scheme is suitable for use in widely different conditions and still provides sizeable gains.

## Chapter 5

### Conclusion and Future Work

This section summarizes the main goals and enumerates the research contributions of this thesis. It also points out areas of improvement that are not covered by the thesis and lists them as future areas of work.

#### Research Contributions

The number of connected sensors is expected to grow exponentially in the near future. As wireless sensors start getting used for more and more applications, it is highly likely that a large number of these devices will be placed in environments where wide area wireless networks, such as LTE, are the only available method of connectivity (e.g. remote areas, inhospitable environments etc.).

The main goal of this thesis is to investigate the feasibility of directly connecting battery powered wireless sensors to LTE. To this effect, this thesis analyzes the power consumption of various aspects of the LTE radio interface and quantifies the device power consumption as a parameter of transmitted data size and measurable LTE device characteristics. This analysis leads to the conclusion that most of the energy spent by the device is used for paging and for staying connected in idle mode.

The core research contribution from this thesis is a new attach signaling scheme called the Periodic Transmission Profile. While using this profile, a connected sensor can periodically transmit data and go back into sleep mode. When it wakes up again, it does not need to perform the attach signaling again as the network is already aware of

when the device will wake up again. By doing this, the device can avoid two of the major sources of energy use (paging and idle mode power consumption) and hence extend its battery life.

Using a mathematical model of power consumption for an LTE terminal, this thesis shows that the PTP signaling scheme proposed in this document can provide significantly increased battery lifetime for LTE connected sensors. For reasonably spaced out periodic transmissions (as low as few minutes), the PTP scheme provides 10 fold increase in battery life.

## **Future Work**

This thesis focuses on improving the battery life of LTE connected sensors. Because the sensors do not receive any data from the network, they do not have to be woken up asynchronously in order to receive data while they are sleeping. It is very likely that there will be other classes of LTE connected devices that have the similar low power, low bit rate constraints but may require asynchronous reception of downlink data. Further research needs to be performed to increase the battery life of such devices. This thesis also does not provide any solutions to address the scaling characteristics of the core network in order to handle the increased number of connected nodes.

## REFERENCES

- [1] ETSI, “M2M Technologies”, available at  
<http://www.etsi.org/Website/Technologies/M2M.aspx>  
, last accessed on March 16<sup>th</sup> 2012
- [2] I.F. Akyildiz, W. Su, Y. Sankarasubramaniam, and E. Cayirci, “A survey on sensor networks”, IEEE Communications magazine, August 2002
- [3] 3GPP TS 23.401: "GPRS Enhancements for E-UTRAN Access", December 2007,  
available at  
[http://www.3gpp.org/ftp/Specs/archive/23\\_series/23.401/23401-800.zip](http://www.3gpp.org/ftp/Specs/archive/23_series/23.401/23401-800.zip)  
, last accessed on March 16<sup>th</sup> 2012
- [4] 3GPP TS 24.301: "Non-Access-Stratum (NAS) protocol for Evolved Packet System (EPS) ", December 2008, available at  
[http://www.3gpp.org/ftp/Specs/archive/24\\_series/24.301/24301-800.zip](http://www.3gpp.org/ftp/Specs/archive/24_series/24.301/24301-800.zip)  
, last accessed on March 16<sup>th</sup> 2012
- [5] 3GPP TR 25.913, “Requirements for Evolved UTRA (E-UTRA) and Evolved UTRAN (E-UTRAN)”, January 2009, available at  
[http://www.3gpp.org/ftp/Specs/archive/25\\_series/25.913/25913-800.zip](http://www.3gpp.org/ftp/Specs/archive/25_series/25.913/25913-800.zip)  
, last accessed on March 16<sup>th</sup> 2012



- [6] 3GPP TS 36.300, “Evolved Universal Terrestrial Radio Access (E-UTRA) and Evolved Universal Terrestrial Radio Access Network (E-UTRAN); Overall description”, April 2007, available at [http://www.3gpp.org/ftp/Specs/archive/36\\_series/36.300/36300-800.zip](http://www.3gpp.org/ftp/Specs/archive/36_series/36.300/36300-800.zip), last accessed on March 16<sup>th</sup> 2012
- [7] N. Wiberg and B. Lindoff, "Terminal Power Consumption - A Flexible Model", Ericsson Internal Technical Document
- [8] 3GPP TS 23.402, “Architecture enhancements for non-3GPP accesses”, December 2007, available at [http://www.3gpp.org/ftp/Specs/archive/23\\_series/23.402/23402-800.zip](http://www.3gpp.org/ftp/Specs/archive/23_series/23.402/23402-800.zip), last accessed on March 16<sup>th</sup> 2012
- [9] E. Dahlman, S. Parkvall, J. Sköld and P. Beming, “3G Evolution - HSPA and LTE for Mobile Broadband”
- [10] H.G. Myung, J. Lim, and D.J. Goodman, "Single carrier FDMA for uplink wireless transmission", IEEE Vehicular Technology Magazine, September 2006
- [11] 3GPP TS 36.331, “ Radio Resource Control (RRC); Protocol specification”, December 2007, available at [http://www.3gpp.org/ftp/Specs/archive/36\\_series/36.331/36331-800.zip](http://www.3gpp.org/ftp/Specs/archive/36_series/36.331/36331-800.zip), last accessed on March 16<sup>th</sup> 2012

- [12] I.F. Akyildiz, W. Su, Y. Sankarasubramaniam, and E. Cayirci, “Wireless sensor networks: a survey”, Elsevier Computer Networks, March 2002
- [13] NIST, “Smart Grid Interoperability Panel”, available at <http://www.nist.gov/smartgrid>, last accessed on March 16<sup>th</sup> 2012
- [14] Ericsson White Paper, “LTE – an introduction”, available at [http://ww.ericsson.com/res/docs/2011/lte\\_an\\_introduction.pdf](http://ww.ericsson.com/res/docs/2011/lte_an_introduction.pdf), last accessed on March 16<sup>th</sup> 2012
- [15] MSC Generator tool available at <http://msc-generator.sourceforge.net>, last accessed on March 16<sup>th</sup> 2012
- [16] S. Krishnan, “Connecting Smart Objects to Wireless WANs”, Internet Architecture Board Smart Objects Workshop, Prague, March 2011
- [17] 3GPP TR 22.868, “Study on facilitating M2M communication in 3GPP systems”, March 2007, available at [http://www.3gpp.org/ftp/Specs/archive/22\\_series/22.868/22868-800.zip](http://www.3gpp.org/ftp/Specs/archive/22_series/22.868/22868-800.zip), last accessed on March 16<sup>th</sup> 2012
- [18] Y. Chen and W. Wang, “Machine-to-Machine communication in LTE-A”, Proc. 72nd IEEE Vehicular Technology Conference Fall (VTC 2010-Fall), September 2010
- [19] 3GPP Technologies, “LTE”, available at <http://www.3gpp.org/LTE>, last accessed on March 16<sup>th</sup> 2012
- [20] J. Postel, “Internet Protocol”, RFC791, Internet Engineering Task Force

- [21] S. Deering and R. Hinden, "Internet Protocol Version 6", RFC2460, Internet Engineering Task Force
- [22] T. Bokareva, "Wireless sensor networks for battlefield surveillance", Land warfare conference 2006
- [23] A. Milenković, C. Otto, and E. Jovanov, "Wireless sensor networks for personal health monitoring: Issues and an implementation", Elsevier Computer Communications, August 2006
- [24] Adi Mallikarjuna Reddy V, "Wireless Sensor Network", Wikimedia Commons, June 2007
- [25] K. Martinez, J.K. Hart, R. Ong, "Environmental Sensor Networks", Elsevier Computer, August 2004
- [26] V.C. Gungor, G.P. Hancke, "Industrial Wireless Sensor Networks: Challenges, Design Principles, and Technical Approaches", IEEE Transactions on Industrial Electronics, October 2009
- [27] A. Wheeler, "Commercial Applications of Wireless Sensor Networks Using ZigBee", IEEE Communications Magazine, April 2007
- [28] V.C. Gungor, B. Lu, G.P. Hancke, "Opportunities and Challenges of Wireless Sensor Networks in Smart Grid", IEEE Transactions on Industrial Electronics, October 2010
- [29] G. Werner-Allen et al. "Deploying a wireless sensor network on an active volcano", IEEE Internet Computing, March-April 2006

- [30] 3GPP TR 25.996, “Spatial channel model for Multiple Input Multiple Output (MIMO) simulations”, December 2008, available at [http://www.3gpp.org/ftp/Specs/archive/25\\_series/25.996/25996-800.zip](http://www.3gpp.org/ftp/Specs/archive/25_series/25.996/25996-800.zip), last accessed on April 16<sup>th</sup> 2012
- [31] 3GPP TS 36.213, “Evolved Universal Terrestrial Radio Access (E-UTRA); Physical layer procedures”, September 2009, available at [http://www.3gpp.org/ftp/Specs/archive/36\\_series/36.213/36213-880.zip](http://www.3gpp.org/ftp/Specs/archive/36_series/36.213/36213-880.zip), last accessed on April 16<sup>th</sup> 2012
- [32] V. Shnayder, M. Hempstead, B. Chen, G.W. Allen, M. Welsh, “Simulating the power consumption of large-scale sensor network applications”, ACM SenSys 2004
- [33] Q. Wang, M. Hempstead, W. Yang, “A Realistic Power Consumption Model for Wireless Sensor Network Devices”, IEEE ComSoc SECON 2006

## Appendix A: Terminal power consumption model

Reference [7] defines a flexible power consumption model for an LTE UE. Since this document is an internal Ericsson document, this appendix summarizes the key components of the model. The structure of this model is detailed in Figure A.1. The model consists of several components that can be enabled and disabled dynamically depending on the operation of the terminal. The purpose of each component is explained in the sections below, as well as the factors that influence the power consumption.

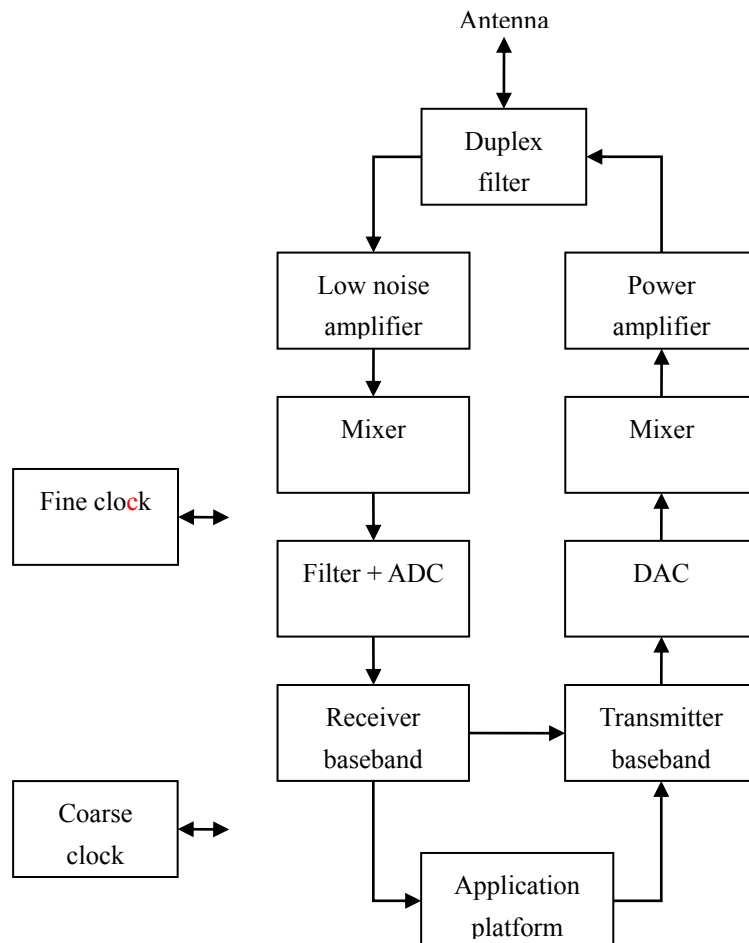


Figure 26: Structure of terminal power consumption model

## **A.1 Clocks**

### **A.1.1 Coarse clock**

The coarse clock is a low accuracy clock that is always on but consumes very less power. This clock is used for activating devices for regularly scheduled events such as paging, performing environmental measurements etc. Since it is always on and running at constant frequency, this clock can be assumed to consume constant power  $p_{\text{coarse}}$ .

### **A.1.2 Fine clock**

The fine clock keeps the terminal synchronized to the air interface. The fine clock must be enabled for any receiver or transmitter operation. When enabled, it is assumed to consume a constant power. The fine clock can be disabled to save power when not needed. The power consumption of the fine clock is labeled  $p_{\text{fine}}$ .

## **A.2 Duplex filter**

A duplex filter is required to create isolation between the transmitter parts and the receiver parts of the system. The filter itself does not consume power, but it does cause a loss in the transmitted output power. The transmit power loss of the duplex filter is labeled  $L_{\text{duplex}}$ .

## **A.3 Receiver chain**

### **A.3.1 Low-noise amplifier and receive mixer**

The low-noise amplifier (LNA) and mixer constitute the receiver front end. They can be enabled/disabled quickly as needed, e.g. on a symbol-by-symbol basis in LTE. When enabled, they are assumed to consume a constant power. The power consumption of the

LNA can be assumed to be independent of system bandwidth and carrier frequency, while the mixer (the local oscillator) power consumption is increasing with increasing carrier frequency. The power consumption of the LNA and receiver mixer is labeled  $P_{RX,frontend}$ .

### **A.3.2 Filter and analog-to-digital converter**

The filter and analog-to-digital converter (ADC) are enabled/disabled together with the LNA and mixer, and exist in one instance per receiver branch. The power consumption of these components is assumed to be proportional to the bandwidth of the desired signal.

The power consumption of the filter and ADC is expressed as  $p_{RX,analog} = B_{RX} \times k_{RX,dac}$ , where  $B_{RX}$  is the signal bandwidth and  $k_{RX,dac}$  is the proportionality constant.

### **A.3.3 Receiver baseband**

The baseband parts of the receiver include the digital signal processing of the received signal, as well as higher layers. For the purpose of this model, the receiver baseband is assumed to consist of two parts: a basic part that consumes a constant power when enabled, and a high bit rate part whose power consumption is proportional to the received bit rate. The basic part includes all the functions except for the reception of data with high bit rate. The power consumption of the baseband is expressed as

$p_{RX,baseband} = p_{RX,baseband,0} + R_{RX} \times k_{RX,baseband}$ , where  $p_{RX,baseband,0}$  is the power of the basic parts,  $R_{RX}$  is the bit rate (Mbits/s), and  $k_{RX,baseband}$  is the proportionality constant.

## **A.4 Transmitter chain**

### **A.4.1 Power amplifier**

The power amplifier (PA) is enabled only when a signal is transmitted. Its power consumption has a nonlinear relation to the output power; the relative efficiency is higher for higher output powers. There is an additional loss in case of a duplex filter.

The power consumption is assumed to be independent of the bandwidth (1-40 MHz). The power consumption of the power amplifier is expressed as  $p_{TX,PA} = (L_{duplex} \times P_{TX})$  where  $P_{TX}$  is the actual output power.

### **A.4.2 Transmitter mixer**

The mixer is enabled only when a signal is transmitted. When enabled, it is assumed to have constant power consumption, independent of the system bandwidth. The power consumption increases with increasing carrier frequency. The power consumption of the transmitter mixer is labeled  $p_{TX,mixer}$ .

### **A.4.3 Digital-to-analog converter**

The digital-to-analog converter (DAC) is enabled only when a signal is transmitted.

When enabled, its power consumption is assumed proportional to the bandwidth of the transmitted signal. The power consumption of the DAC is expressed as

$p_{TX,DAC} = B_{TX} \times k_{TX,DAC}$ , where  $B_{TX}$  is the signal bandwidth and  $k_{TX,DAC}$  is the proportionality constant.



#### **A.4.4 Transmitter baseband**

The baseband parts of the transmitter include the digital signal processing of the received signal, as well as higher layers. For the purpose of this model, the transmitter baseband is assumed to consist of two parts: a basic part that consumes a constant power when enabled, and a high bit rate part whose power consumption is proportional to the transmitted bit rate. The basic part includes all the functions except for the transmission of data with high bit rate.

The power consumption of the baseband is expressed as  $p_{\text{TX,baseband}} = p_{\text{TX,baseband},0} + R_{\text{TX}} \times k_{\text{TX,baseband}}$ , where  $p_{\text{TX,baseband},0}$  is the power of the basic parts,  $R_{\text{TX}}$  is the bit rate, and  $k_{\text{TX,baseband}}$  is the proportionality constant