

DIGITAL DATA TRANSMISSION  
on  
ANALOG AND DIGITAL CARRIER SYSTEMS

Nicolae D. Calinoiu

A MAJOR TECHNICAL REPORT  
in the  
Faculty of Engineering

Presented in partial fulfilment of the requirements for  
the Degree of Master of Engineering at  
Concordia University  
Montreal, Canada

April, 1975

ABSTRACT  
N. CALINOIU

DIGITAL DATA TRANSMISSION ON ANALOG AND  
DIGITAL CARRIER SYSTEMS

An overall general description of Digital Data Transmission on Analog and Digital Carrier Systems is covered.

The emphasis is on the transmission aspect rather than on the generating sources. The Digital Carriers are the center of attention of this technical report, as all future carriers will be digital in nature.

Factors affecting systems performance are considered and covered to some extent.

Black box approach is employed throughout this report in order to explain most of the pertinent factors.

## ACKNOWLEDGEMENTS

The author wishes to express his appreciation and gratitude to Dr. M.N.S. Swamy for his assistance during the preparation of this report.

Appreciation and gratitude is also extended to Dr. V. Ramachandran for going through the manuscript and providing constant guidance. The author acknowledges the sacrifices made, inspiration and understanding accorded to him by his wife, Mrs. Katalin Calinoiu and their children throughout the period of the program.

Thanks are also due to Mrs. Gloria Baum for her efficiency in typing the manuscript.

TABLE OF CONTENTS

ABSTRACT . . . . . iii

ACKNOWLEDGEMENTS . . . . . iv

LIST OF FIGURES . . . . . viii

LIST OF TABLES . . . . . x

GLOSSARY . . . . . xi

I INTRODUCTION . . . . . 1

II WIDEBAND DATA SYSTEM . . . . . 10

    2.1 Bits and Bauds . . . . . 10

    2.2 General System Representation . . . . . 12

    2.3 System Layout and Functional Description  
        of 50 Kb/s Network . . . . . 21

        2.3.1 Wideband Data Station . . . . . 21

        2.3.2 Local Access Loop . . . . . 26

        2.3.3 The Central Office . . . . . 27

    2.4 Summary . . . . . 28

III CARRIER SYSTEMS . . . . . 29

    3.1 LMX-2 Carrier . . . . . 29

    3.2 N2 Carrier . . . . . 35

    3.3 T1 Carrier . . . . . 40

    3.4 LD-1 Carrier . . . . . 49

    3.5 LD-4 Carrier . . . . . 51

        3.5.1 The DE-2 Channel Bank . . . . . 54

        3.5.2 The Mastergroup Codec . . . . . 56

        3.5.3 The TV Codec . . . . . 56

        3.5.4 The Video Telephone Codec . . . . . 57

3.5.5	The Digital Multiplexers . . . . .	57
3.5.6	The Cross-Connect Bays . . . . .	59
3.5.7	The Digital Regenerative Repeaters . . . . .	60
3.5.8	The Cable . . . . .	62
3.5.9	The Cable Power Feed . . . . .	64
3.5.10	The Protection Switching System . . . . .	65
3.5.11	The Supervisory System . . . . .	65
3.5.12	The Gas Pressure System . . . . .	66
3.6	Summary . . . . .	67
IV	ALL-DIGITAL DATA NETWORK . . . . .	70
4.1	Conditioned Diphasd . . . . .	70
4.2	Customer Loop System . . . . .	73
4.2.1	Subscriber Terminal Equipment . . . . .	76
4.2.2	Loop Regenerative Repeater . . . . .	77
4.2.3	Office Loop Regenerator . . . . .	77
4.2.4	Office Data Multiplexer . . . . .	78
4.3	Time Slot Access Unit . . . . .	80
4.3.1	T.S.A. System Block Diagram . . . . .	80
4.3.2	A Detailed Description of T.S.A. . . . .	82
4.4	Overall Data Network . . . . .	86
4.5	Summary . . . . .	90
V	COAST-TO-COAST DATA NETWORK . . . . .	92
5.1	Overall Network . . . . .	92
5.2	Data Terminating Arrangements . . . . .	104
5.3	Network Synchronization . . . . .	107
5.4	Synchronous or Asynchronous Transmission . . . . .	108
5.5	Summary . . . . .	109

VI	FACTORS AFFECTING SYSTEMS PERFORMANCE . . . . .	113
6.1	Signal to Noise Consideration . . . . .	113
6.2	Envelope Delay Distortion . . . . .	116
6.3	Jitter . . . . .	117
VII	CONCLUSION . . . . .	119
	REFERENCES . . . . .	123

## LIST OF FIGURES

Figure 1.1	Early Semaphore . . . . .	4
Figure 1.2	Lord George Murray's Telegraph . . . . .	4
Figure 2.1	Simplified Block Diagram of a Wideband Data System . . . . .	13
Figure 2.2	Conditioning the Baseband Data Signal . . . . .	20
Figure 2.3	Wideband Data System . . . . .	22
Figure 3.1	LMX-2 Carrier Application . . . . .	31
Figure 3.2	Envelope Delay Equalization for Group Facility . . . . .	33
Figure 3.3	Frequency Spectrum of LMX Group-Data . . . . .	34
Figure 3.4	Envelope Delay for Supergroup Facility . . . . .	34
Figure 3.5	N2WT-1 Wideband Terminal Equipment . . . . .	36
Figure 3.6	Wideband Data System, N2-Carrier Application . . . . .	38
Figure 3.7	Frequency Spectrum of an N2 Group-Rate Data Channel . . . . .	39
Figure 3.8	Logarithmic Compression Characteristics . . . . .	41
Figure 3.9	Signal Processing in the D1 Bank Terminal . . . . .	43
Figure 3.10	Wideband Data System, T1-Carrier Application . . . . .	45
Figure 3.11	Digital Transmission Hierarchy & Services Provided . . . . .	53
Figure 3.12	Cross Sectional View of the LD-4 Cable . . . . .	63
Figure 3.13	Proposed Trans-Canada LD-4 Route . . . . .	68
Figure 4.1	Generation of Conditioned Diphas Signals . . . . .	72

Figure 4.2	Demodulating Conditioned Diphasic Signals . . . . .	74
Figure 4.3	Typical Customer Loop System . . . . .	75
Figure 4.4	Typical Central Office Equipment Arrangement . . . . .	79
Figure 4.5	T.S.A. System Block Diagram . . . . .	81
Figure 4.6	T.S.A. Unit Block Diagram . . . . .	83
Figure 4.7	The Experimental Digital Data Network . . . . .	87
Figure 5.1.a-f	Initial Coast-to-Coast Data Network . . . . .	95-103
Figure 5.2	Data Terminating Arrangements . . . . .	105
Figure 5.3	Synchronous and Asynchronous . . . . .	110
Figure 6.1	Bit Errors Rate vs Signal-to-Noise Ratio . . . . .	115



LIST OF TABLES

Table 1.1	Polybius Code	2
Table 1.2	Morse Code	2

## GLOSSARY

A.M.	Amplitude Modulation
A/D	Analog to Digital Converter
B.P.	Band Pass Filter
C/S	Cycle Per Second
C.O.	Central Office (Telephone Eqpt. Office)
C.P.E.	Customer Provided Equipment
CPLX	Characterplexer
CH	Channel, Usually Voice Frequency Channel
D/A	Digital to Analog Converter
D/D	Digital to Digital Converter (Steps Up or Down the Frequency)
dB	Decibells
D.S.B.	Double Side Band
D1	First Generation of P.C.M. Bank
DE-2	Second Generation of P.C.M. Bank
EQL.	Equalizer
F.D.M.	Frequency Division Multiplex
F.S.D.	Fail Span Detection
Kb/s	Kilo (Thousand) Bits per Second
LD-1	Digital Intermediary Haul Cable Carrier
LD-4	Digital Carrier, Long Haul Coaxial Cable
LMX-2	Analog Transmission Carrier Radio
L.R.R.	Loop Regenerative Repeater
L.W.M.	Wideband Modem for L-Multiplex Radio Carrier
MTRAN	Multitran, Digital Multiplexer

N2 Analog Short Haul Cable Carrier  
O.L.R. Office Loop Regenerator  
Pe Probability of Errors  
P.C.M. Pulse Code Modulation  
R.M.S. Root Mean Square  
S/N Signal-to-Noise Ratio  
S.T.E. Subscriber Terminal Equipment  
T.S.A. Time Slot Access Unit  
T1 Digital Short Haul Cable Carrier  
V.S.B. Vestigial Side Band  
X.D.M. Office Data Multiplexer  
W.L.R. Wideband Loop Repeater  
W.P.M. Word Per Minute

CHAPTER I

INTRODUCTION

- 1 -

CHAPTER I  
INTRODUCTION

Ever since man first existed on this earth, he has felt the need to exchange messages with others. At the beginning only very short point-to-point digital messages were transmitted by means of smoke, fire or drums, used on occasions of beginning of wars, end of wars, or celebrations of happy or sad events.

Throughout the ages of mankind a signaling process of data communications has been developed. This development went from fire and drum signals (still used in some parts of the world), to messengers, telegraph, telephone, radio, television, satellite communications and others. This process of development could be divided in three parts: early development, covering the greatest length of time until the mid-nineteenth century; pioneer era of telecommunications, covering the shortest period of time, from mid-nineteenth century to the beginning of the twentieth century; and finally the modern communication developments, starting with the beginning of this century.

The first systematic method for data transmission was developed by the Greek field general Polybius around 300 B.C. The data code suggested by Polybius, and adapted in battle practices is described in Table 1.1. The telegrapher used to mount the correct number of torches on two walls about 6 feet high to indicate the desired letter. For

LEFT WALL

	1	2	3	4	5
1	A	B	Γ	Δ	E
2	Z	H	Θ	I	K
3	Λ	M	N	Ξ	O
4	Π	P	Σ	T	Υ
5	Φ	X	Ψ	Ω	

RIGHT  
WALL

TABLE 1.1

POLYBIUS CODE

A	·—	N	—·	1	·— — —
B	—···	O	— — —	2	· · — —
C	—·—·	P	·— — ·	3	· · · — ✓
D	—···	Q	— — — ·	4	· · · · —
E	·	R	· · ·	5	· · · · ·
F	· · — ·	S	· · ·	6	— · · · ·
G	— — ·	T	—	7	— — · · ·
H	· · · ·	U	· · —	8	— — — · ·
I	· ·	V	· · · —	9	— — — — ·
J	· — — —	W	· — —	0	— — — — —
K	— · —	X	— · · —	·	· · · · ·
L	· — · ·	Y	— · — —	?	· — — — —
M	— —	Z	— — · ·	?	· — · · ·

TABLE 1.2

MORSE CODE

example, three torches on the left wall and three torches on the right wall represented the letter N.

Later on, more sophisticated developments resulted in the Semaphore code which found intensive application in Europe around the beginning of the last century. The Chappe Semaphore telegraph consisted of a crossarm, 14 feet in length, with a shorter blade at each end making an adjustable angle with the main arm. This arm arrangement was placed on top of a post or tower and a telegrapher, using ropes and pulleys managed to arrange the arm and the side-blades into various configurations to indicate various coded letters. Figure 1.1 illustrates the early semaphore. The longest semaphore of this kind was a 1200 miles system and employed 1300 operators over a chain of 200 repeater sites that connected Leningrad with the Prussian frontier via Warsaw.

In 1795 Lord Murray's six shutter telegraph (Fig. 1.2) was adapted by the British Admiralty. This idea of using shutters is still used by navy forces in ship communication.

The introduction of a galvanic cell by Volta in 1800 led to an invention by Morse in 1835 of the first telegraph system using electrical signals, generated by opening or closing a switch according to an established Morse Code (Table 1.2). Comparing Polybius Code and Morse Code; we can see that there is essentially no difference between them

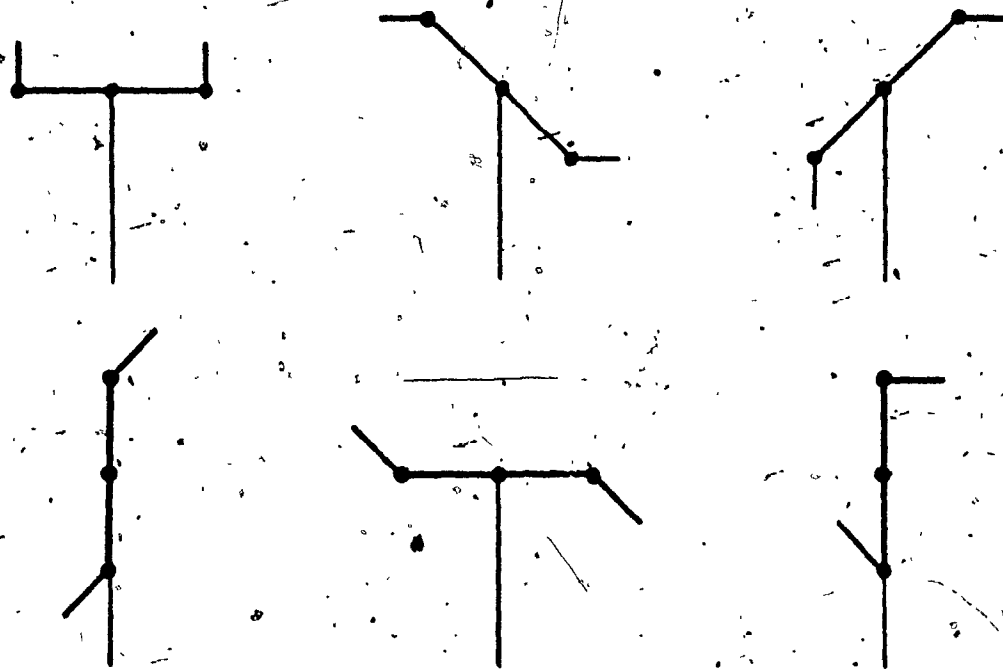

FIGURE 1.1

EARLY SEMAPHORE

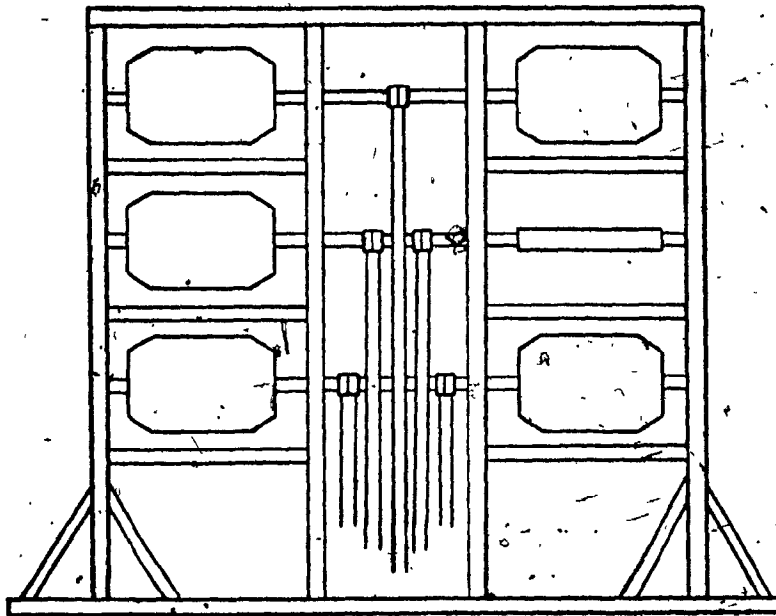

FIGURE 1.2

LORD GEORGE MURRAY'S TELEGRAPH



since both represent a letter symbol. By mid of 1800, more than 50 companies used the Morse telegraph to provide commercial service in the U.S.A. because of higher speed attainable with the code.

With the invention of the telephone by Graham Bell in 1876, the development tended in favour of analog rather than digital transmission techniques. The telephone enjoyed a widespread enthusiasm which led to a complete turning point in the state of art. At the turn of this century, analog telephone systems were in widespread use, whereas digital systems were confined to telegraph applications.

The development of modern digital communications started with World War II as the result of more efficient radars and widespread use of digital computers. Although the development of digital computers was fast, nothing was done about the transmission facilities between these computers. In order to establish a link between any data modules, the analog facilities of telephone companies were and are used. Some of the data modules, due to their high speed requirements for transmission, need a wider frequency band than a telephone voice channel can provide. With this constraint, new words as wideband data services were added to the telephone industry.

Early telegraph services used to occupy bandwidths of about 80 c/sec to transmit low-speed telegraph messages.

With the introduction of carrier telephone systems, data speeds up to 2.4 kb/sec were made feasible. Later on, improved carrier systems utilizing a wider flat portion of the channel bandwidth for data transmission managed to handle speeds up to 4.8 kb/sec.

The explosive expansion of business, governmental and military organizations in recent years created a rising need for volume data transmission. Quite obviously, the logical way to meet this need is to boost the speed of data transmission in order to limit the time needed for the transfer of information. In practical terms based on Nyquist classical studies, higher data speeds can be achieved by utilizing wideband transmission facilities such as those offered by the group bank and the super group bank of modern carrier telephone systems. Due to the latest developments in the art of transmitting more telephone conversations simultaneously over one carrier frequency, new carrier equipment has been introduced in the telephone industry and with it new names such as channel bank, group bank and super group bank. The channel bank is that section of the carrier equipment with the capability of multiplexing 12 voice frequency telephone circuits and placing the total bandwidth between 60 KHz to 108 KHz, known as the "basic group bandwidth". The group bank receives the outputs of as many as 5 channel banks for a total of 60 voice

frequency telephone circuits, multiplexes them and produces one output with a bandwidth from 312 KHz to 552 KHz, known as the "basic super group bandwidth". The super group bank, on the other hand, receives the outputs from 10 group banks for a total of 600 voice frequency telephone circuits, multiplexes them and shifts the bandwidth from 564 KHz to 3084 KHz, known as the "basic master group bandwidth".

The first two, "basic group bandwidth" and "basic super group bandwidth" are used for higher speeds data communications. In fact, three standard data speeds came into general use on carrier telephone systems, namely 19.2 Kb/s requiring half-group bandwidth, 50 Kb/s requiring a full-group bandwidth and 250 Kb/s requiring a super group bandwidth. During the year 1971-72, the 50 Kb/s was increased to 56 Kb/s over the same analog facilities, and in 1973 this bit rate has been transmitted coast-to-coast over both digital and analog facilities. During this year, data messages at a rate of 1.544 Mb/s will be transmitted up to 200 miles over digital facilities for the first time and up to 4000 miles over analog facilities.

In order to successfully use the analog facilities for wideband data transmission, one has to modify these facilities by adding special delay and loss equalizers to group connector points to correct the delay and attenuation distortion introduced on analog facilities. If the analog facilities are not conditioned for wideband data

transmission, then the envelope delay present on these facilities causes phase distortion, commonly known as "phase jitter", which results in intolerable high error-rates. In addition to this, wideband data modems are required in order to condition the baseband data signal for transmission over the analog facilities. Another disadvantage of analog facilities is the accumulative noise over long distances which deteriorates the original information by generating a high error rate. It might be added that too many voice channels have to be sacrificed for one data channel.

On the other hand, when transmitting wideband data over digital facilities, no conditioning of the facilities is required since the base band signal generated by the business machines as well as the carrier are both digital in nature. The error rate is greatly improved since the noise is not additive as the carrier signal is regenerated along the path every one mile in the case of cable carriers.

In spite of the drawbacks, analog facilities are still being used for digital data transmission since analog facilities exist while digital facilities are not available to the extent required. In fact at present more digital data is transmitted over analog than digital facilities. However, by 1976 the digital facilities will carry more digital data than analog ones.

In order to cover the most relevant points of digital data transmission on analog and digital carrier systems, this report is divided into seven chapters:

- Chapter I covers in general terms the history of digital communications.
- Chapter II defines the terms used in digital communications and describes the first wideband data services that are still in use.
- Chapter III discusses important carrier systems, both analog and digital, used for transmitting data information. Advantages and disadvantages of each system are explained in detail.
- Chapter IV discusses the first digital data facilities between subscriber premises and telephone office, as well as the first network between Calgary, Toronto and Ottawa.
- Chapter V puts together what was developed in previous chapters in order to provide a data network from Halifax to Vancouver. The synchronous and asynchronous modes of transmission are covered as well in this chapter.
- Chapter VI covers the agents that contribute to the deterioration of the original base band signal, as well as the ways their effect can be reduced. The jitter term, kinds and sources are covered too.
- Chapter VII summarizes the work covered by this report and outlines the future of data communications.

CHAPTER II

WIDEBAND DATA SYSTEM

## CHAPTER II

### WIDEBAND DATA SYSTEM

Since World War II, telephone companies are faced with the challenge of providing reliable data transmission over analog facilities. This chapter will describe in general terms the system layout of Data Transmission over telephone facilities, from a subscriber location to telephone central office. The functional description of the still existing 50 Kb/sec Wideband Data System will be described in order to establish the higher hierarchy bit rate systems, and the units that measure the quantity of information transmitted over any system.

#### 2.1 Bits and Bauds

It is common practice to use bits and bauds as synonyms as one uses pound (lb) for both mass and force. In reality, there is a big difference between bit and baud rate, although some time both have the same numerical value as do pound force and pound mass.

By definition, bits per second expresses the total number of information pulses in one second. On the other hand, baud is defined as the reciprocal of the time of the shortest signal element in a character. If all time intervals are constant and all signal pulses are information pulses, then the bit

rate as well as the baud rate are equal. This is true in binary transmission.

In order to illustrate the difference between bits and bauds, let us make use of the following example:

- An ordinary teletypewriter transmits 100 wpm and makes use of five-bit code, each bit 13.5 msec. long.

The baud rate is the reciprocal of 13.5 msec and equals approximately 74.2 bauds/sec.

The bit rate is determined as follows: - A single character consists of a start pulse and five information pulses, each of 13.5 msec long, for a total of 81 msec. At the end of each character a 19 msec. stop pulse is added, such that the total length of one character is 100 msec. But bits per second expresses the total number of information pulses in one second, or  $5/100$ sec, which is 50 bits/sec.

In conclusion, a teletypewriter that transmits 100 wpm, has a baud rate of 74.2 bauds/sec and a bit speed of 50 bits/sec only.



## 2.2 General System Representation

A simplified block diagram of a general wide-band data system is represented in Figure 2.1. The major system components involved are:

- a. The wideband data station located close to the business machines of the customer.
- b. The wideband data terminal which accommodates a wideband modulator-demodulator unit (wideband modem) and,
- c. The common carrier facility.

The wideband data transmission system of Figure 2.1 provides a wideband data channel for high-speed data transmission and a voiceband coordination channel which can be used either for voice communication between business machine locations or for the transmission of low-speed data coordination signals.

The data station is a flexible arrangement of functional units that can be adapted for synchronous or asynchronous transmission according to the operational requirements of the business machines. Section 5.4 of this report gives a detailed explanation of synchronous and asynchronous modes of transmission.

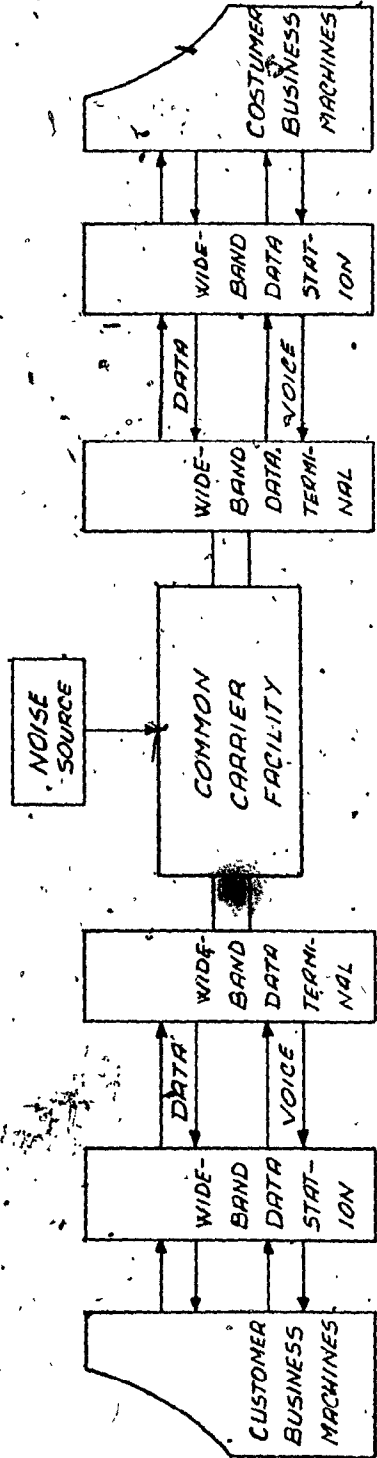

FIGURE 2.1

SIMPLIFIED BLOCKDIAGRAM OF A WIDEBAND DATA SYSTEM

Magnetic tape to magnetic tape communications, real-time information transfer between computers in some phases of computer operation, telemetry signal transmission and several other services require synchronous transmission operation.

Another class of wideband services, such as the transmission of asynchronous facsimile signals, requires asynchronous transmission operation. A synchronous wideband data station can be operated either in synchronous or asynchronous mode under the control of the various business machines. The synchronous station is therefore, more flexible to various operational requirements than an asynchronous station since the latter can operate only in the asynchronous mode. On the other hand, an asynchronous data station is more flexible to various data speeds than a synchronous data station since the latter can handle a single data speed which is determined by its fixed timing function.

The business machines exchange information in a binary format represented by D.C. pulses. The frequency bandwidth of the baseband signal, generated by the business machine, may vary from 0 Hz, while transmitting a series of 1 bit pulses to  $N/2$  Hz during the transmission of a series of alternate 1 and 0 bit pulses,  $N$  being the baud rate of the business machine.

51

The telephone transmission line, over which the baseband signal is transmitted, acts as a bandpass filter, with high attenuation for frequencies lower than 300 Hz and higher than 3300 Hz. Due to these cut off properties of the line between subscriber terminal and the telephone office, all or part of the baseband signal can be lost. In order to overcome this problem, the baseband signal must be shifted within the frequency bandwidth (300 to 3300 Hz) of the telephone line. This is achieved by superimposing the baseband signal on a carrier signal within the permissible band of transmission. Such a process is called modulation. Another reason for modulation is to concentrate more digital data channels over a voice circuit. For example, the baseband of a teletypewriter signal has a maximum bandwidth of 150 Hz. This occupies 1/24th of the maximum available bandwidth of a voice channel. Hence, up to 24 teletypewriter circuits can be concentrated over the facilities of a V.F. circuit. This is very attractive from both economical and frequency bandwidth utilization points of view.

There are several types of modulation techniques employed for both analog and digital signals. The choice of which type is to be used for a particular system is up to the system design engineer who must know all relevant factors concerning the system

under consideration. Some of the important types of modulation used are:

- a) Continuous Wave (C.W.)
- b) Frequency Shift Keyed (F.S.K.)
- c) Amplitude Modulation (A.M.)
- d) Frequency Modulation (F.M.)
- e) Phase Modulation (P.M.)
- f) Pulse Code Modulation (P.C.M.)

- In continuous wave (C.W.) modulation, a sinusoidal carrier of a steady frequency, say 600 KHz if radio is used, will be generated by a local oscillator. The carrier frequency is transmitted when a key in the local oscillator circuit path is closed and it will stop transmitting when the same key is open. This type of modulation is generally employed when transmitting morse code.

- The F.S.K. modulation is not much more complicated than C.W. It makes use of two carrier frequencies: one frequency is transmitted when the key is closed or a mark is generated, and the second frequency is transmitted when the key is released or a space is generated. This type of modulation is mainly used for teletypewriter transmission systems. Its main advantage over C.W. modulation, is that steady power is applied to the transmitter, obtaining maximum efficiency.

- In amplitude modulation, the amplitude of the carrier frequency is varied in accordance with the amplitude of the modulating baseband signal that is impressed upon it. If the carrier frequency is "C" and the modulating one is "M", then two frequencies ( $C + M$  and  $C - M$ ) called upper and lower side bands are produced. This way, the baseband signal is transmitted using double the bandwidth required. Although this type of modulation looks unprofitable, it is widely used as the present technique allows it to suppress one of the unwanted sidebands.

- The frequency modulation depends upon varying the frequency of a carrier wave of a fixed amplitude in accordance with the amplitude variations of the modulating baseband signal. The amount of frequency change that is produced by the signal is called the frequency deviation. As in A.M., the resultant F.M. signal contains the carrier frequency and other frequencies above and below the carrier frequency ( $C+M$ ,  $C+2M$ ,  $C+3M$ , -----). Although the F.M. signal covers a large bandwidth, some restrictions are imposed in order to avoid communications interference. The maximum permissible deviation from the carrier ("C") is 75 KHz for F.M. Broadcasting and 15 KHz for such applications as mobile radio service. These guidelines are controlled by the Department of Communications in Ottawa, in view of technical considerations.

- The phase modulation (P.M.) uses a completely different approach. A change in the amplitude of modulating signal produces a corresponding change in phase in the carrier signal. For example, a binary baseband data signal, as it changes states (1 to 0 and 0 to 1), will cause a corresponding  $180^\circ$  shift in the phase of the carrier frequency. This type of modulation is called two-phase modulation. Four-phase or higher modulation is possible. For example, in the four-phase modulation, the pair of binary digits combined in four possible ways: 00, 01, 10, 11 with the corresponding phase shift in the carrier at: 0, 90, 180, 270 degrees are used.

- The pulse code modulation (P.C.M.) is a type of modulation that takes place in time domain rather than in frequency domain as do the previous types of modulations. The P.C.M. is discussed in chapter III sections 3 and 5 and need not be repeated here.

All types of modulations described are employed for transmission of data messages. However, when transmitting a wideband data signal over telephone wires, the baseband data signal is conditioned rather than modulated since there is no frequency bandwidth where the same is to be shifted. The conditioning is done by scrambling the baseband signal (removing the D.C. component), and limiting the data baseband to

within about 100 Hz to 37 KHz for a 50 Kb/s baseband signal. This conditioning is illustrated by Fig. 2.2.

In wideband data modems, two types of demodulation techniques can be encountered: coherent demodulation or non-coherent demodulation. Coherent demodulation implies that a replica of the transmitted wideband carrier is available at the demodulator used for detecting the received data signal. In most cases, the frequency and phase of the carrier required for the demodulation process is determined from the received data signal itself. The receiving side works therefore in synchronisation with the time pattern of the transmitting far end. Non-coherent demodulation, on the other hand, does not require carrier recovery and no phase reference. It is, therefore, preferably used where due to carrier frequency offset or due to unreliable transmission, the carrier phase cannot be easily recovered at the receiving far end. Envelope detectors and linear discriminators are examples of non-coherent type detectors. Wideband modems utilizing non-coherent detection techniques provide the advantage of circuit simplicity and low cost at the expense of degraded error performance.

In Figure 2.1, it has been assumed that signal impairments are introduced mainly by the common



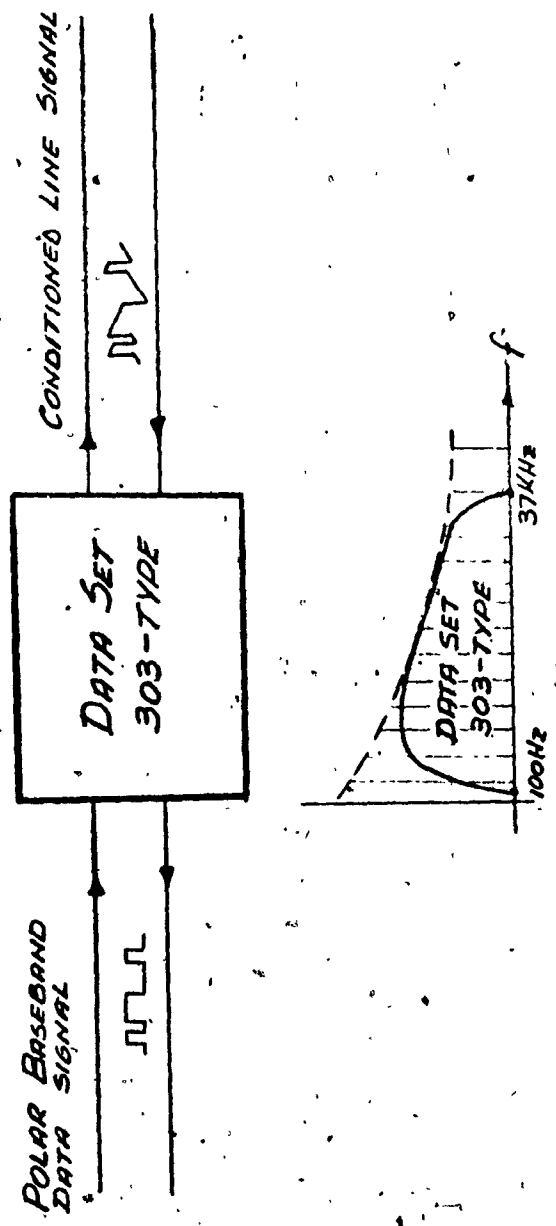

FIGURE 2.2

CONDITIONING THE BASEBAND DATA SIGNAL

carrier facility which may consist of an analog carrier system such as the LMX or N2 type carrier, or a digital carrier system such as the T1 carrier. A coast-to-coast connection consists of several sections of common carrier facilities which may involve a mixture of all three carrier systems mentioned above.

### 2.3 System Layout and Functional Description of 50 Kb/s Network

A typical 50 Kb/s wideband data system is illustrated in Figure 2.3. The baseband data signal that originates in the data equipment on customer's premises is fed into the wideband data station.

#### 2.3.1 Wideband Data Station

The main functions provided by the wideband data station are:

- a. Conditioning the baseband data signal for optimum transmission over the wideband transmission facilities.
- b. Interfacing the various business machines with the local access loop.
- c. Providing line and remote test functions in coordination with the wideband test bay of the central office.

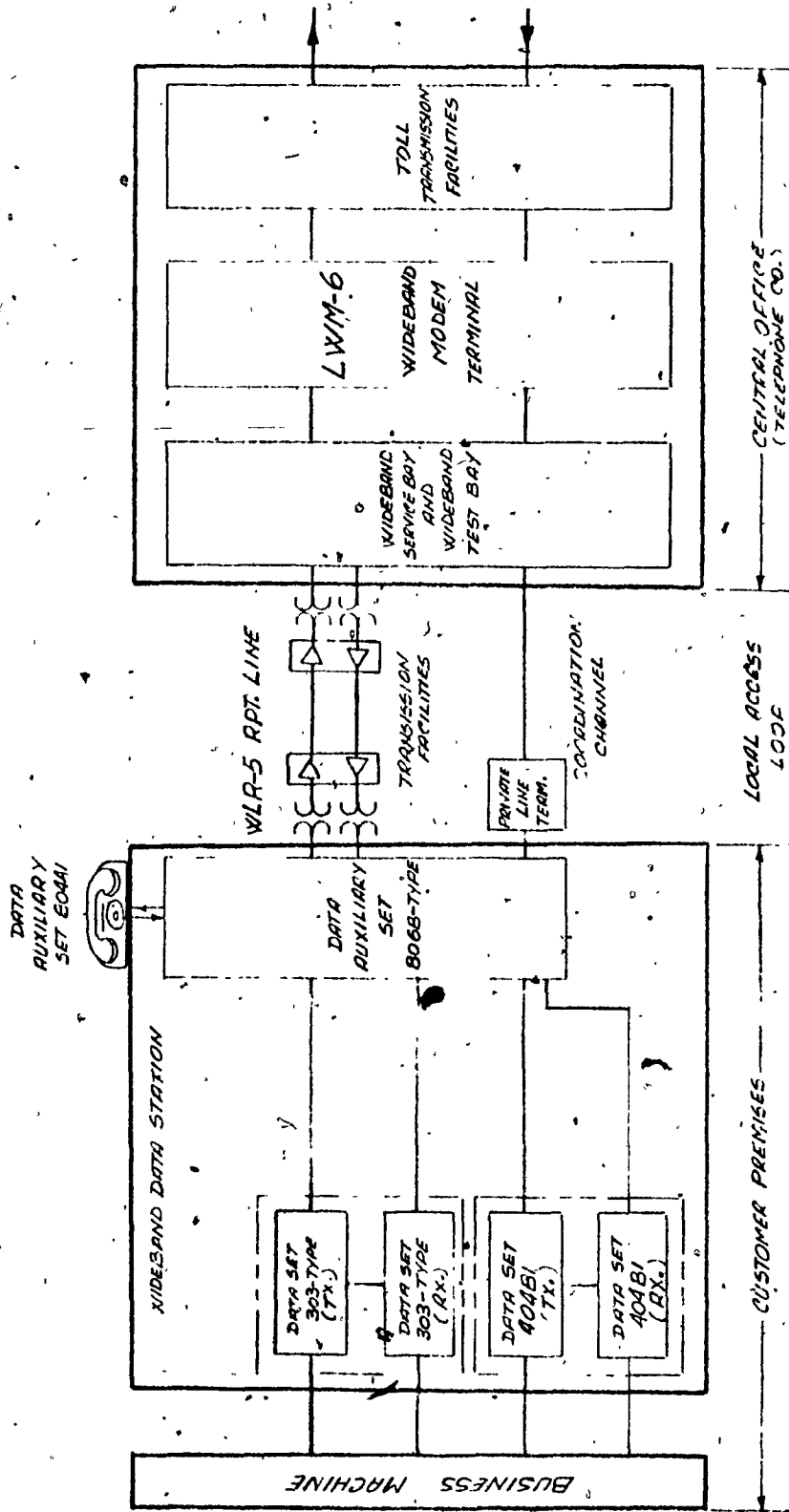

FIGURE 2.3.

WIDEBAND DATA SYSTEM

Conditioning the baseband data signal for optimum transmission is accomplished by the 303-type data set of the wideband data station. The conditioning process is illustrated in Figure 2.2. It involves:

- a. Removing the DC component of the signal in order to adapt it for transmission through DC blocking circuits and transformers encountered along the various transmission facilities. At the receiving end, the DC component is restored back to the received line signal by means of special circuitry (regenerative slicer circuit).
- b. Attenuating the low-frequency components of the signal to allow easy recapturing of the wideband carrier at the receiving end.
- c. Limiting the data baseband to within about 100 Hz to 37 KHz.

In addition to the basic functions a, b and c which are common to both synchronous and asynchronous data sets, a synchronous data set incorporates synchronization recovery and signal regeneration in addition to a scrambler - descrambler arrangement.

The transmitter of the synchronous data set incorporates a scrambler which spreads the energy of the data signal across the data channel band in order to limit high level discrete frequencies which could otherwise intermodulate with strong talker signals to create intelligible crosstalk conditions.

The receiver of the set retimes and reshapes the received data signal prior to passing it to a descrambler which is key locked to the scrambler of the transmitting side and performs the inverse operation to restore the original energy distribution. It is therefore very important to realize that some restrictions have to be made if a synchronous data station is used for non-synchronous wideband services. Since the scrambler - descrambler arrangement is not used in the asynchronous mode of operation, the type of signals used must be necessarily of random nature (asynchronous facsimile or cryptograph signals). Such signals do not have repetitive patterns which could give rise to extreme concentration of power at discrete frequencies and consequently to interference and crosstalk coupling.

The necessary interface and test functions are accomplished by the 806B type data auxiliary set of the wideband data station. This set is mainly concerned with interfacing the various data auxiliary sets of the station with the local access loop. It also provides means for looping data transmit leads to data receive leads for testing the associated data sets, as well as monitor and termination jacks for test access on wideband and voiceband lines.

Other auxiliary sets needed only in non-synchronous wideband data stations are the 404B type data set and the 804A type data auxiliary set. The 404B type data set is a voiceband transceiver which receives voltage data signals from the business machines and converts them into parallel multifrequency signals. These signals are then passed to the voiceband transmission circuits of the 806B type data auxiliary set. The receive side of the 404B type data set performs the inverse operation and passes the voltage data signals to the business machines.

Together with the 404B type data set, an 804A type data auxiliary set is required to

provide a telephone receiver, and supervisory features for voice communication over the voiceband coordination channel. Attached to this set is a loudspeaker arranged to operate when the 804A set is in the data mode and the telephone receiver is on hook. A private line terminal must be used with the 804A set to provide various control functions.

### 2.3.2 Local Access Loop

A local wideband loop consisting of an unloaded four-wire telephone cable is used for transmitting the restored polar line signal between the wideband data station and the central office. WLR-5 wideband repeaters are needed to provide gain equalization and pilot controlled regulation to compensate for attenuation loss and ambient temperature changes of the cable.

The repeaters may be housed in a case for pole or manhole mounting and powered either locally or remotely by sending simplex current over the cable pairs. For longer distances of more than 20 miles, the access facility may consist of repeatered carrier circuits, such as the N2- or T1 carrier. In

such applications, a wideband modem is required at the data station to condition the data signal for transmission over the carrier facility.

For the voiceband coordination channel, a separate two-wire facility is used. Both the coordination channel and the wideband data channel terminate in the wideband service bay located at the central office.

### 2.3.3 The Central Office

The wideband service bay functions as an access arrangement and provides the necessary interface between the baseband and the carrier facility or between separate carrier facilities. It provides wideband distribution frames and accommodates wideband and voice jack strips for testing the data and voice circuits in both directions. Adjacent to this bay, a wideband test access bay is usually installed. This bay accommodates transmission testing equipment needed for remote testing of wideband data sets and the associated data and voice circuits.

The wideband data modem is a modulator-demodulator unit required to allocate the



restored polar line signal in the groupband of the multiplex facility. The modem must be therefore fully compatible with the carrier system used for transmission.

2.4 Summary

The previous sections have defined the terms used in Digital Data Communications (bits and bauds), and concentrated mainly on the first wideband data services (50 Kb/s) that are still in use. The most frequent types of modulation schemes have been covered also. Black Box approach, to represent systems layout has been employed. This technique will be used throughout this report.

CHAPTER III

CARRIER SYSTEMS

## CHAPTER III CARRIER SYSTEMS

In this chapter the most common carrier facilities will be discussed. Some of these facilities are operating and carrying data messages across the country. Other systems are in the development stage and are expected to be in service by the end of this year or early next year. The major systems to be discussed are:

- a. LMX-2 Carrier
- b. N2 Carrier
- c. T1 Carrier
- d. LD-1 Carrier
- e. LD-4 Carrier

### 3.1 LMX-2 Carrier

The NE-LMX-2 system is an analog carrier system which utilizes SSB-SC and frequency division multiplexing to provide up to 600 voice frequency channels (expandable to 1200 ch) on long-haul routes up to 4000 miles. Twelve voiceband channels which are normally multiplexed in a groupband extending from 60 to 108 KHz can be replaced with either two half-group wideband channels each capable of carrying 19.2 kb/sec data service, or one full-group wideband channel capable of carrying 50 kb/sec data service. Five groups are modulated into the supergroup band

(312 to 552 KHz) and ten supergroups are combined in a mastergroup band (564 to 3084 KHz). The transmission facility is either a repeatered coaxial cable line or a radio link.

To modify the LMX-2 equipment in the central office to be used for wideband data transmission, special delay and loss equalizers have to be added to group connector points to correct the delay and attenuation distortion introduced by the group bandpass filters. The modification is shown in figure 3.1. The reason for the necessary equalization can be explained as follows:

The bandpass filters of the LMX group connector are designed originally to handle voice frequency transmission. The bandpass filter of each connector introduces about 150 us delay at the edges of the groupband. Since the ear is not very sensitive to delay distortion, the delay characteristic of the group connector does not degrade the voice transmission. Yet in wideband data systems the envelope delay causes phase distortion, commonly known as "phase jitter", which results in intolerably high error-rates. Therefore, special delay equalizers must be inserted ahead of the bandpass filter of the group connectors to equalize the time delay characteristic, such that the relative delay time is

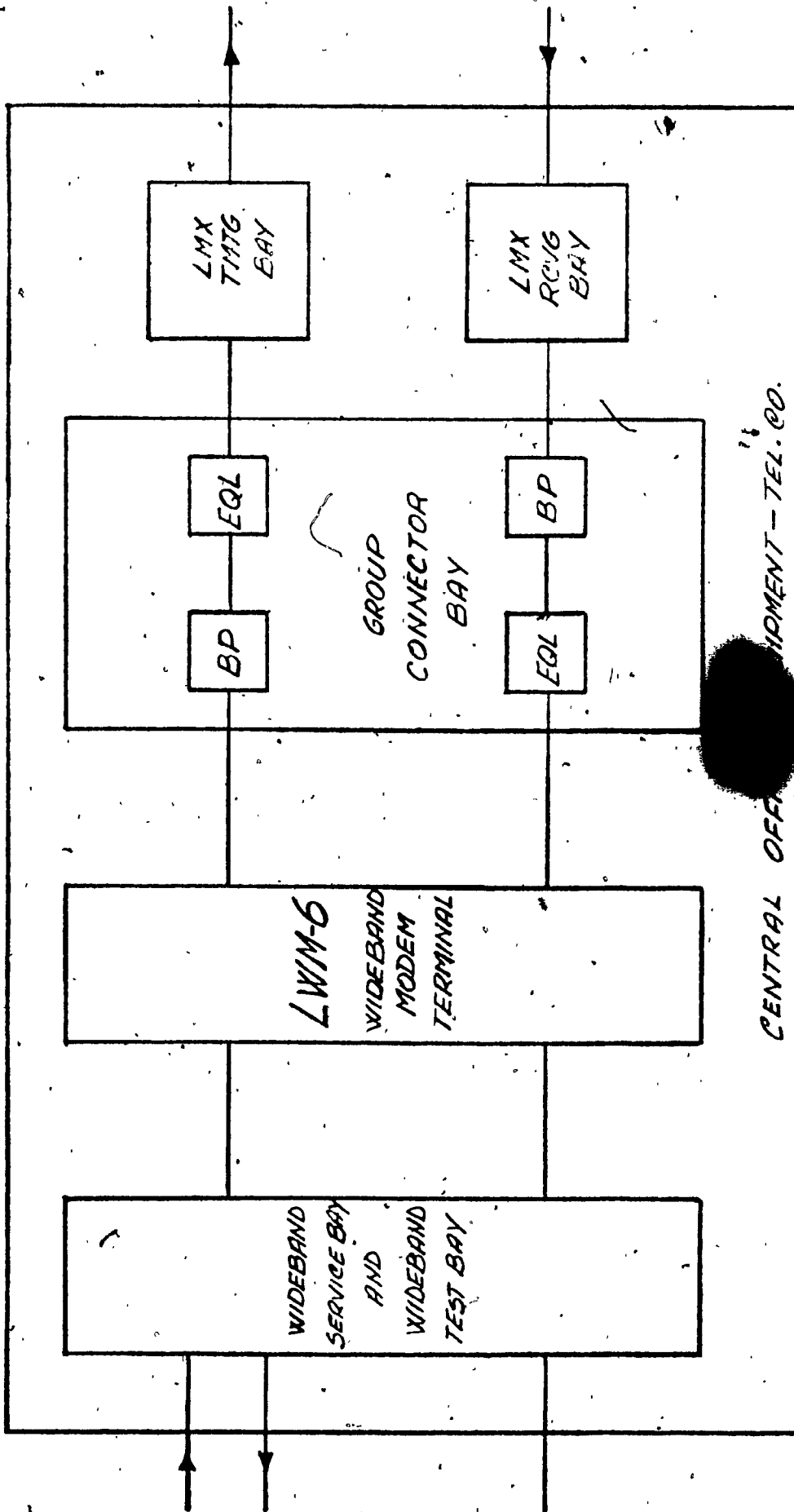

CENTRAL OFFICE EQUIPMENT - TEL. CO.

FIGURE 3.1

LMX-2 CARRIER APPLICATION

within few us along the whole groupband (figure 3.2).

The LWM-6 wideband data modem (figure 3.1) is designed to place the baseband data signal and a voiceband frequency channel in the LMX basic groupband, 60 to 108 KHz. The baseband data signal (100 Hz to 37 KHz) modulates a locally generated 100 KHz carrier. The DSB-AM spectrum is then shaped by a vestigial filter to produce a VSB signal. At this stage a 100 KHz pilot tone which is in phase with the wideband carrier is added to the VSB-signal. The resulting composite signal (figure 3.3) is then at the proper level and correct frequency band for introduction into the LMX group connector. The equalized data signal is then passed to the LMX transmitter, which places it into the basic supergroup band (312 to 552 KHz).

The supergroup bank is not delay equalized. The data group therefore cannot be allocated at the edges of the supergroup band. As shown in figure 3.4, group 3 is most suitable to accommodate the data group because of its flat delay response. If required, two additional data groups can also be accommodated in the unequalized supergroup band to occupy group 2 and group 4.

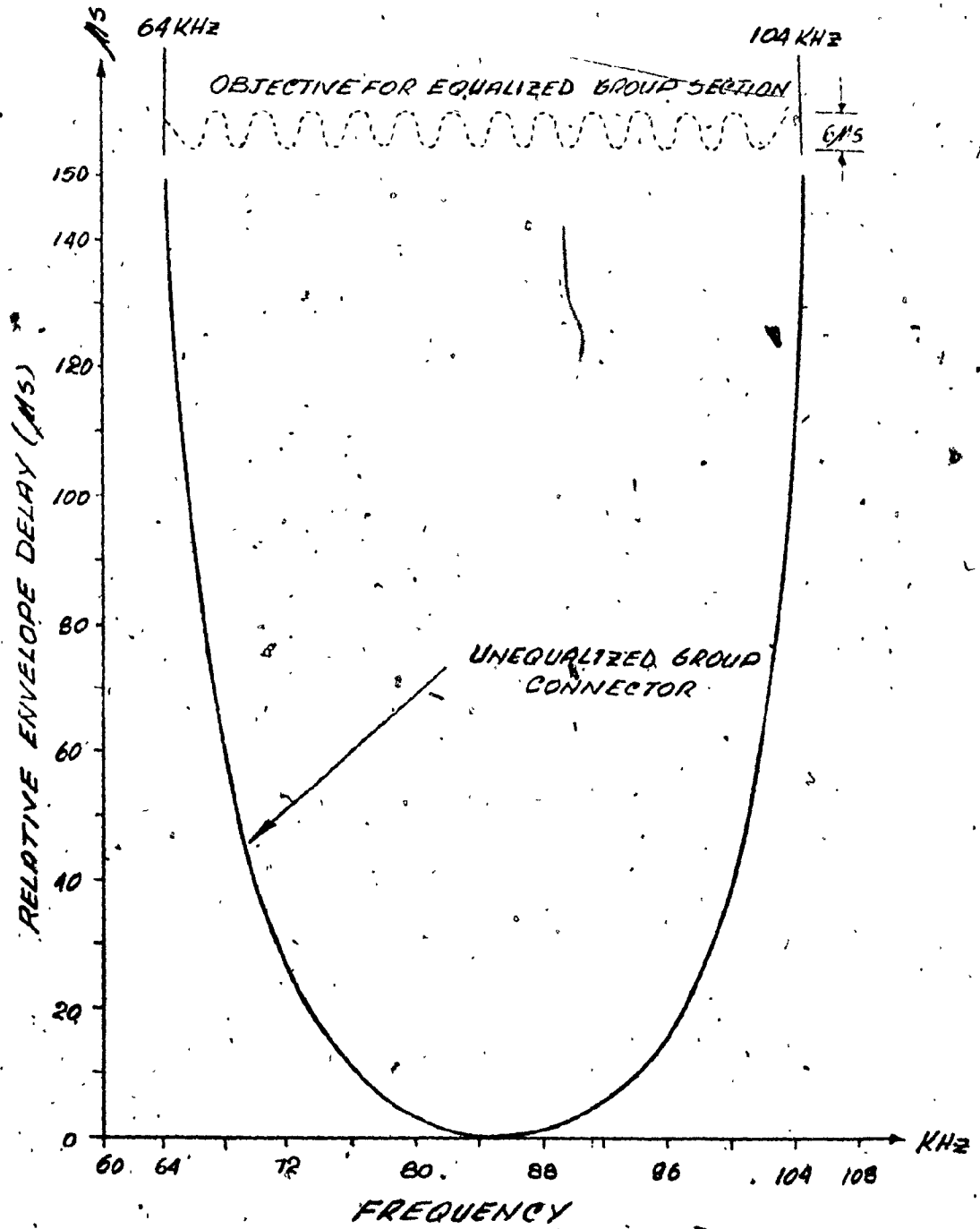

FIGURE 3.2

ENVELOPE DELAY EQUALIZATION FOR GROUP FACILITY

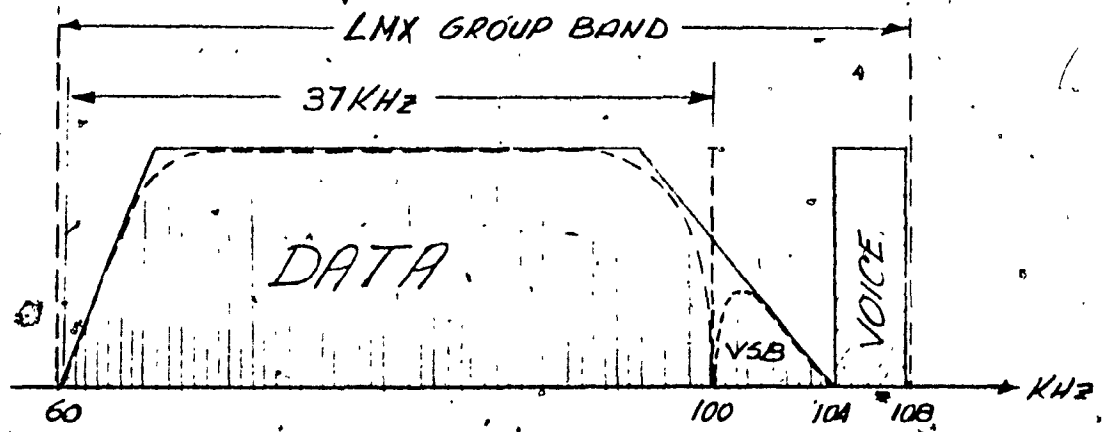

FIGURE 3.3

FREQUENCY SPECTRUM OF LMX GROUP-DATA

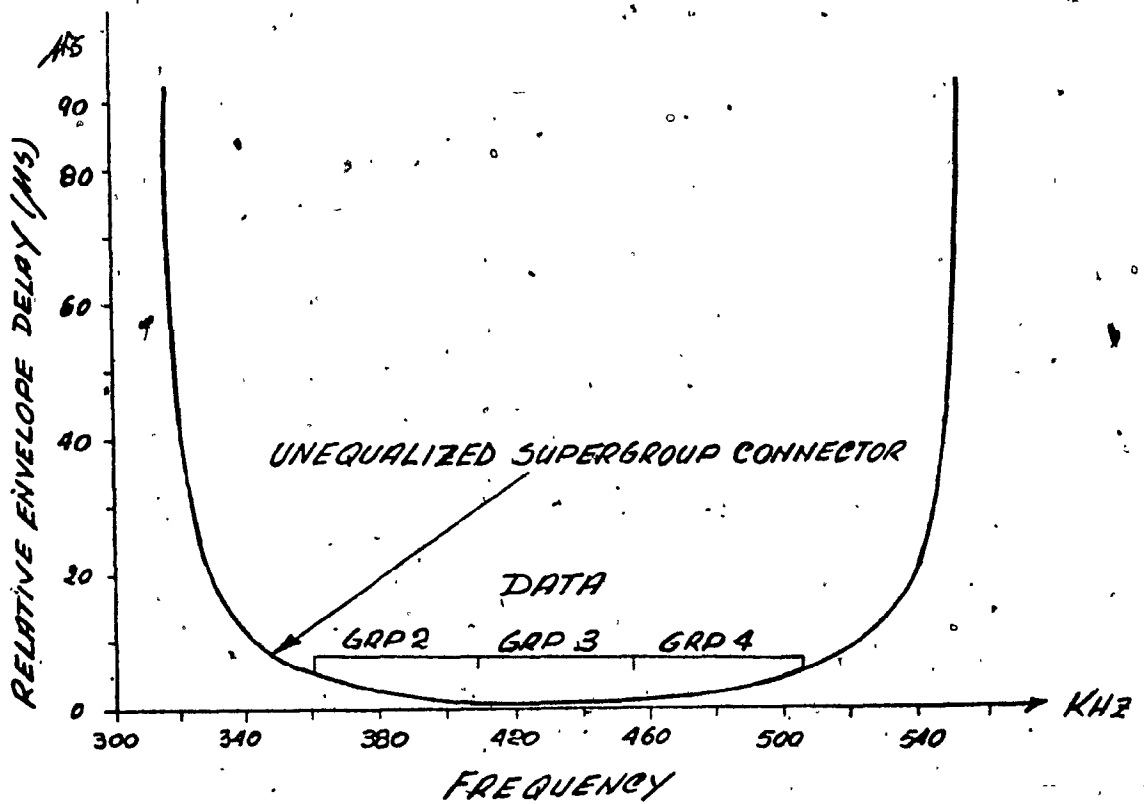

FIGURE 3.4

ENVELOPE DELAY FOR SUPERGROUP FACILITY



### 3.2 N2 Carrier

The NE-N2 system is an analog carrier system, which utilizes DSB-Modulation and frequency division multiplexing to provide up to 72 voice frequency channels (expandable to 96 ch) on short-haul routes up to 200 miles (exchange area range). Twelve voiceband channels are multiplexed in a groupband. The group frequencies assigned to the two directions of transmission are frogged at each repeater site. The low group extends from 36 to 140 KHz, the high group extends from 164 to 268 KHz. The transmission facility is either aerial or underground cable (non-loaded pairs). The groupband is sufficient for two half-group wideband channels each capable of carrying 19.2 kb/sec data service, or one full-group wideband channel capable of carrying 50 kb/sec data service.

To adapt an N2-office for wideband data transmission, we have to install an N2WT-1 wideband terminal (figure 3.5 which accommodates the plug-in units of an N2WM-2 data modem, an N2WM-1 high freq. equalizer unit, the N2 group transmitting and receiving units, a line terminating unit plus an arrangement for the alternate use of the N2 carrier line for either the wideband or voice mode of operation. In the voice mode, eleven VF-channels (Ch 2,4,5...13)

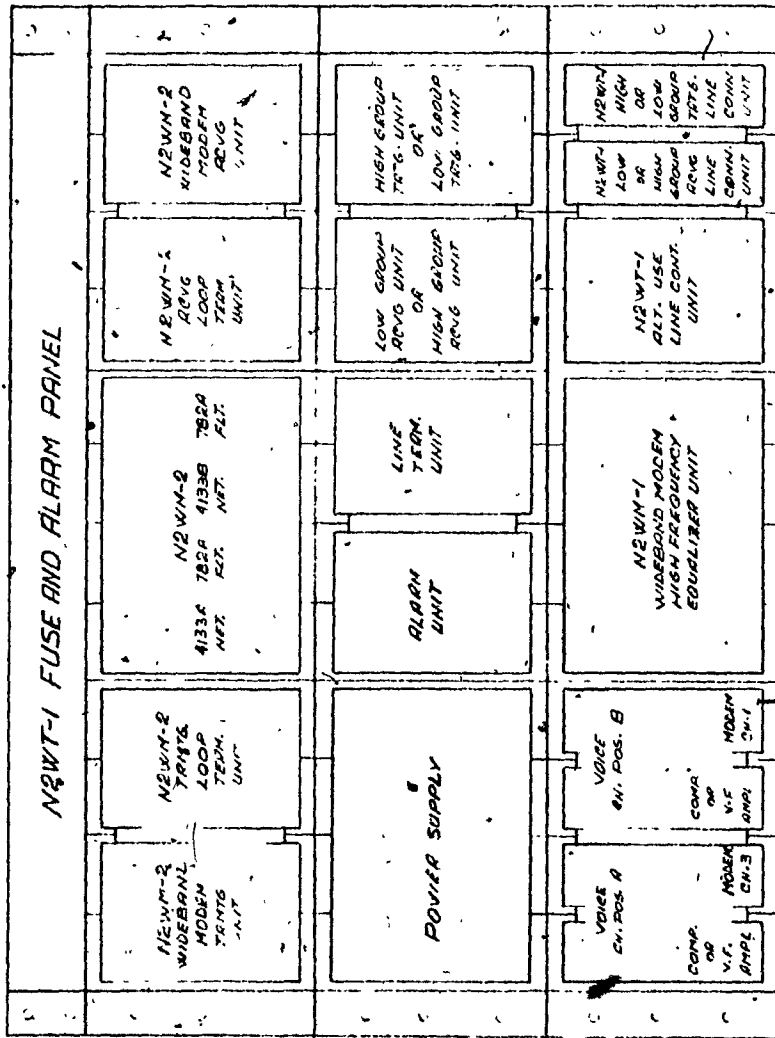

FIGURE 3.5

N2WT-1 WIDEBAND TERMINAL EQUIPPED WITH N2WM-2 WIDEBAND MODEM AND ADAPTED FOR ALTERNATE USE

replace the wideband data channel. Channels 1 and 3 are used for voice communication at all times. Figure 3.6 shows a fully equipped N2-office.

The N2WM-2 wideband modem is designed to place the restored polar data signal and two voice frequency channels in the N2 high group band. The restored polar data signal (100 Hz to 37 KHz) modulates a locally generated 240 KHz wideband carrier. The DSB-AM output is fed into a VSB shaping network, which passes the lower SB, the carrier frequency and a vestige of the upper sideband. This network includes also delay equalization to correct its own delay distortion. The shaped and equalized output is then combined with two high group voice channels 1 and 3 plus a 176 KHz tone required to properly load the N2 system when operating in the wideband mode. The power of this tone is adjustable to provide a total system output of +12.0 dBm for HGTx and +3.0 dBm for LGTx. The composite total spectrum of figure 3.7 is then transmitted by the group transmitting unit over the N2 carrier line.

The N2WM-2 receiving unit utilizes envelope detection to achieve non-coherent demodulation. The time delay caused by the group equipment and the N2 repeaters is pre-equalized by an N2WM-1 wideband modem high frequency equalizer unit.

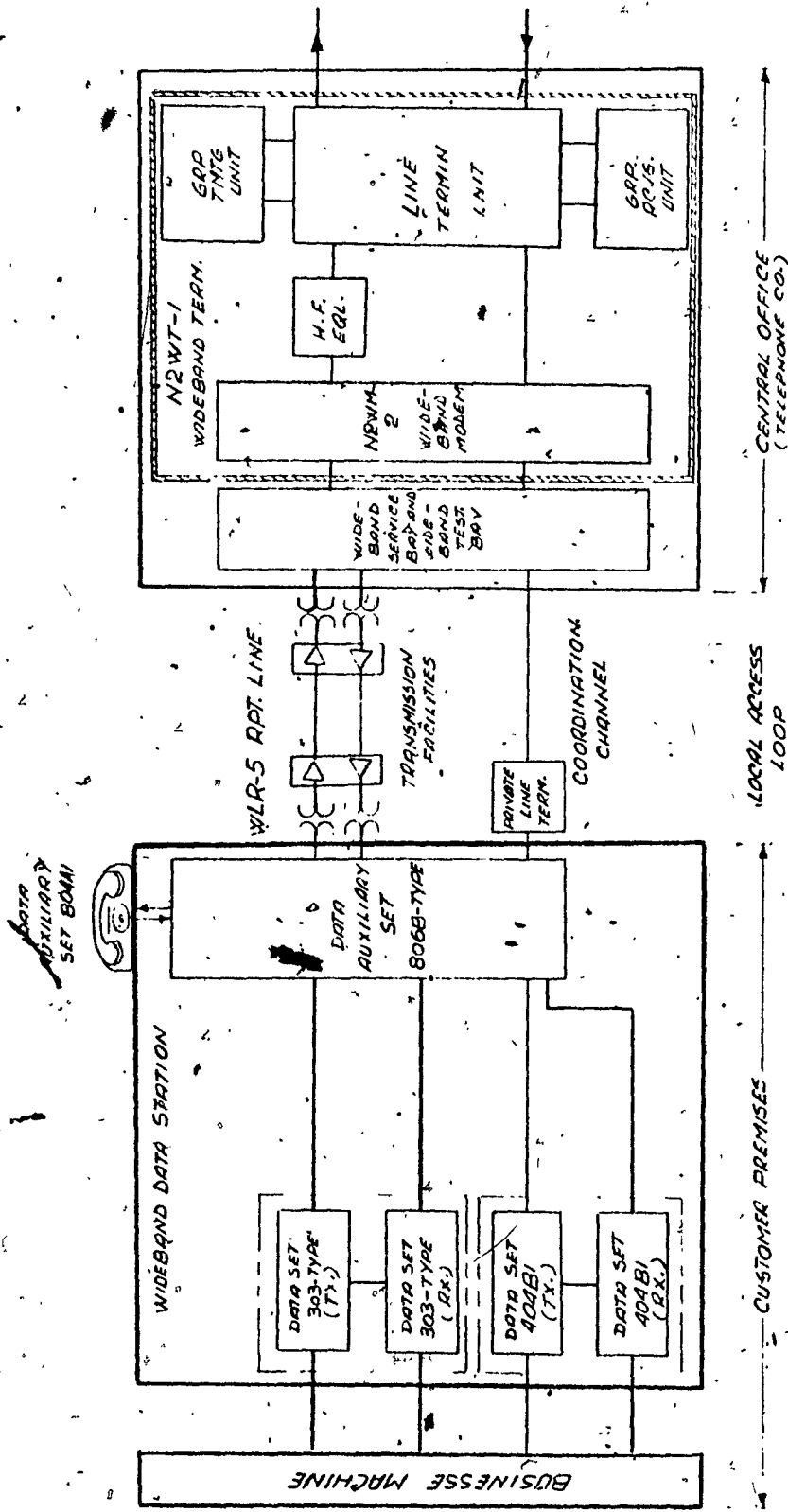

FIGURE 3.6

WIDEBAND DATA SYSTEM, NB-CARRIER APPLICATION

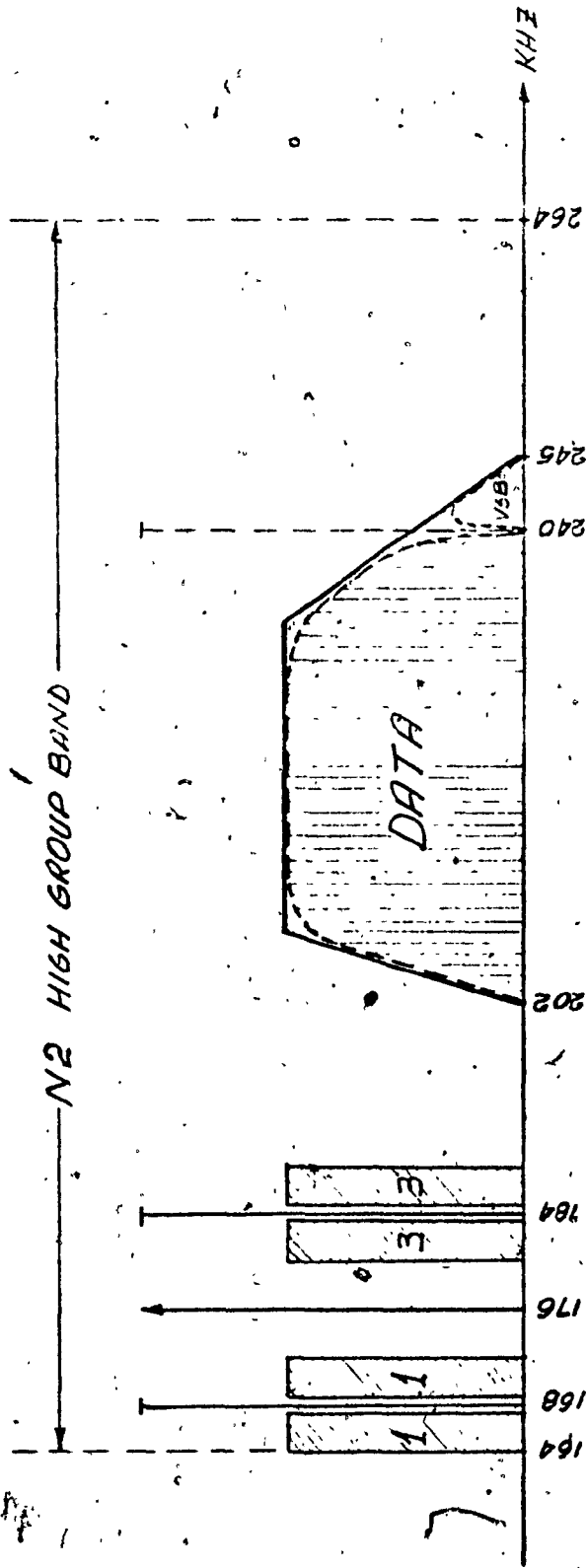

FIGURE 3.7

FREQUENCY SPECTRUM OF AN N2 GROUP-RATE DATA CHANNEL  
- VSB-DATA, TWO V.F.-CHANNELS, 176 KHZ-TONE -

3.3

T1 Carrier

The T1-Carrier is the first digital carrier system that utilizes P.C.M. technique and it has the lower bit rate of 1.544 Mb/s in the P.C.M. hierarchy. This is an american designed system used originally to provide telephone exchange area services of 24 V.F. channel on two wire pairs for distances of up to 50 miles and introduced in Canada during 1965. It is largely in use and by now it might well have passed the million circuits mark.

An important part of this system is the D1 terminal bank which makes use of time division multiplexing technique to combine 24 V.F. channels. All 24 channels are sampled at a fixed rate of 8000 times per second, in accordance with Nyquist sampling rate. Each sample consists of 24 pulse positions for a total of 24 P.A.M. - pulses. Each P.A.M. - pulse is then quantized using a companding technique which employs  $\mu=100$  as shown in Fig. 3 8 and with input output relations defined by:

$$y = F(x) = V_{max} \left[ \frac{\ln \left( 1 + \frac{\mu x}{V_{max}} \right)}{\ln (1 + \mu)} \right] \quad \text{for } 0 \leq x \leq V_{max}$$

and

$$y = F(x) = V_{max} \left[ \frac{\ln \left( 1 - \frac{\mu x}{V_{max}} \right)}{\ln (1 + \mu)} \right] \quad \text{for } -V_{max} \leq x \leq 0$$

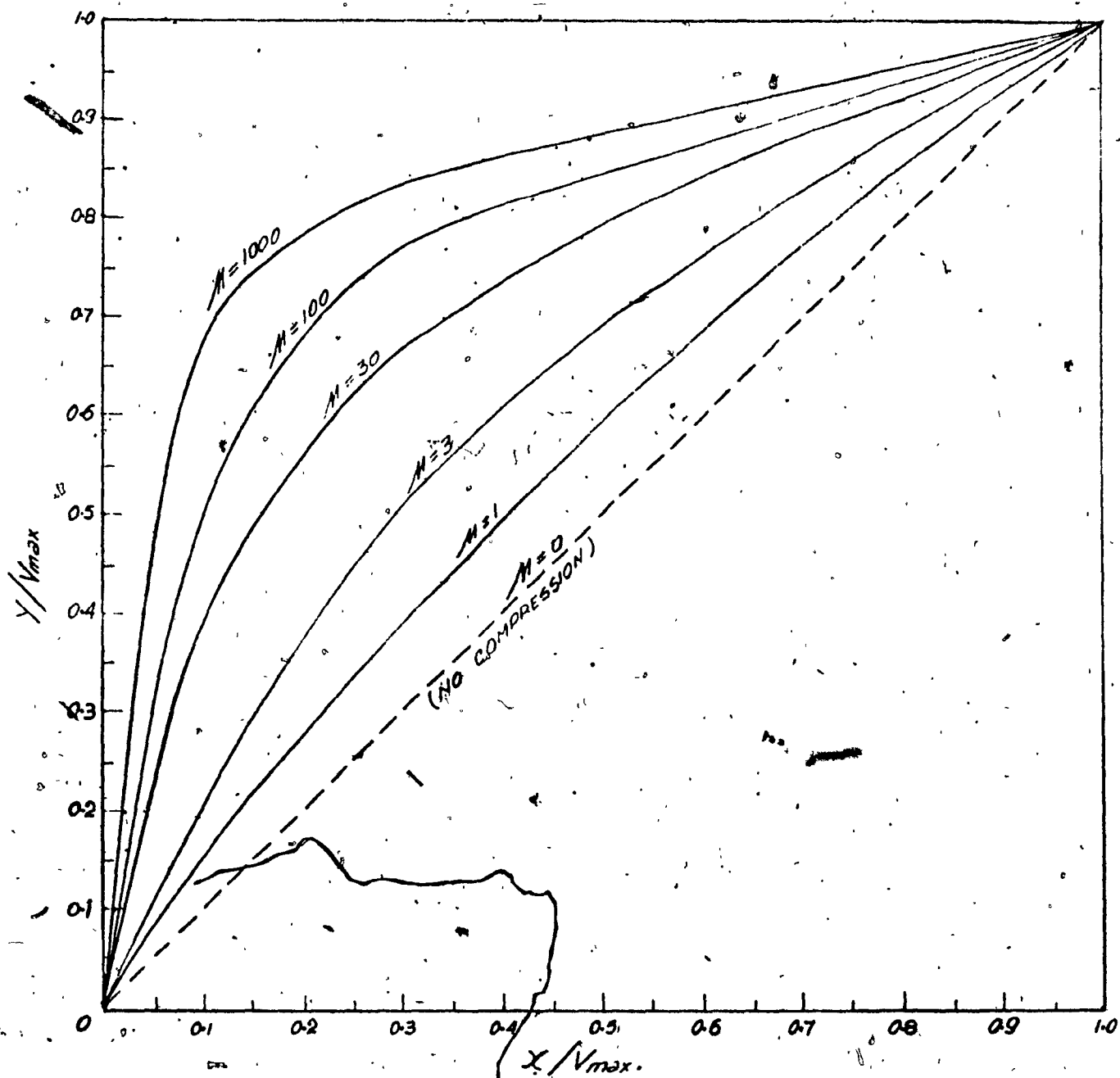

FIGURE 3.8

LOGARITHMIC COMPRESSION CHARACTERISTICS

After quantization, each sample is encoded into a seven bit code. A signaling bit is added to the seven bit pulse train of each channel and a framing bit is added at the end of each frame. Figure 3.9 depicts the signaling processing in the D1 terminal bank.

It is rather misleading to believe that a single D1 channel represented by an 8 bit pulse train and sampled 8000 times per second can transmit  $8 \times 8000 = 64000$  data bits per second. In fact three T1 carrier bits are required for each data bit. The first transmitted bit indicates the occurrence of a data transition. The second transmitted bit carries information on the time duration of the data bit. The third and final bit relays the direction of the transition that is plus or minus. Similarly three D1-channels must be released from voice-use for each group rate data channel (50 kb/sec) or 12 D1-channels for each supergroup rate data channel (250 kb/sec). This shows quite clearly, that wide-band data can be transmitted 4 to 5 times more efficiently on a T1-carrier system than on analog carrier systems as far as bandwidth utilization is concerned. Yet in most practical cases, the engineering of a nationwide wideband data network could not avoid transmitting data signals via existing



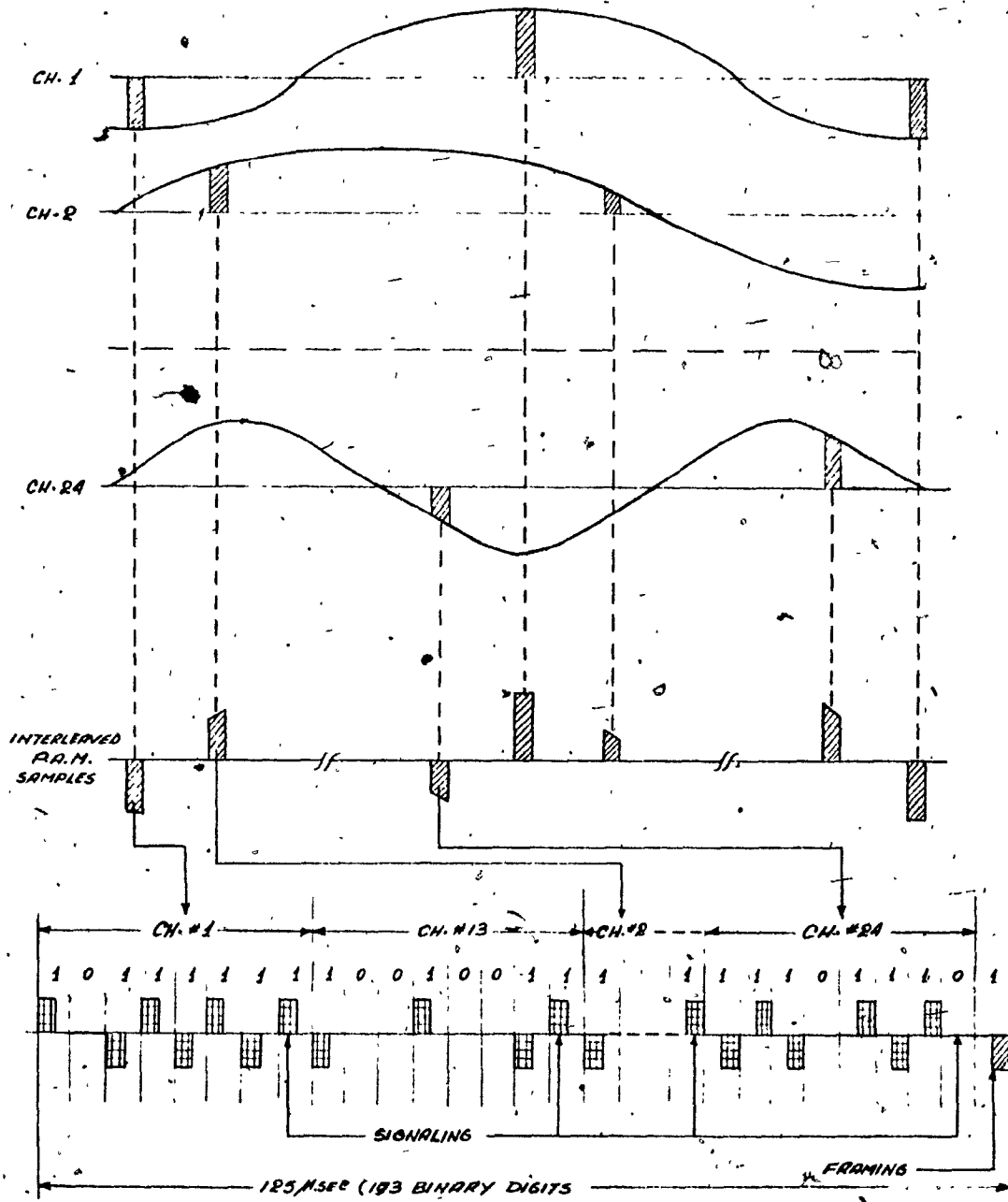

**FIGURE 3.9**

**SIGNAL PROCESSING IN THE DI BANK TERMINAL**

analog systems at locations where digital facilities did not readily exist.

To adapt a T1-carrier system for wideband data transmission, T1WB-3 wideband data banks were needed in conjunction with existing D1 voice banks at terminal locations to form data/voice hybrid terminals which provide a full duplex operation for time multiplexing data signals with PCM voice signals. Figure 3.10 shows a fully equipped central office arranged for mixing 21 voice channels with one 50 kb/sec wideband data channel.

The transmitting section of the T1WB-3 data bank is used to:

- a. Convert from one to four channels of 2-level synchronous or non-synchronous serial data or facsimile signals into unipolar PCM signals that have the same characteristics as the unipolar PCM signals used in the D1 voice bank.
- b. Convert the bipolar PCM voice train from the D1 bank into a unipolar PCM train.
- c. Remove all PCM pulses from three unused voice channels of this unipolar PCM voice train for each group-rate data channel to be transmitted.

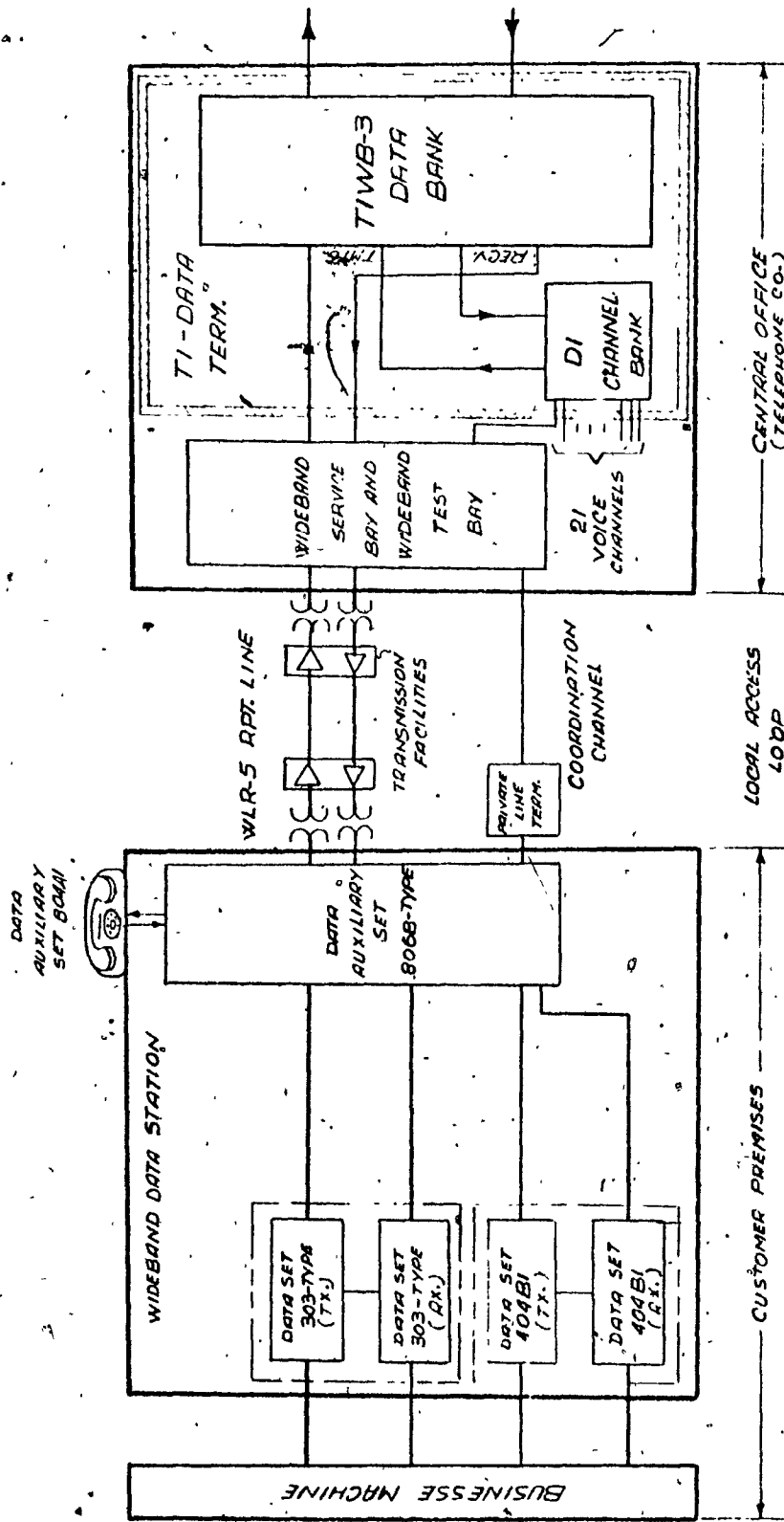

FIGURE 3.10

WIDEBAND DATA SYSTEM, TI-CARRIER APPLICATION

- d. Multiplex the data and voice channels by inserting the unipolar PCM data pulses into the pre-empted voice channel slots.
- e. Convert the resultant unipolar PCM data-voice train into a bipolar PCM train.
- f. Transmit this bipolar PCM data-voice train over the T1 repeatered line.

The receiving section of the TLWB-3 data bank is used to:

- a. Receive the bipolar PCM data-voice train being transmitted over the T1 repeatered line from the far end.
- b. Convert this bipolar pulse train into a unipolar train.
- c. Demultiplex the PCM data and voice trains by extracting the unipolar PCM data train from the unipolar PCM data-voice train.
- d. Insert a PCM pulse code into each now-empty voice slot to prevent a signal from being generated in the D1 decoder during any pre-empted channel slot.
- e. Convert the unipolar PCM voice train into a bipolar pulse train and apply it to the D1 voice bank for decoding, demultiplexing and distribution to the external voice circuits.

- f. Demultiplex the unipolar PCM data train and distribute the resultant to one to four individual PCM data trains to the channel decoding circuits.
- g. Convert the individual PCM data trains into 2-level serial data signals for application to the connected data sets.

Possible data/voice combinations which can be achieved by the T1WB-3 wideband data bank are listed in Table 1.

WIDEBAND BANK	CHANNEL ARRANGEMENTS
T1WB-3	1 Channel - 50 kb/s 21 Channels Voice
	2 Channels - 50 kb/s 18 Channels Voice
	3 or 4 Channels - 50 kb/s 12 Channels Voice

Table 1 - Possible channel arrangements for mixed wideband data and voice transmission

The voiceband coordination channel normally required with the wideband data channel can be provided as a separate T1 channel on the D1 bank.

In system applications where wideband data is the only service provided on the T1 line, a choice of several wideband data terminals can be made. The various channel arrangements and data speeds provided by these terminals are listed in Table 2.

WIDEBAND BANK	CHANNEL ARRANGEMENTS
T1WB-1	8 Channel - 50 kb/s
	4 Channel - 50 kb/s 1 Channel - 250 kb/s
	2 Channel - 250 kb/s
T1WB-2	2 Channel - 250 kb/s
T1WM-1	up to 250 kb/s

Table 2 - Possible channel arrangements for transmitting wideband data only (no voice channels)

The T1WB-1 wideband data bank has several possible arrangements depending on the type of wideband data service required, whereas the T1WB-2 is used where only 250 kb/sec wideband data is serviced. The T1WM-1 wideband modem provides a full-duplex wideband service at any speed up to 250 kb/sec of synchronous or non-synchronous serial data.

The 1.544 Mbs P.C.M. bipolar pulses from any of the T1 wideband banks are transmitted over T1 repeatered line. The T1 repeatered line is made up of two ordinary cable pairs (one TX and one RX) and line

repeaters along the line at a nominal 6000 ft apart of 22 gauge wire and 0.082 uF capacitance. The 6000 ft section is equivalent to 31 dB loss at 772 KHz; but the repeater is designed to cope with losses up to 35 dB. For short sections, the repeaters are equipped with build out network to provide an artificial line in multiples of 2.4 dB loss at 772 KHz. The power required for the line repeaters is transmitted from the terminal or intermediary office over the same two cable pairs using a simplex approach. The line repeaters are housed in sealed cabinets and mounted on poles or in manholes. The word "line repeater" is rather misleading since it does not repeat the incoming signals. It regenerates a new train of pulses based on the information received. The amplitude of these new pulses have 3 volts in amplitude and 0.33 usec width. The appropriate name would be "line regenerators".

#### 3.4 LD-1 Carrier

It is the second digital carrier system generation that utilizes P.C.M. technique and has been in operation since summer of 1974. Unlike the T1 carrier, the LD-1 system has been fully developed and designed in Canada by B.N.R. (Bell-Northern Research). It too has the lower bit rate in the P.C.M. hierarchy, 1.544 Mbs and like T1 carrier

transmits 24 V.F. channels or equivalent over two pairs of ordinary cable wires. Since it makes use of the latest development in the art of integrated circuits and thick film technology, the LD-1 carrier turns out to be net superior to its counterpart T1 carrier.

The power feeding points for the repeatered line is now 25 miles, versus 15 miles for T1-carrier. The line current has decreased to 100 mA from 140 mA for T1 which implies about 30% energy saving. The overall system length has increased to 200 miles from 50 miles for T1. Although compatible with T1 carrier, its maintainability has great advantages over T1. Equipped with a new type of fault locate system it makes possible to fault locate a faulty line repeater in an apparatus case from any terminal office of a span line, the line section between two power feeding offices. As an added feature the LD-1 employs a fail span detecting (F.S.D.) system that automatically interrogates up to three routes, each 200 miles long, and displays the status of each span. The size of line as well as the office repeaters has been reduced by 50% which makes it now possible to increase the number of line repeaters up to 50 in an apparatus case and up to 75 office repeaters per 9 ft. bay. This is a great improvement



in space allocation which becomes very critical day by day.

All above features makes the LD-1 carrier an attractive system for short haul communication networks.

Since its inauguration, it has not been used for data communications, although like T1 carrier, it is designed for data as well.

Like T1 the LD-1 carrier makes use of the D1 terminal bank or the newly developed DE-2 bank, which multiplexes up to 96 V.F. channels or equivalent and then groups them in four (each equivalent to 24 V.F.) carrier P.C.M. pulses for transmission over LD-1 or T1 facilities. The DE-2 is further described in section 3.5.

Due to its compatibility with T1-carrier, its transmission characteristics are the same as T1 and need not be repeated.

### 3.5 LD-4 Carrier

The LD-4 long haul transmission system is the latest digital P.C.M. carrier being developed by B.N.R. since 1970. The target date for the first system to operate is during 1975.

This digital long haul system is composed of the LD-4 digital line and associated terminal multiplex and codecs. It is designed to operate over coaxial cable at a bit rate of about 274 megabits per second and for a distance up to 4000 miles.

The capacity of this system is 4032 standard voice circuits or equivalent, per one pair of coaxial tubes. The system employs a 12 tube cable and provides a total route capacity of more than 20,000 two-way circuits.

The digital line operates over 0.375" coaxial cable and includes all required auxiliary systems such as line power, cable gas pressure system, surveillance and fault locating, etc.

Codecs and channel banks are based on P.C.M. encoding. Close cooperation with international organizations will insure compatibility throughout the world as standards are established.

The digital multiplexing is based on the North American compatibility hierarchical system. Figure 3.11 illustrates this hierarchy. Interconnection with microwave radio systems is also facilitated. The data messages will interface with the LD-4 carrier via wideband data codecs at DX-1 points as illustrated by Fig. 3.11.

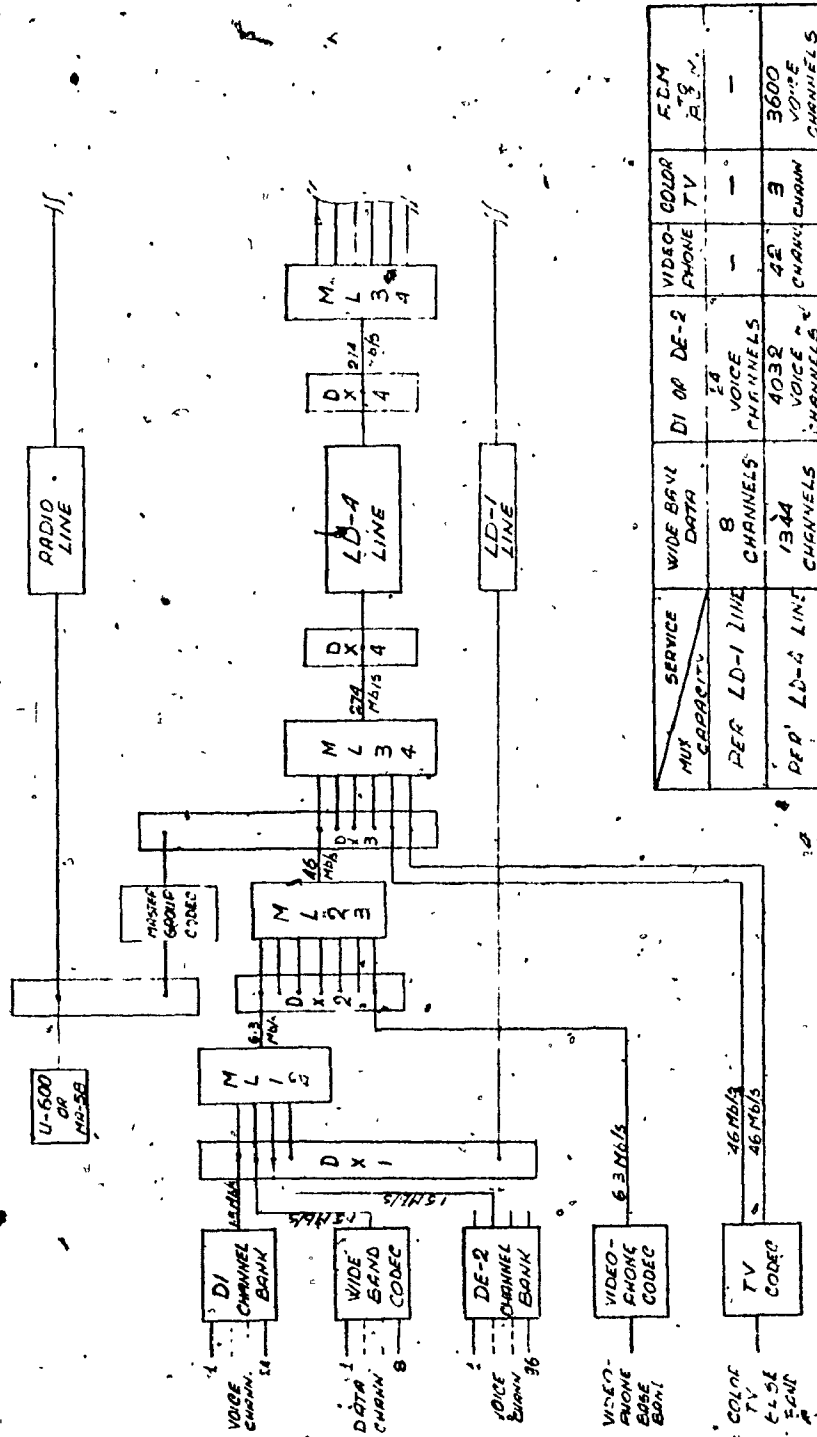

MUX CAPACITY	SERVICE	WIDE BAND DATA CHANNELS	DI OR DE-2 VOICE CHANNELS	VIDEO-PHONE TV	PCM
PER LD-1 LINE	LD-1 LINE	8	4032	42	—
PER LD-4 LINE	LD-4 LINE	32	1632	168	3600

FIGURE 3.11  
DIGITAL TRANSMISSION HIERARCHY AND SERVICES PROVIDED

The only way to describe the LD-4 system is to break it down into subsystems such as:

- 1) DE-2 Channel Bank
- 2) Mastergroup Codec
- 3) T.V. Codec
- 4) Video Telephone Codec
- 5) Digital Multiplexers (ML-12, ML-23 and ML-34)
- 6) Cross-connect Bays (DX-1, DX-2, DX-3 and DX-4)
- 7) Digital Regenerative Repeaters
- 8) The Cable
- 9) Cable Power Feed
- 10) Protection Switching System
- 11) Supervisory System
- 12) Gas Pressure System

### 3.5.1. The DE-2 Channel Bank

The DE-2 channel bank is a voice terminal using 8-bit pulse code modulation (PCM) for the economical transmission of toll quality voice channels on digital transmission networks. The 96-channel version of the DE-2 channel bank is divided into four digroups, each of which provides a 24-channel digital output which may be connected, over T1 type PCM carrier system lines, to the digroups of DE-2 channel banks at up to four different locations. Integrated circuitry

and advanced packaging techniques result in such compact equipment that two DE-2 banks, 192 channels with all associated equipment, mount in one single sided 11'6" (3.5m) bay. The DE-2 channel bank is end-to-end compatible with the Western Electric D2 channel bank.

Channel units provide the interface between the trunk and the common equipment of the channel bank. Fifteen types of plug-in channel units may be intermixed on a channel bank to meet the requirements of the various trunk circuits. The channel units include built-in terminating sets and telephone splitting jacks for restoration patching or testing. Common plug-in channel units may be intermixed on a channel bank to meet the requirements of the various trunk circuits. The channel units include built-in terminating sets and telephone splitting jacks for restoration patching or testing. Common plug-in units translate the analog signals into 1.544 Mb/s pulse trains for transmission on the four digital lines. At the receiving end, the DE-2 channel bank decodes and separates the PCM signals into the 96 original voice signals.

### 3.5.2 The Mastergroup Codec

The Mastergroup codec is a terminal equipment that allows the transmission of a 600-channel mastergroup signal over the long-haul digital networks. The transmit terminal accepts the analog signal (564 KHz to 3084 KHz), translates it to a lower frequency band (40 KHz to 2560 KHz), samples it at a 5.1 MHz rate and converts the samples into a 9-bit code. The 45 Mb/s output is multiplexed into a high capacity digital link. The receive terminal accepts the 45 Mb/s signal and reconverts it to the original analog signal.

### 3.5.3 The TV Codec

The TV codec is a terminal equipment that processes the video baseband signal for transmission over the digital system. The sampling rate is 10.3 MHz and the output is two 44.8 Mb/s bit streams. This output is fed to two adjacent 45 Mb/s inputs of the ML-34 multiplexer for transmission over the LD-4 line. Up to three high quality colour TV channels may be transmitted per coaxial tube.

### 3.5.4 The Video Telephone Codec

The design requirements for this equipment are under investigation and little information is available at this time.

The overall objective will be to convert the video telephone baseband signal to a 6.3 Mb/s digital bit stream. Up to 42 of these bit streams can be interleaved via the ML-23 and ML-34 multiplexers into one 274 Mb/s bit stream for transmission on one coaxial tube.

### 3.5.5 The Digital Multiplexers

There are three levels of multiplexers associated with the Digital Long-Haul System: The ML-12, ML-23 and ML-34 multiplexers.

A multiplexer consists of a transmitter which combines several low rate digital bit streams of slightly different bit rates into one high speed bit stream, and a receiver which performs the inverse function.

#### a) The ML-12 Multiplexer

Up to four 1.544 Mb/s bit streams can be combined into one 6.314 Mb/s bit stream by the transmitter. The receiver performs the inverse function.

The low speed connections may be to a DE-2 channel bank, a D1 channel bank or a wide band (50 or 250 kb/s data terminal).

Up to 28 ML-12 multiplexers and a standby multiplexer may be housed in one 11'6" bay.

b) The ML-23 Multiplexer

Up to seven data streams of 6.312 Mb/s can be combined into one 46 Mb/s bit stream by the transmitter section of the multiplexer. The receiver section performs the inverse function.

The low speed connections of the multiplexer may be either to seven ML-12's or seven Video Telephone codecs or a combination of two.

Up to twelve units and a standby can be housed in one 11'6" bay.

c) The ML-34 Multiplexer

A maximum of six 46 Mb/s bit streams may be combined into one 274 Mb/s bit stream by the transmitter section of the multiplexer.

Again the receiver performs the inverse function. The low speed connections to the ML-34 may be either six ML-23's or six Mastergroup codecs or three TV codecs or any combination of the three.



Up to five ML-34 multiplexers and one standby may be housed in one 11'6" bay.

### 3.5.6 The Cross-Connect Bays

There are four cross-connect bays associated with the Digital Long-Haul System: DX-1, DX-2, DX-3 and DX-4. These bays all serve a similar purpose in that they permit access to lines in between major processing points. In the event of failures at these major processing points, patching at the cross-connect bay will restore service.

- a) The DX-1 bay is located 0 to 750 feet from the ML-12 and is the cross-connect point between the terminal equipment and first multiplex (ML-12).
- b) The DX-2 bay is located between the ML-12 and ML-23, 0 to 1500 Ft. apart.
- c) The DX-3 bay is located between the ML-23 and ML-34, 0 to 500 Ft. apart.
- d) The DX-4 bay is located between the ML-34 and the terminal repeater, 0 to 50 Ft. apart.

All the cross-connect bays are operated in a central office environment and are essentially passive devices.

### 3.5.7 The Digital Regenerative Repeaters

There are two types of repeater used in the 274 Mb/s digital line system: The line repeater and the terminal repeater. The two repeaters are essentially the same except that the line repeater transmit and receive sections are contained in one unit, whereas the terminal repeater transmit and receive sections are mounted in separate plug-in units. A further difference is that the line repeater is powered by DC supplied through the centre conductor of the coaxial line, while the terminal repeater is powered by the office power supply.

#### a) The Line Repeater

The LD-4 line repeater reshapes, retimes and regenerates the high speed bit stream every 6000 Ft. maximum along the LD-4 transmission line. For less than 6000 Ft. spacing, the Line Built Out (L.B.O.) networks incorporated in the repeater reduce the repeater input level to acceptable limits.

Up to twelve repeater can be housed in three separate sealed apparatus cases (four repeaters per case) mounted in manholes placed along the route. There are twelve coaxial

tubes per cable assembly. Each repeater transmits data in one direction only, therefore, a pair of tubes is required for the transmission and reception of two-way data. Of the twelve tubes in a cable, five pairs can be used for information transmission and reception and one pair for hot standby. The Protection Switching System (described later) automatically switches any faulty tube to the standby tube.

The line repeaters are all identical in construction, and do not have to be altered for the various classes of service to be offered. The repeaters offer high immunity against noise, permitting efficient use of the coaxial cable medium. The latest high frequency, high reliability transistors and active circuits, as well as reliable passive devices and rugged mountings, have been utilized to meet the stringent reliability requirements necessary for these units.

b) The Terminal Repeater

The operation of the terminal repeater is similar to that of the line repeater. Up to six transmit and receive repeaters can be mounted in one bay equipped with power supply

units, violation monitors and the Protection Switching System. An adjacent bay, housing the Supervisory and Alarm System, continually monitors the state of the transmission paths and generates visual and audible alarms when a fault occurs. If a fault is detected, the data on the faulty tube is automatically switched to the standby tube. The changeover time, is about 5 ms.

### 3.5.8 The Cable

The composite coaxial carrier cable to be used for the LD-4 transmission medium is designed for a buried installation. The cable may be buried by ploughing or laying in a prepared trench at a recommended depth of four feet, or pulled through ducting of lengths (approximately 1200 ft.) depending upon the duct resistance, curvature, etc.

Attached Figure 3.12 shows the cross-sectional view of the LD-4 composite coaxial carrier cable. The cross-section diagram shows the number of units and the assembly of these units.

The overall dimension of 2.8" diameter includes the metal sheath and polyethylene

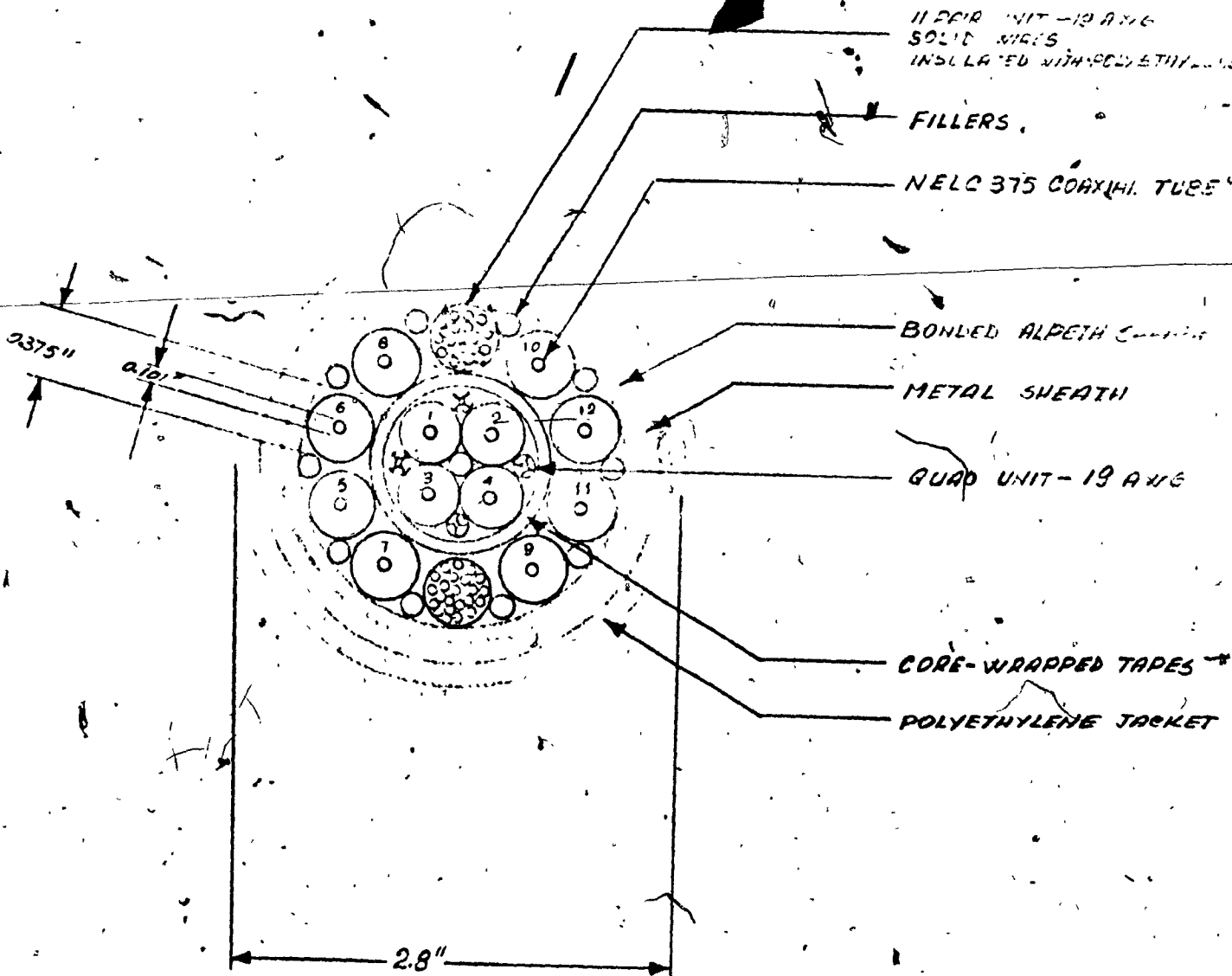

FIGURE 3.12

CROSS SECTIONAL VIEW OF THE LD-4 CABLE

outer jacket. The sheath and jacket are designed to provide considerable mechanical protection for the cable under all ground conditions. A submarine version of the cable will be available for a major river crossing. A dry air or nitrogen gas pressure system is used with the installed cable to provide protection against any ingress of moisture. The gas pressure at each manhole is monitored to provide a means of rapidly detecting and accurately locating any partial or complete cable break that may occur.

#### 3.5.9 The Cable Power Feed

Power is applied to the cable at power feed points spaced a maximum of approximately 120 miles. The centre conductors of a two-way coaxial system, together with the associated repeaters, form a closed loop. Positive and negative voltages (up to 1800 volts each) are applied at each end of long sections (65 to 120 miles) and at one end only of sections under 65 miles. The system is grounded at one end, and floated at the other with a ground protection panel to prevent excessive voltages.

The power supplies are DC to DC converters operating from a -48 volt battery type DC power plant. Diesel standby is available to protect the AC supply, should the commercial power be interrupted.

### 3.5.10 The Protection Switching System

The Protection Switching System, automatically protects the LD-4 Repeated Line System against prolonged loss of traffic in the event a transmission failure occurs on one channel. It also provides automatic transference of traffic from a working channel to a spare channel, without loss of service, when the working channel transmission is degraded (error rate out of specification). Manual transfer of traffic to a spare channel can be effected when measurements or adjustments are necessary on the working channel. An indication panel shows the status of all channels and alarms. Connections are available for remote alarming and controlling through the Supervisory system.

### 3.5.11 The Supervisory System

Each Supervisory system provides a continuous monitor of the performance of all the

LD-4 line and terminal equipment within a radius of approximately 300 miles. By reporting alarms from the line and terminal equipment to a central location, the repair and maintenance operations for the complete LD-4 system in the area may be coordinated from one point. In addition, the remote control function of the system allows many routine maintenance and repair functions to be carried out from the supervisory centre.

The Supervisory system consists of an alarm and control system capable of monitoring and operating two-state (on-off) alarms and controls, plus an analog telemetering system to report the state of sensors located in the manholes. Four order wires give the system flexibility to assure communication under any emergency condition.

### 3.5.12 The Gas Pressure System

The gas pressure system provides means of rapidly identifying and accurately locating cable breaks and excessive leaks as well as preventing an ingress of moisture.

The system is dynamic in that a constant supply of dry air is provided



to maintain the air pressure in the event minute leaks appear. This keeps the maintenance requirements to a minimum. Should a failure occur in the air pressurizing equipment, or a large leak occur in the cable, nitrogen backup system maintains the air pressure until a maintenance crew arrives.

The office equipment at the Alarm Point sequentially interrogates each of the manhole pressure transducers, and activates alarms when a fault occurs.

The overall LD-4 carrier equipment may be grouped as follows:

- Line Equipment
- Repeater Sites
- Terminal Equipment

Figure 3.13 illustrates the proposed overall Trans Canada LD-4 network.

### 3.6 Summary

The previous five sections of this chapter have covered analog and digital carrier systems used for digital data transmission. The major drawbacks of analog systems are:

**LEGEND:**

- X — ROUTE X MILES LONG
- — MAIN REPEATER-OFFICE SITE
- — — MAIN REPEATER-JUNCTION SITE
- — — PROVINCIAL BOUNDARY

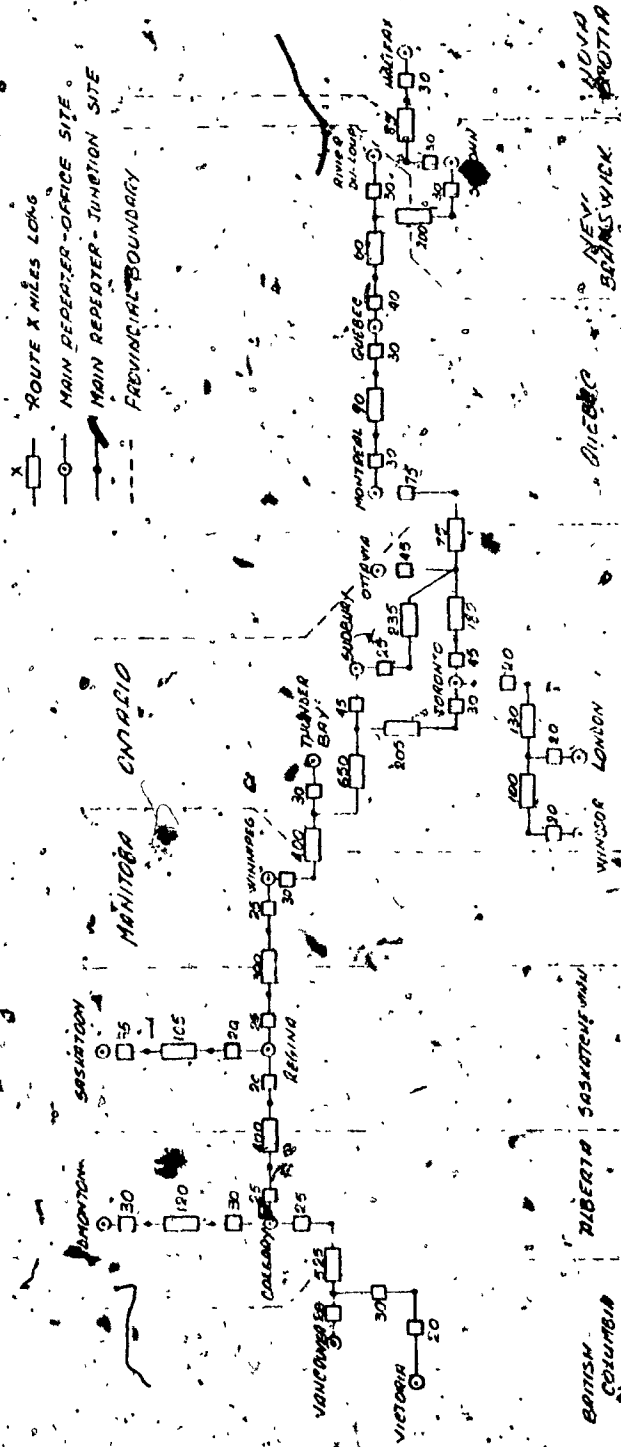

**FIGURE 5.15**  
**PROPOSED TRANSCANADA LD-4 ROUTE**

- a) The need for system conditioning (delay loss equalization),
- b) Too many voice channel circuits must be sacrificed for one data channel (12 channels for a 50 Kb/s data channel over N2 carrier),
- c) Modems are required to interface with data baseband signal, and
- d) High error rate performance.

On the other hand, since the digital carriers are designed to carry information in digital format, they:

- a) Do not need modems for interfacing with the data signal,
- b) Have no line conditioning problems,
- c) Use a minimum of bandwidth, and
- d) Have a minimum error rate which is crucial for data transmission.

Therefore, for digital data, it is preferable to use digital transmission facilities to analog ones.

CHAPTER IV

ALL-DIGITAL DATA COMMUNICATION NETWORK

## CHAPTER IV

### ALL-DIGITAL DATA COMMUNICATION NETWORK

In Chapter II it has been described how the data produced by the business machines at the customer premises is transmitted to the central telephone offices over analog facilities by means of wideband data modems. This chapter will describe the digital facilities over which the data information from the business machines is transmitted from customer to customer through the telephone system. The digital facilities over which data is now transmitted across Canada were developed in late 1971 by a team of technical staff from B.N.R., Bell Canada and N.E.Co. The first network linked on experimental basis, the cities of Calgary, Toronto and Ottawa. This experiment was carried through the year 1972 in order to obtain sufficient information to enable the same team of people to put together the first Trans/Canada digital data network known as the "data-route" which was implemented in the summer of 1973. This will be discussed in Chapter V.

#### 4.1 Conditioned Diphased Signal (C.D.S.)

In order to transmit the information originated at the business machine to the telephone office in the digital form, a new type of modulation that contains its own clock information was required. It is the conditioned-diphased type of modulation that

provides this information. The modulation process is illustrated in Fig. 4.1. The baseband signal is conditioned with timing pulses from a local clock source. The conditioned baseband is then modulated with a square wave at the timing-pulse rate. The resultant pulses ready to be transmitted over the ordinary twisted pair cable are shown in Fig. 4.1 (e). Assume that the original baseband data to be transmitted as shown in Fig. 4.1 (b) is 1010110100. The conversion to the conditioned baseband is done by supplying a change of level on "1" and no changes of level on "0" at the time bit pulses are supplied by the local clock. The resultant pulses are shown in the Fig. 4.1 (c). If a square wave in synchronism with the original timing pulses clock, Fig. 4.1 (d) is added to the conditioned baseband (c), the conditioned - diphasé modulated signal is produced as shown in Fig. 4.1 (e). That is, the signal now contains binary "1" codes as phase reversals. The term "conditioned" means that information is now contained in the transition rather than in the level. An "0" may be interpreted as a continuing level or no change of state at a clock pulse time, while a "1" may be interpreted as a change of levels at the time of a clock pulse.

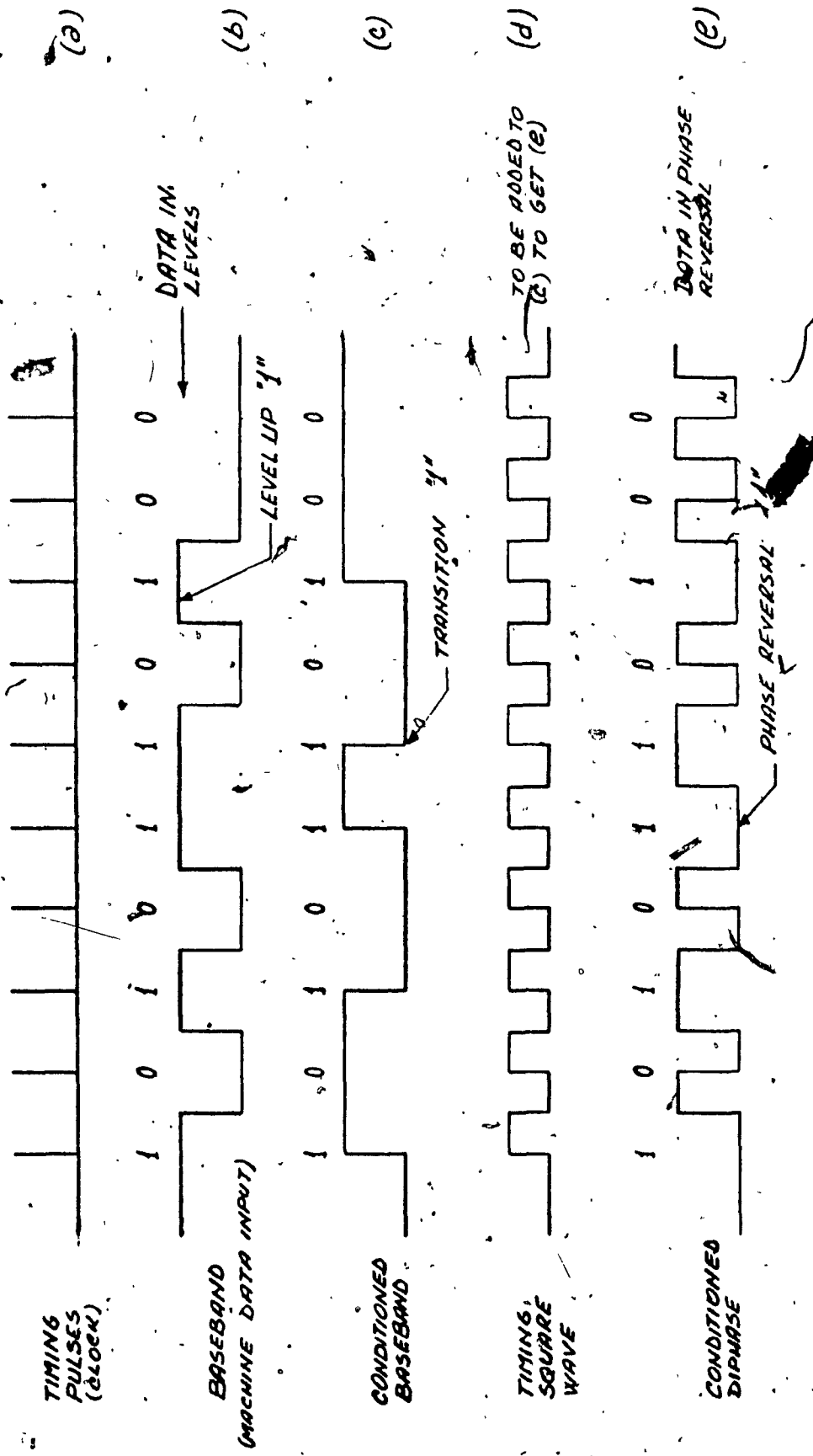

FIGURE 4.1  
GENERATION OF CONDITIONED DIPHASE SIGNALS

Figure 4.2 illustrates the demodulating process of the C.D.S. received at the customer premises. To recover the baseband data, the incoming signal is delayed one-bit time and added to itself undelayed. The resultant sum is the restored baseband signal illustrated in Fig. 4.2 (d).

It is the subscriber terminal equipment known as (S.T.E.) that interfaces with the customer data machines and telephone cable loop. The S.T.E. converts the binary baseband data from the business machine into the C.D.S. for transmission over the cable loop. The traffic bit rate between S.T.E. and central telephone office is carried at 19.2 Kb/s for distances up to 36 miles with loop regenerative repeaters every 30 db line loss at 10 KHz.

#### 4.2 Customer Loop System

Figure 4.3 illustrates a typical customer loop system. The data generated at the customer's premises by the business machine is fed into the subscriber terminal equipment for conversion into C.D.S. and for digital transmission over the telephone line to the central office. Once the signal reaches the telephone line, it can be regenerated en-route by the loop regenerative repeater, if the cable loop resistance is greater than  $1300\Omega$  which is



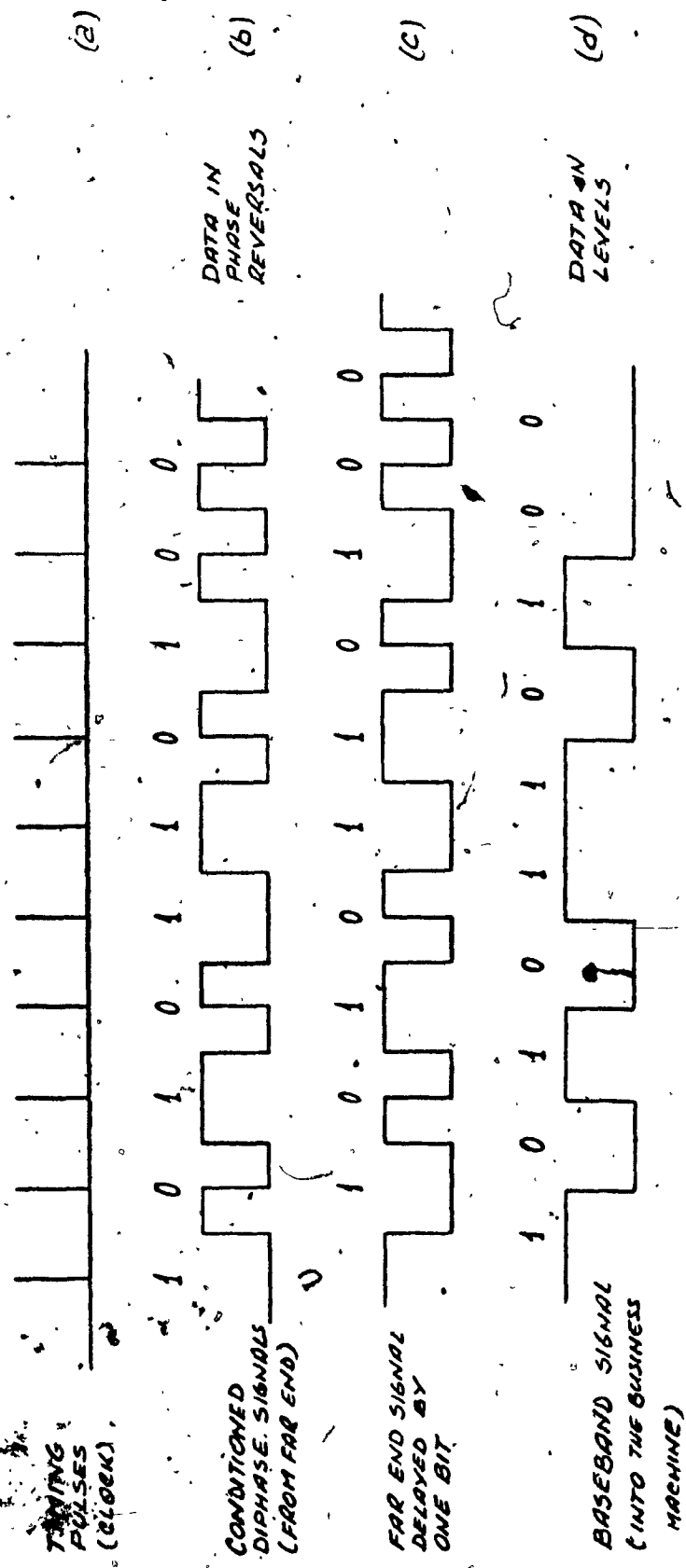

FIGURE 4.2  
DEMOMULATING CONDITIONED DIPPHASE SIGNALS

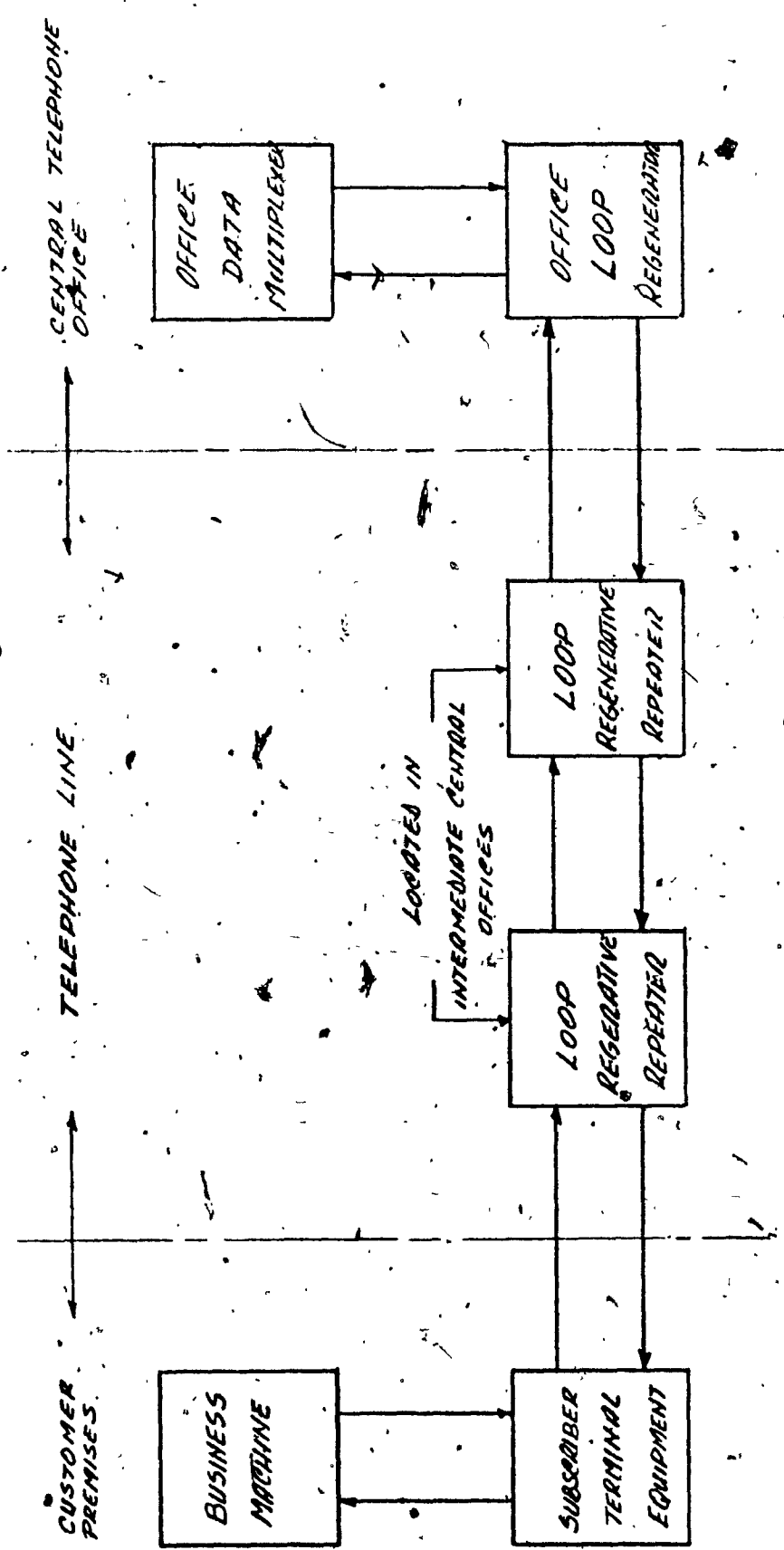

FIGURE 4.3  
TYPICAL CUSTOMER LOOP SYSTEM

equivalent to about 30 KFT loop length of 22 GA wire cable. Although the loop regenerative repeaters are part of the cable loop portion of the system, they are located in telephone intermediate offices. Upon reaching the central telephone office, the signal is fed into the office loop regenerator for conversion from diphas to binary as originated by the business machine.

#### 4.2.1 Subscriber Terminal Equipment (S.T.E.)

As illustrated by Figure 4.3, the S.T.E. provides an interface between the business machine and the telephone line. It converts the binary information into C.D.S. and transmits it over the cable loop. On the other hand, it receives the C.D.S. from the cable loop and converts it into binary information and transmits it to the business machine.

The data rates at which S.T.E. transmits and receives are: 2.4, 4.8 or 9.6 Kb/s synchronous by means of a selector switch.

The maximum loop loss from the S.T.E. to the first L.R.R. or O.L.R. is 30 db at 10 KHz which is equivalent to loop length of 30 KFT of 22 GA wire cable.

#### 4.2.2 Loop Regenerative Repeater (L.R.R.)

The loop regenerative repeater is located anywhere in the cable loop when the maximum loss of 30 db at 10 KHz between S.T.E. and O.L.R. is exceeded. The maximum loss between two L.R.R.s remains as before or 30 db at 10 KHz. Up to six L.R.R.s can be connected in tandem (six miles apart) before the signal is out of spect.

The main function of L.R.R. is to regenerate fresh signals from an S.T.E., L.R.R. or O.L.R. located six miles away, such as to increase the customer loop system to cca 36 miles if need may arise.

#### 4.2.3 Office Loop Regenerator (O.L.R.)

The O.L.R. provides the interface between the telephone line (cable loop) and the office data multiplexer (X.D.M.). It converts the condition diphase signal from the loop into binary information for the X.D.M., and from the X.D.M. receives the binary information and transforms it into C.D.S. for the loop to be sent at S.T.E. The O.L.R. transmits and receives synchronous data at rates of 2.4, 4.8 or 9.6 Kb/s. The maximum distance

loss between O.L.R. and either S.T.E. or L.R.R. is 1300  $\Omega$  or 6 miles for a maximum attenuation of 30 db at 10 KHz. For the interface with the X.D.M. the maximum resistance is that of 1 KFT 24 GA copper pair.

#### 4.2.4 Office Data Multiplexer (X.D.M.)

The X.D.M. time division multiplexes up to twenty 2.4 Kb/s synchronous channel, ten 4.8 Kb/s synchronous channel, five 9.6 Kb/s synchronous channel or any suitable combination whose input total is 48 Kb/s. This side of the X.D.M. receives its data from the O.L.R. through 0 to 1 KFT of No. 24 GA office cable. On the other side, the X.D.M. is connected to a 303 type data set for transmission over "L" carrier facilities, or to a time slot access unit (T.S.A.) for transmission over a T1 or LD-1 P.C.M. line. Both arrangements are illustrated in Fig.

4.4. The X.D.M. interface with 303 or T.S.A. is done at 56 Kb/s which is now the basic speed data rate for long transmission systems. The distance to 303 or T.S.A. is reduced to maximum 50 ft and the transmission is done over coaxial cable type RG180 B/U.

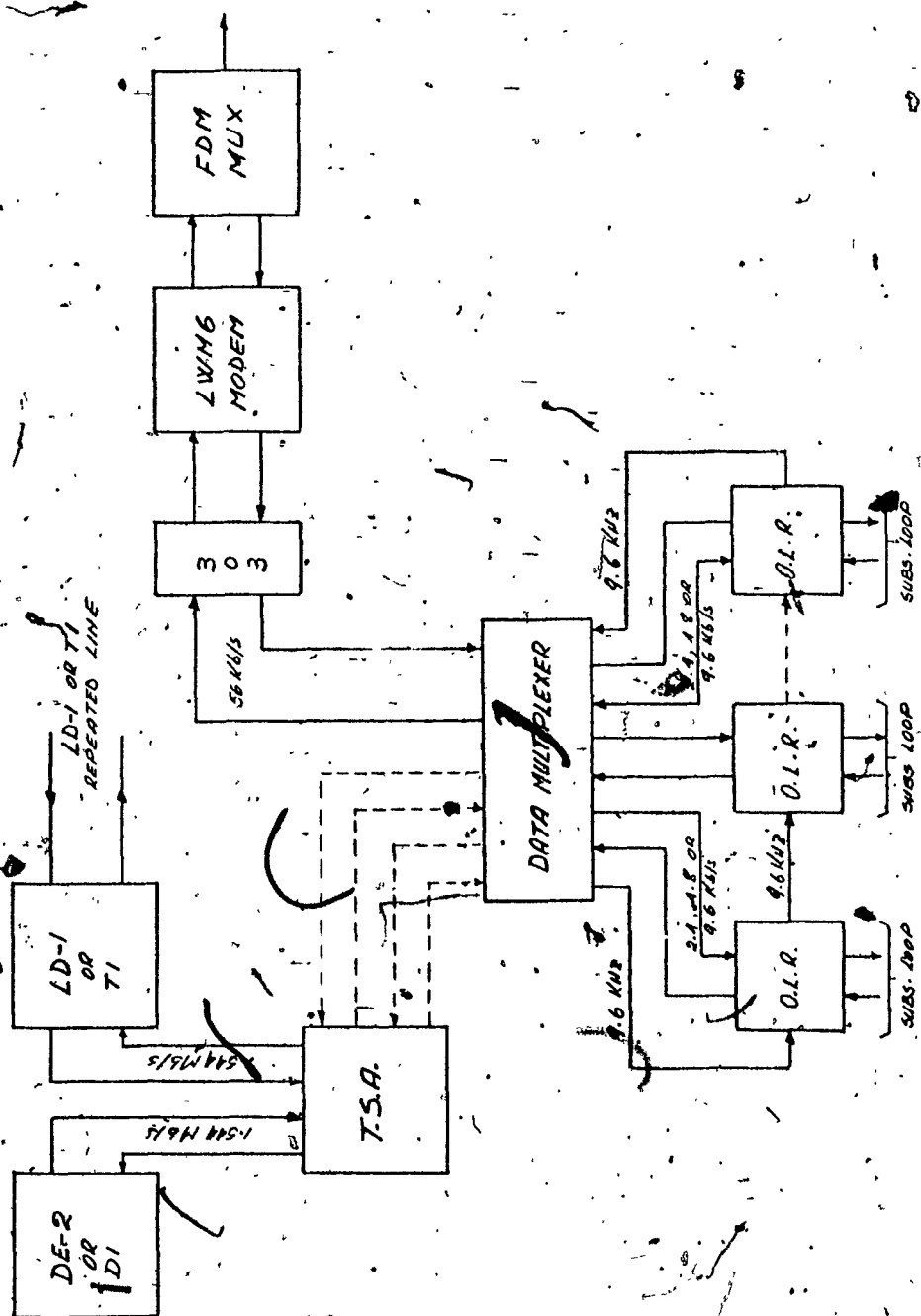

FIGURE 4.4  
 TYPICAL CENTRAL OFFICE EQUIPMENT ARRANGEMENT

### 4.3 Time Slot Access Unit (T.S.A.)

Because of its importance in the development of data transmission, it is appropriate to explain its functions in more detail.

The T.S.A. is always associated with D1/D2 or D3 P.C.M. channel bank, and its main function is to pre-empty one or more voice channel time slots at the T1 level and insert in their place 56 Kb/s data channel from the X.D.M. Originally up to 8 full duplex wideband synchronous channels could be provided by T.S.A. for transmission over the P.C.M. facilities. Figure 4.4 illustrates the T.S.A. interface with the X.D.M. and DE-2/LD-1 or D1/T1 office arrangement.

#### 4.3.1 T.S.A. System Block Diagram

Figure 4.5 illustrates a duplex LD-1/T1 line connected between master and slave terminals. Each terminal consists of a DE-2/D1 type channel bank and a T.S.A. which has two main sections: transmit and receive. At the master terminal, the master clock is connected to the D-type channel bank to ensure frequency stability.

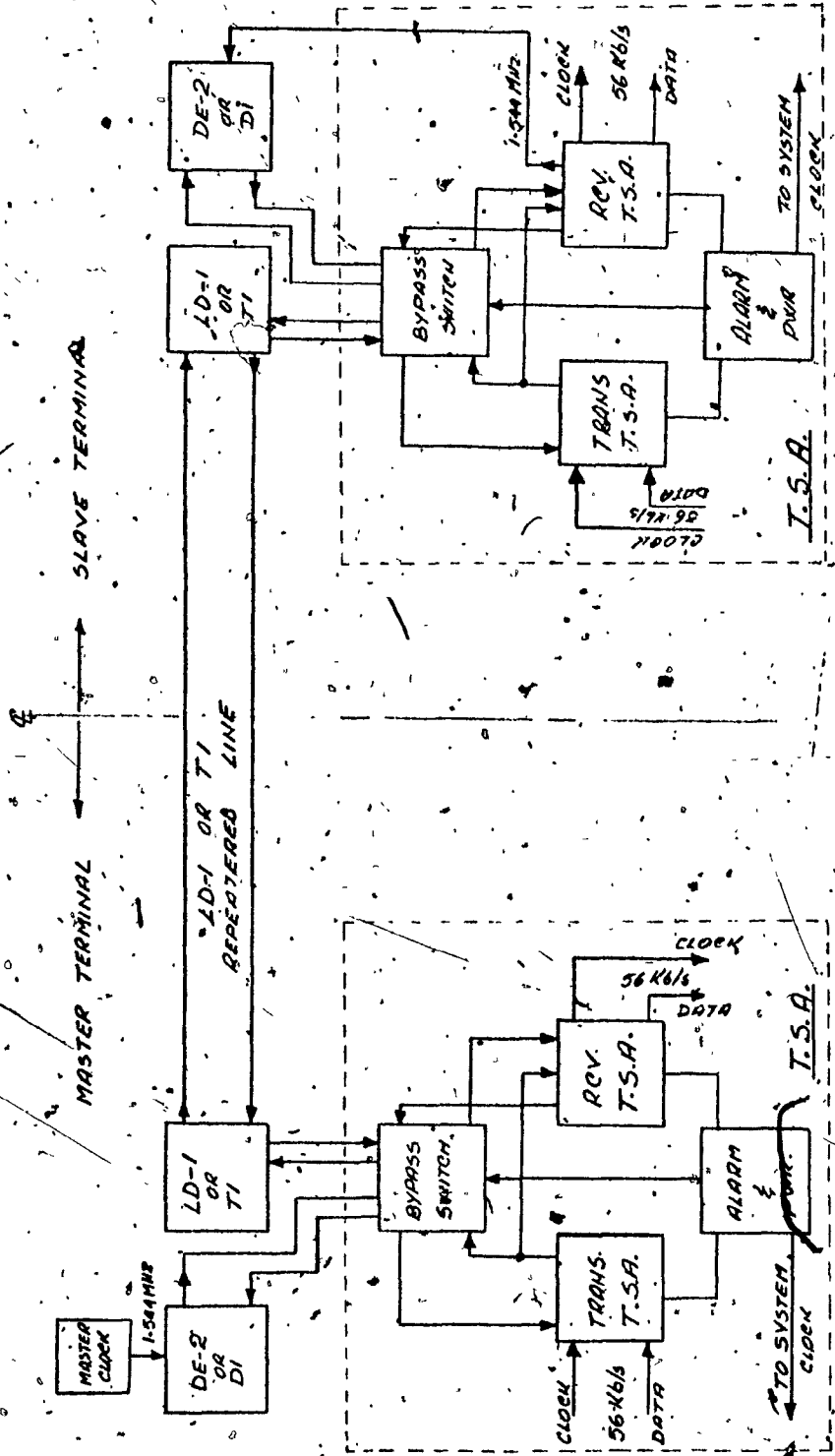

FIGURE 4.5  
T.S.A. SYSTEM BLOCK DIAGRAM



The transmit section of the T.S.A. extracts timing from the channel bank P.C.M. train pulses and preempts 1-24 time slots in which it substitutes 1-8 data channels at 56 Kb/s. The 56 Kb/s data arrives from the X.D.M. or 303 wideband data modem. The 1.544 Mb/s, generated by the output of the transmit section, is connected to the LD-1 or T1 P.C.M. repeatered line for transmission to the slave terminal which can be as far as 200 miles.

The receiving section of the T.S.A. has a complementary function of that of transmit section. Here both the data channels and the voice frequency P.C.M. time slots are separated for transmission to the X.D.M., 303 or channel bank.

The bypass switch illustrated in the block diagram has the function to connect the channel bank directly to the repeatered line in the case of a T.S.A. failure.

#### 4.3.2 A Detailed Description of T.S.A.

Figure 4.6 illustrates a detailed T.S.A. including transmit, receive sections and the common units associated with T.S.A. The

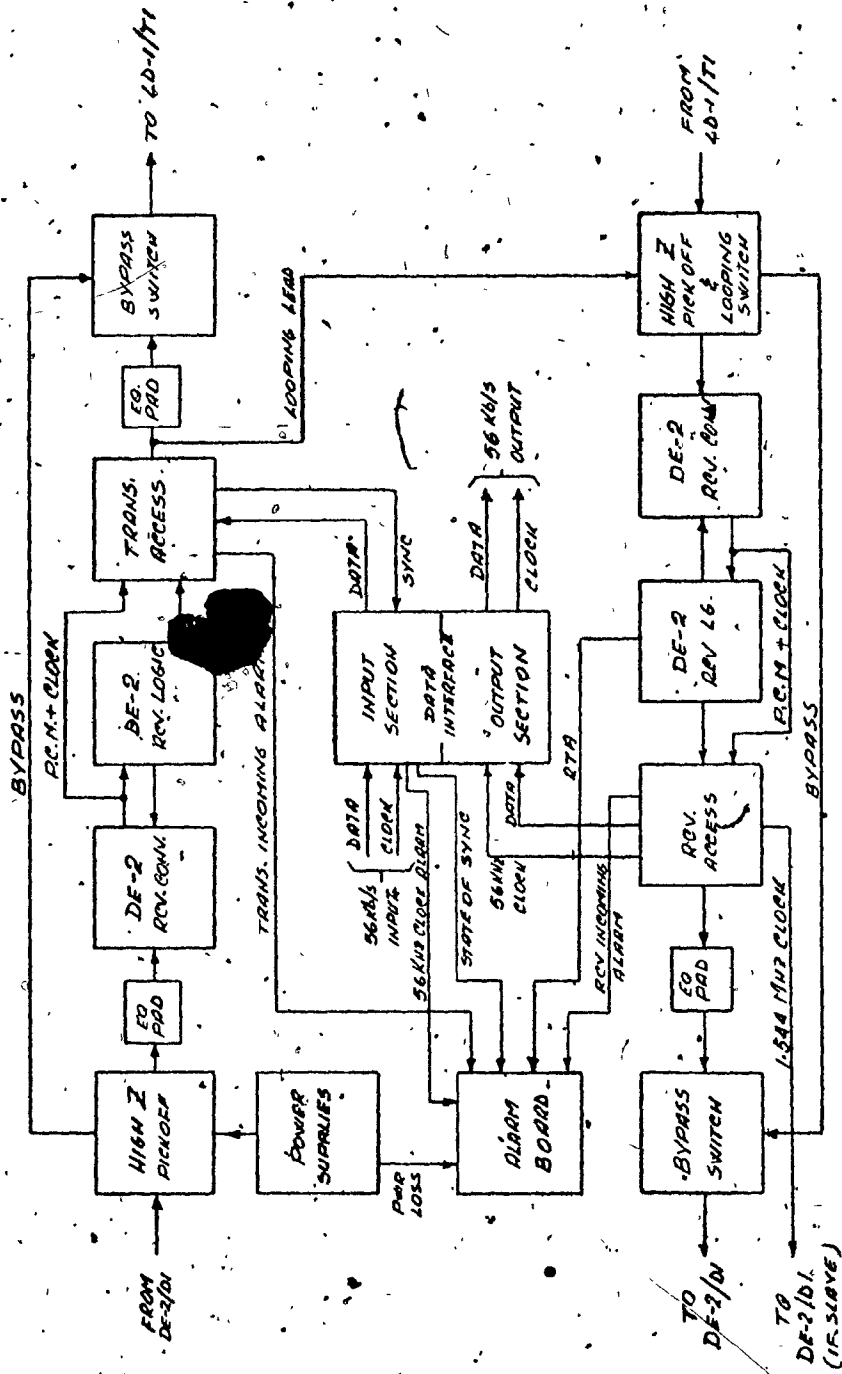

FIGURE 4.6  
T.S.A. UNIT BLOCK DIAGRAM

transmit section covers the upper portion of the diagram, while the receive section covers the lower portion. The bypass switching protection is provided on both transmit and receive directions.

The input part of the transmit section is equipped with a high-impedance pickoff to avoid mismatching the P.C.M. bank when the bypass protection switching is operated. The output of the high-impedance pickoff is connected to an attenuator and equalizer pad that provides a maximum distance of 750 ft. to the D-type channel bank. From the eq. pad, the signal is fed to a DE-2 receive converter which makes part of the T.S.A. unit. The receive converter extracts the 1.544 MHz clock and regenerates the P.C.M. pulse stream. Together with the DE-2 receive logic (another DE-2 card that makes part of the T.S.A. unit), they extract framing information from the incoming P.C.M. pulses. The receive converter and the receive logic stages supply P.C.M. and clock signals to the transmit access stage. At this point in the T.S.A., the data information is stuffed into the P.C.M. time slots previously emptied.

The combined information is fed into a bipolar converter, part of the transmit access stage, which converts the complex signal into a T1/LD-1 line format. This signal is now attenuated and equalized by appropriate pads for distances up to 750 ft. to the T1/LD-1 office repeater. It is important to note that the overall distance from DE-2/D1 to LD-1/T1 via T.S.A. unit is not to exceed 750 ft. From the attenuator and equalizer, the complex signal passes through the bypass protection switch to the LD-1 or T1 office repeater for the transmission to the far end. The bypass switch could be either closed or open. When closed, the signal from the D-type channel bank will bypass the T.S.A. unit and go direct to the P.C.M. office repeater without alteration. A manual looping feature to loop the transmission output stage into the input of the receive section is provided.

The receive section is almost the mirror image of the transmit one with a few changes. The complex signal from the LD-1/T1 office repeater passes through the high-impedance pickoff and is fed direct to the DE-2 receive converter without any attenuator and equalizer pad in between. The pad is not required

here since the signal comes from a T1/LD-1 office regenerator located into the office within 750 ft. from D-type channel bank. Instead of a transmit access stage this path is equipped with a receive access unit. At this stage, the data and P.C.M. information from the far end are separated, with data going to the T.S.A. 56 Kb/s output section and P.C.M. toward the D-type channel bank.

4:4 Experimental Data Network

Figure 4.7 illustrates a block diagram of the first three-point digital data network. All data or modem units used in this experimental data network are shown by means of black box approach. This data network provides full duplex synchronous data transmission at 2.4, 4.8 or 9.6 Kb/s.

Data originated at the subscriber's premises, (let's say, eight miles outside central office at Vanier) is converted into a conditioned diphasic signal by the S.T.E. for digital transmission to Vanier C.O. Since the loop loss between S.T.E. and O.L.R. is greater than 30 dB, the digital signal is regenerated en-route by the L.R.R. and transmitted to the C.O. where it is received, regenerated and converted into its original format by the O.L.R. The

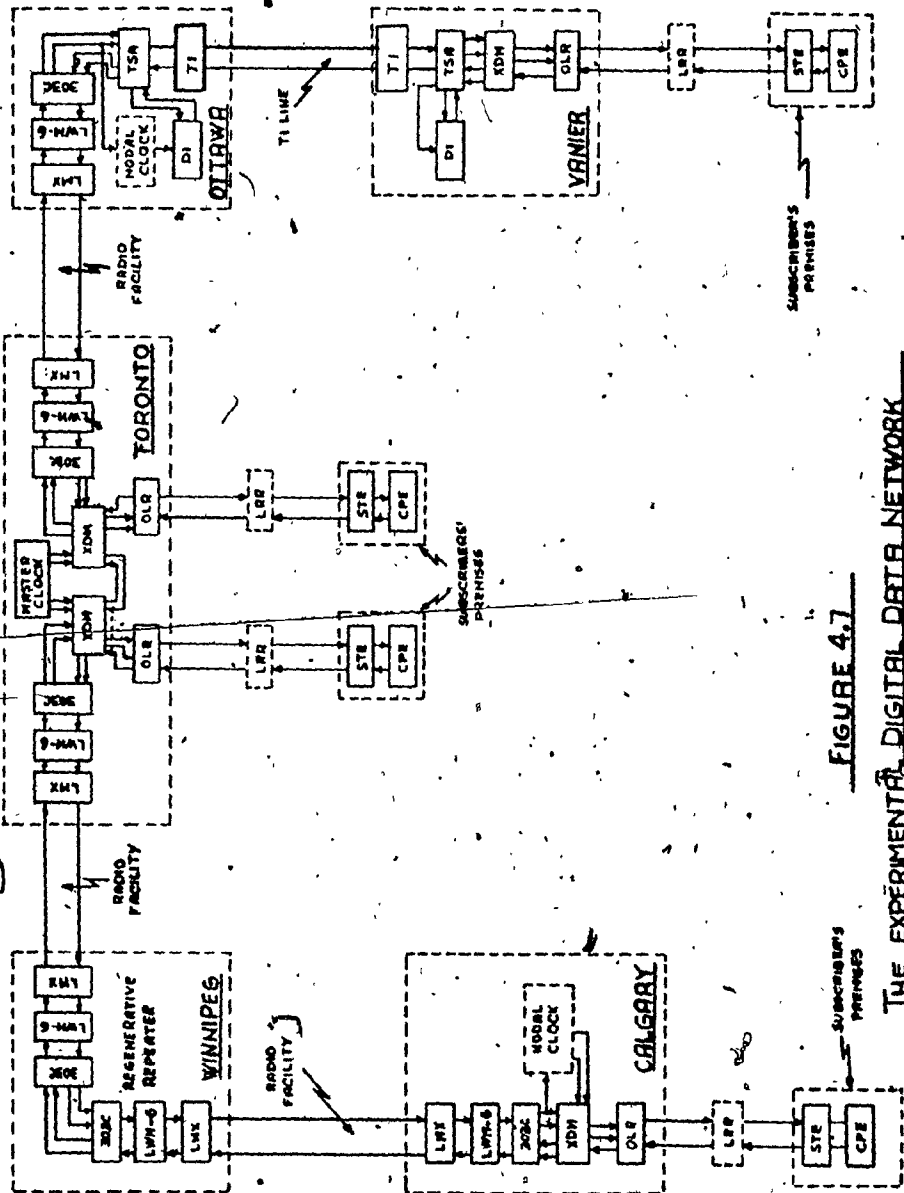

FIGURE 4.7

THE EXPERIMENTAL DIGITAL DATA NETWORK

data signal from the Q.L.R. is fed to X.D.M. for time-division multiplexing of up to twenty 2.4 Kb/s channels, ten 4.8 Kb/s channels, five 9.6 Kb/s channels or any combination for a total input of 48 Kb/s. The X.D.M.'s output is 56 Kb/s which becomes now the basic system data rate for intermediary or long distance data transmission. From X.D.M. the signal is fed to T.S.A. where it is combined with P.C.M. signals from a D1 bank for transmission over T1 1.544 Mb/s line to Ottawa C.O. where the signal is received again by a T1 terminal and down converted to 56 Kb/s by a T.S.A. unit. It is this part of the network that one can say is all-digital since no data modems are involved. The digital information originated by C.P.E. remains in digital format all the way to Ottawa C.O. where eventually it is converted to an analog signal for long haul transmission to Toronto and Calgary.

In Ottawa C.O., after the signal is converted to 56 Kb/s by the T.S.A. unit, the signal is then fed to 303 modem which conditions the basic system data rate (56 Kb/s) for optimum transmission over radio facilities. In Chapter II, the 303 data set was described as receiving 50 Kb/s. Now the same 303 data set is modified in order to accept 56 Kb/s. From the 303 data modem, the signal in a scrambled

format and baseband limited within circa 100 Hz to 37 KHz, is fed to L.W.M.-6 which is designed to place the 37 KHz bandwidth into a basic groupband, 60 to 108 KHz for transmission over microwave network from Ottawa to Toronto.

In Toronto, the arrangement is a combination of customer information terminating here, or continuing via Toronto all the way to Calgary. Up to and including the 303 unit, everything is the mirror image of Ottawa C.O. facing Toronto. From 303 unit, the signal enters one X.D.M. unit for demultiplexing. If the signal is to terminate in Toronto, then it is fed to an O.L.R. and the process in the reverse order repeated as in Vanier area. In the case that the signal is to continue to Calgary, then the signal from one X.D.M. is fed to the X.D.M. unit facing Calgary and into 303, L.W.M.-6 and microwave system towards Winnipeg. Because of the great distance between Toronto and Calgary, the analog radio facilities become too noisy and the error rate for data information increases to about  $10^{-5}$ . That is why a regenerative repeater site is required somewhere enroute. Winnipeg being about the half-point is the most desired place.

As the block diagram illustrates, two 303 back to back and two L.W.M.-6 units, each facing one.



side of the Winnipeg C.O. are required to reinforce the signal for transmission to Calgary C.O.

In Calgary, the system is nothing more than half of the Toronto office.

If we wish to follow a signal that originates in Calgary, then it is nothing more than the mirror image of the signal terminating here. This way, data circuits Calgary to Ottawa or Toronto were established by making use of all-digital facilities.

#### 4.5 Summary

The system discussed in Chapter II could carry wideband data of 50 Kb/s and required 3 V.F. channels on D1 P.C.M. bank. On the other hand, the experimental data network described in this chapter has shown that a data channel of 56 Kb/s can be transmitted over the time slot of only one V.F. channel of the same bank. The modems: 303 and LWM-6 which were previously used (discussed in Ch. II), have been modified to accept the higher bit rate of 56 Kb/s. By introducing three new types of data sets namely, S.T.E., L.R.R. and O.L.R., a complete data network between subscriber's premises and the telephone office was established. In addition, the T.S.A. was developed and new modulation scheme (C.D.S.) was proven to be reliable for data transmission.

This experimental data communication network was in existence between Ottawa, Toronto and Calgary for over a year and provided sufficient technical information that became the key factor in establishing a coast-to-coast data network to be described in Chapter V.

At the same time, the experimental network also demonstrated that for radio systems longer than about 400 miles, regeneration for data signals is required as the error rate increases above the recommended level ( $10^{-6}$ ).

CHAPTER V

COAST-TO-COAST DATA NETWORK

## CHAPTER V COAST-TO-COAST DATA NETWORK

The experimental digital data network that linked the cities of Ottawa, Toronto and Calgary, and described in Chapter IV, has produced sufficient information to proceed with the Trans-Canada data network. The implementation of this project is the first in Canada as well as the first in the world. Since its completion during the summer of 1975, further developments have been carried through for higher digital data multiplexers that will have an output as high as 1.544 Mb/s and all data. This will be a tremendous increase from the present 56 Kb/s recognized as the basic digital data channel.

In Chapter IV, the emphasis was on synchronized baseband data signal. The coast-to-coast data network was designed to carry both synchronized and asynchronous data signals. With this, the input bit rate into the data system has widened from 110 bits per second to 1200 bps for asynchronous subscribers and from 2.4 Kb/s to 56 Kb/s for synchronous subscribers. This coast-to-coast network provides point-to-point private line data communication on one-to-one basis.

### 5.1 Overall Network

The overall coast-to-coast network is more complicated than any of its kind before. It makes

use of all available data and modem equipment on the market plus the addition of new equipment called "tran". The long-haul transmission part is not changed in respect to what was described in Chapter IV. As a matter of fact, this part of the system is kept the same with the only modification being that more cities are added to the network. The big change is in the terminal equipment at the C.O. and in the customer loop equipment, as now we employ analog data sets and wideband data equipment to cover all possible bit rates.

Figure 5.1 illustrates the initial coast-to-coast data network bridging the major Canadian cities such as Vancouver, Calgary, Regina, Winnipeg, Toronto, Ottawa, Montreal, Quebec, St-John, N.B., Moncton and Halifax. If we take a good look at Fig. 5.1 and Fig. 4.7 of Chapter IV, we find nothing changed in the network between 303 to 303 data sets. The network remains the same in one arm at Winnipeg where regeneration is required. At Quebec City, this regeneration is repeated since it is required. In Fig. 5.1 the X.D.M. equipment, illustrated in Fig. 4.7, is replaced with new equipment called "multi-tran" which has the capability of time-multiplexing synchronous data from several O.L.R.'s and from another "tran" equipment called "characterplexer".

The characterplexer time-multiplexes all asynchronous bit rates from 110 onward into one bit rate of 1200 bits synchronous. Because of the size of this network, it is rather impossible to illustrate each customer loop with the appropriate synchronous or asynchronous equipment. Figure 5.1 illustrates the data equipment located at the C.O. of each telephone company across the country: The network beyond the C.O. was described both in Chapter II for asynchronous systems and in Chapter IV for synchronous ones. Although in Chapter IV the development and uses of the T.S.A. and T1 P.C.M. line was stressed, we find out that Figure 5.1 does not employ any of these facilities. The simple reason is that in the initial phase of the coast-to-coast network the need did not arise, but these facilities have become part of data network as described in Chapter IV.

Let us now follow the point-to-point data communication from coast-to-coast:

In Vancouver, Fig. 5.1.a the asynchronised subscribers will enter the network on the two characterplexers, one assigned for Calgary and one for Toronto. This means that subscribers assigned to one location will terminate at that location and nowhere else. A customer may be reassigned to another city, if so wishes, but this is done by hard wires

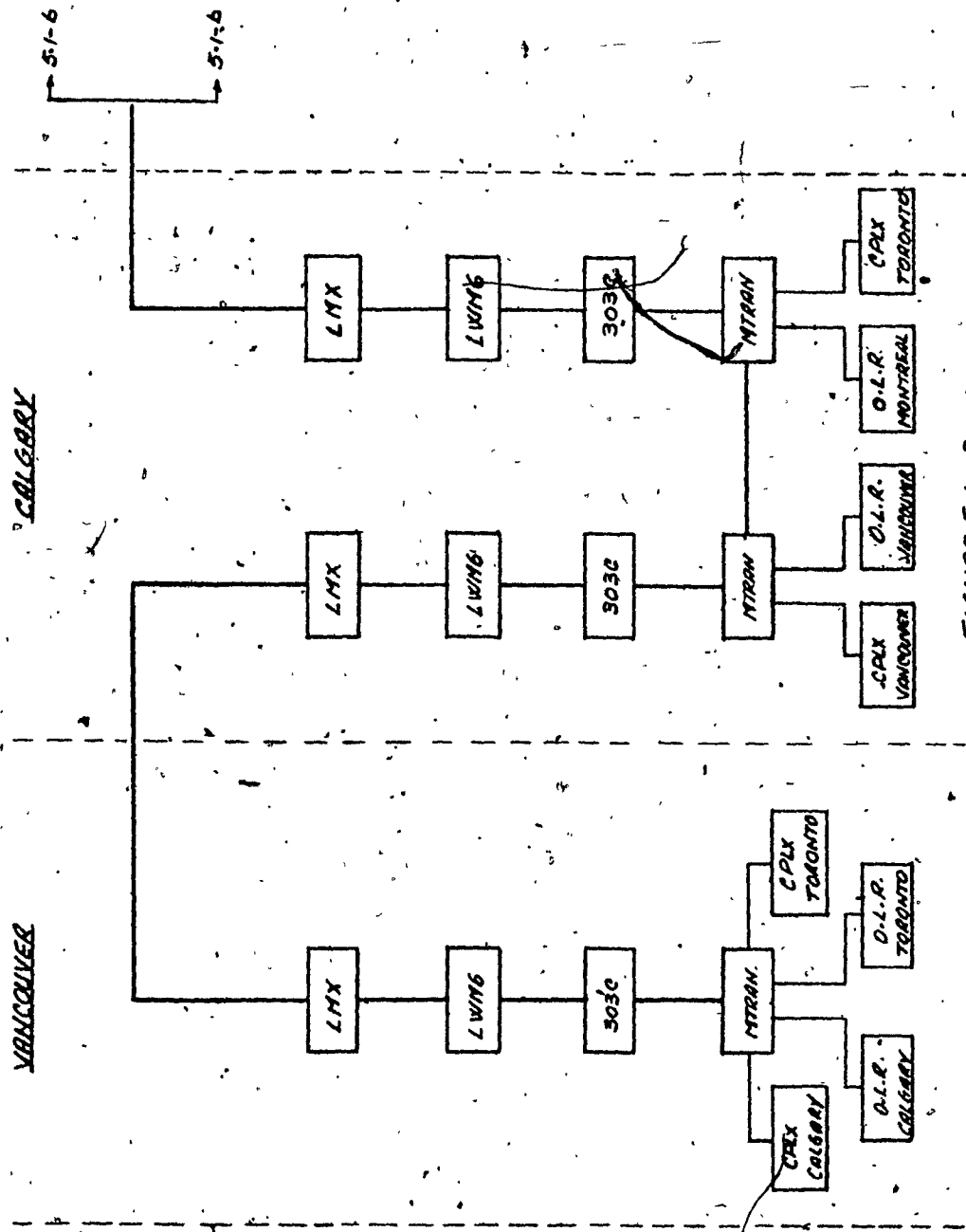

FIGURE 5.1-2

INITIAL COAST-TO-COAST DATA NETWORK

on the appropriate cross-connect points. The synchronous subscribers will enter the network on the assigned O.L.R., one for Calgary and one for Toronto. The characterplexers and O.L.R.(s) do terminate on the multitrans for further multiplexing. The multitrans output is 56 Kb/s synchronous that establishes the basic data channel for long-haul transmission. From here, the data is fed in the 303 and the rest of the facilities already described in chapters III and IV. The Vancouver site may be called a terminal or end office.

In Calgary, Fig. 5.1.-a, part of the data information is demodulated all the way to the subscriber bit rate and the other part is regenerated for further transmission to the next site. Together with the regenerated signal, more local (other subscribers) data information is picked up and multiplexed by the same means and transmitted toward Winnipeg. The Calgary site can be called both intermediary and terminal office.

In Winnipeg, Fig. 5.1-b), the entire signal from Calgary is regenerated and sent to Toronto since there is no need to drop subscribers from Vancouver or Calgary. In addition to one data channel from Calgary, one more channel is being built up from Winnipeg itself and Regina, such that two data



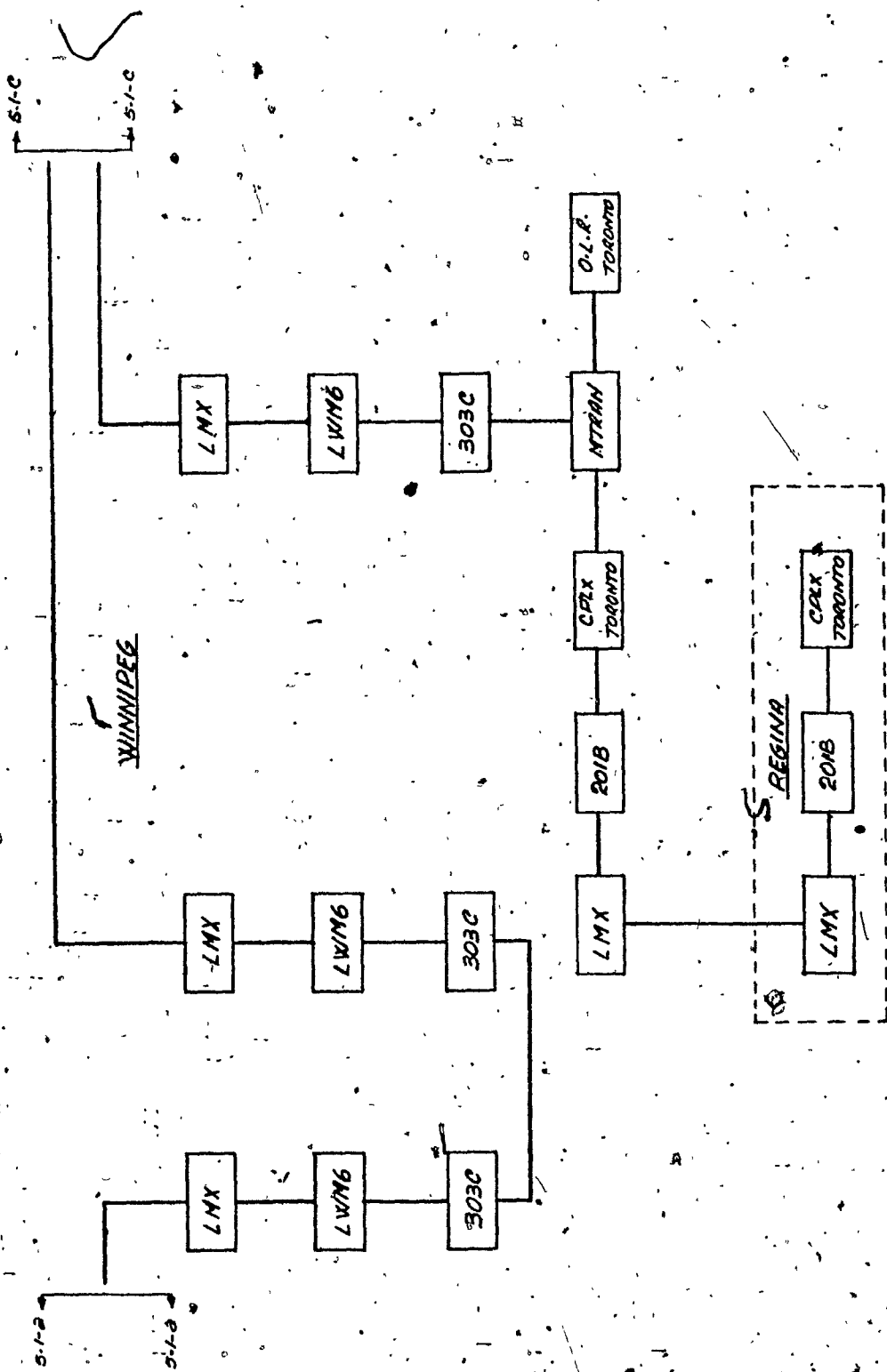

FIGURE 5.1-6  
INITIAL COAST-TO-COAST DATA NETWORK

channels are being carried between Winnipeg and Toronto. Unlike Calgary, the Winnipeg site can be called intermediary, terminal and regenerative site.

In Toronto, Fig. 5.1-c, the two data channels from Winnipeg are both terminated and regenerated for further transmission toward east. Here, the complete channel that originated in Winnipeg terminates. The other channel that originated in Vancouver, drops some of its subscribers here via O.L.R. or characterplexers; bridges from multitrans to multitrans those subscribers from west-to-east and picks up more subscribers originating in Toronto for transmission toward east. In addition to its complex block diagram, the Toronto site houses the nation's master clock for synchronisation from coast-to-coast. Because of this function, the Toronto site in addition to being a terminal and intermediary point, is called the main data route office.

In Montreal, Fig. 5.1-d, like in Toronto, the system is very complex. Here three multitrans are connected back-to-back, while in Figures 5.1-a to 5.1-c, maximum of two are connected together. Montreal becomes a nodal point as well, since an arm to Ottawa is established similar to the one between Winnipeg and Regina, but this time the network

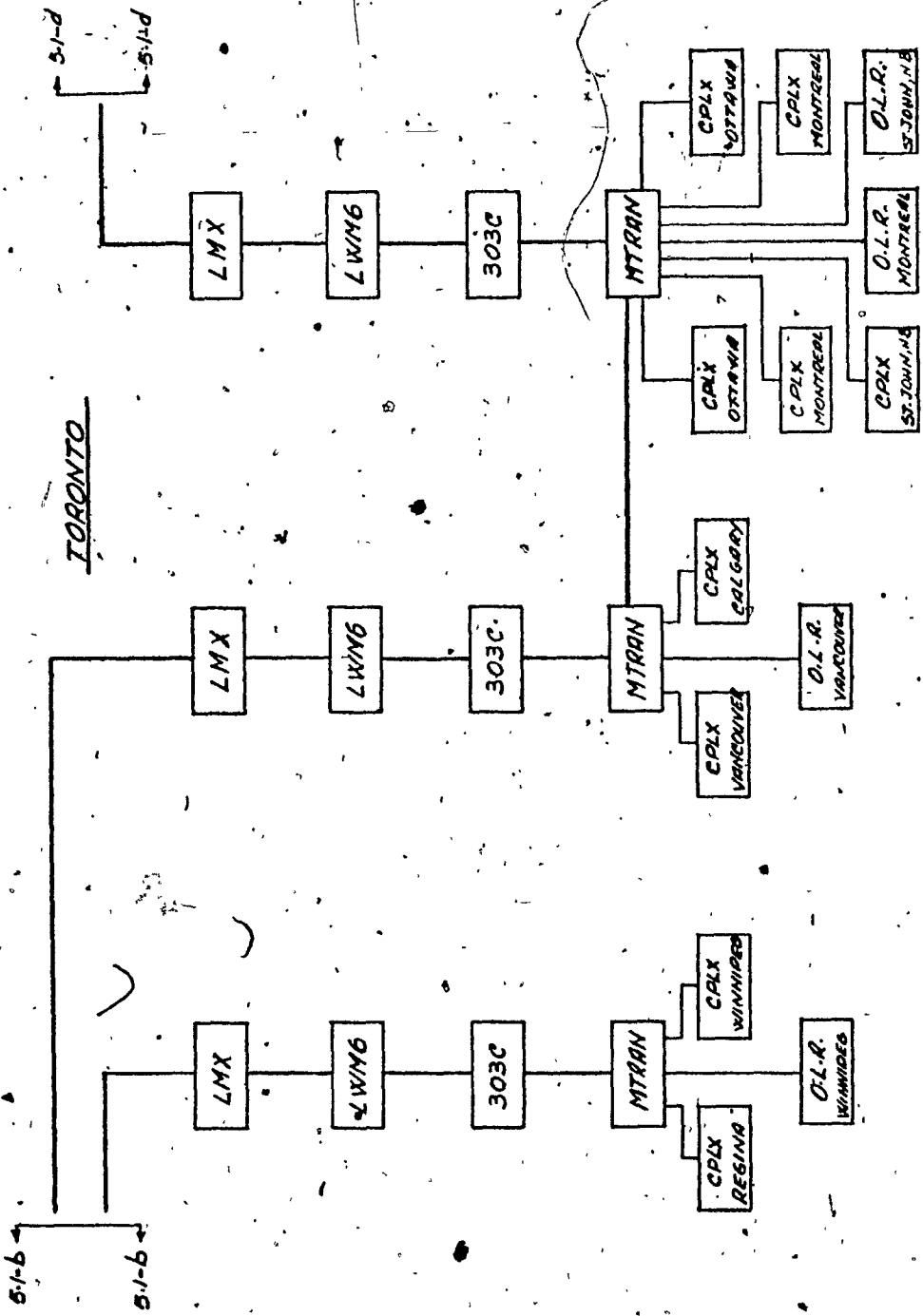

FIGURE 5.1-C  
INITIAL COAST-TO-COAST DATA NETWORK

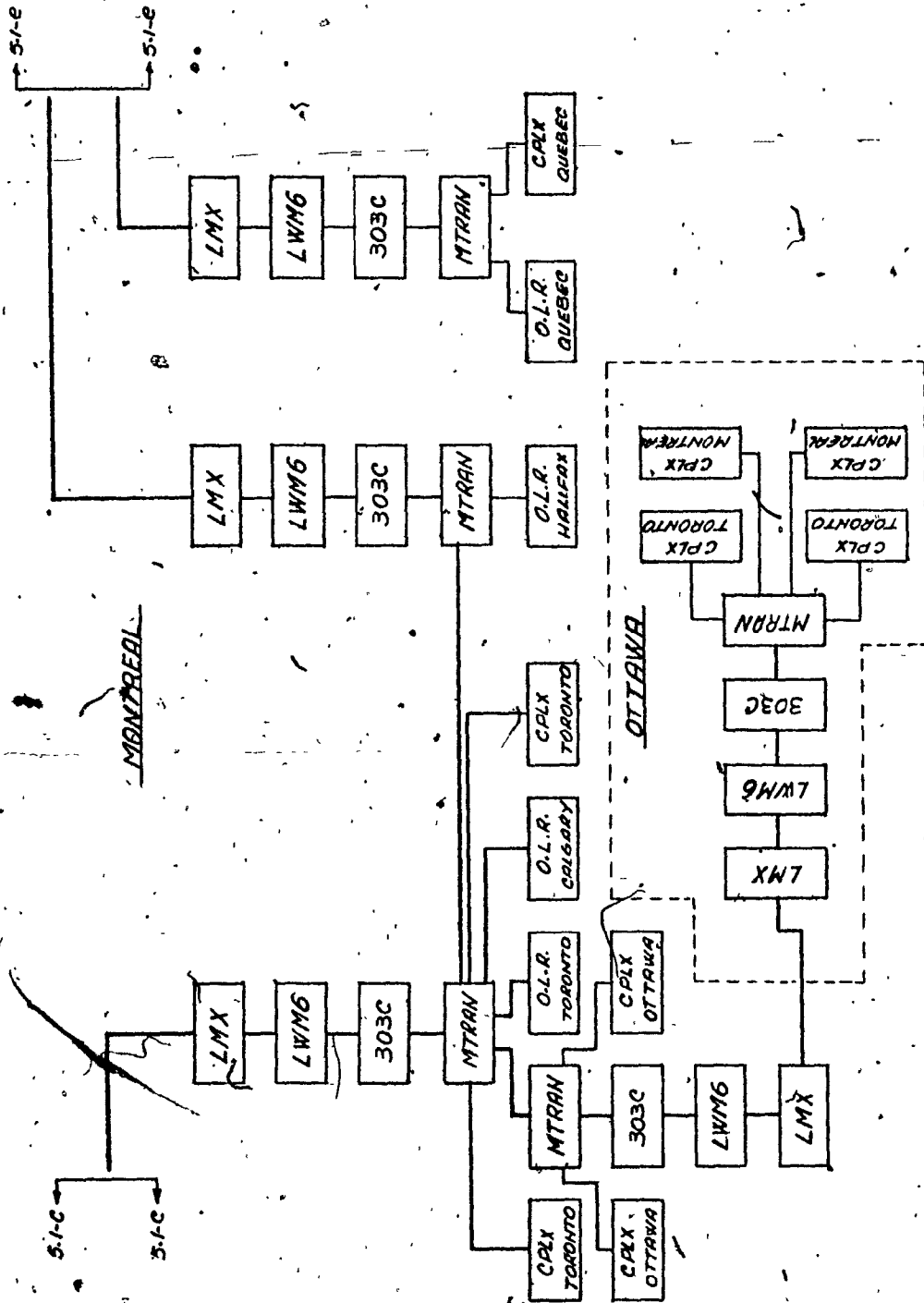

FIGURE 5-1-P  
INITIAL COAST-TO-COAST DATA NETWORK

employs both synchronous and asynchronous bit rates that make the system more complicated. The three back-to-back multitrans are required in order to drop customers from Toronto, bridge customers from west-to-east and drop customers from Ottawa. In addition to the three back-to-back multitrans, the fourth one is added in order to establish the second data channel between Montreal and Quebec City.

In Ottawa, Fig. 5.1-d, the system is similar to the one in Vancouver with the exception that the system is bridged to ongoing network and if removed, it will not affect the coast-to-coast operation.

In Quebec City, Fig. 5.1-e, two channels are entering from Montreal and one from St. John, N.B. The channel that originated in Montreal terminates here, while the other one is regenerated for transmission to St. John, N.B. This site is similar to the Winnipeg site but less complex.

In St. John, N.B., Fig. 5.1-e, one channel from Quebec City and one from Moncton, enter the C.O. It is a straightforward application of Calgary site, Fig. 5.1-a. Like Calgary, this site is both intermediary and terminal point.

In Moncton, Fig. 5.1-f, one channel from St. John and one from Halifax enter the C.O. with very

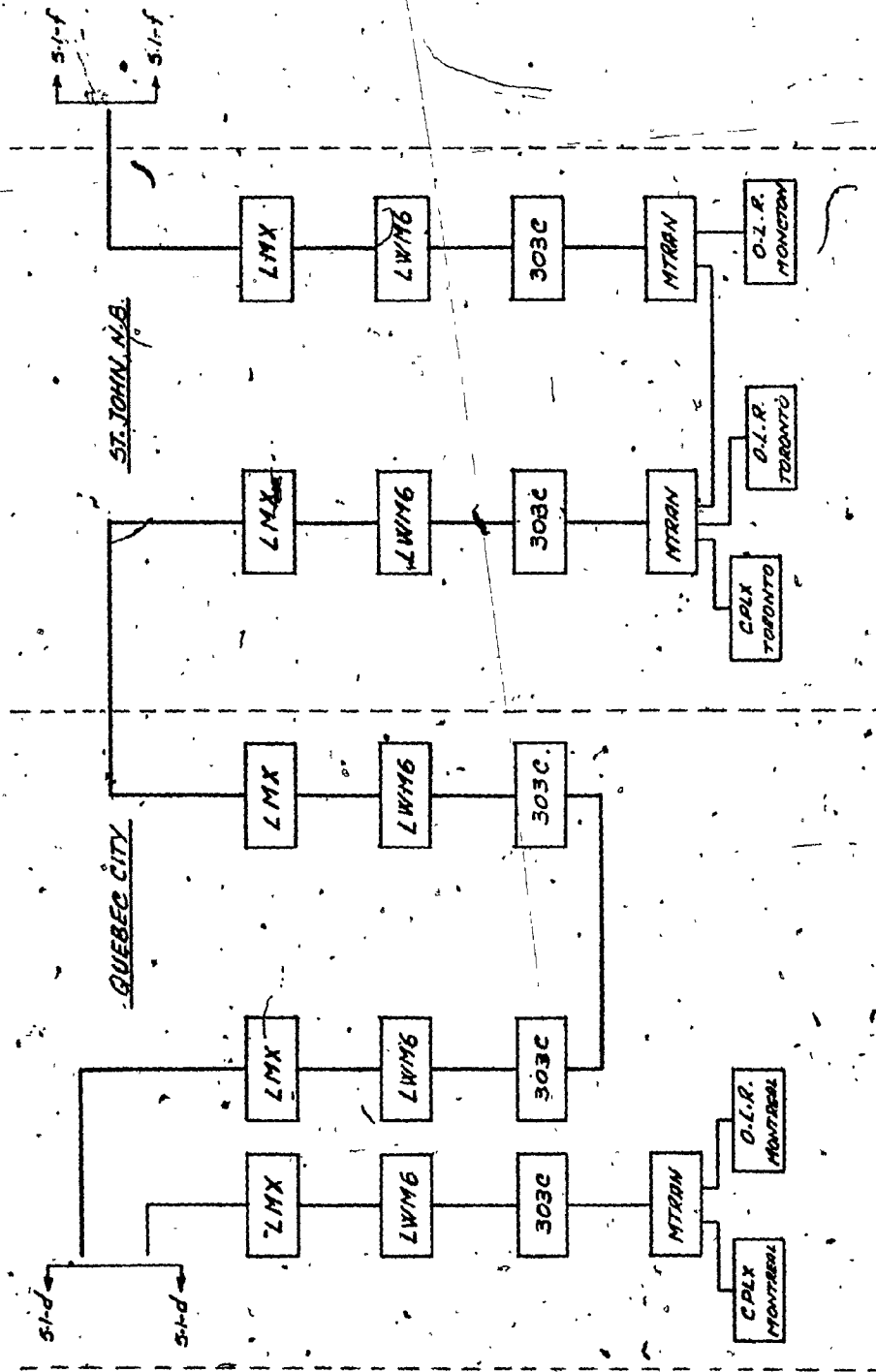

FIGURE 5.1-E  
INITIAL COAST-TO-COAST DATA NETWORK

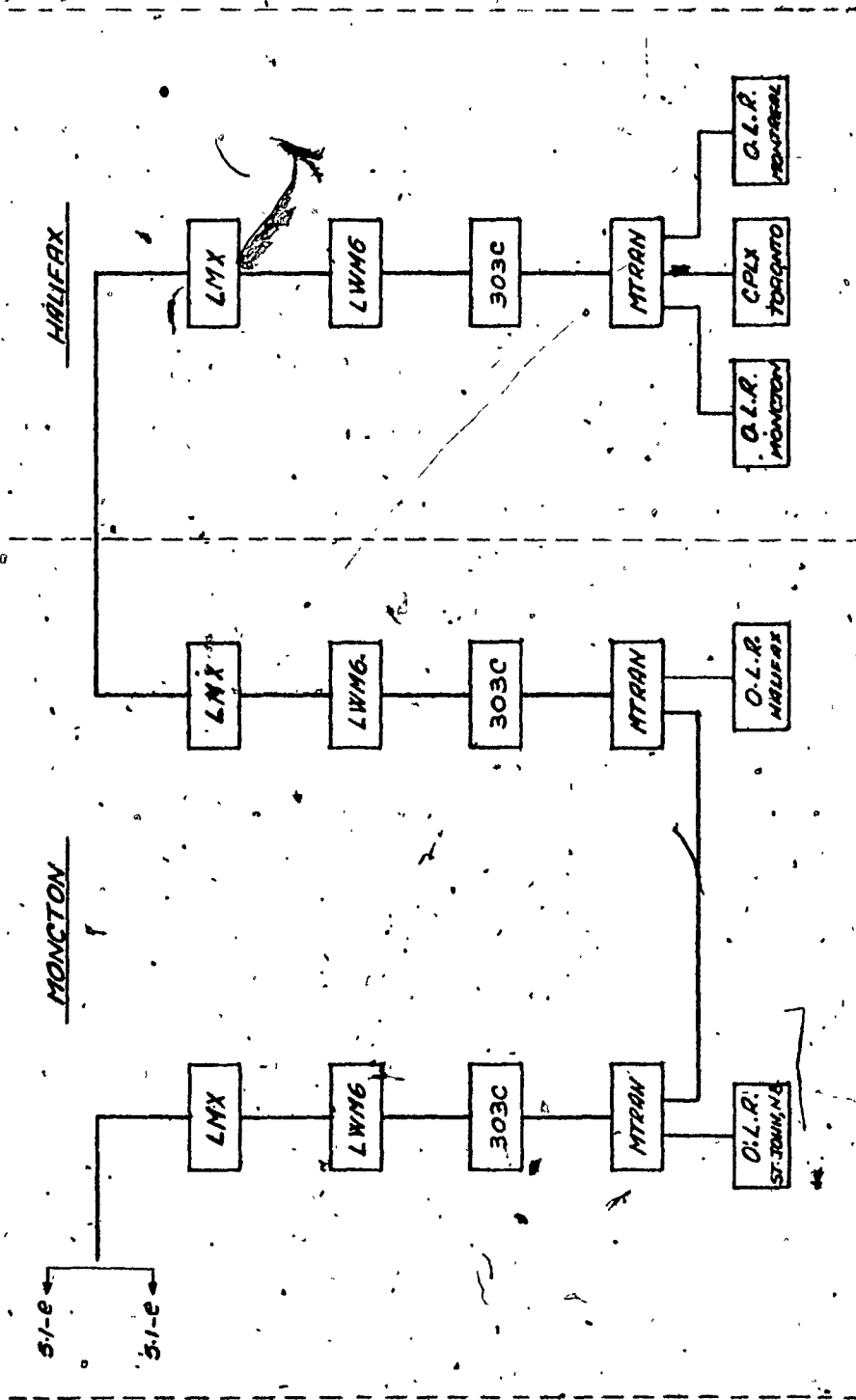

FIGURE 5.1-f

INITIAL COAST-TO-COAST DATA NETWORK

few subscriber drops. This site is nothing more than the replica of St. John and it too may be called both intermediary and terminal point.

In Halifax, Fig. 5.1-f, one data channel from Moncton enters the C.O. and terminates here. The block diagram illustrates subscribers drops from Moncton, Montreal and Toronto only, but circuits as far as Vancouver can be carried if required. Like Vancouver, this is a terminal or end office.

Since the data network is bidirectional, the description of Fig. 5.1 could have started from Halifax toward Vancouver without loss of information.

## 5.2. Data Terminating Arrangements

The overall terminating arrangements may be grouped in four classes as illustrated by Fig. 5.2. Other ways of grouping the terminating loops are possible, but for the purpose of this report we shall discuss the ones in Fig. 5.2.

In Chapter IV, the arrangement of Fig. 5.2-(a) was discussed in detail. It serves business machines that produce bit rates from 2.4 Kb/s to 9.6 Kb/s. The transmission line is synchronous and full duplex, one pair of cable for transmit and one pair for receive. With the addition of L.R.R. in



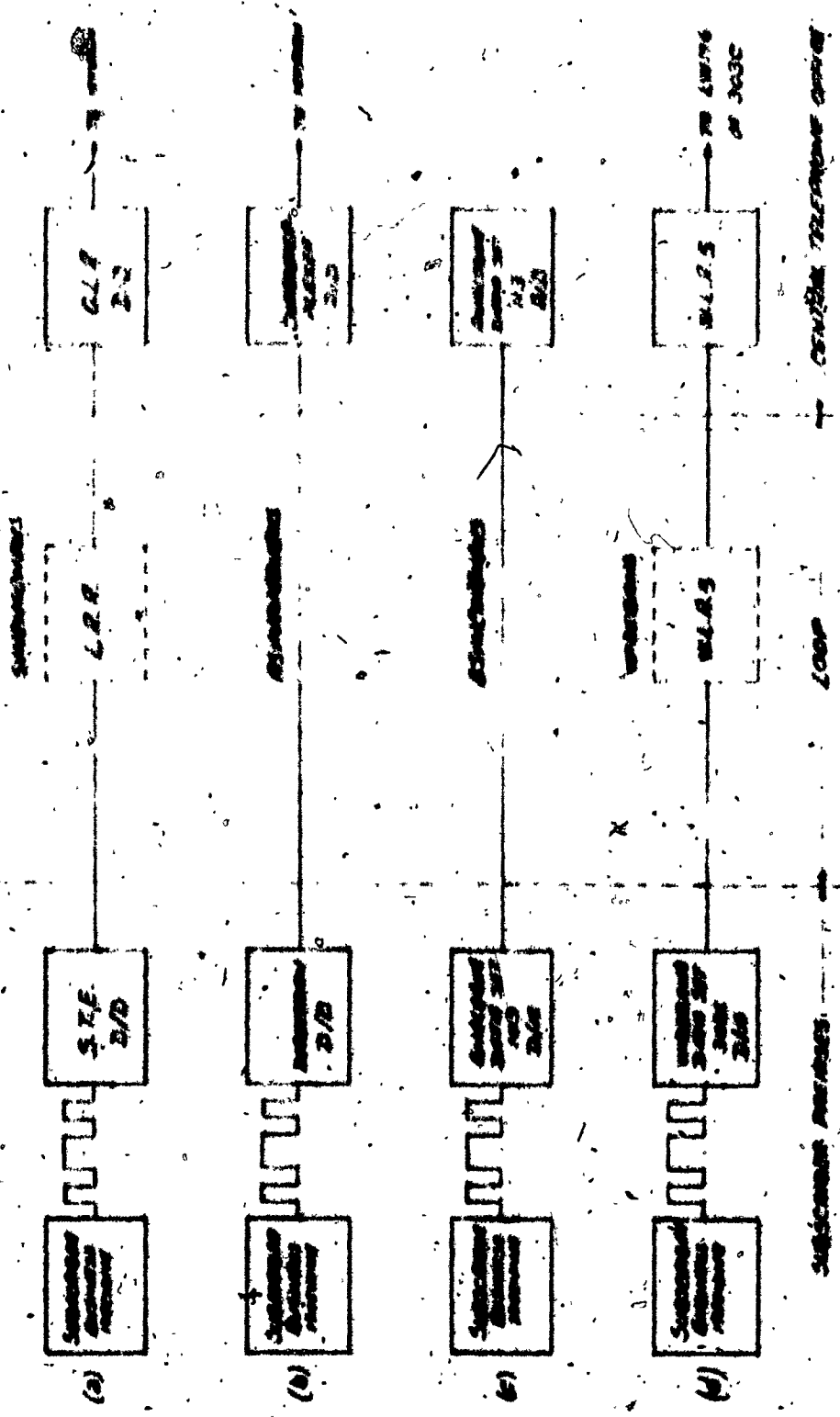

FIGURE 5-2  
DATA TERMINATING COMPONENTS

the loop circuit, this arrangement can extend for about 4 miles. The arrangement illustrated in 3.2-(a) is fully digital.

Figure 3.2-(b) illustrates the arrangement of short loop circuits that serve business machines with bit rates from 110 b/s to 1,200 b/s. These bit rates are in the asynchronous range of data network and then the loop facilities are asynchronous as well. The transmission makes use of one cable pair only. As in 3.2-(a), this arrangement is fully digital and it employs two new pieces of equipment, directran and characterplexer. No loop regenerative repeaters are used in this layout.

Figure 3.2-(c) illustrates the arrangement of longer loop circuits than those in 3.2-(b). It too serves business machines with bit rates from 110 b/s to 1,200 b/s in the asynchronous range. The transmission is asynchronous but analog since the 103 data set at customer premises is a digital to analog converter. At the central telephone office, a 113 data set is used to convert the analog information into a digital format for transmission to a characterplexer machine. The loop circuit makes use of one cable pair only and it does not employ loop repeaters.

In Chapter II, the arrangement of Fig. 5.2-(d) was discussed in detail. It was the first data high bit rate developed in late sixties with a basic bit rate of 50 Kb/s for one data channel. This arrangement is employed when the customer's business machine produces bit rates as high as 50 to 56 Kb/s. As illustrated by Fig. 5.2-(d), this is a wideband loop arrangement, analog in nature and employs two cable pairs for transmission. The maximum range of this arrangement, including the loop repeater, is about 20 miles. Beyond this distance, a N2 or T1 carrier system must be added.

All above described arrangements are being employed by the coast-to-coast data network, but other arrangements are possible.

### 5.3 Network Synchronization

It is rather important to have such a wide network running on the same clock in order to keep all sites in synchronism. As described in section 5.1, there is a master clock at Toronto from which all required frequencies at nodal points are derived. The master clock is a precision clock that uses rubidium standard for stability. It is what many people call an atomic clock. At intermediary (nodal) and end sites, less precision clocks are

provided. From these clocks, the loop circuits extract the required clock information. These clocks are known as slave clocks since they extract the required information from the master clock.

In the event that the master clock fails, the network operates on its nodal clocks which will function as long as needed. Upon restoration of the master clock, the reestablishment of the network synchronization will follow suit.

#### 5.4 Synchronous or Asynchronous Transmission

Both synchronous and asynchronous modes of transmission were used throughout this report, but no explanation for the similarities or differences between the two were provided. This section is reserved for these purposes.

Synchronous transmission is that type of data transmission that employs the use of clocking devices which lock the transmitted signal to a fixed transmission rate. With or without a message signal to be transmitted, a synchronous transmission line always carries at least the clocking signal. In a synchronous transmission, no extra bits are required to transmit a character than the established ones. It is to say that it has a maximum efficiency. For example, if an eight-bit code is used to transmit

each character of a message, then eight bits for each character will be transmitted and no more. High-speed data with rates from 2.4 Kb/s onward make use of synchronous modes of transmission.

Asynchronous transmission on the other hand, does not make use of clocking devices but employs "start" and "stop" bits to frame each character being transmitted. This implies that more bits must be transmitted than required for each character. This will reduce the efficiency of transmission on one hand, but the most costly equipment like clocks will be eliminated. If, for example, an eight-bit code is also used to transmit each character, then we must transmit 10 or 11 bits for each character (one start, one stop and may be one pause). This will make the asynchronous transmission 25% to 35% less efficient than synchronous one for the same bit rate. The asynchronous transmission is used for data bit rates 110 bits/s up and including 1800 b/s.

Figure 5.3 illustrates the similarities and differences between the two.

#### 5.5 Summary

By making use of the information collected from the experimental data network as well as the latest data equipment available on the market, it

ASYNCHRONOUS

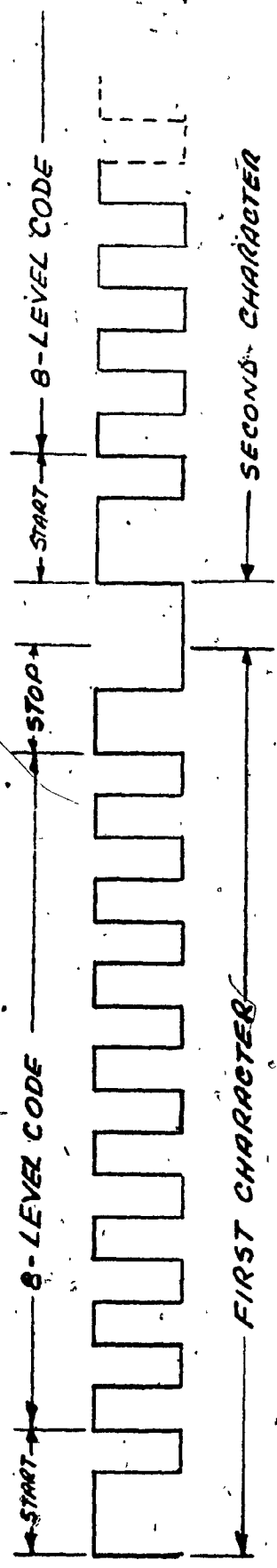

SYNCHRONOUS

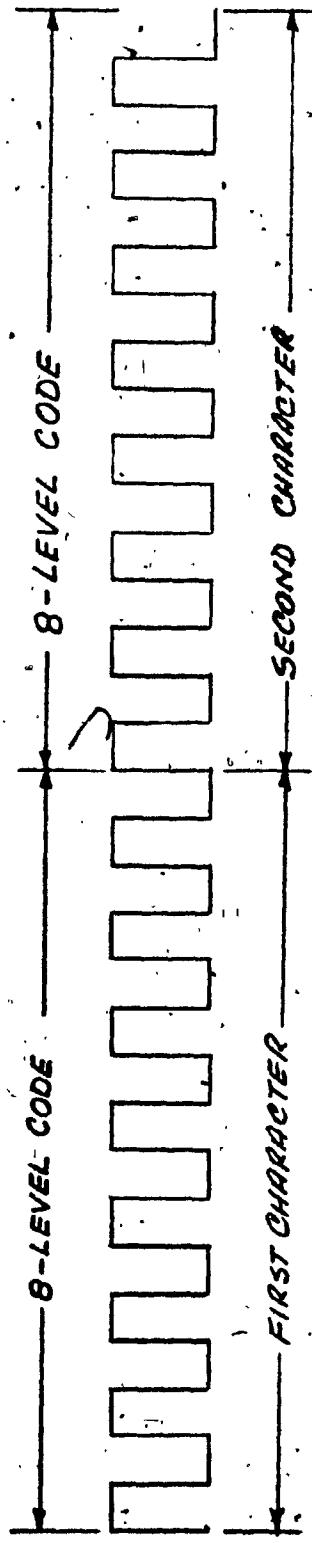

FIGURE 5.3  
SYNCHRONOUS AND ASYNCHRONOUS

was possible to build for the first time in Canada and in the world, a data system that covers about 4000 miles. The X.D.M. equipment developed for the experimental network is not used for the coast-to-coast network. This equipment is replaced by a more versatile one called multitrans which can receive synchronous data rates from 1.2 Kb/s to 9.6 Kb/s. In addition, two new data sets, characterplexer and directrans are introduced. The directrans is a D/D converter that interfaces with the business machine of low bit rates and transmits an asynchronous signal for short distances to a telephone office where a characterplexer receives the signal, multiplexes it with other ones for an output of 1.2 Kb/s synchronous signal. Although the terminal arrangements for the coast-to-coast network employs a variety of data equipment and two modes of transmission, synchronous and asynchronous, the error objectives of  $10^{-6}$  for 4000 miles are met. This fact combined with a low cost, (about 1/10th the previous rates), have attracted a tremendous number of subscribers to use these facilities. In spite of all the advantages of the coast-to-coast network there is one major drawback; the communication is on a one-to-one basis. That is to say, a subscriber is limited to only one address. The next step will be to have the flexibility of the communication being on a one-to-many.

basis. This objective is under study and it is anticipated that within one or two years, such facilities will be available.



---

CHAPTER VI

FACTORS AFFECTING SYSTEMS PERFORMANCE

## CHAPTER VI

### FACTORS AFFECTING SYSTEMS PERFORMANCE

The previous chapters have described how certain systems are being put together without taking into consideration the factors that do affect the system layout and system performance of any proposed facilities. In order to design the best network facilities, one must first of all have knowledge of all factors that will affect the system performance. This chapter is intended to discuss some of the overall factors and, as in the preceding chapters, a general description will be provided only.

#### 6.1 Signal to Noise Consideration

Noise is the external or internal agent that affects most the performance of a communication network. In designing any network, the objective is to keep the noise to a minimum.

A two level signal can be thought of as the presence or absence of a pulse. If an undistorted pulse-present signal is represented by "ONE" and amplitude + 1 volt, and pulse-absent signal is represented by "ZERO" and amplitude + 0.5 volt, then when random (gaussian) noise is added to this signal. an error will result whenever -0.5 volt more of noise is added to the "ONE", signal and + 0.5 volt or more added to the "ZERO" signal.

In data transmission, it is convenient to rate the signal impairment in terms of S/N degradation equal to:  $20 \log$  (reduction in relative resistance to noise). Whereas in analog transmission a reduction of the resistance to noise results in reduced intelligibility, a greater probability of error,  $P_e$ , can be expected in digital transmission as the result of a reduced resistance to noise. Figure 6.1 illustrates the signal-to-noise ratio versus probability of error rate,  $P_e$ , expressed as peak signal to RMS noise and assuming an ideal signal. The quality of data transmission is considered acceptable if the probability of error rate is  $10^{-6}$  or less. This objective of a maximum of one bit error in every million bits, corresponds to a very high relative resistance to noise. To achieve this high resistance to noise ratio, it has been empirically determined that:

- a) The tolerable signal-to-noise ratio at the input of any data receiver should not measure less than 22 dB for a distorted binary signal.
- b) The impulse count should not be higher than 225 counts per half hour for a complete system.

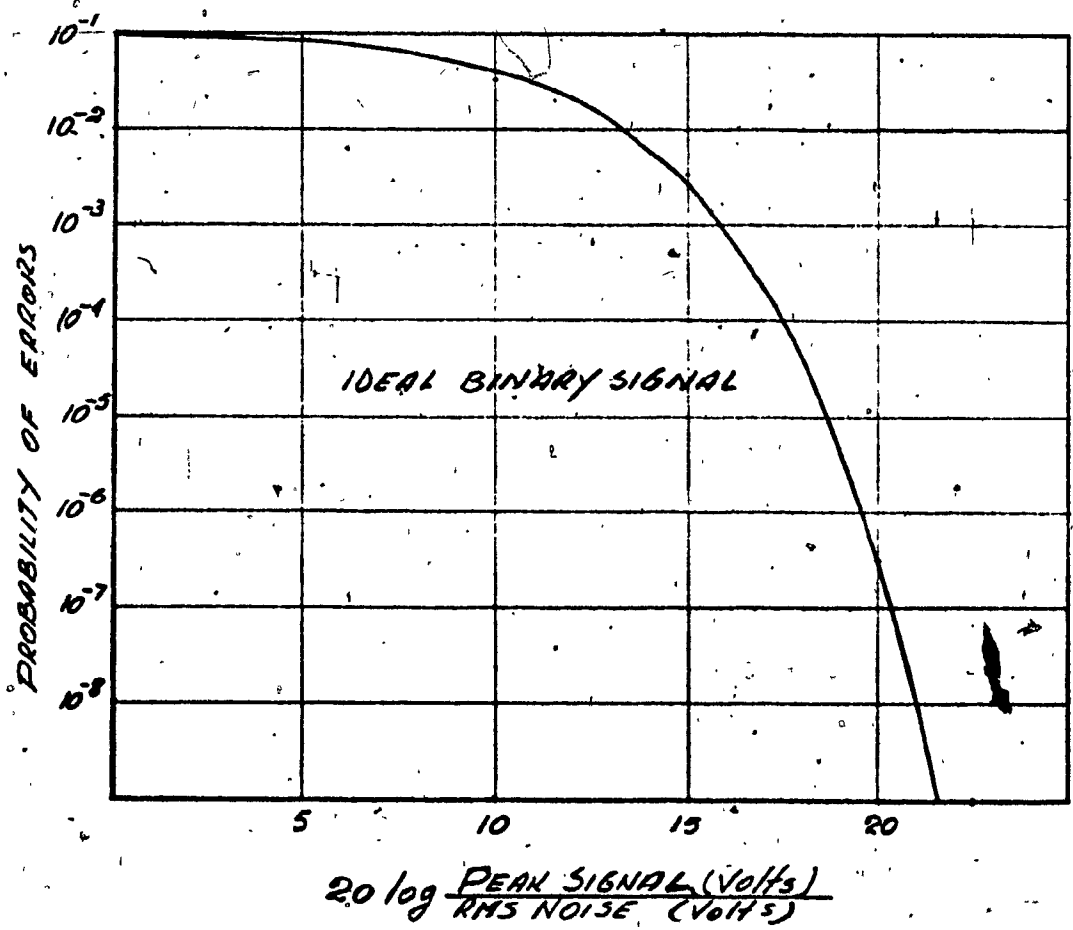

FIGURE 6.1

BIT ERRORS RATE VS. SIGNAL-TO-NOISE RATIO

## 6.2 Envelope Delay Distortion

The human ear is relatively insensitive to minor distortions, so that the telephone message plant, designed for speech transmission, has not required extremely low distortions. On the other hand, for data transmission this is very important. In Chapter III, two figures are given illustrating the unequalized and equalized group frequencies. For data transmission over analog facilities, envelope delay equalization is required at group connector points of long-haul carrier facilities because of the inherent parabolic delay distortion characteristic of the connecting group filter. The objective for the degree to which this envelope delay distortion should be equalized, calls for the following maximum allowable deviations on a data over analog facilities:

deviation from flat gain	$\pm 0.9$ dB
deviation from linear phase	$\pm 0.1$ rad.
deviation from uniform delay	$\pm 30$ usec.

According to the "paired echo theory" which relates distortion in frequency domain to S/N impairment in the time domain, the above deviations from flat gain on linear phase are equivalent to a S/N impairment of 1.5 dB.

### 6.3 Jitter

Jitter is the term used to describe the slight and erratic displacement of data transmissions from where they are supposed to be if the input data signal is to be accurately reproduced.

Like error rate, jitter is the byproduct of digital transmission. In present data systems, jitter can come from many sources such as:

- a) A source of jitter common to all data systems, is the uncertainty in the transition decision taking place in data sets or line regenerative repeaters. This uncertainty is a function of the design of the circuit making the decision and the noise on the system.
- b) In analog wideband data systems employing data modems for coherent detection, the wideband carrier frequency pilot is separated from the received data signal by means of a highly selective pick-off filter which introduces phase errors due to its inherent characteristic. Such phase errors are more or less corrected by automatic phase control circuit, part of the hardware. The phase correction performed by this circuit results usually in a sort of phase jitter. It is desirable to maintain the maximum pick phase error resulting from phase

jitter below 5 degrees so that the transmission impairment from this source be insignificant.

- c) In digital data systems, timing error introduced during the process of coding and encoding data transitions and the timing distortion which is a natural function of roll-off networks, result in a sort of timing jitter.
- d) The combined effect of amplitude and delay distortion on the digital network, shows up as jitter and can be described in terms of peak distortion. This is also known as eye jitter. It is a qualitative measurement that tells about the quality performance of the system (bigger the eye, less jitter present).

Whatever the nature of the jitter might be, according to established standards  $\pm 1.3$  usec. of jitter is accepted as maximum for a terminal-to-terminal link. A coast-to-coast data network can consist of several tandem links provided that the total peak jitter ( $\pm 1.3$  usec. x number of links in tandem) does not exceed 25% of the minimum bit length.

CHAPTER VII

CONCLUSION



## CHAPTER VII

### CONCLUSION

Throughout the preceding chapters the overall development of digital data transmission has been covered, and a coast-to-coast data network was described.

In the past the development of digital data facilities was very slow, and not until recent years (due to the explosive expansion of private business, governmental and military organizations), were the communication engineers forced to look for better ways of transmitting high speed data messages.

The analog facilities employed to transmit data messages became very difficult to handle when carrying high rate digital data. These facilities exhibit high envelope delay and attenuation distortion which is acceptable for telephone conversations since the human ear can not detect such defects. However, if data is transmitted over these facilities without previous conditioning, then the envelope delay present causes phase jitter which results in intolerable high error rate. In order to successfully use the analog facilities for data transmission, special delay and loss equalizers must be added at group connector points to correct the delay and attenuation distortion introduced. Another great disadvantage of analog facilities is the accumulation of noise along the route which deteriorates the

original information by generating a high error rate when transmitting data messages. A further drawback of analog facilities is the volume of voice channels that must be sacrificed for a data channel, and the need for data modems in order to condition the binary baseband signal for transmission over analog facilities.

On the other hand, since the digital facilities are designed for binary transmission, they need no conditioning of the baseband data signal generated by the business machine, and no envelope delay or attenuation problems are encountered here. The error rate is superior to the analog facilities, since the noise is not additive as the carrier signal is regenerated at every mile along the route. The bandwidth for a data channel is improved considerably (by a factor of 12 when compared with N2 analog facilities). These factors make the digital systems more attractive than the analog ones and it is expected that by the end of this decade the digital facilities will carry all available digital data.

Although the digital systems are superior to the analog ones, certain factors do affect their performance as well. The agent that affects most is the impulse noise which has the capability of canceling or producing one or more bits in the train of pulses transmitted over the facilities. These cancellations or additions of pulses are errors that become additive thereby restricting a system to

certain distances. Another strong agent that affects the digital systems is the time jitter, which is the slight and erratic displacement of data transmission from where a pulse is supposed to be if the input data signal is to be accurately reproduced.

This report starts with a general history of digital communications and goes on to describe the first wideband data services that are still in use. In Chapter 3 the most important carrier systems, both analog and digital, are covered in order to determine the superiority of digital facilities. The second part of the report deals with the experimental digital data network which became the backbone for the design of the coast-to-coast data network called "dataroute". The discussion of the most important interfering agents was left purposely to the very end since they affect all carrier systems.

The report employs the black-box approach and does not go into details of any particular topic since any one of these would have to be treated by itself.

Digital data transmission is today a dynamic and rapidly expanding field stimulated by the increasing need to link more and more high speed computers and other business machines across the world. Its present growth of 20 percent per year is expected to continue into the late eighties. This implies a need for doubling the facilities every 4 to 5 years. It is for this very fact that further developments

are being carried on continuously. The next step is "Digits Under Voice" (D.U.V.), a system that will provide the additional needed capacity to the present coast-to-coast network for the next decade. The objective of this system is to multiplex 23 data channels, each 64 Kb/s, into one data channel of 1.544 Mb/s that is to be transmitted over LD-1, LD-4 P.C.M. networks or over analog radio facilities in the unused portion of the frequency spectrum.

REFERENCES

1. Armstrong & Jaminson, "Wideband Data Repeaters for Customer Loops", Bell Laboratory Record - May 1968
2. AT&T, "N2WM-2 Wideband Modem", PEM-9696
3. AT&T, "LWM-6 Wideband Modem", E.M. 687
4. Bell Telephone Laboratories, "Transmission Systems for Communication", Fourth Edition - 1970
5. Bell System Practices:
  - 314-601-120CA Wideband Service Bay
  - 365-120-100 TIWB-3 Wideband Data Bank
  - 593-800-100 Wideband Data Station Using Data Set 303-Type
6. Bennet & Davey, "Data Transmission", McGraw-Hill Book Co.
7. Mitchell, "Orbiting Satellites for Data Transmission", Bell Laboratories Record, Jan. 1965
8. Ronne, "Transmission Facilities for General Purpose Wideband Services on Analog Carrier Systems", IEEE Communication Technology, Oct. 1966
9. The Lenkurt Demodulator, "P.C.M." April 1968
10. Travis & Yaeger, "Wideband Data on T1-Carrier", Bell Telephone Systems, Monograph 5076
11. Davenport, "Modern Data Communication", Hayden Book Company, Inc., New Jersey

12. Lathi, "Signals, Systems and Communication", John Wiley & Sons, Inc.
13. Telephony Publishing Co., "Data Communications"
14. Northern Electric Co., "Courier", Presented at ICC Convention, June 1974 in Minn., U.S.A.
15. Bell Canada, "Digital Appreciation Course", 1974
16. Bell Northern Research, "Digital Data Network Operating and Maintenance Manual", Jan. 1972
17. A. Antonio, "Introduction to Digital Filters", Notes for Course E.E.705 S.G.W. University, 1971
18. Proceedings of the Seventh Hawaii International Conference on System Sciences, 1974
19. G.R. Woolnough, "The LD-4 Digital Signal Repeater Line, Associated Multiplex & Codecs", Northern Electric - Research & Development Laboratories - S.E.P. # 89, 1970
20. D. Chan, "Analysis of a Groupband Data System", Bell-Northern Research, Technical Report TR 1K10-2-71, November 1971