

University of Southern Queensland
Faculty of Health, Engineering and Sciences

**Power Utility Remote Device Communications using
a Low Power Wide Area Network (LPWAN) based on
the LoRa Communications Standard**

A dissertation submitted by
Kurt Gavin Beutel

in fulfilment of the requirements of
ENG4111 and 4112 Research Project
towards the degree of
Bachelor of Engineering (Electrical/Electronic)

Submitted October, 2016

Abstract

Electricity Distributors currently face heavily reduced operating and capital investment budgets in an effort to reduce household power bills. With the predicated high growth rate of the Internet of Things the following project has researched the possibility of using this wireless technology for use in an electrical distribution network. The low cost and long range ability of LoRaWAN system provides numerous opportunities to provide distributors and customer's information about power usage as well as provide access to once un-financially viable communications.

The project researches the LoRaWAN specification and where the technology currently sits in Australia. It will define possible uses for the technology in the electrical distribution industry and also examine the types of devices to establish a LoRaWAN network. Most of the objects and devices that will connect to the LoRaWAN network will only require low data rates/response times and small packet data.

After conducting a literature review which details the LoRaWAN specification, LoRa modulation techniques and system architecture the project methodology then identified possible devices to use for the design and implementation of a LoRaWAN network. Theoretical analysis of coverage plots and expected range was completed which was then used for testing the live system.

Lab testing of the LoRaWAN system was completed together with line of sight drive testing using various data rates in urban and rural environments. Data rates were chosen from some typical devices that may be used in the network such as smart meters. The system functioned in line of sight applications as specified with objects having a range of 20km. Lastly limitations and recommendations have been made for the system to be used in a real life application.

**University of Southern Queensland
Faculty of Health, Engineering and Sciences**

ENG4111/ENG4112 Research Project

Limitations of Use

The Council of the University of Southern Queensland, its Faculty of Health, Engineering & Sciences, and the staff of the University of Southern Queensland, do not accept any responsibility for the truth, accuracy or completeness of material contained within or associated with this dissertation.

Persons using all or any part of this material do so at their own risk, and not at the risk of the Council of the University of Southern Queensland, its Faculty of Health, Engineering & Sciences or the staff of the University of Southern Queensland.

This dissertation reports an educational exercise and has no purpose or validity beyond this exercise. The sole purpose of the course pair entitled “Research Project” is to contribute to the overall education within the student’s chosen degree program. This document, the associated hardware, software, drawings, and other material set out in the associated appendices should not be used for any other purpose: if they are so used, it is entirely at the risk of the user.

**University of Southern Queensland
Faculty of Health, Engineering and Sciences**

ENG4111/ENG4112 Research Project

Certification of Dissertation

I certify that the ideas, designs and experimental work, results, analyses and conclusions set out in this dissertation are entirely my own effort, except where otherwise indicated and acknowledged.

I further certify that the work is original and has not been previously submitted for assessment in any other course or institution, except where specifically stated.

Kurt Beutel

0019822481

Acknowledgements

I would like to thank my supervisor Mark Phythian (USQ) for your help and feedback whilst completing this project. Your timely responses and availability over the past year have been very helpful to complete this project.

I would also like to acknowledge my employer Ergon Energy and my work colleagues for the help and ongoing support whilst completing this task. A special mention must go to Sanjeewa Athuraliya (Ergon Energy) for the introduction to the topic of LoRa and knowledge of networking protocols.

Thanks also go to Eric Hamilton and Robert Zagarella (NNNCo) for their knowledge of LoRa /LoRaWAN and loan of devices that were used for testing, together with Jason Reiss (Multitech Systems) for device firmware to suit Australian spectrum band.

Finally I would like to thank my family for your love, support and encouragement to undertake my university studies.

Kurt Beutel

Table of Contents

| | |
|--|-------------|
| ABSTRACT..... | II |
| LIMITATIONS OF USE | III |
| CERTIFICATION OF DISSERTATION | IV |
| ACKNOWLEDGEMENTS..... | V |
| TABLE OF CONTENTS | VI |
| LIST OF TABLES | XII |
| LIST OF FIGURES | XIII |
| GLOSSARY OF TERMS..... | XVI |
| 1. INTRODUCTION | 1 |
| 1.1. Project Overview..... | 1 |
| 1.2. Project Aim | 2 |
| 1.3. Project Background | 3 |
| 1.4. The Need for the Project | 3 |
| 1.5. Project Objectives | 5 |
| 2. LITERATURE REVIEW | 6 |
| 2.1. Overview..... | 6 |
| 2.2. LoRa Alliance..... | 6 |
| 2.2.1. LoRaWAN Specification V1.0 | 8 |
| 2.2.2. LoRa Modulation Technique | 9 |
| 2.2.2.1. LoRa v FSK modulation | 12 |

| | |
|---|-----------|
| 2.3. LoRaWAN | 14 |
| 2.3.1. Adaptive Data Rate Scheme (ADR) | 15 |
| 2.3.2. LoRaWAN Classes | 15 |
| 2.3.3. LoRa End Device Classes | 16 |
| 2.3.3.1. Class A | 16 |
| 2.3.3.2. Class B | 17 |
| 2.3.3.3. Class C | 17 |
| 2.3.4. LoRaWAN Security | 18 |
| 2.3.4.1. Over the Air Activation | 20 |
| 2.3.4.2. Activation by Personalisation | 21 |
| 2.3.5. LoRaWAN Message Format | 22 |
| 2.4. Protocol Architecture of a LoRaWAN System | 23 |
| 2.5. IoT Protocols | 25 |
| 2.5.1. OMA-LWM2M | 25 |
| 2.5.2. COAP Protocol | 25 |
| 2.5.3. UDP Protocol | 26 |
| 2.5.4. TCP Protocol | 26 |
| 2.6. Health/Safety Standards | 26 |
| 2.6.1. Maximum Exposure Levels to Radiofrequency Fields 3 kHz to 300 GHz | 26 |
| 2.7. OSI Model | 27 |
| 2.7.1. Layer 1 – Physical Layer | 28 |
| 2.7.2. Layer 2 – Data Link Layer | 28 |
| 2.7.3. Layer 3 – Network Layer | 29 |
| 2.7.4. Layer 4 – Transport Layer | 29 |

| | |
|---|-----------|
| 2.7.5. Layer 5 – Session Layer | 29 |
| 2.7.6. Layer 6 – Presentation Layer | 30 |
| 2.7.7. Layer 7 – Application Layer | 30 |
| 2.8. LoRaWAN Architecture | 30 |
| 2.9. LoRaWAN Data Transmission | 31 |
| 2.10. End Device | 32 |
| 2.11. Gateway devices | 34 |
| 2.12. Network Server | 36 |
| 2.12.1. The Things Network 2016 Fair Access Policy | 37 |
| 2.13. Application Server | 38 |
| 2.14. Chapter Summary | 38 |
| 3. PROJECT METHODOLOGY | 39 |
| 3.1. Coverage of a LoRaWAN trial site | 39 |
| 3.2. Multitech mDot Theoretical range | 41 |
| 3.3. LoRaWAN uses in the Electrical Distribution Industry..... | 43 |
| 3.3.1. Feeder Cabling Temperature sensing | 43 |
| 3.3.2. Substation Monitoring | 44 |
| 3.3.3. Pad Mount Transformer | 44 |
| 3.3.4. Metering Applications..... | 44 |
| 3.3.5. Solar Photovoltaic Installations | 45 |
| 3.3.6. Demand Response Applications | 45 |
| 3.4. Communication Requirements..... | 46 |
| 4. LORAWAN TEST SYSTEM DESIGN | 50 |
| 4.1. Introduction..... | 50 |

| | |
|---|-----------|
| 4.2. Gateway Design | 50 |
| 4.2.1. The Multitech MultiConnect Conduit | 51 |
| 4.3. Multitech Multiconnect mDot | 53 |
| 4.4. Network Server | 56 |
| 4.5. Application Server | 57 |
| 5. LORAWAN TEST PLATFORM CONFIGURATION | 58 |
| 5.1. How the System will work..... | 58 |
| 5.1.1. Test setup 1..... | 59 |
| 5.1.2. Test setup 2..... | 59 |
| 5.2. Gateway - Multitech Multiconnect Conduit AEP Configuration | 60 |
| 5.3. End Device – Multitech mDot Configuration..... | 67 |
| 5.3.1. Multitech mDot Setup Procedure..... | 69 |
| 5.4. Network Server Configuration..... | 71 |
| 5.4.1. LoRa End node Communication to Network Server | 72 |
| 5.4.1.1. mDot Communication to network server no acknowledgment class ‘A’ device | 72 |
| 5.4.1.2. Network Server Configuration for Full LoRaWAN Test System Design | 74 |
| 5.5. Application Server Design | 76 |
| 6. PROJECT TESTING | 77 |
| 6.1. Lab Environment Testing..... | 77 |
| 6.1.1. mDot Communication to network server to test acknowledgment with class ‘A’ device | 77 |
| 6.1.1.1. mDot Communication to network server no acknowledgment with class ‘A’ device..... | 78 |

| | |
|---|------------|
| 6.1.1.2. mDot Communication to network server with acknowledgment with class 'A' device | 79 |
| 6.1.1.3. Class "A" mDot TX/RX Communication | 80 |
| 6.1.2. LoRaWAN Testing..... | 81 |
| 6.1.2.1. End Device to Application Server using UDP Output | 81 |
| 6.1.2.2. End Device to Application Server using TCP Output | 82 |
| 6.2. Line Of Sight Testing - Rural..... | 84 |
| 6.2.1. Test Location A..... | 85 |
| 6.2.2. Test Location B..... | 86 |
| 6.2.3. Test Location C..... | 87 |
| 6.2.4. Test Location D..... | 88 |
| 6.2.5. Line of Sight Testing Results | 89 |
| 6.3. Line of Site Testing - Urban..... | 90 |
| 6.3.1. Test Location U1 | 91 |
| 6.3.2. Test Location U2 | 92 |
| 6.3.3. Test Location U3 | 93 |
| 6.3.4. Test Location U4 | 94 |
| 6.3.5. Urban Testing Results | 95 |
| 7. PROJECT FINDINGS | 97 |
| 7.1. Laboratory Testing | 97 |
| 7.2. Line Of Sight Testing..... | 98 |
| 7.3. Limitations of the LoRaWAN | 99 |
| 8. RECOMMENDATIONS | 100 |
| 9. CONCLUSIONS AND FURTHER WORK | 101 |

| | |
|---|------------|
| 9.1. Conclusion..... | 101 |
| 9.2. Further Work | 102 |
| 10. LIST OF REFERENCES | 103 |
| 11. APPENDICES..... | 108 |
| 11.1. Appendix A – Projection Specification | 108 |
| 11.2. Appendix B - Personal Risk Assessment..... | 109 |
| 11.3. Appendix C – Multitech mDot Firmware Upgrade | 110 |

List of Tables

| | |
|--|----|
| Table 1 mDot Configuration Settings to determine Predicated Range | 42 |
| Table 2 Communication Requirements (Kuzlu, Pipattanasomporn & Rahman, 2014) | 47 |
| Table 3: Power Consumption Draw for Multiconnect mDot – (Multitech Systems 2016) | 54 |
| Table 4: Line of Sight Testing Results | 89 |
| Table 5: Urban Testing Results..... | 95 |

List of Figures

| | |
|---|----|
| Figure 1: LoRa Alliance Sponsor Members (LoRa Alliance 2016) | 7 |
| Figure 2: LoRaWAN Modulation Settings USA (MicroChip, LoRaWAN 101 Class Slides, 2015)..... | 11 |
| Figure 3: LoRaWAN Modulation Settings USA (Multitech Systems, 2015) | 12 |
| Figure 4: LoRa Modulation v Narrowband FSK comparison (Semtech Rev 2 AN1200.22, 2015) | 13 |
| Figure 5: LoRaWAN Classes (LoRa Alliance 2015) | 16 |
| Figure 6: LoRaWAN Class 'A' Device (MicroChip, LoRaWAN 101 Class Slides, 2015) | 17 |
| Figure 7: LoRaWAN Class 'B' Device (MicroChip, LoRaWAN 101 Class Slides, 2015) | 17 |
| Figure 8: LoRaWAN Class 'C' Device (MicroChip, LoRaWAN 101 Class Slides, 2015) | 18 |
| Figure 9: Logical Diagram of LoRaWAN Security (MicroChip, LoRaWAN 101 Class Slides, 2015) | 19 |
| Figure 10: LoRa End Device- Device Address Structure (LoRa Alliance 2015) | 19 |
| Figure 11: LoRaWAN Packet Structure (Vannel, F) | 23 |
| Figure 12: LPWA Architecture Principles (Hamel, E 2015) | 23 |
| Figure 13: Transport and Application Layer Protocols (Athuraliya, S 2015)..... | 24 |
| Figure 14: OSI Model (ccna5 OSI-Model) | 28 |
| Figure 15: Physical LoRaWAN Topology (MicroChip, LoRaWAN 101 Class Slides, 2015) | 31 |
| Figure 16: Star Topology (Link-Labs 2015) | 34 |
| Figure 17: Predicted LoRa Coverage using Radio Mobile..... | 39 |
| Figure 18: Predicted LoRa Coverage using EDX Signal Pro 8.0 | 40 |
| Figure 19: Gabbinbar Comms Site Predicted Coverage using EDX Signal Pro 8.0 | 41 |
| Figure 20: Multitech Multiconnect mDot Range (Multitech 2016)..... | 42 |
| Figure 21: Semtech LoRa Modem Calculator (Semtech 2015)..... | 48 |
| Figure 22: Multitech MultiConnect Conduit (Multitech Systems 2015) | 51 |
| Figure 23: Multitech Conduit Rear Faced Connections (Multitech Systems, 2015)..... | 52 |
| Figure 24: Multitech MultiConnect mDot (Multitech Systems 2015) | 53 |
| Figure 25: Multitech Developer board MTUDK2-ST (Multitech Systems 2015)..... | 55 |
| Figure 26: Multitech Developer board MTUDK2-ST (Multitech Systems 2015)..... | 56 |
| Figure 27: Multitech Conduit Login Screen..... | 61 |
| Figure 28: Multitech Conduit Wizard Step 1..... | 62 |
| Figure 29: Multitech Conduit Wizard Step 2..... | 62 |
| Figure 30: Multitech Conduit Wizard Step 3..... | 63 |

| | |
|---|----|
| Figure 31: Multitech Conduit Wizard Step 4..... | 63 |
| Figure 32: Multitech Conduit Wizard Step 5..... | 64 |
| Figure 33: Multitech Conduit Wizard Step 6..... | 64 |
| Figure 34: Multitech Conduit Wizard Step 7..... | 65 |
| Figure 35: Multitech Conduit LoRa Configuration..... | 67 |
| Figure 36: Multitech mDot AT! command..... | 68 |
| Figure 37: Multitech mDot AT+JOIN command | 69 |
| Figure 38: Multitech mDot AT&V display settings command | 71 |
| Figure 39: Node-Red Network Server Configuration | 72 |
| Figure 40: Node-Red Debug Message Property Only..... | 72 |
| Figure 41: Node-Red Debug Window Complete MSG Object..... | 73 |
| Figure 42: Node-Red UDP Configuration | 74 |
| Figure 43: Node-Red TCP Configuration | 75 |
| Figure 44: Terminal Session Configuration | 75 |
| Figure 45: Node Red LoRa Setup..... | 77 |
| Figure 46: Multitech mDot AT+SEND No ACK..... | 78 |
| Figure 47: Multitech mDot AT+SEND with ACK G/way off..... | 79 |
| Figure 48: Multitech mDot AT+SEND with ACK G/way on | 79 |
| Figure 49 Node-Red Configuration | 80 |
| Figure 50: Multitech mDot SEND/RECEIVE with ACK..... | 80 |
| Figure 51: Node-Red Debug UDP Output..... | 81 |
| Figure 52: Wireshark Capture UDP | 82 |
| Figure 53: Packet Sender Payload..... | 82 |
| Figure 54: Node-Red Debug TCP Output AT+SEND used twice..... | 83 |
| Figure 55: Wireshark Capture TCP | 83 |
| Figure 56: Terminal Window..... | 84 |
| Figure 57: Test Location A Path & Elevation Profile..... | 85 |
| Figure 58: Test Location B Path & Elevation Profile..... | 86 |
| Figure 59: Test Location C Path & Elevation Profile..... | 87 |
| Figure 60: Test Location D Path & Elevation Profile..... | 88 |
| Figure 61: Test U1 Path & Elevation Profile | 91 |
| Figure 62: Test U2 Path & Elevation Profile | 92 |

| | |
|---|----|
| Figure 63: Test U3 Path & Elevation Profile | 93 |
| Figure 64: Test U4 Path & Elevation Profile | 94 |

Glossary of Terms

| | |
|----------|---|
| ABP | Activation by Personalization |
| ACMA | Australian Communications and Media Authority |
| ADR | Adaptive Data Rate |
| AES | Advanced Encryption Standards |
| AppEUI | Application Identifier |
| AppSKey | Application Session Key |
| CoAP | Constrained Application Protocol |
| CRC | Cyclic Redundancy Check |
| DevAddr | Device Address |
| FSK | Frequency Shift Keying |
| GUI | Graphical User Interface |
| HV | High Voltage |
| IP | Internet Protocol |
| IoT | Internet of Things |
| LAN | Local Area Network |
| LPWAN | Low Power Wide Area Network |
| LoS | Line of Sight |
| LV | Low Voltage |
| MAC | Media Access Control |
| NwkSKey | Network Session Key |
| OSI | Open Systems Interconnection |
| OTAA | Over the air activation |
| PHDR | LoRa Physical Header |
| PHDR_CRC | LoRa Physical Header Cyclic Redundancy Check |
| RSSI | Received Signal Strength Indicator |
| RX | Receive |
| SCADA | Supervisory Control and Data Acquisition |
| SNR | Signal to Noise Ratio |
| TCP | Transmission Control Protocol |
| TTN | The Things Network |

| | |
|-----|------------------------------|
| TX | Transmit |
| UDP | User Datagram Protocol |
| UPS | Uninterruptible Power Supply |
| USB | Universal Serial Bus |
| WAN | Wide Area Network |

1. Introduction

1.1. Project Overview

The Internet of Things is a system of many objects and devices that can collect and transfer information over a wireless network connected to the internet. The low power wide area network (LPWAN) is a long range network that can provide this function. The Internet of things is a things network not a human network so the LPWAN is something that is based on low data rates, low response times. The electricity industry is one such industry that can greatly benefit with the use of these technologies.

There are various forms of architecture that have been used in this industry to provide connectivity to remote devices such as 3G/4G cellular networks for high data applications and Wi-Fi/Bluetooth in short distance applications. These technologies will still be used in the future however these architectures usually have devices that are power hungry with high data speeds and fast latency times. Many objects do not require high data speeds and fast latency and this is where a LPWAN and in particular a LoRaWAN may be of benefit. LoRa which is short for long range is one long range network that is showing a high adoption rate due to its low costs and long range capabilities.

The project will look at developing a trial LPWAN using the LoRa communications standard to use within the electrical industry. Some of the possible uses of the LPWAN could be

- line fault indicators
- Remote Meter Reading (Smart meters)
- Hot water relay operation
- SCADA (low data speeds)
- Vehicle Monitoring
- Temperature sensing in control rooms

As the LoRa technologies are developed and adopted by manufacturers it is highly likely that these devices may have an inbuilt LoRa module installed which will make an easy transition into the LPWAN. The project will focus on the LoRaWAN communications medium and will research the system architecture consisting of the end device, gateway and the network and application servers. The project will aim to achieve a full working LPWAN as detailed below.

1.2. Project Aim

The Aim of this project is to build a trial LPWAN system that will incorporate the LoRa standard that can be used for the electricity industry. The hope is that potentially with this network, existing remote devices and potential new ones can be incorporated. It is also hoping to provide a solid platform for future networks to be based on to be built.

The project will initially connect an end device to a gateway which will pass data through to a network server and bring this information back to an application server. The system will need to be low cost as electricity distributors in particular Ergon Energy in Queensland have had major cuts in spending to their operating budgets for the next 5 years (AER determination 2015-2020). This technology could potentially save distributors money and provide various smarter services to the business. The project aims to reduce operating costs whilst maintaining and increasing remote services.

The LPWAN that the LoRa standard operates in Australia is the unlicensed frequency band of 915-928MHz (therefore no ongoing licencing cost). Also the equipment is very cheap to purchase as End nodes for example could cost as low as \$5 per unit and commercial base stations around \$5000.

LoRa provides a high security network using AES 128 bit encryption with layers of security on a network and application level.

1.3. Project Background

As current electricity distributors such as Ergon Energy have had major reductions to their operating budgets for the next 5 years (2015-2020) the business has to work smarter and innovate to help save costs to their customers. As we seek to get more information on how the network is operating, communications with many devices is required. Currently most remote communications is provided via a cellular network both private and public and with satellite services. These networks have large operating costs from maintenance, ongoing licensing charges and high equipment costs.

As information of the real time network is vital the use of a LPWAN would significantly give the network a high coverage, high security and low cost solution for certain applications. The Internet of things currently exists to some degree with current SCADA systems and metering devices such as smart meters however this technology has not been widely adopted. A LoRaWAN could potentially be able to do some of these functions whilst future proofing the grid for new future devices.

1.4. The Need for the Project

The need for this project is to innovate and incorporate new technologies into the industry to give a better overall picture of the network. Due to the current and future growth of the Internet of Things there will be significantly more devices that could potentially be able to be controlled by the electricity distributor such as smart meters and different types of sensors.

A white paper by Internet society details some forecast growth during the next five to ten years. Cisco believes there could be 24 billion internet connected devices by 2020 and Huawei believe it could be up to 100 billion devices by 2025. With this huge growth in IoT devices it is very necessary that an electrical distribution company embraces this technology so it is ready to meet the future

requirements of the customer and operations of the business. Some of the requirements that the industry will require are:

- Reducing Operating Costs
- Provide innovation
- High Safety Standards
- Work Smarter
- Future Proof the Network
- Security
- Better communication in Rural Environments

LoRaWAN with its secure, robust and long range capability could provide an option to help meet these requirements. For example The Things Network has been able to get coverage in Amsterdam with 10 Gateways at a cost of \$1200 each. The project will hope to outline ways that this model could be used in the industry to get more information and control from the network.

1.5. Project Objectives

The project hopes to achieve and develop a LoRaWAN network and trial an end device connecting to a gateway and thus back to a network server. The project will focus on creating a LoRaWAN and to determine possible uses for this in the electrical industry. The end node devices and gateway will be a development system only and thus the end nodes etc. will differ from what could be possibly used in reality.

The objectives of the project will be to determine

- Does the technology have uses in the electrical industry
- Possible data rates
- Coverage of Signal
- Potential Uses
- Security

With this being in mind the project hopes that this research can and will be used in industry and with this being the case allow for an easier transition for future devices to use this network.

2. Literature Review

2.1. Overview

The following literature review aims to provide clarity to current standards, legislation and impacts on creating a LoRaWAN network. It will look distinctively at creating this network for an electrical industry and any requirements needed to implement a full network. As described in subsequent headings the review will look into at requirements to implement such as system;

- Health/Safety Requirements
- LoRa Alliance
- LoRa Modulation
- LoRaWAN
- LoRaWAN security/device activation
- LPWAN Protocols

2.2. LoRa Alliance

The LoRa Alliance was started by manufacturers, developers and designers to create a standard by which could be used in the ever growing world of the internet of things. The LoRa (short for Long Range) platform was built as a low power long range network needed to provide

- Security
- Low cost
- Long Range Coverage
- Works well in high interference which is helpful in the unlicensed spectrum band as well as city environments

The Alliance consists of was many members that have been operational since March 2015. The Alliance is continually growing and as of December 2015 had 120+ members (Hamel, E 2015, pg. 23). As shown in Figure 1 below the Alliance currently has the following sponsor members. There are also contributing members and adopter membership available. Each membership has various rights to particular information and direction of the Alliance.



Figure 1: LoRa Alliance Sponsor Members (LoRa Alliance 2016)

The LoRa Alliance’s aim was to try and standardise low power wide area networks in use around the world to be used for the Internet of things. The alliance members use this to standardise knowledge, interoperability under one standard of the LoRa protocol. As described by the LoRa Alliance, their primary goal

“is to standardise LPWAN and through standardization enable large scale volume IoT deployments.” (LoRa Alliance, 2015)

The Internet of things is a concept where in the future millions of local devices will be connected to the internet such as fridges, etc. To connect all these things wireless networks will be required and one such architecture will be used with the use of long range networks.

2.2.1. LoRaWAN Specification V1.0

The following standard was released in January 2015. It is a very detailed document that is property of the LoRa Alliance and details the LoRaWAN specification detail. It is very much a live working document with version 1.0.1 very soon to be released. Currently this specification does not include the Australian spectrum as this is still very much up in the air regarding regulation for the IoT.

Rob Zagarella in an NNNCo submission to the parliamentary inquiry of agricultural innovation has also noted this issue for the IoT in Australia

“No agreed standard for data acquisition and transmission, which may mean Australian innovations become orphans” (Zagarella, R, pg. 5).

In this same article it is also mentioned that the 900 MHz band spectrum should be looked at and a set IoT application spectrum be set aside in the 928MHz to 935MHz band. Currently the Australian deployed gateways and end nodes use a modified version of the US specification together with current ACMA Low Interference Potential Devices (LIPD) licence requirements.

The LoRaWAN specification document does describe the LoRaWAN network protocols and details the

- System Architecture
- End Devices
- Data Rates
- Adaptive Data Schemes
- LoRaWAN Classes
- Security Options

As detailed on the disclosure page the information currently provided is an “AS IS” basis. During this project continuation the new specification once released will be required to be reviewed to ensure project does comply with the standard.

2.2.2. LoRa Modulation Technique

LoRa is the wireless modulation technique that is used for a long range digital transmission link. LoRa radio modulation technology was

“invented in 2010 by the French start up Cycleo and then acquired in 2012 by Semtech” (Orange-LoRa Developer Guide, 2016).

It is able to transmit very long distances due to its high link budget (157dB) compared to traditional communication mediums. The distance is dependant however on obstructions and environmental factors such as weather patterns or terrain.

The LoRa modulation technique is based on spread spectrum techniques and is a variation of chirp spread spectrum CSS with integrated forward error correction. The LoRa modulation however differs from a traditional direct sequence spread spectrum technology (DSSS). Direct sequence spread spectrum is by modulating the carrier frequency with chips to spread the transmission across more

spectrum which increases coding gain and chip depth. In LoRa the carrier is unmodulated in a frequency modulation chirp. By doing this it spreads the energy across a wider band compared to traditional FSK.

Spread spectrum works by the theory that increasing bandwidth of the signal we can compensate for degrading of the signal to noise ratio (SNR) of a radio channel. As described by Semtech

“LoRa can demodulate signals 19.5dB below the noise floor compared to most frequency shift keying systems (FSK)” (“Lora FAQ”, n.d)

FSK systems usually require 8-10db above the noise floor to demodulate correctly (Section 2.2.2.1 will detail a trial about this). The LoRa modulation is found on layer 1 of the OSI model or the PHY layer which and can be utilised by many different protocol architectures such as star and mesh topologies. In Australia the modulation works in the unlicensed spectrum band of 915-928MHz. This band has a regulatory requirement of a maximum transmit power of 1W EIRP. LoRa devices will meet this requirement as they are low power usually having no more than a 20dBm or 100mW transmit ability.

LoRa is a half-duplex system in being the end node can only talk to the gateway or vice versa one at a time. Full duplex systems can continually TX/RX simultaneously. It has a variable data rate that can use different spreading factors to allow the user to have a higher data rate lower distance system or a low data rate longer range system. There are six possible spreading factors that can be programmed (SF7, 8, 9, 10, 11, 12) that allow orthogonal transmissions at various data rates. The spreading factor works by the higher the SF used the higher processing gain is available. As seen in Figure 2 below shows how the spreading factor, range and bitrates are all related (Note US Spec Shown)

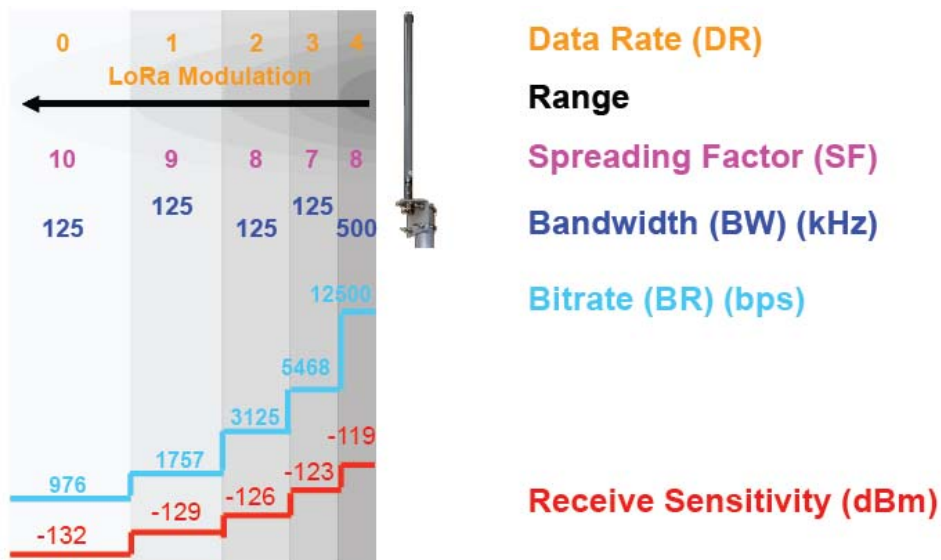

Figure 2: LoRaWAN Modulation Settings USA (MicroChip, LoRaWAN 101 Class Slides, 2015)

The spreading factor determines how much unused /redundant data is spread across the transmission path. As seen above the higher the spreading factor the higher the amount of redundant payload is sent which allows a longer range. The longer communication range then causes a lower bitrate thus this has to be taken into account when designing a LoRaWAN.

Figure 3 shows the Data rates and Payload sizes for certain spreading factors. The figure currently only shows the US and European specification which could alter for the Australian LoRaWAN specification.

| Spreading Factor & Bandwidth | Transmit Data rate | Maximum Payload Size | |
|------------------------------|--------------------|----------------------|-----------|
| | | North America | Europe |
| SF_8 500kHz (AT+SENDH) | 12.5 kbps | 242 bytes | - |
| SF_7 125kHz | 5.47 kbps | 242 bytes | 242 bytes |
| SF_8 125kHz | 3.125 kbps | 129 bytes | 242 bytes |
| SF_9 125kHz | 1.76 kbps | 53 bytes | 115 bytes |
| SF_10 125kHz | 0.98 kbps | 11 bytes | 51 bytes |
| SF_11 125kHz | 0.44 kbps | - | 51 bytes |
| SF_12 125kHz | 0.25 kbps | - | 51 bytes |

Figure 3: LoRaWAN Modulation Settings USA (Multitech Systems, 2015)

2.2.2.1. LoRa v FSK modulation

As part of the LoRa modulation literature review the Semtech Paper AN1200.22 discusses the LoRa modulation in an urban environment how it compares to a traditional narrowband FSK network. The trial was setup in an urban environment in Shinko Tokyo Japan and used a maximum transmit power of 13dbm.

As shown by Figure 4 the LoRa modulation coverage was approximately 3 times greater than the FSK modulation.

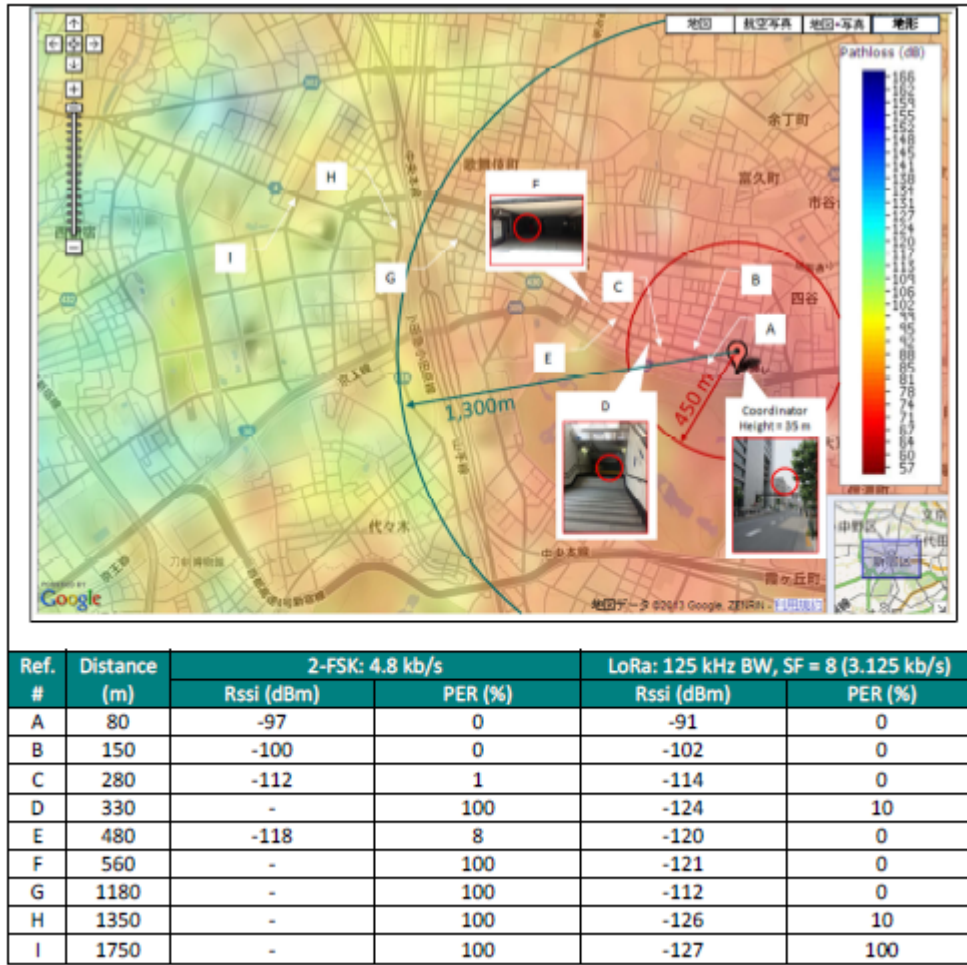

Figure 9: Shinjuku Urban Range Test

Figure 4: LoRa Modulation v Narrowband FSK comparison (Semtech Rev 2 AN1200.22, 2015)

The LoRa modulation data rate was slightly slower but the extra range is something that would greatly help in Australia due to the vast land area but also dense urban environments. The study also showed LoRa's ability to penetrate buildings as seen in Ref D, F of the table in Figure 4.

2.3. LoRaWAN

LoRaWAN is a communications protocol that resides on layer 2 of the OSI model which is the data link or MAC layer (Media Access Control Layer). It also details the architecture of the LPWAN. LoRaWAN has many benefits as the protocol is bi-directional, is highly secure with several security keys and devices can be registered over the air. It was designed to make low power wide area networks have a better data rate/capacity, range, low power consumption and low costs.

LoRaWAN is basically on the server side of the system that requires a server application to run MAC functions over a network. It is usually used in a star topology with the use of gateways. One of the main reasons for using a star topology is for its simplicity and is able to help with remote device power consumption. In a mesh network devices communicate with each other to get back to an application server. This can increase range of the system however it also increases power consumption in remote devices as they are transmitting much more. With an overlapping star network the end device can communicate to the best gateway thus reducing unit power on times.

In most cases the LoRaWAN layer looks after the encryption/decryption part of the network. The LoRaWAN will receive packet data from the end node and then forward this data from the gateway through to an application by some type of backhaul option such as Ethernet or even an existing cellular network. The LoRaWAN network is a much better platform than normal LPWAN's as it has the ability to use an adaptive data rate by utilizing numerous channels on the one gateway. As described in section 2.2.2 the LoRa modulation is based on a spread spectrum technique. With this being the case numerous spreading factors can be used which will allow the gateway to receive different data rates on these different channels as well. One of the benefits to help in the LoRaWAN as mentioned in chapter two is the network's ability to manage network capacity is with an ADR schema.

2.3.1. Adaptive Data Rate Scheme (ADR)

The LoRaWAN network has the ability to use an adaptive data rate scheme (ADR). ADR allows the LoRaWAN to manage data and RF output to help extend end device battery life as well as traffic management through the use of MAC commands. ADR allows the system the ability to receive numerous packets simultaneously. How the ADR works is by when the network server receives a packet from the end device a SNR figure is captured from this.

The network server has a set threshold that when met will use the SNR information from the received packet of an end device and can then use MAC commands to it to adjust the required data rate. When using an ADR scheme the transmit power of the devices should be set to a maximum to allow the server to correctly judge the SNR from the specified device. The ADR scheme as defined the current LoRaWAN specification should be only used for fixed end node applications. The reason being if the device was continually moving the environmental changes would not be practical for the server.

2.3.2. LoRaWAN Classes

As described by the LoRa alliance a LoRaWAN is distinguished as a basic system class "A" and has options (Class "B" & "C" devices). Figure 5 details the LoRaWAN Classes and where they sit in the Network stack.

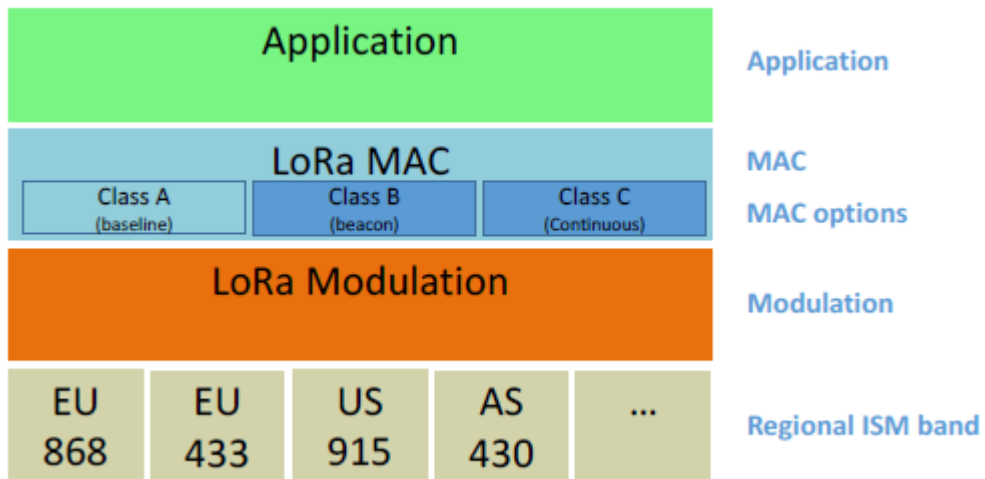

Figure 5: LoRaWAN Classes (LoRa Alliance 2015)

2.3.3. LoRa End Device Classes

Devices that connect on the LoRaWAN network comprise of three different types. Data transmission is bi-directional however most design is aimed at end device initiated transmissions.

2.3.3.1. Class A

A class 'A' device is one that is referred to as a bi-directional device. Class 'A' devices are ones that will only listen once they have transmitted data. Communications are established by the end node with a transmit followed by two short receive packets from the server in predetermined response windows.

Any request from the server will have to wait for the device to re-transmit at its direction. With this form of communication pattern this device has the lowest power consumption of all LoRa end nodes however has the longest latency time. This device must be supported by all other classes.

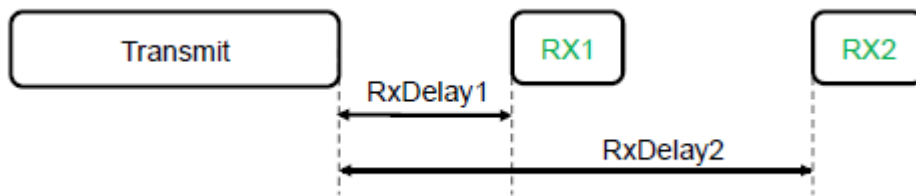

Figure 6: LoRaWAN Class 'A' Device (MicroChip, LoRaWAN 101 Class Slides, 2015)

2.3.3.2. Class B

A class 'B' device is one that is bi-directional like the class A however the class B device has scheduled receive slots. How it receives its receive signal is by receiving a timed signal beacon from the gateway so it notifies the server that the device is ready to receive. With this being the case the device will use more power

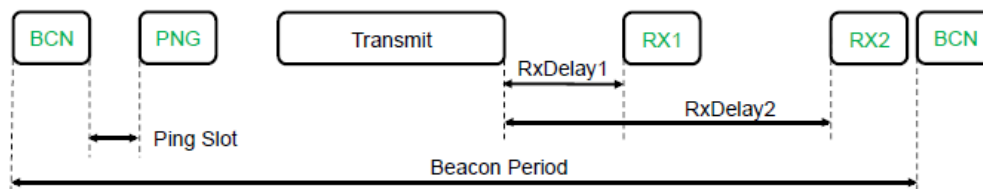

Figure 7: LoRaWAN Class 'B' Device (MicroChip, LoRaWAN 101 Class Slides, 2015)

2.3.3.3. Class C

A class 'C' device is one that is continually listening for receive packets. The only time it is not listening is when it is transmitting. As the device is constantly listening it will require much more power to run however will have the best latency times. Class C devices are usually used on sites that have a continuous supply.

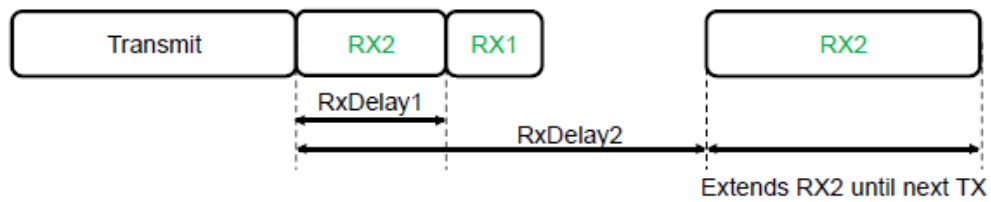

Figure 8: LoRaWAN Class 'C' Device (MicroChip, LoRaWAN 101 Class Slides, 2015)

The classes basically work by the lowest power usage has the highest latency. Class A has high latency low power consumption, Class B low latency higher power consumption and Class C no latency highest power consumption.

2.3.4. LoRaWAN Security

The LoRaWAN protocol has been designed to be very secure due to the nature of any IoT system as it is operated over a cloud/internet. The domains that are in a LoRaWAN system are:

- Network Domain
- Application Domain

The Network domain is where the end device data is authenticated. This is achieved with a unique AES 128 bit shared key between the remote device and network server. The Application domain is where the devices data is ensured it is private. Here there is also another 128 bit shared key that is used between the application and the remote end device. Figure 9 shows the logical diagram of security in the LoRaWAN.

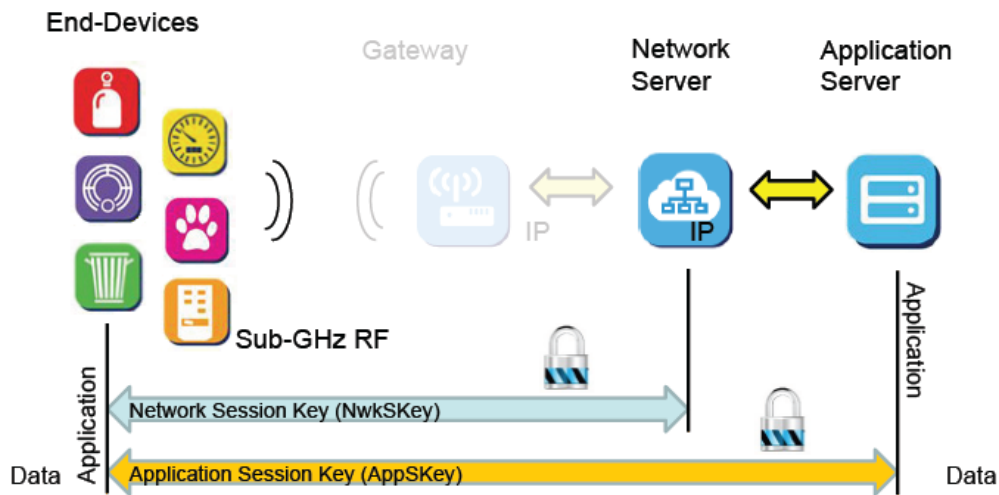

Figure 9: Logical Diagram of LoRaWAN Security (MicroChip, LoRaWAN 101 Class Slides, 2015)

To join an end node to a LoRa network there are two ways that this can be achieved. They can be using:

1. Over the air activation method (OTAA)
2. Activation by Personalization (ABP)

The two methods both achieve the same end response however it differs between them. After the device is activated on the network the following information is kept on the end node being a Device Address (DevAddr), Application Identifier (AppEUI) Network Session Key (NwkSKey) and an Application Session Key (AppSKey).

Device Address (DevAddr)

The device address is a 32 bit address and follows the format refer Figure 10

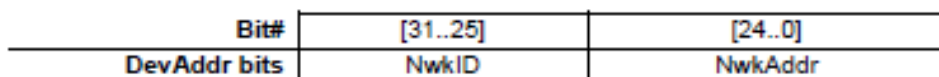

Figure 10: LoRa End Device- Device Address Structure (LoRa Alliance 2015)

As shown by Figure 10 (LoRa Specification sect 6.1.1) the least significant bits 0-24 consist of the NwkAddr and the most significance bits 25-31 holds the NwkID information. The device address is unique within the network and differentiates the end devices.

Application Identifier (AppEUI)

The application identifier is a unique application ID in the IEEE EUI64 space. It directly identifies the owner of the end device.

Network Session Key (NwkSKey)

The network session key is used by the end device to ensure data integrity. It also provides encryption/decryption on the payload of MAC address only messages. This key is used between the end node and network server. It is a 128 bit AES encryption and is unique in each end node.

Application Session Key (AppSKey)

This key is used for providing security to the network. It is used to encrypt and decrypt data between the end device and application server. It is a 128 bit AES encryption and is unique in each end node.

2.3.4.1. Over the Air Activation

Over the air activation is one form of end node activation to a LoRa network. It provides a large amount of freedom as the end device does not know what network it will be connecting to. Initially for the new end device to authenticate

it will require an end device identifier (DevEUI), application identifier (AppEUI) and 128bit application key (AppKey).

End Device Identifier (DevEUI)

The end device identifier is a unique application ID in the IEEE EUI64 space which is purchased by the manufacturer of the device. This identifier is added by the manufacturer at build and is not modified by the user.

Other than the DevEUI the AppEUI and AppKey can be determined by the owner of the device. How the authentication works basically follows the following steps.

1. The end device transmits a join request to the application server. The request includes is DevEUI, AppEUI and optional AppKey
2. The application server will respond with a join accept if the end device is permitted to join the network.
3. The end device will receive a join accept from the application server. This will contain the DevAddr and AppNonce which will then use this to generate the NwkSKey and AppSKey.
4. End Device is now active on the LoRaWAN

2.3.4.2. Activation by Personalisation

This type of authentication is where the end node has its Devaddr and two session keys stored in the device (NwkSKey and AppSKey). As per the LoRa specification section 6.3 which states

“Each device should have a unique set of NwkSKey and AppSKey. Compromising the keys of one device shouldn’t compromise the security of the communications of other devices. The process to build those keys should be such that the keys cannot be derived in any way from publicly available information (like the node address for example).” (LoRaWAN Specification V1.0, 2015)

As the specification warns each device should be unique as there is a potential to access the whole network if this wasn’t the case. As there is a high potential for some end devices to be open to attack due to installation in house switchboards, activation by personalisation is best suited to smaller networks.

Activation by personalisation does not have the freely option of joining to other future networks and with the possibility of thousands of future sensors could become a cumbersome process.

2.3.5. LoRaWAN Message Format

Figure 11 shows the LoRaWAN packet detail information. The structure consisting of

- A preamble
- PHDR – LoRa Physical Header
- PHDR_CRC – LoRa header cyclic redundancy check
- PHYPayload – The data payload
- CRC - Cyclic Redundancy Check (Note the LoRa PHY level the CRC is only used in uplink messages)

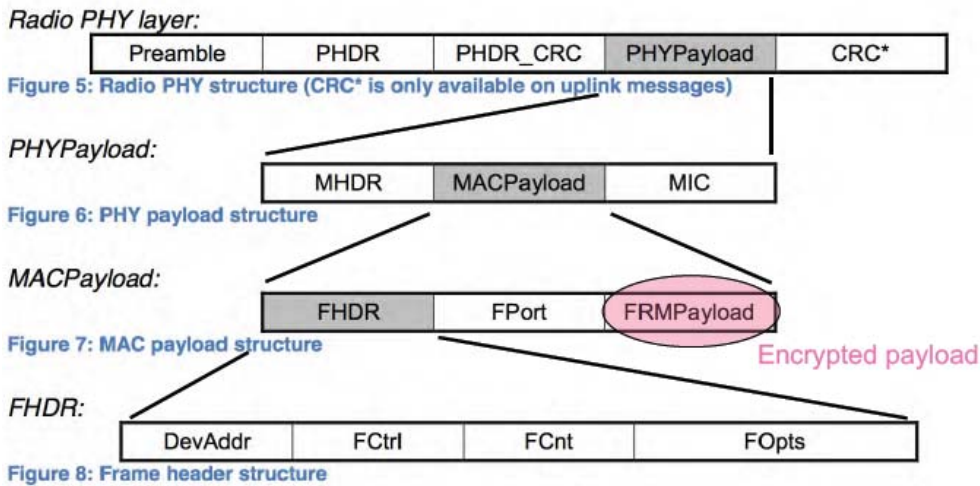

Figure 11: LoRaWAN Packet Structure (Vannel, F)

As detailed in the LoRaWAN specification all uplink and downlink packets carry PHY Payload. The structure can then be broken down further to show the MAC payload and Frame Header structure.

2.4. Protocol Architecture of a LoRaWAN System

The protocol architecture for a LoRaWAN can be seen in Figure 12 below. The gateway and end device is found on the PHYS layer 1 and the LoRaWAN is in the MAC layers between the network server and end device. The other layers of the OSI model are not defined by the LoRa standard. The protocols on the transport and application layers will depend on what type of device and function that is required.

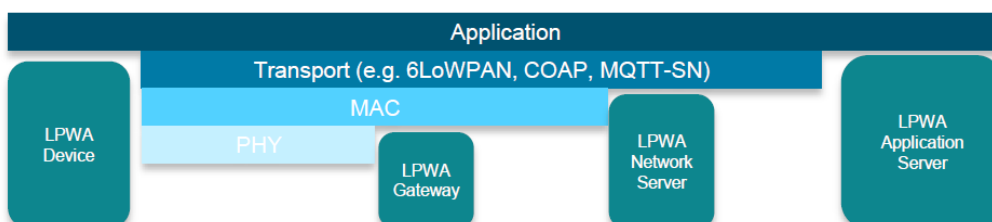

Figure 12: LPWA Architecture Principles (Hamel, E 2015)

If we consider a possible trial of a load control system as shown in Figure 13 below. The system shown defines a generic application of possible protocols used in a LoRaWAN. Between each device shows the payload stack protocols used in a LoRaWAN. Between each device shows the payload stack protocols between each layer of the network.

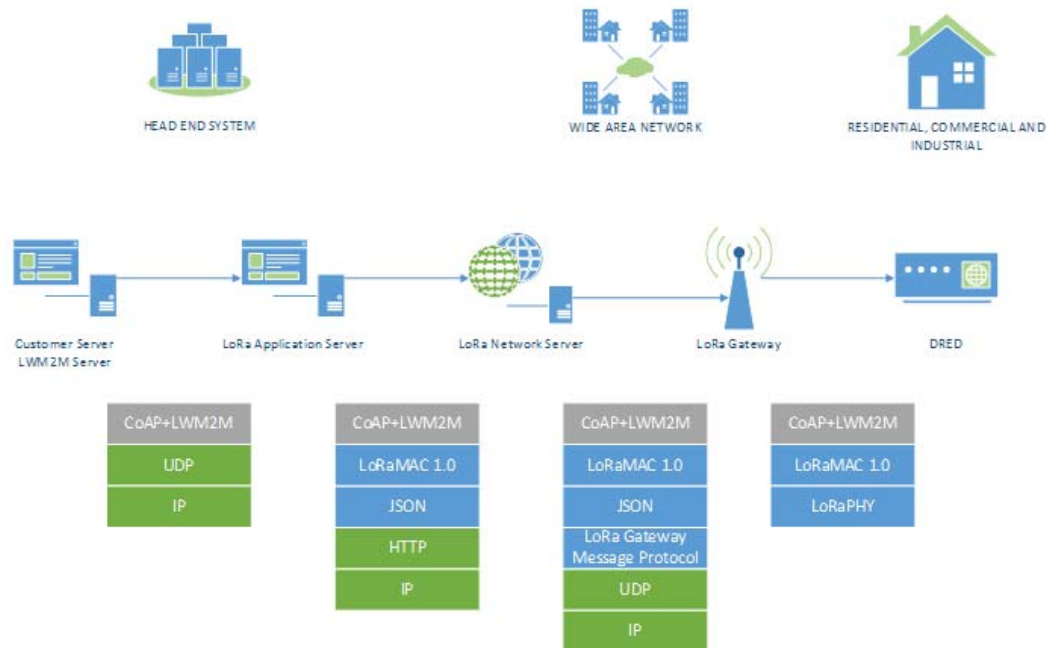

Figure 13: Transport and Application Layer Protocols (Athuraliya, S 2015)

As seen in Figure 13 the trial load control network encompasses a customer server using a LoRaWAN to talk to an end device in this case it is referred to as a DRED. The end device in this application would be classified as a class 'C' device as it is required to listen for transmissions to activate the load control relay at a customer's premise and is connected to a permanent power supply source.

As shown the application protocol to manage the end device will be using the Lightweight M2M protocol built on the COAP protocol. These protocols will be discussed further in the subsequent sections of this chapter. The COAP protocol is then carried by the LoRaWAN. As discussed in earlier chapters the gateway connects to the network server using an IP connection.

2.5. IoT Protocols

2.5.1. OMA-LWM2M

LWM2M is a newly developed Light weight machine to machine protocol developed by the Open Mobile Alliance (OMA). The protocol was developed to be able to manage M2M services. Some of the features of LWM2M are

- Monitor devices
- Device configuration
- Service Provisioning

The LWM2M protocol is found on the application layer and is used to talk between the LWM2M server and client. The server is usually found in the main application server and the client is found in the end device. The LWM2M will be built on the Constrained Application Protocol (COAP).

2.5.2. COAP Protocol

The Constrained Application Protocol (COAP) is one that was developed for low speed internet of things applications. It is found in the application layer and is defined by the standard specification RFC 7252. As defined by the standard

“specialized web transfer protocol for use with constrained nodes and constrained (e.g., low-power, lossy) networks” (RFC 7252 Standard, 2014).

It has been designed to work with microcontrollers with small amount of memory (RAM & ROM), could be in a high collision network therefore expected packet loss and throughput of 10 seconds of Kbit/s. COAP is able to carry the JSON data payload which is what is used in the LoRaWAN. The COAP payload is the protocol that is able to be transported over the LoRaWAN.

2.5.3. UDP Protocol

User Datagram Protocol is used between the Gateway and network server for communication and contains in the data region of the packet the LoRa Gateway Message Protocol. UDP is a connectionless protocol for low latency connections and does not worry about possible packet loss. UDP is more concerned with latency rather than reliable transmission. In a LoRaWAN the UDP connection transmits a PULL_DATA message (Semtech, 2015) to the network server it keep firewall connections open. The period for this is transmission is set by the gateway. UDP uses port numbers to decipher between transmitting and receiving end points. UDP is able to run on top of IP and is found on layer 4 of the OSI model.

2.5.4. TCP Protocol

Transmission Control Protocol works much like UDP however requires a connection to be established between end points. TCP varies from UDP as it is more concerned with reliable transmission rather than latency. TCP can have high latency times due to the error checking it performs. TCP like UDP is able to run on top of IP and is found on layer 4 of the OSI model. TCP also uses port numbers to decipher between transmitting and receiving end points.

2.6. Health/Safety Standards

2.6.1. Maximum Exposure Levels to Radiofrequency Fields 3 kHz to 300 GHz

The following standard is one that was released by the Australian Radiation Protection and Nuclear Safety Agency on the 20th March 2002. The standard sets the limits for human exposure to radiofrequency (RF) fields in the frequency range 3 kHz to 300GHz. It mandates the basic restrictions to operational and public exposure to the body.

The Semtech chips that are currently available for the Australian spectrum are the SX1276 (end device) and SX1301 (gateway). They have a maximum transmit power of 20dBm = 100mW. As per the standard item S5.2.2 Equipment with mean power output not exceeding 100mW and equipment sites between 100kHz to 2500MHz (LoRa 915-928Mhz) the standard is not required as the nominal mean power output delivered to the antenna does not exceed 100mW. With this being the case it can be seen that no action is required regarding working distances due to the very low power involved with this system.

2.7. OSI Model

As part of the literature review the Open Systems Interconnection (OSI) model has had to be reviewed to see where LoRa and LoRaWAN sit in this model. As described by Wikipedia

“it is a conceptual model that characterizes and standardizes the communication functions of a telecommunication or computing system without regard to their underlying internal structure and technology” (“OSI Model”, 2016)

The model will detail each layers to show where LoRa sits in the model as well as other transport layers such as TCP for the network server to application server transport sits. The OSI consists of seven layers as shown in Figure 14

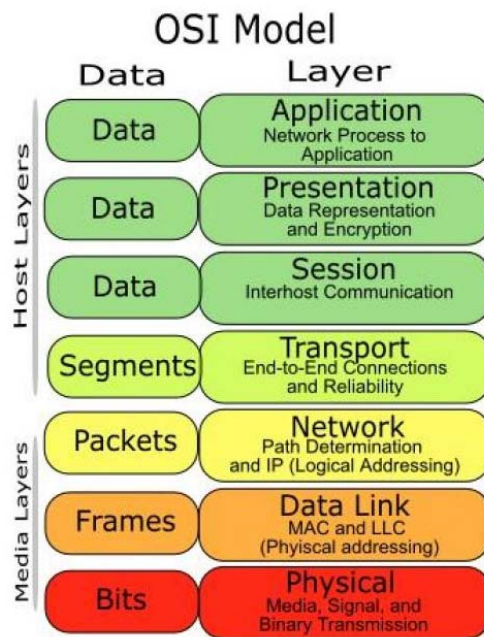

Figure 14: OSI Model (ccna5 OSI-Model)

2.7.1. Layer 1 – Physical Layer

Layer one is the lowest layer of the OSI model and is where the physical hardware exists. It defines the electrical/mechanical properties through the network. It is concerned with transmitting/receiving of raw binary data over the physical hardware. It describes the characteristic of the network such as voltage levels. LoRa fits in the layer one layer as it describes the voltage levels, data rates, error rates and timing.

2.7.2. Layer 2 – Data Link Layer

The data link layer is where the application protocol is defined. This is the layer that the LoRaWAN protocol sits. The data link layer controls the communications between Layer 1 (PHYS) and layer 3 (Network). Basically it will determine the data from the network layer and define how it is transmitted through the physical layers. This layer also controls the data sequencing.

The data link layer can be separated into two smaller layers which are the Media Access Control (MAC) layer and the Logical Link Control (LLC) layer. The logical link layer identifies and network layer protocol as well as performing error checking. The MAC layer determines how a network device gains access to data and if it is allowed to transmit it.

2.7.3. Layer 3 – Network Layer

The network layer is where it is decided how the data will be sent to a remote device from the transmitter. Logical protocols and routing is determined on this layer. This layer uses switching/routing technology to create paths or virtual containers to transmit data from one node to another.

2.7.4. Layer 4 – Transport Layer

The transport layer details the transfer of data between hosts via one or more networks. The transport layer is responsible for making sure the payload is delivered error free, The transport layer has the ability to track and resend data that fail and acknowledge that the data had arrived in tact. In the LoRa network server the transport of TCP/UDP data is found at this layer.

2.7.5. Layer 5 – Session Layer

The session layer is responsible for establishing connections between computers. As described by Wikipedia

“it provides the mechanism for opening, closing and managing a session” (“Session Layer”, 2016)

It provides detail on the connection of the systems such as the path being half/full duplex.

2.7.6. Layer 6 – Presentation Layer

The presentation layer controls how the data is to be presented to the application data. It formats the data from a remote computer to suit the required application or vice versa. It is able to provide encryption/decryption to help secure the network.

2.7.7. Layer 7 – Application Layer

The application layer provides network services to the application. For example in a browser window the use of HTTP or HTTPS. The LWM2M and COAP protocols can be found in this layer that will be used in a typical LoRaWAN network.

2.8. LoRaWAN Architecture

LoRa and LoRaWAN as described earlier are a physical and MAC protocols. The overall architecture of the system is seen by Figure 15. A basic description of the system is there are end node devices that connect to a gateway possibly many gateways depending on coverage and traffic on the network. These gateways are then connected via a backhaul system such as Ethernet or a cellular data network back to a cloud network server which then sends this data to an application server for display.

Physical Topology

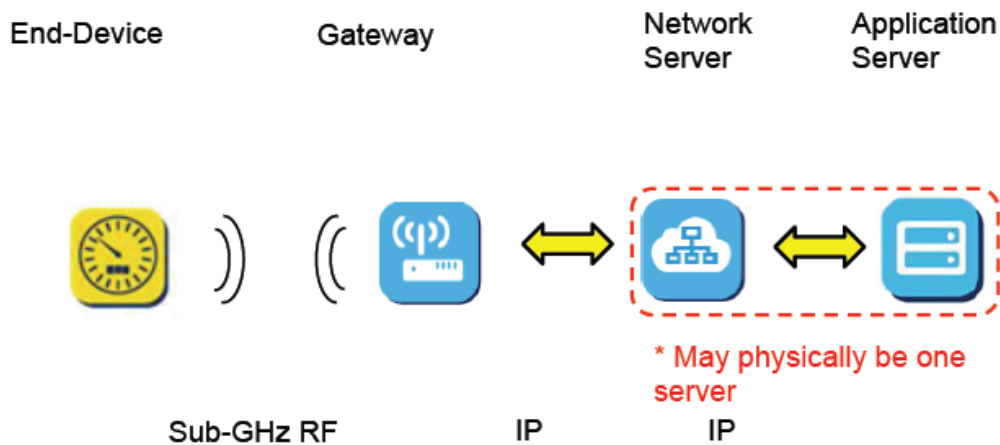

Figure 15: Physical LoRaWAN Topology (MicroChip, LoRaWAN 101 Class Slides, 2015)

Data transmission between the Gateway and Application Server is via IP. With the selection of gateways and end node devices the engineer will have to factor in range of signal together with the data time on the air. As communication between end devices and gateways may use different frequency channels and data rates there may be the need for more gateways to achieve required data rates and coverage.

2.9. LoRaWAN Data Transmission

As the LoRaWAN specification is still relatively new in Australia the specification is yet to be released for the Australian component in the standard. With this being the case to test and develop a working system the design has to be based on using a US standard as it works in the 915MHz spectrum. The US range however can use the range from 902 – 928Mhz which is not available for use in Australia. With this being the case the components will require firmware to allow the use of them in the Australian unlicensed band. The longest range of a LoRa network is achieved by using the lowest data rate and data payload size.

2.10. End Device

As the LoRa modulation is owned by Semtech they are currently the only manufacturer that makes the LoRa modulation chipset. Other manufacturers assuming they are part of the LoRa Alliance can then use this patented chipset on their typical device. Currently many believe that to have a working LoRaWAN system all the chips have to be manufactured by Semtech however this is not the case and another chip manufacturer HopeRF is beginning to build LoRa chipsets under licence from Semtech. Semtech have stated they are willing to allow other manufacturers to build LoRa chipsets under a licence agreement.

The chip that best suits the Australian spectrum is the Semtech SX1276. The Semtech SX1276 set chip works in a wide frequency range 137-1020MHz. It is a spread spectrum device that uses spreading factors 6 to 12. As detailed in the literature review the spreading factor works by the higher the SF used the higher processing gain is available.

The design of an end device, the chip is incorporated into another manufacturer's logical board which in turn will allow it to be connected into a microprocessor. The Semtech chip is used only for the layer one LoRa modulation.

There are currently many end devices available from commercial fully built end devices to more developer options and can incorporate the LoRa Modem into their device for example a Raspberry Pi/Arduino platform. The LoRa alliance currently displays current manufacturer end nodes and setup guides for other developer platforms. LoRa devices have to be certified by the alliance to be compliant.

End nodes should follow the following guidelines when deciding which on to use

- Cost
- Sensitivity
- Power consumption
- Interference characteristics
- Availability

As described for the LoRa Alliance there are currently many manufacturers that are making end devices. LoRa end node devices using Semtech SX1276 chip are made to decode one modulation type and one frequency. Currently in Australia there are not a great amount of suppliers that are building devices to work in the Australian spectrum of 915-928 MHz frequency spectrum.

Some of the current suppliers of these devices are Multitech mDot and Modtronix inair9 modems. This however is ever changing with companies such as Lielbillium and Cisco also beginning to release devices of their own. The most practical way to stay up to date news and device release/compatibility is to regularly keep in regular contact on the LoRa alliance website which regularly has updates.

The project will use the Multitech mDot LoRa Modem as the end device for this project. The mDot best suits the application as it is currently available, does not require a micro-coprocessor as it can be interfaced using the Multitech developer board and meets the time requirements for this report. As the LoRa LPWAN is still very new in Australia there will be many more manufacturers of LoRa modems available but it is envisaged that these devices will be incorporated into future devices like Bluetooth/Wi-Fi.

2.11. Gateway devices

Much like the end node devices the gateway devices will also use a LoRa modulation chip. However the gateways will differ as they work on layer 2 the mac layer which is the layer that the LoRaWAN resides on. The LoRaWAN network is a star topology where all end devices are connected through to a gateway is based on a star network in being all end nodes will talk to a gateway. It works in the same way as a typical repeater site would work in VHF (refer Figure 16).

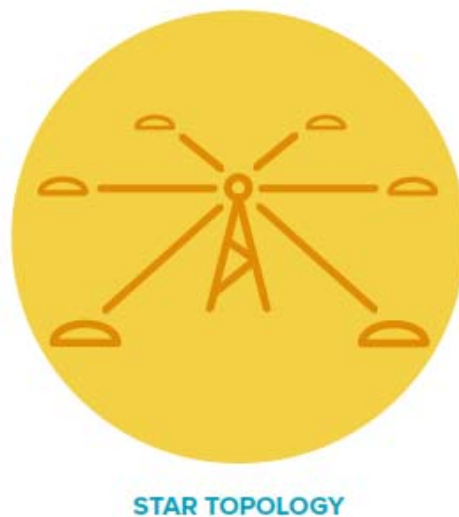

Figure 16: Star Topology (Link-Labs 2015)

The gateway is used to connect data from the end node to the network server; it can often be referred as a transparent device. There are currently numerous gateways that are available however many are still being made to be used in the Australian unlicensed spectrum band of 915 – 928 MHz.

Some of the current manufacturers are

- Multitech
- Kerlink
- Cisco
- Link Labs
- Raspberry Pi using above manufacturers modems

The Multitech gateway is one that will currently work in the Australian spectrum as many other possible gateways are working in the 868 MHz region in EU and 915 MHz regions in the USA. In Australia the 868MHz spectrum is licensed for commercial two way radio and the 900 MHz region is quite strict as we have licensed GSM mobile transmitters that work in this frequency to up 915MHz.

A LoRa Gateway has to have the ability to decipher multiple channels over various frequencies in parallel. To do this the gateway requires a different Semtech chip compared to the end device. Currently most manufacturers use a chip from Semtech being the SX1301. As most of the gateways use this chip most of the functions between manufacturers are quite similar.

When deciding to choose a gateway as described by Loriot the key factors to choosing a likely gateway are

- Radio Performance (Receiver sensitivity and transmit performance)
- Connection of the SX1301 chip to the Microcontroller(MCU)
- Support and distribution of a pulse per second (PPS) signal

Currently there are manufacturers that sell LoRaWAN gateways however ones that are made for the Australian spectrum are quite few. Some can modify firmware to work in this spectrum but many are still in a testing phase. For availability/support and access the project will use the Multitech gateway for a test platform. It is able to be interfaced to the correct frequency for testing, meet required sourcing timeframes for the report and had an on board network server that was very helpful to use in a test environment.

The Multitech conduit meets the LoRa specification of 8 channels at 125 kHz. This will allow an approximate data rate of anywhere from 300bps to 50kbps depending on packet size of transmission and the latency times that are required. The band that will be used is mid band thus being 922MHz. The gateway is able to receive simultaneous packet data on multiple channels and as well as this is able to receive data at different rates due to the spreading factors that are used with the modulation. The gateway has the ability to install a LoRa M-card (LoRa modem) that can be interfaced with an Omni directional antenna. The gateway then has the ability to interface to a network server via the Ethernet backhaul RJ45 port or a cellular backhaul option.

2.12. Network Server

The network server is where the IP connection is connected to the LoRaWAN gateway. The network server is used to provide radio management and manage data rates/RF outputs for each end node using adaptive data rate scheme (ADR). The network server is a cloud where data from this is then transferred to the application servers. The network server and application servers can be one physically one server.

The gateways in the network all connect back to the network server and it is the network server's decision which gateway should respond to each particular end device and also tell the other gateways to ignore the communication. Some of the current providers of network servers are from The Things Network, Actility, IBM and Loriot. These providers do have some limitations due to the nature of working in the unlicensed spectrum. For example the Things Network has a fair access policy to allow for future users to not congest the spectrum.

2.12.1. The Things Network 2016 Fair Access Policy

The Things Network is an organisation that hopes to build a global IoT network. By doing this they have a Fair Access Policy to try to keep the network as reliable as possible. By having this policy will allow for less collisions, more nodes and less packet loss.

As described by TTN architect Thomas Telkamp the TTN want to support around 1000 nodes per gateway with a duty cycle of less than 10 percent. Basically the policy wants to work on the basis of a maximum of 30 seconds of air time per device per day. Therefore if a 10 byte packet was used would be around 500 messages per day at spreading factor 7 (shorter range/higher bitrate) or 20 per day at a spreading factor of 12 (longer range/lower bitrate).

One of the benefits of using the Multitech conduit gateway is it has an on board application called Node-RED. The Node-Red application will act as an on board network server which will suit development for the built test environment. The Node-Red application allows the user to configure various simulations from a LoRa input to a LoRa output or TCP/UDP input/outputs. For a test environment it allows many different configurations and has good viewing of the network with debug windows.

2.13. Application Server

The application server is connected to the network server. In a LoRaWAN the application server can be either in the one or multiple servers each handling a different data payload. The system could have a server to handle metering data and a server that is to handle load control management. The application server is where the data from the end node is decrypted and displayed. As more developers make new devices to work in a LoRaWAN network more applications to handle this payload will be developed. One such company that can provide application server software is Loriot. Loriot is able to provide software for most common gateways today from major players such as Multitech, Kerlink, Cisco and Link-Labs also through to more developer gateways using Raspberry Pi platforms.

2.14. Chapter Summary

The following chapter has completed the required amount of literature review to begin the research project. It gives detail the where LoRa and LoRaWAN fit into the OSI models and also how the technology will work. It provides the reader with the required background knowledge to begin to build a possible system but also makes sure the engineer is aware of security risks that can be associated with this network.

The literature review will allow the engineer to devise what type of end device and system architecture they require from using LoRa at layer 1 for a simple point to point link or the information required to build a LoRaWAN network to potentially cater for thousands of remote devices. It should be noted that as this technology at time of writing report is still quite new in Australia the standard is still very much a live working document. Future releases of the standard may change which could lead to current information strategies changing.

3. Project Methodology

3.1. Coverage of a LoRaWAN trial site

Section 3.1 of the report details the possible coverage of the LoRaWAN Multitech gateway with a radius of 20km. The plot has been achieved using a +20dBm transmitter power and a receiver threshold of -137dBm. The antenna used for this plot is Omni-directional with a unity power gain. The modelling has used two different software packages to allow for comparison, one being a licenced copy of EDX Signal Pro 8.0.0 and the other free software called Radio Mobile version 11.6.0.

The following plots are purely theoretical using topographical, land terrain and clutter data (EDX). The clutter data is a basic template for the types of possible objects that cause interference. Once I had completed the coverage plots I was then able to convert these files into a .kmz file extension which could be loaded into google earth software. Figure 17 below shows the coverage plot for the potential test site at Ergon Energy South St Toowoomba.

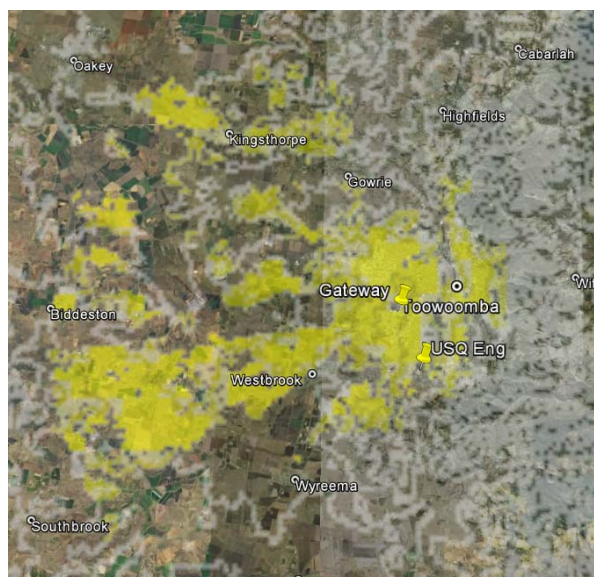

Figure 17: Predicted LoRa Coverage using Radio Mobile

Figure 18 below is the same test location as Figure 17 however the predicted coverage was completed using the software platform EDX Signal for comparison.

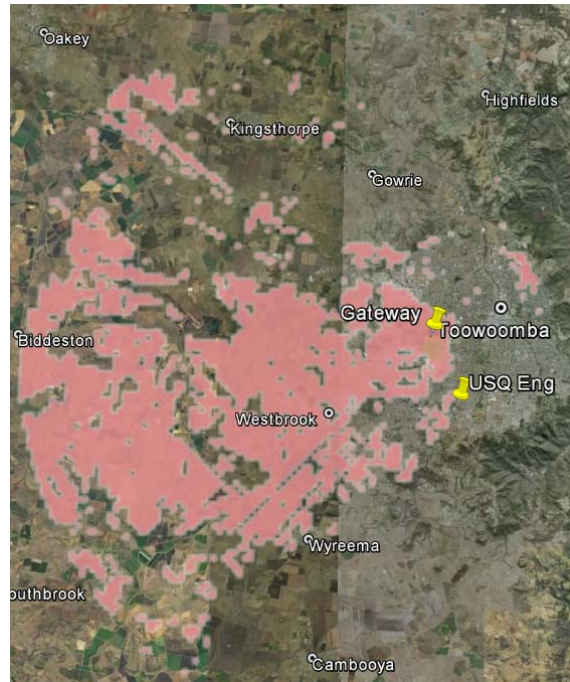

Figure 18: Predicted LoRa Coverage using EDX Signal Pro 8.0

If this system was going to be implemented a better test site for the gateway would be used. The main reasons for using the Ergon Depot was ease to equipment for programming, power available and a secure environment. If this was to be implemented in a permanent location to trial, Ergon's Communications site at Gabbinbar Toowoomba would be a better option. For interest a coverage plot with the gateway at Gabbinbar and with higher gain antenna (7dB) would achieve an even better result (refer Figure 19).

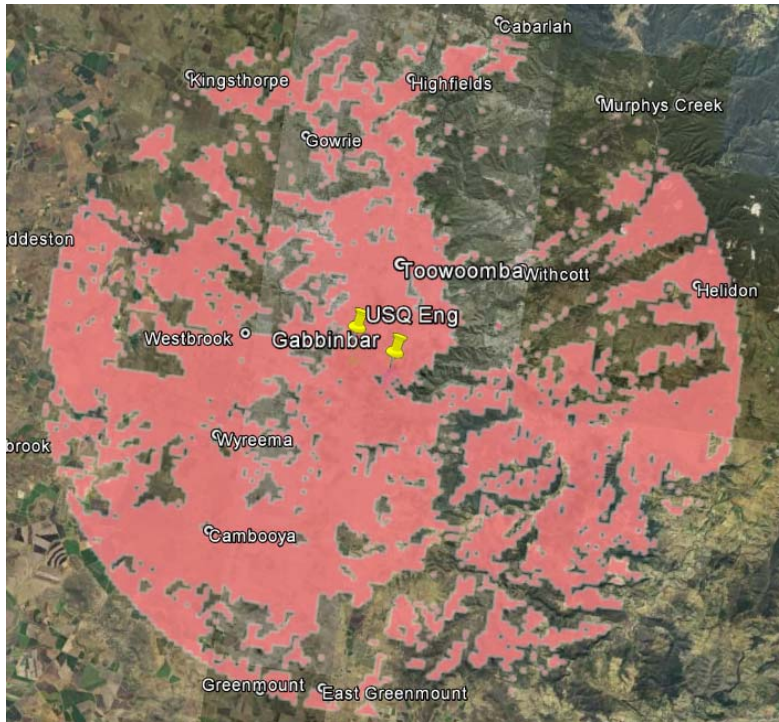

Figure 19: Gabbinbar Comms Site Predicted Coverage using EDX Signal Pro 8.0

3.2. Multitech mDot Theoretical range

The theoretical range of the Multitech LoRa mDot can be affected by many variables below

- TX Power
- Antenna Gain
- Receiver Sensitivity
- Fade Margin
- Curvature of the Earth

Figure 20 below is a formula that is provided in the Multitech mDot developer guide to calculate the theoretical maximum range of the mDot.

$$Range_{Miles} = 10^{\left(\frac{TxPower + Antenna\ gain\ total - RX\ Sensitivity - Fade\ Margin - 36.56}{20} - LOG_{10}(F_{MHz})\right)}$$

Figure 20: Multitech Multiconnect mDot Range (Multitech 2016)

The Range is in Miles but will be converted to work with kilometers. For a safe working RF system the Receiver sensitivity and fade margins used do give a large amount margin to allow for fading due to weather conditioners and environment noise. With this being the case the calculated range of the system has been set with a receiver sensitivity of -120dBm even though the LoRa module can go as low as -137dBm and a fade margin of 30dB will be used.

The mDot was configured for the Australian Spectrum and will use the following specifications

Table 1 mDot Configuration Settings to determine Predicated Range

| | |
|----------------------------|---------|
| Frequency | 915MHz |
| TX Power | 20dBm |
| Total TX & RX Antenna Gain | 0dB |
| RX Sensitivity | -120dBm |
| Fade Margin | 30dB |
| Range (km) | 11.44km |
| | |

Table 1 above shows the calculated range that the mDot should be able to communicate reliably to the gateway depending on the environment is a distance of 11.44km. If the sensitivity was taken to a figure of -137dBm an approximate range would be 23.5km.

3.3. LoRaWAN uses in the Electrical Distribution Industry

Currently most remote site applications in Queensland do not have very good cellular coverage and the industry has had to use very expensive and power hungry satellite options. Existing short range options are cheaper such as Bluetooth and Wi-Fi however do not have the required range. The low power requirement of a LoRa node together with the long range availability could provide access to data that was once not financially viable.

The following section will detail possible applications the technology could provide the industry. As described earlier in the chapter 2 the LoRaWAN has data rates ranging from 300bps to 50kbps depending on chip selection, distance, spreading factors and packet sizes required. Some of the possible scenarios will be discussed below.

3.3.1. Feeder Cabling Temperature sensing

Temperature sensing of LV, HV cabling is one application that would provide great benefits to the distribution industry. This would allow the network to be able to get a better picture of the network and provide efficiencies. The long range capabilities of the LoRa modulation would allow for numerous sensors over most parts of the network with little costs involved.

3.3.2. Substation Monitoring

There are various applications that could be used in a substation environment for example

- Monitoring of Electromagnetic Field Levels
- Transformer Oil Leak Detection
- Flood Sensors
- Remote Site Alarming i.e. Battery chargers
- Security Applications i.e. Gate Opening, Remote Recloser door alarms
- Gas Detection in Battery Rooms

3.3.3. Pad Mount Transformer

There are numerous pad mount transformers that would benefit from having some SCADA capabilities attached to them. As most new housing developments have underground power the use of pad mount transformers is ever growing. Some of the possible applications of LoRa modem end devices are

- Security Applications i.e. Door Opening
- Flood Detection
- Gas Detection
- Temperature Collection
- Oil Levels/Leaking

3.3.4. Metering Applications

Most likely the biggest application for a LoRaWAN is to be used in a metering application. The benefit of LoRa compared to a telecommunications carrier 4G network is the cost saving to set this system up. Coverage to cover a city does not require a large amount of gateways to provide good reception. The benefit

of having such coverage is the ability to monitor different tariffs, provide up to date usage and allow the customer to have more information regarding their energy usage.

Currently many manufacturers are beginning to adopt the LoRaWAN technology due to its robustness and long range capability. Companies that have begun to manufacture commercial devices with LoRa technology are ZTE and Digimondo. ZTE currently have three meters that contain a LoRa interface available, they are a single phase, single phase prepaid and three phase smart meters. ZTE smart meters can reach a sensitivity of -136 ± 1 dbm @ 240bs.

3.3.5. Solar Photovoltaic Installations

Another possible application for the LoRaWAN technology is also to monitor public and private solar applications. Once again the data can help with tariffs loading temperature and weather condition impacts onto the network. As the uptake of greener technologies is adopted LoRa is able to provide great low cost applications to help monitor these applications.

3.3.6. Demand Response Applications

Demand Response as described by Wikipedia states:

“Demand Response is a change in the power consumption of an electricity utility customer to better match the demand for power with the supply” (“Demand Response”, 2016)

By using this can help reduce demand in peak loading times and thus by doing this will allow the customer to have some financial reward by means of a cheaper tariff. The use of a LoRa smart meter could allow for the potential cost

saving provided by changing their power consumption requirements in peak periods.

3.4. Communication Requirements

There are numerous devices that the distributor could possibly communicate to as mentioned in the earlier section. Each of the mentioned possible applications will require certain communication requirements such as payload sizes, latency requirements, availability, security and how often the data is required. Due to use of the unlicensed spectrum and the possibly interference from other vendors in future years as the amount of devices increase it is best to use a LoRaWAN for devices with low transmission requirement using low data rates.

A paper on smart grid Communication network requirements (Kuzlu, Pipattanasomporn & Rahman, 2014) describes the required data rates, sampling requirements and latency times of numerous possible grid applications. From the paper some of the possible applications that the LoRa nodes could meet are shown in Table 2.

There are certain applications such as a meter firmware updates that could be up to 2000k bytes that would not be feasible in a LoRaWAN. Such applications would require another communications technology for a higher bandwidth.

Table 2 Communication Requirements (Kuzlu, Pipattanasomporn & Rahman, 2014)

| Application | Typical Data Size | Typical Data Requirement | Latency | Reliability |
|---|-------------------|----------------------------|---------|-------------|
| Meter Reading on demand from meter to utility | 100 bytes | As required | <15s | >98% |
| Demand Response Application from utility (load control) | 100 bytes | 1 per device per broadcast | <60s | >99.5% |
| Distribution Automation – Fault Detection | 25 bytes | 1 per event | <5s | >99.5% |
| Customer Info/Response from Utility | 50/200 bytes | As needed (7am-10pm) | <15s | >99% |

A helpful tool to help calculate possible time on air bit rates experimenting with different spreading factors is by using Semtech's LoRa modem calculator tool (refer Figure 21). The tool also helps to look at energy profiles which are very helpful for class 'A' devices (assumed to be battery operated).

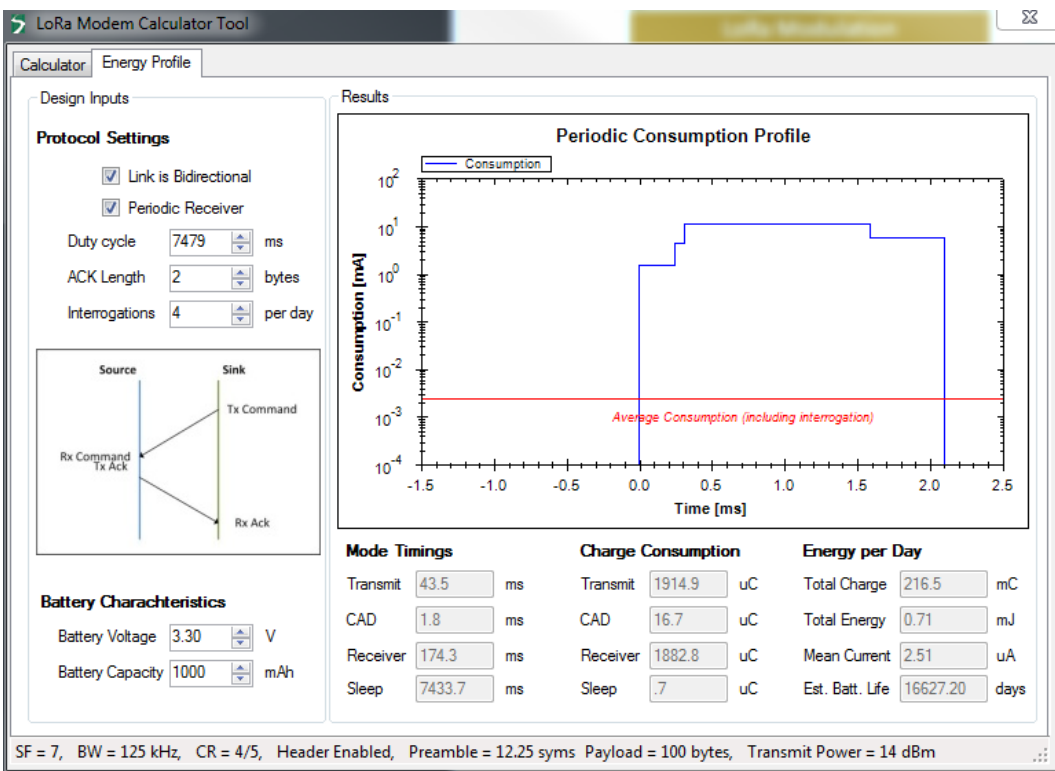
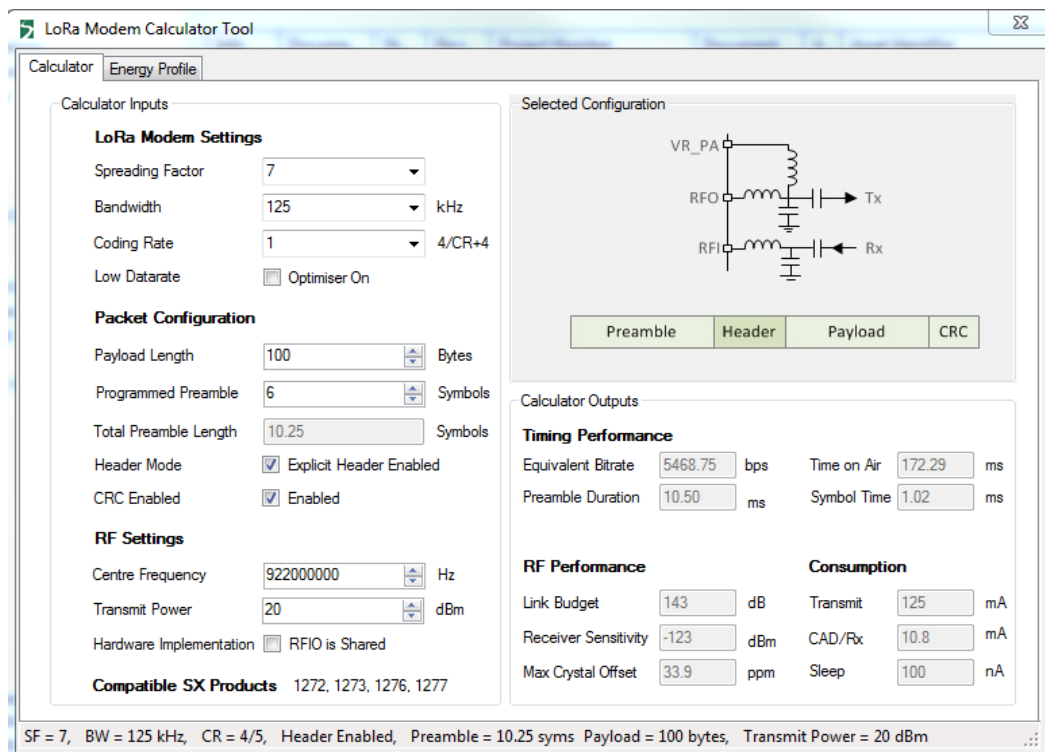

Figure 21: Semtech LoRa Modem Calculator (Semtech 2015)

The calculator allows input for numerous settings to be entered such as desired spreading factor, bandwidth, coding rate, payload lengths, centre frequency and transmit power. An example of the calculator could be with a demand response application. As detailed in Table 2 it would require a 100 byte packet and have to comply with ACMA/LoRaWAN regulations using a centre frequency of 922 MHz with a 20dBm transmit power.

Various spreading factors can be used but if a spreading factor of 7 with a bandwidth of 125 kHz is used a predicated time on air is 172.29ms which meets the latency requirements. With the use of the acknowledgement between network server and end device reliability requirements could be greatly increased. The use of an acknowledgement does increase the header information size which will also affect the latency timings.

4. LoRaWAN Test System Design

4.1. Introduction

The following LoRaWAN will be developed as a test system rather than a full working system using a cloud Network Server. Some of these factors are due to equipment sourcing, the relatively new age of the technology in Australia and the best environment to successfully test the equipment. As mentioned earlier the system will be using the Multitech mDot LoRa modem as the end device and a Multitech Conduit containing a LoRa M-card. The gateway also has an on-board development server from IBM called Node-Red which can simulate the network server. The test system will be configured as a private LoRa network rather than a public network (one that uses third party equipment for network server/gateways)

4.2. Gateway Design

Currently there are many manufacturers that are beginning to make gateways for use in the Australian Spectrum. The Multitech Conduit will be used equipped with a LoRa module M-card. The conduit is able to provide the system requirements at a reasonable cost and is able to be adapted to use for this project.

4.2.1. The Multitech MultiConnect Conduit

The Multitech Multiconnect Conduit (Figure 22) is a device that can be used as the gateway in a LoRaWAN network.



Figure 22: Multitech MultiConnect Conduit (Multitech Systems 2015)

The device can be configured for many different applications setups due to the available port options (refer Figure 23). For the research project only one of the available two interface cards will be used to equip the LoRa M-card. The M-card will provide the radio interface for the gateway. The gateway M-card has a maximum node amount of 3500 nodes.

The conduit has many benefits as the backhaul option to the network server can be via an Ethernet LAN connection or it can use a cellular backhaul option when equipped with a telco SIM card. The conduit works on wide voltage DC input of 9 to 32 volts thus can be easily powered from the supplied plug pack or from an external battery supply. Where the gateway/s will be installed will be in communication rooms or substations where the supplied can be guaranteed by either UPS or by easily running off the battery supply.

One issue in a live situation regarding powering of the device is having a single DC input, possibly in future release a second input would be advantageous so the

device does not power down in a supply fault or during maintenance of battery banks.

The device has various interfaces that can be used in different situations (refer to Figure 23 below).

Cell – For cellular Antenna

Aux – To provide cellular diversity

USB Device – USB 2.0 Micro USB connector that can be defined by the user

E-NET – Ethernet RJ45 10/100 BaseT Ethernet Port. As mentioned in the Manual this port is intended for private networks only

USB HOST - USB 2.0 Micro USB connector that can be defined by the user

AP1, AP2 – These ports are to allow or Multitech Accessary cards in this case for the LoRa Radio module

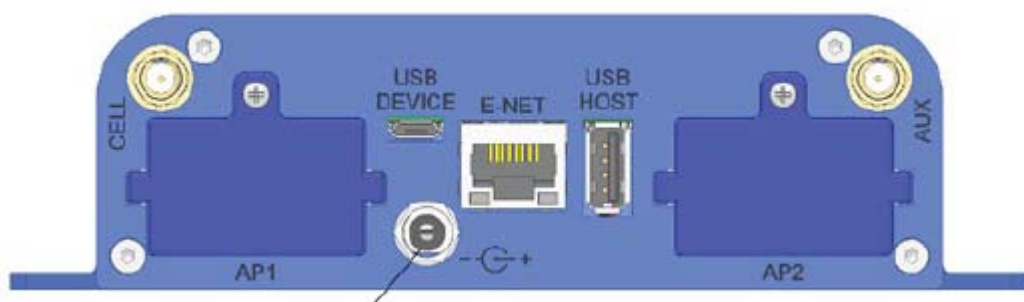

Figure 23: Multitech Conduit Rear Faced Connections (Multitech Systems, 2015)

4.3. Multitech Multiconnect mDot

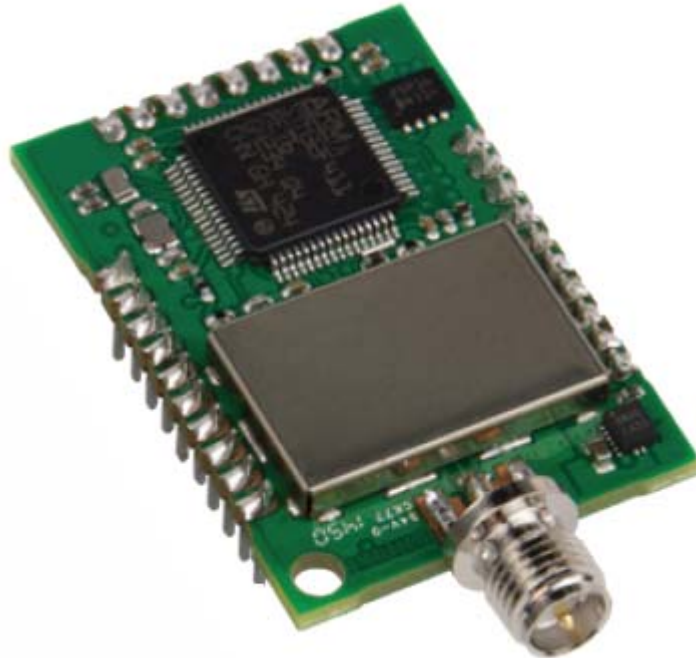

Figure 24: Multitech MultiConnect mDot (Multitech Systems 2015)

The Multitech mDot is a LoRa module that will be able to send data to the Multitech gateway. The model that will be used is the MTDOT-915 as it is able to interface to the developer board and works in the Australian frequency band. As described in chapter 2 it will be used as the end node device for this project.

Due to the nature of the LoRa modulation technique the chip has very good building penetration, works well in noisy environments and can be used in the Australian unlicensed spectrum of 915-928MHz. The chip can be programmed using its on-board development software using AT command interface or can also use Multitech's compiler on the internet to compile and transfer specially written coding.

The mDot card meets LoRaWAN specification v1.0 and in being so can be used as a class A, B or C device. At the time of the project minimal support for class 'B' and 'C' was available; however the supplier was changing this with future firmware releases.

The device has a very low power consumption having numerous options of sleep commands to help lower power consumption. Table 3 below is from the manufacturer regarding the power consumption of the device working at either 3.3 or 5V DC input. The figures are based on a situation much like what is will be used with the test platform - working in the 915Mhz band, TX/RX to a Multitech Conduit Gateway and using a voltage of 3.3V (from developer board).

Table 3: Power Consumption Draw for Multiconnect mDot – (Multitech Systems 2016)

| Voltage | Sleep Mode | Idle current Average (Amps) | Packet Size (Bytes) | Average Current (Amps) at Low Transmit Power Setting (TXP 2) | Average Current (Amps) at Default Transmit Power Setting (TXP 11) | Average Current (Amps) at Maximum Transmit Power Setting (TXP 20) | Total Inrush Charge Measured in Millicoulombs (mC) | Total Inrush Charge Duration during Powerup (InRush Duration) |
|------------|--|-----------------------------|---------------------|--|---|---|--|---|
| 3.3 | Stop mode (Sleep = 1) .45mA | 0.032 | 10 | 0.026 | 0.028 | 0.031 | 1.14 | 661uS |
| | Standby Mode (Sleep = 0) (Deep Sleep) 30uA | 0.032 | 53 | 0.026 | 0.029 | 0.041 | 1.14 | 661uS |
| 5.0 | Stop mode (Sleep = 1) .45mA | 0.032 | 10 | 0.026 | 0.028 | 0.032 | 1.79 | 1.24mS |
| | Standby Mode (Sleep = 0) (Deep Sleep) 40uA | 0.032 | 53 | 0.025 | 0.028 | 0.042 | 1.79 | 1.24mS |

The Multitech mDot LoRa modem provided the best option to use for the project due to the following factors

- Ability to interface with the Multiconnect Gateway
- Ability to use the serial interface
- Able to work in the Australia unlicensed spectrum band of 915-928Mhz
- Low Cost
- Low Power consumption
- Availability

The mDot card for the project will be used with a Multitech developer board MTUDK2-ST (Figure 25). The reasoning for this is ease of programming and to power the device. In future field applications the mDot could be designed to avoid this. A brief overview of the Multitech developer board

As seen below is the various options available to be configured on this board. The test platform will use the mbed USB connector to power the device, RS232 DB9 serial interface for programming of the mDot and to send/receive data.

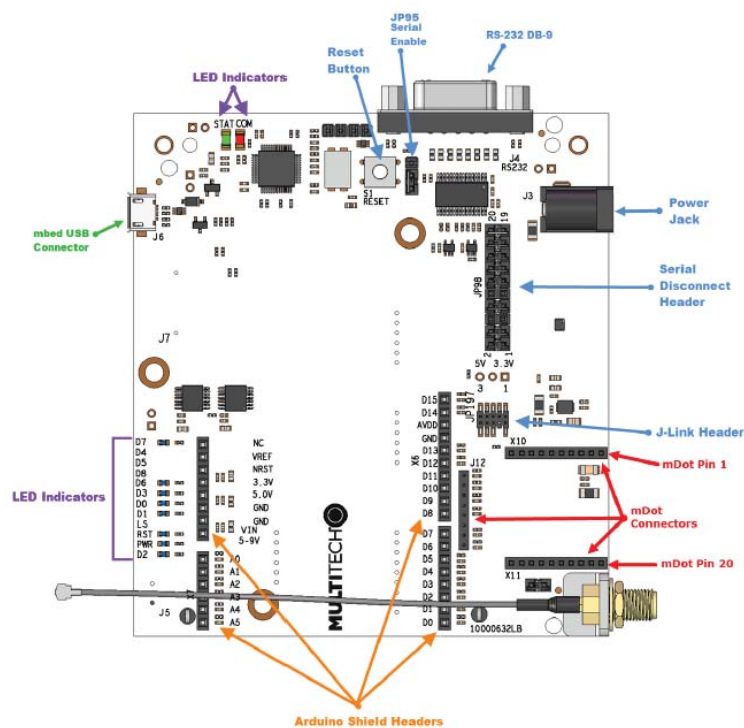

Figure 25: Multitech Developer board MTUDK2-ST (Multitech Systems 2015)

As shown in Figure 26 below the mDot is mounted directly onto this board.

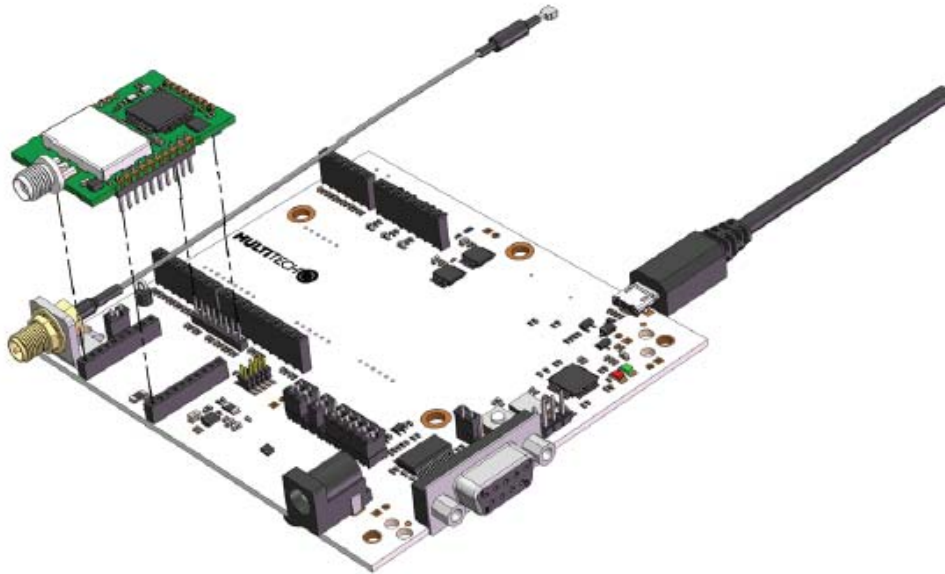

Figure 26: Multitech Developer board MTUDK2-ST (Multitech Systems 2015)

The antenna connection has been made directly onto the mDot card on the SMA port. There is the option to mount the antenna to the developer board but this did not provide any benefit to the test application.

4.4. Network Server

For ease of testing the test platform will use the Multitech Conduits on-board network server. The network server application was developed by IBM and is called Node-Red. Node-Red is an internet of things application that uses a browser editor to design the required working model. It allows the user to configure different types of logic with different protocol inputs/outputs and functions to suit the required application. The network server also has the benefit of a debug window to help see the incoming or outgoing payload.

4.5. Application Server

For the test environment that is to be developed there is no major requirement to source/develop an application server as such. There are a variety of applications on the market to suit different applications however for ease of the test environment with the current equipment available it has been determined that an application of putty/telnet will be used and will receive TCP packet data from the application server. This will still show the full LoRaWAN system working in a test environment.

5. LoRaWAN Test Platform Configuration

The LoRaWAN Test platform will be designed to simulate a fully working LoRaWAN system – A LoRa end node device, Gateway, Network Server and a software application to simulate the Application Server. The Components that have been chosen due to suitability and availability requirements are

- Multitech mDot LoRa Module for the End Device
- Multitech MultiConnect Conduit AEP with installed LoRa M-card Module for Gateway
- Node-Red Network Server (Installed on-board the Gateway)
- Terminal Session for the Application Server.

5.1. How the System will work

The LoRaWAN will be designed as two types of systems. One will be an end device transmission which will require acknowledgement that the data has arrived. The other system will be an end device transmission which will then receive data back from an application server.

The network will use a class “A” end node that will require an acknowledgement from the network server that the data has arrived. The data rate will be determined by the network server using an adaptive data rate scheme to maximise system coverage.

The test LoRaWAN system will initially configure the Gateway device then continue to configure the end node device and network/application servers.

5.1.1. Test setup 1

1. The end node device will transmit a certain size payload which will be received at the gateway.
2. The gateway will then pass this data through to the network server.
3. The network server would then pass the data through to the application server.
4. The application server will then send an acknowledgement back to the network server (With the test platform the acknowledgement will come from the network server.)
5. The network server will then select the gateway to send information to.
6. The gateway will then transmit the acknowledgement back to the end device

5.1.2. Test setup 2

1. The end node device will transmit a certain size payload which will be received at the gateway.
2. The gateway will then pass this data through to the network server.
3. The network server would then pass the data through to the application server. (With the test platform the data will send a response back from the network server.)

4. As the end device is a class 'A' device it will only receive data after a transmission in two scheduled receive windows. The network server will then send data back

5.2. Gateway - Multitech Multiconnect Conduit AEP Configuration

To initially construct the LoRaWAN network the Multitech Conduit gateway had to be configured. The model that was used had a GUI web interface which made programming of the device much easier than the Linux model. The initial setup was initially to connect a PC to the programmable E-NET port (refer chapter 4 for port allocations) of the conduit. The connection was completed by connected a LAN Ethernet cable from the PC LAN port to the gateways E-Net RJ45 port.

The conduit that has been selected is the AEP model that can be interfaced via its Ethernet port to a PC LAN port with a CAT5 Ethernet cable. The default IP-address to manage the conduit is (note using an IPV4 address):

IP Address 192.168.2.1
Subnet Mask 255.255.255.0

To access this address the PC will require a static address to be configured on its LAN port that fits in this range. For the project the PC was configured as

IP Address 192.168.2.2
Subnet Mask 255.255.255.0

Once configured a RJ45 CAT5 Ethernet/LAN cable was connected between the two devices. The next step in the configuration process is to open a browser window (Internet Explorer, Google Chrome, Mozilla Firefox etc.) on the PC.

In the browser window go to the address of the conduit of 192.168.2.1 and the Conduit login screen as shown in Figure 27 will appear .

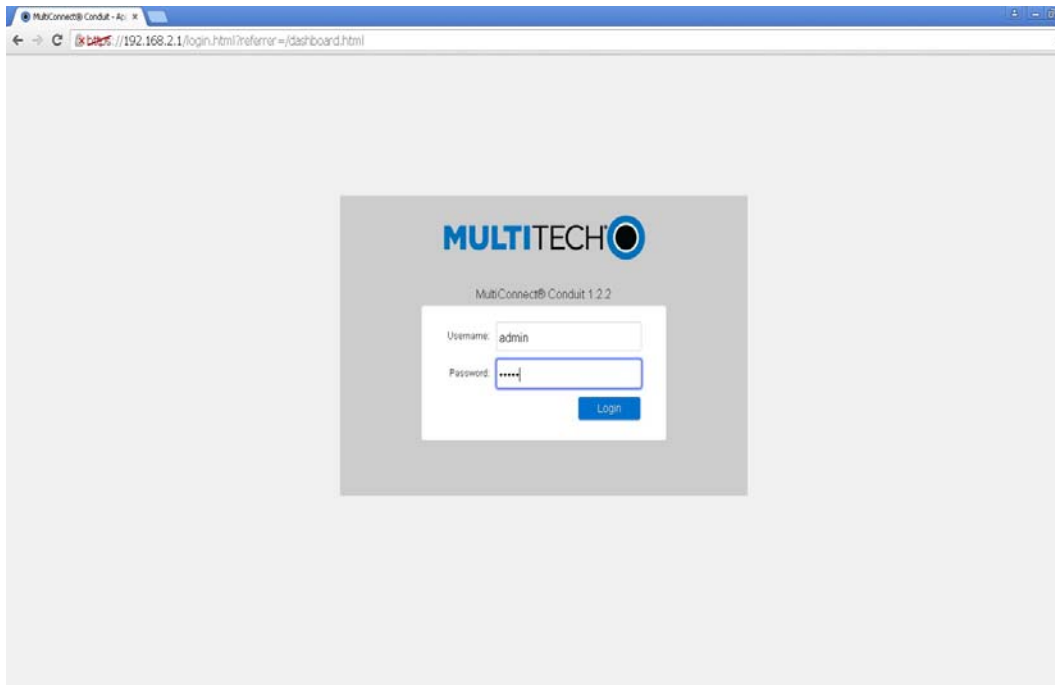

Figure 27: Multitech Conduit Login Screen

The default login details used are:

Username: admin

Password: admin

The following Steps will now configure the conduit

1. Once logged into the conduit if this is the unit's first login the following Figure 28 will appear. Proceed with the "Next" button

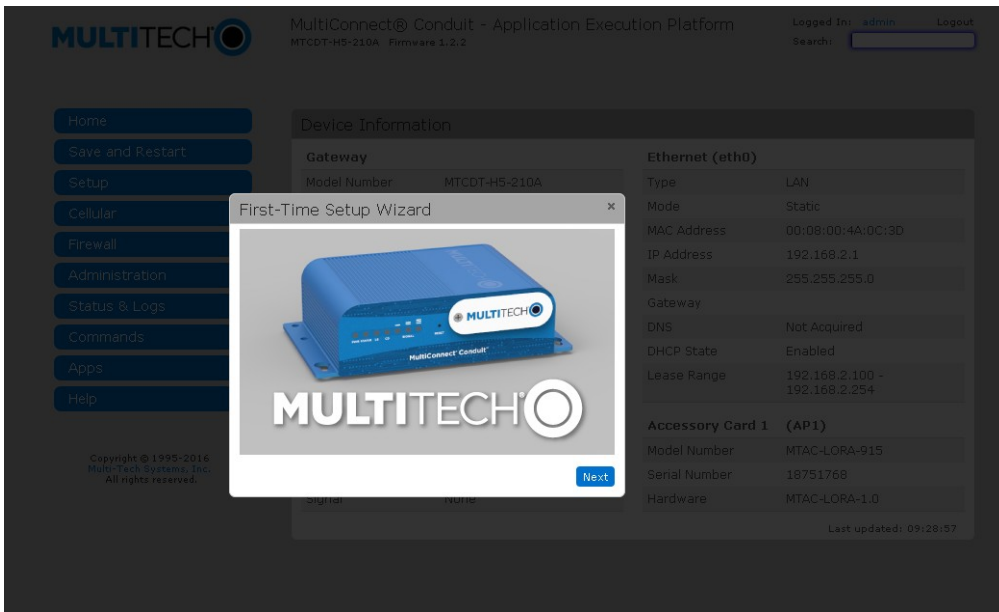

Figure 28: Multitech Conduit Wizard Step 1

2. The next step in the initial setup procedure is to setup the device password. The device kept the original so the “skip” button was used

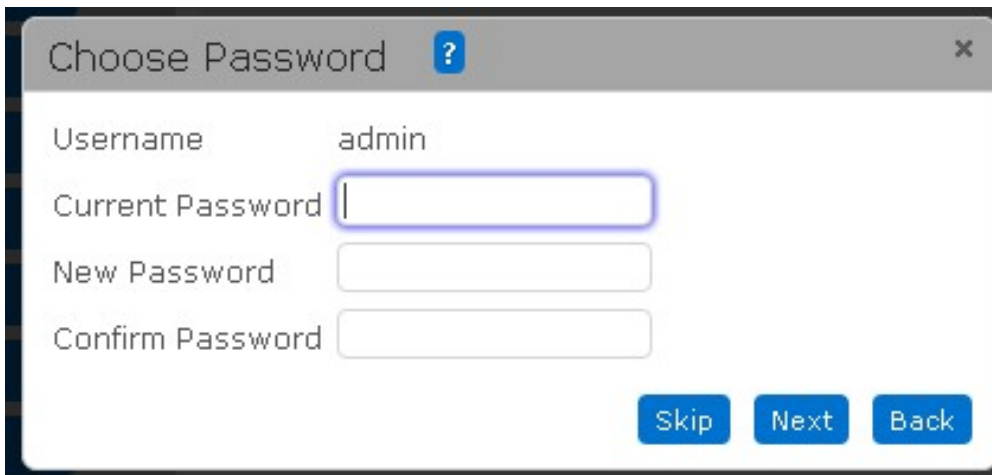

Figure 29: Multitech Conduit Wizard Step 2

3. Set the Current Date, Time and Time zone

Time Configuration ?

Current 08/16/2016 18:44:19 (UTC)

Date MM/DD/YYYY

Time HH:MM (24 hr)

Time Zone UTC ▼

Next Back

Figure 30: Multitech Conduit Wizard Step 3

4. As the conduit can use a cellular backhaul option (with a SIM card installed) this is where it can be setup. This option was not used and thus skipped.

Cellular PPP Configuration ?

Enabled

Diversity

Dial-on-Demand

APN

Next Back

Figure 31: Multitech Conduit Wizard Step 4

5. Once again process can be skipped

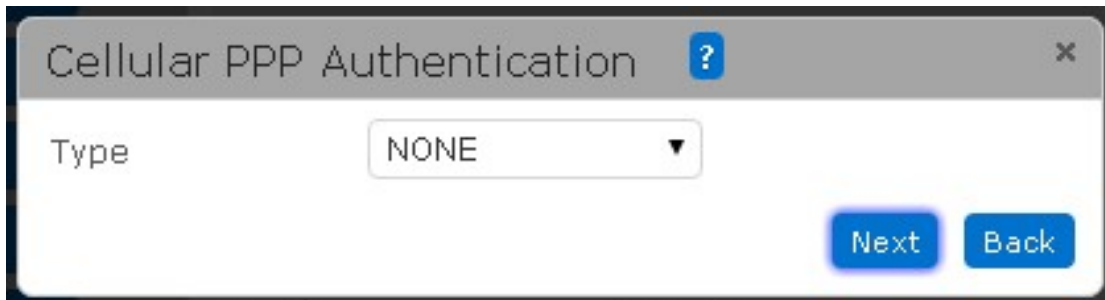

Figure 32: Multitech Conduit Wizard Step 5

6. The Conduit will now give the option to configure a new IP-address for the device by either using a static or a dynamically assigned address using a DHCP server if it was going onto a private network. The project kept the standard IP-address

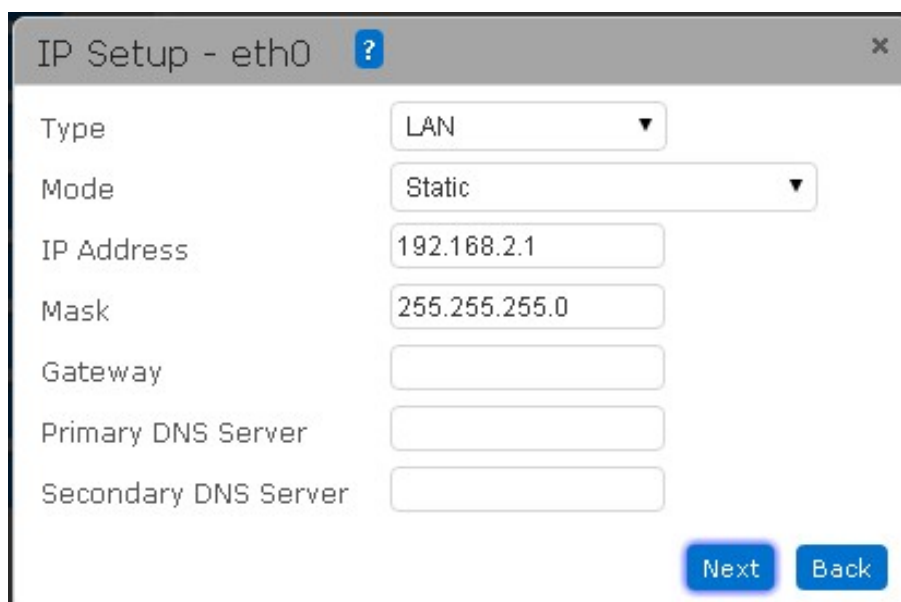

Figure 33: Multitech Conduit Wizard Step 6

7. The conduit will now need the access configuration setup for the device. It will allow different ports to be used on a browser window and the option of using a more secure window with https. Access will be left as only via the LAN Ethernet interface however the device could be setup to allow configuration on the WAN interface. As this is a test situation the defaults will be kept.

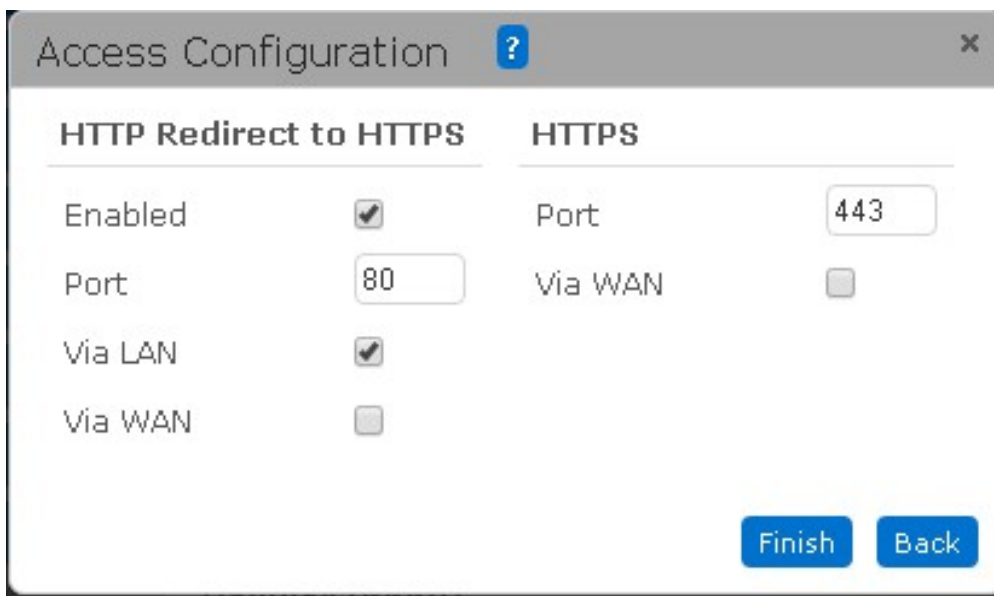

Figure 34: Multitech Conduit Wizard Step 7

8. The initial setup is now completed for the conduit. The setup for the LoRa gateway will now continue. To setup the LoRa Network the setup will be selected and then the LoRa Network Server tab selected. The following options will then be configured (refer Figure 35)

Enabled = Checkbox ticked - To enable the use of the installed mDot card

Frequency Band = 915 MHz - in this current Model only option (Firmware Upgrade to Conduit AEP was required to make ready for Australia)

Frequency Sub-Band = 5 (Initially set as a spreading factor of 5 however can be modified later for testing)

TX Power = User defined for LoS testing set to 20dBm

RX Offset 1 = Receive window one offset, left as standard can be modified if required

RX Offset 2 = Receive window two offset, left as standard can be modified if required

Network ID = User defined "ergconduit" (Multitech hexadecimal converted to be AppEUI)

Network Key = User defined "ergconduit" (Multitech hexadecimal converted to be AppKey)

Mode = Network Server (option of packet forwarder if using an external network server)

Public = Not ticked (using test as a private LPWAN)

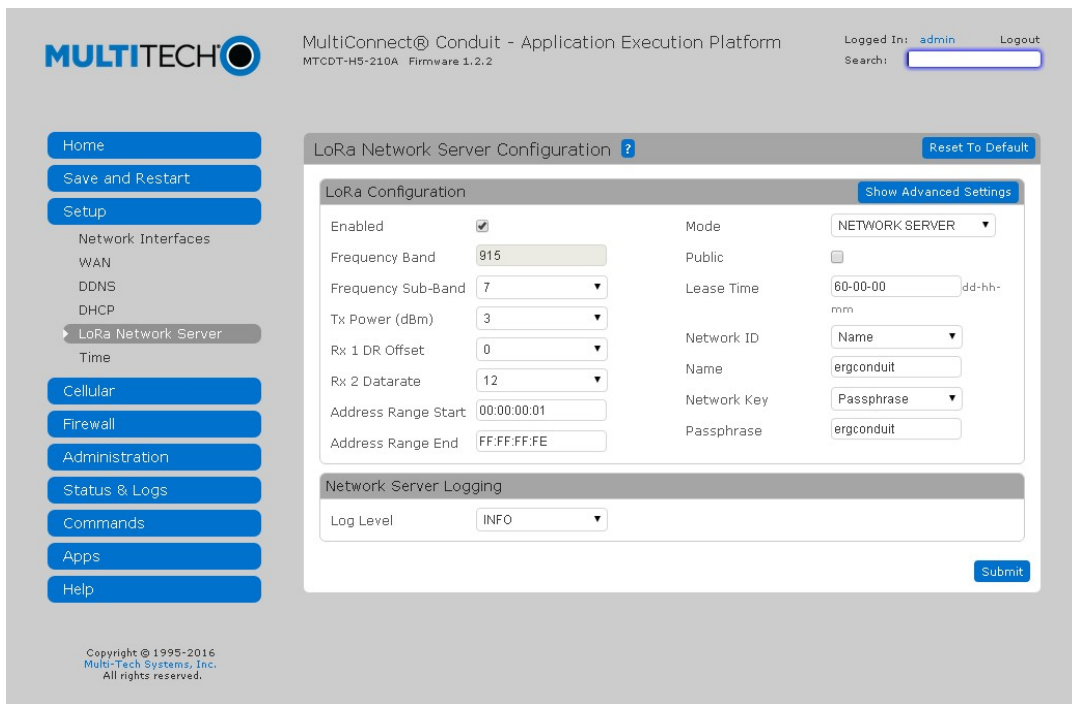

Figure 35: Multitech Conduit LoRa Configuration

5.3. End Device – Multitech mDot Configuration

As per section 4.3 the Multitech mDot has been installed onto a development platform board MDUK-TUK. This allows for ease of configuration as the test board is able to power the mDot as well as provide a DB9 RS232 interface. The mDot naturally comes with an AT+ command interface which will allow set commands to be used to program the mDot.

The AT+ command interface commands can be found in the Multitech Multiconnect Dot Reference guide. It is now assumed that at this stage the Multitech Conduit has been configured (Section 5.2) and is ready to interface with the mDot. The mDot will be configured by the DB9 interface on the developer board with a serial cable to the PC's serial port.

Once cabled the mDot will be accessed using a putty/terminal session. The Serial settings to create the terminal session are

Baud Rate = 115,200

Data bits = 8

Parity = None

Stop Bits = 1

Flow Control = Not used

The session window will now be shown below and a “?” will show available commands available to the version of firmware that is currently running on the mDot.

The test device initially required later firmware to allow for the device to work successfully in the Australia spectrum. The device firmware was upgraded using the set procedure for Multitech systems. This can be seen from the Appendix C. Once upgraded the mDot firmware status was shown using the command ATI (refer Figure 36)

```
ATI
MultiTech mDot
Firmware: 2.0.1-debug
Library : 2.0.1-debug
OK
```

Figure 36: Multitech mDot ATI command

5.3.1. Multitech mDot Setup Procedure

The following steps will detail the mDot setup procedure

1. Configure the mDot to the Australian frequency band of 915MHz.
AT+FREQ=AU915
2. Configure the required Frequency Sub band
AT+FSB=5 (Will set device to 5 to match Conduit)
3. Configure the mDot to Receive Acknowledgment from Network Server
AT+ACK=1
4. Configure mDot Network Key (App key in LoRaWAN)
AT+NK=ergconduit
5. Configure mDot Network Id (App EUI in LoRaWAN)
AT+NI=ergconduit
6. Join mDot to Gateway
AT+JOIN

Once joined the mDot should respond with a network successfully joined as shown in Figure 37

```
AT+JOIN
Successfully joined network
OK
```

Figure 37: Multitech mDot AT+JOIN command

If the node does not connect it will respond with an error unable to join network.

7. Configuration of ADR

```
AT+ADR=1
```

8. Configure device class (For testing a class 'A' device will be used)

```
AT+DC=A
```

9. Configure device to receive data as raw otherwise device will show hexadecimal (for ease of reading)

```
AT+RXO=1
```

10. Device settings can now be saved to the device

```
AT&W
```

11. Restart the mDot

```
ATZ
```

12. The mDot settings can be displayed with the AT&V command

```
COM1 - PuTTY
at&v
Frequency Band: AU915
Frequency Sub Band: 5
Public Network: off
Start Up Mode: COMMAND
Network Address: 00000001
Network ID: 8d:96:8d:72:54:18:77:2c
Network ID Passphrase: ergconduit
Network Key: 03.34.b9.fb.a5.92.1b.54.8f.97.d7.1e.e1.71.c2.32
Network Key Passphrase: ergconduit
Network Session Key: d3.9c.b2.00.a2.9a.5c.42.eb.67.6e.ad.83.08.b5.19
Data Session Key: b1.57.41.bf.a3.93.b5.75.8c.44.08.d0.12.cc.f4.ee
Network Join Mode: OTA
Network Join Retries: 2
Preserve Session: off
Join Byte Order: LSB
Join Delay: 1
Join Rx1 DR Offset: 0
Join Rx2 Datarate: DR8 - SF12BW500
Join Rx2 Frequency: 923300000
App Port: 1
Link Check Threshold: off
Link Check Count: off
Error Correction: 1 bytes
ACK Retries: 1
Packet Repeat: 1
Encryption: on
CRC: on
Adaptive Data Rate: on
Command Echo: on
Verbose Response: off
TX Frequency: 0
TX Data Rate: DR3 - SF7BW125
TX Power: 11
TX Antenna Gain: 1
TX Wait: on
TX Inverted Signal: off
RX Delay: 1 s
RX Inverted Signal: on
RX Output Style: BINARY
Debug Baud Rate: 115200
Serial Baud Rate: 115200
Serial Flow Control: off
Serial Clear On Error: on
Wake Mode: INTERVAL
Wake Interval: 10 s
Wake Delay: 100 ms
Wake Timeout: 20 ms
Wake Pin: D18
Log Level: 0
```

Figure 38: Multitech mDot AT&V display settings command

The mDot is now be configured to TX/RX with the gateway/network server.

5.4. Network Server Configuration

The Node-red application that has been installed has the option to use LoRa input and outputs pre-configured in the device.

The Project will use two different network server setups depending on what test is required. The two test platforms will be one that is to transmit and receive data between gateway/end device which will then be used for some Line of sight distance checks. The other setup will simulate the data from the end node being

transmitted to the network server which will then forward this data via a TCP packet to terminal session which will simulate the application server.

5.4.1. LoRa End node Communication to Network Server

5.4.1.1. mDot Communication to network server no acknowledgment class 'A' device

The following network server configuration in Node-Red is to test the functionality of the LoRa modulation technique between the end node and Gateway device and show transmission between these devices. Figure 39 below is the Node-Red Browser design.

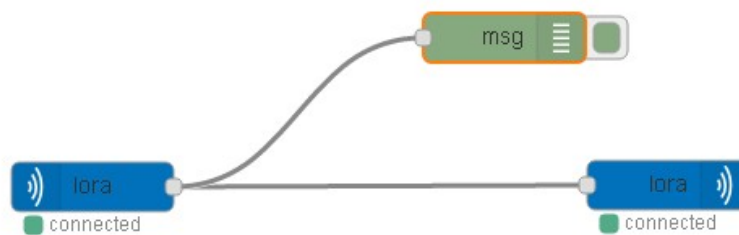

Figure 39: Node-Red Network Server Configuration

It has been configured by selecting from the side menu a LoRa Input and interfacing it with a LoRa Output. A debug window was used to show any data that was transmitted to the end node to the network server. The debug window can be configured to show just the payload data (Figure 40).



Figure 40: Node-Red Debug Message Property Only

The debug window can also be configured to display the full message object (Figure 41).

```
[msg] : object
{ "chan": 4, "cls": 0, "codr": "4/5", "datr":
"SF7BW125", "freq": "922.4", "lsnr": "11.5",
"mhdr": "8001000000800200", "modu":
"LORA", "opts": "", "port": 1, "rfch": 1, "rssi":
-93, "seqn": 2, "size": 32, "timestamp":
"2016-09-05T23:01:32.310514Z", "trnst":
1846591875, "payload": "USQ PROJECT
Kurt Beutel", "eui": "00-80-00-00-00-00-b2-
dd", "_msgid": "eeb3d90b.114c28" }
```

Figure 41: Node-Red Debug Window Complete MSG Object

The full message will detail RSSI levels, SNR, Spreading Factor and Bandwidth used, what channel was used, coding rate and size of the payload.

The input and output are joined together which will then activate a deploy button selection. Once deployed the network server will then activate the system for testing. How the system works is when the end node device transmits to the gateway and thus the network server the data is then sent back to the end node device.

With the use of the debug window any transmission incoming to the server from the end node will appear in the debug window. As the test platform will use a class "A" end device (refer sect 2.3.3.1) the device will only receive data after it initially sends a transmission.

5.4.1.2. Network Server Configuration for Full LoRaWAN Test System Design

To test the full LoRaWAN system the following network server configuration has been completed using two Node-Red sessions one use a UDP packet and the other using a TCP packet. The System will still use a LoRa input and send this information to the gateway/network server which will forward this information onto an application server. As the network server is on-board the conduit the Ethernet LAN port will then forward the payload onto the server. The first test will use a LoRa input to UDP output (UDP is a connectionless protocol more focused on latency speeds than reliability) and the second will use a LoRa input to a TCP output (TCP is a connection protocol for more reliable transmission)

UDP TEST 1

The Network Server (Node-Red) has been configured as per Figure 42

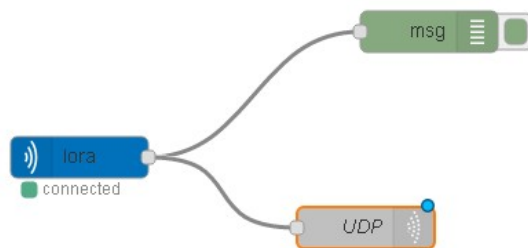

Figure 42: Node-Red UDP Configuration

The LoRa input is connected to a UDP output. The UDP output has to be configured to the application server's IP-address (in this case PC address of 192.168.2.2) and also detail what UDP port is to be used (port 2000). The packet sender program will be configured to listen for UDP data on port 2000.

TCP TEST 2

The Network Server (Node-Red) has been configured as per Figure 43

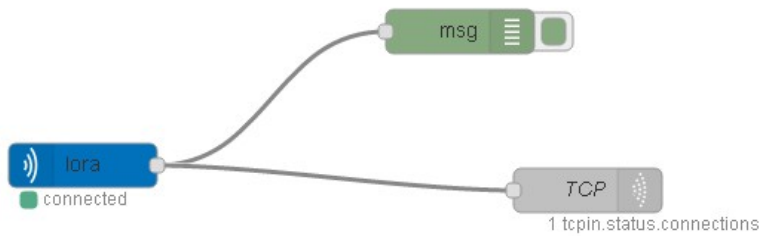

Figure 43: Node-Red TCP Configuration

The LoRa input is connected to a TCP output. The TCP output has to be configured to the application server's IP-address (in this case PC address of 192.168.2.2) and also detail what TCP port is to be used (port 1782). The Terminal window will be configured as per Figure 44. The IP-address will be the network server of 192.169.2.1 and the TCP port that is network server is outputting has been set 1782).

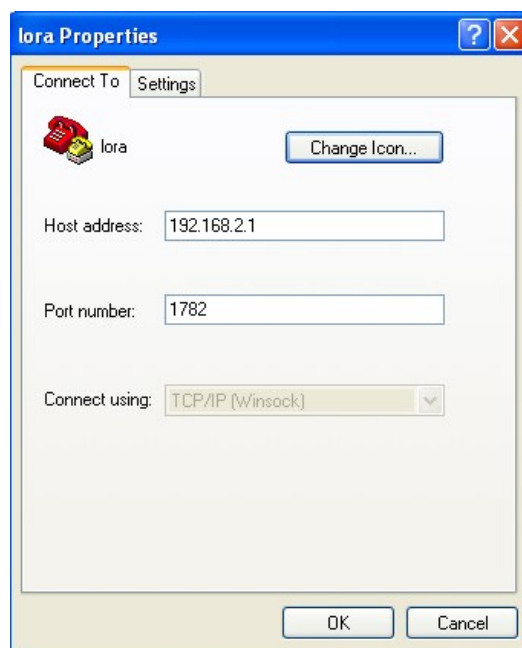

Figure 44: Terminal Session Configuration

Once the connection is established with Node-Red the TCP output will show a connection.

5.5. Application Server Design

To simulate the application server the local connected PC will be used with a packet sender/receiver program (for UDP) and a terminal session (for TCP). The Conduit will require the firewall settings modified to allow for incoming and outgoing TCP/UDP data. Once the connection is established the TCP output in Node-Red Network server should show “connected” and the session is ready to receive data from the End node device. The UDP payload being connectionless will not show a connection in Node-Red.

6. Project Testing

The following chapter details the LoRaWAN testing that was performed once the devices were configured as per Chapter 5. The tests that will be performed is coverage tests - line of site in a rural environment using locations from the predicated path modelling as well as urban coverage checks with terrain/building obstructions. The testing will also complete lab testing to show data transmission of a complete LoRaWAN system back to an application server simulation. Testing will use a packet sizing range for possible known applications for example a demand response poll from a device such as a smart meter.

6.1. Lab Environment Testing

6.1.1. mDot Communication to network server to test acknowledgment with class 'A' device

The Network Server configuration Figure 45 below

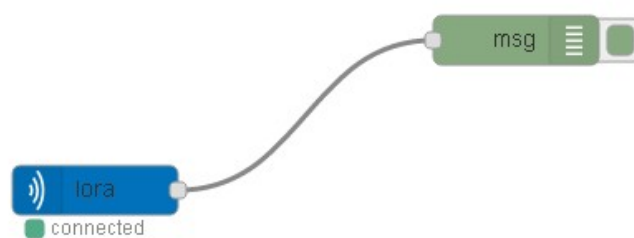

Figure 45: Node Red LoRa Setup

As shown it is a very basic LoRa input which will display payload information in the debug window. This will be used to test the acknowledgement function between network server and end device.

6.1.1.1. mDot Communication to network server no acknowledgment with class 'A' device

To test a basic LoRa class 'A' device with no acknowledgement (where end node transmits and does not care if information reaches its destination). The mDot configuration for acknowledgement had to be changed from the initial setup and the following command was used to disable it.

```
AT+ACK=0
```

The gateway was then powered off and some data was then sent from the end device. To send data from the mDot the AT+SEND command was used

```
AT+SEND USQ PROJECT Kurt Beutel
```

As shown in Figure 46 the end device did not show any errors and proved the end device was not worried whether the data arrived at destination or not.



```
AT+SEND USQ PROJECT Kurt Beutel
OK
```

A terminal window with a black background and white text. The first line shows the command 'AT+SEND USQ PROJECT Kurt Beutel'. The second line shows the response 'OK'. A small red cursor is visible at the end of the 'OK' line.

Figure 46: Multitech mDot AT+SEND No ACK

6.1.1.2. mDot Communication to network server with acknowledgment with class 'A' device

To test LoRa class 'A' device with acknowledgement (where end node transmits and does care if information reaches its destination). The mDot configuration had to be changed back to the initial setup and set the following command

```
AT+ACK=1
```

The gateway was then powered off and using the AT+SEND command in the mDot, data (USQ PROJECT Kurt Beutel) was sent to the gateway. As shown in Figure 47 the device did bring the error ACK not received.

```
AT+SEND USQ PROJECT Kurt Beutel
ACK not received

ERROR
```

A terminal window with a black background and white text. The text shows the command 'AT+SEND USQ PROJECT Kurt Beutel' followed by the response 'ACK not received' and then 'ERROR'. A small green cursor is visible at the end of the 'ERROR' line.

Figure 47: Multitech mDot AT+SEND with ACK G/way off

With the gateway now powered on and mDot connected to the network the data was re sent. As shown in Figure 48 the acknowledgement was received as end device did not get any errors.

```
AT+SEND USQ PROJECT Kurt Beutel

OK
```

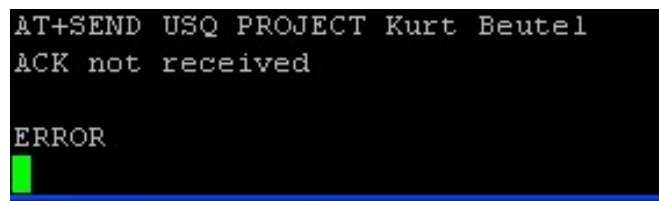
A terminal window with a black background and white text. The text shows the command 'AT+SEND USQ PROJECT Kurt Beutel' followed by the response 'OK'. A small green cursor is visible at the end of the 'OK' line.

Figure 48: Multitech mDot AT+SEND with ACK G/way on

6.1.1.3. Class "A" mDot TX/RX Communication

To test the transmission of data between the end device and network server the configuration in Figure 49 was used.

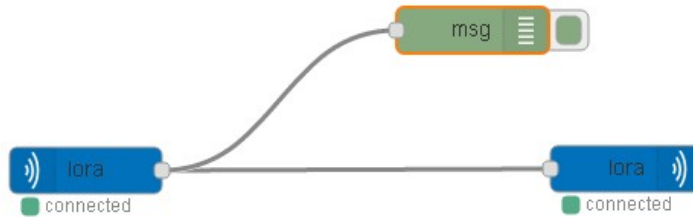

Figure 49 Node-Red Configuration

The AT+SEND command was used again in the mDot and as shown in Figure 50 below the data was received in the mDot (received payload from the Network Server is shown on the second line).

```
SEND USQ PROJECT Kurt Beutel
USQ PROJECT Kurt Beutel

OK
```

Figure 50: Multitech mDot SEND/RECEIVE with ACK

6.1.2. LoRaWAN Testing

6.1.2.1. End Device to Application Server using UDP Output

To test the full LoRaWAN system to a simulated application server the test was configured as per chapter 5 design. It is assumed that the end device, gateway network server (UDP TEST1) and application software have been configured correctly. The command AT+SEND was then used in the end device to send “USQ PROJECT Kurt Beutel” as shown in Figure 48 (Note each character equals to 1 byte of data). The data can be seen reaching the network server in the debug window in Figure 51 below (note payload).

```
[msg] : object
{ "chan": 4, "cls": 0, "codr": "4/5", "datr":
"SF7BW125", "freq": "922.4", "lsnr": "11.5",
"mhdr": "8001000000800200", "modu":
"LORA", "opts": "", "port": 1, "rfch": 1, "rssi":
-93, "seqn": 2, "size": 32, "timestamp":
"2016-09-05T23:01:32.310514Z", "tmst":
1846591875, "payload": "USQ PROJECT
Kurt Beutel", "eui": "00-80-00-00-00-00-b2-
dd", "_msgid": "eeb3d90b.114c28" }
```

Figure 51: Node-Red Debug UDP Output

The network server then forwards the payload out the LAN port on to the simulated application server. This can be seen by listening to the LAN port connected to the PC (simulated app server) with a Wireshark capture (Figure 52). The capture shows the UDP protocol from the network server 192.168.2.1 to application server 192.168.2.2 and also the data in the packet USQ PROJECT Kurt Beutel

| No. - | Time | Source | Destination | Protocol | Info |
|-------|----------|-------------|-------------|----------|--|
| 1 | 0.000000 | 192.168.2.1 | 192.168.2.2 | UDP | Source port: 46327 Destination port: cisco-sccc |
| 2 | 0.003585 | 192.168.2.1 | 192.168.2.2 | TCP | vsat-control > 1232 [PSH, ACK] Seq=1 Ack=1 Win=1124 Len=359 TSV=221001 TSER=946193 |
| 3 | 0.149337 | 192.168.2.2 | 192.168.2.1 | TCP | 1232 > vsat-control [ACK] Seq=1 Ack=360 Win=32768 Len=0 TSV=946270 TSER=221001 |

| | | | | | | | | | | | | | | | | | |
|------|----|----|----|----|----|----|----|----|----|----|----|----|----|----|----|----|-------------------|
| 0000 | 64 | 31 | 50 | 89 | 3b | 1f | 00 | 08 | 00 | 4a | 0c | 3d | 08 | 00 | 45 | 00 | d1P.;... .J.=..E. |
| 0010 | 00 | 33 | 42 | ef | 40 | 00 | 40 | 11 | 72 | 77 | c0 | a8 | 02 | 01 | c0 | a8 | .3B.@.@. rw..... |
| 0020 | 02 | 02 | b4 | f7 | 07 | d0 | 00 | 1f | ba | 19 | 55 | 53 | 51 | 20 | 50 | 52 |USQ PR |
| 0030 | 4f | 4a | 45 | 43 | 54 | 20 | 4b | 75 | 72 | 74 | 20 | 42 | 65 | 75 | 74 | 65 | OBJECT Kurt Beute |
| 0040 | 6c | | | | | | | | | | | | | | | | l |

Figure 52: Wireshark Capture UDP

Finally the data can now be shown in the PC simulated application server Packet Sender Program (Figure 53)

| | Time | From IP | From Port | To IP | To Port | Method | Error | ASCII | Hex |
|---|-----------------|-------------|-----------|-------|---------|--------|-------|-------------------------|--|
| 1 | 11:19:22.437 am | 192.168.2.1 | 46327 | You | 2000 | UDP | | USQ PROJECT Kurt Beutel | 55 53 51 20 50 52 4f 4a 45 43 54 20 4b 75 72 74 20 42 65 75 74 65 6c |

Figure 53: Packet Sender Payload

6.1.2.2. End Device to Application Server using TCP Output

It is assumed that the end device, gateway network server (TCP TEST2) and application software have been configured correctly.

The command AT+SEND was then used in the end device to send “USQ PROJECT Kurt Beutel” as shown in Figure 48. The data can be seen reaching the network server in the debug window in Figure 54 below. The payload was sent to the server twice to show how the gateway can use different channels to receive from multiple devices. One of the transmissions used is ch4 922.4 MHz and another used is ch7 923MHz.

```

{ "chan": 4, "cls": 0, "codr": "4/5", "datr": "SF7BW125", "freq":
"922.4", "lsnr": "9.8", "mhdr": "800100000800200", "modu":
"LORA", "opts": "", "port": 1, "rfch": 1, "rssi": -57, "seqn": 2,
"size": 32, "timestamp": "2016-09-06T20:30:51.844711Z",
"trnst": 2095808539, "payload": "USQ PROJECT Kurt Beutel",
"eui": "00-80-00-00-00-b2-dd", "_msgid":
"fbf326bf.040cd8" }

[msg] : object
{ "chan": 7, "cls": 0, "codr": "4/5", "datr": "SF7BW125", "freq":
"923", "lsnr": "10.2", "mhdr": "800100000800100", "modu":
"LORA", "opts": "", "port": 1, "rfch": 1, "rssi": -58, "seqn": 1,
"size": 32, "timestamp": "2016-09-06T20:30:04.532622Z",
"trnst": 2048484932, "payload": "USQ PROJECT Kurt Beutel",
"eui": "00-80-00-00-00-b2-dd", "_msgid":
"2018b0e8.dfe75" }

```

Figure 54: Node-Red Debug TCP Output AT+SEND used twice

The network server then forwards the payload out the LAN port on to the simulated application server. This can be seen by listening to the LAN port connected to the PC (simulated app server) with a Wireshark capture (Figure 55). The capture shows the UDP protocol from the network server 192.168.2.1 to application server 192.168.2.2 and also the data in the packet USQ PROJECT Kurt Beutel

| No. - | Time | Source | Destination | Protocol | Info |
|-------|----------|-------------|---------------|----------|---|
| 1 | 0.000000 | 192.168.2.2 | 192.168.2.255 | UDP | Source port: iad2 destination port: hlsrver |
| 2 | 3.157242 | 192.168.2.1 | 192.168.2.2 | TCP | hp-hcip > isbconference1 [PSH, ACK] Seq=1 Ack=1 win=905 Len=23 TSV=184539 TSER=942148 |
| 3 | 3.169307 | 192.168.2.1 | 192.168.2.2 | TCP | vsat-control > 1232 [PSH, ACK] Seq=1 Ack=1 win=1124 Len=359 TSV=184540 TSER=942471 |
| 4 | 3.343685 | 192.168.2.2 | 192.168.2.1 | TCP | isbconference1 > hp-hcip [ACK] Seq=1 Ack=24 win=64205 Len=0 TSV=942620 TSER=184539 |
| 5 | 3.343686 | 192.168.2.2 | 192.168.2.1 | TCP | 1232 > vsat-control [ACK] Seq=1 Ack=360 win=32157 Len=0 TSV=942620 TSER=184540 |

| | | | |
|------|-------------------------|-------------------------|-------------------|
| 0000 | 64 31 50 89 3b 1f 00 08 | 00 4a 0c 3d 08 00 45 00 | d1P.;... .J.=..E. |
| 0010 | 00 4b 4b d2 40 00 40 06 | 69 87 c0 a8 02 01 c0 a8 | .KK.@. i..... |
| 0020 | 02 02 06 f6 04 dc 16 6d | cd 4a 61 e6 ee 19 80 18 |m .Ja..... |
| 0030 | 03 89 79 8c 00 00 01 01 | 08 0a 00 02 d0 db 00 0e | ..y..... |
| 0040 | 60 44 55 53 51 20 50 52 | 4f 4a 45 43 54 20 4b 75 | USQ PR OJECT KU |
| 0050 | 72 74 20 42 65 75 74 65 | 6c | rt Beute] |

Figure 55: Wireshark Capture TCP

Finally the data can now be shown in the PC simulated application server Terminal window (Figure 56)

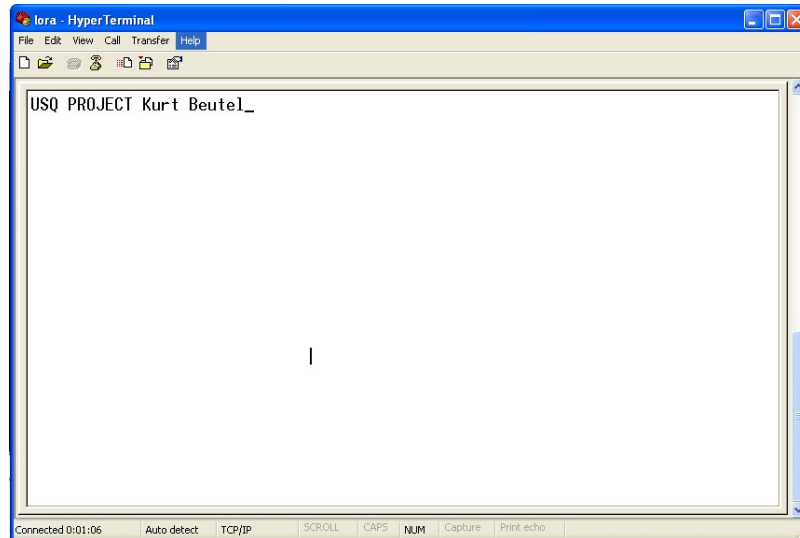

Figure 56: Terminal Window

6.2. Line Of Sight Testing - Rural

Line of Sight tests were performed at four sites in the Toowoomba region. The sites were chosen from the predicated coverage model from radio mobile as shown in Chapter 3.1. One of the locations is in a semi urban environment and the three remaining sites will be in a rural environment to determine line of sight distance coverage. Coverage strength RSSI levels, Signal to Noise Ratio and data transmission will be undertaken from each site. To test this simulation the following setup will be used for all scenarios.

- End Devices will be configured as a class “A” device
- Tests will use a 25, 50 and 100 byte payload
- Each Payload will be sent 5 times
- Acknowledgment will be required
- An Adaptive Data Rate (ADR) schema will be used
- 922Mhz frequency band will be used

6.2.1. Test Location A

Line of Sight testing was completed in Toowoomba between the following positions (refer Figure 57)

Gateway

GPS coordinates - Latitude 27deg33'18.42"S Longitude 151deg52'54.83"E

Elevation - 629m

Test Location A

GPS coordinates - Latitude 27deg33'15.7"S Longitude 151deg52'51.96"E

Elevation - 585m

The line of sight distance was approximately 4.18km.

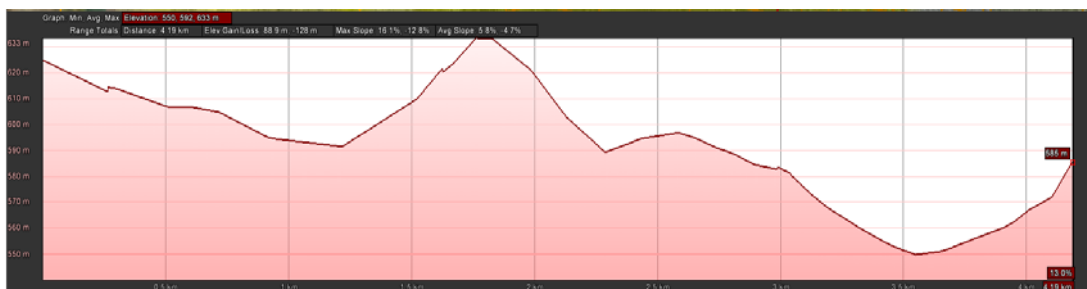

Figure 57: Test Location A Path & Elevation Profile

6.2.2. Test Location B

Line of Sight testing was completed in Toowoomba between the following positions (refer Figure 58)

Gateway

GPS coordinates - Latitude 27deg33'18.42"S Longitude 151deg52'54.83"E

Elevation - 629m

Test Location B

GPS co-ordinates - Latitude 27deg35'39.36"S Longitude 151deg51'54.65"E

Elevation - 524m

The line of sight distance was approximately 5.88km.

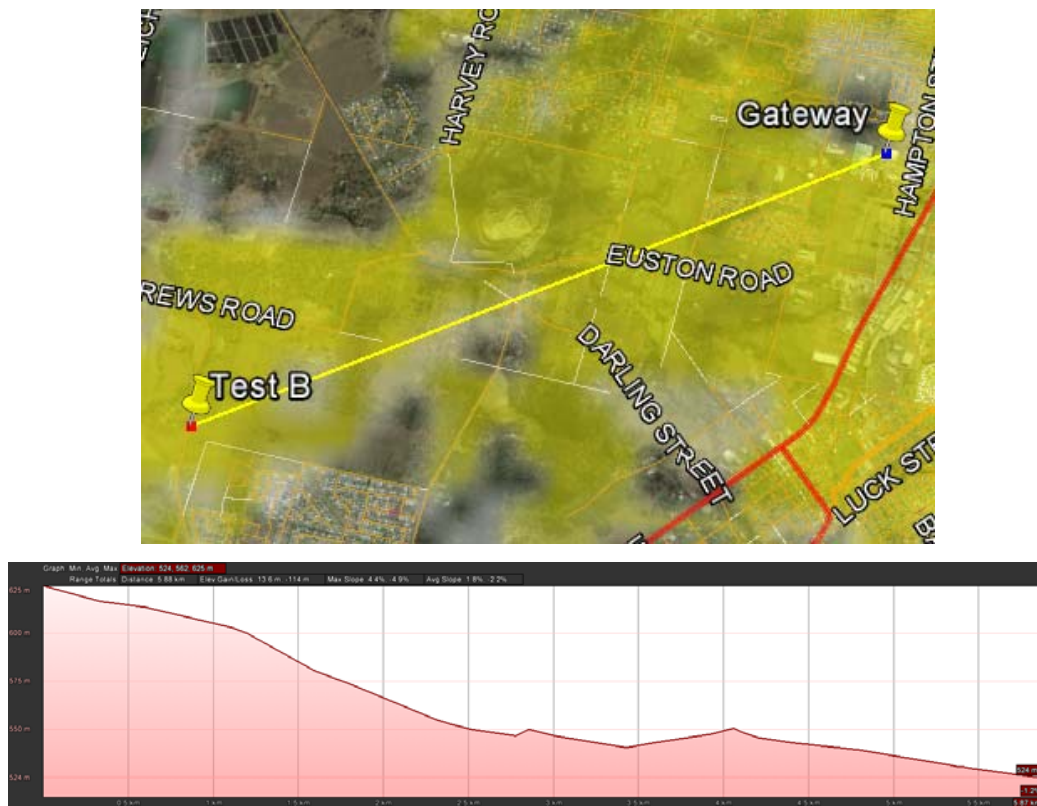

Figure 58: Test Location B Path & Elevation Profile

6.2.3. Test Location C

Line of Sight testing was completed in Toowoomba Region between the following positions (refer Figure 59)

Gateway

GPS coordinates - Latitude 27deg33'18.42"S Longitude 151deg52'54.83"E

Elevation - 629m

Test Location C

GPS coordinates- Latitude 27deg35'39.36"S Longitude 151deg51'54.65"E

Elevation - 511m

The line of sight distance was approximately 14.9km.

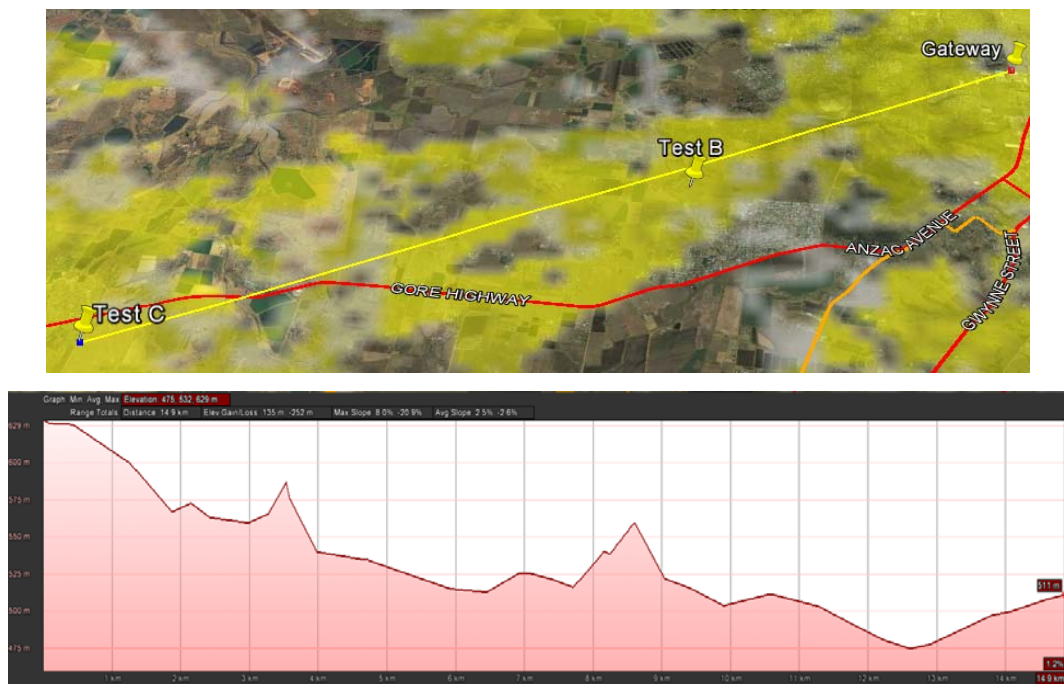

Figure 59: Test Location C Path & Elevation Profile

6.2.4. Test Location D

Line of Sight testing was completed in Toowoomba Region between the following positions (refer Figure 60)

Gateway

GPS coordinates - Latitude 27deg33'18.42"S Longitude 151deg52'54.83"E

Elevation - 629m

Test Location D

GPS coordinates - Latitude 27deg35'39.36"S Longitude 151deg51'54.65"E

Elevation - 565m

The line of sight distance was approximately 14.9km.

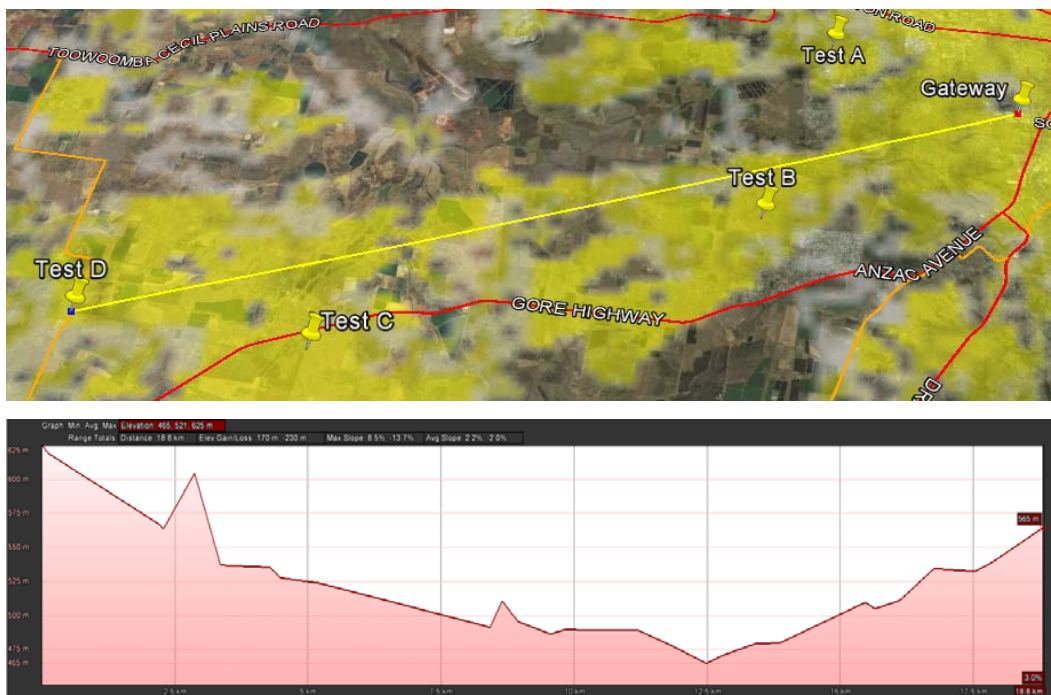

Figure 60: Test Location D Path & Elevation Profile

6.2.5. Line of Sight Testing Results

Table 4 below show the results for the line of sight testing at the four test locations.

Table 4: Line of Sight Testing Results

| Location | RSSI (dB) | SNR (dB) | TX/RX of 25 Byte Packet | TX/RX of 50 Byte Packet | TX/RX of 100 Byte Packet | SF | ACK Received |
|-------------|-----------|----------|-------------------------|-------------------------|--------------------------|----------|--------------|
| | Avg | Avg | | | | | |
| Test Site A | -105 | 0.5 | YES | YES | YES | SF7BW125 | YES |
| Test Site B | -106 | 2.7 | YES | YES | YES | SF7BW125 | YES |
| Test Site C | -114 | -3 | YES | YES | YES | SF7BW125 | YES |
| Test Site D | -128 | -7.6 | YES | YES | YES | SF7BW125 | YES |

As mentioned earlier the received signal strength indicator (RSSI), Signal to Noise Ratio (SNR) were taken from the end device using the AT command window. The mDot was able to display an average RSSI and SNR. The commands used were the following

- AT+SEND "25/50/100 byte payload data"
- AT+ACK=1 (To make sure Acknowledgement is received from the network server)
- AT+RSSI (RSSI level in db)
- AT+SNR (SNR in db)
- AT+ADR = 1 (End device will use an Adaptive Date Rate by the network server)

The RSSI, SNR, Spreading factor, Payload was also able to be seen in the Network Server debug window in Node-Red.

As seen from the results the predicated coverage of 20km is able to be achieved whilst there is a clear line of sight. As mentioned in the LoRaWAN specification the modem can receive signals to -137dB from the testing this is achievable. From test point D the device was able to work perfectly even though it had a SNR level of -7.6dB.

6.3. Line of Site Testing - Urban

Line of Sight tests were also performed at four sites urban sites in the Toowoomba region most around 1km or less. The sites were chosen from the predicated coverage model from radio mobile as shown in Chapter 3.1. The sites chosen were ones that may have potential buildings/obstructions in the LoS. As per the Rural LoS tests the same variables will be measured - RSSI levels, SNR and data transmission will be undertaken from each site. To test this simulation the following setup will be used for all scenarios.

- End Devices will be configured as a class “A” device
- Tests will use a 25, 50 and 100 byte payload
- Each Payload will be sent 5 times
- Acknowledgment will be required
- An Adaptive Data Rate (ADR) schema will be used
- 922Mhz frequency band will be used

The four locations trialled as described in the following report sections below

6.3.1. Test Location U1

Line of Sight testing was completed in Toowoomba Region between the following positions (refer Figure 61)

Gateway

GPS coordinates - Latitude 27deg33'18.42"S Longitude 151deg52'54.83"E

Elevation - 629m

Test Location U1

GPS coordinates - Latitude 27deg34'9.88"S Longitude 151deg54'50.78"E

Elevation - 605m

The line of sight distance was approximately 0.53km.



Figure 61: Test U1 Path & Elevation Profile

6.3.2. Test Location U2

Line of Sight testing was completed in Toowoomba Region between the following positions (refer Figure 62)

Gateway

GPS coordinates - Latitude 27deg33'18.42"S Longitude 151deg52'54.83"E

Elevation - 629m

Test Location U2

GPS coordinates - Latitude 27deg33'54.21"S Longitude 151deg55'12.89"E

Elevation - 655m

The line of sight distance was approximately 0.7km.



Figure 62: Test U2 Path & Elevation Profile

6.3.3. Test Location U3

Line of Sight testing was completed in Toowoomba Region between the following positions (refer Figure 63)

Gateway

GPS coordinates - Latitude 27deg33'18.42"S Longitude 151deg52'54.83"E

Elevation - 629m

Test Location U3

GPS coordinates - Latitude 27deg35'39.36"S Longitude 151deg55'26.99"E

Elevation - 646m

The line of sight distance was approximately 0.7km.

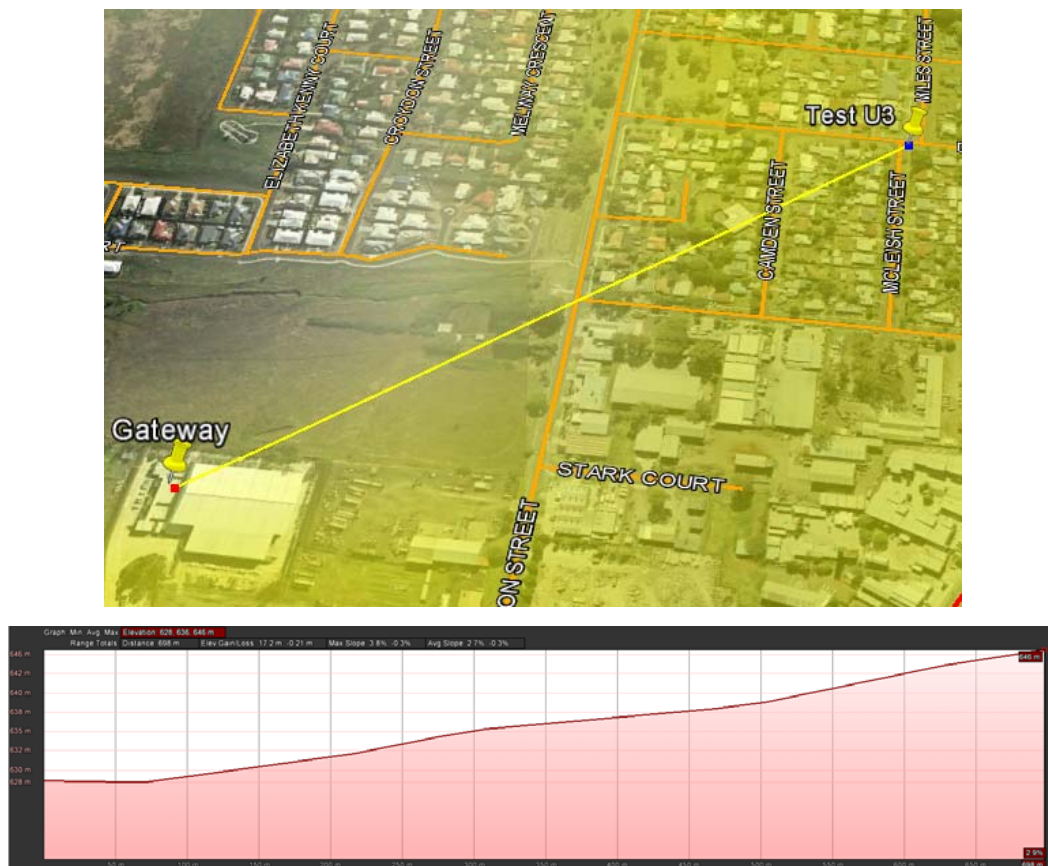

Figure 63: Test U3 Path & Elevation Profile

6.3.4. Test Location U4

Line of Sight testing was completed in Toowoomba Region between the following positions (refer Figure 64)

Gateway

GPS coordinates - Latitude 27deg33'18.42"S Longitude 151deg52'54.83"E

Elevation - 629m

Test Location U4

GPS coordinates - Latitude 27deg35'39.36"S Longitude 151deg55'26.99"E

Elevation - 650m

The line of sight distance was approximately 0.63km.

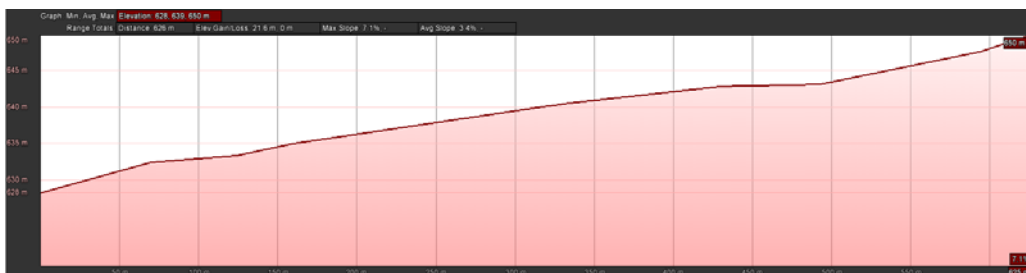

Figure 64: Test U4 Path & Elevation Profile

6.3.5. Urban Testing Results

Table 5: Urban Testing Results

| Location | RSSI (dB) | SNR (dB) | TX/RX of 25 Byte Packet | TX/RX of 50 Byte Packet | TX/RX of 100 Byte Packet | SF | ACK Received |
|--------------|-----------|----------|-------------------------|-------------------------|--------------------------|----------|--------------|
| | Avg | Avg | | | | | |
| Test Site U1 | -99 | 4.8 | YES | YES | YES | SF7BW125 | YES |
| Test Site U2 | -103 | 1.2 | YES | YES | YES | SF7BW125 | YES |
| Test Site U3 | - | - | NO | NO | NO | - | NO |
| Test Site U4 | - | - | NO | NO | NO | - | NO |

The urban testing requirements followed the same strategy as the line of sight testing – RSSI, SNR were taken from the end device using the AT command window. The following commands were used

- AT+SEND “25/50/100 byte payload data”
- AT+ACK=1 (To make sure Acknowledgement is received from the network server)
- AT+RSSI (RSSI level in db)
- AT+SNR (SNR in db)
- AT+ADR = 1 (End device will use an Adaptive Date Rate by the network server)

As seen in Table 5 the urban testing results did not have the coverage range like the rural line of sight testing. The terrain profiles looked to have line of sight coverage however the signal was affected by man-made structures. The test sites at location U3 & U4 the end device was unable to even join the network.

From the google earth path profiles it can be seen large buildings were in the path blocking the signal. As predicated in the earlier coverage modelling the test location of the gateway was not an ideal location to use for the test. If the site was at a higher location that could see the city, coverage at these locations would be achievable.

7. Project Findings

7.1. Laboratory Testing

The project has been able to successfully test the LoRaWAN in a laboratory simulation. As per the project testing phase (Chapter 6.1) of report the system was able to successfully transmit packet sizes that could be found in a live network. The project was able to test data from a class 'A' end device all the way to a simulated application server via a network server.

During the testing the LoRaWAN devices were true to the LoRaWAN specification v1.0 and whilst testing did not find issues that would contradict this. Some of the testing identified

- How the different spreading factors affected packet sizing
- Test the functionality of the class 'A' end device and prove it was able to receive packet data only after a transmission had occurred
- Proved the use of acknowledgement
- ADR scheme

The tests were successfully able replicate a LoRaWAN system demand response application - Send a 100 byte packet from the end device to the node red network server and through to the application server. It was able to send this data from the Network Server to the Application server using UDP/IP as well as TCP/IP. Other tests proved maximum byte sizing capability of a LoRa packet and proved that certain packet sizes could not be sent when using particular spreading factors.

7.2. Line Of Sight Testing

The laboratory test system was used to complete the line of sight testing in a rural and urban environment. The testing was able to show that the end device could transmit and receive data to the gateway to a range of 20km in a clear line of sight test. As the 922Mhz frequency band is used, the test proved that this frequency is severely hindered by obstructions. This was proved in the urban short distance testing at locations U3 and U4 which could not register to the network.

Whilst completing this task the coverage models were fairly accurate however the software package was not able to factor a very accurate clutter data figure which showed coverage in areas but in reality would not work.

The system did prove that the ADR scheme used was able to adjust to the received SNR values and increase/decrease power and transmission rates depending on location.

As per the communications requirements of a smart meter/demand response application the system was able to transmit a probable packet sizing with no error rates. Due to the relative new release of LoRa devices in the Australian market it would be advantageous to use class C devices for this type of application.

7.3. Limitations of the LoRaWAN

Possible issues that were discovered during project:

- LoRaWAN Specification at time of project did not include an Australian specification
- Technology still relatively new for Australia
- Not currently a large amount of devices for sale for the Australian market
- Class 'A' device not suitable for many utility requirements
- Potential high data loss with numerous devices that try to transmit at same time
- Possible future clashes with other provider gateways due to using the unlicensed spectrum
- Not really suitable for mission critical data due to potential for high packet loss/collisions
- 900Mhz band affected by LoS obstructions
- Maximum Packet Size of 256 bytes

8. Recommendations

The discussed in findings the LoRaWAN system was able to work with the characteristics that had to be adhered to. During the testing there were some recommendations that will be detailed below:

- LoRaWAN Specification requires a set Australian Standard to follow. The standard could possibly specify using a maximum TX duty cycle to help with congestion of the unlicensed spectrum band. Another possibility is to have the ACMA regulate the band and allow for a possible duty cycle requirement for the band to cope with the future increase of IoT devices
- Site locations should be in placed to allow for a good line of sight
- Use of a higher gain antenna at gateways and end device locations to help with coverage
- Due to the nature of the LoRaWAN being used in a star configuration, overlap of gateway coverage should be followed to allow for adaptability of end device connections
- Most smart meter/demand response applications should use a class 'C' device. (During time of project class 'A' was only available due to the relative new release of devices into the Market)

9. Conclusions and Further Work

9.1. Conclusion

The research project was able to conclude that the LoRaWAN system does have a future place for the electrical distribution industry. The low cost long range capability of a LoRaWAN is something that will have definite uses in the industry. The project objectives to build and test a LoRaWAN system was able to be achieved however there are a few recommendations that will need to happen before the system is fully suitable for a live network. The main recommendation is to have a defined Australian standard together with the possibility of ACMA look at the unlicensed band spectrum to be able to cope for future growth requirements of the IoT. Once the LoRaWAN specification includes Australia, this will allow for more manufacturers and applications to be developed for these devices.

The LoRaWAN system was able to provide a long range coverage that with more gateway devices in suitable locations will definitely be able to be used in a live environment. As the uptake of LoRaWAN is happening worldwide the technology is already beginning to be incorporated into many devices like Bluetooth. Numerous devices and applications in the world are being developed to use this technology so by having a developed system will help to future proof the electrical network for new challenges these will bring. As the uptake of LoRa devices is occurring at a fast rate devices are changing regularly with different firmware and end node applications. During this project many LoRa products are still in development that in future would be able to achieve a more desired result

In conclusion the project believes that a LoRaWAN network is a very good long range low cost network for low speed low data devices. A LoRaWAN network is a viable system to be used in the electrical industry. Currently most applications for this industry will suit a class 'C' mains connected device for applications like

demand response and smart meters. The technology has numerous benefits and is also able to co-exist with many other current communications technologies.

9.2. Further Work

Whilst completing this project there was not available time and resources to test all areas of the LoRaWAN system. Some future possible areas that could be further researched include

- Re-testing of the working system when the LoRaWAN specification has been updated to allow for a defined specification for the Australian Standard. Whilst completing this task the number of devices for purchase was limited and there was not a large amount of support for class 'B' and 'C' end devices. With this being the case the project had to focus solely on a class 'A' end device; however the project believes most applications for the electrical distribution industry would be mains connected class 'C' devices.
- Due to the availability of test equipment the possibility of testing latency times would be beneficial.
- Power consumption could also be measured to see impact of devices at remote solar sites (at time of project only theoretical values were discussed using the Semtech Power calculator).
- Testing of a LoRaWAN using an external provider Network Server application

10. List of References

ccna5, OSI Model. , viewed 10 May 2016

<http://ccna5.com/wp-content/uploads/2010/06/The-Data-Link-Layer-Layer-2.jpg>

Session Layer, viewed 6 September 2016

https://en.wikipedia.org/wiki/Session_layer

Prajzler, V 2015, LoRa, LoRaWAN and LORIoT.io. , viewed 12 March 2016

<https://www.loriot.io/lorawan.html>

LoRa Alliance, Sponsor Members., viewed 12 March 2016

<https://www.lora-alliance.org/The-Alliance/Member-List>

LoRa Alliance, 2015, A technical overview of LoRa and LoRaWAN, viewed 12 March 2016

<https://www.lora-alliance.org/portals/0/documents/whitepapers/LoRaWAN101.pdf>

Orange, 2016, LoRa Device Developer Guide., viewed 12 April 2016

<https://partner.orange.com/wp-content/uploads/2016/04/LoRa-Device-Developer-Guide-Orange.pdf>

Semtech, 2015, SX1276/77/78/79 Datasheet. , viewed 26 April 2016

http://www.semtech.com/images/datasheet/sx1276_77_78_79.pdf 26-04-16

Semtech, 2015, AN1200.22 LoRa Modulation Basics. , viewed 11 February 2016

<http://www.semtech.com/images/datasheet/an1200.22.pdf>

Semtech, 2014, Semtech Wireless Products. , viewed 20 February 2016

<http://www.semtech.com/wireless-rf/wireless-rf/LoRa-Wireless-Public-Network.pdf>

Semtech, 2015, LoRaWAN Network Server Demonstration: Gateway to Server Interface Definition.

Link-Labs, 14 LoRa FAQs Answered. , viewed 20 February 2016

<http://www.link-labs.com/lora-faqs/>

Link-Labs, What is LoRa?. , viewed 18 August 2016

<http://www.link-labs.com/what-is-lora/>

Link-Labs, n.d, Low Power, Wide Area Networks

Zagarella, R n.d, Submission to Parliamentary Inquiry into Agricultural Innovation. , viewed 10 May 2016

http://www.nnnco.com.au/uploads/6/0/7/9/60799127/nnnco_submission_parliamentary_inquiry_20

Lawson, S 2015, These IoT networks are 'unapologetically slow'. , viewed 20 February 2016

<http://www.goodgearguide.com.au/article/563606/these-iot-networks-unapologetically-slow/150925.pdf>

Multitech Systems, 2014, MultiConnect Conduit. , viewed 20 February 2016

<http://www.multitech.com/white-papers/multiconnect-conduit-whitepaper-multitech-systems-9-2014.pdf>

<https://www.thethingsnetwork.org/> viewed 20 February 2016

Hamel, E 2015, (Cisco Live Presentation – BRKSPM-2073 Low Power Wide Area (LPWA) Technologies for IOT)

Ergon Energy, (GC000400R102 Corporate Risk Assessment Tables)

Athuraliya, S 2015, (Specification for Load Control via a Wide Area Wireless Network)

ACMA, 2016, Wi-Fi. , viewed 2 April 2016

<http://www.acma.gov.au/Citizen/Consumer-info/Rights-and-safeguards/EME-hub/wifi>

LoRa-Alliance, 2015, (LoRaWAN Specification V1.0)

Miller, R 2016, LoRa Security, viewed 20 April 2016

<https://labs.mwrinfosecurity.com/assets/BlogFiles/mwri-LoRa-security-guide-1.2-2016-03-22.pdf>

Poole, I n.d, LoRa Network:LoRaWAN , viewed 5 April 2016

<http://www.radio-electronics.com/info/wireless/lora/lorawan-network-architecture.php>

SentriFarm, 2015, Project Details. , viewed 5 April 2016

<https://hackaday.io/post/15164>

MicroChip, 2015, (LoRaWAN 101 Class Presentation)

Wikipedia, 2016, OSI Model. , viewed 10 May 2016

https://en.wikipedia.org/wiki/OSI_model

<http://acma.gov.au/Industry/Spectrum/Radiocomms-licensing/Class-licences/lipd-class-licence-spectrum-acma> viewed 12 July 2016

<http://acma.gov.au/Industry/Spectrum/Radiocomms-licensing/Class-licences/shortrange-spreadspectrum-devices-fact-sheet> viewed 12 July 2016

<https://iotblog.org/lora-hands-on/> viewed 15 July 2016

https://en.wikipedia.org/wiki/Constrained_Application_Protocol viewed 15 July 2016

RFC 7252 The Constrained Application Protocol (CoAP) viewed 16 July 2016

<https://tools.ietf.org/html/rfc7252>

http://www.libelium.com/downloads/documentation/waspmote_lora_868mhz_915mhz_sx1272_networking_guide.pdf viewed 12 August 2016

Multitech Systems, 2016, Multiconnect mDot MTDOT Developer Guide

Multitech Systems, 2016, Multiconnect Dot AT Command Reference Guide

Multitech Systems, 2015, Multiconnect Conduit Quick Start Guide

Multitech Systems 2016:Introduction to LoRa, viewed 12 August 2016

<http://www.multitech.net/developer/software/lora/introduction-to-lora/>

Multitech Systems 2016:Flashing mDot firmware, viewed 15 August 2016

<http://www.multitech.net/developer/software/mdot-software/mdot-firmware-upgrade/>

<http://www.zte.com.cn/global/about/press-center/news/201603/20160315LoRa>

viewed 29 August 2016

Demand Response, viewed 29 August 2016

https://en.wikipedia.org/wiki/Demand_response

<http://www.m2mconnectivity.com.au/sites/default/files/more-information/LoRa-FAQs.pdf> viewed 29 August 2016

Kuzlu, M, Pipattanasomporn M, Rahman S, 2014, Communication network requirements for major smart grid applications in HAN, NAN and WAN. , viewed 29 August 2016

<http://www.saifurrahman.org/wp-content/uploads/2014/12/Communication-network-requirements-for-major-smart-grid-2.pdf>

Vannel, F, LoRaWAN., viewed 29 August 2016

https://cyberlearn.hes-so.ch/pluginfile.php/859103/mod_resource/content/1/3_LoRaWAN.pdf

The Internet of Things: An Overview viewed 4 September 2016

https://www.internetsociety.org/sites/default/files/ISOC-IoT-Overview-20151014_0.pdf

The Things Network 2016 Update, viewed 4 September 2016

<https://speakerdeck.com/wienke/the-things-network-2016-update#28>

Semtech Systems, 2016 Semtech LoRa Airtime Calculator

Open Mobile Alliance, 2014, LWM2M Overview

Semtech, 2013, AN1200.13 Lora Modem Designers Guide , viewed 5 September 2016

https://www.semtech.com/images/datasheet/LoraDesignGuide_STD.pdf

Transmission Control Protocol, viewed 19 September 2016

https://en.wikipedia.org/wiki/Transmission_Control_Protocol

User Datagram Protocol, viewed 19 September 2016

https://en.wikipedia.org/wiki/User_Datagram_Protocol

11. Appendices

11.1. Appendix A – Projection Specification

Appendix A

ENG4111/4112 Research Project

Project Specification

For: Kurt Beutel

Title: Power Utility Remote Device communications using a low power wide area network (LPWAN) based on the LoRa communications standard.

Major: Electrical Engineering

Supervisor: Mark Phythian

Enrolment: ENG4111 – EXT S1 2016
ENG4112 – EXT S2 2016

Project Aim: To develop a lost cost, secure LPWAN for Power Utility Remote Device Communications using the LoRa communications standard.

Programme: Issue B, 14th April 2016

Identify and analyse the LPWAN based on LoRa Comms standard

Research Operational Equipment that could use the LPWAN Comms medium

Research possible sensors, gateways that will be required to achieve this

Research the LWM2M client interface

Design a possible trial location (equipment that would be required)

Use of LoRaWAN devices to test functionality of system

If time permits and resources permit:

Potential cost savings to implement this system versus other architectures

Design a LWM2M client interface for Control Centre

11.2. Appendix B - Personal Risk Assessment

Due to the practical nature of this project a personal risk assessment is required to be completed. This is a mandatory requirement of Ergon Energy before completing any work activities. This project will use the Ergon Energy Daily Task Risk Management Plan (DTRMP). The DTRMP will help to determine the risk with the use of a table as shown below

| Likelihood \ Consequence | Rare | Unlikely | Possible | Likely | Almost Certain |
|--------------------------|----------|----------|----------|---------|----------------|
| Catastrophic | Medium | High | High | Extreme | Extreme |
| Major | Medium | Medium | High | High | Extreme |
| Moderate | Low | Medium | Medium | High | High |
| Minor | Very Low | Low | Medium | Medium | Medium |
| Insignificant | Very Low | Very Low | Low | Medium | Medium |

The table shows the likelihood of the risk happening versus the consequences if it did happen. For this project the following Personal Risk Management matrix was used. This will be completed on site and any specific hazards will be entered. The second table below is the version that will be used.

| Work Activity | Hazard | Inherent Level of Risk | Controls to be Applied | Residual Level of Risk |
|-------------------|---------|------------------------|--------------------------------------|------------------------|
| LoS Drive Testing | Driving | High | Drive to Conditions, obey road rules | Medium |
| | | | | |
| | | | | |
| | | | | |

11.3. Appendix C – Multitech mDot Firmware Upgrade

The following procedure was used to complete the mDot firmware upgrade to allow it to be used in the Australian unlicensed frequency band. The procedure to upgrade the mDot is specified by Multitech Systems.

1. The mDot is connected to the Multitech developer board (MTUDK2-ST) and is powered via the microUSB interface. This interface will also transfer the required firmware

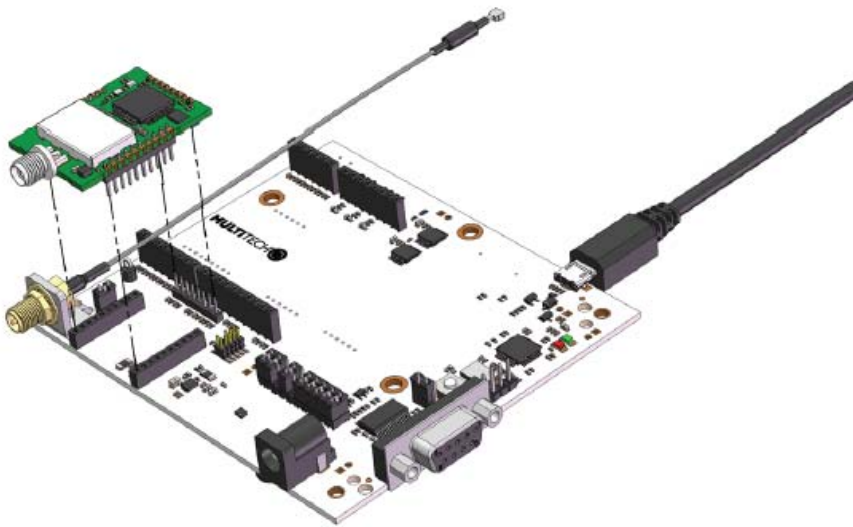

Source: Multitech Developer board MTUDK2-ST (Multitech Systems 2015)

2. The PC will detect the Multitech Mdot

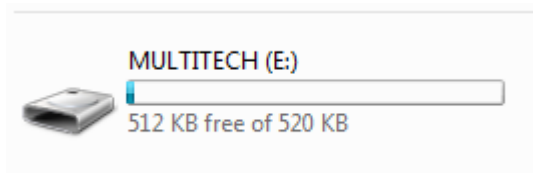

3. Go to location of the firmware.bin file and drag and drop the file to the Multitech device location

4. After the connectivity lights on the developer board stop flashing the reset button can then be pressed to reset the device.
5. Connect to the Serial DB9 interface and establish a connection with the device (refer chapter 5.3)
6. Use the following commands as specified by Multitech
 - `AT&F` – reset to factory defaults
 - `AT&W` – save factory defaults
 - `ATZ` – reset the mDot
 - `ATI` – confirm the firmware has been updated

```
at&f
OK
at&w
OK
atz
OK
ati
MultiTech mDot
Firmware: 0.0.14
Library : 0.0.3
OK
```

Source: Multitech Systems: Flashing mDot Firmware

<http://www.multitech.net/developer/software/mdot-software/mdot-firmware-upgrade/>