



Operation of the NuMI Beam Monitoring System

Robert M. Zwaska, Dharma Indurthy, Ryan Keisler, Sacha Kopp, Steven Mendoza, Zarko Pavlovich, Marek Proga, Mary Bishai, Milind Diwan, Brett Viren, Debbie Harris, Alberto Marchionni, Jorge Morfin, Jeffrey McDonald, Donna Naples, David Northacker, Albert Erwin, Huican Ping, and Cristos Velissaris

Citation: [AIP Conference Proceedings](#) **868**, 558 (2006); doi: 10.1063/1.2401447

View online: <http://dx.doi.org/10.1063/1.2401447>

View Table of Contents: <http://scitation.aip.org/content/aip/proceeding/aipcp/868?ver=pdfcov>

Published by the [AIP Publishing](#)

Articles you may be interested in

[The NuMI Neutrino Beam at Fermilab](#)

AIP Conf. Proc. **773**, 276 (2005); 10.1063/1.1949545

[Profile Monitor SEMs for the NuMI Beam at Fermilab](#)

AIP Conf. Proc. **732**, 341 (2004); 10.1063/1.1831167

[Ion Chambers for Monitoring the NuMI Neutrino Beam at Fermilab](#)

AIP Conf. Proc. **732**, 332 (2004); 10.1063/1.1831166

[Preliminary Design of the Beam Loss Monitoring System for the SNS](#)

AIP Conf. Proc. **648**, 345 (2002); 10.1063/1.1524419

[RHIC Beam Loss Monitor System commissioning in RHIC Year 0 Run](#)

AIP Conf. Proc. **546**, 313 (2000); 10.1063/1.1342600

Operation of the NuMI Beam Monitoring System

Robert M Zwaska^{*¶}, Dharma Indurthy^{*}, Ryan Keisler^{*}, Sacha Kopp^{*}, Steven Mendoza^{*}, Zarko Pavlovich^{*}, Marek Proga^{*}, Mary Bishai[†], Milind Diwan[†], Brett Viren[†], Debbie Harris[¶], Alberto Marchionni[¶], Jorge Morfin[¶], Jeffrey McDonald[§], Donna Naples[§], David Northacker[§], Albert Erwin[#], Huican Ping[#], and Cristos Velissaris[#]

^{*}*The University of Texas at Austin, Austin, Texas*

[†]*Brookhaven National Laboratory, Upton, New York*

[¶]*Fermilab, Batavia, Illinois*

[§]*University of Pittsburgh, Pittsburgh, Pennsylvania*

[#]*University of Wisconsin - Madison, Madison, Wisconsin*

Abstract. The NuMI (Neutrinos at the Main Injector) facility produces an intense neutrino beam for experiments. The NuMI Beam Monitoring system consists of four arrays of ion chambers that measure the intensity and distribution of the remnant hadron and tertiary muon beams produced in association with the neutrinos. The ion chambers operate in an environment of high particle fluxes and high radiation.

Keywords: Ionization chambers, neutrino beams, radiation hardness, beam-based alignment, beam monitoring.

PACS: 29.40.Cs, 06.60.Sx, 14.60.Pq, 81.40.Wx

INTRODUCTION

The NuMI beam is a new, intense neutrino beam at Fermi National Accelerator Laboratory. The beam was commissioned during the 2004-5 winter months and is now operating as the world's most intense accelerator neutrino beam. The neutrinos are produced from the decays of mesons, which are produced from the interactions of 120 GeV protons on a solid carbon target. The Beam Monitoring System was built as part of the NuMI project and is used for commissioning and continuous operation of the beam.

This system measures the spatial distribution of the remnant hadron beam after passing through the meson production target, and the tertiary muon beam produced concomitantly with the neutrino beam. The system is designed to measure beam characteristics on a pulse-to-pulse basis. The measurements are used for precision verification of the neutrino beam spectrum and to assist in commissioning of the neutrino beamline components. The monitors are placed directly in the beams and are thus designed to withstand the harsh radioactive environments.

CP868, *Beam Instrumentation Workshop 2006: Twelfth Workshop*,

edited by T. S. Meyer and R. C. Webber

© 2006 American Institute of Physics 978-0-7354-0369-7/06/\$23.00

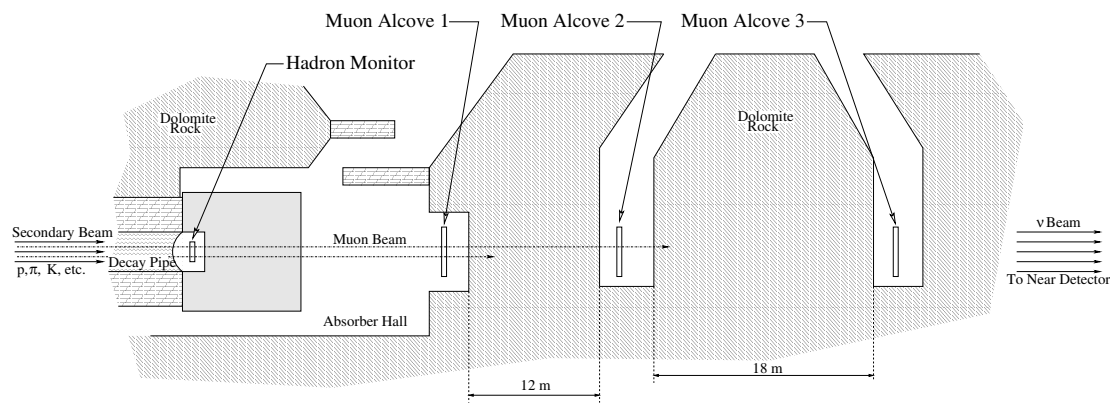

FIGURE 1. Plan view of the downstream end of the NuMI decay region. The Hadron Monitor measures the distribution of remnant proton and hadron beam before the beam absorber. The Muon Monitors measure the distributions of the muon beam after some portion has been absorbed through the shielding.

THE BEAM MONITORING SYSTEM

The NuMI Beam Monitoring system consists of four arrays of helium gas ionization chambers. The first array is called the Hadron Monitor and sits at the end of the decay volume; it measures the spatial distribution of the protons that survive passage through the target, as well as charged hadrons that were produced by the proton interactions. The latter three arrays constitute the Muon Monitors, which measure the spatial distributions of the muon beams at three locations in the shielding; the locations allow sampling of different energy ranges of muons. The layout of the system and the downstream portion of the NuMI beamline are shown in Fig. 1. The system is described in greater detail elsewhere [1,2].

By measuring the spatial distribution (2D profiles) of the beam, the monitoring system provides quality-control information for every nominal spill, as well as data for special-purpose spills (e.g. commissioning). The intensity of the signals provides counts of particles surviving to each stage. The centroids of the distributions are used for pointing and alignment of the beam. The widths of the distributions change with the amount of upstream material traversed by the beam. These quantities were used extensively in the commissioning of the NuMI beam and beam-based alignment of its components [2,3].

Being directly in the beam, the monitors are subject to high particle fluxes and radiation. The devices were designed to maintain signal linearity and to survive in this environment [2,4]. The chambers were chosen to be thin and wide rectangular volumes, to allow efficient charge collection at high fluxes. The 1 mm gap Hadron Monitor was designed to be linear to 4×10^9 particles / cm^2 , and the 3 mm gap Muon Monitors to 10^8 particles / cm^2 . The materials used in the construction of the chambers were metal, ceramic, polyimide, and PEEK plastic. These materials were used in such a way that they could survive the 10 GRad of radiation possible at the Hadron Monitor in a year of radiation, and 20 MRad at the Muon Monitors.

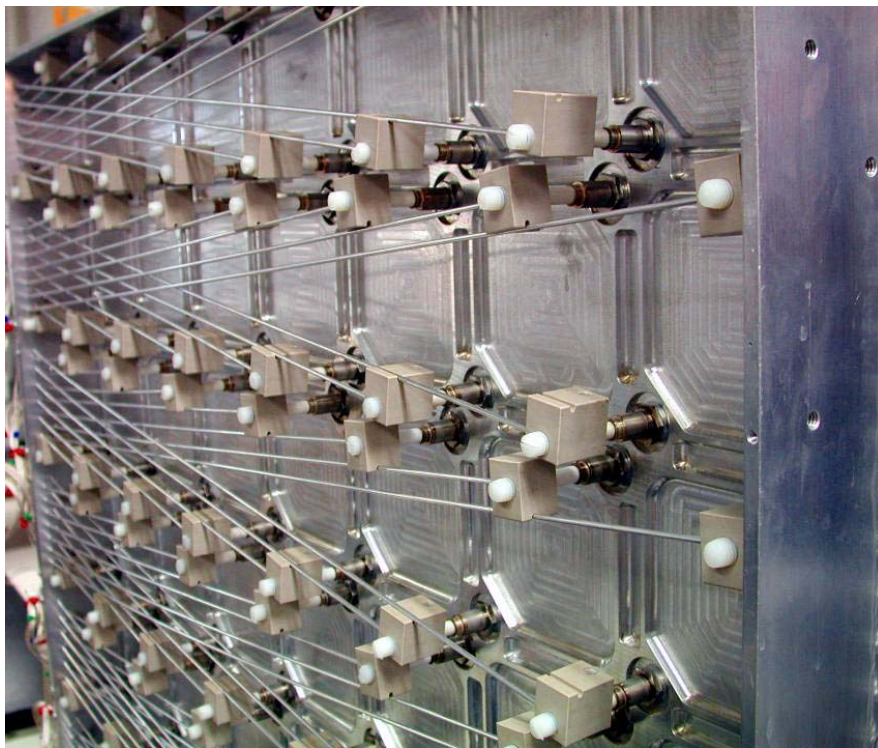

FIGURE 2. Exterior photograph of the rear of the Hadron Monitor. Shown are the 98 feedthroughs for the high voltage and signal channels. Also visible are the hard-line cables designed to survive the radiation environment.

The Hadron Monitor

The Hadron Monitor is a 7 x 7 array of pixels, separated by 4.5" center-to-center, for a total array area of about 1 m². The pixels are housed within a monolithic gas vessel that is installed as a single unit. Ceramic feedthroughs are used for all electrical connections through the vessel wall. The chamber plates are mounted directly on the feedthroughs to minimize internal electrical connections.

Custom hardline cable brings the electrical connections across the body of the Hadron Monitor to each of its feedthroughs (shown in Fig. 2). These cables lie in the beam, so they are subject to radiation damage and possible signal pickup. To guard against both, the cables are designed with both polyimide and ceramic insulators about the conductor, with the whole shielded by aluminum tubing.

To allow possible replacement, the Hadron Monitor was designed to limit radioactivation. Aluminum was used instead of steel wherever possible, and only the minimum amount of material necessary was used.

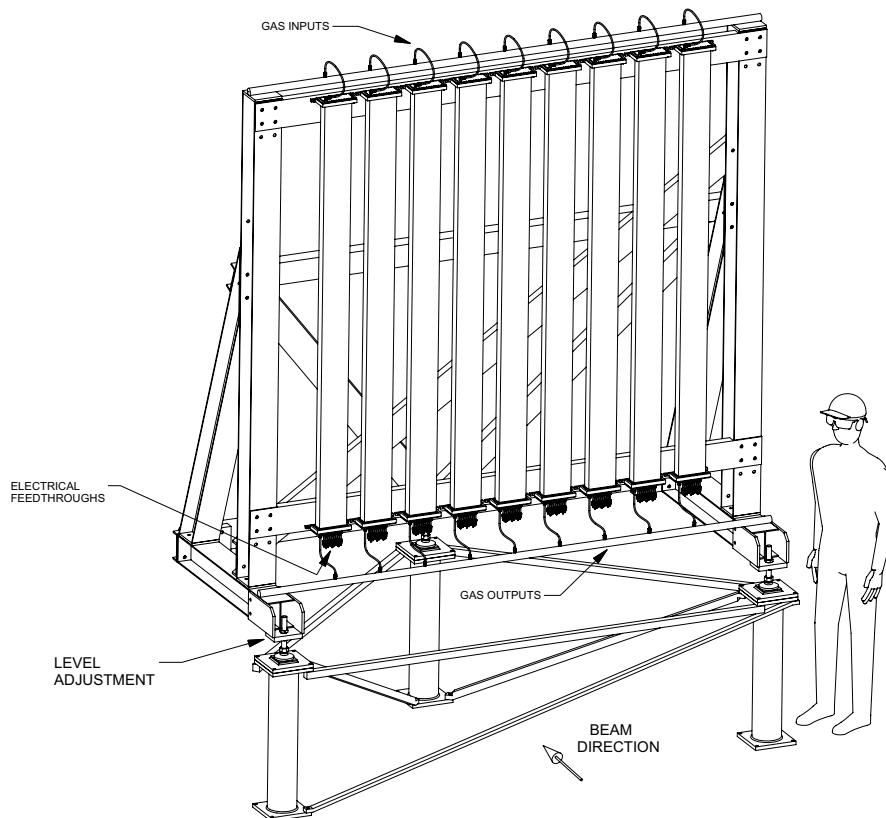

FIGURE 3. Diagram of a Muon Monitor array (one of three). Each of nine tubes contains nine ionization chambers. The 9x9 grid measures 2.2 x 2.2 m² and samples the spatial distribution of the muon beam.

The Muon Monitors

The Muon Monitors are composed of three identical 9 x 9 arrays of ionization chambers. The arrays are separated by 10" center-to-center, for a total area of 2.2 x 2.2 m². Because of the large separation between chambers, each array is broken into nine identical "tubes", each of which includes nine chambers. The tubes are oriented vertically and mounted to a single, adjustable stand, as shown in Fig. 3.

Inside each tube the chambers are mounted to a "tray" that provides support and positioning. All of the electrical connections are made at one end of the tube. Separate PEEK/compression fitting feedthroughs are used for the high voltage connections. Nine-pin ceramic feedthroughs were used for the signal connections. Coaxial polyimide cable was used internally for routing the bias and signal. The layout of a tray is shown in Fig. 4.

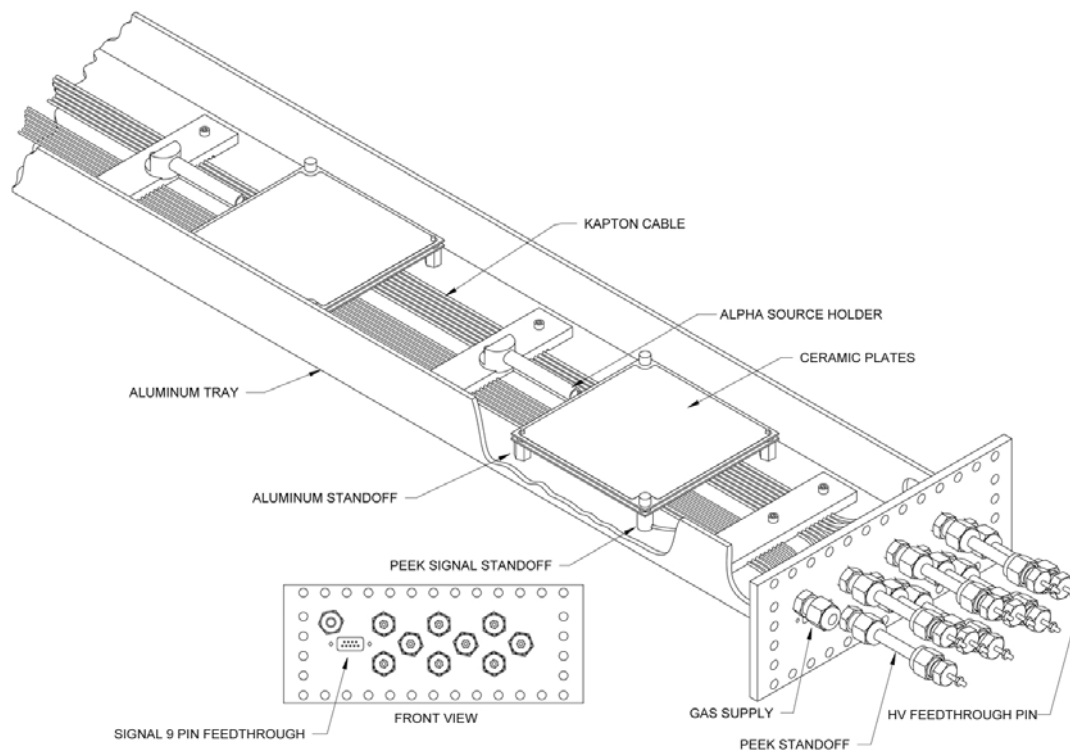

FIGURE 4. Interior of a Muon Monitor tube. Two (of nine) ion chambers are shown in the tray. All of the high-voltage and signal connections come to one end where they are fed through the flange. The HV lines have individual feedthroughs, while the signals connect via a 9-pin feedthrough.

DETECTOR OPERATION IN THE BEAM

The first use of the Beam Monitors was to check the positioning and pointing of the primary proton beam. The protons were directed by the primary instrumentation through the target hall, but with the target removed such that the protons followed straight-line trajectories to the end of the decay volume. A measurement by the Hadron Monitor is shown in Fig. 5 for one of the first such spills.

The Hadron Monitor had been surveyed to a position accuracy of ± 2 cm with respect to the primary beamline. Combined with a lever arm of 730 m from the target position, this positioned the Hadron Monitor to within $30 \mu\text{rad}$ of the centerline. The centroids of the beam measured in the Hadron Monitor were centered within 2 cm, so we concluded that the beam was aligned to within $50 \mu\text{rad}$. Similar techniques were used in a program of measurements to align the other neutrino beam components, i.e. target and horns [2,3].

During continuous operations the Hadron Monitor and Muon Monitors are used to diagnose beam problems, such as missteering or overly wide beam. A typical set of distributions measured in the first two alcoves are shown in Fig. 6. The beam has characteristic intensity, centroids, and width at each alcove, a change in any of these parameters indicates a change in the neutrino beam. One slight complication is shown in the humped distribution in alcove 1. We found that some portion of the hadron beam was penetrating the hadron absorber and contaminating the signal. This is a result of the seams in the absorber being parallel to the beam direction.

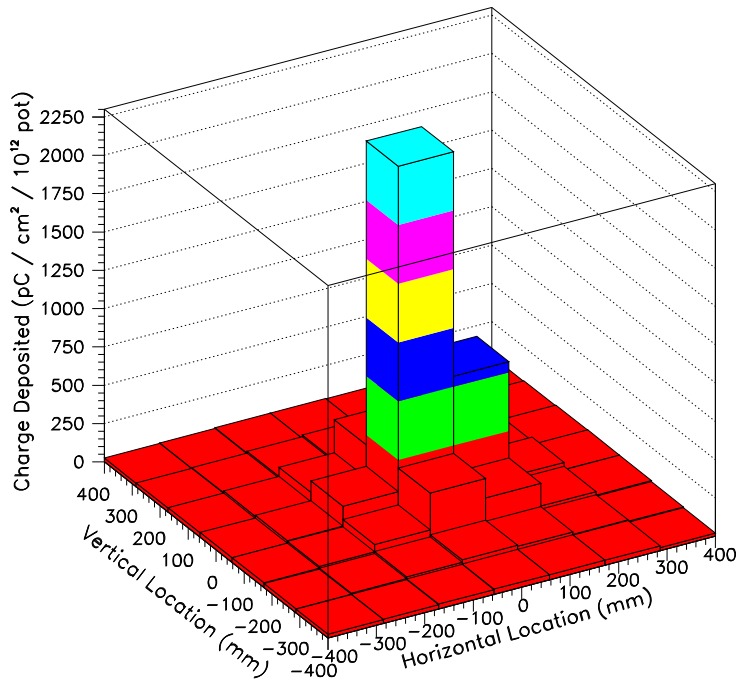

FIGURE 5. Measured charge distribution at the Hadron Monitor when the proton beam is directed through the target hall, but without the target in place. This data establishes the pointing accuracy of the primary instrumentation and decay pipe to $< 50 \mu\text{rad}$.

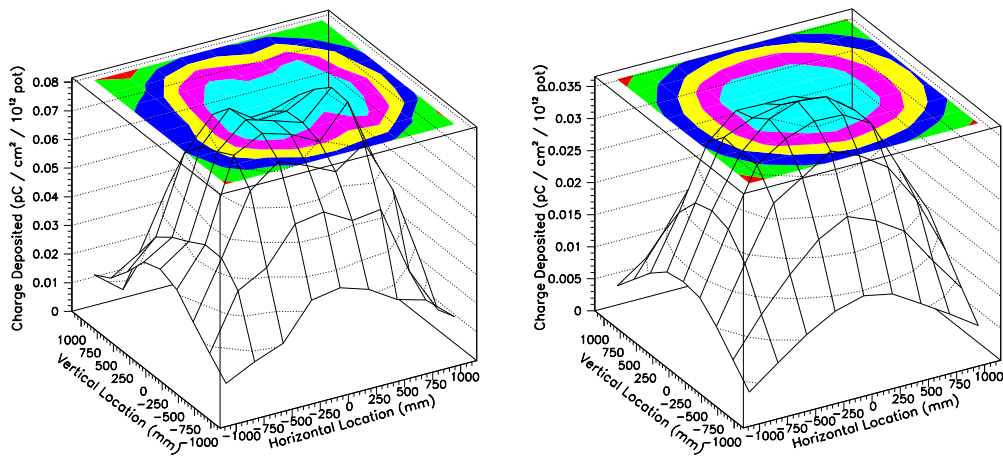

FIGURE 6. Measured charge distributions from Muon Alcove 1 (left) and Alcove 2 (right) when the proton beam is directed onto the carbon target, but without horn focusing of secondary particles. The distributions are well-centered, establishing the alignment of the proton beam, target, decay pipe, and Muon Monitors. The distribution in Alcove 1 is contaminated by hadrons penetrating the hadron absorber via seams between shielding blocks; the contamination leads to the two horizontal humps.

DETECTOR PERFORMANCE WITH INTENSE BEAMS

The monitoring data has been examined over the run to verify the monitors' linearity with beam intensity and resistance to radiation. The signal response of the monitors to known beam intensity has not changed since the start of operation, indicating that radiation damage has not yet been observed. The Hadron Monitor has been exposed to a beam flux corresponding to 35% of its design lifetime. We expect that continued ionization and deposition of gas impurities may eventually lead to reduced charge collection efficiency in the Hadron Monitor; additionally, its polyimide and PEEK components may have their dielectric properties compromised. The Muon Monitors are not expected to suffer from radiation damage.

The signal response of the detectors is more carefully examined through the performance of special runs known as plateau scans. During these runs the beam intensity is held roughly constant while the bias voltage is adjusted. The signal response of each chamber then varies from near 0 at 0 volts, to a plateau of constant response over a range of biases, to an increasing curve at higher biases. Desired operation is on the plateau where relative ionization is affected only linearly by pressure and temperature. The plateau can be depleted at high particle fluxes due to space-charge enhanced recombination at low biases and space-charge enhanced multiplication at high biases. A representative sample of measurements at different intensities is shown in Fig. 7 for pixels of the Hadron Monitor and Muon Alcove 1.

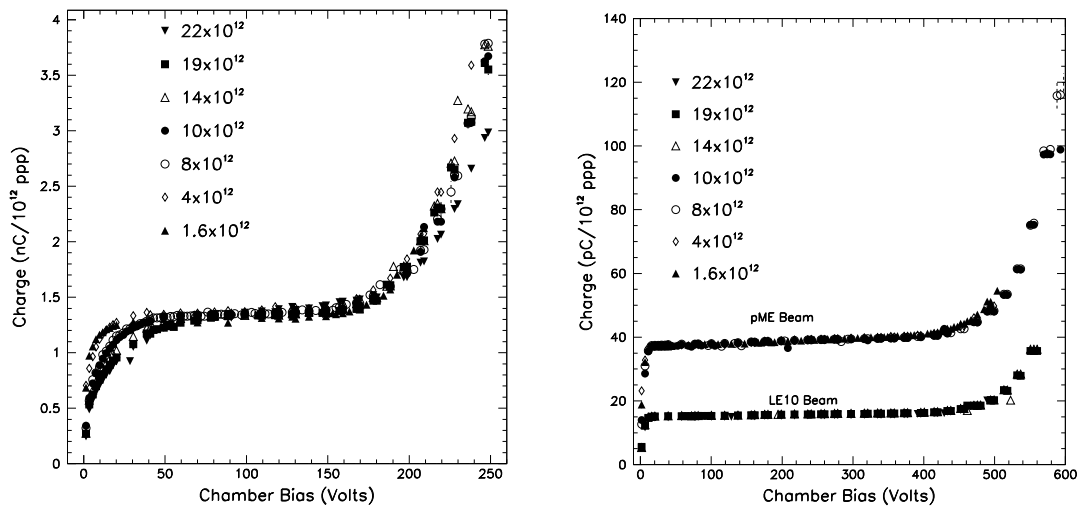

FIGURE 7. Signal response of Hadron (left) and Muon (right) Monitor pixels as a function of the bias applied across the chamber. The hadron plateau is partially depleted as beam intensity increases. The muon plateaus show no depletion with intensity, though the plateau is somewhat tilted. (The muon curves were taken with two different energy beams, which have different numbers of muons per proton.)

The Hadron Monitor has an adequate plateau for all beam intensities achieved so far, but it also shows depletion. At the highest intensity (2.2×10^{13} protons), the plateau extends only from 80-150 V. With the nominal operating bias of 130 V, we expect the Hadron Monitor to behave linearly to up to twice this intensity. Such intensity would exceed the design intensity of the NuMI beamline, and is not expected in the lifetime of the Hadron Monitor. Still, the plateau depletion is somewhat greater than expected – we attribute this to the less-pure helium that the monitor operates with. These data may be used if a new Hadron Monitor is designed for higher beam intensities.

The Muon Monitor shows no plateau depletion at any beam intensity, but its plateaus tend to have a slight slope. This slope is likely due to stray ionization being collected outside of the active chamber. Stray ionization is unwanted, but likely to be linear if the nominal bias of 300 V is maintained.

CONCLUSION

The NuMI Beam Monitors have operated to specifications within the NuMI beam where they have contributed to commissioning, alignment, and quality control. The system design has been shown effective for operation in the intense particle flux and radiation in the NuMI beam.

ACKNOWLEDGMENTS

We would like to thank the numerous people and organizations who contributed to the NuMI Beam Monitoring System: the University of Texas Nuclear Engineering Teaching Laboratory and Physics Department Machine Shop, the University of Wisconsin Physical Sciences Laboratory, and Fermilab personnel: Bruce Baller, Leon Beverly, Dixon Bogert, Bob Ducar, Al Franck, Jim Hylan, Adam Para, Dave Pushka, Wes Smart, Kent Triplett, and Gianni Tassotto.

REFERENCES

1. Kopp, S. *et al.*, “Secondary Beam Monitors for the NuMI Facility at FNAL”, to be submitted to *Nucl. Inst. Meth.* (2006).
2. Zwaska, R., *Accelerator Systems and Instrumentation for the NuMI Neutrino Beam*, Ph. D. dissertation, University of Texas at Austin, FERMILAB-THESIS-2005-73, (2005)
3. Zwaska, R. *et al.*, “Beam-Based Alignment of the NuMI Target and Horns”, to be submitted to *Nucl. Inst. Meth.* (2006).
4. Zwaska, R. *et al.*, *IEEE Trans. Nucl. Sci.* **50**, 1129-35 (2003).