

Sheffield Hallam University

Could Smart Communities Improve the Efficiency of Cancer Services in Sheffield?

WOOLLISCROFT, Tim

Available from the Sheffield Hallam University Research Archive (SHURA) at:

<http://shura.shu.ac.uk/24738/>

A Sheffield Hallam University thesis

This thesis is protected by copyright which belongs to the author.

The content must not be changed in any way or sold commercially in any format or medium without the formal permission of the author.

When referring to this work, full bibliographic details including the author, title, awarding institution and date of the thesis must be given.

Please visit <http://shura.shu.ac.uk/24738/> and <http://shura.shu.ac.uk/information.html> for further details about copyright and re-use permissions.

Could Smart Communities Improve the
Efficiency of Cancer Services in Sheffield?

Timothy J Woolliscroft

A thesis submitted in partial fulfilment of the requirements of
Sheffield Hallam University
for the degree of Doctor of Philosophy

August 2018

Declaration

Author's Declaration

I confirm that this thesis is the sole work of the author. A draft of the thesis was proofread for potential spelling and grammatical issues.

Name Tim Woolliscroft

Acknowledgements and Dedication

I acknowledge the support of and give thanks to my PhD supervisors; I would like to thank both my original team of PhD supervisors, and the final team who stepped in after my original supervisors left Sheffield Business School. Between all five of them I benefitted from quite a range of different academic expertise and appreciate the emotional encouragement as well as academic inspiration. I also thank all the staff and PhD students at Sheffield Hallam University who gave me support, advice or encouragement including the Sheffield Hallam Disability Service who arranged interview transcribing and proofreading.

This research would not have been possible without all the healthcare managers, practitioners, cancer survivors and others who agreed to be interviewed or to take part in workshops. As agreed your names remain anonymous, but if you read this you will be aware of your involvement and I hope be aware of my gratitude.

I thank the friends and family members who supported and encouraged me along the way: friends who let me share my thoughts as my ideas were evolving, friends who helped me fix layout and formatting issues and those who were there to support and encourage me along the way.

Most of all however I would like to dedicate this thesis to my father who inspired me, but sadly passed away during the process. Through many long conversations about academic ideas and the nature of the current health system he encouraged me to start this endeavour. As well as inspiring me academically, my thinking has also been influenced by his approach to being an active and engaged patient living with long term conditions.

Research Output

During my PhD journey I have submitted related papers and delivered presentations at academic conferences. I outline an overview in date order below.

2015

- The SBS Doctoral Conference - An overview of my PhD in poster form.

2016

- The SBS Doctoral Conference – Methodology: Overcoming False Consciousness.

2017

- SBS Doctoral Conference – Improving Healthcare Through Smart Community, Utopia or Dystopia?
- METHOD - Overcoming False Consciousness, Why Neither Positivism or Action Research Hits The Spot
- BAM - Could Smart Communities Improve the Efficiency of Cancer Services in Sheffield? - Development Paper.
- ICEIS - Improving Healthcare Through Human City Interaction.
<http://shura.shu.ac.uk/15786/>

2018

- IMPACT - The Potential Impact of my PhD Research.
- SHU Humanities Conference - Agency Vs Structure in the Age of Digital Healthcare.
- SBS Doctoral Conference – A Theory of Digital Healthcare Efficiency.
- Sheffield Hallam Creating Knowledge - Could Smart Communities Improve the Efficiency of Cancer Services in Sheffield?
- EASST: Could Smart Community Improve Healthcare Efficiency?
- OR60 : Could Smart Community Improve Healthcare Efficiency?

Abstract

This critical digital health study draws upon smart community and smart city literature to gain insights into how to address the practical and complex issue of improving healthcare, with a focus on cancer services in Sheffield. The study's approach brought together ideas from literature and primary data through a process of theory informed critical reflexivity. It applied a critical systems heuristics methodology that included 3 workshops and 30 semi-structured interviews. Workshops focussed on creating rich pictures of what future systems might look like based on the smart community concept. The interpretation of data applied Bourdieu's Practice Theory to help understand and highlight power dynamics in existing and proposed solutions. The three corners of the study's sense making process were: expressed ideas of interviewees and workshop participants, reflections of the researcher, based on his life experience and ideas expressed in journals.

By reflecting on opportunities and challenges within smart city, smart community and digital health literature, strengths and weaknesses of emergent ideas were identified. Theory emerged through the creation of a framework that maps out what a more efficient system of cancer services might look like based on the concept of smart community. Whilst smart city and community literature has acknowledged differences between top down and bottom up approaches the divisions within top down and bottom up approaches are rarely given much consideration.

To address these limitations a framework was developed that subdivides top down into private vs government led and bottom up between individual and collective approaches. The study concludes that a new system based on smart community is only likely to improve efficiency without undesirable ethical consequences if applied in a specific way. New relationships with and through smart technology would be required as would greater consideration of the structural factors that impact on health outcomes.

Table of Contents

Declaration	1
Acknowledgements and Dedication	2
Research Output	3
Abstract	4
Table of Contents	5
Table of Figures	13
Table of Tables	15
Section A Introduction	17
Chapter 1 Introduction	17
1.1 Setting the scene	17
1.2 Research Philosophy and Its Implications	18
1.3 Explaining the question	20
1.4 Aims and Objectives	22
1.5 The Problem	23
1.5.1 The nature of the problem.....	23
1.5.2 The Local Picture	23
1.5.3 The system	25
1.5.4 Modernity and the Biomedical Model.....	25
1.6 Structure	27
Chapter 2 Literature Review	30
2.1 Introduction.....	30
2.2 Part 1: The Evolution of the Smart Community Concept.....	30
2.2.1 The early years, before 2002	32
2.2.2 Evolving 2002 – 2010	33
2.2.3 Recent 2011 – 2018.....	33
2.2.4 My Smart Community Definition	36
2.3 Part 2: Related Concepts	39
2.3.1 Social Capital	39
2.3.2 Coproduction /Community Development	40

2.3.3	Social Computing.....	44
2.3.4	Cyber Physical Systems	47
2.4	Part 3: Research Gaps.....	49
2.4.1	Smart Community Healthcare Gap	49
2.4.2	Smart Community Gap.....	50
2.4.3	Smart Cities	51
2.4.4	Fragmented Knowledge Gap.....	52
2.4.5	Philosophy	52
2.5	Part 4: Scope.....	54
2.5.1	Industry 4.0 / Health 4.0	54
2.5.2	Human Computer Interaction	55
2.5.3	The nature of smart communities	56
2.5.4	Existing Research.....	57
2.5.5	Literature Navigation	59
2.6	Conclusion	62
Section B Methodology.....		64
Chapter 3	Research Design and Delivery.....	64
3.1	Part 1: Philosophy and Methodology.....	64
3.1.1	Philosophical Perspectives	64
3.1.2	Systems Thinking.....	65
3.1.3	Philosophy Conclusion	71
3.2	Part2: Overview of Methodology.....	72
3.2.1	A Critical Methodology	73
3.2.2	Boundaries	74
3.2.3	Authenticity Not Objectivity	75
3.2.4	Bourdieu’s Theory of Practice.....	76
3.2.5	Challenging the Status Quo with False Consciousness	83

3.3 Part 3: Structure, Methods, Procedure and Activities	88
3.3.1 Process and procedures	88
3.4 Research Methods.....	94
3.4.1 Interviews.....	94
3.4.2 Workshops	95
3.4.3 Ethics	101
3.5 Part 4: Interpretation	103
3.5.1 Reflexivity.....	103
3.5.2 The ethnography of my life.....	105
3.5.3 Thematic coding.....	106
3.5.4 Theory Building	109
3.5.5 Triangulation	112
3.6 Part 5: Additional Theory	113
3.6.1 Structuration Theory.....	113
3.6.2 Adaptive Structuration Theory	114
3.6.3 Actor Network Theory.....	115
3.7 Conclusion	116
Section C Sense Making	118
Chapter 4 First Steps of Interpreting Findings.....	118
4.1 Part 1: Scoping Review Findings.....	119
4.1.1 Scoping Review Section A: Thoughts about Methodology.....	119
4.1.2 Scoping Review Section B: Thoughts about Scope	123
4.1.3 Reports / Initiatives.....	123
4.2 Part 2: Main Phase.....	126
4.2.1 Main Interviews	126
4.2.2 Workshops	131
4.3 Part 3: Themes.....	133
4.3.1 Diagram.....	142

4.4 Chapter Conclusion	144
Chapter 5 Storytelling	145
5.1 Applying Bourdieu’s Theory of Practice to Interpret Data.....	145
5.1.1 Social Capital	145
5.1.2 Cultural Capital.....	148
5.1.3 Symbolic Capital	150
5.1.4 Habitus	150
5.2 Hunches	151
5.2.1 Hunch 1: A system more focused on maintaining good health than treating illness would be more efficient (lifestyle).....	152
5.2.2 Hunch 2: A shift away from the biomedical model towards a biopsychosocial model would increase efficiency.....	153
5.2.3 Hunch 3. The aviation industry offers lessons we could learn from	155
5.2.4 Hunch 4: A less hospital focussed system might be more efficient	157
5.3 Stories.....	159
5.4 Chapter Conclusion	166
Chapter 6 The Current System.....	167
6.1 Part 1 Scoping Interviews	167
6.1.1 Thoughts about the Current System.....	167
6.2 Part 2: Workshops	171
6.2.2 Asset list: Stage 2	178
6.2.3 Rich Pictures.....	180
6.3 Part 3: Main Interviews	185
6.3.1 Links to Themes, Hunches and Stories.....	187
6.3.2 The Current Maze.....	191
6.3.3 Lack of ambition	191
6.3.4 Costs in the system	192
6.4 Part 4: Reports and Initiatives	195
6.4.1 Local	195

6.4.2	National / International	195
6.4.3	Reflections on initiatives	196
6.5	Part 5: Modelling the Current System.....	197
6.5.1	What is good	197
6.5.2	What is Not Good / Problems	199
6.5.3	Conclusion	202
Chapter 7	Utopia.....	204
7.1	Visions of Utopia.....	204
7.1.1	A Smart Community Utopia	205
7.2	Workshops and Interviews	211
7.2.1	Utopia Workshop	211
7.3	A Top Down, Modernist Vision.....	214
7.3.1	Faith in technology.....	214
7.3.2	Urban Planning / Smart City.....	215
7.3.3	Prediction	219
7.4	The Biopsychosocial Model	221
7.4.1	Prevention / Psychographics.....	223
7.5	Capital.....	226
7.6	Specific examples	228
7.7	Conclusion	234
Chapter 8	Dystopia	236
8.1.1	A Smart Dystopian Nightmare	236
8.2	Issues with Data.....	238
8.2.1	Faith in Modernity.....	238
8.2.2	Power	240
8.2.3	Data Ownership.....	241
8.3	Top Down Corporate	243
8.3.1	Social Control	244
8.3.2	New Walls.....	247

8.4 Top Down Public Sector.....	247
8.4.1 Techno-centric Governance.....	248
8.4.2 Urban Design.....	249
8.4.3 Managerialism.....	250
8.5 Bottom up.....	251
8.5.1 Individualistic Counterculture.....	251
8.5.2 Consumerism	252
8.5.3 Lifestyle	253
8.6 Social Control.....	253
8.7 Surveillance	256
8.8 Capital revisited.....	257
8.8.1 Economic Capital.....	257
8.8.2 Cultural Capital.....	259
8.8.3 Symbolic Capital	261
8.8.4 Social Capital	261
8.9 Ethics.....	263
8.10 Conclusion	264
Section D Conclusion.....	267
Chapter 9 Towards A Smart Community Theory	267
9.1 Part 1: Workshop 3.....	267
9.1.1 Rich Pictures.....	267
9.1.2 Costs	272
9.2 Part 2: Moving Towards a Future Model	274
9.2.1 Smart Health and Care	274
9.2.2 Smart Governance.....	280
9.2.3 Combining Care with Governance	284
9.3 Part 3: Framework and Theory.....	286
9.3.1 Step 1: Framework	286
9.3.1.1 Vision 1: Top down government led	287

9.3.1.2	Vision 2: Top down private sector led.....	288
9.3.1.4	Vision 4: Collective bottom up.	289
9.3.2	Step 2: Towards Theory with Conceptual Models.....	292
9.3.3	A Substantive Smart Community Theory.....	301
Chapter 10	Conclusions and Next Steps	308
10.1	Contribution to Knowledge	308
10.1.1	Implications for Future Research / Policy	309
10.1.2	Limitations / What I would do differently.....	311
10.1.3	Next steps.....	312
References.....		314
Appendixes.....		351
10.1	Appendix 1 Coding System	351
10.2	Appendix 2: Glossary: How terms are defined in this study	352
10.2.1	Concepts Directly Related to Smart Community	352
10.2.2	Concepts connected to Practice Theory	352
10.2.3	Methodological concepts.....	353
10.2.4	Words that define the medical system.....	353
10.2.5	Abbreviations	353
10.3	Appendix 3: Evidence of Workshop Outputs, including Rich Pictures and other Supporting Photographs.....	354
10.4	Appendix 4 Comments of Participants.....	358
10.5	Appendix 5 Consent Forms and Information Sheets	374
10.5.1	Participant information Sheet.....	374
10.5.2	Participant Consent form	377
10.5.3	Photo / Video Consent	379
10.6	Appendix 6. Steps Taken to Create Theory	381
10.6.1	Creating the data and interim sense making.....	381
10.6.2	Categorising the data	382
10.6.3	Bringing it all together	383

10.6.4	Overarching how systems thinking was applied.....	383
10.7	Appendix 7: Workshop Structure and Information.....	384
10.7.1	Example of Workshop Structure (Workshop 3).....	384
10.8	Appendix 8: Information Received from Participants.....	385
10.8.1	The Current System.....	385
10.8.2	Sheffield Cancer Stakeholders	385
10.8.3	Relevant Initiatives.....	386
10.9	Appendix 9: Interviews	387
10.9.1	Overview of a typical scoping interview	387
10.9.2	Questions /Themes for Main Interviews	387
10.10	The NHS / IRAS Application for This Study	389

Table of Figures

Figure 1 Thesis Content.....	16
Figure 2: Johnson and Duberleys Ontology and Epistemology Matrix.....	18
Figure 3 Overview of My Research Project Structure.....	21
Figure 4 Overview of Research Project 2.....	38
Figure 5 How Concepts Relate to Smart Community	39
Figure 6 : Concepts Relating to Social Computing	45
Figure 7 Bourdieu Field Theory (Harrison 2014).....	77
Figure 8 Conditions of Existence, Habitus and Lifestyle (Bourdieu, 1984).....	79
Figure 9: The Nonlinear Nature of My Research Process	89
Figure 10 Illustration of Post-It Exercise	97
Figure 11: Soft Systems Methodology (Checkland, 1999).....	99
Figure 12 Appreciative Inquiry (Acosta and Douthwaite, 2005).....	100
Figure 13 How Workshops Link to Methodology	101
Figure 14: BMI Conceptual Model Example (Chaloupka and Powell, 2009).....	108
Figure 15 Constructivist Grounded Theory (Johnson and Duberley 2015).....	111
Figure 16 Themes.....	143
Figure 17 Social Capital	147
Figure 18: Cultural Capital.....	150
Figure 19 : Story 1	163
Figure 20: Post-it Note Exercise	172
Figure 21 : Curent Rich Picture 1.....	181
Figure 22: Current Rich Picture 2	182
Figure 23 : Curent Rich Picture 3.....	183
Figure 24 : Costs in the Current System.....	193

Figure 25 Good parts of the Current System	199
Figure 26 Inefficiencies in the Current System	202
Figure 27: Utopia.....	211
Figure 28 A Smart Community Healthcare Utopia	232
Figure 29 Dystopia.....	238
Figure 30: A Rich Picture of Dystopia.....	244
Figure 31 : Panopticon Prison Inside A Mobile Phone (Green, 2013).....	256
Figure 32 A Potentially Efficient Dystopia.....	266
Figure 33 Workshop 3 Future System Rich Picture.....	268
Figure 34 Workshop 2 Future System Rich Picture.....	269
Figure 35 Ideas About Change from Workshop 3.....	271
Figure 36: Cost Centres Current System	272
Figure 37 Cost Centres Future System	273
Figure 38 : A Model of Smart Community Efficiency	278
Figure 39 How Health and Governance Ideas Fit Together	285
Figure 40: Four Smart Community Visions Framework	287
Figure 41 Smart Community Definition Reminder	292
Figure 42: How Efficiency Ideas Link to Visions	296
Figure 43 : A vision representation of Ideas outlined in Table 21	299
Figure 44: How Smart Community Ideas relate to Bourdieu’s Theory of Practice	300
Figure 45: An Illustration of My Smart Community Theory.....	305

Table of Tables

Table 1 Objectives	22
Table 2 Where Concepts are Discussed	29
Table 3 Related Research Outside of the Scope of this Study	58
Table 4: Where Smart Community Concepts are Discussed.....	60
Table 5 Procedures, Methods and Activities	90
Table 6 : Suggested Research.....	123
Table 7 Ideas that Emerged in Scoping Interviews	124
Table 8 : Healthcare Without Walls	158
Table 9 Interviewee Comments about the Current System	168
Table 10 Asset list.....	173
Table 11 Good and Problematic in the Current System	178
Table 12 : Good and Problematic in Current System 2	184
Table 13 : Good in Current System	186
Table 14 : Issues in the Current System	188
Table 15 Where Ideas about Costs in the Current System are Discussed	194
Table 16: What is Good	198
Table 17: Parts of the Current System that are Not Good.....	200
Table 18 : Examples of Current Smart Technology	230
Table 19 : Utopian Efficiency Ideas	233
Table 20 Strengths and Weaknesses of Smart Community Visions	291
Table 21 Where Smart Community Ideas are Discussed	293
Table 22 Connections with Theory	297

Figure 1 illustrates the layout of the thesis.

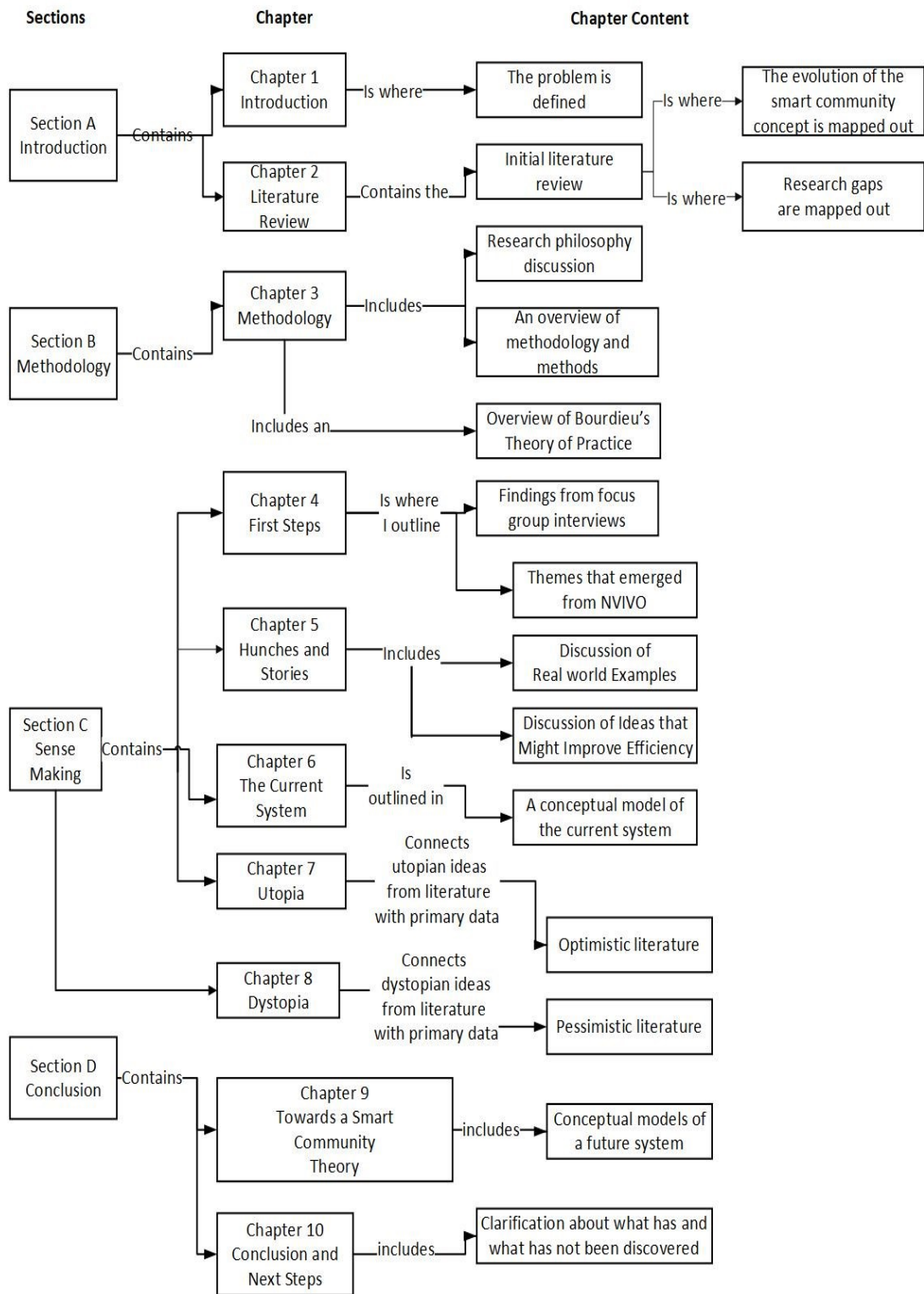

Figure 1 Thesis Content

Section A Introduction

Chapter 1 Introduction

This chapter gives an overview of the entire thesis, setting out the aims and objectives of the investigation. It includes an introduction to the research philosophy and the ideas relating to the problem being examined. Finally there is an overview of the structure and the focus of each chapter. In line with some of the stories that emerged from interviews, I also set the scene and introduce the main characters. The research question is ‘Could Smart Communities Improve the Efficiency of Cancer Services in Sheffield?’

1.1 Setting the scene

Why this research is needed - The practical need for this research is the strain that health and social care services in the UK are currently facing. Its theoretical need is a lack of academic research into the concept of smart community applied to healthcare. This theoretical issue has practical value, as it might open up insights into how to address the practical issue.

Why it’s important to me - My interest in this study emerged whilst I was working for a healthcare charity. I noticed rhetoric used by some digital health companies that was very similar to the language of empowerment used by community health organisations. The concept of smart community connects these ideas. My academic interest in smart community and related concepts including the smart city emerged from an undergraduate degree in urban planning and a master’s degree in sociology. I have a personal interest in cancer services that emerged from my own experience of surviving cancer.

Characters - The main characters that emerged from this research were; healthcare professionals, health managers, social care providers including charities, cancer survivors, digital health companies and local authorities. To capture the perspectives of each, primary data was collected from all of these groups.

The setting - Sheffield has been selected for this project as survival rates are lower than most other cities. The focus on a city is deliberate as the concept of smart community, like smart city, has roots in urban design. Throughout this document I

have made connections between ideas that emerged in urban design and ideas that perhaps now need to be learned in relation to the adoption of smart technology.

Contribution to theory – This thesis contributes towards theory by developing smart community theory in relation to healthcare efficiency. After defining what is meant by the concept, the thesis concludes that it could improve efficiency if certain conditions are met. These include:

- a shift in focus away from the biomedical focus of the current healthcare system, towards one that places greater focus on prevention
- changing relationships with and through smart technology
- a culture shift away from modernism

These conditions are outlined and discussed in 9.3.3.

1.2 Research Philosophy and Its Implications

Because my methodology chapter follows the literature review chapter, I include a brief introduction here to explain the implications of the research philosophy on how I engaged with data including the articles outlined in the literature review chapter.

The research philosophy, for this project is Critical Systems Thinking (CST). CST is a form of systems thinking with a philosophical view based in a deeply Kantian world view that has close links to both critical theory and critical realism. CST is a philosophy with both a realist ontology and a subjective epistemology. It is located firmly in the bottom left hand quadrant of Johnson and Duberley’s much cited diagram, Figure 2.

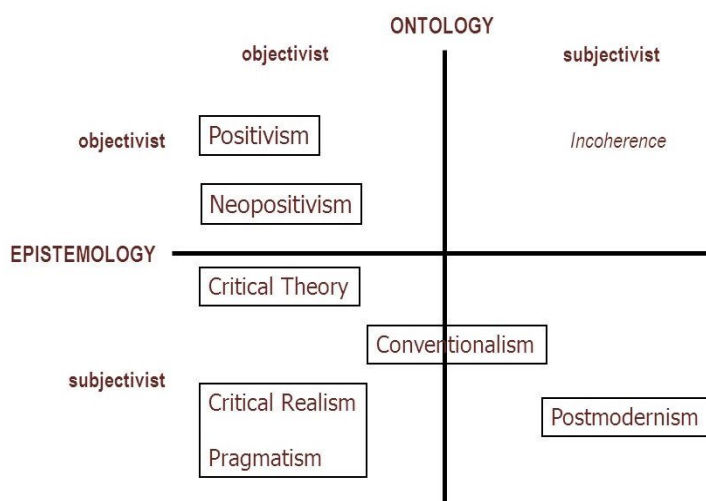

Figure 2: Johnson and Duberley's Ontology and Epistemology Matrix

(Johnson and Duberley, 2000)

CST is outlined in detail in Chapter 3 where the rationale for my choice is given along with its methodical implications. CST includes elements of critical theory and systems thinking. Combined, they give a holistic world view with a subjective epistemology. This subjectivity impacts on details, including the choice of writing style selected and the way that data, including literature, is treated. Systems thinking however is more than simply thinking holistically, or thinking about a whole system. It is to think in systems as well as to think about systems. Thinking in systems is to apply systems diagrams to help understand and make sense of problems (Boardman and Sauser 2008).

Literature frequently includes connections between smart cities and systems thinking (Harrison and Donnelly, 2011; Cosgrave et al., 2013; Khansari, Mostashari, and Mansouri, 2014; Söderström, Paasche, and Klauser, 2014). Harrison and Donnelly make a particularly direct connection defining a smart city as a system of systems. There is also some literature that makes a direct connection between the smart community concept and systems (Terziev and Arabska, 2014; Huang and Miranda, 2015; Dyer, Gleeson, and Grey, 2017). The connection with systems thinking might be expected due to the systemic nature of how cities work. I argue that the connection between systems thinking and the concepts of smart cities and communities makes systems thinking relevant to this study. Both smart community and smart city are concepts that help explain the potential impact of information technologies (Harrison and Donnelly, 2011; Albino et al 2015). Both concepts are defined in chapter 2.

This document is deliberately written in the first person; which is consistent with my choice of research philosophy. In this project there has been no pretence of objectivity. I acknowledge my role as part of the research. I am not claiming the stance of a researcher that is objective and separate from it. My world view is quite the opposite, I am claiming that my own personal and professional experience is an asset that I applied to help make sense of the data I collected. In line with this philosophy, along with the primary data that I collected specifically for this study, all of the literature and theory referenced is data that has informed my conclusions.

Another aspect of my approach that stems from its research philosophy is how I have engaged with concepts. Whilst concepts have been defined when they are first

mentioned, this has not always been possible. Due to its subjective epistemology definitions are considered as context specific, not something that are accepted as general or universal. Due to this, definitions have where possible been included alongside the discussion of related literature.

I propose that the research philosophy selected is of profound significance, as the same subject matter engaged with from a different philosophical perspective would have reached different conclusions. The study's philosophy underpins all choices made in it, including the research methods selected, the approach taken to interpreting the data, the literature selected and the meaning derived from it. I very deliberately referred to interpreting data rather than analysing it, as the approach taken to data is subjective. Because literature and theory are regarded as relevant data sources along with primary data, literature is engaged with throughout this document, not just in the literature review in Chapter 2. The scattered literature approach I applied is discussed in chapter 3 and supported by research literature (Wolcott, 1990; Silverman, 2000; Silverman, 2013). The rationale underpinning the research decisions, including the first person writing style and how to engage with literature, are discussed in Chapter 3.

1.3 Explaining the question

The focus of this thesis is to examine how ideas related to the concept of smart community might be able to improve the efficiency of the system of cancer services in Sheffield. Because multiple definitions of efficiency exist, to give clarity I outline below what I mean by efficiency in this study. By efficiency I mean costs in relation to the quality of service provision. My definition is informed by healthcare research (Palmer and Torgerson, 1999). Palmer and Torgersen state that efficiency is concerned with the relation between resource inputs (including capital) and outputs. With outputs including both quality of life and life expectancy. My criteria is similar to the notion of QALY often used in health economics research¹, but in line with the study's research philosophy in this study it is considered subjectively, in a way that considers that different actors are likely to have differing priorities. Unlike traditional health

¹ A QALY is a Quality adjusted life year. It defines benefit in terms of quality of life as well as extending life.

economics I did not attempt to put a numerical value on the relationship between quality and costs.

Smart communities is a slightly nebulous term, with subtle variances of exactly what it means. I define smart community as:

‘Human and non-human agents² collaborating with the stated aim of significant positive change’.

An overview of some of the literature this definition emerges from is given in 2.2.

Discussion about how the application of the smart community concept might improve efficiency is a cross cutting theme through this document. Figure 3 gives an overview of the key components of this project and how they fit together.

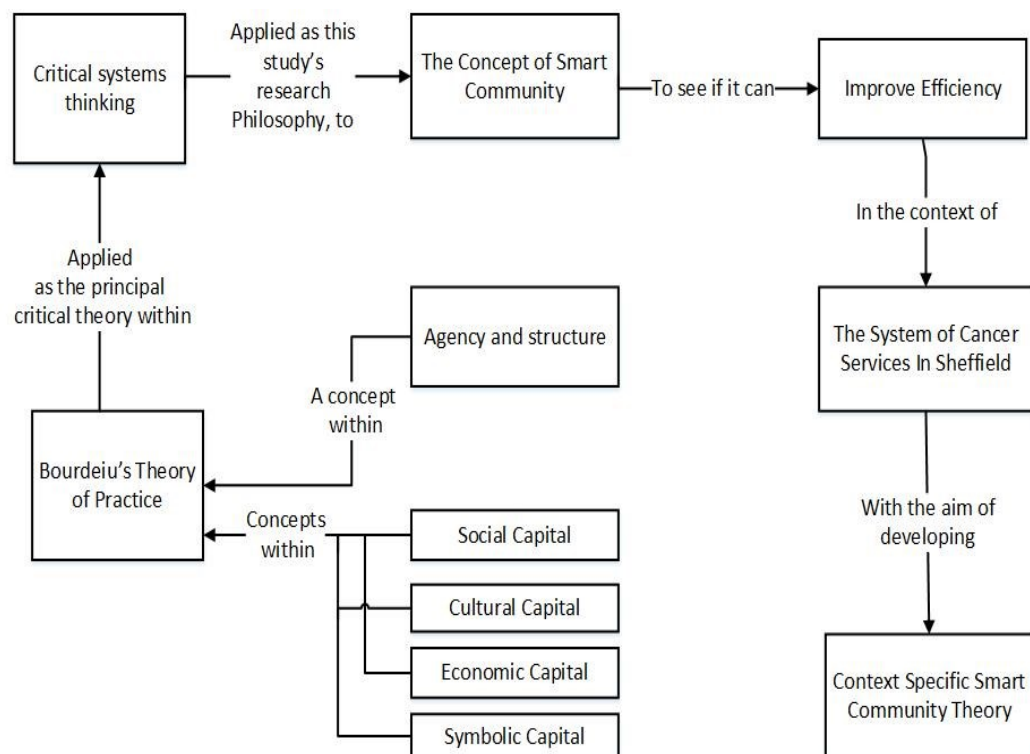

Figure 3 Overview of My Research Project Structure

² I am aware that there is debate about the extent to which objects can have agency. I am taking the perspective outlined in Latour's Actor Network Theory that they can. Bruno Latour is an influential philosopher and Social Theorist. Actor Network Theory is outlined in 6.3

1.4 Aims and Objectives

Now that I have set the scene and explained the question, I clarify what I set out to achieve through this study.

Aims:

The central aims of this study are:

- To explore smart community related approaches that might have the potential to improve the efficiency of the system of cancer services in Sheffield.
- To develop smart community theory.

The objectives of the study are indicated in Table 1, which also indicates where and how they have been achieved.

Table 1 Objectives

Objective	Which chapters address each objective	Notes / comments
Objective 1 - To explore and define the concept of smart communities and its potential role in healthcare provision.	Chapter 2 and chapters 7-9.	It has been achieved through the literature review and the scoping review. Most of the literature review is scattered throughout the thesis.
Objective 2 - To explore current smart community interventions that could be applied to improving the efficiency of the system of cancer services in Sheffield.	Chapters 4-8.	Chapters 4-6 introduce ideas from primary data Chapters 7 and 8 connect these ideas with related literature. Chapters 4-8 contain the content that enable objectives 3 and 4.
Objective 3 - To design models that combine smart community ideas including community engagement and information technology.	Models are outlined through chapters 5-9. In chapter 9 models are closely aligned with objective 4.	This has been achieved through bringing together data from focus group workshops, interviews and existing secondary research.

Objective 4 - To develop smart community theory related to the context of improving healthcare efficiency in Sheffield.	Chapter 9, but informed by chapter 2 and chapters 4-9.	This is closely related to the process of developing conceptual models. Objective 4 is the primary focus of this project.
---	--	---

1.5 The Problem

1.5.1 The nature of the problem

This project is focussed on how it might be possible to improve healthcare efficiency through the application of the concept of the smart community. The issue of how to improve healthcare efficiency is regarded as a wicked problem. Below I discuss some of the literature that informed my choice and the implications of it. The nature of the problem relates to discussion about the choice of research philosophy and methodology discussed in the next chapter.

1.5.1.1 It's a Wicked Problem

Improving healthcare and healthcare efficiency are frequently referred to as wicked problems (Periyakoil, 2007; Westbrook et al., 2007; Raisio, 2010; Ferlie, 2013). Ferlie relates the notion of wicked problems specifically to cancer services. He describes a complex patient pathway provided by many different agencies, including the voluntary centre. It is also frequently referred to in smart city literature (Nam and Pardo, 2011; Chourabi et al 2012; Goodspeed, 2014). The idea of wicked problems dates back to Churchman who suggested that some social system problems are ill-formulated and have many different clients with conflicting values (Churchman, 1967; Buchanan, 1992). The term wicked problem was coined a little later by Rittel and Webber in 1973, who state that nearly all public policy issues are wicked problems (Rittel and Webber, 1973).

1.5.2 The Local Picture

Both the rate of cancer incidence and cancer mortality are higher in Yorkshire than the rest of the UK. This means people in Yorkshire are more likely to get cancer, and the condition is more likely to be fatal for those diagnosed with it (Maher 2014; Yorkshire Cancer Research 2015; Yorkshire Cancer Research 2017). Cancer mortality rates for

people under 75 are worse in Sheffield than in most comparator cities. Cancer and cardiovascular disease account for around 60% of all premature deaths in Sheffield. Over half of all premature deaths from cancer are considered preventable (Sheffield Clinical Commissioning Group 2014).

In 2010 there were 14,600 cancer survivors in Sheffield. A number estimated to double by 2030. This has led some to argue that the current model of medical follow up in hospital will be unsustainable in future (Gore, 2015). Sheffield Clinical Commissioning Group indicate that they believe that change is needed. They state that improvement in the way our services are designed must be accompanied by changes in clinical practice, particularly for people with long term conditions, to help them manage their health and to reduce the number of health crises that might result in a need for urgent care. Common preventable causes of cancer are smoking, alcohol, poor diet and physical inactivity (Sheffield Clinical Commissioning Group, 2014).

- The system of cancer services in Sheffield is a complex web of different services and providers. I give a brief overview below, with more detail given in chapter 6. The overview below is taken from the asset mapping exercise described in chapter 6:
- Delivery organisations include 2 hospital trusts (Sheffield Teaching hospitals and Sheffield Health and Social Care NHS Foundation Trust), Charities (including Macmillan, The Cavendish Centre, The Cancer Support Centre, St Luke's and Age UK), private companies (including BUPA) and local authority departments
- Other organisations /structures include : South Yorkshire and Bassetlaw and North Derbyshire Cancer Alliance and multi-disciplinary teams (MDTS)
- Services include : mental health (e.g. IAPT), medical procedures (including chemotherapy and radiology) and patient support services
- Healthcare providers include: Consultant Oncologists, GP's, Cancer Specialist Nurses and community support workers
- Data includes: GP records, radiology reports and patient surveys
- Information technology systems include: system 1, Lorenzo, Infoflex and EMIS
- Other people in the system include: geneticists, friends and family
- Activities include: the collection of genetics data, chemotherapy redesign, cancer audits, referrals, preventative services and courses

As will be outlined in more detail in chapter 6 whilst there is much about the current system of cancer services in Sheffield that was regarded as good, there was also a lot that was considered as inefficient by the participants I engaged. In general the

biomedical aspects of treating people once they had been diagnosed was considered good.

1.5.3 The system

To find potential solutions to the problem, I started by considering what exactly isn't working. Some have argued it is simply that an ageing population, increasing levels of obesity and rising expectations make the current structure of the NHS unsustainable (Barker, 2010; England, 2014; Ham, 2014). Others argue that it is the way that services are delivered that is unsustainable, or at least that a different approach might be more cost effective (Abelson, Rupel, and Pincus, 2008 ; Engel, 1980: 1997). Many point to an ageing population and rising levels of obesity as the central causes of the financial challenge (Powell, 2010). Some who make this case refer to increasing patient expectations as part of the challenge (Rainsberry 2013; Popejoy 2016). Others argue that it is the focus of the current system on acute conditions which is the problem (Coote and Penny, 2014). Coote and Penny argue that at its inception the majority of NHS patients were treated for one-off illnesses, but now over 70% of NHS expenditure is used to treat people with chronic conditions. Their assertion is supported by reports published by government bodies and think tanks (Horne, Khan, and Corrigan, 2013); DOH 2014; DOH 2012; Kings Fund 2015).

Popejoy (2016) relates the idea that the system isn't working to criticisms of the biomedical model of healthcare provision. He argues that chronic diseases such as cancer are not handled well within this framework. Although his critique is focused on the American healthcare system, much of his logic translates to the UK. He claims that by far the most expensive year of a person's life is the last year, implying that much of the treatment given during that year is unnecessary. He argues that despite faith in the biomedical model, most of the increases in life expectancy during the 20th century were due to improvements in nutrition, hygiene and a decline in birth rates, not due to medical advances.

1.5.4 Modernity and the Biomedical Model

The biomedical model of health is as the name implies has a focus on biological factors that cause illness and ill health. In the biomedical model, healthcare professionals look for biophysical explanations and solutions. The Biomedical model is based on dualism

and reductionism. Its dualism is considering the mind and body separately.

Reductionism assumes that understanding can be gained from analysing component parts separately; its application tends to lead to view nature as involving interactions of discrete entities with simple linear cause and effect influences (Engel 1977).

The reductionist ideology in the medical model connects it to modernism and modernity. These refer to a specific mode of thinking in which technology is identified as the primary method of advancing progress (Schot, 2003). Kernick and Sweeney (2001, p356) support the view that the NHS was constructed as a modernist institution. They argue that it is built upon faith in reason and progress and that:

“Normal science is based on logical positivism... with the application of normal science to medicine - the paradigm of certainty- the modern world had arrived.”

Dent (1995, p876) makes a similar point when he argues that:

“Modern organizations are themselves products of human rationality”

He refers to Bauman (2003) who argues that there are limitations to human reason and it is therefore futile to pursue any such utopian scheme.

Popejoy is one of many who are critical of the biomedical model (Capra, 1983; Abelson 2008; Lupton, 2015; Popejoy, 2017). As the NHS has been described as modernist and the approach that it applies is focussed on the biomedical model I am linking the biomedical model to modernity. Critique of the biomedical model flows through this thesis. It is the focus of section 7.4 and 5.22 (hunch 2). It also enters into discussion about the current system (6.5), related theory (3.2.4) and this study's conclusion (9.2.1.6). Abelson argued that the biomedical model is particularly poor at addressing chronic diseases. His view relates to claims outlined earlier that the focus on acute conditions is part of the problem. Capra specifically links the biomedical model to the treatment of cancer, arguing that diseases such as cancer are related to stress, rich diets, drug abuse, smoking and drinking alcohol. He argues that sedentary lifestyles, and the environmental pollution associated with modern industrialization are not handled well within the biomedical framework. Lupton connects the biomedical model to modernism and argues that both medicine and public health are constructed upon the tenets of classical modernism (Issues with modernism are discussed in, 7.3 and 8.4.1).

Abelson (2008) argued that a biopsychosocial model might be helpful in overcoming some of the limitations of the biomedical model. The biopsychosocial model is an approach that considers psychological, social and biological factors and their complex interactions of health and illness, it was originally introduced in the late 1970's by George Engel (Engel, 1980; 1979). Discussion about the nature of the healthcare system links practice with theory. The extent to which arguments about the limitations of the healthcare system are valid may to some extent be dependent upon views about how the world works. The modernist mode of thinking is one way of thinking about the healthcare system. In Chapter 3 I consider different perspectives.

1.6 Structure

As illustrated in figure 1 this thesis is split into 4 sections. Section A is the introduction; it contains this introduction and the literature review chapter. Section B is where the research philosophy, methodology, methods and theory are outlined and discussed. Section C is where the bulk of the interpreting of data is found. It is by far the largest section. It contains literature which relates to the primary data discussed. Finally, section D outlines conclusions and next steps. I bring together ideas from earlier sections to outline a smart community theory.

Section A Introduction

This chapter gives an overview and explanation of the question being investigated, some discussion of the problem and an introduction to the research philosophy and its implications.

Chapter 2 is the initial literature review. It outlines existing research that this project has built upon in order to make a contribution to theory. It includes an exploration of the evolution of the concept of smart community. The chapter also explains and defines most of the main concepts that are relevant to this study. Next it outlines some areas that are outside of its scope. Finally, it outlines the nature of the problem being investigated.

Section B Methodology

Chapter 3 is the research methodology chapter. As well as outlining the study's research philosophy and methodology it explains why each research method was

selected. This builds upon discussion about the nature of the problem given in this chapter. It also outlines the methods and techniques applied.

Section C Sense Making

Chapter 4 is where the process of making sense of data begins. It starts with some initial reflections.

Chapter 5 starts to make sense of the data through hunches and stories that help communicate the key ideas from data.

Chapter 6 focusses on the current system. It starts by outlining ideas that emerged from data. Later these ideas are linked with theory and literature as part of the process of interpreting data.

Chapter 7 takes an optimistic view of how smart communities might be able to improve efficiency. It is titled utopia.

Chapter 8 takes a pessimistic view, and includes consideration of ethical issues. It is titled dystopia.

Both chapters 7 and 8 bring together primary data with literature and theory.

Section D Conclusions and Next Steps

Chapter 9 is where all the different ideas are brought together to make conclusions, to address the research question.

Chapter 10 outlines the conclusions, what has been achieved and opportunities for future related research.

In table 2 I indicate where some of the central concepts in this study are discussed

Table 2 Where Concepts are Discussed

Concept	Where first introduced	Where concepts is discussed
Smart cities	1.2	In section 2.2.4 I clarify the difference between smart city and smart community
Social Computing	2.2	<p>In 2.3.3 I give an overview of social computing including how it relates to other concepts including web 2.0 and social media.</p> <p>It is the focus of section 7.1.1.1</p> <p>Potential negative impacts are discussed in 8.1.1</p>
Cyber physical systems	2.2	<p>I give an overview in 2.3.4.</p> <p>It is the focus of section 7.1.1.4</p> <p>Potential negative impacts are discussed in 8.1.1</p>
The biopsychosocial model	1.5.4	Most of the discussion about the biopsychosocial model is situated in 5.2.2 (hunch 2) and 7.4
Modernity	1.5.4	Discussion of modernity and its implications is the focus of 1.5.4, 7.3 and 8.2.1
Social capital	2.2.3	2.3.1, 2.3.2, 3.2.4

Chapter 2 Literature Review

2.1 Introduction

The main purpose of this chapter is to outline the research that this study builds on and the gaps it engages with. It also defines and discusses smart community and related concepts and introduces many ideas that are discussed in greater depth in subsequent chapters. It is split into four subsections; the evolution of the concept of smart community, related concepts, the research gap, and the scope of the project. The first subsection outlines the smart community theory this thesis builds on. The second defines key concepts and discusses how they relate to smart community and to this study. The third highlights the need for this research, in terms of contribution to theory. In line with the non-linear research methodology applied³, although this chapter starts to address objective one (outlined in table 1), some subsequent chapters also help to address it. The final subsection outlines some areas that are inside and outside of scope.

A lot of concepts are discussed in this chapter. As indicated in 1.2 due to the research philosophy applied concept definitions are included alongside discussion of related literature. Due to the complex interconnectedness of many of the concepts related to this study, new concepts often emerge during the discussion of other concepts. Many new ideas for example emerge during part one, during the process of working towards a definition of smart community. Many of these concepts are defined in later subsections of this chapter.

2.2 Part 1: The Evolution of the Smart Community Concept

In my initial exploration of the term smart community I found the concept to be nebulous with subtle variances of exactly what it means. To give clarity to what I mean by smart community, I have mapped out how the concept has evolved. Most of the related concepts that emerge through this process are defined and discussed in part 2 of this chapter.

Following an extensive search I found 63 articles with references to smart community or smart communities. My search procedure was as follows: I searched the first 100

³ The non-linear structure is outlined in 3.3.

entries that included the words smart community or smart communities in the following databases; Business Source Premier, Emerald, Proquest Central, Scopus, Sheffield Hallam University Library Gateway, Google Scholar and Researchgate. This process was then repeated including the terms health and healthcare. 43 out of the 63 relevant articles identified include references to health or healthcare.

Articles that refer to smart community in a non-digital sense were rejected as were articles that refer to very mechanistic⁴ definitions of smart community. A second group of articles were excluded as they applied a definition suitable to a different context and not digital healthcare. For example the *“Cloud based management and control system for smart communities”* (Mital, Pani, Damodaran, and Ramesh, 2015, p163) is excluded because it defines a smart community as:

“a multi-hop network of smart homes that are interconnected through radio frequency”.

Whilst this may be a valid definition within the context of looking at smart technology from an engineering perspective, it is outside of the scope of this project and so it was also excluded.

As I outline in this chapter the concept of smart community has evolved over time. Later definitions include concepts including cyber physical systems, web 4.0 and social computing. As these describe aspects of current internet interactivity, it is possible that these were not part of initial smart community definitions because when the term smart community emerged in the early 1990’s the internet as it was then didn’t include the technical means for them.

The term smart community can be traced back to the early nineties in Silicon Valley in response to the financial crisis (Lindskog, 2004). The link with financial crisis is one of the reasons the concept was selected. As outlined in chapter 1 the system of cancer services in Sheffield is currently experiencing financial crisis. The application of the smart community concept to improving healthcare efficiency is supported by literature that associates the concept with finding solutions to social problems including

⁴ Issues with mechanistic approaches are discussed in 8.4.2

healthcare (Bencardino and Greco, 2014; Coppola, Papa, Angiello, and Carpentieri, 2014; Caputo et al, 2016).

2.2.1 The early years, before 2002

Common themes in early smart community literature include: collaboration, significant change, collaborative learning and internet enabled governance arrangements.

Collaboration - Collaboration was a central theme in many early smart community articles (Coe, Paquet, and Roy, 2001; Hughes and Spray, 2002; Wilson, 1997). In articles published before 2002 the focus was primarily on how people can collaborate more effectively through information technology. This included collaboration between the public, business and government officials (Wilson, 1997; Coe, Paquet, and Roy, 2001).

Significant Change - Another idea that featured highly in early literature was significant not just incremental change (Eger 1997, Wilson 1997; Downes, 2000; Coe, Paquet, and Roy, 2001). Downes proposes that smart community is about a fundamental change in the way that communities do business.

Learning – Coe, Paquet, and Roy, (2001) make reference to several concepts related to the generation of knowledge through information technology enabled connectivity. These include collective intelligence and networked intelligence. They claim that this is omnipresent in smart communities. They associate collaborative intelligence with the idea of creative interactions in real-time. At this time their reference to these ideas was an outlier. Reference to networked learning become more common in more recent literature after social media become mainstream.

Governance – The smart community concept is often associated with internet enabled government. It is a collaborative form of governance that involves citizens, business and government officials acting together that is relevant to the operations of services including healthcare (Wilson 1997; Hughes and Spray 2001; Coe, Paquet, and Roy, 2001).

2.2.2 Evolving 2002 – 2010

During this time developments including social media and smartphones started to take hold and become part of online communication and collaboration (Goldsmith and Crawford, 2014).

Collaboration - Collaboration remains a central feature in more recent literature (Milner, 2002; Albert and Fetzer, 2005; Komninos, 2006; Krebs and Holley, 2006).

Significant Change - A truly smart community is one that has made a conscious effort to use information technology to transform life and work in “significant and fundamental,” rather than incremental ways (Eger, 2009).

Vision of the Future - Vision is an idea that becomes central (Lindskog, 2004).

Lindskog (2004, p3) defines a smart community as:

“a community with a vision of the future that involves the application of information and communication technologies in a new and innovative way to make the most of the opportunities that new applications afford, such as better healthcare”

Milner (2002) places vision at the centre of her book. The idea of vision of the future links smart community to utopian ideas outlined in Chapter 7. It may be necessary to outline a vision of the future to understand how to improve efficiency.

Governance – Leadership emerges as a feature of smart community. Leaders can be government officials or other civic minded individuals (Albert and Fetzer, 2005). Albert and Fetzer argue that smart community leaders must be self-directed because they are responsible for a whole product or process.

2.2.3 Recent 2011 – 2018

As indicated by the number of references given in this section there has been a minor explosion of academic smart community literature since 2011.⁵ It may have been in part due to advances in information technology, for example developments such as

⁵ I acknowledge that this may in part be due to the wider increase in published research that took place during this time.

social media that had emerged earlier became mainstream during this time (Goldsmith and Crawford, 2014).

Collaboration - Collaboration remains, but it starts to involve collaboration with technology as well as through technology (Hao et al, 2014; Nahrstedt et al., 2016; Kinkar, Hennessy, and Ray, 2016). Collaboration connects smart community to the concepts of social computing and cyber physical systems. For example, Kinkar, Hennessy, and Ray (2016, p1) define smart communities as “*networks of physical, social, and cyber entities*” and states that members can be:

“humans, physical objects, the cyber world, and even the social media world”.

Nahrstedt, p2 propose a similar definition suggesting that smart communities are:

“a collection of interdependent human-cyber-physical systems”

Li et al (2011) put forward a definition that emphasises the role of technology, defining smart community simply as a class of cyber physical systems. Xia and Ma (2011) give a more balanced view arguing that smart communities will evolve by bringing together social computing and cyber physical systems. The number of writers who make the link with cyber physical systems indicates that there is some, if not universal, consensus in recent literature about the inclusion of cyber devices as smart community members.

Citizen Engagement - Links with citizens don't simply remain in more recent literature but become more prevalent (Townsend, 2013; Gurstein, 2014; Granier and Kudo, 2016).

Smart City - Although emphasis on citizen engagement had been a differentiator between smart city and smart community, in recent literature, as more community and citizen centric conceptualisations of smart city emerge the two concepts become more closely aligned (Nam and Pardo, 2011; Gurstein, 2011; Caputo et al., 2016). During this time some thinking about smart cities is moving away from a focus on technology and other hardware and starting to include softer aspects such as management and administration (Michelucci, Michelucci, De Marco, and De Marco, 2017).

Social Innovation - Within smart city and smart community literature citizen engagement is often connected to social innovation (Townsend 2013; Bencardino and Greco, 2014; Goldsmith and Crawford 2014, Goodspeed 2014, Grainer and Kudo 2016, Michelucci and De Marco 2017). Bencardino and Greco argue that smart communities are central to social innovation and to achieve social innovation a collection of smart people and smart governance is necessary. The idea of social innovation is relevant to this project, as social innovation is a process that might be able to help improve efficiency.

Governance - Smart community and smart city literature frequently refer to different models of governance enabled by information technology (Strateigia 2012; Bencardino and Greco, 2014; Caputo et al, 2016; Goldsmith and Crawford, 2014). Smart city governance is sometimes described as a technical managerial issue and whilst smart communities are often included, they are often related to the social side of governance (Gurstein, 2014).

Learning - Another idea that is prevalent in recent smart community literature is the idea of learning enabled by online networks (Caputo et al., 2016; de Oca, Ambar Murillo Montes, Nistor, Dascalu, and Trausan-Matu, 2014; Goldsmith and Crawford, 2014). Caputo argues that smart communities can help address social and economic challenges because they can stimulate social learning, something they claim is a condition of efficiency. A related concept that frequently emerges is collective intelligence (Caputo et al., 2016; F. Michelucci and De Marco, 2016; Valetto et al., 2015; Vermesan and Friess, 2014). Network enabled learning is sometimes referred to as the collective intelligence of the city (Albino, Berardi, and Dangelico, 2015; Harrison et al., 2010; F. Michelucci and De Marco, 2016).

Social Capital - Social capital frequently occurs in smart community literature (Bencardino and Greco, 2014; Caragliu, Del Bo, and Nijkamp, 2011; Granier and Kudo, 2016b; Gurstein, 2014). Whilst social capital emerged in older literature it was referred to more frequently in recent articles (Albert and Fetzer, 2005; Coe, Paquet, and Roy, 2001). The connection could be expected as social capital and smart communities both connect to networks, communities and relationships. Discussion about the relationship between social capital and smart community is outlined in 2.2

2.2.4 My Smart Community Definition

As indicated in 1.3, I define smart community as:

“Human and non-human agents collaborating with the stated aim of significant positive change.”

This definition emerged from bringing together ideas from more recent literature with core ideas from earlier articles. One of the differences between older and more recent literature is that it has become more closely connected to the concept of the smart city and its related concepts. The idea of collaborating with non-human agents connects my definition with the concepts of: cyber physical systems, the internet of things, and the smart city. This is not to say that all thinking relating to these concepts is relevant to this research project; simply that some is. For example top down technology driven conceptualisations of smart cities remain outside of the scope of this project. Smart city literature with a softer focus is however deemed relevant. Given the relevance of some smart city articles and the paucity of smart community research, during the rest of this thesis I have included literature that focuses on related concepts, including smart cities.

Collaboration, citizen engagement and change are themes that frequently occur in smart community literature. These are also themes that emerged in workshops and interviews, they permeate through both earlier and more recent definitions of smart community. Ideas of collaboration and citizen engagement connect the concept of a smart community to, both community development concepts such as coproduction and to more recent information technology ideas such as mass collaboration and Health 2.0. Whilst the vehicle for enabling collaboration across these concepts varies significantly, the central idea of bringing together the value of assets within networks and communities carries across these. Concepts of capital including social and intellectual appear to offer an explanation as to why there might be value in networks that could be harnessed to improve efficiency.

Within literature that discusses and defines the term smart community there are two extremes. At one end of the spectrum is literature that focuses on technology (Gunardi, Adriansyah, and Anindhito, 2015; Li et al., 2011a; Xia and Ma, 2011b). At the other end are definitions that emphasise the collaboration of people through

information technology (Downes 2000; Coe, Paquet, and Roy, 2001; Albert and Fetzer 2005; Granier and Kudo, 2016). In this project I brought together elements of both.

The inclusion of non-human agents into my definition incorporates social computing and complex adaptive systems. Non-human agents are most obviously within the cyber physical concept as the cyber element is the non-human component. As outlined in the next subsection, social computing increasingly contains non-human elements such as machine learning.

The smart community definition given by Kinkar, Hennessy, and Ray (2016), is helpful as they retain ideas of citizen and governmental involvement but connect these with ideas of data analytics given by Xia, Ma (2011). In other words, as illustrated by Figure 4, my definition includes people communicating with each other through information technology as well as the interactions of computational devices in internet enabled communications systems.

From the origin of the concept I have retained the idea of working towards significant change within the definition of smart community. Doing so is helpful as it gives focus, putting ideas that are likely to result in minor incremental efficiency improvements outside of the scope of this project.

Figure 4 illustrates how the concept of smart community as it is now defined connects to: related concepts, theory and the focus of this study. It shows that technology enabled change, citizen engagement and collaboration emerge from smart community as defined above. Discussion about interactions through internet forums in 4.2.1.5 is an example of smart community enabled collaboration.

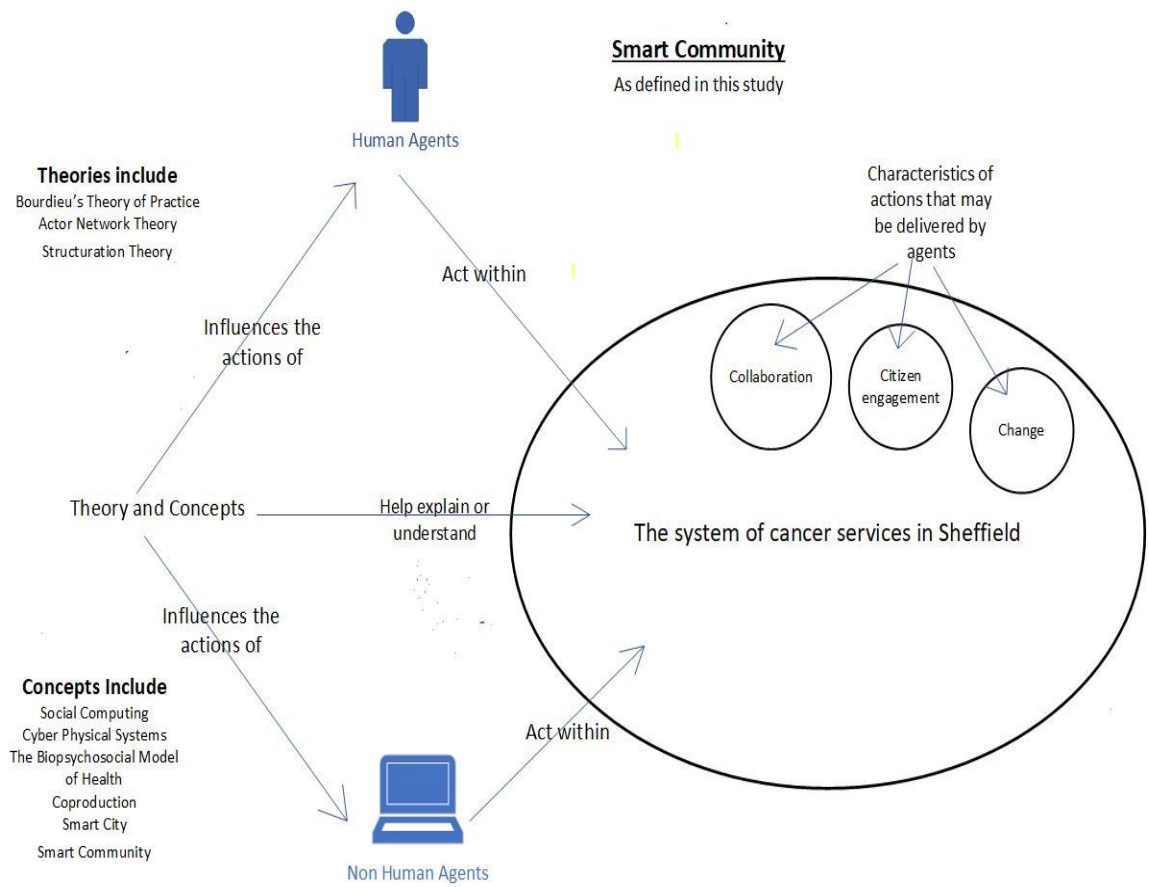

Figure 4 Overview of Research Project 2

2.3 Part 2: Related Concepts

To clarify in more detail what I mean by smart community and how it might improve efficiency I outline some related concepts. I start with concepts of community development before moving onto concepts that are more directly digital.

Figure 5 illustrates the relationship between smart community and some related concepts. Note the main distinction between coproduction and smart community is the connection to social computing and cyber physical systems.

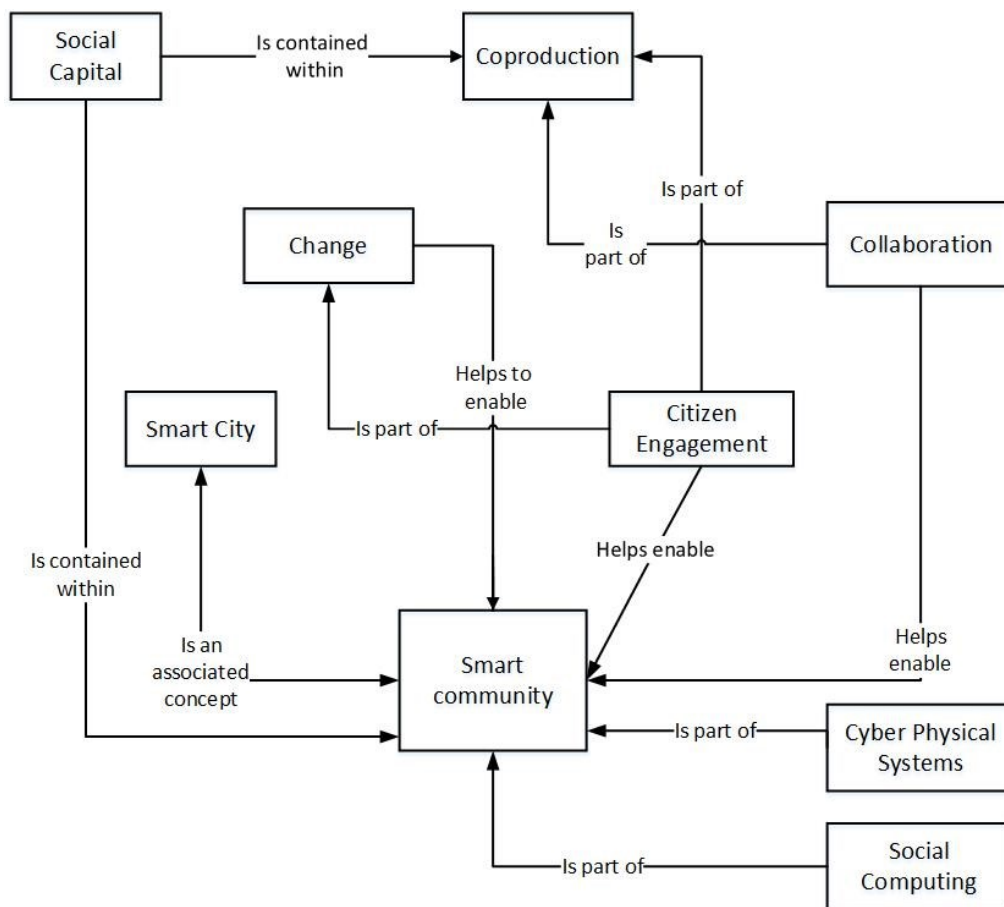

Figure 5 How Concepts Relate to Smart Community

2.3.1 Social Capital

As indicated in 2.2.3, social capital is a concept that frequently occurs in smart community literature. Its existence is logical given the synergy between the two concepts. Both connect to networks, communities and relationships. This is not to suggest that they are in any way the same. I am simply suggesting that smart communities may include social capital within them as part of the fabric that holds together the relationships between the members of a community.

Social capital relates directly to efficiency improvement as the ability of smart communities to improve efficiency or reduce costs may be very much dependent on the amount of social capital that members of a smart community can access. There is however a lack of consistency as to the precise meaning of the term social capital. Putnam defines social capital as the networks, norms, and social trust that facilitate co-operation for mutual benefit (Putnam 1993; Wakefield and Poland, 2005). Bourdieu (1983, p249) defines social capital as:

“the aggregate of the actual or potential resources which are linked to possession of a durable network of more or less institutionalized relationships of mutual acquaintance and recognition”

Bourdieu's definition is relevant as it is considered critical⁶ (Wakefield 2004).

2.3.2 Coproduction /Community Development

Coproduction is related to the concept of social capital, as the logic for why coproduction might help improve efficiency is in part because communities contain social capital (Bovaird 2007, Dunston et al 2009, Realpe and Wallace 2010).

Community development ideas related to social capital include; asset-based models, coproduction, and radical efficiency, the lines between these are however distinctly blurred. A common thread between all of these is the notion that efficiencies could be achieved through a more equal balance of power between patient and health providers and harnessing the assets of volunteer time including patients, their family and community members. In this study I am interested in the extent to which these are relevant to the concept of smart communities, and the insights they offer into improving efficiency.

In terms of efficiency, one of the most extreme ideas is radical efficiency (Gillinson, Horne, and Baeck, 2010). Gillinson, Horne, and Baeck propose that more equal power relations in the delivery of public services could result in significant cost savings. They claim that evidence from case studies indicate cost savings of 20-60% as well as better outcomes. They are far from alone in suggesting that community engagement could result in cost savings or efficiency improvements. Dunston (2009, p40) states that:

⁶ Critical as in critical theory.

“The application of coproduction principles may be crucial for the achievement of necessary service improvement and system sustainability”.

Coproduction and user involvement are frequently linked to efficiency (Tritter and McCallum, 2006; Bovaird, 2007; Needham, 2008). In advocating the potential for coproduction to improve efficiency, Bovaird (2007, p847) argues that:

“By the 1980s the limitations of traditional provider centric models of the welfare state had become obvious”.

The logic for why coproduction and related concepts may deliver cost savings is a simple one. It stems from two ideas. The first is the notion that patient and other community members could be harnessed as a resource to deliver health activity in a voluntary capacity. Tritter and McCallam support the first of these positions arguing that people with chronic diseases have considerable knowledge and experience of their own illness, expertise that can be applied to enable them to play a bigger role in managing their condition. The second is a shift away from a system based on the treatment of disease towards one more focused on maintaining good health. In some articles these two ideas are connected (Nicol and Sang, 2011; Chang et al., 2016)⁷.

Whilst there is not a single definition of coproduction, shared decision making, information sharing, user engagement, and asset-based principles appear in most. Many also refer to the concept of social capital (Bovaird 2007, Dunston et al 2009, Realpe and Wallace 2010). The inclusion of social capital links to the idea of asset approaches i.e. the value within individuals and communities that can be harnessed to improve services.

Researchers frequently state that coproduction is based on the sharing of information (Cahn, 2000; Bettencourt, Ostrom, Brown, and Roundtree, 2002; Needham and Carr 2009). Needham and Carr argue that coproduction is built on the assumption that service users and producers both contribute different and essential knowledge. Cahn builds on this idea describing the relationship between health professionals and health consumers as a learning partnership. This resonates with the idea of knowledge exchange that emerged in part 1 of this chapter.

⁷ The second of these resonates with criticisms of the biomedical model introduced in 1.5.3.

The notion of information sharing connects coproduction to the concepts of agency and structure and smart community because the collaborative aspect of coproduction relate to structural influences⁸. As such, coproduction sits more at the structural end of the agency/structure spectrum. The idea of information exchange relates to the concept of collective intelligence. In 2.2 I argued that collective intelligence can be conceived of as part of smart community. Here I am arguing that it is also part of the concept of social computing. I suggest that it is one of the ideas that connects social computing to smart community.

Bovaird and Loeffler (2010) make a more direct link between coproduction and smart community within their discussion of the role of emerging technologies to enable the coproduction of public services. They directly refer to the term smart community and state that web enabled platforms make it easier for actors to introduce others into the conversation and that collective coproduction has become more practical through this technology. They describe collective coproduction as groups of people engaged in public services. I suggest that where coproduction is digitally enabled and focussed on public service delivery, it is very closely related to the idea of smart community that I outlined in 2.2. As such I argue, that digitally enabled collective coproduction is a mechanism for the application of smart community. My position is influenced by Bovaird and Loeffler who suggest that social network theory, and complexity theory are drivers of collective coproduction. Both of these relate to the idea of systems thinking (introduced in 1.2). Bovaird and Loeffler argue that complexity theory and social network theory are connected by a non-linear relationship between systems and outcomes. Bovaird and Loeffler are not the only coproduction writers to make reference to how information technology might be able to enable community development; Realpe and Wallace (2010, p7) state that:

“mass media such as the internet have challenged the assumption that providers have sole control of information”.

Their idea is very much in line with discussion about patient empowerment⁹.

⁸ It relates to structure, as information sharing can be between many different people in different locations, so the communication is societal.

⁹ As will become clear in subsequent chapters, patients gaining access to information is an idea that flows through this study

2.3.2.1 Communities as Assets

I stated earlier that the idea of assets frequently occurred in definitions of coproduction. The idea that communities are assets links coproduction with social capital, as the assets within communities are a form of social capital. The definition of coproduction given by Morgan and Ziglio (2007) appears to contain social capital. They refer to the resources that individuals and communities have to protect against negative health outcomes. They refer to social, financial, physical, environmental and human resources. Morgan and Ziglio argue that coproduction challenges the theoretical basis of public health, suggesting that epidemiology needs to shift away from generating evidence about the causes of disease towards exploring what creates health. The focus on maintaining health, I argue, is in line with the systems approach of this study as it moves the focus towards a more holistic way of looking at wellness. A system that is more focussed on maintaining health and preventing illness might be significantly different than the current system, as the current one is primarily focussed on treating people when they get ill. Prevention is an idea that re-emerges in different forms within discussion in all subsequent chapters.

Boyle, Clark, and Burns (2006) connect the idea of asset approaches with the notion of shared decision making. They suggest that it challenges the usual relationship between professionals and service users by escalating the latter to the position of experts in their own circumstance, an idea very similar to the one expressed by Tritter and McCallam earlier. It also connects to discussion about social learning as these are mechanisms that could enable such expertise to flow.

Not all of the literature about coproduction and related concepts suggest that these are likely to improve the healthcare system. Friedli (2013) for example is critical of asset based approaches. Her argument is that it places too much emphasis on the role of the individual. She lists individual assets that could be harnessed: self-efficacy, aspiration, confidence, optimism, positive thinking, agency, self-reliance and resilience. The idea that she is criticising is however quite different to the more collective

coproduction definitions applied by some writers. Foot and Hopkins (2010, p6) argue that:

“The asset approach values the capacity, skills, knowledge, connections and potential in a community”

Maller (2015) also favours a collective rather than an individualistic asset approach when she argues in favour of the need to study social practices instead of individual behaviour. She argues that the focus on social practice avoids blaming the victims. The idea of collective coproduction discussed earlier aligns with the collective asset approach described by Maller. It is this collective approach that is aligned with the concept of smart community. Because these criticisms of coproduction focus on the role of the individual, they have limited relevance to the concept of smart community due to its emphasis on cooperation and collective action. To clarify, in relation to healthcare, the idea of personal health budgets is often connected to the concepts of coproduction and asset approaches (Bovaird, 2007; Dunston et al, 2009). Enabling more effective use of personal health budgets links with the narrative of shifting the power relationship away from healthcare professionals towards patients, but it does so through an individualistic rather than at a collective approach.

2.3.3 Social Computing

Social computing is collaboration with and through the internet. It is the virtual interconnections of people (Xia and Ma 2011)¹⁰. As illustrated by figure 6 and outlined below this process of interconnectivity relates to several other concepts including: collective intelligence, social media, web 2.0 and health 2.0.

¹⁰ As discussed later in this section some conceptualisations include the interactions of non-human as well as human agents.

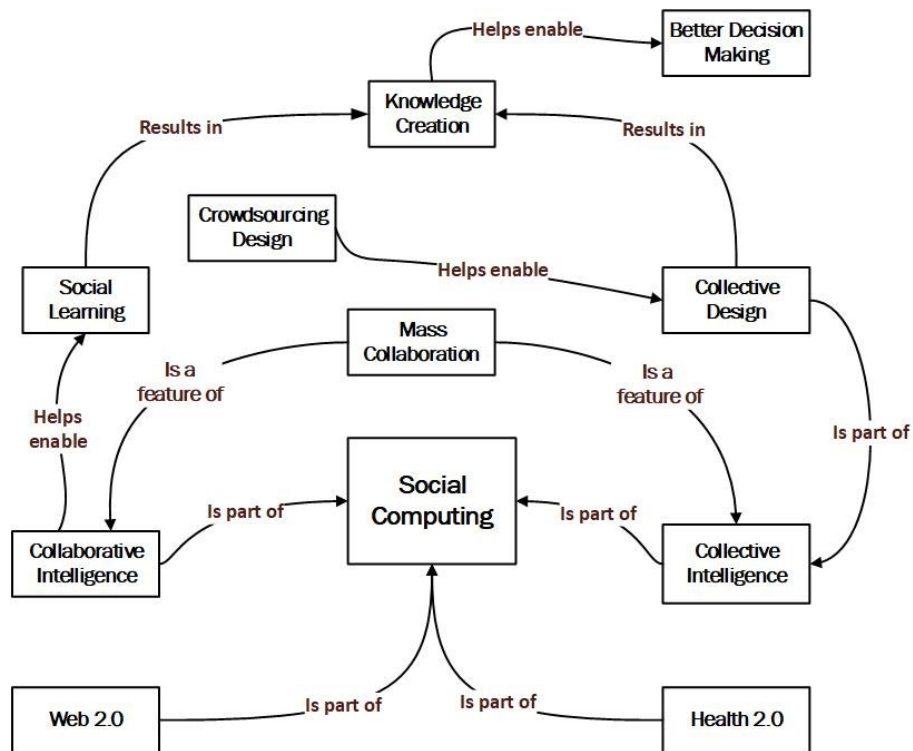

Figure 6 : Concepts Relating to Social Computing

Whilst social computing outdates social media, the emergence of social media platforms have enabled social computing to evolve as new forms of social interactions to take place through the internet. To clarify, social computing is a collaborative field of computing that includes social networks and social media (Parameswaran 2007) Social media are mediums through which social computing takes place, through which online social networks are formed and developed. For example an internet forum is a form of social media. Social networks can be formed by the users of a forum. The interactions of forum members is part of the field of social computing.

Social Computing is relevant to improving healthcare efficiency as it opens up the possibility for new patterns of interaction. Virtual interactions are less confined by time and space than face to face interactions. Communication technologies such as forums and social media enable people to interact with others in different geographies with flexibility about when messages are sent and received. Both patients and healthcare professionals can now engage with each other through internet forums. Communication through forums has led to the emergence of a health specific area of social computing with new terms including health 2.0 and medicine 2.0. Although

some literature suggests subtle differences between them, both are collaborative approaches to engaging patients and healthcare professionals through information technology (Eysenbach, 2008; Hughes, Joshi, and Wareham, 2008).

Social computing relates to the definition of smart community I outlined, as the process of social computing can include interactions between human and non-human agents. It is connected to three sub concepts that are particularly relevant and significant to this study. These are Health 2.0, collective intelligence and web 4.0. Web 4.0 is sometimes referred to as the symbiotic web is the space in which it is argued that human minds and machines can interact in symbiosis. (Aghaei 2011; Naphade et al., 2011; Roche and Rajabifard, 2012; Choudhury, 2014). As such the concept of web 4.0 is close to the ideas of collective and collaborative intelligence.. These move beyond merely sharing ideas with other people towards creating knowledge with other people. Creating knowledge has been connected to social learning, which in turn is related to creating conditions for efficiency (Krebs and Holley, 2006; Hughes, Joshi, and Wareham, 2008b; Tapscott and Williams, 2008; Eger, 2009; Wicks et al., 2010; Hall, Caton, and Weinhardt, 2013; Vermesan and Friess, 2014). Many argue that collaborative intelligence has the potential to result in positive change. An extreme example is the claim that mass collaboration changes everything (Tapscott and Williams, 2008: 2010).

Collective intelligence takes the idea a step further with a shift in power from the individual to the collective. Collective intelligence is not a new idea, but it has received a new meaning through the emergence of Web 2.0 applications (Leimeister, 2010). This new meaning depicts the ability for people digitally connected by the internet to create knowledge collectively. There have been instances of amateur knowledge surpassing professional knowledge, and Wikipedia is given as the most recognised example (Surowiecki, 2005; Kamel Boulos and Wheeler, 2007).

Some argue that collective intelligence can improve evidence based medicine by drawing on a larger knowledge base (Tapscott, Williams, and Herman, 2008). Online networks enrich and contextualise health information and reduce misinformation (Boulos and Wheeler, 2007; Hughes et al, 2008; Aghaei, Nematbakhsh and Farsani, 2012). Similarly, collective intelligence might be the solution to concerns about health

information quality. As thousands of bloggers exchange ideas daily they are effectively acting as filters for information-overloaded Web surfers (Boulos and Wheeler, 2007).

Mass participation is central to the ideas of social computing and collective intelligence. It is also an idea that is subject to criticism. In reality only a small proportion of users may actually be active producers (Van Dijck and Nieborg, 2009). There is also a risk that within mass participation individuals are discouraged from expressing views that differ from those that appear to be the norm. Le Bon (1897) poetically describes conformity as the individual being hypnotised by the crowd. Le Bon's idea of the hypnotism of the crowd resonates with the idea of false consciousness, an idea I define in 3.1.2.1 and discuss in depth in 3.2.5. I am not suggesting that Le Bon specifically refers to the idea of false consciousness. I am saying that I see a connection here: Le Bon argued that being part of a crowd gives people the confidence to act, when doing so along with others. His idea relates to this project, as people in the system of cancer services in Sheffield may hold onto outdated views if others appear to hold the same view, conversely, they may be more likely to accept utopian views about the potential of new technology if many others appear to share them.

Collective intelligence is not the only aspect of social computing to face challenge, critical digital health authors highlight risks including: loss of privacy, social control and commercialisation (Roszak, 1986; Postman, 1992; Van der Laan, 2004; Rich and Miah 2014; Lupton 2014:2017). All of these are discussed in chapter 8, a theme that flows through these criticisms are ethical dilemmas about the extent to which we are prepared to sacrifice freedom or privacy for the sake of potential efficiency improvements.

2.3.4 Cyber Physical Systems

Cyber physical systems include both physical and information systems. They relate to smart community, as human and non-human actors interact with each other through both. A cyber physical system is closely related to the concept of the internet of things (IOT). It is however not the things but the system that connects the things. A cyber physical system contains two layers, the real physical layer where devices and people are situated and the digital layer where information is collected, communicated and

analysed. A cyber physical system forms the interface between the physical real world and cyber world, where information is stored and processed (Gurgen, Gunalp, Benazzouz, and Gallissot, 2013). It is an “*intimate coupling between the cyber and physical*” (Rajkumar, Lee, Sha, and Stankovic, 2010, p731). Cyber Physical Systems are automated systems that connect physical reality with computing and communication infrastructures (Jazdi, 2014).

By connecting with such infrastructures the ‘real-time’ data that is captured by IOT devices can be analysed, and harnessed to inform decision making. The term ‘real-time’ is often used as a characteristic of smart cities and cyber physical cities, to help describe how cyber-digital infrastructures can inform decision making almost instantly. The fusion of the computer and physical world conjures up futuristic imagery that form the foundations of utopian visions. These future visions feature strongly in chapters 7 and 8. Here I am merely setting the scene, by giving an overview of what the concept is and how it relates to improving efficiency. As indicated in 1.2, it is impossible to entirely separate the process of sense-making from defining the problem. In line with the spirit of the methodology outlined in the next chapter, in this section I am consciously discussing concepts related to smart community, discussing the nature of the problem and outlining ideas that might be part of its solution. Utopian visions might contain within them the seeds of what is possible and how efficiency might be improved.

The idea of cyber physical systems connects web 4.0 and collective intelligence to the IOT. Internet forums can now include information uploaded by devices as well as information uploaded by people. An example is a lifestyle forum where participants can see the number of steps recorded by the devices of other participants. By contemplating what forums could look like with the inclusion of cognitive computing systems such as IBM Watson¹¹, we can imagine a complex form of human computer interaction with multiple computing devices symbiotically thinking with people to create knowledge. Seth and Henson (2013) propose a similar idea in their conceptualisation of cyber physical social computing. They describe a form of

¹¹ An overview of IBM Watson is given in 7.6

collective intelligence that is characterized by a form of advanced reasoning that bridges machine and human perceptions.

2.4 Part 3: Research Gaps

This study's contribution to theory builds on and applies ideas from existing smart community literature and related research. Although this project has been primarily focussed on building on existing smart community research there are also research gaps that it helps to address.

The primary research gaps this project is focussed on are:

- Gaps in smart community theory
- A lack of research that applies smart community concepts to healthcare efficiency.

These gaps are intrinsically linked, as developing theory is likely to offer insights into efficiency improvements. Concepts overlap with each other in a similar way. For example, the concept of smart communities is closely connected to the concept of the smart city which in turn is positioned at the intersection of urban design and information technology. Due to links with related areas, this chapter highlights evidence of research gaps beyond just the smart community concept itself.

2.4.1 Smart Community Healthcare Gap

Smart community and related concepts, particularly in relation to healthcare, are under researched. This is illustrated by the range of different definitions for related concepts (outlined in 2.3). Identifying a gap in smart community research is however not a straightforward task. Finding statements that indicate the concept of smart community is under researched is not sufficient, as in a different context, such as energy, smart community sometimes has a different meaning.¹²

Using the search criteria outlined in the last subsection I found articles that refer to both smart communities and healthcare (Wilson, 1997; Hughes and Spray, 2002; Lindskog, 2004; Krebs and Holley, 2006; Caputo, Formisano, Buhnova, and Wallezký,

¹² Examples of smart community having a different meaning in other contexts were outlined in part 1, p33.

2016; Nahrstedt et al 2016; Popejoy, 2017). Whilst health is a frequently occurring term in smart community literature, in most articles the connection between healthcare and the smart community concept is limited. Some articles argue that smart community ideas might be able to help address issues such as healthcare (Nahrstedt et al 2016) or affordability (Wilson 1997). The only author who included detailed relevant discussion about smart community and healthcare efficiency was Popejoy (2017).

In my literature search however I found many articles that were relevant but did not specifically refer to the smart community concept. Some of these were outlined in 2.3. In relation to smart cities Nam and Pardo (2011) use the term 'conceptual cousins' to describe closely related concepts. I suggest 'conceptual cousins' is also relevant to describing concepts related to smart community. Conceptual cousins that I refer to in this document include: cyber physical systems, social computing, collective intelligence, artificial intelligence and big data.

2.4.2 Smart Community Gap

The idea that the smart community concept is under researched is frequently indicated (Li et al, 2011; Xia and Ma, 2011 Stratigea, 2012). Stratigea implies a gap in smart community research when she states that a clear-cut definition of smart communities does not exist and that other terms with similar definitions have appeared. She lists: digital communities, networked communities and intelligent communities amongst these. She also claims that researchers use these terms interchangeably. Her argument appears reminiscent of Nam and Pardo's idea of conceptual cousins. My decision to draw upon literature beyond just that, which directly refers to the term smart community, is informed by her work. The assertion that there is a gap in smart community research is supported by Li et al; they argue that the smart community concept opens up a new research direction. Xia and Ma (2011, p4) make a similar point, when they argue that:

“smart communities will help tackle emerging societal challenges in ways that were impossible a few years ago”.

By stating that addressing challenges through smart community approaches was impossible a few years ago, they imply that there is a lack of research, as researching

the impossible is usually regarded as problematic. They argue that to address challenges for building smart communities, multidisciplinary study is needed. As such their argument supports my decision to draw upon literature from different academic disciplines.

2.4.3 Smart Cities

Like the concept of smart community, smart city is a nebulous concept with undefined theory (Minton, 2006, Harrison and Donnelly, 2011; Chourabi et al 2012; Goodspeed, 2014; Tok et al, 2014; Albino et al 2015). Chourabi, et al certainly take this position when they state that academic research is sparse in its discussion of the phenomenon. A common theme is the suggestion that although smart cities is a term receiving a lot of attention in the press and in policy documents, it has not been supported by academic research. Here I am arguing that because smart communities is a concept closely related to smart cities, articles that state that the smart city arena is under researched are implying a lack of research in the smart community realm (Goodspeed, 2014; Tok, McSparren, Al-Merekhi, Al-Ghaish, and Ali, 2014).

Although there is an increase in frequency of use of the phrase “smart city”, there is a lack of understanding of the concept in academia. Goodspeed (2014, p89) argues that:

“scholarly literature on smart cities contains a confusing jumble of theory and a lack of historical perspective”.

In part 1 I attempted to make sense of some of this jumble by defining ‘smart community’ and tracking its evolution. In part 1 I also indicated how the smart city concept has evolved and becomes more closely aligned with smart community. Due to the merging of the definitions I refer to both concepts throughout this thesis.

The lack of clarity of the terms smart city and smart community is a problem for practical as well as academic reasons (Cosgrave, Arbuthnot, and Tryfonas, 2013). Cosgrave argues that city officials are finding it difficult to transform the higher-level concepts found in smart cities literature into actionable and effective projects. He suggests that concepts are still in their infancy and this may be part of the problem. He also argues that focus needs to move beyond developing the conceptual grounding. By aiming to link the conceptual development of smart community to the practical

issue of healthcare efficiency, I aimed to help improve practice as well as to develop theory.

2.4.4 Fragmented Knowledge Gap

Evidence of the need for this research is found in articles about related areas as well as smart community literature directly. An area where it is frequently claimed that there is a research gap is the one between the different academic disciplines the smart community concept relates to. Claims that support this assertion include:

- Little effort has been made to synthesize the knowledge and insights different research communities have generated, resulting in a fragmented body of knowledge (Chiasson and Davidson, 2002)
- There is a disconnect between different researchers investigating health efficiency (Agarwal and Khuntia, 2009)

A similar knowledge gap is the assertion that there is a lack of understanding between academic knowledge and practice:

- Work on information systems is not underpinned by information theory literature (Checkland, 1999a)

My project crosses the boundaries of academic disciplines including; health, urban design, management and information technology. It aimed to bring together academic knowledge with ideas from people working in practice. Bringing together research and expertise from these different areas resulted in the emergence of insights related to the practical issue of improving healthcare efficiency. By bringing together ideas from different academic fields, as well as primary research, I developed smart community theory.

2.4.5 Philosophy

Another gap relates to the research philosophy I selected, because the majority of research about economic efficiency is conducted from a positivist mind-set (Holmes, Murray, Perron, and Rail, 2006). The implications of this are significant as some academics claim that health economics has become isolated from theoretical and philosophical discourse in other areas of social science (Giddings, 2006; Lessard, 2007; Shiell, Hawe, and Gold, 2008). If true then new knowledge could be created by

connecting insights from different areas of social science to the issue of improving healthcare efficiency. By taking a multidisciplinary approach to exploring how an area of healthcare might become more efficient, I applied insights that are usually excluded from studies about healthcare efficiency to develop new theory.

The idea that economic efficiency research often ignores insights from other disciplines supports the assertion made earlier that knowledge between areas is often fragmented. Economic evaluation can oversimplify complex healthcare decisions and often ignores contextual factors such as relationships (Lessard 2007). Contextual factors such as relationships are regarded as relevant in this study¹³.

Taking research philosophy into account, the lack of similar research is even greater, as to be comparable, as well as focussing on the same concept applied to the same area, it would need to be conducted from the same research philosophy. Research into healthcare efficiency conducted by applying critical systems thinking is distinctly lacking. Following an extensive search I found few articles that study healthcare through the lens of CST¹⁴. I list the results as: Business source Premier 0 results, Emerald 0, Proquest central 20, Scopus 1. Whilst the 20 results from ProQuest may initially appear significant, most had superficial connections. The most relevant article I found applied CST to autism. It was in a study that focussed on the application of the learning organisation model to an autistic community (Raymaker, 2016). My search however uncovered far more research that connects systems thinking in general to healthcare. As discussed in 3.1.1 other systems thinking research however does not always apply either a research philosophy or methodology that is similar to the approach I took.

My assertion that there is a lack of research from a similar research philosophy is informed by Lupton (2016), who argues that there is a lack of digital health research conducted from a critical perspective. She also makes a link between critical digital health research and critical smart city research. As I am aiming to bring together insights from both these areas, I believe that her work is of significant relevance, and as such have drawn upon some of her research.

¹³ Relationships are referred to throughout this thesis and form a key component of the conclusion reached in 9.3.3.

¹⁴ The closest I found were critical digital health articles.

2.5 Part 4: Scope

As outlined in 3.2.2 the idea of boundaries directly relates to the critical systems heuristics methodology applied to this study. Because the problem being considered is a wicked problem the number of solutions that could open up is potentially infinite. Due to the potentially vast scope I put boundaries in place by confining this study to the potential impact of ideas related to one concept, smart community, and its related concepts. This study is focussed on the potential impact of actions related to the concept of smart community, not the application of information technology in a more general sense. Here I clarify what is inside and what is outside of the scope of the study.

2.5.1 Industry 4.0 / Health 4.0

Smart community is associated with the concept of Industry 4.0, the notion that we are now in the 4th industrial revolution, or the second information technology revolution. The third industrial revolution is defined as digitisation through IT (Jazdi 2014; Lee, Kao, and Yang, 2014; Zhou, Liu, and Zhou, 2015). Interventions related to the first and not the second information technology revolution are therefore outside of the scope of this study. This does not mean that all industry 4.0 ideas are relevant, simply that smart community is a related concept. Whilst smart community shares many of the characteristics of Industry 4.0, it is a separate concept. The relationship between the two concepts is simply helpful for indicating what is outside of scope.

Industry 4.0 is associated with advanced information technology including cyber physical systems, intelligent analytics and advanced prediction tools (Jazdi 2014, Lee Kao and Yang 2014; Zhou and Zhou 2015). As outlined in part 2 of this chapter these concepts relate to the concept of smart community, hence the connection between smart community and Industry 4.0. Part of the logic of Industry 4.0 is that cyber technology, including sensors and telecommunications, could enable new business models (Jazdi 2014; Lee Kao and Yang 2014). Part of the logic is that prediction tools can help make better informed decisions (Lee Kao and Yang 2014). How advanced information technology might be able to help improve decision making is directly

relevant to the concept of smart community and is a theme that flows through this thesis.

Health 4.0¹⁵ is the translation of industry 4.0 principles into the health domain (Grigoriadis, Bakirtzis, Politis, Danas, and Thuemmler, 2016). The application of industry 4.0 principles makes health 4.0 conceptually close to smart community applied to healthcare. Gorman and den Braber (2008) argue that this opens up opportunities for preventing illness. They refer to the semantic web, an idea I outlined in 2.5.1. Their arguments relate to smart community as they argue that human agents also need to be involved. Specifically, they state that health 4.0 requires active user engagement. They compare patients choosing not to engage with the semantic web with someone choosing not to take the medication recommended by their doctor. The implication is that both are likely to give the patient improved outcomes, but the patient has the choice to take the steps towards achieving them or not. Prevention is relevant to this study as lifestyle can impact on both the chances of cancer reoccurrence and the chance of secondary conditions occurring.

2.5.2 Human Computer Interaction

The concept of human computer interaction relates to scope because interaction at the micro level (individual computer with individual user) is outside of the scope of this study. The concept of the smart community is very much about human computer interaction. It is a form of human computer interaction that has moved from the individual user and the individual computer, to the interaction of multiple users and multiple computers that have become integrated within the fabric of the smart city. It can be conceptualised as human city interaction (Naphade et al, 2011; Woolliscroft and Polovina, 2017). Reconceptualising human computer interaction from a micro to a macro level is however deeply philosophical. Assumptions about how people engage with technology are likely to change when the use of computing devices moves to complex interactions across the smart city environment.

Bannon, (2011) supports the idea that with smart city technologies we need to change how we think about human computer interaction. He argues that it is time for us to

¹⁵ I am aware that other definitions of health 4.0 exist. Like many of the concepts in this thesis there is not one single universally accepted definition.

rethink the issue of people and technology. This project is part of the process of rethinking human computer interaction, with its specific focus on smart communities and healthcare. In the healthcare sector specifically, this shift has a significant impact on the relationships between patients and doctors, as patients are starting to gain not just access to their healthcare data but also control over who has access to it (Eysenbach, 2008). In chapters 4-7 I discuss some specific examples of the changing relationship between patients and healthcare professionals.

A challenge for aiming to improve efficiency with the relationship between people and machines is that it requires culture change. Technological change can disrupt existing social systems so as to reduce the anticipated benefits of new technologies (Davis, Challenger, Jayewardene, and Clegg, 2014). Naphade (2011) takes a more optimistic view, he argues that the system of systems within a smart city, can improve efficiency by integrating and optimising public and private systems. He argues that information about human behaviour can help achieve a better distribution of resources.

Information about human behaviour is relevant for several reasons. Most immediately because understanding behaviour is helpful when trying to change behaviour¹⁶.

2.5.3 The nature of smart communities

In 1.5.1.1 I defined the nature of the problem being explored as a wicked one. This conceptualisation puts much of the existing research into digital health technology outside of the scope of this study. Whilst some research that has been conducted from different research paradigms is relevant, much digital health research is not, because it is focussed on very different questions or applies a logic that is too narrow to offer relevant insight. Harrison and Donnelly (2011) propose a smart city definition that is very much in line with the ideas of complexity, wicked problems and systems thinking. They argue that the city may be described as a system of systems (Söderström, Paasche, and Klauser, 2014). Given that smart communities are part of the system it is reasonable to define them in the same way.

Harrison and Donnelly's definition shares with Engel (1980), a holistic, non-reductionist view of society. In 1.5.1.1 I highlighted research that connected systems thinking to

¹⁶ As discussed in chapters 5-8 behaviour change could be a component in a more efficient system of cancer services.

wicked problems, and suggested that systems thinking was a useful framework for wicked problems because of the shared systemic nature of the two ideas. The systemic nature of the smart community's concept makes it relevant for investigating wicked problems. Wicked problems require holistic non-reductionist approaches to make sense of their complexity. As the concept of smart communities can have holistic characteristics, it is a useful concept to apply to investigating the efficiency of cancer services. This idea is supported by research that argues that cities are the level at which wicked problems need to be addressed, and city governments can develop solutions through smart city governance and technological innovation (Nayatullah 2011; Nijkamp and Kourtit 2013, Nam and Pardo 2015).

Within smart city literature tensions between top-down and bottom-up models are frequently discussed (Smedley, 2013; Breuer, Walravens, and Ballon, 2014; Robinson, 2014; Goodspeed, 2014). The top down approach is essentially technocratic, focussed on efficiency, including monitoring to enable centralised control. The bottom up approach is focussed on the smart citizen, enabling and connecting them through information technology (Smedley 2013, Breuer, Walravens, and Ballon, 2014). Smedley (2013, p32) eloquently describes the tension between top down bottom up visions using a boxing ring metaphor. In the blue corner, he says is:

“The paternalistic approach with a network of sensors feeding into a central operating centre. In the red corner the rise of apps and social networks¹⁷ allows us to navigate, edit and influence the cities we live in, telling authorities rather than waiting to be told.”

Whilst neither of these is a perfect definition of smart community, both filter into ideas about what a more efficient system might look like. Research subjects might express ideas relating to one end of this spectrum or the other depending on their world view and their past cultural influences¹⁸.

2.5.4 Existing Research

In this project I accept that much relevant research has been done. In table 3 I outline some of the theory that is outside of the scope of this study. As outlined in 3.2.2,

¹⁷ Networks are discussed extensively in 2.2, 2.5 and 5.1

¹⁸ Different visions of smart community are discussed in chapters 8-10.

defining scope is central to the application of CST. The research outlined is accepted as valid. Whilst I am aware that there remains some academic debate relating to areas outlined in table 3, due to the amount of existing research focus on these areas, I did not however consider reengaging in these debates as academically useful. This study aims to build on and apply the research outlined in Table 3 rather than to duplicate it.

Table 3 Related Research Outside of the Scope of this Study

Idea	Examples	Conclusion
Physical activity improves health outcomes	<p>Obesity is estimated to be responsible for approximately 10% of some cancers (e.g. colon, kidney)</p> <p>(Public Health England, 2014)</p> <p>(Warburton, Nicol, and Bredin, 2006)</p> <p>(Maher, 2014)</p> <p>(Ballard-Barbash et al, 2012)</p> <p>(Warburton et al 2006)</p> <p>(Devane, 2012)</p>	<p>From the evidence by the authors listed this study accepts that physical activity leads to better health outcomes.</p>
Physical activity improves health outcomes for people who already have cancer	<p>(Devane, 2012)</p> <p>(Speck, Courneya, Mâsse, Duval, and Schmitz, 2010)</p> <p>(Sheffield Clinical Commissioning Group 2014)</p>	<p>Lifestyle changes can reduce the risk of getting cancer and improve the health outcomes for people with cancer.</p> <p>After treatment is complete, physical activity shows a moderate to large positive effect on cardiorespiratory fitness and vigour.</p> <p>Over half of all premature deaths from cancer are considered preventable.</p> <p>Common preventable causes of cancer are smoking, poor diet and physical inactivity.</p>

<p>Increased health outcomes leads to cost savings</p>	<p>(Maher and Peake 2014) (NESTA, 2013)</p>	<p>Improving health outcomes helps to reduce the cost of delivering healthcare.</p> <p>Savings could be achieved by decreasing:</p> <ul style="list-style-type: none"> • accident and emergency attendances • hospital admissions • length of stay • patient attendances.
<p>Behaviour change</p>	<p>(Hartwell, 2014) (Roberto and Kawachi, 2015) (Hartwell, 2014)</p>	<p>Convincing people to change lifestyle is complicated.</p> <p>Providing information alone is not sufficient.</p> <p>Behaviour change interventions can lead to changes in lifestyle that can lead to improved health</p>

2.5.5 Literature Navigation

In the introduction to this chapter I stated that the literature included in it is just an introduction and that additional literature is included in most subsequent chapters. Table 4 indicates where some of the key areas of literature are included in this document. The decision to scatter the majority of literature throughout the study is supported by research methods literature (Silverman 2000, Wolcott 1990). Silverman (2000) argues that it is effective to bring in appropriate literature as needed during ‘*data analysis*’. Wolcott (1990) argues that literature should be drawn upon selectively as needed to tell the researcher’s story. In Table 4 I indicate where ideas are discussed in future sections of this thesis.

Table 4: Where Smart Community Concepts are Discussed

Related Concept	Why it is related to smart community	Why it is related to efficiency	Where this is discussed
Smart City	Smart city is a concept related to smart community.	Smart city literature frequently refers to efficiency.	7.3.2
Cyber physical systems	Relates to the definition of smart community I applied	Monitoring devices might be able to help keep people out of hospital for longer	7.1.1.4
Social Computing	Relates to the definition of smart community I applied	Internet forums might be able to enable patients and doctors to have better informed discussions	4.2.1.5, 5.1, 7.1.1.1
Collective / collaborative Intelligence	These concepts connect smart computing and cyber physical systems	People and computers working more effectively together might result in better treatment decisions and outcomes ¹⁹	2.2, 2.3.3, 5.2.4, 7.1.1.3, 7.2.1.1
The Biopsychosocial Healthcare Model	Non human agents e.g. AI could help integrate social and psychological factors with physical healthcare	Non medical interventions e.g social prescribing ²⁰ might sometimes be more cost effective than drug or hospital treatments	1.5.4, 5.2.2, 7.4
Psychographics	This may be considered a subset of social computing	Nudging people to change their behaviour may reduce demand for future healthcare	7.4.1, 8.3.1
Coproduction	When applied to the digital realm it is a very similar concept to smart community	Harnessing the ideas, skills and energy of community members brings additional free resources into the system.	2.3.2, 4.2.1, 5.1.1

¹⁹ Based on existing research outlined in 2.5.4 in this study I assume that improving outcomes will reduce service demand

²⁰ Social prescribing is a system that enables GP's and other primary care professionals to refer people to non-clinical activities such as sports or social activities (Kings Fund 2017)

Agency and Structure	Smart community ideas might be able to enable a shift towards structure	Greater focus on structural factors could result in a radically different healthcare system	3.6
Social Capital	Social capital is a concept that frequently occurs in smart community literature	It may help enable collaboration and integration through trust and new relationships.	2.3.1, 3.2.4, 5.1.1, 8.8.4

2.6 Conclusion

In this chapter I have defined smart community by mapping the evolution of the concept in the healthcare context. Following this I outlined some related concepts and discussed potential implications. To give context and to clarify the parameters of this research project I also clarified: research gaps that it engages with, existing research that it builds on and the boundaries of its scope. It is however the web of concepts outlined that I believe has most significant.

All of the concepts I discussed in this chapter are included because they relate to the concept of smart community. These all relate to each other in complex interlocking ways, some more directly than others. Some connections are quite direct, coproduction when moved into the digital context is similar to smart community, collective intelligence can be conceived of as part of social computing, social computing in turn is a process (or a web of processes) that can enable smart community to have impact.

Ideas that cut across the concepts discussed include the sharing of information, the development of networks and the evolving of relationships. The implications of these ideas is potentially profound as bringing them together could result in a different conceptualisation of how the different human and non-human agents in the system of cancer services in Sheffield relate to each other. I stated earlier in this chapter that researchers have argued that the concept of coproduction could have profound significance because it challenges the theoretical basis of public health. As coproduction is closely related to smart community and all of the concepts outlined in this chapter have the potential to form a conceptualisation of smart community, combined they have the potential to challenge the theoretical basis of the system of cancer services in Sheffield. This is possible as public health is part of the system of cancer services and coproduction is part of smart community.

A smart community conceptualisation of collective intelligence could conceive of the city as a platform that enables the collective intelligence of its stakeholders including; inesses, government, universities, citizens (Bencardino and Greco 2014; Michelucci and De Marco, 2017). I stated earlier that in recent literature definitions of smart city and smart community begin to merge. Collective intelligence is an idea that brings them together as it can include collaboration by city stakeholders. This form of

digitally enabled collaboration could have profound implications to how healthcare develops. The idea of web based shareable patient records has been suggested as an example of collective intelligence. If these could be accessed and edited by both healthcare professionals and patients they would share the characteristics of knowledge creation outlined earlier, which could improve clinical outcomes and reduce costs (Boulos and Wheeler 2007).

As will be discussed in depth in chapter 8 smart community ideas have the potential to decrease efficiency and cause undesirable side effects. From literature it appears likely that smart community ideas such as social computing and collective intelligence have the potential to change healthcare. Exactly how internet enabled human computer interaction will develop is as yet unclear. Advocates of the idea of the symbiotic web, sometimes referred to as web 4.0, argue that it has the potential to be transformative. The symbiotic nature of web 4.0 relates directly to the definition of smart community that I outlined in part 2. As such symbiotic interaction is a form of collaboration between human and non-human agents. A characteristic of the symbiotic web is search engines, such as google, learning user preferences and suggesting content accordingly (Bernal, 2010) . Whilst the symbiotic web could have significant benefits including saving users time, there are also risks. The outline given in this chapter is merely intended to introduce the concepts. More detailed discussion of social computing including the extent to which its impact is likely to be positive or negative is given in chapters 7- 9.

Section B Methodology

Chapter 3 Research Design and Delivery

The purpose of this chapter is to outline why the research approach selected was taken as well as to describe and explain the approach that I took. This chapter is split into five parts. The first outlines why a critical systems thinking research philosophy was applied, the next relates discusses some of key methodological issues including giving an overview of the central theory applied. The third section describes the process taken, the fourth explains the approach taken to interpret data. The final section outlines additional theory that was applied to interpret data.

3.1 Part 1: Philosophy and Methodology

3.1.1 Philosophical Perspectives

3.1.1.1 Positivism and Modernism

I decided against a positivist research philosophy for three reasons:

1. Firstly, it is not appropriate for investigating wicked problems such as this one (Patterson and Williams, 1998).
2. Most research into the efficiency of healthcare is conducted from a positivist perspective.
3. Some of the inefficiencies that exist within the current system are due to modernist thinking²¹.

Positivism is often associated with modernism. It is a world view based on progress and reason, in which humanity can perfect itself through rational thought (Cooper and Burrell, 1988). Fitzgerald and Howcroft (1998) criticise positivist research arguing that attention is often devoted to rigorous hypothetico-deductive testing at the expense of relevance.

(Bourdieu, 1990, p20) is even more critical of positivism when he talks about the inadequacies and technical mistakes caused by the positivist conception of science. He states that:

²¹ Issues with modernist thinking are discussed in 1.5.4, 7.3 and 8.2.1

“One soon loses count of the number of cases in which segments of experience aping experimental rigour conceal the total absence of a real sociologically constructed object”.

Here he is implying that positivist research tends to ignore the social theory that can help us understand the social world.

3.1.1.2 Postmodernism

Postmodernism is at the opposite end of the spectrum of research approaches to positivism. It is an approach that aims to deconstruct both accepted concepts and scientific method (Silverman, 2013).

The extreme relativity within postmodernism makes it problematic as a research philosophy (Johnson and Duberley, 2003). Its inherent relativity makes the process of searching for truth somewhat abstract. Johnson and Duberley appear to take the view that postmodern subjectivity can be problematic in research. They express the view that postmodern research could end up in a cycle of continuous reflexivity and deconstruction. With reference to Baudrillard, they argue that within postmodernism we could be left with:

“nothing but simulacra, images that refer to nothing but themselves, divorced from linguistic reference points” (Johnson and Duberley, 2000: p98 Baudrillard, 1994)

In this realm Truth is a matter of discursive hegemony determined by acceptance by the research community nor from any external validation (Berg, 1989; Johnson and Duberley, 2000).

3.1.2 Systems Thinking

Philosophically systems thinking is interesting as it crosses over objectivist and subjectivist research traditions. It originally emerged as an application of engineering principles to social science problems and as such included a positivist philosophy. Positivist systems thinking has been criticised by soft systems thinkers (Checkland and Holwell, 1997; Reason and Bradbury, 2006). Reason and Bradbury claim that it places too much emphasis on structure and function.

Checkland (1999c, p52) makes a similar point when he states that:

"The hard tradition assumes that systems exist in the world and can be engineered to achieve declared objectives. The soft tradition assumes that the world is problematical, always more complex than any of our thinking accounts of it"

The philosophical gap results in significant differences between hard and soft systems thinking and includes profound variations in approaches to problem solving and research. Hadamard²² used billiards to describe systems interactions (Hooker, 2011). This gives a useful metaphor to describe the differences. If hard science principles are assumed, then it should be possible to predict the outcome of an initial impetus. If the balls are set up the same way, each time a shot is taken, the result should be the same. It may for example result in multiple collisions followed by a ball ending up in one of the pockets. In soft systems thinking environments are not expected to be that predictable.

A form of systems thinking usually associated with the hard end of the spectrum is general systems thinking (GST). It was developed by Bertalanffy who applied principles from science and engineering to create a generalisable theory. Whilst it is sometimes described as holistic, it retains ideas of scientific principles and generalisability that soft and critical systems thinkers find fault in (Ackoff and Sasinieni, 1968; Checkland, 1999). GST is however not always associated with hard systems thinking (Boulding, 1956; Jackson, 2009)²³. Here I am simply clarifying that references to systems thinking are sometimes referring to a research paradigm with very different philosophical assumptions to the ones I applied. The rainbow of different ideas within complexity theory is an issue directly addressed by Jackson who advocates CST is a more appropriate approach to studying complex social issues than complexity theory, in part because it is more clearly defined.

As cancer services are a wicked problem, soft system thinking gives a more appropriate perspective for this research than hard systems thinking. Zexian and Xuhui (2010 p141)

²² Jacques Hadamard (1865 – 1963) was a French mathematician. He is well known for his work in number theory and complex function theory.

²³ Engaging with the debates about the exact nature of GST is outside of the scope of this study.

make a point in line with my assertion that hard systems thinking is not appropriate when they state that:

"Most system practitioners disappointedly find that GST cannot provide them substantive concepts and practical methodologies in dealing with the organized complexity in real problematic situations".

Jackson (1991) appears to support this line when he argues that soft systems thinking is based on understanding reality as the creative construction of human beings.²⁴ This makes soft systems thinking more able to deal with the complexities of wicked problems in a way that hard (positivistic) systems cannot.

3.1.2.1 Critical Systems Thinking

CST is an evolution of soft systems thinking. There are however three main differences; CST has a greater focus on epistemology, it places greater emphasis on sociological influences and recognises the benefits of a wider range of research methods (Flood and Jackson, 1991, Simon, 2002). To clarify, CST shares with soft systems thinking the critique of hard systems thinking, including its limitations in handling cultural and political phenomena (Flood and Jackson, 1991). It is defined as a critical approach to systems problem solving (Jackson and Keys, 1984). CST is defined by three commitments: to critique, to emancipation and to pluralism (Schecter, 1991). Emancipation is a central component of this project. It relates to the discourse on power relations that is a thread weaving through the study. How information technology is changing the power relationship between patients and doctors, is an example of emancipation that plays a significant role in this investigation²⁵.

Emancipation is at the core of the idea of overcoming false consciousness, an idea that CST shares with most other critical research traditions. False consciousness is the act of holding false beliefs that are contrary to your self-interest (Jost 1995). False consciousness is a concept with Marxist roots that has been traced back to Engels

²⁴ Jackson's comment aligns CST with interpretivism as he is suggesting that reality is socially constructed. In a later article Jackson (2001) he makes this link more directly, stating that there is a strong case for always choosing an interpretive methodology.

²⁵ How technology might be changing relationships between patients and healthcare professionals is discussed in 3.2.4.5, 4.2.1.3, 4.2.1.5 and 5.1.2,

(Lewy 1982; Jost 1995). It was developed by Gramsci who argues that it would be naïve to limit examination to what people thought, felt and wanted at any point in history (Patnaik 1988).

The idea of overcoming false consciousness is one of the epistemic ideas that separates CST from soft systems thinking (Cooper, 2003; Flood and Ulrich, 1990). How I attempted to overcome false consciousness is discussed in depth in 3.2.5. In line with the emancipatory nature of CST, I considered who might be currently empowered by the current healthcare system. Focus is given to how patients and citizens might be more empowered by a healthcare system based on the concept of smart community. Consideration has also been given to how a future system based on smart community could be disempowering.

Flood and Jackson (1991) suggest that soft systems thinking is a useful departure from hard systems thinking in addressing wicked problems, but it is too weak in epistemology to be ideal as a research philosophy. Simon (2002) makes a similar point when he states that a major shortcoming in the soft systems paradigm is its failure to question its own theoretical underpinnings.

Brocklesby and Cummings (1996) argue, that CST is a strand of critical theory that emerges from Kant through Habermas and that it seeks to unmask structures and categories that over time have governed the way we think. This, I argue is similar to the notion of making the unconscious conscious applied by Bourdieu²⁶. Ulrich (2003) argues that Churchman's holistic systems thinking, and Habermas's critical theory have shared philosophical roots in the works of Kant.

Mingers (2014) highlights a common criticism of soft systems thinking arguing that in practice it works to sustain rather than challenge the status quo. The risk of reinforcing the status quo has a significant practical implication for this research project. If the medical practitioners and patients I consulted had failed to look beyond existing structures to imagine what a better / different system might look like then the conceptual models that emerged would have had little value if they were based simply on the expressed views of interviewees. The notion that cultural factors are likely to

²⁶ Bourdieu's theories and philosophy are discussed in 3.2.4

influence the expressed views of participants is supported by research that indicates that people working in healthcare are resistant to change or fail to innovate (Fleiser et al 2015, Kessler et al 2017).

Flood and Ulrich (1990), key CST scholars, argue that the influence of dominant ideological forces or worldviews can cause us to misinterpret situations. The influence of dominant worldviews informs the critical focus in this thesis. Views that are challenged include the expressed views of; healthcare professionals, commercial smart city companies and healthcare technology companies. The critique of these relates to the rejection of positivism discussed earlier. It also relates to the domination of positivist approaches within studies of economic efficiency, outlined in 2.4.5. I argue that the dominant position of positivism is one of the factors that may cause us to misunderstand the efficiency of the healthcare system, and technologies that could be applied with the intention of improving its efficiency. By applying an opposing research paradigm, I attempted to overcome such misunderstandings.

Earlier I suggested that this study's problem is a wicked one and that more subjective forms of systems thinking are appropriate for addressing these types of problems. I argue that CST is an appropriate form of systems thinking for researching how to deal with wicked problems. A direct link is made by two CST scholars, Mike Jackson and Gerald Midgely (Jackson, 2003; Midgely, 2003). Jackson makes the connection but with a modification to the idea; he states that social systems are not just complex adaptive systems but complex evolving systems that can change the rules of their development over time²⁷.

The wicked nature of the problem informs my decision to adopt a form of systems thinking as the project's research methodology. Systems thinking is frequently advocated as an appropriate way of engaging with wicked problems (Buchanan, 1992; Mugadza, 2015; Lönngren and Svanström, 2016). Mugadza make a particularly strong connection, stating that systems thinking is the search for ways to tackle wicked problems.

²⁷ Complex evolving systems relate to theories outlined in the next chapter. The ideas of Routinization in Structuration Theory and habitus in Bourdieu's Theory of Practice conceptualise how rules within systems can enable and restrict change.

3.1.2.2 Critical realism / Subjectivity

CST writers often connect their version of systems thinking with critical realism²⁸ (Dobson, 2001; Jackson, 2009; Mingers, 2014). Mingers argues that critical realism embodies systemic and holistic themes at its heart. These include concepts such as totality, holistic causality and emergence. He argues that these concepts have their history of development within systems thinking. Dobson suggests another similarity, working towards the absence of false consciousness. He however argues that there is a difference in focus, with systems thinking being more concerned with the predictive use of theory and purposeful change. Later in this chapter I outline how I applied the use of theory in the methodology.

Johnson (2000) proposes an idea for how critical realism addresses false consciousness. He states that it includes a focus on the identification of structures and mechanisms which are not directly observable. The focus on structures fits with the idea of systems thinking. Johnson states that systems thinking is done through a process called retrodution, a process that aims to uncover causal links. He suggest that for the critical realist there may be causes that are not recognized by, nor accessible to, those actors. Bhaskar asserts an analytical distinction between agency and structure (Bhaskar and Danermark, 2006). The connection with agency and structure connects critical realism with Bourdieu's Theory of Practice²⁹ and Giddens's Structuration Theory³⁰. Bourdieu's Practice Theory is outlined in 3.2.4 and Structuration Theory in 3.6.1

The link with critical realism is helpful in terms of clarifying the nature of subjectivity applied in this project. Bhaskar makes a distinction between the social reality that exists independently of human knowledge (ontology) and the socially constructed dimension (epistemology) that allows us to make sense of our world (Bhaskar, 1989; Johnson and Duberley, 2015). It is this distinction that makes the form of

²⁸ Critical Realism is a philosophy associated with Roy Bhaskar, one of its key thinkers and writers.

²⁹ I am aware that Margret Archer, another key critical realist, has published articles taking issue with how Giddens conceptualises agency and structure in structuration theory, engaging with this debate however is a tangent that I have decided not to pursue.

³⁰ Further discussion of these theories of agency and structure and how they are applied is given in 3.2.4Part 5: Additional Theory . How I have addressed the issue of overcoming false consciousness is outlined in 3.2.5.

interpretivist subjectivity applied in this study different from the more extreme version of subjectivity found in postmodernism.

Wainwright and Forbes (2000) suggest that Bourdieu is best read as critical realism. Their suggestion supports my assertion that CST, critical realism and the philosophical perspective behind much of Bourdieu's work are closely related. Mingers (2000) argues that like CST, critical realism is also embedded in a broadly Kantian world. Maton (2003, p52) states that Pierre Bourdieu's 'epistemic reflexivity' is the "*cornerstone of his intellectual enterprise*", and that it supports his claims to provide scientifically distinctive knowledge of the social world. He states that what remains distinctive is Bourdieu's 'signature obsession' with the epistemological potential of reflexivity³¹.

3.1.3 Philosophy Conclusion

Because most research into the efficiency of healthcare is conducted from a positivist perspective, part of this study's contribution to knowledge is made by applying different thinking.

In this study I have taken a moderate research approach, one that is not at either end of the spectrum of research approaches. The middle ground between positivism and postmodernism is to assume an objective ontology and a subjective epistemology. That is to assume that there is an external reality, however it is not possible to know all of it, or to accurately measure it. As indicated earlier the CST research tradition may be traced back to Kant; he argued that reality existed independently of human consciousness but it is only accessible to us through rational reflection (Johnson and Duberley, 2003).

Due to the systemic nature of what a smart community is, a systems thinking epistemology is relevant. The wicked nature of the problem makes a form of systems thinking with a subjective epistemology more appropriate than an objective one. The limitations of soft systems thinking, including its tendency to reinforce rather than challenge the status quo, has led me to instead select CST as my research philosophy.

³¹ I am aware that Bourdieu has criticised Kantian reflexivity. Discussion of different types of reflexivity emerge in part 2.

CST includes theory as part of its process to gain understanding of the unconscious. Most commonly Habermas's critical theory is applied³². In this study I have instead applied Bourdieu's Theory of Practice as its central theory. Bourdieu's Practice Theory was selected due to the nature of the subject matter, in particular the importance given to the concept of social capital in both health lifestyle theory and within smart community literature. Bourdieu's Practice Theory is outlined in 3.2.4

3.2 Part2: Overview of Methodology

In this section I explain the link with the philosophy, the implications of the methodology and give an overview of Bourdieu's Practice Theory, the main theory applied as part of the methodology.

The overarching methodology I applied in this thesis is Critical Systems Heuristics (CSH). CSH is the methodological application of CST (Mingers, 2014). Heuristics means simply the art or practice of discovery. CSH is appropriate as the primary focus of this project is to develop smart community theory that contains insights and ideas about what a more efficient system might look like. The process of developing theory is a process of discovery that brings together ideas expressed by interviewees, workshop participants, ideas from literature and my own reflections.

The methodology is in essence, discovery through the application of CST. Ulrich (2005) states that in practice CSH can be applied to explore assumptions and solution strategies. To do so he argues that a critical approach is required, as there is no single correct way to decide such issues. I applied CSH in three ways:

1. The adaption of its research methods through a systems thinking philosophical perspective, discussed in part 1
2. Critical reflexivity, discussed in 3.5.1
3. The use of boundaries to consider its research issues, discussed later in this part of this chapter

³² Although Habermas is usually used, other critical theories are sometimes applied as an alternative. Brocklesby and Cummings (1996) for example apply Foucault instead.

3.2.1 A Critical Methodology

In the critical management tradition, methodology is more than simply the techniques used. It also includes how techniques are used and how research is approached in a more general manner (Alvesson, 2000). Due to the inclusion of how techniques are applied, the line between research philosophy and methodology becomes blurred. Alvesson (2000, p5) states that:

“Method is not primarily a matter of data management or the mechanics of data processing but a reflexive activity where material calls for careful interpretation”.

Alvesson argues that within the process of interpretation theoretical, political and ethical issues are central. In critical research there is less focus on the data and more on the interpretation and 'reasoned appraisal' of material. In this context the researcher is assumed to possess knowledge of context through the ethnography³³ of life. A well-developed theoretical frame of reference is needed to help the researcher make good interpretations. In critical research it is necessary to consider the world view of interviewees as well as how they respond (Alvesson and Sköldbberg, 2009). CST does not favour paradigm incommensurability instead it advocates the idea of complementarity. This is not to suggest that paradigms make no difference, it is rather to suggest different approaches can be complementary at the level of methodology (Jackson, 1994).

Jackson (2007) states that CST can provide its greatest benefits in the context of paradigm diversity. He clarifies by explaining that at times it may be useful to employ a single methodology, but when this approach is taken it should be conducted self-consciously to guide the use of methods. I self-consciously applied a single methodology. As explained in part 1, my research project has been conducted from the paradigm of CST. Within this study I engaged with research conducted from different paradigms to inform my conclusions. Whilst doing so I attempted to be conscious of both the paradigm that the research was conducted in and my own world view.

³³ In the introduction I outlined some of my background. More detail is given in 3.5.2

Critical systems thinkers are clear that methodologies are not neutral, each is likely to benefit some individuals and not others (Midgley, 1992). It is therefore necessary to take an ethical stance within interventions and worry about who is benefiting and who is not. Chapter 8 includes consideration of some of the ethical issues I considered.

3.2.2 Boundaries

A central component of CST is the concept of boundaries (Midgely 2000:Jackson, 2003). Jackson (2003, p651) explains that whilst it is necessary to understand the whole system to know if an intervention will improve it:

“Complete understanding is reserved for a god”

The solution he suggests is creating boundaries:

“Taking account of some things and disregarding others”

Midgely makes a similar argument when he states that the process of deciding what is included and excluded is highly ideological, even though in some cases researchers may be unaware that they are making an ideological choice (Midgley 2000). He argues that researchers who favour a positivist philosophy may regard some boundaries as sacred and others profane³⁴. By doing so, Midgely is criticising positivist researchers who regard ideas such as objectivity as essential. Midgely’s comment influenced my decision not to attempt to apply objectivity. To do so would not be consistent with my research philosophy.

The nature of the problem, as outlined in the introduction is one factor that has informed boundary decisions. As the issue being discussed is a wicked problem I judged it inappropriate to focus on a single organisation. Services for people with cancer in Sheffield are not neatly separated. Macmillan’s Survivorship programme overlaps with and is included on Sheffield Clinical Commissioning Group’s (CCG) work-plan. One of the projects within it, Active Everyday (Sheffield City Council 2014), is delivered by Sheffield Hallam University and overlaps with another project, Move More, that is managed by Sheffield City Council. To study just one of these in isolation I believe would have been contradictory to the research paradigm applied as it is likely

³⁴ This is an application of the Durkheim dichotomy to the issue of research methodology (Durkheim 1912; Belk and Wallendorf 1989)

to give a distorted viewpoint, based upon the views of those working in just one organisation. I outline additional points below that are specific to how boundaries have been applied to methodology.

Existing research – The existing research outlined in chapter 2 is one of the boundary judgements I made. For example, due to existing research I assumed that improving health outcomes would improve efficiency³⁵. Making such assumptions relates to the idea of boundaries, as argued by Jackson (2006). Given the need to create boundaries it is impractical not to place some areas outside of scope.

The nature of the problem – Some smart community and digital health research is not considered relevant because it is focussed on questions that are outside of the scope of this study.

Time – This study focused on potential efficiency improvements that could be achieved using technology that exists or is emerging. Efficiencies that might emerge following significant future technological development were considered outside of its scope.

Detail – Hard systems thinking concepts have been applied to create sophisticated detailed models of cities. The form of systems thinking applied in this study does not advocate creating detailed models, because CST assumes that many of the relevant influences on services are not possible to observe or measure. If we accept that influences are not possible to accurately quantify then detailed modelling is not considered possible. Instead I attempted to consider what might be possible in a more general rather than in a detailed sense.

3.2.3 Authenticity Not Objectivity

In my approach to collecting and interpreting data I aimed at authenticity not objectivity. Earlier I argued that objectivity is not consistent with CST. The rejection of objectivity is directly in line with the many critical management and social science researchers who argue that authenticity is more important in critical research than objectivity (Fontana and Frey, 1994; Alvesson and Deetz, 2000; Kenealy, 2012).

³⁵ I am aware that this is an issue that is still debated in research. In chapter 2 I outlined some of the research that supports the assumption that I am applying

Alvesson and Deetz go further, implying that attempts at objectivity may have an adverse effect when they argue that moves to secure objectivity often hide human judgement. They apply their critique of objectivity to guidance about how to conduct interviews arguing that, research interviews work best when conducted as conversations. Fontana and Fray support the idea that interviews should be conversational when they describe the idea of trying not to get involved or give opinions as outdated. They argue that interviewers who give real opinion get more reliable data because this kind of interactive approach treats the interviewer and interviewees as equals. Fontana and Fray's ideas are very much in line with the argument given by Alvesson and Deetz, that an interviewer trying to maximise neutrality and minimise influence may lead to shallow, not very honest answers. Kenealy (2012, p417) also supports the rejection of objectivity in qualitative research, when he argues that the adaptation of positivist cannons such as reliability, validity, generalisability and objectivity is ill founded.

As discussed in part 1 I am not applying the form of extreme subjectivity found in postmodernism, but a more moderate approach that accepts that an external reality exists

3.2.4 Bourdieu's Theory of Practice

Bourdieu's Theory of Practice³⁶ relates to the concept of social capital outlined in 2.3.1. Its key concepts are: different forms of capital, the idea of field and habitus. These elements form a flexible theoretical approach where it is almost impossible to explain one element of this theory without referring to the others (Wather 2014). A slight confusion in the literature is that some of these concepts are sometimes referred to as theory (Benson 1998, Veenstra 2014; Dean, 2017). Dean for example refers to habitus as both theory and concept. Benson refers to Bourdieu's general theory of field and Veenstra (2014) to field theory as well as Bourdieu's Theory of Practice.

³⁶ Bourdieu's Theory of Practice is sometimes referred to as Practice Theory. In this thesis I use the two terms interchangeably.

3.2.4.1 Agency and structure

Bourdieu's Theory of Practice is a theory of structure and agency. Agency and structure is the extent to which people are free independent agents or are agents whose behaviour is socially determined (Baker 2005). As illustrated in **Figure 7** within the field (the environment being investigated), the actions of agents (people in organisations being investigated) are neither socially determined nor entirely free. Behaviour is assumed to be a combination of the two (Carpiano, 2006). Agency is inherently intersubjective and as such is never free of structure (Veenstra 2014).

Another way of expressing this is $(\text{Habitus} \times \text{Capital}) + \text{field} = \text{practice}$ (Grenfell 2008, Dean 2017) or $(\text{Who we are} \times \text{what we've got}) + \text{where we are} = \text{what we do}$ (Dean 2017). This is however complicated by the interrelations between these elements. Practices are not simply the result of habitus, but of the relations between habitus and circumstance. Habitus, capital and field are interrelated, the field as part of the contexts in which we live structures the habitus while at the same time the habitus is the basis for people's understanding of their lives including the field (Grenfell 2008).

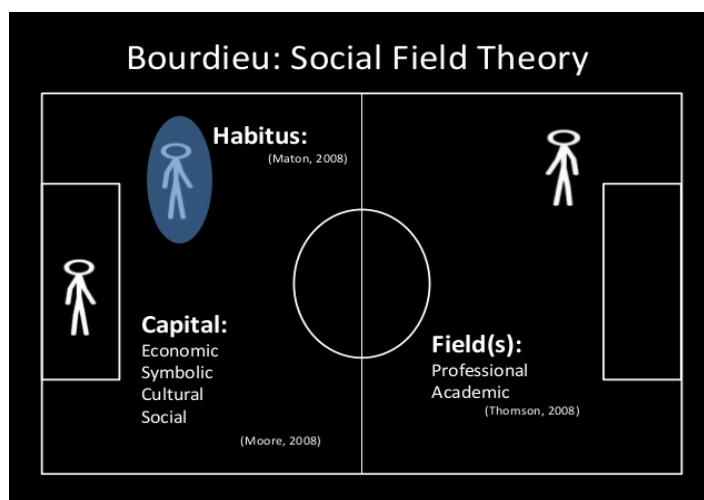

Figure 7 Bourdieu Field Theory (Harrison 2014)

3.2.4.2 Capital

To help understand society and the inequalities that exist within it, Bourdieu introduces four forms of capital; social, economic, cultural and symbolic. I outline definitions for the four forms of capital below:

Cultural Capital – The cultural competence a person has in terms of knowledge behaviour and skills. As well as the skills gained through education it includes the

wider understanding acquired to successfully navigate social environments. It includes understanding of unwritten rules

Social Capital - The aggregate of the actual or potential resources which are linked to possession of a durable network of more or less institutionalized relationships of mutual acquaintance and recognition.

Symbolic Capital – Resources in terms of recognition or prestige

Economic Capital – Financial assets including money and physical items such as equipment and property

(Fries, 2009; Grenfell, 2009; Martin & Geldof, 1997)

Earlier I outlined connections between social capital and the concept of smart community. Social capital is a component of Bourdieu's Theory of Practice. This places it alongside economic, cultural and symbolic capital as part of his explanation of human behaviour. Through these he is critical of the judgement of taste, something that he regards as part of cultural capital.

Cultural capital is relevant to this study as the cultural capital of people employed in the system might be a barrier that could obstruct significant change from taking place. In this context the shared understanding of medical practitioners and health researchers could be regarded as part of a structure that helps to preserve the interests of those in power. This links to the notion of false consciousness, a concept discussed and defined in 3.2.5

3.2.4.3 **Habitus**

The concept of habitus is similar to but different from the concept of habit. Bourdieu defines habitus as:

“systems of durable, transposable dispositions predisposed to operate as structuring structures”

(Bourdieu 1984, p270)

In other words habitus is a set of perceptions that routinely guides choices and options. It provides an enduring disposition towards acting in habitual ways when performing routine tasks (Cockerham 2005). Habitus is the link between the social and

the individual, between structure and agency. Through these it links past, present and future. It links social and individual as, although each person's experiences are individual to them, many aspects of their experiences may be shared with others of the same class, race etc., and shared with others in the same position in society (Grenfell 2008).

The idea of routine behaviour is relevant to this study because, if a more efficient system based on smart community could exist, it is likely to require the key people in the system, including patients, healthcare professionals and managers to change what they do, how they do it, possibly even how they think. This may for example require patients actively engaging in forums and using monitoring devices to change their behaviour. How the concept of habitus relates to lifestyle is illustrated in Figure 8

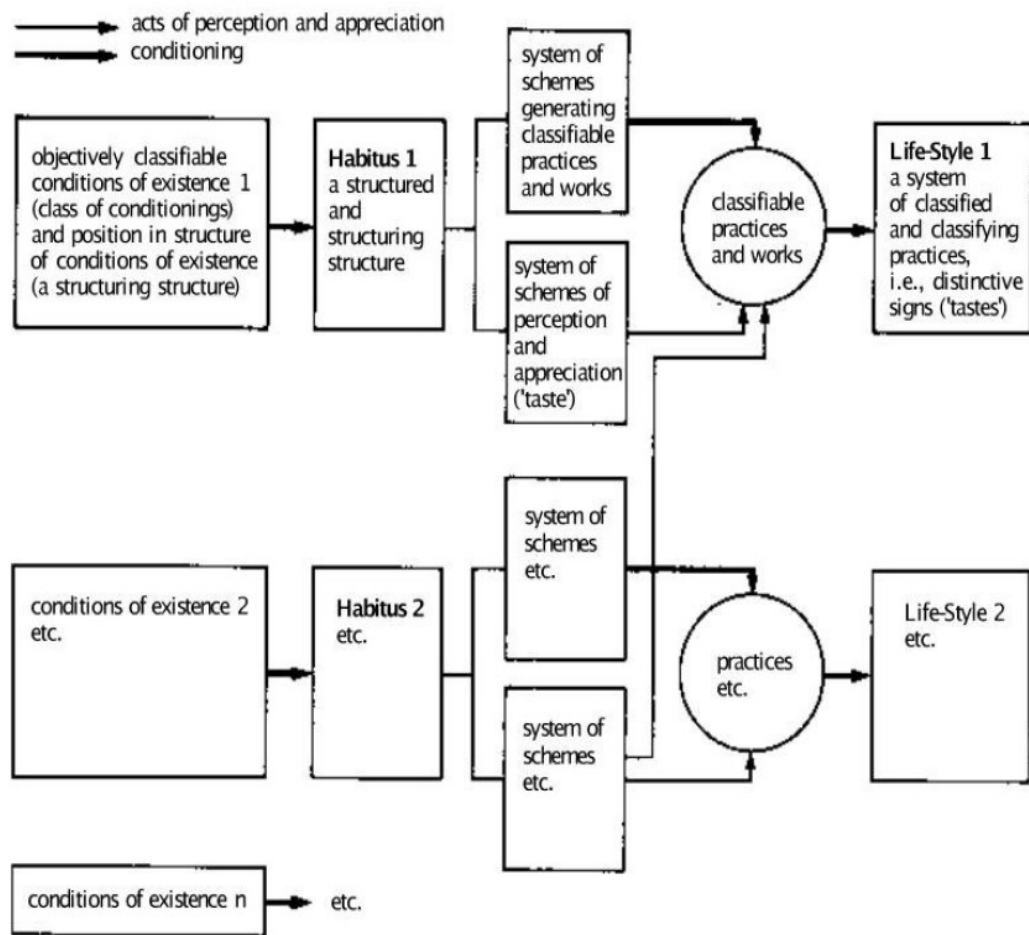

Figure 8 Conditions of Existence, Habitus and Lifestyle (Bourdieu, 1984)

Whilst Bourdieu didn't directly write about how his work relates to health lifestyle, this idea has been taken up by many other academics:

- *“His emphasis on structure with respect to routine operations of the habitus suggest a lesser role for agency than the individualist health lifestyles paradigm”* (Cokerham 2005, p62).
- Pierre Bourdieu’s concept of habitus connects health lifestyle to digital inequality:
“It explains how social conditions influence attitudes and behaviours” (Hale 2013, p501).

3.2.4.4 Field

The social and intellectual arenas where people interact are defined by Bourdieu as fields (Van De Berg 2011). A field is a spatial metaphor of the social environment. There are many different social fields such as academic, artistic and healthcare each with a different set of rules that influence actions and reactions (Veenstra 2014). In each field the rules that influence interactions are different in each field. Due to these rules it is necessary to consider interactions in relation to the characteristics of the field that they take place in (Chudzikowski & Mayrhofer, 2011; Hilgers and Mangez 2011). The borders between fields are however porous, so change including what is likely to successfully influence change can evolve over time (Bourdieu, 1994; Bourdieu & Wacquant, 1992; Ignatow and Robinson 2017).

Bourdieu argued that “The real is relational” (Bourdieu 1997; Hilgers and Mangez 2011; Ignatow and Robinson 2017). Hilgers and Mangez and Ignatow and Robinson connect this idea with field theory. Hilgers and Mangez argue that fields cannot be directly be observed they can only be assessed in terms of their impact and that this is complicated because effects are often not the result of the actions of a single actor but of a network of relations, i.e. the relations between them. The idea of assessing impact through effects is discussed further in 7.3.2 as part of wider discussion about making the invisible visible.

Relations within fields make consideration of the processes of change complex. Due to habitus existing structures of positions are likely to be passed on (Hilgers and Mangez 2011). Bourdieu argues that affinities tend to develop between individuals occupying similar positions within different fields as such people in dominant positions in different fields are likely to be sympathetic towards each other (Bourdieu 1971;

Bourdieu 1988; Bourdieu 1991; Hilgers and Mangez 2011). Bourdieu also argues that greater autonomy leads to a greater ability for dominant agents to control what is regarded as dominant knowledge (Bourdieu 2000; Hilgers and Mangez 2011). Hilgers and Mangez link this idea of control to the concept of doxa arguing that it leads to an adherence to activities due to presuppositions that define the conditions of membership.

3.2.4.5 Doxa

A concept that helps explain the effect of habitus on interactions in the field, or in different fields, is doxa. Doxa is the taken for granted understanding that people have of their social worlds, often resulting from their life experiences (Veentra 2014). Doxa forms our sense of what is possible and what is not (Walther 2014). It is the universe of the undiscussed and undisputed. Doxa can have a significant impact on behaviour as these are the fundamental deep founded beliefs that people rely on for survival in a particular field (Van De Berg 2011). Bourdieu applies the concept of Habitus to define this relationship as a property of social agents that determine action based on past and present circumstances (Grenfell, 2009). Habitus includes traces left in the morals, sentiments and know-how of agents (Stones, 2005). It connects with the idea that different forms of capital are forces that influence action. Bourdieu argues that these are all part of the structural power dynamics that influence action (Bourdieu, 1990). If Bourdieu's world view is accurate, to improve economic efficiency in the health system, it would also be necessary to challenge the undiscussed and undisputed. This notion directly parallels the idea of emancipation in CST, hence this theory, I argue, is relevant to the process of considering the impact of power in this project.

Doxa connects with the idea of false consciousness, introduced in 3.1.2.1, as these taken for granted assumptions are not always true (Kabeer, 1999). It is important for the issue of improving healthcare efficiency as, what people believe is possible may have an impact on the extent to which their behaviour could change. This may in turn restrict the extent to which people can be encouraged to adopt healthier lifestyles. It may also limit the potential for healthcare professionals and managers to consider alternative ways of working. This links to the discourse in methodology about the challenge in getting participants to imagine radically different future health systems.

This is because the current biomedical framework is part of the doxa of the current medical system.

Doxa has potentially significant implications for many of the ideas discussed so far. For example I suggested that the internet might be able to change the relationship between healthcare professionals and patients. If Bourdieu's Theory of Practice is applied in this context then the extent to which this is possible would be dependent upon the existence of capital. Articles on healthcare practice suggest that practice does appear to mirror the processes indicated in this theory. For example Greenhalgh (2015) refers to lay codes of practice and deeply held traditions. A lack of cultural capital could prevent patients from effectively engaging with healthcare professionals. To create a more equal relationship between patients and healthcare professionals through social computing³⁷, might require patients to increase their levels of cultural capital, or this might only be possible for patients who already have high levels of cultural capital.

3.2.4.6 Applying Practice Theory to this Study

To illustrate the idea of conflicts of capital within the field to this study, the idea of collective intelligence introduced in the last section of this chapter could be undermined if patients lack the cultural capital needed to effectively engage. Conversely the existence of social capital in online communities of patients could challenge some of the dominant narratives in the current healthcare system. This could lead to a culture shift where some existing barriers become diluted. For example if online discussion moved health discourse away from medical terminology, capital associated with health discussion would be reduced and so would become more accessible to people without formal medical training.

Bourdieu's Practice Theory is highly relevant to this study as his concepts of field, capital, and habitus have informed digital sociology (Daniels, Gregory, and Cottom, 2016; Lupton, 2014; Marres, 2017; Orton-Johnson and Prior, 2013).

Earlier I stated that within Practice Theory agency is regarded as inherently intersubjective and as such is never free of structure (Veenstra 2014). Placing Practice

³⁷ as discussed in 4.3 and 5.1.2

Theory at the core of my methodology therefore has a significant and profound impact on the process of data collection and interpretation. If within this study agency is regarded as inherently intersubjective, then I must accept that structural factors are likely to have influenced the thinking and actions of all my interviewees and workshop participants. As I outline in 3.5.1. I addressed this through a process of critical reflexivity that includes applying the theories and concepts outlined in this chapter to the process of interpreting data.

3.2.5 Challenging the Status Quo with False Consciousness

CSH promotes a cognitive approach. In CSH interviewees and workshop participants are not considered stakeholders. Changing the world view of participants is therefore not essential. Jackson (1984) and Mingers (1980) are critical of action research, SSM in particular. They argue that in practice giving participants equal ownership of research outcomes to the researcher tends to sustain rather than to challenge the status quo. Jackson's argument is that if the dominant group in the system is given the status of co-researchers, they are likely to suggest changes that support rather than threaten their authority. Because I am interested in the ideas of dominant groups as well as those of people who might be dominated, action research would be less than ideal for this study. Mingers (1980), with reference to ideas of Habermas, states that any consensus reached will be false if understandings are based on systematic distortions. I suggest that due to the likelihood of institutionalisation the stated views of participants are likely to contain systemic distortions. My assertion that institutionalisation is likely to exist is supported by organisational research (Hopton 1996; Davis and Elwyn 2007; Stacey and Griffin; Kelsey 2017). Jost argues that institutional domination enables ideas to be spread that justify inequalities of status and power. Stacey and Griffin support this view arguing that we are all conditioned to take up the norms of the groups in society that they belong. Hopton makes a similar argument connecting false consciousness to the concept of institutionalisation. He concludes that mental health nurses despite seeing themselves as innovative, continued to apply outdated approaches. Informed by Hopton's research I took the view that there was a significant risk of false consciousness in this study because some of my participants were healthcare professionals.

Ulrich (2003) supports Minger's assertion when he talks about structural conditions reinforcing current conditions. Williams and van 't Hof (2014) also make a connection between stakeholder engagement and the reinforcement of the status quo. They apply the idea of single and double loop learning, stating that single loop learning relates to solutions that fit within existing norms and assumptions. The implication here is that stakeholder interests could limit research outcomes to what is possible within existing structures. To address wicked problems Williams and van 't Hof argue, it is necessary to apply double loop learning that looks for solutions that adopt new norms and worldviews. To address the wicked problem of improving the efficiency of cancer services I attempted to look beyond the stated worldviews of interviewees and workshop participants. This does not mean that I ignored their views simply that I attempted to consider if there might be structural factors that influenced participants thinking. I applied Bourdieu's Theory of Practice³⁸ as a framework to consider possible structural distortions. In addition, I triangulated views with my own experience and prior evidence from secondary research.

In this study however it is Bourdieu's perspective that is most relevant, as it is his theory of practice that is given the position as the main critical theory underpinning its application of critical systems heuristics. Bourdieu is both critical of the concept of false consciousness whilst also regarding the concept as of great importance. His criticism of false consciousness is twofold, firstly he is critical of the term consciousness (Burawoy 2012). Bourdieu argues that the word consciousness does not give sufficient consideration to the "accumulated sedimentations of social structure" accumulated sedimentations of social structure (Burawoy 2012). Bourdieu argues that the depth of social structure accumulated over time are beyond what is possible to transform through intellectual conversion (Bourdieu 2000; Burawoy 2012).

Secondly he is more concerned with the influence of social structures than class. To differentiate himself from directly Marxist uses of the term false consciousness Bourdieu instead uses the term misrecognition, referring to the misrecognition of

³⁸ Bourdieu's Theory of Practice is outlined in 3.2.4

power relations (Navarro2006). Bourdieu argues that conditionings from the past have already predisposed the agent to do certain things as second nature (Bourdieu 1980).

Bourdieu's arguments very much mirror those outlined in CST literature. Some of these were included in discussion about emancipation and challenging the status quo in section 3.2. More directly, with reference to Habermas Mingers argues that the problems of society are created by the structures of society (Mingers 1980). Ulrich (2003) makes a similar distinction when he refers to the need to differentiate between the epistemological and methodical importance of considering emancipation. He also supports Mingers assertion when he talks about structural conditions reinforcing current conditions.

CST academics are not alone in highlighting the limitations of participatory research. Lather (1986), with reference to false consciousness make a similar argument, they state that analysis should not be limited to actors perception of their situation.

Simply accepting the stated views of participants could have distorted the data collected from interviews and workshops due to the existence of false consciousness. If research participants had not been able to look beyond existing structures, their ideas about what a more efficient future could have been stilted. A lack of imagination from participants risked preventing this project from meeting its objective of developing forward thinking conceptual models of what a more efficient future might look like. I considered this a significant risk due to existing research that suggests Institutionalisation in the health sector does exist (Hopton, 1997).

As discussed further in 3.6.1 the concept of routinization, (Giddens, 1984)³⁹, is part of the process of creating and maintaining institutionalisation. To counter institutionalisation I applied reflexivity to get beyond some distortions. Johnson and Duberley (2003) argue that Bourdieu's idea of systematic reflection can be applied to make the unconscious conscious. Bourdieu's idea of systematic reflection is very much in line with the approach of critical reflexivity that I applied, as evidenced by the connection between Bourdieu's Practice Theory and getting beyond the unconscious,

³⁹ Routinisation is part of structuration theory.

(outlined in 3.1.2.1). My decision to apply reflexivity is informed by Bourdieu's advocacy of its use to overcome misrecognition (Bourdieu 2000; Burawoy 2012).

As outlined in 3.1.2.1 the idea of emancipation is a core component of CST. Some researchers argue that to apply emancipatory methods in research, methods must be grounded in emancipatory social theory (Schechter, 1991). In line with my CST research philosophy, to incorporate emancipation I applied social theory to help get beyond the superficial and attempt to overcome false consciousness. Applying existing theory is a credible approach as the use of theory in research is frequently advocated in research methods texts (Silverman 2000; Alvesson and Deetz 2000; Seale et al 2004). Silverman argues that social theories help address issues in social research. Alvesson and Deetz appear to take a similar view arguing that the interpretation of data can rely on a framework based on a theory or set of distinct theories. Seale also supports the use of theory arguing that all observations are theory driven. The specific theories I applied are relevant due to links with false consciousness, as stated earlier in this subsection.

Sinkovics and Alfoldi (2012) inform the approach I took. They state that in qualitative research, findings often emerge through an evolutionary process driven by the interaction between theory and data. In line with their argument, I applied social theory within the process of making sense of data, and in line with the study's subjective epistemology, I am explicit about the theories that informed my process.

For the reasons stated above although I did seek to create a sense of community within the workshops that I facilitated, I decided against creating a research community to assist with analysis. Whilst I found it helpful to bring together the ideas of participants with different backgrounds in the workshops, due to the potential of misrecognition (Bourdieu 2000) by participants I deliberately excluded participants from the process of interpretation, outlined in part 4 of this chapter. To counter the potentially constrained thinking of participants, instead of giving them the status of co-researchers (as is the norm in participatory action research) I applied a form of critical reflexivity⁴⁰ to get beyond structural constraints. The form of critical reflexivity I applied is outlined in 3.5.1.

⁴⁰ The form of critical reflexivity I applied is outlined in 3.5.1

Some research methods include strategies for addressing false consciousness. Two of these are CSH and participatory action research. Each of these however differs in how to overcome these limitations. Ulrich (1996) describes action research as research by and with the people. In action research, because participants are considered stakeholders, false consciousness can be overcome by challenging the world views of participants. Within the confines of my PhD study I regarded changing the world view of participants unrealistic due to limitations of time and stakeholder buy in, and so deemed challenging the views of participants alone to be unduly limiting.

To find meaningful understanding from data in line with the research philosophy and methodology applied, I considered it necessary to challenge the status quo. To do so I attempted to look beyond the stated views of participants. In section 1, I argued that overcoming false consciousness was a key part of CST. It is a term that frequently occurs in CST literature (Jackson 1991; Gregory 1992; Phelan 1998; Reason and Bradbury, 2008). In line with this, links have been made between most of the theories I refer to in this chapter and the concept: Actor Network Theory (Doolin and Low 2002), Structuration Theory (Gregory 1992; Dobson 2001) Bourdieu (Gregory 1992; Lincoln and Denzin 2003). Here I explain the implications of challenging the status quo on the research methods and process I adopted.

3.3 Part 3: Structure, Methods, Procedure and Activities

3.3.1 Process and procedures

In keeping with its research philosophy, the different components of this study's methodology have not been conducted through a strictly linear process. This non-linear way of researching is supported by systems thinking researchers including Checkland (1999) who argue that the most effective systems thinker will be working simultaneously, at different levels of detail, on several stages. His research informed my approach. Critical reflection for example, has been an ongoing process that has taken place during and after each section.

As an introduction to the different components of my process in Figure 9 I illustrate how the different techniques and parts of my research fit together. As you can see I applied interviews, workshops, thematic coding and reflexivity. Figure 9 shows a nonlinear process with loops such as the one between critical reflexivity and theory development. This loop illustrates the continual process of reflexivity referred to earlier Figure 9 is a simplification of the actual processes that have taken place. It should however give a good idea of general structure. My first version of the diagram included most of the links and influences, but was too complex and detailed to follow. Influences that are omitted from Figure 9 include;

- the link between the scoping review and the questions asked in main interviews
- the link between scoping reviews and workshop design

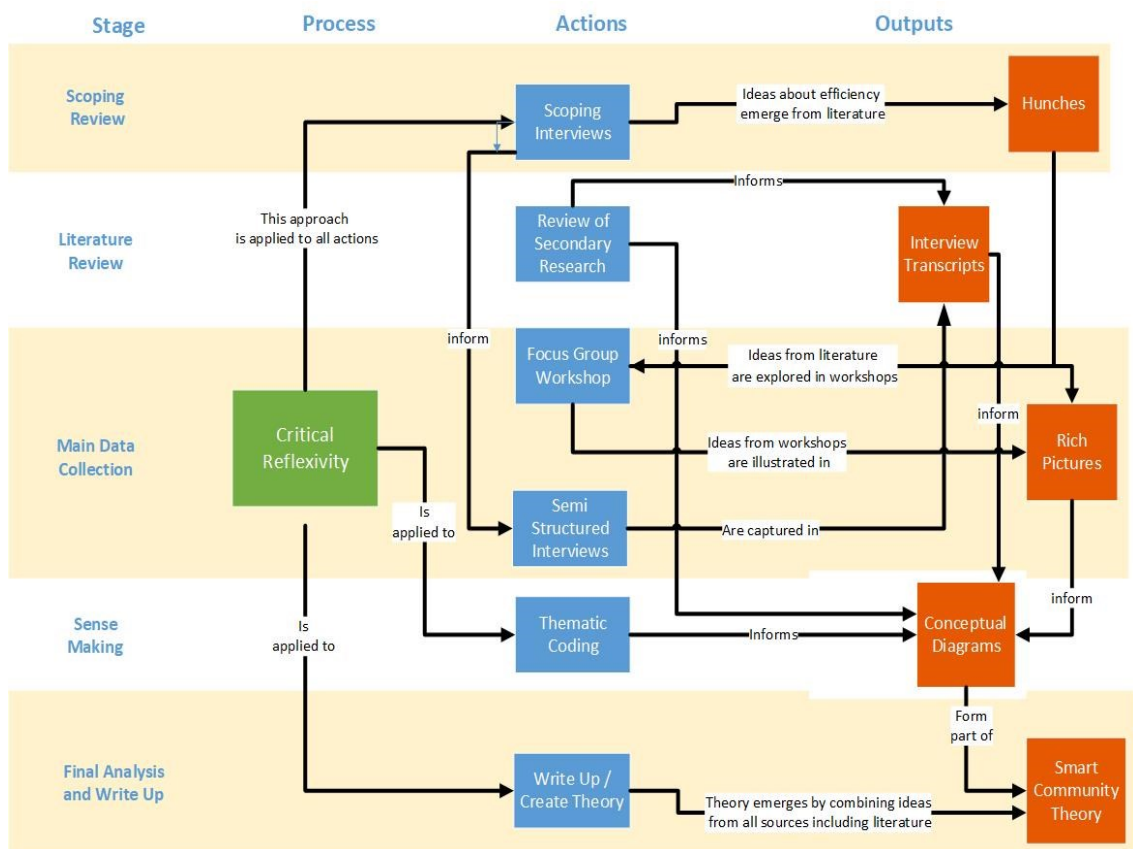

Figure 9: The Nonlinear Nature of My Research Process

In chapter 1 I outlined this study's objectives and indicated where each would be discussed. Below I indicate how each has been addressed:

Objective 1 - was achieved through the literature review and the scoping review

Objective 2 - Ideas about current smart community interventions emerged from literature interviews and workshops.

Objective 3 - Conceptual models have been developed through:

Interviews and focus group workshops to capture the views of experts, including expert patients.

Critical reflexivity to review data collected through the lens of relevant theory

A process of thematic coding that connects primary data with theory and other relevant literature.

Objective 4 - Theory emerged by bringing together all of the different ideas discussed in this study through the process of critical reflexivity I outline in 3.5.1.

The procedures that I included within my research process were: a scoping review, a literature review, participant selection, data collection and analysis.

As stated in 1.2 whilst much of the literature reviewed is discussed in chapter 2, some is deliberately scattered into all other chapters. In line with the non-linear process described above the procedures are not discrete steps taken one at a time, the boundaries between them are blurred. For example the literature review is also part of the scoping review, at the same time literature discussed is also part of the data analysed in this project. The purpose of some of the key components applied in this study are indicated in Table 5.

Table 5 Procedures, Methods and Activities

Procedure	Method	Activity	Logic
Litarature review			To identify knowledge gap to be investigated To inform models developed.
	Workshops		To collect data to inform models and theory.
	Interviews		To collect data to inform models and theory.
		Modelling	To create a structure to illustrate what the current and a potential future system might look like.
		Critical reflection	To uncover gaps and errors in the data collected e.g. data collected may be imperfect if participants exhibit false consciousness.

3.3.1.1 Participant engagement and selection

I applied stratified sampling to the selection of recipients for interviews and workshops to ensure that all key stakeholder groups are represented. Sampling included ensuring that the voices of patients, health professionals, health managers and ICT professionals are all represented. The identification of these specific categories was largely intuitive, it was however an intuitive process that was informed by research literature. For example articles that argue that the smart city should start with the city not with the smart (Hoorweg, 2011; Schaffers et al, 2011) informed by decision to include service users as well as technology professionals. I considered it essential to include cancer survivors as emancipation is a central aspect of CST. Due to the application of the CST philosophy through its CSH methodology the emancipation of patients through information technology is a significant theme through this study. Patients are the core group of service users considered. Bovaird (2007) and Barnes and Cotterell (2012) are amongst the many researchers that advocate the benefits of service user involvement. Barnes and Cotterell argue that active involvement of service user's results in better research. They clarify claiming that it is more reliable and leads to the creation of information that is more useful than research that does not include engagement.

The starting point for identifying potential participants was a combination of existing contacts from my work in Sheffield's health sector, combined with desk research to identify relevant interviewees. From this starting point I applied a process of snowballing, following the suggestions of initial contacts was used to seek out additional suitable interviewees. To illustrate I outline the process I used to engage relevant technology professionals. Through a role on a health committee I was aware of an NHS digital technology testbed project. Through desk research I found that there was a strand of this national initiative taking place in Sheffield, with a focus on the patient pathway. It seemed a good fit for this PhD project as this test bed had an aim to improve healthcare for people with long term conditions through information technology, due to this fit I deliberately approached organisations that were involved in the testbed.

To compliment the snowballing process I promoted the study and workshops through social media (primarily twitter and LinkedIn) to extend my network to make contact with additional potential attendees. This seemed appropriate due to the digital nature

of the project. Cancer survivors were identified through two support organisations, Macmillan and The Weston Park Cancer Support Centre. I actively contacted underrepresented groups to ensure a balance of stakeholders was maintained. By balance I am referring to a balance between the categories listed above.

Criteria for inclusion required participants to fit into one of the following categories:

1. Experience and understanding of the system of cancer services in Sheffield. Cancer survivors, healthcare professionals and managers all qualified under this criteria
2. Smart community expertise. Technology professionals with insight into what is becoming possible through information technology qualified under this criteria. 3 interviewees qualified under this criteria.
3. Specific knowledge of healthcare systems that could inform what a future system might look like. Think tank researchers qualified under this criteria as did healthcare professionals from outside Sheffield who had experience of using cancer specific forums. Cancer survivors from outside Sheffield were included as it was not possible to find cancer survivors in Sheffield with experience of using cancer forums. 7 out of 30 interviewees qualified under this criteria

I conducted 30 interviews in total, ten as part of the scoping review and a further 20 as part of the main stage of data collection. Scoping interviews took place July – September 2016, with main interviews taking place in February – August 2017. All the scoping interviews and one of the main interviews had taken place before the first workshop, the last interview took place after the last workshop.

The breakdown of different people I interviewed were as follows:

- 7 Academics / Researchers - 2 in the scoping review and 5 in the main interviews. 3 worked for universities and 3 for health focussed think tanks
- 9 Healthcare managers, 6 in the scoping interviews 3 in the main interviews. 2 managers were local government employees both of whom worked in professional roles connected to public health, 3 who worked for charities, 3 who worked for Sheffield CCG, and one who worked for a hospital trust
- 6 Healthcare professionals - 3 GPs and 3 oncologists
- 4 People from Technology companies, , three of whom had been involved with the Sheffield NHS test bed project, Perfect Patient Pathway (PPP)
- 3 cancer survivors, two of whom were active users of healthcare forums
- Out of 30 interviewees 18 were male and 12 were female

Workshop attendees were as follows:

- Workshop 1 – 3 cancer survivors, 2 healthcare managers, 1 healthcare geneticist
- Workshop 2 – 2 hospital managers, 1 cancer survivor, 3 technology professionals and 1 informatics specialist
- Workshop 3 – 1 CCG manager, 4 charity managers, 1 local authority manager, 1 cancer survivor, 1 private sector manager and 1 technology professional.
- Out of the 20 people who attended workshops 8 were male and 12 were female

Workshops took place in March, May and July 2017. Due to the availability of potential attendees it was not possible for me to get the exact balance of attendees I wanted in the workshops. Because healthcare professionals, cancer survivors and local authority employees had been underrepresented in workshops I engaged them in interviews. Whilst I found it very easy to find people from all of the other groups to interview, local authority staff took more convincing. This may be due to overall work pressure, or because they saw a less obvious link between the project and their work. The last interview was with managers of a charity that had been spoken about frequently in workshops.

3.3.1.2 Scoping review

My approach was informed by Arksey and O'Malley (2005) who indicate that a scoping review can include both a review of literature and the use of interviews. Arksey and O'Malley argue that a scoping review can be both part of the literature review and something that goes beyond it. The literature component of my scoping exercise was outlined in chapter 2, the findings from scoping interviews are outlined in 6.1. The approach to interviewing that Arksey and O'Malley (2005) and Levac, Colquhoun, and O'Brien (2010) advocate, is open and not guided by highly focussed questions. This is in line with the use of semi structured interviewing that I applied.

The scoping review approach taken is informed by research methods literature (Arksey and O'Malley 2005; Davis, Drey, and Gould, 2009; Levac et al., 2010). I conducted a scoping review for two reasons, the first was to gain a greater understanding of the research area before conducting workshops and the main interviews. The second reason was to identify areas of focus. Some research methods writers state that a scoping review can identify gaps in existing literature (Arksey and O'Malley 2005;

Davis, Drey, and Gould, 2009; Levac et al., 2010). Davis, Drey et al define a scoping review as research of research and suggest that it can guide more focussed approaches. Levac et al suggest that scoping studies may be particularly relevant to disciplines with emerging evidence where there is a paucity of existing research. My approach was informed by these writers. As indicated in chapter 2 there is a paucity of smart community research, and so a scoping review is appropriate for this project

3.4 Research Methods

The research methods applied in this study were workshops and semi structured interviews.

3.4.1 Interviews

Semi-structured interviews were applied in both the scoping review and the main stage of interviews. Semi structured interviews were selected as they are the form of interview most consistent with CST. My decision to apply semi structured interviews was informed by critical and qualitative research literature (Alvesson, 2000). Alvesson supports the flexibility of the semi structured approach when he highlights the importance of the process of interpretation and communication between the interviewer and interviewee during the interview. He argues that without consistent interpretations the process of social interaction in the interview will not work as the interviewer will appear rigid and strange, and so will colour and restrict further responses. Structured interviews were rejected because the objective nature of structured interviews reflects an attitude of scientific objectivity that is inconsistent with CST.

In all interviews I started by clarifying why I was interested in interviewing interviewees, focussing on the work or past research I thought was particularly relevant. For example in the first scoping interview I started by highlighting some of their relevant research. The approach I took was informed by motivational interviewing training that had been recommended by one of my supervisors. One of the key principles that I carried across was giving interviewees space, and time to answer questions, resisting the urge to fill all silent gaps. Another motivational interviewing technique I applied was asking for clarification, to check that I had

understood comments that had been made. This approach often prompted participants to continue and give more detail.

In scoping interviews I focussed most of the discussion on three general areas;

- Existing practice, such as existing initiatives that had taken place in Sheffield or elsewhere
- Existing research that might add to my literature review
- Thoughts about my research plans including scope and methodology

I started all of the main interviews by asking participants what they thought was good about their most significant successes⁴¹. In most cases, they responded with insights about initiatives that had taken place in Sheffield, some however spoke about initiatives that could be applied to Sheffield.

As well as asking interviewees about current or past activity, I asked interviewees to outline some of their ideas about what they thought the future might look like. Discussion in interviews deliberately paralleled discussion about utopia and dystopia in workshops. As part of the process of bringing together ideas from literature with participant's insights, I also discussed hunches that were forming in my mind in response to literature or comments from previous interviewees. For example I asked interviewees about the biopsychosocial model and insights from aviation. In doing so I was mindful that I was influencing outcomes, but also of the value in hearing interviewees either concur with or challenge my emerging hunches. Another area of discussion in all interviews were the costs in the current system and potential efficiency improvements.

3.4.2 Workshops

3.4.2.1 Activity 1 Asset Mapping

The first workshop started with participants listing some of the key assets in the current system. Information collected indicated participants' views about: key people, services, technologies and data sources. First I asked participants to create an asset

⁴¹ Asking interviewees about what was good relates to appreciative inquiry, as outlined under workshops.

list, simply what exists in the current system regardless of merit. Next I asked participants to highlight aspects of the system that they believed were particularly good and others they saw as problematic. In this session they were asked to add coloured stickers to identify areas they thought were good and those that could be improved. Through this activity areas of inefficiency within the current system were identified. Finally participants created two rich pictures both representing the current system. Figures 21 - 23 are photographs of the rich pictures that were created.

3.4.2.2 Activity 2 – Creative Icebreaker

In workshop 2, I started with a creative icebreaker exercise, getting participants to imagine a ship in a storm. I asked participants to imagine that they are on a ship on a stormy sea⁴² and to think of strategies to get themselves and the boat to safety. After these ideas were discussed I asked them to try to find links between these strategies and current challenges in the health system, thinking of the current system as a ship in a stormy sea. Following this, as illustrated in figure 10, I asked them to write down as many ideas as they could, on post-it notes, about what they thought might improve the efficiency of the current system.

3.4.2.3 Activity 3 Rich Pictures

The ideas participants had written on post-it notes informed the next activity, creating a utopian rich picture. To create this I asked them to imagine what a future system of cancer services could look like, based on smart community ideas. In this process I asked them to ignore all practical, legal and ethical considerations, as these risked blocking their thinking. As I outline in 4.1, this approach was informed by the outcome of the scoping review. Next I asked participants to take the opposite approach, to imagine the most dystopian future they could.⁴³ In the final section of workshop 2 I asked participants to review all the previous rich pictures, including the one of the current system from workshop 1, to create a more balanced rich picture of the future.

The inclusion of creative icebreaker exercises and the creativity in rich pictures were included in part because they are advocated within systems thinking (Jackson 2006).

⁴² This inclusion of this activity had been informed by comments in scoping interviews advocating creative activities as outlined in 4.1

⁴³ An outline of dystopian rich pictures and the discussion surrounding it is given in 8.3.

Jackson highlights the importance of creativity in solving complex systemic problems and the strength of CST as a tool to encourage creativity. Creative techniques were also advocated in scoping interviews. The use of creative techniques was also very much in my comfort zone due to my arts background. In line with Jackson's advocacy of creativity, creative exercises were applied to help enable participants to think differently about what a future healthcare system could look like.

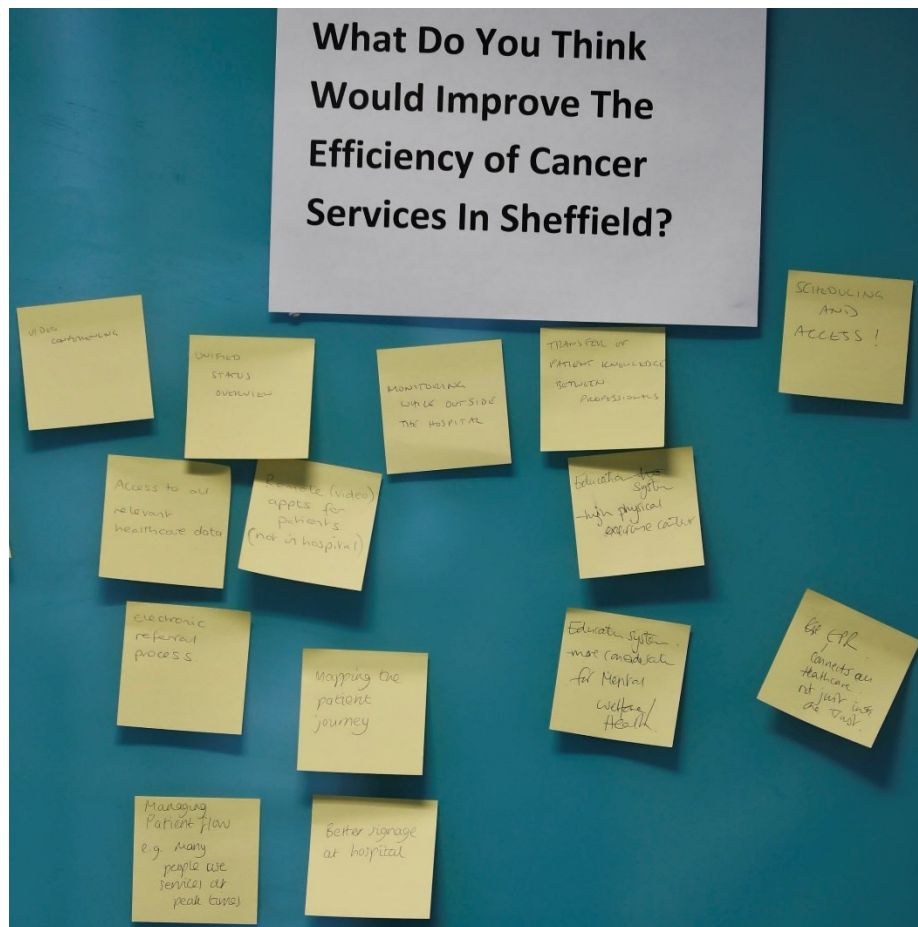

Figure 10 Illustration of Post-It Exercise

3.4.2.4 Activity 4 Ice Breaker quiz

Workshop 3 started with an ice breaker quiz, where participants discussed comments and decided if they were fact, science fiction or social theory. The quiz served as an introduction to smart community ideas to inform subsequent activities.

3.4.2.5 Activity 5 More Rich Pictures

Next I asked them to review and improve the rich pictures from the previous session and then to recreate and improve the final rich pictures of the future and current

system. One of each was created. Next they identified cost centres in the current and future systems they had created. The cost centres they identified informed the final activity, comparing the likely relative efficiency of the systems represented by each vision.

3.4.2.6 Workshop design

Rich Pictures / SSM

Getting participants to collaboratively create rich pictures was the central focus for all three workshops. Rich pictures were selected for two reasons. The first is their association with systems thinking and wicked problems. The second was because they were advocated in a scoping review interview. Rich pictures are a central tool in soft systems methodology (SSM)⁴⁴. They are useful because the complexity of human situations is always one of multiple interacting relationships, and a picture is a good way to show relationships (Checkland and Poulter, 2006). Because rich pictures can capture complex patterns of interrelationships it is understandable that they are often associated with wicked problems and systems thinking (Petkov et al 2007; Sevaldson, 2011; Williams and van 't Hof, 2014). In SSM models there are devices applied to help structure an exploration of the problem situation (Checkland 1981). In all workshops rich pictures were applied in this way. The creation of and comparing of rich pictures was applied as a tool for formulating and sharing ideas about the current system.

Although some of the limitations of SSM were discussed in part 1 I made a distinction between methodology and method. In part 1 I concluded that SSM was inappropriate as the study's overarching methodology. My conclusion does not however mean that SSM is not appropriate as a research method. Ulrich (1996) argues that research methods that are traditionally associated with action research are valid within CSH so long as they are implemented from the philosophical position of CST. As such, my judgement that SSM is appropriate as a research method is supported by Ulrich's argument.

⁴⁴ I discussed soft systems methodology is the application of soft systems thinking discussed in 3.1.2

Sessions 1 and 2 were informed by stages 1-4. Session 3 by stages 4-5. Stage 6 is very much the focus of my sense making process⁴⁵, and took place by me after the workshops concluded, but was informed by discussion in workshops and interviews. Stage 7 may happen after I complete this study. It could be the first stage of a future research project. The stages of SSM are illustrated in Figure 11.

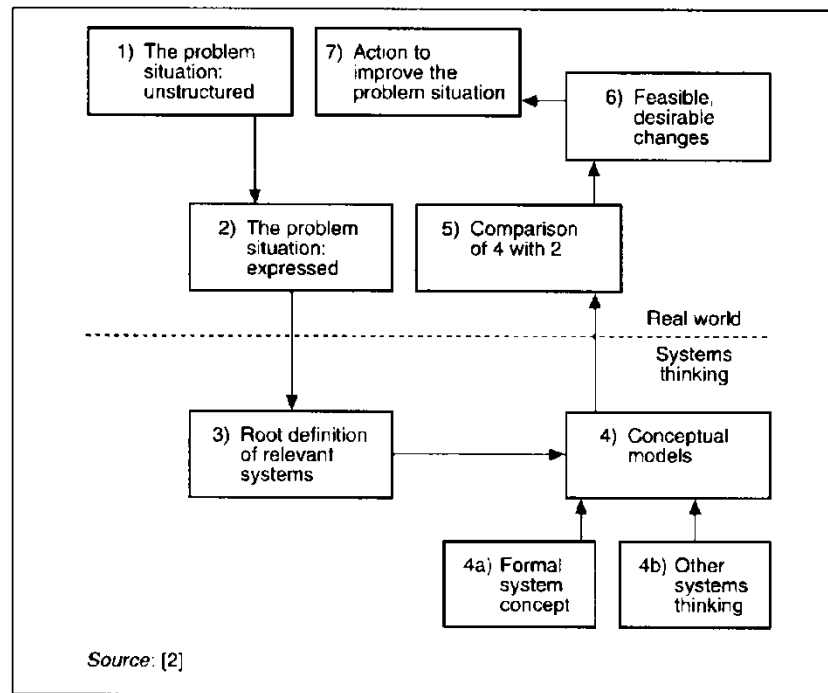

Figure 11: Soft Systems Methodology (Checkland, 1999)

Appreciative Inquiry (Ai)

The structure of workshops were informed by appreciative inquiry as well as SSM. As indicated earlier, workshop 1 started with a focus on what is good in the current system. It was directly informed by Ai stages 1 and 2, these stages also informed the process of creating an asset list that I described earlier. The inclusion of utopian rich pictures in workshop 2 was informed by stages 3 and 4; dream and design. . The stages of Ai are illustrated in Figure 12. Appreciative Inquiry (Ai) was selected as it shares with the asset based form of patient empowerment outlined earlier; a positive perspective. Ai gives participants power by giving them freedom to contribute and to dream (Whitney and Trosten-Bloom, 2010). Whitney and Trosten-Bloom claim that Ai

⁴⁵ Although SSM relates to sense making as well as data collection it does so as a method applied, not at the overarching methodological level. The link between SSM and both workshops and analysis is part of the nonlinear structure I outlined earlier.

levels the playing field by building bridges across boundaries of power and authority. Their idea influenced my workshop facilitation approach. By encouraging participants to imagine a positive future they were encouraged to look beyond existing constraints and power structures⁴⁶.

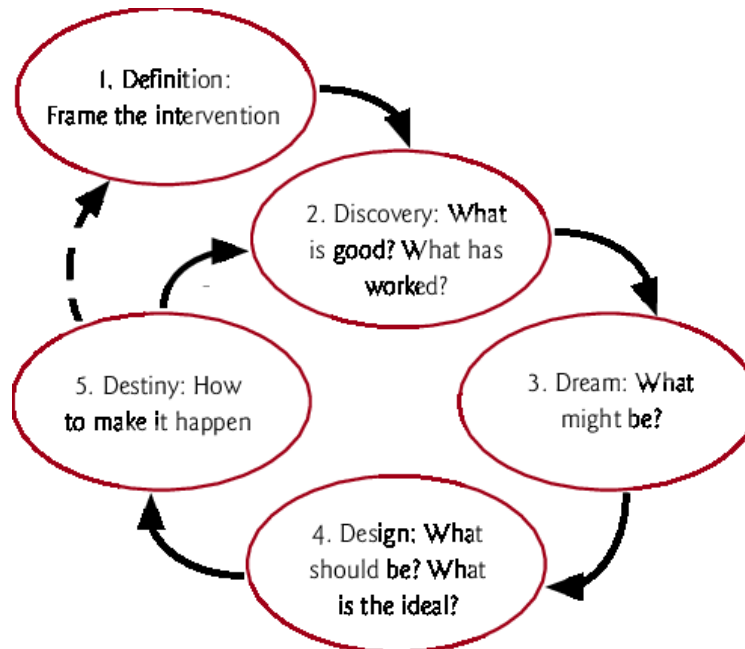

Figure 12 Appreciative Inquiry (Acosta and Douthwaite, 2005)

In Figure 13 I give an overview of how workshops link into the methodology outlined in this chapter. As with other conceptual models in this thesis, it was designed to give a general overview and as such it does not contain all links that took place.

⁴⁶ As with SSM, Ai informs the overall process not just workshops. As with SSM it is part of the methods applied not the overarching methodology applied. Both are applied as part of CSH.

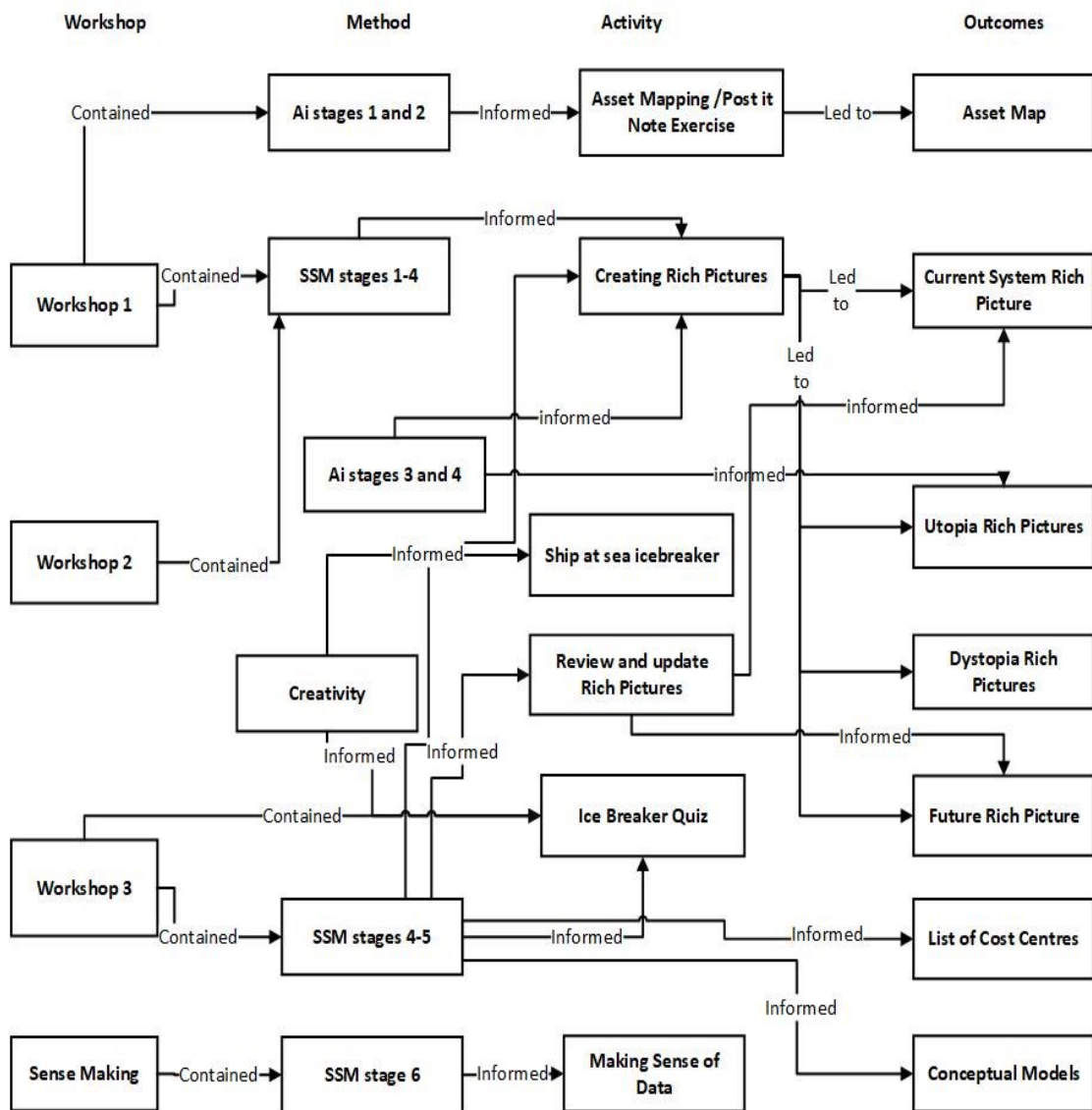

Figure 13 How Workshops Link to Methodology

3.4.3 Ethics

Ethics are relevant to this study in two different ways. Firstly, there were ethical considerations in the methodology. Secondly ethics feature as part of the subject of the research. In the methodology, ethics have been considered in relation to which participants were included and how they were treated within interviews and workshops. To gain a holistic perspective I regarded it essential to include the perspective of cancer patients as well as people involved in the system of cancer services from a professional perspective. As it was deemed unethical to include people who were engaged with the stress of current treatment, cancer survivors who had already been through cancer treatment were engaged. In the sense making stage of this project, ethical as well as efficiency issues were considered. In terms of the

subject of the research, ethics is a particular focus of chapter 8 which draws upon social theory and science fiction as well as the primary research.

An important part of the ethics procedure for this project was securing ethics approval. Because I considered it important to include the perspectives of people who had been cancer patients, this procedure required securing NHS as well as SHU ethics approval.⁴⁷ Securing HRA ethics approval process was not straightforward or streamlined. It included completing an IRAS form and a research passport form and sending across the following additional supplementary information⁴⁸:

- A sponsorship letter
- A schedule of events
- A statement of activities
- HRA approval notification. My IRAS number was 210057
- Obtaining a STH research passport, my reference number was STH19666

⁴⁷ The ethics forms that were submitted are included in the appendixes

⁴⁸ Copies of each are included as an appendix

3.5 Part 4: Interpretation

Here I outline the approach that I took to make sense of the data that I collected. At the core of this process was theory informed critical reflexivity, a process that connected the theory outlined in part two with the reflexivity referred to in part 3. I start by giving an overview of what reflexivity is to help explain the reflexive approach and to put it into context.

In line with my interpretivist research philosophy I refer to sense making rather than data analysis. The process included three components; conceptual modelling, reflexivity and thematic coding. These are not stages, as each component took place in parallel, each informing the other. Reflexivity informed the process of thematic coding and coding informed the development of thematic modelling. How these are combined was guided by intuition as much as by formal process.

3.5.1 Reflexivity

Reflexivity is the primary strategy I applied to overcome false consciousness. Reflexivity is an approach advocated by key CST writers (Jackson 1994; Mingers 2010). Jackson implies that a reflexive approach is needed when he states that the researcher should be explicit about their own ideological commitment. Mingers takes a similar view when he implies a reflexive philosophy when he states that systems research should consider wider processes and context. As an example he suggests that a reductionist approach to research is likely to see errors as one-off events, potentially down to an individual's failure. Critical systems researchers however need to consider the wider system that these errors have taken place in. It is clear that Mingers is explicit about his own ideological position, critical of positivist research and complimentary about systems thinking.

At its most basic level reflexivity can simply refer to taking a self-critical approach in research (D'Cruz, Gillingham, and Melendez, 2007). Holland (1999, p477) outlines 4 levels of reflexivity. He describes the most extreme as a:

“radical mode of reflexivity not bound by either paradigms or disciplines”

He argues that a radical approach is needed as existing systems of knowledge may be tied to interests of power. As outlined later under triangulation, the approach I applied

is not as radical as the approach Holland advocates. His approach, I believe, would have risked bringing in some of the issues of extreme subjectivity I outlined under Postmodernism. Instead I applied a more moderate approach. My approach is guided by research literature (Silverman, 2013). I am mindful that even the more moderate form of reflexivity I attempted was aspirational. Whilst I know that I have highlighted some power interests, I am not claiming to have reflected on all relevant interests. Within my application of reflexivity I applied the life experience I outline in 3.5.2. The understanding I gained from life experience and previous research, helped me identify times when it was helpful for me to question comments made by research participants, during interviews and workshops, as well as during the interpretation of data. Reflecting on comments during interviews enabled me to ask follow up questions to clarify comments made and add to my depth of understanding.

The power interests I attempted to challenge through reflexivity included assumptions held within; health economic research and health research. Through reflexivity I challenged assumptions within some smart city literature and practice. The process of challenging assumptions in relation to power is directly related to the process of overcoming false consciousness. Alvesson and Sköldbberg (2009) argue that to critically interpret power relations ideas that may appear self-evident, require further scrutiny. They also highlight the importance of avoiding pandering to established thinking and dominant interests. In response I deliberately avoided applying a traditional health economics approach and have applied scrutiny to digital health and smart city discourses.

The form of reflexivity described above has implications for all aspects of research, including the status given to each component of the research process (Alvesson and Sköldbberg, 2009). Alvesson and Sköldbberg argue that in critical research, data oriented work such as interviews and observations constitute only a relatively small part of the story being produced. Most of the meaning only becomes apparent through the interpretation of data. Denzin (1994) appears to share this view when he states that data does not speak for itself⁴⁹. Alvesson and Skoldburg and Denzin informed my decision to consider the world view of interviewees as well as their stated views. To

⁴⁹ I revisit the idea of data not being neutral in 8.2.

get beyond surface meaning, I designed questions and structures to encourage participants to question their world views. For example the ice breaker exercise outlined in 3.4.2.2, and the focus on the themes of utopia and dystopia in the same workshop, were deliberately designed to encourage participants to think beyond the boundaries of existing structures and ways of working.

Within my process of reflexivity I found it helpful to consider who was making comments as well as what was being said I have given a code to each interviewee and workshop participant. These codes are outlined in Appendix 1.

3.5.2 The ethnography of my life

The process of reflexivity I applied included reflections based upon my existing experience and prior research. The approach I took was influenced by Alvesson and Skoldberg (Alvesson and Sköldberg 2009). They highlight the benefit of the knowledge about society the researcher has attained to inform the interpretation of data. They coin the phrase the ethnography of life to describe the informal research that a researcher may already have done through their prior life experience. They are not advocating the use of ethnography as a research method. It is suggesting that each researcher through their specific combination of life experience will have valid understanding that may be related to the study. Their attitude towards research is appropriate because of its subjective epistemology. In direct opposition to the positivist attitude of objectivity, the idea of the ethnography of life suggests that the researcher should draw upon their past experience during the process of interpreting data. Acknowledging the influence of Alvesson and Skoldberg and others on my thinking, my world view is that all researchers will be influenced by their academic training and life experience regardless of whether they admit it. In line with discussion about reflexivity in 3.4.2, my view is that it is more authentic to acknowledge such influence. As I argued in 3.2.3, within the methodology applied to this study authenticity is more important than objectivity.

Drawing upon life experience relates to the discussion of boundaries in 3.2.2. Drawing upon my past experience inevitably privileges some ideas whilst diminishing others. In line with this study's research philosophy I very deliberately made value judgments throughout my processes of data collection and interpretation. As well as judgements

about methodical details such as who to interview and what questions to ask, I have been very deliberately subjective about how I interpreted the data collected.

I gained relevant personal experience as a cancer survivor, professional experience as a healthcare manager and prior academic expertise in urban planning, sociology, education and business studies. I applied the expertise gained through these to the interpretation of data at each stage of the research process. My cross disciplinary background helped me bring together knowledge from different disciplines.

The ethnography of my life might have had an impact on the approach and methodology I selected. Being dyslexic is part of my life experience. It is reasonable to assume that dyslexia has an impact on my values, as it affects the way that I think. Davis (2010) states that in his view, most dyslexic people are highly creative people who think multidimensionally. My arts background may indicate that this could have some truth in my case. Dyslexia may have influenced my decision to select a systems thinking research philosophy, as systems thinking requires multidimensional thinking.

3.5.3 Thematic coding

In line with the vast array of research publications that advocates such practices, I used software to help with the complex process of making sense of data (Seale et al, 2004; Denzin and Lincoln, 2005; Leech and Onwuegbuzie, 2011; Sinkovics and Alfoldi, 2012; Silverman, 2013). These sources also discuss how software can support the process of developing themes. The software I used was NVIVO. Most themes were not pre-determined but emerged as I worked through transcripts. The exception was different forms of capital. Because I had already decided that I was applying theory to help make sense of data, as I developed themes I considered possible connections to theory, in particular to Bourdieu's Theory of Practice.

The use of software to help facilitate the process of making links between theory and data is frequently advocated in research methodology literature (Seale, 2000; Denzin and Lincoln, 2005; Sinkovics and Alfoldi 2012). Seale specifically refers to the use of NVIVO. Seale highlight several advantages of using software to assist with data analysis. These include speed, accuracy and rigour. By speeding up the time that it takes to sort data, he argues the researcher is left with more time for creative and

intellectual tasks that are less immersed in routine. In response I applied software to give space for critical reflexivity.

A concern that is often expressed is that researchers might be tempted to simply rely on the outputs from software rather than to use it to enhance the process (Seale 2000, Sinkovics and Alfoldi 2012). Seale (2000, p246) argues that the use of software is no substitute for thinking about the meaning of data. The approach that I attempted is to apply software to give me more rather than less time to think about connections, and to help me find connections that I may have missed by taking an entirely manual approach. These are very much in line with the advantages expressed by Seale. Concerns about researchers becoming overly reliant on software and trusting outputs unquestioningly is very relevant to the subject of this study. Concerns about the use of software in research are very similar to concerns about healthcare professionals deferring to the outputs from information technology such as IBM Watson⁵⁰.

The first step I took in developing codes was to see what comments emerged that related to smart community or healthcare efficiency. In this process I was mindful of my pre-existing ideas as well as ideas from theory and ideas from literature. The next step was to map out more formally which ideas resonated most strongly with: the theories outlined in 3.2.4 and 3.6, the idea of smart community and the nature of the problem. Through this process themes, hunches and stories emerged. These are outlined and discussed in 4.3, 5.2 and 5.3.

3.5.3.1 Stories

The use of stories is a well-established qualitative research tradition (Sandelowski, 1991; Clandinin and Connelly, 2000; Gabriel and Griffiths, 2004). Gabriel and Griffiths argue that stories are windows into the emotional and symbolic lives of organisations that can indicate how field research may be classified and analysed. They argue that the truth of a story is not in accuracy but meaning, and suggest that more focus should be given to the emotion expressed than the facts given. In doing so they are arguing that a subjective qualitative approach should be taken. My decision to develop

⁵⁰ Concerns about the use of information technology in healthcare are discussed in chapter 8.

stories⁵¹ was directly influenced by their ideas. Stories emerged through the process of critical reflexivity described in 3.5.1. I reflected on the stated views of interviewees and workshop participants to construct stories that highlighted relevant aspects of either the current system or ideas about what the future might look like. The process of developing stories was similar to the process I used to construct hunches as outlined in 3.4.1

3.5.3.2 Conceptual Modelling / Design Thinking

The interviews and workshop sessions outlined above, combined with an assessment of relevant secondary research informed my design process. Designs have been structured in the form of conceptual models. Models indicate what a more efficient system might look like. Figure 14 is an example of a conceptual model. I deliberately selected Figure 14 to illustrate conceptual modelling as it illustrates factors that influence obesity and obesity is a risk factor that increases the likelihood of cancer occurrence and reoccurrence.

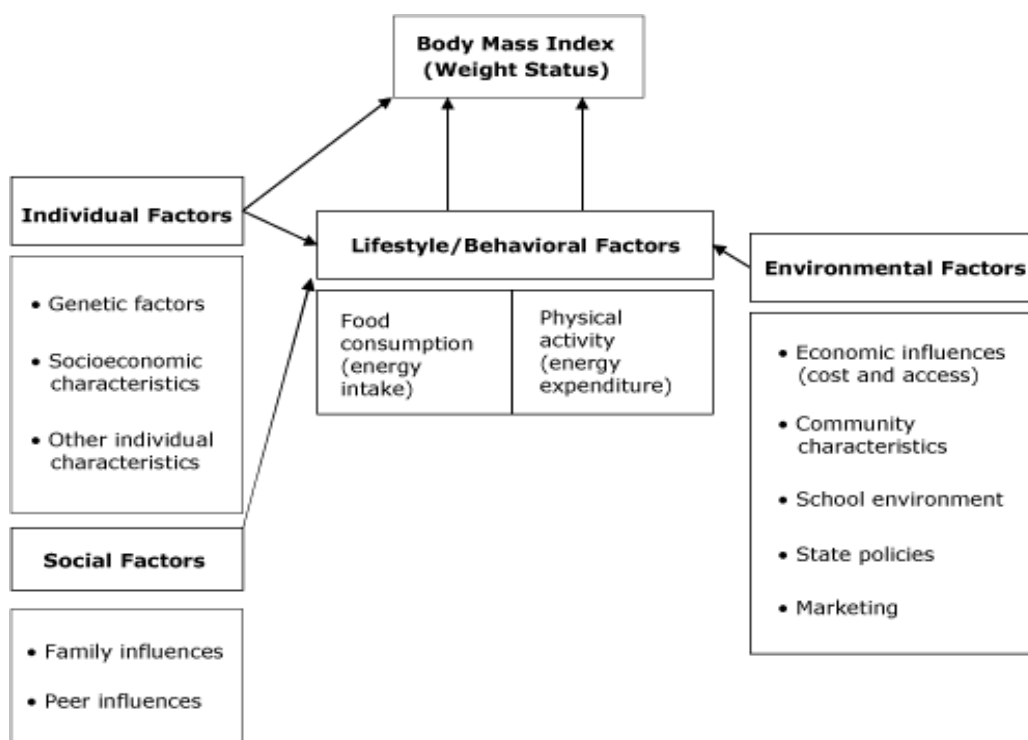

Figure 14: BMI Conceptual Model Example (Chaloupka and Powell, 2009)

At the core of this project is the process of creating and comparing conceptual models to represent what the system of cancer services does or could look like. Through

⁵¹ Stories are outlined in 5.3.

developing and comparing models I gained the understanding required to create smart community theory.

In this study, to develop conceptual models, I combine design thinking with the reflexivity I described earlier. Combining design thinking with reflexivity is an approach frequently used by design thinking researchers (Finkelstein, Harvey, and Lawton, 2008; Kimbell, 2011; Leavy, 2012; Seidel and Fixson, 2013). The creation of conceptual models is a design task.

Design thinking is related to systems thinking. It adopts systems thinking concepts and applies them to design (Mugadza, 2015). My assertion that design is relevant to research conducted within a form of systems thinking with a subjective epistemology is informed by Buchanan (1992), who argues that design is a flexible activity that eludes reduction. As such it is entirely compatible with CST. My approach is influenced by Wolf et al (2006) who connect design to wicked problems. They also connect it to Human Computer Interaction⁵². Design thinking is also relevant because this study is concerned with innovation at a societal level and according to some researchers, design thinking can stimulate innovation and so consequently transform organizations or even societies (Kimbell, 2011).

3.5.4 Theory Building

The ultimate aim of this study (objective 4) is to go beyond just developing conceptual models to create a substantive theory about the relationship between the concept of smart community and the objective of improving the efficiency of cancer services in Sheffield. I outline the steps that I took to create theory in Appendix 6, 10.6.

My approach has been guided by research literature that states that theory is a collection of interrelated that concepts that can help explain or predict (Silverman 2000; Imenda 2014; Alvesson and Skoldburg 2018). Much of this literature suggests that theory should be useful to practice (Silverman 2000; Imenda 2014; Alvesson and Skoldburg 2018). To be useful theory needs to have a degree of validity, to ensure that theory is valid I applied the constant comparison method (Silverman 2000). My process of comparison connected the data I collected with existing theory and

⁵² Human computer interaction was discussed in 2.5.2.

research as well as with the different parts of data I collected. For example I connected ideas expressed by participants recorded in transcripts with ideas outlined in rich pictures created by participants.

In 3.1.1.1 I outlined why positivism is not appropriate for this research project. Such a rejection directly relates to what theory is considered good or valid. In 3.5.1 I argued that data does not speak for itself. Because I conducted this study with a world view that rejects the notion that data is neutral I also reject positivist approaches to determining what theory is good or valid (Silverman 2000; Alvesson and Skoldburg 2018). Accepting that data is socially constructed places interpretation as a central component of the process of creating theory. Alvesson and Skoldburg argue that good research, including research focussed on theory development, should include critical reflection. They also argue that language is often ambiguous. If language is ambiguous as it stands to reason that it requires interpretation. Their research informs the argument I made in 3.2.1 and 3.5.1 that critical research is about the process of interpretation of data as much as it is about bringing together different sources of data; as such the credibility of the data that emerged has been determined by the quality of the interpretation of the data as much as it is about comparing data sources.

Whilst my methodology is not grounded theory, my approach has been informed and influenced by the approach to theory creation through qualitative research outlined by Glaser and Strauss (Glaser and Strauss, 1965). They describe a process of coding and reflection that acknowledges the experience of the researcher to formulate concepts into hypothesis for a substantive area. They also describe how bringing in social theory can be part of the researcher's process of understanding the situation within the process of creating theory. The reference to substantive is important as substantive theory is context specific, it is not necessarily generalizable to other areas.

My approach to theory building is however much closer to constructivist grounded theory than grounded theory in its original form (Charmaz, 2011; Johnson and Duberley, 2015; Hense and McFerran, 2016)

	Rejection of actors' inter-subjectivity as a focus of social science research	Acceptance of actors' inter-subjectivity as a focus of social science research
Epistemic acceptance of a neutral observational language	(1) Promulgation of methodological monism, e.g. contemporary mainstream positivism	(2) Rejection of methodological monism and the promulgation of induction as a means of neutrally accessing other actors' inter-subjectivity, e.g. neo-positivism
Epistemic rejection of a neutral observational language	(4) Philosophically incoherent position as rejection of a neutral observation language recognizes the inevitable role of inter-subjective processes in research processes and the articulation of research outcomes	(3) Rejection of methodological monism and the reformulation of induction as inevitably influenced by a range of inter-subjective processes that affect both the researcher and the researched, e.g. critical theory; critical realism; American Pragmatism

Figure 15 Constructivist Grounded Theory (Johnson and Duberley 2015).

Johnson and Duberley link constructivist grounded theory to: critical theory, critical realism and intersubjectivity⁵³. The approach I took was informed by their description of a subjective form of grounded theory that does not have any pretence of objectivity. Like my approach it is a reflexive and interpretive approach. As I have done in this chapter, they particularly stress the importance of reflexivity. Constructivist grounded theory is illustrated in cell 3 of Figure 15 Johnson and Duberley (2015) and Hense and McFerran (2016) emphasise the need for collaboration between the researcher and participants. This has informed my decision to place group activities at the centre of my data collection. The process I described for engaging participants in developing rich pictures, fits with the kind of collaborative process that they advocate. Hense and McFerran (2016) however, argue that constructivist approaches maintain a degree of separation between the researcher and the researched. As discussed in this chapter, their research is in line with the approach I took, as I deemed it necessary to maintain some separation due to the possibility of structural distortions. Hense and McFerran also argue that constructivist approaches rarely involve participants in the analysis process, as their value system does not require the democratic involvement of participants. My decision not to involve participants in the process of making sense of the data collected and developing theory was influenced by Hense and McFerran.

⁵³ I outlined how my approach relates to critical theory and critical realism in 3.1. The link with intersubjectivity is outlined in 3.2.4

3.5.5 Triangulation

Triangulation is mixing data or methods to enable different viewpoints to inform a topic (Olsen, 2004). As outlined in this chapter I brought together different forms of data and applied a variety of methods. The process of triangulation I applied has three corners; the expressed ideas of participants, ideas outlined in literature and the understanding I gained through my life experience⁵⁴. These sources are brought together through the process of critical reflexivity described in this chapter.

Academics who support this kind of reflexivity as triangulation include Reynolds and Holwell (2010), who argue that within CSH triangulation includes the researcher stepping back from their own perspective or reference system, to consider the perspective of others.

Some research method authors argue that triangulation should begin from a theoretical model and use methods and data that can create meaning from that theoretical perspective (Fielding and Fielding, 1986; Silverman, 2000; Silverman, 2013). My decision to apply CST is influenced by these ideas. All of the methods applied to data collection and interpretation stem from CST.

⁵⁴ The life experience applied to triangulation is outlined in 3.5.2.

3.6 Part 5: Additional Theory

In 3.2.4 I outlined Bourdieu's Theory of Practice. This is the primary theory that I have applied to make sense of the data collected from participants. Below I outline some additional theories that provide insight that is relevant to this study. Structuration Theory, Actor Network Theory and Adaptive Structuration Theory all explain some social influences on action. They are relevant for thinking about how different actors might interact in a new system.

3.6.1 Structuration Theory

Like Bourdieu's Theory of Practice, Structuration Theory is a theory of agency and structure. It shares its notion of duality with Bourdieu's concept of Habitus although Giddens is more ambiguous about the epistemological position of the latter (Stones, 2005b). Structuration Theory suggests that behaviour is influenced by both agency and structure without giving primacy to either. A key distinction between Structuration Theory and Practice Theory is that, in Structuration Theory agents are regarded as more autonomous. Giddens argues that structure is enabling as well as constraining whereas Bourdieu sees agency as more shaped by structural forces (Jones and Karsten 2008). In this study however I am more interested in the similarities than the differences between these theories. The areas where these theories overlap highlight ideas that may help achieve efficiency and potential barriers that may get in the way.

Structuration Theory has been an influential theory in information system research (Dobson, 2001; Jones and Karsten, 2008 ; Greenhalgh and Stones, 2010b). It helps to develop a conceptual understanding of information systems by considering the social context and processes within them (Checkland and Holwell, 1997). Structuration theory relates to the systems thinking research philosophy of this study as the duality in structuration theory is similar to Vickers's⁵⁵ notion of appreciative systems (Checkland and Holwell, 1997; Poole and DeSanctis, 2004).

One of the key concepts in structuration theory is the idea of routinisation, the idea of structure being continuously produced and reproduced through action (Giddens, 1984). Through actions, a social order is established and patterns of behaviour and

⁵⁵ Vickers is an influential writer on social systems. He coined the term appreciative system in an article in 1968. This idea has been highly influential within systems thinking.

ways of performing tasks become institutionalised. This is similar to Bourdieu's concept of Habitus (Stones, 2005b).

Institutionalisation in the healthcare sector connects Bourdieu's concept of habitus and Giddens's idea of routinization, as these rituals can get in the way of introducing new ways of working. Literature that supports this assertion includes:

- *The healthcare setting is heavily institutionalised and behaviour is often ritualised*" (Greenhalgh et al 2015, p5).
- Attempts to introduce healthcare information technology can be obstructed by complex interdependencies and competing perspectives (Ferlie 2013, Greenhalgh et al 2010).

To achieve efficiency existing structures may need to be challenged and disrupted. This is however a little problematic as within systems such as medical diagnosis individuals, who cannot hope to acquire all the necessary technical expertise to understand how 'expert systems' work, have to trust (Jones and Karsten, 2008). The notion of trust is revisited within a wider discourse of power dynamics in subsequent chapters.

3.6.2 Adaptive Structuration Theory

Poole and De Sanctis developed a modification of structuration theory, Adaptive Structuration Theory (AST), aimed at a more direct focus on its application to information systems. AST is centred on the mutual influence of technology and social processes (Jones and Karsten, 2008). AST criticizes the techno-centric view of technology. AST focusses on social structures. This includes the idea that technological objects contain structure (DeSanctis and Poole, 1994).

AST is a theory that is often associated with the concepts connected with smart community and with healthcare information systems:

- Alvarez-Gil and Montes-Sancho (2015) apply AST to analyse the impact of smart city ideas
- O'Leary and Grant (2017) apply AST to assess the impact of social media in the care of cancer patients

- Greenhalgh and Stones (2010) Consider AST in their healthcare information discussion

Alvarez-Gil and Montes-Sancho refer to Bourdieu and Giddens in their discussion. They apply AST to predict how structures are likely to change as new technologies are introduced into the system. AST relates to this study because a system of cancer services based on the concept of smart community is likely to include new technology. AST suggests that technology in use may be different from the way that the technology was originally conceptualised (Sheil 2011; O'Leary and Grant 2017). For example the use of internet forums for discussing health conditions is a significant step away from the origins of social media, as technology evolves over time users become more familiar with its potential (O'Leary and Grant 2017).

3.6.3 Actor Network Theory

Actor Network Theory (ANT) is a theory developed by Bruno Latour about the interaction of human and non-human agents in networks. In Actor Network Theory both human and non-human agents are considered to have agency (Latour 1988: 1990). Given my conceptualisation of smart community, the idea of non-human entities containing agency has potential relevance to help understand how human and non-human agents might be able to collaborate to achieve change. Although ANT was conceived before the internet emerged, it is frequently applied to internet research and to information technology (Doolin and Lowe, 2002; John Mingers, 2004; Jones and Karsten 2008). It is also frequently applied to digital health (Cresswell, Worth, and Sheikh, 2010; Greenhalgh and Stones 2010; Waterson, 2014; Lupton 2015: 2016) and smart city research (Söderström et al 2014, 2016).

The idea of technologies containing agency is significant as it relates to the potential impact of introducing technology. Latour rejects the ideas that objects are neutral and that man has mastery over technology. Instead he argues that technologies as well as conducting the tasks they are given, also impact on our behaviour and that technologies impact on everyone who encounters them (Latour 1988, Macgregor 1998).

In ANT Actors are not only people and physical objects but can also include ideas and concepts. Furthermore if any actor is introduced or removed from a network then the

whole network is affected (Cresswell, Worth, and Sheikh, 2011). The implications of the interconnectedness of the network conceptualised within ANT is profound. It implies that bringing a new actor into a network changes the entire network. If this is true then we would need to conclude that technological change is complex. To enable change we would need to consider not just the impact of introducing or removing technology on the people who would be using it, we would also need to consider the impact across the whole system. As ANT conceives of ideas as well as objects as actors, the implication is that even just introducing a new idea about how to work with technology will ripple across the whole system.

To illustrate, Greenhalgh, Swinglehurst and Stones (2014) refer to the examples of a nurse in a call centre being constrained by the telephone network, and the idea that a physician is only able to be a physician because of the network that they are part of. This illustration of ANT resonates with ideas within Practice Theory outlined earlier. Bringing the two theories together we might conclude that existing capitals, such as cultural and symbolic, are required to enable a physician to continue to be one. Change, even the conceptualisation of change risks altering the nature of what it is to be a physician.

3.7 Conclusion

This study is guided by its research philosophy, CST. Its overarching methodology, CSH is the application of CST. CST is a holistic form of systems thinking embedded in the critical research tradition. Within CSH reflexivity is applied to analyse data with a form of triangulation that draws upon my own life experience, literature and theory as well as the primary data collected. In line with research guidance outlined by Silverman and by Fielding and Fielding, my research approach is consistently guided by its research philosophy rather than attempting the form of radical reflexivity advocated by Holland.

Bourdieu's Practice Theory and Structuration Theory highlight similar ideas of routine, locking in outdated ways of working. Broady Preston (2009) suggests that structuration theory, including AST, is a theory of change and conflict. These theories may offer insight into how smart community ideas might enable a more efficient system of cancer services.

The theories outlined relate back to concepts discussed in 2.3. To harness the potential of emerging forms of cyber physical and social computing requires thinking beyond current ways of providing health and healthcare. Practice Theory and Structuration Theory offer insights into how to look beyond existing structures. Structuration Theory, particularly AST, help explain change through the adoption of technological artefacts. In a similar way Bourdieu's conceptualisation of structure is not static. The structures of habitus evolve; whilst they are durable they are not fixed (Grenfell 2008). Engaging in the complex web of different forces of capital may however be necessary to enable this change.

Due to their focus on structure, the theories outlined in this chapter relate to collaborative approaches to using information technology and literature that suggests collaborative methods of using information technology could result in more efficient ways of working (Tapscott and Williams 2008). The idea of collaboration with and through technology is at the core of the concept of smart community. By connecting these theories back to concepts discussed in 0, I have imagined radically different forms of human computer interaction. The different forms of human computer interaction I imagine are outlined over the next 6 chapters.

Section C Sense Making

Chapter 4 First Steps of Interpreting Findings

The interpretation of the data collected is discussed and compared with theory and secondary research throughout subsequent chapters. This chapter is intended to give a starting point to how I made sense of data. Its focus is to give some initial reflections, an overview of the scoping review and to give an overview of some of the ideas that emerged.

After eliminating day to day terms, frequently occurring words included: people, system, patients, support, change, treatment, better, community, social and person. These words reflect themes that emerged through in-depth interrogation of the material connected at interviews and workshops. For example 'person' or 'patient centred system' frequently occurred in discussion. These words occurred through a word frequency NVIVO query.

This chapter is split into 3 parts. The first looks specifically at findings from scoping interviews. The next part outlines some initial ideas from the main phase of the study. It compares the perspectives of different groups of interviewees such as managers and healthcare professionals. The third part is the themes that emerged. Different groups are considered separately to help explore the possibility of background and experience influencing expressed views. The scoping review section of this chapter is subdivided into 2 subsections. The first is discussion about methodology and the second is about scope. Scoping reviews included discussion about the current system. The discussion about the current system that emerged is outlined and discussed in chapter 6, as that is the focus of that chapter. In line with the non-linear nature of this research project, scoping interviews both informed my methodology and were the first stage in the application of my methodology.

First however I give an example of how some of the ideas outlined in this section emerged. In 4.1 I indicate that 'getting access to data is all about relationships' is a comment made by one of my interviews. I highlighted a comment about relationships for 3 different reasons, each relating to a different aspect of the process of triangulation outlined in 3.5.5. Firstly in relation to literature, as outlined in 2.2 relationships is an idea that relates to the concept of smart community, it is part of

social capital which in turn is part of smart community. In terms of the primary data relationships is relevant as the word relationships was directly used by 8 interviewees. In terms of my own reflexivity it was apparent to me that relationships related to comments made by all interviewees to some extent even when the word is not directly used the specific comment outlined in 4.1 was selected as through my reflexivity is resonated with my own experience and so is relevant due to the ethnography of my life outlined in 3.5.2. Further references to relationships are made during all subsequent chapters.

4.1 Part 1: Scoping Review Findings

4.1.1 Scoping Review Section A: Thoughts about Methodology

Ideas from the scoping review informed many of the methodology decisions that were outlined in the previous chapter. Here I outline and discuss some of the comments made. Discussion includes ideas that informed my methodology. Below I list some of the suggestions from scoping interviews (in bold) and outline how I responded to each of these:

Getting access to data is all about relationships

My experience of enabling constructive workshops and interviews was very much about relationships. I often found that the most valuable interviews benefited from prior communication with interviewees. Potential interviewees were sometimes more willing to meet if they had been suggested by a previous interviewee. Multiple communications sometimes enabled me to gain access to related reports and other documents. The issue of relationships is problematic as it could have led to a tension between impartiality and maintaining good relationships. Even though my research philosophy does not allude to impartiality, this could have risked distorting my findings.

Keep problem space open - to understand real needs

Keeping the problem space open relates to the concept of a wicked problem. To attempt to keep the problem space open I applied a nonlinear, open and flexible process. The nature of the problem also informed my choice of an inductive rather than a deductive study.

For the reasons outlined in 3.2.2 boundaries needed to be set. This pushed lots of potentially interesting content outside of the scope of the study. For example, setting the research question as to what is the most effective way of improving healthcare efficiency would have kept the problem space more open, but risked research going off on multiple tangents.

Visual thematic analysis that allows lay people to see clumps of positive and clumps of negative

Thematic analysis is part of this study's methodology. Some of the results of this are being communicated visually through system diagrams and other illustrations. The study focusses around utopian and dystopian perspectives. The process of thematic analysis includes subjectivity. This process could become hidden when data is visually communicated and subjective ideas could be mistaken for objective truth. To avoid this, when I presented images to participants I attempted to connect them to the wider narrative that they are part of. In addition, the conceptual models that emerged from this study are not intended to have value when separated from its wider narrative.

Creativity leads to novel ideas emerging

An example where I successfully applied creativity was the inclusion of icebreaker exercises. Although some of the actual ideas that emerged were impractical, the creative process led to more imaginative thinking. Another example was getting participants to create utopia and dystopia rich pictures before bringing ideas together. In general this worked well although it was not possible to stop participants talking about actual current issues, even when asking them to imagine utopian or dystopian futures.

Taking everyone out of their comfort zone puts everyone on a more equal footing

This worked well. Getting participants to create rich pictures was at the core of the workshops. I encouraged all participants to engage with the physical act of drawing to enable all participants to think physically as well as mentally. Some participants were more comfortable drawing than others, some took a little more encouragement. Most participants were eventually talked into drawing as well as talking. My use of creative ice breaker exercises was informed by this comment. By starting sessions with ice

breakers I attempted to get people to think outside of their day to day work and roles right from the start.

Avoid Jargon

I tried to avoid academic terms such as cyber physical systems and social computing and instead focus discussion more on practical ideas such as monitoring devices and internet forums. In hindsight I probably still used too much jargon and this may have been a barrier.

Matching sociological literature with clinical ideas

In the process of making sense of data during and beyond the process of thematic coding, I connected academic theories and other literature to comments made by participants. There are far more theories and other sociological literature than I can fit into this thesis. Given this, I focussed on a small amount of the most relevant theories and prior research.

Inter-subjectivity holds a mirror up to a person

This worked well. Through group activity the subjective perspective of participants was shared, including my own. Sociological theory was applied to interpret subjective perspectives.

4.1.1.1 Scoping review comments

To explain how I responded to comments I include a couple of quotes bellow⁵⁶:

1 H,A – E “thinking through making, the kind of brain-hand stuff, because everybody builds it encourages 100% participation, rather than the 80:20 participation that you usually get in a meeting, which I think you could probably apply to a focus group, depending on the skills of the facilitator.”

2 H,A – E “there isn’t enough design in the health service, and people don’t look at the health service and its processes from the designer’s eye, and understand

⁵⁶ The letters before the quotes are from the coding system outlined in appendix 1. In this instance the H indicates that the interviewees was a healthcare professional and the A that they were also an academic or other research professional. The E relates to the name of the interviewee.

how people, you know, behave, and react, in response to how something is designed”.

Comment 1 quite directly supports my decision to use rich pictures in the workshops. As rich pictures are a technique frequently used in systems thinking research⁵⁷, their use is supported by both my research methodology and scoping interviews. Engaging participants in creating rich pictures was part of my process of encouraging them to consider perspectives beyond their usual thinking. The rich pictures that emerged from workshops was the starting point towards designing conceptual models and new theory.

In comment 2 the same interviewee advocated a design led process. His comments influenced my decision to combine design thinking with reflexivity as outlined in 3.5.3.2.

Three of the people interviewed in these focus workshops were academics.

Comments they made occasionally entered the realm of research philosophy:

3 H,A – D “if you go back to a kind of clunky description of kind of research it’s that research tries to generate generalizable data, and yours is absolutely ridden with context”

Comment 3 emerged from discussion about NHS ethics. It became apparent in the view of this interviewee at least, that the term research has a different meaning in social science, to its meaning in the NHS. The interviewee was suggesting that although my study may be considered research by Sheffield Business School, it might not be by an NHS ethics committee. This idea of words having different meanings is significant, as it relates directly to the critical theory notion that data is not independent of context or language (Alvesson and Deetz 2007). This supports the assertion I made in 2.4.5, that one of the research gaps this project has addressed is research from a similar philosophy. By applying different thinking to that applied in most related research, new knowledge has been created.

⁵⁷ I outlined the link between rich pictures and my methodology in 3.4.2.6

4.1.2 Scoping Review Section B: Thoughts about Scope

Questions I considered in the scoping review included; did the scope of my research need narrowing down and if so would focusing on a specific form of cancer be an appropriate way to do so? In terms of the second of these questions from scoping interviews, the response was a clear no. For the most part views outlined by interviewees were not specific to cancer let alone a specific form of cancer, so focussing in on a single type of cancer would do little to reduce complexity.

Where there was more scope for narrowing down is in terms of the nebulous nature of the definition of what a smart community is. Refining the mix of perspectives within smart community literature down to a specific definition, as done in 2.2, narrows the scope by placing ideas that some people might associate with smart community outside of scope. In terms of information technology my definition focussed the study on the impact of internet forums, monitoring devices and AI. This means that some of the articles mentioned in scoping interviews were outside the scope of this study.

4.1.3 Reports / Initiatives

Table 6 outlines some of the existing research that was suggested as potentially relevant by people I interviewed. Where relevant I indicate where I have incorporated suggested research into this thesis.

Table 6 : Suggested Research

Suggested research item		In scope	Outside Scope	Research Field	Location
The snakes and ladders of user involvement		x		Health Policy	2.3.2
Realising the value		x		Policy Document	6.4
UK employment services: understanding			x	Policy / Politics	NA

provider strategies in a dynamic strategic action field					
Robert Wachter. The Digital Doctor		x		Health	5.2.3 8.4
British Journal of Cancer article on benchmarking tools			x	Medical	NA
The National Cancer Vanguard / Cancer Strategy		x		Policy Document	6.4
Morozov, To Save Everything Click Here		x		Sociology	8.1.1, 8.4.1, 8.5.1, 8.7

In this part of this chapter, I move on from responding to literature suggested by research participants onto highlighting some of the key themes that arose.⁵⁸ These ideas are a building block towards the more complete list of themes in 4.3. In Table 7 I outline some of the ideas that emerged in scoping interviews, how they are relevant to this study and where they are discussed further in this thesis.

Table 7 Ideas that Emerged in Scoping Interviews

Research Area	Logic	Location
Design Thinking	Relates to systems thinking Relevant to the idea of developing conceptual models	3.5.3.2

⁵⁸ All of the research listed in 7 was referred to by interviewees

	Was mentioned by two different interviewees	
Behaviour Change	There might be efficiency savings that could be gained from nudging participants towards engaging in lifestyles more conducive to better health	7.1.1.2, 7.4.1 and 8.3.1.1
Biopsychosocial model	2 focus group participants made reference to the current medical model not working	5.2.2 and 7.4
Collaboration	Collaboration is a theme within the concept of smart community. It includes how people can inform each other through internet forums	All
Power	A system of cancer services based on the concept of smart community might be based on different relationships between the actors in the system. Considerations of power is central to the research philosophy selected	All
Trust / Relationships	Relationships and trust are terms that frequently occurred in interviews. They also relate to the concept of social capital, a concept that frequently occurs in smart community literature	All
User Centeredness	The concept of smart community is closely connected to the user centred concept of coproduction, when applied in a digital context	All

4.2 Part 2: Main Phase

4.2.1 Main Interviews

The purpose of the main interviews was to compliment the workshops, to help capture insights that would help develop conceptual models and related theory. From these interviews ideas about how the smart community concept might be able to improve efficiency emerged. These are the second building blocks towards developing the themes outlined in Part 3: Themes.

4.2.1.1 Interviews with Academics / Research Professionals

The primary purpose of interviews with researchers was to bridge ideas from literature with insights about the actual healthcare system in Sheffield. Interviewees however also provided ideas about innovations that had been tested elsewhere that might be applicable to the system of cancer services in Sheffield. Interviewees were from the following organisations: The Kings Fund, The Innovation Unit, Nesta, Sheffield University and Sheffield Hallam University.

I found it interesting that one interviewee A-E (comment 1), stressed the value of relationships. As outlined in 3.2.4 relationships are related to the concept of social capital as they are required to build trust. The idea of relationships aligns with this study as the concept of smart community includes social capital, and relationships are part of the fabric that forms social capital. Reflecting on this, I questioned whether there might be tension between my need to maintain an effective relationship with interviewees and attempting to minimise bias. In my process of making sense of interview transcripts and audio files, as well as reflecting on whether this may impact on the outcomes of the interviewee, I reflected on how my desire to maintain relationships might be impacting on this study. I am aware, that like A-E I am keen to maintain good relationships with contacts. This may have discouraged me from making comments during interviews that could have jeopardised emerging professional relationships. I am also aware that that existing relationships may have distorted some of my perceptions and judgements. Reflecting on this in line with my CSH methodology, I can see that such distortion could be part of my own false consciousness. Whilst this insight about relationships confirmed my view that applying

an objective epistemology would have been problematic, I am mindful that my desire to create and maintain relationships could have distorted my interpretations.

Interviewees highlighted many different points that related to the definition I gave for smart community. For example references were made to social capital, social prescribing and collective intelligence. All three of these terms were discussed in chapter 2.

4.2.1.2 Interviews with Healthcare Managers

Overall, managers were the most enthusiastically helpful group of interviewees. On reflection I considered that this may be because the outcomes of this study are likely to be more relevant to the work of this group than to any of the others. It is concerned with healthcare efficiency, an issue that most managers expressed concern about.

Not all of managers were enthusiastic however. To illustrate I contrast my experience of interviewing two managers from the same organisation. One of the managers was particularly enthusiastic about imagining what a radically different healthcare system might look like. Another appeared quite cagey, and didn't seem to want to give much away. Reflecting on my earlier thoughts about relationships I was aware that the enthusiastic manager was someone I had an existing professional relationship with, having originally met them at an event, two years before interviewing them. Given the potential impact of relationships, it is possible that the reason some interviewees were more forthcoming than others was linked to the social capital in the form of trust that had developed, during the time I had known them. I was aware that the interviewee who appeared most cagey in their comments was quite new in their post. It is possible that their reluctance to answer some questions was due to nothing more than their newness in the post combined with the interview being my first meeting with them.

The caution I am referring to was illustrated by comments such as M –S *“from where I am working I can only talk about”* My perception was highlighted by their apparent contrast with the person who had previously been in that role, who I also interviewed. I describe the difference here. I call the other interviewee M-S and the person who was in role previously as M- R. M-S is very different to M-R. Even though M-S and M-R were in the same role, M-S took over from M-R they expressed quite different

loyalties. M- R described herself as part of N, although expressed commitment to wider system change. M-S appeared to be much more part of D, even though funded by N. Comments such as *“I am not part of N, I am funded by N”*, indicates that his loyalty lay elsewhere. His approach indicated a governmental corporate culture. M-R conversely appeared to be more of a maverick. It is possible that M-R was enthusiastic about change because of the role they saw themselves having in it. They may have perceived themselves to be developing cultural capital relevant to the changes taking place. M-S was new to the post; this may to some extent explain some of his caution. This caution could be explained in part by a lack of cultural capital, or at least a lack of awareness of the extent to which their cultural capital fits within organisational plans.

4.2.1.3 Interviews with Healthcare Professionals

Most healthcare professionals were critical of the current state of healthcare IT. Two of the Oncologists were very critical of Lorenzo in particular⁵⁹. Lorenzo is an electronic patient record system. Its suppliers claim that it can transform the delivery of healthcare by providing an integrated interoperable patient record (DXC Technology, 2017). One of the GP's, H-S, had helped to develop a portal that could be accessed and updated by healthcare professionals and by GP's. Whilst the portal is relevant to the study, views expressed by H-S at times sounded as if they were promoting his platform as much as talking about issues in a more general sense.

Whilst all the healthcare professionals claimed to be patient centred, most expressed concerns about patients accessing information via the internet. This echoes similar ideas in literature⁶⁰.

To illustrate the theme of relationships that emerged through interviews I include some reflections on my interview with one of the oncologists. Relationships were important here as he was my consultant for a while during my cancer recovery. It seems highly likely that this existing relationship was one of the reasons that he agreed to be interviewed i.e. to see a former patient who appears to be healthy. From my

⁵⁹ Discussion about Lorenzo features highly in story 1 in 5.3.1.1

⁶⁰ The issue of patients accessing information online, including the patient perspective is discussed in story 2 and in 5.3.1.2

experience as a patient I remember him as a cordial and humorous man. His slightly eccentric sense of humour was something that I had found helpful as a patient. He admitted that he was a little out of date, having been retired for several years. Perhaps unsurprisingly given this his approach seemed a little top down and paternalistic. He expressed concerns about patients accessing information on the internet which might be problematic. He was actively involved with a cancer charity. This suggests that he was also in favour of community engagement. The kind of patient engagement that he advocated however didn't appear to be involving patients as equals. He made some comments that were in line with the smart community concept, talking extensively about cooperation with other healthcare professionals. The slightly top down paternalistic approach that he appeared to advocate seemed to relate to discussion about power in literature.

4.2.1.4 Private Sector Technology Companies

Each interviewee from a technology company appeared to be promoting the organisations they worked for as much as directly addressing questions. A limitation of interviewees with the Sheffield digital testbed project was that because the project was ongoing no evaluation of the test bed project was available at the time this thesis was written. I did get to sit in on some of the evaluation meetings, from these I became aware that at that point in time understanding of the overall impact of the project was inconclusive.

The fourth private sector interviewee I interviewed worked for IBM. As well as giving a perspective on the test bed they advocated the potential positive impact of IBM Watson. They outlined an interesting vision for how information systems could be improved with data flow between the individual level and aggregate level. They also listed some barriers they believed prevented the adoption of smart city ideas into healthcare in the UK:

- in the NHS there is no business model for remote monitoring,
- there is no clinical risk model,
- political fragmentation at a local level limits opportunities.

In relation to the latter point, he stated that there is no single buyer for smart city services and this leads to fragmentation.

4.2.1.5 Interviews with Cancer Survivors

As I expected, interviews with cancer survivors gave a different perspective to the views expressed by healthcare managers. A particular contrast to the views of healthcare professionals was their views about patients using forums and internet searches. Whilst most healthcare professionals highlighted concerns about the risk of patients finding misleading information online, all the patients dismissed concerns, stating that as well as finding forums to be useful they also found them to be self-regulating. It is however worth considering that there could be power interests at play in the self-regulation of forums.

The idea that the concerns of healthcare professionals is unfounded is supported by research (Esquivel, Meric-Bernstam, and Bernstam 2006 Loane and D'Alessandro, 2014; Tan and Goonawardene, 2017). Esquivel, Meric-Bernstam, and Bernstam 2006). Esquivel suggests that the process by which forums correct themselves is similar to the process of peer review, where the user community reviews and corrects inaccuracies made by members of a community. There is however a clear difference; online communities in most cases are open to anybody. Some may argue that these could restrict the ability of forums to be self-policing. Esquivel and his co-researchers do however admit that their findings were based on a single cancer forum and so might not be generalisable.

The idea of patients collaborating more in healthcare decisions by becoming better informed, relates to the ideas of coproduction and collective intelligence, introduced in 0. From cancer survivors there was a consensus that cancer patients should have access to more information because doing so might improve their outcomes. Other issues highlighted by cancer survivors included:

- poor communication systems
- healthcare professionals with incomplete information records
- the contradiction between urgency expressed by clinicians and the lumbering of the administration process.

4.2.1.6 Interviews with Local Authority Staff

During interviews I noticed a stark contrast between the two members of local authority staff I interviewed. One was very forthcoming, whilst the other appeared quite brief and defensive.

Both local authority employees interviewed made frequent references to the kind of community development ideas I outlined in 2.3.2. Specific prescribing and community development principles including coproduction and co-design. One related these ideas to the need to consider local context:

4 LA – A “when we look at coproduction, and we look at co-design, we have to identify what the needs of the communities are, because every community is diverse in its needs and wants”

4.2.2 Workshops

I started the second workshop with the creative icebreaker exercise outlined in 3.4.2.2. I found this exercise effective in getting people to think outside the box, not to be constrained by their thoughts about the current system. This was helpful preparation for getting participants to imagine utopian and dystopian systems.

Some participants found it challenging to conceptualise the current system as a whole. One asked if it would be possible to think about the different parts of the system. They admitted being from a scientific background. A reflection on this, is that it relates to the research gap outlined in chapter 2 and the methodology in chapter 3. The comment supports my assertion that participants might find it difficult to get beyond current thinking. As I had suspected it was the default position of some participants to take a reductionist position to thinking about solving problems. Below I give the specific comment I am referring to:

5 T – D “an engineer would divide it up into smaller boxes to work with, so, you know, diagnosis, for example, how someone discovers that they have cancer in the first place, I can much easier imagine why doing a rich picture with all of those factors about that part, and another one about treatment, and another one about palliative care, end-of-life, or, whatever other stages there are...I am

not saying it's a better way of doing it, it's just a way that I can get my head around, I don't think I can get my head around the whole concept."

Section 3.1.1.1 of my methodology chapter explains why I did not take the kind of engineering approach that this participant is advocating. Bourdieu's concept of doxa seems relevant here. Doxa forms our sense of feeling about what is possible and what is not (Walther, 2014)⁶¹. This sense of what is and is not possible is very much at the core of this study as it is possible that it is precisely this kind of reductionist thinking that locks in inefficiencies. The idea of doxa cuts across discussion in all subsequent chapters. The reductionist idea that we need to break problems into smaller chunks to understand them is deeply ingrained into our culture (Spier, 2003). Given this it is unsurprising that cultural influences appeared to have had an impact on the thinking of at least some of the people I engaged in the workshops I facilitated. Over the next few chapters I highlight and discuss evidence of this kind of reductionist thinking in the system of cancer services in Sheffield.

Another comment that supports my view that participants' ideas might be constrained by structural factors is this comment by M-E. This at least indicates that he believed that NHS structural factors had constrained his thinking to some extent:

6 M-E "the bit I'm trying to get at, which I suppose is where I tried to start from, and I've been corrupted a little bit, since I've been in the NHS for a bit, which happens very easily"

⁶¹ This workshop participants comments resonates with the idea of false consciousness discussed in 3.2.5

4.3 Part 3: Themes

Themes are the general categories that encompass the ideas expressed by interviewees and workshop participants. In this chapter part I give an introduction to each theme, using references to some comments from interviewees and workshop participants. In Figure 16, I illustrate how each theme fits with either the smart community concept or the current system.

Themes

1. Top Down Vis Bottom Up
2. Collaboration
3. Relationships
4. Social capital
5. Cultural Capital
6. Artificial Intelligence
7. Behaviour Change
8. Real-Time Monitoring
9. Business model
10. Disjointedness
11. Flexibility
12. Context Matters
13. Information Sharing
14. The Private Sector
15. Silos
16. Staff Shortages
17. Inequalities
18. Data Bias

Top Down Vis Bottom Up

As outlined in chapter 2 this is a common theme in smart city and smart community literature. A top down future system would be very different to a bottom up one. There are two strands connected to this debate, the first is to do with the implementation of technology, the second with how people work with each other. Comment 7 relates to top down approaches:

7 H-L *"I think it's a case of decisions being made by people at the top, EDMS was rolled out on such a massive scale, and, people just found it unusable, and yet they kept having to persevere with it."*⁶²

Top down approaches are discussed further in 5.3.1.1.

Collaboration

In chapter 2 there were many references to collaboration in literature, each having a slightly different meaning depending on context. This quote illustrates a private company wanting to collaborate with the NHS:

8 T-U *"Collaboration for us with our customer, which is the NHS, has been a strategic theme of ours for a number of years, we haven't done it at this level before, but we also know that to integrate further with the NHS in the future hinges on collaboration, at all levels"*

Comment 9 highlights a different aspect to collaboration; the idea of bringing budgets together to enable greater collaboration and as such it relates to theme 9. Comment 9 is also the perspective of someone working in the public sector, whereas comment 8 was the view from a private sector perspective.

9 M-O *"the hospitals are actually doing some work on how they can manage that money in a more collaborative way"*

Relationships Matter

I highlighted the impact of relationships in part one of this chapter. Relationships link to social capital and smart community as developing relationships is a step towards effective collaboration. A comment was made in relation to the feasibility of bringing an initiative from outside of Sheffield into the city. This connects to the theme of context and the theme of social capital. The implication here was, without first establishing effective working relationships the process of bringing in a different initiative could not be repeated. The suggestion was that establishing good working relationships was a fundamental reason why the initiative referred to was a success:

⁶² The EDMS (The Electronic Document Management System) is discussed in story 1, 5.3.1.1

10 A – L *“so much of this was based on personal relationships, you know, you’ve literally got the Chief Exec of the acute hospital, talking directly with the partners of the GP practice. It may be hard to scale that model of relationship-building up”*

Another quote followed on from the quote about the private sector company wanting to develop a relationship with the NHS. This links collaboration with social capital:

11 T-O *“so, the challenge is trying to establish a relationship and a collaboration with the NHS, in order to have that discussion, and then agree on common ground of which to build up, and that’s why the NHS Test Bed is such a unique opportunity”*

Cultural Capital

Like social capital, cultural capital influences how people interact with each other. It is likely to have an impact on the forms of relationships they develop and how they collaborate. One quote, given by a manager, indicates how he believed that how the current system operates should change. The references to ‘the grand round’⁶³ and Downton Abbey suggests he believed that cultural attitudes as well as practice needed to change.

12 M – E *“doctors need to let go of Downton Abbey style approach.... the grand round is about a set of cultural assumptions out of the 1950s”*

A cancer survivor illustrated how patients from middle class backgrounds often got better treatment by being assertive whereas working class people asserting themselves were perceived as pushy. They didn’t have the cultural capital required to work the system in their favour⁶⁴:

13 H-L *“I think there’s a payoff, if you’re too pushy, it does mean that you’re perhaps not as liked by the staff”*

The interviewee was making a distinction between being assertive and being pushy. Their suggestion was that being assertive resulted in getting better treatment whereas

⁶³ The grand round is a form of group teaching where a senior consultant teaches trainee healthcare professionals by engaging them in a round of consultations with patients (Myint and Sabanathan, 2005)

⁶⁴ The link between cultural capital and inequality is discussed further in 5.1.2

being pushy didn't. My interpretation is that it requires cultural capital to be able to understand and successfully apply the difference. Her suggestion was that some people (mostly people from middle class backgrounds) learn how to navigate the system and this resulted in inequality. The impact of cultural capital on gaining access to services is illustrated by comment 14:

14 CS- E "my experience of the health service has been fantastic, I've had fantastic doctors who've been incredibly flexible, but, I am quite proactive, and I do go in and say, 'I think I'd like to do this, how do we make that happen', and then they've made that happen for me".

Artificial Intelligence (AI)

AI is an area of computing concerned with the development of computers to engage in thought like processes such as learning (Dilsizian and Siege 2013). AI relates to the smart community definition applied in this study, as AI is a form of non-human agent that could be part of the system of cancer services in Sheffield. There were plenty of comments that spoke optimistically about how AI could help us overcome current challenges. Comment 15 for example argues that it has a role to play in helping address the challenge of treating people with co-morbidities:

15 A-L "One of the interesting things about AI or machine learning approaches, is it gets us away from this, sort of very pure type that we try to research, right, it should be much better at understanding patient variation and coping with patients that have, co-morbidities"

There were also plenty of comments such as comment 16 that highlighted limitations of AI and the role people still had to play in the system:

16 LA -H "The harnessing of multiple data streams and putting it together in intelligent ways, it has to be driven by humans, it's not yet clever enough to work out what to do itself and human judgement is always required, I don't think AI has quite yet replaced human judgement"

Behaviour Change

Health and fitness monitoring devices are another form of non-human agent that could form part of a future healthcare system. They might help improve health

outcomes by persuading people to engage in healthier behaviour. The interaction of human and non-human agents might result in new ways to influence the behaviour of people in the system, including patients and healthcare professionals. The idea indicated by comment 17 is discussed further in 7.4.1.

17 M-F "It's part of the nudge philosophy, isn't it, and because your data, the data actually makes you go again, because you are 250th out of 600, and you know, 10th in your age range, and you're, you don't really care that you didn't come first, you just feel that you're doing okay and you want to go again"

Real-Time Monitoring

The idea of real-time data, is central to the cyber physical system concept. Comments suggested that it is an idea that could help enable efficiency improvements enabled by non-human agents. This idea is illustrated by a GP who talked about how his patient portal gives him close to real-time data because patients can directly upload data:

18 H-U "it gives me much more timely, real-time data from the patient, in order for me to make, you know, changes, and, er, manage by exception, as I call it"

Whilst the extent to which patients uploading information is actually close to real-time may be disputed, it was clear that this GP believed that his system gave healthcare professionals something that was closer to real-time than what had been in place previously. Comment 19 links the idea of real-time monitoring to story 2. My interviewee argued that the technology applied is a form of real-time monitoring:

19 H-B-E "there's a group in Canada who came up with a really funky system to support, palliative care, and it was developed in Canada, it's called eShift, and/or EnComPass, is the name of the particular brand of what we're doing in St Luke's Hospice. It's basically a system where you can have a, senior specialist nurse at base, and you have kind of smartphone-enabled staff who go out into people's homes and they do assessments, and you get real-time data coming back through to the nurse back at base"

Business Model

Many interviews included discussion about perverse incentives in the current system and how these were a barrier. Comment 20 expresses this nicely. Comment 21 implies that to fully implement smart community ideas a different business model is likely to be required, or at least the business model will need to change.

20 H-B-E "there are some weird and wonderful perverse incentives around stuff, and my, my analogy is, the price of end-of-life care in Sheffield is like an archipelago of islands, and on each island everybody's striving to do the best that they can, but there's nobody with any kind of oversight."

21 A-J "all significant innovation is business model innovation"

Disjointedness

A new system of cancer services based on the concept of smart community might be able to overcome some of the disjointedness of the current system, such as by using information technology to enable more people in more different places to have access to the same information. There was a consensus amongst interviewees and workshop participants that the current system was disconnected in many different ways:

22 H-C "it should be in the notes, they try to put it all on the computer system, but it just completely broke down, because it, the stuff you needed was never there, the up-to-date letters weren't on there, you need a quick reference in the paper notes in front of you, so, sometimes you'd get a set of notes with no information in them, apart from the patient's name and details."

23 H-C "I don't know how they, they've not got the same systems at the hospital, so, I don't think they can see our records"

Flexibility

The implications of a future smart community system are that non-human agents would need to be able to work flexibly with the people that they interact with and that both would need to enable flexibility for patients. The two most common ideas within comments about flexibility were that a future system should be flexible to meet the wishes of the patient, as illustrated by quotes 24 and 25, and the adoption of information technology needed to be flexible and evolve with the people using it

rather than requiring the people using it to do all the changing. The second point is discussed in story 1.

24 M-Y "Rather than a one-size-fits-all, it says the first thing we need to do is take a view of what's the likely consequences of your cancer, and what's important to you, and then you're put on a relevant pathway, based on all of that"

25 A-W "the offer of digital technology is access, convenience, flexibility"

Context matters

Ideas about context link back to discussion about relationships. What works will be dependent on existing and future relationships. These will be dependent on social and cultural capital. Participants argued that an 'off-the-peg' smart community approach is unlikely to work in Sheffield, as all ideas need to be adapted to fit with this context. Theory that emerged would be context specific, as ideas that work in Sheffield might not work elsewhere because of the characteristics of the local context:

26 LA-B "when you're co-designing for things, you've got to know what your community's needs and requirements are"

Information Sharing

Many of the disconnections in the current system include disconnects in the sharing of information. A more efficient system may need to address some of these. Comments 27 and 28 outline some of the challenges. Comment 28 also indicates a future that one healthcare professional would like to see. Challenges in information sharing were not restricted to hospitals, although there was a general consensus that information systems were better at GP practices than those at hospitals.

27 H-I "the great challenge with that is that hospitals are trying to cope with providing information to different organisations"

28 H-L "on ICE you can only see your reports, so it's nice to be able to see the scans, but it's a whole other system you have to log into to get that, so if you could find a way of displaying all that together, but I think that comes down to the collaboration of the organisations, because it, I think the technology behind PACS probably doesn't need reinventing, but if there was a way that the system

that you go into then automatically, you click on a link, and it uploads PACS, that you don't have to log into PACS separately, that could work, quite nicely"

Silos

Discussion about silos as well as relating to the disconnect between the different service providers in the system, also related to the biomedical system. See comment 29:

29 M-Y "what treatments do they need, which is this kind of silo approach we have today."

M-Y appears to be suggesting that focussing on treatment creates silos as it focusses on dealing with the current issue or condition, rather than taking a more holistic approach, that considers potential causes and how other people or organisations in the system might be able to help. Comment 28, outlined earlier, as well as highlighting challenges with information sharing also indicates the siloed nature of the current system. Comment 30 illustrates the connection between the siloed nature of provision and the disconnect in information flows. It resonates with me, as at the beginning of this study I had not appreciated just how disconnected information flows were in the current system.

30 M-N "I think often the misconception is that if you go to somewhere like A&E that actually they can see not only your previous hospital world, but anything that's happened in primary care"

The private sector

For non-human agents such as AI to maximise their impact, they would need access to an uninterrupted flow of data. Hiccups connected to the flow of data between public and private companies might restrict the potential impact of these non-human members of a smart community. As illustrated by quote 31, comments made about the current and potential role of private sector organisations highlighted concerns about ethical issues and risks, including those connected to the ownership of and access to data. Comment 32 highlights a data challenge in the current system with multiple providers, some of them private. The healthcare professional who made this comment made it clear that she felt that sometimes patients who have some

treatment, such as tests done privately, actually end up getting worse treatment overall, simply due to the disconnect in information flows.

31 H-B “perhaps, we can utilise a private sector company in some way, but I’m not clear that the way that we’re utilising them doesn’t give them enough power to do what they like.”

32 H-L “if you have a private patient, because you’ve got no access to their notes, you don’t understand what’s going on with them, you don’t have any results”

Staff shortages

A future system based on the smart community concept might not require as many healthcare professionals if it is able to harness patients, family members and non-human agents to play a more active role in the system. As well as suggesting that bringing in more highly skilled medical staff wasn’t going to happen, interviewees highlighted that along with hospitals, medical staff were the most expensive parts of the current healthcare system:

33 H-B “the solution is what we’re not going to get, is more doctors, there’s just not enough staff, for most of the clinics, I don’t think, at local cancer services, they can’t recruit breast, breast consultants, you know, they’re trying to recruit, and they can’t find them”

Inequalities

If a smart community based system is going to harness the time and energy of patients and other citizens then other members of the smart community will need to communicate with these citizens. Some interviewees expressed the concern that more disadvantaged members of society might not be able to benefit from technological changes. This connects to the concept of cultural capital, as the skills required to read and understand smart information is a form of cultural capital:

34 H-I “Inequality - smart information tends to be in American English, and we have to keep in mind that one tenth of our population is not naturally English, and doesn’t speak natural English. So, you always have to think, if it were possible to [pause] well, let me ask you a question: if I go into some information and it’s academic information, then, I sometimes get a little tag up which says

‘translate’, so I can read a Chinese article by simply pressing the ‘translate’. But, that is not, across the board, is it? Most information comes in the language that’s provided”.

As illustrated by comment 34 the impact of technology is mixed; it might reduce inequality amongst some groups whilst decreasing it for others. Whilst people who become able to access health information are likely to gain, those who become less able to engage due to a lack of digital literacy will lose. The issue of inequality and digital literacy is discussed in 5.1.2.

Data bias

If the data that is fed into the system is not accurate, then any analysis based on that data will also be distorted. This could restrict the potential impact of non-human agents such as AI. This connects to the theme of cultural capital as changing these established patterns of behaviour would require a culture shift⁶⁵.

35 H-L “There’s also slight bias in patients that get referred to oncology, in that you can always take the performance status that you’re told with a pinch of salt, because [pause] not, [pause] oh, that’s probably a bad thing to say, but anyway, often times people will say that someone has a performance status slightly better than they perhaps do, because they want them to be considered for treatment”

Whilst AI is very good at analysing data, people remain better at considering the myriad of subjective factors that might bias data. Comment 35 is one example of a reason why the data available might be biased. The issue of data bias is discussed in more detail in 8.2.

4.3.1 Diagram

In Figure 16 I illustrate how all the different themes might fit together⁶⁶. Each theme is either part of the problem that might be solved or potentially part of a smart community solution, sometimes both. As highlighted in some of the discussion in 4.3,

⁶⁵ The concepts of routinization and habitus outlined in 3.6 relate to culture change

⁶⁶ Some of the links between the themes relate to discussion that will emerge in subsequent chapters

some of the issues span across multiple themes, so reality is actually a lot more messy and complicated than the representation given in Figure 16. Whilst the diagram might appear a little complex, it is actually a simplification. The problem is a wicked one; as such, the interrelationships are complex. Links between some of the themes will be clarified within discussion in subsequent chapters.

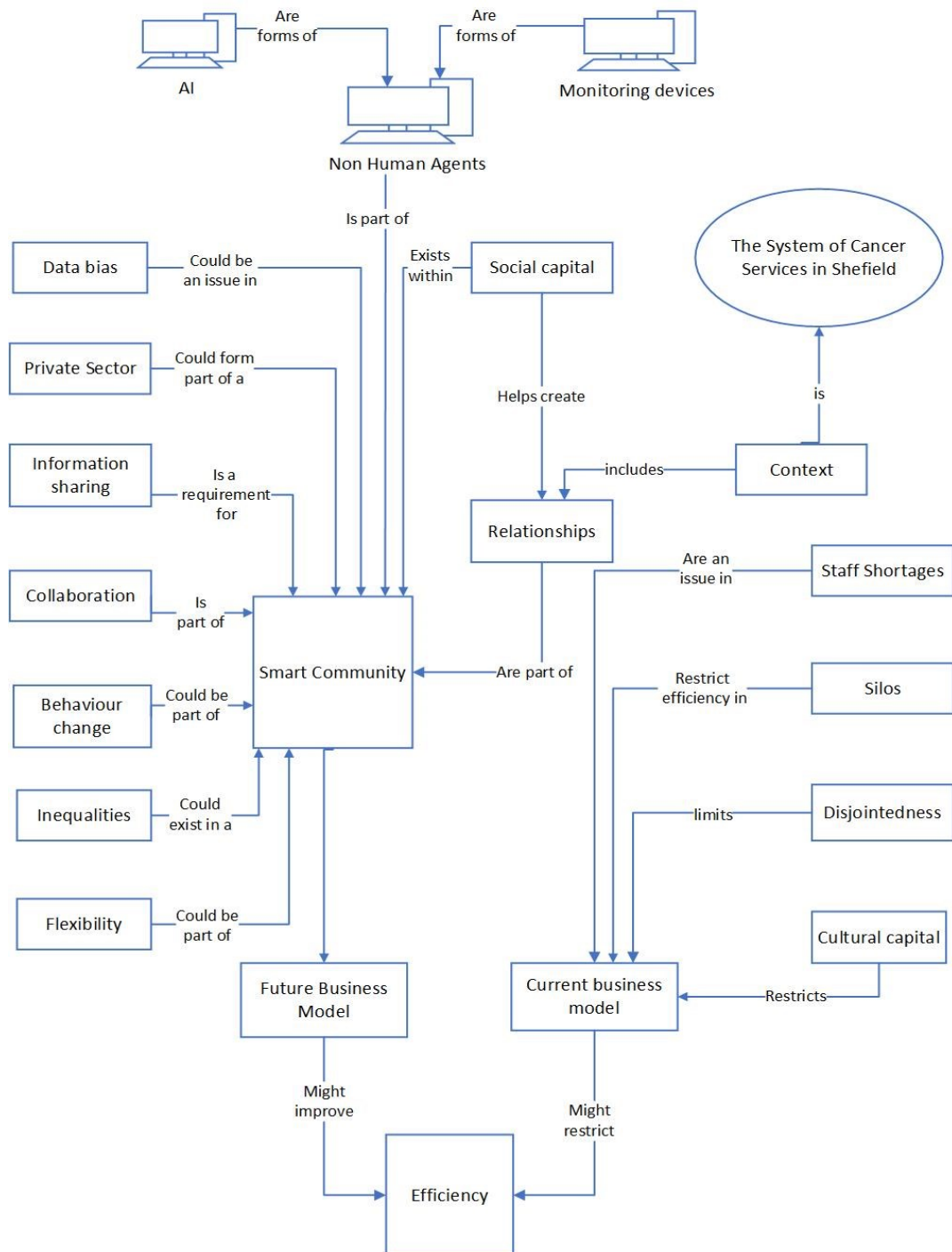

Figure 16 Themes

4.4 Chapter Conclusion

Both the methodology and some of the literature applied to this study have been informed by comments given by participants interviewed in initial scoping review interviews. This is appropriate given the non-linear nature of the methodology outlined in chapter three. A theme that emerged in scoping interviews was relationships. I am aware that relationships are an important theme throughout the study and mindful that there is a risk that existing working relationships with some participants, may have influenced my perceptions. Many of the ideas expressed by the different groups express similar ideas. For example there was a general agreement that change was needed and a patient focussed approach was a good idea. There were however some differences, such as healthcare professionals expressing concern about the quality of online health information. This idea was not shared by cancer survivors. Existing research tends to support the views of cancer survivors rather than the concerns of healthcare professionals.

In many different ways comments made by interviewees resonated with ideas from literature. Criticisms of the current state of the system of cancer services in Sheffield mirrored ideas about the problem given in the introduction. Some workshop participants found the methodology I applied clashed with their world views. This supports the concerns expressed in chapter three, that false consciousness might prove a barrier that would need to be overcome.

Chapter 5 Storytelling

As outlined in 3.5.3.1, 3.4.1 and 3.5.1 stories and hunches emerged through thematic coding, interviews and reflexivity. Hunches are ideas about how efficiency might be improved. Stories are examples that help to illustrate the hunches and some of the other ideas within the themes. These stories and hunches, along with identified themes flow through the rest of this thesis including its conclusion. The themes, hunches and stories often overlap and intertwine with each other. Such entanglement relates to the wicked nature of the problem as outlined in 1.5.1.1 and the non-linear research process discussed in 3.3.1.

5.1 Applying Bourdieu's Theory of Practice to Interpret Data

As outlined in chapter 3, the core theory applied to help interpret the data collected is Bourdieu's Theory of Practice⁶⁷. Theory helped me gain understanding through the process of interpreting comments made by interviewees and workshop participants. Considering dynamics is very much part of CST. According to Bourdieu's Theory of Practice, to understand practice it is necessary to understand the social space where it took place (Bourdieu, 2005; Petit-Dit-Dariel, Wharrad, and Windle, 2014).

So, from this perspective to understand the data that I collected, it was necessary to consider the dynamics taking place in the fields in which cancer services in Sheffield operate. In the previous chapter I included a few sporadic examples of how different forms of capital related to interviewee comments. Here I take a more structured approach to considering how Bourdieu's Practice Theory might uncover insights. To start this process I consider some of the comments in relation to some of the dynamics that appear to be occurring in relation to different forms of capital.

5.1.1 Social Capital

Figure 17 indicates the connection of some of the themes outlined in the last chapter to the concept of social capital. From this it can be seen that relationships are part of social capital. Through the process described in chapter 3 the diagram was constructed by bringing together ideas from literature with comments from

⁶⁷ Bourdieu's Theory of Practice was outlined in 3.2.4

participants. Relevant comments include references to trust, and relationships. Relationships for example, frequently occurred in comments and are a central component in the formation of social capital. In particular relevance to this study is the link with human computer interaction. Because people change how they work as computing devices evolve or are introduced, the emergent technology has an impact on the relationships that are formed. As discussed in 4.2.1.5 the existence of cancer support forums enabled cancer survivors to form online support networks, including virtual online relationships with other forum members. This network became a support structure that provided online advice and psychological support in the form of reassurance. This support network is a form of social capital.

As outlined in 2.3.1 social capital is frequently associated with the notion of trust and community development. The transcripts of most interviews and all the focus group transcriptions made some references to both trust and community development. References were made to lots of different communities including; healthcare professionals, geographical communities and online communities. Links were specifically made to some of the concepts outlined in the last chapter. For example coproduction was referred to in 7 of the interviews. Social capital was specifically referred to in one of them. Interviews also highlighted many other ideas outlined in 0 including; communities as a support network, changes in the relationship between doctors and patients and the shift towards maintaining good health. In relation to the latter point there were several direct links between social prescribing and coproduction.

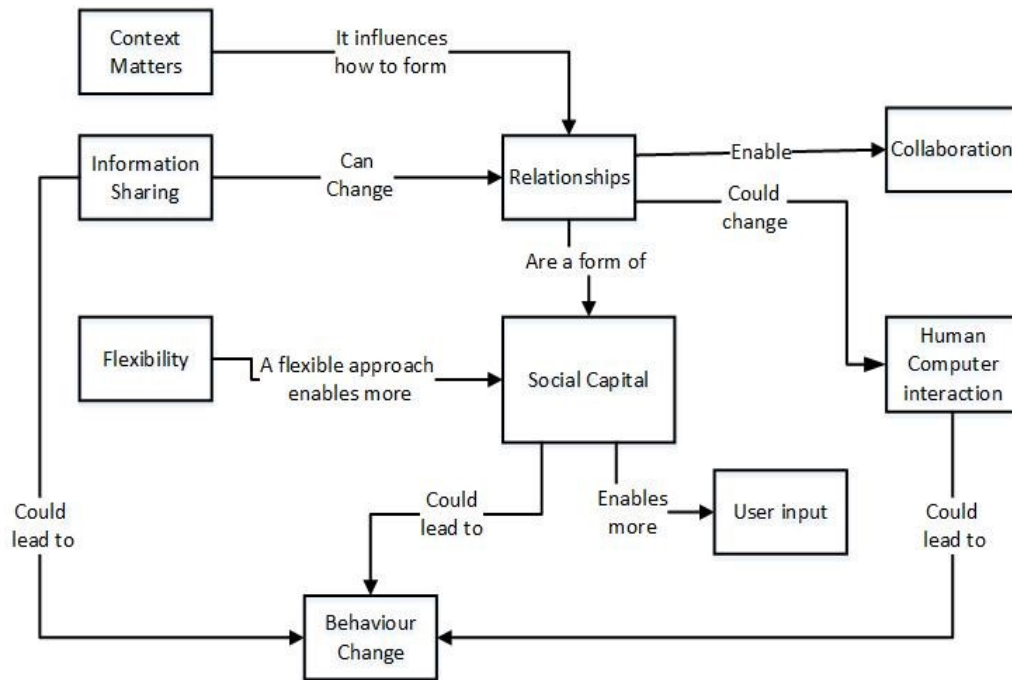

Figure 17 Social Capital

Because social prescribing includes referral to lifestyle interventions such as gym sessions it links social capital to issues about lifestyle change. Bolin et al (2003) argue that social capital improves health through the emotional and informational support provided by networks. They state that their study found that the sharing of information makes individuals more efficient producers of health capital, and that due to this the cost of producing a given amount of health is lower the more social capital they have. Comments also linked social prescribing to coproduction, as illustrated by comment 36:

36 LA-A "I think social prescribing is a key element of that, with that, when we look at coproduction, and we look at co-design, we have to identify what the needs of the communities are, because every community is diverse"

The link between comments about social prescribing and coproduction might be expected given the connections between social capital, coproduction and smart community, outlined in 0.

5.1.2 Cultural Capital

The most overt reference to cultural capital was the suggestion that the Downton Abbey style approach should be left behind⁶⁸. This comment implies that some established ways of working are no longer appropriate. Moving away from these would diminish the cultural capital of those who understand the unwritten rules associated with these practices. Comment 61 in 6.1.1.1 highlights this issue. It is a comment about leaving behind trying to protect existing organisations. This is a reference to leaving behind established ways of working. Some of the staff involved in the current system may have spent many years developing cultural capital that enables them to effectively navigate and succeed within current structures. These people may resist leaving behind the structures that they are used to and know how to operate in. This links to the idea that patients are becoming more able to access health information from sources other than healthcare professionals, such as forums and internet research. The decrease in patients' reliance on healthcare professionals as a source of healthcare information may diminish the cultural capital of doctors as patients are less reliant on them to access health information.

Comments about inequality⁶⁹ relate to a different aspect of cultural capital including the ability to navigate online systems, an issue that was discussed in theme 17, in the previous chapter. Cultural capital, including the ability to understand the more subtle aspects of the English language, was discussed in theme 5. As illustrated in Figure 18 this could restrict online access for some patients and create an increased gap in cultural capital, as more IT literate patients find themselves better equipped to engage in the healthcare system. At the same time less IT literate patients may get left behind as access to healthcare becomes more digitised. This idea of digital inequality is supported by research (Abel, 2007; Hale, 2013). Hale 2013 makes Bourdieu's Practice Theory directly relevant to Smart community through discourse on digital interventions that impact on health lifestyle. Abel claims that although the internet is an important resource for health information, the socially disadvantaged groups who would benefit most from online health resources are likely to have limited internet

⁶⁸ Quote 17 in 4.3

⁶⁹ See comments 17,18, 31 and 34 and discussion in theme 5 – cultural capital

access. As Abel's research was published a decade ago, it is possible that issues about internet access are less relevant now than when his work was published. More recent research however also supports the idea of a digital divide with regard to access to information (Kontos, Blake, Chou, and Prestin, 2014; Mano, 2014). The idea that different levels of access to healthcare information exist within different social groups was indicated strongly in my interviews. Two of the cancer survivors I interviewed stated directly that their background had enabled them to navigate the system better than some other patients might. This statement by one of them illustrates that they believed that this enabled them to get better healthcare:

37 LA-B "active, well-informed, you know, patients, can benefit more from the NHS than inactive, poorly-informed patients"

The ability to navigate the system, indicated in my interviews, implies that cultural capital has an impact both on access to healthcare information and subsequently the quality of care that can be accessed. This idea is informed by research (Phelan, Link, Stueve and Pescosolido, 2000). Link and Phelan argue that innovations beneficial to health are developed within the social contexts of existing inequalities in knowledge, money, power, prestige, and social connections. Although this is not directly referring to different forms of capital, it appears to be making a link between capital as defined by Bourdieu and access to healthcare.

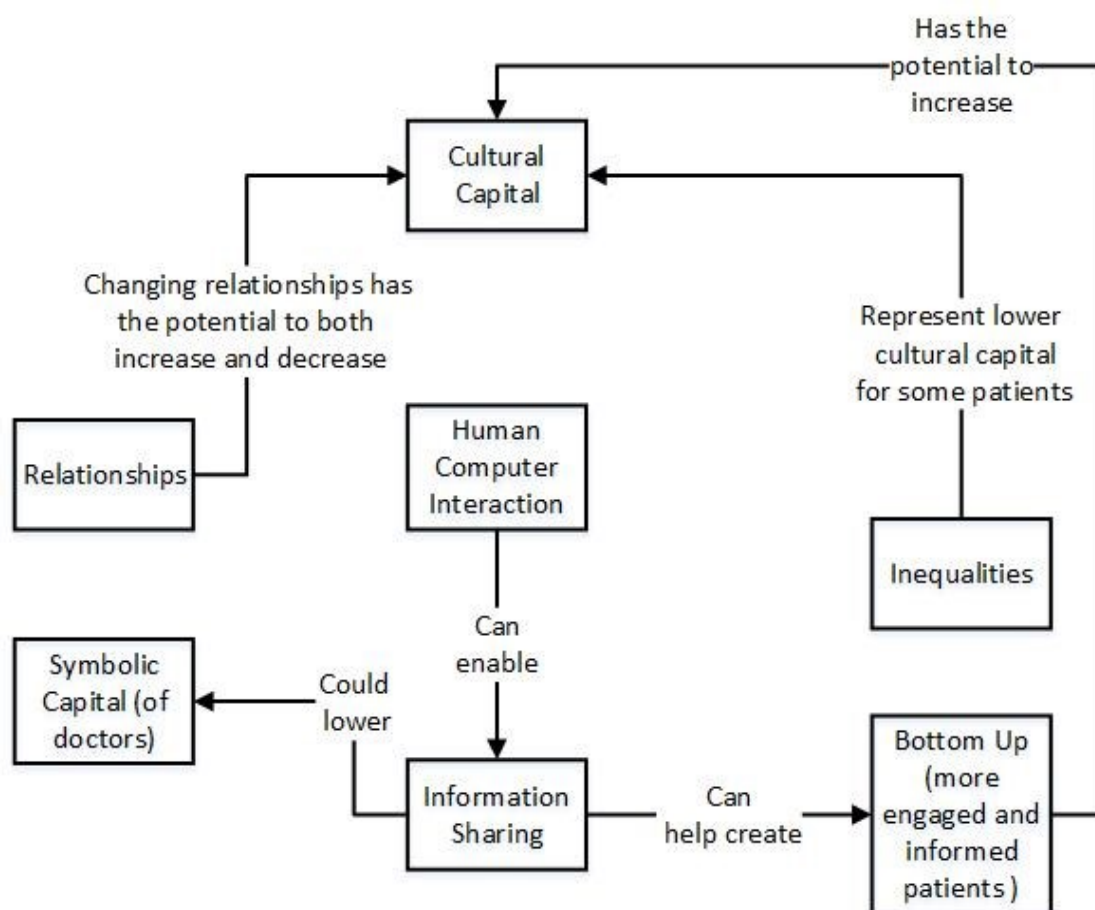

Figure 18: Cultural Capital

5.1.3 Symbolic Capital

The connection to symbolic capital is similar to cultural capital. Changes to the healthcare system are likely to reduce the prestige of some, for example healthcare professionals who have status tied up in the current system are likely to find their symbolic capital reduced. It is also possible that system change will increase the status of others. In 4.2.1.2 I indicated that most of the managers that I interviewed were enthusiastic about change. It is possible that consciously or otherwise, they believed that they may gain symbolic capital through leading the change process. They might also consider that recognition for their role in the change process could lead to a more senior role in the new system that emerges.

5.1.4 Habitus

The idea of digital inequality discussed in 5.1.2 is relevant to the concept of habitus. This is not surprising as cultural capital and habitus are closely linked, as cultural

capital includes the cultural appreciation created in early life socialisation (Browne-Yung, Ziersch, and Baum, 2013).

As outlined in 3.2.4.3 habitus is the idea of individual behaviour being influenced by structuring structures (Bourdieu, 1984). It is at the structure end of the concept of agency and structure, it tends to link people with others in the same position in society, such as other people of the same class. Through interactions with others in the same social group habitus passes on an understanding of the rules of the game that assures continued inequality⁷⁰. In this sense, there is a parallel between Bourdieu's observation that economic and cultural capital are required to access the elite schools that are the gateway to future elite jobs, and the idea that cultural capital is required to access online healthcare information (Bourdieu, 1989; Walther, 2014). Figure 8 (in 3.2.4.3) illustrates how the concept of habitus influences lifestyle and therefore also behaviour.

As indicated in 5.1.2 accessing online information might be required to get better treatment and health outcomes. If Bourdieu's Theory is to be accepted in this context, the online healthcare information that is becoming available is not sufficient, as discussed earlier in theme 17 (inequality). To address this issue, some of the structural issues that lead to the reproduction of the cultural capital needed to navigate the system might also need to be considered. By highlighting the continuing existence of inequality of access, comments from my interviewees and workshop participants indicate that Bourdieu's Theory of Practice does seem to be relevant here, as cultural capital and habitus appear to be present.

5.2 Hunches

Hunches are ideas about how to improve the efficiency of cancer services in Sheffield based on the smart community concept. In line with the non-linear methodology outlined in chapter 3 some hunches emerged from interviews and workshops whilst others emerged from literature.

Hunches are listed below:

⁷⁰ This was illustrated by comment 34, and discussion in theme 5 i.e. people from middle class backgrounds are better at navigating the healthcare system

- A system more focused on maintaining good health than treating illness would be more efficient (lifestyle)
- A biopsychosocial health system might be more efficient
- The aviation industry contains lessons we could learn from
- A less hospital focussed health system might be more efficient

5.2.1 Hunch 1: A system more focused on maintaining good health than treating illness would be more efficient (lifestyle)

Hunch 1 is informed by the criticism of the current system introduced in 1.5; the idea that chronic conditions are not handled well within the biomedical framework. In that chapter I referenced Capra (1998) who argued that cancer was often related to lifestyle factors. Hunch 1 is informed by comments made by participants who make links between lifestyle and cancer. For example one of the managers stated that:

38 M-B “all of that important lifestyle stuff is relevant to the prevention of things that they might not even have yet, you know, so there’s still, there’s still a benefit, a primary prevention benefit, for them preventing getting other things”

Cancer survivors also made links between health outcomes and lifestyle. Comment 39 is a comment from a cancer survivor who specifically connects lifestyle to the likelihood of certain cancers occurring. She argues that womb cancers are associated with being obese.

39 CS-E “because most common womb cancers are, stimulated by too much oestrogen, and, excess body weight produces oestrogen, hence the link with womb cancer. So, there’s a lot of very, very large ladies in the womb cancer community, and, several of them have had discussions on the community about losing weight, and a lot of them have, they have talked about using things like a pedometer to measure their 10,000 steps a day, a lot of them have joined, a slimming group”

She goes on to describe conversations where forum members have encouraged each other to engage in physical activity and to lose weight. This comment supports the assertion I made in 2.5.4 that lifestyle changes will improve healthcare efficiency. Comments from interviewees suggest that there are some cases where engagement in

forums has encouraged participants to make lifestyle changes. The idea of internet forum members supporting each other most directly connects to theme 7, as this hunch is very much about the impact of changes in behaviour. It however also connects to theme 4, as this encouragement is about social capital and trust, and without trust it is unlikely that lifestyle changes would have occurred.

In terms of Bourdieu's Practice Theory, hunch 1 links to social capital. The online support structure that encouraged forum members to lose weight is a form of social capital.

5.2.2 Hunch 2: A shift away from the biomedical model towards a biopsychosocial model would increase efficiency

Hunch 2 is also informed by the ideas of Engel introduced in 1.5.3. I am suggesting that comments by interviewees about the lack of social and psychological support, imply that Engel's theory appears to be relevant to the system of cancer services in Sheffield.⁷¹ This hunch connects to and follows on from the idea of lifestyle change outlined in hunch 1. It however focuses on a specific aspect of lifestyle, the idea that the current system doesn't place sufficient emphasis on social or psychological issues. As is made clear in chapter 6, there was a general consensus that the current system is quite good in terms of medical procedures, but it is less good at providing social and psychological support. In workshop 2 a participant asked:

40 T-D "How do you get them to live a healthy lifestyle if they're suicidal with the cancer?"

Comment 40 links the psychological aspect of the biopsychosocial model to hunch 1, by 'them' he was talking about people who had been diagnosed with cancer. By using the term suicidal he was emphasising the extent that he imagined people might be distressed by a cancer diagnosis. The comment also highlights why the lack of psychological support might be an issue. If hunch 1 is correct then anything that gets in the way of people making lifestyle changes is a problem. The comment about patients being suicidal could be a problem if it reduces their motivation to make changes. This was picked up by a participant in workshop 3 who stated that "*cancer is*

⁷¹ There is further discussion about the biopsychosocial model in 7.4

a mental health issue". This resonates with my own experience, and that of most cancer survivors I have talked to. Most agreed that a cancer diagnosis affected them psychologically as well as physically. If this is the case more generally and it gets in the way of patients making lifestyle changes then psychological support might be helpful as a motivator to encourage people to make lifestyle changes. Many interviewees and workshop participants, expressed concern about the lack of psychological support in the current system. Comments that indicated concern included:

41 M-E *"Because we don't talk about feelings, we don't talk about people being mentally healthy, that's going to be the biggest problem"*

42 H-B *"There's not psychological support"*

One interviewee, a GP, whom I call H-Q suggested that the biopsychosocial model falls short as it is too focussed on the individual. He argued that greater focus on the social context and that the social in biopsychosocial is very much around people's individual social situation and that its conceptualisation of social is still in a health context. They stated that the principles of the biopsychosocial model are great, but it didn't go far enough into the social realm.

Both cancer survivors and healthcare professionals made comments about how smart community ideas might improve efficiency.⁷² For example references were made to the impact of forums providing psychological support. A healthcare professional suggested that if you gave people connections with others who had been through similar treatment they wouldn't need as much support from Cancer Nurse Specialists. A similar point was made by a cancer survivor who stated that although she had been offered counselling she had found engagement with a patient forum preferable, as she could access this from home, at a time she found convenient without the need for travel. She stated that the ability to access this from home had been a great benefit when she was going through chemotherapy and had low energy. By negating the need for a medical intervention as well as saving money, demands on staff time are reduced. This connects to theme 16 staff shortages. Like hunch 1 this theme also connects to theme 4, social capital, as without trust it is unlikely that interactions

⁷² To clarify, I am not claiming that they used the term smart community, simply that they referred to ideas that I have linked to the smart community concept

would have had an impact. This suggests that these interactions built social capital in the form of an online support structure.

As well as relating to social capital and hunch 1, hunch 2 relates to the idea of agency and structure, the idea that the current system is too focussed on agency and not focussed enough on structure. The lack of social and psychological support referred to indicates a lack of focus on structure.

5.2.3 Hunch 3. The aviation industry offers lessons we could learn from

Hunch 3 emerged from a comment made by a cancer survivor in the first workshop, CS-K, who had worked as an engineer. As will be outlined in chapter 7, his ideas parallel arguments made by Wachter (2015), Ideas expressed were in line with the smart community idea of continuous real-time monitoring, or at least the idea that there are benefits from getting closer to it. CS-K describes how aeroplanes collect and communicate data:

43 CS-K "let me tell you what happens for an aircraft that's flying in on a service route. It's sending data on the operation of all the electronics, automatically all the time from the aircraft to its maintenance base. When it arrives, it should be that there is a guy standing on the tarmac with a black box, a trolley behind him, he knows exactly what he's doing, where it is, what the heck was wrong with it, how to fix it. And he'll go up there, and he'll take something out of a rack, put a new box in, and do the necessary tests".

44 CS-K "the aircraft coming in off a service, the maintenance crew know exactly what's wrong with that, because it's been sending all that information all the way, all the way across the Atlantic, or wherever the hell it's going, it's all there already, plus what that says out of the diagnostics, and if the diagnostics can in fact be improved to become cognitive, you pick up what you learn to be right, you learn."

M-Y argued that there are already some parallels between this and the current cancer system. To support this assertion they made reference to the tracking of patients on the cancer pathway. Another manager, M-E, supported the assertion that the healthcare system has already learned from aviation with reference to Atul Gawande. He stated that the writer had taken a systemic view of healthcare to assess

performance, and this had resulted in checklists for healthcare professionals to follow, including basic stuff like hand washing. Looking at issues from a systemic view is relevant to this study as it directly relates to my research approach. Gawande's research found that the use of checklists had a significant impact on results, resulting in a 36% reduction in postoperative complication rates. Gawande argues that information technology can help reduce errors by improving communication, providing access to information and assisting with calculations (Gawande et al 2003; Haynes et al, 2009; Gawande and Lloyd, 2010).

The former engineer CS-K, pointed out that in the current system, unlike an aeroplane the human body doesn't have a built in set of sensors that report all the time on the situation of individual organs, with the exception of a few basic things like someone's heart rate. Over the next two chapters I discuss the extent to which smart community ideas might be able to bring in monitoring that could bring healthcare closer to aviation, and the extent to which this would be a good thing.

Hunch 3 most directly relates to theme 8, as it is the monitoring part of aviation that cancer services might be able to learn from. As will be discussed in 7.2.1.1, this is also about theme 6, human computer interaction.

In line with comments about capital, outlined earlier in this chapter, moving towards a future system with more monitoring could disrupt the cultural, symbolic and economic capital of people in positions that are part of the current system. I found comments that suggested some participants could already see parallels between aviation and healthcare interesting. I considered if these might be subconscious attempts by workshop participants to imagine how their existing capital might be maintained in a future aviation based healthcare system.

One of the insights from aviation suggested by Wachter (2015) is the idea of alarm fatigue; the suggestion that as more and more is monitored, to make alerts useful they need to be stratified into levels of importance and urgency. He makes the point that in aviation even something as serious as an engine fire does not automatically make it into the highest rank of alerts.

5.2.4 Hunch 4: A less hospital focussed system might be more efficient

Hunch 4 emerged when my first interviewee suggested that to improve healthcare efficiency we would need to imagine and create a future system that is less hospital focussed. This was an idea that was subsequently repeated in many interviews and several of the workshops in several variations. The initial comment was:

45 H,A-E “the first thing you do is knock down medical outpatients. Put your consultants in the back of taxis, and visit people in their own homes.

They described this future system as a holistic future system, with more being done at people’s homes and in GP surgeries and less in hospitals. As an example they stated that a truly person-centred outpatient service would not include a hospital. A similar idea was expressed in the second workshop, as illustrated by this statement from one of the participants:

46 M-E “it may not even be a building. So, maybe the building doesn’t exist in the future, maybe a lot of things that we think are right now don’t exist, and they probably won’t”

The logic of a less hospital focussed system was frequently connected to reducing costs and improving efficiency as illustrated by the following comments:

47 M VS–D “The expensive bit of health is hospitals, so anything which reduces demand in hospitals is going to have cost savings”

48 M-Y “to reduce costs more care needs to be provided by less expensive people and hospital beds need to be reduced”

49 H-Q “you have to start closing wards. So, if you can make a real difference to your length of stay, you can start closing wards, and that’s what really saves money”

A workshop participant connected hunch 4 to hunch 1 stating that:

50 M-Y “if people maintain good health through their lives, then there’s going to be less intervention points needed for hospitals”.

The theme that is most directly connected to hunch 4 is theme 9, as to make savings by moving away from hospitals would require a business model that is quite different

to the way that healthcare organisations are currently funded. It is unlikely that a hospital trust is going to start closing hospitals unless there is a financial incentive for them to do so. Comment 51 gives another perspective on business models. It highlights one of the cracks in the current system that may indicate that a new model is needed. If people are going to A&E because they are struggling to be seen by healthcare professionals in other parts of the system, then comment 51 indicates that there could be a problem:

51 CS-B “people just go to A&E because you get seen”

Table 8 : Healthcare Without Walls

Innovation	How this might contribute towards efficiency	Outside of hospitals
Monitoring collecting real-time data	Real-time data could help enable more accurate predictive analytics	Remote monitoring can help keep patients out of hospital until trigger points are reached
Collective intelligence	The idea of a ‘hive mind’ continually sharing and responding to ideas and information (Turner 2006)	It could enable new approaches that we have not yet considered
Moving away from the bio medical model	More focus on keeping people healthy reduces the demand for treatment later	Intervening earlier results in less people in hospital

In addition to comments by my interviewees and workshop participants there is research that suggests keeping people away from hospital reduces costs. For example in Sweden patient hotels have been found to cost less than 30% of the cost of a hospital per bed night (Gillinson et al., 2010). This relates to the concept of smart community as, smart technology such as monitoring devices are increasingly enabling patients to be treated outside of hospitals. Table 8 outlines ideas about how being less hospital focussed might improve efficiency.

Hunch 4 is at least in part about economic capital, the financial costs and savings related to moving to a radically different kind of healthcare system. Cultural capital and symbolic capital are also relevant, as the people in the current system are likely to need different skills and acquire different status by moving to the new system indicated by comments 45-48. As discussed in subsequent chapters there is a strong link between social capital and the community based lifestyle changes indicated. Most directly, chapter 7 includes a vision of what a less hospital focussed system might look like.

5.3 Stories

The following stories illustrate ideas about the themes and hunches outlined above. Stories communicate the views of some of the people I engaged in interviews and workshops. The term story is deliberately used to communicate the subjectivity of these accounts. The subjectivity in stories connects directly to the concepts of social and cultural capital, concepts that are at the core of Bourdieu's Theory of Practice. Social and cultural capital are developed and maintained by the telling and recreation of the stories that we tell each other about how the world works. This process works because in Bourdieu's Theory the social world is regarded as accumulated history (Bourdieu, 2011) . Introducing stories is not intended to do more than highlight some relevant aspects of the world views of some participants. These world views are critiqued and challenged in subsequent chapters.

5.3.1.1 Story 1. The story of the Electronic Document Management Service

Story 1 emerged directly from the account given by the first oncologist I interviewed. She started by asking:

52 H-Q "has anyone told you the story of the Electronic Document Management Service?"

Next she starts to outline the situation. Initially she set the scene: the trust was trying to go digital, but as usual trying to do it cheaply. First she says the trust bought Lorenzo followed by an EDMS system, the latter although designed as an archiving system was used as a live patient record system. Then she continues; the trust appointed a clinical information officer, but didn't appoint the person that everybody thought would be the best. She suggested that this person was not appointed because

they were critical of the Lorenzo system, as was she. Overall they stated that it has been a disaster, even going as far as to say that it was a clinical risk. She claimed that there was chaos in outpatients resulting from the introduction of the EDMS. As an example, to back up her argument she referred to a specific incident, a bug in the system to do with letters. Due to the bug she argued letters could be generated but not printed. As a result the DNA (did not attend) rate went up threefold. The issue was, that people using the system assumed when it told them that letters had been generated they had been sent out. 10,000 patients had letters generated but not printed and so also not sent out.

To counter the top down example that she described as a colossal disaster, she gave an example of a system that she viewed as positive. She described a clinical portal and highlighted that it had much more clinical involvement in its introduction. She made it clear that she viewed involvement as important. She argued that if you look at how doctors work and then develop systems that take that into account, they can be very good. Conversely she said if you implement a system and just say, *'there it is, now you must use it'* and take no account of how we work, then it doesn't go very well. To illustrate I give a direct quote from her:

53 H-Q "if you look at how doctors work and develop systems that take that into account, they can be very good, if you implement a system and say, 'there it is now you must use it' and take no account of how we work, then it doesn't go very well."

Lorenzo was also firmly criticised by another oncologist, H-L. When asked for her view on it she stated that she hated it, and that it is a really badly designed system. She suggested the only reason trusts use it was because of government subsidies. She echoed the criticisms given by H-Q of the EDMS system, describing it as the worst computer program that she had ever used. Another issue that she implies is a lack of trust between managers and healthcare professionals (see comment 54):

54 H-L "you've got these top-down initiatives, and you have got this complete reversal of what they're supposed to be trying to do, but everyone in the back of their minds is thinking there's this alternative agenda."

The suggestion that there is likely to be an alternative agenda indicates that current working relationships are distinctly fractious, and lacking in trust. H-L does however give ICE as an example of a system she liked better. The reasons she preferred it echoed the view expressed by the first oncologist, that it was user involvement that made it better. She highlighted its greater flexibility, specifically stating that she liked that it evolved with use.

H-L made comments related to theme 14, private sector, raising frustration about competition between IT providers. She compared this unfavourably with the culture of transparency in medicine. She stated that because of transparency we all learn from mistakes, so we don't all go on making the same errors. She made it clear that she believed this practice was not replicated by IT providers as illustrated by comment 55:

55 H-L "you've got different companies doing it in their own little silos, never talking to one another, just in competition, you're never going to get the best service that you can get"

Criticism of Lorenzo also emerged in two of the workshops. Furthermore, none of the participants made any positive comments about either the EDMS or Lorenzo, nor did anyone attempt to defend either when they were criticised. One of the researchers interviewed in a scoping interview, A-E, offered some explanation as to why trusts might use systems like Lorenzo and EDMS, despite issues expressed by some healthcare professionals. He appeared to have professional as well as academic knowledge as he had been a healthcare professional in the past. A-E suggested that off-the-peg solutions might be attractive to commissioners, as it appears to be more straightforward.

A-E echoed comments made by the healthcare professionals suggesting that in reality systems could be developed in-house, far more sensitively, and for less money. He linked his argument with the wicked problem concept, implying that to find effective solutions the complex interactions between: staff, patients, commissioners, providers, social norms and technology provision needs to be engaged with as a whole.

The criticism made by interviewees is in sharp contrast to the claims of its suppliers outlined in 4.2.1.3. It is possible that Lorenzo's marketing material may have helped to

sell it to Sheffield Teaching Hospitals Foundation Trust. Criticisms of Lorenzo are supported by research (Heather, 2016). National Board papers reveal 554 incidents relating to Lorenzo between its introduction and May 2016. In February 2016 a report to Sheffield Teaching Hospitals NHS Foundation Trust, said fixing Lorenzo performance issues was “critical” to improving its declining financial position (Heather, 2016).

Story one appears to be one of cultural and symbolic capital, and the failure to recognise their importance in system change. Clinicians had the cultural capital necessary to engage with the previous system. The chaos referred to appears to indicate that the people who were asked to use the system, had not been given the time and support needed to develop the capital required to effectively engage in the new system. By the new system, I am talking about something wider than new technology. As indicated from interview comments, technological changes required people to work and interact with each other differently. The change required is therefore significantly broader than just learning the skills needed to use the technology, it requires people to make different relationships and to interact differently with people across the whole system. ANT may offer insight into what went wrong. In 3.6.3 I stated that ANT suggests that change in any part of a network impacts the entire network not just the people directly using it. The wider considerations implied by this theory did not appear to have been considered when introducing Lorenzo.

The two technology introductions that were spoken of favourably appeared to involve staff in the process of change. This inclusion may be a recognition of the cultural capital of the staff involved in using the technology. It is possible that staff were happier with ICE and the clinical portal examples, partly because their cultural, and possibly also their symbolic capital, was less disrupted. Considering the potential relevance of ANT, another way of conceptualising what went wrong may be failure to recognise the impact of the agency of the technology and how it may resonate across the system. What appeared to go wrong in story 1 is illustrated by figure 19

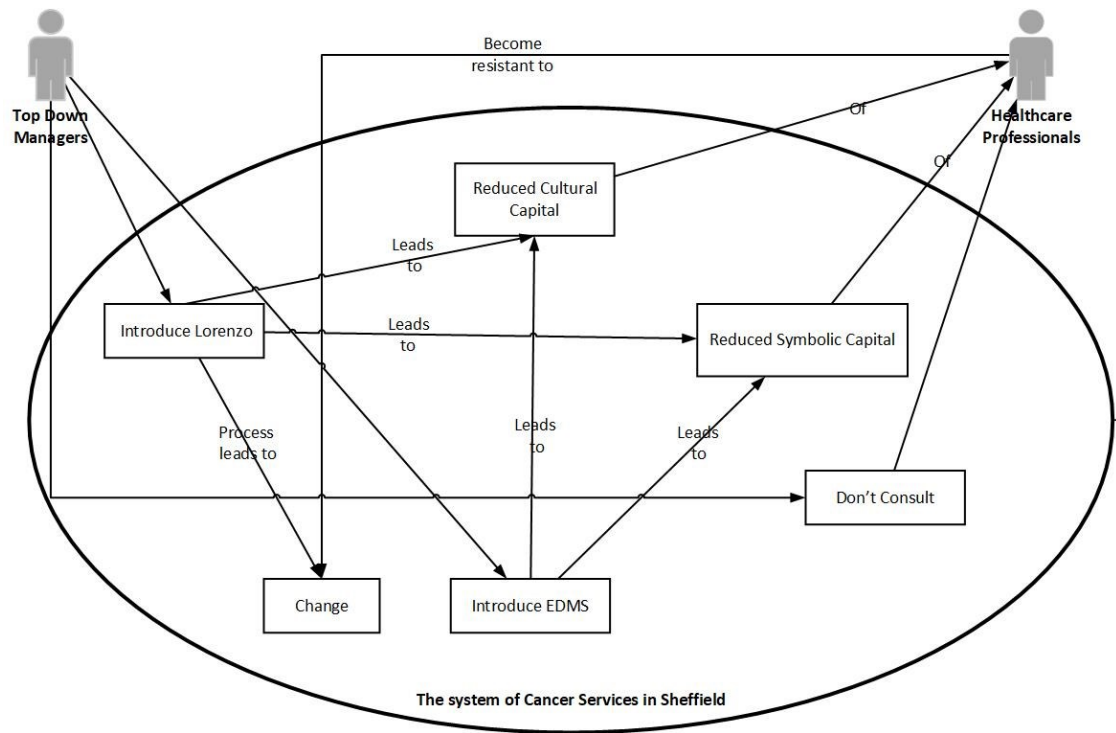

Figure 19 : Story 1

5.3.1.2 Story 2. E-Shift

The story of E-shift emerged from accounts given by three different interviewees and one workshop participant. Although like story 1 it is a story about information technology adoption in Sheffield, the story of E-Shift differs distinctly, not least because there were more positive comments about it from interviewees. It was first mentioned by one of the researchers, H, A -E⁷³. He described how the system had been brought over from Canada, to support frontline staff involved in palliative care through smartphone connections to a senior nurse specialist. He described how E-Shift enabled the communication of real-time data to the nurse back at base. Through smartphone communication, he argued it can extend the number of people who can be provided with specialist care, because it enables more junior staff to go out collecting data.

One of the managers of the charity managing the pilot project, M-B, gave a similar overview of this system. He started by saying that it's not quite a full command and control system. I found this interesting as command and control systems often feature

⁷³ The project discussed in story 2 was first mentioned in comment 19. The Encompass project mentioned is a pilot using E-shift technology.

in top down smart city /smart community approaches. The command and control notion connects with theme 1 (top down) and theme 8 (monitoring). M-B continued saying that it's a technologically supportive way of enabling lower grade community staff to get advice about particular problems or symptoms. He talked about how the E-Shift idea could be applied across community services to transform how nurses, community healthcare assistants and care workers do their jobs. He spoke about how this kind of technology could enable greater access to specialists, including chronic obstructive pulmonary disease healthcare professionals and more senior district nurses. He also spoke about how E-Shift could involve patients, saying that it could enable everyone to access the care planning that had been done with that patient. He highlighted benefits to patients, mentioned that it could give them a way of communicating concerns to healthcare professionals. This comment implies an approach quite different from the top down command and control system idea he referred to earlier. He also advocated the idea of some kind of patient portal.

The third group of interviewees to talk about e-shift were two people from a charity in Sheffield, M-SL, that had adopted the technology in a pilot project. I specifically interviewed these people to get their perspective following suggestions made by earlier interviewees. Echoing the comments made from the healthcare manager, they spoke of a vision to use the technology on a much broader scale. In line with the comments from the healthcare manager, they also spoke about how this vision would engage and support cancer patients in the community.

Talking about what they had already done, they claimed that the technology had exceeded their expectations, highlighting how delegated had a profound impact on the functioning of their team. They emphasised the impact that this had on communication, timing and workflow. Ideas of real-time monitoring and constant communication were emphasised in terms of how this enabled them to respond more quickly to symptoms and concerns. Previously they stated that there was often a delay because even when patients were seen directly by a senior nurse, they would often have to consult with GPs or other healthcare professionals and this caused a delay in care delivery. Now with this communication technology, that decision making timeframe can be reduced from weeks to minutes. The result of this, they claimed,

was a reduction in acute hospital admission of between 6,000 – 7,000 hospital bed days.

Another benefit they described was greater access to patient records. Because senior clinical staff were able to access more information about patients than they could in the field, the impact of this was not only faster decision making but decision making based on more patient data. This they claimed had a dramatic effect on the team's ability to make decisions.

The charity staff spoke about the culture change involved in adopting the technology. They described the steps they took to involve staff, including setting up a working group. They talked about how it required ownership at all levels; at executive level, at senior management level, at operational level and at grass roots level. This contrasts sharply with the approach taken with the EDMS, where some staff expressed frustration that they had not been listened to. I am however aware that the people I interviewed had all been involved in the project in some way; The first from a funding perspective, the second from a Sheffield Clinical Commissioning Group position and the third were leading the pilot. It is possible that if I'd interviewed frontline staff who had actually been using the technology I might have been given a different perspective.

This story relates to most forms of capital. From a staff involvement perspective it appears that user's cultural capital was less threatened than it was in story one. In relation to social capital, E-shift appears to have increased the social capital of staff and patients by giving them access to a wider network. In terms of economic capital there seem to be financial drivers incentivising the charity and potentially also of benefit to the hospital trust. Looking at the adoption of E-shift through an ANT lens, it does appear that a holistic approach was taken. In ANT terminology it appears that the impact of the agency of E-shift was considered across the network. Consideration appeared to have been given to the interactions of many of the actors in the system including community healthcare assistants, senior nurses, patients, GPs, smartphones, patient records and the E-shift technology itself⁷⁴.

⁷⁴ In 3.6.3 I outlined ANT and explained how within it people, objects and ideas may all be considered as actors, and may all be thought of as containing agency.

Some research indicates that the E-shift system enabled better communication, greater flexibility and more support. It emphasised that it enables the needs of individual clients to be addressed more flexibly. Research also claims that it is not simply a technological solution (Ralph, Regan and Donelle, 2013; Royackers, Regan, and Donelle, 2016; Royackers et al., 2016; Ralph, Regan, and Donelle, 2016). Other sources that made reference to e-shift however, also praised the system and highlighted how it improved efficiency by allowing each registered nurse to manage four support workers through a web enabled smartphone (Zeidenberg, 2015).

5.4 Chapter Conclusion

Stories, hunches and themes were introduced in this chapter. These intertwined with each other and connected back to ideas introduced in the literature review. One such link was the connection between story two and hunch four. The CEO of Sensory Technologies, the company that created E-Shift claimed that this model can keep people out of hospital by enabling more support to be given to people in their own homes. As such he is making a point that supports hunch four. Hunch four is supported by the discussion about health lifestyle in hunches one and two.

Within hunches and stories I started making links between ideas expressed by interviewees and theories introduced in chapter 4. This was done to consider why comments might have been made and the implications of these comments in relation to theory. For example cultural capital was used to help explain why some people still appear to be disconnected from the benefits of online health information. Comments were outlined that support the idea of the biopsychosocial model that was introduced in 1.5. Different approaches to information technology adoption were discussed. It was clear that expressed views went far beyond being positive or critical towards information technology, views were more specific, they highlighted benefits or issues with certain technologies or approaches to implementing technologies.

Chapter 6 The Current System

Following ideas introduced in chapters 4 and 5, this chapter focusses on the current system. It starts with an overview of ideas from scoping interviews. Next it outlines ideas from the first workshop. After that it adds in ideas from the main interviews. Ideas about the current system link to themes introduced in chapter 4 and the hunches introduced in chapter 5. The areas where there was most agreement was that the current system is disjointed and that there is not enough focus on preventative measures.

6.1 Part 1 Scoping Interviews

6.1.1 Thoughts about the Current System

Many comments about the current system made by interviewees in scoping interviews mirrored literature outlined in chapter 2. For example interviewees spoke about; financial pressure, the focus of the current system on acute issues, issues with the current structure and of the limitation of the medical model. One interviewee specifically referred to improving the healthcare system as a wicked problem. Table 9 shows some of these connections. The reference column highlights some of the literature discussed previously that related to comments made by interviewees. All of the ideas introduced in the table are discussed in more detail afterwards and re-emerge in subsequent chapters.

Table 9 Interviewee Comments about the Current System

Issue	Interviewee Comment	Reference
The current system isn't working	56 M-B "cancer numbers are going up and up and up, with more and more survivors, keeping people in hospital for prolonged periods of time is less and less viable"	(Barker, 2010) (Ham, 2014) (Stevens, 2014)
Wicked problem	57 H, A-D "there are wicked problems, there is no one right answer. These are multifaceted, complex, interactions between staff, patients, commissioners, providers, societal norms, technology provision, it's this kind of whole, and there is potentially a sweet spot in there, somewhere, but unless you can take a bit of time and keep that problem space open for a little bit longer, you won't know." 58 M, VS-G "the limitations of the medical model, just, obviously, that it isn't sustainable we know that, financially it's not sustainable"	(Churchman, 1967; Ferlie, 2013; Rittel and Webber, 1973b; Popejoy 2016)
Complexity	59 H,A-D "It's really complicated, because actually there's probably about three directorates involved, erm, and there's various bits, so District Nursing have an input, er, erm, there's a team called intensive Home Nursing, who have a, er, unique role in the city in terms of delivering kind of a sitting service in your last hours of life, erm, there are out-of-hours stuff, which is both Sheffield Teaching Hospitals and GPs, and then there are GPs, and of course GPs are not a homogeneous group"	(Kukk, Moors, and Hekkert, 2015)

Breaking Down Silo's	60 M-V "we need to get more interdisciplinary sort of stuff"	(Chiasson 2002, Checkland 1999a; Checkland, 1999b; Chiasson and Davidson, 2002)

6.1.1.1 The Current System Isn't Working

Most interviewees advocated need for change. Comments in interviews overwhelmingly supported the notion that the current system isn't working, as. In this respect comments from interviewees mirrored comments about the current system outlined in 1.5.

Reflecting on why all three of the healthcare managers interviewed spoke enthusiastically about change it occurred to me that there could be a selection bias; the people most dissatisfied with the current system might be those most willing to talk about what a different system might look like. Another possibility could be the influence of the dominant media narrative that the NHS is in crisis and that this means that the system needs to change. In this respect it is possible that the people I interviewed appeared to share the views expressed in policy reports from organisations such as Nesta and The Kings Fund, simply because they have been influenced by similar publications. There is also a counter view that the NHS might simply be underfunded (Iliffe and Manthorpe, 2015; Maynard, 2017). I considered that my own position may be influenced by this narrative, as discussed in chapter one, my view is that financial strains on the healthcare system are real and there is scope for improving efficiency. This view is supported by comments from interviewees and workshop participants.

To illustrate the point I make about openness to change I enclose a direct quote below:

61 M, VS-G "I think if we could ever get coproduction to its, you know, truest sense, it would have to be with an ability to kind of leave behind trying to protect your own organisation and protect your own income and everything else."

As illustrated by the comment above, M, VS-G, as well as suggesting the need for a system less focussed on hospitals indicated that vested interests get in the way. This is interesting and relevant for two reasons. Firstly it links user centeredness to

efficiency. Literature discussed in 0 made reference to user centeredness and links it to smart community. Secondly it highlights the issue of power⁷⁵.

Comment 61 supports to assertion I made earlier about change no being in the interests of healthcare managers, especially as the person making this comment worked in a hospital. Comment 61 relates to cultural, symbolic and economic capital as it implies that that trying to get to this pure form of coproduction would require that accepting a drop in all three forms of capital is likely.

6.1.1.2 Wicked Problems

As part of the discussion about why the current system isn't working, wicked problems were outlined in the introduction chapter. Comment 61 is similar to the definition of wicked problems given by Weber and Khademian (2008). They argue that wicked problems cut across hierarchies and organisational boundaries including policy domains, political and administrative jurisdictions. This is the case with the boundaries between organisations and departments delivering cancer services in Sheffield. Macmillan's Survivorship programme overlaps with and is included on Sheffield CCG's work-plan. One of the projects within this, Active Everyday (Sheffield City Council 2015) is delivered by Sheffield Hallam University and overlaps with another project, Move More that is managed by Sheffield City Council. To study just one of these in isolation could be problematic, as different actors and agencies may perceive different boundaries between different services.

6.2 Part 2: Workshops

This section gives a brief introduction to some of the key ideas that emerged from workshops. Comments from participants at my first workshop were more balanced than those made in initial scoping interviews. They included many comments about what was good as well as issues with the current system.

⁷⁵ As discussed in 3.1.2.1 power is a central component of CST

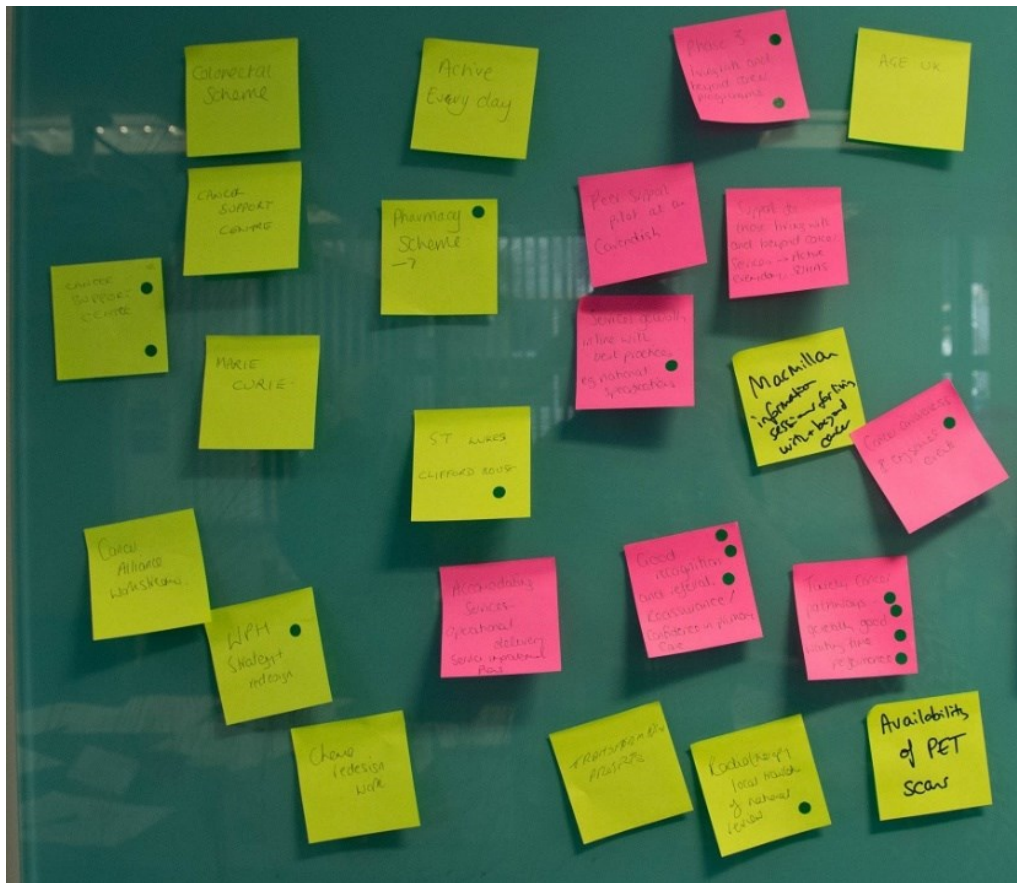

Figure 20: Post-it Note Exercise

As illustrated by Figure 20, assets were identified using the post-it note exercise described in 3.4. The assets identified are listed in Table 10

Table 10 Asset list

People /Organisations	Projects and Services	Services / Stuff that Technology is used for	Types of Data	Technology
Community services	Cancer Support Centre	Record sharing	GP records	System 1
Primary care - GPs / PNS	Care at home available	Compilation of diagnosis treatment outcomes for the patient	Genetics collection of data	EMIS
Cancer commissioners	Self-referral for holistic needs assessment	Communication	Radiology reports on PACS	Lorenzo
Sheffield CCG	Local pharmacies	Radiotherapy reports on PACS	Patient surveys	software
Consultants	St Luke's, Clifford House	Telephone consultations		Infoflex
BUPA	Active Everyday	Clinic appointments		Bleepers
Cancer Information and Support Centre	Peer support pilot at Cavendish Centre	MDT's		Radiotherapy machines
CCG	Support for those living with and beyond cancer	Local authority systems		E-prescribing system

Generic Support Services e.g. Age UK	Transformation projects	National Cancer Registration Service		E - HNAS
Public Health England	Accommodation services	Cancer data portal		
Cavendish Cancer Care	Cancer awareness events	Tertiary referral forms for patients Coming to Sheffield for treatment		
SOHAS	Macmillan information sessions for living with and beyond cancer	Recognition and referral reassurance		
Cancer specialist nurses	Pathology LIMS	The organisation of cancer commissioners		
Macmillan	CDC	Different options to test results		
Relatives	Colorectal scheme	Skill mix - Ancillary roles supported by technology to make best use of resources		
Patients	Active Everyday	Patient experience surveys		
SYBND Cancer Alliance	£6m LWBC project	Cancer audits		
Geneticists	Phase 3 living with and beyond cancer programme	Genetics collection of data		

Local authority	WPH strategy redesign	Discharge letters		
SCC Support Workers	Cancer Information and Support Centre courses	Cancer care review		
Age UK	Walking for Health	LWW referrals		
St Luke's	Preventative services	Chemotherapy redesign		
IAPT	STP work together programme	Radiotherapy - national translation of national reviews		
Marie Curie	Cancer screening programme	Cancer Alliance work streams		
Sheffield Teaching Hospital		Systematic treatment summaries		
SYBND Cancer Alliance		Information sharing referrals from DGM to the tertiary centre		
Sheffield City Council				

Most of the comments on post-it notes were perceived problems. Some comments, however, were examples of good practice and what participants thought were good. I outline some expressed ideas below.

6.2.1.1 Identified Problems / Suggestions for improving the system

- Computer systems should be compatible for GPs Hospitals etc., with all information for patients. It was suggested that NHS numbers could be used to link datasets.
- Availability of PET scans
- All the information available needs to be given at diagnosis
- Innovation schemes need to be rolled out to less common cancers
- Information should be given to patients whilst they are waiting for chemotherapy
- More real-time information
- Earlier discharge from secondary care & monitoring via blood tests
- Outside organisations doing HNA's need to be linked up with GP systems
- Chemotherapy services are overstretched
- Information handovers should be improved
- GP Service to provide chemotherapy
- Make the most of time waiting in chemo suite to give patients information

6.2.1.2 Comments about what is good

- Timely cancer pathways
- Timely treatments
- Advice available
- Services are generally in line with best practice

Whilst the comments about the current system include ideas about what is good, it is notable that far more problems and suggestions for improvement were outlined. It is also important to consider that these comments emerged despite participants initially being asked to focus on what was good. The inclusion of negative comments may highlight the extent of the concerns some participants had about the current system. It was clear from this initial exercise that there are lots of different organisations

and initiatives in the current system and many different components. As indicated in table 11 there was also much that participants perceived of as good.

6.2.2 Asset list: Stage 2

Table 11 Good and Problematic in the Current System

Good	Green Dots	Problems	Red dots
Timely cancer pathways	4		
Cancer Information and Support Centre	4	Lorenzo	2
Consultants	2	More real-time information	2
Sheffield Teaching Hospital	2	Information handovers should be improved	2
Recognition and referral reassurance	2	Communication	2
Cancer specialist nurses	2	The organisation of cancer commissioners	2
E-prescribing system	1	Organisation of cancer commissioning	2
Relatives	1	Information should be given to patients whilst they are waiting for chemotherapy	1
Geneticists	1	Chemotherapy services are overstretched	1

Local pharmacies	1	Systematic treatment summaries	1
Radiotherapy - national translation of national reviews	1	Software	1
Cancer awareness events	1	Record sharing	1
St Luke's	1	Skill mix - ancillary roles supported by technology to make best use of resources	1
Phase 3 Living With and Beyond Cancer Programme	1	Patients wasting time waiting for chemotherapy, suggestion that more should be done to make use of this time	1
WPH strategy redesign	1	Could improve and systematise treatment summaries	1
Cancer data portal	1	More information around treatment options should be given in a digestible format to enable informed decisions	1
Transformation projects	1	Could enable skill mix with ancillary roles supported by technology to make best use of resources	1
Services generally in line with best practice	1	Availability of PET scans	0
Lots of funding for breast cancer	0	Things take forever	0
		There are poorer services for rarer cancers and for lymphoma	0

When participants were asked to emphasise good and problematic aspects of the system using coloured dots, some slightly surprising indications emerged. Firstly, whilst participants used all of their green dots to indicate positive aspects of the system, just over half the red dots given out were applied. Another surprise is that participants appeared to indicate that pathways were good and timely. This point appears to be contradicted by comments made during the workshop discussions and by comments made in interviews. Another surprise was the significance given to the work of the Cancer Information Centre.

6.2.2.1 Issues / Suggestions for Improvement

- More record sharing is needed, currently only 1-3 %
- Computer systems should be compatible for GPs, Hospitals etc. with all information on patient
- The colorectal pathway should be extended to all cancers – currently holistic needs assessments only available for patients with colorectal cancer, should be available for all
- All the information available needs to be given at diagnosis
- Innovative schemes are good but need to be rolled out to rarer cancers faster
- Cancer support should be mentioned at diagnosis
- Could we have more real-time information on what is happening e.g. test reporting / MDT review

6.2.3 Rich Pictures

As can be seen in figures 21 - 23 rich pictures identified many similar ideas to those identified in the asset list above.

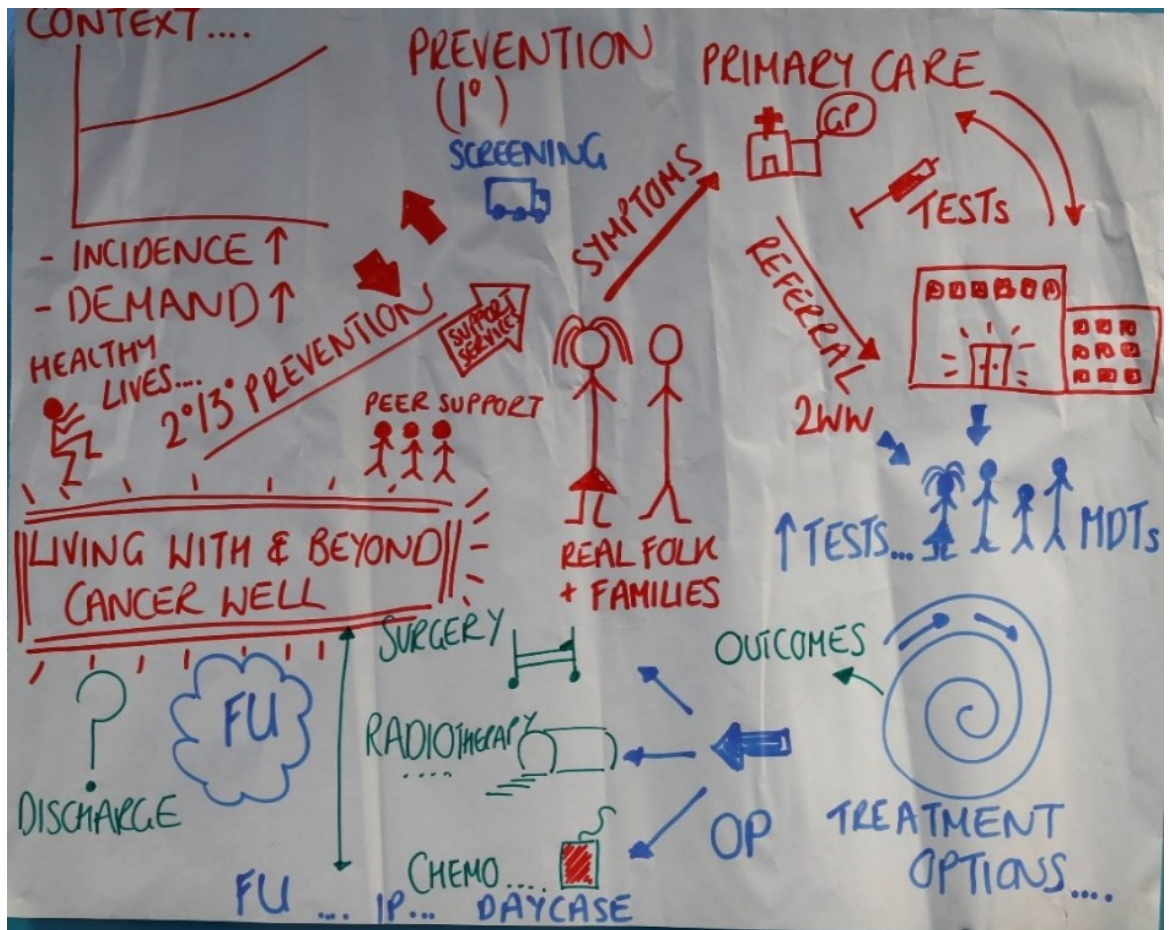

Figure 21 : Curent Rich Picture 1

Note

- Lack of prevention
- Increasing demand
- The length of waiting times
- The reliance of primary care and hospitals
- The maze of treatment options

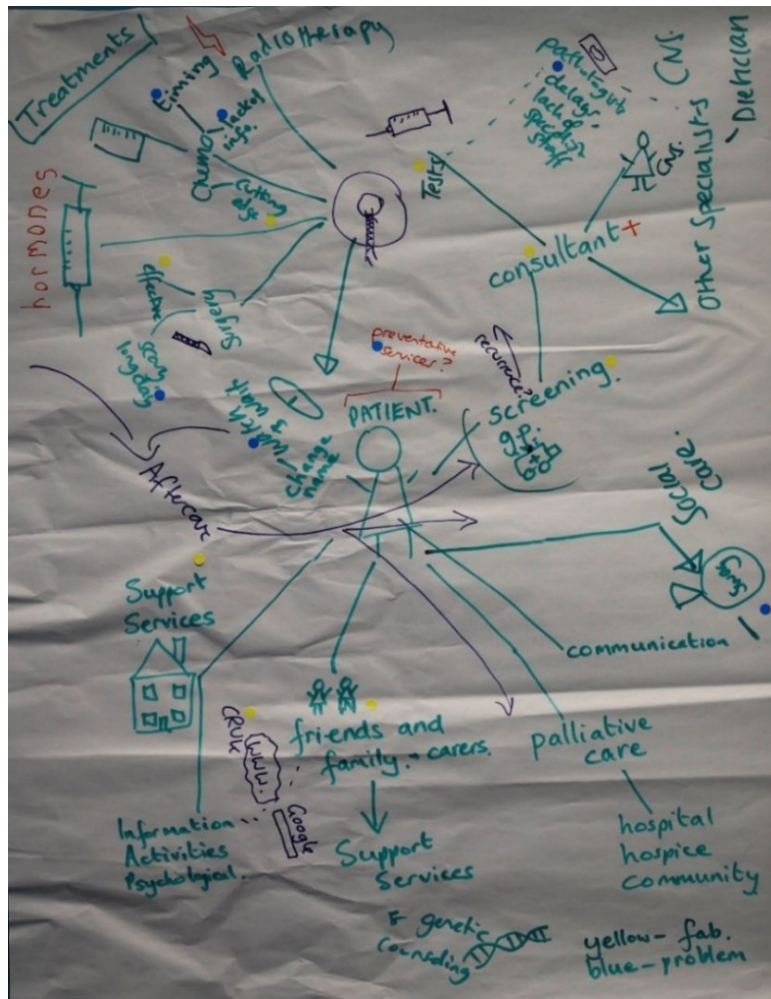

Figure 22: Current Rich Picture 2

Yellow dots – Fab – These Include

- Consultants
- Friends and family
- Support Services
- Surgery
- Screening
- Cancer research

Blue Dots – Problems – These include

- Money
- Timing /delays
- Lack of Specialist Staff
- Long working days for staff
- A lack of preventative services
- A lack of information

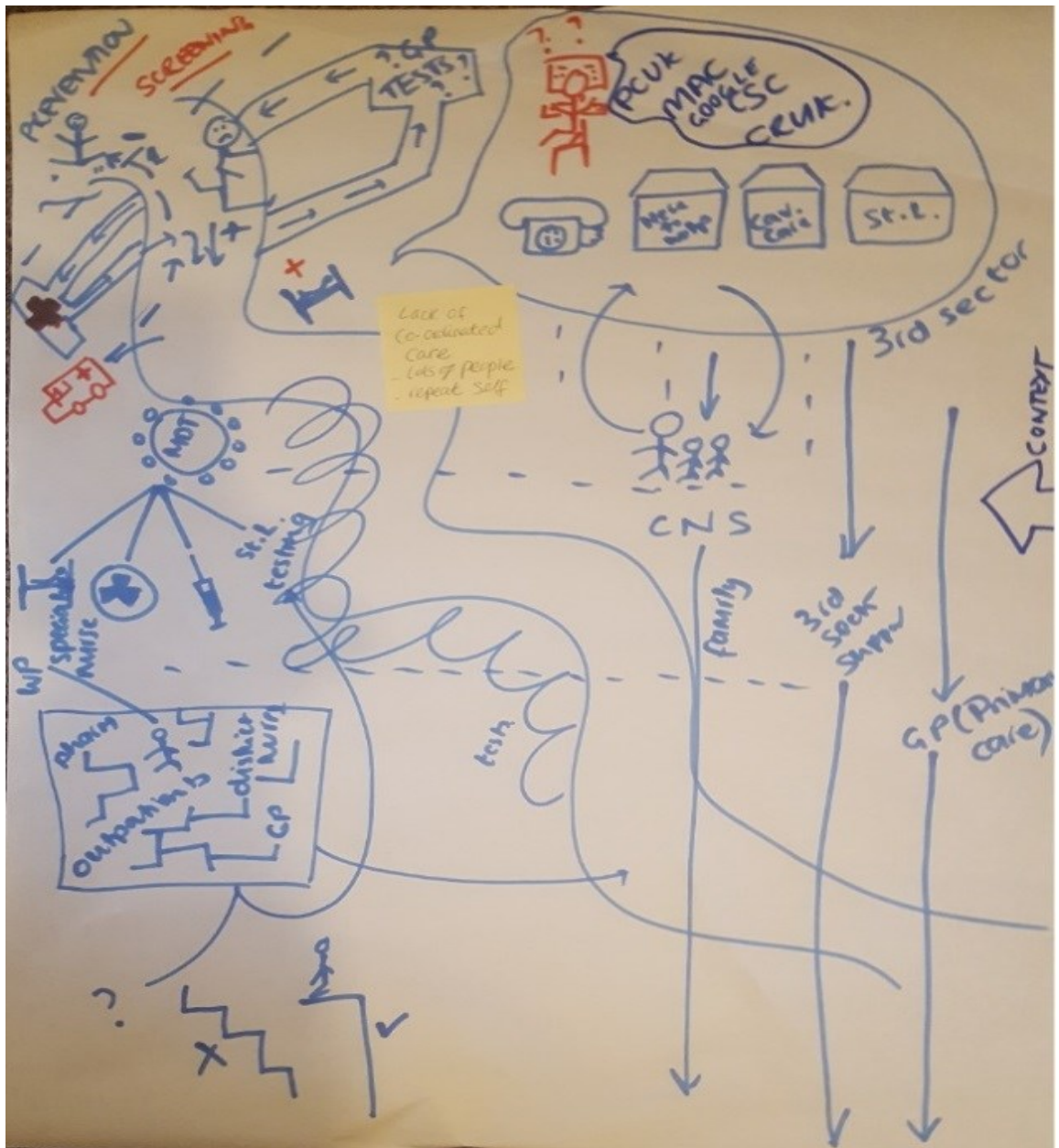

Figure 23 : Curent Rich Picture 3

- Another maze
- A lack of coordinated care and loads of people repeat self-indicated on the post- it note
- The different forms of information and the confused person trying to make sense of it all
- The winding pathway
- Reliance of hospital beds and GP services
- Lack of clarity

As can be seen in Table 12, whilst rich pictures highlighted many of the same problems and positive differences, each emphasised slightly different issues.

- The reference to friends and family in one of the rich pictures is in line with the inclusion of relatives in the asset list.
- Reference to genetics was included in both the asset list and one of the rich pictures.
- Reference to the voluntary sector links directly to the inclusion of voluntary sector organisations, specifically Macmillan, St Luke’s, The Cavendish Centre and Age UK. St Luke’s is the charity who implemented the E-Shift pilot⁷⁶.

Table 12 : Good and Problematic in Current System 2

Good	Number of rich pictures ideas were identified in	Problems	Number of rich pictures this was identified
Chemotherapy cutting edge	1	Patient not in the centre	1
GP screening	1	Patients needing to repeat themselves	1
Friends and family	1	Information not getting passed on	1
Support services	2	Too hospital focussed	1
Genetic coding	1	Lack of coordination	2
Macmillan project living with and beyond Cancer	1	The current system is like a maze	3
3rd sector	1	Discharge?	1
Tests	1	Demand increasing	
Cancer research	1	Incidence increasing	1
		Communication	1

⁷⁶ E-shift was discussed in story 1, 5.3.1.1

		Social care	1
		Watch and wait	1
		Long working hours, scary long day for surgeons	1
		Preventative services , 1%	3
		Delays	2
		Lack of specialist staff	1
		Lack of information	1
		Poor timing	1
		Money not spent where it should be	1

One of the rich pictures specifically makes reference to the Macmillan initiative, 'Living With and Beyond Cancer'. This was indicated as 'good' in the asset list. The asset list and rich pictures both indicate that participants perceived many aspects of the current system to be good. The asset list showed that some participants perceived Sheffield Teaching Hospitals, Consultants, and Clinical Nurse Specialists to be doing a good job; each of these were given 2 green dots by participants. Where rich pictures appear to give a different picture to the asset list is in relation to the idea of timely cancer pathways. These were given 4 green dots in the asset mapping exercise. Conversely, two out of three of the rich pictures indicate delays as being a problem.

6.3 Part 3: Main Interviews

This section builds on ideas introduced in part 1 but with a focus on ideas from main interviews. Connections were also made between emerging ideas and related literature. Reflections are included to help interpret and understand comments made.

Many comments made in interview and workshop transcripts echo comments made earlier about what is good in the system. In general, comments suggest that medical treatments are perceived to be good. Looking at the language used in comments in table 13 it appears that there might be some vested interests and personal relationships involved. For example comment 64 CS-K" *because X will love me for*

putting them down twice". This appears interesting because it indicates a positive relationship between a cancer survivor and a member of staff at the centre. It could help explain why they scored so high in the asset exercise. I am mindful of the fact that half of the participants at the session when that exercise was completed, were cancer survivors. It is possible that the comment and the score suggest that the centre is successful at developing positive relationships with cancer patients, as much as it reflects that the service is doing a good job in general. It may well be doing both, but it might be naïve to assume that this score necessarily indicates that the centre is performing an excellent service overall. As the comment was made by a cancer survivor it may be safe to assume that this says little about the actual efficiency of the service⁷⁷. This comment relates to theme 3 (relationships) outlined in 4.3.

In comment 66, the use of the word 'we' indicates that the manager see themselves as part of the system that is doing well, the comment could indicate that they are defending the good service of something they see themselves as part of, rather than a more objective view of what is good.

Table 13 : Good in Current System

What is good	Source	Comment
Screening	Workshop – comment made by cancer survivor	62 CS-B "I put a yellow dot by screening, because I think that's excellent"
Sheffield Teaching Hospitals	Workshop – healthcare manager	63 M-L "Sheffield's quite unique, the Sheffield Teaching Hospital, because, the incentive to work there is, it's a better option for doctors than being in, say, Chesterfield, so quite often you see the resource shift of, they may start their lives out in the district general hospitals, but they move towards Sheffield Teaching Hospital, because there's more options there."

⁷⁷ Because it would be unusual for a patient to have detailed information about the overall efficiency of the service.

The Cancer Information and Support Centre	Workshop – cancer survivor	64 CS-K “3 - Cancer Information and Support Centre, because will love me for putting them down twice”
Diagnostics and treatment	Workshop – healthcare manager	65 M-N “we’re generally pretty good at getting people through their kind of diagnostics, into their treatment, within a timeframe that’s reasonable”
Cancer treatment	Interview – manager	66 M-N “if you look at genuinely what we’ve got in this city, what’s good, we’ve got some of the best services, not only in the country, but in the world”
Cancer services	Workshop – healthcare manager	67 D “My consultants were brilliant”

6.3.1 Links to Themes, Hunches and Stories

There are many links between ideas expressed by participants about issues with the current system and the themes outlined in chapter 4 and stories and hunches outlined in chapter 5. I outline some of these in Table 14.

Table 14 : Issues in the Current System

Issue	Where issue is identified	Connects to
The current system is uncoordinated /disjointed	Fig 21 , Table 14	Theme 10
Cancer is not always regarded as a long term condition	Comment 68 and 69	Theme 9
Information not given to patients at the right time	Table 12 and suggestions following it , Tables 17	Theme 13
Lack of interoperability	4.2.1.2 , Comments 74, 75 and 152	Theme 13, Theme 10
Information overload	Comments 77, 78, 79	Theme 13
Poor communication	4.2.1.5 , Tables 13 and 14, Comments 80, 81	Theme 13, story 1 ,
The system is disjointed	Figure 21 and Figure 23 , Comments 22, 23	Theme 10
The system is difficult to navigate	Figure 21 and Figure 23	Theme 10
Time constraints	Comments 80, 81	Theme 9
Not Person-centred	4.2.1.3	Hunch 4 , Theme 10
Not enough focus on prevention	Comment 38	Hunch 1 , Hunch 2
Drug focussed	Table 4	Theme 9
Perverse incentives	Comment 20	Theme 9
Unnecessary expensive treatment	The system ch 1 , Comments 47, 85	Theme 9
Staff are expensive	Comment 48, 49	Hunch 4 ,
Hospitals are expensive and overused	Comments 47. 49	Theme 9 , Hunch 4
Social care cuts are increasing demand for hospitals	Table 17	Theme 9
Not enough coordinated data to know what is working	76	Theme 6
Expensive / inefficient	Comments 47,49 ,140	Theme 9

Cancer not always regarded as a long term condition

68 M-N *"50% of people who have a cancer diagnosis now will be with us for another ten years, so we need to start thinking about cancer as a long-term condition"*

69 H-Q *"we're increasingly seeing cancer as a long-term condition as people survive from cancer"*

Lack of interoperability⁷⁸

70 CS-E *"When they set up Patient Centre I never understood, we've got this brilliant computer system, but all the operation notes are done on a separate system, that doesn't talk to the first, none of those talk to each other"*

71 M-N *"what they (community nurses) can't see is anything that's been recorded about you in Lorenzo or InfoFlex about your cancer journey"*

The current system is uncoordinated

72 VS-K *"my experience with my family, there's a lot of sort of communication breakdown between NHS, different divisions, has caused so many problems"*

73 VS-K *"there's just no connectivity"*

74 H-L *"on PACS you can see your reports, and you can see the actual images of the scans, on ICE you can only see your reports, so it's nice to be able to see the scans, but it's a whole other system you have to log into to get that"*

75 H-Q *"there's a whole pile of different datasets, and therein lies the problem."*

Not enough Data

76 M-N *"so you say, 'oh, this project worked brilliantly, because we stopped them going into hospital'. Now, of course, ultimately [whispers: you can't genuinely prove, prove that they would have gone into hospital] [pause] there's a good chance they did, you can't prove that"*

Information Overload

⁷⁸ Interoperability is the ability of different devices, applications or information systems to connect in a coordinated manner across organisational boundaries (HIMSS 2018)

77 M-N *"often what I find is that, what I found with [community?] cancer is that I have way too much information"*

78 H-L *"you can almost guarantee that the fact that they're seeing an oncologist means that there is only so much information they can take in anyway, because it's overwhelming"*

79 CS-E *"there is so much information and all I was concerned with at that time was my treatment"*

Poor communication

80 M,VS-L *"Communication, and time, yeah, it's not about money"*

81 CS-B *"Communication and time are two big issues."*

Time constraints

82 CS-B *"Our GP has, like all GPs, a ten minute, and that's if you book it in advance."*

83 CS-B *"they don't do double appointments anymore, because they've got so many patients."*

Perverse incentives

84 M-N *"all of the hospitals, and they all work as individual businesses, with their own individual ledgers"*

Expensive treatment at end of life

85 H-L *"I had a couple of patients recently who I had treated in their eighties, and they've come in fighting fit, looking brilliant, like you wouldn't think they were eighty, you'd think they were sixty, or fifty, or whatever, but then they really feel their age, and that difference to their quality of life, from someone who was eighty but acting like a sixty-year-old, to someone who really is acting like an eighty-year-old, that really knocked them sideways, and that's really made me think about how, perhaps, they shouldn't maybe, maybe we should have thought about that slightly differently in the consultation"*

Social care cuts are increasing demand for hospitals

86 T-I *“with social care and budgets being reduced it’s meant that there’s less management of people out in the community, and some more people going out, and, you know, ending up in an acute setting.”*

6.3.2 The Current Maze

The idea that the current system is like a maze occurred in all three rich pictures created to represent the current system. This is echoed by comments from workshop transcripts. The word maze occurred 8 separate times in the transcript of the 3rd workshop. The notion that the UK healthcare system is like a maze is also included in research articles (Peel and Harding, 2014). The idea links back to theme 10 (disjointedness) introduced in chapter 4. It also relates to theme 9 (business model), as comments suggested that the current maze is very expensive. This implies that they believed that a different business model would be more efficient.

The idea of the healthcare system being like a maze echoes comments about the problem outlined in chapter 2. Here I reflect on ideas outlined in chapter 2 and theory discussed in chapter 3, to consider some possible factors that could help explain why the current system is how it is. This is done for two reasons. Firstly to develop conceptual models of the current system it is necessary to consider some of the dynamics within it. The second is to try to gain a slightly deeper understanding of the current system to help compare the conceptual model created to models of future systems.

- 87 M3 *“the maze that they’ve drawn is a very costly maze”*
- 88 M, VS-L *“how cost effective is the current system, well, it’s not cost effective, because it’s not joined-up”*
- 89 M, VS-L *“one hand doesn’t talk to the other”*
- 90 M-L *“it’s not cost effective”*
- 91 CS-J *“Bit hard to estimate any amount of this at all, because this can be many, many times round the loop”*

6.3.3 Lack of ambition

It struck me that some of the comments that appeared to about what was good in the current system, lacked ambition. For example:

92 M-N *“services are generally in line with best practice ... what we’re finding is that in Sheffield we’re not very far behind, in most cases”*

Comment 92 appeared to be given as a suggestion that things were generally OK. The lack of ambition implied implies a cultural acceptance of the status quo rather than enthusiasm for radical change. An earlier Comment, 65 appears to indicate a similar level of complacency; being pretty good at getting people through treatment in a reasonable timeframe is hardly ambitious. There were however exceptions, comment 66 paints a distinctly more positive picture, with claims that we have some of the best services in the world in Sheffield. Where complacency does appear to exist, it supports the argument I made earlier about the potential for institutionalisation⁷⁹. Comments such as in line with best practice used to indicate what participants believed was good appears to mirror the findings of Hopton (1997), he argued that nurses failed to innovate, despite their own self-belief being to the contrary. As such these comments appear to indicate the existence of routinization or habitus that some participants had been shaped by the culture of their work environment.

6.3.4 Costs in the system

It was frequently indicated that the main costs in the current system were; people, hospitals and drugs.

People

The cost of people was mentioned in comments 48, 93, 94 and 95

Comment 93 - H-L “People are the biggest cost”.

Comment 94 - M- H “But, if you costed that, it would be however much a consultant costs times however many people round the table, specialist nurses”.

Comment 95 – M-H “ A & E and admissions, high cost. [pause] MDT, you’ve got a lot of people physically sitting round a table at the same time, I mean, some people do, like, tap in by phone, but that could be more efficient.

⁷⁹ In 3.2.5, and 3.6.1

Comments 94 and 95 refer specifically to the cost of meetings. MDTs were identified as a particularly expensive type of meeting as they involve bringing together expensive people to discuss and review medical cases. One of the successes of the system discussed in story 2, was the potential for the E-Shift technology to reduce the reliance on MDT meetings.

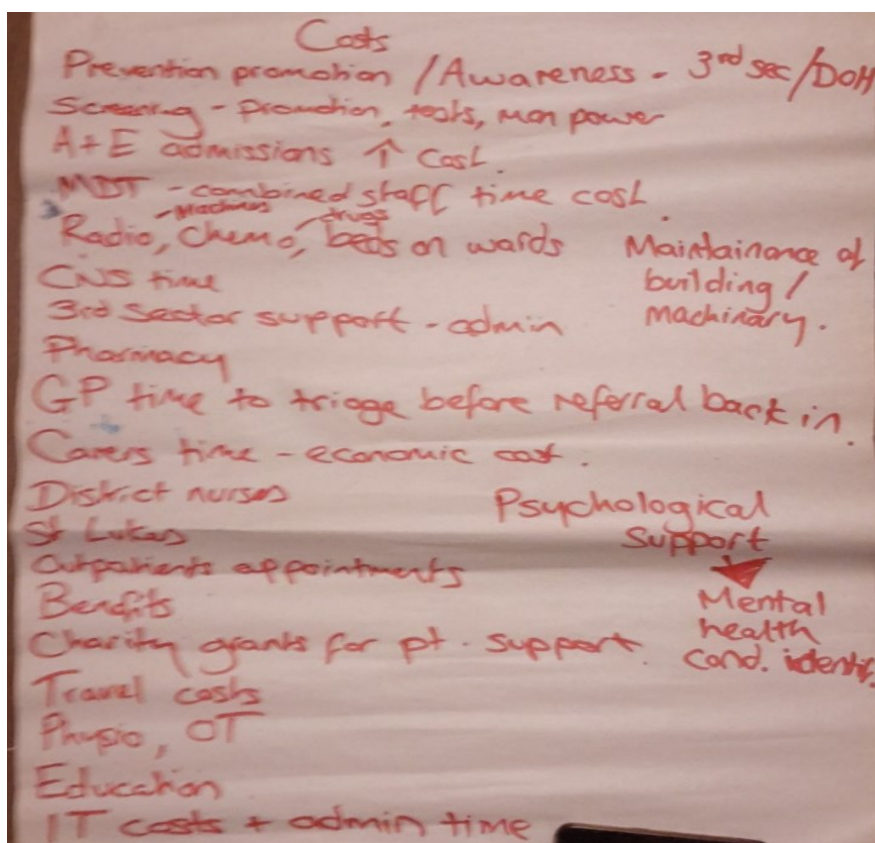

Figure 24 : Costs in the Current System

The disjointedness discussed in 6.3.2 adds to the cost of people. Going around the loop several times as suggested in comment 91, is likely to take up a lot of people time. The cost of people time is also identified in figure 26. Figure 24 is a list of costs in the current system created by participants during workshop 3.

Hospitals

The cost of hospitals was the focus of hunch 4. In 5.2.4 I outlined comments about the cost of hospital provision along with ideas about how a future system less reliant on

hospitals might be more efficient. Comment 96 supports the assertion that hospitals are expensive. The cost of hospitals is indicated in Table 15 and figure 26.

96 H-P "the NHS is either salaries, or running expensive buildings."

Drugs

Although the costs of drugs was discussed less than the cost of people or hospitals it did occur frequently. Drugs featured on all of the rich pictures of the current system. Comments about the cost of drugs in the current system are illustrated by comments 97 and 98:

97 P-H – P "we use some hideously expensive drugs"

98 LA-G "we spent £300million on the cancer drugs fund"

Table 15 Where Ideas about Costs in the Current System are Discussed

Cost	Identified in workshop	Identified in interview transcript	Comments
Testing	x	x	More tests would increase costs in the short term, but may reduce costs longer term if they result in earlier diagnosis and treatment
Public health	x	x	Public health interventions could reduce costs in that they change peoples lifestyles
MDT	x	x	This is expensive because it involves bringing lots of expensive people together
Financial cost to this person going through it	x		The use of technology such as apps and fitness monitoring devices increase the costs to individuals
A and E	x		Participants thought this was a high cost

6.4 Part 4: Reports and Initiatives

Local initiatives were frequently mentioned and generally talked about positively as part of what is good in the current system. 'The Sustainability and Transformation Project' (STP) and 'Living with and Beyond Cancer' were both highlighted in workshop 1 as good. The STP was also discussed in workshop 2 and 4 interviews. In workshop 2 it was suggested as a positive example of working together. One of the managers I interviewed praised the collaborative nature of the STP, and stated categorically that she was an STP supporter.

The Macmillan initiative 'Living With and Beyond Cancer' was praised in three interviews and in workshop 1. Vanguards were highlighted as positive examples in two interviews and the national initiative 'Realising the Value', was also praised in two interviews. Below I give an overview of some local and national initiatives.

6.4.1 Local

Sustainability and Transformation Plan, South Yorkshire and Bassetlaw (STP). I refer to the STP in tables 10 and 16 Lifestyle factors including diet can increase the risk of cancer. The report claims that:

- A healthier happier population relies less on the NHS.
- Early detection and intervention is crucial for helping people to live better for longer. Prediction software can help enable earlier detection
- Social prescribing can reduce demand for services including A&E
- More holistic coordinated care can reduce A&E attendances by 3%. Technology can help create more joined-up care
- Technology and digital integration will help shape the future of health and care services

(Sheffield Teaching Hospitals, NHS Trust 2017)

Sheffield City Council Technology 2020 – Sheffield City Council are interested in buying off the shelf not bespoke solutions.

6.4.2 National / International

International Cancer Benchmarking Report - Concluded that cultural differences have an impact on cancer survival rates (Forbes et al., 2013).

National Cancer Vanguard – Earlier diagnosis, prevention and joined-up working can improve efficiency (NHS 2016).

Realising the Value – Advocates person and community centred approaches for long term condition management. Putting people and communities at the centre of the healthcare system requires systematic change in the way people access, interact with and experience health and social care. Asset approaches, coproduction and social prescribing were suggested as components of a better future system. The report claims that nationally £550 million could be saved by moving to a more person-centred system.

6.4.3 Reflections on initiatives

Due to the positive comments from workshop participants, at first glance we might assume that all initiatives are examples of what is good in the current system. Many aspects of the initiatives outlined above are certainly in line with wider discussion about what would improve efficiency in a positive way. Integration, earlier detection, taking a person-centred approach and asset approaches are in line with previous comments I have outlined. The Sheffield City Council technology 2020 initiative however, takes a position that is contradictory to the ideas outlined in 5.3. In story 1 it was clear, that from the perspective of two healthcare professionals at least, flexible bespoke initiatives were more successful than off the shelf ones. Overall however many initiatives were regarded as positive, and initiatives feature highly in Figure 25. Comment 99 refers to the STP. It indicates that in the view of this healthcare professional it is positive because it includes joined-up working.

99 H-B-A “Sheffield Children’s, Sheffield Teaching Hospitals, Leeds Teaching Hospital Trust, and Newcastle-upon-Tyne Hospital, and to have those four trusts working together in a collaborative, and in a, a risk-sharing agreement, is really very unusual, this has not happened before, and in actual fact for a long time, the, I would say, the trusts were, in various combinations, at odds with each other, this builds on other structures that are being put in place, or have come into being, such as the STPs, the Sustainability and Transformation Programmes”

This comment is consistent with the claims of the report and the positive comments from a healthcare manager M-N, as well as stating that she was a fan of the STP, also spoke positively about the collaborative nature of the STP:

100 M-N "in South Yorkshire and Bassetlaw we've been, well, wider part of this, we've been doing it for way beyond the STP, we've know that working together is the only way"

6.5 Part 5: Modelling the Current System

To create a conceptual model of the current system I now bring together ideas about the current system that I introduced in chapters 1,4 and 5 as well as those outlined previously in this chapter. I split these ideas into what is good and what is problematic. The ideas that were perceived as good, as well as being part of the current system are also ideas that might be retained or built on in a future system. Aspects of the system identified as problems might need to be dropped or fixed. Table 16 summarises the main points indicated as good and Table 17 those that were considered problematic. Figure 25 and Figure 26 give a visual representation of these ideas.

6.5.1 What is good

As has been outlined over the last few chapters, there was a lot that was identified as good in the current system. The main aspect of the system perceived of as good was medical procedures; including staff and specific initiatives. As identified in 6.3.4 however, staff and medical procedures are also expensive.

Table 16: What is Good

What is good	Reference	Note
Medical staff including consultants and clinical nurse specialists	Table 14	Also expensive
E-Shift	Story 2	The technology used in the Encompass project
Innovation schemes e.g. Living with and Beyond cancer, Perfect Patient Pathway	Tables 11 and 11, Fig 22	The evaluation of these schemes is not conclusive
Cancer pathways	Table 10, Hunch 3, comment 24	Contradicted by statements indicating that the system is not joined-up
STP	Table 10 , Comments 99 and 100	Many of the report claims are in line with comments from interviewees and workshop participants
Friends and Family	Figure 21, 22 and 33 Tables 12, 19 and 21	Relates to ongoing discussion about social capital
Genetics	Table 10	As will be discussed in chapter 8, there are also risks
Patient support e.g. Cancer Information and Support Centre	Tables 10, 11, 12 and 13	Patient support can be either top down or bottom up

In Figure 25 I illustrate how the components listed in Table 16 fit together. Encompass for example is the project discussed favourably in story 2. It is also a local project. Another local scheme is the Perfect Patient Pathway, which is part of a wider national initiative. Overall the main components of the current system that were highlighted as positive were; biomedical services (including testing), local initiatives and community support. Community support is not always fully connected to the rest of the system.

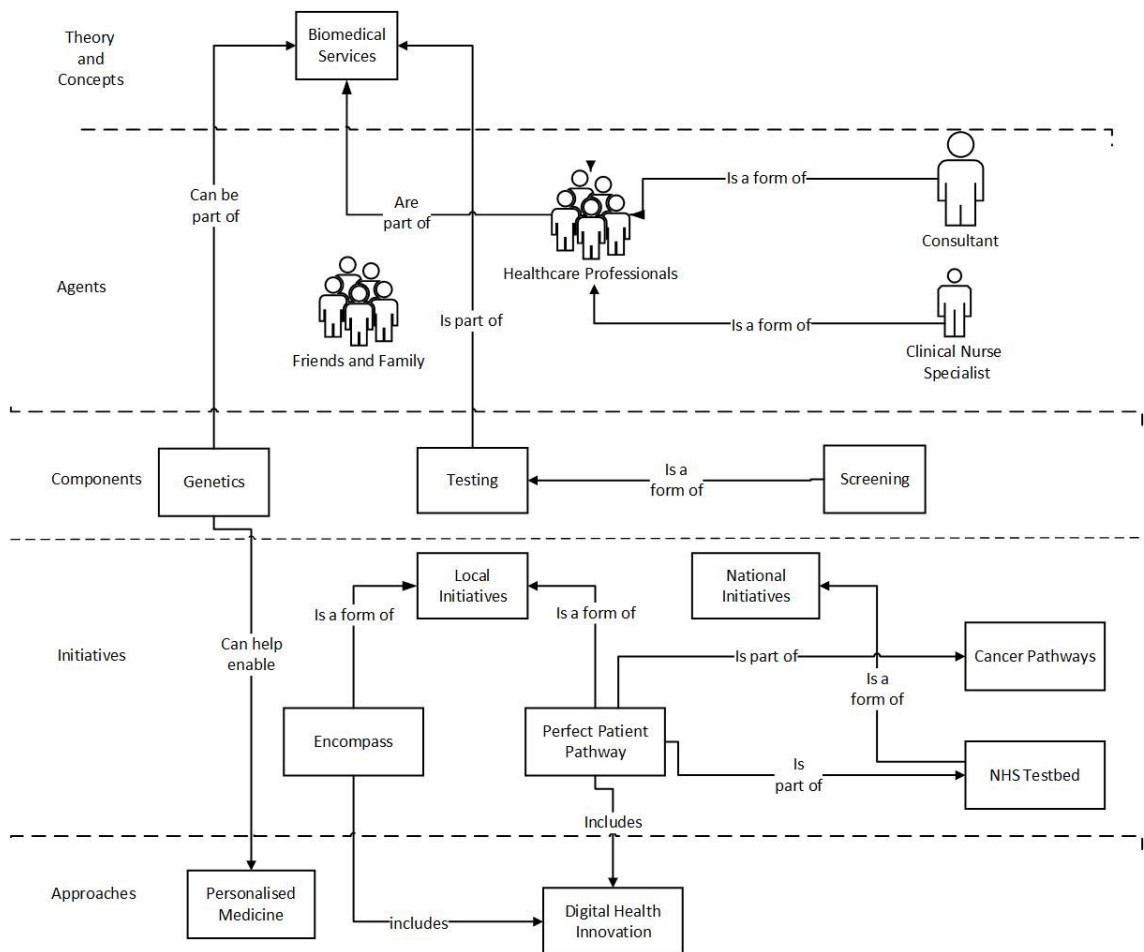

Figure 25 Good parts of the Current System

6.5.2 What is Not Good / Problems

As outlined in Table 17, whilst there is much that is good in the current system there are also many issues. These are illustrated in Figure 26. Whereas Story 2 was incorporated into Figure 25, aspects of Stories 21 and hunch 4 are represented in Figure 26. For example, Story 1 was an example of a poor information system, as the technology appeared flawed and it was not applied to improve the efficiency and effectiveness of the staff using it. Hunch 4 highlighted some issues with an overly hospital focussed system. Figure 26 illustrates how an over-reliance on hospital treatment can lead to inefficiency. The disjointedness that has been discussed frequently is also illustrated in Figure 26.

Table 17: Parts of the Current System that are Not Good

What is not good	Reference	Note
Poor communication Systems	Table 14 Comments 80 and 81	Poor communication contributes towards the disconnections in the system
Interoperability	Comments 75,76 and 152	Information technology between different parts of the system not always compatible
Inequality	Comment 34	Relates to cultural capital, gains from smart technology are not evenly distributed
Not joined-up	Comments 22, 23 and 73	Disjointedness make collecting and analysing data problematic
Staff shortages	Comment 33	Staff shortages impacts on the quality of current service provision
Silos	Comments 20, 29, 55	Different components of treatment are not integrated, treatment planning is not considered holistically
Poor information systems e.g. Lorenzo	Story 1, Table 11, Table 12 and Table 14 Comments 71	Issues include how technology is applied as well as the technology itself
Insufficient capacity / Services are stretched	Comment 83	People use the wrong part of the system because they can't get seen by the most appropriate healthcare professionals Waiting times too long Social care cuts increasing demand for hospitals

Not enough prevention	Figure 21 Figure 23 Comment 58	The lack of preventative interventions results in more expensive treatment further downstream
Over reliant on hospitals	Hunch 4	Relates to criticisms of the biomedical system
Too focussed on the biomedical model	Table 8 and 16 Hunches 1 and 2 Hunch 4	As above
Delivered by expensive people e.g. MDT's	Hunch 4	Story 2 illustrates how staff can be applied more efficiently
Not enough information	Table 16, Comment 22	A lack of information prevents informed decision making
Too much information	Table 14 Comments 78, 79	People need the right information at the right time to make good decisions. Too much information at the wrong time can be counter productive
Not patient focussed	Table 14	Patient expertise in an under utilised resource
Timing	Table 12, Figure 22	Expensive treatment end of life, would have been less costly to intervene earlier
Maze	Comment 87, Table 14 Figure 21 and Figure 23	The system is difficult to navigate

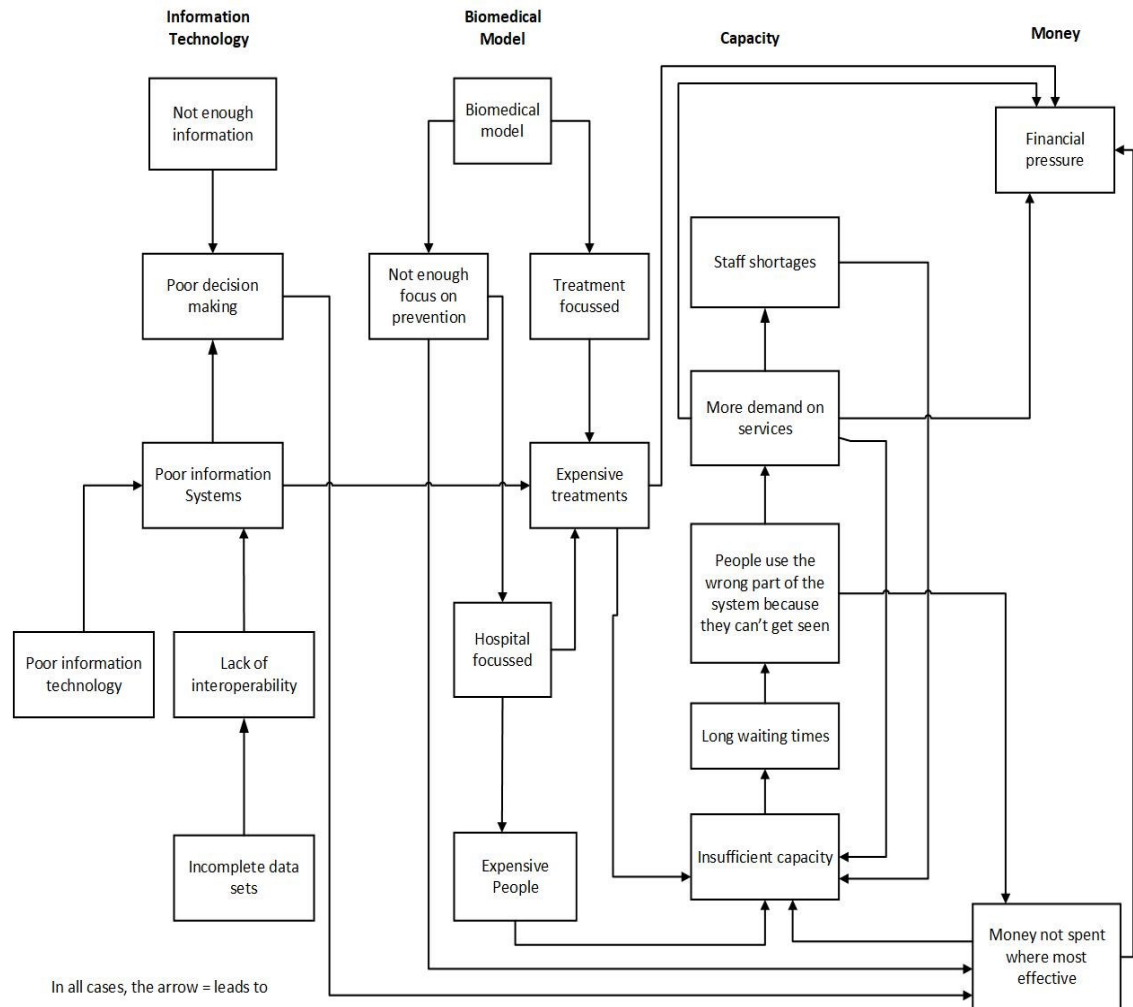

Figure 26 Inefficiencies in the Current System

6.5.3 Conclusion

Whilst interviewees and workshop participants identified a lot that they perceived to be good in the current system, they also identified issues. Most regarded the current system to be good at the physical side of treating people with cancer. Some aspects of wider care such as the Cancer Support Centre were also identified. Many people suggested that the current system was disjointed and difficult to navigate. Data collection and analysis in the current system was also criticised; one manager stated that there was not enough data to know what is working. In terms of efficiency, several people suggested that the problem is about more than just money, and that people are the biggest cost. One even suggested that cancer is overfunded. Participants also suggested that greater focus on prevention would improve efficiency.

The issues that were identified related back to the themes outlined in chapter 4 and stories outlined in chapter 5.

Chapter 7 Utopia

Over the next two chapters the focus shifts from looking at the current system towards what a future system might look like. Within the process of making sense of data I considered the extent to which responses may have been influenced by wider cultural narratives. This chapter brings together ideas from literature with primary data collected for this study. It starts with a brief overview of literature about efficiency and utopia to give context to discussion later in this chapter. I argue that like much research into the potential of technology, many of the responses given by participants were quite utopian. As I move through this chapter I gradually introduce more ideas, so that by the end of the chapter the focus has flipped into primarily discussing ideas from primary research.

7.1 Visions of Utopia

The concepts of smart city and smart community are embedded within the idea of utopia. As outlined and discussed in this chapter much related literature is connected to visions of what a better future might look like. There are however many different utopian visions of smart societies. This is hardly surprising as the term utopia has been inspired by the idea of perfect society (Hodgson, 1999).

Many utopias have been socialist or communist in character including collectivist ideals (Hodgson, 1999). Free market ideals have also however been described as utopian (Hodgson, 1999; Muntaner and Lynch, 2002 ; Vanolo, 2016). The concept of utopia is often traced back to work by Thomas Moore in the 16th Century (Vanolo 2016).

The word utopia fosters a likelihood of change; a utopian vision may be seen as a necessary condition of historical change (Hodgson 1999). If this is true, then to get to a more efficient healthcare system we might first create a utopian vision for what that might look like, hence utopia was a core theme in this study. The idea of imagining utopian visions is entirely appropriate as the concepts of smart city and smart community, to some extent at least, have roots in urban design. Debates in urban design on issues including urban citizenship and urban life are frequently linked to urban utopias (MacLeod and Ward, 2002; Sackett, 2017). The concept of utopia is deeply embedded in spatial imageries, often on islands and sometimes in cities (Mumford, 1965; Pinder, 2005; Vanolo, 2016).

Early on in workshop 2, in the icebreaker exercise described in 3.4.2.4 and 4.2.2, one of the participants made a comment that was very much in the spirit of utopia outlined above:

101 T-N “we have the intelligence inside, let’s use it, really, and take that with us, if we were going to the beach, assume the beach is a new landscape, we could build our own utopian fantasy on.”

7.1.1 A Smart Community Utopia

The language used within much of the literature related to the concept of smart community conjures up utopian imagery. Some argue that whenever there are new technologies, people project all sorts of fantasies and dreams onto them (Kellner, 2006). In the first part of this chapter I explore ideas that might help conceptualise what a more efficient healthcare system might look like.

At the core of most of the utopian visions of better healthcare is the idea that better data and better data analysis is the key to improving healthcare (Mesko, 2013). This is powerfully communicated by Mesko (2013, part1)⁸⁰ when he states that:

“I think I might tell my children in 10 years that the early 2010s was a barbaric era because neither physicians nor patients had access to the data they truly needed”.

Batty et al (2012) appear convinced of technological benefits when they argue that there is something specific and unique about this current point in technological development. They claim that this makes new ways of working possible. They propose the idea that the convergence of information and communication technologies is quite different to anything we have experienced before. According to some commentators, the smart city is the urban utopia of the 21st century (Townsend 2013;Datta, 2015;Vanolo, 2016). Others claim that the opportunities smart communities can offer, if correctly combined with the digital ecosystem view, are unimaginable (Caputo et al., 2016).

⁸⁰ I’ve included part 1 instead of page number, as Mesko (2013) is an ebook with no page numbers

7.1.1.1 Social Computing

In 2.3.3 I indicated how social computing is related to smart community. There are many different ways that social computing might be able to improve efficiency. These include nudging patients towards making lifestyle changes to enable more accurate and informed decision making. By nudging I mean interventions or architecture (including digital architecture) that seek to alter people's behaviour in a predictable way (Thaler & Sunstein 2008). The last of these connects to the ideas of collaborative and collective intelligence introduced in chapter 2. These concepts relate to smart community and social computing, as the information technology applied to interactions between people may take on agency. As outlined in 3.6.3 objects as conceptualised within Actor Network Theory can be thought of as containing agency (Cresswell, Worth, and Sheikh, 2010). With web 3.0 and web 4.0 I argue that this is becoming increasingly so. At the 3.0, semantic web level technologies add value by structuring data. This connects to the idea of collaborative intelligence as the potential for knowledge creation is increased by enabling more analysis of information from multiple sites (Gruber, 2008).

Wang, Carley, Zeng, and Mao (2007) argue that social computing takes power away from institutions and gives it to communities. They claim that through social computing, communities are increasingly driving innovation from the bottom up. Whilst they don't directly state who these communities are likely to include, they do relate them to public health. Many academics link social computing to healthcare (Sheth, Anantharam and Henson, 2013; Gamache-O'Leary and Grant, 2017; Thota, Sundarasekar, Manogaran, Varatharajan, and Priyan, 2018). Some apply a similar logic to that applied by Wang and Zeng, arguing that the connection and access to information that social computing brings is helping to create a more equal relationship between patients and healthcare professionals (Bos, Marsh, Carroll, Gupta, and Rees, 2008; Gamache-O'Leary and Grant, 2017). Others argue that social computing will have a significant impact on healthcare, some even going as far as to suggest that it will impact on all areas of medical practice (Hughes, Joshi, and Wareham, 2008). Common themes in Health 2.0 literature include; participation, collaboration, openness and change (Belt et al, 2010; Eysenbach, 2008).

The connection of the theory outlined in chapter 3 unlocks some exciting possibilities when applied to social computing. AST for example, suggests that technology such as social media is starting to be used in new and exciting ways (DeSanctis and Poole, 1994). As I discuss below, the significant developments in information technology since DeSanctis and Poole were writing, make this far more so today than was possible in 1994.

7.1.1.2 Nudging

As discussed previously⁸¹ the idea that health forums might have a positive impact was indicated in interviews and workshops. In the health context, forums where cancer survivors support each other through online discussion is an example of healthcare social computing⁸². In its current form, human computer interaction includes search engines and social media platforms making suggestions based on patterns of past behaviour.⁸³ In the future, if social computing was linked to monitoring devices, we can imagine computing devices such as mobile phones nudging behaviour by suggesting exercise if recorded activity falls below a certain level. An example of nudging behaviour that already exists, is Westfield Health's [3 rings](#) monitoring devices, connected to a kettle or other kitchen appliance that sends alerts to friends and relatives if usual behaviour patterns are not followed (Westfield Health, 2017). The idea of technology nudging behaviour change is discussed further, in the Prevention / Psychographics section of this chapter.

7.1.1.3 Collective Intelligence

In chapter 2 I outlined the link between social computing and collective intelligence. As people and computers begin to work synergistically with information technology systems, the form of collaboration could result in a form of collective intelligence. This is the idea that through interaction the whole can produce something that is greater than the sum of its parts. The intelligence produced when cooperating exceeds the intelligence of each of the agents (Maher, Paulini, and Murty, 2012). As the sum of the

⁸¹ 2.3.3, 4.2.1.5 and Hunch 1

⁸² An idea discussed in 2.3.3, 4.2.1.5 and 5.1.2

⁸³ An idea related to the notion of symbiotic computing in 2.3.3

parts may include multiple users connected to monitoring devices and AI, the impact of this may be transformative.

In terms of what a future system might look like, the term collective intelligence occurred in two interviews. One was with a researcher, the other with a technology company. The IT professional connected the collective intelligence idea to internet forums and the value of gaining direct ongoing feedback from patients. The researcher made a similar point connecting collective intelligence to online communities where people share insights. A specific forum, Health Unlocked, was given as an example. The Westfield Health 3 rings example was referred to in the 3rd workshop.

The way people use the internet is moving beyond being simply a knowledge source towards becoming a human computer system. The reasoning techniques of the semantic web combined with the social web could unlock collective intelligence through a form of collective knowledge system (Gruber, 2008). The idea of a collective knowledge system links to ideas of web 3.0 and web 4.0 (forms of social computing). In web 3.0 and web 4.0 computers as well as users become active. This resonates with the assertion I made in 3.6.3 and 2.5.1; that the agency of computing devices including the internet is increasing through advances in information technology as such discussion here builds on discussion in 2.5.2, where I introduced the idea of human city interaction. We are at the early stages of this form of human computer interaction, the potential is yet to be discovered.

Social computing and cyber physical systems converge in a form of collective intelligence where devices have agency. This form of collective intelligence could include AI and internet connected monitoring devices. Within it I am suggesting that smart community could include the mass collaboration of many different people and many different computing devices⁸⁴. In the health context, people could include patients, health professionals, family members and managers. Devices could include fitness monitoring gear (such as Fitbit) and AI such as IBM Watson. Specific technologies are discussed in more detail in 7.6.

⁸⁴ This is the concept of human city interaction referred to in 2.5.2

7.1.1.4 Cyber Physical Systems

Following on from the introduction to the cyber physical systems concept given in 2.3.4, here I consider to what extent the concept gives a utopian vision of the future. Through the application of cyber physical systems and social computing, the concept of smart community offers the potential for a healthcare system that could be very different from the current one. It might for example include different organisational and societal structures, enabled or created by the emergence of a form of human computer interaction based on smart community ideas.

Cyber physical systems literature offers idealistic visions of what different structures might look like, for example; they could be ecosystems with harmoniously evolving societies, economies, culture, science and technologies (Shi and Zhuge, 2011). Within a utopian idea of a smart community health system, the potential for efficiency improvements are many (Broy, Cengarle, and Geisberger, 2012). Broy et al are optimistic about the potential impact of cyber physical systems stating that it could be as revolutionary as the internet⁸⁵. They link the cyber physical systems concept to the healthcare system claiming that embedding computing systems into medical devices would provide additional intelligence. They describe how a smart health system could recommend a medical appointment on detecting a change in someone's weight. Lee (2008) shares Broy et al's optimism arguing that this has the potential to dwarf the 20th century IT revolution. They also make reference to medical devices and systems.

Shi (2010) argues that cyber physical ecosystems will accelerate the development of sciences, technologies, economy and culture. This is directly relevant to the concept of the smart community as it concerns the relationship between the individuals and communities in the cyber physical system and the cyber physical environment itself. Amongst the utopian claims about the cyber physical society is the idea that it will influence society more than the web (Shi and Zhuge, 2011). This mirrors the idea within smart community literature that suggests that it is about significant rather than incremental change.

⁸⁵ Stating it is as revolutionary as the internet resonates with the idea of industry 4.0 introduced in 2.5.1

7.1.1.5 Cyber Physical Ecosystem

In workshop 2, discussion about the cyber physical ecosystem included discussion about the brother of one of the participants who had used Facebook to engage a social network of friends, to provide support when they had been ill with cancer. Another participant connected the discussion about engaging friends to a book by a journalist, who had applied a similar technique⁸⁶. These ideas resonate with ideas in social computing literature earlier in this chapter, where I suggest that web 2.0 can include cancer survivors supporting each other. In the above example participants were describing people helping out a friend with cancer coordinated by social media. This is an illustration of an idea of asset based community support outlined in 0. Here the social capital of the participant's brother was harnessed and perhaps even developed through social media.⁸⁷ Although the connection between Bourdieu's theories and the digital realm is still an emerging area, several sources make a direct link in support of the assertion that social media can be used to create social capital (Ignatow and Robinson, 2017).

Some of the more extreme ideas from literature, such as cyber physical society, were less directly represented in the comments from workshop participants. The rich pictures of a utopian future created in workshop 2, see Figure 27, do however appear to express some fragments of these ideas. As illustrated by Figure 27, this rich picture contains some ideas about what a different system could look like. For example it includes fully integrated health and social care and collaborative leadership for decision making. Comments such as *"trusted authentic smart data"* and *"tailored health services"* connect these to the smart community concept as they are part of the same future system vision. When all these ideas are put together they do appear to have some echoes of the cyber physical society outlined earlier, even if it is not quite as ambitious as the idea of a harmoniously evolving society described by (Shi and Zhuge, 2011).

⁸⁶ According to T-D it was called Private Parts

⁸⁷ As discussed in 0 there is a link between this form of online community development and the concept of smart community

7.2 Workshops and Interviews

7.2.1 Utopia Workshop

One third of workshop 2 was devoted to exploring the idea of utopia in future healthcare scenarios. I specifically asked participants to consider utopian ideas. Much of the content in the Utopia section of workshop 2, related to the literature outlined earlier in this chapter. The literature discussed in this chapter has broadly been about faith in the potential of technology, the ecology of the system, lifestyle changes, real-time monitoring and person-centred approaches. To conclude this chapter, I outline some of the ideas from workshops related to these areas and discuss some of the similarities and differences between the ideas outlined in literature.

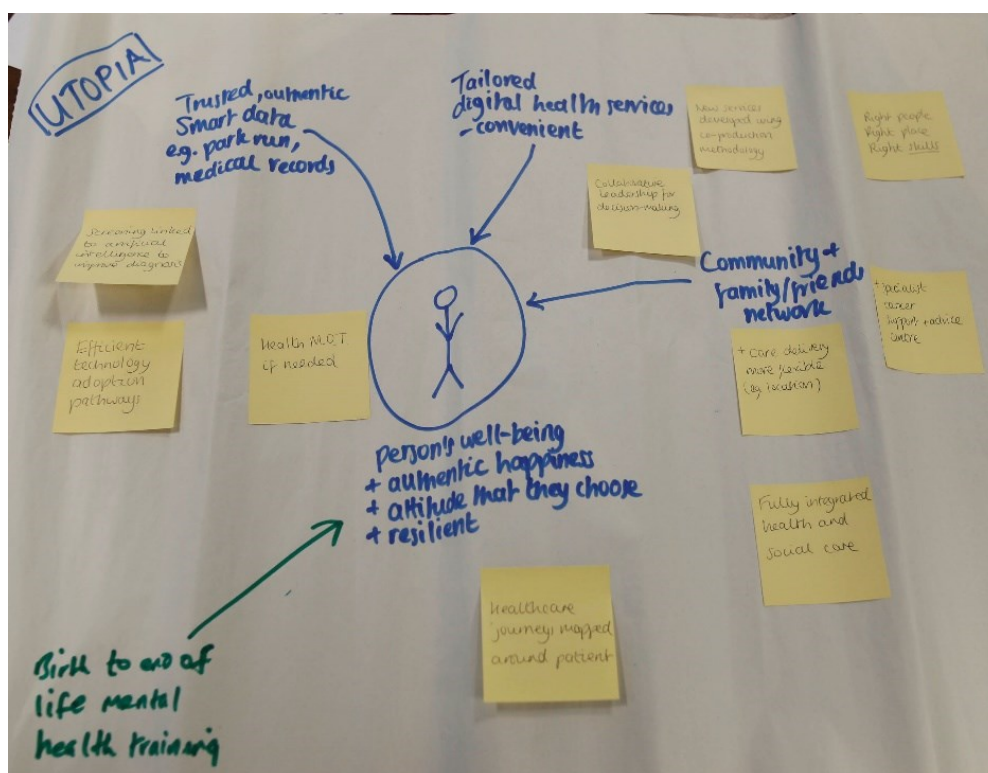

Figure 27: Utopia

As can be seen in Figure 27 themes in this workshop included:

- personalised healthcare
- prevention linked to smart data
- mental health
- service integration
- community support (friends and family)

Some of these ideas are counters to issues in the current healthcare system identified previously. I discussed prevention in 5.2.2, lack of mental health provision is part of the biopsychosocial health dialogue⁸⁸. The idea of service integration is in direct opposition to the suggestion that the current system is disjointed⁸⁹.

7.2.1.1 Monitoring

The idea of monitoring was discussed in all the workshops and seven interviews. It was mentioned by healthcare professionals, cancer survivors, private technology companies and researchers. One cancer survivor spoke of his experience of using a fitness tracking device, noticing himself getting ill as his performance levels dropped. Another spoke about the connection between monitoring technology and the aviation industry⁹⁰. In workshop 3 connections were made between monitoring devices, AI and patients feeding in data. The idea of a patient portal was discussed. As discussed in 4.2.1.3 and in comment 18, one of the healthcare professionals spoke extensively about the benefits of a portal they had designed.

The IOT in the form of monitoring devices attached to people, adds another dimension to the idea of collaborative intelligence. Fitness tracking devices are increasingly integrated into mobile operating systems such as Apple's Health Kit or Samsung's 'S Health Environment'. These typically have tracking on by default, enabling data flow about individual bodies to become another part of the connected system (Williamson 2015; Rich and Miah 2017). Monitoring devices have the potential to give computational devices additional information to inform their suggestions. Web 4.0, as outlined in chapter 2, may be conceived as part of a collective intelligence system. In this form it may be conceived of as a form of intelligent web, moving towards being a form of AI (Aghaei et al., 2012). In this context, monitoring devices can be conceived of as part of a system that may use the data collected to nudge some of the people in the system towards different behaviour.

⁸⁸ The biopsychosocial health model previously discussed in 1.5.4 and 5.2.2 and shortly discussed in detail in 7.4

⁸⁹ As discussed in 6.3.2

⁹⁰ Hunch 3 , 5.2.3

7.2.1.2 Person-centred

As indicated in chapter 6, the idea of patient centeredness was at the centre of all of the rich pictures of a future healthcare system created in workshops, with the exception of those that were intended to represent dystopia. The idea also frequently occurred in interviews. The term the patient centred occurred directly in three interviews and person-centred in four. Some discussion of a patient centred future was given in story three in chapter 6. To illustrate the prominence of discourse about person centeredness and its relationship to utopia, I enclose a quote from one of the managers who attended workshop 2:

102 M-E "If you were redesigning the healthcare system from scratch, you would probably start with the wellbeing of the patient, and work out from there, and what community, what, but it's very difficult to think in that way, because that's, it's totally utopian."

The same manager goes on to describe what he imagines a future system of cancer services to look like:

103 M-E "the technology should enable you to say, 'I'm working this week, sorry, I can't do my appointment then, but I want you to build it round my work lunchtime', and they say, 'no, we can't do that, because doctor so-and-so says you've got to come in then', well, actually, no, I'm working, and so that's when you do it, and that's a long way off, isn't it? But that's probably what we need to do."

As illustrated by comment 103, M-E's suggestion was to design healthcare around the patient rather than expecting patients to fit in with providers. This is one of the most radical ideas I heard in interviews and workshops. Even if they rarely go as far as comment 103, ideas in literature frequently link the idea of patient centeredness to improving the healthcare system. Mesko (2014) makes a connection between discourse on the potential of emerging information technology and the concept of coproduction introduced in 2.3.2. He states that we need to engage with communities and citizens in new ways, involving them directly in decisions about the future of health and care services. At the centre of the future he describes, is the notion of the

e-patient⁹¹. These digitally aware patients, he argues, will soon be able to measure any health parameter about themselves at home and as a result they will disrupt healthcare.

The concept of the e-patient is however only relevant to the concept of smart community when they are digitally connected to others in the healthcare system, such as healthcare professionals or other patients. Mesko (2014) refers to the idea of patients launching movements that promote lifestyle and information management. This connected conceptualisation of the e-patient connects to structural arguments about healthcare as it focuses on societal factors that influence change, even though in his idea patients are engaged in influencing structure.

Another link with the concept of smart community is the idea of disruption and significant change (Mesko 2014). There is also a link between the notion of the e-patient with concepts of urban governance that will be discussed in 8.4 and 9.2.2.

7.3 A Top Down, Modernist Vision

Utopian visions often contain a faith in cybernetics and the potential of complex models to precisely inform solutions to urban problems. Cybernetics in this context is, a systemic science of effective organisations that includes identifying principles of control that apply in complex systems (Beer 1985; Romm 1996). Optimism about the potential of these kind of data driven approaches was prevalent in urban design approaches in the 1950's and is frequently found in current smart city literature (Hillier and Healey, 2010; Townsend, 2013; Kitchin, 2014b; Rönkkö, Herneoja, and Oikarinen, 2018).

7.3.1 Faith in technology

Faith in technology is often associated with smart city concepts (Charlton, 1993; Rinehart, 2009). This resonates with the modernist enlightenment vision; the idea that knowledge can solve the world's problems. Some literature makes a direct link between modernism and utopia (Rinehart 2010). Rinehart p2 states that:

“utopia thrived under modernism”

⁹¹ An e-patient is a patient who is digitally equipped, empowered and engaged in their health and care decision (Medicine X, 2018).

Charlton proposes the view that when truth is known there will be the possibility of a stable, sustainable utopia. He claims that by adding together all the little bits of truth, humankind will build a master vision of the world and our place in it. Charlton's ideas relate to this study as for him, medicine is modernity in action.

In common with most of the literature outlined earlier in this chapter, there were many comments made that expressed optimism about the potential of technology. One of the most optimistic is this comment from a health manager:

104 M-E "for me, the biggest problems are that we don't have technology in the way that we should have it, so all the smart stuff and all the Star-Trek stuff is desperately needed"

This and other similar comments share the techno optimism expressed by smart city commentators including (Michael Batty et al., 2012) and (Robinson, 2014a). It is perhaps unsurprising that some workshop participants expressed this kind of view given discussion around comment 11 in 4.3.

In this session direct reference was made to some of the specific technologies outlined in Table 18 including IBM and Google Deepmind. Comments included references to predictive technology, as discussed earlier in this chapter. The following comment, although it doesn't go as far as some of the ideas expressed in the literature outlined in the prediction subsection of this chapter, does appear to share a similar faith that medical technology can or will be able to accurately predict and diagnose:

105 VS, M-H "we've done like a telephone, because we're predicting in the future it will probably go more to monitoring patients so that they don't have to keep coming in regularly"

Some discussion linked back to hunch 3, the engineering based aviation metaphor. Before I get to this however, I outline some literature that shares this techno utopian perspective.

7.3.2 Urban Planning / Smart City

As outlined in chapter 2, the idea of efficiency is at the heart of the ideas of a smart city and smart community. It frequently occurs within smart city literature (Kitchin, 2014; Goodspeed, 2014; Söderström et al, 2014; Calzada and Cobo, 2015). The

concept of the smart city emerged as a fusion of ideas about how information and communication technologies might improve the functioning and efficiency of cities (M Batty et al., 2012). Smart community has a similar origin, helping people in Silicon Valley overcome financial crisis⁹². Smart community and smart city are both about applying computing to improve efficiency. Smart city ideas suggest that smart computing technologies can make the critical infrastructure of the city more intelligent, interconnected and efficient (Nam and Pardo, 2011). The smart community concept, in relation to healthcare, is directly linked into this conceptualisation of the smart city. Nam and Pardo refer to healthcare as part of the critical infrastructure of a smart community.

Advocates of Big Data, including Tim Berners Lee and Rick Robinson, highlight the potential social and economic benefits of sharing data (Berners-Lee, 2012; Robinson, 2014). Nam T and Pardo T (2011) refer to the potential of data sharing to enable collaborations. They stress that Technology is key because of its potential to transform life and work within a city. They do however acknowledge that without real engagement and willingness to collaborate there is no smart city.

7.3.2.1 Real-time

Harrison and Donnelly (2011) assert that one of the foundations of the smart city approach is access to real-time information at the level of individual citizens. They refer to the process of accessing real-time information as “making the invisible visible’. As was outlined in 3.2.4.4 the notion of how to make the invisible visible is central to the philosophical perspective of this study. Both Bourdieu and Habermas have used this phrase (Sandercock, 1998; Bourdieu, 2011) . In this study, theory informed critical reflexivity has been applied to make the invisible visible. In this context the invisible is the part of the research story that cannot be directly observed or measured. In the smart city context the phrase making the invisible visible has the opposite definition; it is specifically focussed on increasing understanding through collecting and analysing more data. It is the opposite in the sense that it is philosophically opposed. The smart city definition is about measuring more to gain a greater understanding, whereas in my

⁹² The origin and evolution of the smart community concept was outlined in 2.2

application of CSH I attempted to look beyond what can be measured. These two uses of the phrase do however connect in the notion of gaining understanding of events within city systems that was previously thought of as impossible to access. Within the CST paradigm, even though smart city data might have been collected by people with a different philosophical perspective, it may still be valid. The CSH approach applied in this study however, required the process of interpreting the data collected rather than taking it at face value.

The idea of gaining insight from real-time monitoring is part of the ideas of cyber physical systems and collaborative intelligence, as discussed earlier. Smart city literature is awash with ideas about real-time information helping people make better informed decisions (Mayer-Schönberger and Cukier, 2013; Gil-Garcia, Pardo, and Nam, 2015). Pardo et al apply the term 'concentrated intelligence' to the insights that emerge from real-time monitoring. They suggest that this intelligence can enable more effective collaboration between organisations.

In the health context real-time information enables people to monitor their own behaviour. At the most extreme end of the spectrum are people who actively engage in the quantified self-movement⁹³. Self-monitoring can motivate behaviour change by self-knowledge. By sharing information it can motivate further through competition. The act of sharing may also motivate through peer support. This can help people achieve goals by holding them to account (Spring, Gotsis, Paiva, and Spruijt-Metz, 2013).

The idea of real-time data frequently occurred in my workshops and interviews in relation to both the current system and ideas about what a future system might look like based on the smart community concept. In relation to the current system the real-time idea was discussed as part of story two. Interviewees suggested that the E-Shift system enabled a form of real-time data flow, with the staff in people's homes. How the real-time monitoring worked using the E-shift system⁹⁴ is illustrated by this quote from the service manager:

⁹³ The quantified self is a term to describe the use of self-tracking through apps and wearables that enable users to generate detailed personal information about their bodies (Lupton, 2017)

⁹⁴ As discussed in story 1, 5.3.1.1

106 M, VS-L *“what we found is the technology has really, has quite a profound impact on the functioning of our team, enabling us to more effectively manage workflow, and really also upscale our clinicians in the community, in a way much quicker than we had ever expected. [Said quietly: This okay?] Erm, because they’re effectively being supervised constantly, and they’re, it’s almost like being mentored by the bedside”*

The comment about constant supervision is interesting as it clashes slightly with the otherwise positive picture that has been painted of the impact of the technology. The idea of supervision is an issue I return to in chapter 8. Another perspective on where real-time monitoring is heading was given by one of the technology companies. They suggested that monitoring helps physicians to make better decisions, but also suggest that this real-time technology is just starting to emerge:

107 T-H *“right now, you know we’re starting to see pockets, so-called population health IT, technology where you can surveil a group of patients and have a dashboard for the physician to log into, where, every day they can look at, you know, their patient population and see who’s doing well, or who’s doing badly, so, we’re just starting, that’s probably, you know”.*

Comments about better decision making and how technology is still emerging were in line with indications from literature. In terms of what is possible now, in comment 108, a healthcare professional H-S⁹⁵ indicates how they could make better decisions by using real-time data. Like comment 107, the system he is describing provides doctors with more information to inform decisions. In comment 108 the idea becomes a little more patient focussed as it allows patients to add information into their patient records. Although in this quote he is primarily talking about diabetes, elsewhere in the interview he said that he believed that the technology would also be able to help with other conditions including cancer. It is interesting that like T-H and M, VS-L and H-S also refers to surveillance:

108 H-S *“I have a dashboard, and I have individual records of the, of the person as well, so I can, I can go into that individual record at any one time, and also*

⁹⁵ Note this is the same healthcare professional that I referred to in Interviews with Healthcare Professionals in chapter 5 and who made comment 18 in 4.3

look on the dashboard to see whose diabetes is controlled, whose blood pressure is controlled, who isn't controlled. So, it gives me much more timely, real-time data from the patient, in order for me to make, you know, changes, and, manage by exception"

7.3.3 Prediction

Following on from discussion about real-time data, the availability of large volumes of data including real-time data is also increasing our ability to predict. The idea of prediction has led to many claims about the impact this will have.

By studying huge datasets on the medical histories of millions of people we may be able to identify the causes of cancer (Goldacre, 2014).

- In many areas including healthcare, computer systems can now predict better than humans (Ayres, 2008)
- Technology is transforming our ability to predict, diagnose and treat disease (Stevens, 2014)

The idea that information technology can help improve decision making was also reflected in my workshops:

109 T-N stated "I like the idea of AI, also learning from different diagnoses and mapping out exactly if there's any correlatable links with what the patient's lifestyle is"

110 M-Y "it could be a text thing, that, you know, it just automatically, you're not fit, you know, leave it. Is the patient fit or not fit? Right, bang the buttons, text the patient, it's all that kind of slick system"

I see a direct connection between these comments and ideas outlined from literature. By referring to AI, T-N in relation to lifestyle, is asking a question that writers including Ayres (2008) and Stevens (2014) claim to be answering. T-N appears to be asking if AI can learn from correlation data to help inform medical decisions. Ayres is confidently claiming that computers can make healthcare decisions through correlating large data sets.

The above statements link the idea of monitoring and analytic technology with lifestyle, an idea I return to later in this chapter. Allwinkle and Cruickshank (2011)

imply a connection between prediction and efficiency. They assert that data technology can work to make a city more knowable and controllable in a way that improves the performance and delivery of public services. Another idea, that of increased data volume, is stated by the chief economist at google who estimates that more data is now being produced every 2 days than in all of history prior to 2003 (Smolan and Erwit, 2012). Other researchers propose that these rich streams of data can be used to better depict, model and predict urban processes and simulate the likely outcomes of future urban development (Schaffers et al 2011; Batty et al 2012). As discussed in this section, predictive technology has been applied to the analysis of large amounts of data to help healthcare professionals make better diagnosis and treatment decisions. This idea was discussed in most interviews and in the 2nd and 3rd workshop. To illustrate I enclose a few quotes from interviewees below:

111 CS-B "I think there are, some things that where machine learning, I think, can, can greatly benefit us, I think that the key areas are probably diagnostics"

112 CS-B "the percentage of misdiagnoses from a, a machine system, or a machine doctor, is less than, say the percentage of diagnoses you would get from a human doctor"

113 M-Y "the technology involved would probably, probably make for much better diagnoses and quicker and more accurate and more effective"

114 H-Q "we're not as good as computers as like systematically going through data, making sure we're not missing patterns"

I find it interesting that a healthcare professional, a cancer survivor and a manager are all expressing similar optimism about how information technology can help improve healthcare decision making. In terms of how and why technology might be able to help, common ideas include speed and accuracy. This resonates with the reference by Seale (2000) discussed in 3.5.3 , who stated that software could assist in data analysis in research because computers are faster and more accurate than people. Comments 111 -114 also imply some support for the ideas of technology advocates such as Ayres (2008).

7.4 The Biopsychosocial Model

A common strand in literature on the need to change the healthcare structures is articles that offer criticism of the biomedical model (Abelson, Rupel, and Pincus, 2008; Cockerham, 2013; Forsman and Nyqvist, 2015; Popejoy, 2017). These connect the biopsychosocial model with discussion of agency and structure in chapter 3 as advocating greater consideration of social and psychological factors is also advocating greater focus on structure, as these are part of structure. Forsman and Nyqvist connect the biopsychosocial model with social capital and theories of agency and structure including habitus. They describe how these can help explain some of the social determinants of health. Cockerham connects ideas of structure and agency to criticisms of the biomedical model when he states that any individualistic paradigm of health lifestyles is too narrow because it fails to consider structural influences on health lifestyle choices.

As outlined in 1.5.3 a common criticism of the biomedical model is that it is not good at dealing with chronic conditions such as cancer (Abelson 2008; Popejoy 2016). Following on from this is the idea that these limitations lead to increasing costs (Popejoy 2016). The logic here is the idea that the most effective ways of supporting people with chronic conditions goes beyond just medical treatments.

Engel (1980) criticises the biomedical nature of the healthcare system for failing to take into account data that is psychological or social. Cockerham (2013) links this to debates about lifestyle change; he argues that the biomedical approach to health, disease and healthcare delivery is reaching the upper limits of its efficacy. He also argued that when applied to health lifestyle the agency-structure debate becomes about the extent to which decisions about food, exercise and smoking are a matter of choice or are moulded by structural variables. Extending this to the idea of a smart community would include the extent to which smart technology can help people make healthier lifestyle choices, or healthcare professionals make more effective treatment decisions.

With advances in information technology, including significant developments over the last decade, it is useful to re-engage in the agency structure debate. It is possible that some of the conclusions that were reached previously about the limitations of agency and the biomedical model, may no longer be valid as it becomes increasingly possible

to analyse vast amounts of data to enable more effective and targeted interventions. Technological advancements including artificial intelligence make it possible to extract meaning from 'big data'. Big data is not simply large in volume, it is also unstructured and rapidly expanding (Gewirtz 2018). Such technologies offer both the potential to more effectively measure impact at an individual level but also to gain insights at a wider structural level. The next two subsections of this chapter explore some potential opportunities emerging from these changes and also some of the limitations in doing so.

I perceive some direct parallels between Bourdieu's Practice Theory and the Biopsychosocial Model. Most directly there is the link with agency and structure outlined earlier. Like Bourdieu's Theory of Practice, the biopsychosocial Model is concerned with the impact of wider structural factors, not just individual human agency. When applied to the digital realm both of these ideas relate to the concept of smart community for similar reasons.

Throughout this study I have made links between Practice Theory and smart community. This included discussion of links with social capital and how smart community links to the idea of doxa. To clarify, the community component of the concept of smart community connects it to theories of agency and structure including Practice Theory. As The Biopsychosocial Model is also concerned with structural factors it also relates to the community aspect of smart community. In relation to healthcare, Bourdieu is critical of the judgement of taste, something that he regards as part of cultural capital. In the context of healthcare, the shared understanding of medical practitioners and health researchers could be regarded as part of a structure that helps to preserve the interests of those in power (Martin and Geldof, 1997). In this context those who defend the hegemony of positivist health economics could be regarded as amongst those who mask the real nature of what is true. Finding significant efficiency improvements would therefore require an unmasking of ideas that obscure these real ideas. The logic and values embedded within the biomedical system may be regarded as ideas that mask truth and the biopsychosocial model could perhaps be regarded as playing a role in the process of unmasking it. Taking these masks away might then be required to give the space for a new radically different system based on the smart community concept.

McHattie, Cumming, and French (2014) are a little more sympathetic towards the biomedical model stating that until recently the biomedical paradigm has been effective in delivering healthcare. They do however argue that it has its limitations, suggesting that this model is not able to solve current problems facing healthcare. Furthermore they argue that there is a consensus that current models of healthcare are unsustainable. Ham (2014) supports the assertion made by McHattie et al when he states that there is a growing consensus that current models of health and social care provision are not fit for purpose.

McHattie, Cumming, and French (2014) share with Engel (1980) the notion that a shift to a patient centric model may help. They connect their ideas to the notion of smart communities by stating that the internet has a role to play in enabling this. As well as in literature, limitations of the biomedical model occurred frequently in interviews and workshops. In workshop 2 there was a lot of discussion related to the idea of a biopsychosocial model of health and care. Participants spoke at length about benefits of contact with other people. This discussion also relates to ideas of community development outlined in 2.3.2.

Participants spoke about the benefits of support networks, community care and non-geographical communities of care. As discussed in 2.3.2 these community development ideas of contact, link the idea of the biopsychosocial model to the concept of social capital to the structural part of agency and structure, and to Bourdieu's Practice Theory. The emphasis on community support links to hunch four; beyond hospitals. Conversations included discussions about AI and the idea of a virtual clinic. The idea of a virtual clinic resonates with the idea of patient hotels referred to in hunch 4 discussion.

7.4.1 Prevention / Psychographics

An increased focus of preventative measures is part of the biopsychosocial model, as social and psychological interventions have the potential to influence lifestyle change. An increased focus on prevention also frequently occurs in utopia discussion. Psychographics sits firmly in the biopsychosocial sphere of prevention as it is a digital approach to psychologically influencing behaviour. Psychometrics is a form of analytics based behaviour change. It is sometimes also called psychographics and has

a focus on measuring psychological traits, such as personality (Grassenger and Krogerous, 2017). The idea of psychographics is the application of the market segmentation that advertisers apply to the area of healthcare behaviour change. It starts from the recognition that changing behaviour is about more than simply giving out generic information. It includes a recognition that effective interventions should include an analysis of the reasons why certain individuals are not yet motivated to change. This analysis could then be used to inform more targeted interventions. These could be based on the interests, values and lifestyles of individuals (Hardcastle and Hagger, 2015).

Psychographics links to the argument given in the above section on the biopsychosocial model. It includes the idea that better understanding of social dynamics and local conditions could influence behaviour (Maus, 2015). Chou et al (2013) link the idea of psychographics to the idea of social computing. They argue that health promotion could benefit from listening to social media health dialogue whilst giving consideration to the characteristics of individual users. Their ideas support my assertion that psychographics links to the wider body of literature on social influences on health. It however connects these influences on health to the digital age and the concept of smart community. One link is the use of computer analytics to influence change, an idea discussed in 7.1.1.2.

In the workshops I facilitated there was a lot of discussion about the need for a healthcare system that was more focussed on prevention than treating people after they have become ill. For example, speaking about prevention, T-D states that for him it would be the biggest focus.

Psychographics as well as relating to the biopsychosocial model, also connects to nudging. One participant, M-E, spoke enthusiastically about Sheffield's parkrun program suggesting that its competitive element encouraged people to keep taking part. His argument was that motivation didn't just come from people getting better themselves, but getting better in relation to others that they regarded as their peers, such as others in the same age range. The idea of connectedness relates to the concept of smart community as they suggested that more data would nudge people into taking more exercise, and that greater use of apps and monitoring devices could be used to provide data. He was not the only participant to talk about nudging people

into lifestyle change; T-D outlined a range of different strategies including gamification and information architecture. He related both of these to behavioural economics and social norms. When put into a social context as done by T-D, the information technology ideas of gamification and information architecture may be considered as manifestations of smart community. They may change people's behaviour through interactions with human and non-human agents.

Gamification is the use of game design in non-game contexts (Khaled, 2011; Hall, Caton, and Weinhardt, 2013). The idea that gamification can nudge people towards healthier lifestyles is frequently made in health and health technology literature (Hall, 2011; Lupton, 2017; Mesko, 2013). Hall, Caton, and Weinhardt make a similar argument to the one put forward by T-D; that gamification can improve wellbeing. Linking gamification to the smart community concept, he argues that by gamifying well-being, leaders take proactive steps towards smart community management. Lupton (2017) makes a similar case, with reference to specific apps including Pokemon Go. There is extensive literature that supports T-D's assertion that architecture can nudge people to change their lifestyle (Thaler et al 2008; Hollands, 2015). Hollands et al suggest that nudging often involves how information is provided. Danaher, McKay, and Seeley (2005) relate this idea to a specific example, website design, suggesting that the information architecture of websites has an impact on their effectiveness in changing user's behaviour.

Computer analytics could have a significant impact as emerging computing technology could enable automated algorithms to influence the behaviour of individuals and groups on a massive scale. In some respects this is nothing new as social control through adjustments to the environment is well documented as part of planning and architecture (Maus, 2015). If the concepts of smart city and smart community are conceived as aspects of 21st century urban design, then this may be thought of as an entirely natural development. I return to the idea of smart design in 8.4.2.

7.5 Capital

The idea of social norms influencing behaviour (as implied by M-E), I argue is an expression of social and cultural capital. The concepts of doxa⁹⁶ and routinization⁹⁷ are useful here to help understand the potential impact of these ideas. Whilst comments imply that technology might be able to nudge people to make lifestyle changes, if we accept the concepts of doxa and routinisation to be valid, then this is not a simple process as it requires people to reject deeply with ingrained habits and their own sense of what is possible.

Some researchers have specifically applied Bourdieu's ideas to the impact digital interventions could have on influencing behaviour (Van Dijk, 2005; Hale, 2013; Ignatow and Robinson, 2017). Through the application of Bourdieu's ideas to the digital realm, some new terms have emerged that may help to understand the potential impact of the smart community concept. These include the invention of new forms of capital that may help understand the digital age. Two of these are information capital and digital capital (Ignatow and Robinson 2017). Another term, human capital, often appears in smart city /smart community literature (Robert G Hollands, 2008; venditti, 2012; Kummitha and Crutzen, 2017).

The emergence of new forms of capital support my assertion that Bourdieu's ideas are relevant to this study. This idea is supported by the emergence of the term human capital in the Move More Sheffield Report (Sheffield City Council, 2014). Move More is an initiative that includes the park run that was spoken about enthusiastically by M-E. The Move More Plan states that it is their ambition that everyone in the city should have the human capital to be sufficiently active to be of benefit to their health and wealth. The inclusion of wealth alongside health is interesting as it positions the plan away from a purely health focussed approach. Given the reference to human capital it is unsurprising that the report makes reference to community development ideas similar to those outlined in 2.3.2, including asset based ideas and coproduction. The report resonates with many of the smart community ideas I refer to. For example it

⁹⁶ Doxa as outlined in 3.2.4.5 is the taken for granted understanding that people have of their social worlds, often resulting from their life experiences (Veentra 2014).

⁹⁷ As outlined in 3.6.1 Routinisation is the idea of patterns of behaviour becoming continuously reproduced through action (Giddens, 1984)

advocates social media communication and the creation of a digital hub for physical activity signposting. When combined with ideas such as coproduction the Move More plan appears to be advocating an approach that is in line with Health 2.0 literature (Linders, 2012).

The Move More Plan states an intention to change the culture of physical activity in Sheffield. This relates to the concepts of; cultural capital, habitus and doxa⁹⁸ as they form our sense of what is possible and what is not. In relation to behaviour change M-E spoke passionately about attitude. He argues that consideration of attitude is missing from the health service. He connects the idea of attitude to the concepts of doxa and habitus when he argues that attitude relates to what is done in schools and throughout people's lives. By doing so he is in essence, suggesting that attitude is people's sense of what is possible and what is not, based on their life experience. I argue that what M-E calls attitude is what Bourdieu calls doxa. This appears to in line with its original definition as Bourdieu refers to doxa as the 'natural attitude' of the dominated groups (Myles 2004). M-E then argues that he believes technology can help people to change their attitude. But as he also argues that people change from within, like Cockerham he is not suggesting that it is likely to be a simple process, he suggests that unless people's attitude is changed from within it is not likely to be effective. Through its stated aim of changing culture, the Move More Plan appears to be aiming to change people's attitude.

Hale (2013) argues that the internet is already changing the culture of medicine and how people think about health including the relationship between lifestyle and health. If this is true then perhaps the digital aspects of initiatives such as Move More may be considered part of this change. Hale (p513) however qualifies his comments stating that:

"The utopian discourse surrounding ICT and the Internet is derived from a broader set of cultural values of individualization, personal empowerment and actualization, egalitarianism, and the emphasis on freedom of speech and access to information"

⁹⁸ The meaning of the terms cultural capital, doxa and habitus were outlined and discussed in 3.2.4

Hale's comments are in line with M-E's assertion about the importance of attitude, stating that attitudes are important for maintaining health.

The link between cultural attitudes and health lifestyles frequently emerges in literature (Giddens, 1991; Eysenbach and Till, 2001; Cockerham, 2005; Hale, 2013). Giddens suggests that lifestyle is linked to social identity and status, a conceptualisation that is close to Bourdieu's idea of symbolic capital⁹⁹. Social identity within information technology discourse is interesting as it cuts across both collective and individualistic ideologies (Turner, 2010).

7.6 Specific examples

Two of the most talked about products in the smart community cyber computing realm are Babylon and IBM Watson. Watson is a cognitive computing system that analyses its vast database to assist oncologists to make better diagnoses (Schmidt, 2015). Watson is potentially useful due to the amount of medical data available. Without computer assistance it is not possible for any human to apply all of the data available, and currently 1 in 5 cancer diagnoses is either incorrect or incomplete (Lee, 2014). Babylon is similar in some respects but more focussed on giving information to patients. They claim that users will be able to use the app to get suggested causes of action based on a comparison of patient history within its database (Parkin, 2016).

Watson and Babylon fit with the smart community ideas outlined earlier. Together they could be vital components of a system (of human and non-human agents) that involves both better informed doctors collaborating with better informed patients, both assisted by cutting edge technology to make better decisions that will improve outcomes and cut costs.

IBM Watson was referred to in 8 out of 30 interviews. As illustrated by the quote below, one healthcare, suggested that technology such as Watson will have the greatest impact when connected to geonomics.

115 H,A-B "there are some really, really bright people out there who are doing a lot of AI work, you know, Dr Watson, all that stuff, and they're integrating

⁹⁹ as outlined and discussed in 3.2.4.2 and 5.1.3 symbolic capital is concerned with social identity and status.

geonomics into it, and this is the, really, where big data is going to come into its own”

Another comment used the metaphor of magic to describe IBM’s analytics. This gives the impression that it is viewed as something mysterious and powerful. It is also language that connects with fiction.

116 T-U “IBM Watson, they perform their magic in terms of analytics”

I find it significant that comment 116 is from a technology company. I usually expect technologists to apply the language of rationality rather than that of mysticism. However in the utopian realm of imagining technology futures these ideas are sometimes connected.

Davis (2015, p8) describes this connection poetically when he states that:

“The virtual topographies of our millennial world are rife with angels and aliens, with digital avatars and mystic Gaian minds, with utopian longings and gnostic science fictions”

Table 18 connects some of the smart technology that exists now to ideas which could potentially be incorporated in a future system of cancer services in Sheffield. Some of these ideas are discussed further in chapters 8 and 9.

Table 18 : Examples of Current Smart Technology

Example	Literature Source	Connection to Smart Community	Potential Implications	How this might improve efficiency
HealthVault	(Eysenbach 2008)	Social Computing	Change in the relationship between patients and doctors, as patients gain control over who has access to their healthcare information	By improving health outcomes through better treatment decision / also by enabling patients to make better, more informed lifestyle decisions
IBM Watson for Oncology	(Mesko, 2017) (Schmidt, 2015) (H. Lee, 2014)	AI (a form of non human agent)	It has the potential to help oncologists and other healthcare professionals make better treatments and diagnosis decisions	Suggestions could include social prescribing and other innovative ideas that at times might be less expensive and more effective long term, potentially helping to enable a more holistic approach
Medical Sieve	(Mesko, 2017) (Mesko, 2013)	It's a non human agent	Assists decision making in radiology, spots and detects problems faster and more reliably	Needs less radiologists. Better outcomes resulting in less treatment needed
Babylon	(Mesko 2017) (Parkin 2016).	AI (a form of non human agent)	Medical consultation that analyses personal medical history	The efficiency of diagnosing patients could increase and waiting times for doctors could decrease
Health Trackers	(Mesko 2017)	A non human agent	Low cardiorespiratory fitness increases cancer risk	Reducing cancer risk saves money by reducing the need for treatment

Open AI ecosystem	(Mesko 2017)	Social computing. Web 3 or 4.0 symbiotic computing	Could help everyone in the system including patients to be better informed and make better informed decisions	More information could lead to better decisions potentially also including better lifestyle choices
Data mining business processes	(Mesko 2017)	Could support managers	Analysing invoices to spot repeated mistakes	It could avoid unnecessary hospitalisation
Second life	(Aziz and Madani, 2015)	A virtual patient is a non human agent	Virtual patients can receive real information from real physicians about medical conditions	It could help test innovative approaches that could lead towards the creation of more efficient ways of working
Etiobe	(Acampora et al, 2013)	It's an interface where human and non human agents can collaborate	This system combines monitoring and e-therapy. Monitoring provides information (physical and psychological) for clinicians. Therapy includes online questionnaires	Nudging behaviour change might reduce obesity and reduce costs. More information could result in more cost effective treatment

In Figure 28 I have outlined how some of the ideas discussed in this chapter could fit together, to form a utopian system of cancer services based on the smart community idea. As can be seen, the smart community idea of monitoring flows into an integrated health and care system. Ideas from human and non-human actors are brought together through forums and other information exchanges to improve decision making, including the lifestyle decisions of citizens, the treatment decisions of healthcare professionals and the organisational decisions of managers. The concept of psychographics described in this chapter links into the idea of behaviour change.

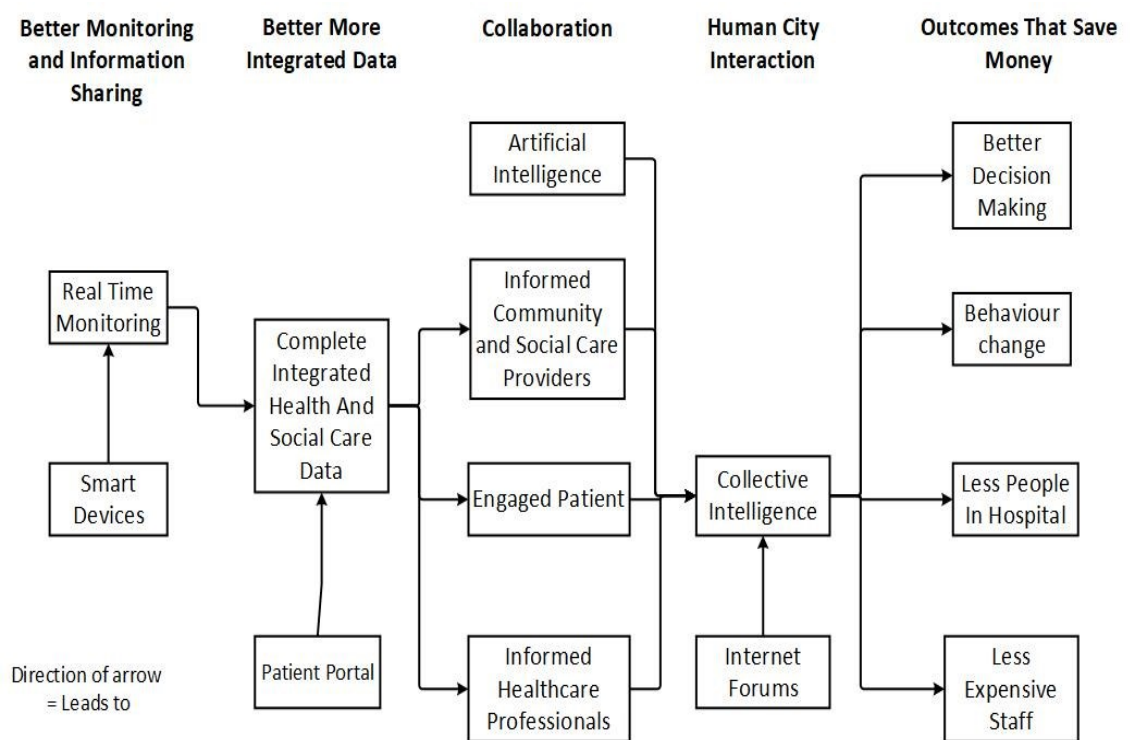

Figure 28 A Smart Community Healthcare Utopia

In Table 19 I indicate how some of the ideas indicated in the utopia section of workshop 2, might inform a conceptual model of more efficient cancer services.

Table 19 : Utopian Efficiency Ideas

Text from Utopia Rich Picture	Area where this might impact on a new system	Connection to Smart Community	How it might Improve Efficiency
Screening linked to AI to improve diagnostics	Prediction	AI is a form of non-human agent	Better diagnostics can improve health outcomes
Efficient technology adoption pathways	System	A pathway could bring all the different non-human agents together with human ones in a more efficient way	
Health MOT if needed	Prevention	Non-human agents could be included in the MOT	Early intervention can reduce the amount of treatment required
Healthcare journey mapped around patient	Person-centred	Patients are one of the human agents in the system	Patients can help create more informed decisions and lifestyle interventions
Fully integrated health and social care	System	The human and non human agents in the system and the data that they apply to inform decisions would be better integrated	Less duplication and more effective treatment given e.g. sometimes less hospital focussed – see hunch 4
Care delivered more flexibly e.g. location	System	The agencies employing people (non human agents) might be able to take on different roles	
Specialist cancer support and advice centre	Prevention	Human and non human agents could work collaboratively to deliver cancer advice e.g. through an app	Better advice might improve outcomes through lifestyle change
New services developed using coproduction methodology	Person-centred	See community development discussion in 2.3.2	Coproduction might lead to better designed more efficient services by harnessing the

			expertise of a wider range of experts including patients
Collaborative leadership for decision making	System	See collaboration chapter 2 and leadership in 7.1	Better decision making might reduce waste and improve health outcomes
Birth to end of life mental health training	Link between the biopsychosocial system and smart community discussed in 1.5.4, 5.2.2, 7.4		Improving mental health may improve health outcomes
Person's well-being and authentic happiness and attitude.			
Community and family friends network	Social Capital	Discussion about facebook as a tool to engage support. In this chapter	Community support may reduce the need for professional services Community support might improve outcomes via social capital
Trusted, authentic smart data e.g. park run data linked to medical records	Lifestyle	The kind of fitness devices used to collect park run data are a form of non human agent	More data to inform decisions could result in better outcomes. It could also lead to more physical activity and social prescribing

7.7 Conclusion

Within the concepts outlined above there are many different ideas that could result in improving efficiency. Efficiency improvements fall broadly into four areas; more data, better decision making, behaviour change and mutual support.

Many of the ideas in this chapter include discussion about how smart community ideas might result in more data, resulting in better decisions. These include; how real-time data can help uncover insights that were previously invisible. More data might enable

healthcare professionals to make better decisions that could improve health outcomes and subsequently the need for future treatment.

By bringing together very large numbers of people, such as through forum discussions with advanced computer analytics, it is becoming possible to consider a very large number of factors, far more than any single human is capable of. Combining computer analytics with forums could result in more effective treatment decisions that may improve outcomes and reduce costs. This form of analytics enables a wider range of options to be considered including when lifestyle changes might be more effective than drugs or operations.

Engagement in the decision making process as well as generating better information can be linked to behaviour change. Engaging people in data collection and decision making is more effective at changing behaviour than giving information about health risks. Engagement enables community members, including patients, to nudge each other towards making lifestyle changes and to provide mutual support, such as through internet forum discussions. Lifestyle changes can improve outcomes and reduce risks. Mutual support can also reduce the demand on formal healthcare provision. For example, if forum users are able to access information from each other they may not see the need to go to healthcare professionals for advice so often. Utopian visions of how the internet can empower people are however not always collective, many are individualistic.

Chapter 8 Dystopia

In chapter 7 I outlined and discussed some optimistic visions of what a more efficient system of cancer services might look like in Sheffield if it was based on the concept of smart community. In this chapter I focus on the counter narrative, where cracks appear in these optimistic visions. Here I am deliberately going to the opposite end of the spectrum to the optimistic vision. My approach is influenced by Kellner (2006) who argues that we need to develop a critical theory of technology in order to counter the technological utopia that computers will solve all of our problems.

This chapter is split into 5 sections; issues with data, top down corporate, top down public sector, social control and capital. Issues with data, sets the scene for subsequent subsections by revisiting some of the philosophical assumptions about data and how these might lead to unfortunate consequences. The top down and bottom up sections explore how dystopia can emerge within a variety of different smart community governance models. The social control and surveillance sections focus in on two important issues that emerge in discussion of smart community governance models. Capital applies the lens of Bourdieu's Practice Theory to explore how different forms of capital could relate to dystopian smart community futures.

8.1.1 A Smart Dystopian Nightmare

Dystopian visions of the future contain some nightmarish visions of how information technology could transform society for the worse. In chapter 7 I outlined an optimistic vision of the impact of smart community and related concepts including: cyber physical systems, social computing and smart cities. However, not all literature relating to these concepts is positive. Morozov (2014) outlines a critical perspective arguing that the real internet is different from the mythical internet. The implication here is that many of the utopian visions, such as those I outlined in the last chapter, are somewhat removed from reality. Morozov's idea serves as a good introduction to many of the ideas discussed in this chapter. I argue that governments and private companies have deliberately sold utopian dreams, underneath which lies a darker counter narrative.

There is plenty of dystopia in smart urban design literature (Hollands, 2008; Allwinkle and Cruickshank, 2011; Söderström et al, 2014; Yigitcanlar and Lee, 2014; Hollands,

2015). The Same is true in the realm of digital health (Lupton, 2014; Rich and Miah 2014). The most extreme digital health dystopias however are found in science fiction. Fiction is littered with dystopian views of what could go wrong if we unquestioningly place our faith in technology (Geyh, Cieza, and Stucki, 2009). Geyh, with reference to William Gibson's *Necromancer*, states that literature and arts tend to fare better at portraying and theorising post-modernity than do our theories, which are often superseded by fast moving reality. *Blade Runner*, *Gattaca*, *I Robot*, *Minority Report*, *Robocop* and *The Terminator* all offer insight into the dark future that technology could deliver. In *Gattaca* we see a dystopian future where employment opportunities are closed to many based on the analysis of their genetic code; people seen as having low intelligence or those seen as likely to develop poor health are excluded from more senior professions. *Minority Report* takes the idea of surveillance combined with predictive analytics to the extreme, creating a world where people can be arrested and sentenced because they are at risk of committing crime. Combining these ideas, I can imagine a future where opportunities are closed off to people with or at risk of developing cancer. We already live in a world where health and travel insurance premiums for those with cancer are significantly higher than average. Workforce wellbeing programs are already starting to give benefits to those who engage in recorded physical activity (Bina et al Caffa, 2014; Greenbaum, 2014; Méndiz Noguero, 2014; Kiejziewicz, 2018).

Many dystopian narratives centre on the potential for governments and / or private companies to manipulate the power of the internet for their own ends. Themes of power, surveillance and social control flow through these visions. These ideas also frequently occurred in interviews and workshops. Within workshops, as illustrated by Figure 29, these ideas were usually associated with top down visions of the future. However within workshop 2, two quite different counter visions were created. Whilst both created narratives that opposed the utopian visions discussed in the last chapter, they were quite different from each other. The first as well as placing the patient on the periphery rejected data technology to improve the healthcare system.

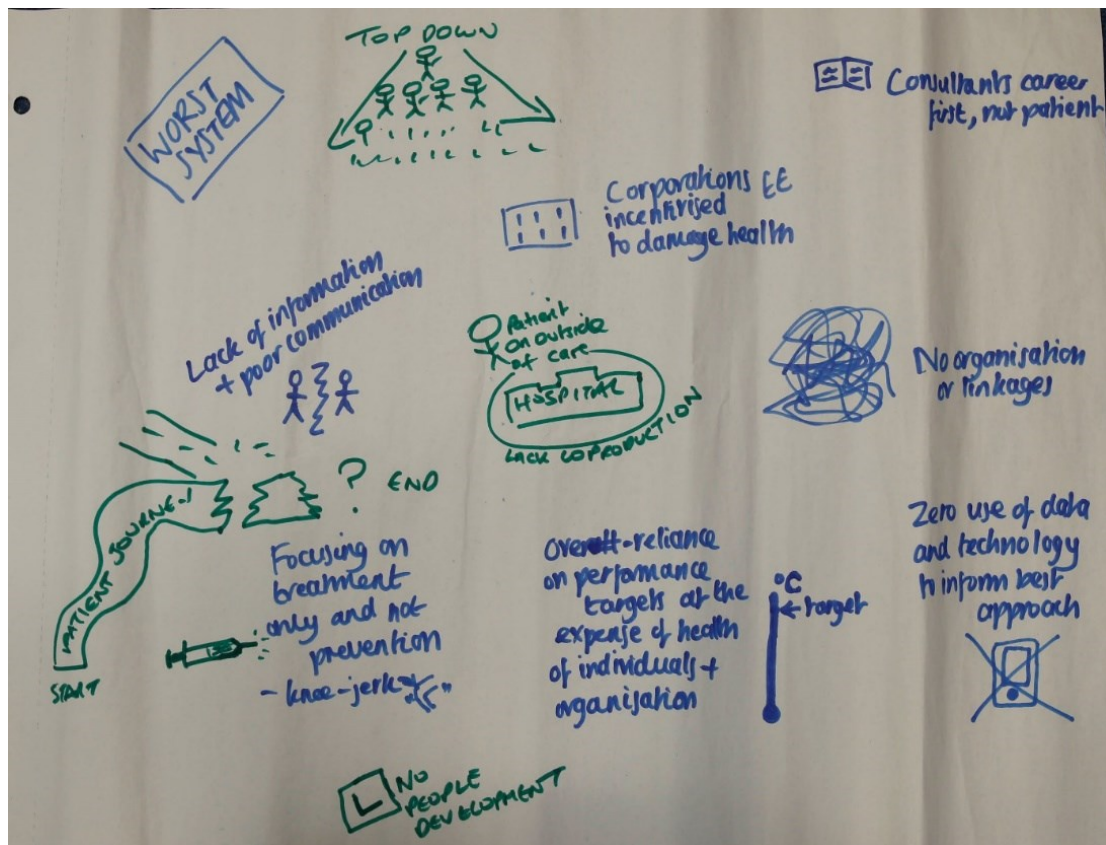

Figure 29 Dystopia

The second vision, as illustrated by Figure 29, embraced technology but applied it to serve the interests of large private sector companies. This second vision is discussed alongside literature with similar themes in the top down corporate subsection of this chapter.

8.2 Issues with Data

The critique of smart city ideology outlined above contains two related but distinct issues with data. The first is the recognition that data is not as separate from the power interests of the different actors and agencies in the healthcare systems as it might sometimes appear. The second is the recognition that due to those power interests, the value of information based on the analysis of data is inherently limited. I consider each of these ideas in turn.

8.2.1 Faith in Modernity

As argued in chapters 1.5.4 and 7.3 many smart future visions are based on a modernist world view where positivist principles of objectivity are dominant. These are all underpinned by the world view that it is or would be possible to predict and

solve problems if we had enough data. The modernist world view assumes that data exists independently of the power interests of those who collect it. Kitchin (2014a) challenges the positivist idea of objectivity when he asserts that although data within smart city initiatives is often characterised as benign and lacking in political ideology, data does not exist independently of the ideas of the people that: conceive, produce, process, manage, analyse and store them.

Discourse in smart city literature about the extent cities are knowable, is a resurgence of a long standing modernist debate about the impact of technology on society. In 'The Coming of Post-Industrial Society' Daniel Bell sets out an optimistic view of a technocentric future (Bell, 1973). Haralambos, Holborn, and Heath (2000) associate faith in the ability of technology and science to tackle human problems as part of modernity. The faith in technology that is often associated with smart city concepts, may be regarded as a resurgence of the kind of modernist enlightenment vision advocated by writers such as Bell. Postmodernist and critical authors frequently highlight the many times that modernist optimism has failed to achieve positive results. To illustrate this point I enclose two quotes that powerfully communicate such limitations more powerfully than I can:

“Visions of utopias which were still frequent in the 1960’s have been replaced by dystopias” (Montuori, 1998, p5)

“History is littered with failed plans and false utopias that didn’t live up to their promises” (Townsend, 2013, p164)

Poststructuralist and postmodernist thinkers reject the foundations of modernism, arguing that the very idea of impartial truth is impossible and social scientific knowledge is a strategy by which individuals or groups pursue their own interests (Seidman and Wagner, 1992). Some critical smart city writers go further and suggest that the positioning of smart city agencies is more about commercial interest than a genuine desire to solve urban problems (Hollands 2015; Söderström et al, 2014). Soderstrom focuses on IBM in particular and argues that the modernist narrative told by IBM is primarily about commercial interest. IBM is a technology company that promotes a utopian vision that combines systems thinking with data analytics to solve

urban problems. Some smart city authors are critical of the approach that IBM takes. Söderström et al (2014, p317) powerfully argue that IBM's faith in technology takes us:

“back to the epistemology dominant during the 1950s and 1960s, the heyday of spatial analysis and the belief in the universal power of quantitative models”

Criticisms of the foundations of modernism undermine some of the utopian claims about the potential of new technologies such as big data, predictive analytics and artificial intelligence. They are assuming that the world is formed with knowable and definable parameters that would enable us to predict with perfection if we were able to measure them all (Maton, 2003; Kitchin, 2014:2015). The echoes of the idea of cybernetics (outlined in 7.3) seem apparent in their criticism. The idea of cybernetics is further criticised in 8.4.2.

8.2.2 Power

The second issue with data concerns the notion of power. It is the idea that data might be influenced by power interests. The existence of power interests within data is frequently asserted by critical researchers (Denzin, 1994; Maton, 2003; Baetens, 2014). The idea that data is not neutral links back to methodology discussion in 3.1 I argued that reflexivity is needed because data is not neutral and so it is also necessary to consider world views. If data is distorted by power then the argument given by Ayres (2008)¹⁰⁰ that information technology can make better decisions than humans is weakened. It is weakened because the existence of flawed data would inevitably lead to less perfect recommendations or decisions based on any analysis of the data¹⁰¹.

Baetens et al (2014, p2) express a similar concern to Maton when they argue that the very idea of raw data is an oxymoron:

“data are always already ‘cooked’ and never entirely ‘raw’.

Hollands (2015) applies scepticism of data neutrality to a criticism of IT companies. He argues that, the idea that we need to become technologically smarter to save our cities, is ideological.

¹⁰⁰ Ayres's argument was outlined in 7.3.3.

¹⁰¹ I am suggesting that this world view is based on a resurgence of modernist thinking as outlined in 8.2.1

In healthcare, data is likely to be imperfect because not all published research is entirely accurate and some includes spin (Goldacre, 2014). Furthermore much research is unpublished, some deliberately so. This appears to support the idea proposed earlier that perfect unbiased data does not exist. Products such as Babylon's health app and IBM Watson's supercomputer analyse vast amounts of data. Watson's database includes 25 million abstracts to help with decision making (Schmidt, 2015). Technology such as Watson and Babylon Health could be problematic if the suggestions they give are accepted without question. The risk is that they might be flawed due to the imperfections of the data that their analysis is based on.

8.2.3 Data Ownership

A third issue with data emerged from discussion in workshop 3, the issue of data ownership. T-D highlighted this issue with comments about Google DeepMinds, in relation to their contract with The Royal Free. He stated:

117 T-D "ostensibly, they're using one-and-a-half million patients-worth of data, their full care records, for a year, it's a renal application, but the hospital have signed over everything to them, you know, they have the complete dataset."

The concern indicated by T-D is also expressed by researchers (Powles and Hodson 2017; Hodson 2016; Armstrong 2016; Hawkes 2016). Powles and Hodson (2017, p12) state that:

"DeepMind will keep all algorithms that are developed during the studies. In other words, the knowledge DeepMind extracts from these public resources will belong exclusively to DeepMind."

Powles and Hodgson also highlight other NHS contracts that Google DeepMind are involved with, including one with UCL, concerned with cancer diagnosis. Concerns they express include lack of transparency and developing a monopolistic position in terms of both expertise and access to data.

In workshop 2, M-Y highlights concerns about data ownership that are similar to concern expressed by Powles and Hodson. M-Y states that '*data is king*'. He illustrates his concern in relation to his own experience:

118 M-Y "I was looking at something from a company that are looking at how to record MDTs".

His view was that they would take the contract for free because they want the data, stating that: *"data is money, it's their currency"*. This supports the argument that in their contract with The Royal Free and other trusts, Google DeepMind are likely to be at least as interested in the data as the value of the contract.

Another point made by Powles and Hodson (2017) is that Google DeepMind had no expertise in healthcare prior to their partnership with the Royal Free. DeepMind's lack of prior expertise in healthcare relates to the first two data issues I have outlined in this subsection of this chapter. I argued in 8.2.1 that decision making based purely on data is embedded in a positivistic world view, a perspective that is problematic because it misses out on the subtle nuances of human subjectivity. The positivist approach I suggest is not likely to be neutral in the direction that it is likely to steer the healthcare system. It is likely to steer it in a direction that is in line with the ideology that underpins its assumptions. In 1.5.4 I suggested that some of the issues with the current system are associated with its modernist ideology and lack of focus on the social and cultural influences that maintain health. If these arguments are valid then digital health technology may be taking us in entirely the wrong direction if it remains embedded within a neo-modernist worldview.

Whilst advanced analytics devices are much better than people at analysing vast amounts of data, for now at least, people are better at understanding the sometimes subtle and nuanced factors that influence the make-up of the data pool that they are analysing to make their decisions. The sheer quantity of data involved makes it almost impossible for anyone to question with any accuracy the limitations of all of the data that these devices are analysing. Added to this there is the issue of who owns the data and the algorithms used to analyse it. Babylon, Watson and DeepMind are all owned by private companies. For commercial reasons they might be unwilling to share too much information about the data and the processes that go into the recommendations their products give. If we don't understand the processes involved in giving health recommendations the temptation could be to blindly accept them.

8.3 Top Down Corporate

Critical digital health researchers frequently highlight the commercial interests in healthcare. Several also suggest a link with lifestyle arguments outlined in the last chapter (Sosnowy and Collette, 2014; Rich and Miah, 2014; Lupton, 2014). Rich and Miah argue that the dominant discourses in digital health are inextricably linked to neoliberal ones and as such undermine narratives of empowerment.

Concerns about the role of the private sector were expressed in many interviews and workshops. In workshop 3 one of the managers related concern about private sector involvement with theme 16, skill shortages:

119 M-L "we might have to go out to the private sector to do the endoscopies, which is much more expensive than having your own people within the NHS ...although the jobs are there and the money's there to fund them, you can't get people to come into those roles because, you know, well, I'm guessing they can earn more in the private sector"

Large private corporations are at the centre of many dystopian visions both in workshops and in literature. In workshop 2 one participant stated:

120 T-D "How about, corporations are incentivised to get people to lead unhealthy lifestyles, because this kind of health system allows them to market, things to people's extended networks, and see this whole thing as a commercial opportunity"

K-M immediately supported this idea stating that:

121 M-K "it's happening, isn't it? Scary. You just need to walk round the supermarket"

Concerns about commercialisation are also illustrated by Figure 30

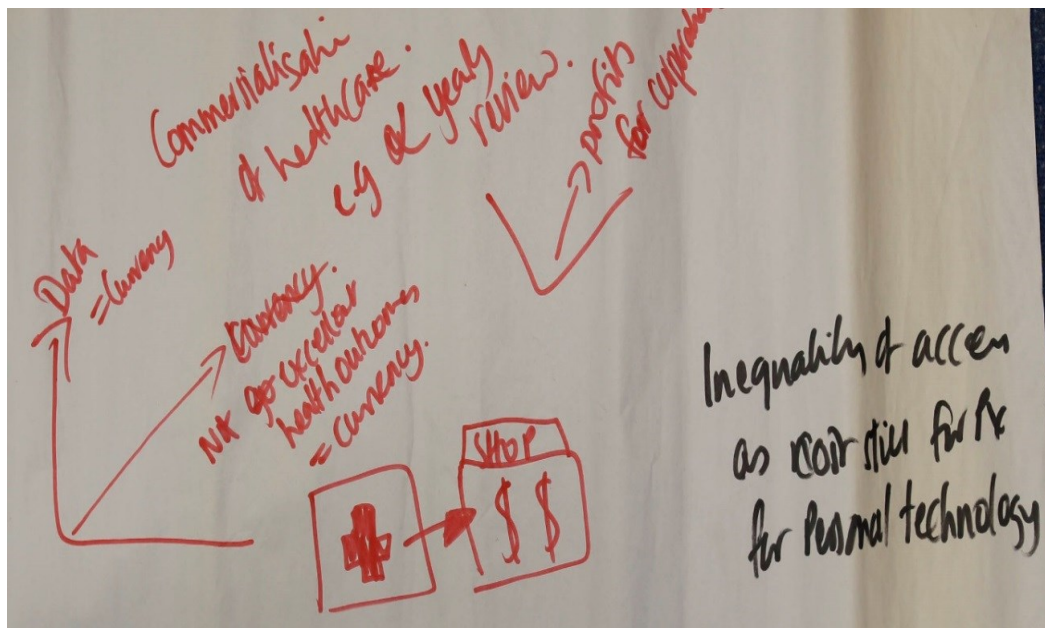

Figure 30: A Rich Picture of Dystopia

8.3.1 Social Control

Söderström et al (2014) make a similar point to T-D in comment 120 focussing on the idea of social control. Social control is implied by T-D and K-M as they talk about incentivisation. Söderström et al, with reference to IBM's smart city marketing, argue that IBM are telling a story that presents their smart technologies as the only solution for various urban problems. They highlight concerns about IBM's approach that they describe as technocratic. One concern is that by requiring the use of their systems the city is made to speak the language of IBM. Thinking of where this could lead has nightmarish undercurrents. IBM are particularly relevant to this study as they are a major player in both the smart city and digital health realms. I return to Söderström et al's research in the social control subsection of this chapter. The issue of social control also relates to how psychometrics influences lifestyle.

8.3.1.1 Lifestyle / Psychometrics

T-D was quite influential in initiating and steering much of the discussion about the influence of corporations and data. In response to D-M's discussion about nudging (in relation to Sheffield Parkrun)¹⁰² T-D states that it:

¹⁰² Parkrun Sheffield was discussed in 7.4.1.

122 “Opens up a whole, a whole can of worms, though, doesn’t it? Because people’s information environment, you know, influences their behaviour, massively, obviously”.

The can of worms he was referring to seem to become apparent within dystopia discussion when he argues that:

123 T-D “corporations see people’s involvement in the health service as a, as a commercial opportunity, and try and get people engaged in it, they are actively incentivised to get people into the health service, so they can use all these channels to market at, and, so, there’s no point trying to get people to lose weight, they have to make them fat first.”

I should however qualify the above statement. It was within the part of the workshop where I had asked participants to try to create a dystopian vision, to try to imagine the worst system they could think of based on smart community ideas. Given the context, it is unclear whether T-D is really critical of corporations or simply engaging in the exercise as asked¹⁰³.

T-N talked about what Facebook is already doing with data; collecting data about people’s interests and employment to feed into advertising. His ideas link back to discussion about psychographics in 7.4.1. T-N refers to the commercialisation of healthcare and talks about how corporations might incentivise us to eat sugar and that sugar is a factor in cancer. CS-K concurs that eating sugar may damage health.

T-D links discussion to how companies manipulate people’s behaviour. He refers to “*weaponised data*” and

124 “what companies like Cambridge Analytica have done, where they’ve determined whether or not you might be, neurotic, say, or what your self-esteem is like, or whether you sleep well or not, and serve political messages at you”.

González (2017) makes a similar argument, referring to the term weaponised AI.

Whilst he expresses scepticism about the impact that Cambridge Analytica have had so far, Gonzalez highlights the possibility that in the future similar companies might be

¹⁰³ As outlined in 3.4.2 the purpose of asking participants to imagine radical utopian or dystopian futures was to get them to think beyond some of the structural constraints that influence their thinking.

able to develop potent methods of mass manipulation. By extending the idea of social control he outlines a future where institutions can mould the ideas, attitudes and behaviours of their audience.

T-D takes ideas of social media influence to its ultimate conclusion in terms of efficiency, arguing that the most effective way of saving money is to influence people to engage in lifestyle choices where they will die as soon as possible:

125 T-D "Instead of investing money in prevention and diagnosis, you invest money in, or, do you, you know, you try and get people who are going to use up a lot of resources, to not need them anymore, as quickly as possible. So, you actually want people to die, as early as possible, if they're, if they're likely to use more resources, you want the heavily smoking, overweight, unhealthy people to not hang on, they cost a disproportionate amount of the current budget."

M-Y supports this argument with reference to obesity surgery:

126 M-Y "the cost of obesity surgery is far cheaper than a lifetime of diabetic drugs, but then that lifetime is therefore longer, so then they start dying of cancer, which is far more expensive to treat."

As outlined in chapter 2 there is research that counters these opinions, research that indicates that lifestyle interventions tend to save money as well as improving health outcomes. It is however difficult to argue with the narrative that certain groups of people, those who are already in poor health, are already costing the healthcare system a lot of money. Given this, it would be financially efficient if they died quickly¹⁰⁴.

Sosnowy (2014) connects lifestyle issues to discussion of forums. She argues that patients donating information online may appear at first glance to be an act of rebellion against current healthcare providers¹⁰⁵, however consideration needs to be given to who else gains from data sharing. Her implication is that private companies would do so.

¹⁰⁴ This relates to the argument put forward by Popejoy (2016) in 1.5.3 that by far the most expensive year of most people's lives for the healthcare system is their last

¹⁰⁵ Patients may appear to be in rebellion because they are taking their health into their own hands rather than relying entirely on healthcare providers

In 5.2.2 I argued that engagement in forums might be a way that patients might to some degree challenge the current medical paradigm. In response to Sosnowy's argument, by doing so I might be simply advocating a perspective that would shift power from one set of dominant interests (senior healthcare professionals) towards another (corporate digital health companies). Her counter narrative is strengthened by her assertion that organisations such as the MS society are funded by pharmaceutical companies. As all the cancer survivors who referred to forums had been active users of the Macmillan forum, this may be relevant. It would be relevant if Macmillan Cancer support are also supported by drug companies.

8.3.2 New Walls

In chapter 4, hunch 4 I argued that digital health technology could knock down the physical and cultural walls that exist in the current healthcare system. There is however a counter narrative. Till (2014) argues that the private ownership of apps has resulted in data being tied up '*within corporate walls*' and that companies' resistance to sharing data is making it difficult for individuals to capture a holistic picture of their health. Concerns about Google DeepMind discussed earlier in this chapter relate directly with the concern expressed by Till. DeepMind were initially contracted by Royal Free to construct an app. If the concerns expressed by T-D and by the researchers listed earlier are valid, then there appears to be a significant risk that this example could become an illustration of data being tied up within corporate walls.

8.4 Top Down Public Sector

The issue of improving the efficiency of cancer services in Sheffield is very much about governance. Although many researchers have indicated that the private sector is playing an increasing role within the UK health and care system, it is still primarily a public sector entity. Much of the discourse within smart community literature is about how smart technology can help improve the efficiency of the public sector. Many similar ideas occur in digital health articles¹⁰⁶.

Throughout this thesis I have discussed issues with smart government; I introduced the idea that there were tensions between top down and bottom up narratives in

¹⁰⁶ How digital health technology might improve efficiency was discussed throughout chapter 7

chapter 2. I identified this tension as a theme in chapter 5. In that chapter issues with top down approaches were central to discussion in story 1. In that story the way that the introduction of information technology had been introduced was distinctly dystopian. The issue with letters not being sent out was a horror story.

Smart governance relates to smart community as it is about significant change through new relationships between human and non-human agents. Some argue significant change cannot be achieved without major changes in governance and digital technology can enable the emergence of new bureaucratic structures (Goldsmith and Crawford, 2014). There is however no guarantee that smart governance will be benign. Smart governance is often associated with top down control systems, often involving the use of dashboards. The idea of dashboards are frequently mentioned in smart city literature (Naphade et al., 2011; Goldsmith and Crawford, 2014; Luque-Ayala and Marvin, 2015; Powells, Bulkeley and Mc Lean, 2016) and in digital health literature (Loder, Bunt, and Wyatt, 2013; Geissbühler et al, 2015; Puppala et al, 2015; Wachter, 2015).

8.4.1 Techno-centric Governance

Central control systems signify a form of techno-centric governance that resonates with the form of modernism discussed earlier in this chapter. Technocratic governance assumes that complex problems can be solved or optimised by monitoring, measuring and computation (Mattern, 2013, Morozov, 2013, Luque-Ayala, McFarlane and Marvin, 2016). This is problematic because it is highly reductionist and so not appropriate for addressing complex wicked problems¹⁰⁷. Luque-Ayala, McFarlane and Marvin argue that technological approaches tend to paper over the cracks rather than addressing the deep-rooted structural problems underpinning them.

Issues with techno-centric governance frequently occurred in interviews and workshops. Whilst participants discussed how AI might be able to improve the efficiency of the system¹⁰⁸ they also expressed caution. To illustrate these concerns a few of these are given below:

¹⁰⁷ Technocentric approaches adopt a positivist approach. In 3.1.1 I outlined why this was not appropriate for addressing wicked problems

¹⁰⁸ As discussed in 4.3

127 CS-K *“What happens when it goes wrong?”*

128 M-H *“who’s to blame if it goes wrong?”*

129 M-Y *“never cut people out of the process due to the subjectivity involved”*

I find it significant that concern is expressed by participants with a range of different experience. A commonly expressed view was the idea that there are some things that people are better at than computers. These included dealing with subjectivity, an idea related to this study due to the wicked complex nature of the problem, as defined in 1.5.1.1.

8.4.2 Urban Design

The roots of the smart city concept are embedded in mid-20th century urban planning, urban cybernetics and a form of city managerialism (Greenfield, 2013; Townsend, 2013; Kitchin, 2014b; Goodspeed, 2014). Due to this complex interplay of influences, in the smart city arena the line between public and private is often blurred. Smart city researchers, particularly those engaged in critical research, frequently make a link between smart city and managerialism (Hollands, 2008; Wolfram, 2012; Kitchin, 2014b; Söderström et al, 2014; Vanolo, 2014; Marvin, Luque-Ayala, and McFarlane, 2016). There are two different smart city dystopias related to the urban design origins of smart cities. The first is the shared modernist techno utopianism, the second the ideology of managerialism. I now address each of these in turn.

Many critical smart city researchers highlight dangers of the certainty placed in urban modelling in the mid-20th century. Some researchers make a link between Le Corbusier and techno-centric smart city ideas (Rabari and Storper, 2014; Vanolo, 2016; Marvin et al, 2016; Cowley, Joss, and Dayot, 2018)¹⁰⁹. The association is deliberately dystopian as Le Corbusier had an extremely mechanistic vision, describing a house as a machine for living in and an office as a machine for working in (Bonda and Sosnowchik, 2006). Townsend (2013, p110) offers some explanation as to why there might be a problem with the utopian attitudes of smart city advocates when he states:

¹⁰⁹ In 1947 Le Corbusier advocated a top down planning approach to accommodate motor transport in Paris. Using a medical metaphor he argued that surgery was inevitable (Corbusier 1947).

“the technology giants are out of sync with what we know about how cities need to evolve”.

In his comment Townsend certainly appears critical of centralist grand designs.

Soderstrom et al, appear to have a similar perspective. They argue that we could be about to watch history repeat itself, a Le Corbusier redux, repeating the worst planning disasters of the 20th Century (Söderström et al., 2014, p309). Marvin et al make a similar point describing smart city ideas as *“wild frontiers of digital speculation”* and *“some parody of Le Corbusier’s City of Tomorrow”* (Marvin et al., 2016, p166).

The critical association with Le Corbusier is relevant to healthcare for several reasons. First, as argued in chapter 2, the idea of smart community is closely related to that of the smart city. Next, as outlined in 7.3.1, digital health literature shares a similar utopian optimism to smart city and smart community texts. Furthermore, as outlined in 3.1.1 the NHS was a modernist institution, built upon faith in reason and progress (Kernick and Sweeney, 2001) and as such it shares its ideological foundations with the heyday of urban design.

8.4.3 Managerialism

As implied by the word, managerialism is a focus on management principles. As such it often focuses on targets such as improving efficiency. It is also associated with top down smart city approaches including the use of dashboards (Mäntysalo, 2016; Marvin et al., 2016). Within the managerialist conceptualisation of smart cities, service users are viewed as customers rather than active citizens (Mäntysalo, 2016). Managerialism has been associated with digital health as well as smart city ideas (Hoque, Davis, and Humphreys, 2004; Greenhalgh, Swinglehurst, and Stones, 2014).

Critics of managerial and techno-centric views argue that the smart city should start with the city and not with the smart (Hoornweg, 2011; Schaffers et al, 2011).

Townsend (2013) makes an argument that connects these ideas to the issues with taking a techno-centric approach that I made earlier. He argues that simply installing new technology, no matter how elegant or powerful, cannot solve a city’s problems in isolation. Lupton (2014) makes a similar argument in relation to digital health, arguing that digital health ideas are often portrayed uncritically as solutions. She argues that a more critical approach is needed to address broader implications such as power

relations including the doctor–patient relations. In line with the insights I referred to earlier, Lupton refers to the issues of surveillance¹¹⁰ and social control¹¹¹.

8.5 Bottom up

Bottom up visions are sometimes given as an antidote to the more technocratic ideas discussed earlier (Hollands, 2008; Harvey, 2012; Townsend 2013; Söderström et al, 2014). Harvey and Townsend both suggest that more inclusive processes are needed. Townsend argues that the broader community of technologists, civic leaders, and citizens themselves need to be involved in making choices. Hollands (2008) also talks about social and economic inclusion. He advocates a shift in power away from corporate business towards ordinary people and communities. He argues that technology can enable increased community participation. The shift in power that Hollands advocates is clearly in line with the views expressed by Söderström, Paasche et al in their criticism of IBM's smart city vision, outlined in 8.3.1.

8.5.1 Individualistic Counterculture

Bottom up approaches however risk becoming naïve utopian dreams as there is a dark side to bottom up as well as top down approaches. Arguments about digital governance date back to the early days of the internet. Some authors link the ideology of the internet back to a form of counterculture that existed before the internet emerged (Turner, 2006; Van Dijck and Nieborg, 2009; Margolis and Moreno-Riaño, 2016). Some portray this form of counterculture as a form of dystopia (Turner, 2006, Van Dijk and Nieborg, 2009) Van Dijk and Nieborg argue that the reality of the internet is actually an environment where people are driven by the desire for status, such as by posting the top ranking video or becoming the top posting user. I suggest that such a desire may be thought of as the desire to gain symbolic capital.

Those involved in shaping the web were influenced by different countercultural ideologies. These included both left wing collectivist views and strong libertarian views about freedom (Turner, 2006, Margolis and Moreno-Riaño, 2016). Turner argues that

¹¹⁰ Surveillance was discussed in story 2 and in relation to comments 72 and 73. It will be discussed later in 8.7

¹¹¹ I return to the idea of social control in 8.6

Stuart Brand¹¹² was particularly influential in influencing the countercultural values that shaped the net. Brand argued that top down politics is bankrupt and change must now come from individuals acting with other likeminded individuals. Unrestricted freedom however risks opening up the internet to a whole host of issues, including the potential that freedom in the internet could result in lawlessness in the real world (Morozov, 2014). Morozov's claim is illustrated by the emergence of the dark net and its links to organised crime. Another risk as discussed below, is the possibility that unrestricted freedom benefits some far more than others resulting in increased inequality. As discussed earlier the issue of inequality relates to the concept of cultural capital¹¹³. Ideas relate to the idea of a dystopian future as technological advances may benefit some and leave others behind. Taking the idea discussed in previous chapters forward, we can imagine a future where people who have acquired sufficient cultural capital to navigate the system, achieve improved health outcomes whilst many others get left behind. Life expectancy for those living in the most affluent areas of Sheffield is already 10.1 years higher for men and 7.6 for women than life expectancy for those living in more deprived parts of Sheffield (*State of Sheffield Report — Sheffield City Partnership*, 2018). It is easy to imagine gaps in life expectancy increasing significantly as those from more affluent backgrounds are disproportionately able to gain access to information and understanding through apps, forums and online research.

8.5.2 Consumerism

An important ideological difference between bottom-up visions of healthcare is between customer centric and citizen centric models. Whilst both at one level enable patients to become actively involved in healthcare decisions, there are significant differences. In the customer centric model although patients have a degree of choice about which treatments they receive, patients remain passive recipients of healthcare, whilst in the second they are actively involved. The idea of citizen centric healthcare is

¹¹² Stuart Brand gained notoriety by publishing the Whole Earth Catalogue, an influential countercultural resource that some argue became a kind of blueprint for the internet (Turner, 2006, Margolis and Moreno, 2009)

¹¹³ Inequality was introduced in theme 5 and discussed around comments 17, 18, 31 and 34

closely connected to the concept of coproduction¹¹⁴. Customer focussed approaches are however sometimes associated with managerialism (Dent, 2006) and with an increased role of market forces (Dent, 2006; McLaughlin, 2009; Sturgeon, 2014). McLaughlin argues that whilst citizens have rights customers have choice. McLaughlin's conceptualisation of customer choice resonates with the libertarian ideology discussed earlier, as within it customers are conceived of as people with freedom rather than people who just have health or care done to them. The ideology of choice however links to earlier discussion of inequality as some are more able to consume healthcare than others.

8.5.3 Lifestyle

Although the ideal of improving health outcomes through encouraging people to change their lifestyle may appear to be a worthy aim, lifestyle interventions have the potential to contain within them the dystopian ideas of surveillance and inequality. Until fitness devices become available through the NHS, people using monitoring devices such as Fitbit are consumers¹¹⁵ of healthcare. The act of purchasing devices that may improve healthcare leads back to the discussion of consumerism discussed earlier. The process of influencing behaviour through such devices requires the user to actively monitor and log their everyday lives. Such actions may be seen as a form of self-imposed surveillance (Fotopoulou and O'Riordan, 2017).

8.6 Social Control

The idea of nudging behaviour through lifestyle interventions, as discussed above, is a form of influence bordering on social control. Authors including Theodor Roszak, Charles Reich, Neil Postman and Jerry Mander, offer warnings about what could go wrong in a technological age (Roszak, 1986; Postman, 1992; Van der Laan, 2004). Postman suggested that today's technologies are out of our control and instead control us. Postman asserts the idea that all technological developments bring with them unintended consequences, and often create problems as well as solutions.

¹¹⁴ Coproduction was discussed in detail in 2.3.2 and re-emerged in 4.2, 5.1.1, 6.1.1 and 7.5

¹¹⁵ Viewing users of fitness tracking devices links back to discussion of Consumerism

Roszak expresses concerns about the invasion of privacy, corruption of education and economic sustainability.

Soderstrom (2014) implies social control or even worse social engineering, with the potential that people may have to live in a certain way to benefit from the efficiency of their machines. These ideas resonate with the discussion I outlined about lifestyle in 7.4.1 and 8.3.1.1 . Whilst the idea of gamification discussed in the last chapter may at first glance appear quite benign, if we consider where these trends could get to, a darker subtext emerges. Ideas of social control connect to the idea of patients and citizens needing to change their behaviour to enable efficiency improvements that frequently occur in healthcare technology literature. One example of such a system is outlined by Broy et al (2012). He describes a smart health system that includes monitoring and alerts to remind the patient to take medicine. Whilst monitoring and alerts might improve efficiency, the role of the patient is passive and the technology appears designed to control her behaviour rather than to adapt to it. In short this environment appears rigid and lacking in flexibility. It describes a top down approach that assumes a world view in which all meaningful flows and activity can be sensed and measured.

H-Q made a point that connects parkrun discussion in 8.3.1.1 to the idea of social control. He stated:

130 "We know that people who are more physically active take less sick leave, so you can imagine bosses saying, 'right, you've got to be active"

Whilst comment 130 might appear at first glance like a dystopian fantasy, insurance companies and employers have already introduced wearables as part of workplace wellbeing packages offered to employees (Olson and Tilley, 2014; Fotopoulou and O'Riordan, 2017). It's not such a leap of imagination to conceive of a future where the use of such devices and engagement in related workplace wellbeing activities has become a condition of employment.

Another healthcare professional also engages with the idea of employers controlling the behaviour of its staff outside of the workplace:

131 H,A-B "an American company, or a, a company from a different country, or based in a different country that takes a more ruthless view of its staff? Or how

that, but I actually think that is one of the sequelae of the breach, another, sequelae of the breach might be insurance and discrimination regarding insurance, but also there's something fundamental about, manipulation, that, that you can then potentially be manipulated, within your societal role you can be controlled in ways that are, would be, potentially very, very much more sinister."

T-D refers to an apparent contradiction in lifestyle interventions aimed at improving efficiency. He states:

132 "we want them (implying patients and citizens) to behave in certain ways, but we also want them to have complete autonomy over their attitudes".

Whilst the interventions proposed by Broy et al (2012) and others might improve efficiency, they also require people to be compliant, to behave in certain ways rather than becoming active and equal participants in their healthcare decisions. Such ideas appear to clash with T-D's advocacy of the need for complete autonomy. The issue of patients needing to change behaviour to benefit from technology relates to the idea of cultural capital as discussed in 7.5. For nudging to work, people's attitudes and behaviour need to change (Rich and Miah, 2014; Sosnowy and Collette, 2014). Sosnowy introduces the idea of personal responsibility, arguing that both public and private institutions aim to influence behaviour. They imply a paternalistic approach stating that institutions seek to discipline citizens by making certain behaviours moral imperatives. Associating both public and private institutions is interesting as it implies the interests of public and private institutions are aligned with each other and that citizens are in opposition to both. Harvey (1989)¹¹⁶ also aligns public institutions with private companies. He critically describes it as an entrepreneurial form of governance. The partnership between Google DeepMind and The Royal Free¹¹⁷ appears to be an example of the type of relationship criticised by Harvey. The idea of personal responsibility outlined by Sosnowy is reminiscent of the criticism of asset approaches,

¹¹⁶ Harvey (1989) is an influential paper, about the marketization of urban government. As of March 2018 it had 5095 citations

¹¹⁷ Discussed in 8.2.3

outlined in 2.3.2.1; the idea that asset approaches place too much emphasis on the role of the individual (Friedli, 2013).

8.7 Surveillance

The idea of surveillance was frequently referred to in interviews and workshops¹¹⁸. One of the most powerful surveillance ideas associated with smart technology is the idea that social computing has become a self-imposed panopticon¹¹⁹ (Morozov, 2011; Kandias et al, 2013).

Figure 31, by showing a panopticon prison within a smartphone, illustrates the idea of social media being part of a surveillance system. The idea of social media surveillance relates back to discussion about Cambridge Analytica in Lifestyle / Psychometrics as the use of social media data to inform targeted advertising links the dystopian ideas of surveillance and social control. The idea of the social media panopticon has been connected directly to health lifestyle specifically (Lupton, 2012; Rich and Miah, 2014; Depper and Howe, 2017). Depper argues that by being observed through digital technologies users are subjected to social control via peer pressure¹²⁰.

Figure 31 : Panopticon Prison Inside A Mobile Phone (Green, 2013)

Marvin et al (2016) apply ANT to the idea of the digital panopticon. If we conceive of artefacts such as smartphones having agency within a network, then these non-human agents may also influence behaviour. In 3.6.3 I stated that within ANT non-human actors can be concepts, and that actors that people are not directly in contact with, can influence change. Because social media platforms contain ideas, in this context we might consider that it is not just the physical devices we use that exert control over our behaviour, but also social media sites such as Facebook that are accessed through

¹¹⁸ Surveillance was discussed in story 2 and in relation to comments 74 and 75

¹¹⁹ A panopticon is an architectural design of a prison designed by Jeremy Bentham, where custodians are located in a central position where they can observe all the cells in the circumference. The idea was adopted by Foucault (1975) as a metaphor for surveillance in the modern age.

¹²⁰ The inclusion of peer pressure links to discussion about the negative aspects of Social Capital later in 8.8

them. This possibility is supported by research that suggests that people can become addicted to social media (Kuss and Griffiths, 2011; Andreassen et al, 2016).

8.8 Capital revisited

Ideas relating to power and influence frequently occurred in interviews and workshops. Many of these relate to Bourdieu's Theory of Practice. Much of the discussion outlined so far in this chapter, relates to the concept of economic capital. This is entirely appropriate as this project is focussed on how to improve efficiency. Discussion about how commercial companies are positioning themselves in both the smart city and digital health arenas, most directly relates to this form of capital as it relates to future commercial gain. The positioning of smart city companies however also relates to many other forms of capital. Cultural capital is relevant as, digital and smart city healthcare companies appear to be gaining traction in part due to a lack of digital cultural capital amongst public sector employees. Powles and Hodson (2017) made it clear that in their view, The Royal Free was enthusiastic about working with Google DeepMind, because of their perceived expertise in AI; expertise (and therefore also cultural capital) that the Royal Free did not possess.

When different forms of capital are applied to understanding the challenge of encouraging lifestyle change, issues become apparent; a lack of economic capital may prevent some from purchasing fitness monitoring devices, a lack of cultural capital may prevent people from engaging with the system, and a lack of symbolic capital may prevent healthcare professionals recognising that patients have ideas worth listening to.

8.8.1 Economic Capital

I outline below some comments related to economic capital:

133 T-D "I don't think, I don't think we wrote a pound sign or a dollar sign on the utopian, on either of the utopian visions, but they appeared on the dystopian vision, and the motivations in the utopian were about health outcomes and the healthy, healthy outcomes for individuals, in the second ones it was having those motivations captured and co-opted by corporate interests"

134 H,A-B “perhaps, we can utilise a private sector company in some way, but I’m not clear that the way that we’re utilising them doesn’t give them enough power to do what they like”

Both of these raise concerns about the economic capital of private sector companies in the UK healthcare sector. In comment 133 T-D appears to be suggesting that it is significant that utopian visions were focussed on health outcomes, in this dystopian vision, the focus was on the economic capital of corporations. In comment 134 H,A-B expresses similar concerns. She is concerned about the power of private companies. She expresses a dilemma between the potential benefits of tapping into private sector expertise and concerns about the potential impact of this involvement. She was particularly concerned about the involvement of overseas companies. She argues that even if thorough regulations are put in place, because private companies can go bankrupt they are almost impossible to control:

135 H, A-B “if the company is, for example, an American company, and a private company, it can be taken over, could be bought out. It will have signed up to, I’m sure, a whole series of agreements regarding confidentiality and, cyber security, et cetera, et cetera, but the bottom line is that if they breach, they go bankrupt. And then they reopen.”

The risks of private sector involvement relate to cultural as well as economic capital. In comment 135 H, A-B appeared to be implying that private companies may have cultural capital relating to getting around regulations that may exceed the cultural capital of the healthcare organisations that they are working for. If we relate her concern back to the example of healthcare trusts working with Google DeepMinds¹²¹, it appears that she is concerned about the potential risks involved with the public sector becoming more involved in the delivery of healthcare. Her concerns appear in line with Harvey (1989)¹²² as outlined earlier. Her concerns appear to relate back to story 1 where interviewees expressed concerns about top down interventions. Whilst

¹²¹ Discussed in chapter 8, Data Ownership

¹²² As outlined in Social Control earlier in this chapter

H, A-B is expressing different concerns she appears to share concerns about top down technology driven approaches with the interviewees referred to in that story.

8.8.2 Cultural Capital

The main dystopian ideas related to cultural capital discussed by participants were the risks that people working in the system of cancer services, might become less able to engage in the system as it evolves with technological change. I discussed the patient issue of cultural capital in 5.1.2. It is an issue of equality, with some patients getting left behind as they fail to develop the skills to navigate the evolving system.¹²³ The quote given below outlines the concerns given by two healthcare professionals about challenges that have emerged due to technological change:

136 H-Q “healthcare professionals as well, they’re going to be asked to delve into an area that they weren’t trained in, they feel a bit vulnerable in, they don’t feel like they’re really expert, you know, erm, there’s a lot of insecurities within that”

Comment 136 indicates that in the view of H-Q, healthcare professionals are finding that their cultural capital is reducing. By stating that they are being asked to delve into an area they are not trained in he is implying that they don’t yet have the cultural capital required to thrive in the new system. ANT is also relevant here, as discussed previously it implies that change resonates throughout the network. From an ANT perspective concerns expressed may be entirely legitimate. If change is likely to resonate throughout the network then the extent of the change that they need to adjust to could be significant.

I outline below two further comments that indicate the need for healthcare practitioners to retrain

137 M-I “you know we’re at the potty-training end of it really. I mean we really are absolutely stumbling in the semi-darkness on this stuff, er, and you know the danger is that it could all end up in utter chaos, and we’re all going to want to go back to being Sir Lancelot Spratt again or one of his patients”

¹²³ I referred back to this in inequality earlier in 8.5.1

138 M-VS-C *"I think the interesting thing about Cop a Feel is, specific point, is it wasn't a woman with breast cancer who needed educating, it was a GP who needed educating."*

M-I expresses similar concerns to H-Q about the lack of relevant expertise relating to the ICT driven healthcare environment we are moving into. The reference to Sir Lancelot Spratt¹²⁴ is significant as he represents an approach to healthcare where the view of the healthcare professional reigns supreme. The idea he represents is in clear opposition to the idea of internet informed patients entering into a dialogue to collectively discuss what might be wrong, and what the best treatment options might be. M-I is suggesting that given the challenges of dealing with the impact of information technology, some professionals might like the idea of a healthcare system like the one where the fictional character existed in. Both the Lancelot Spratt system and the internet driven one have the potential to be dystopias. As discussed previously, if professionals don't have the expertise to engage effectively with the system they are operating in, they are vulnerable to exploitation by private sector companies. The autocratic system dominated by a character such as Sir Lancelot could also be a dystopia, as they may not have all the information and are not likely to fully consider social and psychological factors. The limitations of this type of approach has been discussed within the critique of the biomedical model that has flowed through this study. Comment 138 supports the idea that the cultural capital of healthcare professionals is declining as a result of technological change. In the view of M-VS-C there is a need for further education, at least for the specific GP that he refers to.

Comment 139 supports the assertion made in the paragraph above that some healthcare professionals are concerned about the process of patients informing themselves online. It also relates to the concern some healthcare professionals have that patients will access inappropriate information online, an idea that has flowed through this thesis¹²⁵:

¹²⁴ Sir Lancelot Spratt is a fictional representation of a doctor, from a series of films from the 1950's. He is an autocratic character that gives a stylised representation of a bygone era of medical life, Over a bedside sermon, the patient is not allowed as much as a word of response (Drife, 1994, p318)

¹²⁵ Healthcare professionals concerns about patients accessing information online emerged initially in 4.2.1.3, it was also at the core of hunch 1.

139 H-B *“there’s a lot of people who don’t particularly want to work in the breast clinics, because people are reading so much online, and come in with all these things that they’ve read”*

8.8.3 Symbolic Capital

Given the threats professionals face from technological change it might be anticipated that some people might believe their positions in the current system are being threatened, that their symbolic as well as their cultural capital is being diminished.

This appears to be the view of M-E:

140 M-E *“there’s a lot of politics, there’s a lot of money, there’s a lot of businesses, there’s a lot of careers and consultants looking at their careers, there’s a lot of people working on stuff that actually is of no value”*

M-E appears to be taking a cynical perspective, suggesting that much of the work being done in the current system is of no value beyond its symbolic representation. A lot of people doing work that is of no value is clearly not efficient. It is hardly surprising he argues, if you were designing a new system it would be very different. I am suggesting here that a system that includes a lot of people doing work that has no value is dystopian. It is a theme that emerges in dystopian science fiction, including ‘Brazil’ and ‘1984’.

8.8.4 Social Capital

Social capital as well as being an asset that can assist disadvantaged communities, also has a dark side (Fukuyama, 2001; Wakefield and Poland, 2005). Social capital can be used to reinforce the prestige and power of affluent social groups to the detriment of others in society. They highlight the notion that people can be constrained rather than empowered by social ties and social ties can lead to conformity in behaviour. Fukuyama refers to both the Ku Klux Klan and the Mafia as groups with strong social capital but negative externalities for the larger society in which they are embedded. He suggests that there is a natural tendency to divide the world up into friends and enemies.

Indications of negative aspects of social capital emerged in both interviews and workshops. In Sheffield health outcomes vary greatly between different geographical

areas; the gap in healthy life expectancy between least and most deprived parts of the city are 20 years for men and 25 for women (Arnold et al, 2017, Thomas et al, 2009)¹²⁶.

According to the 2017 State of Sheffield Report, 60% of health outcomes are due to lifestyle factors (Arnold et al 2017). Research also suggests that lifestyle decisions including smoking are largely socially determined (Pearce and Smith, 2003). The link between lifestyle and where people live was stated in workshop 3:

141 VS-M-C “people of the Manor, you know, you get the worst cancer outcomes, what are you doing about your eating or your smoking? is not going to do anything, and it’s a, more fundamental, exactly”

As well as stating that the worst cancer outcomes in Sheffield are in the Manor. In line with the research outlined above, M-C appears to be making a link between geographical location and lifestyle choice. It is however significant that he is stating that encouraging people to change their lifestyle is not likely to have an impact. This point was supported by M-B, who relates this conversation to the culture change discussion about Move More given in chapter 8, Prevention / Psychographics¹²⁷.

142 M-B “Needing to be healthy, it’s not going to happen, but it’s about how do we address that, how can we change that culture, how can we, it’s the stuff what Active Everyday are trying to do, aren’t they, as a, trying to tackle the city to make them more active, so ...effort’s being made to change the culture”

As illustrated by comment 142, whilst forms of capital help understand the dynamics taking place, the real world does not fall discreetly into boxes relating to different forms of capital. Sometimes, as in example 142, more than one form of capital is relevant. Lifestyle appears to be influenced by both social and cultural capital. The points made in comments 141 and 142 were broadly supported by other participants, there were lots of heads nodding and murmurs of approval.

LA-B talked a lot about community. He implied a connection with social capital when he states that “every community is diverse in its needs and wants”. By stating that a

¹²⁶ Healthy life expectancy is a population health measure that indicates the years of good health that are expected. As indicated in inequality, actual life expectancy between those living in the more affluent areas of Sheffield is 10.1 years higher for men and 7.6 for women than those living in less affluent areas

¹²⁷ Active Everyday is a sub project within the Move More Programme of physical activity in Sheffield

community has wants, he is implying that there are different shared values in different communities. His comment relates to the discussion above about the link between lifestyle and health, as what is wanted by most people in a community has the potential to have negative as well as positive impacts on health outcomes¹²⁸.

Another criticism of social capital is the idea that placing too much focus on social capacity can lead to the blaming of the community for its problems (Kawachi, Subramanian, and Kim, 2008). These criticisms are similar to the concerns about coproduction outlined in chapter 2, that coproduction can place blame on the individual (Friedli, 2013). The risk of blaming the individual, emerged in discussion in workshop 3, as illustrated by the quote below.

143 M-H "The impact of doing all this prevention stuff is, people who I see at the centre, erm, feel absolutely guilty, even though they've exercised and eaten right their whole life, they're like, 'what have I done wrong?' And it's trying to say, 'you haven't done anything wrong', necessarily, so the media has a lot to answer for, for, psychological trauma of these patients"

Comment 143 relates to a dystopian aspect of psychometric related lifestyle interventions, discussed earlier. Whilst social media messaging might encourage people to take more exercise, give up smoking and make other positive lifestyle choices, there is a risk that at the same time they may have a negative psychological impact.

8.9 Ethics

One of the core ethical concerns expressed by both digital health research and by science fiction (Gattaca, Jennifer Government) is the risk that insurance and /or employment opportunities could be jeopardised by employers or insurers gaining access to healthcare data (Barry, 2004; Grech, 2018). Concerns about insurance and employment were also expressed in interviews. A concern about insurance was expressed in workshop 3:

¹²⁸ This type of influencing behaviour was discussed in 2.3.3. I referred to Le Bon (1897), wisdom of the crowds

144 M-L *“what your results are could affect you as a person, and whether you’d get insurance, and all sorts of things”*

The issue of ethics resonates with me as it triggers my own memories of the cost and challenge of trying to gain travel insurance after my own cancer diagnosis. Through my own experience as well as the comments from participants I can imagine this issue extending into other areas of insurance and employability.

8.10 Conclusion

In this chapter I have outlined some ideas about what could go wrong when designing a future system of cancer services on the concept of smart community. In most cases ideas discussed were the flip side of ideas introduced in chapter 7. Concerns were supported by both literature and comments from workshops and interviews. Many of the ideas discussed related back to discussion in earlier chapters. For example, the issue about data sharing relates right back to story one outlined in 5.3.1.1. In this story I highlighted an example of a top down approach, including a private sector information technology system failing to achieve positive results. The two healthcare professionals I interviewed both gave examples of more user driven approaches that they believed would give better results. Their experience with Lorenzo appears to mirror both some of the top down ideas expressed by participants of workshop 2, and concerns outlined by critical researchers, such as the criticisms of positivism outlined in Faith in Modernity. Kitchen (2014) supports these criticisms when he states that big data, as with all data is a selective sample and as such is framed within a thought system. The limitations of medical data argued by Goldacre (2014) supports Kitchen’s view. Lupton (2016) links these arguments to the definition of smart community I have applied in this project. As well as arguing that big data is not impartial or neutral she claims that big data are the products of specific interactions between humans and non-humans.

Parallels between community development and collaborative models of information technology, as well as offering shared ideas for improvement also share some of the same risks and ethical issues. Criticisms of social capital and coproduction have been applied to digital models of collaboration. Digital collaboration however brings with it new risks and ethical concerns that could potentially lead towards a dystopian future

just as easily as it could a utopian one. To avoid a dystopian future and to increase the likelihood of a more utopian one, we might need to consider some of the forces that may be at play within potential utopian and dystopian models. This chapter has discussed what some of these forces might be, specifically some of the forces related to the concept of a smart community. By exploring some of these notions, this study aims to uncover ideas that might lead towards understanding how to create a brighter future.

Figure 32 illustrates one of the many ways that ideas discussed in this chapter could be combined. Many of the components of Figure 32 are the same as those included in the diagram at the end of chapter 7. They are however put together differently. Following the logic of discussion from this chapter, the differences could be significant. The key difference regards who has access to information, and who is involved in decision making. In Figure 28 patients were placed alongside healthcare providers and AI as part of collective intelligence. The suggestion was that both could be active and involved in making decisions. In Figure 32 they are compliant, nudged into changing their lifestyles towards healthier behaviours that will have less impact on the healthcare system. Fig 33 is a future system that might be more efficient than the current system, but due to the ethical and dystopian ideas discussed in this chapter, might not be desirable.

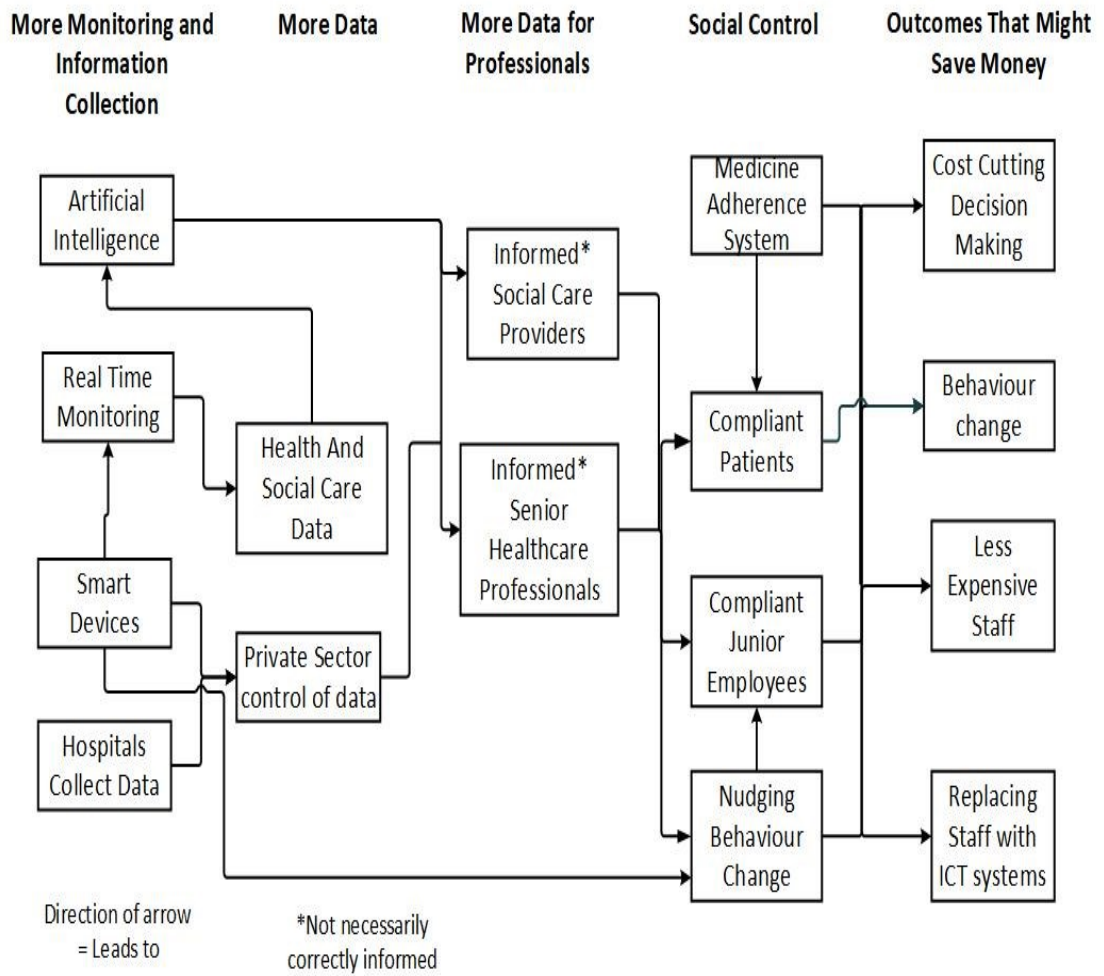

Figure 32 A Potentially Efficient Dystopia

Section D Conclusion

Chapter 9 Towards A Smart Community Theory

In previous chapters I have discussed many different ways the concept of smart community could be applied to the system of cancer services in Sheffield. Over the last two chapters, I have deliberately outlined and discussed opposing perspectives about what a system of cancer services in Sheffield could look like based on this concept. In this chapter, I bring together ideas outlined in all the previous chapters to create conceptual models about what a healthcare system might look like based on the concept of smart community.

Within this process two final pieces of the jigsaw are introduced. The first is content from workshop 3, the second is literature about smart governance. Just like the last two chapters were informed significantly by discussion from workshop 2, this chapter is informed by workshop 3. In workshop 3 I facilitated activities that steered participants towards the creation of a more balanced rich picture of the future. This rich picture and the dialogue that accompanied its creation is the core foundation for the conceptual model that emerges at the end of this chapter. Smart governance literature is introduced as part of my process of reflexivity, to help me understand and interpret comments that were made.

9.1 Part 1: Workshop 3

In workshop 3, participants updated and compared rich pictures, building on ideas from previous workshops. In this section I give an initial overview; more detail and discussion is given later in this chapter as I connect these ideas with literature¹²⁹.

9.1.1 Rich Pictures

Figure 33 is the rich picture of a future healthcare system that was created in workshop 3. Participants insisted that it revolved around placing the person at the centre. They emphasised that it was the person not just the patient. This was because it included *'people who are not even patients yet'*. The person-centred idea relates to it

¹²⁹ Discussion about the current system is not included in this chapter as it was outlined and discussed in chapter 6.

being a system to support people from the cradle to the grave. There was also discussion about it being a system to support life; so the emphasis is on life, not healthcare, nor prevention but on maintaining a good quality of life. This is illustrated by the images in the top right hand corner. The images are a boat and a woodworking plane, to indicate that different people have different life interests and the emphasis of the healthcare system should be giving people the time and ability to pursue these. I list some of the other ideas that were emphasised in discussion alongside figure 33.



- Gene Mapping
- Community Data
- Artificial Intelligence
- Communication
- Risk Stratification
- Health MOT
- Signposting
- Gene Mapping
- Family and Friends
- Continuous monitoring
- Holistic
- Data driven

Figure 33 Workshop 3 Future System Rich Picture

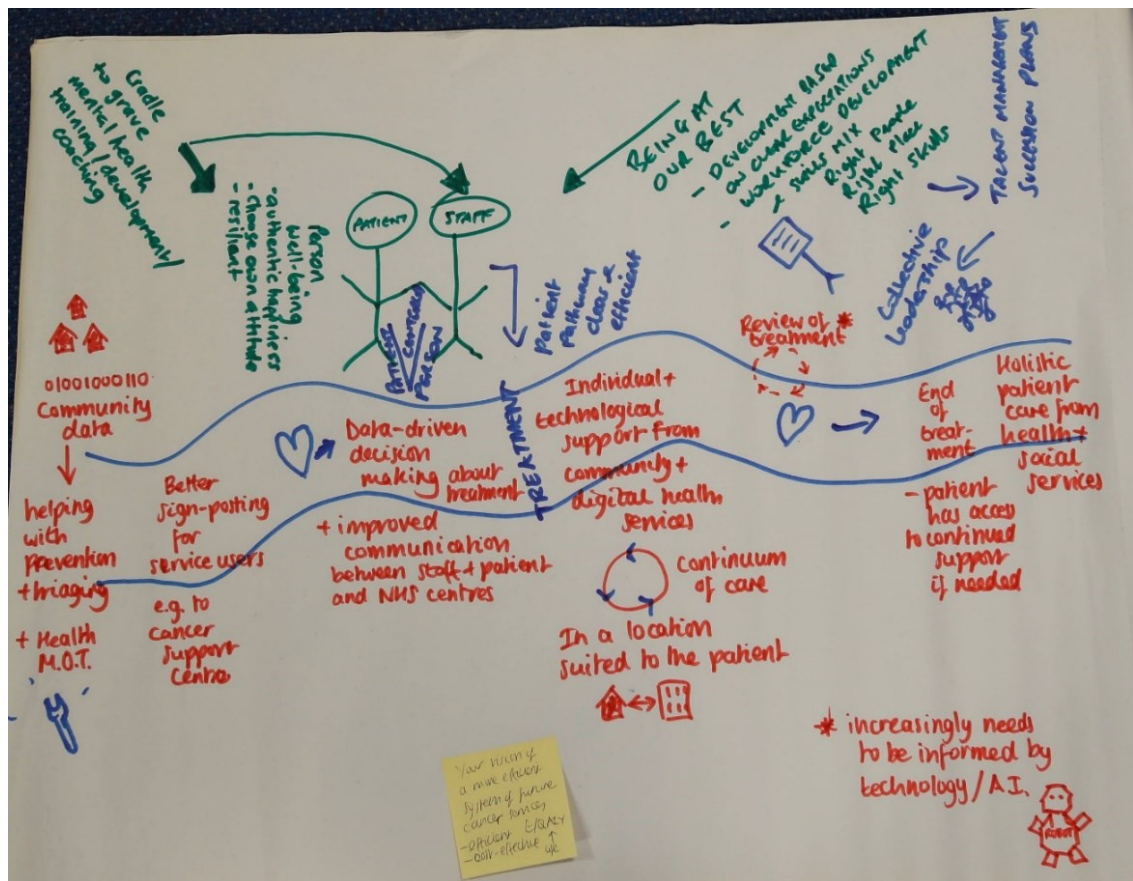

Figure 34 Workshop 2 Future System Rich Picture

As illustrated by Figure 33 and Figure 34 Ideas that were emphasised in workshop 3¹³⁰, included; person in the middle, health MOT, mental health, signposting, data driven and cradle to grave.

Person in the Middle

As illustrated by the comments below participants emphasised that being patient centred was not enough, because there also needed to be focus on keeping people healthy before they become patients as well as afterwards:

145 M-H “. . . it’s a person at the centre, so, they’re not even a patient yet”

146 VS-M- C “I think it should be elastic, I think it should be something which is about the person at the centre, and everything around, sitting around them”.

¹³⁰ These ideas emerged when participants were asked to bring their ideas together with the future system ideas outlined in previous rich pictures.

Comment 146 connects the idea with theme 11, flexibility. Participants believed that a person-centred service was a way of making it more flexible and responsive and that being person-centred also meant being responsive to and giving space for patient needs and interests such as their hobbies.

Health MOT

The idea of the health MOT was part of wider discussion about monitoring and what a streamlined joined-up system might look like:

147 M-H "health MOTs, anything that pops up, health wise, then it gets referred into this system, that is all beautifully linked by technology"

148 M-H "Prevention training, health MOT, so the health MOT would be part of tele-monitoring"

Signposting

Signposting was also part of a wider discussion about what a more streamlined joined-up service might look like:

149 M-Y "once they've had their health MOT then they get signposted to somewhere and then in terms of help with prevention and things like that, you might be signposted earlier, like, literally the first, signs of it"

Data Driven

Discussion about how data could inform decision making closely mirrored ideas outlined in chapter 8:

150 M-H "Data-Driven decision-making about treatment"

Cradle to Grave

The idea that the system should span from cradle to grave first emerged in workshop 2, but really took hold in workshop 3 where it was mentioned 5 times. It was directly connected to the idea of a holistic health and care system that included looking after psychological as well as physical wellbeing. It was also connected to culture change, encouraging people to be health focussed throughout their lives.

Summary

Figure 35 is a summary written by participants of workshop 3 about what they believed needed to change and ideas about an ideal vision.

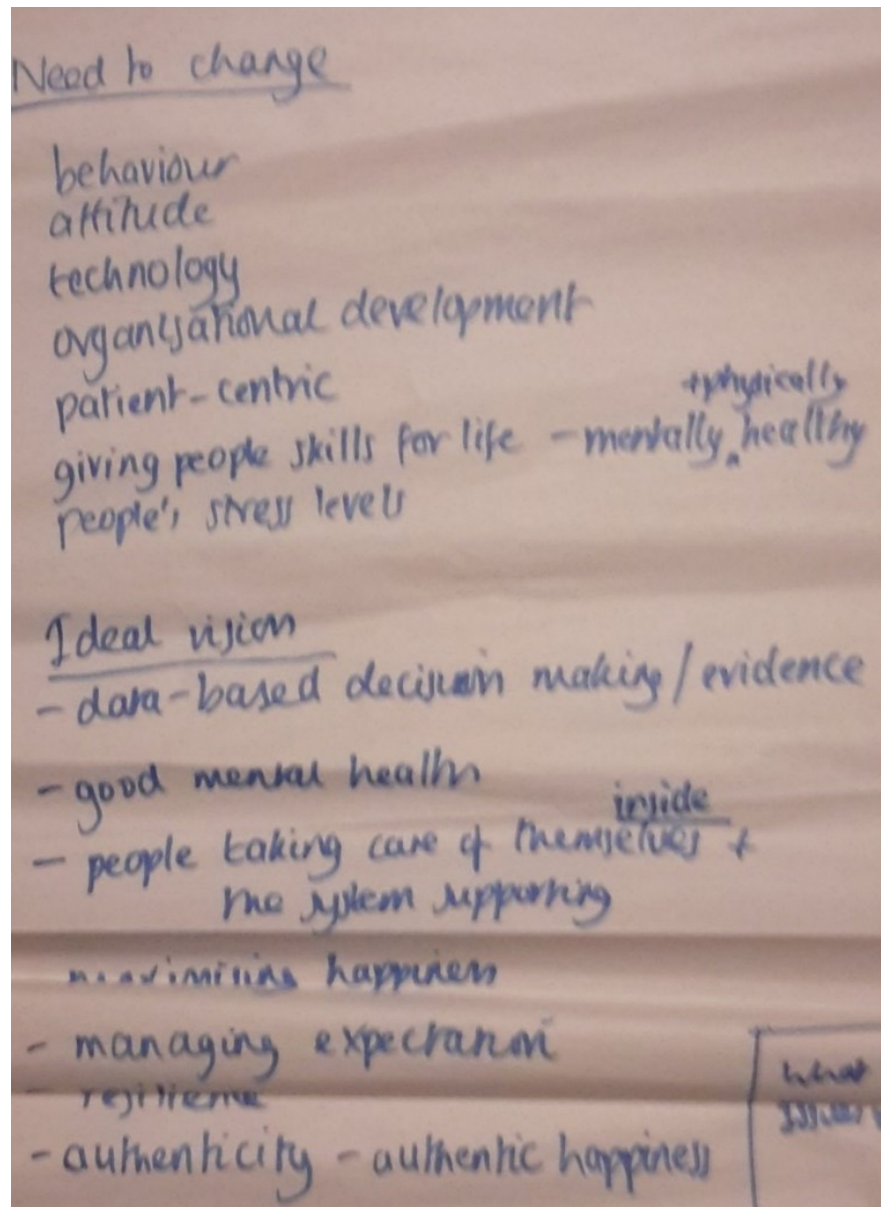

Figure 35 Ideas About Change from Workshop 3.

9.1.2 Costs

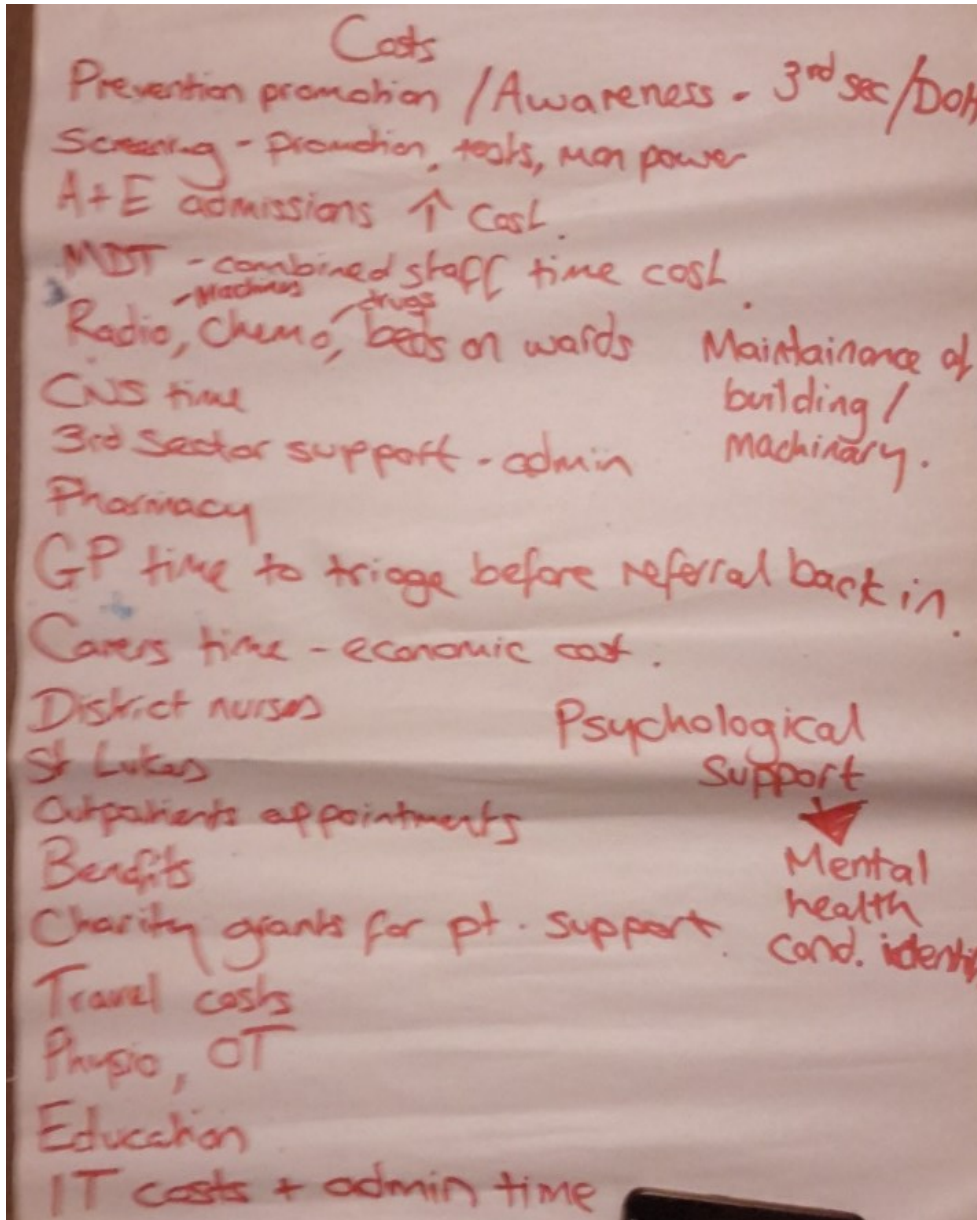

Figure 36: Cost Centres Current System

Images 36 and 37 indicate some of the costs expected to be in the current and future systems, as illustrated by the rich pictures outlined earlier.

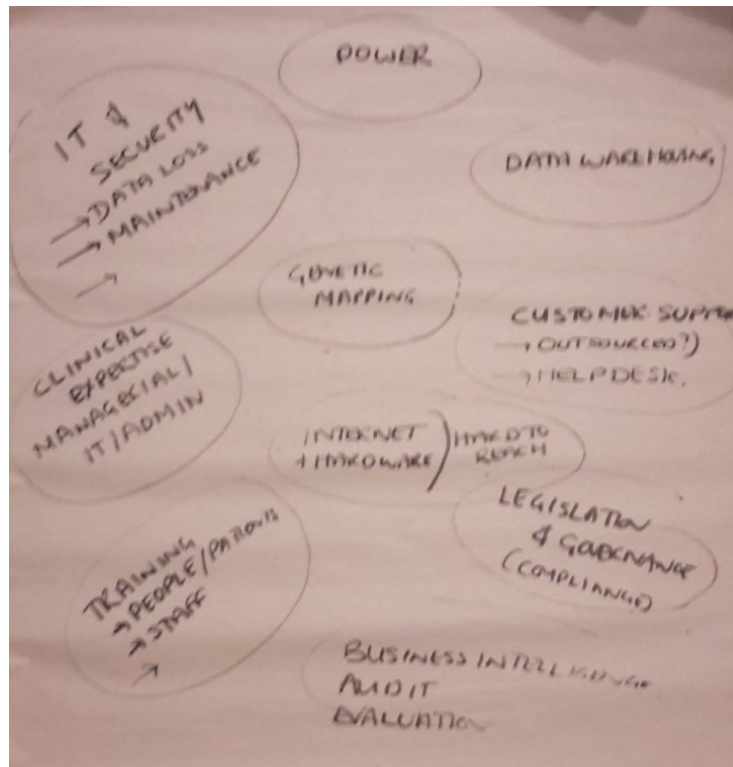

Figure 37 Cost Centres Future System

Discussion about whether participants believed the current or future system was likely to be more or less expensive was inconclusive. There was however general agreement that some cost savings could be achieved, such as by more targeted treatments. However there would also be additional costs such as continual investment into IT systems and increased cost of power. Participants also thought that there would be significant costs of getting to anything like the future system illustrated by the rich picture they had created. Participants universally agreed that much of the current system would need to be maintained. Comment 151 was typical of the ideas expressed. Overall they agreed that the smart community ideas discussed would probably make the system better, but was less likely to actually make it less expensive.

151 M-Y “a future scenario which will still be complex, difficult and mixed, but, some of the stuff which is captured there will allow it to work better than it currently does now, but it will be based on the infrastructure and you know, we’re still going to have a hospital.”

9.2 Part 2: Moving Towards a Future Model

Within this thesis I have looked at both the management and delivery of health and social care. To bring together ideas from previous chapters I now separate these out and look at how the ideas I have discussed relate to each of these. In the next two subsections I discuss some of the most frequently occurring ideas, firstly in relation to the process of health and care treatment, then from a management and governance perspective.

9.2.1 Smart Health and Care

9.2.1.1 Flexibility

I introduced the idea of flexibility as theme 11. It was a central part of discussion in both story 1 and story 2. The benefits of flexibility influenced my conclusion that ICE and E-shift were more successful than the adoption of Lorenzo. I connected the idea of flexibility to cultural capital and ANT. I suggested that ANT implies that information technology adoption in one part of the system impacts across the whole system. Considering impacts across the whole system relates back to the idea of a wicked problem as outlined in 1.5.1.1. Wicked problems cut across group interests and other problems. Given that, it seems logical that the adoption of information technology is likely to create problems as well as solving them. A flexible approach is required to address the sometimes unexpected problems that emerge, as the impact of change ripples across the system.

Flexibility and the lack of it, cuts across discussion between utopian and dystopian ideas. In chapter 7 I outlined how ideas such as psychometrics might be able to improve efficiency by improving health outcomes through behaviour change (theme 7) interventions that lead people to adopt healthier lifestyles. Specifically, I referred to how technologies such as fitness devices can help nudge people towards changing their lifestyle. In chapter 8 I linked the idea of nudging to the dystopian ideas of social control and surveillance. A risk here is that along with the aim of improving efficiency, flexibility is reduced and because we are dealing with a wicked problem that may lead to the emergence of new problems.

9.2.1.2 User Centred

The idea of a person-centred approach relates to the idea of flexibility. Flexibility may be required to develop person-centred approaches. User centred approaches may also require ongoing flexibility. Comment 24, outlined in theme 11, highlighted the idea that every patient is different and has different ideas about what is important to them. Different options therefore, need to be given to each patient not just due to the physical nature of their specific cancer, but also the characteristics of each patient, adapted to their values and interests. In this respect, the idea of person-centred health relates to flexibility, as an ideal system would have the flexibility to be adapted to each patient.

9.2.1.3 Data Driven

Whilst all versions of a smart community future involve more use of data to inform decision making, there are significant differences in terms of who has access to information. Advances in information technology are enabling patients as well as healthcare professionals and managers to make better informed decisions. Healthcare professionals concerns about patients having access to information was discussed in 4.2.1.3 and 4.2.1.5. Patients however argued that concerns were unfounded as information sources such as forums tend to self-regulate. The patient perspective is supported by research (Esquivel et al, 2006; Hughes et al, 2008a; Loane and D'Alessandro, 2014; Tan and Goonawardene, 2017).

The idea of patients gaining access to information was also a theme in coproduction literature. Some researchers argue that the internet has challenged the assumption that providers have sole access to information (Realpe and Wallace, 2010; Fugini, Bracci, and Sicilia, 2016). Building on the idea of patients gaining access to more health information, we can imagine a positive vision where better informed patients can make better decisions by engaging with better informed healthcare professionals.

9.2.1.4 Bottom Up vs Top Down

As discussed in 2.5.3 and 4.3 a future system of cancer services based on the smart community concept could be either top down or bottom up. There are also multiple variations of top down and bottom up approaches. To illustrate, a user centred approach might typically be expected to be bottom up. Some variations certainly are.

As has been discussed, access to information through these sources can enable people to take more practical steps to lead healthier lifestyles and to have more informed discussions with healthcare professionals. Smart technology however can also be applied to a top down person-centred approach. Targeted psychographics similar to the techniques applied by Cambridge Analytica, might be person-centred in the sense that they are focussed on individual people. They however represent a top down approach to controlling or influencing the behaviour of individuals, rather than a bottom up approach that incorporates user ideas into healthcare decision making. A bottom up approach to health and social care decision making could be a form of collaborative decision making if it brought together the strengths of patients, healthcare professionals and artificial intelligence.

9.2.1.5 Joined Up

There was a general consensus amongst interviewees and workshop participants that the current system is not joined-up. I identified disjointedness as theme 10. The idea of disconnectedness also flowed into theme 13, with the idea that data and information flows are disconnected in general. Comment 75 in 6.3.1 states that different healthcare information is kept on different parts of the system. The lack of interoperability in the system would need to be overcome to get to most of the utopian ideas of data driven healthcare outlined in chapter 7. Comments 152 and 153 powerfully illustrate that (in the views of at least one health professional and one manager) the lack of interoperability in the current system is a distinct barrier to joining up services:

152 H-B-A "if we get clinicians that are seeing that working together to deliver patient services across, let's look at the region, and are working together for the first time, what they will be saying to their employing organisations, the trusts, is, 'we can't do this, because the data interoperability is crap'"

153 M-L "if people have, different services have different systems, and don't have the right data sharing agreements in place and things, it could actually make it more messy for the individual receiving care"

9.2.1.6 Biomedical

In 1.5.3, I introduced the idea that the biomedical focus of the current healthcare system might be a source of inefficiency. I argued that moving towards a biopsychosocial model might result in efficiency improvements. I elaborated on this idea in 5.2.2 and 7.4. I connected the idea of the biopsychosocial model to the concept of smart community, discussion I continued in 8.8.2. In 7.4, I also connected the idea to the Bourdieusian ideas of agency and structure, with the suggestion that efficiency improvements could result from a shift in the medical system towards placing more focus on structure. This shift was supported by discussion in hunch 4, where I outlined comments from participants who argue that efficiency savings could be made if we moved towards a healthcare system that was less reliant on hospitals and hospital treatments. As outlined in hunch 2, 5.2.2, one healthcare professional argues that the biopsychosocial model does not go far enough because it still doesn't place enough focus on the social. On a practical basis, moving beyond a focus on agency and the biomedical model of health could include recognising the psychological impact of a cancer diagnosis and the role of the wider structural factors that impact on health and recovery. From an ANT perspective we might also conclude that we need to look at the connectedness between the different parts of the system to improve efficiency.

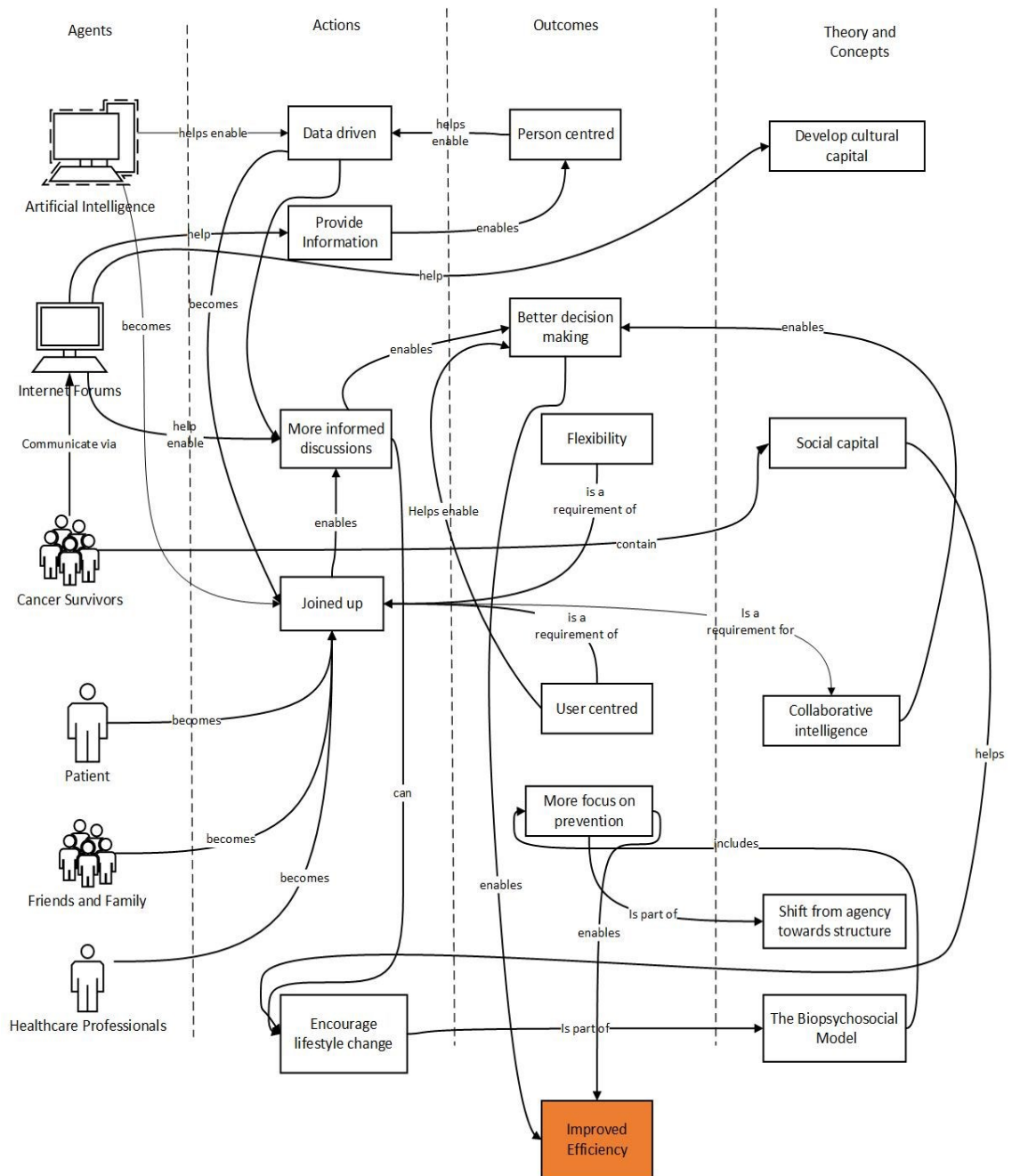

Figure 38 : A Model of Smart Community Efficiency

Social prescribing was frequently referred to as an approach that could bring some social aspects of healthcare into delivery. How social prescribing could be part of a shift towards a system that recognises social as well as medical interventions, is illustrated by comment 154. The idea here isn't that we sacrifice medical interventions so that we can have social support. The point that LA-H is making is quite the opposite. He is saying that by putting wider social support in place, healthcare professionals can focus more on what they are trained to do i.e. deliver healthcare.

154 LA-H “the real win for social prescribing from a clinical perspective is freeing up primary care time. So, instead of GPs spending 30% of their time trying to help Mrs Smith sort out her housing, or her benefits, or her debt problems, or her loneliness and isolation, someone that’s more appropriately skilled, qualified, and trained, and connected with communities can do that, and that frees up a GP to sort out Mrs Smith’s dementia, depression, diabetes, COPD, the things that actually GPs are usually pretty good at”

Figure 38 indicates one way that ideas discussed in this subsection could fit together and connect with central ideas from earlier discussion. To clarify I indicate below how the sections above link to figure 38:

- **Joined up** – All of the agents in the diagram have been discussed many times through this thesis. They are all brought together to create a hypothetical future more joined-up system.
- **User centred** is why the **patient** is one of the agents in the system
- **Bottom up vs top down** is where I discussed collaborative (**better**) **decision making**. I also describe how this could join together **artificial intelligence, patients and healthcare professionals**. Linking the expertise of many different people together relates to the concept of **collaborative intelligence**.
- **Data driven** links internet forums into **better informed discussions**
- **Flexibility** is a characteristic of the system, in some cases a more flexible system could include **lifestyle change** and **prevention**
- **Biomedical** or more accurately a move away from a mostly biomedical system as well as linking to **lifestyle change** and **prevention** also links to the biopsychosocial model and a **shift away from agency towards structure**

I have highlighted above the words that appear in figure 38 to help clarify the links.

The theory and concepts are part of the logic of why the actions might lead to the outcomes listed. For example the social capital of cancer survivors interacting through forums might encourage lifestyle changes¹³¹, a shift that would represent a move towards the biopsychosocial model

¹³¹ In hunch 1, 5.2.1 I gave an example of where participants interacting through a forum had encouraged lifestyle change

9.2.2 Smart Governance

Above I discussed key ideas in relation to the process of providing treatment. Here I take a step back and look at how the same ideas relate to smart community governance. The idea of data driven governance has flowed through this thesis. In 2.2, I outlined literature that highlighted governance as part of the definition of smart community. Governance re-emerged in chapters 7 and 8. In chapter 8 I discussed how both top down and bottom up approaches can be dystopian. Nam and Pardo (2011) take a more optimistic approach. They argue that successful smart cities can emerge from both top down and bottom up approaches. They also however argue that active involvement from every sector of the community is necessary. The idea of active involvement relates to the concept of coproduction¹³².

9.2.2.1 User Centred

Discussion about user centred approaches related as much to the idea of governance as to the actual delivery of health and care. There is however an important difference; from a governance perspective the users are healthcare professionals as well as citizens. From a health and care perspective the users are either patients or people who don't actually become patients due to early interventions such as lifestyle changes and health MOTs. The governance issue of lack of user involvement features firmly in story 1. It appeared that the adoption of the EDMS system did not have the flexibility required to adapt to the ongoing suggestions of the healthcare professionals using the system, suggestions that might have been able to address issues much sooner.

The concept of coproduction relates to both the management and the delivery of services. Coproduction was specifically referred to in seven interviews. Comments 4 and 36 (in sections 4.2.1.6 and 5.1.1) are statements made in these interviews. Similar terms, such as co-design¹³³, were also referred to. The link between coproduction and user design was however made more clearly in literature (Wolf et al., 2006). In 0 I outlined literature that connected coproduction to smart community. Coproduction is

¹³² Coproduction relates closely to the concept of smart community and consequently has flowed through this thesis

¹³³ In comment 26

directly related to the idea of smart governance as it is about engaging communities and citizens in making decisions about health and care services (Bovaird and Loeffler, 2010; Mesko, 2013).

9.2.2.2 Top down vs bottom up

As outlined in 2.3.2 coproduction is generally perceived to be a more bottom up form of governance or decision making because it involves citizens or community members. Smart community related governance however is not necessarily bottom up. In chapter 8 I discussed some dystopian variations of top down and bottom up smart community ideas. I made a distinction between the idea of corporate led top down and a more government led approach. I also outlined potential risks with bottom up approaches.

Arguments about digital governance date back to the early days of the internet. There is a contradiction that is both ideological as well as practical. On one side are those who link the internet with counterculture and see it as an instrument of social revolution and free speech. On the opposing side are those who seek to use it as an instrument of corporate governance (Turner 2006). The contradiction identified by Turner resonates with the smart city tension I discussed in 2.5.3. I argue that the reason for the bottom up vs top down tension within thinking about smart cities and smart communities, goes back to the ideological tensions within the internet, as outlined by Turner. Top down approaches tend to be corporate, whilst bottom up ones are likely to be more individualistic. As discussed in part three of this chapter however, the top down vs bottom up dichotomy does not fully explain tensions that exist.

9.2.2.3 Flexibility

Top down smart city approaches are often thought of as lacking flexibility. Corporate top down smart city approaches have been accused of selling a smart city in a box, a fixed approach that can be replicated in any city in the world ignoring context (Hemment and Townsend, 2013; Soderstrom, 2014, Calzada and Cobo 2015). Corporate top down smart city approaches resonate with the description of how the EDMS system was introduced in story 1. The suggestion was that a top down approach was introduced without engaging with front line staff or taking context into

consideration. Criticism of the EDMS is along the same lines as the criticisms of top down approaches given by Soderstrom, Townsend and others. Top down government led approaches have also been criticised for lacking flexibility, as illustrated with reference to Le Corbusier in 8.4.2.

9.2.2.4 Joined Up

Some participants described the current systems as a maze¹³⁴. The manager who made comment 88 in 6.3.2, argued that the current system is not efficient because it is not joined-up. The implication here is that a more efficient system would be more joined-up. Thus far it may appear that I am favouring bottom up approaches. Whilst bottom up approaches may be more flexible and responsive, making bottom up approaches joined-up is however a challenge, as bottom up approaches tend to be delivered by lots of smaller, mostly private sector companies. In story 1, I outlined concerns from a healthcare practitioner who argued that delivery by private sector tends to result in a fragmentation of data. Similar concerns were made by H,A-B in comment 157 in relation to governance. As argued earlier fragmented sources of data would make it difficult to achieve many of the utopian data driven approaches outlined in chapter 7.

9.2.2.5 Data Driven

Story 2 outlined an approach that appeared to overcome many of the issues discussed in story 1. The Encompass project using E-Shift technology enabled the different people in the organisation to have more access to information to inform decisions, as illustrated by comment 155:

155 M-L "So, being able to access it through the directing nurse has had a, again, it's had another quite dramatic effect on the team's ability to make decisions."

In many respects the system outlined in story 2 was top down. It was however a different kind of top down approach to the one outlined in story 1. A significant difference appeared to be that although the decisions to introduce both E-shift and

¹³⁴ The idea that the current system is like a maze was discussed in 6.3.2 and was identified on the rich pictures illustrated by Figure 21 and Figure 23.

Lorenzo had been made by senior staff, with E-shift more actions were taken to involve and get buy-in from staff at all levels.

As illustrated by comment 156 the governance issue that emerged in workshop 2 was the idea that moving to a smart community future would require new structures to be put in place.

156 TC “where’s the city data agency, that assures that people’s data is taken care of in an appropriate way, and informs people and educates them about how the data is used? It doesn’t exist, no city has got one, you know, you’ve got a data commissioner’s office, you know, nationally, you’ve got, er, you know, ombudsmen”

Comment 157 highlights some of the complexity and significance of moving to a smart community system. The comment is very much in line with the logic of ANT and wicked problems. Wicked problems theory suggests that measures to solve the problem are likely to also create new problems. The suggestion that new governance arrangements would need to be introduced appears to recognise that it is likely that issues would arise. Comment 157 relates to ANT as it appears to recognise that changes are likely to cut across the network. The suggestions outlined in comment 157 appear to advocate a future that to some extent at least would need to be top down.

9.2.2.6 Without Walls

In the Biomedical section earlier in this chapter I made a link back to hunch 4; the idea that a more efficient smart community system might be less dependent on hospitals and hospital treatments than the current system. Shifting away from hospitals is however as much about the governance issues involved in moving towards a new business model (theme 9) as it is about changes in medical practice. The link is illustrated by comment 157:

157 H,A-B “there will be a, a shift from this very rigid, you know, building walls around organisations, into, we’ve got to try and find ways of creating interoperability and data sharing, and there will be far greater drivers to do that. And eventually what will happen is that there will be drivers that are, from the

centre, to do that, and there are drivers now, to look at data sharing, particularly within genomics. It butts up against governance”

9.2.3 Combining Care with Governance

As outlined above, issues emerging from this study relate to both governance and the process of delivering health and social care. In 2.4.4 I argued that healthcare research tends to be siloed, focussing on one paradigm or area of the system with minimal attention given to where they overlap (Chiasson, Davidson, and Pouloudi, 2002; Agarwal and Khuntia, 2009). By creating greater understanding about how they fit together in relating to the smart community concept, I have created new knowledge. In Figure 39 I indicate how both governance and healthcare delivery relate to smart community ideas that have been discussed in this thesis. It shows how the ideas discussed in the two subsections above link to discussion in earlier previous sections of this thesis. Flexibility, joined-up, user centred, top down vs bottom up and data driven were deliberately sub headings in both the smart governance and smart health and care sections to illustrate connections and distinctions of the same issues from these two perspectives. The comments in the boxes in the diagram highlight some of the key points raised. For example smart city in a box was referred to in 9.2.2.3, the flexibility subsection of smart governance. The stories, themes and chapters in the right hand column indicate where these comments had previously been discussed.

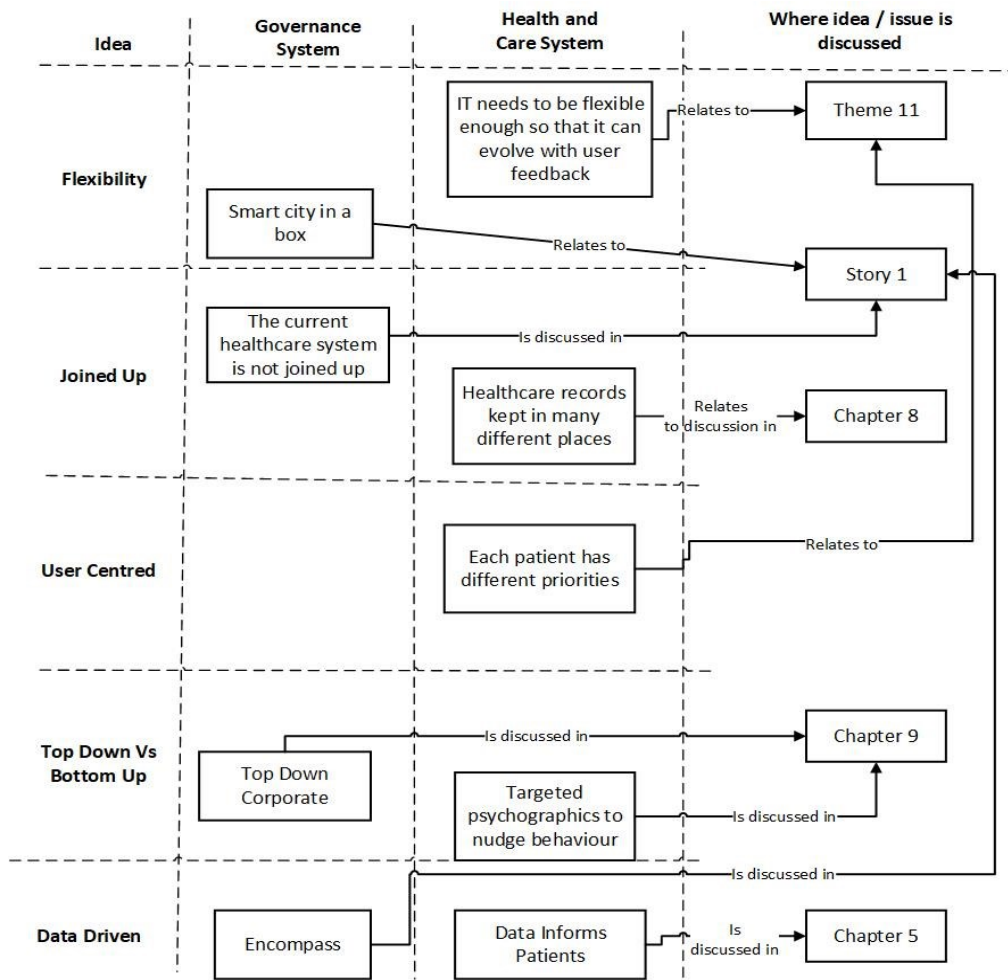

Figure 39 How Health and Governance Ideas Fit Together

9.3 Part 3: Framework and Theory

The focus of this subsection is to bring together the different ideas that have been discussed in this thesis to outline a substantive theory that links the concept of smart community to the aim of improving the efficiency of cancer services in Sheffield. In short the focus here is on objective 4 of this study.

As has been discussed throughout this thesis although there is much that is good, the current system is far from optimal. Both primary data and smart community literature included optimistic visions about what a more efficient future might look like. Both however include a counter narrative about what could go wrong. Contradictions between these two positions is very much at the heart of this study and has informed the structure of this thesis.

As indicated in chapter 1, improving efficiency is a wicked problem and so is complex. The complexity of this challenge has been reflected in discussion throughout this thesis. Discussion in chapter 8 in particular highlighted how potential solutions can be distorted by existing and emerging power interests. In 2.5.3 I referenced literature that suggested that there are two different smart city visions, bottom up versus top down (Smedley, 2013, Breuer, Walravens, and Ballon, 2014; Robinson, 2014; Goodspeed, 2014). After reviewing literature and ideas expressed by interviewees and workshop participants, I suggest that it is closer to the truth to suggest that there are four different visions. I outline these below.

9.3.1 Step 1: Framework

As illustrated in Figure 40 the starting point towards outlining new smart community theory I describe four different visions of what a system of cancer services in Sheffield might look like. The idea of this four spectrum approach is inspired by a variety of works on the political spectrum (Lester, 1996; Ridley-Duff, 2007). Although my 4 visions don't directly follow these, it shares the logic that governance is more complex than just individualistic versus central control. In 2.2, I stated that the concept of smart community was about significant change. Applying Bourdieu's Practice Theory, throughout this study I have argued that significant change would require the disruption of different forms of capital; cultural, social and symbolic as well as economic. Disrupting capital inevitably also disrupts governance arrangements.

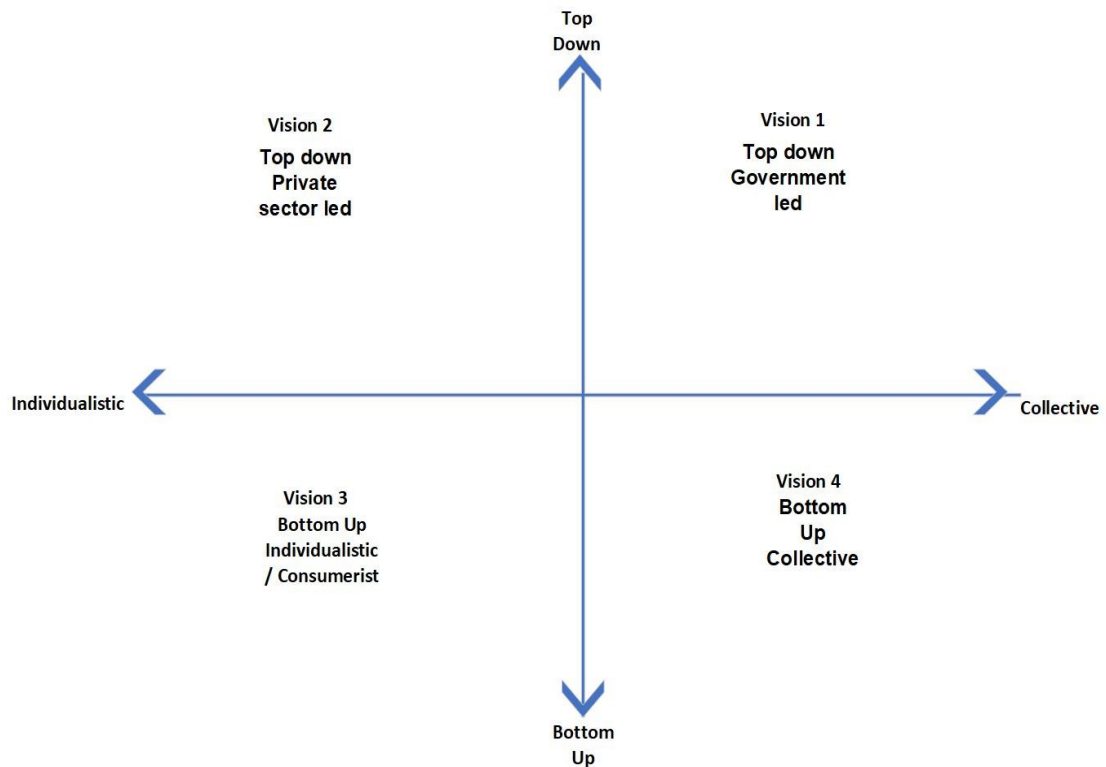

Figure 40: Four Smart Community Visions Framework

9.3.1.1 Vision 1: Top down government led.

In some respects this is the classic smart city vision. It has its roots in the Le Corbusierian tradition of urban design that was critiqued in 8.4. Story 1 illustrates what can go wrong with top down interventions. Top down government (vision 1) is sometimes described as managerialism (Harvey, 1989; Hoque et al, 2004; Marvin, Luque-Ayala, and McFarlane, 2016). The idea of managerialism has a long history in NHS reform. Managers were given powers with the aim of improving efficiency (Hoque et al, 2004; Cribb, 2008; O'Reilly and Reed, 2011). From the beginning, attempts to introduce more management control into the healthcare system was part of an ongoing power struggle between clinicians and managers (Greenhalgh, Swinglehurst, & Stones, 2014). Greenhalgh et al make a criticism of managerialism that connects with the modernist roots of the NHS. They argue that managerialism is more focused on doing things right than doing the right things. Greenhalgh et al argue that smart technology enables a push back by managers. They claim that computational techniques associated with information systems enable managers to

make stronger truth claims. Some critical smart city authors make criticisms of managerialism that are similar to those made by healthcare researchers (Hollands, 2008; Kitchin, 2014; Marvin et al, 2016). Marvin applies the term ‘new managerialism’. He indicates that some local authorities are applying smart technologies, including dashboards, to support the emergence of new managerialism. The conflict between management and clinical professionals that has accompanied moves towards managerialism was illustrated in story 1, where I outlined criticisms given by two healthcare professionals about changes that had been introduced by managers.

9.3.1.2 Vision 2: Top down private sector led.

In some respects this is similar to vision 1, however here the system is dominated by a single private sector company. For example IBM outlines a vision for how cities can harness the power of technology to overcome city challenges. In some respects IBM’s approach resonates with the aim of this study; they outline a smart city vision built upon systems thinking. To an extent the IBM vision takes a user centric approach. They advocate a healthcare approach that is tied to patient’s unique needs. The approach advocated by IBM is however embedded in the hard systems thinking tradition¹³⁵ of command and control. Their approach is primarily focused on giving public sector agencies, including local government and health authorities, more information (Dirks, 2009).

The dystopian nightmares about how the corporate sector could manipulate people towards unhealthy lifestyle, outlined in 8.1.1, is an example of Vision 2. Many of the criticisms of vision 1 also relate to vision 2, although the risks of issues such as social control appear even darker when implemented by private corporations. Vision 2 also brings in additional complications such as issues with service integration and data sharing. Whilst with the public sector the potential for service and data integration can be easily imagined, with the corporate sector it is more difficult to imagine how companies can be motivated to fully integrate or to share data, unless a small number of companies are given access to all of it. The consequences of private companies securing access to full healthcare records of large numbers of people, is where the

¹³⁵ Hard systems thinking was outlined and discussed in 3.1.2

most extreme dystopian nightmares rest. Vision 2 could be described as a move away from managerialism towards entrepreneurialism (Harvey, 1989, Bencardino and Greco, 2014). Bencardino argues that the technology focused top down smart city visions are high tech variations of the entrepreneurial city. Whilst vision 2 is still a form of top down control, it is based on private sector power and influence, not public sector control.

9.3.1.3 Vision 3: Individualistic bottom up.

Vision 3 is an individualistic smart vision focused on smart city citizens. These citizens could include people using fitness trackers and members of the quantified self¹³⁶. Here the focus is on individual consumer choice in healthcare. It could be argued that both visions 3 and 4 have their roots in the American counter culture movement of the late 1970's. The differences between them reflect the contradictions that existed in the movement, contradictions that have flowed through the internet into smart community and smart city thinking. Vision 3 contains a form of libertarian free market ideology. It contains the advantages of flexibility and user centeredness. The idea of customer choice has filtered into current thinking about both healthcare (Depper and Howe, 2015, Rich, 2016) and smart cities (Hollands, 2015; Marsh, Molinari and Rizzo, 2016). Hollands is critical of the idea of customer focus in smart city models. He associates hyper consumerism with dystopian visions. Depper, Howe and Rich are also critical. Rich associates consumerism with neoliberal ideology and the type of surveillance issues discussed in 8.7. She argues that commercialized platforms introduce new modes of surveillance. Depper and Howe are even more critical associating m-health monitoring technology with Foucault¹³⁷.

9.3.1.4 Vision 4: Collective bottom up.

In some respects this is similar to vision 3, as it is a bottom up not a top down vision. The big difference is that in vision 4 the focus is on collective action and cooperation, whereas the focus in vision 3 is on individual freedom and choice. Whilst vision 3 was about customer choice, vision 4 is about citizen engagement and involvement. In

¹³⁶ I introduced the idea of 'the quantified self' in 7.3.2.1, where I associated it with real-time monitoring and the potential health outcomes that could emerge as a result

¹³⁷ I made reference to Foucault in 8.7, in particular his idea of the panopticon and how this has been linked to thinking about social media.

vision 4 patients and other community members are involved, not just in choosing what health services they would like to have but actively involved in the design and delivery of health. Here the focus is on patients collaborating with each other and the rest of the system. As much of the smart community literature outlined in chapter 2 emphasises either user engagement, collaboration or both, vision 4 is a more accurate reflection of the smart community concept than vision 3.

9.3.1.5 Blurred Lines.

It would not be possible to develop a new system of cancer services in Sheffield based entirely on one of the four visions that I outlined. I suggest that doing so would also not be desirable. Each vision contains some components that have the potential to enable some healthcare improvements and also elements that could make it worse.

Potential issues with **vision1** include the risk that agencies become too powerful and impose a form of central control. The issues with data discussed in 8.2 are relevant here; the idea that harnessing more data does not give as much certainty as some (particularly those with a modernist mind-set) might assume.

Vision 2 brings in additional complications such as issues with service integration and data sharing. Whilst with the public sector the potential for service and data integration can be easily imagined, with the corporate sector it is more difficult to imagine how companies can be motivated to fully integrate or to share data, unless a small number of companies are given access to all of it. The consequences of private companies securing access to full healthcare records of large numbers of people, is where the most extreme dystopian nightmares rest.

Vision 3 This individualistic form of user centeredness limits the role of patients, friends and family to customer choice and an individualistic form of healthcare management. Bottom up approaches resonate with coproduction literature, some of which argues that provider centric service delivery is inefficient (Bovaird, 2007). This critique of top down approaches resonates with the ideology of Stuart Brand, one of the counter cultural figures who influenced the evolution of the internet (Turner 2006).

Vision 4. Neither vision 3 nor vision 4 however contain the potential to overcome issues of service integration or data sharing. Some critical smart city authors advocate

evolutionary bottom-up approaches, to counter the limitations of top down approaches (Townsend 2013, Hollands 2015, Leoncini, 2016). If the majority of the city’s service delivery moved to vision 4 then it is even more difficult to imagine how data or service integration might be achieved. In line with the countercultural roots of the internet we could imagine a voluntary code of conduct where a plethora of independent organizations agree to share data and information. Real world events such as Cambridge Analytica¹³⁸ harvesting data from Facebook users, however suggest that some form of regulation might be required.

In Table 20 I summarize some of the strengths and weaknesses of each vision.

Table 20 Strengths and Weaknesses of Smart Community Visions

Vision	Strengths	Weaknesses
Vision 1	The potential of data integration The potential service integration Collaborative	Inflexible Surveillance Social Control
Vision 2	Brings new innovation	Data integration Service integration Inflexible Surveillance Social Control
Vision 3	User centered	Data integration Service integration
Vision 4	User centered collaborative	Data integration Service integration

¹³⁸ Cambridge Analytica was discussed in the Lifestyle / Psychometrics section of chapter 8.

9.3.2 Step 2: Towards Theory with Conceptual Models

As a reminder, to clarify what I mean by smart community, I illustrate the concept in figure 41.

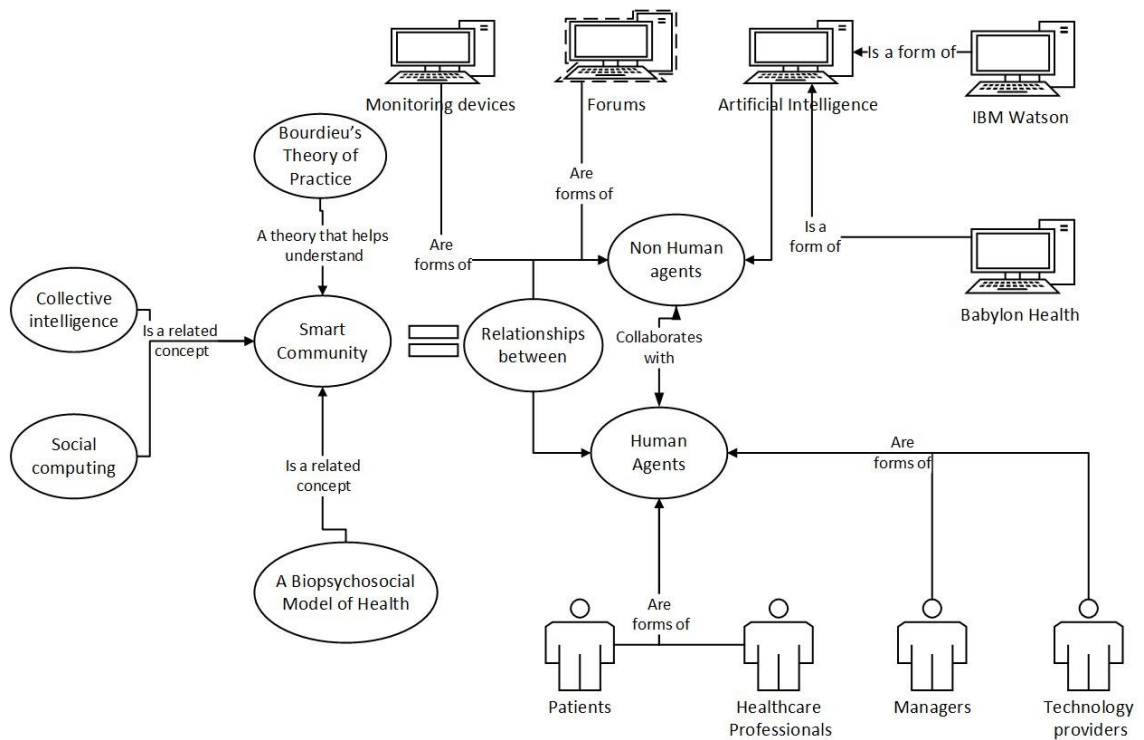

Figure 41 Smart Community Definition Reminder

Next, in Table 21, I indicate what the most commonly occurring ideas have been and where they were discussed. How these ideas connect to each other and to the visions, is illustrated in Figure 42. How figure 42 emerged should be quite transparent as most of its content is listed in the component column of table 21, which also indicates where these ideas were previously discussed. Many of the ideas in figure 42 are also ideas that build on discussion from earlier in this chapter. Flexibility, data driven and person-centred for example were also in figure 39 and smart health and care, 9.2.1. This build up is deliberate as in this chapter I have been bringing together ideas discussed in earlier chapters towards a conclusion. It is clear in Figure 42 that more of the ideas discussed flow into visions 1 and 4 than into visions 2 and 3.

Table 21 Where Smart Community Ideas are Discussed

Component / idea	How this should be applied	Chapters discussed in	Vision idea aligns with
Collective Intelligence	Involves AI and patients, other community members and data analysis.	2, 4, 6, 8	The collaborative nature of this idea connects to visions 1 and 4.
Economic Capital	It's not just about spending more money.	all chapters	Cuts across all 4 visions.
Social Capital	Harnessing the assets of community members provides additional resources that could be applied to provide psychological support and encourage lifestyle change. Social capital incorporates the friends and family suggestion.	2,3, 4, 5, 6, 8, and 9	Harnessing the resources of the community relates closely with the concept of coproduction ¹³⁹ . As such it is primarily bottom up. The collective nature of harnessing the resources of others makes it more collective than individual, so closer to vision 4 and 3.
Forums	Forums are a medium through which psychological support and encouragement can be enabled. Theoretically non-human agents such as AI could engage in forums.	2, 4, 5, 6,7, 8	Vision 4, for the same reasons as social capital, because forums represent a vehicle for harnessing social capital.
Person / Patient Centred	Through active decision making such as adding to patient records and discussions about treatment. Proactive engagement in monitoring connected to lifestyle change.	4, 5, 6, 8	Visions 3 and 4, more 4 than 3.

¹³⁹ As discussed in 2.3.2

Culture Change	Getting to any future vision will require all actors in the system, human and non human agents to make significant changes in what they do and how they relate to each other.	4, 8, 9	All 4 visions.
Lifestyle Change	This is likely to be most effective if achieved through real culture change rather than through nudging.	1, 2,4, 6, 7, 8, 9	Primarily visions 3 and 4 as they are the most user focussed, however visions 1 and 2 could also include interventions aimed at changing patients lifestyles. Likely to be most effective in vision 4 due to active collective user involvement.
Holistic	The idea of a holistic system relates to discussion about the biomedical model. Its application therefore should include social and psychological support as well as medical interventions.	1, , 2, 3, 6, 7, 9, 10	All.
Interoperability	Through service integration as this would also enable a more streamlined model of service delivery. Vision 1 has the most potential for making data more interoperable as only the state can impose regulations that require all providers to share data and to work in a coordinated way.	2, 7 and 9	Vision 1.
Joined up and Integrated	A fully integrated system would include coordinated treatment from cradle to grave and include better signposting. It would also include interventions outside of hospital in line with ideas outlined in hunch 4.	6, 7, 8, 10	All.

Relationships	Moving to a smart community future will require the relationship between human and non-human actors to change and to become more collaborative.	2, 4, 5, 6, 7, 8, 9	Visions 1 and 4.
Monitoring	Patients and other citizens actively monitoring health and fitness levels.	2, 4, 5,6, 7, 8, 9	Visions 3 and 4.
Monitoring	Monitoring should include an annual health MOT and genetic mapping.	7, 9, 10	Visions 1 and 2.
Data Driven	Healthcare providers and managers bringing together information from a wide range of different monitoring devices to inform decision making throughout the system.	2, 4, 5,6, 7, 8, 9	Visions 1 and 2.
Flexible	Smart technology should be able to adapt and evolve following suggestions from front line staff and other users, including patients. Relates to discussion in stories 1 and 2.	6, 10	Visions 2, 3 and 4.
Artificial Intelligence	AI is a non-human actor that could help improve decision making such as by providing both patients and healthcare providers with more information such as possible treatments. Could also be involved in the process of data analysis above.	2, 6, 8, 9	Visions 1 and 2. Vision 2 currently has the most potential to implement AI.

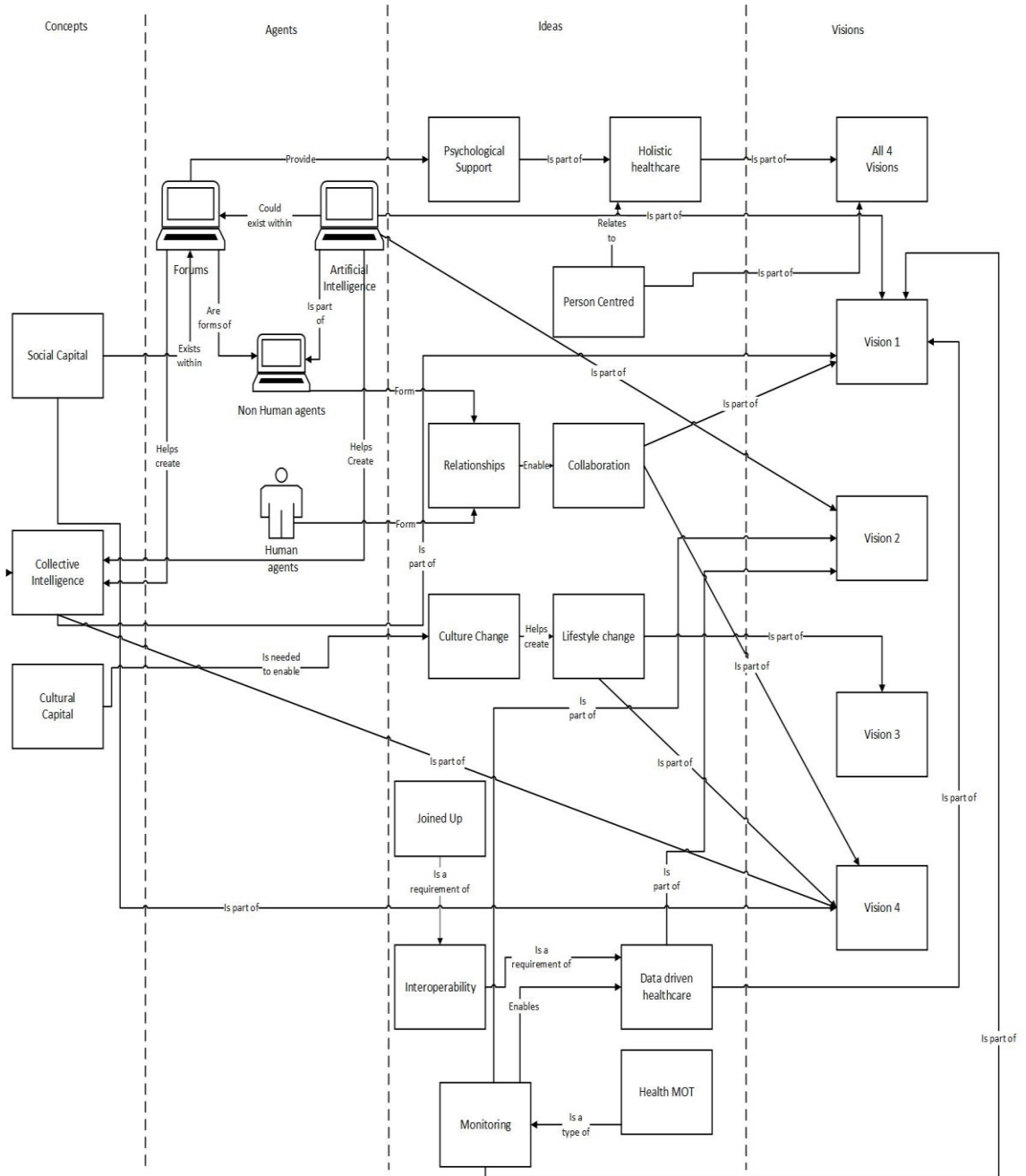

Figure 42: How Efficiency Ideas Link to Visions

To remain true to this study’s methodology and to consider all of the insights discussed, it is also necessary to consider insights from theory and related concepts. Connections between theory, concepts and ideas are outlined in table 22

Table 22 Connections with Theory

Insight	Theory /Concept	Location
The specific needs and relationships within communities need to be considered to successfully harness the resources within communities. The process includes securing trust.	Social Capital	5.1.1
Community members require cultural capital to harness potential gains from digital technology such as forums.	Cultural Capital	5.1.2
Trust is required to convince people to make lifestyle change.	Social Capital	5.2.1
To get people to use technology, cultural and symbolic capital need to be engaged with and adjusted. To do this, trust needs to be established.	Social, Cultural and Symbolic Capital	5.3
To introduce technology effectively, new relationships between all the actors in the network need to be established, including between human and non-human actors.	ANT	5.3
Established ways of working need to be disrupted to secure advantages from new technology. Established rules need to be challenged to get people to change their lifestyle.	Habitus	7.1.1.1
Community support could reduce the demand for professional healthcare services. For this to work social capital needs to be established.	Social Capital	7.5,8.8.4
It's how technology is used more than the technology itself that is likely to result in improvements.	AST	7.1.1.1
Moving towards a biopsychosocial model requires a shift away from focussing on agency towards greater focus on structure.	Practice Theory	7.4

Sustained lifestyle change requires a change in attitude. Attitude (doxa) is shaped by life events. Technology change can change doxa.	Doxa / Habitus	7.4.1
--	----------------	-------

Figure 43 gives a visual representation of what the ideas outlined in table 22 could look like collectively. The theories and concepts in figure 43 directly reflect those in table 22. The action, outcome and impact are potential representation of the text in table 22. For example the first social capital row describes forming relationships and developing trust, a process that is illustrated by the diagonal arrow down from social capital. As indicated the text in table 22 is a reflection of discussion from earlier in this thesis. Hunch 2, 5.2.2 is an example of trust being formed through relationships. Story 2 is an illustration of trust being developed around the use of technology, it contrasted sharply with story 1 where trust was not developed.

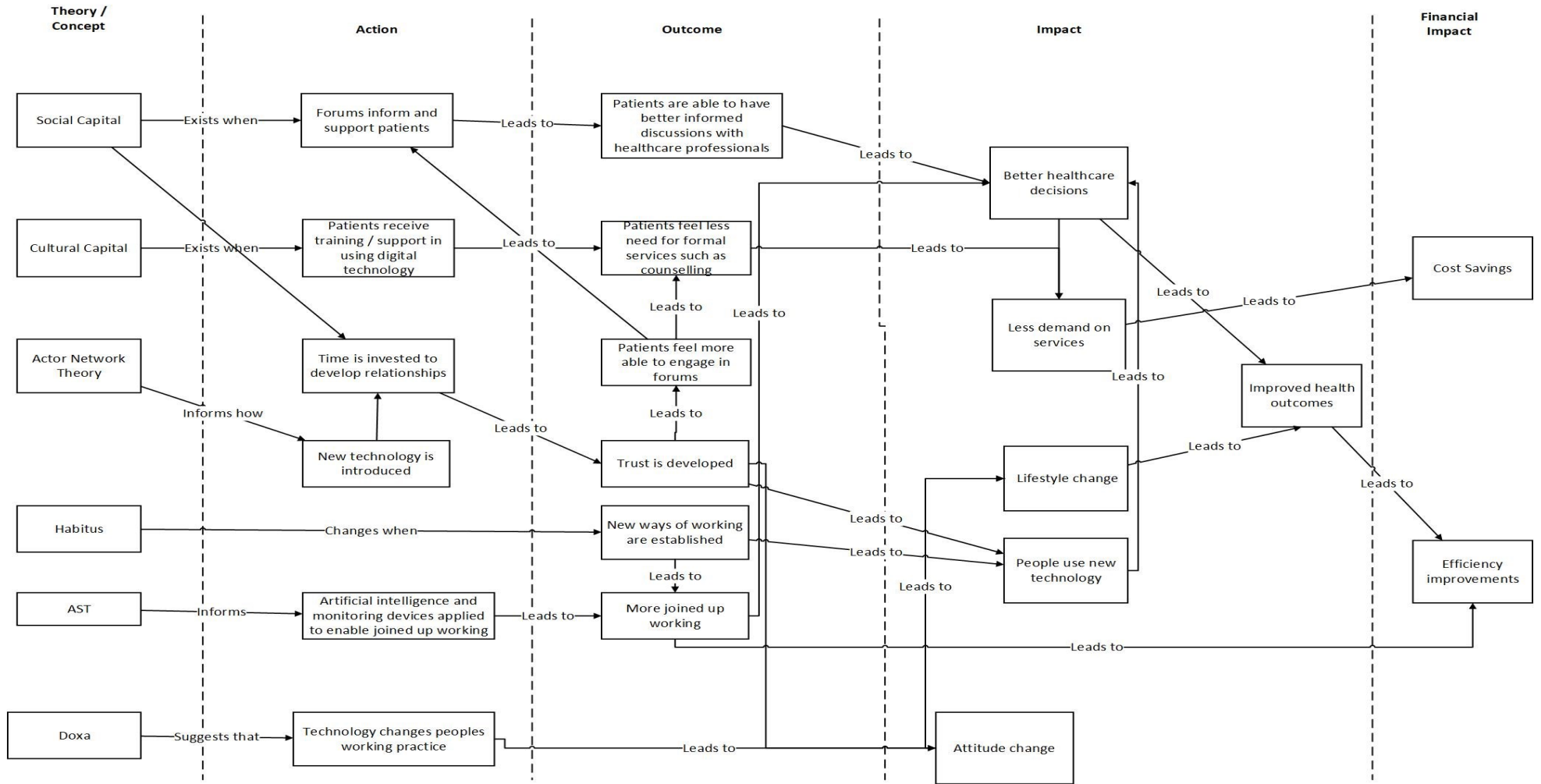

Figure 43 : A vision representation of Ideas outlined in Table 22

To give another example of what is communicated in Figure 43 focussing in on the top row we can see how the social capital in forums could enable patients to become better informed and help create better treatment decisions, which in turn leads to improved outcomes and then improved efficiency. Looking further down the diagram you can see that artificial intelligence and more joined-up working can also help influence this outcome.

9.3.2.1 Applying Bourdieu's Practice Theory

In Figure 44 I illustrate these links and how they relate back to Bourdieu's Practice Theory, its subconcepts and other related concepts.

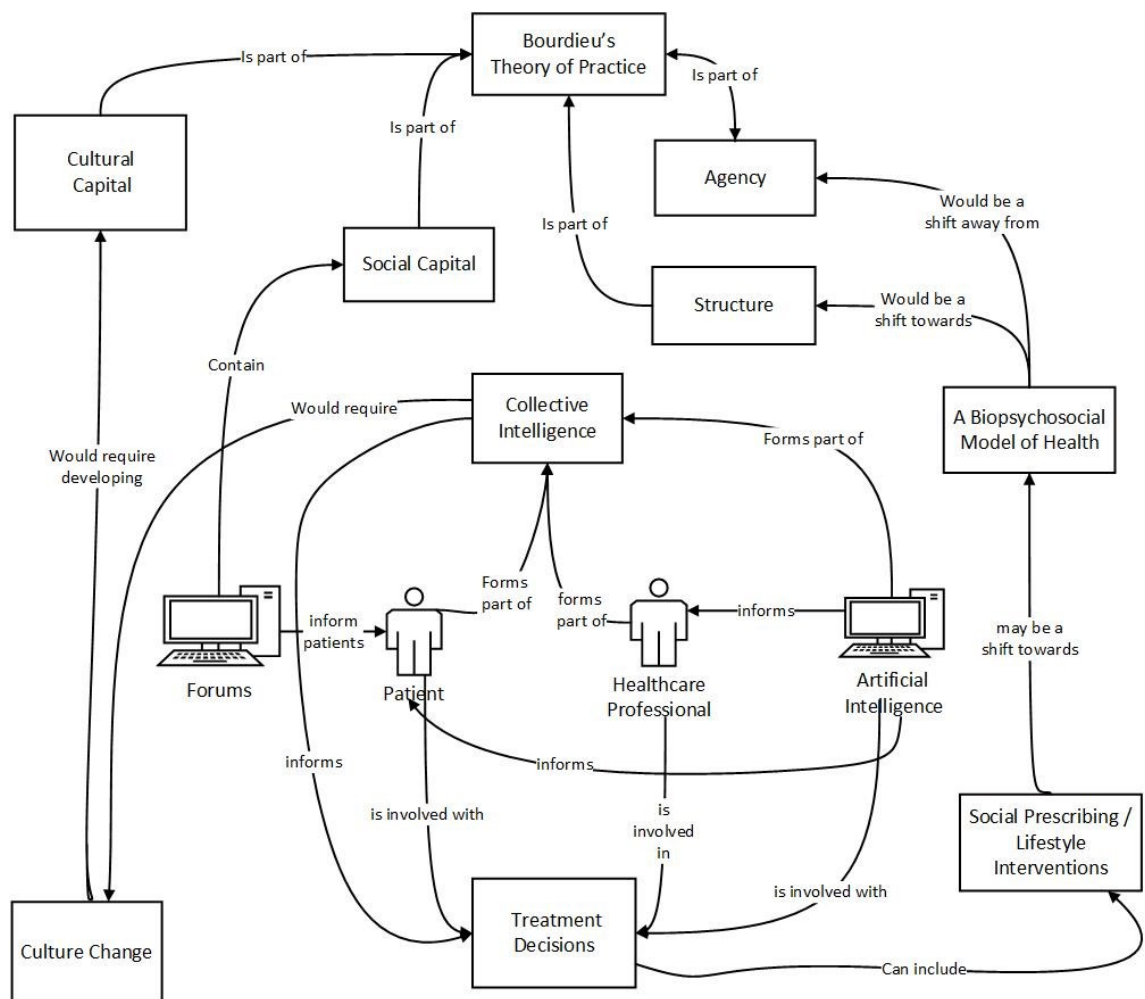

Figure 44: How Smart Community Ideas relate to Bourdieu's Theory of Practice

Linking the concepts illustrated in Figure 44 with ideas that have been discussed through this thesis, we can see that better treatment might include the social

prescribing¹⁴⁰ of lifestyle activities. This is because lifestyle activities could have social and psychological impact on patients, an idea related to the biopsychosocial model of health¹⁴¹. In 7.4 I linked the biopsychosocial model to the idea of agency and structure, key components of Bourdieu's Theory of Practice.

As with figure 44 I illustrate the process of interaction in forums creating social capital. Here however I am simply indicating how that connects to Bourdieu's Practice Theory. The link culture change and collective intelligence connects the utopian ideas about the potential impact of smart community with discussion about culture and cultural capital. In this thesis as well as highlighting potential negative consequences of technology adoption (as I did in chapter 8) I have also indicated why a culture shift would be required to capitalise on potential benefits. One example is the comparison of stories 1 and 2, I concluded that story 2 appeared to be more successful because more consideration had been given to cultural capital. Another example is the discussion about attitude in relation to participation in Move More as discussed in 7.5 and 8.3.1.1. I concluded that nudging people towards behaviour change was undesirable due to the potential for social control, and instead a real change in attitude was required; something that I related to doxa and cultural capital.

In Table 21 and Figure 42 I linked lifestyle intervention primarily to visions 3 and 4, bottom up approaches. In part 2 of this chapter I suggested that it was ideas in vision 4 that are most clearly supported by the stated views of my interviewees and workshop participants. To achieve efficiencies therefore we may need to place focus more on structure.

9.3.3 A Substantive Smart Community Theory

Bringing together the ideas discussed throughout this thesis, I conclude that the concept of smart community does have the potential to improve the efficiency of cancer services but that it is only likely to do so under certain circumstances. Furthermore although smart community ideas have the potential to improve efficiency, they are less likely to actually reduce costs. Better outcomes for the same

¹⁴⁰ Social prescribing was discussed in chapters 5, 6, 7, 8 as well as part 2 of this chapter

¹⁴¹ The biopsychosocial model has also been discussed in most chapters of this thesis

or even increased costs were more likely than actual savings. Better health outcomes for the same ongoing costs would however represent an increase in efficiency. A more efficient smart community based system is however not necessarily desirable. Some visions contain unfortunate consequences such as high levels of surveillance and social control that might not be considered an acceptable price to pay for the efficiencies that can be achieved.

As illustrated by Figure 45, the final conceptual model in this thesis, I conclude that for the concept of smart community to significantly improve efficiency without dystopian consequences, certain conditions would need to be met; new relationships would need to be formed, a culture shift would be required, and greater focus on the structural factors (including social and psychological ones) would be needed. I call the requirements I outline the RCS theory of smart community.

Relationships

The notion of relationships has been fundamental to discussion throughout this thesis. I first made reference to relationships as part of smart community in 2.3.1.

Relationships emerged early on in interviews, in one of my scoping interviews as indicated in 4.2.1.1. In 4.3 I include comments that indicate that participants believed that relationships were a requirement for effective collaboration.

Relationships were central to the issue of successful technology adoption in stories 1 and 2. It was also a key part of the process of patients becoming informed and supported through forums; without trust they would not gain the information they need for better discussion, nor would they be influenced to make lifestyle changes. In Figure 43 I indicated that in the process of successfully introducing new technology it is important to develop trust.

The need for relationships between patients and doctors first emerged in 2.5.2. It continued in 2.3.2 where I introduced the idea of knowledge exchange and learning partnerships, (ideas that were later connected to the concept of collective intelligence when linked to digitally enabled exchanges). In 2.3.2.1 I introduced the notion that patients can be an expert of their own circumstances as part of the asset based model of health. As I linked patient doctor relationships to technological change, dynamics of power emerged. In 2.5.2 I indicate how information technology could give patients

more power as they gain not just access to, but control of their healthcare data. In 4.2.1.5 I discuss the shifting power dynamic, with reference to doctors concern about patients accessing information online.

In chapter 8, I highlighted some of the potential consequences of placing too much trust in technology. If we place too much trust in technology or data then we may find ourselves remaking the mistakes of the past, when we last placed too much faith in science¹⁴². In 8.2.2 I return to the notion of power arguing that it could distort the accuracy of data. In 8.3.1 I suggest that power distortions in relationships as well as having the potential to shift power from healthcare professionals to patients and community members also have the potential to instead shift power towards healthcare professionals. In 8.6 I give an example of where such a power shift appears to have taken place.

Culture Shift Away from Modernism

Critique of modernism has flowed through this thesis. It started in 1.5.4 where I link modernity with positivism and the culture within the current healthcare system. My critique continued in 3.1.1.1 where the critique of modernism was related to the limitations of positivism. In 7.3 I connected modernity was cybernetics and techno-utopianism. In 8.2 and 8.4 I highlight some of the limitations of techno-utopian modernity, highlighting imperfect data and failures in urban design.

To avoid placing too much trust in technology I suggest a significant culture shift is required, away from techno-centric thinking based on modernist ideology. Failing to recognise and respond to the culture change required would risk slipping into a dystopian future. Instead, the unquestioning faith in the potential of data analysis needs to be replaced with a healthy scepticism that places equal weight on considering the limitations and risks of technological advances. A combination of vision 1 and 4 is therefore where the most potential gains are to be found, primarily because these are the visions that have most potential for integrating the controls and critical scepticism required. The focus on collective responsibility has the potential to hold to account and limit the impact of interventions with damaging consequences. By itself, vision 1

¹⁴² An idea that was also discussed in the Techno-centric Governance section of this chapter.

runs the risk of developing into a system of surveillance and social control. To keep this in check the bottom up aspects of vision 4 are required to hold the agents and apparatus to account. By itself, vision 4 lacks the ability to coordinate interventions and impose the regulations that would sometimes be required to ensure coordination and cooperation.

To avoid the dystopian issues outlined in chapter 8, the people in the system would also need to shift their mind-set away from the modernist tendency of placing too much faith in technology. As I have discussed, both the current health system and most digital health systems have their ideological roots in modernism, in a world view that believes in the potential of data and science. In chapter 1 I highlighted some of the limitations of modernity in this context and outlined why different thinking was required. This thread continued through this thesis, and was a particular focus of chapters 7 and 8. I indicated that whilst smart community ideas such as cyber physical systems and social computing might have the potential for significant positive good, they could also be ineffectual or even worse, cause significant harm. To overcome these risks the people in the system need to be given at least as much consideration as the technology. They need to be engaged in such a way that they can contain the technologies and if necessary hold the technology companies to account. This requirement links vision 4 with relationships and the culture shift away from modernity.

Structure

Finally, another shift would be required away from agency¹⁴³ towards a more balanced approach that includes greater consideration of structural factors¹⁴⁴. The shift towards structure would be required to enable the benefits of the biopsychosocial approach that I have highlighted throughout this thesis, as well as positive aspects of vision 4 outlined in part 2 of this chapter. In chapters 7 and 8 I linked the biopsychosocial model to culture in relation to nudging. Through linking discussion in workshops with the concept of social control, I concluded that nudging people towards changing their

¹⁴³ I am arguing that the current healthcare system is focussed on agency because of its focus on biomedical treatment.

¹⁴⁴ As discussed in 7.4 a greater focus on structure links to the biopsychosocial model .

behaviour was not desirable. Instead, as argued by M-E, what is needed is an actual change in attitude and culture. I discussed why I concluded that attitude based on culture shift was more desirable than nudging in relation to figure 44 a little earlier in this chapter. Attitude was also included in the summary written by participants about what they believe needed to change. Their list also included patient centric and giving people skills for life, both of which fit with the social part of the biopsychosocial model. In Figure 43 I illustrated examples of what such a culture shift could look like. Taking the strand I referred to earlier, efficiency savings could be achieved from reduced demand in counselling services. To get to such a reduced demand, patients would need to develop trust (social capital) in the relationships that they develop with other forum users. Another example of how relationships can help improve efficiency is the process of how people were encouraged to make lifestyle changes through the relationships that they developed with other cancer patients and survivors online. To get to the outcome of lifestyle changes they would need to have developed relationships in order to change their cultural attitudes. Such a process is collaborative and bottom up (in line with vision 4) and so is quite different from the top down (vision 1 or 2) process of being coerced into lifestyle changes. Whilst in the short term the outcome could be the same, they represent significantly different visions of what a future system of cancer services might look like.

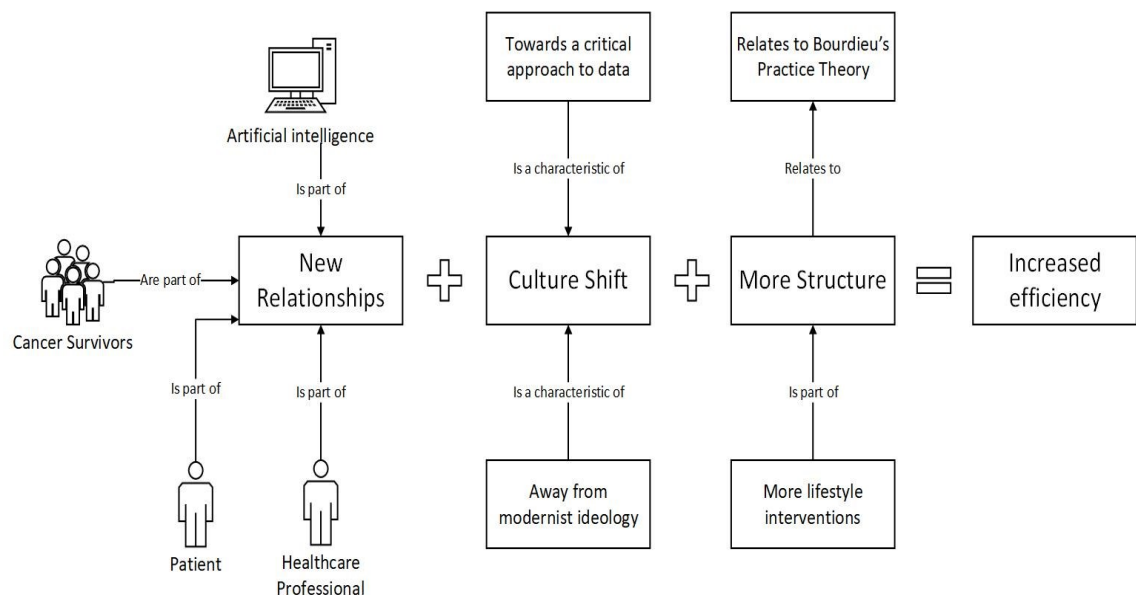

Figure 45: An Illustration of RCS Smart Community Theory

9.3.3.1 Critiquing my theory building approach

In 3.5.4 I stated that theory is a collection of interrelated that concepts that can help explain or predict (Silverman 2000; Imenda 2014; Alvesson and Skoldburg 2018). I also argued that good theory should be useful to practice and that to be useful it required a degree of validity and that I would apply a constant comparison approach to ensure validity.

Interrelated concepts

In terms of interrelated concepts, the RCS theory of smart community certainly fits that criteria. During this chapter I have indicated how the theory that I developed links to many of the concepts discussed in this thesis. Relationships for example links directly to the concept of social capital as social capital is a concept that underpins the value of relationships. In 9.3.3 I argued how my critique of modernity relates to concepts including cyber physical systems and social computing. I argued that they would have quite different meaning if applied in an antimodernist way than if they were applied within a modernist approach that places trust or even faith in data. As argued in 3.2.4 structure is a fundamental component of Bourdieu's Practice Theory and as such relates to the theories of: economic capital, social capital, symbolic capital, cultural capital, doxa and habitus.

I believe that stories 1 and 2 illustrate that this theory is likely to be useful because they indicated that how technology is implemented is as important as how good the technology is. If this is true then the attitude towards information technology and its adoption that I have outlined could have value in enabling organisations to make better, more efficient use out of information technology and avoid potential risks.

Validity

Throughout this thesis I have connected the primary research that emerged from workshops and interviews with: existing secondary research, with existing theory and with my own reflections. Through this constant comparison I believe that the theory I have developed is valid. In chapter 8 for example I connected comments from workshop 3 about the relationship between The Royal Free Hospital and Google Deepmind to research about that relationship. My reflections connected the relationship with the ideology of modernity. I also suggested that there appeared to

have been a lack of consideration of social and cultural factors. In previous chapters I had made direct links between cultural and social factors to Bourdieu's Practice theory, they are part of the concepts of social and cultural capital. Social and cultural factors are also part of the biopsychosocial model of health, a concept that I connected to Bourdieu's Practice theory in 7.4.

As outlined above RCS theory is valid according to the criteria I outlined in 3.5.4 because it has been developed through the process outlined and justified in chapter 3. It is valid because of the process of constant comparison that includes my own critical reflexivity and it is potentially useful because it could, if applied change the way that people use the technologies related to smart community and its related concepts.

Chapter 10 Conclusions and Next Steps

In this thesis I have applied theory and my own prior experience to critique ideas from research participants and literature. Bringing these ideas together through a theory informed process of reflexivity, a substantive theory about how smart community ideas might be able to improve healthcare efficiency in the context of cancer services in Sheffield.

As there is a dearth of methodology literature, specifically about how to conduct research from a critical systems heuristics approach, this study has been informed by wider research literature, including critical research and qualitative approaches (Glaser and Strauss, 1965; Alvesson, 2000; Silverman, 2000; Johnson and Duberley, 2003: 2015). Glaser and Strauss argue that theory can emerge from a small number of cases. They actually go so far as to state that a conceptual category can be created from a single case, and confirmed by a few more. Their logic is that the aim here is to create rather than to test theory. Through the process of testing theory, it is likely that the theory will evolve and be refined.

10.1 Contribution to Knowledge

The contribution to knowledge of this study is greater understanding of the concept of smart community in the context of healthcare, the system of cancer services in Sheffield specifically. In chapter 2 I argued that the concepts of smart community and smart city were under theorised. The first step towards creating theory was defining what the concept of smart community means in this context and at this point in time. Part of the understanding gained through the review of smart community literature was a recognition that the concepts of smart community and smart city have become closely aligned. By defining smart community, it was possible to bring together the ideas of different human actors involved with the system to gain perspectives about how smart community ideas might be able to improve efficiency.

In line with the wicked nature of the problem that has been explored, the process has been distinctly non-linear. Discussion in the literature review and even the methodology chapter linked back into the solution. One strand that flowed through this thesis was a critique of modernity. My critique started in chapter 1, and was later

incorporated into criticisms of the current system of cancer services and some potential smart community health systems.

Because the concept of smart community was ill defined and in flux as technology evolved, understanding of the concept at this point in time was lacking. Due to the evolution of information technology the meaning of the concept has changed as new ways of working and forming relationships through and with technology emerged. Because of this change understanding of the smart community concept in relation to healthcare was lacking. By defining smart community and applying it to create substantive theory knowledge of the concept in this context has been advanced. New theory was outlined in 9.3 and illustrated in Figure 45. All the conceptual models in chapter 9 combined give an overview of how ideas in this theory might be able to improve efficiency. Whilst figure 45 gives an illustration of the theory that has been developed through this thesis, it is merely a summary and a visual illustration to help communicate this new theory. It is not intended to have any validity when removed from the wider discussion that it is part of.

Critical digital health is another area that is both under researched and in flux. By applying smart communities to a critical digital health study, new knowledge has also been gained in this area. The new knowledge is where smart community ideas have become part of the critical health discourse. New knowledge is most directly outlined in chapter 9. The ideas outlined in that chapter were however informed by discussion in all earlier chapters. For example links were made between the conceptual models and substantive theory that emerged and themes outlined in chapter 4 and story's outlined in chapter 5. Most directly however were the links made back to discussion in chapters 7 and 8, as these were the chapters where most of the ideas in the theory started to take shape. As the theory is not intended to be valid when separated from the discussion that supports it, the discourse in these chapters is part of the new knowledge that emerged.

10.1.1 Implications for Future Research / Policy

The most direct future research implications are that if the substantive theory that has been developed is to be of practical value, further research is needed first to test the validity of the theory that emerged through this study in the context of cancer services

in Sheffield. Beyond this immediate case, if the theory is found to be valid in this context, there may be value in further research in exploring the extent that the ideas that emerged from this study are applicable to other areas, both geographic and in subject. As much of the discussion through this thesis has been about the interactions between people and information technology, it is possible that insights from this study are relevant outside of healthcare.

As outlined in chapter 6 there are local initiatives taking place that include aspects of what I identified aspects of what a more efficient smart community inspired future system might look like. For example The Sustainability and Transformation Plan includes references to social prescribing (included in Figure 44) and more holistic care (Figure 42). These, or similar local initiatives, could provide an opportunity for future research to test the impact of some of the ideas included in the diagrams in chapter 9.

With NHS trusts facing ongoing challenges and hospitals frequently reporting deficits, policy implications are significant. This study is directly relevant to this challenge as digital health is frequently reported as a potential solution to financial demands in the media (Hudson, 2016 Chaudhry, 2017 DHI Admin, 2018). Whilst there appears to be optimism about the potential of digital technology, reality however continues to fall short. Recently an app launched by Babylon Health¹⁴⁵ has faced significant opposition (Bhatti, 2017; Mathews-King, 2017; Crouch, 2018). Opposition suggests that the way that digital technology is being introduced might not be being introduced appropriately. One of the issues raised with the Babylon app, is the idea that patients might 'game the system' to get appointments, an idea that resonates with discussion of cultural capital and inequality outlined in chapter 5. I suggest that this research, and future research that could emerge from it, could have practical value if it was applied to influence how digital healthcare was introduced.

The issue of power has flowed through this thesis, and relates directly to why some of the digital health interventions that are being introduced are not having intended results. As illustrated by discussion in chapter 9, there is a risk that digital health interventions could lead to a power shift from managers and healthcare professionals

¹⁴⁵ Babylon Health is a company I discussed in chapters 8 and 9.

towards digital companies, not towards patients and other community groups. Discussion of Google Deepmind's relationship with The Royal Free is an example of this kind of power shift. Such a shift is contradictory to the many comments outlined about developing a person or patient centred system, and is not in line with vision 4. Through the need to develop new relationships between the different actors in the system, including patients and technology, RCS theory implies that a more person or patient centred approach is likely to be more efficient. More research might be needed to test the theory to see if this is so. Research to test the theory would require a different methodology to the one I have applied in this study, and may well benefit from a quantitative component.

There may also be value into more related qualitative research. As I have outlined the changing power relationship between patients and healthcare professionals emerged in this thesis. It was not however the primary focus of this study. From the findings of this study it appears that patients and healthcare professionals tend to have different perspectives, however more research would be required before reaching firm conclusions. Such a study could focus on questions such as, how is the relationship between healthcare professionals and cancer survivors likely to change through the use of apps, forum use and internet searches.

10.1.2 Limitations / What I would do differently

The main limitation of this study is that although I have developed theory, it remains untested. Other limitations include a lack of ongoing buy-in from stakeholders. In terms of buy-in; whilst I did manage to engage a wide cross section of participants (including managers, healthcare practitioners, IT professionals and cancer survivors) including some in senior positions, there was a lack of continuity, only one participant attended all three workshops.

If I was able to turn back time and start the process of developing this thesis again, the main thing that I would do differently would be to prioritise developing and maintaining relationships with stakeholders to a greater extent. Whilst I did engage with potential stakeholders early on, I let communication drop whilst I engaged with the process of starting to write literature review sections. Maintaining relationships, I believe, would have added value by giving more joined-up input from organisations

and more continuous input from individuals. Continuity would for example, have enabled a greater continuation of discussion from one workshop to the next. Continuity and buy-in would also have been useful in terms of future research, as it would have put me in a stronger position to encourage organisations to test some of the ideas that emerged.

Something else I would do differently would be the timing of how I approached the project. Specifically I would start the process of data collection earlier. I found that the reading that I did after I had started the data collection a lot more focussed than the articles I read earlier on. This is because the reading was guided by the data that emerged. One factor that delayed the start of the data collection was the NHS ethics process. I significantly underestimated how long that process would take. So to start data collection earlier I would have needed to start the NHS ethics application process earlier.

Another limitation of this research is that I was researching something that is constantly evolving. As smart technologies evolve, so do ideas about working with them. In this sense the strength of this research, the idea that most prior research is now out of date, becomes a weakness. From this limitation another area of future research emerges; research into the extent my substantive theory is specific to this point in time, or is likely to remain true over time.

10.1.3 Next steps

Moving forward I am keen to engage in future research that builds on the ideas that emerge from this study. Ideally I would however like to engage in this research collaboratively with researchers from other disciplines and also with greater buy-in from stakeholders. Despite the arguments outlined against the suitability of action research and quantitative methods in terms of suitability for this study, both could be appropriate for future research. Action research in particular might be an appropriate way of testing the impact of the theory that developed if sufficient buy in could be secured. I would however, need to remain mindful of the potential limitations and bias of research with a high level of stakeholder buy-in in the interpretation of results. Opportunities to conduct such future research may however be dependent on securing suitable employment as well as stakeholder buy-in. In terms of the key

theory applied in this study, employment that gives me a high level of symbolic capital may be required to secure sufficient trust of stakeholders to enable the future research that would be of most practical value.

References

- Abel, T. (2007). Cultural capital in health promotion. In *Health and modernity* (pp. 43–73). Springer.
- Abelson, B., Rupel, A., & Pincus, T. (2008). Limitations of a biomedical model to explain socioeconomic disparities in mortality of rheumatic and cardiovascular diseases. *Clinical & Experimental Rheumatology*, 26(5), S25.
- Aberg, L., Albrecht, B., & Rudolph, T. (2012). How health systems can improve value in cancer care. *Health International*, 39–51. Retrieved from https://www.mckinsey.com/~media/mckinsey/dotcom/client_service/healthcare_systems_and_services/health_international/issue_12_pdfs/hi12_38-51_oncology_r5.ashx
- Acampora, G., Cook, D. J., Rashidi, P., & Vasilakos, A. V. (2013). A Survey on Ambient Intelligence in Health Care. *Proceedings of the IEEE. Institute of Electrical and Electronics Engineers*, 101(12), 2470–2494.
<https://doi.org/10.1109/JPROC.2013.2262913>
- Ackoff, R. L., & Sasinieni, M. W. (1968). *Fundamentals of operations research*.
- Acosta, A. S., & Douthwaite, B. (2005). *Appreciative inquiry: An approach for learning and change based on our own best practices*.
- Agarwal, R., & Khuntia, J. (2009). *Personal health information management and the design of consumer health information technology: background report*. HHS A290200710072T, 72, 9–75.
- Aghaei, S., Nematbakhsh, M. A., & Farsani, H. K. (2012). Evolution of the world wide web: From WEB 1.0 TO WEB 4.0. *International Journal of Web & Semantic Technology*, 3(1), 1.
- Albert, S. R., & Fetzer, R. C. (2005). Smart community networks: self-directed team effectiveness in action. *Team Performance Management*, 11(5/6), 144–156. Retrieved from http://shulinks.shu.ac.uk/?url_ver=Z39.88-2004&rft_val_fmt=info:ofi/fmt:kev:mtx:journal&genre=article&sid=ProQ:ProQ%253Acentral&atitle=Smart+community+networks%253A+self-

directed+team+effectiveness+in+action&title=Team+Performance+Management&issn=13527592

Allwinkle, S., & Cruickshank, P. (2011). Creating smart-er cities: An overview. *Journal of Urban Technology*, 18(2), 1–16.

Alvesson, M. (2000). *Doing critical management research*. (S. A. Deetz, S. A. Deetz, & Dawsonera, Eds.). London; Thousand Oaks, Calif. ; London: London : SAGE.

Alvesson, M., & Sköldbberg, K. (2009). *Reflexive methodology: New vistas for qualitative research*. Sage.

Andreassen, C. S., Billieux, J., Griffiths, M. D., Kuss, D. J., Demetrovics, Z., Mazzoni, E., & Pallesen, S. (2016). The relationship between addictive use of social media and video games and symptoms of psychiatric disorders: A large-scale cross-sectional study. *Psychology of Addictive Behaviors*, 30(2), 252.

Anna Coote and Joe Penny. (2014). *The wrong medicine*.

Arksey, H., & O'Malley, L. (2005). Scoping studies: towards a methodological framework. *International Journal of Social Research Methodology*, 8(1), 19–32.

Ayres, I. (2008). *Super crunchers: how anything can be predicted*. New York: John Murray. Retrieved from

<http://shu.summon.serialssolutions.com/2.0.0/link/0/eLvHCXMwzV07T8MwEDagLkWI RwfRHlInFhQU52V7YEAlxMJEO1f2->

[SwqIQiFLvz72sZOogzMjJcMVs7W3Xc5f98Rkmf3aTKICaoQmQSgyH0OZZpjRamGFG1KIJ7U35Mx2Ik3ibpn_3zjB4i4NSOp4wubO2hspvrArknz-NOEUBAOQqzx-aDG95dorOMbGcOD07xijurn5NC](http://shu.summon.serialssolutions.com/2.0.0/link/0/eLvHCXMwzV07T8MwEDagLkWI RwfRHlInFhQU52V7YEAlxMJEO1f2-SwqIQiFLvz72sZOogzMjJcMVs7W3Xc5f98Rkmf3aTKICaoQmQSgyH0OZZpjRamGFG1KIJ7U35Mx2Ik3ibpn_3zjB4i4NSOp4wubO2hspvrArknz-NOEUBAOQqzx-aDG95dorOMbGcOD07xijurn5NC)

Aziz, H., & Madani, A. (2015). *Evolution of the Web and its Uses in Healthcare*.

Barker, Chris. 2005. [Cultural Studies: Theory and Practice](#). London: Sage.

Baetens, J. (2014). "Raw Data" is an Oxymoron edited by Lisa Gitelman (review).

Leonardo, 47(3), 303–304. Retrieved from

http://shu.summon.serialssolutions.com/2.0.0/link/0/eLvHCXMw3V3NS8MwFA_DkyLipuL8gDBQNkYla7qtFTyoTD0Iok7xFtI1k8Kso-3U_fe-t7RdO3Z1B6GHtgSS30vyvngfhHDzjBkLPGGoWtjL3VLWwLUUkzbKadOTVtvIXXgpljEopdnS83__YeNPTPNJfsN2oI5oYsNyuMIPP2Djh7DTIKtirXTe-5Fs3sLXCN34oGiG-cK

http://shu.summon.serialssolutions.com/2.0.0/link/0/eLvHCXMw3V3NS8MwFA_DkyLipuL8gDBQNkYla7qtFTyoTD0Iok7xFtI1k8Kso-3U_fe-t7RdO3Z1B6GHtgSS30vyvngfhHDzjBkLPGGoWtjL3VLWwLUUkzbKadOTVtvIXXgpljEopdnS83__YeNPTPNJfsN2oI5oYsNyuMIPP2Djh7DTIKtirXTe-5Fs3sLXCN34oGiG-cK

- Bannon, L. (2011). Reimagining HCI: Toward a more human-centered perspective. *Interactions*, 18(4), 50–57.
- Barker, R. (2010). 2030 - The Future of Medicine .
<https://doi.org/10.1093/med/9780199600663.001.0001>
- Barnes, M., & Cotterell, P. (2012). Critical perspectives on user involvement. Bristol: Policy.
- Batty, M., Axhausen, K. W., Giannotti, F., Pozdnoukhov, A., Bazzani, A., Wachowicz, M., ... Portugali, Y. (2012). Smart cities of the future. *The European Physical Journal Special Topics*, 214(1), 481–518. <https://doi.org/10.1140/epjst/e2012-01703-3>
- Batty, M., Axhausen, K. W., Giannotti, F., Pozdnoukhov, A., Bazzani, A., Wachowicz, M., ... Portugali, Y. (2012). Smart cities of the future. *The European Physical Journal Special Topics*, 214(1), 481–518.
- Baudrillard, J. (1994). *Simulacra and simulation*. University of Michigan press.
- Bauman, Z. (2003). *Intimations of postmodernity*. Routledge.
- Bell, D. (1973). *The Coming of post-industrial society: a venture in social forecasting*. Basic Books. Retrieved from
http://shu.summon.serialssolutions.com/2.0.0/link/0/eLvHCXMwdV09b8lwED2VdkFioBTEp3RLURISxR9gZ0ZF_QHdkUkdqQsghaE_n7vESWiB0bZkWSef353t9w5Ayfc4-ncmpEIZvVI68d4JJJaQ00jInCLyclWnq_8oY1Hljc4VxraDP9bGkUOyPLWgRcHJEdKFFZyzt3iYWokyAEkFrCIY6hSX8glQ3EkrVbCXH0wzWbR5fXtY
- Bencardino, M., & Greco, I. (2014). Smart communities. Social innovation at the service of the smart cities. *Tema. Journal of Land Use, Mobility and Environment*.
- Berg, P. O. (1989). Postmodern management? From facts to fiction in theory and practice. *Scandinavian Journal of Management*, 5(3), 201–217.
- Bernal, P. A. (2010). Web 2.5: the symbiotic web. *International Review of Law, Computers & Technology*, 24(1), 25–37.
- Berners-Lee. (n.d.). Sir Tim Berners-Lee: Raw data, now! | WIRED UK. Retrieved June 20, 2018, from <http://www.wired.co.uk/article/raw-data>

- Bettencourt, L. A., Ostrom, A. L., Brown, S. W., & Roundtree, R. I. (2002). Client co-production in knowledge-intensive business services. *California Management Review*, 44(4), 100–128.
- Bhaskar, R., & Danermark, B. (2006). Metatheory, interdisciplinarity and disability research: a critical realist perspective. *Scandinavian Journal of Disability Research*, 8(4), 278–297.
- Bhatti, N. (2017). Seeing a GP on a smartphone sounds wonderful – but it’s not | Healthcare Professionals Network | The Guardian. The Guardian. Retrieved from <https://www.theguardian.com/healthcare-network/views-from-the-nhs-frontline/2017/nov/16/seeing-gp-smartphone-sounds-wonderful-its-not>
- Bina, O., Mateus, S., Pereira, L., & Caffa, A. (2014). The future imagined: exploring utopia and dystopia in popular art as a means of understanding today’s challenges and tomorrow’s options. In 5th International Conference on Future-Oriented Technology Analysis (FTA): Engage today to shape tomorrow. European Commission.
- Bonda, P., & Sosnowchik, K. (2006). *Sustainable commercial interiors*. John Wiley & Sons.
- Bos, L., Marsh, A., Carroll, D., Gupta, S., & Rees, M. (2008). Patient 2.0 Empowerment. In *SWWS* (pp. 164–168).
- Bourdieu, P. (1983). 1986 “The Forms of Capital” pp. 241-258 in. *Handbook of Theory*.
- Bourdieu, P. (1984). *Distinction: A Social Critique of the Judgement of Taste*. Harvard University Press.
- Bourdieu, P. (1989). Social space and symbolic power. *Sociological Theory*, 7(1), 14–25.
- Bourdieu, P. (2005). *The social structures of the economy*. Polity.
- Bourdieu, P. (2011). The forms of capital.(1986). *Cultural Theory: An Anthology*, 81–93.
- Bovaird, T. (2007). Beyond engagement and participation: User and community coproduction of public services. *Public Administration Review*, 67(5), 846–860.
- Bovaird, T., & Loeffler, E. (2010). User and community co-production of public services and public policies through collective decision-making: the role of emerging technologies. *The Future of Governance*.

Boyle, D., Clark, S., & Burns, S. (2006). *Hidden work. Co-Production by People Outside Paid Employment*. York: Joseph Rowntree Foundation.

Breuer, J., Walravens, N., & Ballon, P. (2014). Beyond defining the smart city. Meeting top-down and bottom-up approaches in the middle. *Tema. Journal of Land Use, Mobility and Environment*.

Brocklesby, J., & Cummings, S. (1996). Foucault plays Habermas: An alternative philosophical underpinning for critical systems thinking. *Journal of the Operational Research Society*, 47(6), 741–754.

Brown, H., Ellins, J., Kearney, J., Singh, K., Jackson, O., Krelle, H., ... Greenwood, E. (2014). Measuring up? The health of NHS cancer services. Retrieved from http://www.cancerresearchuk.org/sites/default/files/measuring_up_health_of_nhs_cancer_services_sept2014.pdf

Browne-Yung, K., Ziersch, A., & Baum, F. (2013). 'Faking til you make it': Social capital accumulation of individuals on low incomes living in contrasting socio-economic neighbourhoods and its implications for health and wellbeing. *Social Science & Medicine*, 85, 9–17.

Broy, M., Cengarle, M. V., & Geisberger, E. (2012). Cyber-physical systems: imminent challenges. In *Monterey workshop* (pp. 1–28). Springer.

Buchanan, R. (1992). Wicked problems in design thinking. *Design Issues*, 8(2), 5–21.

Cahn, E. S. (2000). *No more throw-away people: The co-production imperative*. Edgar Cahn.

Calzada, I., & Cobo, C. (2015). Unplugging: Deconstructing the smart city. *Journal of Urban Technology*, 22(1), 23–43.

Cancer in Yorkshire | Yorkshire Cancer Research. (n.d.). Retrieved June 10, 2018, from <https://yorkshirecancerresearch.org.uk/cancerinyorkshire/#.VUn3SpNmrpJ>

Caputo, F., Formisano, V., Buhnova, B., & Wallezky, L. (2016). Beyond the digital ecosystems view: Insights from Smart Communities. In *9th Annual Conference of the EuroMed Academy of Business*.

Chaloupka, F. J., & Powell, L. M. (2009). Price, Availability, and Youth Obesity: Evidence From Bridging the Gap. *Preventing Chronic Disease*, 6(3).

Chang, C. K., Chiari, L., Cao, Y., Jin, H., Mokhtari, M., Aloulou, H., & Chang, C. K. (2016). Inclusive Smart Cities and Digital Health, 9677. <https://doi.org/10.1007/978-3-319-39601-9>

Charlton, B. G. (1993). *Journal of the Royal Society of Medicine*.
<https://doi.org/10.1177/014107689308600901>

Charmaz, K. (2011). A constructivist grounded theory analysis of losing and regaining a valued self. *Five Ways of Doing Qualitative Analysis: Phenomenological Psychology, Grounded Theory, Discourse Analysis, Narrative Research, and Intuitive Inquiry*, 165–204.

Checkland, P. (1999a). *Soft systems methodology : a 30-year retrospective ; and, Systems thinking, systems practice* ([New ed.]). Chichester: Chichester : John Wiley.

Checkland, P. (1999b). *Systems thinking, systems practice: includes a 30-year retrospective*.

Checkland, P. (1999c). *Systems thinking. Rethinking Management Information Systems*, 45–56.

Checkland, P., & Poulter, J. (2006). *Learning for action: a short definitive account of soft systems methodology and its use, for practitioners, teachers and students*. John Wiley and Sons Ltd.

Chiasson, M., & Davidson, E. (2002). Getting the two to dance: Examining barriers to health information systems research in mainstream IS journals. In *System Sciences, 2002. HICSS. Proceedings of the 35th Annual Hawaii International Conference on* (pp. 1966–1974). IEEE.

Chiasson, M., Davidson, E., & Pouloudi, N. (2002). *Integrating Information Systems Theory and Health Informatics Research Getting the Two to Dance : Examining Barriers To Health Information Systems Research in Mainstream IS journals* Elizabeth Davidson , Assistant Professor, 00(c), 1–2.

- Chou, W. S., Prestin, A., Lyons, C., & Wen, K. (2013). Web 2.0 for health promotion: reviewing the current evidence. *American Journal of Public Health*, 103(1), e9-18. <https://doi.org/10.2105/AJPH.2012.301071>
- Chudzikowski, K., Ogliastri, E., Ituma, A., Mayrhofer, W., & Khapova, S. N. (2011). Culture and context: Understanding their influence upon careers. In J. P. Briscoe, D. T. Hall, & W. Mayrhofer (Eds.), *Careers Around the World* (pp. 147-165). London: Routledge
- Churchman, C. W. (1967). Wicked Problems. *Management Science*, 14 (4), 141–142.
- Clandinin, D. J., & Connelly, F. M. (2000). Narrative inquiry: Experience and story in qualitative research.
- Clark, M. C. (2007). Life History. *The Blackwell Encyclopedia of Sociology*.
- Cockerham, W. C. (2005). Health Lifestyle Theory and the Convergence of Agency and Structure*. *Journal of Health and Social Behavior*, 46(1), 51–67.
- Cockerham, W. C. (2013). Bourdieu and an update of health lifestyle theory. In *Medical sociology on the move* (pp. 127–154). Springer.
- Coe, A., Paquet, G., & Roy, J. (2001). E-governance and smart communities: A social learning challenge. *Social Science Computer Review*, 19(1), 80–93. Retrieved from http://shulinks.shu.ac.uk/?url_ver=Z39.88-2004&rft_val_fmt=info:ofi/fmt:kev:mtx:journal&genre=article&sid=ProQ:ProQ%253Acentral&atitle=E-governance+and+smart+communities%253A+A+social+learning+challenge&title=Social+Science+Computer+Review&issn=08944393&d
- Cosgrave, E., Arbuthnot, K., & Tryfonas, T. (2013). Living labs, innovation districts and information marketplaces: A systems approach for smart cities. *Procedia Computer Science*, 16, 668–677.
- Cowley, R., Joss, S., & Dayot, Y. (2018). The smart city and its publics: insights from across six UK cities. *Urban Research & Practice*, 11(1), 53–77.
- Cresswell, K. M., Worth, A., & Sheikh, A. (2010). Actor-Network Theory and its role in understanding the implementation of information technology developments in healthcare. *BMC Medical Informatics and Decision Making*, 10(1), 67.

- Cresswell, K., Worth, A., & Sheikh, A. (2011). Implementing and adopting electronic health record systems: How actor-network theory can support evaluation. *Clinical Governance: An International Journal*, 16(4), 320–336.
- Crouch, H. (2018). GP at Hand expansion reduced after NHS England objections. Retrieved June 26, 2018, from <https://www.digitalhealth.net/2018/01/gp-at-hand-babylon-nhs-england/>
- D’Cruz, H., Gillingham, P., & Melendez, S. (2007). Reflexivity, its meanings and relevance for social work: A critical review of the literature. *British Journal of Social Work*, 37(1), 73–90.
- Danaher, B. G., McKay, H. G., & Seeley, J. R. (2005). The information architecture of behavior change websites. *Journal of Medical Internet Research*, 7(2), e12. <https://doi.org/10.2196/jmir.7.2.e12>
- Datta, A. (2015). New urban utopias of postcolonial India: ‘Entrepreneurial urbanization’ in Dholera smart city, Gujarat. *Dialogues in Human Geography*, 5(1), 3–22.
- Davis, E. (2004). *TechGnosis : myth, magic, & mysticism in the age of information*. Serpent’s Tail. Retrieved from <https://books.google.co.uk/books?id=kdJnBAAAQBAJ&pg=PT21&lpg=PT21&dq=The+virtual+topographies+of+our+millennial+world+are+rife+with+angels+and+aliens,+with+digital+avatars+and+mystic+Gaian+minds,+with+utopian+longings+and+gnostic+science+fictions&source=b>
- Davis, K., Drey, N., & Gould, D. (2009). What are scoping studies? A review of the nursing literature. *International Journal of Nursing Studies*, 46(10), 1386–1400.
- Davis, M. C., Challenger, R., Jayewardene, D. N. W., & Clegg, C. W. (2014). Advancing socio-technical systems thinking: A call for bravery. *Applied Ergonomics*. Oxford : <https://doi.org/10.1016/j.apergo.2013.02.009>
- Davies, M., & Elwyn, G. (2007). Advocating Mandatory Patient ‘Autonomy’ in Healthcare: Adverse Reactions and Side Effects. *Health Care Analysis*, 16, 315-328.
- Davis, R. (2010). *The gift of dyslexia: why some of the brightest people can’t read and how they can learn*. Souvenir Press.

- Dean, J. (2017). *Doing reflexivity: An introduction*. Policy Press.
- Deetz, S., & Alvesson, M. (2000). *Doing critical management research*. Thousand Oaks.
- Dent, M. (1995). The new national health service: a case of postmodernism? *Organization Studies*, 16(1), 875–899. Retrieved from http://shu.summon.serialssolutions.com/2.0.0/link/0/eLvHCXMw3V1bS8MwFD6IwhBE3NRuU1mehjJa0jRb2wcfvEwE2YtOEF9GLxkMcaitD_57Ty7NymR_wMe0eUjyhXMj33cAAuZRd80m-DykcR5jOpKiywrzOGRRklGex5idxeptZk3GwOo9rr79F-AxVh7YMP-mOg4KbRXq0WidiKmEZmsvCm-FViSYLN7EqjQgqdaromBiHhK
- Dent, M. (2006). Patient choice and medicine in health care: Responsibilization, governance and proto-professionalization. *Public Management Review*, 8(3), 449–462. <https://doi.org/10.1080/14719030600853360>
- Denzin, N. K. (1994). Evaluating qualitative research in the poststructural moment: The lessons James Joyce teaches us. *Qualitative Studies in Education*, 7(4), 295–308.
- Denzin, N. K., & Lincoln, Y. S. (2005). *Qualitative research*. Denzin, NK y Lincoln YS, 2.
- Depper, A., & Howe, P. D. (2017). Are we fit yet? English adolescent girls' experiences of health and fitness apps. *Health Sociology Review*, 26(1), 98–112.
- DeSanctis, G., & Poole, M. S. (1994). Capturing the complexity in advanced technology use: Adaptive structuration theory. *Organization Science*, 5(2), 121–147.
- Devane, C. (2012). *Physical activity the underrated 'wonder drug.'* Macmillan.
- Dilsizian, S.E., and Siegel, E.L. (2014). Artificial intelligence in medicine and cardiac imaging: harnessing big data and advanced computing to provide personalized medical diagnosis and treatment. *Current cardiology reports*, 16 1, 441 .
- Dirks, S. (2009). A vision of smarter cities: How cities can lead the way into a prosperous and sustainable future. Retrieved from <http://www-31.ibm.com/solutions/cn/government/downloads/GBE03227USEN.PDF>
- Dobson, P. J. (2001). The philosophy of critical realism—an opportunity for information systems research. *Information Systems Frontiers*, 3(2), 199–210.
- Doolin, B., & Lowe, A. (2002). To reveal is to critique: actor-network theory and critical information systems research. *Journal of Information Technology*, 17(2), 69–78.

- Downes, S. (2000). S2000 - What is a Smart Community? ~ Stephen Downes. Retrieved June 10, 2018, from <https://www.downes.ca/post/321>
- DXC Technology. (2017). Lorenzo – Better, Safer Care | DXC Technology. Retrieved June 13, 2018, from http://www.dxc.technology/uki/ahp/134149-lorenzo_better_safer_care
- Dyer, M., Gleeson, D., & Grey, T. (2017). Framework for collaborative urbanism. In *Citizen empowerment and innovation in the data-rich city* (pp. 19–30). Springer.
- Eger, J. M. (2009). Smart growth, smart cities, and the crisis at the pump a worldwide phenomenon. *I-WAYS-The Journal of E-Government Policy and Regulation*, 32(1), 47–53.
- Engel, G. L. (1979). Conservation—withdrawal: Dysphoria and Depression. A biopsychosocial model. Presentation at University of Texas Health Science Center at Dallas.
- Engel, G. L. (1980). The clinical application of the biopsychosocial model. *Am J Psychiatry*, 137(5), 535–544.
- England, N. H. S. (2013). *The NHS belongs to the people: a call to action*. NHS England, London. Retrieved from <http://scholar.google.com/scholar?hl=en&btnG=Search&q=intitle:The+NHS+belongs+to+the+People.+A+call+to+Action#0>
- England, P. H. (2014). *Health Profile 2014 - Sheffield - 00CG*.
- Esquivel, A., Meric-Bernstam, F., & Bernstam, E. V. (2006). Accuracy and self correction of information received from an internet breast cancer list: content analysis. *BMJ (Clinical Research Ed.)*, 332(7547), 939–942. <https://doi.org/bmj.38753.524201.7C> [pii]
- Eysenbach, G. (2008). Medicine 2.0: social networking, collaboration, participation, apomediation, and openness. *Journal of Medical Internet Research*, 10(3), e22.
- Eysenbach, G., & Till, J. E. (2001). Ethical issues in qualitative research on internet communities. *Bmj*, 323(7321), 1103–1105.
- Fielding, N. G., & Fielding, J. L. (1986). Linking data: the articulation of qualitative and quantitative methods in social research.

- Finkelstein, S., Harvey, C., & Lawton, T. (2008). Vision by design: a reflexive approach to enterprise regeneration. *Journal of Business Strategy*, 29(2), 4–13.
- Fitzgerald, B., & Howcroft, D. (1998). Towards dissolution of the is research debate: from polarization to polarity. *Journal of Information Technology*, 13(4), 313.
<https://doi.org/10.1057/jit.1998.9>
- Flood, R. L., & Jackson, M. C. (1991). *Critical systems thinking*. Springer.
- Fontana, A., & Frey, J. (1994). The art of science. *The Handbook of Qualitative Research*, 361376.
- Foot and Hopkins. (2010). A glass half-full: Retrieved from
[http://www.assetbasedconsulting.net/uploads/publications/A glass half full.pdf](http://www.assetbasedconsulting.net/uploads/publications/A%20glass%20half%20full.pdf)
- Forbes, L. J. L., Simon, A. E., Warburton, F., Boniface, D., Brain, K. E., Dessaix, A., ... International Cancer Benchmarking Partnership Module 2 Working Group. (2013). Differences in cancer awareness and beliefs between Australia, Canada, Denmark, Norway, Sweden and the UK (the International Cancer Benchmarking Partnership): do they contribute to differences in cancer survival? *British Journal of Cancer*, 108(2), 292–300. <https://doi.org/10.1038/bjc.2012.542>
- Forsman, A. K., & Nyqvist, F. (2015). 16.1 Social Capital in Health Research Focusing on the Older Population. *International Perspectives on Aging*, 257.
- Fotopoulou, A., & O’Riordan, K. (2017). Training to self-care: fitness tracking, biopedagogy and the healthy consumer. *Health Sociology Review*, 26(1), 54–68.
- Friedli, L. (2013). “What we’ve tried, hasn’t worked”: The politics of assets based public health1. *Critical Public Health*, 23(2), 131–145.
<https://doi.org/10.1080/09581596.2012.748882>
- Fugini, M., Bracci, E., & Sicilia, M. (Eds.). (2016). *Co-production in the Public Sector*. Cham: Springer International Publishing. <https://doi.org/10.1007/978-3-319-30558-5>
- Fukuyama, F. (2001). Social capital, civil society and development. *Third World Quarterly*, 22(1), 7–20.
- Gabriel, Y., & Griffiths, D. S. (2004). *Stories in organizational research*.

Gamache-O'Leary, V., & Grant, G. (2017). Social media in healthcare. In Proceedings of the 50th Hawaii International Conference on System Sciences.

Gawande, A. A., Studdert, D. M., Orav, E. J., Brennan, T. A., & Zinner, M. J. (2003). Risk factors for retained instruments and sponges after surgery. *New England Journal of Medicine*, 348(3), 229–235.

Gawande, A., & Lloyd, J. B. (2010). *The checklist manifesto: How to get things right* (Vol. 200). Metropolitan Books New York.

Geissbühler, A., Demongeot, J. (Jacques), Mokhtari, M., Abdulrazak, B., & Aloulou, H. (2015). Inclusive smart cities and e-Health : 13th International Conference on Smart Homes and Health Telematics, ICOST 2015, Geneva, Switzerland, June 10-12, 2015, Proceedings. In 13th International Conference on Smart Homes and Health Telematics (p. 386). Geneva: ICOST. Retrieved from https://books.google.co.uk/books?id=YF_ACQAAQBAJ&pg=PA373&lpg=PA373&dq=Geissbühler+et+al+2015+digital+health&source=bl&ots=jF26qsW3Kd&sig=HzHQPzJBfLL4XpUc5Nc_oIV4Th0&hl=en&sa=X&ved=0ahUKEwikjbC8_-fbAhVSyaQKHxSLBVsQ6AEIbjAJ#v=onepage&q=Geissbühle

Geyh, S., Cieza, A., & Stucki, G. (2009). Evaluation of the German Translation of the Stroke Impact Scale Using Rasch Analysis. *The Clinical Neuropsychologist*, 23(6), 978–995. <https://doi.org/10.1080/13854040802665782>

Giddens, A. (1984). *The constitution of society: Outline of the theory of structuration*. Univ of California Press.

Giddens, A. (1991). *Modernity and self-identity : self and society in the late modern age*. Stanford University Press. Retrieved from https://books.google.co.uk/books?hl=en&lr=&id=Jujn_YrD6DsC&oi=fnd&pg=PA1&dq=Modernity+and+Self-Identity:&ots=pZTSy7xrlb&sig=yc1fRodSeES1BD4IZEkxW6RMxAwC#v=onepage&q=Modernity+and+Self-Identity%3A&f=false

Giddings, L. S. (2006). Mixed-methods research Positivism dressed in drag? *Journal of Research in Nursing*, 11(3), 195–203.

- Gil-Garcia, J. R., Pardo, T. A., & Nam, T. (2015). What makes a city smart? Identifying core components and proposing an integrative and comprehensive conceptualization. *Information Polity*, 20(1), 61–87. <https://doi.org/10.3233/IP-150354>
- Gillinson, S., Horne, M., & Baeck, P. (2010). Radical Efficiency, Different, better, lower cost public services.
- Girwitz D (2018) [DIY-IT](#) | March 21, 2018 -- 14:47 GMT (14:47 GMT) | Topic: [Big Data Analytics](#), <https://www.zdnet.com/article/volume-velocity-and-variety-understanding-the-three-vs-of-big-data/>
- Glaser, B. G., & Strauss, A. L. (1965). Discovery of substantive theory: A basic strategy underlying qualitative research. *American Behavioral Scientist*, 8(6), 5–12.
- Goldacre, B. (2014). Preventing bad reporting on health research. *BMJ (Clinical Research Ed)*, 349, g7465.
- Goldsmith, S., & Crawford, S. (2014). *Responsive City, The : Engaging Communities Through Data-Smart Governance*. Jossey-Bass. Retrieved from <http://www.myilibrary.com?ID=637354>
- González, R. J. (2017). Hacking the citizenry?: Personality profiling, 'big data' and the election of Donald Trump. *Anthropology Today*, 33(3), 9–12. <https://doi.org/10.1111/1467-8322.12348>
- Goodspeed, R. (2014). Smart cities: moving beyond urban cybernetics to tackle wicked problems. *Cambridge Journal of Regions, Economy and Society*, rsu013.
- Gore, A. (2015). *Survivorship Making a Difference*.
- Gorman, J. M., & den Braber, M. (2008). Semantic Web Sparks Evolution of Health 2.0—A Road Map to Consumer-Centric Healthcare. *Health*, 2, 1–2.
- Granier, B., & Kudo, H. (2016). How are citizens involved in smart cities? Analysing citizen participation in Japanese “smart Communities.” *Information Polity*, 21(1), 61–76. <https://doi.org/10.3233/IP-150367>
- Grassenger and Krogerous. (2017). *The Data That Turned the World Upside Down - Motherboard*. Retrieved June 17, 2018, from

https://motherboard.vice.com/en_us/article/mg9vvn/how-our-likes-helped-trump-win

Green. (2013). Brazil iPhone Prison - Business Insider. Retrieved June 22, 2018, from <http://www.businessinsider.com/brazil-iphone-prison-2013-4?IR=T>

Greenbaum, D. (2014). *The Picture of Health: Medical Ethics and the Movies*. Oxford University Press.

Greenfield, A. (2013). Against the smart city, Do projects.

Greenhalgh, T., & Stones, R. (2010a). Theorising big IT programmes in healthcare: strong structuration theory meets actor-network theory. *Social Science & Medicine*, 70(9), 1285–1294.

Greenhalgh, T., Swinglehurst, D., & Stones, R. (2014). Rethinking resistance to 'big IT': a sociological study of why and when healthcare staff do not use nationally mandated information and communication technologies. *Health Services and Delivery Research*

Gregory, W.J. (1992). **Critical systems thinking and pluralism : a new constellation**. (Unpublished Doctoral thesis, City University London)

Grenfell, M. (2009). Applying Bourdieu's field theory: The case of social capital and education. *Education, Knowledge & Economy*, 3(1), 17–34.

Grigoriadis, N., Bakirtzis, C., Politis, C., Danas, K., & Thuemmler, C. (2016). Health 4.0: The case of multiple sclerosis. In *e-Health Networking, Applications and Services (Healthcom)*, 2016 IEEE 18th International Conference on (pp. 1–5). IEEE.

Gruber, T. (2008). Collective knowledge systems: Where the social web meets the semantic web. *Web Semantics: Science, Services and Agents on the World Wide Web*, 6(1), 4–13.

Gurgen, L., Gunalp, O., Benazzouz, Y., & Gallissot, M. (2013). Self-aware cyber-physical systems and applications in smart buildings and cities. In *Proceedings of the Conference on Design, Automation and Test in Europe* (pp. 1149–1154). EDA Consortium.

Gurstein, M. (2014). Smart cities vs. smart communities: Empowering citizens not market economics. *The Journal of Community Informatics*, 10(3).

Hale, T. M. (2013). Is there such a thing as an online health lifestyle? Examining the relationship between social status, Internet access, and health behaviors. *Information, Communication & Society*, 16(4), 501–518.

Hall, M., Caton, S., & Weinhardt, C. (2013). Well-being's predictive value a gamified approach to managing smart communities. *Lecture Notes in Computer Science (Including Subseries Lecture Notes in Artificial Intelligence and Lecture Notes in Bioinformatics)*. <https://doi.org/10.1007/978-3-642-39371-6-2>

Ham, C. (2014). *Reforming the NHS from within*.

Haralambos, M., HOLBORN, M., & HEATH, R. (2000). *Sociology: themes and perspectives* (London, Collins).

Hardcastle, S. J., & Hagger, M. S. (2015). Psychographic Profiling for Effective Health Behavior Change Interventions. *Frontiers in Psychology*, 6, 1988. <https://doi.org/10.3389/fpsyg.2015.01988>

Harrison, C., & Donnelly, I. (2011). A theory of smart cities. *Proceedings of the 55th Annual Meeting ...*, 1–15.

Hartwell, H. (2014). Behaviour change. *Perspectives in Public Health*, 134(1), 2.

Harvey, D. (1989). From Managerialism to Entrepreneurialism: The Transformation in Urban Governance in Late Capitalism. *Geografiska Annaler. Series B, Human Geography*, 71(1), 3–17. Retrieved from http://shu.summon.serialssolutions.com/2.0.0/link/0/eLvHCXMwIV3LSsQwFL2IG0XxLY4PzMJttUnTNHUjUhxduNR1aZIWB7QzjiPi33uTtBofIC4b0gfJJfek9-QcglQdx9GXNUFmmWI8U5i_eI6LYqpFww1LcLOgZe4OqQUyBtAbF1qSpWMJupo-wiV1X5_w3GqYnE0eI-sdZWusnZEGLsSYrbyReRFiBsFCSXKE6GHpDRN8koc

Harvey, D. (2012). *Rebel cities: from the right to the city to the urban revolution*. New York: Verso. Retrieved from http://shu.summon.serialssolutions.com/2.0.0/link/0/eLvHCXMwdV09b8IwED0VWKoy0EBVviRPF1AiePEeEYfgA7shN7qIjK0n_PnXOhLS1j7CRKnnJ-l5PfO4BcrtLlzZpQScwj9MhSONDXiEPKatIXrnauXUlv20Mrv-N3yWMvw76WewIV1A8dqCDxEkZEXvRxQILfqzIxiTm0tRcArISNRpyXBtMqjQbPrWTko_b-exnv4P

- Haynes, A. B., Weiser, T. G., Berry, W. R., Lipsitz, S. R., Breizat, A.-H. S., Dellinger, E. P., ... Lapitan, M. C. M. (2009). A surgical safety checklist to reduce morbidity and mortality in a global population. *New England Journal of Medicine*, 360(5), 491–499.
- Haynes, K. (2012). Reflexivity in qualitative research. *Qualitative Organizational Research: Core Methods and Current Challenges*, 72–89.
- Heather, B. (2016). Lorenzo: the end of the beginning | Digital Health. Retrieved June 14, 2018, from <https://www.digitalhealth.net/2016/07/lorenzo-the-end-of-the-beginning/>
- Hense, C., & McFerran, K. S. (2016). Toward a critical grounded theory. *Qualitative Research Journal*, 16(4), 402–416. <https://doi.org/10.1108/QRJ-08-2015-0073>
- Hilgers, Mathieu & Mangez, Éric. (2015). Bourdieu's Theory of Social Fields: Concepts and Applications. 10.4324/9781315772493.
- Hillier, J., & Healey, P. (2010). *The Ashgate research companion to planning theory : conceptual challenges for spatial planning*. Ashgate Pub. Retrieved from https://books.google.co.uk/books?id=wZDWh3xUITEC&pg=PA430&lpg=PA430&dq=cybernetics+urban+planning+1950%27s+60%27s&source=bl&ots=HGmAn_PAAk&sig=pKhj8P3HuWDFIpU4iU__T_Kkbes&hl=en&sa=X&ved=0ahUKEwiJyJOr5OfbAhXLGewKHQs hCZwQ6AEIPzAJ#v=onepage&q=cybernetics urban planning 1950's 60's&f=false
- Hodgson, G. M. (1999). *Economics and Utopia: Why the learning economy is not the end of history* (Vol. 11). Psychology Press.
- Holland, R. (1999). Reflexivity. *Human Relations*, 52(4), 463–484. <https://doi.org/10.1023/A:1016909508400>
- Hollands, R. G. (2008). Will the real smart city please stand up? Intelligent, progressive or entrepreneurial? *City*, 12(3), 303–320.
- Hollands, R. G. (2015). Beyond the corporate smart city? Glimpses of other possibilities of smartness. In *Smart Urbanism* (pp. 184–200). Routledge.
- Hollands, R. G. (2015). Critical interventions into the corporate smart city. *Cambridge Journal Of Regions Economy And Society*, 8(1), 61–77. <https://doi.org/10.1093/cjres/rsu011>

- Hooker, C. A. (2011). *Philosophy of complex systems*. Elsevier/North-Holland.
- Hoorweg, D. (2011). *Smart Cities for Dummies*. Retrieved from <http://blogs.worldbank.org/sustainablecities/smart-cities-for-dummies>
- Hopton, J. (1997). Towards a critical theory of mental health nursing. *Journal of Advanced Nursing*, 25(3), 492–500. <https://doi.org/10.1046/j.1365-2648.1997.1997025492.x>
- Hoque, K., Davis, S., & Humphreys, M. (2004). Freedom to do what you are told: Senior management team autonomy in an NHS acute trust. *Public Administration*, 82(2), 355–375. <https://doi.org/10.1111/j.0033-3298.2004.00398.x>
- Huang, S., & Miranda, P. (2015). Incorporating human intention into self-adaptive systems. In *Proceedings of the 37th International Conference on Software Engineering-Volume 2* (pp. 571–574). IEEE Press.
- Hughes, B., Joshi, I., & Wareham, J. (2008a). Health 2.0 and medicine 2.0: Tensions and controversies in the field. *Journal of Medical Internet Research*, 10(3). <https://doi.org/10.2196/jmir.1056>
- Hughes, B., Joshi, I., & Wareham, J. (2008b). Health 2.0 and Medicine 2.0: tensions and controversies in the field. *Journal of Medical Internet Research*, 10(3), e23.
- Hughes, C., & Spray, R. (2002). Smart communities and smart growth-Maximising benefits for the corporation. *Journal of Corporate Real Estate*, 4(3), 207–214.
- Ignatow, G., & Robinson, L. (2017). Pierre Bourdieu: theorizing the digital. *Information, Communication & Society*, 20(7), 950–966.
- Iliffe, S., & Manthorpe, J. (2015). The English NHS after the general election. *Soundings*, 61(61), 72–83.
- Jackson, M. C. (1994). Critical systems thinking: beyond the fragments. *System Dynamics Review*, 10(2-3), 213–229.
- Jackson, M. C. (2003). *Systems thinking: Creative holism for managers*. Wiley Chichester.
- Jackson, M. C. (2007). *Systems approaches to management*. Springer Science & Business Media.

- Jazdi, N. (2014). Cyber physical systems in the context of Industry 4.0. In Automation, Quality and Testing, Robotics, 2014 IEEE International Conference on (pp. 1–4). IEEE.
- Johnson, P. (2000). Understanding management research : an introduction to epistemology. (J. Duberley & Dawsonera, Eds.). London: London : SAGE.
- Johnson, P., & Duberley, J. (2000). Understanding management research: An introduction to epistemology. Sage.
- Johnson, P., & Duberley, J. (2003). Reflexivity in Management Research*. *Journal of Management Studies*, 40(5), 1279–1303.
- Johnson, P., & Duberley, J. (2015). Inductive praxis and management research: Towards a reflexive framework. *British Journal of Management*, 26(4), 760–776.
- Jones, M. R., & Karsten, H. (2008). Giddens’s structuration theory and information systems research. *Mis Quarterly*, 32(1), 127–157.
- Kabeer, N. (1999). Resources, Agency, Achievements: Reflections on the Measurement of Women’s Empowerment. *Development and Change*, 30(3), 435–464.
<https://doi.org/10.1111/1467-7660.00125>
- Kamel Boulos, M. N., & Wheeler, S. (2007). The emerging Web 2.0 social software: an enabling suite of sociable technologies in health and health care education¹. *Health Information & Libraries Journal*, 24(1), 2–23.
- Kandias, M., Mitrou, L., Stavrou, V., & Gritzalis, D. (2013). Which side are you on? A new Panopticon vs. privacy. In *Security and Cryptography (SECRYPT)*, 2013 International Conference on (pp. 1–13). IEEE.
- Kawachi, I., Subramanian, S. V., & Kim, D. (2008). *Social capital and health*. Springer.
- Keen, A. (2010). Improving the health and well-being of people with long term conditions World class services for people with long term conditions –information tool for commissioners. The Department of Health.
- KELLNER, D. (2006). No Title. *New Technologies, TechnoCities, and the Prospects for Democratization*.1997.
- Kenealy, G. J. J. (2012). Grounded theory: A theory building approach. *Qualitative Organizational Research: Core Methods and Current Challenges*, 408–425.

- Kernick, D., & Sweeney, K. (2001). Post-normal medicine. *Family Practice*, 18(4), 356–358.
- Khaled, R. (2011). It's Not Just Whether You Win or Lose: Thoughts on Gamification and Culture. In *Proceedings of the 2011 Annual Conference on Human Factors in Computing Systems*. Association for Computing Machinery.
- Kiejziewicz, A. (2018). Dystopia, new society and machines. The 1980s as the period of emergence and development of cyberpunk cinema. *80s Again!*, 169.
- Kim, Y. M., Bazant, E., & Storey, J. D. (2006). Smart patient, smart community: improving client participation in family planning consultations through a community education and mass-media program in Indonesia. *International Quarterly of Community Health Education*, 26(3), 247–270.
- Kimbell, L. (2011). Rethinking design thinking: Part I. *Design and Culture*, 3(3), 285–306.
- King, A. (2010). The odd couple: Margaret Archer, Anthony Giddens and British social theory. *The British Journal of Sociology*, 61(s1), 253–260.
- Kings Fund, What is social prescribing?. (2019). Retrieved from <https://www.kingsfund.org.uk/publications/social-prescribing>
- Kinkar, S., Hennessy, M., & Ray, S. (2016). An Ontology and Integration Framework for Smart Communities. *Journal of Computing and Information Science in Engineering*, 16(1), 11003.
- Kitchin, R. (2014a). Big Data, new epistemologies and paradigm shifts. *Big Data & Society*, 1(1), 2053951714528481.
- Kitchin, R. (2014b). The real-time city? Big data and smart urbanism. *GeoJournal*, 79(1), 1–14. <https://doi.org/10.1007/s10708-013-9516-8>
- Kitzinger, J. (1995). Qualitative research. Introducing focus groups. *BMJ (Clinical Research Ed.)*, 311(7000), 299–302.
- Komninos, N. (2006). The architecture of intelligent cities. In *Conference Proceedings Intelligent Environments (Vol. 6, pp. 5–6)*. IET.

- Kontos, E., Blake, K. D., Chou, W. Y., & Prestin, A. (2014). Predictors of eHealth usage: insights on the digital divide from the Health Information National Trends Survey 2012. *Journal of Medical Internet Research*, 16(7), e172. <https://doi.org/10.2196/jmir.3117> [doi]
- Krebs, V., & Holley, J. (2006). Building smart communities through network weaving. Appalachian Center for Economic Networks. Retrieved from [Www.Acenetworks.Org](http://www.acenetworks.org).
- Kukk, P., Moors, E. H. M., & Hekkert, M. P. (2015). The complexities in system building strategies—The case of personalized cancer medicines in England. *Technological Forecasting and Social Change*, 98, 47–59.
- Kuss, D. J., & Griffiths, M. D. (2011). Online social networking and addiction—a review of the psychological literature. *International Journal of Environmental Research and Public Health*, 8(9), 3528–3552.
- Le Bon, G. (1897). *The crowd: A study of the popular mind*. Fischer.
- Leavy, B. (2012). Collaborative innovation as the new imperative—Design thinking, value co-creation and the power of “pull.” *Strategy & Leadership*, 40(2), 25–34.
- Lee, E. A. (2008). Cyber physical systems: Design challenges. In *Object Oriented Real-Time Distributed Computing (ISORC), 2008 11th IEEE International Symposium on* (pp. 363–369). IEEE.
- Lee, J., Kao, H.-A., & Yang, S. (2014). Service innovation and smart analytics for industry 4.0 and big data environment. *Procedia Cirp*, 16, 3–8.
- Leech, N. L., & Onwuegbuzie, A. J. (2011). Beyond constant comparison qualitative data analysis: Using NVivo. *School Psychology Quarterly*, 26(1), 70.
- Leimeister, J. M. (2010). Collective intelligence. *Business & Information Systems Engineering*, 2(4), 245–248.
- Leoncini, R. (2016). 1 Issues and challenges for smart specialisation. *Smart Development in Smart Communities*, 19.
- Lessard, C. (2007). Complexity and reflexivity: two important issues for economic evaluation in health care. *Social Science & Medicine*, 64(8), 1754–1765.

- Lester, J. C. (1996). THE POLITICAL COMPASS (AND WHY LIBERTARIANISM IS NOT RIGHT-WING). *Journal of Social Philosophy*, 27(2), 176–186.
- Levac, D., Colquhoun, H., & O'Brien, K. K. (2010). Scoping studies: advancing the methodology. *Implement Sci*, 5(1), 1–9.
- Li, X., Lu, R., Liang, X., Shen, X., Chen, J., & Lin, X. (2011). Smart community: an internet of things application. *Communications Magazine, IEEE*, 49(11).
<https://doi.org/10.1109/MCOM.2011.6069711>
- Linders, D. (2012). From e-government to we-government: Defining a typology for citizen coproduction in the age of social media. *Government Information Quarterly*, 29(4), 446–454.
- Little Daniel. (2009). false consciousness. Retrieved July 20, 2018, from [http://www-personal.umd.umich.edu/~delittle/iess false consciousness V2.htm](http://www-personal.umd.umich.edu/~delittle/iess%20false%20consciousness%20V2.htm)
- Loane, S. S., & D'Alessandro, S. (2014). Empowered and knowledgeable health consumers: the impact of online support groups on the doctor–patient relationship. *Australasian Marketing Journal (AMJ)*, 22(3), 238–245.
- Loder, J., Bunt, L., & Wyatt, J. C. (2013). Doctor Know a knowledge commons in health. Retrieved from <https://youngfoundation.org/wp-content/uploads/2013/03/Doctor-Know-a-knowledge-commons-on-health-March-2013.pdf>
- Lönngren, J., & Svanström, M. (2016). Systems thinking for dealing with wicked sustainability problems: beyond functionalist approaches. In *New Developments in Engineering Education for Sustainable Development* (pp. 151–160). Springer.
- Lupton, D. (2012). M-health and health promotion: The digital cyborg and surveillance society. *Social Theory & Health*, 10(3), 229–244.
- Lupton, D. (2014). Health promotion in the digital era: a critical commentary. *Health Promotion International*, 30(1), 174–183.
- Lupton, D. (2015). Health promotion in the digital era: a critical commentary. *Health Promotion International*, 30(1), 174–183. <https://doi.org/10.1093/heapro/dau091>
[doi]

Lupton, D. (2016). Towards critical digital health studies: Reflections on two decades of research in health and the way forward. *Health*, 20(1), 49–61.

Lupton, D. (2017). *Self-tracking, health and medicine*. Taylor & Francis.

Luque-Ayala, A., & Marvin, S. (2015). Developing a critical understanding of smart urbanism? *Urban Studies*, 52(12), 2105–2116.

<https://doi.org/10.1177/0042098015577319>

MacLeod, G., & Ward, K. (2002). Spaces of Utopia and Dystopia: Landscaping the Contemporary City. *Geografiska Annaler: Series B, Human Geography*, 84(3-4), 153–170. <https://doi.org/10.1111/j.0435-3684.2002.00121.x>

Maher, J. and P. M. (2014). *Routes from Diagnosis* (<http://www>). Macmillan. Retrieved from

<http://www.macmillan.org.uk/Aboutus/Ourresearchandevaluation/Programmesofwork/Routesfromdiagnosis.aspx>

Maher, M. Lou, Paulini, M., & Murty, P. (2012). Motivating Collective Intelligence in Design: Is Social Intelligence Relevant? *Design Computing and Cognition*, 12. Retrieved from

<http://citeseerx.ist.psu.edu/viewdoc/download?doi=10.1.1.717.4697&rep=rep1&type=pdf>

Maller, C. J. (2015). Understanding health through social practices: performance and materiality in everyday life. *Sociology of Health & Illness*, 37(1), 52–66.

Mano, R. S. (2014). Social media and online health services: A health empowerment perspective to online health information. *Computers in Human Behavior*, 39, 404–412.

Mäntyselä, R. (2016). From Public-Private-People Partnerships to Trading Zones in Urban Planning. In *Human Smart Cities* (pp. 141–157). Springer.

Margolis, M., & Moreno-Riaño, G. (2016). *The prospect of internet democracy*. Routledge.

Marsh, J., Molinari, F., & Rizzo, F. (2016). Human smart cities: a new vision for redesigning urban community and citizen's life. In *Knowledge, information and creativity support systems: Recent trends, advances and solutions* (pp. 269–278). Springer.

- Martin, A., & Geldof, K. (1997). Authority, reading, reflexivity: Pierre Bourdieu and the aesthetic judgment of Kant. *Diacritics*, 27(1), 20–43.
- Marvin, S., Luque-Ayala, A., & McFarlane, C. (2016). Smart urbanism : utopian vision or false dawn? Retrieved from <http://researchdirect.uws.edu.au/islandora/object/uws%3A34757>
- Mathews-King, A. (2017). NHS deal to hand GP data to immigration officials causing “serious risk” | News Article | Pulse Today. Retrieved June 26, 2018, from <http://www.pulsetoday.co.uk/news/political-news/nhs-deal-to-hand-gp-data-to-immigration-officials-causing-serious-risk/20034343.article>
- Maton, K. (2003a). Reflexivity, relationism, & research: Pierre Bourdieu and the epistemic conditions of social scientific knowledge. *Space and Culture*, 6(1), 52–65. <https://doi.org/10.1177/1206331202238962>
- Maus, G. (2015). Decoding, hacking, and optimizing societies: Exploring potential applications of human data analytics in sociological engineering, both internally and as offensive weapons. In *Science and Information Conference (SAI), 2015* (pp. 538–547). IEEE.
- Mayer-Schönberger, V., & Cukier, K. (2013). *Big Data—A Revolution That Will Transform How We Live, Think and Work*.
- Maynard, A. (2017). Shrinking the state: the fate of the NHS and social care. *Journal of the Royal Society of Medicine*, 110(2), 49–51.
- McHattie, L. S., Cumming, G., & French, T. (2014). Transforming patient experience: health web science meets medicine 2.0. *Medicine 2.0*, 3(1), e2–Jun. <https://doi.org/10.2196/med20.3128> [doi]
- McLaughlin, H. (2009). What’s in a name: ‘client’, ‘patient’, ‘customer’, ‘consumer’, ‘expert by experience’, ‘service user’—what’s next? *The British Journal of Social Work*, 39(6), 1101–1117.
- Medicine X. (2018). What is an ePatient? Retrieved July 10, 2018, from <https://medicinex.stanford.edu/what-is-an-epatient-2/>
- Méndiz Noguero, A. (2014). The cusp of life in science fiction films: the meaning of human existence in *Blade Runner*. *Comunicazioni Sociali*, 2(2), 265–276.

- Mesko, B. (2013). *The Guide to the Future of Medicine: Technology AND The Human Touch*. (D. R. E. Cytowic, Ed.) (Vol. 308). Webicina Kft.
<https://doi.org/10.1038/scientificamerican0413-48>
- Mesko, B. (2017). *Artificial Intelligence Will Redesign Healthcare - The Medical Futurist*. Retrieved June 14, 2018, from <http://medicalfuturist.com/artificial-intelligence-will-redesign-healthcare/>
- Michelucci, F. V., Michelucci, F. V., De Marco, A., & De Marco, A. (2017). Smart communities inside local governments: a pie in the sky? *International Journal of Public Sector Management*, 30(1), 2–14.
- Midgley, G. (1992). The sacred and profane in critical systems thinking. *Systems Practice*, 5(1), 5–16.
- Midgley, G. (2000). *Systemic intervention: philosophy, methodology, and practice*.
- Midgley, G. (2003). *Systems thinking*. Sage London, Thousand Oaks, CA.
- Milner, E. (2002). *Delivering the Vision: Public services for the information society and the knowledge economy*. Routledge.
- Mingers, J. (2000). The contribution of critical realism as an underpinning philosophy for OR/MS and systems. *Journal of the Operational Research Society*, 51(11), 1256.
<https://doi.org/10.1057/palgrave.jors.2601033>
- Mingers, J. (2004). Real-izing information systems: critical realism as an underpinning philosophy for information systems. *Information and Organization*, 14(2), 87–103.
- Mingers, J. (2014). *Systems Thinking, Critical Realism and Philosophy*, 1–253.
- Mital, M., Pani, A. K., Damodaran, S., & Ramesh, R. (2015). Cloud based management and control system for smart communities: A practical case study. *Computers in Industry*, 74, 162–172.
- Montuori, A. (1998). Postmodern systems theory, epistemology, and environment: The challenge of reconceptualization. In *Best papers of the proceedings of the academy of management conference*.

Morgan, A., & Ziglio, E. (2007). Revitalising the evidence base for public health: an assets model. *Promotion & Education*, 14(2_suppl), 17–22.

<https://doi.org/10.1177/10253823070140020701x>

Morozov, E. (2011). *The net delusion: How not to liberate the world*. Penguin UK.

Morozov, E. (2014). To save Everything, click here. The folly of Technological solutionism. *PublicAffairs*, (1), 1–5. <https://doi.org/10.1007/s13398-014-0173-7.2>

Morrison. (2015). The wicked problem of emergency management exercising. Retrieved from <https://www.linkedin.com/pulse/some-thoughts-current-state-emergency-management-ian-morrison/>

Mugadza, G. (2015). Systems Thinking and Design Thinking: Complimentary Approaches. *Systems Thinking World Journal: Reflection in Action*, 4, 1–7.

Mumford, L. (1965). Utopia, the City and the Machine. *Daedalus*, 271–292.

Muntaner, C., & Lynch, J. (2002). Social capital, class gender and race conflict, and population health: an essay review of Bowling Alone's implications for social epidemiology. *Bowling alone. The collapse and revival of American community*. RD

Putnam. New York: Simon & Schuster, 2000, pp. *International Journal of Epidemiology*, 31(1), 261–267. Retrieved from <http://dx.doi.org/10.1093/ije/31.1.261>

Myint, P., & Sabanathan, K. (2005). Role of grand rounds in the education of hospital doctors. *British Journal of Hospital Medicine*, 66(5), 297–299.

<https://doi.org/10.12968/hmed.2005.66.5.18425>

Nahrstedt, K., Lopresti, D., Zorn, B., Drobnis, A. W., Mynatt, B., Patel, S., & Wright, H. V. (2016a). Smart communities internet of things. ArXiv Preprint ArXiv:1604.02028.

Nahrstedt, K., Lopresti, D., Zorn, B., Drobnis, A. W., Mynatt, B., Patel, S., & Wright, H. V. (2016b). Smart Communities Internet of Things. ArXiv Preprint ArXiv:1604.02028.

Nam, T., & Pardo, T. A. (2011). Conceptualizing smart city with dimensions of technology, people, and institutions. In *Proceedings of the 12th Annual International Digital Government Research Conference: Digital Government Innovation in Challenging Times* (pp. 282–291). ACM.

- Naphade, M., Banavar, G., Harrison, C., Paraszczak, J., & Morris, R. (2011). Smarter cities and their innovation challenges. *Computer*, 44(6), 32–39.
- Needham, C. (2008). Realising the potential of co-production: negotiating improvements in public services. *Social Policy and Society*, 7(2), 221–231.
- Needham C and Carr S. (2009). SCIE Research briefing 31: Co-production: an emerging evidence base for adult social care transformation. Retrieved June 12, 2018, from <https://www.scie.org.uk/publications/briefings/briefing31/>
- Neil, P. (1992). *Technopoly: the surrender of culture to technology*. Alfred A. Knopf, New York.
- NESTA. (2013). *The Business Case for People Powered Health*. NESTA.
- Nicol, E., & Sang, B. (2011). A co-productive health leadership model to support the liberation of the NHS. *Journal of the Royal Society of Medicine*, 104(2), 64–68. <https://doi.org/10.1258/jrsm.2010.100339>
- Olsen, W. (2004). Triangulation in social research: qualitative and quantitative methods can really be mixed. *Developments in Sociology*, 20, 103–118.
- Olson, P., & Tilley, A. (2014). The quantified other: Nest and fitbit chase a lucrative side business. *Forbes*. Com, 5.
- Parkin, S. (2016). The Artificially Intelligent Doctor Will Hear You Now - MIT Technology Review. Retrieved June 21, 2018, from <https://www.technologyreview.com/s/600868/the-artificially-intelligent-doctor-will-hear-you-now/>
- Palmer, S., & Torgerson, D. J. (1999). Economic notes: definitions of efficiency. *BMJ (Clinical research ed.)*, 318(7191), 1136.
- Patnaik, Arun K. (1988). Gramsci's Concept of Common Sense: Towards a Theory of Subaltern Consciousness in Hegemony Processes. *Economic and Political Weekly*, 23(5), PE2-PE10. Retrieved from <http://www.jstor.org/stable/4378042>
- Patterson, M. E., & Williams, D. R. (1998). Paradigms and problems: The practice of social science in natural resource management.

- Peel, E., & Harding, R. (2014). 'It's a huge maze, the system, it's a terrible maze': Dementia carers' constructions of navigating health and social care services. *Dementia*, 13(5), 642–661. <https://doi.org/10.1177/1471301213480514>
- Periyakoil, V. S. (2007). Taming wicked problems in modern health care systems. *Journal of Palliative Medicine*, 10(3), 658–659.
- Petit-Dit-Dariel, O., Wharrad, H., & Windle, R. (2014). Using Bourdieu's theory of practice to understand ICT use amongst nurse educators. *Nurse Education Today*, 34(11), 1368–1374. <https://doi.org/10.1016/j.nedt.2014.02.005> [doi]
- Petkov, D., Petkova, O., Andrew, T., & Nepal, T. (2007). Mixing multiple criteria decision making with soft systems thinking techniques for decision support in complex situations. *Decision Support Systems*, 43(4), 1615–1629.
- Phelan, J. C., Link, B. G., Stueve, A., & Pescosolido, B. A. (2000). Public conceptions of mental illness in 1950 and 1996: what is mental illness and is it to be feared? *Journal of Health and Social Behavior*, 188–207.
- Phelan, S.E. *Systemic Practice and Action Research* (1999) 12: 237.
<https://doi.org/10.1023/A:1022495500485>
- Pinder, D. (2005). *Visions of the City: Utopianism. Power and Politics in Twentieth.*
- Plan, M. more. (2014). *The Move More Plan : A framework for increasing physical activity in Sheffield 2014-2019 .*
- Popejoy, M. W. (2017). *Big Data Predictive Analytics: How Smart Communities Become Healthy Communities Through Big Data Informed Public Policy Formulation and Implementation.* American Society for Public Administration Conference, (March).
- Powell, T. and T. G. (2010). Value for money in the NHS. *British Journal of Hospital Medicine*, 57, 230–231.
- Powles, J., & Hodson, H. (2017). Google DeepMind and healthcare in an age of algorithms. *Health and Technology*, 7(4), 351–367.
- Public Health England, NHS England Yorkshire and the Humber clinical network - cancer, & Yorkshire Cancer Research. (2017). *Cancer in Yorkshire and the Humber.*

- Public Health. Retrieved from <https://www.yorkshirecancerresearch.org.uk/wp-content/uploads/2016/11/Cancer-in-Yorkshire-and-the-Humber-Nov-2016.pdf>
- Puppala, M., He, T., Chen, S., Ogunti, R., Yu, X., Li, F., ... Wong, S. T. C. (2015). METEOR: an enterprise health informatics environment to support evidence-based medicine. *IEEE Transactions on Biomedical Engineering*, 62(12), 2776–2786.
- Putnam, R. D. (1993). The prosperous community. *The American Prospect*, 4(13), 35–42.
- Rabari, C., & Storper, M. (2014). The digital skin of cities: urban theory and research in the age of the sensed and metered city, ubiquitous computing and big data. *Cambridge Journal of Regions, Economy and Society*, 8(1), 27–42.
- Raisio, H. (2010). Embracing the Wickedness of Health Care. *Essays on Re.*
- Rajkumar, R. R., Lee, I., Sha, L., & Stankovic, J. (2010). Cyber-physical systems: the next computing revolution. In *Proceedings of the 47th design automation conference* (pp. 731–736). ACM.
- Ralph, A., Regan, S., & Donelle, L. (2016). The eShift model of care: Informal caregivers' experience of a new model of palliative home care. *Progress in Palliative Care*, 9260(September). <https://doi.org/10.1179/1743291X15Y.0000000006>
- Ralph, A., Sandra Regan, S., & Donelle, L. (2013). The eShift Model of Care: Informal Caregivers' Experience of Caring for a Family Member who Received Palliative Care at Home Graduate Program in Nursing. Retrieved from <http://ir.lib.uwo.ca/etd>
- Realpe, A., & Wallace, L. M. (2010). What is co-production? *The Health Foundation*, 19.
- Reason, P., & Bradbury, H. (2008). *The SAGE handbook of action research*. : SAGE Publications Ltd doi: 10.4135/9781848607934
- Reynolds, M., & Holwell, S. (2010). Systems approaches to managing change: A practical guide. *Systems Approaches to Managing Change: A Practical Guide*. <https://doi.org/10.1007/978-1-84882-809-4>
- Rich, E., & Miah, A. (2014). Understanding digital health as public pedagogy: A critical framework. *Societies*, 4(2), 296–315.

- Ridley-Duff, R. (2007). Communitarian perspectives on social enterprise
Communitarian Perspectives on Social Enterprise. *Corporate Governance*, 15(2).
- Rinehart, R. (2009). *Utopia Now and Then*. University of Auckland.
- Rittel, H. W. J., & Webber, M. M. (1973). Dilemmas in a general theory of planning. *Policy Sciences*, 4(2), 155–169.
- Roberto, C. A., & Kawachi, I. (2015). *Behavioral Economics and Public Health*. Oxford University Press.
- Robinson. (2014a). No-one wants top-down, technology-driven cities. They'd be dumb, not smart. | The Urban Technologist. Retrieved June 10, 2018, from <https://theurbantechnologist.com/2014/04/08/no-one-wants-top-down-technology-driven-cities-theyd-be-dumb-not-smart/>
- Robinson. (2014b). open data benefit | Search Results | The Urban Technologist. Retrieved June 20, 2018, from <https://theurbantechnologist.com/?s=open+data+benefit>
- Roche, S., & Rajabifard, A. (2012). Sensing places' life to make city smarter. In *Proceedings of the ACM SIGKDD International Workshop on Urban Computing* (pp. 41–46). ACM.
- Rönkkö, E., Herneoja, A., & Oikarinen, E. (2018). Cybernetics and the 4D Smart City: Smartness as Awareness. *Challenges*, 9(1), 21. <https://doi.org/10.3390/challe9010021>
- Roszak, T. (1986). *The Cult of information: the folklore of computers and the true art of thinking*. Lutterworth Press. Retrieved from http://shu.summon.serialsolutions.com/2.0.0/link/0/eLvHCXMwdZ09b8lwEIZPBRakDnyXNkieqnagir-SeEZF_AB2ZDtY6kKH9v-LO-MQCnSMrSTKKZd7_fE-AZDi119efR00d0J6HoKT1krpvDPGEk4M673ktf-LMTiPG9spjFuCptYtpUVO-diBDhZOUkQXLDoi66hWK6PsN8Rejyu2RmlVCGHiOJ6jyCxKpRKOp-mU6bjp55f
- Royackers, A., Regan, S., & Donelle, L. (2016). The eShift model of care: informal caregivers' experience of a new model of home-based palliative care. *Progress in Palliative Care*, 24(2), 84–92. <https://doi.org/10.1179/1743291X15Y.0000000006>
- Sackett, J. D. (2017). Anecdotes on the Urban Design of Utopia: Part II of III of the Utopia 500th Anniversary Series - UrbDeZine Los Angeles. Retrieved June 26, 2018,

from <https://losangeles.urbdezine.com/2017/09/02/anecdotes-urban-design-utopia-part-ii-iii-utopia-500th-anniversary-series/>

Sandelowski, M. (1991). Telling stories: Narrative approaches in qualitative research. *Journal of Nursing Scholarship*, 23(3), 161–166.

Sandercock, L. (1998). *Making the invisible visible: Insurgent planning histories*. University of California Press, Berkeley, CA.

S. C. C. G. (2014). *Commissioning Intentions 2014-2019*.

Schaffers, H., Sallstrom, A., Pallot, M., Hernandez-Munoz, J. M., Santoro, R., & Trousse, B. (2011). Integrating Living Labs with Future Internet experimental platforms for co-creating services within Smart Cities. In 2011 17th International Conference on Concurrent Enterprising (pp. 1–11). IEEE. Retrieved from http://shu.summon.serialssolutions.com/2.0.0/link/0/eLvHCXMwnV3fS4RAEB6ipyCo6CKrg3no1Wt1_XH3fCQd9BDUu4zrCgdmclp_fzurnIIQEli6CuMPZL7Zceb7AKS_EO43nxDH SgVcKtII4RdeHOIVII3X1CtPK18UUxoDGFQWWe_ElqLpBe_aP_tm3NxR1qRUlpZWkHa9eEbE3FEhN_NJGbKMQ7QZ8y0GWhn6bG9XGMfCRJX

Schechter, D. (1991). Critical systems thinking in the 1980s: A connective summary. *Critical Systems Thinking: Directed Readings*. Wiley: Chichester, 213–227.

Schmidt, C. (2015). Cancer: Reshaping the cancer clinic. *Nature*, 527(7576), S10–S11.

Schot, J. (2003). The contested rise of a modernist technology politics. *Modernity and Technology*, 257.

Seale, C. (2000). Using computers to analyse qualitative data. *Doing Qualitative Research: A Practical Handbook*, 155–174.

Seale, C., Gobo, G., Gubrium, J. F., & Silverman, D. (2004). *Qualitative research practice*. Sage.

Seidel, V. P., & Fixson, S. K. (2013). Adopting design thinking in novice multidisciplinary teams: The application and limits of design methods and reflexive practices. *Journal of Product Innovation Management*, 30(S1), 19–33.

Seidman, S., & Wagner, D. G. (1992). *Postmodernism and Social Theory the Debate Over General Theory*.

- Sevaldson, B. (2011). GIGA-Mapping: Visualisation for complexity and systems thinking in design. *Nordes*, (4).
- Sheth, A., Anantharam, P., & Henson, C. (2013). Physical-cyber-social computing: An early 21st century approach. *IEEE Intelligent Systems*, 28(1), 78–82.
- Shi, X., & Zhuge, H. (2011). Cyber physical socio ecology. *Concurrency and Computation: Practice and Experience*, 23(9), 972–984.
- Shiell, A., Hawe, P., & Gold, L. (2008). Complex interventions or complex systems? Implications for health economic evaluation. *BMJ: British Medical Journal*, 336(7656), 1281.
- Silverman, D. (2000). *Doing qualitative research: A practical guide*. London: Sage.
- Simon, H. (1991) Bounded Rationality and Organizational Learning, *Organization Science*, 2(1), 125–134.
- Silverman, D. (2013). *Doing qualitative research: A practical handbook*. SAGE Publications Limited.
- Simon, K.-H. (2002). Critical Systems Thinking. *Systems Science and Cybernetics*, 2.
- Sinkovics, R. R., & Alfoldi, E. A. (2012). Progressive focusing and trustworthiness in qualitative research. *Management International Review*, 52(6), 817–845.
- Sitwala Imenda (2014) Is There a Conceptual Difference between Theoretical and Conceptual Frameworks?, *Journal of Social Sciences*, 38:2, 185-195, DOI: 10.1080/09718923.2014.11893249
- Smedley, T. (2013). Top down, or bottom up? Making sense of the city. *New Scientist*, 220(2946), 50–51.
- Smolan, R., & Erwitte, J. (2012). What Data Says About us. *Fortune*, 166(5), 162.
- Söderström, O., Paasche, T., & Klauser, F. (2014). Smart cities as corporate storytelling. *City*, 18(3), 307–320.
- Sosnowy, C., & Collette. (2014). Practicing Patienthood Online: Social Media, Chronic Illness, and Lay Expertise. *Societies*, 4(2), 316–329.
<https://doi.org/10.3390/soc4020316>

Speck, R. M., Courneya, K. S., Mâsse, L. C., Duval, S., & Schmitz, K. H. (2010). An update of controlled physical activity trials in cancer survivors: a systematic review and meta-analysis. *Journal of Cancer Survivorship*, 4(2), 87–100.

Spier, R. E. (2003). *Science and technology ethics*. Routledge.

Spring, B., Gotsis, M., Paiva, A., & Spruijt-Metz, D. (2013). Healthy Apps: Mobile Devices for Continuous Monitoring and Intervention. *IEEE Pulse*, 4(6), 34–40.
<https://doi.org/10.1109/MPUL.2013.2279620>

State of Sheffield 2018 Report — Sheffield City Partnership. (2018). Sheffield.
Retrieved from <https://www.sheffieldcitypartnership.org/scp-reports/2018/3/5/state-of-sheffield-2018-report-tyte2>

Stevens, S. (2014). *NHS Five Year Forward View*.

Stones, R. (2005). *Structuration theory*. Basingstoke: Palgrave Macmillan. Retrieved from
http://shu.summon.serialssolutions.com/2.0.0/link/0/eLvHCXMwdV25DslwDLU4FiQGaEGcUkcYito60HTmECMS7FWaJiMLMPD3JKblZnQijbES27KV9wyA0SzwP3yCFhgL4xYyxeYq5klmIXlpZCQ41wn18HuhMXjkjc8SxjeDvmVqYgmz9liF6oLZzGsVUeaFiJb2LcYXgYcF3U45GbzL9k_ds78BRZdNC2oWcdCGijo60NiVzQW

Sturgeon, D. (2014). The business of the NHS: The rise and rise of consumer culture and commodification in the provision of healthcare services. *Critical Social Policy*, 34(3), 405–416. <https://doi.org/10.1177/0261018314527717>

Surowiecki, J. (2005). *The wisdom of crowds*. Anchor.

Tan, S. S.-L., & Goonawardene, N. (2017). Internet Health Information Seeking and the Patient-Physician Relationship: A Systematic Review. *Journal of Medical Internet Research*, 19(1), e9. <https://doi.org/10.2196/jmir.5729>

Tapscott, D., & Williams, A. D. (2008). *Wikinomics: How mass collaboration changes everything*. Penguin.

Tapscott, D., & Williams, A. D. (2010). *MacroWikinomics Rebooting Business and the World*. New York: Atlantic Books Ltd.

Tapscott, D., Williams, A. D., & Herman, D. (2008). *Government 2.0: Transforming government and governance for the twenty-first century*. New Paradigm, 1.

Terziev, V. K., & Arabska, E. (2014). *Open Innovation for Sustainable, Smart and Inclusive Growth: User-Driven Development of Products and Services in Living Labs*.

Thaler, R. H., Sunstein, C. R., Leonard, T. C., & Leonard, T. C. (2008). *Sunstein, Nudge: Improving decisions about health, wealth, and happiness*. Yale University Press, 19, 356–360. <https://doi.org/10.1007/s10602-008-9056-2>

Thompson, M. J. (2015). False Consciousness Reconsidered: A Theory of Defective Social Cognition. *Critical Sociology*, 41(3), 449–461. <https://doi.org/10.1177/0896920514528817>

Thota, C., Sundarasekar, R., Manogaran, G., Varatharajan, R., & Priyan, M. K. (2018). Centralized fog computing security platform for IoT and cloud in healthcare system. In *Exploring the convergence of big data and the internet of things* (pp. 141–154). IGI Global.

Till, C. (2014). Exercise as labour: Quantified self and the transformation of exercise into labour. *Societies*, 4(3), 446–462.

Townsend, A. M. (2013). *Smart cities : big data, civic hackers, and the quest for a new utopia* / Anthony M. Townsend. Library Catalogue U6 - ctx_ver=Z39.88-2004&ctx_enc=info%3Aofi%2Fenc%3AUTF-8&rft_id=info:sid/summon.serialssolutions.com&rft_val_fmt=info:ofi/fmt:kev:mtx:book&rft.genre=book&rft.title=Smart+cities+%3A+big+data%2C+civic+hackers%2C+and+the+quest+for+a+new+u. Retrieved from

http://shu.summon.serialssolutions.com/2.0.0/link/0/eLvHCXMwpV09T8MwED1RWJAYQID4qnQLWxtMbCK3CDEglhiYYESKbCemIVAaISDUf8-dG1cVA0unSLaciwdfXi7vvQOQaSKGf3KCDsDcuRtP37g2vXZe2MxII2e00CbYzq7ZGECsbDeGLZ_8LDHnhFmWXLzgMf4js9J0L0Ve8Zr8yOaWUup8cfdcji_TNFpDfEYtOJtIK6k

Tritter, J. Q., & McCallum, A. (2006). The snakes and ladders of user involvement: Moving beyond Arnstein. *Health Policy*, 76(2), 156–168. <https://doi.org/10.1016/j.healthpol.2005.05.008>

- Turner, F. (2006). How digital technology found utopian ideology. *Critical Cyberculture Studies*, 257.
- Turner, F. (2010). *From counterculture to cyberculture: Stewart Brand, the Whole Earth Network, and the rise of digital utopianism*. University of Chicago Press.
- Ulrich, W. (1996). *A primer to critical systems heuristics for action researchers*. Centre for Systems Studies Hull.
- Ulrich, W. (2003). Beyond methodology choice: critical systems thinking as critically systemic discourse. *Journal of the Operational Research Society*, 54(4), 325–342.
- Ulrich, W. (2005). A brief introduction to critical systems heuristics (CSH). ECOSENSUS Project Website.
- Van Dijck, J., & Nieborg, D. (2009). Wikinomics and its discontents: a critical analysis of Web 2.0 business manifestos. *New Media & Society*, 11(5), 855–874.
- Van Dijk, J. A. G. M. (2005). *The deepening divide: Inequality in the information society*. Sage Publications.
- Vanolo, A. (2013). Alternative Capitalism and Creative Economy: the Case of Christiania. *International Journal of Urban and Regional Research*, 37(5), 1785–1798. <https://doi.org/10.1111/j.1468-2427.2012.01167.x>
- Vanolo, A. (2014). Smartmentality: The smart city as disciplinary strategy. *Urban Studies*, 51(5), 883–898.
- Vanolo, A. (2016). Is there anybody out there? The place and role of citizens in tomorrow's smart cities. *Futures*, 82, 26–36.
- Venditti, S. (n.d.). *The Modern Utopia Smart Cities and other images of the future*.
- Vermesan, O., & Friess, P. (2014). *Internet of things—from research and innovation to market deployment*. River Publishers Aalborg.
- Wachter, R. (2015). *The digital doctor. Hope, Hype and at the Dawn of Medicines Computer Age*, 2015.
- Wainwright, S. P., & Forbes, A. (2000). Philosophical problems with social research on health inequalities. *Health Care Analysis*, 8(3), 259–277.

Wakefield, S. E. L., & Poland, B. (2005). Family, friend or foe? Critical reflections on the relevance and role of social capital in health promotion and community development. *Social Science & Medicine*, 60(12), 2819–2832.

<https://doi.org/10.1016/j.socscimed.2004.11.012>

Walther, M. (2014). *Repatriation to France and Germany: A comparative study based on Bourdieu's theory of practice*. Springer.

Wang, F.-Y., Carley, K. M., Zeng, D., & Mao, W. (2007). Social computing: From social informatics to social intelligence. *IEEE Intelligent Systems*, 22(2).

Warburton, D. E., Nicol, C. W., & Bredin, S. S. (2006). Health benefits of physical activity: the evidence. *CMAJ : Canadian Medical Association Journal = Journal de l'Association Medicale Canadienne*, 174(6), 801–809. <https://doi.org/10.1503/cmaj> [pii]

Waterson, P. (2014). Health information technology and sociotechnical systems: A progress report on recent developments within the UK National Health Service (NHS). *Applied Ergonomics*, 45(2), 150–161.

Weber, E. P., & Khademian, A. M. (2008). Wicked problems, knowledge challenges, and collaborative capacity builders in network settings. *Public Administration Review*, 68(2), 334–349.

Westbrook, J. I., Braithwaite, J., Georgiou, A., Ampt, A., Creswick, N., Coiera, E., & Iredema, R. (2007). Multimethod evaluation of information and communication technologies in health in the context of wicked problems and sociotechnical theory. *Journal of the American Medical Informatics Association : JAMIA*, 14(6), 746–755. <https://doi.org/10.1196/jamia.M2462> [pii]

Westfield Health. (2017). Connect to your ageing loved ones | Westfield Health. Retrieved June 28, 2018, from <https://www.westfieldhealth.com/3rings/overview>

Whitney, D. D., & Trosten-Bloom, A. (2010). *The power of appreciative inquiry: A practical guide to positive change*. Berrett-Koehler Publishers.

Wicks, P., Massagli, M., Frost, J., Brownstein, C., Okun, S., Vaughan, T., ... Heywood, J. (2010). Sharing health data for better outcomes on PatientsLikeMe. *Journal of Medical Internet Research*, 12(2), e19.

- Williams, B., & van 't Hof, S. (2014). Wicked solutions: a systems approach to complex problems. Retrieved from <http://www.bobwilliams.co.nz/wicked.pdf>
- Wilson, P. (1997). Chapter 1 The SmartCommunities™ Concept. In Smart Communities Guidebook (pp. 1–113). California: Caltrans. Retrieved from <http://citeseerx.ist.psu.edu/viewdoc/download;jsessionid=52C56772FAB1C736448C0AEAF0134BA9?doi=10.1.1.102.8832&rep=rep1&type=pdf>
- Wolf, T. V., Rode, J. A., Sussman, J., & Kellogg, W. A. (2006). Dispelling design as the black art of CHI. In Proceedings of the SIGCHI conference on Human Factors in computing systems (pp. 521–530). ACM.
- Wolfram, M. (2012). Deconstructing smart cities: an intertextual reading of concepts and practices for integrated urban and ICT development. na.
- Woolliscroft, Tim and Polovina, Simon (2017). Improving healthcare through human city interaction. In: HAMMOUDI, Slimane, SMIALEK, Michal, CAMP, Olivier and FILIPE, Joaquin, (eds.) Proceedings of the 19th International Conference on Enterprise Information Systems, April 26-29, 2017, in Porto, Portugal. Scitepress, 172-177.
- Xia, F., & Ma, J. (2011). Building smart communities with cyber-physical systems. In Proceedings of 1st international symposium on From digital footprints to social and community intelligence (pp. 1–6). ACM.
- Yigitcanlar, T., & Lee, S. H. (2014). Korean ubiquitous-eco-city: A smart-sustainable urban form or a branding hoax? *Technological Forecasting and Social Change*, 89, 100–114.
- Zeidenberg. (2015). Innovative eShift platform helps nurses monitor home-care patients | Canadian Healthcare Technology. Retrieved June 19, 2018, from <http://www.canhealth.com/2015/09/29/innovative-eshift-platform-helps-nurses-monitor-home-care-patients/>
- Zexian, Y., & Xuhui, Y. (2010). A revolution in the field of systems thinking-a review of Checkland's system thinking. *Systems Research and Behavioral Science*, 27(2), 140–155. <https://doi.org/10.1002/sres.1021>

Zhou, K., Liu, T., & Zhou, L. (2015). Industry 4.0: Towards future industrial opportunities and challenges. In *Fuzzy Systems and Knowledge Discovery (FSKD), 2015 12th International Conference on* (pp. 2147–2152). IEEE.

Appendixes

10.1 Appendix 1 Coding System

Key

- M = Manager
- T = Technologist
- CS = Cancer survivor
- VS = Voluntary sector
- PS = Private sector
- LA = Local authority
- H = Healthcare Professional
- A = Academic or researcher

Based on this coding system some participants may be given more than one code, for example a manager might also work for a voluntary sector organisation and so start with VS, M.

10.2 Appendix 2: Glossary: How terms are defined in this study

10.2.1 Concepts Directly Related to Smart Community

Smart Community – human and non-human agents collaborating with the stated aim of significant positive change. (My definition, how it emerges is outlined in chapter 2)

Collective Intelligence – The collaborative creation of knowledge including a shift in power from the individual to the collective (Leimeister, 2010)

Social Computing – Collaboration with and through the internet (Xia & Ma, 2011)

Cyber Physical System – The interface between the cyber and physical worlds (Gurgen et al., 2013)

10.2.2 Concepts connected to Practice Theory

Doxa - The taken for granted understanding that people have of their social worlds

Habitus – a systems of durable, transposable dispositions predisposed to operate as structuring structures (the link between structure and agency / the social and the individual)

Field - The social and intellectual arenas where people interact

Cultural Capital – The cultural competence a person has in terms of knowledge behaviour and skills. As well as the skills gained through education it includes the wider understanding acquired to successfully navigate social environments. It includes understanding of unwritten rules

Social Capital - The aggregate of the actual or potential resources which are linked to possession of a durable network of more or less institutionalized relationships of mutual acquaintance and recognition.

Symbolic Capital – Resources in terms of recognition or prestige

Economic Capital – Financial assets including money and physical items such as equipment and property

Agency – The capacity of agents to act independently and to make choices

Structure – The societal patterns and arrangements that influence or limit the ability of agents to act independently

(Fries, 2009; Grenfell, 2009; Martin & Geldof, 1997)

10.2.3 Methodological concepts

Intersubjectivity – Shared subjectivity or perception of reality between two or more individuals or agents (Clark, 2007)

False Consciousness – This concept suggests that people can develop a mental construction that distorts perception of social reality, usually in such a way that privileges the interests of others. The existence of False Consciousness tends to result in an acceptance of the status quo (Little, 2009.)

Reflexivity – is conducting research with awareness of the researcher's role in the practice of research including the process and outcomes. It includes an awareness that the researcher and the objects of the research influence each other continuously through the research process including interpretation. (K. Haynes, 2012)

10.2.4 Words that define the medical system

Institutionalisation – The process of embedding conceptions or belief within an organisation, social system or society. It shares with false consciousness the notion of acceptance of a certain state. Institutionalisation is sometimes described as the acceptance of value and cultural patterns. (Thompson, 2015)

E-patient - An e-patient is a patient who is digitally equipped, empowered and engaged in their health and care decision (Medicine X, 2018)

The Grand Round - The grand round is a form of group teaching where a senior consultant teaches trainee healthcare professionals by engaging them in a round of consultations with patients (Myint and Sabanathan, 2005)

10.2.5 Abbreviations

CST – Critical Systems Thinking

CSH – Critical Systems Heuristics

SSM – Soft Systems Methodology

AI – Artificial Intelligence

Ai – Appreciate Inquiry

GP – General Practitioner

DNA – Did Not Attend

10.3 Appendix 3: Evidence of Workshop Outputs, including Rich Pictures and other Supporting Photographs

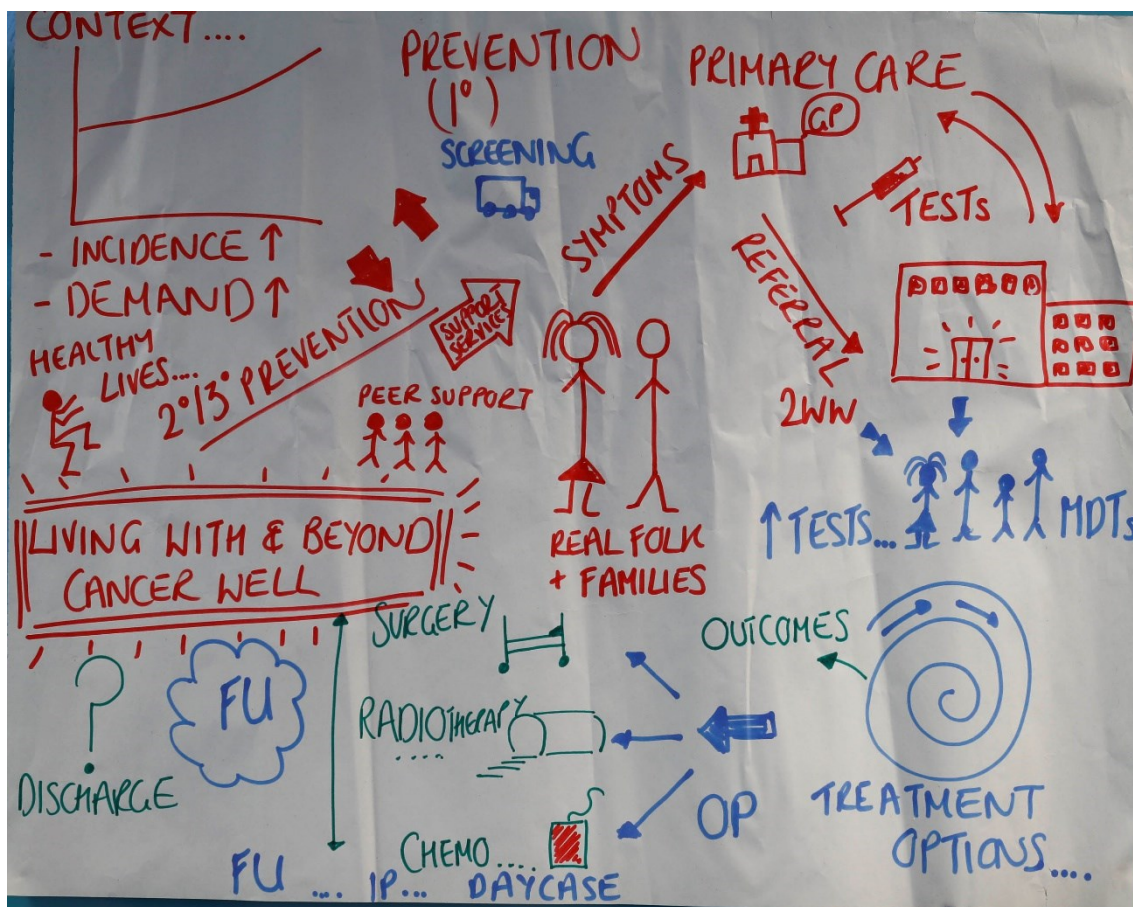

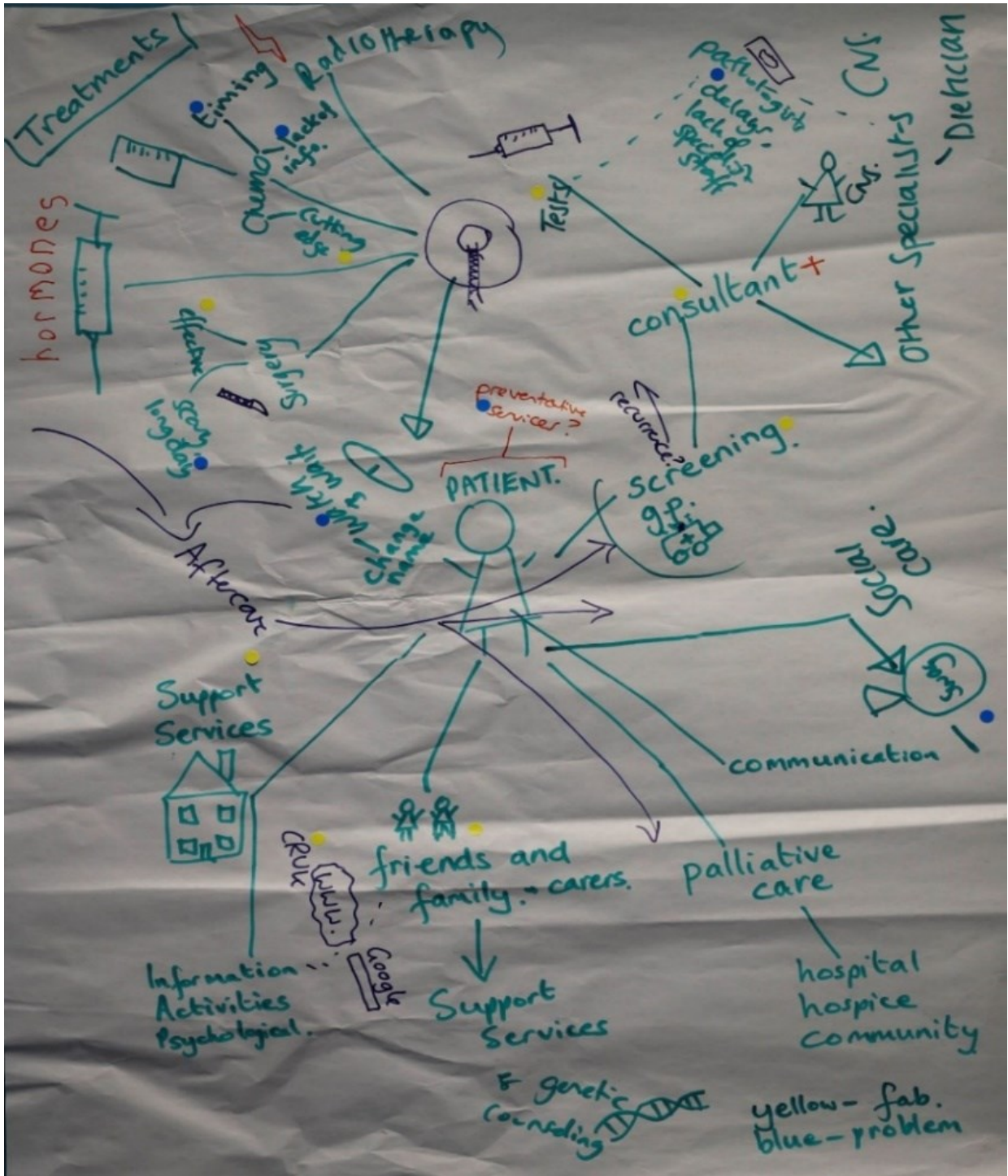

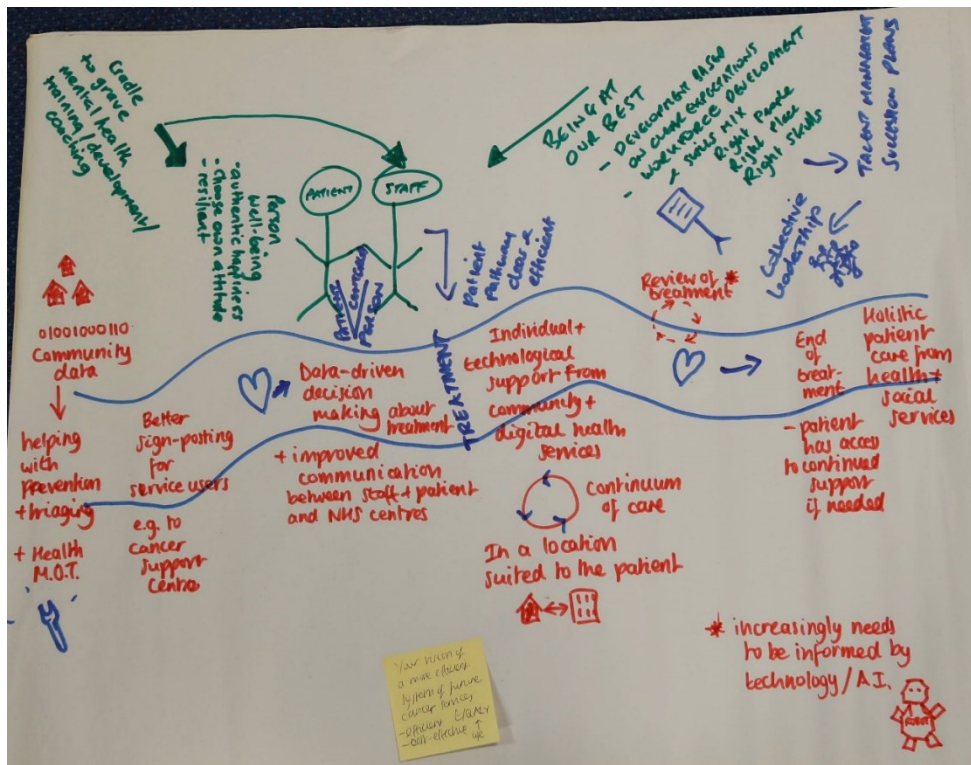
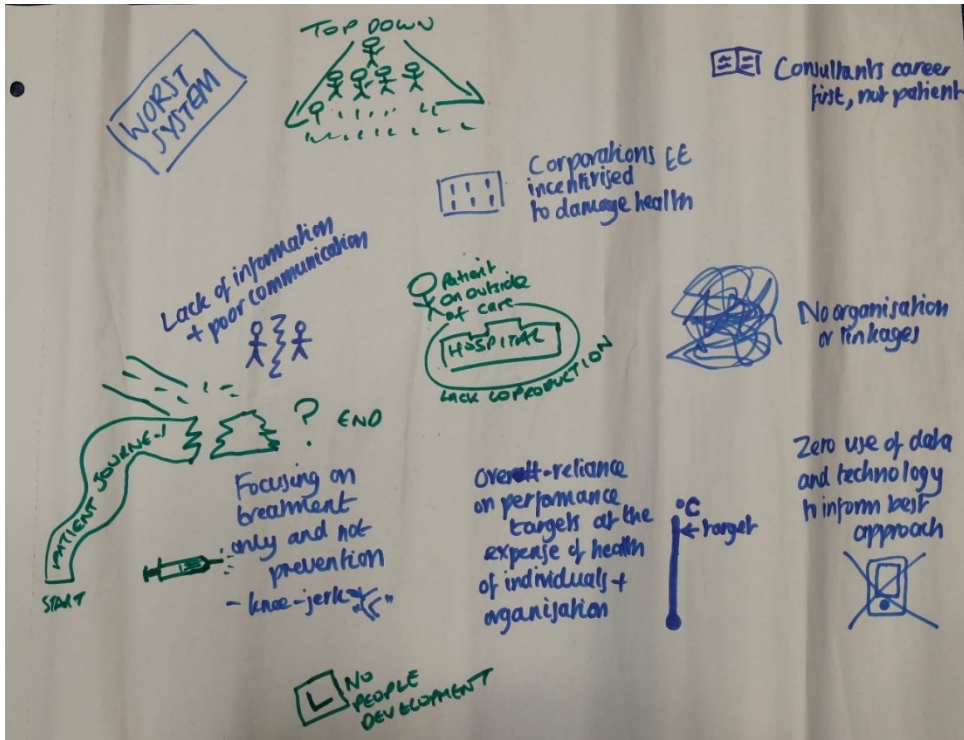

Need to change

behaviour

attitude

technology

organisational development

patient-centric

giving people skills for life - ^{+physically} mentally healthy

people's stress levels

Ideal vision

- data-based decision making / evidence

- good mental health

- people taking care of themselves ^{inside} +
the system supporting

- maximising happiness

- managing expectations

- resilience

- authenticity - authentic happiness

What can go wrong
Issues = Trust

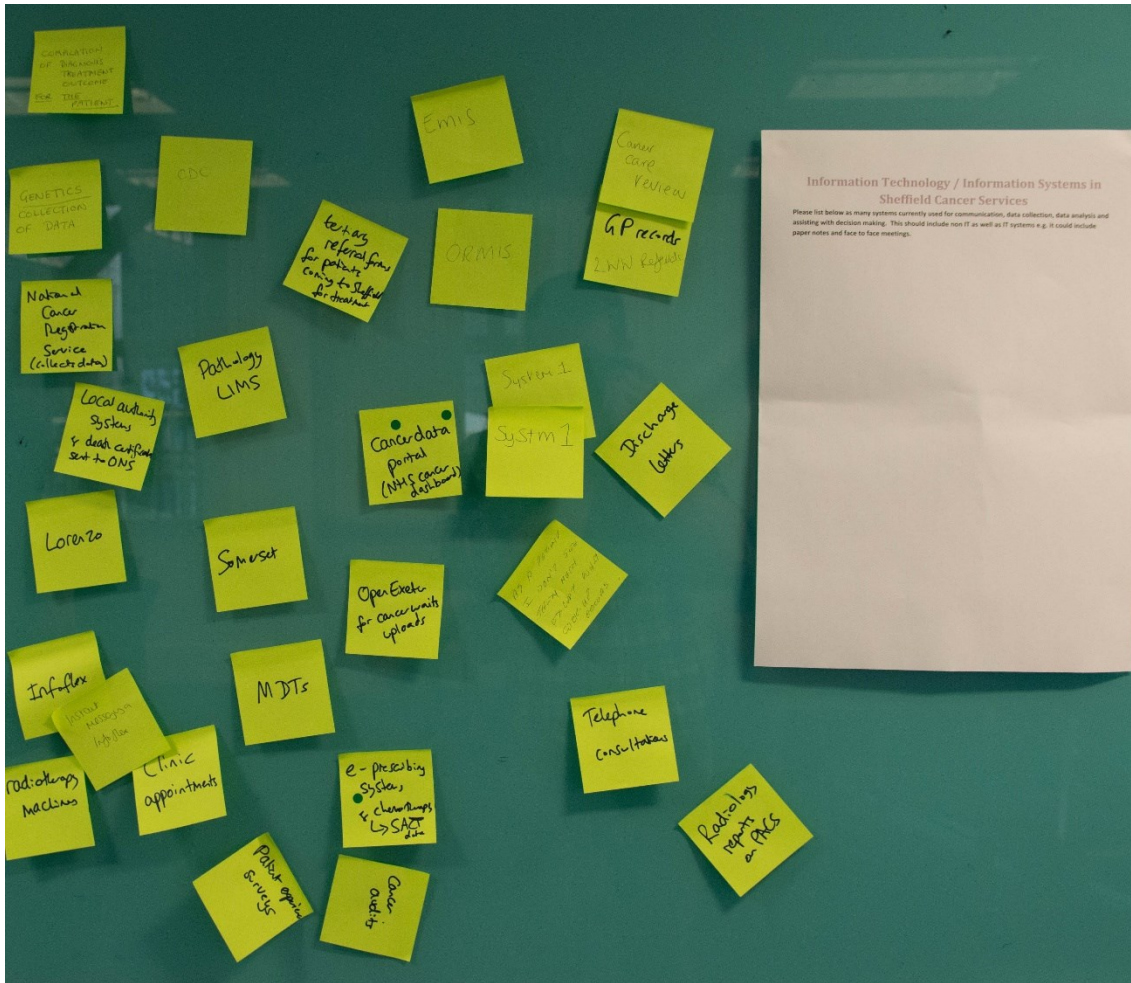

10.4 Appendix 4 Comments of Participants

1 H,A – E “thinking through making, the kind of brain-hand stuff, because everybody builds it encourages 100% participation, rather than the 80:20 participation that you usually get in a meeting, which I think you could probably apply to a focus group, depending on the skills of the facilitator.”121

2 H,A – E “there isn’t enough design in the health service, and people don’t look at the health service and its processes from the designer’s eye, and understand how people, you know, behave, and react, in response to how something is designed”121

3 H,A – D “if you go back to a kind of clunky description of kind of research it’s that research tries to generate generalizable data, and yours is absolutely ridden with context”122

4 LA – A “when we look at coproduction, and we look at co-design, we have to identify what the needs of the communities are, because every community is diverse in its needs and wants”131

5 T –D “an engineer would divide it up into smaller boxes to work with, so, you know, diagnosis, for example, how someone discovers that they have cancer in the first place, I can much easier imagine why doing a rich picture with all of those factors about that part, and another one about treatment, and another one about palliative care, end-of-life, or, whatever other stages there are...I am not saying it’s a better way of doing it, it’s just a way that I can get my head around, I don’t think I can get my head around the whole concept.”131

6 M-E "the bit I’m trying to get at, which I suppose is where I tried to start from, and I’ve been corrupted a little bit, since I’ve been in the NHS for a bit, which happens very easily”132

7 H-L “I think it’s a case of decisions being made by people at the top, EDMS was rolled out on such a massive scale, and, people just found it unusable, and yet they kept having to persevere with it.”134

8 T-U “Collaboration for us with our customer, which is the NHS, has been a strategic theme of ours for a number of years, we haven’t done it at this level before, but we also know that to integrate further with the NHS in the future hinges on collaboration, at all levels”134

9 M-O “the hospitals are actually doing some work on how they can manage that money in a more collaborative way”134

10 A – L “so much of this was based on personal relationships, you know, you’ve literally got the Chief Exec of the acute hospital, talking directly with the partners of the GP practice. It may be hard to scale that model of relationship-building up”135

11 T-O “so, the challenge is trying to establish a relationship and a collaboration with the NHS, in order to have that discussion, and then agree on common ground of which to build up, and that’s why the NHS Test Bed is such a unique opportunity”135

12 M – E “doctors need to let go of Downton Abbey style approach.... the grand round is about a set of cultural assumptions out of the 1950s”135

13 H-L “I think there’s a payoff, if you’re too pushy, it does mean that you’re perhaps not as liked by the staff”135

14 CS- E “my experience of the health service has been fantastic, I’ve had fantastic doctors who’ve been incredibly flexible, but, I am quite proactive, and I do go in and say, ‘I think I’d like to do this, how do we make that happen’, and then they’ve made that happen for me”.
.....136

15 A-L “One of the interesting things about AI or machine learning approaches, is it gets us away from this, sort of very pure type that we try to research, right, it should be much better at understanding patient variation and coping with patients that have, co-morbidities”136

16 LA –H “The harnessing of multiple data streams and putting it together in intelligent ways, it has to be driven by humans, it’s not yet clever enough to work out what to do itself and human judgement is always required, I don’t think AI has quite yet replaced human judgement”136

17 M-F “It’s part of the nudge philosophy, isn’t it, and because your data, the data actually makes you go again, because you are 250th out of 600, and you know, 10th in your age range, and you’re, you don’t really care that you didn’t come first, you just feel that you’re doing okay and you want to go again”137

18 H-U “it gives me much more timely, real-time data from the patient, in order for me to make, you know, changes, and, er, manage by exception, as I call it”137

Whilst the extent to which patients uploading information is actually close to real-time may be disputed, it was clear that this GP believed that his system gave healthcare professionals something that was closer to real-time than what had been in place previously. Comment 19 links the idea of real-time monitoring to story 2. My interviewee argued that the technology applied is a form of real-time monitoring:137

20 H-B-E “there are some weird and wonderful perverse incentives around stuff, and my, my analogy is, the price of end-of-life care in Sheffield is like an archipelago of islands, and on each island everybody’s striving to do the best that they can, but there’s nobody with any kind of oversight.”138

21 A-J “all significant innovation is business model innovation”138

22 H-C “it should be in the notes, they try to put it all on the computer system, but it just completely broke down, because it, the stuff you needed was never there, the up-to-date letters weren’t on there, you need a quick reference in the paper notes in front of you, so, sometimes you’d get a set of notes with no information in them, apart from the patient’s name and details.”138

23 H-C “I don’t know how they, they’ve not got the same systems at the hospital, so, I don’t think they can see our records”138

24 M-Y “Rather than a one-size-fits-all, it says the first thing we need to do is take a view of what’s the likely consequences of your cancer, and what’s important to you, and then you’re put on a relevant pathway, based on all of that”139

25 A-W “the offer of digital technology is access, convenience, flexibility”139

26 LA-B “when you’re co-designing for things, you’ve got to know what your community’s needs and requirements are”139

27 H-I “the great challenge with that is that hospitals are trying to cope with providing information to different organisations”139

28 H-L “on ICE you can only see your reports, so it’s nice to be able to see the scans, but it’s a whole other system you have to log into to get that, so if you could find a way of displaying all that together, but I think that comes down to the collaboration of the organisations, because it, I think the technology behind PACS probably doesn’t need reinventing, but if there was a way that the system that you go into then automatically, you click on a link, and it uploads PACS, that you don’t have to log into PACS separately, that could work, quite nicely”139

29 M-Y “what treatments do they need, which is this kind of silo approach we have today.”140

30 M-N “I think often the misconception is that if you go to somewhere like A&E that actually they can see not only your previous hospital world, but anything that’s happened in primary care”140

31 H-B “perhaps, we can utilise a private sector company in some way, but I’m not clear that the way that we’re utilising them doesn’t give them enough power to do what they like.”141

32 H-L “if you have a private patient, because you’ve got no access to their notes, you don’t understand what’s going on with them, you don’t have any results”141

33 H-B “the solution is what we’re not going to get, is more doctors, there’s just not enough staff, for most of the clinics, I don’t think, at local cancer services, they can’t recruit breast, breast consultants, you know, they’re trying to recruit, and they can’t find them”141

34 H-I “Inequality - smart information tends to be in American English, and we have to keep in mind that one tenth of our population is not naturally English, and doesn’t speak natural English. So, you always have to think, if it were possible to [pause] well, let me ask you a question: if I go into some information and it’s academic information, then, I sometimes get a little tag up which says ‘translate’, so I can read a Chinese article by simply pressing the ‘translate’. But, that is not, across the board, is it? Most information comes in the language that’s provided”141

35 H-L “There’s also slight bias in patients that get referred to oncology, in that you can always take the performance status that you’re told with a pinch of salt, because [pause] not, [pause] oh, that’s probably a bad thing to say, but anyway, often times people will say that someone has a performance status slightly better than they perhaps do, because they want them to be considered for treatment”142

36 LA-A “I think social prescribing is a key element of that, with that, when we look at coproduction, and we look at co-design, we have to identify what the needs of the communities are, because every community is diverse”147

37 LA-B “active, well-informed, you know, patients, can benefit more from the NHS than inactive, poorly-informed patients”149

38 M-B “all of that important lifestyle stuff is relevant to the prevention of things that they might not even have yet, you know, so there’s still, there’s still a benefit, a primary prevention benefit, for them preventing getting other things”152

39 CS-E “because most common womb cancers are, stimulated by too much oestrogen, and, excess body weight produces oestrogen, hence the link with womb cancer. So, there’s a lot of very, very large ladies in the womb cancer community, and, several of them have had discussions on the community about losing weight, and a lot of them have, they have talked about using things like a pedometer to measure their 10,000 steps a day, a lot of them have joined, a slimming group”152

40 T-D “How do you get them to live a healthy lifestyle if they’re suicidal with the cancer?”153

41 M-E “Because we don’t talk about feelings, we don’t talk about people being mentally healthy, that’s going to be the biggest problem”154

42 H-B “There’s not psychological support”154

43 CS-K “let me tell you what happens for an aircraft that’s flying in on a service route. It’s sending data on the operation of all the electronics, automatically all the time from the aircraft to its maintenance base. When it arrives, it should be that there is a guy standing on the tarmac with a black box, a trolley behind him, he knows exactly what he’s doing, where it is, what the heck was wrong with it, how to fix it. And he’ll go up there, and he’ll take something out of a rack, put a new box in, and do the necessary tests”155

44 CS-K “the aircraft coming in off a service, the maintenance crew know exactly what’s wrong with that, because it’s been sending all that information all the way, all the way across the Atlantic, or wherever the hell it’s going, it’s all there already, plus what that says out of the diagnostics, and if the diagnostics can in fact be improved to become cognitive, you pick up what you learn to be right, you learn.”155

45 H,A-E “the first thing you do is knock down medical outpatients. Put your consultants in the back of taxis, and visit people in their own homes.157

46 M-E “it may not even be a building. So, maybe the building doesn’t exist in the future, maybe a lot of things that we think are right now don’t exist, and they probably won’t” ...157

47 M VS–D “The expensive bit of health is hospitals, so anything which reduces demand in hospitals is going to have cost savings”157

48 M-Y “to reduce costs more care needs to be provided by less expensive people and hospital beds need to be reduced”157

49 H-Q “you have to start closing wards. So, if you can make a real difference to your length of stay, you can start closing wards, and that’s what really saves money”157

50 M-Y “if people maintain good health through their lives, then there’s going to be less intervention points needed for hospitals”.157

51 CS-B “people just go to A&E because you get seen”158

52 H-Q “has anyone told you the story of the Electronic Document Management Service?”159

53 H-Q “ if you look at how doctors work and develop systems that take that into account, they can be very good, if you implement a system and say, ‘there it is now you must use it’ and take no account of how we work, then it doesn’t go very well.”160

54 H-L “you’ve got these top-down initiatives, and you have got this complete reversal of what they’re supposed to be trying to do, but everyone in the back of their minds is thinking there’s this alternative agenda.”160

55 H-L “you’ve got different companies doing it in their own little silos, never talking to one another, just in competition, you’re never going to get the best service that you can get” 161

56 M-B “cancer numbers are going up and up and up, with more and more survivors, keeping people in hospital for prolonged periods of time is less and less viable”168

57 H, A–D “there are wicked problems, there is no one right answer. These are multifaceted, complex, interactions between staff, patients, commissioners, providers, societal norms, technology provision, it’s this kind of whole, and there is potentially a sweet spot in there, somewhere, but unless you can take a bit of time and keep that problem space open for a little bit longer, you won’t know.”168

58 M, VS–G “the limitations of the medical model, just, obviously, that it isn’t sustainable we know that, financially it’s not sustainable”168

59 H,A–D “It’s really complicated, because actually there’s probably about three directorates involved, erm, and there’s various bits, so District Nursing have an input, er, erm, there’s a team called intensive Home Nursing, who have a, er, unique role in the city in

terms of delivering kind of a sitting service in your last hours of life, erm, there are out-of-hours stuff, which is both Sheffield Teaching Hospitals and GPs, and then there are GPs, and of course GPs are not a homogeneous group”168

60 M–V “we need to get more interdisciplinary sort of stuff”169

61 M, VS–G “I think if we could ever get coproduction to its, you know, truest sense, it would have to be with an ability to kind of leave behind trying to protect your own organisation and protect your own income and everything else.”170

62 CS-B “I put a yellow dot by screening, because I think that’s excellent”186

63 M-L “Sheffield’s quite unique, the Sheffield Teaching Hospital, because, the incentive to work there is, it’s a better option for doctors than being in, say, Chesterfield, so quite often you see the resource shift of, they may start their lives out in the district general hospitals, but they move towards Sheffield Teaching Hospital, because there’s more options there.”186

64 CS–K “3 - Cancer Information and Support Centre, because will love me for putting them down twice”187

65 M-N “we’re generally pretty good at getting people through their kind of diagnostics, into their treatment, within a timeframe that’s reasonable”187

66 M-N “if you look at genuinely what we’ve got in this city, what’s good, we’ve got some of the best services, not only in the country, but in the world”187

67 D “My consultants were brilliant”187

68 M-N “50% of people who have a cancer diagnosis now will be with us for another ten years, so we need to start thinking about cancer as a long-term condition”189

69 H-Q “we’re increasingly seeing cancer as a long-term condition as people survive from cancer”189

70 CS-E “When they set up Patient Centre I never understood, we’ve got this brilliant computer system, but all the operation notes are done on a separate system, that doesn’t talk to the first, none of those talk to each other”189

71 M-N “what they (community nurses) can’t see is anything that’s been recorded about you in Lorenzo or InfoFlex about your cancer journey”189

72 VS-K “my experience with my family, there’s a lot of sort of communication breakdown between NHS, different divisions, has caused so many problems”189

73 VS-K “there’s just no connectivity”189

74 H-L “on PACS you can see your reports, and you can see the actual images of the scans, on ICE you can only see your reports, so it’s nice to be able to see the scans, but it’s a whole other system you have to log into to get that”189

75 H-Q “there’s a whole pile of different datasets, and therein lies the problem.”189

76 M-N “so you say, ‘oh, this project worked brilliantly, because we stopped them going into hospital’. Now, of course, ultimately [whispers: you can’t genuinely prove, prove that they would have gone into hospital] [pause] there’s a good chance they did, you can’t prove that”189

77 M-N “often what I find is that, what I found with [community?] cancer is that I have way too much information”190

78 H-L “you can almost guarantee that the fact that they’re seeing an oncologist means that there is only so much information they can take in anyway, because it’s overwhelming” ..190

79 CS-E “there is so much information and all I was concerned with at that time was my treatment”190

80 M,VS-L “Communication, and time, yeah, it’s not about money”190

81 CS-B “Communication and time are two big issues.”190

82 CS-B “Our GP has, like all GPs, a ten minute, and that’s if you book it in advance.”190

83 CS-B “they don’t do double appointments anymore, because they’ve got so many patients.”190

84 M-N “all of the hospitals, and they all work as individual businesses, with their own individual ledgers”190

85 H-L “I had a couple of patients recently who I had treated in their eighties, and they’ve come in fighting fit, looking brilliant, like you wouldn’t think they were eighty, you’d think

they were sixty, or fifty, or whatever, but then they really feel their age, and that difference to their quality of life, from someone who was eighty but acting like a sixty-year-old, to someone who really is acting like an eighty-year-old, that really knocked them sideways, and that’s really made me think about how, perhaps, they shouldn’t maybe, maybe we should have thought about that slightly differently in the consultation”190

86 T-I “with social care and budgets being reduced it’s meant that there’s less management of people out in the community, and some more people going out, and, you know, ending up in an acute setting.”191

- 87 M3 “the maze that they’ve drawn is a very costly maze”191
- 88 M, VS-L “how cost effective is the current system, well, it’s not cost effective, because it’s not joined-up”191
- 89 M, VS-L “one hand doesn’t talk to the other”191
- 90 M- L “it’s not cost effective”191
- 91 CS -J “Bit hard to estimate any amount of this at all, because this can be many, many times round the loop”191

92 M-N “services are generally in line with best practice ... what we’re finding is that in Sheffield we’re not very far behind, in most cases”192

Comment 93 - H-L “People are the biggest cost”192

Comment 94 - M- H “But, if you costed that, it would be however much a consultant costs times however many people round the table, specialist nurses”192

Comment 95 – M-H “ A & E and admissions, high cost. [pause] MDT, you’ve got a lot of people physically sitting round a table at the same time, I mean, some people do, like, tap in by phone, but that could be more efficient.....192

96 H-P “the NHS is either salaries, or running expensive buildings.”194

97 P-H – P “we use some hideously expensive drugs”194

98 LA-G “we spent £300million on the cancer drugs fund”194

99 H-B-A “Sheffield Children’s, Sheffield Teaching Hospitals, Leeds Teaching Hospital Trust, and Newcastle-upon-Tyne Hospital, and to have those four trusts working together in a

collaborative, and in a, a risk-sharing agreement, is really very unusual, this has not happened before, and in actual fact for a long time, the, I would say, the trusts were, in various combinations, at odds with each other, this builds on other structures that are being put in place, or have come into being, such as the STPs, the Sustainability and Transformation Programmes”196

100 M-N “in South Yorkshire and Bassetlaw we’ve been, well, wider part of this, we’ve been doing it for way beyond the STP, we’ve know that working together is the only way”197

101 T-N “we have the intelligence inside, let’s use it, really, and take that with us, if we were going to the beach, assume the beach is a new landscape, we could build our own utopian fantasy on.”205

102 M-E “If you were redesigning the healthcare system from scratch, you would probably start with the wellbeing of the patient, and work out from there, and what community, what, but it’s very difficult to think in that way, because that’s, it’s totally utopian.”213

103 M-E “the technology should enable you to say, ‘I’m working this week, sorry, I can’t do my appointment then, but I want you to build it round my work lunchtime’, and they say, ‘no, we can’t do that, because doctor so-and-so says you’ve got to come in then’, well, actually, no, I’m working, and so that’s when you do it, and that’s a long way off, isn’t it? But that’s probably what we need to do.”213

104 M-E “for me, the biggest problems are that we don’t have technology in the way that we should have it, so all the smart stuff and all the Star-Trek stuff is desperately needed”215

105 VS, M-H “we’ve done like a telephone, because we’re predicting in the future it will probably go more to monitoring patients so that they don’t have to keep coming in regularly”215

106 M, VS-L “what we found is the technology has really, has quite a profound impact on the functioning of our team, enabling us to more effectively manage workflow, and really also upscale our clinicians in the community, in a way much quicker than we had ever expected. [Said quietly: This okay?] Erm, because they’re effectively being supervised constantly, and they’re, it’s almost like being mentored by the bedside”218

107 T-H “right now, you know we’re starting to see pockets, so-called population health IT, technology where you can surveil a group of patients and have a dashboard for the physician to log into, where, every day they can look at, you know, their patient population and see who’s doing well, or who’s doing badly, so, we’re just starting, that’s probably, you know”218

108 H-S “I have a dashboard, and I have individual records of the, of the person as well, so I can, I can go into that individual record at any one time, and also look on the dashboard to see whose diabetes is controlled, whose blood pressure is controlled, who isn’t controlled. So, it gives me much more timely, real-time data from the patient, in order for me to make, you know, changes, and, manage by exception”218

109 T-N stated “I like the idea of AI, also learning from different diagnoses and mapping out exactly if there’s any correlatable links with what the patient’s lifestyle is”219

110 M-Y “it could be a text thing, that, you know, it just automatically, you’re not fit, you know, leave it. Is the patient fit or not fit? Right, bang the buttons, text the patient, it’s all that kind of slick system”219

111 CS-B “I think there are, some things that where machine learning, I think, can, can greatly benefit us, I think that the key areas are probably diagnostics”220

112 CS-B “the percentage of misdiagnoses from a, a machine system, or a machine doctor, is less than, say the percentage of diagnoses you would get from a human doctor”220

113 M-Y “the technology involved would probably, probably make for much better diagnoses and quicker and more accurate and more effective”220

114 H-Q “we’re not as good as computers as like systematically going through data, making sure we’re not missing patterns”220

115 H,A–B “there are some really, really bright people out there who are doing a lot of AI work, you know, Dr Watson, all that stuff, and they’re integrating geonomics into it, and this is the, really, where big data is going to come into its own”228

116 T-U “IBM Watson, they perform their magic in terms of analytics”229

117 T-D “ostensibly, they’re using one-and-a-half million patients-worth of data, their full care records, for a year, it’s a renal application, but the hospital have signed over everything to them, you know, they have the complete dataset.”241

118 M-Y "I was looking at something from a company that are looking at how to record MDTs"242

119 M-L “we might have to go out to the private sector to do the endoscopies, which is much more expensive than having your own people within the NHS ...although the jobs are there and the money’s there to fund them, you can’t get people to come into those roles because, you know, well, I’m guessing they can earn more in the private sector”243

120 T-D "How about, corporations are incentivised to get people to lead unhealthy lifestyles, because this kind of health system allows them to market, things to people’s extended networks, and see this whole thing as a commercial opportunity"243

121 M-K "it’s happening, isn’t it? Scary. You just need to walk round the supermarket"243

122 “Opens up a whole, a whole can of worms, though, doesn’t it? Because people’s information environment, you know, influences their behaviour, massively, obviously”245

123 T–D “corporations see people’s involvement in the health service as a, as a commercial opportunity, and try and get people engaged in it, they are actively incentivised to get people into the health service, so they can use all these channels to market at, and, so, there’s no point trying to get people to lose weight, they have to make them fat first.”245

124 “what companies like Cambridge Analytica have done, where they’ve determined whether or not you might be, neurotic, say, or what your self-esteem is like, or whether you sleep well or not, and serve political messages at you”245

125 T-D “Instead of investing money in prevention and diagnosis, you invest money in, or, do you, you know, you try and get people who are going to use up a lot of resources, to not need them anymore, as quickly as possible. So, you actually want people to die, as early as possible, if they’re, if they’re likely to use more resources, you want the heavily smoking, overweight, unhealthy people to not hang on, they cost a disproportionate amount of the current budget.”246

126 M-Y “the cost of obesity surgery is far cheaper than a lifetime of diabetic drugs, but then that lifetime is therefore longer, so then they start dying of cancer, which is far more expensive to treat.”246

127 CS-K “What happens when it goes wrong?”249

128 M-H “who’s to blame if it goes wrong?”249

129 M-Y “never cut people out of the process due to the subjectivity involved”249

130 “We know that people who are more physically active take less sick leave, so you can imagine bosses saying, ‘right, you’ve got to be active’”254

131 H,A-B "an American company, or a, a company from a different country, or based in a different country that takes a more ruthless view of its staff? Or how that, but I actually think that is one of the sequelae of the breach, another, sequelae of the breach might be insurance and discrimination regarding insurance, but also there’s something fundamental about, manipulation, that, that you can then potentially be manipulated, within your societal role you can be controlled in ways that are, would be, potentially very, very much more sinister.".....254

132 "we want them (implying patients and citizens) to behave in certain ways, but we also want them to have complete autonomy over their attitudes"255

133 T-D “I don’t think, I don’t think we wrote a pound sign or a dollar sign on the utopian, on either of the utopian visions, but they appeared on the dystopian vision, and the motivations in the utopian were about health outcomes and the healthy, healthy outcomes for individuals, in the second ones it was having those motivations captured and co-opted by corporate interests”257

134 H,A-B “perhaps, we can utilise a private sector company in some way, but I’m not clear that the way that we’re utilising them doesn’t give them enough power to do what they like”258

135 H, A-B “if the company is, for example, an American company, and a private company, it can be taken over, could be bought out. It will have signed up to, I’m sure, a whole series of agreements regarding confidentiality and, cyber security, et cetera, et cetera, but the bottom line is that if they breach, they go bankrupt. And then they reopen.”258

136 H-Q “healthcare professionals as well, they’re going to be asked to delve into an area that they weren’t trained in, they feel a bit vulnerable in, they don’t feel like they’re really expert, you know, erm, there’s a lot of insecurities within that”259

137 M-I “you know we’re at the potty-training end of it really. I mean we really are absolutely stumbling in the semi-darkness on this stuff, er, and you know the danger is that it could all end up in utter chaos, and we’re all going to want to go back to being Sir Lancelot Spratt again or one of his patients”259

138 M-VS-C “I think the interesting thing about Cop a Feel is, specific point, is it wasn’t a woman with breast cancer who needed educating, it was a GP who needed educating.” ..260

139 H-B “there’s a lot of people who don’t particularly want to work in the breast clinics, because people are reading so much online, and come in with all these things that they’ve read”261

140 M-E “there’s a lot of politics, there’s a lot of money, there’s a lot of businesses, there’s a lot of careers and consultants looking at their careers, there’s a lot of people working on stuff that actually is of no value”261

141 VS-M-C “people of the Manor, you know, you get the worst cancer outcomes, what are you doing about your eating or your smoking? is not going to do anything, and it’s a, more fundamental, exactly”262

142 M-B “Needing to be healthy, it’s not going to happen, but it’s about how do we address that, how can we change that culture, how can we, it’s the stuff what Active Everyday are trying to do, aren’t they, as a, trying to tackle the city to make them more active, so ...effort’s being made to change the culture”262

143 M-H “The impact of doing all this prevention stuff is, people who I see at the centre, erm, feel absolutely guilty, even though they’ve exercised and eaten right their whole life, they’re like, ‘what have I done wrong?’ And it’s trying to say, ‘you haven’t done anything wrong’, necessarily, so the media has a lot to answer for, for, psychological trauma of these patients”263

144 M-L “what your results are could affect you as a person, and whether you’d get insurance, and all sorts of things”264

145 M-H “. . . it’s a person at the centre, so, they’re not even a patient yet”	269
146 VS-M- C “I think it should be elastic, I think it should be something which is about the person at the centre, and everything around, sitting around them”	269
147 M-H “health MOTs, anything that pops up, health wise, then it gets referred into this system, that is all beautifully linked by technology”	270
148 M-H “Prevention training, health MOT, so the health MOT would be part of tele-monitoring”	270
149 M-Y “, once they’ve had their health MOT then they get signposted to somewhere and then in terms of help with prevention and things like that, you might be signposted earlier, like, literally the first, signs of it”	270
150 M-H “Data-Driven decision-making about treatment”	270
151 M-Y “a future scenario which will still be complex, difficult and mixed, but, some of the stuff which is captured there will allow it to work better than it currently does now, but it will be based on the infrastructure and you know, we’re still going to have a hospital.”	273
152 H-B-A “if we get clinicians that are seeing that working together to deliver patient services across, let’s look at the region, and are working together for the first time, what they will be saying to their employing organisations, the trusts, is, ‘we can’t do this, because the data interoperability is crap”	276
153 M-L “if people have, different services have different systems, and don’t have the right data sharing agreements in place and things, it could actually make it more messy for the individual receiving care”	276
154 LA-H “the real win for social prescribing from a clinical perspective is freeing up primary care time. So, instead of GPs spending 30% of their time trying to help Mrs Smith sort out her housing, or her benefits, or her debt problems, or her loneliness and isolation, someone that’s more appropriately skilled, qualified, and trained, and connected with communities can do that, and that frees up a GP to sort out Mrs Smith’s dementia, depression, diabetes, COPD, the things that actually GPs are usually pretty good at”	279
155 M-L “So, being able to access it through the directing nurse has had a, again, it’s had another quite dramatic effect on the team’s ability to make decisions.”	282

156 TC “where’s the city data agency, that assures that people’s data is taken care of in an appropriate way, and informs people and educates them about how the data is used? It doesn’t exist, no city has got one, you know, you’ve got a data commissioner’s office, you know, nationally, you’ve got, er, you know, ombudsmen”283

157 H,A-B “there will be a, a shift from this very rigid, you know, building walls around organisations, into, we’ve got to try and find ways of creating interoperability and data sharing, and there will be far greater drivers to do that. And eventually what will happen is that there will be drivers that are, from the centre, to do that, and there are drivers now, to look at data sharing, particularly within genomics. It butts up against governance”283

10.5 Appendix 5 Consent Forms and Information Sheets

10.5.1 Participant information Sheet

Project involvement

As a project participant you will be asked to take part in interviews, focus group workshops. Details of these are outlined below. Minimum involvement will be to take part in 1 3 hour consultation session or 1 x 1 hour interview.

Involvement will simply include answering questions and contributing to discussion about the existing and potential future healthcare systems.

Unless participants request otherwise interviews and focus group workshops will be held at Sheffield Hallam University's city centre campus.

Project Overview

This is a PhD project. Whilst the intention is that it should have practical benefits, within this project these need to be balanced with academic requirements such as demonstrating a gap in knowledge

The research question is 'Could Smart Communities Improve the efficiency of Cancer Services in Sheffield?'

In this context the term smart communities is used to describe digitally connected communities. These communities include both people and devices such as exercise trackers. The people in these communities include patients as well as health managers and clinicians.

Efficiency is defined as £ per QALY (Quality Adjusted Life Year) and cost savings within systems.

The two main areas of need this study is focused on is

1. The financial pressures within the current system, such as the £30 billion funding gap identified in the NHS 5 year forward view
2. A research gap within smart community literature

Methodology

This is an inductive research project. Its focus is on creating conceptual models that indicate where efficiency improvements are likely to be.

The project will have 5 sections

1. Literature research - This is ongoing. It started in October 2014.. It started with exploring existing research, concepts and theories and how these relate to potential efficiencies.
2. Interviews and Focus Group Workshops (March 2016 - July 2017) these will inform the development of conceptual models. Ideas from these sessions will inform what different approaches to delivering cancer services could look like with greater digital collaboration, including the digital engagement of patients within the system.
3. Modelling (July -- September 2017). Ideas that emerged from interviews and focus groups will inform the modelling stage of the project.
4. Writing up (September - December 2017)

Selection of participants

In keeping with the study's methodology no attempt at random sampling has been used. You are being invited to take part as you have been identified as having relevant skills and or experience. My aim is to select participants from groups that could make up a smart community in Sheffield. For this reason I am keen to include health managers, healthcare professionals and cancer survivors

Consent / anonymity

By agreeing to take part in this research project you are agreeing that comments that you make during interviews and consultation sessions to be included in the research

Comments made will be expressed as anonymous. A list of stakeholders will however be included in the project report.

Leaving the project

If for any practical reason you decide to leave the project steering group you are welcome to do so. Previous comments made will remain included as part of the project research findings. These will be included anonymously.

Next steps / Data

I request that all data collected during this project remains active after this project so that it can be used in subsequent related research. The data collected includes discussion notes, diagrams /pictures relating to discussion, photo's, video files, and audio files. For example audio files may be of interview discussion, photographs may show a physical representation of the answers to some focus group questions.

I will retain control over who else can access this data. Nobody will have access to this data other than for research purposes. Electronic data will be stored on an encrypted drive. Paper and video content will be kept in a locked box at Sheffield Hallam University.

The findings of this research will be published in related journal articles and presented at subsequent conferences and events

Questions

If you have any questions or concerns please contact me for clarification: Tim Woolliscroft - t.woolliscroft@shu.ac.uk - 01142252871

If you have already done this and have not received a satisfactory response contact my PhD Supervisor - Trevor Simper t.simper@shu.ac.uk / 0114 2253978

10.5.2 Participant Consent form

Participant Consent form

Improving the Efficiency of Cancer Services in Sheffield - PhD Research Project

Please answer the following questions by ticking the response that applies

	YES	NO
1. I have read the Information Sheet for this study and have had details of the study explained to me.	<input type="checkbox"/>	<input type="checkbox"/>
2. My questions about the study have been answered to my satisfaction and I understand that I may ask further questions at any point.	<input type="checkbox"/>	<input type="checkbox"/>
3. I understand that I am free to withdraw from the study within the time limits outlined in the Information Sheet, without giving a reason for my withdrawal or to decline to answer any particular questions in the study without any consequences to my future treatment by the researcher.	<input type="checkbox"/>	<input type="checkbox"/>
4. I agree to provide information to the researchers under the conditions of confidentiality set out in the Information Sheet.	<input type="checkbox"/>	<input type="checkbox"/>
5. I wish to participate in the study under the conditions set out in the Information Sheet.	<input type="checkbox"/>	<input type="checkbox"/>
6. I consent to the information collected for the purposes of this research study, once anonymised (so that I cannot be identified), to be used for any other research purposes.	<input type="checkbox"/>	<input type="checkbox"/>

7. I consent to my interview /interviews being audio recorded

Participant's Signature: _____ **Date:**
—

Participant's Name (Printed): _____

Contact details:

—

Researcher's Name (Printed): _____

Researcher's Signature: _____

Researcher's contact details:

(Name, address, contact number of investigator)

Please keep your copy of the consent form and the information sheet together.

10.5.3 Photo / Video Consent

Improving the Efficiency of Cancer Services in Sheffield - PhD Research

Photography and Video Consent

Photographs and video taken form a valuable part of the data collected. For example these may compliment notes and audio transcriptions of the words expressed. In addition images could enhance conference presentations, journal articles and reports that emerge from this research. Please tick the boxes that indicate what you agree or don't agree to.

To be completed by the participant:

- | | YES | NO |
|---|--------------------------|--------------------------|
| 1. I agree to have my photograph taken and to be included in video content. | <input type="checkbox"/> | <input type="checkbox"/> |
| 2. I understand that my question responses will not be linked to the photograph(s) or video images in any published content . | <input type="checkbox"/> | <input type="checkbox"/> |
| 3. I understand that my name will not be linked to the photograph(s) or video images. | <input type="checkbox"/> | <input type="checkbox"/> |
| 4. I understand that I will not be given credit for my appearance in photograph(s). | <input type="checkbox"/> | <input type="checkbox"/> |
| 5. I give the project team permission to: | | |

- use photo and video images of me by the studies researcher as part of the data analysed
- use photographs of diagrams, sketches and other images that emerge as part of the data analysed
- use photographs of diagrams, sketches and other images that emerge in conference presentations, papers, journal articles and /or other reports
- use photograph(s) and video images of me in presentations (e.g. at conferences or seminars)

Signature of participant: _____ **Date:**

Name of participant (block letters): _____

Signature of investigator: _____ **Date:**

(Name, address, contact number of investigator)

10.6 Appendix 6. Steps Taken to Create Theory

10.6.1 Creating the data and interim sense making

- The process towards developing smart community theory has been outlined throughout different parts of this thesis. To give clarity here I bring these ideas together by outlining the steps that were followed to create theory.

Step 1- Code interview transcripts to highlight themes

- Coding with NVIVO. This process is described in 3.5.3; some of the results of the coding process are outlined in the first part of chapter 4.

Step 2- Identify hunches and story's to identify ideas about what seems to be working

- They mostly emerged directly from ideas expressed in interviews and workshops, although some emerged by connecting ideas from literature with comments expressed by participants. For example as outlined in 5.2.4 hunch 4 emerged initially in response to comment 45. By contrast, Hunch 2 emerged when comments such as comment 40 appeared to resonate with the literature about the biopsychosocial system discussed initially in 1.5.4.

Step 3- Highlight assets in the current system

- Assets were identified in the asset mapping exercise described in 3.4.2.1; its findings are outlined in 6.2.

Step 4- Facilitate the creation of rich pictures of the current system

- How rich pictures were created is outlined in 3.4.2.6. The format of the workshop that these rich pictures were outlined in 3.4.2.1. The rich pictures that emerged are outlined in 6.2.3.

Step 5- Connect asset list to: ideas from current system rich pictures, themes, stories interview comments and secondary research.

- The process of connecting ideas about the current system takes place throughout chapter 6, the process of how the ideas are combined in outlined in 3.5.1 and 3.5.5.

Step 6- Facilitate the creation of utopian rich pictures of the current system

- The workshop where utopian rich pictures were created is outlined in 3.4.2.3

Step 7- Connect ideas from utopian rich pictures to: themes, stories, hunches, interview comments and secondary research

- The results of the utopia workshop are outlined in 7.2.1. The narrative throughout chapter 7 connects ideas from this workshop to literature to themes, stories, hunches, interview comments and secondary research. The process of how the ideas are combined is outlined in 3.5.1 and 3.5.5.

Step 8- Facilitate the creation of dystopian rich pictures

- The workshop where dystopian rich pictures were created is outlined in 3.4.2.3

Step 9- Connect ideas from dystopian rich pictures to: themes, stories, hunches, interview comments and secondary research

- Findings from the dystopia workshop session are outlined in 8.1.1, 8.2.3, 8.3, 8.4.1 and 8.7. The narrative throughout chapter 8 connects ideas from this workshop to literature to themes, stories, hunches, interview comments and secondary research. The process of how the ideas are combined is outlined in 3.5.1 and 3.5.5.

Step 10- Facilitate workshop sessions that combined utopian and dystopian rich pictures

- Appendix 7 gives a breakdown of the format of one of the workshops where utopian and dystopian ideas were combined. Sessions where utopian and dystopian ideas were connected are outlined in 3.4.2.3 and 3.4.2.5. The results of the sessions that brought these ideas together are outlined in 9.1

Step 11- Connect ideas from balanced ideas from rich pictures to: themes, stories, hunches, interview comments and secondary research

- The process of how the ideas are combined is outlined in 3.5.1 and 3.5.5. Ideas are combined throughout chapter 9

10.6.2 Categorising the data

Step 12- Separate out emerging ideas into those that relate to governance from those that relate to the application of healthcare. Connect these ideas to; themes, stories, hunches, interview comments and rich pictures

- This process is outlined in 9.2. It is informed by the approach outlined in 3.5.4.

Step 13- Create and apply a framework that connects ideas to 4 different visions as outlined in 9.3.1.

- The visions emerged from data, the process is outlined in 9.3.1. It is informed by the approach outlined in 3.5.4.

10.6.3 Bringing it all together

Step 14- Connect the categorisations from steps 12 and 13 with ideas that emerged from steps 1-11

- This process is outlined in 9.3.2. It is informed by the approach outlined in 3.5.4.

Step 15 Create substantive theory by connecting central messages together

- Ideas were combined through the process of critical reflexivity outlined in 3.5 and the theory building approach outlined in 3.5.4. Through this reflexive process I highlighted the central messages that emerged from steps 1-14. These messages and how they fit together are the substantive theory outlined in 9.3.3. In 9.3.3 I outlined how ideas in the theory connect with ideas discussed throughout the thesis

10.6.4 Overarching how systems thinking was applied

As indicated in 1.2 systems thinking is about thinking in systems as well as about systems.

This was applied in two ways.

1. Facilitating the creation of rich pictures. Through this process I encouraged participants to think in systems
2. Creating conceptual diagrams through the process of critical reflexivity outlined in 3.5. To help me make sense of data from the different sources outlined above I created conceptual diagrams as part of my process of thinking in systems. These diagrams are included throughout chapters 4-9 e.g. figure 32 is a conceptual diagram I created to help make sense of dystopian ideas
3. Bourdieu's Practice Theory was applied as part of the sense making process. For example in section 5.1 I connected forms of capital to interview comments and in figure 44 (9.3.2.1) I connected ideas from throughout my thesis to Bourdieu's practice theory

10.7 Appendix 7: Workshop Structure and Information

10.7.1 Example of Workshop Structure (Workshop 3)

9.45 – 10 Arrivals / Networking

10 -10.15 - 1 Introduce session / self /hunches

10.15-10.30 Group Introductions

10.30 -10.45 Ice breaker - Hunches

10.45 -11 Discussion – Why are services structured as they are?

11 -11.20 Review info about current system- including asset map and existing rich pictures

11.20 –11.50- Recreate / Refine Rich Pictures – bring together create 1 of each

11.50 -12.20 – Compare current rich picture with future rich picture

- List how / why future might be more efficient than current rich picture – costs and QALY's
- List how / why future might be less efficient than current rich picture
- Ethics – why this might not be a good idea even if more efficient

12.20 -12.30 Discuss

- 8 – further actions / information needed
- 9 – Recommended next steps / is another workshop needed?

12.30 – 1pm Lunch /networking and informal discussion

10.8 Appendix 8: Information Received from Participants

10.8.1 The Current System

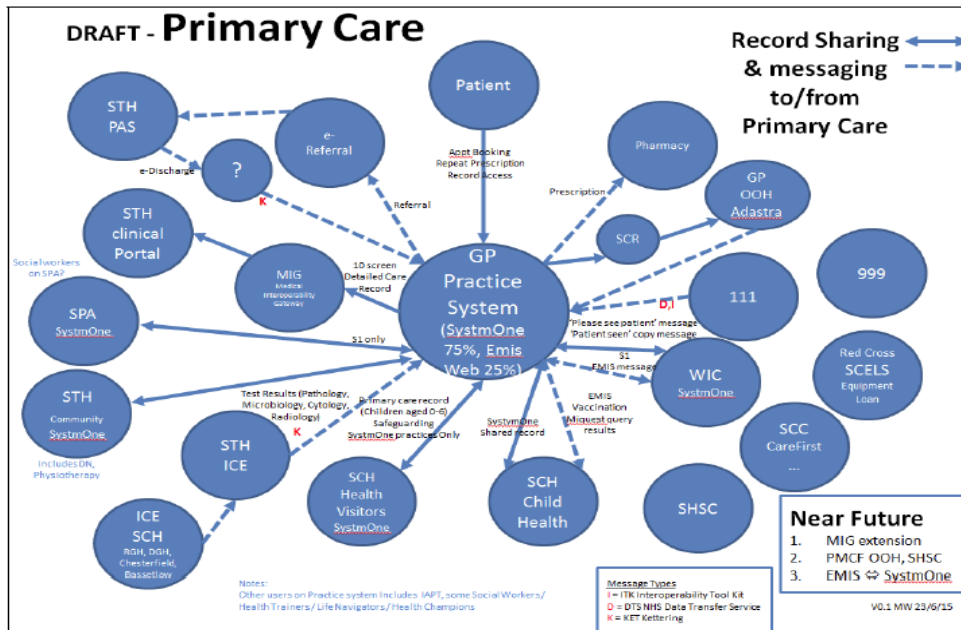

10.8.2 Sheffield Cancer Stakeholders

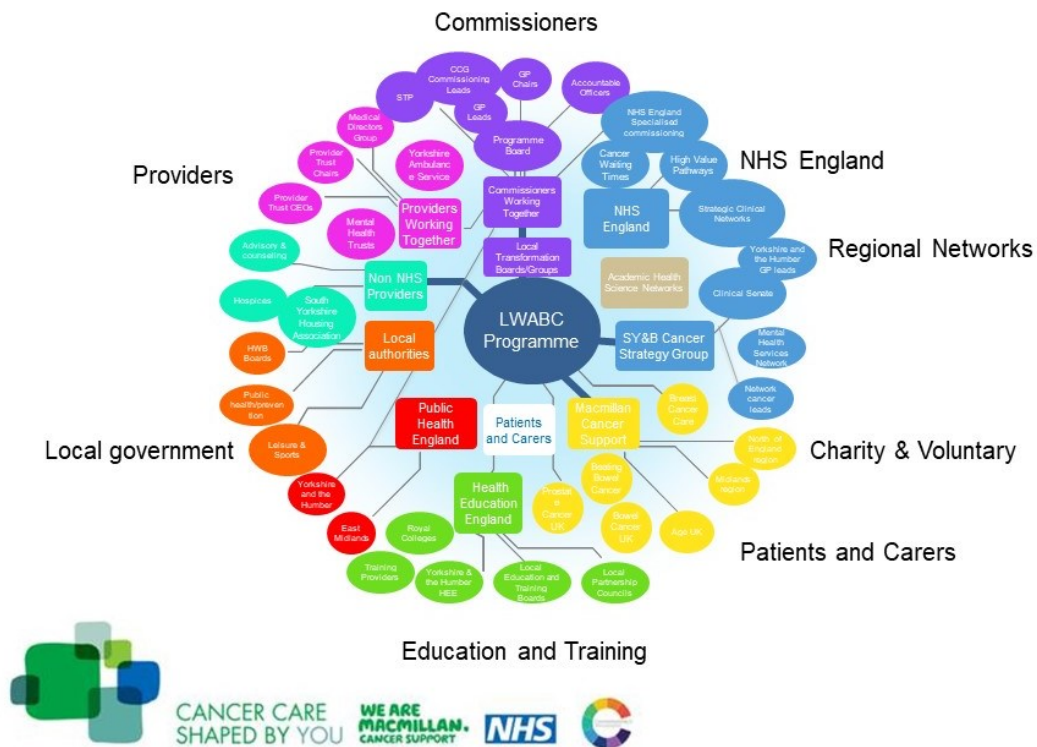

10.8.3 Relevant Initiatives

Shaping Sheffield /STP

- <http://www.sheffieldccg.nhs.uk/Downloads/get%20informed/SheffieldPlaceBasedPlanFinalVersion.pdf>
- <http://www.sheffieldccg.nhs.uk/Downloads/Our%20Projects/ShapingSheffieldDelegatePack%2021.04.16%20final.pdf>
- <https://smybndccgs.nhs.uk/what-we-do/stp>
- <http://www.sheffieldccg.nhs.uk/get-involved/sustainability-and-transformation-plan-2.htm>

Sheffield Cancer Alliance Plan –

- [https://smybndccgs.nhs.uk/application/files/9814/8467/0317/Cancer Alliance Delivery Plan 20172021.pdf](https://smybndccgs.nhs.uk/application/files/9814/8467/0317/Cancer_Alliance_Delivery_Plan_20172021.pdf)

Improving Cancer Care in Sheffield –

- <https://sheffield.citizenspace.com/ccg-sheffield/improving-cancer-care-sheffield/>

Sheffield digital roadmap –

- <http://www.sheffieldccg.nhs.uk/Downloads/Our%20strategy/LDR%20Sheffield%20Narrative%20Jun2016%20Published.pdf>

10.8.3.1 Beyond Sheffield

Living beyond Cancer

- <https://www.macmillan.org.uk/about-us/what-we-do/evidence/cancer-intelligence/routes-from-diagnosis.html>
- <http://www.sheffieldccg.nhs.uk/news/The-Macmillan-Living-With-Bnd-Beyond-Cancer-Programme.htm>
- <http://www.macmillan.org.uk/documents/aboutus/commissioners/movemorereport.pdf>

10.9 Appendix 9: Interviews

10.9.1 Overview of a typical scoping interview

Thank you for agreeing to take part in this scoping interview. Just to give time to collect your thoughts advance I outline below an overview of the general themes for discussion

- What has gone well / what are your relevant achievements?
- What barriers did you have to overcome?
- What strategies did you apply?
- What would you like to do but have not done yet?
- What would you like to see that hasn't happened yet?
- What do you think about the potential of collaboration including patient engagement through information technology?
- Who else do you think could be useful to interview and /or invite to focus group workshops?
- Can you signpost me towards related research and /or information about the cost of service provision that I might not be aware of yet.

10.9.2 Questions /Themes for Main Interviews

Introduction

What are your initial thoughts about the information that I sent you / discussion at the event that you attended?

Now - First 5 interviews - after focus group session 1

- Describe the current system; who are the key actors / agencies in this system, what does each do, how do they work with and share information with each other?
- What works well in the current system?
- Why do you think this works well?
- Who is involved, what are their roles?
- What could be better?
- What barriers exist that prevent improvements being made?

- What information technology do you use currently e.g. apps, forums, monitoring devices. How do / could these help you and /or others make better decisions?
- Where is money spent in the current system?
- Who decides where resources are allocated?
- What information is used to collect data?
- What devices / systems are used to collect, share and analyse data?

Then - second 5 interviews - after focus group session 2

- Describe a hypothetical future system that applies existing and emerging information technology developments (including wearable devices, forums, apps) towards improving the economic efficiency of the current system.
- Who is enabled to make better decisions and how in this future?
- In this future system; who are the key actors / agencies in this system, what does each do, how do they work with and share information with each other?
- What role would you imagine patients, cancer survivors and communities to have in this future?
- Can you imagine data collecting and sharing moving beyond health and social care to link with other city services? What do you think might be possible? What would this look like?
- What does collaborative intelligence mean to you? Do you think this could play a role in improving efficiency if so how?
- If digitally enabled collective intelligence could help improve efficiency in the current system what conditions do you think would be needed to make this possible?
- What do you see as the most significant innovations that could enable a different way of working, what would this look like?
- How would decisions be made in this system? , who would make them what technology / information exchange would they use them to make decisions - e.g. diagnosis, treatment, financial decisions?
- In the context of smart communities - to improve efficiency are there areas where you think more investment is needed and are there any areas where spending could be reduced?

Note: These were free flowing conversational style semi structured interviews so the ideas above were introduced in response to other comments. This not a firm checklist that was asked in interviews. The wording varied between interviews as did the order.

10.10 The NHS / IRAS Application for This Study

The Click on the document below for a PDF of the IRAS application form that was submitted and approved for this study.

Full Set of Project Data IRAS Version 5.3.2

Welcome to the Integrated Research Application System

IRAS Project Filter

The integrated dataset required for your project will be created from the answers you give to the following questions. The system will generate only those questions and sections which (a) apply to your study type and (b) are required by the bodies reviewing your study. Please ensure you answer all the questions before proceeding with your applications.

Please complete the questions in order. If you change the response to a question, please select "Save" and review all the questions as your change may have affected subsequent questions.

Please enter a short title for this project (maximum 70 characters)
 Could Smart Communities Improve the Efficiency of Cancer Services ..

1. Is your project research?

Yes No

2. Select one category from the list below:

Clinical trial of an investigational medicinal product

Clinical investigation or other study of a medical device

Combined trial of an investigational medicinal product and an investigational medical device

Other clinical trial to study a novel intervention or randomised clinical trial to compare interventions in clinical practice

Basic science study involving procedures with human participants

Study administering questionnaires/interviews for quantitative analysis, or using mixed quantitative/qualitative methodology

Study involving qualitative methods only

Study limited to working with human tissue samples (or other human biological samples) and data (specific project only)

Study limited to working with data (specific project only)

Research tissue bank

Research database

If your work does not fit any of these categories, select the option below:

Other study

2a. Please answer the following question(s):

a) Does the study involve the use of any ionising radiation? Yes No

b) Will you be taking new human tissue samples (or other human biological samples)? Yes No

c) Will you be using existing human tissue samples (or other human biological samples)? Yes No

3. In which countries of the UK will the research sites be located?(Tick all that apply)

England

Scotland