



<https://theses.gla.ac.uk/>

Theses Digitisation:

<https://www.gla.ac.uk/myglasgow/research/enlighten/theses/digitisation/>

This is a digitised version of the original print thesis.

Copyright and moral rights for this work are retained by the author

A copy can be downloaded for personal non-commercial research or study, without prior permission or charge

This work cannot be reproduced or quoted extensively from without first obtaining permission in writing from the author

The content must not be changed in any way or sold commercially in any format or medium without the formal permission of the author

When referring to this work, full bibliographic details including the author, title, awarding institution and date of the thesis must be given

Enlighten: Theses

<https://theses.gla.ac.uk/>  
[research-enlighten@glasgow.ac.uk](mailto:research-enlighten@glasgow.ac.uk)

**Study of Cathodic Protection Related to Thermal  
Desalination Plant**

**Thesis**

**Submitted in Fulfillment of the Requirements for the Degree of Doctor of  
Philosophy**

**By  
Nader Abdulaziz Najm-Mohammed**

**Department of Mechanical Engineering,  
University of Glasgow,  
November 1997**

**© Nader Abdulaziz Najm-Mohammed, 1997**

ProQuest Number: 10391173

All rights reserved

INFORMATION TO ALL USERS

The quality of this reproduction is dependent upon the quality of the copy submitted.

In the unlikely event that the author did not send a complete manuscript and there are missing pages, these will be noted. Also, if material had to be removed, a note will indicate the deletion.



ProQuest 10391173

Published by ProQuest LLC (2017). Copyright of the Dissertation is held by the Author.

All rights reserved.

This work is protected against unauthorized copying under Title 17, United States Code  
Microform Edition © ProQuest LLC.

ProQuest LLC.  
789 East Eisenhower Parkway  
P.O. Box 1346  
Ann Arbor, MI 48106 – 1346

بِسْمِ اللَّهِ الرَّحْمَنِ الرَّحِيمِ

”وَجَعَلْنَا مِنَ الْمَاءِ كُلَّ شَيْءٍ حَيٍّ“

*In the name of God, Most Gracious,  
Most Merciful.*

We made from water  
Every living thing.

GLASGOW UNIVERSITY  
LIBRARY

11190 (copy 2)



**This thesis is dedicated to my sons Saud and Abdul Aziz**

## Summary

This project comprised an in-depth study of the application of cathodic protection in thermal desalination plant and used as its based an extensive cathodic protection system in multi stage flash units located at Dubai Aluminum Company in United Arab Emirates. A review of the literature confirmed that the Dubai cathodic protection system is unique since cathodic protection has seen only moderate application in desalination plant and this is particularly true of its application in respect of carbon steel components such as pipe-work. The practical work of the project included a detailed survey and assessment of the performance of the cathodic protection system in the multi stage flash units at Dubai. This confirmed that the system, even after some 15 years of operations, continues to successfully control corrosion in the inside of a wide range of carbon steel components. The examination of cathodically protected components clearly revealed the crucial role of calcareous deposition in the corrosion control process. The major part of the research comprised an in-depth experimental study of cathodic protection in a range of environmental conditions related to thermal desalination plant. This work involved some experiments on a relatively simple laboratory flow loop but with more emphasis on the utilization of a larger rig comprising a pipe 0.25 meter diameter and approximately 15 meter length attached to one of the multi stage flash units at Dubai.

The results have provided substantial detailed evidence of the crucial role of calcareous scale deposition on the overall performance, and especially the current/time relations of cathodic protection systems and have significantly extended the knowledge available from previous studies which limited to conditions experienced on offshore installations. The work has involved the study of the influences of set potentials, temperature, flow conditions and cathodic protection control mode (potentiostatic or galvanostatic) on the performance of the cathodic protection system and the deposition characteristic of the calcareous scales. Doubled layered scale, comprises an inner  $Mg(OH)_2$  (brucite) and an outer zone of  $CaCO_3$  (aragonite) crystals have been identified over a range of conditions and tentative models for the mechanism of growth of the scales have been postulated. Since both phases of the research had confirmed the technical success of cathodic protection for protecting carbon steel components in thermal desalination plant, the final part of the work comprised a cost comparison study. This was focused on a pipe loop containing a number of fittings and the findings indicated that carbon steel protected by cathodic protection is considerably less costly than stainless steel for high temperature parts of multi stage flash plant but that glass reinforced epoxy pipes are likely to be cheaper than cathodically protected carbon steel unless modes of cathodic protection operation can be identified that successfully protect with lower capital cost.

## ACKNOWLEDGEMENTS

I would like to thank Dr Trevor Hodgkiess for all his advice, patience, and guidance throughout the period of this research.

I am greatly indebted to my family especially my wife for their patience, understanding and support. Also many thanks due to my friends Mr. A. Ali, A. Al-madani, M. Ismail, Dr A. Neville, Dr D. Hollingworth, Abdulla and my Uncle Mr. Abdulrazak for their support.

I would also like to thank the staff of Dubai Aluminum Company especially the C.E.O Mr. E.L. Rugeroni who provided me the full support, which led to the completion of this research.

Finally, my sincere thanks to all my Colleagues in Desalination plant in particular S. Janceh, M. Fayaz, S. Al-madani and W. Johnson for their support.



**CONTENTS**

	<b>Pages</b>
Summary	i
Acknowledgements	ii
Contents	iii-vii
List of figures	viii-xii
List of table's	xiii-xiv
Abbreviations	xv

**Chapter 1**  
**(General introduction)**

1. Introduction	1
-----------------	---

**Chapter 2**  
**(Various processes of seawater desalination)**

1. Introduction	4
2. MSF process	5
a. MSF history	5
b. MSF operational principal	5
c. Materials of construction	9
d. Corrosion in MSF plant	10
e. Scaling in MSF plant	12
3. Reverse Osmosis process	15
a. R.O history	15
b. R.O. principal	15
c. R.O accessories	16
d. R.O materials of construction	17
e. Corrosion in R.O	18

**Chapter 3**  
**(Seawater corrosion)**

1. Introduction	19
2. Electrochemical mechanism of aqueous corrosion	19
3. Types of aqueous corrosion	21
4. Influence of environmental factors on corrosion rate	24
5. Corrosion control method	26
6. Conclusions	29

## **Chapter 4** **(Cathodic protection)**

1.	Introduction	30
2.	Historical background	31
3.	Cathodic protection basic principal	32
4.	Designing of cathodic protection system	34
5.	Anode materials	35
6.	Cathodic protection system selection criteria	35
7.	Criteria of protection	36
8.	Magnitude of current density required	37
9.	Calcareous deposits	37
10.	Temperature	41
11.	Velocity	41
12.	Oxygen	41
13.	Effect of Bio fouling on cathodic protection	42
14.	Cathodic protection in seawater installations	42
15.	Cathodic protection in desalination plant	43
16.	Summary of impressed current C.P at Chula Vista	44
17.	Conclusions	47

## **Chapter 5** **(Summary of impressed current C.P as applied to desalting plant at Dubal)**

1.	Introduction	48
2.	Design guidelines-procurement-installation	49
3.	Description of installation	51
4.	Other phenomena observed on Dubal C.P system	62
5.	Operational and maintenance requirements	62
6.	Conclusions	63

## **Chapter 6** **(Overall methodology of the research work)**

1.	Introduction	65
2.	Description of Dubal once-through test loop	65
3.	Dubal test loop components and measurement technique	68
4.	Description of Glasgow flow rig	72
5.	Glasgow test loop components and measurement technique	73
6.	Samples examination	75

## Chapter 7 (Internal inspection findings)

1.	Introduction	77
2.	Seawater intakes pipes	77
3.	Band-screens	77
4.	Sand filter associated pipelines	78
5.	Seawater header	78
6.	Evaporators	81
	a. Brine inlet manifold	81
	b. Seawater feed and low temperature brine	85
	c. Water boxes	90
	d. Brine pump canister	91
7.	General discussion	91

## Chapter 8 (Tests findings)

1.	Introduction	95
2.	Brief summary of tests 1 to 57 findings	95
	a. Tests 1 to 6	96
	b. Test 7	97
	c. Test 8	100
	d. Test 9	102
	e. Test 10	105
	f. Test 11	107
	g. Test 12	110
	h. Test 13	112
	i. Test 14	114
	j. Test 15	116
	k. Test 16	118
	l. Test 17	120
	m. Test 18	123
	n. Test 19	127
	o. Test 20	129
	p. Test 21	132
	q. Test 23	136
	r. Test 24	139
	s. Test 25	142
	t. Test 26	145
	u. Test 27	149
	v. Test 28	152
	w. Test 29	155
	x. Test 30	159
	y. Test 31	162
	z. Test 32	165

a.1.	Test 33	168
b.1.	Test 34	170
c.1.	Test 35	173
d.1.	Test 36	176
e.1.	Test 37	180
f.1.	Test 38	183
g.1.	Test 39	186
h.1.	Test 40	189
i.1.	Test 41	192
j.1.	Test 42	194
k.1.	Test 43	197
l.1.	Test 44	199
m.1.	Test 45	202
n.1.	Test 46	206
o.1.	Test 47	211
p.1.	Test 48	217
q.1.	Test 49	224
r.1.	Test 50	229
s.1.	Test 51	234
t.1.	Test 52	239
u.1.	Test 53	243
v.1.	Test 54	246
w.1.	Test 55	251
x.1.	Test 56	255
y.1.	Test 57	259
3.	Tests brief summary	264

### **Chapter 9** **(Specimens examination)**

1.	Introduction	265
2.	Scanning electron microscopy	265
3.	Glasgow specimens examination	265
4.	Dubal specimens examination	281
5.	x-ray Diffraction	302
6.	Summary of SEM and XRD result	303

### **Chapter 10** **(General discussion of tests findings and specimens examination)**

1.	Calcareous deposition effect	307
2.	Control potential	310
3.	Temperature effect	311
4.	Flow rate effect	312
5.	Specimen orientation	314
6.	Antiscalant	315

7.	Modes of operation of C.P systems	315
8.	Comments on mechanisms of scale growth during C.P	316

**Chapter 11**  
**(Cost comparison)**

1.	Introduction	319
2.	Technical and economical evaluation	320
3.	Cathodic protection supply cost allocation	322
4.	Cathodic protection cost breakdown	323
5.	Cost comparison exercise	325
6.	Materials advantages and disadvantages	325
7.	General discussion	326

**Chapter 12**  
**(Conclusions and recommendation for future work)**

1.	Conclusions	328
	a. MSF plant assessment	328
	b. Experimental study	329
	c. Cost exercise	330
3.	Recommendations for future work	

	<b>Bibliography</b>	332
--	---------------------	-----

## LIST OF FIGURES

Chapter	Figure No	Title	Page No
1	1.1	Desalting process	3
2	2.1	Lay out of an MSF evaporator plant	6
2	2.2	MSF evaporator recovery stage	7
2	2.3	MSF evaporator temperature profile	8
2	2.4	Reverse osmosis principal	15
2	2.5	Simple layout of reverse osmosis plant	16
2	2.6	Reverse osmosis system flow diagram	16
3	3.1	Electrochemical cell involving two different metals	20
3	3.2	Pitting corrosion	21
3	3.3	Crevice corrosion	22
3	3.4	Galvanic corrosion	22
3	3.5	Corrosion fatigue	23
3	3.6	Erosion corrosion	23
3	3.7	Cavitation corrosion	23
4	4.1	Sacrificial anode cathodic protection	33
4	4.2	Impressed current cathodic protection	34
4	4.3	Direction of electrode reactions as a function of electrode potential	36
5	5.1	A schematic diagram of anodes and reference electrodes location in B.I.M.	57
5	5.2	A schematic diagram of anodes and reference electrodes location in B.I.M after modification	58
6	6.1	Dubal once-through test loop	66
6	6.2	Schematic diagram of Dubal once-through test loop	67
6	6.3	Photo of test loop spool piece	68
6	6.4	Carbon steel specimen	69
6	6.5	Platinised titanium anode	70
6	6.6	Silver/Silver Chloride reference electrode	71
6	6.7	Schematic diagram of Glasgow University test loop	73
6	6.8	Photo of anode and reference electrode	76
6	6.9	Control panel ammeter	76
7	7.1	Photo of sand filter associated pipelines	78
7	7.2	Photo of seawater header	79
7	7.3	Seawater header connected to seawater pumps	79
7	7.4	Photo of seawater header internal pipe surface	80
7	7.5	Photo of seawater header internal pipe surface	80
7	7.6	Photo of brine inlet manifold	82
7	7.7	Photo of cavitation attack on B.I.M target plate	83
7	7.8	Photo of calcareous scale around / away from anode	83
7	7.9	View along length of BIM, no corrosion extensive scale	84

7	7.10	View along length of BIM	84
7	7.11	Diagram of seawater feed and low Temp brine	85
7	7.12	Photo of cooling seawater inlet	86
7	7.13	Seawater cooling water outlet pipeline	86
7	7.14	Photo of evaporator feed line	87
7	7.15	Brine pump discharge pipelines	87
7	7.16	Brine pipeline to last stage of recovery	88
7	7.17	Inside photo of cooling water inlet line	88
7	7.18	Inside photo of cooling water outlet line	89
7	7.19	Inside photo of brine pump discharge line	89
7	7.20	Internal inspections of last stage of heat recovery	90
7	7.21	Photo of evaporator water box	91
8	8.1	Test No.7 specimen location	98
8	8.2	Test 7 current trend verse time	98
8	8.3	Flow effect on applied current	101
8	8.4	Pre-scaling effect on test applied current	103
8	8.5	Effect of control potential on current	103
8	8.6	Effect of scale on test applied current	108
8	8.7	Pre-scaling effect on applied current	108
8	8.8	Temperature effect on test applied current	111
8	8.9	Temperature effect on test applied current	113
8	8.10	Flow effect on test applied current	113
8	8.11	Group 'A' current trend versus time	121
8	8.12	Photo of Scale built up at end of T17 inside the loop	122
8	8.13	Group 'A' current trend versus time	125
8	8.14	Photo of S2 of test 20	130
8	8.15	Group 'A' current trend versus time	131
8	8.16	Specimen condition at the end of test 21	133
8	8.17	Effect of negative potential in test applied current	134
8	8.18	Flow effect on test applied current (T24)	140
8	8.19	Control potential effect on test applied current (T24)	140
8	8.20	Control potential effect on test applied current (T25)	143
8	8.21	Specimen condition at the end of test 25	143
8	8.22	Specimen condition after 2 days (T26)	146
8	8.23	Specimen condition after 7 days (T26)	146
8	8.24	Temperature effect on test applied current (T26)	147
8	8.25	Specimen condition at the end of test 27	150
8	8.26	Temperature effect on test applied current (T27)	150
8	8.27	Control potential effect on test applied current (T27)	151
8	8.28	Specimen condition at the end of test 28	153
8	8.29	Flow rate effect on test applied current	153
8	8.30,8.31	Specimen and spool piece condition at the end of T29	156
8	8.32	Pipeline condition at end of test 29	157
8	8.33	Flow rate variation on test 29 applied current	157
8	8.34	Control potential effect on test applied current	158

8	8.35	S1 and S2 applied current trend versus time	160
8	8.36	Flow rate effect on test applied current (T30)	161
8	8.37	Photo of specimen 1 at the end of test 31	163
8	8.38	Specimen orientation effect on test current (T31)	163
8	8.39	Potential effect on test applied current (T31)	164
8	8.40	Pre-scaling effect on test applied current (T32)	166
8	8.41	Orientation effect on test applied current (T32)	166
8	8.42	Orientation effect on test applied current (T33)	169
8	8.43	Control potential effect on test applied current (T33)	169
8	8.44	Orientation effect on test applied current (T34)	171
8	8.45	Wet pre scaling effect on test current compared to new	171
8	8.46	Applied current demand for wet pre-scaled specimen when compared to dry pre-scaled specimen (T34)	172
8	8.47	Control potential effect on test 34 applied current	172
8	8.48	Wet pre-scaled specimen on test 35 applied current	174
8	8.49	Re-reproducibility effect	174
8	8.50	Specimen condition at the end of test 36	177
8	8.51	Temperature effect on test 36 applied current	178
8	8.52	Specimens condition at the end of test 37	181
8	8.53	Control potential effect on test 37 applied current	181
8	8.54	Temperature effect on test 37 applied current	182
8	8.55	Specimens condition at the end of test 38	184
8	8.56	Temperature effect on test 37 applied current	184
8	8.57	Specimens condition at the end of test 39	187
8	8.58	Flow rate effect on test 39 applied current	187
8	8.59	Specimens condition at the end of test 40	190
8	8.60	Temperature effect on test 40 applied current	190
8	8.61	Specimens condition at the end of test 41	193
8	8.62	Specimens condition at the end of test 42	195
8	8.63	Tests 40 and 42 current trend versus time	196
8	8.64	Control potential effect on test 43 applied current	198
8	8.65	Spool piece condition at the end of test 44	200
8	8.66	Test reproducibility results (T40, 42, 44)	200
8	8.67	Applied current trend before and after T 44 acid wash	204
8	8.68, 8.69	Spool piece and specimens condition at the end of T46	207
8	8.70	Current demand comparison of T45 and T46	208
8	8.71, 8.72	Spool piece and specimens condition at the end of T47	213
8	8.73	Temperature effect on test 47 applied current	214
8	8.74, 8.75	Spool piece and specimens condition at the end of T48	219
8	8.76, 8.77	Specimens condition before and after C.P being switch off in test 48	220
8	8.78	Spool piece condition at the end of test 48	221



8	8.79	Re-reproducibility results of tests 45 and 48	221
8	8.80	Flow rate effect on test 49 applied current	225
8	8.81, 8.82	Spool piece and specimens condition at the end of T49	226
8	8.83	Specimens condition before C.P Switched off T50	230
8	8.84	Specimens condition after C.P switched off T50	231
8	8.85	Temperature effect on test applied current (T48, T50)	231
8	8.86	Specimens condition at the end of T51	236
8	8.87	Pre-scaling effect on test 51 applied current	236
8	8.88	Control potential effect on test 51 applied current	237
8	8.89	Spool piece condition at the end of T52	240
8	8.90	Pre-scaling effect on test 52 applied current	241
8	8.91	Specimens condition at the end of T53	244
8	8.92	Spool piece condition at the end of T54	247
8	8.93	Flow rate effect on test 54 applied current	248
8	8.94	Temperature effect on test 55 applied current	252
8	8.95	Specimens condition at the end of T56	256
8	8.96	Test 56 current trend versus time	256
8	8.97	Specimens condition at the end of T57	260
8	8.98	Temperature effect on test 57 applied current	261
8	8.99	Control potential effect on test applied current	261
9	9.1	Low Mag photo of featureless scale mainly Mg	266
9	9.2	High Mag photo of featureless scale mainly Mg	266
9	9.3	High Mag photo of clumps shape of Calcium scale	267
9	9.4	Chemical composition of S1 test 7 (fig 9.1, 9.2)	268
9	9.5	Chemical composition of S1 test 7 (fig 9.4)	269
9	9.6	Low Mag photo shows good coverage of scale T7 S3	270
9	9.7	High Mag photo of plate shape calcium scale	270
9	9.8	Chemical composition of S3 test 7 (fig 9.6)	271
9	9.9	Good coverage of scale over entire specimen 1 T11	272
9	9.10	High Mag photo of tiny crystals shape calcium scale	272
9	9.11	Chemical composition of S1 test 11 (fig 9.10)	273
9	9.12	High Mag photo of featureless scale mainly Mg	274
9	9.13	Spalled, featureless scale mainly Mg	274
9	9.14	Chemical composition of S1 test11 (fig 9.12)	275
9	9.15	High Mag photo of tiny crystals shape calcium scale	276
9	9.16	Low Mag, featureless mainly Mg	277
9	9.17	High Mag photo of featureless scale mainly pure Mg	277
9	9.18	Chemical composition of S2 test 34(fig 9.16 point 'B')	278
9	9.19	Chemical composition of S2 test34(fig 9.16 point 'A')	279
9	9.20	Photo of specimen 1 T35 show good coverage of scale	280
9	9.21	High Mag photo of clumps, pure calcium scale crystal	280
9	9.22	Low Mag photo of clumps, uniform scale	281
9	9.23	Chemical composition of test43(fig 9.22 point 'C')	282
9	9.24	Low Mag of smooth, honeycomb shape pure Mg	283

9	9.25	High Mag of smooth honeycomb shape pure Mg	283
9	9.26	Chemical composition of test43(fig 9.22 point 'B')	284
9	9.27	High Mag shows a coarse column like crystals	285
9	9.27	Chemical composition of test49(fig 9.26)	286
9	9.28	High Mag shows different type of crystals	287
9	9.29	Low Mag of an area shows clear pores on the scale	287
9	9.30	Chemical composition of test49 (fig 9.29)	289
9	9.31	Low Mag of an area shows pores on the scale surface	287
9	9.32	High Mag of an area of Figure 9.31	288
9	9.33	High Mag of an area of Figure 9.32	288
9	9.34	High Mag of an area of featureless scale and pores	290
9	9.35	High Mag of an area shows featureless scale and pores	290
9	9.36	Chemical composition of test49 (fig 9.34, 9.35)	291
9	9.37	High Mag of featureless scale and pores network	292
9	9.38	Chemical composition of test55 S4 (fig 9.37)	293
9	9.39	Chemical composition of test55 S5 (fig 9.40)	294
9	9.40	An area of specimen shows needle like crystal	295
9	9.41	Low Mag shows network of needle like crystals	295
9	9.42	High Mag shows network of mesh like crystals	296
9	9.43	High Mag shows network of mesh like crystals	296
9	9.44	Cross section of T57 s4 shows multi-layer scale	297
9	9.45	High Mag of area 1 of Fig 9.44 Featureless scale	298
9	9.46	High Mag of area 2 of Fig 9.44 Needle-like crystals	298
9	9.47	Chemical composition of test57 (fig 9.44 region 1)	299
9	9.48	Chemical composition of test 57 (fig 9.44 region 2)	300
9	9.49	Chemical composition of test 57 (fig 9.44 region 3)	301
9	9.50	High Mag of area 3 Fig 9.44, needle like scale	302
9	9.51	XRD analytical results of test 43	304
9	9.52	XRD analytical results of test 55	305
9	9.53	XRD analytical results of test 57	306
10	10.1	Turbulent conditions surrounding specimen	315
10	10.2	Schematic representation of cracked/porous scale	318
10	10.3	Non-porous scale layer	318
11	11.1	Controlled loop used for cost comparison	320

## LIST OF TABLES

Chapter	Table No.	Title	Page No.
2	2.1	Typical analysis of seawater	4
2	2.2	Selected materials for MSF evaporator	10
2	2.3	Typical summary of materials for MSF plant	10
2	2.4	Summary of material selection for Seawater R.O	17
3	3.1	Selected material versus design velocity	25
3	3.2	General corrosion in moving aerated seawater at ambient temperature for different materials	27
3	3.3	Corrosion of carbon steel as a function of flow rate	27
4	4.1	Impressed current Cathodic protection anode materials	35
4	4.2	Advantages and limitations of sacrificial anode system	35
4	4.3	Advantages and limitations of impressed current system	36
4	4.4	Minimum values of metal/electrolyte potentials for cathodic protection	37
4	4.5	Anode materials of seawater installation	43
4	4.6	Current density VS. Temperature and velocity	46
5	5.1	Summary of Evap 1 C.P system development	53
5	5.2	Summary of Evap 2 C.P system development	54
5	5.3	Summary of Evap 3 C.P system development	54
5	5.4	Summary of Evap 4 C.P system development	55
5	5.5	Summary of Evap 5 C.P system development	55/56
5	5.6	Summary of Evap 6 C.P system development	56
8	8.0	Summarizes of test conditions	96
8	8.1	Summary of test 7 daily readings	99
8	8.2	Summary of test 8 daily readings	101
8	8.3	Summary of test 9 daily readings	104
8	8.4	Summary of test 10 daily readings	106
8	8.5	Summary of test 11 daily readings	109
8	8.6	Summary of test 12 daily readings	111
8	8.7	Summary of test 13 daily readings	113
8	8.8	Summary of test 15 daily readings	117
8	8.9	Summary of test 16 daily readings	119
8	8.10	Summary of test 17 daily readings	122
8	8.11	Summary of test 18 daily readings	126
8	8.12	Summary of test 19 daily readings	128
8	8.13	Summary of test 20 daily readings	131
8	8.14	Summary of test 21 daily readings	134
8	8.15	Summary of test 23 daily readings	138
8	8.16	Summary of test 24 daily readings	141
8	8.17	Summary of test 25 daily readings	144
8	8.18	Summary of test 26 daily readings	148

8	8.19	Summary of test 27 daily readings	151
8	8.20	Summary of test 28 daily readings	154
8	8.21	Summary of test 29 daily readings	158
8	8.22	Summary of test 30 daily readings	161
8	8.23	Summary of test 31 daily readings	164
8	8.24	Summary of test 32 daily readings	167
8	8.25	Summary of test 33 daily readings	169
8	8.26	Summary of test 34 daily readings	172
8	8.27	Summary of test 35 daily readings	175
8	8.28	Summary of test 36 daily readings	179
8	8.29	Summary of test 37 daily readings	182
8	8.30	Summary of test 38 daily readings	185
8	8.31	Summary of test 39 daily readings	188
8	8.32	Summary of test 40 daily readings	191
8	8.33	Summary of test 41 daily readings	193
8	8.34	Summary of test 42 daily readings	196
8	8.35	Summary of test 43 daily readings	198
8	8.36	Summary of test 44 daily readings	201
8	8.37	Summary of test 45 daily readings	205
8	8.38	Summary of test 46 daily readings	210
8	8.39	Summary of test 47 daily readings	216
8	8.40	Summary of test 48 daily readings	224
8	8.41	Summary of test 49 daily readings	228
8	8.42	Summary of test 50 daily readings	233
8	8.43	Summary of test 51 daily readings	238
8	8.44	Summary of test 52 daily readings	242
8	8.45	Summary of test 53 daily readings	245
8	8.46	Summary of test 54 daily readings	250
8	8.47	Summary of test 55 daily readings	254
8	8.48	Summary of test 56 daily readings	258
8	8.49	Summary of test 57 daily readings	263
9	9.1	Summary of XRD results	302
10	10.1	Summary of current density by other workers	308
11	11.1	Tabulated figures of obtained quotation for 10" pipe	321
11	11.2	Tabulated figures of obtained quotation for 36" pipe	321
11	11.3	Total cost breakdown of C.P system	323
11	11.4	GRE. VS. Carbon steel	325
11	11.5	Carbon steel with C.P VS. stainless steel	325
11	11.6	Average cost comparison between GRE and Carbon steel equipped with on line cathodic protection	327

### Abbreviations

B.I.M	Brine Inlet Manifold
C.P	Cathodic protection
DC	Direct current
DUBAL	Dubai Aluminum Company Limited
$E_0$	Equilibrium electrode potential
Evap	Evaporator
G.R.E	Glass Reinforced Epoxy
M.E	Multi effect
MSF	Multi stage flash
Mag	Magnification
MGPD	Million gallon per day
PPM	Parts per million
R.O	Reverse osmosis
R.E	Reference electrode
Sp	Specimen
SCE	Saturated Calomel electrode
SEM	Scanning electron microscopy
TDS	Total dissolved solid
V.C	Vapour compression
XRD	X-ray diffraction

## CHAPTER ONE INTRODUCTION

Corrosion is a major problem at any sea water desalination plant and normally results in frequent plant shut down, lower output, and increased replacement and maintenance cost. The extent of the problem depends on the materials that are used as well as the unit operating condition. A number of corrosion control methods are used in desalination technology, one of which is the selection of high-grade material. However, such a strategy involves high capital cost. The selection of a material with good engineering design and alternate corrosion control methods can be more reasonable from an economical standpoint than building a plant from a noble material. One alternative for possible use in desalination plant is impressed cathodic protection, which has proved to be one of the most effective and economically viable methods of controlling corrosion in pipelines and metallic structures of large desalination plant.

Desalination plants of any selected process are normally located in coastal areas where humid salt laden atmospheres occur. They are also exposed to corrosive chemical and highly concentrated hot brine with high turbulent flow condition. Therefore, desalination plant design is a special case in which corrosion is one of the most important factors. This governs the choice of construction materials and the methods of protection, which consequently leads to a process selection, based on both economic and technical characteristics.

The major desalination processes available are Distillation, Reverse Osmosis, Electrodialysis, and Freezing (figure 1.1). Primarily the salinity and composition of the feed water determine the applicability of one process over the other<sup>1</sup>. Distillation has been used for centuries, and reverse osmosis has become commercially available and has been used widely during the past twenty years.

Distillation is a desalination process, which removes impurities from feed water by boiling, collecting the water vapour and then cooling the vapour until it condenses. The condensed water is virtually free of any contamination and is referred to as distilled water. Three of the most common seawater distillation processes are multi stage flash distillation (M.S.F), multi effect (M.E), and Vapour compression (V.C).

MSF is the only mature technology capable of producing fresh water in a large scale. Its distillation is based on the principal that a pressure/temperature scale effects the water boiling point. M.S.F plants are normally combined with power plants in a dual-purpose operation in order to minimise energy conservation<sup>2</sup>.

Reverse Osmosis on the other hand is a membrane based process, which separates, concentrates and desalts the saline water by making use of the phenomenon of osmosis and use of a membrane. Osmosis is a natural process in which pure water flows from a dilute saline solution, through a membrane into a more concentrated solution. Water, which flows across the membrane, continues until the pressure created by the osmotic head equals the osmotic pressure of the salt solution. This is called osmotic equilibrium. Reverse Osmosis is a method, which reverses the direction of water molecule transport by applying an external pressure greater than the osmotic pressure of the salt solution<sup>2</sup>.

Corrosion as mentioned earlier is a common problem in multi stage flash distillation plants, as the conventional construction material of the plants is made of carbon steel. Carbon steel is used extensively (i.e. seawater intakes pipelines, seawater header and feed, low temperature brine systems, water boxes, and flash chambers) due to its good mechanical and physical properties and its lower cost. The corrosion problems that had been encountered in MSF and R.O plants are of a various types, e.g. erosion corrosion, failure of coating, biological -induced corrosion and pitting corrosion.

It is therefore essential that the modern designers of desalination concentrate their efforts to combat corrosion problems, either by using corrosion-resistant materials or introducing alternate corrosion control methods (i.e. cathodic protection).

Cathodic protection is a long-established method of corrosion control for numerous applications in engineering plant and equipment. Its application at ambient temperature has been substantial in marine equipment operation. However, it has not seen extensive application in large MSF plant, and to date its use has been limited to intake screens and the occasional location of sacrificial anodes in water boxes and flash chamber floors. An important exception to this general scenario exists at Dubai Aluminum Co where an extensive cathodic protection system is employed in six 5 MGPD evaporators.

The major objective of this project was to study cathodic protection in detail in a range of conditions relevant to desalination plant in order:

1. To demonstrate clearly to the industry the potential benefits using this method of corrosion control.
2. To obtain a clearer understanding of the performance of cathodic protection in the range of conditions (especially temperature) prevalent in distillation plant.

The study involved construction of a control loop for dedicated tests and a detailed study of the present performance of the cathodic protection system on Dubal's 5 MGD multi stage flash evaporator plant. Both the loop and plant pipelines are manufactured from carbon steel of 0.25-1.56 meters in diameter and length of about 6 to 250 metres, and equipped with dedicated cathodic protection control system. This enables tests to be carried out using seawater of different concentration (35,000 up to 65,000) and temperature (20 up to 115 °C) at various flows through the system, either as once through or closed loop. Additional tests were undertaken on a simple flow loop situated in the Glasgow University laboratory.

The tests also aimed to assess the role and potential benefits in formation of alkaline scale on the surfaces where cathodic protection is applied in a sea water environment, in particular the system current demand relative to time at the target pre-set control potential. This is relevant as scale significantly reduces the power consumption and hence running costs of the cathodic protection.

Additionally, a cost comparison of Dubal's controlled loop has been undertaken, in order to predict the economics of constructing a loop using carbon steel with an on line impressed current cathodic protection system versus glass reinforced epoxy or stainless steel.

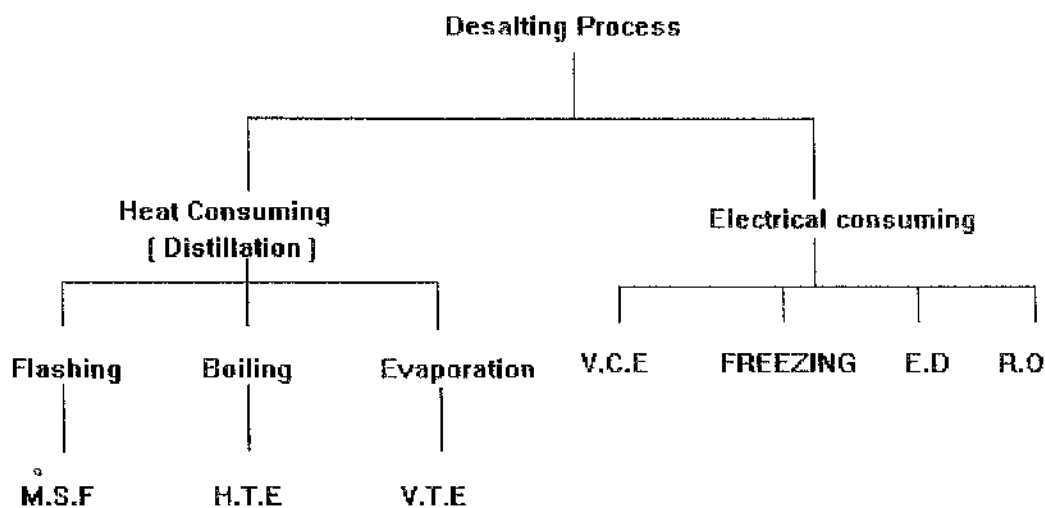

[ FIGURE 1.]DESALTING PROCESS



## CHAPTER TWO

### VARIOUS PROCESSES OF SEA WATER DESALINATION

#### 1. Introduction

Human life depends on having sufficient water to drink and also making use of it in many other ways in order to improve the standard of living. As world population increased and achieved a better standard of living, the demand for a steady, economical supply of water also increases all around the world. In some countries, especially the Middle East, the availability of natural water was insufficient to meet the rapidly growing demand for drinking, industrial and irrigation purposes, and hence total demand did not match available supply<sup>2</sup>.

There are many solutions, such as the reduction or control of water consumption, conservation, and improvements in water system distribution and storage. As a final solution the construction of desalination plant are considered in order to overcome the water shortage in many countries worldwide.

Seawater is an aqueous solution of which 96% is water and the remaining 4% various types of dissolved minerals or salts (table 2.1).

IONS AND COMPOUNDS	PPM
Chloride	18,980
Sodium	10,556
Sulphate	02,649
Magnesium	01,272
Calcium	400
Potassium	380
Bicarbonate	140
Bromide	65
strontium	17
Iron	0.01
Silica	40
pH	8.2
T.D.S	35,000

TABLE 2.1. TYPICAL ANALYSIS OF SEA WATER<sup>1</sup>

Seawater desalination is the art of producing fresh potable water from a saline supply at a reasonable cost with reasonable reliability. To remove fresh water from seawater, processes like distillation, crystallization, reverse osmosis, solvent extraction, electrodialysis and ion exchange resin processes are well known. The concept of desalination is not new, what is new is the development of a number of processes over the past 50 years, which have demonstrated and proven their commercial viability to a point

where, the potential of desalting as a source of a new water to meet the current demand is recognized.

The current obvious aim of all research and development in the field of desalination has been concentrated in improving and advancing the available processes, in order to provide a process which requires the minimum of energy and capital cost, good reliability and availability, and built to ensure simplicity of operation and maintenance.

The following are the two major commercially proven desalination processes for producing large quantities of fresh water from seawater.

\* MSF (Distillation process).

\* R.O (Membrane process).

## **2. MSF Process**

### **a. MSF history**

Flash distillation for potable water production was developed in the 1950's and MSF plants were the only ones, which could be operated relatively scale free for extended periods<sup>3,4</sup>. Since MSF plants could be built in large capacities the process became popular and in 1977 the USA Office of Water Research and Technology reported that approximately 65% of the world's desalination capacity was being produced by MSF. Multi stage flash remains a current production leader in seawater desalting, and in the past two decades, design, operation, costs, maintenance, and other process characteristics have been extensively developed.

### **b. MSF operation principal**

Multi stage flash distillation is highly developed and the most widely used of the distillation process, which is considered to be economically cheap in producing potable water from seawater. An MSF Evaporator is made of a massive block of carbon steel which normally consists of a number of stages dependent on the unit performance ratio. As shown in figure 2.1<sup>3</sup>, MSF plant is consists of three sections, heat input, heat recovery and heat reject. Heat recovery and reject are enclosed in a single vessel, which is divided into compartments and separated by interstate thin walls. The inter-stage flash chamber walls are designed to withstand pressure differentials relative to atmospheric pressure.

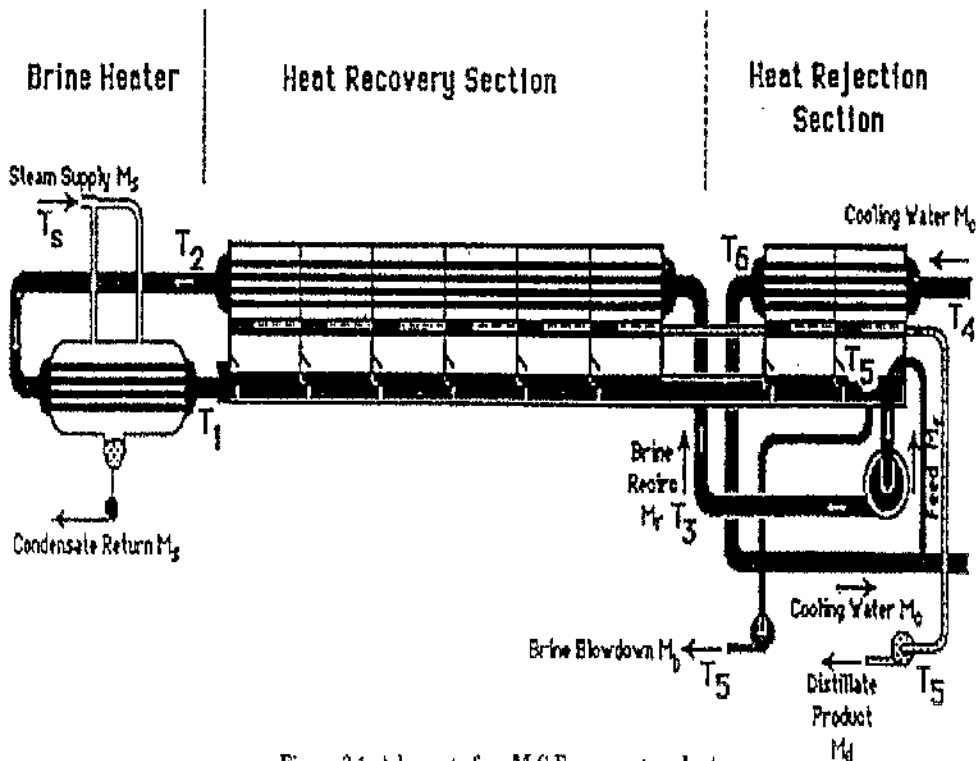

Figure 2.1. A lay out of an M.S.F evaporator plant

Each stage consists of condenser, flash chamber, deflecting plates, demister pads, flow guide vane, product tray, and distillate storage and non-condensable gas extraction pipes with all these components welded together. Each stage is made of upper and lower parts with, adjacent stages connected at the top of the stage dividing wall, by non condensable gas extracting pipes connected to the evaporator venting (air ejector) system. The flash chamber, which is located at the lower part of each stage, is the most important part of the evaporator. This is where brine flashes and distillate is produced (figure 2.2<sup>3</sup>).

Pretreated seawater from a common seawater header is pumped to the inlet of the last stage of the evaporator reject section. It flows through the condenser tubes of all reject stages, where water preheated by vapours is generated in flash chambers and passed through demister pads. The condense vapours on the condenser tube is collected on distillate trays. On leaving the final stage of the heat reject section the cooling water, except for a portion equal to sea water feed make-up is rejected to the sea. Make up seawater is chemically treated for scale prevention before passing through either internal or external deaerators to reduce oxygen corrosion.

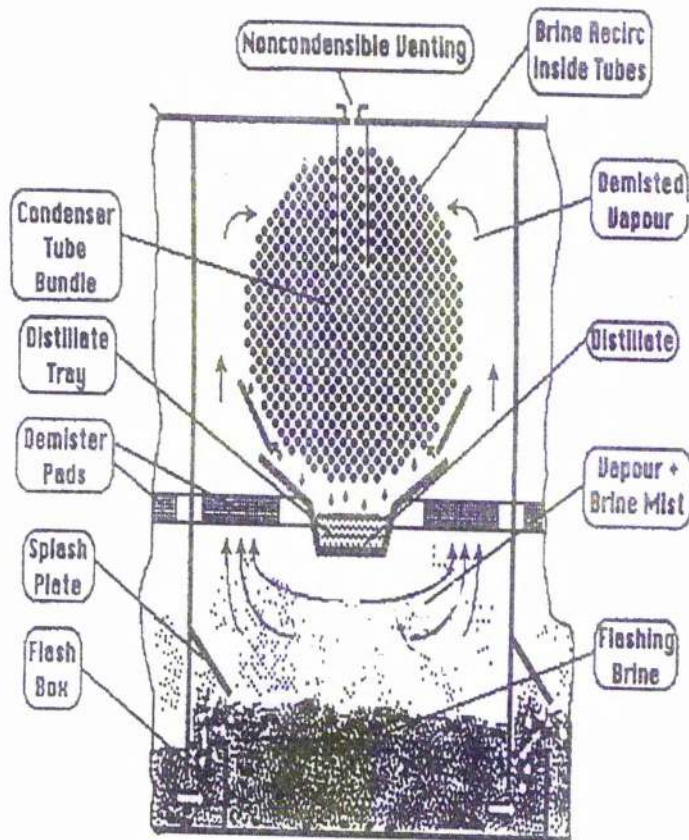

Figure 2.2: MSF evaporator recovery stage<sup>3</sup>

Feed make up is then introduced into the flash chamber of the last heat reject section where it mixes with concentrated brine. Part of the feed is rejected as blow down and the rest is mixed with brine and introduced using the brine-recirculating pump as a coolant into the last stage of the multi stage flash evaporator recovery section.

Recirculated brine temperature within the heat recovery section increases as it gains latent heat of condensation from the last to the first stage of recovery. From the outlet of stage one heat recovery section, recirculated hot brine flows to the heat input

section where its temperature increases by a few degrees using low pressure steam until it reaches its required top end temperature.

The heated sea water before entering the first stage of the recovery section flash chamber passes through a control valve in order to maintain the pressure required to avoid boiling within the heat input section of the evaporator. Part of the hot brine introduced into the first stage flash chamber flashes into vapour where it condenses on the condenser tubes, and liberated heat is used to preheat the recirculating brine.

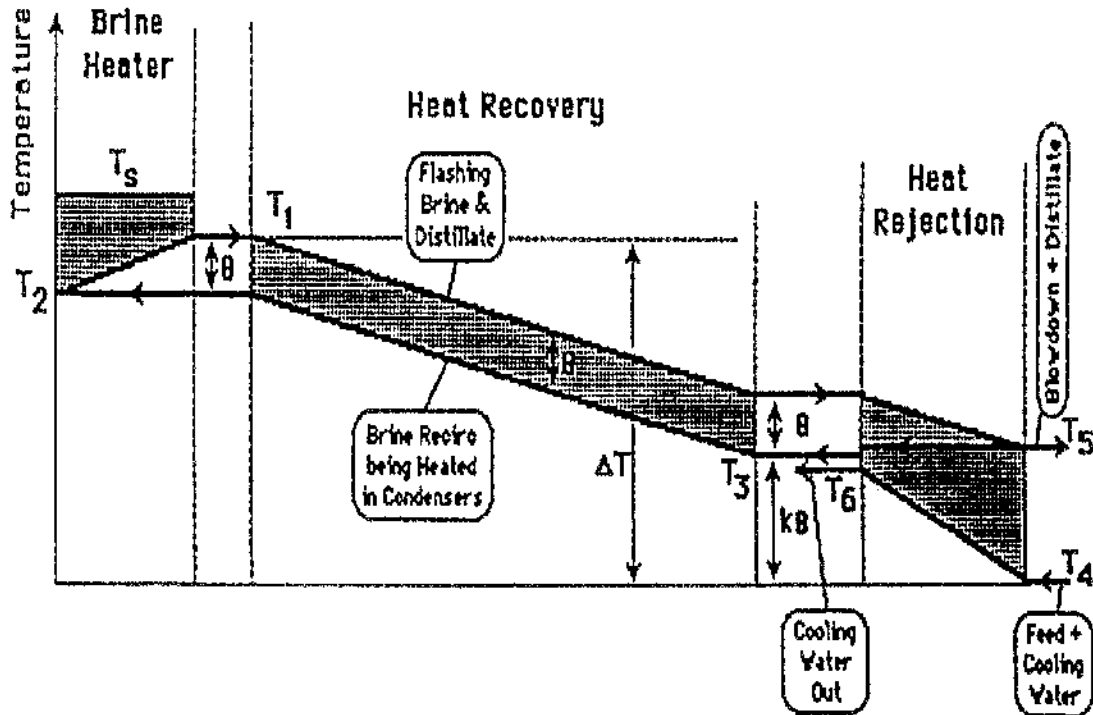

Figure 2.3. Multi stage flash evaporator temperature profile<sup>3</sup>(refer to figure 2.1)

As air ejector is used to maintain the required vacuum at each stage of the process and removes air and non-condensable gases. The pressure in every stage is controlled so that incoming heated brine flashes instantaneously. After flashing the temperature of circulating brine reduces and passes into the next lower pressure stage where further flashing takes place. This operation continuous at lower temperature and pressure until circulating brine reaches the last stage of the reject section where it is mixed with feed make-up sea water. The brine then flows into the brine recirculating pump and the process is repeated.

Distillate from each stage of both recovery and reject is collected in a common product water tray. As the product cascades from a higher to a lower pressure stage it flashes, and subsequently cools down. Vapours from distillate flashing condense on the condenser tube bundle and drop back as liquid into the product tray. The process of brine and distillate passing in parallel continues until they reach the last stage of the evaporator reject section where distillate is pumped out using a dedicated product pump.

Heat is rejected as the temperature of the circulating brine and distillate is reduced to the temperature of the incoming feed at the last stage of the evaporator reject section, in order to maintain the overall plant temperature profile (figure 2.3<sup>3</sup>).

### c. **Materials of construction (MSF plant)**

The selection of construction material for an MSF evaporator is of the outmost importance as it needs the consideration of many interrelated technical and economical factors<sup>5,6,7,10</sup>, such as: -

1. Capital investment.
2. Temperature operating regime.
3. Feed water salinity.
4. Plant life expectancy.
5. Availability, and plant reliability.
6. Sea water intake location.
7. Chemical or acid treated.
8. Plant output.
9. Environmental impact.
10. Design configuration.
11. Plant location, and type of life in the selected location.
12. Materials properties.
14. Maintainability.
15. Safety of operation

The above mentioned factors must be seriously considered in selection of materials during the design stage of the units, since a majority of the previously mentioned components in the MSF plant are exposed to various streams which are extremely corrosive in nature. As a result the plant faces various type of corrosion. The corrosion of materials in MSF mainly depends on the maximum operating temperature, brine recirculation flow rate, pH and sea and brine water oxygen and carbon dioxide content<sup>6</sup>. Therefore, the selected materials for an M.S.F evaporator should be categorized according to the quality of the media each section handles as well as being in a possession of a high degree of resistance to corrosion.

The following tables (2.2 and 2.3) outlines the current trend of material selection for a large MSF plant and the factors which influence their selection for the major parts of an MSF evaporator. As shown, corrosion aspects have been given priority since it goes hand in hand with material selection.

Material	Corrosion behavior in saline water
Carbon Steel	Very poor and suffers rapid general corrosion
Aluminum brass	Good resistance to general and crevice corrosion but susceptible to pitting and impingement corrosion
Stainless steel 316L	Excellent resistance to general corrosion but susceptible to pitting
Cu/Ni alloys 90/10 or 70/30	Excellent resistance to general corrosion, slightly susceptible to crevice corrosion
Titanium	Excellent corrosion resistance to all forms of attack
Monel	Excellent resistance to general corrosion, slightly susceptible to pitting corrosion
Non metallic ( G.R.P )	Excellent resistance to general corrosion, limitation in hot environment

**Table 2.2: Comparison corrosion resistance of some selected materials for MSF evaporator<sup>3,4,5,6,8</sup>**

Component	Materials
Flash Chambers	Generally Carbon Steel but in some plant cladding such as 316L stainless steel used for the high temperature stage. epoxy paint as well is used
Condenser tubes	70/30 Cu/Ni ( H.L.S ), 90/10 Cu/Ni ( H.R.S and H.RE.J.S )
Water Boxes	Carbon steel, 90/10 Cu/Ni cladding, Monel and rubber lining for recovery section and Nickel Aluminum bronze for cladding of reject section
Tube plates	90/10 Cu/Ni for recovery section and Nickel Aluminum bronze for reject section
Distillate tray	316L Stainless steel
Piping brine	Carbon steel with paint coating or selected cladding
Piping sea water	Carbon steel with paint coating or G.R.P
Piping-vent	316L Stainless steel
Piping product	Carbon steel or G.R.P
Pumps	316L Stainless steel and Ni-resist or ceramic coating

**Table 2. 3: Typical material summary selection of an MSF evaporator<sup>3,4,5,6</sup>**

It is apparent from the tables 2.2 and 2.3 that the modern designers of MSF desalination plant tries to combat a corrosion problem by using corrosion resistant materials, or by restricting the contact and interaction between carbon steel and sea water by using cladding such as monel and copper nickel which normally involves a very high cost. The tables also indicate that designers still prefer to use carbon steel as the main construction material. It is worth mentioning that the initial cost of the equipment or material is not a good economic criterion when comparing alternate materials of construction. What has to be considered is total material, erection, maintenance, output interruption, plant life and replacement costs.

#### **d. Corrosion in MSF plant**

Corrosion is a natural process, which involves deterioration of metallic material by interaction with its environment<sup>9</sup>. It is a factor with very important consequences on the life of any process plant and in particular on the efficiency of water production of MSF desalination plants. Corrosion is a common problem in MSF distillation plants, as the

conventional construction material of the plants is made of carbon steel. Carbon steel is used extensively (i.e. seawater intakes pipelines, seawater header and feed, low temperature brine systems, water boxes, and flash chambers) due to its good mechanical and physical properties, and lower cost. The following is a summary of the types of corrosion, which normally occur in an MSF desalination plant.

#### \* **Seawater Intake and Header**

Seawater is a corrosive fluid and therefore materials, which are in direct contact with the seawater, should be carefully selected with substantial corrosion allowance. Carbon steel is a commonly used material for seawater intake and main header lines where seawater is chlorinated at the intakes. This discourages large marine organisms (small fish, crabs, etc.) and eradicates microorganisms (algae, bacteria, etc.) from access to the seawater header and inside MSF units. The adverse effect of chlorinating on intake metals, along with suspended particles and chemical constituents of seawater, are the main reasons for crevice, general metal wastage, erosion and failure of coating corrosion which occur in the sea water intake and header pipe lines.

#### \* **Flash Chambers**

After condenser tube corrosion the other main cause of plant forced outages, which leads to production losses in MSF plant is corrosion of flash chambers<sup>10</sup>. The conventional material for this application has been ordinary structural carbon steel, which is strongly favored on economic, mechanical properties and fabricability grounds but has a poor corrosion resistance.

The corrosion types, which common in flash chambers is galvanic, general metal wastage, and failure of coating<sup>3,10</sup>. The first two stages of the flash chambers have the most severe corrosion, and this takes place more frequently due to high temperature and inadequate deaeration.

#### \* **Water Boxes**

A variety of materials are used to manufacture water boxes. Presently the trend is to use carbon steel boxes, which are lined with rubber or Cu/Ni depending on the location of the water box. The corrosion types found most often in water boxes are general metal wastage, crevice, pitting, impingement, weld and heat effect zone, and failure of lining<sup>10,11</sup>.

#### \* **Condenser Tubes**

Failure of condenser tubes constitutes the largest cause of MSF plant outages, and hence the choice of tube material is crucial. Tubes have to have high thermal conductivity and their corrosion performance should be well understood. Three types of materials currently being used are copper-based alloys, stainless steel, and titanium. The most common types of tube failures are, pitting, erosion by suspended solids, impingement,



crevice corrosion, deposit attack, vapor-side corrosion by non-condensable gases, and stress corrosion cracking<sup>11</sup>.

#### \* **Piping**

Different types of materials such as carbon steel and G.R.E have been used in MSF piping, as pipes are required to handle a wide variety of fluids, such as sea water, brine, distillate, chemicals and non condensable gases. Carbon steel coated with epoxy paint has been widely used for the majority of pipes in MSF desalination plants through out the world<sup>10</sup>. The types of attack common in piping are, impingement, crevice corrosion, deposit attack, erosion corrosion, general metal wastage, weld and heat effect zone, and failure of paint coating.

#### \* **Pumps**

Pumps are the most important plant components because they experience higher fluid velocities than many other parts of the plant. Choice of material is influenced by a number of factors such as, material ability to withstand corrosion, maintenance and replacement costs. The conventional material for the pump impeller and casing are normally stainless steel type 316, monel, Ni-resist and aluminum bronze<sup>3</sup>. The types of attack, which usually occur in pumps, are, cavitation corrosion, crevice corrosion, erosion corrosion, fatigue and galvanic corrosion.

#### \* **Venting System**

316L stainless steel or higher, grade stainless steels are used for the venting system mainly as the system has to handle non condensable gases which are highly corrosive in nature. The types of attack usually faced by the venting system are impingement, crevice attack, and general wastage of metal<sup>3,5</sup>.

#### \* **Valves**

Valves have to operate at conditions, which can be very destructive due to turbulent flow, suspended solids, cavitation, and high velocity of fluids and valve throttling. The types of attack which valves are subjected are galvanic attack, crevice corrosion, and erosion corrosion and impingement attack.

#### e. **Scaling in MSF plant**

Scale, which adheres to heat transfer surfaces, is defined as a crystalline deposit formed by precipitation from solution of a substance with limited solubility<sup>1,3</sup>. Some of the most important scale compounds have a solubility that decreases with increase in temperature. Scale deposition rate in MSF plant is purely dependent on the composition of the feed water, which contains a variety of suspended solids and dissolved minerals, its treatment and control. The dissolved minerals can precipitate and deposit scale on the

working surfaces of a process plant and cause innumerable problems, the most serious of these being a reduction in the heat transfer ability of the plant. This decreases the plant efficiency and could eventually cause plant shutdown for maintenance and repair. Consequently the penalties for running a process plant, which is scaled up are very high, and methods of avoiding deposition are crucial<sup>1</sup>.

This research is focused on the effect which scale could have on the cathodic protection system current demand when the system is operated at various modes. The approach involved in this study was first to see the duration needed for scale to form on the surface of either the specimen or loop pipelines. This was followed by a variation of operating parameters in order to understand the rate of scale precipitation. Finally, tests results were obtained on assessing the effectiveness of scale deposition on the current demand for protected areas of the test loop pipelines.

#### \* **Scale mechanism**

Scale formation can take place if the thermodynamic requirement of saturation of water with the substance is met. The three conditions, which must be satisfied simultaneously for scale to form are<sup>3</sup>: -

- a. Local supersaturation.
- b. Nucleation site.
- c. Adequate contact time for nucleation to begin.

All three factors must be present initially for scale to form. Prevention of scaling requires elimination of one or more of these three factors.

#### \* **Types of scaling**

Scale deposition from seawater or most brackish water is classified as:

- a. Alkaline scale (calcium carbonate or magnesium hydroxide. Mainly these types of scale are being formed on the test loop pipelines and specimens of this project). Alkaline scale formation varies with change in system operating temperature, pH and solution concentration. In this part of the report only the effect of temperature and pH will be discussed mainly due to its direct relation with the carried out work of this research.

#### \* **Effects of temperature & pH on alkaline scale**

The tendency for both  $\text{CaCO}_3$  and  $\text{Mg(OH)}_2$  precipitation increases with increasing in temperature partly because of reduced solubility of magnesium hydroxide and calcium carbonate at higher temperatures and also due to thermal decomposition of bicarbonate ion which tends to disintegrate, producing carbon dioxide, water, and a carbonate ion. The carbonate ion combines with a calcium ion to form calcium carbonate, which is insoluble, and consequently precipitates. At temperature above 60-80 °C carbonate ion tend to react

with water to form more carbon dioxide and hydroxyl ion. These hydroxyl ion combine with magnesium to form magnesium hydroxide. These reactions are summarized as below:

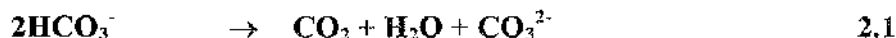

As feed water temperature for any process plant increases the degree of water ionization as well increases which in turn increases the concentration of hydroxyl ion. The rise in hydroxyl ion is summarized by the following reactions: -

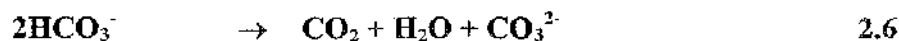
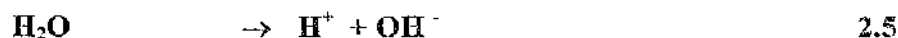

The above reactions show an increase in carbonate and hydroxide, thus causing the pH to rise. Therefore, an increase in carbonate and hydroxyl ion concentration will clearly increase the tendency for  $\text{CaCO}_3$  precipitation at low  $\text{Ca}^{2+}$  so during cathodic protection because the cathodic reaction is mainly oxygen reduction, pH on metal surface increases significantly hence the bicarbonate tendency increases toward carbonate disassociation by reaction (2.1). Therefore, tendency to precipitation  $\text{CaCO}_3$  by reaction (2.2) increases also of course this increase in pH on the metal surface will also promote precipitation of  $\text{Mg}(\text{OH})_2$  by reaction (2.4).

#### b. **Non-alkaline scale (calcium sulfate)**

In thermal desalination plants, the precipitation of this compound is usually only a problem at temperature above  $120^\circ\text{C}$ .

#### \* **Methods of scale control**

Since scale formation is a common problem in all process plants, control has been the subject of extensive research. The following are methods, which can be adopted in order to prevent or minimize the effects of scaling<sup>1,3,5</sup>; -

- a. Direct removal of deposits mechanically or chemically.
- b. Antiscalant dosing.
- c. Operation at a plant condition in which the solid phase does not form.
- d. Provision of alternative sites for deposition (seeding).

- e. Partial or complete removal of deposit forming constituents.
- g. Passage of water through a magnetic device.

### 3. Reverse Osmosis process

#### a. R.O history

Various people studied osmotic properties during the past 100 years, but membranes were hardly ever used for water treatment until the early 50's. During the 1950's Loeb and Sourirajan conducted research work on introducing new membranes that combined salt rejection and high flux. Since the 1950's various companies have started to introduce new membrane technology by using different materials for the desalination of sea or brackish water for potable purposes in direct competition to the distillation processes<sup>12</sup>. The first commercial seawater R.O plants were commissioned in the late 1970's. The spectacular growth rate since then has established R.O as a viable seawater desalting process. The largest single R.O unit in operation to date is a 15 MGD in Saudi Arabia.

#### b. R.O. principal

Osmosis is a term used for the transmission of water molecules through a membrane from a less concentrated solution into a more concentrated solution (e.g. pure to saline water). Reverse osmosis is a process, which reverses the direction of water molecule transport by applying a pressure, greater than osmotic pressure of a sea or brackish water<sup>3,13</sup> (figure 2.4). Thus the R.O process uses hydraulic pressure to force pure water from pretreated and filtered seawater which is pumped by a high pressure feed pump through modules contain semi-permeable membranes. The total energy required running the process is equivalent to the quantity of salt to be removed.

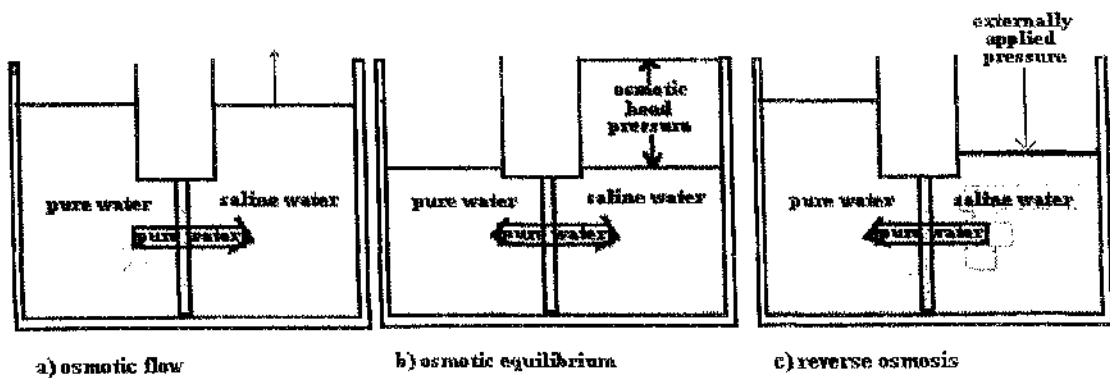

Figure 2.4: Reverse osmosis principal

The feed water is separated into two streams of product (permeate) and concentrated brine by the module where brine continuously rejected, and product either transferred as feed to the next modules or collected for further treatment. Pressure as mentioned earlier is the only energy used in R.O where the source for driving the high-

pressure pump shaft is electrical power (figure 2.5). The R.O process does not heat up the feed, and the temperature of both brine reject and product are discharged at the same temperature as the feed water.

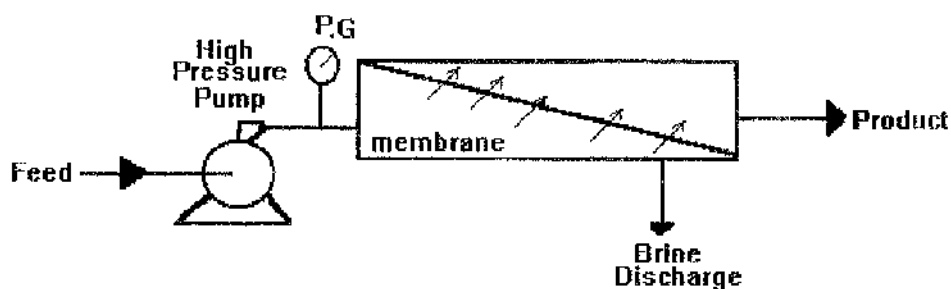

Figure 2.5: Simple lay out of reverse osmosis plant

### c. R.O Accessories

The reverse osmosis system consists of four major components, which are pre-treatment, high-pressure pump, membrane assembly and post treatment plant (figure.2.6).

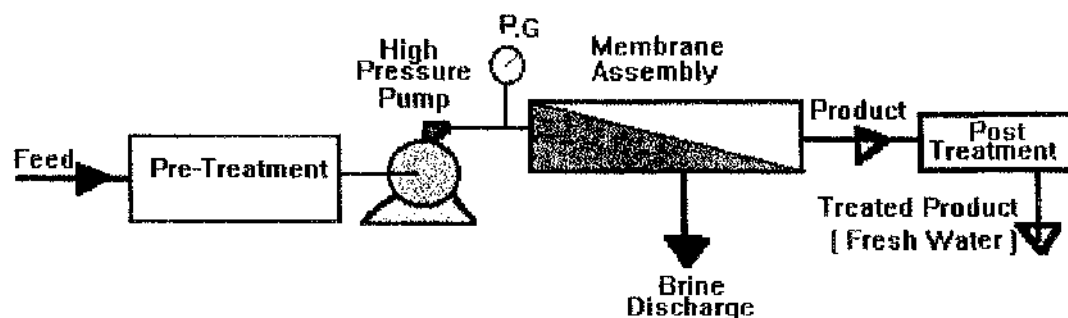

Figure 2.6: Reverse osmosis system flow diagram

#### \* Pretreatment

Feed water pre-treatment is the most important factor in contributing to successful R.O plant operation. Its functions are to chlorinate and de-chlorinate seawater, and filtration (usually sand filter) for removal of solids to protect the high-pressure pump and membranes. Pre-treatment also consists of pH adjustment for reduction of pH to a region where scale formation is prevented.

The costs of a pre-treatment system are about 60% to 65 % of the total process capital cost<sup>3,10</sup>. Thus the investment costs for pretreatment should be viewed in the light of cost for cleaning, replacement of membranes and associated a costs of down-time.

\* **High pressure pump**

The function of this component is to pump pre-treated feed water to the membrane at a pressure where reverse osmosis process takes place

\* **Membrane assembly**

Membranes are thin sheets like materials, which form a barrier in the feed water path and are usually permeable to some species and impermeable to others. The semi-permeable membrane acts as a filter to separate water of different salinity and inhibit the passage of dissolved salts while allowing almost salt- free water to pass through. Flux and salt rejection ratio are the two major factors in R.O membrane efficiency as both have a direct effect on unit output<sup>3</sup>.

\* **Post treatment**

Post treatment is a method, which involves the application of standard water treatment and chemistry techniques before being distributed as potable water. Post treatment consists of pH adjustment, disinfecting the unit using sodium hypochlorite, and addition of calcium salt to the product water. Product water from R.O units does not need the addition of salts as required in the distillation processes.

d. **R.O materials of construction**

The choice of materials is very crucial for R.O operational reliability and plant availability. Non metallic materials such as G.R.P and P.V.C are used for construction of almost all the areas except the high pressure parts since the process operates at almost ambient temperatures. Stainless steel of a type 316L of higher grade is recommended for the high pressure component and high pressure pump since these metals minimize pump maintenance and avoids membrane fouling from pump corrosion (table 2.4).

COMPONENT	MATERIAL
Sea water intake pipes	G.R.P or Carbon Steel
High Pressure Pump	Stainless Steel 316L or Nickel alloys
High Pressure Pipelines	20%Cr/6%Mo austenitic stainless steel
Low Pressure Pipelines	Plastic based material ( P.V.C )

Table 2.4: Material summary selection of seawater R.O plant<sup>3,14</sup>

**e. Corrosion in R.O**

Material failure due to corrosion in a sea water R.O system, although reduced still exists and can mainly attributed to factors such as improper material selection, poor plant operation, poor maintenance and poor system design. Corrosion products in R.O will result in blockage of the membrane surface, which disturbs the production programme. The following is a summary of the types of corrosion in particular component of seawater R.O plant.

**\* High pressure system**

The improper selection of materials for the high pressure section of the plant which handle high level of chlorides and dissolved oxygen results in pitting, crevice corrosion and stress corrosion cracking. The resistance of the material to these forms of corrosion should therefore be considered as the basis of material selection (table 2.4).

**\* Low pressure system**

Corrosion on the area of low pressure is limited to mechanical failures such as crack or general corrosion in cases where selected material of intakes are carbon steel. Non metallic materials such as G.R.P and P.V.C are commonly used for construction of low-pressure areas since the process operates at almost ambient temperatures<sup>3</sup>. Many plastics prove to be excellent materials for use in seawater R.O. plant.

## CHAPTER THREE SEAWATER CORROSION

### 1. Introduction

Corrosion is a natural process, which involves the deterioration of a metallic material by interaction with its environment<sup>9</sup>. It occurs as an electrochemical reaction at the metallic material surface in electrolytic solutions (e.g. seawater). Corrosion therefore, is a factor with very important consequences on the life of any process, plant and in particular the efficiency of water production in distillation process plant (e.g. MSF). The corrosion performance of a process plant is mainly dependent on plant design and the material of construction, as corrosion phenomenon is basically affected by physical factors, such as temperature, water velocity, and solution concentration.

### 2. Electrochemical mechanism of aqueous corrosion

Corrosion can be seen as nature's way of returning processed metals, which come in contact with an aqueous solution to their native state as chemical compounds or minerals. It is a complex process and can only occur if the following conditions are fulfilled (Figure.3.1): -

a. Formation of a cell contains both anodes and cathodes.

\* The anode is an area within the metal where corrosion occurs as, a positively charged ions leave the metal, entering the solution and leave negative electron behind. In the corrosion of metal, each metal atom becomes a metal ion carrying "n" positive charges and generates "n" electrons. These electrons travel through the metal or an external electronic conductor to complete the circuit at the cathode, where a corresponding reaction consumes these electrons.



\* The cathode is the region where these electrons are consumed in reaction (involving substances in the solution) such as oxygen reduction or hydrogen evolution.



or

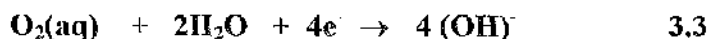



- b. Availability of an electrolyte which carries a current between anode and cathode.

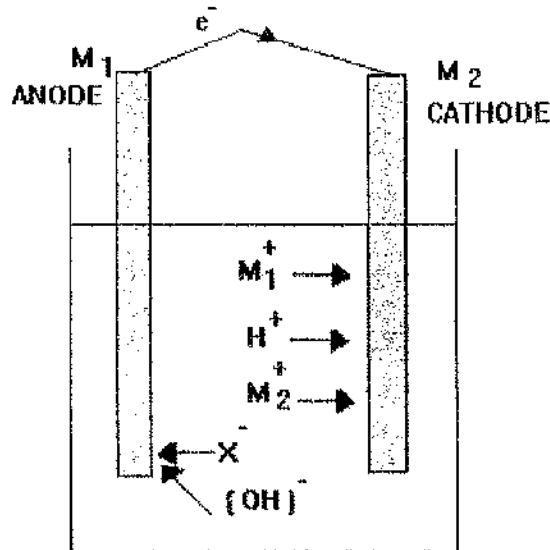

**Figure 3.1. Electrochemical cell involving two different metals**

The electrochemical reaction involved in the corrosion of iron (Fe) which is immersed in seawater will involve two steps:

- \* The metallic iron dissolves and releases positively charged ions into a solution spontaneously from the fixed metallic bond, leaving behind electrons in the metal where loss occurs.



- \* The electrons, which flow to the cathode, react with oxygen, which is present in the electrolyte and forms hydroxyl ions at the metal surface.



or

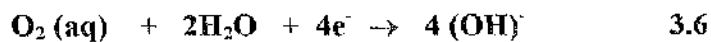

Hence, corrosion is possible since two different electrode reactions proceed simultaneously, where one supplies and the other consumes electrons.

### 3. Types of aqueous corrosion

#### a. General corrosion

This is the most common form of corrosion experienced by carbon steel, low steels alloy, and cast iron in sea water, where wastage of metal takes place at a generally equal rate over the entire surface of the metal. General corrosion is electrochemical in nature where any small irregular spots on the metal surface act as anodes and cathodes. This type of corrosion is the main focus of attention in this research.

#### b. Pitting corrosion

Pitting is localized corrosion, which can occur due to local failure of the protective oxide film on the surface of the metal<sup>15</sup>. This form of corrosion is common in aluminum and stainless steel alloys where metal chlorides are present. On the other hand, titanium is the metal more resistant to pitting corrosion.

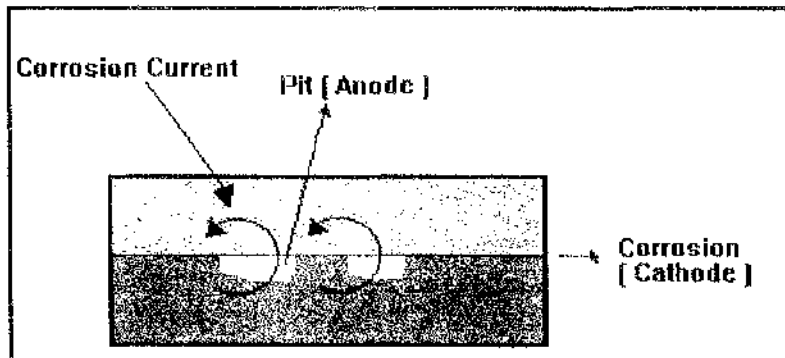

Figure 3.2: Pitting corrosion

#### c. Crevice corrosion

Crevice corrosion is a localized corrosion resulting from crevices formed between two surfaces, one of which is a metal<sup>3,15</sup> (figure 3.3). Oxygen concentration cells are present in crevices, and also in water lines, adherent deposit and deep recesses, which hinder the diffusion of oxygen and set up differences in solution concentration. The low oxygen concentration areas are anodic and thus corrosion prone. Metal ion concentration cells, much like their oxygen counterparts, strive to balance out concentration differences. Thus, when the solution over a metal ions at one point lower than another, metal goes into solution where ion concentration is low.

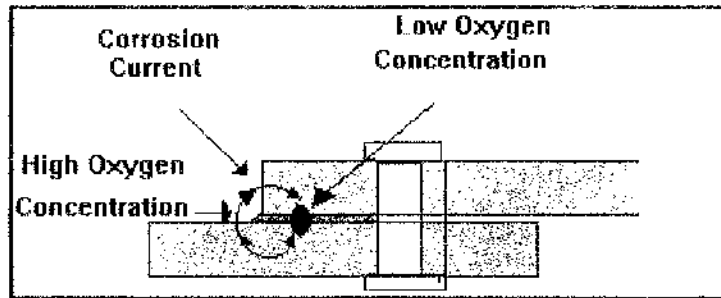

Figure 3.3: Crevice Corrosion

d. **Galvanic (BI-metallic) corrosion**

Galvanic corrosion is associated with contact of two different metals or alloys, which are exposed to an aqueous electrolyte such as seawater<sup>15</sup> (figure 3.4). In desalination plant such as M.S.F design galvanic (BI-metallic) corrosion is an important concern as it is virtually impossible to avoid the combination of dissimilar materials.

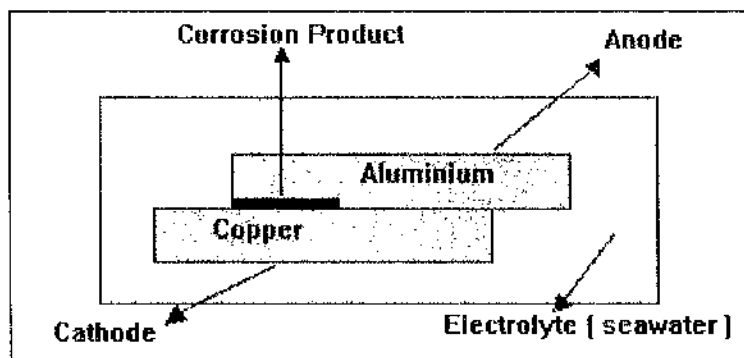

Figure 3.4: Galvanic corrosion

e. **Stress Corrosion Cracking**

Stress corrosion cracking is a form of corrosion resulting from the combination of constant tensile and a specific chemical environment<sup>15</sup>.

f. **Corrosion fatigue**

Corrosion fatigue is failure by cracking caused by alternating stresses in the presence of a corrosive environment.

also well decrease the protective current requirements. Factors which increase the protective current demands include:

- \* Internal or external coating degradation.
  - \* Increase in water temperature and velocity.
  - \* Higher oxygen level.
  - \* Removal of scale formed deposits.
  - \* High vibration.
- b. There must be sufficient capacity in the system to give the required design life.
- c. The system must ensure that a uniform current distribution over the whole structure is achieved without resulting in overprotection.

The system current density, economics, and environment in which anodes are installed mainly govern selection of proper anode materials. These play an important role in fulfilling the above design criteria for protecting sea water installation structures such as off-shore facilities. Table 4.5 lists some of the current proven anodes, which are in use for seawater installation structures worldwide.

Anode Material	Types	Place of use
Zinc	Sacrificial	Platform, jetty, Ships hulls, pipelines
Aluminum	Sacrificial	Platform, jetty, drilling rig, Ships tanks
Platinized Titanium	Impressed	Ships Hulls, pipelines
Lead-Silver	Impressed	Ships Hulls, pipelines

**Table 4.5: Anode materials of seawater installation<sup>19</sup>**

Finally, continuous performance monitoring of the system by measuring controlled set-potential, using zinc or silver/silver chloride reference electrodes ensures effectiveness of a cathodic protection system in seawater installations, whether of the sacrificial anode or the impressed current type.

### **13. Cathodic protection in desalination plant structures (MSF)**

Multi stage flash (MSF) distillation of seawater is an established technique for desalinating seawater in many countries, in particular in coastal arid countries. Although MSF distillers differ in design, size and capacity, their operation encompasses a number of standard processes. These aim to overcome a performance difficulty or improve production efficiency where the operation of these processes (e.g. sea water chlorination or unit acid cleaning) affect the corrodability of certain elements of the distiller, either

beneficially (cleaning) or detrimentally. Corrosion as mentioned earlier, is a common problem in multi stage flash distillation plants, since carbon steel is used extensively (i.e. sea water intakes pipelines, sea water header and feed, low temperature brine systems, water boxes, and flash chambers), due to its good mechanical and physical properties, and its lower cost.

Cathodic protection is a long-established method of corrosion control at ambient temperature for numerous applications in marine engineering plant and equipment operation. However, application of this technique in large desalination plants (MSF) to date has been limited to intake screens and the occasional location of sacrificial anodes in water boxes, flash chamber floors, and water box/condenser tubeplates<sup>6,50</sup>. Some attention has also been given to the possible deleterious effect of tube plate, cathodic protection system on hydrogen embrittlement of titanium tubes<sup>51</sup>.

The application of this technique to long runs of pipe containing either seawater feed or hot brine in desalination plants has had limited application. An important exception to this general scenario exists at Dubai Aluminum Co where an extensive cathodic protection system is employed in six 5 MGD evaporators. The only other similar extensive cathodic protection system in desalination plant appears to have been an earlier installation at Chula Vista, California in the multistage plant where impressed current cathodic protection was used for the hot parts of the brine recirculation system. The Dubai system is described in detail in a later chapter but the earlier application in California is summarized at this point.

#### **16. Summary of Impressed current cathodic protection as applied to desalting plants at Chula Vista, California<sup>52</sup>**

The Clair Engle Multi Stage, multi effect flash desalination plant is located in Chula Vista, California. Its maximum operating temperature can reach 138<sup>o</sup> C. The pipelines of the first section are made of steel which recycle and mainly handle hot concentrated brine at a temperature of 110<sup>o</sup> C and velocity of up to 1.83 m/sec. The nominal corrosion rate for steel at such condition is approximately 1.54 mm/year. The total length of the recycle pipeline is 40.54 metre long and 16 inch diameter.

##### **a. Problem and method of approach**

After only two years operation of the Clair Engle Multi Stage, multi effect flash desalination plant severe corrosion damage was occurring at impingement points especially elbows of the hot concentrated recycle pipeline<sup>52</sup>. Also, the general corrosion was approaching the maximum design allowable thickness for the recycle piping which was carrying brine at temperatures above 100<sup>o</sup> C. It was clear that correction of damage inflicted by corrosion was a costly and time consuming business as it was adversely affecting the future performance of the plant and its availability. It was therefore decided that the only solution was to arrest the corrosion completely by installing impressed current cathodic protection. The main purpose of the installation was:

- \* To combat corrosion by protecting the hot brine pipelines.
- \* To increase the plant availability and hence reduce maintenance costs.
- \* To increase plant life.

**b. Equipment**

The importance of constant protection and low maintenance costs resulted in the selection of the following equipment, for protection of steel pipelines in a hot brine environment.

- \* Automatic potential controller
- \* Platinized titanium anode
- \* Silver/Silver chloride reference electrode where the reference electrode signals the Potentiostat so that the correct current is supplied to maintain the required setting.

**c. Design guidelines and equipment installation.**

Prior design of an impressed current system for the brine pipeline of the Clair Engle desalination plant and extensive laboratory studies were carried out in order to understand the initial required limit of polarizing current density for steel. The effect of the following parameters on the system current density were studied in detail:

- \* System velocity.
- \* Area.
- \* Different control, potential setting.
- \* Temperature.
- \* Salinity

The results obtained from the laboratory study indicated that the system current density varies with a change in any of the above mentioned parameters (table 4.6). It also indicated that the effect of salinity is less marked than that of temperature and velocity. Therefore, based on the obtained data for steel the design estimate for the system was made on the current density requirements of bare steel for different environmental conditions. The installation of the required equipment, such as number and types of anode, reference electrodes, anode spacing, and the location of reference electrodes was based on

a design estimation of the current density and operating environment in which the impressed current protection system was to be operated.

Current density ( mA/Ft <sup>2</sup> )	Temperature (°F)
155	120
170	130
200	140
240	150
290	160
400	170
500	180

**Table 4.6: Current density vs. Temperature at constant velocity of 1.6 ft/sec<sup>52</sup>**

**d. Operation and cathodic protection system assessment**

After the installation was put into operation on the brine recycle pipeline an assessment of the system performance in preventing corrosion was carried out using the following methods:

- \* Ultrasonic wall thickness measurements.
- \* Weight loss on steel coupons.
- \* On line monitoring of system current density.

The protection set point was kept at -800 to -900 mV with the the automatic system controller automatically controlling the set point voltage supplying the necessary current for protection of the lines. The value of total anode current and voltage was taken and monitored 3 to 4 times a day.

**e. Results**

The results of the impressed current cathodic protection system at Clair Engle Multi Stage, multi effect flash desalination plant was assessed and proved satisfactory after being in operation for almost two years.

## **f. Summary and conclusion**

Overall, the impressed current cathodic protection unit provided an excellent protection, for the brine recycle piping evidenced by ultrasonic wall thickness measurement and a notable lack of piping failures at high velocity points such as elbows. The system current requirements were initially very high but dropped gradually with operating time. This was mainly due to the initial scale formation of  $Mg(OH)_2$  and copper sulfate on the surface of the pipe wall.

## **15. Conclusion**

As shown in this chapter cathodic protection is a mature corrosion control method for numerous structures and equipment subjected to ambient temperature, especially in marine conditions. However, its application has been extremely restricted in desalination plant and to date its use has been limited to intake screens and the occasional location of sacrificial anodes in water boxes and flash chamber floors. This research therefore undertakes a careful assessment of cathodic protection in M.S.F in two ways: -

1. Investigate the operation and particularly the long term performance of an existing large system at Dubal MSF plant.
2. To undertake and focus on tests in the laboratory also in a test loop at Dubal's site in order to assess the important influence of the MSF process condition, such as temperature, seawater salinity, calcareous deposit, velocity in the performance of the cathodic protection equipment and design.



## CHAPTER FIVE

### Summary of Impressed current cathodic protection as applied to desalting plants at Dubai Aluminum Company (Dubai, U.A.E)

#### 1. Introduction

The Dubai Aluminum Company Limited (Dubal) wholly owned by the Government of Dubai. Began production of primary Aluminum in 1979 and commenced the delivery of potable water to the Dubai Water Authority in 1980. Dubal is a relatively modern smelter by industry standards but has expanded rapidly since the early days to become one of the largest non-oil foreign exchange earners in the United Arab Emirates<sup>53</sup>.

The Dubal operation is unique in that it is the only installation in the world to produce aluminum from electrical energy derived from gas turbines fueled by flare gas and then to desalinate sea water by utilizing the thermal energy recovered from the exhaust of back pressure steam turbines operating in a combined cycle mode.

The Desalination plant comprises six multi-stage flash evaporators each of 5.2 MGD capacity, seawater intakes, electro-chlorination plant, blending plant and two back pressure steam turbines. After only a few months of operation severe corrosion damage was occurring in the seawater manifold, bandscreens, sand filter pipelines, brine pipe into stage 17, all rubber lined water boxes and the brine entry manifolds, despite very conscientious attention by the contractor to ensure the units were put in good condition at the end of the contractual maintenance period. It was clear that correction of corrosion damage was going to be a costly and time-consuming business, which would adversely affect the future plant performance, its reliability and availability. A solution had to be found.

DUBAL, faced the prospect of lengthy outages on individual Evaporators on a planned annual basis in order to carry-out expensive repair work to failed protective coatings and linings. More serious however was the fact that the sea water header, which comprises 800 meters of 0.9 to 1.6 meter diameter fabricated carbon steel pipe could only be worked on when the plant was totally shutdown (the sea water header has now been sectionalized and currently does not need a full header outage for any internal or external repair).

By the early part of 1980's it became clear that the cost of recurring remedial work to combat internal corrosion would be in the range of several Million Dirhams per annum and that the security of the water supply to Dubai and near by industry would be adversely affected. The only solution was to combat and arrest the corrosion totally. Periodic repair of protective coatings and linings offered an unending expensive battle, which led ultimately to, forced major capital expenditure on new parts of the plant. The alternative, to purchase new units in order to maintain water supply expectations to the customers in particular Government of Dubai water authority was even more economically expensive.

In the early 1980's Mr. R.Bailey (Manager of Dubal's power and desalination) who had previous practical knowledge in design, installation and operation of cathodic protection equipment decided to adopt a retrofit impressed current cathodic protection system for combating corrosion of the desalination plant at Dubal. He was confident that an impressed current cathodic protection system could be readily applied to the seawater

areas, but realized that successful protection of systems handling hot brine required some experimentation. The decision by Dubal's management to install cathodic protection received financial approval subject to the new installation meeting the agreed criteria: -

"The Evaporators must operate continuously without corrosion and with shutdowns limited to convenient short outages to permit acid cleans, internal inspections and unavoidable rotating plant and valve maintenance<sup>54</sup>".

The following sections describe how Dubal has won this battle with corrosion.

## **2. Design guidelines-procurement-installation**

### **a. General philosophy**

The Electro-mechanical process of corrosion and the counter e.m.f. applied by the use of cathodic protection which arrests this corrosion has been discussed in detail in earlier chapters.

It is common practice to produce an estimate of the current required for protection by equating measured surface area with current density factors ranging from  $x$  m. a/m<sup>2</sup> to  $y$  m.a. /m<sup>2</sup>. Dubal however, did not consider that it was possible to estimate current requirements in this way as conditions in desalination is likely to be very variable and quite different from those in which most of the previous application of cathodic protection has involved.

The Dubal cathodic protection systems were, therefore, designed on the basis of previous experience<sup>55</sup> but now supported by an experimental installation on one of the operating evaporators.

### **b. Choice of anode and reference electrode**

For all sea water systems and low temperature brine systems, the basic cantilever rod design of platinised titanium set in an integral plastic mounting boss threaded 1" B.S.P. was specified. The titanium rod was 1/2" nominal diameter with the plated platinised end being 4" in length and .0001" deep. The rod length was such that it projected about 8" inwards from the inner wall of the vessel. This anode was regarded as having a current rating of 4 to 5 amperes.

The reference electrode specified was high purity zinc (Zn reference electrode indicates potential which are +1.05 volts relative to saturated Calomel Electrode) rod mounted in the same manner as the anode, but with an internal projection of about 2".

### **c. The quantity of anodes and reference electrodes**

If the total current requirement is known then, it would seem a simple matter to decide on the total number of anodes assuming the current rating of the anode is known. It has already been stated that conventional methods of estimation of required current will result in much larger figures than are actually needed, but that it is also necessary to consider how far the protective zone or current-reach, of each anode will extend. The

Code of Practice<sup>56</sup> recommends an anode spacing of 4 pipe diameters, but Mr. R.bailey had already seen successful protection achieved with an anode spacing of 50 pipe diameters. The actual number of anodes was therefore estimated on the basis of at least one anode for each vessel or section of pipe. Also by exercising a judgment based on knowledge of the nature of electrolyte in the particular section, and with hindsight, knowledge of the location and severity of corrosion being suffered.

#### **d. Design of transformer - rectifier and control equipment**

As the total number of anodes, reference electrodes and a "ball park" figure for the total protective current based on the assumption summarized in the previous section were known it was not necessarily to calculate the arithmetic total of anode ratings. However, it was necessary to decide on the maximum anode voltage required and if all units should be the same. Since it was foreseen that some sea-bed anodes might be needed in the future, it was decided that a top voltage of 15 V DC would be specified, mainly to provide ample margin to cover voltage drop in long cable runs, although in practice the actual driving voltage at an anode was around 5 to 7 volts.

After consideration for the transformer rectifier units location and total ratings it was decided to use 5 units each of 300 A and 15 V capacity, with each unit having 10 groups with each group capable of individual control and supplying 6 x 5 A individual anode circuits. The individual groups were specified to have a facility for automatic or manual control of output, with provision for 2 reference electrode circuits in each group. The individual anode circuits were equipped with a fuse, an ammeter shunt and a series impedance device to allow a limited range of adjustment of anode current.

#### **e. Procurement of material**

On completion of the design assessment, a list of material was put out to tender with reputable manufacturers in this field. The requested materials did not include anodes and reference electrodes for use in high temperature brine since there was no previous experience in this application. The design was discussed with a selected UK manufacturer<sup>19</sup> and 6 anodes and 2 reference electrodes were manufactured based on the simple cantilever rod concept. The first anodes failed due to mechanical vibration and a second design using a thicker and shorter titanium rod has since proved satisfactory. The third and final development was to increase the platinum coating thickness from .0001" (2.5 microns) to .0003" (7.5 microns).

#### **f. Installation of material**

The anode and reference electrode-mounting bosses including system wiring was completed prior arrival of the purchased material from overseas. The method of wiring used by Dubal was based on simplicity and low cost. The wires from each anode and reference electrode were run direct from anode or reference electrode to the circuit terminal of the transformer/rectifier unit using single conduct PVC insulated wires with a minimum conductor size of 2.5 sq. mm. The runs of wire were secured to the structure

using existing cable tray work as available and fitting more supports as needed where for single wires on pipes, the use of plastic clips secured with adhesive was found quite adequate. A flexible single core cable with a screen earth-return conductor has been used for reference electrodes in order to eliminate possible interference with protective potential readings caused by voltage drops in the structure.

In order to reduce the actual installation time of mounting bosses, the 1" BSP tapped bosses were welded to the outside of the pipes whilst water production continued. The hole through the pipe wall would then be drilled during the planned shutdown and either anodes or blank plugs inserted. The protection, when commissioned, was quite satisfactory.

Three rectifier/ transformer control units were located - one in each of the local evaporator sub-stations where each unit designed to supply the required current density for two Evaporators. Two more units were installed in the sea water intake sub-station.

### **3. Description of installations**

On the desalination plant at present there is in service, a total of 261 platinised titanium anodes and 159 zinc a reference electrode. Ideally, it is preferable for one circuit to supply a single anode, but it has not been possible to achieve this fully since the Evaporator systems were developed by experimentation and the present set-up has been created by utilizing the spare capacity which was found in the original sea water manifold system. The choice of units with 10 separate groups of 6 circuits has allowed sufficient flexibility to give satisfactory segregation of systems. Individual installations are described as follows: -

#### **a. Seawater intake works**

Sea water flows into the pump suction through 3 pipes laid in the sea bed and into a common stilling chamber when it passes through any of the 7 trains of coarse-screen, band-screen and pump. The coarse-screens and sea water pumps are made of corrosion-resistant material.

#### **\* Seawater intake pipes**

These comprise of 3 pipes of 2 metres diameter each about 410 meters in length and are of carbon-steel without any protective coating. Sacrificial anodes are installed throughout the length of the pipes internally, a total of 800 zinc alloy anodes being used. In 1980, a report from a diver indicated rapid waste of these anodes taking place, but inspection by Dubal's own staff in subsequent years has not borne this out. An anode removed for assessment in 1985 was judged to have a further 10 year's life based on the observed condition after 6 years. On the basis of the original report of rapid wastage, it was decided to include some sea bed impressed current anodes in the sea water manifold equipment to take over the protection of these pipes in due course, but to date this has not been found necessary. The pipes are at a depth of 6 metres below the beach level and test wires have been attached to each pipe and brought to the surface, thus enabling the

protective potentials to be monitored easily at any time without having to stop the flow which is, of-course, necessary if a diver is to go down.

\* **Band-screens**

These screens were originally installed with a mixture of protective coatings and "corrosion-resistant" materials. They suffered rapid attack particular to the plastic-coated steel frame and during 1981 the contractor refurbished all 7 units and reinstalled them with 10 aluminum alloy sacrificial anodes welded to each frame. This gave satisfactory protection to the frame, but was not entirely effective on the traveling screen, which is never completely submerged. By mid-1984, potential checks had indicated that the sacrificial anodes were reaching the end of their lives. In early 1985 an impressed current anode was installed in the outlet of each screen which proved to give a total protection to the frames and also the traveling screens, even though they had suffered corrosion prior to this and despite the fact that for 50% of the time they are not sub-merged. In order to ensure that a bandscreen receive an even distribution of the cathodic protection, band screen is kept in operation for 45 minutes a day.

\* **Sand filters associate pipelines**

These are rubber-lined steel vessels, which filter the seawater feed to the Electro-chlorination plant and the blending plant. The filters themselves have not yet suffered corrosion, but the painted steel pipe work associated with inlet, outlet, backwash and drain lines has constantly needed attention to leaks caused by corrosion. This complex arrangement of pipes and valves, ranging from 60 to 161 mm in diameter, was considered not suitable for application of impressed current protection and it was intended to replace the pipes with plastic. This substantial capital expenditure has been deferred since it is always possible to take a filter out of service for pipe repairs without affecting production. By 1985 the pipe work was a patchwork of welded steel plates and in early 1986 some surplus anodes were modified to fit these small pipes. An impressed current system is now protecting this entire area, using 19 anodes and 6 zinc reference electrodes connected to spare circuitry in the unit which supplies the sea water manifold.

**b. Seawater header**

This system comprises the common sea water distribution pipes which feed the water from any of the seven sea water supply pumps to any of the six evaporator units and other parts of the plants. Each pump has a capacity of 7000 m<sup>3</sup>/hr. The pipes are of welded steel with bolted flanged joints and with bellows sections of stainless steel. In all, there are some 800 metres of 0.90 metre to 1.62 metre diameter pipe, which are sectionalized into three parts. These pipes were not sectionalizing at the time when cathodic protection system was installed. In April 1983 the cathodic protection system for the seawater manifold was commissioned with a total of 112 anodes and 22 reference electrodes. Total current after system commissioned was about 59 Amperes and it was clearly evident from the potential reading (The established potential criteria for protection

at cathode was +0.25 volts relative to zinc reference electrode) that a high level of overprotection was being achieved as the current required to achieve protection was indicated almost zero. A number of experiments were carried out prior to 1984 header outage to determine anode reach in order to optimize the required number of anodes and reference electrodes which needed to give satisfactory protection. During the header total shutdown in March 1984, the cathodic protection system wiring to anodes and reference electrodes were modified and the number of active anodes and reference electrodes reduced from 112 and 22 to 18 and 6. All the surplus anodes and reference electrodes were removed and those, which were to remain, were replaced with new. On February 1990 the header was sectionalized into three parts and accordingly some of the anodes and reference electrodes were re-located and majority of the wiring defects corrected and some of the faulty anodes, reference electrodes were also replaced. It is now in its thirteenth year and based on the gained experience the frequency of anode, and reference electrode replacement is between 4 to 6 years.

### c. Evaporators

Each of the 6 evaporator's uses 42 anodes and 27 zinc reference electrodes arranged in 9 sub-systems. The present arrangement was developed after experimentation carried-out on no. 2 evaporator brine inlet manifold, which started in June 1982, and on no. 5 Evaporator for the remaining parts of the evaporator, which started in August 1983. Following tables is the development summary of impressed current cathodic protection system of each evaporator: -

DATE	Summary
22-9-1983	Brine entry manifold commissioned
1984	Cathodic protection system was installed fully and commissioned
1985	Few system adjustment such as total current was carried out
1986	Circuit wiring of water box, canister, and air ejector were modified
1987	Brine pump anode canister current adjusted and cleaning frequency increased
1988	An additional anodes installed upstream of taproge collection guide vanes
1989	An additional anodes installed in the sea water feed line
1990	New control panel installed and majority of the circuits modified
1990	Cathodic protection commissioned in air ejector return line
1990-1997	Cathodic protection system is 100% effective. Only on unit 2 or 4 yearly planned outage defectives anodes and reference electrodes are being replaced
1990-1997	A regular monitoring of the system performance has been carried out by myself

**Table 5.1: Summary of evaporator no.1 CATHODIC PROTECTION SYSTEM DEVELOPMENT**

DATE	Summary
1982	6 nos. of high temperature anodes installed on Brine inlet manifold initially. The installed anodes failed and later modified due to fatigue. System inspected after six month and result was satisfactory
1983	B.I.M anodes reduced to 4 from 6 after test period, internal protection confirms continuing total
1984	Cathodic protection system was installed fully and commissioned
1985	Due to lower water demand, evaporator placed in trial storage mode full of sea water for three months with cathodic protection on auto. System performed okay.
1986	Circuit wiring of water box, canister, and air ejector were modified
1987	Brine pump anode canister current adjusted and cleaning frequency increased
1988	An additional anodes installed upstream of taprogge collection guide vanes
1989	Water box anode location changes due to calcareous deposit buildup, which caused blockage of the tubes particularly in heat, reject section.
1989	An additional anodes installed in the sea water feed line
1990	New control panel installed and majority of the circuits modified
1990	Cathodic protection commissioned in air ejector return line
1993 - 1995	Due to lower water demand, evaporators were put on low T.D.S modes where the salinity of water reduced to 12,000 PPM. A series tests on cathodic protection system were carried out in order to achieve the required protection
1990-1997	Cathodic protection system is 100% effective. Only on unit 2 or 4 yearly planned outage defectives anodes and reference electrodes are being replaced
1990-1997	A regular monitoring of the system performance has been carried out by myself

Table 5.2: Summary of evaporator 2 cathodic protection system development

DATE	Summary
1982	Experimental C.P system on B.I.M which was installed by Weir Westgarth failed after a few hours due to breaking of the anodes
1983	B.I.M protection system put in operation using Dubal design anodes
1984	Cathodic protection system was installed fully and commissioned. Internal inspection of B.I.M showed that corrosion was virtually arrested
1985	Evaporator internal inspection showed that corrosion was arrested completely. Faulty anodes were replaced.
1986	Circuit wiring of water box, canister, and air ejector were modified.
1987	Brine pump anode canister current adjusted and cleaning frequency increased.
1988	Water box anode location changes due to calcareous deposit buildup, which caused blockage of the tubes particularly in heat, reject section.
1988	An additional anodes installed upstream of taprogge collection guide vanes.
1989	Additional anodes installed in the seawater feed line.
1992	New control panel installed and majority of the circuits modified.
1992	Cathodic protection commissioned in air ejector return line.
1992	New control panel installed and majority of the circuits modified.
1992	Cathodic protection commissioned in air ejector return line.
1990-1997	Cathodic protection system is 100% effective. Defective anodes were replaced during unit 2 or 4 yearly planned outage.
1990-1997	Myself have carried out a regular monitoring of the system performance.

Table 5.3: Summary of evaporator 3 cathodic protection system development

DATE	Summary
1983	B.I.M protection system put in operation using Dubal design anodes
1984	Cathodic protection system was installed fully on the rest of the evaporator and commissioned.
1985	Evaporator internal inspection showed that corrosion was arrested completely. Faulty anodes were replaced.
1986	Circuit wiring of water box, canister, and air ejector were modified.
1987	Brine pump anode canister current adjusted and cleaning frequency increased.
1988	Water box anode location changes due to calcareous deposit buildup, which caused blockage of the tubes particularly in heat, reject section.
1988	An additional reference electrode was introduced into B.I.M section.
1988	An additional anodes installed upstream of taprogge collection guide vanes.
1989	Additional anodes installed in the seawater feed line.
1992	New control panel installed and majority of the circuits modified.
1992	Cathodic protection commissioned in air ejector return line.
1992	New control panel installed and majority of the circuits modified.
1992	Cathodic protection commissioned in air ejector return line.
1993 - 1995	Due to lower water demand, evaporators were put on low T.D.S modes where the salinity of water reduced to 12,000 PPM. A series tests on cathodic protection system were carried out in order to achieve the required protection
1990-1997	Cathodic protection system is 100% effective. Defective anodes were replaced during unit 2 or 4 yearly planned outage.
1990-1997	Myself have carried out a regular monitoring of the system performance.

Table 5.4: Summary of evaporator 4 cathodic protection development

DATE	Summary
1983	Original experimental design to protect the seawater feed, brine, blowdown, and rubber lined waterboxes drawn up. C.P system was Installed through out the unit.
1983	All system was achieving satisfactory protection potentials. Various changes were made to the anode locations and grouping and also number of anodes and reference electrodes were reduced. Dissolved oxygen samples, brine flow, temperature, and anode currents on brine system were checked using specially installed recorder.
1993	Protection variation observed as a result of chlorine sludge dosing. The continuous monitoring of the protected areas as well revealed that the chlorine level did not had a measurable effect on sea water feed system but had a very corrosive effect on the brine systems.
1994	The practice of chlorine sludge dosing was stopped and continuous dosing reduced.
1984	Anode wiring and circuit connection modified to the final design.
1985	Internal inspection of the unit showed no active corrosion.
1986	Circuit wiring of water box, canister, and air ejector were modified, and also a number of defective anodes and reference electrodes were replaced.
1987	Brine pump anode canister current adjusted and cleaning frequency increased
1988	An additional anodes installed upstream of taprogge collection guide vanes
1989	Water box anode location changes due to calcareous deposit buildup, which caused blockage of the tubes particularly in heat, reject section.
1989	An additional anodes installed in the sea water feed line
1993	New control panel installed and majority of the circuits modified including air ejector
1993 - 1995	Due to lower water demand, evaporators were put on low T.D.S modes where the



	salinity of water reduced to 12,000 PPM. A series tests on cathodic protection system were carried out in order to achieve the required protection
1990-1997	Cathodic protection system is 100% effective.
1990-1997	A regular monitoring of the system performance has been carried out by myself

**Table 5.5: Summary of evaporator 5 cathodic protection development**

DATE	Summary
1982	Due to severe corrosion in the B.I.M Weir Westgarth Installed partial cupro-nickel lining. The lining failed extensively and was removed.
1983	B.I.M protection system put in operation using Dubal design anodes
1994	Cathodic protection system was commissioned on the rest of the evaporator.
1985	Internal inspection of the unit indicated that C.P system is 100% effective.
1986	Anode wiring and circuit connection modified to the final design.
1986	Circuit wiring of water box, canister, and air ejector were modified, and also a number of defective anodes and reference electrodes were replaced.
1987	Brine pump anode canister current adjusted and cleaning frequency increased
1988-1989	An additional anodes installed upstream of taproge collection guide vanes and water boxes anode location changed.
1989	An additional anodes installed in the sea water feed line
1993	New control panel installed and majority of the circuits modified
1993	Cathodic protection commissioned in air ejector return line
1993	New control panel installed and majority of the circuits modified
1993	Cathodic protection commissioned in air ejector return line
1990-1997	Cathodic protection system is 100% effective.
1990-1997	A regular monitoring of the system performance has been carried out by myself

**Table 5.6: Summary of evaporator 6 cathodic protection development**

\* **Brine inlet manifolds**

After only a few months of operation a disastrous corrosion attack on brine inlet manifold was occurring and despite very conscientious attention by the contractor to ensure that the units were put in good condition at the end of the contractual maintenance period of the evaporators. The contractor attempted to combat it with protective coatings which included the "glass-flake" type and finally with the attachment of a monel lining as a trial on the unit. All the linings were torn off almost immediately by the severe turbulence and cavitation, together with released carbon dioxide and other dissolved gases present in this area. The galvanic couple where the 1.2 metre diameter cupro-nickel pipe is bolted to the steel manifold entrance caused rapid attack and leakage at the flanged joint and this either leaked out hot brine or sucked in air (to accelerate the corrosion) depending on the evaporator operating conditions. A 20-mm thick impingement (target) plate was welded to the inside of the manifold opposite to the entrance, which suffered rapid cavitation attack. On the first unit the plate was torn away and bent over like a piece of paper. It was at this stage when Mr. R.Bailey proposed an experimental application of cathodic protection.

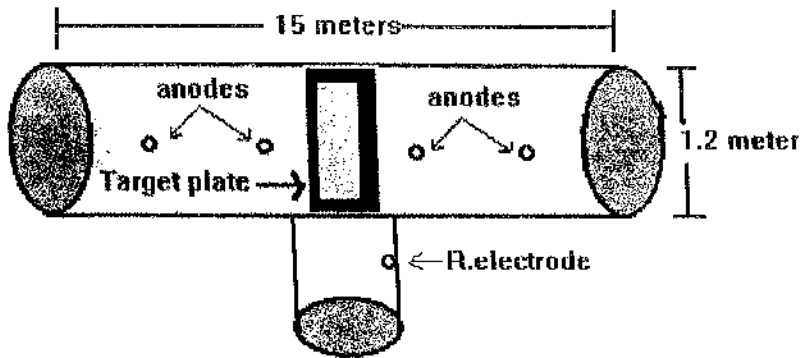

**Figure 5.1: A schematic diagram of anodes and reference electrode location in B.I.M**

As mentioned earlier, a simple cantilever rod anode and reference electrode design was discussed with a selected UK cathodic protection company and these were manufactured and installed in June 1982. The anode locations were chosen so as to be clear of the area where the most severe turbulence was thought to be, but the titanium rods failed after a few days due to vibrational fatigue. The failed anodes were stripped down, re-machined and reassembled using epoxy-resin encapsulation and reinstalled with the rods internal projection being now reduced from 250 mm to 150 mm. The protection continued in service and protective potentials indicated satisfactory levels.

The failure of the anodes was discussed with the supplier and an improved design, with the rod diameter increased from 11 mm to 16 mm and the internal projection reduced to 130 mm. In September 1983 the number of anodes was reduced from 6 to 4 and almost by that year's end protection had been applied to the remaining 5 evaporator brine inlet manifolds (figure 5.1).

The zinc reference electrode was positioned adjacent to the flange joint with the incoming cupro-nickel pipe. This was the area of most severe turbulence and cavitation. The zinc rod snapped off almost immediately, but nevertheless it continued to supply a stable reading which experience has proved to be a correct indication of corrosion mitigation. The reference electrodes are now cut off with a saw prior to installation so that the end of the steel mount, the insulating bush and the zinc rod are all flush. The assembly is then screwed in and locked up so that the end is flush with the pipe wall. The cavitation still causes the zinc rod to be eroded, but the readings are reliable. The reference electrodes are renewed every 4 years as a precaution against a mechanical failure causing a leak. Operational experience has shown that voltage and current requirements on BIM cathodic protection system vary substantially, especially in the months following evaporator acid wash where the demand for current density increases by the factor of two. The current variation along with high turbulence, and high operating temperature has therefore categorized BIM as one of the most critical area for anode wear. Cavitation attack on the 20-mm thick target plate has been the other major problem, which Dubal is encountering since commissioning of the present in placed cathodic protection system. On 1988 an additional anode and controlled electrodes (figure 5.2) were installed mainly:

- \* To protect taprogge guide vane which was made of unpainted carbon steel plate.

- \* To avoid unnecessary anode wear or the risk of corrosion in the B.I.M, due to failure of installed controlled electrode. Installation of an additional controlled electrodes has greatly improved the situation.

In summary, the installed impressed current cathodic protection in B.I.M has been almost 100% effective. As the disastrous corrosion attack on the system has been minimized to zero and all required remedial works on this section be done during unit 2 or 4 yearly planned outages.

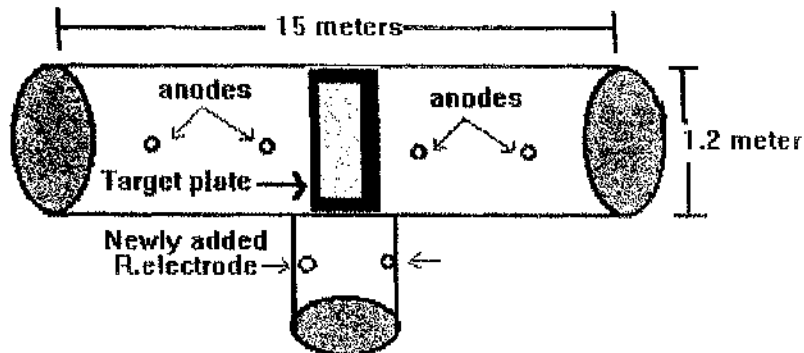

**Figure 5.2: A schematic diagram of anodes and reference electrode location in B.I.M after modification**

#### \* **Seawater feed and low temperature brine systems**

Although quite severe corrosion was being experienced at all flanged joints, particular where bellows of dissimilar metal occur, and in areas of high turbulence, the application of Cathodic Protection was immediately successful. The original judgment of location and quantity of anodes in the initial experiment on evaporator No. 5 required hardly any subsequent modification. The only additional works, which have been done in this section, is the installation of an additional anode and relocation of the anode, which was initially, installed right after the feed control valve. The relocation was carried out mainly due to frequent breakage of the anode due to area turbulence. A recent Internal inspection of low temperature brine systems on all the evaporators indicated the installed impressed current cathodic protection has been almost 100% effective. It is worth mentioning at this stage that no internal paintwork for the area of low temperature brine system has been carried out after installation of the system protection.

#### \* **Water Boxes**

There are total of 19 water boxes on each evaporator, which are part of heat recovery and reject section of the unit. From mid-way in the unit, towards the higher temperatures, 10 of these boxes are lined with monel and after some remedial welding in the first two years or so these boxes did not suffer corrosion. The 9 boxes in the lower temperature ranges were rubber-lined and were in trouble due to lining failures at flange

face joints manhole joints and on seamed joints, within a few months of commissioning. The Contractor carried-out extensive and costly remedial work at the end of the maintenance period which in some cases involved removal of the water box. This seemed an obvious application for cathodic protection, but locating anodes and reference electrodes in what were considered to be the correct positions meant having to cut through the rubber linings. When the initial experiment was set up on No. 5 evaporator, an anode was mounted on the blanking plate, which covered the drain pocket with a reference electrode similarly positioned at the other end of the loop. Whilst the reference electrode was in a logical position, the anode was adjacent to a tube plate and barely protruded into the water box. When the current was switched on the protection potential was achieved within a few hours and visual inspection some weeks later showed that all corrosive attack had ceased. Whilst protection has been satisfactory, problems have been seen due to calcareous deposits build up near to the anodes which was causing blockage of the tubes particularly in heat reject section. In view of this problem which was envisaged in this section of the evaporator the anode positioned was relocated in 1989.

Frequent system inspection of the units has indicated that the installed protection system has been fully effective with no major worries. The only problem, which we have been encountering, is the rare minor repatch of the rubber lining due to rubber degradation.

#### \* **Brine pump canisters**

Each Evaporator has 2 large brine recirculation pumps. The pumps are made of stainless steel and bronze but take their suction from sumps, which are in the form of carbon steel cylinders, 2.2 metres diameter and 6.5 metres below ground level. Internally, these canisters are rubber-lined and no problems have been experienced to date. Externally, each canister sits in a hole in the concrete foundation with a clearance of a few centimeters around it and below it and it is protected with "epoxy-type" paint. The pits were designed to be kept pumped dry, but in practice this proved difficult and also severe atmospheric corrosion was occurring. To inspect and repair damaged canister paintwork involved the complete dismantling of this vertical 1.1 MW motor / pump units, an activity, which kept a team of skilled men busy for 2 weeks.

The solution was to fill the space with sea water and install by suspending 1 anode and 1 reference electrode in each pit. The anodes and reference electrodes are made of encapsulated standard cantilever rod units with silicon rubber compound. This protection has proved to be totally effective when canisters have been inspected during routine pump overhaul, which now takes place once in every 4 years. The only operational problem encountered with the canister of the brine recirculation pump cathodic protection has been the growth of crystal layer on the anodes which eventually hinders the effectiveness of the anode. The rate of crystal build up appears to be dependent on the canister well water brine ingress. The brine pump anode canister current has been therefore adjusted and cleaning frequency increased in order to prevent anode non-functioning due to crystal growth.

**d. Other phenomena observed on Dubal cathodic protection system**

During the history of the Dubal cathodic protection system certain interesting phenomena have been observed. These phenomena are discussed below.

**\* Effect of brine conditions on corrosion levels**

When the experimental installation was put into operation on evaporator No. 5 in August 1983, satisfactory potential readings were obtained within a few hours and readings were then monitored twice a day. During the next month, variations in protective potentials were observed in the low temperature brine system at times when the Evaporator was running under steady conditions and occasionally the potentials moved into the corrosion zone above +0.25 V even when the anode current, into the "auto" mode, had increased to the maximum value. At first it was thought that the level of dissolved oxygen was the factor involved, but after an exhaustive procedure of taking brine samples and chemically analyzing for dissolved oxygen over some weeks, a relationship could not be seen.

At the end of November 1983, a multi pen chart recorder was set up on No.5 evaporator. This instrument had been purchased specially for this application and had great flexibility to accommodate the differing signals available. Initially, it was set up to record, brine flow, top brine temperature, reference potential at brine low temperature, anode current for brine low temperature group, and reference potential at brine inlet manifold.

Within 24 hours it was seen that with the evaporator in steady operation, a series of peaks had been traced in the low temperature brine potential and anode current at intervals of 4 hours. It did not take long to establish that these peaks coincided with the chlorine slug dosing regime that was in operation as protected potential moved from +0.20 V to +0.30 V during the period of the slug dose. Similar effect in seawater feed did not appear to be a problem as no change in potential observed during the slug dosing period. This phenomenon has not been investigated further since in January 1984 Dubal made the decision to stop slug dosing in view of its serious corrosive effect on the brine system. The sea water system has since received continuous low level chlorination, which has, given satisfactory control of marine fouling.

The chart recorder was kept in service on the No. 5 evaporator experiment until June 1984. The following facts concerning the effects of brine conditions on corrosion were noted: -

- a. The high temperature brine at the brine inlet manifold was most aggressive at lower brine flow mainly due to increase in pressure (turbulence). This therefore enhanced the cavitation rate and increased the corrosion rate.
- b. No major shift in potential observed on the instrument with an increase in dissolved oxygen.

- c. The low temperature brine systems were subjected to severe corrosive attack if high level chlorination is used, but the impressed current protection is able to control this.

\* **The effects of calcareous deposition**

One of the most noticeable features observed in various sections of the Dubal cathodic protection system has been the build-up of the familiar calcareous deposit in the following areas of the plant: -

- a. Around anode. The build up is not desirable as it leads to stifle the anode effectiveness.
- b. General deposition on carbon steel surface away from the anode site. This deposition heals over any corroded or bare metal areas and if left undisturbed, it forms a self healing protective coating which is thought to be a major factor in yielding good cathodic protection performance by assisting current reach and reducing the anode current demand. During the history of the use of the cathodic protection system, it has been noticed that the calcareous deposit formation is assisted by the use of a degree of overprotection in the cathodic protection supply. This observation was particularly prevalent in respect of certain parts of the plant (i.e. water boxes and brine inlet manifold) from which the calcareous deposit was removed from time to time during acid cleaning. Thus after each evaporator acid cleans, a potential of +0.1 volts (zinc) applied for around a month on these particular sections of the plant before altering the cathodic protection potential level to the normal level of +0.25 volts.

\* **Persistence of polarization**

This phenomenon could be said to be a feature of so-called "over protection", but it is certainly most beneficial when present. The effective protection of the moving bandscreens depends on this during the period that it is exposed to the atmosphere. It is rarely necessary for Dubal to run the screens continuously and the normal operating regime ensures that each bandscreen is rotated one and half times per day.

A good example of persistence of polarization was observed on 8th March 1988 when the sea water manifold was drained for a brief inspection during a planned one day shutdown for modifications to the steam main. The manifold was drained for 20 hours and when refilled with slow flowing sea water for a further 33 hours it was observed that the zinc reference electrodes were all reading + 0.20 V or less before the anodes were switched on. In some cases this phenomenon is explained as an effect which is been caused by scale formation on the surface of the protected area. This has been also checked in the test loop where a system was runned for few days with protection system were switched off.

\* **Brine pump canister crystal growth**

As described previously, the anodes to protect the outside of the brine pumps suction canisters were made by encapsulating anodes with plastic mounts and suspending them in the annular space. A plastic shield was also screwed on to the mount to prevent the anode rod making direct contact with the cathode surface. After a few months of satisfactory operation, it was noted that the anode current was falling. Inspection of the anodes showed them to be almost totally blocked with a semi transparent growth of columnar monoclinic crystals. Analysis showed the crystals to be calcium sulphate dihydrate. At present they are cleaned on a routine monthly basis before anode current starts to reduce. The growth of crystals had been observed on the outside of the canister, which is the cathode surface.

**5. Operational and maintenance requirements**

The most important requirement for the installed cathodic protection of the desalination plant was the availability of a comprehensive manual covering a description of the system which in turn gave a precise guidelines for operation and maintenance of the newly installed equipment's. Some aspects of the operational and maintenance activities are described below: -

\* **Operation**

The values of total anode current and voltage were recorded initially for each group of anode circuits once per shift as part of the Evaporator Operator's normal duties, this reading has been discontinued. Any noticeable change is logged and is investigated further by an Engineer during the next few days. At present on monthly basis a complete set of individual anode currents and reference potentials is recorded and any variations are investigated by either this writer or by area engineer. Any adjustments needed are made by the Electrical Engineer in consultation with the Operations Engineer.

\* **Safety**

The whole of Dubal's Power and Desalination operation and maintenance are controlled by a comprehensive and rigidly enforced Permit-To-Work system (PTW). Fortunately, the impressed current Cathodic Protection system does not constitute an electrical hazard under any conditions. In normal operation, the highest voltage to earth is less than 10 V DC, but an anode, if energized in the auto mode in a pipe or vessel that is empty, could reach 15 V DC. Since entry into vessels is controlled by the PTW system, which would require anode circuits to be isolated, there is little chance of exposure to even this very minor hazard.

It is possible for a spark to be generated from an anode, but in Dubal's plant anodes are not located in an areas where an explosive atmosphere exists. There is a remote chance of hydrogen gas accumulating due to electrolysis in a pocket of static water



Figure 3.5: Corrosion Fatigue

g. **Erosion corrosion**

Erosion corrosion is deterioration associated with rapidly flowing fluids and involves both mechanical and chemical modes of attack. Erosion corrosion of metals can result from the removal of the protective film of corrosion products, which serves as a barrier to corrosive attack of some metal<sup>3</sup>. It is more severe when suspended solids (like sand from the seawater intake) are present in the fluid. Erosion corrosion often occurs in the condenser of the heat reject section of an M.S.F plant, containing entrained air, and solid particles, which circulates at very high flow velocity.



Figure 3.6: Erosion corrosion

h. **Cavitation corrosion**

Cavitation corrosion results from the damage of material associated with the collapsed of cavities in the liquid at a solid - liquid interface<sup>15</sup> (figure 3.7). It is mainly due to repeated collapsed of the vapour bubbles on the metal surface, which removes the protective film (cavitation corrosion). Flowing divergence, water rotation, and restriction orifice create the low-pressure regions. This type of corrosion is very common in the M.S.F plant brine circulating pump impeller.

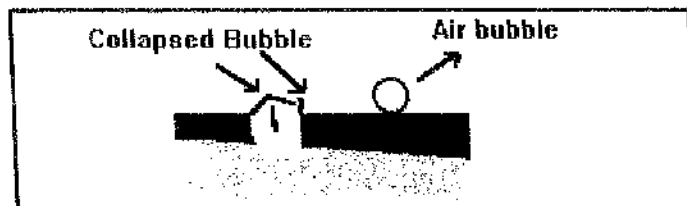

Figure 3.7: Cavitation damage



### **i. Intergranular Corrosion**

Intergranular corrosion results from preferential attack on the grain boundary zone, and or in an adjacent zone which has lost an element necessary for adequate corrosion resistance.

## **4. Influence of environmental factors on corrosion rate**

### **a. Introduction**

There are many environmental factors, which affect the corrosion behavior of metals or alloys in aqueous environments, especially seawater. The corrosive effects of seawater are caused mainly by six factors: solution salinity, temperature, velocity, pH, and dissolved gases and microorganism bacteria<sup>3,7,14</sup>. In the present study the first four factors are those which determine the different experimental conditions.

### **b. Sea water salinity**

Corrosion, as previously mentioned is an electrochemical phenomenon, and the electrical conductivity of the medium that progresses corrosion is important and complex. Dissolved salts present in the form of charged ions increase the electrical conductivity of seawater and therefore increases the current flowing in corrosion cells. However, corrosion rate dose not increase linearly with an increase in solution salinity, as some ions increases the corrosion (e.g. chlorides and sulphate ions) and some reduce corrosion (e.g. carbonates, bicarbonates) as these ions tend to form a protective layer.

Higher conductivity is a beneficial element in this study where cathodic protection is applied, as it enables the impressed current cathodic protection to reach large and remote surfaces by installation of anodes.

### **c. Temperature**

Temperature affects the corrosion rate. This is because each metal can only operate up to a maximum allowable limit, above which it is likely to be attacked in sea water at an excessive rate. The effect of temperature is complicated as higher temperatures cause more rapid chemical reaction rates but also increase in temperature can in some ways decrease corrosion by formation of insoluble scales on metal surface on account of the lower solubility of some scale compounds with increase in temperature. Increase in temperature as well can cause a reduction in the solubility of O<sub>2</sub> and other gases in water and this might in some case results in a lower corrosion rate.

The effect of temperature on corrosion rate of metal has other complications, which depend very much on the metal composition. For instance, in the case of stainless

steel, the ability of chloride ions to penetrate and destroy passive local films increases with increase in temperature. In addition, temperature accelerates the possibility of stress corrosion cracking.

#### d. Velocity

When seawater flows at a certain velocity past a metal surface, the consequences with regard to corrosion of metal are twofold and opposed: -

\* Flowing seawater at recommended (table 3.1) velocity prevents fouling and formation of marine growth on the metal surface, and hence reduces corrosion rate e.g. pitting corrosion.

\* Higher rates of flow, increases the corrosion rate mainly due to increase in the supply of cathodic reaction ( $O_2$ ) by mass transfer to the metal surface and by removal of corrosion products as protective film breakdown is more prevalent.

Material	Design Velocity ( m/s )
Copper	0.75
aluminum brass	2.5
90/10 Copper Nickel	3
70/30 Copper Nickel	3.5

Table 3.1: Selected material. Vs. design velocity<sup>16</sup>

#### e. pH

Change in the hydrogen ion concentration of a solution is one of the most critical factors affecting the rate of corrosion<sup>3</sup>. In general, when the solution pH value is maintained high, passive oxide films are more likely to be stable, whereas at lower pH oxides tend to be unstable and hence the corrosion rate increases. Also at low pH hydrogen ( $H_2$ ) evolution cathodic reaction (cathodic reaction) becomes importance and where this reaction often can occur more rapidly then the  $O_2$  reduction reaction.

#### f. Dissolved gases

Dissolved gases present e.g., free carbon dioxide in solution, reduce the solution pH and hence prevent a formation of a passive film. This therefore increases the corrosiveness of the solution, mainly due to the presence of a higher concentration of dissolved  $O_2$ , which leads to fueling of cathodic reaction. Some other gases, e.g. hydrogen sulphide, chlorine, can impart extremely aggressive characteristics to water in which they are present. For instance chlorine can cause increase in corrosion rate of many materials if overdosed or slug dosed.

### **g. Biological organisms**

Certain bacteria and other biological organism can cause corrosion. This may be done due to microorganisms reproducing on a metal surface and their metabolic processes producing corrosive condition. For example, Sulphate reduction bacteria (SRB) produce highly corrosive  $H_2S$ . Additionally larger biological organism (e.g. barnacles) may shield the underlying metal making it depleted in  $O_2$  and hence promote underlying pitting.

### **5. Corrosion control methods**

The material of construction for any process plant (e.g. MSF desalination plant) where corrosion is an important factor is selection based on corrosion resistance of a candidate material to the process plant environment. Within the economic limits of the application, usually the most corrosion-resistant material is used. However, even the most corrosion-resistant material is subject to some corrosion. At times of plant design, economics may not permit the use of the most corrosive-resistant material and it may be necessary to use a less costly material with corrosion rates higher than desirable. When used, such materials must be protected against corrosion, as corrosion will result in frequent plant shut down, lower output, and increased replacement and maintenance cost. Corrosion cannot be completely prevented or stopped, but it can be minimized to a rate, which can be justified economically and technically. The following are six important methods, which are used to either reduce or prevent corrosion<sup>3,5</sup>:-

#### **a. Design**

Corrosion can be either reduced or prevented by incorporation of the corrosion principles at the design stage of any process plant. The following are some examples, which should be considered during plant design.

- \* Provision of the correct draining facility in order to prevent or minimize water contact with parts of plant during plant shut down periods, since shallow pools of water are highly aerated and therefore highly corrosive.
- \* Avoiding galvanic corrosion by preventing contact of dissimilar metals, especially if the metals are widely separated in electrode potential value.
- \* Cladding or using good corrosion-resistant materials for areas of the plant which operate under high temperature and velocity conditions.
- \* Cavitation should be avoided.
- \* Avoid stray currents from electrical installations.
- \* Crevice and ledges should be avoided, and adequate access should be provided to allow removal of debris.

## b. Material selection

As mentioned earlier selection of material has a significant role in deciding the capital cost and eventual life of any process plant. It is not straight forward process because of the many types of corrosion and their dependence on the environmental conditions. Lower plant output and higher maintenance cost is mainly due to incorrect choice of materials (table 3.2).

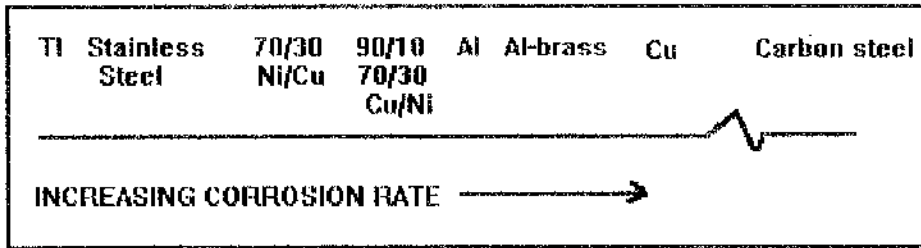

**Table 3.2: General Corrosion rate in moving, aerated seawater at ambient temperature for different materials<sup>3</sup>**

### \* Carbon steel

Carbon steel is an inexpensive alloy, which has been used extensively in the manufacture of desalination plants<sup>10</sup>. It has the advantage of being abundant, easy to fabricate and structurally strong. However, high corrosion rate of unprotected carbon steel is major problem in the plant. For example, in ambient-temperature seawater the corrosion rate of carbon steels increases with increase in flow velocity (table 3.3). The form of corrosion is experienced by carbon steel in sea water is usually general corrosion over the entire component surface where the attack is enhanced at elevated temperature, low pH and high flow rate. A number of approaches; for example, design, cathodic protection, anodic protection, protective coating and modification in environments are available in principal for the control of corrosion on component made of carbon steel. Indeed the basis of this study is the use of cathodic protection of carbon steel pipelines.

Seawater flow ( m/sec )	Corrosion rate ( mm/year )
0	0.1 to 0.2
3	0.75
40	5

**Table 3.3: Corrosion rate of carbon steel as a function of flow rate<sup>3</sup>**

### \* **Alternative metallic materials**

There are many occasions where the most suitable tactic is to choose a material with more corrosion-resistant such as titanium, copper base alloys and stainless steel. Tables 2.2 and 2.3 of Chapter 2 outline the current trend of material selection for a large range of MSF plants and the factors which influence their selection for the major parts of a plant.

### \* **Polymer based materials**

A polymer is usually defined as a high-molecular weight organic compound, natural or synthetic, made up of the repetition of a small simple unit, the mer<sup>8</sup>. Polymers have been used for intakes and venting systems in distillation plants as their corrosion resistance is greater than that of metals in low temperature corrosive environments like seawater. However, polymers also degrade with high temperature since their strength decreases and leads to thermal degradation. Materials such as glass reinforced plastic are characterized by improved mechanical strength. Within the scope of this thesis a cost comparison of Dubal's controlled loop has been undertaken, in order to predict the economics of constructing a loop using G.R.P material or carbon steel, together with an on line impressed current cathodic protection system.

### c. **Cathodic protection**

Cathodic protection is an application which is used to protect metals, in particular carbon steel, from corroding, by reducing and shifting the metal potential in the negative direction to a value at or below its equilibrium electrode potential<sup>17,18</sup>. This allows the metal to support only cathodic reaction upon its surface. There are two methods of achieving this, either by using an impressed current from a D.C generator or by connecting the component to a material, which is more electronegative. This is known as the sacrificial anode.

A more detail explanation of this method will be explained in the next chapter of this thesis. The main work of this research has been concentrated on the benefits of an impressed cathodic protection system in MSF plant, where carbon steel material in seawater at various conditions is used.

### d. **Anodic protection**

Anodic protection is an application used to protect some metals in certain environments from corroding, by shifting potential to more-positive values where passive oxide films become more stable<sup>15</sup>. It is extremely unsuitable for use in sea water systems mainly due to the chlorides present, which has a great tendency to destroy the protection given by oxide films.

### e. **Coatings**

Many types of coating are available and used for general corrosion protection. The main types of coatings, are metal, organic and inorganic coatings, where the main function is metal surface protection by exclusion of the corrosive environment. The most common and widely used form of surface protection for iron and carbon steel component is painting (e.g. flash chamber), where the efficiency of the applied paint is mainly dependent on the initial cleaning of the metal surface.

### f. **Modification of the environment**

There are two basic methods of modifying the environment in order to reduce corrosion rates. These are: -

- \* Removal of aggressive species such as a reduction of dissolved oxygen in the circulating brine.
- \* Dosage of a corrosion inhibitor to reduce corrosion rates in the circulating water system.

## 6. **Conclusions**

This chapter has comprised a summary of the main features of sea water corrosion, the different forms that corrosion can take and a review of the various approaches to corrosion control.

However, of the various segments of this chapter, the most relevant to the research described in this thesis are the general corrosion of carbon steel (and the influence of environmental factors on this) and the role of cathodic protection in controlling such corrosion. These particular aspects will receive more detailed attention in subsequent part of this thesis.

## CHAPTER FOUR CATHODIC PROTECTION

### 1. Introduction

Cathodic protection is an electrochemical technique that is often used to reduce or prevent corrosion in pipelines and other buried or submerged metallic structures. Cathodic protection may be used alone or in combination with an insulating coating where coating forms the first line of defense.

It is important to realize the direct impact of the role that cathodic protection plays in today's realm, as it virtually extends into every industry in our economy. In the financial area one can calculate the impact simply by assessing the costs of the original installation, replacement, labor, maintenance, and production losses due corrosion. Comparing the said cost factors, the end result of corrosion and the total cost associated with, it is easily realized when the losses continue to soar to astronomic plateaus.

Figuratively, cathodic protection can be compared to a falcon; it extends its large wings over a wide variety of engineering and scientific fields as it is directly affected and intertwined with metallurgy, electrical engineering, geology, chemistry, biology, ecology, instrumentation, material sciences, and mathematics.

There are two types of cathodic protection systems used to protect metal in corrosive environments; these are sacrificial anode and impressed-current systems<sup>18</sup>. Often, the decision to use one type of system over the other appears to be arbitrary, but it is usually based on economic, technical, and application factors. However, when properly designed, either type of system can be effective in reducing the corrosion rate on the structure to be protected.

The success of cathodic protection installations depends on correct design. Every precaution should be taken at the design stage to allow for deviations, extensions and other problems that may arise at the site during installation. Numerous mathematical equations are calculated for the safe and effective implementation and performance of the system.

The pipeline industry, shipping, and jetties are three of the major users of cathodic protection<sup>19</sup>, particularly in under ground pipelines which carry fuel. Therefore, it is

essential to study fully during design stage certain conditions such as the soil condition, water salinity, velocity, temperatures, geographical locations, as these are the indicators that are useful in evaluating underwater and underground corrosion rate.

Mainly, due to an increased awareness in the minds of buyers whom are concerned with productivity and profitability, cathodic protection is now becoming accepted as a practical and economic method of corrosion control to the extent that it is now being incorporated in the initial concept of a project rather than being added as a palliative where corrosion is already being experienced on existing plant or equipment.

## **2. Historical background**

The first recorded mention of cathodic protection is by the British physicist Sir Humphry Davy. As a result of a laboratory experiments in salt water Humphry reported in 1824 that copper could be successfully protected against corrosion by coupling it to iron or zinc<sup>9</sup>. He recommended cathodic protection of copper-sheathed ships, employing sacrificial blocks of iron attached to the hull in the ratio of iron to copper surface of about 1:100.

In practice, the corrosion rate of copper sheathing was appreciably reduced, as Davy had predicted, but unfortunately cathodically protected copper is subject to fouling by marine organisms. Since the fouling reduced the speed of the ships under sail, the British Admiralty decided against the idea.

After Davy's death in 1829, his cousin, Edmund Davy (professor of chemistry at the Royal Dublin University), successfully protected the iron work of buoys by attaching zinc blocks, and Robert Mallet in 1840 produced alloy particularly suited as a sacrificial anode. When wooden hulls were replaced by steel, the fitting of zinc slabs became traditional on all Admiralty vessels.

These slabs provided localized protection, especially against the galvanic effects of the bronze propeller, but the Canadian Navy did not explore the overall cathodic protection of seagoing ships again until about 1950, this time. By proper use of antifouling paints in combination with anti-corrosion paints, it was shown that cathodic protection of ships is feasible and can save appreciably in maintenance cost.



The first application of an impressed current system for protection of underground structures took place in England and in the U.S.A, about 1910-1912. Since then the general use of cathodic protection has spread rapidly, and now thousands of miles of buried pipelines, canal gates, offshore platforms, and various process plants such as MSF are effectively protected against corrosion by this means.

### **3. Cathodic protection basic principle**

There are a number of ways of describing the cathodic protection process principle<sup>18</sup>. One way is to view the corroding metallic surface as being made up of local anodes and cathodes that develop when the metal is first immersed in an electrolyte such as seawater. In this situation the corrosion reaction takes place at the anode sites resulting in the oxidation of the metal to form metal ions. At the cathodes, simultaneous reactions must occur in order to maintain a balanced electrical charge.

When cathodic protection is applied, a net cathodic direct current is applied to the metal surface. As the metal surface begins to polarize (or change in potential), the anodic current corresponding to the corrosion rate decreases in a proportion to the applied net cathodic current. When the cathodic current is made sufficiently large, the anodic reaction or corrosion rate is reduced to a negligible value.

In general, the quantity of current, specifically, the current density, to achieve protection will depend upon the metal, the environment where metal is immersed (e.g. temperature, water velocity, oxygen level, calcareous deposits) and time where these factors are interrelated, and will also influence the selection of the type of cathodic protection system which will be considered to achieve protection.

The cathodic protection process, therefore, is an application which is used to protect many metals, in particular carbon steel from corroding by reducing and shifting the metal potential in the negative direction to a value at or below its equilibrium electrode potential.

As mentioned earlier, there are two methods of applying cathodic protection to a metal structure in a corrosive condition such as a marine environment; these are sacrificial anode and impressed-current systems.

**a. Sacrificial anode system**

An anode, made of a metal with a more negative electrode potential than that of the structure, is submerged in the electrolyte and connected externally to the structure to form a galvanic cell. The protective or 'sacrificial' anode corrodes in preference to the cathodic structure (figure 4.1). Specially formulated alloys of magnesium, zinc or aluminum are used for making sacrificial anodes for the protection of steel.

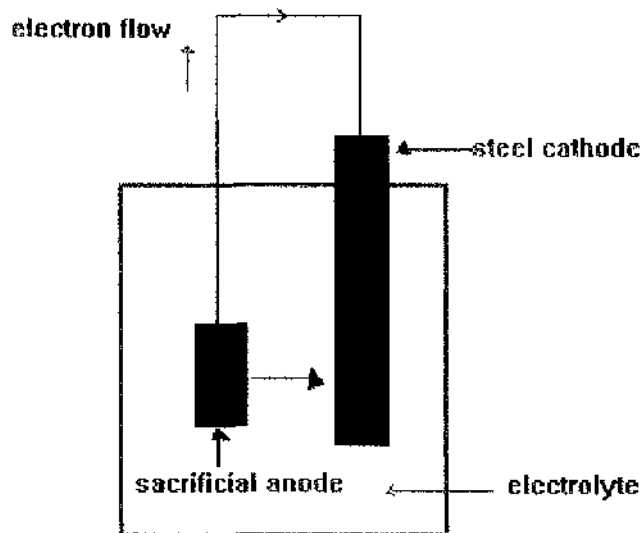

**Figure 4.1: Sacrificial anode cathodic protection<sup>19</sup>**

**b. Impressed-current cathodic protection**

The required protective direct current in impressed-current systems is provided by an external source, which drives a direct current from nearby anodes through the electrolyte to the structure to be protected. The power supply source is generally a transformer-rectifier, which converts AC to DC (figure 4.2). This type of cathodic protection system is employed to protect the constructed test loop and is placed in many parts of Dubal's MSF plant. The impressed cathodic protection system also includes the automatic control of the protective current such that a pre-selected level of potential is maintained on the protected structure regardless of the change in conditions.

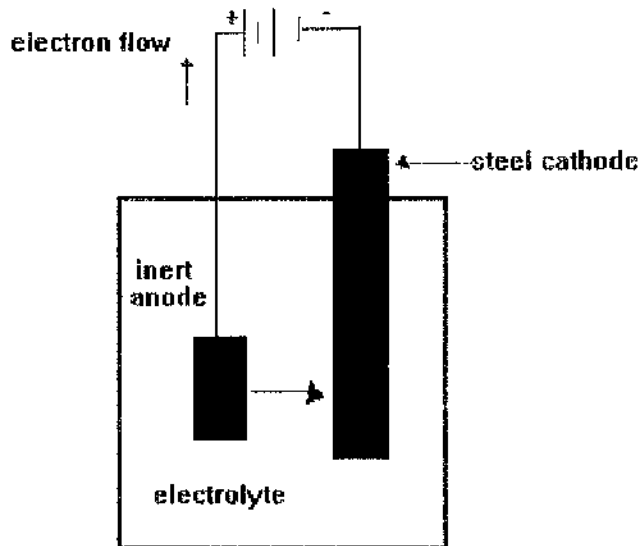

**Figure 4.2: Impressed current cathodic protection<sup>19</sup>**

#### 4. Designing of cathodic protection system

Cathodic protection systems need to be carefully designed and engineered in order to ensure that all parts of a component or structure are completely protected without incurring excessive costs in electricity or sacrificial anodes. Therefore, before designing a cathodic protection system the following data will be required and must be considered<sup>10, 17, 18, 19</sup>.

- a. Customer preference in system design.
- b. Approximate surface area to be protected.
- c. The configuration of all structural steel work to ensure adequate distribution of anodes.
- d. Details of pipelines steel works above and under water.
- e. Nature of any coatings, to be applied and extent of application.
- f. Period of the time the protection is required, together with estimates of coating performance.
- g. In the case of an existing installation, age and condition of the structure's steel, work and coating.
- h. Availability of electrical power supplies.
- i. Location of the structure, weather cycle, water depth, and nature of sea bed.
- j. Water salinity and temperature.
- k. Design limitation especially with respect to weight loading of structure.

However, the main criteria during the design of a cathodic protection system is largely based upon the level of potential to be achieved and/or system current densities, which involves calculation of the surface area of the structure which needs to be protected. The required current for protection, as explained earlier, varies around the

world and indeed will vary locally in one particular area dependent on a variety of conditions.

## 5. Anode materials

A number of anode materials are now available for both cathodic protection methods. In case of impressed current the anodes should be effectively inert with very low consumption rates as compared with the sacrificial anode system. Table 4.1 illustrates several types of anodes, which are used for impressed current systems in marine environments. For protection of structures in seawater, platinized titanium has been widely used and recommended as corrosion resistant anodes using impressed current. Alternatively, active metals such as aluminum, zinc and magnesium are normally used with sacrificial anode, cathodic protection systems. Zinc and aluminum are far the most commonly used in marine applications. The environment and the temperature in which the anode operates can alter the efficiency and capacity of each anode.

Anode Material	Comments
Scrap steel	life predication is difficult
Graphite	Very brittle
Lead-silver	Susceptible to failure
Lead-Platinum	*****
Platinized Titanium	Susceptible to failure, 10 years life obtainable

Table 4.1: Impressed current cathodic protection anode materials<sup>19</sup>

## 6. Cathodic protection system selection criteria

To obtain a situation where there is no corrosion at the cathode surface, it is necessary to ensure that the protective current is passing onto all parts of the cathode surface. Therefore, the decision to use one type of system over the other is not a straightforward decision as the current required to establish full protection depends on many factors such as size and complexity of structure, availability of power supply, nature of the electrolyte, and economics. Tables 4.2 and 4.3 list some of the advantages and limitations to both types of cathodic protection systems.

Advantages	Limitations
Simple installation and low maintenance	Limited current possible
Immediate protection and reliable	Anode weight
No capital cost for power equipment	Critical weld region of anode attachment
Prevent over protection	Limited accessibility
Even current distribution with little supervision	Limited driving voltage

Table 4.2: Advantages and limitations of sacrificial anode system<sup>19</sup>

Advantages	Limitations
Flexible in protection level	Continuous Availability of D.C power
Availability of continuous protection monitoring	Requirement for trained and technical personnel
Availability of automatic control potential	Possibility of overprotection
Low initial capital cost	Uneven current distribution
Immediate accessibility to the monitoring system and most equipment in case of any fault	Equipment damage in certain rough environments

Table 4.3: Advantages and limitations of impressed-current systems<sup>19</sup>

### 7. Criteria of protection

The effectiveness of cathodic protection in practice can be established in any environment by maintaining a predetermined adequate level of protection throughout the expected life of the structure. Basically, the level of protection required corresponds to the "equilibrium electrode potential ( $E_0$ )" for a given metal in a particular environment since at potentials more negative to  $E_0$  (figure 4.3) the anodic reaction can not occur. The design of cathodic protection systems is largely based upon current densities required to force the component electrode potential to the value of  $E_0$ , but the actual monitoring of the cathodic protection level is assessed by measurement of the potential of the structure in the environment with respect to a reference electrode. The most commonly used reference electrodes in seawater are zinc, silver/silver chloride, and copper/copper sulphate<sup>19</sup>. It is generally accepted that a potential of at least  $-0.8$  v (Ag/AgCl) at the steel in seawater interface is sufficient for complete protection (table 4.4).

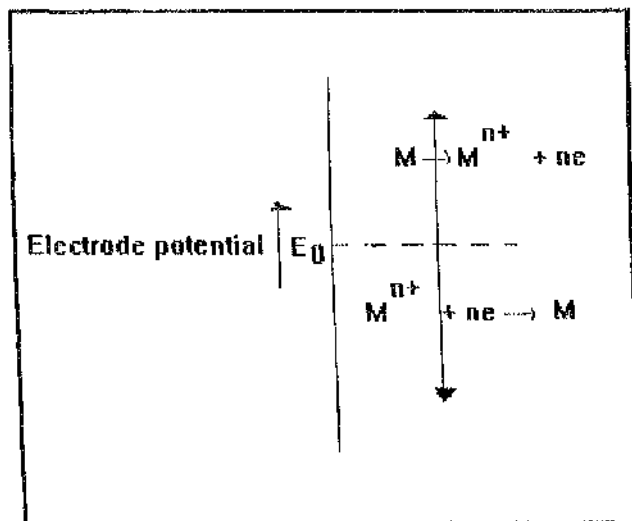

Figure 4.3: Direction of electrode reactions as a function of electrode potential

Metal or alloy	Ag/AgCl <sup>+</sup>	Cu/Cu sulphate	Zinc
*****	Volt	Volt	Volt
Iron and Steel	-0.8 to -0.9	-0.85 to -0.95	+0.25 to +0.15
Lead	-0.55	-0.6	+0.5
Aluminum	-0.9 to -1.15	-0.95 to -1.2	+0.15 to -0.1
Copper based alloys	-0.45 to -0.6	-0.5 to -0.65	+0.6 to +0.45

**Table 4.4: Minimum values of metal/electrolyte potentials for cathodic protection<sup>20</sup>**

\* Note: Potentials recorded using Ag/AgCl reference electrode are very close to those recorded using saturated calomel Electrode (SCE).

However, because of the complex and varied nature of marine environments, variances from these -0.8 v criterion and current density requirements have been recognized. Cathodic protection system monitoring is carried out to ensure that the structure under protection has been polarized to at least the minimum required level. Silver-silver chloride or zinc reference electrodes are often used for these measurements.

### 8. Magnitude of current density required

The current density required for complete protection depends on the metal and on the environment. The applied current density as a norm must always exceed the current density equivalent to the measured corrosion rate in the same environment. Hence, the greater the corrosion rate, the higher must be the impressed current density for protection. The precise requirements of current density for complete protection can be determined in several ways; the most important is potential measurement of the protected structure. In commercial practice a range of current density has been quoted for the protection of exposed iron or steel in seawater at ambient temperature which vary from 80 to 500 (mA/m<sup>2</sup>)<sup>20, 21,22</sup>. However, these can only be used as an guide since, following interrelated factors effect the need for current density and system driving voltage for achieving the required level of protection of a specified structure: -

### 9. Calcareous deposits

The term 'calcareous deposit' is generally taken to refer to either Ca-rich or Mg-rich scale. The formation of alkaline scale deposits such as CaCO<sub>3</sub> and Mg(OH)<sub>2</sub> on steel surfaces in seawater environments generally will result in a reduction of the cathodic protection system current density requirements as calcareous deposits act as an effective barrier to oxygen diffusion to the steel surface. As mentioned earlier in Chapter 3, oxygen reduction and hydrogen evolution reactions, depending upon the applied potential, occur on the metal surface and generate hydroxyl ions, as follows: -



or

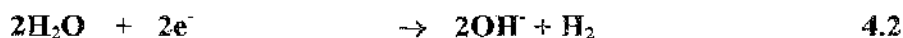

These reactions therefore increase the pH near the metal surface to values of about 11 as calculated by Hartt and Wolfson<sup>23</sup>, and Engell<sup>24</sup>. This results in the precipitation of either or both magnesium hydroxide or calcium carbonate, as follows:

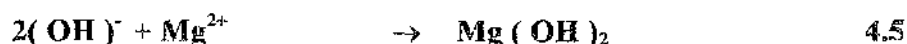
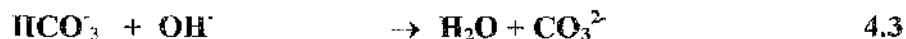

Normal seawater at ambient temperature is very close to saturation with  $\text{CaCO}_3$  and requires very little extra assistance in the form of an increase in local pH to push reaction (4.3) to the right and hence saturate the seawater with  $\text{CaCO}_3$ . Seawater at ambient temperature is well below saturation with  $\text{Mg}(\text{OH})_2$ . However an increase in local pH, to values calculated<sup>25</sup> as about 9.2 at 25 °C, can result in saturation with  $\text{Mg}(\text{OH})_2$ .

It has also been suggested that precipitation also assisted by attraction of  $\text{Mg}^{2+}$  and  $\text{Ca}^{2+}$  ions to cathode sites<sup>26</sup>. As calcareous scale covers the metal surface, the overall rate of cathodic reaction decreases. Some of the earliest work on the role of calcareous deposits on cathodic protection by Humble<sup>27</sup> studied the effect of chemical composition of the scale, i.e. the relative amounts of  $\text{CaCO}_3$  and  $\text{Mg}(\text{OH})_2$ , on current density, water composition, and velocity. Scale of either type might be expected to precipitate and grow faster under seawater flowing conditions than those formed under stagnant conditions mainly due to supply of ions. However, increasing flow velocity tends to decrease the deposit thickness due to hydrodynamic effects. A number of studies have been done to better understand the relationship between the parameters of cathodic protection and various properties of the deposit. For instance Hartt et al<sup>28</sup> provided a useful review of the formation of calcareous deposits from seawater and the influence of cathodic protection. Since the Hartt<sup>28</sup> review in 1984, a number of other investigations of cathodic protection/scale inter-action have been undertaken. For example a paper by Kunjopor et al<sup>29</sup>, contains some interesting discussion of the comparative precipitation of  $\text{Mg}(\text{OH})_2$  and  $\text{CaCO}_3$  and the location of the cathodic reaction which will be referred to in the later part of this thesis but the comparison was complicated by the use of incorrect data that was supposed to show that the solubility of  $\text{Mg}(\text{OH})_2$  increases with increasing temperature in contrast evidence of a decrease solubility of  $\text{Mg}(\text{OH})_2$  with increase temperature<sup>30</sup>. A possible complication is that  $\text{Mg}^{2+}$  in seawater may inhibit precipitation of  $\text{CaCO}_3$ <sup>31</sup>. Ambrose et al<sup>32</sup> also provided a detailed discussion of cathodic protection and scale inter-reaction but were unsuccessful in attempts to determine the morphology and composition

of calcareous deposits. Their paper also contains constant errors in converting from  $\text{mA/m}^2$  to  $\mu\text{A/cm}^2$ .

Another study<sup>33</sup> was mainly devoted to the relative effect of the type of cathodic polarization (potentiostatic, galvanostatic or mixed mode) upon the properties of the calcareous deposit. The authors discussed the important point that in potentiostatic control the cathodic protection current density and thus the  $(\text{OH})^-$  production decreases with time but in the galvanostatic mode, the current density and  $(\text{OH})^-$  production stays constant. They reported that the calcareous deposits generally consisted of a relatively thick continuous Mg-rich inner layer and a more voluminous, Ca-rich outer layer consisting of individual particles. However the presence of the Mg-rich sub-layer was not confirmed at  $-900 \text{ mV Ag/AgCl}$  in this work, or in the other research<sup>34</sup>. Luo et al<sup>33</sup> also discussed the notion that Mg-rich deposits provide poor protection compared to Ca-rich ones which was an idea also mentioned earlier by<sup>29</sup> the same group of the workers. Another assertion by the authors<sup>33</sup> was that at  $-1000 \text{ mV Ag/AgCl}$  (but not at  $-900 \text{ mV}$ ), calcareous deposits spall because of  $\text{H}_2$  gas evolution. Perhaps the most interesting aspect of this study was the indication that a mixed-mode of cathodic protection, a brief (4 minutes) period of galvanostatic operation followed by potentiostatic control, provides a more protective calcareous deposit than either potentiostatic or galvanostatic alone. Probably one of the best paper<sup>35</sup> to emanate from the Florida Atlantic University group, included a number of very interesting findings. For instance, specimen surface finish was found to have no significant effect on calcareous scale properties and current density decay. Moreover it was demonstrated clearly that the first calcareous film deposited (in the early minutes of cathodic protection application, at  $-900 \text{ mV}$  and  $24-28^\circ\text{C}$ ) is Mg-rich. The longer-term calcareous deposits comprised a thin uniform Mg-rich inner layer (probably  $\text{Mg}(\text{OH})_2$ ) and thicker outer layers of interlaced  $\text{CaCO}_3$ . The  $\text{CaCO}_3$  was identified as aragonite and it was reasoned that this formed in preference to the more stable calcite modification because of the effect of  $\text{Mg}^{2+}$  on inhibiting calcite nucleation and growth.

However at less negative potential thus the  $-900 \text{ mV Ag/AgCl}$  involved in the work described above, the scale composition and morphology may be different. Thus some worker<sup>36</sup> reported a uniform coating of Ca-rich (no Mg) scale found on mild steel polarized to  $-700 \text{ mV (SCE)}$  at  $20^\circ\text{C}$ .

One study involved obtaining data from an instrumented system on a North Sea platform<sup>37</sup>. Although again containing statements as to the temperature dependence of  $\text{Mg}(\text{OH})_2$  (and  $\text{CaCO}_3$ ) solubility, this work yielded interesting current density/time and current density/potential data which will be considered in detail in the general discussion of this thesis in chapter 10. Evan<sup>38</sup> also discussed the influence of calcareous deposits on current density in relation to operation of offshore platforms and stated that, after deposition of a calcareous layer, protection current densities may fall to  $38-50 \text{ mA/m}^2$  from typical initial values of  $320 \text{ mA/m}^2$ .

Calcareous deposits have also been observed on the cathode of bimetallic couples in laboratory investigation in seawater<sup>39, 40</sup>. The calcareous deposits were found to reduce the galvanic current in an exactly analogous way to their effect on impressed current cathodic protection systems.



Some modeling work has been undertaken<sup>34, 41, 42</sup> in which a model was developed to examine how a variety of physical and chemical properties of seawater and cathodic protection affect calcareous scale formation. A problem with the model is that it appears to use data for  $Mg(OH)_2$  solubility that again incorrectly shows increased solubility with temperature. However its main findings are summarized below: -

- \* Deposits formed at more negative potential have a low ratio of  $CaCO_3 : Mg(OH)_2$
- \* A large influence of potential on current density associated with deposition of a more protective scale at more negative potential.
- \* Increased current density under more severe hydrodynamic conditions which were suggested to inhibit the scale growth.
- \* Lower scale coverage at temperature below 25 °C.
- \* There is only a small effect of salinity on calcareous deposition.

Jelinek<sup>42</sup> carried out another piece of relevant modeling work related to a cathodic protection system on a North Sea oil production platform. This computer model yielded prediction in good agreement with data acquisition studies from the platform. The workers found<sup>42</sup> a reduction in current density on the platform with the passage of time, which they associated with excellent calcareous scale, deposits. Although the reason for this excellent quality of the deposits was not fully understood, the authors suggested that a good calcareous deposit be formed by early overprotection. This was also the opinion of Evan<sup>38</sup> and indeed Wang et al<sup>43</sup> stated that application of a high initial current density to stimulate calcareous deposition, the so-called "rapid polarization" approach is now routines in the design of offshore cathodic protection structure. Thick adherent scale deposits were observed around anodes, an observation, which is in conflict with the assertion<sup>33</sup> that more negatives potential causes spalling of the calcareous deposit. The deposits comprised of calcite/brucite in the ratio 3:1.

In summary, although quite a lot of effort has gone into studying cathodic protection/calcareous scale interactions over a period of some 50 years, there is still much to be ascertained about this matter especially in relation to conditions pertaining to thermal desalination plant. For instance, the role of temperature has received more attention in relation to temperature below 25 °C rather, than the elevated temperatures of interest in Middle-East desalination plants. One clearly important aspect concerns the composition and morphology of the calcareous deposit. Most workers have not considered this in a really structured manner. Although an exception to this is the work of Mantel et al<sup>35</sup> which has demonstrated the formation of an initial thin Mg-rich layer followed by deposition of thicker  $CaCO_3$ . However it must be noted that these observation<sup>35</sup> were restricted to one condition (-900 mV Ag/AgCl and 24-28 °C) and it is quite possible that the nature of the calcareous scales in other condition may be different. Moreover, the detailed mechanism by which the calcareous scale causes the reduction in current density hence hardly, been considered at all. Therefore, one of the main intentions of this research is to extensively

study the above-mentioned influential parameters especially in desalination plant conditions and see its effects on the cathodic current requirement as a consequence of calcareous deposit formation.

## 10. Temperature

Current density and minimum potential requirement usually increases with increase in protected system operating temperature. Although, the effect of temperature is rather complex because an increase in temperature will result in a reduction of the  $O_2$  solubility (beneficial for corrosion) but also increases the rate of transport of oxygen to the steel surface by diffusion (which will tend to increase corrosion rate and hence cathodic protection current requirement) and will affect calcareous deposition. Some workers<sup>37</sup> have suggested that this competition results in the net current density slightly increasing with temperature. In contrast, Kettle<sup>44</sup> indicated that a calcareous deposit formation caused a large reduction of current density from initial  $435 \text{ mA/m}^2$  to  $35 \text{ mA/m}^2$  after 722 hours at  $40^\circ\text{C}$ .

## 11. Velocity

It would be expected that, on bare steel, the current density requirements for cathodic protection increase with increasing velocity. In fact, it has been suggested<sup>45</sup> that the required current density in seawater varies in direct proportion to water velocity. An increase in system velocity in seawater causes the products of the cathodic reaction to be removed more rapidly, and also increases the amount of oxygen arriving at the cathodic surface. However, one factor that can reduce the effect of velocity is the formation of calcareous deposits on the steel surface. Some very interesting detailed results were reported<sup>35</sup> in which the current density in the early stages of cathodic protection application at  $-900 \text{ mV Ag/AgCl}$  and  $24\text{-}28^\circ\text{C}$  (when Mg-rich film was identical) is linearly related to flow rate and the authors postulated that this could be due to either differences in dissolved oxygen transport through an  $\text{Mg(OH)}_2$  film and/or differences in the diffusion boundary layer beyond the film. In contrast, in a later phase of cathodic protection (when a thicker outer  $\text{CaCO}_3$  layer have also precipitated), the current density was found to be flow-rate independent. The authors suggested that this was because the calcareous deposit was sufficiently thick and resistive compared to the electrolyte diffusion boundary layer. Similar trends, involving a transition from a current density dependence on flow rate to a situation in which current density becomes independent of flow rate as a dense calcareous deposit is established, are reported<sup>37</sup> from offshore operations. Smith et al<sup>46</sup> have developed a relationship between the current requirements for cathodic protection in flowing seawater which also takes account of the presence of calcareous deposit.

## 12. Oxygen

The oxygen content of sea water is related to several factors, such as temperature, water salinity, and velocity. An increase in the oxygen content will generally promote

greater cathodic currents, and hence increase the current required to maintain adequate protection.

### 11. Effect of bio-fouling on cathodic protection

A number of studies have addressed this matter and findings are not particularly consistent. Some findings<sup>47, 48</sup> indicated that higher current densities are required in cathodic protection in the presence of bio-films due to less adherent calcareous scale. But Wagen suggests that they're some circumstances in which a combined covering of bio-film and calcareous deposit can be more effective as a barrier film during cathodic protection. Other workers<sup>49</sup> concluded that bio-films could be beneficial or detrimental for cathodic protection, depending on the magnitude of the cathodic protection current. Whilst the interaction between cathodic protection and bio-film are possibly important in many seawater application of cathodic protection (e.g. ships and offshore structure), they are relatively un-important in a thermal desalination plant where bio-film activity is likely to be minimal because of combined effect of temperature and feed chlorinations.

### 12. Cathodic protection in seawater installations

Cathodic protection has been successfully applied extensively to prevent corrosion on the exterior and interior surfaces of many seawater installations where the design of an efficient and effective cathodic protection scheme can be extremely complex and require high levels of attention. Cathodic protection of either type has proved to be more economical in seawater installations when the system is used in conjunction with organic coatings since the coating acts as a primary means of protection. Seawater installations can be broadly classified as: -

- a. Jetties / sheet piling
- b. Sub-sea pipelines.
- c. Water intake structures.
- d. Internal plant (e.g. storage tanks, pipelines, water boxes etc).
- e. Screening equipment and pumps.
- f. Ships (internal and external surfaces).
- g. Platform.

Normally for sea water installation structures require low current density, sacrificial anodes are generally most economical. Alternatively where large structures are protected, impressed current systems are cheaper to install for an area where the continuity of electrical power is not a problem. Therefore, factors such as economics and practical conditions determine which protective system will be use. Whichever system is chosen the results must satisfy the following main design criteri<sup>17, 18, 19</sup>: -

- a. Availability of sufficient current output from the system to polarize in order to maintain adequate level of protection. Sufficient current requirement varies from the type of seawater installation. Generally, factors, which reduce corrosion, will

if the anode remains immersed and energized, but the PTW procedures for draining and venting confined spaces ensure that this condition cannot occur.

\* **Storage**

Evaporators when drained and shutdown for long periods are exposed to atmospheric corrosion and special measures are needed to protect against this. At Dubal, it was found that a small modification to pipe work enabled an evaporator to be placed in a long term storage mode with all the systems normally under cathodic protection fully immersed in seawater and hence totally protected. The evaporator body itself was held under vacuum by intermittent use of the steam ejectors. This gives the advantage of a unit ready for rapid return to production even though in a long term storage mode. The present steam set up cycle makes it un-likely that this feature will be used in the foreseeable future on Dubal's plant.

\* **Maintenance in general**

This involves routine inspection of the wiring installation on a periodic basis together with investigation of any discrepancies, which are reported by operation as a result of the regular study of log sheets as recorded. The plant history over the years shows that there have been very few problems with wiring defects. Occasionally, anode terminals have caused problems due to corrosion. The combined transformer rectifier and control modules have been remarkably free from defects.

A principal maintenance activity is replacement of anodes and reference electrodes. There have been a small number of mechanical failures due to breakage, but the main reason for anode replacement is falling off of current output accompanied by increased driving voltage as a result of loss of the platinum coating. The following table summarized the anode life of individual anode as per area of use.

**6. Conclusions**

The installation of cathodic protection system at Dubal was initiated on experimental basis mainly due to severe corrosion damage which was occurring on many parts of its desalination plant i.e. evaporators brine section. Subsequent, to its success in protecting the plant against corrosion in broad basis, cathodic protection system was developed and upgraded in parts. The economics of this activity are starkly simple. Dubal has spent less on installing cathodic protection than it would have spent every year on combating corrosion damage.

Thus at Dubal cathodic protection system is a major successful application against combating corrosion on a large scale on a desalination plant. But, as summarized in earlier chapters, application of cathodic protection to desalination plant elsewhere has been extremely limited. This situation was the driving force for the Ph.D. project. Therefore it was felt that a detailed, focused study of cathodic protection on a desalination plant involving a further inspection of its current performance of the main desalination unit but

with the main emphasis on an experimental loop attached to one desalination unit would yield more detailed data and understanding of this corrosion control technique in the context of its application on desalination plant. The following aspects were focused on details during the core of this study: -

1. Influence of calcareous deposition on performance of an impressed current cathodic protection in desalination plant conditions with respect to: -
  - a. Temperature
  - b. Time
  - c. Applied potential
  - d. Antiscalant effect
  - e. Flow rate
  - f. Influence of intermitted cathodic protection system shut down on long term protection performance of cathodic protection system.
2. Economics of using carbon steel protected by cathodic protection versus G.R.E, which has seen extensively applied in other desalination plant and stainless steel.

These particular aspects will receive more detailed attention in subsequent part of this thesis.

## CHAPTER SIX OVERALL METHODOLOGY OF THE RESEARCH WORK

### 1. Introduction

The major aspect of the Ph.D. project was a detailed focused study of cathodic protection on relatively small controllable loops. Thus one loop was constructed at Glasgow University and a more substantial loop was constructed at Dubai and attached to one of desalination units. These loops are described in a later part of this chapter. The important philosophy behind the Dubai loop was to obtain additional detail information on the performance of the cathodic protection in desalination plant conditions in order to complement the more general information obtained from the major components within the large desalination units.

The additional aspect of the project comprised of a close internal inspection of the condition of a number of segments of the desalination units in respect of the performance of the cathodic protection system. The aims of this part of the project were twofold: -

- a. To record the current condition of the plant and therefore effectiveness of the cathodic protection system so as to facilitate a assessment of the effectiveness of the cathodic protection after 10 to 12 years of operation.
- b. To serve as a link between the results of the main detailed loop studies and their interpretation in terms of their relevance to the performance of cathodic protection on the large units.

### 2. Description of Dubai's once through test loop

To facilitate the trials on impressed current cathodic protection system, a once through test loop was set up using sections of evaporator 5 and 6 off load acid cleaning system. The choice of the selection was made based on section accessibility throughout the year and its flexibility in term of altering test required flow rate, temperature, and water salinity. The loop is shown in figures 6.1 and 6.2. It comprised a main horizontal leg, approximately 15 metre long and 0.25 metre diameter constructed of carbon steel. This was connected via an elbow shape of similar pipe to the holding tank, which acted as the interface between the loop and the evaporator. By connection of the holding tank to various parts of the evaporator, experiments would be carried out using sea water of different concentration (35,000 up to 65,000 PPM) and temperature (20 up to 60 °C) at various flows rates. The feed to the holding tank (capacity 10 M<sup>3</sup>) to accomplish the above tests was introduced from one of the following: -

- a. Seawater header i.e. feed to evaporator.
- b. Evaporator stage 17 inlet; i.e. brine pump discharge line at approximately 40 °C.
- c. Brine heater outlet; i.e. recirculation brine at a temperature up to 110 °C.

The maximum test temperature of the research was 60 °C, the feed for this was obtained by appropriate mixing of either 'a' or 'b' with 'c' as above depending on the required salinity. The appropriate feed solution could be supplied at various flow rates to the loop using orifices. The loop contained a spool piece (figure 6.3) comprising a steel section (length of about 0.77 m) which could be removed to allow inspection of internal surfaces of the loop. The anodes, reference electrodes and test metal specimens were all instated in the test loop. Provisions were made available in the test loop for incorporating various probes, e.g.; thermometers, glass pH electrodes, conductivity meter; this provides on-line measurement of test temperature, pH, and other parameters during the actual test run. Many tests at different flow, control potential, temperature etc, were carried out.

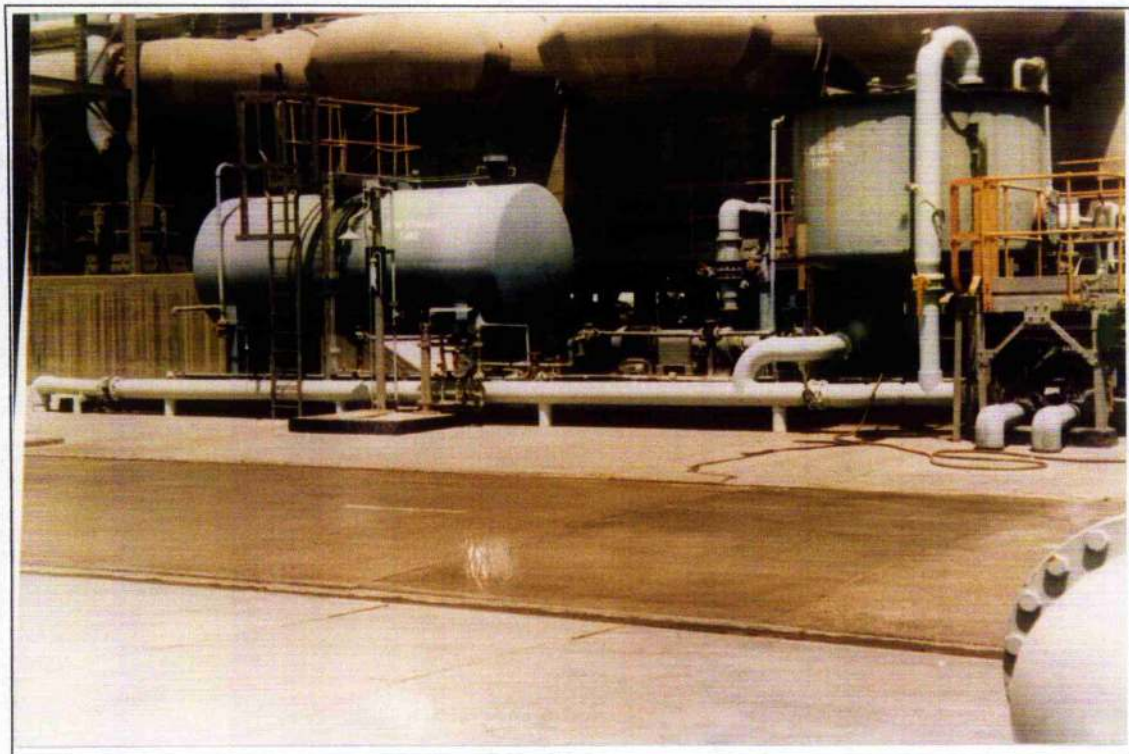

**Figure 6.1: Photo of Dubal once-through test loop**

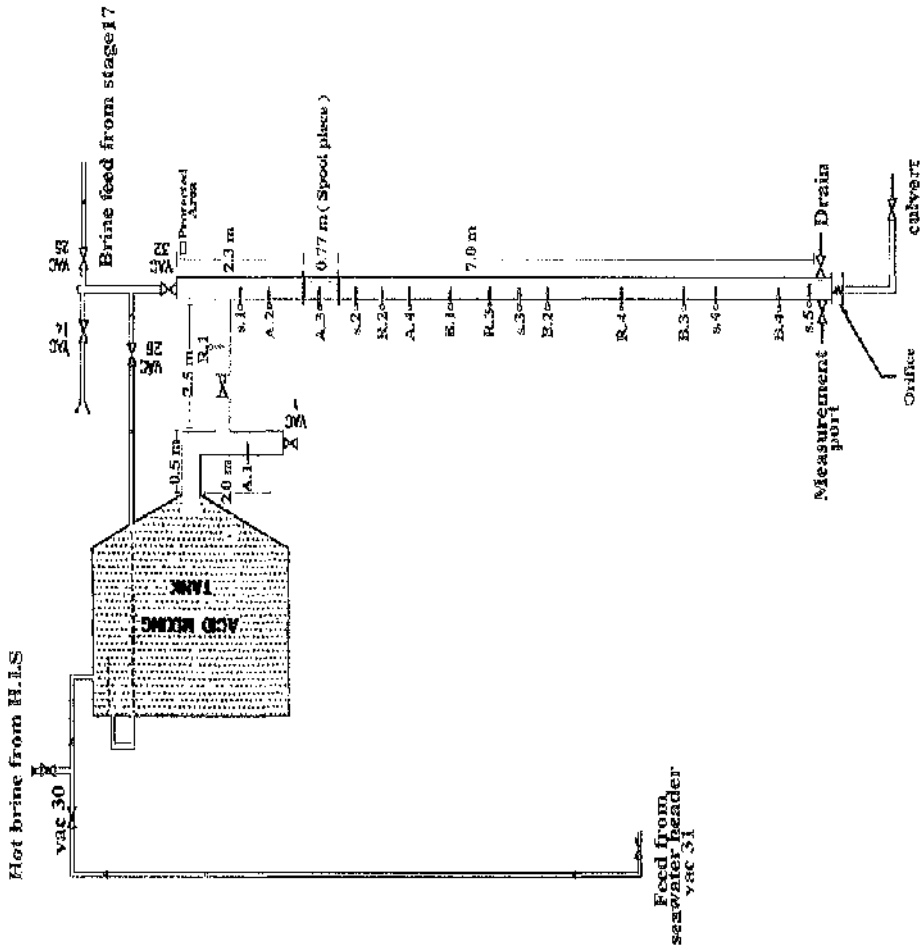
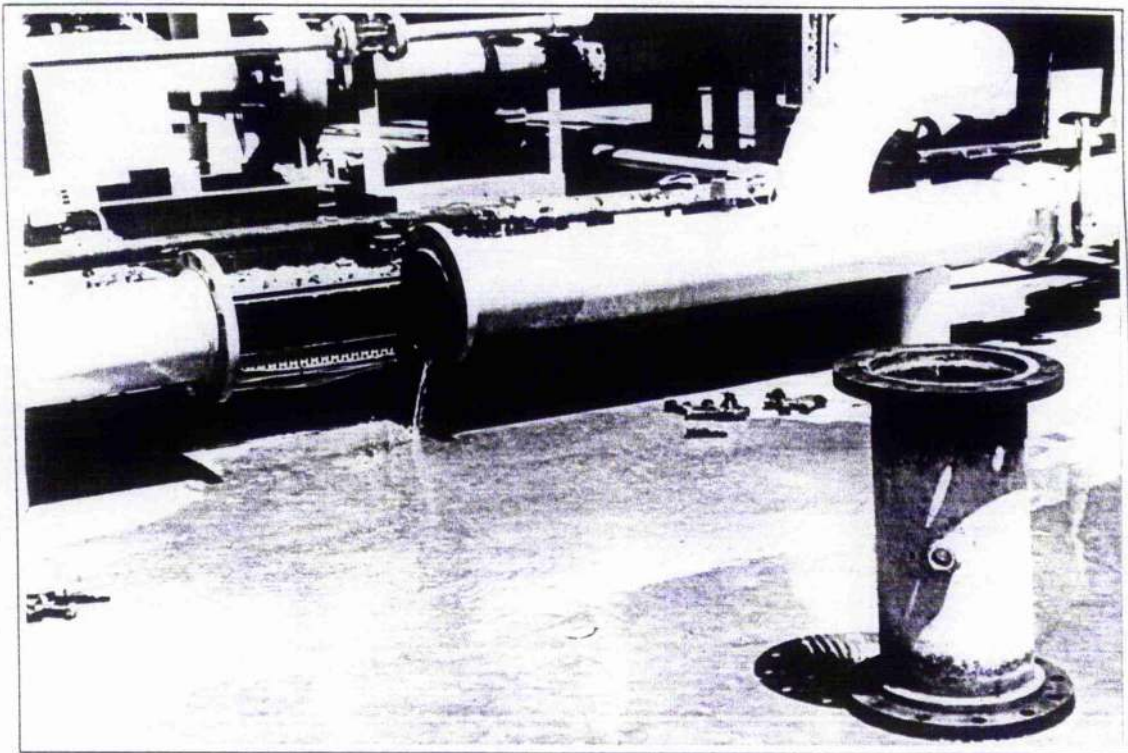

Figure 6.2: Schematic diagram of Dubal once-through test loop





**Figure 6.3: Photo of test loop spool piece**

### **3. Dubal's test loop components description and measurement technique**

A brief description of the major components of the test loops, and measurement techniques involved for analysis are described as follow: -

#### **a. Components description**

##### **\* Test specimen**

For assessment of the condition of protected steel two methods were used; -

- a.1.** Small size (18-cm length by 3-cm width) specimen made of carbon steel cut out from sheet. Each specimen was then welded with a screw type cap, which enabled the specimen to be inserted into the test loop (figure 6.4). The surface and the edges of the specimens were then smoothed out before they were installed in the test loop.

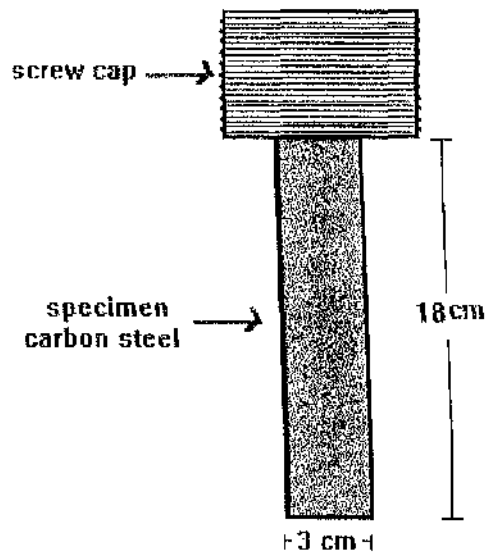

**Figure 6.4: Carbon steel specimen**

- a.2. The main internal bore of the pipe was inspected by removal of the spool piece described earlier.

\* **Cathodic protection basic design**

a.3. **Surface area calculation & number of anodes requirement**

Total pipe length of protected area	:	15 meters
Pipeline Diameter	:	0.25 meter
Assumed protection current density used for carbon Steel in seawater	:	500 mA/m <sup>2</sup>
Anode rating	:	1.00 Amps

$$\text{Area} = (\text{Diameter}) \times (\text{Length}) \times (\Pi)$$

$$\text{Area} = (15) \times (0.25) \times (3.14)$$

$$= 12 \text{ m}^2$$

$$\begin{aligned} \text{Total cathodic protection current} &= (\text{Area}) \times (\text{Assumed Current density}) \\ &= (12 \text{ m}^2) \times (500 \text{ mA/m}^2) \\ &= 6000 \text{ mA} \quad \text{or } 6 \text{ Amps} \end{aligned}$$

$$\begin{aligned} \text{Number of anodes} &= \text{Total cathodic protection current} / \text{Anode rating} \\ &= 6 / 1 \\ &= 6 \end{aligned}$$

#### a.4. Transformer rectifier

Transformer Rectifier specification as per manufacturer<sup>19</sup> is as follows: -

<b>Application</b>	: Cathodic protection indoor use
<b>Power Supply</b>	: 10 Amp 12 Volt supplied through 2 No. 5 Amp modules
<b>Control</b>	: Automatic control of each module to a single voltage from associated sensing electrode. Individual anode control with variable trimming resistor.
<b>Monitoring Facility</b>	: D.C rectifier voltage, Total Amps output, individual anode circuit Amps, sensing electrode voltage, and reference electrode voltage.
<b>Protection</b>	: Each individual anode circuit fused.
<b>Enclosure</b>	: Equipment supplied fitted within a ventilated steel cabinet.

#### a.5. Anodes

Anodes are one Amp rated platinised titanium where the active surface of the anode is a thin layer of platinum metal, assemblies in a steel 1" BSP mount and complete with anode junction box (figure 6.5 and 6.8).

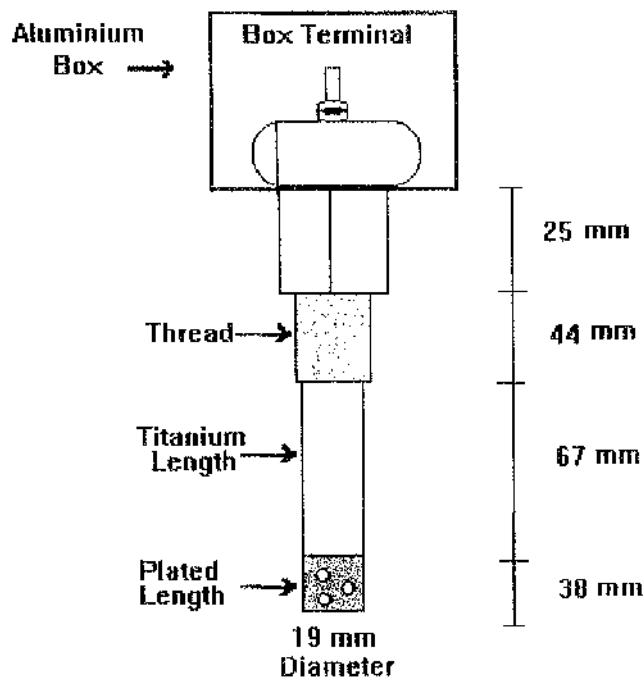
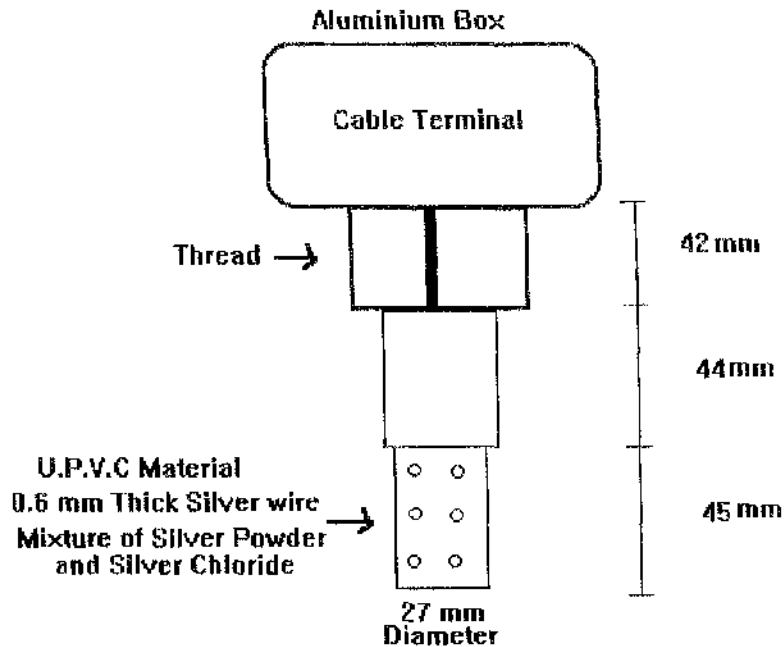

Figure 6.5: Platinised Titanium anode

### a.6. Reference electrode

Reference electrodes are Silver/Silver Chloride, assembled in 1" BSP mount and complete with anode junction box (figure 6.6 and 6.8).



**Figure 6.6: Silver / Silver Chloride reference electrode**

### b. Measurement technique

#### b.1. Electrode potential

Connecting a high impedance voltmeter to pipeline body (positive point) and the Silver/Silver Chloride (negative point) carried out the steel electrode potential measurements.

#### b.2. Current

The current measurement of the cathodically protected system was done periodically using on line ammeter at the protection control panel (figure 6.9).

#### b.3. Control Potential

The set control potential measurement was taken periodically using on line voltmeter at the protection control panel or locally using multimeter.

**b.4. Temperature**

The measurement of the system operating temperature was taken using Mercury in glass (ranges from 0 to 100 °C) thermometer.

**b.5. pH**

The solution pH was checked frequently as required (at least daily) using portable pH meter.

**b.6. Solution concentration**

The solution total dissolved solids were determined using electrical-conductivity meter.

**b.7. Flow rate**

The linear flow rates were calculated based on measured volume flow rates and pipe diameter. Accordingly, based on the calculated figure flow orifices were made (the measured flow rates were in the range of 7.5 m<sup>3</sup>/hr to 180 m<sup>3</sup>/hr).

**4. Description of Glasgow flow rig**

The flow rig at Glasgow laboratory was mainly used to re-simulate some of the findings obtained at Dubal's test loop at smaller scale. This flow rig has a reservoir for filling and a loop, which allows the continuous recirculation of solution through cathodically protected specimens under controlled laboratory conditions. The flow rig provides access for removing water samples and the addition of make up bulk solution in case of any evaporation. The platinum auxiliary electrodes, calomel reference electrodes and test metal specimens were all inserted in the flow rig. Accordingly, in order for the specimens to be protected cathodically all the required connection were made between the electrodes, specimen and and ministat Potentiostat. Ports in the flow rig were made for incorporating various probes, e.g.; thermometers, glass pH electrodes, conductivity meter; this provides on-line measurement of test temperature, pH, and other parameters periodically (figure 6.7). Many tests at different flow, control potential, temperature etc. were carried out.

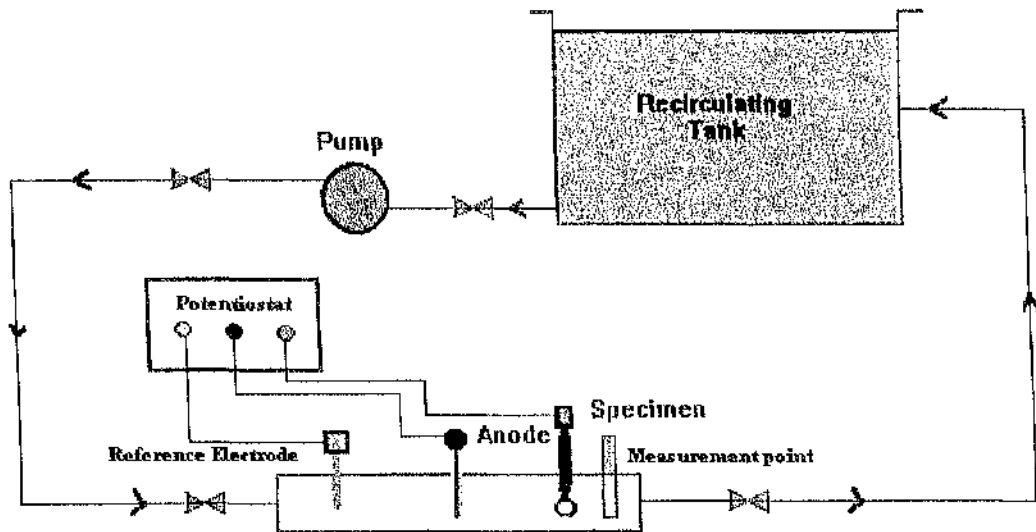

**Figure 6.7: Schematic diagram of test loop at Glasgow University**

## 5. Glasgow University test loop components description and measurement technique

A brief description of the major components of the test loop, and measurement techniques involved for analysis is described as follow: -

### a. Component description

#### \* Test specimen

Carbon steel (BS 4360 grade 50 D) was in the form of sheet from which samples of the required sizes were cut. A wire was then attached securely to ensure good electrical contact to one face of specimen prior to casting. The specimen is then place into a plastic container ready to be set in epoxy resin. The resin was then poured into the container which had the specimen placed at the bottom centrally. The container was then left overnight. When the resin had hardened the molded specimen was pressed out from the container, and the exposed metal surface was ground in a hand grinder to a surface finished of 600 grit.

#### \* Reference electrode

The reference electrode used was the saturated Calomel Electrode (SCE).

\* **Anode**

The platinum auxiliary electrodes were used as anodes.

\* **Circulating tank**

The rig circulating tank capacity was 20 litres.

\* **Potentiostat**

The ministat Potentiostat by Thompson Electrochem LTD was used.

\* **Circulating pump**

The selected pump for this test loop was Grundfos UP 20-45 N 1 x 240 x 50 HZ. The pump internal made of stainless steel housing, which ensures continuous circulation of, contaminated-free of hot water ( $110^{\circ}\text{C}$ ) in the closed circuit of high T.D.S solution.

\* **Multimeters**

Two types of multimeters were used namely the Thurlby 1905a and Thandor TM 451 for the measurement of both test current and potential.

**b. Measurement technique**

\* **Electrode potential**

Connecting the high impedance voltmeter to specimen (positive point) and the standard Calomel Electrode (negative point) carried out the specimen electrode potential measurements.

\* **Current**

The current measurement of the cathodically protected system was done periodically using either Thurlby 1905a or Thandor TM451 multimeters which was installed on line.

\* **Control potential**

The set control potential measurement was taken periodically using on line installed voltmeter.

\* **Temperature**

The measurement of the system operating temperature was taken using Mercury in glass thermometer and digital thermometers of the following range: -

\* Mercury in glass: - 0 to 100 ° C

\* Digital : - 0 to 250 ° C

\* **pH**

Solution pH was checked on daily bases using a Griffin portable pH meter model 60.

\* **Solution concentration**

The Solution T.D.S was measured using digital conductivity meter type P.T.I-18. Additionally calcium and alkalinity were measured using an Aquamerck calcium and alkalinity reagent kits.

\* **Flow rate**

The linear flow rates were calculated based on measured volume flow rates and pipe diameter.

\* **Solution preparation**

All the test solutions were prepared from tap water and the addition of the synthetic seawater or "Instant Ocean" which provided a medium containing all the main known elements present in seawater.

6. **Samples examination**

In both Glasgow and Dubal set ups, the condition of samples, were examined as appropriate during and after individual tests with photograph recording. Additionally, a number of specimens were examined in more detail on SEM (Scanning electron microscopy) where such examination included elemental microanalysis using the energy- dispersive analysis equipment on the SEM.



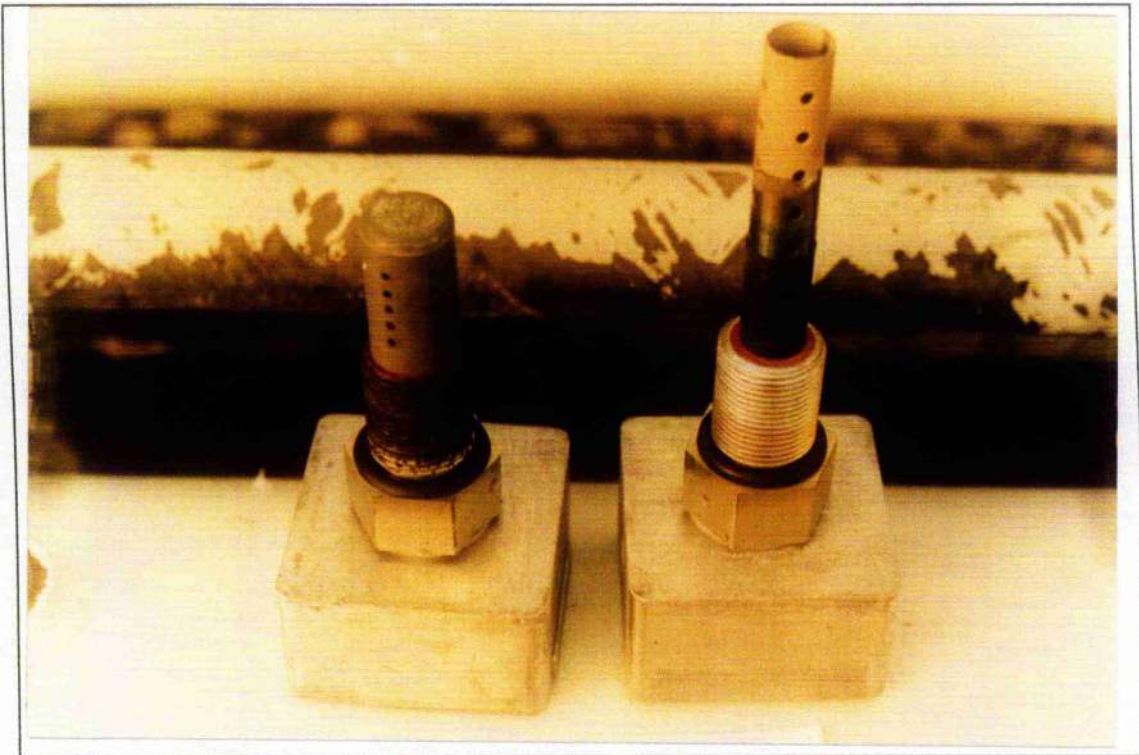

Figure 6.8: Photo of an anode and reference electrode

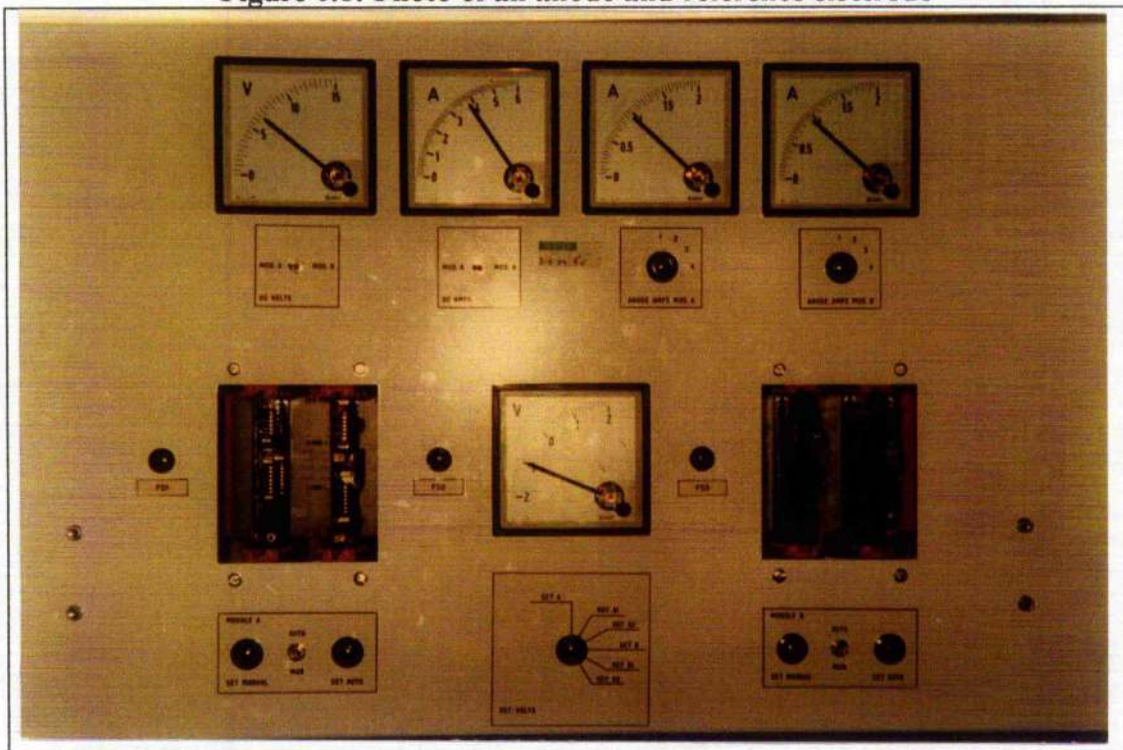

Figure 6.8: Photo of ammeter at the protection control panel

## CHAPTER SEVEN INTERNAL INSPECTION FINDINGS

### 1. Introduction

Throughout the duration of this Ph.D. project (1993-1997), various sections of the desalination plant and associated pipe work were inspected at times appropriate in term of overall plant operation/maintenance schedule. These inspections comprised entry to the various section of the plant and appropriate photograph records of the internal surfaces of concern. The observations made during these inspections are described and discussed in the remainder of this chapter.

The aims of this part of the project as mentioned earlier were twofold: -

- a. To record the current condition of the plant and therefore effectiveness of the cathodic protection system so as to facilitate a assessment of the effectiveness of the cathodic protection after 10 to 15 years of operation.
- b. To serve as a link between the results of the main detailed loop studies and their interpretation in terms of their relevance to the performance of cathodic protection on the large units.

The following sections describe internal inspection of the various segments of the desalination plant i.e. evaporators, seawater header and sand filter.

### 2. Seawater intake pipes

These comprise 3 pipes of 2 metres diameter each about 410 metres in length and are of carbon-steel without any protective coating but are protected sacrificially using zinc alloy anodes. An internal inspection of the pipelines involving the services of a specialist diver in 1996 indicated that the headers were in good condition and all exposed metal was seen to be free from active corrosion. The anodes are still in acceptable condition and recommended to have at least a further 5 year's life based on observed condition after being in operation for the past 18 years.

### 3. Band-screens

Band screens are the second stage of filtration for removal of smaller size objects from seawater before entering seawater pumps. In early 1985 an impressed current cathodic protection system was installed in the outlet of each screen due to severe corrosion of the frames and also the traveling screens.

Over the last four years (1993 through 1997), band screens were inspected regularly during each seawater pump major overhaul. The visual inspection of the band screens has clearly indicated that the band screens are fully protected and in placed cathodic protection are fully effective.

#### 4. Sand filters associated pipelines

The painted steel pipe work associated with inlet, outlet, backwash and drain lines of the sand filter (figure 7.1) was inspected internally.

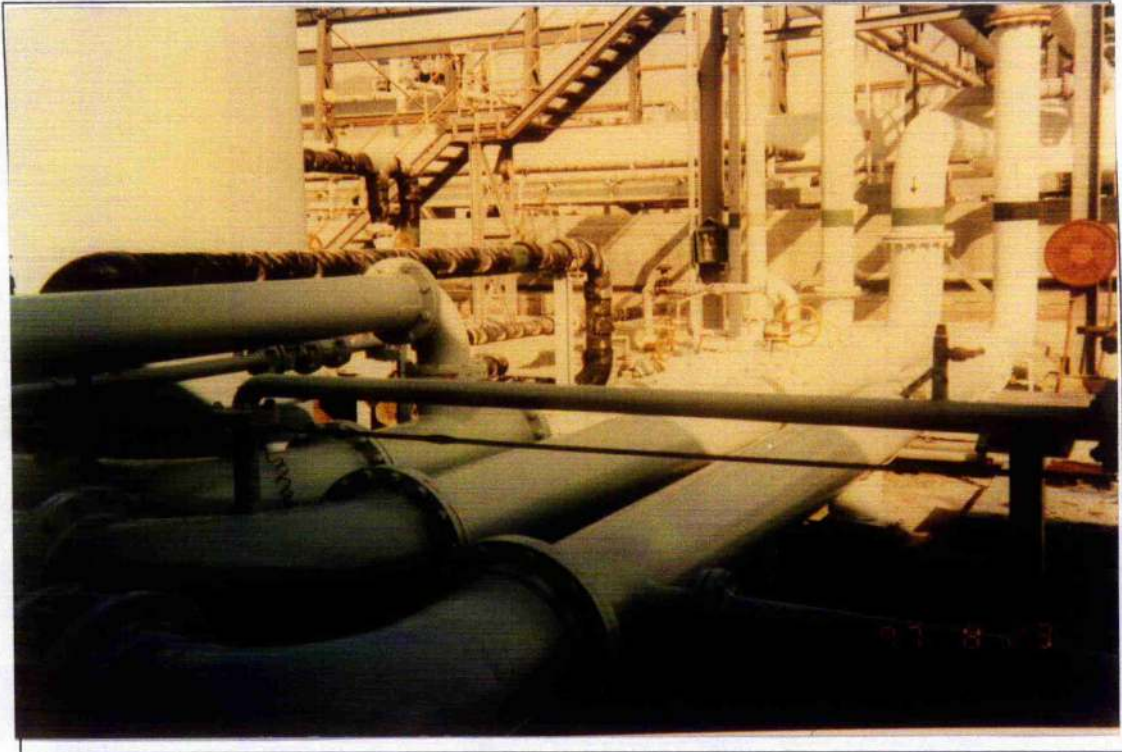

**Figure 7.1: Photo of sand filters associated pipelines**

The physical inspection of the pipe lines have indicated that the installed protection system has been fully effective as no major problem been observed (this part of the plant was initially selected for the construction of the once-through test loop but due to unavailability of the hot brine the idea was dropped).

#### 5. Sea Water Header

The seawater header (figures 7.2 and 7.3) comprises the common sea water distribution pipes which feed the water from any of the seven sea water supply pumps to any of the six Evaporator and other parts of the smelter. The most recent internal inspection of the seawater header (in its 13<sup>th</sup> year of cathodic protection application) which was carried out as part of this Ph.D. project revealed the following: -

- \* No active corrosion either on the internal pipe surface or at the weld seams, flanges and expansion bellows (figures 7.4 and 7.5).



**Figure 7.2: Photo of two seawater headers running parallel to evaporators**

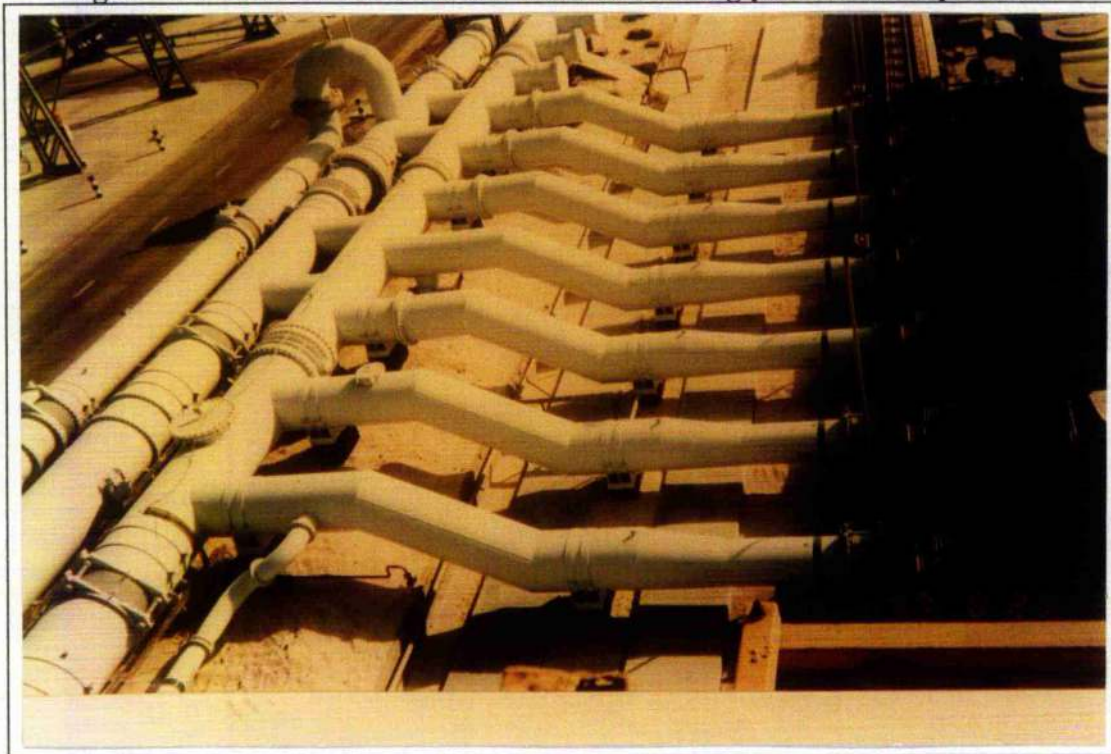

**Figure 7.3: Seawater header connected to seawater pump discharge pipelines**



**Figure 7.4: Photo of seawater internal pipe surface at the expansion bellow**



**Figure 7.5: Photo of seawater internal pipe surface next to expansion bellow**

- \* No sign of any corrosion was seen underneath of dead barnacles.
- \* A dense calcareous deposit was observed away from the anodes, site on the seawater header surface. This was covering almost entire surface surrounding and away from the anodes which is a major factor in yielding good cathodic protection performance by assisting current reach and reducing the applied current demand.
- \* A slight calcareous build up observed around two anodes. Individual anodes setting were adjusted accordingly.
- \* Cathodic protection system is 100% effective for the entire seawater header.

## 6. Evaporators

The following summary reveals the internal condition of evaporators segments, which are protected cathodically. During the period 1993-1997, the evaporator segments were inspected in order to evaluate the effectiveness of the cathodic protection system after 10 to 12 years of operation. -

### a. Brine inlet manifolds

Brine inlet manifold acts as an interconnection between heat input section and evaporator first stage flash chamber. This part of the plant represents one of the most severe for corrosion since it receives the high temperature brine from brine heater and involves changes in flow direction and much turbulence. As described in chapter five after only a few months of operation a disastrous corrosion attack was occurring in this area due to turbulence and cavitation, together with released of carbon dioxide and other dissolved gases present. The cathodic protection system now in brine inlet manifold is in its fifteenth year. Because of the critical conditions, this part of the plant has been inspected most frequently during this Ph.D. project and the excellent condition and successful performance of the cathodic protection system are described as follows: -

- \* Cathodic protection system is almost 100% effective for the entire internal surfaces of brine inlet manifold as no active corrosion was seen during any internal inspection of the inspected evaporators.
- \* Cavitation attack on the 20 mm thick target plate has not been stopped completely but situation has improved tremendously since commissioning of the present cathodic protection system (figure 7.7).
- \* A slight build up of calcareous deposits, occur time to time around some anodes (figure 7.8). This indicates that the current level is within the optimum level of protection. The formation of such deposit around anodes is believed to be during the use of a degree of overprotection in the cathodic protection supply, just after evaporator off load acid cleaning.

- \* A dense calcareous deposition on carbon steel surface away from the anode site is clearly evident (figures 7.9-7.10). This is a major factor in yielding good cathodic protection performance as it covered entire surface surrounding and away from the anodes. This in principal assists to reduce the applied current demand and hence reduce the operating cost of cathodic protection system. These evidences from inspection have allowed the continued operation until next scheduled shutdown in the occasional case of anode failure because of the beneficial effect of calcareous deposition.



**Figure 7.6: Photo of brine inlet manifold along with interconnection pipelines to flash chamber and also shows the 4 anodes installed in B.I.M**

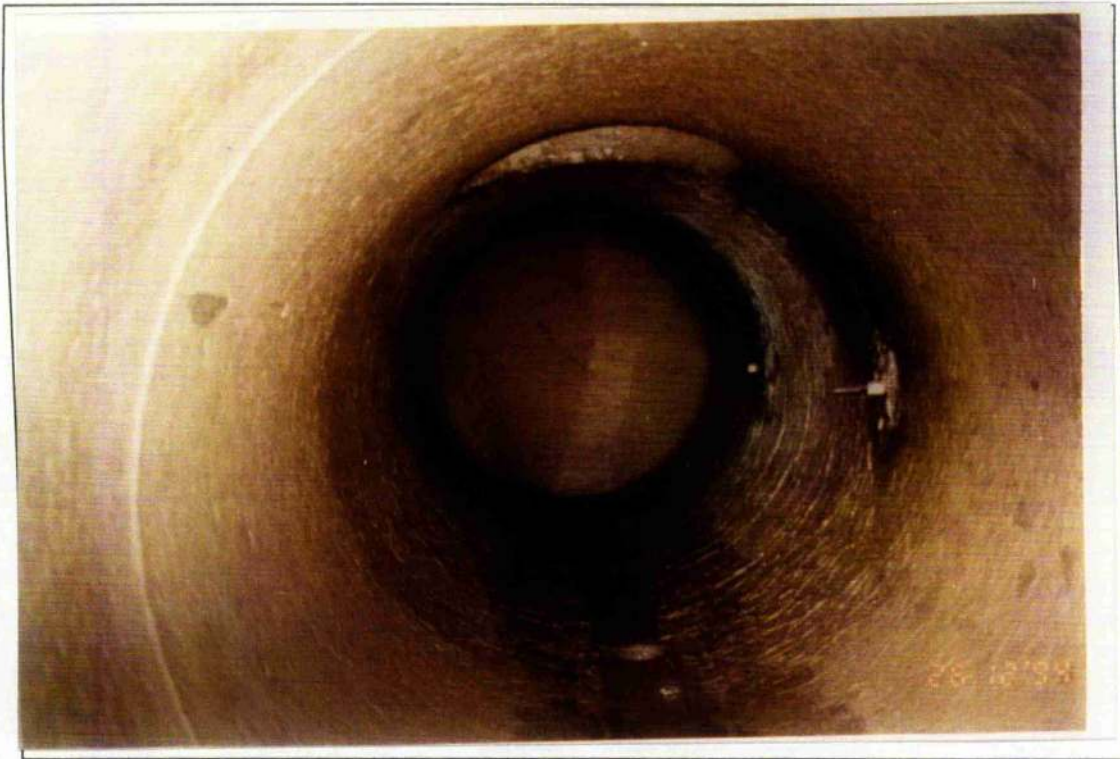

**Figure 7.7: Photo of cavitation attack on B.I.M target plate**



**Figure 7.8: Photo of calcareous deposition around and away from anode**





**Figure 7.9: View along length of BIM showing no corrosion and extensive scale**



**Figure 7.10: View along length of BIM showing no corrosion and extensive scale**

### b. Sea Water Feed and Low Temperature Brine Systems (figure 7.11)

The following sequences of photograph shows the pipe work associated with: -

- Cooling seawater to lowest temperature stage (last heat reject section stage 19, figure 7.12).
- Cooling water outlet (figure 7.13) and evaporator feed line (figure 7.14).
- Brine pump discharge (figure 7.15).
- Brine inlet to last stage of heat recovery section, stage 17 (figure 7.16).

A recent internal inspection (1993-1996) of the above associated pipelines revealed the followings: -

- \* The installed impressed current cathodic protection has been 100% effective. It is worth mentioning at this stage that no internal paintwork for the area of low temperature brine system has been carried out after installation of cathodic protection system.
- \* The corrosion on all flanged joints, particularly where bellows of dissimilar metal occur, and in areas of high turbulence has been arrested completely as no sign of corrosion was seen during any inspections.
- \* A dense calcareous deposition on carbon steel surface away from the anode site was clearly evident.

The following series of photographs (figures 7.17 to 7.20) shows the above-summarized findings.

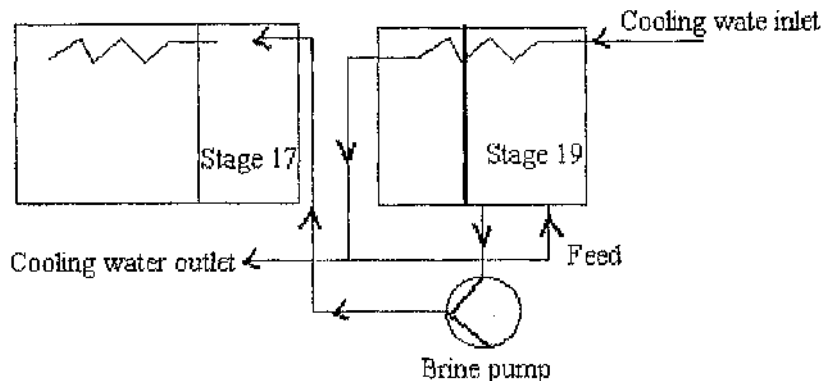

**Figure 7.11: Diagram of seawater feed and low temperature brine systems**

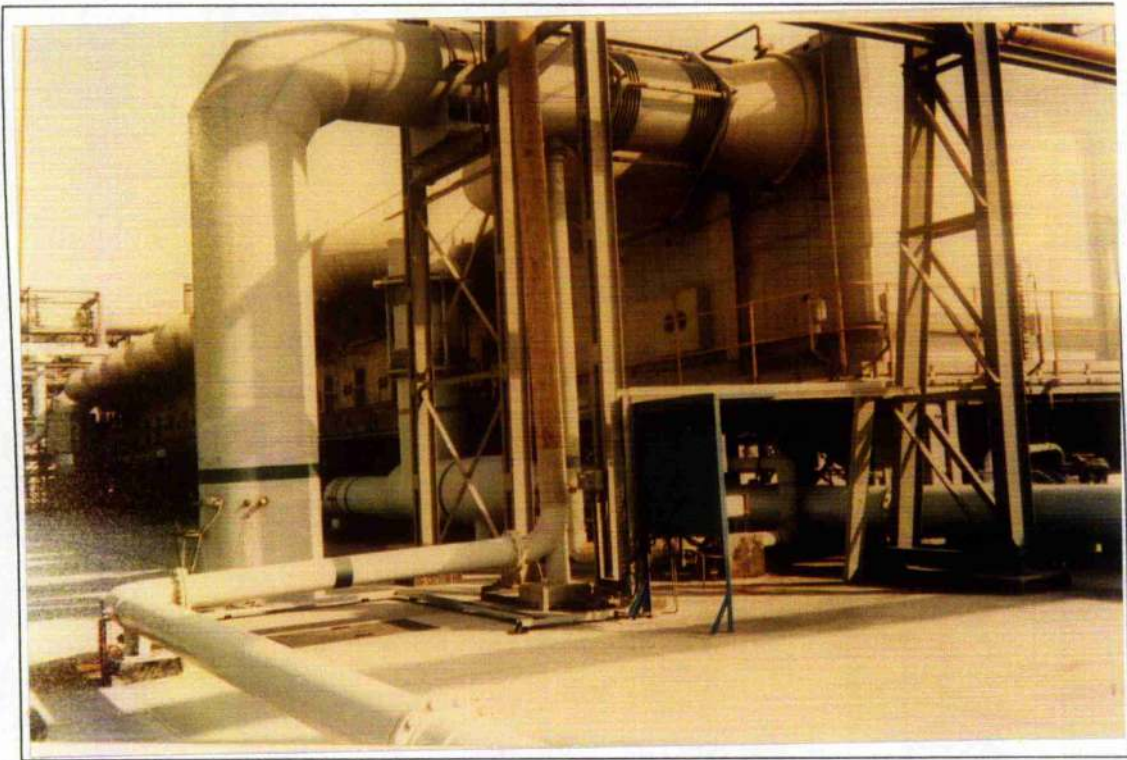

**Figure 7.12: Photo of cooling seawater inlet**

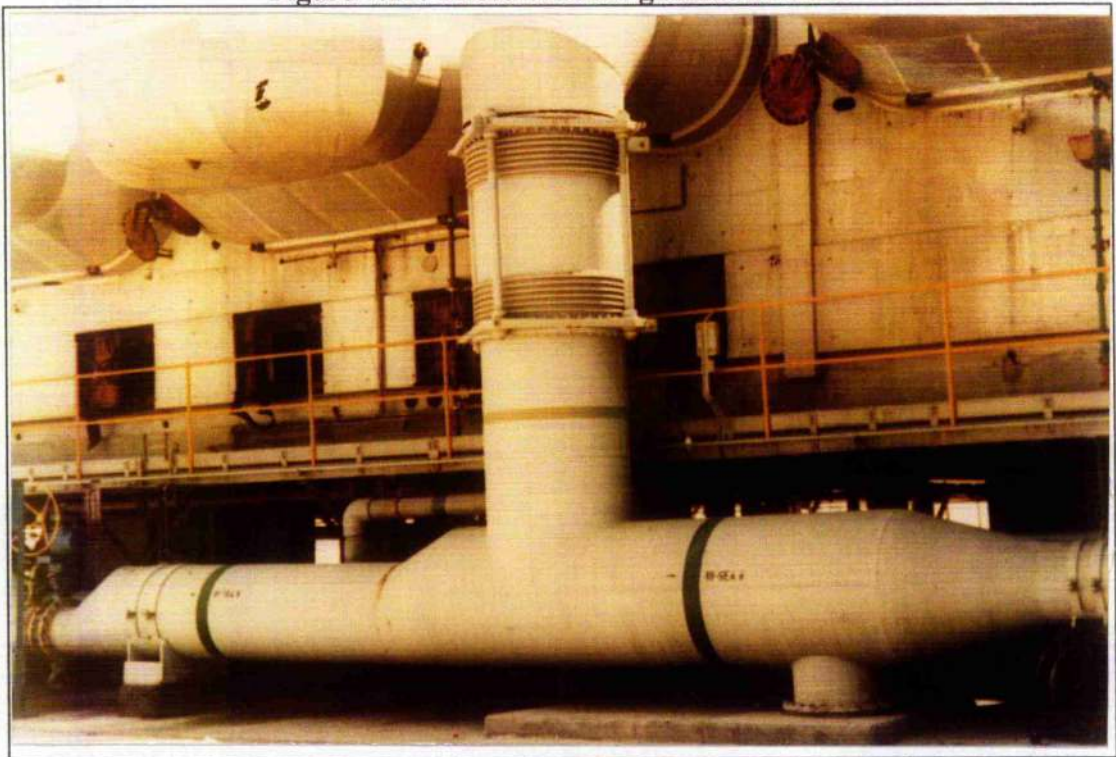

**Figure 7.13: Seawater cooling water outlet pipeline**



**Figure 7.14: Photo of evaporator feed line**

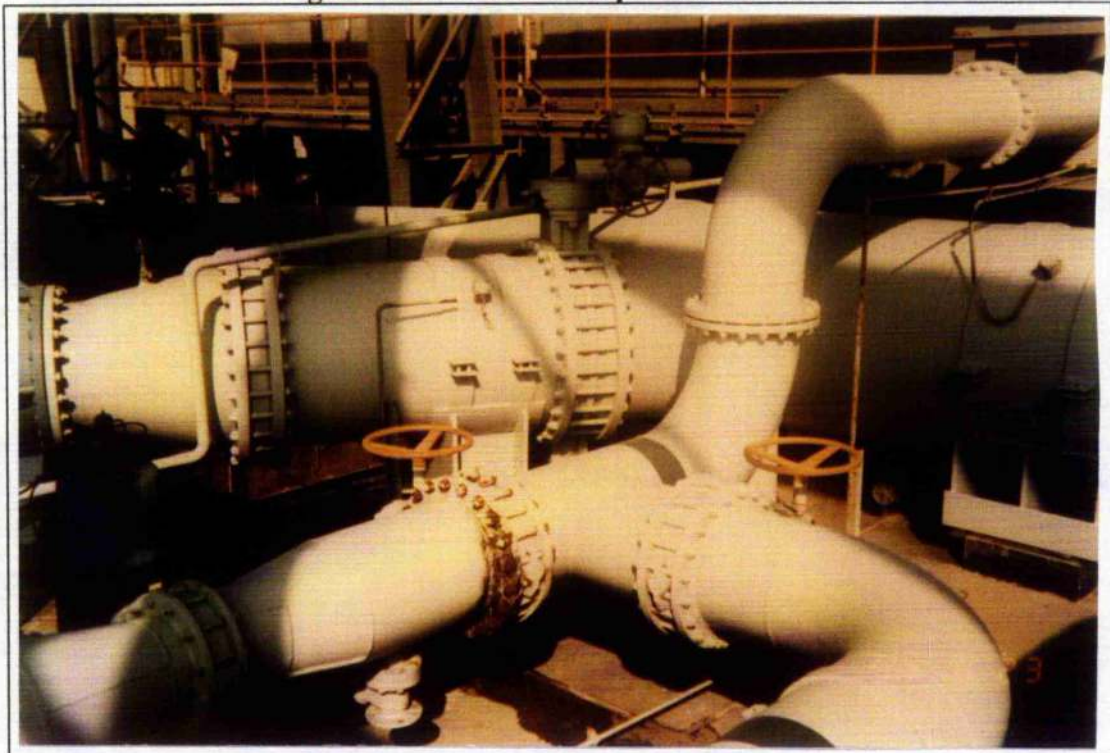

**Figure 7.15: Brine pump discharge pipelines**

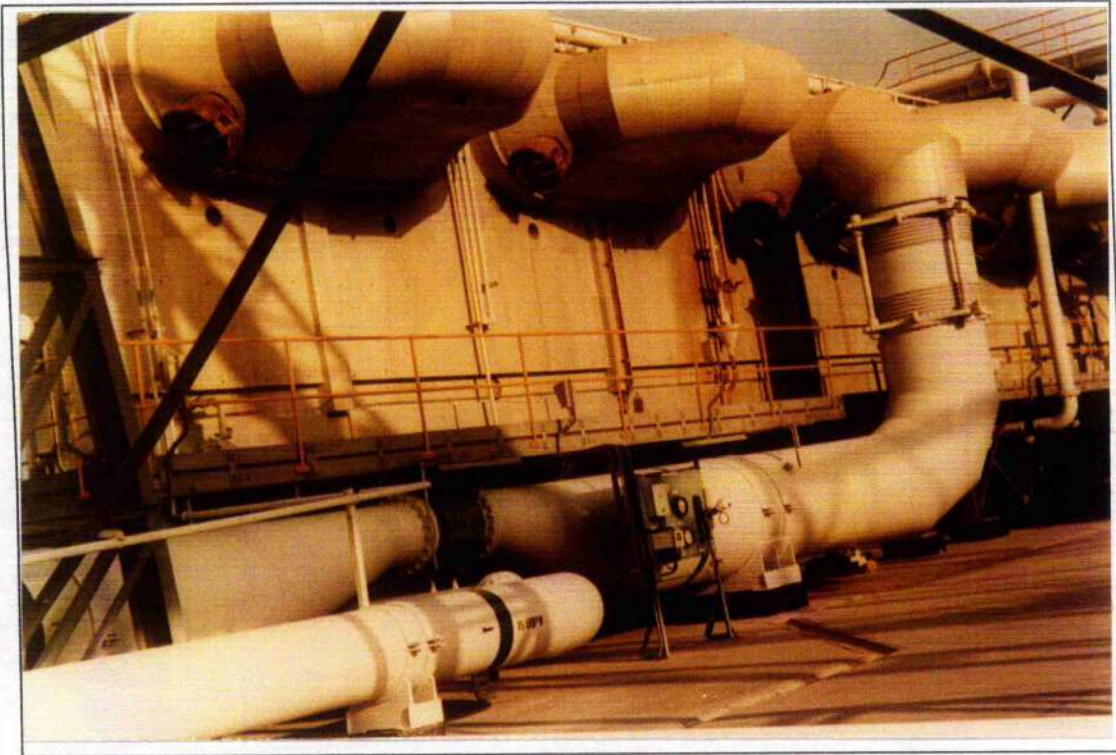

**Figure 7.16: Brine pipeline to stage 17 heat recovery section**



**Figure 7.17: Seawater cooling water inlet (see figure 7.12)**



**Figure 7.18: seawater cooling water outlet (see figure 7.13)**



**Figure 7.19: Brine pump discharge (see figure 7.15)**

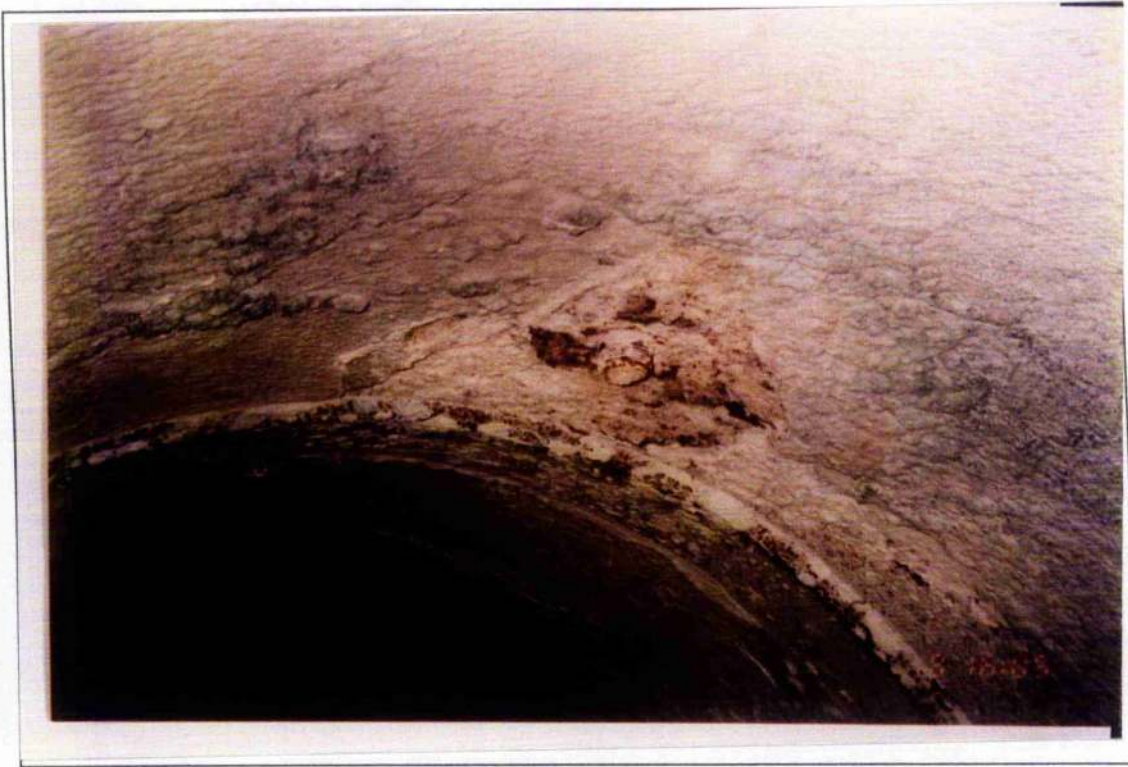
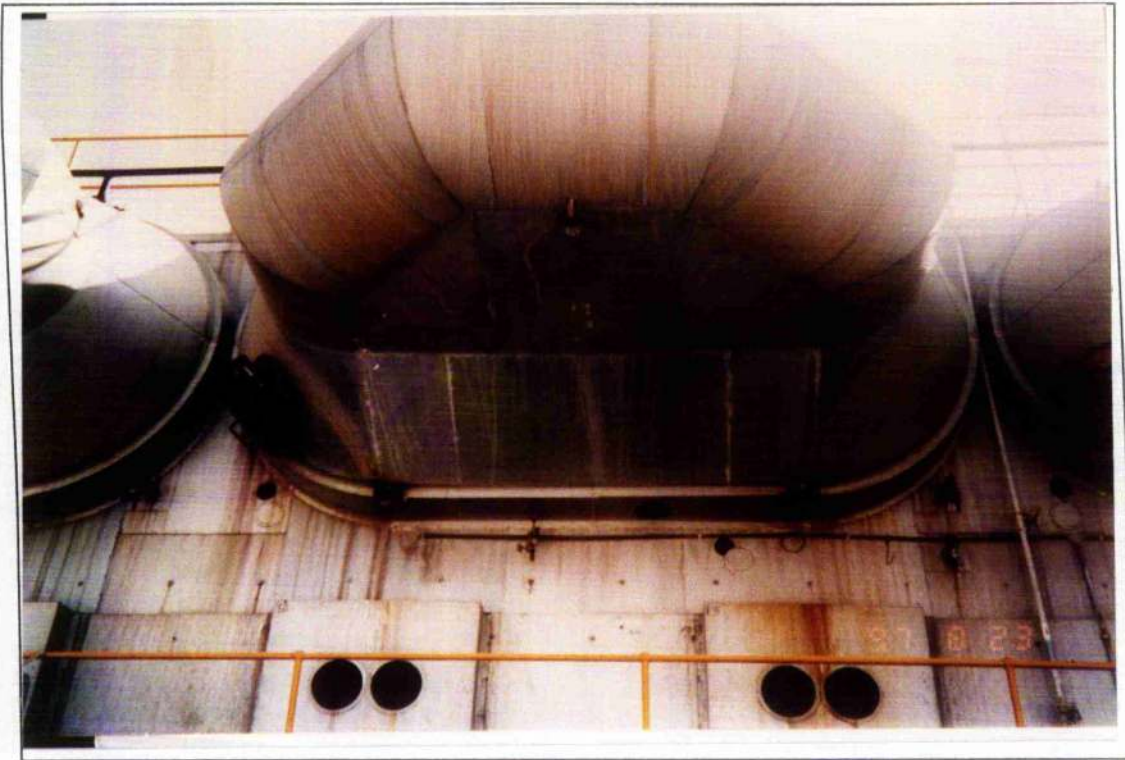

**Figure 7.20: Inlet to stage 17 of heat recovery section (see figure 7.16)**

**c. Water Boxes**

Evaporator water boxes (figure 7.21) represent a significant factor in both capital and energy costs (i.e. material of construction, pressure drop minimization, and simplicity of construction). The most recent internal inspection of each evaporator water boxes revealed the following: -

- \* Re-assured that the installed protection system has been fully effective as lining failures at flange face joints, manhole joints, and on seamed joints almost stopped. The rare minor repatch of the rubber lining due rubber degradation only occurs from time to time (the repairs of rubber lining is done using Belzona ceramic and rubber repair kits).
- \* Calcareous deposit, build up near to the anodes. This build up was causing blockage of the tubes particularly in heat reject section. In view of this problem The anode positioned was relocated.
- \* A dense calcareous deposition on rubber lined surface away from the anode site was observed. The deposition was not to the extents, which were seen on the brine inlet manifold and other parts of the plant.



**Figure 7.21: Photo of evaporator water box**

**d. Brine pump canisters**

The visual inspection of the canisters during Ph.D. project indicated that the external canister surfaces are fully protected. The following are the only minor operational problems, which we have been encountering since installation of cathodic protection system: -

- \* The growth of crystal layer on the anodes. This hinders the effectiveness of the anode. The brine pump anode canister current has been therefore adjusted, and cleaning frequency increased.
- \* The minor failure of the outer shell paint.

**7. General discussion**

The performance of installed impressed current cathodic protection at Dubal desalination plant has been almost 100% successful as forced outages due to corrosion has almost been reduced to zero. The most recent internal inspections, carried out as part of this Ph.D., have confirmed the continuing success of the cathodic protection in combating corrosion of the desalination plant at Dubal. The formation of calcareous deposits on the surface of the protected area, which acts as a protective coating does reduce the quantity



of current, needed to establish protection. Moreover, these recent inspections have provided overwhelming evidence of the widespread deposition of calcareous deposit in various parts of the plant covering a wide temperature range (18 to 112 °C). This clearly demonstrates the benefits of such deposit by reducing applied current demand and facilitating more uniform spread of cathodic protection current in all parts of desalination equipment. Thus, in these thermal desalination plant conditions, there is evidence that calcareous deposition occurs and is beneficial in elevated temperature conditions as well as in the ambient temperature conditions that have been reported for other engineering equipment in the past.

In order to provide a somewhat more quantitative indication of cathodic protection performance, some simple calculations (involving two parallel sections of the header, figure 7.2) are presented below for the seawater header and brine inlet manifold. Seawater header is a long, essentially straight pipe, whose geometry facilitates reasonable comparison with more general pipeline application of cathodic protection. On the other hand, brine inlet manifold is located in an area within plant which represent one of the most severe for corrosion since it receives the high temperature brine and much turbulence. The calculation of brine inlet manifold hence, provides an information in relation to the demand for current density for an area subjected to hot concentrated turbulent brine.

#### Example 1: Seawater header

Total pipe length of protected area	****	249 meter
Pipeline Diameter	****	1.56 meter
Anode Rating	****	5.00 Amps
Area = ( Diameter ) x ( length ) x ( $\Pi$ )	****	m <sup>2</sup>
Area = ( 249 ) x ( 1.56 ) x ( 3.14 )	****	<b><u>1220 m<sup>2</sup></u></b>

Currently 6 anodes are installed along this 249 meters length pipeline, and in general the total current supply to this header is about 17 amps. Since the anode ratings are 5 amps and total current is 17 amps, in principal only 4 anodes are required to maintain the header under the required protection cathodiactly. The additional two have been installed to provide added security in case of anode failure in series.

$$\begin{aligned} \text{Total cathodic protection current} &= (\text{Area}) \times (\text{Current Density}) \\ \text{Current Density} &= \text{Total cathodic protection current} / \text{Area} \\ &= 17 / 1220 \\ &= \mathbf{0.014 \text{ A} / \text{m}^2 \text{ or } 14 \text{ mA} / \text{m}^2} \end{aligned}$$

$$\begin{aligned} \text{Anode spacing} &= \text{Total pipe length} / \text{Number of anodes} \\ &= 249 / 6 \\ &= \mathbf{41.5 \text{ meter or } 41.5 / 1.56 = 26 \text{ pipe diameter}} \end{aligned}$$

**Example 2: Seawater header**

Total pipe length of protected area	**** 98 meter
Pipeline Diameter	**** 1.25 meter
Anode Rating	**** 5.00 Amps
Area = ( Diameter ) x ( length ) x ( $\Pi$ )	**** m <sup>2</sup>
Area = ( 98 ) x ( 1.25 ) x ( 3.14 )	**** <u>385 m<sup>2</sup></u>

Currently 3 anodes are installed along this 98 meters length pipeline, and in general the total current supply to this header is about 9 amps. Since the anode ratings are 5 amps and total current is 9 amps, in principal only 2 anodes are required to maintain the header under the required protection cathodiactly. The additional one has been installed to provide added security in case of anode failure in series.

$$\begin{aligned} \text{Total cathodic protection current} &= (\text{Area}) \times (\text{Current Density}) \\ \text{Current Density} &= \text{Total cathodic protection current} / \text{Area} \\ &= 9 / 385 \\ &= \mathbf{0.024 \text{ A} / \text{m}^2 \text{ or } 24 \text{ mA} / \text{m}^2} \end{aligned}$$

$$\begin{aligned} \text{Anode spacing} &= \text{Total pipe length} / \text{Number of anodes} \\ &= 98 / 3 \\ &= \mathbf{32.7 \text{ meter or } 32.7 / 1.25 = 26.2 \text{ pipe diameter}} \end{aligned}$$

**Example 3: Brine inlet manifold**

Total pipe length of protected area	**** 15 meter
Pipeline Diameter	**** 1.20 meter
Anode Rating	**** 5.00 Amps
Area = ( Diameter ) x ( length ) x ( $\Pi$ )	**** m <sup>2</sup>
Area = ( 15 ) x ( 1.20 ) x ( 3.14 )	**** <u>57 m<sup>2</sup></u>

Currently 4 anodes are installed along this 15 meters length manifold, and in general the total current supply to this header is about 16 amps. Since the anode ratings are 5 amps and total current is 15 amps, in principal only 3 anodes are required to maintain the header under the required protection cathodiactly. The additional one has been installed to provide added security in case of anode failure in series.

$$\begin{aligned} \text{Total cathodic protection current} &= (\text{Area}) \times (\text{Current Density}) \\ \text{Current Density} &= \text{Total cathodic protection current} / \text{Area} \\ &= 16 / 57 \\ &= \mathbf{0.28 \text{ A} / \text{m}^2 \text{ or } 280 \text{ mA} / \text{m}^2} \end{aligned}$$

$$\begin{aligned}
 \text{Anode spacing} &= \text{Total pipe length} / \text{Number of anodes} \\
 &= 15 / 4 \\
 &= \mathbf{3.75 \text{ meter or } 3.75 / 1.20 = 3.1 \text{ pipe diameter}}
 \end{aligned}$$

The benefits of dense formation of calcareous deposit at the surface of the areas which are under protection cathodically was discussed extensively in the earlier parts of this thesis. As in many literature<sup>20,21,22</sup> bare steel in seawater at ambient temperature normally requires between 100 to 500 mA/m<sup>2</sup>, in order to place the bare steel under immediate protection followed by long-term operating levels of 100 to 150 mA/m<sup>2</sup>. A current density calculation of seawater headers was carried out; mainly to check the benefits of formation such deposits on the overall cathodic protection with respect to applied current demand. The calculation revealed the current density being used on the seawater headers are in the range, i.e. a reduction by factor of almost 15 when compared to the above reported figures. This is a clear indication of the considerable benefits provided by the calcareous deposits.

Similar calculation of the brine inlet manifold indicated that the demand for the current density is much higher (i.e. about 280 mA/m<sup>2</sup>) than seawater header. This is virtually due to severe conditions of elevated temperature and extremely turbulence, which is, exists in the brine inlet manifold. However, even this figure demonstrates benefits of scale deposition since it is in the same range of the recommended current density reported for ambient temperature.

It should also be pointed out that no problems have been experienced in Dubai due to calcareous deposits breaking off pipe walls and causing downstream blockages of equipment's.

## CHAPTER EIGHT TESTS FINDINGS

### 1. Introduction

This is the first time, known to the writer, that a detailed investigations of cathodic protection in a plant-size rig has been carried out certainly in relation to thermal conditions in a desalination plant. Certainly all the previous work, known to the author, in which the crucially important issue of cathodic protection/calcareous scale interaction has been studied in detail, have been in laboratory-sized tests set ups. During the test programme both at Glasgow University simple test flow rig and Dubal's more substantial once through test loop attached to one of desalination units, a number of features in relation to the application of cathodic protection in seawater were studied (i.e temperature, control potential, flow rate, antiscalant etc). The main aim was to illustrate in detail the variation effect of the above parameters on the: -

- a. Test applied current requirement for protecting both the Dubal's once through test loop and Glasgow flow rig cathodically at pre-determined control potential.
- b. Rate and duration at which scale forms on the surface of the specimens and test loop pipelines, which were protected cathodically, and the effect of scale formations on current demand to achieve any specific target potential.
- c. Ability of cathodic protection application to prevent corrosion by monitoring its durability and respond to changes made during each test.
- d. To relate the findings observed during the tests both at Glasgow University and Dubal with desalination plant.
- e. To study the influence of scale formations on residual of corrosion protection during periods of non-application of cathodic protection.

### 2. Brief summary of tests conditions and findings

Tests 1 to 6 were carried out at Glasgow University mainly to familiarize and commission the equipment which, were followed by tests 7 to 13. Tests 14 to 29 all were carried out at Dubal using once through test loop. This was followed by tests 30 to 35 using Glasgow flow rig. Upon completion of test 35 all remaining tests were carried out at Dubal using once through test loop (36 to 57).

Test No	Temperature (°C)	Potential (mV)	Flow rate (m <sup>3</sup> /hr)	Acid Wash	Antiscalant	Compared with test No
7	25	-1000	1.8	No	No	N/A
8	18	-1000	Static	No	No	N/A
9	25	-1000 To -1100	1.8	No	No	Test 7
10	18	-1000	Static	No	No	Test 8
11	25 To 45	-900 To -1100	1.8	No	No	Test 9
12	45	-1000 To -1100	Static	No	No	Test 10
13	45	-1000	1.8	No	No	Test 12
15	25	Manual	7.5	No	No	N/A
16	25	Manual	7.5	No	No	N/A
17	25	-1050	7.5	No	No	N/A
18	30	-900	170	No	No	Test 17
19	40	-900	170	No	Yes	Test 18
20	40	-1000	170	No	Yes	N/A
21	40	-1050	170	No	Yes	Test 20
23	25	-1050	40	No	No	Test 21
24	25	-1050	40	No	No	Tests 17,23
25	25	-1000	40	No	No	Test 24
26	50	-1000	40	No	Yes	Test 25
27	50	-1050	40	No	Yes	Test 24
28	50	-1000	7.5	No	Yes	Test 26
29	50	-1050	7.5	No	Yes	Test 27
30	28 To 32	-800 To -1100	0.85	No	No	N/A
31-32	28 To 32	-900 To -1050	0.85	No	No	N/A
33	28 To 32	-800 To -1050	0.85	No	No	Test 31
34	31	-1050	0.85	No	No	N/A
35	31	-1050	0.85	No	No	N/A
36	30 To 35	-1000	7.5	No	No	Test 28
37	30	-1050	7.5	No	No	Test 36
38	60	-1000	7.5	No	Yes	Test 36
39	30	-1000	40	No	No	Test 36
40	35	-1050	7.5	No	No	Test 29
41	60	-900	7.5	No	Yes	Test 38
42-44	35	-1050	7.5	No	No	N/A
43	35	-1000	7.5	No	No	Test 42
45-48	35	-1050	7.5	Yes	No	Test 44
46	50 To 55	-1050	7.5	Yes	Yes	Test 45
47	55 To 30	-1050	40	No	Yes	Test 46
49	30	-1050	180	Yes	No	Test 48
50	50 To 60	-1050	7.5	Yes	Yes	Test 48
51	23 To 28	-950	7.5	Yes	No	Test 48
52	50 To 60	-1050	7.5	No	Yes	Test 50
53	25 To 30	-1050	40	Yes	No	Test 48
54	35 To 55	-1050	40	Yes	Yes	Test 48
55	60 To 40	-1050	7.5	Yes	Yes	Test 45
56	45 To 48	-900	180	Yes	Yes	N/A
57	30	-900	180	Yes	No	Test 56

Table 8: Summarizes of test conditions

**TEST NO 7****1. Parameters summary**

Items	Units	Data
Control Potential	mV	Specimens 1,2, and 3 were set at -1000
Flow Rate	m <sup>3</sup> /hr	1.8
Temperature	°C	25
T.D.S	ppm	35,000
Test Duration	Days	8
Specimen orientation	*****	Parallel to Perpendicular for all specimens
Specimen status	*****	All specimens were new
pH	*****	8.5

**2. PURPOSE**

The purpose of this test was: -

1. To investigate the rate and duration in which scale forms on the surface of the specimens.
2. To compare the current demand of three different specimens which are set at the same control potential but placed at different locations and orientations in the flow rig.

**3. PROCEDURE**

1. Flow rig fully cleaned and flushed.
2. Potentiostat checked and found operational.
3. Reference Electrodes accuracy checked against 50D specimen.
4. Reference Electrodes and 50D specimens mounted in flow rig (salt bridges).
5. Test parameters adjusted as per above set points.
6. Protection switched on.

**4. FINDINGS**

Full protection of the specimens which, were installed at different locations within the flow rig was achieved. Reduction in applied current demand was less for specimens which, were positioned at more turbulent location within the flow rig (figure 8.1).

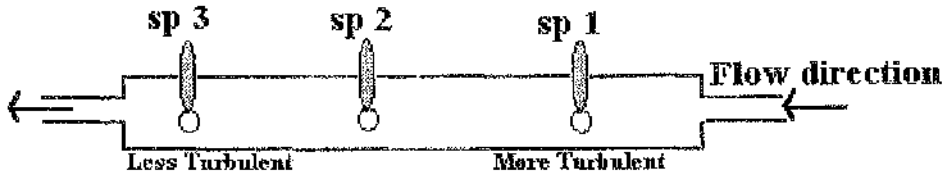

Figure 8.1: Test no.7 specimens location

After 3 days the specimens orientation from being parallel to flow was changed to perpendicular to flow. Figure 8.2 shows that the change in specimen orientation only caused an initial increase in current for all three specimens but reduced later. Upon test completion, scale was seen on the surface of the specimens. This was re-confirmed, when specimens were viewed under a microscope.

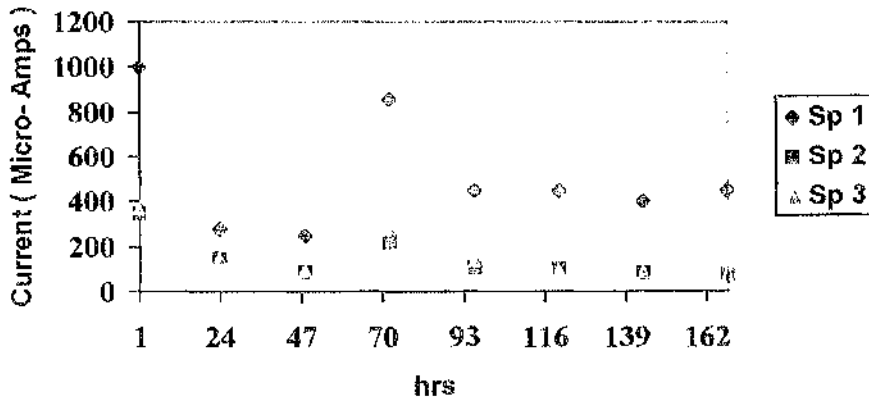

Figure 8.2: Test no.7 current trend vs. time

## 5. CONCLUSIONS

1. Demand for current decreased as flow condition becomes less turbulent (table8.1).
2. Scale precipitated on the surface of the specimens after only one day. Rate of scale deposition increases as flow velocity decreases (this was observed after visual inspection of the specimens). This is mainly due to: -
  - \* A reduction in the contact time between the specimen surface and the flow.
  - \* Control potential (being more negative).

3. Figures 8.2 shows that specimens 2 and 3 give identical result after only one day and therefore appears to be similar in terms of hydrodynamics.

#### 6. Note

For tests 8 to 13 specimens orientation was always positioned perpendicular to flow

Specimen	*****	1	2	3
Control Potential	mV	-1000	-1000	-1000
Current	$\mu$ A	$\mu$ A	$\mu$ A	$\mu$ A
Time	hrs	*****	*****	*****
0	hrs	5000	1600	4000
1	hrs	1000	350	370
24	hrs	280	150	150
48	hrs	250	90	96
72	hrs	860	220	280
96	hrs	450	110	140
120	hrs	450	106	95
144	hrs	400	85	91
168	hrs	450	77	75

**Table 8.1: Summary of test daily readings**



**TEST NO 8****1. Parameters summary**

Items	Units	Data
Control Potential	mV	Specimen no 1 set at -1000
Flow Rate	m <sup>3</sup> /hr	Static
Temperature	°C	18
T.D.S	ppm	35,000
Test Duration	Days	6
Specimen orientation	*****	Not applicable
Specimen status	*****	All specimens were new
pH	*****	8.5

**2. PURPOSE**

The purpose of this test was to investigate the rate and duration in which scale forms on the surface of the specimen and its effect on the system current demand while operating the test at static conditions (beaker test).

**3. PROCEDURE**

1. Beaker fully cleaned and flushed.
2. Potentiostat checked and found operational.
3. Reference Electrodes accuracy checked against 50D specimen.
4. Reference Electrodes and 50D specimens mounted in beaker .
5. Test parameters adjusted as per above set points.
6. Protection switched on.

**4. FINDINGS and CONCLUSIONS**

Scale formed during the first 48 hr (scale in test 7 formed in 1 day i.e. rather faster in moderately flowing condition) but was darker in nature. Figure 8.3 shows that the current demand for protecting the 50D specimen was much less when compared to the flow condition of test 7. Static condition does reduce the initial current demand.

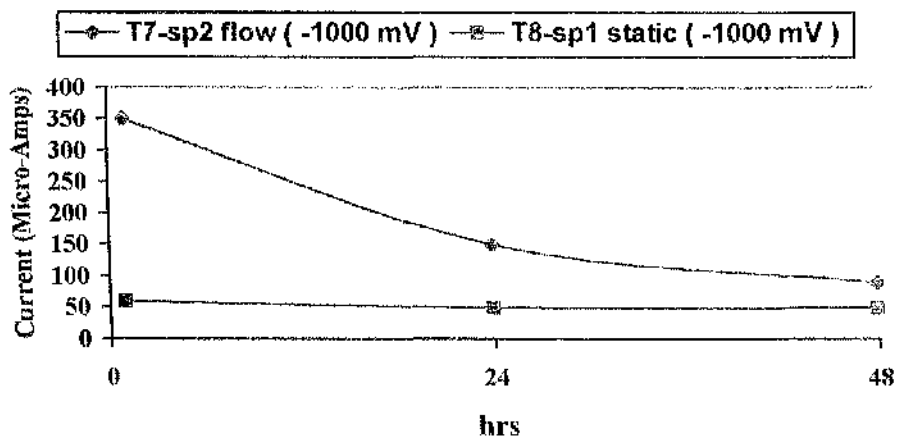

Figure 8.3: Flow effect on applied current  
(Comparison between tests 7 and 8)

Specimen	*****	1
Control Potential	mV	-1000
Current	$\mu$ A	$\mu$ A
Time	hrs	*****
0	hrs	92
1	hrs	60
24	hrs	50
48	hrs	50
72	hrs	56
96	hrs	65
120	hrs	70

Table 8.2: Summary of test daily readings

**TEST NO 9****1. Parameters summary**

Items	Units	Data
Control Potential	mV	Specimens 1 ( -1100 ), 2 and 3 set at ( -1000 )
Flow Rate	m <sup>3</sup> /hr	1.8 to Static
Temperature	<sup>0</sup> C	25
T.D.S	ppm	35,000
Test Duration	Days	8
Specimen orientation	*****	All specimens were Perpendicular to flow
specimens status	*****	Specimen 1( new ), 2, and 3 ( Pre - scaled )
pH	*****	8.5

**2. PURPOSE**

The purpose of this test was: -

- 1 To check the effect of pre-scaled specimens on current demand.
2. To investigate the rate and duration in which scale forms on the surface of the specimens when control potential is set at -1100 mV.
3. To compare the system current demand between static and flow conditions.

**3. PROCEDURE**

The test procedure used was similar to test 7.

**4. FINDINGS**

Pre-scaled specimen no 3 was visually inspected after 8 hrs in operation, part of the pre formed scale was washed away. Figure 8.4 shows that the effect of pre-scaling causes low current right from the start of the test.

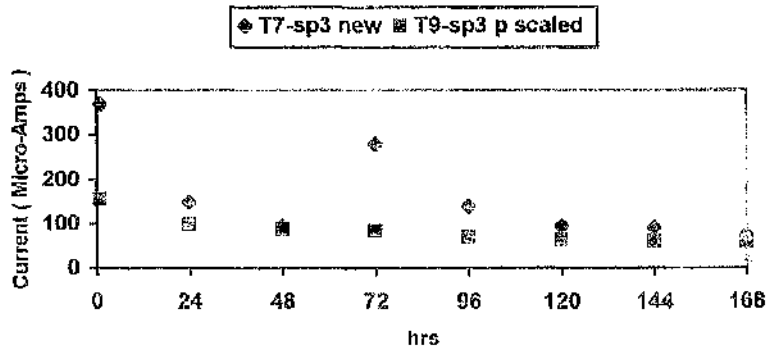

Figure 8.4: Pre-scaling effect on test applied current

Table 8.3 also reveals that current demand for specimens of the same size increases when control potential sets at more negative value. After 7 days, the rig was stopped but not depressurised. This was to check the static condition effects on current in comparison with flow conditions (Table 8.3) and recorded only a small decrease in current upon stopping the flow. Upon completion of the test scale was seen on the surface of the specimens. This was re-confirmed when specimens were viewed under a microscope.

## 5. CONCLUSIONS

- Figure 8.5 shows that demand for current decreases when: -
  - \* Control potential was set at less negative value.
  - \* Flow condition.

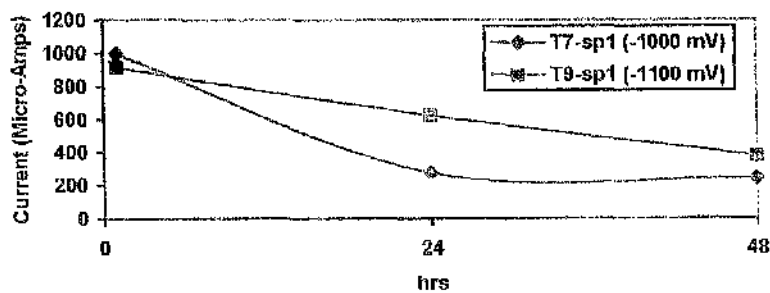

Figure 8.5: Effect of control set potential on the applied current

- Scale precipitated on the surface of specimen no 1 after only one day mainly due to more negative potential.

3. Pre-scaled specimens reduced the applied current demand when compared with the experiment, which was carried out under the same operating conditions.

Specimen	*****	1	2	3
Control Potential	mV	-1100	-1000	-1000
Current	$\mu$ A	$\mu$ A	$\mu$ A	$\mu$ A
Time	hrs	*****	*****	*****
0	hrs	4000	3600	4000
1	hrs	920	110	156
24	hrs	630	60	100
48	hrs	380	30	89
72	hrs	250	30	85
96	hrs	200	30	70
120	hrs	162	30	65
144	hrs	160	25	61
168	hrs	130	25	60
192	hrs	100	20	51

**Table 8.3: Summary of test daily readings**

**TEST NO 10****1. Parameters summary**

Items	Units	Data
Control Potential	mV	Specimens 1 and 2 set at ( -1000 )
Flow Rate	m <sup>3</sup> /hr	Static
Temperature	°C	18
T.D.S	ppm	35,000
Test Duration	Days	10
Specimen orientation	*****	Not applicable
specimens status	*****	Specimen 1 and 2 were new
pH	*****	8.4

**2. PURPOSE**

The purpose of this test was to re-produce test 8 findings: -

1. To investigate the rate and duration in which scale forms on the surface of the specimen.
2. To observe the effect on system applied current, while operating the test at static conditions (beaker test).
3. To examine effect of control potential variation on test applied current.

**3. PROCEDURE**

Test procedure was similar to test 8.

**4. FINDINGS**

Scale formed during the first 72 hr. and was whitish in nature. The current increased for specimen no 2 when the control potential was changed to a more negative set potential of -1100 mV (table 8.4).

**5. CONCLUSIONS**

1. Scale of almost same quantity was formed in 42 to 72 hours in tests 8 and 10.

2. Static conditions requirement for current is less when compared to flow condition in test 9.
3. Table 8.4 shows that demand for current increases when control potential sets at more negative value.

## 6. NOTE

Specimen no 1 from this test was also used in test 11.

Specimen	*****	1	2
Control Potential	mV	-1100	-1000
Current	$\mu$ A	$\mu$ A	$\mu$ A
Time	hrs	*****	*****
0	hrs	1200	1000
1	hrs	50	70
24	hrs	40	30
48	hrs	40	40
72	hrs	40	30
96	hrs	35	30
120	hrs	35	35
144	hrs	50	35
168	hrs	50	30
192	Hrs	40	100 ( Potential varied to -1100 mV)
216	hrs	25	100
240	hrs	25	96

**Table 8.4: Summary of test daily readings**

**TEST NO 11****1. Parameters summary**

Items	Units	Data
Control Potential	mV	Specimens 1 ( -1100 ), 2 and 3 set at ( -900 )
Flow Rate	m <sup>3</sup> /hr	1.8
Temperature	°C	25 raised to 45 after 7 days
T.D.S	ppm	35,000
Test Duration	Days	8
Specimen orientation	*****	All specimens were Perpendicular to flow
specimens status	*****	Specimen 1, and 2 ( Pre - scaled ), 3 new
pH	*****	8.4

**2. PURPOSE**

The purpose of this test was to monitor the temperature effect on protection system applied current.

**3. PROCEDURE**

Test procedure was similar to test 7, except temperature was raised during the test.

**4. FINDINGS**

Table 8.5 indicates the effect of temperature, scale, flow velocity and specimen location on applied current demand for achieving full protection. After 7 days control supply of specimen 3 was found to be inadvertently tripped. This had produced a rusty solution and specimen no 3 corroded. The test was stopped and the following were found: -

- \* A thick layer of scale was seen on the surface of specimen no 1.
- \* Scale was observed on the surface of specimen no 2 but less than 1.

**5. CONCLUSIONS**

1. Table 8.5 shows that for both pre-scaled specimens 1 and 2, the initial current, were high before dropping after 1 hour to much-lower values. It also reveals an immediate increase in applied current for specimens 2 and 3 when operating temperature raised from 25 to 45 °C.



3. Figure 8.6 shows, the effect of pre-scaling reduces the current, but effect is rather short lived and disappears when scale forms on the surface of the specimen.

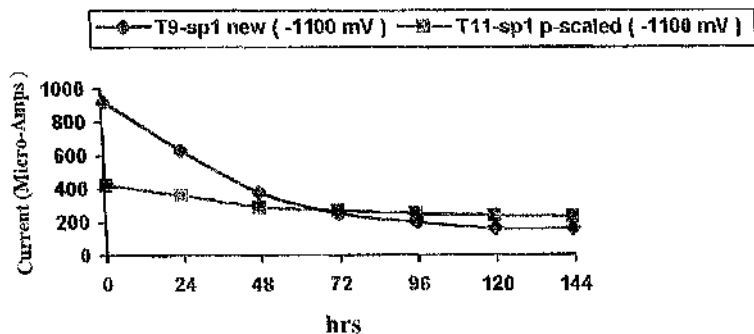

Figure 8.6: Scale effect on the applied current demand

2. Figure 8.7 shows the effect of pre-scale is longer lasting when compared to figure 8.6. This might be due to less negative control potential, which takes longer for scale to form on the surface of the new specimen.

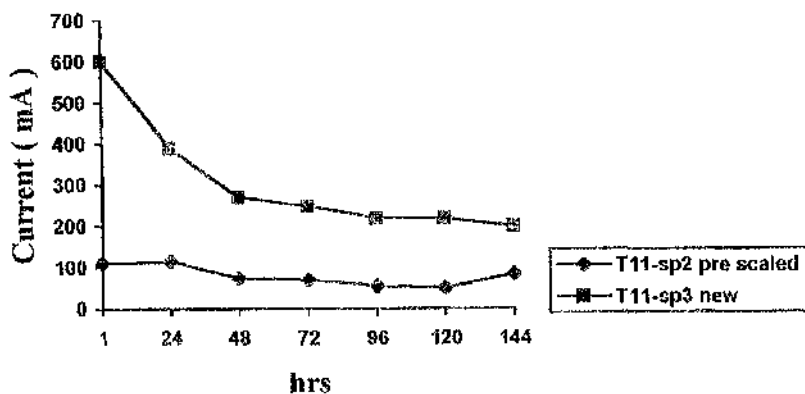

Figure 8.7: Pre-scaling effect on the system applied current

Specimen	*****	1	2	3
Control Potential	mV	-1100	-900	-900
Current	$\mu$ A	$\mu$ A	$\mu$ A	$\mu$ A
Time	hrs	*****	*****	*****
0	hrs	1100	800	1000
1	hrs	420	110	600
24	hrs	360	115	390
48	hrs	290	75	270
72	hrs	270	70	250
96	hrs	250	55	220
120	hrs	240	51	220
144	hrs	230	85	200
168	hrs	270	185	224
192	hrs	192	230	N/A

Table 8.5: Summary of test daily readings

**TEST NO 12****1. Parameters summary**

Items	Units	Data
Control Potential	mV	Specimens 1 ( -1100 ), 2 set at ( -1000 )
Flow Rate	m <sup>3</sup> /hr	Static
Temperature	°C	45
T.D.S	ppm	35,000
Test Duration	Days	7
specimens status	*****	Specimen 1 ( Pre - scaled ) , 2 ( new )
Specimen orientation	*****	Not applicable
pH	*****	8.4

**2. PURPOSE**

The purpose of this test was to investigate the effect of scale deposition on the test applied current.

**3. PROCEDURE**

Test procedure was similar to test 10, except for temperature which was raised to 45 °C.

**4. FINDING AND CONCLUSION**

The test was, interrupted by an unknown individual after 3 days. Upon visual inspection specimen no 2 was found corroded. Test re- started and run for 4 days. The following was found on completion and removal of the specimens.

- \* Specimen no 1 was found fully covered with scale and no 2 was found to be corroded. This indicates the benefit of a scale layer formed during cathodic protection. The scale provided protection from corrosion during a subsequent period with no cathodic protection (specimen no. 1).
- \* Figure 8.8 shows that the demand for current increased with increase in temperature. The sharp increase in current for the test 12 specimen after 48 hours is due to the interruption in the cathodic protection supply.

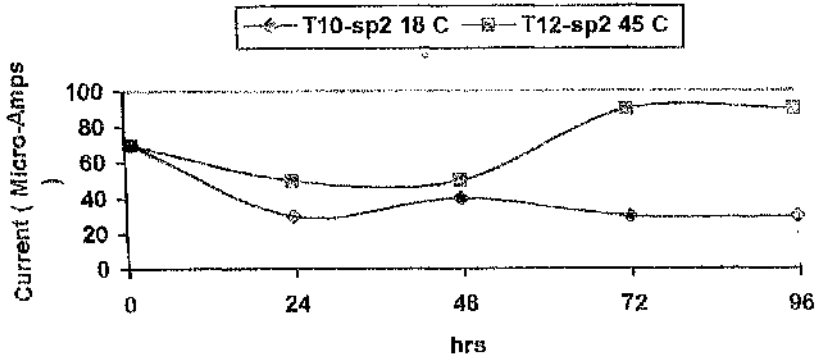

Figure 8.8: Temperature effect on protection applied current vs. time

Specimen	*****	1	2
Control Potential	mV	-1100	-1000
Current	$\mu$ A	$\mu$ A	$\mu$ A
Time	hrs	*****	*****
0	hrs	200	1300
1	hrs	150	70
24	hrs	58	50
48	hrs	60	50
72	hrs	75	90
96	hrs	70	90
120	hrs	55	62
144	hrs	45	60
168	hrs	45	60

Table 8.6: Summary of test daily readings

**TEST NO 13****1. Parameters summary**

Items	Units	Data
Control Potential	mV	Specimens 1, 2, and 3 were set at -1000
Flow Rate	m <sup>3</sup> /hr	1.8
Temperature	°C	45
T.D.S	ppm	35,000
Test Duration	Days	5
Specimen orientation	*****	All specimens were Perpendicular to flow
Specimen status	*****	Specimens 1 and 2 (pre-scaled), 3 new
pH	*****	8.4

**2. PURPOSE**

The purpose of this test was to re-assess the findings obtained during test 7 to 12 (mainly to compare the temperature, flow and pre-scaling effect on protection applied current).

**3. PROCEDURE**

Same as test 7, except operating temperature was raised to the required level.

**4. FINDINGS**

Test completed after 5 days, all the specimens found scaled up.

**5. CONCLUSIONS**

- Figure 8.9 shows that the demand for current increased with increase in temperature. As expected the effect of temperature on demand for applied current is higher for bare metal than pre-scaled.

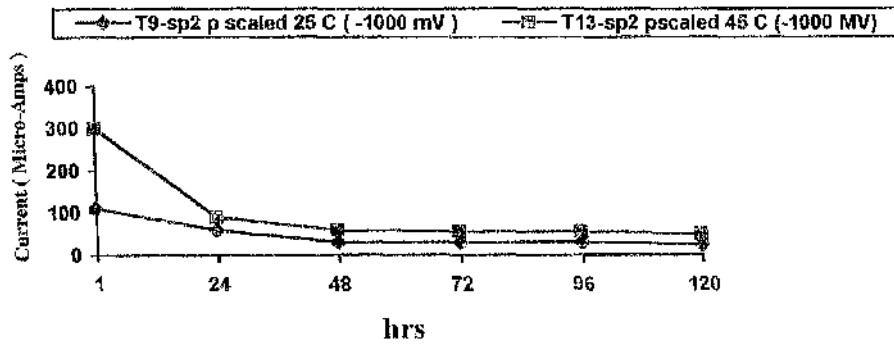

Figure 8.9: Effect of temperature on applied current demand

2. Figure 8.10 shows a comparison between static and moderate flow condition and also shows that the difference in current diminishes as the specimen scale up.

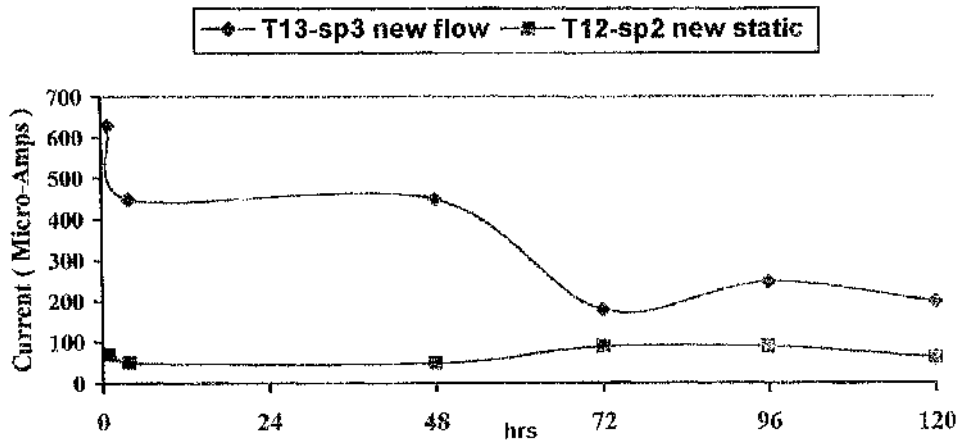

Figure 8.10: Effect of flow on system applied current vs. time

Specimen	*****	1	2	3
Control Potential	mV	-1000	-1000	-1000
Current	$\mu$ A	$\mu$ A	$\mu$ A	$\mu$ A
Time	hrs	*****	*****	*****
0	hrs	500	440	980
1	hrs	140	300	630
24	hrs	150	90	450
48	hrs	80	60	450
72	hrs	58	55	180
96	hrs	53	55	250
120	hrs	55	50	220

Table 8.7: Summary of test daily readings

**TEST NO. 14****1. PURPOSE**

The purpose of this test was to familiarise the writer with the parameters used during tests at Dubal. These parameters are mainly related to the table attached to each test. The following are the brief explanation of the terms used for each parameter: -

**a. C.P. Status**

This is to indicate whether the cathodic protection is on or off.

**b. Modes of Operation**

The cathodic protection system on the rig was operated in two groups. Group 'A' comprised 4 anodes (see below), which were subjected to the so-called 'Auto Operation'. This represents potentiostatic control, i.e. the cathodic protection system is set to a controlled potential with the current free to have any value up to its maximum (of 4 Amps in each group) necessary to yield the set potential. Group 'B' comprised of the remaining 4 anodes which were subjected to 'Manual Operation'. This was a galvanostatic control where the protection is achieved using optimised level of applied current without automatic control of potential.

\* Group 'A' was made: -

- Anodes (A1, A2, A3, and A4)
- Reference electrodes (R1 and R2)
- Specimens (S1, S2, and S3)
- Length (7 metre)

\* Group 'B' was made: -

- Anodes (B1, B2, B3, and B4)
- Reference electrodes (R3 and R4)
- Specimens (S4, and S5)
- Length (8 metre)

**c. Specimen**

**Specimens (1 to 5) were cleaned at the end of each test. Thus clean specimens were utilised at the start of each test.**

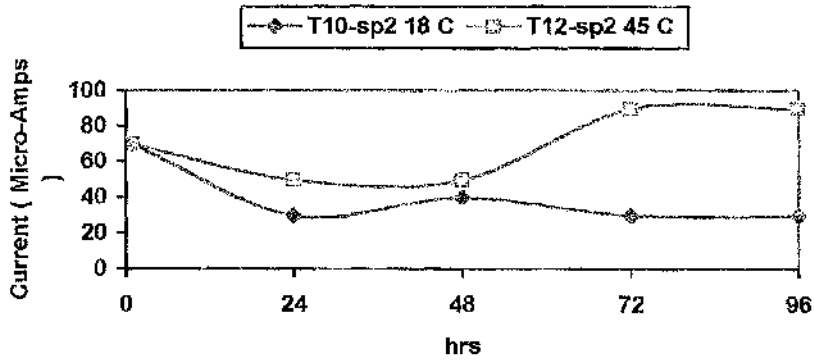

Figure 8.8: Temperature effect on protection applied current vs. time

Specimen	*****	1	2
Control Potential	mV	-1100	-1000
Current	$\mu$ A	$\mu$ A	$\mu$ A
Time	hrs	*****	*****
0	hrs	200	1300
1	hrs	150	70
24	hrs	58	50
48	hrs	60	50
72	hrs	75	90
96	hrs	70	90
120	hrs	55	62
144	hrs	45	60
168	hrs	45	60

Table 8.6: Summary of test daily readings



**TEST NO 13****1. Parameters summary**

Items	Units	Data
Control Potential	mV	Specimens 1, 2, and 3 were set at -1000
Flow Rate	m <sup>3</sup> /hr	1.8
Temperature	°C	45
T.D.S	ppm	35,000
Test Duration	Days	5
Specimen orientation	*****	All specimens were Perpendicular to flow
Specimen status	*****	Specimens 1 and 2 (pre-scaled), 3 new
pH	*****	8.4

**2. PURPOSE**

The purpose of this test was to re-assess the findings obtained during test 7 to 12 (mainly to compare the temperature, flow and pre-scaling effect on protection applied current).

**3. PROCEDURE**

Same as test 7, except operating temperature was raised to the required level.

**4. FINDINGS**

Test completed after 5 days, all the specimens found scaled up.

**5. CONCLUSIONS**

- Figure 8.9 shows that the demand for current increased with increase in temperature. As expected the effect of temperature on demand for applied current is higher for bare metal than pre-scaled.

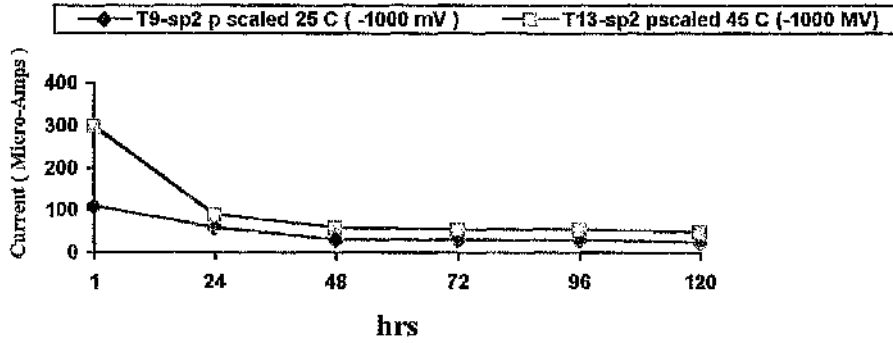

Figure 8.9: Effect of temperature on applied current demand

2. Figure 8.10 shows a comparison between static and moderate flow condition and also shows that the difference in current diminishes as the specimen scale up.

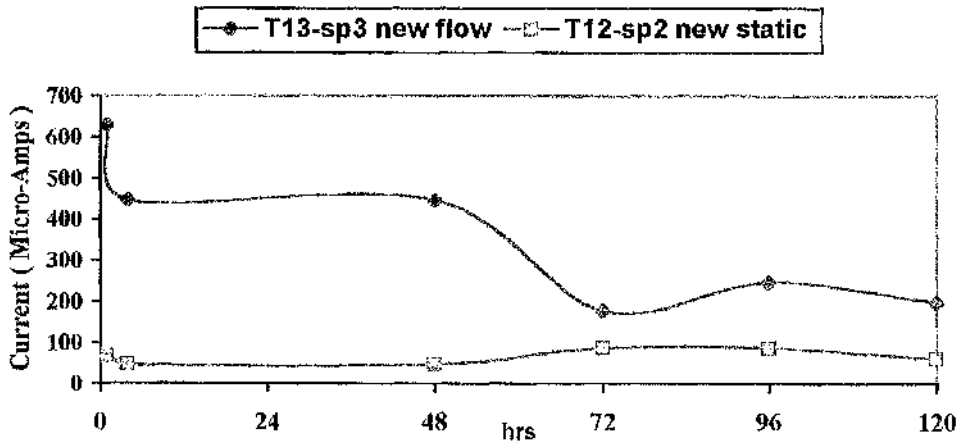

Figure 8.10: Effect of flow on system applied current vs. time

Specimen	*****	1	2	3
Control Potential	mV	-1000	-1000	-1000
Current	μ A	μ A	μ A	μ A
Time	hrs	*****	*****	*****
0	hrs	500	440	980
1	hrs	140	300	630
24	hrs	150	90	450
48	hrs	80	60	450
72	hrs	58	55	180
96	hrs	53	55	250
120	hrs	55	50	220

Table 8.7: Summary of test daily readings

**TEST NO. 14****1. PURPOSE**

The purpose of this test was to familiarise the writer with the parameters used during tests at Dubal. These parameters are mainly related to the table attached to each test. The following are the brief explanation of the terms used for each parameter: -

**a. C.P. Status**

This is to indicate whether the cathodic protection is on or off.

**b. Modes of Operation**

The cathodic protection system on the rig was operated in two groups. Group 'A' comprised 4 anodes (see below), which were subjected to the so-called 'Auto Operation'. This represents potentiostatic control, i.e. the cathodic protection system is set to a controlled potential with the current free to have any value up to its maximum (of 4 Amps in each group) necessary to yield the set potential. Group 'B' comprised of the remaining 4 anodes which were subjected to 'Manual Operation'. This was a galvanostatic control where the protection is achieved using optimised level of applied current without automatic control of potential.

\* Group 'A' was made: -

- Anodes (A1, A2, A3, and A4)
- Reference electrodes (R1 and R2)
- Specimens (S1, S2, and S3)
- Length (7 metre)

\* Group 'B' was made: -

- Anodes (B1, B2, B3, and B4)
- Reference electrodes (R3 and R4)
- Specimens (S4, and S5)
- Length (8 metre)

**c. Specimen**

**Specimens (1 to 5) were cleaned at the end of each test. Thus clean specimens were utilised at the start of each test.**

**d. Anode, Reference electrodes and specimens locations**

Figure 6.1 in chapter six showed the exact locations of each anode, reference electrodes and specimens.

**e. Flushing**

Once through test loop was flushed using potable water at the end of each test.

**f. Acid wash**

Test loop was acid washed starting from test 45 with exception to tests 47, and 52.

**g. Flow Rate**

Tests were carried out using the following flow rates:

<b>Flow rate (m<sup>3</sup>/hr)</b>	<b>Flow rate (m/s)</b>
7.5	0.06
40	0.22
180	1

**TEST NO. 15****1. Parameters summary**

Items	Units	Data
Control Potential	mV	Manual
Flow Rate	m <sup>3</sup> /hr	7.5
Temperature	°C	25
T.D.S	ppm	43,000
Test Duration	Days	6

**2. PURPOSE**

The purpose of this test was to check test loop, performance and reliability after previous commissioning tests.

**3. PROCEDURE**

1. Reference electrode accuracy checked against 50 D specimen.
2. Anodes cleaned and calcareous deposits removed.
3. Rig primed, fully flushed and vented.
4. Specimens installed in the rig.
5. Potential monitoring system switched on, set of local potentials taken and checked against system monitoring panel.
6. Test criteria set i.e. flow rate, current.
7. Cathodic protection of both groups left on manual operation. Current was set at value of 4 amps (group 'A') and 3 amps (group 'B').

**4. FINDINGS**

Potential prior to switching on, cathodic protection (-615 to -660 mV) was indicative of corroding steel. Operation of the test loop proved to be working as system responded to all the changes that were made during the test. No sign of corrosion was seen at the surface of the specimens apart from specimen 1. Scale had formed on the surface of the specimen 2 to 5. Calcareous deposits observed around anodes of group 'B'. The electrode potential readings showed that the cathodic protection system resulted in different potential being established at different point of the pipe. The different between potential

recorded at the control panel and these measured locally demonstrated that the effect of cathodic protection builds up with time within the pipe.

## 5. CONCLUSIONS

1. Test rig performed satisfactory to the required level and proved to be suitable for further experimental work.
2. Over protection of system in the area of group 'B' anode zone indicated by formation of calcareous deposit around anodes.

## 6. COMMENTS

1. A sample of formed scale on the surface of specimen no. 5 and calcareous deposits were analysed. The results indicated of magnesium and calcium. This is likely to be a combination of calcium carbonate and magnesium hydroxide.
3. Group 'B' current to be reduced to 2.5 Amps.

<b>C.P. Status</b>	****	<b>OFF</b>	<b>ON</b>	<b>ON</b>	<b>ON</b>	<b>ON</b>	<b>ON</b>	<b>ON</b>
<b>Time</b>	hrs	0	24	48	72	96	120	144
<b>Group 'A'</b>	<b>Manual Ops</b>	<b>M</b>	<b>M</b>	<b>M</b>	<b>M</b>	<b>M</b>	<b>M</b>	<b>M</b>
<b>Current</b>	<b>Amps</b>	4	4	4	4	3	3	3
<b>Voltage</b>	<b>V</b>	6	5.9	5.9	5.9	4.8	4.8	4.8
<b>R. Electrode</b>	<b>MV</b>							
<b>R1</b>	<b>PANEL</b>	-550	-900	-950	-1000	-1000	-1000	-1000
<b>R2</b>	<b>PANEL</b>	-630	-1000	-1050	-1100	-1030	-1080	-1090
<b>R1</b>	<b>LOCALLY</b>	-530	****	****	****	-885	-905	-925
<b>R2</b>	<b>LOCALLY</b>	-640	****	****	****	-975	-975	-988
<b>Group 'B'</b>	<b>Manual Ops</b>	<b>M</b>	<b>M</b>	<b>M</b>	<b>M</b>	<b>M</b>	<b>M</b>	<b>M</b>
<b>Current</b>	<b>Amps</b>	4	3	3	3	3	3	3
<b>Voltage</b>	<b>V</b>	6	4.8	4.8	4.8	4.8	4.8	4.8
<b>R. Electrode</b>	<b>MV</b>	****	****	****	****	****	****	****
<b>R3</b>	<b>PANEL</b>	-660	-900	-1250	-1250	-1100	-1200	-1200
<b>R4</b>	<b>PANEL</b>	-630	-1020	-1120	-1130	-1060	-1120	-1150
<b>R3</b>	<b>LOCALLY</b>	-640	****	****	****	-1070	-1100	-1100
<b>R4</b>	<b>LOCALLY</b>	-615	****	****	****	-1030	-1050	-1050

Table 8.8: Summary of test daily readings

**TEST NO.16****1. Parameters summary**

Items	Units	Data
Control Potential	mV	Manual
Flow Rate	m <sup>3</sup> /hr	7.5
Temperature	°C	25
T.D.S	ppm	43,000
Test Duration	Days	6

**2. PURPOSE**

The purpose of this test was: -

1. To repeat test loop performance and reliability run.
2. To study the time required for scale precipitation on the surface of the specimen under pre-set conditions using seawater.

**3. PROCEDURE**

1. Test Rig pre-start check carried out and specimens were mounted into the line.
2. Test rig primed, fully flushed and vented.
3. Potential monitoring system switched on. Set of local potential readings taken and checked against system monitoring panel.
4. Test parameters adjusted as per above data i.e. current.
5. Protection of both groups left on manual operation at pre-set current of 2.5 amps.

**4. FINDINGS**

Again, potential measured prior, to cathodic protection switched on were in the expected corroding range. No leaks were evident throughout the experiment and the system responded to changes made throughout the test. On a number of occasions flow was stopped to check status of the specimens visually. Scale had formed on the surface of all the specimens at variable rates dependent on the location of the specimens (scale formed faster on the surface of specimen 5, as it was positioned at less turbulent point within the

test loop). After 6 days, test completed, loop de-pressurised, specimens removed and following observed.

## 5. CONCLUSIONS

1. Test loop proved to be dependable for future experimental work.
2. Scale precipitated out on the surface of the specimens within 24 hrs. Rate of precipitation was dependent on the following parameters: -
  - \* Specimen location and hence flow conditions (i.e. more or less turbulent).
  - \* Local potential next to the specimens.
3. No calcareous deposit or sign of corrosion was observed around the anodes. This proved that the reduction of current from 4 to 2.5 amps as was suggested during test 15 was essential for achieving an optimum current level for system protection at a pre set control potential.

<b>C.P. Status</b>	<b>****</b>	<b>OFF</b>	<b>ON</b>	<b>ON</b>	<b>ON</b>	<b>ON</b>	<b>ON</b>	<b>ON</b>
<b>Time</b>	<b>hrs</b>	<b>0</b>	<b>24</b>	<b>48</b>	<b>72</b>	<b>96</b>	<b>120</b>	<b>144</b>
<b>Group 'A'</b>	<b>Manual Ops</b>	<b>M</b>	<b>M</b>	<b>M</b>	<b>M</b>	<b>M</b>	<b>M</b>	<b>M</b>
<b>Current</b>	<b>Amps</b>	<b>3</b>	<b>3</b>	<b>2.5</b>	<b>2.5</b>	<b>2.5</b>	<b>2.5</b>	<b>2.5</b>
<b>Voltage</b>	<b>V</b>	<b>4.8</b>	<b>4.8</b>	<b>4.4</b>	<b>4.4</b>	<b>4.4</b>	<b>4.4</b>	<b>4.4</b>
<b>R. Electrode</b>	<b>MV</b>	<b>****</b>	<b>****</b>	<b>****</b>	<b>****</b>	<b>****</b>	<b>****</b>	<b>****</b>
<b>R1</b>	<b>PANEL</b>	<b>-610</b>	<b>-1000</b>	<b>-1100</b>	<b>-1100</b>	<b>-1100</b>	<b>-1100</b>	<b>-1100</b>
<b>R2</b>	<b>PANEL</b>	<b>-670</b>	<b>-1050</b>	<b>-1050</b>	<b>-1050</b>	<b>-1050</b>	<b>-1050</b>	<b>-1050</b>
<b>R1</b>	<b>LOCALLY</b>	<b>-590</b>	<b>****</b>	<b>****</b>	<b>****</b>	<b>****</b>	<b>****</b>	<b>****</b>
<b>R2</b>	<b>LOCALLY</b>	<b>-650</b>	<b>****</b>	<b>****</b>	<b>****</b>	<b>****</b>	<b>****</b>	<b>****</b>
<b>Group 'B'</b>	<b>Manual Ops</b>	<b>M</b>	<b>M</b>	<b>M</b>	<b>M</b>	<b>M</b>	<b>M</b>	<b>M</b>
<b>Current</b>	<b>Amps</b>	<b>3</b>	<b>2.5</b>	<b>2.5</b>	<b>2.5</b>	<b>2.5</b>	<b>2.5</b>	<b>2.5</b>
<b>Voltage</b>	<b>V</b>	<b>4.7</b>	<b>4.4</b>	<b>4.4</b>	<b>4.4</b>	<b>4.4</b>	<b>4.4</b>	<b>4.4</b>
<b>R. Electrode</b>	<b>MV</b>	<b>****</b>	<b>****</b>	<b>****</b>	<b>****</b>	<b>****</b>	<b>****</b>	<b>****</b>
<b>R3</b>	<b>PANEL</b>	<b>-560</b>	<b>-1150</b>	<b>-1200</b>	<b>-1200</b>	<b>-1200</b>	<b>-1200</b>	<b>-1200</b>
<b>R4</b>	<b>PANEL</b>	<b>-580</b>	<b>-1100</b>	<b>-1100</b>	<b>-1100</b>	<b>-1100</b>	<b>-1100</b>	<b>-1100</b>
<b>R3</b>	<b>LOCALLY</b>	<b>-550</b>	<b>****</b>	<b>****</b>	<b>****</b>	<b>****</b>	<b>****</b>	<b>****</b>
<b>R4</b>	<b>LOCALLY</b>	<b>-560</b>	<b>****</b>	<b>****</b>	<b>****</b>	<b>****</b>	<b>****</b>	<b>****</b>

**Table 8.9: Summary of test daily readings**



**TEST NO. 17****1. Parameters summary**

<b>Control Potential</b>	<b>mV</b>	<b>-1050</b>
<b>Flow Rate</b>	<b>m<sup>3</sup>/hr</b>	<b>7.5</b>
<b>Temperature</b>	<b>°C</b>	<b>25</b>
<b>T.D.S</b>	<b>ppm</b>	<b>43,000</b>
<b>Test Duration</b>	<b>Days</b>	<b>7</b>

**2. PURPOSE**

The purpose of this test was: -

1. To check group "A" auto operation mode behaviour when system protection set at control potential of -1050 mV.
2. To re-examine the time required for scale to precipitate on the surface of mounted specimens.

**3. PROCEDURE**

1. Test rig pre-start check carried out and clean specimens mounted into the line.
2. Test rig primed, fully flushed and vented.
3. Potential monitoring system switched on. Set of local potential readings taken and checked against system monitoring panel.
4. Control potential of, group "A" set at -1050 mV (auto operation). Group "B" current set at 2.5 Amps (manual or galvanostatic operation).

**4. FINDINGS**

The test loop pipelines and specimens were protected cathodically for about 7 days at a set control potential of -1050 mV. The total current demand for group "A" was reduced to 0.8 Amps from 4 Amps. Within 24 hrs of test start up, specimens 2 and 5 were checked, scale was deposited at the surface of the specimens. After 7 days, test completed, loop stopped, de-pressurised and specimens removed. The visual inspection revealed almost the same finding as in test 16 (namely specimens scaled and not corroded), except scale precipitation on the surface of group "A" specimens were slightly less than test 16.

## 5. CONCLUSIONS

1. System positively responded to, auto mode operation at pre-set value of -1050 mV control potential.
2. Figures 8.11 and 8.12 shows that the system current demand dropped as scale was formed on the surface of the specimens and the pipelines. The amount of applied current required for protection is principally dependent on the following factors: -

- \* Area to be protected.
- \* Rate of scale precipitation at the surfaces of the area which are kept under, protection.
- \* Applied potential.
- \* Temperature.
- \* Flow rate.

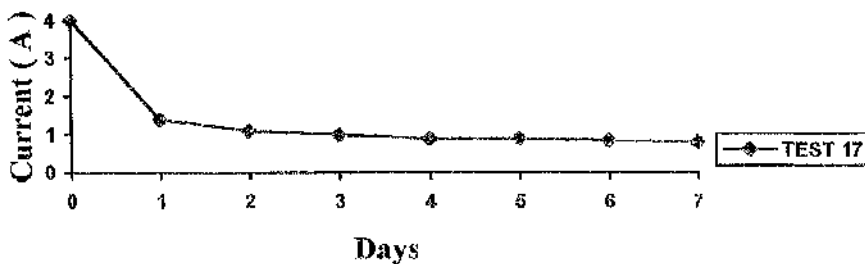

Figure 8.11: Group 'A' current trend versus time

3. Scale precipitation pattern was almost the same as test 16 (namely specimens scaled and not corroded). The scale deposits were distributed evenly over the specimen's surface and had adhered to the surface of specimens for group 'B'. This is mainly due to the followings: -
  - \* Higher contact time between seawater and the protective area, as flow becomes less turbulent along the pipeline and.
  - \* Local potential. Table 8.10 shows that the potential next to the specimens for group 'B' was more negative than in group 'A'.
4. No sign of any calcareous deposits were observed around the anodes.



Figure 8.12: Scale built up on the surface of the test loop pipeline

C.P. Status	****	OFF	ON	ON	ON	ON	ON	ON
Time	hrs	0	24	48	72	96	120	144-168
Group 'A'	Auto Ops	Auto	Auto	Auto	Auto	Auto	Auto	Auto
Set Potential	mV	-1050	-1050	-1050	-1050	-1050	-1050	-1050
Current	Amps	4	1.4	1.1	1	0.9	0.9	0.85-0.8
Voltage	V	6	3.5	3.3	3.2	3.1	3.1	3
R. Electrode	MV	****	****	****	****	****	****	****
R1	PANEL	-620	-1050	-1050	-1050	-1050	-1050	-1050
R2	PANEL	-670	-1000	-1000	-1000	-1000	-1000	-1000
R1	LOCALLY	-590	****	****	****	****	****	****
R2	LOCALLY	-650	****	****	****	****	****	****
Group 'B'	Manual Ops	M	M	M	M	M	M	M
Current	Amps	2.5	2.5	2.5	2.5	2.5	2.5	2.5
Voltage	V	4.4	4.4	4.4	4.3	4.3	4.4	4.3
R. Electrode	MV	****	****	****	****	****	****	****
R3	PANEL	-600	-1120	-1120	-1120	-1120	-1120	-1120
R4	PANEL	-620	-1100	-1100	-1100	-1100	-1100	-1100
R3	LOCALLY	-570	****	****	****	****	****	****
R4	LOCALLY	-590	****	****	****	****	****	****

Table 8.10: Summary of test daily readings

**TEST NO.18****1. Parameters summary**

Items	Units	Data
Control Potential	mV	-900
Flow Rate	m <sup>3</sup> /hr	170
Temperature	<sup>0</sup> C	30
T.D.S	ppm	43,000
Test Duration	Days	12

**2. PURPOSE**

The purpose of this test was: -

1. To check protection system reliability when both groups put on auto operation at pre-set control potential of -900 mV.
2. To investigate the rate of scale precipitation on the surface of specimens in direct relation to a reduction in current, while performing the test at a higher flow rate than test. 17, and less negative potential.

**2. TEST RIG MODIFICATION**

A section of the pipeline within group 'A' protection zone was removed and modified. This modification provided access to inspect visually the protected area of the pipeline (spool piece, figure 6.3 of chapter six).

**3. PROCEDURE**

1. Reference electrode accuracy checked against 50D specimens.
4. Spool piece or inspection window sand blasted.
5. A larger size orifice was installed into the test rig.
4. Test loop full pre start check carried-out and clean specimens mounted in their original positions.
5. Test loop primed, fully flushed and vented.
6. Potential monitoring system switched on. Set of local potential reading taken and checked against system monitoring panel.

7. Control potential and current of both groups set at -900 mV and 4 amps.
8. Protection switched to auto operation for both groups.

#### 4. FINDINGS

System reliability checked with both groups on auto operation at a pre set control potential of -900 mV. Very early (1<sup>st</sup> hour) in this test it was found that group 'B' could not operate in the auto mode. Thus group "B" was switched to manual and current adjusted to 2.5 amps. After 11 days, test completed, specimens and spool piece removed for inspection. No sign of corrosion or scale were observed on the spool piece. Also scale formation on the surface of the specimens was much less than in previous test.

#### 5. CONCLUSIONS

1. Auto operation of both groups was not achievable mainly due to the higher actual local potential above the set point and the rate of scale precipitation on group "B" zone being faster than group "A" zone. This is due to following: -
  - \* Flow condition in zone "B" area.
  - \* Group 'B' local potentials were more negative than group 'A'.

Consequently it was decided that, in all succeeding tests, the system would be operated with group 'A' on auto and group 'B' on manual. This provided an interesting combinations of potentiostatic and galvanostatic control.

2. System proved to be protected at control potential of -900 mV as no signs of corrosion observed at the specimen surfaces or on the pipelines.
3. Scale precipitation was seen reduced at the surface of the specimens. This was due to the increase in flow rate as the flow contact duration decreased in the pipeline and specimens and less negative control potential.
4. Figure 8.13 shows that the system applied current demand dropped as scale was formed on the surface of the specimens and the pipelines (some of the scale was formed in previous test).

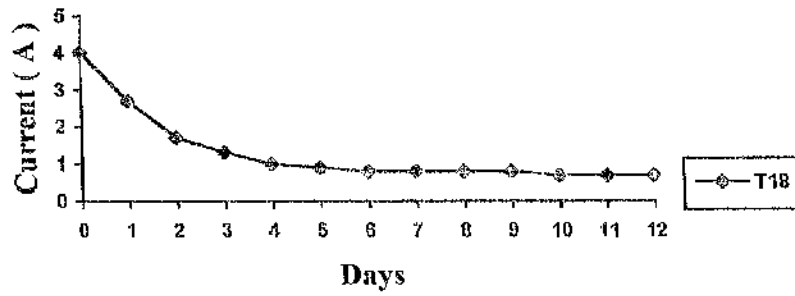

Figure 8.13: Group 'A' current trend versus time

6. NOTE

- \* All succeeding tests carried out with group 'A' on auto and manual on group 'B'.

C.P. Status	****	OFF	ON	ON	ON	ON	ON	ON
Time	hrs	0	24	48	72	96	120	144
Group 'A'	Auto Ops	Auto	Auto	Auto	Auto	Auto	Auto	Auto
Set Potential	mV	-900	-900	-900	-900	-900	-900	-900
Current	Amps	4	2.7	1.7	1.3	1	0.9	0.8
Voltage	V	6	4.5	3.5	3.2	3	2.8	2.7
R. Electrode	MV	****	****	****	****	****	****	****
R1	PANEL	-640	-900	-900	-900	-900	-900	-900
R2	PANEL	-700	-840	-840	-840	-840	-840	-840
R1	LOCALLY	-590	****	****	****	****	****	****
R2	LOCALLY	-650	****	****	****	****	****	****
Group 'B'	Manual Ops	M	M	M	M	M	M	M
Current	Amps	2	2	2	2	2	2	2
Voltage	V	3.7	3.7	3.7	3.7	3.7	3.7	3.7
R. Electrode	MV	****	****	****	****	****	****	****
R3	PANEL	-600	-1060	-1060	-1060	-1060	-1060	-1060
R4	PANEL	-630	-1010	-1010	-1010	-1010	-1010	-1010
R3	LOCALLY	-570	****	****	****	****	****	****
R4	LOCALLY	-590	****	****	****	****	****	****

ON	ON	ON	ON	ON
168	192	216	240	264
Auto	Auto	Auto	Auto	Auto
-900	-900	-900	-900	-900
0.8	0.8	0.8	0.7	0.7
2.7	2.7	2.7	2.6	2.6
****	****	****	****	****
-900	-900	-900	-900	-900
-840	-840	-840	-840	-840
****	****	****	****	****
****	****	****	****	****
M	M	M	M	M
2	2	2	2	2
3.7	3.7	3.7	3.7	3.7
****	****	****	****	****
-1060	-1060	-1060	-1060	-1060
-1010	-1010	-1010	-1010	-1010
****	****	****	****	****
****	****	****	****	****

Table 8.11: Summary of the test daily readings

**TEST NO. 19****1. Parameters summary**

Items	Units	Data
Control Potential	mV	-900
Flow Rate	m <sup>3</sup> /hr	170
Temperature	°C	40
T.D.S	ppm	43,000
Test Duration	Days	1

**2. PURPOSE**

The purpose of this test was to re-asses test. 18 findings in relation to the applied current required to maintain a potential of -900 mV Ag/AgCl while running the test at higher temperature( 39 °C instead of 30 °C ).

**3. PROCEDURE**

1. Reference electrodes accuracy checked against 50D specimens
4. Test rig pre start check carried-out and clean specimens reinstated.
3. Test rig primed, fully flushed and vented.
4. Potential monitoring system switched on. Set of local potential readings taken and checked against system monitoring panel.
5. Control potential of Group 'A' set at -900 mV, group 'B' set at 2.5 amps.

**5. FINDINGS and CONCLUSIONS**

System behaved as expected reduction in current was the same as in the previous test. After one day, test stopped and specimens removed. A blackish layer of unknown substance was observed on the surface of the specimens within the protected area of zone 'A' and 'B'. The brownish colour was also observed at the edge of the specimens. Normally the corrosion in low oxygen environment is blackish in color. In this test the seawater was directly introduced from the Brine pumps discharge line which contains lower oxygen and an antiscalet agent (Belgard EV). In some of the succeeding tests similar feed water was used.



## 6. Note

The presence of corrosion on the specimen in this test is probably due to the lack of time for the local potential to reach protection values.

<b>C.P. Status</b>	<b>****</b>	<b>OFF</b>	<b>ON</b>
<b>Time</b>	<b>hrs</b>	<b>0</b>	<b>24</b>
<b>Group 'A'</b>	<b>Auto Ops</b>	<b>Auto</b>	<b>Auto</b>
<b>Set Potential</b>	<b>mV</b>	<b>-900</b>	<b>-900</b>
<b>Current</b>	<b>Amps</b>	<b>4</b>	<b>0.8</b>
<b>Voltage</b>	<b>V</b>	<b>6</b>	<b>2.7</b>
<b>R. Electrode</b>	<b>MV</b>	<b>****</b>	<b>****</b>
<b>R1</b>	<b>PANEL</b>	<b>-650</b>	<b>-900</b>
<b>R2</b>	<b>PANEL</b>	<b>-690</b>	<b>-860</b>
<b>R1</b>	<b>LOCALLY</b>	<b>-610</b>	<b>****</b>
<b>R2</b>	<b>LOCALLY</b>	<b>-660</b>	<b>****</b>
<b>Group 'B'</b>	<b>Manual Ops</b>	<b>M</b>	<b>M</b>
<b>Current</b>	<b>Amps</b>	<b>2.5</b>	<b>2.5</b>
<b>Voltage</b>	<b>V</b>	<b>4.4</b>	<b>4.4</b>
<b>R. Electrode</b>	<b>MV</b>	<b>****</b>	<b>****</b>
<b>R3</b>	<b>PANEL</b>	<b>-610</b>	<b>-1050</b>
<b>R4</b>	<b>PANEL</b>	<b>-620</b>	<b>-1020</b>
<b>R3</b>	<b>LOCALLY</b>	<b>-590</b>	<b>****</b>
<b>R4</b>	<b>LOCALLY</b>	<b>-590</b>	<b>****</b>

**Table 8.12: Summary of the test daily readings**

**TEST NO. 20****1. Parameters summary**

Items	Units	Data
Control Potential	mV	-1000
Flow Rate	m <sup>3</sup> /hr	170
Temperature	°C	40
T.D.S	ppm	43,000
Test Duration	Days	5

**2. PURPOSE**

The purpose of this experiment was: -

1. To re-asses test.18 findings in relation to current density while running the test at higher temperature (40 °C instead of 30 °C) and at more negative potential (-1000 mV instead of -900 mV).
2. To investigate the rate of corrosion on the surface of the specimen retained in the test loop unprotected zone (during this test, the location of specimen no.2 was changed from within protected part of the loop to an area which was insulated and was not protected cathodically).

**2. PROCEDURE**

1. Test rig pre-start check carried-out and cleaned specimens and anodes reinstated in the pipeline.
2. System primed, flushed and fully vented.
3. Potential monitoring system switched on and set of local potential readings taken and checked against system monitoring panel.
4. Control potential of, group 'A' set at -1000 mV. Group 'B' current raised to 3 Amps from 2.5 following test 19 findings.

### 3. FINDINGS

Test loop was stopped after 24 hrs. Specimens 1 and 4 were removed and found to be satisfactory as no corrosion was observed at the surface of the specimens. A sharp drop in current was observed for group 'A' during the first day. Specimen 2 was checked, patches of a brownish substance were observed at the edge of the specimen. After 5 days, test completed, rig depressurised, specimen removed and following observation were recorded:-

- \* Specimens 1 & 3 were covered with brown colour substance but less than test 19.
- \* Specimen 2, fully corroded and brown/ green in colour (un-protected zone, figure 8.14).

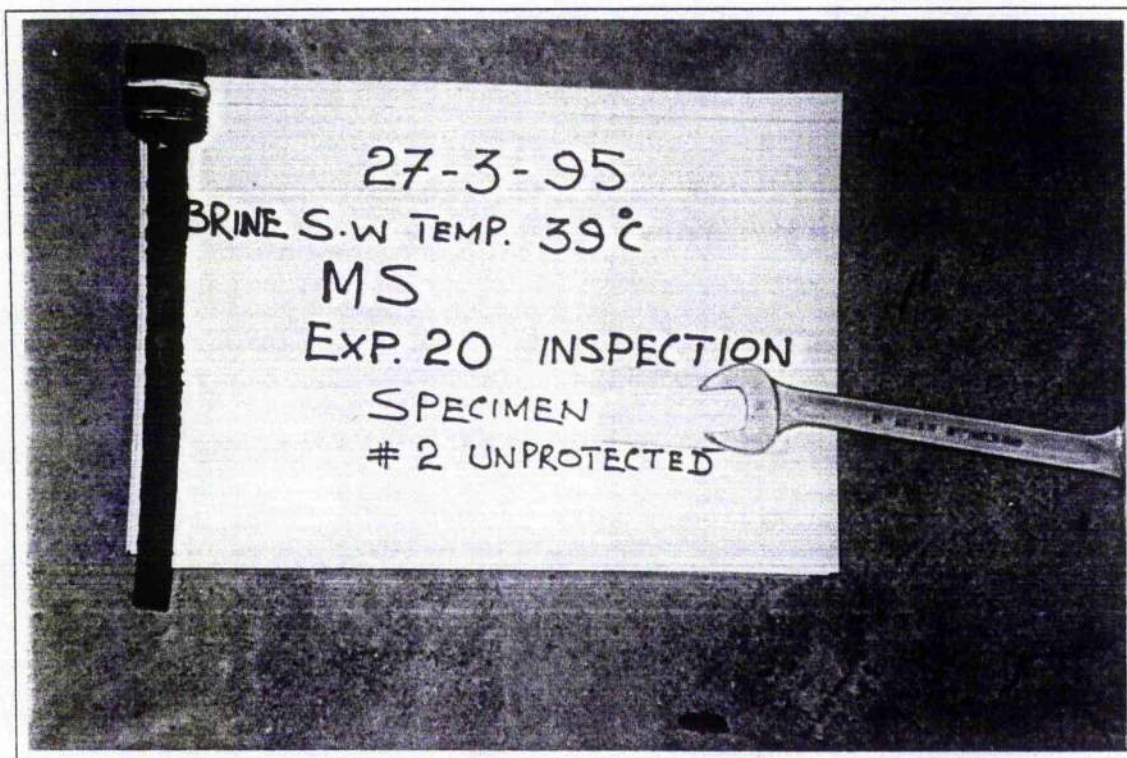

**Figure 8.14: Photo of specimen no.2 which, was corroded, as specimen was installed in an area within test loop with out cathodic protection**

- \* Specimens 4 & 5, no sign of corrosion, thin layer of scale was seen on the surface of the specimens. This is mainly due to local potential being more negative than group 'A'.

#### 4. CONCLUSIONS

1. Corrosion on the surface of the un-protected specimen appeared within 24 hrs.
2. The brown colour substance on the surface of specimens 1 & 3 was identified as oxide of iron and was therefore corrosion product. This indicates that some corrosion had occurred in initial period of test before potential reaches protection level.
3. Figure 8.15 shows that the system current demand dropped with time as scale was formed on the surface of the specimens and the pipelines.

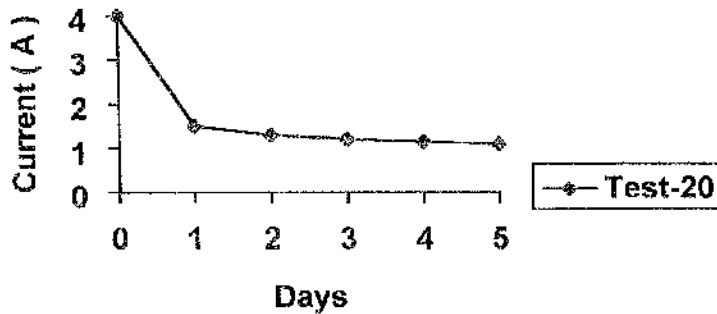

Figure 8.15: Group 'A' current trend versus time

<b>C.P. Status</b>	****	OFF	ON	ON	ON	ON	ON
<b>Time</b>	hrs	0	24	48	72	96	120
<b>Group 'A'</b>	Auto Ops	Auto	Auto	Auto	Auto	Auto	Auto
<b>Set Potential</b>	mV	-1000	-1000	-1000	-1000	-1000	-1000
<b>Current</b>	Amps	4	1.5	1.3	1.2	1.15	1.1
<b>Voltage</b>	V	6	3.4	3.3	3.2	3.2	3.1
<b>R. Electrode</b>	MV	****	****	****	****	****	****
<b>R1</b>	PANEL	-590	-1000	-1000	-1000	-1000	-1000
<b>R2</b>	PANEL	-600	-950	-950	-950	-950	-950
<b>R1</b>	LOCALLY	-570	****	****	****	****	****
<b>R2</b>	LOCALLY	-580	****	****	****	****	****
<b>Group 'B'</b>	Manual Ops	M	M	M	M	M	M
<b>Current</b>	Amps	3	3	3	3	3	3
<b>Voltage</b>	V	4.5	4.6	4.5	4.5	4.6	4.6
<b>R. Electrode</b>	MV	****	****	****	****	****	****
<b>R3</b>	PANEL	-720	-1150	-1150	-1150	-1150	-1150
<b>R4</b>	PANEL	-710	-1080	-1080	-1080	-1080	-1080
<b>R3</b>	LOCALLY	-700	****	****	****	****	****
<b>R4</b>	LOCALLY	-700	****	****	****	****	****

Table 8.13: Summary of the test daily readings

**TEST NO 21****1. Parameters summary**

Items	Units	Data
Control Potential	mV	-1050
Flow Rate	m <sup>3</sup> /hr	170
Temperature	°C	40
T.D.S	PPM	43,000
Test Duration	Days	2

**2. PURPOSE**

The purpose of this test was to re-asses test 20 finding, while performing the test at a more negative control potential (-1050 mV instead of -1000 mV).

**3. PROCEDURE**

1. Test loop pre-start check carried-out and cleaned specimens and anodes reinstated in the pipeline. Specimen 5 was installed in an unprotected zone.
2. System primed, flushed and fully vented.
3. Potential monitoring system switched and set of local potential readings taken and checked against system monitoring panel.
4. Control potential of, group 'A' set at -1050 mV. Group 'B' applied current reduced to 2.5 amps.

**4. FINDINGS**

Test was conducted for approximately 2 days. On inspection it was found that almost all the specimens (1-4) were evenly protected and no sign of corrosion and minor scale was observed on the surface of specimen 3, and 4, specimen 5 was corroded (figure 8.16).

## 5. CONCLUSIONS

1. Protection of the specimens was achieved as no sign of black or brown substances was observed while test performed at a control potential of -1050 mV. Figure 8.17 shows the effect of more negative potential on requirement for applied current.
2. High flow rate and the presence of an antiscalent in the circulating flow slightly reduced the scale formation at the surface of the specimens.
3. Table 8.14 shows a reduction in applied current initially.
4. Specimen 5 was corroded as it was placed in an area which, was insulated and was not protected cathodically.

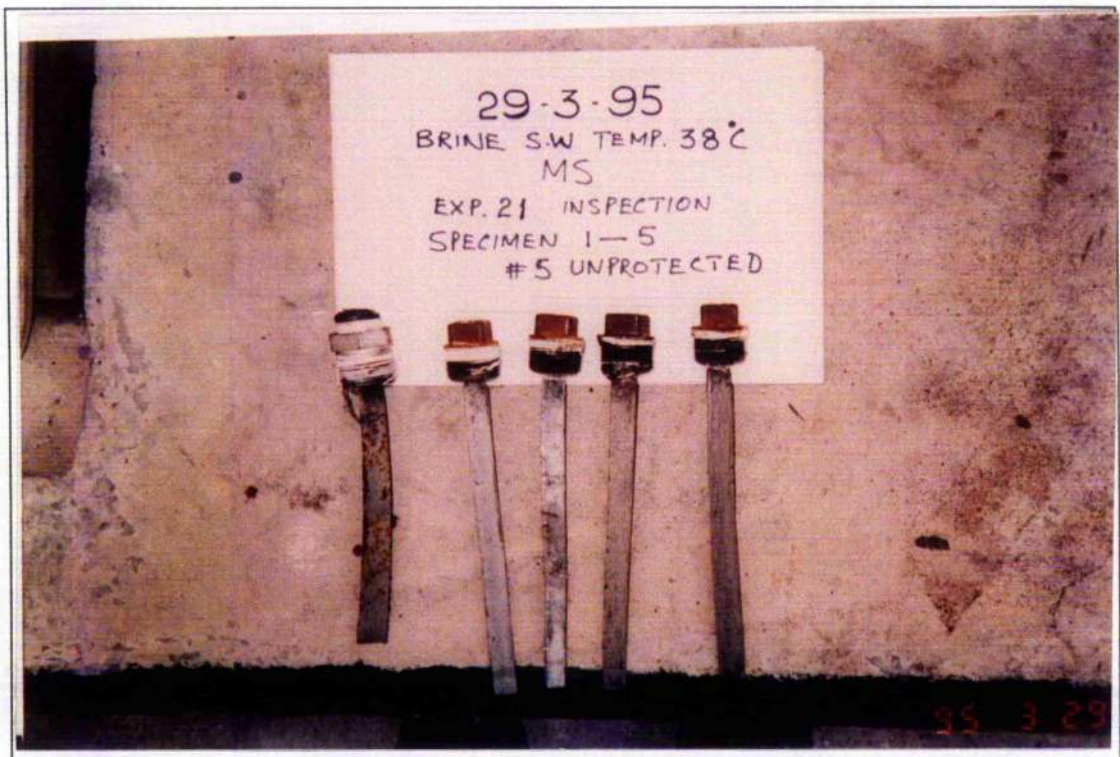

Figure 8.16: Specimen condition at the end of test 21

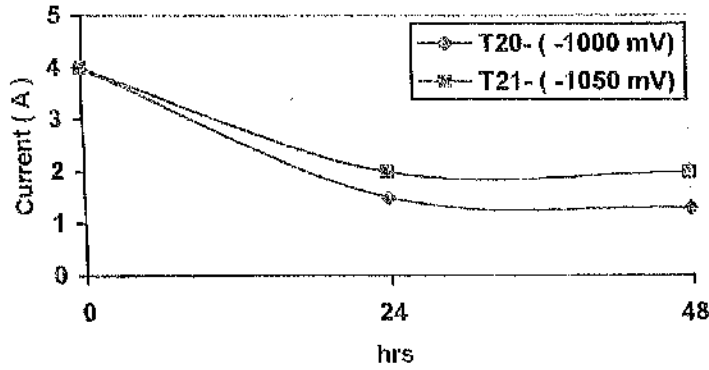

Figure 8.17: Effect of more negative potential in applied current

C.P. Status	****	OFF	ON	ON
Time	hrs	0	24	48
Group 'A'	Auto Ops	Auto	Auto	Auto
Set Potential	mV	-1050	-1050	-1050
Current	Amps	4	2	2
Voltage	V	6	3.8	3.7
R. Electrode	MV	****	****	****
R1	PANEL	-590	-1050	-1050
R2	PANEL	-600	-1100	-1080
R1	LOCALLY	-570	****	****
R2	LOCALLY	-580	****	****
Group 'B'	Manual Ops	M	M	M
Current	Amps	2.5	2.5	2.5
Voltage	V	4.4	4.4	4.4
R. Electrode	MV	****	****	****
R3	PANEL	-720	-1200	-1200
R4	PANEL	-710	-1090	-1090
R3	LOCALLY	-700	****	****
R4	LOCALLY	-700	****	****

Table 8.14: Summary of the test daily readings

**TEST NO 22**

**THIS TEST WAS BEEN ABANDONED DUE TO A HEAVY LEAK ON THE  
EVAPORATOR NO 5 SEA WATER SYSTEM PIPELINE DURING THE TEST.**



**TEST NO 23****1. Parameters summary**

Items	Units	Data
Control Potential	mV	-900
Flow Rate	m <sup>3</sup> /hr	40
Temperature	°C	25
T.D.S	ppm	43,000
Test Duration	Days	6

**2. PURPOSE**

The purpose of this test was: -

1. To compare the rate of scale deposition on the surface of specimens with test 21.
2. To examine, the effect of less negative set control potential on system protection.

**3. PROCEDURE**

Test procedure was similar to test 20, with exception that the set potential, temperature, flow rate were different.

**4. FINDINGS**

The pipelines of test loop and specimens were protected cathodically for approximately 6 days at a set control potential of -900 mV for group 'A' protection zone. Group 'B' continued on manual operation at a pre-set optimised current level of 2.5 amps. The electrode potential was observed to be different at various locations in the loop. The locally measured potential shows that the potential had stabilised at values close to the meter values after 6 days.

After 6 days, test completed, rig depressurised and specimens and inspection window removed. The following was observed: -

- \* Specimens 1, 2 and 3, no scale on the surface but slight corrosion at the specimens edges.
- \* Specimens 4 and 5, no corrosion but scale had formed uniformly at the specimen surface.

- \* Inspection windows (spool piece) and the pipelines found to be generally in good condition, with only minor signs of corrosion in the area of the pipeline where the line was not fully primed. Scale also observed in the spool piece, no indication of any calcareous deposit around anodes.

Test was restarted on 7.04.95 following specimen cleaning and reference electrode checks.

On 08.04.95 test stopped and no corrosion observed on any of the specimens, except specimen 3 which was due to insulation failure.

## **5. CONCLUSIONS**

1. The absence of corrosion on any specimen indicates that potential of  $-900$  mV and more negative potential used in this test were successful in controlling corrosion.
2. Corrosion at the upper side of the inspection window and the pipeline was mainly due to incorrect system priming, not protection.
3. Scale formation rate reduced when compared to test 21. This was mainly due to drop in temperature and less negative control potential.

<b>C.P. Status</b>	<b>****</b>	<b>OFF</b>	<b>ON</b>	<b>ON</b>	<b>ON</b>	<b>ON</b>	<b>ON</b>
<b>Time</b>	<b>hrs</b>	<b>0</b>	<b>24</b>	<b>48</b>	<b>72</b>	<b>96</b>	<b>120</b>
<b>Group 'A'</b>	<b>Auto Ops</b>	<b>Auto</b>	<b>Auto</b>	<b>Auto</b>	<b>Auto</b>	<b>Auto</b>	<b>Auto</b>
<b>Set Potential</b>	<b>mV</b>	<b>N/A</b>	<b>-900</b>	<b>-900</b>	<b>-900</b>	<b>-900</b>	<b>-900</b>
<b>Current</b>	<b>Amps</b>	<b>4</b>	<b>2.8</b>	<b>1.55</b>	<b>0.9</b>	<b>0.7</b>	<b>0.7</b>
<b>Voltage</b>	<b>V</b>	<b>6</b>	<b>4.6</b>	<b>3.5</b>	<b>3</b>	<b>2.9</b>	<b>2.8</b>
<b>R. Electrode</b>	<b>MV</b>	<b>****</b>	<b>****</b>	<b>****</b>	<b>****</b>	<b>****</b>	<b>****</b>
<b>R1</b>	<b>PANEL</b>	<b>-580</b>	<b>-900</b>	<b>-900</b>	<b>-900</b>	<b>-900</b>	<b>-900</b>
<b>R2</b>	<b>PANEL</b>	<b>-590</b>	<b>-950</b>	<b>-950</b>	<b>-950</b>	<b>-950</b>	<b>-950</b>
<b>R1</b>	<b>LOCALLY</b>	<b>-570</b>	<b>****</b>	<b>****</b>	<b>****</b>	<b>****</b>	<b>-890</b>
<b>R2</b>	<b>LOCALLY</b>	<b>-580</b>	<b>****</b>	<b>****</b>	<b>****</b>	<b>****</b>	<b>-940</b>
<b>Group 'B'</b>	<b>Manual Ops</b>	<b>M</b>	<b>M</b>	<b>M</b>	<b>M</b>	<b>M</b>	<b>M</b>
<b>Current</b>	<b>Amps</b>	<b>2.5</b>	<b>2.5</b>	<b>2.5</b>	<b>2.5</b>	<b>2.5</b>	<b>2.5</b>
<b>Voltage</b>	<b>V</b>	<b>4.4</b>	<b>4.4</b>	<b>4.4</b>	<b>4.4</b>	<b>4.4</b>	<b>4.4</b>
<b>R. Electrode</b>	<b>MV</b>	<b>****</b>	<b>****</b>	<b>****</b>	<b>****</b>	<b>****</b>	<b>****</b>
<b>R3</b>	<b>PANEL</b>	<b>-710</b>	<b>-1100</b>	<b>-1100</b>	<b>-1100</b>	<b>-1100</b>	<b>-1100</b>
<b>R4</b>	<b>PANEL</b>	<b>-720</b>	<b>-1020</b>	<b>-1020</b>	<b>-1020</b>	<b>-1020</b>	<b>-1020</b>
<b>R3</b>	<b>LOCALLY</b>	<b>-700</b>	<b>****</b>	<b>****</b>	<b>****</b>	<b>****</b>	<b>-1080</b>
<b>R4</b>	<b>LOCALLY</b>	<b>-700</b>	<b>****</b>	<b>****</b>	<b>****</b>	<b>****</b>	<b>-980</b>

**Table 8.15: Summary of the test daily readings**

**TEST NO 24****1. Parameters summary**

Items	Units	Data
Control Potential	mV	-1050
Flow Rate	m <sup>3</sup> /hr	40
Temperature	°C	25
T.D.S	ppm	43,000
Test Duration	Days	7

**2. PURPOSE**

The purpose of this test was: -

1. To re-asses test 17 findings in relation to the applied current required to maintain a potential of -1050 mV Ag/AgCl while performing the test at a higher flow rate ( 40 m<sup>3</sup>/hr instead of 7.5 m<sup>3</sup>/hr).
2. To study the general effect of more negative set control potential on system applied current when compared with test 23.

**3. PROCEDURE**

Similar to test 23, with exception that control potential was varied.

**4. FINDINGS**

As in test 23, potential measurement again indicated that, after a few days, application of cathodic protection, the meter potential reading were good indicator of actual potential within the pipeline. On two occasions during the experiment the test loop was stopped for specimen inspections. On both occasions the specimens condition was satisfactory and no sign of corrosion was observed at the surface of the installed specimens. After 7 days, test completed, loop depressurised and specimens removed. The following were observed: -

- \* Specimen 1, no corrosion or scale observed at the surface.
- \* Specimens 2 & 3, no corrosion, but surface was coated with a very fine scale.
- \* Specimens 4 & 5 were coated with a uniform layer of scale.

## 5. CONCLUSIONS

1. Full protection of the test loop pipelines and specimens was achieved as no sign of corrosion product was observed.
2. The test showed a good connection between less scale on specimen and higher flow rate. In comparison to test 17, the specimens exhibited less scale at the higher flow rate (higher the flow the thinner and less protective the calcareous film became). Figure 8.18 shows that the required current for group 'A' was higher in test 24 (as expected of higher flow rate).

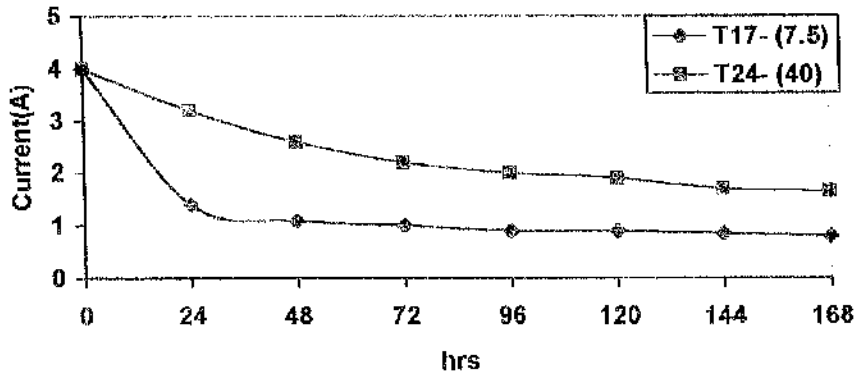

Figure 8.18: Effect of higher flow rate on applied current

3. The test also showed a good correspondence between more scale on specimens and more negative local potential. In comparison to test 23, the specimens exhibited more scale at the more negative potential in test 24. Figure 8.19 shows that the required current for group 'A' was higher in test 24 (as expected of the more negative potential).

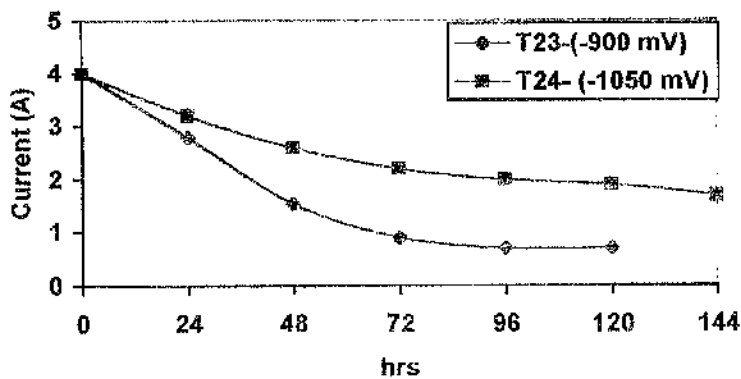

Figure 8.19: Effect of more negative control potential on applied current

<b>C.P. Status</b>	****	<b>OFF</b>	<b>ON</b>	<b>ON</b>	<b>ON</b>	<b>ON</b>	<b>ON</b>	<b>ON</b>
<b>Time</b>	hrs	0	24	48	72	96	120	144
<b>Group 'A'</b>	<b>Auto Ops</b>	<b>Auto</b>	<b>Auto</b>	<b>Auto</b>	<b>Auto</b>	<b>Auto</b>	<b>Auto</b>	<b>Auto</b>
<b>Set Potential</b>	mV	-1050	-1050	-1050	-1050	-1050	-1050	-1050
<b>Current</b>	Amps	4	3.2	2.6	2.2	2	1.9	1.7
<b>Voltage</b>	V	6	5.2	4.5	4.3	4	4	3.8
<b>R. Electrode</b>	<b>MV</b>	****	****	****	****	****	****	****
<b>R1</b>	<b>PANEL</b>	-580	-1050	-1050	-1050	-1050	-1050	-1050
<b>R2</b>	<b>PANEL</b>	-590	-1090	-1090	-1090	-1090	-1090	-1090
<b>R1</b>	<b>LOCALLY</b>	-570	****	****	****	****	****	-1030
<b>R2</b>	<b>LOCALLY</b>	-580	****	****	****	****	****	-1050
<b>Group 'B'</b>	<b>Manual Ops</b>	<b>M</b>	<b>M</b>	<b>M</b>	<b>M</b>	<b>M</b>	<b>M</b>	<b>M</b>
<b>Current</b>	Amps	2.5	2.5	2.5	2.5	2.5	2.5	2.5
<b>Voltage</b>	V	4.4	4.4	4.4	4.4	4.4	4.4	4.4
<b>R. Electrode</b>	<b>MV</b>	****	****	****	****	****	****	****
<b>R3</b>	<b>PANEL</b>	-710	-1200	-1200	-1200	-1200	-1200	-1200
<b>R4</b>	<b>PANEL</b>	-720	-1100	-1100	-1100	-1100	-1100	-1100
<b>R3</b>	<b>LOCALLY</b>	-700	****	****	****	****	****	-1150
<b>R4</b>	<b>LOCALLY</b>	-700	****	****	****	****	****	-1060

<b>C.P. Status</b>	****	<b>OFF</b>
<b>Time</b>	hrs	168
<b>Group 'A'</b>	<b>Auto Ops</b>	<b>Auto</b>
<b>Set Potential</b>	mV	-1050
<b>Current</b>	Amps	1.65
<b>Voltage</b>	V	3.8
<b>R. Electrode</b>	<b>MV</b>	****
<b>R1</b>	<b>PANEL</b>	-1050
<b>R2</b>	<b>PANEL</b>	-1090
<b>R1</b>	<b>LOCALLY</b>	-1030
<b>R2</b>	<b>LOCALLY</b>	-1050
<b>Group 'B'</b>	<b>Manual Ops</b>	<b>M</b>
<b>Current</b>	Amps	2.5
<b>Voltage</b>	V	4.4
<b>R. Electrode</b>	<b>MV</b>	****
<b>R3</b>	<b>PANEL</b>	-1200
<b>R4</b>	<b>PANEL</b>	-1100
<b>R3</b>	<b>LOCALLY</b>	-1150
<b>R4</b>	<b>LOCALLY</b>	-1060

Table 8.16: Summary of the test daily readings

**TEST NO 25****1. Parameters summary**

Items	Units	Data
Control Potential	mV	-1000
Flow Rate	m <sup>3</sup> /hr	40
Temperature	°C	25
T.D.S	ppm	43,000
Test duration	Days	7

**2. PURPOSE**

The purpose of this experiment was to study the general effect of less negative control potential on the following parameters when compared to test 24: -

- \* Applied current requirement for maintaining the test loop under an adequate level of cathodic protection.
- \* Rate of scale deposition.

**3. PROCEDURE**

Test procedure was similar to test 24, with exception that the set control potential was different.

**4. FINDINGS**

The locally measured potential at R1 and R2 at the end of the test were very close to the set control potential of -1000 mV. The potential in group 'B' were more negative than the set potential in group 'A' obviously on account of the higher current (2.5 amps) in the galvanostatic controlled section of the rig than for most of the test in group 'A'. Test result based on visual inspection of the specimens at the end of the test was satisfactory. The scale precipitation was, slightly less than test 24.

- \* No corrosion on any specimens.
- \* Specimens 1, 2 and 3 light covering of scale. Specimens, 4, and 5 more scale.

## 5. CONCLUSIONS

1. Protection was fully achieved when the system was operated at a less negative control potential than test 24. Figure 8.20 shows that the applied current was higher in test 24 mainly due to more negative potential.

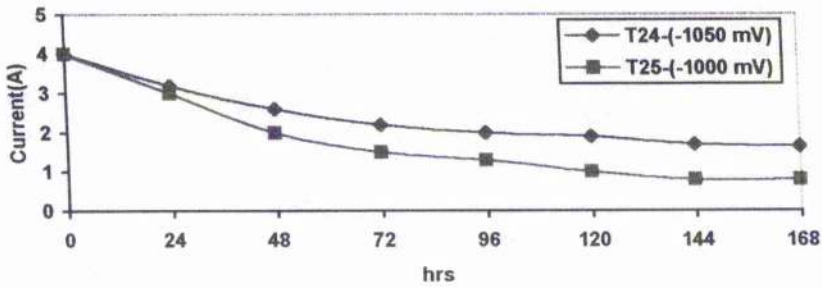

**Figure 8.20: Effect of less negative control potential on applied current**

2. As the system control potential becomes less negative the calcareous film became thinner and less protective (figure 8.21).

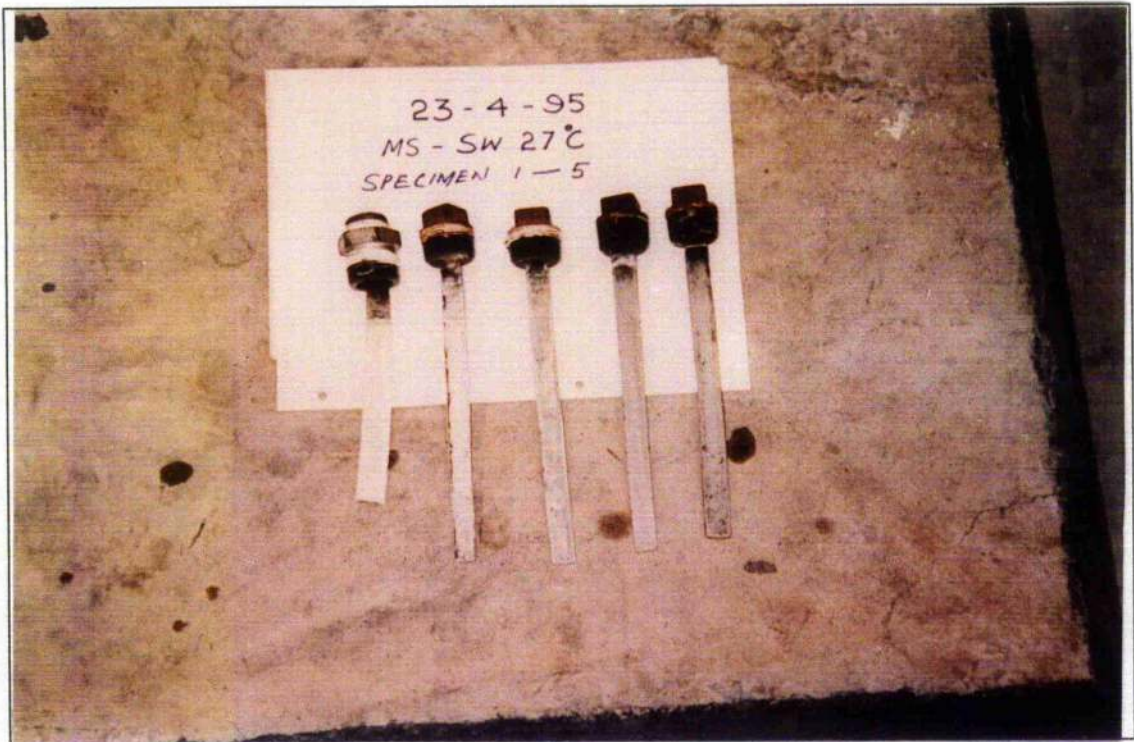

**Figure 8.21: Specimen condition at the end of test 25.**



<b>C.P. Status</b>	****	OFF	ON	ON	ON	ON	ON	ON
<b>Time</b>	hrs	0	24	48	72	96	120	144
<b>Group 'A'</b>	Auto Ops	Auto	Auto	Auto	Auto	Auto	Auto	Auto
<b>Set Potential</b>	mV	-1000	-1000	-1000	-1000	-1000	-1000	-1000
<b>Current</b>	Amps	4	3	2	1.5	1.3	1	0.8
<b>Voltage</b>	V	6	4.9	4.1	3.8	3.6	3.2	3
<b>R. Electrode</b>	MV	****	****	****	****	****	****	****
<b>R1</b>	PANEL	-650	-1000	-1000	-1000	-1000	-1000	-1000
<b>R2</b>	PANEL	-660	-1080	-1080	-1080	-1080	-1080	-1080
<b>R1</b>	LOCALLY	-630	****	****	****	****	****	****
<b>R2</b>	LOCALLY	-640	****	****	****	****	****	****
<b>Group 'B'</b>	Manual Ops	M	M	M	M	M	M	M
<b>Current</b>	Amps	2.5	2.5	2.5	2.5	2.5	2.5	2.5
<b>Voltage</b>	V	4.4	4.4	4.4	4.4	4.4	4.4	4.4
<b>R. Electrode</b>	MV	****	****	****	****	****	****	****
<b>R3</b>	PANEL	-700	-1180	-1180	-1180	-1180	-1180	-1180
<b>R4</b>	PANEL	-720	-1100	-1100	-1100	-1100	-1100	-1100
<b>R3</b>	LOCALLY	-690	****	****	****	****	****	****
<b>R4</b>	LOCALLY	-700	****	****	****	****	****	****

<b>C.P. Status</b>	****	ON
<b>Time</b>	hrs	168
<b>Group 'A'</b>	Auto Ops	Auto
<b>Set Potential</b>	mV	-1000
<b>Current</b>	Amps	0.8
<b>Voltage</b>	V	3
<b>R. Electrode</b>	MV	****
<b>R1</b>	PANEL	-1000
<b>R2</b>	PANEL	-1080
<b>R1</b>	LOCALLY	-980
<b>R2</b>	LOCALLY	-1030
<b>Group 'B'</b>	Manual Ops	M
<b>Current</b>	Amps	2.5
<b>Voltage</b>	V	4.4
<b>R. Electrode</b>	MV	****
<b>R3</b>	PANEL	-1180
<b>R4</b>	PANEL	-1100
<b>R3</b>	LOCALLY	-1130
<b>R4</b>	LOCALLY	-1080

Table 8.17: Summary of the test daily readings

**TEST NO 26****1. Parameters summary**

Items	Units	Data
Control Potential	mV	-1000
Flow Rate	m <sup>3</sup> /hr	40
Temperature	°C	50
T.D.S	ppm	43,000
Test Duration	Days	7

**2. PURPOSE**

The purpose of this test was to monitor the effect of temperature on system applied current and scale deposition when compared to test 25.

**3. PROCEDURE**

Test procedure was similar to test 25, with exception that the test operating temperature was different.

**4. FINDINGS**

High temperature operation of 50 °C was achieved by introduction of treated hot water from the outlet of the Evaporator heat input section. System was protected cathodically for approximately 7 days at a set control potential of -1000 mV. As in test 25, at the end of the 7 days test, the locally measured potential in group 'A' had attained approximately the set potential of -1000 mV and the potential in group 'B' (galvanostatic control) were more negative. The current demand for obtaining the required protection in group 'A' at higher temperature was higher than test 25 towards the end of the test. After 2 days, specimens were removed for visual inspection. Figure 8.22 shows the specimen condition after removal.

\* Specimens 1 to 3, no corrosion and scale.

\* Specimen 4 and 5, no corrosion but scale had formed on the specimens surface.

Lack of adherence of the precipitate to specimen 4 surface was noticeable.

On the same day the position of specimen 5 was changed with 1 as scale had formed uniformly on 5. This was done mainly to check the behaviour of formed scale at more turbulent condition within the test loop. Test continued for 5 more days. After 7 days, test completed, de-pressurised, specimens removed and indicates that scale was formed on the surface of all the specimens (Figure 8.23).

4. Close observation of the rearranged specimen no.5 revealed that the already formed scale at the surface had slightly reduced, but a majority remained untouched.



Figures 8.22 and 8.23: Specimens condition after 2 and 7 days of test 26.

## 5. CONCLUSIONS

1. Protection was fully achieved when the test was carried-out at a higher operating temperature than test 25. Figure 8.24 shows that the applied current to achieve the cathodic protection at higher temperature declined more rapidly in initial 24 hours but was slightly higher toward the end of the test.

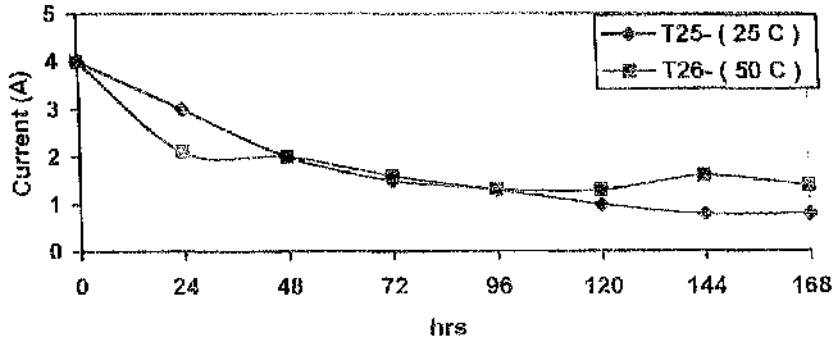

**Figure 8.24: Effects of increase in temperature in test applied current**

2. Scale deposition increased when compared to test 25, mainly due to an increase in test operating temperature. Presence of scale inhibitor in feed did not prevent the expected increase in scale formation at higher temperature. This important result implies that the beneficial effects of calcareous deposition during cathodic protection can be also expected in the desalination plant even when scale inhibitors are present.
3. Complete removal of an already formed scale at the surface of a specimen is not achievable by changing the specimen location (i.e. varying operating condition).

<b>C.P. Status</b>	<b>****</b>	<b>OFF</b>	<b>ON</b>	<b>ON</b>	<b>ON</b>	<b>ON</b>	<b>ON</b>	<b>ON</b>
<b>Time</b>	<b>hrs</b>	<b>0</b>	<b>24</b>	<b>48</b>	<b>72</b>	<b>96</b>	<b>120</b>	<b>144</b>
<b>Group 'A'</b>	<b>Auto Ops</b>	<b>Auto</b>	<b>Auto</b>	<b>Auto</b>	<b>Auto</b>	<b>Auto</b>	<b>Auto</b>	<b>Auto</b>
<b>Set Potential</b>	<b>mV</b>	<b>-1000</b>	<b>-1000</b>	<b>-1000</b>	<b>-1000</b>	<b>-1000</b>	<b>-1000</b>	<b>-1000</b>
<b>Current</b>	<b>Amps</b>	<b>4</b>	<b>2.1</b>	<b>2</b>	<b>1.6</b>	<b>1.32</b>	<b>1.3</b>	<b>1.6</b>
<b>Voltage</b>	<b>V</b>	<b>6</b>	<b>4.1</b>	<b>4</b>	<b>3.6</b>	<b>3.4</b>	<b>3.6</b>	<b>3.5</b>
<b>R. Electrode</b>	<b>MV</b>	<b>****</b>	<b>****</b>	<b>****</b>	<b>****</b>	<b>****</b>	<b>****</b>	<b>****</b>
<b>R1</b>	<b>PANEL</b>	<b>-580</b>	<b>-1000</b>	<b>-1000</b>	<b>-1000</b>	<b>-1000</b>	<b>-1000</b>	<b>-1000</b>
<b>R2</b>	<b>PANEL</b>	<b>-520</b>	<b>-1050</b>	<b>-1050</b>	<b>-1050</b>	<b>-1050</b>	<b>-1050</b>	<b>-1050</b>
<b>R1</b>	<b>LOCALLY</b>	<b>-570</b>	<b>****</b>	<b>****</b>	<b>****</b>	<b>****</b>	<b>****</b>	<b>****</b>
<b>R2</b>	<b>LOCALLY</b>	<b>-530</b>	<b>****</b>	<b>****</b>	<b>****</b>	<b>****</b>	<b>****</b>	<b>****</b>
<b>Group 'B'</b>	<b>Manual Ops</b>	<b>M</b>	<b>M</b>	<b>M</b>	<b>M</b>	<b>M</b>	<b>M</b>	<b>M</b>
<b>Current</b>	<b>Amps</b>	<b>2.5</b>	<b>2.5</b>	<b>2.5</b>	<b>2.5</b>	<b>2.5</b>	<b>2.5</b>	<b>2.5</b>
<b>Voltage</b>	<b>V</b>	<b>4.4</b>	<b>4.4</b>	<b>4.4</b>	<b>4.4</b>	<b>4.4</b>	<b>4.4</b>	<b>4.4</b>
<b>R. Electrode</b>	<b>MV</b>	<b>****</b>	<b>****</b>	<b>****</b>	<b>****</b>	<b>****</b>	<b>****</b>	<b>****</b>
<b>R3</b>	<b>PANEL</b>	<b>-750</b>	<b>-1180</b>	<b>-1180</b>	<b>-1180</b>	<b>-1180</b>	<b>-1180</b>	<b>-1180</b>
<b>R4</b>	<b>PANEL</b>	<b>-720</b>	<b>-1100</b>	<b>-1100</b>	<b>-1100</b>	<b>-1100</b>	<b>-1100</b>	<b>-1100</b>
<b>R3</b>	<b>LOCALLY</b>	<b>-760</b>	<b>****</b>	<b>****</b>	<b>****</b>	<b>****</b>	<b>****</b>	<b>****</b>
<b>R4</b>	<b>LOCALLY</b>	<b>-700</b>	<b>****</b>	<b>****</b>	<b>****</b>	<b>****</b>	<b>****</b>	<b>****</b>

<b>C.P. Status</b>	<b>****</b>	<b>ON</b>
<b>Time</b>	<b>hrs</b>	<b>168</b>
<b>Group 'A'</b>	<b>Auto Ops</b>	<b>Auto</b>
<b>Set Potential</b>	<b>mV</b>	<b>-1000</b>
<b>Current</b>	<b>Amps</b>	<b>1.4</b>
<b>Voltage</b>	<b>V</b>	<b>3.5</b>
<b>R. Electrode</b>	<b>MV</b>	<b>****</b>
<b>R1</b>	<b>PANEL</b>	<b>-1000</b>
<b>R2</b>	<b>PANEL</b>	<b>-1050</b>
<b>R1</b>	<b>LOCALLY</b>	<b>-970</b>
<b>R2</b>	<b>LOCALLY</b>	<b>-1020</b>
<b>Group 'B'</b>	<b>Manual Ops</b>	<b>M</b>
<b>Current</b>	<b>Amps</b>	<b>2.5</b>
<b>Voltage</b>	<b>V</b>	<b>4.4</b>
<b>R. Electrode</b>	<b>MV</b>	<b>****</b>
<b>R3</b>	<b>PANEL</b>	<b>-1180</b>
<b>R4</b>	<b>PANEL</b>	<b>-1100</b>
<b>R3</b>	<b>LOCALLY</b>	<b>-1150</b>
<b>R4</b>	<b>LOCALLY</b>	<b>-1060</b>

Table 8.18: Summary of, test daily readings

TEST NO 27**1. Parameters summary**

Items	Units	Data
Control Potential	mV	-1050
Flow Rate	m <sup>3</sup> /hr	40
Temperature	°C	50
T.D.S	ppm	43,000
Test Duration	Days	7

**2. PURPOSE**

The purpose of this test was: -

1. To compare with test 24 findings in relation to the applied current required for maintaining a potential of -1050 mV  $\Delta$ g/ $\Delta$ gCl while performing the test at higher temperature (50° C instead of 25° C).
3. To investigate the rate and morphology of scale precipitation on the surface of specimens with respect to an increase in test operating temperature.

**3. PROCEDURE**

The test procedure was the same as test 24, with the exception that the test operating temperature was varied.

**4. FINDINGS**

The locally measured potential at the end of the test were, all very close to the group 'A' set potential of -1050 mV. Figure 8.25 shows the specimens after removal from the test rig loop. This reveals that protection achieved, and scale was formed on the surface of all specimens even with the presence of scale inhibitor in the water media. No corrosion product was observed at the surface of all the specimens. A section of specimens 4 and 5 were analysed which indicated presence of magnesium and calcium.

**5. CONCLUSIONS**

1. System protection was fully achieved even when the test was operated at a higher temperature than test 24.
2. Presence of antiscalent within the water media slightly effected the rate of scale formation at the surface of the specimen, as applied current was similar to test 24.

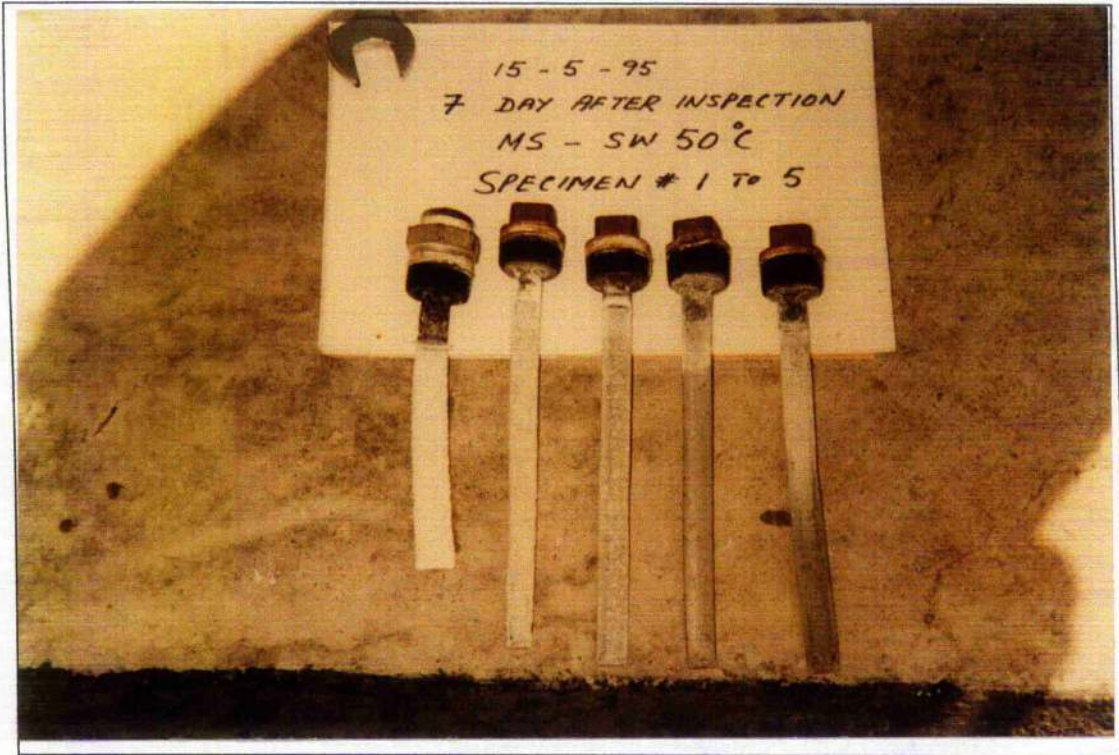

Figure 8.25: Specimen condition at the end of test 27.

3. Figures 8.26 shows that increase in temperature caused an initial more rapid decrease in current because of faster scale built up but then get 'steady state' current. Figure 8.27 shows just a slightly higher current at more negative potential.

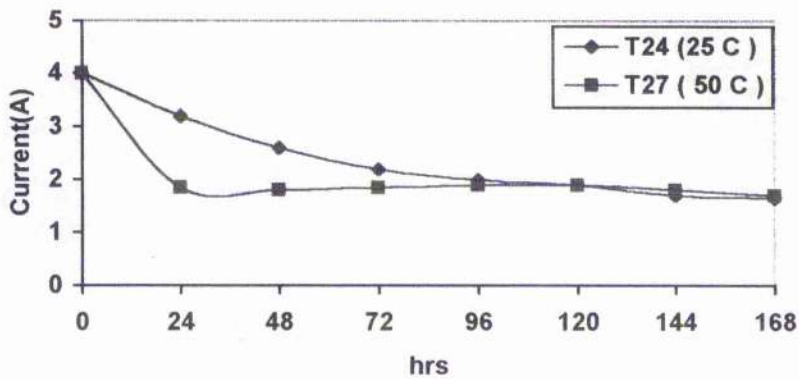

Figure 8.26: Effect of temperature on applied current

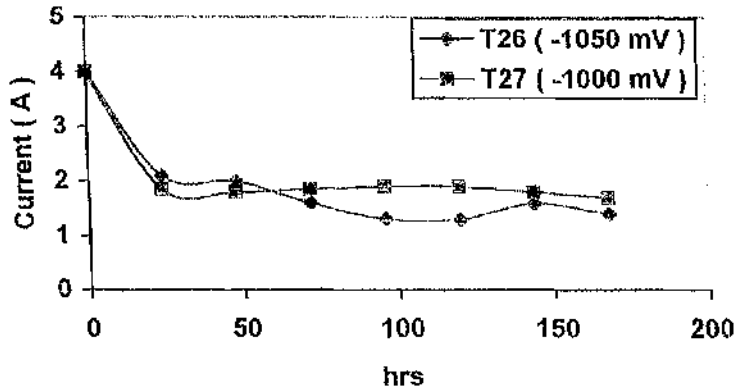

Figure 8.27: Effect of control potential on applied current

C.P. Status	****	OFF	ON	ON	ON	ON	ON	ON
Time	hrs	0	24	48	72	96	120	144-168
Group 'A'	Auto Ops	Auto	Auto	Auto	Auto	Auto	Auto	Auto
Set Potential	mV	-1050	-1050	-1050	-1050	-1050	-1050	-1050
Current	Amps	4	1.85	1.8	1.85	1.9	1.9	1.8-1.7
Voltage	V	6	3.8	3.8	3.8	3.9	3.9	3.8-3.7
R. Electrode	MV	****	****	****	****	****	****	****
R1	PANEL	-610	-1050	-1050	-1050	-1050	-1050	-1050
R2	PANEL	-630	-1070	-1070	-1070	-1070	-1070	-1070
R1	LOCALLY	-620	****	****	****	****	****	-1040
R2	LOCALLY	-640	****	****	****	****	****	-1060
Group 'B'	Manual Ops	M	M	M	M	M	M	M
Current	Amps	2.5	2.5	2.5	2.5	2.5	2.5	2.5
Voltage	V	4.4	4.4	4.4	4.4	4.4	4.4	4.4
R. Electrode	MV	****	****	****	****	****	****	****
R3	PANEL	-700	-1200	-1200	-1200	-1200	-1200	-1200
R4	PANEL	-690	-1100	-1100	-1100	-1100	-1100	-1100
R3	LOCALLY	-690	****	****	****	****	****	-1050
R4	LOCALLY	-730	****	****	****	****	****	-1060

Table 8.19: Summary of the test daily readings



**TEST NO 28****1. Parameters summary**

Items	Units	Data
Control Potential	mV	-1000
Flow Rate	m <sup>3</sup> /hr	7.5
Temperature	<sup>o</sup> C	50
T.D.S	ppm	43,000
Test Duration	Days	6

**2. PURPOSE**

The purpose of this test was:

1. To compare with test 26 findings in relation to the applied current required to maintain a control potential of -1000 mV Ag/AgCl, while performing the test at a lower flow rate (7.5 m<sup>3</sup>/hr instead of 40 m<sup>3</sup>/hr).
2. To monitor the rate of scale precipitation at the surface of specimens with respect to a drop in test operating flow rate.

**5. PROCEDURE**

The test procedure used was the same as test 26, with the exception that the flow orifice was replaced with a blank in order to achieve the lower flow rate.

**5. FINDINGS**

Figure 8.28 shows that protection was achieved during the test and the system was cathodically protected for about 6 days at a set control potential of -1000 mV for group 'A' protection zone. It also revealed that scale precipitation at the surface of all the specimens had increased when compared to test 26, mainly due to reduction in test operating flow rate. The result in table 8.20 confirm that after 3 days the local potential were very close to the panel readings, thus confirming the effectiveness of cathodic protection supply.

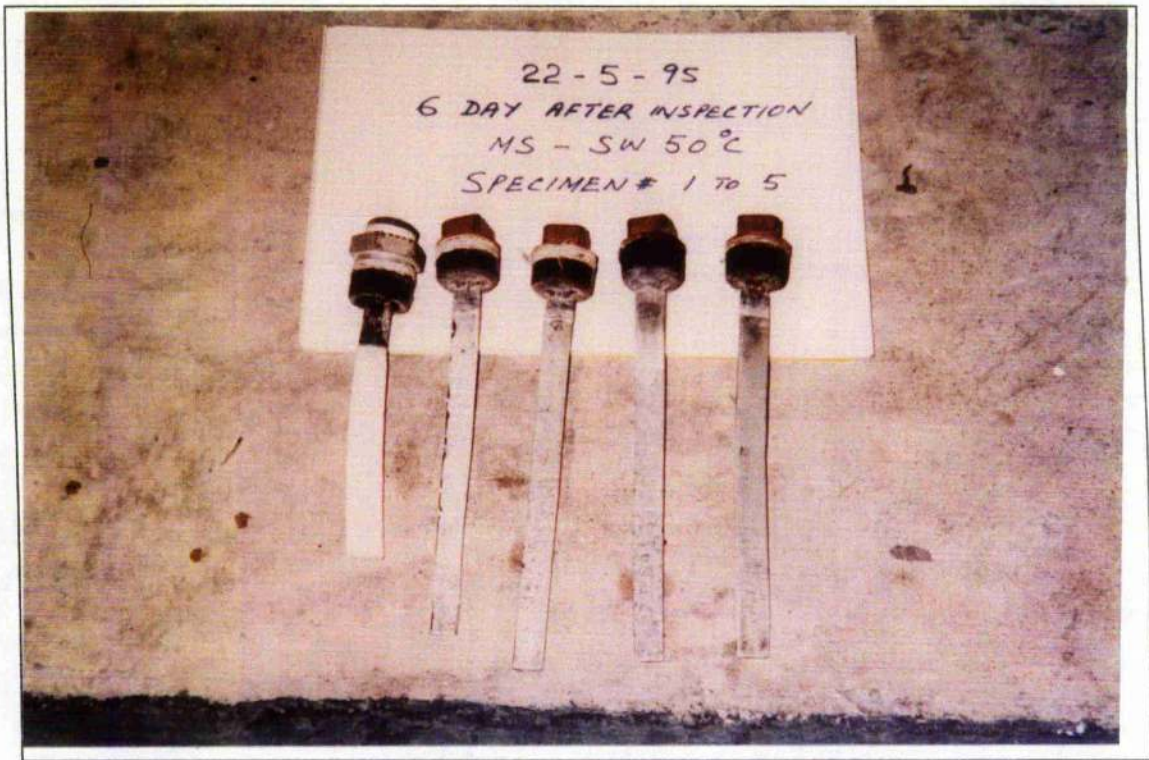

Figure 8.28: Specimen condition at the end of test 28.

## 5. CONCLUSIONS

1. Scale deposition thickness increased, mainly due to reduction in the test operating flow rate.
2. Figure 8.29 shows that applied current demand reduced when compared to test 26. This is mainly due to reduction in test operating flow rate. The figure also shows that the effect of flow in demand for current reduces with time as the pipe and the specimens were scaled up.

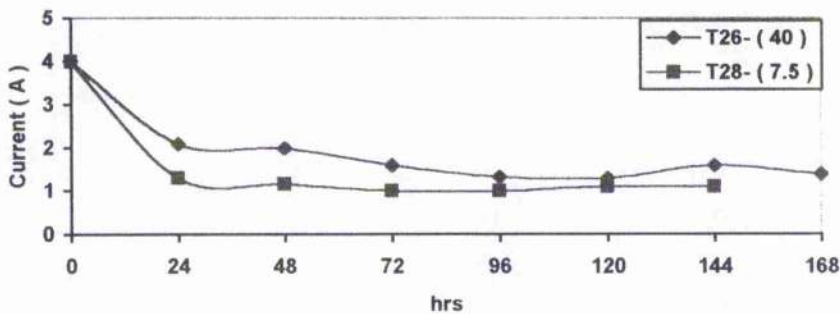

Figure 8.29: Effect of flow rate variation on applied current at  $-1000$  mV and  $50^{\circ}\text{C}$

<b>.C.P. Status</b>	<b>****</b>	<b>OFF</b>	<b>ON</b>	<b>ON</b>	<b>ON</b>	<b>ON</b>	<b>ON</b>	<b>ON</b>
<b>Time</b>	<b>hrs</b>	<b>0</b>	<b>24</b>	<b>48</b>	<b>72</b>	<b>96</b>	<b>120</b>	<b>144</b>
<b>Group 'A'</b>	<b>Auto Ops</b>	<b>Auto</b>	<b>Auto</b>	<b>Auto</b>	<b>Auto</b>	<b>Auto</b>	<b>Auto</b>	<b>Auto</b>
<b>Set Potential</b>	<b>mV</b>	<b>-1000</b>	<b>-1000</b>	<b>-1000</b>	<b>-1000</b>	<b>-1000</b>	<b>-1000</b>	<b>-1000</b>
<b>Current</b>	<b>Amps</b>	<b>4</b>	<b>1.3</b>	<b>1.15</b>	<b>1</b>	<b>1</b>	<b>1.1</b>	<b>1.1</b>
<b>Voltage</b>	<b>V</b>	<b>6</b>	<b>3.3</b>	<b>3.2</b>	<b>3</b>	<b>3</b>	<b>3.1</b>	<b>3.1</b>
<b>R. Electrode</b>	<b>MV</b>	<b>****</b>	<b>****</b>	<b>****</b>	<b>****</b>	<b>****</b>	<b>****</b>	<b>****</b>
<b>R1</b>	<b>PANEL</b>	<b>-600</b>	<b>-1000</b>	<b>-1000</b>	<b>-1000</b>	<b>-1000</b>	<b>-1000</b>	<b>-1000</b>
<b>R2</b>	<b>PANEL</b>	<b>-610</b>	<b>-1050</b>	<b>-1080</b>	<b>-1100</b>	<b>-1090</b>	<b>-1090</b>	<b>-1090</b>
<b>R1</b>	<b>LOCALLY</b>	<b>-580</b>	<b>****</b>	<b>****</b>	<b>-970</b>	<b>****</b>	<b>****</b>	<b>-980</b>
<b>R2</b>	<b>LOCALLY</b>	<b>-590</b>	<b>****</b>	<b>****</b>	<b>-1050</b>	<b>****</b>	<b>****</b>	<b>-1060</b>
<b>Group 'B'</b>	<b>Manual Ops</b>	<b>M</b>	<b>M</b>	<b>M</b>	<b>M</b>	<b>M</b>	<b>M</b>	<b>M</b>
<b>Current</b>	<b>Amps</b>	<b>2.5</b>	<b>2.5</b>	<b>2.5</b>	<b>2.5</b>	<b>2.5</b>	<b>2.5</b>	<b>2.5</b>
<b>Voltage</b>	<b>V</b>	<b>4.4</b>	<b>4.4</b>	<b>4.4</b>	<b>4.4</b>	<b>4.4</b>	<b>4.4</b>	<b>4.4</b>
<b>R. Electrode</b>	<b>MV</b>	<b>****</b>	<b>****</b>	<b>****</b>	<b>****</b>	<b>****</b>	<b>****</b>	<b>****</b>
<b>R3</b>	<b>PANEL</b>	<b>-710</b>	<b>-1200</b>	<b>-1200</b>	<b>-1180</b>	<b>-1180</b>	<b>-1180</b>	<b>-1180</b>
<b>R4</b>	<b>PANEL</b>	<b>-700</b>	<b>-1100</b>	<b>-1100</b>	<b>-1090</b>	<b>-1090</b>	<b>-1090</b>	<b>-1090</b>
<b>R3</b>	<b>LOCALLY</b>	<b>-700</b>	<b>****</b>	<b>****</b>	<b>-1150</b>	<b>****</b>	<b>****</b>	<b>-1160</b>
<b>R4</b>	<b>LOCALLY</b>	<b>-690</b>	<b>****</b>	<b>****</b>	<b>-1070</b>	<b>****</b>	<b>****</b>	<b>-1070</b>

**Table 8.20: Summary of test daily readings**

**TEST NO 29****1. Parameters summary**

Items	Units	Data
Control Potential	mV	-1050
Flow Rate	m <sup>3</sup> /hr	7.5
Temperature	°C	50
T.D.S	ppm	43,000
Test Duration	Days	7

**2. PURPOSE**

The purpose of this test was to compare with test 27 findings in relation to the current required to maintain a potential of -1050 mV Ag/AgCl while running the test at a lower flow rate (7.5 m<sup>3</sup>/hr instead of 40 m<sup>3</sup>/hr).

**3. PROCEDURE**

The test procedure was the same as test 27, with the exception that the test operating flow rate was varied.

**4. FINDINGS**

Figures 8.30, 8.31, and 8.32 show the specimens, spool piece and pipeline condition after completion of the test. No corrosion was evident on specimen or inside the spool piece or in the main pipeline. The specimens were covered by a significant scale layer. The interior of the spool piece displayed an excellent uniform layer of scale coating. The main pipeline interior had a much more uniform scale deposit. Table 8.21 shows the summary of the test daily readings. The data indicates that current demand during the test at the same control potential but lower flow rate has no significant effect and remained almost the same when compared to test 27. However, the effect of more negative control potential on applied current was more visible.

**5. CONCLUSIONS**

1. Figures 8.33 and 8.34 shows that test applied current is more effected by the change in control potential setting rather than flow rate (flow rate effect is less on demand for current).

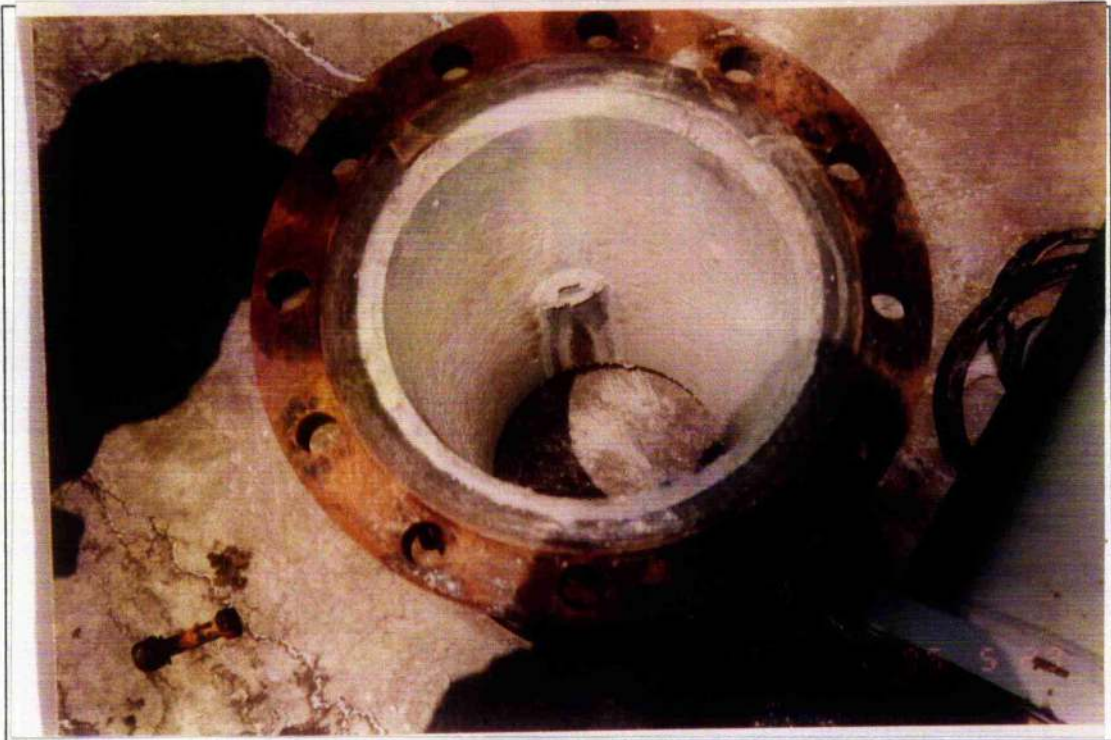
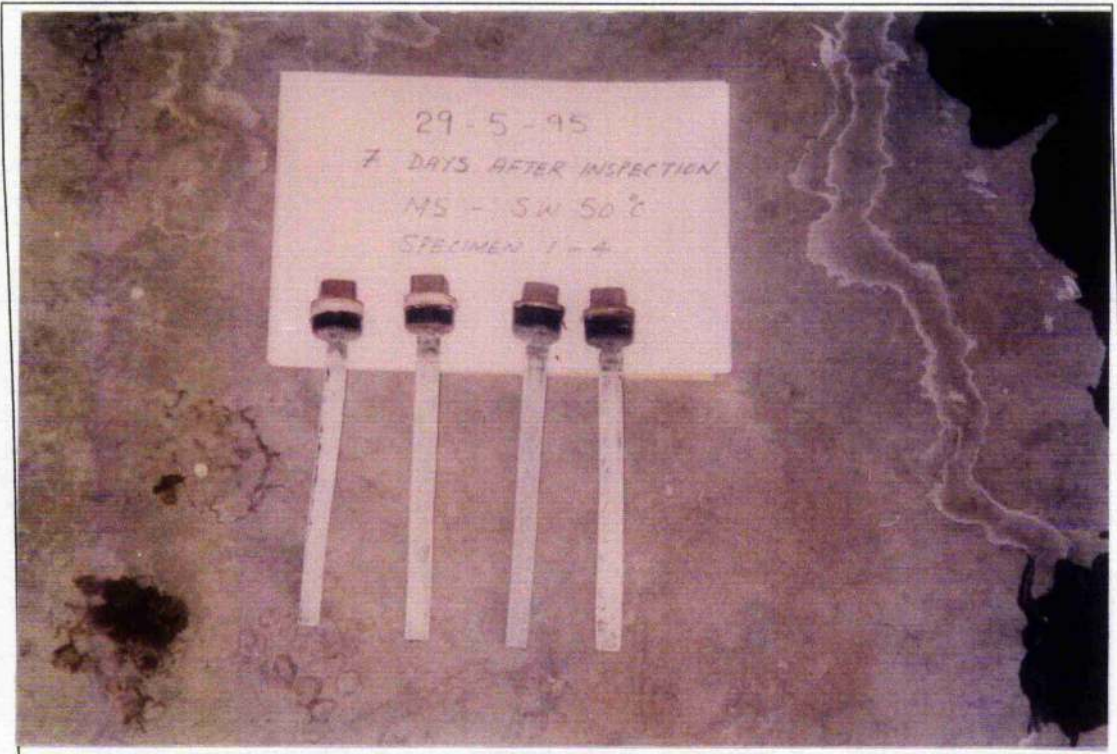

Figures 8.30, and 8.31: Specimens and spool piece condition of test 29.



Figure 8.32: Pipeline condition at the end of test 29.

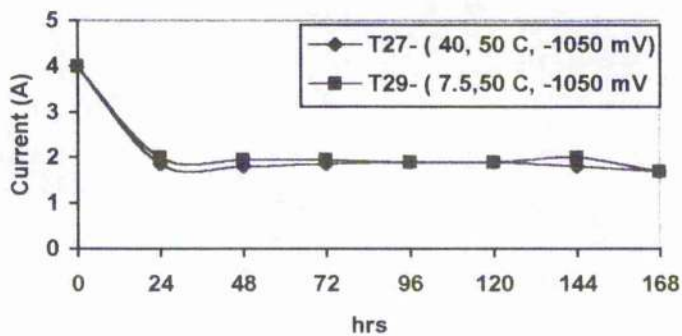

Figure 8.33: Effect of flow rate variation on test applied current

2. Scale deposition on the surface of the spool piece, specimens and pipeline acts as a protective layer.
3. Test loop protection was achieved as no sign of corrosion was observed.

4. No major calcareous deposit was observed around the anodes. This indicated that the system was operating at optimum level of applied current.

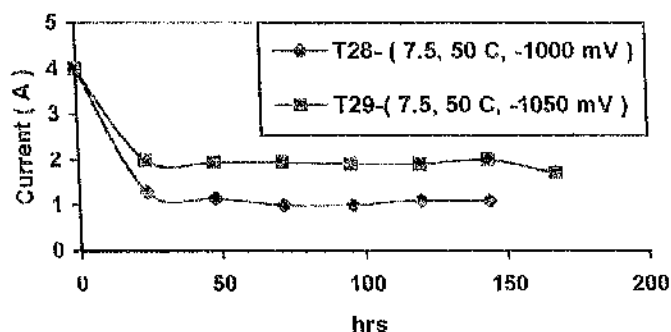

Figure 8.34: Effect of more negative potential in test applied current

C.P. Status	****	OFF	ON	ON	ON	ON	ON	ON
Time	hrs	0	24	48	72	96	120	144-168
Group 'A'	Auto Ops	Auto	Auto	Auto	Auto	Auto	Auto	Auto
Set Potential	mV	-1050	-1050	-1050	-1050	-1050	-1050	-1050
Current	Amps	4	2	1.95	1.95	1.9	1.9	2-1.7
Voltage	V	6	4	3.9	3.9	3.9	3.9	4.1-3.7
R. Electrode	MV	****	****	****	****	****	****	****
R1	PANEL	-650	-1050	-1050	-1050	-1050	-1050	-1050
R2	PANEL	-640	-1100	-1100	-1100	-1100	-1100	-1100
R1	LOCALLY	-620	****	****	****	****	****	-1040
R2	LOCALLY	-610	****	****	****	****	****	-1095
Group 'B'	Manual Ops	M	M	M	M	M	M	M
Current	Amps	2.5	2.5	2.5	2.5	2.5	2.5	2.5
Voltage	V	4.4	4.4	4.4	4.4	4.4	4.4	4.4
R. Electrode	MV	****	****	****	****	****	****	****
R3	PANEL	-700	-1210	-1210	-1200	-1200	-1210	-1200
R4	PANEL	-690	-1100	-1100	-1100	-1100	-1100	-1100
R3	LOCALLY	-680	****	****	****	****	****	-1170
R4	LOCALLY	-690	****	****	****	****	****	-1050

Table 8.21: Summary of the test daily readings

**TEST NO 30****1. Parameters summary**

Items	Units	Data
Control Potential	mV	Specimens 1 ( -1050 ), 2 ( -900 ), and 3 set at ( -800 )
Flow Rate	m <sup>3</sup> /hr	0.85
Temperature	°C	28 up to 32
T.D.S	ppm	35,000
Test Duration	Days	6
Specimens orientation	*****	Specimens 1, 2, and 3 were all perpendicular to flow
specimens status	*****	Specimens 1, 2, and 3 were all new
pH	*****	8.3

**2. PURPOSE**

The aim of this test was to re-examine using the Glasgow flow rig the findings which were obtained from the tests carried out in Dubal's test loop, with respect to the following parameter: -

1. To investigate the rate and duration in which scale forms on the surface of the specimens in relation to the drop in applied current.
2. To check effect of control potential on: -
  - \* System applied current.
  - \* Scale deposition rate.

**3. PROCEDURE**

1. Flow rig fully cleaned and flushed.
2. Potentiostat checked and found operational.
3. Reference Electrode accuracy checked against 50D specimen.
4. Reference Electrode and 50D specimens inserted in the flow rig.
5. Test parameters adjusted as per above set points.
6. Protection switched on.



#### 4. FINDINGS

The installed 50D specimens were protected cathodically for six days at a pre-determined set control potential. The specimens were all installed in a manner to face a flow, i.e. similar to brine inlet manifold condition in the evaporators (perpendicular to flow). Table 8.22 shows that the critical water chemistry, which determine the precipitation of calcareous scale did not change (i.e. M and P Alkalinity).

#### 5. CONCLUSIONS

1. System protection was achieved, as no sign of corrosion was observed at the specimens surface (slight sign of corrosion was found at the edge of specimen no 3 which was operating at set potential of -800 mV).
2. Scale precipitated on the surface of the specimens after only two days.
3. Scale precipitation was found to be less for specimens, which were set at less negative control potential and were placed at more turbulent area within the test flow rig.
4. Figure 8.35 shows, drop in applied current for specimens 2 and 3 are identical, despite the fact that the specimens were set at two different set control potential. This hence reveals that, operating the cathodic protection system at slightly more negative potential has no cost implication to the users.

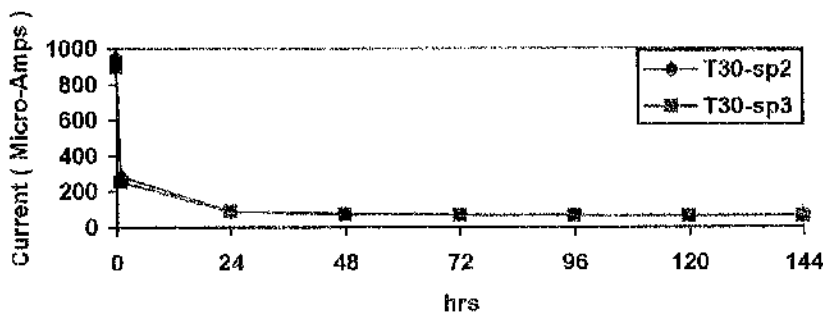

Figure 8.35: Specimens 1 and 2 applied current trend vs. time

4. Figure 8.36 shows the demand for higher applied current when test performed under higher flow rate.

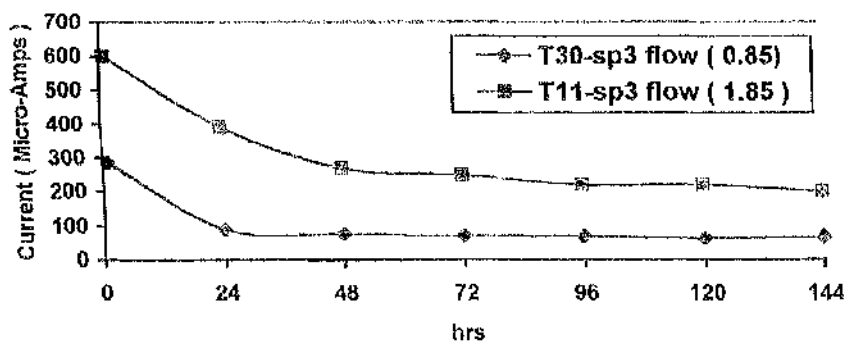

Figure 8.36: Effect of operating flow rate on test applied current

Specimen	*****	1	2	3
Control Potential	mV	-1050	-900	-800
Current	$\mu$ A	$\mu$ A	$\mu$ A	$\mu$ A
Time	hrs	*****	*****	*****
0	hrs	4500	950	900
1	hrs	570	285	256
24	hrs	182	91	88
48	hrs	168	78	70
72	hrs	178	73	68
96	hrs	185	70	65
120	hrs	189	66	62
144	hrs	195	68	63
M-Alkalinity	mmol	0.5-0.6	0.5-0.6	0.5-0.6
P-Alkalinity	mmol	3.7-3.5	3.7-3.5	3.7-3.5

Table 8.22: Summary of, test daily readings

**TEST NO. 31****1. Parameters summary**

Items	Units	Data
Control Potential	mV	Specimens 1 ( -1050 ), 2 ( -900 ), and 3 set at ( --1050 )
Flow Rate	m <sup>3</sup> /hr	0.85
Temperature	<sup>0</sup> C	28 up to 32
T.D.S	ppm	35,000
Test Duration	Days	4
Specimens orientation	*****	Specimens 1, 2, were parallel to flow and 3 was perpendicular
specimens status	*****	Specimens 1, 2, and 3 were all new
pH	*****	8.2

**2. PURPOSE**

The purpose of this test was: -

1. To asses the specimen's orientation effect on system applied current.
2. To check the effect of increase in control potential on system:-
  - \* Applied current.
  - \* Deposition rate (specimens surface).

**3. PROCEDURE**

Test proccdure was similar to test 30, except for variation on test set potential and specimen orientation.

**5. FINDINGS**

Figure 8.37 of specimen no.1 show that a full protection was achieved and a good coverage of scale when specimen placed at different orientation when compared to test 30. Figure 8.38 shows the effect of orientation on the applied current.

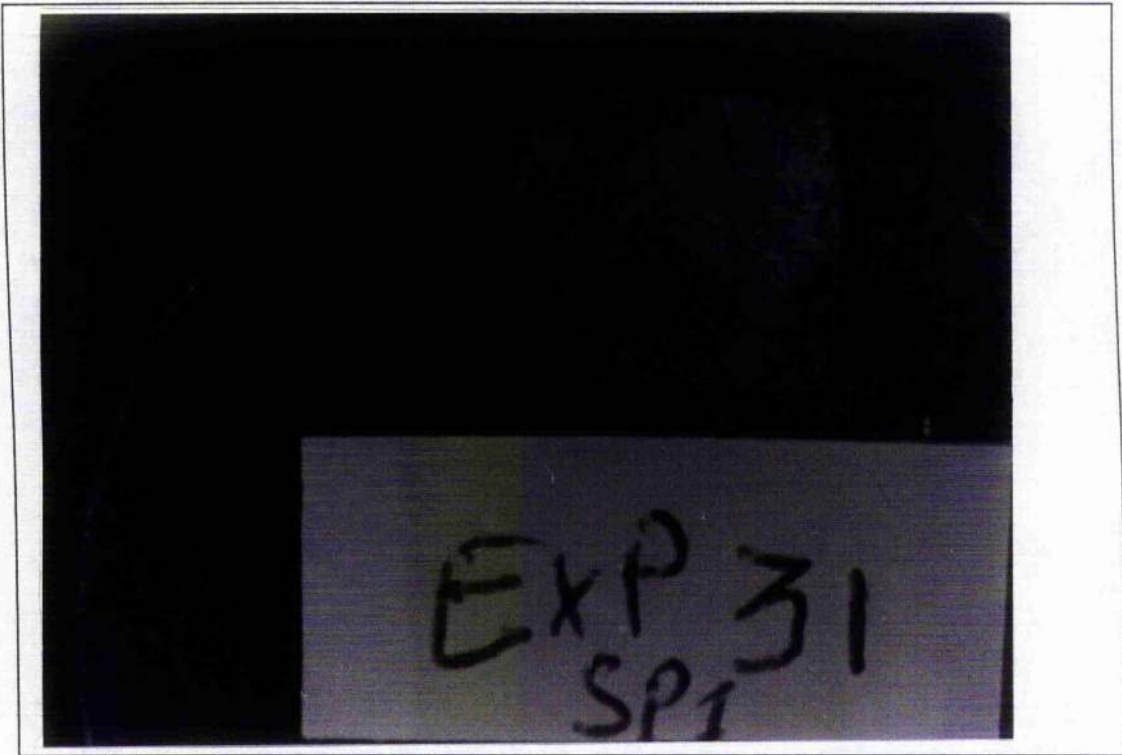

Figure 8.37: Photo of specimen 1 at the end of test 31

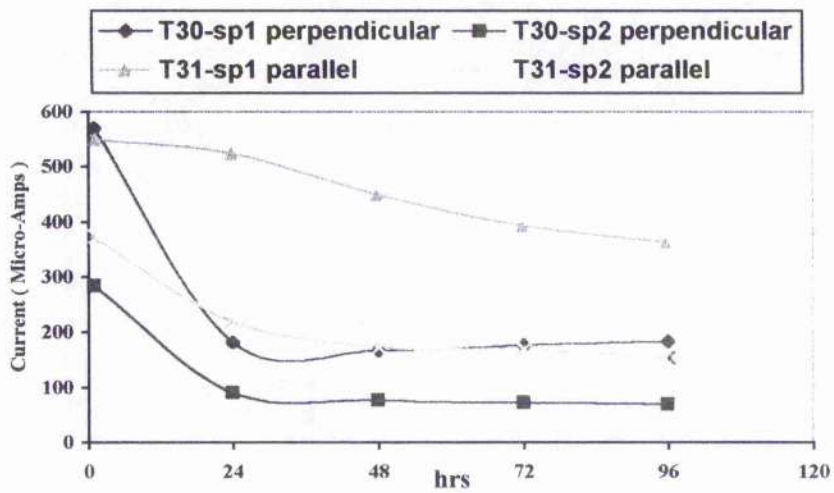

Figure 8.38: Orientation effect on the applied current

## 5. CONCLUSIONS

1. The system current demand increased with change in specimen orientation (from perpendicular to parallel). This is thought to be due to the flow behavior, as flow in this situation is more turbulent (creation of vortex around specimen).
2. Scale precipitation was observed to be less on the surface of the specimens, which were placed parallel to flow. This may be due to a lower contact time between the specimens, surface and the circulating flow and greater turbulence.
3. As the system control potential becomes less negative, calcareous scale becomes thinner. Figure 8.39 shows the potential effect on the applied current for achieving the optimum level of protection.

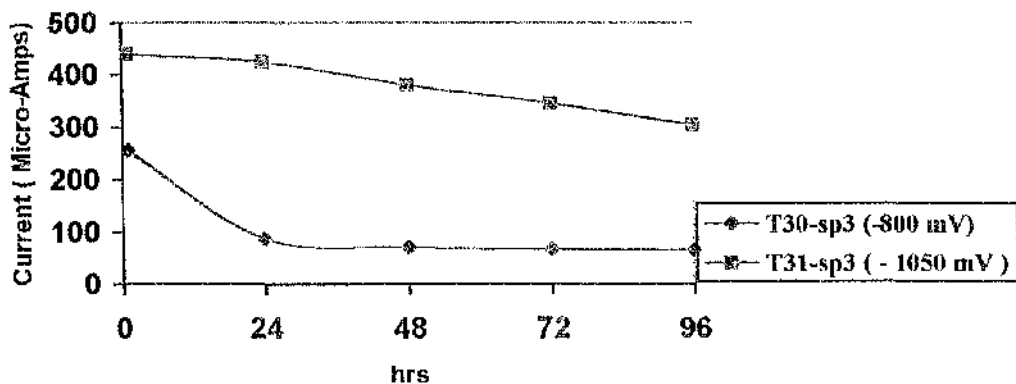

Figure 8.39: Potential effect on system applied current

Specimen	*****	1	2	3
Control Potential	mV	-1050	-900	-1050
Current	$\mu$ A	$\mu$ A	$\mu$ A	$\mu$ A
Time	hrs	*****	*****	*****
0	hrs	2000	1000	1600
1	hrs	550	375	440
24	hrs	525	220	425
48	hrs	450	175	380
72	hrs	395	170	345
96	hrs	365	155	305
M-Alkalinity	mmol	0.5-0.52	0.5-0.52	0.5-0.52
P-Alkalinity	mmol	3.6-3.5	3.6-3.5	3.6-3.5

Table 8.23: Summary of, test daily readings

**TEST NO. 32****1. Parameters summary**

Items	Units	Data
Control Potential	mV	Specimens 1 ( -1050 ), 2 ( -900 ), and 3 set at ( -1050 )
Flow Rate	m <sup>3</sup> /hr	0.85
Temperature	°C	28 up to 32
T.D.S	ppm	35,000
Test Duration	Days	4
Specimens orientation	*****	Specimens 1, 3 perpendicular to flow and 2 was parallel
Specimen status	*****	Specimens 1 was new and 2,3 were pre-scaled
pH	*****	8.25

**2. PURPOSE**

The purpose of this test was: -

1. To investigate the rate of scale precipitation at the surface of the specimens in direct relation to drop in applied current.
2. Pre-scaling effect on applied current for both specimens which either perpendicular, or parallel to flow.
3. To re-examine the orientation effect.

**3. PROCEDURE**

Test procedure was similar to test 31, except for specimen orientation.

**4. FINDINGS**

Table 8.24 shows the drop of current was similar to specimen.1 of test 30 (in both tests the specimens orientation and control potential were the same). It as well indicates that benefit of pre-scale is short-lived (figure 8.40).

**4. CONCLUSIONS**

1. Overall system protection was achieved, as no sign of corrosion was observed when specimens were inspected.

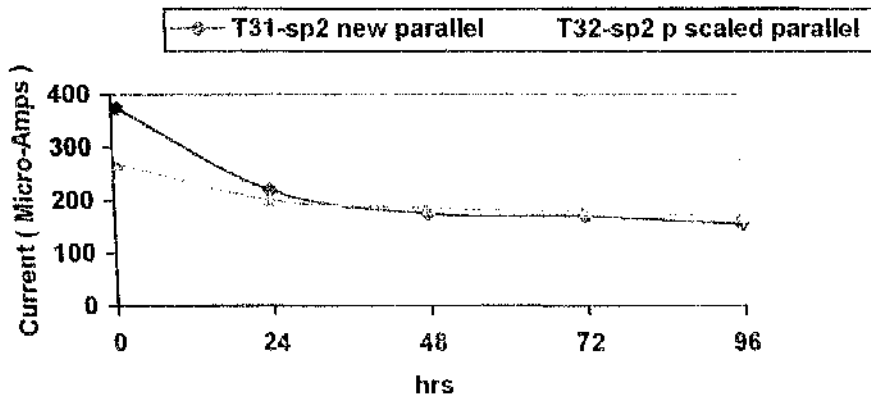

Figure 8.40: Pre-scaling effect on applied current vs. time

2. Complete removal of already formed scale from the surface of the specimens does not appear to occur.
3. Figure 8.41 shows that, applied current increased with change in specimen orientation (from perpendicular to parallel). This is the similar result which was obtained earlier which is thought to be due to the flow behavior

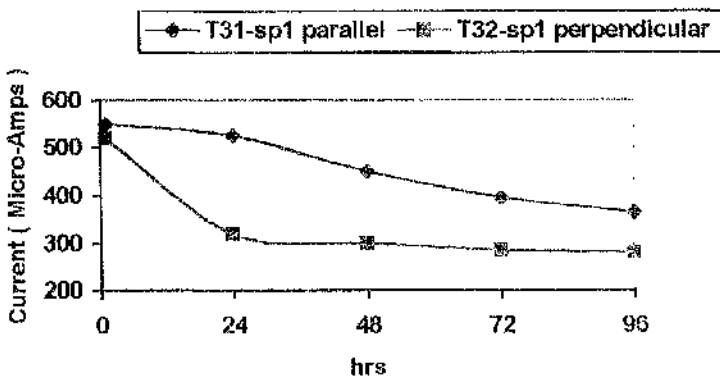

Figure 8.41: Orientation effect on applied current vs. time

Specimen	*****	1	2	3
Control Potential	mV	-1050	-900	-1050
Current	$\mu$ A	$\mu$ A	$\mu$ A	$\mu$ A
Time	hrs	*****	*****	*****
0	hrs	4500	1200	4200
1	hrs	520	270	510
24	hrs	320	202	280
48	hrs	300	185	270
72	hrs	285	180	265
96	hrs	280	170	255
96 ( static )	hrs	200	48	220
M-Alkalinity	mmol	0.55-0.6	0.55-0.6	0.55-0.6
P-Alkalinity	mmol	3.8-3.6	3.8-3.6	3.8-3.6

Table 8.24: Summary of test daily readings



**TEST NO. 33****1. Parameters summary**

Items	Units	Data
Control Potential	mV	Specimens 1 ( -1050 ), 2 ( -900 ), and 3 set at ( -800 )
Flow Rate	m <sup>3</sup> /hr	0.85
Temperature	°C	28 up to 32
T.D.S	ppm	35,000
Test Duration	Days	4
Specimens orientation	*****	Specimens 1, 2, and 3 all were perpendicular
specimens status	*****	Specimens 1, 2 and 3 all were new
pH	*****	8.3

**2. PURPOSE**

The purpose of this test was: -

1. To re-assess specimens orientation effect on applied current.
2. To investigate the rate of scale deposition on the surface of specimens in direct relation to control set potential.

**3. PROCEDURE**

Same as test 30.

**4. FINDINGS**

Overall system protection was fully achieved for all three specimens and no sign of corrosion was observed following specimen inspection. On two occasions orientation of specimens no 1 and 2 were changed from the original setting of perpendicular to parallel to flow. On both occasions the effect was immediately observed and current demand varied as expected (table 8.25).

**5. CONCLUSIONS**

1. As observed earlier applied current decreased when specimen orientation is perpendicular rather than parallel (figure 8.42).

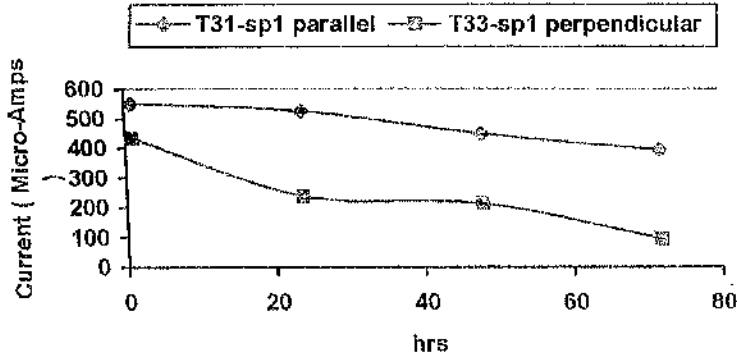

Figure 8.42: Orientation effect on applied current

2. Figure 8.43: shows a general effect of higher current for a more negative control potential. A slight change in lower current for specimens at control potential of  $-900$  mV is due to change in specimen orientation.

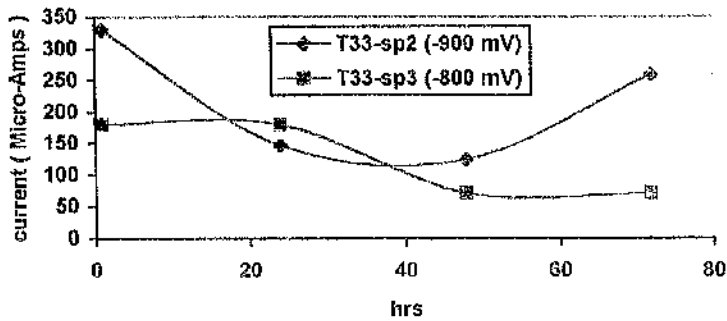

Figure 8.43: Control potential effect on applied current

Specimen	*****	1	2	3
Control Potential	mV	-1050	-900	-800
Current	$\mu$ A	$\mu$ A	$\mu$ A	$\mu$ A
Time	hrs	*****	*****	*****
0	hrs	4200	1900	1800
1	hrs	435	330	180
24	hrs	240	147	72
48	hrs	215	125	72
48 ( change in specimens orientation )	hrs	298	260	72
72	hrs	275	230	72

Table 8.25: Summary of, test daily readings

**TEST NO 34****1. Parameters summary**

Items	Units	Data
Control Potential	mV	Specimens 1, 2 and 3 were all set at -1050
Flow Rate	m <sup>3</sup> /hr	0.85
Temperature	°C	31
T.D.S	ppm	35,000
Test Duration	Days	3
Specimens orientation	*****	Specimens 1 parallel and 2, 3 perpendicular
specimens status	*****	Specimens 1, 2 new and 3 wet- pre scaled
pH	*****	8.3

**2. PURPOSE**

The purpose of this test was: -

- To assess the effect of a pre-scaled specimen, which is kept wet compared to one which was dried. The relevance of such comparison is that both, situation simulate different practical condition in the plant. Thus when a plant is shutdown for maintenance, scaled components will dry where a short interruption to the plant without draining would result in wet condition.
- To re-examine the change in specimens orientation and control potential on system:-

\* Applied current.

\* Deposition rate.

**3. PROCEDURE**

Same as test 30.

**4. FINDINGS**

Table 8.26 shows again a higher current demand due to the nature of the flow around the specimen for specimen 1 which, is positioned in parallel to flow. As explained earlier, circulating water which, is discharged from the pump, collides with the specimen and creates a turbulent condition around the specimen (in this case oxygen reduction is a cathodic reaction, and hence the rate of dissolved oxygen to the surface of the specimen is stimulated. This therefore increases the rate of corrosion and hence a greater need for

applied current). Upon completion of the test all three specimens were viewed by using a microscope. Close observation of the specimens revealed the followings: -

- \* Scale of different type and structure found formed on the surface of the specimen.
- \* No sign of corrosion observed.

## 5. CONCLUSIONS

1. Figure 8.44 shows a general effect of higher need for applied current for specimen, which is positioned in parallel to flow.

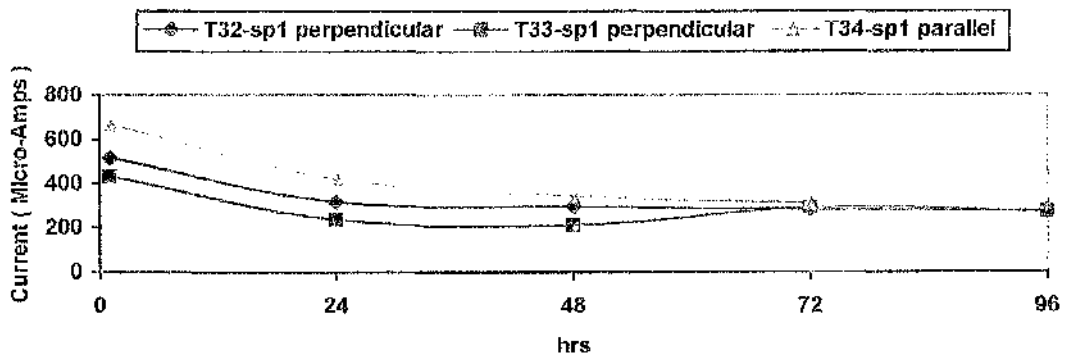

**Figure 8.44: Specimen orientation effect for applied current demand**

2. Figures 8.45 and 8.46 shows current trend versus time for specimen, which was wet pre-scaled against both new and dried pre-scaled specimens. In general both the figures shows that wet pre-scaled specimen requires less applied current. This might be due to cracks in scale, which is formed on the surface of dry pre-scaled specimen.

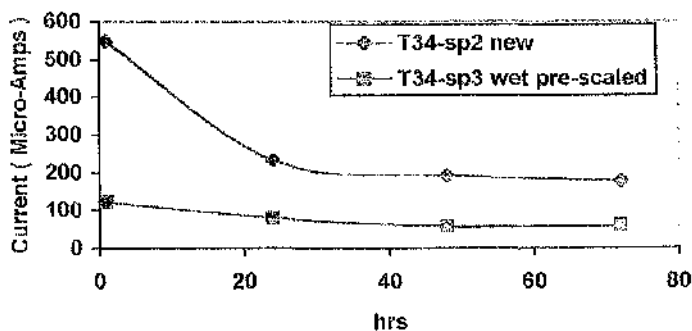

**Figure 8.45: Applied current requirement for wet pre scaled specimen when compared to new**

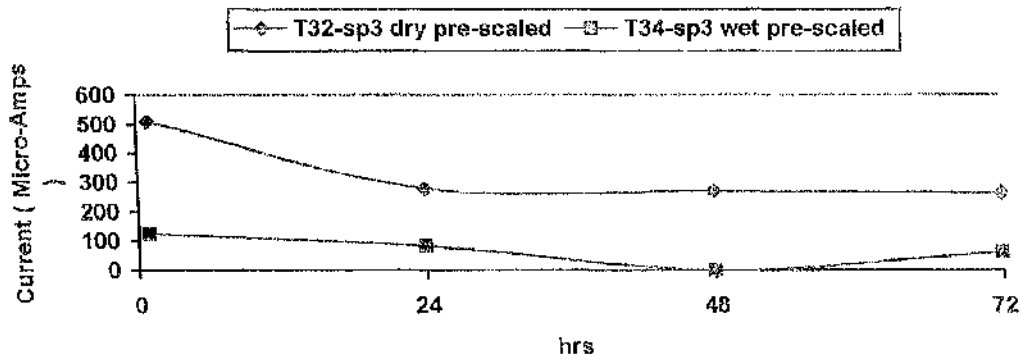

Figure 8.46: Applied current requirement for wet pre-scaled specimen when compared to dry pre-scaled specimen

2. Figure 8.47 shows a general effect of more negative potential on applied current

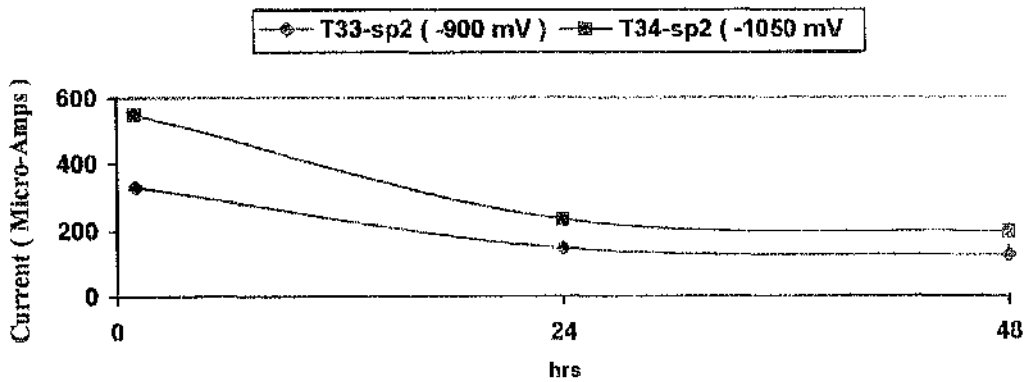

Figure 8.47: Potential effect on protection applied current

Specimen	*****	1	2	3
Control Potential	mV	-1050	-1050	-1050
Current	$\mu A$	$\mu A$	$\mu A$	$\mu A$
Time	hrs	*****	*****	*****
0	hrs	4300	3300	1000
1	hrs	670	550	125
24	hrs	425	235	83
48	hrs	348	195	60
72	hrs	315	180	62

Table 8.26: Summary of test daily readings

**TEST NO 35****1. Parameters summary**

Items	Units	Data
Control Potential	mV	Specimens 1, 3 set at -1050 and 2 with no protection
Flow Rate	m <sup>3</sup> /hr	0.85
Temperature	°C	31
T.D.S	ppm	35,000
Test Duration	Days	2
Specimens orientation	*****	Specimens 1, 2, and 3 all perpendicular to flow
specimens status	*****	Specimens 1 dried pre scaled , 2 and 3 wet- pre scaled
pH	*****	8.2

**2. PURPOSE**

The purpose of this test was: -

1. To re-assess the effect of a wet pre-scaled specimen on applied current.
2. To examine the behavior of a wet pre-scaled specimens at moderate flow conditions when cathodic protection is switched off.

**3. PROCEDURE**

1. Flow rig fully cleaned and flushed.
2. Potentiostat checked and found operational.
3. Reference Electrode accuracy checked against 50D specimen.
4. Reference Electrode and pre-scaled 50D specimens removed from beaker and inserted in the flow rig.
5. Test parameters adjusted as per above set points (specimen 2 left unprotected).
6. Protection switched on for specimens 1 and 3.

**4. FINDINGS**

The test was concluded after 48 hr. Specimen 1 and 3 removed and found in perfect condition. An slight spots of corrosion observed on the surface of specimen 2 as potential did go active (table 8.27 shows that the value of specimens 2 went to values at which corrosion is expected).

## 5. CONCLUSIONS

1. Immediate interruption to the test (for reason of failure) was not necessary, as scale acts as protective layer. The benefit of pre-formed scale was seen for specimen 2, which was not protected cathodically.
3. Figure 8.48 re-confirmed the effect of wet pre scaled specimen on applied current. In general it shows that wet pre-scaled specimen requires less applied current. This might be due to cracks or porosity of formed scale.

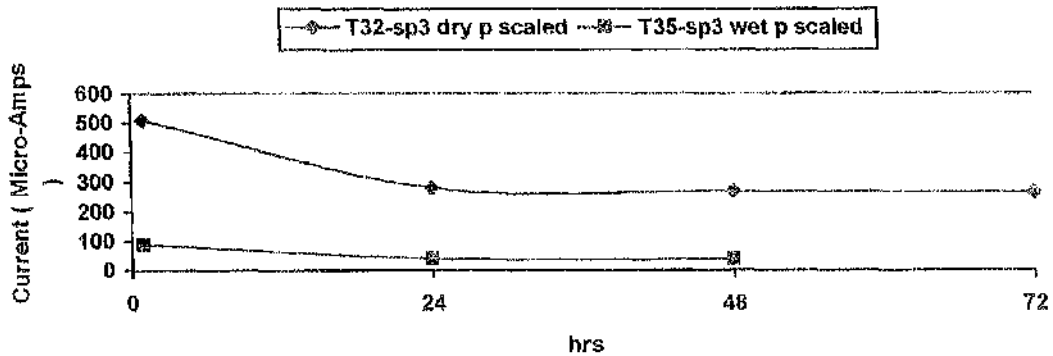

Figure 8.48: Effect of wet pre-scaled specimen on applied current

4. Figure 8.49 Show the re-productibility effect.

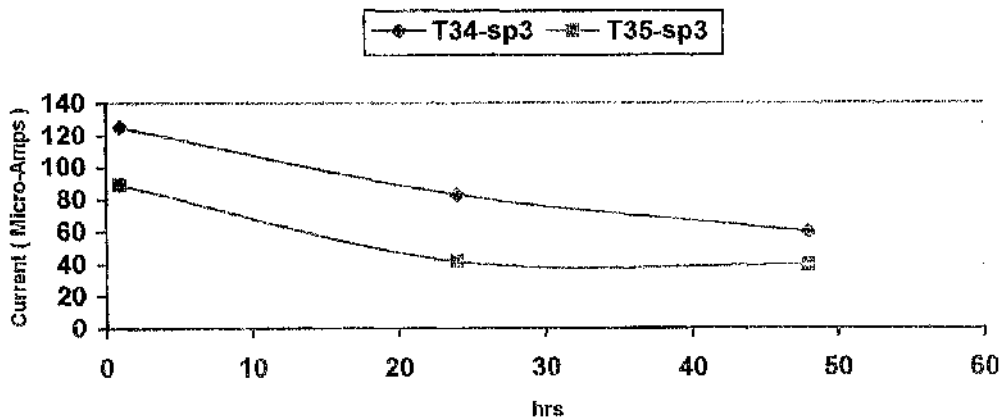

Figure 8.49: Re-productibility effect

Specimen	*****	1	3	2
Control Potential	mV	-1050	-1050	N/A
Voltage	V	N/A	N/A	mV
Current	$\mu$ A	$\mu$ A	$\mu$ A	N/A
Time	hrs	*****	*****	*****
0	hrs	1000	450	-860
1	hrs	175	89	-825
24	hrs	45	42	-650
48	hrs	42	40	-600

Table 8.27: Summary of test, daily readings



**TEST NO 36****1. Parameters summary**

Items	Units	Data
Control Potential	mV	-1000
Flow Rate	m <sup>3</sup> /hr	7.5
Temperature	°C	30-34
T.D.S	ppm	43,000
Test Duration	Days	9

**2. PURPOSE**

The purpose of this test was to study the effect of lower temperature when compared to test 28 on the: -

- \* Rate of scale deposition.
- \* Demand for applied current.

**3. PROCEDURE**

The test procedure was the same as test 17, with the exception that the test operating set control potential was different. Additionally, local potential was measured frequently throughout the test.

**4. FINDINGS**

In the early tests at Dubai prior to this, it was clear that the potentials obtained in the rig were a complex function of time and location. Thus in this and all succeeding tests, a full set of potential were obtained locally by making a temporary connection of the in-situ reference electrode to a voltmeter and the pipe wall.

The locally measured potentials showed some interesting features. Thus the potential (R3 & R4) in group 'B' were much more negative after 24 hours than there in group 'A' despite a higher current in group 'A'. This represents an example of the influence of hydrodynamic condition since the condition were clearly more turbulent at positions R1 and R2 than R3 and R4. The subsequent more negative potential in, group 'B' was obviously associated with the higher current in this group compared to group 'A'. The less negative potential at R4 compared to R3 is likely to have been to the R4 location (near to the end of the test rig) being under the influence of less anodes than R3.

The R1 potential was more positive than R2 for about 6 days presumably due to the greater turbulence in position R1 but the gradual convergence of the two potentials

indicates that this factor evidently became less significant with passage of time. Result based on visual inspection of the specimens at the end of test was satisfactory (figure 8.50).



**Figure 8.50: Specimens condition at the end of test 36**

## 5. CONCLUSIONS

1. System protection was fully achieved when test performed at a control potential of -1000 mV and seawater temperature of 30-35 °C. The scale was formed at the surface of the specimens and was thicker in nature at the surface of specimen 5.
2. Figure 8.51 shows that the demand for applied current is only slightly reduced due to lower operating temperature toward the end of the test. This might be due to scale build up on the test loop pipeline.

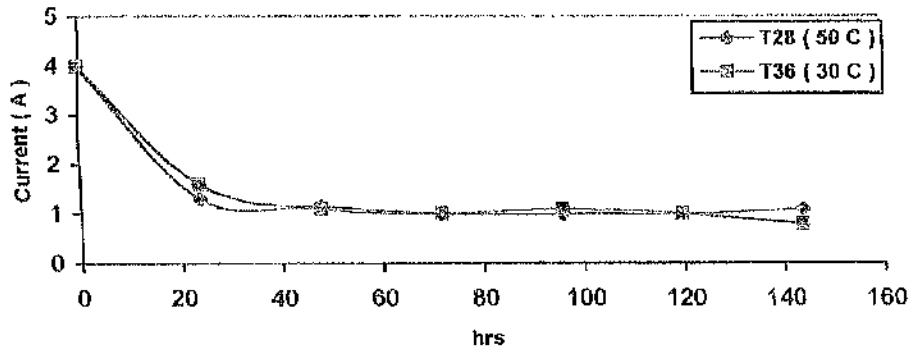

Figure 8.51: Temperature effect on applied current

<b>C.P. Status</b>	****	OFF	ON	ON	ON	ON	ON	ON
<b>Time</b>	hrs	0	24	48	72	96	120	144
<b>Group 'A'</b>	Auto Ops	Auto	Auto	Auto	Auto	Auto	Auto	Auto
<b>Set Potential</b>	mV	-1000	-1000	-1000	-1000	-1000	-1000	-1000
<b>Current</b>	Amps	4	3	1.6	1.1	1	1	1.1
<b>Voltage</b>	V	6	4.9	3.7	3.1	3	3	3.2
<b>R. Electrode</b>	MV	****	****	****	****	****	****	****
<b>R1</b>	PANEL	-690	-1000	-1000	-1000	-1000	-1000	-1000
<b>R2</b>	PANEL	-700	-1060	-1080	-1080	-1070	-1080	-1080
<b>R1</b>	LOCALLY	-680	-790	-830	-840	-860	-900	-940
<b>R2</b>	LOCALLY	-690	-870	-890	-900	-920	-950	-960
<b>Group 'B'</b>	Manual Ops	M	M	M	M	M	M	M
<b>Current</b>	Amps	2.5	2.5	2.5	2.5	2.5	2.5	2.5
<b>Voltage</b>	V	4.4	4.4	4.4	4.4	4.4	4.4	4.4
<b>R. Electrode</b>	MV	****	****	****	****	****	****	****
<b>R3</b>	PANEL	-720	-1200	-1200	-1200	-1200	-1200	-1200
<b>R4</b>	PANEL	-750	-1100	-1100	-1100	-1100	-1100	-1100
<b>R3</b>	LOCALLY	-700	-1100	-1120	-1100	-1140	-1140	-1150
<b>R4</b>	LOCALLY	-720	-980	-990	-1000	-1020	-1020	-1020

<b>C.P. Status</b>	****	ON	ON	ON
<b>Time</b>	hrs	168	192	216
<b>Group 'A'</b>	Auto Ops	Auto	Auto	Auto
<b>Set Potential</b>	mV	-1000	-1000	-1050
<b>Current</b>	Amps	1	0.8	0.8
<b>Voltage</b>	V	3.1	3	3
<b>R. Electrode</b>	MV	****	****	****
<b>R1</b>	PANEL	-1000	-1000	-1000
<b>R2</b>	PANEL	-1090	-1100	-1090
<b>R1</b>	LOCALLY	-970	-980	-980
<b>R2</b>	LOCALLY	-970	-990	-990
<b>Group 'B'</b>	Manual Ops	M	M	M
<b>Current</b>	Amps	2.5	2.5	2.5
<b>Voltage</b>	V	4.4	4.4	4.4
<b>R. Electrode</b>	MV	****	****	****
<b>R3</b>	PANEL	-1200	-1190	-1210
<b>R4</b>	PANEL	-1100	-1090	-1080
<b>R3</b>	LOCALLY	-1150	-1150	-1150
<b>R4</b>	LOCALLY	-1030	-1020	-1020

Table 8.28: Summary of test daily readings

**TEST NO 37****1. Parameters summary**

Items	Units	Data
Control Potential	mV	-1050
Flow Rate	m <sup>3</sup> /hr	7.5
Temperature	°C	30
T.D.S	ppm	43,000
Test Duration	Days	7

**2. PURPOSE**

The purpose of this test was to: -

1. Investigate the effect of more negative potential on the rate of scale deposition and applied current when compared to test 36 (potential set at -1050 mV vs. -1000 mV on test 36).
2. To study the general temperature effect on applied current when compared with test 29.

**3. PROCEDURE**

The test procedure was the same as test 17, with the exception that the test operating temperature was different.

**4. FINDINGS**

The local potential readings showed the same comparative trend as in test 36 with the values in group 'A' attaining the set value after about 5 to 6 days. Figure 8.52 shows the specimens condition after completion of the test. It revealed that scale precipitation at the surface of the specimens was greater in comparison to test 36, mainly due to control potential being more negative. No sign of corrosion was seen either in any specimen surface or at the loop pipelines including spool piece.



Figure 8.52: Specimen condition at the end of test 37.

## 5. CONCLUSIONS

- Figure 8.53 reveals a more rapid decline in group 'A' current when the test is performed at more negative potential.

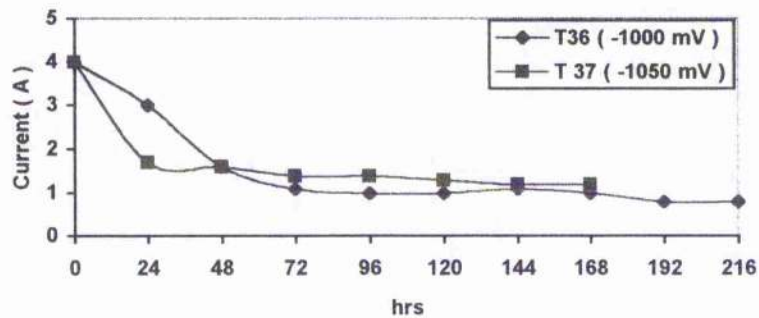

Figure 8.53: Effect of more negative potential on applied current

2. A higher rate of scale deposited on the surface of test 37 specimens, since test was carried out at more negative potential.
3. Figure 8.54 illustrates the effect of higher temperature on applied current when compared to test 29. There was a similar rate of early decline of group 'A' current at the two temperature but the subsequent steady state current was significantly higher at 50 °C.

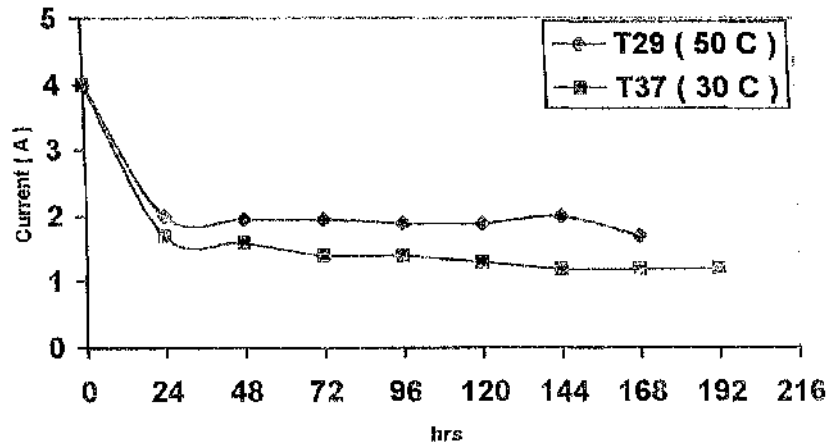

Figure 8.54: Temperature effect on test applied current

C.P. Status	****	OFF	ON	ON	ON	ON	ON	ON
Time	hrs	0	24	48	72	96	120	144-168
Group 'A'	Auto Ops	Auto	Auto	Auto	Auto	Auto	Auto	Auto
Set Potential	mV	-1050	-1050	-1050	-1050	-1050	-1050	-1050
Current	Amps	4	1.7	1.6	1.4	1.4	1.3	1.2
Voltage	V	6	4	3.9	3.7	3.7	3.6	3.5
R. Electrode	MV	****	****	****	****	****	****	****
R1	PANEL	-710	-1050	-1050	-1050	-1050	-1050	-1050
R2	PANEL	-760	-1160	-1160	-1160	-1160	-1160	-1160
R1	LOCALLY	-690	-860	-900	-940	-990	-1020	-1030
R2	LOCALLY	-740	-920	-980	-1000	-1020	-1040	-1040
Group 'B'	Manual Ops	M	M	M	M	M	M	M
Current	Amps	2.5	2.5	2.5	2.5	2.5	2.5	2.5
Voltage	V	4.4	4.4	4.4	4.4	4.4	4.4	4.4
R. Electrode	MV	****	****	****	****	****	****	****
R3	PANEL	-790	-1200	-1210	-1200	-1220	-1200	-1200
R4	PANEL	-820	-1100	-1100	-1090	-1100	-1100	-1100
R3	LOCALLY	-760	-1100	-1080	-1120	-1140	-1100	-1120
R4	LOCALLY	-800	-980	-990	-980	-1000	-1010	-1010

Table 8.29: Summary of test daily readings

**TEST NO 38****1. Parameters summary**

Items	Units	Data
Control Potential	mV	-1000
Flow Rate	m <sup>3</sup> /hr	7.5
Temperature	°C	60
T.D.S	ppm	43,000
Test Duration	Days	7

**2. PURPOSE**

The purpose of this test was to monitor the effect of temperature increase on the rate of scale precipitation and applied current, while running the test at the same control potential of test 36 (-1000 mV) but higher temperature (60 °C instead of 30 °C).

**3. PROCEDURE**

The test procedure was the same as test.17, with the exception that the test operating temperature and control potential were different.

**4. FINDINGS**

Figure 8.55 shows the specimens after removal from the once-through test loop. This reveals that protection was fully achieved, and scale formation at the surface of the specimens was were same as test 36. This indicates that the presence of an antiscalent in the test feed did not affect the deposition rate. The local potential readings exhibited the same comparative trends as in test 36 with, in particular, the feature of a more negative potential attained in group 'B' than in group 'A' after 24 hours despite a higher current in group 'A'.

**5. CONCLUSIONS**

1. At higher temperature, a slight greater initial rate of current decline, but slightly higher longer term current than in test 36 (figure 8.56).
2. Presence of antiscalent within the water media did not reduce the rate of scale formation at the surface of the specimen.



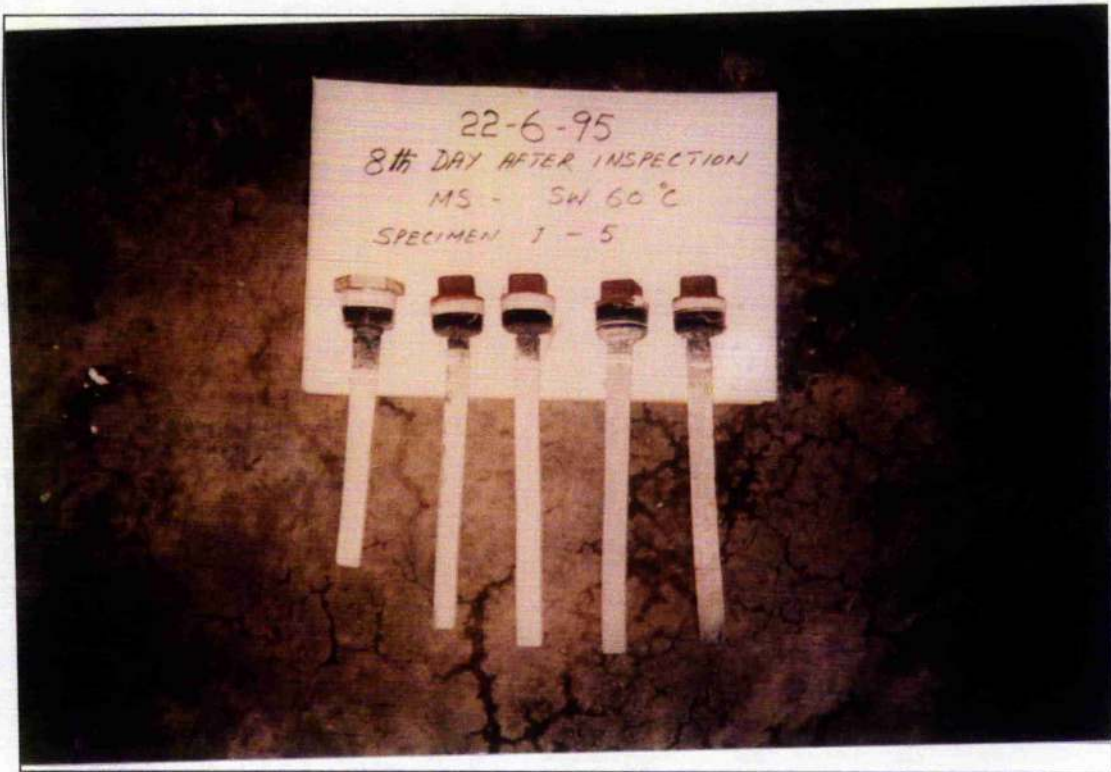

Figure 8.55: Specimens condition at the end of test 38

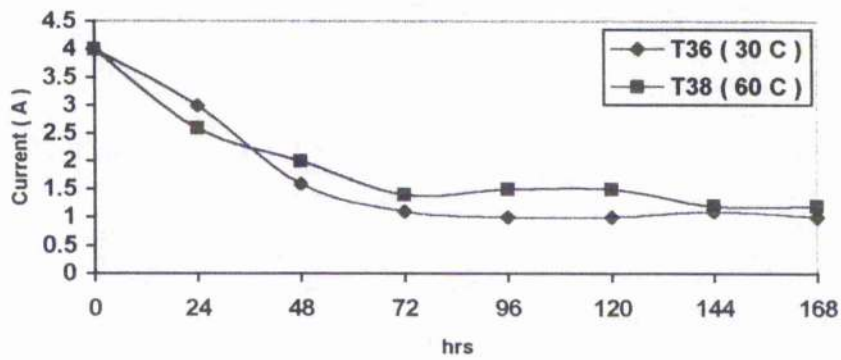

Figure 8.56: Temperature effect on applied current requirement

<b>C.P. Status</b>	<b>****</b>	<b>OFF</b>	<b>ON</b>	<b>ON</b>	<b>ON</b>	<b>ON</b>	<b>ON</b>	<b>ON</b>
<b>Time</b>	<b>hrs</b>	<b>0</b>	<b>24</b>	<b>48</b>	<b>72</b>	<b>96</b>	<b>120</b>	<b>144-168</b>
<b>Group 'A'</b>	<b>Auto Ops</b>	<b>Auto</b>	<b>Auto</b>	<b>Auto</b>	<b>Auto</b>	<b>Auto</b>	<b>Auto</b>	<b>Auto</b>
<b>Set Potential</b>	<b>mV</b>	<b>-1000</b>	<b>-1000</b>	<b>-1000</b>	<b>-1000</b>	<b>-1000</b>	<b>-1000</b>	<b>-1000</b>
<b>Current</b>	<b>Amps</b>	<b>4</b>	<b>2.6</b>	<b>2</b>	<b>1.4</b>	<b>1.5</b>	<b>1.5</b>	<b>1.2</b>
<b>Voltage</b>	<b>V</b>	<b>6</b>	<b>4.6</b>	<b>4.2</b>	<b>3.6</b>	<b>3.7</b>	<b>3.7</b>	<b>3.5</b>
<b>R. Electrode</b>	<b>MV</b>	<b>****</b>	<b>****</b>	<b>****</b>	<b>****</b>	<b>****</b>	<b>****</b>	<b>****</b>
<b>R1</b>	<b>PANEL</b>	<b>-710</b>	<b>-1000</b>	<b>-1000</b>	<b>-1000</b>	<b>-1000</b>	<b>-1000</b>	<b>-1000</b>
<b>R2</b>	<b>PANEL</b>	<b>-750</b>	<b>-1050</b>	<b>-1040</b>	<b>-1060</b>	<b>-1050</b>	<b>-1040</b>	<b>-1060</b>
<b>R1</b>	<b>LOCALLY</b>	<b>-680</b>	<b>-760</b>	<b>-810</b>	<b>-860</b>	<b>-910</b>	<b>-940</b>	<b>-980</b>
<b>R2</b>	<b>LOCALLY</b>	<b>-710</b>	<b>-790</b>	<b>-850</b>	<b>-920</b>	<b>-950</b>	<b>-980</b>	<b>-990</b>
<b>Group 'B'</b>	<b>Manual Ops</b>	<b>M</b>	<b>M</b>	<b>M</b>	<b>M</b>	<b>M</b>	<b>M</b>	<b>M</b>
<b>Current</b>	<b>Amps</b>	<b>2.5</b>	<b>2.5</b>	<b>2.5</b>	<b>2.5</b>	<b>2.5</b>	<b>2.5</b>	<b>2.5</b>
<b>Voltage</b>	<b>V</b>	<b>4.4</b>	<b>4.4</b>	<b>4.4</b>	<b>4.4</b>	<b>4.4</b>	<b>4.4</b>	<b>4.4</b>
<b>R. Electrode</b>	<b>MV</b>	<b>****</b>	<b>****</b>	<b>****</b>	<b>****</b>	<b>****</b>	<b>****</b>	<b>****</b>
<b>R3</b>	<b>PANEL</b>	<b>-760</b>	<b>-1190</b>	<b>-1210</b>	<b>-1220</b>	<b>-1220</b>	<b>-1200</b>	<b>-1200</b>
<b>R4</b>	<b>PANEL</b>	<b>-770</b>	<b>-1110</b>	<b>-1100</b>	<b>-1140</b>	<b>-1120</b>	<b>-1100</b>	<b>-1120</b>
<b>R3</b>	<b>LOCALLY</b>	<b>-750</b>	<b>-870</b>	<b>-1010</b>	<b>-1050</b>	<b>-1100</b>	<b>-1100</b>	<b>-1100</b>
<b>R4</b>	<b>LOCALLY</b>	<b>-750</b>	<b>-880</b>	<b>-920</b>	<b>-960</b>	<b>-1000</b>	<b>-1030</b>	<b>-1050</b>

Table 8.30: Summary of, test daily readings

**TEST NO 39****1. Parameters summary**

Items	Units	Data
Control Potential	mV	-1000
Flow Rate	m <sup>3</sup> /hr	40
Temperature	°C	30
T.D.S	ppm	43,000
Test Duration	Days	7

**2. PURPOSE**

The aim of this test was to study flow rate effect on test loop applied current when compared to test 36 (40 m<sup>3</sup>/hr instead of 7.5 m<sup>3</sup>/hr in test 36).

**3. PROCEDURE**

The test procedure was the similar to test 38, with the exception that the test operating flow rate was different. This was achieved as flow orifice was replaced.

**4. FINDINGS**

At this higher flow rate, the group 'A' potential were, less negative in the first 48 hours than in test 36 but this flow rate affect was not evident in, group 'B'. Test result based on visual inspection of the specimens at the end of the test was satisfactory. Scale also was formed on the surface of all the specimens but the pattern was less uniform than test 36, as formed scale was not as uniform as test 36. Slight evidence of corrosion was also seen on the surface of specimens 1 and 2 (figure 8.57).

**5. CONCLUSIONS**

1. Figure 8.58 illustrates that the applied current increased slightly with increase in test flow rate.
2. The rate of formed scale on the surface of the specimens was similar to test 36 but was less adhered to the surface.
3. The locally measured potentials (R1 and R2) in, group 'A' attained but did not exceed the set potential value. This demonstrates the effectiveness of the cathodic protection of group 'A' system in its basic control function. This was also confirmed in later tests.

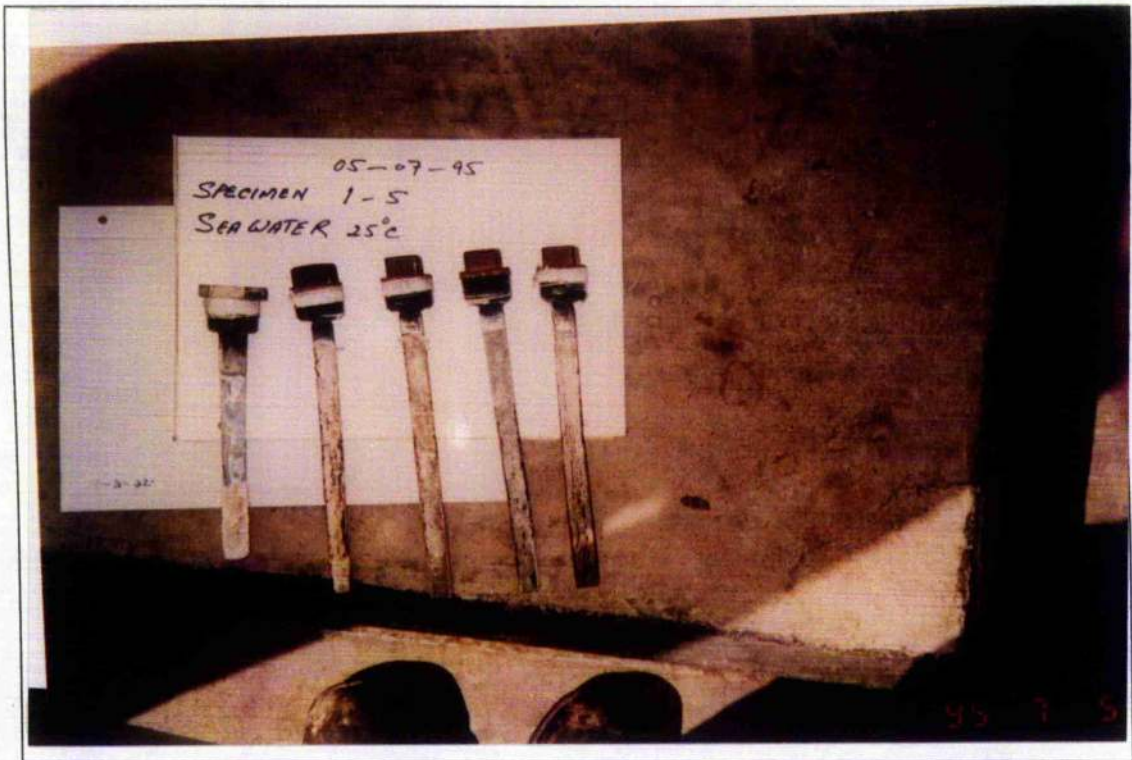

Figure 8.57: Specimens condition at the end of the test 39

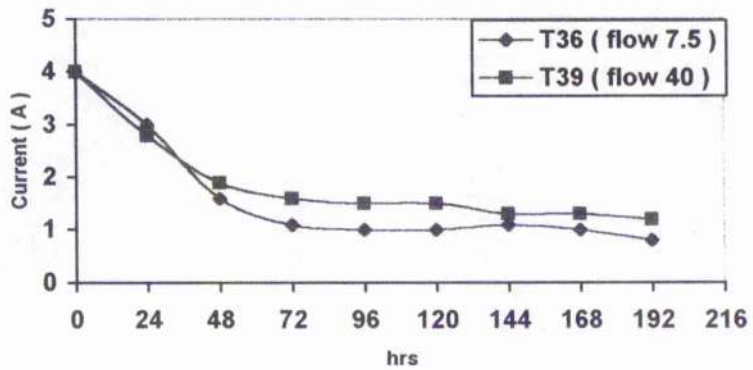

Figure 8.58: Effect of flow on protection applied current

<b>C.P. Status</b>	<b>****</b>	<b>OFF</b>	<b>ON</b>	<b>ON</b>	<b>ON</b>	<b>ON</b>	<b>ON</b>	<b>ON</b>
<b>Time</b>	<b>hrs</b>	<b>0</b>	<b>24</b>	<b>48</b>	<b>72</b>	<b>96</b>	<b>120</b>	<b>144</b>
<b>Group 'A'</b>	<b>Auto Ops</b>	<b>Auto</b>	<b>Auto</b>	<b>Auto</b>	<b>Auto</b>	<b>Auto</b>	<b>Auto</b>	<b>Auto</b>
<b>Set Potential</b>	<b>mV</b>	<b>-1000</b>	<b>-1000</b>	<b>-1000</b>	<b>-1000</b>	<b>-1000</b>	<b>-1000</b>	<b>-1000</b>
<b>Current</b>	<b>Amps</b>	<b>4</b>	<b>2.8</b>	<b>1.9</b>	<b>1.6</b>	<b>1.5</b>	<b>1.5</b>	<b>1.3</b>
<b>Voltage</b>	<b>V</b>	<b>6</b>	<b>4.7</b>	<b>3.8</b>	<b>3.7</b>	<b>3.6</b>	<b>3.7</b>	<b>3.6</b>
<b>R. Electrode</b>	<b>MV</b>	<b>****</b>	<b>****</b>	<b>****</b>	<b>****</b>	<b>****</b>	<b>****</b>	<b>****</b>
<b>R1</b>	<b>PANEL</b>	<b>-720</b>	<b>-1000</b>	<b>-1000</b>	<b>-1000</b>	<b>-1000</b>	<b>-1000</b>	<b>-1000</b>
<b>R2</b>	<b>PANEL</b>	<b>-740</b>	<b>-1050</b>	<b>-1070</b>	<b>-1090</b>	<b>-1080</b>	<b>-1090</b>	<b>-1090</b>
<b>R1</b>	<b>LOCALLY</b>	<b>-690</b>	<b>-770</b>	<b>-790</b>	<b>-820</b>	<b>-840</b>	<b>-890</b>	<b>-940</b>
<b>R2</b>	<b>LOCALLY</b>	<b>-710</b>	<b>-800</b>	<b>-840</b>	<b>-890</b>	<b>-920</b>	<b>-960</b>	<b>-990</b>
<b>Group 'B'</b>	<b>Manual Ops</b>	<b>M</b>	<b>M</b>	<b>M</b>	<b>M</b>	<b>M</b>	<b>M</b>	<b>M</b>
<b>Current</b>	<b>Amps</b>	<b>2.5</b>	<b>2.5</b>	<b>2.5</b>	<b>2.5</b>	<b>2.5</b>	<b>2.5</b>	<b>2.5</b>
<b>Voltage</b>	<b>V</b>	<b>4.4</b>	<b>4.4</b>	<b>4.4</b>	<b>4.4</b>	<b>4.4</b>	<b>4.4</b>	<b>4.4</b>
<b>R. Electrode</b>	<b>MV</b>	<b>****</b>	<b>****</b>	<b>****</b>	<b>****</b>	<b>****</b>	<b>****</b>	<b>****</b>
<b>R3</b>	<b>PANEL</b>	<b>-770</b>	<b>-1190</b>	<b>-1180</b>	<b>-1190</b>	<b>-1180</b>	<b>-1200</b>	<b>-1190</b>
<b>R4</b>	<b>PANEL</b>	<b>-780</b>	<b>-1030</b>	<b>-1020</b>	<b>-1040</b>	<b>-1040</b>	<b>-1040</b>	<b>-1040</b>
<b>R3</b>	<b>LOCALLY</b>	<b>-750</b>	<b>-1100</b>	<b>-1140</b>	<b>-1150</b>	<b>-1150</b>	<b>-1150</b>	<b>-1150</b>
<b>R4</b>	<b>LOCALLY</b>	<b>-750</b>	<b>-950</b>	<b>-980</b>	<b>-1010</b>	<b>-1000</b>	<b>-1000</b>	<b>-1000</b>

<b>C.P. Status</b>	<b>****</b>	<b>ON</b>	<b>ON</b>	<b>ON</b>	<b>ON</b>	<b>ON</b>	<b>ON</b>	<b>ON</b>
<b>Time</b>	<b>hrs</b>	<b>168</b>	<b>192</b>	<b>216</b>	<b>240</b>	<b>264</b>	<b>288</b>	<b>302</b>
<b>Group 'A'</b>	<b>Auto Ops</b>	<b>Auto</b>	<b>Auto</b>	<b>Auto</b>	<b>Auto</b>	<b>Auto</b>	<b>Auto</b>	<b>Auto</b>
<b>Set Potential</b>	<b>mV</b>	<b>-1000</b>	<b>-1000</b>	<b>-1000</b>	<b>-1000</b>	<b>-1000</b>	<b>-1000</b>	<b>-1000</b>
<b>Current</b>	<b>Amps</b>	<b>1.3</b>	<b>1.2</b>	<b>1.3</b>	<b>1.1</b>	<b>1.3</b>	<b>1</b>	<b>1</b>
<b>Voltage</b>	<b>V</b>	<b>3.5</b>	<b>3.5</b>	<b>3.5</b>	<b>3.4</b>	<b>3.5</b>	<b>3.4</b>	<b>3.4</b>
<b>R. Electrode</b>	<b>MV</b>	<b>****</b>	<b>****</b>	<b>****</b>	<b>****</b>	<b>****</b>	<b>****</b>	<b>****</b>
<b>R1</b>	<b>PANEL</b>	<b>-1000</b>	<b>-1000</b>	<b>-1000</b>	<b>-1000</b>	<b>-1000</b>	<b>-1000</b>	<b>-1000</b>
<b>R2</b>	<b>PANEL</b>	<b>-1080</b>	<b>-1090</b>	<b>-1090</b>	<b>-1080</b>	<b>-1080</b>	<b>-1090</b>	<b>-1090</b>
<b>R1</b>	<b>LOCALLY</b>	<b>-970</b>	<b>-990</b>	<b>-980</b>	<b>-990</b>	<b>-980</b>	<b>-990</b>	<b>-980</b>
<b>R2</b>	<b>LOCALLY</b>	<b>-980</b>	<b>-990</b>	<b>-990</b>	<b>-990</b>	<b>-990</b>	<b>-990</b>	<b>-990</b>
<b>Group 'B'</b>	<b>Manual Ops</b>	<b>M</b>	<b>M</b>	<b>M</b>	<b>M</b>	<b>M</b>	<b>M</b>	<b>M</b>
<b>Current</b>	<b>Amps</b>	<b>2.5</b>	<b>2.5</b>	<b>2.5</b>	<b>2.5</b>	<b>2.5</b>	<b>2.5</b>	<b>2.5</b>
<b>Voltage</b>	<b>V</b>	<b>4.4</b>	<b>4.4</b>	<b>4.4</b>	<b>4.4</b>	<b>4.4</b>	<b>4.4</b>	<b>4.4</b>
<b>R. Electrode</b>	<b>MV</b>	<b>****</b>	<b>****</b>	<b>****</b>	<b>****</b>	<b>****</b>	<b>****</b>	<b>****</b>
<b>R3</b>	<b>PANEL</b>	<b>-1200</b>	<b>-1200</b>	<b>-1190</b>	<b>-1200</b>	<b>-1180</b>	<b>-1190</b>	<b>-1190</b>
<b>R4</b>	<b>PANEL</b>	<b>-1040</b>	<b>-1030</b>	<b>-1040</b>	<b>-1040</b>	<b>-1040</b>	<b>-1040</b>	
<b>R3</b>	<b>LOCALLY</b>	<b>-1150</b>	<b>-1160</b>	<b>-1150</b>	<b>-1170</b>	<b>-1150</b>	<b>-1160</b>	<b>-1160</b>
<b>R4</b>	<b>LOCALLY</b>	<b>-1000</b>	<b>-1010</b>	<b>-990</b>	<b>-1000</b>	<b>-1010</b>	<b>-1000</b>	<b>-1010</b>

Table 8.31: Summary of test daily readings

**TEST NO 40****1. Parameters summary**

Items	Units	Data
Control Potential	mV	-1050
Flow Rate	m <sup>3</sup> /hr	7.5
Temperature	°C	35
T.D.S	ppm	43,000
Test Duration	Days	7

**2. PURPOSE**

The purpose of this test was to illustrate the following twofold: -

- \* Effect of decrease in test temperature on the rate of scale precipitation and applied current when compared to test 29 (35 °C instead of 60 °C).
- \* Effect of less negative control potential in applied current.

**3. PROCEDURE**

The test procedure was similar to test 17.

**4. FINDINGS**

Table 8.32 shows the daily potential measurement and shown that, by the end of the test, R1 and R2 measured locally had effectively attained the pre-set control potential. After 7 days, test completed, loop depressurised and specimens removed. The following were observed: -

- \* Specimen 1 to 2, no corrosion, but surface was coated with a very fine scale.
- \* Specimens 3,4, and 5, no corrosion, but were coated with a uniform layer of scale.
- \* Spool piece and the test loop pipelines were fully covered with scale.

**5. CONCLUSIONS**

1. Figure 8.59 shows that system was protected, as no sign of corrosion was seen on the surface of the specimens. Scale deposition rate was less when compared to test 29 (figure 8.30).



**Figure 8.59: Specimens condition at the end of test 40**

2. Figure 8.60 shows drop in current as test temperature reduces in test 40 when compared to test 29.

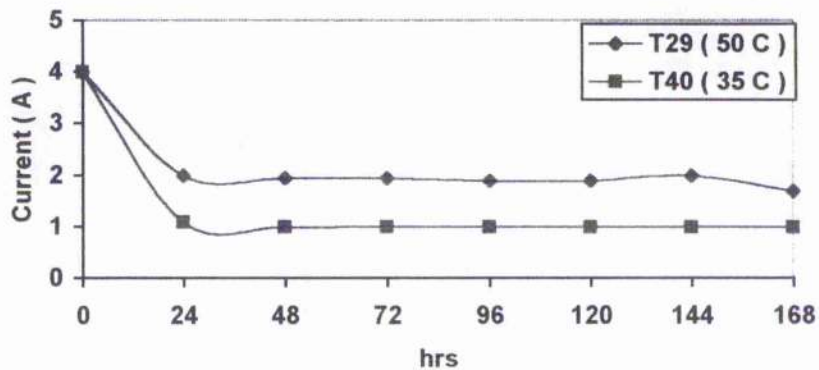

**Figure 8.60: Effect of temperature on applied current**

3. Tables 8.28 and 8.32 shows that the effect of more negative control potential was less than expected as the test loop pipeline was mostly scaled up. This therefore

causes the actual effect of more negative control potential on applied current to be not very evident.

<b>C.P. Status</b>	<b>****</b>	<b>OFF</b>	<b>ON</b>	<b>ON</b>	<b>ON</b>	<b>ON</b>	<b>ON</b>	<b>ON</b>
<b>Time</b>	<b>hrs</b>	<b>0</b>	<b>24</b>	<b>48</b>	<b>72</b>	<b>96</b>	<b>120</b>	<b>144-168</b>
<b>Group 'A'</b>	<b>Auto Ops</b>	<b>Auto</b>	<b>Auto</b>	<b>Auto</b>	<b>Auto</b>	<b>Auto</b>	<b>Auto</b>	<b>Auto</b>
<b>Set Potential</b>	<b>mV</b>	<b>-1050</b>	<b>-1050</b>	<b>-1050</b>	<b>-1050</b>	<b>-1050</b>	<b>-1050</b>	<b>-1050</b>
<b>Current</b>	<b>Amps</b>	<b>4</b>	<b>1.1</b>	<b>1</b>	<b>1</b>	<b>1</b>	<b>1</b>	<b>1</b>
<b>Voltage</b>	<b>V</b>	<b>6</b>	<b>3.4</b>	<b>3.3</b>	<b>3.3</b>	<b>3.3</b>	<b>3.3</b>	<b>3.3</b>
<b>R. Electrode</b>	<b>MV</b>	<b>****</b>	<b>****</b>	<b>****</b>	<b>****</b>	<b>****</b>	<b>****</b>	<b>****</b>
<b>R1</b>	<b>PANEL</b>	<b>-710</b>	<b>-1050</b>	<b>-1050</b>	<b>-1050</b>	<b>-1050</b>	<b>-1050</b>	<b>-1050</b>
<b>R2</b>	<b>PANEL</b>	<b>-730</b>	<b>-1090</b>	<b>-1100</b>	<b>-1120</b>	<b>-1100</b>	<b>-1090</b>	<b>-1080</b>
<b>R1</b>	<b>LOCALLY</b>	<b>-660</b>	<b>-780</b>	<b>-840</b>	<b>-870</b>	<b>-940</b>	<b>-1000</b>	<b>-1030</b>
<b>R2</b>	<b>LOCALLY</b>	<b>-680</b>	<b>-800</b>	<b>-850</b>	<b>-900</b>	<b>-1000</b>	<b>-1020</b>	<b>-1030</b>
<b>Group 'B'</b>	<b>Manual Ops</b>	<b>M</b>	<b>M</b>	<b>M</b>	<b>M</b>	<b>M</b>	<b>M</b>	<b>M</b>
<b>Current</b>	<b>Amps</b>	<b>2.5</b>	<b>2.5</b>	<b>2.5</b>	<b>2.5</b>	<b>2.5</b>	<b>2.5</b>	<b>2.5</b>
<b>Voltage</b>	<b>V</b>	<b>4.4</b>	<b>4.4</b>	<b>4.4</b>	<b>4.4</b>	<b>4.4</b>	<b>4.4</b>	<b>4.4</b>
<b>R. Electrode</b>	<b>MV</b>	<b>****</b>	<b>****</b>	<b>****</b>	<b>****</b>	<b>****</b>	<b>****</b>	<b>****</b>
<b>R3</b>	<b>PANEL</b>	<b>-780</b>	<b>-1190</b>	<b>-1180</b>	<b>-1190</b>	<b>-1180</b>	<b>-1180</b>	<b>-1190</b>
<b>R4</b>	<b>PANEL</b>	<b>-800</b>	<b>-1030</b>	<b>-1020</b>	<b>-1040</b>	<b>-1030</b>	<b>-1040</b>	<b>-1040</b>
<b>R3</b>	<b>LOCALLY</b>	<b>-750</b>	<b>-950</b>	<b>-1000</b>	<b>-1020</b>	<b>-1090</b>	<b>-1100</b>	<b>-1120</b>
<b>R4</b>	<b>LOCALLY</b>	<b>-770</b>	<b>-900</b>	<b>-940</b>	<b>-970</b>	<b>-1010</b>	<b>-1040</b>	<b>-1040</b>

**Table 8.32: Summary of test daily readings**



**TEST NO 41****1. Parameters summary**

Items	Units	Data
Control Potential	mV	-900
Flow Rate	m <sup>3</sup> /hr	7.5
Temperature	°C	60
T.D.S	ppm	43,000
Test Duration	Days	10

**2. PURPOSE**

The purpose of this test was to monitor the effect of a set control potential variation toward less negative set point on the applied current and rate of scale deposition on the surfaces of the specimen when compared with test 38.

**3. PROCEDURE**

The test procedure was similar to test 38, with the exception that the test operating control potential was set at more positive value.

**4. FINDINGS**

Tables 8.33 and 8.30 clearly indicate that the system current demand reduces with decrease in control potential. Figure 8.61 shows that scale did form in the same pattern and quantity at the surface of the specimens even when test carried out at less, negative potential. Although specimens were non corroded and were covered with scale. The scale layer were not as thick as in test 38, which had been carried at the same temperature but more negative potential.

**5. CONCLUSIONS**

1. Increase/decrease in system control potential has a far more effect on the test applied current demand than temperature.
2. Type of scale formed at higher temperature is normally uniform with better adherence to the surface even though scale inhibitor was present.
3. Table 8.33 shows that the local potential reduce to a value more negative than -800 mV within 24 hrs. This might be due to previously formed scale on the surfaces of the test loop pipeline. Also the steady state currents were significantly smaller than in previous tests.



Figure 8.61: Specimens condition after the end of test 41

C.P. Status	****	OFF	ON	ON	ON	ON	ON	ON
Time	hrs	0	24	48	72	96	120	144-240
Group 'A'	Auto Ops	Auto	Auto	Auto	Auto	Auto	Auto	Auto
Set Potential	mV	-900	-900	-900	-900	-900	-900	-900
Current	Amps	4	0.6	0.65	0.5	0.45	0.4	0.4
Voltage	V	6	2.6	2.4	2.6	2.5	2.4	2.4
R. Electrode	MV	****	****	****	****	****	****	****
R1	PANEL	-700	-900	-900	-900	-900	-900	-900
R2	PANEL	-710	-990	-980	-980	-980	-960	-960
R1	LOCALLY	-650	-800	-820	-840	-850	-860	-880
R2	LOCALLY	-640	-790	-840	-860	-880	-880	-890
Group 'B'	Manual Ops	M	M	M	M	M	M	M
Current	Amps	2.5	2.5	2.5	2.5	2.5	2.5	2.5
Voltage	V	4.4	4.4	4.4	4.4	4.4	4.4	4.4
R. Electrode	MV	****	****	****	****	****	****	****
R3	PANEL	-760	-1160	-1150	-1170	-1160	-1180	-1190
R4	PANEL	-790	-1030	-1030	-1040	-1050	-1040	-1060
R3	LOCALLY	-740	-1000	-1010	-1010	-1020	-1030	-1050
R4	LOCALLY	-760	-910	-920	-920	-940	-980	-970

Table 8.33: Summary of, test daily readings

**TEST NO 42****1. Parameters summary**

Items	Units	Data
Control Potential	mV	-1050
Flow Rate	m <sup>3</sup> /hr	7.5
Temperature	°C	35
T.D.S	ppm	43,000
Test Duration	Days	8

**2. PURPOSE**

The aim of this test was to re-produce test 40 findings.

**3. PROCEDURE**

The test procedure was similar to test 17, with the exception that the test operating temperature was different.

**4. FINDINGS**

Table 8.34 shows summary of daily readings, the data obtained clearly indicates that the flow rig pipeline was scaled up fully as test applied current demand was very low after the initial 24 hours. This was re-confirmed upon visual inspection of the test spool piece. Figure 8.62 show the specimens condition after completion of the test. The pictures reveal the followings: -

- \* Specimens 1, 2 and 4 were covered with minor layer of scale.
- \* Specimens 3, and 5, no sign of corrosion, more uniform layer of scale was seen on the surface of the specimens.

**5. CONCLUSIONS**

1. Previously formed scale acted as protective layer during the test. This result suggests a reduced requirement for test, applied current, and hence lower operating cost of cathodic protection system.



**Figure 8.62: Specimen condition at the end of test 42**

3. System protection was fully achieved as no sign of corrosion was observed at the specimen surfaces.
4. Figure 8.63 illustrates the applied current comparison between test 40 and 42. The current trend shows a good reproducibility of the results. A drop of current from 0.8 to 0.5 amps of test 42 indicated that the loop has been further fouled. In general the rate of scale growth on the surface which is scaled up is much higher than bare metal due to surface roughness.

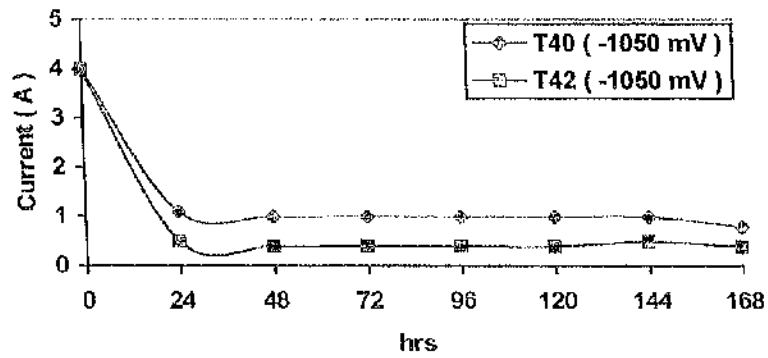

Figure 8.63: Current trend vs. time

C.P. Status	****	OFF	ON	ON	ON	ON	ON	ON
Time	hrs	0	24	48	72	96	120	144-192
Group 'A'	Auto Ops	Auto	Auto	Auto	Auto	Auto	Auto	Auto
Set Potential	mV	-1050	-1050	-1050	-1050	-1050	-1050	-1050
Current	Amps	4	0.5	0.4	0.4	0.4	0.4	0.4
Voltage	V	6	2.5	2.4	2.4	2.4	2.4	2.4
R. Electrode	MV	****	****	****	****	****	****	****
R1	PANEL	-720	-1050	-1050	-1050	-1050	-1050	-1050
R2	PANEL	-730	-1090	-1100	-1090	-1090	-1090	-1090
R1	LOCALLY	-660	-820	-860	-900	-920	-940	-980 to -1030
R2	LOCALLY	-670	-860	-910	-960	-990	-1020	-1040
Group 'B'	Manual Ops	M	M	M	M	M	M	M
Current	Amps	2.5	2.5	2.5	2.5	2.5	2.5	2.5
Voltage	V	4.4	4.4	4.4	4.4	4.4	4.4	4.4
R. Electrode	MV	****	****	****	****	****	****	****
R3	PANEL	-730	-1200	-1190	-1220	-1200	-1210	-1220
R4	PANEL	-780	-1100	-1080	-1100	-1080	-1080	-1080
R3	LOCALLY	-720	-950	-1000	-1000	-1030	-1050	-1060
R4	LOCALLY	-750	-930	-960	-990	-1000	-1010	-1030

Table 8.34: Summary of the test daily readings

## TEST NO 43

### 1. Parameters summary

Items	Units	Data
Control Potential	mV	-1000
Flow Rate	m <sup>3</sup> /hr	7.5
Temperature	°C	35
T.D.S	ppm	43,000
Test Duration	Days	6

### 2. PURPOSE

The purpose of this test was to re-produce test 42 findings, while performing the test at more positive set control potential (-1000 mV instead of -1050 mV).

### 3. PROCEDURE

The test procedure was similar to test.17.

### 4. FINDINGS

Table 8.35 shows the daily readings from the test. Figure 8.64 indicates that the current demand was higher for the first 48 hrs but shifted more or less towards the values similar to test 42. This was mainly due to built up of scale at the surface of the once-through test loop pipelines. After 6 days, test completed, rig depressurised, specimen removed and following observation recorded: -

- \* Specimens 1,2 and 3, no corrosion but specimens were covered with fine scale.
- \* Specimens 4 and 5, no sign of corrosion, thicker layer of scale was seen on the surface of the specimens.

### 5. CONCLUSIONS

When system (e.g. pipe) is heavily scaled, the galvanostatic operation on group 'B' at 2.5 amps causes significant overprotection in-group 'B'. This aspect is also a feature of the test immediately prior to this test.

## 6. NOTE

Acid cleaning of the test loop was thought to be necessary, In order to carry out further test using test loop on the subject.

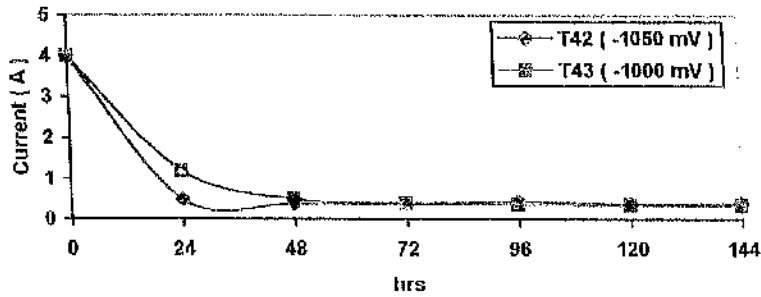

Figure 8.64: Effect of control potential on applied current

<b>C.P. Status</b>	****	OFF	ON	ON	ON	ON	ON	ON
<b>Time</b>	hrs	0	24	48	72	96	120	144
<b>Group 'A'</b>	Auto Ops	Auto	Auto	Auto	Auto	Auto	Auto	Auto
<b>Set Potential</b>	mV	-1000	-1000	-1000	-1000	-1000	-1000	-1000
<b>Current</b>	Amps	4	1.2	0.5	0.4	0.38	0.35	0.35
<b>Voltage</b>	V	6	3.5	2.4	2.4	2.3	2.3	2.3
<b>R. Electrode</b>	MV	****	****	****	****	****	****	****
<b>R1</b>	PANEL	-670	-1000	-1000	-1000	-1000	-1000	-1000
<b>R2</b>	PANEL	-700	-1040	-1060	-1050	-1050	-1050	-1050
<b>R1</b>	LOCALLY	-650	-740	-780	-850	-920	-950	-970
<b>R2</b>	LOCALLY	-660	-760	-800	-860	-940	-940	-980
<b>Group 'B'</b>	Manual Ops	M	M	M	M	M	M	M
<b>Current</b>	Amps	2.5	2.5	2.5	2.5	2.5	2.5	2.5
<b>Voltage</b>	V	4.4	4.4	4.4	4.4	4.4	4.4	4.4
<b>R. Electrode</b>	MV	****	****	****	****	****	****	****
<b>R3</b>	PANEL	-740	-1210	-1200	-1200	-1210	-1210	-1200
<b>R4</b>	PANEL	-750	-1100	-1080	-1090	-1090	-1100	-1100
<b>R3</b>	LOCALLY	-720	-850	-900	-980	-1040	-1060	-1090
<b>R4</b>	LOCALLY	-740	-900	-920	-950	-970	-990	-1000

Table 8.35: Summary of the test daily readings

## TEST NO 44

### 1. Parameters summary

Items	Units	Data
Control Potential	mV	-1050
Flow Rate	m <sup>3</sup> /hr	7.5
Temperature	°C	35
T.D.S	ppm	43,000
Test Duration	Days	16

### 2. PURPOSE

The aim of this test was to re-asses the tests 40 and 42 findings.

### 3. PROCEDURE

The test procedure was the same as test. 17, with the exception that the test operating temperature was different.

### 4. FINDINGS

Table 8.36 shows the test daily readings. The applied current data indicates similar results as of test 42. The following observations were made after the test: -

- \* Specimens 1, 2, and 3, no sign of corrosion, minor layer of scale was observed.
- \* Specimens 4 and 5, no sign of corrosion, more uniform layer of scale was seen on the surface of the specimens.
- \* Spool piece and pipeline were fully covered with scale with no sign of corrosion (figure 8.65).

### 5. CONCLUSIONS

1. Figure 8.66 shows a good reproducibility of results when compared with test 40 and 42.
2. The results obtained both via daily readings and test loop pipelines visual inspection confirmed that acid wash of system is necessary at this stage. Further, tests using such status flow rig does not generates any useful information.





Figure 8.65: Specimen condition after the end of test 44

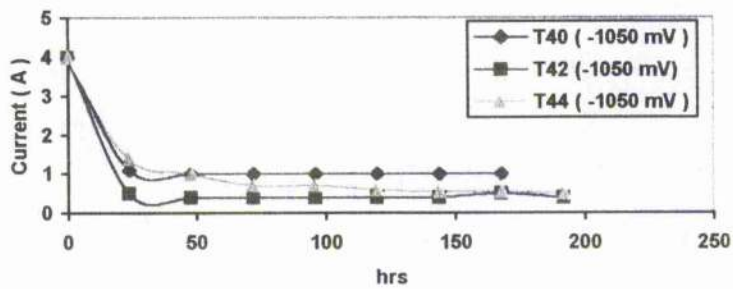

Figure 8.66: The graph shows the tests reproducibility results

## 6. RECOMMENDATION

- \* Full acid wash of the system before commencing the next test.

C.P. Status	****	OFF	ON	ON	ON	ON	ON	ON
Time	hrs	0	24	48	72	96	120	144
Group 'A'	Auto Ops	Auto	Auto	Auto	Auto	Auto	Auto	Auto
Set Potential	mV	-1050	-1050	-1050	-1050	-1050	-1050	-1050
Current	Amps	4	1.4	1	0.7	0.7	0.6	0.55
Voltage	V	6	3.3	3.1	2.9	2.9	2.8	2.5
R. Electrode	MV	****	****	****	****	****	****	****
R1	PANEL	-680	-1050	-1050	-1050	-1050	-1050	-1050
R2	PANEL	-700	-1080	-1150	-1160	-1140	-1150	-1160
R1	LOCALLY	-660	-820	-880	-950	-1000	-1010	-1000
R2	LOCALLY	-650	-840	-920	-970	-1020	-1020	-1030
Group 'B'	Manual Ops	M	M	M	M	M	M	M
Current	Amps	2.5	2.5	2.5	2.5	2.5	2.5	2.5
Voltage	V	4.4	4.4	4.4	4.4	4.4	4.4	4.4
R. Electrode	MV	****	****	****	****	****	****	****
R3	PANEL	-760	-1300	-1280	-1290	-1280	-1260	-1250
R4	PANEL	-750	-1110	-1120	-1100	-1110	-1100	-1110
R3	LOCALLY	-730	-820	-1010	-1100	-1110	-1100	-1120
R4	LOCALLY	-750	-880	-960	-1000	-1050	-1060	-1050

C.P. Status	****	ON	ON	ON	ON	ON	ON	ON
Time	hrs	168	192	216	240	264	288	312-384
Group 'A'	Auto Ops	Auto	Auto	Auto	Auto	Auto	Auto	Auto
Set Potential	mV	-1050	-1050	-1050	-1050	-1050	-1050	-1050
Current	Amps	0.55	0.5	0.55	0.5	0.55	0.6	0.5
Voltage	V	2.5	2.5	2.5	2.5	2.5	2.5	2.5
R. Electrode	MV	****	****	****	****	****	****	****
R1	PANEL	-1050	-1050	-1050	-1050	-1050	-1050	-1050
R2	PANEL	-1150	-1150	-1160	-1150	-1150	-1160	-1160
R1	LOCALLY	-1010	-1020	-1020	-1030	-1030	-1040	-1040
R2	LOCALLY	-1030	-1030	-1030	-1040	-1040	-1050	-1040
Group 'B'	Manual Ops	M	M	M	M	M	M	M
Current	Amps	2.5	2.5	2.5	2.5	2.5	2.5	2.5
Voltage	V	4.4	4.4	4.4	4.4	4.4	4.4	4.4
R. Electrode	MV	****	****	****	****	****	****	****
R3	PANEL	-1260	-1270	-1280	-1290	-1300	-1280	-1290
R4	PANEL	-1120	-1130	-1120	-1140	-1110	-1150	-1150
R3	LOCALLY	-1110	-1120	-1150	-1150	-1160	-1140	-1160
R4	LOCALLY	-1060	-1070	-1050	-1060	-1050	-1050	-1070

Table 8.36: Summary of the test daily readings

**TEST NO 45****1. Parameters summary**

Items	Units	Data
Control Potential	mV	-1050
Flow Rate	m <sup>3</sup> /hr	7.5
Temperature	°C	35
T.D.S	ppm	43,000
Test Duration	Days	20
Acid Wash	****	Yes

**2. PURPOSE**

The purpose of this experiment was:

1. To investigate the rate and duration in which scale forms at the surface of the specimen, and test loop pipelines after complete acid wash of the test loop.
2. To determine the effect of scale precipitation in relation to the applied current required for maintaining a potential of -1050 mV, when compared to tests 40, 42, and 44.

**3. PROCEDURE**

1. Test loop acid washed, inspected and fully flushed upon completion of test 44.
2. Reference electrode accuracy was checked against 50D specimen, and found ok.
3. Anodes were cleaned and reinstated in their original positions.
4. Test loop primed and fully vented.
5. Specimen's cleaned and reinstated in their original positions.
6. Potential monitoring system switched on. Set of local potential readings taken and checked against system monitoring panel.
7. Test required parameters were adjusted (i.e. control potential of -1050 mV).
8. Protection switched to auto, operation on group "A" and to manual for group "B".

#### 4. FINDINGS

The test loop which included the mild steel pipelines and the specimens were protected cathodically for about 20 days at a set control potential of -1050 mV (group 'A') and constant current of 2.5 amp in group 'B'. Tables 8.36, and 8.37 shows the current demand was much higher than test 44. This is due to the complete acid wash of test loop exposing the entire pipe steel surface. Tables 8.36 and 8.37 shows that the initial local potential was in the average region of -600 mV for test 45 versus -700 mV in test 44. It also took longer time for system to reach the safe zone potential of -800 mV. In fact the current demand in, group 'A' was such that the group 'A' system was effectively also under galvanostatic control at the maximum current supply of 4 amps for several days. Despite the higher currents in, group 'A' in the first 7 days, the local potentials at R1 were less negative than R4 almost in account of more turbulent flow conditions in the location of R1. Similar comparison between R2 and R3 may involve the additional factor of R3 being also partly under the influence of the group 'A' anodes. Only after some 20 days the local potential at R1 reached in the region of the pre-set potential. The eventual declined in current in group 'A' and the fact that, towards the end of test the currents had fallen to levels near to the plateau currents observed in previous tests (figure 8.67), provided indications that the pipe was becoming covered with scale. After 3 and 12 days, the test loop was stopped for specimen inspection. On both occasions the specimens condition was satisfactory and no sign of corrosion was observed at the surface of installed specimens. Scale was formed on the surface of the specimens and the test pipeline. After 20 days, test completed, rig stopped, specimens and spool piece removed and following observations recorded: -

- \* Specimens 1 to 5, no corrosion, but surface was coated with a fine to a uniform layer of scale.
- \* Spool piece and the test loop pipelines found to be generally in a good condition, scale also observed in the most area of the inspected pipelines.

#### 5. CONCLUSIONS

1. Scale precipitation rate found sufficient and whitish in nature.
2. Upon visual inspection scale was found precipitated at the surface of the specimens, and loop pipelines within 72 hrs. This test shows scale forms over significant area of the pipeline within a short period of application of cathodic protection.
3. Test loop was fully protected against corrosion as no sign of corrosion was observed.

## 6. NOTE

- \* System was acid washed again upon completion of the test.45.
- \* Test loop was inspected after acid wash and prior commencing next test.

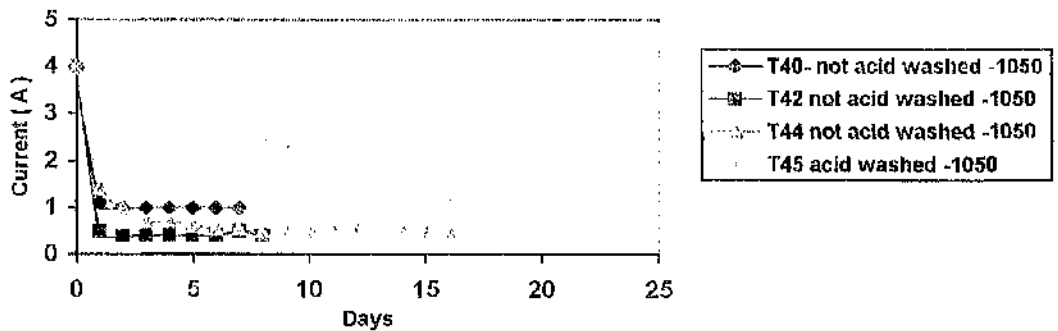

Figure 8.67: Test applied current trend before and after acid wash

C.P. Status	****	OFF	ON	ON	ON	ON	ON	ON
Time	hrs	0	24	48	72	96	120	144
Group 'A'	Auto Ops	Auto	Auto	Auto	Auto	Auto	Auto	Auto
Set Potential	mV	-1050	-1050	-1050	-1050	-1050	-1050	-1050
Current	Amps	4	3.9	3.9	3.9	3.4	3.1	2.9
Voltage	V	6	5.6	5.6	5.5	5.2	4.9	4.8
R. Electrode	MV	****	****	****	****	****	****	****
R1	PANEL	-620	-1050	-1050	-1050	-1050	-1050	-1050
R2	PANEL	-610	-1150	-1160	-1150	-1160	-1150	-1150
R1	LOCALLY	-620	-700	-720	-730	-750	-770	-780
R2	LOCALLY	-615	-800	-840	-880	-900	-920	-940
Group 'B'	Manual Ops	M	M	M	M	M	M	M
Current	Amps	2.5	2.5	2.5	2.5	2.5	2.5	2.5
Voltage	V	4.4	4.4	4.4	4.4	4.4	4.4	4.4
R. Electrode	MV	****	****	****	****	****	****	****
R3	PANEL	-720	-1300	-1310	-1300	-1310	-1310	-1300
R4	PANEL	-580	-1120	-1110	-1100	-1100	-1100	-1100
R3	LOCALLY	-740	-1040	-1060	-1090	-1100	-1120	-1140
R4	LOCALLY	-570	-700	-760	-800	-840	-850	-870

C.P. Status	****	ON	ON	ON	ON	ON	ON	ON
Time	hrs	168	192	216	240	264	288	312
Group 'A'	Auto Ops	Auto	Auto	Auto	Auto	Auto	Auto	Auto
Set Potential	mV	-1050	-1050	-1050	-1050	-1050	-1050	-1050
Current	Amps	2.8	2.5	2.3	2.3	2	1.5	1.6
Voltage	V	4.7	4.6	4.5	4.5	4.2	4.1	4
R. Electrode	MV	****	****	****	****	****	****	****
R1	PANEL	-1050	-1050	-1050	-1050	-1050	-1050	-1050
R2	PANEL	-1150	-1150	-1160	-1140	-1150	-1150	-1160
R1	LOCALLY	-800	-810	-830	-840	-850	-860	-880
R2	LOCALLY	-950	-960	-980	-980	-990	-990	-1000
Group 'B'	Manual Ops	M	M	M	M	M	M	M
Current	Amps	2.5	2.5	2.5	2.5	2.5	2.5	2.5
Voltage	V	4.4	4.4	4.4	4.4	4.4	4.4	4.4
R. Electrode	MV	****	****	****	****	****	****	****
R3	PANEL	-1310	-1300	-1310	-1300	-1280	-1300	-1300
R4	PANEL	-1090	-1100	-1100	-1100	-1200	-1210	-1200
R3	LOCALLY	-1150	-1180	-1190	-1200	-1200	-1200	-1200
R4	LOCALLY	-900	-920	-930	-950	-960	-980	-1000

C.P. Status	****	ON	ON	ON	ON	ON	ON	ON
Time	hrs	336	360	384	408	432	456	480
Group 'A'	Auto Ops	Auto	Auto	Auto	Auto	Auto	Auto	Auto
Set Potential	mV	-1050	-1050	-1050	-1050	-1050	-1050	-1050
Current	Amps	1.3	1.3	1.2	1.1	1.1	1	1
Voltage	V	3.8	3.8	3.7	3.5	3.5	3.4	3.4
R. Electrode	MV	****	****	****	****	****	****	****
R1	PANEL	-1050	-1050	-1050	-1050	-1050	-1050	-1050
R2	PANEL	-1140	-1150	-1150	-1150	-1150	-1140	-1160
R1	LOCALLY	-900	-920	-940	-960	-990	-1010	-1030
R2	LOCALLY	-1010	-1020	-1020	-1030	-1030	-1040	-1050
Group 'B'	Manual Ops	M	M	M	M	M	M	M
Current	Amps	2.5	2.5	2.5	2.5	2.5	2.5	2.5
Voltage	V	4.4	4.4	4.4	4.4	4.4	4.4	4.4
R. Electrode	MV	****	****	****	****	****	****	****
R3	PANEL	-1310	-1300	-1310	-1300	-1310	-1290	-1300
R4	PANEL	-1210	-1200	-1200	-1210	-1220	-1220	-1200
R3	LOCALLY	-1200	-1210	-1200	-1200	-1190	-1200	-1200
R4	LOCALLY	-1020	-1050	-1070	-1080	-1100	-1120	-1130

Table 8.37: Summary of the test daily readings

**TEST NO 46****1. Parameters summary**

Items	Units	Data
Control Potential	mV	-1050
Flow Rate	m <sup>3</sup> /hr	7.5
Temperature	°C	50-55
T.D.S	ppm	43,000
Test Duration	Days	24
Acid Wash	****	Yes

**3. PURPOSE**

The purpose of this test was: -

1. To study the effect on an acid washed pipe of temperature increase in test applied current and rate of scale deposition when compared to test 45.
2. To check the benefits of scale deposition on test current density when compared to test 29 which was covered with scale and not been acid washed.

**3. PROCEDURE**

The test procedure was the same as test 45, except operating temperature was raised.

**4. FINDINGS**

The test loop pipelines and specimens were protected cathodically for about 24 days at a set control potential of -1050 mV group 'A' and galvanostatic control at 2.5 amps (group 'B'). Tables 8.37 and 8.38 shows that again the higher current in, group 'A' in the first few days failed to produce local potential as negative as in group 'B'. Interesting, it took less time for a protection potential of -800 mV to be attained at R1 in this test at 50-55 °C than in test 45 at lower temperature. Also there was slight evidence (figure 8.70) that the eventual current decay in this test was more rapid than in test 45. On the other hand, in the later stage of the test, the current was higher in test 46 when compared with test 45, mainly due to increase in the test operating temperature. The rate of current demand was higher by about 50% for test 46 toward the end. After 6 days, test loop was stopped for specimen inspection. The specimens condition was satisfactory and no sign of corrosion was observed at the surface of installed specimens. Scale also was formed on the surface of all specimens. After 24 days, the test was completed, the loop opened, specimens and spool piece removed and the following observations recorded based on the visual inspection: -

- \* Specimens 1 to 5, no corrosion, but surface was coated with a fine to a uniform layer of scale. Scale rate on the surface of the specimens in particular no 5 found to be more (figure 8.68). Spool piece and the pipelines found to be generally in a good condition and were covered with much less scale when compared to test 45 (figure 8.69).

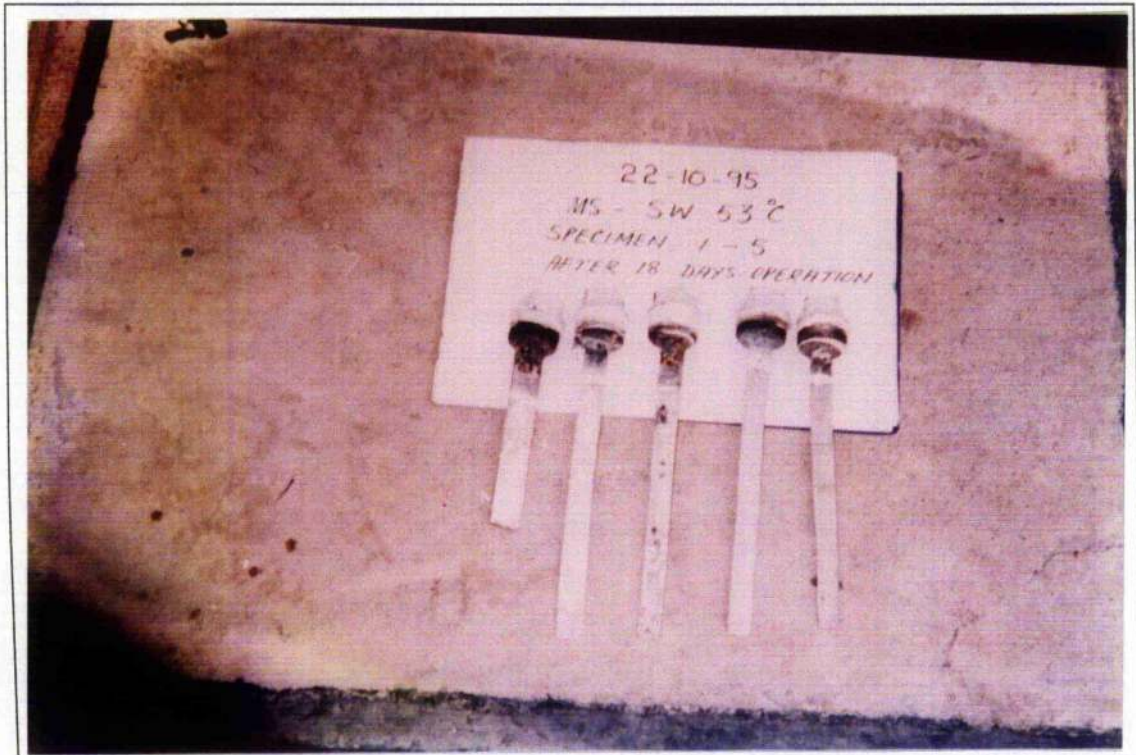
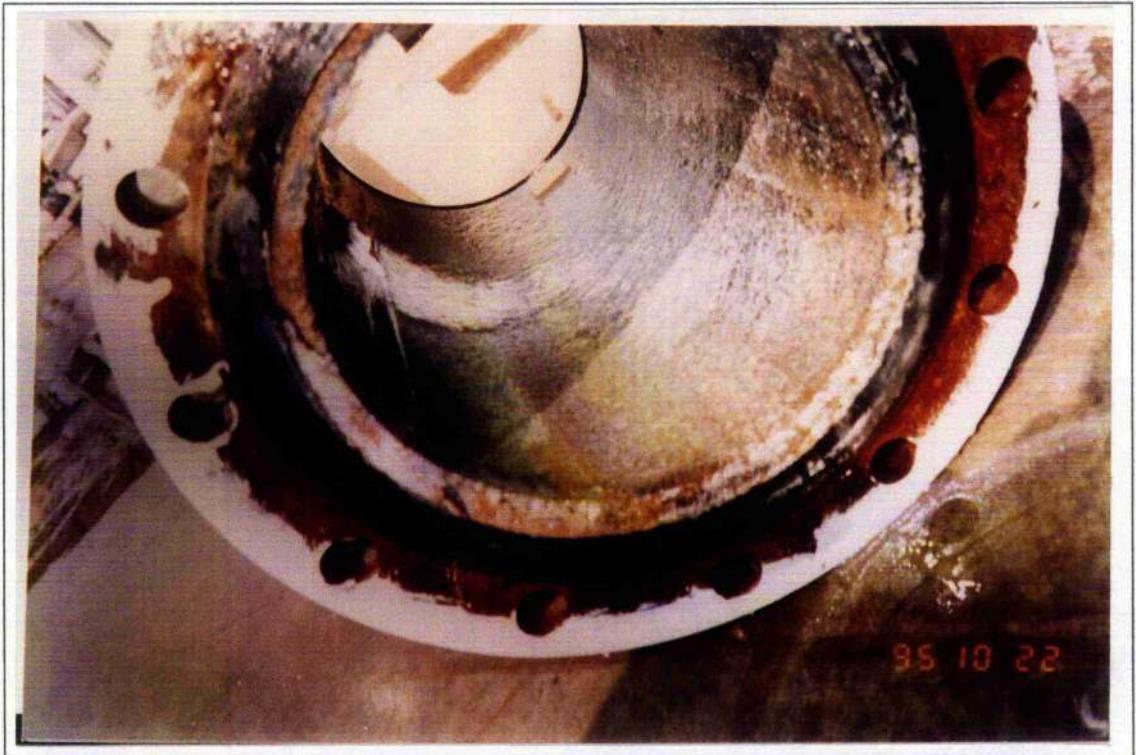

Figures 8.68 and 8.69: Specimens and spool piece condition at the end of test 46.



## 5. CONCLUSIONS

1. Antiscalant presence in the feed did not prevent the scale formation at the surface of the specimens and test pipeline.
2. The shape of the formed scale on the specimens surface and pipelines were different in comparison to the previous obtained results.
3. Overprotection of a system in the area of group 'B' zone anodes was indicated by formation of calcareous deposit. This indicates that galvanostatic operation at 2.5 amps (equivalent to  $397 \text{ mA/m}^2$ ) was higher than desirable. The very negative local potential in, group 'B' supported this conclusion. Thus it was decided to reduce the group 'B' current from 2.5 to 2 amps in the succeeding test.
4. System not to be acid wash for the next test as the rate of scale was not to the extent which could have any effect on test results.

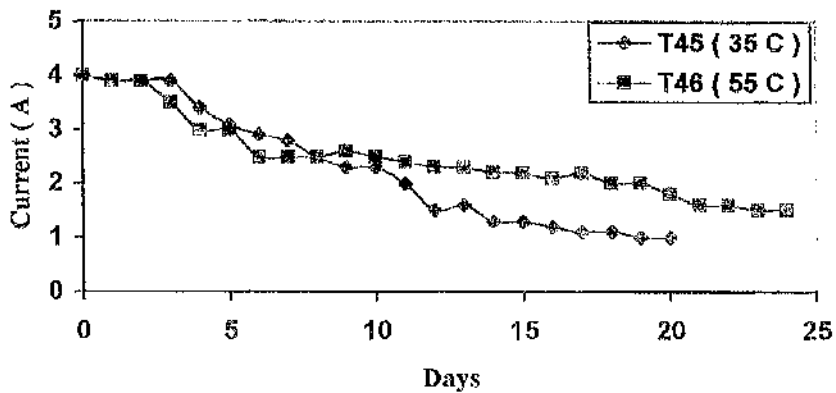

Figure 8.70: Current trend comparison of test 45 and 46

<b>C.P. Status</b>	****	OFF	ON	ON	ON	ON	ON	ON
<b>Time</b>	hrs	0	24	48	72	96	120	144
<b>Group 'A'</b>	Auto Ops	Auto	Auto	Auto	Auto	Auto	Auto	Auto
<b>Set Potential</b>	mV	-1050	-1050	-1050	-1050	-1050	-1050	-1050
<b>Current</b>	Amps	4	3.9	3.9	3.5	3	3	2.5
<b>Voltage</b>	V	6	5.6	5.6	5.3	5.3	5	4.5
<b>R. Electrode</b>	MV	****	****	****	****	****	****	****
<b>R1</b>	PANEL	-570	-1050	-1050	-1050	-1050	-1050	-1050
<b>R2</b>	PANEL	-590	-1100	-1100	-1120	-1120	-1150	-1150
<b>R1</b>	LOCALLY	-590	-690	-750	-800	-830	-860	-900
<b>R2</b>	LOCALLY	-570	-790	-850	-870	-920	-910	-980
<b>Group 'B'</b>	Manual Ops	M	M	M	M	M	M	M
<b>Current</b>	Amps	2.5	2.5	2.5	2.5	2.5	2.5	2.5
<b>Voltage</b>	V	4.4	4.4	4.4	4.4	4.4	4.4	4.4
<b>R. Electrode</b>	MV	****	****	****	****	****	****	****
<b>R3</b>	PANEL	-610	-1280	-1280	-1300	-1300	-1300	-1300
<b>R4</b>	PANEL	-600	-1120	-1120	-1130	-1120	-1120	-1130
<b>R3</b>	LOCALLY	-550	-1000	-1050	-1100	-1110	-1100	-1100
<b>R4</b>	LOCALLY	-590	-850	-900	-1000	-1090	-1100	-1080

<b>C.P. Status</b>	****	ON	ON	ON	ON	ON	ON	ON
<b>Time</b>	hrs	168	192	216	240	264	288	312
<b>Group 'A'</b>	Auto Ops	Auto	Auto	Auto	Auto	Auto	Auto	Auto
<b>Set Potential</b>	mV	-1050	-1050	-1050	-1050	-1050	-1050	-1050
<b>Current</b>	Amps	2.5	2.5	2.6	2.5	2.4	2.3	2.3
<b>Voltage</b>	V	4.7	4.6	4.5	4.5	4.3	4.3	4.3
<b>R. Electrode</b>	MV	****	****	****	****	****	****	****
<b>R1</b>	PANEL	-1050	-1050	-1050	-1050	-1050	-1050	-1050
<b>R2</b>	PANEL	-1140	-1140	-1140	-1150	-1180	-1170	-1170
<b>R1</b>	LOCALLY	-920	-940	-960	-980	-1010	-1020	-1020
<b>R2</b>	LOCALLY	-1000	-1020	-1050	-1080	-1050	-1040	-1040
<b>Group 'B'</b>	Manual Ops	M	M	M	M	M	M	M
<b>Current</b>	Amps	2.5	2.5	2.5	2.5	2.5	2.5	2.5
<b>Voltage</b>	V	4.4	4.4	4.4	4.4	4.4	4.4	4.4
<b>R. Electrode</b>	MV	****	****	****	****	****	****	****
<b>R3</b>	PANEL	-1290	-1290	-1290	-1300	-1300	-1290	-1300
<b>R4</b>	PANEL	-1300	-1300	-1300	-1300	-1300	-1300	-1290
<b>R3</b>	LOCALLY	-1100	-1110	-1100	-1100	-1100	-1110	-1100
<b>R4</b>	LOCALLY	-1200	-1200	-1150	-1200	-1200	-1200	-1200

<b>C.P. Status</b>	****	ON	ON	ON	ON	ON	ON	ON
<b>Time</b>	hrs	336	360	384	408	432	456	480
<b>Group 'A'</b>	Auto Ops	Auto	Auto	Auto	Auto	Auto	Auto	Auto
<b>Set Potential</b>	mV	-1050	-1050	-1050	-1050	-1050	-1050	-1050
<b>Current</b>	Amps	2.2	2.2	2.1	2.2	2	2	1.8
<b>Voltage</b>	V	4.2	4.2	4.1	4.2	4.1	4.1	4
<b>R. Electrode</b>	MV	****	****	****	****	****	****	****
<b>R1</b>	PANEL	-1050	-1050	-1050	-1050	-1050	-1050	-1050
<b>R2</b>	PANEL	-1150	-1150	-1150	-1150	-1180	-1150	-1160
<b>R1</b>	LOCALLY	-1030	-1020	-1030	-1040	-1030	-1040	-1040
<b>R2</b>	LOCALLY	-1040	-1040	-1050	-1050	-1030	-1020	-1040
<b>Group 'B'</b>	Manual Ops	M	M	M	M	M	M	M
<b>Current</b>	Amps	2.5	2.5	2.5	2.5	2.5	2.5	2.5
<b>Voltage</b>	V	4.4	4.4	4.4	4.4	4.4	4.4	4.4
<b>R. Electrode</b>	MV	****	****	****	****	****	****	****
<b>R3</b>	PANEL	-1290	-1300	-1300	-1300	-1250	-1250	-1230
<b>R4</b>	PANEL	-1300	-1300	-1320	-1300	-1280	-1300	-1270
<b>R3</b>	LOCALLY	-1130	-1100	-1100	-1100	-1100	-1100	-1100
<b>R4</b>	LOCALLY	-1200	-1210	-1200	-1150	-1140	-1140	-1200

<b>C.P. Status</b>	****	ON	ON	ON	ON
<b>Time</b>	hrs	504	528	552	576
<b>Group 'A'</b>	Auto Ops	Auto	Auto	Auto	Auto
<b>Set Potential</b>	mV	-1050	-1050	-1050	-1050
<b>Current</b>	Amps	1.6	1.6	1.5	1.5
<b>Voltage</b>	V	4.1	4	4	4
<b>R. Electrode</b>	MV	****	****	****	****
<b>R1</b>	PANEL	-1050	-1050	-1050	-1050
<b>R2</b>	PANEL	-1150	-1150	-1160	-1150
<b>R1</b>	LOCALLY	-1040	-1030	-1030	-1040
<b>R2</b>	LOCALLY	-1040	-1040	-1050	-1050
<b>Group 'B'</b>	Manual Ops	M	M	M	M
<b>Current</b>	Amps	2.5	2.5	2.5	2.5
<b>Voltage</b>	V	4.4	4.4	4.4	4.4
<b>R. Electrode</b>	MV	****	****	****	****
<b>R3</b>	PANEL	-1280	-1270	-1260	-1280
<b>R4</b>	PANEL	-1300	-1300	-1300	-1300
<b>R3</b>	LOCALLY	-1130	-1150	-1140	-1150
<b>R4</b>	LOCALLY	-1200	-1210	-1200	-1220

Table 8.38: Summary of test daily readings

**TEST NO 47****1. Parameters summary**

Items	Units	Data
Control Potential	mV	-1050
Flow Rate	m <sup>3</sup> /hr	40
Temperature	°C	50-55 Changed to 30 after 13 days
T.D.S	ppm	43,000
Test Duration	Days	29
Acid Wash	****	No

**4. PURPOSE**

The purpose of this test was to study the effect of flow rate increase in test applied current and rate of scale deposition when compared to test 46. In fact the loop was not acid washed prior to this test but the amount of scale was not great.

**3. PROCEDURE**

The test procedure was similar to test 45, with the exception that the test operating temperature and flow rate were increased by introducing treated hot brine from heat input section of the evaporator no 5 and replacing blank with an orifice.

**4. FINDINGS**

The test loop was protected cathodically for about 29 days at a set control potential of -1050 mV in, group 'A' and galvanostatic operation at 2.0 amps in group 'B'. As shown in figure 8.73, the group 'A' current showed an initial decline in this test (as opposed to test 46) possibly on account of the pre-scale formed in test 46. However, the longer term, currents were higher for test 47 thus indicating an effect of higher flow rate even on scaled surfaces. Another effect of the higher flow rate was that the early local potential in, group 'A' in this test were rather less negative (certainly for R2) than in test 46.

After 12 days, test loop was stopped for specimen inspections. The followings were observed: -

- \* Specimens 1 and 2, no sign of corrosion, but surface was coated with thin layer of scale.
- \* Specimens 3,4, and 5, no corrosion, but surface was coated with fine to uniformed layer of scale.

On the same day the test operating temperature was reduced to 30 °C due to evaporator no 5 planned outage. The seawater used as a feed did not contain scale inhibitor.

After 29 days, test completed, the rig was stopped, and specimens and spool piece removed. The following was observed: -

- \* Specimens 1 to 5, no corrosion, but surface was coated with a fine to a uniform layer of scale (figure 8.71).
- \* Spool piece (figure 8.72) and pipelines found to be fairly covered with scale.
- \* Calcareous deposit was not observed for group 'B' anodes.

## 5. CONCLUSIONS

1. Initial presence of antiscalant in the feed flow and high test operating flow rate reduced the scale formation rate at the surface of the specimens, test pipeline, and pool piece (visually). Increase in operating flow rate in general reduced the flow contact time with surfaces of the pipeline and specimens.
2. Table 8.39 shows that any variation in test operating temperature would have a direct impact on the test applied current demand. Test applied current reduced from 2.8 to 2 amps when test, operating temperature reduced from 55 to 30 °C.
3. No calcareous deposit was observed around group 'B' anodes. However, the group 'B' local potentials were still very negative indicating that even this reduced current represented significant overprotection conditions.

## 6. Note

It was as well observed that the thin layer of scale from previous experiment was not visible right after completion of the test. This could justify the reason for a lower initial current demand in comparison to the previous tests even when the test was carried out at a higher flow rate.

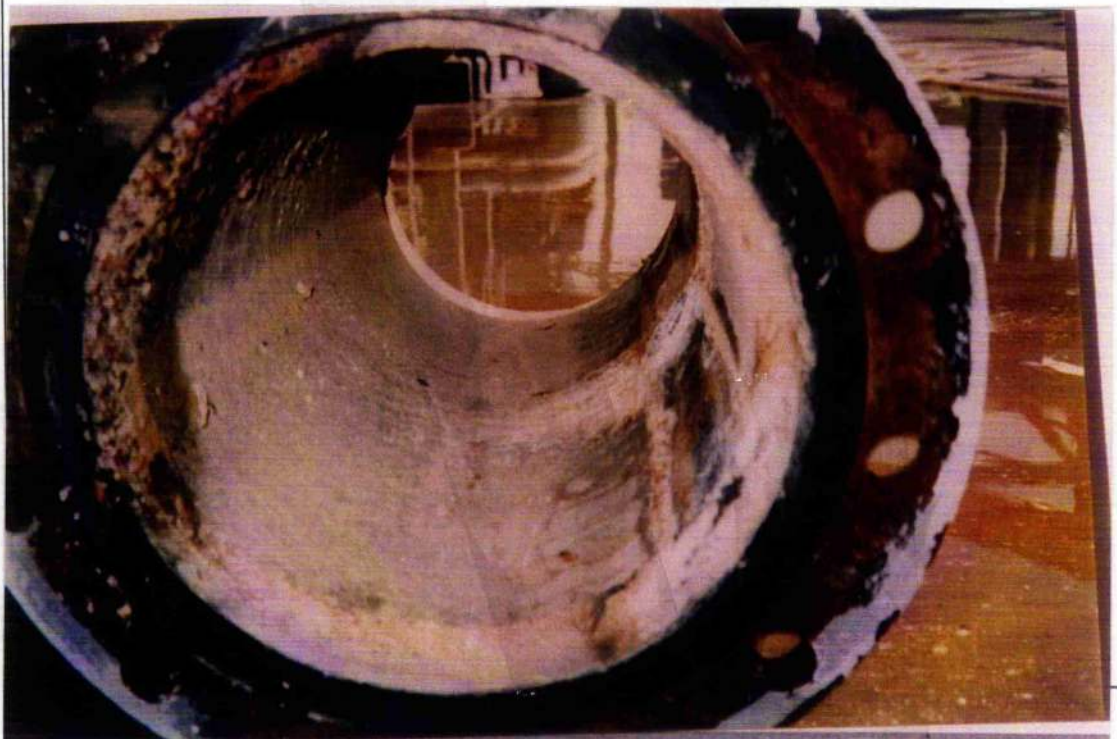
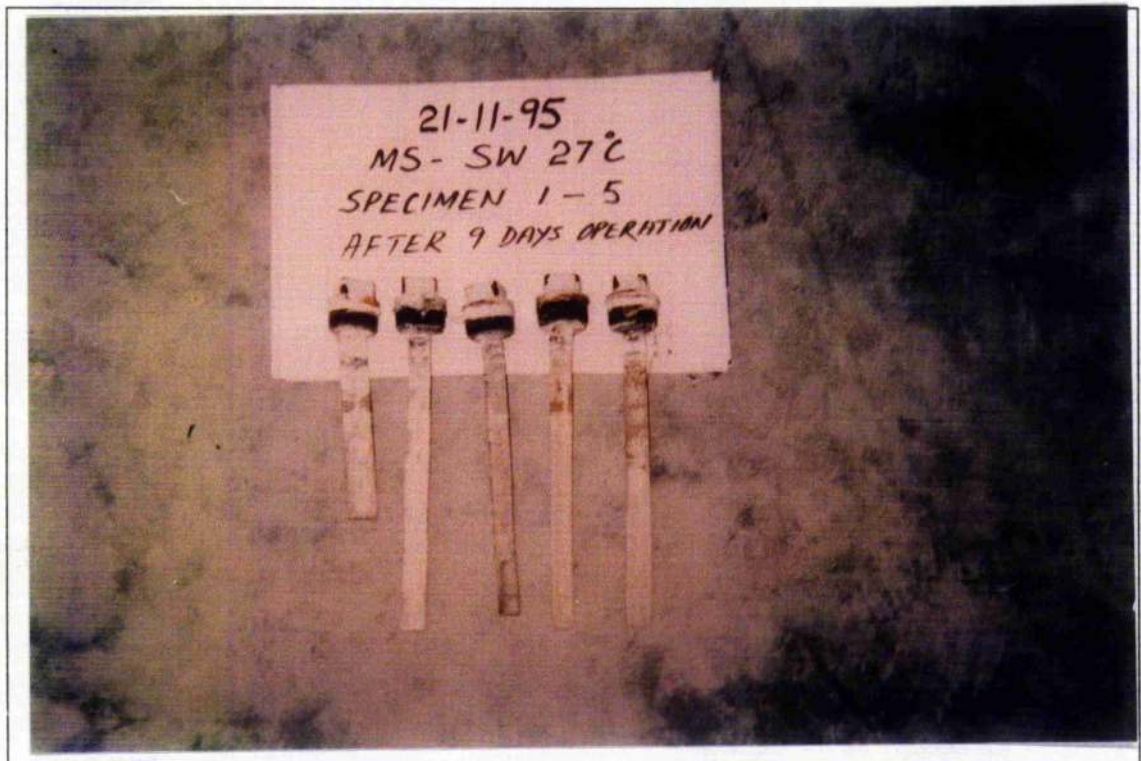

Figures 8.71 and 8.72: Specimens and spool piece condition at the end of test 47.

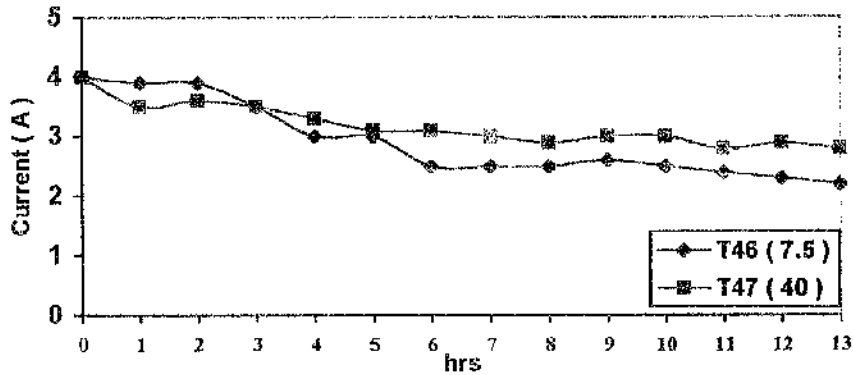

Figure 8.73: Effect of increase in flow rate on test applied current  
The comparison was done for the first 13 days since all the test parameters were the same. Test operating temperature was reduced to 30 after 13 days

C.P. Status	****	OFF	ON	ON	ON	ON	ON	ON
Time	hrs	0	24	48	72	96	120	144
Group 'A'	Auto Ops	Auto	Auto	Auto	Auto	Auto	Auto	Auto
Set Potential	mV	-1050	-1050	-1050	-1050	-1050	-1050	-1050
Current	Amps	4	3.5	3.6	3.5	3.3	3.1	3.1
Voltage	V	6	5	5	5	4.9	5	4.9
R. Electrode	MV	****	****	****	****	****	****	****
R1	PANEL	-630	-1050	-1050	-1050	-1050	-1050	-1050
R2	PANEL	-560	-1200	-1180	-1180	-1160	-1160	-1180
R1	LOCALLY	-620	-730	-750	-790	-820	-845	-850
R2	LOCALLY	-560	-760	-800	-820	-850	-860	-850
Group 'B'	Manual Ops	M	M	M	M	M	M	M
Current	Amps	2	2	2	2	2	2	2
Voltage	V	4	4	4	4	4	4	4
R. Electrode	MV	****	****	****	****	****	****	****
R3	PANEL	-620	-1280	-1280	-1250	-1250	-1250	-1250
R4	PANEL	-720	-1300	-1310	-1300	-1300	-1300	-1300
R3	LOCALLY	-600	-1080	-1100	-1150	-1170	-1180	-1150
R4	LOCALLY	-700	-1150	-1200	-1200	-1200	-1200	-1200

C.P. Status	****	ON	ON	ON	ON	ON	ON	ON
Time	hrs	168	192	216	240	264	288	312
Group 'A'	Auto Ops	Auto	Auto	Auto	Auto	Auto	Auto	Auto
Set Potential	mV	-1050	-1050	-1050	-1050	-1050	-1050	-1050
Current	Amps	3	2.9	3	3	2.8	2.9	2.8
Voltage	V	4.8	4.8	4.9	4.9	4.8	4.9	4.8
R. Electrode	MV	****	****	****	****	****	****	****
R1	PANEL	-1050	-1050	-1050	-1050	-1050	-1050	-1050
R2	PANEL	-1150	-1170	-1150	-1150	-1170	-1150	-1170
R1	LOCALLY	-870	-900	-910	-940	-960	-980	-1000
R2	LOCALLY	-920	-950	-990	-1020	-1010	-1020	-1030
Group 'B'	Manual Ops	M	M	M	M	M	M	M
Current	Amps	2	2	2	2	2	2	2
Voltage	V	4	4	4	4	4	4	4
R. Electrode	MV	****	****	****	****	****	****	****
R3	PANEL	-1250	-1250	-1250	-1250	-1250	-1250	-1240
R4	PANEL	-1300	-1300	-1300	-1300	-1300	-1300	-1290
R3	LOCALLY	-1140	-1150	-1140	-1150	-1150	-1150	-1150
R4	LOCALLY	-1200	-1200	-1200	-1200	-1190	-1200	-1210

C.P. Status	****	ON	ON	ON	ON	ON	ON	ON
Time	hrs	336	360	384	408	432	456	480
Group 'A'	Auto Ops	Auto	Auto	Auto	Auto	Auto	Auto	Auto
Set Potential	mV	-1050	-1050	-1050	-1050	-1050	-1050	-1050
Current	Amps	2	1.5	1.3	1.2	1.2	1.2	1.3
Voltage	V	4.1	3.6	3.5	3.5	3.5	3.4	3.5
R. Electrode	MV	****	****	****	****	****	****	****
R1	PANEL	-1050	-1050	-1050	-1050	-1050	-1050	-1050
R2	PANEL	-1180	-1170	-1180	-1150	-1180	-1180	-1160
R1	LOCALLY	-1010	-1030	-1020	-1030	-1030	-1030	-1030
R2	LOCALLY	-1040	-1040	-1030	-1040	-1030	-1040	-1040
Group 'B'	Manual Ops	M	M	M	M	M	M	M
Current	Amps	2	2	2	2	2	2	2
Voltage	V	4	4	4	4	4	4	4
R. Electrode	MV	****	****	****	****	****	****	****
R3	PANEL	-1210	-1210	-1210	-1200	-1200	-1210	-1200
R4	PANEL	-1300	-1300	-1320	-1300	-1280	-1300	-1270
R3	LOCALLY	-1150	-1150	-1150	-1150	-1150	-1150	-1150
R4	LOCALLY	-1200	-1210	-1200	-1200	-1200	-1200	-1200



<b>C.P. Status</b>	<b>****</b>	<b>ON</b>	<b>ON</b>	<b>ON</b>	<b>ON</b>	<b>ON</b>	<b>ON</b>	<b>ON</b>
<b>Time</b>	<b>hrs</b>	<b>504</b>	<b>528</b>	<b>552</b>	<b>576</b>	<b>600</b>	<b>624</b>	<b>648-720</b>
<b>Group 'A'</b>	<b>Auto Ops</b>	<b>Auto</b>	<b>Auto</b>	<b>Auto</b>	<b>Auto</b>	<b>Auto</b>	<b>Auto</b>	<b>Auto</b>
<b>Set Potential</b>	<b>mV</b>	<b>-1050</b>	<b>-1050</b>	<b>-1050</b>	<b>-1050</b>	<b>-1050</b>	<b>-1050</b>	<b>-1050</b>
<b>Current</b>	<b>Amps</b>	<b>1.3</b>	<b>1.2</b>	<b>1</b>	<b>1</b>	<b>0.9</b>	<b>0.8</b>	<b>0.8</b>
<b>Voltage</b>	<b>V</b>	<b>3.5</b>	<b>3.5</b>	<b>3.1</b>	<b>3.1</b>	<b>3</b>	<b>3</b>	<b>2.9</b>
<b>R. Electrode</b>	<b>MV</b>	<b>****</b>	<b>****</b>	<b>****</b>	<b>****</b>	<b>****</b>	<b>****</b>	<b>****</b>
<b>R1</b>	<b>PANEL</b>	<b>-1050</b>	<b>-1050</b>	<b>-1050</b>	<b>-1050</b>	<b>-1050</b>	<b>-1050</b>	<b>-1050</b>
<b>R2</b>	<b>PANEL</b>	<b>-1180</b>	<b>-1170</b>	<b>-1180</b>	<b>-1180</b>	<b>-1160</b>	<b>-1190</b>	<b>-1170</b>
<b>R1</b>	<b>LOCALLY</b>	<b>-1030</b>	<b>-1030</b>	<b>-1030</b>	<b>-1030</b>	<b>-1030</b>	<b>-1030</b>	<b>-1030</b>
<b>R2</b>	<b>LOCALLY</b>	<b>-1040</b>	<b>-1040</b>	<b>-1040</b>	<b>-1040</b>	<b>-1040</b>	<b>-1040</b>	<b>-1040</b>
<b>Group 'B'</b>	<b>Manual Ops</b>	<b>M</b>	<b>M</b>	<b>M</b>	<b>M</b>	<b>M</b>	<b>M</b>	<b>M</b>
<b>Current</b>	<b>Amps</b>	<b>2</b>	<b>2</b>	<b>2</b>	<b>2</b>	<b>2</b>	<b>2</b>	<b>2</b>
<b>Voltage</b>	<b>V</b>	<b>4</b>	<b>4</b>	<b>4</b>	<b>4</b>	<b>4</b>	<b>4</b>	<b>4</b>
<b>R. Electrode</b>	<b>MV</b>	<b>****</b>	<b>****</b>	<b>****</b>	<b>****</b>	<b>****</b>	<b>****</b>	<b>****</b>
<b>R3</b>	<b>PANEL</b>	<b>-1200</b>	<b>-1200</b>	<b>-1200</b>	<b>-1200</b>	<b>-1200</b>	<b>-1210</b>	<b>-1200</b>
<b>R4</b>	<b>PANEL</b>	<b>-1300</b>	<b>-1300</b>	<b>-1300</b>	<b>-1300</b>	<b>-1280</b>	<b>-1300</b>	<b>-1290</b>
<b>R3</b>	<b>LOCALLY</b>	<b>-1150</b>	<b>-1150</b>	<b>-1150</b>	<b>-1150</b>	<b>-1150</b>	<b>-1150</b>	<b>-1150</b>
<b>R4</b>	<b>LOCALLY</b>	<b>-1200</b>	<b>-1210</b>	<b>-1200</b>	<b>-1200</b>	<b>-1200</b>	<b>-1200</b>	<b>-1200</b>

Table 8.39: Summary of, test daily readings

**TEST NO 48****1. Parameters summary**

Items	Units	Data
Control Potential	mV	-1050
Flow Rate	m <sup>3</sup> /hr	7.5
Temperature	<sup>o</sup> C	25 to 30
T.D.S	ppm	43,000
Acid wash	****	Yes
Test Duration	Days	30

**2. PURPOSE**

The purpose of this test was: -

1. To re-produce test 45 findings in respect to the: -
  - \* Rate and duration in which scale forms at the surface of the specimen, and test loop pipelines after complete test loop acid wash prior commencing this test.
  - \* Demand for test applied current.
2. To check the consequences of the on line impressed current cathodic protection failure on the areas of protection.

**3. PROCEDURE**

The test procedure used was Similar to test 45.

**4. FINDINGS**

The test loop was protected cathodically for approximately 30 days at a set control potential of -1050 mV for group 'A' protection zone. Group 'B' continued on manual operation at 2 amps.

The test was stopped after 3 days because of an anode failure and not surprisingly, there was evidence of slight corrosion on 2 of the specimens. However, the spool piece was in remarkably good condition and was covered completely by scale (figure 8.74). The specimens were cleaned and the test re-started and after one further day (4 days total) the test specimens were checked again to see the conditions of the specimens after replacement of the anode insulation. Scale was found formed on the surface of all the specimens with no sign of corrosion (figure 8.75).

The protection was switched off as local protection potential reached target set control potential of -1050 mV after 22 days. The test was continued with protection off for 9 days. On a daily basis system local potential and visual inspection of all the specimens were performed. Table 8.40 shows the reduction in local potential on daily basis as was expected. No sign of corrosion was seen during the periods when the cathodic protection was switched off, even when the R1 local potential had been less than -800 mV. After 30 days, test stopped as local potential reduced to below -700 mV, rig depressurised and specimens along with spool piece and pipelines checked, following observation recorded: -

\* Specimens 1 to 5, no corrosion, specimen surface was coated with a fine layer of scale. Comparison of figure 8.76 (taken before switching off cathodic protection) and figure 8.77 (taken at the end of the test, i.e 9 days after switching off cathodic protection) shows clearly the benefit of a calcareous deposit in maintaining corrosion protection for long period with out cathodic protection.

\* The spool piece (figure 8.78) and pipelines were also generally covered with scale and hence still protected.

## 5. CONCLUSIONS

1. Scale deposition rate found sufficient and whitish in nature (seawater turbidity was high during the test).
2. Scale precipitated at the surface of the specimens and loop pipelines within 72 hrs (similar to test 45).
3. System protection was maintained even when on-line impressed current cathodic protection was switched off. No sign of corrosion was observed at the surface of specimens and the spool piece (it took approximately 5 days for local potential to reduce to -700 mV from -1020 mV).
5. The consequences of the on-line impressed current cathodic protection failure would not lead to an immediate shut down of the plant as scale act as a protective layer.
5. Figure 8.79 shows the good reproducibility in, group 'A' currents between test 48 and 45.

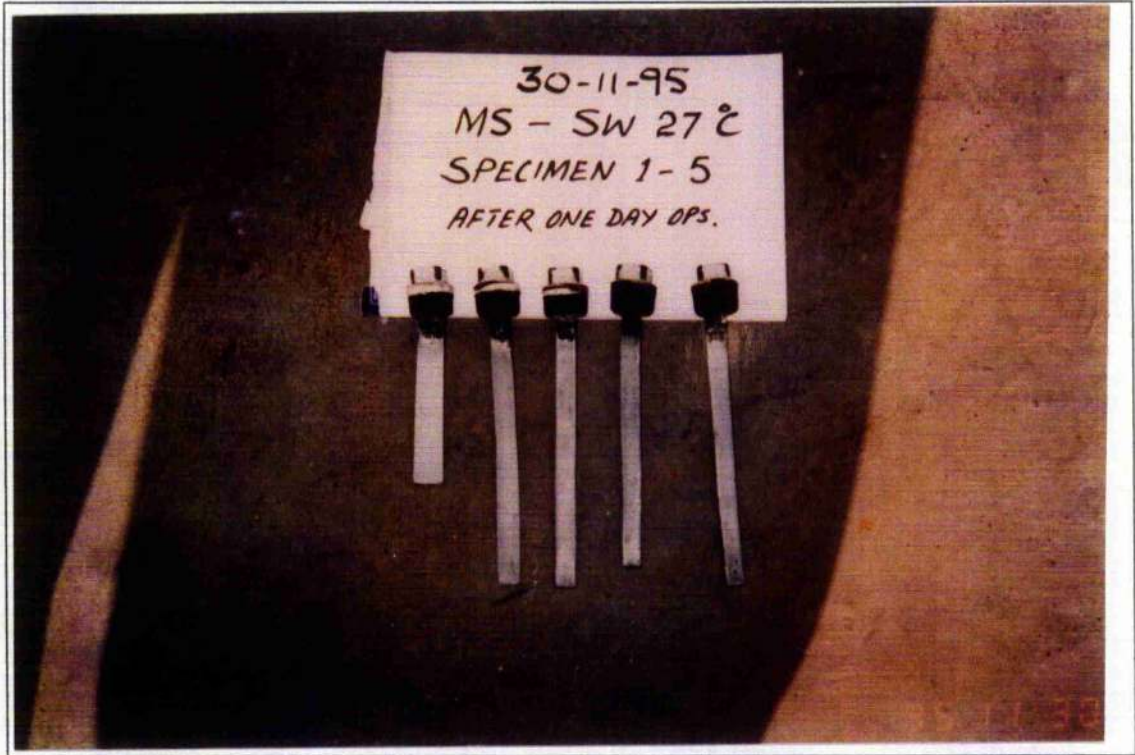

Figures 8.74 and 8.75: Specimens and spool piece condition.

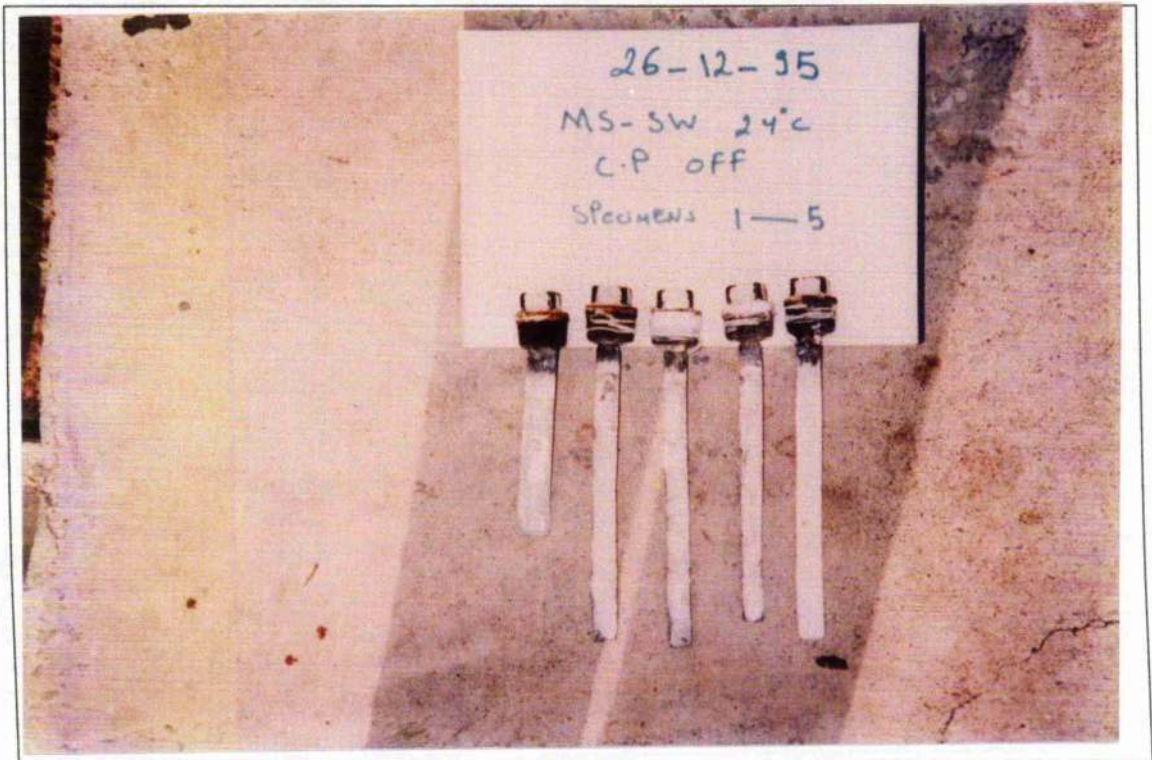
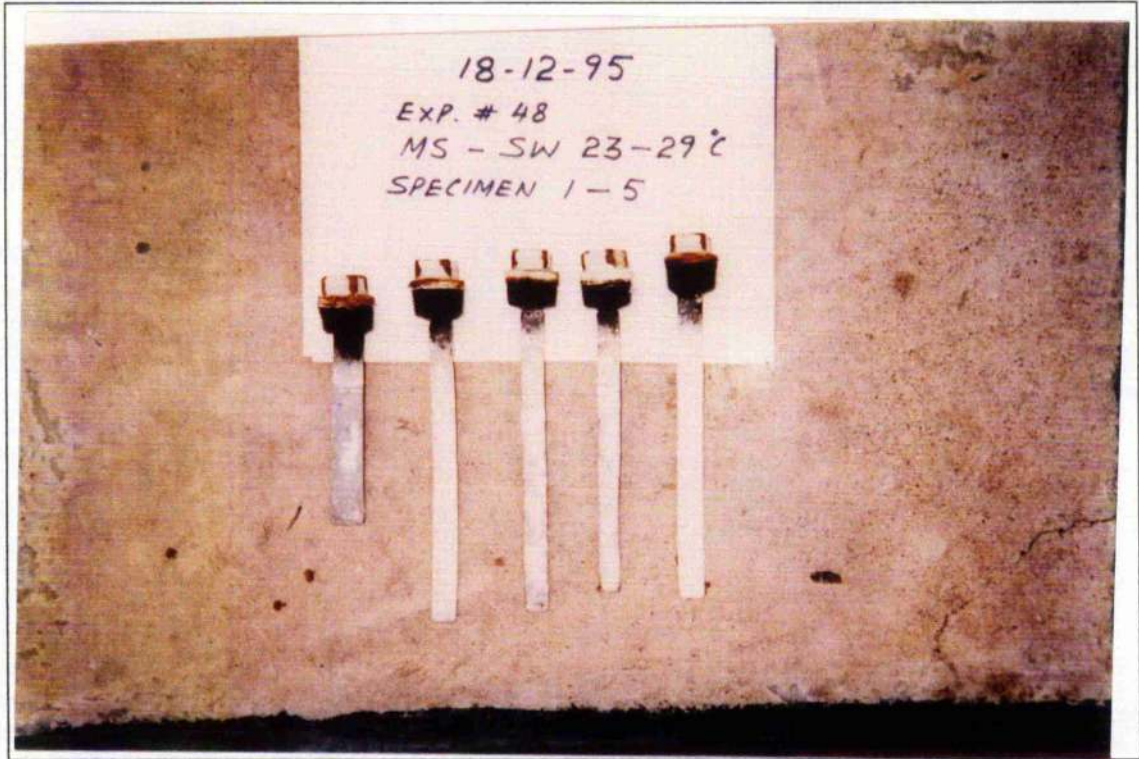

Figures 8.76 and 8.77: Specimens condition before and after C.P being switched off.

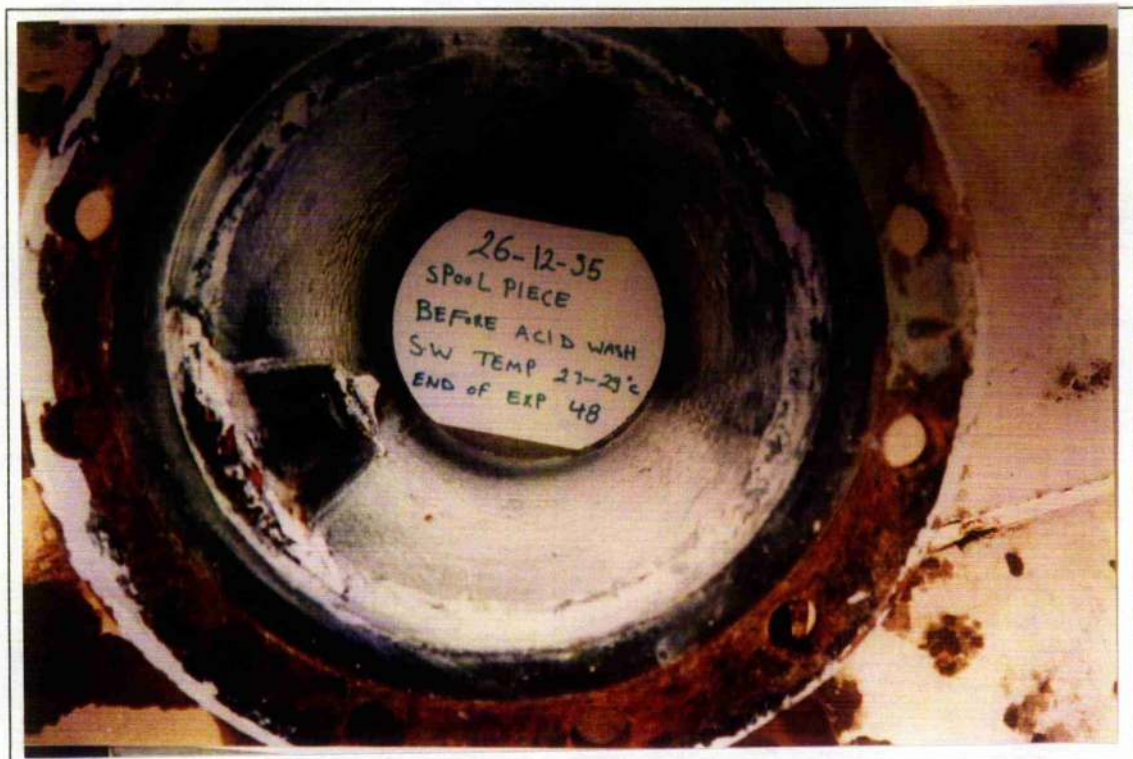

Figures 8.78: Spool piece condition at the end of test 48.

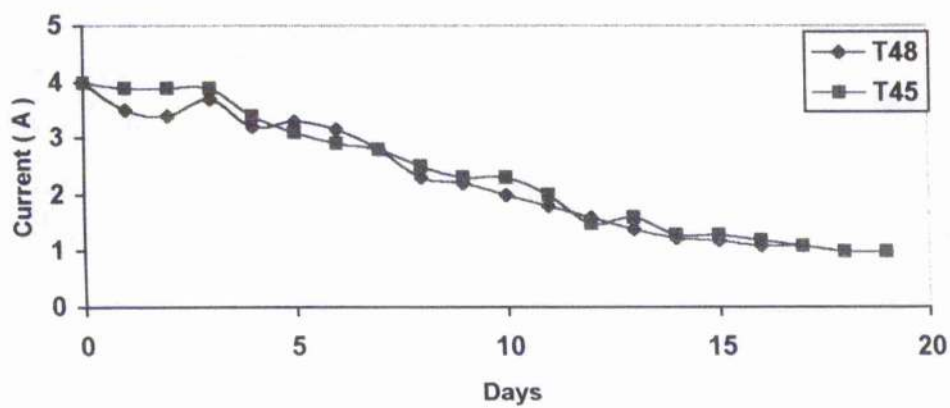

Figure 8.79: Reproducibility results of tests 48 with 48

C.P. Status	****	OFF	ON	ON	ON	ON	ON	ON
Time	hrs	0	24	48	72	96	120	144
Group 'A'	Auto Ops	Auto	Auto	Auto	Auto	Auto	Auto	Auto
Set Potential	mV	-1050	-1050	-1050	-1050	-1050	-1050	-1050
Current	Amps	4	3.5	3.4	3.7	3.2	3.3	3.15
Voltage	V	6	5.6	5.6	5.5	5.5	5.5	5.5
R. Electrode	MV	****	****	****	****	****	****	****
R1	PANEL	-550	-1050	-1050	-1050	-1050	-1050	-1050
R2	PANEL	-600	-1170	-1180	-1160	-1180	-1180	-1180
R1	LOCALLY	-555	-733	-769	-707	-750	-760	-780
R2	LOCALLY	-600	-952	-957	-945	-948	-960	-970
Group 'B'	Manual Ops	M	M	M	M	M	M	M
Current	Amps	2	2	2	2	2	2	2
Voltage	V	4	4	4	4	4	4	4
R. Electrode	MV	****	****	****	****	****	****	****
R3	PANEL	-710	-1400	-1390	-1400	-1410	-1410	-1400
R4	PANEL	-650	-1290	-1300	-1300	-1300	-1300	-1300
R3	LOCALLY	-720	-1040	-1036	-1085	-1145	-1136	-1126
R4	LOCALLY	-665	-911	-882	-785	-878	-940	-1040

C.P. Status	****	ON	ON	ON	ON	ON	ON	ON
Time	hrs	168	192	216	240	264	288	312
Group 'A'	Auto Ops	Auto	Auto	Auto	Auto	Auto	Auto	Auto
Set Potential	mV	-1050	-1050	-1050	-1050	-1050	-1050	-1050
Current	Amps	2.8	2.3	2.2	2	1.8	1.6	1.4
Voltage	V	5.2	4.6	4.5	4.5	4.2	4.1	4
R. Electrode	MV	****	****	****	****	****	****	****
R1	PANEL	-1050	-1050	-1050	-1050	-1050	-1050	-1050
R2	PANEL	-1150	-1150	-1150	-1150	-1160	-1150	-1150
R1	LOCALLY	-790	-800	-815	-830	-840	-852	-860
R2	LOCALLY	-977	-960	-975	-980	-980	-990	-1015
Group 'B'	Manual Ops	M	M	M	M	M	M	M
Current	Amps	2	2	2	2	2	2	2
Voltage	V	4	4	4	4	4	4	4
R. Electrode	MV	****	****	****	****	****	****	****
R3	PANEL	-1410	-1400	-1400	-1400	-1400	-1400	-1400
R4	PANEL	-1300	-1300	-1310	-1300	-1300	-1300	-1300
R3	LOCALLY	-1132	-1126	-1127	-1127	-1123	-1123	-1123
R4	LOCALLY	-1016	-1039	-1056	-1065	-1020	-1060	-1060

C.P. Status	****	ON	ON	ON	ON	ON	ON	ON
Time	hrs	336	360	384	408	432	456	480
Group 'A'	Auto Ops	Auto	Auto	Auto	Auto	Auto	Auto	Auto
Set Potential	mV	-1050	-1050	-1050	-1050	-1050	-1050	-1050
Current	Amps	1.25	1.2	1.1	1.1	1	1	1
Voltage	V	3.8	3.8	3.7	3.5	3.5	3.4	3.4
R. Electrode	MV	****	****	****	****	****	****	****
R1	PANEL	-1050	-1050	-1050	-1050	-1050	-1050	-1050
R2	PANEL	-1180	-1180	-1180	-1180	-1160	-1150	-1160
R1	LOCALLY	-870	-885	-900	-920	-940	-960	-985
R2	LOCALLY	-1010	-1045	-1040	-1040	-1050	-1050	-1050
Group 'B'	Manual Ops	M	M	M	M	M	M	M
Current	Amps	2	2	2	2	2	2	2
Voltage	V	4	4	4	4	4	4	4
R. Electrode	MV	****	****	****	****	****	****	****
R3	PANEL	-1380	-1400	-1390	-1400	-1390	-1380	-1390
R4	PANEL	-1300	-1310	-1300	-1300	-1310	-1300	-1300
R3	LOCALLY	-1125	1130	-1190	-1125	-1120	-1120	-1150
R4	LOCALLY	-1052	-1070	-1090	-1075	-1095	-1090	-1080

C.P. Status	****	ON	ON	OFF	OFF	OFF	OFF	OFF
Time	hrs	504	528	552	576	600	624	648-720
Group 'A'	Auto Ops	Auto	Auto	Auto	Auto	Auto	Auto	Auto
Set Potential	mV	-1050	-1050	N/A	N/A	N/A	N/A	N/A
Current	Amps	0.7	0.7	0	0	0	0	0
Voltage	V	3.3	3.3	0	0	0	0	0
R. Electrode	MV	****	****	****	****	****	****	****
R1	PANEL	-1050	-1050	-900	-820	-750	-700	-695
R2	PANEL	-1160	-1140	-910	-830	-780	-754	-680
R1	LOCALLY	-1000	-1020	-875	-790	-730	-700	-691
R2	LOCALLY	-1050	-1040	-825	-800	-740	-730	-720
Group 'B'	Manual Ops	M	M	N/A	N/A	N/A	N/A	N/A
Current	Amps	2	2	0	0	0	0	0
Voltage	V	4	4	0	0	0	0	0
R. Electrode	MV	****	****	****	****	****	****	****
R3	PANEL	-1370	-1400	-1030	-900	-883	-860	-810
R4	PANEL	-1300	-1310	-100	-930	-933	-900	-850
R3	LOCALLY	-1150	1130	-980	-895	-890	-863	-820
R4	LOCALLY	-1080	-1035	-990	-940	-920	-906	-895 to -845

Table 8.40: Summary of the test daily readings



**TEST NO 49****1. Parameters summary**

Items	Units	Data
Control Potential	mV	-1050
Flow Rate	m <sup>3</sup> /hr	180
Temperature	°C	30
T.D.S	ppm	43,000
Test Duration	Days	30
Acid Wash	****	Yes

**2. PURPOSE**

The purpose of this test was: -

1. To study the effect of flow rate increase in test applied current and rate of scale deposition when compared to test 48.
2. To check the consequences of the on line impressed current cathodic protection failure on the areas of protection.

**3. PROCEDURE**

The test procedure used was the same as test 45, with the exception that the test operating flow rate increased to the maximum allowable limit.

**4. FINDINGS**

The test loop which includes the mild steel pipelines and the specimens were protected cathodically for about 25 days at a set control potential of -1050 mV group 'A' and group 'B' galvanostatic operation at 2 amps. As shown in figure 8.80 the current in, group 'A' was always higher than at lower flow in test 48.

During first phase of the test, seawater condition was rough and turbidity was higher than normal. As a result, after 13 days, specimens were removed and visually checked and no sign of corrosion was evident, but scale was formed on the surfaces of specimens 3 to 5 only. In the same day 4 of the specimens location were changed (specimens 4 and 5 were changed with 1 and 2). This was mainly to re-check flow impact on formed scale as scale formation has been found to be different on specimen surfaces for different location within the test loop. After 25 days, specimens were once again checked and no sign of corrosion observed but all the specimens were covered with fine layer of scale. Scale was slightly removed from specimen 5, which was placed in specimen 1 position within the test (after 12 days). This is mainly due to flow turbulence and less

negative control potential within zone 'A'. On the same day the cathodic protection was switched off. The test was continued with protection off for 4 days. On a daily basis system local potential and visual inspection of all the specimens were performed. No sign of corrosion was seen during the periods when the cathodic protection was switched off.

After 30 days, the test was completed, loop depressurised, specimens and spool piece removed and following found: -

- \* Specimens 1 to 5, no corrosion, specimen surface was coated with a fine layer of scale (figure 8.81).
- \* Spool piece and the pipelines were generally covered with scale and no sign of corrosion (figure 8.82).

## 5. CONCLUSIONS

1. Scale deposition reduced when compared to test 48, mainly due to increase in, flow velocity, which hence reduced the flow contact time with the pipeline surface.
2. The consequences of the on line impressed current cathodic protection failure would not require an immediate shut down of the plant as scale will act as a protective layer.

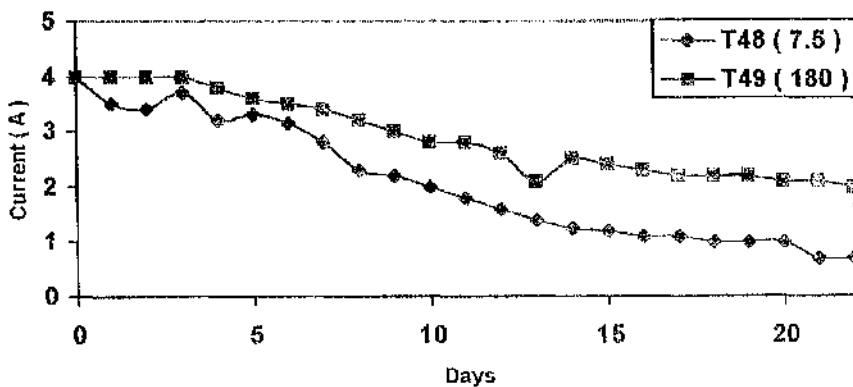
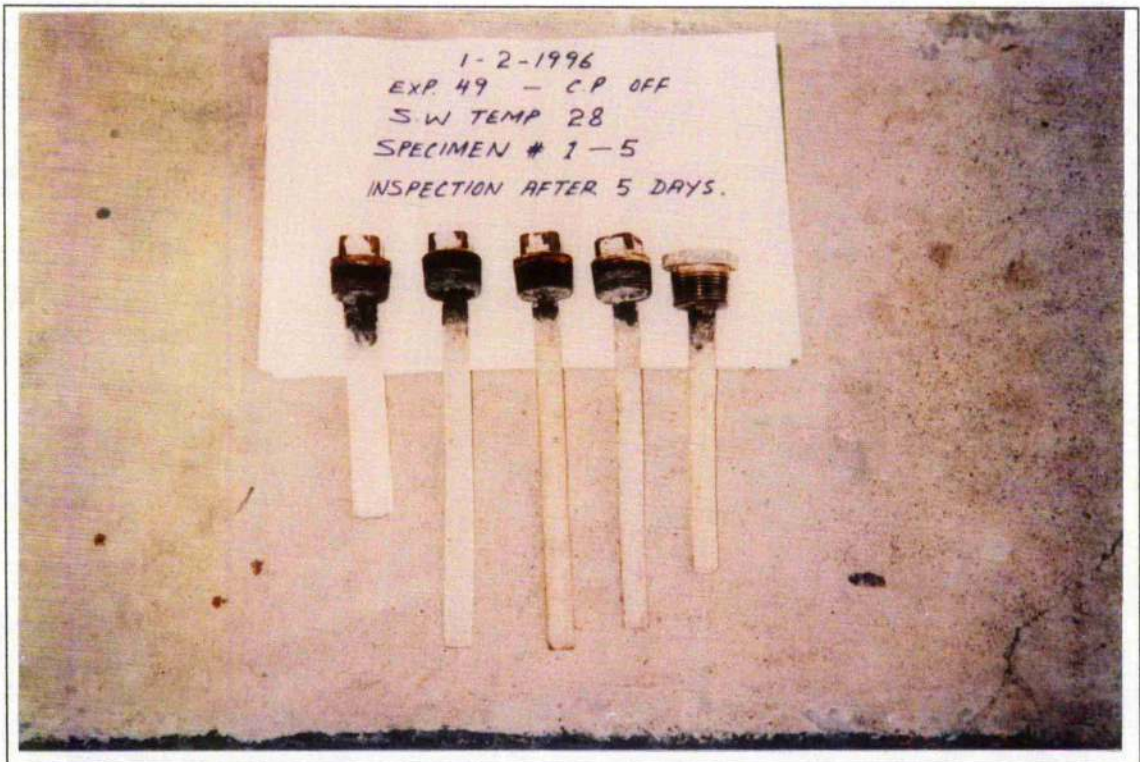

Figure 8.80: Effect of increase in flow rate on test applied current



Figures 8.81 and 8.82: Specimens and spool piece condition at the end of test 49.

C.P. Status	****	OFF	ON	ON	ON	ON	ON	ON
Time	hrs	0	24	48	72	96	120	144
Group 'A'	Auto Ops	Auto	Auto	Auto	Auto	Auto	Auto	Auto
Set Potential	mV	-1050	-1050	-1050	-1050	-1050	-1050	-1050
Current	Amps	4	4	4	4	3.8	3.6	3.5
Voltage	V	6	5.6	5.6	5.6	5.5	5.5	5.5
R. Electrode	MV	****	****	****	****	****	****	****
R1	PANEL	-520	-1050	-1050	-1050	-1050	-1050	-1050
R2	PANEL	-580	-1190	-1150	-1150	-1150	-1160	-1160
R1	LOCALLY	-550	-653	-720	-730	-740	-750	-770
R2	LOCALLY	-685	-920	-950	-960	-1000	-1035	-1045
Group 'B'	Manual Ops	M	M	M	M	M	M	M
Current	Amps	2	2	2	2	2	2	2
Voltage	V	4	4	4	4	4	4	4
R. Electrode	MV	****	****	****	****	****	****	****
R3	PANEL	-700	-1400	-1350	-1350	-1330	-1330	-1320
R4	PANEL	-650	-1310	-1280	-1300	-1290	-1300	-1290
R3	LOCALLY	-670	-1220	-1210	-1200	-1200	-1200	-1190
R4	LOCALLY	-690	-1130	-1125	-1150	-1160	-1180	-1150

C.P. Status	****	ON	ON	ON	ON	ON	ON	ON
Time	hrs	168	192	216	240	264	288	312
Group 'A'	Auto Ops	Auto	Auto	Auto	Auto	Auto	Auto	Auto
Set Potential	mV	-1050	-1050	-1050	-1050	-1050	-1050	-1050
Current	Amps	3.4	3.2	3	2.8	2.8	2.6	2.1
Voltage	V	5.3	5.3	5.2	5.1	5.1	5	4.8
R. Electrode	MV	****	****	****	****	****	****	****
R1	PANEL	-1050	-1050	-1050	-1050	-1050	-1050	-1050
R2	PANEL	-1150	-1180	-1190	-1180	-1180	-1150	-1150
R1	LOCALLY	-780	-800	-810	-815	-820	-825	-830
R2	LOCALLY	-1045	-1050	-1045	-1040	-1045	-1045	-1050
Group 'B'	Manual Ops	M	M	M	M	M	M	M
Current	Amps	2	2	2	2	2	2	2
Voltage	V	4	4	4	4	4	4	4
R. Electrode	MV	****	****	****	****	****	****	****
R3	PANEL	-1280	-1290	-1300	-1300	-1280	-1300	-1310
R4	PANEL	-1320	-1300	-1300	-1290	-1320	-1280	-1290
R3	LOCALLY	-1200	-1200	-1200	-1210	-1200	-1210	-1200
R4	LOCALLY	-1145	-1150	-1180	-1180	-1210	-1190	-1200

C.P. Status	****	ON	ON	ON	ON	ON	ON	ON
Time	hrs	336	360	384	408	432	456	480
Group 'A'	Auto Ops	Auto	Auto	Auto	Auto	Auto	Auto	Auto
Set Potential	mV	-1050	-1050	-1050	-1050	-1050	-1050	-1050
Current	Amps	2.5	2.4	2.3	2.2	2.2	2.2	2.1
Voltage	V	5	4.9	4.9	4.8	4.7	4.7	4.7
R. Electrode	MV	****	****	****	****	****	****	****
R1	PANEL	-1050	-1050	-1050	-1050	-1050	-1050	-1050
R2	PANEL	-1120	-1180	-1190	-1180	-1190	-1150	-1150
R1	LOCALLY	-830	-840	-855	-870	-890	-915	-935
R2	LOCALLY	-1010	-1045	-1040	-1040	-1050	-1050	-1050
Group 'B'	Manual Ops	M	M	M	M	M	M	M
Current	Amps	2	2	2	2	2	2	2
Voltage	V	4	4	4	4	4	4	4
R. Electrode	MV	****	****	****	****	****	****	****
R3	PANEL	-1250	-1320	-1300	-1300	-1300	-1300	-1280
R4	PANEL	-1300	-1290	-1300	-1270	-1260	-1270	-1280
R3	LOCALLY	-1250	-1260	-1250	-1260	-1250	-1220	-1250
R4	LOCALLY	-1210	-1220	-1210	-1220	-1170	-1200	-1200

C.P. Status	****	ON	ON	ON	OFF	OFF	OFF	OFF
Time	hrs	504	528	552-600	624	648	672	696
Group 'A'	Auto Ops	Auto	Auto	Auto	N/A	N/A	N/A	N/A
Set Potential	mV	-1050	-1050	-1050	0	0	0	0
Current	Amps	2.1	2	2.1	0	0	0	0
Voltage	V	4.8	4.6	4.7	0	0	0	0
R. Electrode	MV	****	****	****	****	****	****	****
R1	PANEL	-1050	-1050	-1050	-880	-760	-720	-700
R2	PANEL	-1150	-1180	-1150	-885	-770	-735	-710
R1	LOCALLY	-960	-980	-1030	-850	-750	-710	-690
R2	LOCALLY	-1050	-1040	-1050	-860	-760	-740	-695
Group 'B'	Manual Ops	M	M	M	N/A	N/A	N/A	N/A
Current	Amps	2	2	2	0	0	0	0
Voltage	V	4	4	4	0	0	0	0
R. Electrode	MV	****	****	****	****	****	****	****
R3	PANEL	-1270	-1280	-1280	-1090	-1050	-1040	-1000
R4	PANEL	-1290	-1300	-1290	-1100	-1040	-1030	-1010
R3	LOCALLY	-1250	-1300	-1280	-1070	-1040	-1030	-1010
R4	LOCALLY	-1200	-1210	-1220	-1080	-1050	-1040	-1020

Table 8.41: Summary of the test daily readings

**TEST NO 50****1. Parameters summary**

Items	Units	Data
Control Potential	mV	-1050
Flow Rate	m <sup>3</sup> /hr	7.5
Temperature	<sup>0</sup> C	50 to 60
T.D.S	ppm	43,000
Test Duration	Days	16
Acid wash	****	Yes

**2. PURPOSE**

1. To investigate the rate and duration in which scale forms at the surface of the specimen, and test loop pipelines after complete test loop acid wash, while performing the test at higher temperature than test 48 (50 to 60 <sup>0</sup>C instead of 30 <sup>0</sup>C).
2. To re-check the consequences of the on line impressed current cathodic protection failure for the areas where temperature is almost twice the normal summer condition.

**3. PROCEDURE**

The test procedure used was the same as test. 45, with the exception to the temperature increase as treated hot brine was introduced from evaporator heat input section.

**4. FINDINGS**

The test loop was protected cathodically for about 12 days at a set control potential of -1050 mV for group 'A' protection zone group 'B' continued on manual operation at a pre-set current level of 2 amps. After 12 days, the test rig was stopped for visual inspection of specimens. Findings were satisfactory as no sign of corrosion was seen on the specimens surface, but layer of scale was formed uniformly on the surface of all the specimens (figure 8.83). After 12 days, cathodic protection was switched off as local potential reached at about set control potential of -1050 mV. The test was continued with protection off for 5 days. On a daily basis system potential and visual inspection of all the specimens were carried out. Figure 50.1 shows the reduction in local potential on daily basis as was expected. No sign of corrosion was seen during the periods when the cathodic protection was switched off. After 16 days, the test was stopped as the local potential of R1 had reduced to -720 mV, rig depressurised and specimens along with spool piece and pipelines checked. The following were observed: -

- \* Specimens 1 to 5 were found in good conditions with no sign of corrosion. Scale was formed on the surfaces of all the specimens (figure 8.84). Spool piece and pipeline, were found to be covered with scale and no corrosion.

## 5. CONCLUSIONS

1. Scale deposition rate found sufficient and whitish in nature.
2. Scale was formed on the surface of the pipelines and specimens just after first system visual inspection (after 12 days in operation). Scale formation was found to be, slightly more in comparison to test 48. This indicated that scale formed at higher temperature even with scale inhibitor being present.
3. Figure 8.85 shows that the current declined after the first day or so in at a slightly greater rate of the higher temperature but, after about 8 days, the currents are higher at the higher temperature.
4. System protection was achieved even in duration when on line impressed current cathodic protection was switched off as no sign of corrosion was observed at the surface of specimens and the spool piece (it took approximately 5 days for local potential to reach  $-720$  mV from  $-1040$  mV, figure 8.95).

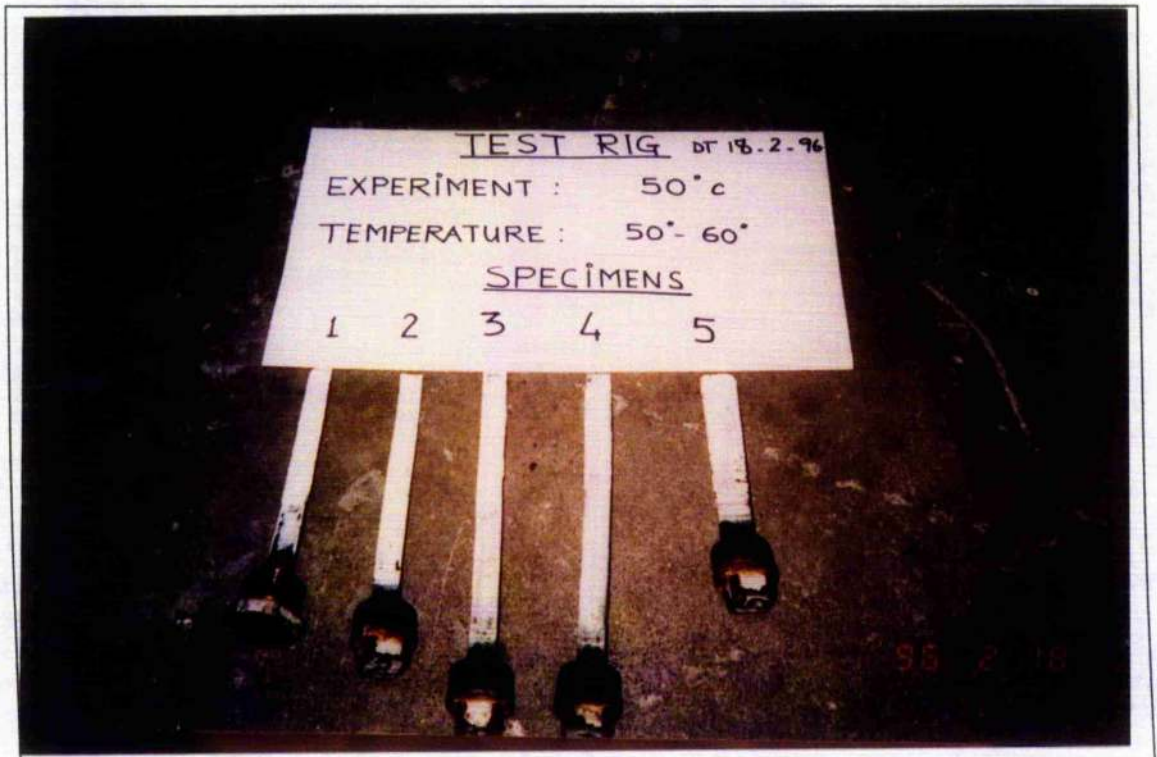

Figures 8.83:Specimens condition before C.P being switched off.

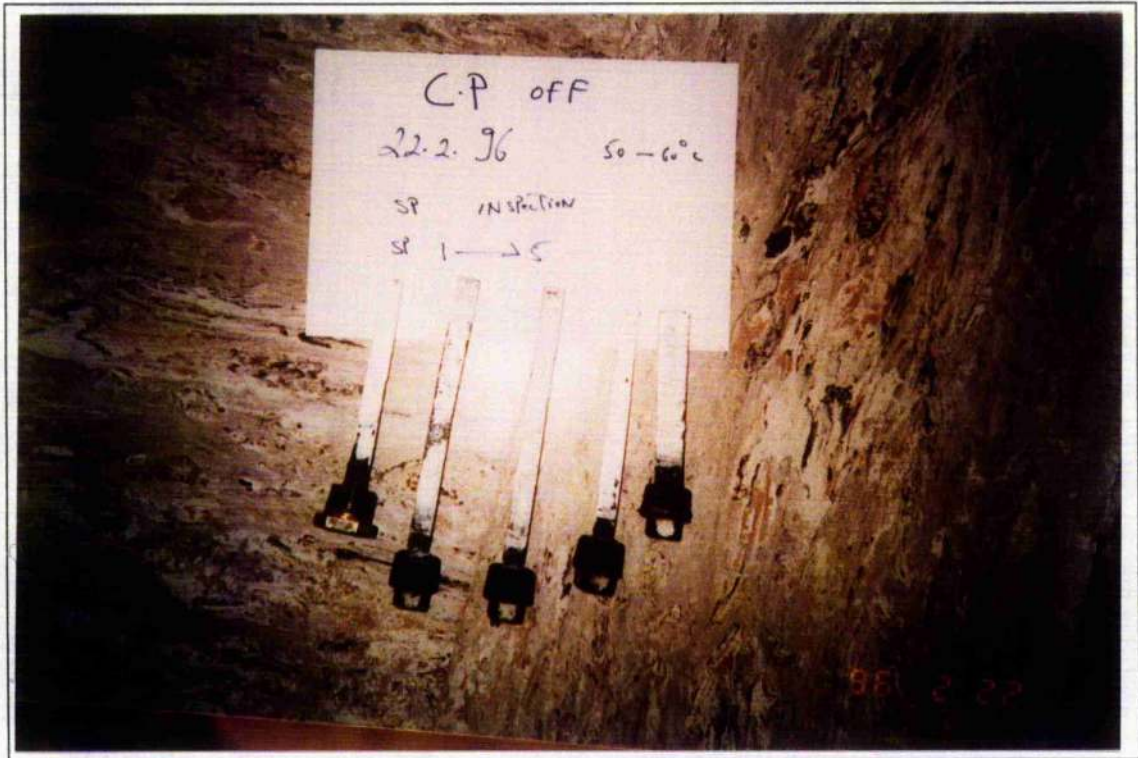

Figure 8.84: Specimens condition after C.P being switched off, end of test 50.

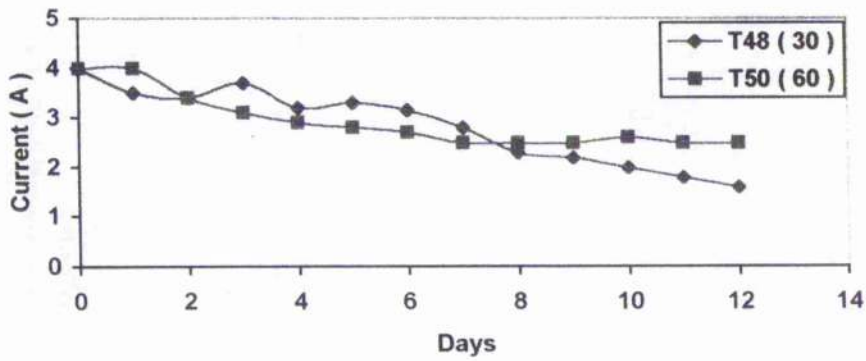

Figure 8.85: Effect of higher temperature on test applied current



C.P. Status	****	OFF	ON	ON	ON	ON	ON	ON
Time	hrs	0	24	48	72	96	120	144
Group 'A'	Auto Ops	Auto	Auto	Auto	Auto	Auto	Auto	Auto
Set Potential	mV	-1050	-1050	-1050	-1050	-1050	-1050	-1050
Current	Amps	4	4	3.4	3.1	2.9	2.8	2.7
Voltage	V	6	5.6	5.3	5.2	5.1	5.1	4.9
R. Electrode	MV	****	****	****	****	****	****	****
R1	PANEL	-534	-1050	-1050	-1050	-1050	-1050	-1050
R2	PANEL	-500	-1010	-1160	-1150	-1160	-1140	-1160
R1	LOCALLY	-510	-770	-850	-890	-930	-960	-990
R2	LOCALLY	-515	-900	-1010	-1030	-1020	-1040	-1045
Group 'B'	Manual Ops	M	M	M	M	M	M	M
Current	Amps	2	2	2	2	2	2	2
Voltage	V	4	4	4	4	4	4	4
R. Electrode	MV	****	****	****	****	****	****	****
R3	PANEL	-630	-1350	-1320	-1300	-1300	-1280	-1280
R4	PANEL	-650	-1230	-1250	-1260	-1280	-1300	-1290
R3	LOCALLY	-650	-1020	-1100	-1180	-1220	-1260	-1260
R4	LOCALLY	-680	-1150	-11200	-1220	-1210	-1250	-1250

C.P. Status	****	ON	ON	ON	ON	ON	ON	OFF
Time	hrs	168	192	216	240	264	288	312
Group 'A'	Auto Ops	Auto	Auto	Auto	Auto	Auto	Auto	Auto
Set Potential	mV	-1050	-1050	-1050	-1050	-1050	-1050	N/A
Current	Amps	2	2	2	2	2	2	0
Voltage	V	4	4	4	4	4	4	0
R. Electrode	MV	****	****	****	****	****	****	****
R1	PANEL	-1050	-1050	-1050	-1050	-1050	-1050	-950
R2	PANEL	-1150	-1140	-1120	-1100	-1150	-1150	-940
R1	LOCALLY	-1020	-1030	-1030	-1020	-1030	-1040	-940
R2	LOCALLY	-1045	-1050	-1045	-1040	-1045	-1045	-950
Group 'B'	Manual Ops	M	M	M	M	M	M	N/A
Current	Amps	2	2	2	2	2	2	0
Voltage	V	4	4	4	4	4	4	0
R. Electrode	MV	****	****	****	****	****	****	****
R3	PANEL	-1280	-1290	-1280	-1270	-1280	-1280	-1100
R4	PANEL	-1320	-1300	-1300	-1290	-1290	-1280	-1120
R3	LOCALLY	-1260	-1260	-1250	-1250	-1250	-1250	-1080
R4	LOCALLY	-1260	-1270	-1260	-1260	-1260	-1260	-1100

<b>C.P. Status</b>	<b>****</b>	<b>OFF</b>	<b>OFF</b>	<b>OFF</b>	<b>OFF</b>
<b>Time</b>	<b>hrs</b>	<b>336</b>	<b>360</b>	<b>384</b>	<b>408</b>
<b>Group 'A'</b>	<b>Auto Ops</b>	<b>N/A</b>	<b>N/A</b>	<b>N/A</b>	<b>N/A</b>
<b>Set Potential</b>	<b>mV</b>	<b>0</b>	<b>0</b>	<b>0</b>	<b>0</b>
<b>Current</b>	<b>Amps</b>	<b>0</b>	<b>0</b>	<b>0</b>	<b>0</b>
<b>Voltage</b>	<b>V</b>	<b>0</b>	<b>0</b>	<b>0</b>	<b>0</b>
<b>R. Electrode</b>	<b>MV</b>	<b>****</b>	<b>****</b>	<b>****</b>	<b>****</b>
<b>R1</b>	<b>PANEL</b>	<b>-890</b>	<b>-850</b>	<b>-800</b>	<b>-760</b>
<b>R2</b>	<b>PANEL</b>	<b>-900</b>	<b>-870</b>	<b>830</b>	<b>-790</b>
<b>R1</b>	<b>LOCALLY</b>	<b>-880</b>	<b>-860</b>	<b>-760</b>	<b>-720</b>
<b>R2</b>	<b>LOCALLY</b>	<b>-880</b>	<b>-860</b>	<b>-800</b>	<b>-740</b>
<b>Group 'B'</b>	<b>Manual Ops</b>	<b>N/A</b>	<b>N/A</b>	<b>N/A</b>	<b>N/A</b>
<b>Current</b>	<b>Amps</b>	<b>0</b>	<b>0</b>	<b>0</b>	<b>0</b>
<b>Voltage</b>	<b>V</b>	<b>0</b>	<b>0</b>	<b>0</b>	<b>0</b>
<b>R. Electrode</b>	<b>MV</b>	<b>****</b>	<b>****</b>	<b>****</b>	<b>****</b>
<b>R3</b>	<b>PANEL</b>	<b>-1050</b>	<b>-1050</b>	<b>-1040</b>	<b>-1010</b>
<b>R4</b>	<b>PANEL</b>	<b>-1100</b>	<b>-1090</b>	<b>-1070</b>	<b>-1040</b>
<b>R3</b>	<b>LOCALLY</b>	<b>-1020</b>	<b>-1020</b>	<b>-1010</b>	<b>-980</b>
<b>R4</b>	<b>LOCALLY</b>	<b>-1070</b>	<b>-1040</b>	<b>-1040</b>	<b>-1010</b>

Table 8.42: Summary of the test daily readings

**TEST NO 51****1. Parameters summary**

Items	Units	Data
Control Potential	mV	-950
Flow Rate	m <sup>3</sup> /hr	7.5
Temperature	°C	23 to 28
T.D.S	ppm	43,000
Test Duration	Days	38
Acid washed	****	Yes

**2. PURPOSE**

The purpose of this test was: -

1. To study the effect of less negative control potential when compared to test 48 (-950 mV instead of -1050 mV) on the: -
  - \* Rate and duration of scale deposition in which scale forms at the surface of the specimen, and test loop pipelines after complete test loop acid wash.
  - \* Demand for applied current.
2. To illustrate the benefits of scale deposition on test applied current when compared to test 36 (test 36 was covered with scale and was not acid washed and was set at slightly more negative potential -1000 mV than this test).

**3. PROCEDURE**

The test procedure used was the same as test 45, with exception to set control potential which was set at less negative value.

**4. FINDING**

The test rig was stopped twice (after 7 and 9 days) in duration of the test to check scale deposition rate on the specimen surface. The finding was acceptable as no sign of corrosion was observed. On both occasions scale was formed of different thickness on the surfaces of the specimens. After 38 days, the test was stopped, rig depressurised and specimens along with spool piece and pipelines checked. The following was observed: -

- \* Specimens 1 to 5, no corrosion, but surfaces were coated with a fine layer of scale.
- \* Spool piece and pipelines, no corrosion but again were covered with thin layer of scale.

## 5. CONCLUSIONS

1. Scale deposition rate was found to be sufficient but was less than test 48, mainly due to control potential was set at less negative value than test 48 (figure 8.86).
2. Scale was formed on the surface of the specimens within 96 hrs.
3. Figure 8.87 illustrates the applied current trend comparison between test 36 and 51. The trend shows a higher current demand for test 51 through out the test, even though test 51 was performed at less negative potential (acid wash effect).
4. Figure 8.88 demonstrates the effect of control potential variation on test applied current. Demand for applied current decreased as control potential set at less negative value. Current trend toward the end of the test is similar to test 48, this illustrate that even at less negative potential scale forms but at lower rate than when test perform at more negative control potential (-1050 mV). However, towards the end of the two tests, the currents were similar. This suggests that once a scale formed currents at higher potential not significantly higher.

## 6. NOTE

- \* Test loop was not acid washed for the next test. This was mainly to study the effect of pre-scaling on test applied current.



Figures 8.86: Specimens condition at the end of test 51.

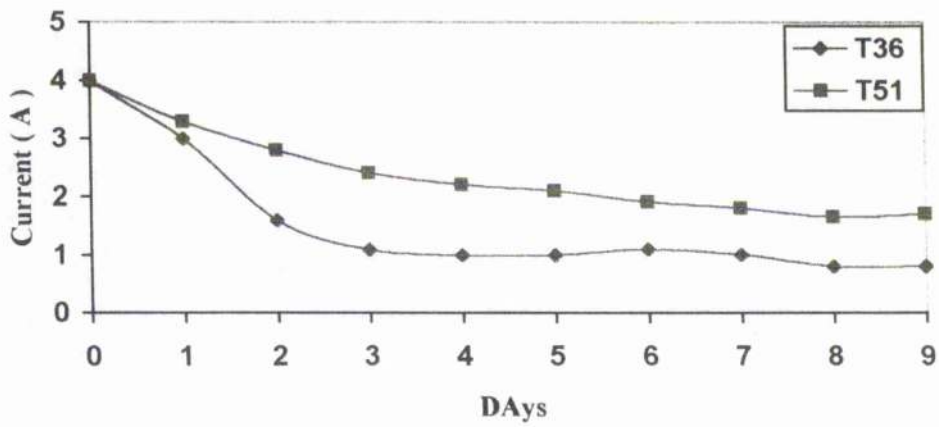

Figure 8.87: Pre-scaling effect on test applied current

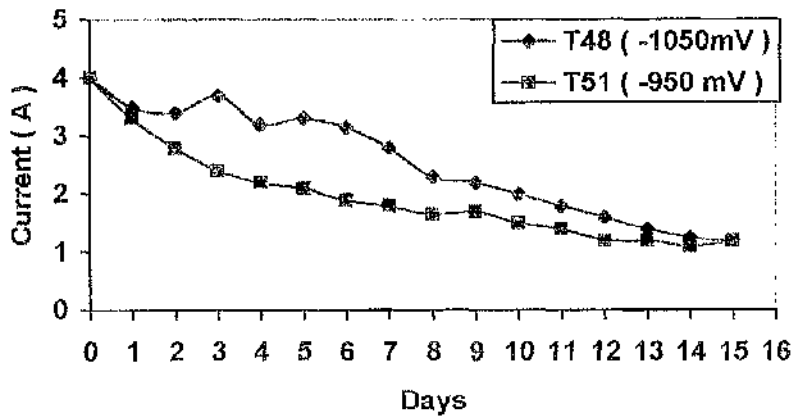

Figure 8.88: Effect of less negative potential on test applied current

C.P. Status	****	OFF	ON	ON	ON	ON	ON	ON
Time	hrs	0	24	48	72	96	120	144
Group 'A'	Auto Ops	Auto	Auto	Auto	Auto	Auto	Auto	Auto
Set Potential	mV	0	-950	-950	-950	-950	-950	-950
Current	Amps	4	3.3	2.8	2.4	2.2	2.1	1.9
Voltage	V	6	5.4	5.2	4.8	4.5	4.4	4.3
R. Electrode	MV	****	****	****	****	****	****	****
R1	PANEL	-510	-950	-950	-950	-950	-950	-950
R2	PANEL	-500	-1050	-1050	-1040	-1000	-1000	-1020
R1	LOCALLY	-520	-560	-580	-610	-650	-660	-680
R2	LOCALLY	-510	-650	-700	-720	-750	-770	-800
Group 'B'	Manual Ops	M	M	M	M	M	M	M
Current	Amps	2	2	2	2	2	2	2
Voltage	V	4	4	4	4	4	4	4
R. Electrode	MV	****	****	****	****	****	****	****
R3	PANEL	-620	-1300	-1280	-1280	-1290	-1280	-1250
R4	PANEL	-550	-1220	-1210	-1190	-1200	-1200	-1190
R3	LOCALLY	-610	-1100	-1150	-1200	-1200	-1210	-1210
R4	LOCALLY	-530	-820	-950	-1000	-1110	-1100	-1120

C.P. Status	****	ON	ON	ON	ON	ON	ON	ON
Time	hrs	168	192	216	240	264	288	312
Group 'A'	Auto Ops	Auto	Auto	Auto	Auto	Auto	Auto	Auto
Set Potential	mV	-950	-950	-950	-950	-950	-950	-950
Current	Amps	1.8	1.65	1.7	1.5	1.4	1.2	1.2
Voltage	V	4.2	4.1	4.1	4	4	3.8	3.8
R. Electrode	MV	****	****	****	****	****	****	****
R1	PANEL	-950	-950	-950	-950	-950	-950	-950
R2	PANEL	-1000	-1010	-1030	-1000	-1020	-1030	-1020
R1	LOCALLY	-710	-740	-760	-790	-810	-820	-850
R2	LOCALLY	-830	-850	-860	-880	-910	-915	-920
Group 'B'	Manual Ops	M	M	M	M	M	M	M
Current	Amps	2	2	2	2	2	2	2
Voltage	V	4	4	4	4	4	4	4
R. Electrode	MV	****	****	****	****	****	****	****
R3	PANEL	-1280	-1260	-1250	-1260	-1280	-1260	-1260
R4	PANEL	-1180	-1180	-1190	-1180	-1180	-1170	-1190
R3	LOCALLY	-1200	-1210	-1200	-1190	-1200	-1200	-1200
R4	LOCALLY	-1100	-1090	-1100	-1090	-1090	-1100	-1100

C.P. Status	****	ON	ON	ON	ON	ON	ON	ON
Time	hrs	336	360	384	408	432	456	480-912
Group 'A'	Auto Ops	Auto	Auto	Auto	Auto	Auto	Auto	Auto
Set Potential	mV	-950	-950	-950	-950	-950	-950	-950
Current	Amps	1.1	1.2	1	0.9	0.9	0.8	0.8-0.5
Voltage	V	3.6	3.8	3.4	3.3	3.3	3.3	3.3
R. Electrode	MV	****	****	****	****	****	****	****
R1	PANEL	-950	-950	-950	-950	-950	-950	-950
R2	PANEL	-1020	-1010	-1030	-1020	-1020	-1020	-1030
R1	LOCALLY	-870	-900	-910	-920	-930	-930	-940
R2	LOCALLY	-920	-930	-930	-930	-930	-940	-940
Group 'B'	Manual Ops	M	M	M	M	M	M	M
Current	Amps	2	2	2	2	2	2	2
Voltage	V	4	4	4	4	4	4	4
R. Electrode	MV	****	****	****	****	****	****	****
R3	PANEL	-1270	-1290	-1280	-1270	-1270	-1270	-1280
R4	PANEL	-1180	-1180	-1190	-1200	-1200	-1190	-1190
R3	LOCALLY	-1220	-1210	-1220	-1230	-1230	-1230	-1240
R4	LOCALLY	-1090	-1100	-1110	-1130	-1130	-1130	-1140

Table 8.43: Summary of, test daily readings

**TEST NO 52****1. Parameters summary**

Items	Units	Data
Control Potential	mV	-1050
Flow Rate	m <sup>3</sup> /hr	7.5
Temperature	°C	50 to 60
T.D.S	ppm	43,000
Test Duration	Days	17
Acid wash	****	No

**2. PURPOSE**

The purpose of this test was to monitor the pre-scaling effect on demand for applied current when compared to test 50.

**3. PROCEDURE**

The test procedure used was the same as test 45, with the exception of introducing hot brine from heat input section, in order to obtain higher operating temperature of 50 to 55 °C. Test loop was not acid washed.

**4. FINDINGS**

The pre-scaled test loop was protected cathodically for about 17 days at a set control potential of -1050 mV for group 'A' protection zone. Group 'B' continued on manual operation at a pre-set current level of 2 amps. The current demand dropped sharply just half an hour after protection was switched on. During the test, the seawater condition was very rough and seawater turbidity was much higher than normal. As a result, on two occasions specimens were removed and visually inspected. The following were observed: -

- \* Specimens 1 and 2, neither corrosion nor scale.
- \* Specimen 3, 4, and 5, no corrosion, but fine layer of scale was formed.
- \* A lot of sand found to be accumulated on the circulating tank and along the test loop pipelines. This is due to seawater being rough in nature.

After 17 days, the test was stopped and depressurised, specimens along with spool piece and pipelines checked. The following observed: -



- \* Specimens 1 to 5, no corrosion, but were covered with scale from minor to an average rate.
- \* Spool piece and pipelines were covered with fine layer of scale (figure 8.89).



**Figures 8.89: Spool condition at the end of test 52.**

## 5. CONCLUSIONS

1. Figure 8.90 shows the pre-scaling effect on test applied current when compared to test 50. The benefit of scale is clearly shown in figure 8.90, as demand for current is almost less by 30% throughout the test.
2. Antiscalant presence did not prevent scale formation, as a lot of sludge was found on the test loop pipelines.
3. Visual inspection at the end of the test loop indicated that deposited scale on the surface of the spool piece and pipeline, were similar in thickness to previous test. This illustrated that a formed scale does not wash away even when flow condition is very turbid.

4. Tables 8.41 and 8.43 shows the trend in which local potential reaches the actual set potential of  $-1050$  mV sooner in test 52 than in test 50. This is mainly due to previously formed scale within the test loop pipeline.

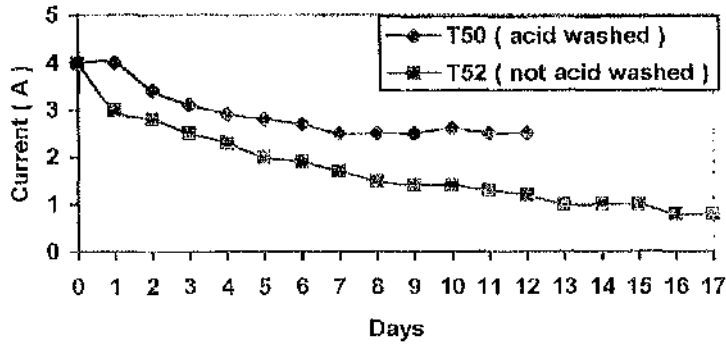

Figure 8.90: Pre-scaling effect on test applied current

C.P. Status	****	OFF	ON	ON	ON	ON	ON	ON
Time	hrs	0	24	48	72	96	120	144
Group 'A'	Auto Ops	Auto	Auto	Auto	Auto	Auto	Auto	Auto
Set Potential	mV	0	-1050	-1050	-1050	-1050	-1050	-1050
Current	Amps	4	3	2.8	2.5	2.3	2	1.9
Voltage	V	6	5.3	5.1	4.7	4.6	4.4	4.4
R. Electrode	MV	****	****	****	****	****	****	****
R1	PANEL	-770	-1050	-1050	-1050	-1050	-1050	-1050
R2	PANEL	-780	-1090	-1100	-1090	-1080	-1100	-1080
R1	LOCALLY	-760	-850	-980	-950	-980	-1000	-1020
R2	LOCALLY	-760	-980	-1020	-1050	-1060	-1080	-1080
Group 'B'	Manual Ops	M	M	M	M	M	M	M
Current	Amps	2	2	2	2	2	2	2
Voltage	V	4	4	4	4	4	4	4
R. Electrode	MV	****	****	****	****	****	****	****
R3	PANEL	-900	-1200	-1210	-1250	-1260	-1280	-1250
R4	PANEL	-920	-1220	-1210	-1190	-1200	-1200	-1190
R3	LOCALLY	-880	-1150	-1150	-1200	-1200	-1210	-1210
R4	LOCALLY	-900	-1100	-950	-1050	-1110	-1100	-1120

<b>C.P. Status</b>	****	ON	ON	ON	ON	ON	ON	ON
<b>Time</b>	hrs	168	192	216	240	264	288	312
<b>Group 'A'</b>	Auto Ops	Auto	Auto	Auto	Auto	Auto	Auto	Auto
<b>Set Potential</b>	mV	-1050	-1050	-1050	-1050	-1050	-1050	-1050
<b>Current</b>	Amps	1.7	1.5	1.4	1.4	1.3	1.2	1
<b>Voltage</b>	V	4.2	3.8	3.8	3.8	3.7	3.6	3.2
<b>R. Electrode</b>	MV	****	****	****	****	****	****	****
<b>R1</b>	PANEL	-1050	-1050	-1050	-1050	-1050	-1050	-1050
<b>R2</b>	PANEL	-1080	-1060	-1070	-1080	-1080	-1090	-1100
<b>R1</b>	LOCALLY	-1030	-1030	-1030	-1040	-1040	-1040	-1035
<b>R2</b>	LOCALLY	-1050	-1050	-1050	-1060	-1050	-1060	-1050
<b>Group 'B'</b>	Manual Ops	M	M	M	M	M	M	M
<b>Current</b>	Amps	2	2	2	2	2	2	2
<b>Voltage</b>	V	4	4	4	4	4	4	4
<b>R. Electrode</b>	MV	****	****	****	****	****	****	****
<b>R3</b>	PANEL	-1260	-1280	-1280	-1260	-1250	-1280	-1290
<b>R4</b>	PANEL	-1180	-1180	-1190	-1190	-1180	-1180	-1190
<b>R3</b>	LOCALLY	-1210	-1220	-1220	-1230	-1220	-1230	-1240
<b>R4</b>	LOCALLY	-1120	-1130	-1120	-1120	-1120	-1130	-1120

<b>C.P. Status</b>	****	ON	ON	ON	ON
<b>Time</b>	hrs	336	360	384	408
<b>Group 'A'</b>	Auto Ops	Auto	Auto	Auto	Auto
<b>Set Potential</b>	mV	-1050	-1050	-1050	-1050
<b>Current</b>	Amps	1	1	0.8	0.8
<b>Voltage</b>	V	3.2	3.2	3	3
<b>R. Electrode</b>	MV	****	****	****	****
<b>R1</b>	PANEL	-1050	-1050	-1050	-1050
<b>R2</b>	PANEL	-1080	-1090	-1090	-1080
<b>R1</b>	LOCALLY	-870	-900	-910	-920
<b>R2</b>	LOCALLY	-920	-930	-930	-930
<b>Group 'B'</b>	Manual Ops	M	M	M	M
<b>Current</b>	Amps	2	2	2	2
<b>Voltage</b>	V	4	4	4	4
<b>R. Electrode</b>	MV	****	****	****	****
<b>R3</b>	PANEL	-1250	-1270	-1280	-1280
<b>R4</b>	PANEL	-1180	-1180	-1190	-1180
<b>R3</b>	LOCALLY	-1240	-1230	-1220	-1250
<b>R4</b>	LOCALLY	-1120	-1130	-1140	-1140

Table 8.44: Summary of, test daily readings

**TEST NO 53****1. Parameters summary**

Items	Units	Data
Control Potential	mV	-1050
Flow Rate	m <sup>3</sup> /hr	40
Temperature	°C	25 to 30
T.D.S	ppm	43,000
Test Duration	Days	27
Acid washed	****	Yes

**2. PURPOSE**

The purpose of this test was to monitor effect of flow variation on test demand for applied current when compared to test 48.

**3. PROCEDURE**

The test procedure used was the same as test 48, with the exception that a blank from the test loop was removed in order to be able to achieve a higher operating flow rate.

**4. FINDINGS & CONCLUSIONS**

System current leakage was found after 14 days due to fault on the on line impressed current cathodic protection earthing system. This fault resulted in complete failure of the test as required protection of the system was not achieved. As table 8.44 shows, the local potential were all in the active corrosion range throughout the test, confirming that the cathodic protection system was not working. Figure 8.91 shows that the specimens had suffered corrosion.

The results of this test indicates that a regular attention and monitoring of cathodic protection system is must. It as well shows that a well trained engineer needs to look after the system closely as any fault in the system will have definitely a direct cost impact.

Test 53 considered to be failed and to be repeated due above mentioned reasons.



Figures 8.91: Specimens condition at the end of test 53.

C.P. Status	****	OFF	ON	ON	ON	ON	ON	ON
Time	hrs	0	24	48	72	96	120	144
Group 'A'	Auto Ops	Auto	Auto	Auto	Auto	Auto	Auto	Auto
Set Potential	mV	0	-1050	-1050	-1050	-1050	-1050	-1050
Current	Amps	4	4	4	4	4	4	4
Voltage	V	6	6	6	6	6	6	6
R. Electrode	MV	****	****	****	****	****	****	****
R1	PANEL	-630	-1050	-1050	-1050	-1050	-1050	-1050
R2	PANEL	-600	-1100	-1120	-1130	-1140	-1150	-1150
R1	LOCALLY	-520	-675	-720	-710	-700	-680	-685
R2	LOCALLY	-610	-650	-680	-700	-800	-820	-800
Group 'B'	Manual Ops	M	M	M	M	M	M	M
Current	Amps	2	2	2	2	2	2	2
Voltage	V	4	4	4	4	4	4	4
R. Electrode	MV	****	****	****	****	****	****	****
R3	PANEL	-810	-1200	-1210	-1250	-1260	-1280	-1250
R4	PANEL	-680	-1400	-1450	-1400	-1400	-1420	-1400
R3	LOCALLY	-690	-840	-860	-870	-850	-860	-850
R4	LOCALLY	-650	-770	-780	-790	-790	-780	-830

<b>C.P. Status</b>	<b>****</b>	<b>ON</b>	<b>ON</b>	<b>ON</b>	<b>ON</b>	<b>ON</b>	<b>ON</b>	<b>ON</b>
<b>Time</b>	<b>hrs</b>	<b>168</b>	<b>192</b>	<b>216</b>	<b>240</b>	<b>264</b>	<b>288</b>	<b>312-648</b>
<b>Group 'A'</b>	<b>Auto Ops</b>	<b>Auto</b>	<b>Auto</b>	<b>Auto</b>	<b>Auto</b>	<b>Auto</b>	<b>Auto</b>	<b>Auto</b>
<b>Set Potential</b>	<b>mV</b>	<b>-1050</b>	<b>-1050</b>	<b>-1050</b>	<b>-1050</b>	<b>-1050</b>	<b>-1050</b>	<b>-1050</b>
<b>Current</b>	<b>Amps</b>	<b>4.1</b>	<b>3.8</b>	<b>3.5</b>	<b>3.5</b>	<b>3.4</b>	<b>3.5</b>	<b>3.5-3.1</b>
<b>Voltage</b>	<b>V</b>	<b>6.2</b>	<b>5.8</b>	<b>5.6</b>	<b>5.6</b>	<b>5.6</b>	<b>5.6</b>	<b>5.7-5.4</b>
<b>R. Electrode</b>	<b>MV</b>	<b>****</b>	<b>****</b>	<b>****</b>	<b>****</b>	<b>****</b>	<b>****</b>	<b>****</b>
<b>R1</b>	<b>PANEL</b>	<b>-1050</b>	<b>-1050</b>	<b>-1050</b>	<b>-1050</b>	<b>-1050</b>	<b>-1050</b>	<b>-1050</b>
<b>R2</b>	<b>PANEL</b>	<b>-1150</b>	<b>-1150</b>	<b>-1150</b>	<b>-1150</b>	<b>-1150</b>	<b>-1150</b>	<b>-1150</b>
<b>R1</b>	<b>LOCALLY</b>	<b>-690</b>	<b>-690</b>	<b>-700</b>	<b>-700</b>	<b>-720</b>	<b>-740</b>	<b>-750</b>
<b>R2</b>	<b>LOCALLY</b>	<b>-800</b>	<b>-790</b>	<b>-790</b>	<b>-780</b>	<b>-790</b>	<b>-800</b>	<b>-830</b>
<b>Group 'B'</b>	<b>Manual Ops</b>	<b>M</b>	<b>M</b>	<b>M</b>	<b>M</b>	<b>M</b>	<b>M</b>	<b>M</b>
<b>Current</b>	<b>Amps</b>	<b>2</b>	<b>2</b>	<b>2</b>	<b>2</b>	<b>2</b>	<b>2</b>	<b>2</b>
<b>Voltage</b>	<b>V</b>	<b>4</b>	<b>4</b>	<b>4</b>	<b>4</b>	<b>4</b>	<b>4</b>	<b>4</b>
<b>R. Electrode</b>	<b>MV</b>	<b>****</b>	<b>****</b>	<b>****</b>	<b>****</b>	<b>****</b>	<b>****</b>	<b>****</b>
<b>R3</b>	<b>PANEL</b>	<b>-1250</b>	<b>-1270</b>	<b>-1270</b>	<b>-1280</b>	<b>-1280</b>	<b>-1280</b>	<b>-1290</b>
<b>R4</b>	<b>PANEL</b>	<b>-1400</b>	<b>-1400</b>	<b>-1420</b>	<b>-1400</b>	<b>-1390</b>	<b>-1380</b>	<b>-1370</b>
<b>R3</b>	<b>LOCALLY</b>	<b>-840</b>	<b>-850</b>	<b>-830</b>	<b>-840</b>	<b>-830</b>	<b>-8400</b>	<b>-840</b>
<b>R4</b>	<b>LOCALLY</b>	<b>-790</b>	<b>-790</b>	<b>-790</b>	<b>-790</b>	<b>-800</b>	<b>-810</b>	<b>-820</b>

**Table 8.45: Summary of, test daily readings**

**TEST NO 54****1. Parameters summary**

Items	Units	Data
Control Potential	mV	-1050
Flow Rate	m <sup>3</sup> /hr	40
Temperature	°C	35 increased to 55 after 20 days
T.D.S	ppm	43,000
Test Duration	Days	26
Acid wash	****	Yes

**1. PURPOSE**

The purpose of this test was: -

1. To monitor effect of flow variation on test demand for applied current when compared to test 48.
2. To check effect of temperature increase on test applied current when test loop is covered with scale.

**3. PROCEDURE**

The test procedure used was similar to test 48, with the exception that a blank from the test loop was removed in order to be able to achieve a higher operating flow rate. Temperature also increased during the test.

**4. FINDINGS**

The test loop which included the mild steel pipelines and the specimens were protected cathodically for about 26 days at a set control potential of -1050 mV in group 'A'. Test loop was stopped in two occasions (after 4 and 18 days) for visual inspection specimens were removed and visually inspected. The following were observed: -

- \* Specimens 1 and 2, no corrosion, fine layer of scale was seen formed.
- \* Specimen 3, 4, and 5, no corrosion, but thicker layer of scale was formed.

Table 8.46 shows that the test current demand for obtaining the required protection was only slightly higher initially when compared to test 48. Immediately upon increase in the test operating temperature after 20 days, current increased sharply.

After 26 days, the test was stopped and depressurised, specimens along with spool piece and pipelines checked. The following was observed: -

- \* Specimens 1 to 5, no corrosion but were covered with scale from minor to an average rate, a brownish colour on the specimen no 3 is a corrosion product. This is due to circulating tank rubber lining failure.
- \* A thin layer of scale was also found formed on the surfaces of the spool piece and test loop pipelines (figure 8.92).



**Figures 8.92: Spool piece condition at the end of test 54.**

## **5. CONCLUSIONS**

1. Visual inspection at the end of the tests reveals the reduction in scale deposition on the spool piece and pipeline in compare to the test 48. This result was expected as test operating flow rate was increased.
2. Figure 8.93 shows the effect of increase in test flow rate on test applied current demand when compared to test 49.



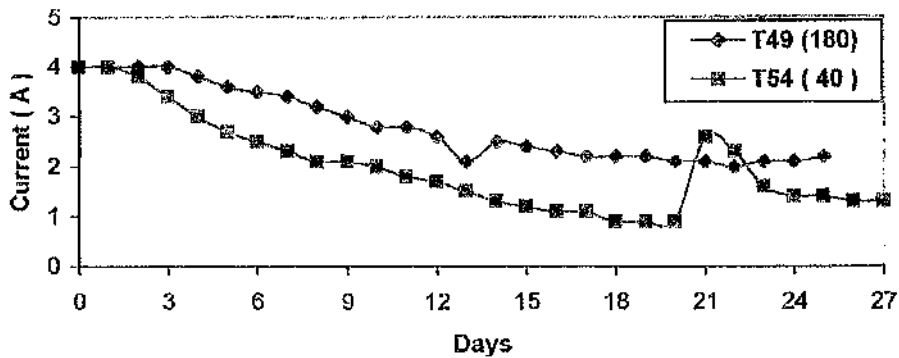

**Figure: 8.93: Effect of increase in operating flow rate and temperature on test applied current (temperature increased from 35 °C to 55 °C after 20 days)**

3. Test loop was fully protected against corrosion as no sign of corrosion was observed.
4. Figure 8.93 also illustrate that demand for applied current increased when test operating, temperature increased after 21 days (from 40 to 55 °C).

**6. NOTE**

It was observed that the circulating tank was corroding due to failure of tank internal rubber lining.

C.P. Status	****	OFF	ON	ON	ON	ON	ON	ON
Time	hrs	0	24	48	72	96	120	144
Group 'A'	Auto Ops	Auto	Auto	Auto	Auto	Auto	Auto	Auto
Set Potential	mV	0	-1050	-1050	-1050	-1050	-1050	-1050
Current	Amps	4	4	3.8	3.4	3	2.7	2.5
Voltage	V	6	6	5.8	5.6	5	4.9	4.7
R. Electrode	MV	****	****	****	****	****	****	****
R1	PANEL	-580	-1050	-1050	-1050	-1050	-1050	-1050
R2	PANEL	-570	-1040	-1090	-1090	-1100	-1090	-1100
R1	LOCALLY	-560	-650	-660	-720	-740	-760	-770
R2	LOCALLY	-560	-800	-820	-850	-870	-920	-950
Group 'B'	Manual Ops	M	M	M	M	M	M	M
Current	Amps	2	2	2	2	2	2	2
Voltage	V	4	4	4	4	4	4	4
R. Electrode	MV	****	****	****	****	****	****	****
R3	PANEL	-790	-1200	-1210	-1220	-1210	-1210	-1220
R4	PANEL	-680	-1150	-1110	-1150	-1120	-1120	-1140
R3	LOCALLY	-780	-1100	-1110	-1110	-1120	-1130	-1120
R4	LOCALLY	-670	-1070	-1070	-1090	-1080	-1090	-1070

C.P. Status	****	ON	ON	ON	ON	ON	ON	ON
Time	hrs	168	192	216	240	264	288	312
Group 'A'	Auto Ops	Auto	Auto	Auto	Auto	Auto	Auto	Auto
Set Potential	mV	-1050	-1050	-1050	-1050	-1050	-1050	-1050
Current	Amps	2.3	2.1	2.1	2	1.8	1.7	1.5
Voltage	V	4.6	4.3	4.4	4.4	4.2	4.2	3.8
R. Electrode	MV	****	****	****	****	****	****	****
R1	PANEL	-1050	-1050	-1050	-1050	-1050	-1050	-1050
R2	PANEL	-1100	-1110	-1100	-1090	-1090	-1100	-1110
R1	LOCALLY	-780	-800	-830	-840	-850	-870	-900
R2	LOCALLY	-950	-980	-1010	-1020	-1020	-1030	-1030
Group 'B'	Manual Ops	M	M	M	M	M	M	M
Current	Amps	2	2	2	2	2	2	2
Voltage	V	4	4	4	4	4	4	4
R. Electrode	MV	****	****	****	****	****	****	****
R3	PANEL	-1230	-1230	-1220	-1220	-1250	-1240	-1240
R4	PANEL	-1140	-1140	-1130	-1140	-1160	-1160	-1160
R3	LOCALLY	-1130	-1140	-1130	-1150	-1150	-1160	-1170
R4	LOCALLY	-1080	-1080	-1090	-1080	-1080	-1090	-1100

C.P. Status	****	ON	ON	ON	ON	ON	ON	ON
Time	hrs	336	360	384	408	432	456	480
Group 'A'	Auto Ops	Auto	Auto	Auto	Auto	Auto	Auto	Auto
Set Potential	mV	-1050	-1050	-1050	-1050	-1050	-1050	-1050
Current	Amps	1.3	1.2	1.1	1.1	0.9	0.9	0.9
Voltage	V	3.6	3.6	3.3	3.3	3.1	3.1	3.1
R. Electrode	MV	****	****	****	****	****	****	****
R1	PANEL	-1050	-1050	-1050	-1050	-1050	-1050	-1050
R2	PANEL	-1120	-1120	-1120	-1090	-1100	-1100	-1120
R1	LOCALLY	-920	-950	-970	-1000	-1020	-1040	-1040
R2	LOCALLY	-1020	-1040	-1050	-1050	-1040	-1050	-1050
Group 'B'	Manual Ops	M	M	M	M	M	M	M
Current	Amps	2	2	2	2	2	2	2
Voltage	V	4	4	4	4	4	4	4
R. Electrode	MV	****	****	****	****	****	****	****
R3	PANEL	-1250	-1240	-1240	-1240	-1250	-1250	-1250
R4	PANEL	-1130	-1140	-1140	-1140	-1150	-1160	-1150
R3	LOCALLY	-1150	-1140	-1150	-1150	-1150	-1150	-1140
R4	LOCALLY	-1080	-1090	-1090	-1090	-1080	-1100	-1100

C.P. Status	****	ON	ON	ON	ON	ON	ON	ON
Time	hrs	504	528	552	576	600	624	648
Group 'A'	Auto Ops	Auto	Auto	Auto	Auto	Auto	Auto	Auto
Set Potential	mV	-1050	-1050	-1050	-1050	-1050	-1050	-1050
Current	Amps	2.6	2.3	1.6	1.4	1.4	1.3	1.3
Voltage	V	4.9	4.6	3.7	3.6	3.6	3.5	3.5
R. Electrode	MV	****	****	****	****	****	****	****
R1	PANEL	-1050	-1050	-1050	-1050	-1050	-1050	-1050
R2	PANEL	-1130	-1140	-1140	-1150	-1150	-1150	-1140
R1	LOCALLY	-1030	-1040	-1040	-1040	-1030	-1040	-1040
R2	LOCALLY	-1050	-1040	-1050	-1050	-1040	-1050	-1050
Group 'B'	Manual Ops	M	M	M	M	M	M	M
Current	Amps	2	2	2	2	2	2	2
Voltage	V	4	4	4	4	4	4	4
R. Electrode	MV	****	****	****	****	****	****	****
R3	PANEL	-1250	-1250	-1250	-1240	-1250	-1250	-1250
R4	PANEL	-1130	-1150	-1150	-1140	-1150	-1150	-1150
R3	LOCALLY	-1150	-1150	-1150	-1150	-1150	-1150	-1140
R4	LOCALLY	-1080	-1100	-1100	-1090	-1090	-1100	-1110

Table 8.46: Summary of, test daily readings

**TEST NO 55****1. Parameters summary**

Items	Units	Data
Control Potential	mV	-1050
Flow Rate	m <sup>3</sup> /hr	7.5
Temperature	°C	55 to 60 then reduced to 40
T.D.S	ppm	43,000
Test Duration	Days	25
Acid washed	****	Yes

**2. PURPOSE**

The purpose of this test was: -

1. To monitor effect of temperature variation on test demand for applied current when compared to test 45.
2. To investigate the rate and duration in which scale forms at the surface of the specimen, and test loop pipelines after complete test loop acid wash.
3. To check effect of decrease in test temperature on test applied current when test loop was covered with scale.

**3. PROCEDURE**

The test procedure used was similar to test 50 (temperature was reduced toward the end of the test).

**4. FINDINGS**

Test rig was stopped once for specimens inspection after 14 days. The following were observed: -

- \* Specimens 1 and 2, were slightly covered with corrosion products from circulating tank. Scale was found formed on specimens surfaces. A closer look at the specimens re-confirmed that actual brown colour is not a rust.
- \* Specimens 3,4, and 5, no corrosion, and were fully covered with thicker layer of scale.

Figure 8.94 shows the effect of increase in test temperature on test current. There was slight tendency for a greater early rate of current decline at the higher temperature but, after about 6 days the current was higher at 60 °C. Immediately upon decrease in the test operating temperature after 20 days, current decreased as expected.

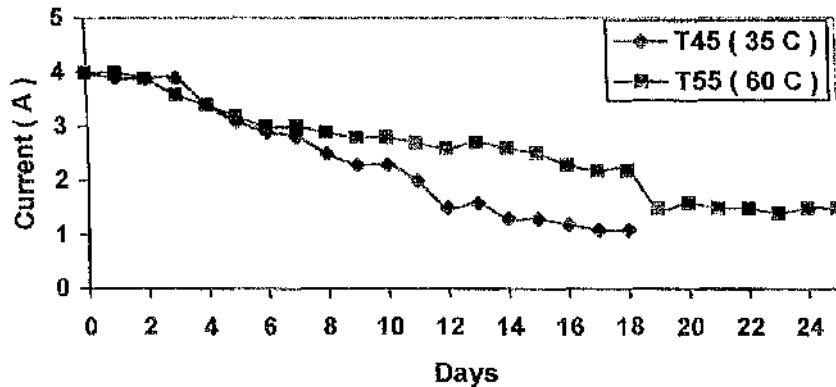

**Figure 8.94: Effect of temperature on test applied current**

After 25 days, test stopped and depressurised, specimens along with spool piece and pipelines checked. Following were observed: -

- \* Specimens 1 to 5, no corrosion found in good conditions, layer of scale of different rate was seen on the surfaces of specimens.
- \* Spool piece and pipelines, no corrosion but were covered with scale.

## 5. CONCLUSIONS

1. Scale deposition rate found sufficient and whitish in nature.
2. Scale was formed on the surface of the pipelines and specimens just after first system visual inspection.

## 6. NOTE

1. Specimens 4 and 5 brought to Glasgow for further chemical analysis.
2. Circulating tank rubber lining failure increased.

<b>C.P. Status</b>	<b>****</b>	<b>OFF</b>	<b>ON</b>	<b>ON</b>	<b>ON</b>	<b>ON</b>	<b>ON</b>	<b>ON</b>
<b>Time</b>	<b>hrs</b>	<b>0</b>	<b>24</b>	<b>48</b>	<b>72</b>	<b>96</b>	<b>120</b>	<b>144</b>
<b>Group 'A'</b>	<b>Auto Ops</b>	<b>Auto</b>	<b>Auto</b>	<b>Auto</b>	<b>Auto</b>	<b>Auto</b>	<b>Auto</b>	<b>Auto</b>
<b>Set Potential</b>	<b>mV</b>	<b>0</b>	<b>-1050</b>	<b>-1050</b>	<b>-1050</b>	<b>-1050</b>	<b>-1050</b>	<b>-1050</b>
<b>Current</b>	<b>Amps</b>	<b>4</b>	<b>4</b>	<b>3.9</b>	<b>3.6</b>	<b>3.4</b>	<b>3.2</b>	<b>3</b>
<b>Voltage</b>	<b>V</b>	<b>6</b>	<b>6</b>	<b>5.8</b>	<b>5.5</b>	<b>5.4</b>	<b>5.2</b>	<b>5</b>
<b>R. Electrode</b>	<b>MV</b>	<b>****</b>	<b>****</b>	<b>****</b>	<b>****</b>	<b>****</b>	<b>****</b>	<b>****</b>
<b>R1</b>	<b>PANEL</b>	<b>-550</b>	<b>-1050</b>	<b>-1050</b>	<b>-1050</b>	<b>-1050</b>	<b>-1050</b>	<b>-1050</b>
<b>R2</b>	<b>PANEL</b>	<b>-610</b>	<b>-1020</b>	<b>-1090</b>	<b>-1100</b>	<b>-1120</b>	<b>-1120</b>	<b>-1130</b>
<b>R1</b>	<b>LOCALLY</b>	<b>-520</b>	<b>-650</b>	<b>-710</b>	<b>-750</b>	<b>-800</b>	<b>-840</b>	<b>-910</b>
<b>R2</b>	<b>LOCALLY</b>	<b>-600</b>	<b>-810</b>	<b>-860</b>	<b>-900</b>	<b>-920</b>	<b>-960</b>	<b>-1000</b>
<b>Group 'B'</b>	<b>Manual Ops</b>	<b>M</b>	<b>M</b>	<b>M</b>	<b>M</b>	<b>M</b>	<b>M</b>	<b>M</b>
<b>Current</b>	<b>Amps</b>	<b>2</b>	<b>2</b>	<b>2</b>	<b>2</b>	<b>2</b>	<b>2</b>	<b>2</b>
<b>Voltage</b>	<b>V</b>	<b>4</b>	<b>4</b>	<b>4</b>	<b>4</b>	<b>4</b>	<b>4</b>	<b>4</b>
<b>R. Electrode</b>	<b>MV</b>	<b>****</b>	<b>****</b>	<b>****</b>	<b>****</b>	<b>****</b>	<b>****</b>	<b>****</b>
<b>R3</b>	<b>PANEL</b>	<b>-590</b>	<b>-1220</b>	<b>-1210</b>	<b>-1250</b>	<b>-1250</b>	<b>-1240</b>	<b>-1250</b>
<b>R4</b>	<b>PANEL</b>	<b>-630</b>	<b>-1120</b>	<b>-1140</b>	<b>-1150</b>	<b>-1140</b>	<b>-1140</b>	<b>-1140</b>
<b>R3</b>	<b>LOCALLY</b>	<b>-550</b>	<b>-1000</b>	<b>-1110</b>	<b>-1100</b>	<b>-1100</b>	<b>-1110</b>	<b>-1100</b>
<b>R4</b>	<b>LOCALLY</b>	<b>-650</b>	<b>-1050</b>	<b>-1100</b>	<b>-1090</b>	<b>-1090</b>	<b>-1090</b>	<b>-1110</b>

<b>C.P. Status</b>	<b>****</b>	<b>ON</b>	<b>ON</b>	<b>ON</b>	<b>ON</b>	<b>ON</b>	<b>ON</b>	<b>ON</b>
<b>Time</b>	<b>hrs</b>	<b>168</b>	<b>192</b>	<b>216</b>	<b>240</b>	<b>264</b>	<b>288</b>	<b>312</b>
<b>Group 'A'</b>	<b>Auto Ops</b>	<b>Auto</b>	<b>Auto</b>	<b>Auto</b>	<b>Auto</b>	<b>Auto</b>	<b>Auto</b>	<b>Auto</b>
<b>Set Potential</b>	<b>mV</b>	<b>-1050</b>	<b>-1050</b>	<b>-1050</b>	<b>-1050</b>	<b>-1050</b>	<b>-1050</b>	<b>-1050</b>
<b>Current</b>	<b>Amps</b>	<b>3</b>	<b>2.9</b>	<b>2.8</b>	<b>2.8</b>	<b>2.7</b>	<b>2.6</b>	<b>2.7</b>
<b>Voltage</b>	<b>V</b>	<b>5</b>	<b>5.1</b>	<b>5.1</b>	<b>5.1</b>	<b>4.9</b>	<b>4.6</b>	<b>4.8</b>
<b>R. Electrode</b>	<b>MV</b>	<b>****</b>	<b>****</b>	<b>****</b>	<b>****</b>	<b>****</b>	<b>****</b>	<b>****</b>
<b>R1</b>	<b>PANEL</b>	<b>-1050</b>	<b>-1050</b>	<b>-1050</b>	<b>-1050</b>	<b>-1050</b>	<b>-1050</b>	<b>-1050</b>
<b>R2</b>	<b>PANEL</b>	<b>-1120</b>	<b>-1110</b>	<b>-1100</b>	<b>-1100</b>	<b>-1090</b>	<b>-1100</b>	<b>-1110</b>
<b>R1</b>	<b>LOCALLY</b>	<b>-940</b>	<b>-970</b>	<b>-980</b>	<b>-990</b>	<b>-1000</b>	<b>-1010</b>	<b>-1010</b>
<b>R2</b>	<b>LOCALLY</b>	<b>-1010</b>	<b>-1030</b>	<b>-1030</b>	<b>-1040</b>	<b>-1040</b>	<b>-1040</b>	<b>-1040</b>
<b>Group 'B'</b>	<b>Manual Ops</b>	<b>M</b>	<b>M</b>	<b>M</b>	<b>M</b>	<b>M</b>	<b>M</b>	<b>M</b>
<b>Current</b>	<b>Amps</b>	<b>2</b>	<b>2</b>	<b>2</b>	<b>2</b>	<b>2</b>	<b>2</b>	<b>2</b>
<b>Voltage</b>	<b>V</b>	<b>4</b>	<b>4</b>	<b>4</b>	<b>4</b>	<b>4</b>	<b>4</b>	<b>4</b>
<b>R. Electrode</b>	<b>MV</b>	<b>****</b>	<b>****</b>	<b>****</b>	<b>****</b>	<b>****</b>	<b>****</b>	<b>****</b>
<b>R3</b>	<b>PANEL</b>	<b>-1240</b>	<b>-1230</b>	<b>-1220</b>	<b>-1230</b>	<b>-1240</b>	<b>-1240</b>	<b>-1240</b>
<b>R4</b>	<b>PANEL</b>	<b>-1140</b>	<b>-1140</b>	<b>-1130</b>	<b>-1140</b>	<b>-1170</b>	<b>-1160</b>	<b>-1170</b>
<b>R3</b>	<b>LOCALLY</b>	<b>-1120</b>	<b>-1140</b>	<b>-1120</b>	<b>-1150</b>	<b>-1160</b>	<b>-1170</b>	<b>-1170</b>
<b>R4</b>	<b>LOCALLY</b>	<b>-1090</b>	<b>-1120</b>	<b>-1090</b>	<b>-1080</b>	<b>-1090</b>	<b>-1100</b>	<b>-1120</b>

<b>C.P. Status</b>	<b>****</b>	<b>ON</b>	<b>ON</b>	<b>ON</b>	<b>ON</b>	<b>ON</b>	<b>ON</b>	<b>ON</b>
<b>Time</b>	<b>hrs</b>	<b>336</b>	<b>360</b>	<b>384</b>	<b>408</b>	<b>432</b>	<b>456</b>	<b>480</b>
<b>Group 'A'</b>	<b>Auto Ops</b>	<b>Auto</b>	<b>Auto</b>	<b>Auto</b>	<b>Auto</b>	<b>Auto</b>	<b>Auto</b>	<b>Auto</b>
<b>Set Potential</b>	<b>mV</b>	<b>-1050</b>	<b>-1050</b>	<b>-1050</b>	<b>-1050</b>	<b>-1050</b>	<b>-1050</b>	<b>-1050</b>
<b>Current</b>	<b>Amps</b>	<b>2.6</b>	<b>2.5</b>	<b>2.3</b>	<b>2.2</b>	<b>2.2</b>	<b>1.5</b>	<b>1.6</b>
<b>Voltage</b>	<b>V</b>	<b>4.8</b>	<b>4.8</b>	<b>4.5</b>	<b>4.4</b>	<b>4.3</b>	<b>4</b>	<b>4.1</b>
<b>R. Electrode</b>	<b>MV</b>	<b>****</b>	<b>****</b>	<b>****</b>	<b>****</b>	<b>****</b>	<b>****</b>	<b>****</b>
<b>R1</b>	<b>PANEL</b>	<b>-1050</b>	<b>-1050</b>	<b>-1050</b>	<b>-1050</b>	<b>-1050</b>	<b>-1050</b>	<b>-1050</b>
<b>R2</b>	<b>PANEL</b>	<b>-1100</b>	<b>-1110</b>	<b>-1100</b>	<b>-1090</b>	<b>-1100</b>	<b>-1120</b>	<b>-1120</b>
<b>R1</b>	<b>LOCALLY</b>	<b>-1010</b>	<b>-1020</b>	<b>-1030</b>	<b>-1030</b>	<b>-1030</b>	<b>-1030</b>	<b>-1040</b>
<b>R2</b>	<b>LOCALLY</b>	<b>-1040</b>	<b>-1050</b>	<b>-1040</b>	<b>-1050</b>	<b>-1050</b>	<b>-1050</b>	<b>-1040</b>
<b>Group 'B'</b>	<b>Manual Ops</b>	<b>M</b>	<b>M</b>	<b>M</b>	<b>M</b>	<b>M</b>	<b>M</b>	<b>M</b>
<b>Current</b>	<b>Amps</b>	<b>2</b>	<b>2</b>	<b>2</b>	<b>2</b>	<b>2</b>	<b>2</b>	<b>2</b>
<b>Voltage</b>	<b>V</b>	<b>4</b>	<b>4</b>	<b>4</b>	<b>4</b>	<b>4</b>	<b>4</b>	<b>4</b>
<b>R. Electrode</b>	<b>MV</b>	<b>****</b>	<b>****</b>	<b>****</b>	<b>****</b>	<b>****</b>	<b>****</b>	<b>****</b>
<b>R3</b>	<b>PANEL</b>	<b>-1250</b>	<b>-1240</b>	<b>-1230</b>	<b>-1250</b>	<b>-1240</b>	<b>-1250</b>	<b>-1260</b>
<b>R4</b>	<b>PANEL</b>	<b>-1170</b>	<b>-1160</b>	<b>-1160</b>	<b>-1160</b>	<b>-1170</b>	<b>-1160</b>	<b>-1170</b>
<b>R3</b>	<b>LOCALLY</b>	<b>-1160</b>	<b>-1150</b>	<b>-1150</b>	<b>-1150</b>	<b>-1150</b>	<b>-1160</b>	<b>-1150</b>
<b>R4</b>	<b>LOCALLY</b>	<b>-1120</b>	<b>-1100</b>	<b>-1100</b>	<b>-1090</b>	<b>-1120</b>	<b>-1130</b>	<b>-1120</b>

<b>C.P. Status</b>	<b>****</b>	<b>ON</b>	<b>ON</b>	<b>ON</b>	<b>ON</b>	<b>ON</b>
<b>Time</b>	<b>hrs</b>	<b>504</b>	<b>528</b>	<b>552</b>	<b>576</b>	<b>600</b>
<b>Group 'A'</b>	<b>Auto Ops</b>	<b>Auto</b>	<b>Auto</b>	<b>Auto</b>	<b>Auto</b>	<b>Auto</b>
<b>Set Potential</b>	<b>mV</b>	<b>-1050</b>	<b>-1050</b>	<b>-1050</b>	<b>-1050</b>	<b>-1050</b>
<b>Current</b>	<b>Amps</b>	<b>1.5</b>	<b>1.5</b>	<b>1.4</b>	<b>1.5</b>	<b>1.5</b>
<b>Voltage</b>	<b>V</b>	<b>4</b>	<b>4</b>	<b>3.9</b>	<b>4</b>	<b>4</b>
<b>R. Electrode</b>	<b>MV</b>	<b>****</b>	<b>****</b>	<b>****</b>	<b>****</b>	<b>****</b>
<b>R1</b>	<b>PANEL</b>	<b>-1050</b>	<b>-1050</b>	<b>-1050</b>	<b>-1050</b>	<b>-1050</b>
<b>R2</b>	<b>PANEL</b>	<b>-1120</b>	<b>-1120</b>	<b>-1130</b>	<b>-1150</b>	<b>-1130</b>
<b>R1</b>	<b>LOCALLY</b>	<b>-1030</b>	<b>-1040</b>	<b>-1040</b>	<b>-1040</b>	<b>-1040</b>
<b>R2</b>	<b>LOCALLY</b>	<b>-1040</b>	<b>-1040</b>	<b>-1050</b>	<b>-1050</b>	<b>-1040</b>
<b>Group 'B'</b>	<b>Manual Ops</b>	<b>M</b>	<b>M</b>	<b>M</b>	<b>M</b>	<b>M</b>
<b>Current</b>	<b>Amps</b>	<b>2</b>	<b>2</b>	<b>2</b>	<b>2</b>	<b>2</b>
<b>Voltage</b>	<b>V</b>	<b>4</b>	<b>4</b>	<b>4</b>	<b>4</b>	<b>4</b>
<b>R. Electrode</b>	<b>MV</b>	<b>****</b>	<b>****</b>	<b>****</b>	<b>****</b>	<b>****</b>
<b>R3</b>	<b>PANEL</b>	<b>-1240</b>	<b>-1250</b>	<b>-1230</b>	<b>-1250</b>	<b>-1250</b>
<b>R4</b>	<b>PANEL</b>	<b>-1150</b>	<b>-1170</b>	<b>-1170</b>	<b>-1160</b>	<b>-1150</b>
<b>R3</b>	<b>LOCALLY</b>	<b>-1160</b>	<b>-1150</b>	<b>-1160</b>	<b>-1150</b>	<b>-1150</b>
<b>R4</b>	<b>LOCALLY</b>	<b>-1110</b>	<b>-1120</b>	<b>-1120</b>	<b>-1120</b>	<b>-1100</b>

Table 8.47: Summary of, test daily readings

**TEST NO 56****1. Parameters summary**

Items	Units	Data
Control Potential	mV	-900
Flow Rate	m <sup>3</sup> /hr	180
Temperature	<sup>o</sup> C	45 to 48
T.D.S	ppm	43,000
Test Duration	Days	27
Acid washed	****	Yes

**2. PURPOSE**

The purpose of this test was to monitor effect of high flow rate and temperature while performing the test at set control potential of -900 mV on the: -

- \* Rate and duration in which scale forms on the specimens and test pipeline surfaces.
- \* Test applied current demand for maintaining the test loop under protection cathodically.

**3. PROCEDURE**

The test procedure used was the same as test 51, with the exception in changing operating parameters.

**4. FINDINGS**

The test loop which included the mild steel pipelines and the specimens were protected cathodically for about 27 days at a set control potential of -900 mV on group 'A' and galvanostatic control at 2 amps in group 'B'. The local potential readings shown in table 8.48 indicates the slow shift in local potential towards the target values over the period of 15 days. Test loop was cathodically protected for 27 days at a set control potential of -900 mV. After 27 days, the test was completed and depressurised, specimens along with spool piece and pipelines were checked and following were observed: -

- \* Specimens 1 to 5, no corrosion, minor layer of scale was seen on the surface of the specimens (figure 8.95).
- \* Spool piece and pipelines, no corrosion, thin layer of scale was seen formed.





Figures 8.95: Specimens condition at the end of test 56.

#### 4. CONCLUSIONS

1. Scale deposition rate found sufficient but less, mainly due to less negative control potential and test high flow rate.
2. Figure 8.96 shows that, test applied current reduced with time, mainly due to scale deposition on the surface of the test loop during the test.

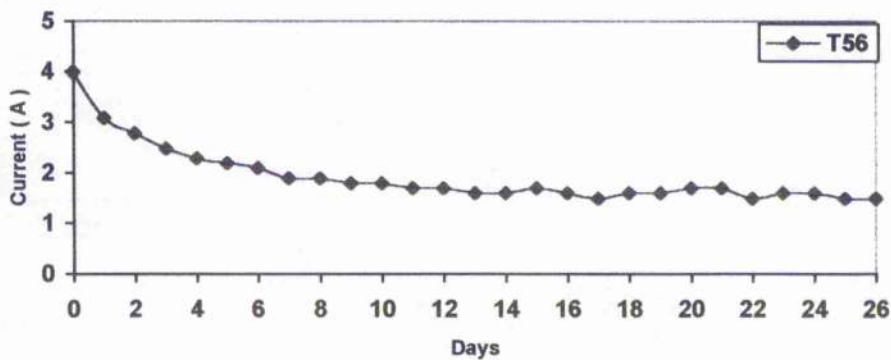

Figure 8.96: Current trend vs. time

<b>C.P. Status</b>	<b>****</b>	<b>OFF</b>	<b>ON</b>	<b>ON</b>	<b>ON</b>	<b>ON</b>	<b>ON</b>	<b>ON</b>
<b>Time</b>	<b>hrs</b>	<b>0</b>	<b>24</b>	<b>48</b>	<b>72</b>	<b>96</b>	<b>120</b>	<b>144</b>
<b>Group 'A'</b>	<b>Auto Ops</b>	<b>Auto</b>	<b>Auto</b>	<b>Auto</b>	<b>Auto</b>	<b>Auto</b>	<b>Auto</b>	<b>Auto</b>
<b>Set Potential</b>	<b>mV</b>	<b>0</b>	<b>-900</b>	<b>-900</b>	<b>-900</b>	<b>-900</b>	<b>-900</b>	<b>-900</b>
<b>Current</b>	<b>Amps</b>	<b>4</b>	<b>3.1</b>	<b>2.8</b>	<b>2.5</b>	<b>2.3</b>	<b>2.2</b>	<b>2.1</b>
<b>Voltage</b>	<b>V</b>	<b>6</b>	<b>5.3</b>	<b>5</b>	<b>4.8</b>	<b>4.5</b>	<b>4.4</b>	<b>4.3</b>
<b>R. Electrode</b>	<b>MV</b>	<b>****</b>	<b>****</b>	<b>****</b>	<b>****</b>	<b>****</b>	<b>****</b>	<b>****</b>
<b>R1</b>	<b>PANEL</b>	<b>-520</b>	<b>-900</b>	<b>-900</b>	<b>-900</b>	<b>-900</b>	<b>-900</b>	<b>-900</b>
<b>R2</b>	<b>PANEL</b>	<b>-510</b>	<b>-1000</b>	<b>-1010</b>	<b>-1010</b>	<b>-1020</b>	<b>-1010</b>	<b>-1020</b>
<b>R1</b>	<b>LOCALLY</b>	<b>-515</b>	<b>-560</b>	<b>-580</b>	<b>-610</b>	<b>-650</b>	<b>-660</b>	<b>-680</b>
<b>R2</b>	<b>LOCALLY</b>	<b>-500</b>	<b>-650</b>	<b>-700</b>	<b>-720</b>	<b>-750</b>	<b>-770</b>	<b>-800</b>
<b>Group 'B'</b>	<b>Manual Ops</b>	<b>M</b>	<b>M</b>	<b>M</b>	<b>M</b>	<b>M</b>	<b>M</b>	<b>M</b>
<b>Current</b>	<b>Amps</b>	<b>2</b>	<b>2</b>	<b>2</b>	<b>2</b>	<b>2</b>	<b>2</b>	<b>2</b>
<b>Voltage</b>	<b>V</b>	<b>4</b>	<b>4</b>	<b>4</b>	<b>4</b>	<b>4</b>	<b>4</b>	<b>4</b>
<b>R. Electrode</b>	<b>MV</b>	<b>****</b>	<b>****</b>	<b>****</b>	<b>****</b>	<b>****</b>	<b>****</b>	<b>****</b>
<b>R3</b>	<b>PANEL</b>	<b>-500</b>	<b>-1250</b>	<b>-1260</b>	<b>-1250</b>	<b>-1260</b>	<b>-1260</b>	<b>-1250</b>
<b>R4</b>	<b>PANEL</b>	<b>-550</b>	<b>-1160</b>	<b>-1160</b>	<b>-1150</b>	<b>-1170</b>	<b>-1170</b>	<b>-1160</b>
<b>R3</b>	<b>LOCALLY</b>	<b>-505</b>	<b>-1050</b>	<b>-1120</b>	<b>-1150</b>	<b>-1150</b>	<b>-1150</b>	<b>-1160</b>
<b>R4</b>	<b>LOCALLY</b>	<b>-560</b>	<b>-1050</b>	<b>-1090</b>	<b>-1090</b>	<b>-1110</b>	<b>-1090</b>	<b>-1110</b>

<b>C.P. Status</b>	<b>****</b>	<b>ON</b>	<b>ON</b>	<b>ON</b>	<b>ON</b>	<b>ON</b>	<b>ON</b>	<b>ON</b>
<b>Time</b>	<b>hrs</b>	<b>168</b>	<b>192</b>	<b>216</b>	<b>240</b>	<b>264</b>	<b>288</b>	<b>312</b>
<b>Group 'A'</b>	<b>Auto Ops</b>	<b>Auto</b>	<b>Auto</b>	<b>Auto</b>	<b>Auto</b>	<b>Auto</b>	<b>Auto</b>	<b>Auto</b>
<b>Set Potential</b>	<b>mV</b>	<b>-900</b>	<b>-900</b>	<b>-900</b>	<b>-900</b>	<b>-900</b>	<b>-900</b>	<b>-900</b>
<b>Current</b>	<b>Amps</b>	<b>1.9</b>	<b>1.9</b>	<b>1.8</b>	<b>1.8</b>	<b>1.7</b>	<b>1.7</b>	<b>1.6</b>
<b>Voltage</b>	<b>V</b>	<b>4.3</b>	<b>4.3</b>	<b>4.1</b>	<b>4.1</b>	<b>4.1</b>	<b>4.1</b>	<b>4</b>
<b>R. Electrode</b>	<b>MV</b>	<b>****</b>	<b>****</b>	<b>****</b>	<b>****</b>	<b>****</b>	<b>****</b>	<b>****</b>
<b>R1</b>	<b>PANEL</b>	<b>-900</b>	<b>-900</b>	<b>-900</b>	<b>-900</b>	<b>-900</b>	<b>-900</b>	<b>-900</b>
<b>R2</b>	<b>PANEL</b>	<b>-1010</b>	<b>-1010</b>	<b>-1010</b>	<b>-1010</b>	<b>-1020</b>	<b>-1010</b>	<b>-1010</b>
<b>R1</b>	<b>LOCALLY</b>	<b>-710</b>	<b>-740</b>	<b>-760</b>	<b>-790</b>	<b>-810</b>	<b>-840</b>	<b>-850</b>
<b>R2</b>	<b>LOCALLY</b>	<b>-830</b>	<b>-850</b>	<b>-860</b>	<b>-880</b>	<b>-910</b>	<b>-910</b>	<b>-920</b>
<b>Group 'B'</b>	<b>Manual Ops</b>	<b>M</b>	<b>M</b>	<b>M</b>	<b>M</b>	<b>M</b>	<b>M</b>	<b>M</b>
<b>Current</b>	<b>Amps</b>	<b>2</b>	<b>2</b>	<b>2</b>	<b>2</b>	<b>2</b>	<b>2</b>	<b>2</b>
<b>Voltage</b>	<b>V</b>	<b>4</b>	<b>4</b>	<b>4</b>	<b>4</b>	<b>4</b>	<b>4</b>	<b>4</b>
<b>R. Electrode</b>	<b>MV</b>	<b>****</b>	<b>****</b>	<b>****</b>	<b>****</b>	<b>****</b>	<b>****</b>	<b>****</b>
<b>R3</b>	<b>PANEL</b>	<b>-1240</b>	<b>-1250</b>	<b>-1250</b>	<b>-1250</b>	<b>-1240</b>	<b>-1250</b>	<b>-1250</b>
<b>R4</b>	<b>PANEL</b>	<b>-1150</b>	<b>-1150</b>	<b>-1160</b>	<b>-1150</b>	<b>-1170</b>	<b>-1160</b>	<b>-1160</b>
<b>R3</b>	<b>LOCALLY</b>	<b>-1160</b>	<b>-1150</b>	<b>-1140</b>	<b>-1150</b>	<b>-1160</b>	<b>-1180</b>	<b>-1180</b>
<b>R4</b>	<b>LOCALLY</b>	<b>-1100</b>	<b>-1110</b>	<b>-1090</b>	<b>-1090</b>	<b>-1110</b>	<b>-1100</b>	<b>-1110</b>

<b>C.P. Status</b>	<b>****</b>	<b>ON</b>	<b>ON</b>	<b>ON</b>	<b>ON</b>	<b>ON</b>	<b>ON</b>	<b>ON</b>
<b>Time</b>	<b>hrs</b>	<b>336</b>	<b>360</b>	<b>384</b>	<b>408</b>	<b>432</b>	<b>456</b>	<b>480</b>
<b>Group 'A'</b>	<b>Auto Ops</b>	<b>Auto</b>	<b>Auto</b>	<b>Auto</b>	<b>Auto</b>	<b>Auto</b>	<b>Auto</b>	<b>Auto</b>
<b>Set Potential</b>	<b>mV</b>	<b>-900</b>	<b>-900</b>	<b>-900</b>	<b>-900</b>	<b>-900</b>	<b>-900</b>	<b>-900</b>
<b>Current</b>	<b>Amps</b>	<b>1.6</b>	<b>1.7</b>	<b>1.6</b>	<b>1.5</b>	<b>1.6</b>	<b>1.6</b>	<b>1.7</b>
<b>Voltage</b>	<b>V</b>	<b>4</b>	<b>4.1</b>	<b>4</b>	<b>3.9</b>	<b>4</b>	<b>4</b>	<b>4.1</b>
<b>R. Electrode</b>	<b>MV</b>	<b>****</b>	<b>****</b>	<b>****</b>	<b>****</b>	<b>****</b>	<b>****</b>	<b>****</b>
<b>R1</b>	<b>PANEL</b>	<b>-900</b>	<b>-900</b>	<b>-900</b>	<b>-900</b>	<b>-900</b>	<b>-900</b>	<b>-900</b>
<b>R2</b>	<b>PANEL</b>	<b>-1010</b>	<b>-1020</b>	<b>-1010</b>	<b>-1000</b>	<b>-1000</b>	<b>-1000</b>	<b>-1010</b>
<b>R1</b>	<b>LOCALLY</b>	<b>-870</b>	<b>-900</b>	<b>-900</b>	<b>-900</b>	<b>-900</b>	<b>-900</b>	<b>-900</b>
<b>R2</b>	<b>LOCALLY</b>	<b>-910</b>	<b>-910</b>	<b>-900</b>	<b>-900</b>	<b>-910</b>	<b>-900</b>	<b>-900</b>
<b>Group 'B'</b>	<b>Manual Ops</b>	<b>M</b>	<b>M</b>	<b>M</b>	<b>M</b>	<b>M</b>	<b>M</b>	<b>M</b>
<b>Current</b>	<b>Amps</b>	<b>2</b>	<b>2</b>	<b>2</b>	<b>2</b>	<b>2</b>	<b>2</b>	<b>2</b>
<b>Voltage</b>	<b>V</b>	<b>4</b>	<b>4</b>	<b>4</b>	<b>4</b>	<b>4</b>	<b>4</b>	<b>4</b>
<b>R. Electrode</b>	<b>MV</b>	<b>****</b>	<b>****</b>	<b>****</b>	<b>****</b>	<b>****</b>	<b>****</b>	<b>****</b>
<b>R3</b>	<b>PANEL</b>	<b>-1240</b>	<b>-1250</b>	<b>-1250</b>	<b>-1250</b>	<b>-1250</b>	<b>-1250</b>	<b>-1250</b>
<b>R4</b>	<b>PANEL</b>	<b>-1160</b>	<b>-1160</b>	<b>-1160</b>	<b>-1170</b>	<b>-1170</b>	<b>-1170</b>	<b>-1170</b>
<b>R3</b>	<b>LOCALLY</b>	<b>-1150</b>	<b>-1150</b>	<b>-1160</b>	<b>-1160</b>	<b>-1150</b>	<b>-1170</b>	<b>-1150</b>
<b>R4</b>	<b>LOCALLY</b>	<b>-1110</b>	<b>-1100</b>	<b>-1110</b>	<b>-1110</b>	<b>-1100</b>	<b>-1110</b>	<b>-1120</b>

<b>C.P. Status</b>	<b>****</b>	<b>ON</b>	<b>ON</b>	<b>ON</b>	<b>ON</b>	<b>ON</b>
<b>Time</b>	<b>hrs</b>	<b>504</b>	<b>528</b>	<b>552</b>	<b>576</b>	<b>600-624</b>
<b>Group 'A'</b>	<b>Auto Ops</b>	<b>Auto</b>	<b>Auto</b>	<b>Auto</b>	<b>Auto</b>	<b>Auto</b>
<b>Set Potential</b>	<b>mV</b>	<b>-900</b>	<b>-900</b>	<b>-900</b>	<b>-900</b>	<b>-900</b>
<b>Current</b>	<b>Amps</b>	<b>1.7</b>	<b>1.5</b>	<b>1.6</b>	<b>1.6</b>	<b>1.5</b>
<b>Voltage</b>	<b>V</b>	<b>4.1</b>	<b>3.9</b>	<b>3.9</b>	<b>3.9</b>	<b>3.8</b>
<b>R. Electrode</b>	<b>MV</b>	<b>****</b>	<b>****</b>	<b>****</b>	<b>****</b>	<b>****</b>
<b>R1</b>	<b>PANEL</b>	<b>-900</b>	<b>-900</b>	<b>-900</b>	<b>-900</b>	<b>-900</b>
<b>R2</b>	<b>PANEL</b>	<b>-1010</b>	<b>-1020</b>	<b>-1000</b>	<b>-1010</b>	<b>-1010</b>
<b>R1</b>	<b>LOCALLY</b>	<b>-900</b>	<b>-900</b>	<b>-900</b>	<b>-900</b>	<b>-900</b>
<b>R2</b>	<b>LOCALLY</b>	<b>-900</b>	<b>-910</b>	<b>-900</b>	<b>-900</b>	<b>-900</b>
<b>Group 'B'</b>	<b>Manual Ops</b>	<b>M</b>	<b>M</b>	<b>M</b>	<b>M</b>	<b>M</b>
<b>Current</b>	<b>Amps</b>	<b>2</b>	<b>2</b>	<b>2</b>	<b>2</b>	<b>2</b>
<b>Voltage</b>	<b>V</b>	<b>4</b>	<b>4</b>	<b>4</b>	<b>4</b>	<b>4</b>
<b>R. Electrode</b>	<b>MV</b>	<b>****</b>	<b>****</b>	<b>****</b>	<b>****</b>	<b>****</b>
<b>R3</b>	<b>PANEL</b>	<b>-1240</b>	<b>-1250</b>	<b>-1240</b>	<b>-1240</b>	<b>-1250</b>
<b>R4</b>	<b>PANEL</b>	<b>-1160</b>	<b>-1170</b>	<b>-1160</b>	<b>-1160</b>	<b>-1160</b>
<b>R3</b>	<b>LOCALLY</b>	<b>-1140</b>	<b>-1160</b>	<b>-1150</b>	<b>-1150</b>	<b>-1160</b>
<b>R4</b>	<b>LOCALLY</b>	<b>-1100</b>	<b>-1100</b>	<b>-1110</b>	<b>-1100</b>	<b>-1100</b>

Table 8.48: Summary of, test daily readings

**TEST NO 57****1. Parameters summary**

Items	Units	Data
Control Potential	mV	-900
Flow Rate	m <sup>3</sup> /hr	180
Temperature	<sup>o</sup> C	30
T.D.S	ppm	43,000
Test Duration	Days	29
Acid washed	****	Yes

**2. PURPOSE**

The purpose of this test was: -

1. To monitor effect of temperature variation on test demand for applied current when compared to test 56.
2. To investigate the rate and duration in which scale forms at the surface of the specimen, and test loop pipelines after complete test loop acid wash.
3. To check effect of less negative potential in test applied current when compared to test 49.

**3. PROCEDURE**

The test procedure used was similar to test 56, with exception that operating temperature was reduced.

**4. FINDINGS**

The test loop which included the mild steel pipelines and the specimens were protected cathodically for about 29 days at a set control potential of -900 mV on group 'A' and galvanostatic control at 2 amps in group 'B'. The effect of reduction in test operating temperature on applied current was obvious when compared to test 56. After 10 days test was stopped specimens inspection, findings were as follows: -

- \* Specimen 1 and 2, no corrosion, scale was formed but did not cover the specimen entirely.
- \* Specimen 3 and 4, no corrosion, scale was thicker and more uniformed.

After 29 days, the test was completed and loop depressurised, specimens along with spool piece and pipelines were removed and following observed: -

- \* Specimens 1 to 5, no corrosion, scale of different rate was formed on the surface of the specimens (figure 8.97).
- \* Spool piece and pipelines were covered with thin layer of scale.



**Figures 8.97: Specimens condition at the end of test 57.**

## 5. CONCLUSIONS

1. Scale deposition rate was almost similar to test 56. This illustrates that, a temperature variation in the areas where flow velocity is higher has less effect in scale deposition. This hence demonstrated that, a flow rate variation has a greater impact in initial designing of the on line impressed current cathodic protection system.
2. Figure 8.98 shows effect of decrease in temperature on test applied. The test applied current reduced as expected when compared to test 56.

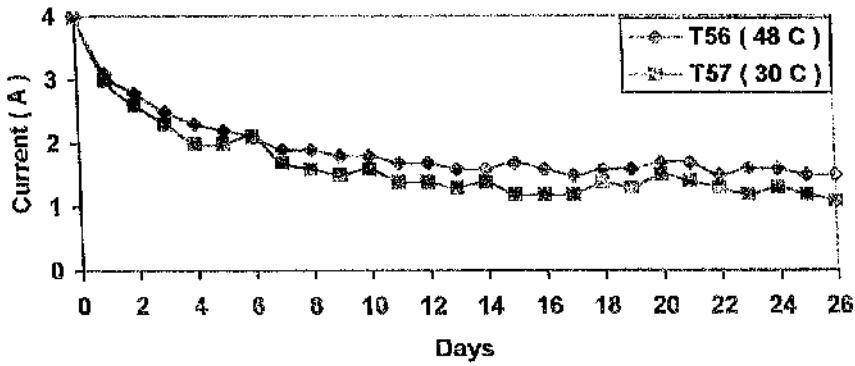

Figure 8.98: Temperature effect on test applied current

3. Figure 8.99 illustrates effect of variation in test control potential on applied current.

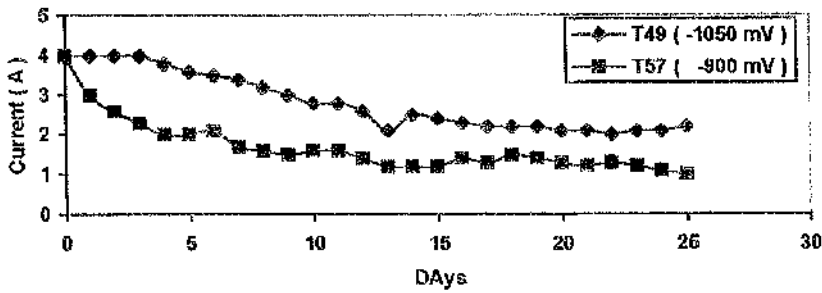

Figure 8.99: Control potential effect on test applied current

<b>C.P. Status</b>	****	OFF	ON	ON	ON	ON	ON	ON
<b>Time</b>	hrs	0	24	48	72	96	120	144
<b>Group 'A'</b>	Auto Ops	Auto	Auto	Auto	Auto	Auto	Auto	Auto
<b>Set Potential</b>	mV	0	-900	-900	-900	-900	-900	-900
<b>Current</b>	Amps	4	3	2.6	2.3	2	2	2.1
<b>Voltage</b>	V	6	5.3	4.7	4.7	4.3	4.3	4.3
<b>R. Electrode</b>	MV	****	****	****	****	****	****	****
<b>R1</b>	PANEL	-610	-900	-900	-900	-900	-900	-900
<b>R2</b>	PANEL	-590	-1000	-1000	-1000	-1000	-1010	-1010
<b>R1</b>	LOCALLY	-615	-670	-710	-720	-740	-760	-780
<b>R2</b>	LOCALLY	-580	-750	-840	-870	-870	-890	-900
<b>Group 'B'</b>	Manual Ops	M	M	M	M	M	M	M
<b>Current</b>	Amps	2	2	2	2	2	2	2
<b>Voltage</b>	V	4	4	4	4	4	4	4
<b>R. Electrode</b>	MV	****	****	****	****	****	****	****
<b>R3</b>	PANEL	-600	-1200	-1230	-1240	-1240	-1250	-1250
<b>R4</b>	PANEL	-650	-1100	-1120	-1120	-1110	-1120	-1130
<b>R3</b>	LOCALLY	-610	-1050	-1100	-1100	-1100	-1100	-1110
<b>R4</b>	LOCALLY	-640	-1040	-1090	-1110	-1110	-1100	-1100

<b>C.P. Status</b>	****	ON	ON	ON	ON	ON	ON	ON
<b>Time</b>	hrs	168	192	216	240	264	288	312
<b>Group 'A'</b>	Auto Ops	Auto	Auto	Auto	Auto	Auto	Auto	Auto
<b>Set Potential</b>	mV	-900	-900	-900	-900	-900	-900	-900
<b>Current</b>	Amps	1.7	1.6	1.5	1.6	1.6	1.4	1.2
<b>Voltage</b>	V	4	4	3.8	3.9	3.9	3.8	3.6
<b>R. Electrode</b>	MV	****	****	****	****	****	****	****
<b>R1</b>	PANEL	-900	-900	-900	-900	-900	-900	-900
<b>R2</b>	PANEL	-1000	-1010	-1010	-1010	-1020	-1000	-1010
<b>R1</b>	LOCALLY	-780	-790	-800	-790	-810	-840	-850
<b>R2</b>	LOCALLY	-900	-890	-890	-900	-910	-900	-900
<b>Group 'B'</b>	Manual Ops	M	M	M	M	M	M	M
<b>Current</b>	Amps	2	2	2	2	2	2	2
<b>Voltage</b>	V	4	4	4	4	4	4	4
<b>R. Electrode</b>	MV	****	****	****	****	****	****	****
<b>R3</b>	PANEL	-1250	-1250	-1250	-1250	-1250	-1250	-1250
<b>R4</b>	PANEL	-1130	-1120	-1130	-1130	-1130	-1140	-1140
<b>R3</b>	LOCALLY	-1110	-1120	-1120	-1120	-1110	-1110	-1120
<b>R4</b>	LOCALLY	-1100	-1100	-1100	-1090	-1100	-1100	-1100

C.P. Status	****	ON	ON	ON	ON	ON	ON	ON
Time	hrs	336	360	384	408	432	456	480
Group 'A'	Auto Ops	Auto	Auto	Auto	Auto	Auto	Auto	Auto
Set Potential	mV	-900	-900	-900	-900	-900	-900	-900
Current	Amps	1.2	1.2	1.4	1.3	1.5	1.4	1.3
Voltage	V	3.4	3.5	3.5	3.5	3.3	3.3	3.5
R. Electrode	MV	****	****	****	****	****	****	****
R1	PANEL	-900	-900	-900	-900	-900	-900	-900
R2	PANEL	-1010	-1020	-1020	-1020	-1010	-1020	-1010
R1	LOCALLY	-870	-900	-900	-900	-900	-900	-900
R2	LOCALLY	-910	-910	-900	-900	-910	-900	-900
Group 'B'	Manual Ops	M	M	M	M	M	M	M
Current	Amps	2	2	2	2	2	2	2
Voltage	V	4	4	4	4	4	4	4
R. Electrode	MV	****	****	****	****	****	****	****
R3	PANEL	-1240	-1250	-1250	-1250	-1250	-1250	-1250
R4	PANEL	-1160	-1160	-1160	-1170	-1170	-1170	-1170
R3	LOCALLY	-1150	-1150	-1150	-1160	-1170	-1170	-1150
R4	LOCALLY	-1110	-1100	-1110	-1110	-1100	-1110	-1100

C.P. Status	****	ON	ON	ON	ON	ON
Time	hrs	504	528	552	576	600-6696
Group 'A'	Auto Ops	Auto	Auto	Auto	Auto	Auto
Set Potential	mV	-900	-900	-900	-900	-900
Current	Amps	1.2	1.3	1.2	1.1	1.1-1.2
Voltage	V					
R. Electrode	MV	****	****	****	****	****
R1	PANEL	-900	-900	-900	-900	-900
R2	PANEL	-1010	-1020	-1000	-1010	-1010
R1	LOCALLY	-900	-900	-900	-900	-900
R2	LOCALLY	-900	-910	-900	-900	-900
Group 'B'	Manual Ops	M	M	M	M	M
Current	Amps	2	2	2	2	2
Voltage	V	4	4	4	4	4
R. Electrode	MV	****	****	****	****	****
R3	PANEL	-1250	-1250	-1250	-1250	-1250
R4	PANEL	-1160	-1160	-1160	-1150	-1160
R3	LOCALLY	-1150	-1160	-1160	-1150	-1160
R4	LOCALLY	-1110	-1100	-1120	-1100	-1100

Table 8.49: Summary of, test daily readings



### 3. Tests brief Summary

A large number of tests were carried out and a consistent feature of the tests at Dubal was the effectiveness of cathodic protection in controlling corrosion over a wide range of conditions relevant to thermal desalination plant. This good performance of cathodic protection was observed to be intimately associated with the rapid deposition of calcareous scales.

Since the next Chapter contains the results of the scanning electron microscopy and X-ray diffraction (XRD) examination of a number of specimens, and also taking account this clear relationship between cathodic protection performance and calcareous deposition, it was considered appropriate to present the main discussion of the cathodic protection test programme in the next Chapter after the SEM and XRD description.

## CHAPTER NINE SPECIMENS EXAMINATION

### 1. Introduction

A limited amount of examination on a scanning electron microscope and a X-ray diffraction (XRD) machine was undertaken to give an indication of the detailed structures and composition of some of the deposits formed on the surfaces of the specimens. The findings of this examination work are presented in the first part of this chapter. There then follows a general discussion of the experimental results presented in Chapter 10 and in this Chapter.

### 2. Scanning Electron Microscopy

The SEM machine used was a "Leo Microscopy" stereo-scan 360 and was equipped with an energy-dispersive microanalysis attachment. The specimens were coated with either carbon or gold prior examination of the specimens on SEM to make them electrically conductive. In general the main objective was to examine at high magnification deposits in plan. The microanalysis attachment on the scanning electron microscope used in this work can only analyse elements with atomic numbers greater than 11 (Na). Hence H, O, C and N can not be detected. However the appearance of just a calcium peak is very strong evidence that the deposit was calcium carbonate. Similarly an analysis showing just a Mg peak is very indicative of a Mg (OH)<sub>2</sub> scale. The microanalysis results were obtained as plots of x-ray emission count verses x-ray energy (which has characteristic values for any given element). Thus the results were semi-quantitative since the x-ray output was not corrected for factors such as absorption and fluorescence. However, in many cases (see following figures) the x-ray spectrum showed either a very strong calcium peak with no detectable magnesium or vice versa. In such cases, this result is termed as a 'pure calcium scale' or a 'pure magnesium scale'; even though such a 'pure calcium scale' might well have contained a tiny amount of magnesium in the CaCO<sub>3</sub>.

The following is the summary of the work, which was carried, out when the selected specimens of different tests performed both at Glasgow University and Dubai were examined under scanning electron microscope.

### 3. Glasgow Specimens (all Glasgow specimens were plan on top surface)

#### a. Test 7, specimen 1 (Potential -1000 mV, Temperature 25 °C, 8 Days)

FINDINGS	PHOTO	GRAPH
Mainly pure magnesium scale and traces of calcium. Featureless plus clumps of pure calcium scale.	Figures 9.1,9.2,9.3	Figures 9.4, 9.5

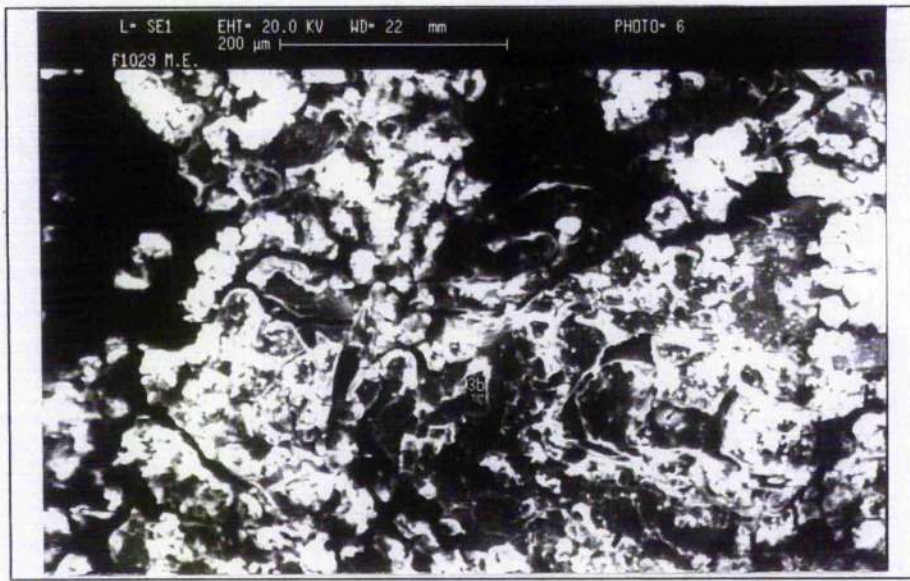

**Figure 9.1: Low magnification photo of featureless scale, mainly magnesium**



**Figure 9.2: High magnification photo of, Featureless scale, mainly magnesium**



**Figure 9.3: high magnification photo of clumps shape of calcium scale**

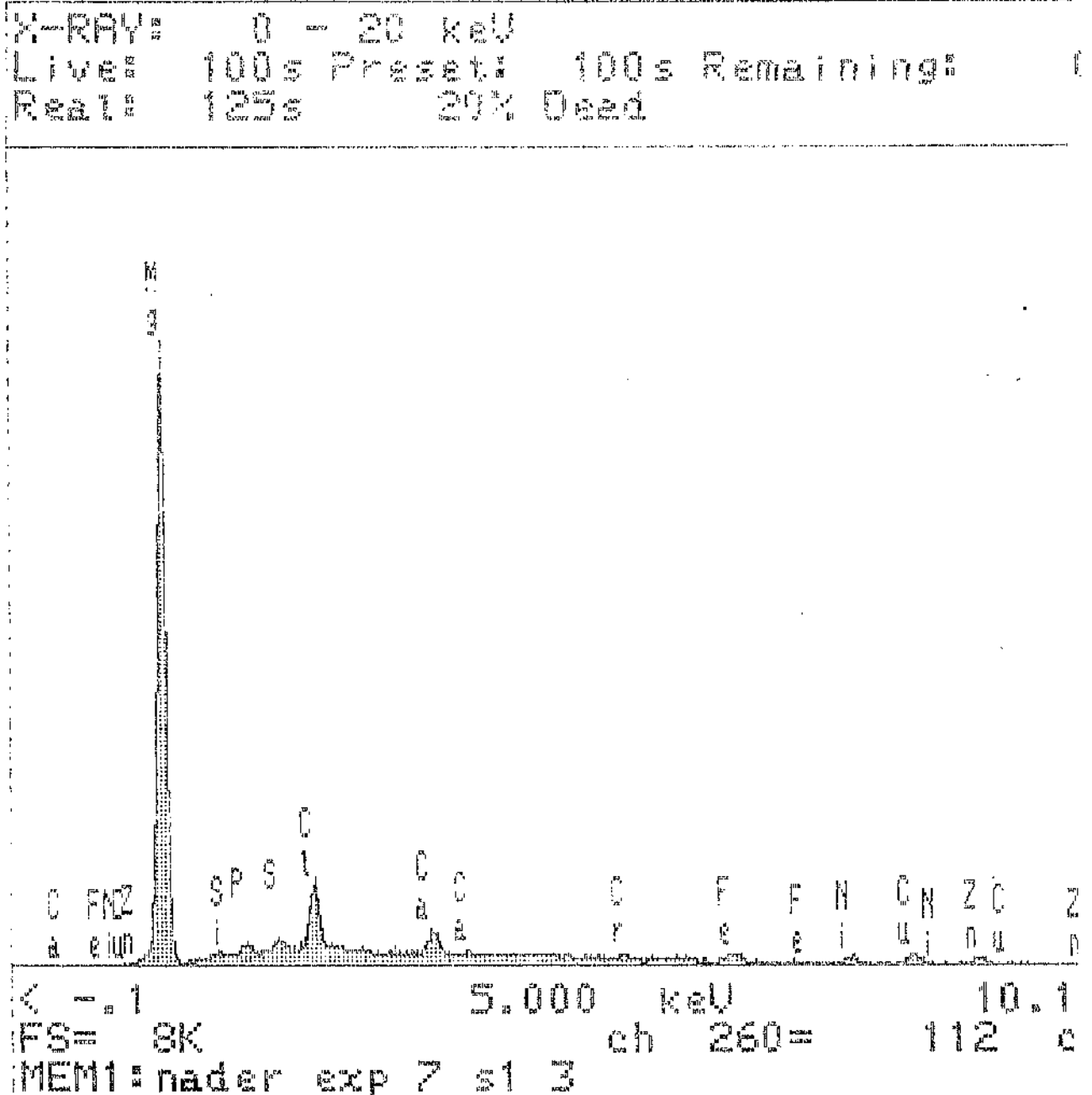

Figure 9.4: Chemical composition of test 7 specimen 1 scale deposit  
 (Reference to figures 9.1 and 9.2)

X-RAY: 0 - 20 keV  
 Live: 100s Preset: 100s Remaining: 0s  
 Real: 136s 26% Dead

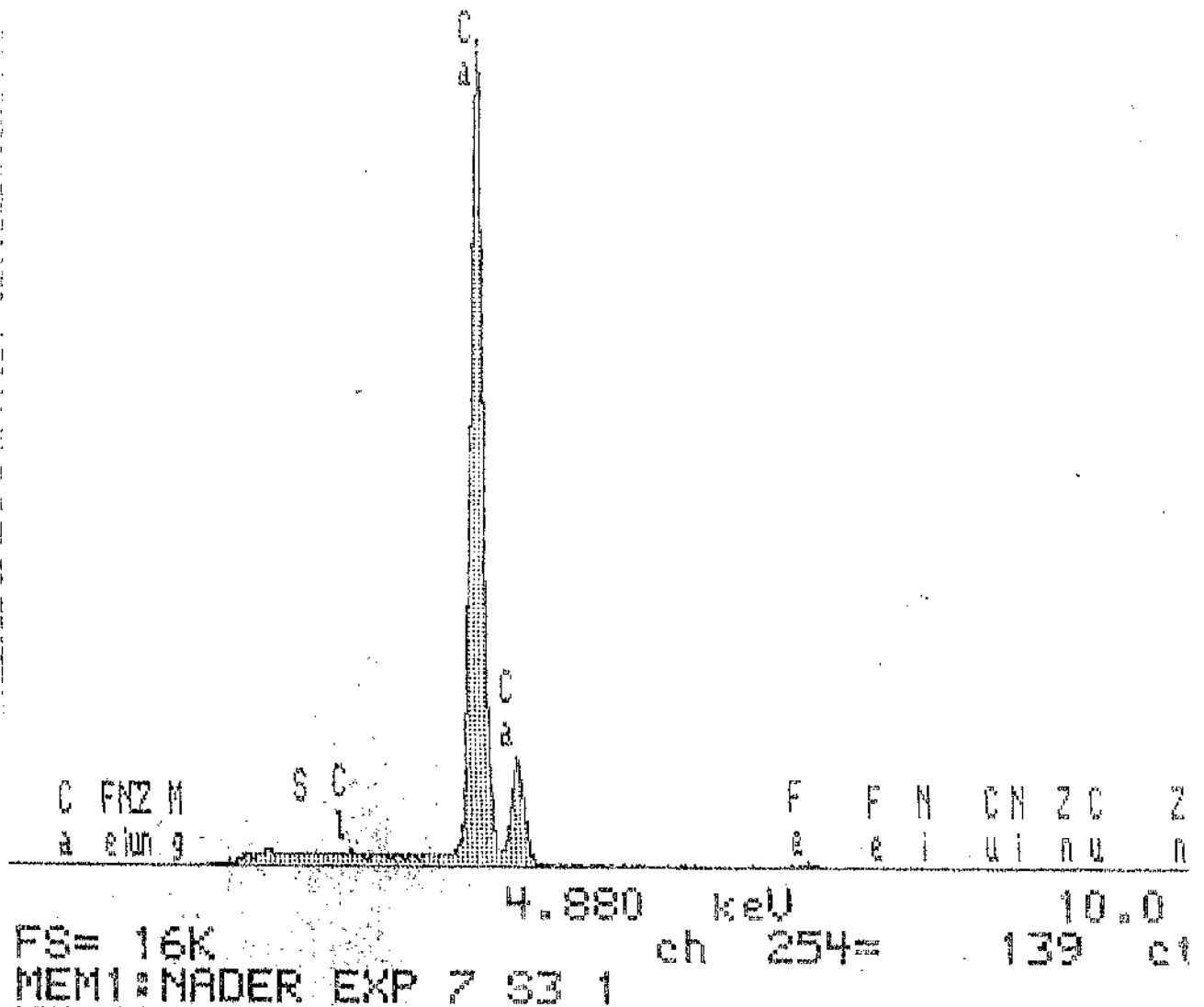

Figure 9.5: Chemical composition of test 7 specimen 1 scale deposit  
 (Reference to figures 9.4)

b. Test 7, specimen 3 (Potential -1000 mV, Temperature 25 °C, 8 Days)

FINDINGS	PHOTO	GRAPH
Good coverage of scale, plate like crystals (pure calcium scale)	Figures 9.6,9.7	Figures 9.8

Note: Specimen 3 was placed at less turbulent condition within the test loop.



Figure 9.6: Low magnification photo, shows a good coverage of scale deposition over the entire specimen surface

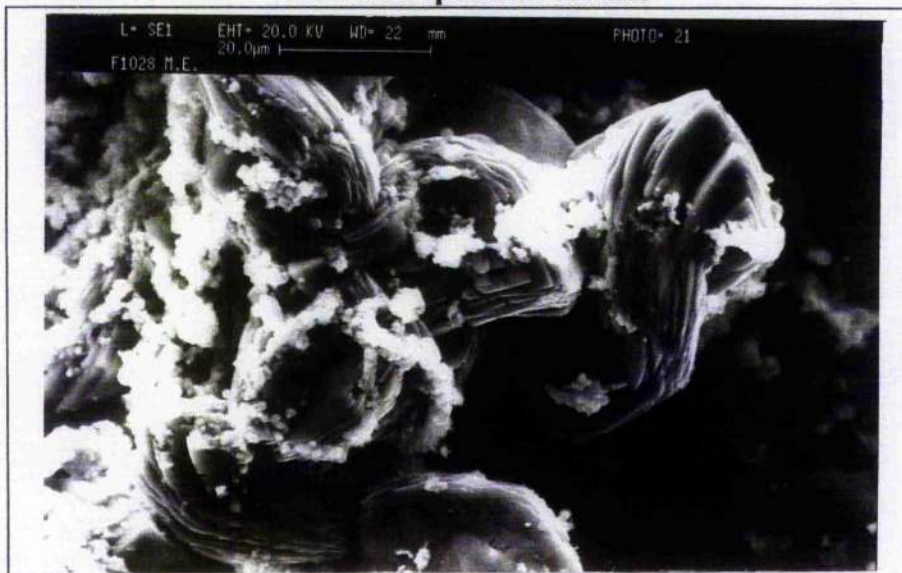

Figure 9.7: high magnification photos, of plate shape of calcium scale

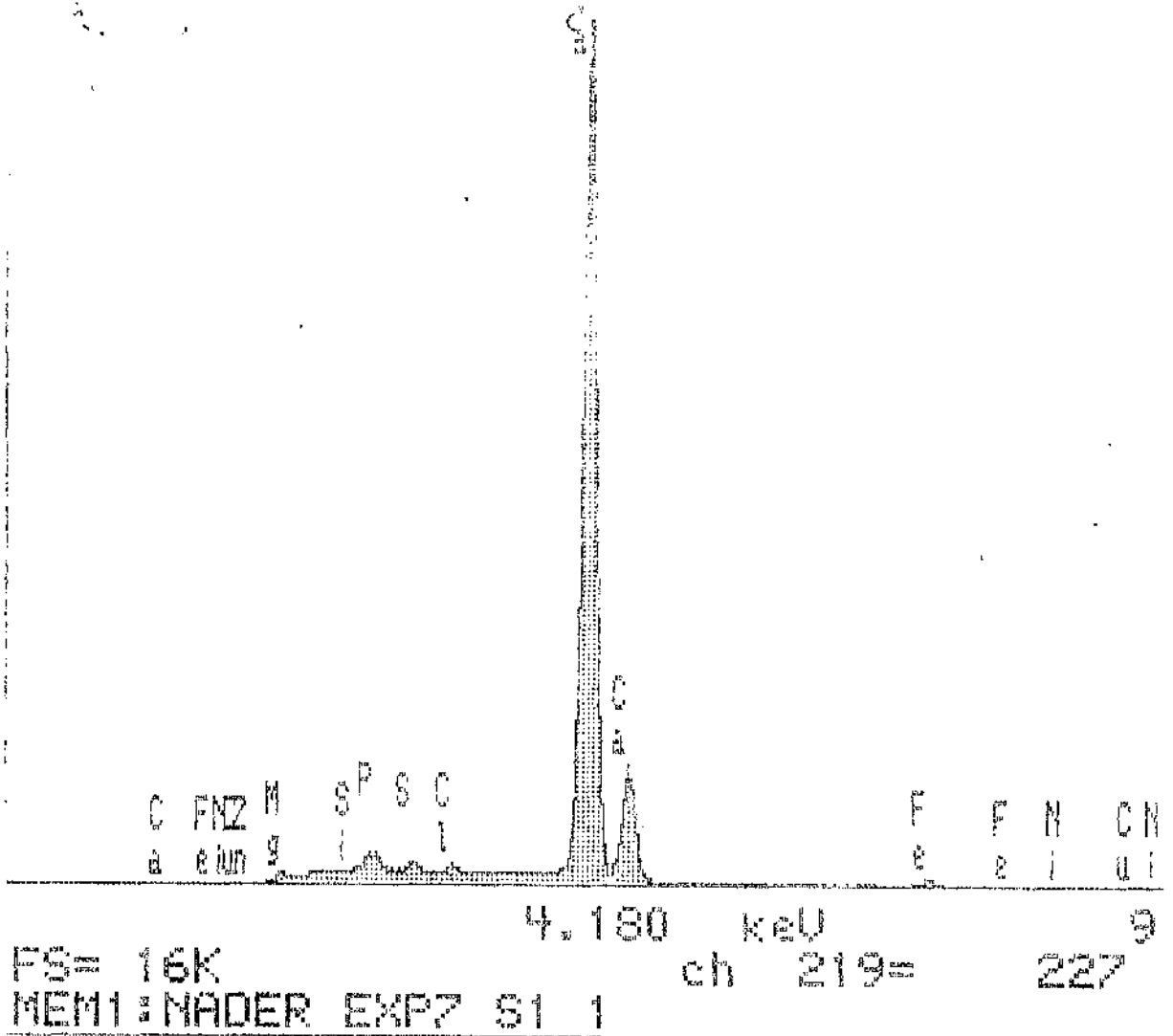

Figure 9.8: Chemical composition of test 7 specimen 3, scale deposit  
(Reference to figures 9.6)



- c. Test 11, specimen 1 (Potential -1100 mV, Temperature 25 for 6 days and raised to 45 °C for the last 2 days, 8 Days)

FINDINGS	PHOTO	GRAPH
Tiny crystals of pure calcium scale over most of the surface plus (where spalled) a featureless pure magnesium scale was seen	Figures 9.9, 9.10 9.12, 9.13	Figures 9.11 9.14



Figure 9.9: Good coverage of scale deposition over the entire specimen surface



Figure 9.10: high magnification photo of tiny crystal shape calcium scales

X-RAY# 0 - 20 keV  
 Live# 67s Preset# 100s Remaining#  
 Real# 76s 12% Dead

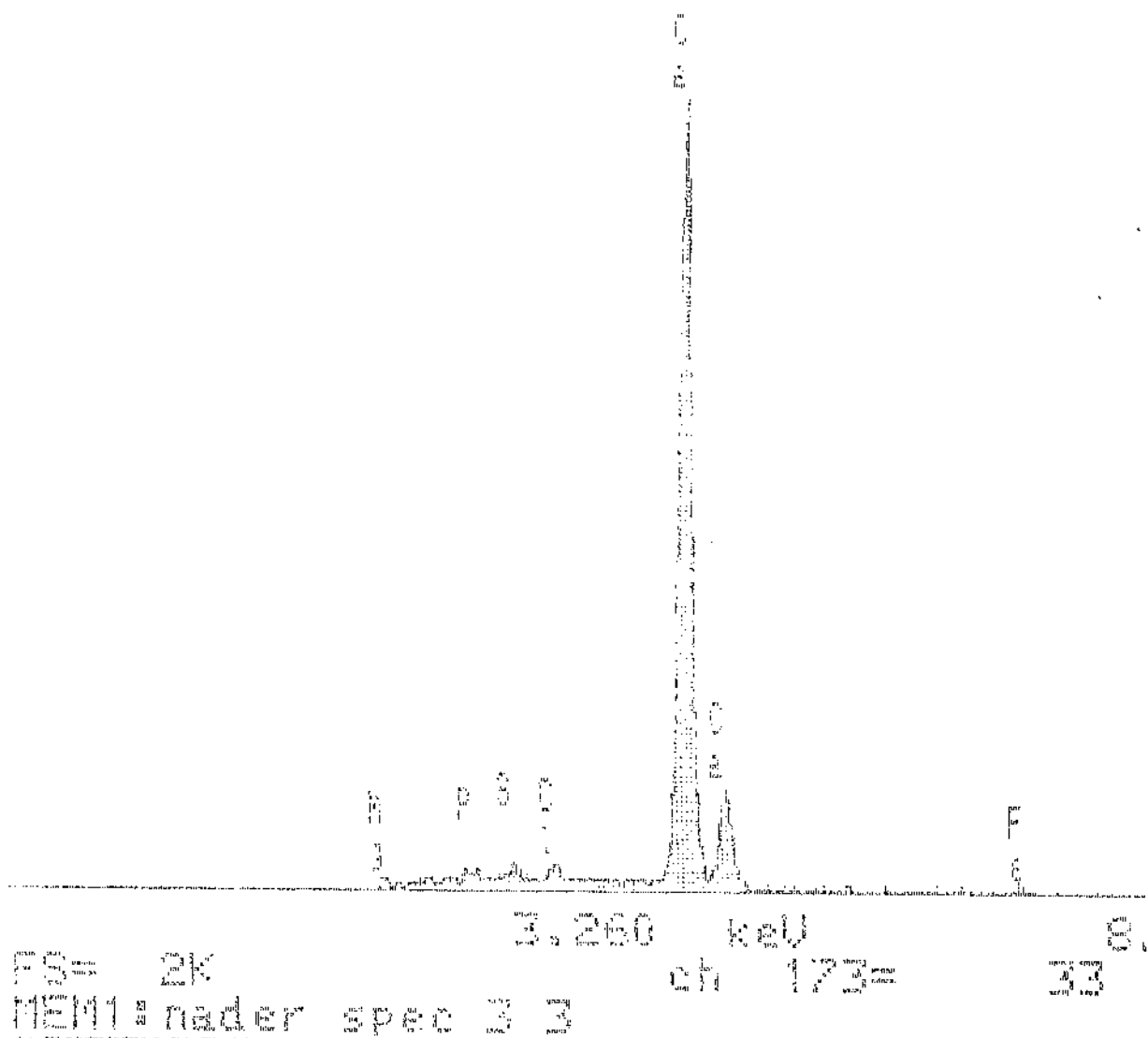

Figure 9.11: Chemical composition of test 11 specimen 1 scale deposit  
 (Reference to figures 9.10)



**Figure 9.12: High magnification, photo of featureless scale mainly magnesium**



**Figure 9.13: Spalled, featureless scale, mainly magnesium**

X-RAY: 0 -- 20 keV  
 Live: 62s Preset: 100s Remaining:  
 Real: 70s 11% Dead

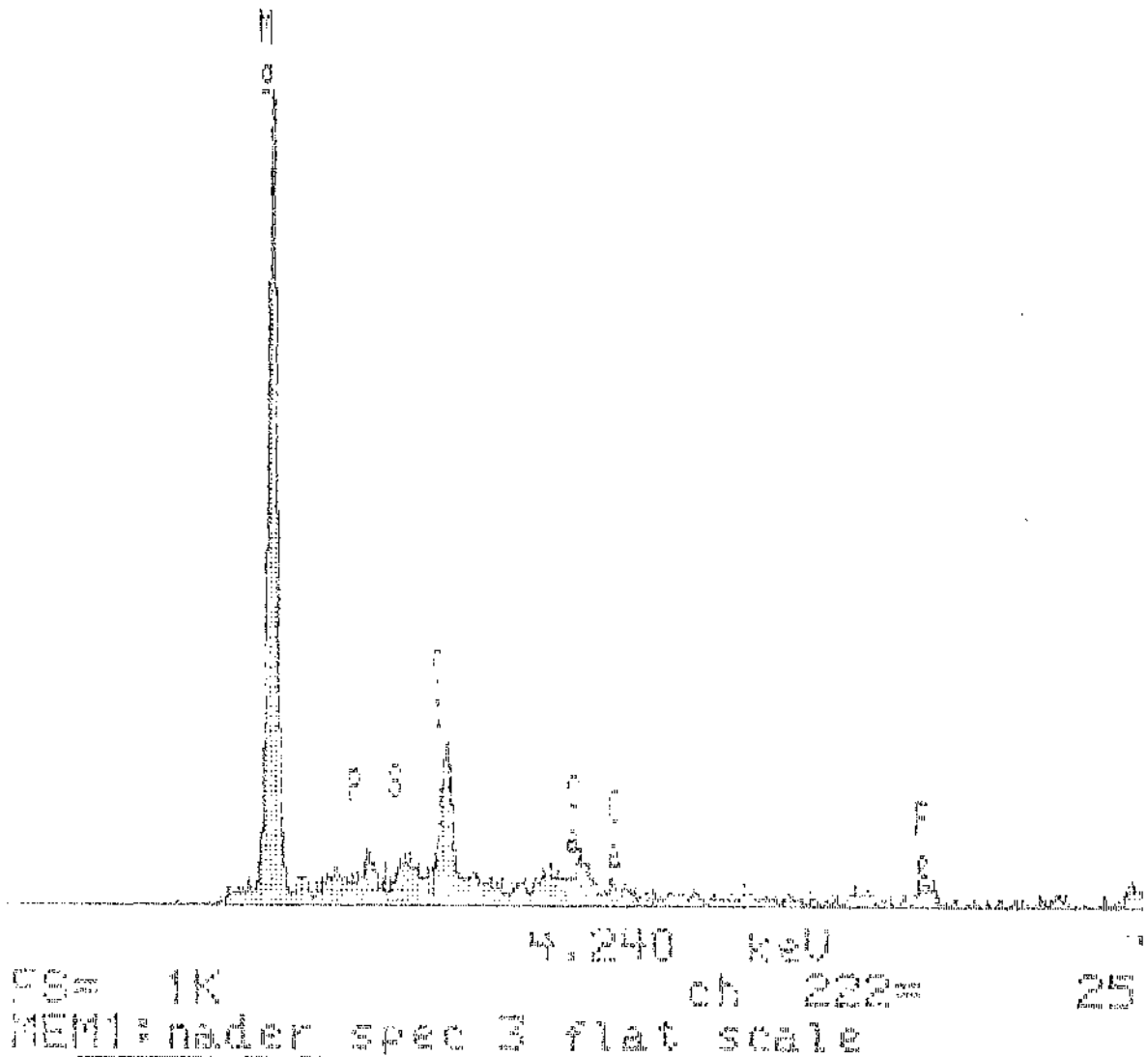

Figure 9.14: Chemical composition of test 11 specimen 1 scale deposit  
 (Reference to figures 9.12)

d. Test 13, specimen 2 (Potential -1000 mV, Temperature 45 °C, 5 Days)

FINDINGS	PHOTO	GRAPH
Very thin coverage of scale on the specimen surface. Tiny crystals, pure calcium scale.	Figures 9.15	N/A

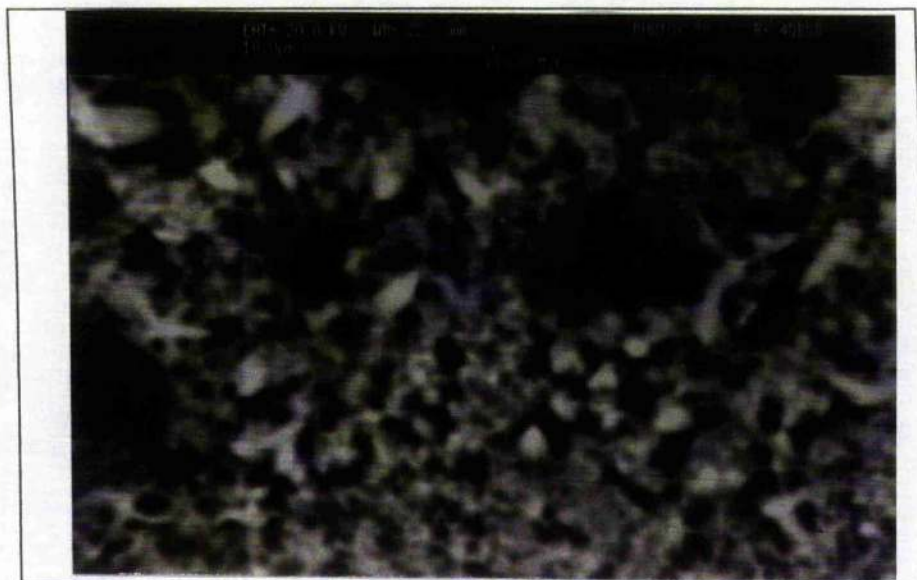

Figure 9.15: High magnification photo of, tiny crystals shape of calcium scales

e. Test 34, specimen 2 (Potential -1050 mV, Temperature 30 °C, 3 Days)

FINDINGS	PHOTO	GRAPH
Good coverage of scale which was featureless (pure magnesium scale, identified as 'B' on figure 9.16) plus clumps(identified as 'A' on figure 9.16) mainly calcium rich with traces of Mg.	Figures 9.16, 9.17	Figures 9.18 9.19



**Figure 9.16: Low magnification shows good coverage of scale mainly featureless (pure magnesium, which identified as 'A')**



**Figure 9.17: High magnification shows featureless type scale (Pure magnesium, which identified as 'A' on figure 9.16)**

W-RAY: 0 - 20 keV  
 Live: 100% Preset: 100% Remaining:  
 Real: 109% 8% Dead

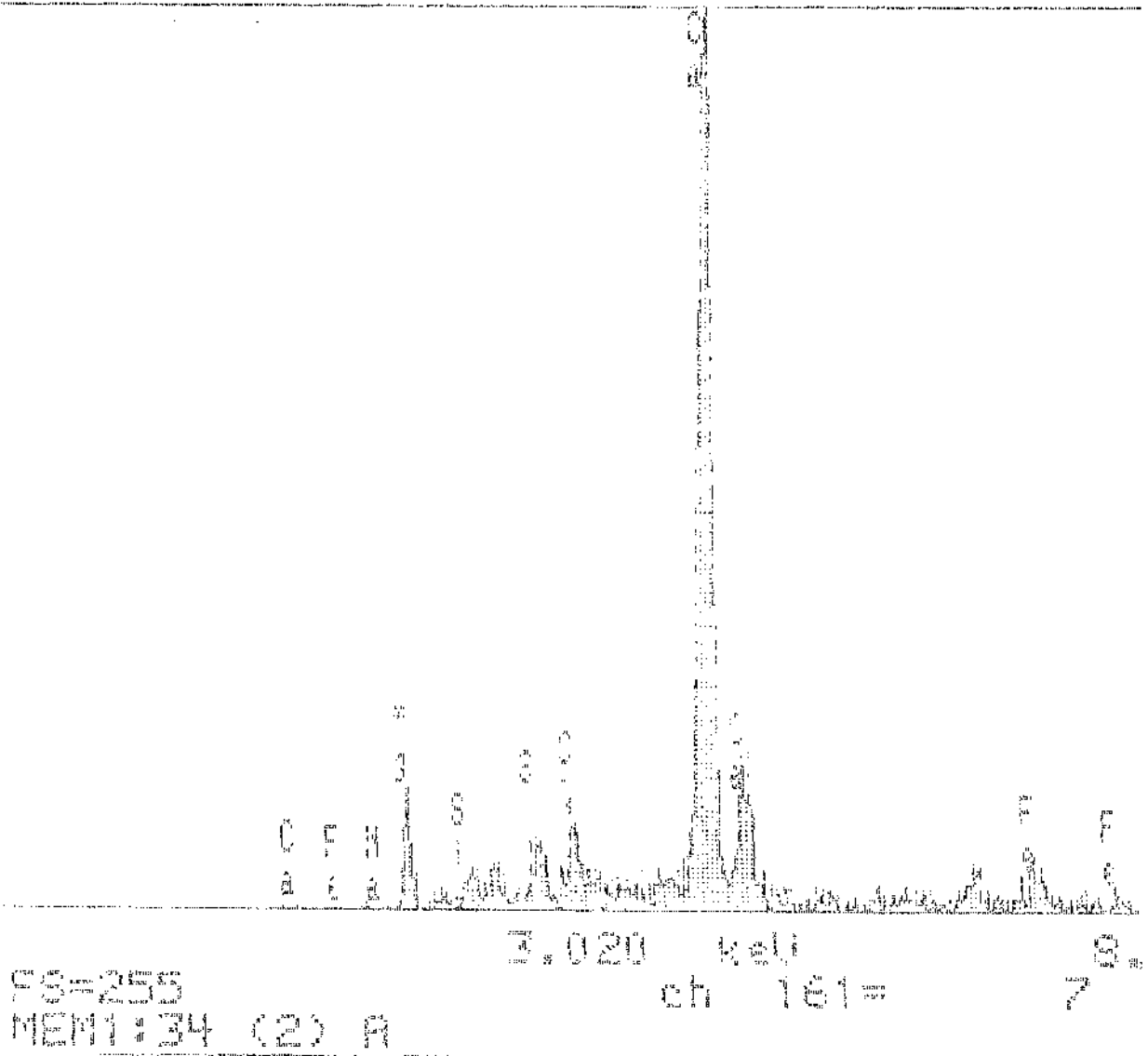
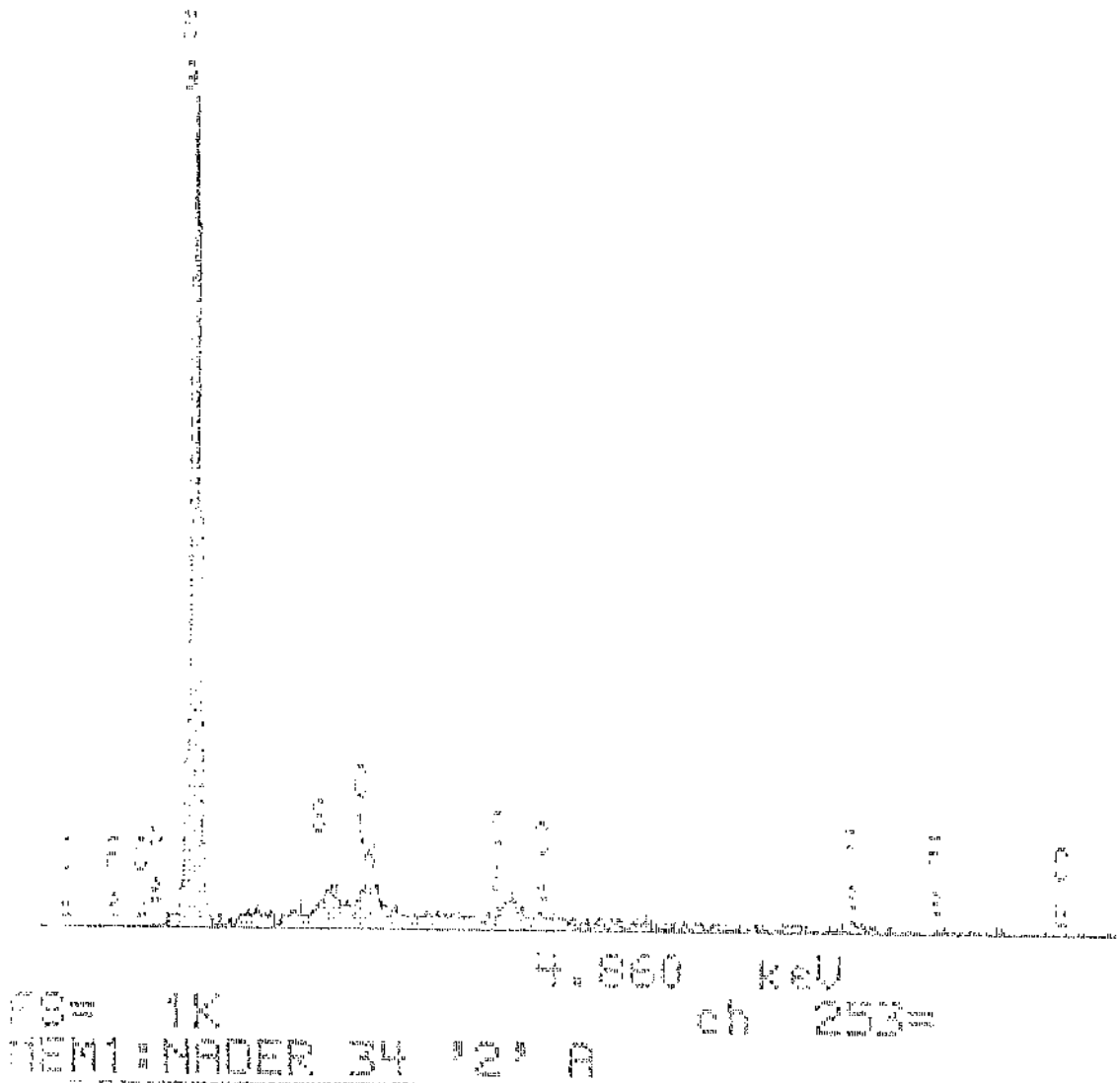

Figure 9.18: Chemical composition of test 34 specimen 2-scale deposit  
 (Reference to figures 9.16 point 'B')

X-RAY: 0 - 20 keV  
 Live: 100s Preset: 100s Remaining:  
 Real: 110s 9% Dead

---



**Figure 9.19: Chemical composition of test 34 specimen 2-scale deposit  
 (Reference to figures 9.16 point 'A')**



f. Test 35, specimen 1 (Potential  $-1050$  mV, Temperature  $30^{\circ}\text{C}$ , 2 Days)

FINDINGS	PHOTO	GRAPH
Very good coverage of scale which was mainly clumps of crystal (pure calcium scale).	Figures 9.20, 9.21	Figures N/A

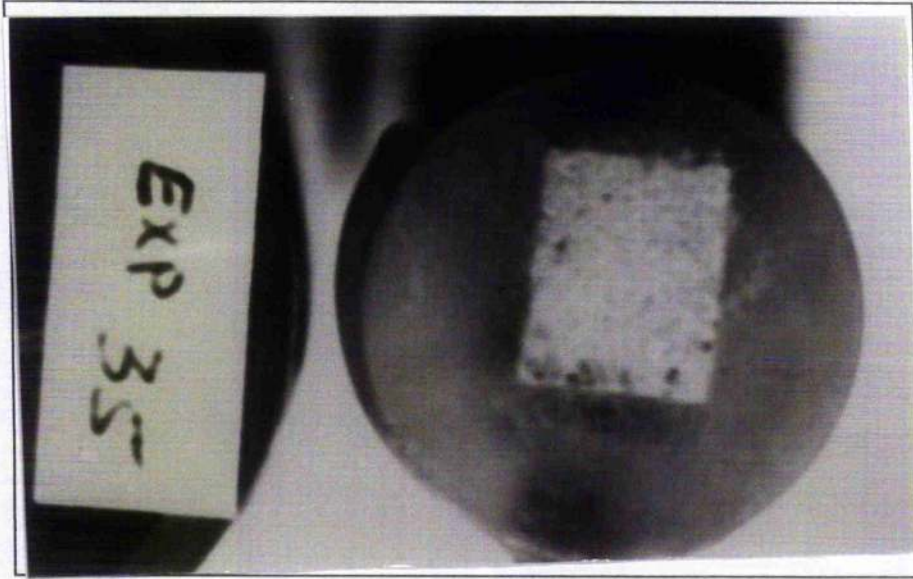

Figure 9.20: Photo of specimen 1 test 35 shows a very good coverage of scale

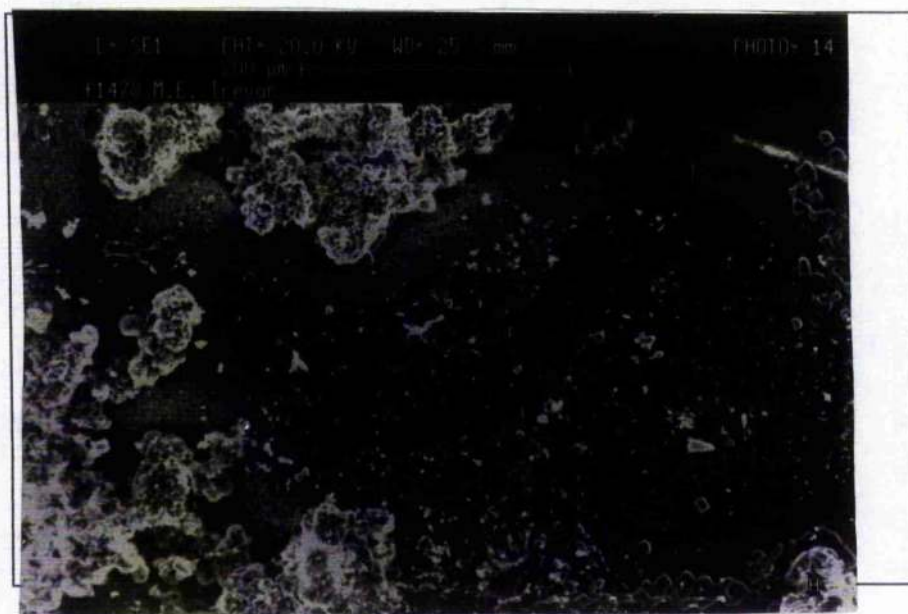

Figure 9.21: High magnification photo of specimen shows clumps pure calcium scale of crystals

#### 4. Dubal's Specimens

##### a. Test 43, specimen 1 (Potential -1000 mV, Temperature 38 °C, 6 Days)

FINDINGS	PHOTO	GRAPH
Very thin uniform scale on top surface and clumps (pure calcium scale)	Figures 9.22	Figure 9.23
At high magnification, smooth background scale has honeycomb shape (pure magnesium scale)	Figures 9.24,9.25	Figure 9.26

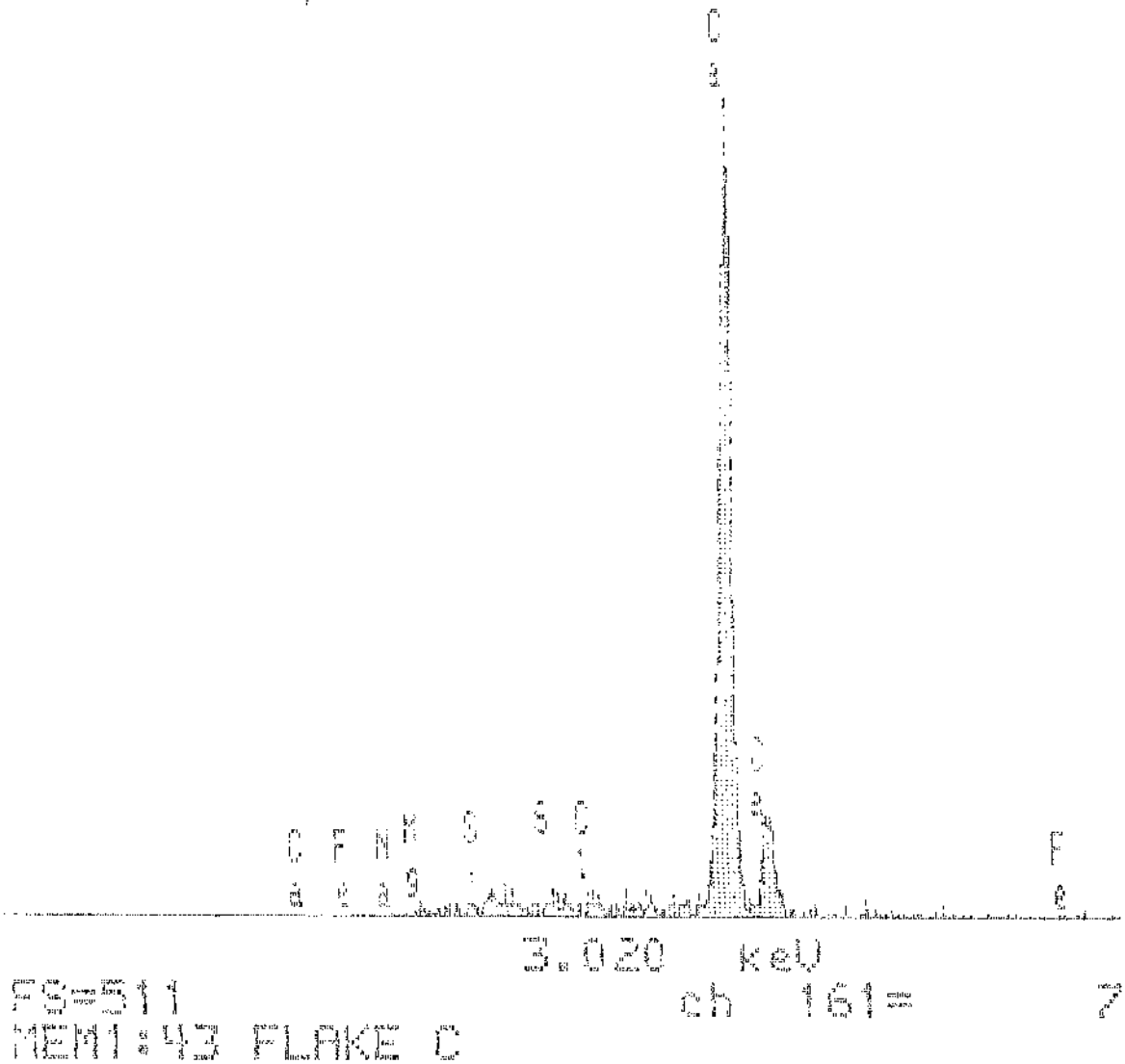

**Figure 9.22: Low magnification photo of specimen shows clumps of crystals and very thin uniform scale on the smooth background**

---

X-RAY: 0 - 20 keV  
 Live: 42s Preset: 100s Remaining:  
 Real: 46s 9% Dead

---



**Figure 9.23: Chemical composition of test 43, scale deposit  
 (Reference to figures 9.22 point 'C')**



**Figure 9.24: Low magnification of smooth background, indicates a honeycomb type shape (pure magnesium)**

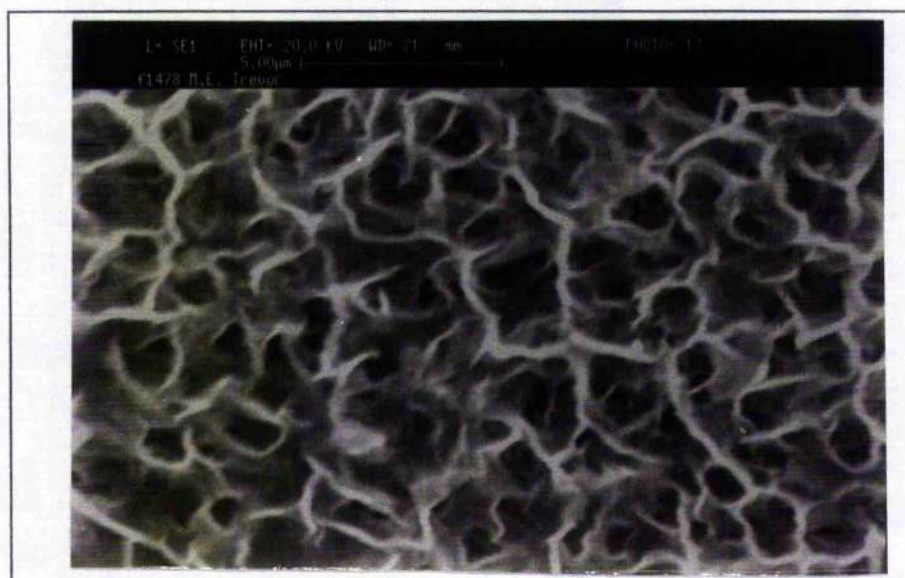

**Figure 9.25: High magnification of smooth background indicates a honeycomb type shape (pure magnesium)**



## b. Test 49, specimen 5 (Potential -1050 mV, Temperature 30 °C, 30 Days)

FINDINGS	PHOTO (figure)	GRAPH (figure)
<u>Top surface of scale</u>		
Two distinct types of region	9.29	
1. Coarse crystals (pure calcium). At high magnification inter-particle pores. In some area, clear pores	9.33	
2. Finer acicular crystals (Mg-rich)	9.31, 9.32 9.27	9.28
<u>Bottom surface of scale</u>	9.34, 9.35	9.36
Featureless shape with network of pores magnesium rich		



Figure 9.27: High magnification of an area shows, a coarse column-like crystals (Mg rich + Ca)

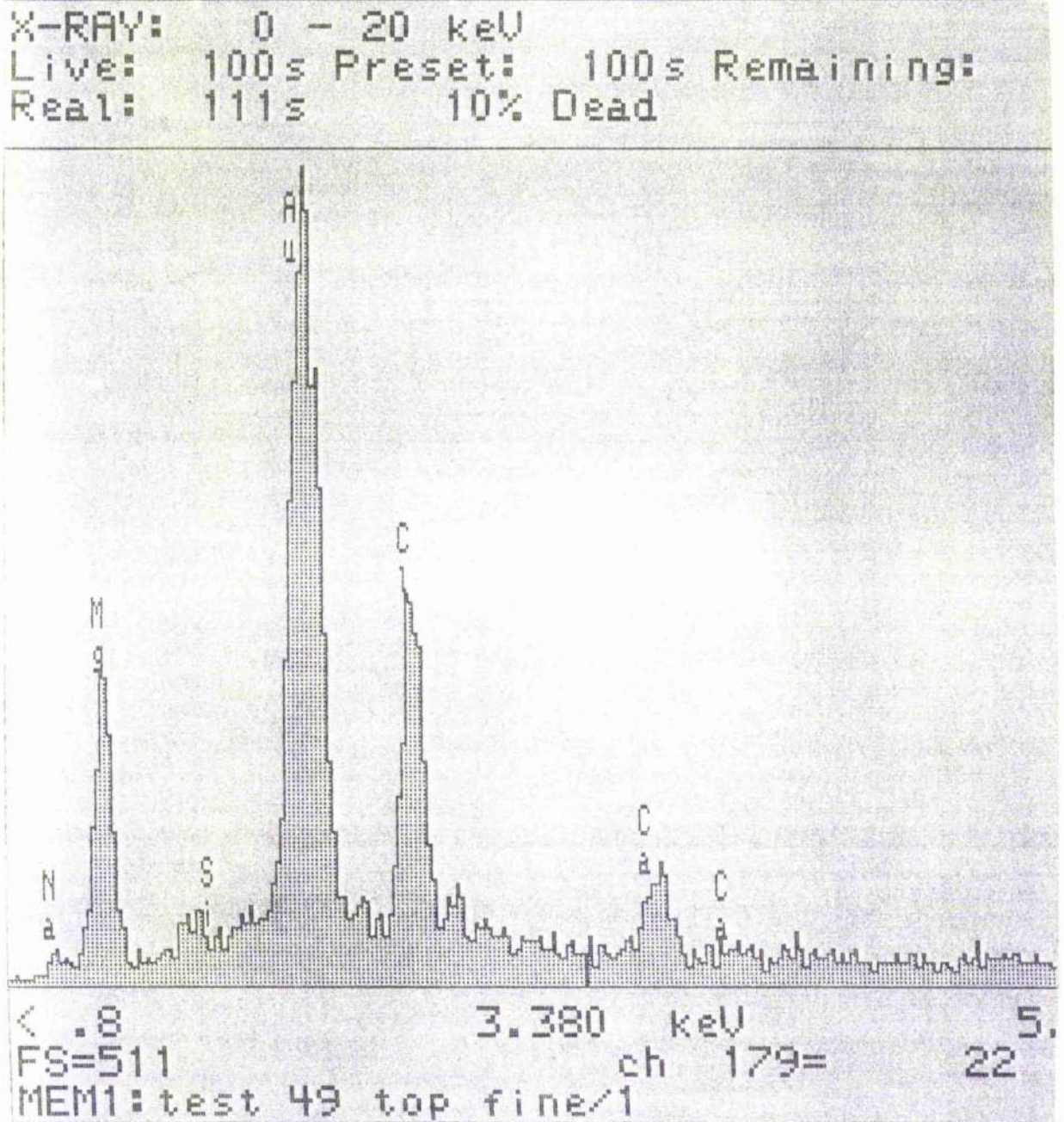
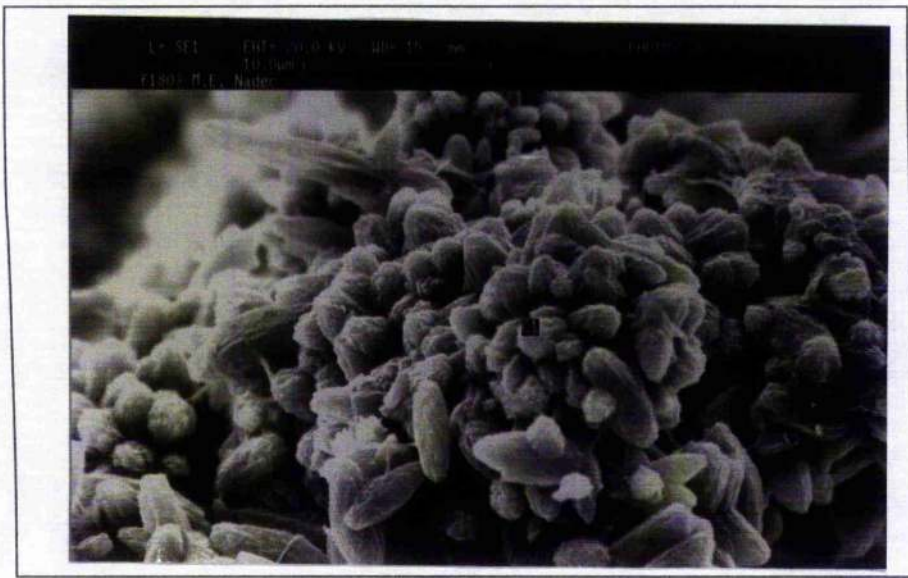

Figure 9.28: Chemical composition of test 49, scale deposit  
 (Reference to figures 9.27)



**Figure 9.29: High magnification of an area shows different type crystals (Calcium rich)**



**Figure 9.31: Low magnification of an area shows clear pores on the surface of the scale**





**Figure 9.32: High magnification of an area of figure 9.31**



**Figure 9.33: High magnification of an area of figure 9.32**

---

X-RAY: 0 - 20 keV  
 Live: 100s Preset: 100s Remaining:  
 Real: 112s 11% Dead

---

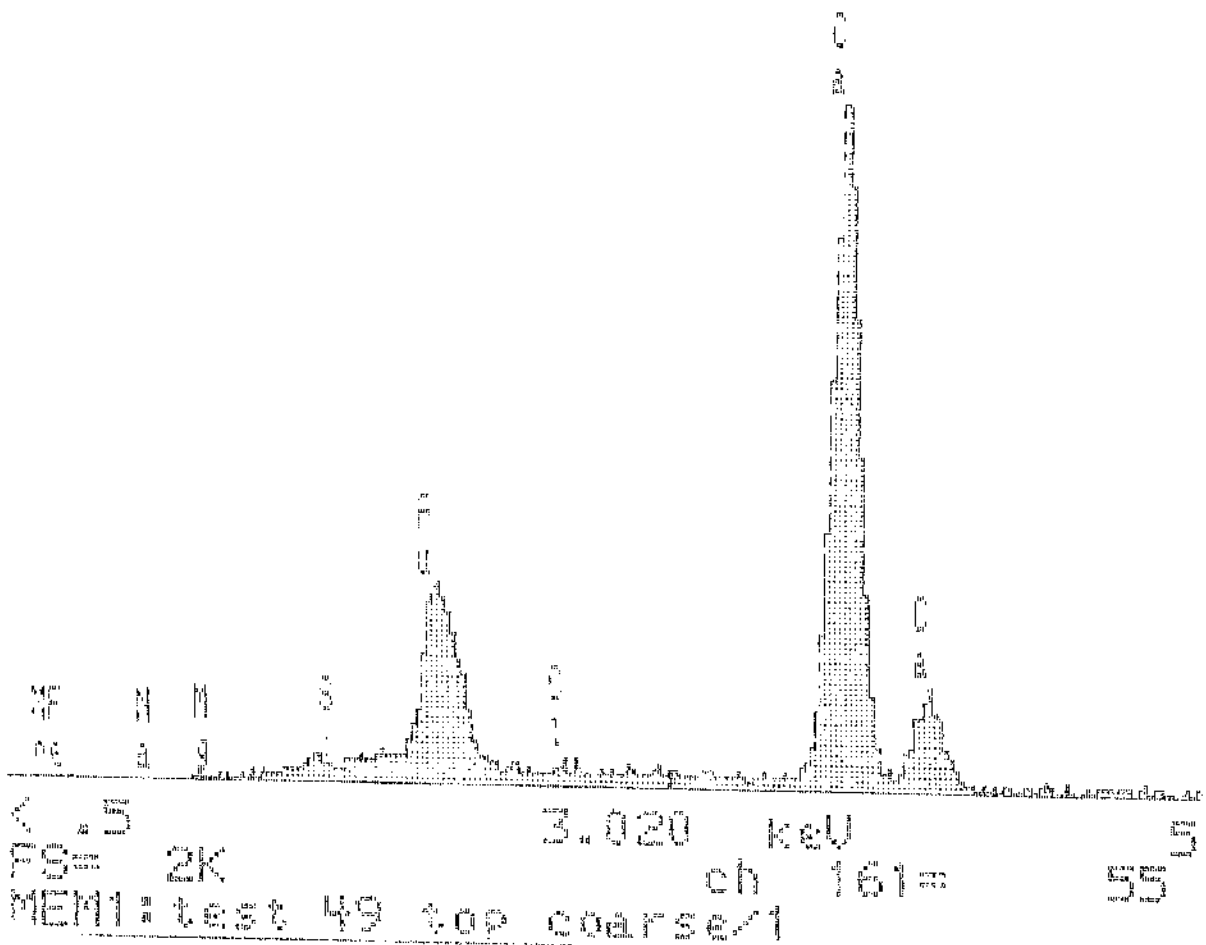

Figure 9.30: Chemical composition of test 49, scale deposit  
 (Reference to figures 9.29)



**Figure 9.34: High magnification of an area shows featureless scale and network of pores (magnesium rich)**



**Figure 9.35: High magnification of an area shows featureless scale and network of pores (magnesium rich)**

X-RAY: 0 - 20 keV  
 Live: 100s Preset: 100s Remaining:  
 Real: 110s 9% Dead

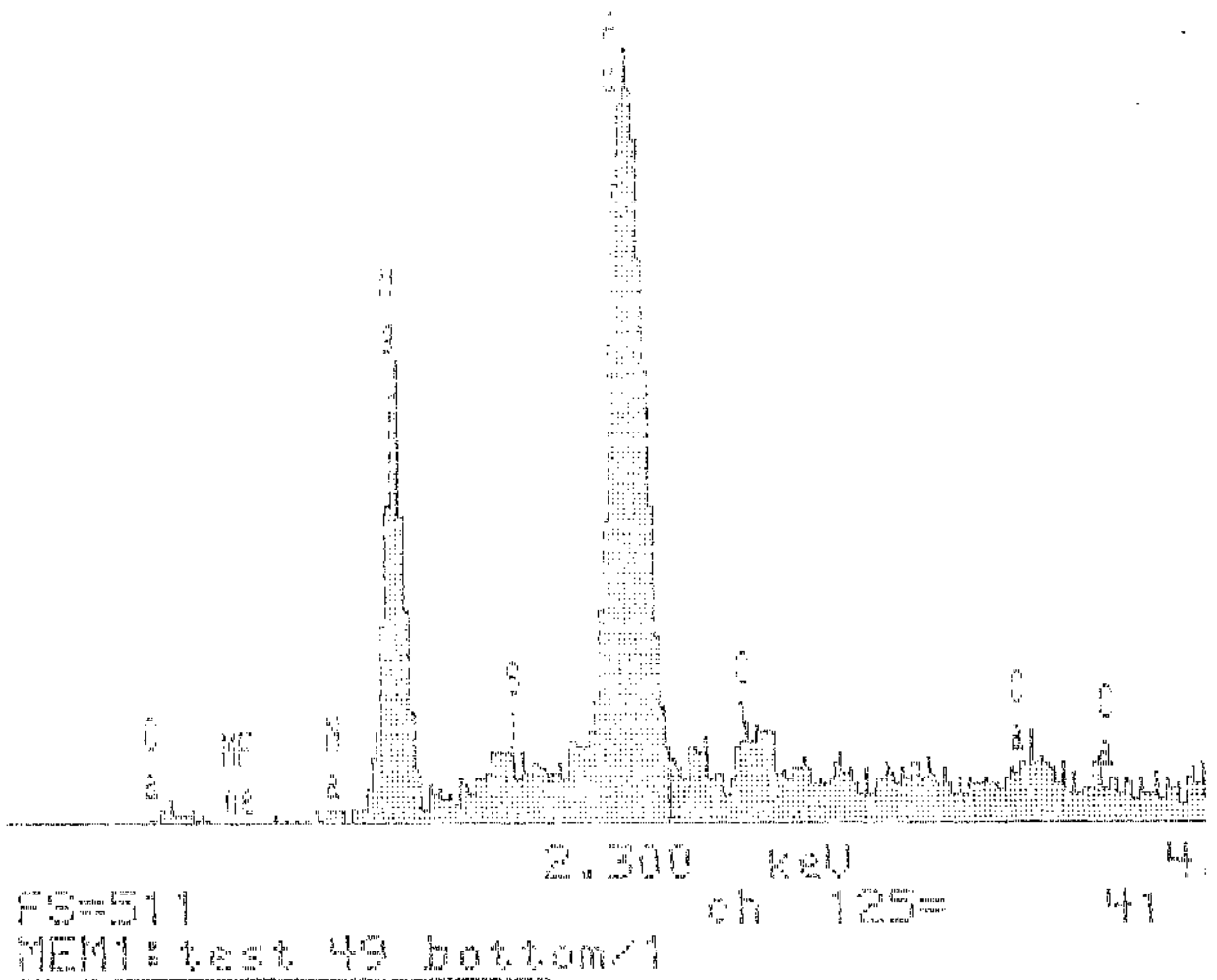

Figure 9.36: Chemical composition of test 49, scale deposit  
 (Reference to figures 9.34 and 9.35)

- a. Test 55, specimen 4 bottom surface of scale (Potential -1050 mV, Temperature 30 °C, 30 Days)

FINDINGS	PHOTO (figure)	GRAPH (figure)
Featureless shape with tiny crystals and pores magnesium rich	9.37	9.38

- b. Test 55, specimen 5 top surface of scale (Potential -1050 mV, Temperature 30 °C, 30 days)

FINDINGS	PHOTO (figure)	GRAPH (figure)
A circular shape crystal feature pure calcium scale	9.40	9.39

- c. Test 55, specimen 5 bottom surface of scale (Potential -1050 mV, Temperature 30 °C, 30 days)

FINDINGS	PHOTO (figure)	GRAPH (figure)
At low magnification an extensive area was seen to be covered with needle-like crystals	9.41	N/A
At high magnification the needle-like crystals was appeared to be mesh-like (magnesium rich and traces of calcium)	9.42, 9.43	N/A



Figure 9.37: High magnification of an area shows featureless scale and network of pores

X-RAY: 0 - 20 keV  
 Live: 100s Preset: 100s Remaining:  
 Real: 11s 10% Dead

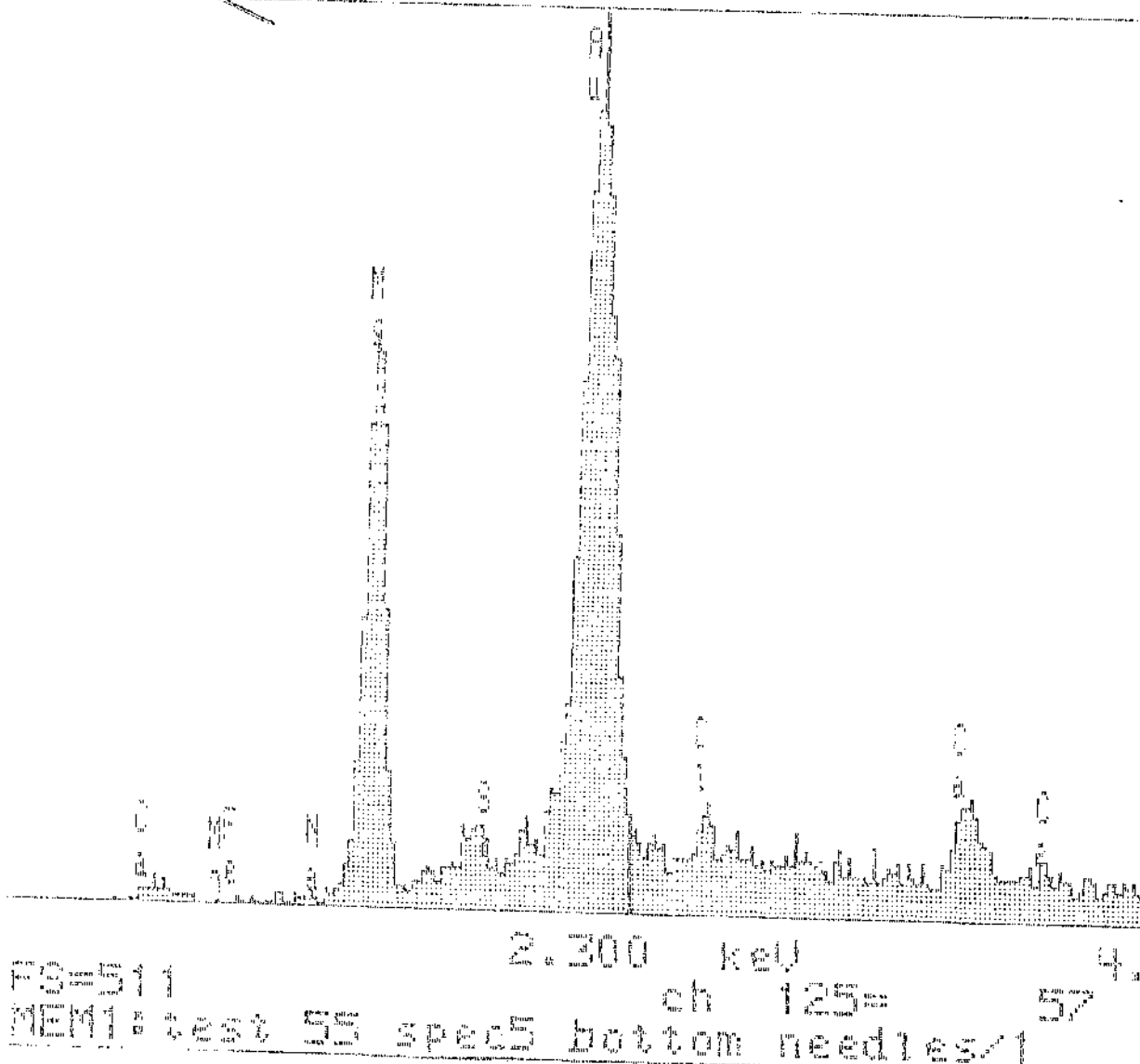
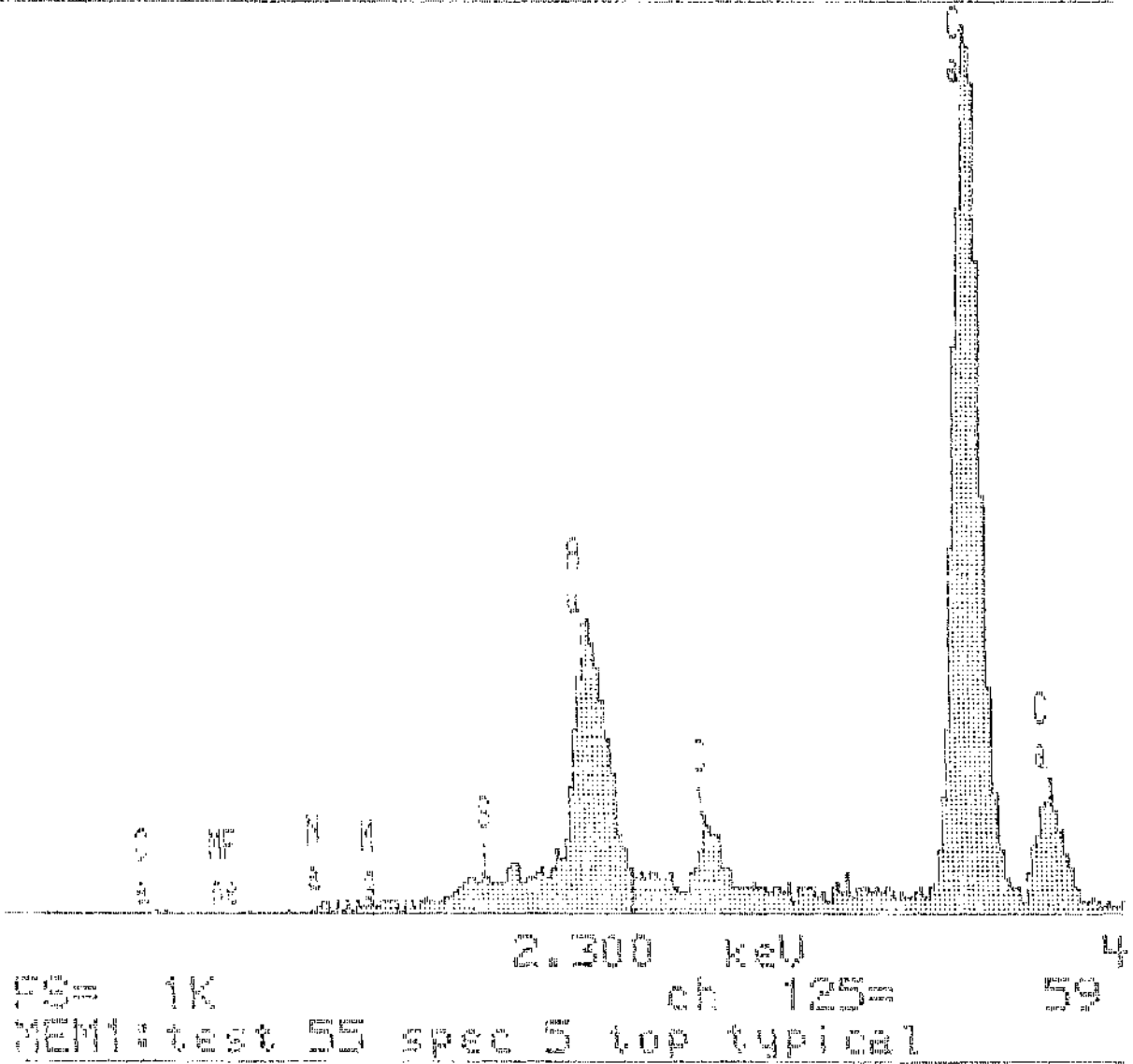

Figure 9.38: Chemical composition of test 55 specimen 4 bottom, scale deposit  
 (Reference to figures 9.37)

---

X-RAY: 0 - 20 keV  
 Live: 79s Preset: 100s Remaining:  
 Real: 85s 12% Dead

---



**Figure 9.39: Chemical composition of test 55 specimen 5 top, scale deposit  
 (Reference to figures 9.40)**







**Figure 9.42: High magnification of an area shows network of mesh-like crystals**



**Figure 9.43: High magnification of an area shows network of mesh-like crystals**

- d. Test 57, specimen 4 top and bottom (Potential -900 mV, Temperature 30 °C, 29 days)

FINDINGS	PHOTO (figure)	GRAPH (figure)
Pure calcium scale crystals were seen (top)	N/A	N/A
Magnesium rich scale and tiny calcium. The shape was featureless (Bottom)	N/A	N/A

- i. Test 57, specimen 4 cross section (Potential -900 mV, Temp 30 °C, 29 days)

FINDINGS	PHOTO (figure)	GRAPH (figure)
Several layers of scale was seen at low magnification	9.44	N/A
High magnification of region 1 of figure 9.44, shows a featureless shape which is magnesium rich	9.45	9.46
High magnification of region 2 of figure 9.44, shows needle-like shape crystals which are rich in calcium plus tiny magnesium	9.47	9.48
High magnification of region 3 of figure 9.44, shows column-like crystals shape which is calcium rich and traces of magnesium	9.49	9.50



Figure 9.44: Cross-section photo of test 57 specimen 4 shows multi-layers of scale



**Figure 9.45:** High magnification of area 1 of figures 9.44 shows featureless scale



**Figure 9.47:** High magnification of area 2 of figure 9.44 shows needle-like crystal

X-RAY: 0 - 20 keV  
 Live: 89s Preset: 100s Remaining:  
 Real: 100s 11% Dead

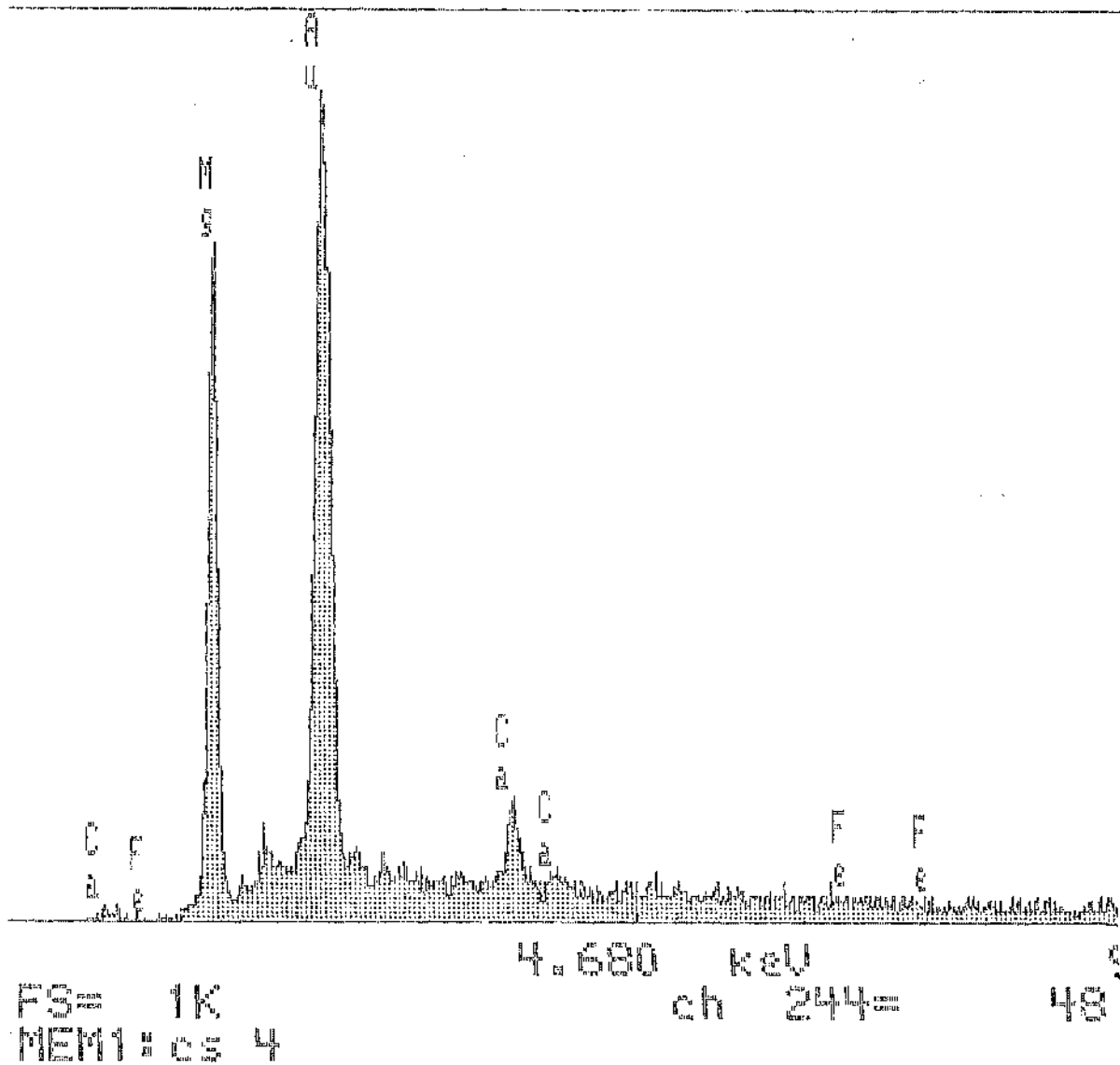
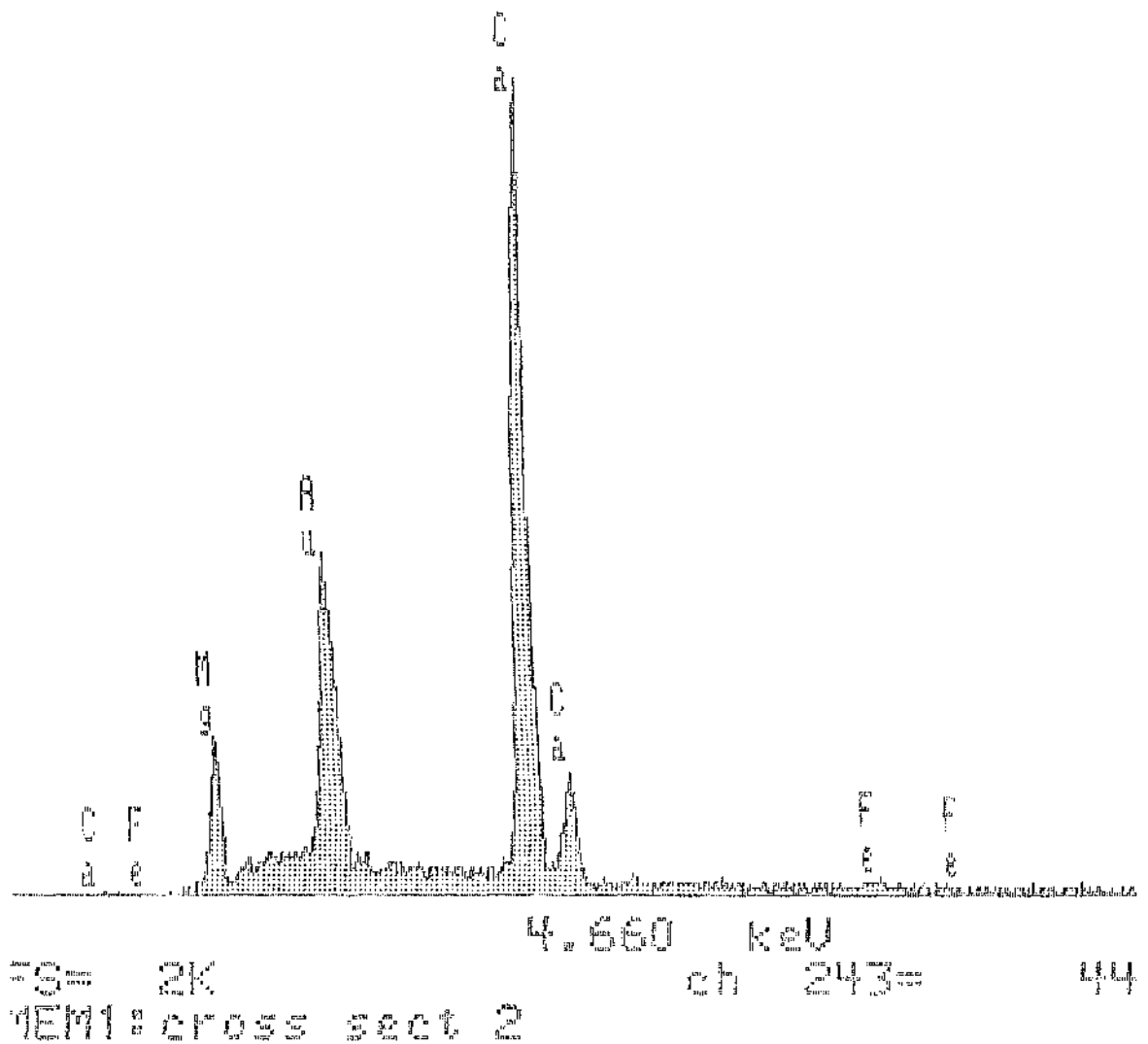

Figure 9.46: Chemical composition of test 57 specimen 4 cross section of region 1, scale deposit (reference to figures 9.44)

---

X-RAY: 0 - 20 keV  
 Live: 100s Preset: 100s Remaining:  
 Deal: 113s 12% Dead

---



**Figure 9.48: Chemical composition of test 57 specimen 4 cross section of region 2, scale deposit (reference to figures 9.44)**

X-RAY: 0 - 20 keV  
 Live: 58s Preset: 100s Remaining:  
 Real: 64s 9% Dead

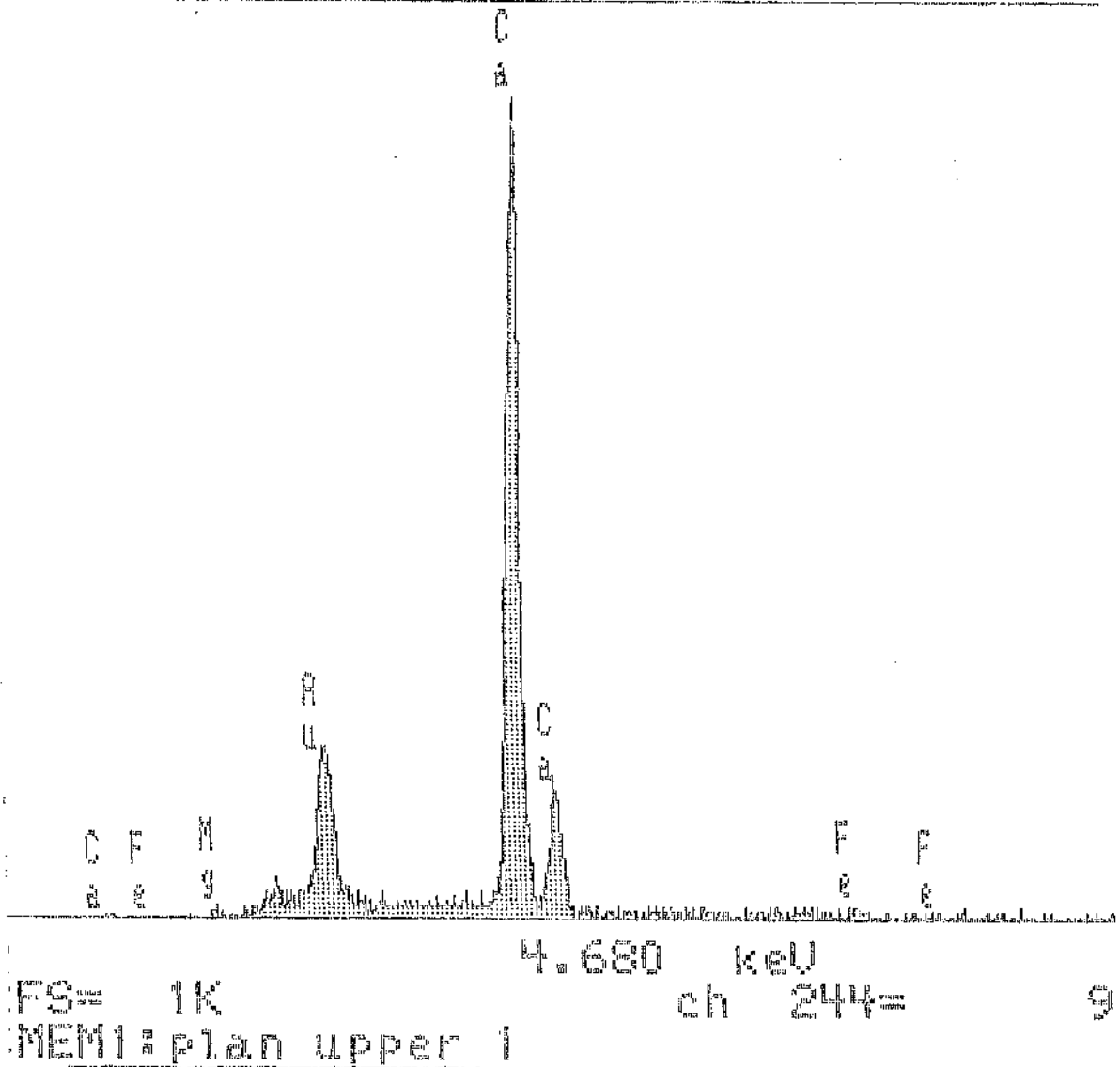
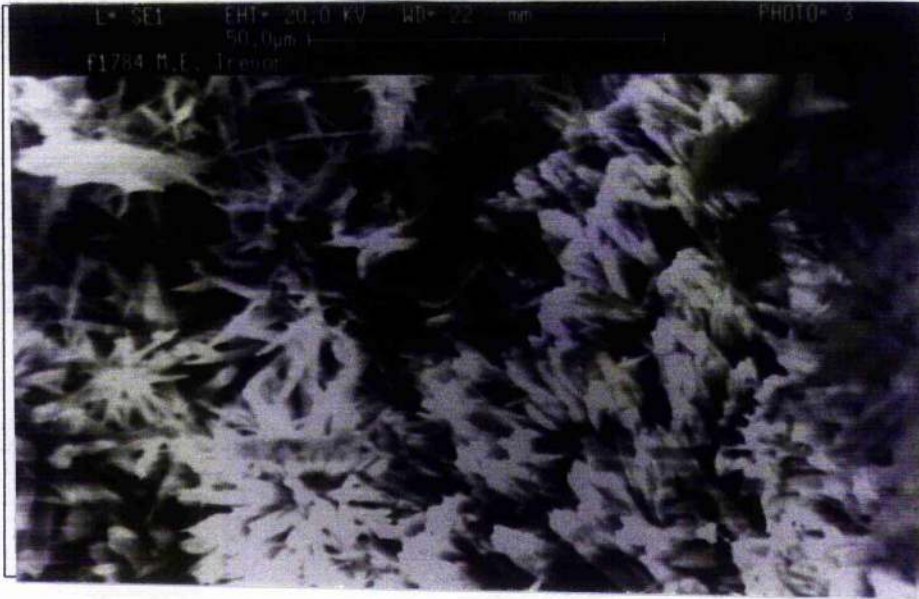

Figure 9.50: Chemical composition of test 57 specimen 4 cross section of region 3, scale deposit (reference to figures 9.44)



**Figure 9.49: High magnification of area 3 of figures 9.44 shows needle-like type scale (pure calcium)**

## 5. X – Ray Diffraction

A very limited amount of XRD was undertaken mainly to provide confirmation that the Mg-rich inner scale layers were  $\text{Mg}(\text{OH})_2$  and that the outer Ca-rich crystals were  $\text{CaCO}_3$  of the aragonite form. The procedure involved taking some powdered scale from a Dubal specimen, mounting in an aluminium stub and examining in an Siemens Daco-MP/Diffract-At version 3 software x-ray machine. The results of these examinations are summarised in table 9.1 and results traces are shown in figures 9.51 to 9.53.

Test No and Temp	Major Compound	Minor Compound	Trace Compound
43 (35 °C)	$\text{Mg}(\text{OH})_2$ (Brucite)	$\text{CaCO}_3$ (aragonite), MgO	$\text{Fe}(\text{OH})_2$
55 (60-45 °C)	$\text{Mg}(\text{OH})_2$ (Brucite) + $\text{CaCO}_3$ (aragonite)	Magnesium Oxide	$\text{CaSO}_4 \cdot 1/2\text{H}_2\text{O}$
57 (30 °C)	$\text{Mg}(\text{OH})_2$ (Brucite) + $\text{CaCO}_3$ (aragonite)	N/A	Al (from mounting stub) + $\text{CaSO}_4 \cdot 1/2\text{H}_2\text{O}$

**Table9.1: Summary of XRD results**

As table 9.1 shows the main findings from the XRD were to confirm the presence of  $\text{Mg}(\text{OH})_2$  and the aragonite form of  $\text{CaCO}_3$ . Other compounds identified were generally only present at traces level with the exception of a minor peak for  $\text{MgO}$  in test 43 and 55.

## 6. Summary of SEM and XRD results

- a. The most striking feature of the SEM examination was that of finding magnesium scale on the lower surface and calcium scale on the upper surface. These findings were observed for all potentials (-900 to -1100 mV) and all temperatures (25 to 60 °C). Moreover, in most cases the calcium scale showed no magnesium and therefore was obviously  $\text{CaCO}_3$  and not a mixed (Ca, Mg) carbonate as some previous workers<sup>29,33</sup> have reported. Also the magnesium scale was generally found to contain no calcium and therefore was  $\text{Mg}(\text{OH})_2$ .
- b. The magnesium scale often appeared to be featureless but examples of crystal shapes (but different) were found. Thus test 55 showed needle like or mesh-like crystals, but test 43 revealed a honeycomb structure.
- c. The calcium scale was always of clear crystal shape with some variations in shape but often appearing column-like which shape is usually consistent to be characteristic of the aragonite form of  $\text{CaCO}_3$  as opposed to the more cuboid-type shape of the calcite form of  $\text{CaCO}_3$ <sup>57</sup>.
- d. Of especial interest was the observation of porosity in the base magnesium scale (tests 55 and 49) and of a holes in the top (calcium scale) surface in the specimen of test 49 and of inter-particle gaps (a kind of porosity) in  $\text{CaCO}_3$  (seen frequently but shown for test 49).





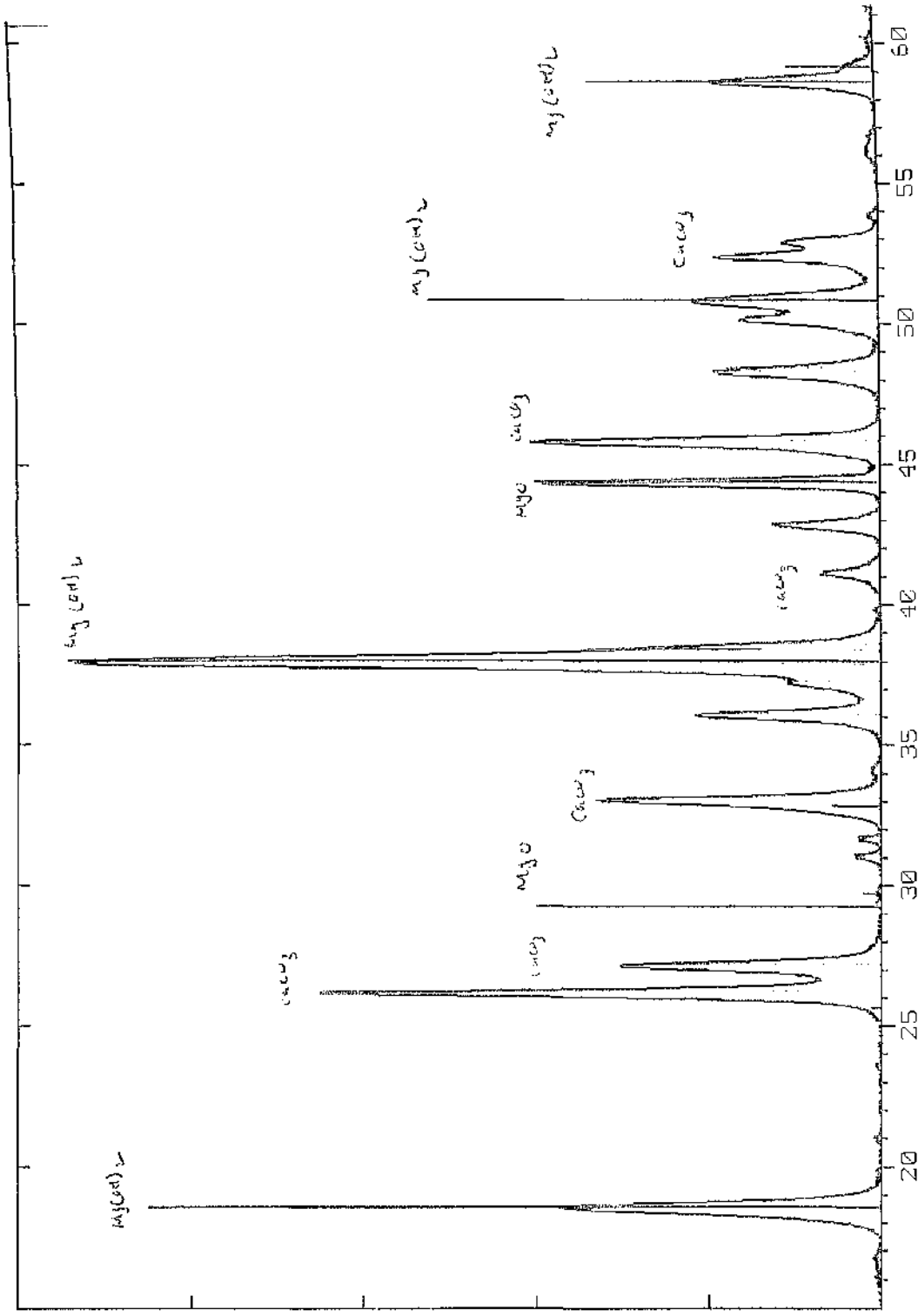

>ANNE03.RAW sample 55 4 (CI: 10.0s, SS:0.020&g, WL: 1.5406Ao)  
-0239 I Mg(OH)2 Brucite, syn(WL: 1.5406Ao)  
-0794 Q MgO Magnesite Oxide(WL: 1.5406Ao)  
-0235 I CaCO3 Calcium Sulfate Hydrate(WL: 1.5406Ao)

Figure 8.52: XRD analytical results of test 55

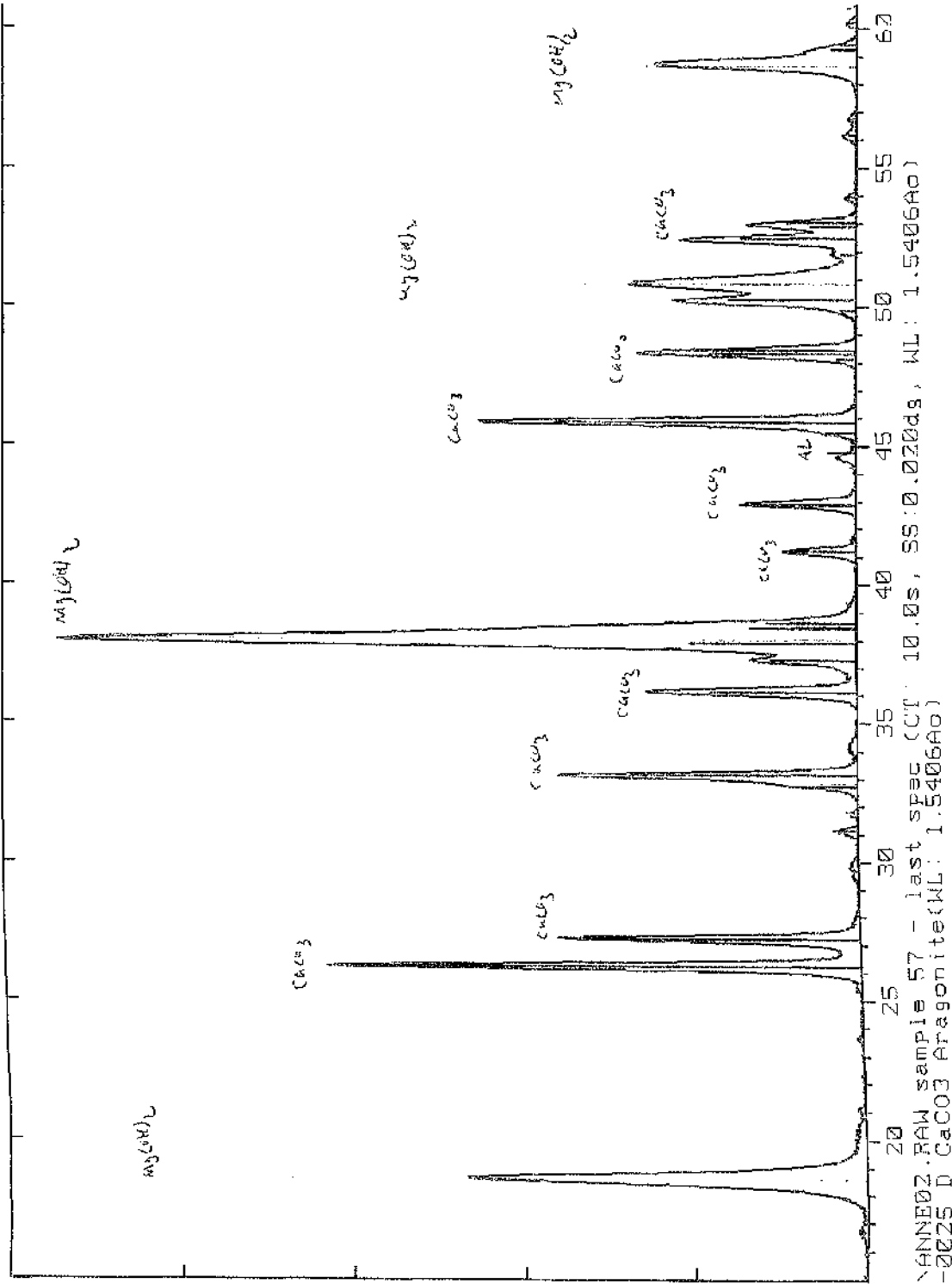

Figure 8.53: XRD analytical results of test 57

00787 x Al Aluminum; Syn (WL: 1.5406Ao)  
 000061 CaSO4.0.5H2O Calcium Sulfate Hemihydrate; Hemihydrate  
 000061 CaSO4.0.5H2O Calcium Sulfate Hemihydrate; Hemihydrate

**CHAPTER TEN**  
**GENERAL DISCUSSION**  
**(TESTS FINDINGS AND SPECIMENS EXAMINATION)**

**1. Calcareous deposition effect**

A characteristic feature associated with application of impressed current cathodic protection in marine environments is the formation of calcareous deposits on the cathodically protected metal surfaces. Indeed, in this project the formation of calcareous scale was a constant feature of the cathodic protection tests over a wide range of environmental and electrochemical conditions. The rate of calcareous deposition on the surfaces of the working metals is purely dependent on the composition of the feed water which contains a variety of suspended solids and dissolved minerals (i.e. calcium and magnesium), its treatment and control. Oxygen reduction and hydrogen evolution reactions, depending upon the set control potential, occur on the cathode or metal surface, which generate hydroxyl ions. As a result pH near to the metal surfaces increases and hence depending upon various conditions, protective calcareous deposits begin to form when the solubility of calcium carbonate or magnesium hydroxide is exceeded (the deposits that form are mainly  $\text{CaCO}_3$ , and  $\text{Mg(OH)}_2$ ). These calcareous deposits form an adherent protective layer, which reduces the required cathodic protection current and also retard rather than accelerate corrosion rate as the overall rate of cathodic reactions reduces.

A series of tests was conducted during this research which focused on the relationship between the parameters of cathodic protection (i.e. control potential) and various properties of calcareous deposit such as rate and duration of which deposit forms. The approach involved in almost all the performed tests with the once through test loop at Dubal, was first to see the duration needed for scale to form on the surface of either the specimen or test loop pipelines. This was followed by a variation of operating parameters in order to understand the rate, thickness, and adherence of scale precipitation. Finally, tests results were obtained on assessing the effectiveness of scale deposition on the current demand for protected areas of the test loop pipelines.

The obtained results are summarized as follows: -

- a. In general calcareous deposits were evident on the surfaces of test specimens and pipelines between 48 to 96 hours. The duration was dependent on test operating temperature, control potential, and flow rate. The rate of calcareous deposition in relation to time was more affected by test set control potential. The more negative the control potential the higher was the rate of calcareous deposition. The calcareous deposits formed at even the most negative potential did not display tendencies to crack and spall in contrast to the views of Luo<sup>33</sup> who claimed  $\text{H}_2$  generation at  $-1000 \text{ mV Ag/AgCl}$  will damage the scale.
- b. As described in the previous part of this Chapter, the calcareous scales were found consistently to compare essentially on inner layer of  $\text{Mg(OH)}_2$  (brucite) with a

overlying region of the aragonite form of  $\text{CaCO}_3$ . This findings extends the contribution made previously by Mental et al<sup>35</sup> who reported a similar scale structure but just for the restricted conditions of  $-900$  mV Ag/AgCl and 24 to 28 °C. In the current research this scale structure was observed for applied potential covering the range  $-800$  to  $-1100$  mV and over the temperature range 25-60 °C. Thus the uncertainty in much of the previous literature concerning the make-up of calcareous scales has been clarified. However, it still remains to characterize the scale structure and composition formed at less-negative potential than  $-900$  mV. In this respect it is of interest to point out that, some time ago<sup>36</sup>, there was a report that the uniform deposit formed at  $-700$ mV (SCE) comprised a Ca-rich scale containing no Mg. Moreover recent work<sup>37</sup> has detected a 2-layer scale ( $\text{Mg}(\text{OH})_2$  / aragonite) when stainless steel was cathodically polarized to  $-1000$  mV (SCE) but that cathodic protection to  $-600$  mV resulted in simply a  $\text{CaCO}_3$  (aragonite) scale containing no sign of Mg.

- c. Calcareous deposits greatly reduced test applied current required for achieving polarization and cathodic protection with time. In practical term this in turn reduces the overall operating cost. It is interesting to compare the findings relating to 'ambient temperature' in the current study with those of other workers. Thus, in the present study the initial currents in the group 'A' segments in tests immediately following an acid wash of the test loop were at the 4-amps maximum. The calculated surface area of the group 'A' part of the pipe is  $5.5 \text{ m}^2$ . Thus the initial current density would have been in excess of  $4/5.5 = 0.72 \text{ A/m}^2$  ( $720 \text{ mA/m}^2$ ) for the current limit. At the other extreme, in conditions when the scale had been allowed to develop in the loop for a series of previous tests, the recorded group 'A' current densities were as low as  $64 \text{ mA/m}^2$ . For comparison, tabulated below are data from the literature (table 10.1).

Reference	Condition	Current density ( $\text{mA/m}^2$ )
Mental et al <sup>35</sup>	Lab	400-500 initially goes to 50 at 100 hours
Jelinek <sup>42</sup>	North-Sea	20 for good scale deposit
Gartland <sup>37</sup>	North-Sea	50 to 100 at $-800$ to $-950$ mV Ag/AgCl and 100 to 150 at $-1050$ mV Ag/AgCl
Evan <sup>38</sup>	Arabian-Gulf and North-Sea	320 initially reduce to 30 to 50 with calcareous deposit layer
Wyatt <sup>58</sup>	North-Sea	30 to 50 with calcareous scale

**Table 10.1: Summary of obtained current density by other workers**

The general correspondence between the current density values from these diverse studies is in many ways remarkable. The rather higher 'clean steel' current densities of greater than  $720 \text{ mA/m}^2$  recorded in the present work (compared to the other figures quoted in table 10.1) is probably due to the higher ambient temperatures (30 to 35 °C in the relevant Dubal tests) and initially bare steel in

Dubal tests. The figure of  $64 \text{ mA/m}^2$ , representing the minimum current density estimated on the scaled rig in the Dubal tests, is nearly within the range of the figures reported by others (table 10.1) for scaled steel. This is especially so considering the fact that the  $64 \text{ mA/m}^2$  figure was obtained on a system operating for just months and may have fallen even further over more extended periods. In this respect, the calculated figure (see chapter 7) of 14 to  $24 \text{ mA/m}^2$  for the Dubal desalination plant seawater header again correlate extremely well with the other data quoted in table 10.1. One detailed aspect of the Dubal rig tests was the observation that the currents in group 'A' commenced to decline well before the local potential in group 'A' had attained the pre-set control value. The reason for this is also linked to the occurrence of scale deposition, which could be seen to be 'signaled' by the current decrease. In some recent relevant work<sup>59</sup> an analogous fall in current was observed during a slow-scan potentiodynamic test in highly-chlorinated seawater which was found to exhibit accelerated scale deposition. Thus it would appear that the scale-induced fall in current actually delays the attainment of the control potential under potentiostatic mode of cathodic protection control. On the other hand, the start of scale deposition should itself be providing a measure of corrosion protection even when the potential has not attained the normal protection values. This is an interesting topic of possible future research.

- d. Evidence was obtained that calcareous deposits would increase the plant security in case of anode failure. This phenomenon of anode failure was examined in tests 48, 49, and 50 where the benefits of calcareous deposit were examined by continuing the tests with cathodic protection supply off. The obtained results based on daily visual inspection and measurements of local potential indicated that calcareous deposits played a major role in providing the required protection from preventing the test loop pipeline and specimens from corroding for the periods of 4 to 9 days. This in fact re-confirmed that an immediate shut down of plants, which are protected cathodically is not required as formed calcareous deposits definitely act as a protective agent. A partial limitation of the protective nature of the calcareous deposit was observed in this research program. Thus a consistent feature of test runs at Dubal was that the initial currents on group 'A' were high in the early stages of a test. This was most apparent in the series of tests preceding the first acid wash (after test 44). In these tests, the test loop was clearly becoming more and more scaled and yet, in every test, the group 'A' current was high for a short period initially. This feature was also apparent in tests on pre-scaled specimens in the simple Glasgow set-up (e.g. test 11). It is interesting to note that Dittmyer and Byre<sup>52</sup> observed similar current 'spikes, on periodic start up of the desalination plant upon which cathodic protection was installed. This may be due to the occurrence of some partial damage to the scale possibly cracking, associated with the drying process and this causes the relatively high currents at the beginning of the next run. Another possible explanation is that the drying of scale allows air to enter the porous network of the scale so that the oxygen-reduction cathode reaction will be accelerated in subsequent operation. Support for the notion that this high initial current density were caused by drying out of the scale layer rather

than some other factor was obtained in test 34. In this test a pre-scaled specimen was kept wet before re-insertion into the Glasgow University rig and the subsequent start-up did not show a high current.

- e. Calcium carbonate is practically insoluble in normal seawater. Consequently, such scale survives and continues to protect surfaces during interruptions to the application of impressed current cathodic protection. It was observed during test 26 that a complete removal of an already formed scale is not achievable when pre-scaled specimen was placed in an area, which was more turbulent. This represents a beneficial aspect of the observed scales comprising an outer  $\text{CaCO}_3$  region over the  $\text{Mg}(\text{OH})_2$  layer since  $\text{Mg}(\text{OH})_2$  in direct contact with seawater would probably dissolve relatively quickly when cathodic protection was off.
- f. General deposition occurs on carbon steel surface away from the anode site. This deposition heals over any corroded or bare metal areas and if left undisturbed, it forms a self healing protective coating which is a major factor in yielding good cathodic protection performance by assisting current reach and reducing the anode current demand.

## 2. Control Potential

The effect of shifting control potential toward more or less negative value was examined in numerous occasions during the test programme both at Glasgow University and Dubai. In general the following features were observed: -

- a. Full system protection was achieved when tests were carried out at ranges of potential from  $-800$  mV up to  $-1100$  mV for Glasgow tests and  $-900$  to  $-1050$  mV for Duabl. Applied current demand increased/decreased as potential was set at more/less negative values.
- b. The study showed the expected effect of higher currents at more negative potential in the initial stages of exposure of bare steel (see figures 8.88 and 8.47). However there was evidence that the occurrence of scaling resulted in a reduction in current differences at different potential. This is shown in figures 8.27, and 8.64. These comparisons involve tests at potential as negative as  $-1050$  mV (SCE) where the  $\text{H}_2$  generation reaction is expected to contribute significantly (in addition to  $\text{O}_2$  reaction) to the cathodic current. Thus the indication is that the production of a calcareous scale retards the  $\text{H}_2$  generation cathodic reaction as well as oxygen reduction and this is in disagreement with the view of Lee and Ambrose<sup>26</sup> but in accord with the predication of Yan et al<sup>41</sup>. This illustrated that, operating cathodic protection at slightly more negative potential has little cost burden to the users. Scale also formed more rapidly surrounding and away from anodes when test was carried out at more negative potential.

- c. Scale deposition of different rate, and thickness was formed on the surfaces of specimens and test loop pipelines both at Glasgow and Dubal when tests were carried out at control potential of  $-800$  up to  $-1050$  mV. The rate and thickness increased and decreased as test control potential was set at more/less value (this was observed throughout the tests both at Glasgow and Dubal).
- d. The electrode potential was observed to be different at various locations in the Dubal once-through test loop. These differences were associated with the different currents in, groups 'A and B' and also with hydrodynamic variations in the loop. Calcareous deposit built up on the surfaces of the specimens and pipelines were greater in locations, which were under more negative local potential (i.e. area of zone 'B' within the test loop, which also included specimens 3, 4, and 5).

### 3. Temperature effect

Temperature affects the corrosion rate. The effect of temperature is complicated, as higher temperatures cause more rapid chemical reaction rates. But also increase in temperature can in some ways decrease corrosion either on account of lower  $O_2$  solubility at higher temperature or by formation of insoluble scales on metal surface on account of the lower solubility of some scale compounds with increase in temperature. For example, in the case of this study the solubility of  $Mg(OH)_2$  and also of  $CaCO_3$  (which normally form in desalination plant) decreases as temperature increases. Hence for instance the  $CaCO_3$  will precipitate out of solution at lower  $Ca^{2+}$  and  $(CO_3)^{2-}$  ion concentrations as temperature rises. The rate of scale formation on the surfaces of the area under cathodic protection is therefore temperature dependent. In general an increase in temperature should cause more rapid decrease in test applied current due to increase in calcareous deposition rate on the surfaces which are protected cathodically. The effect of temperature was thus examined in detail during the tests both at Glasgow University and Dubal. The findings are discussed in general terms as follows: -

- a. Overall temperature effect appears to be an increase in the current requirement with increasing temperature. Actually, there was evidence from some of the tests (e.g. figure 8.70) that the rate of early decline of current was greater at higher temperature; this is in accordance with the idea of faster scale deposition at elevated temperature. Nevertheless, it was consistently found that the later steady or plateau, currents were higher at higher temperature. For example, at a surface temperature of  $55^\circ C$ , a group 'A' current density of  $272$  mA/m<sup>2</sup> was required for protection in test 46 after 24 days in operation which when compared to test 45 the demand reduced considerably to  $180$  mA/m<sup>2</sup> for seawater temperature of  $35^\circ C$ . Also in test 47, there was a sharp drop in current when the temperature was reduced from  $55^\circ C$  to  $30^\circ C$  after 13 days. Again in test 54 there was a sharp increase in current when temperature was raised from  $35^\circ C$  to  $60^\circ C$  after 19 days. Kettle<sup>44</sup> reports the current density after 30 days exposure to seawater of  $66$  mA/m<sup>2</sup> at  $40^\circ C$  and  $152$  mA/m<sup>2</sup> at  $60^\circ C$ . These are in quite good agreement with



the figure quoted in the last sentence. On the other hand, Kettle<sup>44</sup> also reports a large decrease in current density, to 35 mA/m<sup>2</sup>, as the temperature is increased to 90 °C. This feature can not be compared with the Dubal/Glasgow rig results since tests were not carried out above 60 °C but it is relevant to recall that the estimated current density in the brine inlet manifold (temperature 110 °C) on the Dubal desalination plant is 280 mA/m<sup>2</sup>(chapter 5) and figures quoted by Dittmejer and Boyer<sup>52</sup> for rather similar MSF plant location are much higher again. The lack of correspondence with Kettle's<sup>44</sup> 90 °C results is probably much to do with the higher turbulent conditions in such parts of desalination plant.

- b. The effectiveness of cathodic protection at higher temperature was obvious as no sign of corrosion was seen during the performed tests both at Glasgow and Dubal. However, the cost of cathodic protection will be greater at elevated temperature because, as discussed in the above paragraph, the presence of scale layer does not seem to greatly inhibit the normal effect of temperature in accelerating Electrochemical reactions.
- c. The shape and rate of the formed scale on the specimen surface and test loop pipelines was found to be more uniform, and thicker at temperature above 50 °C when compared to tests which were performed at ambient seawater temperature. Scale was visually observed within 48 hours at test temperature above 50 °C verses 72 to 96 hours when the test was conducted at seawater ambient temperature (Note: in fact deposit was probably present on a micro scale at earlier times). Even this time of 72-96 hours is short compare to reported time of 2-3 months for scale to form in the low-temperature North-Sea condition<sup>37</sup>. In many tests scale was formed at high temperature even with scale inhibitor being present at Dubal.

#### 4. Flow rate effect

An increase or decrease in test operating flow rate has a direct effect on the corrosion rate, mainly due to an increase in the supply of cathodic reactant (O<sub>2</sub>) by mass transfer to the metal surface and by removal of corrosion products as protective film breakdown is more prevalent. In terms of the performance of cathodic protection systems, the influence of flow is complex involving the following four aspects: -

- a. The influence of flow on the initial current density on bare steel surfaces.
- b. The influence of flow on the ability to form and rate of formation of calcareous deposit.
- c. The influence of flow on the current density of established, intact calcareous layers.

- d. The tendency for relatively severe hydrodynamic conditions to cause damage to, and removal of, protective calcareous layers.

These aspects are discussed below (considering factor 'b' followed by 'd' and then 'a' & 'c' together): -

- b. The rate of scale deposition on the surfaces of the specimens and test loop pipelines decreased with increase in test operating flow rate. The higher the flow rate the thinner the calcareous film became. An increase in the test flow rate causes the products of the cathodic reaction to be removed more rapidly and the amount of oxygen arriving at the cathode surface per unit of time to increase. The flow increase as well reduces, the flow contact time required between the specimens and test loop pipeline in order for scale to form. Wolfson and Hart<sup>23</sup> also reported this finding. The duration for formation of calcareous deposits on the surfaces of specimens and test loop pipelines reduced with decrease in test operating flow rate. This is mainly due to increase in flow contact time with surfaces, which were protected cathodically and also flow being less turbulent.
- d. In this work, the evidence was that calcareous scale layers are very hard and protective and not subjected to significant damage even at the higher flows of 1 m/s (180 m<sup>3</sup>/hr) employed in the research. This property is what normally expected with scales in industrial situations and the present observation are not in accord with the view<sup>37</sup> that scale rupture at velocity greater than 0.6 m/s. Certainly full protection of the installed specimens and test pipeline were achieved when tests were operated at flow rates of 0.12 to 0.262 m/s at Glasgow and 0.06 to 1 m/s at Dubal. Reduction in applied current was less for specimens, which were positioned at more turbulent location within the flow rig at Glasgow University tests.
- a & c. The current flow relationships displayed in this work were complex. Most often when proper comparisons would be made (e.g. figures 8.18, and 8.80) there was a higher current for higher flow rates throughout the entire duration of a test but in some instances there was a tendency for gradual convergence of the currents (figure 8.29). However in other cases, the currents were initially similar but later diverged with higher current at higher flow (figure 8.58). This is apparently a rather confused situation but points to complex relationships especially in the early stages of exposure. One obvious relevant factor is that, in the early stages, the initial precipitation of columnar-like crystals of aragonite creates a locally rough surface with local turbulence. Being dependent on detailed specimen environmental conditions, these roughness phenomena would clearly complicate otherwise simple current/flow relationships. Another complication arises in relation to longer-term exposure. In this respect, it has been suggested in the past<sup>35,37</sup> that an intact calcareous layer leads to current being independent of flow and recent tests at ambient temperature in model CaCO<sub>3</sub> precipitated solution using a rotating disc electrode<sup>60</sup>, have provided further support for this notion. This suggests that the scales formed in this research programme, although very clearly substantial in

coverage and thickness as illustrated in many photographs in chapter 8, were not sufficiently dense to yield flow independent correlation. This could be either due to inherent differences between these scales formed in desalination plant condition and those involved (e.g. lower temperature) in the studies quoted above or due to insufficient time being elapsed in the tests undertaken in this project to facilitate a sufficiently non-porous scale. This matter is unresolved but will be returned to later in this Chapter.

## 5. Specimen orientation

The orientation aspect and its effect on the application of cathodic protection play an important factor during the initial designing of cathodic protection system for any marine application. Generally the calculated applied current for surfaces which are perpendicular to flow requires a higher rate of applied current as the rate of oxygen supply to the surfaces which are protected cathodically is stimulated and hence the cathodic reaction increases (oxygen reduction or hydrogen evaluation depending on set potential). This phenomena is certainly applicable to desalination plant, for example target plate area of brine inlet manifold and areas after elbows. This issue was the motive behind examining the effect of orientation on performance of cathodic protection system. A number of tests were carried out in which the orientation of the specimens was changed from parallel to perpendicular to flow or vice versa. The findings indicated the change in applied current demand, which was observed to increase when the specimen orientation changed from perpendicular to parallel to flow. The observed results also applied when the pre-scaled specimens were used and as well when the test was carried out at different operating temperature, flow rate and specimen location within the test loop. The obtained findings are thought to be due to creation of vortex and more turbulent condition surrounding the installed specimen (figure 10.1). Although parallel to the flow the specimen protruded into the flow and this caused the specimen to act as a bluff body, i.e. a non-streamlined object, which causes fluid separation and induces vortices on the downstream face<sup>61</sup>.

On the other hand, if the specimen had been part of the pipe wall, i.e. flush, then parallel flow would represent less turbulent condition, which in turn would reduce the demand for current in such condition.

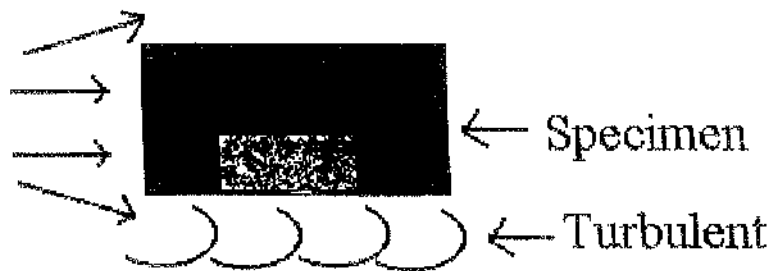

**Figure 8.1: Turbulent conditions surrounding specimen**

## 6. Antiscalant

Antiscalant (scale inhibitor) is widely used by the water treatment industry for reducing scale formation of feed water into any process plant such as multi stage flash evaporator. In general small dosages of antiscalant slow down the rate of scale formation or modify deposit such that they do not adhere to each other or to the metal surfaces. The benefit of calcareous deposits in reducing the test applied current for achieving the required protection was explained in section 1 of this general discussion, since calcareous deposits proved to act as an effective barrier to oxygen diffusion to the test loop pipeline surface. The effect was therefore examined during some of the high temperature tests in order to show the relationships between presence of scale inhibitor within water media (test feed water) on the rate and duration of calcareous deposits. In general, presence of scale inhibitor in feed did not prevent the expected increase in scale formation at higher temperature. This important result implies that the beneficial effects of calcareous deposition during cathodic protection can be also expected in the desalination plant even when scale inhibitors are present. This finding was examined during internal inspection (i.e. low and high temperature sections of the plant where the water media contained the presence of antiscalant) of various parts of the plant in duration of this study at Dubal desalination plant. All the performed internal inspections have re-confirmed the observed findings of the tests performed at Dubal where calcareous deposits was found formed of different thickness, and adherence on the metal surfaces which were under cathodic protection. In conclusion, antiscalant presence in the feed flow reduced slightly but did not fully stop the scale formation at the surface of the specimens and test loop pipeline.

## 9. Modes of operation of cathodic protection systems

The work has shown that the galvanostatic mode of cathodic protection has some attraction in that it provides a mechanism for the rapid attainment of sufficiently negative, corrosion control potential and rapid deposition of calcareous scale without the delaying feature of reducing current associated with the potentiostatic mode of operation. On the other hand, the magnitude of constant current operation would need to be studied and identified in given circumstances in order to control the levels of overprotection in order

to minimize the cathodic protection costs and also the possible damage associated with hydrogen embrittlement (with materials, such as high strength steel, where this is a danger).

The obvious conclusions are that the mixed mode type of cathodic protection system, in which the protection is commenced with a period of galvanostatic operation followed by a long-term potentiostatic control, may represent an attractive type of operation. Indeed this approach has been studied in the laboratory<sup>33</sup> and the rapid polarization strategy appears to have been utilized on offshore platforms<sup>38,42,43</sup>. Also this method is in fact practiced in the very severe part of the brine inlet manifold in the Dubal desalination plants where the potential is maintained for a period of 3 to 4 weeks at a more negative value (by about  $-200$  mV) than normal in order to stimulate calcareous deposit.

## 8. Comments on mechanisms of scale growth during cathodic protection

There is wide general appreciation of the occurrence of calcareous deposition during the application of cathodic protection in seawater and association of this phenomena with the deposition of  $\text{CaCO}_3$  and  $\text{Mg}(\text{OH})_2$  is also frequently acknowledged. However, there appears to have been very little attention given to the detailed processes occurring even for the usually-considered case relating to offshore structures operating at ambient temperatures. Thus a consideration of possible mechanistic factors involved is now presented. The discussion starts with comments on the actual location of the cathodic reaction when a surface is completely covered by a calcareous deposit. Considering at this point the simple schematic case of surface coverage by a single unspecified scale compound, these appear to be two possible scenarios.

Model 1 (figure 10.2): A porous or finely cracked calcareous deposit, which allows a supply of dissolved oxygen to the metal surface at which the cathodic reaction continues to be situated.

Model 2 (figure 10.3): A scale layer, which is effectively non porous but has electrically conducting properties sufficient to maintain the cathodic reaction on the outer scale surface.

These two cases will be referred to as appropriate in the detailed consideration of the mechanisms of progressive growth of calcareous scale which now follows.

It is widely recognized that, upon initial switch on of the cathodic protection, the currents are high and thus the rate of production of  $(\text{OH})^-$  at the metal surface (by oxygen-reduction cathodic reaction) is sufficient to precipitate  $\text{Mg}(\text{OH})_2$ .

In the current research, the  $\text{Mg}(\text{OH})_2$  has been observed to usually form with an apparently fine structure (in fact often difficult to resolve on the SEM). This suggests a fairly rapid rate of formation as similarly reported by Mantel et al<sup>35</sup>.

Moreover, the  $\text{Mg}(\text{OH})_2$  layer is always observed to be relatively thin which implies that the conditions for its continued growth cease quite quickly. Also a thin layer might be considered to give support to the occurrence of model 2 above. On the other hand, some of high magnification microscopy in this research has indicated the presence of

fine porosity in the  $\text{Mg}(\text{OH})_2$  layer. Equally though the SEM images of  $\text{Mg}(\text{OH})_2$  revealed some varying physical structures. Clearly this is a topic for which some useful future work could be done but the evidence gained in the current project might possibly point to  $\text{Mg}(\text{OH})_2$  growth involving both of the above models possibly at different exposure times (with perhaps model 2 involved in the very early stages of film growth) and in different environmental conditions (e.g. varying temperature).

The termination of growth of  $\text{Mg}(\text{OH})_2$  could occur when the film has grown to such a thickness that electron transport (model 2) or  $\text{O}_2$  diffusion (Model 1) is insufficient to maintain the cathodic reaction at high enough rates to maintain the local condition of super-saturation in respect to  $\text{Mg}(\text{OH})_2$ . At such a point in time, therefore, initiation of precipitation of  $\text{CaCO}_3$  commences since the solubility of this compound in seawater can be exceeded at lower pH than is required for deposition of  $\text{Mg}(\text{OH})_2$ . The  $\text{CaCO}_3$  grows as individual crystals of aragonite of columnar or plate-like shape (see SEM photograph).

The deposition of  $\text{CaCO}_3$  might be expected to cause a decrease in current but a counteracting factor will be the local turbulence induced by the presence of clumps of aragonite crystals. This situation would account for the high currents that were measured for 2 or 3 days after the loop had been acid washed (see for example figure 8.67). When complete surface coverage with aragonite crystals is attained, the surface roughness effect would be much smaller and the current would begin to decline (as was observed). Mantel et al<sup>35</sup>, investigating just one condition of  $-900\text{mV Ag/AgCl}$  and  $24-28^\circ\text{C}$ , obtained similarly-shaped current/time curves as just discussed and also obtained correlation between the constant current period and the developing coverage by aragonite crystals but provided no explanation for this correlation.

The subsequent steady fall in current can be rationalized as the occurring as aragonite upper layer densifies as a result of the growing crystals interlocking. However, the mass of current/time profiles in this study all tended to indicate the eventual establishment of a constant residual current the magnitude of which was difficult to specify but with clear indication of it being temperature dependent. This notion of a constant residual current density is well supported both by other work (see earlier this chapter) and also by the measurement of small current densities on the long-running Dubal desalination plant (see for example the calculated value for the seawater header in chapter 7). Linkage of this steady state current density with the two models illustrated earlier tends to favor the "porosity" model 1 rather than the "conductive scale" model 2 for two reasons: -

- \* The interrupted tests on Glasgow rig in which a scale allowed to dry exhibited a subsequent increase in current but a scale kept wet did not.
- \* Very recent observations<sup>62</sup> showing an independence of current on fluid velocity for fully grown (admittedly calcite)  $\text{CaCO}_3$ .

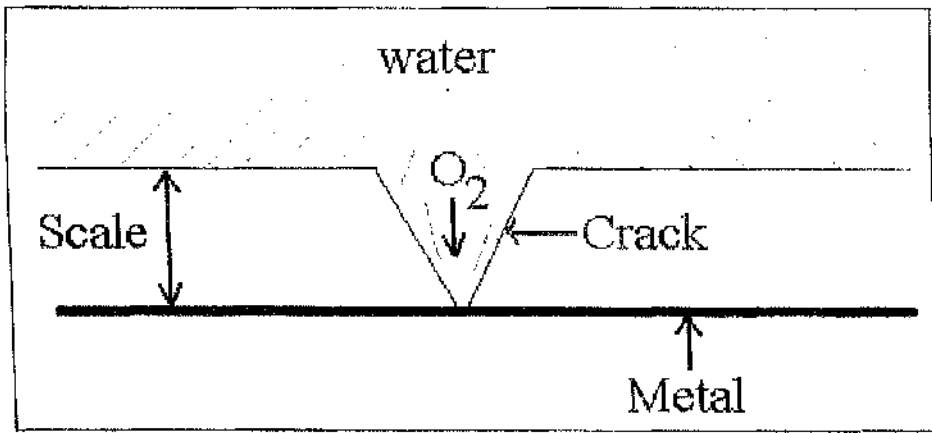

Figure 8.2: Scale cracking effect on current demand

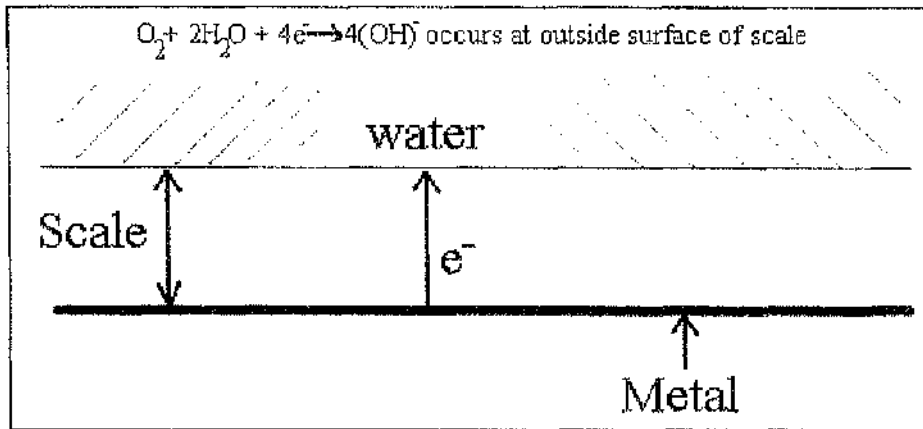

Figure 8.3: Scale

## CHAPTER ELEVEN COST COMPARISON

### I. Introduction

The ultimate objective of any manufacturing activity is to produce a product of a quality acceptable for the intended end use, at a cost that permits a reasonable return on investment when sold at a competitive price i.e. water cost. The cost of production of any, product is largely governed by factors such as: -

- \* Initial capital investment.
- \* Plant availability, and reliability.
- \* Volume output.
- \* Performance expectation in relation to materials resistance to elevated temperature, high water media conductivity, and presence of chemical such as chlorine.
- \* Maintainability, and safety of operation.
- \* Operating cost.

Selection of the material of construction is extremely important factor, since the choice of the material used effects the performance, initial cost, the operating and maintenance cost, and the useful service life of the product or equipment made from it (i.e. materials that are more costly, may result in lower operating costs, because of their contribution to improved efficiency, increased service life, and reduced maintenance which in turns means increased in production). Therefore, selection choice of material should be based on the material physical and mechanical specification, corrosion-and wear resistance properties, joinability, and commercial availability in standard quality, shapes and sections. Therefore, for any application including desalination plant both the technical and economics factors must be considered in the analysis leading to the selection of material.

The third aspect of the Ph.D. project was to undertake a detailed cost comparison of a loop almost similar to Dubal's, in order to predict the economics of constructing a loop using G.R.E material, or carbon steel with an on line impressed current cathodic protection system or stainless steel. The major philosophy behind this was to obtain additional detailed information on the comparative economics of using carbon steel protected by cathodic protection versus stainless steel and G.R.E which has seen extensively applied for feed lines in other desalination plant.

Additionally, a comparison of the costs of loop construction using cathodically protected carbon steel verses stainless steel was undertaken. This comparison was focused on pipe work on a MSF plant transmitting seawater/brine at elevated temperatures, such as between the outlet of the first heat recovery water box and heat input section, and between heat input section outlet and flash chamber. In such elevated temperature locations, the use of G.R.E is more problematical. G.R.E suppliers often make claims of satisfactory performance of their products at elevated temperature<sup>63</sup> but there is much experimental evidence that G.R.E using conventional resin such as polyester or epoxy is vulnerable certainly at temperature above about 60 °C and one major Middle East M.S.F



plant has had to replace G.R.E by metallic pipe for high temperature pipe work<sup>61</sup>. Such pipe work is usually constructed in either stainless steel or copper nickel alloy. Since stainless steel can be obtained at less cost than copper nickel material, this cost comparison was therefore focused on stainless steel.

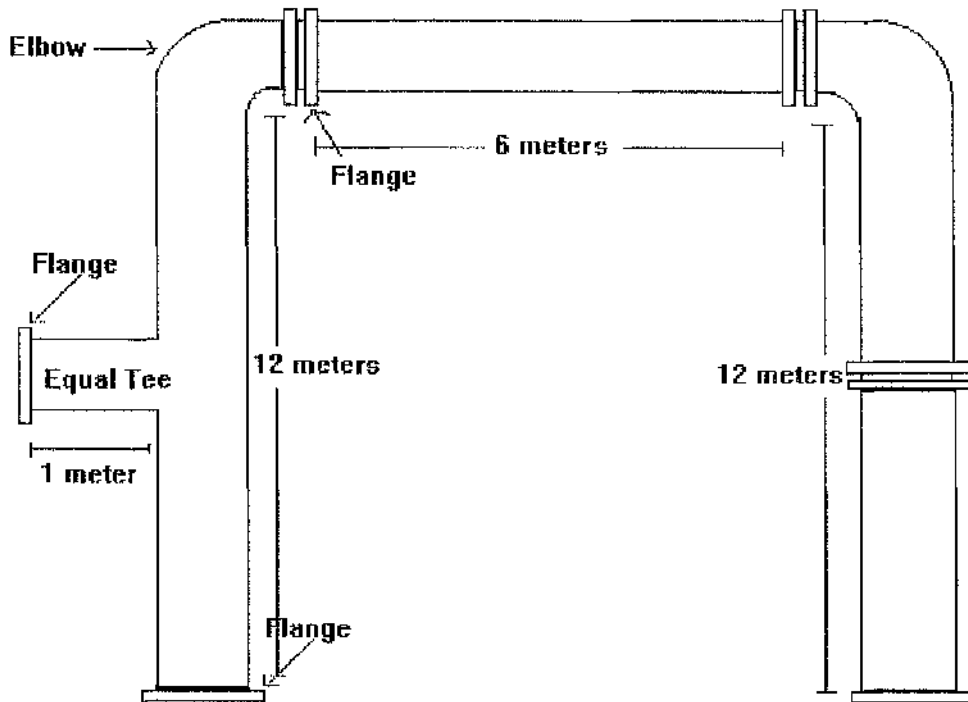

Figure 11.1: Controlled loop used for cost comparison

## 2. Technical and economic evaluation

In general for any corrosion resistance application, the selected material must have reasonably low rate of corrosion under the prevailing environmental conditions i.e. seawater. It also should offer a reasonable corrosion resistance with or without suitable coatings in the application environment. An economic analysis is certainly required in determining the most economic material prior material selection. In many cases if not all, the technical and economic analyses carried out hand to hand before selection, in order to identify its suitability to application and cost.

For the purpose of cost comparison for this study a loop almost similar to Dubal (figure 11.1) was drawn, and sent for quotation to number of pipe work suppliers of G.R.E, carbon steel, and stainless steel. Hence, this allowed simulating components (e.g. flanges, and elbow) in practical pipe work, so as to obtain a better assessment of 'installed costs' rather than simply comparing unit length material cost. Quotations were requested for construction of the loop in two diameters, 10" and 36". The quotations were then analysed and tabulated in tables 11.1, and 11.2. In tables 11.1 and 11.2, 'GRE' stands for glass reinforced, epoxy and 'GRP' stands for glass reinforced polyesters. The figures for some suppliers were for material only and did not include cost of fabrication, and painting

for the case of carbon steel. It can be seen that there were wide variations in cost, by factors of 2 to 3, for both pipe diameters.

	Total cost (Pound)	Material only	Fabrication included	Painting included	Cathodic protection
G.R.E	4,572	Yes	No	N/A	N/A
G.R.E	5,000	Yes	Yes	N/A	N/A
G.R.E	3,260	Yes	Yes	N/A	N/A
G.R.E	3,320	excluding flanges	No	N/A	N/A
G.R.P	6,850	Yes	Yes	N/A	N/A
Carbon Steel	9,678	Yes	Yes	Yes	No
Carbon Steel	2,600	Yes	No	No	No
Carbon Steel	3,400	Yes	Yes	Yes	No
Carbon Steel	3,300	Yes	Yes	No	No
Carbon Steel	2,600	Yes	No	No	No
S/less Steel	11,720	Yes	No	N/A	N/A
S/less Steel	27,500	Yes	Yes	N/A	N/A

**Table 11.1: Tabulated figures of obtained quotations for 10" pipeline of different materials**

	Total cost (Pound)	Material only	Fabrication included	Painting included	Total cost with C.P ( Pound )
G.R.E	48,000	Yes	No	N/A	N/A
G.R.E	28,700	Yes	Yes	N/A	N/A
G.R.E	17,500	Excluding flanges	No	N/A	N/A
G.R.P	31,000	Yes	Yes	N/A	N/A
Carbon Steel	39,000	Yes	Yes	Yes	No
Carbon Steel	17,500	Yes	No	No	No
Carbon Steel	24,000	Yes	Yes	Yes	No
Carbon Steel	44,000	Yes	Yes	No	No
S/less Steel	317,000	Yes	Yes	N/A	N/A

**Table 11.2: Tabulated figures of obtained quotations for 36" pipeline of different materials**

In addition, the obtained quotations for carbon steel did not include the provision for extra cost of cathodic protection system. Hence, a separate simple calculation was carried out in section 3 of this chapter, to illustrate the effect in overall installed cost when carbon steel used with an on line impressed current cathodic protection system.

Note: For the purpose of the following calculations some of the quotation for 10" and 36" diameters of carbon steel and GRE were not considered as the obtained figures were higher by the factor of 2 to 3 when compared to the other received quotations

### 3. Cathodic protection supply cost allocation

A following simple calculations were carried out, to identify the actual cost of installing cathodic protection system on providing the required protection cathodically for loop made of 10" and 36" carbon steel. The reported figures of 80 to 500 mA/m<sup>2</sup> (20,21,22) of current density for protecting both for carbon steel covered with calcareous deposits and bare carbon steel pipe were considered for cost allocation purpose. The assumed figures in general agrees with the obtained results both via tests (Glasgow and Dubal) and calculated current density of Dubal desalination plant seawater header and brine inlet manifold. It also revealed that with time the current density even dropped below 50 mA/m<sup>2</sup> (14 to 33 mA/m<sup>2</sup>). The followings are simple calculations made for incorporating the cost of cathodic protection with carbon steel for both 10" and 36" pipe diameters at assumed current densities of 50 and 500 mA/m<sup>2</sup>.

#### Example 1: 10" Diameter pipeline (for 50 and 500 mA/m<sup>2</sup> current density)

Total pipe length of protected area	****	30	meter
Pipeline Diameter	****	0.25	meter
Anode Rating	****	1.00	Amps
Current density for case 'A'	****	500	mA/m <sup>2</sup>
Current density for case 'B'	****	50	mA/m <sup>2</sup>
Area = ( Diameter ) x ( length ) x ( $\Pi$ )	****		m <sup>2</sup>
Area = ( 30 ) x ( 0.25 ) x ( 3.14 )	****	<u>24</u>	<u>m<sup>2</sup></u>

$$\begin{aligned} \text{Total cathodic protection current for case 'A'} &= (\text{Area}) \times (\text{Current Density}) \\ &= (24) \times (500) \\ &= \mathbf{12000 \text{ mA or } 12 \text{ A}} \end{aligned}$$

$$\begin{aligned} \text{Total cathodic protection current for case 'B'} &= (\text{Area}) \times (\text{Current Density}) \\ &= (24) \times (50) \\ &= \mathbf{1200 \text{ mA or } 1.2 \text{ A}} \end{aligned}$$

#### Example 2: 36" Diameter pipeline (for 50 and 500 mA/m<sup>2</sup> current density)

Total pipe length of protected area	****	30	meter
Pipeline Diameter	****	0.900	meter
Anode Rating	****	1.00	Amps
Current density for case 'A'	****	500	mA/m <sup>2</sup>
Current density for case 'B'	****	50	mA/m <sup>2</sup>
Area = ( Diameter ) x ( length ) x ( $\Pi$ )	****		m <sup>2</sup>

$$\text{Area} = (30) \times (0.900) \times (3.14)$$

$$\text{**** } \underline{\underline{85 \text{ m}^2}}$$

$$\begin{aligned} \text{Total cathodic protection current for case 'A'} &= (\text{Area}) \times (\text{Current Density}) \\ &= (85) \times (500) \\ &= \mathbf{42,500 \text{ mA or } 42.5 \text{ A}} \end{aligned}$$

$$\begin{aligned} \text{Total cathodic protection current for case 'B'} &= (\text{Area}) \times (\text{Current Density}) \\ &= (85) \times (50) \\ &= \mathbf{4,250 \text{ mA or } 4.25 \text{ A}} \end{aligned}$$

Based on the above calculation, the number of anodes requires for both case varies between 2 to 42. Hence, the effect of calcareous deposits indeed has direct effect in selection of the cathodic protection transformer rectifier equipment (rating), which in turn effects the overall initial capital cost when carbon steel with on line impressed current is compared to G.R.E material.

#### 4. Cathodic protection cost breakdown

The actual cost of the cathodic protection system for both 10" and 36" carbon steel pipeline estimated by using the calculated current in section 3 of this chapter, and the following table.

Items	Cost (Pound)
One amps rated platinised titanium anode	60
Five amps rated platinised titanium anode	211
Silver/Silver chloride reference electrode	56
Transformer rectifier (12 Amps ) rated	2500
Transformer rectifier (5 Amps ) rated	1500
Transformer rectifier (3 Amps) rated	1000
Cables for case 'A' 10"	250
Cable for case 'B' 10"	100
Cables for case 'A' 36"	600
Cable for case 'B' 36"	150
Labor cost case 'A' 10"	300
Labor cost case 'B' 10"	150
Labor cost case 'A' 36"	500
Labor cost case 'B' 36"	170

**Table 8.3: Total cost breakdown of cathodic protection system including materials and installation<sup>65</sup>.**

\* **Extra cost of cathodic protection for case 'A' (10" and 36" pipe diameters).**

Calculated current based on current density of 500 mA/m <sup>2</sup>	12 to 43 Amps
Numbers of anodes (one amps rated)	12 to 43 Nos
Numbers of reference electrodes	4 to 8 Nos
Transformer rectifier (12 amps rated)	1 No
Transformer rectifier (43 amps rated)	1 No

Therefore, the total cost of cathodic protection for this case of both pipe diameters will be as follow: -

**a. 10" Diameter**

$$\begin{aligned}
 \text{Cathodic protection cost} &= \text{Labor} + \text{Anodes} + \text{Reference electrode} + \text{Transformer rectifier} \\
 &+ \text{Cables} \\
 &= 300 + 720 + 224 + 2500 + 250 \\
 &= 3,994 \text{ Pound}
 \end{aligned}$$

**b. 36" Diameter**

$$\begin{aligned}
 \text{Cathodic protection cost} &= \text{Labor} + \text{Anodes} + \text{Reference electrode} + \text{Transformer rectifier} \\
 &+ \text{Cables} \\
 &= 500 + 2,580 + 448 + 6,000 + 600 \\
 &= 10,128 \text{ Pound}
 \end{aligned}$$

\* **Extra cost of cathodic protection for case 'B' (10" and 36" pipe diameters).**

Calculated current based on current density of 50 mA/m <sup>2</sup>	1.2 to 4.2
Amps	
Numbers of anodes (one amps rated)	2 to 5 Nos
Numbers of reference electrodes	2 Nos
Transformer rectifier (2 amps rated)	1 No
Transformer rectifier (5 amps rated)	1 No

Therefore, the total cost of cathodic protection for this case of both pipe diameters will be as follow: -

**a. 10" Diameter**

$$\begin{aligned}
 \text{Cathodic protection cost} &= \text{Labor} + \text{Anodes} + \text{Reference electrode} + \text{Transformer rectifier} \\
 &+ \text{Cables} \\
 &= 100 + 120 + 112 + 666 + 100 \\
 &= 1,118 \text{ Pound}
 \end{aligned}$$

**b. 36" Diameter**

$$\begin{aligned} \text{Cathodic protection cost} &= \text{Labor} + \text{Anodes} + \text{Reference electrode} + \text{Transformer rectifier} \\ &\quad + \text{Cables} \\ &= 170 + 300 + 112 + 1,500 + 150 \\ &= 2,232 \text{ Pound} \end{aligned}$$

Note: In both cases the cost of electricity has been omitted due to its low values. The costs for cathodic protection equipments were obtained from same supplier, which provided the cathodic protection for Dubals once through test loop.

**5. Cost comparison exercise**

The following two tables are summaries of price comparison between carbon steel with on line impressed current cathodic protection with both G.R.E, and stainless steel.

C/S 10" case 'A' with C.P	C/S 10" case 'B' with C.P	C/S 36" case 'A' with C.P	C/S 36" case 'B' with C.P	G.R.E 10"	G.R.E 36"
****	****	49,128	41,232	5,000	31,000
7,394	4,518	34,128	26,232	3,260	28,700
7,294	4,418	54,128	46,232	4,572	48,000

**Table 11.4: G.R.E vs. Carbon steel with C.P**

C/S 10" case 'A' with C.P	C/S 10" case 'B' with C.P	C/S 36" case 'A' with C.P	C/S 36" case 'B' with C.P	Stainless Steel 10"	Stainless Steel 36"
****	****	49,128	41,232	****	****
7,394	4,518	34,128	26,232	11,720	****
7,294	4,418	54,128	46,232	27,500	317,000

**Table 11.5: Carbon steel with C.P vs. Stainless steel**

**6. Materials advantages and disadvantages<sup>63</sup>**

**a. GRE (advantages)**

- \* Materials do not corrode, hence cathodic protection and associated future maintenance are not required.
- \* Relatively low weight, hence easier to handle.
- \* Material is durable with a long service life.
- \* No welding is required which eliminate the hot work and reduce safety requirements.
- \* Materials are obtainable locally, with a relatively short delivery time.

**b. GRE (disadvantages)**

- \* Very careful installation by a specialist is required to ensure that pipe does not deform.
- \* Vulnerable to any change in operating parameters, such as proper consideration of vacuum effects on a pipe is required.
- \* Joints cracking are frequent as seen at Dubal.
- \* Specialist can only do repairs.
- \* Its usage at high temperature is questionable, as no concrete evidence of GRE success at elevated temperature is known.

**c. Carbon steel (advantages)**

- \* Carbon steel is rigid and requires less stringent bedding.
- \* Easy to repair by welding in case of cracking.
- \* Available at any required sizes and shape.
- \* Cheaper installed cost compared to GRE<sup>63</sup> and stainless steel.
- \* Applicable to any temperature as long as protected with some means i.e. cathodic protection.
- \* Its applications is proven to be reliable, both for under and above ground.

**f. Carbon steel (disadvantages)**

- \* Material is subjected to corrosion and requires future maintenance and mean of protection either Coating or cathodic protection.
- \* Material unavailable locally and most be imported from abroad, hence a long delivery time and higher transportation cost.
- \* Very high weight, hence require crane for lifting.
- \* Required for hot work, for any welding.

**g. Stainless steel (advantages)**

- \* Corrosion resistance at elevated temperature.

**G. Stainless steel (disadvantages)**

- \* Costly and specialised, time consuming welding.

**4. General discussion**

An extensive cost exercise was undertaken to determine the cost comparison of different materials for a loop similar to Dubal. This study illustrated the economics of constructing a loop using G.R.E material or carbon steel with an on line impressed current cathodic protection or stainless steel. The findings can be summarised as follows: -

- c. The average installed cost of carbon steel with no cathodic protection proved to be cheaper both when compared to GRE and stainless steel.
- d. Carbon steel with on line impressed current cathodic protection was found to be considerably cheaper in both 'A' and 'B' cases when compared to stainless steel material (table 11.5). Economically, carbon steel with on line impressed current certainly has a clear edge over stainless steel for applications which are operating at elevated temperature. In any case stainless steel are themselves vulnerable to localised corrosion in seawater at elevated temperature although the deaerated conditions in recirculating brine are less aggressive in this respect<sup>66</sup>.
- e. The average cost of carbon steel equipped with an on line cathodic protection facility was higher than for glass reinforced epoxy for both assumed case of 10" diameter pipeline by 72% for case 'A' and 5% for case 'B' (table 11.6). In view of long delivery times of carbon steel material and GRE price being cheaper, the decision hence lays in the hand of the operator for selection of material to be used for the low temperature end of the plant. The buyer should give his or her experience consideration in handling any repair work arises in case of GRE failure prior selection of material. As mentioned, the repair of any work on the GRE requires a specialist. This situation has been raised at Dubal, where the repair of the crack, which occurred on the cooling water line to combine cycle, was damaged. The repair of such crack could not be done in house and request for repair was awarded to a company, which had experienced on the field. This procedure is hence not only expensive but also time consuming. On the other hand any repair work at Dubal on carbon steel pipeline is easy as it only requires a short outage and in many cases line draining is not even needed for a welding job on the line.
- f. The average cost of carbon steel equipped with an on line cathodic protection facility were also higher than for GRE but not to the extent of 10" diameter for both assumed cases of 36" diameter pipeline by 28% for case 'A' and 6% for case 'B' (table 11.6). This is an interesting point because the difficulties of on-site installation and any required in service repairs of GRE are clearly going to be greater for large diameter pipeline.

Average C/S 10" case 'A' with C.P	Average C/S 10" case 'B' with C.P	Average C/S 36" case 'A' with C.P	Average C/S 36" case 'B' with C.P	Average G.R.E 10"	Average G.R.E 36"
7,344	4,468	45,800	37,900	4,277	35,900

**Table 11.6: Average cost comparison between GRE and carbon steel equipped with on line impressed cathodic protection**



## CHAPTER TWELVE

### CONCLUSIONS AND RECOMMENDATIONS for Future Work

#### 1. Conclusions

This research comprised 3 main segments, which are listed immediately below followed by the conclusions for each part of the work: -

- \* To assess the performance of cathodic protection system in the multi-stage flash operating units at Dubai Aluminium Company.
- \* To conduct a series of tests to demonstrate clearly the potential benefits of cathodic protection systems when operating at varying parameters, i.e. flow rate, temperature, and control potential.
- \* To determine the costs of constructing a control loop in GRE and stainless steel, and compare these against the costs of a similar loop manufactured from carbon steel, which is equipped with impressed current cathodic protection.

#### a. MSF plant assessment

- \* Detailed internal inspections of the Dubai MSF plant (seawater intakes pipe work, band screens, seawater headers, brine inlet manifolds, and evaporator low temperature pipelines) has revealed no signs of corrosion, and confirmed the continuing success (after 10 to 15 years) of cathodic protection in combating corrosion in MSF plant.
- \* These recent inspections have provided overwhelming evidence of a widespread deposition of calcareous deposit in various parts of the plant covering a wide temperature range (18 to 110 °C). The benefits of such deposit are in reducing the applied current demand and facilitating more uniform spread of cathodic protection current in all parts of desalination equipment. Thus, it has been demonstrated that calcareous deposition occurs, and is beneficial in elevated temperature conditions as well as in the ambient temperature conditions that have been reported for other engineering equipment in the past.
- \* Calculations have provided estimates of current density demands in two locations. 14 to 24 mA/m<sup>2</sup> in the seawater header and 280 mA/m<sup>2</sup> in the BIM. The latter current density represents not only the high temperature (up to 110 °C) but also the very-severe turbulence in the BIM.

## b. Experimental study

- \* The tests confirmed the ability of cathodic protection to provide satisfactory corrosion control in a range of environmental conditions relevant to thermal desalination plant, 18 °C to 60 °C, zero flow to 1 m/s, TDS from 35,000 ppm to 43,000 ppm. Corrosion was only observed in cases where the cathodic protection system had not been operating in the early stages of tests before a calcareous scale had become established.
- \* In all conditions investigated, the application of cathodic protection was seen to promote the deposition of calcareous scales, which caused a reduction of operating current density for a set of potential.
- \* SEM and XRD confirmed that the scales formed over a wide range of conditions comprise a thin inner layer of Mg(OH)<sub>2</sub> (brucite) which form initially followed by the deposition of plate-like crystals of the aragonite modification of CaCO<sub>3</sub>. Tentative mechanism for the formation of the scale and its affect on current density/time trends has been proposed with most confidence being attributed to the proposals for growth of the outer aragonite layer. Thus the proposal is that this consists of a water-filled, porous network of interlocking aragonite crystals through which (OH)<sup>-</sup> can migrate from base cathodic reaction sites and promote growth of CaCO<sub>3</sub> at the outside
- \* The deposited scales are adherent and strong and do not appear to be removed by the flow conditions (including turbulence) involved in the investigations.
- \* The scales provide continued corrosion protection for some time after a switch off of the cathodic protection. This demonstrates a degree of security to interruption in the cathodic protection during service. However, after a switch-off of the cathodic protection and dry-out of the scales, there is a transient current 'spike' when the cathodic protection is again applied; this is considered to be due to some degree of cracking, opening of the pores and/or ingress of air upon drying and appears to be prevented if the scale is kept wet during a switch-off period.
- \* The effect of more negative control potentials was to cause the expected higher initial current density but this also caused precipitation of calcareous scale at a higher rate. This finding, together with associated observations involving constant-current operation, provide indications of likely benefits in operating cathodic protection systems with either relatively negative control potentials or using the galvanostatic mode in the early stages. This conclusion extends similar previous findings to the wider range of conditions (including higher temperature) studied in this project.

- \* The effect of temperature upon cathodic protection operation is rather complex but some evidence of a higher rate of early decline of current and higher long-term current densities once the calcareous scale has become fully established.
  - \* The effect of seawater flow rates is also complex. Higher flow causes, as expected, higher initial current densities and appears to limit somewhat the thickness of the calcareous scales but the flow conditions involved in this research do not damage a developed scale.
- c. **Cost exercise**
- \* The average installed cost of carbon steel with no cathodic protection proved to be cheaper both than GRE and stainless steel.
  - \* Carbon steel with on line impressed current cathodic protection was found to be considerably cheaper when compared to stainless steel material. Economically, carbon steel with on line impressed current certainly has a clear edge over stainless steel for applications which are operating at elevated temperature.
  - \* The average cost of carbon steel equipped with an on line cathodic protection facility was higher than for glass reinforced epoxy for two assumed cases. This indicates that, for a new system, GRE is preferred for low temperature sections of pipe-work. This conclusion may be modified by local factors involving material delivery, installation and repair expertise (especially for large diameter pipe-work) and possible reduction in costs associated with different modes of cathodic protection.
  - \* In a retrofit situation carbon steel with cathodic protection is preferable in initially-installed carbon steel installations, as the only additional cost is for the cathodic protection equipment which in real terms is less than the cost of replacing the pipe work with with GRE or stainless steel.

## 2. Recommendations for future work

- a. Mainly from the point of view of improving the understanding of the mechanisms of calcareous deposition and its effect on cathodic protection operation, some work concentrating on the very early stages of cathodic protection application would be interesting. Tests of very short duration (minutes/hours) would provide more insight into the mechanism of formation and growth of the initially deposited  $Mg(OH)_2$ . Somewhat longer exposures would indicate the development of the upper aragonite layer and its relation to the current density/time trends. The undertaking of such tests at temperatures above 25 °C would extend the previous knowledge available from work under offshore conditions.

- b. More detailed studies at elevated temperatures would be useful. There are two aspects to this; an obvious first aspect involves the extension of cathodic protection-rig tests to temperatures above the maximum used in this research (60 °C). Secondly, undertaking of tests at all elevated temperatures to long enough times to ensure attainment of steady state current densities would yield a more-quantitative grasp of temperature/current density trends. An additional feature of such work might involve assessment of the affect of O<sub>2</sub> concentration on cathodic protection performance.
- c. Another desirable piece of research would be undertaking studies optimising the initial modes of cathodic protection operation under condition relevant to thermal desalination plant. This would investigate the possible benefits of initial operation at more negative control potential and also using the galvanostatic approach upon long-term cathodic protection application.
- d. Another topic of interest relates to the detailed interactions between cathodic protection and hydrodynamics. One aspect of this type of study would be investigating if the long-term current densities were independent of flow after a complete dense aragonite layer has become established.
- e. Another desirable topic of investigation relates to attempting to develop/identify modes of cathodic protection design/operation that would result in a lowering of cathodic protection installation costs and have an improvement of the competitive situation of carbon steel /cathodic protection systems compared to the specification of GRE pipe. One obvious important aspect of this approach would be a test programme that investigated whether significant calcareous scales can form at potentials of between -700 and -800 mV Ag/AgCl and whether such scales would continue to offer effective corrosion control even at such potentials that are less negative than normally required for cathodic protection of carbon steel. Also studies on internally painted steel would provide information on the magnitude of reduction of current compared to bare steel and the longer-term effectiveness of a calcareous deposit in counteracting paint deterioration.
- f. Extension of the cost analysis carried out in this project to a full life cycle cost exercise would be extremely interesting.
- g. Building on the detailed information obtained during this project would be interesting to undertake a future programme on such an on-site test rig as that at Dubal but involving a statically design of tests in order to quantify in greater detail the influence of critical parameters on cathodic protection operation such as temperature, flow rate etc.

### BIBLIAGRAPHY

1. Mohammed, N., "Investigation of the effect of magnetic scale control device on  $\text{CaCO}_3$  deposition," M.Sc. thesis, University of Glasgow, 1992.
2. Mohammed, N., "Various methods of producing potable water," National examination board for supervisory management, Dubai, (March 1989).
3. Hanbury, W.T., Hodgkiess, T., "Desalination technology 1995," Porthan Ltd., Glasgow 1995.
4. Sasakura Engineering Co.Ltd., "General review on desalination" Osaka Japan, 1985.
5. Khan, A.H., "Desalination processes and multi stage flash distillation practice," Elsevier, New York, 1986.
6. Hodgkiess, T., "Current status of materials selection for MSF distillation plants," Desalination 93, pages 445-460, 1993.
7. Shams El Din., A.M., Bushara, M., "Operation processes affecting corrosion in MSF distillers," Material testing laboratory, water and Electricity department, Abu Dhabi, UAE.
8. Chawla, S.L., Gupta, R.K., "Material selection for corrosion control," ASM International, Materials Park, OH, 1993.
9. Herbert, H., Revie, R., "Corrosion and corrosion control," Third edition, A Willy-inter-science publication, Singapore, 1991.
10. Mohammed, N., "Desalination plant own experience and observation" 1988 to 1997.
11. Shams El Din., A.M., "Corrosion of condensers in MSF evaporation distillers," Industrial corrosion and corrosion control technology, Kuwait Institute for Scientific Research, pages 49-65, 1996.
12. Buros, O., "USAID Desalination manual," IDFA, USA, 1981.
13. Dupont Hand book for Reverse Osmosis, city, date
14. Ramadhan, A., "Corrosion problems encountered with the use of sea cooling water," Corrosion symposium proceedings, Kuwait, pages 102-128, 1981.

15. Hodgkiess, T., "Course on Aqueous corrosion-basic principal," Glasgow University, 1992.
16. To check with T.H the selected material design velocity (table 3.1).
17. Nityanandan, P., Said, M., "A hand book of cathodic protection," Published by Abu Dhabi Water and Electricity department, Abu Dhabi, U.A.E.
18. Morgan, J., "Cathodic protection," 2<sup>nd</sup> edition, National association of corrosion engineers, Houston Texas, 1987.
19. Impalloy hand book for cathodic protection, Impalloy Ltd, UK, 1997.
20. British Standards institution, Code of practice for cathodic protection' BS 7361 part 1: 1991.
21. Det Norske Veritas industri Norge: recommended practice RP B401, cathodic protection design, 1993.
22. Lunden, Kingsley C., Stastny, Timothy M., "Rapid polarisation cathodic protection in the Rijn field," Material Performance, pages 24-26, Nov 1991.
23. Hartt, W., Wolfson, S., "An initial investigation of calcareous deposits upon cathodic steel surfaces in seawater," Corrosion, Vol 37 (2), Pages 70-76, Feb 1981.
24. Engell, H., Forchhammer, P., Corrosion Science, volume 5, Page 479, 1965.
25. Hodgkiess, T., Arthor, P., Offshore technology report No, OTH 87242, HMSO, London, 1988.
26. Lee, R., Ambrose, J., "Influence of cathodic protection parameters on calcareous deposit formation" Corrosion-Vol 44 (12), Pages 887-891, Nov1988.
27. Humble, R., "Cathodic protection of steel in seawater with Magnesium anodes" Corrosion, Vol 4, Pages 358-370, July 1948.
28. Hartt, W., Culberson, C., Smith, S., "Calcareous deposits on metal surfaces in seawater," corrosion 40 (11), Pages 609-618, Nov.1994.
29. Kunjapur, M., Hartt, W., Smith, S., "Influence of temperature and exposure time upon calcareous deposits," Corrosion, Vol 33 (11), Pages 674-679, Nov 1987.
30. Linke, W., "Solubilities of inorganic and metal organic compounds," American Chemocal Society, 4<sup>th</sup> edition, Volume 2, Standford, Conn, pages 516-517, 1965.

31. Pytkowicz, R., "Calcium carbonate retention in supersaturated seawater," *American Journal of Science*, Vol 273, Pages 515-522, June 1987.
32. Ambrose, A., Yaniv, E., "Nucleation growth and morphology of calcareous deposits on steel in seawater," *Nace corrosion* 83, paper no 60, 1983.
33. Luo, J., Hartt, W., Chen, T., Smith, S., "Formation of calcareous deposits under different modes of cathodic polarisation," *Corrosion*, Vol 47, Pages 189-196, March 1991.
34. Yan, J., Nguyen, T., White, R., Griffin, R., "Mathematical modelling of formation of calcareous deposits on cathodically protected steel in seawater," *Journal of Electrochemical Soc*, Vol 140 (3), Pages 733-742, March 1993.
35. Mantel, K., Hartt, W., Chen, T., "Substrate, Surface Finish, and flow rate influences on calcareous deposit structure," *Corrosion*, Vol 48 (6), Pages 489-500, 1992.
36. Elbeik, S., Tseung, A., Mackay, A., "The formation of calcareous deposits during the corrosion of mild steel," *Corrosion Science*, Vol 26 (9), Pages 669-680, 1986.
37. Garthland, P., Stormmen, R., Bardel, E., "Current density requirement for cathodic protection of steel structure in the North Sea," *Materials Performance* 22 (6), pages 40-48, June 1983.
38. Evan, S., "Use of initial current density in cathodic protection design," *Materials Performance* 27 (2), pages 9-11, Feb 1988.
39. Hodgkiess, T., Maciver, A., Chong, P., "Galvanic studies related to the use in desalination plant of corrosion resistant materials," *Desalination* 66, pages 147-170, 1987.
40. Hodgkiess, T., Lim, C., "Aspects of galvanic-corrosion behaviour of a range of materials in seawater," *Corrosion Science*, Volume 35, pages 269-283, 1983.
41. Yan, J., White, R., Griffin, R., "Parametric studies of the formation of calcareous deposits on cathodically protected steel in seawater," *Journal of Electrochemical Soc*, Vol 140 (5), pages 1275-1280, May 1993.
42. Jelinek, J., Morton, D., Osvoll, H., Blakset, T., Herfjord, B., "Current density surveys for optimising offshore anodes retrofit design," *Materials Performance*, pages 19-23, April 1996.

43. Wang, w.,Hartt, W., Chen, S., "Sacrificial anode cathodic polarisation of steel in seawater," Corrosion-Vol 52 (6), 1996, Pages 419-427.
44. Kettle, C., Couper, W., "Effect of metal temperature on current density requirements for cathodic protection of bare steel in seawater," British corrosion journal, Vol 28 (1), pages 77-80, 1993.
45. Kettle, C., Corr, M., "An investigation into the cathodic protection criteria for very hot offshore marine risers," Offshore materials and corrosion Engineering, 1990.
46. Smith, S., McCabe, K., Black, D., "Effect of flow parameters on the cathodic protection of a steel plate in natural seawater," Corrosion Science, pages 790-793, October 1989.
47. Videła, H., Saravia, S., Mele, M., "Early stages of bacteria bio-film and cathodic protection interaction in marine environment," Proceeding 12<sup>th</sup> International Corrosion Congress, Nacc, Volume 5B, Houston, pages 3687-3695, Sep 1993.
48. Little, B., Wagner, P., "Interrelationship between marine bio-fouling and cathodic protection," Materials Performance, September 1993.
49. Dexter, S., Lin, S., "Effect of marine bacteria on calcareous deposition," Materials Performance, pages 16-21, April 1991.
50. Asad, S., Narain, S., "Corrosion problems in low-temperature desalination units," Materials Performance, pages 64-67, April 1992.
51. Shams El Din, A.M., Saber, T., Taj El Din, A., "Titanium hydride formation from Arabian Gulf water," Desalination, volume 107 (3), pages 265-276, December 1996.
52. Dittmeier,G., Byrne, P., "Impressed current cathodic protection as applied to desalting plant," Proceeding 3<sup>rd</sup> International Congress on marine corrosion and fouling, Maryland, USA, pages 338-356, Oct 1972.
53. Dubal annual report, Dubai, 1996.
54. Corner, M., "Cathodic protection system at Dubal desalination plant," Dubal internal memorandum, Dubai, 1983.
55. Bailey, R., "Impressed current cathodic protection of desalination plant, the final solution to corrosion," Dubal internal report, Dubai, U.A.E, 1988.



56. British Standards Institution, code of practice for cathodic protection. CP 1021:1973.
57. Neville, A., Hodgkiess, T., Morizot, A., "Surface scales in seawater systems-effects of their formation on the corrosion behaviour of engineering steels," Submitted to British Corrosion Journal.
58. Wyatt, B., Brittain, R., "Experience in offshore structure retrofit cathodic protection system," Materials Performance, pages 16-23, May 1980.
59. Neville, A., Hodgkiess, T., Morizot, A., "Initiation and propagation of localised corrosion on stainless steels in seawater containing high Biocide concentrations" Accepted for publication in Corrosion Science.
60. Neville, A., Hodgkiess, T., Morizot, A.: Unpublished work.
61. Douglas, G., Gasiorek, G., Sweffield. C., "Fluid Mechanics"3<sup>rd</sup> edition, Longman Scientific,1995.
62. Neville, A., Hodgkiess, T., Morizot, A.: Private communication.
63. Future pipe Industries B.V.," Hand book of Epoxy pipe systems" Netherland,1997.
64. Hodgkiess, T.,: Private communication.
65. Impalloy and Dubal quotations for cathodic protection equipment and labour charges.
66. Neville, A., Hodgkiess, T., " An assessment of the corrosion behaviour of high-grade alloys in seawater at elevated temperature and under a high-velocity impinging flow," Corrosion Science, Vol 28 (6), pages 927-956, 1996.

