



<https://theses.gla.ac.uk/>

Theses Digitisation:

<https://www.gla.ac.uk/myglasgow/research/enlighten/theses/digitisation/>

This is a digitised version of the original print thesis.

Copyright and moral rights for this work are retained by the author

A copy can be downloaded for personal non-commercial research or study, without prior permission or charge

This work cannot be reproduced or quoted extensively from without first obtaining permission in writing from the author

The content must not be changed in any way or sold commercially in any format or medium without the formal permission of the author

When referring to this work, full bibliographic details including the author, title, awarding institution and date of the thesis must be given

Enlighten: Theses

<https://theses.gla.ac.uk/>
research-enlighten@glasgow.ac.uk

**Pulmonary Oxygen Uptake Kinetics and Exercise Intensity:
Inferences and Implications**

by

Anthony Pierce Turner



**UNIVERSITY
of
GLASGOW**

A Thesis Presented for the Degree of Doctor of Philosophy

in

The Faculty of Biomedical and Life Sciences

University of Glasgow

August 2003

ProQuest Number: 10390603

All rights reserved

INFORMATION TO ALL USERS

The quality of this reproduction is dependent upon the quality of the copy submitted.

In the unlikely event that the author did not send a complete manuscript and there are missing pages, these will be noted. Also, if material had to be removed, a note will indicate the deletion.



ProQuest 10390603

Published by ProQuest LLC (2017). Copyright of the Dissertation is held by the Author.

All rights reserved.

This work is protected against unauthorized copying under Title 17, United States Code
Microform Edition © ProQuest LLC.

ProQuest LLC.
789 East Eisenhower Parkway
P.O. Box 1346
Ann Arbor, MI 48106 – 1346

GLASGOW
UNIVERSITY
LIBRARY:

13109

Copy 2.

Summary

The kinetic features of the pulmonary oxygen uptake ($\dot{V}O_2$) response to exercise provide insight into the functional status of the cardiovascular, respiratory and muscular systems, in terms of exercise tolerance in health and disease. The focus of the current research was to improve current understanding of $\dot{V}O_2$ kinetics, with particular reference to reliable and accurate modelling and interpretation. Three studies have been carried out:

1. The dependence of $\dot{V}O_2$, intramuscular oxygenation status and arterialised blood lactate response on the work-recovery duty cycle duration during intermittent cycling suggests that the functional intensity of dynamic exercise is determined not only by the work rate *per se*, but also the manner of its imposition. Differences in the average $\dot{V}O_2$ relationship with lactate concentration, compared to constant work rate exercise, demand revision of conventional exercise intensity description.
2. A "priming" bout of supra-critical power cycling significantly reduces the magnitude of the $\dot{V}O_2$ slow component, with no discernible effect on the fundamental component $\dot{V}O_2$ kinetics, during subsequent sub-critical power, but supra-lactate threshold, cycling. The tolerable duration of this exercise was reduced in some, but not all, subjects, raising interesting questions regarding the determinants of the power-duration hyperbola and its relationship with $\dot{V}O_2$ kinetics.
3. Demonstration that the duration of the Phase I portion of the $\dot{V}O_2$ response during the rest-to-20W transition is prolonged in some, but not all, patients diagnosed with moderate-to-severe chronic obstructive pulmonary disease has called into question traditional modelling strategies employed to characterise the $\dot{V}O_2$ fundamental component in this population. Speeding of the overall $\dot{V}O_2$ kinetics as a result of an 8-week exercise-training programme is demonstrated by a significantly speeded fundamental $\dot{V}O_2$ component.

Exact details of the mechanisms underpinning $\dot{V}O_2$ kinetics in health and disease remain conjectural, but discussion has now directed opinion to the potential for $\dot{V}O_2$ kinetics to be obscuring regional differences within the exercising musculature. That $\dot{V}O_2$ kinetics can be determined using sub-maximal exercise, even in severely debilitated patient populations, highlights the utility of this approach when assessing the combined function of the respiratory, cardiovascular and muscular systems responsible for O_2 -delivery and O_2 -

utilisation in patient populations. However, subsequent modelling of the $\dot{V}O_2$ kinetics must be physiologically justified and the interpretation appropriate.

Contents

	Page
Title page	1
Summary	2
Contents	4
Acknowledgements	9
Abbreviations	11
List of Figures	13
List of Tables	18
Chapter 1 Introduction	19
1.1 BACKGROUND	19
1.1.1 Exercise intensity domains	26
1.2 TEMPORAL PROFILES OF $\dot{V}O_2$	30
1.2.1 Phase I	32
1.2.2 Phase II	32
1.2.3 Phase III	32
1.3 $\dot{V}O_2$ KINETICS AND EXERCISE INTENSITY	33
1.3.1 Moderate exercise	33
1.3.2 Heavy exercise	35
1.3.3 Very heavy exercise	38
1.3.4 Severe exercise	38
1.4 MUSCLE O_2 CONSUMPTION	39
1.4.1 Dissociation between \dot{Q}_{mO_2} and $\dot{V}O_2$	39
1.4.2 Simulated modelling approaches	40
1.4.3 <i>In vitro</i> muscle preparations	40
1.4.4 <i>In vivo</i> measurement of \dot{Q}_{mO_2}	42
1.4.5 Inferences about \dot{Q}_{mO_2} using ^{31}P -NMR	46
1.5 CONTROL OF $\dot{V}O_2$ KINETICS	48
1.5.1 Moderate exercise	48
1.5.2 Supra- θ_L exercise	49
1.5.3 Putative mediators of the slow component for $\dot{V}O_2$	52
1.5.3.1 Lactate	53
1.5.3.2 Acid-base status	54
1.5.3.3 Catecholamines	54

1.5.3.4	<i>Muscle temperature</i>	55
1.5.3.5	<i>Additional respiratory and/or cardiac work</i>	55
1.5.3.6	<i>Muscle fibre-type</i>	56
1.6	OBJECTIVES	60
Chapter 2 Methods		61
2.1	SUBJECTS	61
2.2	PROTOCOLS	62
2.2.1	Incremental ramp test	62
2.2.2	Constant work rate tests	65
2.3	EQUIPMENT	69
2.3.1	Cycle ergometer	69
2.3.2	Heart rate and arterial blood oxygen saturation	70
2.3.3	Chart recorder	70
2.3.4	Blood lactate analysis	70
2.3.5	Breath-by-breath gas analysis	71
2.3.5.1	<i>Mass Spectrometer</i>	71
2.3.5.2	<i>Turbine volume transducer</i>	72
2.3.5.3	<i>Algorithms</i>	72
2.3.5.4	<i>Data analysis</i>	74
2.3.5.5	<i>Modelling gas-exchange kinetics</i>	75
2.4	STATISTICAL ANALYSIS	77
Chapter 3 Oxygen uptake and muscle desaturation profiles during intermittent cycling in humans		78
3.1	INTRODUCTION	78
3.2	METHODS	81
3.2.1	Subjects and procedures	81
3.2.2	Near-Infrared Spectroscopy (NIRS)	82
3.2.3	Data analysis	85
3.2.4	Statistical analysis	86
3.3	RESULTS	88
3.3.1	Arterialised [lactate]	88
3.3.2	$\dot{V}O_2$, $\Delta[Hb]$ and HR responses to 10s work:20s recovery test	89
3.3.3	$\dot{V}O_2$, $\Delta[Hb]$ and HR responses to 30s work:60s recovery test	91
3.3.4	$\dot{V}O_2$, $\Delta[Hb]$ and HR responses to 60s work:120s recovery test	92

3.3.5	$\dot{V}O_2$, $\Delta[\text{Hb}]$ and HR responses to 90s work:180s recovery test	93
3.4	DISCUSSION	95
3.4.1	Arterialised [lactate] response	95
3.4.2	Intramuscular oxygenation	96
3.4.3	Pulmonary O_2 -uptake during intermittent exercise	100
3.4.4	Conclusion	103
Chapter 4	Prior heavy cycling and the Critical Power- $\dot{V}O_2$ relationship	104
4.1	INTRODUCTION	104
4.2	METHODS	108
4.2.1	Subjects and procedures	108
4.2.2	Data analysis	110
4.2.3	Statistical Analysis	113
4.3	RESULTS	114
4.3.1	Critical Power estimation	114
4.3.2	Tests at 95% Δ_1 without a priming bout	115
4.3.3	Tests at 95% Δ_1 following a priming bout	117
4.3.4	Priming bout effects	118
4.4	DISCUSSION	123
4.4.1	Priming bout effects on the kinetics of the fundamental component	123
4.4.2	Priming bout effects on the slow component	125
4.4.3	Heart rate and blood lactate responses	126
4.4.4	“Completers” vs. “non-completers”	127
4.4.5	Limiting factors in the “non-completers”	129
4.4.6	Conclusion	131
Chapter 5	Model discrimination in the characterisation of pulmonary oxygen uptake kinetics: an intervention study in Chronic Obstructive Pulmonary Disease	132
5.1	INTRODUCTION	132
5.1.1	Chronic obstructive pulmonary disease	132
5.1.2	Model discrimination for characterising $\dot{V}O_2$ kinetics in COPD patients	135

5.2	METHODS	140
5.2.1	Subjects and procedures	140
5.2.2	Study design	141
5.2.3	Pulmonary function	141
5.2.4	Breath-by-breath gas exchange	142
5.2.5	Exercise tests	142
5.2.6	Analysis	143
5.2.7	Statistical analysis	145
5.3	RESULTS	147
5.3.1	Model discrimination for characterising $\dot{V}O_2$ kinetics in COPD patients	147
5.3.2	Effect of exercise training on $\dot{V}O_2$ kinetics	151
5.3.3	Improvements in exercise capacity	152
5.4	DISCUSSION	154
5.4.1	Modelling $\dot{V}O_2$ kinetics in COPD patients	154
5.4.2	Speeding of $\dot{V}O_2$ kinetics as a result of exercise training	157
5.4.3	Interpretation of training-induced improvements in exercise capacity in COPD patients	160
5.4.4	Future research	163
5.4.5	Conclusion	166
	Chapter 6 Discussion	167
6.1	MODELLING $\dot{V}O_2$ KINETICS	167
6.1.1	Sub- θ_L exercise – Phase I	167
6.1.2	Supra- θ_L exercise - the $\dot{V}O_2$ slow component	169
6.2	EXERCISE INTENSITY	173
6.3	WHAT DO THE $\dot{V}O_2$ KINETICS OF THE FUNDAMENTAL COMPONENT MEAN?	174
6.3.1	Linearity of $\dot{V}O_2$ kinetics	174
6.3.2	Control of $\dot{V}O_2$ kinetics	175
6.3.3	A single or multi-compartment model?	176
6.4	CONCLUSIONS	181
	References	182

Appendices	214
Chapter 2 Appendix	214
Chapter 3 Appendix	219
Chapter 4 Appendix	222
Chapter 5 Appendix	225

Acknowledgements

First and foremost, I thank my supervisor Professor Sue Ward. Throughout the four years that it has taken me to complete this thesis, Sue has provided me with the support and education to make it possible, always giving constructive advice. I thank Sue not only for the guidance during my PhD, but also for the training in exercise testing and interpretation. Secondly, I wish to express my gratitude to Professor Brian Whipp. Although Professor Whipp was not directly responsible for my supervision, our meetings often presented an alternative view of a problem, or result, that had previously not been considered. Thanks to Dr. Alberto Nader who gave some interesting tutorials during our time together. Thanks also to all staff who taught me on my undergraduate course at Glasgow University, especially Professor Neil Spurway, whose exciting lecturing promoted my interest in exercise physiology.

I am forever grateful to everyone in the Centre for Exercise Science and Medicine for making the duration of my research period a “mostly” enjoyable experience. Special thanks to Mr. John Wilson for his excellent technical support and less excellent football opinions, with never a complaint made. In addition to John, thanks also to Dr. Niall MacFarlane for his financial support at lunchtimes and being the perfect guinea pig for pilot work. Thanks to Dr. Yannis Pitsiladis for always helping me whenever I approached him, and to Mrs. Heather Collin for mothering us all at work. Cheers to colleagues Matt Parker, Dr. Liam Kilduff, Dr. Jonathan Fuld and Marios Hadjicharalambous for all help and advice and always having a bit of craic at work. To Andy Cathcart, I say thanks for all the help and friendship during our 8 years at Glasgow University.

I am extremely grateful to all of the people who “volunteered” to participate in all of my research, I obviously couldn’t have done it without you.

I am also indebted to my new department (PESLS) at Edinburgh University for permitting me time to complete the write-up of this thesis.

Thanks to all friends and family for providing me with never-ending encouragement and support. You have all played your part in helping me to complete this thesis. In particular, a million thanks to my mum and dad for always supporting me in whatever I choose to do in life. Your love and support have made all of this work possible.

Finally, but most importantly of all, I thank my wife-to-be Annette Taylor. The last four years have certainly been a struggle in terms of work, but not once have you let me regret anything. I am eternally grateful that we met at Glasgow University and now we will spend the rest of our lives together. The love and support that you give me certainly makes everything worthwhile.

Abbreviations

ADP	adenosine di-phosphate	[HbT]	total concentration of haemoglobin
ATP	adenosine tri-phosphate	HADH	3-hydroxyacyl-CoA dehydrogenase
ANOVA	Analysis of Variance	HCM	hypertrophic cardiomyopathy
BTPS	body temperature and pressure saturated	HR	heart rate
CaO ₂	arterial oxygen content	HRmax	maximum heart rate
CvO ₂	venous oxygen content	i-EMG	integrated EMG
C \bar{v} O ₂	mixed-venous oxygen content	kg	kilogram
Cv _{leg} O ₂	leg venous oxygen content	K _m	enzymatic rate constant
Cv _m O ₂	muscle venous oxygen content	l	litre
CK	creatine kinase	L-NAME	N ^G -nitro-L-arginine methyl ester
cm	centimetre	[La]	lactate concentration
COPD	chronic obstructive pulmonary disease	m	metre
CP	critical power	min	minute
CS	citrate synthase	ml	millilitre
χ^2	sum squared error (Chi- ²)	mmHg	millimetres of mercury
D _L CO	carbon monoxide diffusing capacity	mM	millimoles.litre ⁻¹
DCA	dichloracetate	MLSS	maximum lactate steady state
Δ	amplitude of change	MPF	mean power frequency
ΔG_{ATP}	Gibbs free energy of ATP hydrolysis	MRI	magnetic resonance imaging
δ	delay	MRT	mean response time
ECG	electrocardiograph	μ l	microlitre
EMG	electromyography	μ M	micromoles.litre ⁻¹
F _E O ₂	fraction of expired oxygen	$\mu \dot{V}O_2$	peak rate of pulmonary oxygen uptake
F _I O ₂	fraction of inspired oxygen	$\mu \dot{Q}_{mO_2}$	peak rate of muscle oxygen consumption
F _{O₂(true)}	true fraction of oxygen	NADH	reduced nicotinamide adenine dinucleotide
FEV ₁	forced expired volume in 1 s	NIRS	near-infrared spectroscopy
FVC	forced vital capacity	NMR	nuclear magnetic resonance
[Hb]	concentration of deoxygenated haemoglobin	O ₂ Def	oxygen deficit
[HbO ₂]	concentration of oxygenated haemoglobin	PCr	phosphocreatine

PDH	pyruvate dehydrogenase	τ	time constant
Pi	inorganic phosphate	τ'	"effective" time constant
PIP	peak inspiratory pressure	θ_L	lactate threshold
PEP	peak expiratory pressure	$\hat{\theta}_L$	estimated lactate threshold
P_{O_2}	partial pressure of oxygen	θ_f	fatigue threshold
$P_{ET_{O_2}}$	end-tidal partial pressure of oxygen	\dot{V}^{exp}	flow rate of expired air
P_{CO_2}	partial pressure of carbon dioxide	\dot{V}_E	minute ventilation
$P_{ET_{CO_2}}$	end-tidal partial pressure of carbon dioxide	$\dot{V}_E / \dot{V}_{CO_2}$	ventilatory equivalent for carbon dioxide
\dot{Q}_{leg}	leg blood flow	$\dot{V}_E / \dot{V}_{O_2}$	ventilatory equivalent for oxygen
$\dot{Q}_{leg_{O_2}}$	rate of leg oxygen consumption	\dot{V}_{CO_2}	rate of pulmonary carbon dioxide output
\dot{Q}_m	muscle blood flow	\dot{V}_{O_2}	rate of pulmonary oxygen uptake
$\dot{Q}_{m_{O_2}}$	rate of muscle oxygen consumption	$\dot{V}_{O_{2max}}$	maximum rate of oxygen uptake
\dot{Q}_P	pulmonary blood flow	$\dot{V}_{O_{2peak}}$	peak rate of oxygen uptake
\dot{Q}_T	cardiac output	$\dot{V}_{O_{2(SC)}}$	slow component for pulmonary oxygen uptake
$\dot{Q}_{m_{O_2(ss)}}$	steady state rate of muscle oxygen consumption	$\dot{V}_{O_{2(SS)}}$	steady state rate of pulmonary oxygen uptake
RCP	respiratory compensation point	$\dot{V}_{O_{2(XS)}}$	excess pulmonary oxygen uptake
RER	respiratory exchange ratio	$\dot{V}_{O_{2(20W)}}$	steady state rate of pulmonary oxygen uptake while cycling at 20 Watts
RPE	rating of perceived exertion	W	watts
rpm	revolutions per minute	W'	curvature constant of the power-duration hyperbola
s	seconds	WR	work rate
SaO ₂	saturation of arterial blood with oxygen	WR _{max}	maximum work rate
S.D.	standard deviation	WR _{peak}	peak work rate
S.E.M.	standard error of the mean	WR _{θL}	work rate at lactate threshold
STPD	standard temperature and pressure dry		
t	time		
t _{lim}	time until the limit of tolerance		
TCA	tri-carboxylic acid		
TLC	total lung capacity		

List of Figures	Page
Chapter 1	
Figure 1.1	Diagram summarising the cytosolic and mitochondrial reactions involved in ATP generation. 20
Figure 1.2	Schematic illustrating the interaction and coordination of the pulmonary, cardiac and muscular systems linking oxygen consumption and carbon dioxide production. 21
Figure 1.3	Schematic illustrating the relationship between $\dot{V}O_2$ and cardiac output, and arterio-mixed venous O_2 content difference at increased work rates. 24
Figure 1.4	Diagram showing the oxygen content of arterial, mixed venous and femoral venous blood as $\dot{V}O_2$ increases from resting levels up to maximal levels in response to increased work rates. 24
Figure 1.5	Muscle blood flow, femoral arterio-venous O_2 content difference and muscle oxygen uptake in response to rhythmic knee extension exercise of varying work rates. 26
Figure 1.6	The traditional assignment of exercise intensity based on the profiles of arterial lactate concentration during constant work rate exercise at different work rates. 27
Figure 1.7	Schematic illustration of the dependence of $\dot{V}O_2$ kinetics on the exercise intensity domain. 28
Figure 1.8	Traditional profile of the exponential increase in $\dot{V}O_2$ at the onset of constant work rate exercise. 30
Figure 1.9	Simplified illustration exaggerating the three individual phases of the $\dot{V}O_2$ response at the onset of constant work rate exercise from a baseline of unloaded pedalling. 31
Figure 1.10	Original schematic illustration of the steady state $\dot{V}O_2$ at different work rates. 36
Figure 1.11	Summary of the isolated canine muscle investigations by Grassi <i>et al.</i> , showing the muscle oxygen consumption kinetics in response to contractions at 60% and 100% of maximum under conditions of enhanced O_2 delivery and enhanced peripheral O_2 diffusion. 41

Figure 1.12	Results illustrating the close temporal relationship between the simultaneously measured kinetics of leg and pulmonary oxygen uptake in the non-steady state transition from rest to moderate intensity cycling.	43
Figure 1.13	Illustration showing the similarity of the exponential responses of muscle blood flow and cardiac output in the transition to moderate exercise.	44
Figure 1.14	Example showing the similarity in the kinetics of $\dot{V}O_2$ and PCr degradation at the onset of rhythmic knee extension exercise.	47
Figure 1.15	Diagram showing some of the putative mediators of the $\dot{V}O_2$ slow component.	53
Figure 1.16	$\dot{V}O_2$ data obtained from two subjects differing greatly in the relative distribution of vastus lateralis muscle fibre-types during heavy intensity cycling.	58
 Chapter 2		
Figure 2.1	Schematic of the protocol used during incremental cycle tests to the limit of tolerance.	62
Figure 2.2	Non-invasive estimation of the lactate threshold using the V-slope technique.	63
Figure 2.3	Confirmation of the lactate threshold using the ventilatory-based indices.	64
Figure 2.4	Schematic of the protocol used during constant work rate tests.	66
Figure 2.5	Estimation of the steady state work rate corresponding to the $\dot{V}O_{2L}$ at $\hat{\theta}_L$ using the observed non-steady state $\dot{V}O_2$ -WR response to a rapidly incremental exercise protocol.	67
Figure 2.6	The power-duration relationship for five maximal bouts of constant work rate exercise.	68
Figure 2.7	Measured power output of the cycle ergometer against the power output programmed into the ergometer.	69
 Chapter 3		
Figure 3.1	Capillary blood lactate response to three different intermittent cycling tests of varying work-recovery duty cycle duration.	79
Figure 3.2	Schematic of intermittent test protocol.	82

Figure 3.3	Photographs illustrating the NIRS optodes situated in the optode holder, and a subject cycling with the optodes secured in place.	83
Figure 3.4	Comparison of the change in concentration of deoxygenated haemoglobin induced by performance of a maximal voluntary contraction of the quadriceps with the degree of desaturation induced in the same maximal tests.	84
Figure 3.5	Typical plot of consecutive work-recovery duty cycles visually overlaid, illustrating the data analysis procedures used to characterise the oscillations observed during the intermittent tests for $\dot{V}O_2$ and $\Delta[\text{Hb}]$.	86
Figure 3.6	Capillary blood lactate response to the four different intermittent cycling tests in a representative subject.	88
Figure 3.7	$\dot{V}O_2$, $\Delta[\text{Hb}]$ and HR responses during the 10s work:20s recovery intermittent test in a representative subject.	90
Figure 3.8	$\dot{V}O_2$, $\Delta[\text{Hb}]$ and HR responses during the 30s work:60s recovery intermittent test in a representative subject.	92
Figure 3.9	$\dot{V}O_2$, $\Delta[\text{Hb}]$ and HR responses during the 60s work:120s recovery intermittent test in a representative subject.	93
Figure 3.10	$\dot{V}O_2$, $\Delta[\text{Hb}]$ and HR responses during the 90s work:180s recovery intermittent test in a representative subject.	94
Figure 3.11	$\Delta[\text{HbT}]$ responses during the entire test durations of the four different intermittent cycling tests in a representative subject.	98
Figure 3.12	Overlaid $\Delta[\text{Hb}]$ and $\Delta[\text{HbT}]$ responses during two consecutive duty cycles for a representative subject during the 60s:120s test.	99
Figure 3.13	Modelled responses to the four intermittent tests of varying duty cycle duration assuming a quasi-first-order system with τ of 30 s and no delay.	102
 Chapter 4		
Figure 4.1	Schematic of cycling protocols.	110
Figure 4.2	Identification of the onset of the $\dot{V}O_2$ slow component.	112
Figure 4.3	Critical Power estimation for each subject.	114
Figure 4.4	Oxygen uptake response to cycling at a work rate slightly below Critical Power ($95\% \Delta_1$).	116

Figure 4.5	Oxygen uptake response to cycling at a work rate slightly below Critical Power ($95\%\Delta_1$), following a preceding priming bout of cycling.	118
Figure 4.6	The heart rate response profiles for a representative subject for the tests performed at $95\%\Delta_1$, with and without a preceding priming bout.	120
Figure 4.7	Temporal profiles of $\dot{V}O_2$ for all subjects during cycling performed at $95\%\Delta_1$, with and without a preceding priming bout.	122
Chapter 5		
Figure 5.1	Schematic illustrating the imbalance of ventilatory requirement and ventilatory capacity in COPD patients.	133
Figure 5.2	The “dyspnoea spiral” of Casaburi (1993).	134
Figure 5.3	Effective invisibility of the Phase I $\dot{V}O_2$ response during a single work rate transition.	136
Figure 5.4	Examples showing how the time constant estimate derived from an exponential model is dependent on the time frame used.	137
Figure 5.5	Schematic illustrating how estimates of the $\dot{V}O_2$ kinetics were obtained using three different modelling strategies.	144
Figure 5.6	Comparison of goodness-of-fit between Model τ and Model τ_{20s} .	148
Figure 5.7	Comparison of goodness-of-fit between Model τ_{20s} and Model τ_{real} .	149
Figure 5.8	Group mean residuals for Model τ_{real} .	150
Figure 5.9	Variability of τ estimates obtained using the three modelling strategies.	150
Figure 5.10	Speeding of $\dot{V}O_2$ kinetics during the rest-to-20W transition following an 8-week exercise training programme.	152
Figure 5.11	$\dot{V}O_2$ profiles during symptom-limited ramp incremental cycling for a representative patient, showing a comparison of pre and post-rehabilitation responses.	153
Figure 5.12	$\dot{V}O_2$ profiles during the constant work rate cycling at a work rate equivalent to 80% of the pre-rehabilitation WR_{peak} , for a representative patient, showing a comparison of pre and post-rehabilitation responses.	153

Figure 5.13	The power-duration relationship in COPD patients and age-matched control subjects.	161
Figure 5.14	Schematic of how t_{lim} values for a constant work rate test will be highly variable.	162
Figure 5.15	Schematic illustrating the comparison of the $\dot{V}O_2$ response to moderate intensity constant work rate exercise and incremental exercise.	165
 Chapter 6		
Figure 6.1	Simulation of how the sum of ten individual compartments exhibiting different \dot{Q}_{mO_2} kinetics would be functionally indistinguishable from a single metabolic compartment.	177
Figure 6.2	Regional magnetic resonance spectra within the quadriceps muscles during knee-extension exercise, using magnetic resonance spectroscopy.	178
Figure 6.3	Schematic addressing the effect of regional differences in power-duration characteristics on the “average” power-duration relationship.	180

List of Tables	Page
 Chapter 3	
Table 3.1 Subject characteristics.	81
Table 3.2 Change in lactate concentration during the four intermittent tests.	89
Table 3.3 Amplitudes of the oscillations observed for the change in concentration of deoxygenated haemoglobin during the four intermittent tests.	90
Table 3.4 $\dot{V}O_2$ responses to the four intermittent tests.	91
 Chapter 4	
Table 4.1 Subject characteristics.	108
Table 4.2 Individual and group values for critical power, peak work rate during an incremental test, work rate at θ_1 , the curvature constant of the power-duration hyperbola, 8minWR and 95% Δ_1 .	115
Table 4.3 Arterialised mixed-venous blood lactate concentration and heart rate responses to the test performed at 95% Δ_1 without a preceding priming bout.	115
Table 4.4 $\dot{V}O_2$ kinetics for the response to cycling at 95% Δ_1 without a preceding priming bout.	116
Table 4.5 Arterialised mixed-venous blood lactate concentration and heart rate responses to the test performed at 95% Δ_1 following a preceding priming bout.	117
Table 4.6 $\dot{V}O_2$ kinetics for the response to cycling at 95% Δ_1 following the 8minWR priming bout.	117
Table 4.7 A direct comparison of the blood lactate concentration, heart rate and $\dot{V}O_2$ responses to the tests performed at 95% Δ_1 , with and without a preceding priming bout.	119
 Chapter 5	
Table 5.1 Subject characteristics.	140
Table 5.2 Summary of $\dot{V}O_2$ kinetics for subjects whose data provided τ estimates using all three modelling strategies (τ' , τ_{20} , and τ_{real}).	147
Table 5.3 Summary of $\dot{V}O_2$ kinetics, modelled using three different strategies (τ' , τ_{20} , and τ_{real}).	151
Table 5.4 Group mean results for the exercise tests.	152

Chapter 1 Introduction

1.1 BACKGROUND

It has long been recognised that a necessity of the response to exercise is the essential increase in provision and utilisation of oxygen, in order to fuel the supply of high-energy phosphates to balance the energy demand of muscular work, and hence avoid an intracellular homeostatic “catastrophe” (Chance *et al.*, 1985). The precise details of the control mechanisms responsible for this matching process of oxygen consumption to oxygen demand remain elusive, despite considerable research and debate. The two major competing theories are:

1. Vascular O₂ delivery – feed-forward and/or feed-back mechanisms act to adjust the rate of oxygen delivery to determine the rate of muscle O₂ consumption (\dot{Q}_{mO_2}) and match the O₂ demand (reviewed by Hughson *et al.*, 2001).
2. Intrinsic metabolic control – assumes that O₂ delivery is adequate, and that with feed-forward, or feed-back control, the putative enzymatic controllers of mitochondrial oxidative phosphorylation determine the rate of muscle O₂ consumption (reviewed by, e.g. Grassi, 2001; Whipp *et al.*, 2002b; Korzeniewski & Zoladz, 2003).

It is recognised that there is not an immediate increase in the rate of oxidative phosphorylation to sufficient levels to meet ATP demands, although the underlying mechanisms responsible for these slow kinetics of the increased rate of oxidative phosphorylation remain controversial. Since it is the production of ATP that is the ultimate focus of oxidative metabolism, it is of little surprise that many investigators have proposed that the limitation resides in the mechanisms of ATP production and utilisation. The demonstration of monoexponentiality of the \dot{Q}_{mO_2} response (as described in detail later) is consistent with a single rate-limiting step, although this concept has been challenged more recently (Whipp *et al.*, 2002b). As shown in Figure 1.1, the potential sites for limitation are numerous, although a number of specific mechanisms have been proposed:

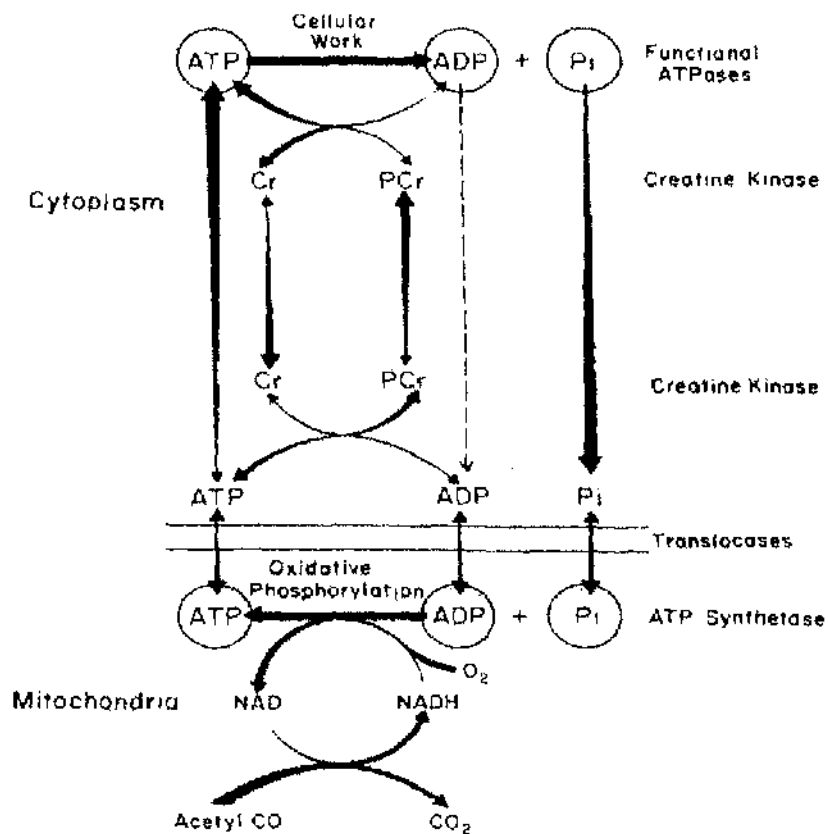

Figure 1.1 – Diagram summarising the cytosolic and mitochondrial reactions involved in ATP generation. From Chance *et al.* (1985).

- One of the earlier proposed mechanisms was that [ADP] is the key factor via Michaelis-Menten kinetics (Chance & Williams, 1956). Subsequently, more complex models have been proposed (Jeneson *et al.*, 1996; Conley *et al.*, 2001). Barstow *et al.* (1994b), using nuclear magnetic resonance (^{31}P -NMRS) spectroscopy techniques, demonstrated that during incremental calf exercise the hyperbolic changes in [ADP] concentration, characteristic of Michaelis-Menten kinetics, were observed for moderate exercise (defined subsequently). At higher work rates, associated with a decrease in intramuscular pH, the hyperbolic relationship was not retained, Barstow *et al.* (1994b) citing this as evidence against direct [ADP] control.
- Thermodynamic control of oxidative metabolism via the phosphorylation potential ($[\text{ATP}]/[\text{ADP}][\text{P}_i]$) has also been postulated (Brown, 1992; Wilson, 1994).
- An alternative proposition for thermodynamic control (Funk *et al.*, 1990; Kushmerick *et al.*, 1992) is via the Gibbs free energy of ATP hydrolysis (ΔG_{ATP}).
- The potential for linear control by [PCr] is based on the role of creatine kinase linking ATP production in the mitochondria and ATP utilisation in the cytosol (Mahler, 1985; Meyer, 1988).

- e) A more recent proposition (Timmons *et al.*, 1998a) is that the limitation lies in the redox potential, more specifically the supply of NADH, which depends on the availability of acetyl-CoA.

That the control of muscle oxygen consumption has not been resolved is perhaps not entirely surprising, given the complexities surrounding the control of oxidative phosphorylation and the multifaceted interaction of the respiratory, cardiovascular and muscular systems responsible for transfer of O₂ from the atmosphere to cytochrome oxidase at opposite ends of the oxygen cascade (e.g. Weibel, 1984; Wagner, 2000). The interdependence of the systems involved in the exchange of O₂ (and CO₂) between the atmosphere and the muscle has been usefully schematised in Figure 1.2, and the potential sites for limitation are numerous (Wasserman *et al.*, 1967).

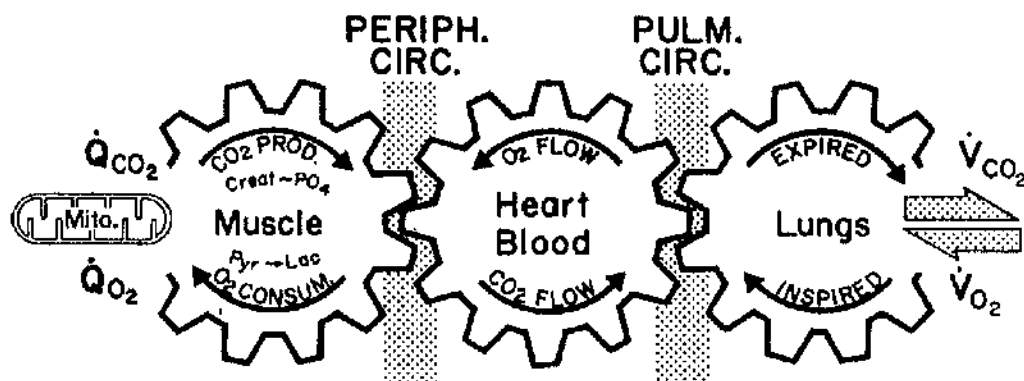

Figure 1.2 -- Schematic illustrating the interaction and coordination of the pulmonary, cardiac and muscular systems linking oxygen consumption and carbon dioxide production. From Wasserman *et al.* (1999).

There has been a concerted interest to further pursue the elusive details of the underlying control mechanisms from a bioenergetics systems control perspective (e.g. Hill & Lupton, 1923; Casaburi *et al.*, 1989; Whipp & Ward, 1990; Linnarsson, 1990; Hughson, 1990; Miyamoto, 1992; Kushmerick *et al.*, 1992; Hughson *et al.*, 2001; Grassi, 2001; Whipp *et al.*, 2002b; Korzeniewski & Zoladz, 2003). The majority of information regarding the system control characteristics can be derived from examining the system during the non-steady state of the response, and so the investigation of the kinetics of \dot{Q}_mO_2 at the onset (and offset) of dynamic exercise remains the focus of attention. Aside from the interest in the kinetics of oxygen consumption from a bioenergetic control aspect, there is also considerable functional interest in their role in exercise tolerance in health and disease, as will be discussed.

According to the laws of mass balance, the rate of muscle oxygen consumption is determined by the components of the Fick Equation:

$$\dot{Q}_m O_2 = \dot{Q}_m \cdot (CaO_2 - Cv_m O_2) \quad (\text{Equation 1.1})$$

where \dot{Q}_m represents muscle blood flow, and CaO_2 and $Cv_m O_2$ represent the oxygen content of the arterial and muscle venous effluent blood respectively. Whipp *et al.* (2002b) have recently argued that whilst this equation may indeed quantify $\dot{Q}_m O_2$, a more appropriate re-arrangement of the equation, in terms of *determinants*, may be:

$$Cv_m O_2 = CaO_2 - (\dot{Q}_m O_2 / \dot{Q}_m) \quad (\text{Equation 1.2})$$

This means that, for a given arterial O_2 content, the muscle venous effluent content will be determined by the ratio of muscle oxygen consumption to muscle blood flow. Recent advances using magnetic resonance imaging (MRI) techniques have shown that within the active musculature, the $\dot{Q}_m O_2 / \dot{Q}_m$ ratio may vary considerably (Richardson *et al.*, 2001a), and the implications of this relating to interpretation of $\dot{Q}_m O_2$ are discussed in more detail in Section 6.3.3.

The greatest challenge in attempting to unravel the control characteristics of $\dot{Q}_m O_2$ is the technical difficulty of monitoring muscle blood flow *in vivo* in the non-steady state of dynamic exercise. Despite these technical obstacles, several techniques, such as Doppler ultrasound (e.g. Hughson *et al.*, 1996) and thermodilution (e.g. Grassi *et al.*, 1996; Bangsbo *et al.*, 2000), have successfully been applied to vascular beds supplied by a major artery (e.g. the femoral artery) during exercise, in order to monitor \dot{Q}_m . However, they do not permit accurate portrayal of temporal features of the changes in regional muscle blood flow. In addition, it is difficult to temporally align observed changes in \dot{Q}_m with the associated CvO_2 which is being measured from samples at a site downstream (Bangsbo *et al.*, 2000). Therefore, some alternative approaches have also been applied:

1. *In vitro* animal preparations of isolated muscle groups (Grassi *et al.*, 1998a & 1998b),
2. Extrapolation from the whole-body, or pulmonary, oxygen uptake ($\dot{V}O_2$) response, based on the premise that increased $\dot{Q}_m O_2$ in response to an increase of work rate should be reflected with reasonable accuracy in $\dot{V}O_2$,
3. Mathematical modelling of the constituents of the Fick equation to investigate their interaction and dependence on one another (Barstow *et al.*, 1990).

The major limitation of using the first approach is the extrapolation of these results to the context of the intact human, although the crucial importance of these tests is discussed later. The use of $\dot{V}O_2$ to approximate steady-state changes in \dot{Q}_mO_2 has been applied for decades. The ability to measure changes in $\dot{V}O_2$ with breath-by-breath temporal resolution by means of rapidly responding flow-volume transducers and gas analysers, and mass-balance algorithms (e.g. Beaver *et al.*, 1973) for the calculation of breath-by-breath gas exchange, have permitted extensive characterisation of the temporal features of the $\dot{V}O_2$ response.

As with the \dot{Q}_mO_2 response, it is useful to consider the Fick equation components for $\dot{V}O_2$:

$$\dot{V}O_2 = \dot{Q}_T \cdot (CaO_2 - C\bar{v}O_2) \quad (\text{Equation 1.3})$$

where \dot{Q}_T and $C\bar{v}O_2$ represent cardiac output and the mixed venous oxygen content, respectively. The relationships between \dot{Q}_T , $(CaO_2 - C\bar{v}O_2)$ and $\dot{V}O_2$ have been established for steady states over a range of work rates, despite the associated difficulties in accurately measuring \dot{Q}_T .

There is a linear relationship between the steady-state \dot{Q}_T and $\dot{V}O_2$ responses to constant work rate exercise, as shown in Figure 1.3 and described by Equation 1.4, irrespective of training status, although the maximal values achieved are dependent on aerobic fitness (Ekblom & Hermansen, 1968).

$$\dot{Q}_T = 5 \dot{V}O_2 + 5 \quad (\text{Equation 1.4})$$

It should however be acknowledged that alternative, but similar, values for the slope and intercept of the response have been reported (Rowell, 1974; Lewis *et al.*, 1983; Higginbotham *et al.*, 1986). With increasing work rates it is noted that the arterio-venous oxygen difference $(CaO_2 - C\bar{v}O_2)$ increases in comparison to resting values (Figure 1.3), indicating that the increases in \dot{Q}_T alone are insufficient to meet the metabolic demand (e.g. Saltin *et al.*, 1968; Clausen, 1976). A consequence of the steady state \dot{Q}_T - $\dot{V}O_2$ relationship being linear and having an intercept is that the increase in arterio-venous O_2 difference follows a hyperbolic function (Figs. 1.3 & 1.4) with respect to $\dot{V}O_2$ (Whipp & Ward, 1982).

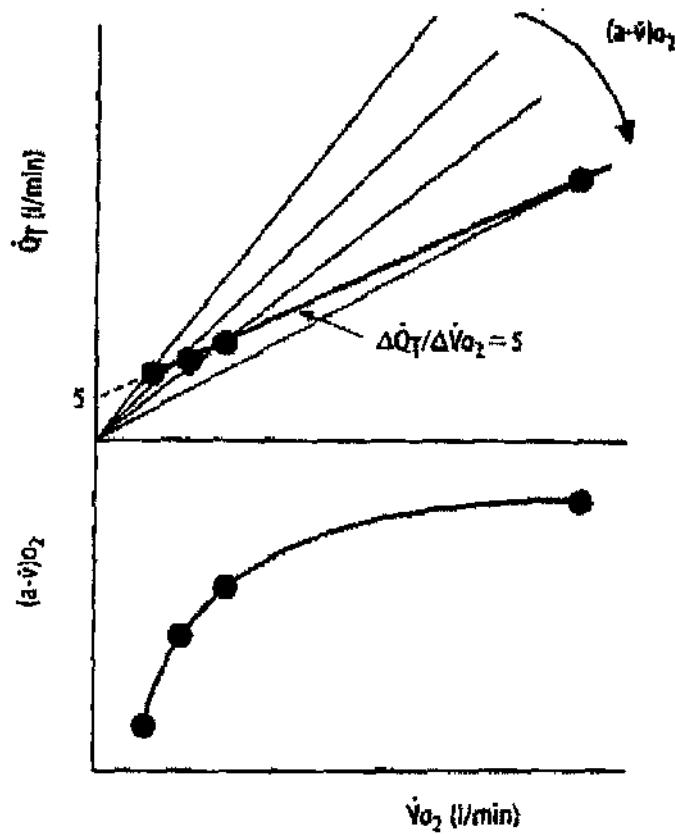

Figure 1.3 – Schematic illustrating the relationship between $\dot{V}O_2$ and cardiac output (\dot{Q}_T - top panel), and arterio-mixed venous O_2 content difference $((a-\bar{v})O_2$ - bottom panel) at increased work rates. From Ward & Whipp (1996).

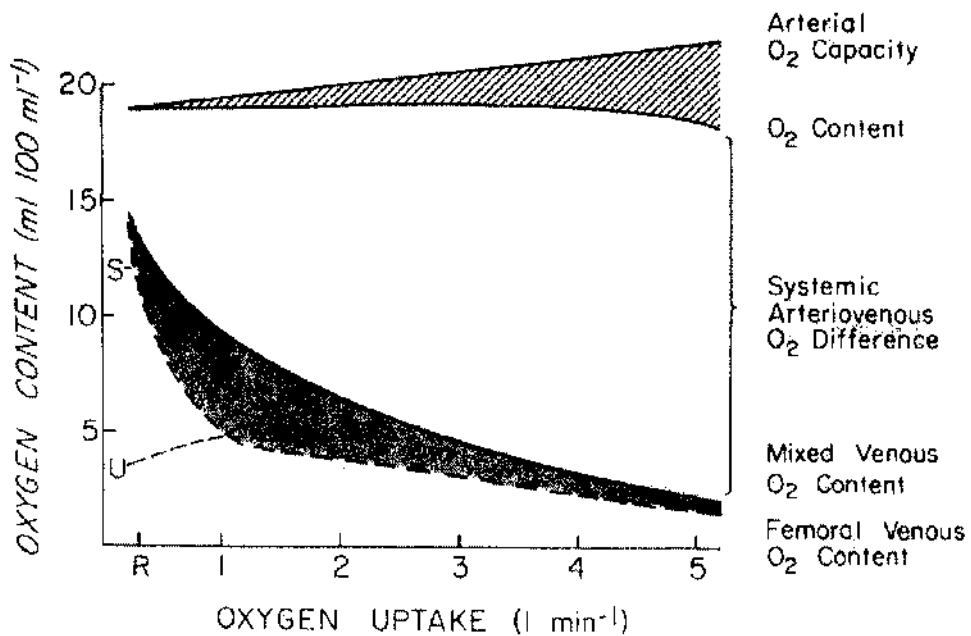

Figure 1.4 – Diagram showing the oxygen content of arterial, mixed venous and femoral venous blood as $\dot{V}O_2$ increases from resting levels (R) up to maximal levels in response to increased work rates. From Rowell (1993).

CaO₂ is found to remain constant in healthy individuals as $\dot{V}O_2$ increases, although arterial desaturation has been observed in some elite athletes in maximal exercise (e.g. Rowell *et al.*, 1964; Dempsey *et al.*, 1984; Powers & Williams, 1987; Pedersen *et al.*, 1996; Harms *et al.*, 2000) and O₂-carrying capacity may increase slightly as a consequence of haemoconcentration (Figure 1.4). Therefore the major component of the widening arterio-venous difference is a hyperbolic fall in CvO₂, with values as low as 2 or 3 ml of O₂ per 100 ml of blood reported in maximal exercise (Rowell, 1974). It is estimated (Knight *et al.*, 1992) that O₂ extraction may be as much as 85% at the point of maximal exercise in healthy individuals when O₂ off-loading is facilitated by the Bohr-shift of the haemoglobin dissociation curve induced by changes in temperature and pH (Wasserman *et al.*, 1991).

Likewise, sampling of the muscle venous effluent in the steady state indicates a curvilinear decline in Cv_mO₂, as shown in Figure 1.4 (e.g. Saltin *et al.*, 1968), suggesting that the increased \dot{Q}_m is insufficient to meet the metabolic demand at increased work rates. These suggestions have been confirmed more recently by direct demonstration of the \dot{Q}_m , \dot{Q}_{mO_2} and (CaO₂ - CvO₂) responses across an exercising limb at exercise onset by serial sampling (Poole *et al.*, 1991; Grassi *et al.*, 1996; Bangsbo, 2000 - detailed in Section 1.4.4). The presently insurmountable technical limitations with direct serial sampling from the muscle venous effluent have prevented detailing of the decline in Cv_mO₂ at the onset of constant work rate exercise. However, despite continued sampling problems, accomplishment of serial femoral venous blood sampling has meant that steady state profiles of \dot{Q}_m , \dot{Q}_{mO_2} and femoral arterio-venous difference, which exhibit the same steady state response patterns as \dot{Q}_T , $\dot{V}O_2$ and (CaO₂ - CvO₂), have been obtained (Andersen & Saltin, 1985 - Figure 1.5). The temporal profiles for the response of \dot{Q}_{mO_2} and \dot{Q}_m at the onset of constant work rate exercise are presented later in Section 1.4.4 (Figures 1.12 & 1.13 respectively).

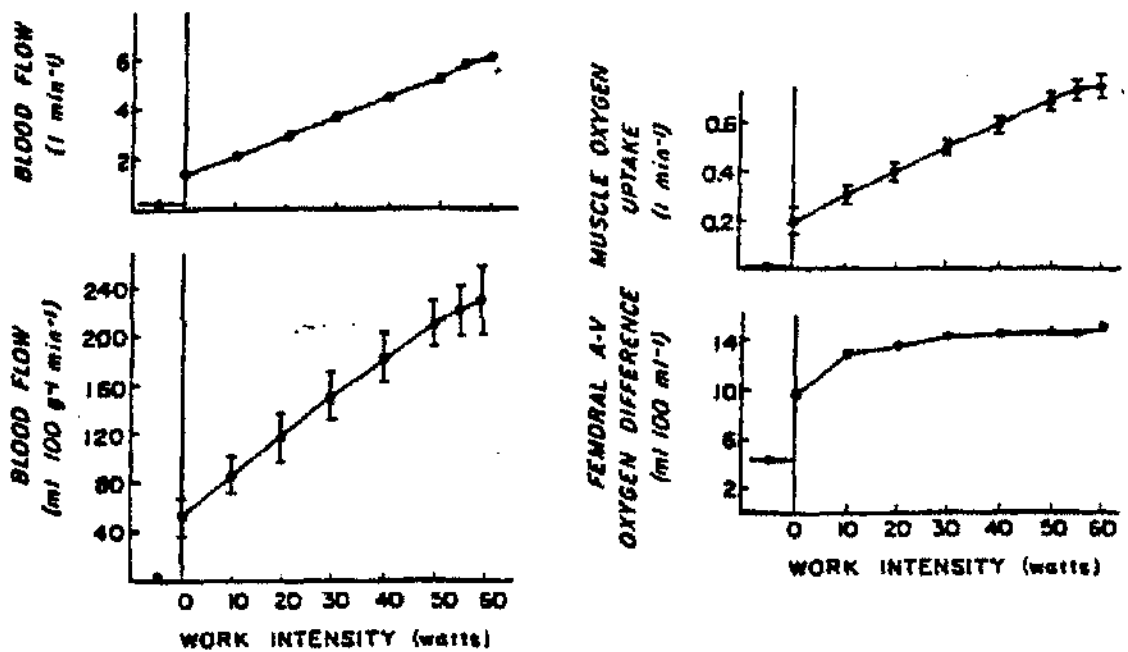

Figure 1.5 – Muscle blood flow, femoral arterio-venous O₂ content difference and muscle oxygen uptake in response to rhythmic knee extension exercise of varying work rates. Adapted from Andersen & Saltin (1985).

1.1.1 Exercise intensity domains

Despite general agreement that the metabolic and cardio-respiratory responses to exercise are dependent on the imposed work rate, there is no clear consensus as to how exercise intensity should be defined. For example, one exercise physiology textbook (McArdle *et al.*, 2001) recognises that there are at least seven different approaches to expressing exercise intensity:

1. The rate of energy expenditure, expressed in absolute units such as kcal.min⁻¹ or kJ.min⁻¹.
2. As a multiple of the resting metabolic rate, usually expressed in METs calculated as a multiple of the resting $\dot{V}O_2$ (1 MET = resting $\dot{V}O_2$ in ml.kg⁻¹.min⁻¹).
3. Based on heart rate, either as an absolute value in beats.min⁻¹ or expressed as a percentage of the predicted maximum heart rate (HR_{max} = 220 – age(years)).
4. As a level of exercise, such as power output, expressed as an absolute value or as a percentage of a maximal value obtained previously, often in an incremental test (e.g. %WR_{max}).
5. According to the individual's perceived level of exertion, usually according to Borg's rating of perceived exertion (RPE) scale (Borg, 1982).

6. As a relative metabolic level, normally expressed relative the individual's peak or maximal rate of oxygen uptake ($\mu\dot{V}O_2$ or $\dot{V}O_{2\max}$ respectively, the difference detailed in Section 2.2.1).
7. Based on whether there is a significant increase in the concentration of lactate in the arterial blood ($[La]$), as detailed subsequently.

However, on physiological grounds, a more rigorous approach is to describe exercise intensity in terms of the resultant profile of arterial $[La]$ (Wasserman *et al.*, 1967), as summarised in Figure 1.6: moderate exercise defined as exercise without any sustained increase in $[La]$; heavy exercise results in a sustained but eventually stable, or even decreased, $[La]$; very heavy exercise exhibits a continually increasing $[La]$ until exhaustion is reached.

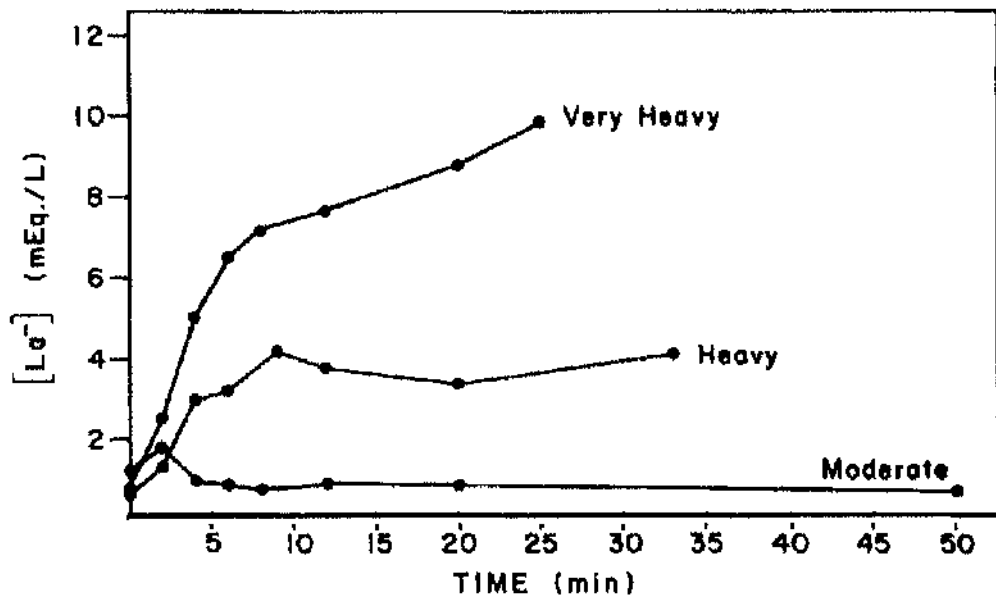

Figure 1.6 – The traditional assignment of exercise intensity based on the profiles of arterial lactate concentration ($[La^-]$) during constant work rate exercise at different work rates. Adapted from Wasserman *et al.* (1967).

The $\dot{V}O_2$ response to dynamic exercise of different intensities has now been comprehensively characterised for cycling (Ozyener *et al.*, 2001) and running (Carter *et al.*, 2002), using multiple repetitions for accurate discrimination of the underlying features of the kinetic response (Lamarra *et al.*, 1987). It is evident that several proposed domains of exercise intensity (Figure 1.7) exist, in line with the $[La]$ profiles of Wasserman *et al.* (1967). The two major boundaries defining these domains are the lactate threshold (θ_L) and critical power (CP or θ_C , fatigue threshold) for cycling (Poole *et al.*, 1988; Ozyener *et al.*, 2001) or critical velocity for running (Carter *et al.*, 2002).

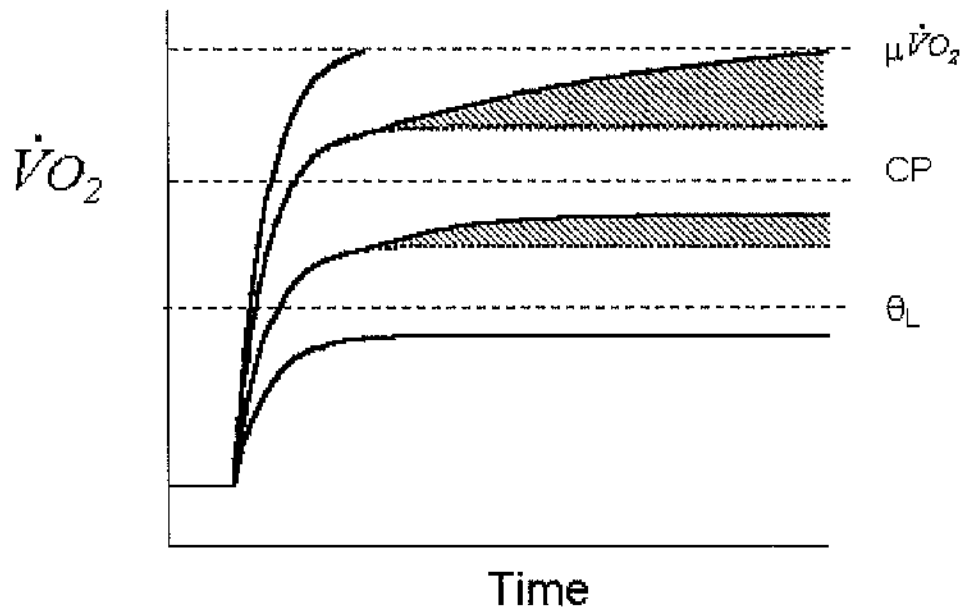

Figure 1.7 – Schematic illustration of the dependence of $\dot{V}O_2$ kinetics on the exercise intensity domain. Thick solid lines represent the $\dot{V}O_2$ response, and dashed lines signify the intensity domain boundaries of lactate threshold (θ_L), critical power (CP) and peak $\dot{V}O_2$ ($\mu\dot{V}O_2$). Shaded areas reflect the additional slow component causing $\dot{V}O_2$ to exceed the expected Phase II response. Based on Figure 4 from Whipp & Ozyener (1998).

The lactate threshold is defined as the work rate, or more appropriately $\dot{V}O_2$, above which a sustained accumulation of lactate is observed in the arterial blood (Wasserman *et al.*, 1973), and the finding of an altered $\dot{V}O_2$ response with this increase in [La] is evidence of a strong association between the two variables (e.g. Whipp & Wasserman, 1986). It is important to note that the lactate threshold does not necessarily translate as the onset of muscle lactate production, since blood [La] reflects the continuous balance of production and clearance of lactate by less active muscles and other organs (Brooks, 2000). Indeed, even at work rates below θ_L the transient production of lactate contributes to the oxygen deficit (Cerretelli *et al.*, 1979), in addition to O_2 and PCr stores as described subsequently.

The critical power (Moritani *et al.*, 1981) has been proposed to represent the metabolic upper boundary for sustainable exercise (Poole *et al.*, 1988; Hill *et al.*, 2002; Coats *et al.*, 2003), above which exercise will inevitably become intolerable, attaining $\dot{V}O_{2\max}$ within a short period of time. CP is determined as the asymptote of the hyperbolic power-duration relationship (Monod & Scherrer, 1965; Moritani *et al.*, 1981; Poole *et al.*, 1988; Hill, 1993), as explained in Section 2.2.2 and shown in Figure 2.6. In addition to being an important boundary for $\dot{V}O_2$ kinetics, CP is also equivalent to the highest work rate at

which a balance between lactate production and clearance can be achieved (Poole *et al.*, 1988), i.e. the maximal lactate steady state (MLSS), providing further support of the strong relationship between $\dot{V}O_2$ kinetics and arterial [lactate].

1.2 TEMPORAL PROFILES OF $\dot{V}O_2$

The traditional concept of an exponential increase of \dot{Q}_mO_2 in humans at exercise onset was introduced by Hill & Lupton (1923), based on their demonstration of an exponential rise in $\dot{V}O_2$ (Figure 1.8).

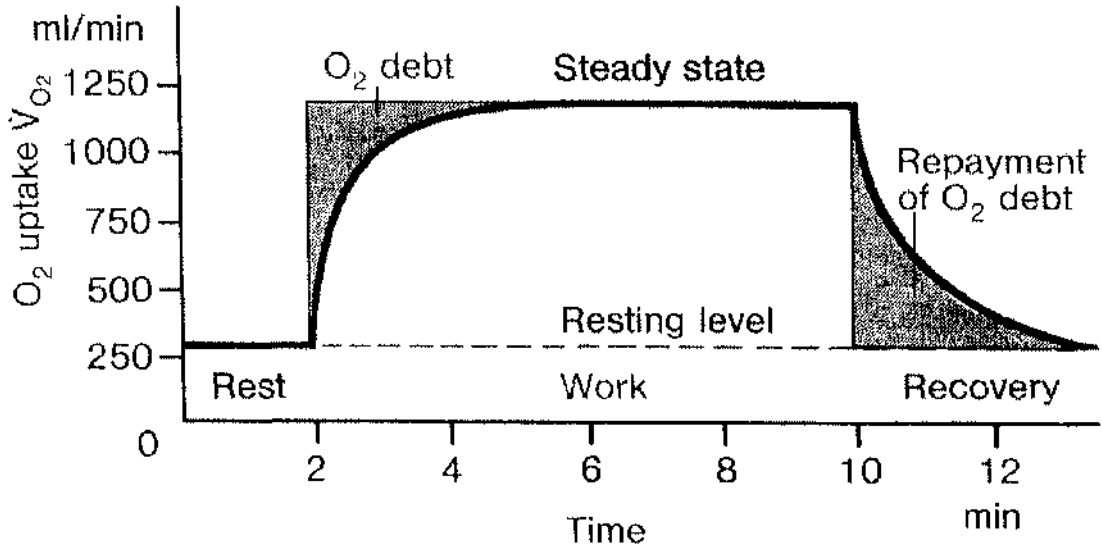

Figure 1.8 - Traditional profile of the exponential increase in $\dot{V}O_2$ at the onset of constant work rate exercise. From Schmidt & Thews (1983).

These original $\dot{V}O_2$ profiles have proved extremely useful as they demonstrated that the increases in $\dot{V}O_2$ are not sufficient to match the O_2 -demand of the work immediately, and so there is a shortfall in O_2 , termed the oxygen deficit (O_2Def). It is now recognised that this O_2 -equivalent for the adequate supply of high-energy phosphates is met by a combination of factors:

1. Depletion of limited available body O_2 -stores, predominantly in the venous pool,
2. Anaerobic phosphorylation of ADP via splitting of a limited intramuscular phosphocreatine (PCr) pool, catalysed by creatine kinase (CK),
3. Anaerobic glycolytic metabolism with concomitant production of lactate and its associated proton (H^+).

Since the stores of O_2 in the blood and PCr in the muscle are limited, the required contribution from glycolysis will depend on the size of the O_2Def , which is determined by the amplitude of the change in \dot{Q}_mO_2 ($\Delta\dot{Q}_mO_2(ss)$), and therefore $\dot{V}O_2$, and the kinetics of the exponential rise (Whipp, 1987). This means that there are two circumstances that will result in an increased reliance on glycolysis. The first is at higher exercise intensities

(above θ_L) since there is a greater O_2 demand (and hence $\Delta \dot{Q}_{mO_2(ss)}$), and the second is if the kinetics are slow (see Chapter 5). The drawbacks of an increased reliance on glycolysis are that energy transfer via this mechanism is less efficient (fewer ATPs generated per molecule of substrate) than oxidative phosphorylation and that there is a concomitant accumulation of H^+ , which is detrimental to both intra- and extra-cellular homeostasis. It is therefore advantageous to have faster kinetics, so that oxidative phosphorylation can be the predominant energy generating process, and this forms the basis of the concept of “tight coupling” of oxidative metabolism (Chance *et al.*, 1985).

Whilst the direct determination of the kinetics of \dot{Q}_{mO_2} with high temporal resolution is invasive and many technical difficulties are encountered, the $\dot{V}O_2$ response at the onset of dynamic exercise has now been well characterised and it is appreciated that the original mono-exponential model is an over-simplification. The use of multiple repetitions to enhance the underlying features (Lamarra *et al.*, 1987) of the $\dot{V}O_2$ response during the exercise transition was employed by Whipp *et al.* (1982) to enable accurate description of the kinetic features of the increase in $\dot{V}O_2$ during cycling. Whilst the general trend of an exponential increase was retained, the complexities of a 3 phase response became evident (schematised in Figure 1.9).

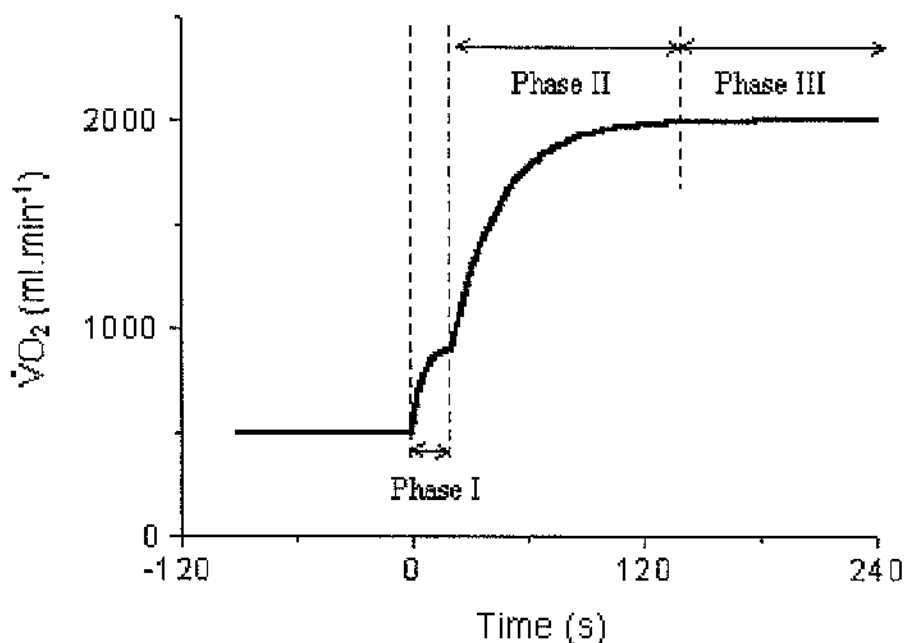

Figure 1.9 – Simplified illustration exaggerating the three individual phases of the $\dot{V}O_2$ response at the onset ($t = 0$ s) of constant work rate exercise from a baseline of unloaded pedalling.

1.2.1 Phase I

This period is the initial increase in $\dot{V}O_2$ at exercise onset and it has been termed the “cardiodynamic” phase (Wasserman *et al.*, 1974), since any increases in $\dot{V}O_2$ will be reflective of increased \dot{Q}_T (and therefore \dot{Q}_P - Krogh & Lindhard, 1913; Linnarsson, 1974), as changes in arterio-venous difference will not yet have been expressed at the lung due to the muscle-to-lung vascular transit delay. Interestingly, performing the transition from a baseline of unloaded pedalling rather than rest reduces the relative contribution of this Phase to the overall $\dot{V}O_2$ response, as the change in \dot{Q}_T is smaller (e.g. Whipp *et al.*, 1982). Further support is provided by the studies of Karlsson *et al.* (1975) and Weiler-Ravell *et al.* (1983), who demonstrated a blunted Phase I $\dot{V}O_2$ response when exercise was instituted in a supine position, assumed to occur in concert with slower increases in stroke volume, and hence \dot{Q}_T , based on previous observations (e.g. Jones *et al.*, 1970; Raynaud *et al.*, 1973).

1.2.2 Phase II

This period is the most prominent component of the $\dot{V}O_2$ response (excluding very small changes in WR, for which the Phase I increase is sufficient), and this phase is well modelled as an exponential process (e.g. Whipp *et al.*, 1982). It is this region of the response that is suggested to reflect the changes in \dot{Q}_{mO_2} most closely, and it has become known as the “fundamental” phase (e.g. Rossiter *et al.*, 2001). The on-going debate concerning control mechanisms of $\dot{V}O_2$, ideally \dot{Q}_{mO_2} , is therefore focussed on this portion of the response, as will be highlighted later. The kinetic parameters of interest in this region are the amplitude ($\Delta\dot{V}O_2$), the delay (δ) and the time constant (τ) of the exponential, which is the time to reach 63% of the steady state response. It should be emphasised that the delay is not physiological, but rather is a factor of the exponential model used (Equation 2.9), although it will approximate the duration of the Phase I response (Whipp *et al.*, 1982).

1.2.3 Phase III

The third section of the response is completely dependent on the intensity of the exercise, as detailed in the following section. In Figure 1.9 this region represents the steady state of the response, the amplitude equivalent to $\Delta\dot{V}O_{2(ss)}$.

1.3 $\dot{V}O_2$ KINETICS AND EXERCISE INTENSITY

1.3.1 Moderate exercise

The lack of a sustained arterial lactate accumulation in the moderate intensity domain is considered to reflect that the combined effects of PCr degradation, venous O_2 stores and any transient glycolysis match the O_2 Def. A typical value for τ of the fundamental $\dot{V}O_2$ response in this domain is approximately 30 s in a healthy young adult, although considerable inter-individual variability exists (e.g. Whipp *et al.*, 2002b). τ has been demonstrated to be dependent on age (Chilibeck *et al.*, 1996; Williams *et al.*, 2001; Fawcner *et al.*, 2002), fitness status (Hickson *et al.*, 1978; Hagberg *et al.*, 1980; Phillips *et al.*, 1995) and cardio-respiratory disease (Nery *et al.*, 1982; Hansen *et al.*, 1987; Sietsema, 1992; Puente-Maestu *et al.*, 2001).

From a control systems perspective an important feature is linearity, enabling insight into whether a process follows first-order principles, consistent for example with a single rate-limiting step (e.g. Milsum, 1966). In terms of $\dot{V}O_2$, the question is whether the τ and amplitude of the fundamental component exhibit linearity. This would require (Fujihara *et al.*, 1973a) that: (a) the amplitude of the output signal ($\Delta\dot{V}O_{2(ss)}$) would need to increase in direct proportion to the input signal, in this case the change in work rate (ΔWR); (b) τ of the response would be independent of the amplitude of response; (c) the response exhibit dynamic symmetry at the onset and offset of constant work rate exercise, according to the principle of superposition (Fujihara *et al.*, 1973b); and (d) that τ is independent of the work rate forcing function, also in accord with the principle of superposition (Fujihara *et al.*, 1973b).

(a) Within the moderate intensity domain it has generally been agreed that the $\dot{V}O_2$ response to cycling exhibits linearity since it has been shown that the steady state $\dot{V}O_2$ amplitude is proportional to the increase in work rate. This relationship between $\Delta\dot{V}O_{2(ss)}$ and the increase in work rate, from a lower work rate such as unloaded pedalling, is described as the gain of the fundamental component, calculated as:

$$\text{Gain} = \Delta\dot{V}O_{2(ss)} / \Delta WR \quad (\text{Equation 1.5})$$

The gain is considered constant for moderate cycling at $\approx 10 \text{ ml } O_2 \cdot \text{min}^{-1} \cdot \text{Watt}^{-1}$ (Hansen *et al.*, 1987; Barstow & Molé, 1991; Barstow *et al.*, 1993), a feature of a linear system. This gain is functionally assumed to reflect the inverse of work

efficiency; however, there is one important difference in that it reflects the O_2 cost of the work rather than the energy cost.

- (b) It has been considered for some time that the τ for moderate cycling is unchanged for different work rates in the moderate intensity domain (Whipp, 1971; Casaburi *et al.*, 1989; Barstow & Molé, 1991), providing further support that sub- θ_L $\dot{V}O_2$ kinetics exhibit first-order properties. However, Hughson & Morrissey (1982) observed that in the higher reaches of the moderate intensity domain τ was longer than in the lower ranges for the same ΔWR . More recently further evidence of this phenomenon has been presented by Brittain *et al.* (2001) who demonstrated that the prior metabolic rate, altered baseline of response, has a significant affect on τ . They too found a longer τ in the higher reaches of the moderate domain as well as significant differences in gain, thus challenging the notion of linearity of the $\dot{V}O_2$ response in this domain.
- (c) The third property of a first-order system is that of dynamic symmetry. For the $\dot{V}O_2$ response to display linearity there must be symmetry between the response at the onset (on-transient) and offset (off-transient) of exercise. Traditionally it has been demonstrated that there is good symmetry between the on and off-transients for sub- θ_L exercise (Whipp & Wasserman, 1972; Linnarsson, 1974; Griffiths *et al.*, 1986; Paterson & Whipp, 1991; Ozyener *et al.*, 2001). One corollary of this observation is that the O_2 Def will be equal to its equivalent at the off-transient, which is termed the oxygen debt (O_2 Debt) (Figure 1.8). Interestingly, Brittain *et al.* (2001) found that for changes in work rate similar to those used by the above authors, the on-off symmetry was preserved. However, the differences in gain and τ observed at the on-transient were not manifest at the off-transient for the various ranges in work rate change, thereby further challenging the traditionally held concept of linearity of the $\dot{V}O_2$ response in the moderate domain.
- (d) The final test of superposition is that $\dot{V}O_2$ kinetics demonstrate independence of the imposed work rate function. $\dot{V}O_2$ kinetics have been modelled in response to a variety of work rate protocols: constant work rate exercise (a step increase in work rate - as described in detail above); incremental exercise protocols (ramp functions - e.g. Whipp *et al.*, 1981; Swanson & Hughson, 1988); impulse protocols (the derivative of the step function - e.g. Hughson *et al.*, 1988); sinusoidal exercise (Casaburi *et al.*, 1977; Fukuoka & Ikcgani, 1990; Haouzi *et al.*, 1993); and, pseudorandom binary sequence

(PRBS) work rate profiles (Kowalchuk & Hughson, 1990; Hughson *et al.*, 1991a; Hoffmann *et al.*, 1992; Edwards *et al.*, 2003). That the response to rapidly incremental exercise displays dynamic linearity has been addressed above (Whipp *et al.*, 1981), although the kinetics are dependent on the incrementation rate (Swanson & Hughson, 1988; Zoladz *et al.*, 1998b). It is important to emphasise that only in work rate protocols imposed in the moderate intensity domain can linearity expect to be observed (e.g. Hoffmann *et al.*, 1992; Haouzi *et al.*, 1993), due to the non-linearities observed for supra- θ_L kinetics, as detailed in the following section. In summary, it appears that the $\dot{V}O_2$ kinetics exhibit first-order linear dynamics in the moderate intensity domain, since they are independent on the work rate function (e.g. Casaburi *et al.*, 1977; Whipp *et al.*, 1981; Fukuoka & Ikegami, 1990; Hughson *et al.*, 1991a; Haouzi *et al.*, 1993), although careful interpretation is required. For example, original work employing PRBS protocols analysed the $\dot{V}O_2$ kinetics in the frequency domain and suggested non-linearity (Kowalchuk & Hughson, 1990), but analysis in the time domain (similar to analysis of ramp and step work rate functions) later demonstrated the kinetics to be linear (Hughson *et al.*, 1991a; Edwards *et al.*, 2003).

1.3.2 Heavy exercise

Despite an abundance of evidence to the contrary, at least one traditional exercise physiology textbook (Astrand & Rodahl, 1986) still assumes linearity of the $\dot{V}O_2$ response for all exercise intensities, based on the sub- θ_L $\dot{V}O_2$ -WR cycling relationship of 10 ml $O_2 \cdot \text{min}^{-1} \cdot \text{Watt}^{-1}$ (Figure 1.10).

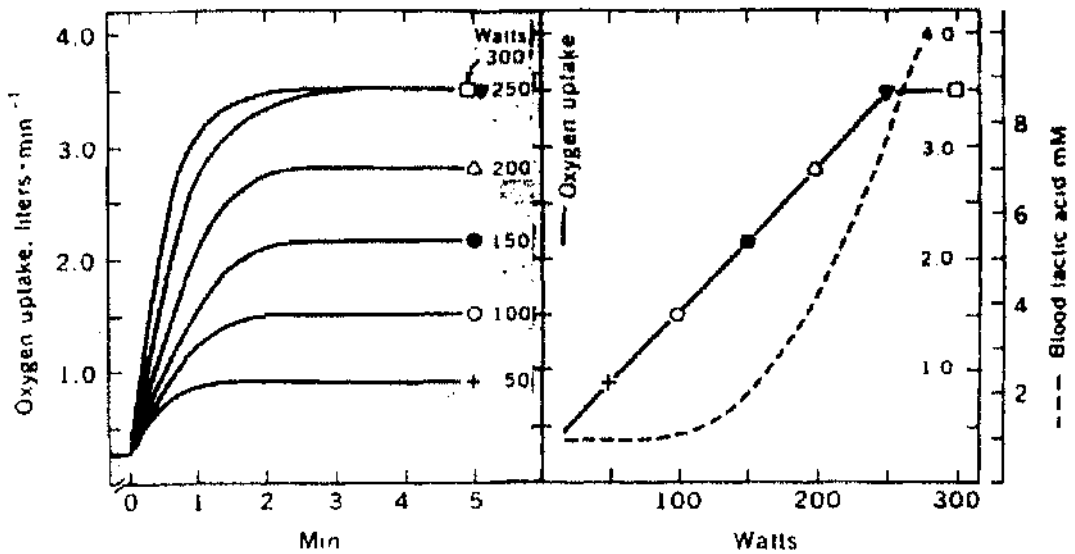

Figure 1.10 – Original schematic illustration of the steady state $\dot{V}O_2$ at different work rates. Note that despite the higher work rates being associated with increased blood lactate concentration the authors neglected to include any slow component for $\dot{V}O_2$, in contrast to Figure 1.9 above. From Astrand & Rodahl (1986).

It has now been repeatedly demonstrated that the gain for supra- θ_L exercise exceeds that for exercise in the moderate intensity domain (Roston *et al.*, 1987; Casaburi *et al.*, 1987; Hansen *et al.*, 1987; Paterson & Whipp, 1991; Barstow & Molé, 1991; Zoladz *et al.*, 1998b), implying non-linearity. Gain values as high as 12 to 13 ml $O_2 \cdot \text{min}^{-1} \cdot \text{Watt}^{-1}$ are not uncommon for these intensities of exercise, reflecting a greater O_2 -cost per unit increase of work rate. Furthermore, these values are only applicable in the heavy domain, i.e. for those tests in which a steady state can eventually be achieved since the gain is based on the $\Delta\dot{V}O_{2(ss)} - \Delta WR$ relationship.

Figure 1.7 illustrates that in the heavy intensity domain, for which there is a sustained metabolic acidosis, the attainment of $\dot{V}O_{2(ss)}$ is delayed. Furthermore, the $\dot{V}O_2$ kinetics for supra- θ_L exercise are more complex than below θ_L . Whipp & Wasserman (1972), and later Paterson & Whipp (1991) and Barstow & Molé (1991), demonstrated that the continued delayed rise in $\dot{V}O_2$ for heavy exercise was due to a separate delayed component in addition to the fundamental Phase II exponential increase. This region has come to be known as the slow component for $\dot{V}O_2$ ($\dot{V}O_{2(SC)}$) due to its delayed onset, or as an “excess” $\dot{V}O_2$ ($\dot{V}O_{2(ex)}$) - Whipp, 1987) due to the additional O_2 cost surplus to sub- θ_L predictions (Roston *et al.*, 1987; Poole *et al.*, 1988; Paterson & Whipp, 1991; Barstow & Molé, 1991; Ozyener *et al.*, 2001). This term (excess) exemplifies that the gain of supra- θ_L exercise is

dependent on work rate, in contrast to the consistent values for all sub- θ_L work rates, as detailed previously.

Interestingly, when the fundamental was modelled as an exponential, independently of the $\dot{V}O_{2(SC)}$, the kinetics remained unaltered from those in the moderate domain (Barstow & Molé, 1991; Burnley *et al.*, 2001; Ozyener *et al.*, 2001), with a τ and gain consistent with linear control dynamics. In contrast, Paterson & Whipp (1991) for cycling, and Carter *et al.* (2002) and Williams *et al.* (2001) for running, have suggested that the supra- θ_L $\dot{V}O_2$ response does not exhibit linearity. Paterson & Whipp (1991) observed a lengthening of τ in this domain and also showed an asymmetry between the on and off-transients, although the gain was consistent with below θ_L . Carter *et al.* (2002) similarly described a lengthening of τ for supra- θ_L running speeds in comparison with sub- θ_L , but also a decrease in the gain of the fundamental as intensity increased. With treadmill running the computation of work performed is more difficult than with cycling (e.g. Consolazio & Johnson, 1971; Borrani *et al.*, 2001) and so the use of running speed, rather than a true gain may partially explain these differences. It is currently unclear as to why there are inconsistencies between the various groups with regard to the constancy of τ , contributing to uncertainties concerning the underlying control dynamics.

Based on the results of Ozyener *et al.* (2001), which is the most comprehensive characterisation to date of $\dot{V}O_2$ kinetics with respect to cycling intensity, it appears that in the heavy domain the on-transient is characterised by an initial cardiodynamic phase, then a fundamental component, perhaps exhibiting linear properties, and finally the additional $\dot{V}O_{2(SC)}$ of delayed onset (typically 90 to 180 s), although with an attainable steady state. The characterisation of this slow component remains a topic of considerable debate (e.g. Whipp, 1994b; Whipp & Ozyener, 1998; Bearden & Moffatt, 2001b; Whipp *et al.*, 2002b), as does the attempted computation of the O_2 Def given the difficulties in estimating the O_2 cost of the work (e.g. Whipp, 1994b; Whipp & Ozyener, 1998; Bearden & Moffatt, 2000; Whipp *et al.*, 2002b), as discussed in Section 6.1.2. Of considerable importance is the observation that the slow component phenomenon is not manifest at the off-transient in this domain (Ozyener *et al.*, 2001), consistent with the results of Paterson & Whipp (1991). There is therefore a striking asymmetry between the on and off-transients in this domain.

1.3.3 Very heavy exercise

The major difference between the heavy and very heavy intensity domains lies in the tolerable duration of the exercise. Above CP, $\dot{V}O_2$ and [La] never attain a steady state, rather projecting inexorably towards $\dot{V}O_{2\max}$ and hence the limit of tolerance (Roston *et al.*, 1987; Poole *et al.*, 1988; Ozyener *et al.*, 2001 - Figure 1.7). The on-transient $\dot{V}O_2$ kinetics are similar to those of the heavy domain although the amplitude of the slow component is increased, in line with the larger and continued increases in [La]. In contrast to the heavy domain, however, an additional component is evidenced at the off-transient (Ozyener *et al.*, 2001), although whilst the fundamental component at the on-transient may be symmetrical with the initial component at the off-transient, the additional component was not the same as the $\dot{V}O_{2(SC)}$. The differences with the slow component were that this phase was not of delayed onset, rather originating at the end of the exercise (Ozyener *et al.*, 2001), and that the size of this component is not dependent on the size of the slow component (Cunningham *et al.*, 2000).

1.3.4 Severe exercise

The severe intensity domain spans the range of work rates which would require an O_2 cost, based on simple sub- θ_L relationships, greater than $\dot{V}O_{2\max}$. In this domain the tolerable duration of the exercise is seriously diminished and the short duration of the exercise (typically several minutes at most) means that there is often no evidence of the $\dot{V}O_{2(SC)}$. Therefore the on-transient response reverts to a simple mono-exponential (Whipp, 1994a), excluding the initial cardiodynamic phase, with a τ not different to the other intensities of exercise. Due to steady state never being attained in this domain and the limitations imposed by $\dot{V}O_{2\max}$, the gain is often lower for these work rates than for the fundamental in the lower intensities (Ozyener *et al.*, 2001). Further asymmetry is observed at the off-transient with a two component response in comparison to the mono-exponential on-transient (Ozyener *et al.*, 2001).

Whilst it is evident that this additional $\dot{V}O_{2(SC)}$ is the source of time and amplitude based non-linearities in the supra- θ_L $\dot{V}O_2$ response, the underlying mechanisms causing it remain unclear (e.g. Whipp, 1994b; Gaesser & Poole, 1996), as detailed in Section 1.5.3.

1.4 MUSCLE O₂ CONSUMPTION

1.4.1 Dissociation between \dot{Q}_{mO_2} and $\dot{V}O_2$

Traditionally the observed increases in $\dot{V}O_2$ during the response to exercise have been thought to reflect increases in \dot{Q}_{mO_2} . Whilst it is generally agreed that equality of $\Delta\dot{V}O_{2(ss)}$ and $\Delta\dot{Q}_{mO_2(ss)}$ holds true for moderate intensity exercise, the relationship is likely to be appreciably more complex at higher intensities.

Whilst the $\dot{V}O_2$ response is considered a suitable proxy variable for \dot{Q}_{mO_2} , given the technical difficulties of non-steady-state \dot{Q}_{mO_2} measurement, it is important to appreciate that changes in $\dot{V}O_2$ do not exactly reflect changes in \dot{Q}_{mO_2} . There are three factors which dissociate the $\dot{V}O_2$ and \dot{Q}_{mO_2} responses, even for small changes in work rate:

1. There exists an anatomical transit delay between events occurring at the muscle and lung levels, resulting in a temporal dissociation of $\dot{V}O_2$ and \dot{Q}_{mO_2} (Whipp *et al.*, 1982; Barstow *et al.*, 1990). Therefore, as O₂ is extracted from the muscle vascular bed, the changes in Cv_{mO_2} will not be expressed in the pulmonary artery (in terms of $C\bar{v}O_2$) instantaneously, but rather after this muscle-to-lung transit delay of some 15-20 s duration (Krogh & Lindhard, 1913; Linnarsson, 1974; Whipp *et al.*, 1982).
2. A further contamination of the $\dot{V}O_2$ - \dot{Q}_{mO_2} association is the influence of body O₂ stores, resulting in a dissociation in the magnitude of the response. The major component of this is the resting O₂ content of the muscle venous blood, and therefore $C\bar{v}O_2$, which may initially be drawn upon during the initial stage of the response to exercise (Barstow *et al.*, 1990). Other potential contributions to the body O₂ stores include a reduction in tissue PO_2 within the contracting muscle and also a small contribution from the desaturation of oxygenated myoglobin within the muscle.
3. There will also be a difference in the initial rates of change of \dot{Q}_{mO_2} and $\dot{V}O_2$, since \dot{Q}_T will have increased throughout the duration of the muscle-to-lung transit delay (Whipp & Ozyener, 1998; Whipp *et al.*, 2002b). This means that the change in muscle arterio-venous O₂ content, as O₂ is extracted, will be associated with a lower blood flow (\dot{Q}_m) than in the pulmonary vascular bed, where the increased \dot{Q}_T (and therefore \dot{Q}_P) during the transit delay will be associated with the same change in arterio-venous difference.

1.4.2 Simulated modelling approaches

As mentioned previously, given the technical difficulties associated with direct measurement of \dot{Q}_{mO_2} in the non-steady state, several authors have applied theoretical models to the constituents of the $\dot{V}O_2$ and \dot{Q}_{mO_2} responses, according to the respective Fick equations. Barstow *et al.* (1990) used computer simulations to investigate the influences of the muscle-to-lung transit delay and intervening O_2 stores on the comparison of $\dot{V}O_2$ and \dot{Q}_{mO_2} kinetics. They concluded that the Phase II $\dot{V}O_2$ kinetics represent a good approximation of the \dot{Q}_{mO_2} kinetics for moderate exercise under normal physiologic conditions, and that the predominant contribution of changes in O_2 stores to the O_2 Def occurs during Phase I. Barstow *et al.* (1990) further suggested that, under normal conditions, increases in cardiovascular determinants of O_2 delivery occur more rapidly than O_2 extraction, in support of other work (De Cort *et al.*, 1991; Yoshida & Whipp, 1994; Grassi *et al.*, 1996), implying that O_2 delivery is not limiting during moderate exercise.

A more recent model based on skeletal muscle being represented by a Krogh-type cylinder arrived at similar conclusions for moderate exercise, but proposed a significant role for both O_2 diffusion and O_2 delivery limitations under conditions of high demand, resulting in hypoxic regions within the muscle (McGuire & Secomb, 2001). Whilst both of these models have provided useful information, the respective authors agreed that the conclusions are limited without experimental evidence and that the assumptions made are at best over-simplified. For example, the model of Whipp *et al.* (1995) illustrated that the use of oxygen levels in muscle venous effluent, as in model simulations, would be insensitive to regional inequalities in the $\dot{V}O_2/\dot{Q}_m$ ratio, and therefore challenges interpretations of muscle venous effluent PO_2 to infer local mitochondrial PO_2 (e.g. Wagner, 2000). Indeed evidence of the lack of homogeneity of skeletal muscle activity *in vivo* has recently been presented (Richardson *et al.*, 2001a).

1.4.3 *In vitro* muscle preparations

Further insight into the temporal features of the \dot{Q}_{mO_2} response at exercise onset has been provided by the isolated *in situ* canine gastrocnemius preparations of Grassi *et al.* (1998a, 1998b & 2000). These studies allowed direct measurement of \dot{Q}_{mO_2} across the electrically stimulated gastrocnemius muscle in conjunction with measurement of O_2 delivery. The model permitted manipulation of O_2 delivery and diffusion in a bid to investigate the influences of both O_2 delivery and diffusion on \dot{Q}_{mO_2} kinetics under both moderate (~60%

$\mu \dot{Q}_{mO_2}$) and peak ($100\% \mu \dot{Q}_{mO_2}$) work rates. Under conditions of enhanced convective O_2 delivery, using a pump and vasodilatory drugs, the \dot{Q}_{mO_2} kinetics were unaltered for moderate work rates (Figure 1.11a), whereas with peak contractions there was a slight, but significant, acceleration of the \dot{Q}_{mO_2} kinetics (Figure 1.11b) resulting in a reduced O_2 Def. Under conditions of enhanced peripheral O_2 diffusion, using a hyperoxic gas mixture to assist arterial O_2 saturation in combination with an allosteric inhibitor of O_2 -haemoglobin to assist O_2 unloading (using the drug RSR13), the kinetics were unaltered for moderate exercise (Figure 1.11c) and peak exercise (reported in Grassi, 2001).

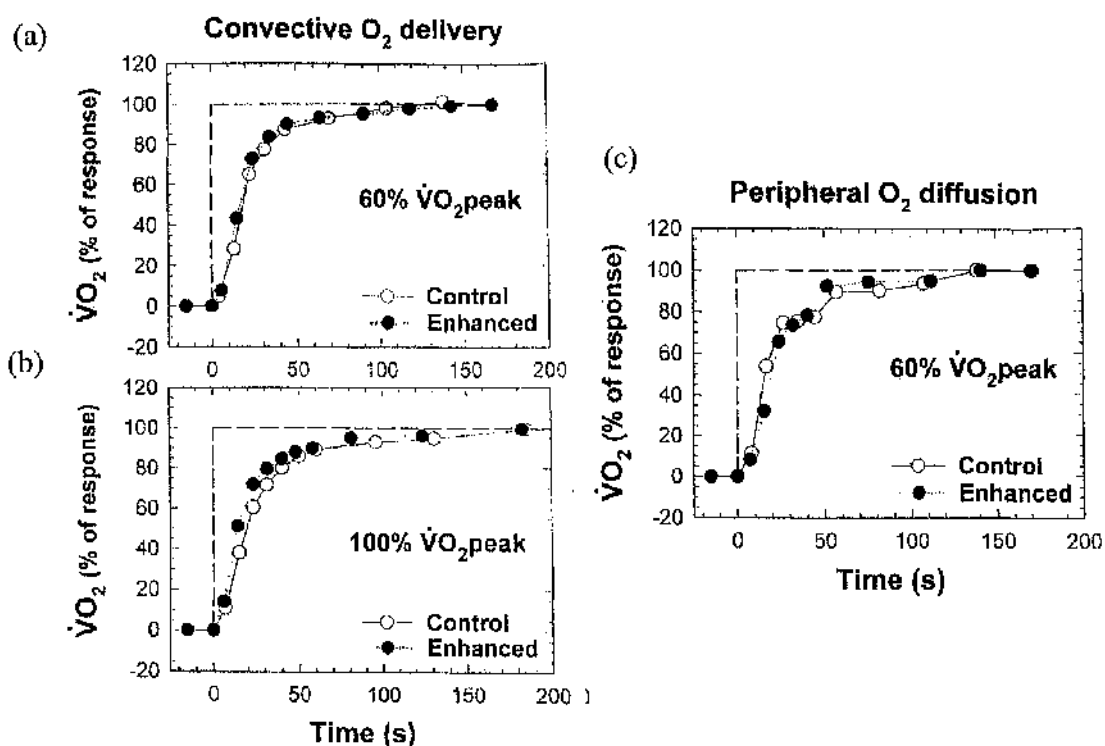

Figure 1.11 – Summary of the isolated canine muscle investigations by Grassi *et al.* (see text for details). Panels (a) and (b) show the muscle oxygen consumption kinetics in response to contractions at 60% (moderate) and 100% of maximum (very heavy) respectively under conditions of enhanced O_2 delivery, whereas panel (c) is under conditions of enhanced peripheral O_2 diffusion for moderate contractions. Note the lack of speeding under both conditions during moderate exercise whilst there was a slight acceleration in heavy exercise when O_2 delivery was facilitated. From Grassi (2001).

These results provide evidence against a role for O_2 -delivery limitation during moderate exercise, favouring the proposed theories of intrinsic metabolic inertia. For higher intensities, however, there is evidence that there may be a potential role for an O_2 -delivery limitation although the relative contribution, in comparison to intrinsic limitations, seems small. Nonetheless, the data only provide indirect evidence since the conditions of the

experiment do not accurately reflect those expected in the exercising musculature at exercise onset in humans. For example, the contraction patterns evoked by electrical stimulation, with all fibres in the muscle undergoing tetanic contractions, are different from *in vivo* where the muscle fibre recruitment patterns will be different. This observation is supported, for example, by the heterogeneity of muscle activity within a large muscle group undertaking dynamic exercise, as evidenced by Richardson *et al.* (2001a) using magnetic resonance imaging.

1.4.4 *In vivo* measurement of \dot{Q}_{mO_2}

Whilst the *in vitro* experiments of Grassi have generated useful information, the direct measurement of \dot{Q}_{mO_2} in exercising humans has been attempted by several different research groups, by examining the response of the constituents of the Fick equation for \dot{Q}_{mO_2} across the exercising leg (e.g. Poole *et al.*, 1991; Grassi *et al.*, 1996; Bangsbo *et al.*, 2000) and forearm (e.g. Hughson *et al.*, 1996). In all of these studies it has been recognised that although the techniques employed are providing the values as close and accurate to \dot{Q}_{mO_2} as is currently achievable, technical limitations of using venous effluent from the limb as opposed to exclusively from the active muscles, mean that the exact temporal profiles of \dot{Q}_{mO_2} remain elusive at present.

Grassi *et al.* (1996) were the first investigators to directly compare the kinetics of $\dot{V}O_2$ and \dot{Q}_{mO_2} with high temporal resolution at the onset of dynamic exercise in humans. They used a modified thermodilution technique (Andersen & Saltin, 1985) in conjunction with serial arterial and femoral venous blood sampling to calculate \dot{Q}_{leg} , $(CaO_2 - Cv_{leg}O_2)$, and hence $\dot{Q}_{leg}O_2$ from the Fick equation. As shown in Figure 1.12, the temporal features of the $\dot{Q}_{leg}O_2$ and $\dot{V}O_2$ responses were remarkably similar.

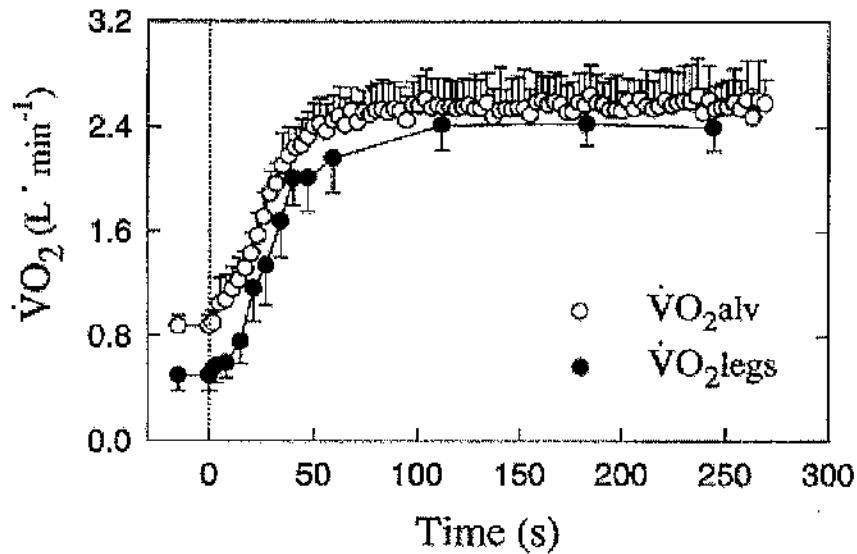

Figure 1.12 – Results illustrating the close temporal relationship between the simultaneously measured kinetics of leg ($\dot{V}O_{2\text{legs}}$) and pulmonary ($\dot{V}O_{2\text{alv}}$ – alveolar) oxygen uptake in the non-steady state transition from rest to moderate intensity cycling. From Grassi *et al.* (1996).

This demonstration, in direct support of the simulations of Barstow *et al.* (1990), implies that the $\dot{V}O_2$ response to cycling of moderate intensity can be assumed to represent the kinetics of the \dot{Q}_{mO_2} response within approximately 10%. It was only in the Phase I region that the responses differ markedly, supporting previous propositions (Krogh & Lindhard, 1913; Linnarsson, 1974; Wasserman *et al.*, 1974) that the Phase I $\dot{V}O_2$ response does not originate in the exercising muscle. It was concluded by Grassi *et al.* (1996) that, during the initial stages of the exercise transition, the demonstration of an immediately increased \dot{Q}_{leg} in synchrony with slightly reduced O_2 extraction implies that $\dot{Q}_{\text{leg}}O_2$ kinetics are not constrained by convective O_2 delivery, in support of their more recent work using muscle preparations.

Bangsbo *et al.* (2000) also directly measured blood flow and O_2 extraction across the leg muscles during exercise. They suggested that whilst the results of Grassi *et al.* (1996) were useful, the use of cycling meant that the venous blood response would be blunted by contamination from inactive muscle. Therefore Bangsbo *et al.* (2000) adapted a knee-extension exercise model to localise activity to the quadriceps muscle to reduce this effect. Perhaps more importantly, the authors suggested that failure to account for the mean transit time for blood passing from the artery to the capillary, and then onto the venous sampling point, meant that the results of Grassi *et al.* (1996) were not as accurate as possible. Using similar thermodilution techniques, but measuring the mean transit time using an

indocyanine green injection and thereby accounting for this delay, Bangsbo *et al.* (2000) presented similar response profiles for thigh \dot{Q}_{mO_2} to Grassi *et al.* (1996). However, by accounting for the mean transit time, which is greatest at exercise onset (Bangsbo *et al.*, 2000), they showed that the \dot{Q}_{mO_2} response did in fact increase within the initial few seconds of exercise and not after the delay reported by Grassi *et al.* (1996). Furthermore, by calculating the difference between O_2 delivery and adjusted \dot{Q}_{mO_2} , Bangsbo *et al.* (2000) proposed that during the initial response to exercise O_2 delivery was in excess of utilisation, supporting theories of an intrinsic metabolic inertia limitation.

The direct demonstration of faster \dot{Q}_T responses at exercise onset (De Cort *et al.*, 1991) and similarly \dot{Q}_m as shown in Figure 1.13, in comparison to $\dot{V}O_2$, (e.g. Yoshida & Whipp, 1994) provided further evidence in support of an intramuscular limitation (Whipp & Ozyener, 1998). Yoshida & Whipp (1994) highlighted that a ratio of $\tau\dot{V}O_2/\tau\dot{Q}_T$ greater than 1.0 during the transition to moderate exercise supported the concept that O_2 delivery would be adequate. The authors commented that insurmountable technical limitations prevented accurate measurement of PO_2 within the muscle, meaning that these hypotheses could not be confirmed.

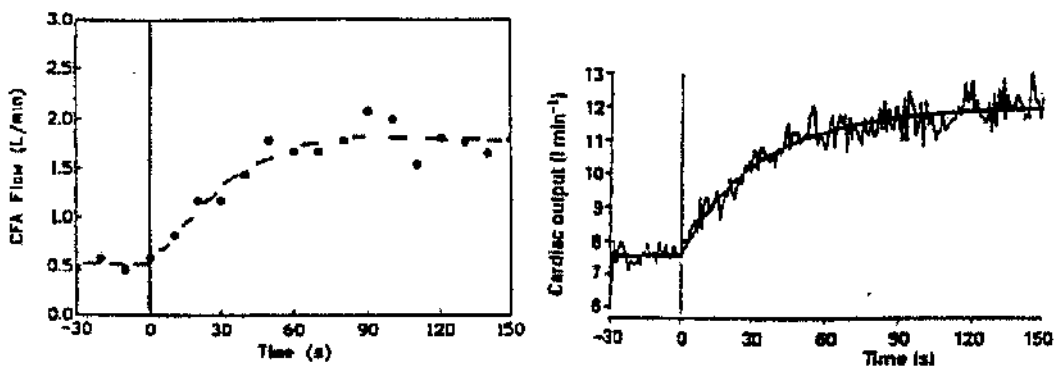

Figure 1.13 – Illustration showing the similarity of the exponential responses of muscle blood flow (CFA – common femoral artery) and cardiac output in the transition to moderate exercise. From Ward & Whipp (1996).

More recently, the use of phosphorescence quenching techniques (Hogan, 1999) to measure changes in both intracellular (Hogan, 2001) and microvascular (Behnke *et al.*, 2001) O_2 pressure (PO_2) at the onset of contractions, in isolated *Xenopus* frog and *in situ* Sprague-Dawley rat skeletal muscle preparations respectively, has been achieved. These studies were therefore able to look at the O_2 delivery- O_2 utilisation relationships at the muscle level directly. The results were in good agreement with the previous theories,

showing no fall in PO_2 during the initial 13 – 19s after exercise onset and then an exponential decline, which interestingly followed a similar time course reported for $\dot{V}O_2$ and \dot{Q}_{mO_2} in humans. These authors concluded that, since there was no decline in PO_2 immediately at the start of muscle contractions, there was no evidence of O_2 delivery limiting oxidative metabolism and that the limiting factor(s) may reside within the mitochondria for this intensity of exercise. Whether or not the effect of increased intensity of contractions results in greater declines in PO_2 remains contentious (Howlett & Hogan, 2001; Richardson *et al.*, 2001b) and so the possibility for an O_2 -delivery limitation at higher exercise intensity remains.

One research group in particular has repeatedly suggested that O_2 delivery does play a significant role in determining \dot{Q}_{mO_2} , and hence $\dot{V}O_2$, kinetics, based on the close temporal relationship with cardiovascular variables, such as heart rate (Hughson & Morrissey, 1982). More recently this group has measured \dot{Q}_{mO_2} as closely as possible using combined pulsed and echo Doppler ultrasound techniques to measure \dot{Q}_m in conjunction with serial arterial and limb venous blood sampling. Hughson *et al.* (1996) performed repeated handgrip exercise in the supine position with the hand exercising both above and below the heart level. They demonstrated a slowing of the \dot{Q}_m and \dot{Q}_{mO_2} kinetics in the above heart position, proposing that the reduced O_2 delivery presented a limitation. In addition, they suggested that the similar temporal features of the \dot{Q}_m and \dot{Q}_{mO_2} responses, for the below heart position, demonstrated dependence of \dot{Q}_{mO_2} kinetics on forearm blood flow. In a more recent modification of the same exercise model, eliminating any isometric component, Perrey *et al.* (2001) used the chemoreflex response to calf ischaemia to increase forearm blood flow. They found that increased flow, compared to no ischaemia after 30s, 1 min and 2 mins into exercise, with no difference in O_2 extraction, resulted in an initial speeding of the \dot{Q}_{mO_2} response, although the exact kinetics could not be modelled due to the lack of data points. The authors further emphasised an important role for O_2 delivery in determining \dot{Q}_{mO_2} kinetics.

In contrast, the same group (MacDonald *et al.*, 1998) provided evidence against an O_2 delivery limitation for moderate knee extension exercise in the upright position when they demonstrated faster leg blood flow responses than $\dot{V}O_2$ kinetics. Therefore the combined results of this group suggest that there is a potential role for O_2 delivery in determining \dot{Q}_{mO_2} kinetics for heavy exercise. However, given the importance of body position on

blood distribution (Jones *et al.*, 1970; Karlsson *et al.*, 1975), it is unclear whether their results are applicable for upright cycling exercise.

1.4.5 Inferences about \dot{Q}_{mO_2} using ^{31}P -NMR

Further evidence concerning \dot{Q}_{mO_2} kinetics has come from using intramuscular [PCr] as a proxy-variable, based on the reported linearities of the increase in \dot{Q}_{mO_2} and decline in [PCr] in response to increased work rate and *vice versa* for decreased work rate (Mahler, 1985; Meyer, 1988). In the exercising human, Barstow *et al.* (1994a) and McCreary *et al.* (1996) used nuclear magnetic resonance spectroscopy (^{31}P -NMRS) to compare the temporal responses of $\dot{V}O_2$ and the high-energy phosphates within the muscle during the response to exercise. However, with the use of different muscle groups, and such small amplitudes of response, the kinetics of the [PCr] decline and $\dot{V}O_2$ increase could not be accurately compared for any discrete differences. The use of knee extension against a rubber stirrup whilst inside the bore of the magnet, in combination with simultaneous breath-by-breath gas analysis (Whipp *et al.*, 1999), has permitted accurate description of the "on" and "off" kinetics for moderate (Rossiter *et al.*, 1999) and heavy (Rossiter *et al.*, 2002a & 2002b) exercise. As shown in Figure 1.14, the kinetics of the corresponding [PCr] and $\dot{V}O_2$ responses, excluding the Phase I $\dot{V}O_2$ response which is not linked to \dot{Q}_{mO_2} , are remarkably similar for both intensities.

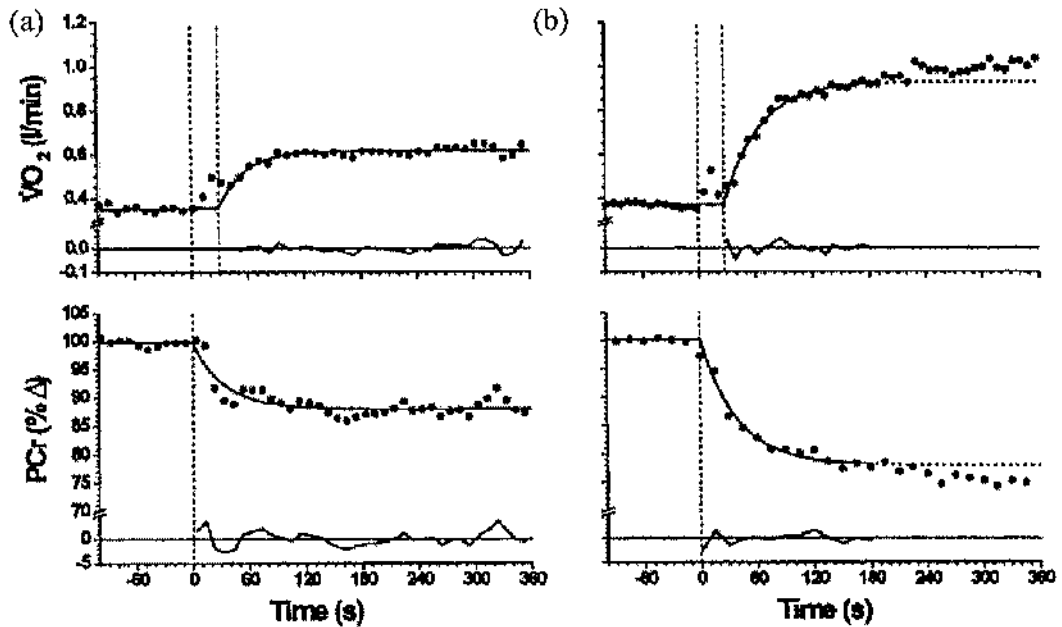

Figure 1.14 – Example showing the similarity in the kinetics of $\dot{V}O_2$ and PCr degradation at the onset of (a) moderate and (b) heavy intensity rhythmic knee extension exercise. Note the evidence of the slow component phenomenon in both variables for heavy exercise. Adapted from Rossiter *et al.* (2002b).

Indeed the reported values for the fundamental τ are within $\pm 10\%$ of each other, as simulated by Barstow *et al.* (1990) and measured by Grassi *et al.* (1996). These data provide further support for the use of the fundamental $\dot{V}O_2$ response to estimate the temporal response of \dot{Q}_{mO_2} . Similar to the experiments of Ozyener *et al.* (2001) there was no demonstrable dependence of τ on exercise intensity, although the questionable linearity of the $\dot{V}O_2$ response has been discussed previously. Whilst “on-off” symmetry was observed for moderate intensities in cycling however, the kinetics for $\dot{V}O_2$ and [PCr] were slower at the off-transient for both moderate and heavy exercise, although the mechanism for these differences remains unclear.

1.5 CONTROL OF $\dot{V}O_2$ KINETICS

1.5.1 Moderate Exercise

The evidence presented above has directed the general consensus towards the kinetics of \dot{Q}_{mO_2} , and hence $\dot{V}O_2$, at the onset of exercise in this intensity domain, being determined by an intrinsic inertia of oxidative metabolism via one of the mechanisms outlined in Section 1.1, although the precise details remain unresolved. However, Tschakovsky & Hughson (1999) speculate that it is a complex interaction between the factors responsible for O_2 delivery and putative controllers of oxidative phosphorylation that determines the rate of increase of \dot{Q}_{mO_2} . Their review examined the evidence for and against both intrinsic metabolic inertia and extrinsic O_2 transport inertia, and it became evident that there was evidence in favour of both theories depending on the details of the exercise condition imposed. Furthermore, they suggested that under conditions where one factor is manipulated, there will be compensatory mechanisms acting to maintain intracellular homeostasis, so such experimental evidence may not confirm the responses under normal conditions.

With regard to an oxidative phosphorylation enzymatic rate-limitation, recent evidence has directed focus (e.g. Spriet & Heigenhauser, 2002) to the possibility that mitochondrial acetyl group availability may play a significant role. Pyruvate dehydrogenase (PDH) is a multi-enzyme complex that is responsible for catalysing the conversion of pyruvate, following glycolysis, to Acetyl-CoA which subsequently enters the TCA cycle (Figure 1.1). It has been proposed that flux through the PDH complex may be a rate-limiting step, thus limiting substrate availability and contributing to the sluggish activation of aerobic ATP production at exercise onset. Indeed, Timmons *et al.* (1998a) and Howlett *et al.* (1999) have demonstrated reduced levels of PCr degradation at the onset of submaximal exercise following pre-exercise pharmacological activation of the PDH complex using dichloroacetate (DCA). It was proposed that these reductions would translate as a reduction in the O_2 Def and hence imply accelerated \dot{Q}_{mO_2} kinetics. However, this hypothesis has yet to be confirmed by direct measurement of \dot{Q}_{mO_2} , or $\dot{V}O_2$, kinetics at the onset of moderate exercise following DCA administration.

A recent study (Campbell-O'Sullivan *et al.*, 2002) proposed that prior moderate exercise stimulated an increase in acetyl group availability, resulting in a reported acceleration of mitochondrial ATP production and $\dot{V}O_2$ kinetics. On closer inspection, inappropriate

modelling of the $\dot{V}O_2$ data by including Phase I in a monoexponential fit of the data, has meant that the reported changes in MRT are inconclusive for inferring detail about the \dot{Q}_{mO_2} kinetics. Indeed, other research groups (Gerbino *et al.*, 1996; Burnley *et al.*, 2000; Bearden & Moffatt, 2001a; Scheuermann *et al.*, 2002) have shown repeatedly that $\dot{V}O_2$ kinetics in the moderate intensity domain are unaltered by prior exercise (Section 4.1), when the fundamental component is characterised independent of the cardiodynamic phase. Therefore, the sound theoretical proposition that acetyl group availability may play a significant role in determining \dot{Q}_{mO_2} kinetics remains to be confirmed.

More recently, an intriguing finding surrounding this question has been presented using the exercising horse (Kindig *et al.*, 2002). They demonstrated that administration of N^G -nitro-L-arginine methyl ester (L-NAME), a nitric oxide (NO) synthase inhibitor, resulted in a significant acceleration of the fundamental $\dot{V}O_2$ kinetics in the horse during the transition to moderate exercise. It was proposed, based on these experimental findings, that NO may play a significant role in limiting the rate of oxidative phosphorylation, which may be the predominant determining factor for $\dot{V}O_2$ kinetics in the horse during exercise. A potential role for O_2 delivery was negated since it might be expected for NO inhibition to reduce exercise-induced vasodilatation (Joyner & Dietz, 1997) and hence accentuate any O_2 limitation so that $\dot{V}O_2$ kinetics would be slowed. Possible mechanisms for this NO limitation on oxidative phosphorylation include inhibition of creatine kinase, inhibition of PDH activation and competitive inhibition of cytochrome oxidase in the electron transport chain. Therefore alleviation of any of these effects would be expected to improve the kinetics of oxidative phosphorylation.

Whilst this finding has proved interesting, it remains to be elucidated whether these findings are applicable to the exercising human, given the greater aerobic capacity and substantially faster $\dot{V}O_2$ kinetics in the horse (Langsetmo *et al.*, 1997).

1.5.2 Supra- θ_L exercise

The kinetics of $\dot{V}O_2$ are considerably more complex for heavier intensities of exercise, no longer described as a monoexponential, although the fundamental retains exponentiality. It is of little surprise therefore, that there is disagreement over whether it is the O_2 -delivery or O_2 -utilisation hypotheses which is the predominant determinant of $\dot{V}O_2$ kinetics for supra- θ_L exercise, the evidence for the fundamental component considered here whilst the focus

on the slow component follows in Section 1.5.3. It would appear from the evidence presented above that the predominant control is via one of the intrinsic metabolic inertia hypotheses outlined above, although the potential for O_2 delivery to play a limited role cannot be refuted. The previously discussed research has mainly focussed on indirect evidence concerning control, with a key question of the plasticity of the \dot{Q}_{mO_2} , and hence $\dot{V}O_2$, kinetics frequently being overlooked.

There is considerable evidence presented that the kinetics of $\dot{V}O_2$ can be slowed, both below and above θ_L , under a variety of circumstances: supine body position (Karlsson *et al.*, 1975; Hughson *et al.*, 1991b); hypoxia (Engelen *et al.*, 1996); β -blockade (Hughson, 1984); disease (Nery *et al.*, 1982; Sietsema, 1992); O_2 diffusion inhibition via carbon monoxide (Koike *et al.*, 1990). Whilst this evidence clearly demonstrates that O_2 delivery has the potential to influence $\dot{V}O_2$ kinetics, it cannot be presented as evidence that it is the predominant determining factor under normal conditions.

Therefore demonstration of accelerated kinetics under conditions of enhanced O_2 delivery is essential for conclusive evidence of the dependence of $\dot{V}O_2$ kinetics on O_2 delivery. Initially, Gausche *et al.* (1989), Gerbino *et al.* (1996) and Bohnert *et al.* (1998) postulated that performance of a priming bout of heavy cycling exercise resulted in faster $\dot{V}O_2$ kinetics in response to a subsequent identical bout of heavy exercise. It was suggested that the residual acidosis incurred following the first bout of exercise resulted in a reactive hyperaemia and enhanced O_2 unloading (Bohr shift) during the second bout, alleviating some of a proposed O_2 delivery limitation that was present originally. Whilst these results were extremely useful in demonstrating a modulation of $\dot{V}O_2$ kinetics by a priming bout of exercise, more recent research has revealed that the details of this modulation are not as initially proposed.

Due to the limitations imposed by using only a single repetition when attempting to characterise $\dot{V}O_2$ kinetics, Gerbino *et al.* (1996) were only able to describe the overall speeding of kinetics as a reduced mean response time (MRT), rather than modelling each phase independently. Macdonald *et al.* (1997) presented similar reductions in MRT, and despite characterising the fundamental component separately, they failed to include these results in their discussion. More recently, two groups in particular have more appropriately examined the effects of prior heavy exercise on subsequent $\dot{V}O_2$ kinetics (Burnley *et al.*, 2000; Koppo & Bouckaert, 2000). In line with the data of Gerbino *et al.* (1996),

Macdonald *et al.* (1997), and also Bohnert *et al.* (1998) and Fukuba *et al.* (2002) using different muscle groups, the recent research has confirmed a reduction in the amplitude of the $\dot{V}O_{2(SC)}$ (detailed in Chapter 4), although this appears to be unrelated to the tolerable duration of the exercise (Koppo *et al.*, 2001).

Despite this modulation of $\dot{V}O_2$ kinetics, the fundamental component remained essentially unaltered, both in terms of τ and net-amplitude, although absolute $\dot{V}O_2$ at the end of phase II was elevated following a priming heavy exercise bout. The possibility that this increase in fundamental amplitude may directly be a consequence of an elevated $\dot{V}O_2$ baseline was further addressed by Patel *et al.* (2001) and Burnley *et al.* (2001). When the recovery between the heavy exercise bouts was extended such that $\dot{V}O_2$ returned to the original baseline levels, yet there remained a residual lactic acidosis, the findings of unchanged fundamental τ and decreased $\dot{V}O_{2(SC)}$ remained, but interestingly the increased fundamental amplitude was also evidenced. This notion of plasticity of the amplitude, but not τ of the $\dot{V}O_2$ response, is addressed in more detail in Section 4.4.

The evidence therefore suggests that O_2 delivery may not be limiting. However, one study by Rossiter *et al.* (2001) demonstrates that the fundamental $\dot{V}O_2$ τ may be accelerated without a speeding of the kinetics of [PCr], proposed to reflect \dot{Q}_{mO_2} , as discussed above. At present it is unclear whether these results can be explained simply in terms of differences in exercise mode and muscle mass utilised, as the bulk of evidence suggests that an exercise-induced metabolic acidosis cannot speed the $\dot{V}O_2$ kinetics of the fundamental.

Using their forearm exercise paradigm, Hughson's group has repeatedly (Hughson *et al.*, 1996; MacDonald *et al.*, 2001; Perrey *et al.*, 2001) proposed that the demonstration of improved O_2 delivery resulting in accelerated \dot{Q}_{mO_2} is evidence of the role of O_2 delivery limitation, however, as highlighted previously, it is uncertain whether these results are only applicable for this supine exercise condition. Similar to the data provided above for moderate exercise, Kindig *et al.* (2001) also demonstrated a significant acceleration of the fundamental $\dot{V}O_2$ kinetics in the horse during the transition to heavy exercise following administration of L-NAME. However, the applicability of these results to the exercising humans remains to be confirmed and indeed a potential role for NO as a modulator of mitochondrial respiration, and also as a mechanism for exercise-induced hyperaemia,

seems disputable given the findings of Frandsenn *et al.* (2001). They found no effect of L-NAME infusion in humans on \dot{Q}_{leg} and $\dot{Q}_{leg}O_2$ during exercise, although they did not look at the early temporal features of the responses but rather values every 10 minutes.

As mentioned in Section 1.5.1, the potential role for PDH activity constituting a major role in determining the rate of oxidative phosphorylation has been addressed for the moderate domain and also heavier exercise (e.g. Timmons *et al.*, 1998b). In contrast to the theoretical basis for moderate exercise, the effect of DCA infusion on $\dot{Q}_{m}O_2$ kinetics has been investigated directly for higher intensity exercise using an *in vitro* dog gastrocnemius model (Grassi *et al.*, 2002) and *in vivo* using a knee-extensor model (Bangsbo *et al.*, 2002). Both of these studies presented evidence that DCA infusion had indeed increased acetyl-group availability, yet there was no effect on $\dot{Q}_{m}O_2$ kinetics, in terms of amplitude or τ . These data strongly suggest that PDH activation is not a significant contributor in determining $\dot{Q}_{m}O_2$ kinetics. However, it should be noted that in contrast to the reduced O_2 Def evidenced in the studies of Timmons *et al.* (1998a & b) and Howlett *et al.* (1999), upon which the proposition is based, there was no demonstration of any sparing of muscle PCr or reduction in lactate production by either the Grassi or Bangsbo experiments.

It is clear that discussion of the kinetics of the $\dot{V}O_2$ and $\dot{Q}_{m}O_2$ responses to supra- θ_L exercise requires consideration of both the fundamental τ and amplitude, as for moderate exercise, but also the characteristics of the additional slow component. The balance of evidence supports the argument that the fundamental kinetics are determined predominantly by the intrinsic metabolic inertia, although the potential for a degree of O_2 -delivery limitation exists for supra- θ_L exercise. The underlying mechanisms of the slow component remain to be elucidated, as discussed below.

1.5.3 Putative mediators of the slow component for $\dot{V}O_2$

Throughout the years, many factors have been postulated to be involved in the mechanistic basis of the slow component (e.g. Whipp, 1987; Poole *et al.*, 1994a; Whipp, 1994b), as shown in Figure 1.15. The following sections examine the evidence for the major competing theories.

“Excess” $\dot{V}O_2$ of Exercise

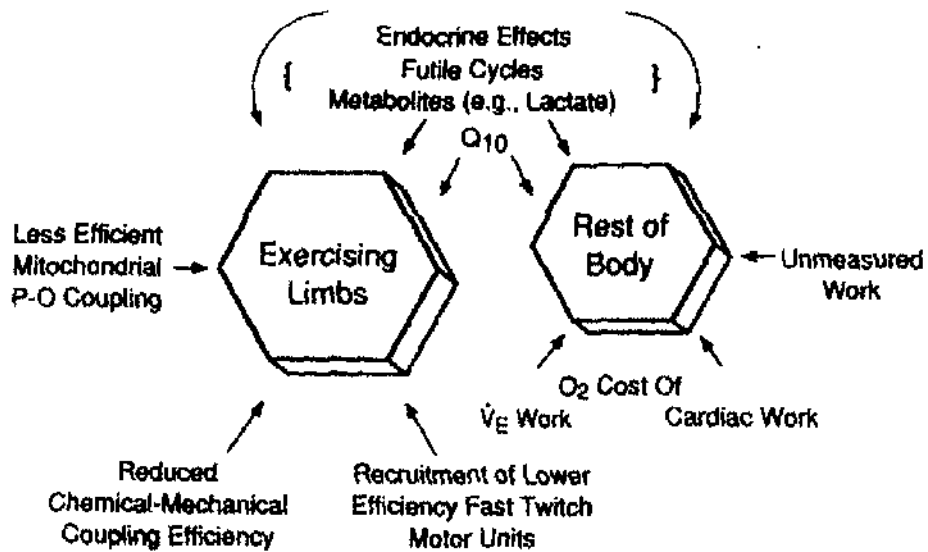

Figure 1.15 – Diagram showing some of the putative mediators of the $\dot{V}O_2$ slow component. From Poole *et al.* (1994a).

1.5.3.1 Lactate

Repeated early observations of an association of a sustained increase in arterial [La] in association with the $\dot{V}O_{2(SC)}$ (e.g. Wasserman *et al.*, 1967; Whipp & Wasserman, 1972; Roston *et al.*, 1987) led to considerable research into whether or not there may exist a cause-and-effect relationship. Wasserman *et al.* (1991) described in detail the importance of the acidosis-induced Bohr shift of the haemoglobin dissociation curve in assisting O_2 unloading at the muscle. They further speculated that an acidosis is essential for supra- θ_L exercise since patients suffering from McArdle’s Disease, who are unable to rely on glycolytic metabolism, are unable to sustain work rates in this intensity domain. Casaburi *et al.* (1987) and Poole *et al.* (1988) provided strong evidence of a temporal association between the $\dot{V}O_{2(SC)}$ and the increase in [La], but not changes in temperature, ventilation or circulating catecholamines. The demonstration of a training-induced decrease in arterial [La] in concert with a decrease in the size of the slow component (Casaburi *et al.*, 1987; Poole *et al.*, 1990) was also presented. Calculations by Whipp (1987) suggested that the additional O_2 cost of gluconeogenesis, oxidation of lactate to regenerate glycogen, in the liver would be small, but that it could be significantly higher in muscle.

More recently, further research has ruled out the likelihood of an increased [La] being the cause of the $\dot{V}O_{2(SC)}$. For example, it has typically been shown that the onset of the slow component is delayed, beginning between 90 and 180 s into the exercise transition, yet increased [La] can occur earlier than this (Roston *et al.*, 1987). Also, the time course of the training induced reductions in [La] and the slow component are not similar (Gaesser, 1994; Womack *et al.*, 1995) providing indirect evidence against a causal role for [La]. Whilst the slow component has been observed across differing exercise modalities of similar exercise intensities, Billat *et al.* (1998) showed that there was no correlation across modalities between the change in [La] ($\Delta[La]$) and the magnitude of the slow component for running and cycling.

Using an isolated dog gastrocnemius *in vitro* preparation, Poole *et al.* (1994b) infused lactate into the working muscle and examined the effects on \dot{Q}_mO_2 . The authors acknowledged the vastly different environment in this experimental set-up from the *in vivo* muscle, but suggested that there was no evidence that lactate was responsible for the slow component.

1.5.3.2 Acid-base status

Following on from these experiments, Zoladz *et al.* (1997 & 1998a) altered the level of acidosis incurred during heavy exercise by prior ingestion of sodium bicarbonate (alkalosis) or ammonium chloride (acidification). They found that whilst acidification resulted in an increased $\dot{V}O_{2(SC)}$, the size of the slow component could not be reduced by alkalosis. They proposed a significant role for acidification in the physiological mechanisms responsible for $\dot{V}O_{2(SC)}$, suggesting that the lack of an effect from the alkalosis may be explained by the observation that there were no changes in [La], which would be associated with natural changes in pH. Evidence contrary to this hypothesis was presented by Scheuermann *et al.* (1998), who induced a decrease in [La] and pH, following acetazolamide administration, but found no change in the $\dot{V}O_{2(SC)}$ in comparison to control conditions.

1.5.3.3 Catecholamines

Additional support against a cause-and-effect relationship for lactate, and indeed adrenaline, was provided by showing that intra-venous infusion of adrenaline during supra- θ_L cycling resulted in significant increases in [La] but there was no change in the $\dot{V}O_{2(SC)}$

in comparison to control conditions (Gaesser *et al.*, 1994). Although infusion of adrenaline did significantly increase resting $\dot{V}O_{2(ss)}$.

1.5.3.4 Muscle temperature

In contrast to other early investigators emphasising the important association between $\dot{V}O_{2(SC)}$ and [La], Hagberg *et al.* (1978) proposed that increases in muscle and body temperature may be the root cause of the slow component. Within the muscle an increase in temperature, frequently observed at higher exercise intensities, could manifest an increase in $\dot{V}O_2$ in several ways. Willis & Jackman (1994) outlined that, according to intramuscular bioenergetics, the $\dot{V}O_{2(SC)}$ implies that within the mitochondria there is either an increase in ATP demand (decreased ATP utilisation efficiency) or that the coupling of oxygen consumption to phosphorylation (P:O₂) is decreased. They proposed that a 3°C increase in temperature could cause a 10% decrease in mitochondrial coupling and therefore could account for a 300 ml.min⁻¹ slow component if $\dot{V}O_2$ was 3000 ml.min⁻¹.

Additional mechanisms of a temperature effect could include a Q₁₀ effect (Brooks *et al.*, 1971) or enhanced O₂ delivery and unloading via a Bohr shift of the haemoglobin dissociation curve, but only if O₂ delivery is limiting and this remains contentious. Interestingly, Rowell (1971) could find no evidence of a rise in $\dot{V}O_2$ with increased temperature and he proposed that some other factors must be off-setting the hypothesised Q₁₀ effect. The most compelling evidence against a major role for increased temperature comes from observations of steady state $\dot{V}O_2$ in concert with rising temperature (Poole *et al.*, 1988), and a reduction in the $\dot{V}O_{2(SC)}$ despite an induced increase in muscle temperature (Koga *et al.*, 1997).

1.5.3.5 Additional respiratory and/or cardiac work

Some authors suggested that at higher intensities of exercise the increased O₂ cost of respiratory and cardiac work may contribute to the $\dot{V}O_{2(SC)}$ (e.g. Hagberg *et al.*, 1978; Wasserman *et al.*, 1995). Calculations based on the increased O₂ cost have estimated that only a relatively minor proportion of the slow component is likely to be accounted for by the increased respiratory cost (Gaesser & Poole, 1996).

The potential relative involvement of increased muscle temperature and/or increased respiratory/cardiac work has been reduced considerably based on two major experimental findings:

1. In the heavy intensity domain there is no evidence of a slow component effect at the off-transient (Ozyener *et al.*, 2001), as discussed above. This suggests that several of the proposed mechanisms, such as increased temperature and increased respiratory and cardiac work, are not significantly responsible, since they would be expected to manifest the same effects at the off-transient (Paterson & Whipp, 1991).
2. The *in vivo* demonstrations, using thermodilution techniques to estimate changes in \dot{Q}_m (Poole *et al.*, 1991), have shown that as much as 86% of the $\dot{V}O_{2(SC)}$ resides within the exercising musculature, negating significant roles for factors out-with the active muscle. These findings have further been supported by the ^{31}P -NMR work of Rossiter *et al.* (2002a & 2002b) which illustrated that up to 90% of the $\dot{V}O_{2(SC)}$ is observed within the muscle as an additional decline in [PCr].

1.5.3.6 Muscle fibre-type

Whilst several of the above listed proposed mechanisms of the $\dot{V}O_{2(SC)}$ have been disproved as significant contributors, the focus since has centred on the active muscle groups, based on observations (see 2. above) that almost all of the $\dot{V}O_{2(SC)}$ is exhibited at the muscle level (\dot{Q}_mO_2). The findings of two studies in particular (Shinohara & Moritani, 1992; Barstow *et al.*, 1996) has provoked strong debate as to whether or not the slow component may be due to a relative change in the proportion of different muscle fibre types employed to sustain the same work rate. Before examining the available evidence it is worth considering the metabolic and energetic basis upon which this theory is founded.

Using isolated animal muscle preparations, the bioenergetic properties of slow (Type I) and fast twitch (Type II) muscle fibres have been investigated (Crow & Kushmerick, 1982; Kushmerick *et al.*, 1992). These studies have shown that the type II fibres are comparatively less efficient than the type I fibres in terms of force generation. They demonstrated that there is an approximately 18% lower mitochondrial coupling ratio (P:O₂) in the mitochondria of type II fibres, possibly due to an increased reliance on the less efficient α -glycerophosphate shuttle for transporting NADH-linked reducing equivalents rather than the malate-aspartate shuttle (Kushmerick *et al.*, 1992). These studies also showed that the \dot{Q}_mO_2 kinetics of muscle groups predominantly made up of

type II fibres were slower than for predominantly slow twitch muscle groups. It might therefore be hypothesised that these slower kinetics represent the slower kinetics of the $\dot{V}O_{2(SC)}$. It has also been shown that there may be an increased ATP cost per unit force generated by type II fibres due to a lower efficiency of energy conversion in the cross-bridges (Saugen & Vollestad, 1995). It is important to appreciate that these mitochondrial studies were performed on isolated animal muscle preparations and so the extrapolation to *in vivo* muscle groups in the exercising human should be proceeded with caution. Nevertheless, the combined evidence suggests that energetic differences between type I and type II motor units may influence the efficiency of mitochondrial O_2 utilisation during heavy exercise and therefore contribute to the $\dot{V}O_{2(SC)}$ (Willis & Jackman, 1994).

In terms of a comparison with sub- θ_L work rates, the size principle of motor unit recruitment (Henneman *et al.*, 1974) dictates that at these lower work rates the required use of type II motor units would be small in comparison to higher work rates when the $\dot{V}O_{2(SC)}$ is evidenced (Vollestad & Blom, 1985). It was therefore perhaps of little surprise that Barstow *et al.* (1996) demonstrated a significant correlation between the relative magnitude of the slow component during heavy cycling and the fibre-type distribution of the vastus lateralis, determined by muscle biopsy. They showed a positive relationship between the %type II fibres and the contribution of the $\dot{V}O_{2(SC)}$ to end-exercise $\dot{V}O_2$, and a negative correlation between the %type I fibres and the relative slow component magnitude. Figure 1.16 highlights this relationship by normalising the $\dot{V}O_2$ kinetics as O_2 cost.

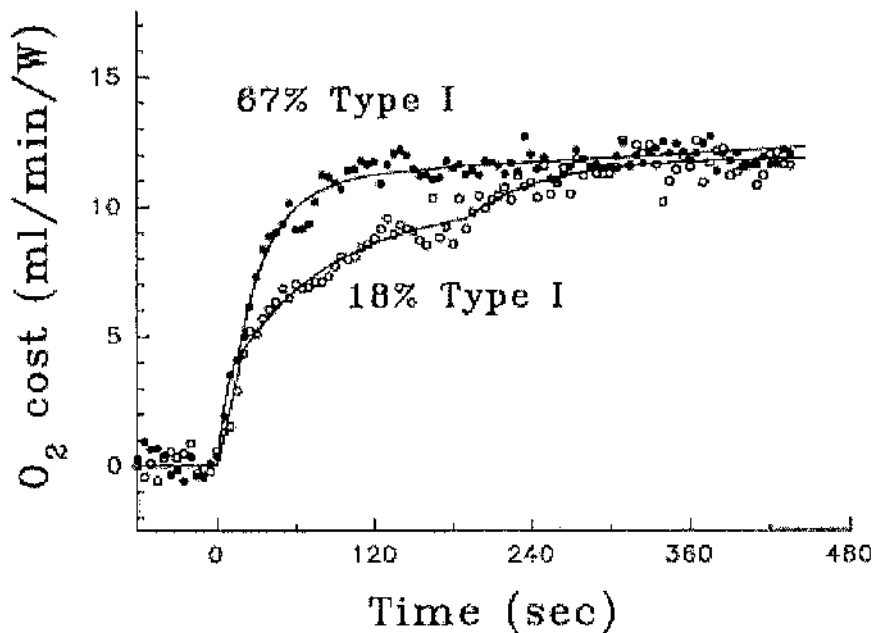

Figure 1.16 – $\dot{V}O_2$ data obtained from two subjects differing greatly in the relative distribution of vastus lateralis muscle fibre-types during heavy intensity cycling. Notice the inverse relationship between the percentage of slow oxidative fibres (Type I) and the amplitude of the slow component. From Barstow *et al.* (1996).

In line with the concepts outlined above, Shinohara & Moritani (1992) sought to establish whether or not the slow component may represent a recruitment of progressively more type II motor units using electromyographic techniques (EMG). They observed an increase in the integrated EMG signal (i-EMG), reflecting changes in motor unit recruitment and/or motor unit firing frequency, during the $\dot{V}O_{2(SC)}$. The results were interpreted as indication that, at this intensity, the initially recruited type I motor units become fatigued and therefore to maintain the same power output, further recruitment of type II motor units was required, resulting in an increased $\dot{V}O_2$. In contrast, Scheuermann *et al.* (2001) describe how the time course of the changes in i-EMG and $\dot{V}O_2$ were different and pointed out that the i-EMG signal merely reflects overall motor unit recruitment and does not permit discrimination between the type I and type II motor units. However, these authors were unable to provide evidence of an increase in i-EMG in conjunction with the $\dot{V}O_{2(SC)}$, nor was there any change in the mean power frequency (MPF), which they suggest would reflect a change in proportion of type I and type II motor units recruited.

Support of the hypotheses of Shinohara & Moritani (1992) has since been provided by three separate studies (Saunders *et al.*, 2000; Borrani *et al.*, 2001; Burnley *et al.*, 2002a). Burnley *et al.* (2002a) showed an increase in i-EMG with the slow component and

suggested that the use of too few muscle groups and differences in exercise intensity may account for the inconsistencies with Scheuermann *et al.* (2001). Borrani *et al.* (2001) demonstrated an increase in MPF in trained runners alongside the slow component, although the authors acknowledged the complexities in interpreting changes in MPF. They described how other factors such as increased muscle temperature and increased neurone discharge rate of slow twitch fibres may also explain the observed increases in MPF. Saunders *et al.* (2000) indicated that the use of EMG during cycling is prone to distortion by movement artefacts and contaminating signals from other muscles, so they used magnetic resonance imaging (MRI) in conjunction with EMG and concluded that increased active muscle mass is at least in part responsible for the $\dot{V}O_{2(SC)}$.

From the available evidence it is plausible that the progressive recruitment of less-efficient muscle fibres may constitute a significant role in the underlying mechanisms of the slow component. It is clear that the details of the mechanisms responsible for control of $\dot{V}O_2$ kinetics for supra- θ_L exercise, and also moderate exercise, remain elusive and require considerable further controlled and appropriately designed research.

1.6 OBJECTIVES

The overall aim of the current research is to improve current understanding of $\dot{V}O_2$ kinetics, with particular reference to accurate characterisation and appropriate interpretation. The three separate investigations conducted (Chapters 3, 4 and 5) share this common objective, although the specific aim for each respective chapter is summarised below:

1. To examine, with high temporal resolution, the dynamics of the $\dot{V}O_2$ and intramuscular oxygenation responses to intermittent cycling of varying work-recovery duty cycle durations, which have been shown to influence the blood lactate profiles, and hence the intensity of the exercise according to traditional description. This investigation will explore whether repeated bouts of exercise influence the overall $\dot{V}O_2$ response in a manner congruent with existing relationships between blood lactate and $\dot{V}O_2$ kinetics for sustained exercise.
2. To further existing evidence regarding the effects of prior supra- θ_j exercise on $\dot{V}O_2$ kinetics in response to subsequent exercise, by normalising the intensity of subsequent exercise in relation to critical power, and hence investigate whether the tolerable duration of the exercise is affected. The first aim permits insight into the effects of repeated bouts of exercise on the overall $\dot{V}O_2$ response to exercise, however, this subsequent aim focuses more on the effects on the individual phases of the $\dot{V}O_2$ response, which would not be evident in the short duration periods of intermittent exercise.
3. To investigate the influence of model structure on the characterisation of the $\dot{V}O_2$ kinetics in COPD patients, prior to, and following, an exercise training intervention. The formal modelling of the $\dot{V}O_2$ kinetics applied in addressing the first two aims is well accepted for healthy subjects based on existing literature. However, for other populations previous research has applied inappropriate modelling techniques such that the inferences made may be physiologically misleading. The final aim is to clarify whether models applied in normal volunteer research are acceptable in a patient population (that has been recruited to a large nutritional intervention project).

Chapter 2 Methods

2.1 SUBJECTS

All subjects who volunteered to participate in the studies were deemed to be recreationally active and of stable fitness. During the subjects' primary visit to the laboratory, the relevant study was described to the subject in detail and a consent form (Appendix for relevant chapter), approved by the University of Glasgow Ethics Committee, was signed. According to the guidelines of this committee all subjects completed an approved Medical Questionnaire (Appendix) to identify any medical condition which may predispose the subject to abnormal risk during subsequent exercise testing. Furthermore, all subjects were screened by a physician for resting cardiac electrical activity (ECG) and blood pressure. Based on the findings of the questionnaire and medical examination any subject deemed unsuitable was excluded. Similarly, on the day of testing if a subject described any symptoms of ill-health then the test was re-arranged for another occasion. Subjects were clearly informed prior to onset of the study that they were free to cease participation at any point should they so wish.

In an attempt to minimise any extraneous influence on performance, subjects were tested as near as possible to the same time of day on each occasion and requested to follow several instructions prior to each test:

1. No heavy exercise for a minimum of 24-hours prior to testing.
2. No food consumption in the 3-hour period prior to testing.
3. No alcohol intake in the 24-hour period prior to testing.
4. No caffeine for 4-hours prior to testing.

Subjects completed a questionnaire (Appendix) prior to each testing session to confirm that these guidance instructions had been adhered to and that subjects were not suffering from any factors such as injury or ill-health which may confound exercise performance.

The exact subject demographics are provided in each chapter since a different subject group was used in each study. The subjects' height (The Leicester Height Measure, Invicta Plastics Ltd., Leicester, UK) and mass (Salter Weigh-tronix, Avery, Birmingham, UK) were recorded prior to the study.

2.2 PROTOCOLS

The exact protocols used in each study are summarised in each chapter, and any specific details about the equipment used, or procedures followed, are found in the relevant chapter. However, the following methods section details equipment and procedures that were common to all exercise testing conducted.

2.1.1 Incremental ramp test

The primary test performed by subjects during all studies was a rapidly incremental exercise test (Figure 2.1) until the limit of tolerance (t_{lim}) was reached, for non-invasive estimation of the lactate threshold ($\hat{\theta}_L$) and determination of peak $\dot{V}O_2$ ($\mu\dot{V}O_2$). In these tests the cycle ergometer was programmed in advance with an incrementation rate of $15 \text{ W}\cdot\text{min}^{-1}$, the work rate increased gradually in a ramp-like fashion by 3 Watts every 12s so that subjects were unable to perceive the progressive increase in work rate.

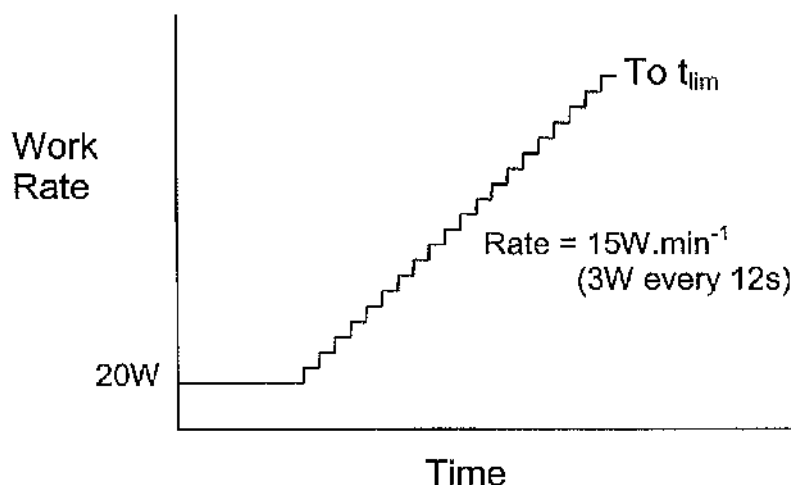
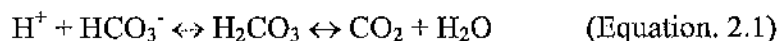

Figure 2.1 – Schematic of the protocol used during incremental cycle tests to the limit of tolerance (t_{lim}).

Prior to all tests, several minutes of resting breathing were analysed to ensure that the subject was relaxed and not hyperventilating, which may result in evidence of a “pseudo- $\hat{\theta}_L$ ” (Whipp *et al.*, 1987; Ward & Whipp, 1992; Ozcelik *et al.*, 1999). Acceptable resting ventilatory response was characterised by a \dot{V}_E below or around $10 \text{ l}\cdot\text{min}^{-1}$, RER close to expected for rest (0.7 – 0.9) and $P_{ET}\text{CO}_2$ between 37 and 43 mmHg. Following a further period of baseline pedalling at 20W for at least 3 minutes, ensuring no hyperventilation, the work rate was gradually increased with the subject oblivious to the start of the test and instructed to increase the cadence at will, within the linear range of the ergometer, as detailed subsequently. The test was terminated when subjects were no longer able to maintain a cadence of 55rpm, despite encouragement and warnings that the test would be completed.

Non-invasive estimation of $\hat{\theta}_L$ was carried out using the V-slope technique (Beaver *et al.*, 1986) and a cluster of ventilatory-based indices (Reinhard *et al.*, 1979; Caiozzo *et al.*, 1982; Davis *et al.*, 1982; Whipp *et al.*, 1986; Wasserman *et al.*, 1999). The V-Slope method is based on the emergence of an additional (surplus to aerobic production) $\dot{V}CO_2$ component above $\hat{\theta}_L$ consequent to buffering of a proportion of the protons associated with lactate by bicarbonate ions in the muscle and blood, according to Equation 2.1 below:



As a result $\dot{V}CO_2$ can be observed to “accelerate away” (Figure 2.2) at $\hat{\theta}_L$ in relation to the increase in $\dot{V}O_2$ as the work rate is increased, and coincident with the increase in arterial [lactate] – (Beaver *et al.*, 1986 - Figure 2.3).

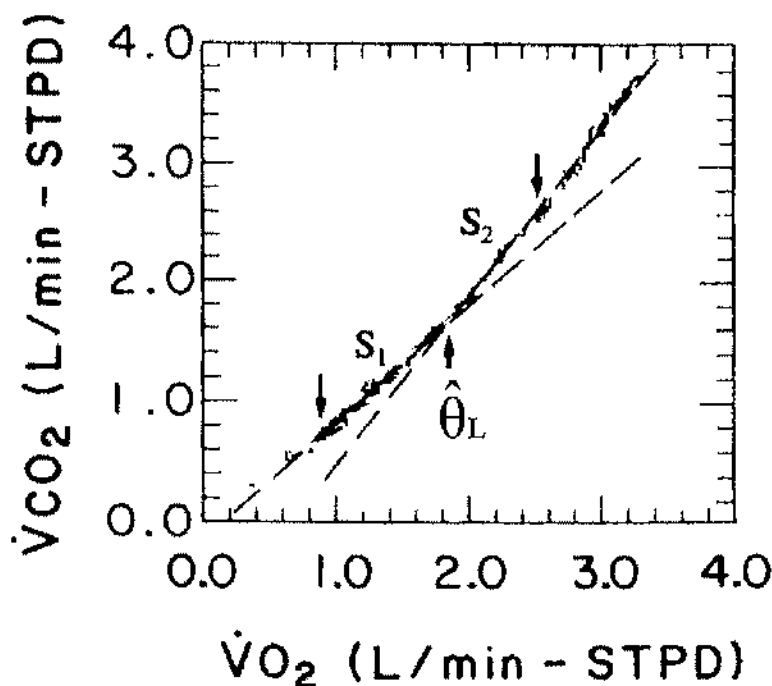

Figure 2.2 – Non-invasive estimation of the lactate threshold ($\hat{\theta}_L$) using the V-slope technique (Beaver *et al.*, 1986). Best-fit lines (S_1 & S_2) are plotted through the sub- and supra- $\hat{\theta}_L$ data respectively, $\hat{\theta}_L$ determined as the point of intersection of the two lines. Adapted from Beaver *et al.* (1986).

When analysing the data for this estimation, only the “region of interest” was considered (Beaver *et al.*, 1986). That is to say, that all resting data, the initial “kinetic” region of the exercise, and the recovery data were excluded, as was data after the Respiratory Compensation Point (RCP) (Wasserman *et al.*, 1977) where a further change in $\dot{V}CO_2$ is typically observed consequent to the fall of arterial pH providing further ventilatory

stimulation. The intersection of the resulting lower (S1) and upper (S2) linear best-fits to the data-ranges is then taken as $\hat{\theta}_L$.

This estimation was then confirmed by examining plots of $P_{ET}O_2$, $P_{ET}CO_2$, $\dot{V}_E/\dot{V}O_2$ and $\dot{V}_E/\dot{V}CO_2$ against $\dot{V}O_2$. Above $\hat{\theta}_L$ a hyperventilation with respect to O_2 is observed, reflected by an immediate increase in $P_{ET}O_2$ and $\dot{V}_E/\dot{V}O_2$ (Figure 2.3). However, for a brief period (typically about several minutes) reflecting the period of isocapnic buffering (Wasserman *et al.*, 1977; Whipp *et al.*, 1989), an equivalent hyperventilation with respect to CO_2 is not observed (no decrease in $P_{ET}CO_2$ or increase in $\dot{V}_E/\dot{V}CO_2$), as shown in Figure 2.3.

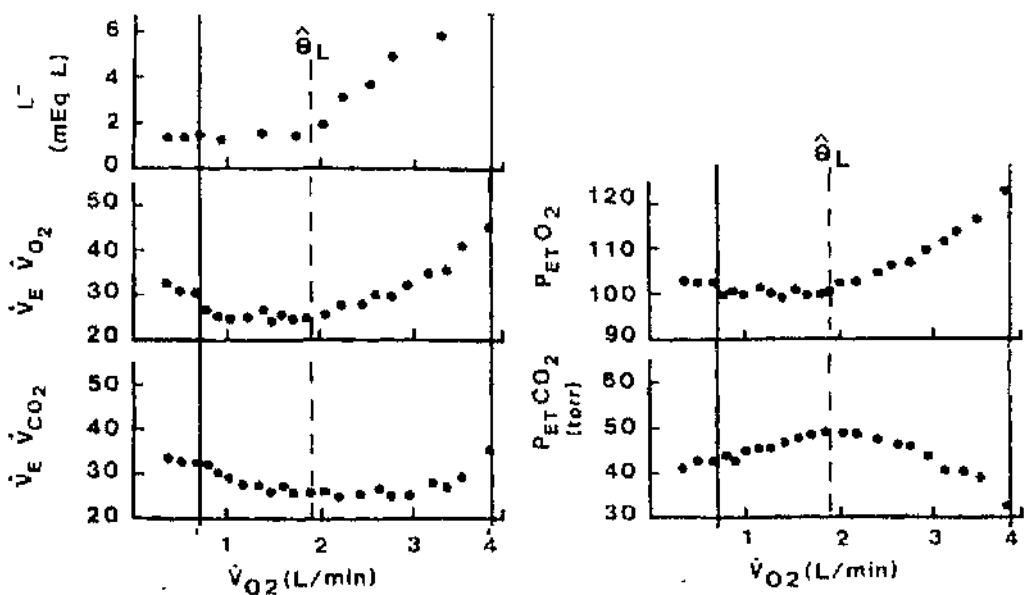

Figure 2.3 – Confirmation of the lactate threshold ($\hat{\theta}_L$) using the ventilatory-based indices (Whipp *et al.*, 1986). Immediately following the lactate threshold, indicated by an increase in blood lactate concentration ($[L^-]$ – *top-left panel*), there is an observed hyperventilation with respect to $\dot{V}O_2$, indicated by increases in $\dot{V}_E/\dot{V}O_2$ and end-tidal PO_2 (*middle panels*). In contrast there is no observable hyperventilation with respect to $\dot{V}CO_2$, reflected in the profiles of $\dot{V}_E/\dot{V}CO_2$ and end-tidal PCO_2 (*bottom panels*). Adapted from Whipp (1994a).

$\mu\dot{V}O_2$ was calculated as the mean value of $\dot{V}O_2$ during the last 20-seconds of exercise. It is crucial during these and other maximal tests that complete effort is given by the subjects to ensure a true t_{lim} is reached. Validity of a maximal estimation for $\mu\dot{V}O_2$ has been suggested to be established by ensuring at least two of the following criteria (Hale *et al.*, 1998) are met:

- (a) The heart rate, at maximum, is within $10 \text{ beats}\cdot\text{min}^{-1}$ of the age-predicted maximum:
(i.e. $220 - \text{age}\{\text{years}\}$).
- (b) A plateau of the $\dot{V}O_2$ occurs as t_{lim} is approached.
- (c) A value of greater than 1.15 is obtained for RER.

In reality, however, a plateau in $\dot{V}O_2$ is often not observed when using rapidly incremental protocols such as described here (e.g. Wagner, 2000). In addition, the predicted maximum heart rate will not be attained in all subjects, since the standard deviation for such prediction equations is $\pm 10 \text{ beats}\cdot\text{min}^{-1}$ (Astrand *et al.*, 1959). In practice, subjects were encouraged to perform to the maximum of their capabilities in all tests. The use of $\mu\dot{V}O_2$ was justified since Cooper *et al.* (1984) and Day *et al.* (2002) showed that there was no significant difference in $\mu\dot{V}O_2$ determined from a rapidly incremental protocol and a “true” plateau observed in $\dot{V}O_2$ obtained using a series of constant work rate protocols of increasing intensity.

2.2.2 Constant work rate tests

The second category of test performed during the studies was a constant work rate or square-wave exercise test. Similar to the incremental test, several minutes of resting breathing were recorded to ensure the subject was relaxed and not hyperventilating, followed by a minimum of 3-minutes baseline pedalling at 20W. Without prior warning the work rate was then increased immediately to the target work rate (Figure 2.4) by advancing the pre-programmed protocol to the next stage. The subject was instructed to increase the cadence in order to overcome the initial inertial difficulties caused by the rapid increase in work rate. In tests when two constant work rate tests were performed in series, a given recovery period of pedalling at 20W was performed between the tests.

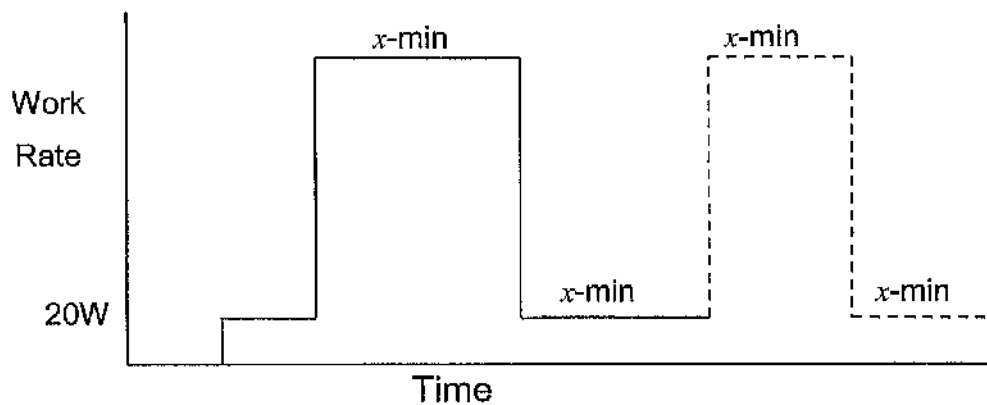

Figure 2.4 – Schematic of the protocol used during constant work rate tests. Following a rest period and at least 3 minutes of pedalling at 20W, the work rate was increased immediately to a pre-determined level based on the desired exercise intensity. The dashed lines illustrate that further transitions could be completed in a single session, with all stage durations ($x\text{-min}$) variable.

The target work rate selected for these tests was dependent on the desired intensity of the exercise and the resulting parameters of interest. As described in detail in Section 1.1.1, four intensity domains (moderate, heavy, very heavy and severe) are demarcated by $\hat{\theta}_L$, CP (the Critical Power) and μWR as summarised by the $\dot{V}O_2$ temporal profiles in Figure 1.7.

When assigning a work rate for $\hat{\theta}_L$ from the $\dot{V}O_2$ -WR relationship during the ramp-test it is crucial to appreciate that the $\dot{V}O_2$ at a given work rate in this non-steady state test is not equal to the $\dot{V}O_{2(ss)}$ that would be elicited by constant work rate cycling. Interestingly, it has been shown that, following an initial lag phase, the linear increase in $\dot{V}O_2$ demonstrates the same slope as for sub- $\hat{\theta}_L$ steady-state exercise of increasing work rate (Figure 2.5 - Whipp *et al.*, 1981).

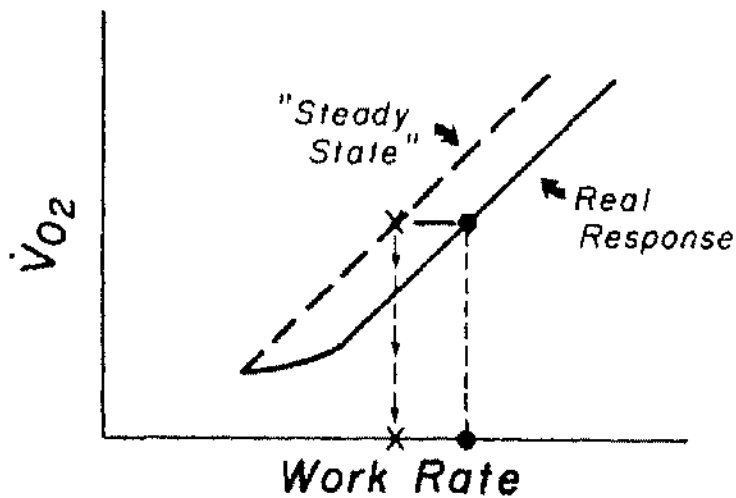

Figure 2.5 – Estimation of the steady state work rate (X) corresponding to the $\dot{V}O_2$ (solid circle) at $\hat{\theta}_L$ using the observed non-steady state $\dot{V}O_2$ -WR response to a rapidly incremental exercise protocol. The difference between the real and steady state response is constant and equivalent to τ' , the corresponding increment in work rate being used to correct the non-steady state value. Taken from Whipp (1987).

Furthermore, the lag between the two relationships becomes constant and equal to τ' , that is the sum of the Phase II τ and delay. Therefore, when a value for $\dot{V}O_2$ at $\hat{\theta}_L$ was estimated, a corresponding WR at these points was determined from the linear $\dot{V}O_2$ -WR relationship. To obtain the steady-state work rates the lag was accounted for by subtracting the work rate equivalent for the duration of τ' based on the incrementation rate, as demonstrated in Figure 2.5. For individuals where τ' was unknown a conservative estimate of 60s was used, since the average Phase II τ and delay are typically approximately 30s and 10s respectively in healthy young individuals (e.g. Whipp *et al.*, 2002b).

Tests are often assigned according to either $x\% \hat{\theta}_L$ or the difference in work rate between $\hat{\theta}_L$ and μWR (Δ), that is using a work rate equivalent to:

$$\hat{\theta}_L + x\% \Delta (\mu WR - \hat{\theta}_L) \quad (\text{Equation 2.2})$$

as initially proposed by Rausch *et al.* (1991). However, to accurately control the intensity of supra- $\hat{\theta}_L$ exercise, it is necessary to determine the Critical Power since this provides the upper limit for sustained exercise, as discussed in Section 1.1.1. Monod & Scherrer (1965) determined Critical Power for a range of muscle groups by performing exhaustive exercise at different work rates and recording t_{lim} . The hyperbolic power-duration relationship observed was later examined in more detail for cycling (Poole *et al.*, 1988), as shown in

Figure 2.6. From this relationship CP is determined as the asymptote of the power-duration hyperbola, more easily established as the y-intercept of the power-time⁻¹ linear regression.

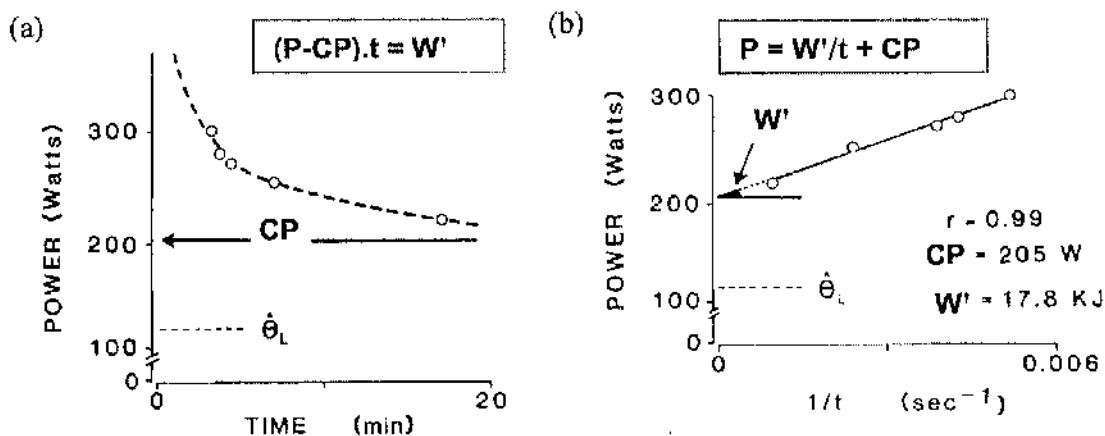

Figure 2.6 – The relationship between work rate (power – P) and tolerable duration (time – t) for five maximal bouts of constant work rate exercise. Panel (a) shows the traditional hyperbolic function described by the equation above, where critical power (CP) and curvature constant (W') represent the asymptote and curvature constant respectively. Panel (b) shows the linear transformation of the same data by plotting power against time⁻¹, CP now the intercept and W' the slope. Adapted from Poolc *et al.* (1988).

In order to obtain accurate predictions of CP , 4-5 maximal constant work rate tests were performed on different days, the durations at least spanning the range of 1-10 minutes as suggested in the review by Hill (1993). From the resultant power-time⁻¹ relationship, CP was estimated as the y-intercept of the linear regression through the data. From the linear regression it is also possible to estimate the tolerable duration of a bout of supra- CP constant work rate exercise via interpolation. On this basis, work rates above CP could not only be assigned as $x\%CP$ but also as a target-duration, i.e. x -minWR. In individuals for whom the data were not well characterised by a hyperbola, some tests were repeated and if there was no improvement in the fit then the subject was not used for supra- $\hat{\theta}_L$ exercise.

In summary, the constant work rate tests, whether single or multiple in series, were assigned according to intensity as a work rate corresponding to a given percentage of either $\hat{\theta}_L$, μWR , CP or x minWR, or the difference (Δ) between these variables.

2.3 EQUIPMENT

2.3.1 Cycle ergometer

All tests were performed on a digitally programmable electro-magnetically-braked cycle ergometer (Excalibur Sport, Lode, Groningen, The Netherlands). The braking force on such bikes changes as an inverse function of pedal cadence so that the work rate, controlled from a remote computer, remains constant regardless of the cadence selected by the subjects. The range of work rates over which the ergometer remains linear is 10W – 1000W, provided the cadence is kept within the range of 30 to 120 rpm, accurate to within $\pm 2\%$ from 20W (Operator Manual V2.0, Lode, Groningen, The Netherlands). Therefore, in all tests 20W was used as the low work rate baseline. Changes in work rate were programmed into the computer associated with the ergometer such that they could be achieved almost instantaneously (maximal rate of $1000 \text{ W}\cdot\text{s}^{-1}$). Subjects were able to visually monitor the cadence via a dial situated on the handlebar arrangement, and were occasionally advised if their cadence was inappropriate. The cycle ergometer power output was checked using a motor-driven torque calibrator (VacuMed, model 17800, Ventura, California, USA). The accepted results are provided in Figure 2.7.

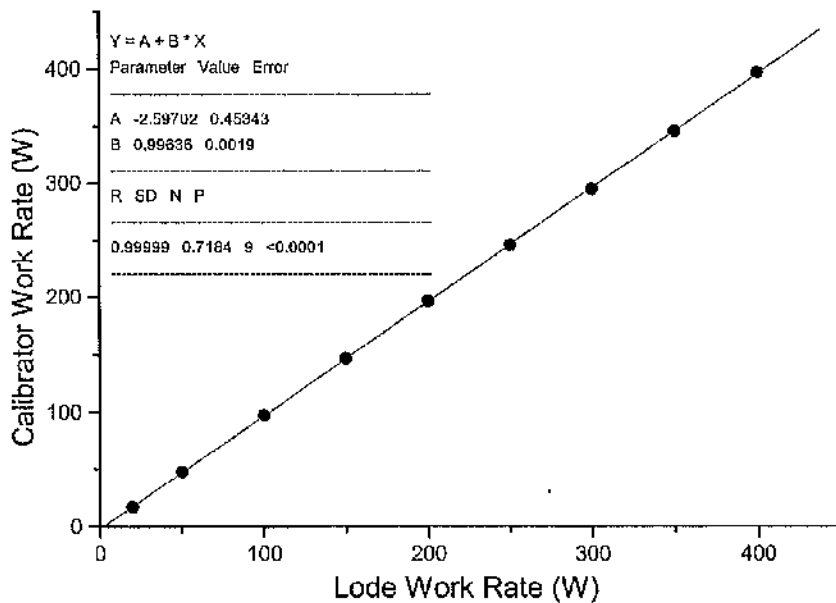

Figure 2.7 – Measured power output of the cycle ergometer (*calibrator work rate*) against the power output programmed into the ergometer (*Lode work rate*). Summary details of the linear regression through the data are shown.

The seat-height and handlebar positions which the subject was most comfortable with were recorded during a familiarisation session and thereafter the ergometer settings were

adjusted subjectively prior to each test. Similarly, the saddle, chosen from several options during familiarisation according to degree of comfort, was kept constant for each subject across all tests.

2.3.2 Heart Rate and arterial blood oxygen saturation

Heart rate was measured continuously during all tests, from the R-R interval determined using a six-lead ECG (Q710, Quinton Medical, Kent, UK). A telemetric heart rate recorder (Polar Sports Tester, Kempele, Finland) was used in addition, the heart rate determined and averaged during consecutive 5s periods. Print-outs from the ECG were taken at regular intervals for identification of any cardiac irregularities which would place the subject at risk, and simultaneously the saturation of oxygen in arterial blood (SaO_2) was recorded non-invasively from a near-infrared pulse oximeter probe (Satlite trans, Datex Engstrom, Finland) placed on the ring finger of the subject's left hand. Correct functioning of the ECG was regularly tested by using a simulator (Glasgow University).

2.3.3 Chart Recorder

During all tests the raw analogue signals for heart rate, work rate, ECG, expired gas volume, and expired O_2 and CO_2 gas concentrations were recorded using a digital chart recorder (Dash 10, Astro-Med Inc., Rhode Island, USA). These charts were recorded at a speed of $1 \text{ mm}\cdot\text{s}^{-1}$ enabling individual breaths to be identified. These raw signals were used to assist in the identification of mis-triggered breaths calculated by the software incorporated in the metabolic cart, as well as permitting real-time visual inspection of the breathing characteristics of each subject throughout the duration of the tests. The process of identifying and editing breaths, which are not indicative of the underlying physiological response, is discussed in detail subsequently.

2.3.4 Blood lactate analysis

Whole blood was sampled from the subjects' fingertips for subsequent analysis of the arterialised mixed-venous blood lactate concentration ($[\text{La}]$). The hand of the subject was pre-warmed using a heat lamp to assist arterialisation of the blood (Forster *et al.*, 1972). At specified time-points the subject's skin was cleaned with an alcohol wipe and then pierced using an automated lancet (Autoclix, Boehringer, Germany). The initial blood, which may contain damaged cells, was wiped away and then approximately 30 μl of blood was collected in a 50 μl capillary tube. The specific capillary tubes used contained heparin,

fluoride and nitrite, which acted as anticoagulant, glycolysis inhibitor and anti-oxidant respectively. The blood was mixed thoroughly for several minutes and then either analysed immediately, or the capillary was capped at both ends and placed on ice until the end of the experiment.

All capillary blood was analysed, at least in duplicate, using an automated lactate analyser (Analox GM-7, Analox Instruments, London, UK). This system contains an oxygen electrode that detects the change in PO_2 when lactate is oxidised to pyruvate in the presence of lactate oxidoreductase:

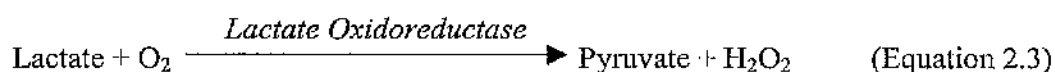

The analyser was calibrated prior to the analysis of each set of capillaries, and the concentration of an 8.0 mM standard was checked following calibration and at the end of each testing session. If the standard was reading outside 8 ± 0.2 mM then the values were not accepted and the test was repeated.

2.3.5 Breath-by-breath gas analysis

Breath-by-breath gas exchange analysis was carried out in all tests for calculations of $\dot{V}O_2$, $\dot{V}CO_2$ and $\dot{V}E$. The metabolic cart used consists of a quadrupole mass spectrometer (QP9000, Morgan Medical, Gillingham, UK) for measurement of respired gas concentrations for O_2 , N_2 and CO_2 , and a low dead-space (90 ml), low resistance ($< 1.5 \text{ cmH}_2\text{O.l}^{-1}.\text{s}^{-1}$ at 3 l.s^{-1}) turbine volume transducer (Interface Associates, Irvine, CA, USA) for inspired and expired volume and flow measurements.

2.3.5.1 Mass Spectrometer

Respired gas was continuously drawn along a capillary line attached to the mouthpiece at a rate of 20 Hertz. The constituent gases were subsequently ionised by electron bombardment before being separated by the electrostatic fields of the quadrupole lens, based on the mass-to-charge ratio of the individual ions. The voltage then generated by the ion detector, upon contact with the respective gas ions, is proportional to the relative concentration of each gas, allowing accurate quantification of O_2 , CO_2 and N_2 concentrations within the respired gas. The mass spectrometer was calibrated prior to all tests by two precision-analysed gas mixtures chosen to span the expected range of gas concentrations observed during exercise, with the calibration being checked for stability

immediately before and after all tests. In tests where there was a significant drift (greater than an absolute change of 0.5%) in the gas concentrations, the results were excluded and the test repeated at a later date.

2.3.5.2 Turbine volume transducer

The turbine volume transducer functions on the basis of respired gas flow turning a small impeller within the turbine, the impeller repeatedly breaking four beams of infrared light for determination of the impeller velocity, with gas flow directly proportional to the speed of the impeller movement. Manufacturer guidelines report the transducer output to be linear over the range 0.1 to 12 l.s⁻¹, with an accuracy of $\pm 2\%$. The turbine was calibrated prior to each test using a high-precision 3-litre syringe (Hans Rudolph, Kansas City, MO, USA) with an acceptable range of 2.99 – 3.01 l. Before each test the ambient conditions of temperature, barometric pressure and relative humidity were entered into the software so that all values were corrected to STPD, except \dot{V}_E (BTPS) which is conventionally described under these conditions. To prevent saliva impeding movement of the impeller a screen was situated in the turbine housing and a saliva trap was located in the mouthpiece set-up between the turbine and the mouthpiece. The gas sample line was positioned to sample respired gas from the mouthpiece set-up such that saliva would not be drawn along the sample line and hence blockages were prevented.

2.3.5.3 Algorithms

Since the response times of the turbine volume transducer and mass spectrometer are not equal and there is a lag between gas concentration and volume signals, it is crucial that the gas concentration and volume signals be phase-aligned, for subsequent calculation of gas exchange variables. The time delay between the volume and gas concentration signals was measured by passing a bolus of a known gas mixture through the system using a low dead-space solenoid valve (Beaver *et al.*, 1973). The gas mixture used was of high CO₂ concentration so that a large change in concentration was evident when the bolus of gas was passed through the system. The delay was then calculated from the chart recorder output of the raw analogue signals, as the time from the expulsion of the gas bolus from the solenoid to the mid-point of the spectrometer response (Lamarra & Whipp, 1995). This value was entered into the software, prior to each test, for subsequent online computation of breath-by-breath gas exchange variables.

The algorithms used (Beaver *et al.*, 1973) are based on the same mass-balance principles as Douglas Bag collection analysis, but with the considerable advantage that serial sampling with high temporal resolution is possible. The process involves functionally dividing the continuous expired flow signal into consecutive sampling intervals, time-aligned to the simultaneous gas concentration signals. Initially, if the continuous flow signal is considered then the volume of expired gas (V_E) over a given period (T) is calculated according to the following equation:

$$V_E = \int_{t=0}^T \dot{V} \text{ exp}(t).dt \quad (\text{Equation 2.4})$$

where $\dot{V} \text{ exp}$ is the expired flow during an infinitesimally short time interval dt . As mentioned above, since the sampling interval is uniform, dt is replaced by a constant Δt and the mean flow across the time interval $(t + \Delta t)$ replaces the instantaneous flow at (t) :

$$V_E = \sum_{t=0}^T \dot{V} \text{ exp}(t + \Delta t) \cdot \Delta t \quad (\text{Equation 2.5})$$

where $\dot{V} \text{ exp}$ is the mean flow rate across the time interval $(t + \Delta t)$. Calculation of V_E for each breath is then the sum of V_E across the expiration duration of that breath, divided by the expiration duration.

Breath-by-breath calculations of $\dot{V}O_2$ and $\dot{V}CO_2$ are based on the same principle but combine the changes in flow signal with the phase-aligned changes in expired gas concentration. Therefore Equation 2.5 becomes Equations 2.7 and 2.8 for $\dot{V}O_2$ and $\dot{V}CO_2$ respectively, where the true O_2 difference $[(\Delta FO_2)_{\text{true}}]$ is described by Equation 2.6 and the fraction of inspired CO_2 ($F_I CO_2$) is assumed to be negligible for air-breathing exercise:

$$[(\Delta FO_2)_{\text{true}}] = \frac{(F_I O_2 - F_E O_2 - F_I O_2 \cdot F_E CO_2)}{(1 - F_I O_2)} \quad (\text{Equation 2.6})$$

$$V_{O_2} = \sum_{t=0}^T \dot{V} \text{ exp}(t + \Delta t) \cdot \Delta t \cdot [(\Delta FO_2)_{\text{true}}] \quad (\text{Equation 2.7})$$

$$V_{CO_2} = \sum_{t=0}^T \dot{V} \text{ exp}(t + \Delta t) \cdot \Delta t \cdot F_E CO_2 \quad (\text{Equation 2.8})$$

The transformation from V_{O_2} and V_{CO_2} to $\dot{V}O_2$ and $\dot{V}CO_2$ for each breath is then simply the sum of each variable across the expiration duration for each breath, divided by the expiration duration.

2.3.5.4 Data analysis

The breath-by-breath gas exchange analysis of the response to exercise is typically associated with "noise", which has been extensively characterised (Lamarra *et al.*, 1987; Rossiter *et al.*, 2000; Puente-Maestu *et al.*, 2001). They demonstrated the noise as an uncorrelated Gaussian distribution and that this confounding noise can prevent accurate characterisation of the underlying physiological response if not considered. The averaging of multiple tests reduces the impact of this noise, the number of transitions required dependent on the standard deviation of the noise.

In all experiments, the breathing pattern was monitored carefully for irregularities such as mis-triggered breaths which can be caused by swallowing, sighing or coughing. Such breaths, which are clearly not indicative of the underlying physiological response, were identified by examining the chart tracing of the volume and gas concentration raw signals as well as the on-line individual breath characteristics, such as tidal volume, the duration of inspiration and expiration, and end-tidal gas concentrations. Individual breaths were compared with preceding and following breaths to determine whether the breath generated by the software was indeed a "real physiological" breath. Breathes which were clearly not part of the underlying physiological response were excluded from subsequent data analysis, although dubious breaths were not removed.

In tests where the response could be justifiably mathematically modelled, either linear (for incremental tests excluding an initial lag) or exponential (constant work rate tests as detailed below), the exclusion of such breaths was carried out by removing breaths which lie ± 4 standard deviations outside the mean response (Lamarra *et al.*, 1987). Similarly, in tests where kinetic analysis of the dynamic response to exercise was carried out, multiple transitions were time-aligned and averaged in order to reduce the confounding effects of breath-by-breath noise.

In tests of an incremental nature, which were analysed for non-invasive estimation of the lactate threshold the responses were edited, as outlined above, and then a stationary average, typically 8 – 12 breaths, was applied so that the underlying response was evident. In contrast, when the response to constant work rate test is to be modelled, it is essential that there is an even distribution of points throughout the response, thereby preventing a bias in the fit to an area of greater density of data points, i.e. increased number of breaths. This was ensured by linear interpolation of the breath-by-breath data so that a data point is generated every 1 s throughout the response. The interpolated response was then averaged

into 10 s bins so that there was an even distribution of points and a further improvement in signal-to-noise ratio.

2.3.5.5 Modelling gas-exchange kinetics

These averaged exponential responses were then modelled by iterative least squares non-linear regression techniques using commercially available analytical software (Origin, Microcal Software, Inc., USA). That is, the exponential which best-fit the data was determined by repeatedly varying the model's constituent parameters until the residual sum square of errors (χ^2) could not be further reduced. As discussed in Chapter 1, the optimal approach to modelling the response to exercise is a subject of debate. The precise details of any models used are described in the short methods section at the beginning of each respective chapter. In summary, the initial 20s of data were excluded in order to prevent contamination of the Phase II response by the initial cardiodynamic phase (Whipp *et al.*, 1982). This Phase I response was not modelled since it is unclear whether this phase is well characterised by an exponential and indeed the complexities of this initial increase in $\dot{V}O_2$ mean that the likelihood of a first-order response is small. For example, when cycling is performed from a baseline of rest, rather than "unloaded" pedalling, the Phase I response is clearly not exponential (Whipp *et al.*, 1982).

For exercise of moderate intensity, the Phase II response was subsequently fit by a single exponential model according to Equation 2.9:

$$\dot{V}O_2(t) = \dot{V}O_{2(20W)} + \Delta\dot{V}O_{2(ss)} * [1 - e^{-(t-\delta)/\tau}] \quad (\text{Equation. 2.9})$$

where $\dot{V}O_{2(20W)}$ is the baseline $\dot{V}O_2$ when pedalling at 20W, calculated as the mean of the 60s preceding the exercise transition; $\Delta\dot{V}O_{2(ss)}$ is the amplitude of the Phase II response; δ is the independent time delay; and τ is the Phase II time constant.

For transitions above $\hat{\theta}_L$ the issue of how to model the slow component of the response arises. It is vital that the Phase II response be isolated, as inclusion of the slow component will result in a lengthening of the time constant and inaccurate determination of the steady state amplitude, and hence Gain, for Phase II. The triple exponential model proposed by Barstow *et al.* (1996) is advantageous in that the Phase II response is modelled separately from the slow component, however the justification in modelling the slow component, and Phase I as mentioned above, as an exponential is highly questionable. Given the complexities surrounding the disputed mechanisms of the $\dot{V}O_{2(SC)}$ (Section 1.5.3), it is

unlikely there will exist a single rate-limiting step, making the assumption of exponentiality unrealistic. Therefore at present there is no consensus on how to justifiably characterise the temporal features of the slow component (Whipp *et al.*, 2002b) and again this is perhaps not surprising, since this additional component can either attain steady-state if below CP or project almost linearly to $\mu \dot{V}O_2$ for very heavy work rates.

In terms of the amplitude characteristics of the slow component, a recent paper by Bearden & Moffatt (2001b) highlighted that traditional computations using a standard time interval such as $\Delta \dot{V}O_{2(6-3)\text{min}}$ (e.g. Casaburi *et al.*, 1987) underestimates the amplitude. This was explained since the emergence of this component typically occurs earlier than three minutes and often continues longer than six minutes, meaning that significant portions of the slow component were excluded from the calculation. They, and others (e.g. Bell *et al.*, 2001b) have since proposed that the amplitude of the slow component be calculated as the difference in $\dot{V}O_2$ between the end of exercise and the time of onset of the slow component. Whilst the cardiodynamic phase has been shown to be excluded by eliminating the first 20s of data from the exponential fit (Whipp *et al.*, 1982), the delayed onset of the slow component does not occur at the same time in different tests (e.g. Ozyener *et al.*, 2001) making the isolation of Phase II considerably more complex in this intensity domain. The consensus in the literature is to use the same exponential model as in Equation 2.9 but variations exist as to what data range this model is applied.

The approach that was used in Chapter 4 has been detailed in Section 4.2.2, but in summary the model was initially applied from $t = 20\text{s}$ until $t = 80\text{s}$ after exercise onset ($t = 0$) and the window was then expanded by a single data point (10s) and the model re-applied (Rossiter *et al.*, 2001). This process was repeated until there was a consistent difference between the actual measured response and the best-fit exponential model. Since this lengthening of the data window will cause an increase in the number of data points used in the response modelling, the typical goodness-of-fit approach (Lamarra *et al.*, 1987) could not be applied to discern improvements, or decrements, in the appropriateness of the exponential fit. Rather two alternative indices were used (Rossiter *et al.*, 2001):

- (a) visual inspection of the residual plot for flatness, indicative of a good fit, and
- (b) demonstration of a dramatic increase in the value of χ^2 as the window is lengthened.

Having successfully identified the emergence of the slow component, the Phase II exponential was then re-applied from 20s until the last time-point before the slow

component onset, the slow component amplitude calculated as the difference between end-exercise and this time-point.

2.4 STATISTICAL ANALYSIS

Details of the statistical analysis used are provided in each respective results chapter, since each study was different in design.

Chapter 3 Oxygen uptake and muscle desaturation profiles during intermittent cycling in humans

3.1 INTRODUCTION

The $\dot{V}O_2$ response to sustained exercise can be assigned according to four intensity domains, demarcated by two important parameters, θ_F and θ_L , as previously discussed in detail in Section 1.1.1. Interestingly, the different intensity domains also exhibit contrasting arterial blood lactate profiles (Figure 1.6), the [La] and $\dot{V}O_2$ responses being strongly related, although there is evidence against a cause-and-effect dependence, as discussed in Section 1.5.3.1. This is of interest since the blood lactate response to intermittent cycling has been demonstrated to be strongly dependent on the duration of the exercise and recovery periods, and so the question of how these intermittent protocols affects the breath-by-breath $\dot{V}O_2$ response is pertinent.

Exercise of an intermittent nature is characterised by short periods of exercise interspersed with short periods of recovery, and this form of exercise is prevalent in both everyday life and sport. The relative physiological demands of intermittent exercise are dependent on the ratio and durations of the exercise and recovery periods, the amplitude of the change in work rate and the average work rate (Saltin *et al.*, 1976). In 1960, Irma Astrand and colleagues investigated the influence of exercise and recovery period duration on the physiological responses to intermittent cycling and running (Astrand *et al.*, 1960a & 1960b; Christensen *et al.*, 1960a & 1960b). The major finding of this work was a demonstration that the so-called “intensity” of a given amount of work could be controlled by varying the duration of the work and, to a lesser extent, recovery periods. The [La] profiles shown in Figure 3.1 highlight the increased physiological demand experienced when the exercise periods became longer than approximately 15s.

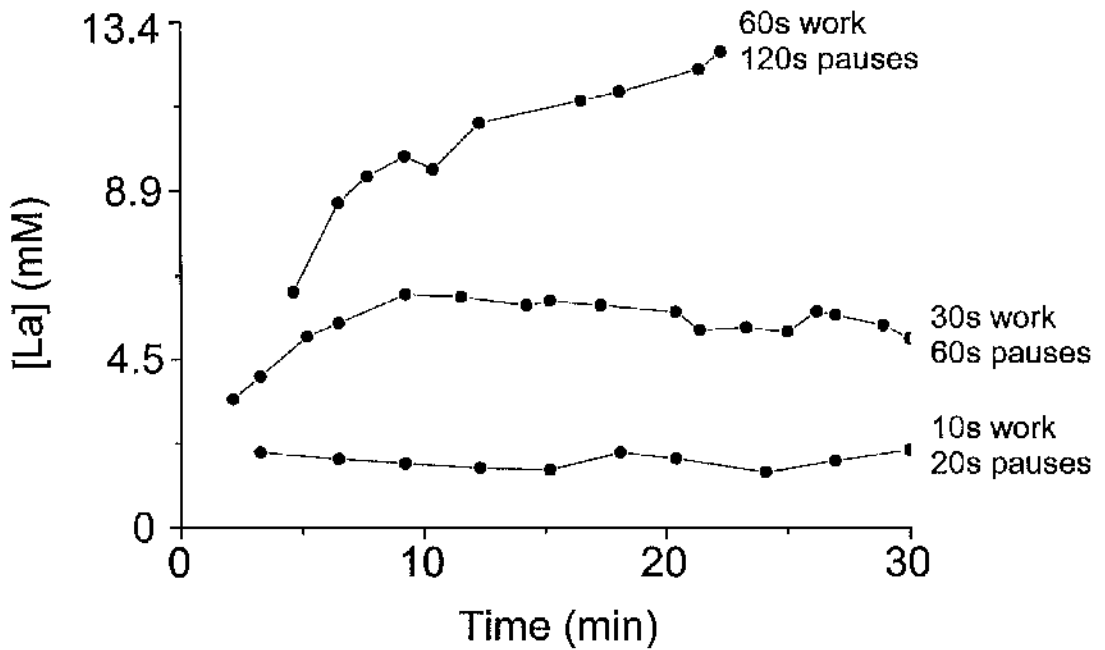

Figure 3.1 - Capillary blood lactate response to three different intermittent cycling tests of varying work-recovery duty cycle duration. This figure was adapted from Astrand *et al.* (1960b).

The lactate profile from these early tests is indeed remarkably similar to the profiles observed in response to sustained exercise, which have been traditionally used to designate the intensity of the exercise (Fig 1.6 – detailed in Section 1.1.1). That is to say, when the work-recovery duty cycle was kept short (10s exercise:20s recovery) there was no significant lactate accumulation, excluding an initial transient increase, similar to sustained exercise of moderate intensity, i.e. below θ_L (Wasserman *et al.*, 1967). However, when the duty cycle was increased to 30s work:60s recovery, despite the same amount of work being performed, there was a significant increase in [La], although a new steady state could be achieved, consistent with sustained exercise in the heavy intensity domain (Wasserman *et al.*, 1967). Further lengthening of the duty cycle resulted in a continuous increase in [La] and the subject was unable to complete the 30-minute duration of the test, consistent with sustained exercise in the very heavy intensity domain (Wasserman *et al.*, 1967). Whilst the intermittent protocols have been shown to elicit changes in [La] similar to sustained constant work rate exercise, it is presently unclear whether the $\dot{V}O_2$ responses to these protocols will reflect this.

In the early studies the investigators did not have the benefit of modern breath-by-breath gas analysis systems and so they were unable to describe the rapidly changing $\dot{V}O_2$ response, although they did suggest that $\dot{V}O_2$ would be increasing during the exercise periods and decreasing during the recovery periods (Christensen *et al.*, 1960b). To further

knowledge of \dot{Q}_{mO_2} control theories it would be beneficial to compare the $\dot{V}O_2$ response with \dot{Q}_{mO_2} , although unfortunately the ability to directly monitor muscle oxygen consumption with high temporal resolution remains difficult (Section 1.4.4), especially so given the highly dynamic nature of intermittent cycling at high work rates. Whilst the technical difficulties preventing accurate portrayal of the changes in leg muscle blood flow and perfusion during cycling prove insurmountable at present, the technique of near-infrared spectroscopy (NIRS) provides a novel approach for investigating the patterns of intramuscular oxygenation during intermittent cycling. Indeed, under conditions of arterial occlusion, NIRS can be used to estimate muscle oxygen consumption (e.g. Chance *et al.*, 1992; Ferrari *et al.*, 1997) and these calculations have been confirmed with estimations of \dot{Q}_{mO_2} using 31-phosphorous nuclear magnetic resonance spectroscopy (Sako *et al.*, 2001).

Near-infrared spectroscopy examines the changes in combined relative concentrations of haemoglobin and myoglobin in their oxygenated and deoxygenated states, although the contribution of myoglobin has been demonstrated to be comparatively small (Mancini *et al.*, 1994) and so is conventionally assumed insignificant. However, one recent study has suggested that data obtained using NIRS techniques may closely reflect changes in the oxygenation status of myoglobin (Tran *et al.*, 1999). NIRS has traditionally been used for monitoring the levels of oxygenation in the brain of the neo-natal (e.g. Wyatt *et al.*, 1989), however it has now been applied extensively during sustained exercise (e.g. Chance *et al.*, 1992; Belardinelli *et al.*, 1995a; Bhambhani *et al.*, 1999; McCully & Hamaoka, 2000; Volianitis *et al.*, 2003; Grassi *et al.*, 2003).

This study therefore provides an opportunity to characterise, with high temporal resolution, the dynamic profiles of the $\dot{V}O_2$ response in conjunction with changes in intramuscular oxygenation during intermittent cycling with varying work-recovery protocols. It is predicted that there will be increases in $\dot{V}O_2$ and desaturation of oxygenated haemoglobin, reflected by an increased concentration of deoxygenated haemoglobin ($\Delta[Hb]$) (Ferrari *et al.*, 1997; Kowalchuk *et al.*, 2002), during the exercise periods and subsequent decreases in $\dot{V}O_2$ and $\Delta[Hb]$ during the recovery periods. Based on the established relationship between $\dot{V}O_2$ kinetics and $[La]$ for constant work rate exercise (e.g. Poole *et al.*, 1988; Ozyener *et al.*, 2001 – Section 1.1.1), it is hypothesised that the average $\dot{V}O_2$ response to intermittent exercise will follow the pattern of $[La]$ and hence be dependent on work-recovery duty cycle duration.

3.2 METHODS

In addition to the overall methods chapter (Chapter 2), the following section details the exact protocol used, and any techniques exclusive to this study.

3.2.1 Subjects and Procedures

Six recreationally active non-smoking adult males (Table 3.1) volunteered to take part in the study, having provided written informed consent approved by the Local Ethics Committee (University of Glasgow - Appendix).

Subject	Age (years)	Height (cm)	Weight (kg)	$\mu \dot{V}O_2$ ($l \cdot \text{min}^{-1}$)	$\mu \dot{V}O_2$ ($\text{ml} \cdot \text{kg}^{-1} \cdot \text{min}^{-1}$)	$\hat{\theta}_L$ ($l \cdot \text{min}^{-1}$)	$\dot{V}O_2$ at $\hat{\theta}_L$ ($\text{ml} \cdot \text{kg}^{-1} \cdot \text{min}^{-1}$)	μWR (Watts)
1	33	186	95.5	4.26	44.6	2.84	29.7	374
2	22	172	66.3	3.30	49.8	1.61	24.3	258
3	22	186	83.2	4.30	51.7	2.60	31.3	401
4	24	191	73.5	3.23	43.9	1.95	26.5	254
5	28	166	71.5	3.69	51.6	1.75	24.5	314
6	22	180	74.1	3.50	47.2	1.53	20.6	290
Mean	25.2	180	77.4	3.71	48.1	2.05	26.2	315
\pm S.D.	4.5	10	10.4	0.47	3.4	0.55	3.9	61

Table 3.1 — Subject characteristics. Peak $\dot{V}O_2$ ($\mu \dot{V}O_2$), the estimated lactate threshold ($\hat{\theta}_L$) and peak work rate (μWR) determined from an incremental test (see text for details).

All exercise testing was performed on the cycle ergometer described previously with all tests separated by a minimum period of 48-hours. Following familiarisation, subjects performed an incremental ramp test, as detailed in Section 2.2.1, to the limit of tolerance (t_{lim}) for determination of $\mu \dot{V}O_2$, maximum work rate attained (μWR), and non-invasive estimation of the lactate threshold ($\hat{\theta}_L$). $\mu \dot{V}O_2$ was established as the mean value over the last 20s of the test. The subjects subsequently underwent four intermittent tests (Figure 3.2) of varying work-recovery duty cycle duration (10s:20s, 30s:60s, 60s:120s and 90s:180s) in a randomised order and on different days. Following several minutes of pedalling at 20W, short periods of exercise were instituted at 120% μWR interspersed with short periods of recovery at 20W. In all tests the total amount of work performed was kept constant by maintaining a consistent work:recovery ratio of 1:2, with a target test duration of 30-minutes or until t_{lim} .

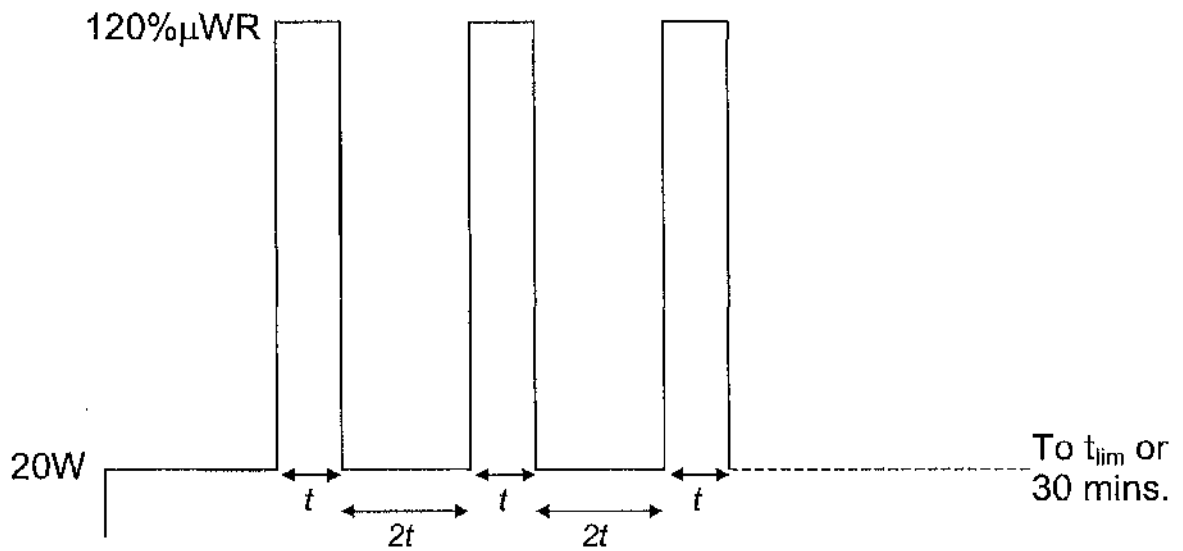

Figure 3.2 - Schematic of intermittent test protocol. Following several minutes of rest and 20W pedalling the work rate was periodically increased to 120% μ WR and reduced to 20W in an intermittent fashion. The four tests had varying work-recovery duty cycle duration: $t = 10\text{s}; 30\text{s}; 60\text{s}; 90\text{s}$.

Breath-by-breath gas exchange and heart rate were monitored continuously during all tests, according to the specifications detailed in Section 2.3. Capillary blood samples of arterialed mixed-venous blood were taken and analysed for lactate concentration as detailed in Section 2.3.4. During the intermittent tests the capillary samples were taken during rest, while pedalling at 20W and at pre-determined time intervals that were standardised across the different protocols at approximately every 3 minutes, ensuring that samples were taken both during the high-intensity bouts and subsequent recovery periods.

3.2.2 Near-InfraRed Spectroscopy (NIRS)

Intramuscular oxygenation status of the lateral quadriceps femoris was monitored non-invasively using transcutaneous near-infrared spectroscopy. The theory of NIRS and details of the instrument used (NIRO 500, Hamamatsu Photonics KK, Japan) have been described in detail (Elwell, 1995). This system incorporates four laser diode light-sources with wavelengths spanning the range 775 – 905 nm, transmitting light in a pulsatile fashion from an optode placed over the belly of the muscle to be interrogated. A second receiving optode, spaced exactly 4 cm away along the long axis of the muscle as shown in Figure 3.3(a), then returns the light to a photon detector in the spectrometer. From the difference in intensity of the transmitted and incident light signals, calculations of the changes in concentration of deoxygenated haemoglobin ($\Delta[\text{Hb}]$), oxygenated haemoglobin ($\Delta[\text{HbO}_2]$) and total haemoglobin ($\Delta[\text{HbT}] = \Delta[\text{Hb}] + \Delta[\text{HbO}_2]$) were made every 0.5 s according to

the modified Beer-Lambert Law using a differential path factor of 3.83 (Kowalchuk *et al.*, 2002). In order to prevent contamination of the light signal by extraneous light, and to ensure no signal escapes, the optodes were encased in a solid plastic holder, with the optodes positioned on the vastus lateralis muscle at mid-thigh level. The holder was taped securely in place and then covered by an optically dense nylon sleeve and finally an elastic bandage to minimise movement of the optodes, as shown in Figure 3.3(b).

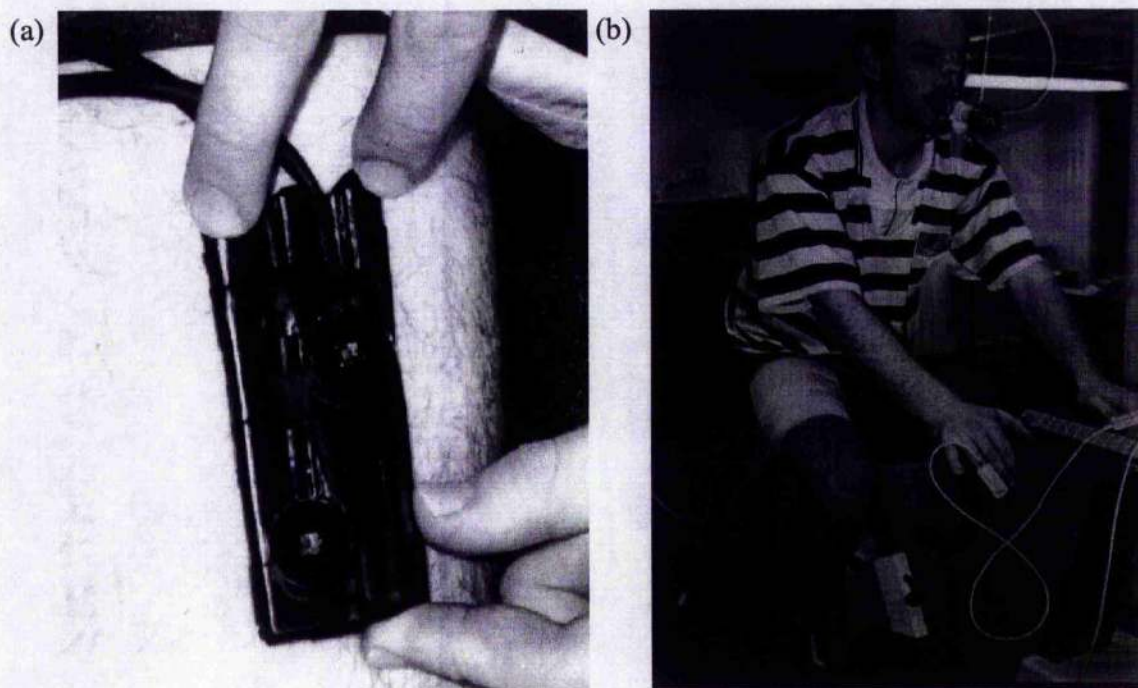

Figure 3.3 - Photographs illustrating (a) the NIRS optodes situated in the optode holder, and (b) a subject cycling with the optodes secured in place.

Changes in the $\Delta[\text{Hb}]$ signal were assumed to represent oxygen extraction within the muscle since this has been shown to be essentially blood-volume insensitive, in comparison to the $\Delta[\text{HbO}_2]$ signal which depends significantly on O_2 -delivery into the field of interrogation (Ferrari *et al.*, 1997; McCully & Hamaoka, 2000). It might be expected that the $\Delta[\text{Hb}]$ and $\Delta[\text{HbO}_2]$ signals are the reciprocal of one another during exercise and this holds true for exercise in which blood flow is kept constant. However, during dynamic exercise when arterial O_2 delivery and muscle perfusion are not constrained, the anticipated decrease in the $\Delta[\text{HbO}_2]$ signal as O_2 is extracted is offset by an increase in $\Delta[\text{HbO}_2]$ signal caused by increased HbO_2 delivery into the field of interrogation due to increased muscle blood flow and perfusion. The $\Delta[\text{HbT}]$ profile is sometimes used to characterise changes in muscle blood flow and perfusion, since this incorporates the total concentration of haemoglobin within the field of interrogation. The assumptions around which this theory is based are comprehensive, however. For example, while $\Delta[\text{HbT}]$ provides an index of changes in flow and perfusion, it will also be sensitive to changes in

plasma osmolarity, especially if these involve any appreciable transcapillary flux of water that then enters or leaves the field of interrogation. High concentrations of metabolites (such as lactate, H^+ , K^+ , P_i) within the muscles during high work rates are likely to influence local osmolarity and thence local haemoconcentration (Convertino *et al.*, 1981).

Since absolute concentration values cannot be calculated for the haemoglobin changes, using simple D.C. spectrometers, and the identical position of the optodes cannot be entirely guaranteed between tests (although this was carefully standardised), it is important to normalise the temporal profiles from different tests. This was achieved by expressing the changes in concentration as a percentage of the maximum change observed either during the sustained maximal voluntary contraction (MVC) of the quadriceps while seated in a chair prior to each test, or during the test if maximal. The appropriateness of this manoeuvre was verified by demonstrating no significant difference between the level of desaturation ($\Delta[Hb]$) invoked by an MVC and the level of desaturation observed during all tests in which exhaustion, and presumably maximal oxygen extraction, was reached (Figure 3.4).

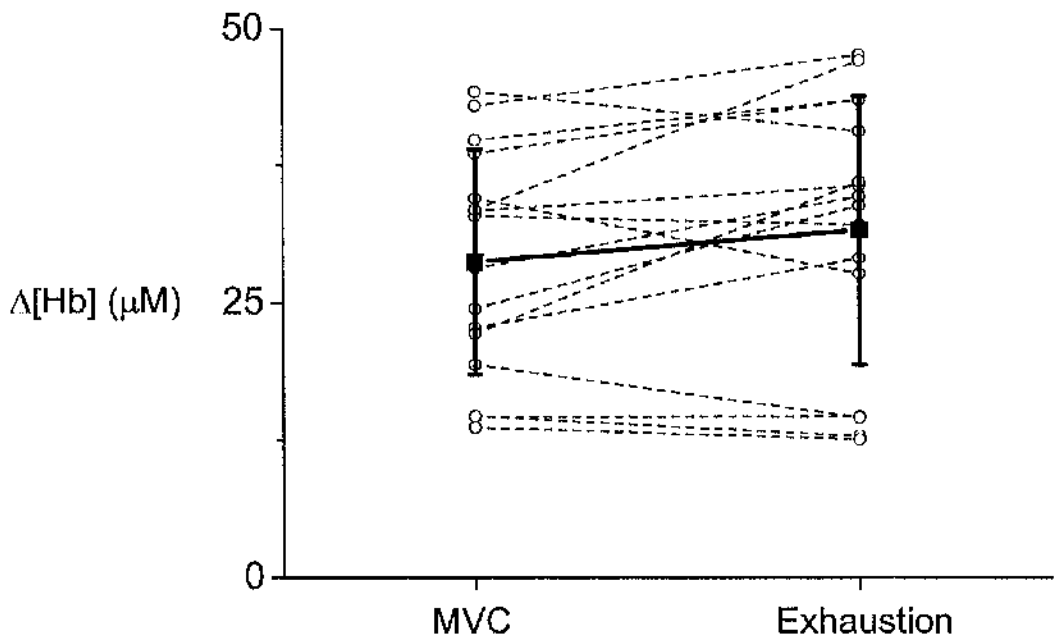

Figure 3.4 - Comparison of the change in concentration of deoxygenated haemoglobin ($\Delta[Hb]$) induced by performance of a maximal voluntary contraction (MVC) of the quadriceps with the degree of desaturation induced in the same maximal tests ("Exhaustion"). *Closed squares and solid line* indicate the mean (\pm S.D.). *Open circles and dashed line* are the individual results. There was no significant difference ($P > 0.05$) thus verifying the process of standardising the $\Delta[Hb]$ results as a percentage of the MVC change.

The assumption of complete O_2 extraction being induced by maximal exercise is supported by Chance *et al.* (1992), who demonstrated no further intramuscular desaturation at the point of exhaustion when ischaemia was induced by an inflatable cuff.

3.2.3 Data Analysis

The “noise” typically associated with breath-by-breath gas analysis, due to inherent breathing irregularities and mis-triggering of breaths has been shown to be an uncorrelated Gaussian distribution (Lamarra *et al.*, 1987; Rossiter *et al.*, 2000). It is common practise to exclude breaths which occur greater than 3 or 4 standard deviations outside the mean response, in a bid to reduce the contaminating influence of this noise. However, the dynamic nature of the intermittent protocols in the present study precluded using any such strategy since the mean response could not be modelled. Instead abnormal breaths were identified according to the breathing pattern, indicated by tidal volume, the duration of inspiration and expiration, and end-tidal gas concentrations as described in more detail in Section 2.3.5.4. These breaths were compared with preceding and following breaths, and also with breaths which occurred at a similar time-point in subsequent work-recovery duty cycles. Based on these criteria, breaths clearly not indicative of the system response were excluded, although dubious breaths were not removed.

Only in the shortest duty-cycle duration test (10s:20s) did noise prevent identification of a clear oscillation of $\dot{V}O_2$ in synchrony with the changes in work rate, the mean $\dot{V}O_2$ value over the 30-minute duration for this test being calculated. In all other intermittent tests the 2-breath averaged $\dot{V}O_2$ responses during each duty cycle, excluding an early kinetic phase, were isolated, time-aligned and graphically overlaid. From these overlaid plots a visual best-fit line was constructed through the band of data-points at the end of each exercise and recovery period respectively, as shown in Figure 3.5, and the amplitude of the oscillations was then calculated as the difference between the end-exercise and end-recovery data.

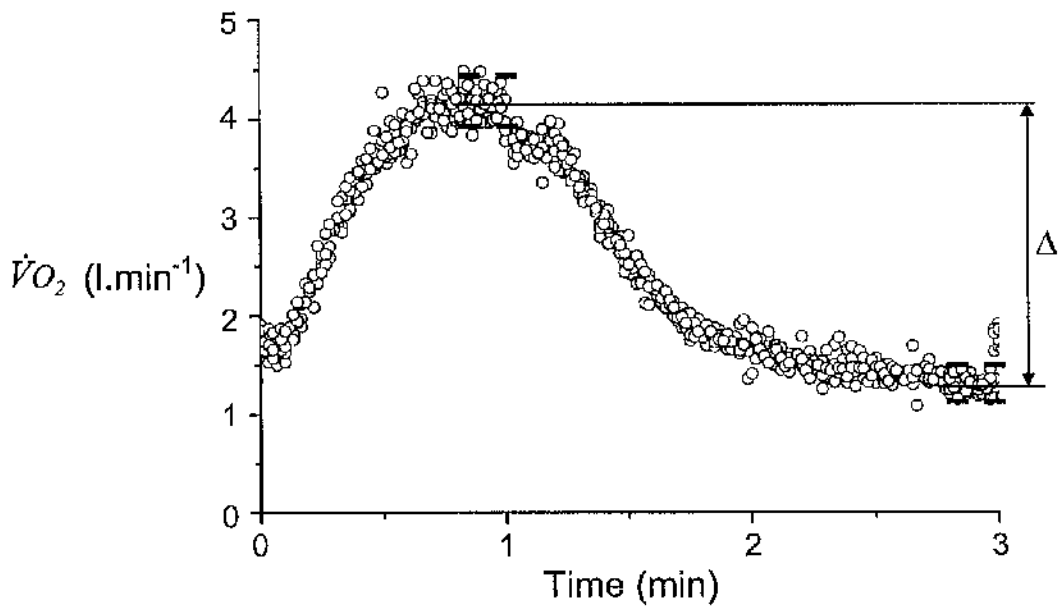

Figure 3.5 - Typical plot of consecutive work-recovery duty cycles visually overlaid, illustrating the data analysis procedures used to characterise the oscillations observed during the intermittent tests for $\dot{V}O_2$ and $\Delta[\text{Hb}]$. The *dashed lines* border the end-exercise and end-recovery values, the *solid line* is constructed as a best-fit line through these data providing values for end-exercise and end-recovery, and from these the amplitude (Δ) of the oscillation is calculated as shown.

The temporal $\Delta[\text{Hb}]$ profiles for all intermittent tests were analysed using the same approach, graphically overlaying isolated consecutive work-recovery duty cycles for identification of end-exercise values at the end of each high-intensity bout, end-recovery values and the amplitude of the oscillations $\{(\text{end-exercise}) - (\text{end-recovery})\}$. Due to the large number of data points, the values were averaged for every 2 seconds and expressed as a percentage of maximum, as described above. The arterialised blood lactate responses were described in absolute terms for visual inspection of the temporal response in each test, but the accumulation of lactate ($\Delta[\text{La}]$) was calculated as the difference between the baseline of pedalling at 20 W and the peak value achieved either during the test or recovery.

3.2.4 Statistical Analysis

In order to examine whether there was an effect of work-recovery duty cycle duration on $\Delta[\text{La}]$ and the amplitude of the $\dot{V}O_2$ and $\Delta[\text{Hb}]$ oscillations, the values obtained for the four intermittent tests were compared using a repeated measures One-Way Analysis of

Variance (ANOVA). Post hoc analysis (Student's paired t -tests) was conducted when ANOVA revealed a significant difference, with significance accepted when $P < 0.05$.

In order to further investigate the influence of exercise intensity on the $\dot{V}O_2$ response, the $\dot{V}O_2$ values were compared with the important aerobic parameters $\hat{\theta}_L$ and $\mu\dot{V}O_2$. Therefore the mean $\dot{V}O_2$ value during the 10s:20s test was compared (paired t -test) with $\dot{V}O_2$ at $\hat{\theta}_L$, and the end-exercise best-fit values obtained from the overlaid plots were compared with $\mu\dot{V}O_2$ during the exhaustive, or near-exhaustive tests, i.e. 60s:120s and 90s:180s. Due to two subjects being unable to complete a single bout in the 90s:180s test the statistical comparisons with this test had a reduced n no. ($n=4$).

To further examine whether there was an indiscernible oscillating $\dot{V}O_2$ response in the 10s:20s test, the amplitude of the breath-by-breath noise in the test was described as the Standard Deviation about the mean during the final 3-minutes of the test. This was compared (paired t -test) with the Standard Deviation of the $\dot{V}O_2$ steady state response during the final 3-minutes of a sub- $\hat{\theta}_L$ constant work rate test previously performed by the same subjects. Since the absolute amplitude of the noise has been shown to be unrelated to work rate (Lamarra *et al.*, 1987; Rossiter *et al.*, 2000) an increased noise amplitude in the 10s:20s intermittent test would be suggestive of an additional fluctuation related to the work rate profile.

3.3 RESULTS

3.3.1 Arterialised [Lactate]

The typical profile of [La] as a function of the work-recovery duty cycle duration is presented in Figure 3.6 for a representative subject. All subjects showed similar patterns of response, with: little accumulation of La during the 10s:20s test; an initial rise but then no further increase in the 30s:60s test; and continuously rising [La] in the 60s:120s and 90s:180s tests until exhaustion or the end of the test.

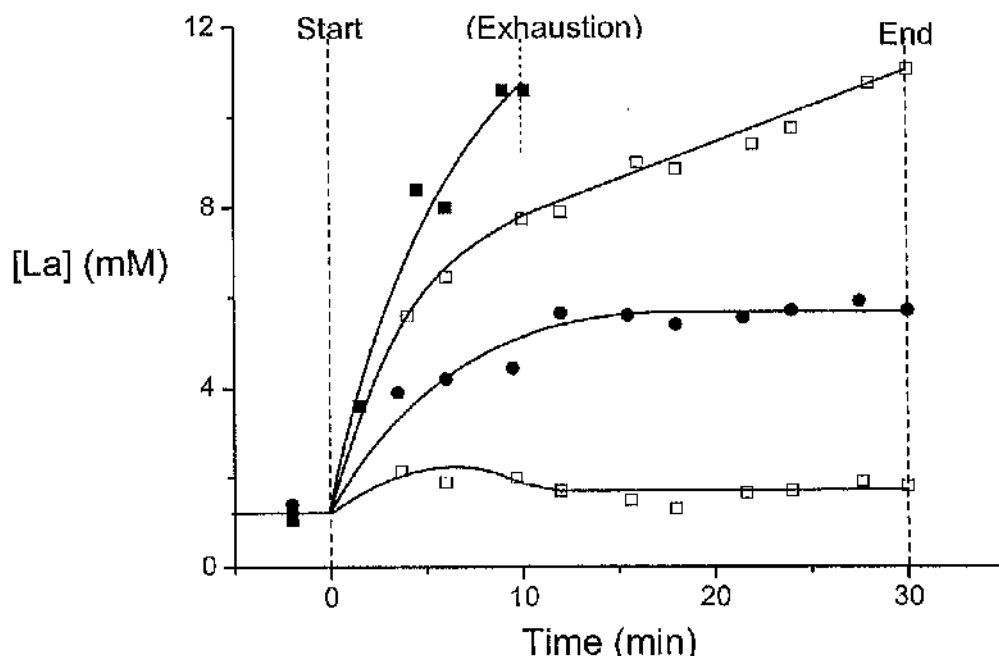

Figure 3.6 - Capillary blood lactate ([La]) response to the four different intermittent cycling tests in a representative subject (subject 1). *Open circles* represent the 10s:20s test, *solid circles* represent the 30s:60s test, *open squares* represent the 60s:120s test and *solid squares* represent the 90s:180s test which the subject was unable to complete. Lines are constructed to approximate the response.

Table 3.2 summarises the individual $\Delta[\text{La}]$ values with the 30s:60s, 60s:120s and 90s:180s tests all resulting in significantly greater increases in [La] than the 10s:20s tests. Furthermore, the 60s:120s test and 90s:180s test resulted in significantly greater increases in [La] than the 30s:60s test, with no significant difference between the 60s:120s and 90s:180s tests. All subjects consequently completed the entire 30-minute duration of the 10s:20s and 30s:60s tests. In the 60s:120s test four of the six subjects completed the test despite very high lactate concentrations, with the mean t_{lim} value for this test being 28.3 (± 2.6) min. No subject could complete the 90s:180s test, with two subjects unable to

complete a single work-recovery duty cycle. The mean t_{lim} for the remaining four subjects was 9.1 (± 4.2) min.

Subject	10s:20s	30s:60s	60s:120s	90s:180s
1	1.1	4.5	9.95	10.55
2	0.3	6.15	9.9	8.6
3	0.75	5.25	10.55	9.2
4	0.2	2.9	4.45	-
5	1.0	5.55	10.85	9.1
6	2.0	5.25	9.05	-
Mean	0.9	4.9*	9.1*§	9.4*§
\pm S.D.	0.7	1.1	2.4	0.8

Table 3.2 - Change in lactate concentration ($\Delta[La]$) during the four intermittent tests, calculated as the increase in $[La]$ (mM) from unloaded (20W) pedalling to the highest value achieved during the test or recovery. *significantly different from 10s:20s test. §significantly different from 30s:60s test.

3.3.2 $\dot{V}O_2$, $\Delta[Hb]$ and HR responses during the 10s work:20s recovery test

The $\dot{V}O_2$, $\Delta[Hb]$ and heart rate responses over the 30-minute duration of the 10s:20s test were similar in all subjects to those shown in Figure 3.7(a) for a representative subject. During the first duty cycle $\dot{V}O_2$, $\Delta[Hb]$ and heart rate all increased and never recovered to baseline values until after completion of the test. The band of data points rises initially and then remains at the same level for the duration of the test, suggesting that the average $\dot{V}O_2$ response becomes stable. The $\Delta[Hb]$ response follows a similar pattern whilst heart rate increases slowly until the test mid-point after which it also remains fairly stable, although there are clear oscillations in synchrony with the changes in work rate. Following an initial kinetic phase, when the average $\dot{V}O_2$ and $\Delta[Hb]$ were rising, consecutive duty-cycles were isolated, time-aligned and graphically overlaid as can be seen in Figure 3.7(b). There is no discernible oscillating pattern for $\dot{V}O_2$ during the duty cycle whereas there is a clear rise in $\Delta[Hb]$ during each work bout and a subsequent decline again during each recovery period. The mean amplitude of these oscillations in $\Delta[Hb]$ was 36.63 (± 16.65) %, as shown in Table 3.3.

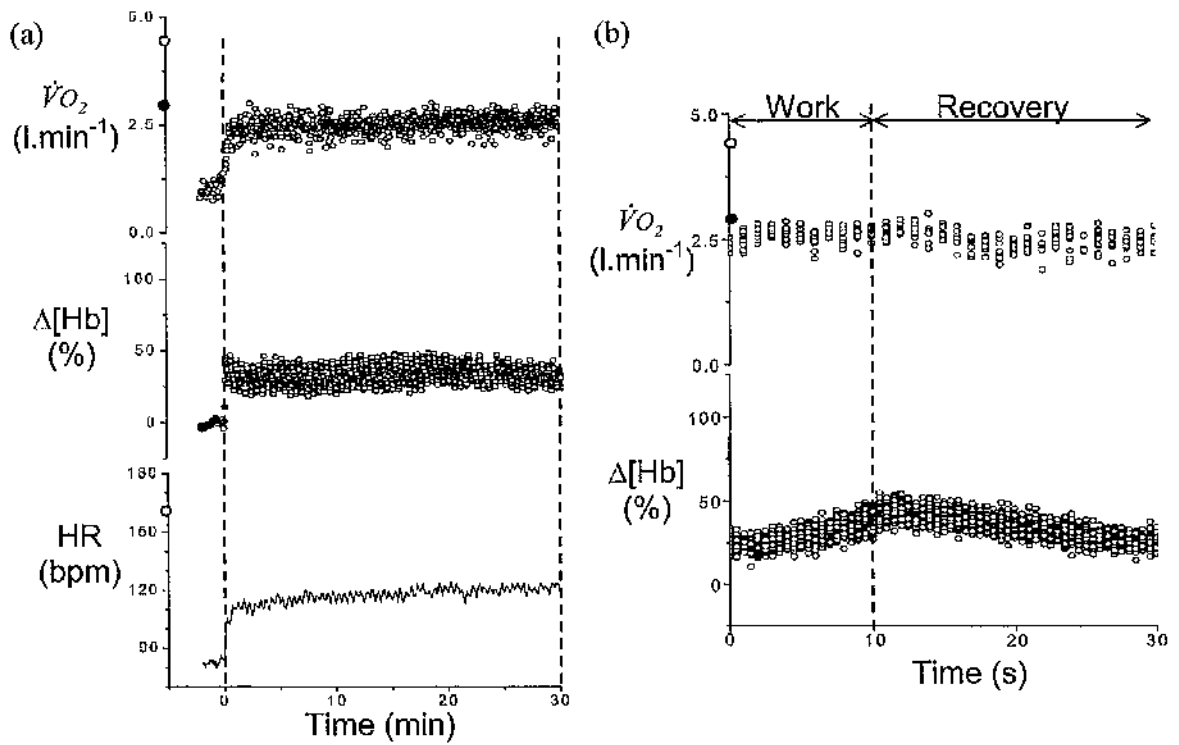

Figure 3.7 - $\dot{V}O_2$, $\Delta[Hb]$ and HR responses during the 10s work:20s recovery intermittent test in a representative subject (no.1). Panel (a) shows the response over the 30-minute duration of the test. Panel (b) shows consecutive work-recovery duty cycles overlaid, following an initial kinetic phase. On the y-axes: \circ = maximum value in incremental test; \bullet = value at $\hat{\theta}_L$.

Subject	10s:20s	30s:60s	60s:120s	90s:180s
1	17.93	66.52	92.35	102.17
2	46.04	64.70	83.74	76.04
3	65.14	94.07	117.81	121.53
4	31.53	61.15	81.75	-
5	31.78	56.21	61.37	64.11
6	27.38	59.87	61.37	-
Mean	36.63	67.09*	83.07 [§]	90.96*
\pm S.D.	16.65	13.71	21.15	25.80

Table 3.3 - Amplitudes of the oscillations observed for the change in concentration of deoxygenated haemoglobin ($\Delta[Hb]$) during the four intermittent tests, determined from the overlaid plots of consecutive duty cycles following an initial kinetic phase (see text for details). Values are expressed as a percentage of the maximum change induced by a maximal voluntary contraction (MVC) of the muscle. *significantly different from 10s:20s test. [§]significantly different from 30s:60s test.

The mean $\dot{V}O_2$ during the 10s:20s test was calculated for all subjects (Table 3.4(a)) since there was no evidence of an oscillation, and this value was found to be not significantly

different from $\dot{V}O_2$ at $\hat{\theta}_L$ ($2.17 \pm 0.27 \text{ l}\cdot\text{min}^{-1}$ vs. $2.05 \pm 0.55 \text{ l}\cdot\text{min}^{-1}$), consistent with low blood lactate concentrations.

(a)		10s:20s		30s:60s		
Subject		Mean	End-ex.	End-rec.	Amplitude	
1		2.50	3.37	2.09	1.28	
2		1.98	2.70	1.33	1.37	
3		2.42	3.30	1.54	1.76	
4		1.80	2.27	1.37	0.90	
5		2.21	2.91	1.41	1.50	
6		2.09	2.76	1.35	1.41	
	Mean	2.17 [§]	2.89	1.52	1.37	
	± S.D.	0.27	0.41	0.29	0.28	

(b)		60s:120s			90s:180s		
Subject		End-ex.	End-rec.	Amplitude	End-ex.	End-rec.	Amplitude
1		4.22	1.72	2.50	4.14	1.42	2.72
2		3.44	1.19	2.25	3.20	0.99	2.21
3		4.22	1.28	2.94	4.18	1.13	3.05
4		2.99	1.10	1.89	-	-	-
5		3.71	1.27	2.44	3.61	1.06	2.55
6		3.30	1.02	2.28	-	-	-
	Mean	3.65 [†]	1.26	2.38*	3.78	1.15	2.63*
	± S.D.	0.50	0.25	0.35	0.47	0.19	0.35

Table 3.4(a) & (b) - $\dot{V}O_2$ responses ($\text{l}\cdot\text{min}^{-1}$) to the four intermittent tests, where the mean was calculated for the 10s:20s test due to lack of discernible oscillation and for the other tests the amplitude of the oscillations was calculated as the difference between the end of each exercise (end-ex.) and recovery (end-rec.) periods. Values determined from the overlaid plots of consecutive duty cycles following an initial kinetic phase (see text for details). *significantly different from $\dot{V}O_2$ amplitude in 30s:60s test. [§]not significantly different from $\dot{V}O_2$ at $\hat{\theta}_L$. [†]not significantly different from $\mu\dot{V}O_2$.

3.3.3 $\dot{V}O_2$, $\Delta[\text{Hb}]$ and HR responses during the 30s work:60s recovery test

All subjects again exhibited similar responses in the 30s:60s test to those shown in Figure 3.8(a) for the representative subject. Clear patterns of oscillation in synchrony with the intermittent protocol can be seen, with the average responses exhibiting the same relationship as in the 10s:20s test, although the end-exercise and end-recovery heart rate values continue to rise for longer. Overlaid plots of consecutive duty cycles in Figure 3.8(b) confirm the recurring pattern of response with $\dot{V}O_2$ and $\Delta[\text{Hb}]$ increasing and decreasing in concert with the changes in work rate, with an initial plateau in $\dot{V}O_2$ at the

onset of the recovery period providing evidence of a short delay phase for $\dot{V}O_2$. The mean amplitudes of the oscillations in $\dot{V}O_2$ (Table 3.4(a)) and $\Delta[\text{Hb}]$ (Table 3.3) were $1.37 (\pm 0.28) \text{ l}\cdot\text{min}^{-1}$ and $67.09 (\pm 13.71) \%$ respectively, the $\Delta[\text{Hb}]$ amplitude being significantly greater than in the 10s:20s test.

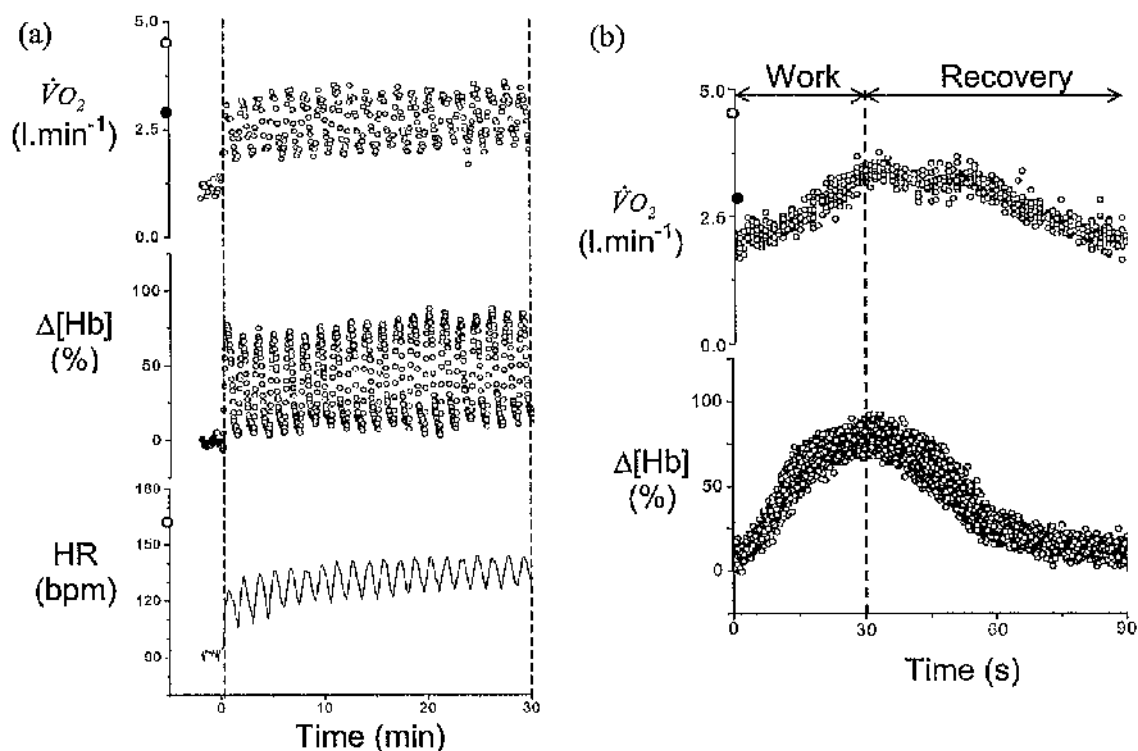

Figure 3.8 - $\dot{V}O_2$, $\Delta[\text{Hb}]$ and HR responses during the 30s work:60s recovery intermittent test in a representative subject (no.1). Panel (a) shows the response over the 30-minute duration of the test. Panel (b) shows consecutive work-recovery duty cycles overlaid, following an initial kinetic phase. On y-axes: \circ = maximum value in incremental test; \bullet = value at $\hat{\theta}_L$.

3.3.4 $\dot{V}O_2$, $\Delta[\text{Hb}]$ and HR responses during the 60s work:120s recovery test

Whilst two subjects were unable to complete this test, the general patterns of response were similar for all subjects to those shown in Figure 3.9(a) for the representative subject. The oscillating pattern for all the variables is evident, and again $\dot{V}O_2$ and $\Delta[\text{Hb}]$ are similar with an initial kinetic phase and then the end-exercise and end-recovery values, and hence the average response, being stable during the latter half of the test. The end-exercise and end-recovery values for heart rate in this case continued to increase until the end of the test or t_{lim} was reached. From overlaid plots of consecutive cycles (Figure 3.9(b)), following the initial kinetic phase, the work and recovery phases of the response have mean amplitudes of the oscillations in $\dot{V}O_2$ (Table 3.4(b)) and $\Delta[\text{Hb}]$ (Table 3.3) of $2.38 (\pm 0.35) \text{ l}\cdot\text{min}^{-1}$ and $83.07 (\pm 21.15) \%$ respectively, both being significantly greater than in the

30s:60s test and also the 10s:20s test for $\Delta[\text{Hb}]$. In line with the high $[\text{La}]$ values, near maximal heart rates and some subjects reaching t_{lim} , the values for end-exercise $\dot{V}\text{O}_2$ were found to be not significantly different from $\mu\dot{V}\text{O}_2$.

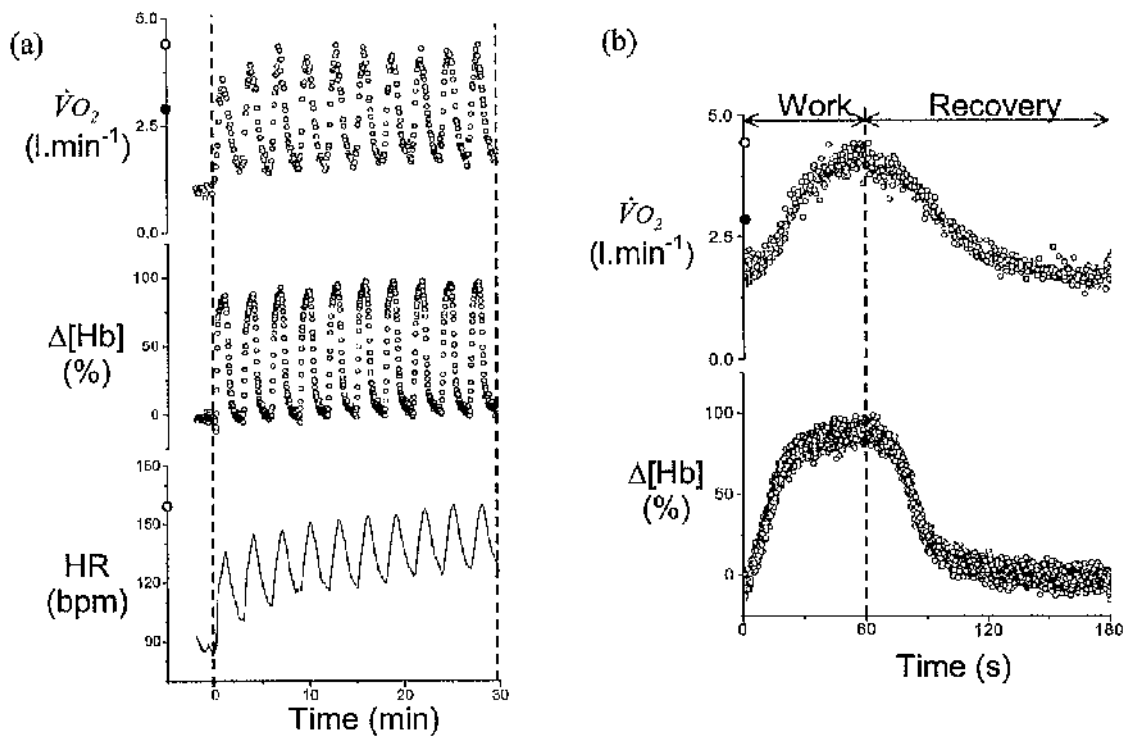

Figure 3.9 - $\dot{V}\text{O}_2$, $\Delta[\text{Hb}]$ and HR responses during the 60s work:120s recovery intermittent test in a representative subject (no.1). Panel (a) shows the response over the 30-minute duration of the test. Panel (b) shows consecutive work-recovery duty cycles overlaid, following an initial kinetic phase. On y-axes: ° = maximum value in incremental test; • = value at \hat{t}_L .

3.3.5 $\dot{V}\text{O}_2$, $\Delta[\text{Hb}]$ and HR responses during the 90s work:180s recovery test

The high physiological demands experienced by subjects in this test meant that no subjects could complete the protocol and indeed two subjects did not complete the first work-recovery duty cycle. The remainder of the subjects demonstrated similar responses to those shown in Figure 3.10(a) for the representative subject. Despite so few duty cycles for comparison, the pattern appears to be the same as in the other intermittent tests with expected oscillations in synchrony with changes in work rate. Figure 3.10(b) describes the $\dot{V}\text{O}_2$ and $\Delta[\text{Hb}]$ profiles during the second duty-cycle in the same subject. The mean amplitudes of the oscillations in $\dot{V}\text{O}_2$ (Table 3.4(b)) and $\Delta[\text{Hb}]$ (Table 3.3) were $2.63 (\pm 0.35) \text{ l}\cdot\text{min}^{-1}$ and $90.96 (\pm 25.8) \%$ respectively. Similar to the 60s:120s test, the $\dot{V}\text{O}_2$ amplitude was found to be significantly greater than in the 30s:60s test although the $\Delta[\text{Hb}]$ amplitude was only significantly greater than in the 10s:20s test.

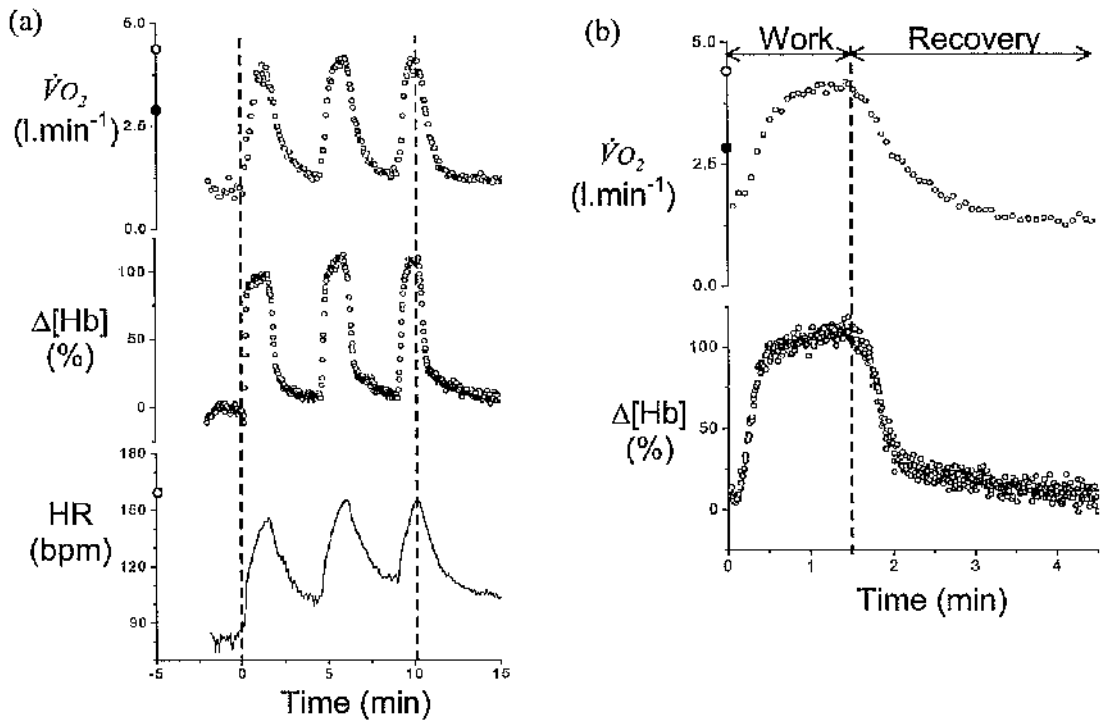

Figure 3.10 - $\dot{V}O_2$, $\Delta[Hb]$ and HR responses during the 90s work:180s recovery intermittent test in a representative subject (no.1). Panel (a) shows the response over the 10-minute duration of the test until exhaustion was reached. Panel (b) shows the second work-recovery duty cycle since the first duty cycle is part of the initial kinetic phase and no other duty cycles were completed. On y-axes: \circ = maximum value in incremental test; \bullet = value at $\hat{\theta}_L$.

3.4 DISCUSSION

This study has demonstrated the dependence of physiological responses to intermittent exercise on the work-recovery duty cycle characteristics in support of previous work (Astrand *et al.*, 1960b; Saltin *et al.*, 1976), emphasising that the effective exercise intensity is not dictated solely by the work rate applied, but also the manner of its imposition. Further insight has been gained into the temporal profiles of $\dot{V}O_2$ and intramuscular oxygenation status during intermittent cycling at high work rates. The anticipated time-aligned association between $\dot{V}O_2$ and haemoglobin desaturation in synchrony with the changes in work rate was observed repeatedly, the amplitudes of the oscillations dependent on the length of the work-recovery duty cycle. Interestingly the close association between $\dot{V}O_2$ kinetics and [La], that has been used to classify the intensity domains of constant work rate cycling (e.g. Poole *et al.*, 1988; Ozyener *et al.*, 2001) does not appear to hold true for the average $\dot{V}O_2$ response during intermittent cycling of varying work-recovery duty cycle duration. Indeed there was no emergence of any slow component effect despite continually increasing [La] in the tests of longest duty cycle duration.

3.4.1 Arterialised [lactate] response

The dependence of the lactate response on work-recovery duty cycle duration, illustrated in Figure 3.6 and Table 3.2, is in full support of previous work on intermittent exercise (for review see Saltin *et al.*, 1976), Figure 3.6 being almost identical to the lactate profile (Figure 3.1) of the single subject reported by Astrand *et al.* (1960b). The authors suggested that, at high work rates with short work and recovery periods, there are sufficient O_2 stores, predominantly bound to myoglobin in the muscle, in combination with increased $\dot{V}O_2$, for oxidative phosphorylation to meet the energy demands of the work. They suggested that with lengthening of the work-recovery duty cycle, the O_2 stores and increase in $\dot{V}O_2$ are insufficient to meet the energy demand, resulting in a shortfall in energy and so increased reliance on anaerobic glycolysis to supplement aerobic metabolism with concomitant increases in [La]. This hypothesis needs only slight modification based on improved understanding of the bioenergetics of intermittent exercise. It is likely that the emphasis placed on the role of myoglobin was too great in these early studies and that some other factor(s) may be involved. For example, Margaria *et al.* (1969) proposed that phosphocreatine (PCr) stored in the muscle might be this additional factor. According to the creatine-shuttle hypothesis (Bessman & Geiger, 1981; Mahler, 1985; Meyer, 1988), the role of PCr as an energy buffer is now well established, the importance during muscular

exercise highlighted by Hultman *et al.* (1967) and more specifically during intermittent cycling by Trump *et al.* (1996).

In the 10s:20s test, with little accumulation of blood lactate, the brevity of the exercise bouts means that O_2 stores, PCr degradation and increased $\dot{V}O_2$ are sufficient for aerobic energy production, in conjunction with some transient anaerobic glycolysis, to meet the energy demand of the work. During the recovery periods between the exercise bouts there is enough time for adequate PCr resynthesis (Harris *et al.*, 1976) and O_2 store replenishment. It is important to appreciate that the low [La] does not necessarily reflect absence of muscle lactate production, since the arterialised mixed-venous [La] will reflect the balance of muscle lactate production and clearance by other organs (e.g. Lindinger *et al.*, 1995; Brooks, 2000; Gladden, 2000). Therefore, in this test the initial transient lactate production does not translate as a sustained increase in [La], as it is presumably utilised by the active muscles and other organs during the subsequent exercise and recovery periods.

The increased duty cycle duration in the 30s:60s test has resulted in an initial rise in [La] of approximately 5mM, before a balance in production and clearance is achieved, resulting in no further increases. In the longest duty cycle tests (60s:120s and 90s:180s) a continuously rising [La] presumably reflects a large increase in glycolytic activation to meet the shortfall in aerobic and non-glycolytic energy production during the work periods, with lactate production exceeding clearance.

3.4.2 Intramuscular oxygenation

In all intermittent tests it was evident that there was a process of increasing and decreasing $\Delta[Hb]$ during each work and recovery period respectively, with the oscillations becoming constant in all tests, following an initial kinetic phase. Even during the 10s:20s tests this recurring pattern was clear (Figure 3.7(b)), despite the shortness of the work periods. There was no evidence of a delay in the desaturation process with immediate changes in $\Delta[Hb]$ as a result of the changes in work rate. Not surprisingly when the work duration was increased from 10s to 30s and also 30s to 60s there was a significant widening of the oscillations in $\Delta[Hb]$, reflecting increased time for O_2 extraction within the muscle. The finding of no further increase in amplitude when the duration was increased to 90s can be explained by appreciating that both the 60s:120s and 90s:180s tests were maximal or near-maximal. It might therefore be expected for maximal O_2 extraction to be occurring during the work periods in both tests, in line with the findings of Chance *et al.* (1992) showing no

further desaturation within the muscle at near-exhaustion when an inflatable cuff was applied to induce ischaemia. That there was no significant difference between the $\Delta[\text{Hb}]$ amplitude in the 90s:180s test and 30s:60s is surprising, but on closer inspection it is plausible that the reduced n no. for this test may have resulted in a Type II statistical error.

The adaptability of NIRS for use during intermittent cycling at high work rates has been demonstrated here and also by Christmass *et al.* (1999a & 1999b), however interpretation of the data generated must be carried out with caution. In the past, many studies (e.g. Belardinelli *et al.*, 1995b; Bhambhani *et al.*, 1999) have described the changes in oxygen extraction as a decreasing concentration of oxygenated haemoglobin ($\Delta[\text{HbO}_2]$) or the difference between $[\text{Hb}]$ and $[\text{HbO}_2]$. As mentioned previously, Ferrari *et al.* (1997) demonstrated the dependence of $[\text{HbO}_2]$ on O_2 -delivery into the field of interrogation and since this could not be measured directly, or controlled, the use of $\Delta[\text{Hb}]$ to approximate muscle O_2 extraction seems justified (Kowalchuk *et al.*, 2002; Grassi *et al.*, 2003). However, the potential for a significant proportion of the signal to be reflecting changes in myoglobin status cannot be refuted (Tran *et al.*, 1999).

It is generally agreed that the increase in O_2 extraction during exercise is a reflection of decreased muscle venous O_2 content (Cv_mO_2) since arterial O_2 content (CaO_2) does not increase and in fact has been shown to decrease in a minority of athletes with maximal exercise (e.g. Rowell *et al.*, 1964; Dempsey *et al.*, 1984; Powers & Williams, 1987; Pedersen *et al.*, 1996; Harms *et al.*, 2000). The use of NIRS to examine changes in O_2 extraction has been disputed by comparing exercise-induced changes in intramuscular oxygenation with femoral venous O_2 saturation (MacDonald *et al.*, 1999; Costes *et al.*, 1996). The authors concluded that significant differences between intramuscular and femoral venous O_2 -saturation render NIRS use during exercise unsatisfactory. Based on demonstrations of heterogeneity of muscle oxygen consumption during exercise (Quaresima *et al.*, 2001; Richardson *et al.*, 2001a – Section 6.3.3), it is perhaps unsurprising that there is a mismatch in O_2 levels between whole-leg venous effluent and one small region of interrogation within one muscle group. The interpretation of NIRS data is therefore difficult and approximations are heavily assumption-laden, yet recent studies (McCully & Hamaoka, 2000; Sako *et al.*, 2001; Van Beekvelt *et al.*, 2001) have concluded that NIRS is a valid and useful tool reflecting systemic O_2 consumption. However, using the instrumentation and protocols of the present study, where muscle blood flow would be expected to fluctuate considerably, such conclusions cannot be reached and so qualitative approximations of O_2 extraction within the muscle are presented.

When considering the components of the Fick equation for oxygen consumption at the muscle level, it is of interest to consider the profiles of $\Delta[\text{HbT}]$ during the intermittent tests. As discussed above, whilst the $\Delta[\text{HbT}]$ signal may not be accurately reflecting changes in muscle blood flow, it will provide qualitative approximations of changes in local haemoglobin volume, portraying a weighted-average of the changes in flow, perfusion and haemoconcentration. Figure 3.11 illustrates the temporal $\Delta[\text{HbT}]$ profile during the four intermittent tests and it is interesting to compare the relationship between these graphs and the respective plots for $\Delta[\text{Hb}]$.

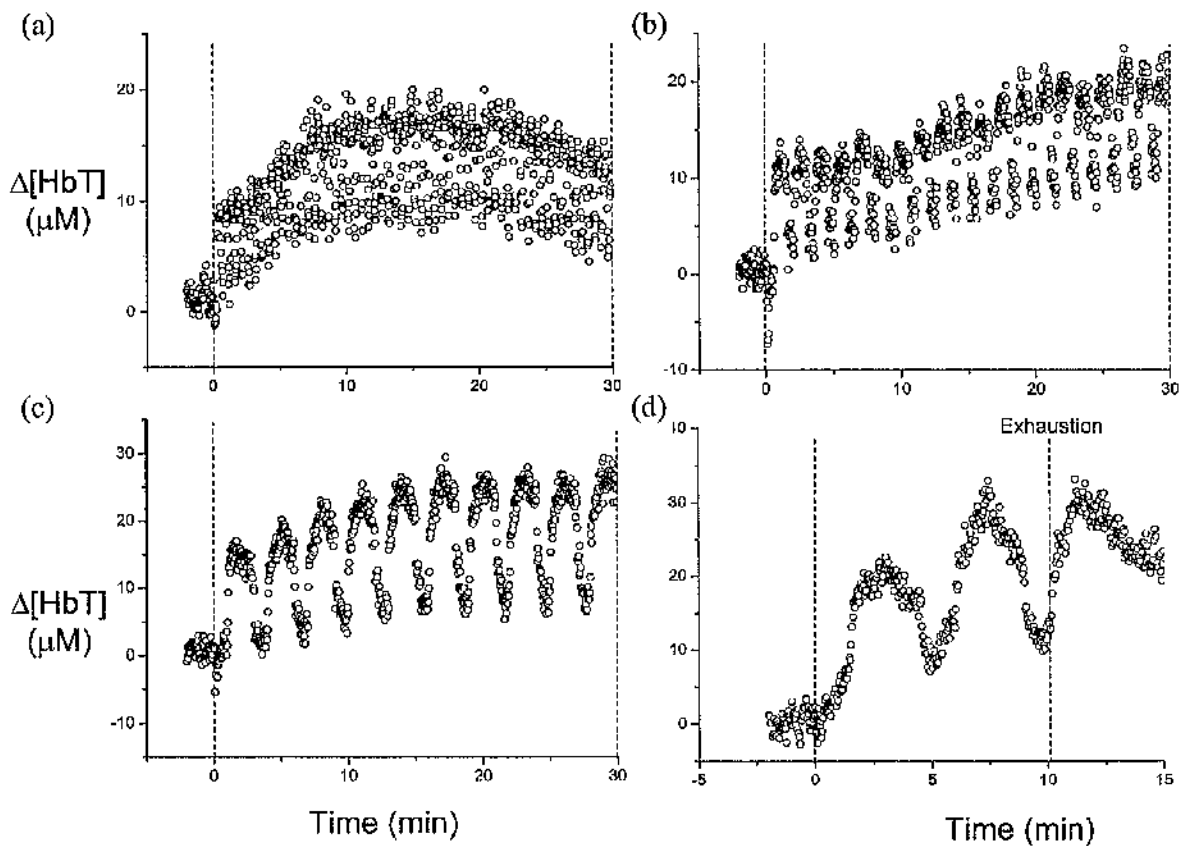

Figure 3.11 - $\Delta[\text{HbT}]$ responses during the entire test durations of the four different intermittent cycling tests in a representative subject (no.1): Panel (a) 10s work:20s recovery; Panel (b) 30s work:60s recovery; Panel (c) 60s work:120s recovery; Panel (d) 90s work:180s recovery. Vertical lines represent the start and end of all tests respectively.

From the plots it is evident that the average total haemoglobin volume is increasing throughout the tests, as might be anticipated on the assumption of increased muscle blood flow. It is important to note that the units in these tests are not absolute concentration changes and therefore the values cannot be compared between tests, the shape of the profile providing qualitative information. The data in these tests could not be normalised in the same way as $\Delta[\text{Hb}]$, since 0% and 100% changes will not be induced by performance

of an MVC. Interestingly, the whole test profiles are suggesting a consistent oscillation as the work rate is changing throughout each duty cycle, although the exact pattern is unclear in the shorter duty cycle tests. Therefore Figure 3.12 illustrates the changes in $\Delta[\text{Hb}]$ and $\Delta[\text{HbT}]$ during two consecutive duty cycles, with the changes in work rate shown.

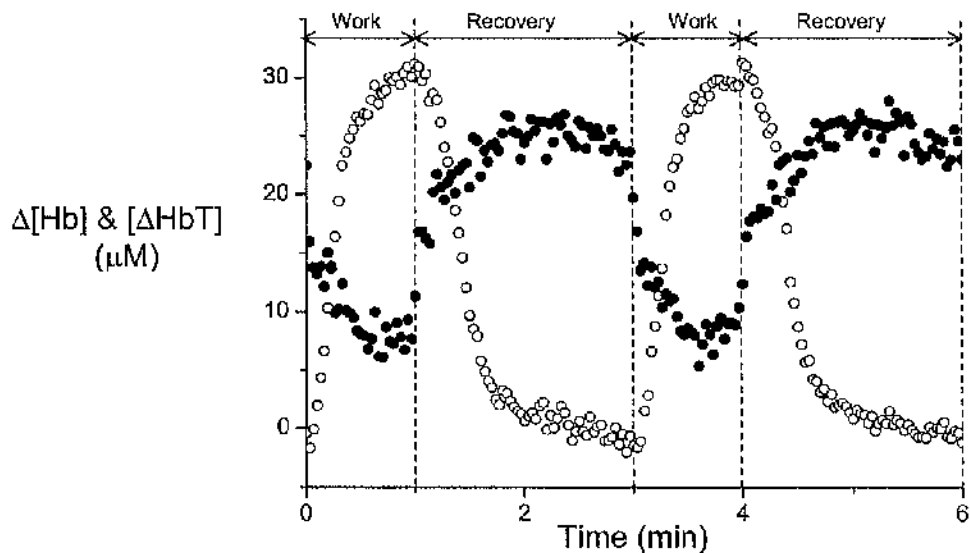

Figure 3.12 - Overlaid $\Delta[\text{Hb}]$ and $\Delta[\text{HbT}]$ responses during two consecutive duty cycles for a representative subject during the 60s:120s test. *Open and closed circles* represent $\Delta[\text{Hb}]$ and $\Delta[\text{HbT}]$ respectively. The units of μM are arbitrary since the absolute concentrations cannot be determined and the $\Delta[\text{HbT}]$ signal cannot be normalised for comparison between tests (see text for details). *Vertical hashed lines* demarcate the work and recovery periods characteristic of intermittent exercise.

Whilst this diagram is only showing a section of data from one test, the pattern was the same in all other tests (even the shortest duty cycle 10s:20s test). During the exercise periods at the high work rates there is a decrease in $\Delta[\text{HbT}]$ from a level which is elevated above the 20W baseline value as this is mid-way through the test (Figure 3.11(c)). It is reasonable to predict that this process is reflective of a constriction in blood supply and muscle perfusion during each of the exercise periods as the force generated to turn the pedals will be so great that the muscle contraction will cause a mechanical temporary local arterial constriction. Then during the recovery periods there is the anticipated reactive hyperaemia response with $\Delta[\text{HbT}]$ rising again. These data, whilst not conclusive for the reasons outlined above, are in line with the observed rising and falling $\Delta[\text{Hb}]$ profile which is assumed to reflect O_2 extraction within the muscle. This explains why there is an evident increase in $\Delta[\text{Hb}]$ even in the shortest 10s:20s test, since O_2 must still be extracted, since it is speculated that there is no increase in O_2 supply, so that in addition to PCr and O_2 store

degradation the increased muscle O_2 consumption, translated as the observed increased $\dot{V}O_2$, can meet the energy demand of the work.

3.4.3 Pulmonary O_2 -uptake during intermittent exercise

Several studies have reported oscillations in $\dot{V}O_2$ in accordance with the changes in work rate during intermittent exercise (Christensen *et al.*, 1960b; Billat *et al.*, 2000; Vuorimaa *et al.*, 2000) and sinusoidal exercise (e.g. Casaburi *et al.*, 1977). In agreement with the results presented here, Christensen *et al.* (1960b) suggested that when the work and recovery periods were kept short (< 10s) then oscillations were not discernible, although their use of Douglas bags over such short durations is prone to error. However, when the duty cycle duration was increased an oscillation was evident and Paterson (1979) predicted that, based on $\dot{V}O_2$ -heart rate relationships, the amplitude of these oscillations would increase with longer work-recovery duty cycle. In support of these findings and predictions, the present results illustrate breath-by-breath $\dot{V}O_2$ profiles during intermittent cycling at high work rates with increasing work-recovery duty cycle duration. The anticipated oscillations in synchrony with changes in work rate were evident in all tests, excluding those of shortest duty cycle duration (10s:20s), the oscillations becoming consistent following the initial few duty cycles. Furthermore, the amplitude of these oscillations was shown to be dependent on the length of duty-cycle as expected.

The lack of clear oscillation in the 10s:20s test may be explained in part by the confounding influence of breath-by-breath "noise" on the underlying system response. In an attempt to discriminate the existence of an underlying response the standard deviation of the mean $\dot{V}O_2$ during the last 3 minutes of the test was compared with the standard deviation of the steady-state $\dot{V}O_2$ response to a sub- $\hat{\theta}_L$ constant work rate cycle test performed by the same subjects. Since the amplitude of breath-by-breath noise has been shown to be independent of exercise intensity (Lamarra *et al.*, 1987; Rossiter *et al.*, 2000), the finding of a significantly larger standard deviation ($P < 0.05$) in the 10s:20s tests suggests the existence of an indiscernible additional underlying response to the 10s:20s intermittent test.

One possible explanation for the discrepancy between a clear oscillating pattern of $\Delta[Hb]$ at the muscle level and no such evidence for $\dot{V}O_2$ is the influence of the muscle-to-lung vascular transit delay, responsible in part for slight differences in pulmonary $\dot{V}O_2$ and

muscle O_2 consumption kinetics (Barstow *et al.*, 1990 – Section 1.4). During the first 10s period of exercise any increases in $\dot{V}O_2$ will be attributable to increased pulmonary blood flow, consequent to increased cardiac output (\dot{Q}_T). This cardiodynamic phase (Wasserman *et al.*, 1974) is dissociated from the rapidly increased muscle O_2 consumption since the muscle venous effluent (decreased $C_{v_m}O_2$) will not have yet reached the pulmonary circulation, as discussed in Section 1.2.1. A further complication is that the given venous O_2 content observed at the muscle will be associated with a different blood flow when it reaches the lung due to changes in \dot{Q}_T , as discussed in Section 1.4.1. Therefore, during the first 20s recovery period of the 10s:20s test, the $\dot{V}O_2$ response will reflect a balance of decreasing muscle O_2 consumption and arrival at the lung of blood having previously drained the active muscle exhibiting increased O_2 extraction. During the remainder of the 10s:20s intermittent test $\dot{V}O_2$ will be continuously reflecting the balance of these conflicting processes and so the lack of a visible oscillation is perhaps not unexpected. In the longer duty cycle duration tests the influence of these dissociating factors will be less since the work and recovery periods will exceed the duration of the muscle-to-lung transit delay, although Figure 3.8(b) shows some evidence of a Phase I response during each duty cycle.

In the 30s:60s, 60s:120s and 90s:180s tests there was an increased [La] and yet, following an initial kinetic phase, the end-exercise and end-recovery (hence average) $\dot{V}O_2$ and $\Delta[Hb]$ values remained stable (Figures 3.7 - 3.10), although the amplitude of the oscillations was lower in the 30s:60s test. Despite the stability in all intermittent tests for the average $\dot{V}O_2$ and $\Delta[Hb]$ responses, the average heart rate responses were shown to continue to increase, particularly in the longer duty cycle 60s:120s and 90s:180s tests. With constant end-exercise and end-recovery values for $\dot{V}O_2$, the gradually increasing heart rate is suggestive of a widening arterio-venous O_2 difference, according to the Fick equation for $\dot{V}O_2$, assuming little change in stroke volume. However, the $\Delta[Hb]$ responses suggest that O_2 extraction within the active muscle ($CaO_2 - C_{v_m}O_2$) is also constant, although as discussed above this is at best an approximation. If the changes in O_2 extraction are assumed to be accurately portrayed by $\Delta[Hb]$ then this would imply an average reduction in stroke volume as the test progresses, rather than increased O_2 extraction. Since the technical limitations inhibited direct determination of ($CaO_2 - C_{v_m}O_2$), stroke volume, and therefore \dot{Q}_T , the exact explanation of the $\dot{V}O_2$ response during high work rate intermittent cycling, in terms of the Fick equation components, remains elusive.

Based on the predictions of Paterson (1979) and the intensity domain relationship between $\dot{V}O_2$ and [La] for constant work rate cycling (e.g. Poole *et al.*, 1988; Ozyener *et al.*, 2001), it was anticipated that there would be some sort of slow component effect in the longer duty cycle duration tests. In the 60s:120s and 90s:180s tests it could be argued that the end-exercise values were limited by the attainment of $\mu\dot{V}O_2$ preventing any upward drift in end-exercise values. Nonetheless, this was not the case for the 30s:60s test and, more importantly, the slow component effect could have been evident during the recovery periods for all tests, yet this was not the case.

Although predictions for the current study were made based on the [La] response, it is of interest to consider how $\dot{V}O_2$ may change in response to such intermittent work patterns if $\dot{V}O_2$ responded as a quasi-first order exponential process. This was achieved by repeatedly applying a theoretical exponential model to the four intermittent protocols investigated here. The modelled outputs are presented in Figure 3.13 and interestingly the patterns of response are remarkably similar to the actual responses observed in the present study.

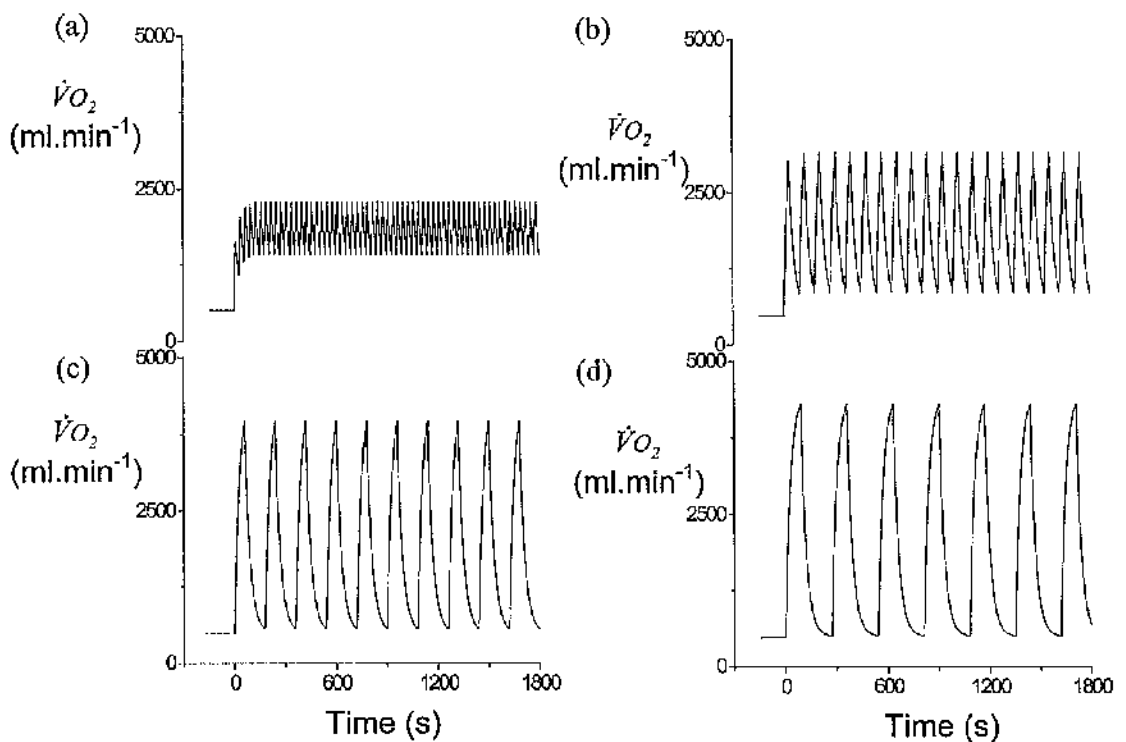

Figure 3.13 - Modelled responses to the four intermittent tests of varying duty cycle duration assuming a quasi-first-order system with τ of 30 s and no delay. The work rate was oscillated between 20 W and 420 W assuming an O_2 demand of $500 \text{ ml}\cdot\text{min}^{-1}$ at 20 W and $4500 \text{ ml}\cdot\text{min}^{-1}$ at 420 W, i.e. steady state Gain of $10 \text{ ml } O_2\cdot\text{min}^{-1}\cdot\text{W}^{-1}$. These values were based on the work rates used for subject no.1. Panel (a) shows the predicted response in the 10s work:20s recovery test, (b) the 30s:60s test, (c) the 60s:120s test and (d) the 90s:180s test.

Following the initial several cycles the oscillations become consistent, the amplitudes dependent on the work-recovery duty cycle duration. If it is assumed that the end-exercise values in the 60s:120s modelled response are equivalent to $\mu\dot{V}O_2$, as in the current study, then the failure to complete the 90s:180s test can be explained simply in terms of the $\dot{V}O_2$ kinetics. This ability to continue exercising at values close to $\mu\dot{V}O_2$ during intermittent exercise has been reported by Billat *et al.* (2000) during running and the authors proposed that this would be advantageous during training.

It is accepted that the model used here is highly questionable since there is no inclusion of a delay term or consideration of a slow component, although during such short periods it is uncertain whether or not a slow component would be manifest. Whilst there is little conclusive evidence presented to support the notion of $\dot{V}O_2$ exhibiting a first-order exponential response during intermittent exercise, it is of interest that the modelled and actual responses reported are so similar and therefore perhaps the $\dot{V}O_2$ -[La] association for constant work rate cycling is not applicable for intermittent exercise.

3.4.4 Conclusion

The dependence of $\dot{V}O_2$, $\Delta[\text{Hb}]$ and [La] on the work-recovery duty cycle characteristics during intermittent cycling at high work rates has been demonstrated, despite performance of the same amount of total work. The temporal association of the $\dot{V}O_2$ and $\Delta[\text{Hb}]$ oscillations in synchrony with the changes in work rate was repeatedly demonstrated, the amplitude of these oscillations related to the duration of the work-recovery duty cycle. The conventional assignment of $\dot{V}O_2$ response according to the exercise intensity domain, dictated by the [La] profile, needs re-assessment for intermittent cycling, based on the lack of a slow component effect for average $\dot{V}O_2$ in intermittent tests of longer duty cycle duration, despite increased [La].

Chapter 4 Prior heavy cycling and the Critical Power- $\dot{V}O_2$ relationship

4.1 INTRODUCTION

Plasticity of the $\dot{V}O_2$ response to exercise is an issue that is important when attempting to reveal the underlying control mechanisms. The potential for a priming bout of heavy exercise to modulate $\dot{V}O_2$ kinetics has been addressed on many occasions, as outlined in Section 1.5.2. Several mechanisms have been hypothesised that could result in an alteration of the $\dot{V}O_2$ response during subsequent periods of exercise, including:

1. A reactive hyperaemia, subsequent to the residual acidosis incurred, and a right-shift of the HbO₂ dissociation curve, improving muscle O₂ delivery and overcoming any existing O₂ delivery limitations, should they exist, resulting in an acceleration of the response (e.g. Gausche *et al.*, 1989; Gerbino *et al.*, 1996; Macdonald *et al.*, 1997; Tordi *et al.*, 2003).
2. The rate of increase of oxidative metabolism at exercise onset being accelerated, such that any inertial limitations be overcome, should they exist, resulting in an acceleration of the fundamental component (e.g. Rossiter *et al.*, 2001; Campbell-O'Sullivan *et al.*, 2002).
3. The local muscle fatigue, caused by the priming bout of heavy exercise, resulting in an increased recruitment of motor units to support the same amount of work, manifest as an increase in amplitude of the fundamental component and decrease in $\Delta\dot{V}O_{2(SC)}$ (e.g. Burnley *et al.*, 2001 & 2002a; Bearden & Moffatt, 2001a).

As detailed in Section 1.5.1, it is generally agreed that a priming bout of exercise, whether heavy or moderate, does not alter $\dot{V}O_2$ kinetics in the response to upright cycling of moderate intensity in young healthy adults (Gerbino *et al.*, 1996; Burnley *et al.*, 2000; Bearden & Moffatt, 2001a; Scheuermann *et al.*, 2002). This is in contrast to theories of Campbell-O'Sullivan *et al.* (2002), who hypothesised that increased acetyl-group availability resulted in an acceleration of the $\dot{V}O_2$ kinetics following previous moderate exercise, although the poor data modelling applied in this study has been previously addressed.

In contrast to this general consensus regarding a lack of modulation of the $\dot{V}O_2$ response to moderate exercise, several research groups have presented evidence that a priming bout of heavy exercise effects change in the $\dot{V}O_2$ response to subsequent supra- θ_L exercise. Earlier

investigations demonstrated an accelerated overall $\dot{V}O_2$ response (Gausche *et al.*, 1989; Gerbino *et al.*, 1996; Macdonald *et al.*, 1997; Bohnert *et al.*, 1998), although the problems associated with using a MRT for supra- θ_L are addressed in detail later (Section 6.1.2). Recent studies, using more repetitions to permit adequate characterisation of the $\dot{V}O_2$ kinetics, suggest that the speed of the fundamental component is unaltered, in favour of theories supporting a role for an O_2 utilisation, rather than O_2 delivery, limitation governing \dot{Q}_{mO_2} kinetics (Burnley *et al.*, 2000, 2001 & 2002a; Koppo & Bouckaert, 2000 & 2001; Scheuermann *et al.*, 2001; Patel *et al.*, 2001; Fukuba *et al.*, 2002). However, one recent study reported that prior sprinting exercise resulted in an acceleration of the fundamental component during subsequent heavy cycling (Tordi *et al.*, 2003), in direct contrast to Burnley *et al.* (2002b) and the other studies cited above.

Furthermore, using an entirely different exercise model, Rossiter *et al.* (2001) showed accelerated fundamental $\dot{V}O_2$ kinetics following prior heavy exercise. This study had the additional design feature of simultaneously monitoring intramuscular changes in [PCr], using 31-phosphorous magnetic resonance spectroscopy ($^{31}\text{P-NMR}$). As discussed in Section 1.4.5, the kinetics of [PCr] have been argued to reflect those of \dot{Q}_{mO_2} , as supported by the close temporal relationship between changes in $\dot{V}O_2$ and [PCr] for moderate (Rossiter *et al.*, 1999), and heavy exercise (Rossiter *et al.*, 2002a & 2002b). That the accelerated $\dot{V}O_2$ kinetics of the fundamental, following prior heavy exercise, were not accompanied by changes in [PCr] kinetics was suggestive of non-linearity of the response (Rossiter *et al.*, 2001).

The initial study by Burnley *et al.* (2000) reported that the fundamental amplitude was similar, with and without a heavy priming bout, when the elevated baseline was accounted for. Further studies have since included a longer recovery period between exercise bouts, so that the baseline $\dot{V}O_2$ returned to previous levels, and observed that there was in fact an increased amplitude of the fundamental component (Burnley *et al.*, 2001 & 2002a; Patel *et al.*, 2001; Bearden & Moffatt, 2001a). It was proposed that, with shorter recovery periods, this effect might be masked by the elevated baseline.

One effect of a priming bout of heavy exercise, reported in almost all of the above studies, is a reduction in the amplitude of the $\dot{V}O_{2(SC)}$. The mechanisms responsible for this decrease are unclear, which is perhaps unsurprising since the mechanisms underlying the slow component remain elusive (Section 1.5.3). The findings of a lessened reduction in

slow component amplitude when the priming exercise bout was performed by a different muscle group (Bohnert *et al.*, 1998; Fukuba *et al.*, 2002; Koppo *et al.*, 2003), provides evidence in support of the mechanisms being predominantly localised in the exercising musculature.

Only one study, to date, has investigated whether this reduction in $\dot{V}O_{2(SC)}$ is functionally related to improved performance, provided by the tolerable duration of exercise at an intensity described as “equivalent to 95% $\mu\dot{V}O_2$ ” (Koppo & Bouckaert, 2002). Despite a significant reduction in the size of the $\dot{V}O_{2(SC)}$, and end-exercise $\dot{V}O_2$, the time to exhaustion was not significantly improved. Since only a single performance of the protocols was used for analysis of the $\dot{V}O_{2(SC)}$, no formal modelling of the kinetics was carried out. Rather, end-exercise values were compared with the value at 2 minutes, an approach which is subject to error (e.g. Bearden & Moffatt, 2001b). Furthermore, determination of the slow component for a single repetition has been shown to be unreliable due to test-to-test variability (Ozyener *et al.*, 2001).

One major limitation in all of the studies discussed, preventing direct comparison of results, is that the exercise intensity, both in the priming and testing periods, was not adequately defined. As discussed previously in considerable detail (Sections 1.1.1 and 2.2.2), describing exercise intensity in relation to $\mu\dot{V}O_2$ and θ_L is insufficient. The existence of the critical power somewhere between these two boundaries means that any given work rate may be either above or below CP, and hence be either unsustainable or sustainable respectively (Monod & Scherrer, 1965; Moritani *et al.*, 1981; Poole *et al.*, 1988; Hill, 1993). This difference in tolerable duration is also evidenced in the kinetic profile of the $\dot{V}O_2$ response, with the $\dot{V}O_{2(SC)}$ attaining steady state below CP, but continuing to rise to $\mu\dot{V}O_2$ and exhaustion above CP (Figure 1.7; Poole *et al.*, 1988). Interestingly, there has been a similar response observed for arterial [lactate] and pH, in terms of steady state being attainable for work rates below CP (Roston *et al.*, 1987; Poole *et al.*, 1990; Smith & Jones, 2001). Therefore, the effects of a priming bout of exercise may depend on the intensity of that exercise relative to CP.

This study provided the opportunity to further investigate the results of Koppo & Bouckaert (2002), but in direct relation to CP. In addition, the novel questions of interest are whether or not a priming bout of very heavy cycling (i.e. inducing a significant metabolic acidosis): (a) alters the $\dot{V}O_2$ kinetics in response to a subsequent bout of heavy

cycling that is above θ_L and only just below CP; and furthermore (b) whether this adversely affects the tolerable duration of the exercise and, by implication, the characteristics of the power-duration relationship.

4.2 METHODS

In addition to the overall Methods chapter (Chapter 2), the following section details the exact protocol used, and describes modelling techniques that were exclusive to this study.

4.2.1 Subjects and Procedures

Six recreationally active non-smoking adult males (Table 4.1) volunteered to take part in the study, having provided written informed consent approved by the Local Ethics Committee (University of Glasgow – Appendix).

Subject	Age (years)	Height (cm)	Weight (kg)	$\mu\dot{V}O_2$ ($l\cdot\text{min}^{-1}$)	$\mu\dot{V}O_2$ ($\text{ml}\cdot\text{kg}^{-1}\cdot\text{min}^{-1}$)	$\hat{\theta}_L$ ($l\cdot\text{min}^{-1}$)	$\dot{V}O_2$ at $\hat{\theta}_L$ ($\text{ml}\cdot\text{kg}^{-1}\cdot\text{min}^{-1}$)	$\hat{\theta}_L$ ($\%\mu\dot{V}O_2$)
1	21	178	84	4.84	58.0	2.33	27.7	48
2	21	188	95	5.07	53.7	2.59	27.3	51
3	24	186	83	4.25	51.2	2.29	27.6	54
4	21	181	92	4.10	44.6	1.55	16.8	38
5	22	166	73	3.25	44.5	1.28	17.5	39
6	25	177	74	3.88	52.4	1.77	23.9	46
Mean	22.3	179	84	4.23	50.7	1.97	23.5	46
\pm S.D.	1.8	8	9	0.66	5.3	0.51	5.1	6

Table 4.1 – Subject characteristics. Peak $\dot{V}O_2$ ($\mu\dot{V}O_2$) and the estimated lactate threshold ($\hat{\theta}_L$) determined from a maximal incremental test (see text for details).

All exercise testing was performed on the cycle ergometer described previously (Section 2.3.1), with tests separated by a minimum period of 48 hours. Breath-by-breath gas exchange and beat-by-beat heart rate were monitored continuously during all tests, as detailed in Sections 2.3.5 and 2.3.2. Following familiarisation, subjects performed an incremental ramp test, as detailed in Section 2.2.1, to the limit of tolerance (t_{lim}) for determination of $\mu\dot{V}O_2$ and non-invasive estimation of the lactate threshold ($\hat{\theta}_L$). $\mu\dot{V}O_2$ and the maximal heart rate obtained (HR_{max}) were established as mean values during the last 20 s of the test. On subsequent visits, on different days, subjects performed 4–7 supra- θ_L constant work rate tests to the limit of tolerance (duration = t_{lim}) for estimation of Critical Power (CP), as described in Section 2.2.2.

CP was estimated using linear regression techniques applied to the power- t_{lim}^{-1} profiles for each subject (Poole *et al.*, 1988). This model is based on the assumption that the power-duration relationship is truly hyperbolic, which implies that the factor(s) causing exhaustion are changing as either “exponential or linear monotonic functions of time” toward a threshold level for supra-CP work rates (e.g. Poole *et al.*, 1988; Gaesser & Poole,

1996). In addition, using the same profiles, the work rate that would be expected to elicit exhaustion at eight minutes (8minWR) was estimated by interpolation. This work rate was selected on the assumption that six minutes of cycling at 8minWR would induce a significant metabolic acidosis (Poole *et al.*, 1988), but that all subjects would be able to complete the required six minutes. An additional work rate was calculated according to the following equation:

$$95\% \Delta_1 = \hat{\theta}_L + 0.95(\text{CP} - \hat{\theta}_L) \quad (\text{Equation 4.1})$$

thus normalising the intensity of exercise according to both $\hat{\theta}_L$ and CP. This intensity was selected on the basis that it was only slightly lower than CP, and hence even any small effect of priming exercise, detailed subsequently, would be evident.

On a further six separate occasions, subjects underwent three different protocols in a random order (i.e. each being repeated). Each of these tests was repeated to enable adequate characterisation of the kinetic features of the $\dot{V}O_2$ response (Section 2.3.5.5). Figure 4.2 summarises the three protocols and illustrates the time-points at which capillary blood was sampled for subsequent lactate analysis (Section 2.3.4).

1. The “priming-bout alone” test required subjects to perform 6 minutes of constant work rate cycling at the 8minWR from a baseline of 20W, followed by 8 minutes of recovery pedalling at 20W. A recovery period of 8 minutes was used so that the $\dot{V}O_2$ kinetics of the recovery transition, including any slow component, could be modelled (Ozyener *et al.*, 2001).
2. The “without priming-bout” test involved 15 minutes of cycling at 95% Δ_1 from a baseline of 20W.
3. The “with priming-bout” test was a combination of tests 1 and 2, with subjects performing 6 minutes of cycling at the 8minWR, followed by a 2-minute recovery period at 20W, before undertaking the 15-minute bout at 95% Δ_1 . Subjects were instructed to continue cycling in this phase of the test until either the end of the test (15-minutes at 95% Δ_1) or to t_{lim} . The recovery duration of 120s was chosen to permit only a partial recovery of $\dot{V}O_2$, heart rate and blood [lactate] towards baseline, prior to the second bout of exercise (Gerbino *et al.*, 1996).

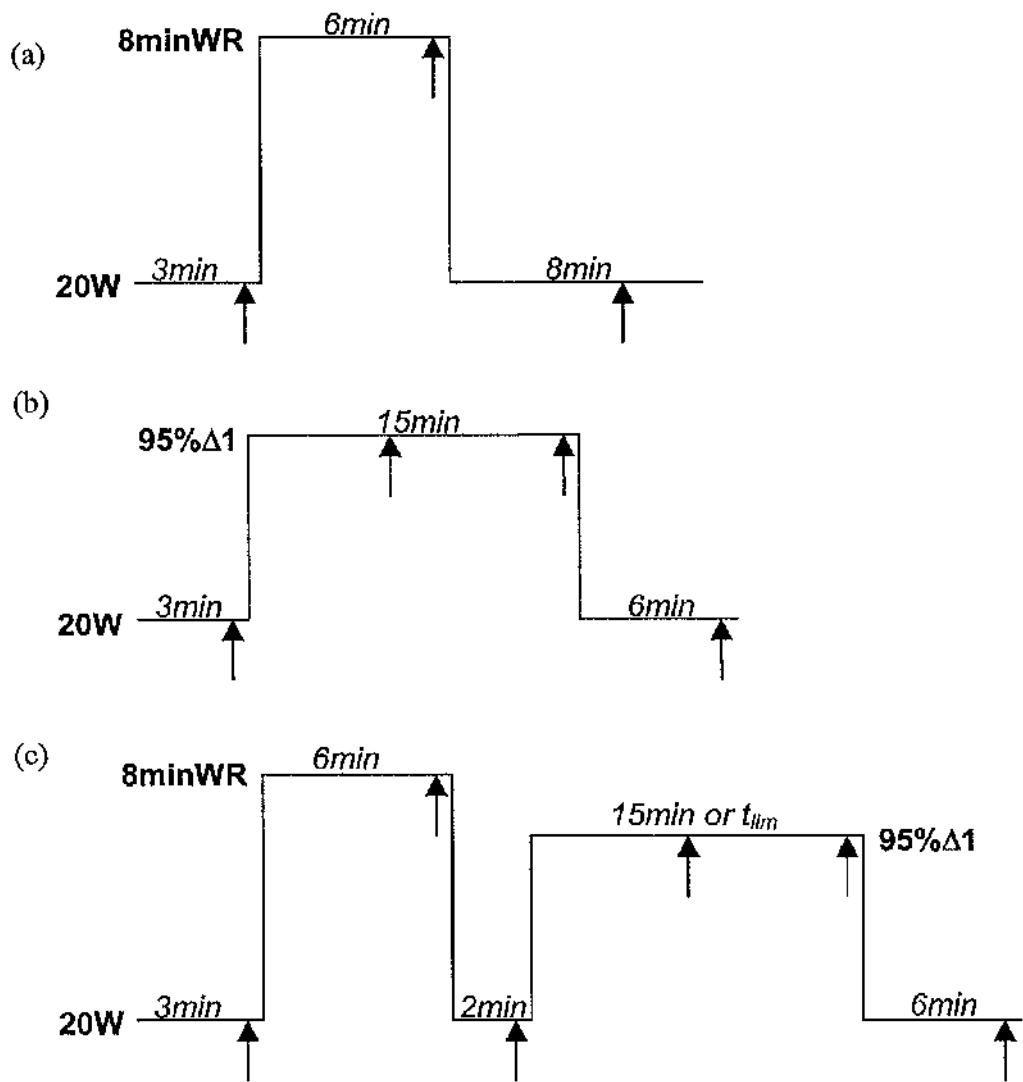

Figure 4.1 - Schematic of cycling protocols for the (a) priming bout alone test, (b) without priming bout test, and (c) with priming bout test. Work rates are shown in bold as 20 Watts (20W) and pre-determined relative intensities of 8minWR and 95% Δ_1 (see text for details). Durations of the relevant stages are given in italics and t_{lim} is the time until exhaustion, if it occurred before completion of that stage. Arrows represent time-points when capillary blood samples were taken during the last 15s of each stage, except during the recovery of test (a) and during the periods at 95% Δ_1 in tests (b) and (c) when blood was sampled after 6 minutes at that stage.

4.2.2 Data Analysis

All breath-by-breath $\dot{V}O_2$ data were edited and interpolated so that “like” transitions could be superimposed and averaged, thus improving the signal-to-noise ratio (detailed in Section 2.3.5.4 - Lamarra *et al.*, 1987). The two pairs of tests performed at 95% Δ_1 (with and without the priming bout) were averaged into 10s bins and modelled using nonlinear least-squares regression, to examine the impact on $\dot{V}O_2$ kinetics, of the priming bout of cycling at the 8minWR.

As discussed previously, it was decided that the most appropriate modelling approach would be to characterise the $\dot{V}O_2$ slow component ($\dot{V}O_{2(SC)}$), characteristic of supra- θ_L exercise, simply as an amplitude at a given time point, rather than using linear or exponential models (Paterson & Whipp, 1991; Barstow & Molé, 1991; Barstow *et al.*, 1996), for which there is little physiological justification (Whipp, 1994b; Bearden & Moffatt, 2001b; Whipp *et al.*, 2002b). The fundamental (Phase II) component of the $\dot{V}O_2$ response was isolated by excluding the initial 20s of data following the change in work rate (Section 2.3.5.5 - Whipp *et al.*, 1982) and fitting a monoexponential (Equation 2.9) from 20s up to the onset of the slow component (e.g. Paterson & Whipp, 1991; Rossiter *et al.*, 2001). The onset of the $\dot{V}O_{2(SC)}$ has been shown to vary not only for different work rates (e.g. Paterson & Whipp, 1991; Barstow, 1994; Bearden & Moffatt, 2000), but also between tests at the same work rate (Ozyener *et al.*, 2001), indicating that an arbitrary duration cannot be used. A logical approach is to vary the window of data to which the model is applied until the optimum fit is obtained for the fundamental component (Rossiter *et al.*, 2001), as discussed subsequently.

However, the typical goodness-of-fit approach used for comparing different models (Lamarra *et al.*, 1987), is dependent on the number of data points used, so by varying the window of data to which the model is applied this approach is invalid. Therefore, it was decided to fit the exponential response initially from 20 s to 90 s following the change in work rate and then repeatedly expanding this window by one datum (10 s) up to approximately 180 s. The onset of the $\dot{V}O_{2(SC)}$ was subsequently identified using two approaches (Rossiter *et al.*, 2001):

1. By visual inspection of the residual profile for a sustained and consistent deviation from the zero-line (Figure 4.2(a)).
2. By plotting the χ^2 values (sum squared error) obtained for each fit against the end time-point for the time range used and looking for a local threshold (Figure 4.2(b)), which would similarly identify a consistent deviation from the exponential fit.

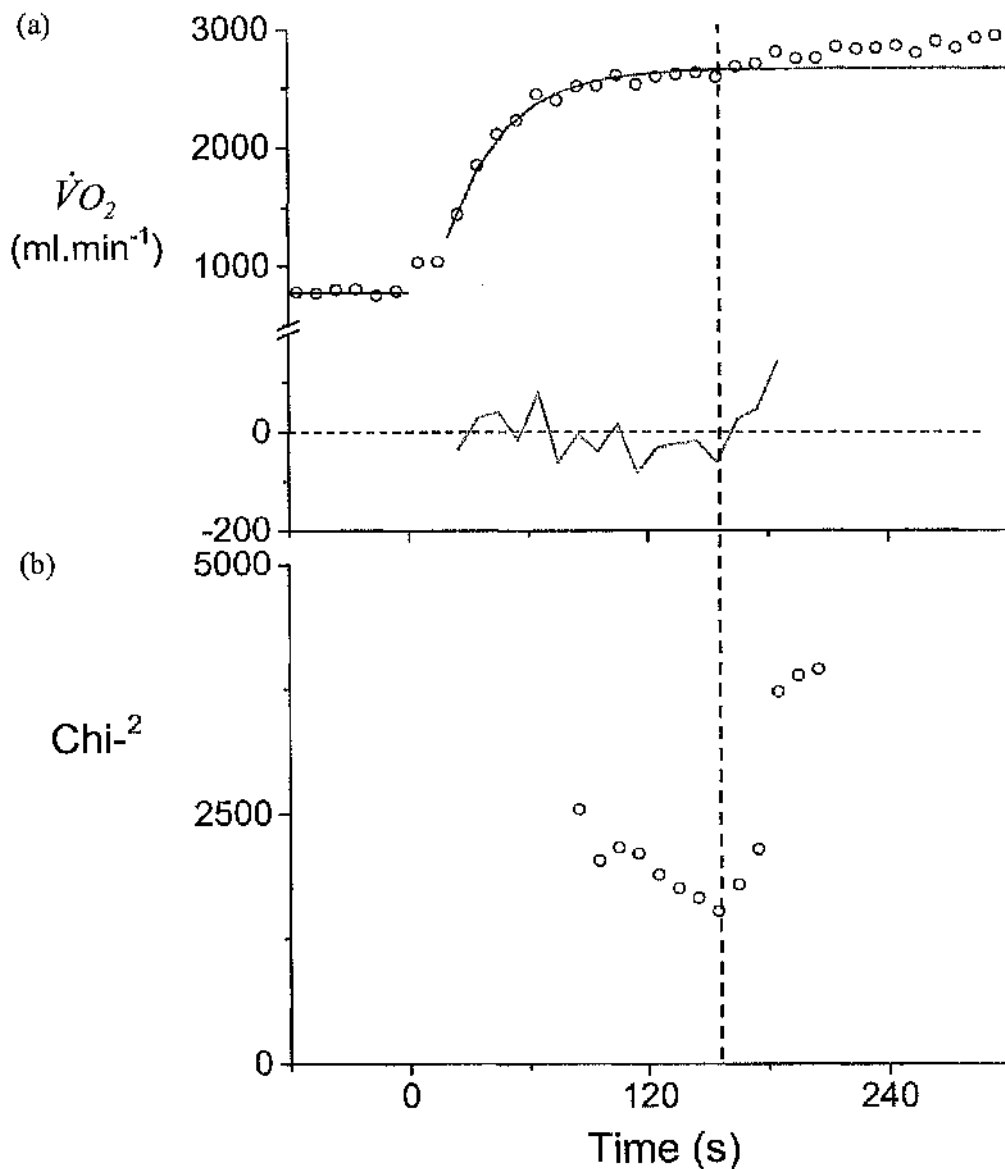

Figure 4.2 – Identification of the onset of the $\dot{V}O_2$ slow component. Panel (a) shows the averaged data from a typical test including the exponential fit, with the residuals shown. The onset of the $\dot{V}O_{2(SC)}$ is marked by the dashed vertical line as the point after which there is a consistent deviation in the residuals. Panel (b) shows the local threshold of Chi⁻² values signifying the onset of the $\dot{V}O_{2(SC)}$ (see text for details).

The monoexponential was then applied to a window of data extending from 20 s to the last point before the onset of the $\dot{V}O_{2(SC)}$. The slow component was quantified as an amplitude ($\Delta\dot{V}O_{2(SC)}$), calculated as the difference between $\dot{V}O_2$ at the end of the exercise period ($\dot{V}O_{2\text{END-EX}}$) and $\dot{V}O_2$ at the onset of the slow component. These values were estimated, respectively, as the mean measured $\dot{V}O_2$ over the final 30 s of exercise and the value estimated from the exponential model at that time-point.

The elevated $\dot{V}O_2$ and HR at the end of the 2-minute 20W-recovery phase, consequent to the priming bout of exercise at 8minWR, needed to be considered for subsequent analysis. Since $\dot{V}O_2$ and HR were observed to be continuing to decrease at this stage (e.g. Figures 4.5 and 4.6), the mean values during the final 20 s of the 20W recovery period were taken as the baseline, in contrast to the mean of 60 s used in the "without priming-bout" test at 95% Δ_1 . In addition, to examine the effect of the priming bout on absolute $\dot{V}O_2$ at exercise onset, the absolute $\dot{V}O_2$ at the onset of the slow component and the projected asymptote of the fundamental component were estimated using the exponential model.

For subjects who were unable to complete the bout at 95% Δ_1 following the priming bout, the duration until the limit of tolerance (t_{lim}) was recorded. For direct comparison of results in the tests performed with and without the priming bout, the $\dot{V}O_2$ and HR values at this same time-point (iso- t_{lim}) were calculated for the tests without a priming bout, in subjects unable to complete the "with priming-bout" protocol. End-exercise heart rate values (HR_{END-EX}) were also recorded for all tests.

4.2.3 Statistical Analysis

In order to examine whether there was a significant effect of the priming bout on tolerable duration and the HR, $\dot{V}O_2$ and [La] responses to constant load cycling at 95% Δ_1 , values from both protocols were compared using Student's paired t-tests.

4.3 RESULTS

4.3.1 Critical Power estimation

The power-duration hyperbolic and power- t_{lim}^{-1} data for all individuals were well characterised by their respective models, as shown in Figure 4.3 and Table 4.2.

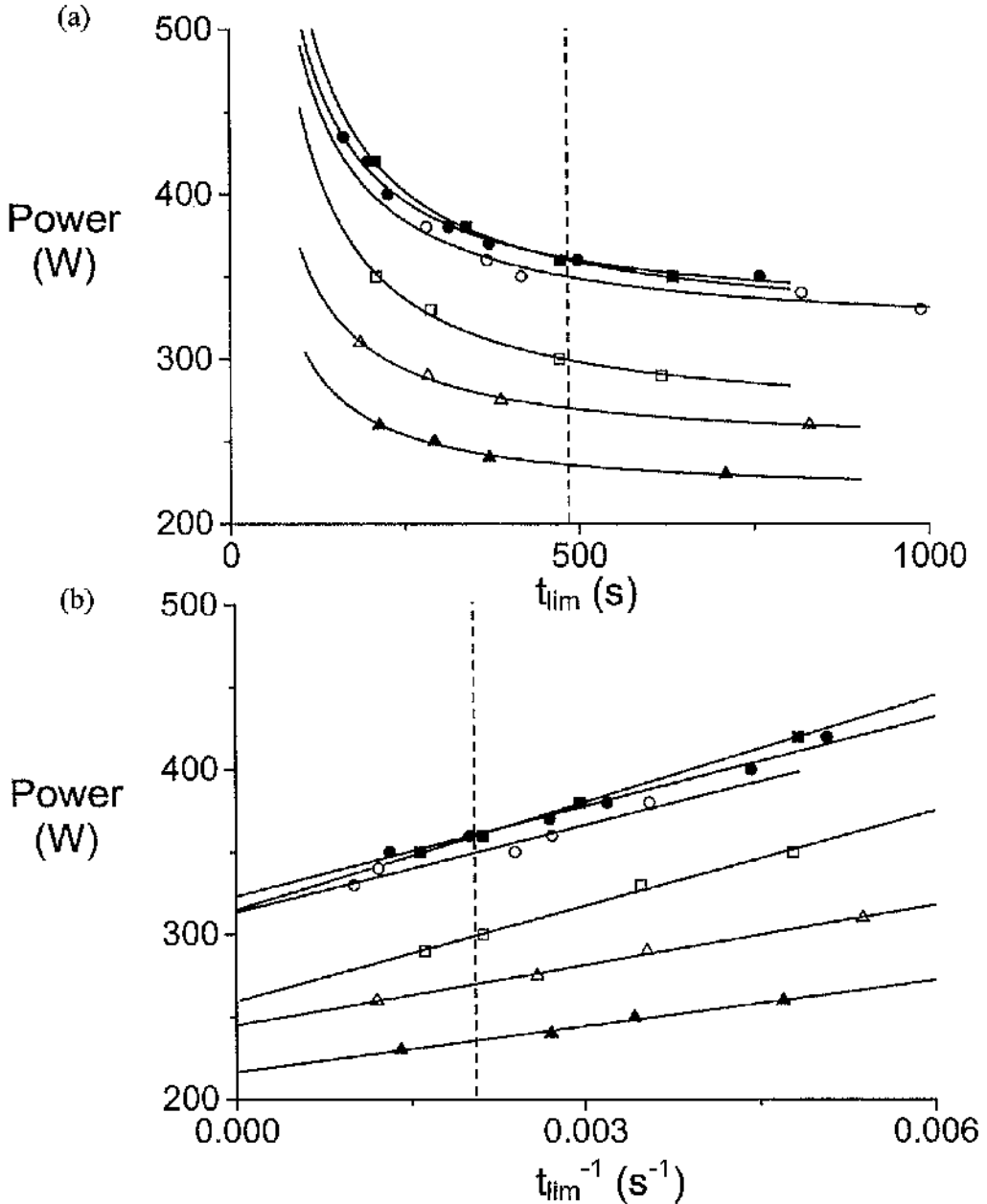

Figure 4.3 – Critical Power estimation for each subject (*different symbols*) using the (a) asymptote of the hyperbolic power- t_{lim} relationship, and (b) intercept of the linear power- t_{lim}^{-1} relationship. Individual points represent tests performed to exhaustion at different work rates. The *dashed vertical line* shows the use of interpolation to estimate 8minWR (see text for details).

Work rates corresponding to Critical Power, 8minWR and 95% Δ_1 averaged 279 (\pm 44) W, 313 (\pm 52) W and 271 (\pm 44) W respectively, as shown in Table 4.2. In all cases the standard deviation of the estimated value for CP fell within \pm 3W.

Subject	Critical Power (W)	WR _{MAX} (W)	WR _{0L} (W)	W' (kJ)	8minWR (W)	95% Δ_1 (W)	R	P
1	323	401	158	18.2	361	315	0.996	<0.01
2	315	401	173	21.7	361	308	0.999	<0.01
3	313	410	179	17.6	349	306	0.974	<0.01
4	260	341	89	19.3	300	251	0.997	<0.01
5	216	275	71	9.4	237	209	0.994	<0.01
6	245	329	110	12.2	270	238	0.998	<0.01
Mean	279	359	130	16.4	313	271		
\pm S.D.	44	54	46	4.6	52	44		

Table 4.2 – Individual and group values for critical power, peak work rate during an incremental test (WR_{MAX}), work rate at 0_L (WR_{0L}), the curvature constant of the power-duration hyperbola (W'), 8minWR and 95% Δ_1 . Goodness-of-fit for the linear Power- t_{lim}^{-1} fits is provided by the correlation coefficient (R) and P-value.

4.3.2 Tests at 95% Δ_1 without a priming bout

In support of the determined values for CP, all subjects were comfortably able to complete the entire 15-minute target duration of this test, despite high end-exercise values averaging 84 (\pm 5) % of $\mu \dot{V}O_2$, 96 (\pm 2) % of HR_{max} and blood lactate concentration of 7.3 (\pm 1.4) mM (Tables 4.3 and 4.4).

Subject	Duration (s)	[La] _{20W} (mM)	[La] _{END-EX} (mM)	Δ [La] (mM)	HR _{END-EX} (beats.min ⁻¹)	HR _{END-EX} (%HR _{max})
1	900	0.6	6.8	6.2	187	97
2	900	0.9	6.8	5.9	181	97
3	900	0.5	6.0	5.5	177	94
4	900	0.6	6.2	5.6	170	98
5	900	0.9	8.8	7.9	177	95
6	900	0.9	9.2	8.3	183	95
Mean	900	0.7	7.3	6.6	179	96
\pm S.D.	0	0.2	1.4	1.2	6	2

Table 4.3 – Arterialised mixed-venous blood lactate concentration ([La]) and heart rate (HR) responses to the test performed at 95% Δ_1 without a preceding priming bout. The change in lactate concentration (Δ [La]) is the difference between baseline of 20 W ([La]_{20W}) and end-exercise ([La]_{END-EX}) values.

Subject	$\dot{V}O_{2\ 20W}$ (ml.min ⁻¹)	τ (s)	δ (s)	$\Delta\dot{V}O_{2\ (Phase\ II)}$ (ml.min ⁻¹)	$\Delta\dot{V}O_{2}/\Delta WR$ (ml O ₂ .min ⁻¹ .W ⁻¹)	$\Delta\dot{V}O_{2\ (SC)}$ (ml.min ⁻¹)	$\dot{V}O_{2\ END-EX}$ (ml.min ⁻¹)	$\dot{V}O_{2\ END-EX}$ (% $\mu\dot{V}O_{2}$)
1	789	27.9	5.2	2754	9.34	573	4103	85
2	947	23.4	6.8	2659	9.23	602	4194	83
3	697	22.3	16.1	2537	8.87	468	3651	86
4	835	19.4	16.8	2012	8.71	485	3328	81
5	778	31.8	6.7	1693	8.96	538	2997	92
6	776	24.7	13.7	1832	8.4	351	2940	76
Mean	804	24.9	10.9	2248	8.92	503	3536	84
\pm S.D.	83	4.4	5.2	457	0.34	90	540	5

Table 4.4 - $\dot{V}O_2$ kinetics for the response to cycling at 95% Δ_1 from a baseline of 20W ($\dot{V}O_{2\ 20W}$) without a preceding priming bout. τ , δ and $\Delta\dot{V}O_{2\ (Phase\ II)}$ refer to the fundamental component, modelled using an exponential function (Equation 2.9), the Gain calculated as $\Delta\dot{V}O_{2\ (Phase\ II)}$ divided by the change in work rate (ΔWR). $\Delta\dot{V}O_{2\ (SC)}$ is the amplitude of the slow component, calculated using the end-exercise ($\dot{V}O_{2\ END-EX}$) values.

As anticipated for exercise in this exercise intensity domain, all subjects demonstrated a considerable slow component for $\dot{V}O_2$, as shown in Figure 4.4 for a representative subject.

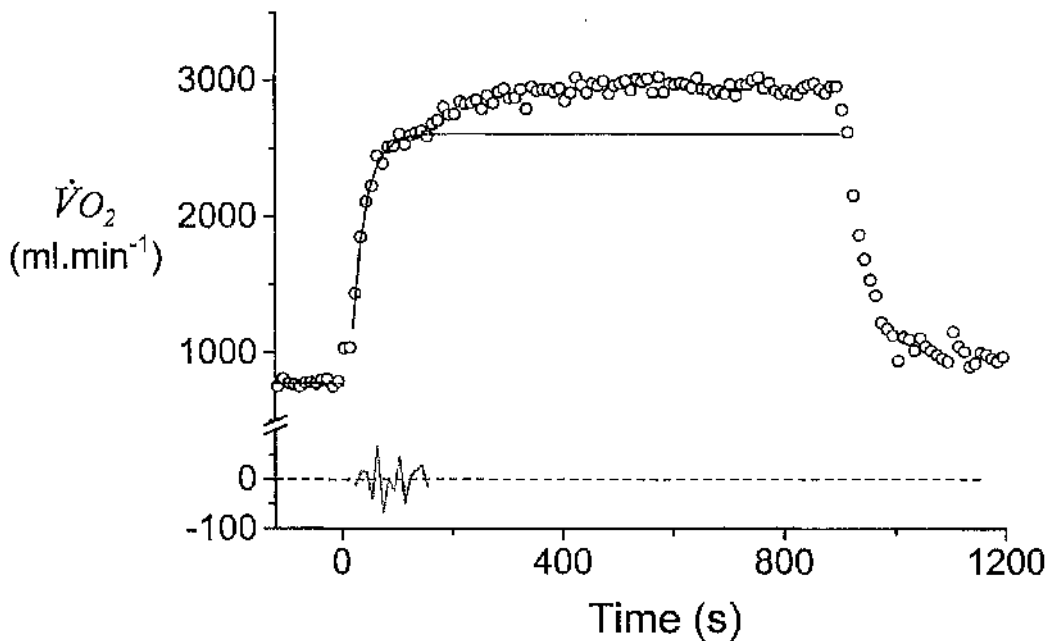

Figure 4.4 – Oxygen uptake ($\dot{V}O_2$) response to cycling at a work rate slightly below Critical Power (95% Δ_1), which begins at $t=0s$ from a baseline of 20W. The data is the average of two identical transitions divided into 10s bins (see text for details). The *dark solid line* is the exponential model applied to the fundamental component, the goodness-of-fit reflected by the normal distribution of the residuals (*light solid line*).

4.3.3 Tests at 95% Δ_1 following a priming bout

In contrast to the tests performed without a preceding priming bout, not all subjects were able to complete the target 15-min duration of the test, despite the work rate still being below CP. However, three subjects were able to complete the test (subjects 3, 4 and 6 - Table 4.5).

Subject	Duration (s)	[La] _{20W} (mM)	[La] _{END-EX} (mM)	Δ [La] (mM)	HR _{END-EX} (beats.min ⁻¹)	HR _{END-EX} (%HR _{max})
1	638	9.9	10.7	0.8	191	99
2	601	8.5	9.2	0.7	184	99
3	900	9.0	7.8	-1.2	182	97
4	900	7.9	7.4	-0.5	166	95
5	478	9.7	10.4	0.7	175	94
6	900	9.0	8.9	-0.1	188	97
Mean	736	9.0	9.1	0.1	181	97
\pm S.D.	187	0.8	1.3	0.8	9	2

Table 4.5 – Arterialised mixed-venous blood lactate concentration ([La]) and heart rate (HR) responses to the test performed at 95% Δ_1 following a preceding priming bout. The change in lactate concentration (Δ [La]) is the difference between the baseline of 20 W ([La]_{20W}) and end-exercise ([La]_{END-EX}) values.

Subject	$\dot{V}O_{2\ 20W}$ (ml.min ⁻¹)	τ (s)	δ (s)	$\Delta\dot{V}O_{2\ (Phase\ II)}$ (ml.min ⁻¹)	$\Delta\dot{V}O_{2\ /}\Delta WR$ (ml O ₂ .min ⁻¹ .W ⁻¹)	$\Delta\dot{V}O_{2\ (SC)}$ (ml.min ⁻¹)	$\dot{V}O_{2\ END-EX}$ (ml.min ⁻¹)	$\dot{V}O_{2\ END-EX}$ (% $\mu\dot{V}O_{2}$)
1	1367	24.7	0.6	2695	9.14	0	4062	84
2	1602	20.6	5.1	2598	9.02	232	4429	87
3	1211	27.5	6.2	2448	8.56	0	3659	86
4	1276	19.3	9.4	2040	8.83	202	3496	85
5	1127	31.6	-2.1	1617	8.56	217	2888	89
6	1130	22.1	9.3	2203	10.11	0	3333	86
Mean	1286	24.3	4.8	2267	9.04	109	3645	86
\pm S.D.	180	4.6	4.7	401	0.58	119	544	1.7

Table 4.6 - $\dot{V}O_2$ kinetics for the response to cycling at 95% Δ_1 from a baseline of 20W ($\dot{V}O_{2\ 20W}$) for 120s following the 8minWR priming bout. τ , δ and $\Delta\dot{V}O_{2\ (Phase\ II)}$ refer to the fundamental component modelled using an exponential function (Equation 2.9), the Gain calculated as $\Delta\dot{V}O_{2\ (Phase\ II)}$ divided by the change in work rate (ΔWR). $\Delta\dot{V}O_{2\ (SC)}$ is the amplitude of the slow component, calculated using the end-exercise ($\dot{V}O_{2\ END-EX}$) values.

Also in contrast to the test at 95% Δ_1 without a priming bout, some subjects did not demonstrate a slow component for $\dot{V}O_2$ (Table 4.6), as shown in Figure 4.5 for the same representative subject as used for Figure 4.4. It should be noted that the three subjects that did not show a $\dot{V}O_{2\ (SC)}$, unexpected in this exercise intensity domain, were not the exact same sub-group that completed the test (Table 4.6).

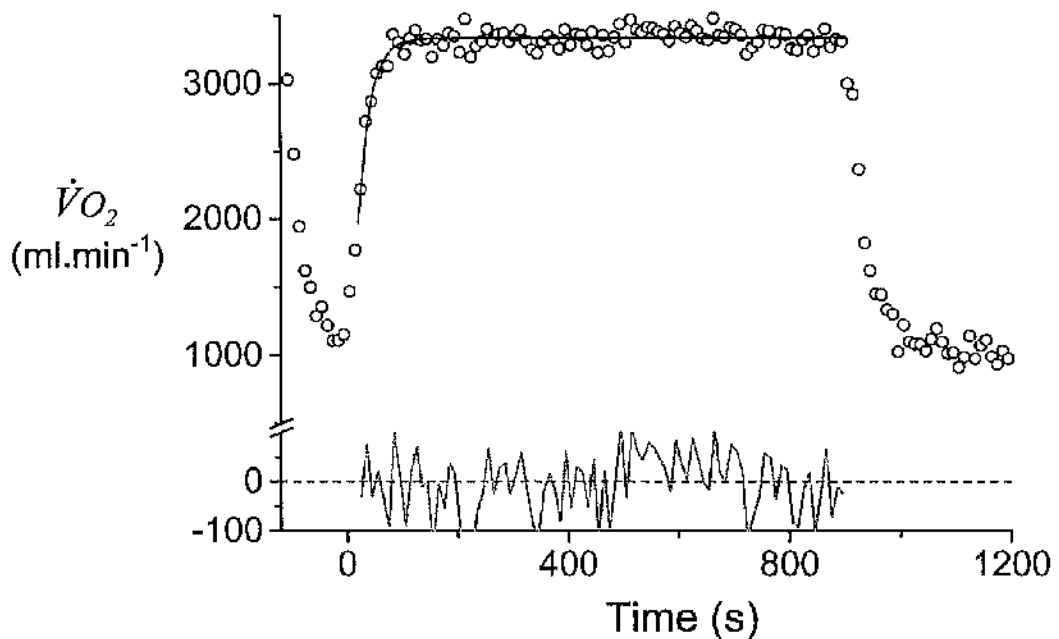

Figure 4.5 – Oxygen uptake ($\dot{V}O_2$) response to cycling at a work rate slightly below Critical Power ($95\%\Delta_1$), which begins at $t=0s$ from a baseline of 20W, following a preceding priming bout of cycling at the 8minWR. The data is the average of two identical transitions divided into 10s bins (see text for details). The *dark solid line* is the exponential model applied to the entire test, the goodness-of-fit reflected by the normal distribution of the residual plot for the fit (*light solid line*).

4.3.4 Priming bout effects

Table 4.7 details the impact of the priming bout performed at the 8minWR on the tolerable duration of, and the $\dot{V}O_2$, HR and [La] responses to, cycling at a work rate below CP ($95\%\Delta_1$). The duration of the exercise performed was not significantly affected by the priming bout. However, it should be noted that three subjects completed the test and three did not (Table 4.5), so comparison is complicated by the observation that some tests were maximal and some were stopped after 15 minutes, i.e. assumed to be still sub-CP despite the effects of the priming bout.

t_{lim}	Duration (s)	Without priming bout	With priming bout
		900 ± 0	736 ± 187
Blood [La] (mM)	20W	0.7 ± 0.2**	9.0 ± 0.8
	EE	7.3 ± 1.4*	9.1 ± 1.3
	EE/iso- t_{lim}	6.4 ± 1.6*	-
	$\Delta[La]_{(EE-20W)}$	6.6 ± 1.2 [†]	0.1 ± 0.8
	$\Delta[La]_{(EE/iso-t_{lim}-20W)}$	5.7 ± 1.4 [†]	-
Heart rate (beats.min ⁻¹)	20W	80 ± 6**	129 ± 10
	EE	179 ± 6	181 ± 9
	EE/iso- t_{lim}	175 ± 8*	-
$\dot{V}O_2$ kinetics (mL.min ⁻¹)	20W	804 ± 83**	1286 ± 180
	Phase II τ (s)	24.9 ± 4.4	24.3 ± 4.6
	Phase II δ (s)	10.8 ± 5.2 [†]	4.8 ± 4.7
	Phase II $\Delta_{(ss)}$	2248 ± 457	2267 ± 401
	$\Delta\dot{V}O_{2(SC)}$	503 ± 90 [†]	109 ± 119
	EE/iso- t_{lim} $\Delta\dot{V}O_{2(SC)}$	448 ± 59 [†]	-
	Abs. Phase II asymptote	3052 ± 481**	3552 ± 538
	Abs. $\dot{V}O_2$ at SC onset	3033 ± 478**	3536 ± 562
	EE	3536 ± 540	3645 ± 544
	EE/iso- t_{lim}	3481 ± 521	-

Table 4.7 – A direct comparison of the blood lactate concentration ([La]), heart rate and $\dot{V}O_2$ responses to the tests performed at 95% Δ_1 , with and without a preceding priming bout. Comparisons were made between end-exercise (EE) values in both tests. However, comparisons were also repeated having substituted the end-exercise value during the “without priming bout” test with the value at the same time-point as exhaustion was reached (iso- t_{lim}) in the “with priming bout” test, for subjects who could not complete this test. 20W – 20 W baseline response; τ – time constant; δ – delay; SC – slow component; Abs. $\dot{V}O_2$ - absolute value. *significantly lower than with priming bout ($P < 0.05$), **significantly lower than with priming bout ($P < 0.01$), [†]significantly higher than with priming bout ($P < 0.01$).

The priming bout had the desired effect of generating a considerable accumulation of lactate in the blood, with the pre-95% Δ_1 baseline [La] being on average 8.3 mM higher following the priming bout, than when no priming bout was performed. In support of the durations of the tests, the end-exercise [La] was significantly lower (by 1.8 mM on average) in the test without a priming bout, which all subjects completed. This effect remained when the shortened test duration, due to t_{lim} being attained in some subjects, was accounted for. Despite the elevated end-exercise [La] due to the priming bout, the elevated baseline meant that $\Delta[La]$ was significantly less following the priming bout, whether end-exercise or iso- t_{lim} values were used. It is noteworthy that the three subjects who were able

to complete the bout at 95% Δ_1 following the priming bout demonstrated lower end-exercise [La] and negative values for Δ [La] (Table 4.5). This means that there was actually a net decrease in [La] from the elevated baseline during this test in these individuals. However, the magnitude of differences between the end-exercise and Δ [La] values in these subjects and the other subjects was very small.

Similar to the [La] response, the priming bout resulted in an elevated baseline heart rate prior to the tests at 95% Δ_1 , by 49 beats.min⁻¹ on average. Although three subjects were unable to complete these tests, the end-exercise heart rates were not significantly different from those in the “without priming bout” test, yet all subjects were able to complete that test. These values were also significantly lower than the HRmax values recorded during the incremental test (Tables 4.3 and 4.5). However, comparing similar time-points, the values are significantly higher in the “with priming bout” test, due to the elevated baseline. This means that subjects were cycling with a higher heart rate at a given time-point following the priming bout, but that the peak values obtained were comparable with the sub-CP test without a priming bout, as shown in Figure 4.6.

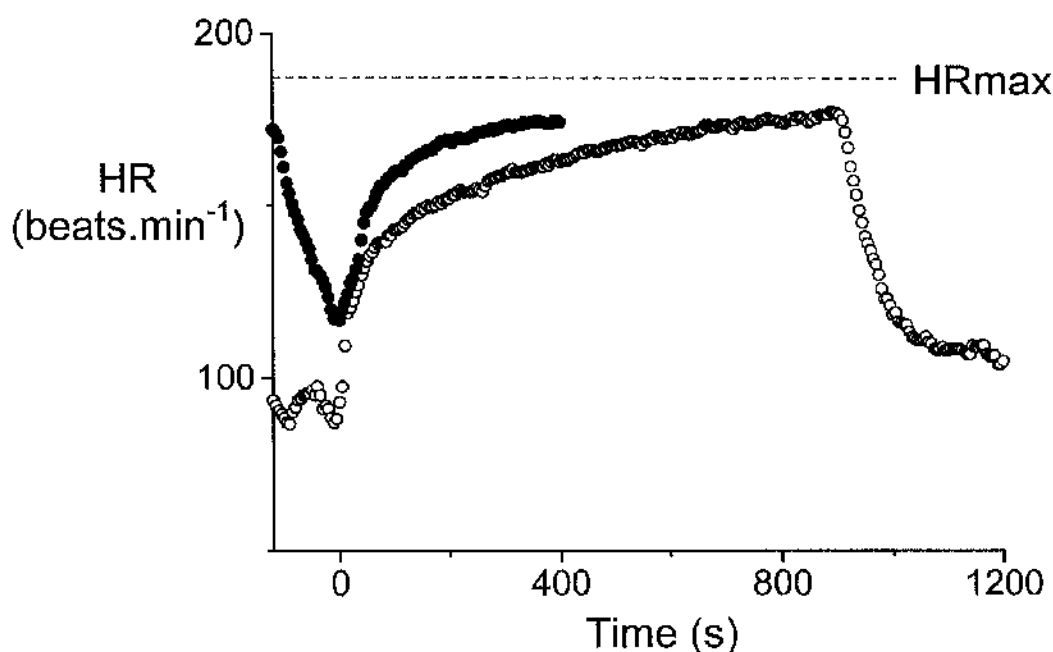

Figure 4.6 – The heart rate response profiles for a representative subject for the tests performed at 95% Δ_1 , with (*solid circles*) and without (*open circles*) a preceding priming bout. Responses shown are the average of two transitions. Also shown is the peak heart rate attained during the maximal incremental test (HRmax). Note that this subject was unable to complete the test following the priming bout.

The most evident effects of the priming bout on $\dot{V}O_2$ kinetics were an increase in the baseline value (by 482 ml.min⁻¹ on average) and a decrease in the amplitude of the slow component amplitude (by 394 ml.min⁻¹ on average). The kinetics of the fundamental component were essentially unaltered by the priming bout, since the time constant and amplitude were not significantly different, however the delay of the exponential model was significantly shortened, by 6s on average. Although the fundamental component amplitude was unchanged, the elevated baseline meant that the absolute $\dot{V}O_2$ at the onset of the slow component and the projected Phase II asymptote were significantly higher following the priming bout. Figure 4.7 illustrates the point that at any given time during the fundamental component, the absolute $\dot{V}O_2$ values are higher in the tests following the priming bout. Despite these higher values at the end of the fundamental component, the end-exercise values for $\dot{V}O_2$ were not significantly different for the two protocols, whether end-exercise (Figure 4.7(a)) or iso-t_{lim} values were used for comparison (Figure 4.7(b)). The data presented in Figure 4.7 illustrates that in some subjects the slow component was completely abolished, and although this was not the case in all subjects, significant reductions were apparent in all subjects (Tables 4.4 and 4.6). This relationship was maintained when the iso-t_{lim} values were included, rather than end-exercise values.

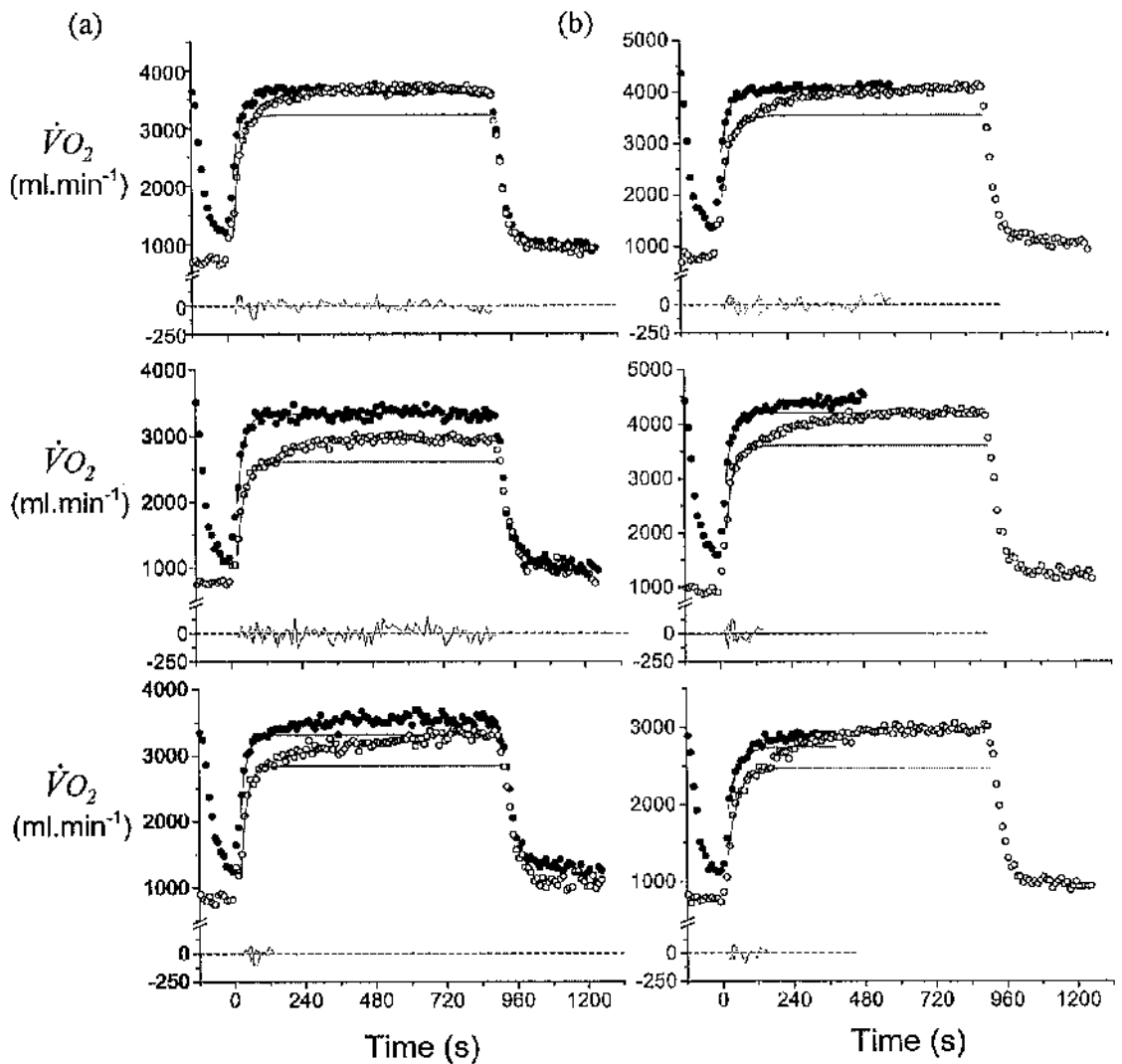

Figure 4.7 – Temporal profiles for $\dot{V}O_2$ during cycling performed at 95% Δ_1 , with (solid circles) and without (open circles) a preceding priming bout. Responses shown are the average of two transitions, for subjects who (a) completed (subjects 3, 6 and 4 from top to bottom), and (b) did not complete (subjects 1, 2 and 5 from top to bottom), the test following the priming bout. Dark solid lines represent the exponential fit to the fundamental component, determined by nonlinear least-squares regression, with light solid lines showing the residuals plots.

4.4 DISCUSSION

The major finding of this study was that the modulation of $\dot{V}O_2$ kinetics in the response to sub-CP, supra- θ_1 cycling, induced by a priming bout of very heavy cycling, did not “push” the imposed work rate above CP; i.e. a steady-state and submaximal $\dot{V}O_2$ was still achieved. However, half of the subject group were unable to complete the 15-min target duration of the sub-CP cycling period, following the priming bout. This was despite there being no significant change in the fundamental component $\dot{V}O_2$ kinetics, a reduced $\Delta\dot{V}O_{2(SC)}$ and unchanged end-exercise $\dot{V}O_2$, in comparison to sub-CP cycling without the priming bout. Whilst conclusions can be made regarding the effect of the preceding very heavy cycling on $\dot{V}O_2$ kinetics, and therefore indirectly CP by implication, the present investigation does not allow any conclusions regarding effects of the priming exercise on the power-duration hyperbola, i.e. CP and/or the curvature constant (W'). Further research is required to investigate this possibility.

4.4.1 Priming bout effects on the kinetics of the fundamental component

In support of previous work (Gausche *et al.*, 1989; Gerbino *et al.*, 1996; Macdonald *et al.*, 1997; Bohnert *et al.*, 1998), the overall $\dot{V}O_2$ kinetics during the response to heavy cycling were accelerated by the priming bout of very heavy exercise, since the fundamental component was unaltered, baseline was elevated and the $\dot{V}O_{2(SC)}$ was significantly reduced. However, as discussed in the Introduction, this acceleration of overall kinetics is not necessarily reflecting a faster fundamental $\dot{V}O_2$ response, and hence \dot{Q}_{mO_2} , since the overall kinetics are influenced by the initial cardiodynamic phase and the additional slow component.

Indeed, when the $\dot{V}O_2$ response during the fundamental component was modelled independently of the other phases, there was no significant change in either τ or amplitude, in support of Burnley *et al.* (2000 & 2002b), Koppo & Bouckaert (2000 & 2001) and Scheuermann *et al.* (2001). The finding of an unaltered amplitude of the fundamental component, in conjunction with the elevated baseline, results in a higher absolute $\dot{V}O_2$ at the end of Phase II, as shown in Table 4.7. That an increased amplitude was not observed, in contrast to Burnley *et al.* (2001 & 2002a), Patel *et al.* (2001) and Bearden & Moffatt (2001a), is unsurprising given the short recovery period (120 s) used in the current study. These studies, showing increased Phase II amplitude, have demonstrated that this is only

manifest when recovery from the priming bout is sufficient for $\dot{V}O_2$ to recover to initial baseline values, so the large baseline elevation in the current study (averaging 482 ± 123 ml.min⁻¹) would obscure observation of such an effect.

The exact mechanisms for the increase in amplitude of the fundamental component remain unclear, although a recent study has provided evidence that the origin may be an increased recruitment of motor units at the onset of exercise following a priming bout of heavy exercise (Burnley *et al.*, 2002a). The hypothesis for this was that the priming bout of exercise may have caused a degree of local muscle fatigue, perhaps due to disruption of the electrochemical gradient (Bangsbo *et al.*, 1996). Therefore, in order to attain the same work rate, an increased number of motor units must be recruited and hence there would be an increased O₂ demand to support this increased cross-bridge turnover. According to the size principle of motor recruitment (Henneman *et al.*, 1974), there had been a potential for there to be a muscle fibre type influence on this response, but Scheuermann *et al.* (2001) did not confirm this. Rather, it appears that there is no bias in the fibre-type proportion recruited, following prior heavy exercise. However, interpretation of EMG signals during cycling is complex, as discussed in Section 1.5.3.6.

Whilst the observed consistency of τ reported here is in agreement with the majority of studies, it is presently unclear why the results from two other studies differ (Rossiter *et al.*, 2001; Tordi *et al.*, 2003). Rossiter *et al.* (2001) suggested that the differences between their results and the majority of other studies, may lie in the exercise mode adopted. Due to spatial constraints when exercising with simultaneous ³¹P-NMR measurement (Whipp *et al.*, 1999), only limited knee-extensor exercise in the prone position can be performed. Therefore, not only is a smaller muscle mass employed in comparison to cycling, but also the differences in exercise modality may contribute to the different effects of prior heavy exercise on subsequent $\dot{V}O_2$ kinetics.

Tordi *et al.* (2003) proposed that their finding of an accelerated fundamental component could perhaps be due to differences in the degree of acidosis induced by the prior exercise. They used three maximal 30 s sprints prior to the exercise and postulated that there would be a considerably greater increase in blood lactate concentration, with concomitant decrease in pH, however they did not measure either variable, preventing comparison with the results of the current study. In addition to this hypothesis, Tordi *et al.* (2003) proposed that previous studies either failed to detect a difference that was present, or did not have sufficient statistical power to illustrate an effect. Given the larger number of studies that

have failed to observe an effect, some of which had a greater n -number than Tordi *et al.* (2003), the latter option appears unlikely. However, the possibility that subtle differences in the kinetics of the fundamental component may not be detected has been highlighted (Hughson *et al.*, 2001; Whipp *et al.*, 2002b), and is discussed in more detail in Section 6.3.

One finding of the current study, in contrast to existing literature, was a significant shortening of the delay duration of the exponential model by 6 (± 3) s (Table 4.7). It is foreseeable that this difference may exist due to the modelling approach used in this study, in comparison to the triple-exponential model (Barstow *et al.*, 1996) employed by other groups. It is important to emphasise that this delay is not physiological, but rather a factor of the exponential model (Whipp *et al.*, 1982). It will, however, provide an approximate indication of the duration of the Phase I response, which reflects the muscle-to lung vascular transit delay (Section 1.2.1). Therefore, the shortening of this delay term may suggest an alteration in the initial cardiodynamic phase of the $\dot{V}O_2$ response, perhaps due to \dot{Q}_T being higher prior to the exercise due to the priming bout of cycling. Whilst studies using the aforementioned triple-exponential model do not support this possibility, the modelling of this portion of the response as an exponential is not physiologically justified (Section 6.1.1).

4.4.2 Priming bout effects on the slow component

The current study has demonstrated that the priming bout of heavy cycling did not affect the end-exercise $\dot{V}O_2$ achieved, despite higher absolute $\dot{V}O_2$ following the fundamental component. This is an important observation for two reasons. Firstly, since the absolute $\dot{V}O_2$ was significantly higher at the end of the fundamental component this implies that the $\Delta\dot{V}O_{2(SC)}$ must be reduced, as shown in the existing literature. This was demonstrated in all six subjects, with the slow component being completely abolished in three out of the six subjects (Table 4.6). The exact mechanisms of this decrease in $\Delta\dot{V}O_{2(SC)}$ remain unclear. Based on the observed relationship between the proportion of Type II muscle fibres and the size of the $\dot{V}O_{2(SC)}$ (Shinohara & Moritani, 1992; Barstow *et al.*, 1996), Burnley *et al.* (2002a) proposed that the reduced slow component following prior heavy exercise may be due to reduced recruitment of Type II motor units. They were unable to support this using EMG data, so they proposed that the increased recruitment of motor units during the fundamental component resulted in a reduced difference between $\dot{V}O_2$ at the onset of the $\dot{V}O_{2(SC)}$ and end-exercise. Consequently, the size of the slow component would be reduced.

This hypothesis, of increased motor unit recruitment at the onset of the “with priming-bout” 95% Δ_1 cycling bout, may be applicable to the results of the current study, since absolute $\dot{V}O_2$ at the onset of the $\dot{V}O_{2(SC)}$ was significantly higher compared to the “without priming-bout” test (Table 4.7).

Secondly, that end-exercise $\dot{V}O_2$ was unaltered by the priming bout, provides information regarding the exercise intensity domain, upon which the $\dot{V}O_2$ kinetics are highly dependent (Section 1.3). The increased amplitude of the fundamental component, proposed in existing literature, could theoretically have pushed $\dot{V}O_2$ above the value equivalent to CP and hence reduced the tolerable duration of the exercise. Whilst three subjects did demonstrate a reduction in tolerable duration of exercise at 95% Δ_1 , the other three did not, and even in those subjects who did not complete the test, it is unlikely that they may now have been exercising in the very heavy intensity domain, i.e. supra-CP. The reason is, that for exercise in this intensity domain, the $\dot{V}O_{2(SC)}$ continues to rise until $\mu\dot{V}O_2$ is achieved (Ozyener *et al.*, 2001; Carter *et al.*, 2002). In this study, $\dot{V}O_2$ at end-exercise was less than $\mu\dot{V}O_2$ in all subjects (Tables 4.4 and 4.6), averaging 84 (± 5)% and 86 (± 2)% of $\mu\dot{V}O_2$ during the “without” and “with priming bout” tests respectively. Therefore, it appears that the priming bout of heavy cycling does not alter the $\dot{V}O_2$ -CP relationship, despite modulation of the $\dot{V}O_2$ kinetics, although, as mentioned previously, the effect of prior heavy cycling on the power-duration hyperbola is unknown.

4.4.3 Heart rate and blood lactate responses

That both heart rate and blood [La] were significantly elevated prior to cycling at 95% Δ_1 following the priming bout (Table 4.7), was a design of the protocol used. The use of the 8minWR for 6 minutes as the priming bout was supported by the high baseline levels of lactate ahead of the subsequent 95% Δ_1 period, and all subjects being able to complete this part of the protocol. Due to this elevated baseline level, the change in [La] during the cycling at 95% Δ_1 was significantly reduced following the prior heavy cycling (Table 4.7).

Similar to end-exercise values for $\dot{V}O_2$, end-exercise heart rate was not significantly different in the “with” and “without priming bout” tests (Table 4.7). Furthermore, in all subjects these values were lower than HRmax, even in subjects who were unable to complete the protocol following the priming bout (Tables 4.3 and 4.5). That heart rate was

elevated, following the prior heavy exercise, when iso- t_{lim} values were used rather than end-exercise, suggests that heart rate at any given time, until end-exercise, was elevated as a result of the prior heavy exercise, in agreement with the blood [La] values obtained.

4.4.4 “Completers” vs. “non-completers”

In contrast to Koppo & Bouckaert (2002), the tolerable duration of exercise was reduced in three of the six subjects used in this study. Before attempting to determine why this occurred in some subjects but not in others, despite the intensity being normalised appropriately, it is useful to consider differences in protocol with Koppo & Bouckaert (2002). Firstly, their study was looking at the duration of exhaustive exercise, equivalent to “95% $\mu\dot{V}O_2$ ”, which therefore implies exercise of supra-CP intensity, in comparison to the sub-CP exercise of the current study. Secondly, the reported reductions in $\Delta\dot{V}O_{2(SC)}$ were considerably larger in the current study and furthermore, only single transitions were performed in their study, preventing adequate characterisation of the $\dot{V}O_2$ kinetics. The limitations of using a single test performance to measure the $\dot{V}O_{2(SC)}$, and describing it as $\Delta\dot{V}O_{2(6min-2min)}$, have been discussed previously. The major objective of the current study was to determine if the modulation of $\dot{V}O_2$ kinetics, induced by prior very heavy exercise altered the $\dot{V}O_2$ -CP relationship, indicated by t_{lim} , in contrast to whether or not maximal exercise performance could be increased (Koppo & Bouckaert, 2002).

One possible explanation as to why three subjects reached exhaustion, following the priming bout, could be that CP had been under-estimated in these individuals. This contention is not supported by the results obtained. From a methodological perspective, at least four tests, under controlled conditions, were used for CP estimation (Hill, 1993). In any cases where the power-duration and power-time⁻¹ plots were not appropriately characterised as hyperbolic and linear functions respectively, further tests were performed to strengthen the relationship and hence make the estimation of CP more accurate. In all cases, the profiles were well characterised by the models (Figure 4.3 and Table 4.2), so that CP was predicted to within ± 3 W. Further evidence comes from two observations related to the $\dot{V}O_2$ kinetics. Firstly, all subjects achieved a steady-state $\dot{V}O_2$ in the tests performed at 95% Δ_1 , including the slow component (Poole *et al.*, 1988; Ozyener *et al.*, 2001). This would not be the case where any subjects to be cycling above CP, as $\dot{V}O_2$ would never attain steady state, rising continuously until $\mu\dot{V}O_2$ was reached. Secondly, the subjects who

did reach t_{lim} following the priming bout, as with all subjects, did not reach $\mu \dot{V}O_2$ at end-exercise.

A second possible explanation could be related to the curvature constant of the power-duration hyperbola (W'). This parameter is considered to reflect a constant amount of supra-CP work that can be performed and is thought to represent an energy store consisting of O_2 , high-energy phosphates and a source related to anaerobic glycolysis (Moritani *et al.*, 1981; Poole *et al.*, 1988), although it may also relate to build-up of fatigue-inducing by-products. Therefore, in theory, those subjects who were able to complete the "with priming-bout" protocol may have a higher value for W' . This hypothesis was not supported since subjects 3, 4 and 6 who completed this protocol did not have the highest values for W' (Table 4.2). That W' does not appear to correlate with completion or non-completion of the test following the priming bout is perhaps not surprising since the intensity of exercise is sub-CP, although the priming bout itself may have disrupted CP and/or W' , as mentioned previously. Interestingly, subjects 5 and 6, who exhibited the lowest values for W' (Table 4.2), also demonstrated the highest [La] values in the test without a priming bout (Table 4.3). Interpretation of this finding is complex as it may be considered to emphasise reduced energy stores in these subjects, but higher [La] may be expected for larger W' , although it must be remembered that this test was sub-maximal.

A third possible explanation could be that the individuals who could not complete the "with priming bout" test exhibited some sort of different modulation in $\dot{V}O_2$ kinetics. For example, three subjects completely abolished the $\dot{V}O_{2(SC)}$ whereas the other three did not. Therefore, perhaps only subjects who demonstrated this $\dot{V}O_{2(SC)}$ abolition were able to complete the test. Again, this was not supported by the results, since subject no. 1 reached t_{lim} , but did not have a $\dot{V}O_{2(SC)}$ and subject no. 4 was able to complete the test despite still having a significant $\dot{V}O_{2(SC)}$ (Table 4.6).

A fourth possible explanation could be that those subjects who were able to complete the test had recovered more during the 120s recovery period, than those who reached t_{lim} . Looking at the absolute values in Table 4.6, this appears unlikely given that the values are more related to body mass than duration of the "with priming bout" test. To further investigate this possibility, the recovery $\dot{V}O_2$ kinetics to the 8minWR bout, without the subsequent test at 95% Δ_1 , were modelled (Figure 4.1(a)). The mean τ for the Phase II "off-kinetics" from this supra-CP exercise was 28.9 (\pm 6.0) s, the values not significantly

different to the “on kinetics” during the tests at 95% Δ_1 in support of previous work (Ozyener *et al.*, 2001). Furthermore, as with the “on kinetics” (Tables 4.4 and 4.6), the values did not explain the differences between subjects who could and could not complete the “with priming bout test”, i.e. the subjects who reached t_{lim} did not necessarily have slower $\dot{V}O_2$ kinetics.

That the Phase II component had a τ of ~ 30 s implies that the asymptote would be attained in approximately 120 s (duration of 4 τ 's will attain $> 98\%$ of steady-state amplitude), meaning that the subjects would on average have completed the Phase II exponential decline in $\dot{V}O_2$ during the 120 s recovery. Therefore, the elevated baseline observed is actually reflecting what has been termed the “excess post-exercise oxygen consumption” (e.g. Gaesser & Brooks, 1984), rather than an uncompleted exponential phase. Since the origins of this additional recovery $\dot{V}O_2$ are multifactorial, it would be inappropriate to attempt to model it as an exponential process. This precluded trying to add the fundamental component in the “without priming bout” test to the kinetics of the remaining recovery component following the priming bout. In any case, the τ and net-amplitude of the fundamental component were unchanged by the prior very heavy cycling.

A fifth potential reason may be differing blood lactate responses to the exercise. Theoretically, the subjects whose [La] at 20W, following the priming bout, were lower may be more likely to complete the test, however this was not supported by the results (Table 4.5). In contrast, the three individuals who were unable to complete the “with priming bout test” exhibited the highest absolute end-exercise [La] values and, therefore, higher Δ [La] values. It is important to appreciate that these differences are quite small, however the significance is unclear given the small n -number in each sub-group. That there appears to be a possible link between the blood [lactate], but not the $\dot{V}O_{2(SC)}$ response and the completion/non-completion of the “with priming bout” test, provides further indirect evidence against a cause-and-effect relationship existing between blood lactate accumulation and the $\dot{V}O_{2(SC)}$ (Section 1.5.3.1).

4.4.5 Limiting factors in the “non-completers”

The major question arising from this issue is what is limiting the performance of the test at 95% Δ_1 , following the priming bout, in those individuals who were unable to complete the test? It would appear from the results (Tables 4.5 and 4.6) that it is not a cardio-respiratory

limitation, since both end-exercise values for $\dot{V}O_2$ and heart rate were less than the peak values obtained during the initial maximal incremental test (in all subjects). Rather, it appears more likely to be some form of peripheral fatigue, induced locally by the priming bout. Muscle fatigue is complex and multi-factorial in nature (e.g. Fitts, 1994; Allen *et al.*, 1995; Jones, 1999), and the potential for central fatigue to play a significant role during exercise must be recognised (Newsholme & Blomstrand, 1995; Davis & Bailey, 1997), although this study provided no indices that might relate to central fatigue.

Although higher absolute end-exercise lactate concentrations were observed in these individuals, the differences were small (average 2.1 mM higher). However, the use of "mixed"-tissue blood [La] to infer muscle lactate production is unjustified (e.g. Brooks, 2000). In any case, the traditional concept of decreased pH, in association with increased [La], being the major cause of muscle fatigue is out-dated (Bangsbo *et al.*, 1996; Westerblad *et al.*, 2002). Whilst it is generally accepted that reduced muscle pH may interfere with muscle contractility and inhibit anaerobic glycolysis, muscle fatigue under physiologic conditions appears more related to intracellular $[Ca^{2+}]$, perhaps mediated by increased intracellular $[P_i]$ (Allen & Westerblad, 2001). This therefore implies that the relationship between blood lactate and fatigue be associative, rather than cause-and-effect (Fitts, 1994; Brooks, 2001).

A further potential factor could be a depletion of available substrate, due to the priming bout of almost-maximal supra-CP exercise. Exercise of this nature will place high demands on the ability to generate ATP from anaerobic glycolysis at high rates. Indeed, high rates of muscle glycogen depletion have been recorded during exercise using muscle biopsy techniques (Bergstrom *et al.*, 1967). Therefore, a potential difference between those who could complete the test, and those who could not, may lie in the degree of intramuscular glycogen depletion caused by the priming bout. The results of Saltin & Karlsson (1971) suggest that, whilst almost-maximal exercise performed for the duration used in this study would cause a significant depletion of muscle glycogen, the level of depletion would be insufficient to have a negative impact on exercise performance. Although this may be the case, it is conceivable that selective glycogen depletion of Type II muscle fibres may reach fatiguing levels during high-intensity exercise (e.g. Gollnick *et al.*, 1973b), despite considerable overall muscle glycogen reserve. The nature of the cycling protocols used in the current study would be anticipated to require significant recruitment of Type II motor units and so this possibility remains, although it could not be confirmed without muscle biopsy sampling and analysis.

Whilst the data from the current study cannot conclusively explain the differences between the subjects who completed the protocol and those who did not, the issue of heterogeneity of muscle activity should be considered. Whilst the arterialised mixed-venous [La] values in the current study showed little difference between the subjects, the model of Whipp *et al.* (1995) illustrated that regional differences in muscle lactate production are unlikely, *a priori*, to be reflected by the whole muscle venous effluent [La]. Therefore, local areas of high metabolic demand may cause considerable localised accumulation of fatiguing by-products, resulting in regional disruption to muscle function in “non-completers”, despite whole muscle values similar to “completers” who perhaps exhibit more homogeneous muscle activity. That is, the estimated CP and W' parameters from the experimentally-determined power-duration relationship could actually comprise the summation of several composite functional compartments within the exercising muscles. These compartments could be defined, for example, by particular \dot{Q}_m/\dot{Q}_mO_2 ratios and anaerobic energy potentials whose expression would lead to a unique “local” power-duration characteristic. One could then hypothesise that overall fatigue might occur when a significant number of local compartments, with low CP (and/or W') values, reach their functional limit.

It would be of some interest to extend the models of Whipp *et al.* (1995 & 2002b) to incorporate such features. This is, however, beyond the scope of the present investigation and whilst this hypothesis cannot be demonstrated from the current results, recent advances in technology have permitted demonstration of regional differences of \dot{Q}_mO_2 within the active musculature (Richardson *et al.*, 2001a). The significance of these results in relation to interpreting $\dot{V}O_2$ kinetics is discussed in greater detail in Section 6.3.3.

4.4.6 Conclusion

In conclusion, a priming bout of very heavy cycling followed by 120 s of recovery modulated the kinetics of the $\dot{V}O_2$ response to sub-CP, supra- θ_L cycling, but did not “push” the imposed work rate above CP, since a steady-state and submaximal $\dot{V}O_2$ was still achieved. However, t_{lim} was reached in the test following the priming bout, in three subjects. The mechanisms for this effect are unclear, however they are unlikely to be cardio-respiratory in origin, perhaps related to local muscular fatigue.

Chapter 5 Model discrimination in the characterisation of pulmonary oxygen uptake kinetics: an intervention study in Chronic Obstructive Pulmonary Disease

5.1 INTRODUCTION

5.1.1 Chronic obstructive pulmonary disease

Chronic obstructive pulmonary disease (COPD) is a major cause of morbidity and mortality which is becoming increasingly prevalent throughout the developed world, associated primarily (but not exclusively) with increased incidence of cigarette smoking (Hurd, 2000; Pauwels *et al.*, 2001). COPD is a complex pathological disorder, with the physiological definition being that of chronic airflow obstruction, and patients often exhibiting either one or a combination of symptoms related to bronchitis, asthma and emphysema (American Thoracic Society, 1995; British Thoracic Society, 1997). The majority of asthmatics are differentiated from COPD patients based on their responsiveness to treatment, such as steroids or bronchodilators.

The major pulmonary limitation of COPD patients is an expiratory flow limitation, both in terms of volume (increased residual volume) and rate of emptying (dramatically reduced forced expired volume in one second, FEV₁). The source of the expiratory flow limitation is usually either: (a) reduced lung recoil in patients exhibiting symptoms characteristic of emphysema; and/or (b) thickening of the small airways resulting in increased airway resistance, characteristic of bronchitis. The combination of these effects is a reduced ventilatory capacity, with COPD patients typically exhibiting significant ventilatory limitation during exercise (Potter *et al.*, 1971; Spiro *et al.*, 1975; Pardy *et al.*, 1988; Bauerle & Younes, 1995; Diaz *et al.*, 2000; O'Donnell *et al.*, 2001). Figure 5.1 is a schematic illustrating that not only is the ventilatory capacity reduced in COPD, but that there is also an increased ventilatory requirement. The increased ventilatory requirement is consequent to: (a) inefficient alveolar ventilation, arising from increased regional mismatch of ventilation to perfusion, that is manifest as an increased dead-space fraction of the breath (V_D/V_T); and (b) increased ventilatory drive, deriving from the consequent arterial hypoxaemia and premature metabolic acidaemia. Therefore, in an attempt to maintain blood-gas homeostasis, a higher total ventilation at a given work rate is required in comparison to healthy individuals (e.g. Casaburi, 1993; Wasserman *et al.*, 1999). The increased respiratory impedance, coupled with increased respiratory drive and possibly the arterial hypoxaemia (Ward & Whipp, 1989), result in exacerbated perceptions of

breathlessness (or “dyspnoea”), especially upon exertion (Casaburi, 1993; Wasserman *et al.*, 1999).

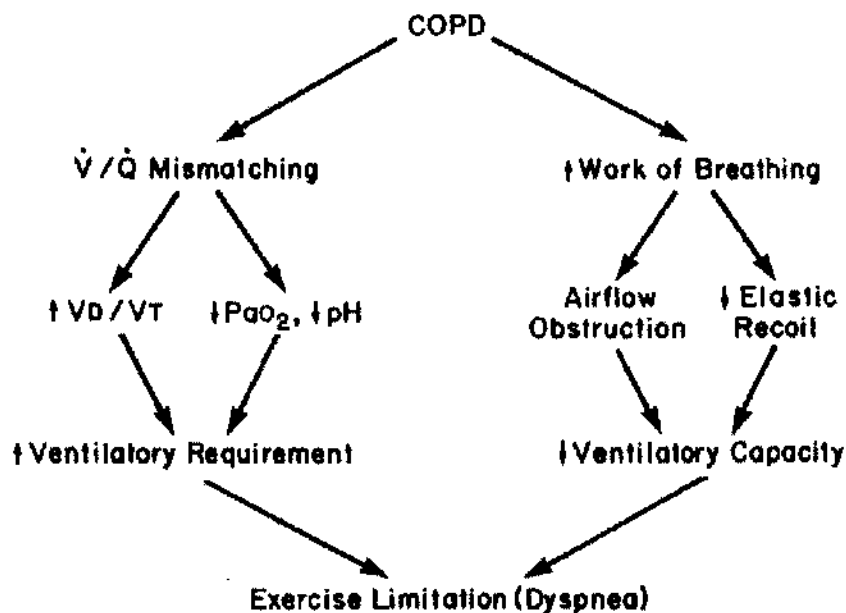

Figure 5.1 – Schematic illustrating the imbalance of ventilatory requirement and ventilatory capacity in COPD patients. Increased ventilatory requirement is caused by a mismatch between ventilation and perfusion in the lungs. Reduced ventilatory capacity is caused by chronic airflow obstruction and/or reduced lung recoil. From Wasserman *et al.* (1999).

As a consequence of the dyspnoea encountered during exercise, COPD patients often do not undertake regular exercise. This lack of physical activity leads to a progressive decline in cardio-respiratory fitness and increased muscular atrophy, which further exacerbates the dyspnoeic sensation (Killian *et al.*, 1992; Gosselink *et al.*, 1996), as schematised in Figure 5.2.

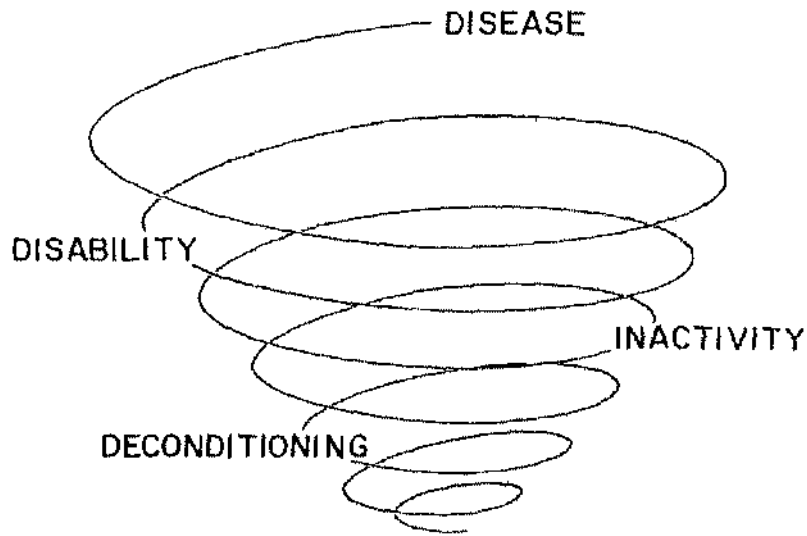

Figure 5.2 – The dyspnoea spiral of Casaburi (1993). The dyspnoea experienced by COPD patients on exertion results in inactivity and further deconditioning, which consequently exacerbates the dyspnoeic sensation.

Exercise rehabilitation has been demonstrated to ameliorate this effect (Casaburi *et al.*, 1991; Lacasse *et al.*, 1996; Maltais *et al.*, 1996; Singh *et al.*, 1998). This evidence suggests that whilst lung function typically cannot be improved by exercise rehabilitation, functional exercise capacity can, which has both a positive influence on quality of life and also a reduction in morbidity levels (Lacasse *et al.*, 1996; Singh *et al.*, 1998).

In patient populations where exercise capacity is severely diminished due to some pathological condition and symptom-limited exercise may in addition place patients at risk, there is a consensus that sub-maximal $\dot{V}O_2$ kinetics may present a safer and still sensitive alternative for assessing the functional status of the cardio-respiratory and muscular systems (e.g. Nery *et al.*, 1982; Sictsema *et al.*, 1994; Koike *et al.*, 1995; Casaburi *et al.*, 1997; Otsuka *et al.*, 1997; Wasserman *et al.*, 1999; Puente-Maestu *et al.*, 2001; Arena *et al.*, 2002).

In comparison to healthy individuals, COPD patients exhibit slowed $\dot{V}O_2$ kinetics both for moderate intensity exercise (Nery *et al.*, 1982; Palange *et al.*, 1995; Puente-Maestu *et al.*, 2000; Somfay *et al.*, 2002) and for higher intensity exercise (Casaburi *et al.*, 1997; Neder *et al.*, 2000). The responsible mechanisms are unclear, although it has been proposed that a combination of circulatory and peripheral metabolic factors may be involved (Nery *et al.*, 1982; Palange *et al.*, 1995; Casaburi *et al.*, 1997; Puente-Maestu *et al.*, 2000; Somfay *et al.*, 2002). That the slower $\dot{V}O_2$ kinetics in COPD patients can be speeded by an exercise

rehabilitation intervention (Casaburi *et al.*, 1997; Otsuka *et al.*, 1997; Puente-Maestu *et al.*, 2000) is considered as advantageous since this will imply a reduction in the oxygen deficit (Section 1.2), and hence a reduced reliance on anaerobic energy sources. In addition, Casaburi *et al.* (1991) showed that, as a result of exercise training, COPD patients exhibited a reduced lactic acidosis and consequently a reduced ventilatory demand for the same work rate, meaning that they were able to exercise at higher work rates before attaining their maximum voluntary ventilation (MVV).

5.1.2 Model discrimination for characterising $\dot{V}O_2$ kinetics in COPD patients

It has been both argued (Barstow *et al.*, 1990) and demonstrated (Grassi *et al.*, 1996) that, for healthy subjects, the Phase II $\dot{V}O_2$ kinetics in moderate exercise (i.e. below θ_L) reflect those of \dot{Q}_{mO_2} (Section 1.4). It is important, therefore, that the model used to estimate the kinetic parameters of the $\dot{V}O_2$ response is physiologically valid, for exploring the mechanistic basis of $\dot{V}O_2$ and thence \dot{Q}_{mO_2} control not only in healthy subjects, but also in pathological conditions such as COPD, where oxygen utilisation during exercise is compromised (i.e. reflected in slow $\dot{V}O_2$ kinetics - Nery *et al.*, 1982; Palange *et al.*, 1995; Puente-Maestu *et al.*, 2000; Neder *et al.*, 2000; Somfay *et al.*, 2002).

As discussed previously, it has become conventional to functionally “exclude” the Phase I $\dot{V}O_2$ response and thus to confine the fit to the Phase II component. This practise stemmed from the 1982 analysis by Whipp and colleagues (Whipp *et al.*, 1982) who, for the first time, accurately characterised the $\dot{V}O_2$ kinetics to repeated step-increases in work rate for cycle ergometry, and were able to reliably discern a discrete Phase I component not only from a resting baseline (abrupt and large) but also from a baseline of “unloaded” pedalling (slower and smaller). That previous investigators had failed to discriminate the Phase I component from a baseline of prior exercise reflected its effective “invisibility” in the breath-to-breath noise characteristic of single work rate transitions (Lamarra *et al.*, 1987; Rossiter *et al.*, 2000), as is evident in Figure 5.3.

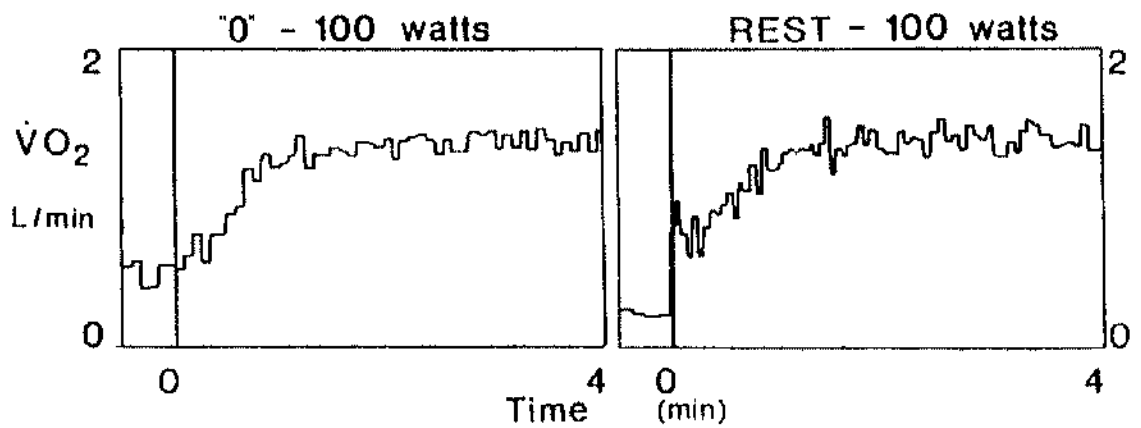

Figure 5.3 – Effective invisibility of the Phase I $\dot{V}O_2$ response during a single work rate transition performed from a baseline of unloaded pedalling (“0” Watts) compared to from a resting baseline. Adapted from Whipp *et al.* (1982).

Thus, there had appeared to be justification, at least on empirical grounds, for modelling the entire non-steady state $\dot{V}O_2$ response profile as a single exponential. However, the inclusion of the Phase I data clearly had a contaminating effect – as was evident from the goodness-of-fit obtained when only the Phase II data-set was included in the fit, in comparison to the whole data-set (Models 3 and 2 of Whipp *et al.*, 1982, respectively). Figure 5.4 illustrates the impact of the poor fit, early in the transient when Phase I was included, on the estimated time constants obtained by Whipp *et al.* with their Model 2 and Model 3 analyses, for both the rest-to-exercise and exercise-to-exercise transitions.

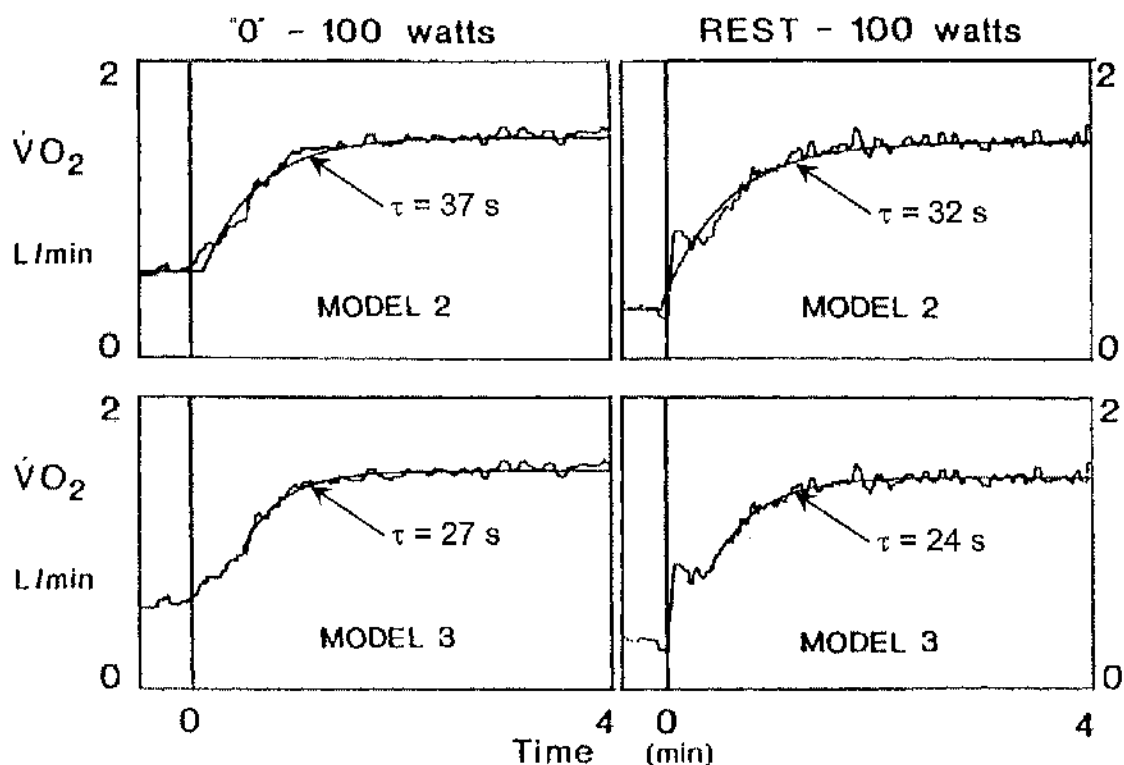

Figure 5.4 – Examples showing how the time constant (τ) estimate derived from an exponential model is dependent on the time frame used, since the Phase I response causes a lengthening of τ when it is included in the fit (Model 2) for both the rest-to-100W and "0"-to-100W transitions. Adapted from Whipp *et al.* (1982).

When the oxygen deficit is to be calculated, however, the Phase I response must be included in the calculation (Whipp, 1987). As discussed previously, this can be achieved by multiplying the MRT (i.e. the time constant of an exponential constrained to begin at exercise onset: Model 1 of Whipp *et al.*, 1982), by the amplitude. Alternatively, but also equally validly, an exponential model containing a delay term can be applied from exercise onset (Model 2 of Whipp *et al.*, 1982), with the oxygen deficit being calculated as the product of the amplitude and the sum of the time constant and delay values. The sum of the time constant and delay using this model is numerically equivalent to the "effective time constant" (τ'), or the MRT, of Model 1 above (Linnarsson, 1974; Barstow *et al.*, 1990).

The estimation of a MRT, using either Model 1 or 2 above, has been carried out in patients presenting with a variety of clinical conditions: COPD (Casaburi *et al.*, 1997; Puente-Maestu *et al.*, 2000; Neder *et al.*, 2000; Somfay *et al.*, 2002); Type II diabetes (Brandenburg *et al.*, 1999); chronic heart failure (Koike *et al.*, 1994; Sietsema *et al.*, 1994; Picozzi *et al.*, 1999; Rocca *et al.*, 1999; Arena *et al.*, 2002); and other cardiovascular disorders such as dilated cardiomyopathy and hypertensive heart disease (Koike *et al.*, 1995). Where the exercise transitions could be confirmed as being of moderate intensity,

these calculations would permit valid estimation of the oxygen deficit. Unfortunately, however, many of these studies have confused the MRT estimate with a valid estimate of the Phase II τ , and consequently, have made invalid comparisons either with other populations (Sietsema *et al.*, 1994; Koike *et al.*, 1995; Picozzi *et al.*, 1999; Neder *et al.*, 2000; Arena *et al.*, 2002; Somfay *et al.*, 2002), or “pre” and “post” an exercise training intervention (Casaburi *et al.*, 1997; Brandenburg *et al.*, 1999; Puente-Maestu *et al.*, 2000). In such circumstances, ascribing changes in $\dot{V}O_2$ kinetics to those of \dot{Q}_{mO_2} would clearly not be warranted. Indeed, whilst there is little argument concerning the use of a τ' or MRT as an expedient, there has been no definitive description, to date, of how it relates to the actual Phase II τ in COPD patients.

As Lamarra *et al.* (1987) have pointed out, however, the ability to reliably resolve $\dot{V}O_2$ response kinetics is compromised when the amplitude of the asymptotic or steady state $\dot{V}O_2$ response is small, as is the case for many patient groups (e.g. Nery *et al.*, 1982; Koike *et al.*, 1994 & 1995; Sietsema *et al.*, 1994; Palange *et al.*, 1995; Casaburi *et al.*, 1997; Picozzi *et al.*, 1999; Rocca *et al.*, 1999; Brandenburg *et al.*, 1999; Puente-Maestu *et al.*, 2000; Neder *et al.*, 2000; Arena *et al.*, 2002; Somfay *et al.*, 2002). An additional concern in COPD patients relates to the influence of Phase I, since in any condition characterised by a relatively hypokinetic circulation (e.g. Slutsky *et al.*, 1980; Mahler *et al.*, 1984; Matthay *et al.*, 1992), it might not be unreasonable to expect that the Phase I duration might be prolonged relative to that of healthy individuals. Such a scenario would thus complicate physiologically-meaningful interpretation of a prolonged $\dot{V}O_2$ τ' or MRT, which could reflect a true slowing of \dot{Q}_{mO_2} kinetics, a prolonged Phase I duration, or both.

There are also concerns about modelling strategies above θ_L , where the development of the $\dot{V}O_2$ slow component places additional requirements on the definition of the Phase II (or fundamental) $\dot{V}O_2$ component. As discussed later, some previous investigations have used an arbitrary percentage of the WR_{peak} attained during an incremental test as a means of normalising exercise intensity for subsequent constant work rate transitions (e.g. Casaburi *et al.*, 1997). However, none of these studies has formally considered the possibility that these work rates may (or may not) consistently correspond to a supra- θ_L exercise intensity. If this were to be the case, then the possible emergence of the $\dot{V}O_2$ slow component would need to be considered in the modelling discrimination, although to date the supra- θ_L $\dot{V}O_2$ kinetics have not been formally characterised in COPD patients.

The aim of this study was therefore to investigate the influence of model structure on the characterisation of the $\dot{V}O_2$ kinetics in COPD patients, prior to, and following, an exercise training intervention. This chapter focuses on data collected as part of a major interdepartmental collaborative research study into the effects of creatine supplementation on functional exercise capacity and quality of life (see patient consent form in Appendix 5). Due to the large assortment of variables being examined, ranging from field-based walking tests to muscle strength, questionnaire data, pulmonary function and lab-based exercise tests, the overall structure of the project prevented optimal design of the $\dot{V}O_2$ kinetics assessment. Due to the large number of visits to the lab that patients had to make, it was decided to investigate $\dot{V}O_2$ kinetics during the standardised warm-up to other tests since this meant that multiple repetitions could be gained without requiring additional visits. Furthermore, due to the severe nature of the exercise limitation experienced by these patients, the protocols had to incorporate the rest-to-exercise transition, as detailed in Section 5.2.5, rather than the more conventional exercise-to-exercise transition. Despite the limitations imposed, the $\dot{V}O_2$ kinetics assessment formed an interesting and valuable sub-project within the overall investigation, permitting accurate model discrimination in this population both before and after an exercise training intervention, as discussed subsequently.

5.2 METHODS

In addition to the overall Methods chapter (Chapter 2), the following section details the exact protocols and study design that were implemented, and describes modelling strategies that were exclusive to this study.

5.2.1 Subjects and Procedures

Twenty-two patients (15 males, 7 females) were recruited from the out-patient Pulmonary Rehabilitation Assessment Clinic, at the Department of Respiratory Medicine, Glasgow Royal Infirmary. Due to the large subject numbers, the individual patient characteristics are presented in the Appendix, and summarised in Table 5.1. Informed written consent was obtained from all patients according to the Research Ethics Committee of Glasgow Royal Infirmary (Appendix).

Variable	Units	Mean	S.D.
Age	years	62	7
Height	m	1.67	0.04
Weight	kg	68.7	4.8
$\dot{V}O_{2\text{ peak}}$	ml.min ⁻¹	900	255
$\dot{V}O_{2\text{ peak}}$	ml.kg ⁻¹ .min ⁻¹	13.4	3.7
FEV ₁	l (BTPS)	1.12	0.04
FEV ₁	%pred.	43	4
FEV ₁ /FVC	%	36	1.4
TLC	l (BTPS)	7.4	0.3
TLC	%pred.	127	12
D _L CO	%pred.	45	10
PIP	mmHg	66	15
PEP	mmHg	80	19

Table 5.1 – Subject characteristics. All data presented are means (\pm S.D.) calculated from individual data (Appendix). Peak $\dot{V}O_2$ ($\dot{V}O_{2\text{ peak}}$) was determined from a symptom-limited ramp incremental test (see text for details). Pulmonary function indices (see text for details): forced expired volume in 1 s (FEV₁); forced vital capacity (FVC); total lung capacity (TLC); carbon monoxide diffusing capacity (D_LCO); peak inspiratory and expiratory pressures (PIP and PEP respectively). Some values are presented as a percentage of predicted values (%pred. – see text for details).

All patients participating in the investigation were diagnosed with stable moderate-to-severe COPD (FEV₁ < 60% predicted and FEV₁/FVC ratio < 70% - Table 5.1). Inclusion criteria were absence of locomotor or neurological diseases, and no change in medication dosage or exacerbation of symptoms requiring oral prednisolone or antibiotics in the preceding 4 weeks. All patients were optimised in terms of standard medical therapy:

maintenance medication included β_2 -agonists, anticholinergics, theophylline or inhaled steroids (American Thoracic Society, 1999).

5.2.2 Study design

Lung function, body composition and both field and laboratory-based exercise performance were assessed in all patients before they undertook an eight-week training intervention. This exercise rehabilitation course, supervised by the Physiotherapy Department at Glasgow Royal Infirmary, comprised a one-hour session, two days per week for the duration. According to the guidelines of the British Thoracic Society (2001) and the American Thoracic Society (1999), the classes incorporated a wide-range of exercise modalities and tasks, each session consisting of a warm-up and cool-down, mobility training, dynamic strength training of the upper and lower extremities, endurance training and stretching. Exercise intensity was monitored throughout the course according to the level of dyspnoea experienced (Borg, 1982; Horowitz & Mahler, 1998), allowing training work rates to be increased as the course proceeded, according to the overload principle of training (e.g. Bompa, 1999; Hoffman, 2002). In addition to the exercise classes, patients were instructed to perform a variety of exercises at home, on additional days. Throughout the rehabilitation course, patients maintained a log of the training performed, detailing relative intensity as the rating of dyspnoea and absolute intensity as durations, weights, sets and repetitions. On completion of the training course, patients repeated the same exercise assessments as for pre-rehabilitation.

5.2.3 Pulmonary Function

All pulmonary function tests were performed according to the guidelines established by the European Respiratory Society (Quanjer *et al.*, 1994) and recommended by the British Thoracic Society (1994). Accordingly, at least three satisfactory manoeuvres were performed for each test, with the highest value being presented for FEV₁ and FVC and the mean of the three results presented for other indices. Normal values used for comparison were obtained from Quanjer *et al.* (1994), with values lying ± 2 standard deviations outside the predicted values being considered as abnormal.

Standard spirometric tests were carried out using the flow-volume module of a constant volume body plethysmograph incorporating a heated wire anemometer (V6200 Autobox, SensorMedics Corporation, California, USA). Maximal forced and "slow" expiratory manoeuvres were performed for measurement of forced vital capacity (FVC), forced

expiratory volume in one second (FEV_1) and inspiratory capacity (IC). Static lung volumes were measured using the same constant volume body plethysmograph (V6200 Autobox, SensorMedics Corporation, California, USA), for calculation of residual volume (RV) and total lung capacity (TLC). Single breath carbon monoxide diffusing capacity (D_{LCO}) was measured using the Transflow System (Model 540, Morgan Medical, Kent, UK). Peak inspiratory and expiratory pressures (PIP and PEP) were determined using a Morgan handheld pressure monitor (Ferraris Medical, Kent, UK).

5.2.4 Breath-by-breath gas exchange

A CPX/D Medical Graphics (St. Paul, MN, USA) metabolic cart was used for measuring breath-by-breath gas exchange. This system incorporates a zirconium cell and an infrared cell for analysis of respired air for O_2 and CO_2 concentrations, respectively. Prior to all tests, the analysers underwent a two-point calibration using a reference gas (CO_2 5%, O_2 12%, N_2 balance) and room air. Gas flow was measured using an infrared Pitot tube that was calibrated over a range of flow rates prior to all tests using a high precision 3-litre syringe (Hans Rudolph, Kansas City, MO, USA). The algorithms for online computation of breath-by-breath values for $\dot{V}O_2$ were the same as described in Section 2.3.5.3 (Beaver *et al.*, 1973). All laboratory-based exercise tests were performed on an electrically braked cycle ergometer (Corival 400, Lode, Groningen, The Netherlands).

5.2.5 Exercise Tests

Similar to Chapter 2, patients initially performed an incremental test to the limit of tolerance (t_{lim}) for determination of symptom-limited or peak $\dot{V}O_2$, calculated as the mean value over the final 20 s. The protocol began with 3 minutes of quiet rest on the cycle ergometer followed by 3 minutes of pedalling at 20W, with the work rate subsequently being increased at an incrementation rate of 5 or 10 $W \cdot min^{-1}$ depending on the habitual physical activity level and pulmonary function of each patient. For the rest-to-20W transitions, the experimenters manually turned the pedals during the first few revolutions (< 5 s) of the test to overcome the initial associated mechanical inertia. On a different day, allowing at least 48 hours recovery between tests, patients also performed an “endurance” test that consisted of the same baseline (3 minutes rest and 3 minutes at 20W), and then constant work rate cycling until t_{lim} at a work rate equal to 80% of the peak work rate attained in the incremental test (80% WR_{peak}). In total, patients performed at least two rest-to-20W transitions (some patients early in the study did not perform the endurance test), both pre- and post-rehabilitation.

5.2.6 Analysis

The strategy for handling the breath-by-breath data for the rest-to-20W transitions was identical to that detailed in Section 2.3.5.4: erroneous breaths were removed; transitions were interpolated on a second-by-second basis; like transitions were time-aligned and added before averaging the data into 10 s bins for subsequent modelling (Lamarra *et al.*, 1987). Single transitions that were not considered representative, i.e. due to excessive “noise”, were not included. In addition, in order to improve visual identification of the start of the Phase II $\dot{V}O_2$ response, it was decided to also further average the data into 5 s bins to increase the density of data points in this region of the response.

As detailed in Section 2.3.5.5, the data were modelled using iterative non-linear least squares regression. The monoexponential equation used for all kinetic modelling was the same as Equation 2.9, taken from Whipp *et al.* (1982), however, the data range to which the model was applied was dependent on the modelling strategy employed. Three modelling strategies were used (Figure 5.5):

1. Model τ' - To allow comparisons with existing research (Casaburi *et al.*, 1997; Puente-Macstu *et al.*, 2000; Neder *et al.*, 2000; Somfay *et al.*, 2002), the effective time constant (τ') was calculated as the sum of the τ and δ terms of Equation 2.9, derived when the model is applied to the entire data-set from exercise onset ($t = 0$ s), i.e. including Phase I (“Model 2” of Whipp *et al.*, 1982).
2. Model τ_{20s} - Based on existing evidence for healthy subjects, “Model 3” of Whipp *et al.* (1982) was used in an attempt to isolate and model the Phase II $\dot{V}O_2$ kinetics. This modelling approach traditionally requires that the first 20 s of the $\dot{V}O_2$ response is excluded from the monoexponential fit, thus the τ estimate is assumed to reflect the Phase II response, free from contamination of the Phase I response.
3. Model τ_{real} - Since the response dynamics of the Phase I $\dot{V}O_2$ response in the rest-to-20W transition have yet to be formally described for COPD patients, the start of the Phase II response was visually identified from the $\dot{V}O_2$ profile when the averaging interval was deliberately reduced to 5 s to increase the density of data points. In patients where the start of the Phase II response was clearly later than 20 s, Equation 2.9 was applied from this point rather than being constrained to begin from $t = 20$ s, in an attempt to completely exclude the Phase I response from the exponential fit, and hence accurately estimate the Phase II τ of the $\dot{V}O_2$ response (“ τ_{real} ”). In cases where this modelling strategy did not produce a discernible improvement in the fit, as

described subsequently, and the onset of the Phase II response occurred earlier than $t = 20$ s, the same value for “ τ_{real} ” was recorded as using “Model $\tau_{20\text{s}}$ ” above.

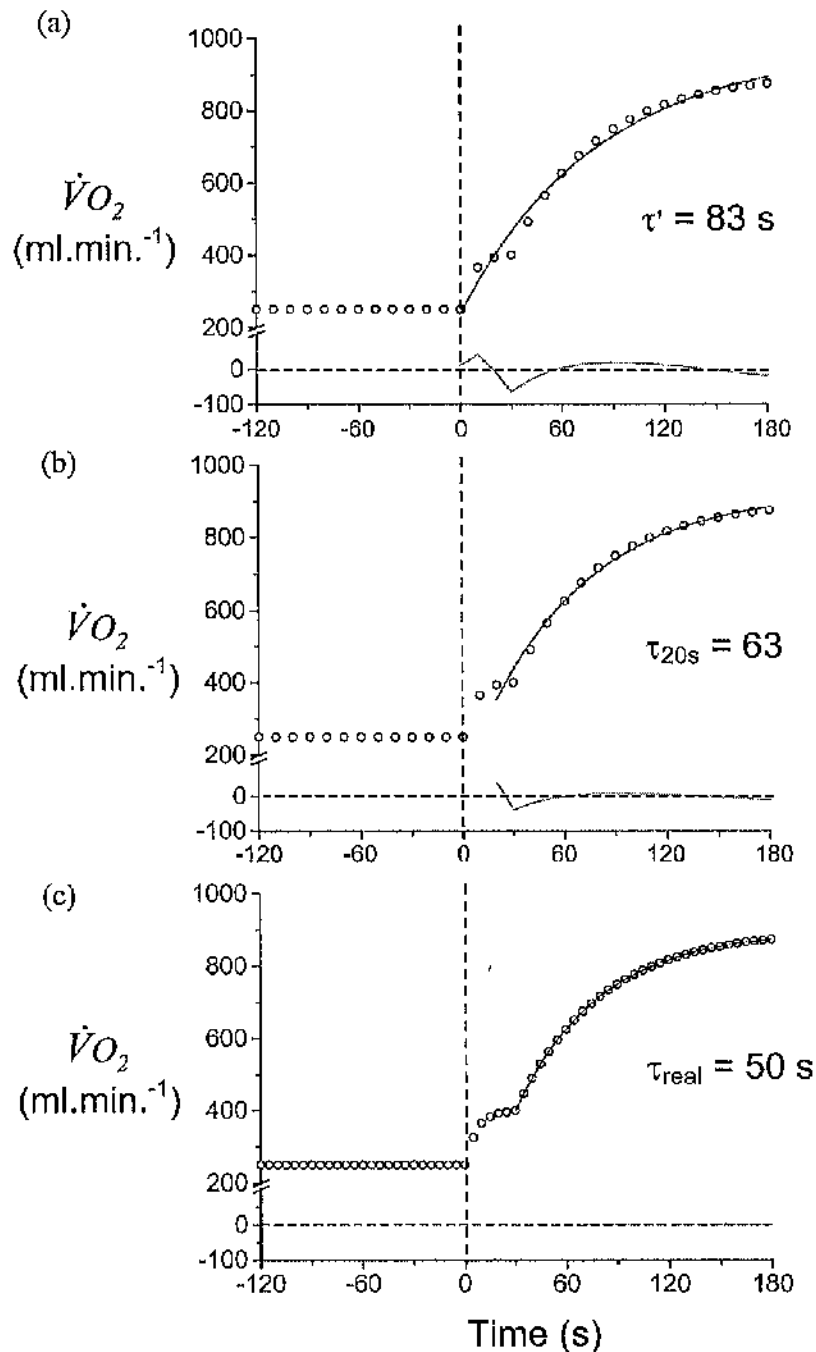

Figure 5.5 – Schematic illustrating how estimates of the $\dot{V}O_2$ kinetics were obtained using three different modelling strategies: (a) Model τ' - τ' is the sum of the τ and δ estimates of an exponential applied to the whole data-set (“Model 2” of Whipp *et al.*, 1982); (b) Model $\tau_{20\text{s}}$ - the τ estimate obtained from a monoexponential constrained to begin 20 s after exercise onset (“Model 3” of Whipp *et al.*, 1982); and (c) Model τ_{real} - the τ estimate obtained from a monoexponential applied from the start of Phase II, visually identified from the 5 s averaged plot.

5.2.7 Statistical Analysis

Since the number of data points included in the model fit varied between each of these three modelling strategies, the traditional goodness-of-fit statistical comparison could not be performed, as χ^2 is dependent on the number of data points (as discussed in Section 4.2.2 for supra- θ_1 exercise). The group-mean residual plot was obtained for each exponential fitting strategy by averaging the residual plots obtained for each patient. These residual plots were visually compared for each model, to assess which model best-characterised the data. Using these plots, goodness-of-fit was described by the residual plot showing flatness and a normal distribution about the zero-amplitude line. For example, in Figure 5.5 (to exaggerate the outcomes of the different modelling strategies) the residual plot for the τ' and τ_{20s} models could not reasonably be considered to be flat, whereas the residual plot for the τ_{real} model was completely flat – i.e. the portion of the data-set used conformed (by definition) to a true exponential beginning from $t = 30$ s.

To assess whether or not the residuals were normally distributed, a frequency distribution histogram was constructed for the group-mean residual plot, using each modelling strategy. These histograms were compared not only with each other, but also with the corresponding hypothetical “normal” curve that would be expected for each frequency distribution histogram. Therefore, the degree of flatness and normal distribution of the residual plot were used as criteria for comparing the appropriateness of the modelling strategies used, i.e. in the context of deciding which τ estimate most accurately reflected the Phase II $\dot{V}O_2$ kinetics (“ τ_{real} ”).

To investigate whether the exercise training rehabilitation programme had a speeding effect on the $\dot{V}O_2$ kinetics during the rest-to-20W transition, Student’s paired t -tests were used to compare the pre- and post-rehabilitation τ estimates obtained for each modelling strategy. To test whether the magnitude of change in $\dot{V}O_2$ kinetics was dependent on the modelling strategy used, further paired t -tests were carried out on the difference in τ ($\Delta\tau$) as a result of training, for the three modelling strategies (“ τ' ”, “ τ_{20s} ”, and “ τ ”). Note that such comparisons could only be made in individuals for whom all three modelling strategies provided an acceptable τ estimate.

In addition, some investigators have highlighted that simple statistical comparisons, as used here, may not provide a complete portrayal of an intervention effect (e.g. Hopkins, 2000; Koufaki *et al.*, 2002). These authors have documented that the impact of an

intervention should be assessed relative to the standard error of the measurement, since this will provide additional information regarding whether such effects will be reflected in adaptations for all subjects. Therefore a comparison was also made of the proportion of patients whose training-effect was greater than the standard error of the mean (S.E.M.).

5.3 RESULTS

Tables in the following sections summarise the group results. In addition, all results are presented in the Appendix on an individual basis.

5.3.1 Model discrimination for characterising $\dot{V}O_2$ kinetics in COPD patients

Of the twenty-two patients who underwent the exercise rehabilitation programme, the data from 11 (50%) patients provided τ estimates using all three modelling strategies (τ' , τ_{20s} , and τ_{real} – Table 5.2), despite the small amplitude of the response. The differences between the τ estimates are discussed subsequently.

Model	Training status	<i>n</i>	Mean (s)	S.D.
τ'	Pre-rehab	11	62.8**	17.6
	Post-rehab	11	46.2 [†]	16.7
τ_{20s}	Pre-rehab	11	53.4 [†]	15.2
	Post-rehab	11	40.6*	7.4
τ_{real}	Pre-rehab	11	48.4	15.8
	Post-rehab	11	38.3	8.8

Table 5.2 – Summary of group-mean $\dot{V}O_2$ kinetics (τ estimate), modelled using three different strategies (τ' , τ_{20s} , and τ_{real} – see text for details). *significantly longer than τ_{real} estimate at same stage of investigation (pre or post-rehabilitation), $P < 0.05$. **significantly longer than τ_{real} estimate at same stage of investigation, $P < 0.01$. [†]tendency to be longer than τ_{real} estimate at same stage of investigation, $P = 0.08$ and 0.09 respectively.

However, on closer inspection of the individual and group-mean residual plots and the respective frequency distribution histograms, the τ' and τ_{20s} values, estimated using an exponential function applied from $t = 0$ s and $t = 20$ s respectively, may not be accurately reflecting the Phase II $\dot{V}O_2$ kinetics in all patients. For example, for the representative patient presented in Figure 5.6, the same data are better modelled using an exponential from $t = 20$ s (Model τ_{20s} , or “Model 3” of Whipp *et al.*, 1982 - Figure 5.6(b)) than from exercise onset (Model τ' , or “Model 2” of Whipp *et al.*, 1982 - Figure 5.6(a)). These patterns were evident throughout the patient population, as can be seen by the group-mean residual plots, where the residuals are flatter for Model τ_{20s} (Figure 5.6(d)) than Model τ' (Figure 5.6(c)). The difference was particularly striking during the first 30 s of the response, where Model τ' clearly did not characterise the data well; i.e. there is a large negative deflection in the group-mean residual plot, which further compromised the goodness-of-fit for the Phase II portion of the $\dot{V}O_2$ response. Improvement of the fit with

Model τ_{20s} was illustrated by inspection of the frequency distribution histograms for the group-mean residuals (Figures 5.6(e) & (f)). The residuals for Model τ' not only show more spread than those for Model τ_{20s} , but they were not normally distributed, again with a large negative deflection observed, indicating an inferior fit by this model.

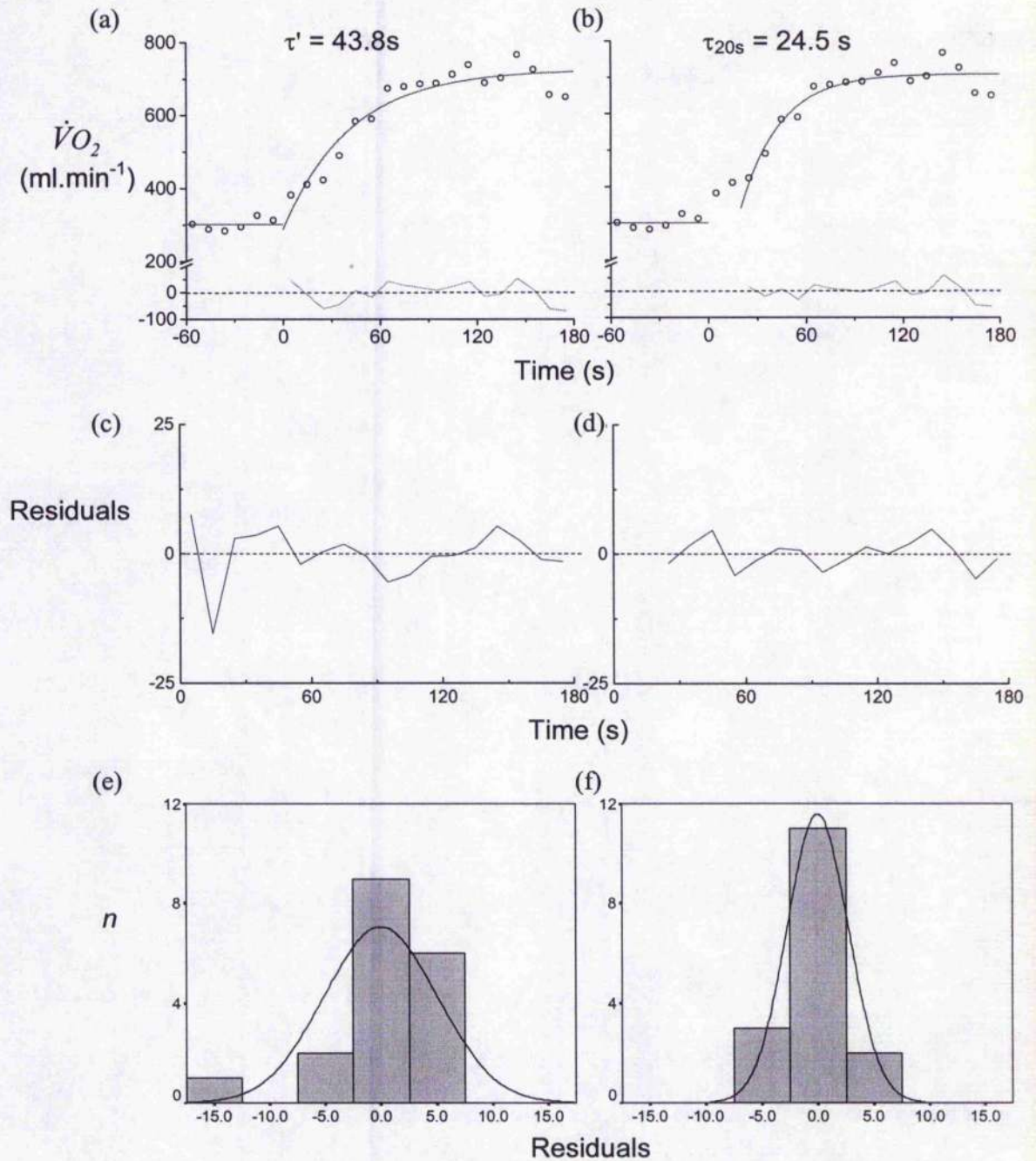

Figure 5.6 – Comparison of goodness-of-fit between Model τ' and Model τ_{20s} . Exponential fits (*dark solid lines*) for a representative patient (no. 23) and τ estimates obtained using (a) Model τ' and (b) Model τ_{20s} , with residuals for each fit shown (*light solid lines*). Group-mean residual profiles for (c) Model τ' and (d) Model τ_{20s} . Frequency distribution histograms for the group-mean residual profiles obtained using (e) Model τ' and (f) Model τ_{20s} , with normal curves shown.

Furthermore, Figure 5.7 illustrates that, for a representative patient, the same data are better modelled using an exponential applied from the visually identified beginning of Phase II (Model τ_{real} - Figure 5.7(b)) than from $t = 20$ s (Model $\tau_{20\text{s}}$, or “Model 3” of Whipp *et al.*, 1982 - Figure 5.7(a)). To further emphasise this point, the frequency distribution histograms for the residual plots are presented for the same exponential fits of this representative patient (Figures 5.7 (c) & (d)).

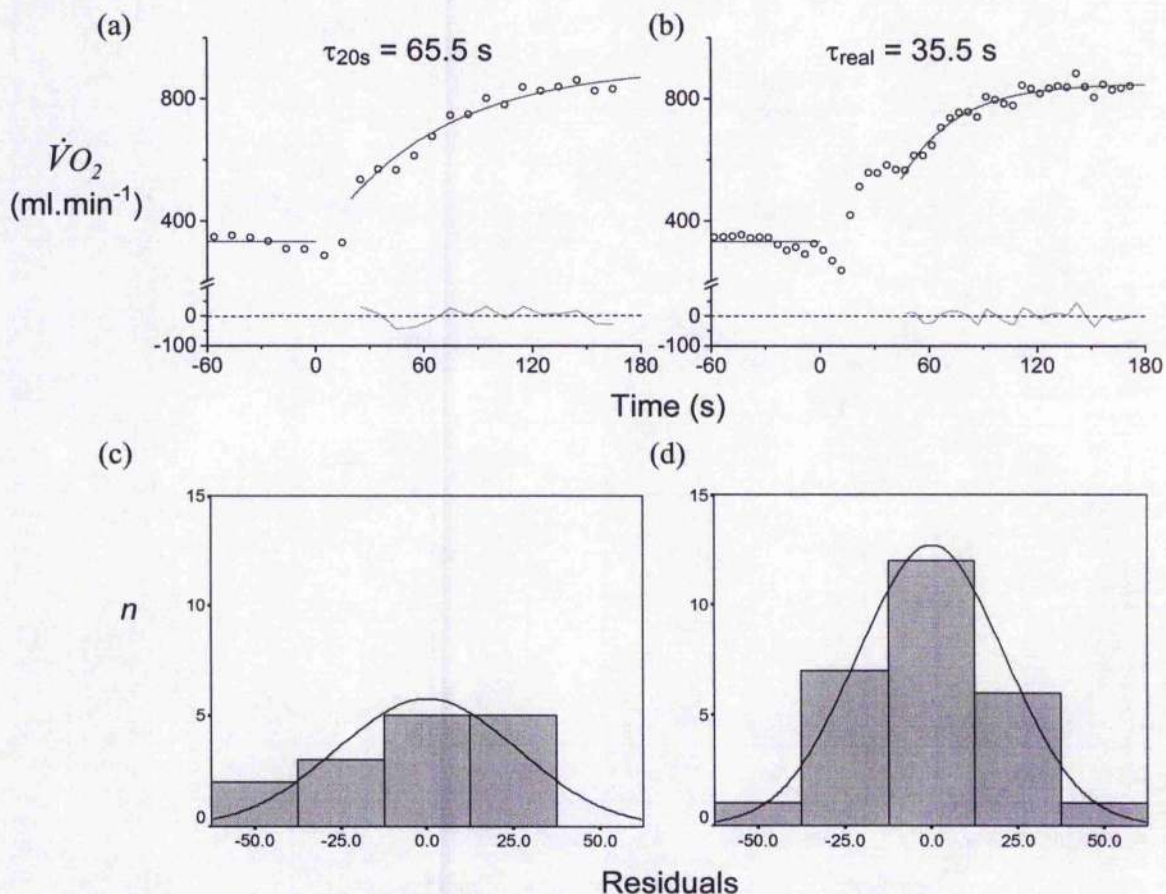

Figure 5.7 – Comparison of goodness-of-fit between Model $\tau_{20\text{s}}$ and Model τ_{real} . Exponential fits (*dark solid lines*) for a representative patient (no. 4) and τ estimates obtained using (a) Model $\tau_{20\text{s}}$ and (b) Model τ_{real} , with residuals for each fit shown (*light solid lines*). Frequency distribution histograms for the respective residual profiles of the same exponential fits as in (a) and (b), obtained using (c) Model $\tau_{20\text{s}}$ and (d) Model τ_{real} , with normal curves shown.

This improvement in fit was not observed in all patients, although Figures 5.8 (a) & (b) clearly show that the group-mean residuals for the Model τ_{real} fits were both flat and normally distributed. These plots were similar to Figures 5.6 (d) & (f) for Model $\tau_{20\text{s}}$, but in contrast to Figures 5.6 (c) & (e) for Model τ' , indicating that the data were well characterised, on average, using both Model $\tau_{20\text{s}}$ and Model τ_{real} , but not Model τ' .

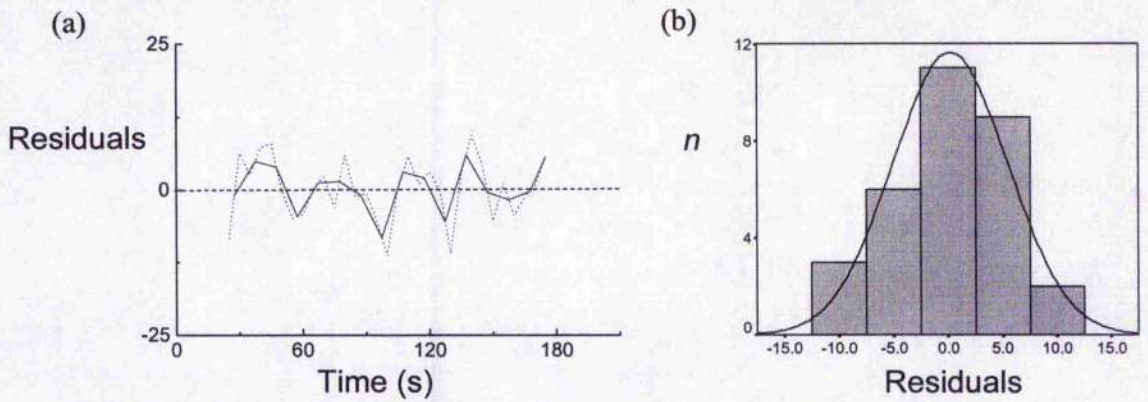

Figure 5.8 – Group-mean residuals for Model τ_{real} : (a) Group-mean residual profile, showing the plot for the data when the data was averaged every 5 s (dotted line) and 10 s (solid line), to allow direct comparison with Figures 5.6 (c) & (d); and (b) frequency distribution histogram for the group-mean residuals, with the normal distribution curve shown.

Whilst these figures clearly illustrate the improvement in the exponential fit when the data range is appropriately selected, there was considerable patient-to-patient variability, with respect to how the various modelling strategies impacted on the τ estimate. Figure 5.9 and Table 5.2 portray this variability and demonstrate that the pre-rehabilitation τ' estimates were significantly longer than the τ_{real} estimates ($P < 0.01$), whilst the τ_{20s} estimates tended to be longer than the τ_{real} estimates ($P = 0.075$). The post-rehabilitation τ' estimates tended to be longer than the τ_{real} estimates ($P = 0.088$), whilst the τ_{20s} estimates were significantly longer than the τ_{real} estimates ($P < 0.05$). Although these figures are insightful, it is the τ_{real} estimates which are considered to most accurately characterise the Phase II $\dot{V}O_2$ kinetics.

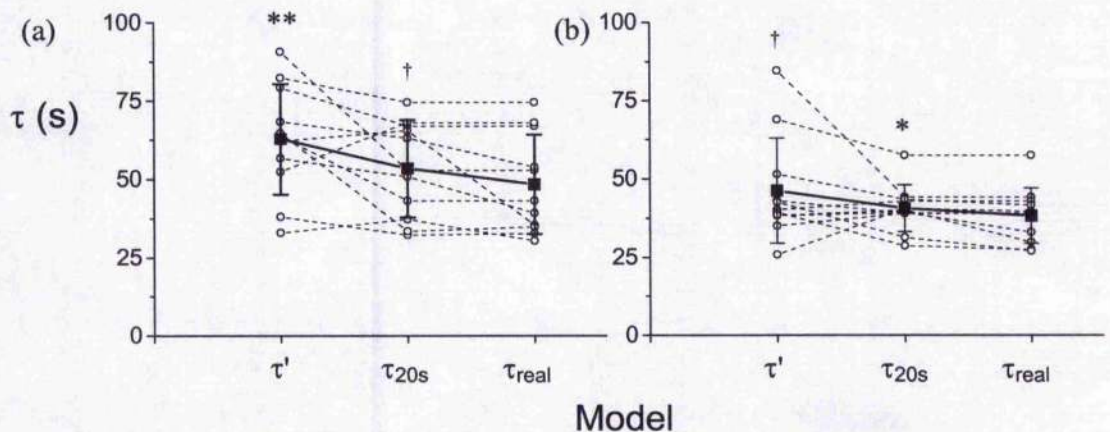

Figure 5.9 – Variability of (a) pre- and (b) post-rehabilitation $\dot{V}O_2$ kinetics, quantified by the time constant (τ), using the three different modelling strategies (Model τ' , Model τ_{20s} and Model τ_{real} - see text for details). *Open circles* and *dashed lines* represent the individual patient data ($n = 11$). *Solid squares, lines* and *error bars* represent the means \pm standard deviations. *significantly longer than τ_{real} estimate, $P < 0.05$. **significantly longer than τ_{real} estimate, $P < 0.01$. †tendency to be longer than τ_{real} , $P = 0.08$ and 0.09 in (a) and (b) respectively.

5.3.2 Effect of exercise training on $\dot{V}O_2$ kinetics

Whilst only the τ_{real} estimates were considered accurate and valid for characterising the Phase II $\dot{V}O_2$ kinetics in all patients, it is worthwhile to consider how the exercise training impacted on all of the τ estimates, for comparison with existing literature. All three modelling strategies provided τ estimates in only 11 patients, when each modelling strategy was considered separately for making comparisons of pre- and post-rehabilitation values. A significant speeding effect was observed for τ estimates obtained using all three modelling strategies (Table 5.3). The speeding of $\dot{V}O_2$ kinetics was greater than the S.E.M. in 10 out of 13 patients (77 %) for whom τ' estimates were obtained, 9 out of 14 patients (64 %) for whom τ_{20s} estimates were obtained and 10 out of 16 patients (63 %) for whom τ_{real} estimates were obtained.

Model	Training status	<i>n</i>	Mean (s)	S.D.
τ'	Pre-rehab	13	63.7	16.3
	Post-rehab	13	48.2**	16.2
τ_{20s}	Pre-rehab	14	51.1	15.6
	Post-rehab	14	41.9*	7.2
τ_{real}	Pre-rehab	16	46.1	14.3
	Post-rehab	16	38.8*	10.4

Table 5.3 – Summary of $\dot{V}O_2$ kinetics (τ estimate), modelled using three different strategies (τ' , τ_{20s} , and τ_{real} – see text for details). Independent of the model used, there was a significant speeding of $\dot{V}O_2$ kinetics (decrease in τ) from pre-rehabilitation (pre-rehab) to post-rehabilitation (post-rehab). *significantly lower than pre-rehab value, $P < 0.05$. **significantly lower than pre-rehab value, $P < 0.01$.

Figure 5.10 illustrates this speeding effect in a representative patient. Interestingly, whilst it was the speeding of the τ_{real} estimates that was of primary importance, when the τ estimates obtained were compared for the 11 subjects whose data could be modelled using all three modelling strategies, there was no significant difference in the magnitude of the speeding effect between the three models.

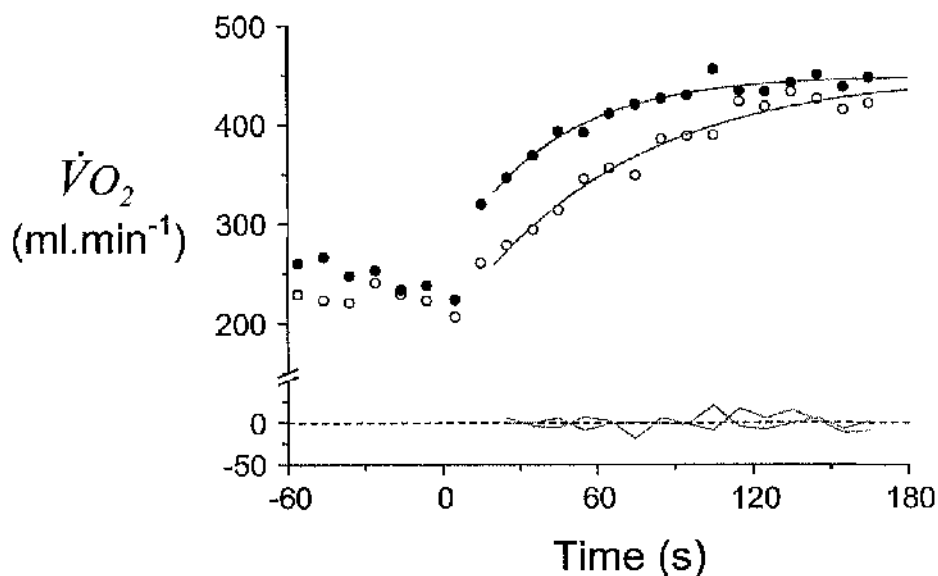

Figure 5.10 – Speeding of $\dot{V}O_2$ kinetics during the rest-to-20W transition following an 8-week exercise training programme, for a representative patient (no. 1). The data were well characterised by a monoexponential function (dark solid line) applied from $t = 20$ s (Model τ_{20s} - see text for details), illustrated by the normal distribution and flatness of the residual plots (light solid lines). Open circles and solid circles represent the pre and post-rehabilitation responses, with time constants (τ_{20s}) of 66.9 and 39.0 s, respectively.

5.3.3 Improvements in exercise capacity

Table 5.4 summarises that there was no significant effect of the training programme on exercise capacity, as judged from the results of the symptom-limited incremental test, i.e. as indicated by $\dot{V}O_{2\text{ peak}}$ and WR_{peak} . However, there was a significant improvement in the tolerable duration of the high-intensity constant work rate test, as shown by Figures 5.11 & 5.12 for a representative patient.

	Pre-rehabilitation			Post-rehabilitation		
	$\dot{V}O_{2\text{ peak}}$ (ml.min ⁻¹)	WR_{peak} (W)	t_{lim} (s)	$\dot{V}O_{2\text{ peak}}$ (ml.min ⁻¹)	WR_{peak} (W)	t_{lim} (s)
Mean	909	60	220	904	62	566**
± S.D.	327	28	80	283	24	415

Table 5.4 – Group-mean results for the exercise tests obtained during either a symptom-limited rapidly incremental ramp test (peak $\dot{V}O_2$ - $\dot{V}O_{2\text{ peak}}$; peak work rate - WR_{peak}), or a constant work rate endurance test (time until the limit of tolerance - t_{lim}). **significantly greater than the corresponding pre-rehabilitation value ($P < 0.01$).

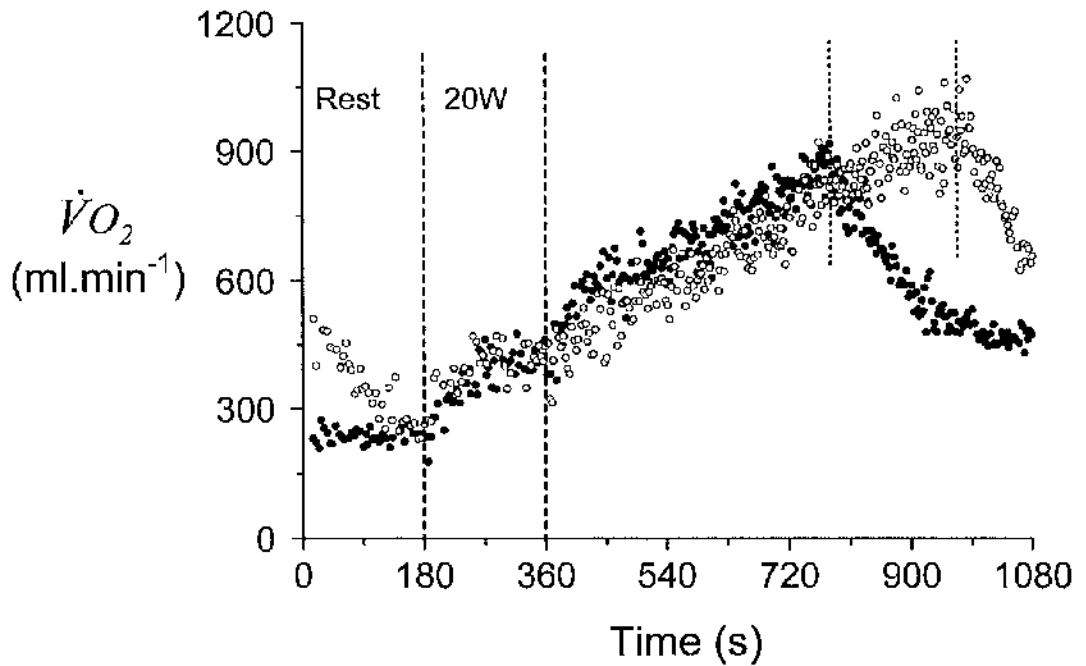

Figure 5.11 – $\dot{V}O_2$ profiles during symptom-limited ramp incremental cycling for a representative patient (no. 1), showing a comparison of pre (solid circles) and post-rehabilitation (open circles) responses. Vertical dashed and dotted lines reflect the different stages of the test and the patient attaining the limit of tolerance (t_{lim}) respectively.

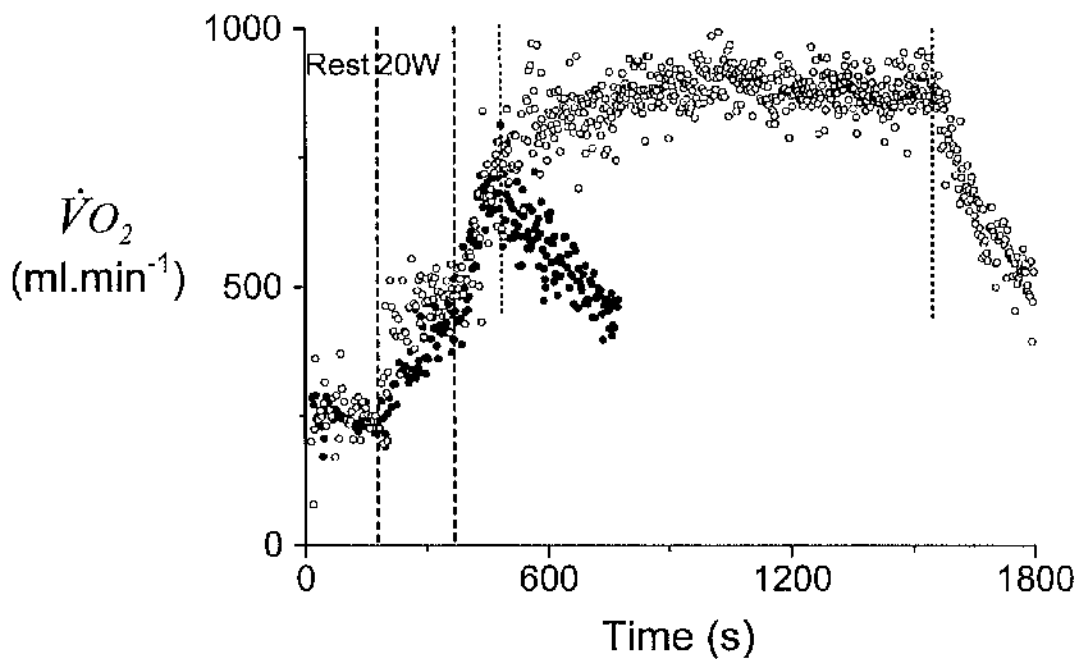

Figure 5.12 – $\dot{V}O_2$ profiles during the constant work rate cycling at a work rate equivalent to 80% of the pre-rehabilitation WR_{peak} , for a representative patient (no. 1), showing a comparison of pre (solid circles) and post-rehabilitation (open circles) responses. Vertical dashed and dotted lines reflect the different stages of the test and the patient attaining the limit of tolerance (t_{lim} – or end of test, post-rehab) respectively.

5.4 DISCUSSION

The major finding of this analysis is that traditional models used to characterise $\dot{V}O_2$ kinetics in clinical populations do not accurately describe the fundamental component $\dot{V}O_2$ kinetics in patients with moderate-to-severe COPD. It was demonstrated that a prolonged duration of Phase I observed in some of these COPD patients significantly affects the goodness-of-fit using traditional models. Therefore, conclusions regarding the kinetics of the Phase II $\dot{V}O_2$ response, considered to reflect the kinetics of \dot{Q}_mO_2 in healthy subjects, may be misleading where these models have been used in COPD patients. Interestingly, however, irrespective of the modelling strategy used there was a significant speeding of $\dot{V}O_2$ kinetics as a result of an 8-week exercise training programme. This study has demonstrated, for the first time, the sensitivity of Phase II $\dot{V}O_2$ kinetics to detect an exercise training effect in COPD patients, where there was no significant improvement in $\dot{V}O_{2\text{ peak}}$ or WR_{peak} .

5.4.1 Modelling $\dot{V}O_2$ kinetics in COPD patients

Although multiple repetitions of the rest-to-20W transitions were performed (Lamarra *et al.*, 1987) the data generated by some patients could not be modelled by an exponential process, as reported previously (Puenta-Maestu *et al.*, 2000 & 2001). This is perhaps unsurprising given the very small amplitude of the $\dot{V}O_2$ responses. Despite these limitations, a realistic estimate for the fundamental component τ (τ_{real}) was still obtained both pre and post-rehabilitation in 73% of these severely debilitated patients, the accuracy of the τ estimates being determined according to the flatness and normal distribution of the group-mean residuals to the exponential fits (Figures 5.8(a) & (b)).

That the τ' model ("Model 2" of Whipp *et al.*, 1982) provided "acceptable" estimates of the $\dot{V}O_2$ kinetics in a reduced number of the patients (i.e. analysis of the residuals suggested that the exponential fit did not convincingly characterise the data in the other patients) is unsurprising, due to the inclusion of Phase I in the exponential fit, and this is exemplified in Figure 5.6. These findings are in direct support of Whipp *et al.* (1982), who used multiple repetitions to accurately characterise the $\dot{V}O_2$ kinetics in healthy individuals, clearly demonstrating that contamination of the exponential fit by the Phase I response results in inaccurate estimates for the Phase II τ . Despite this general consensus being accepted by the majority of research groups undertaking modelling of $\dot{V}O_2$ kinetics in

healthy populations, a considerable number of papers have applied the τ' approach in patients with a variety of pathological conditions: COPD (Casaburi *et al.*, 1997; Puente-Maestu *et al.*, 2000; Neder *et al.*, 2000; Somfay *et al.*, 2002); Type II diabetes (Brandenburg *et al.*, 1999); chronic heart failure (Koike *et al.*, 1994; Sietsema *et al.*, 1994; Picozzi *et al.*, 1999; Rocca *et al.*, 1999; Arena *et al.*, 2002); and other cardiovascular disorders such as dilated cardiomyopathy and hypertensive heart disease (Koike *et al.*, 1995).

Figure 5.6 clearly illustrates that, as this approach takes no account of the temporal phases of the $\dot{V}O_2$ response to constant work rate cycling, the data are consequently not accurately characterised using this modelling strategy. τ' or MRT, which is derived from both Phase I and Phase II data, is an important parameter in the computation of the O_2 deficit (Whipp, 1971). However, to accurately characterise the Phase II kinetics this fundamental component must be successfully isolated from the Phase I contribution. In the 11 patients for whom reliable τ estimates were able to be obtained using all three modelling strategies, it was therefore unsurprising that the pre-rehabilitation values for τ' were significantly longer than τ_{real} ; i.e. the distorting influence of the Phase I $\dot{V}O_2$ data was manifest as a lengthening of the τ estimate. For the same reason, the post-rehabilitation τ' estimates also tended to be longer than τ_{real} . That this difference was not statistically significant is most likely explained by the larger variance of the τ' estimates for the post-rehabilitation responses (Figure 5.9). Therefore, the majority of values previously presented for τ in patient populations should be interpreted with caution due to the distorting influence of the Phase I component, as recently reported (Behnke *et al.*, 2003).

Further improvements in the goodness-of-fit were achieved in some patients when the model fit was not constrained to begin at $t = 20$ s. It was noted, that in ten out of the twenty-two patients (45%), the residual plot associated with the exponential fit was improved by beginning the fit from a later time-point, as shown by the representative example in Figure 5.7. The improvement in fit in these patients was evidenced by a flatter and more nearly normal distribution of the residual plot; it should be emphasised that, as χ^2 is dependent on the number of points included in the fit, it could not be used for direct comparison. However, the corresponding group-mean residual plots were flat and normally distributed, supporting use of Model τ_{real} (Figure 5.8). This finding implies that the Phase I $\dot{V}O_2$ response was prolonged in some of the COPD patients, in comparison to values expected for healthy individuals (e.g. Whipp *et al.*, 1982). The current observation of a

prolonged duration of the Phase I $\dot{V}O_2$ response in some of the patients may be reflect a hypokinetic circulation (e.g. Slutsky *et al.*, 1980; Mahler *et al.*, 1984; Matthay *et al.*, 1992), as has been reported previously for patients with pulmonary vascular disease (Sietsema, 1992), although this could not be confirmed in the present investigation.

Unfortunately, the exact time-point of the emergence of Phase II could not be determined in the current study using the standard gas exchange indices, which reflect the delayed expression of changes in muscle blood gas tensions at the lung, proposed by Linnarsson (1974) and Whipp *et al.* (1982). That is, Phase I increases in $\dot{V}O_2$, $\dot{V}CO_2$ and $\dot{V}E$ have been shown to respond in close association with the increase in \dot{Q}_P at the onset of exercise (Wasserman *et al.*, 1974; Cummin *et al.*, 1986) and so RER, $\dot{V}E/\dot{V}O_2$ and $\dot{V}E/\dot{V}CO_2$ remain essentially unaltered until the onset of Phase II. At the onset of Phase II, a decrease in $\dot{V}E/\dot{V}O_2$ occurs as the Phase II kinetics for $\dot{V}E$ are slower than those for $\dot{V}O_2$ (reviewed in Whipp, 1980 and Whipp & Ward, 1991). In contrast, since the Phase II kinetics for $\dot{V}E$ and $\dot{V}CO_2$ are essentially similar (reviewed in Whipp, 1980 and Whipp & Ward, 1991), $\dot{V}E/\dot{V}CO_2$ remains largely unaltered, and hence RER decreases. That such patterns of response were not observed in the current investigation is most likely due to the impact of "noise" on the breath-by-breath responses, and so the onset of the Phase II response had to be visually estimated, as previously carried out by Nery *et al.* (1982) with COPD patients.

The post-rehabilitation τ_{20s} ("Model 3" of Whipp *et al.*, 1982) estimates were significantly longer than the τ_{real} estimates, although the differences were not significant at the pre-rehabilitation stage. One possible reason why the pre-rehabilitation values were not, and the post-rehabilitation values were only slightly, significantly different ($P = 0.049$) may be that in five patients there was no improvement in the exponential fit when the starting point for the data range was extended. Therefore the same values were presented for τ_{real} and τ_{20s} in these patients, presumably partially offsetting the differences in the other patients. Nonetheless, if valid and accurate values for the fundamental $\dot{V}O_2$ kinetics are required then the demonstration that the duration of Phase I may be longer in some patients must be addressed. That this observation was only evident when the averaging interval was reduced (5 s bins rather than 10 s) suggests that this averaging interval may be more appropriate when multiple repetitions are performed in this population; otherwise a prolonged Phase I response may be obscured and inaccurate values for τ may be reported.

5.4.2 Speeding of $\dot{V}O_2$ kinetics as a result of exercise training

In support of previous research (Casaburi *et al.*, 1997; Otsuka *et al.*, 1997; Puente-Maestu *et al.*, 2000), this study has demonstrated that exercise training induced a significant speeding of the slow $\dot{V}O_2$ kinetics typically exhibited by COPD patients. However, for the first time, this study has demonstrated that this speeding effect is due to a faster Phase II $\dot{V}O_2$ response, and not just a speeding of the overall $\dot{V}O_2$ kinetics (τ) which could reflect changes in the Phase I and/or Phase II $\dot{V}O_2$ responses, as discussed previously.

When the pre and post-rehabilitation τ estimates, obtained using three modelling strategies, are compared, the number of patients for whom τ estimates were obtained varied according to the modelling strategy employed. As shown in Table 5.3, there was a significant reduction in τ of 15.5 ($n = 13$), 9.2 ($n = 14$) and 7.4 s ($n = 16$) for τ' , τ_{20s} and τ_{real} respectively. Some authors have recently highlighted the importance of comparing the magnitudes of intervention effects against the variance of the measurement (e.g. S.E.M.) to ascertain the true significance of the effect (Hopkins, 2000; Koufaki *et al.*, 2002). Using all three modelling strategies it was evident that the magnitudes of the change in τ were greater than the S.E.M. in more than 63% of the patients (see Section 5.3.2), providing strong support that the magnitude of the training-effect is significant.

In the 11 patients for whom estimates of τ' , τ_{20s} and τ_{real} were obtained the magnitude of the reduction in τ , induced by exercise training, was independent of the model used to characterise the $\dot{V}O_2$ kinetics. This demonstration can be interpreted in several ways. Firstly, Figure 5.9 illustrates that a lack of significant difference is probably due to the considerable patient-to-patient variability of τ depending on the model used, particularly for τ' estimates. Secondly, if the reductions in τ are assumed to be similar for all three modelling approaches for estimating τ , this may suggest that the major contributor to reductions in τ' and τ_{20s} could be the speeding of the Phase II response, since changes in τ_{real} were of similar magnitude to those of τ' and τ_{20s} . However, whilst this result is interesting and the interpretation speculative, it is vital to appreciate that only the τ_{real} values were considered to accurately characterise the fundamental $\dot{V}O_2$ kinetics during the rest-to-20W transitions for all patients. "Model 3" of Whipp *et al.* (1982) has been widely accepted and applied in modelling the fundamental component $\dot{V}O_2$ kinetics in healthy subjects. However, the present study has demonstrated that this is not the case for all COPD patients (e.g. Figure 5.7) for this type of exercise transition.

The mechanisms underpinning the reported post-training speeding of $\dot{V}O_2$ kinetics in young healthy subjects remain elusive (Hickson *et al.*, 1978; Hagberg *et al.*, 1980; Whipp & Ward, 1992; Phillips *et al.*, 1995). Within this subject population, the general consensus is that $\dot{V}O_2$ kinetics during moderate exercise are limited by intrinsic inertia of oxidative phosphorylation, as detailed in Section 1.5.1. It would therefore seem likely that adaptations responsible for speeding the fundamental component will reside in the trained skeletal musculature, specifically linked to aerobic metabolism. It has been well documented that exercise training of an aerobic nature will induce an increase in mitochondrial number and/or content (e.g. Holloszy & Coyle, 1984; Hoppeler & Fluck, 2003), accompanied by increased activity of oxidative enzymes (e.g. Gollnick *et al.*, 1973a) and increased capillary-to-muscle fibre ratio (e.g. Hudlicka *et al.*, 1992; Hepple, 2000). The relative importance of these adaptations in causing speeded $\dot{V}O_2$ kinetics is presently unknown, although a recent theoretical modelling paper addressed this issue (Korzeniewski & Zoladz, 2003). This model focused on whether accelerated $\dot{Q}mO_2$ kinetics, as a result of training, were mainly due to increased mitochondrial number or protein content, increased sensitivity of mitochondria to increased [ADP] (decreased maximal rate constant – K_m) and/or intensification of the parallel activation of ATP production by oxidative phosphorylation and subsequent ATP usage. Korzeniewski & Zoladz (2003) concluded that, in their model where O_2 -delivery was assumed to be sufficient, the major adaptations to exercise training were increased amount of mitochondrial proteins and intensification of parallel activation of ATP usage and supply.

In older individuals the training-induced reductions in τ are typically larger, presumably since ageing itself results in a slowing of $\dot{V}O_2$ kinetics (Babcock *et al.*, 1994; Chilibeck *et al.*, 1996), with capacity for a larger margin of improvement. However, on closer inspection this observation is only applicable for muscle groups which are not routinely recruited in everyday activity in older populations (Chilibeck *et al.*, 1997). Since Coggan *et al.* (1992) have shown a significantly reduced capillary-to-muscle fibre ratio in older subjects, the potential for an O_2 -delivery limitation to exist as a determining factor of $\dot{V}O_2$ kinetics in older subjects must be recognised. However, a recent training study with elderly subjects (Fukuoka *et al.*, 2002) concluded that whilst the underlying mechanisms for speeded $\dot{V}O_2$ kinetics could not be confirmed, there is little evidence that O_2 delivery is improved (Chilibeck *et al.*, 1997; Bell *et al.*, 2001a).

The COPD patients of the current study evidenced slower pre-rehabilitation $\dot{V}O_2$ kinetics than typical values for healthy older subjects, both for Phase II τ in support of Nery *et al.* (1982) and Palange *et al.* (1995), and τ' in support of Neder *et al.* (2000) and Somfay *et al.* (2002). The mechanisms for these slowed kinetics in COPD patients, who are typically over fifty years old, are unclear and it has been suggested that both intrinsic metabolic inertia and O_2 -delivery limitations may exist (e.g. Nery *et al.*, 1982; Casaburi *et al.*, 1997; Puente-Maestu *et al.*, 2000). For example, Nery *et al.* (1982) described evidence supporting blunted cardiovascular responses to exercise in COPD patients, due to high pulmonary vascular resistance, decreased vascular bed dilation capacity, changes in intrathoracic pressure affecting ventricular afterload and myocardial dysfunction (e.g. Slutsky *et al.*, 1980; Mahler *et al.*, 1984; Matthay *et al.*, 1992). Furthermore, Jobin *et al.* (1998) demonstrated that skeletal muscle of COPD patients had lower capillary-to-fibre ratios than age-matched healthy individuals, suggesting that any potential O_2 -delivery limitation in elderly individuals may be exacerbated.

The speeding of $\dot{V}O_2$ kinetics observed in the current study might therefore be explained by peripheral adaptations in conjunction with improved cardiovascular function, as suggested by existing literature (Casaburi *et al.*, 1997; Puente-Maestu *et al.*, 2000). Support for enhanced oxidative metabolic activity within the trained musculature of COPD patients has been presented (Maltais *et al.*, 1996) and this was correlated with training-induced speeding of $\dot{V}O_2$ kinetics (Puente-Maestu *et al.*, 2003). Maltais *et al.* (1996) demonstrated that a 12-week endurance training programme increased muscle oxidative capacity, indicated by increased activity of oxidative enzymes citrate synthase (CS) and 3-hydroxyacyl-CoA dehydrogenase (HADH). This improvement in oxidative capacity was associated with reduced lactic acidosis for a given work rate, in support of Casaburi *et al.* (1991).

Puente-Maestu *et al.* (2003) observed similar increases in CS activity following 6 weeks of training and these changes were significantly correlated with faster $\dot{V}O_2$ kinetics at exercise onset and faster restoration of the oxygenated haemoglobin ([HbO₂]) signal (measured using near-infrared spectroscopy) during recovery. Whilst these observations support the notion of improved muscle oxidative function as a result of training, manifest as speeded $\dot{V}O_2$ kinetics, the results must be interpreted with caution. The difficulties in interpreting the [HbO₂] signal have been discussed in Chapter 3, but Puente-Maestu *et al.* (2003) also modelled the $\dot{V}O_2$ kinetics as a MRT, an approach which the current study has

shown to be inaccurate if characterising the Phase II $\dot{V}O_2$ kinetics. Furthermore, whilst it is considered that the $\dot{V}O_2$ kinetics of the fundamental component are considered to reflect those of \dot{Q}_mO_2 in healthy young subjects (Section 1.4), similar evidence has yet to be presented for elderly COPD patients.

Improved circulatory dynamics at exercise onset in COPD patients as a result of exercise training is harder to demonstrate, due to the inherent technical difficulties in continuously monitoring blood flow during dynamic exercise, as discussed in Sections 1.1 and 1.4.4. However, increased peak leg blood flow as a result of exercise training has been demonstrated in elderly healthy individuals (Martin *et al.*, 1990), so such an effect may be likely to have occurred in the patients of the present study. Indirect evidence also comes from observations of faster adjustment of heart rate at exercise onset in COPD patients following exercise training (Casaburi *et al.*, 1997; Puente-Maestu *et al.*, 2000). Although the exact mechanisms explaining speeded $\dot{V}O_2$ kinetics in COPD patients following an exercise rehabilitation programme are yet to be resolved, there is limited evidence suggesting that both improved O_2 -delivery and utilisation may contribute.

5.4.3 Interpretation of training-induced improvements in exercise capacity in COPD patients

The importance of exercise as part of a pulmonary rehabilitation programme is well recognised (e.g. Casaburi *et al.*, 1997; American Thoracic Society, 1999; Puente-Maestu *et al.*, 2000; Cooper, 2001; British Thoracic Society, 2001). Whilst not the primary focus of the present study, it is appropriate to consider any training-induced improvements in exercise capacity. Figure 5.11 showed an example of the pre and post-rehabilitation $\dot{V}O_2$ profiles in response to symptom-limited incremental cycling and Table 5.4 demonstrated that there was no significant improvement in $\dot{V}O_{2\text{ peak}}$ or WR_{peak} . This demonstration is in support of previous research where $\dot{V}O_{2\text{ peak}}$ is sometimes significantly increased (e.g. Lacasse *et al.*, 1996; Casaburi *et al.*, 1997; Sala *et al.*, 1999), but changes are small and not always apparent (Fukuoka *et al.*, 2002). This provides further support for using alternative exercise tests, such as constant work rate tests, in addition to incremental tests, when assessing the efficacy of an exercise rehabilitation programme in COPD patients (e.g. Casaburi *et al.*, 1997; American Thoracic Society, 1999; Wasserman *et al.*, 1999; Puente-Maestu *et al.*, 2000).

This is evidenced by the larger improvement in t_{lim} observed for the same patient during the symptom-limited endurance test at a constant work rate equivalent to 80% of the pre-rehabilitation WR_{peak} (Figure 5.12), and by the significant improvement in t_{lim} (averaging 157%) observed across the group (Table 5.4), in support of Casaburi *et al.* (1997). However, whilst such results were significant, there was considerable variability in the magnitude of improvement, evidenced by the much larger standard deviation of the mean post-rehabilitation t_{lim} values (Table 5.4). This finding is important and raises serious concerns about interpreting improvements in t_{lim} when an arbitrary high percentage of the pre-rehabilitation WR_{peak} , such as 80% as used here, is selected as the imposed work rate for constant work rate “endurance” tests. An absolute, or proportional, change in t_{lim} post-intervention will depend critically on the characteristics of a patient’s power-duration relationship which, as is the case for healthy subjects, have been shown to be quite variable in a group of COPD patients (Neder *et al.*, 2000 - Figure 5.13).

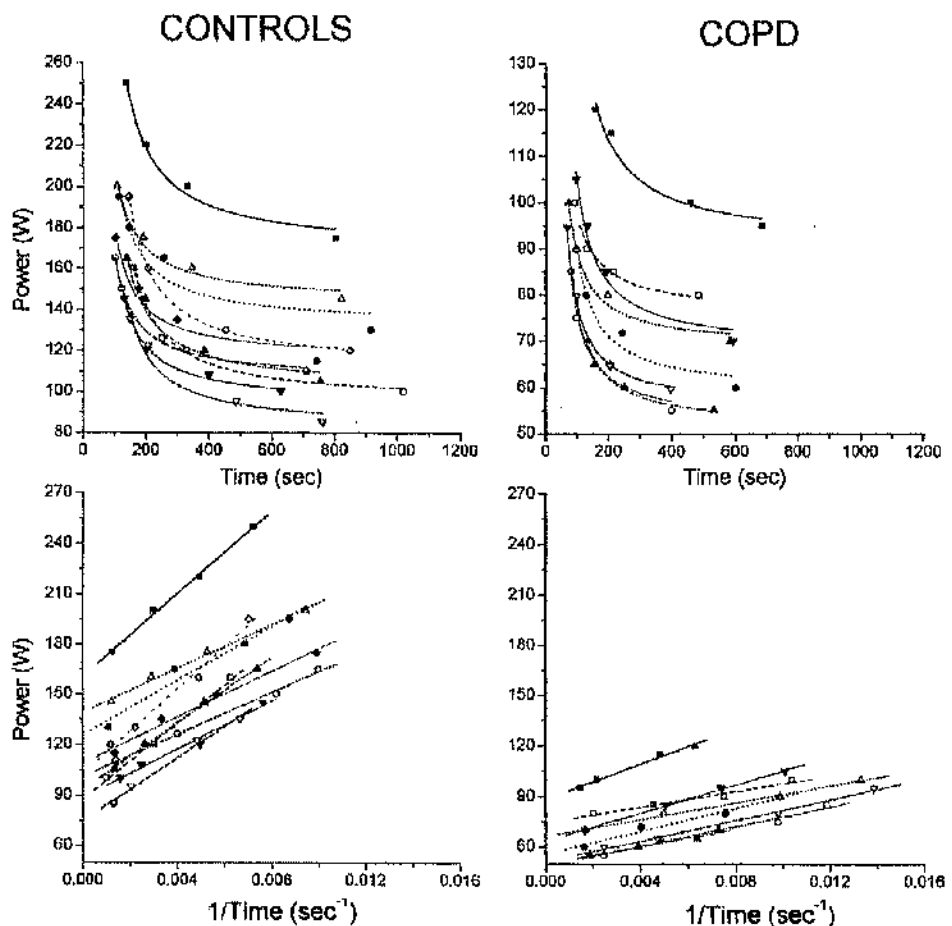

Figure 5.13 – The power-duration relationship in COPD patients and age-matched control subjects. *Top panels* show the power-duration hyperbola for estimation of the critical power (CP) and the curvature constant (W'). *Bottom panels* show the same data linearised as the power-time⁻¹ relationship. From Neder *et al.* (2000).

That is, the magnitude of change in t_{lim} is likely to vary in a complex manner, both with the location of the imposed work rate on the power-duration curve and with intervention-induced changes in CP and/or W' . For example, Figure 5.14 is a schematic, using the group-mean values of Neder *et al.* (2000 - CP = 68W, or 82% WR_{peak} and $W' = 6$ kJ), to show how changes in CP and/or W' could cause t_{lim} to increase over a wide range. There are two hypothetical horizontal lines inserted on the schematic to represent two different patients (x and y), who demonstrate similar pre- and post-rehabilitation power-duration hyperbolae, but the imposed work rate for the constant work rate test (assumed to be a fixed percentage of WR_{peak}) may impact on the power-duration hyperbola at quite different points. Hence, not only will the pre-rehabilitation t_{lim} value be highly variable (106 s in patient x vs. 251 s in patient y), but the same training-induced improvements in CP and/or W' will be manifest as markedly different improvements in t_{lim} (ranging from 17 - 50 s in patient x and 41 - 332 s in patient y).

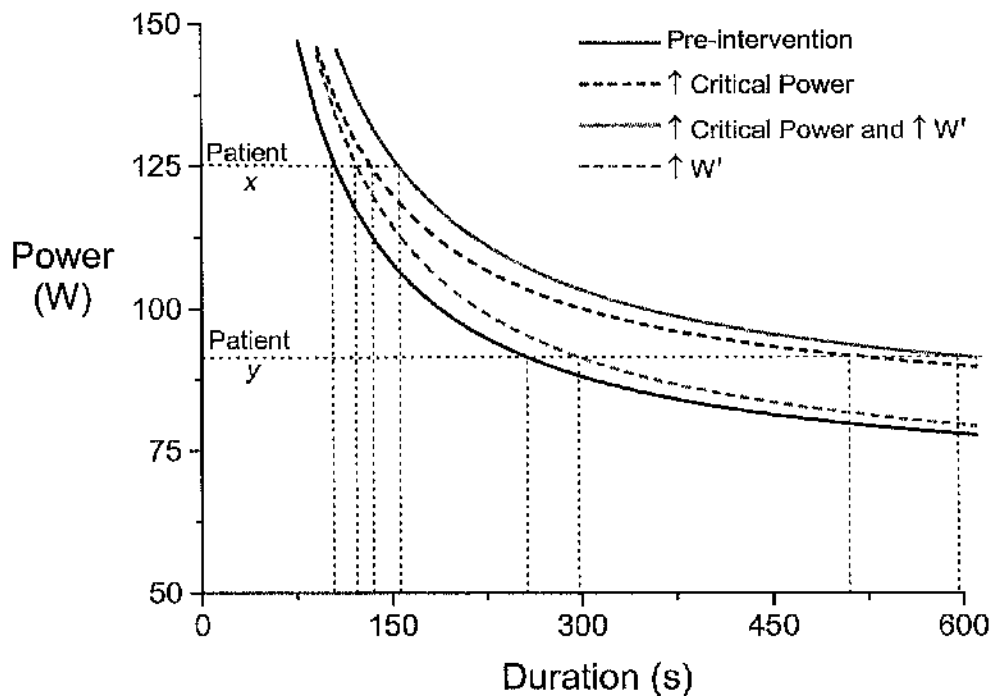

Figure 5.14 – Schematic of how t_{lim} values for a constant work rate test will be highly variable, dependent on the location of the imposed work rate on the power-duration relationship. Two *horizontal lines* reflect two different patients (x and y – see text for details). Three hypothetical effects of a training intervention on both critical power (CP) and/or the curvature constant (W') are shown (\uparrow CP to 80 W, $\uparrow W'$ to 7 kJ, and both \uparrow CP to 80 W and $\uparrow W'$ to 7 kJ). The *pre-intervention* curve reflects the group-mean values (CP = 68 W, $W' = 6.02$ kJ) from Neder *et al.* (2000).

This theoretical example highlights that, whilst t_{lim} for constant work rate cycling may prove a sensitive marker of training-induced adaptation, interpretation of such improvements is extremely difficult without knowledge of the intensity of the imposed

work rate, for which the power-duration relationship must be evaluated. Therefore, the reasons for improved t_{lim} in the current study cannot be provided, since the above schematic has illustrated that either an increased critical power, an increased curvature constant, or a combination of both, may provide the explanation. Furthermore, details of the mechanistic basis of the power-duration relationship are unknown for COPD patients, although it is likely to be related (in part, at least) to ventilatory limitation (Neder *et al.*, 2000).

5.4.4 Future research

The previous discussion has clearly highlighted that an interesting avenue for further research would be to investigate the effects of an exercise training program on the power-duration relationship in COPD patients. Furthermore, since the critical power and curvature constant are hypothesised to have different underlying mechanisms in COPD patients (Neder *et al.*, 2000), it would be of considerable interest to investigate the effect of exercise training intensity on CP and W'.

To follow on from the current results, where the Phase II $\dot{V}O_2$ kinetics during the rest-to-20W transition have been accurately characterised in COPD patients, it would be useful to extend the work rate transitions to include supra- θ_L work rates. Whilst the $\dot{V}O_2$ kinetics have been extensively characterised for all intensity domains in healthy individuals (Ozyener *et al.*, 2001), there has to date been no formal characterisation of supra- θ_L kinetics in COPD patients. In these patients, where O_2 -delivery and O_2 -utilisation may determine the $\dot{V}O_2$ kinetics, such an investigation may provide further insight into the mechanisms underpinning the $\dot{V}O_2$ slow component.

It would also be valuable to extend the results of Grassi *et al.* (1996), which demonstrated the close temporal relationship between the fundamental component $\dot{V}O_2$ and \dot{Q}_mO_2 kinetics during moderate exercise in healthy young individuals. Such a demonstration in COPD patients would allow further interpretation regarding the training-induced speeding of $\dot{V}O_2$ kinetics in COPD patients. However, it is acknowledged that such invasive procedures may prove extremely difficult in such a patient population, particularly considering the small changes in work rate that can be tolerated.

The discussion of $\dot{V}O_2$ kinetics in COPD patients has thus far considered there to be a single value of τ for each patient in the moderate intensity domain. Whipp *et al.* (2002b) have challenged this notion of a single compartment model, rather suggesting a multi-compartment model may exist, whereby τ is progressively increased due to the gradual recruitment of less efficient muscle fibres as work rate increases. Whilst this issue is discussed in considerably more detail in Section 6.3.3, an interesting point related to this has been raised by Whipp *et al.* (2002a) in patients with hypertrophic cardiomyopathy (HCM). This discussion centred on interpretation of the slope of the linear $\dot{V}O_2$ -work rate relationship in rapid ramp-incremental exercise protocols. Following an initial “kinetic” phase, this $\dot{V}O_2$ response is considered to be parallel to the steady state response for moderate intensity constant work rate exercise of increasing work rates, with a constant lag equivalent to the MRT or effective time constant (Whipp *et al.*, 1981). The slope ($\Delta\dot{V}O_2/\Delta WR$) is a useful index of work efficiency in healthy subjects. However, for patients with cardiopulmonary diseases a low reported slope may not necessarily reflect enhanced efficiency, but rather a lengthening of τ with increasing work rate (with implications for system “order”), as shown in Figure 5.15.

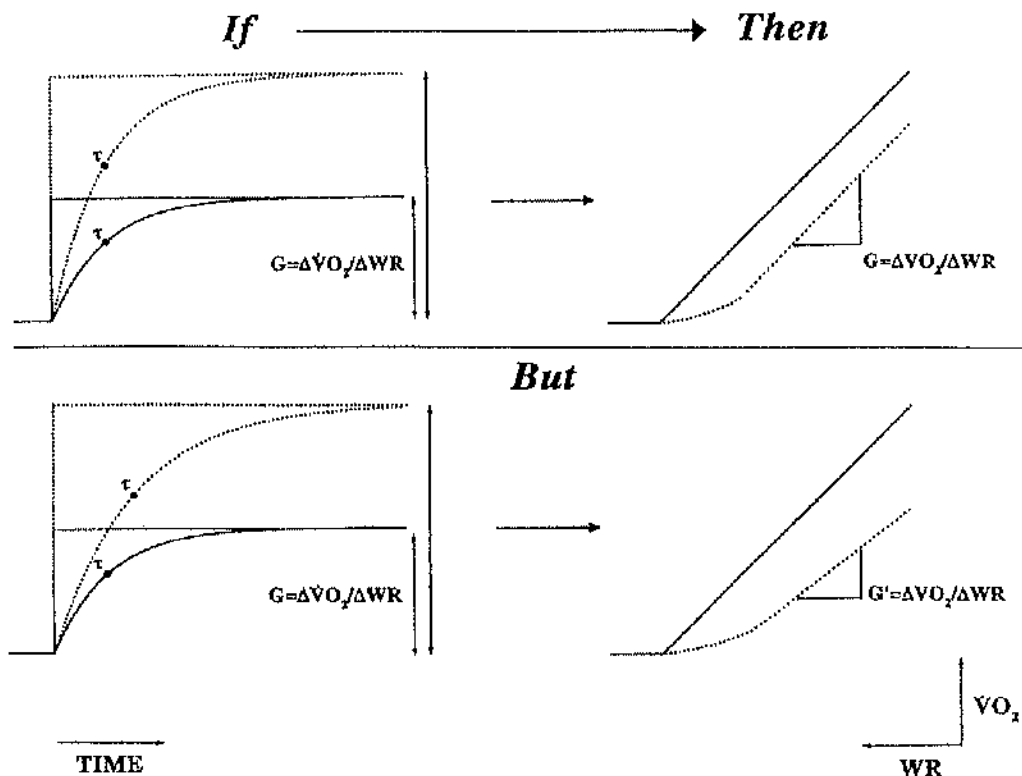

Figure 5.15 – Schematic illustrating the comparison of the $\dot{V}O_2$ response to moderate intensity constant work rate exercise (*left side*) and incremental exercise (*right side*). The *top panels* are representative of healthy individuals with τ independent of work rate, whereas the *lower panels* represent a patient where τ may be lengthened at higher work rates in the moderate intensity domain, but the steady state gain is unaltered. This translates as reduced slope in the incremental test, despite an unchanged gain. Taken from Whipp *et al.* (2002a).

The design of the current study precluded testing of this hypothesis, since only one change in work rate from a resting baseline was feasible for moderate intensity exercise. It is recognised, however, that this postulation requires further investigation, although it may be difficult to perform multiple sub- θ_L transitions to different work rates with sufficient amplitudes of response in patients such as those of the current study, where exercise capacity is severely diminished. This raises the interesting possibility whether other strategies involving repetitive forcing functions such as PRBS (Section 1.3.1) might be of value (Kowalchuk & Hughson, 1990; Hoffmann *et al.*, 1992; Edwards *et al.*, 2003), as long as $\dot{V}O_2$ kinetics in moderate exercise are demonstrably first-order in COPD patients (this has not been investigated formally)

5.4.5 Conclusion

This study has demonstrated the interpretational importance of using an appropriate modelling strategy to characterise the kinetics of $\dot{V}O_2$, and the difficulties associated with interpreting improvements in t_{lim} as a result of exercise training. It has been shown that traditional modelling strategies for isolating the fundamental component may not be applicable for COPD patients during rest-to-moderate exercise transitions, due to a prolonged Phase I response in some patients. However, the fundamental component $\dot{V}O_2$ kinetics, when modelled accurately, have proven to be a sensitive measure of training-induced adaptations in patients with moderate-to-severe COPD, although mechanisms for the speeded $\dot{V}O_2$ kinetics remain conjectural.

Chapter 6 Discussion

6.1 MODELLING $\dot{V}O_2$ KINETICS

Throughout Chapters 1 to 5 there have been a number of issues raised relating to model discrimination for accurate and valid characterisation of $\dot{V}O_2$ kinetics. This is unsurprising, since within existing literature there is no general consensus as to the optimum modelling strategy to be employed, for both sub- and supra- θ_L exercise. It is useful therefore to consider the exercise intensity domains separately in this regard.

6.1.1 Sub- θ_L exercise – Phase I

For sub- θ_L exercise, the primary concern is isolation of the fundamental component from the initial cardiodynamic phase, for subsequent kinetic modelling. Section 5.1.2 addressed how different exponential models (Models 1 or 2 of Whipp *et al.*, 1982) can be used for successful computation of the oxygen deficit in this moderate domain, as demonstrated recently (Ozyener *et al.*, 2003). However, in the majority of instances it is the Phase II or fundamental component $\dot{V}O_2$ kinetics that are modelled, since they have been argued (Barstow *et al.*, 1990) and demonstrated (Grassi *et al.*, 1996) to closely reflect the kinetics of \dot{Q}_{mO_2} in this exercise intensity domain. Therefore, the Phase I response must be excluded from the kinetic analysis and there are presently two main approaches used to achieve this within the literature:

- (a) Applying a monoexponential fit either from $t = 20$ s (“Model 3” of Whipp *et al.*, 1982) or the visually identified onset of Phase II (Model τ_{real} in Chapter 5), thus eliminating the muscle-to-lung vascular transit delay and the majority of the influence of oxygen stores (Whipp *et al.*, 1982; Barstow *et al.*, 1990).
- (b) Applying a double-exponential model from $t = 0$ s, the first exponential component modelling the Phase I response and the second exponential component modelling the Phase II response (e.g. Hughson & Kowalchuk, 1995; Barstow *et al.*, 1996).

With model (a), the concern is whether the model being applied from $t = 20$ s is permitting exclusion of Phase I, but yet not eliminating too much of the data from the fundamental component. Whilst this modelling strategy is justified in healthy young subjects (Whipp *et al.*, 1982), the results of Chapter 5 have clearly shown that this time frame may not be applicable for all populations of subjects, the duration of Phase I being longer in some, but not all, COPD patients in this investigation. Therefore, the use of this traditional modelling approach from $t = 20$ s may require revision when the population under investigation is different from healthy young subjects. The ideal scenario would be to identify the start of

Phase II using respiratory indices (Linnarsson, 1974; Whipp *et al.*, 1982), however, as discussed in Section 5.4.1, the noise typically associated with breath-by-breath gas analysis often prevents such identification. Therefore, it is justifiable to use the “Model 3” of Whipp *et al.* (1982) for healthy young subjects, but perhaps with other populations the averaging interval should be reduced in an attempt to visually identify the start of the Phase II $\dot{V}O_2$ response, as suggested in Section 5.4.1 (Model τ_{real}).

With model (b), the primary concern is the highly questionable use of a monoexponential process to model the Phase I response. This phase is considered to reflect increased \dot{Q}_P (Krogh & Lindhard, 1913; Linnarsson, 1974; Wasserman *et al.*, 1974). For the response to follow first-order kinetics implies that the input signal is square-wave in nature, the response determined by a single rate-limiting step. If the step increase in work rate is considered to be the input signal, the demonstration that the Phase I $\dot{V}O_2$ response is abrupt for the rest-to-exercise transition and slower for exercise-to-exercise (Whipp *et al.*, 1982), clearly challenges the possibility that this phase is first-order. It is indeed plausible that, for the work-to-work transition, the Phase I $\dot{V}O_2$ response may actually follow “zero-order kinetics”, i.e. simply follow the input signal (increasing \dot{Q}_P) in a parallel fashion. With such a scenario, the expectation of first-order kinetics for the Phase I $\dot{V}O_2$ response (as implied by the model of Barstow *et al.*, 1996) would thus not be justified.

Support for questioning the first-order characteristics of Phase I comes from considering a typical value reported for τ during Phase I (e.g. 15 s reported in Burnley *et al.*, 2000). This would imply that steady state for this Phase would be achieved after approximately 60 s ($4 \times \tau$). However, when multiple responses are averaged for healthy individuals (e.g. Figures 4.2 & 4.4), Phase I almost achieves steady state before the emergence of Phase II, a duration of less than 20 s. Furthermore, Figures 5.6 and 5.7 demonstrate that in COPD patients, where the cardiovascular response will be blunted as described in Section 5.4.1, the Phase I response appears to achieve steady state before the onset of the fundamental component. This, therefore, suggests that the response may not indeed be exponential. Furthermore, when the exercise transition is from rest to exercise, rather than exercise-to-exercise, the response is clearly not exponential (e.g. Whipp *et al.*, 1982). Collectively, the results of Chapters 4 and 5 combined with existing evidence, clearly question justification for modelling Phase I as an exponential process.

6.1.2 Supra- θ_L exercise – the $\dot{V}O_2$ slow component

In the heavy and very heavy exercise intensity domains, it is the emergence of the additional $\dot{V}O_{2(SC)}$ that is of primary importance. It is useful to consider how this additional component can impact on interpretation of the fundamental component $\dot{V}O_2$ kinetics. For example, in the “priming” study of Gerbino *et al.* (1996) only single repetitions of the protocols were performed, making the accurate separation of the individual phases of the $\dot{V}O_2$ response effectively impossible, because of low signal-to-noise ratio (Lamarra *et al.*, 1987; Rossiter *et al.*, 2000). The $\dot{V}O_2$ response was therefore characterised by an effective time constant (τ), i.e. a “Model 2 fit” (Whipp *et al.*, 1982) applied to the whole data set – which the authors themselves acknowledged was an empirical expedient to only approximate the underlying $\dot{V}O_2$ kinetics (Gerbino *et al.*, 1996). While this approach allowed the authors to identify a speeding of the overall $\dot{V}O_2$ response following a priming bout of exercise (i.e. τ was shortened), what was not possible was to ascribe the speeding effect specifically to the Phase II and/or the slow component.

As discussed in detail in Chapter 4, it has since been shown that the $\dot{V}O_2$ speeding effect does not involve the fundamental component to any appreciable effect, but rather a reduction in the amplitude of the slow component (Bohnert *et al.*, 1998; Burnley *et al.*, 2000, 2001 & 2002a; Koppo & Bouckaert, 2000, 2001 & 2002; Fukuba *et al.*, 2002). These later results clearly illustrate that inclusion of the slow component in the exponential modelling of the $\dot{V}O_2$ response results not only in a poor characterisation of the $\dot{V}O_2$ kinetics themselves, but more importantly is likely to result in mis-leading conclusions regarding the mechanisms controlling $\dot{V}O_2$, and by implication, \dot{Q}_{mO_2} , in the supra- θ_L exercise intensity domains. However, the optimal approach to modelling supra- θ_L $\dot{V}O_2$ kinetics and the lack of a consistent and valid method for quantifying the $\dot{V}O_{2(SC)}$ have been addressed (c.g. Whipp, 1994b; Bearden & Moffatt, 2001b; Bell *et al.*, 2001b). Several approaches that have been applied merit further discussion:

- (a) Simply characterising the slow component as an amplitude index, calculated over a fixed time interval, e.g. $\Delta\dot{V}O_{2(6-3)\min}$ (e.g. Roston *et al.*, 1987; Whipp, 1987).
- (b) Identifying the onset of the $\dot{V}O_{2(SC)}$ by visual inspection, as described in detail in Section 4.2.2, and applying a monoexponential model (Equation 2.9) from $t = 20$ s until the onset of the slow component (Rossiter *et al.*, 2001).

- (c) A triple exponential model with the three exponential components representing Phase I, Phase II and the slow component respectively (Barstow *et al.*, 1996).

Modelling approach (a) above is constrained since it employs a fixed time-point to describe the onset of the slow component. Comparisons made by Bell *et al.* (2001b) and Bearden & Moffatt (2001b) have highlighted that the use of a fixed time interval, particularly from 3 minutes, can be inaccurate and results in consistent underestimation of the amplitude since the onset of the slow component is typically earlier than 3 minutes (e.g. Barstow & Molé, 1991; Barstow *et al.*, 1996; Bearden & Moffatt, 2000), but is highly variable (Ozyener *et al.*, 2001).

Model (b) above, proposed by Rossiter *et al.* (2001) and used in Chapter 4, focuses on modelling the fundamental component kinetics and then simply describing the slow component as an amplitude, but not over a fixed time interval. The concern here is that identification of the onset of the $\dot{V}O_{2(SC)}$ is accurate so that the data range to which the exponential is applied is not contaminated by the emerging slow component, or too short to permit accurate characterisation of Phase II. The results presented in Chapter 4 (e.g. Figures 4.2 & 4.7) clearly illustrate that when at least two exercise transitions are averaged, the onset of the slow component can be successfully identified using a “local threshold” in the residuals plot, supported by an increase in χ^2 . The slow component is subsequently calculated as an amplitude from the onset of the slow component until end-exercise. Whether this approach is acceptable for all populations remains to be evaluated, however, even when the amplitude of the response is considerably smaller than the values observed in Chapter 4, this approach has been successfully implemented (Rossiter *et al.*, 2001).

The physiological justification for model (c) is highly questionable, based on assumptions regarding the slow component being characterised as an exponential process. When modelling the kinetics of a transient response, whilst the data must be adequately characterised, fewer parameters being included in the model will result in increased confidence in parameter estimation (e.g. Lamarra, 1990). Therefore, the use of a triple-exponential model containing 8 parameters (as proposed by Barstow *et al.*, 1996), whilst attractive due to the consideration of each phase separately, is a disadvantage over a model containing fewer parameters, since the values will become dependent on one another (Casaburi *et al.*, 1989). Secondly, the suggestion that the $\dot{V}O_{2(SC)}$ is an exponential process is flawed, since the trajectory of the slow component is entirely dependent on the exercise intensity relative to the critical power (Section 1.3 – e.g. Poole *et al.*, 1988). As the control

mechanisms underpinning this phase have yet to be conclusively resolved (Section 1.5.3), and the kinetics are unlikely to be determined by a single rate-limiting step (Whipp & Ozyener, 1998), there is at present little physiological justification for modelling the $\dot{V}O_2$ slow component at all.

Although quantification of the oxygen deficit for sub- θ_L exercise is straightforward (in principle), the $\dot{V}O_2$ slow component renders a similar calculation invalid for supra- θ_L exercise, since the steady state oxygen cost of the work cannot be simply estimated according to the sub- θ_L linear steady state $\dot{V}O_2$ -WR relationship and furthermore, a monoexponential process does not adequately characterise the response (e.g. Whipp, 1994b). In the severe intensity domain, there is no emergence of the $\dot{V}O_2$ slow component due to the short tolerable duration. As a result, the $\dot{V}O_2$ response can be characterised as a monoexponential and the O_2 def can be calculated as the product of the MRT and $\dot{V}O_{2\max}$, i.e. it is limited by $\dot{V}O_{2\max}$ (e.g. Whipp, 1994b). However, recent analysis by Ozyener *et al.* (2003) has demonstrated that for heavy and very heavy intensity cycling, conventional calculation of the oxygen deficit is invalid. These results have called into question the concept of a maximal accumulated oxygen deficit, considered to reflect a constant and limited anaerobic capacity, as initially proposed by Medbo *et al.* (1988). Ozyener *et al.* (2003) demonstrated that such a concept is only applicable for work rates that do not engender a $\dot{V}O_2$ slow component. Furthermore, as the energy contributions to the oxygen deficit are not entirely anaerobic (the influence of body O_2 stores – Section 1.2), they question whether the term anaerobic capacity may require revision in the context of the maximally accumulated oxygen deficit.

Bearden & Moffatt (2000) proposed a novel method for calculating the O_2 Def where the oxygen deficit is calculated for the fundamental component, up until the onset of the $\dot{V}O_2$ slow component, and then an additional oxygen deficit is calculated for the slow component. The total O_2 Def (the sum of these values) was not significantly different from the recovery $\dot{V}O_2$, unlike the traditional model which overestimates the $\dot{V}O_2$, citing this as evidence that their novel approach is valid. However, the physiological assumptions upon which this modelling approach are theoretically founded are equivocal, since this calculation assumes that the projected asymptote of the $\dot{V}O_2$ slow component is the true steady state and that the τ reflects a single metabolic compartment (Whipp *et al.*, 2002b). In this regard, the results presented in Chapter 4 prove interesting, as they suggest that the

steady state $\dot{V}O_2$ eventually achieved in the heavy domain may actually reflect the true O_2 cost of the exercise. This suggestion arises from the observation that the end-exercise $\dot{V}O_2$ was the same in the “with” and “without priming-bout” tests, regardless of whether or not a $\dot{V}O_2$ slow component was evidenced. In contrast, the question arises as to whether the oxygen cost actually changes during the $\dot{V}O_2$ slow component due to further recruitment of additional less efficient Type II motor units. This matter has yet to be resolved and has strong implications relating to the attempted computation of the oxygen deficit for heavy exercise, as discussed by Whipp *et al.* (2002b).

6.2 EXERCISE INTENSITY

The results presented in Chapter 4 support the description of exercise intensity according to the boundaries of θ_L and CP, as described in detail in Section 1.1.1, for continuous exercise. Recently, Pringle & Jones (2002) have questioned the significance of the CP as the upper limit for steady state $\dot{V}O_2$ and [La]. They suggested that the maximal lactate steady state (MLSS) represents this upper boundary and that the MLSS is on average 20W lower than CP, in contrast to Poole *et al.* (1988) and Smith & Jones (2001). Their findings are in direct contrast to the results presented in Chapter 4, where the sub-CP tests (95% Δ_1) were typically less than 10W lower than CP (Table 4.2) and yet a steady state $\dot{V}O_2$ was clearly attained in every subject (Figure 4.7). It is presently unclear why such differences exist, although the recent results of Coats *et al.* (2003) are also in support of the existing literature suggesting CP to represent the upper limit for sustained exercise.

For intermittent exercise, however, Chapter 2 clearly showed that the average $\dot{V}O_2$ response did not mirror the close temporal relationship observed between [La] and $\dot{V}O_2$ for constant work rate exercise. Although the exercise intensity, according to the [La] responses (Wasserman *et al.*, 1967), was highly dependent on the duration of the work-recovery duty cycle, there was no evidence of the $\dot{V}O_2$ slow component phenomenon in the average $\dot{V}O_2$ response, indicated by constant end-exercise and end-recovery values during the oscillations observed in synchrony with changes in work rate, despite sustained lactic acidosis. Therefore, the description of exercise intensity would seem to require revision for intermittent exercise, as the effective exercise intensity appears to be not only dependent on the work rate *per se*, but also the manner of its imposition.

6.3 WHAT DO THE $\dot{V}O_2$ KINETICS OF THE FUNDAMENTAL COMPONENT MEAN?

Several papers have recently questioned the traditional interpretation of the fundamental component $\dot{V}O_2$ kinetics as displaying first-order linear control dynamics, at least in the moderate intensity domain (Hughson *et al.*, 2001; Whipp *et al.*, 2002b). The major theory presented that opposes traditional opinion is that the active muscle is typically considered to be a single compartment, whereas there is accumulating evidence that a multi-compartment model may be more representative, as suggested in Section 4.4.5. This concept will be discussed in more detail subsequently, however it is useful to first clarify the balance of opinion regarding both the linearity and control of $\dot{V}O_2$ kinetics.

6.3.1 Linearity of $\dot{V}O_2$ kinetics

According to the principle of superposition (Fujihara *et al.*, 1973b) the bulk of evidence presented in Section 1.3.1 suggests that the fundamental component $\dot{V}O_2$, and by implication \dot{Q}_{mO_2} , kinetics exhibit first-order linearity for the moderate intensity domain when the baseline response is the same for all exercise on-transients in healthy young subjects. However, this relationship is altered by prior metabolic rate, as suggested by Brittain *et al.* (2001). For supra- θ_L exercise, the overall $\dot{V}O_2$ response clearly does not exhibit first-order kinetics due to the emergence of the slow component. That said, it remains to be confirmed whether the fundamental component retains first-order kinetics, based on inconsistencies in the literature regarding exercise modality and the effects of prior exercise, for example.

One area of research that demands further attention is the modelling of overall $\dot{V}O_2$ kinetics using alternate work rate protocols such as pseudorandom binary sequence or sinusoidal protocols. Section 1.3.1 described how results from such experiments suggest that the $\dot{V}O_2$ kinetics exhibit dynamic linearity when the analysis is performed in the time domain. However, it is vital to appreciate that such experimental protocols are only valid when first-order behaviour can be demonstrated (or reasonably assumed). This is because the “lumped” parameters that accrue from such forcing functions reflect both the on- and off-transient responses, and therefore contain the implicit assumption that there is on-off symmetry of the $\dot{V}O_2$ responses and their Phase I and Phase II components.

6.3.2 Control of $\dot{V}O_2$ kinetics

The debate concerning the control mechanisms governing $\dot{V}O_2$ kinetics has yet to be resolved (e.g. Hughson *et al.*, 2001; Grassi, 2001; Whipp *et al.*, 2002b). Section 1.5 discussed, in detail, the balance of current opinion regarding the relative contributions of proposed O_2 -delivery and O_2 -utilisation limitations. Whilst the general consensus may point towards an intrinsic metabolic inertia limitation, there is acknowledgement that there are conditions when other factors will contribute to determining $\dot{V}O_2$ kinetics (e.g. Grassi, 2001). For example, in Chapter 5 the slowed $\dot{V}O_2$ kinetics reported for COPD patients may reflect a degree of O_2 -delivery limitation (Nery *et al.*, 1982; Palange *et al.*, 1995; Casaburi *et al.*, 1997; Puente-Maestu *et al.*, 2000; Neder *et al.*, 2000; Somfay *et al.*, 2002).

Exactly where the metabolic limitation may lie is unclear, as mentioned in Section 1.5.1, although an intriguing prospect is that Acetyl-CoA availability, enzymatically controlled by the PDH complex, may be the determining factor (Timmons *et al.*, 1998a). Whilst it was concluded in Section 1.5.1 that there was little evidence supporting this direct role for $\dot{V}O_2$ kinetics in exercising humans, a recent study has re-ignited interest in this possibility. Howlett & Hogan (2003) demonstrated that DCA infusion, a stimulator of the PDH complex, significantly accelerated the fall in intracellular PO_2 using a frog muscle single-fibre preparation, suggestive of faster muscle oxygen uptake kinetics. Whilst these results are intriguing, it remains to be demonstrated *in vivo* in humans whether Acetyl-CoA is the limiting factor determining the intrinsic rate of oxidative phosphorylation, and hence \dot{Q}_{mO_2} and $\dot{V}O_2$ kinetics.

For supra- θ_L exercise, the general consensus also supports a significant intrinsic metabolic inertia limitation in determining the fundamental component $\dot{V}O_2$ kinetics, however the potential for a degree of O_2 -delivery limitation cannot be excluded, as detailed in Section 1.5.2. Furthermore, the mechanisms responsible for the additional $\dot{V}O_2$ slow component remain to be resolved (Section 1.5.3), although the major source resides in the active musculature (Poole *et al.*, 1991; Rossiter *et al.*, 2001) and the involvement of less-efficient Type II muscle fibres appears likely, based on EMG analysis (Burnley *et al.*, 2002a - Section 1.5.3.6).

Despite the opinions reported above being agreed on by many investigators, there are still those that dispute whether or not the fundamental $\dot{V}O_2$ component actually reflects a

similarly mono-exponential rise in \dot{Q}_{mO_2} (Hughson *et al.*, 2001). Hughson *et al.* (2001) have postulated that there is not a single rate-determining factor, but rather there is an initial phase when O_2 -delivery is sufficient due to parasympathetic withdrawal (feed-forward), but then slower feedback mechanisms match the $\dot{V}O_2$ response to the O_2 demand. Therefore, there will be two additive exponential processes and Hughson *et al.* (2001) presented a simulation of how a monoexponential applied to the overall $\dot{V}O_2$ response would reasonably accurately characterise the data, but that the model output would be weighted by the kinetics of the initial component. Using this simulation example, they further speculated that subtle differences in $\dot{V}O_2$ kinetics might regularly be missed in studies because of a lack of statistical significance. Whilst this exercise proved insightful, there remains a considerable amount of evidence supporting the monoexponentiality of the \dot{Q}_{mO_2} increase, reflected closely by the fundamental component $\dot{V}O_2$ kinetics. A prime example is that there is accumulating evidence surrounding PCr as a key factor, either as an energy buffer or the driving force for oxidative phosphorylation (Mahler, 1985; Meyer, 1988), given the close temporal relationship between $\dot{V}O_2$ and [PCr] during moderate (Rossiter *et al.*, 1999) and supra- θ_L exercise (Rossiter *et al.*, 2001).

6.3.3 A single or multi-compartment model?

Whipp *et al.* (2002b) have recently added a further dimension to the interpretation of $\dot{V}O_2$ kinetics. They discussed how the modelling of the fundamental component of $\dot{V}O_2$, or even whole-muscle \dot{Q}_{mO_2} , kinetics as a monoexponential is largely empirically based, although they accepted that there are perhaps sound theoretical bases for this assumption. In limited agreement with Hughson *et al.* (2001), they hypothesised that this modelling of a single metabolic compartment with first-order kinetics may be concealing the “true” picture. In contrast to Hughson *et al.* (2001) however, they did not dispute the exponentiality of an individual metabolic compartment, but rather proposed that there may exist a large number of metabolic compartments within an active muscle group, each compartment exhibiting different metabolic properties and hence different kinetics. Whipp *et al.* (2002b) presented a simulation of how the overall \dot{Q}_{mO_2} (whole-muscle, and hence $\dot{V}O_2$) response, made up of ten separate components with $\tau \dot{Q}_{mO_2}$ values ranging from 20 to 65 s, would functionally appear to be a monoexponential with a τ of 40 s (Figure 6.1). Whilst this “weighted average” response would not be a true monoexponential, Whipp *et al.* (2002b) emphasise that even with inclusion of a limited amount of breath-by-breath noise in the

simulation, this would preclude discerning the actual response from a true exponential process.

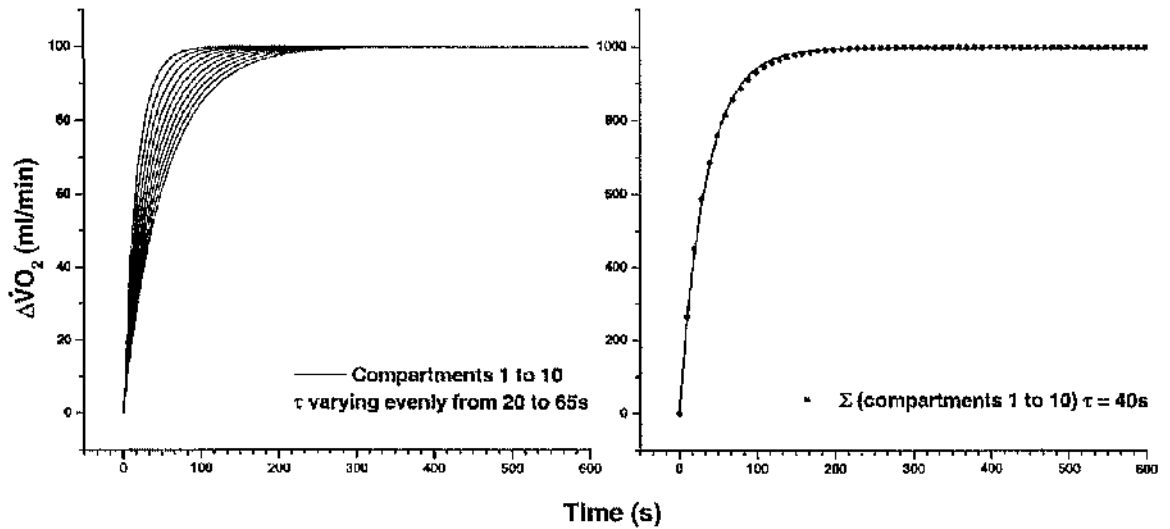

Figure 6.1 – Simulation of how the sum of ten individual compartments exhibiting different \dot{Q}_{mO_2} kinetics (*left panel*) would be functionally indistinguishable from a single metabolic compartment, since the data are still well characterised by a monoexponential function (*right panel*). Taken from Whipp *et al.* (2002b).

Were this simulation to be representative of active muscle during moderate exercise, it would imply that the relative metabolic stress of a given work rate would vary considerably from compartment to compartment, since compartments with slower kinetics would incur a greater oxygen deficit and hence increased reliance on PCr, O_2 stores and anaerobic glycolysis. Furthermore, Brittain *et al.* (2001) proposed that, according to the size principle of motor unit recruitment (Henneman *et al.*, 1974), the progressive recruitment of slow Type II motor units would result in a shift of the weighted average and hence slower “averaged” $\dot{V}O_2$ kinetics in the upper reaches of the moderate intensity domain.

Therefore, whilst the weighted average muscle [La] response might suggest the work rate to be of moderate intensity, some compartments may be producing lactate and others not, perhaps the more oxidative compartments utilising this lactate (Brooks, 2000), and hence the muscle venous effluent [La] would be unchanged. This possibility was addressed briefly in Section 4.4.5 (Yoshida & Whipp, 1994; Whipp *et al.*, 1995), where it was suggested that the differing metabolic compartments may be defined by particular \dot{Q}_m/\dot{Q}_{mO_2} ratios and anaerobic energy potentials. One possible explanation for the potential regional differences in metabolic properties could involve the demonstrations that

Type II muscle fibres exhibit reduced mechanical efficiency and slower \dot{Q}_{mO_2} kinetics (Crow & Kushmerick, 1982; Kushmerick *et al.*, 1992; Saugen & Vollestad, 1995; Barstow *et al.*, 1996), as detailed in Section 1.5.3.6.

Another possibility could be regional differences in muscle activity, as shown recently by Richardson *et al.* (2001a) using magnetic resonance imaging during knee-extension exercise (Figure 6.2). Richardson *et al.* (2001a) also demonstrated local dispersion of the $\dot{Q}_m / \dot{Q}_{mO_2}$ ratio.

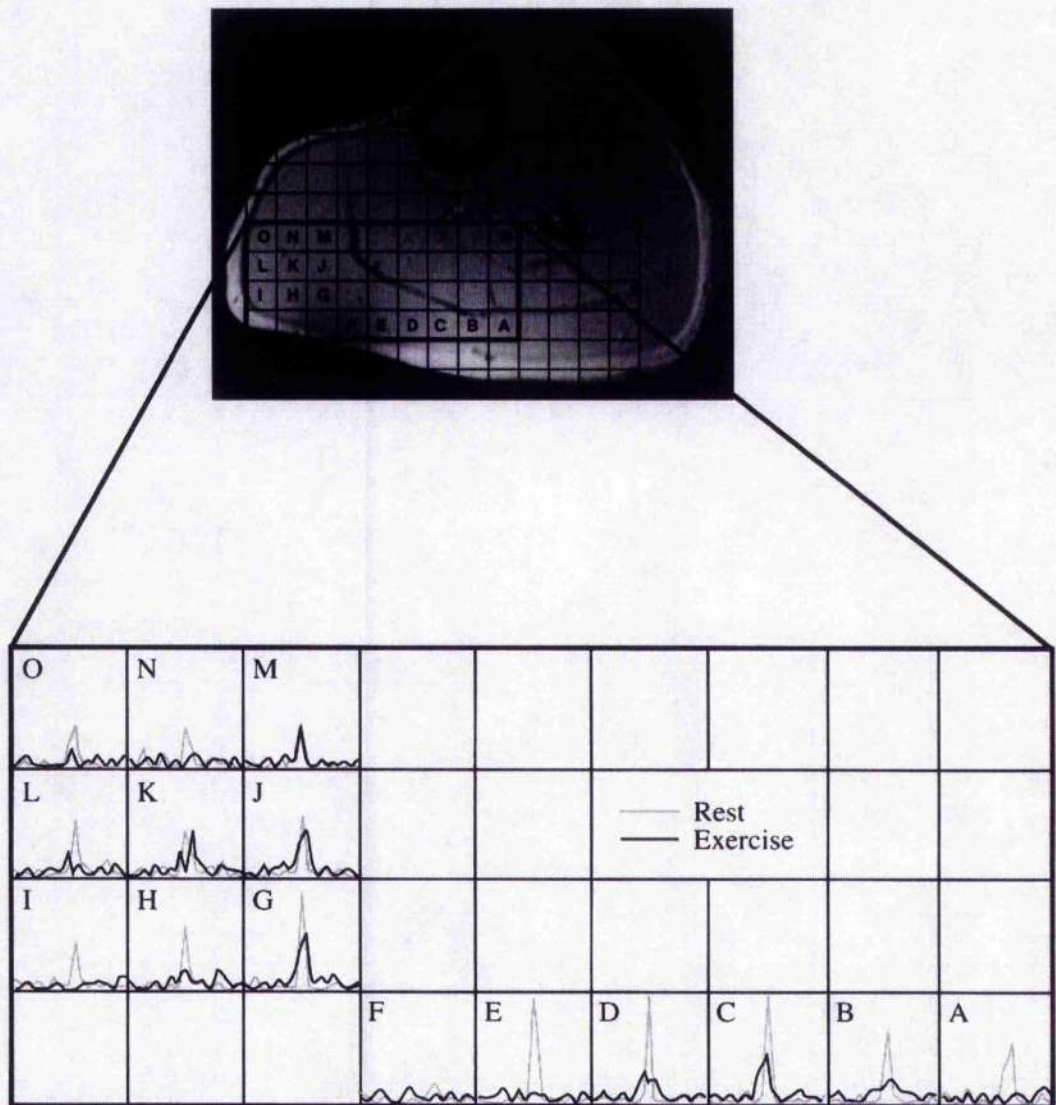

Figure 6.2 – Regional magnetic resonance spectra within the quadriceps muscles during knee-extension exercise, using magnetic resonance spectroscopy. Heterogeneity of muscle activity is inferred from the decrease in the size of the PCr peak whilst increased acidity is suggested by the chemical shift of the Pi peak. From Richardson *et al.* (2001a).

These findings are in support of the theories of Brittain *et al.* (2001) and Whipp *et al.* (2002b) regarding the existence of multiple compartments with differing metabolic

properties within the active musculature. They also add weight to the models of Yoshida & Whipp (1994) and Whipp *et al.* (1995), regarding cautious interpretation of muscle venous [La] and PO_2 , and hence \dot{Q}_{mO_2} calculated using these values.

An interesting consequence of such a phenomenon could be regions within the active muscles exhibiting unique "local" power-duration characteristics for supra- θ_L exercise, as suggested in Section 4.4.5. Were this to be the case, then the overall power-duration relationship would reflect the "average" of these different compartments, the work rate distributed between the compartments until exhaustion is reached in the most "vulnerable" of the compartments. The question therefore arises as to whether such an "average" would still be characterised by a true hyperbola and hence call into question the assumptions associated with the CP and W' . Figure 6.3 is a simplified schematic addressing such issues, showing 10-compartment models where CP and/or W' are varied between compartments to ascertain the shape of the weighted average of these compartments.

Note that for all scenarios presented in Figure 6.3 the average response conforms to a true hyperbola, as illustrated by the complete flatness of the residuals along the zero-line. Furthermore, the values derived for CP and W' from each fit can simply be calculated by averaging the CP and W' values of the 10 compartments (this analysis assuming that the effective "volumes" of the compartments are equal; which may not be the case). It is acknowledged that this theoretical model is greatly simplified. However, the mechanistic and functional implications are important. Thus, the results suggest that if different metabolic compartments exist within the active musculature and even if these compartments exhibit local power-duration characteristics, the overall response will still represent a true hyperbola and hence support the existence of the CP as the upper boundary for sustained exercise. At present there is no straight-forward way for demonstrating *in vivo* such regional differences in metabolic properties, however, perhaps the recent methods of nuclear magnetic resonance imaging could be adapted to examine the regional metabolic conditions within the active muscles.

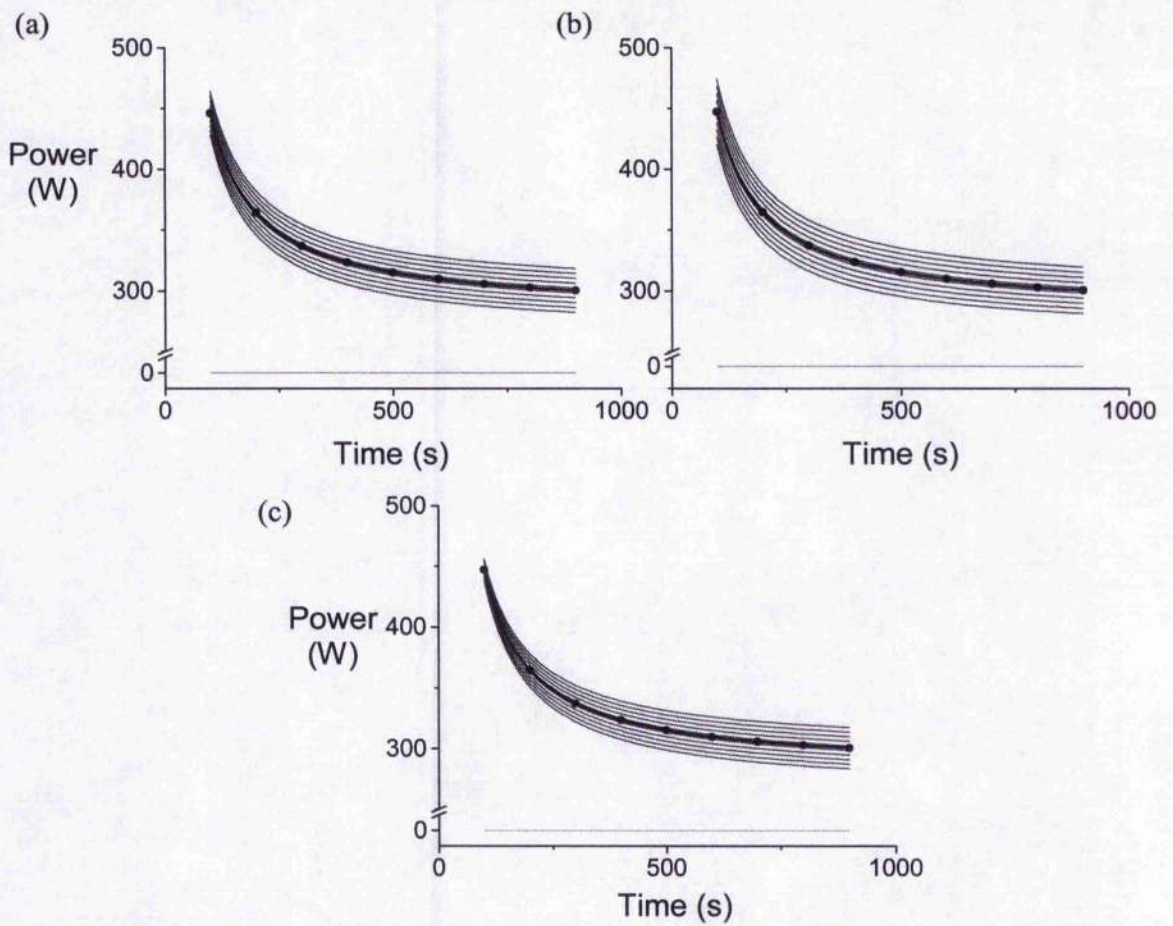

Figure 6.3 – Schematic addressing the effect of regional differences in power-duration characteristics on the “average” power-duration relationship. Three scenarios are presented for the 10-compartment model: (a) only critical power (CP) is increased; (b) CP and the curvature constant (W') are increased; and (d) CP is increased while W' is decreased. In all cases CP values range from 264-300 W and W' ranged from 15.6 to 17.4 kJ, the mean of these ranges equal to the group-mean values estimated in Chapter 4. The residuals are presented for the fit applied to the average of the 10 compartments (*solid circles and dark lines*).

6.4 CONCLUSIONS

The previous discussions have highlighted that where inferences are to be made regarding \dot{Q}_{mO_2} kinetics, not only must the fundamental component for $\dot{V}O_2$ be appropriately isolated and modelled, but the potential for regional differences within the active musculature must be considered. Where inferences are to be made regarding the metabolic responses to exercise, the oxygen deficit proves a useful reference for sub- θ_L exercise, however, the existence of the slow component complicates calculation of the oxygen deficit for heavy and very heavy exercise, as discussed. Accepting that these limitations exist, there is considerable value in examining $\dot{V}O_2$ kinetics in the non-steady state in an attempt to further understanding of the underlying control system dynamics governing the kinetics of \dot{Q}_{mO_2} . Furthermore, that the $\dot{V}O_2$ kinetics are determined using sub-maximal exercise makes this an attractive prospect when assessing the combined function of the respiratory, cardiovascular and muscular systems responsible for O_2 -delivery and O_2 -utilisation in patient populations.

References

- Allen, D. G., Lannergren, J., & Westerblad, H. (1995). Muscle cell function during prolonged activity: cellular mechanisms of fatigue. *Experimental Physiology* **80**, 497-527.
- Allen, D. G. & Westerblad, H. (2001). Role of phosphate and calcium stores in muscle fatigue. *Journal of Physiology* **536**, 657-665.
- American Thoracic Society (1995). Standards for the diagnosis and care of patients with chronic obstructive pulmonary disease. *American Journal of Respiratory and Critical Care Medicine* **152**, S77-121.
- American Thoracic Society (1999). Pulmonary rehabilitation-1999. *American Journal of Respiratory and Critical Care Medicine* **159**, 1666-1682.
- Andersen, P. & Saltin, B. (1985). Maximal perfusion of skeletal muscle in man. *Journal of Physiology* **366**, 233-249.
- Arena, R., Humphrey, R., Peberdy, M. A., & Madigan, M. (2002). Comparison of oxygen uptake on-kinetic calculations in heart failure. *Medicine and Science in Sports and Exercise* **34**, 1563-1569.
- Astrand, I., Astrand, P.-O., & Rodahl, K. (1959). Maximal heart rate during work in older men. *Journal of Applied Physiology* **14**, 562.
- Astrand, I., Astrand, P. O., Christensen, E. H., & Hedman, R. (1960a). Intermittent muscular work. *Acta Physiol.Scand.* **48**, 448-453.
- Astrand, I., Astrand, P. O., Christensen, E. H., & Hedman, R. (1960b). Myohaemoglobin as an Oxygen-Store in Man. *Acta Physiol.Scand.* **48**, 454-460.
- Astrand, P.-O. & Rodahl, K. (1986). *Textbook of work physiology: physiological bases of exercise*, Third ed. McGraw-Hill, Singapore.
- Babcock, M. A., Paterson, D. H., Cunningham, D. A., & Dickinson, J. R. (1994). Exercise on-transient gas exchange kinetics are slowed as a function of age. *Medicine and Science in Sports and Exercise* **26**, 440-446.
- Bangsbo, J. (2000). Muscle oxygen uptake in humans at onset of and during intense exercise. *Acta Physiologica Scandinavica* **168**, 457-464.

- Bangsbo, J., Gibala, M. J., Krstrup, P., Gonzalez-Alonso, J., & Saltin, B. (2002). Enhanced pyruvate dehydrogenase activity does not affect muscle O₂ uptake at the onset of intense exercise in humans. *American Journal of Physiology* **282**, R273-R280.
- Bangsbo, J., Krstrup, P., Gonzalez-Alonso, J., Boushel, R., & Saltin, B. (2000). Muscle oxygen kinetics at onset of intense dynamic exercise in humans. *American Journal of Physiology* **279**, R899-R906.
- Bangsbo, J., Madsen, K., Kiens, B., & Richter, E. A. (1996). Effect of muscle acidity on muscle metabolism and fatigue during intense exercise in man. *Journal of Physiology* **495**, 587-596.
- Barstow, T. J. (1994). Characterization of VO₂ kinetics during heavy exercise. *Medicine and Science in Sports and Exercise* **26**, 1327-1334.
- Barstow, T. J., Buchthal, S., Zanconato, S., & Cooper, D. M. (1994a). Muscle energetics and pulmonary oxygen uptake kinetics during moderate exercise. *Journal of Applied Physiology* **77**, 1742-1749.
- Barstow, T. J., Buchthal, S. D., Zanconato, S., & Cooper, D. M. (1994b). Changes in potential controllers of human skeletal muscle respiration during incremental calf exercise. *Journal of Applied Physiology* **77**, 2169-2176.
- Barstow, T. J., Casaburi, R., & Wasserman, K. (1993). O₂ uptake kinetics and the O₂ deficit as related to exercise intensity and blood lactate. *Journal of Applied Physiology* **75**, 755-762.
- Barstow, T. J., Jones, A. M., Nguyen, P. H., & Casaburi, R. (1996). Influence of muscle fiber type and pedal frequency on oxygen uptake kinetics of heavy exercise. *Journal of Applied Physiology* **81**, 1642-1650.
- Barstow, T. J., Lamarra, N., & Whipp, B. J. (1990). Modulation of muscle and pulmonary O₂ uptakes by circulatory dynamics during exercise. *Journal of Applied Physiology* **68**, 979-989.
- Barstow, T. J. & Molé, P. A. (1991). Linear and nonlinear characteristics of oxygen uptake kinetics during heavy exercise. *Journal of Applied Physiology* **71**, 2099-2106.
- Bauerle, O. & Younes, M. (1995). Role of ventilatory response to exercise in determining exercise capacity in COPD. *Journal of Applied Physiology* **79**, 1870-1877.

- Bearden, S. E. & Moffatt, R. J. (2000). VO_2 kinetics and the O_2 deficit in heavy exercise. *Journal of Applied Physiology* **88**, 1407-1412.
- Bearden, S. E. & Moffatt, R. J. (2001a). VO_2 and heart rate kinetics in cycling: transitions from an elevated baseline. *Journal of Applied Physiology* **90**, 2081-2087.
- Bearden, S. E. & Moffatt, R. J. (2001b). VO_2 slow component: to model or not to model? *Medicine and Science in Sports and Exercise* **33**, 677-680.
- Beaver, W. L., Wasserman, K., & Whipp, B. J. (1973). On-line computer analysis and breath-by-breath graphical display of exercise function tests. *Journal of Applied Physiology* **34**, 128-132.
- Beaver, W. L., Wasserman, K., & Whipp, B. J. (1986). Bicarbonate buffering of lactic acid generated during exercise. *Journal of Applied Physiology* **60**, 472-478.
- Behnke, B. J., Kindig, C. A., Musch, T. I., Koga, S., & Poole, D. C. (2001). Dynamics of microvascular oxygen pressure across the rest-exercise transition in rat skeletal muscle. *Respiration Physiology* **126**, 53-63.
- Behnke, B. J., Kindig, C. A., Musch, T. I., Sexton, W. L., & Poole, D. C. (2002). Effects of prior contractions on muscle microvascular oxygen pressure at onset of subsequent contractions. *Journal of Physiology* **539**, 927-934.
- Behnke, B. J., McDonough, P., Musch, T. I., Poole, D. C., & Arena, R. (2003). Comparison of oxygen uptake on-kinetics calculations in heart failure. *Medicine and Science in Sports and Exercise* **35**, 708-709.
- Belardinelli, R., Barstow, T. J., Porszasz, J., & Wasserman, K. (1995a). Changes in skeletal muscle oxygenation during incremental exercise measured with near infrared spectroscopy. *Eur. J Appl. Physiol Occup. Physiol* **70**, 487-492.
- Belardinelli, R., Barstow, T. J., Porszasz, J., & Wasserman, K. (1995b). Skeletal muscle oxygenation during constant work rate exercise. *Med.Sci.Sports Exerc.* **27**, 512-519.
- Bell, C., Paterson, D. H., Kowalchuk, J. M., Moy, A. P., Thorp, D. B., Noble, E. G., Taylor, A. W., & Cunningham, D. A. (2001a). Determinants of oxygen uptake kinetics in older humans following single-limb endurance exercise training. *Experimental Physiology* **86**, 659-665.

- Bell, C., Paterson, D. H., Kowalchuk, J. M., Padilla, J., & Cunningham, D. A. (2001b). A comparison of modelling techniques used to characterise oxygen uptake kinetics during the on-transient of exercise. *Experimental Physiology* **86**, 667-676.
- Bergstrom, J., Hermansen, L., Hultman, E., & Saltin, B. (1967). Diet, muscle glycogen and physical performance. *Acta Physiologica Scandinavica* **71**, 140-150.
- Bessman, S. P. & Geiger, P. J. (1981). Transport of energy in muscle: the phosphorylcreatine shuttle. *Science* **211 A**, 448-452.
- Bhambhani, Y., Buckley, S., & Susaki, T. (1999). Muscle oxygenation trends during constant work rate cycle exercise in men and women. *Med.Sci.Sports Exerc.* **31**, 90-98.
- Billat, V. L., Richard, R., Binsse, V. M., Koralsztejn, J. P., & Haouzi, P. (1998). The VO₂ slow component for severe exercise depends on type of exercise and is not correlated with time to fatigue. *Journal of Applied Physiology* **85**, 2118-2124.
- Billat, V. L., Slawinski, J., Bocquet, V., Demarle, A., Lafitte, L., Chassaing, P., & Koralsztejn, J. P. (2000). Intermittent runs at the velocity associated with maximal oxygen uptake enables subjects to remain at maximal oxygen uptake for a longer time than intense but submaximal runs. *Eur.J.Appl.Physiol* **81**, 188-196.
- Bohnert, B., Ward, S. A., & Whipp, B. J. (1998). Effects of prior arm exercise on pulmonary gas exchange kinetics during high-intensity leg exercise in humans. *Experimental Physiology* **83**, 557-570.
- Bompa, T. O. (1999). *Periodization: Theory and Methodology of Training*, 4 ed. Human Kinetics, Leeds, UK.
- Borg, G. A. (1982). Psychophysical bases of perceived exertion. *Medicine and Science in Sports and Exercise* **14**, 377-381.
- Borrani, F., Candau, R., Millet, G. Y., Perrey, S., Fuchslocher, J., & Rouillon, J. D. (2001). Is the VO₂ slow component dependent on progressive recruitment of fast- twitch fibers in trained runners? *Journal of Applied Physiology* **90**, 2212-2220.
- Brandenburg, S. L., Reusch, J. E., Bauer, T. A., Jeffers, B. W., Hiatt, W. R., & Regensteiner, J. G. (1999). Effects of exercise training on oxygen uptake kinetic responses in women with type 2 diabetes. *Diabetes Care* **22**, 1640-1646.

British Thoracic Society (1997). BTS guidelines for the management of chronic obstructive pulmonary disease. The COPD Guidelines Group of the Standards of Care Committee of the BTS. *Thorax* **52 Suppl 5**, S1-28.

British Thoracic Society (2001). Pulmonary Rehabilitation: British Thoracic Society Standards of Care Subcommittee on Pulmonary Rehabilitation. *Thorax* **56**, 827-834.

British Thoracic Society (1994). Guidelines for the measurement of respiratory function. Recommendations of the British Thoracic Society and the Association of Respiratory Technicians and Physiologists. *Respiratory Medicine* **88**, 165-194.

Brittain, C. J., Rossiter, H. B., Kowalchuk, J. M., & Whipp, B. J. (2001). Effect of prior metabolic rate on the kinetics of oxygen uptake during moderate-intensity exercise. *European Journal of Applied Physiology* **86**, 125-134.

Brooks, G. A. (2000). Intra- and extra-cellular lactate shuttles. *Medicine and Science in Sports and Exercise* **32**, 790-799.

Brooks, G. A. (2001). Lactate doesn't necessarily cause fatigue: why are we surprised? *Journal of Physiology* **536**, 1.

Brooks, G. A., Hittelman, K. J., Faulkner, J. A., & Beyer, R. E. (1971). Temperature, skeletal muscle mitochondrial functions, and oxygen debt. *American Journal of Physiology* **220**, 1053-1059.

Brown, G. C. (1992). Control of respiration and ATP synthesis in mammalian mitochondria and cells. *Biochemical Journal* **284**, 1-13.

Burnley, M., Doust, J., Carter, H., & Jones, A. (2001). Effects of prior exercise and recovery duration on oxygen uptake kinetics during heavy exercise in humans. *Experimental Physiology* **86**, 417-425.

Burnley, M., Doust, J. H., Ball, D., & Jones, A. M. (2002a). Effects of prior heavy exercise on VO_2 kinetics during heavy exercise are related to changes in muscle activity. *Journal of Applied Physiology* **93**, 167-174.

Burnley, M., Doust, J. H., & Jones, A. M. (2002b). Effects of prior heavy exercise, prior sprint exercise and passive warming on oxygen uptake kinetics during heavy exercise in humans. *European Journal of Applied Physiology* **87**, 424-432.

- Burnley, M., Jones, A. M., Carter, H., & Doust, J. H. (2000). Effects of prior heavy exercise on phase II pulmonary oxygen uptake kinetics during heavy exercise. *Journal of Applied Physiology* **89**, 1387-1396.
- Caiozzo, V. J., Davis, J. A., Ellis, J. F., Azus, J. L., Vandagriff, R., Prietto, C. A., & McMaster, W. C. (1982). A comparison of gas exchange indices used to detect the anaerobic threshold. *Journal of Applied Physiology* **53**, 1184-1189.
- Campbell-O'Sullivan, S. P., Constantin-Teodosiu, D., Peirce, N., & Greenhaff, P. L. (2002). Low intensity exercise in humans accelerates mitochondrial ATP production and pulmonary oxygen kinetics during subsequent more intense exercise. *Journal of Physiology* **538**, 931-939.
- Carter, H., Pringle, J. S., Jones, A. M., & Doust, J. H. (2002). Oxygen uptake kinetics during treadmill running across exercise intensity domains. *European Journal of Applied Physiology* **86**, 347-354.
- Casaburi, R. (1993). Exercise training in chronic obstructive lung disease. In *Principles and Practice of Pulmonary Rehabilitation*, eds. Casaburi, R. & Petty, T. L., pp. 204-224. W.B. Saunders Company, Mexico.
- Casaburi, R., Barstow, T. J., Robinson, T., & Wasserman, K. (1989). Influence of work rate on ventilatory and gas exchange kinetics. *Journal of Applied Physiology* **67**, 547-555.
- Casaburi, R., Patessio, A., Ioli, F., Zanaboni, S., Donner, C. F., & Wasserman, K. (1991). Reductions in exercise lactic acidosis and ventilation as a result of exercise training in patients with obstructive lung disease. *American Review of Respiratory Disease* **143**, 9-18.
- Casaburi, R., Porszasz, J., Burns, M. R., Carithers, E. R., Chang, R. S., & Cooper, C. B. (1997). Physiologic benefits of exercise training in rehabilitation of patients with severe chronic obstructive pulmonary disease. *American Journal of Respiratory and Critical Care Medicine* **155**, 1541-1551.
- Casaburi, R., Storer, T. W., Ben Dov, I., & Wasserman, K. (1987). Effect of endurance training on possible determinants of $\dot{V}O_2$ during heavy exercise. *Journal of Applied Physiology* **62**, 199-207.
- Casaburi, R., Whipp, B. J., Wasserman, K., Beaver, W. L., & Koyal, S. N. (1977). Ventilatory and gas exchange dynamics in response to sinusoidal work. *Journal of Applied Physiology* **42**, 300-301.

- Cerretelli, P., Pendergast, D., Paganelli, W. C., & Rennie, D. W. (1979). Effects of specific muscle training on VO_2 on-response and early blood lactate. *Journal of Applied Physiology* **47**, 761-769.
- Chance, B., Dait, M. T., Zhang, C., Hamaoka, T., & Hagerman, F. (1992). Recovery from exercise-induced desaturation in the quadriceps muscles of elite competitive rowers. *Am.J Physiol* **262**, C766-C775.
- Chance, B., Leigh, J. S., Jr., Clark, B. J., Maris, J., Kent, J., Nioka, S., & Smith, D. (1985). Control of oxidative metabolism and oxygen delivery in human skeletal muscle: a steady-state analysis of the work/energy cost transfer function. *Proceedings of the National Academy of Sciences of the USA* **82**, 8384-8388.
- Chance, B. & Williams, C. M. (1956). The respiratory chain and oxidative phosphorylation. *Advances in Enzymology* **17**, 65-134.
- Chilibeck, P. D., Paterson, D. H., Cunningham, D. A., Taylor, A. W., & Noble, E. G. (1997). Muscle capillarization O_2 diffusion distance, and VO_2 kinetics in old and young individuals. *Journal of Applied Physiology* **82**, 63-69.
- Chilibeck, P. D., Paterson, D. H., Petrella, R. J., & Cunningham, D. A. (1996). The influence of age and cardiorespiratory fitness on kinetics of oxygen uptake. *Canadian Journal of Applied Physiology* **21**, 185-196.
- Christensen, E. H., Hedman, R., & Holmdahl, I. (1960a). The influence of rest pauses on mechanical efficiency. *Acta Physiol Scand.* **48**, 443-447.
- Christensen, E. H., Hedman, R., & Saltin, B. (1960b). Intermittent and Continuous Running. *Acta Physiol Scand.* **50**, 269-286.
- Christmass, M. A., Dawson, B., & Arthur, P. G. (1999a). Effect of work and recovery duration on skeletal muscle oxygenation and fuel use during sustained intermittent exercise. *European Journal of Applied Physiology and Occupational Physiology* **80**, 436-447.
- Christmass, M. A., Dawson, B., Passeretto, P., & Arthur, P. G. (1999b). A comparison of skeletal muscle oxygenation and fuel use in sustained continuous and intermittent exercise. *European Journal of Applied Physiology and Occupational Physiology* **80**, 423-435.

- Clausen, J. P. (1976). Circulatory adjustments to dynamic exercise and effect of physical training in normal subjects and in patients with coronary artery disease. *Progress in Cardiovascular Diseases* **18**, 459-495.
- Coats, E. M., Rossiter, H. B., Day, J. R., Miura, A., Fukuba, Y., & Whipp, B. J. (2003). Intensity dependent tolerance to exercise after attaining VO₂ max in humans. *Journal of Applied Physiology* **95**, 483-490.
- Coggan, A. R., Spina, R. J., King, D. S., Rogers, M. A., Brown, M., Nemeth, P. M., & Holloszy, J. O. (1992). Histochemical and enzymatic comparison of the gastrocnemius muscle of young and elderly men and women. *Journal of Gerontology* **47**, B71-B76.
- Conley, K. E., Kemper, W. F., & Crowther, G. J. (2001). Limits to sustainable muscle performance: interaction between glycolysis and oxidative phosphorylation. *Journal of Experimental Biology* **204**, 3189-3194.
- Consolazio, C. F. & Johnson, H. L. (1971). Measurement of energy cost in humans. *Federation Proceedings* **30**, 1444-1453.
- Convertino, V. A., Keil, L. C., Bernauer, E. M., & Greenleaf, J. E. (1981). Plasma volume, osmolality, vasopressin, and renin activity during graded exercise in man. *Journal of Applied Physiology* **50**, 123-128.
- Cooper, C. B. (2001). Exercise in chronic pulmonary disease: limitations and rehabilitation. *Medicine and Science in Sports and Exercise* **33**, S643-S646.
- Cooper, D. M., Weiler-Ravell, D., Whipp, B. J., & Wasserman, K. (1984). Growth-related changes in oxygen uptake and heart rate during progressive exercise in children. *Pediatric Research* **18**, 845-851.
- Costes, F., Barthelemy, J. C., Feasson, L., Busso, T., Geysant, A., & Denis, C. (1996). Comparison of muscle near-infrared spectroscopy and femoral blood gases during steady-state exercise in humans. *J Appl. Physiol* **80**, 1345-1350.
- Crow, M. T. & Kushmerick, M. J. (1982). Chemical energetics of slow- and fast-twitch muscles of the mouse. *Journal of General Physiology* **79**, 147-166.
- Cummin, A. R., Iyawe, V. I., Mehta, N., & Saunders, K. B. (1986). Ventilation and cardiac output during the onset of exercise, and during voluntary hyperventilation, in humans. *Journal of Physiology* **370**, 567-583.

- Cunningham, D. A., Croix, C. M., Paterson, D. H., Ozyener, F., & Whipp, B. J. (2000). The off-transient pulmonary oxygen uptake $\dot{V}O_2$ kinetics following attainment of a particular $\dot{V}O_2$ during heavy-intensity exercise in humans. *Experimental Physiology* **85**, 339-347.
- Davis, J. A., Whipp, B. J., Lamarra, N., Huntsman, D. J., Frank, M. H., & Wasserman, K. (1982). Effect of ramp slope on determination of aerobic parameters from the ramp exercise test. *Medicine and Science in Sports and Exercise* **14**, 339-343.
- Davis, J. M. & Bailey, S. P. (1997). Possible mechanisms of central nervous system fatigue during exercise. *Medicine and Science in Sports and Exercise* **29**, 45-57.
- Day, J. R., Coats, E. M., Skasick, A., Rossiter, H. B., & Whipp, B. J. (2002). The maximally attained $\dot{V}O_2$ during incremental exercise in humans: the peak vs. maximum issue. *Journal of Physiology* 151P. Reference type: Poster.
- De Cort, S. C., Innes, J. A., Barstow, T. J., & Guz, A. (1991). Cardiac output, oxygen consumption and arteriovenous oxygen difference following a sudden rise in exercise level in humans. *Journal of Physiology* **441**, 501-512.
- Dempsey, J. A., Hanson, P. G., & Henderson, K. S. (1984). Exercise-induced arterial hypoxaemia in healthy human subjects at sea level. *Journal of Physiology* **355**, 161-175.
- Diaz, O., Villafranca, C., Ghezzi, H., Borzone, G., Leiva, A., Milic-Emil, J., & Lisboa, C. (2000). Role of inspiratory capacity on exercise tolerance in COPD patients with and without tidal expiratory flow limitation at rest. *European Respiratory Journal* **16**, 269-275.
- Edwards, A. M., Claxton, D. B., & Fysh, M. L. (2003). A comparison of two time-domain analysis procedures in the determination of $\dot{V}O_2$ kinetics by pseudorandom binary sequence exercise testing. *European Journal of Applied Physiology* **88**, 411-416.
- Ekblom, B. & Hermansen, L. (1968). Cardiac output in athletes. *Journal of Applied Physiology* **25**, 619-625.
- Elwell, C. E. (1995). *A practical users guide to near infrared spectroscopy* Hamamatsu Phototonics KK, UK.
- Engelen, M., Porszasz, J., Riley, M., Wasserman, K., Maehara, K., & Barstow, T. J. (1996). Effects of hypoxic hypoxia on O_2 uptake and heart rate kinetics during heavy exercise. *Journal of Applied Physiology* **81**, 2500-2508.

- Fawcner, S. G., Armstrong, N., Potter, C. R., & Welsman, J. R. (2002). Oxygen uptake kinetics in children and adults after the onset of moderate-intensity exercise. *Journal of Sports Sciences* **20**, 319-326.
- Ferrari, M., Binzoni, T., & Quaresima, V. (1997). Oxidative metabolism in muscle. *Philosophical transactions of the Royal Society of London. Series B, Biological sciences* **352**, 677-683.
- Fitts, R. H. (1994). Cellular mechanisms of muscle fatigue. *Physiological Reviews* **74**, 49-94.
- Forster, H. V., Dempsey, J. A., Thomson, J., Vidruk, E., & DoPico, G. A. (1972). Estimation of arterial PO₂, PCO₂, pH, and lactate from arterialized venous blood. *Journal of Applied Physiology* **32**, 134-137.
- Frandsen, U., Bangsbo, J., Sander, M., Hoffner, L., Betak, A., Saltin, B., & Hellsten, Y. (2001). Exercise-induced hyperaemia and leg oxygen uptake are not altered during effective inhibition of nitric oxide synthase with N^G-nitro-L-arginine methyl ester in humans. *Journal of Physiology* **531**, 257-264.
- Fujihara, Y., Hildebrandt, J., & Hildebrandt, J. R. (1973a). Cardiorespiratory transients in exercising man. II. Linear models. *Journal of Applied Physiology* **35**, 68-76.
- Fujihara, Y., Hildebrandt, J. R., & Hildebrandt, J. (1973b). Cardiorespiratory transients in exercising man. I. Tests of superposition. *Journal of Applied Physiology* **35**, 58-67.
- Fukuba, Y., Hayashi, N., Koga, S., & Yoshida, T. (2002). VO₂ kinetics in heavy exercise is not altered by prior exercise with a different muscle group. *Journal of Applied Physiology* **92**, 2467-2474.
- Fukuoka, Y., Grassi, B., Conti, M., Guiducci, D., Sutti, M., Marconi, C., & Cerretelli, P. (2002). Early effects of exercise training on on- and off-kinetics in 50-year-old subjects. *Pflugers Archiv* **443**, 690-697.
- Fukuoka, Y. & Ikegami, H. (1990). Respiratory response to sinusoidal work load in humans. *The Annals of Physiological Anthropology* **9**, 175-183.
- Funk, C. I., Clark, A., Jr., & Connett, R. J. (1990). A simple model of aerobic metabolism: applications to work transitions in muscle. *American Journal of Physiology* **258**, C995-1005.

- Gaesser, G. A. (1994). Influence of endurance training and catecholamines on exercise VO_2 response. *Medicine and Science in Sports and Exercise* **26**, 1341-1346.
- Gaesser, G. A. & Brooks, G. A. (1984). Metabolic bases of excess post-exercise oxygen consumption: a review. *Medicine and Science in Sports and Exercise* **16**, 29-43.
- Gaesser, G. A. & Poole, D. C. (1996). The slow component of oxygen uptake kinetics in humans. *Exercise and Sport Sciences Reviews* **24**, 35-71.
- Gaesser, G. A., Ward, S. A., Baum, V. C., & Whipp, B. J. (1994). Effects of infused epinephrine on slow phase of O_2 uptake kinetics during heavy exercise in humans. *Journal of Applied Physiology* **77**, 2413-2419.
- Gausche, M. A., Hannon, T., Lamarra, N., & Whipp, B. J. (1989). Pulmonary O_2 uptake kinetics in humans are speeded by a bout of prior exercise above, but not below, the lactate threshold. *Journal of Physiology* **417**, 138P. Reference Type: Abstract
- Gerbino, A., Ward, S. A., & Whipp, B. J. (1996). Effects of prior exercise on pulmonary gas-exchange kinetics during high-intensity exercise in humans. *Journal of Applied Physiology* **80**, 99-107.
- Gladden, L. B. (2000). Muscle as a consumer of lactate. *Medicine and Science in Sports and Exercise* **32**, 764-771.
- Gollnick, P. D., Armstrong, R. B., Saltin, B., Saubert, C. W., Sembrowich, W. L., & Shepherd, R. E. (1973a). Effect of training on enzyme activity and fiber composition of human skeletal muscle. *Journal of Applied Physiology* **34**, 107-111.
- Gollnick, P. D., Armstrong, R. B., Sembrowich, W. L., Shepherd, R. E., & Saltin, B. (1973b). Glycogen depletion pattern in human skeletal muscle fibers after heavy exercise. *Journal of Applied Physiology* **34**, 615-618.
- Gosselink, R., Troosters, T., & Decramer, M. (1996). Peripheral muscle weakness contributes to exercise limitation in COPD. *American Journal of Respiratory and Critical Care Medicine* **153**, 976-980.
- Grassi, B. (2001). Regulation of oxygen consumption at exercise onset: is it really controversial? *Exercise and Sport Sciences Reviews* **29**, 134-138.

- Grassi, B., Gladden, L. B., Samaja, M., Sary, C. M., & Hogan, M. C. (1998a). Faster adjustment of O₂ delivery does not affect VO₂ on-kinetics in isolated in situ canine muscle. *Journal of Applied Physiology* **85**, 1394-1403.
- Grassi, B., Gladden, L. B., Sary, C. M., Wagner, P. D., & Hogan, M. C. (1998b). Peripheral O₂ diffusion does not affect VO₂ on-kinetics in isolated in-situ canine muscle. *Journal of Applied Physiology* **85**, 1404-1412.
- Grassi, B., Hogan, M. C., Greenhaff, P. L., Hamann, J. J., Kelley, K. M., Aschenbach, W. G., Constantin-Teodosiu, D., & Gladden, L. B. (2002). Oxygen uptake on-kinetics in dog gastrocnemius in situ following activation of pyruvate dehydrogenase by dichloroacetate. *Journal of Physiology* **538**, 195-207.
- Grassi, B., Hogan, M. C., Kelley, K. M., Aschenbach, W. G., Hamann, J. J., Evans, R. K., Patillo, R. E., & Gladden, L. B. (2000). Role of convective O₂ delivery in determining VO₂ on-kinetics in canine muscle contracting at peak VO₂. *Journal of Applied Physiology* **89**, 1293-1301.
- Grassi, B., Pogliaghi, S., Rampichini, S., Quaresima, V., Ferrari, M., Marconi, C., & Cerretelli, P. (2003). Muscle oxygenation and pulmonary gas exchange kinetics during cycling exercise on- transitions in humans. *Journal of Applied Physiology* **95**, 149-158.
- Grassi, B., Poole, D. C., Richardson, R. S., Knight, D. R., Erickson, B. K., & Wagner, P. D. (1996). Muscle O₂ uptake kinetics in humans: implications for metabolic control. *Journal of Applied Physiology* **80**, 988-998.
- Griffiths, T. L., Henson, L. C., & Whipp, B. J. (1986). Influence of inspired oxygen concentration on the dynamics of the exercise hyperpnoea in man. *Journal of Physiology* **380**, 387-403.
- Hagberg, J. M., Hickson, R. C., Ehsani, A. A., & Holloszy, J. O. (1980). Faster adjustment to and recovery from submaximal exercise in the trained state. *Journal of Applied Physiology* **48**, 218-224.
- Hagberg, J. M., Mullin, J. P., & Nagle, F. J. (1978). Oxygen consumption during constant-load exercise. *Journal of Applied Physiology* **45**, 381-384.
- Hale, T., Armstrong, N., Hardman, A., *et al.* (1998). Position statement on the physiological assessment of the elite competitor. British Association of Sports Sciences, UK.

- Hansen, J. E., Sue, D. Y., Oren, A., & Wasserman, K. (1987). Relation of oxygen uptake to work rate in normal men and men with circulatory disorders. *American Journal of Cardiology* **59**, 669-674.
- Haouzi, P., Fukuba, Y., Casaburi, R., Stringer, W., & Wasserman, K. (1993). O₂ uptake kinetics above and below the lactic acidosis threshold during sinusoidal exercise. *Journal of Applied Physiology* **75**, 1683-1690.
- Harms, C. A., McClaran, S. R., Nickele, G. A., Pegelow, D. F., Nelson, W. B., & Dempsey, J. A. (2000). Effect of exercise-induced arterial O₂ desaturation on VO₂max in women. *Medicine and Science in Sports and Exercise* **32**, 1101-1108.
- Harris, R. C., Edwards, R. H., Hultman, E., Nordesjo, L. O., Ny Lind, B., & Sahlin, K. (1976). The time course of phosphorylcreatine resynthesis during recovery of the quadriceps muscle in man. *Pflugers Arch.* **367**, 137-142.
- Henneman, E., Clamann, H. P., Gillies, J. D., & Skinner, R. D. (1974). Rank order of motoneurons within a pool: law of combination. *Journal of Neurophysiology* **37**, 1338-1349.
- Hepple, R. T. (2000). Skeletal muscle: microcirculatory adaptation to metabolic demand. *Medicine and Science in Sports and Exercise* **32**, 117-123.
- Hickson, R. C., Bomze, H. A., & Hollozy, J. O. (1978). Faster adjustment of O₂ uptake to the energy requirement of exercise in the trained state. *Journal of Applied Physiology* **44**, 877-881.
- Higginbotham, M. B., Morris, K. G., Williams, R. S., McHale, P. A., Coleman, R. E., & Cobb, F. R. (1986). Regulation of stroke volume during submaximal and maximal upright exercise in normal man. *Circulation Research* **58**, 281-291.
- Hill, A. V. & Lupton, H. (1923). Muscular exercise, lactic acid, and the supply and utilization of oxygen. *The Quarterly Journal of Medicine* **16**, 135-171.
- Hill, D. W. (1993). The critical power concept. A review. *Sports Medicine* **16**, 237-254.
- Hill, D. W., Poole, D. C., & Smith, J. C. (2002). The relationship between power and the time to achieve VO₂max. *Medicine and Science in Sports and Exercise* **34**, 709-714.
- Hoffman, J. (2002). Principles of training. In *Physiological Aspects of Sport Training and Performance*, ed. Hoffman, J., pp. 72-76. Human kinetics, Leeds, UK.

- Hoffmann, U., Essfeld, D., Wunderlich, H. G., & Stegemann, J. (1992). Dynamic linearity of VO₂ responses during aerobic exercise. *European Journal of Applied Physiology and Occupational Physiology* **64**, 139-144.
- Hogan, M. C. (1999). Phosphorescence quenching method for measurement of intracellular PO₂ in isolated skeletal muscle fibers. *Journal of Applied Physiology* **86**, 720-724.
- Hogan, M. C. (2001). Fall in intracellular PO₂ at the onset of contractions in *Xenopus* single skeletal muscle fibers. *Journal of Applied Physiology* **90**, 1871-1876.
- Holloszy, J. O. & Coyle, E. F. (1984). Adaptations of skeletal muscle to endurance exercise and their metabolic consequences. *Journal of Applied Physiology* **56**, 831-838.
- Hopkins, W. G. (2000). Measures of reliability in sports medicine and science. *Sports Medicine* **30**, 1-15.
- Hoppeler, H. & Fluck, M. (2003). Plasticity of skeletal muscle mitochondria: structure and function. *Medicine and Science in Sports and Exercise* **35**, 95-104.
- Horowitz, M. B. & Mahler, D. A. (1998). Dyspnea ratings for prescription of cross-modal exercise in patients with COPD. *Chest* **113**, 60-64.
- Howlett, R. A., Heigenhauser, G. J., Hultman, E., Hollidge-Horvat, M. G., & Spriet, L. L. (1999). Effects of dichloroacetate infusion on human skeletal muscle metabolism at the onset of exercise. *American Journal of Physiology* **277**, E18-E25.
- Howlett, R. A. & Hogan, M. C. (2001). Intracellular PO₂ decreases with increasing stimulation frequency in contracting single *Xenopus* muscle fibers. *Journal of Applied Physiology* **91**, 632-636.
- Howlett, R. A. & Hogan, M. C. (2003). Dichloroacetate accelerates the fall in intracellular PO₂ at onset of contractions in *Xenopus* single muscle fibers. *American Journal of Physiology* **284**, R481-R485.
- Hudlicka, O., Brown, M., & Egginton, S. (1992). Angiogenesis in skeletal and cardiac muscle. *Physiological Reviews* **72**, 369-417.
- Hughson, R. L. (1984). Alterations in the oxygen deficit-oxygen debt relationships with beta- adrenergic receptor blockade in man. *Journal of Physiology* **349**, 375-387.

- Hughson, R. L. (1990). Exploring cardiorespiratory control mechanisms through gas exchange dynamics. *Medicine and Science in Sports and Exercise* **22**, 72-79.
- Hughson, R. L., Cuervo, L. A., Patla, A. E., Winter, D. A., Xing, H. C., Dietrich, B. H., & Swanson, G. D. (1991a). Time domain analysis of oxygen uptake during pseudorandom binary sequence exercise tests. *Journal of Applied Physiology* **71**, 1620-1626.
- Hughson, R. L. & Kowalchuk, J. M. (1995). Kinetics of oxygen uptake for submaximal exercise in hyperoxia, normoxia, and hypoxia. *Canadian Journal of Applied Physiology* **20**, 198-210.
- Hughson, R. L. & Morrissey, M. (1982). Delayed kinetics of respiratory gas exchange in the transition from prior exercise. *Journal of Applied Physiology* **52**, 921-929.
- Hughson, R. L., Sherrill, D. L., & Swanson, G. D. (1988). Kinetics of VO_2 with impulse and step exercise in humans. *Journal of Applied Physiology* **64**, 451-459.
- Hughson, R. L., Shoemaker, J. K., Tschakovsky, M. E., & Kowalchuk, J. M. (1996). Dependence of muscle VO_2 on blood flow dynamics at onset of forearm exercise. *Journal of Applied Physiology* **81**, 1619-1626.
- Hughson, R. L., Tschakovsky, M. E., & Houston, M. E. (2001). Regulation of oxygen consumption at the onset of exercise. *Exercise and Sport Sciences Reviews* **29**, 129-133.
- Hughson, R. L., Xing, H. C., Borkhoff, C., & Butler, G. C. (1991b). Kinetics of ventilation and gas exchange during supine and upright cycle exercise. *European Journal of Applied Physiology and Occupational Physiology* **63**, 300-307.
- Hultman, E., Bergstrom, J., & Anderson, N. M. (1967). Breakdown and resynthesis of phosphorylcreatine and adenosine triphosphate in connection with muscular work in man. *Scandinavian journal of clinical and laboratory investigation* **19**, 56-66.
- Hurd, S. (2000). The impact of COPD on lung health worldwide: epidemiology and incidence. *Chest* **117**, 1S-4S.
- Jeneson, J. A., Wiseman, R. W., Westerhoff, H. V., & Kushmerick, M. J. (1996). The signal transduction function for oxidative phosphorylation is at least second order in ADP. *The Journal of Biological Chemistry* **271**, 27995-27998.

- Jobin, J., Maltais, F., Doyon, J. F., LeBlanc, P., Simard, P. M., Simard, A. A., & Simard, C. (1998). Chronic obstructive pulmonary disease: capillarity and fiber-type characteristics of skeletal muscle. *Journal of Cardiopulmonary Rehabilitation* **18**, 432-437.
- Jones, D. A. (1999). Muscle fatigue during high-intensity exercise. In *Physiological Determinants of Exercise Tolerance in Humans*, eds. Whipp, B. J. & Sargeant, A. J., pp. 1-12. Portland Press, for The Physiological Society, London, UK.
- Jones, W. B., Fincham, R. N., Russell, R. O., Jr., & Reeves, T. J. (1970). Transient cardiac output response to multiple levels of supine exercise. *Journal of Applied Physiology* **28**, 183-189.
- Joyner, M. J. & Dietz, N. M. (1997). Nitric oxide and vasodilation in human limbs. *Journal of Applied Physiology* **83**, 1785-1796.
- Karlsson, H., Lindborg, B., & Linnarsson, D. (1975). Time courses of pulmonary gas exchange and heart rate changes in supine exercise. *Acta Physiologica Scandinavica* **95**, 329-340.
- Killian, K. J., LeBlanc, P., Martin, D. H., Summers, E., Jones, N. L., & Campbell, E. J. (1992). Exercise capacity and ventilatory, circulatory, and symptom limitation in patients with chronic airflow limitation. *American Review of Respiratory Disease* **146**, 935-940.
- Kindig, C. A., McDonough, P., Erickson, B. K., & Poole, D. C. (2002). Nitric oxide synthase inhibition speeds oxygen uptake kinetics in horses during moderate domain running. *Respiratory Physiology & Neurobiology* **132**, 169-178.
- Kindig, C. A., McDonough, P., Erickson, H. H., & Poole, D. C. (2001). Effect of L-NAME on oxygen uptake kinetics during heavy-intensity exercise in the horse. *Journal of Applied Physiology* **91**, 891-896.
- Knight, D. R., Poole, D. C., Schaffartzik, W., Guy, H. J., Prediletto, R., Hogan, M. C., & Wagner, P. D. (1992). Relationship between body and leg VO_2 during maximal cycle ergometry. *Journal of Applied Physiology* **73**, 1114-1121.
- Koga, S., Shiojiri, T., Kondo, N., & Barstow, T. J. (1997). Effect of increased muscle temperature on oxygen uptake kinetics during exercise. *Journal of Applied Physiology* **83**, 1333-1338.
- Koike, A., Hiroe, M., Adachi, H., Yajima, T., Yamauchi, Y., Nogami, A., Ito, H., Miyahara, Y., Korenaga, M., & Marumo, F. (1994). Oxygen uptake kinetics are

determined by cardiac function at onset of exercise rather than peak exercise in patients with prior myocardial infarction. *Circulation* **90**, 2324-2332.

Koike, A., Wasserman, K., McKenzie, D. K., Zanconato, S., & Weiler-Ravell, D. (1990). Evidence that diffusion limitation determines oxygen uptake kinetics during exercise in humans. *The Journal of Clinical Investigation* **86**, 1698-1706.

Koike, A., Yajima, T., Adachi, H., Shimizu, N., Kano, H., Sugimoto, K., Niwa, A., Marumo, F., & Hiroe, M. (1995). Evaluation of exercise capacity using submaximal exercise at a constant work rate in patients with cardiovascular disease. *Circulation* **91**, 1719-1724.

Koppo, K. & Bouckaert, J. (2000). In humans the oxygen uptake slow component is reduced by prior exercise of high as well as low intensity. *European Journal of Applied Physiology* **83**, 559-565.

Koppo, K. & Bouckaert, J. (2001). The effect of prior high-intensity cycling exercise on the VO_2 kinetics during high-intensity cycling exercise is situated at the additional slow component. *International Journal of Sports Medicine* **22**, 21-26.

Koppo, K. & Bouckaert, J. (2002). The decrease in VO_2 slow component induced by prior exercise does not affect the time to exhaustion. *International Journal of Sports Medicine* **23**, 262-267.

Koppo, K., Demeter, S., Lycke, J., & Bouckaert, J. (2001). Decrease in VO_2 slow component induced by prior exercise does not affect the time to exhaustion. *Proceedings of the 6th Annual Congress of the European College of Sport Science*, 933. Reference Type: Abstract.

Koppo, K., Jones, A. M., & Bouckaert, J. (2003). Effect of prior heavy arm and leg exercise on VO_2 kinetics during heavy leg exercise. *European Journal of Applied Physiology* **88**, 593-600.

Korzeniewski, B. & Zoladz, J. A. (2003). Training-induced adaptation of oxidative phosphorylation in skeletal muscle. *The Biochemical Journal* **In Press**.

Koufaki, P., Nash, P. F., & Mercer, T. H. (2002). Assessing the efficacy of exercise training in patients with chronic disease. *Medicine and Science in Sports and Exercise* **34**, 1234-1241.

- Kowalchuk, J. M. & Hughson, R. L. (1990). Effect of beta-adrenergic blockade on VO_2 kinetics during pseudorandom binary sequence exercise. *European Journal of Applied Physiology and Occupational Physiology* **60**, 365-369.
- Kowalchuk, J. M., Rossiter, H. B., Ward, S. A., & Whipp, B. J. (2002). The effect of resistive breathing on leg muscle oxygenation using near-infrared spectroscopy during exercise in men. *Experimental Physiology* **87**, 601-611.
- Krogh, A. & Lindhard, J. (1913). The regulation of respiration and circulation during the initial stages of muscular work. *Journal of Physiology* **47**, 112-136.
- Kushmerick, M. J., Meyer, R. A., & Brown, T. R. (1992). Regulation of oxygen consumption in fast- and slow-twitch muscle. *American Journal of Physiology* **263**, C598-C606.
- Lacasse, Y., Wong, E., Guyatt, G. H., King, D., Cook, D. J., & Goldstein, R. S. (1996). Meta-analysis of respiratory rehabilitation in chronic obstructive pulmonary disease. *Lancet* **348**, 1115-1119.
- Lamarra, N. (1990). Variables, constants, and parameters: clarifying the system structure. *Medicine and Science in Sports and Exercise* **22**, 88-95.
- Lamarra, N. & Whipp, B. J. (1995). Measurement of pulmonary gas exchange. In *Physiological Assessment of Human Fitness*, eds. Maud, P. J. & Foster, C., pp. 19-35. Human Kinetics, Leeds.
- Lamarra, N., Whipp, B. J., Ward, S. A., & Wasserman, K. (1987). Effect of interbreath fluctuations on characterizing exercise gas exchange kinetics. *Journal of Applied Physiology* **62**, 2003-2012.
- Langsetmo, I., Weigle, G. E., Fedde, M. R., Erickson, H. H., Barstow, T. J., & Poole, D. C. (1997). VO_2 kinetics in the horse during moderate and heavy exercise. *Journal of Applied Physiology* **83**, 1235-1241.
- Lewis, S. F., Taylor, W. F., Graham, R. M., Pettinger, W. A., Schutt, J. E., & Blomqvist, C. G. (1983). Cardiovascular responses to exercise as functions of absolute and relative work load. *Journal of Applied Physiology* **54**, 1314-1323.
- Lindinger, M. I., McKelvie, R. S., & Heigenhauser, G. J. (1995). K^+ and Lac^- distribution in humans during and after high-intensity exercise: role in muscle fatigue attenuation? *Journal of Applied Physiology* **78**, 765-777.

- Linnarsson, D. (1974). Dynamics of pulmonary gas exchange and heart rate changes at start and end of exercise. *Acta Physiologica Scandinavica Suppl.* **415**, 1-68.
- Linnarsson, D. (1990). The body as a bioenergetic system--lessons from systems engineering and comparative physiology. *Medicine and Science in Sports and Exercise* **22**, 59-61.
- Macdonald, M., Pedersen, P. K., & Hughson, R. L. (1997). Acceleration of VO_2 kinetics in heavy submaximal exercise by hyperoxia and prior high-intensity exercise. *Journal of Applied Physiology* **83**, 1318-1325.
- MacDonald, M. J., Naylor, H. L., Tschakovsky, M. E., & Hughson, R. L. (2001). Peripheral circulatory factors limit rate of increase in muscle O_2 uptake at onset of heavy exercise. *Journal of Applied Physiology* **90**, 83-89.
- MacDonald, M. J., Shoemaker, J. K., Tschakovsky, M. E., & Hughson, R. L. (1998). Alveolar oxygen uptake and femoral artery blood flow dynamics in upright and supine leg exercise in humans. *Journal of Applied Physiology* **85**, 1622-1628.
- MacDonald, M. J., Tarnopolsky, M. A., Green, H. J., & Hughson, R. L. (1999). Comparison of femoral blood gases and muscle near-infrared spectroscopy at exercise onset in humans. *J Appl. Physiol* **86**, 687-693.
- Mahler, D. A., Brent, B., Loke, J., Zaret, B. L., & Matthay, R. A. (1984). Right ventricular performance and circulatory haemodynamics during upright exercise in patients with chronic obstructive pulmonary disease. *American Review of Respiratory Disease* **130**, 722-729.
- Mahler, M. (1985). First-order kinetics of muscle oxygen consumption, and an equivalent proportionality between QO_2 and phosphorylcreatine level. Implications for the control of respiration. *Journal of General Physiology* **86**, 135-165.
- Maltais, F., LeBlanc, P., Simard, C., Jobin, J., Berube, C., Bruneau, J., Carrier, L., & Belleau, R. (1996). Skeletal muscle adaptation to endurance training in patients with chronic obstructive pulmonary disease. *American Journal of Respiratory and Critical Care Medicine* **154**, 442-447.
- Mancini, D. M., Bolinger, L., Li, H., Kendrick, K., Chance, B., & Wilson, J. R. (1994). Validation of near-infrared spectroscopy in humans. *Journal of Applied Physiology* **77**, 2740-2747.

- Margaria, R., Oliva, R. D., Di Prampero, P. E., & Cerretelli, P. (1969). Energy utilization in intermittent exercise of supramaximal intensity. *Journal of Applied Physiology* **26**, 752-756.
- Martin, W. H., Kohrt, W. M., Malley, M. T., Korte, E., & Stoltz, S. (1990). Exercise training enhances leg vasodilatory capacity of 65-yr-old men and women. *Journal of Applied Physiology* **69**, 1804-1809.
- Matthay, R., Arroliga, A., Wiedemann, H. P., Schulman, D., & Mahler, D. A. (1992). Right ventricular function at rest and during exercise in chronic obstructive pulmonary disease. *Chest* **101**, 255s-261s.
- McArdle, W. D., Katch, F. I., & Katch, V. L. (2001). Training for anaerobic and aerobic power. In *Exercise Physiology: Energy, Nutrition, and Human Performance* pp. 478. Lippincott Williams & Wilkins, USA.
- McCreary, C. R., Chilibeck, P. D., Marsh, G. D., Paterson, D. H., Cunningham, D. A., & Thompson, R. T. (1996). Kinetics of pulmonary oxygen uptake and muscle phosphates during moderate-intensity calf exercise. *Journal of Applied Physiology* **81**, 1331-1338.
- McCully, K. K. & Hamaoka, T. (2000). Near-infrared spectroscopy: what can it tell us about oxygen saturation in skeletal muscle? *Exercise and Sport Sciences Reviews* **28**, 123-127.
- McGuire, B. J. & Secomb, T. W. (2001). A theoretical model for oxygen transport in skeletal muscle under conditions of high oxygen demand. *Journal of Applied Physiology* **91**, 2255-2265.
- Medbo, J. I., Mohn, A. C., Tabata, I., Bahr, R., Vaage, O., & Sejersted, O. M. (1988). Anaerobic capacity determined by maximal accumulated O₂ deficit. *Journal of Applied Physiology* **64**, 50-60.
- Meyer, R. A. (1988). A linear model of muscle respiration explains monoexponential phosphocreatine changes. *American Journal of Physiology* **254**, C548-C553.
- Milsum, J. H. (1966). Transient response characteristics. In *Biological Control Systems Analysis* pp. 115-138. McGraw Hill, New York.
- Miyamoto, Y. (1992). Kinetics of respiratory and circulatory responses to step, impulse, sinusoidal and ramp forcings of exercise load in humans. *Frontiers of Medical and Biological Engineering* **4**, 3-18.

- Monod, H. & Scherrer, J. (1965). The work capacity of a synergic muscle group. *Ergonomics* **8**, 329-338.
- Moritani, T., Nagata, A., deVries, H. A., & Muro, M. (1981). Critical power as a measure of physical work capacity and anaerobic threshold. *Ergonomics* **24**, 339-350.
- Neder, J. A., Jones, P. W., Nery, L. E., & Whipp, B. J. (2000). Determinants of the exercise endurance capacity in patients with chronic obstructive pulmonary disease. The power-duration relationship. *American Journal of Respiratory and Critical Care Medicine* **162**, 497-504.
- Nery, L. E., Wasserman, K., Andrews, J. D., Huntsman, D. J., Hansen, J. E., & Whipp, B. J. (1982). Ventilatory and gas exchange kinetics during exercise in chronic airways obstruction. *Journal of Applied Physiology* **53**, 1594-1602.
- Newsholme, E. A. & Blomstrand, E. (1995). Tryptophan, 5-hydroxytryptamine and a possible explanation for central fatigue. *Advances in Experimental Medicine and Biology* **384**, 315-320.
- O'Donnell, D. E., Reville, S. M., & Webb, K. A. (2001). Dynamic hyperinflation and exercise intolerance in chronic obstructive pulmonary disease. *American Journal of Respiratory and Critical Care Medicine* **164**, 770-777.
- Otsuka, T., Kurihara, N., Fujii, T., Fujimoto, S., & Yoshikawa, J. (1997). Effect of exercise training and detraining on gas exchange kinetics in patients with chronic obstructive pulmonary disease. *Clinical Physiology* **17**, 287-297.
- Ozcelik, O., Ward, S. A., & Whipp, B. J. (1999). Effect of altered body CO₂ stores on pulmonary gas exchange dynamics during incremental exercise in humans. *Experimental Physiology* **84**, 999-1011.
- Ozyener, F., Rossiter, H., Ward, S., & Whipp, B. (2001). Influence of exercise intensity on the on- and off-transient kinetics of pulmonary oxygen uptake in humans. *Journal of Physiology* **533**, 891-902.
- Ozyener, F., Rossiter, H. B., Ward, S. A., & Whipp, B. J. (2003). Negative accumulated oxygen deficit during heavy and very heavy intensity cycle ergometry in humans. *European Journal of Applied Physiology* **In Press**.

- Palange, P., Galassetti, P., Mannix, E. T., Farber, M. O., Manfredi, F., Serra, P., & Carlone, S. (1995). Oxygen effect on O₂ deficit and VO₂ kinetics during exercise in obstructive pulmonary disease. *Journal of Applied Physiology* **78**, 2228-2234.
- Pardy, R. L., Reid, D. W., & Belman, M. J. (1988). Respiratory muscle training. *Clinical Chest Medicine* **9**, 287-296.
- Patel, R., Rossiter, H. B., & Whipp, B. J. (2001). The effect of recovery time between repeated bouts of high-intensity exercise on the on-transient kinetics in humans. *Journal of Physiology* 533[P], 123P. Reference Type: Abstract
- Paterson, D. H. (1979). Respiratory and cardiovascular aspects of intermittent exercise with regard to ice hockey. *Canadian Journal of Applied Sport Science* **4**, 22-28.
- Paterson, D. H. & Whipp, B. J. (1991). Asymmetries of oxygen uptake transients at the on- and offset of heavy exercise in humans. *Journal of Physiology* **443**, 575-586.
- Pauwels, R. A., Buist, A. S., Calverley, P. M., Jenkins, C. R., & Hurd, S. S. (2001). Global strategy for the diagnosis, management, and prevention of chronic obstructive pulmonary disease. NHLBI/WHO Global Initiative for Chronic Obstructive Lung Disease (GOLD) Workshop summary. *American Journal of Respiratory and Critical Care Medicine* **163**, 1256-1276.
- Pedersen, P. K., Mandoe, H., Jensen, K., Andersen, C., & Madsen, K. (1996). Reduced arterial O₂ saturation during supine exercise in highly trained cyclists. *Acta Physiologica Scandinavica* **158**, 325-331.
- Perrey, S., Tschakovsky, M. E., & Hughson, R. L. (2001). Muscle chemoreflex elevates muscle blood flow and O₂ uptake at exercise onset in nonischemic human forearm. *Journal of Applied Physiology* **91**, 2010-2016.
- Phillips, S. M., Green, H. J., MacDonald, M. J., & Hughson, R. L. (1995). Progressive effect of endurance training on VO₂ kinetics at the onset of submaximal exercise. *Journal of Applied Physiology* **79**, 1914-1920.
- Picozzi, N. M., Clark, A. L., Lindsay, K. A., McCann, G. P., & Hillis, W. S. (1999). Responses to constant work exercise in patients with chronic heart failure. *Heart* **82**, 482-485.

- Poole, D. C., Barstow, T. J., Gaesser, G. A., Willis, W. T., & Whipp, B. J. (1994a). VO_2 slow component: physiological and functional significance. *Medicine and Science in Sports and Exercise* **26**, 1354-1358.
- Poole, D. C., Gladden, L. B., Kurdak, S., & Hogan, M. C. (1994b). L-(+)-lactate infusion into working dog gastrocnemius: no evidence lactate per se mediates VO_2 slow component. *Journal of Applied Physiology* **76**, 787-792.
- Poole, D. C., Schaffartzik, W., Knight, D. R., Derion, T., Kennedy, B., Guy, H. J., Prediletto, R., & Wagner, P. D. (1991). Contribution of excising legs to the slow component of oxygen uptake kinetics in humans. *Journal of Applied Physiology* **71**, 1245-1260.
- Poole, D. C., Ward, S. A., Gardner, G. W., & Whipp, B. J. (1988). Metabolic and respiratory profile of the upper limit for prolonged exercise in man. *Ergonomics* **31**, 1265-1279.
- Poole, D. C., Ward, S. A., & Whipp, B. J. (1990). The effects of training on the metabolic and respiratory profile of high-intensity cycle ergometer exercise. *European Journal of Applied Physiology and Occupational Physiology* **59**, 421-429.
- Potter, W. A., Olafsson, S., & Hyatt, R. E. (1971). Ventilatory mechanics and expiratory flow limitation during exercise in patients with obstructive lung disease. *The Journal of Clinical Investigation* **50**, 910-919.
- Powers, S. K. & Williams, J. (1987). Exercise-induced hypoxaemia in highly trained athletes. *Sports Medicine* **4**, 46-53.
- Pringle, J. S. & Jones, A. M. (2002). Maximal lactate steady state, critical power and EMG during cycling. *European Journal of Applied Physiology* **88**, 214-226.
- Puente-Maestu, L., Sanz, M. L., Sanz, P., Cubillo, J. M., Mayol, J., & Casaburi, R. (2000). Comparison of effects of supervised versus self-monitored training programmes in patients with chronic obstructive pulmonary disease. *European Respiratory Journal* **15**, 517-525.
- Puente-Maestu, L., Sanz, M. L., Sanz, P., Nunez, A., Gonzalez, F., & Whipp, B. J. (2001). Reproducibility of the parameters of the on-transient cardiopulmonary responses during moderate exercise in patients with chronic obstructive pulmonary disease. *European Journal of Applied Physiology* **85**, 434-441.

Puente-Macstu, L., Tcna, T., Trascasa, C., Perez-Parra, J., Godoy, R., Garcia, M. J., & Stringer, W. W. (2003). Training improves muscle oxidative capacity and oxygenation recovery kinetics in patients with chronic obstructive pulmonary disease. *European Journal of Applied Physiology* **88**, 580-587.

Quanjer, P. H., Tammeling, G. J., Cotes, J. E., Pedersen, O. F., Peslin, R., & Yernault, J. C. (1994). [Lung volumes and forced ventilatory flows. Work Group on Standardization of Respiratory Function Tests. European Community for Coal and Steel. Official position of the European Respiratory Society]. *Revue des Maladies Respiratoires* **11 Suppl 3**, 5-40.

Quaresima, V., Colier, W. N., van der, S. M., & Ferrari, M. (2001). Nonuniform quadriceps O₂ consumption revealed by near infrared multipoint measurements. *Biochemical and Biophysical Research Communications* **285**, 1034-1039.

Rausch, S. M., Whipp, B. J., Wasserman, K., & Huszczuk, A. (1991). Role of the carotid bodies in the respiratory compensation for the metabolic acidosis of exercise in humans. *Journal of Physiology* **444**, 567-578.

Raynaud, J., Bernal, H., Bourdarias, J. P., David, P., & Durand, J. (1973). Oxygen delivery and oxygen return to the lungs at onset of exercise in man. *Journal of Applied Physiology* **35**, 259-262.

Reinhard, U., Muller, P. H., & Schmulling, R. M. (1979). Determination of anaerobic threshold by the ventilation equivalent in normal individuals. *Respiration* **38**, 36-42.

Richardson, R. S., Haseler, L. J., Nygren, A. T., Bluml, S., & Frank, L. R. (2001a). Local perfusion and metabolic demand during exercise: a noninvasive MRI method of assessment. *Journal of Applied Physiology* **91**, 1845-1853.

Richardson, R. S., Newcomer, S. C., & Noyszewski, E. A. (2001b). Skeletal muscle intracellular PO₂ assessed by myoglobin desaturation: response to graded exercise. *Journal of Applied Physiology* **91**, 2679-2685.

Rocca, H. P., Weilenmann, D., Follath, F., Schlumpf, M., Rickli, H., Schalcher, C., Maly, F. E., Candinas, R., & Kiowski, W. (1999). Oxygen uptake kinetics during low level exercise in patients with heart failure: relation to neurohormones, peak oxygen consumption, and clinical findings. *Heart* **81**, 121-127.

Rossiter, H. B., Howe, F. A., Ward, S. A., Kowalchuk, J. M., Griffiths, J. R., & Whipp, B. J. (2000). Intersample fluctuations in phosphocreatine concentration determined by ³¹P-

- magnetic resonance spectroscopy and parameter estimation of metabolic responses to exercise in humans. *Journal of Physiology* **528**, 359-369.
- Rossiter, H. B., Ward, S. A., Doyle, V. L., Howe, F. A., Griffiths, J. R., & Whipp, B. J. (1999). Inferences from pulmonary O₂ uptake with respect to intramuscular [phosphocreatine] kinetics during moderate exercise in humans. *Journal of Physiology* **518**, 921-932.
- Rossiter, H. B., Ward, S. A., Howe, F. A., Kowalchuk, J. M., Griffiths, J. R., & Whipp, B. J. (2002a). Dynamics of intramuscular ³¹P-MRS Pi peak splitting and the slow components of PCr and O₂ uptake during exercise. *Journal of Applied Physiology* **93**, 2059-2069.
- Rossiter, H. B., Ward, S. A., Kowalchuk, J. M., Howe, F. A., Griffiths, J. R., & Whipp, B. J. (2001). Effects of prior exercise on oxygen uptake and phosphocreatine kinetics during high-intensity knee-extension exercise in humans. *Journal of Physiology* **537**, 291-303.
- Rossiter, H. B., Ward, S. A., Kowalchuk, J. M., Howe, F. A., Griffiths, J. R., & Whipp, B. J. (2002b). Dynamic asymmetry of phosphocreatine concentration and O₂ uptake between the on- and off-transients of moderate- and high-intensity exercise in humans. *Journal of Physiology* **541**, 991-1002.
- Roston, W. L., Whipp, B. J., Davis, J. A., Cunningham, D. A., Effros, R. M., & Wasserman, K. (1987). Oxygen uptake kinetics and lactate concentration during exercise in humans. *American Review of Respiratory Disease* **135**, 1080-1084.
- Rowell, L. B. (1971). Cardiovascular limitations to work capacity. In *Physiology of Work capacity and Fatigue*, ed. Simonson, E., pp. 132-169. Thomas, Springfield, IL.
- Rowell, L. B. (1974). Human cardiovascular adjustments to exercise and thermal stress. *Physiological Reviews* **54**, 75-159.
- Rowell, L. B. (1993). Central circulatory adjustments to dynamic exercise. In *Human Cardiovascular Control*, ed. Rowell, L. B., pp. 162-203. Oxford University Press, Oxford.
- Rowell, L. B., Taylor, H. L., Wang, Y., & Carlson, J. S. (1964). Saturation of arterial blood with oxygen during maximal exercise. *Journal of Applied Physiology* **19**, 286.
- Sako, T., Hamaoka, T., Higuchi, H., Kurosawa, Y., & Katsumura, T. (2001). Validity of NIR spectroscopy for quantitatively measuring muscle oxidative metabolic rate in exercise. *Journal of Applied Physiology* **90**, 338-344.

- Sala, E., Roca, J., Marrades, R. M., Alonso, J., Gonzalez De Suso, J. M., Moreno, A., Barbera, J. A., Nadal, J., de Jover, L., Rodriguez-Roisin, R., & Wagner, P. D. (1999). Effects of endurance training on skeletal muscle bioenergetics in chronic obstructive pulmonary disease. *American Journal of Respiratory and Critical Care Medicine* **159**, 1726-1734.
- Saltin, B., Blomqvist, G., Mitchell, J. H., Johnson, R. L., Jr., Wildenthal, K., & Chapman, C. B. (1968). Response to exercise after bed rest and after training. *Circulation* **38**, VIII-78.
- Saltin, B., Essen, B., & Pedersen, P. K. (1976). Intermittent exercise: its physiology and some practical applications. In *Advances in Exercise Physiology*, eds. Joeckle, E., Anand, R. L., & Stoboy, H., pp. 23-51. Karger Publishers, Basel.
- Saltin, B. & Karlsson, J. (1971). Muscle glycogen utilisation during work of different intensities. In *Muscle Metabolism During Exercise*, eds. Pernow, B. & Saltin, B., pp. 289-300. Plenum Press, New York, USA.
- Saugen, E. & Vollestad, N. K. (1995). Nonlinear relationship between heat production and force during voluntary contractions in humans. *Journal of Applied Physiology* **79**, 2043-2049.
- Saunders, M. J., Evans, E. M., Amgrimsson, S. A., Allison, J. D., Warren, G. L., & Cureton, K. J. (2000). Muscle activation and the slow component rise in oxygen uptake during cycling. *Medicine and Science in Sports and Exercise* **32**, 2040-2045.
- Scheuermann, B. W., Bell, C., Paterson, D. H., Barstow, T. J., & Kowalchuk, J. M. (2002). Oxygen uptake kinetics for moderate exercise are speeded in older humans by prior heavy exercise. *Journal of Applied Physiology* **92**, 609-616.
- Scheuermann, B. W., Hoelting, B. D., Noble, M. L., & Barstow, T. J. (2001). The slow component of O₂ uptake is not accompanied by changes in muscle EMG during repeated bouts of heavy exercise in humans. *Journal of Physiology* **531**, 245-256.
- Scheuermann, B. W., Kowalchuk, J. M., Paterson, D. H., & Cunningham, D. A. (1998). O₂ uptake kinetics after acetazolamide administration during moderate- and heavy-intensity exercise. *Journal of Applied Physiology* **85**, 1384-1393.
- Schmidt, R. F. & Thews, G. (1983). *Human Physiology* Springer-Verlag, New York, USA.

- Shinohara, M. & Moritani, T. (1992). Increase in neuromuscular activity and oxygen uptake during heavy exercise. *The Annals of Physiological Anthropology* **11**, 257-262.
- Sietsema, K. E. (1992). Oxygen uptake kinetics in response to exercise in patients with pulmonary vascular disease. *American Review of Respiratory Disease* **145**, 1052-1057.
- Sietsema, K. E., Ben Dov, I., Zhang, Y. Y., Sullivan, C., & Wasserman, K. (1994). Dynamics of oxygen uptake for submaximal exercise and recovery in patients with chronic heart failure. *Chest* **105**, 1693-1700.
- Singh, S. J., Smith, D. L., Hyland, M. E., & Morgan, M. D. (1998). A short outpatient pulmonary rehabilitation programme: immediate and longer-term effects on exercise performance and quality of life. *Respiratory Medicine* **92**, 1146-1154.
- Slutsky, R. A., Ackerman, W., Karliner, I. S., Ashburn, W. L., & Moser, K. M. (1980). Right and left ventricular dysfunction in patients with chronic obstructive lung disease - Assessment by first-pass radionuclide angiography. *American Journal of Medicine* **68**, 197-205.
- Smith, C. G. & Jones, A. M. (2001). The relationship between critical velocity, maximal lactate steady-state velocity and lactate turnpoint velocity in runners. *European Journal of Applied Physiology* **85**, 19-26.
- Somfay, A., Porszasz, J., Lee, S. M., & Casaburi, R. (2002). Effect of hyperoxia on gas exchange and lactate kinetics following exercise onset in nonhypoxemic COPD patients. *Chest* **121**, 393-400.
- Spiro, S. G., Hahn, H. L., Edwards, R. H., & Pridc, N. B. (1975). An analysis of the physiological strain of submaximal exercise in patients with chronic obstructive bronchitis. *Thorax* **30**, 415-425.
- Spriet, L. L. & Heigenhauser, G. J. (2002). Regulation of pyruvate dehydrogenase (PDH) activity in human skeletal muscle during exercise. *Exercise and Sport Sciences Reviews* **30**, 91-95.
- Swanson, G. D. & Hughson, R. L. (1988). On the modeling and interpretation of oxygen uptake kinetics from ramp work rate tests. *Journal of Applied Physiology* **65**, 2453-2458.
- Timmons, J. A., Gustafsson, T., Sundberg, C. J., Jansson, E., & Greenhaff, P. L. (1998a). Muscle acetyl group availability is a major determinant of oxygen deficit in humans during submaximal exercise. *American Journal of Physiology* **274**, E377-E380.

- Timmons, J. A., Gustafsson, T., Sundberg, C. J., Jansson, E., Hultman, E., Kaijser, L., Chwalbinska-Moneta, J., Constantin-Tcodosiu, D., Macdonald, I. A., & Greenhaff, P. L. (1998b). Substrate availability limits human skeletal muscle oxidative ATP regeneration at the onset of ischemic exercise. *The Journal of Clinical Investigation* **101**, 79-85.
- Tordi, N., Perrey, S., Harvey, A., & Hughson, R. L. (2003). Oxygen uptake kinetics during two bouts of heavy cycling separated by fatiguing sprint exercise in humans. *Journal of Applied Physiology* **94**, 533-541.
- Tran, T. K., Sailasuta, N., Kreutzer, U., Hurd, R., Chung, Y., Molé, P., Kuno, S., & Jue, T. (1999). Comparative analysis of NMR and NIRS measurements of intracellular PO₂ in human skeletal muscle. *American Journal of Physiology* **276**, R1682-R1690.
- Trump, M. E., Heigenhauser, G. J., Putman, C. T., & Spriet, L. L. (1996). Importance of muscle phosphocreatine during intermittent maximal cycling. *J.Appl.Physiol* **80**, 1574-1580.
- Tschakovsky, M. E. & Hughson, R. L. (1999). Interaction of factors determining oxygen uptake at the onset of exercise. *Journal of Applied Physiology* **86**, 1101-1113.
- Van Beekvelt, M. C. P., Shoemaker, J. K., Tschakovsky, M. E., Hopman, M. T. E., & Hughson, R. L. (2001). Blood flow and muscle oxygen uptake at the onset and end of moderate and heavy dynamic forearm exercise. *American Journal of Physiology* **280**, R1741-R1747.
- Volianitis, S., Krstrup, P., Dawson, E., & Secher, N. H. (2003). Arm blood flow and oxygenation on the transition from arm to combined arm and leg exercise in humans. *Journal of Physiology* **547**, 641-648.
- Vollestad, N. K. & Blom, P. C. (1985). Effect of varying exercise intensity on glycogen depletion in human muscle fibres. *Acta Physiologica Scandinavica* **125**, 395-405.
- Vuorimaa, T., Vasankari, T., & Rusko, H. (2000). Comparison of physiological strain and muscular performance of athletes during two intermittent running exercises at the velocity associated with VO₂max. *International Journal of Sports Medicine* **21**, 96-101.
- Wagner, P. D. (2000). New ideas on limitations to VO₂max. *Exercise and Sport Sciences Reviews* **28**, 10-14.
- Ward, S. A. & Casaburi, R. (2001). 21st century perspective on chronic obstructive pulmonary disease. *Respiration* **68**, 557-561.

- Ward, S. A. & Whipp, B. J. (1989). Effects of peripheral and central chemoreflex activation on the isopnoeic rating of breathing in exercising humans. *Journal of Physiology* **411**, 27-43.
- Ward, S. A. & Whipp, B. J. (1992). Influence of body CO₂ stores on ventilatory-metabolic coupling during exercise. In *Control of Breathing and Its Modelling Perspective*, eds. Honda, Y., Miyamoto, Y., Konno, K., & Widdicombe, J. G., pp. 425-443. Plenum Press, New York.
- Ward, S. A. & Whipp, B. J. (1996). Coordination of circulation and respiration during exercise. In *Comprehensive Human Physiology, Vol.2*, eds. Greger, R. & Windhorst, U., pp. 2145-2173. Springer-Verlag, Berlin Heidelberg.
- Wasserman, K., Hansen, J. E., & Sue, D. Y. (1991). Facilitation of oxygen consumption by lactic acidosis during exercise. *News in Physiological Sciences* **6**, 29-34.
- Wasserman, K., Hansen, J. E., Sue, D. Y., Casaburi, R., & Whipp, B. J. (1999). *Principles of Exercise Testing and Interpretation*, Third ed. Lippincott Williams & Wilkins, Baltimore, USA.
- Wasserman, K., Stringer, W. W., & Casaburi, R. (1995). Is the slow component of exercise VO₂ a respiratory adaptation to anaerobiosis? *Advances in Experimental Medicine and Biology* **393**, 187-194.
- Wasserman, K., Van Kessel, A. L., & Burton, G. G. (1967). Interaction of physiological mechanisms during exercise. *Journal of Applied Physiology* **22**, 71-85.
- Wasserman, K., Whipp, B. J., Casaburi, R., & Beaver, W. L. (1977). Carbon dioxide flow and exercise hyperpnea. Cause and effect. *American Review of Respiratory Disease* **115**, 225-237.
- Wasserman, K., Whipp, B. J., & Castagna, J. (1974). Cardiodynamic hyperpnea: hyperpnea secondary to cardiac output increase. *Journal of Applied Physiology* **36**, 457-464.
- Wasserman, K., Whipp, B. J., Koysl, S. N., & Beaver, W. L. (1973). Anaerobic threshold and respiratory gas exchange during exercise. *Journal of Applied Physiology* **35**, 236-243.
- Weibel, E. R. (1984). *The Pathway For Oxygen: structure and function in the mammalian respiratory system* Harvard University Press, Cambridge, MA.

- Weiler-Ravell, D., Cooper, D. M., Whipp, B. J., & Wasserman, K. (1983). Control of breathing at the start of exercise as influenced by posture. *Journal of Applied Physiology* **55**, 1460-1466.
- Westerblad, H., Allen, D. G., & Lannergren, J. (2002). Muscle fatigue: lactic acid or inorganic phosphate the major cause? *News in Physiological Sciences* **17**, 17-21.
- Whipp, B. J. (1971). Rate constant for the kinetics of oxygen uptake during light exercise. *Journal of Applied Physiology* **30**, 261-263.
- Whipp, B. J. (1980). The control of exercise hyperpnea. In *The Regulation of Breathing*, ed. Hornbein, T., pp. 1069-1139. Dekker, New York.
- Whipp, B. J. (1987). Dynamics of pulmonary gas exchange. *Circulation* **76**, VI18-VI28.
- Whipp, B. J. (1994a). The bioenergetic and gas exchange basis of exercise testing. *Clinical Chest Medicine* **15**, 173-192.
- Whipp, B. J. (1994b). The slow component of O₂ uptake kinetics during heavy exercise. *Medicine and Science in Sports and Exercise* **26**, 1319-1326.
- Whipp, B. J., Davis, J. A., Torres, F., & Wasserman, K. (1981). A test to determine parameters of aerobic function during exercise. *Journal of Applied Physiology* **50**, 217-221.
- Whipp, B. J., Davis, J. A., & Wasserman, K. (1989). Ventilatory control of the 'isocapnic buffering' region in rapidly-incremental exercise. *Respiration Physiology* **76**, 357-367.
- Whipp, B. J., Jones, S. J., Elliott, P. M., Sharma, S., & McKenna, W. J. (2002a). Cardiopulmonary and Metabolic Responses to Exercise in Patients with Hypertrophic Cardiomyopathy. In *Cardiopulmonary Exercise Testing and Cardiovascular Health*, ed. Wasserman, K., pp. 151. Futura Publishing Company, Inc., Armonk, NY, USA.
- Whipp, B. J., Lamarra, N., & Ward, S. A. (1987). Required characteristics of pulmonary gas exchange dynamics for non-invasive determination of the anaerobic threshold. In *Concepts and Formulations in the Control of Breathing*, eds. Benchetrit, G., Baconnier, P., & Demongeot, J., pp. 185-200. Manchester University Press, Manchester.
- Whipp, B. J., Lamarra, N., & Ward, S. A. (1995). Obligatory anaerobiosis resulting from oxygen uptake-to-blood flow ratio dispersion in skeletal muscle: a model. *European Journal of Applied Physiology and Occupational Physiology* **71**, 147-152.

- Whipp, B. J. & Ozyener, F. (1998). The kinetics of exertional oxygen uptake: assumptions and inferences. *Medicina Dello Sport* **51**, 139-149.
- Whipp, B. J., Rossiter, H. B., & Ward, S. A. (2002b). Exertional oxygen uptake kinetics: a stamen of stamina? *Biochemical Society Transactions* **30**, 237-247.
- Whipp, B. J., Rossiter, H. B., Ward, S. A., Avery, D., Doyle, V. L., Howe, F. A., & Griffiths, J. R. (1999). Simultaneous determination of muscle ^{31}P and O_2 uptake kinetics during whole body NMR spectroscopy. *Journal of Applied Physiology* **86**, 742-747.
- Whipp, B. J. & Ward, S. A. (1982). Cardiopulmonary coupling during exercise. *Journal of Experimental Biology* **100**, 175-193.
- Whipp, B. J. & Ward, S. A. (1990). Physiological determinants of pulmonary gas exchange kinetics during exercise. *Medicine and Science in Sports and Exercise* **22**, 62-71.
- Whipp, B. J. & Ward, S. A. (1991). The coupling of ventilation to pulmonary gas exchange during exercise. In *Pulmonary Physiology and Pathophysiology of Exercise*, eds. Whipp, B. J. & Wasserman, K., pp. 271-307. Dekker, New York.
- Whipp, B. J. & Ward, S. A. (1992). Pulmonary gas exchange dynamics and the tolerance to muscular exercise: effects of fitness and training. *The Annals of Physiological Anthropology* **11**, 207-214.
- Whipp, B. J., Ward, S. A., Lamarra, N., Davis, J. A., & Wasserman, K. (1982). Parameters of ventilatory and gas exchange dynamics during exercise. *Journal of Applied Physiology* **52**, 1506-1513.
- Whipp, B. J., Ward, S. A., & Wasserman, K. (1986). Respiratory markers of the anaerobic threshold. *Advances in Cardiology* **35**, 47-64.
- Whipp, B. J. & Wasserman, K. (1972). Oxygen uptake kinetics for various intensities of constant-load work. *Journal of Applied Physiology* **33**, 351-356.
- Whipp, B. J. & Wasserman, K. (1986). Effect of anaerobiosis on the kinetics of O_2 uptake during exercise. *Federation Proceedings* **45**, 2942-2947.
- Williams, C. A., Carter, H., Jones, A. M., & Doust, J. H. (2001). Oxygen uptake kinetics during treadmill running in boys and men. *Journal of Applied Physiology* **90**, 1700-1706.

- Willis, W. T. & Jackman, M. R. (1994). Mitochondrial function during heavy exercise. *Medicine and Science in Sports and Exercise* **26**, 1347-1353.
- Wilson, D. F. (1994). Factors affecting the rate and energetics of mitochondrial oxidative phosphorylation. *Medicine and Science in Sports and Exercise* **26**, 37-43.
- Womack, C. J., Davis, S. E., Blumer, J. L., Barrett, E., Weltman, A. L., & Gaesser, G. A. (1995). Slow component of O₂ uptake during heavy exercise: adaptation to endurance training. *Journal of Applied Physiology* **79**, 838-845.
- Wyatt, J. S., Edwards, A. D., Azzopardi, D., & Reynolds, E. O. (1989). Magnetic resonance and near infrared spectroscopy for investigation of perinatal hypoxic-ischaemic brain injury. *Archives of Disease in Childhood* **64**, 953-963.
- Yoshida, T. & Whipp, B. J. (1994). Dynamic asymmetries of cardiac output transients in response to muscular exercise in man. *Journal of Physiology* **480**, 355-359.
- Zoladz, J., Duda, K., Majerczak, J., Emmerich, J., & Domanski, J. (1998a). Pre-exercise acidification induced by ingestion of NH₄Cl increases the magnitude of the slow component of VO₂ kinetics in humans. *Journal of Physiology and Pharmacology* **49**, 443-455.
- Zoladz, J. A., Duda, K., & Majerczak, J. (1998b). VO₂/power output relationship and the slow component of oxygen uptake kinetics during cycling at different pedaling rates: relationship to venous lactate accumulation and blood acid-base balance. *Physiological Research* **47**, 427-438.
- Zoladz, J. A., Duda, K., Majerczak, J., Domanski, J., & Emmerich, J. (1997). Metabolic alkalosis induced by pre-exercise ingestion of NaHCO₃ does not modulate the slow component of VO₂ kinetics in humans. *Journal of Physiology and Pharmacology* **48**, 211-223.

MEDICAL HISTORY

LABORATORY OF HUMAN PHYSIOLOGY

CENTRE FOR EXERCISE SCIENCE AND MEDICINE

(CONFIDENTIAL)

Please read.

It is important to take a record of your medical history. You may have, or may have once had a condition that would make this type of testing unsuitable for you. For this reason we ask you to be as truthful and detailed as possible. At no point will this information be made available to any one other than the principal investigators for this study. If you have any doubts or questions, please ask.

SUBJECT DETAILS:

NAME:

AGE:

D.O.B:

SEX (M/F):

GP NAME & ADDRESS:

SMOKING:

Never Smoked

Not for >6 months

Smoke <10 per day

Smoke >10 per day

ILLNESSES:

ALLERGIES:

HOSPITALISATIONS:

MUSCULO-SKELETAL DISORDER:

(Arthritis, Joint Pain, Fractures, Sports injury, Others)

CARDIOVASCULAR DISORDER: (Fever, Heart Murmurs, Chest Pain, Palpitations, High Blood Pressure, Others)

RESPIRATORY DISORDER: (Asthma, SOB, Cough, URTI, Others)

GASTROINTESTINAL DISORDER: (Jaundice, Bleeding, Others)

DIABETES:

CNS DISORDER: (Fits, Blackouts, Tremor, Paralysis, Epilepsy, Other)

PSYCHIATRIC TREATMENT:

FAMILY HISTORY: (Sudden death in a first degree relative under the age of 35 years)

ARE YOU CURRENTLY TAKING ANY MEDICATION? No / Yes*

(*Please specify) _____

ARE YOU CURRENTLY TAKING ANY SUBSTANCES TO HELP IMPROVE YOUR TRAINING OR CONTROL YOUR WEIGHT i.e. CREATINE, PROTEIN SUPPLEMENT? No / Yes*

(*Please specify) _____

ARE YOU CURRENTLY TAKING ANY OTHER SUPPLEMENTS i.e. FOOD SUPPLEMENTS, VITAMINS? No / Yes*

(*Please specify) _____

CAN YOU THINK OF ANY OTHER REASON WHY YOU SHOULD NOT TAKE PART IN ANY OF OUR TESTS?

SYMPTOMS:

Do you experience any of the following, particularly on exercise?

- Breathlessness
No / Yes
- Chest Pain
No / Yes
- Dizzy Fits/Fainting
No / Yes
- Palpitations
No / Yes

Please note that if you feel unwell on the day of the proposed test, or have been feeling poorly over the preceding day or two, please inform the investigators and DO NOT TAKE PART in the exercise test.

DECLARATION:

I have completed this questionnaire fully and truthfully. I have not kept any information from the investigators that may put myself at risk during high-intensity exercise, or affect the results that they obtain. I understand that I may withdraw from any one test or the study as a whole if I feel unwell, or feel uncomfortable with any part of the testing procedure.

(Signature).....

(Date)

PHYSICAL EXAM:

WEIGHT: _____

HEIGHT: _____

PULSE (Resting): _____

BP (Resting): _____

Screened by:

(Signature)

(Date)

Pre-test activity and diet questionnaire

LABORATORY OF HUMAN PHYSIOLOGY

CENTRE FOR EXERCISE SCIENCE AND MEDICINE

Name:

Experiment No.:

Date:

Have you trained, or undertaken any strenuous physical activity within the last 24 hours? If so please give details:

Could you please list your approximate food and drink intake, and eating times, within the last 24 hours, with special attention given to the last 4 hours:

Can you think of any factors which may affect your performance in today's exercise test?
E.g. Have you strained any muscles or do you have, or have you had recently, a cold?
Please give details:

Signed:

Date:

Checked:

Centre for Exercise Science and Medicine
Institute of Biomedical and Life Sciences
University of Glasgow

INFORMATION SHEET

TITLE OF INVESTIGATION: Physiological determinants of performance for intermittent dynamic exercise

You are invited to take part in a study involving exercise. We wish to describe how the body responds to exercise that lasts for a relatively long period (e.g. 30 minutes) with intermittent exercise (i.e. repeated short bursts of exercise that are interspersed with short recovery periods, lasting a similar period of time). Sports such as soccer and squash involve a lot of intermittent exercise, and we would like to improve our understanding of how the body adapts to this. We will therefore measure the responses of your breathing system, your heart and your muscles and also how you feel during these two kinds of exercise.

Testing will take place in the West Medical Building at Glasgow University. You are asked to take part in the following tests:

Progressive Exercise Test: We will ask you to perform a "progressive" test on an exercise cycle, in which we would like to exercise until you can no longer continue (typically because your legs will become tired). This test will take about 15-20 minutes. The results of this test will allow us to estimate the maximal rate at which your body can take in and consume oxygen (an important "marker" of performance). On a previous occasion, we would like you to attend for a short familiarisation trial. Also, you will have a short warm-up immediately before the test, and a warm-down immediately after the test.

Sustained Exercise Tests and Intermittent Exercise Tests: On separate days, we will ask you to complete two "sustained" (or constant-load) submaximal exercise tests, to provide us with "control" responses: one will be at a moderate effort and the other at a higher effort. Each test will last no longer than 30 minutes. On other days, you will be asked to complete a 30-minute period of "intermittent" exercise, in which each exercise period will last between 10 seconds and 6 minutes, and the intervening recovery periods will be of similar duration. This will allow us to compare the response to the intermittent exercise with those of the "control" tests. All tests will be preceded by a warm-up and followed by a warm-down.

Cardiovascular Measurements: We will monitor the rate at which your heart beats and its electrical activity, using mildly adhesive electrodes attached to the surface of your chest (electrocardiography).

Respired Air Measurements: We will monitor the air that you breathe in and out so that we can calculate the level at which you are breathing and the amount of oxygen that enters your lungs and, we assume, goes to your muscles. To do this, you will be required to breathe normally through a snorkel-type rubber mouthpiece to which is attached an integral monitor for sensing air flow, whilst wearing a nose clip (so that we can "capture" all the gas you breathe). A small fraction of the air will be sampled continuously by analysers for oxygen, carbon dioxide and nitrogen.

Perceptions of Breathlessness and Exertion: At intervals throughout the tests, we will ask you to assess how breathless you feel and also how tired your legs feel, using a standard rating scale (e.g. with a range of numbers with word anchors to help you characterise the intensity of the sensations).

Noninvasive Measurement of Oxygen Levels in Blood: The levels of oxygen in your blood will be measured non-invasively at one of your fingers or at an ear lobe (pulse oximetry), using a lightly-sprung "collar" that attaches to the measuring site. This involves a low intensity infra-red light (which is absorbed by haemoglobin - the oxygen-carrying pigment in your blood) being shone through the measuring site.

Noninvasive Measurement of Oxygen Levels in Muscle: The levels of oxygen in the blood vessels of a part of your thigh muscle (quadriceps femoris) will be measured non-invasively (near-infrared spectroscopy). This involves a low intensity infra-red light (which is absorbed by haemoglobin). This will involve attaching the light transmitter and receiver to the surface of your thigh muscle with mildly adhesive tape.

Measurement of Lactate in Capillary Blood: We will take capillary blood samples by pinprick sampling on a number of occasions during the tests so that we can measure the levels of a blood chemical called lactate, which is produced by exercising muscles when they start to fatigue.

Exercise has a negligible risk in healthy adults, although maximal exercise has a small risk of inducing myocardial ischaemia. The primary symptom of myocardial ischaemia is chest pain on exertion. If you experience any unusual chest sensations in your chest during the experiment, you should cease exercise immediately. Your heart rate will be examined via adhesive surface electrodes for the monitoring of the heart's electrical activity (the "electrocardiogram").

Before you become a subject, you will complete a medical questionnaire and undergo a short medical examination by a trained physician. People who have asthma, heart related and/or circulatory problems, hypertension or any other contraindicated condition will not be allowed to take part in the study. All information obtained from the preliminary medical questionnaire and from the study itself will be treated confidentially. It is our intention to publish the results of this study, but in a way that will not enable individuals or their performance to be identified.

You are free to leave the study at any time. The outcome of the study may not benefit you directly. Some parts of the study constitute a possible transient risk to your health. There is a small cardiac risk to your health. You may feel uncomfortable during certain stages of the tests. If you are worried about any unwanted side effects from any of the above procedures, you should contact:

Professor Susan A Ward
 Director
 Centre for Exercise Science and Medicine
 Institute of Biomedical and Life Sciences
 West Medical Building
 University of Glasgow
 Glasgow, G12 8QQ
 Phone: 0141 330 6287
 E-mail: S.A.Ward@bio.gla.ac.uk

Consent Form

I,.....(PRINT)

of.....

give my consent to the research procedures which are outlined above, the aim, procedures and possible consequences of which have been outlined to me

by.....

Signature-----Date-----

**Centre for Exercise Science and Medicine
Institute of Biomedical and Life Sciences
University of Glasgow**

INFORMATION SHEET

TITLE OF INVESTIGATION: Effects of a priming bout of very heavy cycling on the intensity-dependent kinetics of pulmonary oxygen uptake during a subsequent bout of cycling in humans

We invite you to participate in an investigation which we believe to be of potential importance. In order to help you to understand what the investigation is about, we are providing you with the following information. Be sure you understand it before you formally agree to participate. Ask any questions you have about the information that follows. We will do our best to explain and to provide any further information you require. You have been selected as a possible participant in this investigation because you undertake regularly physical activity and are in good health.

The mechanisms that determine the rate of increase in uptake of oxygen by the body in response to exercise are poorly understood. Such information, however, is crucial if we are to improve exercise tolerance (i.e. the ability of individuals to perform exercise) in both health (e.g. elite athletes) and disease (e.g. patients with heart or lung disease). This study aims to examine the effects of a bout of heavy exercise on the body's ability to take in oxygen during a subsequent bout of exercise.

Testing will take place in the Laboratory of Human Physiology, Lab 245, West Medical Building at Glasgow University. You will be asked to visit the laboratory on up to fifteen occasions and to take part in the following tests:

Progressive Exercise Test: You will be asked to perform a maximal progressive exercise test on a stationary computer-controlled cycle. The test will last 15-25 minutes and will involve the work load of the cycling gradually increasing until you are unable to continue, either because of fatigue or breathlessness. This test enables us to noninvasively assess your level of fitness; indicated by the maximal rate at which your body can take in and consume oxygen (maximal oxygen uptake) and the work rate at which you start to produce lactic acid (the "lactate threshold"). There will be a period of warm-up immediately before all tests, and a recovery immediately after. On a previous occasion, we would like you to attend for a short familiarisation trial.

Constant Load Tests: You will be required to perform at least four short (5-15 minutes duration) maximal exercise tests on different days, during which the cycle load is rapidly increased and then kept constant until you can no longer continue. These tests allow us to estimate another important marker of performance, which is the highest work rate that you are able to sustain for any real length of time (the "critical power"). The remainder of the tests will be performed in a random order. You will be asked to perform several other similar constant load tests on different days that will last 15-30 minutes and will provide a comparison for the double constant-load tests mentioned below.

Double Constant Load Tests: On further separate days you will be asked to perform several double constant load tests. These will consist of similar constant load tests to before, with the addition of a heavy exercise bout performed immediately before the test with only a short time allowed for recovery from the initial bout. These tests should last no longer than about 40 minutes.

Throughout all of the tests the air that you breathe in and out will be monitored continuously so that we can establish the amount of oxygen being taken in and consumed by the body. This requires that you perform all of the tests while breathing through a snorkel-type rubber mouth-piece which is attached to an air-flow sensor and from which a small amount of air is sampled for analysis of oxygen, carbon dioxide and nitrogen content. To ensure that all of the gas is monitored you will be required to wear a nose clip during all tests.

The level of oxygenation of arterial blood will be monitored continuously and noninvasively from a finger by pulse oximetry. On a number of occasions capillary blood will be taken by pinprick sampling from the thumb, for analysis of a chemical called lactate which is produced by muscles when they are working very hard.

Exercise has a negligible risk in healthy adults, although maximal exercise has a small risk of inducing myocardial ischaemia. The primary symptom of myocardial ischaemia is chest pain on exertion. If you experience any unusual chest sensations in your chest during the experiment, you should cease exercise immediately. Your heart rate will be examined via adhesive surface electrodes for the monitoring of the heart's electrical activity (the "electrocardiogram").

Before you become a subject, you will complete a medical questionnaire and undergo a short medical examination by a trained physician. People who have asthma, heart related and/or circulatory problems, hypertension or any other contraindicated condition will not be allowed to take part in the study. All information obtained from the preliminary medical questionnaire and from the study itself will be treated confidentially. It is our intention to publish the results of this study, but in a way that will not enable individuals or their performance to be identified.

You are free to leave the study at any time. The outcome of the study may not benefit you directly. Some parts of the study constitute a possible transient risk to your health. There is a small cardiac risk to your health. You may feel uncomfortable during certain stages of the tests.

If you are worried about any unwanted side effects from any of the above procedures, you should contact:

Professor Susan A Ward
Director
Centre for Exercise Science and Medicine
Institute of Biomedical and Life Sciences
West Medical Building
University of Glasgow
Glasgow, G12 8QQ
Phone: 0141 330 6287
Fax: 0141 330 6345
E-mail: S.A.Ward@bio.gla.ac.uk

Consent form

I

Give my consent to the research procedures which are outlined above, the aim, procedures and possible consequences of which have been outlined to me.

Signature

Date

**Department of Respiratory Medicine
Glasgow Royal infirmary**

Patient Information

TITLE OF INVESTIGATION: Creatine supplementation in COPD

You suffer from chronic obstructive pulmonary disease (COPD), that is, you have problems with your breathing because of damage to your lungs. One of the effects of COPD is that it leads to weak muscles in your arms and legs. Because your arms and legs are weak, everything is more effort and you get more breathless. As well as your usual medications such as inhalers or nebulisers, your specialist has decided that your condition would improve by a special exercise course (called pulmonary rehabilitation). This is an eight-week programme of special exercises, which will help you be more active without feeling short of breath. These exercises strengthen the muscles in your arms and legs, so you can do more, and feel less breathless. Most people who complete the course of exercises feel generally better.

For many years, athletes have taken creatine to improve their performance in competition. Creatine occurs naturally in the body and is also made by the liver. It is present in the food we eat and is an important part of muscles. It is thought that taking extra creatine as a drink stops the muscles tiring so easily.

We think that taking creatine drinks could increase the benefits of our exercise course. To prove this, we need to carry out a study. This involves taking a group of people with COPD who are going to start our exercise course and giving half of them creatine drinks. The other half would take a sugary drink which would not have any effect (a placebo). Neither the doctor looking after you, nor you yourself, will know who is taking the sugary drink and who is taking the creatine drink.

At the beginning and end of the study all the patients will be asked questions and do some breathing tests to see how effective the treatment has been. This way we can find out if we can improve the treatment of patients with your lung condition.

During this study, you would carry on with all your other medications as before. You would take the supplements up to four times a day. Studies of creatine supplements have not shown any problems, they do not upset the stomach or cause any harm to the patients who take them. In fact you can buy creatine supplements in health food shops. If you decide that you do not want to continue in the study, you may stop your extra supplements and you will be looked after in the chest clinic as normal.

If you decide that you would rather not participate in the study, you can still take part in the exercise programme and be looked after in the chest clinic in the usual way.

Patient consent form: Creatine Supplementation in COPD.

I, (Name).....

of (Address)

.....

agree to take part in the Research Project described overleaf.

Dr has explained to me what I have to do, how it might affect me and the purpose of the Research Project.

Signed _____ Patient

Date ___ / ___ / ___

Signed _____ Witness

Date ___ / ___ / ___

Patient Characteristics

Patient	Age (years)	Height (cm)	Weight (kg)	$\dot{V}O_{2\text{ peak}}$ (ml.min ⁻¹)	$\dot{V}O_{2\text{ peak}}$ (ml.kg ⁻¹ .min ⁻¹)
1	55	1.66	55.3	863	15.6
2	65	1.60	48.5	502	10.4
3	73	1.65	66.4	967	14.6
4	69	1.61	104.4	1004	9.6
5	66	1.68	49.3	720	14.6
6	64	1.54	55.7	791	14.2
7	63	1.71	74.4	848	11.4
8	73	1.65	68.0	578	8.5
9	48	1.59	56.4	571	10.1
10	70	1.78	84.4		
11	55	1.70	75.6	528	7.0
12	70	1.55	56.0	722	12.9
13	64	1.69	82.5		
14	52	1.59	59.7	667	11.2
15	51	1.74	94.3	1431	15.2
16	69	1.54	47.6	672	14.1
17	55	1.70	75.6	770	10.2
18	66	1.75	82.2	1584	19.3
19	73	1.85	62.0	1304	21.0
20	61	1.63	71.3	1308	18.3
21	50	1.71	77.6	1289	16.6
22	55	1.70	64.4	871	13.5
Mean	62	1.67	68.7	900	13.4
± S.D.	7	0.04	4.8	255	3.7

Peak $\dot{V}O_2$ ($\dot{V}O_{2\text{ peak}}$) was determined from a symptom-limited ramp incremental test (see text for details). Missing values represent two patients for whom valid $\dot{V}O_{2\text{ peak}}$ values could not be estimated, due to technical problems with the metabolic cart.

Patient Pulmonary Function

Patient	FEV ₁ (l, BTPS)	FEV ₁ (%pred.)	FEV ₁ /FVC (%)	TLC (l, BTPS)	TLC (%pred.)	D _L CO (%pred.)	PIP (mmHg)	PEP (mmHg)
1	0.93	30	25	6.91	111	41	72	89
2	0.88	35	27	7.34	128	27	51	62
3	1.28	51	29	8.05	131	39	89	83
4	1.08	43	42	6.84	115	88	76	66
5	0.65	27	32	7.26	138	22	45	52
6	1.15	61	34	5.71	130	22	47	70
7	1.17	39	33	7.71	118		101	134
8	0.86	34	38	9.47	155	69	41	92
9	0.98	39	41	6.58	139	20	41	80
10	0.96	30	31	8.31	116	52	66	83
11	0.64	20	23	9.72	143	21	88	137
12	0.95	54	46	5.17	116	77	25	37
13	1.35	46	36	6.08	94	42	68	129
14	0.68	31	21	7.33	167	41	65	70
15	1.37	39	38	8.20	120	68	126	117
16	1.06	60	44	6.45	147	34	70	64
17	1.60	49	46	7.55	116	34	60	48
18	2.08	66	52	7.41	107	97	82	86
19	1.59	51	35	8.51	116	39	24	15
20	1.47	73	50	5.66	123		72	69
21	1.04	30	32	8.40	128		89	92
22	0.95	35	32	7.69	143	21	57	82
Mean	1.12	43	36	7.4	127	45	66	80
± S.D.	0.04	4	1.4	0.3	12	10	15	19

Pulmonary function indices (see text for details): forced expired volume in 1s (FEV₁); forced vital capacity (FVC); total lung capacity (TLC); carbon monoxide diffusion capacity (D_LCO); peak inspiratory and expiratory pressures (PIP and PEP respectively). Some values are presented as a percentage of predicted values (%pred. – see text for details).

Patient Oxygen Uptake Kinetics

Patient	Pre-rehabilitation			Post-rehabilitation		
	τ' (s)	τ_{20s} (s)	τ_{real} (s)	τ' (s)	τ_{20s} (s)	τ_{real} (s)
1	79.2	35.1	66.9	39.0	66.9	39.0
2	90.7	84.6	52.8	44.2	52.8	44.2
3	52.3	40.2	68.0	42.9	68.0	42.9
4	62.0	25.9	65.5	40.6	35.5	39.7
5			44.5	48.0	44.5	48.0
6	71.6	54.7			42.3	44.5
7	68.3	51.4	63.0	43.5	53.8	41.6
8	82.4	68.9	74.6	57.5	74.6	57.5
9	38.1	39.3	32.3	28.7	32.8	27.5
10	56.6	38.3	50.7	39.3	39.3	33.1
11						
12	66.0	64.8			52.4	56.5
13	63.6	43.0	43.2	39.1	43.2	39.1
14						
15						
16						
17						
18						
19	64.6	42.6	33.5	31.4	34.9	27.0
20	33.0	38.4	37.3	40.0	30.5	29.9
21			24.5	49.9	24.5	26.9
22			58.5	42.8	42.3	22.7
Mean	63.7	48.2	51.1	41.9	46.1	38.8
\pm S.D.	16.3	16.2	15.6	7.2	14.3	10.4

$\dot{V}O_2$ kinetics (τ estimate), modelled using three different strategies (τ' , τ_{20s} , and τ_{real} — see text for details). Missing values represent profiles where an acceptable fit of the data could not be attained due to “noise”, and so estimates of τ could not be obtained.

Patient exercise test indices

Patient	Pre-rehabilitation			Post-rehabilitation		
	$\dot{V}O_{2\text{ peak}}$ (ml.min ⁻¹)	WR _{peak} (W)	t _{lim} (s)	$\dot{V}O_{2\text{ peak}}$ (ml.min ⁻¹)	WR _{peak} (W)	t _{lim} (s)
1	863	55	106	937	70	1200
2	502	40		595	40	
3	967	90	200	1021	80	232
4	1004	45	293	946	55	478
5	720	45	91	680	40	135
6	791	60	159	858	60	158
7	848	45	423	1001	60	1200
8	578	35	224	532	30	204
9	571	40	238	778	55	775
10		40	154		60	1200
11	528	35	249	629	35	305
12		60			60	
13		60	242		65	1156
14	667	45		677	45	
15	1431	100		1260	110	
16	672	20		408	20	
17	770	45		847	55	
18	1584	120	260	1336	100	287
19	1304	120	253	1088	100	218
20	1308	70	208	1435	75	585
21	1289	100	267	1235	100	675
22	871	50	151	908	55	250
Mean	909	60	220	904	62	566
± S.D.	327	28	80	283	24	415

Performance indices for all patients obtained during either a symptom-limited rapidly incremental ramp test ($\dot{V}O_{2\text{ peak}}$ & WR_{peak}), or a constant work rate endurance test (t_{lim}). Peak oxygen uptake ($\dot{V}O_{2\text{ peak}}$) and peak work rate (WR_{peak}) were calculated as the mean during the last 30 s of the test and the highest work rate attained, respectively. The time until the limit of tolerance (t_{lim}) during the endurance test was calculated from the onset of that work rate. Missing values for $\dot{V}O_{2\text{ peak}}$ are due to technical problems with the metabolic cart, whereas missing values for t_{lim} represent patients who did not perform the constant work rate test. Note that only when values could be obtained at both pre and post-rehabilitation were values recorded.