



University
of Glasgow

McCulloch, Kirsty Mary (1996) *Vascular reactivity in pulmonary resistance arteries: influence of pulmonary hypertension and endothelin.*

PhD thesis

<http://theses.gla.ac.uk/4404/>

Copyright and moral rights for this thesis are retained by the author

A copy can be downloaded for personal non-commercial research or study, without prior permission or charge

This thesis cannot be reproduced or quoted extensively from without first obtaining permission in writing from the Author

The content must not be changed in any way or sold commercially in any format or medium without the formal permission of the Author

When referring to this work, full bibliographic details including the author, title, awarding institution and date of the thesis must be given

Vascular Reactivity in Pulmonary Resistance Arteries : Influence of
Pulmonary Hypertension and Endothelin.

by

Kirsty Mary McCulloch

A thesis submitted for the degree of
Doctor of Philosophy

University of Glasgow
Institute of Biomedical and Life Sciences

June 1996.

To my mother, father and sister.

Summary.

The normal adult pulmonary circulation comprises a low pressure, low-resistance circuit which is under the control of both active and passive factors (Fishman, 1985). In the disease pulmonary hypertension, the pulmonary circulation becomes a high-resistance circuit, as a result of structural and functional changes in the pulmonary vasculature. Endothelin-1 (ET-1), a potent endothelium-derived vasoconstrictor peptide has been implicated in the pathogenesis of both clinical and experimental pulmonary hypertension (Barnes, 1984).

The small pulmonary arteries are thought to be important determinants of pulmonary vascular resistance *in vivo*. Therefore, the main aim of my research was to investigate the vascular reactivity of pulmonary resistance arteries *in vitro*, and assess any functional changes which may occur as a result of pulmonary hypertension. Particular influence was given to investigation of the vascular effects ET-1 in pulmonary arteries, and characterisation of the ET receptors present in these vessels. To investigate changes in vascular reactivity in pulmonary hypertension, a chronic hypoxic rat model was utilised.

In control adult rats, ET-1 (non selective ET_A / ET_B receptor agonist) produced potent vasoconstrictor responses in both large extrapulmonary arteries (3-5 mm i.d.) and pulmonary resistance arteries (~150 μ m i.d.) whereas responses to SxS6c (selective ET_B agonist) were observed only in pulmonary resistance arteries. The selective ET_A receptor antagonist FR 139317 was more effective in attenuating ET-1 mediated vasoconstriction in larger calibre pulmonary arteries than in pulmonary resistance arteries. Therefore it was found that ET_A receptors predominate in large calibre extrapulmonary arteries, but pulmonary resistance arteries contain populations of both ET_A and ET_B receptors mediating vasoconstriction.

Young male rats exposed to 14-16 days chronic hypobaric (418 mmHg) hypoxia exhibited significantly increased pulmonary artery pressure, right ventricular hypertrophy and pulmonary vascular remodelling all of which are associated with the development of pulmonary hypertension. Responses to ET-1 were significantly augmented in chronic hypoxic rat pulmonary resistance arteries compared to age

matched controls, and this potentiation appeared to be mediated via activation of ET_A receptors.

Pulmonary resistance arteries from chronic hypoxic, but not control rats, exhibited endogenous inherent tone, which was counteracted by basal release of nitric oxide (NO). Evidence was displayed for augmented endothelium-dependent vasodilatation in chronic hypoxic pulmonary resistance arteries.

Using selective and non-selective ET receptor antagonists, evidence for the presence of a putative “inhibitory” ET_A-like receptor was found in control, but not hypoxic pulmonary resistance arteries. Responses to SxS6c and ET-3 (agonist at ET_B > ET_A receptor) were antagonised by the selective ET_B receptor antagonist BQ-788. A consistent finding was the need for combined blockade of both ET_A and ET_B receptor sites in order to antagonise ET-1-mediated vasoconstriction in both control and hypoxic preparations, indicating “cross-talk” between the receptor subtypes in these vessels.

Whenever possible, functional studies were conducted in human tissue in order to classify the ET receptor subtypes present in the normal human pulmonary arterial tree. ET-1 produced equipotent contractile responses in human large intrapulmonary (~5 mm i.d.) and pulmonary resistance arteries (~200 μm i.d.). Responses to ET-1 were attenuated by ET_A receptor antagonists in the large calibre vessels only. Potent vasoconstrictor responses to SxS6c and ET-3 were also observed in resistance arteries, of approximately 30 % of the maximum response achieved to ET-1 in these vessels. ET-3 mediated vasoconstriction was antagonised by blockade of the ET_B receptor subtype. These results show that ET-1 mediated vasoconstriction in the human pulmonary vasculature is mediated predominantly via ET_A receptors in large calibre intrapulmonary arteries, whereas pulmonary resistance arteries contain populations of both ET_A and ET_B receptors at an approximate ratio of 70 : 30, both of which mediate vasoconstriction.

The influence of vascular tone and NO on vasoconstrictor responses to 5-hydroxytryptamine (5-HT) were examined in bovine pulmonary resistance arteries. Preliminary studies were also conducted examining 5-HT in pulmonary resistance arteries from control and chronic hypoxic rats. Increasing vascular tone, or inhibition

of NO synthase, augmented responses to 5-HT and dramatically potentiated responses to sumatriptan (selective 5-HT_{1D} agonist) in bovine pulmonary resistance arteries. As inherent tone is increased in resistance arteries from hypoxic rats, the vascular effects of 5-HT and sumatriptan were studied in these vessels. Responses to 5-HT were significantly potentiated in hypoxic resistance arteries compared to controls. Contractile responses to sumatriptan were absent in both control and chronic hypoxic vessels, and significant responses could not be uncovered by NOS inhibition or raised vascular tone.

The levels of intracellular cyclic nucleotides are important regulators of pulmonary vascular tone. Preliminary studies were conducted to investigate the effect of hypoxic pulmonary hypertension on levels of the intracellular cyclic nucleotides ([cAMP]_i and [cGMP]_i) and total phosphodiesterase (PDE) activity in the pulmonary arterial tree. Total [cGMP]_i was significantly decreased in the larger calibre pulmonary arteries (> 0.5 mm i.d.) from hypoxic rats in comparison to control vessels, and these changes were associated with a corresponding increase in cGMP PDE activity. [cAMP]_i was decreased in hypoxic pulmonary artery branches and a corresponding increase in cAMP PDE activity was found in this vessel. The observed decreases in cyclic nucleotide concentrations may equate with increased vascular tone observed in pulmonary hypertension. No significant changes in cyclic nucleotide levels or PDE activity were observed in chronic hypoxic rat pulmonary resistance arteries.

List of Contents.

Page Number

Title Page	1
Abstract	3
List of Contents	6
List of Tables	11
List of Figures	13
Acknowledgements	17
Authors declaration & publications	18
List of abbreviations	20
<u>Chapter 1 - Introduction and Literature Review</u>	22
1. Introduction to research	23
1.1 The vascular endothelium	23
1.1.1 Background	23
1.1.2 Endothelium-derived relaxing factors	24
1.1.2.1 EDRF / nitric oxide	24
1.1.2.2 Other EDRF's	26
1.1.3 Endothelium-derived contracting factors	27
1.1.3.1 Candidates for EDCF's	27
1.2. Endothelin	27
1.2.1 Discovery	27
1.2.2 Protein structure of the endothelins	28
1.2.3 Endothelin gene expression	30
1.2.3.1 Tissue expression of endothelins	30
1.2.3.2 Regulation of endothelin gene expression	31
1.2.4 Biosynthesis of mature endothelins	33
1.2.4.1 Endothelin-converting enzyme (ECE)	34
1.2.4.2 ECE inhibitors	35
1.2.5 Endothelin receptor subtypes	36
1.2.5.1 Cloning of endothelin receptors	36
1.2.5.2 Endothelin A receptors	36
1.2.5.3 Endothelin B receptors	37
1.2.5.4 Endothelin C receptors	37
1.2.5.5 Tissue distribution of endothelin receptor subtypes	38
1.2.5.6 Regulation of endothelin receptor expression	39
1.2.6 Structure / activity relationship	39
1.2.7 Agonists and antagonists of endothelin receptor subtypes	40
1.2.7.1 Selective agonists for endothelin receptors	40
1.2.7.2 Peptide endothelin receptor antagonists	40
1.2.7.3 Non-peptide endothelin receptor antagonists	41

1.2.8	Intracellular mechanisms	45
1.2.8.1	Phospholipase C activation	45
1.2.8.2	Transmembrane influx of extracellular calcium	46
1.2.8.3	Activation of protein kinase C	47
1.2.8.4	Other intracellular pathways	48
1.2.9	Pharmacological actions of endothelin-1	48
1.2.10	Direct cardiovascular effects	48
1.2.10.1	Haemodynamic actions in intact animals	48
1.2.10.2	Cardiac actions	49
1.2.10.3	Vascular actions	49
1.2.10.4	Interaction with vascular endothelium	51
1.2.10.5	Growth / proliferative effects	51
1.2.11	Indirect cardiovascular actions	52
1.2.12	Evidence for receptor subdivisions	53
1.2.13	Possible physiological role for endothelin in the cardiovascular system	55
1.2.14	Clearance and metabolism of endothelin	56
1.2.15	Pathological role of endothelins	57
1.3.	The Pulmonary Circulation	59
1.3.1	Functions of the pulmonary circulation	59
1.3.2	Structure of pulmonary arterial circulation	59
1.3.3	Pulmonary pressures and vascular resistance	62
1.3.4	Regulation of low pulmonary vascular tone	62
1.3.4.1	Neural regulation	63
1.3.4.2	Humoral regulation	63
1.3.4.3	Endothelial regulation	64
1.3.4.5	Intracellular cyclic nucleotides	65
1.3.5	Respiratory gases	66
1.3.5.1	Hypoxic pulmonary vasoconstriction	66
1.3.5.2	Mechanism of hypoxic pulmonary vasoconstriction	67
1.3.6	Pulmonary hypertension	68
1.3.6.1	Pulmonary vascular remodelling	69
1.3.7	Animal models of pulmonary hypertension	70
1.3.7.1	Chronic hypoxic model	70
1.3.7.2	Other models	71
1.4	Endothelin in the pulmonary circulation	71
1.4.1.	Biosynthesis	72
1.4.2	Binding - pulmonary receptors	72
1.4.3	Pulmonary actions of endothelins	73
1.4.3.1	<i>In vivo</i> studies	73

1.4.3.2	<i>In vitro</i> studies	74
1.4.4	Mechanism of action	76
1.4.5	Physiological role for endothelin in pulmonary circulation	77
1.4.5.1	Endothelin in hypoxic pulmonary vasoconstriction	77
1.4.6	Endothelin in pulmonary hypertension	78
1.5	Reasons for studying pulmonary resistance arteries <i>in vitro</i>	78
1.6	Aims of Project	79
<u>Chapter 2 - Materials and Methods</u>		81
2.1	Techniques for studying isolated vessels	82
2.1.1	Organ bath set up for larger diameter pulmonary artery	82
2.1.2	Wire myography	82
2.1.2.1	Background	82
2.1.2.2	Description of myograph equipment	84
2.1.3	Dissection of pulmonary arteries	85
2.1.3.1	Rat pulmonary arteries	85
2.1.3.2	Bovine pulmonary resistance arteries	86
2.1.3.3	Human pulmonary arteries	87
2.1.4.1	Myograph mounting procedure	88
2.1.4.2	Normalisation	89
2.1.4.3	Choosing the correct pressure	90
2.1.5	Calibration of equipment	91
2.1.6	General procedure for myograph and organ bath experiments	91
2.1.7	Gas mixture	92
2.1.8	Note on endothelin	92
2.2	Animal models used in these studies	93
2.2.1	“In house” adult Wistar rat	93
2.2.2	Bovine	93
2.2.3	Human tissue	94
2.2.4	Hypoxic / hypobaric rat	94
2.2.4.1	Introduction to model	96
2.2.4.2	Chamber design and components	98
2.2.4.3	Maintenance of animals	100
2.2.5	Assessment of pulmonary hypertension	100
2.2.5.1	Using ventricular ratios	100
2.2.5.2	Histological methods	100
2.2.5.3	Direct <i>in vivo</i> measurement of pulmonary artery pressure	102
2.3	Biochemical Methods	103
2.3.1	Measurement of intracellular cyclic nucleotide concentrations	103
2.3.1.1	Introduction	103

2.3.1.2	Preparation of samples	103
2.3.1.3	Assay procedure	105
2.3.2	Measurement of phosphodiesterase activity	106
2.3.2.1	Preparation of samples	106
2.3.2.2	Assay procedure	106
2.3.3	Protein assay - Lowry method	107
2.4	Data analysis	108
2.4.1	Calculation of results	108
2.4.2	Measurement of agonist potency	108
2.4.3	Measurement of antagonist potency	108
2.4.4	Statistical analysis	110
2.5	Solutions	110
2.6	Drugs and chemical reagents	111
<u>Chapter 3 -</u>	<u>Endothelin Receptor Subtypes in Small and Large Pulmonary Arteries of the Rat.</u>	113
3.1	Introduction	114
3.2	Materials and Methods	115
3.3	Results	118
3.4	Discussion	127
<u>Chapter 4 -</u>	<u>Validation of Chronic Hypoxic Rat Model.</u>	132
4.1	Introduction	133
4.2	Materials and Methods	134
4.3	Results	137
4.4	Discussion	151
<u>Chapter 5 -</u>	<u>Responses to Endothelin in Pulmonary Resistance Arteries : Effect of Pulmonary Hypertension.</u>	157
5.1	Introduction	158
5.2	Materials and Methods	159
5.3	Results	161
5.4	Discussion	178
<u>Chapter 6 -</u>	<u>Endothelin Receptor Subtypes in Pulmonary Resistance Arteries : Effect of Pulmonary Hypertension</u>	187
6.1	Introduction	188
6.2	Materials and Methods	189

6.3	Results	191
6.4	Discussion	211
<u>Chapter 7 - Endothelin Receptor Subtypes in Human Pulmonary Arteries.</u>		220
7.1	Introduction	221
7.2	Materials and Methods	222
7.3	Results	224
7.4	Discussion	237
<u>Chapter 8 - Responses to 5-Hydroxytryptamine in Pulmonary Resistance Arteries. Role of Cyclic Nucleotides in Hypoxic Pulmonary Hypertension</u>		245
8.1	Introduction	246
8.2	Materials and Methods	247
8.3	Results	249
8.4	Discussion	260
Chapter 9 - General Discussion		268
Appendix 1		273
Bibliography		281

List of Tables.

<u>Table</u>	<u>Description</u>	<u>Page</u>
1.1	Characteristics of ET receptor agonists and antagonists used in these studies.	43
1.2	Diseases for which ET-1 may play a pathophysiological role.	57
2.1	Drugs and chemical reagents.	111
3.1	Summary of experimental procedures performed.	117
3.2	pEC ₅₀ values for peptides in rat pulmonary arteries.	120
3.3	Estimated pK _B values for FR 139317 in rat pulmonary arteries.	123
4.1	Internal diameter and pressures of vessels from chronic hypoxic rats.	143
4.2	Potency of agonists in chronic hypoxic rat pulmonary resistance arteries.	146
4.3	Body weights, ventricular weights and ventricular ratios for control rats.	148
4.4	Body weights, ventricular weights and ventricular ratios for chronic hypoxic rats.	149
4.5	Body weights, ventricular weights and ventricular ratios in different chronic hypoxic rat groups.	150
5.1	Summary of experimental procedures performed.	160
5.2	Internal diameters and pressures of rat pulmonary resistance arteries.	161
5.3	pEC ₅₀ values for peptides in control and chronic hypoxic pulmonary resistance arteries.	164
5.4	pEC ₂₀ values for peptides in control and chronic hypoxic pulmonary resistance arteries.	165
5.5	Sensitivity to ACh in control and chronic hypoxic pulmonary resistance arteries.	172
6.1	Summary of experimental procedures performed.	190

6.2	Internal diameters and pressures of rat pulmonary resistance arteries.	192
6.3	Potency ET peptides in the presence and absence of selected antagonists : FR 139317, BMS 182874 and bosentan.	194
6.4	Potency of ET-1 in the presence and absence of selected antagonists : BQ-788 and BQ-788 + BMS 182874.	199
6.5	Potency of ET-1 in the presence and absence of SB 209670.	204
6.6	Potency of SxS6c and ET-3 in the presence and absence of selected antagonists : bosentan and BQ-788.	208
6.7	Estimated pK_B values for antagonists in control and chronic hypoxic rat pulmonary resistance arteries.	211
7.1	Summary of experimental procedures performed.	223
7.2	pEC_{50} values for ET-1 and ET-3 in human large calibre intrapulmonary arteries.	226
7.3	pEC_{50} values for ET-1 in the presence and absence of FR 139317 in human large calibre intrapulmonary arteries.	226
7.4	pEC_{50} values for peptides in human pulmonary resistance arteries in the presence and absence of antagonists : FR 139317, BMS 182874 and BQ-788.	233
7.5	Estimated pK_B values for antagonists in human pulmonary arteries.	233
8.1	pEC_{50} values for 5-HT and sumatriptan in bovine pulmonary resistance arteries : effect of tone and L-NAME.	254
8.2	Internal diameters and pressures of rat pulmonary resistance arteries.	254

List of Figures.

<u>Figure</u>	<u>Description</u>	<u>Page</u>
1.1	Major endothelium-derived relaxing factors : mechanism of release and action on vascular smooth muscle.	25
1.2	Structure of endothelins and sarafotoxin S6c.	29
1.3	Biosynthetic pathway for endothelin-1 production.	32
1.4	Structure of endothelin receptor antagonists used in this thesis.	44
1.5	Endothelin intracellular signalling pathways.	46
1.6	Structure of pulmonary arterial tree in normal and pulmonary hypertensive states.	61
2.1	Diagrammatic representation of organ bath experimental apparatus.	83
2.2	Schematic diagram of Mulvany / Halpern wire myograph.	84
2.3	Dissection procedure for rat pulmonary resistance arteries.	86
2.4	Mounting procedure for pulmonary resistance arteries.	88
2.5	Relationship between O ₂ concentration and atmospheric pressure.	96
2.6	Hypoxic / hypobaric chamber.	97
2.7	Location of the arterial preparations used in biochemical studies.	104
3.1	Responses to ET-1 and SxS6c in rat extrapulmonary arteries and pulmonary resistance arteries.	119
3.2	Effect of FR 139317 on responses to ET-1 in rat extrapulmonary arteries.	122
3.3	Effect of FR 139317 on responses to ET-1 in rat pulmonary resistance arteries.	124
3.4	Effect of L-NAME and FR 139317 on responses to SxS6c in rat pulmonary resistance arteries.	126
4.1	Measurement of pulmonary artery pressures in control and chronic hypoxic rats.	138

4.2	Structure of pulmonary arterioles from control and chronic hypoxic rat lungs.	140
4.3	Structure of pulmonary resistance arteries - light microscopy.	141
4.4	Structure of pulmonary resistance arteries - electron microscopy.	142
4.5	Responses to KCl in chronic hypoxic rat pulmonary resistance arteries.	145
4.6	Responses to ET-1 in chronic hypoxic rat pulmonary resistance arteries.	145
4.7	Responses to 5-HT in chronic hypoxic rat pulmonary resistance arteries.	147
4.8	Responses to ACh in 5-HT precontracted pulmonary resistance arteries from chronic hypoxic rat.	147
5.1	ET-1 and SxS6c-induced vasoconstriction in control rat pulmonary arteries : effect of resting tension.	163
5.2	ET-1 and SxS6c-induced vasoconstriction in chronic hypoxic rat pulmonary resistance arteries : effect of resting tension.	167
5.3	Maximum contraction to peptides in control and chronic hypoxic preparations : effect of resting tension.	168
5.4	Maximum contraction to NA and relaxation achieved to ACh in control and chronic hypoxic rat pulmonary resistance arteries : effect of resting tension.	170
5.5	Relaxation responses to ACh in control and chronic hypoxic rat pulmonary resistance arteries.	171
5.6	Effect of SNP and L-NAME on resting tone in control and chronic hypoxic pulmonary resistance arteries.	173
5.7	Responses to ET-1 and SxS6c in control vessels : effect of L-NAME.	175
5.8	Responses to ET-1 and SxS6c in chronic hypoxic vessels : effect of L-NAME.	170

5.9	Responses to SxS6c in pulmonary resistance arteries in the presence of raised vascular tone.	177
6.1	ET-1, ET-3 and SxS6c induced vasoconstriction in control rat pulmonary resistance arteries.	193
6.2	ET-1, ET-3 and SxS6c induced vasoconstriction in chronic hypoxic rat pulmonary resistance arteries.	195
6.3	Responses to ET-3 in control and chronic hypoxic rat pulmonary resistance arteries.	196
6.4	Effect of FR 139317 and BMS 182874 on responses to ET-1 in rat pulmonary resistance arteries.	198
6.5	Effect of bosentan on responses to ET-1 in rat pulmonary resistance arteries.	207
6.6	Effect of BQ-788, and a combination of BQ-788 and BMS 182874 on responses to ET-1 in rat pulmonary resistance arteries.	203
6.7	Effect of SB 209670 on responses to ET-1 in rat pulmonary resistance arteries.	205
6.8	Effect of bosentan on responses to SxS6c in rat pulmonary resistance arteries.	207
6.9	Effect of BQ-788 on responses to SxS6c in rat pulmonary resistance arteries.	209
6.10	Effect of BQ-788 on responses to ET-3 in rat pulmonary resistance arteries	210
7.1	Responses to ET-1 and ET-3 in human large calibre intrapulmonary arteries.	225
7.2	Effect of FR 139317 on responses to ET-1 in human large calibre intrapulmonary arteries.	228
7.3	Effect of BMS 182874 on responses to ET-1 in human large calibre intrapulmonary arteries.	229
7.4	Effect of bosentan on responses to ET-1 in human large calibre intrapulmonary arteries.	230

7.5	Responses to ET-1, ET-3 and SxS6c in human pulmonary resistance arteries.	232
7.6	Effect of FR 139317 on responses to ET-1 in human pulmonary resistance arteries.	234
7.7	Effect of BMS 182874 on responses to ET-1 in human pulmonary resistance arteries.	235
7.8	Effect of BQ-788 on responses to ET-3 in human pulmonary resistance arteries.	236
8.1	Responses to 5-HT and sumatriptan in bovine pulmonary resistance arteries : effect of time.	251
8.2	Responses to 5-HT and sumatriptan in bovine pulmonary resistance arteries : effect of raised vascular tone.	252
8.3	Responses to 5-HT and sumatriptan in bovine pulmonary resistance arteries : effect of L-NAME.	253
8.4	Responses to 5-HT and sumatriptan in control and chronic hypoxic rat pulmonary resistance arteries.	256
8.5	Intracellular cyclic nucleotide levels in control and chronic hypoxic rat pulmonary arteries.	257
8.6	Total PDE activity in control and chronic hypoxic rat pulmonary resistance arteries.	259

Acknowledgements.

I am indebted to my supervisor Dr. M MacLean for her friendship, advice and encouragement during my PhD. I would also like to thank the Division of Neuroscience and Biomedical Systems for allowing me to undertake this research project within their Department.

I wish also to thank Dr. A.G.B. Templeton, for her advice and encouragement with my research, for lending me a computer (on which to type this) and for basically just being a great friend.

A big thank you to all my work colleagues past and present for their support, friendly advice and most of all for providing a happy working environment (but not nearly enough gossip!).

Thanks to Dr. C. Wilson (Zeneka) and Dr. E.H. Ohlstein (SmithKline Beecham) for their kind donation of novel endothelin agonists and antagonists.

I would like to extend my gratitude to the Medical Research Council for supporting me financially.

Last but not least, I would like to thank my close friends and family for their unbounded love and support.

Declaration

This thesis is entirely my own composition and the experimental work detailed within was undertaken wholly by myself, with the exception of figures 4.3 and 4.4 which were produced in collaboration with Dr. I. Montgomery; and figures 8.5 and 8.6 which were produced in collaboration with Dr. G. Sweeney.

Signed

.....

Some of the results within this thesis have been published, details of which are given below.

Publications.

Full papers.

MACLEAN, M.R., McCULLOCH, K.M. & BAIRD, M. (1994). Endothelin ET_A- and ET_B- mediated vasoconstriction in rat pulmonary arteries and arterioles. *Journal of Cardiovascular Pharmacology*, **23**, 838-845.

MACLEAN, M.R., McCULLOCH, K.M. & BAIRD, M. (1995). Effects of pulmonary hypertension on vasoconstrictor responses to endothelin-1 and sarafotoxin S6c, and on inherent tone in rat pulmonary arteries. *Journal of Cardiovascular Pharmacology*, **26** (5), 882-830.

McCULLOCH, K.M. & MACLEAN, M.R. (1995). Evidence for endothelin_B receptor-mediated contraction of human and rat pulmonary resistance arteries and the effect of pulmonary hypertension in the rat. *Journal of Cardiovascular Pharmacology*, **26** (Suppl. 3); S169-S167.

Abstracts.

MACLEAN, M.R., McCULLOCH, K.M. & BAIRD, M. (1993). Endothelin vasoconstriction in rat extra-lobar pulmonary arteries is mainly ET_A-receptor mediated; in rat intra-lobar pulmonary resistance arteries it is mainly ET_B-receptor mediated. *British Journal of Pharmacology*. **111**, 227P.

McCULLOCH, K.M., TEMPLETON, A.G.B. & MACLEAN, M.R. (1994). Effect of nitric oxide synthase inhibition on contractile responses to sumatriptan in bovine pulmonary arterioles. *Thorax* **49** (No. 4) p426.

McCULLOCH, K.M., BAIRD, M. & MACLEAN, M.R. (1994). Heterogeneity and distribution of endothelin receptors involved in vasoconstrictor responses to endothelin-1 in human pulmonary arteries. *British Journal of Pharmacology*. **113**, 161P.

McCULLOCH, K.M., BAIRD, M. & MACLEAN, M.R. (1995). Endothelin-1-induced contraction in human pulmonary arteries : mediated by ETA-receptors in large arteries but non-ETA/non-ETB-receptors in resistance arteries. *Thorax*. **50** (4), 453P.

McCULLOCH, K.M., BAIRD, M. & MACLEAN, M.R. (1995). Endothelin receptors in rat pulmonary arteries and arterioles : effect of pulmonary hypertension. *Thorax*. **50** (4), 452P.

MACLEAN, M.R., BAIRD, M. & McCULLOCH, K.M. (1995). Responses to 5-HT and sumatriptan in control and pulmonary hypertensive rats. *Thorax*. **50** (4), 453P.

KARAMSETTY, V.S.N.M.R., WADSWORTH, R.M., KANE, K.A., MACLEAN, M.R. & McCULLOCH, K.M. (1995). Hypoxic constrictor response in intrapulmonary artery rings from chronic hypoxic rats. *Thorax*. **50** (4), 452P.

McCULLOCH, K.M., MACLEAN, M.R. (1995). Effects of bosentan and L-NAME on responses to sarafotoxin S6c in arterioles from control and pulmonary hypertensive rats. *American Journal of Respiratory and Critical Care Medicine*, **151** (4) A729.

McCULLOCH, K.M., BAIRD, M. & MACLEAN, M.R. (1995). Endothelium dependent relaxation, nitric oxide and vascular tone in control and chronic hypoxic rat pulmonary arteries. *British Journal of Pharmacology*. **116**, 190P.

MACLEAN MR, MCCULLOCH KM, TEMPLETON AGB, CLAYTON RA & MORECROFT I. Further evidence for 5HT1D-like receptors in human pulmonary arteries. *European Respiratory Journal*, **8**, suppl.19, 466s

SWEENEY G, MCCULLOCH KM, JOHNSON E, BAIRD M, MORECROFT I, DOCHERTY C, POOLEY, L & MACLEAN MR (1996). The role of cyclic nucleotides in pulmonary hypertension. *American Journal of Respiratory and Critical Care Medicine*, **153** (4), A189.

List of Abbreviations.

AA	arachidonic acid
ACE	angiotensin converting enzyme
ACh	acetylcholine
Ang II	angiotensin II
ANP	atrial natriuretic peptide
ATP	adenosine triphosphate
AVP	arginine vasopressin
BSA	bovine serum albumin
Ca ²⁺	calcium
cAMP	cyclic adenosine monophosphate
cGMP	cyclic guanosine monophosphate
cNOS	constitutive nitric oxide synthase
CO ₂	carbon dioxide
COLD	chronic obstructive lung disease
cpm	counts per minute
DAG	diacylglycerol
ECE	endothelin-converting enzyme
EDCF	endothelium-derived contracting factor
EDHF	endothelium-derived hyperpolarising factor
EDRF	endothelium-derived relaxing factor
ET-1, -2, -3	endothelin types 1, 2, 3
ET _A , -B, -C	endothelin receptors type A, B, C
HCl	hydrochloric acid
HPV	hypoxic pulmonary vasoconstriction
i.d.	internal diameter
i.p.	intra peritoneal
i.v.	intra venous
iNOS	inducible nitric oxide synthase
IP ₃	Inositol 1,4,5-triphosphate
kPa	kilopascals
mbar	milibar
min	minute
N ₂	nitrogen
NA	noradrenaline
NEP	neutral endopeptidase
NO	nitric oxide
NOS	nitric oxide synthase
O ₂	Oxygen

°C	degrees centigrade
PDE	phosphodiesterase
PG	prostaglandin
PGI ₂	prostacyclin
PIP ₂	phosphatidylinositol 4,5-bisphosphate
PKC	protein kinase C
PLC	phospholipase C
PO ₂	partial pressure of O ₂
preproET	preproendothelin
rpm	revolutions per minute
SEM	standard error of the mean
SNP	sodium nitroprusside
SxS6c	sarafotoxin S6c
TxA ₂	thromboxane A ₂
wt / vol.	weight per volume
[cAMP] _i	intracellular cAMP concentrations
[cGMP] _i	intracellular cGMP concentrations
~	approximately
%	percentage
5-HT	5-hydroxytryptamine

Amino acid one letter code

C - cysteine	I - isoleucine	Q - glycine	Y - tyrosine
D - aspartic acid	K - lysine	S - serine	
E - glutamine	L - leucine	T - threonine	
F - phenylalanine	M - methionine	V - valine	
H - histidine	N - asparagine	W - tryptophan	

Chapter 1

Introduction & Literature Review

Introduction and literature review.

1. Introduction to research.

Over the past 40 - 50 years the pulmonary circulation has been extensively studied, documenting its unique physiological properties and highlighting the complex regulatory control of the pulmonary vasculature. Morphological and functional investigations have indicated that the pulmonary circulation is more than a passive conduit for the flow of blood to and from the respiratory alveoli. In the last ten years the fundamental role of the vascular endothelium in the regulation of both systemic and pulmonary vascular tone has emerged, and is thought to be of considerable importance in both normal and disease states. The focus of my research centres upon the vascular reactivity of pulmonary resistance arteries, investigating in particular the role of the potent endothelium-derived peptide endothelin. The pulmonary circulation will be discussed in detail in section 1.3 of my introduction, but to begin with, I will review the major endothelium-derived vasoactive factors with particular detail to the physiology and pharmacology of endothelin.

1.1 The vascular endothelium.

1.1.1 Background

Historically the vascular endothelium was considered to be a simple cellular inner lining to blood vessels, providing a physical barrier and regulating vascular permeability. However, it is now known that endothelial cells regulate many functions including, vascular remodelling, haemostasis and inflammation via metabolism synthesis and release of a range of chemical mediators (Lüscher, *et al.*, 1989). The endothelium also regulates vascular tone in response to humoral and physical forces, via the synthesis and release of vasoactive compounds which both constrict and relax vascular smooth muscle.

1.1.2 Relaxing factors.

1.1.2.1 Endothelium-derived relaxing factor (EDRF) / Nitric oxide.

In 1980, Furchgott & Zawadzki reported that acetylcholine (ACh)-induced relaxations in rabbit isolated aortic strips were dependent upon an intact vascular endothelium. By showing that a donor artery with intact endothelium could relax an endothelium denuded preparation, Furchgott also showed that ACh released a soluble factor from the endothelium, which was termed endothelium-derived relaxing factor (EDRF). Many substances including bradykinin, substance P, serotonin, adenosine diphosphate, histamine and thrombin, were also shown to mediate vasodilatation via release of EDRF (Lüscher, 1989; Furchgott, 1990). Besides chemical activation, physical forces such as pulsatile flow and shear stress mediate EDRF production (Tsefamariam & Halpern, 1987; Tsefamariam & Cohen, 1988).

Similarities in the chemical actions of EDRF and the free radical gas nitric oxide (NO) were reported, and it is now generally accepted that the biological activity of EDRF is due to the release of NO or a related compound (Palmer, *et al.*, 1987; Ignarro, *et al.*, 1987). The amino acid L-arginine was shown to be the precursor for the synthesis of NO in endothelial cells, and a synthetic pathway incorporating an enzyme nitric oxide synthase (NOS) was proposed (Palmer *et al.*, 1988a,b, 1989). The proposed synthetic pathway for NO production in endothelial cells is shown in figure 1.1. NO is generated from the guanidino nitrogen of L-arginine in the presence of molecular oxygen to yield L-citrulline and NO.

At present two main NOS isoforms have been described. A constitutive enzyme (cNOS) which was first described in vascular endothelium and in neurones but has also been detected in other cell types (Palmer, *et al.*, 1989; Mayer, *et al.*, 1989). The second is an inducible form (iNOS) located primarily in macrophages and neutrophils (Marletta, *et al.*, 1988; Moncada, *et al.*, 1991). cNOS is strongly regulated by calcium / calmodulin, continually expressed, and once activated will produce picomolar amounts of NO until calcium levels decrease (Moncada, *et al.*, 1991). In contrast, iNOS is regulated at the level of transcription, requiring the actions of inducers such as cytokines or endotoxin for expression and is calcium independent (Moncada, *et al.*,

1991). After induction, iNOS remains active for 4 - 24 hours, yielding nanomolar concentrations of NO, 100 fold greater than those of cNOS. The synthesis of NO is stereo-specifically inhibited by various L-arginine analogues which act as competitive inhibitors of NOS, such as L-N^G-monomethyl-arginine (L-NMMA) (Palmer, *et al.*, 1988b), and L-N^G-arginine-methyl-ester (L-NAME) (Rees, *et al.*, 1990).

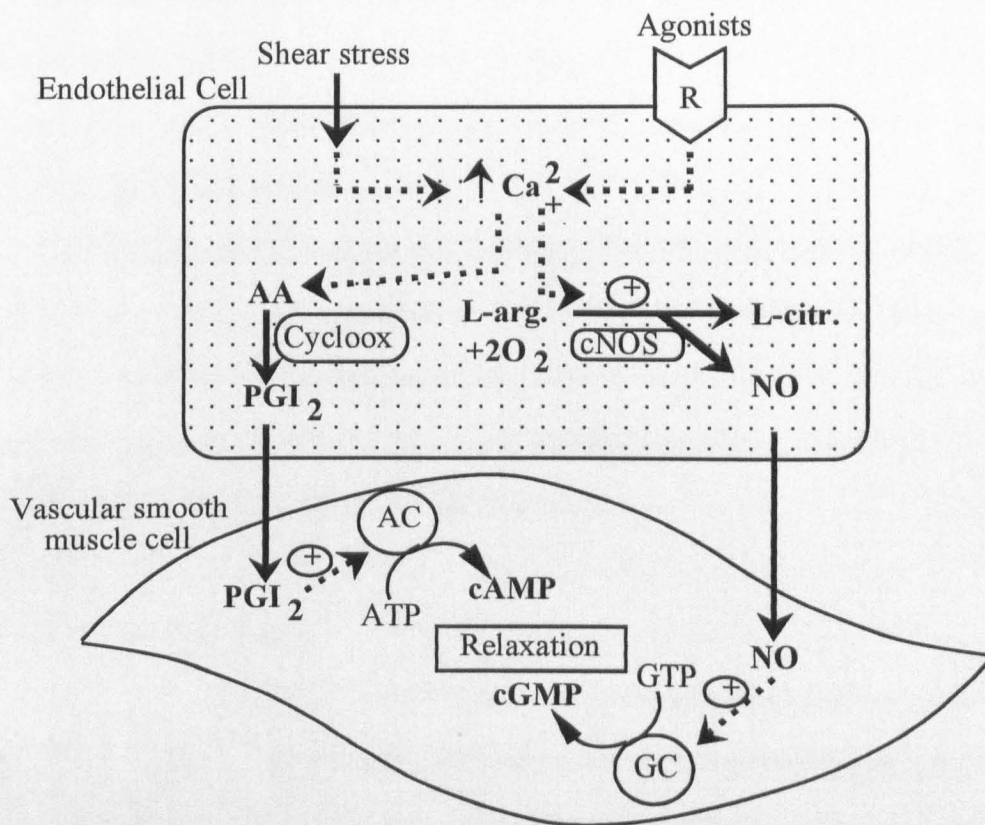

Figure 1.1.

Major endothelium-derived relaxing factors. Mechanism of release and action on vascular smooth muscle cells. For full explanation see text. Examples of agonists which stimulate synthesis and release of EDRF : acetylcholine, bradykinin, adenosine diphosphate, endothelin, histamine. AA = arachidonic acid; AC = adenylate cyclase; Ca²⁺ = calcium; cAMP = cyclic AMP; cGMP = cyclic GMP; cNOS = constitutive nitric oxide synthase; Cycloo = cyclooxygenase; GC = guanylate cyclase; GTP = guanosine triphosphate; L-arg = L-arginine; L-citr. = L-citrulline; NO = nitric oxide; PGI₂ = prostacyclin; R = receptor.

The biological action of EDRF / NO on vascular smooth muscle is to mediate vasodilatation. Upon release NO diffuses freely through the endothelial cell to the smooth muscle where it activates soluble guanylate cyclase, stimulating the production

of cyclic 3',5' guanosine monophosphate (cGMP) from guanosine-5'-triphosphate (Ignarro, *et al.* 1989). Activity of NO is short lived somewhere in the range of 3-30 seconds, and decomposes rapidly to form mixtures of nitrate and nitrite in oxygenated solutions (Tolins, *et al.*, 1991). The short half life of NO in plasma is reflective of the existence of several reactants in the plasma milieu that cause inactivation, including haemoglobin and superoxide anions (Moncada, *et al.*, 1991). In accordance with the interaction between NO and superoxide, Rubanyi & Vanhoutte (1986) showed that EDRF half life was prolonged in the presence of superoxide dismutase (SOD) a scavenger of superoxide anions.

In addition to the effects on vascular tone, NO has also been shown to inhibit vascular smooth muscle cell proliferation (Garg & Hassid, 1989), and inhibit platelet aggregation and adhesion (Radomski, *et al.*, 1987 a, b). The terms of EDRF and NO are often used in the same context, but it must also be remembered that endothelial cells synthesise and release other EDRF's distinct from NO.

1.1.2.2 Other relaxing factors

Arachidonic acid (AA) metabolites, the prostaglandins and leucotrienes are known to have vasoactive properties. The main prostaglandin synthesised and released from the endothelium is prostacyclin (PGI₂) which is synthesised via cyclooxygenase breakdown of AA (Moncada & Vane, 1979). PGI₂ relaxes bovine coronary arteries (Bunting, *et al.*, 1977), and accounts for at least part of the endothelium-dependent relaxation in some vascular preparations (Forstermann, *et al.*, 1986; Lamontagne, *et al.*, 1992). Like NO, PGI₂ is a vasodilator that also inhibits platelet aggregation, but through activation of adenylate cyclase rather than guanylate cyclase (Vegesna & Diamond, 1986; Côte, *et al.*, 1993). As the synthesis of both PGI₂ and NO are calcium dependent processes (see figure 1.1), many stimuli, such as shear stress cause the release of both factors (Busse, *et al.*, 1993).

Another proposed non-prostanoid EDRF that differs from NO is endothelium-derived hyperpolarising factor (EDHF) (Feletou & Vanhoutte, 1988). This substance, as yet not chemically identified, is thought to be released from endothelial cells by a

calcium-dependent process similar to that for NO and prostanoids (Chen, *et al.*, 1988; Chen & Suzuki, 1990). EDHF mediates vasodilatation by hyperpolarisation of vascular smooth muscle via stimulating K⁺ efflux through ATP-sensitive channels (Nakashima, *et al.*, 1993). The hyperpolarisation of the smooth muscle cell membrane likely inhibits calcium entry into the cell via voltage-dependent calcium channels and thereby causes relaxation (Taylor & Weston, 1988)

1.1.3 Endothelium-derived contracting factors (EDCF).

1.1.3.1 Candidates for EDCF's.

Katusic & Shepherd (1991) have described endothelium-dependent contractions mediated by the activation of AA metabolites via the cyclooxygenase pathway in arteries and veins. Thromboxane A₂ (TxA₂), and the primary prostaglandins PGD₂, PGE₂, PGF_{2 α} and PGI₂ may contribute to endothelium-dependent contraction in certain preparations (Miller & Vanhoutte, 1985). The endoperoxides (e.g. PGH₂) are good candidates for EDCF's as they act upon the same receptors as TxA₂, and because as precursors of all the prostanoids, they are necessarily made in the greatest abundance (Kato, *et al.*, 1990; Ito, *et al.*, 1991). Superoxide anions have also been suggested as EDCF's (Katusic & Vanhoutte, 1989), however this effect may be due to inhibition of the vasodilator effects of NO (Rengasamy & Johns, 1993; Gryglewski, *et al.*, 1986). Of all the endothelium-derived contracting factors, arguably the most important is the recently discovered vasoconstrictor peptide endothelin.

1.2 Endothelin.

1.2.1 Discovery.

In 1985, Hickey and colleagues demonstrated that the medium of cultured endothelial cells possessed potent vasoconstrictor properties. When applied to bovine isolated coronary arteries, the culture medium from endothelial cells triggered a slowly-developing well maintained contraction, which could not be contributed to any known vasoconstrictor agents. Subsequent studies by other groups confirmed this initial observation (Gillespie, *et al.*, 1986), and by 1988, this peptidergic constrictor factor had

been isolated, purified, sequenced, cloned, and termed endothelin (ET) (Yanagisawa, *et al.*, 1988). Following the initial identification of ET, it was soon reported that this peptide belonged to a family of structurally similar peptides. Low hybridisation stringency Southern blot analysis of human genomic DNA revealed the existence of three distinct genes which encode three distinct ET peptides termed endothelin-1 (ET-1), endothelin-2 (ET-2) and endothelin-3 (ET-3) (Inoue, *et al.*, 1989a,b).

1.2.2 Protein structure of the endothelins

The newly identified ET's showed no similarity to any known peptides of mammalian origin. However it was soon reported that ET's showed strong structural similarity to another family of peptides, the sarafotoxins, found in the venom of the Israeli burrowing asp *Atractaspis engaddensis* (Kloog & Sokolovsky, 1989). There are five members of the sarafotoxin family termed sarafotoxin S6a-e (SxS6a-e). The amino acid structural sequences of the ET's and one member of the sarafotoxin family SxS6c, are shown in figure 1.2. All family members comprise of 21 amino acid residues and show homology at ten positions, including all cysteine residues (positions 1, 3, 11, 15), as well as at positions 8 (aspartic acid), 10 (glutamine), 16 (histidine), 18 (aspartic acid), 20 (isoleucine) and 21 (tryptophan). All of the peptides possess two intrachain disulphide bridges linking Cys¹-Cys¹⁵ and Cys³-Cys¹¹. Human and porcine ET-1 possess identical sequences. Human ET-2 has two substitutions relative to the ET-1 sequence, and shows homology with a fourth peptide cloned from mouse intestine termed endothelin-β or vasoactive intestinal constrictor (V.I.C.) (Saida, *et al.*, 1989). Human ET-2 and mouse V.I.C. differ by one another by only one amino acid and it is suggested that V.I.C. is the murine equivalent of ET-2. ET-3 sequence is identical in both human and rat, and differ from ET-1 by six amino acids. The COOH-terminal hexapeptide is conserved in sequence throughout the ET family, is largely hydrophobic, and has been shown to have biological activity in its own right (Rovero, *et al.*, 1990).

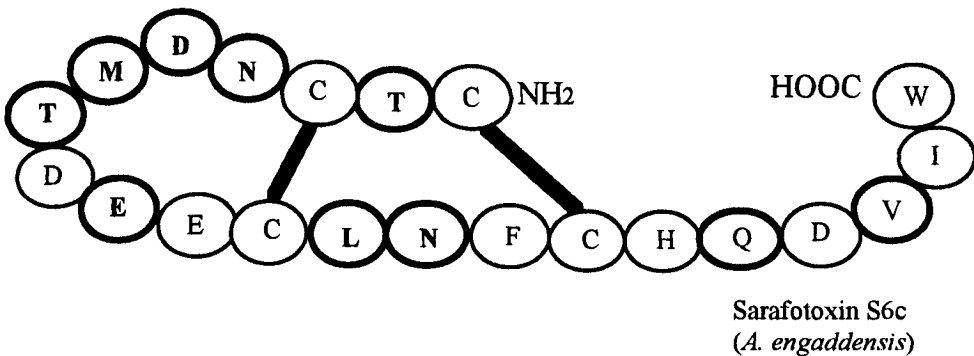
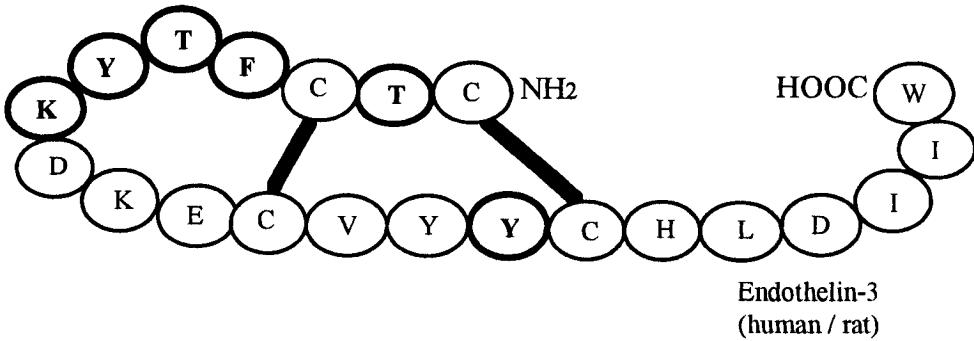
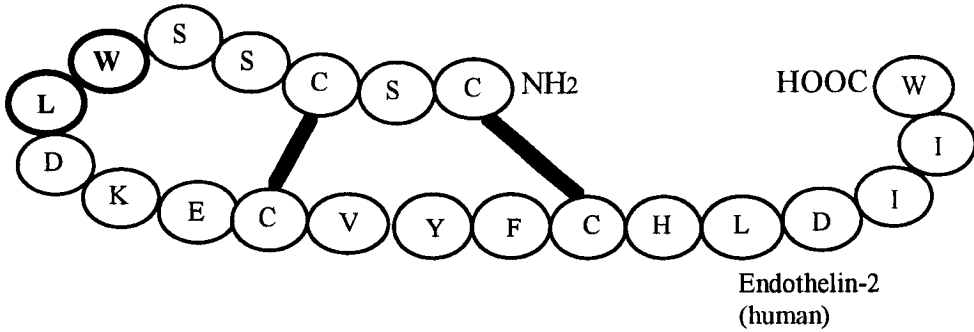
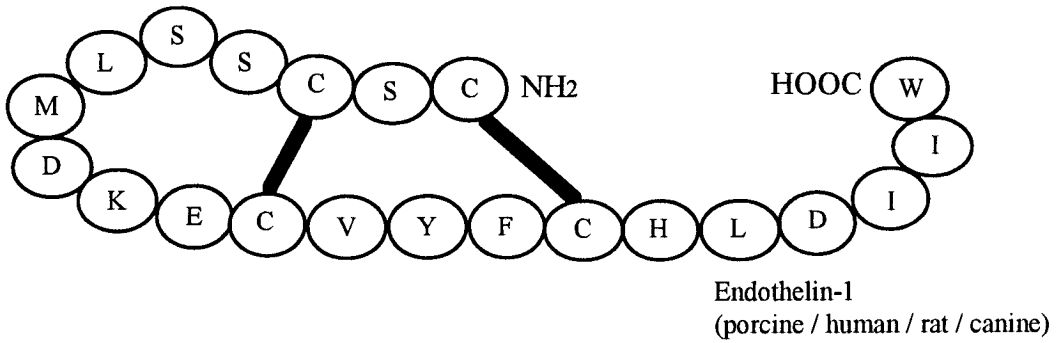

Figure 1.2

Amino acid structure (one letter code) of endothelin-1, 2 and 3 and the related peptide sarafotoxin S6c (SxS6c). Structural difference from ET-1 is indicated by a bold circle outlining amino acid. Bold black lines indicate disulphide bonds between Cys¹ - Cys¹⁵, and Cys³ - Cys¹¹.

ET's are thought to exist as compact structures in solution. Nuclear magnetic resonance imaging (NMR) of ET-1 suggested that a helix region dominates the central core between Lys⁹-Cys¹⁵, encompassing both disulphide bridges (Endo, *et al.*, 1989; Reily & Dunbar, 1991). The structure of the COOH-terminal peptide is less well defined, some models suggesting the tail folded back toward the central helix, whilst other models suggest that the COOH terminus was a flexible structure (Endo, *et al.*, 1989; Reily & Dunbar, 1991). The overall NMR determined structure of ET-3 appears to be similar to those of ET-1, as would be expected considering the degree of homology between peptides (Mills, *et al.*, 1992). Janes, *et al.*, (1994) described the crystal structure of ET-1 which differs significantly from the structures defined by NMR. The crystal structure was found to have an N-terminal extended β strand with a bulge between residues Ser⁵ and Met⁷, and a long irregular helix that extends from residues Lys⁹ to Trp²¹, in the COOH-terminus. Defining the structure of ET's may prove useful for the pharmacological design of selective receptor agonists and antagonists.

1.2.3 Endothelin gene expression

The three distinct human genes for ET-1, ET-2 and ET-3 have been mapped to chromosome 6, chromosome 1 and chromosome 20 respectively (Arinami, *et al.*, 1991; Bloch, *et al.*, 1989a,b). Each ET is a product of a separate gene that codes for a large preproendothelin (preproET) mRNA. The human ET-1 gene contains five exons, of which exon 2 encodes the complete sequence of mature ET-1 (Inoue, *et al.*, 1989a,b). A variety of growth factors and vascular proteins can modulate the transcription and / or translation of the ET-1 gene (see section 1.2.3.2 and figure 1.3).

1.2.3.1 Tissue expression of endothelins.

Although ET-1 was originally isolated from porcine endothelial cells, it is now known that the ET's are produced from a variety of tissue and cell types. The majority of studies have focused on ET-1 expression. ET-1 mRNA has been detected in endothelial cells from many different locations including aorta (Tokunaga, *et al.*, 1992),

umbilical vein (Inoue, *et al.*, 1989b) and brain microvessel (Yoshimoto, *et al.*, 1990). Vascular smooth muscle cells have also been shown to express ET-1 mRNA (Yanagisawa, *et al.*, 1988; Resink, *et al.*, 1990). Expression of ET-2 and ET-3 mRNA gene was not detected in either vascular endothelium or smooth muscle cells (Bloch, *et al.*, 1989a,b), and to date ET-1 is the only member of the ET family known to be produced from endothelial cells.

ET-1 is also expressed in many non vascular cell types, for example neurones (Giaid, *et al.*, 1989), epithelium (Baley, *et al.*, 1990) and bone marrow mast cells (Rubanyi & Polokoff, 1994). Expression of ET-2 mRNA is less widespread, but has been detected predominantly within the kidney and intestine, with smaller amounts produced in the myocardium, placenta, and uterus, although the exact cells of origin are not clear (Saida, *et al.*, 1989; Firth & Radcliffe, 1992). ET-3 has been detected in high concentrations in the porcine brain (Shinmi, *et al.*, 1989), and in a similar fashion to ET-1, ET-3 mRNA can be detected in numerous tissue and organ types including lung, heart, kidney, intestine and brain (Firth & Radcliffe, 1992).

1.2.3.2 Regulation of endothelin gene expression

The rate of release of ET-1 from cultured endothelial cells is linear suggesting constitutive release of the peptide *in vitro* (Hexum, *et al.*, 1990), however it has also been shown that several important stimuli enhance de novo synthesis of ET-1 and expression of the preproET-1 gene. Reports demonstrated that vasoactive compounds such as adrenaline, angiotensin II and bradykinin led to either increased expression of the preproET-1 gene or to ET-1 release (Yanagisawa, *et al.*, 1988; Dohi, *et al.*, 1992; Marsden, *et al.*, 1991). Treatment with growth factors and cytokines also increase ET-1 message within cultured endothelial cells (Yanagisawa, *et al.*, 1989; Emori, *et al.*, 1992; Marsden, *et al.*, 1991). Increased ET-1 mRNA expression was also stimulated by exposure to oxidised low density lipoprotein (Boulanger, *et al.*, 1992), or to hypoxia (Kourembanas, *et al.*, 1991). Reports have shown opposing effect of shear stress on ET-1 expression and release. Enhanced expression and production of ET-1 by cyclic stretch of endothelial cells has been reported (Sumpio. & Widmann, 1990; Yoshizumi,

Figure 1.3

Biosynthetic pathway for endothelin-1 production.

Regulation of endothelin-1 gene and proposed biosynthetic pathway for conversion of preproendothelin to endothelin. Examples of hormones and vascular factors modulate the synthesis of the preproendothelin-1 by the endothelin-1 gene through regulating the binding of transcription factors to specific elements on the endothelin-1 gene promoter. The mRNA is translated to a 203 amino acid preproendothelin protein, which is then converted to the 39 amino acid form (porcine) referred to as big endothelin-1 by dibasic endopeptidases and carboxypeptidase. Big endothelin-1 is then cleaved at the Trp⁷³ - Val⁷⁴ bond by specific endopeptidases referred to as endothelin-converting enzyme. The final product is the 21 amino acid peptide, endothelin-1, consisting of amino acids Cys⁵³ to Trp⁷³.

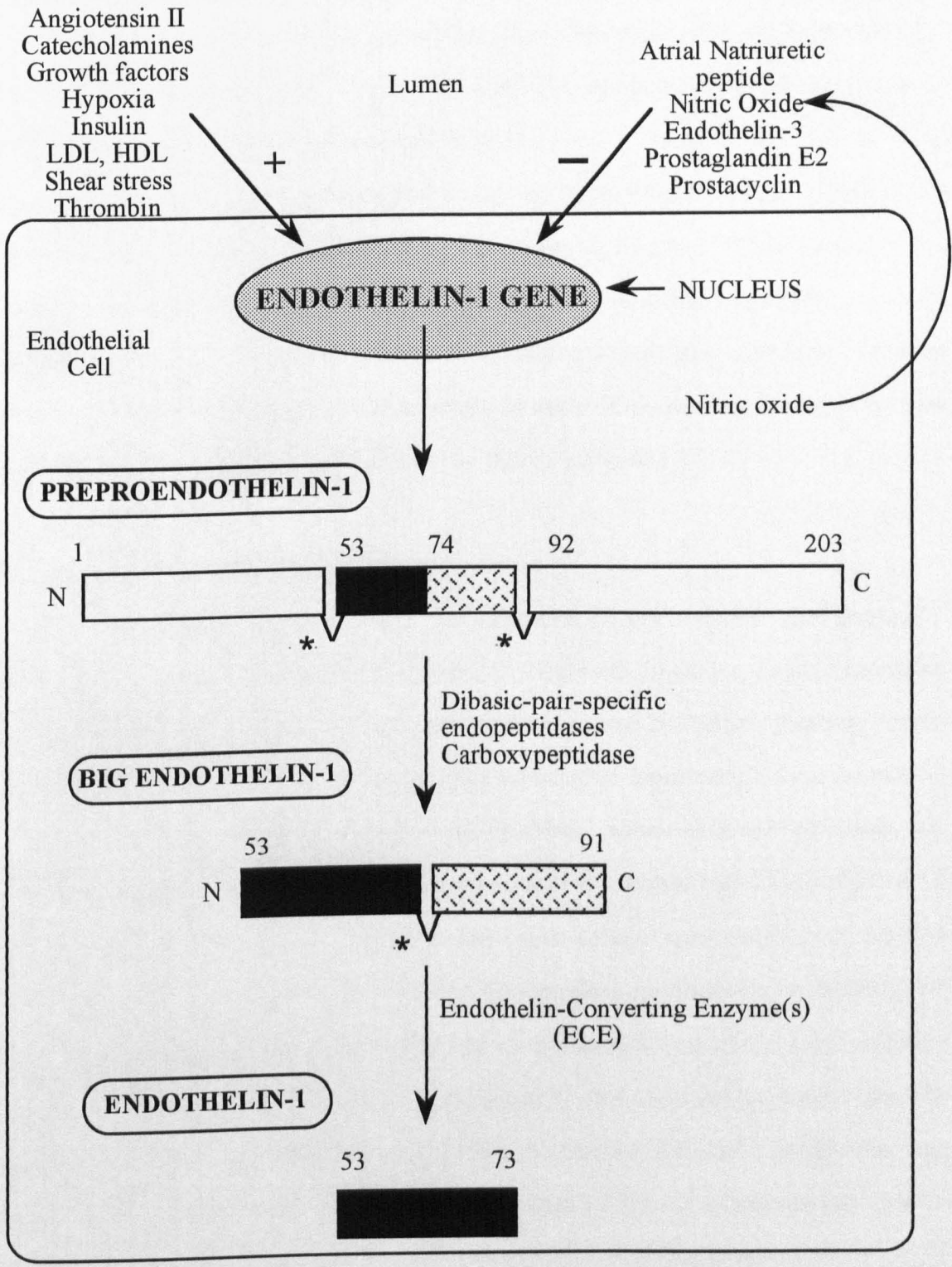

Figure 1.3

Biosynthetic pathway for endothelin-1 production.

et al., 1989), as has an opposing decrease in ET-1 mRNA levels with increasing shear stress (Sharefkin, *et al.*, 1991; Malek & Izumo, 1992). The contrasting results may be in part due to the origins of the endothelial cells used, or in the actual physiological levels of shear stress applied. Rapid release of ET-1 has been observed in response to increases in fluid flow rate (Milner, *et al.*, 1990).

Atrial natriuretic peptide (ANP) and NO have been shown to inhibit ET-1 synthesis and release (Hu, *et al.*, 1992; Boulanger & Lüscher, 1990). Many of the reported inducers of ET-1 production are known to promote intracellular calcium accumulation and / or protein kinase C activation which may act at the level of transcription and / or translation. A summary of some of the substances which regulate gene transcription and translation of ET-1 is shown in figure 1.3.

1.2.4 Biosynthesis of mature endothelins.

The gene sequences predict that all the ET's are derived from preproET precursors comprised of between 160 and 238 amino acid residues, depending on the isoform and the species. Figure 1.3 shows the proposed proteolytic pathway for the biosynthesis of mature ET-1. The large precursors (203 amino acids for preproET-1) are first subject to intermediate processing by dibasic amino acid endopeptidases, and carboxypeptidases to yield pro-ET's (more commonly termed big ET's) of 37 to 41 amino acid residues. Big ET's can be secreted from cells *in vitro* and *in vivo*, and big-ET-1 levels in the plasma of normal human subjects are approximately twice the levels of ET-1 (Sawamura, *et al.*, 1989). The reported plasma levels of ET-1 fall within a relatively wide range (0.1 - 20 pg / ml plasma) and vary substantially between publications (Rubanyi & Parker-Botelho, 1991; Rubanyi & Polokoff, 1994). The final stage of ET synthesis involves an unusual cleavage of big ET's between the Trp²¹ - Val²² (ET-1 and ET-2) and Trp²¹ - Ile²² (ET-3) bond, which is proposed to occur via specific endothelin-converting enzymes (ECE) (Yanagisawa, *et al.*, 1988; Inoue, *et al.*, 1989a). The presence of big ET-1, mature ET-1 and its carboxyl terminal fragment can be detected in the conditioned medium of cultured endothelial cells indicating that all of the biosynthetic stages can occur within the endothelial cells (Emori, *et al.*, 1989). The

vasoconstrictor actions of big ET-1 are over 100 fold less potent than mature ET-1 in the pig coronary artery (Kimura, *et al.*, 1989), therefore the biosynthetic step converting big ET-1 to mature ET-1 appears to be important for expression of full vasoconstrictor actions. In the anaesthetised rat intravenous administration of big ET-1 produced vasoconstrictor responses with 4 times less potency, or equal potency to ET-1 (Sawamura, *et al.*, 1989), but infusion of the neutral endopeptidase (NEP) inhibitor phosphoramidon greatly reduced the pressor effect of big ET-1 (Matsumura, *et al.*, 1990). This suggests a rapid and efficient conversion of exogenous big ET-1 to biologically active ET-1 *in vivo*. Once synthesised ET-1 is immediately secreted and appears not to be stored in intracellular secretory granules (Nakamura, *et al.*, 1990; Rubanyi & Parker Botelho, 1991), therefore active control of ET-1 release appears to depend upon de novo synthesis of the peptide.

1.2.4.1 Endothelin-converting enzymes (ECE).

Characterisation of ECE activity in cultured bovine carotid artery and porcine aortic endothelial cells revealed that the enzyme may be a membrane bound neutral metalloprotease, as production of ET-1, or conversion of big ET-1 to ET-1 by endothelial cells displayed a narrow pH optimum (at pH 7.1), and could be selectively inhibited by phosphoramidon but not by various inhibitors of aspartic, serine or cysteine proteases (Okada, *et al.*, 1990). Although there is good sequence homology between big ET-1 and big ET-3, this ECE described in bovine endothelial cells converted big ET-3 poorly, suggesting the existence of other types of enzymes converting the various isoforms of big ETs (Okada, *et al.*, 1990). Human whole blood has been shown not to be a major site of conversion of big ET-1 to ET-1 (Watanabe, *et al.*, 1991a). In addition the conversion of big ET-1 to ET-1 in isolated blood vessels has been shown to be dependent on the presence of an intact vascular endothelium (Fukuroda, *et al.*, 1990d). This evidence would suggest that conversion of big ET-1 to ET-1 *in vivo* occurs by an ECE present in the vascular endothelium.

Studies have reported cloning of an ECE activity from rat, bovine and human sources (Ikura, *et al.*, 1994; Schmidt, *et al.*, 1994; Shimada, *et al.*, 1994; Xu, *et al.*,

1994). The enzyme expressed in rat endothelial cells was also shown to be phosphoramidon sensitive, but thiorphan insensitive (Shimada, *et al* 1994). Advances in ECE research have shown the previous hypothesis of the existence of more than one ECE isoform to be correct. The first ECE isoform to be identified and cloned was termed ECE-1, which was described as a type II metalloprotease that processed endogenously produced big ET-1 intracellularly and exogenously supplied big ET-1 on the cell surface (Shimada, *et al.*, 1994; Xu, *et al.*, 1994). The second isoform, ECE-2, is structurally similar to ECE-1 but was found to have an unusually acidic pH 5.5 optimum, which may imply the enzyme acts intracellularly in acidified compartments and not on the cell surface (Emoto & Yanagisawa, 1995). ECE-1 was found to be abundantly expressed in endothelial cells *in vivo*, but could not be detected in neurones (Xu, *et al.*, 1994). In contrast to ECE-1, ECE-2 is strongly expressed in neuronal cells (Emoto & Yanagisawa, 1995). Both ECE-1 and ECE-2 isoforms are substrate selective preferentially cleaving big ET-1 over big ET-2 and ET-3, implying that there may be yet more ECE(s) that cleave big ET-2 and big ET-3 more efficiently. Two isoenzymes of ECE-1 have recently been described which are derived from the same gene (Shimada, *et al.*, 1995), and have subsequently been termed ECE-1a and ECE-1b. ECE-1a is expressed and localised in the vascular endothelial cells of all organs, whereas ECE-1b is present in human renal adenocarcinoma cells, human umbilical vein endothelial cells and bovine aortic endothelial cells (Battistini, *et al.*, 1995).

1.2.4.2 ECE inhibitors.

As previously mentioned, ECE's are sensitive to the actions of the NEP inhibitor phosphoramidon. However, phosphoramidon usefulness as a therapeutic agent targeting ET production are limited by its low inhibitory potency, selectivity and short duration of action. Some recently developed compounds which demonstrate ECE inhibitory effects include FR 901533 (Emoto & Yanagisawa, 1995), CGS 26303 and CGS 16393 (Trapani, *et al.*, 1995) and WS75624 A and B (Tsurumi, *et al.*, 1995). In addition some phosphoramidon analogues demonstrate increased potency for ECE,

whilst showing a corresponding decrease in potency against NEP 24.11 (Kukkola. *et al.*, 1995), and this may prove useful in the search for selective ECE inhibitors.

1.2.5 Endothelin receptor subtypes

1.2.5.1 Cloning of endothelin receptor subtypes.

Before the receptors for ET had been cloned, the existence of more than one receptor subtype had been inferred from the discovery of varying agonist potencies in different tissues of the C-terminal fragment of ET-1, [endothelin]₁₆₋₂₁ (Maggi, *et al.*, 1989). This hexapeptide produced contractions in the rat isolated aorta, but was inactive in the guinea-pig bronchus. Early experiments using ¹²⁵I-ET-1, -2 and -3 binding affinities, along with SDS-PAGE analysis of molecular mass, suggested two ET receptor subtypes were present in chick cardiac membranes and in rat lung membranes (Watanabe, *et al.*, 1989a; Masuda *et al.*, 1989). By the end of 1990, two groups simultaneously reported the isolation and cloning of two different ET receptors. One of the receptors was isolated from bovine lung cDNA library, and once expressed in *Xenopus* oocytes, showed extremely high selectivity of ET and SxS6 peptides (Arai, *et al.*, 1990). The second cloned receptor was identified in rat lung cDNA library, and showed equal affinity for ET-1, ET-2 and ET-3 (Sakurai, *et al.*, 1990). Both receptor subtypes have subsequently been identified from human rat and bovine cDNA (Hosoda, *et al.*, 1991; Sakurai, *et al.*, 1992). These two cloned receptors are homologous to other hepta-helical receptors of the rhodopsin superfamily, having seven hydrophobic regions predicted to form transmembrane helices, with an extracellular N terminus and a cytoplasmic C terminus. Each of these receptors is coupled to a G protein.

1.2.5.2 Endothelin A receptor. (ET_A).

The cloned receptor which showed selectivity for ET's in the following order, ET-1 = ET-2 > ET-3, was subsequently termed ET_A (Arai, *et al.*, 1990; Masaki, *et al.*, 1991). Strangely, it must be noted that cloned ET_A receptors show 1000 fold selectivity for ET-1 over ET-3, whereas radioligand and functional studies indicate ET_A receptors selectivity for ET-1 in the range of 10 to 100 fold. However, in many cases

this discrepancy may be due to the tissues concerned containing a mixture of receptor subtypes.

1.2.5.3 Endothelin B receptor. (ET_B)

The second cloned receptor which demonstrated equal affinities for the members of the ET family was termed ET_B (Sakurai, *et al.*, 1990; Masaki, *et al.*, 1991). As this receptor is non isopeptide selective it therefore demonstrates equal rank order of potency, i.e. ET-1 = ET-1 = ET-3. The ET_A and ET_B receptors have approximately 63 % homology in their amino acid sequence, and each type is highly conserved across mammalian species (85 to 90 %). Before the discovery of selective agonists and antagonists, the relative potency of the three ET peptides was used to classify the presence of ET_A or ET_B receptor subtypes. However, vascular endothelial cell function appears to be particularly sensitive to the action of ET-3, perhaps suggesting a further receptor subtype.

1.2.5.4 Endothelin C receptor (ET_C)

An ET receptor present on cultured bovine endothelial cells was shown to have functional selectivity for ET-3 over ET-1 (Emori, *et al.*, 1991). Similar observations were found by Warner *et al* (1992), in that endothelial cell release of NO was particularly sensitive to the actions of ET-3 over ET-1. cDNA for a receptor with relatively high affinity for ET-3 was reported in *Xenopus laevis* dermal melanophores, and had approximately 50 % amino acid homology with ET_A and ET_B receptor subtypes (Karne, *et al.*, 1993). A mammalian counterpart of this putative third ET receptor has yet to be cloned, and is therefore not accepted within IUPHAR regulations. If a third ET receptor was present in mammalian tissues, it would probably have a considerably different amino acid sequence from the ET_A and ET_B receptors, as southern blots of human genomic DNA have revealed only two signals corresponding to the ET_A and ET_B subtypes (Sakamoto, *et al.*, 1991).

1.2.5.5. Tissue distribution of endothelin receptor subtypes.

It is difficult to make strong conclusions on the differential distribution of ET receptors determined by northern blotting, as results vary markedly between publications, even for the same receptors and species (Miller, *et al.*, 1993). In general, ET_B receptors appear to be more widely distributed on many different tissue types, for example in the brain, liver, kidney and uterus (Sakurai, *et al.*, 1990; Miller, *et al.*, 1993; Simonsen, 1993). The mRNA for ET_A receptors appears to be strongly associated with vascular tissue, and is particularly expressed in the heart and lungs (Arai, *et al.*, 1990). In the brain ET_A receptors were found to be associated with blood vessels, and ET_B receptors with glial and epithelial cells, but few receptors if any were associated with neurones (Hori, *et al.*, 1992). In the kidney, there is a similar situation in that ET_A receptors are located on vascular smooth muscle, whereas ET_B receptors are located on vascular endothelium, vasa recta and the loop of Henlé (Simonsen, *et al.*, 1993).

Therefore with reference to the vasculature in general, the majority of evidence would indicate that ET_A receptors are located on the smooth muscle cells of many vessel types. Stimulation of vascular ET_A receptors mediates a slowly developing long-lasting contraction (Rubanyi & Parker-Botelho, 1991). ET_B receptors have been shown to be expressed in vascular endothelial cells, and analysis of rat ET_B receptor messenger RNA, showed strong signals in endothelial and epithelial cells but did not reveal any significant expression of ET_B receptors in vascular smooth muscle cells (Hori, *et al.*, 1992; Sakurai, *et al.*, 1990). However, ET_B receptor mRNA has been detected in vascular smooth muscle cells from human tissue samples including coronary, pulmonary and intermammary artery (Davenport, *et al.*, 1993; Winkles, *et al.*, 1993). When present on the vascular endothelium, activation of ET_B receptors is generally thought to mediate vasodilatation, whereas activation of ET_B receptors on smooth muscle cells mediates vasoconstriction (Rubanyi & Polokoff, 1994). Due to the opposing functional responses of endothelial and vascular ET_B receptors, they are often referred to as ET_{B1} (endothelial - vasodilatation) and ET_{B2} (vascular - contractile). For further discussion of ET effects in the vasculature see section 1.2.11.3.

1.2.5.6 Regulation of endothelin receptor expression.

The regulation of the production of ET-receptors often parallels that of ET's. Hypoxia and cyclosporine rapidly stimulate the production of ET-1 and ET_A receptors in endothelial cells and vascular smooth muscle cells respectively (Simonsen, *et al.*, 1993). Epidermal growth factor, basic fibroblast growth factor, cAMP, and estrogen up-regulate ET_A receptors in some tissues, and C-type natriuretic hormone, angiotensin II and basic fibroblast growth factor up regulate ET_B receptors. In contrast, ET's, platelet derived growth factor, angiotensin II and transforming growth factor- β downregulate ET_A receptors, whereas cAMP catecholamines and perhaps ET's downregulate ET_B receptors (Levin, *et al.*, 1995).

1.2.6 Structure / activity relationships.

Early studies indicated the importance of conserving free amino and carboxy terminals to retain the biological activity of ET-1 and related peptides (Nakajima, *et al.*, 1989a). The terminal Trp²¹ must be present and in the L-configuration for these peptides to exert biological actions (Kimura, *et al.*, 1988). Reduction of the disulphide bonds, or scrambling of the bonds results in peptides that are less active in promoting vasoconstriction via activation of ET_A receptors (Nakajima, *et al.*, 1989b). The amino and carboxy groups of Asp⁸ and Glu¹⁰, and the aromatic group of Phe¹⁴, contribute to the expression of ET-1 vasoconstrictor actions (Nakajima, *et al.*, 1989b).

The linear analogue [Ala^{1,3,11,15}]ET-1, in which both disulphide bridges are absent, has been shown to mediate depressor responses in anaesthetised rats (ET_B-mediated response) and lack sustained vasoconstrictor properties (ET_A-mediated response) (Douglas & Hiley, 1991; Bigaud & Pelton, 1992). Amino terminal truncated versions of linear ET-1 analogues also act as potent ET_B receptor agonists, and lack ET_A receptor activity (Rubanyi & Polokoff, 1994). In general it would appear that ET_A receptor activity requires the highly ordered ET helical core to be retained as well as the presence of the linear COOH-terminal domain. Activation of ET_B receptors appears to require only the COOH-terminal domain. Manipulation of these structure activity

relationships led to the discovery of the first selective ET-receptor agonists and antagonists, as described in the following section.

1.2.7. Agonists and antagonists at endothelin receptors

1.2.7.1. Selective agonists.

With the relative potencies of the three ET peptides at the ET_A and ET_B receptors, ET-3 is the only endogenous ET which could be considered a selective agonist, having preference for ET_B receptors. However, ET-3 can, in some preparations, have potency in the low nanomolar range at ET_A receptor sites, therefore it is important when using ET-3, to assess the ratio of potency to that of ET-1. The structurally similar sarafotoxin S6c (SxS6c) has become accepted as a selective ligand for ET_B receptors. Williams, *et al.*, (1991) demonstrated that SxS6c was at least 50,000 times less potent than ET-1 at inhibiting binding of ¹²⁵I ET-1 in rat aorta and atria, tissues rich in ET_A receptors. BQ-3020, is a potent agonist of ET_B receptors, with a selectivity ratio of 4700 for ET_B : ET_A (Saeki, *et al.*, 1991). Other compounds often used as selective ligand for ET_B receptors are [Ala^{1,3,11,15}]ET-1 (Hiley, *et al.*, 1990) and IRL 1620 (Takai, *et al.*, 1992). Since the discovery of ET-1 in 1988, the research into selective agonists and antagonists is yet to elude a selective agonist at the ET_A receptor site.

1.2.7.2 Peptide endothelin receptor antagonists.

The first ET receptor antagonists to be described were peptide or peptoid derivatives of the ET's or structurally related analogues.

Peptide ET_A receptor antagonists.

The cyclic pentapeptide, BQ-123 was shown to be highly selective for ET_A receptors in binding experiments, and also inhibited contractile responses to ET-1 in the pig coronary artery (Ihara, *et al.*, 1992). Following the development of BQ-123, a second peptide ET_A receptor antagonist, FR 139317, was described (Sogabe, *et al.*, 1993). This peptide antagonist showed approximately 90-fold selectivity for ET_A receptors with a pA₂ value of 7.2 against ET-1-induced contractions in rabbit aorta.

Other peptide antagonists which have been described as selective for ET_A receptors are BQ-610 (Verheyden, *et al.*, 1994), and PD 151,242 which has been introduced in its iodinated form as a selective radioligand for ET_A receptors. (Davenport, *et al.*, 1994). The peptide antagonist TAK-044 displays unusual properties in that it demonstrates high selectivity for ET_A receptors in binding experiments, but functionally it acts as a non selective ET_A / ET_B receptor antagonist (Ikeda, *et al.*, 1994; Kikuchi, *et al.*, 1994).

Peptide ET_B receptor antagonists.

A truncated sequence of ET-1, IRL 1038, was reported to be a selective ET_B receptor antagonist, although it was apparently less potent as a functional antagonist when compared with binding studies (Urade, *et al.*, 1992). Unfortunately, the affinity of the antagonist for ET_B receptors was reported to be highly variable between batches, and data obtained with this compound should be considered with caution (Urade, *et al.*, 1994). Other ET_B receptor antagonists described are BQ-788, and the less potent RES-701-1 (Ishikawa *et al.*, 1994; Morishita, *et al.*, 1994).

Non-selective peptide, endothelin receptor antagonists.

Very few non-selective peptide ET receptor antagonists have been described. Derivatives of the ET C-terminal hexapeptide have led to the production of PD 142,893 and PD 145,065 which functionally inhibit ET_A and ET_B mediated responses with pA₂ values in the range of 6.0 - 7.1 (Doherty, *et al.*, 1993).

1.2.7.3 Non-peptide antagonists.

In 1993 and 1994, the first non-peptide ET antagonists were described. These compounds would have possible therapeutic advantages over peptide antagonists as they would be orally active.

Non-peptide ET_A receptor antagonists.

BMS 182874 is a selective non-peptide antagonist at ET_A receptor sites, with a pA₂ value of 6.3 against ET-1 mediated contraction of the rabbit carotid artery (Stein, *et al.*, 1994). Recently described novel non-peptide ET_A receptor antagonists PD155,080,

PD155,719 and PD156,707, show varying degrees of selectivity and potency at the ET_A receptor site (Reynolds, *et al.*, 1995; Doherty, *et al.*, 1995)

Non-peptide ET_B receptor antagonists.

Non-peptide ET_B receptor antagonists have been slow to emerge, but recently such a compound Ro 468443 has been described, which displays approximately 2000 fold selectivity for the ET_B receptor (Clozel, *et al.*, 1995).

Non-selective non-peptide endothelin antagonists.

Other non-peptide ET antagonists show less selectivity between ET_A and ET_B receptor subtypes and are often classes as non-selective. The first orally active ET receptor antagonist to be described was Ro 46-2005 (Clozel, *et al.*, 1993), which was subsequently structurally optimised to produce bosentan (Ro 47-0203) a more potent mixed antagonist of ET_A and ET_B receptors (Clozel, *et al.*, 1994). Although bosentan acts upon both ET_A and ET_B receptor subtypes, it demonstrates approximately 20 fold selectivity for the ET_A receptor subtype. The most potent of the non-peptide ET antagonists to date is SB 209670, which antagonises ET-1 induced contractions of rat aorta (ET_A receptors) with a pA₂ value of 9.39, whereas in the rabbit pulmonary artery (ET_{B2} receptors) the pA₂ value was 6.7. Binding studies demonstrated less selectivity between the two receptor subtypes with K_i values of 0.2 nM (ET_A receptor) and 18 nM (ET_B receptor) indicating at least 90 fold selectivity for the ET_A receptor subtype (Ohlstein, *et al.*, 1994). More recently, additional non-peptide non-selective ET antagonists have been described including PD 160,672, PD 160,874, L749329, L751281 and SB 217242. (Doherty, *et al.*, 1995; Battistini, *et al.*, 1995; Barone, *et al.*, 1995).

A summary of the selectivity and potency of the ET agonists and antagonists used in my studies is shown in table 1.1 (see also experimental chapters). The structures of these peptide and non peptide antagonists are shown in figure 1.4.

Ligand	Peptide	Non-peptide	IC ₅₀		pA ₂		Reference
			ETA	ETB	ETA	ETB ₂	
ET-1	✓	✗	160 pM	110 pM	-	-	Saeki, <i>et al.</i> , 1991
SxS6c	✓	✗	4.5 μM	20 pM	-	-	Williams, <i>et al.</i> , 1991a
ET-3	✓	✗	4.5 nM	70 pM	-	-	Saeki, <i>et al.</i> 1991
FR 139317	✓	✗	0.53 nM	4.7 μM	7.2	n.t.	Sogabe, <i>et al.</i> , 1993
BMS 182874	✗	✓	150 nM	>200 μM	6.3	n.t.	Stein, <i>et al.</i> , 1994
BQ-788	✓	✗	1.3 μM	1.2 nM	n.t.	8.4	Ishikawa, <i>et al.</i> , 1994
Bosentan	✗	✓	4.7 nM*	95 nM*	7.3	5.9	Clozel, <i>et al.</i> , 1994
SB 209670	✗	✓	0.2 nM*	18 nM*	9.4	6.7	Ohlstein, <i>et al.</i> , 1994a

Table 1.1.

Potency of agonists and antagonists at ETA and ETB receptors. The above table gives information of compounds used in this thesis. *Ki values given as opposed to IC₅₀. n.t. = not tested. All pA₂ values are calculated against ET-1 mediated contraction with the exception of BQ-788 which is vs. BQ-3020.

Figure 1.4

Structure of selected endothelin antagonists used in this thesis. The full chemical names are given below. Further information on receptor selectivity can be found in table 1.1.

BQ-788

[N-*cis*-2,6- dimethylpiperidinocarbonyl - L- γ -methylleucyl-D-1-methocarbonyltryptophanyl-D-norleucine]. Peptide antagonist selective for ET_B receptor subtype.

FR 139317

((R)2-[(R)2-[(S)2-[[1-(hexahydro-1H-azepinyl)]carbonyl]amino-4-methylpentanoyl]amino-3-[3-(1-methyl-1H-indoyl)]propionyl]amino-3-(2-pyridyl)propionic acid. Peptide antagonist selective for the ET_A receptor subtype.

BMS 182874

5-(Dimethylamino)-N-(3,4-dimethyl-5-isoxazolyl)-1-naphthalenesulfonamide. Non-peptide antagonist selective for the ET_A receptor subtype.

Bosentan (Ro 47-0203)

4-tert-butyl-N-[6-(2-hydroxyl-ethoxy)-5-(2-methoxy-phenoxy)-2, 2'-bipyrimidin-4-yl]-benzene-sulfonamide. Non-peptide antagonist at both ET_A and ET_B receptor subtypes (shows slight selectivity for ET_A receptor subtype).

SB 209670

[(+)-(1S,2R,3S)-3-(2-carboxymethoxy-4-methoxyphenyl)1-(3,4-methylenedioxyphenyl)-5-(prop-1-yloxy)indane-2-carboxylic acid]. Non-peptide antagonist at both ET_A and ET_B receptor subtypes (shows slight selectivity for ET_A receptor subtype).

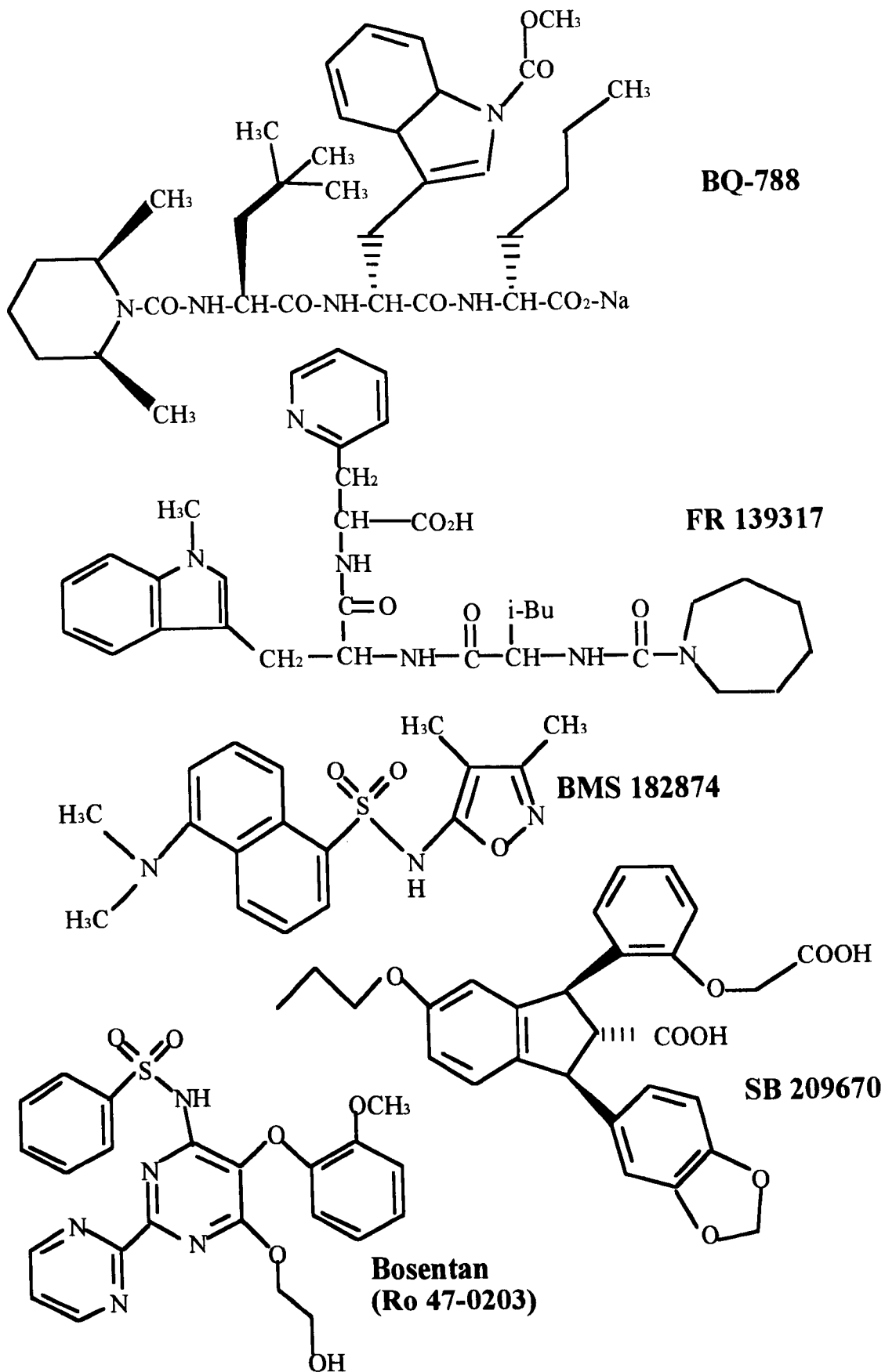

Figure 1.4

Structure of endothelin receptor antagonists used in this thesis.

1.2.8 Intracellular mechanisms.

As my interest in the biological actions of ET's centres on their pulmonary vascular effects, in this section I will introduce the main signal transduction pathways linked to ET receptor subtypes in vascular tissue. As the contractile effects of ET are most extensively studied, the signal transduction pathways stimulated by ET-1 activation of ET_A receptors are best understood. To generalise in most vascular preparations, ET-1 mediates increase in cytosolic Ca²⁺ concentration in two distinct phases; a transient initial phase, which is the result of Ca²⁺ mobilisation from intracellular stores, and a sustained phase which is dependent on extracellular Ca²⁺ (Rubanyi & Polokoff, 1994). ET-peptide interaction with ET-receptors is essentially irreversible (Marsault, *et al.*, 1991), which in part explains the well maintained vasoconstriction produced by ET-1 in vascular preparations.

1.2.8.1 Phospholipase C activation.

Overwhelming evidence suggests that the major signal transduction pathway mediating ET-1-induced contraction in the vasculature is by activation of phospholipase C (PLC), leading to and rapid formation of inositol 1,4,5-triphosphate (IP₃) and diacylglycerol (DAG) accumulation. This has been shown to occur both in isolated arterial preparations (Pang, *et al.*, 1989; Kasuya, *et al.*, 1989), and also in vascular smooth muscle cells in culture (Resink, *et al.*, 1988; Araki, *et al.*, 1989). Both ET_A and ET_B receptor subtypes have been described to be coupled to this pathway (Masaki, *et al.*, 1994). The intracellular cascade of events triggered by PLC activation by vascular ET receptors is shown in figure 1.5. ET's interaction with the membrane ET receptor activates PLC (via a G protein), which catalyses phosphatidylinositol 4,5-bisphosphate (PIP₂) breakdown. The products of this reaction are IP₃ and DAG, the former of which acts upon specific receptors to release intracellularly stored Ca²⁺. The increase in intracellular Ca²⁺ activates the enzyme myosin light-chain kinase, which leads to the phosphorylation of myosin light-chain protein triggering contractile events. The second product DAG, may in turn activate protein kinase C (PKC), see section 1.2.8.3. Activation of PLC leading to IP₃ accumulation is one mechanism linked to

ET-1 mediated contraction via intracellular Ca^{2+} stores and is probably responsible for the initial transient phase, however, ET-1 also stimulates increases in intracellular Ca^{2+} concentration by utilising extracellular calcium.

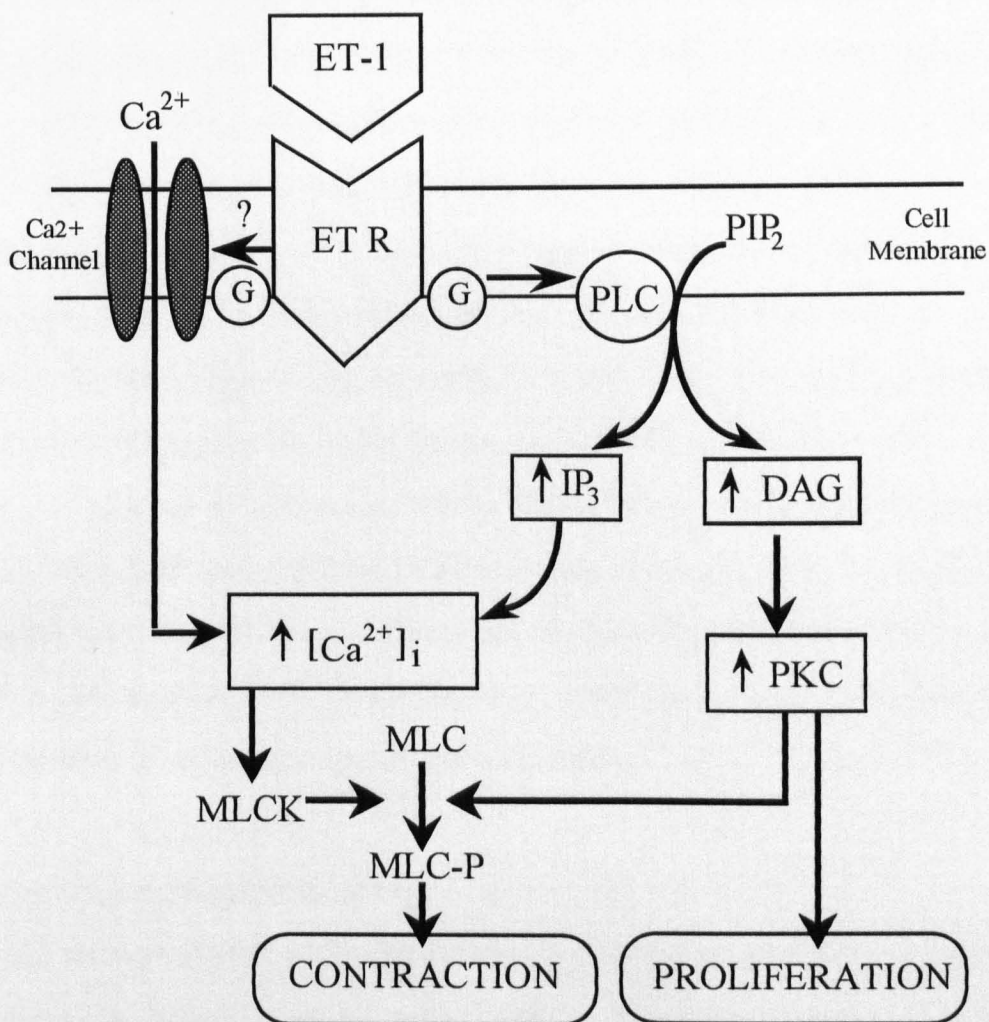

Figure 1.5.

ET-1 intracellular signalling pathways. Main intracellular signalling events due to activation of membrane ET_A and ET_B receptors. For full explanation see text. ET R = ET receptor; G = G protein; PLC = phospholipase C; PIP_2 = phosphatidylinositol bisphosphate; IP_3 = 1,4,5-inositol triphosphate; PKC = protein kinase C; MLC = myosin light-chain; MLC-P = phosphorylated myosin light-chain; MLCK = myosin light-chain kinase; ? = link between ET receptor and Ca^{2+} channel still uncertain.

1.2.8.2 Transmembrane influx of extracellular calcium.

A number of studies in different isolated tissue preparations have indicated that part of the ET-1 mediated contractile response is dependent on the presence of

extracellular Ca^{2+} . The initial study by Hickey, *et al* (1985) showed that the EDCF-induced contractile response from cultured endothelial cell medium could be attenuated by removal of extracellular calcium, or by addition of the L-type Ca^{2+} channel blocker verapamil. Similar inhibitory effects of L-type Ca^{2+} channel blockers on ET-1 mediated responses have been noted in a number of preparations including rat aorta (Sakata, *et al.*, 1989), rat mesenteric arteries (Godfraind, *et al.*, 1989) and pig coronary arteries (Egashira, *et al.*, 1990). However, in other preparations such as the rat pulmonary artery (Leach, *et al.*, 1990) and rabbit pulmonary vein (Steffan & Russell, 1990), L-type Ca^{2+} channel antagonists were not effective in attenuating ET-1 mediated responses. Evidence would suggest that ET-1 is not an endogenous ligand of L-type Ca^{2+} channels (Kasuya, *et al.*, 1989; Hirata, *et al.*, 1988) and therefore activation must be the consequence of indirect gating by ET-1. Therefore it would appear that activation of voltage operated (VOC) Ca^{2+} channels, either indirectly or via coupling to a G-protein may be partly responsible for the influx on extracellular Ca^{2+} due to ET-1 activation (Inoue, *et al.*, 1990; Takayasu, *et al.*, 1989) but the exact channels involved and mechanism of activation may vary between tissues.

1.2.8.3 Activation of protein kinase C.

As mentioned previously, the production of DAG via PLC activation, may in turn activate the enzyme protein kinase C (PKC). There is evidence to suggest that activation of PKC may play a role in ET-1-induced vascular contraction; for example in the rabbit pulmonary vein, the PKC inhibitor H-7 effectively blocked ET-1-induced contractions (Steffan & Russell, 1990). Contractile responses mediated by ET-1 are similar to the slowly developing and long-lasting contractile responses produced by phorbol esters (PKC activators). The irreversibility of ET-1-induced responses is due to a late intracellular signalling event for which PKC activation may be in part responsible (Marsault, *et al.*, 1991). PKC activation mediates the long term effects of ET-receptor activation, in that it stimulates DNA synthesis, gene transcription and mitogenesis (Simonsen, *et al.* 1993)

1.2.8.4 Other intracellular pathways.

ET-1 may activate phospholipase A₂ in certain tissues to mediate the release of PGI₂ and TxA₂ through metabolism of AA (Resink, *et al.*, 1989), and this may be one of the mechanisms by which ET's mediate vasodilatation. In cultured bovine endothelial cells, as well as being coupled to PLC, ET_B receptors may be negatively coupled to adenylate cyclase via an inhibitory G-protein (Eguchi, *et al.*, 1993). Activation of these receptors would result in intracellular cAMP levels decreasing, which in turn would result in a rise in intracellular free calcium, and perhaps stimulate NOS activity resulting in NO production. ET-1 has also been shown to activate the Na⁺-H⁺ antiporter leading to intracellular alkalisation in vascular smooth muscle cells (Koh, *et al.*, 1990).

1.2.9 Pharmacological actions of endothelins.

Many pharmacological and physiological studies have indicated that ET's have a diverse effects in various biological systems; including endocrine, reproductive, gastrointestinal and nervous systems (Rubanyi & Polokoff, 1994). In this section some of the main pharmacological effects of ET's in the cardiovascular system will be introduced. The pharmacological actions and potential physiological role of ET's in the pulmonary circulation will be discussed separately in section 1.4.

1.2.10 Direct cardiovascular effects.

1.2.10.1 Haemodynamic actions in intact animals.

Intravenous infusion of ET-1 into conscious, anaesthetised or pithed rats produces a biphasic response which comprises of an initial transient vasodilatation followed by a profound sustained increase in systemic blood pressure (Yanagisawa, *et al.*, 1988; Gardiner, *et al.* 1990; MacLean, *et al.*, 1989). The initial transient depressor response has since been demonstrated to be mediated via activation of ET_B receptors, due to the ability of ET_B receptor antagonists such as BQ-788 to abolish this response (Ishikawa, *et al.*, 1994), and the ability of ET-3 and SxS6c to mediate the depressor response (Gardiner, *et al.*, 1990; Clozel, *et al.*, 1992). The depressor action of ET's

may be due to the release of PGI₂ (Le Monnier de Gouville, *et al.*, 1989) and / or NO (Gardiner, *et al.*, 1990), although the exact mediator of this response may be species dependent. The sustained pressor response to ET-1 in the pithed rat was shown to be due to increased total peripheral resistance, with no change observed in heart rate or cardiac output (MacLean, *et al.*, 1989). Although it was initially thought that the pressor response to ET-1 in intact animals was solely due to activation of ET_A receptors (Ihara, *et al.*, 1992; Douglas, *et al.*, 1992), it is now known that vascular ET_B receptors also contribute to this response *in vivo* (Clozel, *et al.*, 1992). Additional evidence for vascular ET_B receptors will be discussed in section 1.2.11.3.

1.2.10.2. Cardiac actions.

High affinity ET-binding sites are present in cardiac tissue (Nayler, 1990). Cultured cardiac myocytes can also synthesis and release ET-1, therefore suggesting a regulatory role for ET's in the heart. In isolated perfused hearts and cardiac tissue, application of ET-1 induced positive inotropic effects (Rubanyi & Polokoff, 1994; Moravec, *et al.*, 1989) which is accompanied by prolongation of the cardiac action potential (Watanabe, *et al.*, 1989b). Both positive and negative chronotropic effects of ET-1 have been observed, which may be due to differences in experimental preparations and the site of ET-1 application (Rubanyi & Polokoff, 1994). One reason for such differences could be due to the potent coronary vasoconstrictor actions of ET's (Kurihara, *et al.*, 1989). Intracoronary arterial infusion of ET-1 could lead to significant myocardial ischemia, decreasing cardiac output and contractility, hence giving opposing results to those observed in isolated tissue preparations.

1.2.10.3. Vascular actions.

Since the first reports by Hickey, *et al.*, (1985) and Yanagisawa, *et al.*, (1988) demonstrating the potent vasoconstrictor actions of ET-1, numerous studies in a different types of isolated blood vessels have confirmed the initial observation that ET-1 produces slowly-developing well-maintained constrictor responses (Randall, 1991; Rubanyi & Parker-Botelho, 1991). In the majority of preparations, ET-1-mediated

vasoconstriction could be attributed to direct activation of vascular ET_A receptors, indicated by the relative potency of ET's and the ability of selective ET_A receptor antagonists to attenuate these responses (Masaki, *et al.*, 1991, 1994). However, it was observed that in some vascular preparations that ET-1-mediated vasoconstriction was partially or totally resistant to the actions of ET_A receptor antagonists, and therefore could not be entirely contributed to ET_A receptor activation. In the rabbit saphenous vein, the ET_B receptor agonist SxS6c produced contractile responses of equal potency to ET-1, and responses to ET-1 were resistant to the actions of BQ-123 (Moreland, *et al.*, 1992). Shortly after this a similar observation was demonstrated by Sumner, *et al.*, (1992) who demonstrated that vasoconstriction to ET-1 in the rabbit jugular vein was resistant to antagonism by BQ-123, and potent contractile responses were also observed to the ET_B agonist [Ala^{1,3,11,15}] ET-1 in this preparation. Many reports have since demonstrated functional populations of contractile ET_B receptors in isolated tissue preparations such as the porcine coronary artery (Harrison, *et al.*, 1992; Shetty, *et al.*, 1993) and canine coronary artery (Teerlink, *et al.*, 1994). There is also growing evidence for ET_B receptor mediated vasoconstriction in animals *in vivo* (Clozel, *et al.*, 1992; Bigaud & Pelton, 1992; McMurdo, *et al.*, 1993; Moreland, *et al.*, 1994). As well as its effects on larger arteries and veins, ET-1 is a potent vasoconstrictor of resistance arteries and the microcirculation (Rubanyi & Polokoff, 1994) which together are important determinants of peripheral vascular resistance. As well as exhibiting potent contractile responses in isolated vascular preparations, ET's can mediate vasodilatation through interaction with the vascular endothelium (see section 1.2.11.4).

Comparing responses in isolated blood vessel preparations is has been generally found that ET-1 is between 3- to 10- fold more potent in systemic venous preparations than in corresponding arterial preparations (Rubanyi & Polokoff, 1994). It has been postulated that the increased sensitivity in venous preparations may be due to activation of different receptor populations, as evidence for vascular ET_B receptors is most commonly detected in systemic venous preparations.

1.2.10.4 Interaction with vascular endothelium.

Although ET's are potent vasoconstrictors of vascular preparations, *in vivo* evidence showed that administration of ET's produced a transient depressor response. Warner *et al.*, (1989a,b) showed that ET-1 and ET-3 produced vasoconstrictor actions in isolated perfused vessels of the rat and rabbit, and that ET-1 was 10 fold more potent than ET-3 in mediating vasoconstriction. However when vascular tone was artificially raised in these preparations, equipotent vasodilatation to ET-1 and ET-3 was observed. Removal of the endothelium and administration of methylene blue inhibited this effect suggesting the involvement of endothelium-derived NO in this response. The relative potency of the ET's, and the ability of selective ET_B agonists and antagonists to mediate and inhibit these responses indicated that activation of endothelial ET_B receptors are responsible for ET-mediated vasodilatation (Douglas & Hiley, 1990; Takayanagi, *et al.*, 1991). NO release can also be demonstrated in cultured endothelial cells via activation of ET_B receptors (Hirata, *et al.*, 1993).

As has been observed with other factors which mediate endothelium-dependent vasodilatation (see section 1.2.2), ET's can also stimulate endothelial release of PGI₂ in some preparations. This has been demonstrated in isolated vascular preparations (Rakugi, *et al.*, 1989) and in intact animals (De Nucci, *et al.*, 1988; Filep, *et al.*, 1991). ET-1 and ET-3 have been shown to stimulate the release of PGI₂ from cultured endothelial cells (Emori, *et al.*, 1991).

1.2.10.5 Growth / proliferative effects.

As well as mediating changes in vascular tone, there is evidence to suggest that ET-1 may also regulate growth and proliferation of vascular cell types. ET-1 stimulates mitogenesis in Swiss 3T3 fibroblasts (Takuwa, *et al.*, 1989), stimulates vascular smooth muscle cell proliferation (Komuro, *et al.*, 1988) and increases mitotic activity in cultured aortic smooth muscle cells (Muldoon, *et al.*, 1989; Yu, *et al.*, 1991). The proliferative effects of ET's are variable between publications, and it is thought that ET's may be co-mitogenic with other growth factors and vasoactive compounds such as platelet derived growth factor (Nakaki, *et al.*, 1989; Weissberg, *et al.*, 1990).

Weissberg, *et al.*, (1990) demonstrated that ET-1 and ET-2 were equipotent in stimulating mitogenesis, whereas ET-3 displayed significantly less potency suggesting this action is mediated via ET_A receptors. ET's may also regulate endothelial cell growth, proliferation and migration (Vigne, *et al.*, 1990; Wren, *et al.*, 1993), and would appear to be mediated via ET_B receptor activation (Morbidelli, *et al.*, 1995).

1.2.11 Indirect cardiovascular actions.

Intracerebroventricular injection of ET-1 in rats evokes profound increase in arterial blood pressure and vasoconstriction, (Yamamoto, *et al.*, 1991; Rubanyi & Parker-Botelho, 1991). These vascular effects appeared to be mediated in part via increased plasma catecholamine levels. ET's may also regulate firing activity of mechanoreceptors in the circulation, both in the carotid sinus and aortic arch, and also those in the heart and lungs (Rubanyi & Parker-Botelho, 1991).

ET-1 is a potent vasoconstrictor of renal vasculature which result in marked decreases in renal blood flow (Hirata, *et al.*, 1989; Edwards, *et al.*, 1990). This results in decreased urine volume and decreased sodium excretion probably mediated through reduction in glomerular filtration rate.

As mentioned in section 1.2.3.2, ET-1 production can be regulated by many factors including vasoactive hormones. However, it is also now known that ET's interact with the endocrine system, causing inhibition and release of various hormones. ET's stimulate aldosterone biosynthesis and secretion both *in vivo* and *in vitro* (Miller, *et al.*, 1989). ET-1 also stimulates atrial natriuretic peptide (ANP) secretion (Hu, *et al.*, 1988), the physiological actions of which will oppose those of ET-1. The main effects of ANP are vasodilatation, and this hormone has been shown to inhibit ET-1 synthesis and secretion (see section 1.2.3.2). ET-1 also stimulates arginine vasopressin (AVP) release, elevates plasma renin concentration and increases angiotensin II (AII) levels (Rubanyi & Parker-Botelho 1991; Rubanyi & Polokoff 1994). Both AVP and AII stimulate ET-1 synthesis and release, and may act synergistically with ET-1 in increasing vascular tone.

1.2.11 Evidence for receptor subdivisions.

Before introducing the possible physiological role of ET's in the cardiovascular system, I will take this opportunity to review evidence for possible ET receptor subdivisions. As most of this evidence has arisen from functional studies it was of importance to first introduce the vascular actions of ET's before approaching this topic. Analysis of genetic material from mammalian species has resulted in the identification of only two signals corresponding to the ET_A and ET_B receptor subtypes, therefore this would suggest that analysis of the biological actions of ET's would be easily identified as either ET_A-mediated, ET_B-mediated or a combination of dual receptor activation. In many experimental conditions, this assumption is the case, however, some studies have suggested that possible ET_A and ET_B and non-ET_A / non-ET_B receptor subtypes may exist.

Possible ET_A receptor subtypes.

The involvement of ET_A receptors in ET-1 mediated responses is generally classified by the relative potencies of ET-1 over ET-3 and the inability of ET_B receptor agonists (such as BQ-3020 and SxS6c) to elicit equivalent responses. Use of the selective ET_A receptor antagonists BQ-123 and FR 139317 would also indicate the involvement of ET_A receptors. In some tissues where agonist potencies would suggest ET_A receptor populations, it was found that the ET_A receptor antagonists was more effective in shifting ET-3 mediated responses in comparison to ET-1 (Sumner, *et al.*, 1992; Salom, *et al.*, 1993). In the rabbit saphenous vein contractile responses are mediated via both ET_A and ET_B receptors, however, it was found that the ET_A receptor mediated response could be subdivided into a BQ-123 sensitive and BQ-123 resistant component (Sudjarwo, *et al.*, 1994; Nishiyama, *et al.*, 1995). Sudjarwo, and colleagues (1994) suggested that these "subtypes" of ET_A receptor could be classified as ET_{A1} (BQ-123 sensitive) and ET_{A2} (BQ-123 insensitive).

Possible ET_B receptor subtypes.

Although the ET_B receptors mediating vasodilatation and vasoconstriction appear functionally and anatomically distinct (being present on endothelium and smooth muscle cells respectively) it still remains uncertain whether these receptors are “true” structurally distinct subtypes. The ET_B receptor antagonists IRL1038 and RES 701-1, were thought to be selective for the ET_{B1} receptor mediating vasodilatation (Sudjarwo, *et al.*, 1993; Karaki, *et al.*, 1994) indicating that ET_{B1} and ET_{B2} receptors may be structurally dissimilar. However, as mentioned in section 1.2.7.2, questions have arisen over the suitability of IRL 1038 as a consistent ET_B receptor antagonist. RES 701-1 will also antagonise ET_{B2} mediated vasoconstriction in some vessel preparations, although greater concentrations of the antagonist were required to antagonise ET_{B2} mediated vasoconstriction in comparison to ET_{B1} mediated vasodilatation (Sudjarwo, *et al.*, 1994). The non selective ET receptor antagonist PD 142,893 may selectively inhibit ET_{B1} receptor mediated vasodilatation, whilst being ineffective in inhibiting ET_{B2} mediated contractile responses (Warner, *et al.*, 1993; Douglas, *et al.*, 1995). Radioligand binding studies in canine coronary artery membranes have indicated possible ET_B receptor subtypes, exhibiting either high or low affinity for both ET-1 and ET-3 (Teerlink, *et al.*, 1994), but although a functional correlate could be identified for the high affinity site, none could be found for the low affinity site.

Possible non ET_A / non ET_B receptors.

The apparent atypical ET receptor-mediated responses observed in some vascular preparations have been attributed either to novel subtypes of ET_A or ET_B receptors, or some authors have attributed these responses to the presence of non-ET_A / non-ET_B receptors. In the human saphenous vein contractile responses to ET-1 are resistant to the actions of the ET_A receptor antagonist BQ-123, whereas responses to SxS6b in this preparation are partially antagonised by BQ-123 (Bax, *et al.*, 1993). The authors therefore suggested that ET-1 was mediating its vasoconstrictor action via a non-ET_A / non-ET_B receptor. Similar non ET_A / non ET_B receptors have been reported

to exist in pig coronary artery (Harrison, *et al.*, 1992), rat vas deferens (Eglezos, *et al.*, 1993), human coronary artery (Godfraind, 1993) and human small omental veins (Riezebos, *et al.*, 1994). Douglas, *et al.*, (1995) have also suggested the presence of a ET_C-like receptor mediating vasoconstriction in the rabbit saphenous vein, which demonstrates selectivity for ET-3 over ET-1. If further distinct subtypes were to exist in mammalian tissues, they must be markedly different from the known ET_A / ET_B receptors, or so similar in structure that they may be mistaken for the known receptor subtypes. It could also be the case that multiple receptors may be derived from a single gene, and that differences in pharmacological responses are due to alternate splicing or post-translational modification. Although no strong conclusions concerning possible ET-receptor subtypes other than ET_A and ET_B can be made, what is apparent from all of these studies is that considerable heterogeneity in ET-receptor mediated responses occur in a number of tissue preparations.

1.2.13 Possible physiological role for endothelin in the cardiovascular system.

From the pharmacological evidence previously reviewed, a speculative role for ET's in cardiovascular homeostasis can be proposed. ET's may act in a paracrine or autocrine fashion to regulate basal vascular tone, having both direct effects on vascular smooth muscle cells and through indirect interaction with the vascular endothelium. It has been shown that inhibition of PGI₂ and NO production potentiates the vasoconstrictor actions of ET's *in vivo* and *in vitro* (De Nucci, *et al.*, 1988; Schini, *et al.*, 1991; Filep, *et al.*, 1993). In anaesthetised rats, infusion of the NOS inhibitor L-NAME resulted in increased mean arterial pressure which was significantly reduced by both the ET_A receptor antagonist BQ-123 and the mixed receptor antagonist bosentan (Richard, *et al.*, 1995). This evidence would support the hypothesis that under basal conditions, NO suppresses ET-induced vascular tone. A role for ET-1 in control of human vascular tone was described by Haynes & Webb (1994). In this study, infusion of BQ-123 into the brachial artery of normal subjects caused progressive vasodilatation and a 64% increase in blood flow after one hour, indicating the presence of endogenous ET-1-induced tone under normal physiological conditions. Experimental mice which

are deficient in ET-1 (partial knockout of ET-1 gene) were shown to have significantly elevated blood pressure in comparison to control animals implicating the importance of the depressor actions of ET's in the maintenance of vascular tone (Kurihara, *et al.*, 1994). ET's may also have an indirect effect on vascular tone through central and reflex effects, interaction with other vasoactive hormones and control of plasma volume through fluid balance. The importance of ET as a vascular growth factor in control situations is still unclear, but may be of more importance in vascular remodelling observed in some disease states.

1.2.14 Clearance and metabolism of endothelins.

Although ET's appear stable in blood and plasma *in vitro*, the half life of circulating ET's *in vivo* is relatively short-lived. In anaesthetised rats the half-life of ¹²⁵I-ET-1 in the plasma was only 40 seconds (Sirviö, *et al.*, 1990), with approximately 60 % of infused ET-1 or ET-3 being removed from the circulation within the first minute (Anggard, *et al.*, 1989). The importance of pulmonary clearance of circulating ET's was initially shown by De Nucci, *et al.*, (1988). In the aforementioned study the authors showed that greater than 50% of infused ET-1 was removed in the first passage through isolated perfused guinea-pig lung. In anaesthetised rats approximately 80 % of circulating ET-1 is removed by the lungs, with lesser amounts being removed by kidney, liver, heart and spleen (Sirviö, *et al.*, 1990; Fukuroda, *et al.*, 1994c). It has also been shown that infusion of the ET_B receptor antagonist BQ-788 significantly reduced (over 95%) the pulmonary clearance of ET-1 (Fukuroda, *et al.*, 1994c). The same effects were not observed with ET_A receptor antagonists showing the importance of ET_B receptors in clearance of circulating ET-1. Mature ET's may also be degraded by the actions of NEP, as infusion of the NEP inhibitor SQ-29,072 significantly increased plasma levels and urinary excretion of ET-1 in the anaesthetised rat (Abassi, *et al.*, 1992).

1.2.15 Pathological role of endothelins.

Ever since their discovery in the late 1980's, ET's (ET-1 in particular) have been implicated in many disease states. The involvement of ET-1 in pathology of certain diseases has centred on increased local or circulating levels of ET-1 and or changes in tissue responsiveness to the peptides in both human and animal models of disease. Table 1.2 illustrates some of the diseases for which a pathophysiological role for ET's has been postulated.

Cardiovascular diseases -

- | | |
|-----------------|--|
| (General) | - Hypertension |
| (Heart) | - Myocardial ischemia |
| | - Congestive heart failure |
| | - Coronary vasospasm |
| (Blood vessels) | - Vasospasm due to
subarachnoid haemorrhage |
| | - Stroke |
| | - Atherosclerosis |
| | - Raynaud's disease |

Lung diseases

- | | |
|------------|-----------------------------|
| (Vascular) | - Pulmonary hypertension |
| (Airway) | - Asthma |
| | - Parenchymal lung diseases |

Kidney diseases

- | | |
|--|------------------------------------|
| | - Postischemic acute renal failure |
| | - Chronic renal failure |

Gastrointestinal diseases

- | | |
|--|------------------------------|
| | - Gastric ulcer |
| | - Inflammatory bowel disease |
-

Table 1.2.

Diseases for which ET's may play a pathophysiological role. (For further examples see Rubanyi & Polokoff, 1994; Levin, 1995)

Cardiovascular diseases.

With its potent vasoconstrictor properties, ET-1 has been of particular interest in cardiovascular diseases where local vascular tone (vasospasm) and generalised vascular

tone (hypertension) are increased. Indeed elevated plasma ET-1 levels (above the range found in normal subjects) are found in patients with essential hypertension (Saito, *et al.*, 1990), cerebral vasospasm following subarachnoid haemorrhage (Rubanyi & Polokoff, 1994), coronary vasospasm (Matsuyama, *et al.*, 1991) and primary Raynaud's syndrome (Zamora, *et al.*, 1990). The role of ET-1 in pulmonary diseases (pulmonary hypertension) will be discussed in section 1.4 and throughout my relevant experimental chapters in this thesis. The maintained vasoconstrictor actions of ET-1 suggested a possible involvement of the peptides in ischemic insult to organs and tissues, and in accordance with this, plasma ET-1 levels are increased in patients with acute myocardial infarction (Miyachi, *et al.*, 1991). Elevated plasma ET-1 levels have been observed in patients with congestive heart failure (Stewart, *et al.*, 1992), and may as a result of decreased clearance of the peptide as well as increased production.

Disruption of the ET, or ET-receptor gene in mice indicates the importance of these peptides in the development of neural crest derived structures. Total knockout of the ET-1 gene in mice causes severe craniofacial and thoracic blood vessel malformation, and these mice die of respiratory failure at birth (Kurihara, *et al.*, 1994). This developmental effect would appear to be mediated by ET-1 activation of ET_A receptors as malformations are increased by treatment with BQ-123, antibodies of the ET_A receptor or by knockout of the ET_A gene (Kurihara, *et al.*, 1995). Mice lacking in ET-3, unlike ET-1 deficient mice, are viable at birth but die at 3-4 weeks age as a result of toxic megacolon (Baynash, *et al.*, 1994). Similar changes are observed in mice by knockout of the ET_B receptor gene (Hosoda, *et al.*, 1994) and indeed mutations of the ET_B receptor gene have been found in a human hereditary form of Hirschsprung's disease (aganglionic megacolon) (Puffenberger, *et al.*, 1994). The evidence presented above is only a small example of the growing literature implicating ET's in the pathophysiology of certain disease states. The effectiveness of ET antagonists has been studied some animal models of diseases for which they have been implicated with some promising results (Battistini, *et al.*, 1995). However, whether this treatment will prove effective for treatment of human disorders is yet to be elucidated.

1.3. The Pulmonary circulation.

The adult pulmonary circulation is characterised as a low-pressure, low-resistance vascular bed that accommodates the entire output of the right ventricle at less than 20% of systemic vascular pressure. Vasodilator drugs have little or no effect on the pulmonary circulation at rest suggesting that under normal conditions the pulmonary vasculature possesses little or no resting vascular tone (Fishman, 1985). A key feature of the pulmonary vasculature is its high degree of compliance, which ensures maintenance of low pressure even in the face of increased cardiac output.

1.3.1 Functions of the pulmonary circulation.

One of the main functions of the pulmonary circulation is to deliver deoxygenated blood to the lungs, distributing it through the sheets of pulmonary capillaries in the alveoli, to allow gas exchange to occur. However, the lungs also serve several non-respiratory functions. The pulmonary microvasculature represents an enormous area for processing of circulating vasoactive substances (Vane, 1969), and has a unique position in that all the venous blood from the body tissues must pass through the lungs before it is recycled. Several mediators including histamine, noradrenaline and 5-HT are removed from the blood upon passing through pulmonary vasculature. The conversion of angiotension I (AI) to the more potent vasoconstrictor AII occurs in the pulmonary circulation, via an angiotensin converting enzyme (ACE) present in the vascular endothelium (Fishman, 1985).

1.3.2 Structure of pulmonary arterial tree.

Considerable structural differences between pulmonary and systemic arterial vessels are apparent, as would be expected from their marked pressure differences. In keeping with a low-pressure system, pulmonary arteries generally have much thinner walls, and contain less smooth muscle and elastin in comparison to systemic vessels.

The main pulmonary trunk leaving the right ventricle passes upwards through the heart, and rapidly divides into two daughter branches (approximately at the level of the fifth thoracic vertebra). The left pulmonary artery extends to the hilum of the left

lung were it divides into two branches , one passing to each lobe. The right pulmonary artery also divides into two branches, the larger of which extends to the middle and lower lobes of the right lung, and the smaller to the upper lobe. Pulmonary arteries form a rapidly branching structure throughout the lungs, following the branching pattern of the airways. In the human lung, 17 orders of pulmonary arterial branching have been estimated (Singhall, *et al.*, 1973). The pulmonary trunk and its primary branches are defined as elastic arteries, comprising of several elastic laminae with interposed smooth muscle (Heath & Edwards, 1958). Continuing through the branching pattern of the human pulmonary vascular tree, the number of elastic laminae gradually decreases, with arteries >1 mm i.d. still classified as elastic pulmonary arteries. The predominantly muscular pulmonary arteries (100 μ m - 1 mm i.d.) accompany the bronchioles and consist of approximately 4-6 layers of vascular smooth muscle cells bound by distinct internal and external elastic laminae (Brenner, *et al.*, 1935; Heath, *et al.*, 1958). Below the level of the terminal bronchus, the layers of vascular smooth muscle are abruptly reduced, and smooth muscle is obliquely arranged in the vascular wall. The vessels are classed as partially muscular or nonmuscular arteries, and accompany the respiratory bronchioles (Heath, *et al.*, 1958). In the human lung, pulmonary arterioles can generally be classed as arterial vessels less than 100 μ m i.d. (Brenner, 1935). These vessels consist of a single elastic lamina, with extremely sparse smooth muscle (Heath & Edwards, 1958).

There is however, considerable variation in the structure and branching pattern of pulmonary vessels between species (Kay, 1983). Interspecies differences are observed in the arrangement of collagen, smooth muscle and elastic tissue in the pulmonary trunk, as well as in the medial thickness of muscular pulmonary arteries. In general the structure of pulmonary arteries is similar in man, ferret and monkey with most other mammals demonstrating more muscular pulmonary arteries (Kay, 1983). In some mammals, the muscular pulmonary arteries can extend to vessels below 100 μ m i.d. This is in contrast to the human pulmonary vasculature, in which vessel below 100 μ m i.d. are normally nonmuscular in structure.

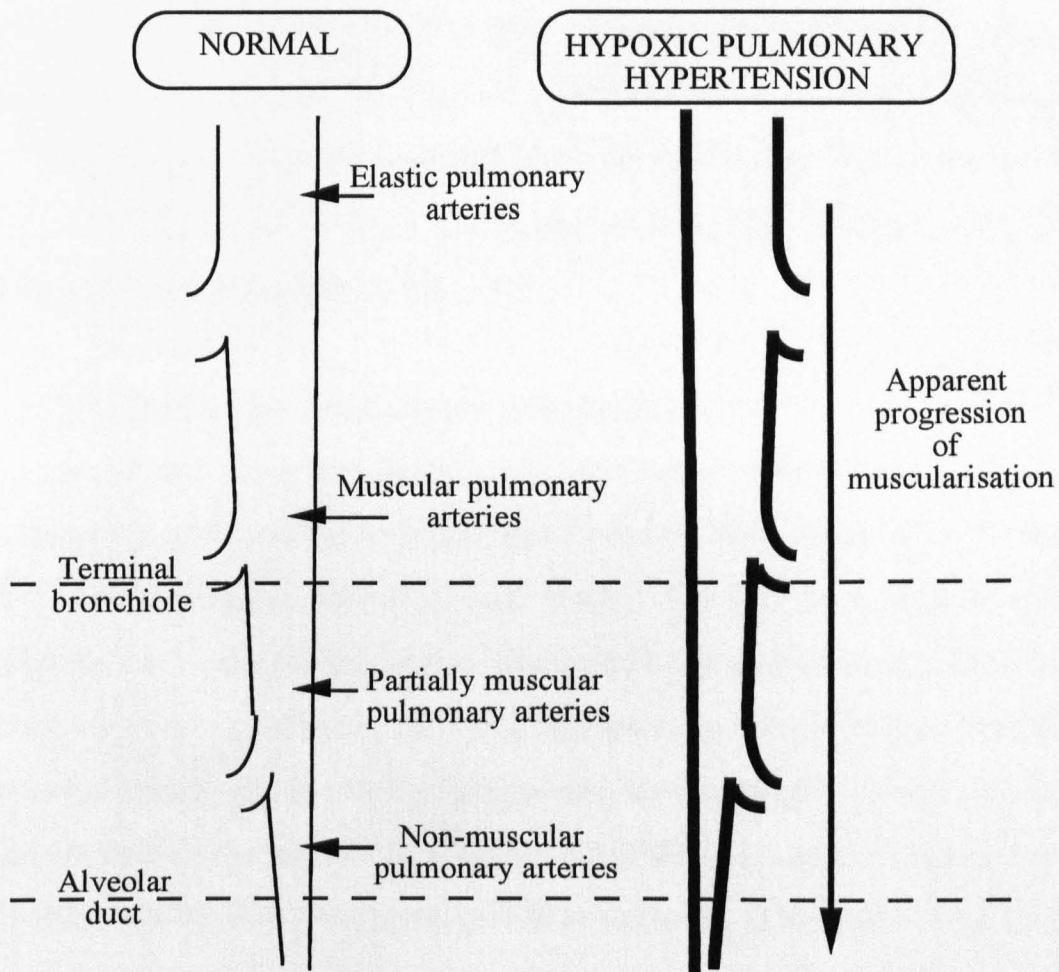

Figure 1.6

Structure of pulmonary arterial tree in normal and pulmonary hypertensive states. Schematic diagram showing approximate location of different types of pulmonary artery. The figure to the right indicate the effect of hypoxic pulmonary hypertension, showing the apparent progression of muscularisation into previously nonmuscular arteries, and the thickening of already muscular vessels. For full explanation see text.

In the rat lung, elastic and muscular pulmonary arteries can clearly be identified. Meyrick & Reid, (1978) divided the muscular pulmonary arteries of the rat lung into three main groups, being classed as muscular, partially muscular or nonmuscular arteries. Nonmuscular arteries comprise the smallest part of the pulmonary arterial tree. Vessels of this type lack a muscular media, consist of a single elastic lamina and are comprised of pericytes instead of smooth muscle cells (Meyrick & Reid, 1978). A recent study by Sasaki, *et al* (1995) further subdivided the arteries of the rat pulmonary circulation. The large elastic artery was subdivided into two segments, a classic elastic and transitional elastic segment. Muscular pulmonary arteries (originating at vessels

~300 μm i.d.) were subdivided into thick muscular, ordinary muscular, partially muscular and nonmuscular. The pulmonary resistance arteries used in my own studies (~150 μm i.d.) would probably be classed within the ordinary muscular group described above. The structure of the pulmonary arterial tree giving approximate location of the different vessel types is shown in figure 1.6.

1.3.3 Pulmonary pressure and pulmonary vascular resistance.

In normal humans subjects, mean pulmonary artery pressure (PAP) is approximately 12-15 mmHg, with peak systolic and diastolic values of 20-30 mmHg and 7-12 mmHg respectively (Fishman, 1985). Although there is some species variation in PAP, values in the range of 15-20 mmHg are most commonly found under normal conditions. In human, cat and dog lungs, the pressure drop across the pulmonary vascular bed is ~10 % of the pressure drop across the systemic circulation (Fishman, 1985). The pressure drop across each of the three major components of the pulmonary vascular bed; the arteries, capillaries and veins; is fairly even suggesting an even distribution of pulmonary vascular resistance throughout the lung. This is in contrast to the systemic circulation where 70 % of resistance to blood flow is located in the arterioles. However, morphometric analysis of the human lung indicates that the major site of pulmonary vascular resistance may be located in the small muscular arteries (100 μm - 1 mm i.d.) and the arterioles (<100 μm i.d.) (Horsfield, 1978; Singhal, 1973).

1.3.4 Regulation of low vascular tone.

In order to maximise gas exchange, the air-blood interface in the alveoli must be extremely thin. Maintenance of low pulmonary pressure is therefore of utmost importance to prevent capillary leakage and pulmonary oedema. The pulmonary circulation is under the control of both passive and active factors which mediate changes in pulmonary vascular tone and hence pulmonary pressure (Barnes & Lui, 1994). Passive factors include, changes in cardiac output, gravitational force, airway and interstitial pressure, however of more interest to my research are the active factors

which alter pulmonary tone by mediating constriction or dilatation of pulmonary vascular smooth muscle. Included in this groups are autonomic nervous control, humoral factors and respiratory gases.

Active control.

1.3.4.1 Autonomic nerves.

The pulmonary vasculature is innervated primarily from the anterior and posterior pulmonary plexi (Downing & Lee, 1980). The density and type of innervation appears to be strongly species dependent, and varies with the location and or size of the vessel (Downing & Lee, 1980; Barnes & Lui, 1994). In general it would appear that larger muscular pulmonary arteries are more densely innervated, whereas the smaller pulmonary arteries and arterioles tend to have sparse, or are absent of innervation. Both sympathetic and parasympathetic nerve fibres have been detected in the lungs of most species (Fishman, 1985). Stimulation of sympathetic (adrenergic) nerve fibres in the pulmonary vasculature mediates predominately vasoconstrictor responses (Ingram , *et al.*, 1968; Barnes & Lui, 1994), whereas stimulation of parasympathetic (cholinergic) nerve fibres mediates vasodilatation (Downing & Lee, 1980; Daly & Hebb, 1952). Evidence also exists for the presence of non-adrenergic non-cholinergic nerve (NANC) fibres in the pulmonary vasculature of some species (Liu, *et al.*, 1992) which mediate vasoconstriction or vasodilatation depending on the neurotransmitter / preparation involved (Barnes & Lui, 1994). Whether autonomic innervation contributes to basal pulmonary vascular tone is uncertain, but may be involved during conditions of stress (Fishman, 1985).

1.3.4.2 Humoral control.

Many circulating hormones and chemical mediators can effect pulmonary vascular tone through direct effects on vascular smooth muscle, or via interaction with the vascular endothelium. The effects of these humoral mediators can vary dramatically with species, the preparation studied and the level of pre-existing vascular tone. Humoral control of pulmonary vascular tone has been extensively studied and in

general agents such as AII, thromboxane and thrombin are pulmonary vasoconstrictors, whereas PGI₂, ACh and ANP tend to mediate vasodilatation (Fishman, 1985; Barnes & Lui, 1994). Under conditions of basal vascular tone agents such as bradykinin, AVP, substance P, histamine and 5-HT will mediate vasoconstriction, but have also been shown to mediate pulmonary vasodilatation when vascular tone is raised.

1.3.4.4 Endothelial control.

As previously mention in section 1.1. and 1.2, endothelium-derived mediators can have profound influences on vascular tone in both the systemic and pulmonary vasculature (Lüscher, *et al.*, 1989; Daugherty, *et al.*, 1995). Cyclooxygenase products such as PGF_{2α}, PGE₂, TxA₂ and endoperoxides tend to mediate vasoconstriction whereas, PGI₂ and PGE₁ are pulmonary vasodilators (Fishman, 1985; Barnes & Liu, 1994). The pulmonary circulation can produce relatively large quantities of PGI₂ (Gryglewski, *et al.*, 1978) and TxA₂ (Engineer, *et al.*, 1978), and are implicated in the vasodilator and vasoconstrictor actions of other vasoactive compounds e.g. adenosine and histamine (Lipton, *et al.*, 1992; Fishman, 1985). The lipoxygenase products of AA metabolism, the leucotrienes, have been shown to be potent pulmonary vasoconstrictors *in vitro* and *in vivo* (Voelkel, *et al.*, 1984; Barnes & Liu, 1994).

Since the identification of the EDRF NO the role of endothelium-derived NO in the control of pulmonary vascular tone has been extensively studied (Adnot, *et al.*, 1995; Higenbottam, 1995). Many humoral factors and autocooids have been shown to induce pulmonary vasodilatation via endothelial release of NO (Barnes & Liu, 1994; Adnot, *et al.*, 1995) and may even be released from NANC nerve terminals in pulmonary vessels (Liu, *et al.*, 1992). However, it has been postulated that continual, basal release of NO may be an important regulator in the maintenance of low pulmonary vascular tone. Under conditions of basal tone, inhibition of NOS activity resulted in increased pulmonary vascular resistance of sheep, pig and human isolated perfused lungs (Cremona, *et al.*, 1994), but had no effect on basal tone in isolated perfused lungs of the dog or rat (Cremona, *et al.*, 1994; Barer, *et al.*, 1993; Liu, *et al.*, 1991). However, increases in pulmonary vascular resistance have been reported

following intravenous infusion of the NOS inhibitor L-NMMA in healthy human adults (Stamler, *et al.*, 1994). The role of basal NO in regulation of pulmonary vascular tone would therefore appear to be species dependent.

The role of ET's in the pulmonary circulation will be discussed in section 1.4.

1.3.4.5 Intracellular Cyclic Nucleotides.

Many vasoactive compounds exert their biological actions upon the pulmonary vasculature by regulating intracellular concentrations of the second messengers cAMP and cGMP, for example the vasodilators NO and PGI₂ (see section 1.1.2) which increase intracellular levels of cGMP and cAMP respectively. By stimulating or inhibiting the activity of the enzymes adenylate cyclase and guanylate cyclase, vasoactive compounds can alter [cAMP]_i and [cGMP]_i, which in turn regulate vascular tone. The exact mechanisms responsible for cGMP-mediated relaxation are not completely understood but may involve activation of protein kinase G, inhibition of IP₃ formation, dephosphorylation of myosin light chain kinase and inhibition of Ca²⁺ influx (Lincoln, 1989). Similarly, cAMP is thought to mediate vasodilatation through activation of several mechanisms including activation of cAMP-dependent protein kinase thus decreasing myosin light chain kinase activity, inhibition of Ca²⁺ influx and stimulation of Ca²⁺ efflux (Murray, 1990). Changes in these signalling systems have been noted in a number of disease states including cardiovascular disease, asthma and inflammation. The levels of [cAMP]_i and [cGMP]_i can be controlled not only by production but also through degradation by cyclic nucleotide phosphodiesterases (PDE's). These enzymes are the only known means by which cells inactivate cyclic nucleotides, by hydrolysis to the corresponding 5'-nucleotide. PDE's exists as a large family of enzymes (currently there are greater than 30 recognised isoenzymes) which can be classified into seven main families based on the basis of their amino acid sequence, substrate specificity and sensitivity to pharmacological agents (Beavo, *et al.*, 1994).

PDE 1 is able to hydrolyse both cAMP and cGMP and is profoundly activated by calcium and calmodulin. PDE 2 can also hydrolyse both cAMP and cGMP, and

hydrolysis of cAMP by this enzyme can be stimulated by low concentrations of cGMP. The third enzyme, PDE 3 has the ability to hydrolyse cAMP specifically and can be inhibited by low concentrations of cGMP. PDE4 and PDE 7 also hydrolyse cAMP specifically but are unaffected by cGMP concentrations. PDE 5 and PDE 6 hydrolyse cGMP specifically (Bolger, 1994; Beavo, *et al.*, 1994). Five of these PDE's (PDE 1 to 5) are known to be present in the cardiovascular system, and targeting of these enzymes may prove useful in the treatment diseases such as thrombosis, inflammatory disease, cardiac arrhythmias and could prove useful in the treatment of pulmonary vascular disease (Stoclet, *et al.*, 1995).

1.3.5 Respiratory gas regulation.

Pulmonary vascular tone is strongly influenced by the relative components of respiratory gases. Both hypoxia and hypercapnia induce pulmonary vasoconstriction, a feature which is unique to the pulmonary circulation (Fishman, 1961). Although mixed venous PO₂ contributes to the hypoxic response, the main stimulus for hypoxic pulmonary vasoconstriction (HPV) appears to be alveolar hypoxia (Marshall & Marshall, 1983).

1.3.5.1 Hypoxic pulmonary vasoconstriction.

HPV has been extensively studied since it was first described by von Euler and Liljestrand (1947). The physiological function of HPV in the adult lung appears to be in maximising ventilation-perfusion matching, diverting blood from the hypoxic alveoli toward better ventilated areas of the lung. Although pulmonary arteries of different calibre exhibit HPV, the vessels most effected by hypoxia are the small muscular pulmonary arteries. This was first demonstrated in isolated lungs by Kato & Staub (1966), and subsequent studies have confirmed this to be the case (Hauge, 1969; Shirai, *et al.*, 1986). Direct micropuncture measurements in the cat lung have also indicated that the predominant site of HPV is the precapillary arteries (Nagasaka, *et al.*, 1984).

1.5.3.2 Mechanism of hypoxia-induced pulmonary vasoconstriction.

Despite extensive research over the past 50 years, the exact mechanism underlying HPV remains unclear. Evidence suggests that HPV activates mechanisms intrinsic to the pulmonary vasculature, and is independent of circulating humoral substances and neuronal control (Fishman, 1985; Voelkel, 1986). Failure to identify a conclusive mediator of HPV has implied that hypoxia may have a direct effect on vascular smooth muscle cells. In support of this theory, hypoxia has been shown to contract isolated pulmonary vascular smooth muscle cells (Madden, *et al.*, 1992) and pulmonary smooth muscle cells in culture (Murray, *et al.*, 1990). Several possible mechanisms have been proposed to explain this direct action of hypoxia, including inhibition of : O₂ sensitive K⁺ channels, voltage gated K⁺ channels and / or Ca²⁺ activated K⁺ channels (Post, *et al.*, 1992; Weir & Archer, 1995). Another theory is that HPV is initiated via decreased oxidative phosphorylation within pulmonary smooth muscle cells (Rounds & McMurtry, 1981). However, there is evidence to indicate that hypoxia may activate an endothelium-dependent mechanism leading to HPV. Several studies, in a range of species have indicated that HPV in isolated arterial preparations is dependent upon an intact vascular endothelium (Holden & McCall, 1984; Demiryürek, *et al.*, 1993; Leach, *et al.*, 1994), postulating that release of an EDCF or inhibition of an EDRF may be responsible for these effects. The role of endothelium-derived NO is unclear as inhibition of NOS activity has been shown to both attenuate (MacLean & McGrath, 1991) and augment (Liu, *et al.*, 1991) HPV. Release of endothelium-derived leucotrienes and prostaglandins have also been implicated as mediators of HPV (Barnes & Liu, 1994).

The effect of hypoxia on pulmonary tissues is universal, although there appears to be species variations in the intensity of the vasoconstrictor response (Fishman, 1985). Acute hypoxic stimuli produce HPV which is maintained only for the duration of hypoxia, and is reversed upon exposure to normoxic gas mixture. However, when exposed to chronic hypoxia, the reflex appears malignant, and is maintained even upon return to normoxia.

1.3.6 Pulmonary Hypertension.

An increase in mean pulmonary artery pressure of 10-15 mmHg above normal values is generally accepted as evidence of pulmonary hypertension (Fishman, 1985). The condition of pulmonary hypertension can occur as a primary phenomenon (sometimes referred to as idiopathic pulmonary hypertension) the cause of which is unknown. Primary pulmonary hypertension is rare, occurring most frequently in women of 30-40 years of age, and with a mean survival rate of 2-3 years after the onset of symptoms (Rich, 1988). Pulmonary hypertension occurs more frequently as a secondary phenomenon as a result of other disease states including, chronic obstructive lung disease (COLD), congenital heart defects, congestive heart failure and the adult respiratory distress syndrome. Exposure to low inspired O₂ due to environmental factors can also lead to the development of pulmonary hypertension, as displayed in some residents of high altitudes (Peñaloza, *et al.*, 1962). Regardless of the mediator of pulmonary hypertension, the condition is often progressive, characterised by a relentless increase in pulmonary vascular resistance that ultimately leads to right-heart failure and death.

The contributing factors to secondary pulmonary hypertension can vary, and will depend on the primary disease involved. Examples of possible contributing factors in chronic obstructive lung disease would include prolonged HPV and acidosis, whereas in Eisenmenger syndrome (congenital heart defect) the main contributory feature is increased pulmonary flow due to intracardiac shunting of blood (Fishman, 1985). Although these facts contribute to the development of pulmonary hypertension, the exact mechanisms by which pulmonary hypertension develops is not fully understood. A feature common to all form of pulmonary hypertension is pulmonary vascular remodelling, where pulmonary arteries, particularly those less than 100 µm i.d., show various degrees of intimal thickening and muscular hypertrophy (Heath, 1993).

1.3.6.1 Pulmonary vascular remodelling.

In the early stages of both primary and secondary pulmonary hypertension, a progression of muscularisation into the nonmuscular terminal portion of the pulmonary arterial tree is observed (Haselton, *et al.*, 1968; Heath, *et al.*, 1987, 1993). This occurs as a result of hyperplasia of vascular smooth muscle cells which extend distally in a layer internal to the original internal elastic lamina (Heath, *et al.*, 1987), thus forming an inner layer of longitudinal smooth muscle. In the latter stages of the remodelling, the pattern of cell migration and proliferation differs depending on the type of pulmonary hypertension; i.e. plexogenic pulmonary hypertension (typical of the primary condition and Eisenmengers syndrome) in which distinct plexiform lesioning develops; or hypoxic pulmonary hypertension (Heath, 1992, 1993). However common to most cases is proliferation of vascular smooth muscle cells in the vascular media and frequently the intima (Heath, 1992). The resulting intimal and medial thickening may reduce the calibre of resistance vessels and occlude small vascular channels, resulting in increased vascular resistance. A reduction in the number of peripheral vessels (probably as a result of vascular occlusion) is a feature of primary pulmonary hypertension (Anderson, *et al.*, 1973). In some cases (especially hypoxic pulmonary hypertension), vasoconstriction may also contribute to inappropriate increases in pulmonary vascular resistance in many patients with pulmonary hypertension (Wood, 1958). In hypoxic pulmonary hypertension blood viscosity is increased owing to hypoxia induced polycythaemia contributing to increased pulmonary vascular resistance (Leach & Treacher, 1995). In many cases of pulmonary hypertension the increased pulmonary vascular resistance leads to right ventricular hypertrophy (cor pulmonale) resulting in right heart failure.

Once pulmonary hypertension is developed, the associated vascular changes renders the pulmonary circulation relatively resistant to the actions of standard vasodilators, and often results in intolerable side effects, such as systemic hypertension. In the search for selective treatment for pulmonary hypertension virtually every vasodilator agent has been tested including, hydralazine, Ca²⁺ channel antagonists, adrenoceptor antagonists, ACh, PGI₂, nitroprusside and ACE inhibitors (Rich, 1988;

Fishman, 1985; Barnes and Liu, 1995). More recently the effects of inhaled NO in the treatment of pulmonary hypertension have been investigated. Inhaled NO significantly reduced PAP in patients with both primary and secondary pulmonary hypertension without effecting the systemic circulation (Pepke-Zaba, *et al.*, 1991; Adnot, *et al.*, 1993). However, high doses of NO are known to be toxic and therefore its use as a long term vasodilator therapy is yet to be elucidated. In the search for selective therapy, and greater knowledge into the underlying causes of pulmonary hypertension, several animal models have been developed and studied.

1.3.7 Animal models of pulmonary hypertension.

1.3.7.1 Chronic hypoxic model.

Chronic hypoxic animals (mainly rats and mice) are commonly used and are a well studied model of hypoxic pulmonary hypertension. A full description of this model will be given in chapter 2 of this thesis. Rats exposed to chronic (hypobaric or normobaric) hypoxia exhibit significant pulmonary hypertension, and develop similar morphological changes in the pulmonary vascular bed that are observed in human pulmonary hypertension (Hislop & Reid, 1976; Rabinovitch, *et al.*, 1979). The hypoxia-induced morphological changes in the pulmonary vasculature of the rat is characterised by a progression of spirally arranged smooth muscle into smaller, more peripheral arteries ($< 80 \mu\text{m}$) where smooth muscle is not normally present. This apparent progression of vascular smooth muscle is actually as a result of differentiation of precursor cells normally present in these vessel, the pericyte and intermediate cell, into smooth muscle cells (Meyrick & Reid, 1978). The pericyte and intermediate cell normally lie internal to a single elastic lamina, and once differentiated, the new muscle cells induce the production of an internal lamina. Intra acinar vessels as small as $20 \mu\text{m}$ i.d. can exhibit medial hypertrophy and significant muscularisation (Meyrick & Reid, 1978). There is also an increase in the medial muscular wall thickness of normally muscular arteries ($\sim 100 \mu\text{m}$ i.d.) and a reduction in the number of peripheral arteries (Hislop & Reid, 1976; Rabinovitch, *et al.*, 1981). The increase in vascular smooth muscle cell mass is accounted for by hypertrophy of the smooth muscle cells already

present and proliferation of fibroblasts and collagen in the adventitia (Meyrick & Reid, 1978). Chronic hypoxic animals also exhibit polycythaemia which exacerbates the development of pulmonary hypertension and right ventricular hypertrophy (Naeye, 1965; Hunter, 1974).

1.3.7.2 Other models of pulmonary hypertension.

Ingestion of the seeds from the leguminous plants *Crotalaria* in humans leads to severe damage to the liver, lungs and central nervous system (Fishman, 1985). The toxic effects of this plant are as a result of the alkaloid monocrotaline which it contains. However in animals such as the rat, ingestion of *Crotalaria* or subcutaneous injection of monocrotaline results in the development of pulmonary hypertension within several days (Fishman, 1985; Olson, *et al.*, 1984). Monocrotaline itself does not act directly on the pulmonary circulation but is converted by the liver to dehydromonocrotaline, a substance which is highly toxic to the pulmonary vasculature. A beagle model of pulmonary hypertension has also been described (Okada, *et al.*, 1995). Features of monocrotaline induced pulmonary hypertension are early vascular endothelial damage, followed by increased vascular smooth musculature and rise in pulmonary artery pressure (Rosenberg & Rabinovitch, 1988). Unlike chronic hypoxic rats, these animals do not develop polycythaemia, but do exhibit right ventricular hypertrophy.

More recently, the fawn hooded rat has been postulated as a possible model of primary pulmonary hypertension. This strain of rat has hereditary bleeding tendency due to platelet storage pool disease and has been shown to develop idiopathic pulmonary hypertension (Stelzner, *et al.*, 1992).

1.4 Endothelin in the Pulmonary circulation.

In the following section, a basic outline of the effects of ET's in the pulmonary circulation will be introduced, with reference to their possible implications in the physiology and pathophysiology of the pulmonary vasculature. As this area is the focus of my research, further detailed analysis of ET in the pulmonary circulation will be discussed in each of the relevant experimental chapters.

1.4.1 Biosynthesis.

Analysis of tissue levels of ET-1 in rat organs found that pulmonary tissues contained relatively high concentrations of the peptide (3400 pg/g wet weight) (Matsumoto, *et al.*, 1989). Similarly high levels of ET-1 have also been demonstrated in porcine and human lungs (Hemsén, 1991). In the rat, analysis of ET-gene expression showed that both ET-1 and ET-3 were strongly detected in lung tissue (Firth & Radcliffe, 1992). The lungs were also shown to be the predominant site of ET-1 expression, being 5-fold greater than expression in large intestine and at least 15-fold higher than any other organ. ET-1 would appear to be synthesised by a number of pulmonary cell types including vascular endothelium (Giaid, *et al.*, 1991; Naruse, *et al.*, 1989; MacCumber, *et al.*, 1989; Ohlstein, *et al.*, 1989), parenchymal cells (Marciniak, *et al.*, 1992), airway epithelial cells (Giaid, *et al.*, 1991; Endo, *et al.*, 1992) and tissue macrophages (Ehrenreich, *et al.*, 1990). ET-3 expression can also be detected in human lung parenchyma (Marciniak, *et al.*, 1992) although the exact cells of origin are unclear. All this evidence would implicate the lungs as an important site for the biosynthesis of ET-1.

1.4.1.2 Binding - Pulmonary receptors.

Autoradiographic studies have shown widespread, high density binding of ET's in pulmonary tissues, namely in tracheal and bronchial smooth muscle, blood vessels of all sizes, parenchyma and alveolar walls (Power, *et al.*, 1989; Koseki, *et al.*, 1989; McKay, *et al.*, 1991a). Even before the identification of the known ET_A and ET_B receptor subtypes, Masuda, *et al.*, (1989) described two different forms of ET receptors in the rat lung. This initial observation was verified by the solubilisation of both ET_A and ET_B receptors from the rat lung, with retention of their characteristic binding activities (Kondoh, *et al.*, 1991).

Use of selective agonists and antagonists for ET-receptors in binding experiments, and *in situ* hybridisation techniques has revealed some indication of tissue / cell distribution of ET-receptors within the lung. Using the selective ET_A receptor antagonist BQ-123, Nakamichi, *et al.*, (1992) demonstrated that in porcine lungs, ET_A

receptors appear to be predominantly localised in bronchi and blood vessels, whereas ET_B receptors were detected diffusely throughout the parenchyma. Observations in the rat lung using *in situ* hybridisation, showed high levels of ET_A receptor mRNA were observed in smooth muscle layers of airway and pulmonary vasculature, whereas both ET_A and ET_B receptor mRNA were detected in parenchymal tissue (Hori, *et al.*, 1992). Autoradiographic studies showed that ET_A receptors predominate in adult human pulmonary artery (Fukuroda, *et al.*, 1994a; Davenport, *et al.*, 1993) however a high proportion of ET_B receptors are present in the rabbit pulmonary artery (Fukuroda, *et al.*, 1994a; Panek, *et al.*, 1992). Therefore, the subtypes of ET-receptor appear to vary not only with tissue localisation, but there may also be species variations. Functional experiments have also show evidence for the presence of both ET_A and ET_B receptors in the lung, as will discussed in the following sections.

1.4.3 Pulmonary actions of Endothelins.

ET's are known to elicit biological effects on both airway and vascular tissues within the lung (Filep, *et al.*, 1992). Although ET's are implicated in the physiology and pathophysiology of airway function, I will concentrate only on the pulmonary vascular effects of ET's.

1.4.3.1 *In vivo* studies

Intravenous administration of ET-1 to anaesthetised dogs resulted in a mild constriction of the pulmonary vascular bed (Miller, *et al.*, 1989; Goetz, *et al.*, 1988). Similar slight vasoconstrictor actions of ET-1 were demonstrated in the pulmonary circulation of the conscious catheterised rat (Raffestin, *et al.*, 1991). Both mild (Lipton, *et al.*, 1989), and potent (Minkes, *et al.*, 1990) pulmonary vasoconstrictor actions of ET-1 have been reported in the anaesthetised cat, and may be due to actual dose of the peptide administered. In conscious rats, in which pulmonary vascular tone was increased by airway hypoxia, i.v. administration of ET-1 produced rapid pulmonary vasodilatation which was sustained over approximately 10 minutes (Hasunuma, *et al.*, 1990). ET's also produce vasodilatation in the pulmonary vascular

bed of the cat, where pulmonary vascular tone has been raised by U46619 administration (Lippton, *et al.*, 1991). Earlier studies from the same group (Lippton, *et al.*, 1989) had failed to show any vasodilator actions of ET's in the cat pulmonary vasculature, however the authors suspect that this may have been due to unrecognised tachyphylaxis of the response. Infusion of the K⁺ channel blocker glibenclamide, significantly attenuated the vasodilator action of ET's in the cat pulmonary circulation suggesting that ET activation of K⁺ channels was mediating vasodilatation in this model (Lippton, *et al.*, 1991, 1995). The relative potency of the ET peptides in mediating vasodilatation suggested that activation of ET_B receptors mediated this response (Lippton, *et al.*, 1991). It is unclear from these studies *in vivo*, whether ET-induced pulmonary vasodilatation is due to direct action on the vascular smooth muscle, or is mediated through another cell type (i.e. endothelium).

1.4.3.2 In vitro Studies.

Isolated perfused lungs.

As is observed *in vivo*, the pulmonary vascular response to ET's in isolated perfused lungs is dependent upon the initial degree of vascular tone. Under conditions of basal tone, ET-1 produced mild to moderate (dose-dependent) increases in pulmonary pressure and pulmonary vascular resistance in isolated perfused lungs from most species including, lamb (Toga, *et al.*, 1991), rat (Hasunuma, *et al.*, 1990; Raffestin, *et al.*, 1991; Eddahibi, *et al.*, 1991; Crawley, *et al.*, 1992) and rabbit (Mann, *et al.*, 1991). ET-1 is generally more potent than ET-3 in mediating the vasoconstrictor response suggesting the involvement of ET_A receptors, although the exact potency ratio varies between species. In isolated perfused lungs in which pulmonary vascular tone has been raised either naturally (as in the fetus) (Wong, *et al.*, 1995), or artificially (by airway hypoxia or vasoconstrictor drugs) (Hasunuma, *et al.*, 1990; Raffestin, *et al.*, 1991; Eddahibi, *et al.*, 1991; Crawley, *et al.*, 1992), administration of low concentrations of ET's produces rapid dose-dependent vasodilatation. In isolated perfused rat lungs, the vasodilator response of low concentrations of ET-1 are of short duration, and pulmonary artery pressure returns to pre-ET-1 infusion levels within

minutes (Hasunuma, *et al.*, 1990; Eddahibi, *et al.*, 1991). With subsequent application of greater concentrations of ET-1, vasodilatation is no longer apparent, and only vasoconstriction is observed. The relative potency of the ET's in mediating vasodilatation in the pulmonary circulation of the rat and pig would indicate that activation of ET_B receptors mediates this response (Crawley, *et al.*, 1992; Perrault, *et al.*, 1995). However, the actual mechanism of vasodilatation is less clear. In the rabbit pulmonary vasculature, ET-1 mediates release of PGI₂ and NO (De Nucci *et al.*, 1988). Vasodilatation to ET's can be attenuated by inhibition of NOS in the pulmonary vasculature of the rat (Raffestin, *et al.*, 1991) and pig (Perrault & DeMarte, 1991). There is also evidence to suggest that ET activation of ATP-sensitive K⁺ channels mediates pulmonary vasodilatation in isolated perfused rat lungs (Hasunuma, *et al.*, 1990; Eddahibi, *et al.*, 1991) as is observed in the cat pulmonary vasculature *in vivo* (Lippton, *et al.*, 1991).

Isolated tissue preparations.

ET-1 and ET-3 have been demonstrated to be more potent in constricting the isolated rat pulmonary artery than aorta (Rodman, *et al.*, 1989). Indeed ET-1 has been shown to induce potent vasoconstriction in isolated pulmonary arteries from many species including, pig (Sudjarwo, *et al.*, 1993) sheep (Toga, *et al.*, 1992) rabbit (Panek, *et al.*, 1992) and human pulmonary arteries (McKay, *et al.*, 1991b; Hay *et al.*, 1993). Cardell, *et al.*, (1990) reported that ET-1 was more potent in small pulmonary arteries of the guinea-pig than corresponding veins, however, the opposite relationship was found in the adult sheep, with veins being more sensitive to ET-1 than arteries (Toga, *et al.*, 1992). Although there is strong evidence for vasodilatation to ET's *in vivo* and in isolated pulmonary vascular beds (see above), evidence demonstrating ET mediated vasodilatation in isolated pulmonary arterial preparations is less apparent. Hasunuma, *et al.*, (1990) showed that ET-1-mediated vasodilatation was absent in rat isolated extrapulmonary arteries with intact endothelium. A similar situation is observed in lamb isolated pulmonary resistance arteries with ET-1 failing to produce vasodilatation in precontracted vessels (Wang & Cocceani, 1992). In isolated pig pulmonary arteries

and veins, ET-1 produced equipotent contractile responses under conditions of basal tone (Zellers, *et al.*, 1994), however in precontracted vessels ET-1 produced endothelium-dependent relaxations (at picomolar concentrations) which were greater in veins than arteries (Sudjarwo, *et al.*, 1993; Zellers, *et al.*, 1994). In contrast to the observations by Hasunuma, *et al.*, (1990), Carville, *et al.*, (1993) demonstrated endothelium-dependent relaxatory responses to ET-3 in rat isolated extrapulmonary arteries. The endothelium-dependent relaxation in isolated pig and rat pulmonary vessels was suggested to be mediated via activation of endothelial ET_B receptors due to the relative potency of ET's, and could be prevented by inhibition of NOS (Zellers, *et al.*, 1994; Carville, *et al.*, 1993).

1.4.4 Mechanism of action.

The exact signal transduction mechanisms activated by ET's in the pulmonary circulation are not yet clear. The vasoconstrictor action (mainly due to activation of ET_A receptors) may involve mobilisation of extracellular and intracellular calcium (Leach, *et al.*, 1990; Sudjarwo, *et al.*, 1995) and activation of PKC (Mann, *et al.*, 1991; Barman & Pauly, 1995) all of which mechanisms are linked to ET-1 mediated contraction of the systemic vasculature (see section 1.2.8). Release of cylooxygenase products may also contribute to the vasoconstrictor action of ET's the dog lung (Barnard, *et al.*, 1991). As mentioned above, vasodilatation to ET's has been attributed to the release of PGI₂, NO and / or activation of ATP-sensitive K⁺ channels, depending on the preparation and species under observation. Recently Lipton, *et al.*, (1995) reported that although all ET isopeptides promote vasodilatation through activation of ATP-sensitive K⁺ channels, the vasodilator actions of ET-1 and ET-2 in the cat pulmonary vasculature were mediated via a pertussis toxin (PTX) sensitive G protein mechanism, whereas vasodilator responses to ET-3 were resistant to PTX treatment, suggesting different signal transduction mechanisms are activated by the different peptides.

1.4.5 Physiological role for endothelin in the pulmonary circulation.

A physiological role for ET-1 in maintenance of pulmonary vascular tone is difficult to determine from the aforementioned evidence. From the pharmacological actions of ET-1 in intact lungs, the vasodilator actions of ET's could be implicated in the maintenance of low vascular tone through interaction with the vascular endothelium, or through direct actions on vascular smooth muscle. However what may be of more physiological importance is that the pulmonary circulation appears to be an important site for both the production (see section 1.4.1.1) and clearance of ET-1 (see section 1.2.14). The extent of pulmonary clearance of ET-1 appears to depend on the species under study as no significant extraction was found across the pulmonary circulation of the pig (Pernow, *et al.*, 1989). However, investigations by Stewart, *et al.*, (1991) showed that in normal humans, arterial to venous ratio of ET-1 was less than unity suggesting pulmonary clearance of ET-1 in the healthy human lung.

1.4.5.1 Endothelin in hypoxic pulmonary vasoconstriction.

Alveolar hypoxia has been shown to stimulate ET-1 production in rat lungs (Shirakami, *et al.*, 1991) and has therefore been examined as a possible mediator of HPV. The rapid onset of vasoconstriction upon hypoxic exposure would rule out de novo synthesis and release of ET-1, and the reversibility of HPV upon the return to normoxia is also not compatible with the relative irreversibility of ET-1 mediated vasoconstriction. The ET_A receptor antagonist BQ-123 has been shown to be ineffective in preventing HPV in isolated canine pulmonary arteries (Douglas, *et al.*, 1993), isolated perfused rat lungs (Takeoka, *et al.*, 1995) and in the intact lamb (Wong, *et al.*, 1993). However, recent evidence has shown that ET antagonists can effectively block HPV in some preparations. In conscious rats, acute HPV could be inhibited by both the ET_A receptor antagonist BQ-123, and the mixed ET receptor antagonist bosentan (Oparil, *et al.*, 1995; Chen, *et al.*, 1995). BQ-123 was also effective in blocking HPV in the intact lamb, and isolated pulmonary resistance arteries of the lamb (Wang, *et al.*, 1995). Although ET-1 is thought to be secreted immediately upon synthesis, there may be some evidence to suggest that ET-1 can be stored in secretory

vesicles and released in response to stimuli such as stretch and hypoxia (MacArthur, *et al.*, 1994; McClellan, *et al.*, 1994). The role of ET-1 in HPV is still unclear with positive evidence both for and against ET-1 as a mediator of HPV, however there is more positive evidence to implicate ET-1 in chronic hypoxic pulmonary hypertension.

1.4.6 Endothelin in pulmonary hypertension.

ET-1 has been implicated in the pathophysiology of both primary and secondary pulmonary hypertension. An outline of the evidence will be introduced below, with further detailed discussion given in the relevant experimental chapters of this thesis. Evidence for a pathophysiological role of ET-1 in pulmonary hypertension has centred around three main points.

- 1) ET-1 produces potent well-maintained vasoconstrictor responses in isolated pulmonary arterial preparations (see section), implying that subtle disturbances in its production and release could induce sustained vasoconstriction typically observed in pulmonary hypertensive states.
- 2) ET-1 stimulates DNA synthesis and cell proliferation of cultured pulmonary artery smooth muscle cells (Hassoun, *et al.*, 1992; Janakidevi, *et al.*, 1992) and also stimulates the replication of pulmonary artery fibroblasts (Peacock, *et al.*, 1992). Therefore suggesting a role for ET-1 in vascular remodelling associated with pulmonary hypertension.
- 3) Increased local tissue, and circulating plasma levels of ET-1 have been reported in both animal models (Li, *et al.*, 1994a), and patients with primary and secondary forms of pulmonary hypertension (Stewart, *et al.*, 1991; Giaid, *et al.*, 1993).

All of these points would therefore implicate that abnormalities in the physiological status of ET-1 production and metabolism may be a factor in the development of pulmonary hypertension.

1.5 Reasons for studying pulmonary resistance arteries *in vitro*.

It had been proposed that the pre-capillary resistance vessels, which can account for up to 50% of the total vascular resistance in the systemic circulation, were not

present in the pulmonary circulation (Barer, 1976). In 1989 Leach *et al.*, were one of the first groups to investigate the properties of small pulmonary arteries of the rat using the Mulvany wire myograph. The wire myograph (which will be described in detail - chapter 2 this thesis) allows the study of small resistance vessels *in vitro*. In this study, Leach, *et al.* (1989) demonstrated that vessels of a diameter in the range of 200-400 μm produced considerably more force for a given intervention than vessels with smaller or larger internal diameters, and therefore suggested that these vessels may play an important role in the generation of pulmonary vascular resistance. As described previously the small pulmonary arteries of the lung which are thought to be the main site of pulmonary vascular resistance and hypoxic pulmonary vasoconstriction *in vivo* (Staub, 1985) incorporating vessels of 60-500 μm i.d. depending of the species (Tod, *et al.*, 1987; Fike, *et al.*, 1988). Reports have also shown that physiological and pharmacological characteristics of the pulmonary artery are heterogeneous. Large and small pulmonary arteries of the rat have different membrane properties (Suzuki and Twarog, 1982), and show different responses to vasoactive agents (Leach, *et al.*, 1992). By use of vascular occlusion techniques ET-1 has been shown to preferentially increase small-artery resistance in the rat lung (Barnard, *et al.*, 1991). Taking all of these points into consideration, characterisation of the vasoactive properties of pulmonary resistance arteries is extremely important.

Main Aims of Project.

Although isolated pulmonary vessels have been studied for some time *in vitro*, technical limitations restricted the size of vessel which could be studied without causing substantial damage to the tissue. With the development of the wire myograph, smaller and more physiologically relevant pulmonary vessels can now be studied. I have outlined the importance of the small pulmonary resistance arteries *in vivo*, therefore the main points I wished to address with my research were to :

- 1) Study the vascular reactivity of isolated pulmonary resistance arteries *in vitro* to selected vasoactive agents. With the possible implications of ET-1 in pulmonary

function, particular attention was given to the vascular reactivity of pulmonary resistance arteries to ET's and related peptides.

2) Compare and contrast ET-mediated responses in control and pulmonary hypertensive (chronic hypoxic) rat pulmonary resistance arteries.

3) Identify the receptor subtypes mediating ET-induced responses in control and pulmonary hypertensive rat pulmonary resistance arteries.

4) Identify the receptor subtypes mediating ET-induced responses in human pulmonary arteries.

Additional preliminary studies were also conducted investigating the effect of pulmonary hypertension on intracellular cyclic nucleotide levels in the pulmonary arterial vasculature.

Chapter 2

Materials & Methods

2.1 Techniques for studying isolated vessels.

2.1.1 Organ bath set up for larger diameter pulmonary artery

Standard organ bath procedures were used for studying larger calibre pulmonary arteries (2-5 mm) *in vitro*. The technique used is similar to that described by Hooker, *et al* (1976). Figure 2.1 shows a schematic diagram of the organ bath set up. Rings of larger calibre pulmonary artery were suspended between two wire supports, the upper support being connected by cotton to a (Grass FT03) isometric transducer and the lower support was connected to a glass tissue holder. Isometric contractions were recorded via a transducer connected to a 6 channel Gould (model number BS-Z76) chart recorder. Each arterial segment was then mounted in 5 ml isolated organ baths containing modified Krebs-Heinslet solution (hereafter referred to as Krebs solution). Appropriate tension was then placed on the vessels (see experimental chapters) and were maintained at 37 °C, by means of an insulating water jacket surrounding the bath, bubbling with an appropriate gas mixture (for exact gas details see section 2.1.7).

2.1.2 Wire myography.

2.1.2.1 Background

The small vessel wire myograph was first described by Mulvany and Halpern (1976). This was a breakthrough in the investigations of blood vessels *in vitro* as it allowed measurement of isometric responses of small resistance arteries. Previously, due to technical limitations these experiments had to be carried out in larger diameter vessels, with the smallest vessel studied *in vitro* being the rat tail artery. Measurements of pressure taken from various regions of the systemic vascular tree demonstrated that in some vascular beds at least 50% or more of the pre-capillary pressure drop occurs in vessels with internal diameters greater than 100 μm (Bohlen, 1986). Therefore vessels with internal diameters ranging from 100-400 μm must contribute substantially to peripheral vascular resistance. The technique which was developed is ideally suited to vessels with internal diameters of 100-400 μm , but can be adapted to study vessels of up to 1000 μm . As previously mentioned initial studies involving wire myography

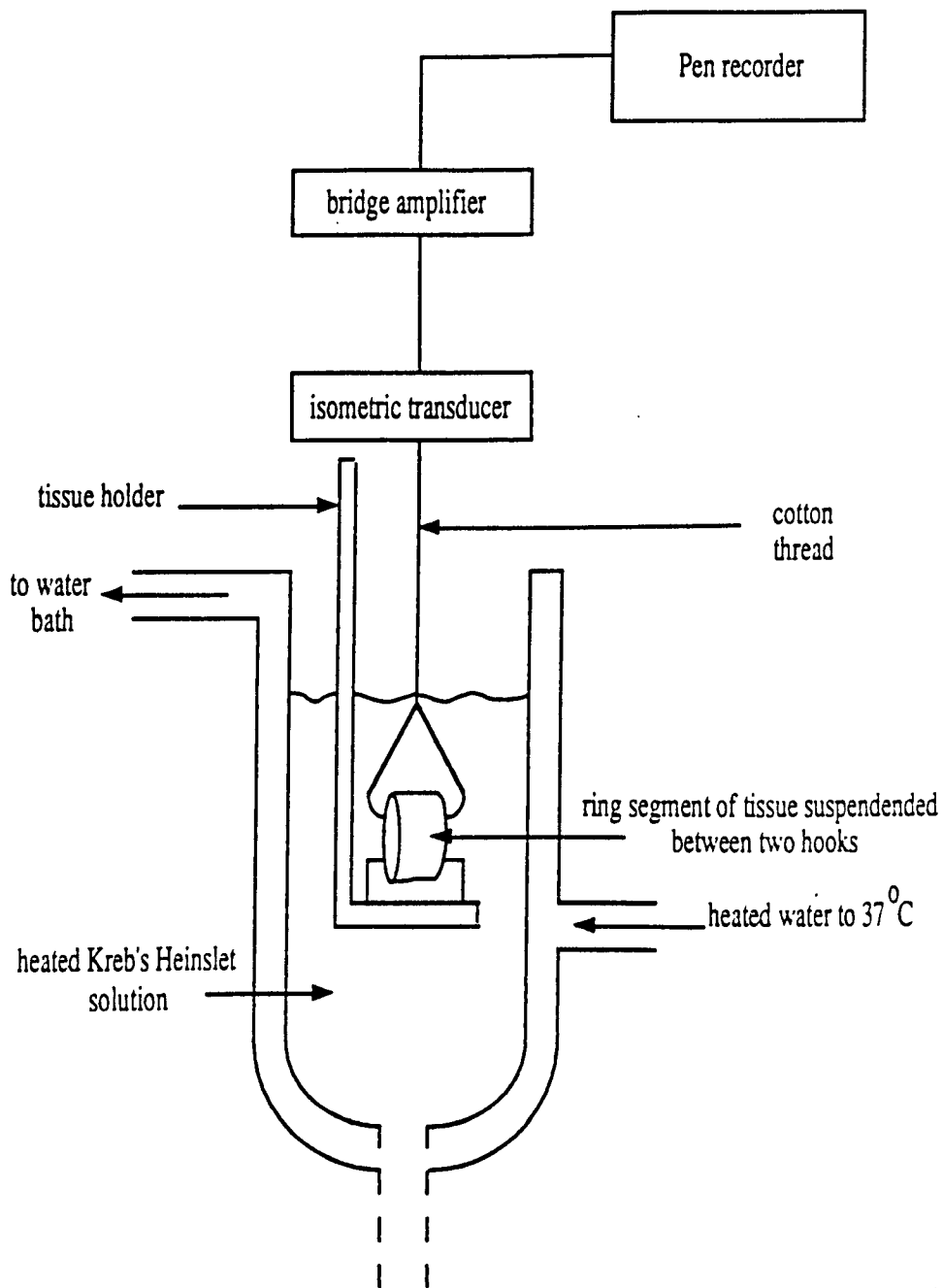

Figure 2.1.

Diagrammatic representation (not to scale) of the organ bath experimental apparatus used for studying larger diameter pulmonary arteries *in vitro*. Volume of the organ bath was 5 ml, gas bubbling apparatus is not shown on diagram.

concentrated on systemic resistance vessels, however the technique can essentially be applied to any small tubular structure such as bronchi and ureter (Chopra, *et al.*, 1994; Prieto, *et al.*, 1994).

2.1.2.2 Description of Myograph equipment

Mulvany / Halpern small vessel wire myograph models 500A and 510A were used in the following experiments. The myograph consists of a stainless steel organ chamber (as shown in figure 2.2) which can house up to two vessel preparations. The vessels are mounted on the myograph by means of wire (see mounting procedure section 2.1.4.1) to vessel support heads shown in figure 2.2.

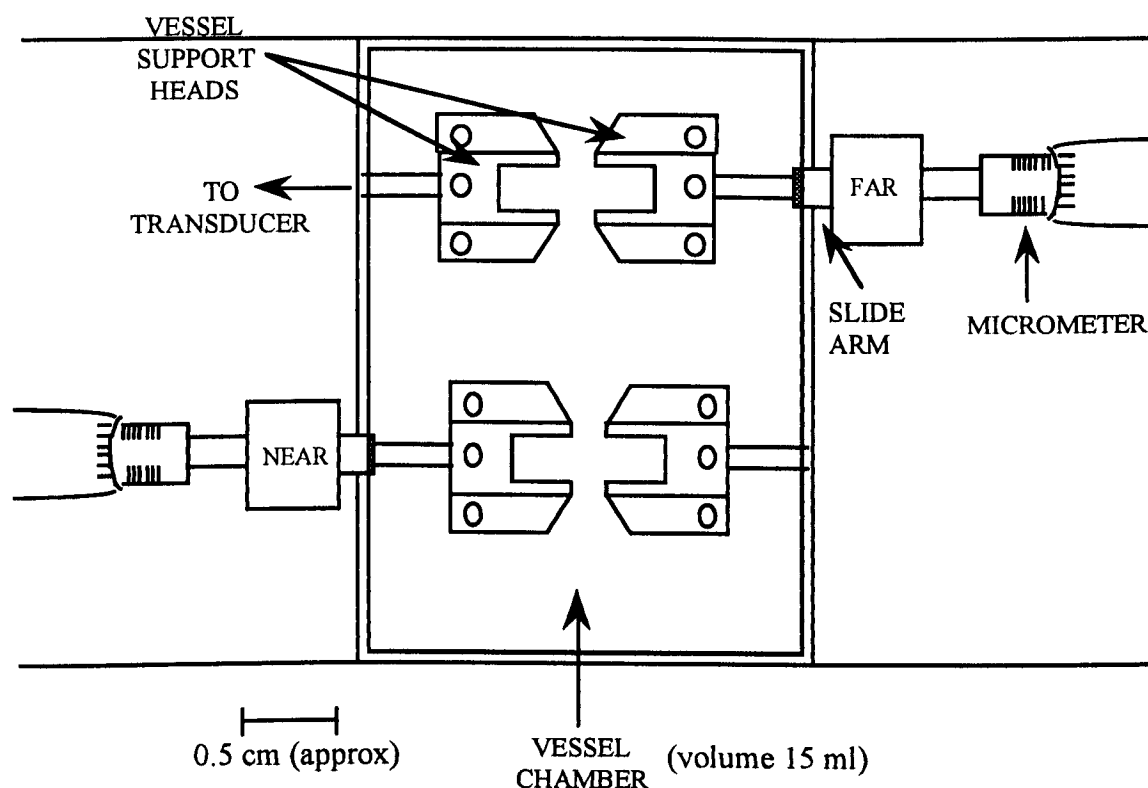

Figure 2.2.

Schematic diagram (not to scale) of Mulvany / Halpern wire myograph. The above model 500 A allows *in vitro* isometric measurement of a maximum of two preparations. Vessels are attached by means of wire to the vessel support heads. The vessel chamber is filled with Krebs solution, and is electronically heated to 37 °C.

One of the vessel supports is attached to a sensitive isometric force transducer, and the other is attached to an adjustable slide arm which is controlled by a micrometer. This allows distance between the supporting heads to be accurately adjusted, allowing tension to be placed on the preparation.

The temperature of the vessel chamber is electronically controlled via internal heating pads (within 0.1 °C). A digital readout of force and temperature is displayed on a separate myograph controller module. This in turn has output connections to a Linseis 6 channel chart recorder (model Typ 2065), to allow a hard copy of the force readout from both transducers.

2.1.3 Dissection of pulmonary arteries.

2.1.3.1 Rat pulmonary arteries.

Large extrapulmonary arteries.

Rats were killed by overdose of sodium pentobarbitone (60 mg/kg i.p.) and the heart and lungs removed and immediately placed into ice cold Krebs. The main pulmonary artery leaving the right ventricle was identified, and surrounding tissue cleared so that the right and left branches were visible. The vessels were then carefully dissected free and cleaned of connective tissue and fat. Each vessel constituted one ring, main pulmonary artery (3-4 mm i.d., 2-3 mm long), and pulmonary artery branches (2-3 mm i.d., 5-6 mm long), therefore giving a total of three arterial rings per rat. These vessels were placed in a vial of ice cold Krebs in preparation for mounting in the organ bath (see section 2.1).

Intrapulmonary resistance arteries.

The left lung was cut free and pinned to dissecting dish with its visceral surface exposed and parietal surface lying inferiorly. During the dissection, the preparation was frequently washed with ice cold Krebs solution. Using a dissecting microscope an incision was made along the superficial aspect of the bronchus, cutting from large proximal airway along the bronchial tree to distal bronchus / bronchiole (see figure 2.3).

Once completed, the associated pulmonary artery (~ 150 μm i.d.), branching parallel to the bronchus in the bronchovascular bundle was then easily identified beneath the bronchial wall. The bronchial tissue was then gently dissected free and removed from the artery beneath. The lung tissue lateral to the artery was carefully dissected free, the artery removed and placed into a vial of ice cold Krebs solution, in preparation for mounting on the myograph.

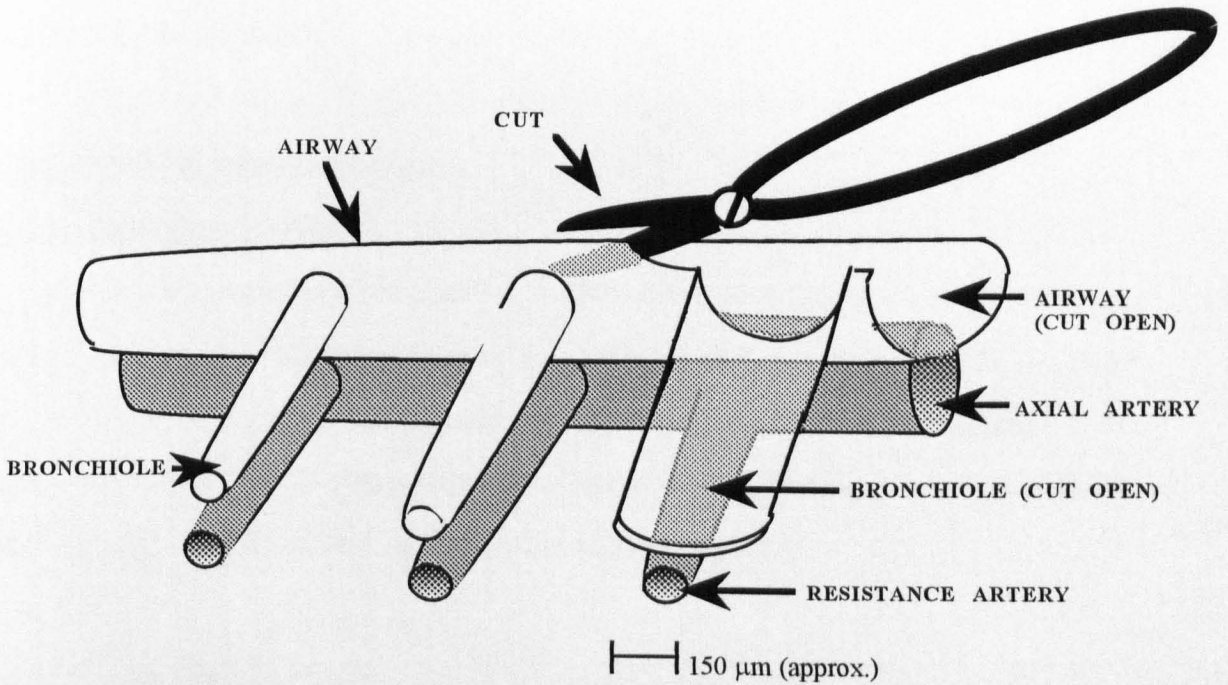

Figure 2.3.

Schematic diagram showing dissection procedure for rat pulmonary resistance arteries. The above diagram show the close association between the bronchial tree and the pulmonary arterial tree. The venous circulation has been removed from this diagram to avoid complication, but normally lies superior to the bronchial tree. Orientation of the lung in the above diagram is as follows : Visceral surface superior, parietal surface inferior, rostral region to the right. The arrows indicate the approximate location and size of pulmonary resistance arteries used in these studies.

2.1.3.2 Bovine pulmonary resistance arteries.

A lobe of bovine lung was placed on a dissecting tray with its visceral surface exposed. The main internal pulmonary artery was identified, and the airway lying superior to the artery was dissected free. The branching pathway of the pulmonary

arterial tree was followed until an intrapulmonary artery of approximately 3 mm i.d. was identified. A block of lung tissue (approximately 10 cm³) surrounding the 3 mm i.d. artery branch was then removed from the lobe. Using a dissecting microscope the branching pathway of the artery was followed until resistance arteries of the appropriate size were located (150-250 µm). Identification of a pulmonary resistance artery was assured by the proximity of the accompanying bronchiole. The resistance arteries were carefully dissected free from the surrounding parenchymal tissue and placed in to a vial of ice cold Krebs solution.

2.1.3.4 Human pulmonary arteries.

Large intrapulmonary arteries.

The lung samples were placed in a Krebs filled petri dish and a large pulmonary artery segment was identified. Depending on the original size of the sample, the artery was followed along its branching pathway until branches with internal diameters of 3-5 mm were located. The artery was then cleaned of surrounding parenchymal tissue, removed and mounted in the organ bath (see section 2.1).

Pulmonary resistance arteries.

Using a dissecting microscope the artery (3-5 mm) remaining within the lung sample was then followed further along its branching network until pulmonary resistance arteries of the appropriate size (~200 µm) were located. The arteries were cleaned of surrounding tissue, removed and placed in a vial of ice cold Krebs solution in preparation for mounting. The identification of a resistance artery was verified by the proximity of the accompanying bronchiole. This was found to be a useful tool when only small sections of lung were obtained. The location of the area of lung removed during surgery, and the size of the section obtained varied between samples, due to obvious differences in the surgery required for individual patients. However, great care was taken to ensure that vessels of the appropriate size were removed from each lung sample to minimise variation.

2.1.4.1 Myograph mounting procedure.

Vessels were mounted as pairs in the same bath of a Mulvany / Halpern small vessel wire myograph (J.P. Trading). The mounting procedure is similar to that described by Mulvany, *et al.*, (1977), although there are slight modifications. The mounting procedure for pulmonary vessels is shown in figure 2.4. The length of the arterial preparation once mounted on the myograph was ~2 mm. The myograph vessel chamber was filled with Krebs solution, and once the vessels were mounted, the heating mechanism was activated to increase the temperature to 37 °C. Vessels were bubbled with the appropriate gas mixture (see section 2.1.7.).

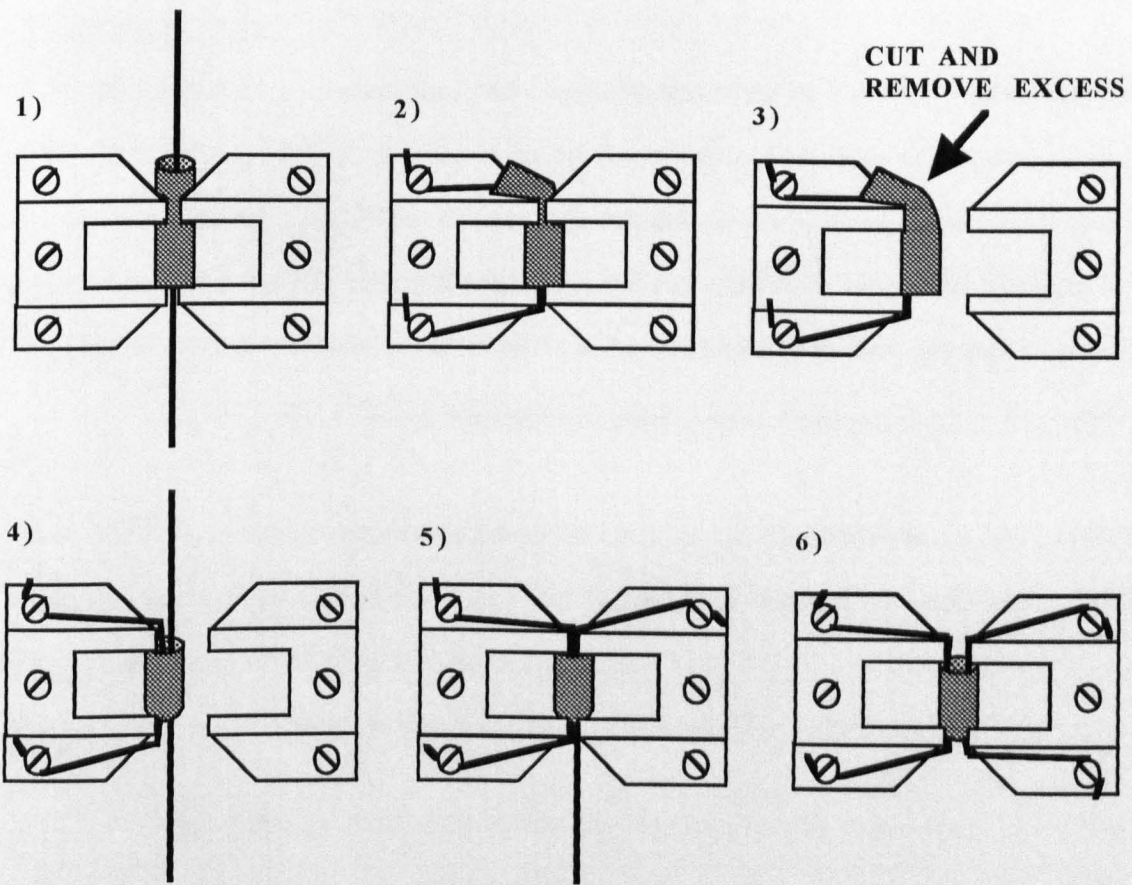

Figure 2.4.

Mounting procedure for pulmonary resistance arteries. Vessels to be mounted were placed in a petri dish containing Krebs, and whilst holding onto the cut end of the artery, a 40 μm diameter stainless steel wire was carefully passed through the lumen of the vessel.

1) This was then transferred to the Krebs filled organ bath of the myograph and the wire secured between the mounting heads such that the artery segment was correctly

positioned in the gap between the mounting jaws. 2) The free ends of the wire were then secured to the left mounting jaw by means of attaching screws. 3) The heads were then separated and any excess vessel that lay outside the jaw, and that had served to allow manipulation of the vessel whilst mounting, was carefully cut away. 4) A second 40 μm wire was then carefully passed through the lumen of the vessel. 5) The mounting heads were then closed and the free ends of the second wire were secured to the right mounting head. 6) The mounting heads were then separated and appropriate tension could now be placed on the vessel.

2.1.4.2 Normalisation

The normalisation procedure was originally described by Mulvany and Halpern in 1977. This procedure allows vessels to be stretched to stimulate a required resting transmural pressure. The Laplace relationship can derive the wall tension in a cylinder if its radius and the pressure within it are known. It can therefore be modified to give the relationship between these three variables for a vessel mounted on the myograph.

$$P_i = \text{Wall tension} / (\text{internal circumference} / 2\pi) \dots \dots \dots (1)$$

Where P_i is the effective pressure, being an estimate of the pressure (in kPa) which would be necessary to extend the vessel to the measured internal circumference. Wall tension is the force divided by the wall length i.e..

$$\text{Wall tension} = \text{Force (F)} / (\text{Length (L)} \times 2)$$

Note that the wall length is equal to twice the segment length, since there is both an "upper" and "lower" wall. After a given amount of stretch is placed on the vessel, the internal circumference (IC) can be calculated as follows.

$$IC_1 = (\text{micrometer reading at 1} - \text{micrometer reading at point B}) \times 2 + (IC_B)$$

Where point B is the point at which the two securing wires are just touching, and when using 40 μm diameter wires IC_B would equal 205.6 μm . The difference in the micrometer reading will be equivalent to the distance between the two wires.

Rearranging equation (1) gives

$$P_i = (2\pi) \times \text{Wall tension} / \text{IC}$$

substitute values for wall tension, and internal circumference

$$P_i = (2\pi) \times F / 2 \times L (205.6 + (2 \times \text{distance between wires}))$$

Therefore by using this relationship vessels could be stretched to mimic a required equivalent transmural pressure.

2.1.4.3 Choosing the correct pressure.

For the majority of systemic vessel preparations, the figure of 0.9 of L100 is used as a normalisation pressure. L100 is the diameter which the vessel would have if relaxed and under a transmural pressure of 100 mmHg. When set under these conditions the equivalent pressure of the vessel is normally in the range of 60-70 mmHg (depending on vessel type). As the pulmonary circulation normally operates under conditions of low pressure and resistance they should clearly be set up under appropriate conditions. It was therefore decided that pulmonary arteries taken from normal lungs would be tensioned to give equivalent transmural pressures of ~16 mmHg. This is approximately the pulmonary artery pressure which would be experienced *in vivo* (Fishman, 1976). For studies using pulmonary resistance arteries from pulmonary hypertensive animals, vessels were set up to mimic equivalent transmural pressures to which they would be exposed to *in vivo* (~16 mmHg for control, and ~36 mmHg for chronic hypoxic). These are representative pressures which have been demonstrated in rats under similar conditions and exposed to the same degree and duration of hypoxic exposure in order to develop pulmonary hypertension (Herget, *et al.*, 1978; Rabinovitch, *et al.*, 1979). Pulmonary artery pressure in control and chronic hypoxic rats used in this study was measured to ensure that these values were appropriate (see chapter 4). An extensive study on the effects of resting tension, on responsiveness in rat pulmonary resistance arteries was also carried out (see chapter 5).

2.1.5 Calibration of equipment.

The transducers and chart recorder used in the organ bath set up were calibrated daily using known weights. Calibration of the myograph equipment is more time consuming and therefore the myograph transducers, and the 6 channel Linseis recorder were calibrated every fortnight using known weights, however little variation was observed in readings from calibration to calibration.

2.1.6 General procedure for myograph and organ bath experiments.

The general procedure for *in vitro* studies are listed as follows, but may vary between individual experiments, therefore exact procedures are given in each experimental chapter.

- 1) After mounting of the preparations in the organ bath, or myograph, vessels were allowed to equilibrate for one hour in Krebs solution at 37 °C, bubbling with appropriate gas mixture, prior to the addition of any drugs.
- 2) Following this, vessels were then stimulated with 50 mM KCl to verify tissue viability and give a reference contractile response. Once the response reached plateau the vessels were then washed with fresh Krebs solution and allowed to return to baseline tension.
- 3) The vessels were then left for a further 30 minutes before the addition of any drugs.
- 4) A cumulative concentration response curve (CCRC) was then conducted to the required agonist covering a range of concentrations which ensured that threshold response, and maximum response (if possible) were included.
 - i) For agonists which reversibly bound to their receptor, following the initial CCRC, vessels were washed with fresh Krebs solution until the tension returned to baseline level. The tissues were then left for 20 minutes before the required antagonist / inhibitor was added and left for its required incubation period. Following this a second CCRC to the agonist was conducted. Some vessel preparations were used as time controls in that the second CCRC was conducted without the addition of the antagonist / inhibitor.
 - ii) For agonists which irreversibly bound to their receptor, only one CCRC could be conducted in each preparation. Therefore, separate tissues were used to perform

experiments using antagonists / inhibitors. In such experiments the antagonist / inhibitor drug was added 30 minutes after the KCl response and left for its required incubation period, before the CCRC was performed.

2.1.7 Gas mixture.

As the pulmonary vasculature is actively sensitive to O₂ and CO₂ concentration, a gas mixture which would mimic physiological conditions was chosen. The contents of the gas mixture used for bubbling tissues *in vitro* was as follows : 16 % O₂, 5 % CO₂, Balance N₂. Bubbling the Krebs bicarbonate solution with this mixture gives final bath O₂ tension of approximately 100 - 110 mmHg and CO₂ tension of 35 - 36 mmHg, with pH 7.4 (measurements taken by oxygen electrode and blood gas analyser), which are values equivalent to those found in pulmonary arteriolar blood. Although larger diameter pulmonary arteries will be carrying deoxygenated blood towards the lung (approximate O₂ tension of 40 mmHg), it was decided to use 16 % O₂ in these vessels to minimise variation between groups (with one exception, see chapter 3). The same gas mixture was also used when studying pulmonary vessels from chronic hypoxic rats and was also chosen in order to minimise variables between groups.

The standard gas mixture used for *in vitro* studies of isolated tissues is 95 % O₂, 5 % O₂, and this hyperoxic gas mixture was originally chosen to prevent areas of the isolated tissue preparation becoming hypoxic or anoxic. Decreasing O₂ tension from 95% may effect vascular reactivity in relatively thick walled preparations, for example umbilical arteries (Nair & Dyer, 1976). However as pulmonary arterial preparations are relatively non muscular and are thin walled, O₂ diffusion through the tissue wall should be a limiting factor in this case (Fishman, 1976).

2.1.8 Note on endothelin.

Cumulative concentration response curves conducted to ET-1 in pulmonary vessels were normally taken to a maximum concentration of 0.3 µM, and addition of this final concentration often produced a further contractile response in the tissue, and can

therefore not strictly be considered “maximal”. There are two reasons for not increasing the concentration of ET-1 further 1) The relative solubility of the peptide yields a stock solution of 100 μM therefore a large volume of stock solution must be added to 15 ml baths to give final concentrations of 1 μM 2) ET-1 (and related peptides) are extremely expensive and we could therefore not afford to use large volumes of stock solution. In some organ bath experiments, and a couple of myograph experiments, the maximum concentration achieved in the CCRC to ET-1 in control vessels was increased to 1 μM . In these experiments no further contractile response was observed to ET-1 therefore 0.3 μM seems to be an approximate value for achieving maximum contraction to ET-1 in pulmonary arteries.

2.2 Animal models used in these studies.

2.2.1 "In House" adult Wistar rat.

The adult Wistar rat from the "In House" breeding stock of the Institute of Physiologists own Animal Unit was used in initial experiments. The rat is a commonly used model for the study of the pulmonary circulation in many research groups (Hunter *et al.*, 1974; Rabinovitch *et al.*, 1979; Bonvallet, *et al.* , 1993) therefore it was important to characterise vascular reactivity of the resistance vessels in the rat pulmonary circulation. The Wistar rat would also be used to produce the pulmonary hypertensive model used in my studies. Animals were maintained on a twelve hour light-dark cycle and allowed free access to standard diet and water.

2.2.2 Bovine.

Bovine pulmonary resistance arteries were used in some experiments involving responses to 5-hydroxytryptamine (5-HT). These vessels were chosen for these studies as bovine intrapulmonary arteries have been shown to exhibit similar 5-HT receptor populations to those observed in human intrapulmonary arteries (Templeton *et al.* , 1993). Bovine lungs were obtained on the day of experimentation from the local abattoir (Duke St. Glasgow). Lungs were removed from freshly slaughtered cattle. The lobes of

lung were transported to the laboratory in a container filled with oxygenated Krebs solution.

2.2.3 Human.

Whenever possible studies were carried out using human pulmonary arteries. As human tissue was only available approximately once every month, the tissue was used to verify key experimental results obtained in the animal models used. Macroscopically normal sections of human lung were obtained from patients undergoing surgery for bronchial carcinoma, who did not have evidence of any other chronic lung disease. Samples were supplied by the Royal and Western Infirmaries, Glasgow. Samples were refrigerated in fresh Krebs solution on site, collected and studied no longer than 12 hours post-operative. Details of individual patient histories are not known. The treatment provided for each patient is variable and depends strictly on individual needs.

2.2.4 Hypoxic / hypobaric Rat.

2.2.4.1 Introduction.

Hypoxic animal models (mainly rats and mice) have been used since the 1920's to study various environmental effects and disease states. The animal models were exposed to hypoxic environments by use of environmental chambers (normobaric - decreased inspired O₂ at normal atmospheric pressure; or hypobaric - decreased inspired O₂ due to decreased atmospheric pressure), or by actual relocation of the animals to altitude where the inspired O₂ levels are lower than at sea level (see Campbell, 1927a,b,c and Timiras, *et al.*, 1957). These early investigations studied the acclimatisation of animals to altitude, or O₂ tensions which would be experienced at altitude. Animals exposed to these hypoxic environments exhibited initial weight loss and alterations in certain internal organ weights (Campbell, 1935; Timiras, *et al.*, 1957).

As previously stated in chapter 1, exposure to chronic global hypoxia is one of the factors which can lead to the development of pulmonary hypertension. By the late 1960's early 1970's, the normobaric and hypobaric animal models were being studied as

possible models of the human pulmonary hypertensive state (Naeye, 1965, 1967; Abbot, *et al.*, 1968; Bartlett, *et al.*, 1971). Further studies showed that the chronic hypoxic rat developed right ventricular hypertrophy, muscularisation of pulmonary arteries, polycythaemia and carotid body enlargement within 8-14 days, whereas recovery in air was slower (Hunter, *et al.*, 1974; Herget, *et al.*, 1978). All of these changes are also shown in human chronic hypoxia (Haselton, *et al.*, 1968; Naeye, 1961,1962). The basic principles of both models are described below.

• NORMOBARIC HYPOXIA

The normobaric method used by most investigators has been adapted from a chamber described by Cryer and Bartly in 1974. The oxygen concentration within the chamber is reduced from the normal 21% to ~10% (160 mmHg to ~80 mmHg O₂) by intermittent infusion of nitrogen from a liquid N₂ reservoir, the gas outflow of which is regulated electronically. To prevent the build up of CO₂, humidity and ammonia gas the air is circulated through specific chemical absorbers.

• HYPOBARIC HYPOXIA

Hypobaric hypoxia reduces the inspired O₂ content of the environment by reducing the atmospheric pressure within the chamber. This is the equivalent of taking the animals to high altitude. As the atmospheric pressure decreases, the partial pressure of the gaseous components of air decrease, therefore the partial pressure of O₂ inspired decreases. The relationship between atmospheric pressure and inspired O₂ is shown in figure 2.5. Note however that the percentage of the gaseous components of air will remain constant i.e. O₂ ~ 21%, N₂ ~ 78%, CO₂ and inert gases ~ 1%.

Hypobaric hypoxia is achieved by withdrawing air from the chamber by use of a pump, until the pressure within the chamber is equivalent to ~0.5 atmosphere (exact pressure may vary between groups; 500 mbar ≡ 380 mmHg) which reduces the inspired O₂ pressure from 160 mmHg to 80 mmHg. The chamber is continuously flushed with room air to maintain conditions of low humidity and CO₂.

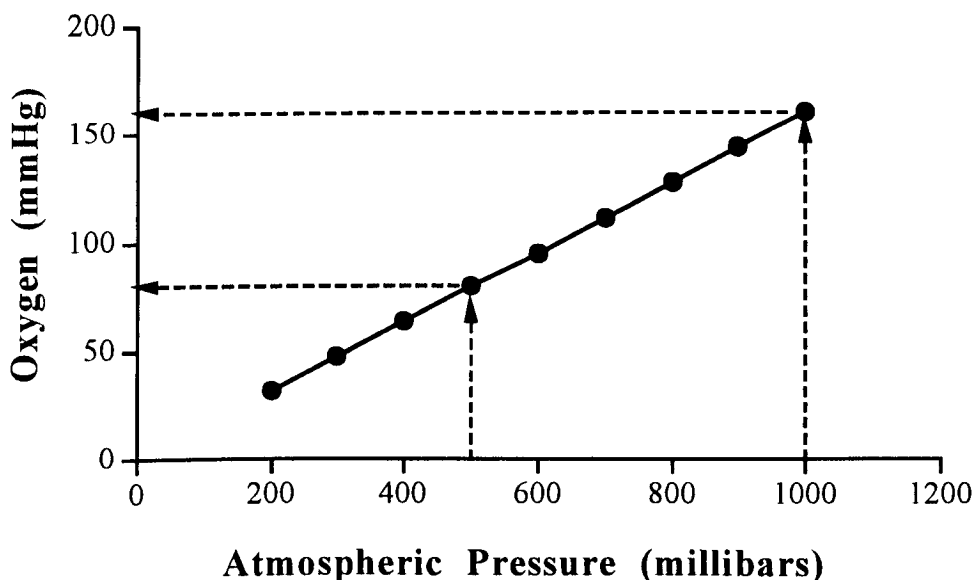

Figure 2.5.

Relationship between O₂ concentration and atmospheric pressure. Dotted lines indicate O₂ concentration at control atmospheric pressure (1000 mbar) and experimental pressure (500 mbar in the above case).

The hypoxic rat has been extensively studied and both normobaric and hypobaric hypoxic animal models are still commonly used by pulmonary research groups for example : Normoxic model (Eddahibi, *et al.*, 1992; Elton, *et al.*, 1992; Xue, *et al.*, 1994); Hypobaric model (Rabinovitch, *et al.*, 1981; Bonvallet, *et al.*, 1994; Petit, *et al.*, 1995). Normobaric and hypobaric hypoxic animals show similar structural and haemodynamic changes within the pulmonary circulation. The hypoxic hypobaric chamber has proved to be more economical than the normobaric chamber and it is the hypobaric model that is used in my studies. The Royal Hallamshire Hospital Sheffield designed and manufactured the hypoxic hypobaric chamber used in the following experiments, which conforms to the high safety standards required by the Home Office.

2.2.4.2 Chamber design and components

The design and layout of the hypoxic / hypobaric chamber are shown in figure 2.6. The chamber is designed to hold two standard rat cages, with up to four rats in each

Figure 2.6

Hypoxic / hypobaric chamber.

Diagrammatic representation of hypoxic / hypobaric chamber (not to scale). The inlet valve which controls pressure within the chamber is located on the door. A length of tubing connects the chamber to the pump, and can be seen leaving the rear of the chamber (vacuum hose connection). The safety vacuum switch and pressure gauge are also located at the rear of the chamber.

The photograph shows two standard rat cages within the chamber. The pressure reading at the time the photograph was taken reads ~840 mbar, as the chamber was being returned to experimental pressure after cleaning.

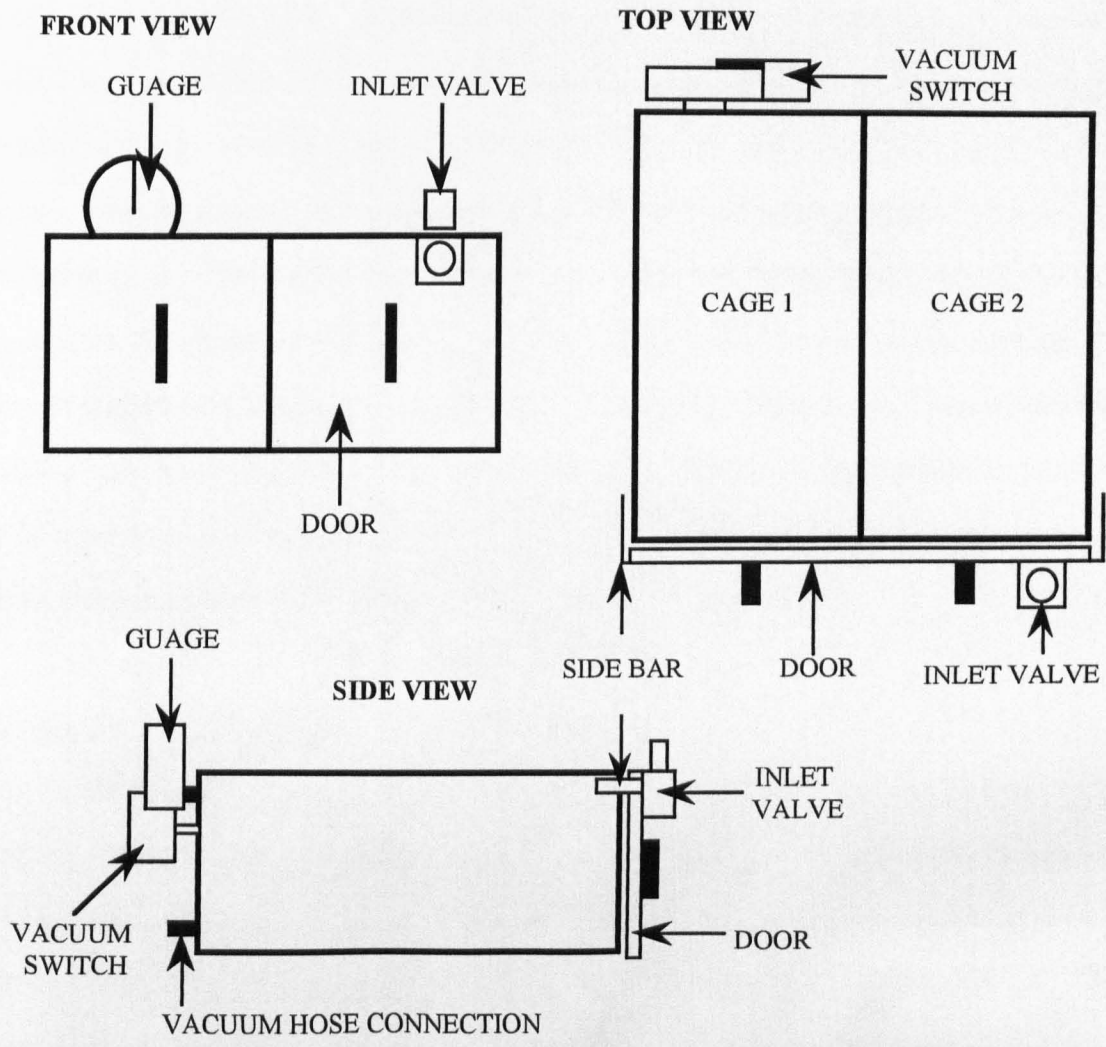

Figure 2.6. Hypoxic hypobaric chamber.

cage. The structure of the chamber is made from transparent high resistance Plexiglas which is rigid except for the door which can be removed to allow the rat cages to be placed in the chamber, or removed. Air is removed continually from the chamber by the pump, and the resulting pressure within the chamber is displayed on the gauge. The pressure is adjusted by the inlet valve positioned on the door; closing the inlet valve decreases the pressure within the chamber. Air is constantly flowing through the chamber at 45 L/min, ensuring that moisture and CO₂ do not build up. Temperatures are similar both inside and outside of the chamber. The animals are protected from exposure to low pressures by the vacuum safety switch (set at 460 mbar) which when triggered turns the pump off, allowing the pressure to return to its set value.

2.2.4.3 Maintenance of animals.

The chamber was housed in a specially designed environmental room which maintains temperature at approximately 21°C, humidity at 55 %, gives 20 changes of filtered air per hour and maintains a 12 hour on 12 hour off light cycle. Animals used in the experiments were obtained from credited commercial suppliers Harlan UK Ltd. The rats supplied were male specific pathogen free, and ordered in at age 28-30 days (approximately 60 g weight). Animals were allowed to acclimatise within the environmental chamber for five days before being split into two groups of four. One group of animals were placed in the chamber and the other group remained in normal atmospheric conditions to act as age matched controls.

Production and maintenance of chronic hypoxic rats.

- 1) The chamber door was removed and the rat cage was placed in the chamber so that the food and water dispensers were at the rear. This ensures that the animals could be observed at all times. Food hoppers and water dispensers had previously been filled to maximum capacity.
- 2) The chamber door was replaced and the pump switched on.

3) The inlet valve was closed slightly and the door was gently pushed closed to form a tight seal.

4) The chamber was taken down to the desired pressure (550 mbar \equiv 418 mmHg) in small steps by slowly closing the inlet valve, and observing the pressure reading on the gauge. Initially the rats were taken down slowly over two days to the desired pressure. Animals were carefully watched for any signs of distress at all times. Once the stable experimental pressure was reached rats were checked every 15 minutes for the following hour to ensure the pressure remained stable and the animals were not in distress.

5) The chamber could then be left to run for the experimental time required. Checks were made five times a day to ensure that

- pressure reading was not fluctuating below or above desired level
- temperature inside and outside the chamber was not fluctuating above 23°C or below 20°C.
- animals were not showing signs of distress
- pump was operative, not overheating or making unusual noises etc.

6) At weekends the chamber was checked by a member of the Central animal facility staff, University of Glasgow.

7) When the animals required fresh diet and water, usually every three days, the chamber was gradually taken to atmospheric pressure by opening the inlet valve, over a period of two hours. Once atmospheric pressure was reached the pump was switched off and allowed to cool for half an hour while the rat cages were cleaned and animals given fresh food and water. Following this the animals were placed back in the chamber, the pump switched on, and taken back to 550 mbar over a period of two hours.

After 14 days in the chamber, two of the rats were removed and the remaining two rats were taken back to experimental pressure for a further two days. Of the two rats removed one was immediately sacrificed and studied on that day along with an aged matched control. The second rat was left in room air to be studied no longer than 24 hours after removal from the chamber. The same procedure occurred on day 16 for the remaining two rats.

2.2.5 Assessment of pulmonary hypertension.

2.2.5.1 Using ventricular ratio measurements

In both clinical and experimental forms of pulmonary hypertension thickening of the right ventricular wall is observed. Chronic global hypoxia causes global pulmonary vasoconstriction, increasing pulmonary vascular resistance and pulmonary pressure. Right ventricular hypertrophy occurs due to the increased work load required to pump blood through a high resistance pathway. The degree of right ventricular hypertrophy gives an index of the development and degree of pulmonary hypertension (Hunter, *et al.*, 1974; Leach, *et al.*, 1977).

Procedure for ventricular measurements.

Rats from control and chronic hypoxic groups were sacrificed by overdose of sodium pentobarbitone (60 mg / kg i.p.). The thoracic cage was opened and the heart and lungs were removed. Atria and associated large calibre vessels were dissected from the ventricular mass, and the heart was dissected so to isolate the free wall of the right ventricle from the left ventricle plus septum as described by Fulton, *et al.*, 1952. The ventricles were first washed in Krebs saline, blotted dry on tissue and then wet weights were measured on a Oertling NA 114 balance. The ratio of right ventricular (RV) free wall weight to left ventricle plus septum (LV+S) was used as an index of right ventricular hypertrophy. The ratio of ventricular weight to body weight of the animals was also assessed to eliminate any possible error occurring from this.

2.2.5.2 Using histological methods

Pulmonary vascular remodelling due to pulmonary hypertension can be assessed histologically, by estimation of the number of thick-walled peripheral pulmonary vessels. Thick walled peripheral vessels (TWPV) are generally characterised by their proximity to the alveolar ducts, their size, and the nature of their elastic coat.

Procedure for histological examination of TWPV.

Rats were killed by overdose (as stated above) and the heart and lungs removed en bloc. The lungs were dissected free and fixed in 10% formal-saline. Complete transverse sections of the middle right lobe were cut 5 μm thick, and stained for elastic tissue and smooth muscle with elastic-van Gieson stain. The resulting sections were examined using a Zeiss Axiophot microscope. A double elastic lamina was said to be present when two laminae with a space between were visible for at least half the diameter in cross section. The counting of thick peripheral vessels is a time consuming job. As estimations of the percentage of thick walled peripheral vessels in the hypoxic hypobaric model of pulmonary hypertension are well documented (Hunter, *et al.*, 1974; Leach, *et al.*, 1977; Bonvallet, *et al.*, 1994) I chose not to systematically count each stained section, but simply visualise the presence or absence of these vessels in our rat groups. This would aid in the validation of the hypoxic model of pulmonary hypertension I was using.

Histological examination of pulmonary resistance arteries

Electron microscopy.

Pulmonary resistance arteries were dissected from control and chronic hypoxic rat lungs according to the methods stated in section 2.1.3. The vessels were fixed for 1 hour using 2% glutaraldehyde in 0.1M sodium cacodylate buffer at pH 7.2 (Sabatini, *et al.*, 1963). The specimens were then given three 20 minute washes in 0.1 M sodium cacodylate buffer at pH 7.2. Post-fixation was carried out using 1 % osmium tetroxide in 0.1 M sodium cacodylate buffer at pH 7.2. Following fixation the specimens were dehydrated with graded alcohol and embedded in araldite.

Semithin sections were cut with a glass knife on a L.K.B.3. Ultratome and stained by the polychrome method of Pasyk, *et al.*, (1989). The sections were then examined using a Zeiss Axiophot microscope and micrographs taken using Kodak Ektachrome 64 film.

Ultrathin sections were cut with a diamond knife and mounted on Formvar coated 1000 µm aperture grids. The ultrathin sections were double stained with uranyl acetate (Stempak & Ward, 1964) and lead citrate (Reynolds, 1963). The stained sections were examined using J.E.O.L. 100S electron microscope at 80kV and electronmicrographs taken on Kodak electron microscope film.

2.2.5.3. Using direct *in vivo* measurement of pulmonary artery pressure.

Direct measurement of the pulmonary artery pressure of the animals gives a clear indication of the extent of pulmonary hypertension. The closed chest method of pulmonary artery pressure requires placement of a vascular cannula in the pulmonary artery. The cannula enters through the right jugular vein, passing through the right atrium to right ventricle, and then is manipulated into the pulmonary artery (Kydd, 1966). The positioning of the cannula in the pulmonary artery is identified by the shape of the pressure wave. I adopted this technique initially when attempting to measure pulmonary artery pressure, however the pressure wave form within the pulmonary artery can also be simulated when the tip of the catheter leans against the ventricular wall (Herget and Palacek, 1972). I therefore decided to adopt the open chest method of pulmonary artery pressure measurement as described by Wanstall & O'Donnell, 1990.

Procedure for measurement of pulmonary artery pressure (open chest).

Rats from control and hypoxic groups were anaesthetised with sodium thiopentone 120 mg/kg i.p injection. The level of anaesthesia was constantly monitored throughout the procedure by absence of blink reflex and hind limb withdrawal reflex in the unlikely event of further anaesthetic administration being required. Once fully anaesthetised, the trachea was cannulated and the rat was artificially ventilated via a Harvard apparatus 680 rodent respirator. The thorax was opened and a heparin filled (100 u /ml) 23G hypodermic needle with the sharp point removed was inserted into the right ventricle and carefully advanced into the pulmonary artery. The hypodermic needle was attached via polyethylene tubing to a Spectramed physiological pressure transducer

(model number P23XL). The pulmonary artery pressure was measured on a 2 channel Linseis flat bed recorder (model number TYP LS). Correct placement of the needle in the pulmonary artery was confirmed by sight and the wave form of the pressure record, which differed from that obtained when the needle was withdrawn into the right ventricle. Mean pulmonary artery pressure (PAP) was taken as diastolic PAP + one third pulse pressure (systolic-diastolic PAP).

Measurement of pulmonary artery pressure with indwelling cannulae is also well documented within hypoxic animal models (Rabinovitch, *et al.*, 1979; Elton, *et al.*, 1992; Eddahibi, *et al.*, 1992) therefore I decided to verify pulmonary pressures in two animals to validate the development of pulmonary hypertension in the chronic hypoxic model.

2.3 Biochemical Methods.

2.3.1 Measurement of intracellular cyclic nucleotide concentrations.

2.3.1.1 Introduction.

Intracellular cyclic AMP (cAMP) and intracellular cyclic GMP (cGMP) concentrations were quantified by using a modified version of the technique described by Brown, *et al.*, (1972). The process involves competition for protein binding sites between radiolabelled cAMP / cGMP, and the unlabelled cAMP / cGMP to be quantified.

2.3.1.2 Preparation of samples

Control and chronic hypoxic (14 day exposure to hypoxia) rats were killed by overdose of sodium pentobarbitone (60 mg/kg i.p.), the heart and lungs removed and immediately placed into ice cold Krebs. Sections of pulmonary artery from different locations in the pulmonary vascular tree were then dissected free. Arteries were taken from the following four locations, main pulmonary artery (pulmonary trunk), first right and left branch, main intrapulmonary artery and pulmonary resistance arteries (see figure 2.7).

Figure 2.7.

Arterial preparations used in biochemical studies (not to scale).

Vessels were taken from 4 different locations in the rat pulmonary vasculature. Figure 2.7.A shows location extrapulmonary arteries used i.e. main pulmonary artery (4-5 mm i.d.) and branch pulmonary arteries (3-4 mm i.d.), in reference to other main vessels leaving the heart.

Figure 2.7.B shows location of intrapulmonary arteries used i.e. main intrapulmonary artery or axial artery (2-0.5 mm i.d.) and pulmonary resistance arteries (150-200 μ m i.d). The left lung is illustrated in figure 2.7.B rostral side to left, ventrolateral side to bottom.

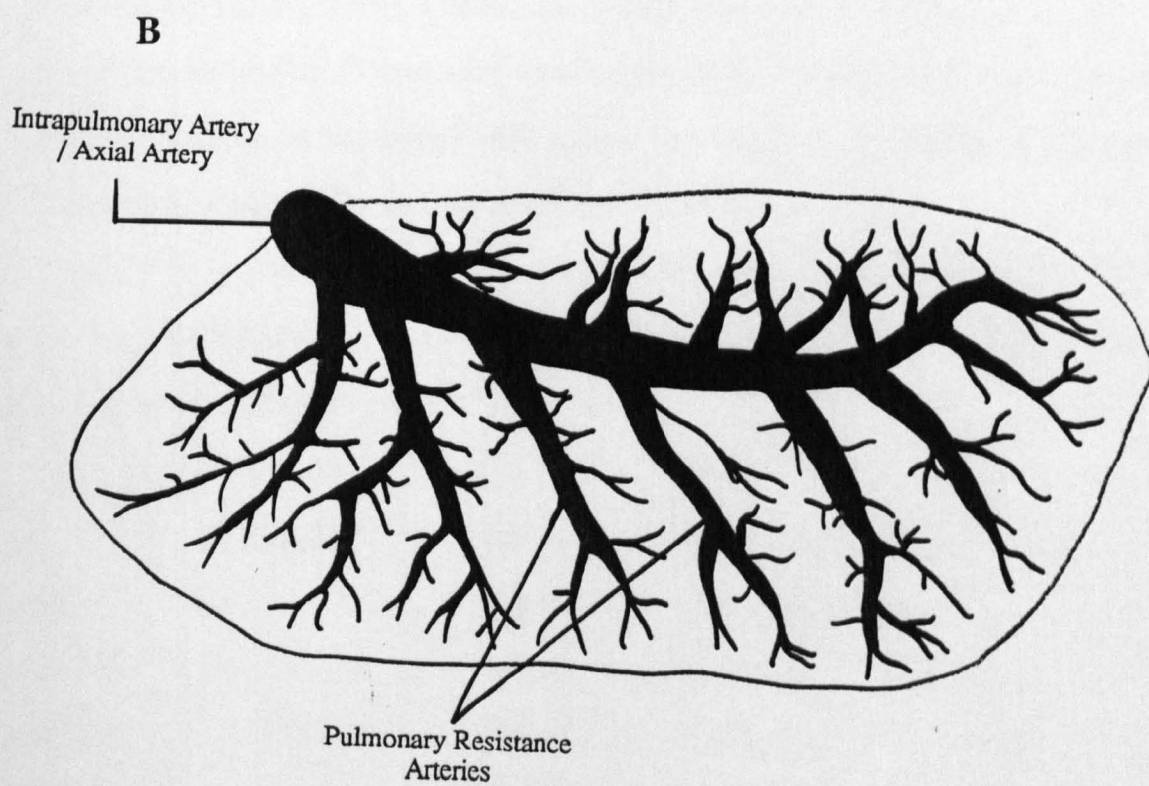
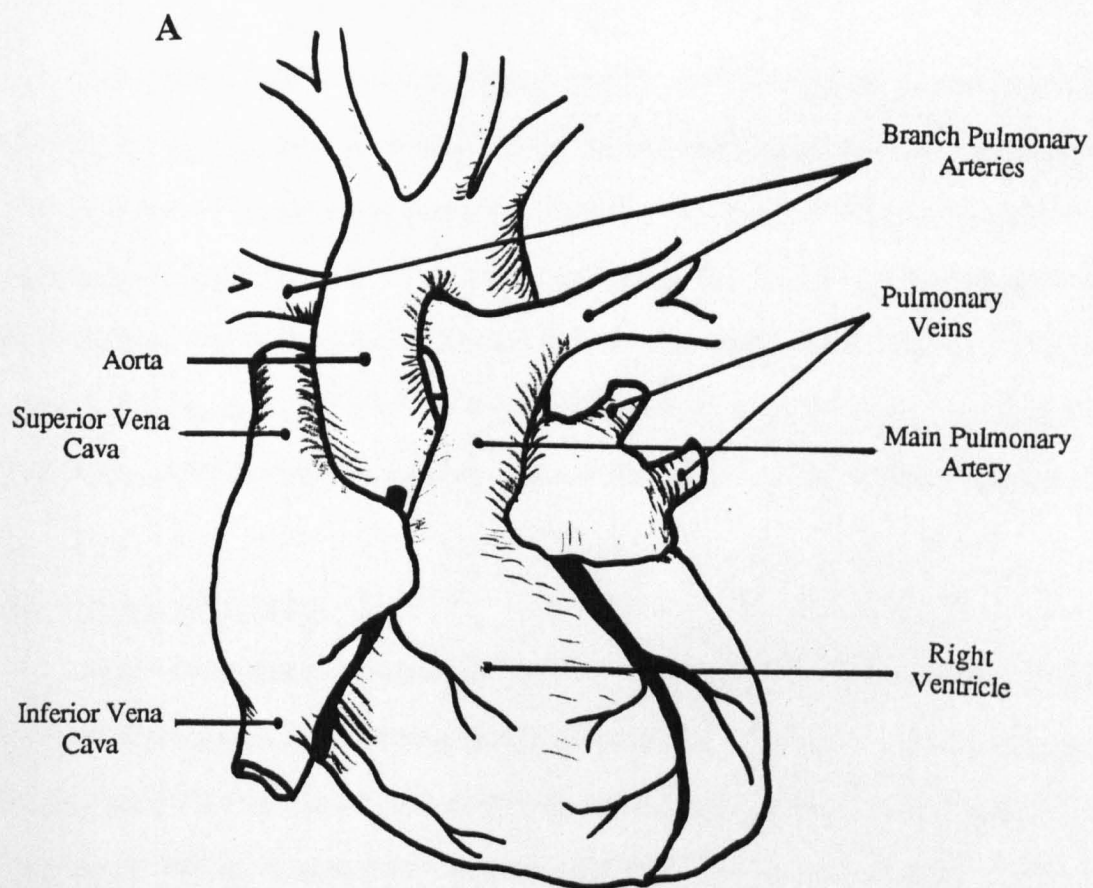

Figure 2.7.

Location of the arterial preparations used in biochemical studies (not to scale).

The arteries were cleaned of surrounding fat and parenchymal tissue, placed in a vial of Krebs solution and gassed at 37 °C for 30 minutes. The tissues were then rapidly frozen in liquid nitrogen before being homogenised in 0.6 ml of 4% perchloric acid and then left for at least 1 hour at 4 °C. After sonicating for 15 minutes the samples were then centrifuged at 3000 rpm for 10 minutes and the supernatant retained; 200 µl for Lowry protein assay, and the remainder of the supernatant was neutralised using KOH. Intracellular cAMP / cGMP concentration was determined by competition binding assay.

2.3.1.3 Assay procedure

Assay procedure for measurement of intracellular cAMP concentrations is given below. The procedure for measurement of intracellular cGMP was identical, except for the substitution of ³H-cGMP, and cGMP specific binding protein, where appropriate. Using assay buffer, various dilutions (0-320 pmols/ml) of unlabelled cAMP were prepared giving corresponding values in the assay of 0.06, 0.12, 0.25, 0.5, 1.0, 2.0, 8.0, and 16 pmol / 50 µl. These were used to prepare a standard curve for unknown cAMP determination by incubating with a fixed concentration of labelled cAMP and binding protein, also used for unknown samples as shown below.

[5',8-³H]-cAMP was diluted in assay buffer to give approximately 500 000 c.p.m. / ml. Binding protein was diluted 1 : 30 in assay buffer for use. Samples were then set up as shown below :

	<u>Sample</u>	<u>Buffer</u>	<u>³H-cAMP</u>	<u>Binding Protein</u>
Background	-	200 µl	100 µl	-
Total bound	-	100 µl	100 µl	100 µl
Standards	50 µl	50 µl	100 µl	100 µl
Unknowns	50 µl	50 µl	100 µl	100 µl

The incubation process was initiated by the addition of binding protein, hence this was always added last. After a 2 hour incubation period to allow the reaction mixture to reach equilibrium, unbound cAMP was precipitated by addition of 250 µl of a well mixed

suspension of 2 % (wt/vol.) activated charcoal and 1 % (wt/vol.) bovine serum albumin, in ice-cold assay buffer. Tubes were rapidly vortexed then centrifuged for 5 minutes at 12 000 rpm at 4 °C, to sediment the charcoal containing cAMP which had not bound to binding protein during the incubation. A 300 µl volume of each supernatant was taken to which 3 ml of scintillation fluid was added, and ³H-cAMP concentration was assessed by liquid scintillation counting, incorporating a purpose-designed curve fitting programme.

2.3.2 Measurements of phosphodiesterase activity.

2.3.2.1 Preparation of samples.

PDE activity was measured as described previously by Marchmont and Houslay, (1980). Use of ³H-cyclic nucleotide as a radioactive tracer allows enzyme activity to be assayed at subsaturating concentrations of substrate. Samples were prepared as described for measurement of intracellular cyclic nucleotides with the exception of the tissues being homogenised in 0.4 ml Tris HCl buffer containing a cocktail of protease inhibitors, as opposed to 4 % perchloric acid. Once again 200 µl of supernatant was retained for Lowry protein assay.

2.3.2.2. Assay procedure for phosphodiesterase activity.

At 4 °C, 25 µl of sample was added to 25 µl of 20 mM Tris HCl pH 7.4, containing 5 mM MgCl₂. Blanks, containing 50 µl of Tris / Mg²⁺ buffer only, were incorporated in every assay. To this 50 µl of ³H-cyclic AMP was added. In all experiments an unlabelled cAMP concentration of 1 µM was used. Tubes were then incubated at 30 °C for 10 minutes. Samples were boiled immediately for two minutes and allowed to cool to 4 °C again. Boiling terminates the reaction by completely inactivating PDE activity. Following this 25 µg (25 µl of a 1 mg / ml solution) of snake venom (*Hannah ophiophagus*) was added to the samples. Snake venom contains the enzyme 5' nucleotidase which converts 5'-nucleotide monophosphate, formed during the initial incubation, to 5'-nucleotide. Samples were incubated again at 30 °C for 10 minutes to allow the excess of 5' nucleotidase to act. Following this 400 µl of Dowex

was added, which selectively binds and therefore precipitates cyclic nucleotides. Note, Dowex was kept well stirred during use to ensure a homogenous suspension. Tubes were mixed well and left to stand for 15 minutes then vortexed again before sedimenting the Dowex resin by centrifugation at 12 000 rpm. A 150 μ l aliquot of the resulting supernatant was added to 3 ml of scintillation fluid for counting.

The cGMP PDE activity assay procedure adopted was exactly as stated above except for the substitution of cGMP for cAMP.

2.3.3 Protein Assay - Lowry Method.

The sample protein content was measured by the modified Lowry method as described by Peterson (1977), using a Sigma diagnostics protein assay kit (procedure No. P 5656). The principle of this method involves the formation of complexes between an alkaline reagent and the peptide to be measured, which subsequently turns purple-blue colour upon the addition of a phenyl reagent. Absorbance at a suitable wavelength can then be recorded, and the protein concentration determined from a calibration curve.

Procedure.

- 1) Standard solutions of BSA were prepared containing 0 - 80 μ g/ml of protein per ml, to compare with unknown samples from control and chronic hypoxic rat pulmonary arteries (100 μ l of retained homogenate supernatant).
- 2) All samples were diluted to 1 ml volume.
- 3) 1 ml Lowry reagent solution was added to all samples and mixed well.
- 4) Following 20 minutes incubation at room temperature, 0.5 ml of Folin & Ciocalteu's Phenol Reagent working solution was added to each tube and mixed well.
- 5) Samples were left for a further 30 minutes to allow colour to develop, and following this absorbance was measured at 500 nM. A calibration curve of absorbance vs. protein content of standard samples was plotted.
- 6) Protein concentration of unknown samples were determined from the calibration curve and multiplied by the appropriate dilution factor to obtain protein content of original sample.

2.4 Data analysis.

2.4.1 Calculation of results.

For *in vitro* measurements of isometric tension, data from preparations undergoing the same procedure were grouped together and are expressed as the mean value \pm standard error of the mean (SEM). Data are expressed as absolute contraction (mg wt. tension), percentage of reference contraction to 50 mM KCl (% 50 mM KCl), or as percentage of own maximum response in each tissue (% own maximum) depending on the agonist used (see individual chapters).

For measurement of PDE activity correct c.p.m. per sample was calculated by subtracting the blank value in each case. This is necessary as it is generally found that 2-5% of tritiated cAMP does not bind to the Dowex resin. Determining the protein content of each sample allowed results to be expressed relative to the protein content of each sample. Finally, specific activity in each case was calculated as pmol/min/mg protein. Data for intracellular cyclic nucleotide levels are expressed as absolute concentration pmol / mg. The n numbers for each group are given as standard in parenthesis and are expressed as n / n = number of ring preparations from number of animals (lungs).

2.4.2 Measurement of agonist potency.

As a measurement of agonist potency in tissue preparations pEC₅₀ values are given as standard; where EC₅₀ is the concentration of an agonist that produces 50 % of the maximum possible effect of that agonist, and the pEC₅₀ is equal to the -log of the EC₅₀. In some cases other percentage values for example pEC₂₀ and pEC₈₀ values were also calculated. pEC₂₀, pEC₅₀ and pEC₈₀ values were calculated by computer extrapolation from individual concentration response curves in each vessel.

2.4.3. Measurement of antagonist potency.

To assess the effects of antagonists and give an estimation of antagonist affinity pK_B and pA₂ values (where appropriate) have been calculated.

The pK_B value is the $-\log$ of the K_B which is the dissociation equilibrium constant for an antagonist; defined as the molar concentration of ligand required to occupy 50 % of the receptor pool. An estimate of the pK_B value where only one concentration of antagonist has been studied were calculated using the following direct fit equation.

$$pK_B = -\log K_B \quad \text{and} \quad K_B = [\text{Antagonist}] / r - 1$$

where r = concentration ratio $[A'] / [A]$, that is the concentration of agonist required to elicit an equal effect in the presence ($[A']$) and absence ($[A]$) of antagonist. The common value chosen here is the EC_{50} .

The pA_2 is the negative logarithm of the concentration of antagonist required to produce a two-fold shift to the right of the control response to an agonist. In this thesis pA_2 values for antagonist were calculated where three or more concentrations of an antagonist were studied, according to the methods described by Arunlakshana & Schild (1959). In brief this process involves plotting values obtained for $\log(r-1)$ (see above) against the \log concentration of antagonist studied. If the relationship between antagonist and receptor is competitive, this graph should yield a straight line with a slope not significantly different from unity, and an intercept on the abscissa equal to the pA_2 . In cases where the Schild plot is unity, the pA_2 value is equivalent to the pK_B value (Arunlakshana & Schild, 1959).

Several assumptions have to be taken into account when estimating pK_B values in the direct fit model. The equation used to calculate pK_B assumes that the antagonist interacts with agonist for unoccupied receptors in a simple, reversible manner. As has been discussed in chapter 1, the nature of ET's interaction with receptors is thought to be essentially irreversible, and this factor therefore questions the validity of the pK_B and pA_2 calculations. For calculation of pA_2 and pK_B values, response curves to agonists are normally with and without antagonist, in the same tissue preparation. The fact that only a single response curve to ET and related peptides can be constructed in isolated vessels will also increase the degree of error. However, it was decided to include these values as estimates of antagonist potency, although these main points must be taken into account when interpreting the data.

2.4.4. Statistical analysis.

Statistical comparisons between the means of three or more groups of data were studied using one way analysis of variance (ANOVA) followed by the appropriate ad hoc post test to assess which groups were statistically different. Comparisons between two groups were made using Students t-test for paired or unpaired data where appropriate. * $p < 0.05$ was considered to be statistically significant. Where a significant difference is indicated, the test used is always stated. The statistics software package InStat P203 base on a Macintosh IICI computer was used.

2.5. Solutions.

The composition of the modified Krebs-Heinslet solution was as follows : NaCl 118.4 mM, NaHCO₃ 25 mM, KCl 4.7 mM, KH₂PO₄ 1.2 mM, MgSO₄ 1.2 mM, CaCl₂ 2.5 mM, glucose 11 mM.

Normal saline : 9 g Na Cl / litre distilled H₂O.

Assay buffer for cAMP / cGMP : 50 mM Tris HCl (pH 7.4) containing 4 mM EDTA.

Assay buffer for PDE measurements : 20 mM Tris HCl (pH 7.4) containing 5 mM MgCl₂.

Protease Inhibitor cocktail composition was as follows. 2.5 mM Benzanidine, 0.2 mM PMSF, 1 µg/ml Antipain, 1 µg/ml Leupeptin and 1 µg/ml Pepstatin A.

cAMP and cGMP binding proteins, 3', 5' cAMP, 3', 5'cGMP, *Hannah ophiophagus* snake venom, Dowex 1-chloride, were kindly prepared by collaborators in the laboratory of Professor M.D. Houslay, Institute of Biochemistry, University of Glasgow.

2.6 Drugs and chemical reagents.

Compound	Supplier	Solvent / stock
Acetylcholine	Sigma	H ₂ O / 1 mM
BMS 182874 (5-(Dimethynamino)-N-(3,4-dimethyl-5-isoxzoly)-1-naphtalenesulphonamide)	Gift	H ₂ O / 1 mM
Bosentan (4-tert-butyl-N-[6-(2-hydroxyethoxy)-5-(2-methoxy-phenoxy)-2,2'-bipyrimidin-4-yl]-benzenesulphonamide))	Gift	H ₂ O / 1mM
Bovine Serum Albumin	Sigma	-
BQ-788 (N-cis-2,6-dimethylpiperidinocarbonyl L-γ-MeLeu-D-Trp(COOCH ₃)-D-Nle)	Peptide International	0.1 % DMSO / 1 mM
Charcoal (Norit A)	Sigma	-
Dowex-1-chloride	Sigma	-
Endothelin-1	Biomac Glasgow	H ₂ O / 100 μM
Endothelin-3	Peninsula Laboratories	H ₂ O / 100 μM
FR 139317 (N-CO-L-Leu-D-1-Me-Trp-D-3(2-Pyridyl) Ala-OH)	Neosystems	H ₂ O / 100 μM
Heparin	Evans	500 u/ml
L-NAME (N ^ω -nitro-L-arginine methylester)	Sigma	H ₂ O / 0.1 M
Lowry Protein assay kit (P 5656)	Sigma	-
Noradrenaline	Sigma	H ₂ O / 10 mM
Pentobarbitone Sodium (Uthetal)	Rhone	200 mg/ml
Sarafotoxin S6c	Sigma	0.1 % acetic acid / 100 μM
SB 209670 (1S,2R,3S)-3-(2-carboxymethoxy-4-methoxyphenyl)-1-(3,4-methyleudioxy-phenyl)-5-(prop-1-yloxy-indane-2-carboxylic acid)	Gift	H ₂ O / 1 mM
Sodium nitroprusside	Sigma	H ₂ O / 1 mM
Sumatriptan (GR 43175)	Glaxo	H ₂ O / 1 mM

<u>Compound</u>	<u>Supplier</u>	<u>Solvent / stock</u>
Thiopentone Sodium	Evans	Saline / 120 mg/ml
U46619 (9,11-Dideoxy-11 α ,9 α -epoxymethanoprostaglandin F _{2α})	Upjohn	absolute alcohol / 1 mM
5-Hydroxytryptamine	Sigma	H ₂ O / 10 mM
³ H cAMP	Amersham	-
³ H cGMP	Amersham	-

H₂O = distilled water. DMSO = dimethylsulphoxide. All subsequent dilutions were made in distilled water.

Chapter 3

Endothelin Receptor Subtypes in Small and Large Pulmonary Arteries of the Rat

3.1 Introduction

The importance of the pulmonary circulation as a site of biosynthesis and clearance of ET-1 has previously been introduced in this thesis (section 1.4). In similar fashion to many vasoactive compounds, ET-1 has been shown to mediate both vasoconstriction and vasodilatation of the pulmonary vasculature depending on the species, preparation and the degree of initial vascular tone present (see section 1.3). There are two main subtypes of ET-receptor denoted ET_A and ET_B (Arai, *et al.*, 1990; Sakurai, *et al.*, 1990). To briefly re-cap on the properties of these receptors : ET_A demonstrates selectivity for ET-1 over ET-3, whereas the ET_B receptor is non-isopeptide selective.

In similar fashion to the systemic vasculature, it is generally accepted that vasodilator responses to ET-1 in the pulmonary circulation are mediated via activation ET_B receptors, however the receptor mediating the vasoconstrictor response appears to vary between species. In rat, dog and guinea-pig isolated pulmonary arteries, the vasoconstrictor response to ET-1 appears to be mediated solely via the ET_A receptor subtype, due to the relative potency of the ET isopeptides and / or the ability of ET_A selective antagonists to attenuate the response (Watanabe, *et al.*, 1991b; Douglas, *et al.*, 1993; Cardell, *et al.*, 1993). However, in the rabbit pulmonary circulation, potent vasoconstrictor responses to selective ET_B agonists are observed and vasoconstriction to ET-1 in this preparation are relatively resistant to the actions of BQ-123 (selective ET_A receptor antagonist) (Panek, *et al.*, 1992; LaDouceur, *et al.*, 1993). This therefore suggests the involvement of vascular ET_B receptors mediating vasoconstriction in the rabbit pulmonary artery. All of these *in vitro* studies were conducted in large pulmonary arteries, internal diameters ranging from 2 to 5 mm and the *in situ* location of the vessel varied from main or branch extrapulmonary arteries, to intrapulmonary arteries depending on the species studied. The relative sizes of blood vessels in the rat pulmonary vasculature has resulted in the majority of *in vitro* isolated vessel studies being conducted on extrapulmonary capacitance arteries, i.e. the pulmonary trunk and primary left and right branches. As the pulmonary resistance arteries are important

determinants of pulmonary vascular resistance it is of interest to examine the vascular responses to ET-1 and related peptides in these vessels.

In this chapter, I examined the vascular reactivity to ET-1 in the intrapulmonary resistance arteries of the normal adult rat. In addition, the vascular effects of ET-1 in the larger extrapulmonary capacitance arteries were also studied, to compare and contrast vessels of different size, structure and location in the pulmonary arterial tree. The peptide sarafotoxin S6c (SxS6c) was used as a selective ligand for the ET_B receptor subtype (Williams, *et al.*, 1991), and responses to this peptide were compared to the endogenous peptide ET-1, which will act on both ET_A and ET_B receptor subtypes. At this early stage of my research, very few receptor antagonists were commercially available, and therefore the relative potencies of the constrictor peptides was an important determinant of the receptor subtypes present. The receptor antagonist FR 139317 is highly selective for the ET_A receptor subtype and was used to determine the role of ET_A receptors in mediating vasoconstriction (Sogabe, *et al.*, 1993). Therefore, using the limited compounds available, I attempted to identify the receptor subtypes mediating ET-induced responses in both extrapulmonary and pulmonary resistance arteries of the rat.

3.2 Methods.

Control adult Wistar rats from the Institute of Physiology's own animal unit were used in this initial study. Male animals of approximately 250g were killed by overdose of sodium pentobarbitone (60 mg / kg i.p.) and the heart and lungs removed en bloc.

Large diameter pulmonary arteries.

The left and right branch extrapulmonary arteries were dissected out and mounted in 5 ml organ baths as described in the methods section (chapter 2). After mounting in the organ bath, an initial tension of 1.5g was placed on each vessel (optimal tension, personal observations). In these experiments, pulmonary artery rings were placed in Krebs solution at 37 °C and bubbled with a gas mixture of 8 % O₂, 6 %

CO₂ balance N₂, yielding final bath O₂ tension of 45-50 mmHg and CO₂ tension of 35-36 mmHg (measurements taken with oxygen electrode and blood gas analyser). This bubbling mixture mimics the gas tensions found in deoxygenated blood which would be flowing through large diameter extrapulmonary arteries *in vivo*. This study is an exception in that 8 % O₂ was used in comparison to 16 % O₂ in all other studies. As it was observed that contractile responses to ET-1 in large capacitance pulmonary arteries were similar in both gas mixtures (personal observations, data not shown), it was therefore decided to minimise variation between groups and use 16 % O₂ for all subsequent studies.

Pulmonary resistance arteries.

Pulmonary resistance arteries (~150 µm i.d) were dissected out and mounted according to methods section (chapter 2). Using the normalisation procedure vessels were then stretched to an equivalent transmural pressure of ~16 mmHg, which is the physiological pressures that these vessels would experience *in vivo* (Herget, *et al.*, 1978). The vessels were bathed in Krebs solution at 37 °C and bubbled with 16 % O₂, 5 % CO₂ balance N₂.

Experimental protocol.

Both sizes of arterial preparation were allowed to equilibrate for 1 hour prior to the addition of any drugs. Vessels were then stimulated with exogenous application of 50 mM KCl, and once the contractile response had reached plateau, the vessels were washed three times with fresh Krebs solution. Following this, the integrity of the vascular endothelium was assessed by the ability of 1 µM ACh to cause relaxation after precontraction with 1 µM NA. Following washout and return to baseline tension, cumulative concentration response curves (CCRC's) to ET-1 and SxS6c (0.01 pM - 300 nM or 1 µM) were constructed following either :

A) 45 minute "rest period" or

B) 45 minute incubation period with a chosen concentration of FR 139317.

Table 3.1 below illustrates the experiments carried out in the different vessel types.

	Large extrapulmonary artery	Pulmonary resistance artery
Endothelin-1	✓	✓
Sarafotoxin S6c	✓	✓
ET-1 + FR 139317	✓ (0.1 - 10 μ M)	✓ (0.1 - 10 μ M)
SxS6c + FR 139317	✗	✓ (at 1 μ M)

Table 3.1

Summary of experimental procedures performed.

There is evidence to suggest that endothelial ET_B receptors can mediate vasodilatation in isolated pulmonary arteries via endothelial release of NO (Zellers, *et al.*, 1994; Carville, *et al.*, 1993). Therefore the effect of the nitric oxide synthase inhibitor L-NAME on responses to SxS6c in pulmonary resistance arteries was also investigated. In these experiments, L-NAME (100 μ M) was added 15 minutes prior to construction of CCRC to SxS6c.

Data analysis.

Graphical data are expressed as percentage of reference contractile response to 50 mM KCl or as percentage of own maximum contractile response. pEC₂₀ pEC₅₀ and pEC₈₀ values (where appropriate) were calculated according to the methods stated in chapter 2. Relaxations induced by ACh were calculated as a percentage of the level of precontraction to NA in each preparation. Except where otherwise stated, all statistical comparisons of the means of groups of data were made by Students t-test for unpaired data. pA₂ values and pK_B values for the antagonists FR 139317 were calculated according to methods section 2.4.3.

3.3 Results.

Contractile responses to 50 mM KCl were 379 ± 20 mg wt tension and 187 ± 12 mg wt tension in rat extrapulmonary arteries and pulmonary resistance arteries respectively ($*** p < 0.001$; $n = 20$ rings from 20 lungs for both arterial preparations). Both extrapulmonary arteries and pulmonary resistance arteries had intact vascular endothelium with relaxations to ACh of 64 ± 3 % in extrapulmonary arteries and 45 ± 4 % in pulmonary resistance arteries ($** p < 0.01$; $n = 10$ rings from 10 lungs for both arterial preparations). The average internal diameter of rat pulmonary resistance arteries was 175 ± 6 μm at an equivalent transmural pressure of 17 ± 0.5 mmHg ($n = 16$ preparations from 16 lungs).

Responses to ET-1 and SxS6c.

Extrapulmonary artery rings.

Figure 3.1.A shows responses to ET-1 and SxS6c in rat extrapulmonary arteries. ET-1-induced contractile responses in these vessels were slow to develop (between 3 - 5 minutes at threshold concentration) but contractile responses were well maintained once established. Threshold response to ET-1 was at 0.2 nM and the maximum response was achieved at 0.1 μM , with maximum contractile values of 204 ± 14 % of the reference contraction to KCl in these vessels. $p\text{EC}_{50}$ values for ET-1 are shown in table 3.2. In contrast to ET-1, the ET_B receptor agonist SxS6c was almost completely inactive in this vessel preparation, producing a slight vasoconstriction at 0.1 μM of 20 ± 3 % of 50 mM KCl response ($*** p < 0.001$ vs. ET-1).

Pulmonary resistance arteries.

Figure 3.1.B shows responses to ET-1 and SxS6c in rat pulmonary resistance arteries. ET-1 also produced contractile responses in these pulmonary resistance arteries which demonstrated slow onset, but were well maintained once developed. Threshold response to ET-1 was at 8 pM and the maximum contractile response was achieved at 0.1 μM , with values of 210 ± 5 % of the reference contraction to 50 mM

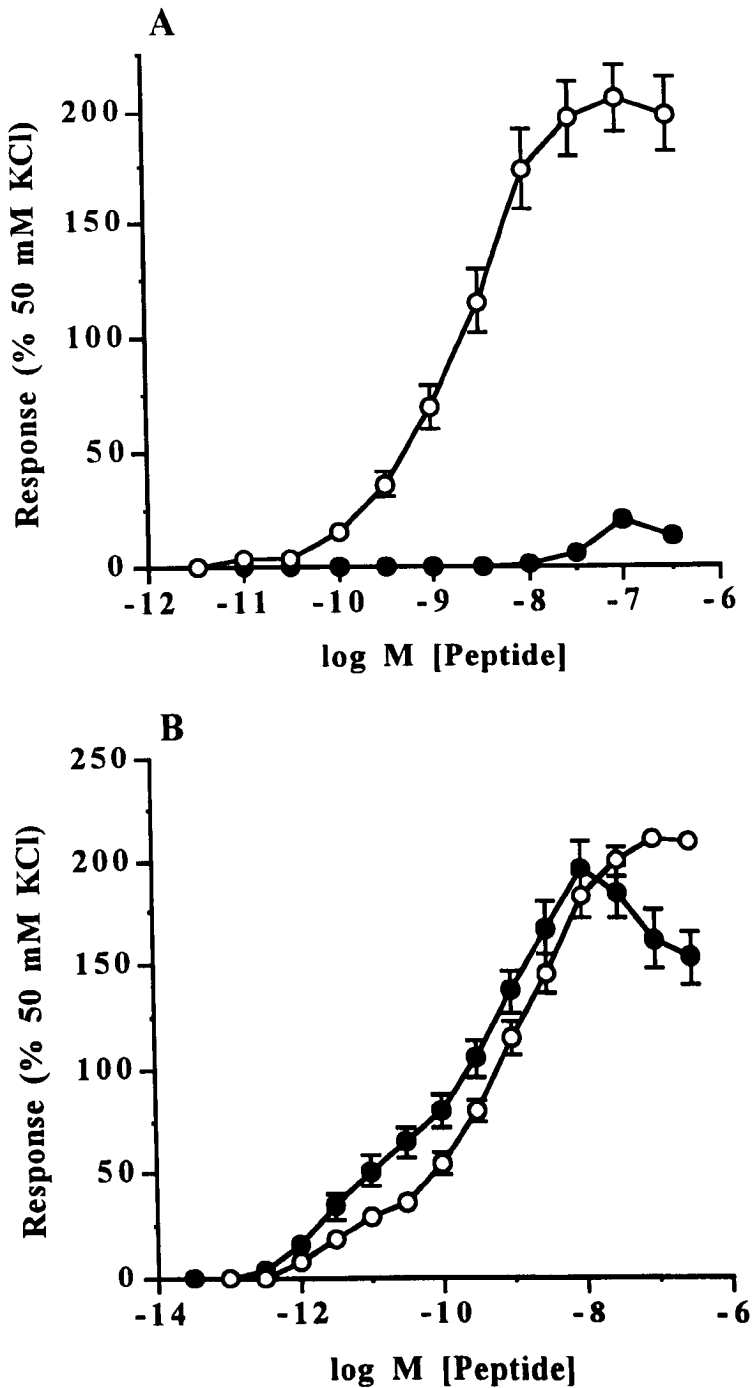

Figure 3.1

Responses to ET-1 and SxS6c in rat extrapulmonary artery and pulmonary resistance arteries. **A** Rat extrapulmonary arteries : CCRC to ET-1 (○, n = 12 / 11); CCRC to SxS6c (●, n = 5 / 4). **B** Rat pulmonary resistance arteries : CCRC to ET-1 (○, n = 8 / 8); CCRC to SxS6c (●, n = 10 / 8). Data are expressed as percentage of reference contraction to 50 mM KCl in each vessel. Each point represents the mean ± SEM.

	Extrapulmonary artery		Pulmonary resistance artery	
	pEC ₅₀	n / n	pEC ₅₀	n / n
Endothelin-1	8.56 ± 0.09	12 / 11	9.05 ± 0.08 ^a	8 / 8
Sarafotoxin S6c	inactive	5 / 4	9.75 ± 0.15 ^{††}	10 / 8
ET-1 + FR 139317 (0.1 μM)	8.47 ± 0.09	7 / 7	9.06 ± 0.27	6 / 6
ET-1 + FR 139317 (1 μM)	7.68 ± 0.22 ^{**}	11 / 9	8.48 ± 0.24 [*]	6 / 6
ET-1 + FR 139317 (10 μM)	7.13 ± 0.22 ^{***}	6 / 5	8.42 ± 0.21 ^{**}	5 / 5
SxS6c + L-NAME (100 μM)	✗	✗	10.11 ± 0.13	5 / 5
SxS6c + FR 139317 (1 μM)	✗	✗	10.02 ± 0.08	8 / 5

Table 3.2 pEC₅₀ values for peptides in rat pulmonary arteries.

pEC₅₀ values for ET-1 in the presence and absence of FR 139317, and SxS6c in the presence and absence of L-NAME or FR 139317. n /

n = number of ring preparations from number of animals. Statistical comparisons were made using Students unpaired t-test.

^ap < 0.01 ET-1 in extrapulmonary artery vs. ET-1 in pulmonary resistance arteries.

^{††}p < 0.01 ET-1 vs. SxS6c in pulmonary resistance arteries.

^{*}p < 0.05, ^{**}p < 0.01, ^{***}p < 0.001, ET-1 + FR 139317 vs. ET-1 control.

KCl in these vessels. ET-1 was approximately 3 fold more potent in pulmonary resistance arteries compared than in extrapulmonary arteries (see table 3.2 for pEC₅₀ values). The response curve to ET-1 in pulmonary resistance arteries appears biphasic in nature with a shallow component from 1 pM to 0.1 nM, followed by a steeper component at higher concentrations. In contrast to observations in extrapulmonary arteries, the ET_B receptor agonist SxS6c produced significant contractile responses in pulmonary resistance arteries which were 5 fold more potent than contractile responses to ET-1 in this preparation. Responses to SxS6c were similar to ET-1 in that they demonstrated slow onset. The threshold contractile response for SxS6c was at 2 pM and maximum vasoconstriction achieved at 10 nM. Maximum contractile response to SxS6c was 196 ± 13 % of the reference contraction to 50 mM KCl, and did not differ significantly from the maximum contractile response to ET-1. The response curve to SxS6c exhibits a “drop off” in tension at concentration above 10 nM.

Effect of FR 139317 on responses to ET-1.

Extrapulmonary arteries.

Figure 3.2A and B show the effect of the ET_A receptor antagonist FR 139317 (0.1 - 10 μM) on contractile responses to ET-1 in rat extrapulmonary arteries. The pEC₅₀ values for ET-1 in the presence and absence of FR 139317 are shown in table 3.2. Incubation with the antagonist (at all concentrations tested) had no significant effect on baseline tension of rat extrapulmonary arteries. From figure 3.2 and table 3.2 it can be seen that FR 139317 at 0.1 μM had no effect on contractile responses to ET-1, whereas 1 and 10 μM of the antagonist produced significant rightward shifts in the response curve to ET-1. The maximum contractile response to ET-1 is not significantly reduced in the presence of any concentration of the antagonists tested, as shown in figure 3.2.A. Table 3.3 shows the pK_B values for FR 139317 in this preparation. Schild regression produced a pA₂ value of 6.83 ± 0.07; with a corresponding slope of 0.81 ± 0.06 (n = 6) which is significantly less than unity (*p < 0.05; one sample t-test).

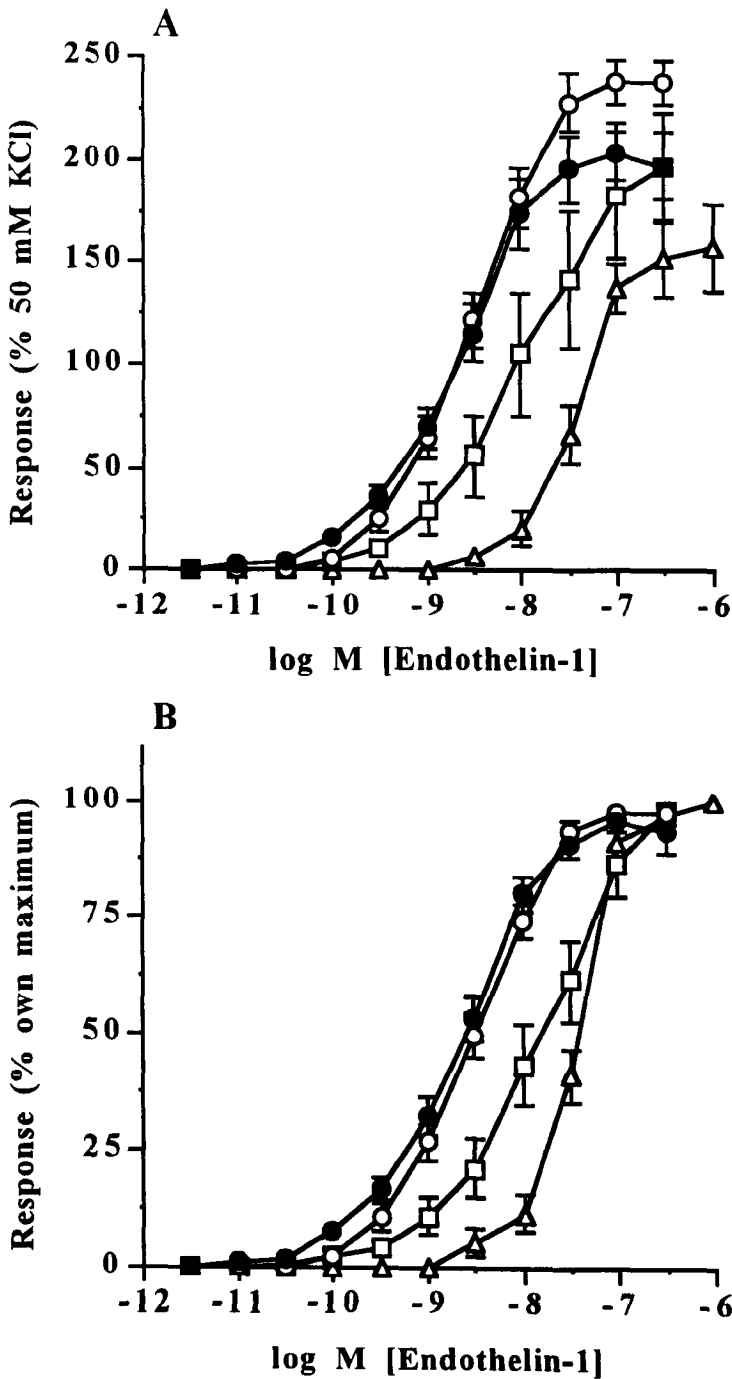

Figure 3.2

Effect of FR 139317 on responses to ET-1 in rat extrapulmonary arteries. CCRC's to ET-1 (●, n = 12 / 11); in the presence of 0.1 μM FR 139317 (○, n = 7 / 7); in the presence of 1 μM FR 139317 (□, n = 11 / 9) and in the presence of 10 μM FR 139317 (△, n = 6 / 5). **A** Data are expressed as percentage reference contraction to 50 mM KCl. **B** Data are expressed as percentage own maximum contraction. Each point represents the mean ± SEM.

The calculated pA_2 value is not significantly different from pK_B values at both 1 and 10 μM in this preparation.

Pulmonary resistance arteries.

The effect of the ET_A receptor antagonist FR 139317 (0.1 - 10 μM) on responses to ET-1 in rat pulmonary resistance arteries is demonstrated in figure 3.3.A and B. A summary of the pEC_{50} values for ET-1 in the presence and absence of FR 139317 are shown in table 3.2. Incubation with the antagonist (at all concentrations tested) had no significant effect on baseline tension of rat pulmonary resistance arteries. FR 139317 at 1 and 10 μM (but not 0.1 μM) caused a significant rightward shift in responses to ET-1 in this preparation. However FR 139317 does not appear to be working in a concentration-dependent fashion as 1 and 10 μM of the antagonist produce the same degree of rightward shift. The maximum contractile response to ET-1 in these vessels was not affected by FR 139317 at any of the concentrations studied (see figure 3.3.A).

	Extrapulmonary artery		Pulmonary resistance artery	
	pK_B value	n	pK_B value	n
ET-1 + FR (1 μM)	6.95 ± 0.13	11	$6.28 \pm 0.23^*$	6
ET-1 + FR (10 μM)	6.48 ± 0.19	6	$5.34 \pm 0.19^{** \dagger}$	5

Table 3.3

Estimated pK_B values for FR 139317 in rat pulmonary arteries. FR = FR 139317. * $p < 0.05$ FR (1 μM) extrapulmonary vs. FR (1 μM) pulmonary resistance artery. ** $p < 0.01$ FR (10 μM) extrapulmonary vs. FR (10 μM) pulmonary resistance artery. † $p < 0.05$ FR (1 μM) vs. FR (10 μM) pulmonary resistance artery, Students unpaired t-test.

The pK_B values for FR 139317 in pulmonary resistance arteries are shown in table 3.3 (above). Schild analysis produced a pA_2 value of 7.22 ± 0.32 ; with a corresponding slope of 0.23 ± 0.03 which is significantly less than unity (** $p < 0.001$ one sample t-test). The pK_B values at 1 and 10 μM are significantly different and not comparable with the calculated pA_2 value. All this evidence shows that FR 139317 is

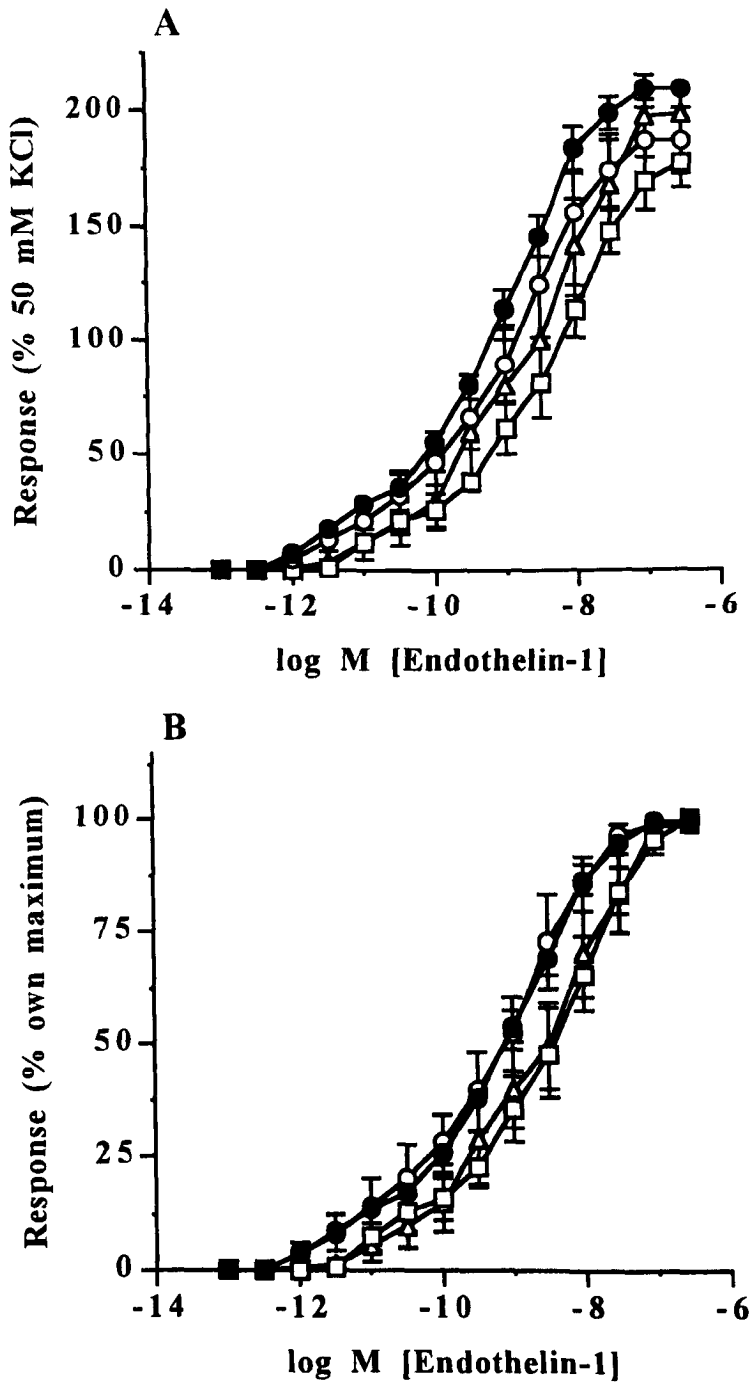

Figure 3.3

Effect of FR 139317 on responses to ET-1 in rat pulmonary resistance arteries. CCRC's to ET-1 (●, n = 8 / 8); in the presence of 0.1 μ M FR 139317 (○, n = 6 / 6); in the presence of 1 μ M FR 139317 (□, n = 6 / 6) and in the presence of 10 μ M FR 139317 (Δ, n = 5 / 5). **A** Data are expressed as percentage reference contraction to 50 mM KCl. **B** Data are expressed as percentage own maximum contraction. Each point represents the mean \pm SEM.

not acting as a competitive antagonist in rat pulmonary resistance arteries. The pK_B values calculated at 1 and 10 μM are significantly greater in the extrapulmonary artery compared to pulmonary resistance arteries.

Effect of NOS inhibition and FR 139317 on SxS6c responses.

Figure 3.4 A and B show the effect of the NOS inhibitor L-NAME (100 μM) on responses to SxS6c in pulmonary resistance arteries. L-NAME itself produced contractile responses in 53 % of treated vessels which were only 4 ± 1 % of the reference contractile response to 50 mM KCl (16 ± 4 mg wt tension in absolute values; $n = 5$). pEC_{50} values for SxS6c in the presence and absence of L-NAME are shown in table 3.2. Figure 3.4.B demonstrates that L-NAME has no effect on the response curve to SxS6c at low concentrations (below 0.3 nM) but causes a significant leftward shift in the higher concentration range of the curve. This is also demonstrated by a significant change in the pEC_{80} value, with no apparent change in the pEC_{50} value. (pEC_{80} values were 8.43 ± 0.24 for SxS6c control, and 9.18 ± 0.12 for SxS6c in the presence of L-NAME; * $p < 0.05$). The “drop off” in tension at the end of the SxS6c response curve is also observed in the presence of L-NAME.

The effect of the ET_A receptor antagonist FR 139317 on responses to SxS6c in rat pulmonary resistance arteries is also shown in figure 3.4. A and B. The pEC_{50} values are summarised in table 3.2. Incubation of tissues with 1 μM FR 139317 had no effect baseline tone in pulmonary resistance arteries. Figures 3.4 A and B and table 3.2 show that contractile responses to SxS6c are resistant to the actions of the ET_A receptor antagonist FR 139317 (1 μM). In fact the ET_A antagonist, in a similar fashion to L-NAME causes a significant leftward shift in the higher concentration range of the response curve to SxS6c. (pEC_{80} values were 8.43 ± 0.24 for SxS6c control and, 9.13 ± 0.12 for SxS6c in the presence of FR 139317, * $p < 0.05$).

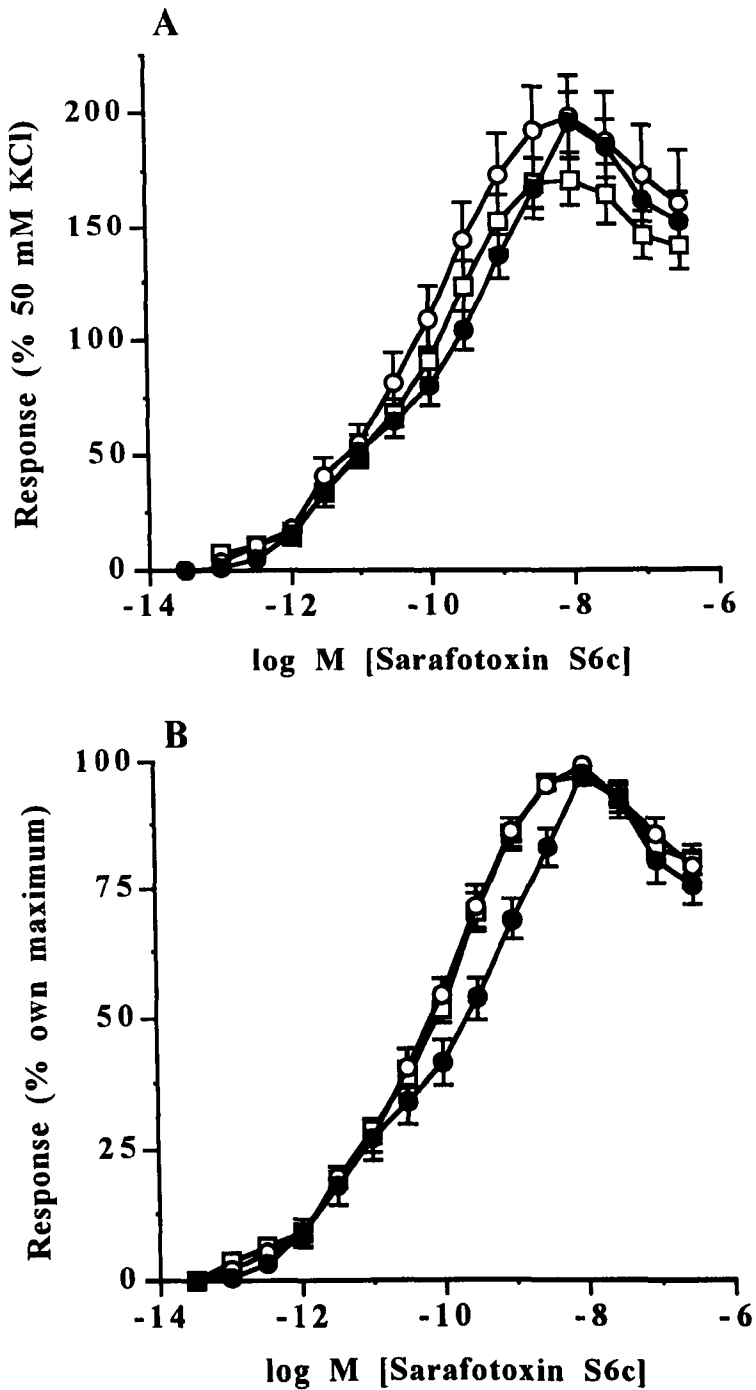

Figure 3.4

Effect of L-NAME (100 μ M), and FR 139317 (1 μ M) on responses to SxS6c in rat pulmonary resistance arteries. CCRC's to SxS6c (●, n = 10 / 8); in the presence of 100 μ M L-NAME (○, n = 5 / 5) and in the presence of 1 μ M FR 139317 (□, n = 8 / 5). **A** Data are expressed as percentage reference contraction to 50 mM KCl. **B** Data are expressed as percentage own maximum contraction. Each point represents the mean \pm SEM.

3.4 Discussion.

Responses to ET-1 and SxS6c : Effect of FR 139317.

Rat Extrapulmonary arteries

In rat extrapulmonary arteries, potent vasoconstriction to ET-1 was observed. The contractile responses to ET-1 were slow to develop but well maintained as has been documented in other isolated arterial preparations (Rubanyi & Parker-Botelho, 1991). As ET-1 can act at both ET_A and ET_B receptors sites, I examined the effects of the selective ET_B agonist SxS6c in this preparation. This selective ET_B ligand produced no significant vasoconstriction in the rat extrapulmonary artery, immediately suggesting that ET-1 is acting solely via the ET_A receptor subtype in these vessels.

The involvement of the ET_A receptor subtype in ET-1-mediated contraction in rat extrapulmonary artery is further supported by the ability of the ET_A receptor antagonist FR 139317 to attenuate ET-1 responses. FR 139317 produced concentration dependent antagonism in this preparations with a pA₂ value of 6.83. This is comparable to values obtained for FR 139317 in rabbit aorta (pA₂ of 7.2) rat aorta (pA₂ of 6.7) and guinea-pig pulmonary artery (pA₂ of 6.65); (Sogabe, *et al.*, 1993; Kengatharan, *et al.*, 1993; Cardell *et al.*, 1993). Although FR 139317 appeared to produce concentration-dependent antagonism of ET-1-induced contractions in the rat extrapulmonary artery, Schild analysis produced a slope significantly less than unity, which indicates non-competitive antagonism. This may be due to the nature of ET-receptor interaction with ET-1, which is essentially irreversible (as discussed in chapter 1; see also section 2.4.3) therefore making true competitive antagonism impossible. Non-competitive antagonism with another ET_A receptor antagonist BQ-123 has also been described in cell based assay systems (Hiley *et al.*, 1992; Vigne, *et al.*, 1993) and in human small omental vessels (Riezebos, *et al.*, 1994). However, the inability of the ET_B agonist SxS6c to mediate contractions, and the ability of FR 139317 to antagonise ET-1-mediated responses, supports previous observations that ET-1 mediated contractions in rat extrapulmonary arteries are mediated via activation of vascular ET_A receptors (Watanabe, *et al.* (1991b); Bonvallet, *et al.*, 1993) .

Pulmonary resistance arteries.

ET-1 produced contractile responses in pulmonary resistance arteries which were approximately 3 fold more potent than those observed in extrapulmonary artery preparations. Differences in the sensitivity of different sized arterial segments from the guinea-pig lung has also been described, in which smaller diameter intrapulmonary arterial segments are more sensitive to ET-1 compared to large diameter pulmonary arteries (Cardell, *et al.*, 1990). My observations are in contrast those found by Leach, *et al.*, (1990) where they demonstrated greater sensitivity to ET-1 in rat large diameter pulmonary arteries (pEC₅₀ of 8.05) compared to the smaller pulmonary resistance arteries (pEC₅₀ of 7.48). This may be partly due to the resting tension placed on the resistance vessels under study, as I have found that over stretching of pulmonary resistance arteries significantly decreases tissue sensitivity to ET-1 (chapter 5 this thesis). The response curve to ET-1 in pulmonary resistance arteries is biphasic in nature suggesting a heterogeneous population of ET receptors. In contrast to extrapulmonary arteries, the pulmonary resistance arteries demonstrated significant contractile responses to the selective ET_B agonist SxS6c, which were 5 fold more potent than responses to ET-1 in this preparation. The maximum contractile response to SxS6c was not significantly different from values observed for ET-1. This evidence would suggest the presence of a significant population of ET_B receptors mediating contractile responses, similar to the situation observed in the rabbit pulmonary artery (Panek, *et al.*, 1992; LaDouceur, *et al.*, 1993).

The ET_A receptor antagonist FR 139317 caused a significant shift in the response curve to ET-1 in pulmonary resistance arteries, but was significantly less effective in these vessels compared with rat extrapulmonary arteries as shown by the difference in pK_B values. These results are comparable with the observations of Bonvallet, *et al.*, (1993), which showed that the ET_A receptor antagonist BQ-123 was more effective in antagonising responses to ET-1 in larger pulmonary arteries compared to the smaller pulmonary arteries of the rat. In pulmonary resistance arteries FR

139317 produced non-concentration dependent shift of the ET-1-mediated response, producing significantly different pK_B values for the antagonist at 1 and 10 μ M. The non-competitive nature of antagonism is indicated by the extremely shallow slope of the Schild plot (0.23) which gives a pA_2 value of 7.22. This non-competitive antagonism could be due to the irreversible binding kinetics of ET-1, but a more probable explanation is that ET-1 is activating multiple receptor subtypes in this preparations. The incomplete antagonist action of FR 139317 on ET-1 responses in pulmonary resistance arteries would indicate that only part of ET-1 contractile response is mediated by the ET_A receptor subtype. Potent contractile responses to the ET_B agonist SxS6c suggest the presence of vascular ET_B receptors in rat pulmonary resistance arteries. As ET-1 will activate both ET_A and ET_B receptor subtypes, blocking the ET_A mediated contraction with FR 139317 means that ET-1 may act preferentially on the vacant ET_B receptor site, which can also mediate substantial vasoconstriction.

Effect of L-NAME and FR 139317 on SxS6c-mediated responses in pulmonary resistance arteries.

The response curve to SxS6c demonstrates a dramatic “drop off” in tension after 10 nM. There is evidence to suggest that ET's can mediate vasodilatation via endothelial cell release of NO and this is thought to be mediated via ET_B receptor activation (Carville, *et al.*, 1993; De Nucci *et al.*, 1988; Eddahibi, *et al.*, 1991). The possibility that this “drop off” in tension was due to NO release was tested by pre-treatment of vessels with the NOS inhibitor L-NAME. Administration of L-NAME caused small increases in tone in approximately 50 % of the pulmonary resistance arteries tested, and this is probably due to the removal of basal release NO. The “drop off” in SxS6c response curve at high concentrations is still observed in the presence of L-NAME and is therefore cannot be attributed to NO release. Although the actions of other mediators (e.g. PGI_2 , EDHF) cannot be ruled out, this fall in tension appeared to be non-concentration dependent indicating desensitisation of response rather than

release of another compound. Desensitisation of ET_B receptor-mediated responses has been shown to occur in isolated vascular preparations (LaDouceur, *et al.*, 1993; Sudjarwo, *et al.*, 1993) and *in vivo* (Lippton, *et al.*, 1991). Responses to SxS6c in porcine pulmonary vein exhibit marked desensitisation even in the absence of endothelium (Sudjarwo, *et al.*, 1993), therefore this seems the most plausible explanation for the “drop off” in tone.

L-NAME did however cause a significant increase in tissue sensitivity to the high concentration range of the SxS6c response curve which suggests that endogenous NO modulates the response to SxS6c in these vessels. Unfortunately, the effect of L-NAME on ET-1-mediated responses was not tested, therefore it is not clear whether this potentiation is specific to SxS6c. L-NAME may be causing this increase in sensitivity by preventing the relaxatory effects of NO produced by endothelial ET_B receptors, or by removing basal released NO. Responses to ET's in the presence of raised vascular tone were not studied in these preparations, however, I can find no evidence for endothelial ET_B receptor-mediated relaxation in rat pulmonary resistance arteries (separate study, chapter 5 this thesis), and have not been observed in the rat extrapulmonary artery (MacLean, *et al.*, 1994).

SxS6c is highly selective for ET_B receptors over ET_A receptors (Williams, *et al.*, 1991), but in order to verify SxS6c was mediating contractile responses via ET_B receptors, I studied the effects of the ET_A antagonist FR 139317 on SxS6c-induced contractions. Responses to SxS6c were resistant to antagonism by FR 139317, but in a similar fashion to L-NAME, FR 139317 also caused a significant leftward shift in the high concentration range of the SxS6c response curve. D' Orleans-Juste, *et al.*, (1992) showed that ET-1-stimulated release of PGI₂ from rat isolated perfused lungs was mediated via an ET_A-like receptor as responses could be inhibited by the ET_A receptor antagonist BQ-123. However, it seems unlikely that SxS6c could activate ET_A receptors to release PGI₂ due to its selectivity for the ET_B receptor subtype. Another possible explanation may be that there is basal release of ET-1 in these vessels, and with the ET_A receptor subtype blocked by FR 139317, this ET-1 acts on ET_B receptors

therefore potentiating the SxS6c response. Basal release of ET-1 has been demonstrated in isolated pulmonary artery rings from human, sheep and rabbit lungs, with values in the range of 1 - 20 fmol detected in the vessel bathing solutions *in vitro* (Demiryürek, *et al.*, 1994).

Maximum contractile responses to ET-1 were considerably greater than 50 mM KCl contractile response in both extrapulmonary artery and pulmonary resistance arteries. This was also found to be the case with SxS6c in pulmonary resistance arteries. KCl elicits its contractile response through membrane depolarisation which causes activation of voltage-gated calcium channels. This allows calcium entry into the smooth muscle cell raising intracellular calcium concentration, and activated the contractile process. The initial membrane event in the action of ET-1 on vascular ET_A receptors is to induce phospholipase C stimulated PIP₂ hydrolysis, which is increased by subsequent and indirect influx of extracellular calcium through voltage gated calcium channels (Resink, *et al.*, 1988; Marsden, *et al.*, 1989; Xuan, *et al.*, 1989; see also chapter 1). There is also evidence to suggest that ET-1 increases the sensitivity of the contractile proteins to calcium (Marsault, *et al.*, 1990; Nishimura, *et al.*, 1992), which may explain the magnitude of the contractile response to ET-1 in comparison to KCl

To summarise, these results demonstrate diversity in the ET receptor subtype mediating vasoconstriction at different anatomical levels of the pulmonary circulation of the rat. In large calibre extrapulmonary arteries responses to ET-1 appear to be mediated solely via activation of the ET_A receptor subtype as responses to ET-1 are antagonised by the ET_A antagonist FR 139317, and vessels are insensitive to the ET_B receptor agonist SxS6c. In rat pulmonary resistance arteries there appears to be a significant population of vascular ET_B receptors mediating vasoconstriction which coexist alongside vascular ET_A receptors due to the partial antagonism with the ET_A receptor antagonist FR 139317. Further analysis of ET receptor subtypes in rat pulmonary resistance arteries using novel ET antagonists can be found in chapter 6 (this thesis).

Chapter 4

Validation of Chronic Hypoxic Rat Model

4.1 Introduction.

The chronic hypoxic / hypobaric rat, as previously discussed in this thesis, has been extensively studied as a model of pulmonary hypertension. Rats exposed to these hypoxic conditions develop significant pulmonary hypertension, right ventricular hypertrophy and pulmonary vascular remodelling (Hunter, *et al.*, 1974; Rabinovitch, *et al.*, 1979), which are similar to the structural changes observed in human hypoxic pulmonary hypertension (Haselton, *et al.*, 1968). After the installation of the hypoxic hypobaric chamber within our laboratory, I wished to verify that rats maintained in this chamber exhibited the same structural changes observed in similar rat models.

It was also necessary to validate the protocol for studying hypoxic rats removed which would be used for *in vitro* studies. Returning the chamber to normal atmospheric pressure daily is time consuming (2 hours in total from 550 to 1000 mbar) and also reduces the duration of time at which the animals are exposed to the hypoxic environment. A possible protocol was therefore decided upon which involved removing 2 rats from the chamber after 14 days hypoxia : one to be studied on the same day, and the other would be kept in normobaric / normoxic conditions to be studied the next day. The final 2 rats would be removed on day 16 of hypoxic exposure a studied in the same fashion as day 14 rats. I wished to verify that there would be no *in vitro* functional differences between pulmonary resistance arteries removed from rats exposed to these hypoxic / normoxic regimes.

The rate of reversal of the structural changes associated with chronic hypoxia has been studied by a number of groups, and although there is some discrepancy in the time duration taken for reversal, most authors agree that this process is slow to occur, over many weeks or months (Heath, *et al.*, 1973; Leach, *et al.*, 1977). It has also been reported that certain structural changes reverse more rapidly than others after returning to normoxic environment. For example, a significant fall in pulmonary artery pressure is observed during the first 9 days after return to normoxia (Fried & Reid, 1984); the degree of right ventricular hypertrophy was reported to have reversed to control values after 12 week recovery from chronic hypoxia, whereas the percentage of thick walled

peripheral vessels was still significantly greater in hypoxic animals after 20 weeks recovery (Herget, *et al.*, 1978; Rabinovitch, *et al.*, 1981). The functional changes associated with exposure to chronic hypoxia, and their recovery in normoxia, have been studied in less detail and usually investigate changes occurring after at least 48 hours recovery in normoxic conditions (Adnot, *et al.*, 1991; Maruyama & Maruyama, 1994).

In this chapter I examined pulmonary artery pressure and muscularisation of small pulmonary vessels comparing a small number of control with rats exposed to 14 days chronic hypobaric hypoxia. I also investigated *in vitro* responses in pulmonary resistance arteries to KCl, ET-1, 5-HT and relaxatory responses to ACh in precontracted vessels in four experimental groups of rats : exposed to 14 days hypoxia, 14 days hypoxia plus 1 day normoxia, 16 days hypoxia and 16 days hypoxia plus 1 day normoxia. The degree of right ventricular hypertrophy was also examined comparing control and chronic hypoxic rats.

4.2 Methods.

Weaning male specific pathogen free rats (age approximately 28 days, weight approximately 65 g) were divided into groups of four (maximum for each cage), one group being placed in the hypoxic hypobaric chamber and maintained at 550 mbar for up to 16 days (see chapter 2 for exact details of maintenance). The other group were maintained in normoxic conditions to act as age matched controls. Following 14 days exposure to hypoxia, rats were removed from the chamber and studied according to the following procedures.

***In vivo* measurement of pulmonary artery pressure.**

For this procedure rats were maintained in hypoxic conditions as described above for 14 days only then removed. A hypoxic rat was then anaesthetised and pulmonary artery pressure measured according to the procedure described in methods section 2.2.5.3. Following this the same procedure was carried out on age an matched control animal. As pulmonary artery pressure measurements are well documented in

this model of pulmonary hypertension, I decided to perform measurements in only one animal from each group, therefore maximising the tissue available for *in vitro* studies.

Histological examination of lung sections.

Rats were maintained in hypoxic conditions for 14 days as described above. Preparation of lung sections for light microscopy were carried out according to methods section 2.2.5.2. The preparations were then examined to detect the presence of thick walled peripheral lung vessels (TWPV).

Histological examination of pulmonary resistance arteries.

Pulmonary resistance arteries of the same size and location as used in *in vitro* studies were dissected from control and chronic hypoxic lungs by the procedure detailed in section 2.1.3.1. Vessels were then processed and examined using light microscopy and electron microscopy to assess any structural changes in these vessels (section 2.2.5.2).

In vitro studies of pulmonary resistance arteries.

Rats were maintained in hypoxic conditions for 14 days, after which animals were sacrificed and studied according to the following time protocol.

- | | |
|----------------|---|
| Day 14 hypoxia | <ul style="list-style-type: none">• Chamber opened and 2 rats are removed.• Remaining 2 rats in the group are returned to 550 mbar• 1 rat is sacrificed - termed Day 14 / 0; i.e. 14 days hypoxia / sacrificed on day 0 after removal from chamber (within 5 minutes removal from chamber)• 1 rat remains in normoxic conditions overnight. |
| Day 15 hypoxia | <ul style="list-style-type: none">• Chamber is maintained at 550 mbar |

- Rat removed from chamber on day 14 is sacrificed - termed **Day 14 / 1** i.e. 14 day exposure to hypoxia, sacrificed 1 day after removal from chamber.

Day 16 hypoxia

- Chamber opened and final 2 rats are removed.
- 1 rat is sacrificed - termed **Day 16 / 0**; i.e. 16 days hypoxia / sacrificed on day 0 after removal from chamber (within 5 minutes removal from chamber)
- 1 rat remains in normoxic conditions overnight.

Day 17

- Final hypoxic rat is sacrificed - termed **Day 16 / 1**; i.e. 16 days hypoxia / sacrificed after 1 day removal from chamber.

After sacrifice of the animals, the heart and lungs were removed. Pulmonary resistance arteries (~150 μm i.d.) were dissected from the lungs and mounted on the wire myograph according to methods section 2.2.5.2. Vessels were bathed in Krebs solution at 37 °C and bubbled with 16 % O₂, 5 % CO₂ balance N₂. Using the normalisation procedure vessels were tensioned to give an equivalent transmural pressure of ~36 mmHg, which would be the pressures these vessels would be exposed to *in vivo*. (Rabinovitch, *et al.*, 1979; Herget, *et al.*, 1978). Following a 1 hour equilibration period, vessels were first stimulated with exogenous application of 50 mM KCl, and once the contraction had reached plateau, vessels were washed three times with fresh Krebs. After a further 30 minute equilibration period, vessels were then subjected to one of the following protocols.

- Cumulative concentration response curve to KCl (from 5 mM to 100 mM)
- Cumulative concentration response curve to 5-HT (from 1 nM to 30 μM)
- Cumulative concentration response curve to ET-1 (from 0.01 pM to 0.3 μM)
- Relaxation response curve to ACh (0.1 nM to 100 μM), following precontraction with 10 μM 5-HT.

Right ventricular hypertrophy.

The hearts from control and hypoxic animals were dissected into right ventricle and left ventricle & septum, blotted and weighed according to the procedure described in section 2.2.5.1. Data for hypoxic rats were also divided into the four experimental groups i.e. day 14 / 0, day 14 / 1, day 16 / 0 and day 16 / 1 to assess any differences.

Data analysis.

As measurement of pulmonary artery pressure and pulmonary vascular remodelling were only carried in a limited number of animals, representative traces and photographs of lung sections are shown in the following results section. For *in vitro* studies, pEC₂₀ pEC₅₀ and pEC₈₀ values were calculated for all compounds according to methods stated in chapter 2. CCRC's to KCl are expressed as absolute contraction (mg wt. tension), CCRC's to ET-1 and 5-HT are expressed as percentage of reference contraction to 50 mM KCl in each preparation, and CCRC's to ACh are expressed as percentage level of precontraction to 5-HT in each preparation. Data for body weight and ventricular weights are expressed as g or mg, and ventricular ratios were calculated for each individual heart. Statistical comparisons were made by one way analysis of variance (ANOVA) followed by Tukeys post test, or by Students unpaired t-test. $p < 0.05$ was considered statistically significant.

4.3 Results.

Measurement of pulmonary artery pressure.

Figure 4.1 shows the traces obtained for pulmonary artery pressure measurement in the control and chronic hypoxic rats. From the control animal trace the right ventricular pressure wave can be clearly seen, which becomes blunted in amplitude once the needle is carefully manipulated into the pulmonary trunk. The position of the needle within the main pulmonary artery was confirmed by sight and by the pressure wave form obtained. Typical pulmonary artery pressure wave form can be observed in the trace from the control animal (indicated by arrows, PA). From this

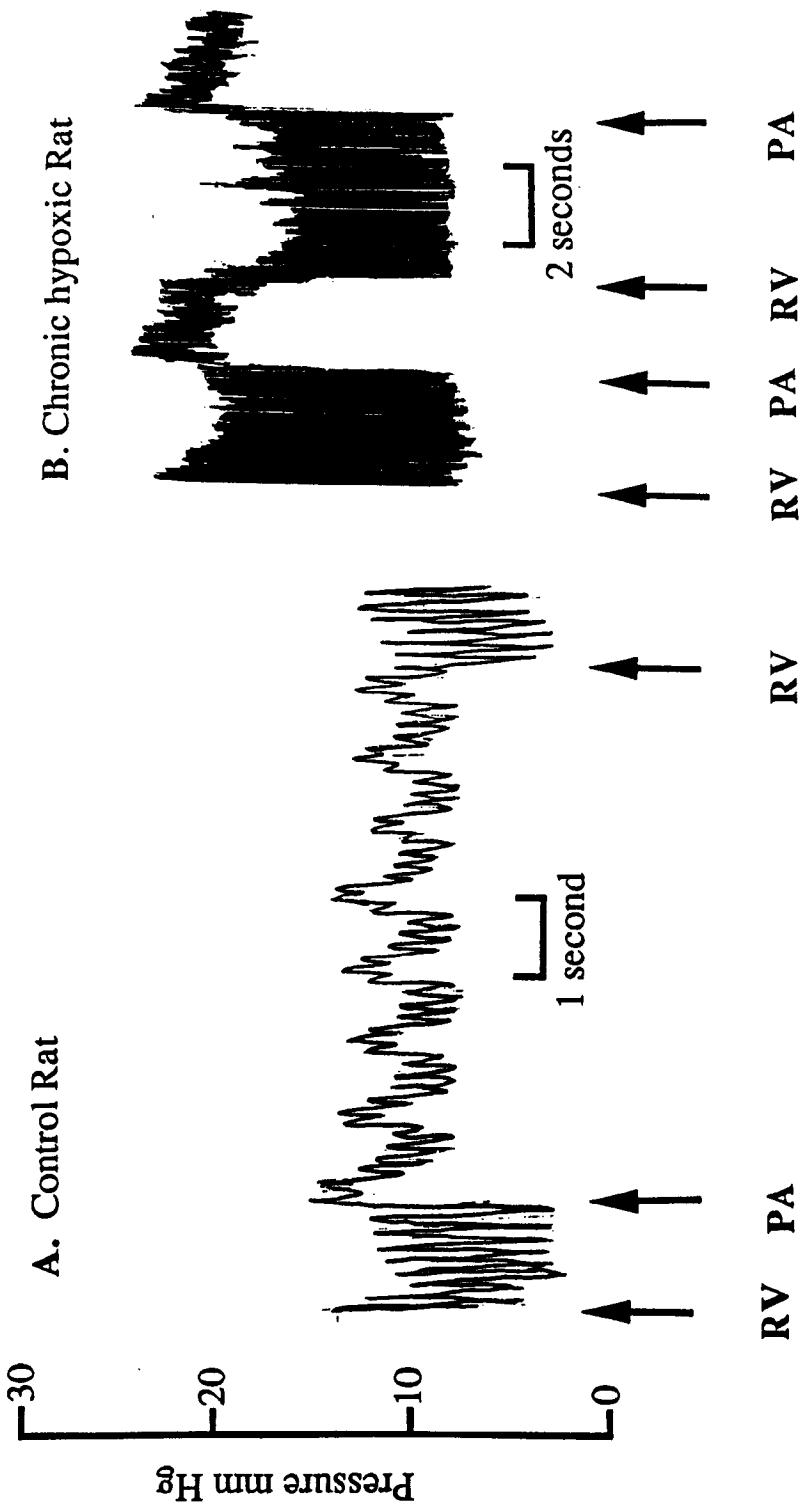

Figure 4.1. Measurement of pulmonary artery pressures in control and chronic hypoxic rats. RV = right ventricle, PA = pulmonary artery.

trace the measurements of pulmonary artery pressure of the control rats were, systolic pressure of 14 mmHg, diastolic pressure of 8 mmHg, and therefore a calculated mean pulmonary artery pressure of 10 mmHg. The trace to the right shows measurements obtained from a chronic hypoxic rat. The paper speed is unfortunately only half of that used for measurement in control animal which makes pulmonary artery wave from impossible to detect. (This was due to one of the limitations of this measurement technique : as insertion of the needle into the right ventricle allows blood to seep from the heart the pressure measurements must be taken rapidly before too much blood is lost. In the case of hypoxia animals, blood loss is rapid due to the increased right ventricular pressure). What is apparent from this trace however is the much greater right ventricular pressure, and a significantly greater pulmonary artery pressure in this hypoxic animal compared to the control. From this trace the hypoxic animals had a pulmonary artery systolic pressure of 25 mmHg, diastolic pressure of 19 mmHg, with a mean pulmonary artery pressure of 21 mmHg.

Histology.

Figure 4.2 shows photographs take from sections of lung viewed under light microscopy. Figure 4.2.A shows a typical example of a pulmonary arteriole (~50 μm) from a control rat which comprises a single elastic lamina with sparse traces of vascular smooth muscle. Figure 4.2.B shows a section obtained from the lung of a 14 day chronic hypoxic rat. An arteriole of similar size to the control plate has developed a relatively thick muscular media bound by two distinct elastic laminae. On viewing the sections obtained from the rat lungs, TWPV were abundant and easily detected in chronic hypoxic preparations in comparison to control preparations.

Figure 4.3 shows stained sections of control and chronic hypoxic pulmonary resistance artery viewed by light microscopy. These vessels are of identical size and location to pulmonary resistance arteries used in *in vitro* studies (between 150-200 μm). Figure 4.3.A shows cross section of a pulmonary resistance artery from a control rat. The control vessel displays a distinct inner elastic lamina, with the external elastic

Figure 4.2

Structure of pulmonary arterioles from control and chronic hypoxic rat lungs.

Sections are stained with Elastic van Gieson stain. Elastic tissue stains black; Cell cytoplasm stains pink.

A. Section of lung showing pulmonary arteriole from control rat (~ 50 μm i.d.)

B. Section of lung showing pulmonary arteriole from chronic hypoxic rat (~50 μm i.d.), note presence of muscular media and double elastic lamina.

Figure 4.2

Structure of Pulmonary Arterioles from Control and Chronic Hypoxic rats

A. Control Rat

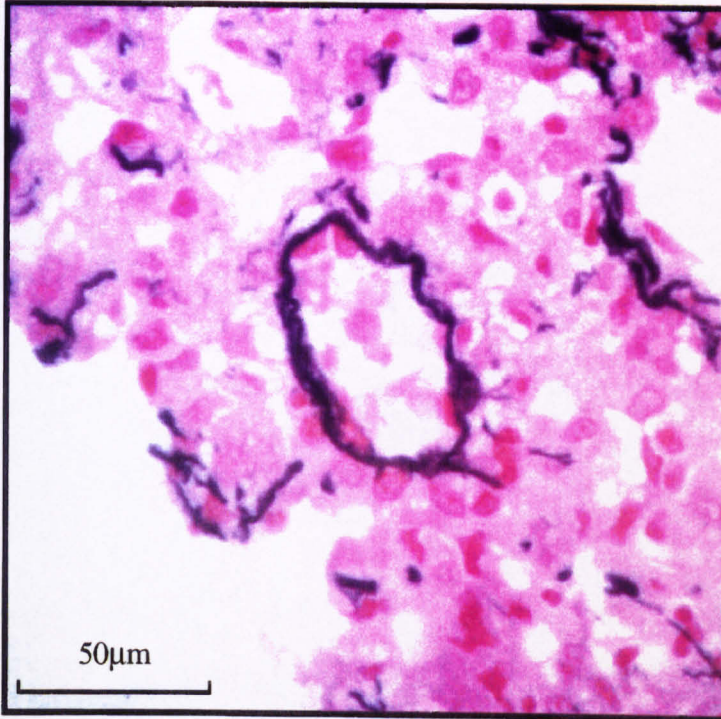

B. Chronic Hypoxic Rat

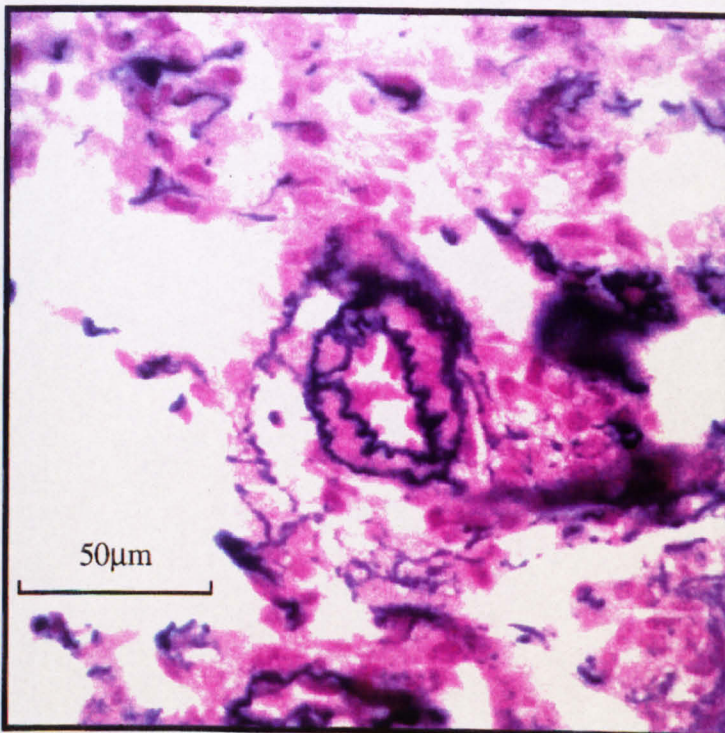

Figure 4.3

Structure of pulmonary resistance arteries - light microscopy.

Sections are stained by polychromal method. Connective tissue stains pink / brown, cell cytoplasm stains blue / purple.

A. Pulmonary resistance artery from control rat.

B. Pulmonary resistance artery from chronic hypoxic rat. Note significant **thickening** of tunica media in comparison to control.

Key : A = adventitia; E = endothelium; L = lumen; TM = tunica media.

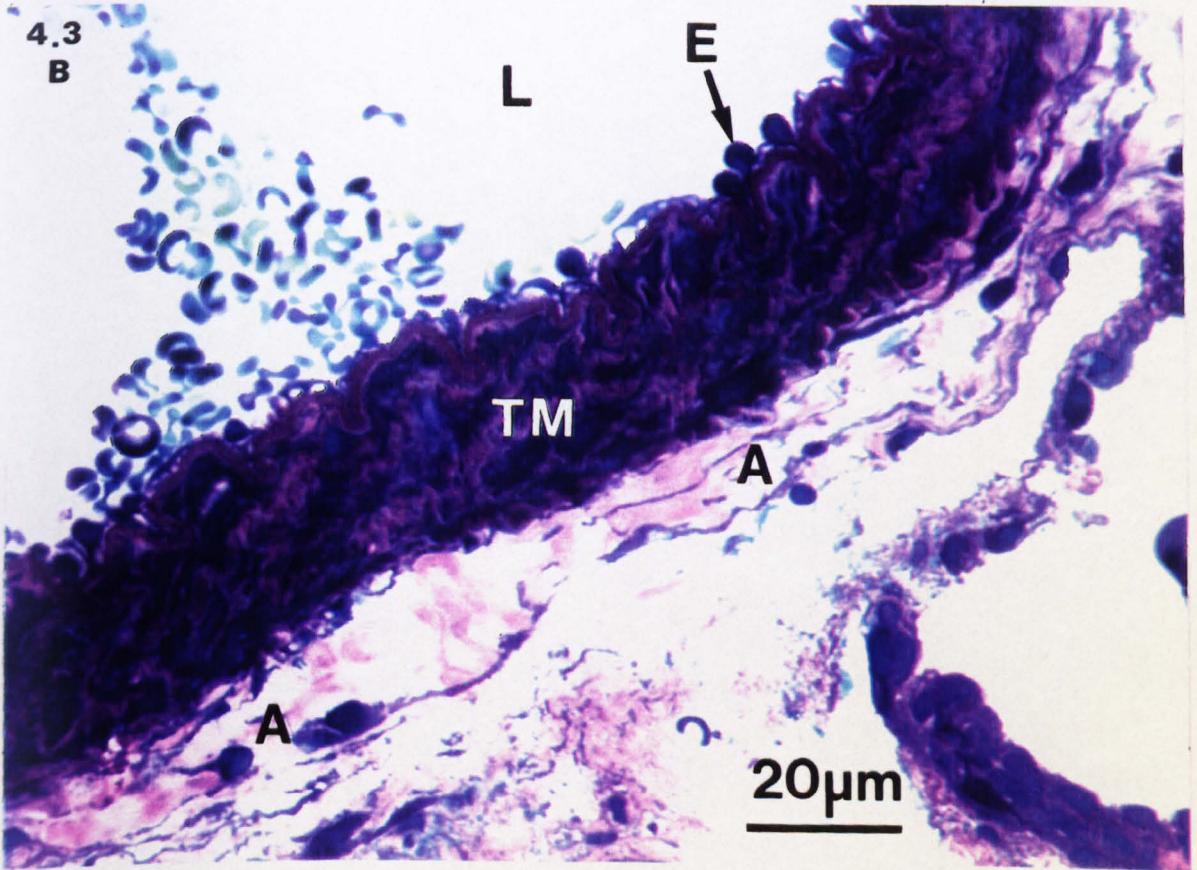
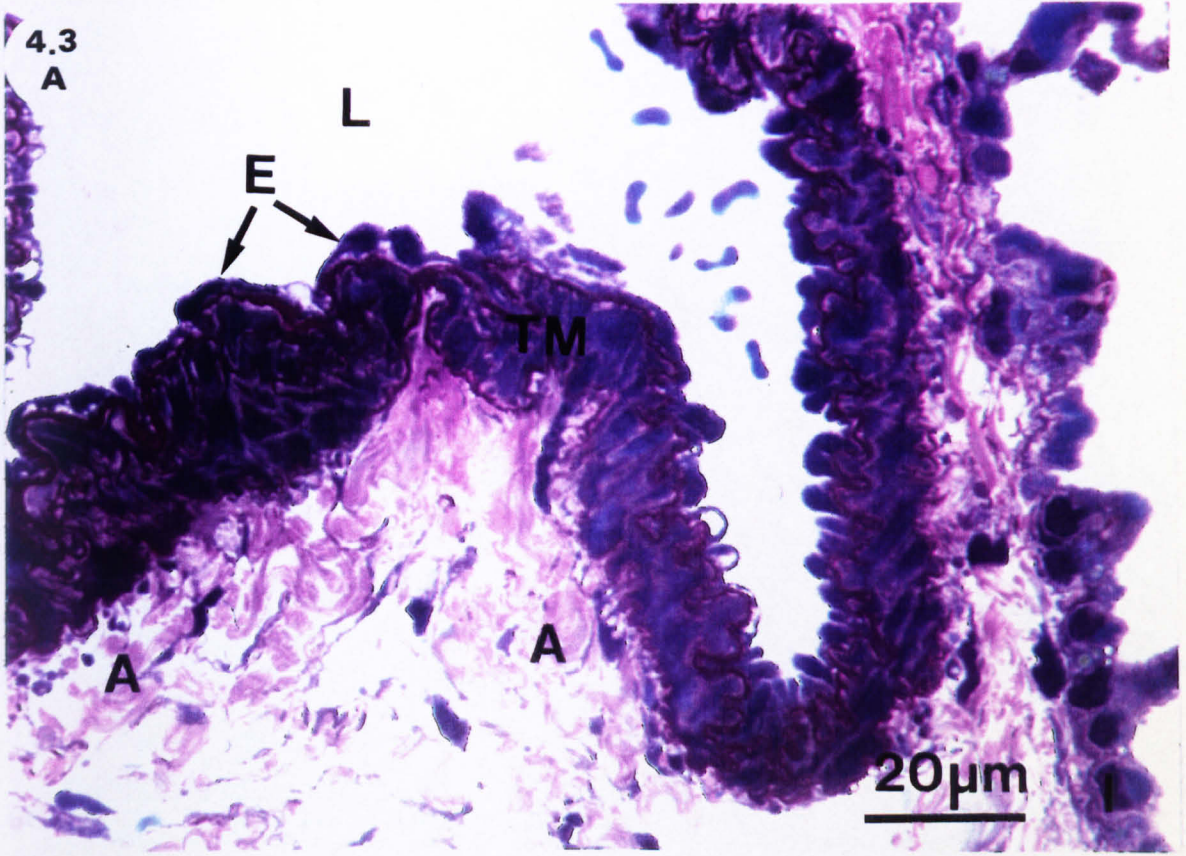

Figure 4.4.

Structure of pulmonary resistance arteries - electron microscopy.

A. Pulmonary resistance artery from control rat.

B. Pulmonary resistance artery from chronic hypoxic rat. Note significant thickening of tunica media, and increased connective tissue in comparison to control.

Key : A = adventitia; CT = connective tissue; E = endothelial cell; IEL = inner elastic lamina; L = lumen; SM = smooth muscle cell

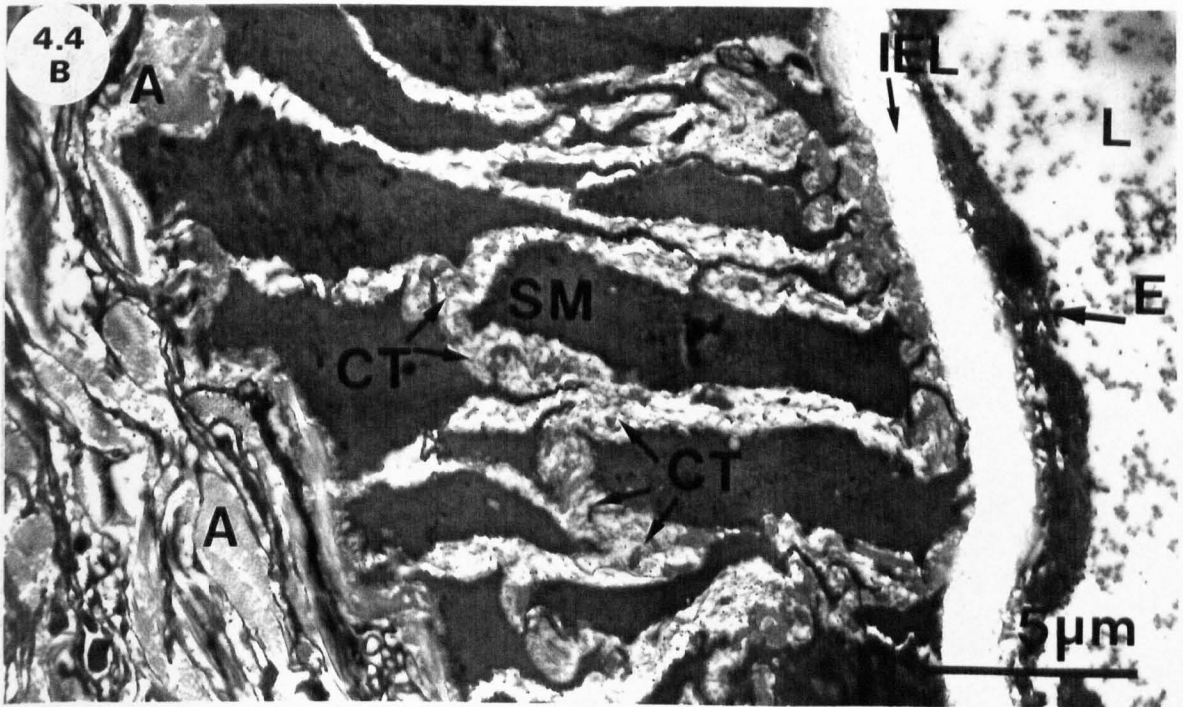
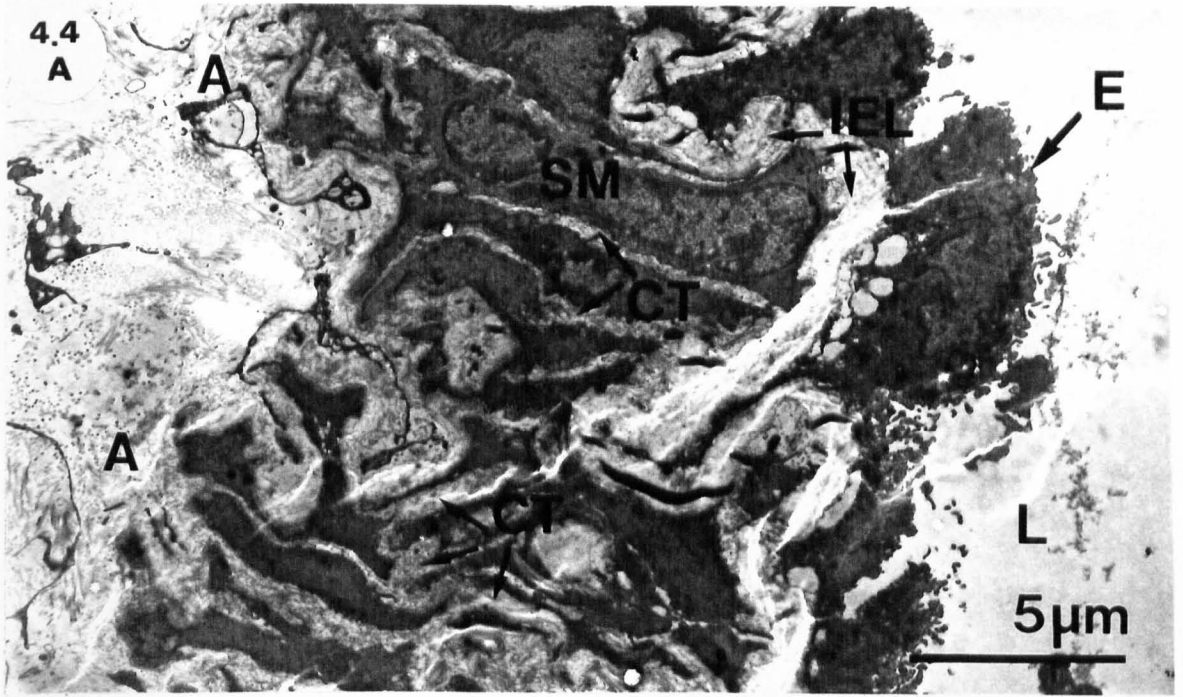

lamina bordering the tunica media and adventitia being less prominent. The tunica media comprises of approximately 1-2 smooth muscle cell layers surrounded by connective tissue. Comparing the control vessel with the chronic hypoxic vessel shown in figure 4.3.B, it can be seen that the artery from the hypoxic rat has a significantly thicker tunica media (approximately twice as thick as control vessel), comprising of approximately 3 smooth muscle cell layers and large areas of connective tissue. Again note the distinct inner elastic lamina which appears thicker in comparison to the control preparation.

Figure 4.4 shows electron micrographs of pulmonary resistance arteries from control and chronic hypoxic rats. In the control vessel (figure 4.4.A.) the media again comprises of a maximum of 2 smooth muscle cell layers with sparse areas of connective tissue visible between cells. Distinct inner elastic lamina is visible between the media and endothelium, with the external elastic lamina again less prominent. Figure 4.4.B shows a hypoxic vessel, which as seen under light microscopy, has a significantly thicker tunica media in comparison to the control vessel. The media comprises of approximately 2 smooth muscle cell layers and displays larger areas of connective tissue between smooth muscle cells and in the adventitia in comparison to the control vessel. Note also the more prominent internal elastic lamina in the chronic hypoxic vessel in comparison to control.

In vitro functional studies.

	Internal Diameter (μm)	Pressure (mmHg)	n / n
Day 14 / 0	192.3 \pm 18.1	35.0 \pm 0.9	4 / 4
Day 14 / 1	195.8 \pm 15.6	36.5 \pm 0.6	4 / 4
Day 16 / 0	212.5 \pm 14.0	35.5 \pm 0.6	4 / 4
Day 16 / 1	191.2 \pm 21.0	36.0 \pm 0.7	4 / 4

Table 4.1 Internal diameter and pressures of vessels from chronic hypoxic rats.

Average internal diameter of arteries removed mounted on the wire myograph from the four groups of chronic hypoxic rats. Data are expressed as the mean \pm SEM.

Table 4.1 gives measurements of internal diameter and resting transmural pressure in pulmonary resistance arteries removed from chronic hypoxic rats. This table demonstrates that pulmonary resistance arteries from these animals exhibit very similar internal diameters when set up at the same equivalent transmural pressure.

Figure 4.5 shows contractile responses to increasing concentrations of exogenous applied KCl. The pEC₂₀, pEC₅₀ and pEC₈₀ values for all rat groups are summarised in table 4.2. From this figure and table 4.2.A it can be seen that there is no significant difference in responses to KCl between the four groups of rats. Figure 4.6 shows response curves to ET-1 in chronic hypoxic rats. ET-1 produced potent contractile responses in all tissues which showed no significant difference in sensitivity or maximum contractile response between the four hypoxic rat groups (see also table 4.2.B). 5-HT also produced contractile responses in pulmonary resistance arteries as shown in figure 4.7. From this figure and table 4.2.C it can be seen that there is no difference in either tissue sensitivity to 5-HT or maximum contractile response between the four hypoxic rats groups. In vessels precontracted with 10 µM 5-HT, cumulative addition of ACh produced concentration dependent vasodilatation as is demonstrated in figure 4.8. Pulmonary resistance arteries from the four rat groups demonstrated no difference in tissue sensitivity to ACh or the maximum relaxatory response achieved to the agonist (see figure 4.8 and table 4.2.D).

Right ventricular hypertrophy.

Tables 4.3 and 4.4 show body weight, ventricular weights and ventricular ratios obtained from a control and hypoxic group of rats. In this table data from the four groups of hypoxic rats are grouped together. (Rats number H1 and H5 are equivalent to day 14 / 0, H2 and H6 to day 14 / 1, H3 and H7 to day 16 / 0 and H4 and H8 to day 16 / 1). The average weight of rats at the beginning of the study was not significantly different between the control and hypoxic groups (average weight of control group was 73.4 ± 1.9 g and average weight of hypoxic group was 71.0 ± 2.4 g). Comparing data from tables 4.3 and 4.4, hypoxic animals are significantly lighter than aged matched

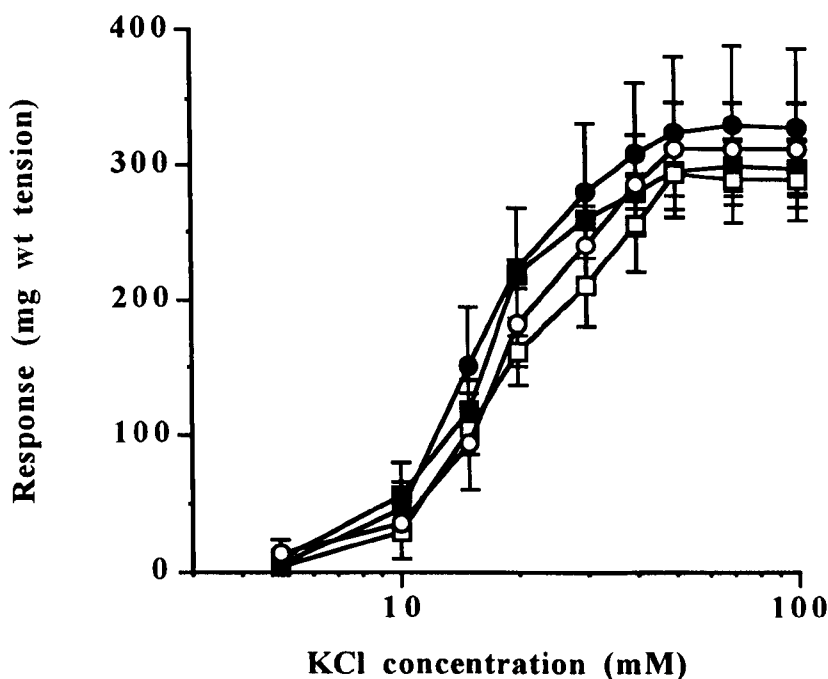

Figure 4.5

Responses to KCl in chronic hypoxic rat pulmonary resistance arteries. CCRC's to KCl Day 14 / 0 (○); Day 14 / 1 (●); Day 16 / 0 (□) and day 16 / 1 (■). $n = 4 / 4$ for all preparations. Data are expressed as absolute contraction mg wt. tension. Each point represents the mean \pm SEM.

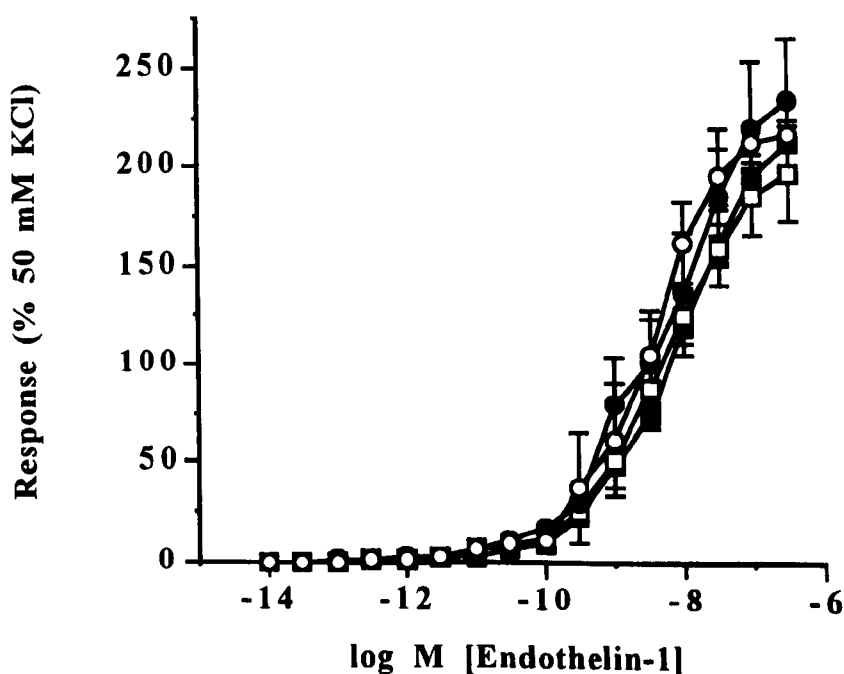

Figure 4.6

Responses to ET-1 in chronic hypoxic rat pulmonary resistance arteries. CCRC's to ET-1 in Day 14 / 0 (○); Day 14 / 1 (●); Day 16 / 0 (□) and Day 16 / 1 (■). $n = 4 / 4$ for each preparation. Data are expressed as percentage of reference contraction to 50 mM KCl in each preparation. Each point represents the mean \pm SEM.

Table 4.2.

Potency of agonists in chronic hypoxic rat pulmonary resistance arteries.

pEC₂₀, pEC₅₀ and pEC₈₀ values obtained for : **A** KCl; **B** ET-1; **C** 5-HT and **D** ACh, in chronic hypoxic rat pulmonary resistance arteries. Data are expressed as **mean** ± SEM. Statistical comparisons were made using one way analysis of **variance** (ANOVA), followed by Tukeys post test.

Day 14 / 0 = rats exposed to 14 days hypoxia.

Day 14 / 0 = rats exposed to 14 days hypoxia / 1 day normoxia.

Day 16 / 0 = rats exposed to 16 days hypoxia.

Day 16 / 1 = rats exposed to 16 days hypoxia / 1 day normoxia.

Table 4.2.A

KCl	pEC ₂₀	pEC ₅₀	pEC ₈₀	n / n
Rat 14 / 0	1.94 ± 0.08	1.74 ± 0.05	1.50 ± 0.05	4 / 4
Rat 14 / 1	2.08 ± 0.14	1.87 ± 0.09	1.62 ± 0.06	4 / 4
Rat 16 / 0	1.94 ± 0.06	1.71 ± 0.08	1.42 ± 0.10	4 / 4
Rat 16 / 1	1.99 ± 0.08	1.83 ± 0.06	1.62 ± 0.05	4 / 4

Table 4.2.B

ET-1	pEC ₂₀	pEC ₅₀	pEC ₈₀	n / n
Rat 14 / 0	9.09 ± 0.25	8.24 ± 0.06	7.71 ± 0.13	4 / 4
Rat 14 / 1	8.90 ± 0.15	8.14 ± 0.16	7.47 ± 0.11	4 / 4
Rat 16 / 0	8.75 ± 0.04	8.12 ± 0.03	7.47 ± 0.08	4 / 4
Rat 16 / 1	8.71 ± 0.17	8.08 ± 0.05	7.32 ± 0.14	4 / 4

Table 4.2.C

5-HT	pEC ₂₀	pEC ₅₀	pEC ₈₀	n / n
Rat 14 / 0	6.23 ± 0.08	5.78 ± 0.06	5.31 ± 0.06	6 / 4
Rat 14 / 1	6.41 ± 0.09	6.01 ± 0.08	5.45 ± 0.11	6 / 4
Rat 16 / 0	6.20 ± 0.10	5.73 ± 0.10	5.25 ± 0.08	6 / 4
Rat 16 / 1	6.32 ± 0.13	5.97 ± 0.11	5.47 ± 0.13	6 / 4

Table 4.2.D

ACh	pEC ₂₀	pEC ₅₀	pEC ₈₀	n / n
Rat 14 / 0	7.76 ± 0.29	6.91 ± 0.27	6.01 ± 0.26	5 / 4
Rat 14 / 1	7.30 ± 0.14	6.84 ± 0.15	6.13 ± 0.23	5 / 4
Rat 16 / 0	7.36 ± 0.34	6.62 ± 0.34	5.91 ± 0.38	5 / 4
Rat 16 / 1	7.64 ± 0.20	7.18 ± 0.13	5.92 ± 0.24	5 / 4

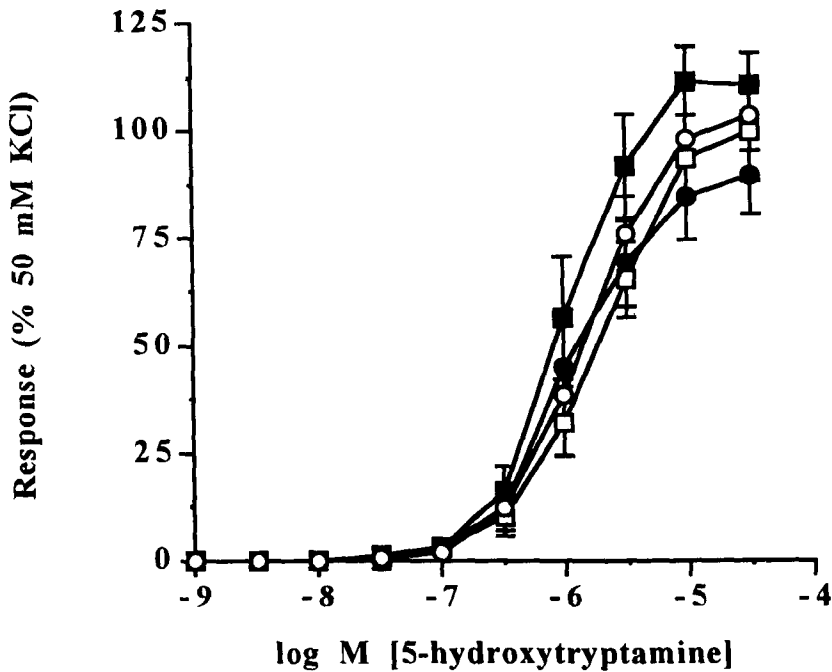

Figure 4.7

Responses to 5-HT in chronic hypoxic rat pulmonary resistance arteries. CCRC's to 5-HT Day 14 / 0 (○); Day 14 / 1 (●); day 16 / 0 (□) and Day 16 / 1 (■). n = 6 / 4 for all groups. Data are expressed as percentage of reference contraction to 50 mM KCl in each vessel. Each point represents the mean ± SEM.

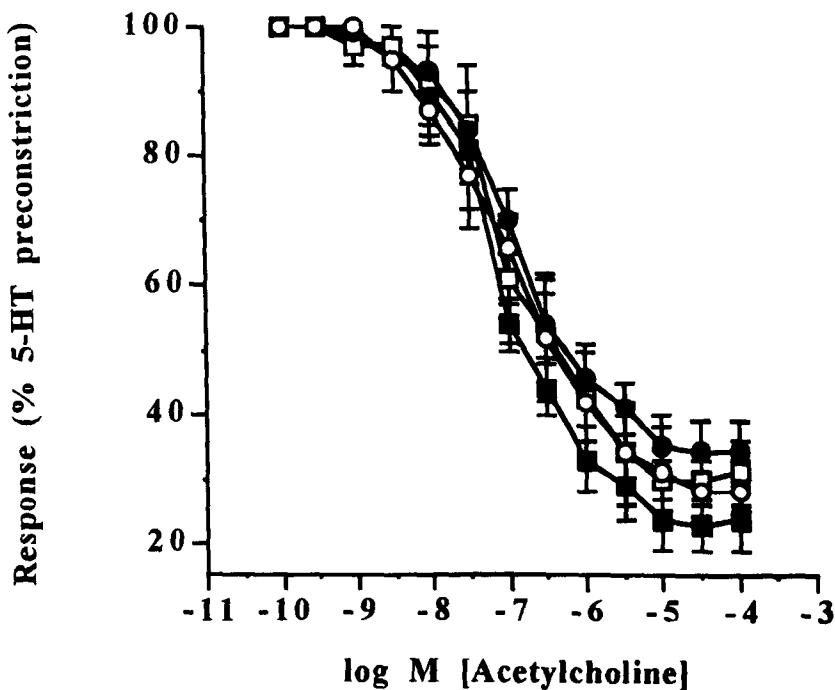

Figure 4.8

Responses to ACh in 5-HT precontracted pulmonary resistance arteries from chronic hypoxic rats. CCRC to ACh Day 14 / 0 (○); Day 14 / 1 (●); day 16 / 0 (□) and Day 16 / 1 (■). n = 5 / 4 for all groups. Data are expressed as percentage of precontraction to 10 mM 5-HT. Each point represents the mean ± SEM.

Rat	BW (g)	RV (mg)	LV & S (mg)	TV (mg)	RV/LV & S mg / mg	RV/TV mg / mg	RV/BW mg / g	LV & S / BW mg / g
C1	168	150	436	586	0.334	0.256	0.893	2.595
C2	201	194	512	706	0.379	0.275	0.965	2.547
C3	186	177	452	629	0.392	0.281	0.952	2.430
C4	207	195	472	667	0.413	0.292	0.942	2.280
C5	160	155	429	584	0.361	0.265	0.969	2.681
C6	148	150	346	496	0.433	0.302	1.014	2.338
C7	180	166	425	592	0.391	0.281	0.922	2.361
C8	178	151	439	590	0.344	0.256	0.848	2.466
AV. ± SEM	178.5 ± 7.0	167.2 ± 6.8	438.9 ± 16.7	606.1 ± 22.2	0.381 ± 0.01	0.276 ± 0.01	0.938 ± 0.02	2.462 ± 0.05

Table 4.3. Body weights, ventricular weights and ventricular ratios for control rats.

Average weights ± SEM are given in the bottom row. BW = body weight; RV = right ventricle weight; LV & S = left ventricle plus septum weight; TV = total ventricular weight. For comparison with hypoxic rat data see table 4.4.

Rat	Body Weight (g)	RV (mg)	LV & S (mg)	TV (mg)	RV/LV & S mg/mg	RV/TV mg/mg	RV/BW mg/g	LV & S / BW mg/g
H1	161	267	390	657	0.685	0.406	1.658	2.422
H2	155	231	395	626	0.585	0.369	1.490	2.548
H3	150	242	380	622	0.637	0.389	1.613	2.533
H4	171	248	469	717	0.529	0.364	1.450	2.743
H5	125	234	354	588	0.661	0.398	1.872	2.832
H6	136	208	359	567	0.579	0.367	1.529	2.640
H7	130	226	363	589	0.623	0.384	1.738	2.792
H8	160	269	382	651	0.704	0.413	1.681	2.388
AV.	**	***	*		***	***	***	
± SEM	148.5 ± 5.8	240.6 ± 7.3	386.5 ± 12.9	627.1 ± 17.0	0.625 ± 0.02	0.384 ± 0.01	1.629 ± 0.05	2.612 ± 0.06

Table 4.4. Body weights, ventricular weights and ventricular ratios for chronic hypoxic rats.

Average weights ± SEM are given in the bottom row. BW = body weight; RV = right ventricle weight; LV & S = left ventricle plus septum weight; TV = total ventricular weight. Statistical comparisons were made using Students unpaired t-test. * p < 0.05; ** p < 0.01; *** p < 0.001.

Rat	BW (g)	RV (mg)	LV & S (mg)	TV (mg)	RV / LV & S mg / mg	RV / TV mg / mg	RV / BW mg / g	LV & S / BW mg / g
Day 14/0	156.1 ± 5.2	259.9 ± 6.2	434.4 ± 24.2	694.3 ± 24.2	0.609 ± 0.02	0.372 ± 0.01	1.67 ± 0.03	2.78 ± 0.10
Day 14/1	164.5 ± 4.9	243.0 ± 8.9	438.0 ± 15.7	681.0 ± 24.0	0.607 ± 0.03	0.376 ± 0.01	1.57 ± 0.04	2.66 ± 0.04
Day 16/0	159.1 ± 5.5	276.9 ± 18.4	448.0 ± 28.7	721.5 ± 38.8	0.637 ± 0.04	0.387 ± 0.01	1.73 ± 0.09	2.73 ± 0.09
Day 16/1	173.2 ± 6.4 ^x	290.5 ± 11.3 [*]	452.5 ± 19.5	743.0 ± 27.9	0.646 ± 0.02	0.391 ± 0.01	1.68 ± 0.06	2.61 ± 0.07

Table 4.5 Body weights, ventricular weights and ventricular ratios in different hypoxic rat groups.

Average body weights, ventricular weights and ventricular ratios obtained from rats exposed to different durations of hypoxia. Data are expressed as mean ± SEM. BW = body weight; RV = right ventricle weight; LV & S = left ventricle plus septum weight; TV = total ventricular weight. Statistical comparisons were made using one way ANOVA followed by Tukeys post test, and Students unpaired t-test. * p < 0.05 day 14 / 0 vs. day 16 / 1 (ANOVA, Tukeys post test). ^xp = 0.057 day 14 / 0 vs. day 16 / 1 (Students unpaired t-test).

controls. Rats exposed to chronic hypoxia showed a dramatic increase in the absolute size of the right ventricle, and a corresponding slight decrease in the size of the left ventricle plus septum. The absolute total weight of the hearts was not significantly different between control and hypoxic animals. The significant right ventricular hypertrophy is demonstrated by the increase in RV / LV & S, RV / TV and RV/ BW ratios in hypoxic animals compared to controls. No significant difference was found between control and hypoxic animals in the LV & S / BW ratio

To assess if there was any significant difference between hypoxic rats exposed to different durations of hypoxia, I examined body weight, ventricular weight and ventricular ratios in day 14 / 0, day 14 / 1, day 16 / 0 and day 16 / 1 rats. Data from these animals are summarised in table 4.5. From this table it can be seen that there is a tendency for an increase in body weight of the animals between day 14 / 0 and day 16 / 1, which was verging on being statistically significant ($p = 0.057$ Students unpaired t-test). The right ventricular weight had increased significantly in absolute terms between at 14 / 0 and day 16 / 1, however there was no significant difference in left ventricular weight or in total ventricular weight between groups. This apparent increase in right ventricular weight is not observed when ventricular ratios are studied. No significant difference was found in RV / LV & S, RV / TV, RV / BW or LV & S / BW, between the four hypoxic groups.

4.5 Discussion.

Pulmonary artery pressure.

In vivo measurements showed that pulmonary artery pressure was greater in the hypoxic animal than in the control animal indicating the development of pulmonary hypertension. The average pulmonary artery pressures in these animals appear slightly lower than measurements observed in other control and hypoxic rats for example; control values of 16 ± 1 mmHg and 18 ± 0.5 mmHg, and hypoxic values of 40 ± 2 and 45 ± 4 mmHg (Chen, *et al.*, 1995; Rabinovitch, *et al.*, 1979 respectively). One of the reasons for this difference in pulmonary artery pressure values may be the procedure

used for measurement, as all these studies used the closed chest procedure of measuring pulmonary artery pressure. The open chest method may give lower readings due to the removal of the physiologically normal negative pressure in the thoracic cavity by opening the chest wall. This results in the lungs deflating and the animals have to be artificially ventilated. I do however observe comparable figures to those obtained by Wanstall *et al* (1992) who also use the open chest method for measurement of pulmonary artery pressure. In this study the authors demonstrated a mean pulmonary artery pressure of 13 ± 2 mmHg for control animals and 26 ± 2 for chronic hypoxic animals. Another reason for this apparent discrepancy between studies may be due to the use of anaesthetics, as indwelling pulmonary artery catheters allow readings to be taken from conscious animals, whereas other methods required the animals to be fully anaesthetised, as in this case. My measurements for both control and hypoxic animals were obtained in animals breathing normal room air. This would not effect control animal readings but may effect chronic hypoxic animals readings as there may be an acute HPV component over and above the increased pulmonary resistance due to vascular remodelling. Acute responses to hypoxia in chronic hypoxic animals have been shown to be either augmented or attenuated depending on the preparation species (Karamsetty, *et al.*, 1995). Comparing published data between groups, there appears to be little difference in pulmonary artery pressure measurements in 14 day hypoxic rats breathing normoxic gas mixture or hypoxic gas mixture (comparing normoxic measurements from Herget, *et al.* 1978; Rabinovitch, *et al.*, 1979; Bonvallet, *et al.*, 1994; Morrell, *et al.*, 1995 a, b with hypoxic measurements of Eddahibi, *et al.*, 1991, 1995; Kouyoumdjian, *et al.*, 1994; Chen, *et al.*, 1995; Petit, *et al.*, 1995). Systemic arterial pressure was not measured in this study, but previous studies have shown that chronic hypoxia has selective effects on the pulmonary circulation and no changes are observed in systemic pressure (Rabinovitch, *et al.*, 1979). From my limited examination from a control and hypoxic rat, my results do however demonstrate greater pulmonary artery pressure in the hypoxic animal compared to the age matched control. As the pulmonary artery pressures recorded in my limited studies are lower than values

obtained in the majority of the literature, in future experiments I have chosen to tension pulmonary resistance arteries at ~16 mmHg for controls and ~ 36 mmHg for chronic hypoxic. This is in keeping with the values obtained wealth of *in vivo* recordings indicated above, and with studies previously performed in isolated rat pulmonary resistance arteries (Rogers, *et al.*, 1992).

Histology.

The sections taken from control and hypoxic rat lungs show that pulmonary vascular remodelling has taken place, similar to that previously described in other hypoxic rat models (Hunter, *et al.*, 1974). Pulmonary arterioles of ~50 μm are normally nonmuscular, thin walled and comprise of a single elastic lamina as is demonstrated in this case. However in the hypoxic animals, vessels of the same size and location were now muscular and comprised of two elastic laminae, surrounding the newly developed smooth muscle layer. This apparent progression of muscularisation occurs due to the pericytes normally present in nonmuscular vessels differentiating into a smooth muscle cell via an intermediate cell (Meyrick & Reid, 1978).

Pulmonary vascular remodelling has also been described throughout the pulmonary vascular tree, for example in pulmonary resistance arteries (100 - 300 μm internal diameter) substantial medial thickening has been reported (Rabinovitch, *et al.*, 1981). In my studies substantial medial hypertrophy the pulmonary resistance arteries (~150 μm i.d.) is observed in chronic hypoxic rats compared to controls. From my limited observations it is difficult to make any strong quantitative conclusions as to which components of the medial wall are altered in chronic hypoxia. Comparing the electron micrographs from control and chronic hypoxic preparations it would appear that both vessels comprise of approximately 2 smooth muscle cell layers. Therefore it would appear that hypertrophy rather than hyperplasia is responsible for medial thickening in these vessels. This has previously been demonstrated in larger diameter hilar pulmonary arteries of the chronic hypoxic rat (Meyrick & Reid, 1978). What is also apparent from the electron micrographs is that chronic hypoxic vessels appear to

have greater areas of connective tissue in the media and adventitia, and also display significant thickening of the internal elastic lamina, indicating increased deposition of connective tissue in chronic hypoxia. Increased matrix deposition is also well documented in pulmonary hypertension. Significant increase in the width of the arterial adventitia due to increase in collagen deposition is observed after only 3 days hypoxic exposure (Meyrick & Reid, 1978; Hislop & Reid, 1976). Early medial thickening is also as a result of collagen deposition around the existing muscle cells prior to the development of muscle cell hypertrophy (Meyrick & Reid, 1978; Hislop & Reid, 1976). These results indicate that the experimental animals from this chamber exhibit the same structural changes previously observed in chronic hypoxic rats.

Functional Responses.

In order to assess if an extra 48 hour longer exposure to hypoxia with or without 24 hour exposure to normoxia had any effect on functional responses in pulmonary resistance arteries, I looked at vasoconstriction and vasodilatation to a range of agonists in vessels from the four chronic hypoxic rat groups. I observed no statistically significant differences between groups in any of the agonists studied. Pulmonary resistance arteries taken from day 14 / 0, day 14 / 1, day 16 / 0 and day 16 / 1 rats demonstrated identical sensitivities to all the contractile agents studied. Each of the agents mediate vasoconstriction by triggering events leading to increases in intracellular calcium, however different intracellular pathways are involved. As mentioned previously in chapter 3, KCl mediates vasoconstriction by depolarisation which opens voltage gated calcium channels, whereas ET-1 and 5-HT act upon a surface membrane receptor activating PLC. These results indicate that functional responses to the contractile agents are not effected by additional 48 hour exposure to hypoxia, or by a subsequent 24 hour exposure to normoxia. I would not expect dramatic structural changes to be occurring between day 14 and day 16 hypoxia, as it has previously been demonstrated that vascular remodelling in the rat is well developed after 14 days of chronic hypoxia, and no significant differences are apparent with longer periods of

exposure to hypoxia (Hunter, *et al.*, 1974; Wanstall, *et al.*, 1992). Therefore a dramatic alteration in functional responses would not be expected to be as a result of structural changes. As previously mentioned, reversal of the structural changes associated with chronic hypoxia is extremely slow therefore a 24 hour exposure to normoxia would not result in any major reversal of vascular remodelling. However hypoxia can have effects on the release of vasoactive compounds, gene expression and overall cell activity (Fandrey, 1995), which could effect functional responses in these tissues. In my studies I found no significant difference in tissue sensitivity or maximum contractile response to any of the contractile agents studied.

Endothelium-dependent relaxation mediated via a variety of compounds has been reported to be abolished in isolated extrapulmonary artery rings, and isolated perfused lungs of rats exposed to chronic hypoxia (Adnot, *et al.*, 1991; Carville, *et al.*, 1993; Eddahibi, *et al.*, 1993; Maruyama, *et al.*, 1994). It was also demonstrated that endothelium-dependent relaxations were completely or partially restored after as little as 48 - 72 hours recovery from hypoxia (Adnot, *et al.*, 1991; Maruyama, *et al.*, 1994). ACh has been demonstrated to mediated endothelium-dependent vasodilatation in rat isolated pulmonary arteries (Carville, *et al.*, 1993). I therefore compared vasodilatation to ACh in the four groups of hypoxic rats to assess if there were any differences between groups, as this agonist has been shown to mediate endothelium-dependent relaxation in isolated pulmonary arterial preparations (Carville, *et al.*, 1993; Leach, *et al.*, 1992). Contrary to the above reports, pulmonary resistance arteries from all groups of hypoxic rats demonstrated significant vasodilatory responses to ACh, which were not effected by additional 48 hour exposure to hypoxia, or subsequent 24 hour recovery in normoxia (for comparison with control pulmonary resistance arteries see chapter 5). The differences between my own, and other groups observations may lie in the preparations studied i.e. pulmonary resistance arteries as opposed to isolated extrapulmonary arteries or isolated perfused lungs, in that functional changes may be occurring in vessels other than pulmonary resistance arteries.

Right ventricular hypertrophy

Rats exposed to hypoxia gain less weight over the experimental period than aged matched controls. This has been well documented in chronic hypoxic rats, in that over the first 3 days exposure to hypoxia, rats lose both water and food appetite, but will subsequently gain weight at the same rate as control animals (Hunter, *et al.*, 1974; Rabinovitch, *et al.*, 1981). However due to lack of appetite and / or increased metabolic rate as a result of hypoxic stress over the first few days, chronic hypoxic animals are significantly lighter in weight than age matched controls. Rats exposed to chronic hypoxia exhibited significant right ventricular hypertrophy as demonstrated by RV / LV & S, RV / TV and RV / BW ratios, all of which have been used previously as an index of right ventricular hypertrophy. The degree of right ventricular hypertrophy observed in these hypoxic rats is comparable to values demonstrated previously for rats of similar age and weight, for example Rabinovitch, *et al.*, (1981) reported RV / LV & S ratio for control animals = 0.32 ± 0.03 , and chronic hypoxic RV / LV & S = 0.64 ± 0.04 . Although the absolute weight of the right ventricle tended to be greater in day 16 / 1 rats compared to day 14 / 0 rats this proved not to be significant when examined as ratio of RV / LV & S, RV / TV & S or RV / BW, which takes into account any growth or weight gain which may have occurred over the 4 day period. No significant differences were found in the ratio of LV & S / BW or TV weight indicating the significant increased workload for the right heart to increased pulmonary vascular resistance.

To summarise, rats exposed to 14 days chronic hypobaric hypoxia within the newly installed chamber exhibited increased pulmonary artery pressure, right ventricular hypertrophy and pulmonary vascular remodelling. No functional differences to KCl, ET-1, 5-HT or ACh were found between chronic hypoxic rats exposed to 14 or 16 days hypoxia, with or without subsequent 24 hour exposure to normoxia. As no differences in responses to these agonist were found, subsequent results for hypoxic pulmonary resistance arteries includes data from all four groups.

Chapter 5

Responses to Endothelin in Pulmonary Resistance Arteries : Effect of Pulmonary Hypertension

5.1 Introduction.

As mentioned in the general introduction of this thesis there is growing evidence to suggest the involvement of ET-1 in the pathogenesis of pulmonary hypertension in both clinical studies and in various animal models of pulmonary hypertension. In the chronic hypoxic rat it has been shown that pulmonary arterial responses to ET-1 are augmented (Eddahibi, *et al.*, 1991), and that hypoxia increases the expression of the ET-1 gene in the rat lung (Elton, *et al.*, 1992). Increased ET-1 expression has also been shown to occur in the fawn hooded rat, a species which develops idiopathic pulmonary hypertension (Stelzner, *et al.*, 1992), and is associated with the development of monocrotaline induced pulmonary hypertension in the rat (Yorikane, *et al.*, 1993). Hypoxia stimulates ET-1 release from rat mesenteric resistance vessels *in vitro* (Rakugi, *et al.*, 1990) and in addition acute alveolar hypoxia has also been shown to increase lung and plasma ET-1 levels in conscious rats (Shirikami, *et al.*, 1991). The role of ET-1 in human forms of pulmonary hypertension will be discussed in chapter 7 of this thesis.

My results from chapter 3 in this thesis suggested that the vasoconstrictor responses to ET-1 in control rat pulmonary resistance arteries were mediated via both ET_A and ET_B receptors whereas the response to ET-1 in the large extrapulmonary arteries is mediated by the ET_A receptor alone. With the development and validation of a chronic hypoxic rat model of pulmonary hypertension (chapter 4 this thesis), I could now assess any changes in pulmonary vascular reactivity between control and pulmonary hypertensive rat pulmonary resistance arteries. In this chapter I investigated vascular responses to ET-1 in pulmonary resistance arteries from rats exposed to chronic hypoxia and their aged matched controls. As pulmonary resistance arteries from chronic hypoxic animals would experience greater pressures *in vivo* due to their pulmonary hypertensive state, the role of initial resting tension on vascular responses to ET-receptor agonists was also investigated. The possibility of the presence of inherent tone in pulmonary resistance arteries was also examined by determining the response of isolated vessels to sodium nitroprusside. I have also investigated the influence of NO

on vascular tone, and responses to ET-1 and SxS6c, by studying the effects of the NOS inhibitor L-N^ω-nitroarginine methylester (L-NAME).

5.2 Methods.

Chronic hypoxic rats were prepared according to the methods stated in chapter 2. After exposure to 14-16 days of chronic hypoxia rats were sacrificed along with aged matched controls, and pulmonary resistance arteries were dissected out according to section 2.1.3.1. Control and chronic hypoxic pulmonary resistance artery vessel pairs were then mounted as ring preparations in the same bath of a wire myograph. Using the normalisation process explained in chapter 2, vessels were placed under "low tension" or "high tension" . "Low tension" being equivalent to a transmural pressure of ~16 mmHg, which is approximately the pressure of pulmonary arteries and arterioles of control animals *in vivo*; and high tension being equivalent to ~36 mmHg, which is approximately the pulmonary artery pressure of pulmonary hypertensive animals *in vivo*. The vessels were bathed in Krebs solution at 37 °C and bubbled with 16 % O₂, 5 % CO₂, balance N₂.

Experimental protocol

After 1 hour equilibration period vessels were stimulated with two separate administrations of 50 mM KCl with the vessels being washed with fresh Krebs solution and allowed to return to baseline tension between KCl stimulations. Following this the integrity of the vascular endothelium was assessed by the ability of 1 μM ACh to cause relaxation after precontraction with 1 μM NA. In a further set of experiments full cumulative concentration relaxation curves were conducted to ACh in control preparations at low tension and chronic hypoxic preparations at high tension, following precontraction with 10 μM 5-HT (this proved to produce a more stable contractile response to that of NA)

Cumulative concentration response curves (CCRC's) to ET-1 and SxS6c (0.01 pM-0.3 μM) were constructed at both resting tensions with or without 100 μM L-

NAME. Experiments were also carried out to assess the possible vasodilator effects of SxS6c. Preparations were first precontracted with 10 μM 5-HT and following this 1 μM ACh was added to verify the presence of an intact vascular endothelium. Following washout and 30 minute rest period, vessels were again precontracted with 10 μM 5-HT, and CCRC's to SxS6c (0.01 pM to 0.3 nM) were conducted, allowing 1 minute intervals between the addition of each concentration of SxS6c. To ensure that any relaxations observed were not due to a "fall off" in tone, some preparations were run as time controls i.e. no addition of SxS6c. These experiments were carried out with control pulmonary resistance arteries at low tension and chronic hypoxic pulmonary resistance arteries at high tension only.

To assess the possible presence of endogenous tone in these vessels, 1 μM sodium nitroprusside (SNP) was administered, prior to the addition of KCl or any drugs, and following washout the response to 50 mM KCl was tested. These experiments were carried out in endothelial intact preparations. As SNP induced relaxations are produced independently of the endothelium, I chose to avoid the damaging effect of endothelium removal. The table 5.1 below lists the experiments carried out within the groups tested.

	CONTROL RAT		HYPOXIC RAT	
	LOW	HIGH	LOW	HIGH
Endothelin-1 CCRC	✓	✓	✓	✓
Sarafotoxin S6c CCRC	✓	✓	✓	✓
ET-1 + L-NAME (100 μM)	✓	✓	✓	✓
SxS6c + L-NAME (100 μM)	✓	✓	✓	✓
Effect of 1 μM SNP on tone	✓	✓	✓	✓
Effect of 100 μM L-NAME on tone	✓	✓	✓	✓
1 μM NA followed by 1 μM ACh	✓	✓	✓	✓
ACh CCRC (tone induced by 5-HT)	✓	✗	✗	✓
SxS6c CCRC (tone induced by 5-HT)	✓	✗	✗	✓

Table 5.1
Summary of experimental procedures performed

Data analysis.

pEC₅₀, and pEC₂₀ values (where appropriate) were calculated according to the methods stated in chapter 2. CCRC's to ET-1 and SxS6c, relaxations to SNP and contractions to L-NAME are expressed as percentage reference contraction to 50 mM KCl in each preparation. Cumulative responses induced by ACh and SxS6c were calculated as a percentage of the level of precontraction in each preparation. Statistical comparisons were made using one way ANOVA or Students t-test for unpaired data. $p < 0.05$ was considered to be statistically significant.

5.3 Results.

Assessment of pulmonary hypertension

Pulmonary hypertension was assessed by measuring right ventricular to total ventricular ratio as described in chapter 2. This ratio was found to be significantly greater in chronic hypoxic rats ($***p < 0.001$, Students unpaired t-test) indicating a significant degree of pulmonary hypertension. For individual data on rats see appendix 1. Internal diameters and pressures of pulmonary resistance arteries set up at low and high tensions are summarised in table 5.1 below.

	Internal Diameter (μm)	Transmural pressure (mmHg)	n / n
Control Low	165.1 ± 5.4	16.9 ± 0.8	10 / 10
Control High	$203.4 \pm 8.2^{**}$	$34.3 \pm 0.4^{**}$	10 / 10
Hypoxic Low	171.7 ± 6.0	16.0 ± 0.3	10 / 10
Hypoxic High	$201.7 \pm 7.7^{\dagger}$	$36.4 \pm 0.6^{\dagger\dagger}$	10 / 10

Table 5.2 Internal diameter and pressures of rat pulmonary resistance arteries

Average internal diameter of arteries removed mounted on the wire myograph from the four groups of control and chronic hypoxic rats. Data are expressed as the mean \pm SEM. Statistical comparisons were made using one way ANOVA followed by Tukeys post test. $**p < 0.01$ control high vs. control low, $^{\dagger}p < 0.05$, $^{\dagger\dagger}p < 0.01$ hypoxic high vs. hypoxic low.

As would be expected table 5.1 shows that pulmonary resistance arteries from both control and chronic hypoxic rats exhibit significantly greater internal diameters when normalised to the higher resting tension. No significant difference was found between control and hypoxic vessels mounted at low tension, or at high tension.

ET-1 and SxS6c responses and the effect of basal tension.

Control pulmonary resistance arteries.

50 mM KCl induced contractions were of the same magnitude at low and high tensions in control rats, being 235 ± 29 mg wt (16 rings) and 305 ± 34 mg wt (16 rings) respectively. Figure 5.1.A and B shows CCRC's for ET-1 and SxS6c in pulmonary resistance arteries from control rats at low and high tension. The figure shows that responses to ET-1 and SxS6c are biphasic in nature, there being a low gradient component at lower concentrations (0.1 pM - 30 pM for SxS6c and 0.1 pM - 0.3 nM for ET-1) and a steeper gradient at higher concentrations. For this reason I have chosen to compare the pEC₂₀ values of the response as well as the pEC₅₀ values. A summary of the pEC₅₀ values can be seen in table 5.3 and pEC₂₀ values in table 5.4. From figure 5.1.A and tables 5.3 and 5.4 it can be seen that an increase in the resting tension in control vessels caused a significant decrease in the tissue sensitivity to ET-1 at both pEC₂₀ and pEC₅₀ levels. The maximum contraction achieved to ET-1 was unaltered by an increase in resting tension. Figure 5.1.B also shows that SxS6c produced contractions in control rat pulmonary resistance arteries which were over 10 fold more potent than ET-1 in control pulmonary resistance artery at both low and high tension. From this figure and tables 5.3 and 5.4 it can be seen that the sensitivity to SxS6c was not significantly altered by changes in resting tension, although high tension appears to cause a slight right-ward shift in the SxS6c CCRC. This was not significant at the pEC₂₀ or pEC₅₀ level. The maximum contraction achieved to SxS6c appears to be decreased in vessels placed at higher resting tensions although this again proved to be not significant.

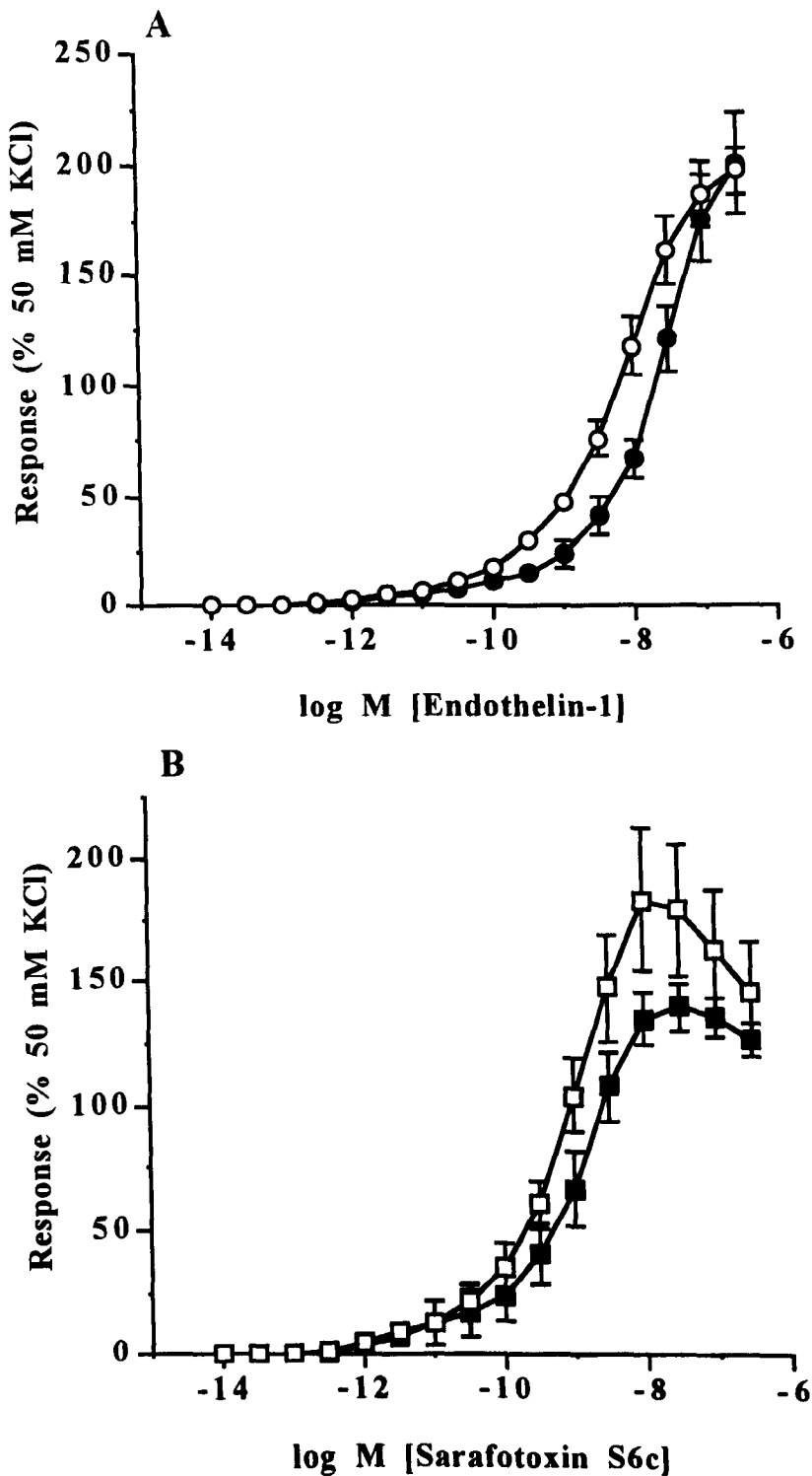

Figure 5.1.

ET-1 and SxS6c-induced vasoconstriction in control rat pulmonary arteries. **A** CCRC's for ET-1 in control vessels at : low tension (○, n = 8 / 8), and at high tension (●, n = 5 / 5). **B** CCRC's for SxS6c in control vessels at : low tension (□, n = 8 / 8), and at high tension (■, n = 5 / 5). Data are expressed as percentage of reference contraction to 50 mM KCl in each vessel. Each point represents the mean ± SEM.

Group	Transmural pressure = 16 mmHg				Transmural pressure = 36 mmHg			
	Control Rat		Hypoxic Rat		Control Rat		Hypoxic Rat	
	pEC ₅₀	n/n	pEC ₅₀	n/n	pEC ₅₀	n/n	pEC ₅₀	n/n
Endothelin-1	8.11 ± 0.10	8/8	8.04 ± 0.10	6/6	7.68 ± 0.11 ^a	5/5	8.35 ± 0.18 ^b	6/6
Sarafotoxin S6c	9.12 ± 0.10	8/8	8.89 ± 0.09	5/5	8.95 ± 0.15	5/5	9.21 ± 0.13	8/8
Endothelin-1 + L-NAME	8.19 ± 0.12	6/6	8.29 ± 0.13	7/7	8.03 ± 0.11	6/6	8.49 ± 0.14	7/7
Sarafotoxin S6c + L-NAME	9.01 ± 0.17	6/6	10.06 ± 0.37 ^c	5/5	9.00 ± 0.11	7/7	9.85 ± 0.22 ^d	5/5

Table 5.3. pEC₅₀ values for peptides in control and chronic hypoxic pulmonary resistance arteries

L-NAME, L-N^o-nitroarginine methylester. n/n, number of ring preparations/ number of animals.

Statistical comparisons were made by Students unpaired t-test. Values are mean ± SEM.

^a p < 0.05 control low vs. control high. ^b p < 0.05 control high vs. chronic hypoxic high.

^c p < 0.05 chronic hypoxic low vs. chronic hypoxic low + L-NAME.

^d p < 0.05 chronic hypoxic high vs. chronic hypoxic high + L-NAME.

Group	Transmural pressure = 16 mmHg				Transmural pressure = 35 mmHg			
	Control Rat		Hypoxic Rat		Control Rat		Hypoxic Rat	
	pEC ₂₀	n / n	pEC ₂₀	n / n	pEC ₂₀	n / n	pEC ₂₀	n / n
Endothelin-1	9.15 ± 0.08	8 / 8	8.76 ± 0.15 ^b	6 / 6	8.52 ± 0.20 ^a	5 / 5	8.99 ± 0.19	6 / 6
Sarafotoxin S6c	9.91 ± 0.13	8 / 8	9.42 ± 0.06 ^c	5 / 5	9.84 ± 0.38	5 / 5	9.97 ± 0.22	8 / 8
Endothelin-1 + L-NAME	9.45 ± 0.37	6 / 6	8.93 ± 0.25	7 / 7	8.82 ± 0.17	6 / 6	9.35 ± 0.26	7 / 7
Sarafotoxin S6c + L-NAME	10.58 ± 0.38	6 / 6	11.24 ± 0.56 ^d	5 / 5	10.31 ± 0.26	7 / 7	10.93 ± 0.33 ^e	5 / 5

Table 5.4 pEC₂₀ values for peptides in control and chronic hypoxic rat pulmonary resistance arteries.

L-NAME, L-N^ω-nitroarginine methyl ester. n / n, number of ring preparations / number of animals.

Statistical comparisons were made by Student's unpaired t-test. Values are mean ± SEM.

^a p < 0.01 control low vs. control high. ^b p < 0.05 control low vs. chronic hypoxic low.

^c p < 0.05 control low vs. chronic hypoxic low.

^d p < 0.05 chronic hypoxic low vs. chronic hypoxic low + L-NAME.

^e p < 0.05 chronic hypoxic high vs. chronic hypoxic high + L-NAME.

Chronic hypoxic pulmonary resistance arteries.

50 mM KCl-induced contractions were of the same magnitude at low and high tensions in chronic hypoxic rats being 246 ± 30 mg wt (16 rings) and 264 ± 33 mg wt (16 rings) respectively; and did not differ from control rat pulmonary resistance artery responses to 50 mM KCl at low and high tensions. Figure 5.2 A and B shows CCRC's for ET-1 and SxS6c in chronic hypoxic pulmonary resistance arteries. A summary of the relevant pEC_{50} values is shown in table 5.3 and pEC_{20} values are shown in table 5.4. From this it can be seen that an increase in the resting tension in chronic hypoxic vessels had no effect on the tissue sensitivity to ET-1 at the pEC_{50} or pEC_{20} level, and had no effect on the maximum contraction achieved to the peptide. Comparing tissue sensitivity to ET-1 between control and chronic hypoxic vessels at low tension, control vessels were significantly more sensitive to ET-1 at the pEC_{20} level but not at the pEC_{50} level. Conversely, at high tension chronic hypoxic vessels were significantly more sensitive to ET-1 at the pEC_{50} value only. Pulmonary resistance arteries from chronic hypoxic rats were over 10 fold more sensitive to SxS6c than ET-1 at both tensions studied, and changes in resting tension appear to have no significant effect on responses to SxS6c in chronic hypoxic rat pulmonary resistance artery. Comparing sensitivity between control and chronic hypoxic vessels, at low tension SxS6c was more potent in control vessels at the pEC_{20} value only and there was no significant difference between groups at high tension. The shape of the CCRC's to SxS6c appear different comparing control (figure 5.1.B) and chronic hypoxic (figure 5.2.B). Both curves demonstrate a "drop off" in tone at the higher concentrations of SxS6c however this is much more dramatic in chronic hypoxic vessels making the curves appear almost bell shaped.

Figure 5.3 shows the maximum contractions achieved to ET-1 and SxS6c in control and chronic hypoxic pulmonary resistance artery at low and high tensions. Altering resting tension had no effect on the maximum contractile response to ET-1 in control and chronic hypoxic rats, however, the maximum contraction to ET-1 is significantly increased in chronic hypoxic pulmonary resistance artery at both low and

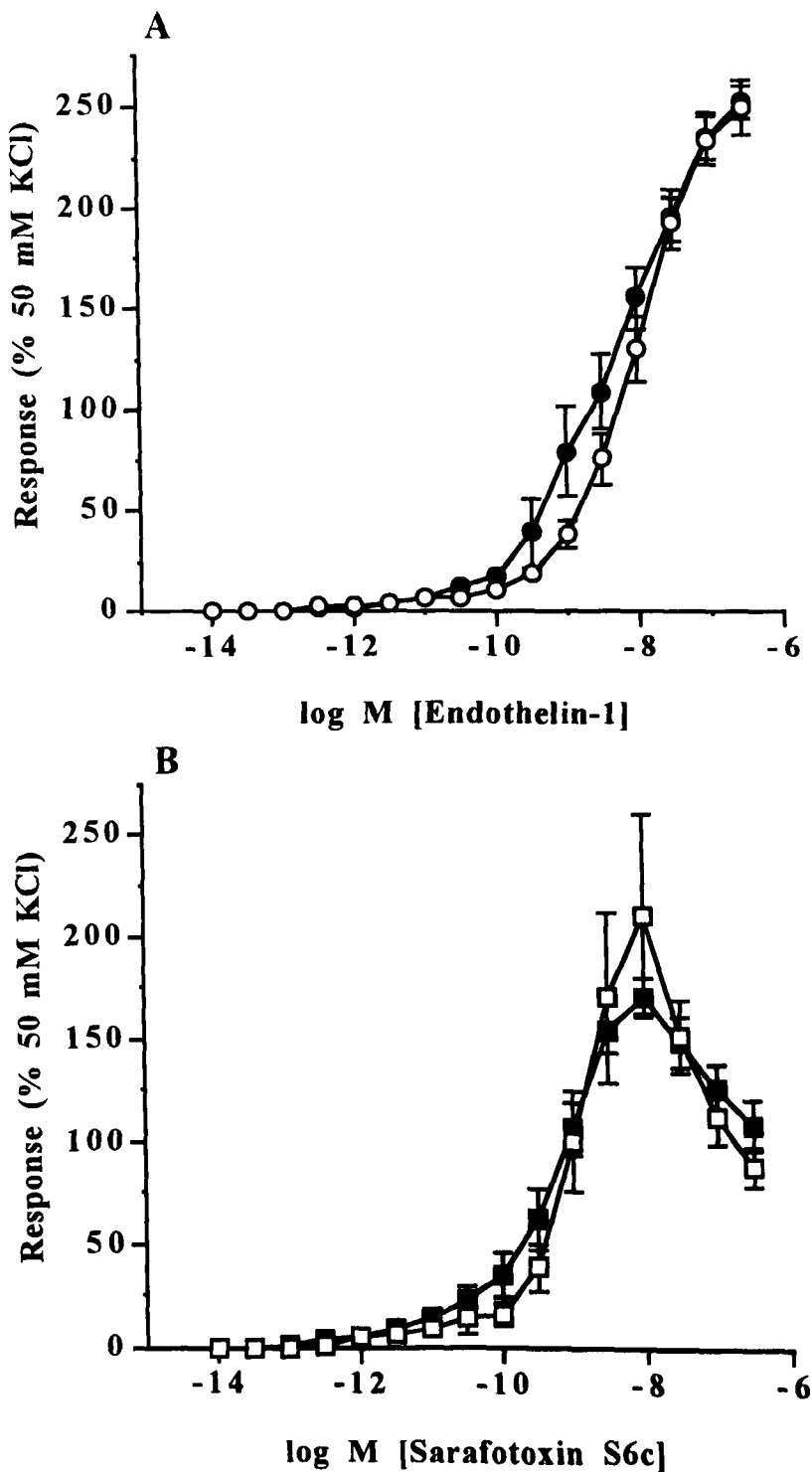

Figure 5.2.

ET-1 and SxS6c-induced vasoconstriction in chronic hypoxic rat pulmonary resistance arteries. **A** CCRC's for ET-1 in chronic hypoxic vessels at : low tension (○, n = 6 / 6), and at high tension (●, n = 6 / 6). **B** CCRC's for SxS6c in chronic hypoxic vessels at : low tension (□, n = 5 / 5) and at high tension (■, n = 8 / 8). Data are expressed as percentage reference contraction to 50 mM KCl in each vessel. Each point represents the mean ± SEM.

Figure 5.3.

Maximum contraction to peptides in control and chronic hypoxic preparations.

A Maximum contraction achieved to ET-1 in control and chronic hypoxic rat pulmonary resistance arteries. Open columns show data from vessels at low tension (control, n = 8 / 8; chronic hypoxic, n = 6 / 6). Hatched columns show data from vessels at high tension (control, n = 5 / 5; chronic hypoxic, n = 6 / 6). Data are expressed as a percentage reference contraction to 50 mM KCl in each vessel. Each point represents the mean \pm SEM. Statistical comparisons were made using Students unpaired t-test. *p < 0.05 Control vs. chronic hypoxic .

B Maximum contraction achieved to SxS6c in control and chronic hypoxic rat pulmonary resistance arteries. Open columns show data from vessels at low tension (control, n = 8 / 8; chronic hypoxic, n = 5 / 5). Hatched columns show data from vessels at high tension (control, n = 5 / 5; chronic hypoxic, n = 8 / 8). Data are expressed as a percentage reference contraction to 50 mM KCl in each vessel. Each point represents the mean \pm SEM.

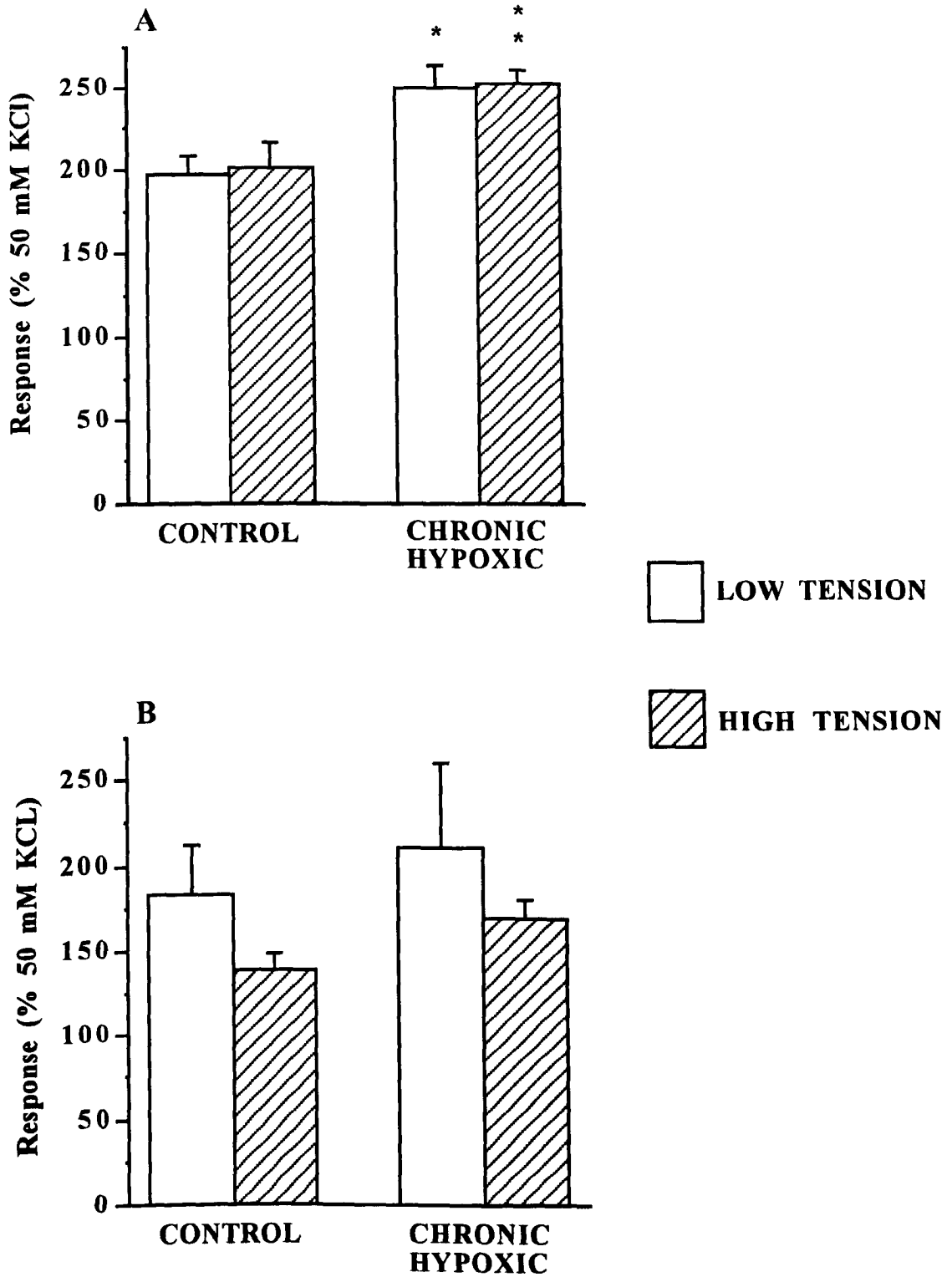

Figure 5.3.

Maximum contraction to peptides in control and chronic hypoxic preparations.

high tension when compared to control preparations. In contrast to ET-1 the maximum contractions to SxS6c were not significantly different in chronic hypoxic pulmonary resistance artery compared with controls. Although maximum response to SxS6c appears to be greater at low tension than at high tension in control and chronic hypoxic preparations this difference was found to be not significant.

Integrity of the vascular endothelium

Control and chronic hypoxic pulmonary resistance arteries precontracted with 1 μ M NA showed similar percentage relaxations to 1 μ M ACh. Values being : control at low tension 42.2 ± 3.0 %, control at high tension 43.1 ± 4.1 %, chronic hypoxic at low tension 52.1 ± 4.3 % and chronic hypoxic at high tension 51.7 ± 3.9 %. However Figure 5.4 shows that the precontraction with 1 μ M NA was significantly greater in chronic hypoxic vessels at both low and high tensions compared with control vessels. The resulting tone after the administration of ACh is also illustrated in figure 5.4 and it can be seen that although the percentage relaxation was not different between groups, the overall magnitude of relaxation is much greater in chronic hypoxic vessels.

A further study was undertaken to see if the sensitivity to ACh was different between control and chronic hypoxic vessels preparations. In this study vessels were first precontracted with 10 μ M 5-HT as this produced greater and more stable resting tone than NA in control preparations. However 5-HT induced tone was again greater in chronic hypoxic preparations than in controls values being 34.5 ± 3.2 % of 50 mM KCl contraction in controls and 87.6 ± 5.2 % of 50 mM KCl contraction in chronic hypoxic preparations (** $p < 0.01$ Students unpaired t-test). Figure 5.5 shows relaxation response curves to ACh in control and chronic hypoxic pulmonary resistance arteries. Data for pEC_{20} and pEC_{50} values are shown in table 5.5 below. From this table and figure 5.5 it can be seen that chronic hypoxic pulmonary resistance artery were over 10 fold more sensitive to ACh than control preparations. Also the overall maximum relaxation observed to ACh was significantly greater in chronic hypoxic vessels

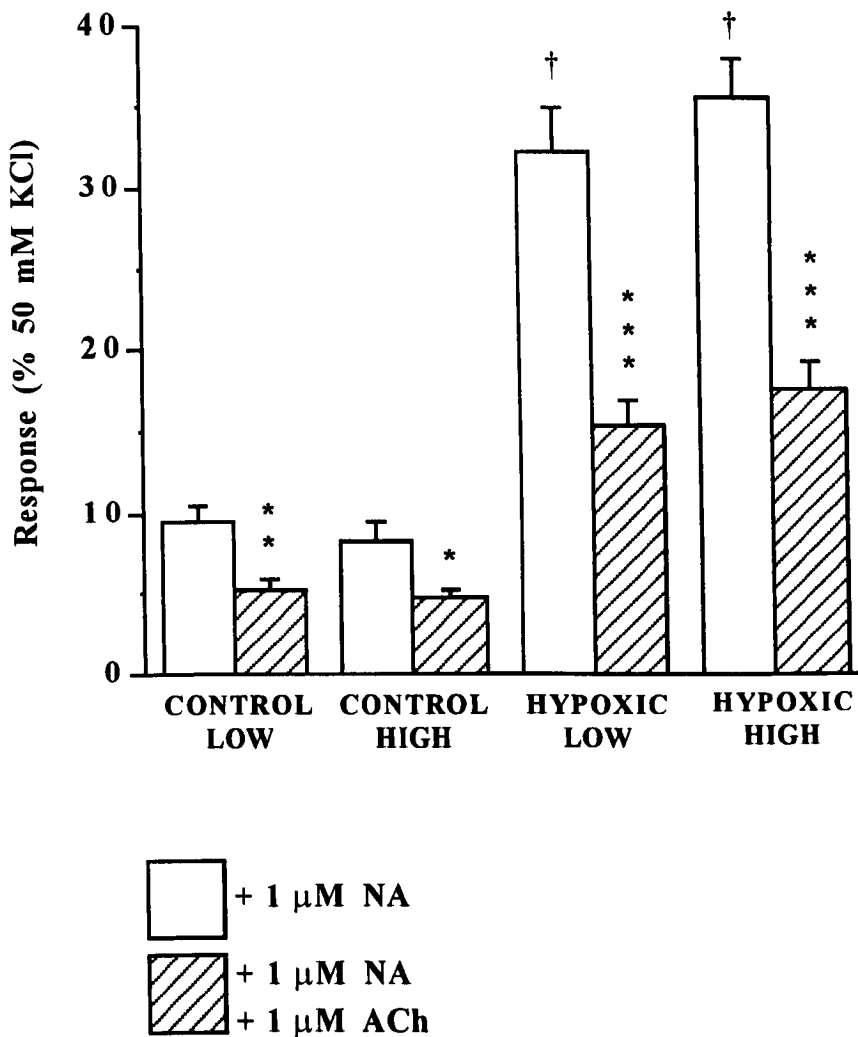

Figure 5.4.

Maximum contraction to 1 μM NA, and relaxation achieved to 1 μM ACh in control and chronic hypoxic rat pulmonary resistance arteries at low and high resting tensions. Open columns show data for contractile responses to NA, and hatched columns show remaining vascular tone after the administration of ACh. $n = 16 / 16$ for all groups. Data are expressed as percentage reference contraction to 50 mM KCl. Each point represents the mean \pm SEM. Statistical comparisons were made using Students t-test for paired or unpaired data. * $p < 0.05$, ** $p < 0.01$, *** $p < 0.001$ effect of ACh of NA induced tone. † $p < 0.001$ control NA induced tone vs. chronic hypoxic NA induced tone.

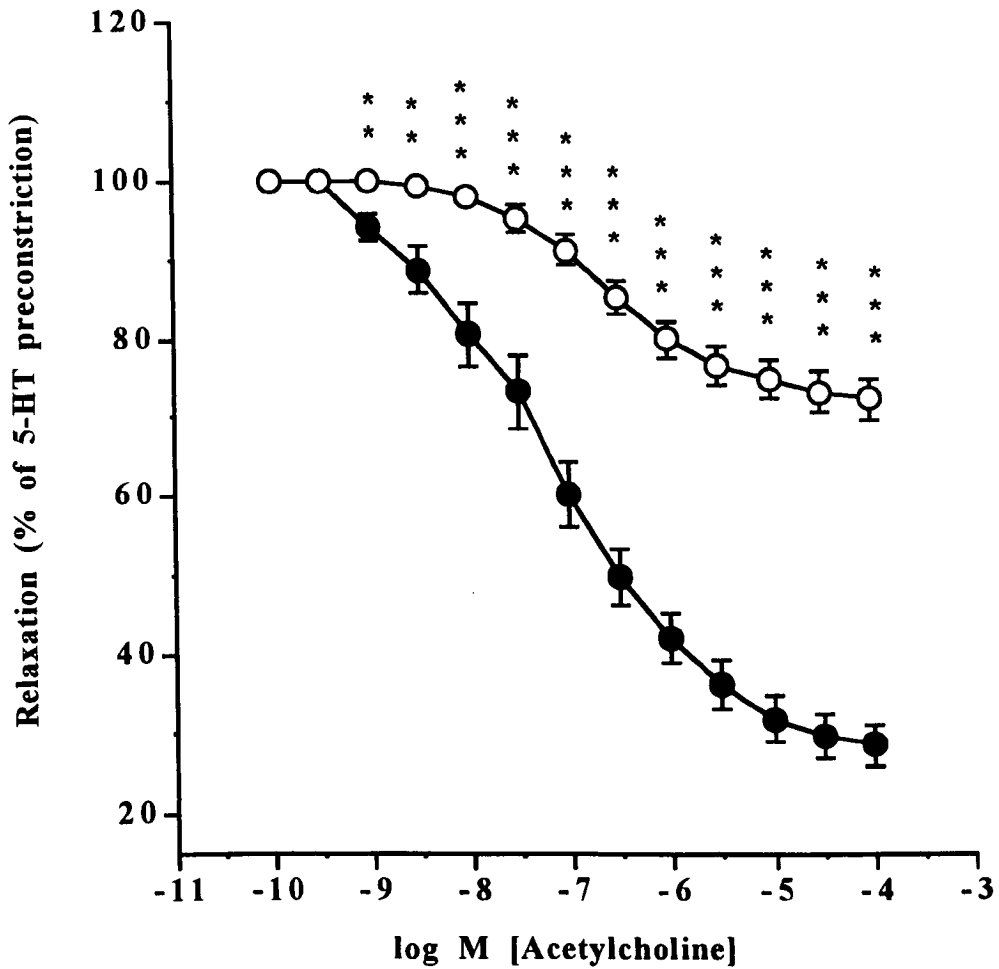

Figure 5.5.

Relaxation responses to ACh in control and chronic hypoxic pulmonary resistance arteries (tone raised with 10 μ M 5-HT). CCRC to ACh in control pulmonary resistance arteries at low tension (○, n = 20 / 10). CCRC to ACh in chronic hypoxic pulmonary resistance arteries at high tension (●, n = 20 / 10). Data are expressed as a percentage of contractile response to 10 μ M 5-HT. Each point represents the mean \pm SEM. Statistical comparisons were made using Students unpaired t-test. ** p < 0.01, *** p < 0.001 Control vs. chronic hypoxic.

compared with controls (maximum relaxation being : control $27.9 \pm 2.7 \%$, and $71.6 \pm 2.7 \%$ chronic hypoxic; *** $p < 0.001$, Students unpaired t-test).

	pEC ₂₀	n / n	pEC ₅₀	n / n
Control	6.81 ± 0.09	20 / 10	5.77 ± 0.15	20 / 10
Chronic hypoxic	$7.73 \pm 0.16^{***}$	20 / 10	$7.12 \pm 0.19^{***}$	20 / 10

Table 5.5 Sensitivity to ACh in control and chronic hypoxic pulmonary resistance arteries

pEC₂₀ and pEC₅₀ values for ACh in control and chronic hypoxic pulmonary resistance arteries. Data are expressed as mean \pm SEM. Statistical comparison were made using Students unpaired t-test. *** $p < 0.001$ control vs. chronic hypoxic

Assessment of endogenous tone in pulmonary resistance arteries.

Figure 5.6.A shows the effect of SNP (1 μ M) when administered prior to any other agent. Not all vessels relaxed to SNP, in control vessels at low tension 29 % of vessels relaxed, in control vessels at high tension and in chronic hypoxic vessels at low tension 88 % of vessels relaxed; and in chronic hypoxic vessels at high tension 93 % of vessels relaxed. Figure 5.6.A demonstrates that there is a significantly greater relaxation in the chronic hypoxic vessels at high tension, indicating a greater degree of endogenous tone in these vessel preparations.

Effect of L-NAME (100 μ M)

Figure 5.6.B shows vasoconstriction produced by the administration of 100 μ M L-NAME itself. In control preparations at low tension 33 % of vessels contracted to L-NAME, whereas in control vessels at high tension 53 % of vessels contracted to administration of L-NAME. In chronic hypoxic animals at low tension 56 % of vessels contracted, and at high tension 88 % of vessels contracted. Figure 5.6.B shows that L-NAME produced a significantly greater vasoconstriction in chronic hypoxic pulmonary resistance arteries at high tension.

Figure 5.6.

Effect of SNP and L-NAME on control and chronic hypoxic vessels.

A Relaxation to 1 μ M SNP in control and chronic hypoxic rat pulmonary resistance arteries. Open columns show data from vessels at low tension (control, n = 14 / 8; chronic hypoxic, n = 8 / 6). Hatched columns show data from vessels at high tension (control, n = 8 / 6; chronic hypoxic, n = 14 / 8). Data are expressed as percentage of reference contraction to 50 mM KCl in each vessel. Each point represents the mean \pm SEM. Statistical comparisons were made using Students unpaired t-test. **p < 0.01 Control vs. chronic hypoxic.

B Effect of 100 μ M L-NAME on vascular tone. Open columns show data from rat pulmonary resistance arteries at low tension (n = 15 / 8 for both control and chronic hypoxic). Hatched columns show data for rat pulmonary resistance arteries at high tension (n = 15 / 8 for both control and chronic hypoxic). Data are expressed as percentage of the reference contraction to 50 mM KCl in each vessel. Statistical comparisons were made using Students unpaired t-test. **p < 0.01 control vs. chronic hypoxic; †p < 0.05 chronic hypoxic low vs. chronic hypoxic high.

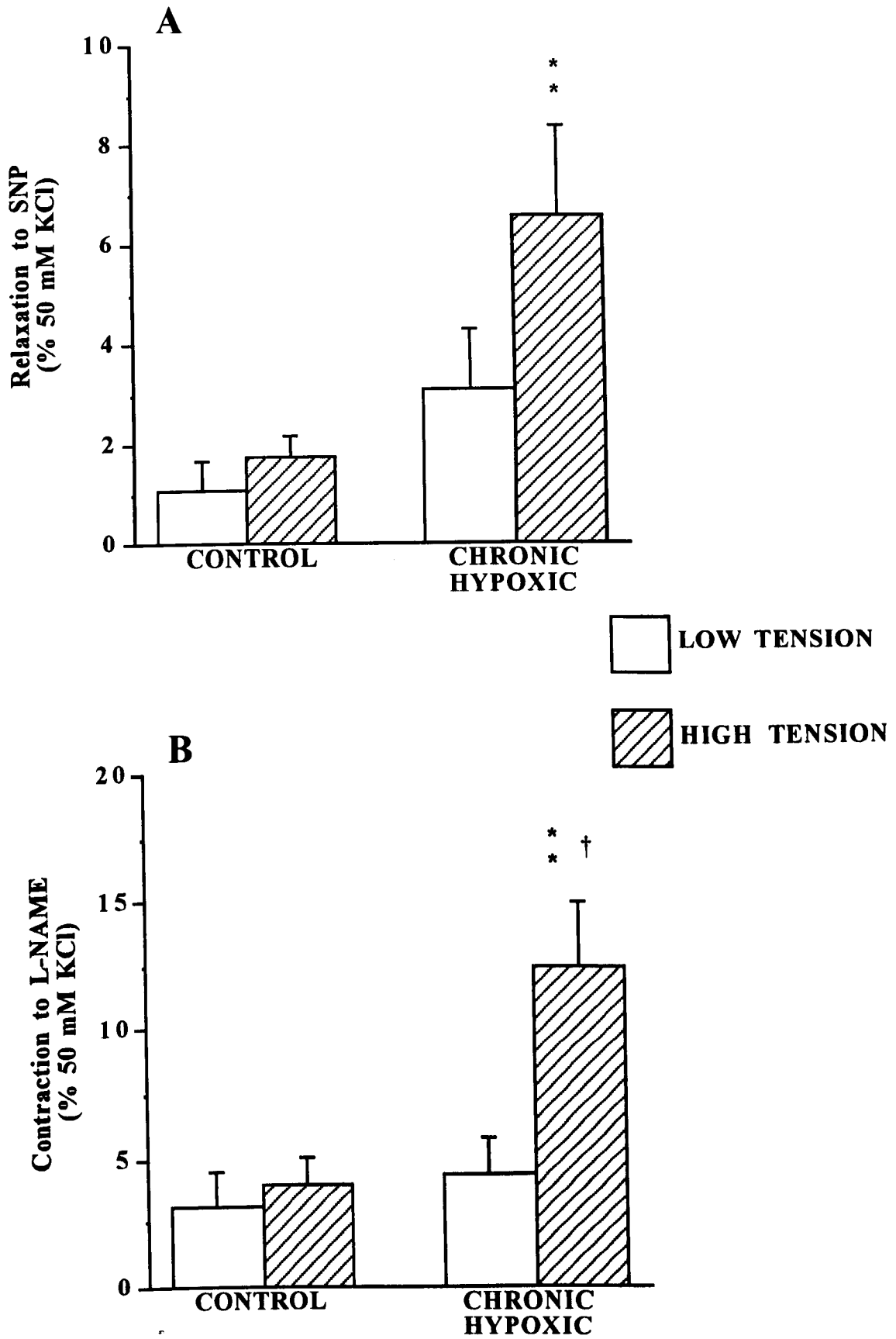

Figure 5.6.

Effect of SNP and L-NAME on control and chronic hypoxic vessels.

The effect of L-NAME on responses to ET-1 in control pulmonary resistance arteries at low and high tension is shown in figure 5.7.A. A summary of the pEC₅₀ values is shown in table 5.3, and pEC₂₀ values in table 5.4. L-NAME had no effect on tissue sensitivity to ET-1 in control vessels at low tension. However, the decrease in sensitivity which was observed when control pulmonary resistance arteries were set at high resting tension, was not seen in the presence of L-NAME. Figure 5.7.A also demonstrates that the maximum contraction achieved to ET-1 was significantly decreased in the presence of L-NAME at both low and high tensions. Figure 5.7.B shows the effect of L-NAME on responses to SxS6c in control pulmonary resistance artery at low and high tensions, with the pEC₅₀ and pEC₂₀ values listed in table 5.2 and 5.3 respectively. The administration of L-NAME had no effect on the tissue sensitivity to SxS6c (at pEC₂₀ or pEC₅₀ level) or the maximum contraction to the peptide in control preparations.

The effect of L-NAME on responses to ET-1 in chronic hypoxic rat pulmonary resistance arteries at low and high tension is demonstrated in figure 5.8.A. The tissue sensitivity to ET-1 was not effected by L-NAME (see tables 5.3 and 5.4 for pEC₅₀ and pEC₂₀ values) at both low and high tensions. However in a similar fashion to that observed in control rat pulmonary resistance artery, L-NAME caused a significant decrease in the maximum contraction achieved to ET-1. There was a dramatic effect of L-NAME on responses to SxS6c in chronic hypoxic pulmonary resistance artery at low and high tensions which is demonstrated in figure 5.8.B. Data for pEC₂₀ and pEC₅₀ values are also shown in tables 5.1 and 2. From this we can see that L-NAME significantly increased the sensitivity of chronic hypoxic pulmonary resistance vessels to SxS6c at both low and high tensions. L-NAME also caused a significant increase in the maximum contraction to SxS6c in chronic hypoxic pulmonary resistance artery at high tension only. Figures 5.8.A and B illustrate that the biphasic nature of the ET-1 and SxS6c curves is exaggerated in the chronic hypoxic vessels and is particularly prominent in the L-NAME treated vessels.

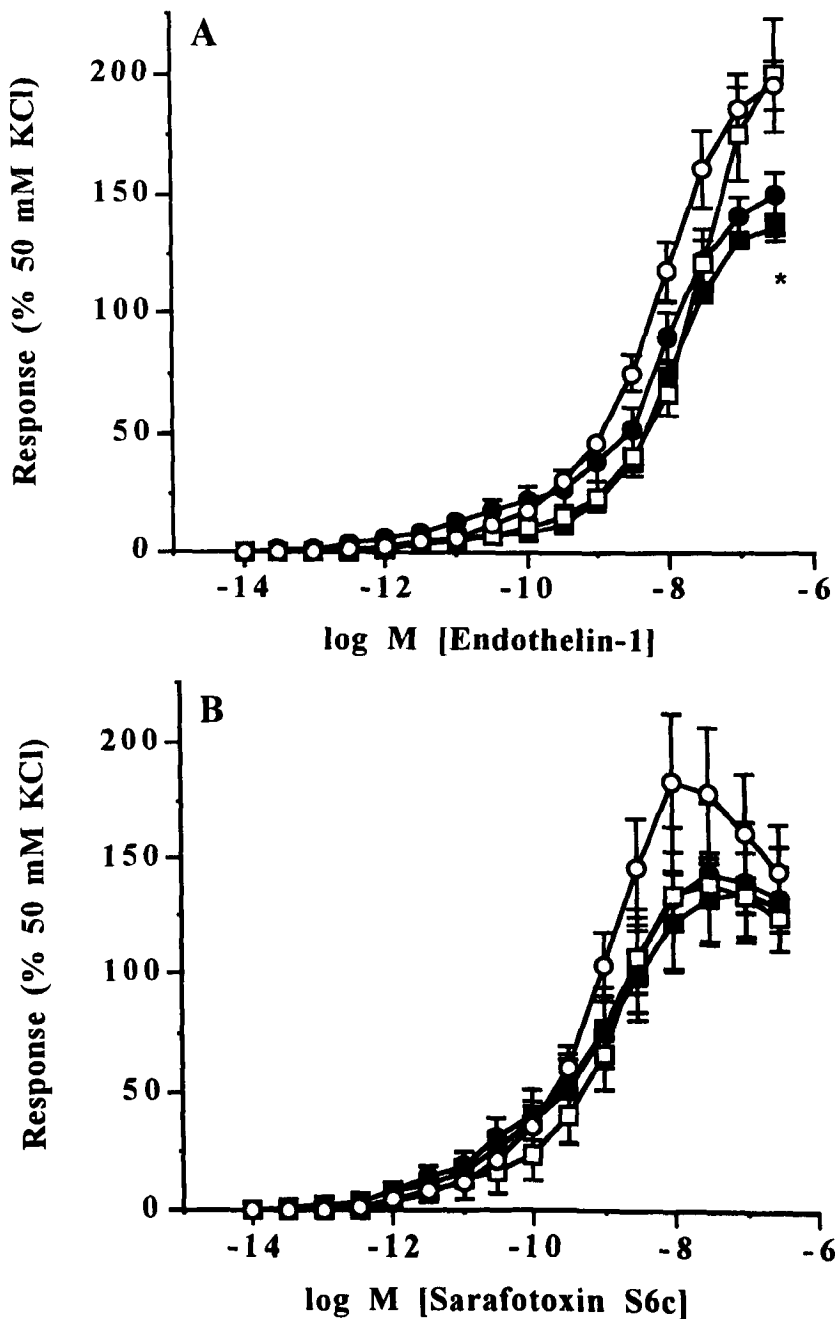

Figure 5.7.

Responses to ET-1 and SxS6c in control vessels: effect of 100 μ M L-NAME.

A CCRC's to ET-1 in control vessels at low tension (\circ , $n = 8 / 8$), control low + L-NAME (\bullet , $n = 6 / 6$), control vessels at high tension (\square , $n = 5 / 5$), control high + L-NAME (\blacksquare , $n = 6 / 6$).

B CCRC's to SxS6c in control vessels at low tension (\circ , $n = 8 / 8$), control low + L-NAME (\bullet , $n = 6 / 6$), control vessels at high tension (\square , $n = 5 / 5$), control high + L-NAME (\blacksquare , $n = 7 / 7$). Data are expressed as a percentage of the reference contraction to 50 mM KCl in each vessel. Each point represents the mean \pm SEM. Statistical comparisons were made using Students unpaired t-test. * $p < 0.05$, control vs. control + L-NAME.

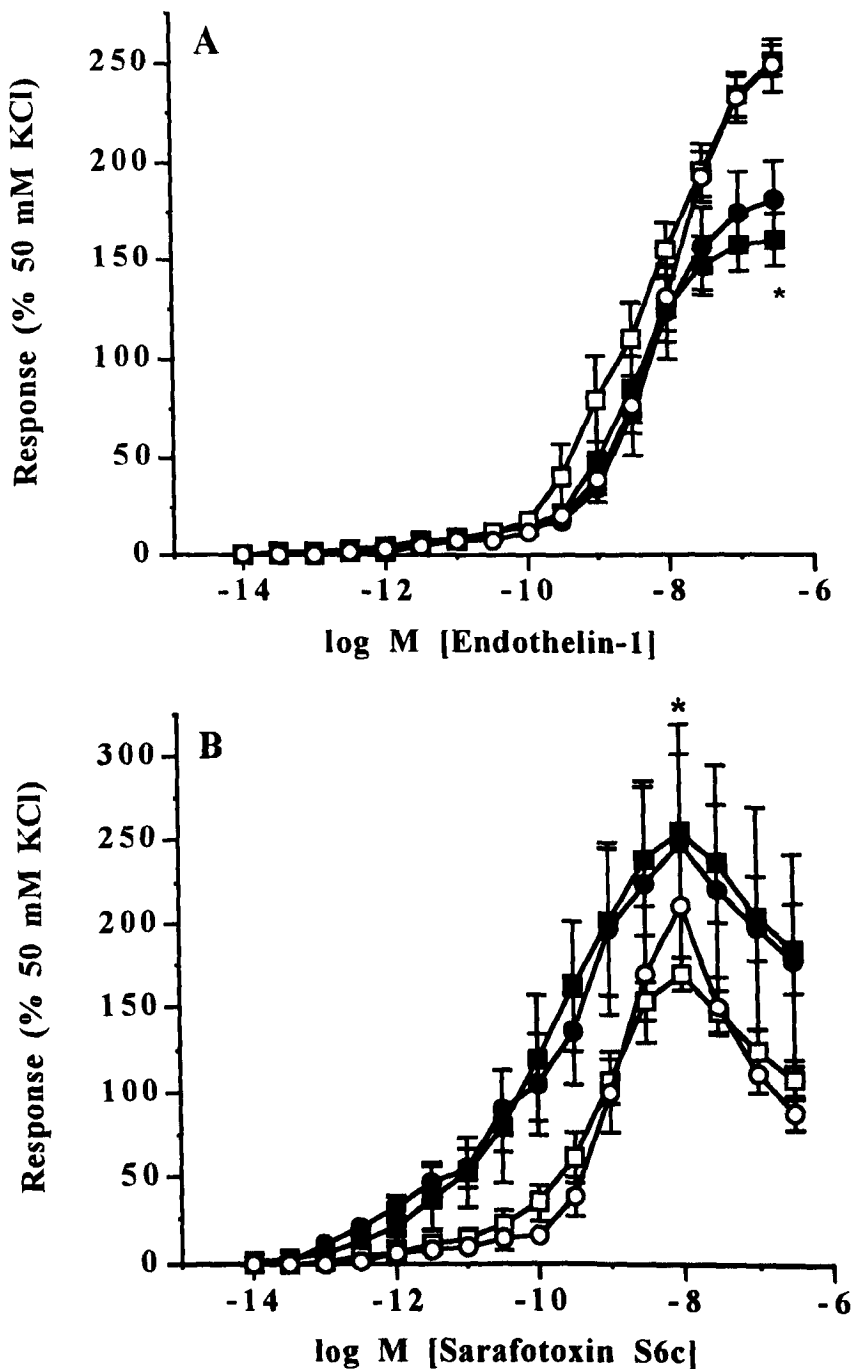

Figure 5.8.

Responses to ET-1 and SxS6c in chronic hypoxic vessels : effect of 100 μ M L-NAME.

A CCRC's to ET-1 in chronic hypoxic vessels at low tension (\circ , n = 6 / 6), low + L-NAME (\bullet , n = 7 / 7), chronic hypoxic vessels at high tension (\square , n = 6 / 6), high + L-NAME (\blacksquare , n = 7 / 7). **B** CCRC's to SxS6c in chronic hypoxic vessels at low tension (\circ , n = 5 / 5), low + L-NAME (\bullet , n = 5 / 5), chronic hypoxic vessels at high tension (\square , n = 8 / 8), high + L-NAME (\blacksquare , n = 5 / 5). Data are expressed as a percentage of the reference contraction to 50 mM KCl in each vessel. Each point represents the mean \pm SEM. Statistical comparisons were made using Students unpaired t-test. * p < 0.05 chronic hypoxic vs. chronic hypoxic + L-NAME.

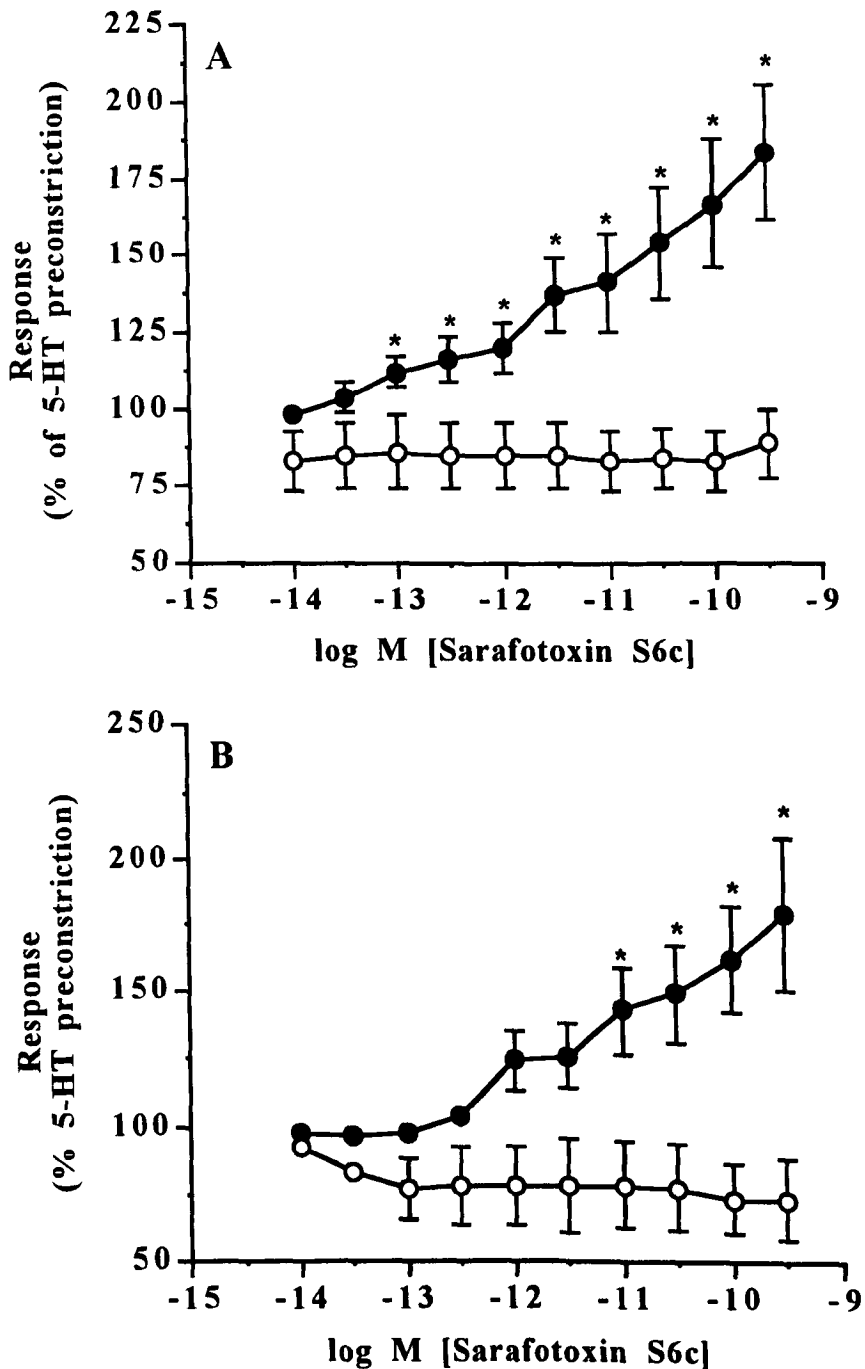

Figure 5.9.

Responses to SxS6c in presence of raised vascular tone (induced by 5-HT 10 μ M).

A Time controls for control rat pulmonary resistance arteries at low tension (○, n = 3 / 3), CCRC to SxS6c in control pulmonary resistance arteries at low tension (●, n = 6 / 6).

B Time controls for chronic hypoxic rat pulmonary resistance arteries at high tension (○, n = 3 / 3), CCRC to SxS6c in chronic hypoxic pulmonary resistance arteries at high tension (●, n = 5 / 5). Data are expressed as a percentage of the contraction achieved to 10 μ M 5-HT. Each point represents the mean \pm SEM. Statistical comparisons were made using Student's unpaired t-test. * p < 0.05 time control vs. SxS6c.

Effects of sarafotoxin S6c in precontracted vessels.

Figure 5.9.A shows the effect of SxS6c on control pulmonary resistance arteries precontracted with 5-HT. In these preparations no relaxations were observed to SxS6c but significant vasoconstriction was observed from 0.1 pM onwards compared with the time controls. Figure 5.9.B shows the responses to SxS6c in chronic hypoxic pulmonary resistance arteries precontracted with 5-HT. Again no vasodilatation was observed to SxS6c in these preparations compared with the time controls, and significant vasoconstriction was observed from 10 pM onwards. The precontraction induced by 5-HT was significantly greater in chronic hypoxic vessels compared to controls values being 34.0 ± 5.7 % of 50 mM KCl contraction for controls and 60.0 ± 8.9 % 50 mM KCl contraction for chronic hypoxic vessels (* $p < 0.05$, Students unpaired t-test). All vessels studied were shown to have intact vascular endothelium with ACh induced relaxations of 44 ± 5 % in control preparations (n = 9 preparations in 6 animals); and 59 ± 6 % in chronic hypoxic preparations (n = 8 preparations in 8 animals).

5.4 Discussion.

The results from this study show that in the pulmonary resistance arteries from control young specific pathogen free rats, responses to ET-1 appear to be mediated via predominantly ET_B receptors due to the relative potency of SxS6c and ET-1. This is what I have previously reported in pulmonary resistance arteries from older 'in house' Wistar rats (chapter 3 this thesis). Due to the possible involvement of ET-1 in pulmonary hypertension, it was of interest to localise the effect of chronic hypoxia in the pulmonary circulation, and assess any changes in ET vascular reactivity in pulmonary resistance arteries from chronic hypoxic rats. In a parallel study, colleagues within our laboratory looked at the effects of chronic hypoxia on the main pulmonary artery and pulmonary artery branches of the rat. This study has subsequently been published (MacLean, *et al.*, 1995). As pulmonary pressure would be greater in chronic

hypoxic animals than aged matched controls, I examined the effects of resting tension on vascular responses to ET's in these rat vessels.

In control pulmonary resistance arteries, responses to ET-1 were significantly less sensitive when placed under the higher resting tension. This may have been due to over stretching of the smooth muscle layers causing damage, but seems unlikely as responses to SxS6c were not significantly decreased in sensitivity under the same conditions. The maximum contractile response to ET-1 was similar at both low and high tension again suggesting that the smooth muscle was not damaged. The decrease in sensitivity to ET-1 at high tension was not observed in vessels pre-treated with 100 μ M L-NAME. This may suggest that NO release in response to the increased vessel stretch at high tension, may be responsible for the decrease in sensitivity to ET-1. Indeed shear stress has been shown to stimulate NO production (Teschfariam & Cohen, 1988). Responses to SxS6c in control rat pulmonary resistance arteries demonstrated no significant change in sensitivity when set up at high tension. Why resting tension should effect the sensitivity to one agonist and not another is unclear, but this has been previously demonstrated in rat pulmonary resistance arteries where responses to different contractile agonists appear to show different length-tension relationships when set up at equivalent transmural pressures of 17 mmHg and 36 mmHg (Rogers, *et al.*, 1992). In control vessels, the maximum contraction achieved to SxS6c was not significantly different to the maximum to ET-1, however responses to SxS6c in chronic hypoxic vessels were significantly less than maximum responses to ET-1. This could be as a result of the desensitisation observed with ET_B receptors illustrated by a "fall off" at high concentrations of SxS6c (Sudjarwo, *et al.*, 1993).

In chronic hypoxic animals, altering resting tension had little effect on sensitivity to ET-1 although there appeared to be a slight leftward trend observed at high tension, in the lower portion of the ET-1 response curve. The maximum contractile response to ET-1 in chronic hypoxic vessels was not altered by changes in resting tension. In a similar fashion to ET-1, responses to SxS6c were not significantly altered by changes in tension in chronic hypoxic pulmonary resistance artery. From my

results it appears that control preparations show greatest sensitivity to ET-1 when set at what would be their equivalent transmural pressure *in vivo*. A similar tendency is shown in chronic hypoxic vessels although this is not statistically significant.

Chronic hypoxia increases the maximum response to ET-1, and this appears to be mediated via the ET_A receptor subtype as maximum responses to SxS6c were unchanged. Chronic hypoxia causes pulmonary vascular remodelling, in which small pulmonary resistance arteries become muscularised (Hunter, *et al.*, 1974, see also chapter 4). If it were simply the case that all vasoconstrictor responses were increased due to pulmonary vascular remodelling then we would have seen an increase in the maximum contraction to all vasoconstrictors tested (e.g. KCl and SxS6c). It could be argued that a significant increase in the SxS6c maximum response is not observed due to receptor desensitisation. However, I have examined the absolute contractile responses to SxS6c at each concentration step prior to desensitisation, and there is no significant difference between control and chronic hypoxic pulmonary resistance artery contractility at any of these points. Increased vasoconstrictor responses to ET-1 have previously been demonstrated in a hypoxic rat model of pulmonary hypertension (Eddahibi, *et al.*, 1991). The results from my study would suggest that this increase is mediated via the ET_A receptor subtype. It has also been demonstrated that lung ET-1 levels are increased due to chronic hypoxia (Elton, *et al.*, 1992). If this were the only process occurring a relative decrease in the ET receptors present would be expected due to receptor down regulation. This has been shown to occur in the monocrotaline lung injury model of pulmonary hypertension. In this model, lung and venous plasma ET-1 levels are also raised, and this results in a relative decreased expression of the ET_B receptor mRNA in the lung (Yorikane, *et al.*, 1993). However, it has subsequently been shown that not only does hypoxia stimulate increases in lung ET-1 levels, but it also has a direct effect on ET receptors : increasing the ET_A receptor mRNA levels in the rat lung (Li, *et al.*, 1994 a, b). Therefore in the hypoxic state there must be some balance occurring between the opposing factors of receptor gene expression and down regulation. My results would agree with an increase in ET_A receptor gene expression in

chronic hypoxia due to the observation of increased vasoconstrictor responses to ET-1 with no effect on SxS6c. Eddahibi, *et al.*, (1993) observed no differences in ET_A and ET_B receptor binding between control and chronic hypoxic the rat lungs. If such a situation is occurring then increased vasoconstrictor responses to ET-1 may be due to an increase in efficacy of ET-1 through alteration of the intracellular signalling mechanism, rather than an increase in receptor number.

In parallel studied looking into vascular changes in main pulmonary artery and pulmonary artery branches of the rat, an increased sensitivity to ET-1 in the in the pulmonary artery branch of chronic hypoxic rats was observed (MacLean, *et al.*, 1995). ET_B mediated responses were also uncovered in both the main pulmonary artery and pulmonary artery branches of the hypoxic rats. Comparing my own observations with this parallel studied indicates that not only do ET-receptor subtypes vary with the size or the location of the vessel, but the effect of pulmonary hypertension due to chronic hypoxia on the pulmonary circulation also varies with the vessel type studied.

All vessels had intact vascular endothelium, and after precontraction with 1 μ M NA there were no differences in percentage ACh induced relaxations between groups. Endothelium-dependent relaxation has been shown to be attenuated in pulmonary hypertensive rat models (Adnot, *et al.*, 1991; Shaul, *et al.*, 1993) and in human pulmonary arteries from patients with COLD (Dinh-Xuan, *et al.*, 1991, 1993). The aforementioned studies in the pulmonary hypertensive rat model were either carried out on isolated main pulmonary arteries, or isolated perfused lung preparations, therefore it may be the case that the decreased endothelium-dependent relaxation is occurring in vessel types other than pulmonary resistance arteries (for example large calibre pulmonary arteries or small pulmonary arterioles and venules). One problem encountered in the initial study was that NA produced poor vasoconstriction in control pulmonary resistance artery, and significantly greater responses to NA were observed in chronic hypoxic pulmonary resistance arteries. Although there was no significant difference in the percentage relaxation to 1 μ M ACh between groups, the overall magnitude of relaxation was greater in chronic hypoxic vessels. I therefore decided to

carry out a full relaxation response curve to ACh in vessels precontracted with 5-HT (as this proved to be a more reliable agent for contracting control pulmonary resistance arteries). Contrary to previous results showing decreased endothelium-dependent relaxation in chronic hypoxic pulmonary arteries, results from this study showed that after precontraction with 5-HT, ACh caused significantly greater relaxation in chronic hypoxic pulmonary resistance arteries compared with controls. This study also demonstrated that chronic hypoxic vessels were over 10 fold more sensitive to ACh. Endothelium-dependent relaxations were extremely poor in control pulmonary resistance arteries, giving a maximum relaxation of only 30 %. This poor relaxatory response to ACh has been previously demonstrated in control rat pulmonary resistance arteries (Leach, *et al.*, 1992).

There is evidence to show that there may be increased production of NO in chronic hypoxic rat lungs. For example Isaacson, *et al.*, (1994) showed increased vasodilator responses to substance P in isolated perfused lungs from pulmonary hypertensive rats compared with control animals. Concentration of NO decomposition products was also significantly increased in the effluent from hypertensive rat lungs. Augmented endothelium-dependent vasodilatation to AVP has also been reported in isolated perfused lungs from chronic hypoxic rats (Eichinger, *et al.*, 1994). There is also immunohistochemical evidence to suggest the upregulation of NOS expression in chronic hypoxic rat lungs (Xue, *et al.*, 1994). This paper demonstrated an absence of NOS staining in the endothelium of pulmonary resistance arteries from control animals, but after a two week exposure to chronic hypoxia NOS staining was prominently expressed in the endothelium and smooth muscle of these resistance vessels. Subsequent studies from this group have indicated that both cNOS and iNOS are upregulated in chronic hypoxic rat lungs, with de novo cNOS staining observed in the endothelium of resistance arteries (Le Cras, *et al.*, 1996). Whether the increased endothelium-dependent relaxation observed in pulmonary resistance arteries in this study is due to increased NO production, can only be speculated at this stage. The involvement of other endothelium-derived relaxing factors such as prostacyclin and

EDHF have also been implicated in the vasodilatory responses to ACh in some isolated vessel preparations (see section 1.1.2.2). However, in isolated rat extrapulmonary arteries and isolated perfused rat lungs ACh-induced vasodilatation has been attributed to the release of endothelium-derived NO (Adnot, *et al.*, 1991; Carville, *et al.*, 1993). Therefore this evidence would indicate that increased production of NO would a likely candidate for increased vasodilatation to ACh in chronic hypoxic rat lungs.

Administration of L-NAME produced increases in vascular tone in some, but not all, vascular preparations. The percentage of preparations which contracted and the absolute magnitude of response was greatest in the chronic hypoxic preparations, and significantly greater at high tension. It was previously suggested in this discussion that stretching the control vessels to higher tension may have stimulated the release of NO. In the control preparations at higher tension there is an increase in the number of preparations contracting to L-NAME but no significant increase in the magnitude of contraction is observed. My observation that L-NAME caused greater contraction in chronic hypoxic rat pulmonary resistance arteries suggests that there may be increased basal release of NO in the pulmonary hypertensive state compared to controls, or that there is a greater degree of inherent tone in pulmonary hypertensive vessels, and removal of basal NO release uncovers the increase in vascular tone. In support of the first theory it has been demonstrated that L-NAME induced a greater increase in pulmonary pressure in isolated perfused lungs from chronic hypoxic rats but was greatly reduced or not observed in control rats (Barer, *et al.*, 1993; Isaacson, *et al.*, 1994). However, Barer *et al.*, (1993) also demonstrated that control preparations would show an increase in perfusion pressure if the pulmonary circulation were in a precontracted state. This suggests that tonic vasoconstriction could be the stimulus for increased release of basal NO. It is clear from my own investigations that it is not simply an increase in tension which causes increased NO release, in that I observed no significant increase in contraction to L-NAME when control preparations were stretched to higher tension. This supports the theory that there is an increase in the degree of inherent tone in the pulmonary hypertensive vasculature, which is uncovered

by the inhibition of basal NO release. Basal NO release may also be enhanced due to the upregulation of iNOS in chronic hypoxic rat lungs (Le Cras, *et al.*, 1996). This suggests that NO may be of more importance in counteracting the increased vasoconstriction in pulmonary hypertensive rat lungs, rather than playing a role in maintenance of low pulmonary vascular tone in control rats.

To further investigate the degree of inherent tone in each preparation, I examined the effect of SNP on basal vascular tone in pulmonary resistance arteries. In a similar fashion to L-NAME, relaxations to SNP were infrequent in control preparations at low and high tension, increasing in frequency in chronic hypoxic vessels, and were significantly greater in chronic hypoxic vessels at high tension. This suggests that chronic hypoxic pulmonary resistance arteries exhibit endogenous inherent tone at an equivalent transmural pressure they would experience *in vivo*. Relaxations to SNP in controls were infrequent and extremely small in magnitude, suggesting that controls exhibit little endogenous inherent tone *in vivo*. The increased effect of L-NAME on preparations from chronic hypoxic animals could therefore be explained by the increased degree of inherent tone observed in the pulmonary resistance arteries from chronic hypoxic rats. This has also been suggested to occur in larger diameter pulmonary arteries from chronic hypoxic rats (Oka, *et al.*, 1993; Wanstall *et al.*, 1995).

L-NAME had no effect on responses to ET-1 in control preparations at low tension, however as mentioned previously, the decrease in sensitivity observed at high tension was not seen in those vessels pre treatment with L-NAME. The maximum contraction to ET-1 was however significantly decreased at both low and high tensions in the presence of L-NAME. There was no effect with L-NAME on SxS6c responses at low and high tension in control preparations. L-NAME had no significant effect on ET-1 responses at either tension in chronic hypoxic preparations, however the maximum contraction was again significantly reduced in the presence of L-NAME. The observed decrease in the maximum contraction to ET-1 in control and chronic hypoxic vessels pre-treated with L-NAME was unexpected. In isolated perfused rat

lungs, contractile responses to ET-1 are potentiated upon inhibition of NOS (Eddahibi, *et al.*, 1991). The reasons for this effect of L-NAME can only be speculated at this stage. It could be that decreasing the intracellular levels of cGMP by NOS inhibition alters certain intracellular signalling pathway, for example regulation of PDE activity. Further investigations would be required to elucidate the mechanisms involved.

Pre-treatment with L-NAME significantly increased tissue sensitivity to SxS6c in chronic hypoxic pulmonary resistance arteries. This indicates that NO may somehow be suppressing responses to SxS6c in chronic hypoxic pulmonary resistance arteries, further supporting the suggestion that there is increased NO production in the chronic hypoxic vessels. Alternatively there may be endothelial ET_B-receptors releasing NO, and that pre-treatment with L-NAME inhibition this production, and subsequently increases the sensitivity to SxS6c. In this study I was unable to demonstrate any relaxations to SxS6c in precontracted pulmonary resistance arteries from control or chronic hypoxic rat lungs, although it may be that the endothelial ET_B receptors are such a small population that contractile ET_B receptors overwhelm the relaxant component. Although vasodilatation to ET's have been demonstrated in isolated perfused lungs, the vessel types involved in this response have yet to be identified in the rat (Eddahibi *et al.*, 1993). However, it has also been shown that pulmonary resistance arteries of the lamb do not demonstrate vasodilatory responses to ET's, whilst such responses are apparent in the small pulmonary veins of the lamb (Wang, *et al.*, 1995). A similar relationship is demonstrated in isolated pulmonary vessels from the pig lung, with ET's mediating vasodilatation in pulmonary veins rather than pulmonary arteries (Zellers, *et al.*, 1994). It therefore seems likely that vasodilator responses to ET's in the rat pulmonary circulation are mediated by vessel types other than pulmonary resistance arteries, perhaps the pulmonary veins. Eddahibi, *et al.*, (1993) have also demonstrated that vasodilatation to ET's are reduced in chronic hypoxic isolated perfused lungs from the rat, so it seems unlikely that endothelial ET_B-receptors are increased in chronic hypoxia.

The response curves to ET-1 and SxS6c were biphasic in nature, there being a low gradient component to 0.1 nM, followed thereafter by a steep gradient component. In my previous study in chapter 3, where I examined the larger extrapulmonary arteries of the rat, this biphasic response curve to ET-1 was not evident, and therefore is unique to the pulmonary resistance arteries. Such a biphasic nature usually suggests different affinity binding sites or receptor subtypes. As this effect was observed with SxS6c also this suggests the presence of an atypical ET receptor in these vessels. This study shows that the first component of the curve is most pronounced in those vessels treated with L-NAME. This suggests that this receptor-mediated response is normally suppressed by the presence of NO. The exact ET receptor subtypes present in the rat pulmonary resistance artery are studied in more detail in the following chapter (6) of this thesis, using selective ET receptor agonists and antagonists.

In conclusion this study indicates that the vascular response to ET-1 in pulmonary resistance arteries is increased in chronic hypoxia and this appears to be mediated via ET_A receptors. Resting tension appears to be an important determinant for tissue sensitivity to ET-1 although this is only statistically significant in control pulmonary resistance arteries. These preparations show greatest sensitivity for ET-1 at an equivalent transmural pressure of ~16 mmHg. Exposure to chronic hypoxia increases vasodilatation to ACh, and increases the role of endogenous NO on vascular reactivity. Basal NO release also appears to suppress responses to SxS6c in pulmonary resistance arteries whilst having no effect on responses to ET-1. Isolated pulmonary resistance arteries from chronic hypoxic rats exhibit inherent tone in comparison to control animals.

Chapter 6

Endothelin Receptor Subtypes in Pulmonary Resistance Arteries : Effect of Pulmonary Hypertension

6.1 Introduction.

For the possible role of ET-induced vasoconstriction in pulmonary hypertension to be fully understood, it is of importance to classify which ET receptors are present in the pulmonary vasculature. As previously mentioned in this thesis, the ET receptors mediating vasoconstriction in the pulmonary circulation varies between species. My results from chapter 3, using the limited agonists and antagonists available suggested that in control rat pulmonary resistance arteries both ET_A and ET_B receptors are involved in vasoconstriction to ET-1. A similar situation is thought to occur in piglet pulmonary arteries (Perrault, *et al.*, 1995); and in the rabbit pulmonary artery ET-1 mediated vasoconstriction is almost entirely ET_B receptor mediated (LaDouceur, *et al.*, 1993). In my initial studies, research into ET receptor antagonists was in its early stages, with only ET_A receptor antagonist commercially available (e.g. FR 139317 Sogabe, *et al.*, 1993). This made full classification of ET receptors difficult.

Subsequently further ET receptor agonists and antagonists have been developed (as mentioned in chapter 1), and have proved useful in the classification of ET receptor subtypes. The properties of these antagonists are summarised in table 1.1, and their chemical structures are illustrated in figure 1.4. The ET_B receptor antagonist BQ-788, demonstrates greater potency and reliability than earlier reported ET_B receptor antagonists. It shows high selectivity for the ET_B receptor subtype and was shown to have a pA₂ value of 8.4 against BQ-3020 in the isolated rabbit pulmonary artery (Ishikawa, *et al.*, 1994). One of the first non-peptide selective ET_A receptor antagonists to be described was BMS 182874. This compound demonstrates greater than 3600-fold selectivity for the ET_A receptor subtype, and has a pK_B value of 6.3 in rabbit carotid artery rings (predominantly ET_A receptor population) (Stein, *et al.*, 1994). The other non-peptide ET receptor antagonists used in this study demonstrate less selectivity between the ET_A and ET_B receptor subtypes, although differences have been observed between functional and binding studies. In binding assays the non peptide mixed ET receptor antagonist bosentan displayed around 30 fold greater potency for ET_A receptor over the ET_B receptor subtype, and in functional studies the pA₂ value for ET_A receptor

mediated contraction was 7.28, compared with a value of 5.9 for ET_B mediated constriction. (Clozel, *et al.*, 1994). The most potent non-peptide ET antagonist described to date is SB 209670. This compound has a pK_B value of 9.39 against ET-1 at an ET_A receptor site, and a pK_B of 6.70 against ET-1 at an ET_{B2} receptor site (Ohlstein, *et al.*, 1994).

In chapter 5, I examined the effects of resting tension on ET responses in control and chronic hypoxic rat pulmonary resistance arteries. Relying on the relative potency of ET receptor agonists ET-1 and SxS6c, I suggested that rat pulmonary resistance arteries contained populations of both ET_A and ET_B receptors, and that there may be a possible increase in the role of the ET_A receptor subtype in the pulmonary hypertensive rat. In this chapter I investigated the effects of a range of ET receptor antagonists on responses to ET-1 and SxS6c in control and chronic hypoxic rat pulmonary resistance arteries. The endogenous ligand ET-3, according to receptor classification, should be selective for ET_B receptors at low concentrations, but at higher concentrations will also activate ET_A receptors. Responses to ET-3 were also investigated in control and chronic hypoxic rat pulmonary resistance arteries.

6.2 Methods

Chronic hypoxic rats were prepared as stated in chapter 2. After exposure to 14-16 days of chronic hypoxia rats were sacrificed along with aged matched controls and pulmonary resistance arteries were dissected out according to the methods stated in chapter 2. Control and chronic hypoxic vessel pairs were then mounted as ring preparations in the same bath of a wire myograph. Using the normalisation process explained in chapter 2, vessels were tensioned to an equivalent transmural pressure of ~16 mmHg for controls and ~35 mmHg for chronic hypoxic. These pressure were chosen as not only are they the physiological pressures that these pulmonary resistance arteries would experience *in vivo*, but also results from chapter 5 (this thesis) suggest that these pressures also produce optimum responses to ET-1 in control and chronic

hypoxic rat pulmonary resistance arteries. The vessels were bathed in Krebs solution at 37 °C and bubbled with 16 % O₂, 5 % CO₂, balance N₂.

Experimental Protocol.

After 1 hour equilibration period, vessels were stimulated with two separate administrations of 50 mM KCl with the vessels being washed with fresh Krebs solution and allowed to return to baseline tension between KCl stimulations. Following this, the integrity of the vascular endothelium was assessed by the ability of 1 μM ACh to cause relaxation after precontraction with 1 μM 5-HT. CCRC's to ET-1, SxS6c and ET-3 (0.01 pM - 300 nM) were constructed in control and chronic hypoxic vessels following either

A) 45 minute “rest period” or

B) 45 minute incubation period with selected concentration of an ET receptor antagonist.

Table 6.1 below illustrates the antagonists studied against each agonist, in control and chronic hypoxic rat pulmonary resistance arteries.

ANTAGONIST	AGONIST		
	Endothelin-1	Endothelin-3	Sarafotoxin S6c
FR 139317	✓ (at 1 μM)	✗	✗
BMS 182874	✓ (at 1 μM)	✗	✗
BQ-788	✓ (at 1 μM)	✓ (at 1 μM)	✓ (at 1 μM)
BMS + BQ-788 ^x	✓ (at 10 and 1 μM)	✗	✗
Bosentan	✓ (at 1 and 10 μM)	✗	4 (at 0.1 and 1 μM)
SB 209670	✓ (10 nM - 1 μm)	✗	✗

Table 6.1 Summary of experimental procedures performed.

BMS = BMS 182874. ^x = addition of both BMS 182874 (10 μM) and BQ-788 (1 μM) together.

Note.

Control responses to ET-1 were carried out, whenever possible, in each tissue sample. Due to equipment and time limitations it was not always possible to run a control ET-1 CCRC when studying different antagonists. Therefore the data for ET-1 CCRC have been “pooled” over many samples. However the ET-1 control CCRC results in this study have been updated with each group of experiments, and are stated separately in tables along with the antagonist under study. No differences were found between the updated ET-1 groups in control or chronic hypoxic animals. Concentrations of antagonists studied were chosen due to their calculated pA_2 / pK_B values in other vascular preparations (see table 1.1). Unfortunately due to time constraints it was not always possible to study a range of antagonist concentrations in each tissue.

Data Analysis.

Results are expressed graphically as percentage of reference contraction to the second application of 50 mM KCl, or as percentage of own maximal contraction. The pEC_{20} , pEC_{50} and pEC_{80} values (where appropriate) were calculated according to the methods stated in chapter 2. Statistical comparisons were made using one sample t-test or Students t-test for unpaired data. pA_2 and pK_B values for antagonists (where appropriate) were calculated according to methods section chapter 2.

6.3 Results.

Assessment of pulmonary hypertension

Pulmonary hypertension was assessed by measuring right ventricular to total ventricular ratio as described in chapter 2. This ratio was found to be significantly greater in chronic hypoxic rats (***) $p < 0.001$, Students unpaired t-test) indicating a significant degree of pulmonary hypertension. For individual data on rats see appendix 1.

Responses to ET-1, SxS6c and ET-3.

Control and Chronic Hypoxic rats.

50 mM KCl induced contractions were of the same magnitude in both control and chronic hypoxic pulmonary resistance arteries, being 270 ± 24 and 294 ± 24 mg wt tension respectively ($n = 20$ rings from 20 animals for both control and chronic hypoxic groups). The average equivalent transmural pressures placed on the vessels and their resulting internal diameter measurements are listed in table 6.2 below.

	Effective Pressure (mmHg)	Internal Diameter (μm)
Control PRA	15.9 ± 0.4	170.5 ± 5.0
Chronic hypoxic PRA	$35.6 \pm 0.3^{***}$	$205.4 \pm 5.0^{***}$

Table 6.2 Internal diameter and effective pressures of vessels.

Data are expressed as mean \pm SEM. $n = 25$ rings for both control and chronic hypoxic groups. $^{***} p < 0.001$ control vs. chronic hypoxic.

As would be expected the effective resting pressure of chronic hypoxic vessels is significantly greater than control vessel preparations, and chronic hypoxic vessels show a corresponding greater internal diameter due to being stretched to higher tension. Both control and chronic hypoxic vessels exhibited vasodilatation to ACh, with values of 28.1 ± 2.5 % of 5-HT-induced precontraction in control preparations and 55.2 ± 3.3 % of 5-HT precontraction in chronic hypoxic preparations ($n = 20$ for both groups) $^{***} p < 0.001$ control vs. chronic hypoxic, Students unpaired t-test. This degree of relaxation was similar to results observed in chapter 5 in this thesis for control and chronic hypoxic vessel preparations.

Figure 6.1 A and B show responses to ET-1, SxS6c and ET-3 in control rat pulmonary resistance arteries. A summary of pEC_{20} and pEC_{50} values are shown in table 6.3. Responses to ET-3 in control rat pulmonary resistance arteries were also 5 fold more potent than ET-1, and were equipotent with SxS6c at the pEC_{20} level. The potencies of SxS6c and ET-3 were verging on being significantly different at the pEC_{50} level. By the pEC_{80} level tissue sensitivity to ET-3 was significantly less than that to

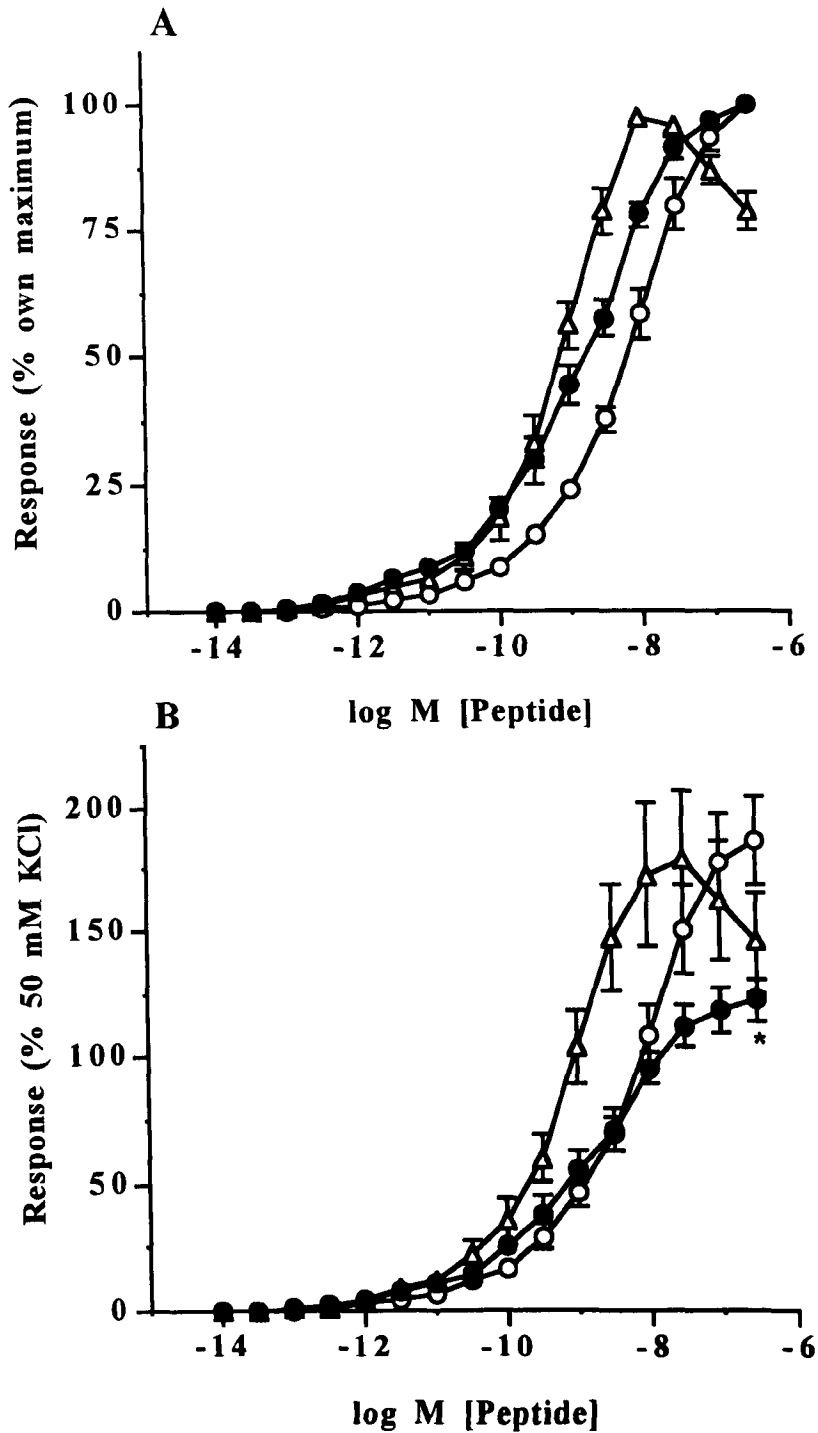

Figure 6.1.

ET-1, ET-3 and SxS6c-induced vasoconstriction in control rat pulmonary resistance arteries. CCRC's for ET-1 (○, n = 8 / 8), SxS6c (●, n = 8 / 8), and ET-3 (△, n = 4 / 4). **A** Data are expressed as percentage of own maximum contraction in each vessel. **B** Data are expressed as percentage of reference contraction to 50 mM KCl in each vessel. Each point represents the mean ± SEM. Statistical comparisons were made using Students unpaired t-test. *p < 0.05, ET-1 vs. ET-3.

	CONTROL RAT			HYPOXIC RAT		
	pEC ₂₀	pEC ₅₀	n / n	pEC ₂₀	pEC ₅₀	n / n
Endothelin-1	9.20 ± 0.08	8.12 ± 0.04	8 / 8	8.95 ± 0.12	8.25 ± 0.08	6 / 6
Sarafotoxin S6c	9.91 ± 0.13 ^a	9.12 ± 0.10 ^a	8 / 8	9.97 ± 0.22 ^b	9.21 ± 0.13 ^b	8 / 8
Endothelin-3	9.90 ± 0.12 ^c	8.76 ± 0.14 ^c	4 / 4	9.73 ± 0.27 ^d	8.82 ± 0.15 ^d	4 / 4
ET-1 + FR (1 µM)	9.30 ± 0.39	8.02 ± 0.22	6 / 6	8.67 ± 0.31	8.00 ± 0.19	6 / 6
ET-1 + BMS (1 µM)	10.11 ± 0.52 [*]	8.86 ± 0.23 ^{**}	5 / 5	9.38 ± 0.36	8.31 ± 0.09	5 / 5
ET-1 + Bos (1 µM)	9.86 ± 0.20 ^{***}	8.40 ± 0.09 ^{**}	4 / 4	9.23 ± 0.40	8.15 ± 0.05	4 / 4
ET-1 + Bos (10 µM)	8.72 ± 0.19 [*]	8.03 ± 0.04	3 / 3	8.52 ± 0.16 ^x	7.83 ± 0.09 [*]	3 / 3

Table 6.3 Sensitivity to ET peptides in the presence and absence of selected antagonists.

FR = FR 139317 ET_A receptor antagonist, BMS = BMS 182874 ET_A receptor antagonist, Bos = bosentan mixed ET_A / ET_B receptor antagonist.

n / n = number of preparations from number of animals. Statistical comparisons were made using Students unpaired t-test.

^a p < 0.001 control ET-1 vs. control SxS6c. ^b p < 0.001 chronic hypoxic (CH) ET-1 vs. CH SxS6c. ^c p < 0.001 control ET-1 vs. control ET-3. ^d

p < 0.01 CH ET-1 vs. CH ET-3. * p < 0.05, ** p < 0.01, *** p < 0.001 ET-1 vs. ET-1 (+ antagonist). (^x p = 0.073 CH ET-1 vs. ET-1 + bosentan, verging on significance)

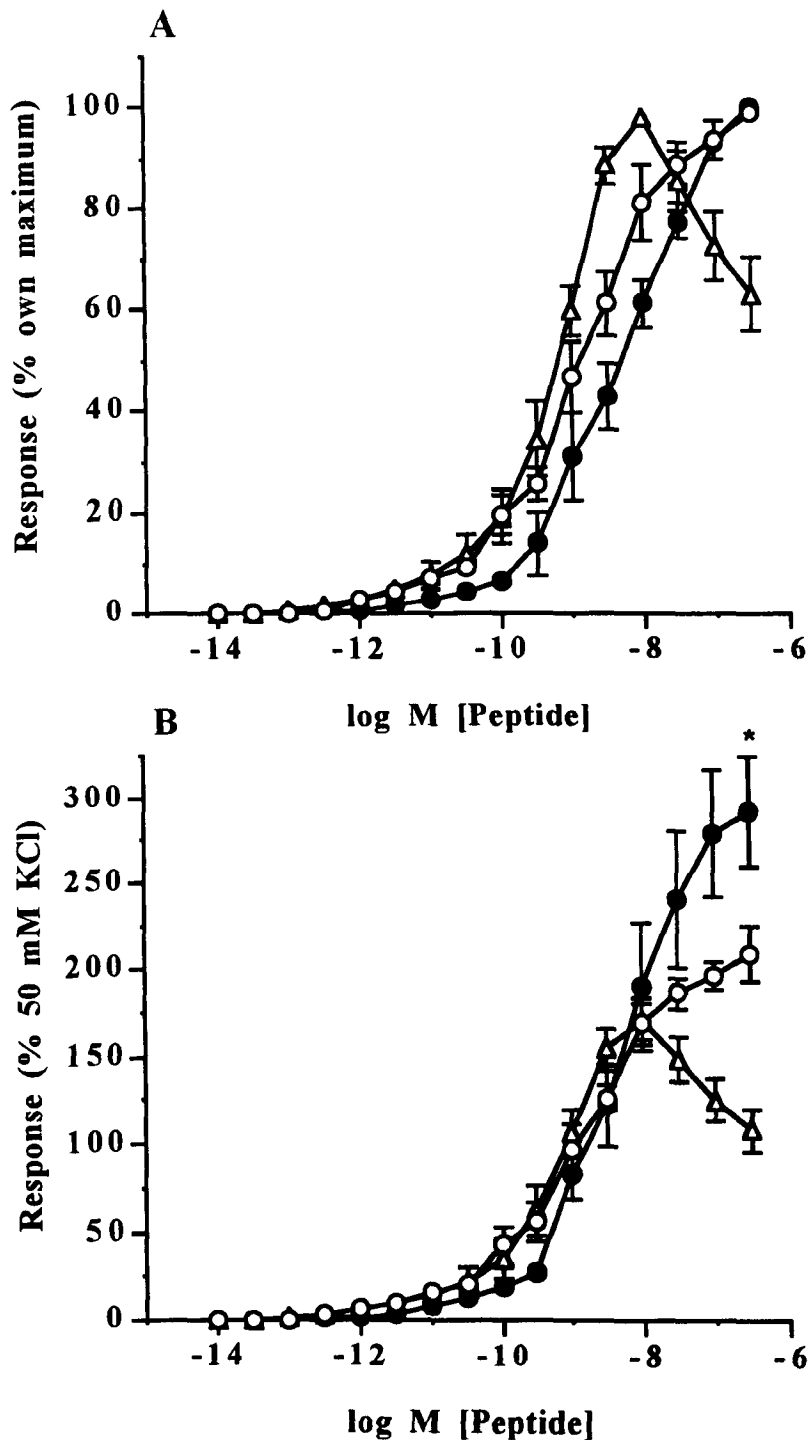

Figure 6.2.

ET-1, ET-3 and SxS6c-induced vasoconstriction in chronic hypoxic rat pulmonary resistance arteries. CCRC's for ET-1 (○, n = 6 / 6), SxS6c (●, n = 8 / 8), and ET-3 (△, n = 4 / 4). **A** Data are expressed as percentage of own maximum contraction in each vessel. **B** Data are expressed as percentage of reference contraction to 50 mM KCl in each vessel. Each point represents the mean ± SEM.

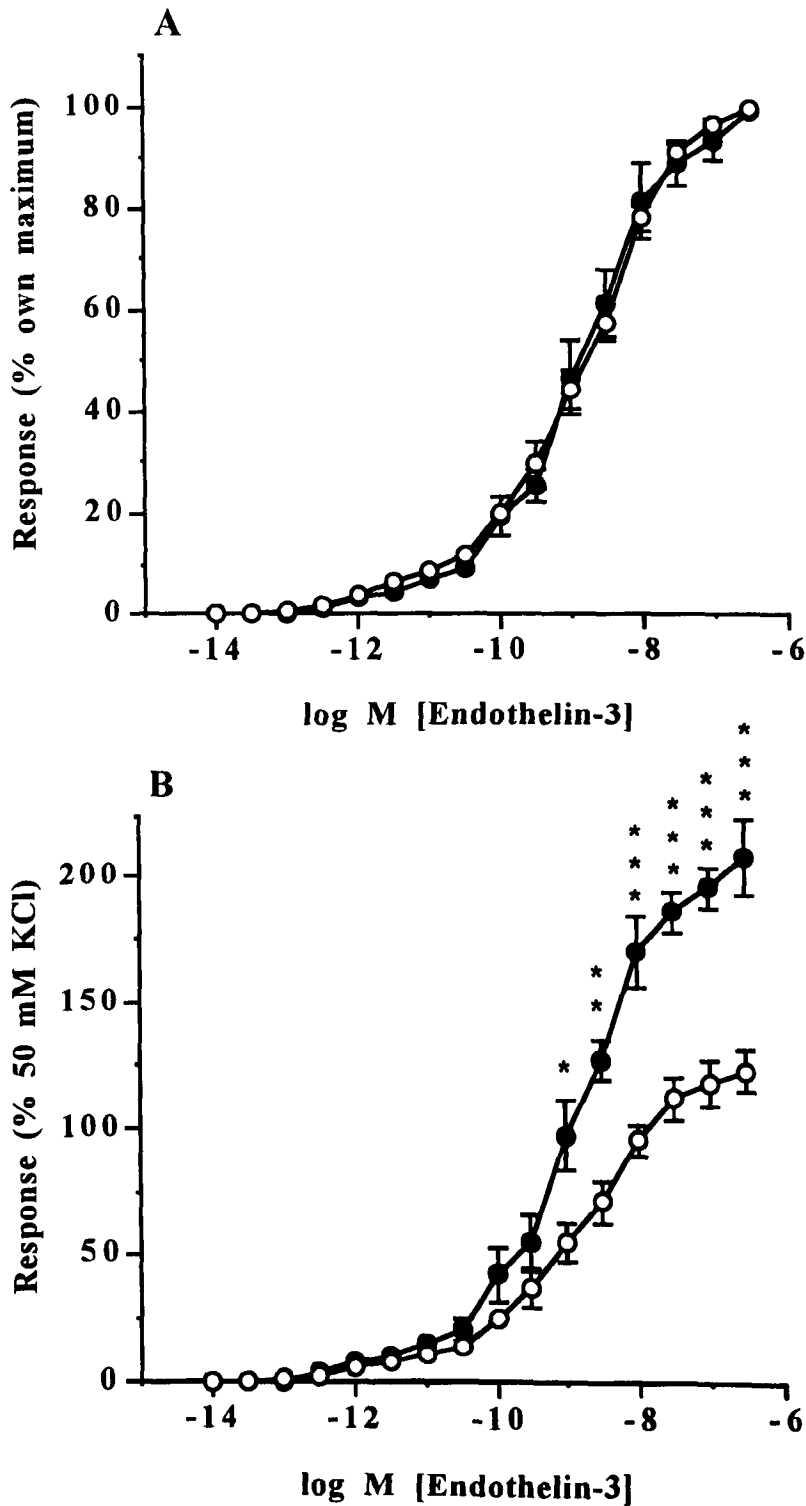

Figure 6.3.

Responses to ET-3 in control and chronic hypoxic rat pulmonary resistance arteries. CCRC's to ET-3 in control vessels (○, n = 4 / 4), and in chronic hypoxic vessels (●, n = 4 / 4). **A** Data are expressed as percentage of own maximum contraction in each vessel. **B** Data are expressed as percentage of reference contraction to 50 mM KCl in each vessel. Each point represents the mean ± SEM. Statistical comparisons were made using Students unpaired t-test ** p < 0.01, *** p < 0.001 control vs. chronic hypoxic.

SxS6c (pEC₈₀ values being ET-3 control 7.89 ± 0.08 , and SxS6c control 8.51 ± 0.12 ; **p < 0.01, Students unpaired t-test). The maximum contractile response achieved to ET-3 in control vessels was significantly less than that achieved to ET-1 but not significantly different to SxS6c.

Figure 6.2 A and B show responses to ET-1, SxS6c and ET-3 in chronic hypoxic rat pulmonary resistance arteries. As summary of the pEC₂₀ and pEC₅₀ values are shown in table 6.3. Again SxS6c was over 10 fold more potent than ET-1 in this preparation, but ET-1 produced a significantly greater maximum contraction than SxS6c. Responses to ET-3 were 5 fold more potent than ET-1 and were equipotent with SxS6c at the pEC₂₀ levels. As observed in control preparations responses to SxS6c were verging on being significantly more potent than ET-3 at the pEC₅₀ level. By the pEC₈₀ level tissue sensitivity to ET-3 was significantly less than that to SxS6c (pEC₈₀ values being ET-3 hypoxic 7.84 ± 0.16 , and SxS6c hypoxic 8.64 ± 0.08 ; *p < 0.05, Students unpaired t-test). The maximum contractile response to ET-3 was similar to that of ET-1 and significantly greater than SxS6c (*p < 0.05, Students unpaired t-test).

In figures 6.1, 2 and 3 it can be seen that responses to ET-3 in both control and chronic hypoxic vessels are biphasic in nature, there being a slow gradual component to 0.3 nM, and a steeper component thereafter. The responses to ET-3 appear to follow the time course for SxS6c at low concentrations and then verge towards the ET-1 CCRC at higher concentrations of ET-3. Figures 6.3 A and B show that responses to ET-3 are equipotent in control and chronic hypoxic rat pulmonary resistance arteries, but the maximum contractile response to the peptide is significantly increased in chronic hypoxic preparations.

Effect of ET_A receptor antagonists on responses to ET-1.

Figure 6.4 A and B illustrate responses to ET-1 in control and chronic hypoxic rat pulmonary resistance arteries in the presence of 1 μM of the ET_A receptor antagonists FR 139317 or BMS 182874. Table 6.4 shows pEC₂₀ and pEC₅₀ values for

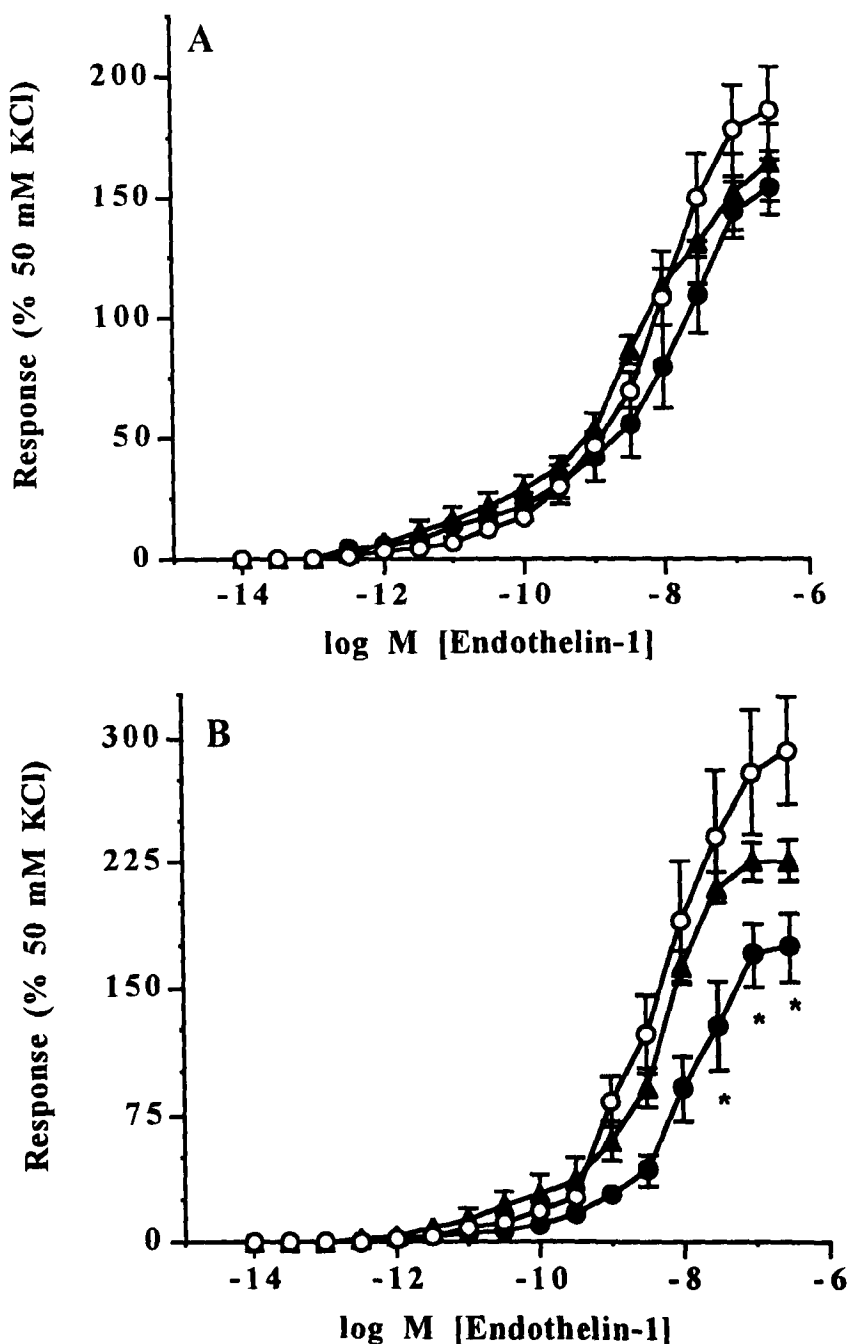

Figure 6.4

Effect of FR 139317 and BMS 182874 on responses to ET-1 in rat pulmonary resistance arteries.

A. CCRC's to ET-1 in control vessels (○, n = 8 / 8), ET-1 in the presence of 1 μ M FR 139317 (●, n = 6 / 6), and ET-1 in presence of 1 μ M BMS 182874 (▲, n = 5 / 5).

B CCRC's to ET-1 in chronic hypoxic vessels (○, n = 8 / 8), ET-1 in the presence of 1 μ M FR 139317 (●, n = 6 / 6), and ET-1 in presence of 1 μ M BMS 182874 (▲, n = 5 / 5). Data are expressed as percentage of reference contraction to 50 mM KCl in each vessel. Each point represents the mean \pm SEM. Statistical comparisons were made using Students unpaired t-test * $p < 0.05$ ET-1 vs. ET-1 + FR 139317.

	CONTROL RAT			HYPOXIC RAT		
	pEC ₂₀	pEC ₅₀	n / n	pEC ₂₀	pEC ₅₀	n / n
Endothelin -1	9.14 ± 0.07	8.13 ± 0.03	9 / 9	8.89 ± 0.10	8.17 ± 0.09	8 / 8
ET-1 + BQ-788	9.45 ± 0.34	8.48 ± 0.23	5 / 5	9.12 ± 0.28	8.47 ± 0.18	5 / 5
ET-1 + BQ + BMS	8.81 ± 0.28	8.10 ± 0.09	7 / 7	8.36 ± 0.09**	7.91 ± 0.07*	7 / 7

Table 6.4 Potency of ET-1 in the presence and absence of selected antagonists.

BQ = BQ-788 ET_B receptor antagonist (1 μM), BMS = BMS 182874 ET_A receptor antagonist (10 mM). n / n = number of preparations from number of animals.

Statistical comparisons were made using Students unpaired t-test.

* p < 0.05, ** p < 0.01 CH ET-1 vs. ET-1 + (BQ-788 1 μM and BMS 182874 10 μM).

ET-1 in the presence and absence of the ET_A receptor antagonists. Incubation with all the antagonists used in these studies had no effect or baseline tension in control and chronic hypoxic preparations. FR 139319 did not effect the sensitivity or the maximum contractile response to ET-1 in control preparations, but caused a significant decrease in the maximum contractile response to ET-1 in chronic hypoxic vessels (see figure 6.4.B). This decrease in the maximum contractile response occurred without effecting the tissue sensitivity to ET-1 (see table 6.4).

Responses to ET-1 in chronic hypoxic pulmonary resistance arteries were unaltered in the presence of BMS 182874, but the antagonist caused a significant increase in tissue sensitivity to ET-1 in control preparations at both pEC₂₀ and pEC₅₀ levels (see figure 6.4.A and table 6.4). This significant increase in tissue sensitivity occurred without effecting the maximum contractile response to ET-1 in control preparations.

Effect of bosentan on responses to ET-1.

The non peptide mixed ET_A / ET_B receptor antagonist bosentan was the next antagonist available for use in this study. Figure 6.5 A shows the effect of bosentan on responses to ET-1 in control rat pulmonary resistance arteries. From this figure and table 6.4 it can be seen that incubation with 1 µM bosentan causes a significant increase in the tissue sensitivity to ET-1 in control preparations at both pEC₂₀ and pEC₅₀ values. This increase in tissue sensitivity occurred without effecting the maximum contractile response to ET-1. In the presence of 10 µM bosentan the lower concentrations of the CCRC to ET-1 are significantly antagonised, and this is illustrated also by a significant decrease in the pEC₂₀ value for ET-1 (see table 6.4). Neither the pEC₅₀ value or the maximum contraction to ET-1 were effected by incubation with 10 µM bosentan.

Figure 6.5.B shows responses the effect of bosentan on responses to ET-1 in chronic hypoxic rat pulmonary resistance arteries. When present at 1 µM there was no effect on responses to ET-1 in chronic hypoxic preparations, however 10 µM bosentan caused a rightward shift in the CCRC to ET-1, and also significantly decreased the

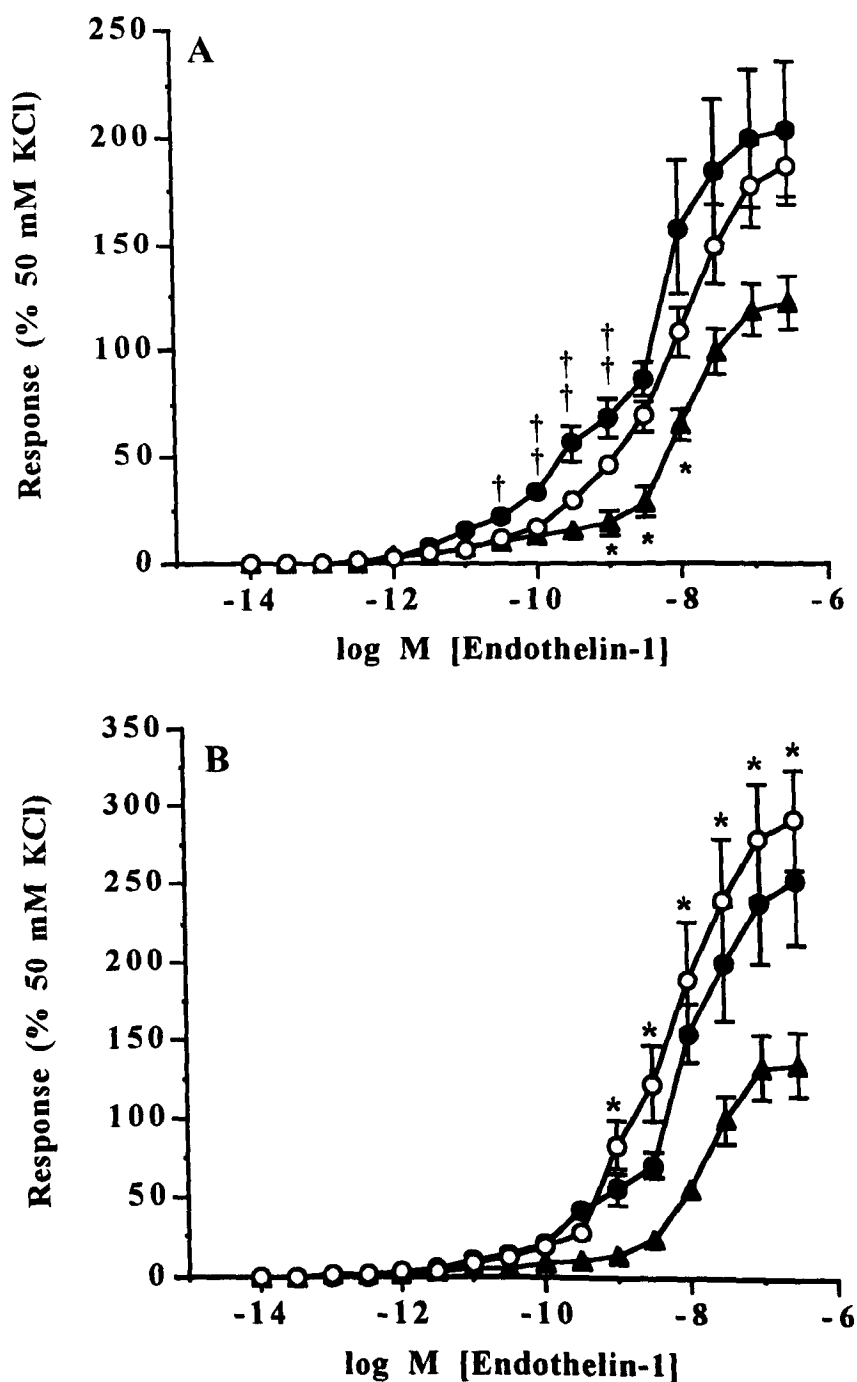

Figure 6.5

Effect of bosentan on responses to ET-1 in rat pulmonary resistance arteries.

A. CCRC's to ET-1 in control arteries (○, n = 8 / 8), ET-1 in the presence of 1 μM bosentan (●, n = 4 / 4), and ET-1 in presence of 10 μM bosentan (▲, n = 3 / 3). **B**

CCRC's to ET-1 in chronic hypoxic arteries (○, n = 8 / 8), ET-1 in the presence of 1 μM bosentan (●, n = 4 / 4), and ET-1 in presence of 10 μM bosentan (▲, n = 3 / 3).

Data are expressed as percentage of reference contraction to 50 mM KCl in each vessel.

Each point represents the mean ± SEM. Statistical comparisons were made using Students unpaired t-test. †p < 0.05, ††p < 0.01, ET-1 vs. ET-1 + bosentan (1 μM). *p

< 0.05, **p < 0.01, ET-1 vs. ET-1 + bosentan (10 μM).

maximum contractile response to ET-1 in these preparations. The antagonism of the CCRC to ET-1 by bosentan 10 μ M is illustrated by a significant decrease in the pEC₅₀ value (see table 6.4). The pEC₂₀ values in the presence and absence of 10 μ M bosentan were verging on statistical difference.

Effect of ET_B, and mixed ET_A/ET_B receptor blockade on ET-1 responses.

Figure 6.6 shows the effect of the ET_B receptor antagonist BQ-788 alone, and BQ-788 and BMS 182874 together on responses to ET-1 in control and chronic hypoxic rat pulmonary resistance arteries. A summary of pEC₂₀ and pEC₅₀ values are shown in table 6.4. BQ-788 alone had no effect on responses to ET-1 in control or chronic hypoxic preparations. However a combination of both BQ-788 and BMS 182874 causes a slight but insignificant rightward shift the lower portion of the CCRC to ET-1 in control preparations, and causes a significant rightward shift in the response to ET-1 in chronic hypoxic preparations. This is similar to observations in the presence of the mixed ET_A / ET_B receptor antagonist bosentan.

The effect of the non peptide mixed ET_A / ET_B antagonist SB 209670 on responses to ET-1 is shown in figure 6.7. Incubation with the antagonist had no effect of resting vessel tone in either control or chronic hypoxic preparations. The pEC₂₀ and pEC₅₀ values for ET-1 in the presence and absence of SB 29670 are shown in table 6.5. Figure 6.7.A shows the effect of the mixed receptor antagonist on responses to ET-1 in control pulmonary resistance arteries. It can be seen from this figure and table 6.5 that SB 209670 causes concentration dependent rightward shifts in the CCRC to ET-1. When present at 1 μ M SB 2096709, significantly decreased the maximum contractile response achieved to ET-1. SB 209670 also demonstrates concentration dependent rightward shifts of the CCRC to ET-1 in chronic hypoxic vessel preparations. The maximum contractile response to ET-1 is significantly decreased at both 0.1 μ M and 1 μ M SB 209670. The pK_B values for SB 209670 in control and chronic hypoxic preparations are shown in table 6.7. The pK_B values for SB 209670 were significantly greater at 0.1 μ M than 1 μ M in both control and chronic hypoxic pulmonary resistance

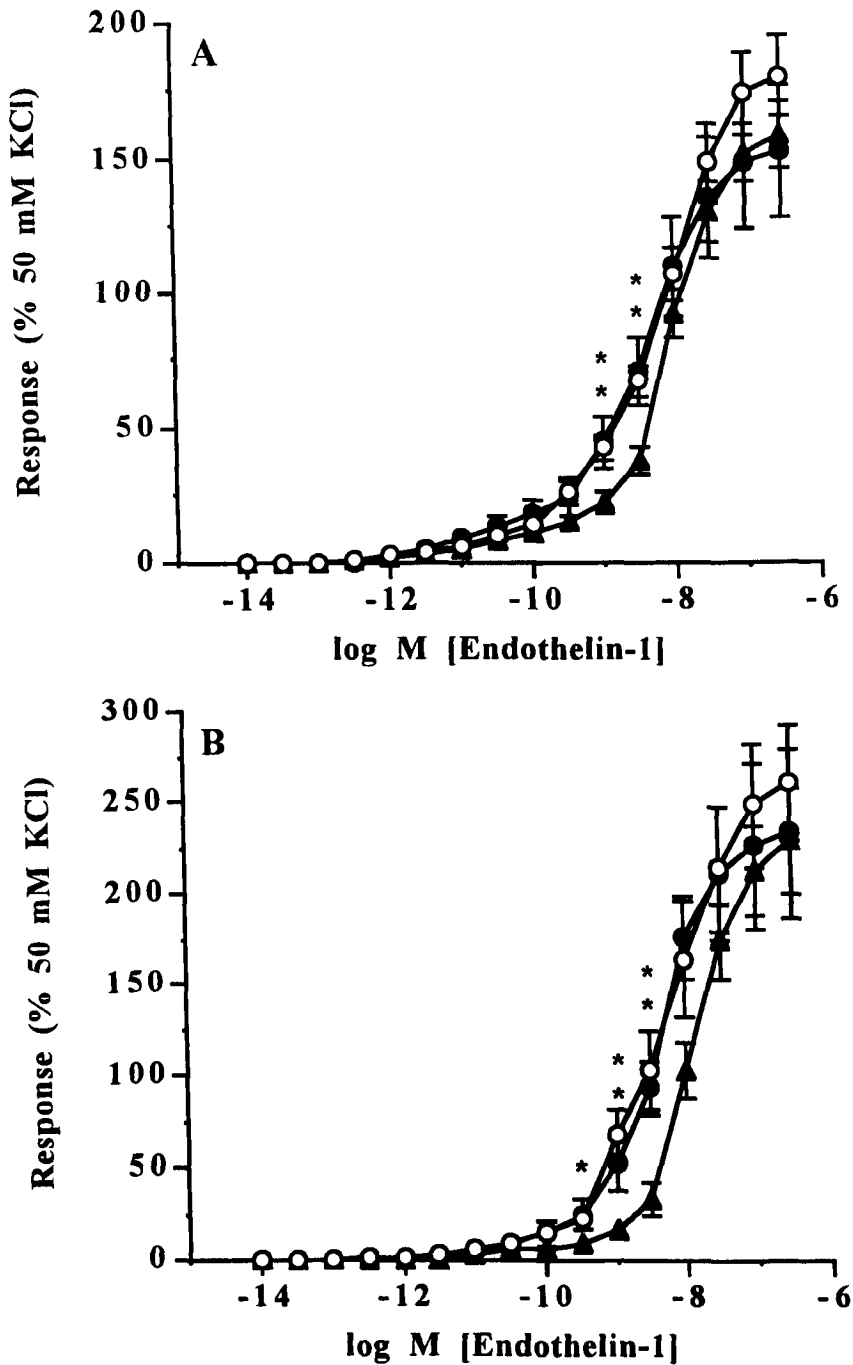

Figure 6.6

Effect of BQ-788, and a combination of BQ-788 + BMS 182874 on responses to ET-1. **A.** CCRC's to ET-1 in control vessels (○, n = 9 / 9), ET-1 in the presence of 1 μM BQ-788 (●, n = 5 / 5), and ET-1 in presence of 1 μM BQ-788 and 10 μM BMS 182874 (▲, n = 7 / 7). **B** CCRC's to ET-1 in chronic hypoxic vessels (○, n = 8 / 8), ET-1 in the presence of 1 μM BQ-788 (●, n = 5 / 5), and ET-1 in presence of 1 μM BQ-788 and 10 μM BMS 182874 (▲, n = 7 / 7). Data are expressed as percentage of reference contraction to 50 mM KCl in each vessel. Each point represents the mean ± SEM. Statistical comparisons were made using Students unpaired t-test. *p < 0.05, **p < 0.01, ET-1 vs. ET-1 in presence of BQ-788 and BMS 182874.

	CONTROL RAT			HYPOXIC RAT		
	pEC ₂₀	pEC ₅₀	n / n	pEC ₂₀	pEC ₅₀	n / n
Endothelin-1	8.95 ± 0.11	8.01 ± 0.05	9 / 9	8.85 ± 0.11	8.11 ± 0.07	9 / 9
ET-1 + SB (10 nM)	8.48 ± 0.16*	7.78 ± 0.19	4 / 4	8.71 ± 0.30	8.11 ± 0.19	4 / 4
ET-1 + SB (0.1 μM)	8.26 ± 0.25*	7.71 ± 0.13*	4 / 4	8.18 ± 0.21**	7.56 ± 0.16**	4 / 4
ET-1 + SB (1 μM)	7.90 ± 0.21***	7.16 ± 0.07***	5 / 5	7.67 ± 0.16***	7.07 ± 0.08***	5 / 5

Table 6.5 Potency of ET-1 in the presence and absence of SB 209670.

SB = SB 209670 mixed ET_A / ET_B receptor antagonist. n / n = number of preparations from number of animals.

Statistical comparisons were made using Students unpaired t-test.

* p < 0.05, ** p < 0.01, *** p < 0.001, ET-1 vs. ET-1 + SB 209670.

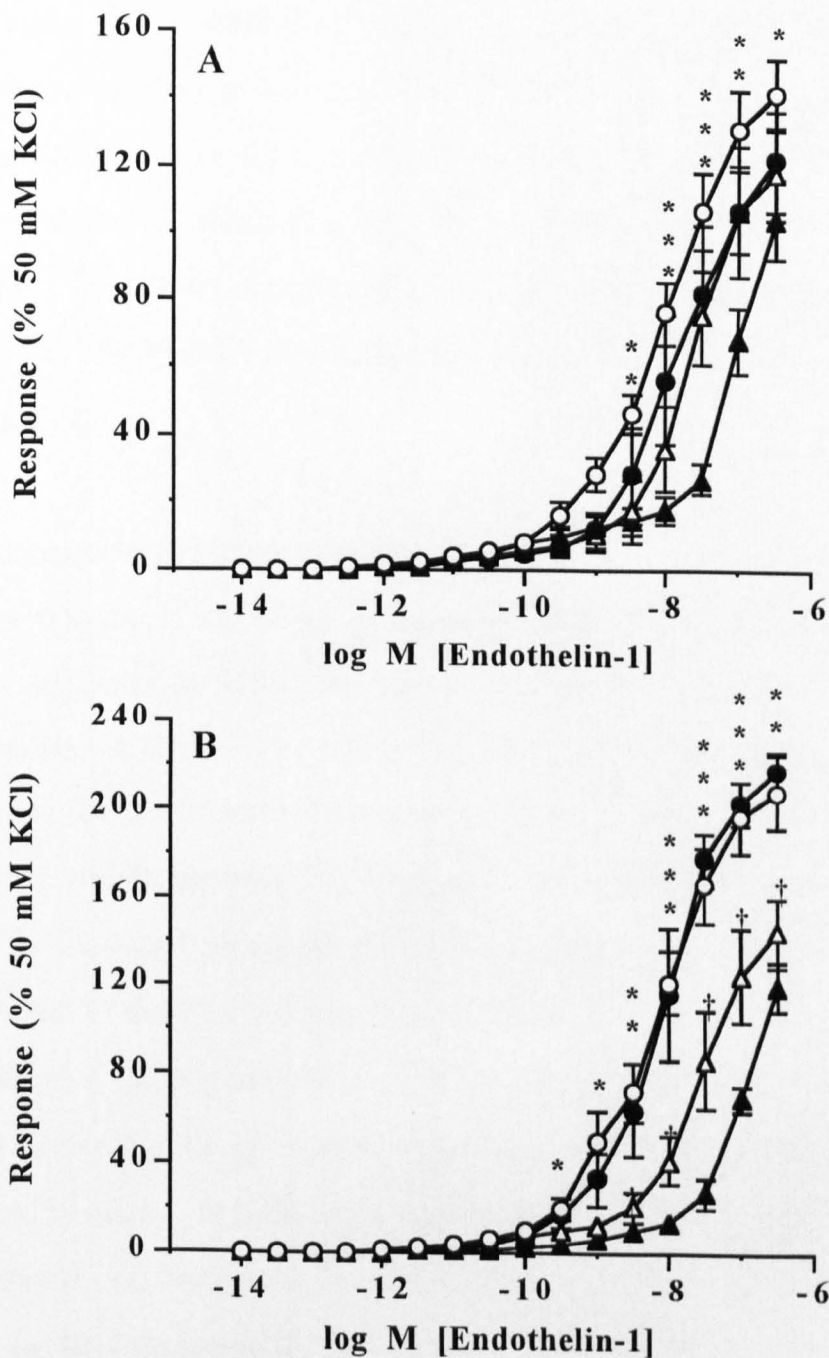

Figure 6.7

Effect of SB 209670 on responses to ET-1. **A.** CCRC's to ET-1 in control vessels (○, $n = 9 / 9$), ET-1+10 nM SB 209670 (●, $n = 4 / 4$), ET-1 + 0.1 μM SB 209670 (△, $n = 4 / 4$), and ET-1 + 1 μM SB 209670 (▲, $n = 5 / 5$). **B** CCRC's to ET-1 in chronic hypoxic vessels (○, $n = 9 / 9$), ET-1 + of 10 nM SB 209670 (●, $n = 4 / 4$), ET-1 + 0.1 μM SB 209670 (△, $n = 4 / 4$), and ET-1 + 1 μM SB 209670 (▲, $n = 5 / 5$). Data are expressed as percentage of reference contraction to 50 mM KCl in each vessel. Each point represents the mean \pm SEM. Statistical comparisons were made using Students unpaired t-test. † $p < 0.05$, †† $p < 0.01$, ET-1 vs. ET-1 + SB 209670 (100 nM); * $p < 0.05$, ** $p < 0.01$, *** $p < 0.001$ ET-1 vs. ET-1 + SB 209670 (1 μM).

arteries. The pK_B values obtained at 1 μM were also significantly greater in chronic hypoxic preparations than in controls. Using Schild analysis, pA_2 values were calculated for SB 209670 vs. ET-1 in these preparations. In control preparations the pA_2 value for SB 209670 was 7.95 ± 0.12 , with a slope of 0.46 ± 0.03 (significantly less than unity $*** p < 0.001$, one sample t-test). In chronic hypoxic preparations the pA_2 value for SB 209670 was 7.28 ± 0.14 , with a slope of 1.01 ± 0.14 (not significantly different from unity).

Effect of antagonists on SxS6c responses.

Figure 6.8 shows the effect of the mixed ET_A / ET_B receptor antagonist bosentan on responses to SxS6c on control and chronic hypoxic rat pulmonary resistance arteries. A summary of pEC_{20} and pEC_{50} values are shown in table 6.6. When present at 0.1 μM bosentan had no effect on responses to SxS6c in control or chronic hypoxic vessels, however 1 μM bosentan caused a significant decrease in the pEC_{50} value for SxS6c in both control and chronic hypoxic preparations.

The effect of the ET_B receptor antagonist BQ-788 on responses to SxS6c is shown in figure 6.9. pEC_{20} and pEC_{50} values are shown in table 6.6. Pre-treatment with BQ-788 caused significant antagonism of responses to SxS6c in both control and chronic hypoxic vessels. BQ-788 did not effect the maximum contractile response achieved to SxS6c in either control or chronic hypoxic preparations. The pK_B values for bosentan and BQ-788 against SxS6c induced contractions are shown in table 6.7.

Effect of BQ-788 on ET-3 responses.

Figure 6.10 shows the effect of BQ-788 on responses to ET-3 in control and chronic hypoxic rat pulmonary resistance arteries. pEC_{20} and pEC_{50} values are shown in table 6.6. In a similar fashion to that observed with SxS6c, BQ-788 caused a significant rightward shift in the CCRC to SxS6c in both control and chronic hypoxic rat vessels. As observed with SxS6c, BQ-788 did not effect the maximum contractile response achieved to ET-3 in either control or chronic hypoxic

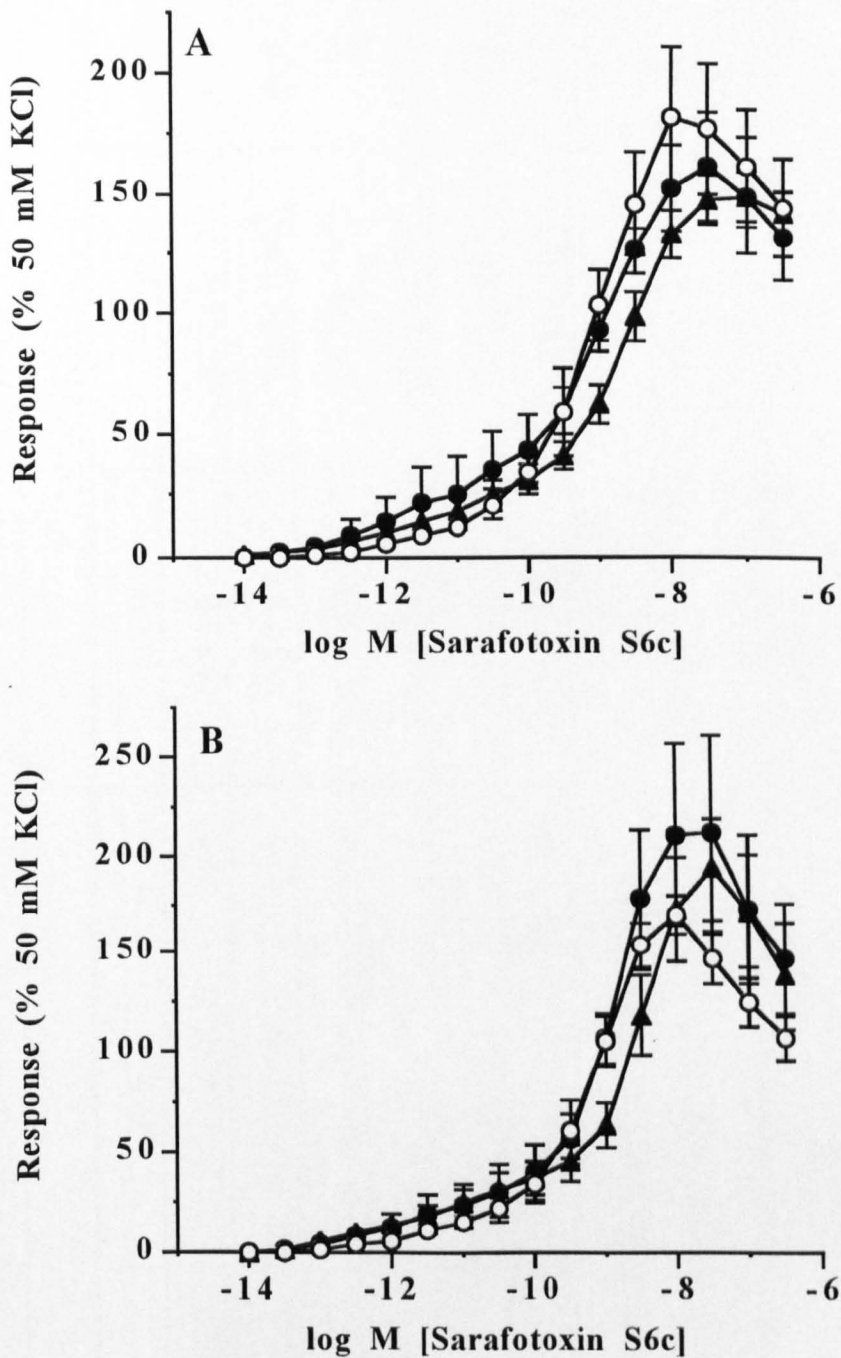

Figure 6.8

Effect of bosentan on responses to SxS6c in rat pulmonary resistance arteries.

A. CCRC's to SxS6c in control vessels (○, n = 8 / 8), SxS6c in the presence of 0.1 μM bosentan (●, n = 4 / 4), and SxS6c in presence of 1 μM bosentan (▲, n = 5 / 5).

B CCRC's to SxS6c in chronic hypoxic vessels (○, n = 8 / 8), SxS6c in the presence of 0.1 μM bosentan (●, n = 4 / 4), and SxS6c in presence of 1 μM bosentan (▲, n = 5 / 5). Data are expressed as percentage of reference contraction to 50 mM KCl in each vessel. Each point represents the mean ± SEM.

	CONTROL RAT			HYPOXIC RAT		
	pEC ₂₀	pEC ₅₀	n / n	pEC ₂₀	pEC ₅₀	n / n
Sarafotoxin S6c	9.91 ± 0.13	9.12 ± 0.10	8 / 8	9.97 ± 0.22	9.21 ± 0.13	8 / 8
SxS6c + Bos(0.1 µM)	10.55 ± 0.91	9.54 ± 0.58	4 / 4	10.3 ± 0.87	9.36 ± 0.45	4 / 4
SxS6c + Bos (1 µM)	10.16 ± 0.32	8.79 ± 0.09*	5 / 5	10.15 ± 0.51	8.67 ± 0.12*	5 / 5
SxS6c + BQ (1 µM)	8.46 ± 0.10***	7.85 ± 0.08***	4 / 4	8.35 ± 0.15***	7.79 ± 0.07***	4 / 4
Endothelin-3	9.90 ± 0.12	8.76 ± 0.14	4 / 4	9.73 ± 0.17	8.82 ± 0.15	4 / 4
ET-3 + BQ (1 µM)	8.52 ± 0.30†	8.01 ± 0.22†	3 / 3	8.57 ± 0.42†	7.78 ± 0.33†	3 / 3

Table 6.6 Potency of SxS6c and ET-3 in presence and absence of antagonists.

Bos = bosentan mixed ET_A / ET_B receptor antagonist, BQ = BQ-788 ET_B receptor antagonist.

Statistical comparisons were made using Students unpaired t-test.

* p < 0.05, *** p < 0.001, SxS6c vs. SxS6c (+ antagonist).

† p < 0.05, ET-3 vs. ET-3 + BQ-788.

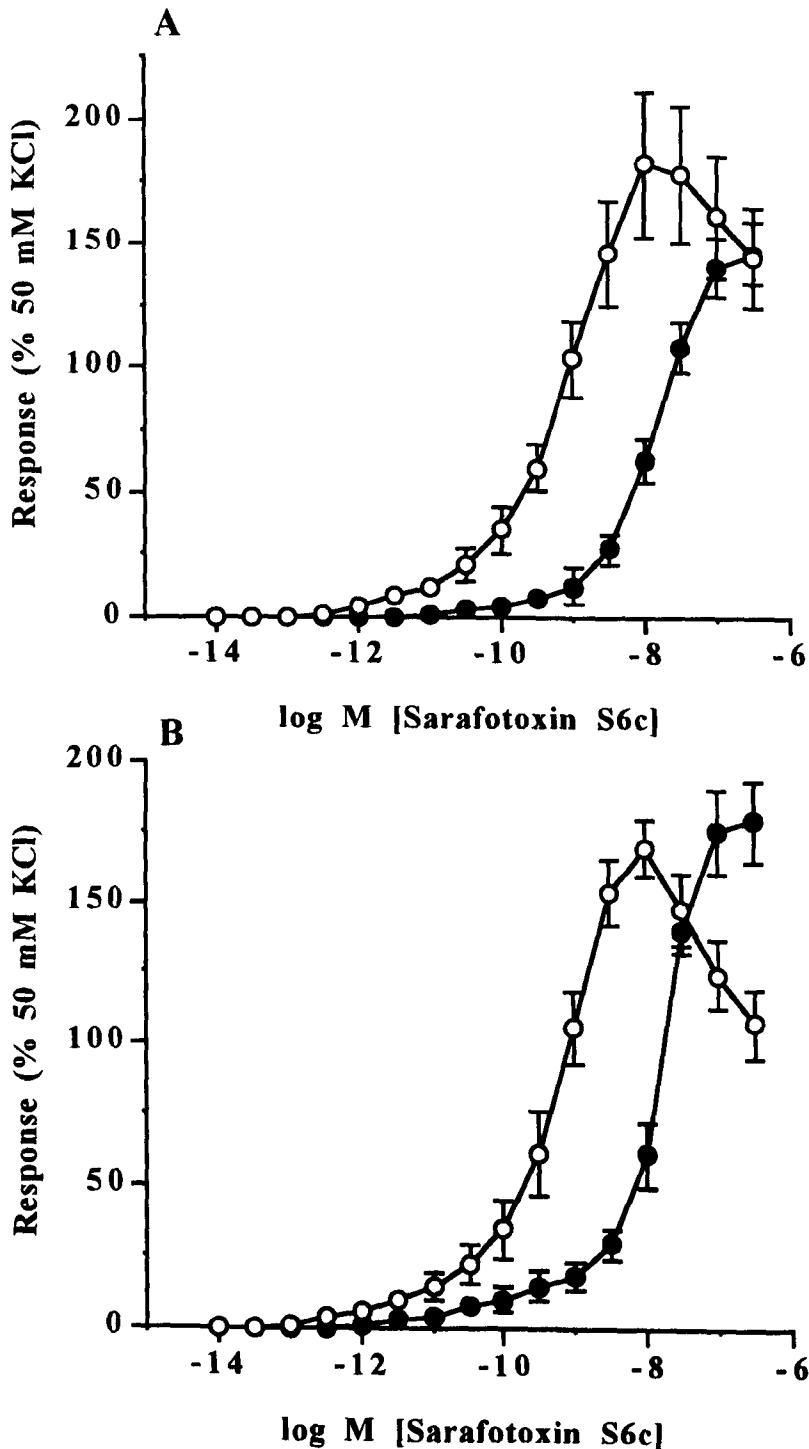

Figure 6.9.

Effect of BQ-788 on responses to SxS6c in rat pulmonary resistance arteries.

A. CCRC's to SxS6c in control vessels (○, n = 8 / 8), SxS6c + 1 μM BQ-788 (●, n = 4 / 4). **B** CCRC's to SxS6c in chronic hypoxic vessels (○, n = 8 / 8), SxS6c + 1 μM BQ-788 (●, n = 4 / 4). Data are expressed as percentage of reference contraction to 50 mM KCl in each vessel. Each point represents the mean ± SEM.

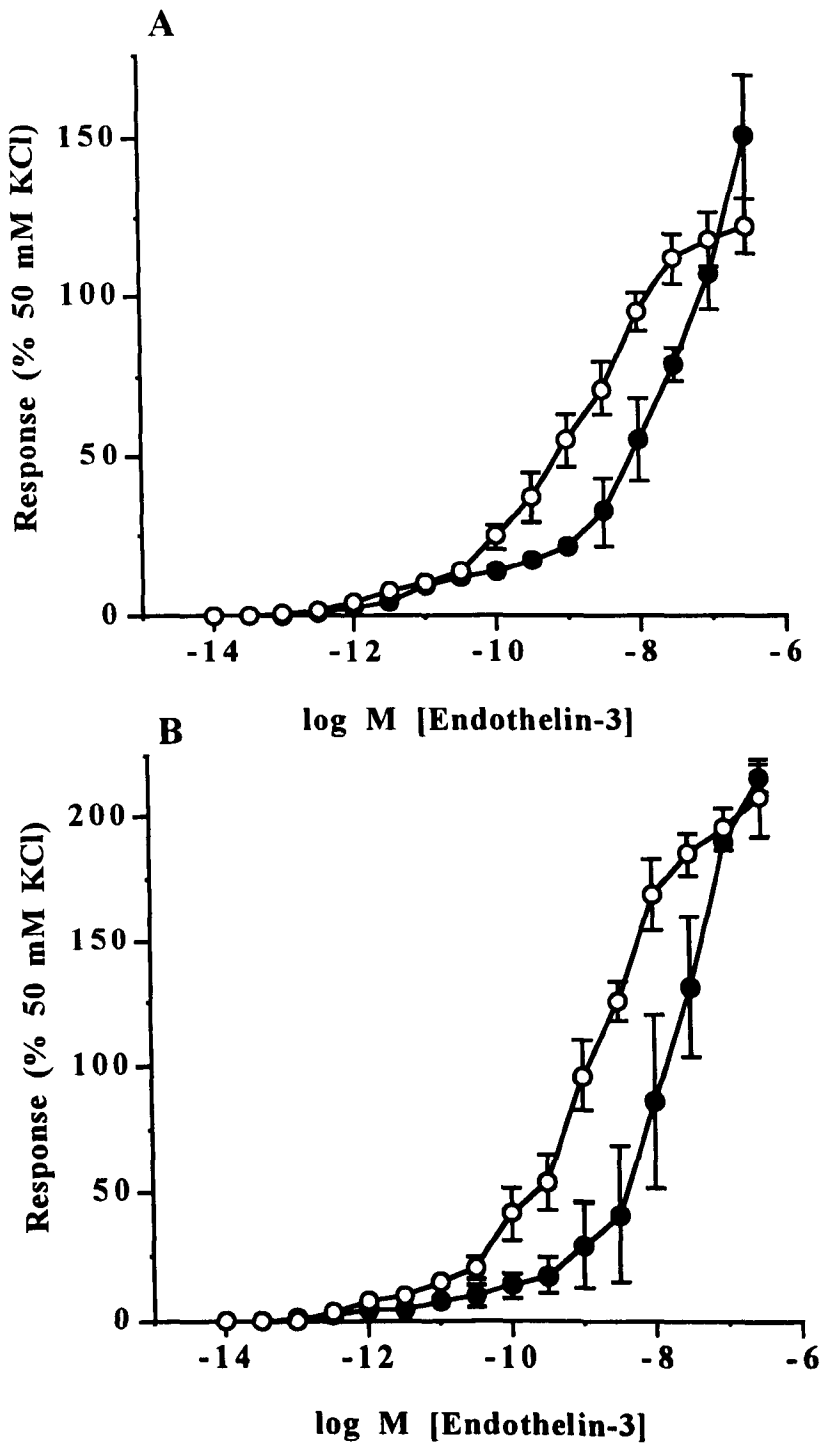

Figure 6.10.

Effect of BQ-788 on responses to ET-3 in rat pulmonary resistance arteries.

A. CCRC's to ET-3 in control vessels (○, n = 4 / 4), ET-3 + 1 μM BQ-788 (●, n = 3 / 3). **B** CCRC's to ET-3 in chronic hypoxic vessels (○, n = 4 / 4), ET-3 + 1 μM BQ-788 (●, n = 3 / 3). Data are expressed as percentage of reference contraction to 50 mM KCl in each vessel. Each point represents the mean ± SEM.

preparations. The pK_B values for BQ-788 against ET-3 are illustrated in table 6.7. pK_B values for BQ-788 against ET-3 were found to be significantly less than values obtained for BQ-788 against SxS6c.

ANTAGONIST	CONTROL		HYPOXIC	
	pK_B	n	pK_B	n
SB 209670 (0.1 μ M) vs. ET-1	$7.36 \pm 0.04^{**}$	4	$7.39 \pm 0.03^{**}$	4
SB 209670 (1 μ M) vs. ET-1	6.91 ± 0.04	5	7.12 ± 0.04^a	5
Bosentan (1 μ M) vs. SxS6c	5.84 ± 0.13	5	6.11 ± 0.11	5
BQ-788 (1 μ M) vs. SxS6c	7.15 ± 0.04	4	7.22 ± 0.02	4
BQ-788 (1 μ M) vs. ET-3	$6.68 \pm 0.07^{\dagger\dagger}$	3	$6.89 \pm 0.17^{\dagger}$	3

Table 6.7 pK_B values for antagonists.

Statistical comparisons were made using Students unpaired t-test. $^{**}p < 0.01$ SB 209670 at 0.1 μ M vs. SB 209670 at 1 μ M. $^ap < 0.01$ control SB 209670 1 μ M vs. chronic hypoxic SB 209670 1 μ M. $^{\dagger}p < 0.05$, $^{\dagger\dagger}p < 0.01$ BQ 788 (ET-3) vs. BQ 788 (SxS6c).

6.4 Discussion.

Responses to ET-1 ET-3 and SxS6c

I had previously proposed in chapters 3 and 5 of this thesis that ET_B receptors play an important role in ET-1-induced vasoconstriction in rat pulmonary resistance arteries, due to the greater potency of SxS6c over ET-1. In this chapter I have investigated this possibility further using selective and non-selective ET antagonists, against vasoconstrictor responses to ET-1, ET-3 and SxS6c. In both control and chronic hypoxic rat pulmonary resistance arteries, SxS6c is some ten-fold more potent than ET-1 in inducing vasoconstrictor responses. Control and chronic hypoxic rat pulmonary resistance arteries were also more sensitive to ET-3 than ET-1. Again, as previously reported in chapter 5, there was no difference in tissue sensitivity to ET-1 and SxS6c between control and chronic hypoxic vessels. This was also found to be no difference in tissue sensitivity to ET-3 between control and chronic hypoxic

preparations. Maximum contractile responses to ET-1 and ET-3 were significantly increased in chronic hypoxic pulmonary resistance arteries compared to control preparations, whereas the maximum contractile response to SxS6c was unchanged.

The shape of the response curve to ET-3 is biphasic in nature, following the time course of SxS6c at low concentrations (up to 0.3 nM), then verging toward the ET-1 curve at higher concentrations. This would suggest that ET-3 is may be acting on ET_B receptors at lower concentrations, and at higher concentrations is acting on the ET_A receptor subtype. If this was the case it would support the theory that increased vasoconstriction to ET-1 in chronic hypoxic pulmonary resistance arteries is mediated via the ET_A receptor subtype, as the contractile response to ET-3 is significantly increased at higher concentrations of the peptide. The shape of the agonist response curves, and the relative potency of the peptides in these preparations would suggest a heterogeneous population of ET receptors. If there was a homogeneous population of "classical" ET_B receptors, ET-1 and ET-3 would be expected to be equipotent. There are two possible explanations for the greater potency of ET-3 and SxS6c over ET-1. Firstly, it could be that there is a receptor present which shows selectivity for ET-3 over ET-1. Such a receptor has been cloned from *Xenopus laevis* dermal melanophores and has been denoted ET_C (Karne, *et al.*, 1993). However a counterpart has yet to be cloned from a mammalian vascular preparation, although a receptor with similar pharmacological characteristics has been described in mammalian bronchial smooth muscle (Nally, *et al.*, 1994). A second possible explanation for the relative potency of SxS6c, ET-3 and ET-1 in rat pulmonary resistance arteries could be the presence of an inhibitory receptor which ET-1 activates. These possible explanations will be discussed in more detail later in this section.

Antagonism of ET-1-induced vasoconstriction.

In control pulmonary resistance arteries responses to ET-1 were insensitive to the actions of the ET_A receptor antagonist FR 139317 (1 μM). The maximum contractile responses to ET-1 (from 30 nM to 300 nM) were however reduced in

chronic hypoxic pulmonary resistance arteries treated with FR 139317. The effect of the ET_A antagonist reduced the contractile response to values similar to those exhibited in control preparations, and occurred without altering tissue sensitivity to ET-1. This would support my previous assumption that increased vasoconstriction to ET-1 in chronic hypoxic rat pulmonary resistance arteries is mediated via activation of ET_A receptors. The non peptide ET_A receptor antagonist BMS 182874 (1 μM) caused a significant increase in the tissue sensitivity to ET-1 in control preparations. This could suggest the presence of an inhibitory ET_A-like receptor in control pulmonary resistance arteries which can be blocked by the actions of BMS 182874 (1 μM). A similar inhibitory effect to the situation observed here has been demonstrated in the rat fundus, where responses to ET-1 are potentiated in the presence the ET_A selective antagonist BQ-123 (Gray & Clozel, 1994). It has also been demonstrated that low doses of BQ-123 potentiate the pulmonary vasoconstrictor response to ET-1 in the isolated perfused lung preparation taken from control rats (Lal, *et al.*, 1995a). In chronic hypoxic rat pulmonary resistance arteries, BMS 182874 had no effect on the responses to ET-1. This suggests either that the influence of the putative inhibitory ET_A-like receptor is absent in chronic hypoxic rats, or that it has decreased, given that the presence of a population of inhibitory ET_A-like receptors may mask the effects of ET_A antagonists on the contractile responses to ET-1. If the actions of a putative inhibitory ET_A-like receptor were reduced in chronic hypoxic pulmonary resistance arteries an increase in sensitivity and / or the maximum contractile response to ET-1 in chronic hypoxic preparations would be expected. The increase in tissue sensitivity to ET-1 is not observed in chronic hypoxic vessels however we do observe an increase in the maximum contractile response to ET-1. As explained in chapter 5 this increase in the contractile response ET-1 is unlikely to be solely due to increased smooth muscle due to pulmonary vascular remodelling, and may in part be the effect of decreased influence of an inhibitory ET_A-like receptor.

In rabbit pulmonary arteries ET_B receptors predominate (LaDouceur, *et al.*, 1993). However, it has been shown that a small population of ET_A receptors is also

present and that responses to ET-1 can only be inhibited by blocking both the ET_A and ET_B receptor sites (Fukuroda, *et al.*, 1994b). In order to investigate if such a synergistic phenomenon exists in rat pulmonary resistance arteries, I studied the effects of the non-peptide mixed ET_A / ET_B receptor antagonist bosentan and SB 209670. I also investigated the effects of the ET_B antagonist BQ-788 alone, and combined with the ET_A receptor antagonist BMS 182874. As 1 μM BMS 182874 caused a potentiating effect on the response to ET-1 it was decided to increase the concentration of this antagonist to 10 μM. In the presence of bosentan (1 μM) I again observed a significant increase in tissue sensitivity to ET-1 in control rat pulmonary resistance arteries. This supports the suggestion that ET-1 is acting on an inhibitory receptor subtype and that bosentan as well as BMS 182874 can actively block this receptor site. As with BMS 182874, this effect of bosentan was not observed in chronic hypoxic rat pulmonary resistance arteries. Upon increasing the concentration of bosentan to 10 μM, it was found that the leftward shift in the ET-1 response observed at 1 μM bosentan in control vessels did not occur, and that the lower portion of the curve was now significantly shifted to the right. Higher concentrations of the ET-1 CCRC in control pulmonary resistance arteries were not effected by 10 μM bosentan. In chronic hypoxic vessels, 10 μM bosentan caused a significant rightward shift in the response to ET-1, and also significantly decreased the maximum contractile response to ET-1 in these preparations. In a similar fashion to the ET_A receptor antagonist FR 139317, the contractile responses to ET-1 in chronic hypoxic vessels was reduced by bosentan (1 μM) to values similar to those seen in control preparations.

The selective ET_B antagonist BQ-788 alone had no effect on responses to ET-1 in either control or chronic hypoxic pulmonary resistance arteries. In control rat pulmonary resistance arteries the combination of BMS 182874 and BQ-788 had a slight but non significant rightward shift at low concentrations of ET-1, though the potentiating effect of BMS 182874 was not observed when present at 10 μM combined with BQ-788. In the chronic hypoxic rat pulmonary resistance arteries, responses to ET-1 were significantly shifted in the presence of the combination of BMS 182874 and

BQ-788, however the maximum contractile response was not effected. If, as proposed, the influence of an inhibitory ET_A receptor is less in the chronic hypoxic rats, the presence of BMS 182874 would facilitate the ability of BQ-788 to inhibit these responses as is shown in these studies. Indeed comparable results are observed between the actions of the mixed receptor antagonist bosentan, and the combination of the effects of BMS 182874 and BQ-788, in that the responses to ET-1 in control preparations show greater resistance to the action of ET_A / ET_B receptor blockade.

The final antagonist studied against ET-1 induced vasoconstriction was the non-peptide mixed receptor antagonist SB 209670. This antagonist produced concentration dependent antagonism in the response curved to ET-1 in both control and chronic hypoxic rat pulmonary resistance arteries. Unlike the actions of 1 μM bosentan in control pulmonary arteries, SB 209670 did not produce any potentiation of the ET-1 response at any of the concentrations tested. This may be due to the relative potency of the antagonists, with SB 209670 being more potent than bosentan at ET_A and ET_B receptors. The pK_B values obtained for this antagonist were significantly greater at 0.1 μM compared to 1 μM. This difference may be due to the fact that the maximum contractile response to ET-1 is significantly reduced control preparations with the antagonist present at 1 μM, and in chronic hypoxic preparations at both 0.1 and 1 μM concentrations of SB 209670. The shape of the response curves suggests that if it were possible to further increase the concentration of ET-1 in the bathing solution, then control values for contractile responses may be reached. This may cause a decrease in the estimated pK_B value for 1 μM SB 209670 in control and chronic hypoxic preparations. The calculated pA₂ values for SB 209670 was significantly greater in control than in chronic hypoxic preparations, however Schild regression yielded a shallow slope for SB 209670 in control vessels indicating non-competitive antagonism. The slope of the Schild plot for this antagonist in chronic hypoxic vessels was not significantly different from unity, indicating that SB 209670 is acting in a competitive manner. The non-competitive interactions of SB 209670 in control preparations cannot be attributed ET-1 / receptor kinetics (see section 2.4.3) as competitive interaction is

observed in chronic hypoxic preparations. Non-competitive interactions may suggest receptor heterogeneity, however, as SB 209670 is a mixed antagonist of both ET_A and ET_B receptors we would therefore expect the antagonist to act in a competitive manner. This anomaly could be explained by the presence of the aforementioned putative inhibitory ET_A-like receptor, which would interfere with SB 209670 antagonism in control preparations but not chronic hypoxic preparations. The estimated pA₂ and pK_B values for SB 209670 are comparable with values of 6.7 obtained in the rabbit pulmonary artery (predominantly ET_B receptors) (Ohlstein, *et al.*, 1994).

Antagonism of ET-3 and SxS6c responses.

It has been previously suggested in this discussion that one of the reasons for the relatively potency of SxS6c and ET-3 over ET-1 may be the presence of a receptor which is selective for these peptides over ET-1. Responses to SxS6c in both control and chronic hypoxic preparations were antagonised by the mixed receptor antagonist bosentan, and both SxS6c and ET-3 are antagonised by BQ-788. This would suggest that SxS6c and ET-3 are acting at ET_B receptor subtypes, rather than a non ET_A / ET_B receptor. The pK_B values for bosentan against SxS6c were similar in control and chronic hypoxic preparations and comparable to pA₂ values of 5.9 described for SxS6c in the rat trachea (Clozel, *et al.*, 1994). The pK_B values for BQ-788 against SxS6c in control and chronic hypoxic pulmonary resistance arteries were also similar to the pA₂ value of 8.2 described for BQ-788 vs. BQ-3020 in the rabbit isolated pulmonary artery (Ishikawa, *et al.*, 1994). BQ-788 exhibited a significantly lower pK_B value against ET-3 than against SxS6c in both control and chronic hypoxic rat pulmonary resistance arteries. The fact that ET-3 would be acting on both ET_B and ET_A receptor subtypes may explain this difference. The results from SxS6c and ET-3 would suggest a functional population of ET_B receptors being present in both control and chronic hypoxic rat pulmonary resistance arteries.

There is evidence to suggest that ET_B receptors are present in rat pulmonary resistance arteries, although the relative size of the ET_B receptor population varies

between authors and may depend on the preparation being studied. In 1993 Bonvallet, *et al.*, reported that the ET_A receptor antagonist BQ-123 was much more effective in larger pulmonary arteries than small diameter pulmonary arteries. Contractile responses to ET-3 were also observed to be greater in small pulmonary artery preparations in comparison to larger diameter vessels. The ET_B receptor agonists SxS6c, ET-3 and IRL 1620 have also been shown to cause increases in pulmonary perfusion pressures in isolated perfused rat lung preparations, and vascular responses to SxS6c were resistant to the actions of the ET_A receptor antagonist BQ-123 (Lal, *et al.*, 1995b; Uhlig, *et al.*, 1995). Results from retrograde perfusion of isolated perfused lung of the rat also suggested that the majority of ET_B receptors in the rat pulmonary circulation appear to be located on the arterial rather than venous side (Lal, *et al.*, 1995b). There is also evidence to suggest the presence of a significant population of ET_B receptors in pulmonary hypertensive rat lungs. In isolated perfused lungs of chronic hypoxic rats vasoconstriction to ET-1 is significantly attenuated by the ET_A receptor antagonist BQ-123, but are almost completely abolished by treatment with bosentan (Eddahibi, *et al.*, 1995).

One of the most interesting observations in this study is the relative resistance of ET-1-mediated vasoconstriction to the actions of selective ET_A and selective ET_B antagonists. In a preparation with both contractile ET_A and ET_B receptor populations it would be expected that at least part of the response curve would be effected by the action of a selective ET_A or selective ET_B receptor antagonist. Partial antagonism of ET-1 mediated contraction with ET_A antagonists has been demonstrated in the rabbit pulmonary artery (LaDouceur, *et al.*, 1993; Fukuroda, *et al.*, 1994b) and pig pulmonary vein (Sudjarwo, *et al.*, 1993). In this present study it would appear that during blockade of the ET_A receptor alone, ET-1 can still mediate almost identical vasoconstrictor actions through activation of the ET_B receptor, and vice versa. To produce any substantial antagonism to ET-1 in these preparations required blockade of both the ET_A and the ET_B receptor site.

The possible use of ET antagonists in the treatment of pulmonary hypertension has been investigated in various animal models. The ET_A receptor antagonist BQ-123 (infusion 0.15 mg / hour by osmotic minipump) attenuates pulmonary hypertension in rats exposed to chronic hypoxia, decreasing pulmonary artery pressure, right ventricular hypertrophy and remodelling of small diameter arterial peripheral lung vessels when compared to saline treated animals (Bonvallet, *et al.*, 1994). However treatment with the ET_A receptor antagonist did not completely prevent the development of pulmonary hypertension, and animals treated with the ET_A receptor antagonist still exhibited some degree of pulmonary hypertension and vascular remodelling. More effective actions of BQ-123 in both preventing and reversing established pulmonary hypertension were observed by DiCarlo, *et al.*, (1995). In this study, administration of 0.4 mg / hour of BQ-123 completely prevented the development of hypoxic pulmonary hypertension in the rat, with treated hypoxic animals displaying pulmonary artery pressure, ventricular ratios and pulmonary arteriolar structure similar to normoxic control animals. In rats with established pulmonary hypertension, BQ-123 significantly decreased pulmonary artery pressure and prevented further increases in right ventricular hypertrophy in the continued presence of hypoxic environment. Non-peptide ET receptor antagonists have advantages as therapeutic targets as they are orally active. Chronic oral administration of bosentan also (100 mg / kg / day) attenuates the development of chronic hypoxic pulmonary hypertension in rats, but in a similar fashion to treatment with the ET_A receptor antagonist, pulmonary artery pressure, right ventricular hypertrophy and vascular remodelling were still significantly greater in bosentan treated animals when compared with controls (Eddahibi, *et al.*, 1995). Chen *et al* (1995) also looked at the effects of the antagonists on animals with established pulmonary hypertension. The results from this study showed that treatment with bosentan (100 mg / kg / day) completely prevented the development of hypoxic pulmonary hypertension in rats, as compared to only attenuation of response in the previously mentioned study. Oral administration of the mixed antagonist to animals with established hypoxic pulmonary hypertension significantly decreased pulmonary artery pressure and induced regression

of pulmonary vascular remodelling even in continued exposure to hypoxic environment. ET-1 has also been shown to stimulate collagen production in pulmonary vascular smooth muscle cells suggesting a role for ET-1 in stimulating matrix deposition in pulmonary hypertension (Mansoor, *et al.*, 1995). These results all suggest an important role for endogenous ET-1 in not only the establishment but also the maintenance of hypoxic pulmonary hypertension, and may indicate that ET receptor blockade may prove to be useful in the treatment of hypoxic pulmonary hypertension in humans.

In conclusion, the results of this study indicate that typical ET_A-receptor interactions do not account for the vasoconstrictor effects of ET-1 in rat pulmonary resistance arteries. The results suggest that both control and chronic hypoxic pulmonary resistance arteries contain ET_A and ET_B receptors mediating vasoconstriction with the presence of a putative inhibitory ET_A receptor in control pulmonary resistance arteries. The presence of ET-1 activated inhibitory ET_A receptors may mask any inhibitory effects of ET_A- and ET_B- receptor antagonists on responses to ET-1. The possibility that ET-1 is acting at a non ET_A / non ET_B receptor resistant to the effects of the ET_A and ET_B antagonists used cannot, however, be ruled out. The development of pulmonary hypertension in these rats was associated with an increase in the maximum response to ET-1 which may be in part due to a reduction of the influence of inhibitory ET_A-receptors, and an increased influence of vasoconstrictor ET_A receptors. Effective antagonism of ET-1 mediated responses in rat pulmonary resistance arteries requires dual blockade of both ET_A and ET_B receptor subtypes.

Chapter 7

Endothelin Receptors Subtypes in Human Pulmonary Arteries

7.1 Introduction

There is growing evidence that ET's may be involved in the pathogenesis of human forms of pulmonary hypertension. Significantly increased plasma ET-1 levels above the normal range have been observed in patients with primary pulmonary hypertension (Stewart, *et al.*, 1991) and secondary pulmonary hypertension due to chronic congestive heart failure and congenital heart defects (Cody, *et al.*, 1992; Yoshibayashi, *et al.*, 1991). Cody, *et al.*, (1992) also showed that the plasma levels of ET-1 were well correlated with the degree of pulmonary hypertension observed and with the prognosis of the patient. High levels of ET-1, and ET-1 mRNA are present in the vascular endothelial cells of patients with primary and secondary pulmonary hypertension (Giaid, *et al.*, 1993).

Evidence also indicates that inspired O₂ concentration can influence circulating plasma levels of ET-1. Patients exposed to low inspired O₂ concentrations due to COPD, or due to exposure to high altitude exhibit increased levels of circulating ET-1, which are inversely related to arterial PO₂ and positively correlated with pulmonary artery pressure (Ferri, *et al.*, 1995; Goerre, *et al.*, 1995; Morganti, *et al.*, 1995). It was also demonstrated that administration of 35 % O₂ at high altitude normalised arterial PO₂, tended to decrease ET-1 levels and decreased pulmonary artery pressure accordingly (Goerre, *et al.*, 1995). All this evidence suggests strong links between hypoxia, pulmonary hypertension and ET-1 levels. Indeed hypoxia has been shown to induce ET-1 gene expression and increase ET-1 secretion 8-fold in cultured human endothelial cells (Kourembanas, *et al.*, 1991). ET-1 may also play a role in pulmonary vascular remodelling due to its proliferative effect on pulmonary vascular smooth muscle cells (Janakidevi, *et al.*, 1992; Hassoun, *et al.*, 1992; Peacock, *et al.*, 1992). The proliferative effects of ET-1 in human pulmonary vascular smooth muscle cells are inhibited by the actions of BQ-123 therefore suggesting ET_A receptors mediate this response (Zamora, *et al.*, 1993).

With the implication of ET-1 in the aetiology of pulmonary hypertension, targeting the production and actions of ET-1 in the pulmonary circulation may provide

a novel therapy. If control of the actions of ET-1 turns out to be a viable therapeutic strategy for pulmonary hypertension, it is of importance to characterise the receptors mediating the actions of ET's in the pulmonary vasculature. Various techniques have been utilised to identify ET receptors in human pulmonary arteries including : reverse transcriptase-polymerase chain reaction, *in situ* hybridisation, autoradiography and *in vitro* functional studies; and as a whole these results would suggest that ET-1 induced vasoconstriction in the human pulmonary artery was mediated exclusively via the ET_A-receptor subtype (Davenport, *et al.*, 1993; McKay, *et al.*, 1991a,b; Buchan, *et al.*, 1994; Hay, *et al.*, 1993). However, Davenport, *et al.* , (1993, 1995) have also demonstrated that ET_B receptors are expressed in media of human isolated intrapulmonary arteries.

I have previously demonstrated that the receptor subtype mediating ET-1 induced vasoconstriction in isolated pulmonary arteries of the rat varies depending on the size and or location of the artery under study (chapter 3 this thesis), with a predominant population of ET_B receptors located in the pulmonary resistance arteries. The majority of these aforementioned studies in human vessels were carried out on large diameter pulmonary arteries (average 3-5 mm i.d.), the smallest diameter pulmonary artery used in functional; studies being approximately 1 mm (Fukuroda, *et al.*, 1994a). Therefore, I wished to examine and compare responses to ET's in small intrapulmonary resistance arteries with the larger diameter intrapulmonary arteries from the human lung.

7.2 Methods.

Human pulmonary arteries of the two sizes under study (3-5 mm i.d and ~200 µm i.d.) were dissected and set up according to the procedures shown in methods section (see chapter 2). Great care was taken when mounting preparations, to assure that the vascular endothelium was not damaged. Large calibre pulmonary arteries were placed under 1.5g initial tension (optimal tension, personal observation data not shown), and pulmonary resistance arteries were normalised to give an equivalent

transmural pressure of ~16 mmHg. All vessels were bubbled with 16 % O₂, 5% CO₂, balance N₂. After 1 hour equilibration period the vessels were stimulated with application of 50 mM KCl. Following this vessels were washed out three times with fresh Krebs solution and allowed to return to baseline tension. The vessels were then again contracted with a second challenge 50 mM KCl. Following washout and return to baseline tension the vessels were subjected to the following protocols.

A) 45 minute equilibration period followed by CCRC (0.01 pM to 0.3 μM) to either ET-1, ET-3 or SxS6c.

B) 45 minute incubation with one concentration of selected antagonist (listed below) followed by CCRC to selected agonist.

Due to the unfortunate rarity of human tissue samples it was not possible to complete all of the chosen studies in the different sized arterial preparations. The experiments carried out in each of the artery preparations is listed in table 7.1.

Agonist / Antagonist	Large Pulmonary Artery	Small Pulmonary artery
Endothelin-1	✓	✓
Endothelin-3	✓	✓
Sarafotoxin S6c	✓	✓
SxS6c + FR 139317	✗	✓ (at 1 μM)
ET-1 + FR 139317	✓ (at 0.1 - 10 μM)	✓ (at 1 and 10 μM)
ET-1 + BMS 182874	✓ (at 1 μM)	✓ (at 10 μM)
ET-1 + bosentan	✓ (at 0.1 and 1 μM)	✗
ET-3 + BQ-788	✗	✓ (at 1 μM)

Table 7.1

Summary of experimental procedures performed.

Note.

Control responses to ET-1 were carried out, whenever possible, in each tissue sample. However, due to the size of the tissue samples and the availability of equipment, it was not always possible to run a control ET-1 CCRC when studying different antagonists. Therefore the data for ET-1 CCRC and data for antagonists have been "pooled" over many samples. It must be noted that in large human intrapulmonary arteries, there are two stated average data for ET-1 in control conditions. The data in table 7.3 for ET-1 \pm FR 139317 was the first study to be carried out and completed. The data in table 7.2 for ET-1 (\pm antagonists) and ET-3 was carried out at a later stage, and the control ET-1 data has been obtained from the same lung samples which were used for the antagonist studies. There was no significant difference found between the two ET-1 control data stated. As it is only possible to study a maximum of two vessels per myograph apparatus, collection of data is a much slower process therefore data has been "pooled" over all samples studied.

Data Analysis.

Results are expressed graphically as percentage of reference contraction to the second application of 50 mM KCl, or as percentage of own maximal contraction. The pEC₅₀ values, pEC₇₅, or pEC₈₀ values (where appropriate) were calculated according to the methods stated in chapter 2. Statistical comparisons of the means of groups of data were made by Students t-test for paired or unpaired data; $p < 0.05$ was considered statistically significant. Where appropriate, pK_B values for the antagonist were calculated as shown in methods section (chapter 2).

7.3 Results.

Large Intrapulmonary Arteries.

50 mM KCl-induced contraction were 570 ± 77 mg wt tension in human large diameter intrapulmonary arteries ($n = 12 / 10$). Contractile responses to ET-1, and ET-3 are demonstrated in figure 7.1. A summary of pEC₅₀ values are shown in table 7.2.

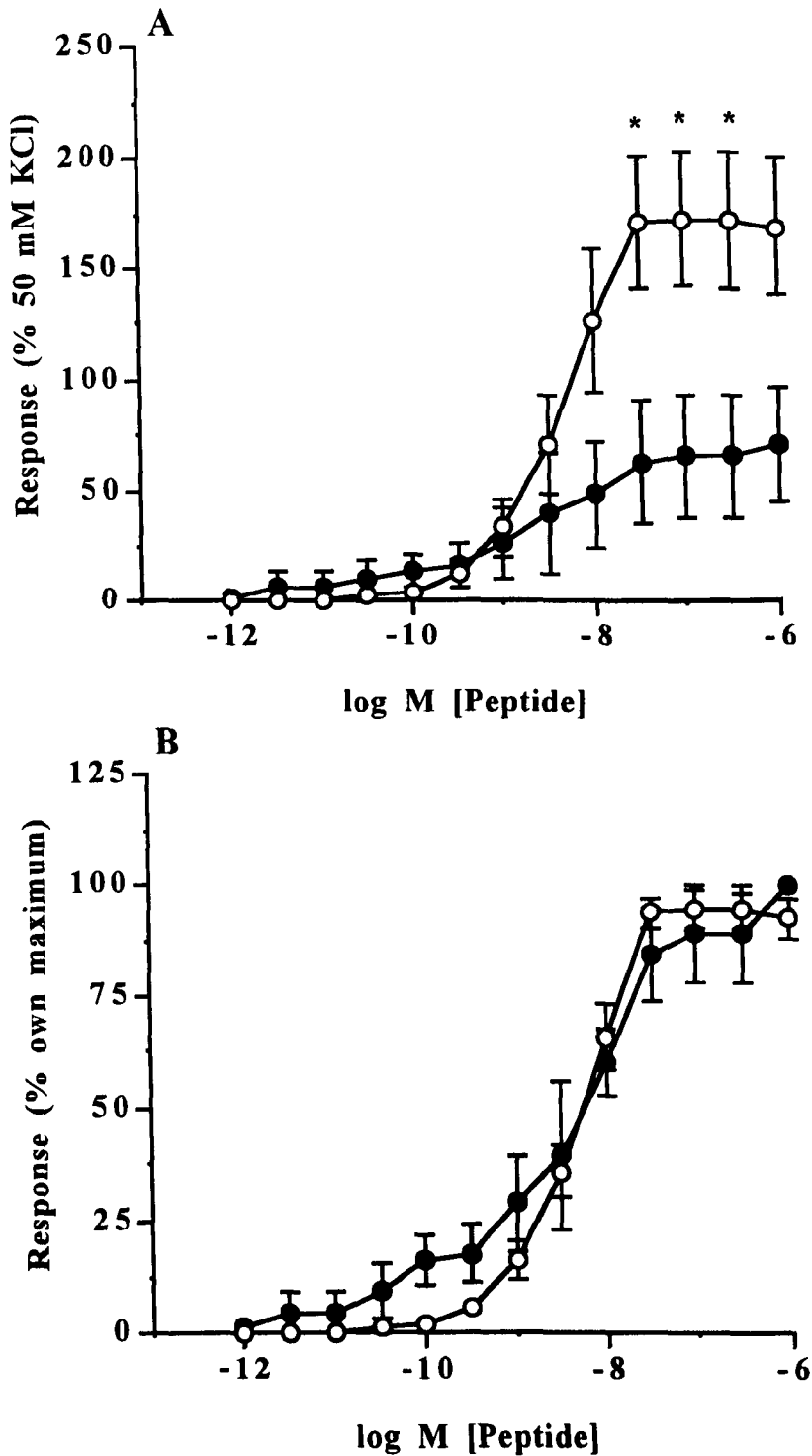

Figure 7.1

Responses to ET-1 and ET-3 in human large calibre intrapulmonary arteries.

CCRC's to ET-1 (○, n = 7 / 7) and ET-3 (●, n = 4 / 3) in human large pulmonary arteries. **A.** Expressed as percentage of reference contraction to 50 mM KCl and **B.** Expressed as percentage of own maximum contraction. Each point represents the mean \pm SEM. Statistical comparisons were made using Students unpaired t-test. *p < 0.05.

Group	pEC ₅₀ value	n / n
ET-1 Control	8.24 ± 0.11	7 / 7
ET-3 Control	8.30 ± 0.11	4 / 3
ET-1 + 1 µM BMS 182874	7.01 ± 0.24***	5 / 4
ET-1 + 0.1 µM bosentan	7.88 ± 0.17*	6 / 3
ET-1 + 1 µM bosentan	7.53 ± 0.14**	6 / 3

Table 7.2.

pEC₅₀ values for ET-3 and ET-1 ± antagonists in human large calibre pulmonary arteries. Data are expressed as mean ± SEM. n/n = number of preparations from number of lungs. Statistical comparisons were made using Students unpaired t-test *p < 0.05, **p < 0.01, ***p < 0.001 vs. ET-1 control.

Group	pEC ₅₀ value	n / n
ET-1 control	8.07 ± 0.15	11 / 9
ET-1 + 0.1 µM FR 139317	7.88 ± 0.17	7 / 7
ET-1 + 1 µM FR 139317	7.31 ± 0.19 **	12 / 10
ET-1 + 10 µM FR 139317	abolished response	3 / 2

Table 7.3

pEC₅₀ values for ET-1 (± FR139317) in human large calibre pulmonary arteries.

Data are expressed as mean ± SEM. n / n = number of preparations from number of lungs. Statistical comparisons were made using Students unpaired t-test. **p < 0.01 vs. ET-1 control.

ET-1 produced potent, well sustained, concentration dependent contractions in human large pulmonary arteries reaching a maximum contraction of 172 ± 31 % of the 50 mM KCl response. ET-3 was equipotent with ET-1 in this preparation (see figure 7.1.B and table 7.2), however ET-3 produced a maximum contraction of only 70 ± 25 % of the 50 mM KCl response. The selective ET_B receptor agonist SxS6c was inactive in human large diameter pulmonary arteries (n = 4 / 3, data not shown on graph).

Incubation with antagonists had no effect on vascular tone in human large diameter intrapulmonary arteries. The effect of the selective ET_A receptor antagonist FR 139317 on ET-1 induced responses is shown in figure 7.2. pEC₅₀ values are shown in table 7.3. When present at 0.1 μM, FR 139317 had no effect on the contractile responses to ET-1, whereas 1 μM FR 139317 caused a significant rightward shift of the ET-1 response curve. FR 139317 (1 μM) appears to cause a greater shift at the higher concentrations of ET-1 (pEC₇₅ for ET-1 control was 7.35 ± 0.2 , and in the presence of FR 139317 (1 μM), 6.63 ± 0.15 ; **p < 0.01), but proved not to be significantly greater than the shift at the pEC₅₀ level. FR 139317 at 0.1 and 1 μM did not affect the maximum contractile response to ET-1 in this preparation (see figure 7.2.A). When present at 10 μM, FR 139137 completely abolished contractile responses to ET-1 (n = 3 / 2, data not shown on graph).

The selective ET_A receptor antagonist BMS 182874 (present at 1 μM) caused a parallel rightward shift in the CCRC to ET-1 without affecting the maximum contraction to the peptide (shown in figures 7.3.A and B). The pEC₅₀ values in the presence and absence of antagonist are given in table 7.2. The pK_B values for all the antagonists studied are shown in table 7.5. When present at both 0.1 and 1 μM, the mixed ET_A / ET_B receptor antagonist bosentan caused a significant rightward shift in the response curves to ET-1 (see figures 7.4.A and B, and table 7.2) without effecting the maximum contraction to the agonist. Bosentan appeared to be acting in a non-concentration dependent fashion, showing a similar degree of shift at both 0.1 and 1 μM. This non concentration dependent effect is reflected in the apparent pK_B values

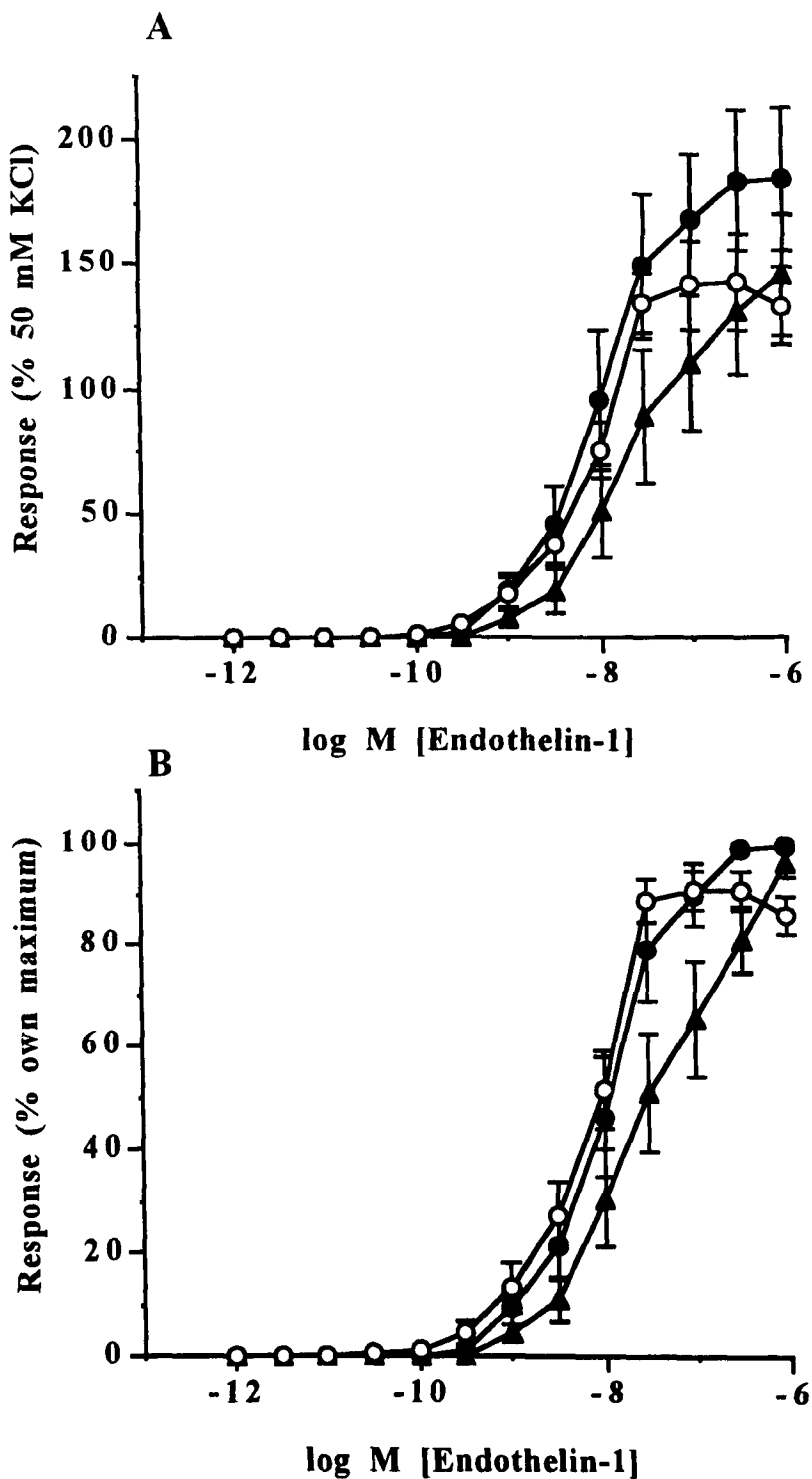

Figure 7.2.

Effect of FR 139317 on responses to ET-1 in human large pulmonary artery. ET-1 control (○, n = 11 / 9); + 0.1 μM FR 139317 (●, n = 7 / 7); + 1 μM FR 139317 (▲, n = 12 / 10). **A.** Expressed as percentage of reference contraction to 50 mM KCl. **B.** Expressed as percentage own maximum contraction. Each point represents the mean ± SEM.

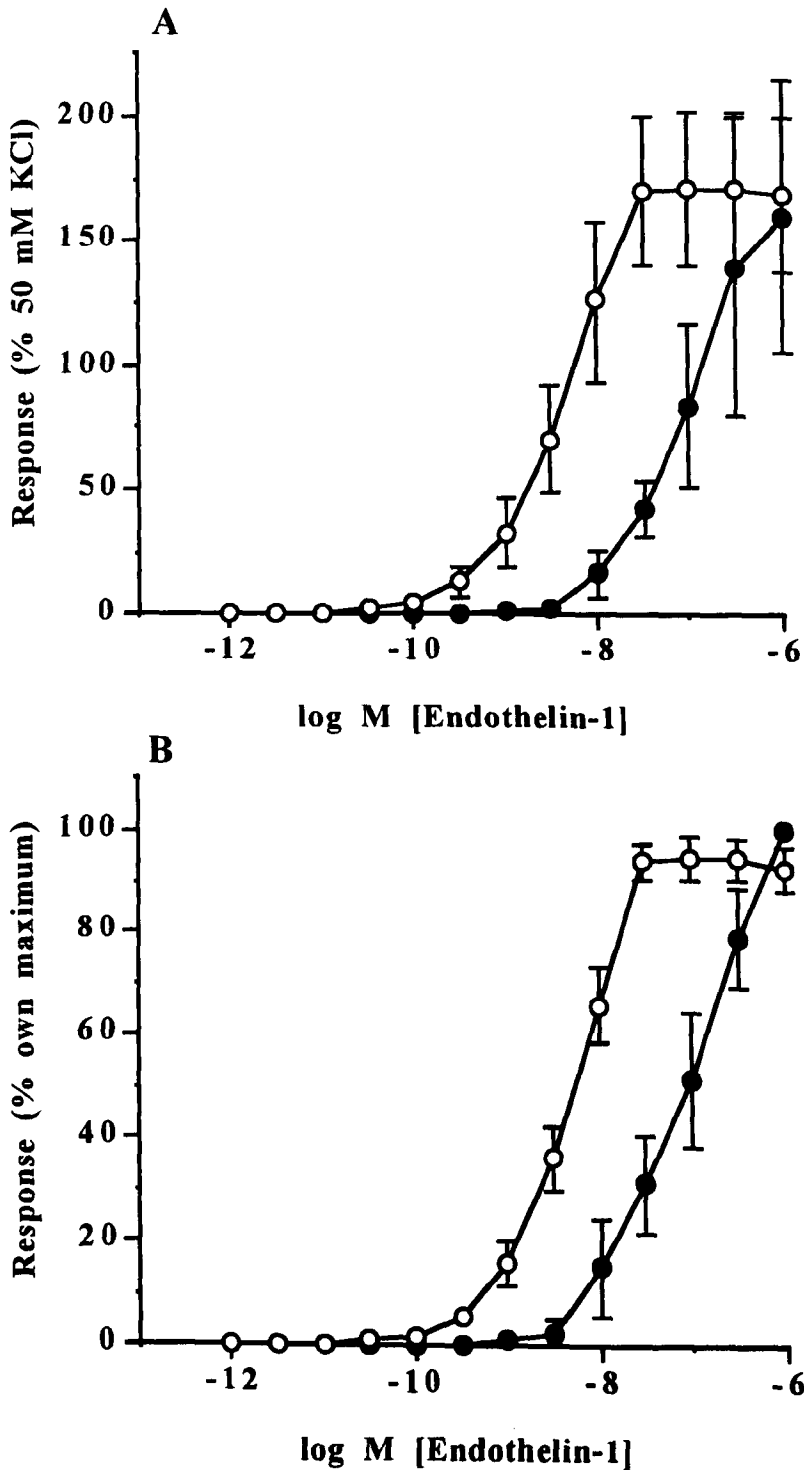

Figure 7.3.

Effect of BMS 182874 on responses to ET-1 in human large pulmonary arteries. ET-1 control (○, n = 7 / 7), ET-1 + BMS 182874 1 μM (●, n = 5 / 4). **A.** Expressed as percentage of reference contraction to 50 mM KCl. **B.** Expressed as percentage of own maximum contraction. Each point represents the mean ± SEM.

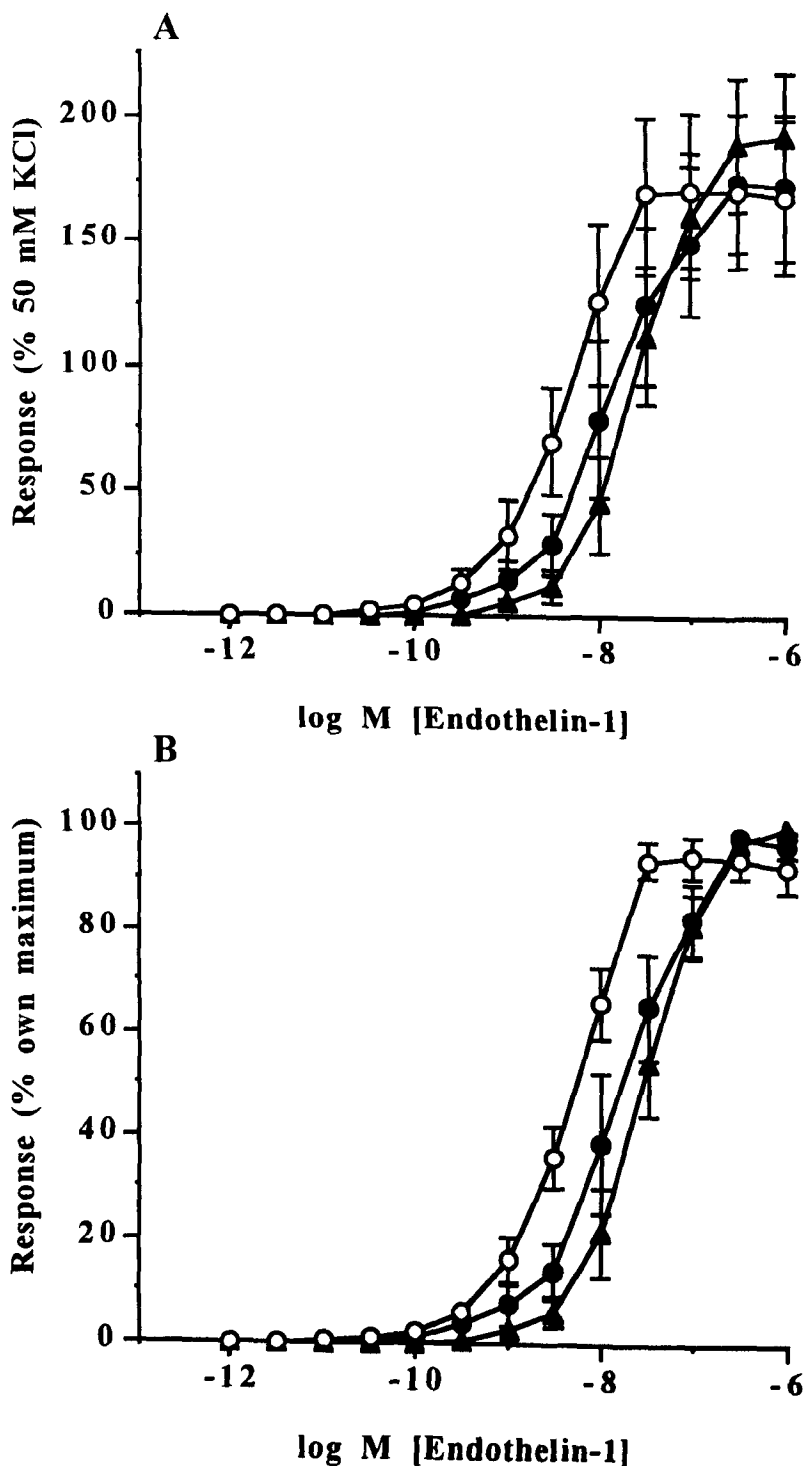

Figure 7.4.

Effect of bosentan on responses to ET-1 in human large pulmonary artery. ET-1 control (○, n = 7 / 7); ET-1 + 0.1 μM bosentan (●, n = 6 / 3), ET-1 + 1 μM bosentan (▲, n = 6 / 3). **A.** Expressed as percentage of reference contraction to 50 mM KCl. **B.** Expressed as percentage of own maximum contraction. Each point represents the mean ± SEM.

(shown in table 7.5), with the pK_B value at 0.1 μM being significantly greater than at 1 μM .

Pulmonary resistance arteries.

The average internal diameter of pulmonary resistance arteries mounted on the myograph was $188 \pm 9 \mu\text{m}$ at an average transmural pressure of $16.3 \pm 0.7 \text{ mmHg}$ ($n = 12$ preparations). 50 mM KCl-induced contractions were $113 \pm 10 \text{ mg wt tension}$ ($n = 12 / 10$). Figure 7.5 illustrates responses to ET-1, ET-3 and SxS6c in human pulmonary resistance arteries. Data for pEC_{50} values are summarise in table 7.4. The response to ET-1 comprises two components, one being a gradual slope up to 0.3 nM and the second a steeper component at higher concentrations. Responses to ET-1 were equipotent in large calibre pulmonary arteries and pulmonary resistance arteries. ET-3 was approximately five times more potent than ET-1 in this preparation (see figure 7.5.B and table 7.4) but produced a maximum contraction of only $65 \pm 9 \%$ of the reference contraction to 50 mM KCl ($*** p < 0.001$ vs. ET-1 control, Students unpaired t-test). Pulmonary resistance arteries demonstrated approximately five times greater sensitivity to ET-3 than the larger calibre pulmonary arteries (pEC_{50} values for ET-3 in pulmonary resistance arteries were 9.05 ± 0.19 , and in large calibre pulmonary artery values were 8.30 ± 0.11 ; $* p < 0.05$, Students unpaired t-test). The selective ET_B agonist SxS6c produced concentration dependent contractions in human pulmonary resistance arteries of greater potency than ET-1, and ET-3 (see figure 7.5.B and table 7.4), which were completely resistant to the actions of the ET_A receptor antagonist FR 139317 (not shown on graph, pEC_{50} values for SxS6c control were 10.65 ± 0.27 $n = 10 / 6$, and in the presence of FR 139317 1 μM pEC_{50} values were 10.55 ± 0.25 $n = 3 / 3$). However in a similar fashion to ET-3, SxS6c produced a maximum contraction of only $67 \pm 19 \%$ KCl response ($*** p < 0.001$ vs. ET-1 control, Students, unpaired t-test).

Incubation with antagonists at all concentrations studied had no effect on resting vascular tone. Figure 7.6 shows the effect of the ET_A receptor antagonist FR 139317 on responses to ET-1 in human pulmonary resistance arteries. From this figure and

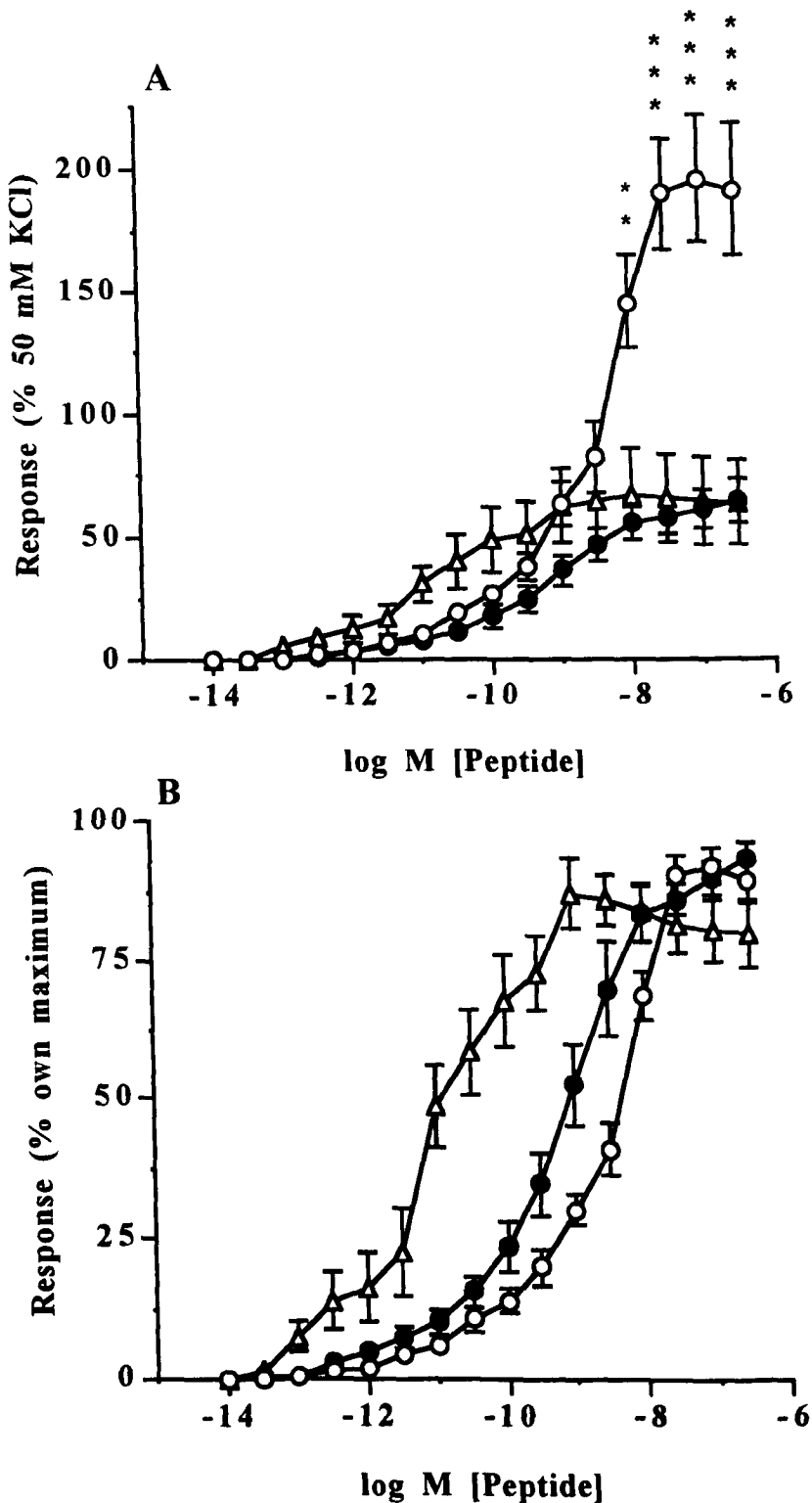

Figure 7.5.

Responses to ET-1 (○, n = 12 / 10); ET-3 (●, n = 10 / 10) and SxS6c (△, n = 10 / 6) in human pulmonary resistance arteries. **A.** Expressed as percentage of reference contraction to 50 mM KCl. **B.** Expressed as percentage of own maximum contraction. Each point represents the mean ± SEM. Statistical comparisons were made using Students unpaired t-test. ** p < 0.01, *** p < 0.001.

Group	pEC ₅₀ value	n / n
ET-1 control	8.32 ± 0.08	12 / 10
SxS6c Control	10.65 ± 0.27*** (†††)	10 / 6
ET-1 + 1 µM FR1 39317	7.98 ± 0.30	8 / 6
ET-1 + 10 µM FR1 39317	8.80 ± 0.21	4 / 4
ET-1 + 10 µM BMS 182874	8.20 ± 0.26	8 / 5
ET-3 control	9.05 ± 0.19**	10 / 10
ET-3 + 1 µM BQ-788	7.43 ± 0.13†††	7 / 5

Table 7.4.

pEC₅₀ values for peptides (± antagonists) in human pulmonary resistance arteries. Data are expressed as mean ± SEM. n / n = number of preparations from number of lungs. Statistical comparisons were made by Students unpaired t-test. ** p < 0.01, *** p < 0.001 vs. ET1 control. †††p < 0.001 vs. ET-3 control.

Antagonist	Large PA	PRA	pK _B value	n
FR 139317 (1 µM)	✓	✗	6.59 ± 0.24	11
BMS 182874 (1 µM)	✓	✗	7.30 ± 0.18	5
Bosentan (0.1 µM)	✓	✗	7.43 ± 0.15	6
Bosentan (1 µM)	✓	✗	6.62 ± 0.30*	6
BQ788 (1 µM)	✗	✓	7.72 ± 0.22	7

Table 7.5.

Estimated pK_B values for antagonist in human pulmonary arteries. Large calibre pulmonary arteries (large PA) and pulmonary resistance arteries (PRA). All antagonist values are calculated against ET-1 CCRC with the exception of BQ-788 which is calculated against ET-3. * p < 0.05 bosentan 0.1 µM vs. 1 µM.

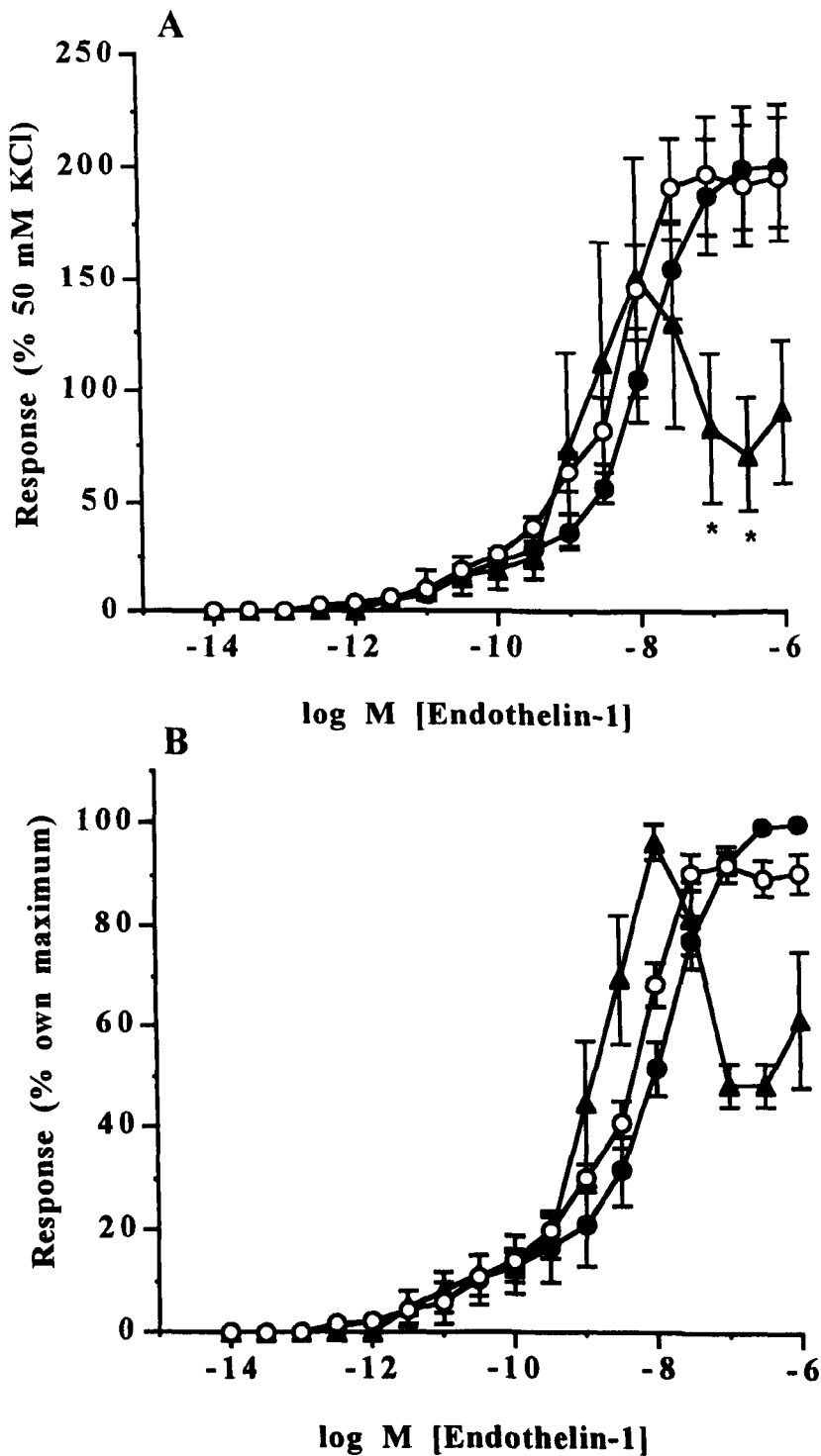

Figure 7.6.

Effect of FR 139137 on responses to ET-1 in human pulmonary resistance arteries. ET-1 control (○, n = 12 / 10); ET-1 + 1 μM FR 139137 (●, n = 8 / 6); ET-1 + 10 μM FR 139137 (▲, n = 4 / 4). **A** Expressed as percentage of reference contraction to 50 mM KCl **B**. Expressed as percentage of own maximum contraction. Each point represents the mean ± SEM. Statistical comparisons made by Students unpaired t-test, * p < 0.05.

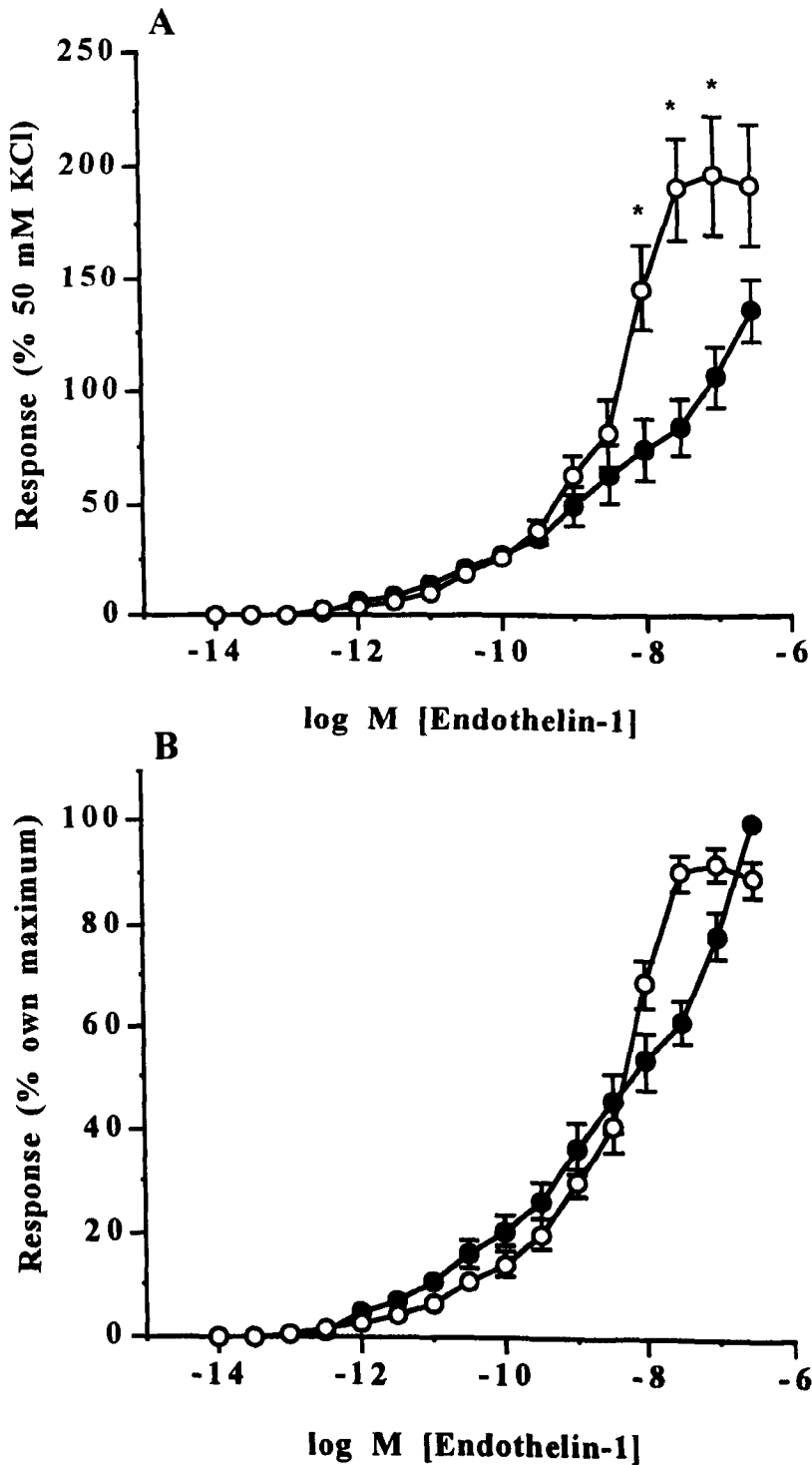

Figure 7.7.

Effect of BMS 182874 on responses to ET-1 in human pulmonary resistance arteries. ET-1 control (○, n = 12 / 10) and ET-1 + 10 μM BMS 182874 (●, n = 8 / 5). **A.** Expressed as percentage of reference contraction to 50 mM KCl. **B.** Expressed as percentage of own maximum contraction. Each point represents the mean ± SEM. Statistical comparisons were made using Students unpaired t-test. * p < 0.05.

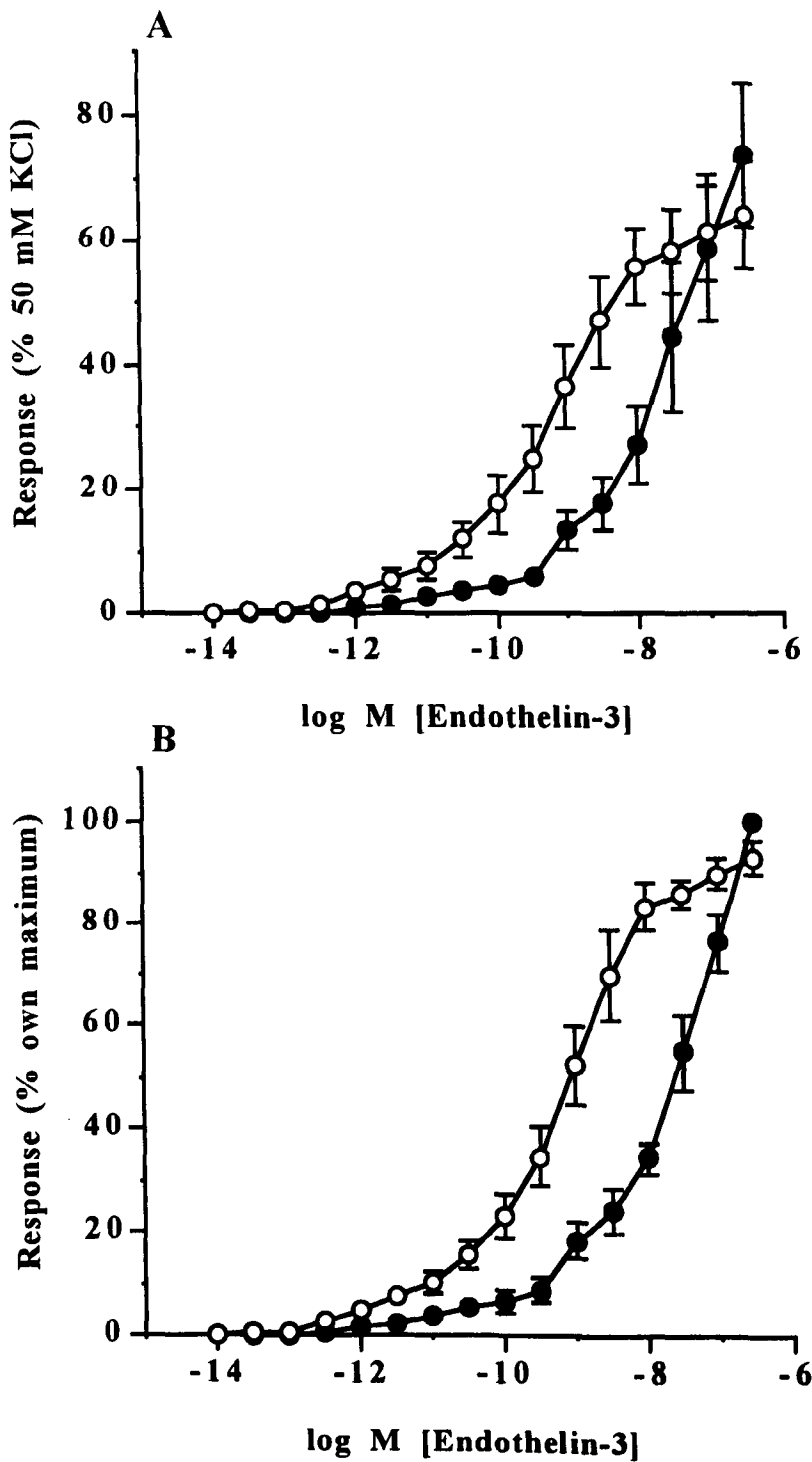

Figure 7.8.

Effect of BQ-788 on responses to ET-3 in human pulmonary resistance arteries. ET-3 control (○, n = 10 / 10), and ET-3 + 1 μM BQ-788 (●, n = 7 / 5). **A.** Expressed as percentage of reference contraction to 50 mM KCl. **B.** Expressed as percentage of own maximum contraction. Each point represents mean ± SEM.

table 7.4 it can be seen that FR 139317 did not antagonise responses to ET-1 when present at 1 μ M. However when present at 10 μ M the antagonist causes a significant decrease in the maximal response to ET-1 at 30 nM and 0.1 μ M, without effecting the tissue sensitivity to ET-1 (see figure 7.6.A). The effect of BMS 182874 (selective ET_A receptor antagonist, 1 μ M) is shown in figure 7.7 and table 7.4. This antagonist appeared to cause a slight rightward shift at the higher concentrations of ET-1, but this proved to be just insignificant (pEC₇₅ value for ET-1 was 7.55 ± 0.19 , and in the presence of BMS 182874 was 7.04 ± 0.05 , $p = 0.07$). However BMS 182874 did cause a significant decrease in the absolute contractile response to ET-1 in the range of 10 nM to 0.1 μ M.

Figure 7.8 shows responses to ET-3 in the absence and presence of 1 μ M BQ-788 (selective ET_B receptor antagonist) in human pulmonary resistance arteries. From this figure and table 7.4 it can be seen that BQ-788 caused a rightward shift in the response curves to ET-3 in human pulmonary resistance arteries, without affecting the maximal contractile response to the peptide. The pK_B value for BQ-788 in this preparation is shown in table 7.5.

7.4 Discussion.

Large calibre intrapulmonary artery

ET-1 produced contractile responses in the human large calibre intrapulmonary artery with a potency similar to that described previously (McKay, *et al.*, 1991; Hay, *et al.*, 1993; Buchan *et al.*, 1994). ET-3 also produced contractile responses in these preparations of equal potency to ET-1, however the maximum response to this peptide was only 35 % of that achieved to ET-1. The fact that ET-1 and ET-3 were equipotent in this preparation would initially indicate the presence of a population of ET_B receptors. However, the selective ET_B receptor agonist SxS6c was completely inactive in all large pulmonary arterial preparations tested, therefore suggesting the absence of vascular ET_B receptors mediating vasoconstriction in human large calibre pulmonary arteries. This would imply that ET-3 is therefore acting either as a partial agonist at the

same receptor as ET-1, or mediating responses via a separate receptor subtype. Further experiments are required to clarify this situation.

In accordance to results from previous studies the contractile response to ET-1 were antagonised by blocking the ET_A receptor. In this study FR 139317 and BMS 182874 significantly antagonised the ET-1 response curve with apparent pK_B values (at 1 μM) of 6.59 and 7.30 respectively. Although BMS 182874 (1 μM) appears to be more effective than FR 139317 (1 μM) in attenuating the ET-1 response, there was no significant difference observed in the apparent pK_B values for the antagonists. When present at 10 μM, FR 139317 completely abolished the response to ET-1 human pulmonary arteries tested. The nature of the antagonism produced by FR 139317 prevents full Schild analysis from being carried out, however it would appear to be acting in a non-competitive dependent manner. As discussed in previous chapters this apparent non-competitive effect of ET antagonists has been observed in a variety of preparations; for example the ET_A receptor antagonist BQ-123 showed non-competitive antagonist action in cell based assay systems (Hiley, *et al.*, 1992; Vigne, *et al.*, 1993), and also in human small omental venules (Riezebos, *et al.*, 1994) and human pulmonary artery (Buchan, *et al.*, 1994).

One of the reasons for non-competitive antagonism in this vessel preparation may be due to receptor heterogeneity. It is possible that ET-1-induced contractions of the human pulmonary artery may be mediated predominantly via the activation of ET_A receptors, but there also may be accompanying simultaneous activation of a small and variable population of non-ET_A receptors. Indeed the fact that contractile responses to ET-3 in the human pulmonary artery are observed may indicate an additional receptor subtype being present. This is unlikely to be a classical ET_B receptor due to the lack of activity of the selective ET_B agonist SxS6c. I also observe a non-concentration dependent effect of the mixed ET_A / ET_B receptor antagonist bosentan, in human pulmonary arteries. There has been suggestion of the presence of a non-ET_A, non-ET_B receptor in human saphenous vein (Bax, *et al.*, 1993), human umbilical artery (Bodelsson and Stjernquist, 1993) and human coronary artery (Godfraind, 1993).

However, this apparent heterogeneous receptor population in the human large intrapulmonary artery may be simply due to the almost irreversible binding of ET's to their receptors (Marsault, *et al.*, 1991), and as mentioned previously this suggests that classical analysis of agonist / antagonist interactions may not hold for ET's. Further experiments using the more potent receptor antagonists on responses to ET-1 and ET-3 may help to elucidate the receptor population in human large calibre intrapulmonary arteries.

Pulmonary resistance arteries.

It can be seen that the response curve to ET-1 in human pulmonary resistance arteries appears biphasic in nature, which would immediately suggest a heterogeneous population of ET-receptors. That ET-1 induced vasoconstriction is not mediated entirely by a typical ET_A-receptor in human pulmonary resistance arteries is suggested by its resistance to both of the ET_A-receptor antagonist studied. However although the antagonists did not competitively shift the ET-1- induced response, both FR 139317 (10 μ M) and BMS 182874 (1 μ M) significantly decreased the contractile response to high concentrations ET-1. This would suggest that ET-1 may be acting at ET_A receptors at high concentrations, but at another receptor at low concentrations.

The selective ET_B receptor agonist SxS6c produced extremely potent contractile responses over 200 fold greater than ET-1 in human pulmonary resistance arteries, which were resistant to the actions of the ET_A receptor antagonist FR 139317. The maximum contraction achieved to SxS6c was however only 35 % of that achieved to ET-1. Concentration dependent contractile responses were also observed to ET-3. This peptide proved to be less potent than SxS6c but 5 fold more potent than ET-1. In a similar fashion to the responses to SxS6c, the maximum contraction to ET-3 was only some 35 % of the maximum response to ET-1 in this preparation. The results also show that the ET-3 CCRC follows a similar time course of the first component of the CCRC to ET-1. The fact that ET-3 is more potent than ET-1 in this vessel preparation suggests the presence of a receptor other than the ET_B subtype. If ET-3 was acting at a

“classical” ET_B receptor subtype ET-1 and ET-3 would be expected to be equipotent, which is not the situation in pulmonary resistance arteries. As mentioned previously a non-ET_A, non-ET_B receptor has been described in human vasculature, and this could offer an alternative explanation for my results. The relative potency of ET-3 over ET-1 in human pulmonary resistance arteries may suggest the presence of an ET_C-like receptor (see section 1.2.5.4) however as a mammalian vascular counterpart this receptor has yet to be identified this explanation appears unlikely. The ET_B receptor antagonist BQ-788 antagonised the contractile responses to ET-3 in this preparation suggesting that ET-3 is mediating its response via ET_B receptors. From this data it would suggest that ET-1 mediates vasoconstriction via ET_A receptor activation at high concentrations, but acts via ET_B receptors at lower (and perhaps more physiologically relevant) concentrations.

Although great care was taken when mounting both arterial preparations as not to damage the vascular endothelium, the integrity of the endothelium in each preparation was not pharmacologically tested. Interaction of ET's with the vascular endothelium in human pulmonary vessels is not well documented. Endothelial ET_B receptors have been shown to mediate pulmonary vasodilatation in rats (Eddahibi, *et al.*, 1991) and lambs (Wong, *et al.*, 1995), but whether this occurs in the human pulmonary circulation is not yet clear. In my experiments, under conditions of basal tone, only contractile responses to ET-1 and related peptides were observed, but it would be of interest to study responses in the presence of raised vascular tone. It has also been reported that responses to ET-1 in human large diameter intrapulmonary arteries were not effected by cyclooxygenase inhibition (indomethacin) or NOS inhibition (L-NOARG), suggesting that local endogenous release of EDRF's may not be important in regulating the contractile responses to ET-1 in human pulmonary arteries *in vitro* (Pussard, *et al.*, 1995).

Under normal physiological conditions ET-1 circulates within the plasma in the low picomolar range, with values often in the range of 0.5 to 5 pg / ml of plasma (Miyachi, *et al.*, 1991b; Lam, *et al.*, 1991; Goerre, *et al.*, 1995; Ferri, *et al.*, 1995).

There is considerable variation between groups as to the precise levels under normal conditions and this is probably due to sample populations, the assay techniques used for measurement, and the site at which the samples are taken. However, all relevant studies are consistent in showing that the ET-1 levels are significantly increased in cases of pulmonary hypertension. The most dramatic increases in circulating ET-1 levels and ET-1 expression, appear to be associated with primary pulmonary hypertension (Cacoub, *et al.*, 1993; Giaid, *et al.*, 1993; Stewart, *et al.*, 1991; Nootens, *et al.*, 1995); and it has been postulated that this may be a link to the greater than expected incidence of Raynauds phenomenon in patients with primary pulmonary hypertension, a condition in which increased plasma ET-1 levels have been documented (Cacoub, *et al.*, 1993; Zamora, *et al.*, 1990). Raised plasma ET-1 levels are also significantly increased in pulmonary hypertension secondary to hypoxia (Ferri, *et al.*, 1995; Stewart, *et al.*, 1991), congenital heart defects (Yoshiyoshi, *et al.*, 1991; Cacoub, *et al.*, 1993; Vincent, *et al.*, 1993), valvular heart disease (Stewart, *et al.*, 1991; Yamamoto, *et al.*, 1994; Zhu, *et al.*, 1994; Chang, *et al.*, 1993), chronic heart failure (Cody, *et al.*, 1992; Kiowski, *et al.*, 1995) and the adult respiratory distress syndrome (Langleben, *et al.*, 1993). Whether the levels of ET-1 are a cause, or an effect of pulmonary hypertension is still under debate.

In primary pulmonary hypertension, there is a strong correlation between the intensity of ET-1-like immunoreactivity in muscular and elastic arteries and pulmonary vascular resistance (Giaid, *et al.*, 1993). Also in pulmonary hypertension related to hypoxia, levels of ET-1 are positively correlated with alveolar / arterial oxygen concentration (Goerre, *et al.*, 1995; Ferri, *et al.*, 1995; Sofia, *et al.*, 1994). In cases of surgically correctable pulmonary hypertension, for example valvular disease and congenital heart defects, circulating ET-1 levels decrease markedly after surgery and correlate strongly with the improvements in pulmonary haemodynamics (Zhu, *et al.*, 1994; Ishikawa, *et al.*, 1995; Chang, *et al.*, 1993). Certainly this evidence would suggest a role for ET-1-mediated vasoconstriction contributing to the increased vascular

resistance observed in pulmonary hypertension. Recent observations by Ishikawa, *et al.*, (1995) involving patients with various congenital heart defects, showed that increase in pressure load to the pulmonary circulation stimulated ET-1 production, whereas increased pulmonary blood flow depressed ET-1 production.

These increased levels of ET-1, although still in the low picomolar range, may be sufficient to mediate vasoconstriction. In the context of my *in vitro* studies, plasma ET-1 concentrations would be at the threshold level (pEC_{10}) required for contraction. Threshold concentrations of ET-1 have also been shown to facilitate contractions to other vasoactive compounds such as 5-HT, angiotensin II and α_2 -adrenoceptor agonists (Itoh, *et al.*, 1992; Takeshita, *et al.*, 1991; MacLean & McGrath, 1990). Indeed it has been demonstrated in the forearm circulation of healthy human volunteers, under control conditions, that infusion of the ET_A receptor antagonist BQ-123 mediates prolonged vasodilatation suggesting that ET-1 plays a role in human vascular tone under normal physiological conditions (Haynes, *et al.*, 1995).

Although plasma levels of ET-1 give an indication of production, the actions of ET-1 may be more paracrine in nature than endocrine. It is thought that approximately 75 % of ET-1 synthesised is secreted towards the vascular smooth muscle cells (Yoshimoto, *et al.*, 1991; Wagner, *et al.*, 1992), and given the small volumes of interstitial fluid, ET-1 levels may be significantly greater at the smooth muscle cells compared to plasma levels. Unfortunately little is known about the actions of ET-1 in human lungs *in vivo*. From studies of isolated systemic vessels *in vitro*, it was thought that ET-1 contracted the majority of human arterial and venous preparations via activation of ET_A receptors (Davenport, *et al.*, 1994, 1995; Maguire, *et al.*, 1995). However, comparative studies *in vivo* would indicate that both ET_A and ET_B receptors mediate vasoconstriction in human resistance and capacitance vessels (Haynes, *et al.*, 1995). This discrepancy may be due to the size and or type of preparation studied, as there is growing evidence *in vitro* to suggest the presence of vascular ET_B receptors in human arteries and veins (Seo, *et al.*, 1994; White, *et al.*, 1994; Dashwood, *et al.*,

1995). It therefore may be expected to see contribution of both ET_A and ET_B receptors in ET-1 mediated vasoconstriction in human pulmonary circulation *in vivo*. Changes in ET-induced responses, and ET receptor subtypes in the pulmonary vasculature are altered in animal models of pulmonary hypertension (Eddahibi, *et al.*, 1991; Li, *et al.*, 1994; Yorikane, *et al.*, 1993; chapters 5 and 6 this thesis). Whether pulmonary vascular responses to ET-1 are altered in human pulmonary hypertension is not yet known, and will be an important factor in determining the possible use of ET receptor antagonists as a therapy for pulmonary hypertension.

ET antagonists have been shown to prevent and reverse pulmonary hypertension in animal models of pulmonary hypertension such as the chronic hypoxic rat (Eddahibi, *et al.*, 1995; DiCarlo, *et al.*, 1995; Oparil, *et al.*, 1995; Chen, *et al.*, 1995); and monocrotaline canine model (Okada, *et al.*, 1995). In the rat, the mixed receptor antagonist bosentan was found to be equally if not more effective than the ET_A receptor antagonist BQ-123, at preventing and reversing the cardiopulmonary changes associated with chronic hypoxic induced pulmonary hypertension. In a recent study, Kiowski, *et al.*, (1995) investigated the effects of the mixed ET receptor antagonist bosentan in patients with chronic heart failure. Patients in this study had increased plasma levels of big ET-1 and ET-1, and a significant degree of pulmonary hypertension. Intra venous administration of 200 mg of bosentan (which yields an approximate plasma antagonist concentration of 0.2 μM) significantly reduced pulmonary artery pressure, pulmonary wedge pressure and right atrial pressure, indicating the possible therapeutic use of mixed ET receptor antagonist in secondary pulmonary hypertension. Bosentan would act on both ET_A and ET_B receptor subtypes mediating vasoconstriction, and possibly endothelial ET_B receptors mediating vasodilatation. Whether the sum effect of the mixed antagonist in the pulmonary circulation proves to be greater than that of a specific ET_A receptor antagonist is yet to be examined.

To summarise, my results indicate that the ET receptors subtypes mediating vasoconstriction in the human pulmonary arterial vasculature varies depending on the

size and / or location of the vessel under examination. Large calibre pulmonary arteries appear to possess only vascular ET_A receptors, whereas pulmonary resistance arteries contain populations of both vascular ET_A and ET_B receptors (at an approximate ratio of 70 : 30) both of which can mediate vasoconstriction.

Chapter 8

Responses to 5-Hydroxytryptamine in
Pulmonary Resistance Arteries.

Role of Cyclic Nucleotides in
Hypoxic Pulmonary Hypertension

8.1 Introduction.

5-HT is produced by activated platelets and pulmonary neuroendocrine cells, and has been implicated in pulmonary hypertension in the presence of pulmonary thromboemboli (Comroe, *et al.*, 1953) and primary pulmonary hypertension (Hervé, *et al.*, 1995). Platelet release of 5-HT has also been shown to contribute to the initiation and progression of monocrotaline-induced pulmonary hypertension in rats (Kanai, *et al.*, 1993). The vascular effect of 5-HT in the pulmonary circulation appears to be dependent on both the species under study and on the degree of initial vascular tone. For example, 5-HT has been shown to both act as a pulmonary vasoconstrictor (Hyman, *et al.*, 1982; Wanstall & O'Donnell, 1990), but in some species such as the cat or sheep, 5-HT can also mediate vasodilatation of the pulmonary vascular bed when vascular tone is raised (Neely, *et al.*, 1993; Cocks & Arnold, 1992).

Sumatriptan (GR43175) has been classified as a selective agonist for the 5-HT_{1D} receptor subtype (Humphrey, *et al.*, 1993). In bovine isolated large intrapulmonary arteries, responses to 5-HT receptor agonists are modulated by the degree of vascular tone and release of endothelium derived NO (MacLean, *et al.*, 1994b). In the aforementioned study it was shown that under conditions of raised vascular tone, NOS inhibition or endothelium denudation, responses to the 5-HT_{1D} receptor agonist sumatriptan were “uncovered”. In the pulmonary hypertensive state, vessels are subjected to increased vascular tone which will therefore modulate responses to various spasmogens. In this study I looked at the effects of increased vascular tone and inhibition of NOS activity in bovine pulmonary resistance arteries to assess if a similar situation occurs as in large intrapulmonary arteries. I also examined responses to 5-HT and sumatriptan in control and chronic hypoxic rat pulmonary resistance arteries, to assess any possible changes in the pulmonary hypertensive state.

As mentioned in chapter 1, regulation of intracellular cyclic nucleotides levels is one of the important mechanisms for regulation of pulmonary vascular tone. cGMP is the key second-messenger of NO-induced pulmonary vasodilatation, whereas cAMP plays a central role in vasodilator responses to β -adrenoceptor agonists, PGI₂, and

vasoconstrictor responses to α_2 -adrenoceptor agonists and 5HT_{1D} receptor agonists. The levels of intracellular cyclic nucleotides are controlled not only via synthesis, but also through degradation via the PDE enzyme family. The overall activity of these enzymes will therefore also influence vascular tone by the regulation of intracellular nucleotide concentrations. Therefore in this study I also investigated the intracellular concentrations of cAMP ([cAMP]_i) and cGMP ([cGMP]_i) within pulmonary arteries of different sizes and locations from control and chronic hypoxic rats. To assess if any observed changes were as a result of altered PDE activity, total cAMP and cGMP PDE activity was also studied in these vessels.

8.2 Methods.

Isolate bovine pulmonary resistance arteries.

Bovine pulmonary resistance arteries were dissected from the lungs of freshly killed cattle according to methods stated in chapter 2. Vessel pairs were then mounted in the same bath of a wire myograph, bathed in Krebs saline solution at 37 °C and bubbled with 16 % O₂ 5 % CO₂ balance N₂. Using the normalisation process (described in chapter 2) vessels were tensioned to mimic an equivalent transmural pressure of ~16 mmHg.

Experimental protocol

After 1 hour equilibration period vessels were stimulated with 50 mM KCl and, following plateau of response, vessels were washed three times with fresh Krebs solution. Integrity of the vascular endothelium was then assessed by the ability of 1 μ M ACh to mediate relaxation in 5-HT (1 μ M) precontracted vessels. After a further 30 minute equilibration period cumulative concentration response curves to either 5-HT or sumatriptan (1 nM to 30 μ M) were constructed. The vessels were then washed 5 times with fresh Krebs solution and allowed to return to baseline tension. Following a further 15 minute rest period vessels were then subjected to one of the following protocols.

A Addition of 100 μ M L-NAME, After 15 minute incubation period, a second CCRC was conducted for the same first agonist used in each tissue.

B Vascular tone was raised by administration of the stable thromboxane-mimetic U46619, at a concentration which increased vascular tone by around 20 % of the maximum contraction to KCl (around 10 - 30 nM). After tone had stabilised, normally within 20 minutes, a second CCRC was conducted for the same first agonist used in each tissue.

C No addition of drugs. Vessels allowed to equilibrate for further 15 - 20 minutes before construction of second CCRC, to act as time controls.

Isolated rat pulmonary resistance arteries.

Chronic hypoxic rats were prepared as stated in chapter 2. After exposure to 14 - 16 days of chronic hypoxia rats were sacrificed along with aged matched controls, and pulmonary resistance arteries were dissected out according to the methods stated in chapter 2. Control and chronic hypoxic pulmonary resistance artery vessel pairs were then mounted as ring preparations in the same bath of a wire myograph, bathed in Krebs saline solution at 37 °C and bubbled with 16 % O₂ 5 % CO₂ balance N₂. Using the normalisation process explained in chapter 2, vessels were tensioned to give equivalent transmural pressures of ~16 mmHg for control preparations, and ~36 mmHg for hypoxic preparations.

Experimental protocol.

The same experimental protocol was conducted as described for bovine pulmonary resistance arteries except that only a single CCRC to either 5-HT or sumatriptan was conducted in each preparation. In a smaller subsequent study of sumatriptan responses, some vessels were pre-treated with 100 μ M L-NAME, or were subjected to conditions of raised vascular tone by administration of U46619 of a concentration to give 20 % of the maximum response to 50 mM KCl.

Measurement of cyclic nucleotides and phosphodiesterase activity.

Chronic hypoxic rats were prepared as stated in chapter 2. After exposure to 14 - 16 days of chronic hypoxia rats were sacrificed along with aged matched controls, and pulmonary arteries were dissected from four different locations in the pulmonary vascular tree, main pulmonary artery, branch pulmonary arteries, intrapulmonary artery, and pulmonary resistance arteries (see methods section 2.). Tissue samples were then processed and assayed to measure total cAMP, cGMP and total PDE activity under basal conditions (see methods section 2.). Lowry protein assay was carried out for all samples.

Data analysis.

pEC₂₀, pEC₅₀ and pEC₈₀ values (where appropriate) were calculated by computer extrapolation from individual CCRC's. Responses to 5-HT and sumatriptan are expressed as the percentage of reference contraction to 50 mM KCl in each vessel. Relaxations to ACh were calculated as the percentage of the level of precontraction in each vessel. Biochemical results of cyclic nucleotide levels are expressed as total concentration in picomols per mg protein, and PDE activity is expressed as total activity picomol per minute per mg protein. Data are expressed as mean \pm SEM. Statistical comparison were made using one way ANOVA followed by Tukeys post test, or by Students unpaired t-test. $p < 0.05$ was considered statistically significant.

8.3 Results.

Bovine pulmonary resistance arteries.

Isolated bovine pulmonary resistance arteries were of an average size of 194 ± 6 mm at an equivalent pressure of 16.4 ± 0.7 mmHg. 50 mM KCl contractions were 448 ± 36 mg wt tension and vessels were shown to have intact vascular endothelium, ACh induced relaxation's were 69 ± 3 % of 5-HT precontraction ($n = 12 / 10$ for all groups).

Responses to 5-HT and sumatriptan.

5-HT produced potent contractile responses in bovine pulmonary resistance arteries (see figure 8.1), and no significant difference was found between time controls. pEC₅₀ values for first curve time control was 6.19 ± 0.26 , and pEC₅₀ for second curve time control was 5.85 ± 0.19 . Maximum contractile responses were over 250 % of the reference contraction to 50 mM KCl in each vessel. Sumatriptan produced small contractile responses which were only 10 % of the reference contraction to 50 mM KCl. No significant difference was found between time control curves for sumatriptan, pEC₅₀ value for first time control curve was 5.61 ± 0.11 , and pEC₅₀ for second curve was 5.51 ± 0.15 .

Effect of raising vascular tone.

U46619 produced a well maintained contractile response of approximately 20 % or less of the maximum obtained to 5-HT. Raising vascular tone produced a significant increase in tissue sensitivity to 5-HT in bovine pulmonary resistance arteries, without effecting the maximum contractile response to the agonist (see figure 8.2.A). A summary of the pEC₅₀ values in the presence and absence of tone are illustrated in table 8.1. Responses to the 5-HT_{1D} receptor agonist sumatriptan were dramatically potentiated in the presence of raised tone, decreasing the threshold for contraction from 30 nM to 0.3 nM, and increasing the maximum contraction approximately 10 fold. The tissue sensitivity to sumatriptan was also significantly increased in the presence of tone (see table 8.1 for pEC₅₀ values).

Effect of L-NAME

In approximately 10 % of treated vessels, small contractile responses to L-NAME were observed (3 ± 1 % of 50 mM KCl reference contraction). Responses to 5-HT in the presence and absence of L-NAME are demonstrated in figure 8.3.A. Maximal contractile responses to 5-HT were significantly potentiated in the presence of L-NAME, without effecting tissue sensitivity at the pEC₅₀ value (see table 8.1).

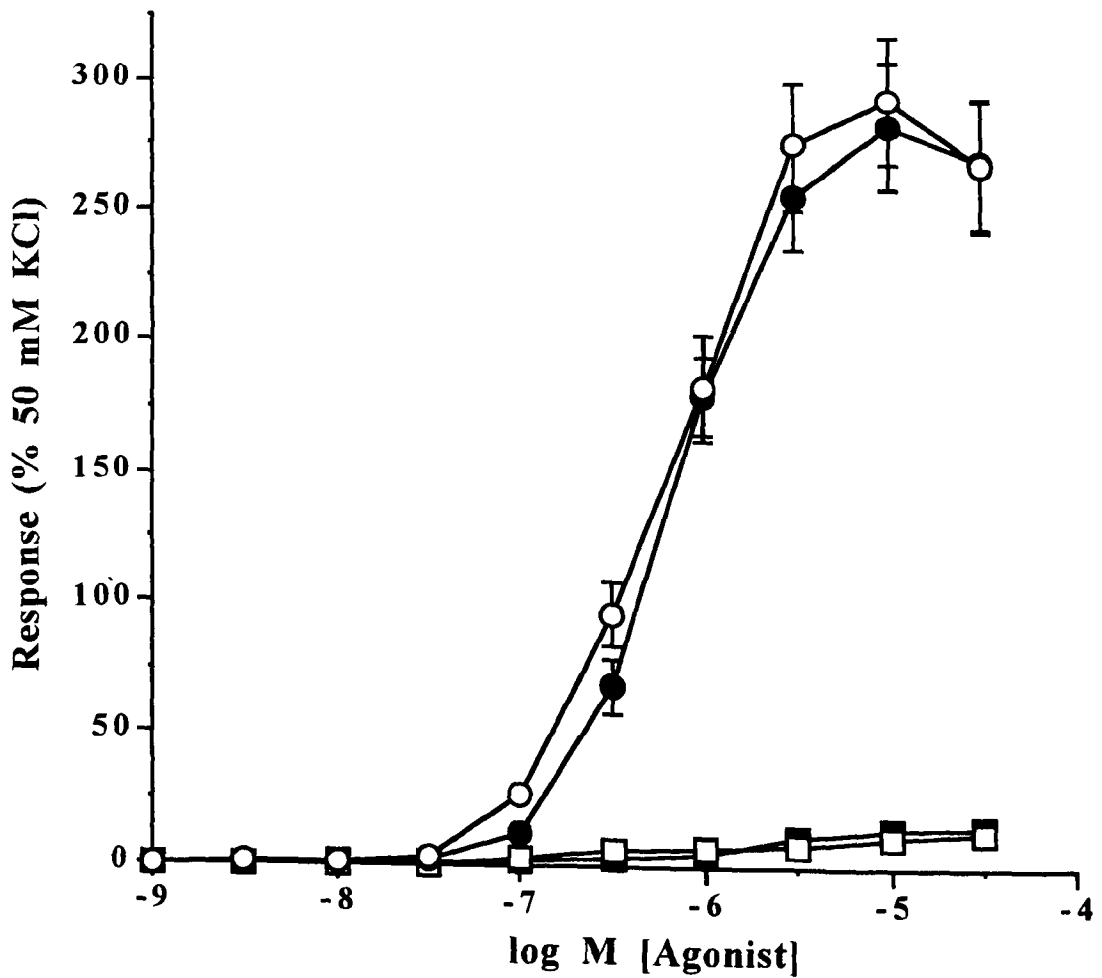

Figure 8.1.

Responses to 5-HT and sumatriptan in bovine pulmonary resistance arteries : Effect of time. CCRC's to 5-HT first curve (○, n = 6 / 6); 5-HT second curve (●, n = 6 / 6). CCRC's to sumatriptan first curve (□, n = 4 / 4) sumatriptan second curve (■, n = 4 / 4). Data are expressed as percentage of reference contraction to 50 mM KCl in each vessel. Each point represents the mean ± SEM.

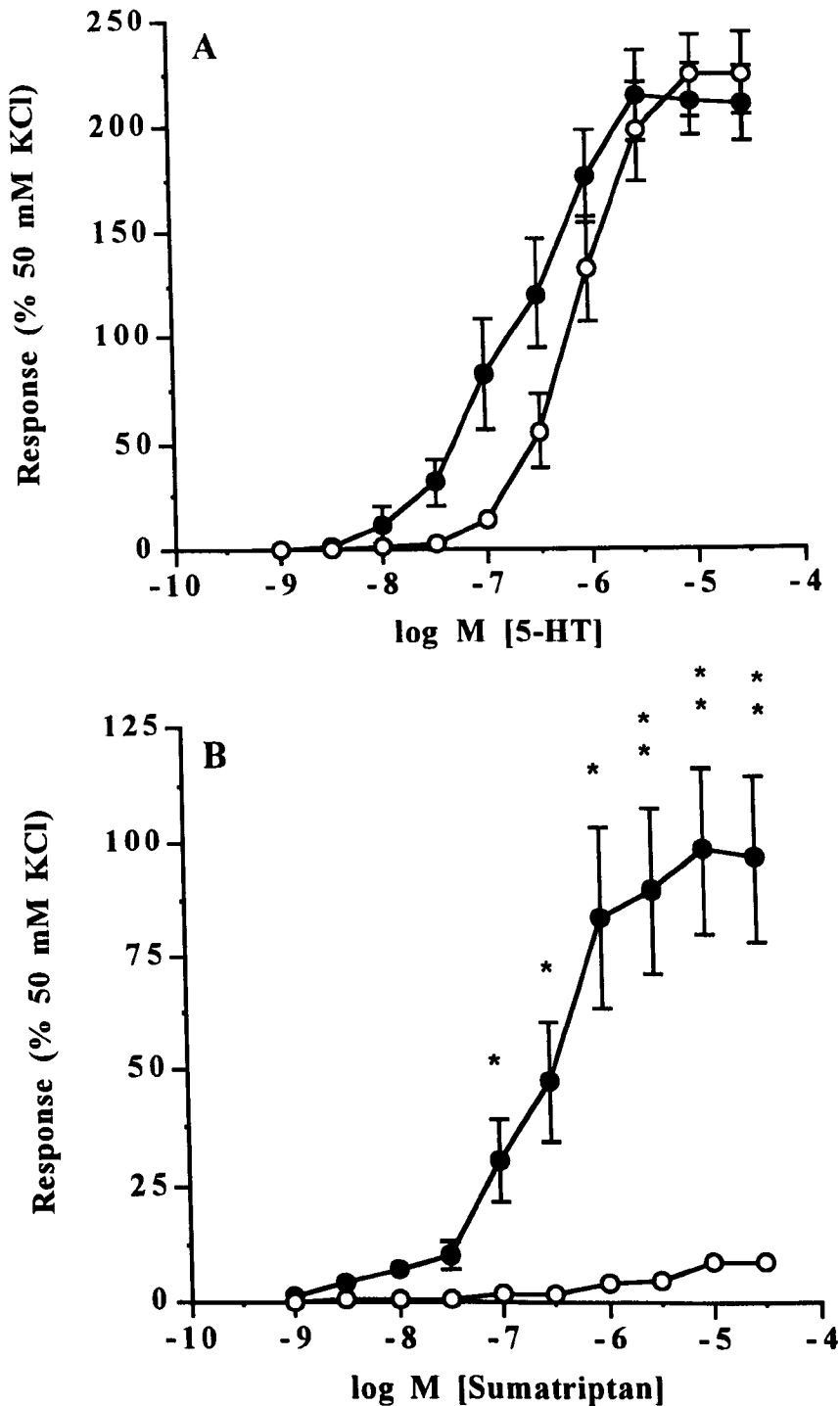

Figure 8.2.

Responses to 5-HT and sumatriptan in bovine pulmonary resistance arteries : Effect of raised vascular tone.

A CCRC's to 5-HT control (○, n = 8 / 8); 5-HT + tone (●, n = 8 / 8). **B** CCRC's to sumatriptan control (○, n = 7 / 7); sumatriptan + tone (●, n = 7 / 7). Data are expressed as percentage of reference contraction to 50 mM KCl in each vessel. Each point represents the mean ± SEM. Statistical comparisons were made by Students paired t-test. *p < 0.05, **p < 0.01, ***p < 0.001 control vs. + tone.

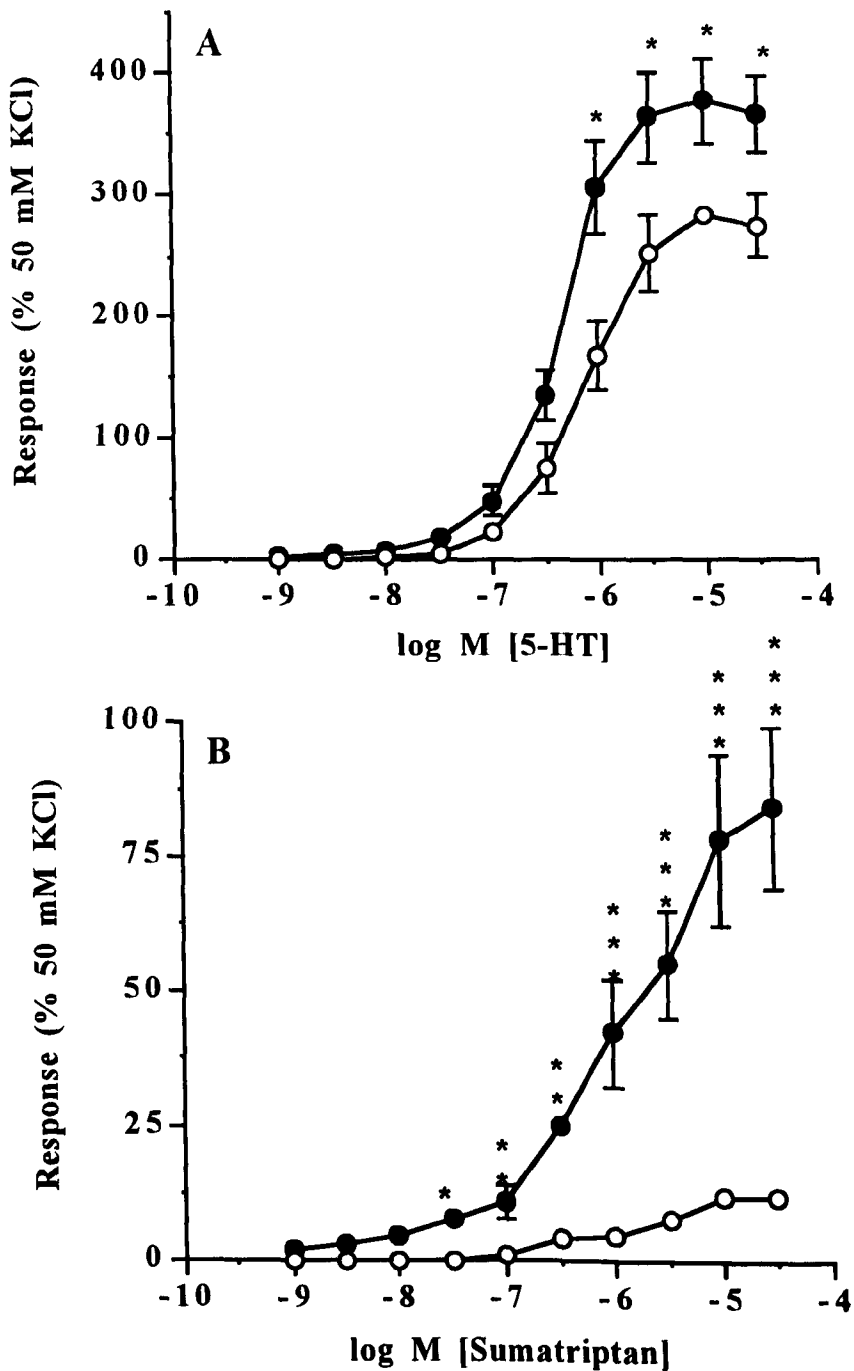

Figure 8.3.

Responses to 5-HT and sumatriptan in bovine pulmonary resistance arteries : Effect of L-NAME.

A CCRC to 5-HT control (○, n = 7 / 7); 5-HT + L-NAME (●, n = 7 / 7). **B** CCRC's to sumatriptan control (○, n = 8 / 8); sumatriptan + L-NAME (●, n = 8 / 8). Data are expressed as percentage of reference contraction to 50 mM KCl in each vessel. Each point represents the mean ± SEM. Statistical comparisons were made by Students paired t-test. *p < 0.05, **p < 0.01, ***p < 0.001 control vs. + L-NAME.

A significant increase was however demonstrated at the pEC₈₀ values being 5.63 ± 0.13 without L-NAME, and 5.93 ± 0.13 in the presence of L-NAME (**p < 0.01 Students paired t-test). Similar to the effect of increasing vascular tone, application of L-NAME produced a significant potentiation of responses to sumatriptan (see figure 8.3.B). L-NAME also caused a significant increase in tissue sensitivity to sumatriptan (see table 8.1), and decrease the threshold concentration for contraction from 30 nM to 0.3 nM.

	5-HT	n / n	Sumatriptan	n / n
without tone	6.05 ± 0.01	8 / 8	5.42 ± 0.19	8 / 8
with tone	$6.54 \pm 0.14^{\dagger\dagger}$	8 / 8	$6.04 \pm 0.15^{\dagger}$	8 / 8
without L-NAME	6.18 ± 0.15	7 / 7	5.45 ± 0.16	7 / 7
with L-NAME	6.30 ± 0.06	7 / 7	$5.86 \pm 0.09^*$	7 / 7

Table 8.1 pEC₅₀ values for 5-HT and sumatriptan in bovine pulmonary resistance arteries

Data are expressed as mean \pm SEM. Statistical comparisons were made using Students t-test for paired data. *p < 0.05 agonist without L-NAME vs. agonist with L-NAME. †p < 0.05, ††p < 0.01 agonist without tone vs. agonist with tone.

Control and chronic hypoxic rat pulmonary resistance arteries.

Responses to 5-HT and sumatriptan.

The average internal diameter and pressure of control and chronic hypoxic pulmonary resistance arteries is shown in table 8.2 below.

	Internal Diameter (μ m)	Transmural pressure (mmHg)
Control	157.1 ± 5.84	15.2 ± 0.5
Chronic hypoxic	$193.0 \pm 8.7^{**}$	$35.0 \pm 0.3^{***}$

Table 8.2 Internal diameters and pressures of rat pulmonary resistance arteries. Data is expressed as mean \pm SEM. Statistical comparison were made using Students unpaired t-test. **p < 0.01, ***p < 0.001 control vs. chronic hypoxic.

50 mM KCl induced contractions were similar in control and chronic hypoxic pulmonary resistance arteries values being, 429 ± 33 mg wt tension controls, and 444 ± 38 mg wt tension chronic hypoxic. As observed in chapter 5 and 6, ACh induced relaxations were significantly greater in chronic hypoxic vessels compared to controls; with values of 29.6 ± 2.4 % for controls and 68.1 ± 3.1 % for chronic hypoxic vessels (** $p < 0.001$, Students unpaired t-test).

Figure 8.4 shows responses to 5-HT in control and chronic hypoxic rats pulmonary resistance arteries. From this figure it can be seen that responses to 5-HT were significantly greater in chronic hypoxic vessels compared to controls. pEC_{50} values for 5-HT in control preparations were 5.50 ± 0.07 , and in chronic hypoxic preparation 5.76 ± 0.07 (* $p < 0.05$, Students unpaired t-test, $n = / 10 / 8$). Under control conditions in all vessels tested, the 5-HT_{1D} receptor agonist sumatriptan was found to be inactive. To assess if responses to sumatriptan could be “uncovered” in the preparations, a small separate study was conducted. Administration of L-NAME (100 μ M) had no effect on vascular tone in control preparations but caused slight contraction in 60 % of chronic hypoxic vessels (10 ± 2 % of 50 mM KCl reference contraction). In the presence of L-NAME only slight vasoconstrictor responses were observed to sumatriptan at the highest concentrations tested. Raising vascular tone with U46619 (to approximately 20 % of 50 mM KCl induced contraction) had a similar effect to L-NAME, in that only small contractile responses were observed to sumatriptan. Sumatriptan showed no evidence of causing vasodilatation in the presence of raised vascular tone.

Measurement of intracellular cyclic nucleotides.

Figure 8.5.A shows total [cAMP]_i within pulmonary arteries of control and chronic hypoxic rats. The measurements were taken in the absence of stimulation with any exogenous applied vasoactive factors, therefore indicate total basal levels. Basal [cAMP]_i were similar in all arterial preparations, however intrapulmonary axial arteries

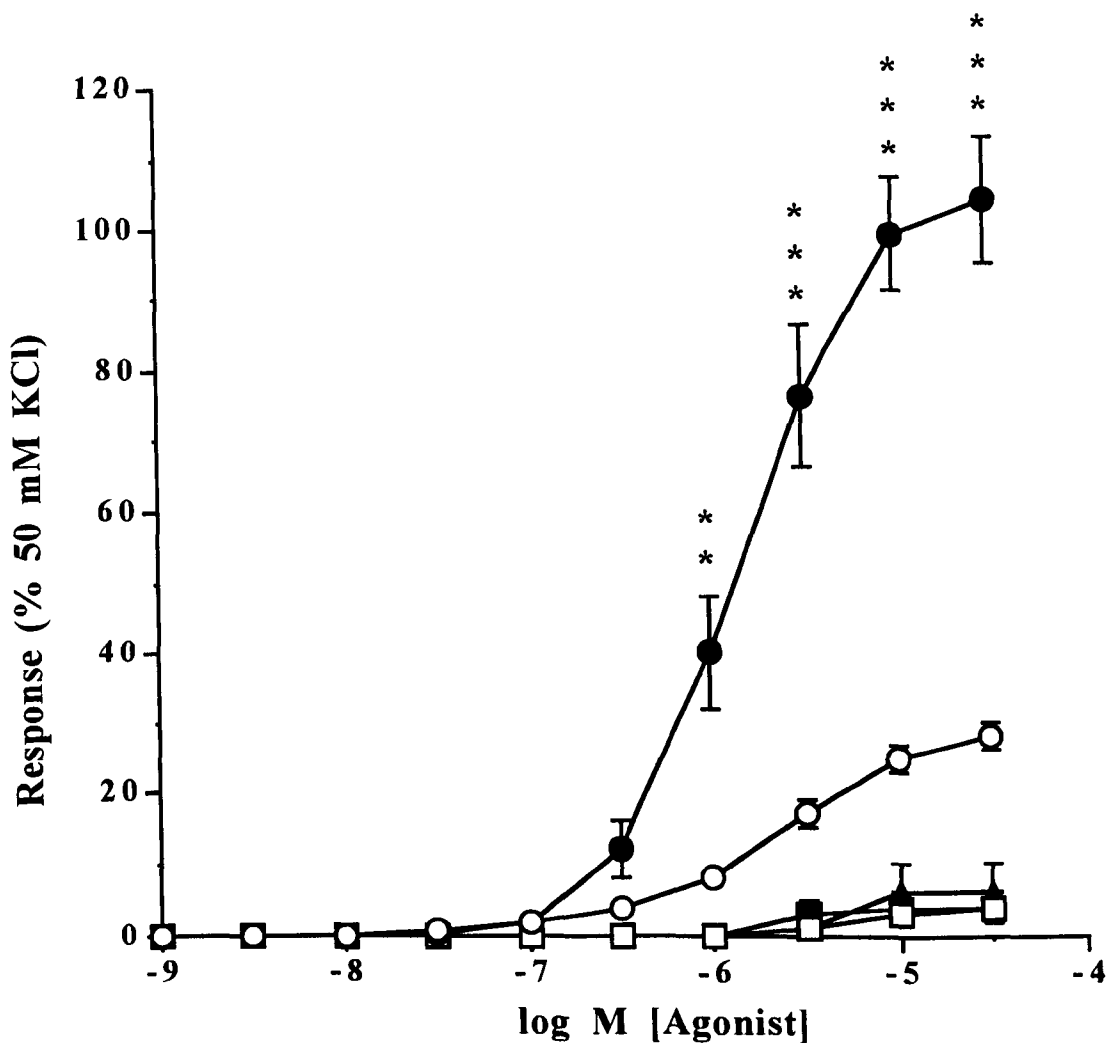

Figure 8.4.

Responses to 5-HT and sumatriptan in control and chronic hypoxic rat pulmonary resistance arteries. CCRC's to 5-HT control (○, n = 10 / 10); 5-HT chronic hypoxic (●, n = 10 / 10) (sumatriptan inactive in both control and chronic hypoxic vessels). CCRC's to sumatriptan control + L-NAME (□, n = 4 / 4), control + tone (△, n = 4 / 4), chronic hypoxic + L-NAME (■, n = 4 / 4), chronic hypoxic + tone (▲, n = 4 / 4). Data are expressed as percentage reference contraction to 50 mM KCl in each vessel. Each point represents the mean ± SEM. Statistical comparisons were made using Students unpaired t-test. *** p < 0.001, ** p < 0.01, control 5-HT vs. chronic hypoxic 5-HT.

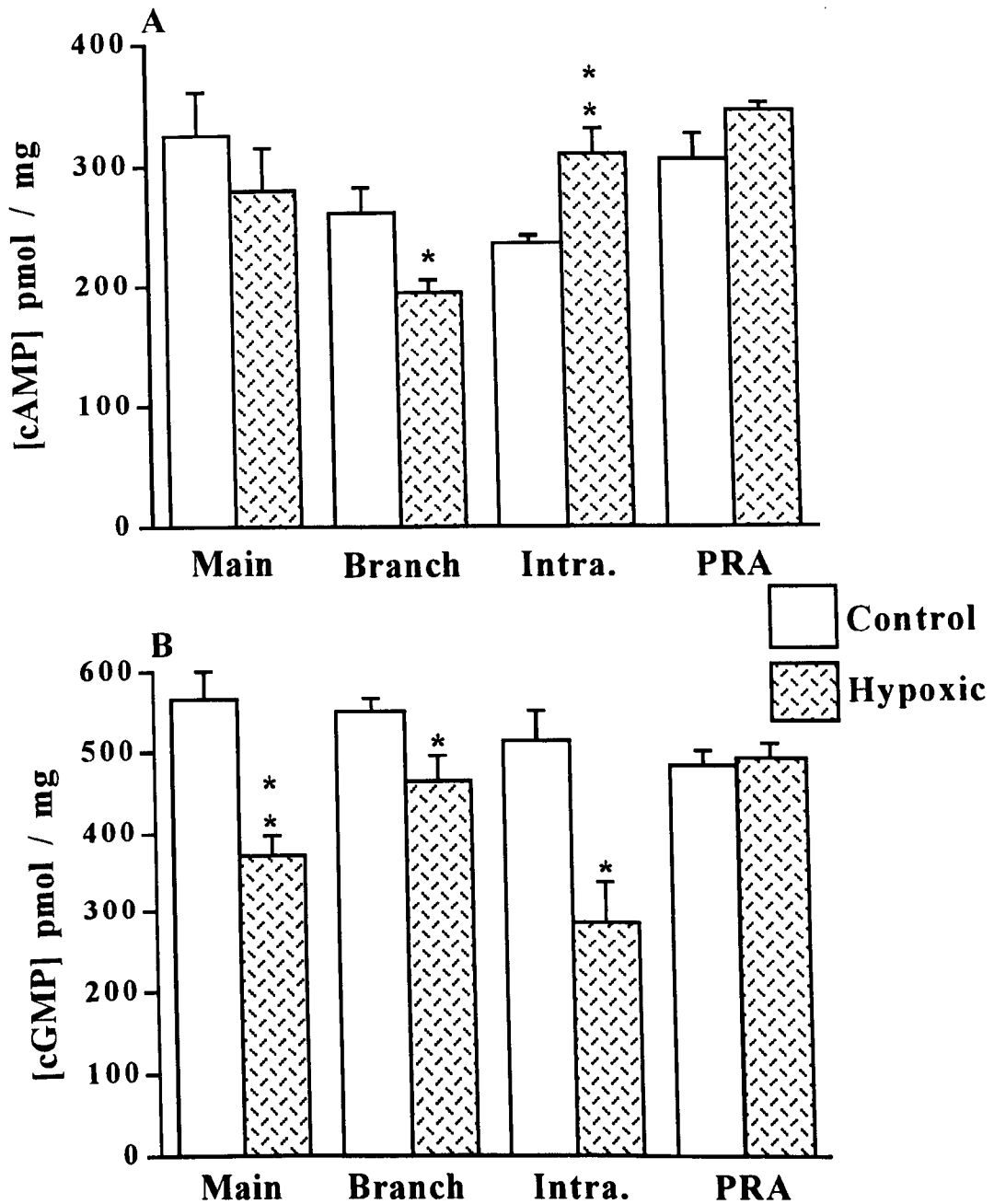

Figure 8.5.

Intracellular cyclic nucleotide levels in control and chronic hypoxic rat pulmonary arteries.

A Total intracellular cAMP levels (n = 8). **B** Total intracellular cGMP levels (n = 8). Open columns show data from control animals and stippled columns show data from hypoxic animals. Main = main pulmonary artery; Branch = first right and left branch; Intra = main intrapulmonary artery; PRA = pulmonary resistance artery. Data are expressed as absolute levels pmol / mg. Each point represents the mean \pm SEM. Statistical comparisons were made using Students unpaired t-test. * p < 0.05, ** p < 0.01 control vs. chronic hypoxic.

had significantly lower [cAMP]_i levels when compared to the other arterial preparations (* p < 0.05 ANOVA). From this figure it can be seen that exposure to chronic hypoxia has no significant effect on basal [cAMP]_i in the main pulmonary artery although there is a tendency for levels to be reduced. However, [cAMP]_i in right and left branch extrapulmonary arteries are significantly reduced in chronic hypoxic preparations compared to controls. In the main intrapulmonary artery of the lung total [cAMP]_i are significantly increased in chronic hypoxic preparations compared to controls. A similar trend is observed in pulmonary resistance arteries, however this proved to be not significant (p = 0.087, Students unpaired t-test).

Total [cGMP]_i are demonstrated in figure 8.5.B. There was no significant difference in [cGMP]_i levels between the four arterial preparations in control animals (p > 0.05 ANOVA). Exposure to chronic hypoxia caused a significant decrease in [cGMP]_i in main pulmonary artery, right and left branch pulmonary artery, and intrapulmonary arteries of the rat. [cGMP]_i in control and chronic hypoxic pulmonary resistance arteries were found to be not significantly different.

Measurement of total phosphodiesterase activity.

Figure 8.6.A shows measurements for total cAMP PDE activity in control and chronic hypoxic rat pulmonary resistance arteries. In control animals total cAMP PDE activity was similar in main, intrapulmonary and pulmonary resistance arteries, but was significantly greater in branch pulmonary arteries (***p < 0.001 ANOVA). Exposure to chronic hypoxia had no significant effect on total cAMP PDE activity in main pulmonary artery or pulmonary resistance arteries, but caused a significant increase in activity in branch and intrapulmonary arteries. Figure 8.6.B shows results obtained for total cGMP PDE activity in control and chronic hypoxic rat pulmonary arteries. In control animals, total cGMP PDE activity was significantly different in the four arterial preparations (*p < 0.05 ANOVA), and a Tukeys post test showed that this variation was between the greater observed activity in branch pulmonary arteries and less activity observed in pulmonary resistance arteries. Comparing control and chronic hypoxic

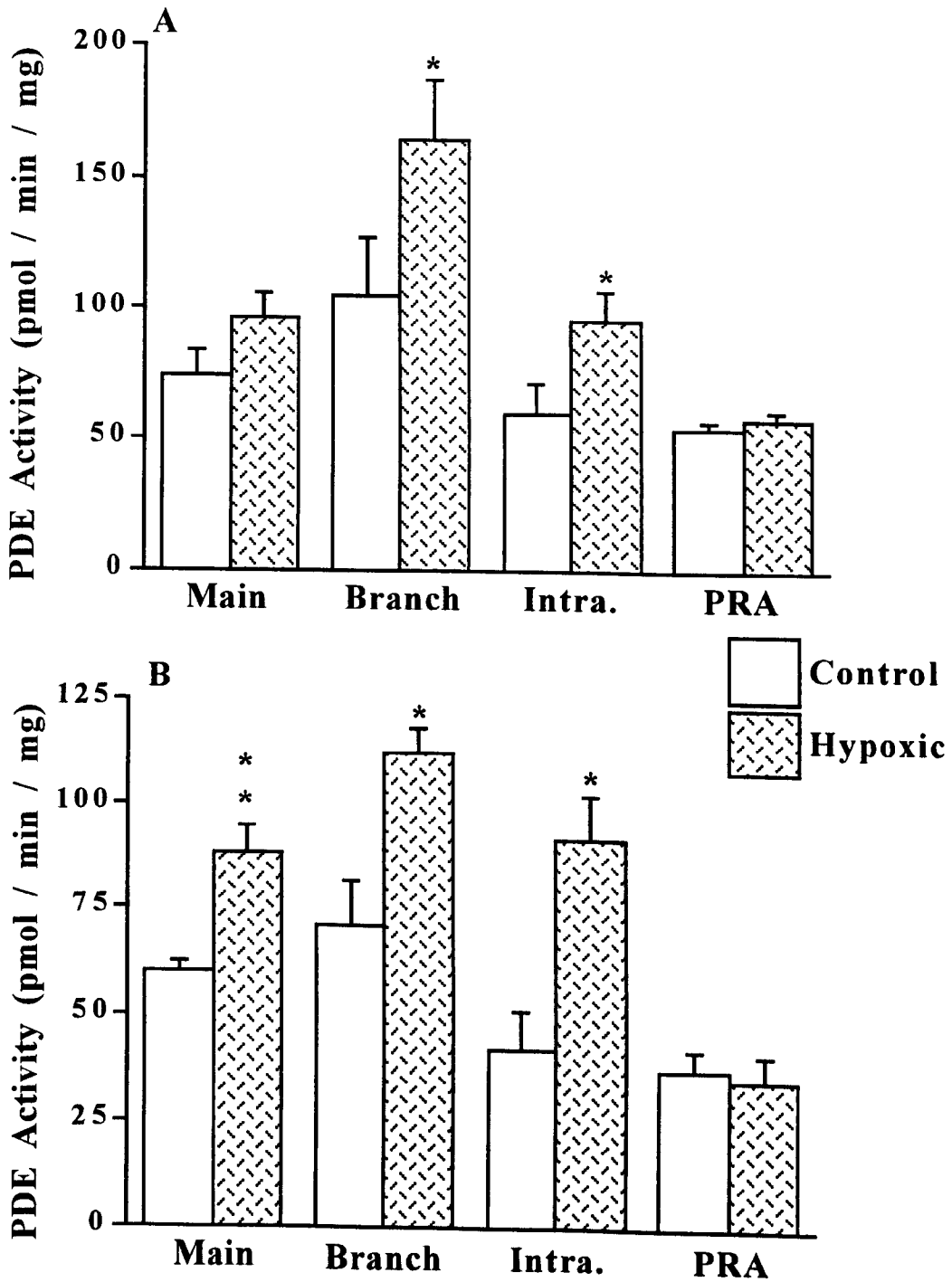

Figure 8.6.

Total PDE activity in control and chronic hypoxic rat pulmonary arteries.

A Total cAMP PDE activity (n = 8). **B** Total cGMP PDE activity (n = 4). Open columns show data from control animals and stippled columns show data from hypoxic animals. Main = main pulmonary artery; Branch = first right and left branch; Intra = main intrapulmonary artery; PRA = pulmonary resistance artery. Data are expressed as absolute activity pmol / minute / mg. Each point represents the mean \pm SEM. Statistical comparisons were made using Students unpaired t-test. *p < 0.05, **p < 0.01 control vs. chronic hypoxic.

preparations, total cGMP PDE activity was found to be significantly increased in all chronic hypoxic arterial preparations with the exception of the pulmonary resistance arteries.

8.4 Discussion.

Bovine pulmonary arteries.

Responses to 5-HT and sumatriptan.

At least 10 different 5-HT-receptor subtypes have been described, including 5-HT_{1A-F}, 5-HT_{2A-C}, 5-HT₃ and 5-HT₄ (Humphrey, *et al.*, 1993). The receptor responsible for mediating contractile responses to 5-HT in pulmonary arteries was thought to be the 5-HT₂ receptor (Frenken & Kauman, 1983). However, McIntyre, *et al.*, (1992) demonstrated that administration of the 5-HT_{1D} receptor agonist sumatriptan to patients undergoing diagnostic coronary angiography, produced a pronounced increase in pulmonary pressure when compared to the overall systemic effect, therefore postulating a role for the 5-HT_{1D} receptor subtype in the pulmonary circulation. 5-HT₂ receptors are thought to mediate vasoconstriction through activation of PLC, production of IP₃, and stimulation of PKC (Roth, *et al.*, 1986), whereas sumatriptan has been shown to mediate vasoconstriction in the canine saphenous vein by decreasing the levels of intracellular cAMP (Sumner & Humphrey, 1990). Hence, the 5-HT_{1D} receptor appears to be negatively coupled to adenylate cyclase in some vascular preparations. There is evidence to show that sumatriptan contracts isolated bovine pulmonary arteries, but is inactive in mesenteric arteries, suggesting the pulmonary circulation is more sensitive to the effects of sumatriptan (Templeton, *et al.*, 1993b). In my results illustrated in this chapter it was found that under control conditions, 5-HT produced potent contractile responses in bovine pulmonary resistance arteries, whereas the 5-HT_{1D} receptor agonist sumatriptan was 4-fold less potent and produced only small contractile responses (around 10 % of 50 mM KCl) in these vessels. Responses to both agonists were reproducible over time. This suggests that under conditions of basal tone 5-HT-mediated vasoconstriction occurs via a receptor other than the 5-HT_{1D}

subtype. A similar situation is observed in larger diameter bovine pulmonary arteries *in vitro*, where it was shown that responses to 5-HT are mediated via activation of 5-HT_{2A} receptors (MacLean, *et al.*, 1994b).

Effect of raising vascular tone.

In the presence of raised vascular tone, an increase in tissue sensitivity to both 5-HT and sumatriptan was observed. A significant potentiation of the maximum contractile response to sumatriptan is also observed under these experimental conditions. Identical effects in the presence of raised vascular tone are observed in larger diameter bovine pulmonary arteries (MacLean, *et al.*, 1994b). 5-HT has been shown to mediate vasodilatation in precontracted sheep pulmonary veins (Cocks & Arnold, 1992) and in the cat pulmonary vascular bed (Neely, *et al.*, 1993), however, in this present study only vasoconstrictor responses to 5-HT were observed in pulmonary resistance arteries. The potentiation of the maximum contractile response to sumatriptan, but not 5-HT in these vessels may be a reflection of the intracellular signalling pathways by which they mediate their vascular effects. In bovine isolated pulmonary arteries of larger calibre than used in the present study, responses to both sumatriptan and the α_2 -adrenoceptor agonist UK 14304 were significantly potentiated in the presence of raised vascular tone (Sweeney, *et al.*, 1995). A feature common to both of these agonists is that they induce vasoconstriction via negative coupling to adenylate cyclase. In the aforementioned study it was also shown that responses to the α_1 -adrenoceptor agonist phenylephrine were less effected by tone in that only a slight increase in potency to the agonist was observed. Phenylephrine is thought to mediate vasoconstriction via the same intracellular pathway as 5-HT, i.e. activation PLC leading to IP₃ production. Therefore raising vascular tone in both large intrapulmonary arteries and pulmonary resistance arteries from the bovine lung, appears to have a more dramatic effect on agonists which mediate vasoconstriction via negative coupling to adenylate cyclase.

Effect of L-NAME.

Release of NO has been shown to influence vasoconstrictor responses to a variety of contractile agents; for example, L-NAME has been shown to potentiate responses to both 5-HT and α -adrenoceptor agonists in the rabbit pulmonary artery (MacLean, *et al.*, 1993a,b). Inhibition of NOS activity also potentiated responses to sumatriptan in both human pulmonary arteries (MacLean, *et al.*, 1993c) and bovine pulmonary arteries (MacLean, *et al.*, 1994b). My results are in agreement with these earlier studies in that inhibition of NOS potentiates responses to both sumatriptan and 5-HT in bovine pulmonary resistance arteries. In a similar fashion to the effects of raised vascular tone, L-NAME appears have a more dramatic effect on the sumatriptan responses. This is illustrated by an increase in both potency and maximum contraction to sumatriptan in the presence of L-NAME, whereas only the maximum contraction to the high concentrations of 5-HT were potentiated. MacLean, *et al.*, (1994b) found that inhibition of NOS had no effect on contractile responses to 5-HT in large diameter intrapulmonary arteries from the bovine lung. This suggests that basal NO release has greater influence on 5-HT-mediated responses in small diameter pulmonary arteries compared to larger diameter vessels. Ignarro, *et al.*, (1987) found that smaller branches of bovine pulmonary arteries had higher intracellular levels of cGMP, were more sensitive to endothelium-dependent vasodilators and were more sensitive to methylene blue when compared to larger branches from a common vascular bed. All of these differences were not observed in endothelium denuded vessels suggesting regional variation in the influence of endothelium-derived NO.

The mechanism by which NOS inhibition results in dramatic potentiation of the vasoconstrictor responses to sumatriptan may again be linked to the intracellular signalling pathways activated by sumatriptan. Investigations by Sweeney *et al.*, (1995) showed that under control conditions, sumatriptan in itself significantly increased intracellular levels of cGMP in bovine large calibre pulmonary arteries via endothelial release of NO. This increase in cGMP would counteract any vasoconstrictor effects of

sumatriptan, as was illustrated by the ability of SNP (which directly increases intracellular cGMP concentrations) to inhibit vasoconstrictor responses to sumatriptan in these vessels (Sweeney, *et al.*, 1995). Therefore, inhibiting NOS activity will prevent sumatriptan from increasing intracellular cGMP levels therefore “uncovering” the vasoconstrictor component. In my investigations, L-NAME also potentiated vasoconstrictor responses to 5-HT in bovine pulmonary resistance arteries although the observed effects were clearly less dramatic than in the case of sumatriptan. Vasodilatation to 5-HT was not observed in precontracted pulmonary resistance arteries, however it could be the case that these effects are masked by the profound vasoconstrictor actions of 5-HT. Therefore whether the effect of L-NAME on 5-HT mediated responses is due to the removal of stimulated NO release (as is proposed for sumatriptan) or basal NO activity in these vessels is not yet clear.

As mentioned previously, sumatriptan is thought to mediate vasoconstriction through decreasing $[cAMP]_i$. Sweeney, *et al* (1995), demonstrated that in bovine pulmonary arteries, responses to sumatriptan in the presence of raised vascular tone could be further potentiated by administration of compounds that increase $[cAMP]_i$ (for example forskolin and isoprenaline). Therefore expression of 5-HT_{1D}-mediated responses is markedly influenced by the levels of intracellular cyclic nucleotides. As responses to the 5-HT receptor agonists in bovine pulmonary resistance arteries are manipulated by the degree of vascular tone, it was of interest to investigate responses to 5-HT and sumatriptan in chronic hypoxic rat pulmonary resistance arteries which exhibit inherent vascular tone (chapter 5 this thesis).

Rat pulmonary resistance arteries.

Responses to 5-HT and sumatriptan.

In chronic hypoxic vessels, 5-HT was found to be 2-fold more potent than in control vessels, and produced a significantly greater maximum response. Pulmonary arterial hyperreactivity to 5-HT has also been observed in rats with monocrotaline-induced pulmonary hypertension (Wanstall & O'Donnell, 1990) and pulmonary

hypertension secondary to platelet 5-HT storage disorder (Ashmore, *et al.*, 1991). However, there is no evidence for elevation of plasma 5-HT in the chronic hypoxic model rat model of pulmonary hypertension (Oka, *et al.*, 1993), and these rats are not known to exhibit abnormalities in platelet 5-HT storage. Therefore other factors must be responsible for the observed changes in 5-HT activity in this model. It seems unlikely that pulmonary vascular remodelling alone is responsible for the increased responses to 5-HT, as not all agonist responses are increased in chronic hypoxic vessels; e.g. responses to KCl are unchanged. As vascular tone is an important modulator of 5-HT mediated responses in bovine pulmonary arteries, the increased inherent tone in pulmonary resistance arteries from chronic hypoxic rats may also be a factor involved in the observed changes.

Under conditions of basal tone, the 5-HT_{1D} agonist sumatriptan was found to be inactive in both control and chronic hypoxic preparations. After inhibition of NOS activity with L-NAME, or in the presence of increased vascular tone, only small contractile responses to sumatriptan were observed at the two highest concentrations tested. Therefore in contrast to bovine pulmonary resistance arteries, control and chronic hypoxic rat pulmonary resistance arteries do not contain a significant population of 5-HT_{1D} receptors mediating vasoconstriction. Preliminary studies conducted in larger calibre pulmonary arteries from the same rats used in my own studies demonstrated that contractile responses to sumatriptan in these vessels could be uncovered after exposure to chronic hypoxia (MacLean, *et al.*, 1995b). This suggests possible regional variation in 5-HT receptor populations within the rat pulmonary vasculature.

Measurement of cyclic nucleotides.

The importance of intracellular cyclic nucleotides in both the control of vascular tone and in regulating 5-HT_{1D} like responses in pulmonary arteries has already been mentioned in this chapter. I examined the concentrations of these nucleotides in different arterial segments from four regions of the pulmonary vascular tree in both

control and chronic hypoxic rats. In control arterial preparations slight regional variation was observed in basal [cAMP]_i. This may be as a result of different levels of local synthesis and release of vasoactive compounds in certain regions of the pulmonary vasculature (e.g. NO and PGI₂). Indeed Ignarro, *et al.*, (1987), demonstrated regional variations in cyclic nucleotide levels in different sized bovine pulmonary arteries, however the variations observed were in cGMP levels and not cAMP levels as in this case.

Exposure to chronic hypoxia significantly decreased [cAMP]_i in branch pulmonary arteries, whereas in intrapulmonary arteries there is a significant increase in [cAMP]_i when compared to controls. This regional effect of chronic hypoxia on different vessel types may again be as a result of stimulation or inhibition of certain vasoactive factors. Significant decreases in [cGMP]_i levels were observed in all pulmonary artery preparation from chronic hypoxic rats with the exception of the pulmonary resistance arteries. Chronic hypoxic exposures have been shown to decrease [cGMP]_i in the main pulmonary artery of the rat, and this was presumed to be as a result of decreased endothelial NO production (Shaul, *et al.*, 1993). In agreement with this is the observed loss of endothelium-dependent relaxation in extrapulmonary artery rings of chronic hypoxic rats (Carville, *et al.*, 1993). Therefore decreased endothelial release of NO may contribute to the observed decrease in [cGMP]_i in chronic hypoxic rat pulmonary arteries. There is however contrasting evidence to indicate that exposure to chronic hypoxia may in fact increase NO production in the rat lung (Isaacson, *et al.*, 1994) and increase NOS activity (Xue, *et al.*, 1994). Indeed I have also demonstrated in this thesis (chapter 5) that vasodilatation to ACh is augmented in chronic hypoxic pulmonary resistance arteries suggesting that endothelial release of NO is not impaired. This may explain why no changes are observed in [cGMP]_i levels between control and chronic hypoxic rat pulmonary resistance arteries. As decreasing [cGMP]_i is known to facilitate 5-HT_{1D}-like responses in bovine pulmonary resistance arteries, this may play a role in the apparent “uncovering” of sumatriptan vasoconstriction in large calibre chronic hypoxic rat vessels which exhibit decreased [cGMP]_i (MacLean, *et al.*, 1995a).

Although $[cGMP]_i$ is unchanged in chronic hypoxic pulmonary resistance arteries, this would appear not to be a factor in the apparent inactivity of sumatriptan in these vessels, as NOS inhibition does not uncover responses to sumatriptan in these preparations.

Measurement of PDE activity.

Another mechanism which may be responsible for the observed changes in cyclic nucleotide concentrations will be the overall level of PDE activity in these preparations. The decreased levels $[cAMP]_i$ observed in branch pulmonary arteries appears to be related to a corresponding increase in cAMP PDE activity in these preparations. However, in intrapulmonary arteries both $[cAMP]_i$ levels and cAMP PDE activity are significantly increased. One reason for this apparent anomaly may be alterations in the activity and/or expression of adenylate cyclase, resulting in an increased production of cAMP. In all the arterial segments which demonstrated decreased levels of $[cGMP]_i$, a corresponding significant increase in cGMP PDE activity was observed. In keeping with the unchanged levels of intracellular cyclic nucleotides, there were no observed differences in total cAMP or cGMP PDE activity in control and chronic hypoxic pulmonary resistance arteries.

The decreased levels of $[cGMP]_i$ in larger diameter pulmonary vessels, possibly due to a combination of decreased endothelial NO and increased activity of cGMP PDE activity, will in part explain the endogenous tone exhibited in these vessel types (MacLean, *et al.*, 1995a). Results obtained from pulmonary resistance arteries indicate no changes in either intracellular cyclic nucleotide levels or total PDE activity. Therefore, although these vessels exhibit endogenous tone *in vitro* (chapter 5), this vascular tone cannot be accounted for by alterations in cyclic nucleotide levels. However, there are many other factors which can influence pulmonary vascular tone and may be involved in the increased levels of tone observed in chronic hypoxic vessels; for example IP_3 levels stimulated by PLC, activity of membrane Ca^{2+} and K^+ channels and intracellular Ca^{2+} handling (Barnes & Liu, 1994)

Therefore in summary, I have found that responses to 5-HT and sumatriptan in bovine pulmonary resistance arteries are significantly modulated by the degree of vascular tone and release of NO. Pulmonary vasoconstrictor responses to 5-HT are augmented in chronic hypoxic rat pulmonary resistance arteries and neither control or chronic hypoxic vessels appear to contain functional populations of 5-HT_{1D}-like receptors. Intracellular cyclic nucleotide levels and PDE activity are altered in regions of the chronic hypoxic pulmonary arterial tree, however no changes were observed in pulmonary resistance arteries.

Chapter 9

General Discussion

9. General discussion.

A feature which appears common to both the rat and human pulmonary vasculature is the apparent ET receptor heterogeneity, between arterial vessels of different sizes and location within the lung. In both species, I observed an increased influence of vascular ET_B receptors mediating vasoconstriction in pulmonary resistance arteries. This could well be a feature which is not unique to the pulmonary vasculature. Using radioligand binding techniques, Dashwood, *et al.*, (1995) showed that the ratio of vascular ET_B : ET_A receptors in the human coronary vasculature significantly increased as the diameter of the vessel decreased. The actual cause of this regional variation in ET receptor subtype is not clear, but may be a reflection of the structural differences between large (more elastic) and small (more muscular) vessels.

In the pulmonary hypertensive rat model used in my studies, the influence of vascular ET_B receptors is diminished in comparison to increased ET_A receptor mediated vasoconstriction. However, it is not yet clear if a similar situation occurs in human pulmonary hypertensive states. What would be of extreme interest for future study would be to examine responses to ET's in pulmonary arteries from patients with pulmonary hypertension. This would assess any changes in vascular reactivity to the peptides, and resolve possible changes in the ET receptor subtypes present. The growing literature from animal models of pulmonary hypertension would suggest that ET antagonists may prove a useful and novel therapy in the treatment of pulmonary hypertension. Stewart, *et al.* (1991) demonstrated that the arterial to venous ratio of ET-1 levels were highest in patients with primary pulmonary hypertension (ratio > 1) compared to patients with secondary pulmonary hypertension (ratio ~ 1). It was therefore postulated that increased ET-1 levels in secondary pulmonary hypertension may be due to abnormal clearance of the peptide, whereas in primary pulmonary hypertension there may be both decreased pulmonary clearance and increased pulmonary production of ET-1. If this proves to be the case then perhaps ECE inhibitors, in addition to ET antagonists, may prove to be a useful therapy in the treatment of primary pulmonary hypertension.

The requirement for dual receptor antagonism in order to attenuate responses to ET-1 in rat pulmonary resistance arteries suggested "cross talk" between ET_A and ET_B receptor subtypes in these vessels. Full expression of ET-1 vasoconstriction could be mediated by sole activation of the ET_A or ET_B receptor subtype, as shown by the resistance of ET-1 constriction to the actions of selective ET_A and ET_B receptor antagonists. The fact that ET_B-mediated vasoconstriction (SxS6c and ET-3 responses) could be significantly antagonised by the use of selective ET_B receptor antagonists, highlights this the role of ET_A receptors in these vessels. Clearly what would be of use to examine this further would be a selective ET_A receptor agonist, however as mentioned in chapter 1 such a compound has remained elusive. This feature of "cross talk" between ET receptors mediating vasoconstriction is not unique to the rat pulmonary resistance artery. Similar observations were found in the rabbit pulmonary artery (Fukuroda, *et al.*, 1994b) and in human isolated bronchi (Fukuroda, *et al.*, 1996e), where dual antagonism of both ET_A and ET_B receptors is required to attenuate ET-1 mediated vasoconstriction. The actual mechanism by which this "cross talk" between receptors occurs is not yet known, but may involve intracellular interaction through a common second messenger system. The exact intracellular pathways activated by ET_A and ET_B receptors in the pulmonary vasculature is not yet clear, but is currently being examined within our laboratory. This may also aid in the examination of the putative inhibitory ET_A-like receptor response observed in control rat pulmonary resistance arteries. It may well be that this inhibitory effect is a result of a mechanism which limits increases in the ET_B stimulated intracellular signal.

The increased vasodilatation to ACh observed in pulmonary hypertensive rat pulmonary resistance arteries may be due to increased endothelial release of NO, but further studies are required to clarify this situation. The use of NOS inhibitors and the effect of removal of the endothelium will help assess if increased production of endothelium-derived NO is mediating this response, or if some other process is occurring. Chronic hypoxia could perhaps stimulate upregulation of endothelial muscarinic receptors, or enhance vascular reactivity to NO via alteration of an

intracellular signalling pathway, for example increased expression of soluble guanylate cyclase. The upregulation of both cNOS and iNOS in chronic hypoxic rat lungs (Xue, *et al.*, 1994; Le Cras, *et al.*, 1996) highlights the increased regulatory role for NO in experimental hypoxic pulmonary hypertension. The increased basal release of NO appears to counteract inherent vascular tone observed in chronic hypoxic rat pulmonary resistance arteries. This increased vascular tone was shown not to be as a result of changes in intracellular cyclic nucleotide levels in these vessels. In the systemic circulation of the rat, inhibition of NOS activity uncovered basal vascular tone which was attributed to the actions of ET-1 (Richard, *et al.*, 1995). Therefore examining the actions of ET antagonists on inherent vascular tone in pulmonary resistance arteries would be of interest.

Increased vasoconstrictor responses were observed to both ET-1 and 5-HT in chronic hypoxic rat pulmonary resistance arteries. Although this may be in part explained by the smooth muscle hypertrophy observed in pulmonary hypertension, there must be an additional mechanism involved, as responses to all vasoconstrictors are not increased in these vessels. Common to the aforementioned agonists is that they are both thought to mediate vasoconstriction through activation of PLC. It would therefore be of interest to study agonists which mediate vasoconstriction via other intracellular pathways distinct from PLC activation. It could be that chronic hypoxia is modulating components of the PLC - IP₃ signal transduction mechanism, resulting in augmentation of responses to agonists which stimulate this pathway. Measurements of the intracellular levels of IP₃ would also be of interest in pulmonary resistance arteries considering that responses to both 5-HT and ET-1 are potentiated in pulmonary hypertensive vessels.

The biochemical studies that were carried out investigated the effect of hypoxic pulmonary hypertension on intracellular cyclic nucleotide levels. No significant changes were observed in pulmonary resistance arteries, however, significant changes were observed in large calibre vessels. What is of interest from these studies is the observed decrease in [cGMP]_i in the larger calibre pulmonary hypertensive arteries.

This was attributed to a combination of both decreased endothelium-derived NO and increased cGMP PDE activity. PDE inhibitors have been the subject of recent investigation as possible therapeutic agents in experimental pulmonary hypertension. Infusion of PDE inhibitors results in pulmonary vasodilatation in rabbits and lambs with experimental pulmonary hypertension (Clarke, *et al.*, 1994; Zeigler, *et al.*, 1995), and may prove even more effective in combination with inhaled NO therapy (Thusu, *et al.*, 1995; Ichinose, *et al.*, 1995). As mentioned previously PDE's exist as a large family of enzymes and therefore current investigations are ongoing in our laboratory to assess which isoforms are altered in the pulmonary hypertensive state. Characterisation of the exact PDE isoforms present in the pulmonary vasculature, and the changes in their relative activity in pulmonary hypertension may prove to be of value in the search for a novel selective therapeutic agent.

Appendix 1

The following tables list data for individual experimental rats including duration of hypoxic exposure (duration), body weight (BW, g), right ventricular weight (RV, mg), left ventricular plus septum weight (LV & S, mg), total ventricular weight (TV, mg) and ventricular ratio (RV/LV&S, mg/mg). Av. = average for batch, C = control, H = chronic hypoxic. Example rat 1C1 = batch 1, control rat 1.

Rat	Duration	BW	RV	LV & S	TV	RV/LV&S
1C1	-	213	160	543	703	0.295
1C2	-	207	156	529	685	0.295
1C3	-	214	162	575	737	0.282
1C4	-	226	179	531	710	0.337
Av.	-	215 ± 4	164 ± 5	545 ± 11	709 ± 11	0.302 ± 0.012
1H1	14/0	153	189	461	650	0.410
1H2	14/1	167	167	351	518	0.476
1H3	16/0	172	220	442	662	0.498
1H4	16/1	202	234	483	717	0.484
Av.	-	173 ± 10	203 ± 15	434 ± 29	637 ± 42	0.470 ± 0.02
2C1	-	233	174	603	777	0.289
2C2	-	297	206	626	832	0.329
2C3	-	265	176	607	783	0.290
2C4	-	260	216	548	764	0.394
2C5	-	270	248	565	813	0.439
2C6	-	267	189	592	781	0.319
2C7	-	290	174	625	799	0.278
2C8	-	318	226	479	705	0.472
Av.	-	275 ± 9	201 ± 10	581 ± 17	782 ± 13	0.351 ± 0.026
2H1	14/0	185	276	480	756	0.575
2H2	14/1	237	374	601	975	0.622
2H3	16/0	215	344	500	844	0.688
2H4	16/1	250	321	550	871	0.584
2H5	14/0	244	382	504	886	0.758
2H6	14/1	220	256	482	738	0.531
2H7	16/0	245	417	515	932	0.810
2H8	16/1	273	356	615	971	0.579
Av	-	234 ± 9	341 ± 19	531 ± 19	871 ± 32	0.643 ± 0.035

Rat	Duration	BW	RV	LV & S	TV	RV/LV&S
3C1	-	216	197	559	756	0.352
3C2	-	205	169	663	832	0.255
3C3	-	235	178	605	783	0.294
3C4	-	236	201	571	772	0.352
3C5	-	205	155	512	667	0.303
3C6	-	246	210	596	806	0.352
3C7	-	247	194	553	747	0.351
3C8	-	235	185	562	747	0.329
Av.	-	228 ± 6	186 ± 6	578 ± 16	764 ± 17	0.324 ± 0.013
3H1	14/0	169	278	492	770	0.565
3H2	14/1	201	346	494	840	0.700
3H3	16/0	185	359	435	794	0.825
3H4	16/1	172	328	489	817	0.671
3H5	14/0	183	333	473	806	0.704
3H6	14/1	246	210	596	806	0.352
3H7	16/0	195	312	508	820	0.614
3H8	16/1	190	315	537	852	0.587
Av.	-	193 ± 9	310 ± 17	503 ± 17	813 ± 9	0.627 ± 0.049
4C1	-	202	165	571	736	0.289
4C2	-	215	184	588	772	0.313
4C3	-	215	163	564	727	0.289
4C4	-	221	169	599	768	0.282
4C5	-	186	142	495	637	0.287
4C6	-	203	158	497	655	0.318
4C7	-	215	192	514	706	0.374
4C8	-	192	150	504	654	0.298
Av.	-	206 ± 4	165 ± 6	542 ± 15	707 ± 19	0.306 ± 0.011
4H1	14/0	149	221	493	714	0.448
4H2	14/1	181	283	515	798	0.550
4H3	16/0	170	289	502	791	0.576
4H4	16/1	182	245	501	746	0.489
4H5	14/0	138	169	387	556	0.437
4H6	14/1	155	242	418	660	0.579
4H7	16/0	165	279	449	728	0.621
4H8	16/1	165	251	476	730	0.534
Av.	-	163 ± 5	248 ± 14	468 ± 16	715 ± 27	0.529 ± 0.023

Rat	Duration	BW	RV	LV & S	TV	RV/LV&S
5C1	-	168	126	436	562	0.289
5C2	-	207	173	521	694	0.332
5C3	-	187	148	472	620	0.314
5C4	-	200	152	513	665	0.296
5C5	-	190	163	465	628	0.351
5C6	-	187	157	452	609	0.347
5C7	-	220	163	543	706	0.300
5C8	-	228	176	571	747	0.308
Av.	-	198 ± 7	157 ± 6	497 ± 17	654 ± 21	0.317 ± 0.008
5H1	14/0	162	267	479	746	0.557
5H2	14/1	169	212	414	626	0.512
5H3	16/0	162	207	426	633	0.486
5H4	16/1	179	287	468	755	0.613
5H5	14/0	160	247	414	661	0.597
5H6	14/1	168	247	463	710	0.533
5H7	16/0	175	283	468	762	0.628
5H8	16/1	162	301	417	718	0.722
Av.	-	167 ± 2	258 ± 13	444 ± 10	701 ± 19	0.581 ± 0.027
6C1	-	210	159	552	711	0.288
6C2	-	201	162	559	721	0.290
6C3	-	213	162	564	726	0.287
6C4	-	205	159	531	690	0.299
6C5	-	187	180	490	670	0.367
6C6	-	191	192	498	690	0.386
6C7	-	225	182	546	728	0.333
6C8	-	200	167	476	643	0.351
Av.	-	204 ± 4	170 ± 4	527 ± 12	697 ± 11	0.325 ± 0.014
6H1	15/0	170	285	564	849	0.505
6H2	15/1	168	259	467	726	0.555
6H3	17/0	172	343	531	874	0.646
6H4	17/1	194	311	531	843	0.585
6H5	14/0	162	274	467	741	0.587
6H6	14/1	166	276	470	746	0.587
6H7	16/0	165	352	454	806	0.775
6H8	16/1	165	333	487	820	0.684
Av.	-	170 ± 4	304 ± 13	497 ± 14	801 ± 20	0.615 ± 0.03

Rat	Duration	BW	RV	LV & S	TV	RV/LV&S
7C1	-	168	150	436	586	0.344
7C2	-	201	194	512	706	0.379
7C3	-	186	177	452	629	0.392
7C4	-	207	195	472	667	0.413
7C5	-	160	155	429	584	0.361
7C6	-	148	150	346	496	0.434
7C7	-	180	166	425	591	0.391
7C8	-	178	151	439	590	0.344
Av.	-	179 ± 7	167 ± 7	439 ± 17	606 ± 22	0.381 ± 0.010
7H1	14/0	161	267	390	657	0.685
7H2	14/1	155	231	395	626	0.585
7H3	16/0	150	242	380	622	0.637
7H4	16/1	171	248	469	717	0.529
7H5	14/0	125	234	354	588	0.661
7H6	14/1	136	208	359	567	0.579
7H7	16/0	130	226	363	589	0.623
7H8	16/1	160	269	382	651	0.704
Av.	-	149 ± 6	241 ± 7	387 ± 13	627 ± 17	0.625 ± 0.021
8C1	-	216	182	539	721	0.338
8C2	-	228	235	534	769	0.440
8C3	-	215	185	541	726	0.342
8C4	-	237	223	589	812	0.379
8C5	-	209	173	515	688	0.336
8C6	-	178	146	440	586	0.332
8C7	-	192	169	471	640	0.359
8C8	-	190	170	448	618	0.379
Av.	-	208 ± 7	185 ± 10	510 ± 18	695 ± 27	0.363 ± 0.013
8H1	14/0	166	264	436	700	0.606
8H2	14/1	184	270	489	759	0.552
8H3	16/0	173	273	527	800	0.518
8H4	16/1	204	323	488	811	0.662
8H5	14/0	143	241	371	612	0.650
8H6	14/1	170	241	447	688	0.539
8H7	16/0	148	270	344	614	0.785
8H8	16/1	151	252	377	629	0.668
Av.	-	167 ± 7	267 ± 9	435 ± 23	702 ± 29	0.622 ± 0.031

Rat	Duration	BW	RV	LV & S	TV	RV/LV&S
9C1	-	159	167	435	602	0.384
9C2	-	171	143	436	579	0.328
9C3	-	170	147	439	586	0.355
9C4	-	178	177	406	583	0.436
9C5	-	200	175	496	671	0.353
9C6	-	177	169	426	595	0.397
9C7	-	201	190	511	701	0.372
9C8	-	165	168	516	684	0.326
Av.	-	178 ± 5	167 ± 5	458 ± 15	625 ± 18	0.366 ± 0.014
9H1	14/0	125	199	332	531	0.599
9H2	14/1	139	244	338	582	0.722
9H3	16/0	140	329	407	736	0.808
9H4	16/1	160	246	400	646	0.615
9H5	14/0	156	272	402	674	0.677
9H6	14/1	152	213	376	589	0.566
9H7	16/0	160	355	380	715	0.882
9H8	16/1	200	279	461	740	0.605
Av.	-	154 ± 8	265 ± 17	387 ± 15	651 ± 28	0.684 ± 0.040
10C1	-	212	198	492	690	0.402
10C2	-	229	190	571	761	0.333
10C3	-	249	206	553	759	0.374
10C4	-	237	209	516	725	0.405
10C5	-	192	205	485	690	0.423
10C6	-	207	188	508	696	0.370
10C7	-	172	165	432	597	0.382
10C8	-	203	226	478	704	0.473
10C9	-	200	194	480	674	0.404
Av.	-	211 ± 8	198 ± 6	502 ± 14	700 ± 16	0.396 ± 0.013
10H1	14/0	173	262	451	713	0.581
10H2	14/1	192	322	439	761	0.733
10H3	16/0	192	273	481	754	0.568
10H4	16/1	197	322	442	764	0.729
10H5	14/0	137	265	395	660	0.671
10H6	14/1	158	272	441	713	0.617
10H7	16/0	166	280	445	725	0.629
10H8	16/1	177	298	415	713	0.718
10H9	16/1	181	273	433	706	0.630
Av.	-	175 ± 6	285 ± 8	438 ± 8	723 ± 11	0.653 ± 0.021

Rat	Duration	BW	RV	LV & S	TV	RV/LV&S
11C1	-	251	224	570	794	0.393
11C2	-	257	210	627	837	0.335
11C3	-	226	207	504	711	0.411
11C4	-	208	154	476	621	0.330
11C5	-	202	157	453	610	0.347
11C6	-	212	170	440	610	0.386
11C7	-	220	180	442	622	0.407
11C8	-	223	189	479	668	0.395
Av.	-	226 ± 7	186 ± 9	498 ± 24	684 ± 31	0.378 ± 0.012
11H1	14/0	172	257	431	688	0.596
11H2	14/1	179	286	403	689	0.710
11H3	16/0	182	311	472	783	0.659
11H4	16/1	195	261	382	643	0.683
11H5	14/0	183	312	431	743	0.724
11H6	14/1	179	218	395	613	0.552
11H7	16/0	180	283	374	657	0.757
11H8	16/1	203	274	455	729	0.602
Av.	-	184 ± 4	275 ± 11	418 ± 12	693 ± 20	0.660 ± 0.025
12C1	-	189	231	368	599	0.628
12C2	-	168	185	388	573	0.477
12C3	-	185	179	428	607	0.418
12C4	-	167	204	423	627	0.482
12C5	-	185	146	393	539	0.372
12C6	-	175	144	405	549	0.356
12C7	-	171	165	418	583	0.395
Av.	-	177 ± 3	179 ± 12	403 ± 8	582 ± 12	0.447 ± 0.035
12H1	16/0	170	299	429	729	0.697
12H2	16/0	159	236	442	678	0.534
12H3	16/0	145	318	445	763	0.715
12H4	16/0	177	302	432	734	0.699
12H5	16/0	178	251	397	648	0.632
12H6	14/0	150	255	418	673	0.610
12H7	14/0	143	242	362	604	0.669
Av.	-	160 ± 6	272 ± 13	418 ± 11	690 ± 21	0.651 ± 0.024

Rat	Duration	BW	RV	LV & S	TV	RV/LV&S
13C1	-	168	145	408	553	0.355
13C2	-	188	162	476	638	0.340

Rat	Duration	BW	RV	LV & S	TV	RV/LV&S
13C3	-	215	187	448	635	0.417
13C4	-	206	199	509	708	0.391
13C5	-	186	157	425	582	0.369
13C6	-	198	166	415	581	0.400
13C7	-	198	154	413	567	0.373
13C8	-	209	164	383	547	0.428
13C9	-	228	178	501	679	0.355
13C10	-	207	154	472	626	0.326
Av.	-	200 ± 5	167 ± 5	445 ± 14	612 ± 17	0.375 ± 0.010
13H1	14/0	142	222	376	598	0.590
13H2	14/0	163	239	413	652	0.579
13H3	14/0	153	241	359	600	0.671
13H4	14/0	130	205	321	526	0.639
13H5	14/0	150	233	306	539	0.761
13H6	14/0	183	291	449	740	0.648
13H7	14/1	156	202	397	599	0.509
13H8	16/0	176	273	434	707	0.629
13H9	16/1	177	226	399	625	0.566
13H10	16/1	177	204	373	577	0.547
Av.	-	161 ± 6	234 ± 9	383 ± 14	616 ± 21	0.614 ± 0.023
14C1	-	192	158	419	577	0.377
14C2	-	178	135	376	511	0.359
14C3	-	199	163	462	625	0.535
14C4	-	191	141	462	603	0.305
14C5	-	213	166	453	619	0.366
14C6	-	214	173	535	708	0.323
14C7	-	218	158	475	633	0.333
14C8	-	184	139	396	535	0.351
Av.	-	199 ± 5	154 ± 5	447 ± 18	601 ± 22	0.356 ± 0.008
14H1	14/0	155	209	389	598	0.537
14H2	14/0	165	234	395	629	0.592
14H3	14/0	166	245	404	649	0.606
14H4	14/0	160	205	423	628	0.485
14H5	14/0	145	186	395	581	0.471
14H6	14/0	138	165	397	562	0.416
14H7	14/0	155	212	383	595	0.554
14H8	14/0	157	227	380	607	0.597
Av.	-	155 ± 3	210 ± 9	396 ± 5	606 ± 10	0.532 ± 0.024

Bibliography

- Abassi, Z., Golomb, E. & Keiser, H.R. (1992) Neutral endopeptidase inhibition increases the urinary excretion and plasma levels of endothelin. *Metabolism*, **41**, 683-685.
- Abbott, J., Barer, G.R., Clegg, E.J. & Shaw, J.W. (1968) Changes in the small pulmonary blood vessels of mice exposed chronically to low oxygen tensions. *Journal of Physiology*, **196**, 118p-119p
- Adnot, S., Defouilloy, C., Andrivet, P., Koumoundjian, C., Sediame, S., Herigault, R. & Fratacci, M.D. (1993) Hemodynamic and gas exchange responses to infusion of acetylcholine and inhalation of nitric oxide in patients with chronic obstructive lung disease and pulmonary hypertension. *American Review of Respiratory Disease*, **148**, 310-316.
- Adnot, S., Raffestin, B. & Eddahibi, S. (1995) NO in the lung, *Respiration Physiology*, **101**, 109-120.
- Adnot, S., Raffestin, B., Eddahibi, S., Braquet, P. & Chabrier, P-E. (1991) Loss of endothelium-dependent relaxant activity in the pulmonary circulation of rats exposed to chronic hypoxia. *Journal of Clinical Investigation*, **87**, 155-162.
- Anderson, E.G., Simon, G. & Reid, L. (1973) Primary and thromboembolic pulmonary hypertension : a quantitative pathological study. *Journal of Pathology*, **110**, 273.
- Anggard, E., Galton, S., Rae, G., Thomas, R., McLoughlin, L., De Nucci, G. & Vane, J.R. (1989) The fate of radio-iodinated endothelin-1 and endothelin-3 in the rat. *Journal of Cardiovascular Pharmacology*, **13 (Suppl. 5)**, S46-S49.
- Arai, H., Hori, S., Arimori, I., Ohkubo, H. & Nakanishi, S. (1990) Cloning and expression of a cDNA encoding an endothelin receptor. *Nature*, **348**, 730-732.
- Araki, S., Kawahara, Y., Kariya, K., Sunako, M., Fukizaki, H. & Takai, Y. (1989) Stimulation of phospholipase C mediated hydrolysis of phosphoinositides by endothelin in cultured rabbit aortic smooth muscle cells. *Biochemical and Biophysical Research Communications*, **159**, 1072-1079.
- Arinami, T., Ishikawa, M., Inoue, A., Yanagisawa, M., Masaki, T., Yoshida, M.C. & Hamaguchi, H. (1991) Chromosomal assignments of the human endothelin family genes : the endothelin-1 gene (EDN1) to 6p23 p24, the endothelin 2 gene (EDN2) to 1p34, and the endothelin-3 gene (EDN3) to 20q13.2 q13.3. *American Journal of Human Genetics*, **48**, 990-996.
- Arunlakshana, O. & Schild, H.O. (1959) Some quantitative uses of drug antagonists. *British Journal of Pharmacology and Chemotherapy*, **14**, 48-56.
- Ashmore, R.C., Rodman, D.M., Sato, K., O'Brien, R.F., McMurtry, I.F. & Stelzner, T.J. (1991) Paradoxical constriction to platelets by arteries from rat with pulmonary hypertension. *American Journal of Physiology*, **260**, 1929-1934.
- Baley, P.A., Resink, T.J., Eppenberger, U. & Hahn, A.W. (1990) Endothelin messenger RNA and receptors are differentially expressed in cultured human breast epithelial and stromal cells. *Journal of Clinical Investigation*, **85**, 1320-1323.
- Barer, G.R. (1976) The physiology of the pulmonary circulation and methods of study. *Pharmacology and Therapeutics*, **2**, 247-273.
- Barer, G.R., Emery, C.J., Stewart, A., Bee, D. & Howard, P. (1993) Endothelial control of the pulmonary circulation in isolated lungs of chronically hypoxic rats. *Journal of Physiology*, **463**, 1-16.
- Barman, S.A. & Pauly, J.R. (1995) Mechanism of action of endothelin-1 in the canine pulmonary circulation. *Journal of Applied Physiology*, **79**, 2014-2020.

- Barnard, J.W., Barman, S.A., Adkins, W.K., Longenecker, G.L. & Taylor, A.E. (1991) Sustained effects of endothelin-1 on rabbit, dog and rat pulmonary circulations. *American Journal of Physiology*, **261**, H479-H486.
- Barnes, P.J. (1994) Endothelins and pulmonary diseases. *Journal of Applied Physiology*, **77**, 1051-1059.
- Barnes, P.J. & Liu, S.F. (1995) Regulation of pulmonary vascular tone. *Pharmacological Reviews*, **47**, 87-131.
- Barone, F.C., White, R.F., Elliott, J.D., Feuerstein, G.Z. & Ohlstein, E.H. (1995) The endothelin antagonist SB 217242 reduces cerebral focal ischemic brain injury. *Journal of Cardiovascular Pharmacology*, **26 (Suppl. 3)**, S404-S407.
- Bartlett, D. Jr. & Remmers, J.E. (1971) Effect of high altitude exposure on the lungs of young rats. *Respiratory Physiology*, **13**, 116-125.
- Battistini, B., Botting, R. & Warner, T.D. (1995) Endothelin : a knockout in London. *Trends in Pharmacological Sciences*, **16**, 217-222.
- Bax, W.A., Bos, E & Saxena, P.R. (1993) Heterogeneity of endothelin / sarafotoxin receptors mediating contraction of the human isolated saphenous vein. *European Journal of Pharmacology*, **239**, 267-268.
- Baynash, A.G., Hosada, K., Giaid, A., Richardson, J.A., Emoto, N., Hammer, R.E. & Yanagisawa, M. (1994) Interaction of endothelin-3 with endothelin-B receptors is essential for development of epidermal melanocytes and enteric neurons. *Cell*, **79**, 1277-1285.
- Beavo, J.A., Conti, M. & Heaslip, R.J. (1994) Multiple cyclic nucleotide phosphodiesterases. *Molecular Pharmacology*, **46**, 399-405.
- Bigaud, M. & Pelton, J.T. (1992) Discrimination between ET_A and ET_B receptor mediated effects of endothelin-1 and [Ala^{1,3,11,15}]endothelin-1 by BQ-123 in the anaesthetised rat. *British Journal of Pharmacology*, **107**, 912-918.
- Bloch, K.D., Eddy, R., Shows, T.B. & Quertermous, T. (1989a) cDNA cloning and chromosomal assignment of the gene encoding endothelin-3. *Journal of Biological Chemistry*, **264**, 18156-18161.
- Bloch, K.D., Friedrich, S.P., Lee, M.E., Eddy, R.L., Shows, T.B. & Quertermous, T. (1989b) Structural organisation and chromosomal assignment of the gene encoding endothelin. *Journal of Biological Chemistry*, **264**, 10851-10857.
- Bodelsson, G & Stjernquist, M (1993) Characterisation of endothelin receptors and localisation of ¹²⁵I-endothelin-1 binding sites in human umbilical artery. *European Journal of Pharmacology*, **249**, 299-305.
- Bohlen, H.G. (1986) Localisation of vascular resistance changes during hypertension. *Hypertension*, **8**, 181-183.
- Bolger, G.B. (1994) Molecular biology of the cyclic AMP-specific cyclic nucleotide phosphodiesterases : a diverse family of regulatory enzymes. *Cellular Signalling*, **6**, 851-859.
- Bonvallet, S.T., Oka, M., Yano, M., Zamora, M.R., McMurtry, I.F. & Stelzner, T.J. (1993) BQ 123 an ET_A-receptor antagonist attenuates endothelin-1-induced vasoconstriction in rat pulmonary circulation. *Journal of Cardiovascular Pharmacology*, **22**, 39-43.

- Bonvallet, S.T., Zamora, M.R., Hasunuma, K., Sato, K., Hanasato, N., Anderson, D., Sato, K. & Stelzner, T.J. (1994) BQ-123, an ET_A-receptor antagonist, attenuates hypoxic pulmonary hypertension in rats. *American Journal of Physiology*, **266**, H1327-H1331.
- Boulanger, C.M. & Lüscher, T.F. (1990) Differential effect of cyclic GMP on the release of endothelin 1 from cultured endothelial cells and intact porcine aorta. *Journal of Cardiovascular Pharmacology*, **17** (Suppl. 7), S264-S266.
- Boulanger, C.M., Tanner, F.C., Bea, M.L., Hahn, A.W.A., Werner, A. & Lüscher, T.F. (1992) Oxidised low density lipoproteins induce mRNA expression and release of endothelin from human and porcine endothelium. *Circulation Research*, **70**, 1191-1197.
- Brenner, O. (1935) Pathology of vessels of pulmonary circulation. *Archives of International Medicine*, **56**, 211-237.
- Brown, B.L., Elkins, R.P. & Albano, J.D.M. (1972) Saturation assay for cyclic AMP using endogenous binding protein. *Advances in Cyclic Nucleotide Research*, **2**, 25-35.
- Buchan, K.W., Magnusson, H., Rabe, K.F., Sumner, M.J. & Watts, I.S. (1994) Characterisation of the endothelin receptor mediating contraction of human pulmonary artery using BQ-123 and Ro 46-2005. *European Journal of Pharmacology*, **260**, 221-225.
- Bunting, S., Moncada, S. & Vane, J.R. (1977) Antithrombotic properties of vascular endothelium. *Lancet*, **19**, 1075-1076.
- Busse, R., Fleming, I. & Hecker, M. (1993) Signal transduction in endothelium-dependent vasodilatation. *European Heart Journal*, **14** (Suppl 1), 2-9.
- Cacoub, P., Dorent, R., Maistre, G., Nataf, P., Carayon, A., Piette, C., Godeau, P., Cabrol, C. & Gandjbakhch, I. (1993) Endothelin-1 in primary pulmonary hypertension and the Eisenmenger syndrome. *American Journal of Cardiology*, **71**, 448-450.
- Campbell, J.A. (1927a) Further observations on oxygen acclimatisation. *Journal of Physiology*, **63**, 325-342.
- Campbell, J.A. (1927b) Note on some pathological changes in the tissues during attempted acclimatisation to alterations of O₂-pressure in the air. *British Journal of Experimental Pathology*, **8**, 347-351.
- Campbell, J.A. (1927c) Prolonged alterations of oxygen pressure in the inspired air with special reference to tissue oxygen tension, tissue carbon dioxide and haemoglobin. *Journal of Physiology*, **62**, 211-231.
- Campbell, J.A. (1935) Further evidence that mammals cannot acclimatise to 10 p.c. oxygen or 20,000 feet altitude. *British Journal of Experimental Pathology*, **16**, 39-48.
- Cardell, L.O., Uddman, R. & Edvinsson, L. (1990) Analysis of endothelin-1-induced contractions of guinea-pig trachea, pulmonary veins and different types of pulmonary arteries. *Acta Physiologica Scandinavica*, **139**, 103-111.
- Cardell, L.O., Uddman, R. & Edvinsson. (1993) A novel ET_A-receptor antagonist, FR 139317, inhibits endothelin-induced contractions of guinea-pig pulmonary arteries, but not trachea. *British Journal of Pharmacology*, **108**, 448-452.
- Carville, C., Raffestin, B., Eddahibi, S., Blouquit, Y. & Adnot, S. (1993) Loss of endothelium-dependent relaxation in proximal pulmonary arteries from rat exposed to chronic hypoxia : effects of in vivo and in vitro supplementation with L-arginine. *Journal of Cardiovascular Pharmacology*, **22**, 889-896.

- Chang, H., Wu, G.J., Wanh, S.M. & Hung, C.R. (1993) Plasma endothelin levels and surgically correctable pulmonary hypertension. *Annals of Thoracic Surgery*, **55**, 450-458.
- Chen, G. & Suzuki, H. & Weston, A.H. (1988) Acetylcholine releases endothelium-derived hyperpolarising factor and EDRF from rat blood; vessels. *British Journal of Pharmacology*, **95**, 1165-1174.
- Chen, G. & Suzuki, H. (1990) Calcium dependency of the endothelium-dependent hyperpolarisation in smooth muscle cells of the rabbit carotid artery. *Journal of Physiology*, **421**, 521-534.
- Chen, S., Chen, Y., Meng, Q.C., Durand, J., DiCarlo, V.S. & Oparil, S. (1995) Endothelin receptor antagonist bosentan prevents and reverses hypoxic pulmonary hypertension in rats. *Journal of Applied Physiology*, **79**, 2122-2131.
- Chopra, L.C., Twort, C.H.C. & Ward, J.P.T. (1994) Differences in sensitivity to the specific protein kinase C inhibitor Ro31-8220 between small and large bronchioles of the rat. *British Journal of Pharmacology*, **113**, 1237-1242.
- Clarke, W.R., Uezono, S., Chambers, A. & Doepfner, P. (1994) The type III phosphodiesterase inhibitor milrinone and type V PDE inhibitor dipyridamole individually and synergistically reduce elevated pulmonary vascular resistance. *Pulmonary Pharmacology*, **7**, 81-89.
- Clozel, M. & Gray, G.A. (1995) Are there different ET_B receptors mediating constriction and relaxation? *Journal of Cardiovascular Pharmacology*, **26** (Suppl. 3), S262-S264.
- Clozel, M., Breu, V., Gray, G. & Löffler, B.M. (1993) In vivo pharmacology of Ro 46-2005, the first synthetic nonpeptide endothelin receptor antagonist : implications for endothelin physiology. *Journal of Cardiovascular Pharmacology*, **22** (Suppl. 8), S377-S379.
- Clozel, M., Breu, V., Gray, G., Kalina, B., Löffler, B., Burri, K., Cassal, J., Hirth, G., Müller, M., Neidhart, W. & Ramuz, H. (1994) Pharmacological characterisation of bosentan, a new potent orally active non-peptide endothelin receptor antagonist. *Journal of Pharmacology and Experimental Therapeutics*, **270**, 228-235.
- Clozel, M., Gray, G.A., Breu, V., Löffler, B., Osterwald, R. (1992) The endothelin ET_B receptor mediates both vasodilatation and vasoconstriction in vivo. *Biochemical and Biophysical Research Communications*, **186**, 867-873.
- Cocks, T.M. & Arnold, P.J. (1992) 5-hydroxytryptamine (5-HT) mediated potent relaxation in the sheep isolated pulmonary vein via activation of 5-HT₄ receptors. *British Journal of Pharmacology*, **107**, 591-596.
- Cody, R.J., Haas, G.J., Binkley, P.F., Capers, Q. & Kelley, R. (1992) Plasma endothelin correlates with the extent of pulmonary hypertension in patients with chronic congestive heart failure. *Circulation*, **85**, 504-509.
- Comroe, J.H.J., Lingen, B.V., Stroud, G.C. & Roncorni, A. (1953) Reflex and direct cardiopulmonary effects of 5-OH-tryptamine (serotonin). The possible role in pulmonary embolism and coronary thrombosis. *American Journal of Physiology*, **73**, 379-386.
- Côte, S., Van Sande, J. & Boeynaems, J-M. (1993) Enhancement of endothelial cAMP accumulation by adenine nucleotides : role of methylxanthine-sensitive sites. *American journal of Physiology*, **264**, H1498-H1503.
- Crawley, D.E., Lui, S.F., Barnes, P.J. & Evans, T.W. (1992) Endothelin-3 is a potent pulmonary vasodilator in the rat. *Journal of Applied Physiology*, **72**, 1425-1431.

- Cremona, G., Wood, A.M., Hall, L.W., Bower, E.A. & Higenbottam, T.W. (1994) Effects of inhibitors of nitric oxide release and action on vascular tone in isolated lungs of pig, sheep, dog and man. *Journal of Physiology*, **48**, 185-195.
- Cryer, A. & Bartley, W.E. (1974) The design and use of a hypoxic chamber for small animals. *Laboratory Practice*, **23**, 713-715.
- D'Orleans-Juste, P., Telemaque, S., Claing, A., Ihara, M. & Yano, M. (1992) Human big-endothelin-1 and endothelin-1 release prostacyclin via activation of ET₁ receptors in the rat perfused lung. *British Journal of Pharmacology*, **105**, 773-775.
- Daly, I. de B. & Hebb, C. (1952) Pulmonary vasomotor fibres in the cervical vagosympathetic nerve of the dog. *Quarterly Journal of Experimental Physiology*, **37**, 19-43.
- Dashwood, M.R., Timm, M. & Kaski, J.C. (1995) Regional variations in ET_A / ET_B binding sites in human coronary vasculature. *Journal of Cardiovascular Pharmacology*, **26** (Suppl. 3), S351-S354.
- Daugherty, M.O., Rich, G.F. & Johns, R.A. (1995) Vascular Endothelium. *Current Opinion in Anaesthesiology*, **8**, 88-94.
- Davenport, A.P. & Maguire, J.J. (1994b) Is endothelin-induced vasoconstriction mediated only by ET_A receptors in humans. *Trends in Pharmacological Sciences*, **15**, 9-11.
- Davenport, A.P., Kuc, R.E., Fitzgerald, F., Maguire, J.J., Berryman, K. & Doherty, A.M. (1994a) ¹²⁵I-PD 15242 : a selective radioligand for human ET_A receptors. *British Journal of Pharmacology*, **111**, 4-6.
- Davenport, A.P., O'Reilly, G. & Kuc, R.E. (1995) Endothelin ET_A and ET_B mRNA and receptors expressed by smooth muscle in the human vasculature : majority of the ET_A subtype. *British Journal of Pharmacology*, **114**, 1110-1116.
- Davenport, A.P., O'Reilly, G., Molenaar, P., Maguire, J.J., Kuc, R.E., Sharkey, A., Bacon, C.R. & Ferro, A. (1993) Human endothelin receptors characterised using reverse transcriptase-polymerase chain reaction, in situ hybridisation, and subtype-selective ligands BQ-123 and BQ-3020 : evidence for expression of ET_B receptors in human vascular smooth muscle. *Journal of Cardiovascular Pharmacology*, **22** (Suppl 8), S22-S25.
- De Nucci, G., Thomas, R., D'Orleans-Juste, P., Antunes, E., Walder, C., Warner, T.D. & Vane, J.R. (1988) Pressor effects of circulating endothelin are limited by its removal in the pulmonary circulation and by the release of prostacyclin and endothelium-derived relaxing factor. *Proceedings of the National Academy of Sciences USA*, **85**, 9797-9800.
- Demiryürek, A.T., MacLean, M.R., Wadsworth, R.M. & Kane, K.A. (1994) Effects of hypoxia on endothelin-1 release from human, sheep and rabbit pulmonary artery rings. *Endothelium*, **1**, 251-258.
- Demiryürek, A.T., Wadsworth, R.M., Kane, K.A. & Peacock, A.J. (1993) The role of endothelium in hypoxic constriction of human pulmonary artery rings. *American Review of Respiratory Disease*, **147**, 283-290.
- DiCarlo, V.S., Chen, S-J., Meng, Q.C., Durand, J., Yano, M., Chen, Y-F. & Oparil, S. (1995) ET_A-receptor antagonist prevents and reverses chronic hypoxia-induced pulmonary hypertension in rat. *American Journal of Physiology*, **269**, L690-L697.
- Dinh-Xuan, A.T., Higenbottam, T.W., Clelland, C.A., Pepke-Zaba, J., Cremona, G., Butt, Y., Large, S.R., Wells, F.C. & Wallwork, J. (1991) Impairment of endothelium-derived pulmonary artery relaxation in chronic obstructive lung disease. *New England Journal of Medicine*, **324**, 1539-1547.

- Dinh-Xuan, A.T., Pepke-Zaba, J., Butt, A.Y., Cremona, G. & Higenbottam, T.W. (1993) Impairment of pulmonary-artery endothelium-dependent relaxation in chronic obstructive lung disease is not due to dysfunction of endothelial cell membrane receptors not to L-arginine deficiency. *British Journal of Pharmacology*, **109**, 587-591.
- Doherty, A.M., Cody, W.L., He, J.X., DePue, P.L., Cheng, X-M., Welch, K.M., Flynn, M.A., Reynolds, E.E., LaDouceur, D.M., Davis, L.S., Keiser, J.A. & Haleen, S.J. (1993) In vitro and in vivo studies with a series of hexapeptide endothelin antagonists. *Journal of Cardiovascular Pharmacology*, **22** (Suppl. 8), S98-S102.
- Doherty, A.M., Patt, W.C., Repine, J., Edmunds, J.J., Berryman, K.A., Reisdorph, B.R., Walker, D.M., Haleen, S.J., Keiser, J.A., Flynn, M.A., Welch, K.M., Hallak, H. & Reynolds, E.E. (1995) Structure-activity relationship of a novel series of orally active nonpeptide ET_A and ET_{A/B} endothelin receptor-selective antagonists. *Journal of Cardiovascular Pharmacology*, **26** (Suppl. 3), S358-S361.
- Dohi, Y., Hahn, A.W., Boulanger, C.M., Bühler, F.R. & Lüscher, T. (1992) Endothelin stimulated by angiotensin II augments contractility of spontaneously hypertensive rat resistance arteries. *Hypertension*, **19**, 131-137.
- Douglas, S.A. & Hiley, C.R. (1990) Endothelium-dependent vascular activities of endothelin-like peptides in the isolated superior mesenteric arterial bed of the rat. *British Journal of Pharmacology*, **101**, 81-88.
- Douglas, S.A. & Hiley, C.R. (1991) Endothelium-dependent mesenteric vasorelaxant effects and systemic actions of endothelin (16-21) and other endothelin related peptides in the rat. *British Journal of Pharmacology*, **104**, 311-320.
- Douglas, S.A., Beck, G.R. Jr., Elliott, J.D. & Ohlstein, E.H. (1995) Pharmacologic evidence for the presence of three functional endothelin receptor subtypes in rabbit saphenous vein. *Journal of Cardiovascular Pharmacology*, **29** (Suppl. 3), S163-S168.
- Douglas, S.A., Vickery-Clark, L.M. & Ohlstein, E.H. (1993) Endothelin-1 does not mediate hypoxic vasoconstriction in canine isolated blood vessels : effect of BQ-123. *British Journal of Pharmacology*, **108**, 418-421.
- Douglas, S.A., Elliott, J.D. & Ohlstein, E.H. (1992) Regional vasodilation to endothelin-1 is mediated by a non-ET_A receptor subtype in the anaesthetised rat : effect of BQ-123 on systemic haemodynamic responses. *European Journal of Pharmacology*, **221**, 315-324.
- Downing, S.E. & Lee, J.C. (1980) Nervous control of the pulmonary circulation. *Annual Reviews in Physiology*, **42**, 199-210.
- Eddahibi, S., Adnot, S., Carville, C., Blouquit, Y. & Raffestin, B. (1992) L-Arginine restores endothelium-dependent relaxation in pulmonary circulation of chronically hypoxic rats. *American Journal of Physiology*, **263**, L194-L200.
- Eddahibi, S., Raffestin, B., Braquet, P., Chabrier, P.E. & Adnot, S. (1991) Pulmonary vascular reactivity to endothelin-1 in normal and chronically pulmonary hypertensive rats. *Journal of Cardiovascular Pharmacology*, **17** (Suppl. 7), S358-S361.
- Eddahibi, S., Raffestin, B., Clozel, M., Levame, M. & Adnot, S. (1995) Protection from pulmonary hypertension with an orally active endothelin receptor antagonist in hypoxic rats. *American Journal of Physiology*, **268**, H828-H835.
- Eddahibi, S., Springall, D., Mannan, M., Carville, C., Chabrier, P., Levame, M., Raffestin, B., Polak, J. & Adnot, S. (1993) Dilator effects of endothelins in pulmonary circulation : changes associated with chronic hypoxia. *American Journal of Physiology*, **265**, L571-L580.

- Edwards, R.M., Trizna, W. & Ohlstein, E.H. (1990) Renal microvascular effects of endothelin. *American Journal of Physiology*, **259**, F217-F221.
- Egashira, K., Pipers, F.S., Rush, J.E. & Morgan, J.P. (1990) Effects of calcium channel blockers on coronary vasoconstriction induced by endothelin-1 in closed chest pigs. *Journal of the American College of Cardiology*, **16**, 1296-1303.
- Eglezos, A., Cucchi, P., Patacchini, R., Quartara, L., Maggi, C.A. & Mizrahi, J. (1993) Differential effects of BQ-123 against endothelin-1 and endothelin-3 on the rat vas deferens : evidence for an atypical endothelin receptor. *British Journal of Pharmacology*, **109**, 736-738.
- Eguchi, S., Hirata, Y. & Marumo, F. (1993) Endothelin subtype B receptors are coupled to adenylate cyclase via inhibitory G protein in cultured bovine endothelial cells. *Journal of Cardiovascular Pharmacology*, **22 (Suppl. 8)**, S161-S163.
- Ehrenreich, H., Anderson, R.W., Fox, C.H., Rieckmann, P., Hoffman, G.S., Travis, W.D., Coligan, J.E., Kehrl, J.H. & Fauci, A.S. (1990) Endothelins, peptides with potent vasoactive properties, are produced by human macrophages. *Journal of Experimental Medicine*, **172**, 1714-1748.
- Eichinger, M.R. & Walker, B.R. (1994) Enhanced pulmonary arterial dilation to arginine vasopressin in chronically hypoxic rats. *American Journal of Physiology*, **267**, H2413-H2419.
- Elton, T.S., Oparil, S., Taylor, G.R., Hicks, P.H., Yang, R., Jin, H. & Chen, Y.F. (1992) Normobaric hypoxia stimulates endothelin-1 gene expression in the rat. *American Journal of Physiology*, **263**, R1260-R1264.
- Emori, T., Hirata, Y. & Marumo, F. (1991) Endothelin-3 stimulates prostacyclin production in cultured bovine endothelial cells. *Journal of Cardiovascular Pharmacology*, **17 (Suppl. 7)**, S140-S142.
- Emori, T., Hirata, Y., Imai, T., Ohta, K., Kanno, K., Eguchi, S. & Marumo, F. (1992) Cellular mechanism of thrombin on endothelin-1 biosynthesis and release in bovine endothelial cell. *Biochemical Pharmacology*, **44**, 2409-2411.
- Emori, T., Hirata, Y., Ohta, K., Shichiri, M., Shimokado, K. & Marumo, F. (1989) Concomitant secretion of big endothelin and its C-terminal fragment from human and bovine endothelial cells. *Biochemical and Biophysical Research Communications*, **162**, 217-223.
- Emoto, N. & Yanagisawa, M. (1995) Endothelin-converting enzyme-2 is a membrane-bound, phosphoramidon-sensitive metalloprotease with acidic pH optimum. *Journal of Biological Chemistry*, **270**, 15262-15268.
- Endo, S., Inooka, H., Ishibashi, Y., Kitada, C., Mizuta, E. & Fujino, M. (1989) Solution conformation of endothelin determined by nuclear magnetic resonance and distance geometry. *F.E.B.S. Letters*, **25**, 149-154.
- Endo, T., Uchida, Y., Matsumoto, H., Suzuki, N., Nomura, A., Hirata, F. & Hasegawa, S. (1992) Regulation of endothelin-1 synthesis in cultures guinea-pig airway epithelial cells by various cytokines. *Biochemical and Biophysical Research Communications*, **186**, 1594-1599.
- Engineer, D.M., Morris, H.R., Piper, P.J. & Sirois, P. (1978) The release of prostaglandins and thromboxanes from guinea pig lung by slow-reacting substance of anaphylaxis and its inhibition. *British Journal of Pharmacology*, **64**, 211-218.

- Fandrey, J. (1995) Hypoxia-inducible gene expression. *Respiration Physiology*, **101**, 1-10.
- Feletou, M. & Vanhoutte, P.M. (1988) Endothelium-dependent hyperpolarisation of canine coronary smooth muscle. *British Journal of Pharmacology*, **93**, 515-524.
- Ferri, C., Bellini, C., De Angelis, C., De Sisti, L., Perrone, A., Properzi, G. & Santucci, A. (1995) Circulating endothelin-1 concentrations in patients with chronic hypoxia. *Journal of Clinical Pathology*, **48**, 519-524.
- Fike, C.D., Lai-Fook, S.J. & Bland, R.D. (1988) Microvascular pressures during hypoxia in isolated lungs of newborn rabbits. *Journal of Applied Physiology*, **65**, 283-287.
- Filep, J.G. (1992) Endothelin peptides : biological actions and pathophysiological significance in the lung. *Life Sciences*, **52**, 119-133
- Filep, J.G., Földes-Filep, E., Rousseau, A., Sirois, P. & Fournier, A. (1993) Vascular responses to endothelin-1 following inhibition of nitric oxide synthesis in the conscious rat. *British Journal of Pharmacology*, **110**, 1213-1221.
- Filep, J.G., Herman, F., Battistini, B., Chabrier, P.E., Braquet, P. & Sirois, P. (1991) Antiaggregatory and hypotensive effects of endothelin 1 in beagle dogs : role for prostacyclin. *Journal of Cardiovascular Pharmacology*, **17 (Suppl. 7)**, S216-S218.
- Firth, J.D. & Radcliffe, P.J. (1992) Organ distribution of the three rat endothelin messenger RNA's and the effects of ischemia on renal gene expression. *Journal of Clinical Investigation*, **90**, 1023-1031.
- Fishman, A.P. (1976) Hypoxia on the pulmonary circulation. How and where it acts. *Circulation Research*, **38**, 221-231.
- Fishman, A.P. (1985) Pulmonary circulation. In *Handbook of Physiology. Section 3 The Respiratory System* (ed. A.P. Fishman and A.B. Fisher), pp 93-165. American Physiological Society, Bethesda, MD.
- Forstermann, U., Hertting, G. Neufang, B. (1986) The role of endothelial and non-endothelial prostaglandins in the relaxation of isolated blood vessels of the rabbit induced by acetylcholine and bradykinin. *British Journal of Pharmacology*, **87**, 521-532.
- Frenken, M. & Kaumann, A.J. (1984) Interaction of ketanserine and its metabolite ketanserino with 5-HT₂ receptors in pulmonary and coronary arteries of the calf. *Naunyn Schmiedeberg's Archives of Pharmacology*, **326**, 334-339.
- Fried, R. & Reid, L. (1984) Early recovery from hypoxic pulmonary hypertension. *Journal of Applied Physiology*, **57**, 1247-1253.
- Fukuroda, T., Fujikawa, T., Ozaki, S., Ishikawa, K., Yano, M. & Nishikibe, M. (1994,c) Clearance of circulating endothelin-1 by ET_B receptors in rats. *Biochemical and Biophysical Research Communications*, **199**, 1461-1465.
- Fukuroda, T., Kobayashi, M., Ozaki, S., Yano, M., Miyauchi, T., Onizuka, M., Sugishita, Y., Goto, K. & Nishikibe M. (1994a) Endothelin receptor subtypes in human versus rabbit pulmonary arteries. *Journal of Applied Physiology*, **76**, 1976-1982.
- Fukuroda, T., Noguchi, K., Tschida, S., Nishikibe, M., Ikemoto, F., Okada, K. & Yano, M. (1990d) Inhibition of biological actions of big endothelin 1 by phosphoramidon. *Biochemical and Biophysical Research Communications*, **172**, 390-395.

- Fukuroda, T., Ozaki, S., Ihara, M., Ishikawa, K., Yano, M. & Nishikibe, M. (1994b) Synergistic inhibition by BQ-123 and BQ-788 of endothelin-1-induced contractions of the rabbit pulmonary artery. *British Journal of Pharmacology*, **113**, 336-338.
- Fukuroda, T., Ozaki, S., Ihara, M., Ishikawa, K., Yano, M. & Nishikibe, M., Ishikawa, S., Onizuki, M., Goto, K. & Nishikibe, M. (1996e) Necessity of dual blockade of endothelin ET_A and ET_B receptor subtypes for antagonism of endothelin-1-induced contraction in human bronchi. *British Journal of Pharmacology*, **117**, 995-999.
- Fulton, R.M., Hutchinson, E.C. & Morgan Jones, A. (1952) Ventricular weight in cardiac hypertrophy. *British Heart Journal*, **14**, 413-320.
- Furchgott, R.F. & Zawadzki, J.V. (1980) The obligatory role of endothelial cells in the relaxation of arterial smooth muscle by acetylcholine. *Nature*, **299**, 373-376.
- Furchgott, R.F. (1990) Studies on endothelium-dependent vasodilatation and the endothelium-derived relaxing factor. *Acta Physiologica Scandinavica*, **139**, 257-270.
- Gardiner, S.M., Compton, A.M., Kemp, P.A. & Bennett, T. (1990) Regional and cardiac haemodynamic responses to glycerol trinitrate, acetylcholine, bradykinin and endothelin-1 in conscious rats : effects of N^G-nitro-L-arginine methyl ester. *British Journal of Pharmacology*, **101**, 632-639.
- Garg, U.C. & Hassid, A. (1989) Nitric oxide-generating vasodilators and 8-bromo-cyclic guanosine monophosphate inhibit mitogenesis and proliferation of cultured vascular smooth muscle cells. *Journal of Clinical Investigation*, **83**, 1774-1777.
- Giaid, A., Gibson, S.J., Ibrahim, B.N., Legon, S., Bloom, S.R., Yanagisawa, M., Masaki, T., Varndell, I.M. & Polak, J.M. (1989) Endothelin-1, an endothelium derived peptide, is expressed in neurones of the human spinal cord and dorsal root ganglia. *Proceedings of the National Academy of Science USA*, **86**, 7634-7638.
- Giaid, A., Polak, J.M., Gaitonde, V., Hamid, A., Moscoso, G., Legon, S., Uwangho, D., Roncalli, M., Shinmi, O., Kiumra, S., Yanagisawa, M., Masaki, T. & Springall, D.R. (1991) Distribution of endothelin-like immunoreactivity and mRNA in the developing and adult human lung. *American Review of Respiratory Diseases*, **4**, 50-58.
- Giaid, M., Yanagisawa, M., Langleben, D., Michel, R.P., Levy, R., Shennib, M., Kimura, S., Masaki, T., Duguid, W. & Stewart, D.J. (1993) Expression of endothelin in the lungs of patients with pulmonary hypertension. *New England Journal of Medicine*, **328**, 1732-1739.
- Gillespie, M.N., Owasoyo, J.D., McMurtry, I.F. & O'Brien, R.F. (1986) Sustained coronary vasoconstriction provoked by a peptidergic substance released from endothelial cells in culture. *Journal of Pharmacology and Experimental Therapeutics*, **236**, 339-343.
- Godfraind, T. (1993) Evidence for heterogeneity of endothelin receptor distribution in human coronary artery. *British Journal of Pharmacology*, **110**, 1201-1205.
- Godfraind, T., Mennig, D., Morel, N. & Wibo, M. (1989) Effect of endothelin 1 on calcium channel gating by agonists in vascular smooth muscle cells. *Journal of Cardiovascular Pharmacology*, **13 (Suppl. 5)**, 112-117.
- Goerre, S., Wenk, M., Bartsch, P., Luscher, T.F., Niroomand, F., Hohenhaus, E., Oelz, O. & Reinhart, W.H. (1995) Endothelin-1 in pulmonary hypertension associated with high-altitude exposure. *Circulation*, **90**, 359-364.
- Goetz, K.L., Want, B.C., Madwed, J.B., Zhu, J.L. & Leadley, R.L. Jr. (1988) Cardiovascular, renal and endocrine responses to intravenous endothelin in conscious dogs. *American Journal of Physiology*, **255**, 1064-1068.

- Gray, G.A. & Clozel, M. (1994) ET-1 activates multiple receptor subtypes, including an inhibitory ETA receptor, in the rat fundic strip. *British Journal of Pharmacology*, **112**, 121P.
- Gryglewski, R.J., Korbut, R. & Ocetkiewicz, A. (1978) Generation of prostacyclin by the lungs in vivo and its release into the arterial circulation. *Nature*, **273**, 765-767.
- Gryglewski, R.J., Palmer, R.M.J. & Moncada, S. (1986) Superoxide anion plays a role in the breakdown of endothelium-derived relaxing factor. *Nature*, **320**, 454-456.
- Harrison, V.J., Randriantsoa, A. & Schoeffter, P. (1992) Heterogeneity of endothelin-sarafotoxin receptors mediating contraction of pig coronary artery. *British Journal of Pharmacology*, **105**, 511-513.
- Haselton, P.C., Heath, D. & Brewer, D.B. (1968) Hypertensive pulmonary vascular disease in states of chronic hypoxia. *Journal of Pathology and Bacteriology*, **95**, 431-440.
- Hassoun, P.M., Thappa, V., Landman, M.J. & Fanburg, B.L. (1992) Endothelin-1 : mitogenic activity on pulmonary artery smooth muscle cells and release from hypoxic endothelial cells. *Proceedings of the Society of Experimental Biological Medicine*, **199**, 165-170.
- Hasunuma, K., Rodman, D.M., O'Brien, R.F. & McMurtry, I.F. (1990) Endothelin-1 causes pulmonary vasodilatation in rats. *American Journal of Physiology*, **259**, H48-H54.
- Hauge, A. (1969) Hypoxia and pulmonary vascular resistance. The relative effects of pulmonary arterial and alveolar PO₂. *Acta Physiologica Scandinavica*, **76**, 121-130.
- Hay, D.W.P., Luttmann, M.A., Hubbard, W.C. & Udem, B.J. (1993) Endothelin receptors in human and guinea-pig pulmonary tissues. *British Journal of Pharmacology*, **110**, 1175-1183.
- Haynes, W.G. & Webb, D.J. (1994) Contribution of endogenous generation of endothelin-1 to basal vascular tone. *Lancet*, **344**, 852-854.
- Haynes, W.G., Strachan, F.E. & Webb, D.J. (1995) Endothelin ET_A and ET_B receptors cause vasoconstriction of human resistance and capacitance vessels in vivo. *Circulation*, **92**, 357-363.
- Heath, C., Edwards, C., Winson, M. & Smith, P. (1973) Effects on the right ventricle, pulmonary vasculature and carotid bodies of the rat on exposure to and recovery from simulated high altitude. *Thorax*, **28**, 24-28.
- Heath, D. & Edwards, J.E. (1958) The pathology of hypertensive pulmonary vascular disease. A description of six grades of structural changes in the pulmonary arteries with special reference to congenital cardiac septal defects. *Circulation*, **18**, 533-547.
- Heath, D. (1992) Pulmonary vascular remodelling in pulmonary hypertension. *Applied Cardiopulmonary Pathophysiology*, **4**, 205-211.
- Heath, D. (1993) The pathology of human pulmonary hypertension. *European Respiratory Reviews*, **3**, 555-558.
- Heath, D., Smith, P., Gosney, J., Mulcahy, D., Fox, K., Yacoub, M. & Harris, P. (1987) The pathology of the early and late stages of primary pulmonary hypertension. *British Heart Journal*, **58**, 204-213.

- Hemsén, A. (1991) Biochemical and functional characterisation of endothelin peptides with special reference to vascular effects. *Acta Physiologica Scandinavica*, **142** (Suppl. 602), 1-62.
- Herget, J. & Palecek, F. (1972) Pulmonary arterial blood pressures in closed chest rats. Changes after catecholamines, histamine and serotonin. *Archives of Internatioles de Pharmacodynamie et de Therapie*, **198**, 107-117.
- Herget, J., Suggett, A.J., Leach, E. & Barer, G.R. (1978) Resolution of pulmonary hypertension and other features induced by chronic hypoxia in rats during complete and intermittent normoxia. *Thorax*, **33**, 468-473.
- Hervé, P., Launay, J.M., Scrobohaci, M-L., Brenot, F., Simonneau, G., Petitpretz, P., Poubeau, P., Cerrina, J., Duroux, P. & Drouet, L. (1995) Increased plasma serotonin in primary pulmonary hypertension. *American Journal of Medicine*, **99**, 249-254.
- Hexum, T.D., Hoeger, C., Rivier, J.E., Baird, A. & Brown, M.R. (1990) Characterisation of endothelin secretion by vascular endothelial cells. *Biochemical and Biophysical Research Communications*, **167**, 294-300.
- Hickey, K.A., Rubanyi, G.M., Paul, R.J. & Highsmith, R.F. (1985) Characterisation of a coronary vasoconstrictor produced by cultures endothelial cells. *American Journal of Physiology*, **248**, C550-C556.
- Higenbottam, T. (1995) Lung disease and pulmonary endothelial nitric oxide. *Experimental Physiology*, **80**, 855-864.
- Hiley, C.R., Cowley, D.J., Pelton, J.T. & Hargreaves, A.C. (1992) BQ-123, cyclo(-D-Trp-D-Asp-Pro-D-Val-Leu), is a non-competitive antagonist of the actions of endothelin-1 in SK-N-MC human neuroblastoma cells. *Biochemical and Biophysical Research Communications*, **184**, 504-510.
- Hiley, C.R., Jones, C.R., Pelton, J.T. & Miller, R.C. (1990) Binding of (125I)-endothelin-1 to rat cerebellar homogenates and its interactions with some analogues. *British Journal of Pharmacology*, **101**, 319-324.
- Hirata, Y., Emori, T., Eguchi, S., Kanno, K., Imai, T., Ohta, K. & Marumo, F. (1993) Endothelin receptor subtype B mediates synthesis of nitric oxide from cultured bovine endothelial cells. *Journal of Clinical Investigation*, **91**, 1367-1373.
- Hirata, Y., Matsuoka, H., Kimura, K., Fukui, K., Hayakawa, H., Suzuki, E., Sugimoto, T., Yanagisawa, M. & Masaki, T. (1989) Renal vasoconstriction by the endothelial cell derived peptide endothelin in spontaneously hypertensive rats. *Circulation Research*, **65**, 1370-1379.
- Hirata, Y., Yoshimi, H., Takaichi, S., Yanagisawa, M. & Masaki, T. (1988) Binding and receptor down regulation of a novel vasoconstrictor endothelin in cultured rat vascular smooth muscle cells. *F.E.B.S. letters*, **239**, 13-17.
- Hislop, A. & Reid, L. (1976) New findings in the pulmonary arteries of rats with hypoxia-induced pulmonary hypertension. *British Journal of Experimental Pathology*, **57**, 542-553.
- Holden, W.E. & McCall, E. (1984) Hypoxia-induced contractions of porcine pulmonary artery strips depend on intact endothelium. *Experimental Lung Research*, **7**, 101-112.
- Hooker, C.S., Calkins, P.J & Fleisch, J. (1976) On the measurement of vascular and respiratory smooth muscle responses in vitro. *Blood Vessels*, **14**, 1-11.

- Hori, S., Komatsu, Y., Shigemoto, R., Mizuno, N. & Nakanishi, S. (1992) Distinct tissue distribution and cellular localisation of two messenger ribonucleic acids encoding different subtypes of rat endothelin receptors. *Endocrinology*, **130**, 1885-1895.
- Horsfield, K. (1978) Morphometry of the small pulmonary arteries in man. *Circulation Research*, **42**, 593-597.
- Hosoda, K., Hammer, R.E., Richardson, J.A., Baynash, A.G., Cheung, J.C., Giaid, A. Yanagisawa, M. (1994) Targeted and natural (piebald-lethal) mutations of endothelin-B receptor gene produce megacolon associated with spotted coat colour in mice. *Cell*, **79**, 1267-1276.
- Hosoda, K., Nakao, K., Tamura, N., Arai, H., Ogawa, Y., Suga, S., Nakanishi, S. & Imura, H. (1992) Organisation, structure chromosomal assignment, and expression of the gene encoding the human endothelin A receptor. *Journal of Biological Chemistry*, **267**, 18797-18804.
- Hu, J.R., Berninger, U.G. & Lang, R.E. (1988) Endothelin stimulates atrial natriuretic peptide (ANP) release from rat atria. *European Journal of Pharmacology*, **158**, 177-178.
- Hu, R-M., Levin, E.R., Pedram, A. & Frank, H.J.L. (1992) Atrial natriuretic peptide inhibits the production and secretion of endothelin from cultured endothelial cells : mediation through the C receptor. *Journal of Biological Chemistry*, **267**, 17384-9.
- Humphrey, P.P.A, Feniuk, W., Perren, M.J., Conner, H.E., Oxford, A.W., Coates, I.H. & Butina, D. (1988) GR43175, a selective agonist for the 5-HT₁-like receptor on dog saphenous vein. *British Journal of Pharmacology*, **94**, 1123-1132.
- Humphrey, P.P.A., Hartig, P. & Hoyer, D. (1993) A proposed new nomenclature for 5-HT receptors. *Trends in Pharmacological Sciences*, **14**, 233-236.
- Hunter, C., Barer, G.R., Shaw, J.W. & Clegg E.J. (1974) Growth of the heart and lungs in hypoxic rodents : A model of human hypoxic disease. *Clinical Science and Molecular Medicine*, **46**, 375-391.
- Hyman, A.L., Spannhake, E.W. & Kadowitz, P.J. (1982) Pharmacology of the pulmonary circulation. *Progress in Cardiology*, **11**, 107-130.
- Ichinose, F., Adrie, C., Hurford, W.E. & Zapol, W.M. (1995) Prolonges pulmonary vasodilator action of inhaled nitric oxide by Zaprinast in awake lambs. *Journal of Applied Physiology*, **78**, 4, 1288-1295.
- Ignarro, L.J. (1989) Endothelium-derived nitric oxide : actions and properties. *F.A.S.E.B. Journal*, **3**, 31-36.
- Ignarro, L.J., Adams, J.B., Horowitz, P.M., et al (1986) Activation of soluble guanylate cyclase by NO-hemoproteins involves NO-heme exchange. *Journal of Biological Chemistry*, **261**, 4997-5002.
- Ignarro, L.J., Buga, G.M., Wood, K.S., Byrns, R.E. & Chaudhuri, G. (1987) Endothelium-derived relaxing factor produced and released from artery and vein is nitric oxide. *Proceedings of the National Academy of Science USA*, **84**, 9265-9269.
- Ignarro, L.J., Byrns, R.E. & Wood, K.S. (1987) Endothelium-dependent modulation of cGMP levels and intrinsic smooth muscle tone in isolated bovine intrapulmonary artery and vein. *Circulation Research*, **60**, 82-92.
- Ihara, M., Ishikawa, K., Fukuroda, T., Saeki, T., Funabashi, K., Fukami, T, m Suda, H. & Yano, M. (1992) In vitro biological profile of a highly potent novel endothelin (ET) antagonist BQ-123 selective for the ET_A receptor. *Life Science*, **50**, 247-255.

- Ikeda, S., Awane, Y., Kusumoto, K., Wakimasu, M., Watanabe, T. & Fujino, M. (1994) A new endothelin receptor antagonist, TAK-044, shows long lasting inhibition of both ET_A and ET_B mediated blood pressure responses in rats. *Journal of Pharmacology and Experimental Therapeutics*, **270**, 728-733.
- Ikura, T., Sawamura, T., Shiraki, T., Hosokawa, H., Kido, T., Hoshikawa, H., Shimada, K., Tanzawa, K., Kobayashi, S., Miwa, S. & Masaki, T. (1994) cDNA cloning and expression of bovine endothelin converting enzyme. *Biochemical and Biophysical Research Communications*, **203**, 1417-1422.
- Ingram, R.H., Szidon, J.P., Skalak, R. & Fishman, A.P. (1968) Effects of sympathetic nerve stimulation on the pulmonary arterial tree of the isolated lobe perfused in situ. *Circulation Research*, **22**, 801-815.
- Inoue, A., Yanagisawa, M., Kimura, S., Kasuya, Y., Miyauchi, T., Goto, K. & Masaki, T. (1989a) The human endothelin family : three structurally and pharmacologically distinct isopeptides predicted by three separate genes. *Proceedings of the National Academy of Science USA*, **86**, 2863-2867.
- Inoue, A., Yanagisawa, M., Takuwa, Y., Mitsui, Y., Kobayashi, M. & Masaki, T. (1989b) The human preproendothelin-1 gene. Complete nucleotide sequence and regulation of expression. *Journal of Biological Chemistry*, **264**, 14954-14959.
- Inoue, Y., Oike, M., Nakao, K., Kitamura, K. & Kuriyama, H. (1990) Endothelin augments unitary calcium channel currents on the smooth muscle cell membrane of guinea pig portal vein. *Journal of Physiology*, **423**, 171-191.
- Isaacson, T.C., Hampl, V., Weir, E.K., Nelson, D.P. & Archer, S.L. (1994) Increased endothelium-derived NO in hypertensive pulmonary circulation of chronically hypoxic rats. *Journal of Applied Physiology*, **76**, 933-940.
- Ishikawa, K., Ihara, M., Noguchi, K., Mase, T., Mino, N., Saeki, T., Fukuroda, T., Fukami, T., Ozaki, S., Nagase, T., Nishikibe, M. & Yano, M. (1994) Biochemical and pharmacological profile of a potent and selective endothelin-B-receptor antagonist, BQ-788. *Proceedings of the National Academy of Science USA*, **91**, 4892-4896.
- Ishikawa, S., Miyauchi, T., Sakai, S., Ushinohama, H., Sagawa, K., Fusazaki, N., Kado, H., Sunugawa, H., Honda, S., Ueno, H., Yamaguchi, I., Sugushita, Y. & Goto, K. (1995) Elevated levels of plasma endothelin-1 in young patients with pulmonary hypertension caused by congenital heart disease are decreased after successful surgical repair. *Journal of Thoracic and Cardiovascular Surgery*, **110**, 271-273.
- Ito, T., Kato, T., Iwama, Y., Muramatsu, M., Shimizu, K., Asano, H., Okumura, K., Hashimoto, H. & Satake, T. (1991) Prostaglandin H₂ as an endothelium-derived contracting factor and its interaction with endothelium-derived nitric oxide. *Journal of Hypertension*, **9**, 729-736.
- Itoh, H., Hiraoka, N., Higuchi, H., Ito, M., Konishi, T. & Nakano, T. (1992) Contractile actions of endothelin-1 in isolated helical strips from rat pulmonary artery : Potentiation of serotonin-induced contraction. *Journal of Cardiovascular Pharmacology*, **20**, 1-6.
- Janakidevi, K., Fisher, M.A., Del Vecchio, P.J., Tiruppathi, C., Figge, J. & Malik, A.B. (1992) Endothelin-1 stimulates DNA synthesis and proliferation of pulmonary artery smooth muscle cells. *American Journal of Physiology*, **263**, C1295-C1301.
- Janes, R.W. & Wallace, B.A. (1994) Modelling the structures of the isolated forms of human endothelin based on the crystal structure of human endothelin-1. *Biochemical Society Transactions*, **22**, 1037-1043.

- Kanai, Y., Hori, S., Tanaka, T., Yasouka, M., Watanabe, K., Aikawa, N. & Hosoda, Y. (1993) Role of 5-hydroxytryptamine in the progression of monocrotaline induced pulmonary hypertension. *Cardiovascular Research*, **27**, 1619-1623.
- Karaki, H., Sudjarwo, S.A., Hori, M., Tanaka, T. & Matsuda, Y. (1994) Endothelin ET_B receptor antagonist, RES-701-1 : effects on isolated blood vessels and small intestine. *European Journal of Pharmacology*, **262**, 255-259.
- Karamsetty, V.S.N.M.R., Kane, K.A. & Wadsworth, R.M. (1995) The effects of chronic hypoxia on the pharmacological responsiveness of the pulmonary artery. *Pharmacology and Therapeutics*, **68**, 233-246.
- Karne, S., Jayawirckreme, C.K. & Lerner, M.R. (1993) Cloning and characterisation of an endothelin-3 specific receptor (ETC receptor) from *Xenopus laevis* dermal melanophores. *Journal of Biological Chemistry*, **268**, 19126-19133.
- Kasuya, Y., Ishikawa, T., Yanagisawa, M., Kimura, S., Goto, K., & Masaki, T. (1989) Mechanism of contraction to endothelin in isolated porcine coronary artery. *American Journal of Physiology*, **257**, H1929-H1835.
- Kato, M. & Staub, N.C. (1966) Response of small pulmonary arteries to unilobar hypoxia and hypercapnia. *Circulation Research*, **19**, 426-440.
- Kato, T., Iwama, Y., Okumura, K., Hashimoto, H., Ito, T., Satake, T. (1990) Prostaglandin H₂ may be the endothelium-derived contracting factor released by acetylcholine in the aorta of the rat. *Hypertension*, **15**, 457-481.
- Katusic, Z.S. & Shepherd, J.T. (1991) Endothelium-derived vasoactive factors II : endothelium-dependent contractions. *Hypertension*, **18** (Suppl. III), III-86-III-92.
- Katusic, Z.S. & Vanhoutte, P.M. (1989) Superoxide anion is an endothelium-derived contracting factor. *American Journal of Physiology*, **257**, H33-H37.
- Kay, J.M. (1983) Pulmonary vasculature and nerves. Comparative morphologic features of the pulmonary vasculature in mammals. *American Review of Respiratory Disease*, **128**, S53-S57.
- Kengatharan, M., Brown, T.J., Raeburn, D. & Roach, A.G. (1993) Study of the endothelin receptor subtypes mediating contraction of the rat aorta and trachea using agonists and putative antagonists. *British Journal of Pharmacology*, **110**, 44P.
- Kikuchi, T., Ohtaki, T., Kawata, A., Imada, T., Asami, T., Masuda, Y., Sugo, T., Kusumoto, K., Kubo, K., Watanabe, T., Wakimasu, M. & Fujino, M. (1994) Cyclic hexapeptide endothelin receptor antagonists highly potent for both receptor subtypes ET_A and ET_B. *Biochemical and Biophysical Research Communications*, **200**, 1708-1712.
- Kimura, S., Kasuya, Y., Sawamura, T., Shinimi, O., Sugita, Y., Yanagisawa, M., Goto, K. & Masaki, T. (1988) Structure-activity relationships of endothelin : importance of the C-terminal moiety. *Biochemical and Biophysical Research Communications*, **156**, 1182-1186.
- Kimura, S., Kasuya, Y., Sawamura, T., Shinimi, O., Sugita, Y., Yanagisawa, M., Goto, K. & Masaki, T. (1989) Conversion of big endothelin 1 to 21 residue endothelin 1 is essential for expression of full vasoconstrictor activity : structure activity relationships of big endothelin 1. *Journal of Cardiovascular Pharmacology*, **13** (Suppl. 5), S5-S7.
- Kiowski, W., Sütsch, G., Hunziker, P., Müller, P., Kim, J., Oechslin, E., Schmitt, R., Jones, R. & Bertel, O. (1995) Evidence for endothelin-1-mediated vasoconstriction in severe chronic heart failure. *Lancet*, **346**, 732-736.

- Kloog, Y. & Sokolovsky, M. (1989) Similarities in the mode and sites of action of sarafotoxin and endothelins. *Trends in Pharmacological Sciences*, **10**, 212-214.
- Koh, E., Morimoto, S., Kim, S., Nabata, T., Miyashita, Y. & Ogihara, T. (1990) Endothelin stimulates Na⁺/H⁺ exchange in vascular smooth muscle cells. *Biochemistry International*, **20**, 375-380.
- Komuro, I., Kurihara, H., Sugiyama, T., Takaku, F. & Yazaki, Y. (1988) Endothelin stimulates c-fos and c-myc expression and proliferation of vascular smooth muscle cells. *F.E.B.S. Letters*, **238**, 249-252.
- Kondoh, M., Hiyazaki, H., Uchiyama, Y., Yanagisawa, M., Masaki, T. & Murakami, K. (1991) Solubilisation of two types of endothelin receptor ET_A and ET_B from rat lung with retention of binding activity. *Biomedical Research*, **12**, 417-423.
- Koseki, C., Imai, M., Yanagisawa, Y. & Masaki, T. (1989) Autoradiographic distribution in rat tissues of binding sites for endothelin : a neuropeptide. *American Journal of Physiology*, **256**, R858-R866.
- Kourembanas, S., Marsden P.A., McQuillan, L.P. & Faller, D.V. (1991) Hypoxia induces endothelin gene expression and secretion in cultured human endothelium. *Journal of Clinical Investigation*, **88**, 1054-1057.
- Kouyoumdjian, C., Adnot, S., Levame, M., Eddahibi, S., Bousbaa, H. & Raffestin, B. (1994) Continuous inhalation of nitric oxide protects against development of pulmonary hypertension in chronically hypoxic rats. *Journal of Clinical Investigation*, **94**, 578-584.
- Kukkola, P.J., Savage, P., Sakane, Y., Berry, J.C., Bilci, N.A., Ghai, R.D. & Jeng, A.Y. (1995) Differential structure-activity relationships of phosphoramidon analogues for inhibition of three metalloproteases : endothelin-converting enzyme, neutral endopeptidase, and angiotensin-converting enzyme. *Journal of Cardiovascular Pharmacology*, **26** (Suppl. 3), S65-S68.
- Kurihara, H., Yamaoki, K., Nagai, R., Yoshizumi, M., Takaku, F., Satoh, H., Inui, J. & Yazaki, Y. (1989) Endothelin : a potent vasoconstrictor associated with coronary vasospasm. *Life Science*, **44**, 1937-1943.
- Kurihara, Y., Kurihara, H., Oda, H., Maemura, K., Nagai, R., Ishikawa, T. & Yazaki, Y. (1995) Aortic arch malformations and ventricular septal defect in mice deficient in endothelin-1. *Journal of Clinical Investigation*, **96**, 293-300.
- Kurihara, Y., Kurihara, H., Suzuki, H., Kodama, T., Maemura, K., Nagai, R., Oda, H., Kuwaki, T., Cao, W.-H., Kamada, N., Jishage, K., Ouchi, Y., Azuma, S., Toyoda, Y., Ishikawa, T., Kumada, M. & Yazaki, Y. (1994) Elevated blood pressure and craniofacial abnormalities in mice deficient in endothelin-1. *Nature*, **368**, 703-710.
- Kydd, G.H. (1966) Pressures in the pulmonary circulation of the rat. *The Physiologist*, **9**, 224.
- LaDouceur, D.M., Flynn, M.A., Keiser, S.A., Reynolds, E. & Haleen, S.J.K. (1993) ET_A and ET_B receptors coexist on rabbit pulmonary artery vascular smooth muscle mediating contraction. *Biochemical and Biophysical Research Communications*, **196**, 209-215.
- Lal, H., Woodward, B & Williams, K.I. (1995a) Low concentrations of BQ-123 potentiate the pulmonary vasoconstrictor and bronchoconstrictor actions of endothelin-1 in the rat isolated perfused lung. *British Journal of Pharmacology*, **114**, 51P.
- Lal, H., Woodward, B. & Williams, K.I. (1995b) Actions of endothelins and sarafotoxin 6c in the rat isolated perfused lung. *British Journal of Pharmacology*, **115**, 653-659.

- Lam, H-C., Takahashi, K., Ghatei, M.A., Warrens, A.N., Rees, A.J. & Bloom, S.R. (1991) Immunoreactive endothelin in human plasma, urine, milk and saliva. *Journal of Cardiovascular Pharmacology*, **17** (Suppl. 7), S390-S393.
- Lamontagne, D., Konig, A., Bassenge, E. & Busse, R. (1992) Prostacyclin and nitric oxide contribute to the vasodilator action of acetylcholine and bradykinin in the intact rabbit coronary bed. *Journal of Cardiovascular Pharmacology*, **20**, 652-657.
- Langleben, D., Demarchie, M., Laporta, D., Spanier, A.H., Schlesinger, R.D. & Stewart, D.J. (1993) Endothelin-1 in acute lung injury and the adult respiratory distress syndrome. *American Review of Respiratory Diseases*, **148**, 1646-1650.
- Le Cras, T.D., Xue, C., Rengasamy, A. & Johns, R.A. (1996) Chronic hypoxia upregulates endothelial and inducible NO synthase gene and protein expression in rat lung. *American Journal of Physiology*, **270**, 164-170.
- Le Monnier de Gouville, A-C., Mondot, S., Lipton, H.L., Hyman, A.L. & Cavero, I. (1989) Endothelin - a new family of endothelium-derived peptides with widespread biological properties. *Life Science*, **45**, 1499-1513.
- Leach, E., Howard, P. & Barer, G.R. (1977) Resolution of hypoxic changes in the heart and pulmonary arterioles of rats during intermittent correction of hypoxia. *Clinical Science and Molecular Medicine*, **52**, 153-162.
- Leach, R.M. & Treacher, D.F. (1995) Clinical aspects of hypoxic pulmonary vasoconstriction. *Experimental Physiology*, **80**, 865-875.
- Leach, R.M., Robertson, T.P., Twort, C.H.C. & Ward, J.P.T. (1994) Hypoxic vasoconstriction in rats pulmonary and mesenteric arteries. *American Journal of Physiology*, **266**, L223-L231.
- Leach, R.M., Twort, C.H., Cameron, I.R. & Ward, J.P. (1989) A comparison of the contractile function in large and small pulmonary arterial vessels of the rat. *Quarterly Journal of Experimental Pharmacology*, **74**, 947-950.
- Leach, R.M., Twort, C.H.C., Cameron, I.R. & Ward, J.P.T. (1990) The mechanism of action of endothelin-1 on small pulmonary arterial vessels. *Pulmonary Pharmacology*, **3**, 103-109.
- Leach, R.M., Twort, C.H.C., Cameron, I.R. & Ward, J.P.T. (1992) A comparison of the pharmacological and mechanical properties in vitro of large and small pulmonary arteries of the rat. *Clinical Science*, **82**, 55-62.
- Levin, E.R. (1995) Mechanisms of disease : Endothelins. *New England Journal of Medicine*, **333**, 356-363.
- Li, H., Chen, S., Chen, Y., Meng, Q.C., Durand, J., Oparil, S. & Elton, T.A. (1994a) Enhanced endothelin-1 and endothelin receptor gene expression in chronic hypoxia. *Journal of Applied Physiology*, **77**, 1451-1459.
- Li, H., Elton, T.S., Chen, F. & Oparil, S. (1994b) Increased endothelin receptor gene expression in hypoxic rat lung. *American Journal of Physiology*, **266**, L553-L560.
- Lincoln, T.M. (1989) Cyclic GMP and mechanisms of vasodilatation. *Pharmacology and Therapeutics*, **41**, 479-502.
- Lipton, H.L., Cohen, G.A., McMurtry, I.F. & Hyman, A.L. (1991) Pulmonary vasodilatation to endothelin isopeptides in vivo is mediated by potassium channel activation. *Journal of Applied Physiology*, **70**, 947-952.

- Lippton, H.L., Hao, Q., Erdemli, O. & Hyman, A. (1995) Role of G proteins in the vasodilator response to endothelin isopeptides in vivo. *Journal of Applied Physiology*, **78**, 2062-2069.
- Lippton, H.L., Hao, Q., Hauth, T. & Hyman, A. (1992) Mechanisms of signal transduction for adenosine and ATP in pulmonary vascular bed. *American Journal of Physiology*, **262**, H926-H929.
- Lippton, H.L., Hauth, T.A., Summer, W.R. & Hyman, A.L. (1989) Endothelin produces pulmonary vasoconstriction and systemic vasodilation. *Journal of Applied Physiology*, **66**, 1008-1012.
- Liu, S.F., Crawley, D.E., Barnes, P.J. & Evans, T.W. (1991) Endothelium-derived relaxing factor inhibits hypoxic pulmonary vasoconstriction in rats. *American Review of Respiratory Diseases*, **143**, 32-37.
- Liu, S.F., Crawley, D.E., Evans, T.W. & Barnes, P.J. (1992) Endothelium-dependent nonadrenergic, noncholinergic neural relaxation in guinea pig pulmonary artery. *Journal of Pharmacology and Experimental Therapeutics*, **260**, 541-548.
- Lüscher, T.F., Yang, Z., Diederich, D & Bühler F.R. (1989) Endothelium-derived vasoactive substances : potential role in hypertension, atherosclerosis , and vascular occlusion. *Journal of Cardiovascular Pharmacology*, **14 (Suppl. 6)**, S63-S69.
- Lüscher, T.F., Yang, Z., Diederich, D. & Bühler, F.R. (1989) Endothelium-derived vasoactive substances : potential role in hypertension, atherosclerosis and vascular occlusion. *Journal of Cardiovascular Pharmacology*, **14**, S63-S69.
- MacArthur, H., Warner, T.D., Wood, E.G., Corder, R. & Vane, J.R. (1994) Endothelin-1 release from endothelial cells in culture is elevated both acutely and chronically by short periods of mechanical stretch. *Biochemical and Biophysical Research Communications*, **200**, 396-400.
- MacCumber, M.W., Ross, C.A., Glaxer, B.M. & Sayder, S.H. (1989) Endothelin : visualisation of mRNA by in situ hybridisation provides evidence for local action. *Proceedings of the National Academy of Sciences USA*, **86**, 7285-7289.
- MacLean, M.R. & McGrath, J.C. (1990) Effects of pre-contraction with endothelin-1 on α_2 -adrenoceptor and endothelium-dependent neuropeptide Y mediated contractions in the isolated vascular bed of the rat tail. *British Journal of Pharmacology*, **101**, 205-211.
- MacLean, M.R. & McGrath, J.C. (1991) The effect of extracellular calcium concentration reduction, nifedipine, ryanodine and L-NAME on hypoxic pulmonary vasoconstriction in the rabbit. *British Journal of Pharmacology*, **104**, 199P.
- MacLean, M.R., Baird, M. & McCulloch, K.M. (1995b) Responses to 5-HT and sumatriptan in control and pulmonary hypertensive rats. *Thorax*, **50**, 435P.
- MacLean, M.R., Clayton, R.A., Hillis, S.W., McIntyre, R.D., Peacock, A.J. & Templeton, A.G.B. (1994b) 5-HT₁-receptor-mediated vasoconstriction in bovine isolated pulmonary arteries : Influence of vascular endothelium and tone. *Pulmonary Pharmacology*, **7**, 65-72.
- MacLean, M.R., McCulloch, K.M, Templeton, A.G.B. & Baird, M. (1993c) Comparison of rabbit neonate and adult pulmonary arterial responses to 5-hydroxytryptamine. *British Journal of Pharmacology*, **110**, 112P.

- MacLean, M.R., McCulloch, K.M. & Baird, M. (1994a) Endothelin ET_A- and ET_B-receptor-mediated vasoconstriction in rat pulmonary arteries and arterioles. *Journal of Cardiovascular Pharmacology*, **23**, 838-845.
- MacLean, M.R., McCulloch, K.M. & Baird, M. (1995a) Effects of pulmonary hypertension on vasoconstrictor responses to endothelin-1 and sarafotoxin S6c and on inherent tone in rat pulmonary arteries. *Journal of Cardiovascular Pharmacology*, **26**, 822-830.
- MacLean, M.R., McCulloch, K.M. & McGrath, J.C. (1993a) Influences of the endothelium and hypoxia on α_1 - and α_2 -adrenoceptor agonists in the rabbit isolated pulmonary artery. *British Journal of Pharmacology*, **108**, 155-161.
- MacLean, M.R., Randall, M.D. & Hiley, C.R. (1989) Effects of moderate hypoxia, hypercapnia and acidosis on haemodynamic changes induced by ET-1 in the pithed rat. *British Journal of Pharmacology*, **98**, 1055-1085.
- MacLean, M.R., Smith, G.C. & Templeton, A.G.B. (1993c) Adverse reactions to sumatriptan. *Lancet*, **341**, 1092.
- Madden, J.A., Vadula, M.S. & Kurup, V.P. (1992) Effects of hypoxia and other vasoactive agents on pulmonary and cerebral artery smooth muscle cells. *American Journal of Physiology*, **263**, L384-L393.
- Maggi, C.A., Giuliani, S., Patacchini, R., Santicoli, P., Rovero, P., Giachetti, A. & Meli, A. (1989) The C-terminal hexapeptide, endothelin-(16-21), discriminates between different endothelin receptors. *European Journal of Pharmacology*, **166**, 121-122.
- Maguire, J.J. & Davenport, A.P. (1995) ET_A-receptor-mediated constrictor responses to endothelin peptides in human blood vessels in vitro. *British Journal of Pharmacology*, **115**, 191-197.
- Malek, A. & Izumo, S. (1992) Physiological fluid shear stress causes down regulation of endothelin 1 mRNA in bovine aortic endothelium. *American Journal of Physiology*, **263**, C389-C396.
- Mann, J., Farrukh, I.S. & Michael, J.R. (1991) Mechanisms by which endothelin 1 induces pulmonary vasoconstriction in the rabbit. *Journal of Applied Physiology*, **71**, 410-416.
- Mansoor, A.M., Honda, M., Saida, K., Ishinaga, Y., Kuramochi, T., Maeda, A., Takabatake, T. & Mitsui, Y. (1995) Endothelin induced collagen remodelling in experimental pulmonary hypertension. *Biochemical and Biophysical Research Communications*, **215**, 981-986.
- Marchmont, R.J. & Houslay, M.D. (1980) A peripheral and an intrinsic enzyme constitute the cyclic AMP phosphodiesterase activity of rat liver plasma membranes. *Biochemistry Journal*, **187**, 381-392.
- Marciniak, S.J., Plumpton, C., Barker, P.J., Huskison, N.S. & Davenport, A.P. (1992) Localisation of immunoreactive endothelin and proendothelin in the human lung. *Pulmonary Pharmacology*, **5**, 175-182.
- Marletta, M.A., Yoon, P.S., Iyengar, R., Leaf, C.D. & Wishnok, J.S. (1988) Macrophage oxidation of L-arginine to nitrate and nitrite : nitric oxide is an intermediate. *Biochemistry*, **27**, 8706-8711.
- Marsault, R., Vigne, P. & Frelin, C. (1990) The effect of extracellular calcium on the contractile action of endothelin. *Biochemical and Biophysical Research Communications*, **171**, 301-315.

- Marsault, R., Vigne, P. & Frelin, C. (1991) The irreversibility of endothelin action is a property of a late intracellular signalling event. *Biochemical and Biophysical Research Communications*, **179**, 1408-1413.
- Marsden, P.A., Danthuluri, N.R., Brenner, B.M., Ballermann, B.J. & Brock, T.A. (1989) Endothelin action on vascular smooth muscle involves inositol trisphosphate and calcium mobilisation. *Biochemical and Biophysical Research Communications*, **158**, 86-93.
- Marsden, P.A., Dorfman, D.M., Collins, T., Brenner, B.M., Orkin, S.H. & Ballermann, B.J. (1991) Regulated expression of endothelin-1 in glomerular capillary endothelial cells. *American Journal of Physiology*, **261**, F117-F125.
- Marshall, C. & Marshall, B.E. (1983) Influence of perfusate PO₂ on hypoxic pulmonary vasoconstriction in rats. *Circulation Research*, **52**, 691-696.
- Maruyama, J. & Maruyama, K. (1994) Impaired nitric oxide-dependent responses and their recovery in hypertensive pulmonary arteries of rats. *American Journal of Physiology*, **266**, H2476-H2488.
- Masaki, T., Kimura, S., Yanagisawa, M., Goto, K. (1991) Molecular and cellular mechanisms of endothelin regulation. Implications for vascular function. *Circulation*, **84**, 1457-1468.
- Masaki, T., Vane, J.R. & Vanhoutte P.M. (1994) International Union of Pharmacology Nomenclature of endothelin receptors. *Pharmacological Reviews*, **46**, 137-142.
- Masuda, Y., Miyazaki, H., Kongoh, M., Watanabe, H., Yanagisawa, M., Masaki, T. & Murakami, K. (1989) Two different forms of endothelin receptors in rat lung. *F.E.B.S. Letters*, **257**, 208-210.
- Matsumoto, H., Suzuki, N., Onda, H. & Fujimo, M. (1989) Abundance of endothelin-3 in rat intestine, pituitary gland and brain. *Biochemical and Biophysical Research Communications*, **164**, 74-80.
- Matsumura, Y., Hisaki, K., Takoaka, M. & Morimoto, S. (1990) Phosphoramidon, a metalloproteinase inhibitor, suppresses the hypertensive effect of big endothelin-1. *European Journal of Pharmacology*, **185**, 103-106.
- Matsuyama, K., Yasue, H., Okumura, K., Saito, Y., Nakao, K., Shirakami, G. & Imura, H. (1991) Increased plasma level of endothelin 1 like immunoreactivity during coronary spasm in patients with coronary spastic angina. *American Journal of Cardiology*, **68**, 991-995.
- Mayer, B., Schmidt, K., Humbert, R. & Bohme, E. (1989) Biosynthesis of endothelium-derived relaxing factor : A cytosolic enzyme in porcine endothelial cells Ca²⁺-dependently converts L-arginine into an activator of soluble guanylyl cyclase. *Biochemical and Biophysical Research Communications*, **164**, 768-685.
- McClellan, G., Weisberg, A., Rose, D. & Winegrad, S. (1994) Endothelial cell storage and release of endothelin as a cardioregulatory mechanism. *Circulation Research*, **75**, 85-96.
- McIntyre, P.E., Bhargava, B., Hogg, K.J., Gemmill, J.D. & Hillis, W.S. (1992) The effect of i.v. sumatriptan, a selective 5-HT₁-receptor agonist on central haemodynamics and the coronary circulation. *British Journal of Clinical Pharmacology*, **34**, 541-546.
- McKay, K.O., Black, J.L. & Armour, C.L. (1991b) The mechanism of action of endothelin in the human lung. *British Journal of Pharmacology*, **102**, 422-428.

- McKay, K.O., Black, J.L., Diment, L.M. & Armour, C.L. (1991a) Functional and autoradiographic studies of endothelin-1 and endothelin-2 in human bronchi, pulmonary arteries, and airway parasympathetic ganglia. *Journal of Cardiovascular Pharmacology*, **17** (Suppl. 7), S206-S209.
- McMurdo, L., Corder, R., Thiemermann, C., Vane, J.R. (1993) Incomplete inhibition of the pressor effects of endothelin-1 and related peptides in the anaesthetised rat with BQ-123 provides evidence for more than one vasoconstrictor receptor. *British Journal of Pharmacology*, **108**, 557-561.
- Meyrick, B. & Reid, L. (1978) The effect of continued hypoxia on rat pulmonary arterial circulation, an ultrastructural study. *Laboratory Investigation*, **38**, 188-200.
- Miller, R.C., Pelton, J.T. & Huggins, J.P. (1993) Endothelins - from receptors to medicine. *Trends in Pharmacological Sciences*, **14**, 54-60.
- Miller, V.M. & Vanhoutte, P.M. (1985) Endothelium-dependent contractions to arachidonic acid are mediated by products of cyclooxygenase in canine veins. *American Journal of Physiology*, **248**, H432-H437.
- Miller, W.L., Redfield, M.M. & Burnett, J.C., Jr. (1989) Integrated cardiac, renal and endocrine actions of endothelin. *Journal of Clinical Investigation*, **83**, 317-320.
- Mills, R.G., O'Donoghue, S.I., Smith, R. & King, G.F. (1992) Solution structure of endothelin-3 determined using NMR spectroscopy. *Biochemistry*, **31**, 5640-5645.
- Milner, P., Bodin, P., Loesch, A. & Burnstock, G. (1990) Rapid release of endothelin and ATP from isolated aortic endothelial cells exposed to increased flow. *Biochemical and Biophysical Research Communications*, **170**, 640-656.
- Minkes, R.K., Bellan, J.A., Saroyan, R.M., Kerstein, M.D., Coy, D.H., Murphy, W.A., Nossaman, B.D., McNamara, D.B. & Kadowitz. (1990) Analysis of cardiovascular and pulmonary responses to endothelin 1 and endothelin 3 in the anaesthetised cat. *Journal of Pharmacology and Experimental Therapeutics*, **253**, 1118-1125.
- Miyauchi, T., Sugishita, Y., Yamaguchi, I., Ajisaka, R., Tomizawa, T., Onizuki, M., Matsuda, M., Kono, I., Yanagisawa, M., Goto, K., Suzuki, N., Matsumoto, H. & Masaki, T. (1991b) Plasma concentrations of endothelin-1 and endothelin-3 are altered differently in various pathophysiological conditions in humans. *Journal of Cardiovascular Pharmacology*, **17** (Suppl. 7), S394-S397.
- Miyauchi, T., Suzuki, N., Kurihara, T., Yamaguchi, I., Sugishita, Y., Matsumoto, H., Goto, K. & Masaki, T. (1991a) Endothelin-1 and Endothelin-3 play different roles in acute and chronic alterations of blood pressure in patients with chronic hemodialysis. *Biochemical and Biophysical Research Communications*, **178**, 276-281.
- Moncada, S. & Vane, J.R. (1979) Pharmacology and endogenous roles of prostaglandin endoperoxides, thromboxane A₂ and prostacyclin. *Pharmacological Reviews*, **30**, 293-331.
- Moncada, S., Palmer, R.M.J. & Higgs, E.A. (1991) Nitric oxide : Physiology, pathophysiology and pharmacology. *Pharmacological Reviews*, **43**, 109-142.
- Moravec, C.S., Reynolds, E.E., Stewart, R.W. & Bond, M. (1989) Endothelin is a positive inotropic agent in human and rat heart in vitro. *Biochemical and Biophysical Research Communications*, **159**, 14-18.

- Morbidelli, L., Orlando, C., Maggi, C.A., Ledda, F. & Ziche, M. (1995) Proliferation and migration of endothelial cells is promoted by endothelins via activation of ET_B receptors. *American Journal of Physiology*, **269**, H686-H695.
- Moreland, S., McMullen, D.M., Abboa-Offei, B. & Seymour, A. (1994) Evidence for differential location of vasoconstrictor endothelin receptors in the vasculature. *British Journal of Pharmacology*, **112**, 704-708.
- Moreland, S., McMullen, D.M., Delaney, C.L., Lee, V.G. & Hunt, J.T. (1992) Venous smooth muscle contains vasoconstrictor ET_B-like receptors. *Biochemical and Biophysical Research Communications*, **184**, 100-106.
- Morganti, A., Giussani, M., Sala, C., Gazzano, G., Pierini, A., Savoia, M.T., Ghio, F., Coga, A. & Zanchetti, A. (1995) Effects of exposure to high altitude on plasma endothelin-1 levels in normal subjects. *Journal of Hypertension*, **13**, 859-865.
- Morishita, Y., Chiba, S., Tsukuda, E., Tanaka, T., Ogawa, T., Yamasaki, M., Yoshida, M., Kawamoto, I. & Matsuda, Y. (1994) Res-701, a novel and selective endothelin type B receptor antagonist produced by *Streptomyces* sp. RE-701. *Journal of Antibiotics*, **47**, 269-275.
- Morrell, N.W., Atochina, E.N., Morris, K.G., Danilov, S.M. & Stenmark, K.R. (1995) Angiotensin converting enzyme expression is increased in small pulmonary arteries of rats with hypoxia induced pulmonary hypertension. *Journal of Clinical Investigation*, **96**, 1823-1833.
- Muldoon, L.L., Roland, K.D., Forsythe, M.L. & Magun, B.E. (1989) Stimulation of phosphatidylinositol hydrolysis, diacylglycerol release, and gene expression in response to endothelin, a potent new agonist for fibroblasts and smooth muscle cells. *Journal of Biological Chemistry*, **264**, 8529-8536.
- Mulvany, M.J. & Halpern, W. (1976) Mechanical properties of vascular smooth muscle cells in situ. *Nature*, **260**, 617-619.
- Mulvany, M.J. & Halpern, W. (1977) Contractile properties of small arterial resistance vessels in spontaneously hypertensive and normotensive rats. *Circulation Research*, **41**, 19-26.
- Murray, K.J. (1990) Cyclic AMP and mechanisms of vasodilation. *Pharmacology and Therapeutics*, **47**, 329-345.
- Murray, T.R., Chen, L., Marshall, B.E. & Macarak, E.J. (1990) Hypoxic contraction of cultured pulmonary vascular smooth muscle cells. *American Journal of Respiratory Cell and Molecular Biology*, **3**, 457-465.
- Naeye, R.L. (1961) Hypoxaemia and pulmonary hypertension. *Archives of Pathology*, **71**, 447-452.
- Naeye, R.L. (1962) Hypoxaemia, effects on the pulmonary vascular bed. *Medicina Thoracalis*, **19**, 494-501.
- Naeye, R.L. (1965) Effect of α -methyl-dopa on heart and pulmonary arteries of hypoxic mice. *American Journal of Physiology*, **209**, 702-704.
- Naeye, R.L. (1967) Polycythaemia and hypoxia : individual effects on heart and pulmonary arteries. *American Journal of Physiology*, **50**, 1027-1033.
- Nagasaka, Y., Bhattacharya, J., Nanjo, S., Gropper, M.A. & Staub, N.C. (1984) Micropuncture measurement of lung microvascular pressure profile during hypoxia in cats. *Circulation Research*, **54**, 90-95.

- Nair, X. & Dyer, D.C. (1973) Effect of metabolic inhibitors and oxygen on responses of human umbilical arteries. *American Journal of Physiology*, **255**, 1118-1122.
- Nakajima, K., Kubo, S., Kumagaye, S-I., Nishio, H., Tsunemi, M., Inui, T., Kuroda, H., Chino, N., Watanabe, T.X., Kimura, T. & Sakakibara, S. (1989b) Structure-activity relationships of endothelin : importance of charged groups. *Biochemical and Biophysical Research Communications*, **163**, 424-429.
- Nakajima, K., Kumagaye, S-I, Nishio, H., Kuroda, H., Watanabe, T.X., Kobayashi, Y., Tamaoki, H., Kimura, T. & Sakakibara, S. (1989a) Synthesis of endothelin-1 analogues, endothelin-3, sarafotoxin S6b : structure activity relationships. *Journal of Cardiovascular Pharmacology*, **13** (Suppl. 5), S8-S12.
- Nakaki, T., Nakayama, M., Yamamoto, S. & Kato, R. (1989) Endothelin mediated stimulation of DNA synthesis in vascular smooth muscle cells. *Biochemical and Biophysical Research Communications*, **158**, 880-883.
- Nakamichi, K., Ihara, M., Kobayashi, M., Saeki, T., Ishikawa, K. & Yano, M. (1992) Different distribution of endothelin receptor subtypes in pulmonary tissues revealed by the novel selective ligands BQ-123 and [Ala^{1,3,11,15}]ET-1. *Biochemical and Biophysical Research Communications*, **182**, 144-150.
- Nakamura, S., Naruse, M., Naruse, K., Demura, H., Uemura, H. (1990) Immunocytochemical localisation of endothelin in cultured bovine endothelial cells. *Histochemistry*, **94**, 475-477.
- Nakashima, M., Mombouli, J.V., Taylor, A.A. & Vanhoutte, P.M. (1993) Endothelium-dependent hyperpolarisation caused by bradykinin in human coronary arteries. *Journal of Clinical Investigation*, **92**, 2867-2871.
- Nally, J.E., McCall, R., Young, L.C., Wakelam, M.J.O., Thompson, N.C. & McGrath, J.C. (1994) Mechanical and biochemical responses to endothelin-1 and endothelin-3 in bovine bronchial smooth muscle. *British Journal of Pharmacology*, **111**, 1163-1169.
- Naruse, M., Naruse, K., Kurimoto, F., Horiuchi, J., Tsuchiya, K., Kawana, M., Kato, Y., Zeng, Z., Sakurai, H., Demura, H. & Shizume, K. (1989) Radioimmunoassay for endothelin and immunoreactive endothelin in culture medium of bovine endothelial cells. *Biochemical and Biophysical Research Communications*, **160**, 662-668.
- Nayler, W.G. (1990) Endothelin : isoforms, binding sites and possible implications in pathology. *Trends in Pharmacological Sciences*, **11**, 96-99.
- Neely, C.F., Haile, D. & Matot, I. (1993) Tone-dependent responses to 5-hydroxytryptamine in the feline pulmonary vascular bed are mediated by two different 5-hydroxytryptamine receptors. *Journal of Pharmacology and Experimental Therapeutics*, **264**, 1315-1326.
- Nishimura, J., Moreland, S., Ahn, H.Y., Kawase, T., Moreland, R.S. & van Breemen, C. (1992) Endothelin increases myofilament Ca²⁺ sensitivity in a-toxin-permeabilised rabbit mesenteric artery. *Circulation Research*, **71**, 951-959.
- Nishiwaki, K., Nyhan, D.P., Rock, P., Desai, P.M., Peterson, W.P., Pribble, C.G. & Murray, P.A. (1992) N^ω-nitro-L-arginine and pulmonary vascular pressure-flow relationship in conscious dogs. *American Journal of Physiology*, **262**, 31-35.
- Nishiyama, M., Shan, L., Moroi, K., Masaki, T. & Kimura, S. (1995) Heterogeneity of endothelin ET_A receptor-mediated contractions in the rabbit saphenous vein. *European Journal of Pharmacology*, **286**, 209-212.

- Nootens, M., Kaufmann, E., Rector, T., Toher, C., Judd, D., Francis, G.S. & Rich, S. (1995) Neurohormonal activation in patients with right ventricular failure from pulmonary hypertension : Relation to haemodynamic variables and endothelin levels. *Journal of the American College of Cardiology*, **26**, 1581-1585.
- Ohlstein, E.H., Arleth, A., Ezekiel, M., Horohonich, S., Ator, M.A., Caltabiano, M.M. & Sung, C.P. (1989) Biosynthesis and modulation of endothelin from bovine pulmonary arterial endothelial cells. *Life Science*, **46**, 181-188.
- Ohlstein, E.H., Nambi, P., Douglas, S.A., Edwards, R.M., Gellai, M., Lago, A., Leber, J.D., Cousins, R.D., Gao, A., Frazee, J.S., Peishoff, C.E., Bean, J.W., Eggleston, D.S., Elshourbagy, N.A., Kumar, C., Lee, J.A., Yue, T., Loudon, C., Brooks, D.P., Weinstock, J., Feuerstein, G., Poste, G., Ruffolo, R.R., Gleason, J.G. & Elliott, J.D. (1994) SB 209670, a rationally designed potent non-peptide endothelin receptor antagonist. *Proceedings of the National Academy of Science*, **91**, 8052-8056.
- Oka, M., Hasunuma, K., Webb, S.A., Stelzner, T.J., Rodman, D.M. & McMurtry, I.F. (1993) EDRF suppresses an unidentified vasoconstrictor mechanism in hypertensive rat lungs. *American Journal of Physiology*, **264**, L587-L597.
- Okada, K., Miyazaki, Y., Takada, J., Matsuyama, K., Yamaki, T. & Yano, M. (1990) Conversion of big endothelin 1 by membrane bound metalloendopeptidase in cultured bovine endothelial cells. *Biochemical and Biophysical Research Communications*, **171**, 1192-1198.
- Okada, M., Yamashita, C., Okada, M. & Okada, K. (1995) Endothelin receptor antagonists in a beagle model of pulmonary hypertension : Contribution to possible therapy. *Journal of the American College of Cardiology*, **25**, 1213-1217.
- Olson, J.W., Hacker, A.D., Altieri, R.J. & Gillespie, M.N. (1984) Polyamines and the development of monocrotaline-induced pulmonary hypertension. *American Journal of Physiology*, **247**, H682-H685.
- Oparil, S., Chen, S.J., Meng, Q.C., Elton, T.S., Yano, M. & Chen, Y.F. (1995) Endothelin-A receptor antagonist prevents acute hypoxia-induced pulmonary hypertension in the rat. *American Journal of Physiology*, **268**, L95-L100.
- Palmer, R.M.J. & Moncada, S. (1989) A novel citrulline-forming enzyme implicated in the formation of nitric oxide by vascular endothelial cells. *Biochemical and Biophysical Research Communications*, **158**, 348-352.
- Palmer, R.M.J., Ashton, D.S. & Moncada, S. (1988a) Vascular endothelial cells synthesise nitric oxide from L-arginine. *Nature*, **333**, 664-666.
- Palmer, R.M.J., Ferrige, J.A.G. & Moncada, S. (1987) Nitric oxide release accounts for the biological activity of endothelium-derived relaxing factor. *Nature*, **327**, 524-526.
- Palmer, R.M.J., Rees, D.D., Ashton, D.S. & Moncada, S. (1988b) L-arginine is the physiologic precursor for the formation of nitric oxide by vascular endothelial cells. *Biochemical and Biophysical Research Communications*, **153**, 1251-1256.
- Panek, R.L., Major, T.C., Hingorani, G.P., Doherty, A.M. Taylor, D.G. & Rapundalo, S.T. (1992) Endothelin and structurally related analogues distinguish between endothelin receptor subtypes. *Biochemical and Biophysical Research Communications*, **183**, 566-571.
- Pang, D.C., Johns, A., Patterson, K., Botelho, L.H. & Rubanyi, G. (1989) Endothelin 1 stimulates phosphatidylinositol hydrolysis and calcium uptake in isolated canine coronary arteries. *Journal of Cardiovascular Pharmacology*, **13** (Suppl. 5), S75-S79.

- Pasyk, S., Bartosik, W. & Fabry, A. (1989) Polychrome staining of epoxy semithin sections using cacodylic buffer as a stain solvent. *Stain Technology*, **64**, 149.
- Peacock, A.J., Dawes, K.E., Shock, A., Gray, A.J., Reeves, J.T. & Laurent, G.J. (1992) Endothelin-1 and endothelin-3 induce chemotaxis and replication of pulmonary fibroblasts. *American Journal of Respiratory Cell and Molecular Biology*, **7**, 492-499.
- Peñaloza, D., Soime, F., Banchemo, N. & Gamboa, R. (1962) Pulmonary hypertension in healthy man born and living at high altitudes. *Medicina Thoracalis*, **19**, 449-460.
- Pepke-Zaba, J., Higenbottam, T.W., Dinh-Xuan, A., Stone, D. & Wallwork, J. (1991) Inhaled nitric oxide as a cause of selective pulmonary vasodilatation in pulmonary hypertension. *Lancet*, **338**, 1173-1174.
- Pernow, J.A., Hensen, A. & Lundberg, J.M. (1989) Tissue specific distribution, clearance and vascular effects of endothelin in the pig. *Biochemical and Biophysical Research Communications*, **161**, 647-653.
- Perrault, T. & DeMarte, J. (1991) Endothelin-1 has a dilator effect on neonatal pig pulmonary vasculature. *Journal of Cardiovascular Pharmacology*, **18**, 43-50.
- Perrault, T. & Baribeau, J. (1995) Characterisation of endothelin receptors in newborn piglet lung. *American Journal of Physiology*, **268**, L607-L614.
- Peterson, G.L. (1977) A simplification of the protein assay method of Lowry, et al., which is more generally applicable. *Analytical Biochemistry*, **83**, 346-356.
- Petit, R.D., Warburton, R.R., Ou, L. & Hill, N.S. (1995) Pulmonary vascular adaptations to augmented polycythaemia during chronic hypoxia. *Journal of Applied Physiology*, **79**, 229-235.
- Post, J.M., Hume, J.R., Archer, S.L. & Weir, E.K. (1992) Direct role for potassium channel inhibition in hypoxic pulmonary vasoconstriction. *American Journal of Physiology*, **262**, C882-C890.
- Power, R.F., Wharton, Y., Zhao, Y., Bloom, S.R. & Polak, J.M. (1989) Autoradiographical localisation of endothelin-1 binding sites in the cardiovascular and respiratory systems. *Journal of Cardiovascular Pharmacology*, **13** (Suppl. 5), S50-56.
- Prieto, D., Simonsen, U., Martin, J., Hernandez, M., Rivera, L., Lema, L., Garcia, P. & GarciaSacristan, A. (1994) Histochemical and functional evidence for a cholinergic innervation of the equine ureter. *Journal of the Autonomic Nervous System*, **47**, 159-170.
- Puffenberger, E.G., Hosoda, K., Washington, S.S., Nakao, K., DeWit, D., Yanagisawa, M. & Chakravarti, A. (1994) A missense mutation of the endothelin-B receptor gene in multigenic Hirschsprung's disease. *Cell*, **79**, 1257-1266.
- Pussard, G., Gascard, J.P., Gorenne, I., Labat, C., Norel, X., Dulmet, E. & Brink, C. (1995) Endothelin-1 modulates cyclic GMP production and relaxation in human pulmonary vessels. *Journal of Pharmacology and Experimental Therapeutics*, **274**, 969-975.
- Rabinovitch, M., Gamble, W., Nadas, A.S., Miettinen, O.S. & Reid, L. (1979) Rat pulmonary circulation after chronic hypoxia : haemodynamic and structural features. *American Journal of Physiology*, **236**, H818-H827.
- Rabinovitch, M., Gamble, W.J., Miettinen, O.S. & Reid, L. (1981) Age and sex influence of pulmonary hypertension of chronic hypoxia and recovery. *American Journal of Physiology*, **240**, H62-H72.

- Radomski, M.W., Palmer, R.J.M. & Moncada, S. (1987a) Comparative pharmacology of endothelium-derived relaxing factor, nitric oxide and prostacyclin in platelets. *British Journal of Pharmacology*, **92**, 181-187.
- Radomski, M.W., Palmer, R.J.M. & Moncada, S. (1987b) Endogenous nitric oxide inhibits human platelet adhesion to vascular endothelium. *Lancet*, **2**, 1057-1058.
- Raffestin, B., Adnot, S., Eddahibi, S., Macquin-Mavier, I., Braquet, P. & Chabrier, P.E. (1991) Pulmonary vascular response to endothelin in rats. *Journal of Applied Physiology*, **70**, 567-574.
- Rakugi, H., Nakamaru, M., Tabuchi, Y., Nagano, M., Mikami, H. & Ogihara, T. (1989) Endothelin stimulates the release of prostacyclin from rat mesenteric arteries. *Biochemical and Biophysical Research Communications*, **160**, 924-928.
- Rakugi, H., Tabuchi, Y., Nakanaru, M., Nagano, M., Higashimori, K., Mikami, H., Ogihara, T. & Suzuki, N. (1990) Evidence for endothelin-1 release from resistance vessels of rats in response to hypoxia. *Biochemical and Biophysical Research Communications*, **169**, 973-977.
- Randall, M.D. (1991) Vascular activities of the endothelins. *Pharmacology and Therapeutics*, **50**, 73-93.
- Rees, D.D., Palmer, R.M.J. & Moncada, S. (1990) Characterisation of three inhibitors of endothelial nitric oxide synthase in vitro and in vivo. *British Journal of Pharmacology*, **101**, 746-752.
- Reily, M.D. & Dunbar, J.B. Jr. (1991) The conformation of endothelin-1 in aqueous solution : NMR derived constraints combined with distance geometry and molecular dynamics calculations. *Biochemical and Biophysical Research Communications*, **178**, 570-577.
- Rengasamy, A & Johns, R.A. (1993) Inhibition of nitric oxide synthase by superoxide generating system. *Journal of Pharmacology and Experimental Therapeutics*, **267**, 1024-1033.
- Resink, T.J., Hahn, A.W., Scott-Burden, T., Powell, J., Weber, E. & Bühler, F.R. (1990) Inducible endothelin mRNA expression and peptide secretion in cultured human vascular smooth muscle cells. *Biochemical and Biophysical Research Communications*, **168**, 1303-1310.
- Resink, T.J., Scott-Burden, T. & Bühler, F.R. (1988) Endothelin stimulates phospholipase C in cultured vascular smooth muscle cells. *Biochemical and Biophysical Research Communications*, **157**, 1360-1368.
- Resink, T.J., Scott-Burden, T. & Bühler, F.R. (1989) Activation of phospholipase A2 by endothelin in cultured vascular smooth muscle cells. *Biochemical and Biophysical Research Communications*, **158**, 279-286.
- Reynolds, E.E., Keiser, J.A., Haleen, S.J., Walker, D.M., Olszewski, B., Schroeder, R.L., Taylor, D.G., Hwang, O., Welch, K.M., Flynn, M.A., Thompson, D.M., Edmunds, J.J., Berryman, K.A., Plummer, M., Cheng, X-M., Patt, W.C. & Doherty, A.M. (1995) Pharmacological characterisation of PD 156707, an orally active ET_A receptor antagonist. *Journal of Pharmacology and Experimental Therapeutics*, **273**, 1410-1417.
- Reynolds, E.S. (1963) The use of lead citrate at high pH as an electron opaque stain in electron microscopy. *Journal of Cell Biology*, **17**, 208-212.
- Rich, S. (1988) Primary pulmonary hypertension. *Progress in Cardiovascular Disease*, **31**, 205-238.

- Richard, V., Hogie, M., Clozel, M., Löffler, B-M., Thuillez, C. (1995) In vivo evidence of an endothelin-induced vasopressor tone after inhibition of nitric oxide synthesis in rats. *Circulation*, **91**, 771-775.
- Riezebos, J., Watts, I.S. & Vallance, P.J.T. (1994) Endothelin receptors mediating functional responses in human small arteries and veins. *British Journal of Pharmacology*, **111**, 609-615.
- Rodman, D.M., McMurtry, I.F., Peach, J.L. & O'Brien, R.F. (1989) Comparative pharmacology of rat and porcine endothelin in rat aorta and pulmonary artery. *European Journal of Pharmacology*, **165**, 297-300.
- Rogers, T.K., Stewart, A.G. & Morice, A.H. (1992) Effect of chronic hypoxia on rat pulmonary resistance vessels : vasodilatation by atrial natriuretic peptide. *Clinical Science*, **83**, 723-729.
- Rosenberg, H.C. & Rabinovitch. (1988) Endothelial injury and vascular reactivity in monocrotaline pulmonary hypertension. *American Journal of Physiology*, **255**, H1484-H1491.
- Roth, B.L., Nakaki, T., Chuang, D-M. & Costa, E. (1986) 5-hydroxytryptamine₂ receptors coupled to phospholipase C in rat aorta : modulation of phosphoinositide turnover by phorbol ester. *Journal of Pharmacology and experimental therapeutics*, **238**, 480-485.
- Rounds, S. & McMurtry, I.F. (1981) Inhibitors of oxidative ATP production cause transient vasoconstriction and block subsequent pressor responses in rat lungs. *Circulation Research*, **48**, 393-400.
- Rovero, P., Patacchini, R. & Maggi, C.A. (1990) Structure-activity studies on endothelin (16-21), the C-terminal hexapeptide of the endothelins, in the guinea-pig bronchus. *British Journal of Pharmacology*, **101**, 232-234.
- Rubanyi, G.M. & Parker-Botelho, L.H. (1991) Endothelins. *FASEB Journal*, **5**, 2713-2720.
- Rubanyi, G.M. & Polokoff, M.A. (1994) Endothelins : Molecular biology, biochemistry, pharmacology, physiology and pathophysiology. *Pharmacological Reviews*, **46**, 325-415.
- Rubanyi, G.M. & Vanhoutte, P.M. (1986) Superoxide anions and hyperoxia inactivate endothelium-derived relaxing factor. *American Journal of Physiology*, **250**, H822-H827.
- Sabatini, D.D., Bensch, K. & Barnett, R.J. (1963) Cytochemistry and electron microscopy - the preservation of cellular ultrastructure and enzymatic activity by aldehyde fixation. *Journal of Cell Biology*, **17**, 19-58.
- Saeki, T., Ihara, M., Fukuroda, T., Yamigawa, M. & Yano, M. (1991) Endothelin-1 analogues with ET_B agonistic activity. *Biochemical and Biophysical Research Communications*, **179**, 286-292.
- Saida, K., Mitsui, Y. & Ishida, N. (1989) A novel peptide, vasoactive intestinal contractor, of a new (endothelin) peptide family. Molecular cloning, expression and biological activity. *Journal of Biological Chemistry*, **264**, 14613-14616.
- Saito, Y., Nakao, K., Mukoyama, M. & Imura, H. (1990) Increased plasma endothelin level in patients with essential hypertension. *New England Journal of Medicine*, **322**, 205.

- Sakamoto, A., Yanagisawa, M., Sakuri, T., Takuwa, Y., Yanagisawa, H. & Masaki, T. (1991) Cloning and functional expression of human cDNA for the ET_B endothelin receptor. *Biochemical and Biophysical Research Communications*, **178**, 656-663.
- Sakata, K., Ozaki, H., Kwon, S.C. & Karaki, H. (1989) Effects of endothelin on the mechanical activity and cytosolic calcium level of various types of smooth muscle. *British Journal of Pharmacology*, **98**, 483-492.
- Sakurai, T., Yanagisawa, M. & Masaki, T. (1992) Molecular characterisation of endothelin receptors. *Trends in Pharmacological Sciences*, **13**, 103-108.
- Sakurai, T., Yanagisawa, M., Takuwa, Y., Miyazaki, H., Kimura, S., Goto, K. & Masaki, T. (1990) Cloning of a cDNA encoding a non-isopeptide selective subtype of the endothelin receptor. *Nature*, **348**, 732-735.
- Salom, J.B., Torregrosa, G., Barberá, M.D., Jover, T. & Alboroch, E. (1993) Endothelin receptors mediating contraction in goat cerebral arteries. *British Journal of Pharmacology*, **109**, 826-830.
- Sasaki, S-I., Kobayashi, N., Dambara, T., Kira, S. & Sakai, T. (1995) Structural organisation of pulmonary arteries in the rat lung. *Anatomy and Embryology*, **191**, 477-489.
- Sawamura, T., Kimura, S., Shinmi, O., Sugita, Y., Yanagisawa, M. & Masaki, T. (1989) Analysis of endothelin related peptides in culture supernatant of porcine aortic endothelial cells : evidence for biosynthetic pathway of endothelin-1. *Biochemical and Biophysical Research Communications*, **162**, 1287-1294.
- Schini, V.B., Kim, N.D. & Vanhoutte, P.M. (1991) The basal and stimulated release of EDRF inhibits contractions evoked by endothelin-1 and endothelin-3 in aortae of normotensive and spontaneously hypertensive rats. *Journal of Cardiovascular Pharmacology*, **17** (Suppl. 7), S267-S271.
- Schmidt, M., Kroger, B., Jacob, E., Seulberger, H., Subkowski, T., Otter, R., Meyer, Schmalzing, G. & Hillen, H. (1994) Molecular characterisation of human and bovine endothelin converting enzyme. *FEBS Letters*, **356**, 238-243.
- Seo, B., Oemar, B.S., Siebermann, R., Segesser, L. & Lüscher, T. (1994) Both ETA and ETB receptors mediate contraction to endothelin-1 in human blood vessels. *Circulation*, **89**, 1203-1208.
- Sharefkin, J.B., Diamond, S.L., Eskin, S.G., McIntyre, L.V. & Diefenbach, C.W. (1991) Fluid flow decreases preproendothelin mRNA levels and suppresses endothelin-1 peptide release in cultured human endothelial cells. *Journal of Vascular Surgery*, **14**, 1-9.
- Shaul, P.W., Wells, L.B. & Horning, K.M. (1993) Acute and prolonged hypoxia attenuate endothelial nitric oxide production in rat pulmonary arteries by different mechanisms. *Journal of Cardiovascular Pharmacology*, **22**, 819-827.
- Shetty, S.S., Okada, T., Webb, R.L., DelGrande, D. & Lappe, R.W. (1993) Functionally distinct endothelin B receptors in vascular endothelium and smooth muscle. *Biochemical and Biophysical Research Communications*, **191**, 459-464.
- Shimada, K., Takahashi, M. & Tanzawa, K. (1994) Cloning and functional expression of endothelin-converting enzyme from rat endothelial cells. *Journal of Biological Chemistry*, **269**, 18275-18278.
- Shimada, K., Takahashi, M., Ikeda, M. & Tanzawa, K. (1995) Identification and characterisation of two isoforms of an endothelin-converting enzyme-1. *FEBS Letters*, **371**, 140-144.

- Shinmi, O., Kimura, S., Sawamura, T., Sugita, Y., Yoshizawa, T., Uchiyama, Y., Yanagisawa, M., Goto, K., Masaki, T. & Kanazawa, I. (1989) Endothelin-3 is a novel neuropeptide : isolation and sequence determination of endothelin-1 and endothelin-3 in porcine brain. *Biochemical and Biophysical Research Communications*, **164**, 587-593.
- Shirai, M., Sada, K. & Ninomiya, I. (1986) Effects of regional alveolar hypoxia and hypercapnia on small pulmonary vessels in cats. *Journal of Applied Physiology*, **61**, 440-448.
- Shirakami, G., Nakao, K., Saito, Y., Magaribuchi, T., Jougasaki, M., Mukoyama, M., Arai, H., Hosoda, K., Suga, S., Ogawa, Y., Yamada, T., Mori, K. & Imura, H. (1991) Acute pulmonary alveolar hypoxia increases lung and plasma endothelin-1 levels in conscious rats. *Life Sciences*, **48**, 969-976.
- Simonsen, M.S. (1993) Endothelins : multifunctional renal peptides. *Physiological Reviews*, **73**, 375-411.
- Singhal, S., Henderson, R., Horsfield, K., Harding, K. & Cumming, G. (1973) Morphometry of the human pulmonary arterial tree. *Circulation Research*, **33**, 190-197.
- Sirviö, M-L., Metsärinne, K., Saijonmaa, O. & Fyhrquist, F. (1990) Tissue distribution and half life of ¹²⁵I endothelin in the rat : importance of pulmonary clearance. *Biochemical and Biophysical Research Communications*, **167**, 1191-1195.
- Sofia, M., Mormile, M., Faraone, S., Carratu, P., Alifano, M., Di Benedetto, M. & Carratu, L. (1994) Increase 24-hour endothelin-1 urinary excretion in patients with chronic obstructive pulmonary disease. *Respiration*, **61**, 263-268.
- Sogabe, K., Nirei, H., Shoubo, M., Nomoto, A., Ao, S., Notsu, Y. & Ono, T. (1993) Pharmacological profile of FR 139317, a novel, potent, endothelin ET_A receptor antagonist. *Journal of Pharmacology and Experimental Therapeutics*, **264**, 1040-1046.
- Stamler, J.S., Loh, E., Roddy, M., Currie, K.E. & Creager, M.A. (1994) Nitric oxide regulates basal systemic and pulmonary vascular resistance in healthy humans. *Circulation*, **89**, 2035-2040.
- Staub, N.C. (1985) Site of hypoxic pulmonary vasoconstriction. *Chest*, **88 (suppl)**, 240-5s.
- Steffan, M. & Russell, J.A. (1990) Signal transduction in endothelin induced contraction of rabbit pulmonary vein. *Pulmonary Pharmacology*, **3**, 1-7.
- Stein, P.D., Hunt, J.T., Floyd, D.M., Moreland, S., Dickinson, K.E.J., Mitchell, C., Lie, E.C-K., Webb, M.L., Murugesan, N., Dickey, J., McMullen, D., Zhang, R., Lee, V.G., Serafino, R., Delaney, C., Schaeffer, T.R. & Kozlowski, M. (1994) The discovery of sulfonamide endothelin antagonists and the development of the orally active ET_A antagonist. 5-(Dimethylamino)-N-(3,4-dimethyl-5-isoxazolyl)-1naphthalenesulfon-amide. *Journal of Medicinal Chemistry*, **37**, 329-331.
- Stelzner, T.J., O'Brien, R.F., Yanagisawa, M., Sakurai, T., Sato, K., Webb, S., Zamora, M., McMurtry, I.F. & Fisher, J.H. (1992) Increased lung endothelin-1 production in rats with idiopathic pulmonary hypertension. *American Journal of Physiology*, **262**, L614-L620.
- Stempak, J.G. & Ward, R.T. (1964) An improved staining method for electron microscopy. *Journal of Cell Biology*, **22**, 697-701.
- Stewart, D.J., Cernacek, P., Costello, K.B & Rouleau, J.L. (1992) Elevated endothelin-1 in heart failure and loss of normal response to postural change. *Circulation*, **85**, 510-517.

- Stewart, D.J., Levy, R.D., Cernacek, P. & Langleben, D. (1991) Increased Plasma Endothelin-1 in pulmonary hypertension : marker or mediator of disease. *Annals of Internal Medicine*, **114**, 464-469.
- Stocklet, J.C., Keravis, T., Komars, N. & Lugnier, C. (1995) Cyclic nucleotide phosphodiesterases as therapeutic targets in cardiovascular diseases. *Expert Opinion on Investigational Drugs*, **4**, 1081-1100.
- Sudjarwo, S.A., Hori, M., Takai, M., Urade, Y., Okada, T. & Karaki, H. (1993) A novel subtype of endothelin B receptor mediating contraction in swine pulmonary vein. *Life Science*, **53**, 431-437.
- Sudjarwo, S.A., Hori, M., Tanaka, T., Matsuda, Y. & Karaki, H. (1995) Coupling of the endothelin ET_A and ET_B receptors to Ca²⁺ mobilization and Ca²⁺ sensitization in vascular smooth muscle. *European Journal of Pharmacology*, **289**, 197-204.
- Sudjarwo, S.A., Hori, M., Tanaka, T., Matsuda, Y., Okada, T. & Karaki, H. (1994) Subtypes of endothelin ET_A and ET_B receptors mediating venous smooth muscle contraction. *Biochemical and Biophysical Research Communications*, **200**, 627-633.
- Sumner, M.J. & Humphrey, P.P.A. (1990) Sumatriptan (GR43175) inhibits cyclic AMP accumulation in dog isolated saphenous vein. *British Journal of Pharmacology*, **99**, 219-220.
- Sumner, M.J., Cannon, T.R., Mundin, J.W., White, D.G. & Watts, I.S. (1992) Endothelin ET_A and ET_B receptors mediate vascular smooth muscle contraction. *British Journal of Pharmacology*, **107**, 858-860.
- Sumpio, B.E. & Widmann, M.D. (1990) Enhanced production of an endothelium-derived contracting factor by endothelial cells subjected to pulsatile stretch. *Surgery*, **108**, 277-282.
- Suzuki, H. & Twarog, B.M. (1982) Membrane properties of smooth muscle cells in pulmonary arteries of the rat. *American Journal of Physiology*, **242**, H900-H906.
- Sweeney, G., Templeton, A., Clayton, R.A., Baird, M., Sheridan, J.S., Johnston, E.D. & MacLean, M.R. (1995) Contractile responses to sumatriptan in isolated bovine pulmonary artery rings : relationship with tone and cyclic nucleotide levels. *Journal of Cardiovascular Pharmacology*, **26**, 751-760.
- Sweeney, G., Templeton, A., Clayton, R.A., Baird, M., Sheridan, S., Johnston, E.D. & MacLean, M.R. (1995) Contractile responses to sumatriptan in isolated bovine pulmonary artery rings : relationship to tone and cyclic nucleotide levels. *Journal of Cardiovascular Pharmacology*, **26**, 751-760.
- Takai, M., Umemura, I., Yamasaki, K., Watakabe, T., Fujitani, Y., Oda, K., Urade, Y., Inui, T., Yamamura, T. & Okada, T. (1992) A potent and specific agonist, Suc-[Glu⁹, Ala^{11,15}]-endothelin-1 (8-21), IRL 1620, for the ET_B receptor. *Biochemical and Biophysical Research Communications*, **184**, 953-959.
- Takayanagi, R., Kitazumi, K., Takasaki, C., Ohnaka, K., Aimoto, S., Tasaka, K., Ohashi, M. & Nawata, H. (1991) Presence of non selective type of endothelin receptor on vascular endothelium and its linkage to vasodilation. *FEBS Letters*, **282**, 103-106.
- Takayasu, M., Kondoh, K. & Terao, S. (1989) Endothelin induced mobilisation of Ca²⁺ and the possible involvement of platelet activating factor and thromboxane A₂. *Biochemical and Biophysical Research Communications*, **160**, 751-757.

- Takeoka, M., Ishizaki, T., Sakai, A., Chang, S.W., Shigemori, K., Higashi, T. & Ueda, G (1995) Effect of BQ-123 on vasoconstriction as a result of either hypoxia or endothelin-1 in perfused rat lungs. *Acta Physiologica Scandinavica*, **155**, 53-60.
- Takeshita, H., Nishikibe, M., Yano, M. & Ikemoto, F. (1991) Coronary vascular response to endothelin in isolated perfused hearts of spontaneously hypertensive rats. *Clinical Experimental Pharmacology and Physiology*, **18**, 661-669.
- Takuwa, N., Takuwa, Y., Yanagisawa, M., Yamashita, K. & Masaki, T. (1989) A novel vasoactive peptide endothelin stimulates mitogenesis through inositol lipid turnover in Swiss 3T3 fibroblasts. *Journal of Biological Chemistry*, **264**, 7856-7861.
- Taylor, S.G. & Weston, A.H. (1988) Endothelium-derived hyperpolarising factor : A new endogenous inhibitor from the vascular endothelium. *Trends in Pharmacological Sciences*, **9**, 272-274.
- Teerlink, J.R., Breu, V., Sprecher, U., Clozel, M. & Clozel, J.P. (1994) Potent vasoconstriction mediated by endothelin ET_B receptors in canine coronary arteries. *Circulation Research*, **74**, 105-114.
- Templeton, A.G.B., Clayton, R.A., McIntyre, P.D., Hillis, W.S. & Peacock, A.J. (1993b) Effect of sumatriptan and 5-HT in bovine pulmonary artery and mesenteric artery. *British Journal of Pharmacology*, **108**, 249P.
- Templeton, A.G.B., Clayton, R.A., McIntyre, P.D., Hillis, W.S., Peacock, A. & MacLean, M.R. (1993a) Sensitivity of human, bovine and rabbit pulmonary arteries to sumatriptan : comparison with 5-HT. *British Journal of Pharmacology*, **110**, 113P.
- Tesfamariam, B. & Cohen, R.A. (1988) Inhibition of adrenergic vasoconstriction by endothelial cell shear stress. *Circulation Research*, **63**, 720-725.
- Tesfamariam, B. & Halpern, W. (1987) Modulation of adrenergic responses in pressurised resistance arteries by flow. *American Journal of Physiology*, **253**, H1112-H1119.
- Thusu, K.G., Morin, F.C.III, Russell, J.A. & Steinhorn, R.H. (1995) The cGMP phosphodiesterase inhibitor zaprinast enhances the effect of nitric oxide. *American Journal of Respiratory Critical Care Medicine*, **152**, 1605-1610.
- Timiras, P.S., Krum, A.A. & Pace, N. (1957) Body and organ weights of rats during acclimatisation to an altitude of 12,470 feet. *American Journal of Physiology*, **191**, 598-604.
- Tod, M.L., McGeady, M.L., Rock, P. & Sylvester, J.T. (1987) Effects of arterial ligation and embolization on pulmonary vascular pressure distribution. *Journal of Applied Physiology*, **63**, 1387-1395.
- Toga, H., Ibe, B.O. & Usha Raj, J. (1992) In vitro responses of ovine intrapulmonary arteries and veins to endothelin-1. *American Journal of Physiology*, **263**, L15-L21.
- Toga, H., Usha Raj, J., Hillyard, R., Ku, B. & Anderson, J. (1991) Endothelin effects in isolated, perfused lamb lungs : role of cyclooxygenase inhibition and vasomotor tone. *American Journal of Physiology*, **261**, H443-H450.
- Tokunaga, O., Fan, J., Watanabe, T., Kabayashi, M., Kumazaki, T. & Mitsui, Y. (1992) Endothelin. Immunohistologic localisation in aorta and biosynthesis by cultured human aortic endothelial cells. *Laboratory Investigation*, **67**, 210-217.
- Tolins, J.P., Shultz, P.J. & Raij, L. (1991) Role of endothelium-derived relaxing factor in regulation of vascular tone and remodeling. *Hypertension*, **17**, 919-916.

- Trapani, A.J., De Lombaert, S., Kuzmich, S. & Jeng, A.Y. (1995) Inhibition of big ET-1-induced pressor response by an orally active dual inhibitor of endothelin-converting enzyme and neutral endopeptidase 24.11. *Journal of Cardiovascular Pharmacology*, **26** (Suppl. 3), S69-S71.
- Tsurumi, Y., Ueda, H., Hayashi, K., Takase, S., Nishikawa, M., Kiyoto, S. & Okuhara, M. (1995) WS75624 A and B, new endothelin-converting enzyme inhibitors isolated from *Saccharothrix* sp. No. 75624. 1. Taxonomy, fermentation, isolation, physico-chemical properties and biological activities. *Journal of Antibiotics*, **48**, 1066-1072.
- Uhlig, S., Von Bethmann, A.N., Featherstone, R.L. & Wendel, A. (1995) Pharmacologic characterisation of endothelin receptor responses in the isolated perfused rat lung. *American Journal of Respiratory and Critical Care Medicine*, **152**, 1449-1460.
- Urade, Y., Fujitani, Y., Oda, K., Watanabe, T., Umemura, I., Takai, M., Okada, T., Sakata, K. & Karaki, H. (1992) An endothelin B receptor-selective antagonist : IRL 1038 [Cys11-Cys 15]-endothelin-1 (1021). *FEBS Letters*, **311**, 12-16.
- Urade, Y., Fujitani, Y., Oda, K., Watanabe, T., Umemura, I., Takai, M., Okada, T., Sakata, K. & Karaki, H. (1994) Retraction : An endothelin B receptor selective antagonist : IRL 1038, (Cys11-Cys15)-endothelin-1(11-21) (FEBS lett. 311(1992) 12-16). *FEBS Letters*, **342**, 103.
- Vane, J.R. (1969) The release and fate of vasoactive hormones in the circulation. *British Journal of Pharmacology*, **35**, 209-242.
- Vegesna, R.V.K. & Diamond, J. (1986) Elevation of cyclic AMP by prostacyclin is accompanied by relaxation of bovine coronary arteries and contraction of rabbit aortic rings. *European Journal of Pharmacology*, **128**, 25-31.
- Verheyden, P., Assche, I.V., Brichard, M.H., Demaude, T., Paye, I., Scarso, A. & Van Binst, G. (1994) Conformational study of three endothelin antagonists with 1H NMR at low temperature and molecular dynamics. *FEBS Letters*, **344**, 55-60.
- Vigne, P., Breittmayer, J.P & Frelin, C. (1993) Competitive and non competitive interactions of BQ-123 with endothelin ET_A receptors. *European Journal of Pharmacology*, **245**, 229-232.
- Vigne, P., Marsault, R., Breittmayer, J.P. & Frelin, C. (1990) Endothelin stimulated phosphatidylinositol hydrolysis and DNA synthesis in brain capillary endothelial cells. *Biochemistry Journal*, **266**, 415-420.
- Voelkel, N.F. (1986) Mechanisms of hypoxic pulmonary vasoconstriction. *American Review of Respiratory Disease*, **133**, 1186-1195.
- Voelkel, N.F., Stenmark, K.R., Reeves, J.T., Mathias, M.M. & Murphy, R.C. (1984) Actions of lipoxigenase metabolites in isolated rat lungs. *Journal of Applied Physiology*, **57**, 860-867.
- von Euler, U.S. & Liljestrand, G. (1947) Observations on the pulmonary arterial blood pressure in the cat. *Acta Physiologica Scandinavica*, **12**, 301-320.
- Wagner, O.F., Christ, G. & Wojta, J. (1992) Polar secretion of endothelin-1 by cultures endothelial cells. *Journal of Biological Chemistry*, **267**, 16066-16068.
- Wang, Y. & Coceani, F. (1992) Isolated pulmonary resistance vessels from fetal lambs : contractile behaviour and responses to idomethacin and endothelin-1. *Circulation Research*, **71**, 320-330.

- Wang, Y., Coe, Y., Toyoda, O. & Coceani, F. (1995) Involvement of endothelin-1 in hypoxic pulmonary vasoconstriction in the lamb. *Journal of Physiology*, **482**, 421-434.
- Wanstall, J.C. & O'Donnell, S.R. (1990) Endothelin and 5-hydroxytryptamine on rat pulmonary artery in pulmonary hypertension. *European Journal of Pharmacology*, **176**, 159-168.
- Wanstall, J.C., Hughes, I.E. & O'Donnell, S.R. (1992) Reduced relaxant potency of nitroprusside on pulmonary artery preparations taken from rats during the development of hypoxic pulmonary hypertension. *British Journal of Pharmacology*, **107**, 407-413.
- Wanstall, J.C., Hughes, I.E. & O'Donnell, S.R. (1995) Evidence that nitric oxide from the endothelium attenuates inherent tone in isolated pulmonary arteries from rats with hypoxic pulmonary hypertension. *British Journal of Pharmacology*, **114**, 109-114.
- Warner, T.D., Allcock, G.H., Mickley, E.J., Corder, R. & Vane, J.R. (1993) Comparative studies with the endothelin receptor antagonists BQ-123 and PD 142893 indicate at least three endothelin receptors. *Journal of cardiovascular Pharmacology*, **22** (Suppl. 8), S117-S120.
- Warner, T.D., De Nucci, G. & Vane, J.R. (1989a) Rat endothelin is a vasodilator in the isolated perfused mesentery of the rat. *European Journal of Pharmacology*, **159**, 325-326.
- Warner, T.D., Mitchell, J.A., Se Nucci, G. & Vane, J.R. (1989b) Endothelin-1 and endothelin-3 release EDRF from isolated perfused arterial vessels of the rat and rabbit. *Journal of Cardiovascular Pharmacology*, **13** (Suppl. 5), S85-S88.
- Warner, T.D., Schmidt, H.H. & Murad, F. (1992) Interactions of endothelins and EDRF in bovine native endothelial cells : selective effects of endothelin 3. *American Journal of Physiology*, **262**, H1600-H1605.
- Watanabe, H., Miyazaki, H., Kondoh, M., Masuda, Y., Kimura, S., Yanagisawa, M., Masaki, T. & Murakami, K. (1989a) Two distinct types of endothelin receptors are present on chick cardiac membranes. *Biochemical and Biophysical research Communications*, **161**, 1252-1259.
- Watanabe, T., Kusumoto, K., Kitayoshi, T. & Shimamoto, N. (1989b) Positive inotropic and vasoconstrictive effects of endothelin-1 in vivo and in vitro experiments : characteristics and the role of L type calcium channels. *Journal of Cardiovascular Pharmacology*, **13** (Suppl. 5), S108-S111.
- Watanabe, T.X., Itahara, Y., Nakajima, K., Kumagaye, S-I, Kimura, T. & Sakakibara, S. (1991b) The biological activity of endothelin-1 analogues in three different assay systems. *Journal of Cardiovascular Pharmacology*, **17** (Suppl. 7), S5-S9.
- Watanabe, Y., Naruse, M., Monzen, C., Naruse, K., Ohsumi, K., Horiuchi, J., Yoshihara, I., Kata, Y., Nakamura, N., Kata, M., Sugino, N. & Demura, H. (1991a) Is big endothelin converted to endothelin-1 in circulating blood? *Journal of Cardiovascular Pharmacology*, **17** (Suppl. 7), S503-S505.
- Weir, E.K. & Archer, S.L. (1995) The mechanism of acute hypoxic pulmonary vasoconstriction. *FASEB Journal*, **9**, 183-189.
- Weissberg, P.L., Witchell, C., Davenport, A.P., Hosketh, T.R. & Metcalfe, J.C. (1990) The endothelin peptides ET-1, ET-2 and ET-3 and sarafotoxin S6b are co-mitogenic with platelet derived growth factor for vascular smooth muscle cells. *Atherosclerosis*, **85**, 257-262.

- White, D.G., Cannon, T.R., Garratt, H., Mundin, J.W., Sumner, M.J. & Watts, I.S. (1993) Endothelin ET_A and ET_B receptors mediate vascular smooth muscle contraction. *Journal of Cardiovascular Pharmacology*, **22** (Suppl. 8), S144-S148.
- White, D.G., Garratt, H., Mundin, J.W., Sumner, M.J., Vallance, P.J. & Watts, I.S. (1994) Human saphenous vein contains both endothelin ET_A and ET_B receptors. *European Journal of Pharmacology*, **257**, 307-310.
- Williams, D.L., Jones, K.L., Pettibone, D.J., Lis, E.V. & Clineschmidt, B.V. (1991) Sarafotoxin S6c : an agonist which distinguishes between endothelin receptor subtypes. *Biochemical and Biophysical Research Communications*, **175**, 556-561.
- Winkles, J.A., Alberts, G.F., Brogi, E. & Libby, P. (1993) Endothelin 1 and endothelin receptor mRNA expression in normal and atherosclerotic human arteries. *Biochemical and Biophysical Research Communications*, **191**, 1081-1088.
- Wong, J., Vanderford, P.A., Fineman, J.R., Chang, R. & Soifer, S.J. (1993a) Endothelin-1 produces pulmonary vasodilatation in the intact newborn lamb. *American Journal of Physiology*, **265**, H1318-H1325.
- Wong, J., Vanderford, P.A., Winters, J. Soifer, S.J. & Fineman, J.R. (1995) Endothelin-B receptor agonists produce pulmonary vasodilation in intact newborn lambs with pulmonary hypertension. *Journal of Cardiovascular Pharmacology*, **25**, 207-215.
- Wong, J., Vanderford, P.A., Winters, J.W., Chang, R., Soifer, S.J. & Fineman, J.R. (1993b) Endothelin-1 does not mediate acute hypoxic pulmonary vasoconstriction in the intact newborn lamb. *Journal of Cardiovascular Pharmacology*, **22** (Suppl. 8), S262-S266.
- Wood, P. (1958) Pulmonary hypertension with special reference to the vasoconstrictive factor. *British Heart Journal*, **20**, 577-570.
- Wren, A.D., Hiley, C.R. & Fan, T-P. (1993) Endothelin-3 mediated proliferation in wounded human umbilical vein endothelial cells. *Biochemical and Biophysical Research Communications*, **196**, 369-375.
- Xu, D., Emoto, N., Giaid, A., Slaughter, C., Kaw, S., De Wit, D. & Yanagisawa, M. (1994) ECE-1 : A membrane bound metalloprotease that catalyses the proteolytic activation of big endothelin-1. *Cell*, **78**, 473-485.
- Xuan, Y-T., Whorton, A.R. & Watkins, W.D. (1989) Inhibition by nicardipine on endothelin-mediated inositol phosphate formation and Ca²⁺ mobilisation in smooth muscle cell. *Biochemical and Biophysical Research Communications*, **160**, 758-764.
- Xue, C., Rengasamy, A., Le Cras, T.D., Koberna, P.A., Dailey, C. & Johns, R.A. (1994) Distribution of NOS in normoxic vs. hypoxic rat lung : upregulation of NOS by chronic hypoxia. *American Journal of Physiology*, **267**, L667-L678.
- Yamamoto, T., Kimura, T., Ota, K., Shoji, M., Inoue, M., Sato, K., Ohta, M. & Yoshinaga, K. (1991) Central effects of endothelin-1 on vasopressin and atrial natriuretic peptide release and cardiac and renal functions in conscious rats. *Journal of Cardiovascular Pharmacology*, **17** (Suppl. 7), S316-S318.
- Yamamoto, K., Ikeda, U., Mito, H., Fujikawa, H., Sekiguchi, H. & Shimada, K. (1994) Endothelin production in pulmonary circulation of patients of mitral stenosis. *Circulation*, **89**, 2093-2098.
- Yanagisawa, M., Kurihara, H., Kimura, S., Tomobe, Y., Kobayashi, M., Mitsui, Y., Yazaki, Y., Goto, K. & Masaki, T. (1988) A novel potent vasoconstrictor peptide produced by vascular endothelial cells. *Nature*, **332**, 411-415.

- Yanagisawa, M., Masaki, T., Hamoaki, M., Kato, H. & Yazaki, Y. (1989) Transforming growth factor beta stimulates the expression of endothelin mRNA by vascular endothelial cells. *Biochemical and Biophysical Research Communications*, **159**, 1435-1440.
- Yorikane, R., Miyauchi, T., Sakai, S., Sakurai, T., Yamaguchi, I., Sugishita, Y. & Goto, K. (1993) Altered expression of ET_B-receptor mRNA in the lung of rats with pulmonary hypertension. *Journal of Cardiovascular Pharmacology*, **22** (Suppl. 8), S336-S338.
- Yoshiyoshi, M., Nishioka, K., Nakao, K., Saito, Y., Matsumura M., Ueda, T., Temma, S., Shirakami, G., Imura, H. & Mikawa, H. (1991) Plasma endothelin concentrations in patients with pulmonary hypertension associated with congenital heart defects. *Circulation*, **48**, 2280-2285.
- Yoshimoto, S., Ishizaki, Y., Kurihara, H., Sasaki, T., Yoshizumi, M., Yanagisawa, M., Yazaki, Y., Masaki, T., Takakura, K. & Murota, S. (1990) Cerebral microvessel endothelium is producing endothelin. *Brain Research*, **508**, 283-285.
- Yoshimoto, S., Ishizaki, Y., Sasaki, T & Murota, S.I. (1991) Effect of carbon dioxide and oxygen on endothelin production by cultured porcine cerebral endothelial cells. *Stroke*, **22**, 378-383.
- Yoshizumi, M., Kurihara, H., Sugiyama, T., Takaku, F., Yanagisawa, M., Masaki, T. & Yazaki, Y. (1989) Haemodynamic shear stress stimulates endothelin production by cultured endothelial cells. *Biochemical and Biophysical Research Communications*, **161**, 859-864.
- Yu, S., Yu, C., Wong, H. & Yuan, H. (1991) Effect of endothelin-1 on the vascular smooth muscle cell cycle. *Journal of Cardiovascular Pharmacology*, **17** (Suppl. 7), S239-S241.
- Zamora, M.A., Dempsey, E.C., Walchak, S.J. & Stelzner, T.J. (1993) BQ-123, an ET_A receptor antagonist, inhibits endothelin-1 mediated proliferation of human pulmonary artery smooth muscle cells. *American Journal of Respiratory Cell Molecular Biology*, **9**, 429-433.
- Zamora, M.R., O'Brien, R.F., Rutherford, R.B. & Weil, J.V. (1990) Serum endothelin-1 concentrations and cold provocation in primary Raynaud's phenomenon. *Lancet*, **336**, 1144-1147.
- Zeigler, J.W., Ivy, D.D., Fox, J.J., Kinsella, J.P., Clarke, W.R. & Abman, S.H. (1995) Dipyridamole, a cGMP phosphodiesterase inhibitor causes pulmonary vasodilation in the ovine fetus. *American Journal of Physiology*, **269**, H473-H479.
- Zellers, T.M., McCormick, J. & Wu, Y. (1994) Interaction among ET-1, endothelium-derived nitric oxide and prostacyclin in pulmonary arteries and veins. *American Journal of Physiology*, **267**, H139-H147.
- Zhu, Z.G., Wang, M.S., Jiang, Z.B., Jiang, Z., Xu, S.X., Ren, C.Y. & Shi, M.X. (1994) The dynamic change of plasma endothelin-1 during the perioperative period in patients with rheumatic valvular disease and secondary pulmonary hypertension. *Journal of Thoracic and Cardiovascular Surgery*, **108**, 960-968.